

**U
N
E**

796FD

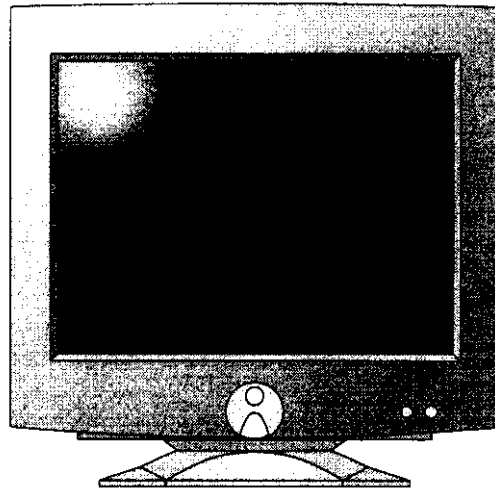

User's Guide



**17" (16.0" viewable)
Ultra High Resolution
Plug & Play Ready
FD Trinitron® Color Monitor
with JAG™ OSD Control**

Notices

Copyright © 1999

MAG Technology Co., Ltd.

15F, No. 287, Sec. 3, Nanking E. Rd,

Taipei, Taiwan

Tel: +886(2)2719-8811

Fax: +886(2)2718-2211

All Right Reserved

No part of this publication may be produced or transmitted in any form or by any means, electronic or mechanical, including photocopying, recording, or translating into any language in any form without the express written permission of MAG Technology Co., Ltd.

JAG™, the MAG InnoVision logo, and the screen logo are trademarks or registered trademarks of MAG Technology Co., Ltd. in the United States and other countries.

Windows® is a registered trademarks of Microsoft Corporation. Macintosh® is a registered trademark of Apple Computers. All other trademarks are the property of their respective owners.

796FD User's Guide

Model no.: U7T009

06/99

Contents

Specifications	4
Safety Precautions	5
Introduction	6
JAG™ Control	6
e-Video Mode	6
On Screen Display (OSD)	7
DDC Plug & Play	7
MPRII and TCO 95 Compliant	7
EPA™ Energy Star® and VESA® Display Power Management System	7
Setting up Your Monitor	8
Operation	9
Image Adjustment	10
OSD Options	10
Video Modes	12
Pin Assignment	13
TCO 95 Environmental Labelling	14
Regulatory Compliance Statements	16
Customer Service	18

Specifications

All Specifications are subject to changed without notice or obligation.

CRT	17-inch (16.0" viewable) SONY FD Trinitron® picture tube with TCO / Anti-reflective coating, anti-glare, anti-static, 90° deflection
Dot pitch	0.24mm
Max Resolution	1600 x 1200 (Non-interlaced)
Display color	Unlimited
Scanning frequency	Horizontal: 30 - 96KHz Vertical: 50 - 160Hz
Display area	Factory presetting 310 x 230 mm (W x H)
Pix Rate	203 MHz nominal
Input signal	Video: Analog, 0.7V _{p-p} , 75ohm Sync: Separate TTL level Composite TTL level
Power supply	100 - 240 Vac, 50/60 Hz
Power consumption	Normal: < 135W Suspend: < 10W Active Off: < 5W
Recommended ambience	Operating temperature: 32°F~104°F (0°C~40°C) Operating humidity: 10~90 % Storage temperature: -4°F~140°F (-20°C~60°C)
Dimensions	410 x 421 x 423 mm (W x H x D)
Weight	Net: 17.5Kg Gross: 21.0Kg
Certifications	UL, CUL, TUV/GS, SEMKO, NEMKO, DEMKO, FINKO, CE, DHHS, FCC B, MPR-II, TCO 95
Power Management	EPA Energy Star®, VESA DPMS™

Safety Precautions

Please read all of the following instructions before use.

- Follow all warnings and instructions marked on this product.
- When cleaning this monitor, first unplug it from the wall outlet. Do not use liquid cleaners or aerosol cleaners. Use a damp cloth for cleaning.
- Do not use this product where water spills may occur.
- Prevention from falling, do not place this product on an unstable surface.
- To protect this monitor from overheating, slots and openings on the back and bottom of this unit (use for ventilation) should never be blocked.
- Never be placed near a radiator or heating element.
- Only operate this monitor from the power source indicated on the marking label. If you are not sure of the type of power source available in your area, consult your dealer or your local power company.
- This product is equipped with a 3-wire grounding type plug. For safety this device is meant to be used with a grounding-type power outlet. If you do not have one, contact your electrician to replace your obsolete outlet. **Do not use a 3-to-2 prong adapter.**
- Do not allow anything to rest on the power cord or leave any cords hanging where people frequently walk.
- If an extension cord is used with this product, make sure that the total amperage ratings do not exceed the extension cord's amperage or 10 amperes.
- Never puncture any objects through the walls of the monitor. High voltage points could result in electric shock, fire hazard or cause a short circuit.
- Never attempt to service this product yourself. Opening this unit may expose you to dangerously high voltages. Refer all servicing to a qualified service personnel.
- Save this instruction manual for later use.

Note: Unplug this product and contact qualified service personnel if:

- The power cord or plug is damaged or frayed
- The product has been exposed to rain or water
- The product does not operate normally when used properly
- Improper adjustments has been made
- The product has been dropped or damaged
- The product does not achieve maximum performance

Sicherheitshinweise

Bitte lesen Sie die folgenden Hinweise vor der Inbetriebnahme sorgfältig durch.

- Beachten Sie alle am Gerät angebrachten Warnungen und Hinweise.
- Trennen Sie das Gerät vor dem Reinigen zunächst vom Stromnetz. Verwenden Sie weder Reinigungsflüssigkeiten noch Sprays. Reinigen Sie das Gerät mit einem leicht angefeuchteten Tuch.
- Betreiben Sie dieses Gerät nicht in einer Umgebung, in der Wasserspritzer auftreten könnten.
- Stellen Sie das Gerät nur an einem sicheren, stabilen Ort auf, um es vor dem Herunterfallen zu schützen.
- Achten Sie darauf, daß die Belüftungsschlitze und -öffnungen auf der Rückseite und Unterseite des Gerätes frei zugänglich sind, damit eine Beschädigung des Monitors durch Überhitzung vermieden wird.
- Vermeiden Sie es, das Gerät in unmittelbarer Nähe einer Heizung aufzustellen.
- Betreiben Sie dieses Gerät ausschließlich mit der auf dem Etikett angegebenen Netzspannung. Falls Sie nicht sicher sind, welche Netzspannung in Ihrer Umgebung verwendet wird, erkundigen Sie sich bei Ihrem Fachhändler oder bei Ihrem Stromversorgungsunternehmen.
- Dieses Gerät ist mit einem dreipoligen, geerdeten Netzstecker ausgerüstet. Es sollte aus Sicherheitsgründen an eine geerdete Steckdose angeschlossen werden. Beauftragen Sie gegebenenfalls Ihren Elektriker, nicht geerdete Steckdosen durch geerdete zu ersetzen. **Verwenden Sie keinesfalls einen 3-auf-2poligen Adapter.**
- Stellen Sie keine schweren Gegenstände auf das Netzkabel, und lassen Sie an stark frequentierten Orten keine Kabel im Weg herumliegen.
- Falls Sie dieses Gerät mit einem Verlängerungskabel betreiben, achten Sie darauf, daß die gesamte Stromlast der angeschlossenen Geräte nicht über der maximal zulässigen Strombelastung des Verlängerungskabels und nicht über 10 Ampère liegt.
- Stecken Sie keinesfalls irgendwelche Gegenstände durch die Gehäuseöffnungen des Monitors. Dies kann zu Stromstößen, Brand oder Kurzschlüssen führen.
- Versuchen Sie keinesfalls, dieses Gerät selbst zu warten oder zu reparieren. Beim Öffnen des Gerätes besteht die Gefahr, daß Sie in Kontakt mit Hochspannung geraten. Überlassen Sie alle Wartungs- und Reparaturarbeiten dem dafür ausgebildeten Fachpersonal.
- Heben Sie diese Anleitung zum späteren Gebrauch auf.

Hinweis: In den folgenden Fällen müssen Sie das Gerät vom Stromnetz trennen und sich mit Ihrer Servicewerkstatt in Verbindung setzen:

- Das Netzkabel ist beschädigt bzw. durchgescheuert
- Das Gerät wurde Regen bzw. anderweitiger Feuchtigkeit ausgesetzt
- Das Gerät funktioniert im normalen Betrieb nicht erwartungsgemäß
- Es wurden falsche Einstellungen vorgenommen
- Das Gerät ist heruntergefallen oder wurde anderweitig beschädigt
- Das Gerät funktioniert nur eingeschränkt

TÜV

Allgemeine Sicherheit Hinweise

Folgende Schritte sollten für die richtige Verbindung des 786FD Bildschirmgerätes mit dem Computer befolgt werden. Die folgenden Hinweise sollten vor der Installation des 786FD sorgfältig beachtet werden

Diese Anleitung für späteren Gebrauch sorgfältig aufbewahren

- Das Bildschirmgerät nicht direkter Sonneneinstrahlung aussetzen.
- Das Bildschirmgerät nicht in der Nähe von Wärmequellen aufstellen, z.B. Heizgeräten, Heizungen.
- Das Bildschirmgerät nicht Regen oder übermäßiger Feuchtigkeit aussetzen.
- Nicht die Belüftungsoffnungen blockieren oder abdecken. Diese Öffnungen und Schlitze im Gehäuse sorgen für die notwendige Ventilation. Das Bildschirmgerät sollte niemals mit einer Verkleidung umgeben oder in einem Regal eingebaut werden, falls nicht für eine ausreichende Belüftung gesorgt ist.
- Niemals versuchen, das Gehäuse zu entfernen oder das Bildschirmgerät selbst zu warten. Alle Wartungsarbeiten sollten nur vom autorisierten Kundendienst durchgeführt werden.
- Niemals versuchen, dieses Gerät selbst zu warten, da beim Öffnen oder Abnehmen des Gehäuses die Gefahr eines elektrischen Schlages besteht.
- Zum Netzanschluß dieses Gerätes ist eine geprüfte Leitung zu verwenden. Für einen Nennstrom bis 6A ist eine Leitung nicht leichter als H05VV-F 3G 0.75mm² einzusetzen.
- Die Steckdose muß nahe dem Gerät angebracht und leicht zugänglich sein.
- Zur Vermeidung von Feuer oder Stromschlag niemals Gegenstände durch die Öffnung des Bildschirmgerätes stecken oder fallen lassen. Keine Flüssigkeiten über dem Gerät verschütten.
- Vor Anschluß des Netzkabels an die Steckdose sollte die Stromversorgung überprüft und sichergestellt werden, daß sie der Netzspannung des Bildschirmgerätes entspricht. Die vorgeschriebene Netzspannung ist auf der Rückseite des Bildschirmgerätes angegeben.
- Nicht die Steckdosen überlasten, da dies zu Feuer oder Stromschlag führen kann.
- Für den Anschluß an den Versorgungsstromkreis muß eine TÜV- oder VDE-geprüfte Anschlußleitung nicht leichter als H05VV-F verwendet werden.

Introduction

The **796FD** is a 17-inch (16.0" viewable) multi-scanning, ultra high resolution color monitor with SONY FD Trinitron® tube. With state-of-the-art electronics, this monitor is capable of resolutions up to 1600x1200 non-interlaced.

The intelligent microprocessor-based design enables the monitor to automatically synchronize and adjust to most common video modes.

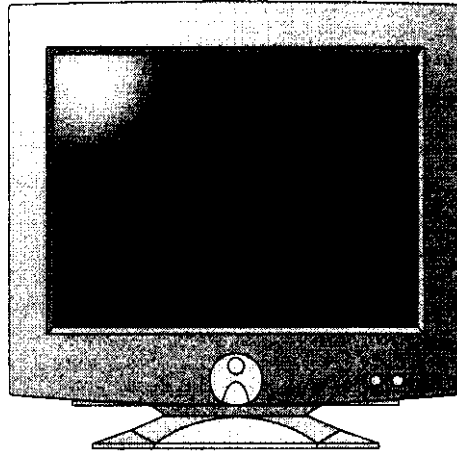

Check list:

Before operating this monitor, please make sure that all of the following items are included:

- 796FD Monitor
 - Power cord
 - This user's Guide
-

JAG™ Control

The JAG™ is designed to provide full user programming capabilities in one simple-to-use location for a more ergonomically-friendly design. This allows you to choose a control function and make necessary display adjustments with just one dial.

e-Video Mode

The monitor provided an Enhance Video Mode. In the TV, PC game or Multi-media Video input, provide higher/brighter video output.

On Screen Display (OSD)

The combination of the JAG™ control and OSD (On-Screen Display) makes it easier for you to make precise screen format adjustments simply. The User Mode control within the OSD allows you to change and save custom display characteristics and timing modes.

DDC Plug & Play

With VESA® DDC1/2B, when the monitor is powered up, it will automatically notify a Windows® 95/98 host computer of its scanning frequencies, capabilities and characteristics. Windows® 95/98 will automatically recognize the connection of the monitor and select the appropriate display resolution.

MPR II and TCO 95 Compliant

The monitor has been designed to meet Swedish MPRII and TCO 95 guidelines for electromagnetic and static emissions.

EPA™ Energy Star® and VESA® Display Power Management System

In the business world, the fastest growing use of electrical power is by computer systems. The amount of electricity used by computers in businesses and homes is phenomenal. A large portion of this electricity is wasted. The Environmental Protection Agency (EPA) has conducted research showing that most of the time PCs are powered up, they are not in use. The EPA promotes the use of energy-efficient equipment because generating electricity causes emissions that pollute the air.

This monitor is Energy Star compliant when used with a computer equipped with VESA® Display Power Management System (DPMS).

Note: The 796FD monitor has three power-saving modes. The power saving operation is indicated by the LED power indicator on the front panel.

- When the LED is green, your monitor is operating normally.
 - When the LED is orange, your monitor is in a power saving mode.
 - If the LED is orange and blinking, the monitor is in a sleep mode. Press a keyboard key or move the mouse to return to normal usage.
 - If the LED is orange and blinking and you cannot return to normal usage by using the mouse or keyboard, check your video signal connection.
 - When the monitor is not in use, save energy by turning off the monitor.
-

Setting up Your Monitor

Setting up your monitor is easy. Just make a few simple connections and adjustments. The following procedure is to guide you to the proper usage of this product.

To connect the monitor to the system:

1. Turn off the power to your system and all its attached options.
2. Make sure that your equipment is in cable-reaching distance from a properly grounded electrical outlet. Position the monitor and the computer so that you can access the back panel of both without difficulty.
3. Connect one end of the signal cable into the video input connector on back panel of the monitor. Plug the other end of the cord into the graphic card video adapter on the back of the computer.
4. Tighten the screws on the video signal cable connector to keep them from coming loose and to prevent radio and TV interference.
5. Connect the power cord that came with the monitor to the AC connector at the back of the monitor. Plug the other end of the power cord into a properly grounded power outlet.

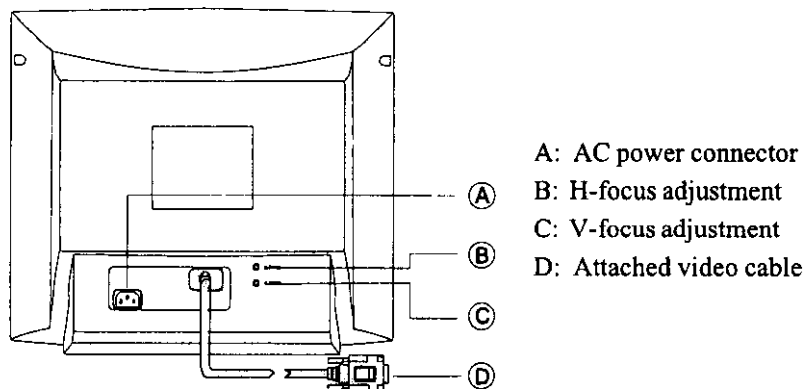

Note: It is important that you use the power cord that came with your monitor in order to insure that the monitor conforms to mandatory FCC standards.

Operation

Make sure you carefully follow the "Safety" and "setting Up Your Monitor" instructions to install your monitor to your system before operating your monitor. You may also want to familiarize yourself with the "Image Adjustment" section of this manual before making any operational adjustments to your operating monitor.

To operate the monitor:

1. Turn on the monitor by pressing the power button once. The power LED lights and the monitor demagnetizes itself for about five seconds.
2. Power up the system.
3. Once the system is completely powered up, the LED power indicator on the monitor should be green. If not, check the connections.
4. Use On-Screen Display to adjust the controls needed to get the best picture. Experiment with the display settings to choose the optimum image size and position for you (refer to the Image Adjustment section of this manual for Instructions).

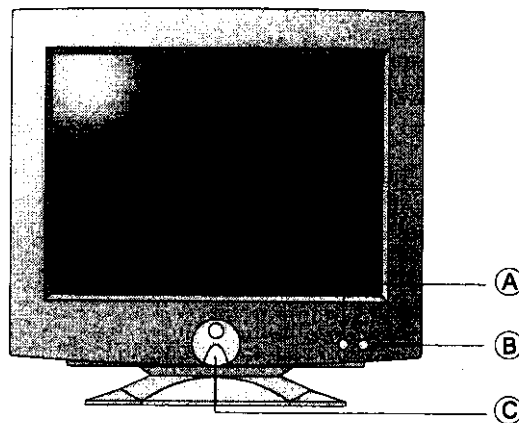

- A. Power button
- B. e-Video button
- C. JAG Dial

Note: If you need to disconnect the power cord from the wall socket or monitor for any reason, be sure to wait at least 30 seconds after you turn off the monitor before you unplug it. This allows the monitor to discharge any static electricity from the screen surface.

Image Adjustment

The JAG™ is designed to provide full user programming capabilities in one simple-to-use location for a more ergonomically-friendly design. This allows you to choose a control and make necessary display adjustments with just one dial.

To adjust other visual settings:

1. Press the JAG. The Main Menu appears, displaying the current resolution and a number of visual setting options. (refer to the "OSD Options" section of this manual).
2. Rotate the JAG to highlight the desired option.
3. Press the JAG again to access the option. A control screen for the option appears.
4. If this option is adjustable, rotate the JAG to adjust it. Some options are not adjustable and are simply activated when the JAG is pressed.
5. Press the JAG when adjustments are complete to exit the control screen and return to the Main Menu.
6. Select Exit and press the JAG to exit the OSD Main Menu.

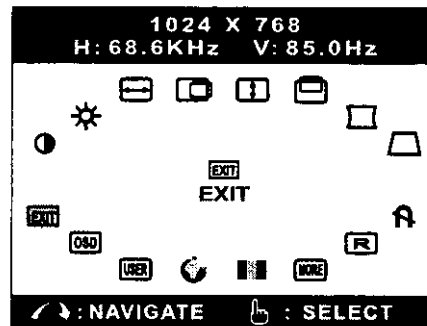

OSD Options

- ◆ **Contrast** - Adjusts the contrast level (black level) in the display.
- ◆ **Brightness** - Adjusts the brightness (white level) level in the display.
- ◆ **Horizontal Size** - Increases and decreases the display width.
- ◆ **Horizontal Position** - Shifts the display to the right or left.
- ◆ **Vertical Size** - Increases and decreases the display height.
- ◆ **Vertical Position** - Shifts the display up or down.
- ◆ **Pincushion** - Bends the sides of the screen display inward or outward.
- ◆ **Trapezoid** - Adjusts the top and bottom display widths to be even.
- ◆ **Degauss** - Removes any discoloration from the display image due to electromagnetic field buildup. It is not usually necessary to degauss your monitor, unless it has been moved.

- ◆ **Reset** - While in a preset video mode, press the JAG dial to reset all customer display setting to the factory default settings.
- ◆ **Advanced options** - Activates the secondary menu that displays options for rotation, bow, parallelogram, corner, and moire.

- **Rotation** - Adjusts the tilt of the display.
- **Parallelogram** - Adjusts the tilt of the display sides to the left or right.
- **Bow** - Bends the sides of the display in the same direction.
- **Corner** - Squares off the display corners.

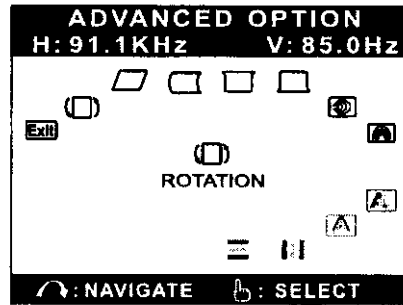

- **V-Moire** - Reduces the optical effect of wavy lines or ripples on the display image in the horizontal direction. These effects are usually more noticeable on large gray areas or on black and white checkerboard patterns.
- **H-Moire** - Reduces the optical effect of wavy lines or ripples on the display image in the vertical direction.
- **Vertical Focus** - Adjust the vertical focus of the display colors.
- **Horizontal Focus** - Adjusts at the horizontal focus of the display colors.
- **Vertical convergence** - Adjusts at the horizontal convergence of the display colors.
- **Horizontal convergence** - Adjusts at the horizontal convergence of the display colors.

- ◆ **Color Manager** - Activates the secondary menu that display three preset level options. Once color temperature option is selected, rotate and press the JAG to choose and adjust the red, green or blue color levels, You may also use recall to return to the original factor settings.

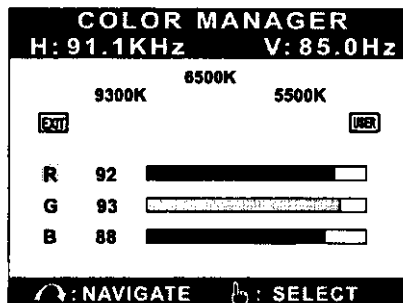

- ◆ **Language Manager** - Activates the Language Manager submenu. Allows you to choose the language for the menu screens.
- ◆ **User Mode** - Activates the User Mode submenu. This stores the display characteristics of a specific resolution (not already defined as a factory preset timing mode) into the monitor's memory. This saves you from having to readjust the display features each time you reboot (refer to the "Video Modes" section for preset timing options) the computer.
- ◆ **OSD Manager** - Activates the OSD Manager submenu. This allows you to adjust the OSD menu position on the display.

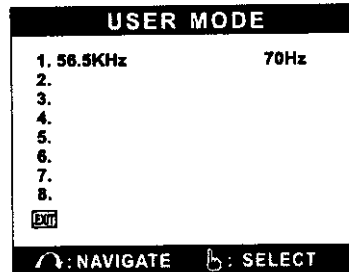

Video Modes

This multi frequency monitor operates at horizontal frequencies of 30 to 96KHz and vertical frequencies of 50 to 160 Hz. The range refers to a maximum flicker-free, usable resolution of 1600x1200 at a non-interlaced refresh rate of 75Hz Vertical.

This monitor offers 17 preprogrammed settings that cover most of the common video modes supported by popular graphics adapters. If the monitor recognizes one of the preset timing signals, it will recall that mode and any stored display adjustments you have made. However, the monitor is multi-scanning, thus, it can accept any signal within its frequency range.

If your video timing mode is not one of the preset timing modes, a screen will appear instructing you to save your timing mode to the User Mode.

Preset modes	Resolution		Frequency	
	H (Pixels)	V (Lines)	H (KHz)	V (Hz)*
1	720	400	31.46	70
2	640	480	31.46	60
3	640	480	37.50	75
4	640	480	43.26	85
5	800	600	37.87	60
6	800	600	46.87	75
7	800	600	53.67	85
8**	832	624	49.71	75
9	1024	768	48.36	60
10	1024	768	60.02	75
11	1024	768	68.67	85
12**	1152	870	68.68	75
13	1280	1024	63.97	60
14	1280	1024	79.97	75
15	1280	1024	91.14	85
16	1600	1200	75.0	60
17	1600	1200	93.75	75

* Refresh rate. ** Macintosh Timing.

Pin Assignment

The pin assignment of the connectors is listed below for professional use only. Please do not attempt to alter the connections yourself as this may seriously damage the monitor.

<u>Pin No.</u>	<u>Assignment</u>
1	Red Video input
2	Green video input
3	Blue video input
4	Ground
5	Ground (DDC)
6	Red video ground
7	Green video ground
8	Blue video ground
9	No connection
10	Ground
11	Ground
12	DDC SDA
13	Horizontal sync./Composite sync.
14	Vertical sync.
15	DDC SCL

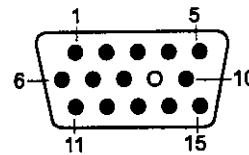
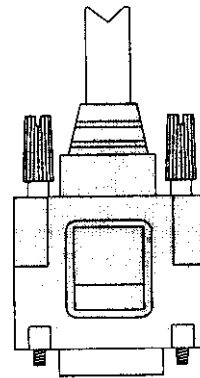

TCO 95 Environmental Labelling

Congratulations! You have just purchased a TCO 95 approved and labelled product! Your choice has provided you with a product developed for professional use. Your purchase has also contributed to reducing the burden on the environment and also, to the further development of environmentally adapted electronics products.

Why do we have environmentally labelled computers?

In many countries, environmental labelling has become an established method for encouraging the adaptation of goods and services to the environment. The main problem, as far as computers and other electronics equipment are concerned, is that environmentally harmful substances are used both in the products and during the manufacturing. Since it has not been possible for the majority of electronics equipment to be recycled in a satisfactory way, most of these potentially damaging substances sooner or later end up in Nature.

There are also other characteristics of a computer, such as energy consumption levels, that are important from the environmental point of view, both in the internal and natural (external) environments. Since a computer's conversion of electrical energy into heat (radioactive waste, etc.), it is vital to reduce energy consumption. The environment in which a computer consumes an enormous amount of energy, since it is often in operation continuously.

What does labelling involve?

This product meets the requirements of the TCO 95 scheme which provides for international and environmental labelling of personal computers. The labelling scheme was developed as a joint effort by the TCO (The Swedish Confederation of Professional Employees), Naturskyddsforeningen (The Swedish Society for Nature Conservation) and NUTEK (The National Board for Industrial and Technical Development in Sweden).

The requirements cover a wide range of environmental, ergonomics, usability, emission of electrical and magnetic fields, energy consumption and electrical and fire safety.

The environmental demands concern, among other things, the presence and use of heavy metals, brominated and chlorinated flame retardants, CFCs (freons) and chlorinated solvents, among other things. The product must be prepared for recycling and the manufacturer is obliged to have an environmental plan which must be adhered to each country where the company implement its operational policy.

The energy requirements include a demand that the computer and/or display, after a certain period of inactivity, shall reduce its power consumption to a lower level in one or more stages. The length of time to reactivate the computer shall be reasonable for the user.

Labelled products must meet strict environmental demands, for example, in respect of the reduction of electric and magnetic fields, physical and visual ergonomics and good usability. In the following paragraphs, you will find a brief summary of the environmental requirement met by this product. The complete environmental criteria document may be ordered from:

TCO Development Unit

S-114 94 Stockholm

Sweden

Fax: +46 8 782 92 07

Email (Internet): development@tco.se

Current information regarding TCO 95 approved and labelled products may also be obtained via the Internet, using the address:

<http://www.tco-info.com/>

TCO 95 is a co-operative project between TCO (The Swedish Confederation of Professional Employees), Naturskyddsforeningen (The Swedish Society for Nature Conservation) and NUTEK (The National Board for Industrial and Technical Development in Sweden)

Environmental Requirements

Brominated flame retardants

Brominated flame retardants are present in printed circuit boards, cables, wires, casing and housings. In turn, they delay the spread of fire. Up to thirty percent of the plastic in a computer casing can consist of flame retardant substance. There are related to another group of environmental toxins, PCBs, which are suspected to give rise to similar harm, including reproductive damage in fish-eating birds and mammals, due to the bio-accumulative* process. Flame retardants have been found in human blood and researchers fear that disturbances in foetus developments may occur.

TCO 95 requirement states that plastic components containing more than 25 grams must not contain organically bound chlorine and bromine.

Lead**

Lead can be found in pigments in display tubes, solders and capacitors. Lead damages the nervous system and is highly toxic, causing brain damage and learning disabilities.

TCO 95 requirement states that solder must not contain more than 100 ppm (parts per million) of lead. Replacement has yet been developed.

Cadmium**

Cadmium is present in rechargeable batteries and color generating layers of certain computer display. Cadmium damages the nervous system and is toxic in high doses.

TCO 95 requirement states that batteries may not contain more than 25 ppm (parts per million) of cadmium. Color generating layers of display tubes must not contain any cadmium.

Mercury**

Mercury is sometimes found in electronic foils and switches. Mercury damages the nervous system and is toxic in high doses.

TCO 95 requirement states that batteries may not contain more than 25 ppm (parts per million) of mercury. It also demands that no mercury is present in any of the electrical or electronics components concerned with the display unit.

CFCs (freons)

CFCs (freons) are sometimes used for washing printed circuit boards and in the manufacturing of expanded foam for packaging. CFCs break down ozone and thereby damage the ozone layer in the stratosphere, causing increased reception on Earth of ultraviolet light with consequent increase risks of skin cancer (malignant melanoma).

TCO 95 requirement states that neither CFCs nor HCFCs may be used during the manufacturing of the product or its packaging.

* Bio-accumulative is defined as substances which accumulate within living organisms.

** Lead, Cadmium and Mercury are heavy metals which are Bio-accumulative.

Regulatory Compliance Statements



American User:

This monitor has been tested to comply with the limits for a Class B digital device, Part 15 of the FCC Rules. These limits are designed to provide protection against harmful interference within a residential area. This equipment is able to radiate radio frequency energy therefore using in nonaccordance with the instructions, may cause harmful interference to radio communications. There is no guarantee that interference will be present in a particular installation. If there is interference, which can be determined by turning this equipment off and on, the user is encouraged to try to correct the interference by the following measures:

- Reorient or relocate the receiving antenna
- Increase the separation between your monitor and your computer.
- Connect the monitor into an outlet different from that to which the computer is connected.
- Consult the dealer, our customer service hotline, or an experienced computer hardware technician for help.

Warning!

This device has been tested and found to comply with the limits of a Class B digital device. The accessories associated with this equipment are as follows:

- Shield video cable
- Shield power cord

Change or modifications not expressly approved by the manufacturer could void the user's authority to operate the equipment.

Power Supply Notice

Install only a UL LISTED/CSA LABELED power supply cord meeting the following specifications:

Plug Type	Nema-Plug 5-15P
Cord Type	SVT or SJT, minimum 3 x 18 AWG
Length	Maximum 15 feet
Rating	Minimum 7A, 125V



EPA Energy Star

This monitor is Energy Star compliant when used with a computer equipped with VESA Display Power Management System (DPMS). The Energy Star emblem does not represent EPA endorsement of any product or service.



Canadian Users:

This digital apparatus does not exceed the Class B digital limits for radio noise emissions from digital apparatus as set out in the radio interference regulations of Industry Canada.

Le présent appareil numérique n'émet pas de bruits radioélectriques dépassant les limites applicables aux appareils numériques de classe B prescrites dans le règlement sur le brouillage radioélectrique édicté par Industrie Canada.



European Users:

This Information Technology Equipment has been tested and found to comply with the following European directives:

- [i] EMC Directive 89/336/EEC amending directive 91/31/EEC 95/263/EE & 93/68/EEC as per
 - EN 50081-1: 1992 according to
 - EN 55022: 1994+A1:1995+A2+1997/CISPR 22:1993+A1+A2/AS/NZS 3548:1995, Class B
 - EN 61000-3-2: 1995, Class A
 - EN 61000-3-3: 1995
 - EN50082-1: 1992/1994 according to
 - EN61000-4-2: 1995 or IEC 801-2: 1987
 - ENV 50140: 1994 or IEC 801-3: 1984
 - EN 61000-4-4: 1995 or IEC 801-4: 1988
- [ii] Low Voltage Directive (Safety) 73/23/EEC as per EN 60950: 1992



Japanese Users:

This equipment is in the Class 2 category (Information Technology Equipment to be used in a residential area or an adjacent area thereto) and conforms to the standards set by the Voluntary Control Council for Interference by Information Technology Equipment aimed at preventing radio interference in such residential area.

When used near a radio or TV receiver, it may become the cause of radio interference. Read instructions for correct handling.

電波障害について

この装置は、情報処理装置等電波障害自由規制協議会(VCCI)の基準に基づく第二種情報技術装置です。この装置は、家庭環境で使用することを目的としていますが、この装置をラジオやテレビジョン受信器に近接してご使用になると、受信障害を引き起こすことがあります。取扱説明書に従って正しい取り扱いをしてください。

Customer Service

Please direct inquiries regarding warranty coverage to your Authorized Ultimate Reseller, Authorized Distributor, or Worldwide service centers listed below:

Australia:

MAGTRON MONITORS (Australia) PTY., LTD.
Unit B2, 1-3 Rodborough Road, Frenchs Forest, NSW 2086
Tel: +61 (2) 9975-3727 Fax: +61 (2) 9975-4872
Internet: <http://www.magtron.com.au>
E-mail: john@magtron.com.au

Europe:

EuroMAG Technology B.V.
Valkenierstraat 10b Donkersloot-Noord 2984 AZ Ridderkerk,
The Netherlands
Tel: +31 (0) 180-461211 Fax: +31 (0) 180-410648
E-mail: service@euromag.nl

Japan:

MagView Co., Ltd.
Taisei Bldg. 1-3-4 Osaki, Shinagawa-Ku, Tokyo 141
Tel: +81 (3) 3493-3588 Fax: +81 (3) 3493-3525

Mainland China:

MAG Technology Co., Ltd. China Div.
Rm. D2, IF, 5.8 Bld Tian An, Industrial Estate, Che Gong Miao, Shenzhen.
Tel: +86 (755) 330-9423 Fax: +86 (775) 330-9411
E-mail: szmag@public.szpt.nt.cn

Taiwan:

MAG Technology Co., Ltd.
15F, No. 287, Sec. 3, Nanking E. Rd, Taipei, Taiwan
Tel: +886 (2) 2719-8811 Fax: +886 (2) 2718-2211
Internet: <http://www.mag.com.tw>
E-mail: service@mail.mag.com.tw

United States and Canada:

MAG Technology USA Inc.
20 Goodyear, Irvine, CA 92618-1813
Tel: +1 (800) 827-3998, +1 (949) 855-4930 Fax: +1 (949) 598-4920
Internet: <http://www.maginnovation.com>



796FD Monitor 19



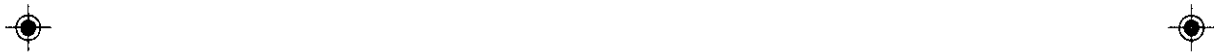

100% Recyclable Paper

Printed in Taiwan

<http://www.tco-info.com/>

TCO 95 is a co-operative project between TCO (The Swedish Confederation of Professional Employees), Naturskyddsforeningen (The Swedish Society for Nature Conservation) and NUTEK (The National Board for Industrial and Technical Development in Sweden)

Environmental Requirements

Brominated flame retardants

Brominated flame retardants are present in printed circuit boards, cables, wires, casing and housings. In turn, they delay the spread of fire. Up to thirty percent of the plastic in a computer casing can consist of flame retardant substance. There are related to another group of environmental toxins, PCBs, which are suspected to give rise to similar harm, including reproductive damage in fish-eating birds and mammals, due to the bio-accumulative* process. Flame retardants have been found in human breast milk. Researchers fear that disturbances in foetus developments may occur.

TCO 95 requirement states that plastic components weighing more than 25 grams must not contain organically bound bromine.

Lead**

Lead can be found in picture tubes, display screens, solders and capacitors. Lead damages the nervous system and in higher doses causes poisoning.

TCO 95 requirement permits the inclusion of lead in the repair kit. The requirement has yet been developed.

Cadmium**

Cadmium is present in rechargeable batteries and in the colour-generating layers of certain computer display. Cadmium damages the nervous system and is toxic in high doses.

TCO 95 requirement states that batteries may not contain more than 25 ppm (parts per million) of cadmium. The colour-generating layers of picture tubes must not contain any cadmium.

Mercury**

Mercury is sometimes found in batteries, relays and switches. Mercury damages the nervous system and is toxic in high doses.

TCO 95 requirement states that batteries may not contain more than 25 ppm (parts per million) of mercury. It also demands that no mercury is present in any of the electrical or electronics components concerned with the display unit.

CFCs (freons)

CFCs (freons) are sometimes used for washing printed circuit boards and in the manufacturing of expanded foam for packaging. CFCs break down ozone and thereby damage the ozone layer in the stratosphere, causing increased reception on Earth of ultraviolet light with consequent increase risks of skin cancer (malignant melanoma).

TCO 95 requirement states that neither CFCs nor HCFCs may be used during the manufacturing of the product or its packaging.

* Bio-accumulative is defined as substances which accumulate within living organisms.

** Lead, Cadmium and Mercury are heavy metals which are Bio-accumulative.

INSULATION TAPE OVERLAPPED 4.0 LAYERS AND THE THICKNESS MUST MORE
a. UL/CSA PVC 1 0.19 x 19 mm WIDE BACK INSULATION TAPE TO BE USED FOR SHROUD

Regulatory Compliance Statements

5. TAPE WRAPPING:
b. THE PVC WIRE AND HOUSING MUST WITHSTAND 2 KG PULLING TEST.
a. UL/CSA VW-1 1617 600V AWG 22 BLUE / BLUE PVC WIRE ARE TO BE USED



American User

This monitor has been tested to comply with the limits for a Class B digital device, Part 15 of the FCC Rules. These limits are designed

to provide protection against harmful interference within a residential area. This equipment is able to radiate radio frequency energy therefore using in non accordance with the instructions, may cause harmful interference to radio communications. There is no interference, which can be determined by turning this equipment off and on, the user is encouraged to try to correct the interference by the following measures:

b. WITHSTAND VOLTAGE : 3.0 mA, 3.0 KVA FOR 1 MINUTE WITHOUT BREAKDOWN

- Increase the separation between your monitor and your computer.
 - Connect the monitor into an outlet different from that to which the computer is connected.
2. TURNS AND WIRE : 20EW ϕ 0.5, C1: 120+/-11S, C2: 120+/-11S
3. ELECTRICAL CHARACTERISTIC :
a. DC RESISTANCE : 17.8 Ω AT 20V
COIL INSIDE CIRCUMFERENCE : C1: 985 \pm 10 mm, C2: 985 \pm 10 mm

Warning!

This device has been tested and found to comply with the limits of a Class B digital device. The accessories associated with this equipment are as follows:

- Shield video cable
- Shield power cord

Change or modifications not expressly approved by the manufacturer could void the user's authority to operate the equipment.

Power Supply Notice

Install only a UL LISTED/CSA LABELED power supply cord meeting the specifications:

- Plug Type: Nema 1P 5-15P
- Cord Type: SVT or SJT, minimum 3 x 18 AWG
- Length: Maximum 15 feet
- Rating: Minimum 1A, 125V

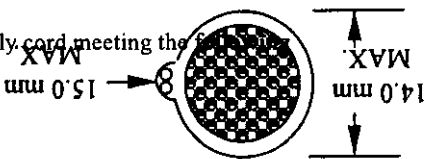

EPA Energy Star

This monitor is Energy Star compliant when used with a computer equipped with VESA Display Power Management System (DPMS). The Energy Star emblem does not represent EPA endorsement of any product or service.



Canadian Users:

This digital apparatus does not exceed the Class B digital limits for radio noise emissions from digital apparatus as set out in the radio interference regulations of Industry Canada.

Le présent appareil numérique n'émet pas de bruits radioélectriques dépassant les limites applicables aux appareils numériques de classe B prescrites dans le règlement sur le brouillage radioélectrique édicté par Industrie Canada.



European Users:

This Information Technology Equipment has been tested and found to comply with the following European directives:

- [i] EMC Directive 89/336/EEC amending directive 91/31/EEC 95/263/EE & 93/68/EEC as per
 - EN 50081-1: 1992 according to
 - EN 55022: 1994+A1:1995+A2+1997/CISPR 22:1993+A1+A2/AS/NZS 3548:1995, Class B
 - EN 61000-3-2: 1995, Class A
 - EN 61000-3-3: 1995
 - EN50082-1: 1992/1994 according to
 - EN61000-4-2: 1995 or IEC 801-2: 1987
 - ENV 50140: 1994 or IEC 801-3: 1984
 - EN 61000-4-4: 1995 or IEC 801-4: 1988
- [ii] Low Voltage Directive (Safety) 73/23/EEC as per EN 60950: 1992



Japanese Users:

This equipment is in the Class 2 category (Information Technology Equipment to be used in a residential area or an adjacent area thereto) and conforms to the standards set by the Voluntary Control Council for Interference by Information Technology Equipment aimed at preventing radio interference in such residential area.

When used near a radio or TV receiver, it may become the cause of radio interference. Read instructions for correct handling.

電波障害について

この装置は、情報処理装置等電波障害自由規制協議会(VCCI)の基準に基づく第二種情報技術装置です。この装置は、家庭環境で使用することを目的としていますが、この装置をラジオやテレビジョン受信器に近接してご使用になると、受信障害を引き起こすことがあります。取扱説明書に従って正しい取り扱いをしてください。

Customer Service

Please direct inquiries regarding warranty coverage to your Authorized Ultimate Reseller, Authorized Distributor, or Worldwide service centers listed below:

Australia:
MAGTRON MONITORS (Australia) PTY., LTD.
Unit B2, 1-3 Rodborough Road, Frenchs Forest, NSW 2086
Tel: +61 (2) 9975-3727 Fax: +61 (2) 9975-4872
Internet: <http://www.magtron.com.au>
E-mail: john@magtron.com.au

Europe:
EuroMAG Technology B.V.
Valkenierstraat 10b Donkersloot-Noord 2984 AZ Ridderkerk,
The Netherlands
Tel: +31 (0) 180-461211 Fax: +31 (0) 180-410648
E-mail: service@euromag.nl

Japan:
MagView Co., Ltd.
Taisei Bldg. 1-3-4 Osaki, Shinagawa-Ku, Tokyo 141
Tel: +81 (3) 3493-3588 Fax: +81 (3) 3493-3525

Mainland China:
MAG Technology Co., Ltd. China Div.
Rm. D2, IF, 5.8 Bld Tian An, Industrial Estate, Che Gong Miao, Shenzhen.
Tel: +86 (755) 330-9423 Fax: +86 (775) 330-9411
E-mail: szmag@public.szpt.nt.cn

Taiwan:
MAG Technology Co., Ltd.
15F, No. 287, Sec. 3, Nanking E. Rd, Taipei, Taiwan
Tel: +886 (2) 2719-8811 Fax: +886 (2) 2718-2211
Internet: <http://www.mag.com.tw>
E-mail: service@mail.mag.com.tw

United States and Canada:
MAG Technology USA Inc.
20 Goodyear, Irvine, CA 92618-1813
Tel: +1 (800) 827-3998, +1 (949) 855-4930 Fax: +1 (949) 598-4920
Internet: <http://www.maginnovision.com>



786FD Monitor 19





100% Recyclable Paper

Printed in Taiwan

