

SV2000

**Digital Video Disc
Player**

Owner's Manual

IMPORTANT!
Return Your Warranty Registration Card
Within 14 Days. See Why Inside.

MODEL SVD100

Return your Warranty Registration Card today to ensure you receive all the benefits you're entitled to.

Once your purchase is registered, you're eligible to receive all the privileges of owning this product. So complete and return the Warranty Registration Card enclosed with your purchase at once. And take advantage of these important benefits.

Warranty Verification

Registering your product within 10 days confirms your right to maximum protection under the terms and conditions of your warranty.

Owner Confirmation

Your completed Warranty Registration Card serves as verification of ownership in the event of product theft or loss.

Model Registration

Returning your Warranty Registration Card right away guarantees you'll receive all the information and special offers which you qualify for as the owner of your model.

SV2000

Congratulations on your purchase, and welcome to the "family!"

Dear product owner:

Thank you for your confidence in this product. You've selected one of the best-built, best-backed products available today. And we'll do everything in our power to keep you happy with your purchase for many years to come.

As a member of the SV2000 "family," you're entitled to protection by one of the most comprehensive warranties and outstanding service networks in the industry.

What's more, your purchase guarantees you'll receive all the information and special offers for which you qualify, plus easy access to accessories from our convenient home shopping network.

And most importantly, you can count on our uncompromising commitment to your total satisfaction.

All of this is our way of saying welcome - and thanks for investing in an SV2000 product.

P.S. Remember, to get the most from your product, you must return your Warranty Registration Card within 10 days. So please mail it to us right now!



Know these

safety symbols



⚡ This "bolt of lightning" indicates uninsulated material within your unit which may cause an electrical shock. For the safety of everyone in your household, please do not remove product covering.

⚠ The "exclamation point" calls attention to features for which you should read the enclosed literature closely to prevent operating and maintenance problems.

WARNING: TO PREVENT FIRE OR SHOCK HAZARD, DO NOT EXPOSE THIS EQUIPMENT TO RAIN OR MOISTURE.

CAUTION: To prevent electric shock, match wide blade of plug to wide slot, fully insert.

ATTENTION: Pour éviter les choc électriques, introduire la lame la plus large de la fiche dans la borne correspondante de la prise et pousser jusqu'au fond.

For Customer Use

Below, enter your product's model number and serial number, which are located on the rear of the cabinet. Keep this information for future reference.

Model No. _____ Serial No. _____

Safety Precautions

Warning: To prevent fire or shock hazard, do not expose this equipment to rain or moisture.

Federal Communications Commission (FCC) Warning: Any unauthorized changes or modifications to this equipment void the user's authority to operate it.

Laser Safety

This unit employs a laser. Only a qualified service person should remove the cover or attempt to service this device, due to possible eye injury.

CAUTION: USE OF CONTROLS OR ADJUSTMENTS OR PERFORMANCE OF PROCEDURES OTHER THAN THOSE SPECIFIED HEREIN MAY RESULT IN HAZARDOUS RADIATION EXPOSURE.

CAUTION: VISIBLE AND INVISIBLE LASER RADIATION WHEN OPEN AND INTERLOCK DEFEATED. DO NOT STARE INTO BEAM. THE BEAM IS LOCATED INSIDE, NEAR THE DECK MECHANISM.

Special Information for Canadian Users

This Class B digital apparatus complies with Canadian ICES-003.

Cet appareil numérique de la classe B est conforme à la norme NMB-003 du Canada.

Radio/TV Interference

This equipment has been tested and found to comply with the limits for a Class B digital device, pursuant to Part 15 of the FCC Rules. These limits are designed to provide reasonable protection against harmful interference in a residential installation. This equipment generates, uses, and can radiate radio frequency energy and, if not installed and used in accordance with the instructions, may cause harmful interference to radio communications. However, there is no guarantee that interference will not occur in a particular installation. If this equipment does cause harmful interference to radio or television reception, which can be determined by turning the equipment off and on, the user is encouraged to try to correct the interference by one or more of the following measures:

- 1) Reorient or relocate the receiving antenna.
- 2) Increase the separation between the equipment and the receiver.
- 3) Connect the equipment into an outlet on a circuit different from that to which the receiver is connected.
- 4) Consult the dealer or an experienced radio/TV technician for help.

Copyright Protection

Unauthorized copying, broadcasting, public performance and lending of Discs are prohibited.

This product incorporates copyright protection technology that is protected by method claims of certain U.S. patents and other intellectual property rights owned by Macrovision Corporation and other rights owners.

Use of this copyright protection technology must be authorized by Macrovision Corporation and is intended for home and other limited viewing uses only unless otherwise authorized by Macrovision Corporation. Reverse engineering or disassembly is prohibited.



As an ENERGY STAR® Partner, Philips Consumer Electronics has determined that this product meets the ENERGY STAR® guidelines for energy efficiency. ENERGY STAR® is a U.S. registered mark. Using products with the ENERGY STAR® label can save energy. Saving energy reduces air pollution and lowers utility bills.

Manufactured under license from Dolby Laboratories. "Dolby" and the double-D symbol are trademarks of Dolby Laboratories. Confidential Unpublished Works. (© 1992-1997 Dolby Laboratories, Inc. All rights reserved.)

DTS is a trademark of Digital Theater Systems Inc. in the United States of America.

Copyright 1999 Philips Consumer Electronics. All rights reserved.

4 Table of Contents

General Information

Safety Information	3
Table of Contents	4
Introduction	5
Playable Discs	6

Getting Started

Remote Control Setup	7
Hookups	8-12
DVD Player Display	13
Front Panel	14
Rear Panel	15
Remote Control Buttons	16-17

Disc Playback and Features

Playing a Disc	18
Disc Menus	19
Pausing Playback	20
Step by Step Playback	21
Fast Forward/Reverse Search	22
Slow Motion	23
Track Playback	24
Title/Chapter Playback	25
Specific Time Playback	26
Repeat Playback	27
A-B Repeat Playback	28
Programmed Playback	29
Random Playback	30
Audio Language/Sound Mode	31
Subtitle Language	32
Camera Angles	33
Parental Lock Password	34
Parental Lock Levels	35

DVD Player Setup and Features

Status Display	36
Video Settings	37
Audio Settings	38-39
Language Settings	40-42
Other Menu Settings	43

Information You May Need

Helpful Hints	44-45
Care and Maintenance	46
Glossary	47
Specifications	48
Limited Warranty	49
Index	50
Supplied Accessories	52

Welcome!

This Digital Video Disc Player will allow you to enjoy better picture quality, clearer sound, and endless playback features available on Digital Video Discs (DVDs). Expanding technology allows you to add options to your viewing - watch a director's cut of a movie, listen to the producer's comments, or play your favorite scene over and over again. Hear a movie in different languages, or listen only to the soundtrack. The possibilities are limited only by your choices and the materials available on the DVD.

Of course, you can listen to your favorite Audio Compact Discs on this DVD Player as well. Determine the order in which you want to hear the songs, or play the Disc repeatedly - all while seeing the status of the CD on your television.

We hope you enjoy this DVD Player and learn to use all of its features. To get the most out of the DVD Player, read this owner's manual carefully. It will describe how you can access all the features listed below.

Features

- Audio Language/Sound Mode Choices
- Automatic Detection of Disc Type (Audio CD or DVD)
- Dolby Digital Sound
- DVD Menus in a Desired Language *
- On-Screen Display for DVD Player
- Parental Lock
- Paused/Fast/Slow/Step-by-Step Playback
- Program Playback (Audio CD only)
- Random Playback (Audio CD only)
- Screen Saver
- Selecting a Camera Angle *
- Subtitles in a Desired Language *

* If available on the Disc

When referring to this manual, remember...

DVD Indicates that the feature described is available on some Digital Video Discs.

AUDIO CD Indicates that the feature described is available on some Audio Compact Discs.

Disc Menus...

Some explanations in this manual are intended to describe the Disc Menus. These menus are set by the movie producers or by the music industry, and the menus will vary among Discs. Furthermore, not all Discs are guaranteed to have menus. However, if the Disc has a menu, you can access the Disc Menu by pressing the MENU button on the remote control.

DVD Player Menus...

Some instructions explain how to use the DVD Player's menu to set up features of the DVD Player or the Disc. You get to the DVD Player Menu by pressing the SETUP button on the remote control when playback is stopped. Even if a feature is set up in the DVD Player's menu, it may not be available if the current Disc does not include that feature.





Available Disc Features...

Not all of the features described in this manual may be available on every DVD or Audio CD. If the feature is not available on the Disc, you cannot use the DVD Player to make these features available. The "No feature" symbol will appear on the TV screen if you try to set up a feature that is not available on the current Disc or not available at the current time.

6 Playable Discs

Playable Discs

This DVD Player will play Digital Video Discs (DVDs) and Audio CDs. In order to play a DVD or Audio CD on this DVD Player, make sure the Disc meets the requirements for Region Codes and Color Systems as described on this page. Also, the Discs should be labelled with the following logos and should meet these standards.

Disc Type	Logo	Contents	Disc Size	Maximum Playback Time	Disc Segments
Digital Video Disc		Sound and Pictures	12 cm	Approx. 4 hours (single-sided) Approx. 8 hours (double-sided)	DVDs are divided into Titles, which are divided into Chapters. Titles and Chapters are numbered.
			8 cm	Approx. 80 minutes (single-sided) Approx. 160 minutes (double-sided)	
Audio CD		Sound	12 cm	74 minutes	Audio CDs are divided into numbered Tracks, i.e., a track may be one song.
			8 cm (singles)	20 minutes	

Region Codes

DVDs also must be labelled for ALL regions or for Region 1 in order to be played on this DVD Player. You can not play Discs that are labelled for other regions.

Look for the symbols below on your DVDs. If these region symbols do not appear on your DVD, you cannot play the DVD in this DVD Player.



The number inside the globe refers to a region of the world. Region 1 represents the United States, Canada, upper regions of North America, Bermuda, the U.S. Virgin Islands, and small regions near Australia.

A Disc encoded in a specific region format can only be played on DVD Players with the same region code. For example, if a Disc is labelled for Region 2, you can not play the DVD on this DVD Player.

Color Systems

Different color systems are available throughout the world. The most common color systems are NTSC, which is used primarily in the United States and North America, PAL, and SECAM.

This DVD Player uses the NTSC color system. Therefore, the Discs that you play must be recorded in the NTSC system. You cannot play Discs recorded in other formats. The color system of the DVD may be listed on the DVD or on the Disc jacket.

Unacceptable Discs

The following Discs cannot be played on this DVD Player:

- CD-ROM
- Compact Disc-Interactive (CD-I)
- Compact Disc-Recordable (CD-R)
- Digital Video Disc-Video Recordable (DVD-VR)
- DVD-RAM
- DVD-ROM
- Photo CD
- Video CD
- Video Single Disc (VSD)

The following discs may be played, but only the audio will be available. There will be no picture.

- Compact Disc-Graphic (CD-G)
- Compact Disc-Video (CD-V)

Putting Batteries in the Remote Control

1

Remove the battery compartment lid on the bottom of the remote control by pressing the tab, then lifting the lid.

2

Place two AA batteries inside the battery compartment with their + and – ends aligned as indicated.

3

Replace the battery compartment lid.



1

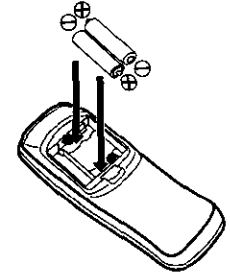

2



3

Using the Remote Control

- Point the remote control at the DVD Player's remote sensor (see page 14) when using the remote control to operate the DVD Player.
- Do not put objects between the remote control and the DVD Player.

Recycling Guidelines/Battery Safety

Your new product and its packaging contain materials that can be recycled and reused. Specialized companies can recycle your product to increase the amount that needs to be properly disposed. Your product uses batteries that should not be thrown away when depleted but should be disposed of as small chemical waste. Please find out about the local regulations on disposal of your old product, batteries, and packaging whenever you replace existing equipment.

Helpful Hints

- The remote control and its batteries are supplied.
- Do not mix alkaline and manganese batteries.
- Do not mix old and new batteries.

8 Hookups

You may connect the DVD Player several different ways, depending on your existing equipment and your preferences for sound and picture quality. To determine which hookup is best for you, examine the options on the following pages, then see which best matches your situation. Before you hook up the DVD Player, remember:

- Connect the DVD Player directly to a TV. If you connect the DVD Player to a VCR, then connect the VCR to the TV, the picture may be distorted by the copyright protection system.
- Turn off the power of all equipment before making any connections.
- Refer to the owner's manuals of your other equipment for additional information.
- Depending on your connection, you may need to purchase additional cables.
- If you do not connect the DVD Player to a Dolby Digital or DTS Decoder, set DOLBY DIGITAL and DTS to OFF on the DVD Player. Details are on pages 11 and 38-39. If you play a DVD when the settings are wrong, the sound will be distorted or you may damage the speakers.

Connecting the DVD Player to a TV only (no stereo or amplifier) **TV has AUDIO (red and white) and VIDEO (yellow) IN jacks**

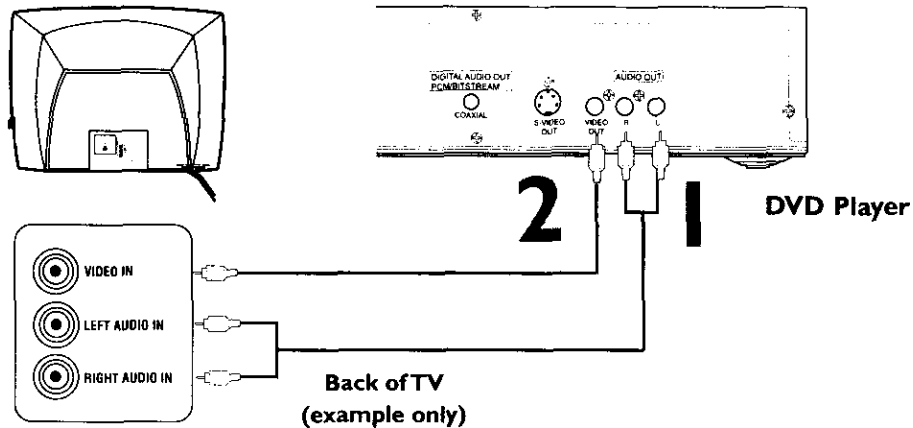

1
Connect the red and white audio cables to the red and white **AUDIO OUT** jacks on the **DVD Player** and to the red and white **AUDIO IN** jacks on the **TV**, matching the cable colors to the jack colors.

2
Connect the yellow video cable to the **VIDEO OUT** jack on the **DVD Player** and to the **VIDEO IN** jack on the **TV**.

3
Connect the **TV's** power cord to a power outlet.
Turn on the **TV** and set it to the **Audio/Video In** channel, which also may be referred to as **AV In** or **Auxiliary In**. This channel usually is located in the vicinity of channel 00. See your **TV** owner's manual for details.

4
Connect the **DVD Player's** power cord to a power outlet.
Press the **POWER** button to turn on the **DVD Player**. "HELLO" will appear briefly on the **DVD Player's** display panel. You should see the **DVD** logo on the **TV** screen. If you do not, check your connections and make sure the **TV** is set to the correct **Audio/Video In** channel.

Connecting the DVD Player to a TV only (no stereo or amplifier)

TV has audio (red and white) and S-Video In jacks

- For better picture quality, use an optional S-Video cable to connect the S-VIDEO OUT jack on the DVD Player to the S-VIDEO IN jack on your TV. You will not use the VIDEO OUT jack on the DVD Player, and you will not need the yellow video cable.
- Set DOLBY DIGITAL and DTS to OFF on the DVD Player. Details are on pages 38-39. If you play a DVD when the settings are wrong, the sound will be distorted or you may damage the speakers.

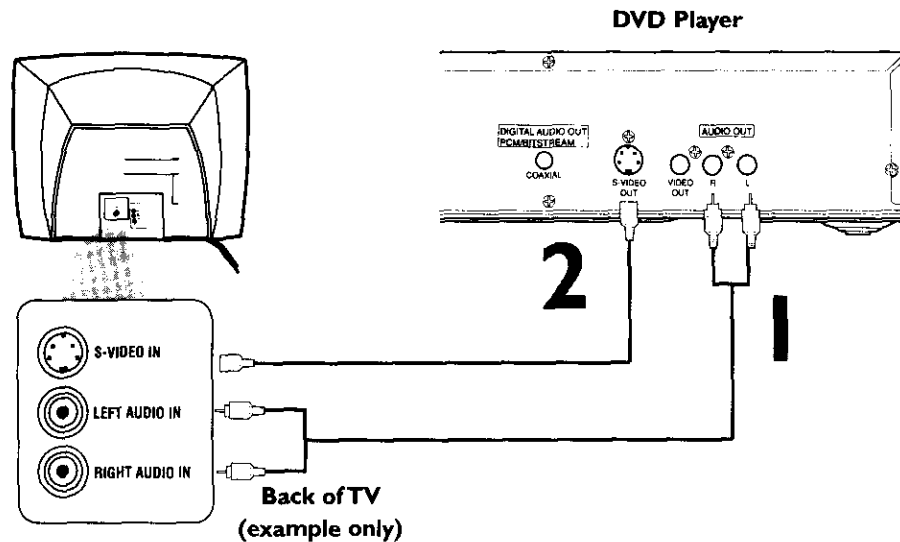

1
Connect the red and white audio cables to the red and white **AUDIO OUT** jacks on the DVD Player and to the red and white **AUDIO IN** jacks on the TV, matching the cable colors to the jack colors.

2
Connect an **S-Video** cable (not supplied) to the **S-VIDEO OUT** jack on the DVD Player and to the **S-VIDEO IN** jack on the TV.

3
Connect the TV's power cord to a power outlet.
Turn on the TV and set it to the **S-VIDEO IN** channel. This channel usually is located near channel 00. See your TV owner's manual for details.

4
Connect the DVD Player's power cord to a power outlet.
Press the **POWER** button to turn on the DVD Player. "HELLO" will appear briefly on the DVD Player's display panel. You should see the DVD logo on the TV screen. If you do not, check your connections and make sure the TV is on the correct Audio/Video In channel.

10 Hookups (cont'd)

Connecting to a TV and a Stereo

- Set DOLBY DIGITAL and DTS to OFF on the DVD Player. Details are on pages 38-39. If you play a DVD when the settings are wrong, the sound will be distorted or you may damage the speakers.

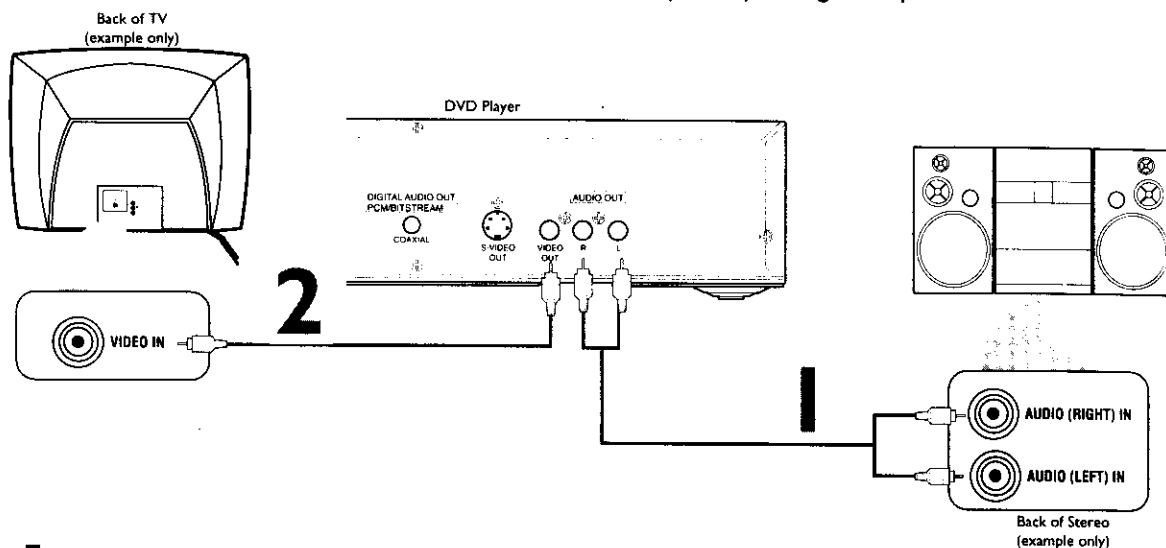

1
Connect the red and white audio cables to the red and white **AUDIO OUT** jacks on the DVD Player and to the red and white **AUDIO IN** jacks on the Stereo, matching the cable colors to the jack colors.

2
Connect the supplied video cable (yellow) to the **VIDEO OUT** jack on the DVD Player and to the **VIDEO IN** jack on the TV.
(Or, you may connect an optional S-Video cable to the S-VIDEO OUT jack on the DVD Player and to the S-VIDEO IN jack on the TV.)

3
Plug in the Stereo's power cord. Turn on the Stereo and select the Stereo's **Auxiliary IN** station. During Disc playback, you will adjust the volume at your Stereo. See your Stereo owner's manual for details.

4
Plug in the TV's power cord. Turn on the TV and set it to the **Video In** channel (or **S-Video In** channel), which usually is located near channel **00**. During Audio CD playback, you may check the status of Audio CDs on your TV screen. During DVD playback, you will watch the program on the TV. See your TV owner's manual for details.

5
Connect the DVD Player's power cord to a power outlet.
Press the **POWER** button to turn on the DVD Player. "HELLO" will appear briefly on the DVD Player's display panel. You should see the DVD logo on the TV screen. If you do not, check your connections and make sure the TV is on the correct channel.

Connecting to a Dolby Digital Decoder or DTS Decoder

Some Discs are recorded in a 5.1 channel Dolby Digital Surround or Digital Theater System (DTS) Surround format. These Discs will sound best if you connect the DVD Player to a Dolby Digital or DTS Decoder.

- You will need a coaxial digital audio cable (not supplied).
- If you connect the DVD Player to a Dolby Digital Decoder, set DOLBY DIGITAL to ON. *Details are on pages 38-39.*
- If you connect the DVD Player to a DTS Decoder, set DTS to ON. *Details are on pages 38-39.*
If the DVD Player is not connected to a Dolby Digital or DTS decoder, set DOLBY DIGITAL and DTS to OFF. Incorrect settings may cause noise distortion and damage the speakers.
- Select the 5.1 channel Dolby Digital Surround sound in the Disc menu.
- Connect a subwoofer and the center, front, and surround speakers to the Decoder as described in the Decoder's owner's manual.

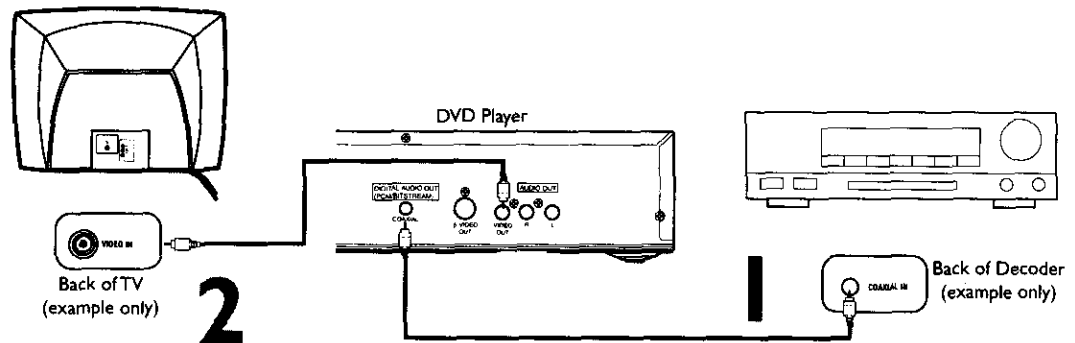

1 Connect a coaxial digital audio cable to the **COAXIAL** jack on the DVD Player and to the **COAXIAL DIGITAL AUDIO IN** jack on the Decoder.

2 Connect the supplied video cable (yellow) to the **VIDEO OUT** jack on the DVD Player and to the **VIDEO IN** jack on the TV. (Or, you may connect an optional S-Video cable to the S-VIDEO OUT jack on the DVD Player and to the S-VIDEO IN jack on the TV.)

3 Plug in the Decoder's power cord. Turn on the Decoder and select the **Auxiliary IN** station. During Disc playback, you will adjust the volume at the Decoder. See your Decoder owner's manual for details.

4 Plug in the TV power cord. Turn on the TV and set it to the **Video In** channel (or **S-Video In** channel), which may be located near channel **00**. During Audio CD playback, you may check the Disc status on your TV screen. During DVD playback, you will watch the program on the TV. See your TV owner's manual for details.

5 Connect the DVD Player's power cord to a power outlet. Press the **POWER** button to turn on the DVD Player. "HELLO" will appear briefly on the DVD Player's display panel. You should see the DVD logo on the TV. If you do not, check your connections and make sure the TV is on the correct channel.

12 Hookups (cont'd)

Connecting to a TV and an Amplifier with Digital Input jacks, Mini-Disc Deck or Digital Audio Tape Deck

- Use a coaxial digital audio cable (not supplied) for this connection.
- If the Disc is recorded in 5.1 channel Dolby Digital Surround, you cannot dub the Disc in digital sound using a Mini-Disc or Digital Audio Tape Deck.
- Set DOLBY DIGITAL and DTS to OFF on the DVD Player. *Details are on pages 38-39.* If you play a DVD when the settings are wrong, the sound will be distorted or you may damage the speakers.

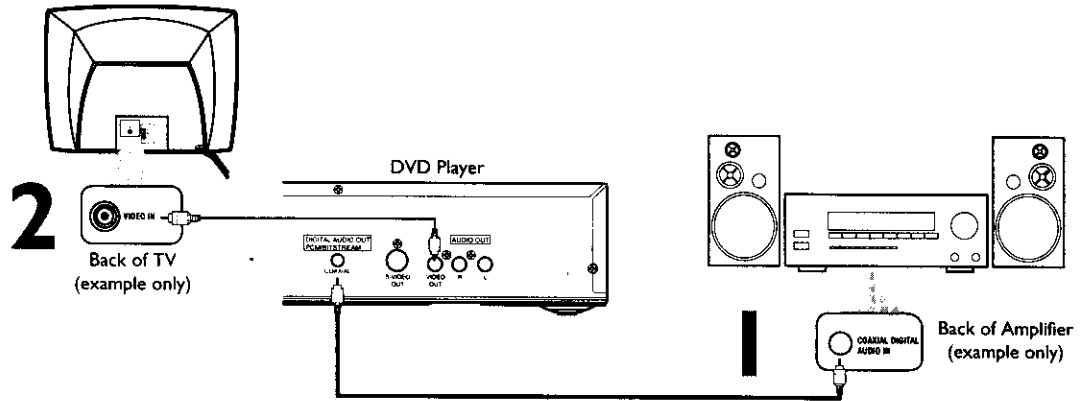

1

Connect a coaxial digital audio cable to the **COAXIAL** jack on the **DVD Player** and to the **COAXIAL DIGITAL AUDIO IN** jack on the **Amplifier**.

2

Connect the supplied video cable (yellow) to the **VIDEO OUT** jack on the **DVD Player** and to the **VIDEO IN** jack on the **TV**. (Or, you may connect an optional S-Video cable to the **S-VIDEO OUT** jack on the **DVD Player** and to the **S-VIDEO IN** jack on the **TV**.)

3

Plug in the **Amplifier's** power cord. Turn on the **Amplifier** and select the **Auxiliary IN** station. During Disc playback, you will adjust the volume at the **Amplifier**. See your **Amplifier** owner's manual for details.

4

Plug in the **TV's** power cord. Turn on the **TV** and set it to the **Video In** channel (or **S-Video In** channel). This channel usually is located near channel 00. During Audio CD playback, you may check the status of the Disc on your **TV** screen. During DVD playback, you will watch the program on the **TV**. See your **TV** owner's manual for details.

5

Plug in the **DVD Player's** power cord. Press the **POWER** button to turn on the **DVD Player**. "HELLO" will appear briefly on the **DVD Player's** display panel. You should see the **DVD** logo on the **TV**. If you do not, check your connections and make sure the **TV** is on the correct channel.

Display

Messages about current DVD Player operations appear here. See Display Messages below.

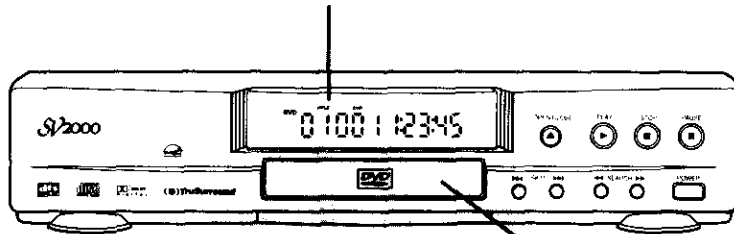

Disc loading tray
Insert a Disc here.

Lit when a DVD is inserted. When the DVD light is on, the disc is loaded completely and is ready for playback.

Lit when an Audio CD is inserted. When the CD light is on, the disc is loaded completely and is ready for playback.

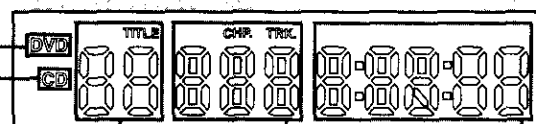

Displays a title number (DVD)

Displays a chapter (DVD) or track (Audio CD) number

Displays the elapsed time of the current title (DVD) or track (Audio CD)

Display Messages

HELLO	Power is turning on.
NO DISC	Appears after the disc tray closes if the tray is empty, if there is an error reading the disc, or if an unacceptable disc is installed.
OPEN	Tray is opening or is open.
CLOSE	Tray is closing.
SEARCH	Appears when you press the SKIP buttons to search for the next or previous track (Audio CD).
BYE	Power is turning off.
LOAD	Disc is loading.

14 Front Panel

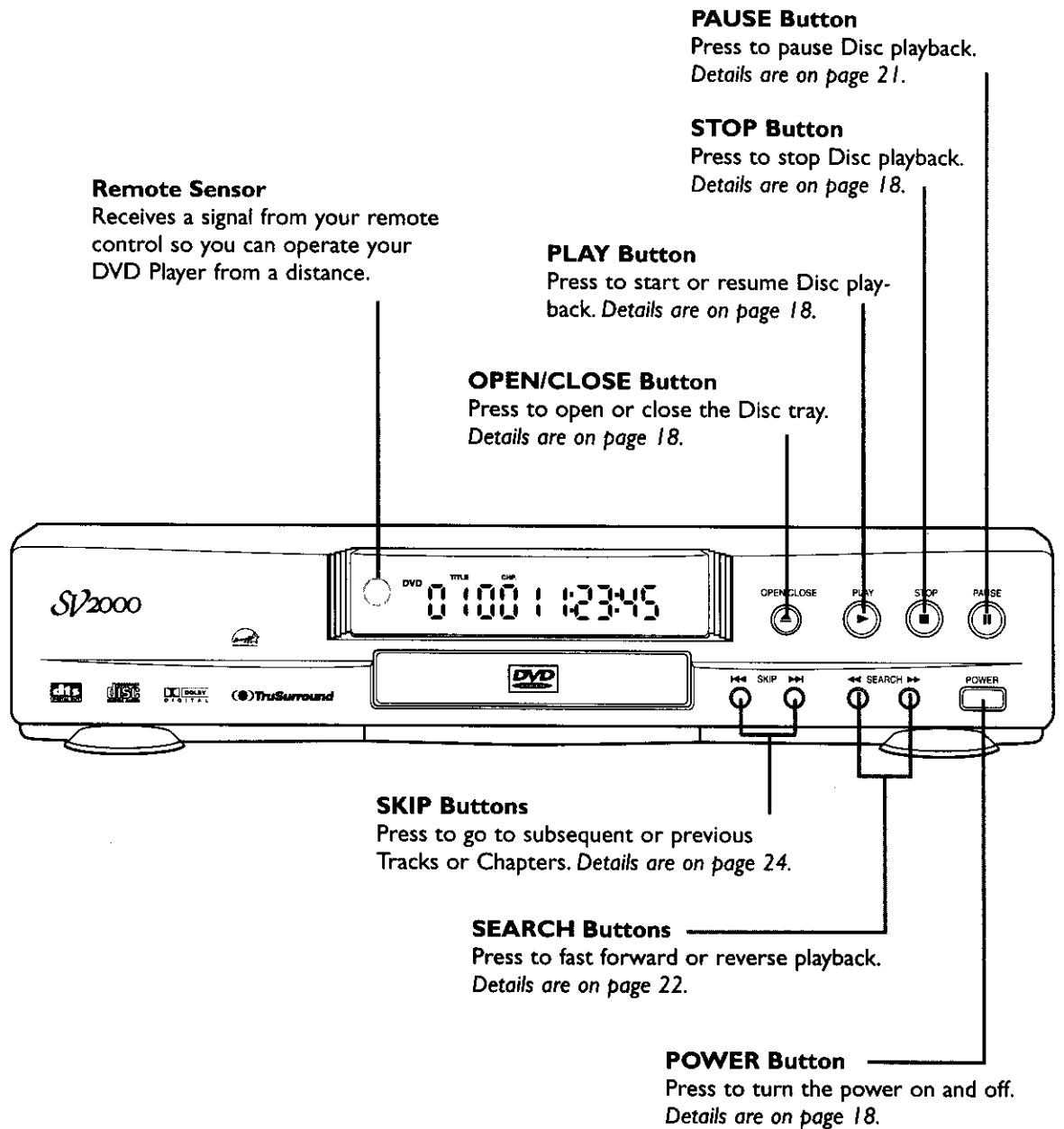

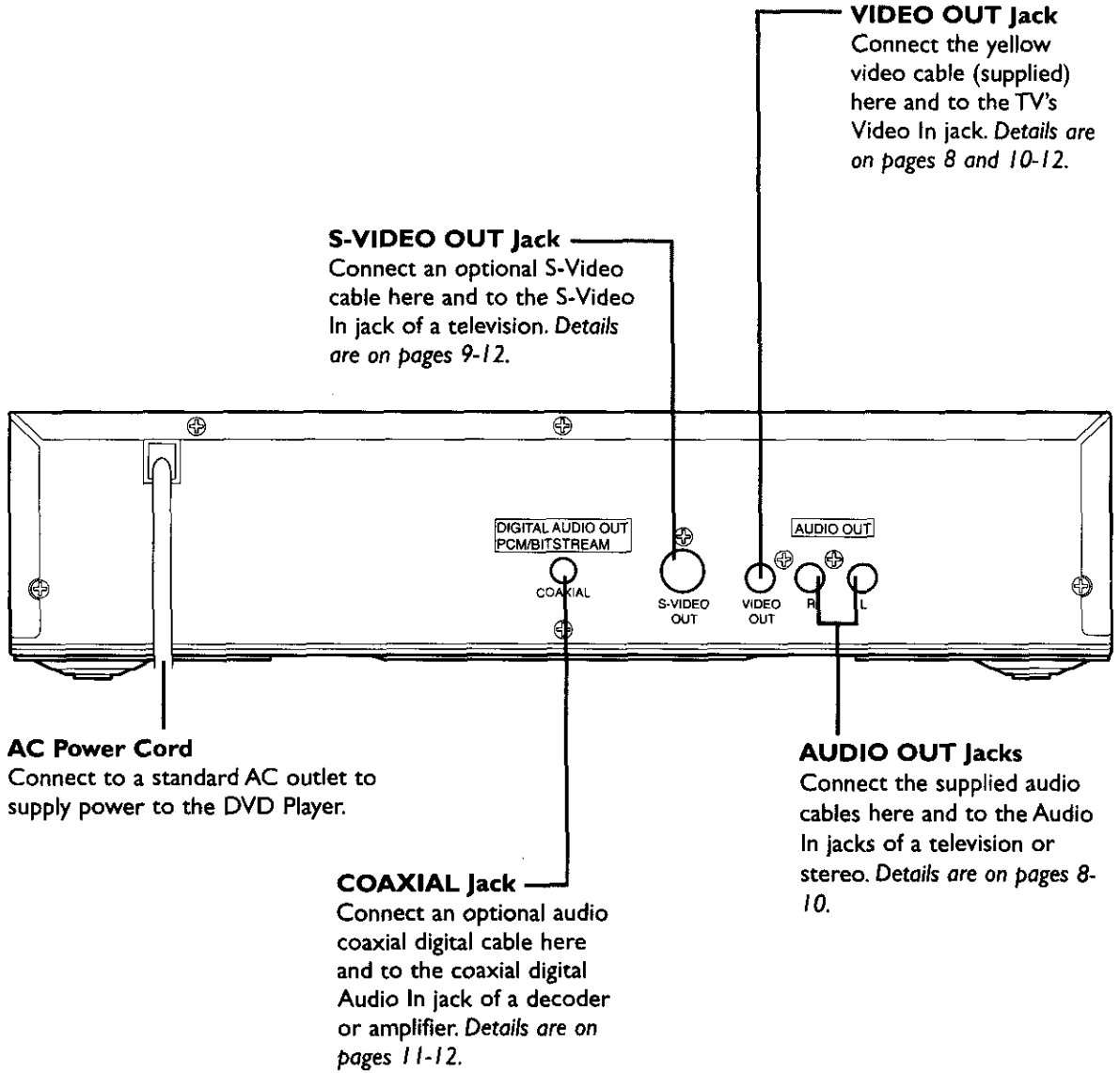

16 Remote Control Buttons

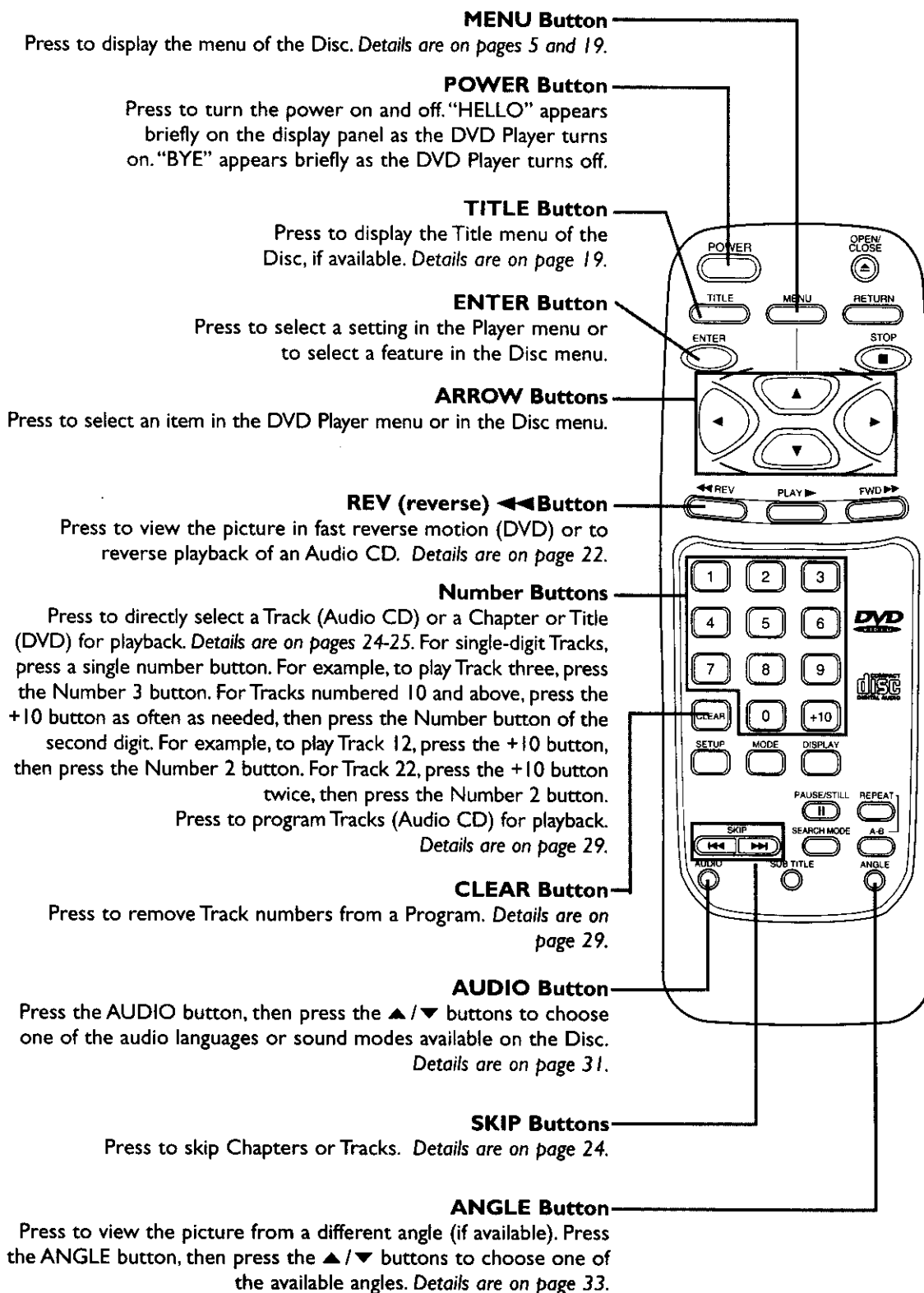

Remote Control Buttons (cont'd) 17

FWD (forward) ►► Button
Press to fast forward the Disc. *Details are on page 22.*
Press the PAUSE/STILL button, then press the FWD button to begin slow motion playback. Press the FWD button repeatedly to change the forward speed of slow motion. *Details are on page 23.*

OPEN/CLOSE Button
Press to open or close the Disc tray.

RETURN Button
Press to return to the previous DVD Player SETUP menu or to remove the SETUP menu from the TV screen.

STOP Button
Press to stop Disc play.

PLAY Button
Press to begin Disc play.

DISPLAY Button
Displays the current status of the Disc during playback. Press again to remove the status display. *Details are on page 36.*

MODE Button
Press to set up programmed or random playback for an Audio CD. *Details are on pages 29-30.*

SETUP Button
When Disc playback is stopped, press to access or remove the DVD Player's SETUP menu. *Details are on pages 34-43.*

SUBTITLE Button
Press to access the subtitle menu, then press the ▲/▼ buttons to select a language for the subtitles (among those available) or to turn off the subtitles. *Details are on page 32.*

SEARCH MODE Button
Press to access or remove the SEARCH menu, which allows you to go directly to a specific Title/Chapter/Track/Time. *Details are on pages 24-26.*

PAUSE/STILL Button
Press to pause Disc playback. *Details are on page 20.* Press repeatedly to advance the DVD picture step by step (or one frame at a time). *Details are on page 21.*

A-B REPEAT Button
Press to set up A-B Repeat Play, which repeatedly plays a specific segment of a Disc. *Details are on page 28.*

REPEAT Button
Press to repeat playback of the current Disc or Track (Audio CD) or a Title or Chapter (DVD). *Details are on page 27.*

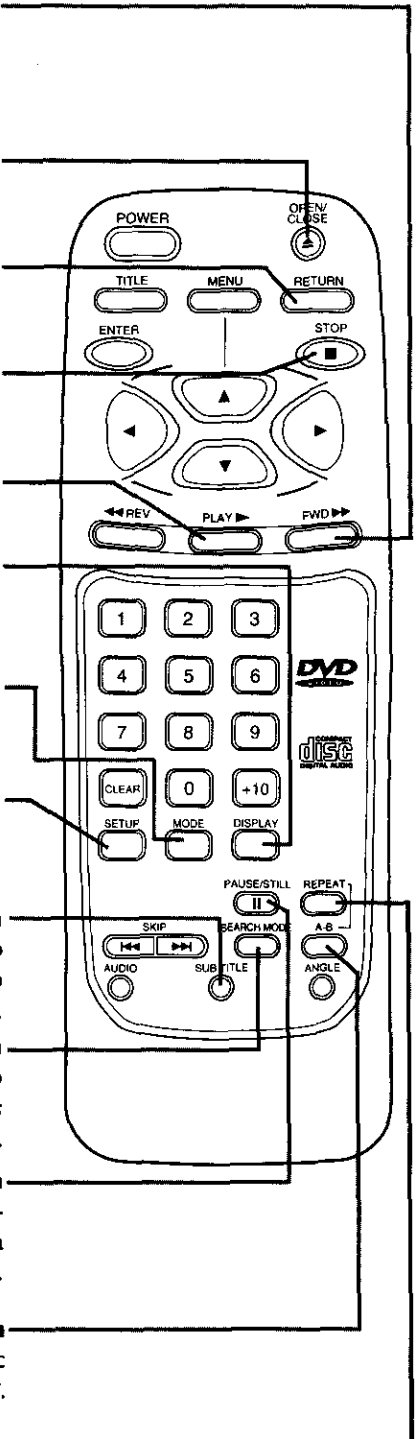

18 Playing a Disc

DVD

AUDIO CD

Playing a DVD or an Audio CD

Before you begin...

Turn on the power of the TV, amplifier and any other equipment connected to the DVD Player. Make sure the TV and the stereo or amplifier (if applicable) are set to the correct channel. Details are on pages 8-12.

1

Press the **POWER** button to turn on the DVD Player. "HELLO" will appear briefly on the display panel.

2

Press the **OPEN/CLOSE** button to open the Disc tray.

3

Place a Disc into the tray. Make sure the Disc is sitting properly in the correct recess.

Some DVDs are recorded on both sides. Make sure the side you want to play is facing up. Or, if the DVD is recorded on only one side, place the Disc in the tray with the label facing up.

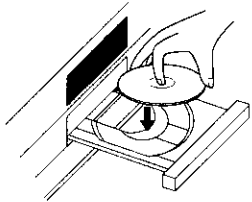

4

Press the **PLAY** button. The tray will close automatically, and playback will begin at the first Chapter or Track of the Disc. Or, you may press the OPEN/CLOSE button to close the tray, and DVD playback will start automatically. (You also may close the tray by gently pressing the Disc tray toward the DVD Player.)

If the DVD in the tray has a menu, the menu may appear on the screen instead. Details are on page 19.

With some Audio CDs, playback will not begin until you press the **PLAY** button.

5

Press the **STOP** button to stop playback.

Remember, this DVD Player will play only certain Discs. See page six for details.

3 Insert a Disc.

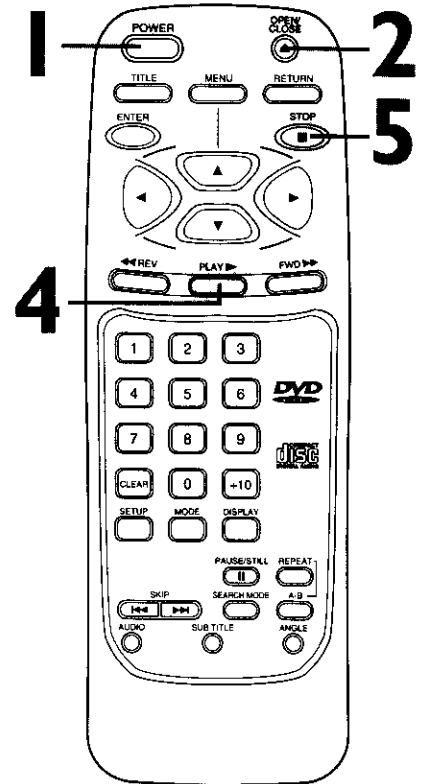

Helpful Hints

- A "No Feature" symbol  may appear at the bottom right of the TV screen. This symbol means either the feature you tried is not available on the Disc, or the DVD Player can not access the feature at this time. This does not indicate a problem with the DVD Player.
- If a Disc is dirty or has scratches, the pictures may appear distorted and playback may stop. In such cases, remove the Disc and turn off the DVD Player. Disconnect the power cord, then reconnect it. Clean the Disc, then turn on the DVD Player again and reinsert the Disc for playback.
- When the DVD or CD light appears on the display panel, the Disc is loaded completely and is ready for playback.

DVD

Using the DVD Menus

Some DVDs contain menus that describe the contents of the Disc or allow you to customize Disc playback. For example, the menu may offer choices for subtitle languages, director's commentary, or soundtrack playback.

To use the DVD menu and select playback features, follow these steps.

1

Press the **MENU** button. The DVD's main menu will appear.

2

Press the arrow buttons (**▲/▼/◀/▶**) to select an item, then press the **ENTER** button. Continue this process to set up all the features you wish to see on the Disc.

To access the DVD's Main Menu...

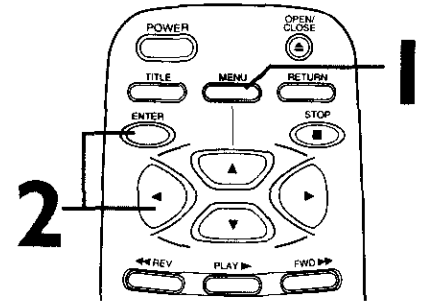

Using the Title Menu

Some DVDs have a Title Menu, which lists the Titles available on the Disc. Use the Title Menu to start playback at a specific Title. Some DVDs may allow you to choose Chapters from the Title menu.

For example, if a DVD has 10 Titles and you want to go directly to Title 5, follow these steps.

1

Press the **TITLE** button. The Title Menu will appear.

If a Title menu is not available, the  symbol will appear on the TV screen.

NOTE: If the DVD only has a main menu, the main menu may appear when you press the **TITLE** button.

2

Press the arrow buttons (**▲/▼/◀/▶**) to select the desired **Title**, then press the **ENTER** button. Playback will begin at the Title you selected.

To access the DVD's Title Menu...

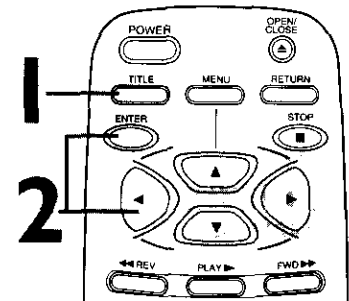

Helpful Hints

- Menus may vary among Discs. Refer to the manual accompanying the Disc for details.
- Not all DVDs have Title menus.
- Some DVDs may refer to Chapters as "scenes." Some DVDs may refer to the Title Menu as the "scene index."

20 Pausing Playback

DVD

AUDIO CD

Pausing Playback

1

During playback, press the **PAUSE/STILL** button on the remote control (or press the **PAUSE** button on the DVD Player). Playback will pause and the sound will be muted.

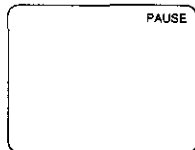

2

Press the **PLAY** button to resume playback.

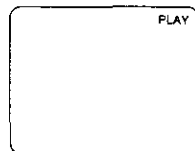

Pausing Playback...

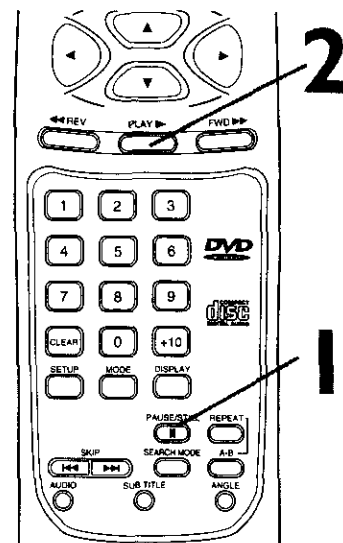

DVD

Memory On:

Resuming playback from the point where playback stopped

1

Press the **STOP** button during playback. Playback will stop, and **STOP** will appear at the top right corner of the TV screen. In a few seconds, **MEMO ON** (Memory On) will appear in the top left corner of the TV screen.

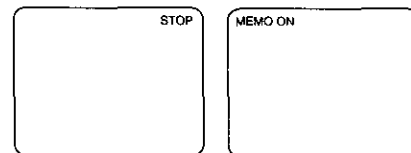

2

Press the **PLAY** button. Playback will resume from the point where playback stopped last.

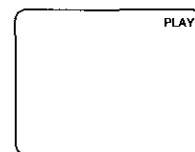

Memory On...

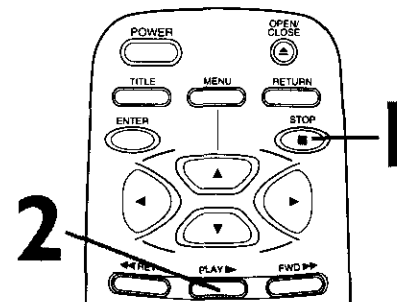

Helpful Hints

- *Memory On* can be erased by pressing the **STOP** button a second time while playback is stopped. **MEMO OFF** will appear briefly at the top left corner of the TV screen.
- *Memory On* is not available with Audio CDs.
- The DVD player will turn itself off automatically after being in Pause mode for 30 minutes. This helps avoid the possible burning of the still image into the TV screen.

Step by Step Playback 21

DVD

1

Press the **PAUSE/STILL** button to pause playback. The sound will be muted.

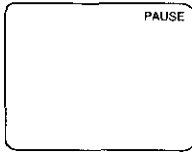

2

Press the **PAUSE/STILL** button repeatedly to see the picture advance one frame (or step) at a time. The sound will remain muted. PAUSE will appear briefly on the screen each time you press the PAUSE/STILL button.

3

Press the **PLAY** button to resume playback. PLAY will appear briefly on the screen.

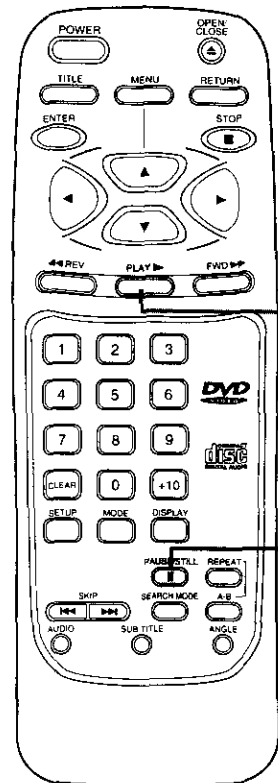
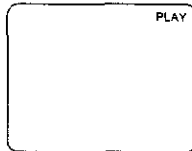

22 Fast Forward/Reverse Search

DVD

AUDIO CD

1
During playback, press the FWD▶▶ button or the REV◀◀ button on the remote control (or press the SEARCH buttons on the DVD Player).

- On a DVD, pressing the FWD▶▶ or REV◀◀ button repeatedly will forward or reverse the picture at twice, eight times, or 32 times the normal playback speed. Sound will be muted during searching.
- Use the FWD▶▶ button for a forward search. Press the REV◀◀ button for a reverse search.

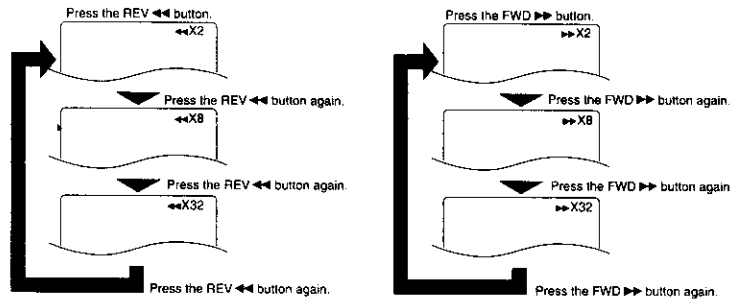

- On an Audio CD, you may search forward or backward at 16 times the normal playback speed (◀◀X16 or ▶▶X16). Pressing the FWD▶▶ or REV◀◀ button repeatedly will not affect the speed of the search. Sound will be intermittent during searching on an Audio CD.
- Use the FWD▶▶ button for a forward search. Press the REV◀◀ button for a reverse search.

Press the REV◀◀ button during Audio CD playback.

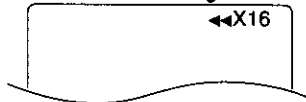

Press the FWD▶▶ button during Audio CD playback.

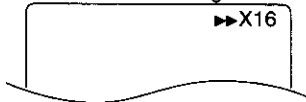

2

Press the PLAY button to return to normal playback.

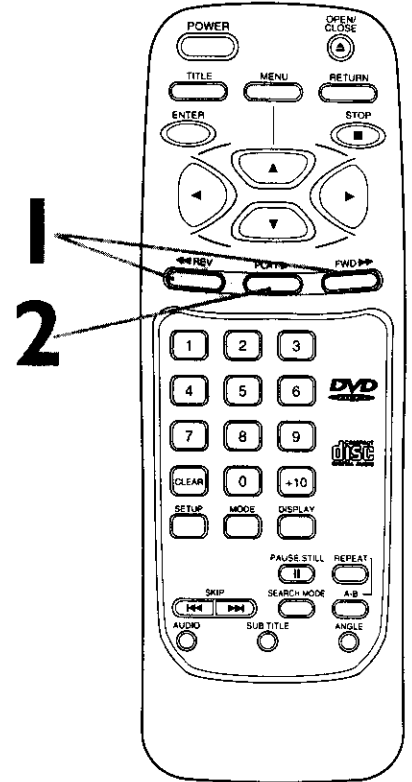

DVD

1

Press the **PAUSE/STILL** button during playback.

2

Press the **FWD** button. Slow motion playback will begin.
Press the FWD button repeatedly during slow motion playback to vary the speed of slow motion playback.
You may play the DVD at 1/16, 1/8, or 1/2 the normal playback speed.

3

Press the **PLAY** button to return to normal playback.

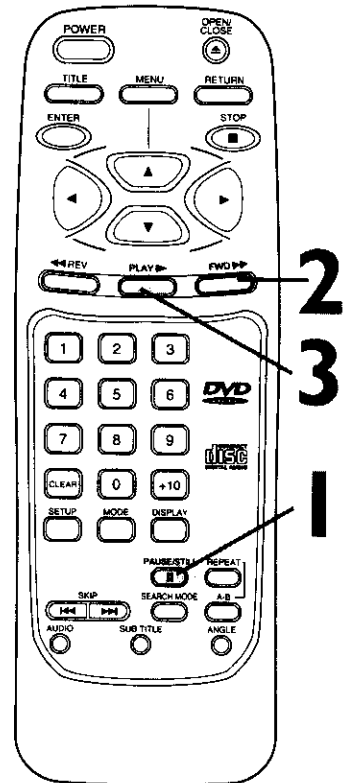

Helpful Hints

- The sound will be muted when playback is paused and during slow motion playback.
- You can not play the DVD in reverse slow motion.

24 Track Playback

AUDIO CD

Starting Playback at a Specific Track

There are three ways to begin playback on an Audio CD at a specific Track. You may use the Number buttons, the SEARCH MODE button, or the SKIP $\lll \ggg$ buttons. For details, read the information below.

A

Using the Number Buttons to Select a Track

Press the Number buttons to enter the desired Track number. The selected Track will be located, and playback will start. You may select a Track with the Number buttons during playback or when playback is stopped.

For single-digit Tracks, press a single Number button. For example, to play Track three, press the Number 3 button.

For Tracks numbered 10 and above, press the +10 button (repeatedly, if necessary), then press the Number button of the second digit.

For example, to play Track 12, press the +10 button, then press the Number 2 button. For Track 22, press the +10 button twice, then press the Number 2 button.

If you enter a Track number that is not available on the Disc, playback will not begin (or the current Track will continue to play).

B

Using the SEARCH MODE Button to Select a Track

Press the SEARCH MODE button once, then press the $\blacktriangle/\blacktriangledown$ buttons to select the Track number you desire. Finally, press the PLAY button to begin playback at the selected Track.

If you press the SEARCH MODE button once during playback, the current Track number will be displayed inside the brackets.

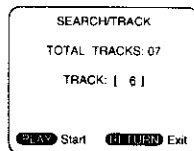

C

Using the SKIP $\lll \ggg$ Buttons to Select a Track

Press the SKIP \ggg button during playback to skip the current Track and move to the next Track. Press the SKIP \ggg button repeatedly to skip subsequent Tracks. The Track number will appear briefly on the TV screen.

Press the SKIP \lll button during playback to return to the beginning of the current Track. Press the SKIP \lll button repeatedly to go to previous Tracks. The Track number will appear briefly on the TV screen.

If you press a SKIP button when playback is paused, you must press the PLAY button to resume playback.

If you press a SKIP button when playback is stopped, the selected Track will begin playing automatically.

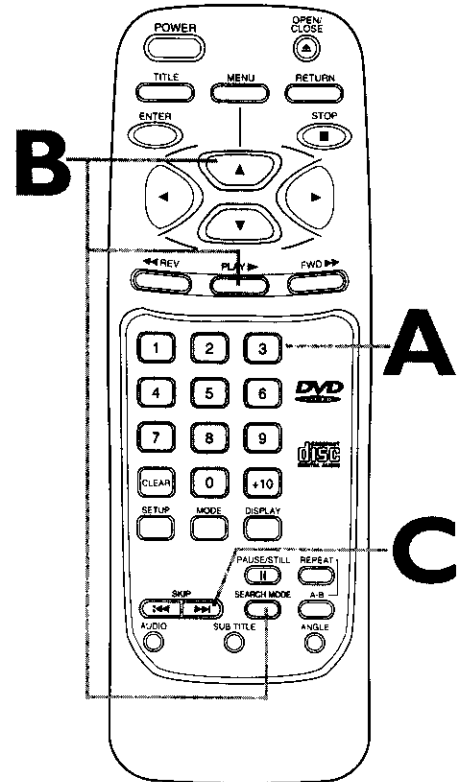

DVD

Starting Playback at a Specific Title/Chapter

There are two ways to begin DVD playback at a specific Title or Chapter. You may use the Number buttons or the SEARCH MODE button.

A

Using the Number Buttons to Select a Title/Chapter
During playback, press the Number buttons to select a Chapter. The Chapter will be located and playback will start.
When playback is stopped, press the Number buttons to select a Title. The Title will be located and playback will begin.
 For single-digit Chapters or Titles, press a single Number button. For example, to play Chapter three, press the Number 3 button during playback. To play Title two, press the Number 2 button while playback is stopped.
 For Chapters/Titles numbered 10 and above, press the +10 button (repeatedly, if necessary), then press the Number button of the second digit. For example, to play Chapter 12, press the +10 button, then press the Number 2 button during playback. For Title 22, press the +10 button twice, then press the Number 2 button when playback is stopped.

B

Using the SEARCH MODE Button to Select a Title/Chapter
To start playback at a specific Chapter, press the SEARCH MODE button once, then press the Number buttons or the ▲/▼ buttons to enter the Chapter number. Press the PLAY button to begin playback at the selected Chapter.

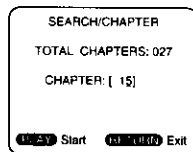
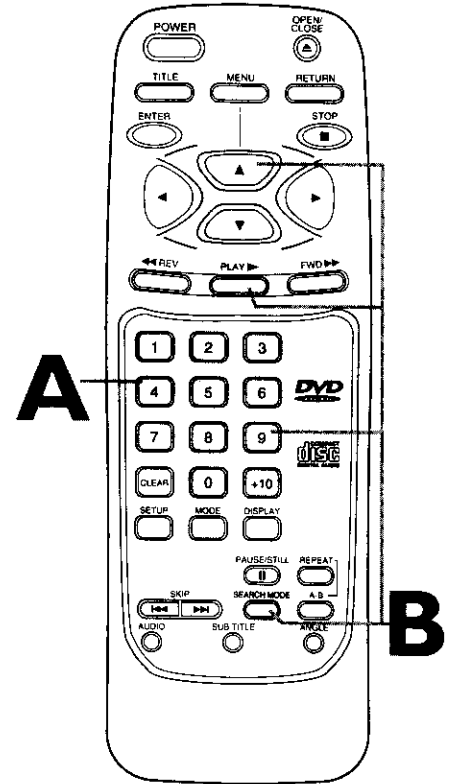

To start playback at a specific Title, press the SEARCH MODE button twice, then press the Number buttons or the ▲/▼ buttons to enter the Title number. Press the PLAY button to begin playback at the selected Title.

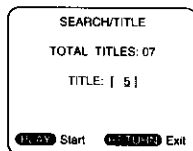

26 Specific Time Playback

DVD

AUDIO CD

Starting Playback at a Specific Disc Time

1
Press the **SEARCH MODE** button repeatedly (three times for DVDs or two times for Audio CDs).

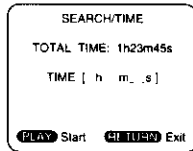

2

Use the Number buttons to enter the Disc time at which you want playback to begin.

- Example: 1 hour, 23 minutes and 30 seconds
1 → +10 → +10 → 3 → +10 → +10 → +10 → 0
- To enter zero, press the Number 0 (zero) button or press the ► button.
- Make sure the time you enter is within the total time of the Disc.
- If you make a mistake, press the ► button repeatedly until you reach the item you need to correct (hour, minute, or second), then enter the correct information.

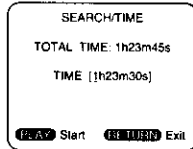

3

Within 30 seconds, press the **PLAY** button. Playback will start at the time that you specified.

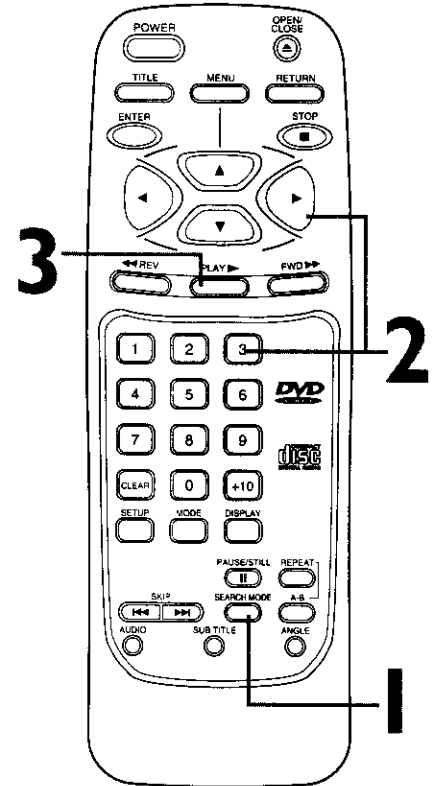

Helpful Hint

- Specific time playback is not available with some discs or if **MEMORY OFF** is activated for a DVD. Details are on page 20.

Press the **REPEAT** button repeatedly until the repeat mode you want appears in the top left corner of the TV screen.

DVD

- Repeatedly pressing the REPEAT button during playback lets you choose REPEAT CHAPTER, REPEAT TITLE, or REPEAT OFF.
- If a Chapter is playing repeatedly, then you press the Number buttons to select a new Chapter, the new Chapter will play repeatedly.

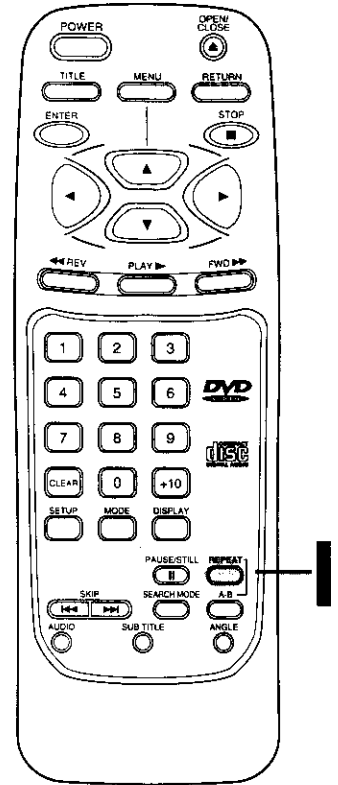
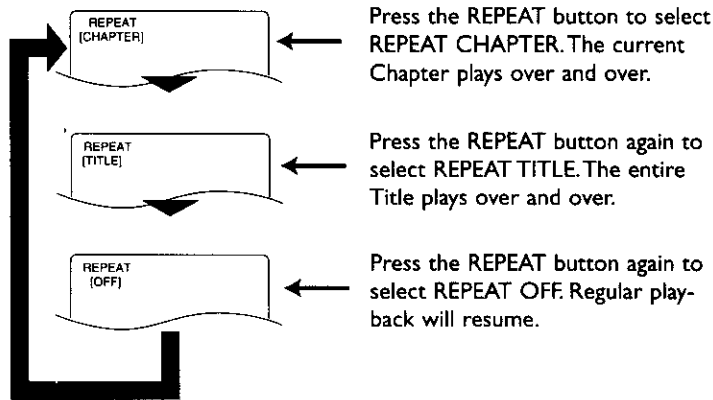

AUDIO CD

- Repeatedly pressing the REPEAT button during playback lets you choose REPEAT TRACK, REPEAT ALL and REPEAT OFF.
- If a Track is playing repeatedly, then you press the Number buttons to select a new Track, the new Track will play repeatedly.

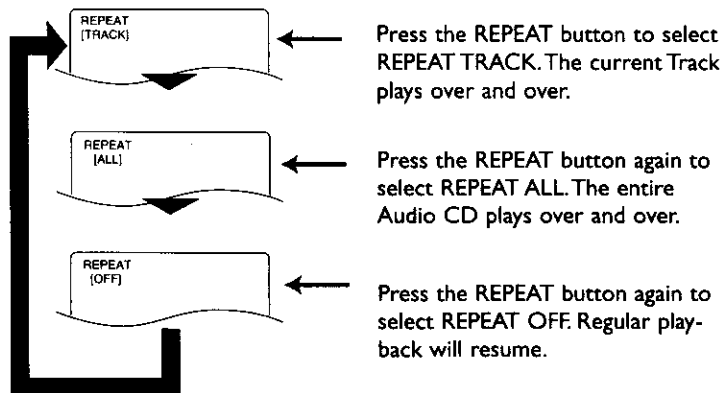

Helpful Hint

- Repeat playback is not available with some discs.

28 A-B Repeat Playback

DVD

AUDIO CD

You can play a section of an Audio CD or DVD repeatedly. Follow these steps to set up the section that you want to play over and over.

1

Play the Disc to the point at which you want repeated playback to begin.

2

Press the A-B REPEAT button to set the starting point (A).

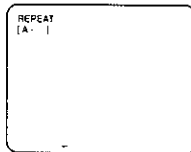

3

Play or fast forward the Disc to the point at which you want repeated playback to end, then press the A-B REPEAT button again.

The section will begin to play immediately, playing over and over until you cancel the A-B Repeat feature.

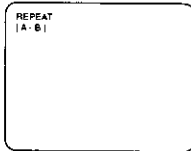

4

To cancel the A-B Repeat feature, press the A-B REPEAT button so that REPEAT [OFF] appears on the TV screen. Regular Disc playback will resume.

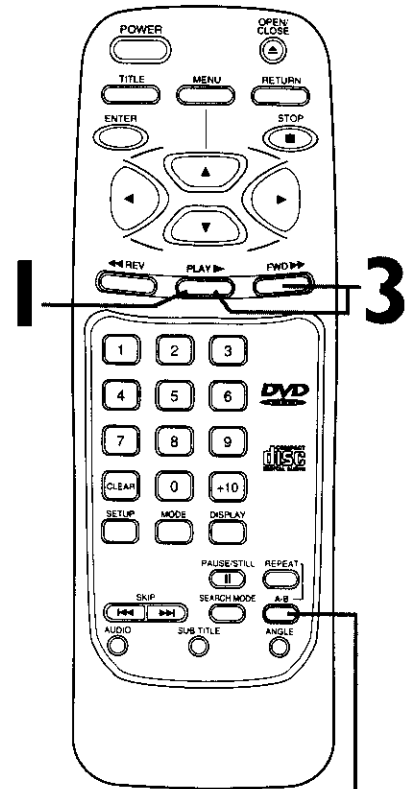
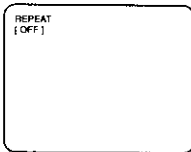

2-4

Helpful Hints

- A-B Repeat playback is not available with some DVDs.
- With DVDs, the entire A-B repeat section must be within a single Title.
- With Audio CDs, the A-B repeat section can contain multiple Tracks.
- Point B must be later on the Disc than Point A.

AUDIO CD

You may determine the order in which Tracks will play. The order that you set is called the Program. To set up programmed playback, follow these steps.

1

While playback is stopped, press the **MODE** button. The program screen will appear.

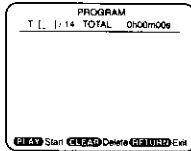

2

Press the **Number** buttons or the **▲/▼** buttons to enter the number of the first Track that you want to play. Then, press the **ENTER** button to store the selected Track in the Program.

- If you enter a wrong Track number, press the **CLEAR** button. The last Track in the Program will be removed.

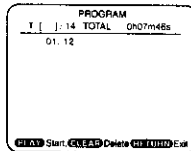

3

Repeat step 2 until you have selected all the Tracks you wish to play in the Program.

- Up to 20 Tracks may be stored in the Program.
- Make sure the Track numbers you enter are available on the Audio CD.

4

Press the **PLAY** button. The Tracks will play in the order in which you programmed them. The Program will play once.

- The contents of the program will be stored until you turn off the DVD Player or open the Disc tray.

2-3

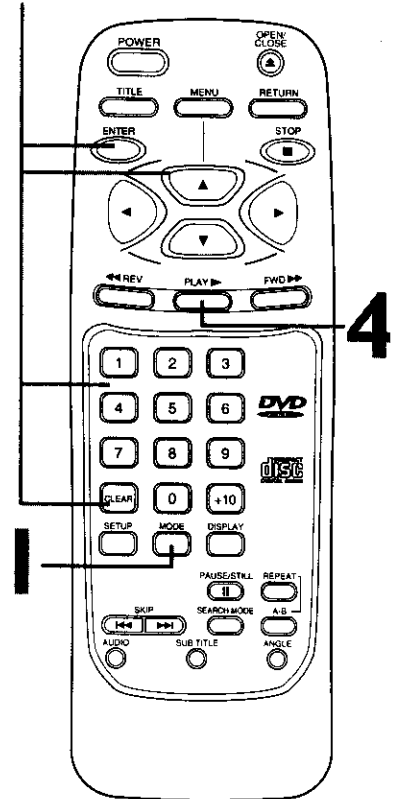

Helpful Hints

- Specific Track and random playback cannot be combined with programmed playback.
- You may play a Program repeatedly. During programmed playback, press the **REPEAT** button so that **REPEAT [ON]** appears. The program will play over and over.
- To see which Tracks you stored in the Program, press the **STOP** button to stop playback, then press the **MODE** button so that the **PROGRAM** screen appears.

30 Random Playback

AUDIO CD

You may play the Tracks of an Audio CD in Random order instead of the order in which they are recorded (1,2,3...). To set up Random Playback, follow these steps.

1
While playback is stopped, press the **MODE** button repeatedly so that the **RANDOM** screen appears.

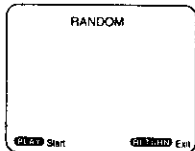

2
While the **RANDOM** screen appears, press the **PLAY** button. The Tracks will play in random order. After all the Tracks on the disc have played once, playback will stop.

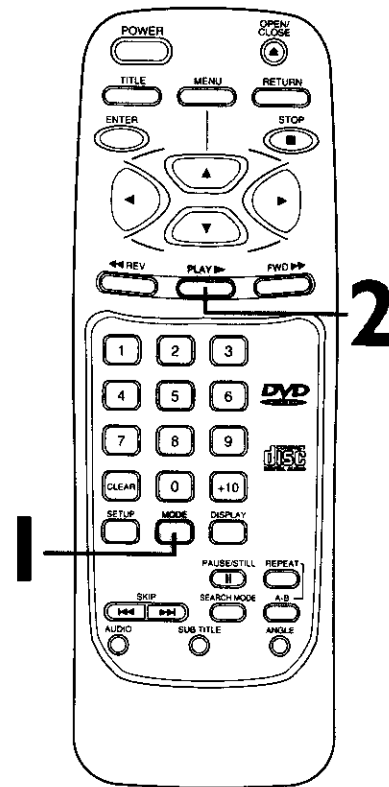

The DVD Player allows you to select a Language for DVDs or a Sound Mode for Audio CDs.

DVD Language

Press the **AUDIO** button during playback, then press the **▲/▼** buttons to select the desired language.

- The language can be changed only if multiple languages are available on the DVD.

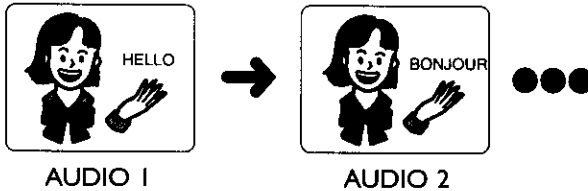
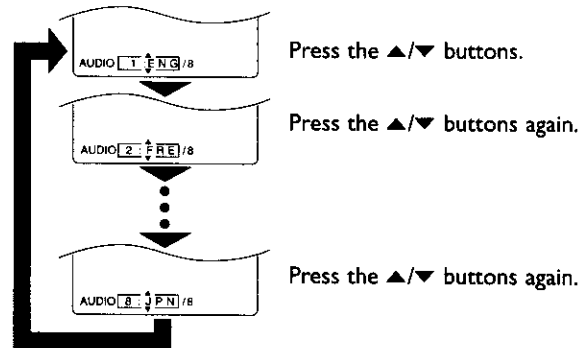

AUDIO CD Sound Mode

Press the **AUDIO** button during playback, then press the **▲/▼** buttons until the sound mode you want appears.

- When producers record an Audio CD, they record the sound on two channels - the left and the right. You can choose to hear the sound on the left channel, the sound on the right channel, or the sound on both channels (Stereo). You will select L-CH, R-CH, or STEREO.

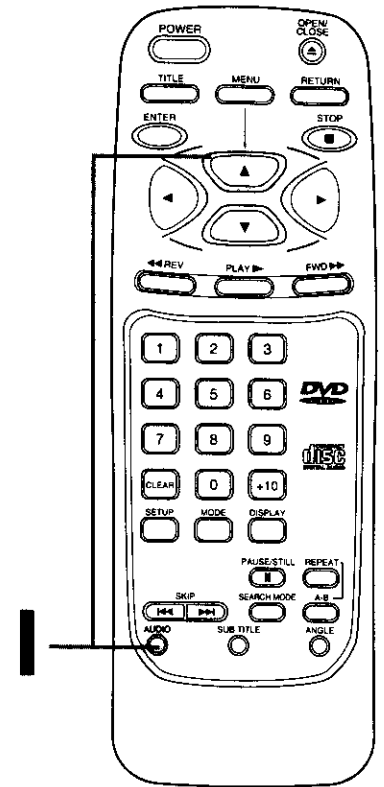
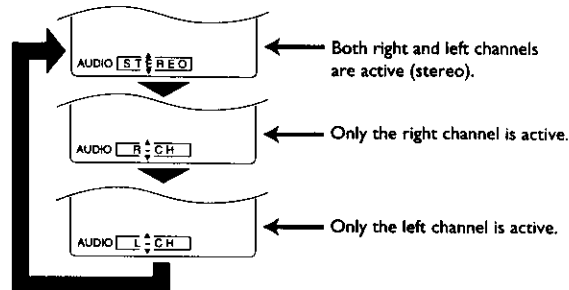

Helpful Hints

- If a desired language is not shown after pressing the ▲/▼ buttons several times, the DVD does not have that language.
- The display will disappear after about 15 seconds.
- Some DVDs only allow you to change the language in the Disc menu.
- When you use the DIGITAL AUDIO OUT COAXIAL jack, the sound mode of audio CDs cannot be changed.

32 Subtitle Language

DVD

The DVD Player allows you to select a language for subtitles.

1

Press the **SUBTITLE** button during playback. The subtitle menu will appear on the TV screen.

2

Within 15 seconds, press the **▲/▼** buttons to select a subtitle language. Select a language from those available on the DVD.

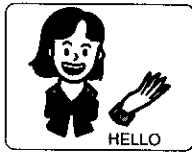
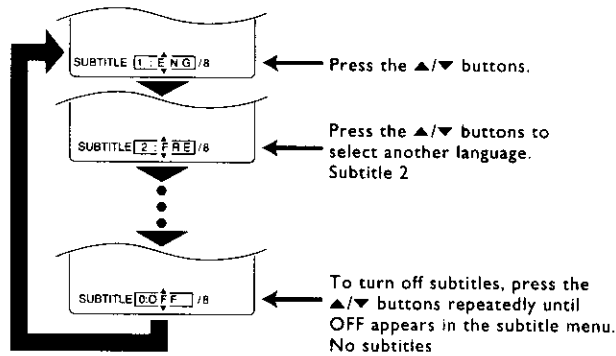

SUBTITLE 1

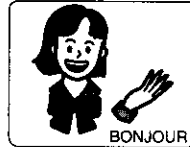

SUBTITLE 2



3

The subtitle menu will disappear after about 15 seconds.

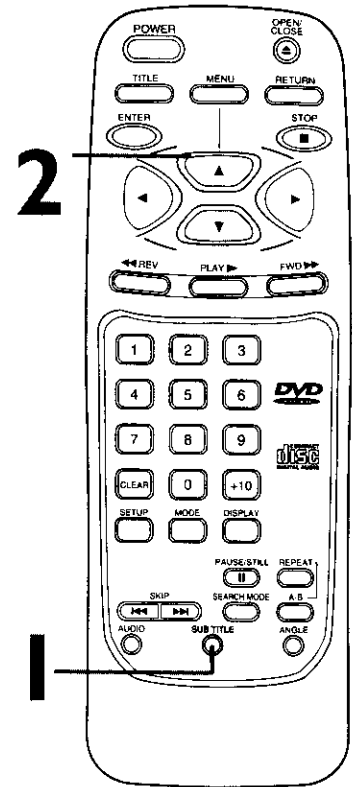

Helpful Hints

- With some DVDs, you may select a subtitle language in the Disc menu.
- If the desired language is not shown after pressing the **▲/▼** buttons several times, the Disc does not have subtitles in that language.
- The subtitles may be delayed for a few seconds.
- Your subtitle selection will be cancelled if you open the Disc tray or turn off the power. The default setting of the DVD will be selected again.

DVD

Some DVDs contain scenes that were recorded from different angles. You may select a camera angle with the DVD Player.

1

Press the **ANGLE** button during playback.

2

Within 15 seconds, press the **▲/▼** buttons to select a different angle.

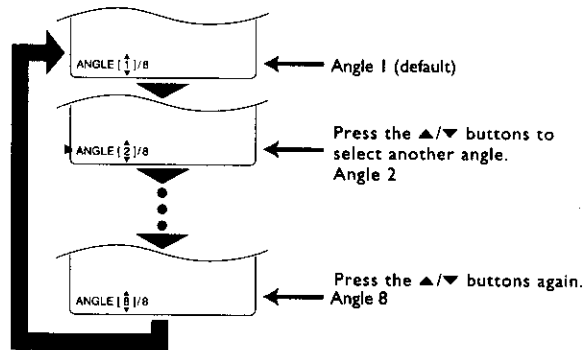

- If the Disc contains sequences recorded from different camera angles, the angle symbol  will appear at the bottom-right of the screen. You can change the camera angle when the symbol appears on the screen.
- The camera angle cannot be changed if the Disc does not contain sequences recorded from different camera angles.

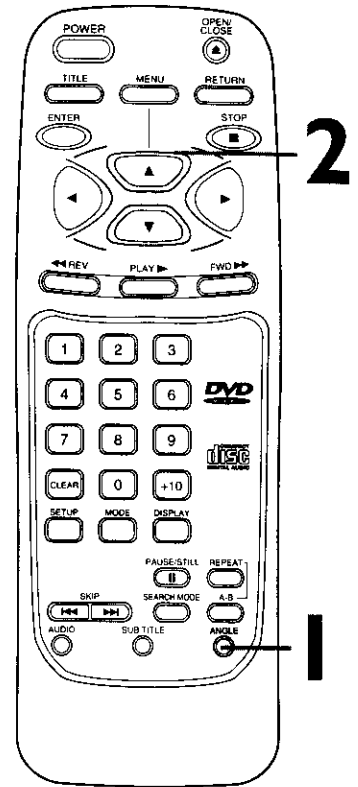

Helpful Hints

- The **ANGLE ICON** must be set to **ON** in order for the angle symbol to appear as described in step 2. To set **ANGLE ICON** to **ON**, see page 43.
- If the angle status appears on the screen (for example, **ANGLE [1]/8**), the angle symbol will not appear on the screen.

34 Parental Lock Password

1 While playback is stopped, press the **SETUP** button. The setup screen will appear.

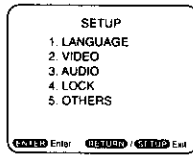

2

Press the **Number 4** button to select **LOCK**. The **SETUP/LOCK** menu will appear.

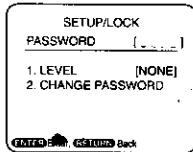

3

Press the **Number** buttons to enter the **4-digit password**.
• When doing this for the first time, enter any 4 digits. That number will be the password until you change it.

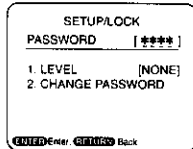

4

Press the **Number 2** button to select **CHANGE PASSWORD**. The first space in the **PASSWORD** will start flashing.

5

Press the **Number** buttons to enter your new password.

6

Press the **RETURN** button twice to remove the menu.

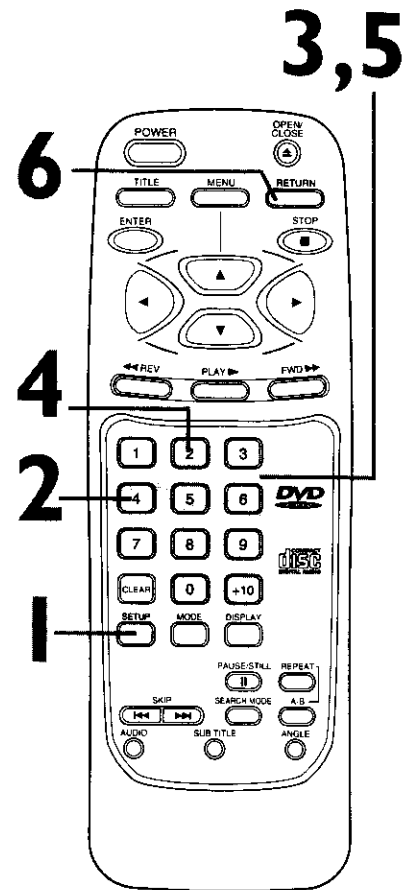

Helpful Hints

- Write down the password in case you forget it.
- To erase the old password, press the **POWER** button to turn off the DVD Player. Then, press and hold the **STOP** button on the DVD Player while pressing the **POWER** button on the DVD Player to turn on the power again. When "HELLO" appears on the display panel, you may release the **STOP** button. Follow the steps on this page to set the password that you desire.

1
While playback is stopped, press the **SETUP** button. The setup screen will appear.

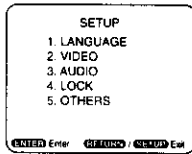

2
Press the **Number 4** button to select **LOCK**. The **SETUP/LOCK** menu will appear.

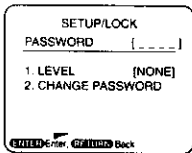

3
Press the **Number** buttons to enter your **4-digit** password.

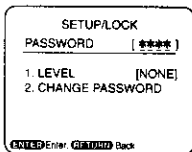

4
Press the **Number 1** button to select **LEVEL**.

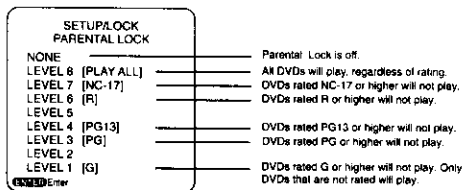

5
Press the **▲/▼** buttons to select the level you desire, then press the **ENTER** button. For example, if you want to play Discs rated PG13, you must select **LEVEL 5** or higher. The **SETUP/LOCK** menu will reappear. The level you selected will appear on the screen beside **LEVEL**.

6
Press the **RETURN** button twice to remove the menu.

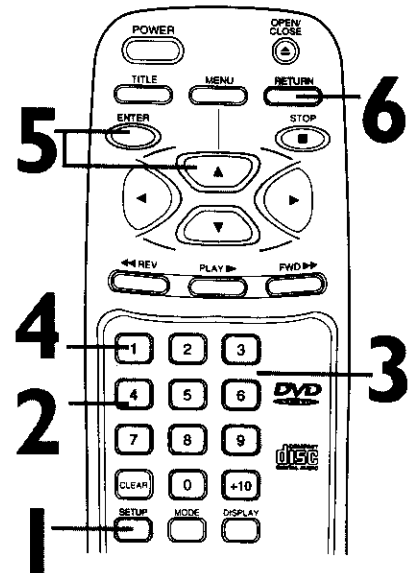

RATING EXPLANATIONS

- NC-17 - Under 17 not admitted
- R - Restricted; under 17 requires accompanying parent or adult guardian
- PG13 - Unsuitable for children under 13
- PG - Parental Guidance suggested
- G - General Audience

Helpful Hints

- Some DVDs are not compatible with Parental Lock. Make sure the DVD plays according to the Parental Lock settings you have made.
- The DVD Player will not allow you to change LEVEL settings until you enter the correct password.
- When you try to play a Disc that has a rating that exceeds the level you set, a message will appear on the screen, indicating the Disc cannot be played. If this happens, eject the Disc, then select a level that allows playback. Or select NONE to turn off Parental Lock. Load the Disc again and begin playback as usual. Some Discs may allow you to simply enter your 4-digit password, then begin playback automatically. Follow the instructions provided by the Disc message.

36 Status Display

DVD

AUDIO CD

Accessing the Status Display

You can check the information about the current Disc by pressing the DISPLAY button on the remote control.

Press the **DISPLAY** button repeatedly to access or remove the status displays.

DVD

TITLE	:	01/04	• Current Title number / total number of Titles
TIME	:	0h24m14s	• Elapsed time of the current Title
REMAIN	:	0h05m25s	• Remaining time of the current Title
CHAPTER	:	001/010	• Current Chapter number / total number of Chapters in the current Title
TIME	:	0h02m25s	• Elapsed time of the current Chapter
REMAIN	:	0h01m31s	• Remaining time of the current Chapter

AUDIO	:	1. ENGLISH	• Current language for the sound
	:	DOLBY DIGITAL	• Current audio format (DOLBY DIGITAL 5.1 Channel is displayed as DOLBY DIGITAL 6 CH.)
	:	6CH	
SUBTITLE	:	2. FRENCH	• Current language for the subtitles
ANGLE	:	8/8	• Selected angle / total number of angles
VIRTUAL 3D	:		• VIRTUAL 3D setting (ON/OFF)

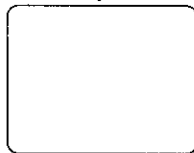

No display

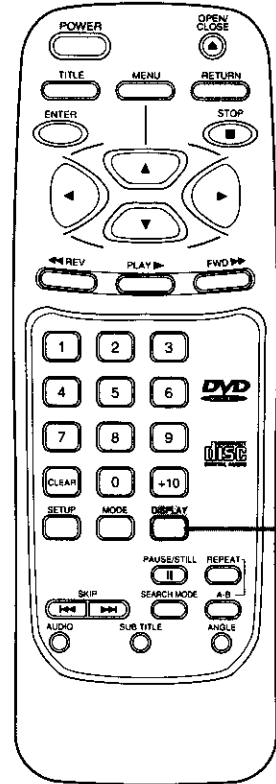

AUDIO CD

TRACK	:	01/04	• Current Track number / total Track number
TIME	:	0h05m25s	• Elapsed time of the current Track
REMAIN	:	0h01m31s	• Remaining time of the current Track
PROGRAM	:		• Current play mode

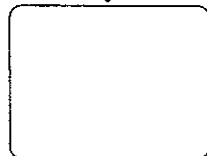

No display

1

When playback is stopped, press the **SETUP** button. The setup screen will appear.



2

Press the Number 2 button to select **VIDEO**.

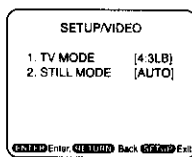

3

Press the corresponding Number button to select an item: **TV MODE** or **STILL MODE**.

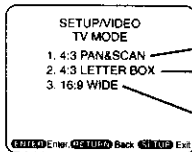

- Full-height pictures are shown, with one or both sides trimmed.
- Wide screen (full-width) pictures are shown, with black bars at top and bottom.
- Select if a wide screen TV is connected to the DVD Player.

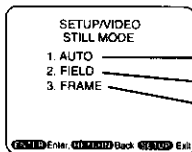

- AUTO is normally selected.
- Select if pictures are blurred in auto mode.
- Select to show Still pictures in high resolution.

4

Press the corresponding Number button to select a setting.

5

Press the **SETUP** button to remove the menu.

2-4

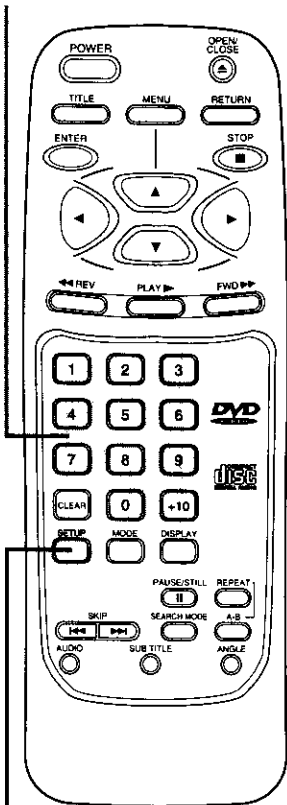

1,5

Helpful Hint

- You may select a different TV MODE setting only if it is available on the Disc.

38 Audio Settings

2-3

1 While playback is stopped, press the **SETUP** button. The setup screen will appear.



2

Press the **Number 3** button to select **AUDIO**.

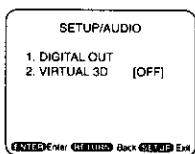

3

Press the corresponding **Number** button to select an item: **DIGITAL OUT** or **VIRTUAL 3D**.

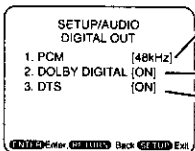

- Sets the sample rate for playing a disc recorded with high sound quality
- Select when a Dolby Digital decoder is connected.
- Select when a DTS decoder is connected.

Go to step 4 to change these settings.



- Select ON to activate the 3D effect.

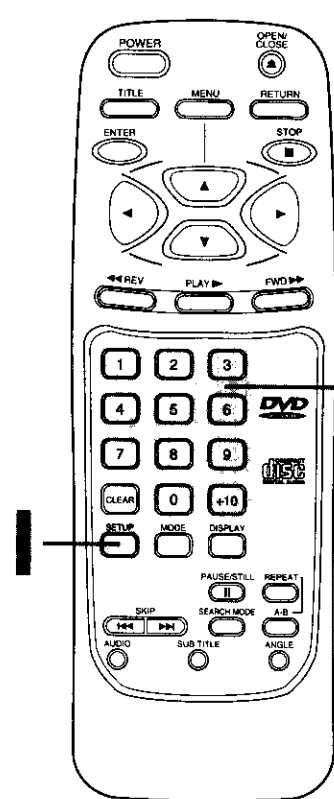

This unit employs TruSurround system **TruSurround**™ of SRS Labs, Inc. as the VIRTUAL 3D technology.

TruSurround and the  symbol are trademarks of SRS Labs, Inc. in the United States and selected foreign countries. TruSurround technology is incorporated under license from SRS Labs, Inc.

Helpful Hint

- To enjoy Dolby Digital Surround or DTS Surround sound, you must have the DVD Player connected to a Dolby Digital or DTS decoder. Details are on page 11.

4

To change the PCM, DOLBY DIGITAL, or DTS settings, press the corresponding Number button to select the desired item, then press the Number button to choose the setting (i.e. ON or OFF).

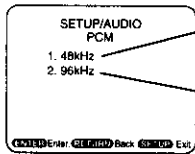

- Audio signals are converted to 48 kHz/16 bit signals when playing a DVD recorded with high sound quality (48 kHz/20 bit/24 bit, 96 kHz).
- Sound is reproduced at 96 kHz if a DVD is recorded with high sound quality. If you are playing 48 kHz discs or if 4:3 LETTER BOX is selected, sound is reproduced at 48 kHz.

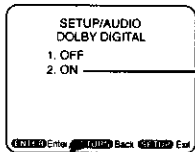

- Select ON when a Dolby Digital decoder is used.

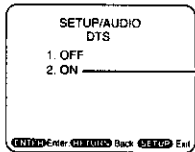

- Select ON when a DTS decoder is used.

5

Press the **SETUP** button to remove the menu.

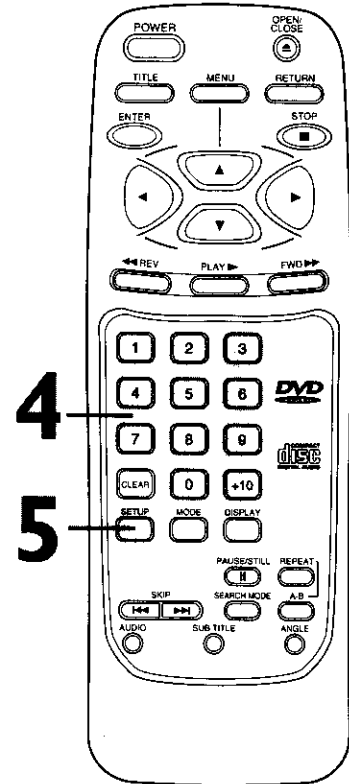

40 Language Settings

DVD

While playback is stopped, press the **SETUP** button. The setup screen appears.



2

Press the **Number 1** button to select **LANGUAGE**.



3

Press a **Number** button to select an item: **AUDIO**, **SUBTITLE**, **DISC MENU**, or **PLAYER MENU**.

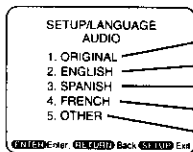

- The original language of each disc will be selected.
- Voice is played back in English.
- Voice is played back in Spanish.
- Voice is played back in French.
- You can select other languages for audio playback.

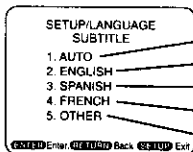

- Subtitles are shown in the automatically selected language.
- Subtitles are shown in English.
- Subtitles are shown in Spanish.
- Subtitles are shown in French.
- You can select other languages for subtitles.

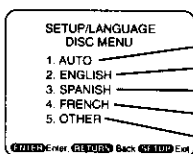

- The disc menu is shown in the automatically selected language.
- The disc menu appears in English.
- The disc menu appears in Spanish.
- The disc menu appears in French.
- You can select other languages for the disc menu.



- The on-screen display and DVD Player menus appear in English.
- The on-screen display and DVD Player menus appear in Spanish.
- The on-screen display and DVD Player menus appear in French.

Go to step 4 to change the settings within **AUDIO**, **SUBTITLE**, **DISC MENU** or **PLAYER MENU**.

2-3

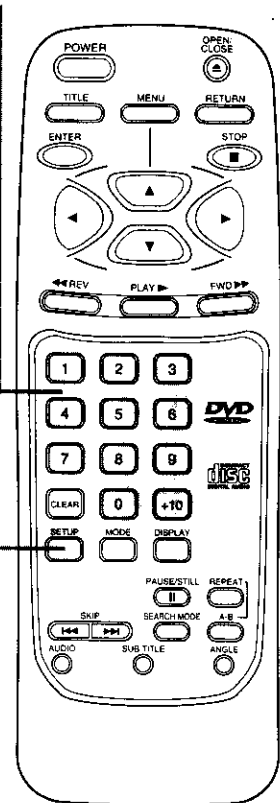

Helpful Hints

- If the automatic settings for **AUDIO** and **SUBTITLE** are the same language, the subtitles will not be shown.
- Language settings for **AUDIO** and **SUBTITLE** are not available with some discs. Use the **AUDIO** and **SUBTITLE** buttons instead to select different languages for the audio and subtitles. Details are on pages 31 and 32.

4

Press a Number button to select a setting.

- If OTHER is selected on the AUDIO, SUBTITLE or DISC MENU screen, the COUNTRY CODE screen will appear. Press four Number buttons to enter the country code you desire, then press the ENTER button. Refer to the list on page 42.
- You can only select other languages for AUDIO, SUBTITLE, and DISC MENU if the language is available on the Disc.

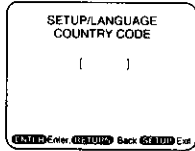

5

Press the SETUP button to remove the menu.

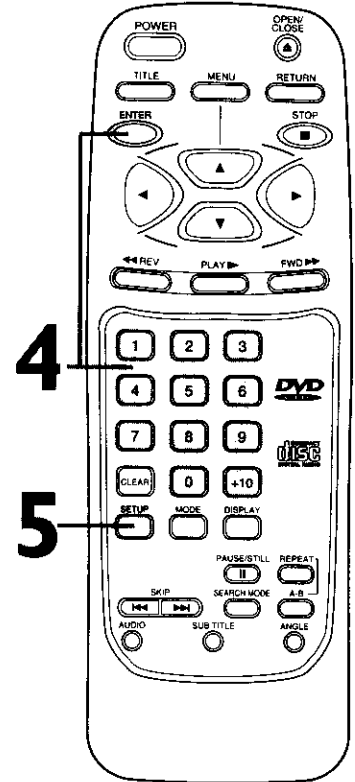

42 Language Settings (cont'd)

<u>Language</u>	<u>Country Code</u>	<u>Language</u>	<u>Country Code</u>	<u>Language</u>	<u>Country Code</u>
A-B		I-K		S	
Abkhazian	4748	Icelandic	5565	Samoan	6559
Afar	4747	Indonesian	5560	Sangho	6553
Afrikaans	4752	Interlingua	5547	Sanskrit	6457
Albanian	6563	Interlingue	5551	Serbian	6564
Amharic	4759	Inupiak	5557	Serbo-Croatian	6554
Arabic	4764	Irish	5347	Sesotho	6566
Armenian	5471	Italian (ITA)	5566	Setswana	6660
Assamese	4765	Japanese (JPN)	5647	Shona	6560
Aymara	4771	Javanese	5669	Sindhi	6550
Azerbaijani	4772	Kannada	5760	Singhalese	6555
Bangla	4860	Kashmiri	5765	Siswat	6565
Bashkir	4847	Kazakh	5757	Slovak	6557
Basque	5167	Kinyarwanda	6469	Slovenian	6558
Bengali	4860	Kirghiz	5771	Somali	6561
Bhutani	5072	Kirundi	6460	Spanish (SPA)	5165
Bihari	4854	Korean (KOR)	5761	Sundanese	6567
Bislama	4855	Kurdish	5767	Swahili	6569
Breton	4864	L-N		Swedish	6568
Bulgarian	4853	Laothian	5861	T	
Burmese	5971	Latin	5847	Tagalog	6658
Byelorussian	4851	Latvian	5868	Tajik	6653
C-E		Lettish	5868	Tamil	6647
Cambodian	5759	Lingala	5860	Tatar	6666
Catalan	4947	Lithuanian	5866	Telugu	6652
Chinese (CHI)	7254	Macedonian	5957	Thai	6654
Corsican	4961	Malagasy	5953	Tibetan	4861
Croatian	5464	Malay	5965	Tigrinya	6655
Czech	4965	Malayalam	5958	Tonga	6661
Danish	5047	Maltese	5966	Tsonga	6665
Dutch (DUT)	6058	Maori	5955	Turkish	6664
English (ENG)	5160	Marathi	5964	Turkmen	6657
Esperanto	5161	Moldavian	5961	Twí	6669
Estonian	5166	Mongolian	5960	U-Z	
F-H		Nauru	6047	Ukrainian	6757
Faroese	5261	Nepali	6051	Urdu	6764
Fiji	5256	Norwegian	6061	Uzbek	6772
Finnish	5255	O-R		Vietnamese	6855
French (FRE)	5264	Occitan	6149	Volapuk	6961
Frisian	5271	Oriya	6164	Welsh	4971
Gaelic (Scots)	5350	Oromo (Afan)	6159	Wolof	6961
Galician	5358	Panjabi	6247	Xhosa	7054
Georgian	5747	Pashto	6265	Yiddish	5655
German (GER)	5051	Persian	5247	Yoruba	7161
Greek	5158	Polish	6258	Zulu	7267
Greenlandic	5758	Portugese	6266		
Guarani	5360	Pushto	6265		
Gujarati	5367	Quechua	6367		
Hausa	5447	Rhaeto-Romance	6459		
Hebrew	5569	Romanian	6461		
Hindi	5455	Russian	6467		
Hungarian	5467				

1

Press the **SETUP** button. The setup screen will appear.

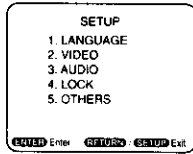

2

Press the **Number 5** button to select **OTHERS**.



3

Press the corresponding **Number** button to select an item: **OSD MESSAGE**, **ANGLE ICON**, or **BACKGROUND**.

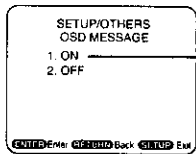

• Select **ON** to display messages on the screen, such as **PLAY**, **STOP**, etc.

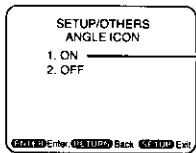

• Select **ON** to display the angle icon.



• Turns the menu background to **blue**
• Turns the menu background to **gray**

4

Press a **Number** button to select a setting.

5

Press the **SETUP** button to remove the menu.

2-4

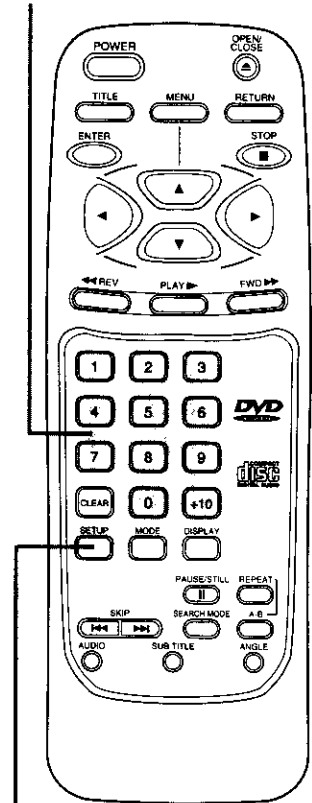

1,5

44 Helpful Hints

If you are having problems with your product, check this list of problems and possible solutions before requesting service. You may be able to solve the problem yourself.

If you need to call a customer service representative, please know the model number and serial number of your product before you call. This information is displayed on the back of the product. Also, please take a moment to identify the problem you are having, and be prepared to explain this to the representative. If you believe the representative will need to help you with operations, please stay near the product. Our representatives will be happy to assist you.

The DVD Player has no power.

- Make sure the power cord is connected completely to an AC (alternating current) outlet.
- Press the POWER button to turn on the DVD Player. "HELLO" will appear briefly on the display panel as the power is turning on.

The remote control will not operate the DVD Player.

- Aim the remote control directly at the DVD Player's remote sensor. *Details are on page 14.*
- Remove all obstacles between the remote control and the DVD Player.
- Inspect and/or replace the batteries in the remote control. *Details are on page seven.*
- Use the remote control within 23 feet of the DVD Player.

No picture

- Make sure the video cable is connected correctly. You may connect either the yellow video cable (supplied) or an optional S-Video cable. *Details are on pages 8-12.*
- Make sure the TV is set to the correct Video or S-Video In channel (usually the AUX IN, A/V IN, Auxiliary In, or S-Video In channel). Check your TV owner's manual for details.
- Insert a Disc that is playable on this DVD Player. *Details are on page six.*

Disc cannot be played.

- Insert a playable Disc. *Details are on page six.*
- Place the Disc correctly in the recesses in the Disc tray. If the Disc is one-sided, place the Disc in the tray with the label facing up. If the Disc is two-sided, make sure the side you want to play is facing up.
- Clean the Disc.
- Cancel the parental lock, enter the password, or change the control level. *Details are on pages 34-35.*
- Make sure the Disc is labelled for use in Region 1 or ALL regions. *Details are on page six.*

No sound

- Connect the audio cables firmly. Make sure the cables are connected to the AUDIO IN jacks on the TV or audio equipment. *Details are on pages 8-12.*
- Check the audio settings of the DVD Player. *Details are on pages 38-39.*
- Turn on the power of the audio equipment and make sure it is set to the correct channel, usually Auxiliary IN. Refer to the owner's manual of the audio equipment for details.
- Check the audio settings of the Disc. For example, you may have selected "sound-track" playback on a DVD. Only the music of the movie will play, not the characters' dialog; music might not be recorded throughout the entire DVD.

Distorted picture

- Connect the DVD Player directly to the TV.
- There are some cases where the picture may be distorted slightly; this is not a malfunction of the DVD Player.

The camera angle cannot be changed.

- The DVD might not contain segments recorded from different camera angles. See if multiple angles are available. *Details are on page 33.*

The audio or subtitle language cannot be changed.

- The DVD does not contain audio or subtitles in the desired language. Not all DVDs contain audio or subtitles in multiple languages. See if other languages are available. *Details are on pages 31-32.*

"No feature" symbol appears on the screen, prohibiting an operation.

- That operation is prohibited by the DVD Player or is not available on the Disc. *Details are on page five.*

The DVD Player turns off after 30 minutes.

- The DVD Player turns off automatically if playback is stopped for more than 30 minutes and no buttons are pressed on the remote control or the DVD Player.

A screen saver appears on the TV screen.

- The DVD whale will appear on the TV screen if Disc playback is stopped for more than one minute (and no buttons are pressed on the remote control or the DVD Player). The DVD whale moves around on the screen to prevent damage to your TV's picture tube. A prolonged still image, including TV station identification logos or video games, may damage the picture tube.

46 Care and Maintenance

Cleaning the DVD Player

- Wipe the front panel and other exterior surfaces of the DVD Player with a soft, slightly damp cloth.
- Never use a solvent, thinner, benzene or alcohol to clean the DVD Player. Do not spray insecticide liquid near the DVD Player. Such chemicals may discolor the surface or damage the DVD Player.



Don't use cleaners.

Cleaning a Disc

- Use a soft, dry cloth to wipe the Disc.
- Wipe the Disc in a straight line from the center to the edge. Never wipe the Disc in a circular motion.
- Do not use detergent or abrasive cleaning agents.
- Handle the Discs so that fingerprints and dust do not adhere to the surfaces of the Discs.
- Always store the Disc in its protective case when it is not in use.



Wipe Discs from the center to the edge.

Checking the Laser

- If the DVD Player does not operate as described in this owner's manual, the laser may be dirty. Consult an Authorized Service Center for inspection and cleaning of the laser.

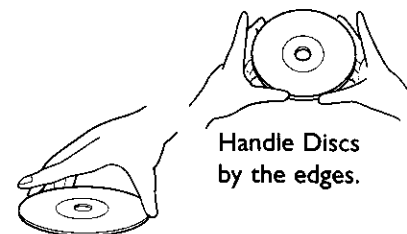

Handle Discs by the edges.

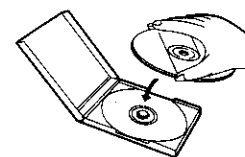

Keep the Disc in its case.

AUDIO OUT Jacks: jacks located on the back of the DVD Player which are used to send audio to another system (TV, decoder, or amplifier).

Coaxial jack: Used to send digital audio to a decoder or amplifier, allowing you to adjust the volume at the decoder or amplifier. This connection provides the 5.1 channel surround sound as heard in movie theaters.

CD: Compact Disc (audio)

Dolby Digital: A surround sound system that provides 5.1 channel sound as used in movie theaters.

DTS: Digital Theater Systems. This is a surround sound system, but it is different from Dolby Digital. The formats were developed by different companies.

DVD: Digital Video Disc.

Remote Control: the small electronic unit that came with your DVD Player; allows you to operate your DVD Player from a distance.

S-Video: Produces a clearer picture by sending separate signals for the luminance and the color. If you connect an optional S-Video cable, you will not need to use the supplied yellow video cable.

VIDEO OUT Jack: jack located on the back of the DVD Player which is used to send video to a TV.

48 Specifications

Product Type

Digital Video Disc Player

Playable Discs

DVD-Video

Audio CD

Color System

NTSC

Frequency Response

DVD (linear sound): 20 Hz to 22 kHz (sample rate: 48 kHz)

20 Hz to 44 kHz (sample rate: 96 kHz)

Audio CD: 20 Hz to 20 kHz

Signal-to-Noise Ratio (S/N Ratio)

Audio CD: 110 dB EIAJ (Electronic Industries Association of Japan)

Dynamic Range

DVD (linear sound): 95 dB

Audio CD: 94 dB (EIAJ)

Total Distortion Factor

Audio CD: 0.007% (EIAJ)

Wow and Flutter

Below the measurement limitation ($\pm 0.001\%$ W PEAK) (EIAJ)

Power Requirement

120V AC $\pm 10\%$, 60 Hz $\pm 0.5\%$

Connections

S-Video output	Mini DIN 4-pin jack (75 Ω)
Video output	One pin jack, 1 Vpp (75 Ω)
Coaxial digital output	One pin jack, 500m Vpp (75 Ω)
Analog audio output	Two pin jacks (one left channel, one right channel) 2 Vrms (47 k Ω)

Power Consumption

Power on: 22 W

Standby (power off): 2.7 W

Operating Temperature

41°F (5°C) to 104°F (40°C)

Relative Humidity

30% to 80%

Dimensions

14-3/16" (W) x 3-3/8" (H) x 11-5/8" (D)

(360mm x 85mm x 295mm)

Weight

5.29 lbs. (2.4 kg.)

NOTE: Designs and specifications are subject to change without notice.

DVD PLAYER

90 Days Free Labor/One Year Parts Exchange. This product must be carried in for repair.

WHO IS COVERED?

You must have proof of purchase to receive warranty service. A sales receipt or other document showing that you purchased the product is considered proof of purchase.

WHAT IS COVERED?

Warranty coverage begins the day you buy your product. For 90 days thereafter, all parts will be repaired or replaced, and labor is free. From 90 days to one year from the day of purchase, all parts will be repaired or replaced, but you pay for all labor charges. After one year from the day of purchase, you pay for the replacement or repair of all parts, and for all labor charges.

All parts, including repaired and replaced parts, are covered only for the original warranty period. When the warranty on the product expires, the warranty on all replaced and repaired parts also expires.

WHAT IS EXCLUDED?

Your warranty does not cover:

- labor charges for installation or setup of the product, adjustment of customer controls on the product, and installation or repair of antenna systems outside of the product.
- product repair and/or part replacement because of misuse, accident, unauthorized repair or other cause not within the control of Philips Consumer Electronics.
- reception problems caused by signal conditions or cable or antenna systems outside the unit.
- a product that requires modification or adaptation to enable it to operate in any country other than the country for which it was designed, manufactured, approved and/or authorized, or repair of products damaged by these modifications.
- incidental or consequential damages resulting from the product. (Some states do not allow the exclusion of incidental or consequential damages, so the above exclusion may not apply to you. This includes, but is not limited to, prerecorded material, whether copyrighted or not copyrighted.)
- damage caused by the use of non-VHS tapes or tapes that have not been tested and labeled for use in two, four, six, and eight hour VHS recorders.
- a product that is used for commercial or institutional purposes (including but not limited to rental purposes).

WHERE IS SERVICE AVAILABLE?

Warranty service is available in all countries where the product is officially distributed by Philips Consumer Electronics. In countries where Philips Consumer Electronics does not distribute the product, the local Philips service organization will attempt to provide service (although there may be a delay if the appropriate spare parts and technical

manual(s) are not readily available).

MAKE SURE YOU KEEP...

Please keep your sales receipt or other document showing proof of purchase. Attach it to this owner's manual and keep both nearby. Also keep the original box and packing material in case you need to return your product.

BEFORE REQUESTING SERVICE...

Please check your owner's manual before requesting service. Adjustments of the controls discussed there may save you a service call.

TO GET WARRANTY SERVICE IN U.S.A., PUERTO RICO OR U.S. VIRGIN ISLANDS...

Take the product to a Philips factory service center (see enclosed list) or authorized service center for repair. When the product has been repaired, you must pick up the unit at the center. Centers may keep defective parts.

(In U.S.A., Puerto Rico and U.S. Virgin Islands, all implied warranties, including implied warranties of merchantability and fitness for a particular purpose, are limited in duration to the duration of this express warranty. Because some states do not allow limitations on how long an implied warranty may last, this limitation may not apply to you.)

TO GET WARRANTY SERVICE IN CANADA...

Please contact Philips at:

1-800-661-6162 (French Speaking)
1-800-363-7278 (English Speaking)

(In Canada, this warranty is given in lieu of all other warranties. No other warranties are expressed or implied, including any implied warranties of merchantability or fitness for a particular purpose. Philips is not liable under any circumstances for any direct, indirect, special, incidental, or consequential damages, howsoever incurred, even if notified of the possibility of such damages.)

REMEMBER...

Please record below the model and serial numbers found on the product. Also, please fill out and mail your warranty registration card promptly. It will be easier for us to notify you if necessary.

MODEL # _____

SERIAL # _____

This warranty gives you specific legal rights. You may have other rights which vary from state to state.

Philips Service Solutions Group, P.O. Box 2976, Longview, Texas 75606, (903) 242-4800

EL6235E004 / MAC6183 / 3-00

50 Index

ac power cord	15	parental lock.....	34-35
accessories.....	52	password	34
angle button.....	16, 33	pause button	14
arrow buttons.....	16	pause/still button.....	17
audio button	16, 31	play button	14, 17
audio cd.....	6, 18	playing	18
audio out jacks	8-12, 15	power	
a-b repeat.....	28	button.....	14, 16
a-b repeat button	17, 28	cord.....	15
		program.....	29
batteries.....	7	random	30
bit rate.....	38-39	rear panel.....	15
		remote	
camera angle	33	control	
chapters	6	buttons.....	16-17
clear button.....	16	sensor	14
coaxial jack.....	11-12, 15	using	7
connections	8-12	repeat button	17, 27
contents, table of.....	4	repeat playback.....	27
controls, remote.....	16-17	resuming play	20
		return button.....	17
display button	17, 36	rev button	16, 22
display panel	13	reverse.....	22
dvd video.....	6		
		safety precautions	3
enter button.....	16	setup button.....	17
		search buttons	14
fast forward.....	17, 22	search mode button.....	17
front panel	14	setting	
fwd button.....	17	audio	38-39
		language.....	40-42
glossary.....	47	other	43
		video	37
helpful hints	44-45	skip buttons.....	14, 16, 24
hookups		slow motion	23
amplifier with digital in jacks/		sound mode	31
md deck/dat deck	12	still picture.....	20
dolby digital decoder/		stop button	14, 17
dts decoder	11	subtitle button.....	17, 32
dolby surround		s-video out jack.....	9, 15
compatible amplifier.....	11		
s-video	9	table of contents	4
stereo.....	10	titles	6
tv	8-12	title button.....	16
tracks.....	6	tracks.....	6
language.....	31-32		
		video out jack	8, 10-12, 15
menus.....	19	warranty	49
menu button.....	16		
mode button	17		
number buttons.....	16		
on-screen display.....	36		
open/close button	14, 17-18		

SUPPLIED ACCESSORIES

**The following items are supplied with your DVD Player;
they are provided to help you use or set up your DVD Player.**

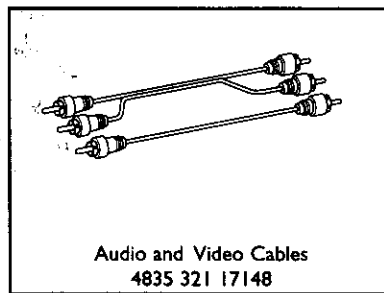
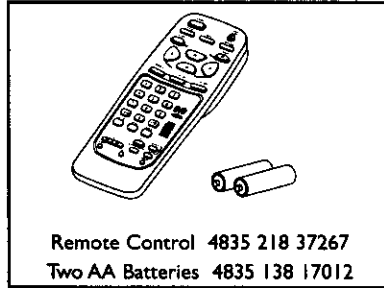

This owner's manual is made of recyclable materials.
Remember to recycle!



As an ENERGY STAR® Partner, Philips Consumer Electronics
has determined that this product meets the
ENERGY STAR® guidelines for energy efficiency.
ENERGY STAR® is a U.S. registered mark.