

MR6221 Serial UHF Reader User Manual

Shenzhen Marktrace Co., Ltd

Address:

Floor5/7, Block D, Changyuan New Material Port, No 2 Central 1st Hi-tech Av., Nanshan Shenzhen, P.

R.C. Post: 518057

Phone: 0755-2654 6392 FAX: 0755-2655 3743

E-mail: technical@marktrace.com Website: www.marktrace.com

FCC caution

Federal Communication Commission (FCC) Radiation Exposure Statement

When using the product, maintain a distance of 20cm from the body to ensure compliance with RF exposure requirements.

FCC statements:

This device complies with part 15 of the FCC rules. Operation is subject to the following two conditions: (1) this device may not cause harmful interference, and (2) this device must accept any interference received, including interference that may cause undesired operation.

NOTE: The manufacturer is not responsible for any radio or TV interference caused by unauthorized modifications or changes to this equipment. Such modifications or changes could void the user's authority to operate the equipment.

NOTE: This equipment has been tested and found to comply with the limits for a Class B digital device, pursuant to part 15 of the FCC Rules. These limits are designed to provide reasonable protection against harmful interference in a residential installation. This equipment generates uses and can radiate radio frequency energy and, if not installed and used in accordance with the instructions, may cause harmful interference to radio communications. However, there is no guarantee that interference will not occur in a particular installation. If this equipment does cause harmful interference to radio or television reception, which can be determined by turning the equipment off and on, the user is encouraged to try to correct the interference by one or more of the following measures:

- Reorient or relocate the receiving antenna.
- Increase the separation between the equipment and receiver.
- Connect the equipment into an outlet on a circuit different from that to which the receiver is connected.
- Consult the dealer or an experienced radio/TV technician for help.

Address:

Floor5/7, Block D, Changyuan New Material Port, No 2 Central 1st Hi-tech Av., Nanshan Shenzhen, P.

R.C. Post: 518057

Phone: 0755-2654 6392 FAX: 0755-2655 3743

E-mail: technical@marktrace.com Website: www.marktrace.com

Dear Customer:

Many thanks for purchasing Marktrace device.

Go through the user manual carefully before you operate.
To make sure Marktrace device work correct. Any questions,
please contact us. We welcome your feedback and comments.

Shenzhen Marktrace Co.,Ltd

MR6221 Serial UHF reader User

Address:

Floor5/7, Block D,Changyuan New Material Port, No 2 Central 1st Hi-tech Av., Nanshan Shenzhen, P.

R.C. Post: 518057

Phone: 0755-2654 6392 FAX: 0755-2655 3743

E-mail: technical@marktrace.com Website: www.marktrace.com

Manual (Ver1.0)

Disclaimer

Marktrace reserve the right to update and modify this user manual. For the new documents may has no further notice.
Don't tear up the warranty label or take reader apart to repair by yourself, we reject perform warranty duties if this happened.

Shenzhen Marktrace Co.,Ltd have trademark right on the trademark which in this user manual and receive legal protection. DO NOT make free with theses trademarks.



Customer Service Center

Phone: 400-022-3382 0755-2654 6392/2654 4205

Fax: 0755-2655 3743

E-mail: technical@marktrace.com

Website: <http://www.marktrace.com>

Address: Floor 3/5, Block D, Changyuan New Material Port, No 2 Central 1st Hi-tech Av., Nanshan Shenzhen, P.R.C.

Post: 518057

Contents

1 MATTERS NEED ATTENTION	7
2 READER INSTRUCTION	8

Address:
 Floor5/7, Block D, Changyuan New Material Port, No 2 Central 1st Hi-tech Av., Nanshan Shenzhen, P.
 R.C. Post: 518057
 Phone: 0755-2654 6392 FAX: 0755-2655 3743
 E-mail: technical@marktrace.com Website: www.marktrace.com

2.1 MR62XX SERIAL UHF READER INTRODUCTION.	8
2.2 READER INSTRUCTION	8
2.3 READER APPLICATIONS	9
2.4 READER MAIN FUNCTIONS	10
2.5 READER TECHNICAL PARAMETER	10
3 READER STRUCTURE AND INTERFACE EXPLANATION.	12
3.1 READER STRUCTURE EXPLANATION	12
3.2 EXPLANATION ON THE READER COMMUNICATION INTERFACE	13
4 QUICK START GUIDE	15
5 READER PARAMETER CONFIGURATION	17
5.1 WEBPAGE CONFIGURATION	17
5.2 DEMO SOFTWARE CONFIGURATION	20
5.2.1 Reader connection	20
5.2.2 Antenna & RF Power setting.	20
5.2.3 Frequency Setting.	21
5.2.4 Working Mode Setting.	22
5.2.5 Buzzer & LED Setting	22
5.2.6 IP Address Setting	23
5.2.7 GPIO Setting	23
6 DEMO SOFTWARE DEMONSTRATION	24
6.1 EPC GEN2 TAG DEMONSTRATION	24
6.1.1 Multi tag Identify	24
6.1.2 Multi Tag Read & Write	25
6.1.3 Tag Filter	26
6.1.4 EPC Gen2 Tag Lock	27
6.1.5 EPC Gen2 Tag Read and write with Access Password	28
6.1.6 EPC Gen2 Tag Kill.	29
6.2 ISO18000-6B PROTOCOL TAG DEMONSTRATION	29
6.2.1 ISO18000-6B tag Identify	29
6.2.2 Multi-tag user data reading	30
6.2.3 Single tag data reading and read with UID.	31

6.2.4 Single tag writing and write with UID	32
6.2.5 Single tag data lock	32
6.2.6 Single tag lock and query	32
7 READER STRUCTION AND INSTALLATION SKETCH MAP	34
8 SECONDARY DEVELOPMENT	37
9 COMMON FAULTS AND EXCLUSION METHODS	38

Address:

Floor5/7, Block D,Changyuan New Material Port, No 2 Central 1st Hi-tech Av., Nanshan Shenzhen, P.

R.C. Post: 518057

Phone: 0755-2654 6392 FAX: 0755-2655 3743

E-mail: technical@marktrace.com Website: www.marktrace.com

1 Matters need attention

- 1、 Dismantle and parts replace: Marktrace has no warranty duties on those faults which caused by dismantle and parts replace by customer .;
- 2、 Power supply: please use the power adaptor which alone with precuts to get power. If not may harm the products.;
- 3、 Falling damage: Mind parts damage by device falling, if this happens, turn off power immediately and connect the distributor or Marktrace customer service center.;
- 4、 Unusual condition: Away from fire. If you find unusual odor when you use this products, or reader on overheating or emitting smog, please power off immediately and drop plug form the plug seat. You can connect the distributor or Marktrace customer service center for helps. If you continue to use this device, may cause the danger of fire or electronic shock.;
- 5、 Place: Don't place device on the site which is not level, mind damage or personal injury on falling.

Address:

Floor5/7, Block D,Changyuan New Material Port, No 2 Central 1st Hi-tech Av., Nanshan Shenzhen, P.

R.C. Post: 518057

Phone: 0755-2654 6392 FAX: 0755-2655 3743

E-mail: technical@marktrace.com Website: www.marktrace.com

2 Reader instruction

2.1 MR62XX Serial UHF reader introduction



MR6211



MR6221



MR6261

Product Model	Product name	Parameter
MR6211E-A	Long range integrated rfid reader	12dBi Linear polarized Frequency 902~928MHz,
MR6211E-E	Long range integrated rfid reader	12dBi Linear polarized Frequency 865~868MHz
MR6221E-A	Middle range integrated rfid reader	9dBi Circular polarized, Frequency 902~928MHz
MR6221E-E	Middle range integrated rfid reader	9dBi Circular polarized, Frequency 865~868MHz
MR6261E-A	Desktop integrated rfid reader	3dBi Circular polarized, Frequency 902~928MHz
MR6261E-E	Desktop integrated rfid reader	3dBi Circular polarized, Frequency 865~868MHz

2.2 Reader instruction

This products has the features like multi protocol compatible, multi-tag identify, multi-tag multi area read and write, fast reader speed, can connect to four

Address:

Floor5/7, Block D, Changyuan New Material Port, No 2 Central 1st Hi-tech Av., Nanshan Shenzhen, P.

R.C. Post: 518057

Phone: 0755-2654 6392 FAX: 0755-2655 3743

E-mail: technical@marktrace.com Website: www.marktrace.com

antennas etc.:

- 1、 Accord with ISO18000-6B and ISO18000-6C(EPC-GEN2) standard;
- 2、 Use unique anti-collision algorithm, has the super multi-tag identify ability;
- 3、 Have tag identify function and data area read, write, lock and kill these functions. And supply the suit API to customer to do secondary development.;
- 4、 Multi-tag identify ability: The MAX reader range can reach 8 meters. (working with 7dBi gain antennas), can connect the different gain antennas like 9dBi、 12dBi etc, can identify the tag which moving speed is 120km/h correctly.;
- 5、 Tag identify speed : Single tag 2000 times/minute , multi-tag 200pcs/second;
- 6、 Can connect to 1 to 4 same gain and different gain planar antennas via high-frequency cable. To expand the identify area of tag and reduce the hardware cost for customer. The RF power of the antennas can set from 0 to 31dBm in separate;
- 7、 Reader will detect antennas when it get power. In case to protect antenna port. The one has no antenna connect will not send RF power.;
- 8、 Have RS232、 RS485、 Weigand、 TCP/IP、 Relay etc output interface;
- 9、 Compatible with tag match function, Reader can identify the tag which match the condition or not identify these condition tags by setting the match conditions.;
- 10、 Compatible with data cache function, Using FRAM (ferroelectric memory) which can save data when power down, memory capacity is 32KBytes, Can save 2200 pcs tag data in 12 Bytes data length.

2.3 Reader applications

This reader are widely use in various RFID system, reference application as

Address:

Floor5/7, Block D, Changyuan New Material Port, No 2 Central 1st Hi-tech Av., Nanshan Shenzhen, P.

R.C. Post: 518057

Phone: 0755-2654 6392 FAX: 0755-2655 3743

E-mail: technical@marktrace.com Website: www.marktrace.com

below:

- 1、 Logistics and warehouse Management: Goods flow, warehouse management, and the flowing management of mail, parcel, luggage.
- 2、 Intelligent parking Management :Parking management and automatic charge
- 3、 Productive lines Management: Production process fixed Identify
- 4、 Product counterfeit-proof inspection: Using memory's write-protect functions inside tags, and identifying with true-false of products
- 5、 Other fields: Used widely in club management, library, student's school, consumption management, time management, dinner management, pool management

2.4 Reader main functions

- 1、 Read tag data: Can read multi-tag same area and same data length in a same time;
- 2、 Write tag: Can write the same data length in multi-tag's same area.;
- 3、 Tag match: Can read match tag or mismatch tag via setting the match conditions;
- 4、 Make data communicate and change with the connection between standard communication interface and controller or PC,;

2.5 Reader technical parameter

- 1、 Compatible ISO18000-6B and ISO18000-6C(EPC-GEN2) protocol standard;
- 2、 Working frequency: fixed-frequency can choose ISM 902~928MHz (America)、ISM920~925MHz (China) 和 ISM 865~868MHz (Europe);
Can also customer made other frequency from ISM 900~930MHz,
stepped frequency is 250KHz;
- 3、 Reading range: Reading from 0~10 meters (working with 7dBi antenna);
- 4、 Tag identify speed: Single tag 2000 times/minute, multi-tag 200pcs/second;

Address:

Floor5/7, Block D, Changyuan New Material Port, No 2 Central 1st Hi-tech Av., Nanshan Shenzhen, P.

R.C. Post: 518057

Phone: 0755-2654 6392 FAX: 0755-2655 3743

E-mail: technical@marktrace.com Website: www.marktrace.com

- 5、 Trigger working mode: Timer and I/O can trigger reader, Timer interval from 10-990ms; I/O trigger MAX time is 255s;
- 6、 Data pre-processing: On trigger working mode, Tag data can store in cache or output directly.;
- 7、 Data cache: Trigger working mode data cache using FRAM (ferroelectric memory) which can save data when power down, memory capacity is 32KBytes, Can save 2200 pcs tag data in 12 Bytes data length;
- 8、 Data output: Data return by instant messaging, Can config RS232、RS485、Weigand、TCP/IP、Relay interface, Can config output data length and start address, Output data format in ASCII;
- 9、 Compatible ISO18000-6C tag match function, match tag by setting conditions;
- 10、 For ISO18000-6B tag. Can do read, write, lock and identify operate to single tag one byte, can read and write specific tag data with UID;
- 11、 Dimensions: 354.00mm (length) *210.00mm (width) *38.00mm (height);
- 12、 Working voltage: DC+9V~+15V;
- 13、 Working temperature: -20°C~+60°C;
- 14、 Storage temperature: -40°C~+85°C;

Address:

Floor5/7, Block D, Changyuan New Material Port, No 2 Central 1st Hi-tech Av., Nanshan Shenzhen, P.

R.C. Post: 518057

Phone: 0755-2654 6392 FAX: 0755-2655 3743

E-mail: technical@marktrace.com Website: www.marktrace.com

3 Reader Structure and Interface Explanation

3.1 Reader Structure Explanation

1、Reader circuit function

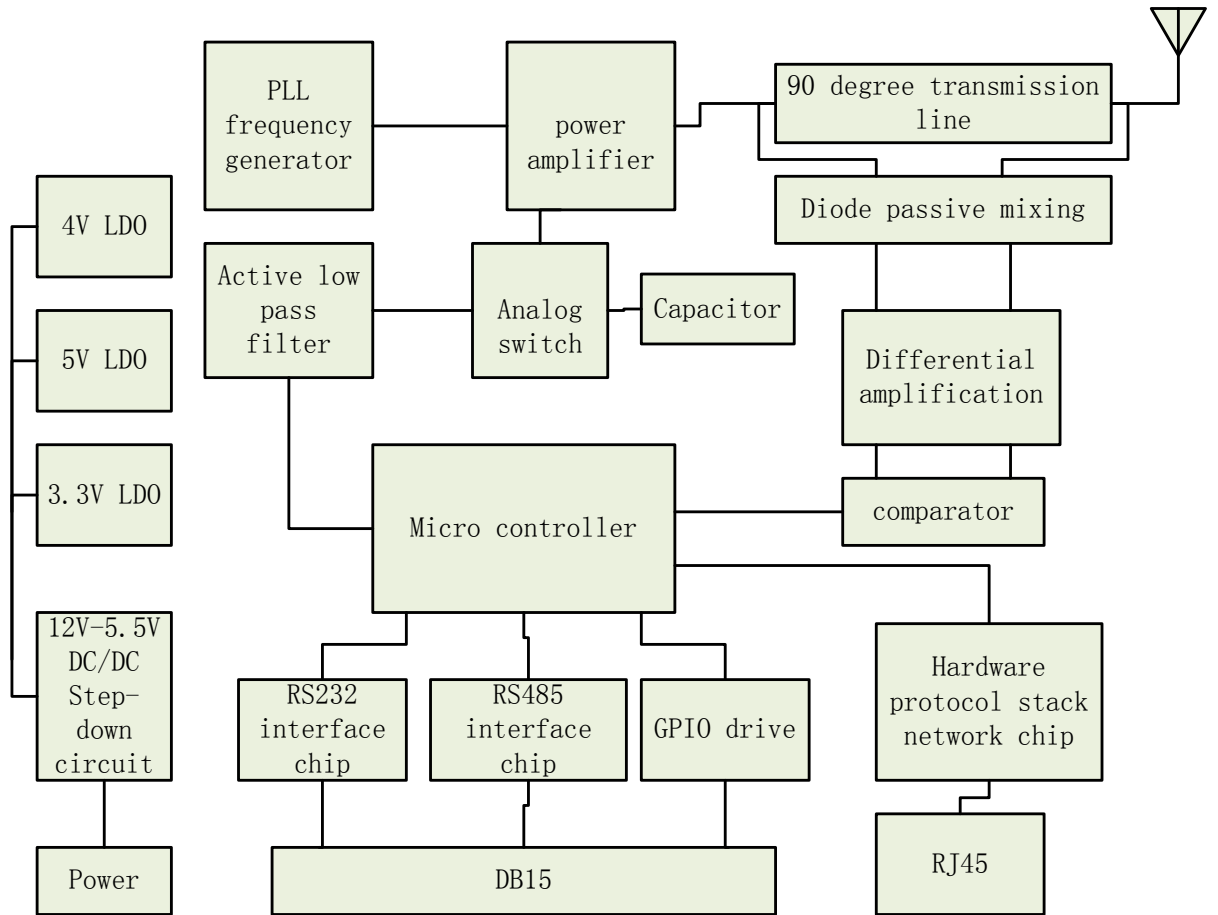

Address:

Floor5/7, Block D, Changyuan New Material Port, No 2 Central 1st Hi-tech Av., Nanshan Shenzhen, P.

R.C. Post: 518057

Phone: 0755-2654 6392 FAX: 0755-2655 3743

E-mail: technical@marktrace.com Website: www.marktrace.com

2、MR6261A Desktop reader structure explanation



3、MR6211A、MR6221A integrated reader structure explanation

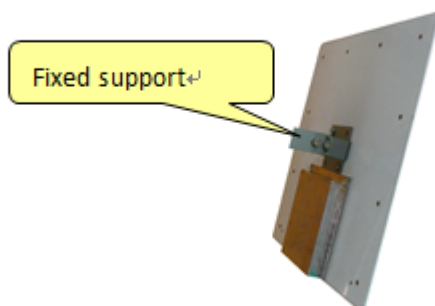

3.2 Explanation on the reader communication interface

1. RS232: the Reader provides standard RS232 communication interface as the output port for data modulation. RS232 has 8 data bits format: 1 start bit and 1 stop bit, no parity bit. The default baud rate is 115200 bps. The interface supports the reader parameters configuration, software upgrading, demo program and all functions for series communication with development kit with functions package;
2. RJ45 (Ethernet Port): 100M Ethernet, TCP Server Mode; It is main mode for connecting communication with PC, also can be data output main mode , The interface supports the reader parameters configuration,

Address:

Floor5/7, Block D, Changyuan New Material Port, No 2 Central 1st Hi-tech Av., Nanshan Shenzhen, P.
R.C. Post: 518057

Phone: 0755-2654 6392 FAX: 0755-2655 3743

E-mail: technical@marktrace.com Website: www.marktrace.com

software upgrading, demo program and all functions for TCP/IP communication with development kit with functions package;

3. Data Interface DB15 diagram and pin definition

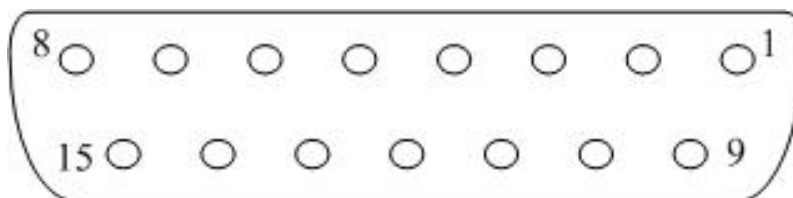

DB15 GPIO Pin definitions								
pin	1	2	3	4	5	6	7	8
define	Out port 2	Out port 1	GND	RX(RS232)	TX(RS232)	GND	In Port2	In Port1
pin	9	10	11	12	13	14	15	
define	GND	A+(RS485)	B-(RS485)	GND	OFF	COM	ON	

4. RS485: Reader provide RS485 communication interface (10、11 pin), work as data main output mode, also can connect with PC via serial port, use RS232-RS485 converter, in this way, RS485 interface support RS232 all supported functions;
5. Programmable output interface : Two sets TTL electrical level programmable output interface (1、2 pin), works as Wiegand output interface, default is high level (5V); one set relay interface (13、14、15 pin), relay default status is OFF and COM short circuit
6. Input check port: 2 team input check port(7、8 pin), can configure as trigger read mode, default as Dangling status is high level (5V);
7. Power supply port: DC+9V~+15V==4A power port;
8. Antenna port: 4 sets TNC antenna port;
9. Indicator light: 6 indicator light, including COM port indicator light、 power indicator light and 4 sets antenna indicator light;

4 Quick Start Guide

- 1、 Connect antenna to reader’s antenna port (one antenna or multi-antenna applicable, maximum 4 antennas), connect power adapter to reader and then power on, connect reader to LAN or PC by network cable;
- 2、 In PC open demo software“MR62XX Demo V1.0”, fill in reader IP address and click“Connect”to connect reader (reader factory default IP address: 192.168.1.200);
- 3、 After reader connection, it will automatically detecting antenna and transmit power query, in“Setting”page selecting detected antenna port (green icon) and click“Set”button, set corresponding port’s transmit power and click“Set”button, see below:

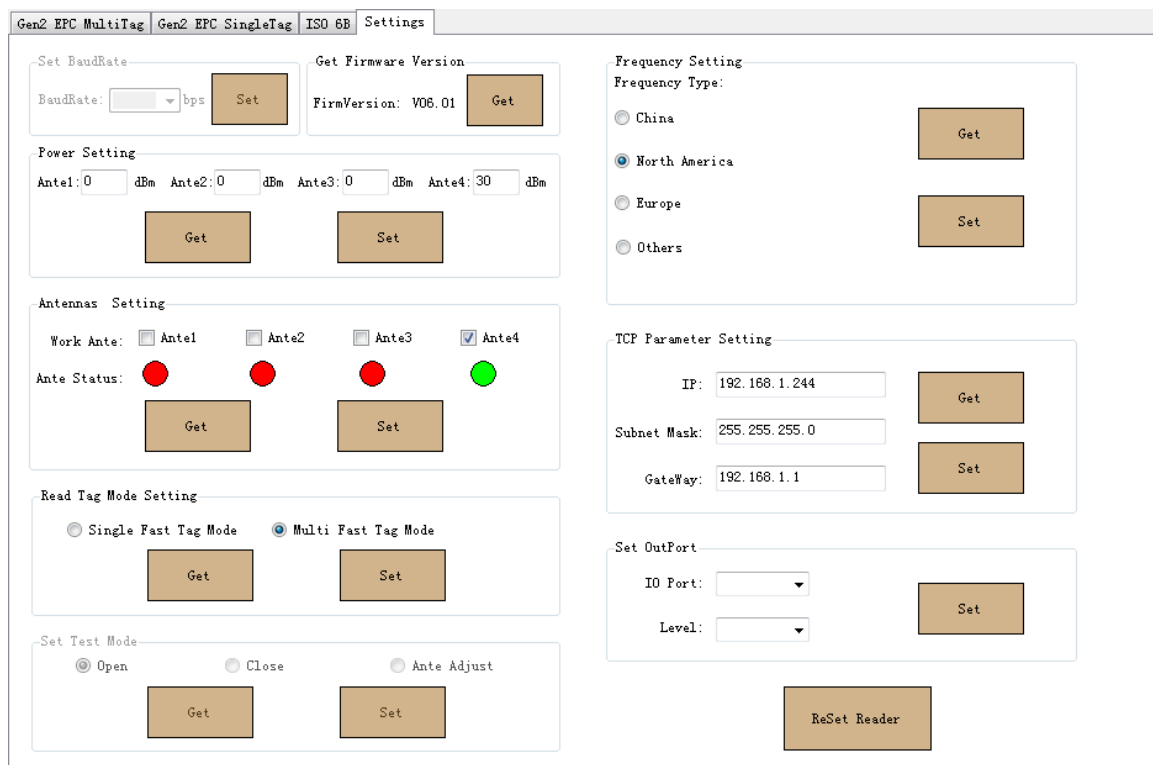

- 4、 In“Gen2 EPC MultiTag” page, click bottom right corner“Identify”button will start EPC tag query operation, see below:

Address:
 Floor5/7, Block D, Changyuan New Material Port, No 2 Central 1st Hi-tech Av., Nanshan Shenzhen, P.
 R.C. Post: 518057
 Phone: 0755-2654 6392 FAX: 0755-2655 3743
 E-mail: technical@marktrace.com Website: www.marktrace.com

Gen2 EPC MultiTag
Gen2 EPC SingleTag
ISO 6B
Settings

[Identify](#)

[MultiTagRead](#)

[MultiTagWrite](#)

NO.	AnteNo.	EPC	Times
1	4	E20010712814023512009B3C	4
2	4	E200107128140100246019FE	4
3	4	E20010712814022612109975	4
4	4	E2001071281400370970AFC9	4
5	4	E200107128140173121098A1	4
6	4	E2001071281401151020ADF6	4
7	4	E2001071281400541020AEEA	4
8	4	E2001071290E02550760CAC4	4
9	4	E2001071290E02330760CA6C	4
10	4	E20010712814014312109829	1
11	4	E2001071281401300880BDEC	1
12	4	E20010712814008024601A4E	4
13	4	E200107128140118123097C7	2
14	4	E2001071281401602460190E	4
15	4	E2001071281401350980B152	2
16	4	E2001071281400970970B0B9	4
17	4	E200107128140049121096E1	4
18	4	E2001071281400360970AFC5	4
19	4	E2001071281401211020ADDE	4
20	4	E2001071281402570910BB53	2
21	4	E200107128140181121098C1	4
22	4	E200107128140116123097BF	2
23	4	E20010712814014524501949	1
24	4	E2001071290E01731120A4B4	4

Data Analysis

Unique Tags: 133	Peak Rate: 298	Read Times: 4
Total Reads: 402	Average Rate: 201	Test Duration: 00:00:02

Stop
Once

Address:
 Floor5/7, Block D, Changyuan New Material Port, No 2 Central 1st Hi-tech Av., Nanshan Shenzhen, P.
 R.C. Post: 518057
 Phone: 0755-2654 6392 FAX: 0755-2655 3743
 E-mail: technical@marktrace.com Website: www.marktrace.com

5 Reader parameter configuration

5.1 Webpage configuration

Reader connect to LAN through TCP/IP port, or directly connect PC, in PC IE browser input reader IP address (reader factory default IP address: 192.168.1.200), after running then open WEB page as below:

Marktrace *RFID* Reader

Product SN :041901060001

Base Items

IP Address	192.168.001.200
Subnet Mask	255.255.255.000
Gateway	192.168.001.001
Application Option	Favor quantity
Rf Power	Ant1: 30 dBm Ant2: 00 dBm Ant3: 00 dBm Ant4: 00 dBm
Frequency Type	North America
Antenna Selection	<input checked="" type="checkbox"/> Ant1 <input type="checkbox"/> Ant2 <input type="checkbox"/> Ant3 <input type="checkbox"/> Ant4
Read Indication	<input checked="" type="checkbox"/> LED <input checked="" type="checkbox"/> Beep

Work Mode

<input type="checkbox"/> Timer	Interval 010 ms (10-990, Must be a multiple of 10)
<input type="checkbox"/> Trigger Port	Effect Time 05 S (1-255)
Tag Type	EPC G2
Membank	EPC (6B invalid)
First Addr	00 (EPC unit is a word, 6B unit is byte)

Can be configure as below:

1、Basic Item configuration

Base Items	
IP Address	192.168.001.200
Subnet Mask	255.255.255.000
Gateway	192.168.001.001
Application Option	Favor quantity
Rf Power	Ant1: 30 dBm Ant2: 00 dBm Ant3: 00 dBm Ant4: 00 dBm
Frequency Type	North America
Antenna Selection	<input checked="" type="checkbox"/> Ant1 <input type="checkbox"/> Ant2 <input type="checkbox"/> Ant3 <input type="checkbox"/> Ant4
Read Indication	<input checked="" type="checkbox"/> LED <input checked="" type="checkbox"/> Beep

- 1) User can configure IP address、RF power、frequency、antenna port、applied mode、read card indicating etc.,
- 2) Each antenna port RF power can be configurable, range: 0-31dBm;
- 3) Frequency standard: China Frequency、US Frequency、EU Frequency three type standard hopping frequency selectable;
- 4) Applied mode:“Favor speed” and“Favor quantity” two mode selectable“Favor speed” for single tag or small batch tags quick speed read mode;
“Favor quantity”for big batch tags read mode;

2、Operating mode configuration

Work Mode	
<input type="checkbox"/> Timer	Interval 010 ms (10-990, Must be a multiple of 10)
<input type="checkbox"/> Trigger Port	Effect Time 05 S (1-255)
Tag Type	EPC G2
Membank	EPC (6B invalid)
First Addr	00 (EPC unit is a word, 6B unit is byte)
Length	06 (EPC unit is a word, 6B unit is byte)
<input checked="" type="checkbox"/> Filter	Time Window 010 s (1-180)
Data Output	Direct Output

- 1) In operating mode configuration, user can configure reader to be timing working mode or pin trigger working mode, timer’s timing interval can be

configure between 10-990ms; When in trigger working mod, reading maximum lasting time can be configure as 255s;

- 2) Read tag type can be 18000-6B or EPC G2, also can be configure read both at same time (expand function) ;
- 3) When read EPC tag, read area can select as EPC、TID or USER memory; 6B tag cannot select area;
- 4) User can select read tag's start address and read data length, EPC tag data use word as unit, 6B tag data use byte as unit;
- 5) User filter repeat tag, Filter set one slide time window, only new data which not show in box can be buffer or direct output;
- 6) Read tag data can be select buffer or directly output, data buffer adapt with power down save ferroelectric memory, storage capacity 32KBytes, when read data length is 12Bytes, can store more than 2200pcs tag data;

3、 output configuration



- 1) In working mode configure, when select data output as directly output mode, user can configure output port;
- 2) Reader data output port have RS232、RS485、Wiegand、Ethernet and relay output;
- 3) Wiegand protocol support Wiegand26 and Wiegand34;
- 4) Relay close delay time configurable between 0-99s;
- 5) For above mentioned port, user can select one type or multiple type to output data;
- 6) Data output as ASCII code format; data format see below:

Address:
 Floor5/7, Block D, Changyuan New Material Port, No 2 Central 1st Hi-tech Av., Nanshan Shenzhen, P.
 R.C. Post: 518057
 Phone: 0755-2654 6392 FAX: 0755-2655 3743
 E-mail: technical@marktrace.com Website: www.marktrace.com

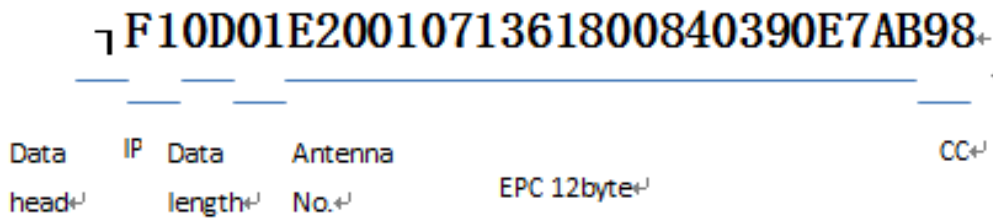

All above configuration will be valid only after click left bottom button “set” button

5.2 Demo software Configuration

5.2.1 Reader connection

Click MR62XXDemo.exe software, input reader’s IP into the IP input box (Default IP: 192.168.1.200, Port: 100 which is fixed), then click ‘connect’ ICON, software information display box will display the reader’s parameter on the success connection. Below image demonstrate the success connection.

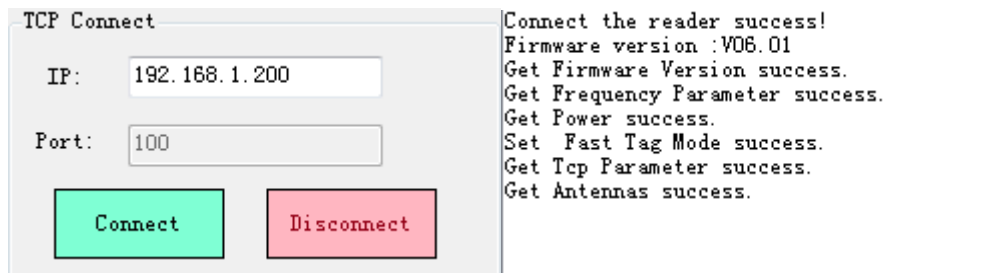

5.2.2 Antenna & RF Power setting

1 On MR62XXDemo.exe software’s Setting interface, query and set Antenna’s RF Power on Power setting; Query and set Antenna on Antennas Setting. Take below image for the reference.

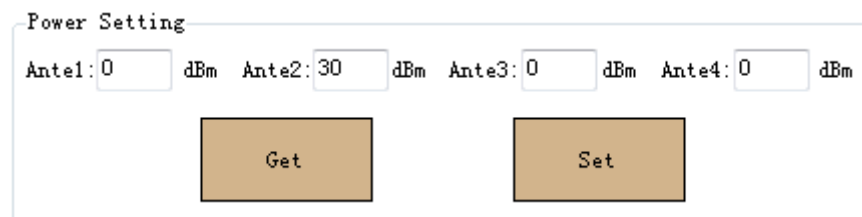

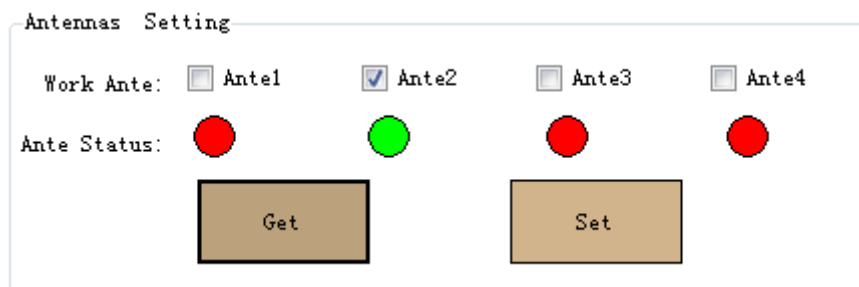

- 2、 Set the 4 antenna ports RF power separately from the range of 0 to 31dBm.
- 3、 On the reader connection, the antenna port will begin self detection, and the connecting Antenna port is on GREEN ICON, Disconnecting Antenna port is on RED ICON. Only the selected GREEN ICON port's antenna works.
- 4、 On Integrated RFID reader and Desktop RFID reader, config and set one antenna port for the reader to work.

5.2.3 Frequency Setting

On MR62XXDemo.exe software's Setting interface, Query Reader's Frequency on Frequency setting menu, there are China Frequency (920-925MHz), North America Frequency (902-928MHz), European frequency (865-868MHz), and others frequency configurable. China, North America, and European Frequency type are in FHSS working mode. Select Fixed frequency or multi fixed frequency working mode on the **others** frequency type, take below images for the reference.



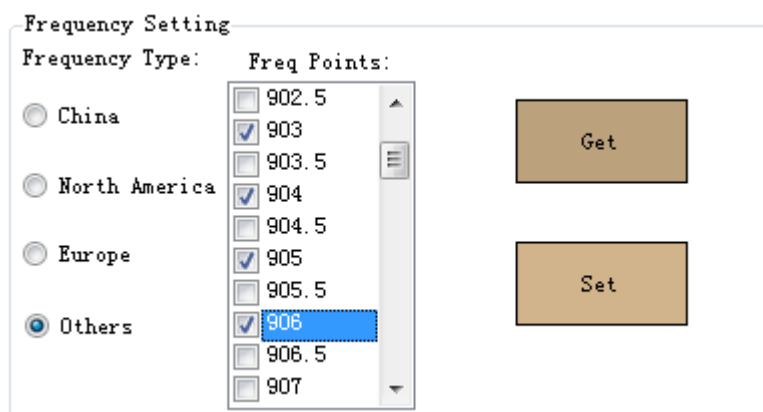

5.2.4 Working Mode Setting.

1、 On setting interface's Working Mode Setting, there are two working mode, Favor speed and Favor quantity for the query and setting, take below image for the reference.

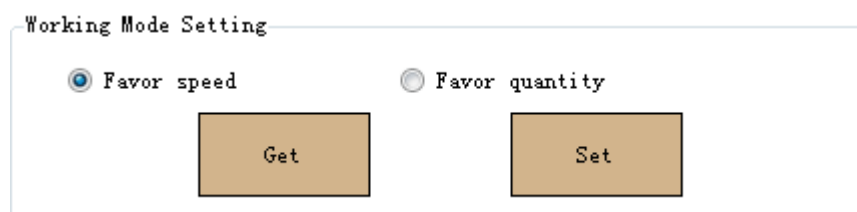

2、 Favor speed is for single tag or few tags reading with the high speed tag reading rate. Favor Speed working mode is configurated for the applications require high speed tag reading rate (e.g. Not-stop Highway toll)

Favor Quantity is for the multi and tense tags reading, Favor Speed working mode is configurated for the applications (e.g. warehouse, logistic)

3、 If the reader is configurated into Favor speed working mode, it's invalid for the Matched EPC tag reading.

5.2.5 Buzzer & LED Setting

1、 On Setting interface's Buzzer & LED Setting menu for Querying and Setting Buzzer & LED ON/OFF. Take below image for the reference.

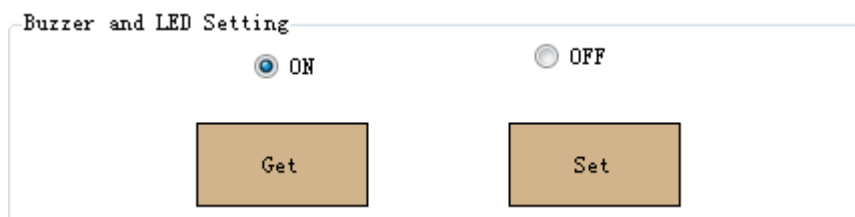

2、 After setting Buzzer & LED ON/OFF, Reader automatically reset, and need to reconnect the reader.

5.2.6 IP Address Setting

1、 On setting interface's TCP Parameter Setting menu for querying and setting reader's IP, take below image for the reference.

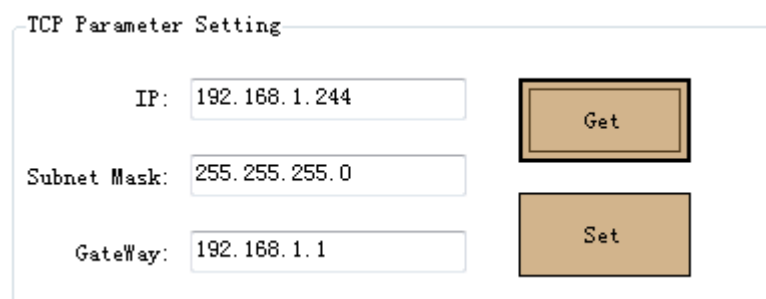

2、 Reader automatically reset when set a new IP address, and need to reconnect the reader with new IP address

5.2.7 GPIO Setting

On Setting interface's Set Out Port menu for the reader output port setting. The reader has two sets output port and one set Relay port. IO Port0 and IO Port1 are output port with default High level voltage (5V) and Low level voltage (0V) configurable. IO port2 is Relay output port with default OFF setting. take below image for the reference.

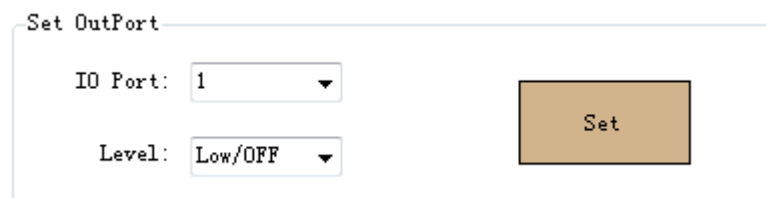

6 Demo software demonstration

6.1 EPC Gen2 tag Demonstration

6.1.1 Multi tag Identify

1、 On Gen2 EPC Multi Tag interface’s Identify menu for the Multi tag identify, and click Identify ICON to start the reading. EPC code, antenna number and tag reading times displayed on the interface info. box. On the interface bottom displays tag number, Peak reading rate, Read times, total reads, Average reading rate, and duration reading time. Take below image for the reference.

The screenshot shows the 'Gen2 EPC MultiTag' software interface. It features a menu on the left with options: 'Identify', 'MultiTagRead', and 'MultiTagWrite'. The main area contains a table with the following data:

NO.	AnteNo.	EPC	Times
1	2	E2001071361801290660D012	4
2	2	E2001071361801100360E8AC	4
3	2	E20010712814009014807D38	4
4	2	E20010712814005014807C98	4
5	2	E20010712814017114807E7C	2
6	2	E2001071361801090360E8A8	3
7	2	E2001071281401060820C0D6	4
8	2	E20010712814012714807DCC	4
9	2	E20010712814013215007A06	4
10	2	E20010712814019214807ED0	2
11	2	E2001071281400450830EFE3	4
12	2	E20010712814009914807D5C	4
13	2	E20010712814006914807CE4	4
14	2	E2001071361801680380E85A	3
15	2	E2001071281401690830C1D3	4
16	2	E20010712814006914807D34	4
17	2	E20010712814011914807DAC	3
18	2	E2001071281401400830C15F	4
19	2	E20010712814011315007A52	2
20	2	E2001071361802010660D132	3
21	2	E2001071281401620830C1B7	4
22	2	E2001071361801370660D032	4
23	2	E20010712814024814707FAF	1
24	2	E2001071361801510660D06A	4

Below the table is a 'Data Analysis' section with the following statistics:

- Unique Tags: 172
- Peak Rate: 277
- Read Times: 4
- Total Reads: 508
- Average Rate: 101
- Test Duration: 00:00:04

At the bottom right, there are two buttons: a red 'Stop' button and a white 'Once' button.

2、 Click ‘Stop’ ICON for stopping tag identify.

3、 Click ‘ Once’ ICON for sending once tag detect command, and returns the tag number, take below image for the reference.

Address:

Floor5/7, Block D,Changyuan New Material Port, No 2 Central 1st Hi-tech Av., Nanshan Shenzhen, P.
R.C. Post: 518057

Phone: 0755-2654 6392 FAX: 0755-2655 3743

E-mail: technical@marktrace.com Website: www.marktrace.com

Membank, and USER Membank at the same time. The steps are: 1) select the encoding Membank, 2) select the tag start encoding address and the encoding word count (EPC tag's unit is word), 3) input the encoding value, then click 'Write' ICON to encoding the multi-tag. Take below image for the reference.

MemBank: WordAddr: WordLen:

WriteValue:

Stop

No.	AnteNo.	EPC
1	2	E2001071290101330970B149
2	2	E20010712905026317605DCC
3	2	E2001071290100920970B0A5
4	2	E200107129050057178059D2
5	2	E20010712905024317605E1C
6	2	E200107129050117153074DD
7	2	E2001071290101140970B0FD
8	2	E200107129050224181055CD
9	2	E2001071290102520920BB40
10	2	E20010712905001515207BDC
11	2	E20010712905017315007962
12	2	E20010712905023522802BF4
13	2	E200107129050222181055D5
14	2	E200107129050200151078F7
15	2	E20010712905019314807ED4
16	2	E200107129050144151079D7
17	2	E20010712905012815207A18
18	2	E200107129050052178059BE
19	2	E2001071290502142330245D
20	2	E200107129050059204040A0
21	2	E20010712905028814808050
22	2	E20010712905021522802BA4
23	2	E200107129050284149077A5

WriteTagCount: 23
Duration: 00:00:13

4、Click 'Stop' ICON to stop the Multi-Tag encoding, at the bottom of the demo software display the Success encoding tag number, and tag encoding duration time.

5、In accordance with the EPC Protocol, On Multi Tag Read & Multi Tag Write, EPC Membank's Start reading address and Start encoding address is from the EPC Membank's Second word address.

6.1.3 Tag Filter

On Gen2 EPC Single Tag interface's Gen2 Select Config menu for the Tag Filter rule setting. Tag Filter setting rule is based on the EPC Membank, TID Membank or USER Membank value for the setting condition. In accordance

with the EPC Gen2 Protocol, RESERVE Membank's data is invalid for the tag filter rule setting. Please 1) select the EPC tag Membank, 2) the word addr. 3) Word Length, 4) Input the value, then Click 'Config' ICON for the Tag filter rule setting.

- 1、 Only on Favor quantity working mode, the Tag filter setting is valid, on Favor speed working mode, tag filter setting is invalid.
- 2、 Match setting, reader reads and displays only the condition matched tag.
- 3、 Mismatch setting, Reader doesn't read and display the condition matched tag.

Gen2 Select Config

Action: Match DisMatch

Membank: Word Addr:

WordLength: Value:

- 4、 Empty the input value for cancel the Tag filter rule.

Gen2 Select Config

Action: Match DisMatch

Membank: Word Addr:

WordLength: Value:

- 5、 If setting EPC Membank as the Tag filter rule, the valid Word Addr is 2.
- 6、 After set the EPC tag filter rule, this rule is valid for all EPC tag detect.
- 7、 After set the EPC tag filter rule, this rule is valid for all the time unless the reader is power off or reset.

6.1.4 EPC Gen2 Tag Lock

- 1、 On Gen2 EPC Single Tag interface's Gen2 Secured Lock menu for the EPC Gen2 Tag Lock setting. With Access Password, it can lock Reserve Membank, EPC Membank, and USER Membank in different lock level. Take below image for the reference.

2、 EPC Gen2 Tag Lock level are unlock, unlock forever, and secure lock, lock forever

- 1) Unlock means the tag is not to encrypted the tag
- 2) Unlock forever means the tag will not be locked forever
- 3) On Secure Lock, RESERVE Membank only can be read and write with Access Password, EPC Memban and USER Membank can be encoded with Access Password.
- 4) Lock forever, if the tag is set to lock forever, it can't be unlock again.

6.1.5 EPC Gen2 Tag Read and write with Access Password

1、 n Gen2 EPC Single Tag interface's Gen2 Secured Read and Gen2 Secured Write menu for the EPC tag reader and write with Access password. Take below image for the reference.

1) Gen2 Secured Read with Access password

2) Gen2 Secured Write with Access password.

2、 EPC Gen2 Secured Read with Access password need to input the Select Read tag's Word Addr, and the WordCnt.

3、 EPC Gen2 Secured Write with Access password need to input the Select

Write tag's Word Addr, and the WordCnt

4、 Secure locked Reserve Membank can only be read & write with Access Password, Secure Locked EPC Membank and Secure Locked USER Membank can be encoded with Access Password, while can read without the Access Password.

5、 In accordance with the EPC Protocol, TID Membank can't be locked, Access Password is invalid for TID Membank.

6.1.6 EPC Gen2 Tag Kill.

1、 On Gen2 EPC Single Tag interface's Gen2 Kill menu for the Tag Kill password to kill the tag, Take below image for the reference.



2、 EPC Gen2 tag can't be read and write if the tag is killed.

6.2 ISO18000-6B Protocol tag Demonstration

6.2.1 ISO18000-6B tag Identify

On ISO 6B interface for the ISO18000-6B tag Identify. Click 'Identify' ICON for the tags Identify, and the software interface displays the ISO18000-6B tag's UID code, Antenna No., and the read times. Click 'Stop' ICON for stoping the tag Identify. Take below image for the reference.

	NO.	AnteNo.	ID	Times
Identify	1	01	E0040000777D2606	63
	2	01	E00400008A8E2606	50
	3	01	E004000082F69D05	64
SingleTag				
MultiTagRead				

Stop

6.2.2 Multi-tag user data reading

Put several 6B tags in the radiation range of antenna, in the ISO 6B operation interface, choose Multi Tag Read to enter into multi-tag data reading interface, choose the start address of data that you want to read, then click "Read" button to operate multi-tag data reading, the interface will indicate 8 bytes data from start address, antennas numbers and times to be read, like following picture indicates, click "Stop" button to stop user data reading;

StartAddr:

[Identify](#)

No.	AnteNo.	Data	Times
1	01	55000002FFFFFFFF	72
2	01	5588CC7788334455	70
3	01	00343434121212B3	42

[SingleTag](#)

[MultiTagRead](#)

6.2.3 Single tag data reading and read with UID

1、 In the ISO 6B operation interface, choose Single Tag to enter into single tag operation interface, choose the start address of data you want to read in the ISO Read menu item, click“Read”button to start reading data, the interface will indicate the tags data that is read, the data length is 8 bytes data from start address:

ISO Read

Address:

Result:

2、 When data read with UID, it needs to know the UID of the tag first, you can set the start address to 0 when query UID, the reading data is tag UID, after inputting UID, choose the start address of reading data, click“Read With UID”button to operate data reading:

ISO Read

Address: UID:

Result:

6.2.4 Single tag writing and write with UID

1、Single Tag operation interface, choose the data address you want to write in the ISO Write menu item, click“Write”button to write data;

ISO Write

Address: UID:

Value:

2、When operate writing data with UID, except for inputting the single byte data that needs to write, it also needs to put the UID number of tag, choose the start address that want to write, click“Write With UID”button to write data;

ISO Write

Address: UID:

Value:

6.2.5 Single tag data lock

1、Single Tag operation interface, choose the data address you want to lock in the ISO Lock menu item, click“Lock”button to lock data, if return “ISO Lock tag success” in “Result”column,it means lock successfully:

ISO Lock

Address: UID:

Result:

2、 It is unable to rewrite data in the address that is successfully locked;

6.2.6 Single tag lock and query

Single Tag operation interface, choose the data address you want to query in the ISO Query Lock menu item, click “Query”button to lock and query, it will

return query result in “Result” column, like “Had locked” and “Not lock”;

ISO Query Lock

Address: UID:

Result:

ISO Query Lock

Address: UID:

Result:

7 Reader struction and installation sketch map

1、MR6134E reader Appearance & CAD Structure Chart:

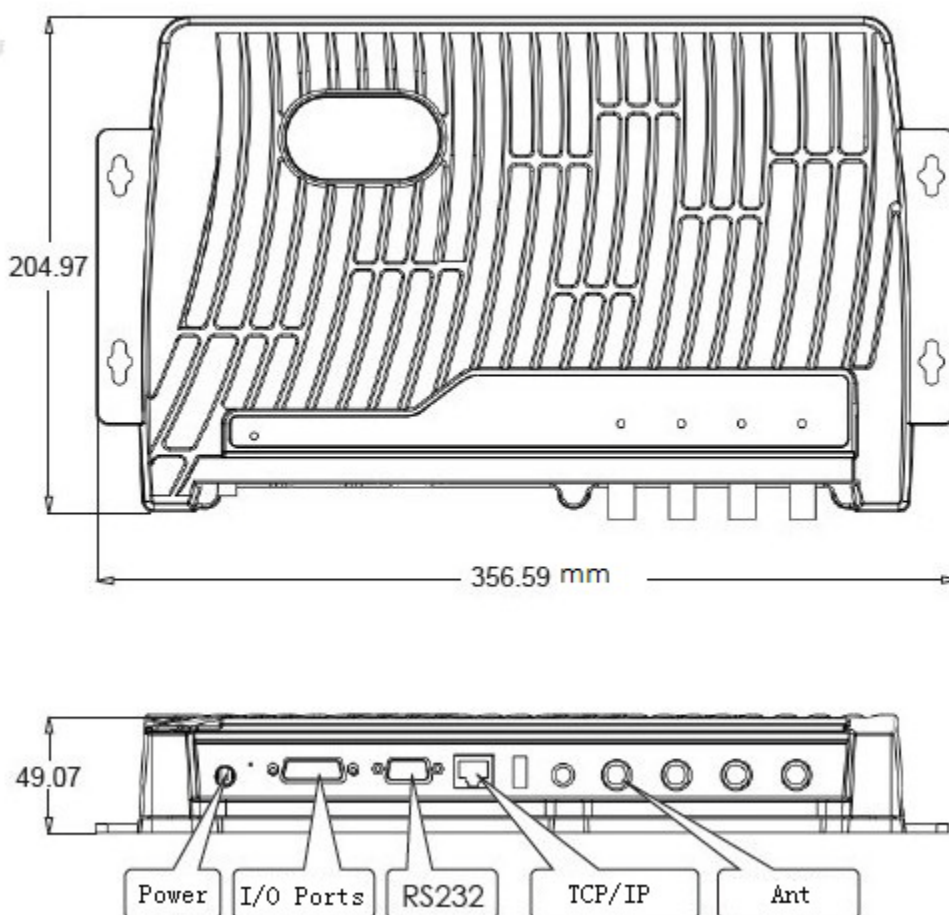

Address:
 Floor5/7, Block D, Changyuan New Material Port, No 2 Central 1st Hi-tech Av., Nanshan Shenzhen, P.
 R.C. Post: 518057
 Phone: 0755-2654 6392 FAX: 0755-2655 3743
 E-mail: technical@marktrace.com Website: www.marktrace.com

2、MR6161 desktop reader Appearance & CAD Structure Chart:

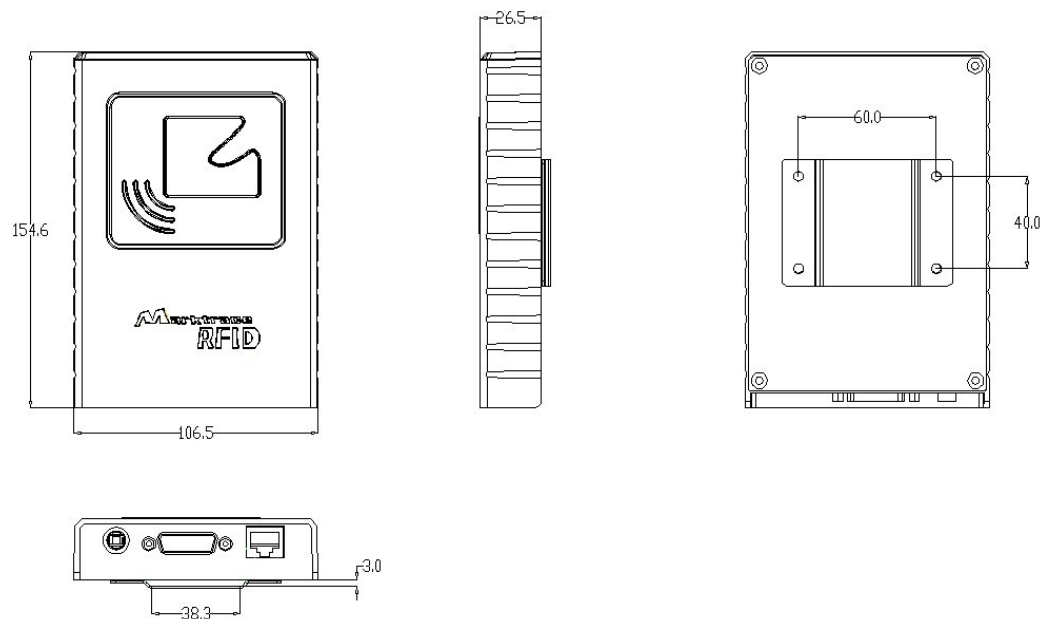

3、MR6134E reader installation sketch map:

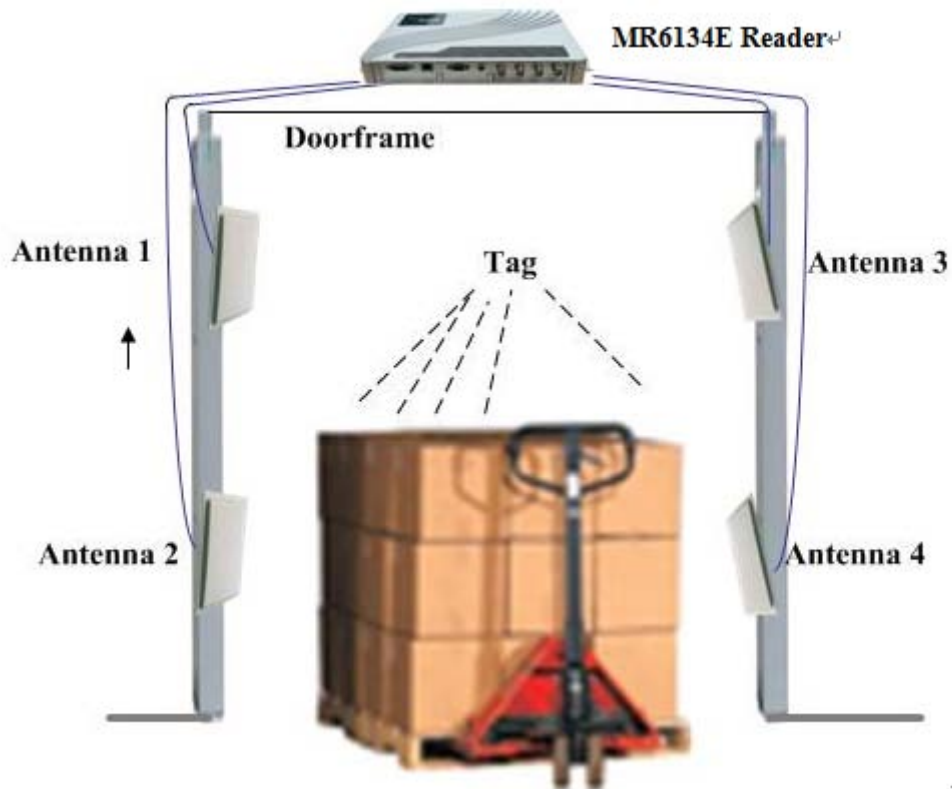

Address:
 Floor5/7, Block D, Changyuan New Material Port, No 2 Central 1st Hi-tech Av., Nanshan Shenzhen, P.
 R.C. Post: 518057
 Phone: 0755-2654 6392 FAX: 0755-2655 3743
 E-mail: technical@marktrace.com Website: www.marktrace.com

Notice: MR6134E can connect with 4 antennas, every antennas installs in different position to read tags on goods better.

4、MR6111、MR6121 integrated reader installation sketch map:

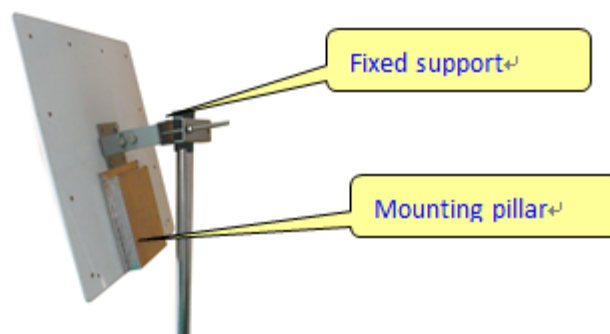

Address:

Floor5/7, Block D, Changyuan New Material Port, No 2 Central 1st Hi-tech Av., Nanshan Shenzhen, P.

R.C. Post: 518057

Phone: 0755-2654 6392 FAX: 0755-2655 3743

E-mail: technical@marktrace.com Website: www.marktrace.com

8 Secondary development

User can make secondary development for reader application software if needing.

We provide SDK, which supports VC++、C#、JAVA and so on, the use of SDK, please refer to 《MR62XX serial reader SDK instruction》。

Address:

Floor5/7, Block D, Changyuan New Material Port, No 2 Central 1st Hi-tech Av., Nanshan Shenzhen, P.

R.C. Post: 518057

Phone: 0755-2654 6392 FAX: 0755-2655 3743

E-mail: technical@marktrace.com Website: www.marktrace.com

9 Common faults and exclusion methods

Failure Description	Simple exclusion methods
Unable to start reader	<ul style="list-style-type: none"> ■make sure the power adapter indicator light is on ■make sure the reader power interface is connected well
Unable to connect reader	<ul style="list-style-type: none"> ■make sure the reader IP address is correct ■make sure the network environment is good
Reader is unable to identify tag	<ul style="list-style-type: none"> ■make sure antenna ports are connected correctly ■make sure antenna power is not to be 0
No sound when reading tag	<ul style="list-style-type: none"> ■make sure the buzzer is open
Tag with password operation failed	<ul style="list-style-type: none"> ■make sure that when tag operates with password,the radiation range of antenna is single tag or small amount of tags
Invalid tag filter settings	<ul style="list-style-type: none"> ■make sure the reading mode for reader is multi-tag read
Unable to refresh the page in the web configuration	<ul style="list-style-type: none"> ■Clear CGI in the web address or re-enter the IP address of the reader and refresh

Address:

Floor5/7, Block D,Changyuan New Material Port, No 2 Central 1st Hi-tech Av., Nanshan Shenzhen, P.

R.C. Post: 518057

Phone: 0755-2654 6392 FAX: 0755-2655 3743

E-mail: technical@marktrace.com Website: www.marktrace.com