

FC-300 User Manual



Brief

Dear customer:

Congratulations on purchasing your new security system and thank you for the confidence you have shown in us. You have chosen a high-quality product that has been produced, tested and packed with the greatest care.

Please familiarize yourself with these instructions before attempting to install the security system because prolonged reliable and trouble-free operation will only be sure if it is fitted properly. We hope your new security system will bring you lasting pleasure.

Content

Accessories	1
Chapter I Introduction	2
1.1 Function introduction	2
1.2 About panel	5
1.3 About I CON	5
Chapter II installation and connection	6
2.1 Open the item Box	6
2.2 Installation of control panel	6
2.3 Wiring	7
2.4 Install wired detector	8
2.5 Intall wireless detector	8
Chapter III easy setup and operation	9
3.1 Factory default setting	9
3.2 Basic setting and operdtion	11
3.3 Alarm receiving phone control	12
3.4 Remote phone control	12
3.5 Alarm center	13
3.6 Alarm proctdure	13
3.7 Telephone line off alarm	15
3.8 Anti-taper function	15
3.9 Event recording and inqaiyv	15
3.10 Easy operation	17
Chapter IV User setting	18

Chapter V system setting	19
5.1 Setting	19
5.2 Setting on main menu	19
5.3 Set password	20
5.4 Set centre monitoring station	22
5.5 Set voice alarm receiving phone number	23
5.6 System setting options	24
5.7 Enroll wireless device	29
5.8 Set zone attribution	32
5.9 Set timing operation	34
5.10 System main tenance	36
Chapter VI alarm and receive alarm	37
Chapter VII technical specification	38
Chapter VIII maintenance	39
Chapter VX limitation of the products	39

Accessories

Before installation please check if the whole set including the components as follow:

- ◆ One Control panel
- ◆ One Wireless PIR sensor
- ◆ One wireless magnetic contact
- ◆ Two remote controllers
- ◆ One adaptor for control panel
- ◆ One user manual
- ◆ 8 resistors for 10K

Chapter I Introduction

1.1 Function Introduction

1. With voice indication all around the operation.
2. LCD screen indication.
3. Total 32 wireless zones: each zone enable learn code automatically or enter code manually on the keypad. The panel compatible with all our made wireless device.
4. Total 8 wired zone, connect resistor on wired zone terminal to achieve N.O. or N.C. alarm.
5. Enable enroll total 8 wireless remote, wireless door bell, and Unlimited for quantity of one way wireless siren.
6. Zone programmable: Before products left factory, will programme alarm type and delay or instant for each zone as factory default. Use can modify the settings.
7. Enroll wireless device: wireless detector and remote via auto enroll code or enter address code manually. User enable enroll / delete detector , remote separately or enroll / delete all simultaneously.
8. Six follow me phone # (voice alarm receiving phone #), two for CMS , four for private alarm receiving.
9. Clock and event list: built-in clock, can be set according to local time.
10. Status inspection function: Enable record and inquiry 120 alarm event messages.
Like the time when happens anti-tamper alarm, detector alarm, tel-line off, arm, disarm, system setting, battery low voltage etc. And also can inquiry the zone number and alarm type.
11. Password operation : Administrator password mainly for system administrator to program the system. User password for user make common operation, like arm, disarm system, remote control. Both Administrator password and user password can be modified.

12. In Central Monitoring System according to quantity of users, user can set 4 ,5 or 6 digit user code.
13. Alarm type auto identify: after alarm triggered, on the LCD screen will display alarm zone #, alarm type, alarm icon. When connect to CMS, panel will report details of alarm to CMS.
14. Compatible with CMS machine: support Contact ID. Report alarm to CMS. Report arm/disarm to CMS optional.
15. Remote control: Enable via tel phone to achieve remote control system like: arm, disarm , listen to the spot, trigger siren,appliance etc.
16. vandal-proof function: If try to cut off the wire between wired detector and panel or cut off the tel line which connect to the panel will make alarm.
17. Anti-tamper function: when someone try to remove panel deliberately panel will make alarm immediately.
18. Timing arm/disarm: Enable set 4 group time arm/disarm tie.
19. Timing testing: At preset time, panel will send signal to CMS to test the panel on-line status.
20. Siren : The panel with built-in siren, it can also enroll extension wireless siren. Both can be settled on/off when alarming.
21. Follow-me number. The panel dials preset follow-me number to report alarm message
22. Voice indication volume enable adjust on the switch.

23. Wired/wireless zone real time monitoring: active the real time monitoring function , then if zone with trouble when doing arm/disarm operation the panel will indicate zone fault.
24. Wireless signal repeat function: via our made wireless repeater panel enable to receive signal from wireless detector from a long distance.
25. Wireless detector low battery real time warning: if wireless detector low battery,it will send signal to panel every one or two hour or when alarm happens,panel will sound dee dee , and on the LCD screen, low battery icon and zone number will display. And panel will also report to the CMS and preset follow me phone #.
26. Tel-line off and wireless transfer function: panel make alarm or under arm status, but find out that Tel line off, panel will send signal to preset neighbour panel, and the neighbour panel report alarm instead.
27. Set enable or disable the built-in siren when pressing emergency key on the panel or the remote, please refer to P32.
28. During the alarm receiving procedure the user should enter 4-digit user password to enter. This avoid others without permission to operate the panel.
29. In the voice indication "back " key corresponding to "Return" on the keypad. The "confirm " key corresponding to "#" or "enter" key

1.2 About panel

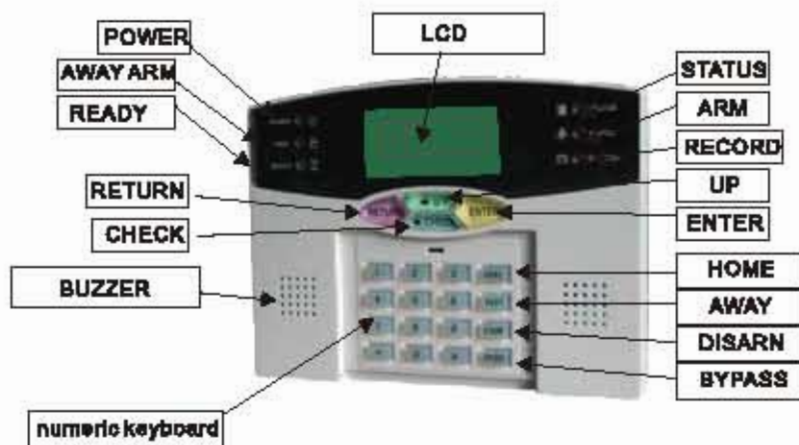
**NOTE:**

POWER LED: Light on when AC power on, light off when AC power off.

STATUS LED: Light on when wired detector zone, magnetic contact zone is ready. Light off when not ready.

1.3 About ICON



Key operation

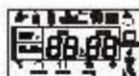

LCD display



Speech indication



Cautions



Indication

2. Installation & wiring

2.1 Unpacking the equipment

Open the cardboard packing box and check whether all items have been included. If you find out that an item is missing, contact your vendors or dealers immediately.

2.2 Mounting

It is easy to connect power supply, telephone line and PART A detectors. Installers don't need to uncover the case.

1. Remove the bracket, as figure shown below.

Pull down the bracket as shown, release the bracket.

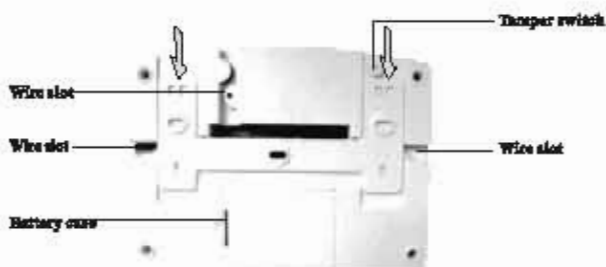

2. Mark and drill holes in mounting surface, fasten the bracket to the mounting surface with screws.

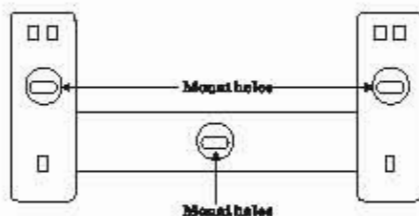

2.3 Wiring

Wire external device to panel:

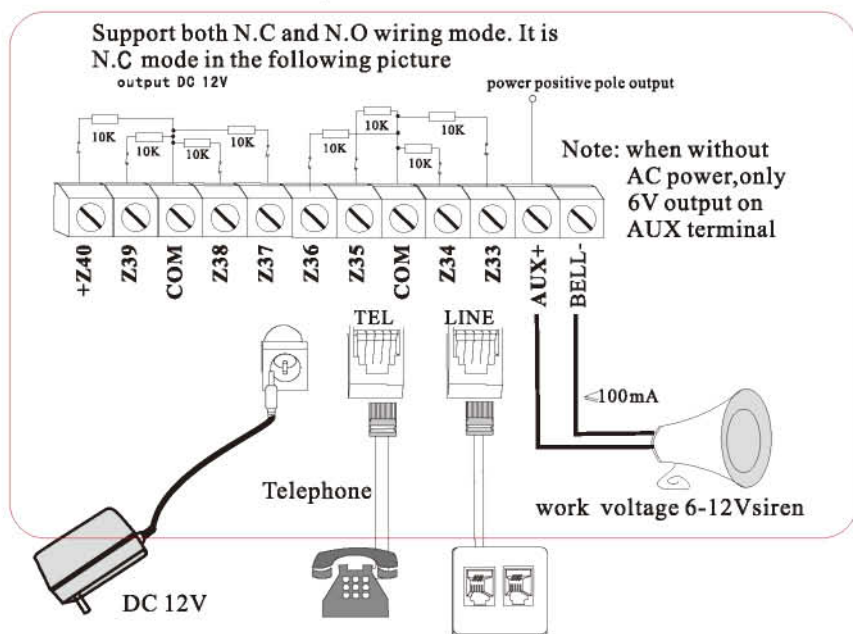

2.4 Install wired detector

2.4.1 The wired zone is on bypass status as factory default. If the user need use wired zones, please active them first. When the wired zone is fault, the user will hear "zone fault" The LCD screen will display the fault zone number+E. But can not arm on remote or keypad successfully.

2.4.2 The control panel can power 12v, 100mA to detectors. The max current can power to wired detectors is 100mA. Do not exceed 100mA, otherwise please adopt extra 12V backup power.

2.5 Intall wireless detector

2.5.1 As the detector's manual says, install coded detector in the area 150m from the control panel. Please test and make sure detector can work with control panel normally.

Chapter III Easy setup and operation

3.1 Factory default setting

Below are factory default of FC-300+ control panel you can keep the default setting or modify .

- ☆ Administrator password: 9876
- ☆ user password: 1234
- ☆ Entry and exist delay: 10s
- ☆ Monitoring time: 10s
- ☆ Cycle dial out to make alarm: 5 times
- ☆ Ringing times to pick phone call automatically: 7 times
(after ringing 7 times the panel will take the phone call automatically)
- ☆ TEL-line cut-off inspection function effective .
- ☆ Arm/disarm message report to CMS function ineffective.
- ☆ Timing arm/disarm option ineffective
- ☆ Auto arm/disarm time, CMS timing inspection time both are zero.
- ☆ Alarm type of siren whistle during alarm all the time: burglar alarm, perimeter alarm fire alarm, gas leak alarm and user defined alarm type.
- ☆ All phone number and user code are empty.
- ☆ Siren type of panic zone is silent
- ☆ 33-40 wired zones, All zone is disabled

zone default set

table one

wireless zone	zone type	siren type
01	delay	sound
02	burglar	sound
03	burglar	sound
04	perimeter	sound
05	perimeter	sound
06	emergency	sound
07	fire alarm	sound
08	gas	mute
09-32	burglar	sound

NOTE:

- ★ Burglar zone :only effective under away arm status .
- ★ Doorbell zone: Under home arm/away arm status, trigger the doorbell zone will report delay alarm. Under disarm status, trigger the doorbell zone will sound ringing tone.
- ★ Perimeter zone/delay zone: only effective under arm and homearm status
- ★ Gas , fire alarm, emergency alarm: under armand disarm status effective
we do not suggest user set zone siren type as mute.
- ★ Delay zone always fit for entrance or exit.

NOTE: The 41 zone is for dual-way wireless siren

Considering the convenience of user, the factory default can meet most users' requirement. So, common user only need to proceed easy setting.

☆Zone trouble indication;















zone+ “C” ——zone open loop trouble(wired zone)

zone+ “O” ——zone shortcut trouble(wired zone)
zone is triggered(wireless zone)

zone+ battery icon—— low voltage on detector trouble

zone+ “L” —— wireless detector loss trouble

★means of icon displayed on LCD:

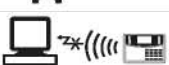
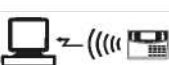
Icon	Meaning	Icon	Meaning
	Perimeter zoon		Enroll devices
	Telephone line fault		Disarm
	Burglar alarm		Home arm
	Panic alarm		Away arm
	Help		Alarm
	Fire alarm		Adequate battery voltage
	Gas leak		Low battery
	Special alarm		
	Center link failure		Alarm information is reporting

3.2 Basic setting and operation

Indication LED:

Arm LED-- Normal ON when under away arm status, normal blink when under home arm or disarm status.

Ready LED-- Normal ON when under disarm status, off after system is armed.

Trouble LED-- Normal ON under AC/DC trouble, communication trouble, TEL line trouble

Alarm LED-- FLASH when making alarm

Status LED--OFF when wired zone fault

★ Basic setting

Before left factory, in whole kit, the panel had already code with all remote, magnetic contact, PIR detector..

Press *key for 3seconds, then enter administrator password[9876] to enter system setting. For each menu press # to enter and press back key to exist. When enter main menu, panel will sound all menu options one time, then user can press corresponding number or press up, down to to the option you want, then press # to enter setting, then press # or confirm key to save setting. When hear [setting saved] means setting successfully otherwise setting failure. On the key button under LCD screen, there are four button with function [home arm, away arm ,disarm, bypass] under normal status, but when under setting status the four button separately with following function [back, up, down, confirm]. The key on numeric keyboard, numbers for user to enter numbers and [*] for delete, [#] for confirm.

★BasicOperation:

Power on/off--When power on AC, after AC power off, backup battery will get ready automatically. When battery voltage reduce to 5.5v, system will turn off automatically to protect battery.

System setting-- press [*]and hold on for 3 seconds+administrator password +[#]key;

Disarm the system -- user password +[#];

The panel will sound voice indication of setting options anytime entering any menu. Change to neighbour option via "up", "down"key , or press numeric button to choose option in menu, then press confirm key or corresponding numeric button again to enter the option. up/down key are for choosing option, [*] for deleting..

★Command: (on disarm status)

Disable tel-line off inspection function-----747410#

Enable tel-line off inspection function-----747411#

Disable magnetic contact inspection function----- 747413#

Enable magnetic contact inspection function -----747412#

Note: Tel-line inspection and magnetic contact inspection function are enable as factory default

3.3 Alarm receiving phones operation

When the detector is triggered, the panel will sound alarm and display the triggered zone number and alarm type on the LCD screen. The panel will dial the preset voice numbers if there is no disarming operation during this period.

When the panel dial the preset voice numbers, if there is no operation or not disable the alarm by pressing "1 or 4" key, then the panel will continue to call other voice numbers.

Alarm receiving

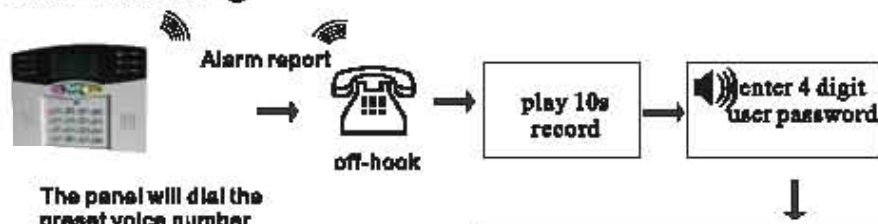

 Alarm occurs, please operate as following indication

- 1** Cancel the alarm press "1"
- 2** Check alarm zone press 2
- 3** Listen to the spot press 3
- 4** Disarm the system press 4
- 5** Arm the system press 5
- 6** Activate the hook press 6
- 7** Play the zone address recording press 7
- 0** Hand up press 0

3.4 Remote phone control

User can remote control the system by phone call. After the preset ringing times then panel will off hook the phone then enter the 4 digit user codes according to voice prompting and operate as per the voice prompting.

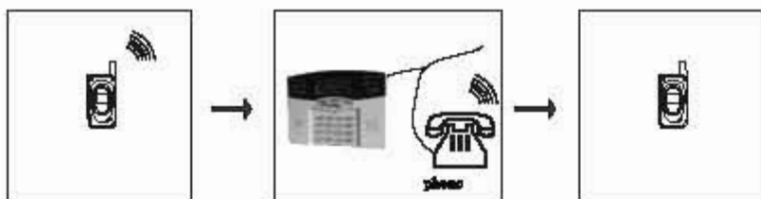

Users to call landline phones

For example, the phone rings 7 times. After 7 times ring, the panel will automatically off-hook.

Enter the user code according to voice prompting



Alarm system welcome your calling, please input your password.

- 1 System arm, please press 1
- 2 system disarm, please press 2
- 3 inquiry the system status please press 3
- 4 listen to the spot
- 0 hang up, please press 0

X X X X # →
4.digital user password

3.5 alarm center

The panel use the Ademco Contact ID to sent alarm information to the alarm center. If the panel got the conformation from the center ,then alarm successfully. Or the panel will repeat alarm (the max times re-dialing the center number is 5). Alarm information will be display and resolve by the alarm center computer software.

3.6 alarm procedure

Burglar zones and delay perimeter zones are enabled/disabled by home/away arming/disarming others zones are 24hr zones

Alarm Process Diagram

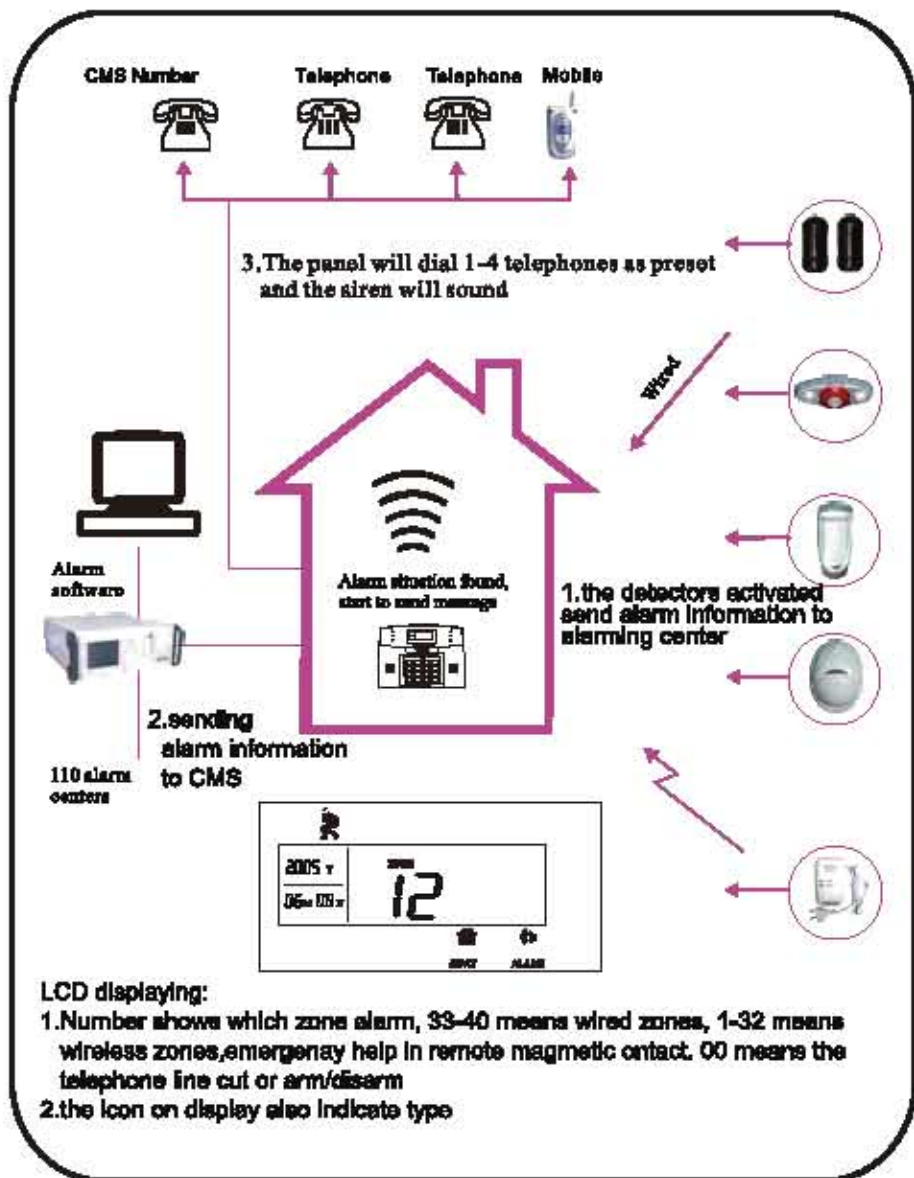

3.7 Telephone line off alarm

If tel-line off check function is effective, when system under arm status, the siren will whistle 15s after the tel-line cut off. Under disarm status, After 15s the panel will give voice to tell telephone line cut off for 60 seconds. And if the tel-line connected again or disarm the system this indication voice will stop. Otherwise, the siren whistle for 5 minutes. And at then same time, the panel will send alarm signal to a neighbour panel.

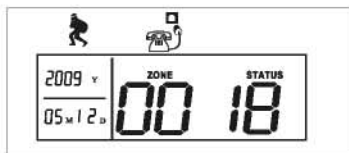

3.8 Anti-tamper function.

1. When the control panel receive a message that the wireless magnetic contact is oping, the panel will solve this as a burglar alarm.(up to the status code, and alarm type). Just after close the door or windows , and panel receive the signal of magnetic contact closed. The panel will then solve the anti-tamper alarm.

2.The display of tamper alarm on the LCD: the zone number , and the status code: 14 for the icon is burglar.

3.9 Event recording and Inquiry

3.9.1 Event record

Arm, away arm, home arm, disarm, telephone line cut-off , low battery status and other information can be recorded by the control panel.

When the battery of Wireless detector (include magnetic contact) is under voltage, the detector can know when it make timing self-testing, and send signal to the control panel, then the control panel will give indication voice to tell detector under voltage, and display on the LCD: low voltage icon, and zone number and low voltage code(19), eg, 16 19, means no.16 zone with low voltage. The panel also will send message to the CMS and call the alarm receiving phone number to remind the system manager and user to change battery.

3.9.2 Event Check

Press the [inquiry] key less than 3sec to inquiry the event recorded. Press the inquiry key continuously you can get the record one by one chronologically. Press any key to exit.

For example: Burglar alarm at the fifth wired zone at 8:30 am 3rd April, 2009

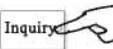
 Press "check" key



 Press "#" key enter next information display

Event Status

- 01 Delay zone
- 02 Perimeter zone
- 03 Burglar zone
- 04 Emergency zone
- 05 Fire alarm zone
- 06 Gas alarm zone
- 07 Anti-tamper zone
- 08 Disarm
- 09 Arm
- 10 Home arm

3.9.3 AC power off and restoration testing function: If the AC power is when the AC is off, the trouble LED on the panel will report AC loss to the CMS, when the AC is restored the panel will send a restoration message to the CMS.

3.9.4 Low voltage inspection function on panel backup battery
 When AC power of the panel is off, and the backup battery voltage gets lower than 6.0 V. The panel will send a message to the CMS.

3.10 Easy operation

☆ Away Arm

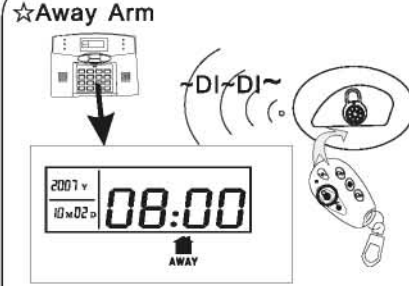

Press the key for arm away on remote or the keypad, then you hear "the system is arming" there will be 10 sounds "Dee" to tell you arm the system successfully

☆ Disarm

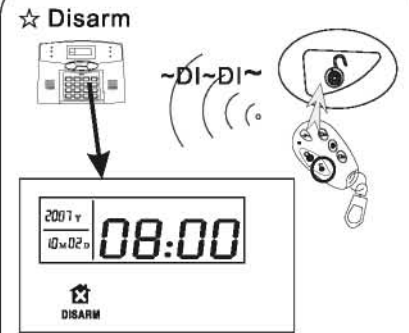

press the disarm key on the remote or enter your user password on the keypad, then you will hear "dee" and voice "system disarmed", then you have disarm successfully.

☆ Home Arm

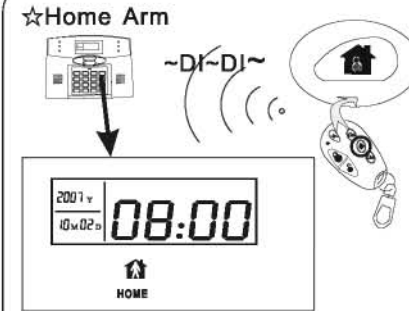

Press the key for home arm on the remote or "HOME" key on the keypad, the panel will give voice to tell system is enter home arming. And it display home arm icon on the LCD screen.

☆ Panic

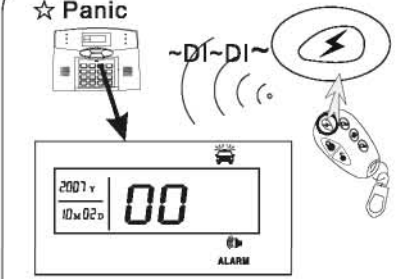

Press the panic button on remoter, or press "help/bypass" key on panel for 3 seconds, and 10seconds later the panel will dial the preset phone number. And you can disarm to cancel alarm.

After above-mentioned operation, press "up/inquiry" button for 3 seconds, and you can inquiry record event like emergency alarm, home arm and so on. Press [up] key to previous option, Press [down] key to inquiry next event. Press [*] key to exit inquiry.

Chapter 4 User setting

user menu

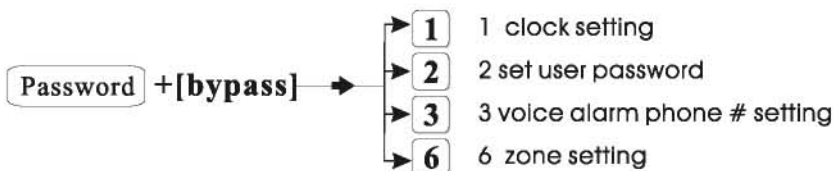

press back key to exist setting.

4.1 Clock setting

Enter[Password]+[bypass]+[1]+[confirm] enter clock setting, details please read P24,chapter 5.61

Press[*]3s

Password bypass → 1 #

▶ 09 → 06 → 01 → 20 → 09 → #

Setting is saved

According to flash of Y.M.D.H.Min on screen,enter 09、06、01、20、09 by turn

4.2 User password setting

[Password] + [bypass] + [2] + [confirm]

enter 4-digit user password, press back key to exist press confirm key to confirm.

+ [xxxx] + [confirm]
enter 4 digit new password

4.3 Voice alarm phone # setting

Enter [Password] + [bypass] + [3] + [confirm] enter voice alarm phone # setting for details please read P 23,chapter 5.5

4.4 Zone setting (effective or ineffective)

[Password] + [bypass] + [6] + [confirm]

enter the zone # from 1-40 to modify, press back key to exist press confirm key to confirm..

+ [xx] + [confirm]

Please choose, press 1 to set on, press 0 to set off.

+ [1] + [confirm]

Chapter V System Setting

We will introduce the function setting of FC-300+ series.

 We are not responsible to any problem which caused by user wrong operation!

5.1 Setting

- ★ When set system on the keypad, [*] key with both "setting" and "exist" function. [#] with confirm function.
- ★ Every time press a key the panel will sound effective indication speech. Every time finish one operation the panel will sound corresponding speech indication anyway it is wrong or right operation. If setting under advanced menu, after finish setting please press [*] key to back to previous menu to continue other setting.
- ★ Press [*] key and hold on for 3 seconds to enter setting status. Enter administrator password, then press the corresponding key to enter option setting. Everytime enter correct command please press [#] to enter the advanced menu. After you enter the advanced menu, for user convenience the screen will display the default or the setting user programmed before. Then the user can enter the setting he want to modify and press [#] key to confirm. If the user do not want to modify, he can press [#] to keep the former setting. After this operation, the LCD display will back to the status of enter command so that the user can enter next option setting. After you finish all settings, press back key to exist. If after 5 minutes no any operation the panel will back to previous menu automatically.
- ★ If incorrect operation during setting you can press [*] and hold on for 3 seconds to back to previous menu.

5.2 Setting on main menu

Let's learn about how to enter the system and functions. Please set the panel according to following method, and the panel will keep the memory of your setting until you modify it again.

Main menu

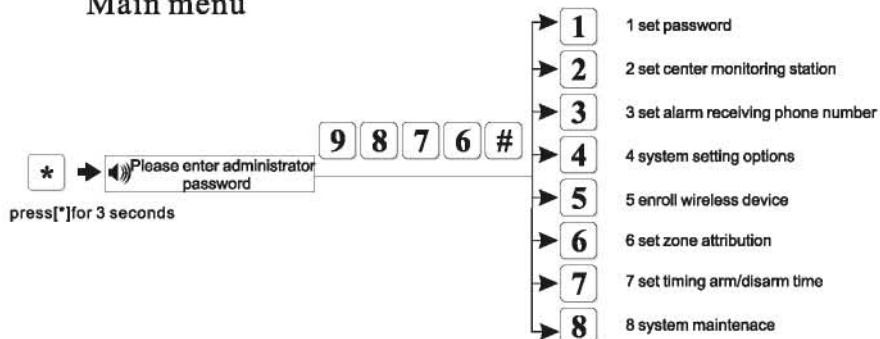

5.3 Set password

- ★ Set password: Password include “user pasword” and “administrator password” “user password” with function to disarm system. It is a private key on remote control. “Adminstrator password” is the only password to set the system. Please do not forget the administrator password otherwise you can not operate the system. Press “*” (hold * for more than 3 seconds) “9876#” “1#”, then operate according to the speech indication.

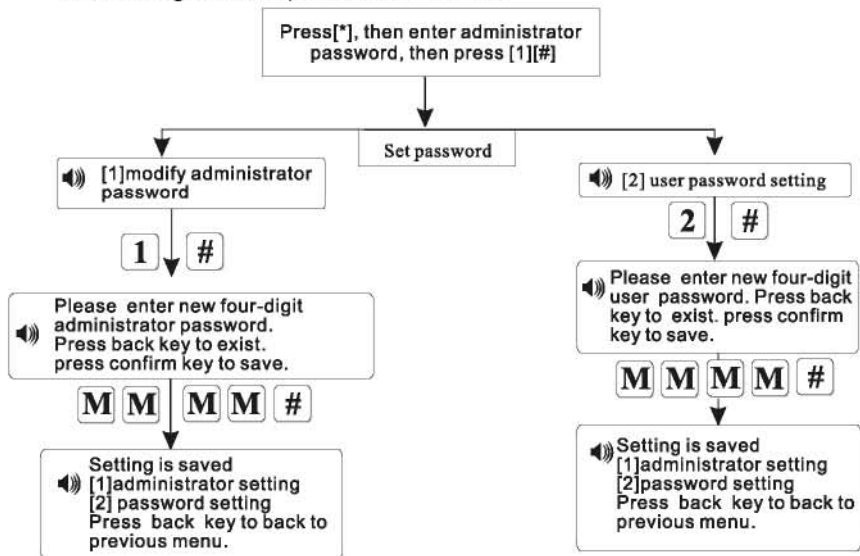

Note: Here [M] stands for entering new password

Example 1: Mmodify the administrator passwor to “1111”

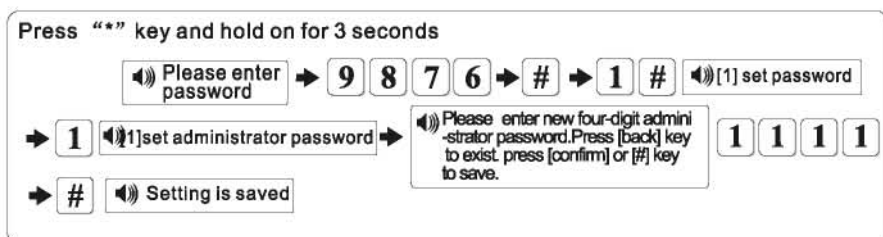

Note:

1. Above are based on correct operation for each step. If incorrect operation occurs, please press [back] key to back to previous menu to reset.
2. The factory default of administrator password is [9876]. If you have modified the password, please enter the new password.

5.4 Set centre monitoring station

Press [*]3 seconds+[9876#]+[2#], then operate as following.

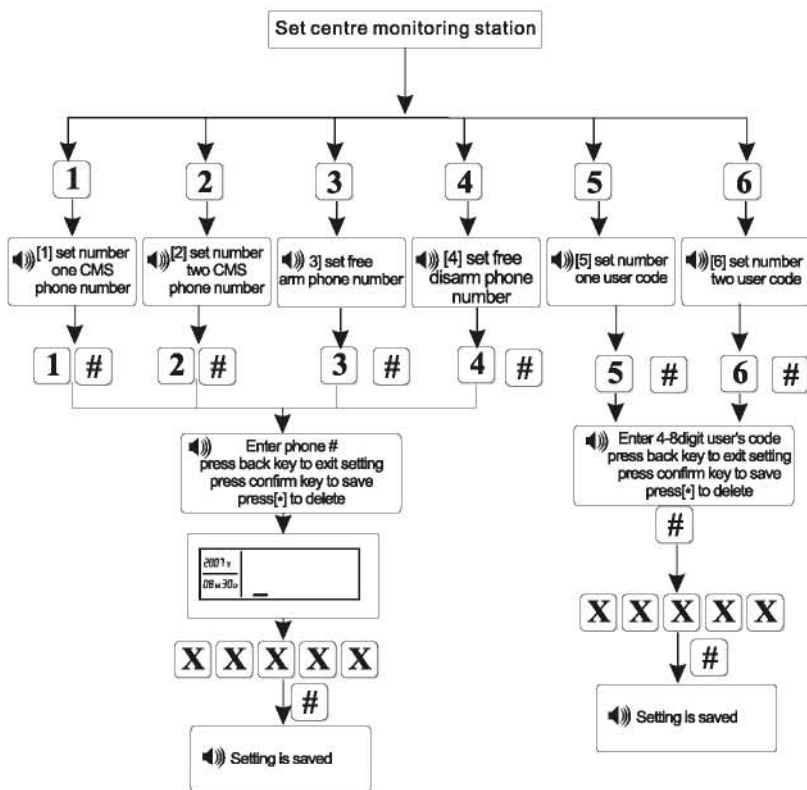

The user code in the CMS setting which is identification code in the CMS. And the user code in transfer alarm setting is user, identification code between same model panel

★After set CMS #, user's code should be also programmed. The panel adopt 4-8digit algorithm user code to meet the demand of different users quantity. It can be used for telecom alarm receiving center system. Use 4,5digit user's code, armed/disarmed message will be sent to first or second receiving alarm center phone; alarm message will be sent to the first or second receiving alarm center and all of voice receiving alarm. Use more 6 digit user's code, disarmed/armed message will be sent to the second receiving alarm center; the alarm message will be sent to the first receiving center and all of voice receiving alarm center phone.

5.5 Set voice alarm receiving phone number

After press[*]3 seconds+[9876#]+[3#], operator follow the voice indication :

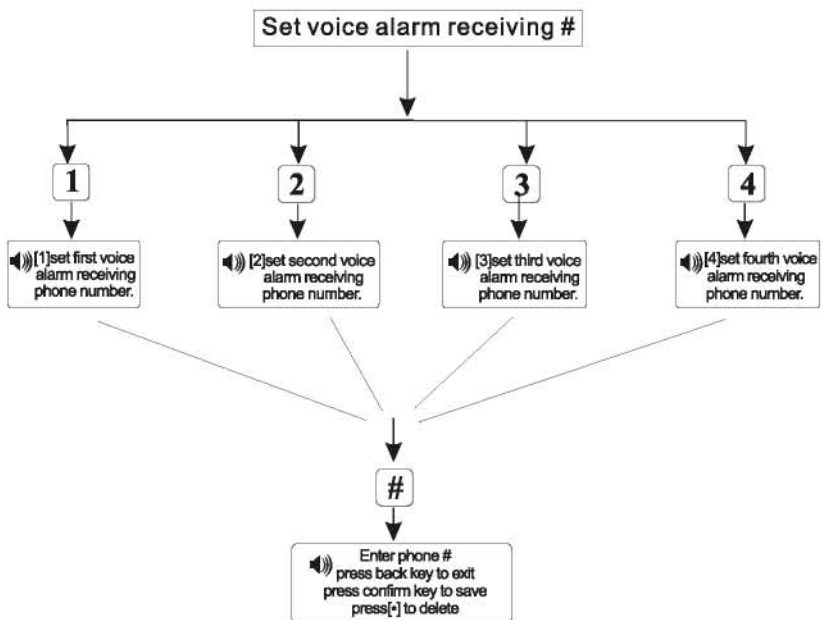

Example 2: panel connect with one telephone .

And set the local phone # “87654321” as first voice alarm receiving # :

Press “*” for 3seconds

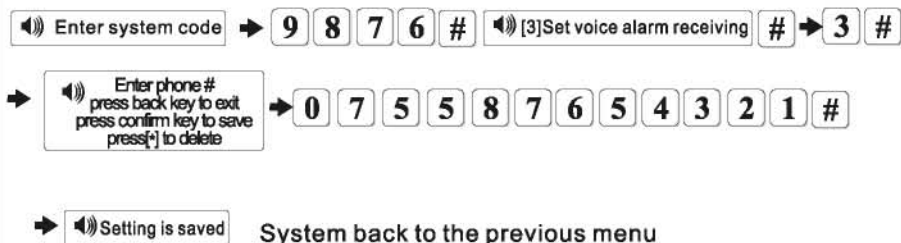

5.6 System setting options

Press[*]3seconds+[9876#]+[4#], operator according voice indication as following:

Press[*]3s

* → 9 8 7 6 # → 4 #

- 1 "1" clock setting
- 2 "2" entry delay setting
- 3 "3" exit delay setting
- 4 "4" siren time setting
- 5 "5" ringing times setting
- 6 "6" detector loss test setting
- 7 "7" communication test interval time setting
- 8 "8" armed/disarmed indication sound setting
- 9 "9" armed/disarm report setting

5.61 clock setting: Set system time administrator june 1st, 2009 20:09.

Operate as : [*]3s→[Administrator password]→[4][#] →[1]→[Y]→[M] →[D]→[H]→[M]→[#]

Press[*]3s

* → 9 8 7 6 # → 4 # → 1 #

Enter Y.M.D.H.M.
press back key to exit
press confirm key to save

2009 20:09 → 0 9 → 0 6 → 0 1 → 2 0 → 0 9

According to flash of Y.M.D.H.Min on screen,enter 09、06、01、20、09 by turn

→ Setting is saved

Save setting

 Indication: Considering the convenience for user to know the alarming time, please set the time same as location time,

5.62 Entry delay setting: the period from system is triggered to panel start alarming(default Value is 10s)

E.g: Set the delay time as 009s

Press [*]and hold on for three seconds

* → 9 8 7 6 # → 4 # → 2 #

Administrator password

Enter the delay time.
Press back key to exit
press confirm key to save

→ 0 0 9 → # Setting is saved

Enter 3 digit number from 001-255s, add 0 if lower than 10. Like, 9 enter as 009.

5.63 Exit delay setting: the period from user arm to the system armed successfully. This is for user's convenience to exit after arm operation.(default value is 10s)

Example: Set delay time as 089s

Press[*]and hold on for 3s

* → 9 8 7 6 # → 4 # → 3 #

Enter the exit delay time .
Press back key to exit
press confirm key to save

→ 0 8 9 → # Setting is saved

Enter 3 digit number from 001-255s, add 0 if lower than 10. Like, 9 enter as 009.

5.64 Siren time setting: the siren time after panel start alarming(default value is 5 minutes).

Example: Set the siren time as 15 minutes(It's suggested not to set the siren time more than 15 minutes)

Press [*] and hold on for 3 seconds

* → 9 8 7 6 # → 4 # → 4 #

Enter 0 to 30 minutes siren time
press back to exist.
Press confirm
to save

→ 1 5 → # Setting is saved

Enter 2digit number from 0-30, add 0 if lower than 10. Like, 9 enter as 09.

5.65 Set the ringing time: user dial the phone which connect to the panel to achieve control the panel remotely(Default value is 7 times).

Example: Set ringing time as 8

Press [*] and hold on for 3 seconds

* → 9 8 7 6 # → 4 # → 5 #

Enter ringing time. If set
as 0, system wont take the
phone. Press [back] to exit.
press [confirm] or [#]
to save the setting

→ 0 8 → # Setting is saved

Enter 2 digit number from 0 to 99,add 0 if lower than 10. Like, 9 enter as 09.

Note: Here user can set ring times from 00-99. When set as 00, the remote control function will be disable. The max time are subject to local max phone time regulation.

5.66 Detector loss test setting: The time interval of detector lose Inspection(Default value is 00) .

Example: Set inspection of detector loss or power status every 18hours

Press [*] and hold on for 3 seconds

* → 9 8 7 6 # → 4 # → 6 #

Enter 0-24hours interval on detector loss inspection, 0 for not inspect. Press back key to exit . Press confirm key to save.

→ 1 8 → #

Setting is saved

Enter 2 digit number from 0 to 24 h, add 0 if lower than 10. Like, 9 enter as 09
We do not suggest set shorter than 4 hours.

5.67 Setcommunication inspection interval time : Time interval for panel communicate with CMS(Default value is 00)

E.g: set panel communicate with CMS every 4 hours.

Press[*] and hold on for three seconds

* → 9 8 7 6 # → 4 # → 7 #

Enter 0 to 24 hours interval on communication inspection, 0 for not inspect. Press back key to exit . Press confirm key to save.

→ 0 4 → #

Setting is saved

Enter 2 digit number from 0-24hours, add 0 if lower than 10. Like, 9 enter as 09

5.68 Set arming/disarming tone: Set the tone type of arming/disarming (default value is no indication)

Example: set armed/disarmed with short sound tone indication

press[*] for 3s

* → 9 8 7 6 # → 4 # → 8 #

 Choose arm/disarm indication voice. One no voice, two short sound. Press back key to exit. Press confirm key to save.

→ 1 → #  Setting is saved

1.no indication 2.short sound

5.69 Set arming/disarming report : Set if report arm/disarm to CMS or not.

Example: Set arm/disarm report to CMS

Press[*] and hold on for 3s

* → 9 8 7 6 # → 4 # → 9 #

 Please choose arm, disarm report one not report, two report. Press back key to exit. Press confirm key to save.

→ 2 → #  Setting is saved

1.not report 2.report

5.7 Enroll wireless device

Pressing[*]+[9876#]+[5#] then operate follow the voice indication

Press [*] and hold on for 3s

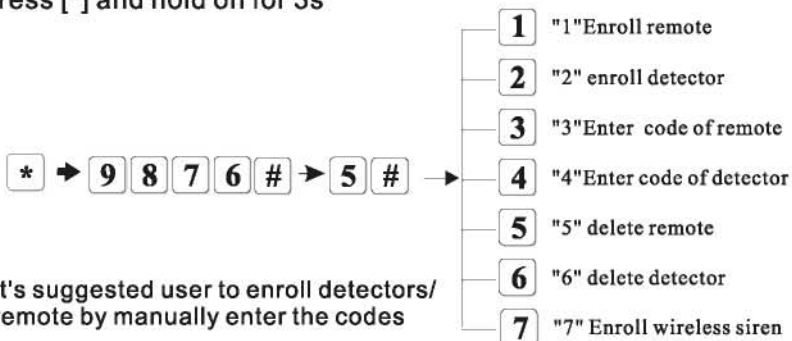

5.7.1 Enroll remote and delete remote

Example: enroll #3 remote

1)Auto enrolling:

Press[*] and hold on for 3S

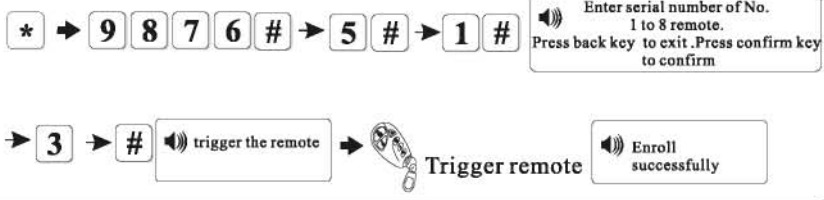

2)Enroll manually

Press[*] and hold on for 3S

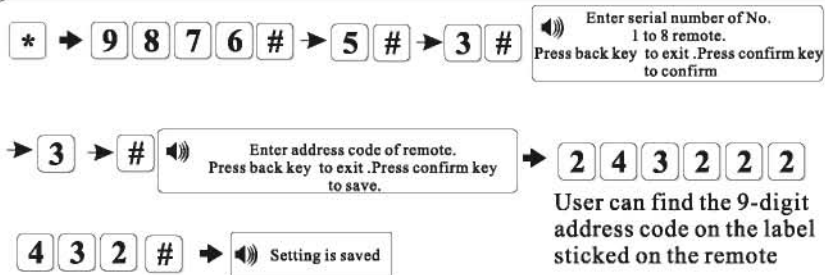

3) Delete remote

Example: delete the #3 remote

press [*] and hold on for 3S

* → 9 8 7 6 # → 5 # → 5 #

enter number 1 to 8 serial number of remote to delete separately. enter [0] to delete all , press back key to exit, press confirm key to confirm.

→ 3 → # → press back key to exit, press confirm key to confirm. # → Setting is saved

Save the settings

5.7.2 Enroll and delete detectors

Example: enroll # 16 wireless detector

1) Auto enrolling:

Press[*] and hold on for 3S

* → 9 8 7 6 # → 5 # → 2 #

enter 1 to 32 serial number of detector, Press back key to exit. Press confirm key to confirm

→ 1 6 → # → trigger the detector → Press the anti-tam per spring → Enroll successfully

2) Manual enrolling

press [*] and hold on for 3S

* → 9 8 7 6 # → 5 # → 4 #

enter 1 to 32 serial number of detector, Press back key to exit. Press confirm key to confirm

→ 1 6 → # → enter address code of detector , Press [back]to exit press [confirm] or [#] to confirm → 1 4 5 2

→ Setting is saved

User can find the 4-digit address code on the label stucked on the detector

3) Example: delete #16 detector

press [*] and hold on for 3S

* → 9 8 7 6 # → 5 # → 6 #

enter number 1 to 32 serial number of detector to delete separately. enter [00] to delete all. Press back key to exit Press confirm key to confirm

→ 1 6 → # # → press back key to exit, press confirm key to confirm. # → Setting is saved

Save the settings

5.7.3 Enroll wireless siren

Example:

press [*] and hold on for 3S

* → 9 8 7 6 # → 5 # → 7 # Enrolling, please wait

Press the [SAVE] key of the wireless siren till the panel and siren sound at the same time, press back key to exit

5.8 Set zone attribution

Press [*]3seconds+[9][8][7][6]+[#]+[6][#], then operate follow the voice indication.

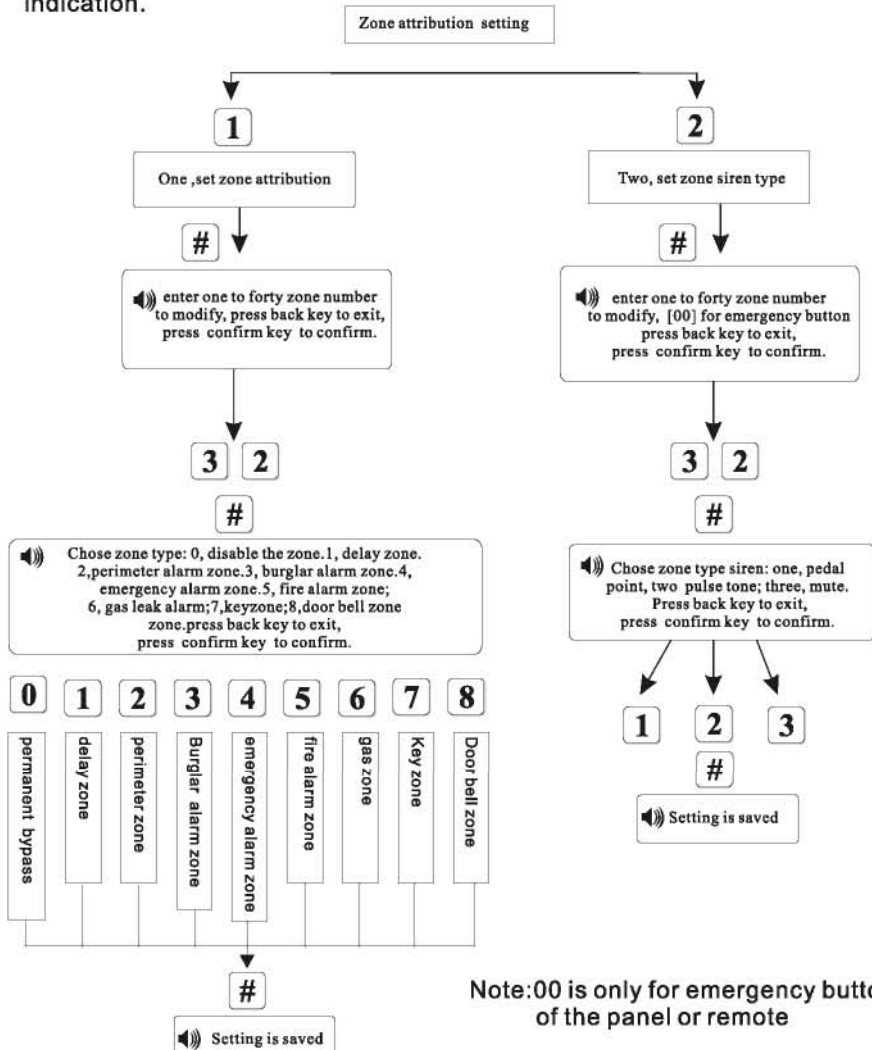

Key zones: only for wired zones(33-40), used for access control. when set as key zones, the burglar function will be disable.

Doorbell zones: only for wireless zones(01-32).Under home arm/away ar m status, triggerthe doorbell zone will report delay alarm. Under disarm status, trigger the doorbell zone will sound ringing tone.

Wiring method of key zones

1.N.C.

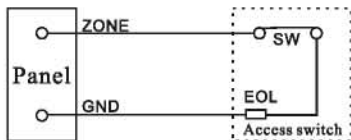

2.N.O.

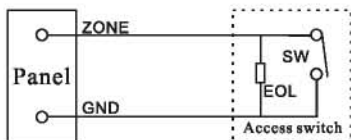

Key zones:

(33-40) wired zones can be programmed as key zones, Press * and hold for 3 seconds, enter administrator password [#]+[6][#]+[1][#]+[zone number]+[#]+[7][#].

When the zone is programmed as key zone, the panel status will be same as current key zones status when power on instead of rest oring to the status before power off. If there is more than one key zones, then the panel status will be the same as the key zones with maximum number.

User can program the zone type, when the zone is triggered, the panel will report the preset zone type information of triggered zone to CMS.

Hint: When the zone type is programmed as 0, that means the zone is disabled/bypassed.

Zone:zone wiring terminal
 GND:common terminal
 SW:switch
 Eol:resistor

Notes: Open circuit is to arm automatically. Disarm when zone is in normal status.

5.9 Set timing operation

Press [*]for 3 seconds+[9][8][7][6]+[#]+[7#], then operate according to the voice indication.

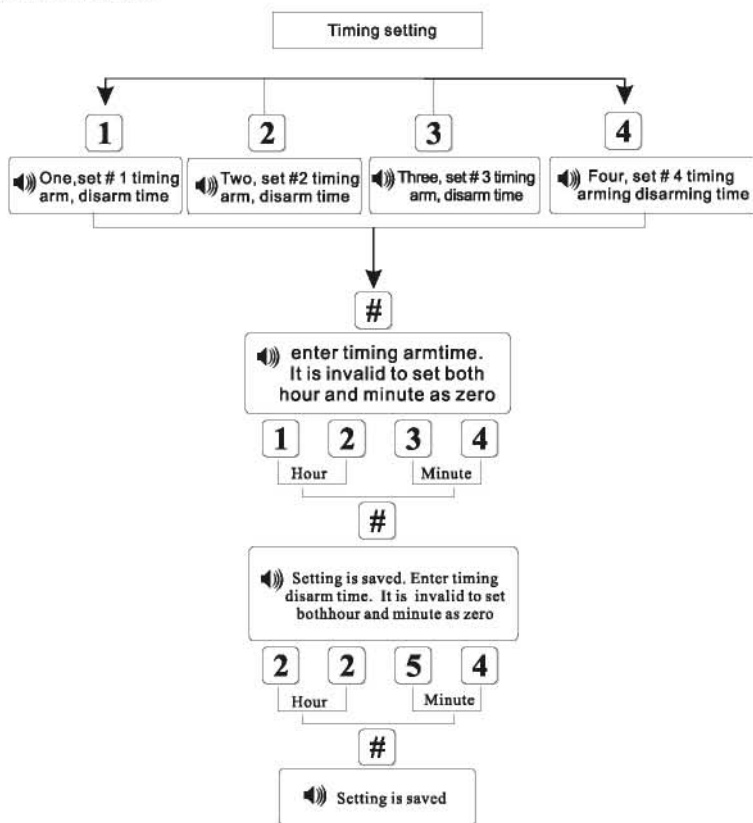

Example: Set timing arm at 6:50 AM , timing disarm at 8:35 PM.(Enable set total 4 groups of timing arm/disarm time)

Press[*] and hold on for 3S

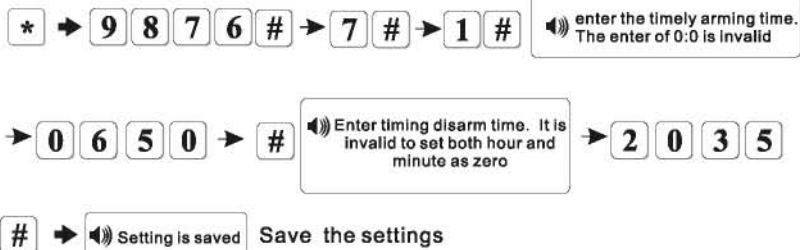

Hint: 4 groups of timing arm/disarm can be set according to the schedule of user

5.10 System maintenance

Press [*]and hold for 3 seconds+[9][8][7][6]+[#]+[8#], then operate follow the the voice indication.

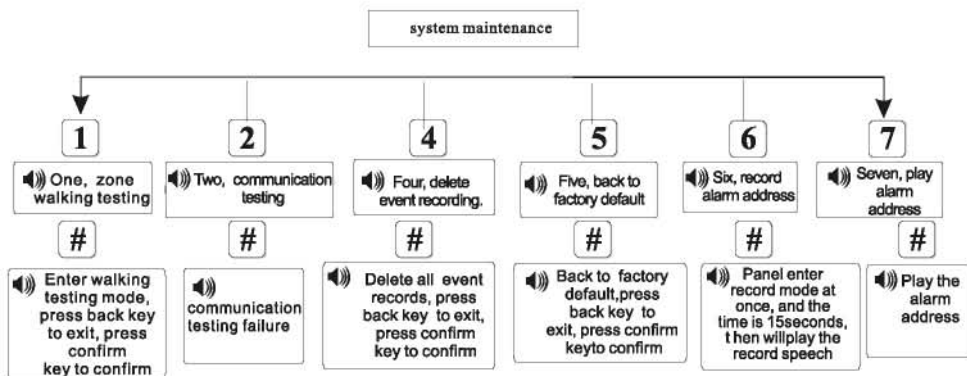

Chapter V alarm and receive alarm

6.1 Only the zone type witch is set to be burglar alarming or perimeter alarming is controlled by the operation of away-arming, home-arming/ disarming. Other zone types are on the statu of the 24 hours valid. If spring alarming, the types of burglar alarm, perimeter alarming and self-defining alarming will alarm after a delay time, but the other types will immediately alarm through dial-up.

6.2 The panels adopt Contact ID for the communication protocol to send the alarming information to the center. If the panel receive the acknowledgement from center, then a successful alarm, if not, the panel will alarm repeatedly .alarming information can be displayed and resolved by the software of center computer.

6.3 If trigger the detector alarming, the corresponding panel will sound warning tone, at the same time, the number of springing zone and alarming type can display on the LCD. If there is no disarming operation during this time, after the warning time, the panel will dial the receiving alarm phone number. You can hear the voice information of the alarming place while listening the phone. If after 10S, there is no alarming disposal operation or other self-defining key, then the alarm process will go on. When the receiving call is connected and the user operate on the panel, if not press key [2] to release alarming, then the panel will go on to dial-up alarm with the other set number.

Chapter VI Technical specification

7.1 General data

- 1 area data: 8 wired areas, 32 wireless zones, 8 remote controllers
- 2 Zone type: robbing alarm, thief alarm, gas leak alarm, ambulance alarm, self-defined alarm, fire alarm and boundary alarm events
- 3 Frequency: 433MHz
- 4 Signal transmit distance: 100 to 150 meters (open area)
- 5 Power supply: 12V/500mA
6. Built-in rechargeable battery: 7.2V/500mAh
7. Main machine static current: 40mA/12v (exclude wire detector current)
8. Main machine alarming current: <250mA/12v (exclude high siren current)
9. Main machine 12v maximum output current: $\leq 100\text{mA}$ for wired detectors
10. Recording time: 15s
11. Frequency: $433\text{MHz} \pm 0.5\text{MHz}$ (868MHz one is different)
12. The trigger delay of wired zones: $\geq 100\text{ms}$
13. The method of alarming dial: DTMF
14. DTMF dial frequency variation : < 1.5%
15. Communication Protocol with CMS: Ademco Contact ID

7.2 Physical Performance

Operation temperature range: 32°F to 120°F (0°C to 45°C)

Storage temperature range: -4°F to 140°F (-20°C to 60°C)

Relative humidity: 85% at 30°C (86°F)

Dimensions: 166*115*30mm

Weight: 430g

Color: white

Chapter VII Maintenance

8.1 Regular test

Design of components of the system is to reduce maintenance cost, but still it is suggested that periodical check may be carried out.

8.2 The cleanliness of control main machine

Main control panel maybe be stained by fingers or covered by dust after using for a while. Use soft cotton cloth or sponge to clean it. Don't use any lubricant, liquor such as kerosene, acetone and strong gel which will damage appearance and the transparency of top window.

ATTENTION: Don't use any lubricant, liquor such as kerosene, acetone and strong gel which will damage appearance and the top transparency of window.

Chapter VIII Limitation of the Products

Although the products is a high standard products, there is also some limitation of them such as false alarm or no alarm, the reasons may be below:

Lack of Maintenance. The system needs maintenance and test regularly test. The sensitive of the detectors may decrease and the siren may not whistle.

Lack of power supply If no power input and the back up power is not enough, the panel can not work normally.

Telephone Line False If the telephone line is cut, the panel could not send alarm signals

Limitation of Smoke Detectors if the smoke is far from the smoke detector, the detector could not alarm

If the intruder break in through some door or window not monitored, or some one knows hot to make the system not work,

FCC WARNING

Changes or modifications not expressly approved by the party responsible for compliance could void the user's authority to operate the equipment.

This equipment has been tested and found to comply with the limits for a Class B digital device, pursuant to Part 15 of the FCC Rules. These limits are designed to provide reasonable protection against harmful interference in a residential installation. This equipment generates uses and can radiate radio frequency energy and, if not installed and used in accordance with the instructions, may cause harmful interference to radio communications. However, there is no guarantee that interference will not occur in a particular installation. If this equipment does cause harmful interference to radio or television reception, which can be determined by turning the equipment off and on, the user is encouraged to try to correct the interference by one or more of the following measures:

- Reorient or relocate the receiving antenna.
- Increase the separation between the equipment and receiver.
- Connect the equipment into an outlet on a circuit different from that to which the receiver is connected.
- Consult the dealer or an experienced radio/TV technician for help

This equipment complies with Part 68 of the FCC rules. Located on the equipment is a label that contains, among other information, the ACTA registration number and ringer equivalence number (REN.) If requested, this information must be provided to the telephone company.

The REN is used to determine the quantity of devices which may be connected to the telephone line. Excessive REN's on the telephone line may result in the devices not ringing in response to an incoming call. In most, but not all areas, the sum of the REN's should not exceed five (5.0). To be certain of the number of devices that may be connected to the line, as determined by the total REN's contact the telephone company to determine the maximum REN for the calling area.

This equipment cannot be used on the telephone company-provided coin service. Connection to Party Line Service is subject to State Tariffs.

If this equipment causes harm to the telephone network, the telephone company will notify you in advance that temporary discontinuance of service may be required. If advance notice isn't practical, the telephone company will notify the customer as soon as possible. Also, you will be advised of your right to file a complaint with the FCC if you believe it is necessary.

The telephone company may make changes in its facilities, equipment, operations, or procedures that could affect the operation of the equipment. If this happens, the telephone company will provide advance notice in order for you to make the necessary modifications in order to maintain uninterrupted service.