

ST-IVB USER MANUAL



P/N 20120525-1

Brief

Dear customer:

Congratulations on purchasing your new security system. Thank you for the confidence you have shown in us. You have chosen a high-quality product that has been produced, tested and packed with the greatest care.

Please familiarize yourself with these instructions before attempting to install the security system because prolonged reliable and trouble-free operation will only be sure if it is fitted properly. We hope your new security system will bring you lasting pleasure.

Content

Accessories	1
Chapter I Introduction	2
1.1 Function introduction	2
1.2 About panel	5
1.3 About I CON	5
Chapter II installation and connection	6
2.1 Open the item Box	6
2.2 Installation of control panel	6
2.3Wiring	7
2.4 Install wired detector	8
2.5 Intall wireless detector	8
Chapter III easy setup and operation	9
3.1 Factory default setting	9
3.2 Basic setting and operdtion	11
3.3 Alarm receiving phone control	12
3.4 Remote phone control	12
3.5 Alarm center	13
3.6 Alarm proctdure	13
3.7 Telephone line off alarm	15
3.8 Anti-taper function	15
3.9 Event recording and inqaivy	15
3.10 Easy operation	17

Chapter IV User setting	18
Chapter V system setting	19
5.1 Setting	19
5.2 Setting on main menu	19
5.3 Set password	20
5.4 Set centre monitoring station	22
5.5 Set voice alarm receiving phone number	23
5.6 System setting options	24
5.7 Enroll wireless device	29
5.8 Set zone attribution	32
5.9 Set timing operation	34
5.10 System main tenance	36
Chapter VI alarm and receive alarm	37
Chapter VII technical specification	38
Chapter VIII maintenance	39
Chapter IX limitation of the products	39

Accessories

Before installation please check if the whole set including the components as follow:

◆ ST-IVB series alarm panel	1PC
◆ Wireless detector	1PC
◆ Wireless door sensor	1PC
◆ Wireless remote	1PC
◆ Adaptor	1PC
◆ Book manual	1PC
◆ Resistor 10K	8PCS
◆ Screws and Plastic dowels	6PCS

Chapter I Introduction

1.1 Function Introduction

1. With voice indication all around the operation.
2. LCD screen indication.
3. Total 32 wireless zones: each zone enable learn code automatically or enter code manually on the keypad. The panel compatible with all our made wireless device.
4. Total 8 wired zone, connect resistor on wired zone terminal to achieve N.O. or N.C. alarm.
5. Enable enroll total 8 wireless remote, 8 electronic switch, 1pc of wireless doorbell and Unlimited for quantity of one way wireless siren.
6. Zone programmable: Before products left factory, will programme alarm type and delay or instant for each zone as factory default. User can modify the settings.
7. Enroll wireless device: wireless detector and remote via auto enroll code or enter address code manually. User enable enroll / delete detector , remote separately or enroll / delete all simultaneously.
8. Six follow me phone # (voice alarm receiving phone #), two for CMS , four for private alarm receiving.
9. Clock and event list: built-in clock, can be set according to local time.
10. Status inspection function: Enable record and inquiry 120 alarm event messages.
Like the time when happens anti-tamper alarm, detector alarm, tel-line off, arm, disarm, system setting, battery low voltage etc. And also can inquiry the zone number and alarm type.
11. Password operation : Administrator password mainly for system administrator to program the system. User password for user make common operation, like arm, disarm system, remote control. Both Administrator password and user password can be modified.

12. In Central Monitoring System according to quantity of users, user can set 4 ,6 or 8 digit user code.
13. Alarm type auto identify: after alarm triggered, on the LCD scree will display alarm zone #, alarm type, alarm icon. When connect to CMS, panel will report details of alarm to CMS.
14. Compatible with CMS machine: support Contact ID. Report alarm to CMS. Report arm/disarm t o CMS optional.
15. Remote control: Enabel via tel phone to achieve remote control system like: arm, disarm , listen to the spot, trigger siren, switch on/off electronic appliance etc.
16. vandal-proof function: If try to cut off the wire between wired detector and panel or cut off the tel line which connect to the panel will make alarm.
17. Anti-tamper function: when someone try to remove panel deliberately panel will make alarm immediately.
18. Timing arm/disarm: Enable set 4 group time arm/disarm time.
19. Timing testing: At preset time, panel will send signal to CMS to test the panel on-line status.
20. Siren : The panel with built-in siren, it can also enroll extension wireless siren. Both can be settled on/off when alarming.
21. Follow-me number. The pane dials preset follow-me number to report alarm message
22. Voice indication volume enable adjust on the switch.
23. Electronic appliance control: Enable remote inquiry and control the on/off status of electronic appliance. And also enable to switch on/off manually electronic appliance.

24. Wired/wireless zone real time monitoring: active the real time monitoring function , then if zone with trouble when doing arm/disarm operation the panel will indicate zone fault.
25. Wireless signal repeat function: via our made wireless repeater panel enable to receive signal from wireless detector from a long distance.
26. Wireless detector low battery real time warning: if wireless detector low battery,it will send signal to panel every one or two hour or when alarm happens,panel will sound dee dee , and on the LCD screen, low battery icon and zone number will display. And panel will also report to the CMS and preset follow me phone #.
27. Tel-line off and wireless transfer function: panel make alarm or under arm status, but find out that Tel line off, panel will send signal to preset neighbour panel, and the neighbour panel report alarm instead.
28. Enable the panel sire by pressing the emergency key on the panel or the remote
29. To set built-in siren enable or disable when presspanic button on remote or panel keypad , please refer to adaptor 5.8.
30. Require user password before enter remote control.

1.2 About panel



1.3 About ICON

[#] OR **1**

Key operation



LCD display



Speech indication



Cautions



Indication

Chapter 2 Installation and Connection

2.1 Open the Item Box

Open the package to check the no accessories missing in the list. If missing accessories , please contact the distributor.

2.2 Installation of control panel

An obvious feature of the ST-IVB is that it can be installed without open it. User just need to connect several wires on the back of the panel.

1.Remove the bracket on the back of the panel.

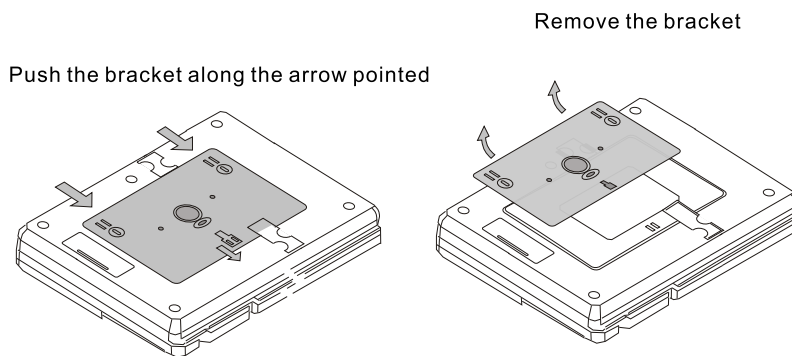

2.Drill a hole on the wall and fixed the bracket on the wall.

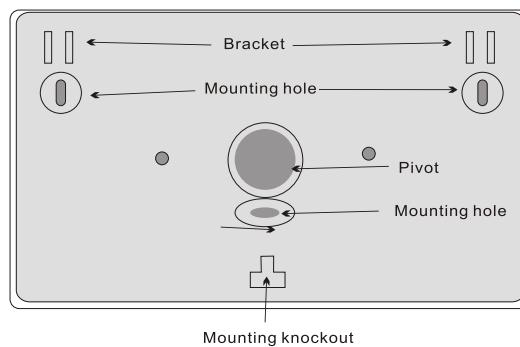

As picture shows: hang the panel on the bracket

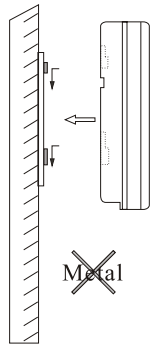

1. There should be no large metal goods around the control.
2. Make sure the distance between the control panels and detectors is valid. And it is better to put the control panel in a covert place.

2.3 Wiring

As picture:

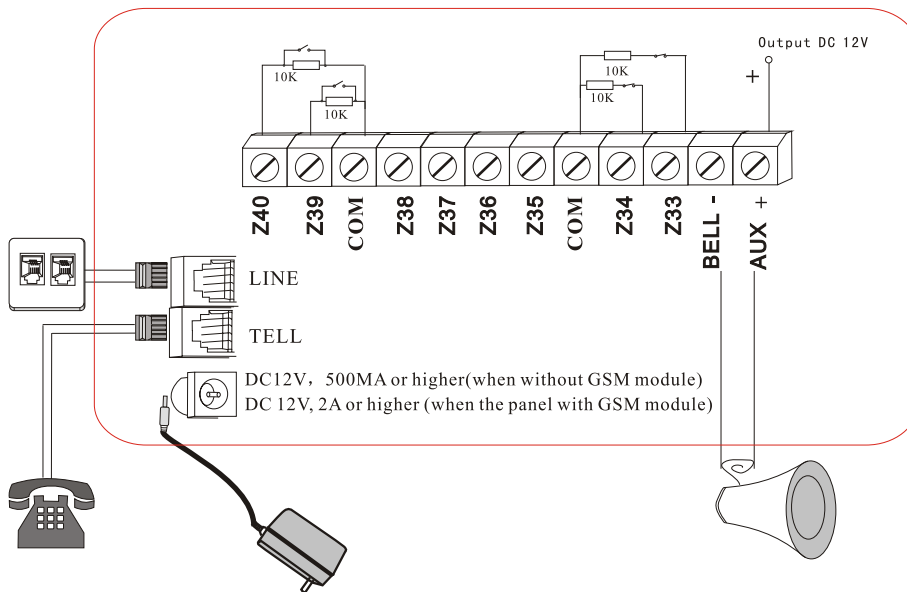

Here only introduce the zone #33,34,39,40. The other zone connect the same way.

2.4 Install wired detector

- 2.4.1 The wired zone is on bypass status as factory default. If the user needs to use wired zones, please activate them first. When the wired zone is fault, if the user arms the system, the user will hear "Operation failure, zone trouble". The LCD screen will display the fault zone number + 0 (zone open loop: zone #+0; zone close loop: zone #+5), under this status please do not arm the system.
- 2.4.2 The control panel can power 12V, 100mA to detectors. The maximum current that can be powered to wired detectors is 100mA. Do not exceed 100mA, otherwise please adopt extra 12V backup power.

2.5 Install wireless detector

- 2.5.1 As the detector's manual says, install the coded detector in the area 150m from the control panel. Please test and make sure the detector can work with the control panel normally.
- 2.5.2 Wireless repeater function: when the wireless detector is too far from the panel or there are some occluders between the panel and the detector which disable the panel from receiving the signal from the wireless detector. Now you can choose our made wireless repeater to achieve wireless signal relay transmitting.

Chapter III Easy setup and operation

3.1 Factory default setting

Below are factory default of ST-IVB control panel you can keep the default setting or modify .

- ☆ Administrator password: 9876
- ☆ user password: 1234
- ☆ Entry and exist delay: 10s
- ☆ Monitoring time: 10s
- ☆ Cycle dial out to make alarm: 5 times
- ☆ Ringing times to pick phone call automatically: 7 times
(after ringing 7 times the panel will take the phone call automatically)
- ☆ TEL-line cut-off inspection function effective .
- ☆ Arm/disarm message report to CMS function ineffective.
- ☆ Timing arm/disarm option ineffective
- ☆ Auto arm/disarm time, CMS timing inspection time both are zero.
- ☆ Alarm type of siren whistle during alarm all the time: burglar alarm, perimeter alarm fire alarm, gas leak alarm and user defined alarm type.
- ☆ All phone number and user code are empty.
- ☆ Siren type of panic zone is silent
- ☆ Wired zone is disabled

zone default set

zone	zone type	siren ring
01	delay	Yes
02	burglar	Yes
03	burglar	Yes
04	perimeter	Yes
05	perimeter	Yes
06	emergency	Yes
07	fire	Yes
08	gas	No
09-32	burglar	Yes

Burglar zone: it is effective only under away arm status, ineffective under disarm and home arm status.
Perimeter zone, delay zone, it is effective under arm status, ineffective under disarm status. Gas leak, fire, emergency zone: it is effective under any status.

Door bell zone: Give ringing tone when trigger under disarm status. Make alarm when trigger under arm status(report delay alarm) We suggest only set the delay zone on entrance or exit

(This function fit for all 40 zones, set the zone attribution as doorbell zone)

special doorbell zone: this function is only fit for # 32 zone. Enroll a wireless device to zone #32, then set the zone attribution as doorbell zone. then enter the command: 858511#. When trigger the #32 zone, pannel and siren will only give ringing tone under both arm and disarm status.

Considering the convenience of user, the factory default can meet most users' requirement. So, common user only need to proceed easy setting.

☆Zone trouble indication;







zone+ “0” ——zone opentcircuit trouble

zone+ “5” ——zone shortcircuit trouble

zone+ battery icon+8—— low voltage on detector trouble

zone+ “L” —— wireless detector loss trouble

★means of icon displayed on LCD:

Icon	Meaning	Icon	Meaning
	Home arm		Away arm
	Telephone line fault		Disarm
	Batter low		Alarm
			Alarm information is reporting

★alarm status code

01	Delay	06	gas leak
02	perimeter	07	tamper
03	burglar	08	disarm
04	emergency	09	away-arm
05	fire alarm	10	home-arm

3.2 Basic setting and operation

Indication LED

Arm: Normal on under away arm, blink under home arm.

Disarm: Light on under disarm status, light off under disarm status.

12V : Light on when AC power connect, light off when AC power off.

Alarm: Blink when alarming.

★ Basic setting

Before left factory, in whole kit, the panel had already code with all remote, magnetic contact, PIR detector..

Press *key for 3seconds, then enter administrator password[9876] to enter system setting. For each menu press # to enter and press back key to exist. When enter main menu, panel will sound all menu options one time, then user can press corresponding number or press up, down to to the option you want, then press # to enter setting, then press # or confirm key to save setting. When hear [setting saved] means setting successfully otherwise setting failure. On the key button under LCD screen, there are four button with function [away arm, home arm, inquiry, panic] under normal status, but when under setting status the four button separately with following function [back, up, down, confirm]. The key on numeric keyboard, numbers for user to enter numbers and [*] for delete, [#] for confirm.

Under panel stanby status press disarm button for 3s for emergency help.

★BasicOperation:

Power on/off--When power on AC, backup battery will get ready automatically. When AC power off for 20seconds and enter [1234#] to disarm the system, press and [#]key and hold on for 3seconds will turn off the backup battery. When battery voltage reduce to 8.5v, system will turn off automatically to protect battery.

System setting-- press [*]and hold on for 3 seconds+administrator password +[#]key;

Disarm the system -- user password +[#];

Shorcut operation: numeric key 1-8 separately correspond to 8 electronic switch. Press the numeric key and hold on for 3seconds will switch on/off the corresponding electronic appliance.

General operation:

press and hold on key"0"for 3seconds to enter electronic appliance setting mode switch on/off electronic appliance.

press and hold on key"0"for 3seconds to enter electronic appliance setting mode inquiry on/off status of electronic appliance.

press and hold on key"0"for 3seconds to enter electronic appliance setting mode set timing on/off electronic appliance.

The panel will sound voice indication of setting options anytime entering any menu. Change to neighbour option via "up" and "down"key.

3.3 Alarm receiving phones operation

When the detector is triggered, the panel will sound alarm and display the triggered zone number and alarm type on the LCD screen. **If the zone is delay zone, the panel will give pre-alarm dee dee sound before make alarm, if user do not disarm during the pre-alarm period, the panel will whistle and dial alarm receiving phone #)** When the panel dial the alarm receiving phone #, but user does not answer or get the call connected but make ineffective operation, the panel will continue the alarm reporting. After the phone call get connect, user make effective operation but do not press 1 to cancel alarm or press 0 to hang up, the panel will call other pre-set phone #.

Alarm receiving

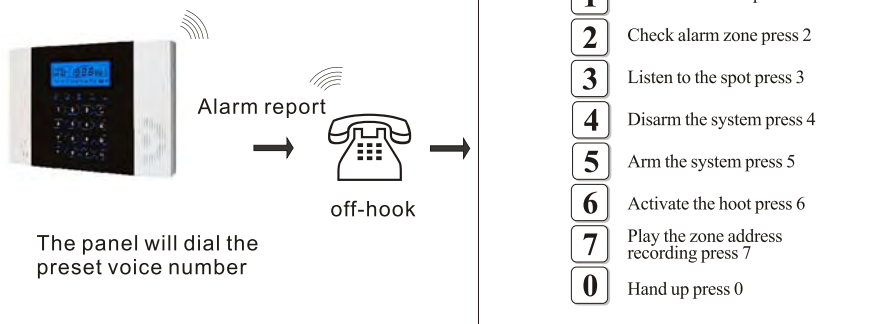

3.4 Remote phone control

User can remote control the system by phone call. After the preset ringing times then panel will off hook the phone then enter the 4 digit user codes according to voice prompting and operate as per the voice prompting.

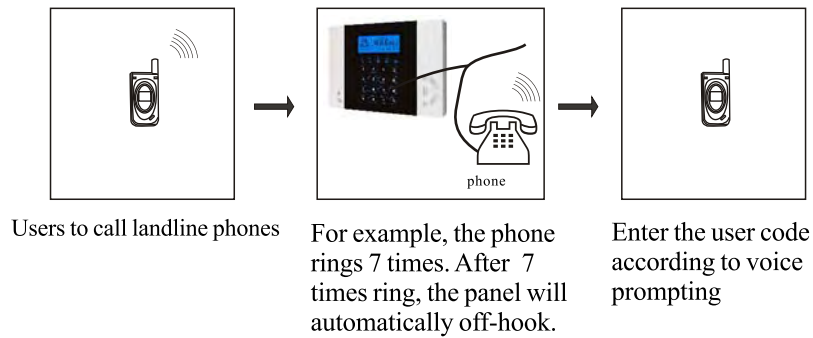

 alarm system welcome your calling, please input your password.

X X X X → 4.digital user password

- 1** System arm, press1
- 2** system disarm, press2
- 3** inquiry the system status press 3
- 4** listen to the spot
- 0** hang up , press 0

3.5 alarm center

The panel use the Ademco Contact ID to sent alarm information to the alarm center. If the panel got the conformation from the center ,then alarm successfully. Or the panel will repeat alarm (the max times re-dialing the center number is 5). Alarm information will be display and resolve by the alarm center computer software.

3.6 alarm procedure

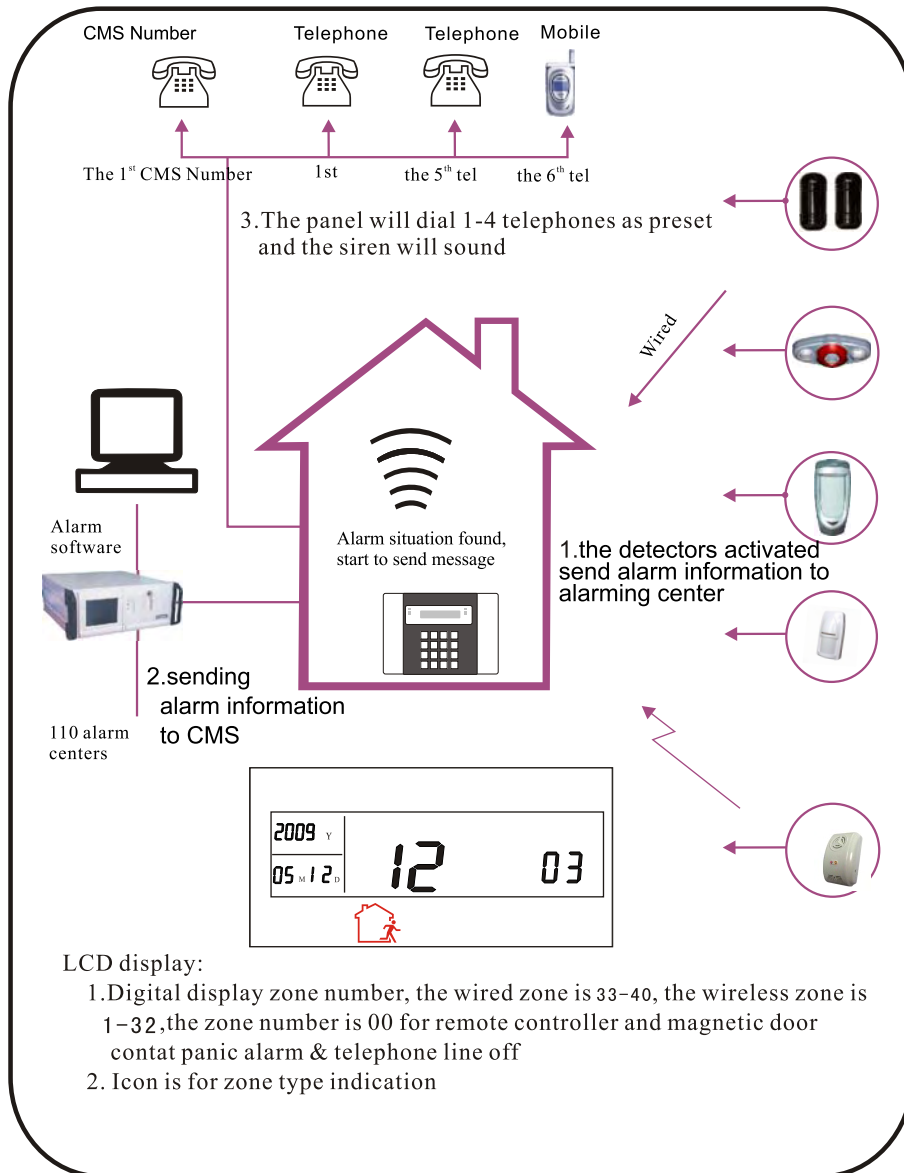

3.7 Telephone line off alarm

If tel-line off check function is effective, when system under arm status, the siren will whistle as soon as the tel-line cut off. Under disarm status, The panel will give voice to tell telephone line cut off for 60 seconds. And if the tel-line connected again or disarm the system this indication voice will stop. Otherwise, the siren whistle for 5 minutes. And at then same time, the panel will send alarm signal to a neighbour panel.

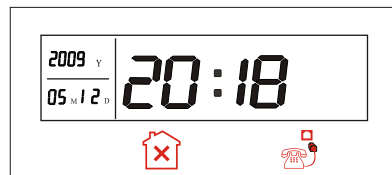

3.8 Anti-tamper function.

1. When the control panel receive a message that the wireless magnetic contact is oping, the panel will solve this as a burglar alarm.(up to the status code, and alarm type). Just after close the door or windows , and panel receive the signal of magnetic contact closed. The panel will then solve the anti-tamper alarm.
- 2.The display of tamper alarm on the LCD: the zone number , and the status code: 14 for the icon is burglar.

3.9 Event recording and Inquiry

3.9.1 Event record

Arm, away arm, home arm, disarm and other information can be recorded by the control panel.

When the battery of Wireless detector (include magnetic contact) is under voltage, the detector can know when it make timing self-testing, and send signal to the control panel, then the control panel will give indication voice to tell detector under voltage, and display on the LCD

The panel also will send message to the CMS and call the alarm receiving phone number to remind the system manager and user to change battery.