



**Klipsch**<sup>®</sup>  
REFERENCE

**RSB-6**

## TABLE OF CONTENTS

- 1-2 - INSIDE
- 3-4 - SOUNDBAR
- 5 - SOUNDBAR PLACEMENT
- 6 - CONNECTIONS - HDMI-ARC
- 7 - TURN HDMI CEC ON
- 7 - TURN OFF TV SPEAKERS
- 8 - CONNECTIONS - DIGITAL OPTICAL
- 9 - CONNECTIONS - 3.5MM AUXILIARY
- 10 - SUBWOOFER PLACEMENT
- 11 - SUBWOOFER WIRELESS CONNECTION
- 12 - SUBWOOFER RECONNECT
- 13-14 - REMOTE
- 15-16 - SURROUND MODES
- 17-18 - **BLUETOOTH®** WIRELESS TECHNOLOGY
- 19-20 - TV REMOTE PROGRAMMING
- 21 - REMOTE CONTROL CODES
- 22 - LED ON/OFF
- 23 - FACTORY RESET
- 23 - CARE AND CLEANING

## INSIDE

CONTENU • CONTENIDO • INHALT • CONTENUTO • CONTEÚDO • 目录

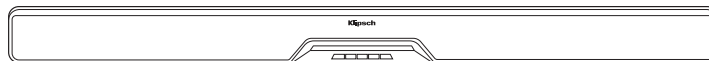

Soundbar

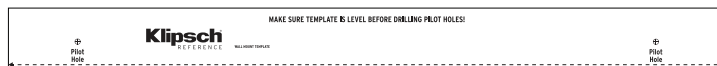

Wall-Mount Template



Subwoofer



Remote

<p><b>Soundbar</b></p> <p>Barre de son Barra de sonido Soundbar SoundBar Barra sonora 条形音箱</p>	<p><b>6.5" Subwoofer</b></p> <p>Caisson de graves Subwoofer Subwoofer Subwoofer Subwoofer 低音炮</p>	<p><b>Wall-Mount Template</b></p> <p>Gabarit de montage mural Plantilla de montaje en la pared Wandbefestigungsschablone Dima per il fissaggio a parete Modelo para instalação na parede 挂壁模板</p>	<p><b>Remote</b></p> <p>Télécommande Control remoto Fernbedienung Telecomando Control remoto 遥控器</p>
--	---	---	--

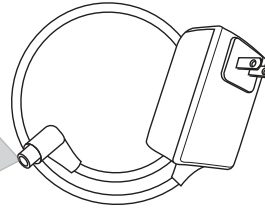
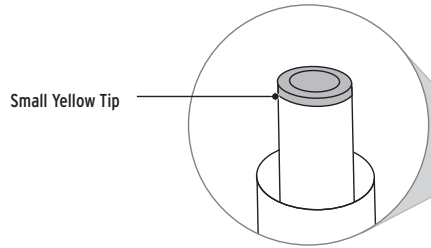

**DC Power Cord -  
Soundbar**

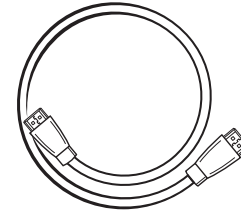

**HDMI Cable**

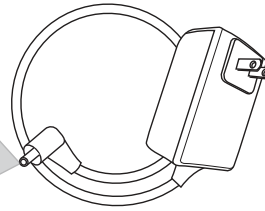
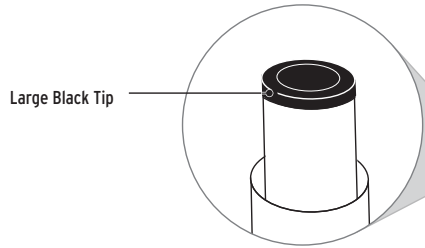

**DC Power Cord -  
Subwoofer**

International Adapters Included.  
 Adaptateurs Internationaux Inclus.  
 Contiene Adaptadores Internacionales.  
 Internationale Adapter Im Lieferumfang Enthalten.  
 Sono Inclusi Adattatori Internazionali.  
 Adaptadores Internacionais Incluídos.  
 中国出售的产品不包括国际电源适配器

<b>Large Black Tip</b>	<b>Small Yellow Tip</b>	<b>DC Power Cord</b>	<b>HDMI Cable</b>
Grand embout noir Punta grande negra Große schwarze Spitze Punta nera grande Ponta preta grande 黑色粗端	Petit embout jaune Punta pequeña amarilla Kleine gelbe Spitze Punta gialla piccola Ponta amarela pequena 黄色细端	Cordon d'alimentation c.c. Cordón de alimentación de CC Gleichstromkabel Cavo di alimentazione CC Cabo de alimentação de CC 直流电源线	Câble HDMI Cable de HDMI HDMI-Kabel Cavo HDMI Cabo HDMI HDMI 电缆

# SOUNDBAR

BARRE DE SON • BARRA DE SONIDO • SOUNDBAR • SOUNDBAR • BARRA SONORA • 条形音箱

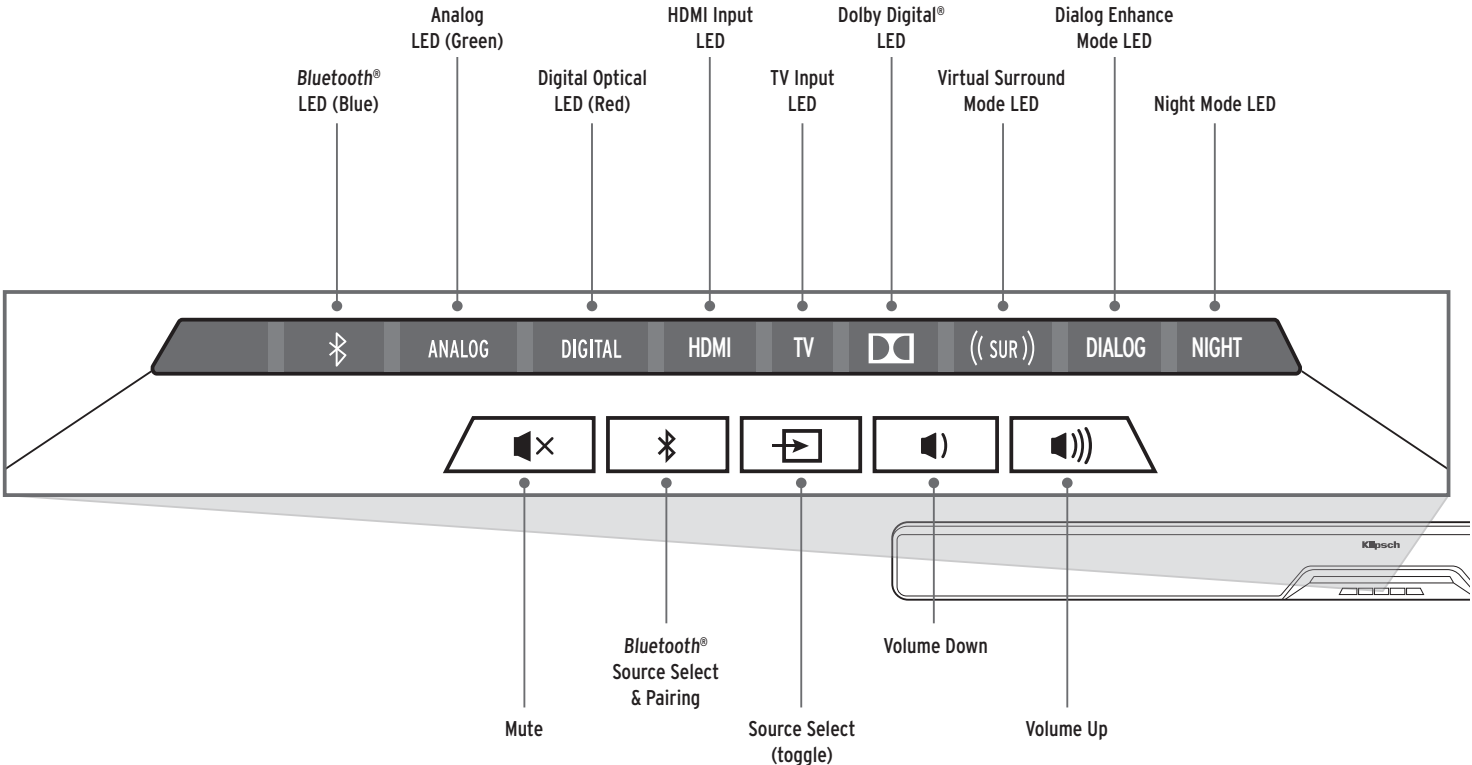

<b>Mute</b> Sourdine Silenciador Stummschaltung Disattivazione audio Desativar áudio 静音	<b>Bluetooth® Source Select &amp; Pairing</b> Sélection de la source Bluetooth® et appariement Selección y vinculación de fuente Bluetooth® Bluetooth®-Quellenwahl und Pairing Selezione e associazione segnale Bluetooth® Seleção e emparelhamento de fonte Bluetooth® Bluetooth® 电源选择与配对	<b>Source Select (Toggle)</b> Sélection de la source (commutation) Selección de fuente (cíclica) Quellenwahl (Umschalten) Selezione segnale (in sequenza ciclica) Seleção da fonte (Alternar) 电源选择 (切换)	<b>Volume Down</b> Volume bas Bajada de volumen Leiser Riduzione volume Diminuir o volume 音量减小	<b>Volume Up</b> Volume haut Subida de volumen Lauter Aumento volume Aumentar o volume 音量增大
---	--	---	--	---

<b>Bluetooth® LED (Blue)</b> DEL Bluetooth (Bleu) LED de fuente Bluetooth (Azul) Bluetooth-LED (Blau) LED segnale Bluetooth (Blu) LED do Bluetooth (Azul) 蓝牙 LED 灯 (蓝色)	<b>Analog LED (Green)</b> DEL Analogique (Vert) LED de fuente analógica (Verde) Analog-LED (Grün) LED segnale analogico (Verde) LED analógico (Verde) 模拟 LED 灯 (绿)	<b>Digital Optical LED (Red)</b> DEL Optique numérique (Rouge) LED de fuente óptica digital (Rojo) Digital-optische LED (Rote) LED segnale ottico digitale (Rosso) LED ótico digital (Vermelho) 数字光学 LED 灯 (红)	<b>HDMI 1 LED (White)</b> DEL HDMI 1 Indicador LED de HDMI 1 HDMI-1-LED LED HDMI 1 LED HDMI 1 HDMI 1 LED
---	--	--	--

<b>TV Source LED</b> DEL Source TV Indicador LED de fuente de TV TV-Quellen-LED LED segnale TV LED de fonte - TV 电视电源 LED	<b>Dolby Digital LED</b> DEL Dolby Digital LED de Dolby Digital Dolby-Digital-LED LED segnale Dolby Digital LED Dolby Digital 杜比数字 LED 灯	<b>Virtual Surround Mode LED</b> DEL Mode ambiophonique virtuel LED de modalidad de surround virtual LED Virtueller Surroundmodus LED modalità surround virtuale LED do modo surround virtual 虚拟环绕声模式 LED 灯	<b>Dialog Enhance Mode LED</b> DEL Mode d'égalisation d'accentuation vocale LED de modalidad de equalización de mejoramiento de voz LED EQ-Modus für verbesserte Stimmen LED modalità equalizzatore potenziamento vocale LED do modo de EQ de melhoria de voz 音效增强均衡器模式 LED 灯	<b>Night Mode LED</b> DEL Mode nocturne LED de modalidad nocturna Nachtmodus-LED LED modalità notturna LED do modo noturno 夜间模式 LED 灯
---	--	---	---	---

# SOUNDBAR PLACEMENT

POSITIONNEMENT DE LA BARRE DE SON • UBICACIÓN DE LA BARRA DE SONIDO • SOUNDBAR-PLATZIERUNG • COLLOCAZIONE DEL SOUNDBAR • POSIÇÃO DA BARRA SONORA • 条形音箱布置

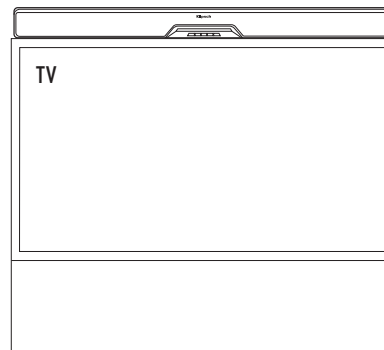
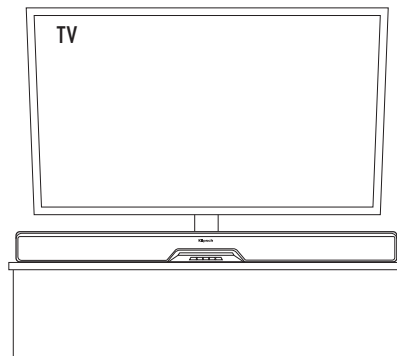
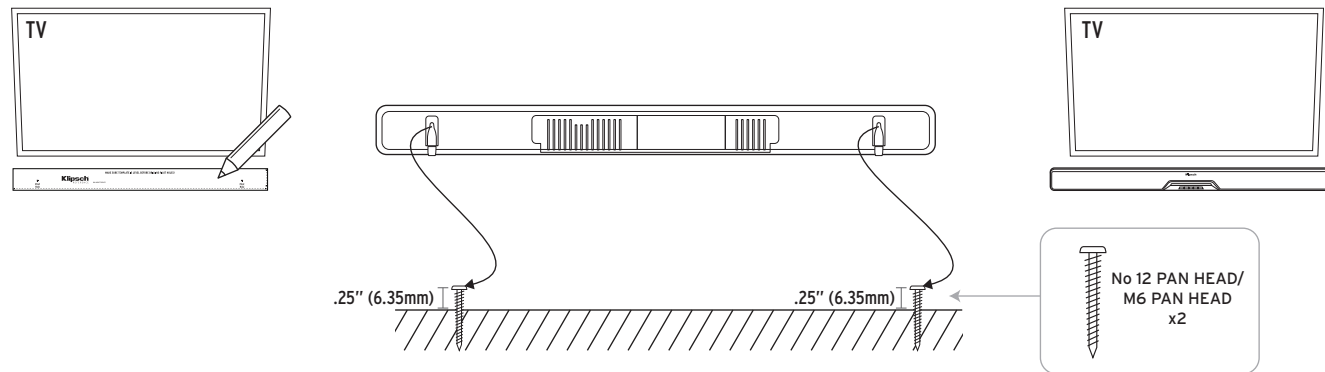

# CONNECTIONS - HDMI-ARC

CONNEXIONS - HDMI-ARC • CONEXIONES - HDMI-ARC • ANSCHLÜSSE - HDMI-ARC • CONNESSIONI - HDMI-ARC • CONEXÕES - HDMI-ARC • 连接 - HDMI-ARC

A Basic TV HDMI input will not transfer the TV audio signal to the Soundbar. The RSB-11 Soundbar will only receive TV audio through HDMI-ARC (with CEC turned ON), Optical or Analog connection.

Une entrée TV HDMI de base ne transférera pas le signal audio TV vers la barre de son. La barre de son RSB-11 ne recevra l'audio TV qu'au moyen d'une connexion HDMI-ARC (avec CEC sur MARCHÉ (ON)), Optique ou Analogique.

Una entrada básica de HDMI de una TV no transfiere la señal de audio de la TV a la barra de sonido. La barra de sonido RSB-11 solo recibirá el audio de la TV a través de una conexión óptica o análoga de tipo HDMI-ARC (con el CEC encendido).

Ein einfacher HDMI-Eingang kann das TV-Audiosignal nicht an die Soundbar übertragen. Die RSB-11 Soundbar kann das TV-Audiosignal nur über HDMI-ARC (bei aktiviertem CEC), eine optische oder analoge Verbindung empfangen.

Il normale input televisivo HDMI non permette di trasmettere i segnali audio televisivi alla soundbar. La soundbar RSB-11 riceve i segnali audio televisivi soltanto dai connettori HDMI-ARC (con CEC impostata su ON), ottici o analogici.

Uma entrada HDMI TV básica não transfere o sinal de áudio da TV para a barra de som. A barra de som RSB-11 recebe áudio da TV somente através de uma conexão HDMI-ARC (com CEC ligado), óptica ou analógica.

一个基本的电视 HDMI 输入端不会将电视音频信号传送到声霸扬声器。RSB-11 声霸扬声器只能通过 HDMI-ARC (CEC 打开状态下) 接收电视音频、光学或类比信号。

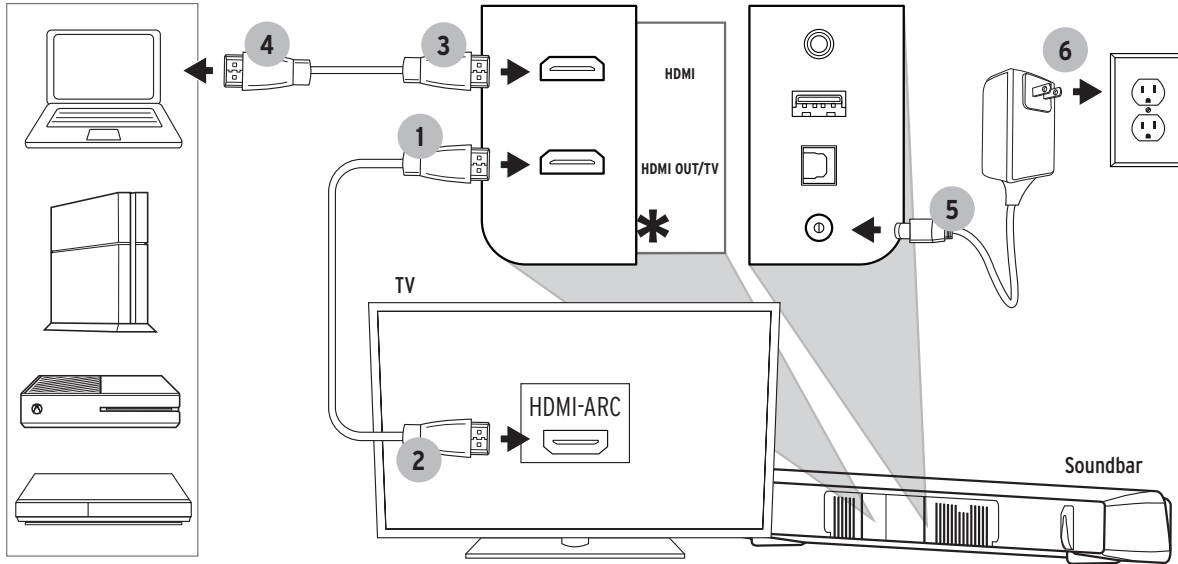

## TURN HDMI CEC ON (OFF BY DEFAULT)

ALLUMER HDMI CEC (ÉTEINT PAR DÉFAUT) • ACTIVACIÓN DEL CEC DE HDMI (PREDETERMINADAMENTE DESACTIVADO) • HDMI-CEC EINSCHALTEN (NORMALERWEISE AUS) • ATTIVAZIONE DI HDMI CEC (DISATTIVATA PER IMPOSTAZIONE PREDEFINITA)  
 COMO LIGAR O HDMI CEC (DESLIGADO POR PADRÃO) • 开启 HDMI CEC 功能 (默认关闭)

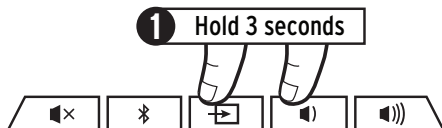

**1 Hold 3 seconds**

### Hold 3 Seconds

Appuyer pendant 3 secondes  
 Mantenga oprimido durante 3 segundos  
 3 Sekunden gedrückt halten  
 Tenere premuto per 3 secondi  
 Manter pressionado por 3 segundos  
 保持 3 秒

### Current Source Flashes

La source active clignote  
 La fuente activa destella  
 Aktuelle Quelle blinkt  
 La sorgente in funzione lampeggia  
 A fonte atual piscará  
 当前源闪烁



**2 Current Source Flashes 2X**

### Repeat Steps to Turn Off

Répétez les étapes pour éteindre  
 Repita los pasos para desactivar  
 Zum Ausschalten Schritte wiederholen  
 Ripetere i passaggi per disattivare  
 Repita o mesmo procedimento para desligar  
 重复步骤以关闭

### Current Source Flashes 3X

\*NOTE\* CEC must be turned ON to enable audio through an HDMI-ARC connection

\*REMARQUE\* CEC doit être sur MARCHE (ON) pour activer l'audio sur une connexion HDMI-ARC.

\*NOTA\* El CEC debe estar encendido para permitir que el audio pase a través de una conexión de HDMI-ARC

\*HINWEIS\* CEC muss EINGESCHALTET sein, damit Audio über eine HDMI-ARC-Verbindung möglich ist

\*N.B.\* per consentire la trasmissione dei segnali audio attraverso i connettori HDMI-ARC è necessario che la funzione CEC sia ON.

\*OBSERVAÇÃO\* O CEC deve estar ligado para permitir que o áudio seja transmitido através de uma conexão HDMI-ARC.

\*注\* CEC 必须要打开才能激活音频信号传送至HDMI-ARC 端的功能。

## TURN OFF TV SPEAKERS

MISE HORS TENSION DES HAUT-PARLEURS DU TÉLÉVISEUR • APAGADO DE LOS ALTAVOCES DEL TELEVISOR • TV-LAUTSPRECHER DEAKTIVIEREN • SPEGNIMENTO DEGLI ALTOPARLANTI DEL TELEVISORE  
 DESLIGUE OS ALTO-FALANTES DA TV • 关闭电视机扬声器



(Recommended)

OR

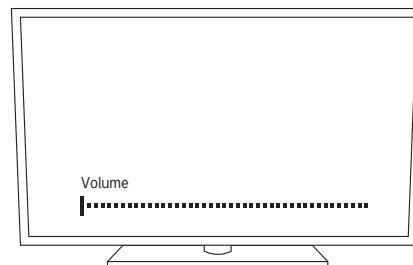



## CONNECTIONS - DIGITAL OPTICAL (IF TV HAS NO OPTICAL OUT SEE NEXT PAGE)

CONEXÕES - ÓTICA DIGITAL (SE A TV NÃO TIVER SAÍDA ÓTICA, CONSULTE A PRÓXIMA PÁGINA) • CONEXIONES - DIGITAL ÓPTICA (SI EL TELEVISOR NO TIENE SALIDA ÓPTICA, VEA LA PÁGINA SIGUIENTE.) • ANSCHLÜSSE - DIGITAL-OPTISCH (WENN TV KEINEN OPTISCHEN AUSGANG HAT, SIEHE NÄCHSTE SEITE) • CONNESSIONI - OTTICA DIGITALE (SE IL TELEVISORE NON HA UN'USCITA OTTICA, VEDERE ALLA PAGINA SUCCESSIVA) • CONEXÕES - ÓTICA DIGITAL (SE A TV NÃO TIVER SAÍDA ÓTICA, CONSULTE A PRÓXIMA PÁGINA) • 连接 - 数字光学 (如果电视没有光学输出, 请参见下一页)

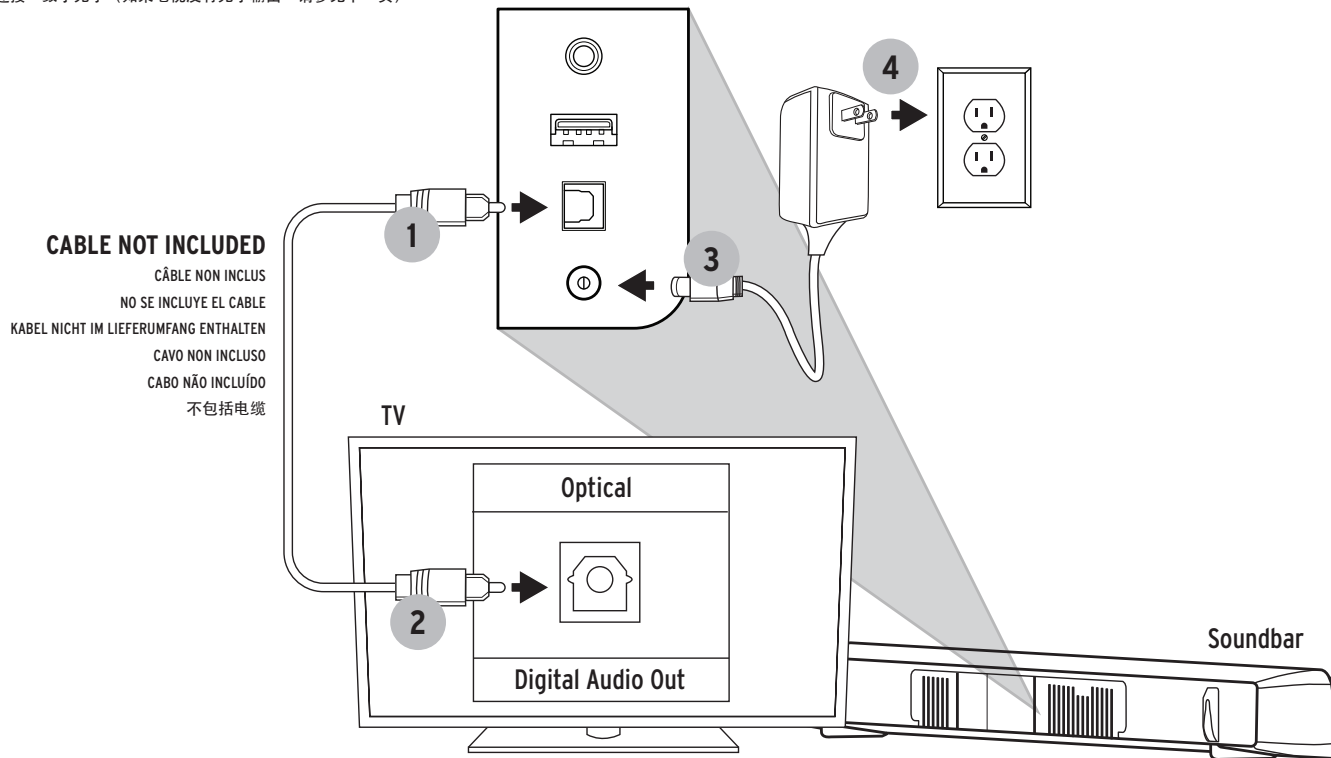

## CONNECTIONS - 3.5mm AUXILIARY

CONNEXIONS - AUXILIAIRE 3,5MM • CONEXIONES - 3.5 MM AUXILIAR • ANSCHLÜSSE - 3,5-MM-AUX • CONNESSIONI - INGRESSO AUSILIARIO DA 3,5 MM • CONEXÕES - AUXILIAR DE 3,5 MM • 连接 - 3.5MM 辅助电缆

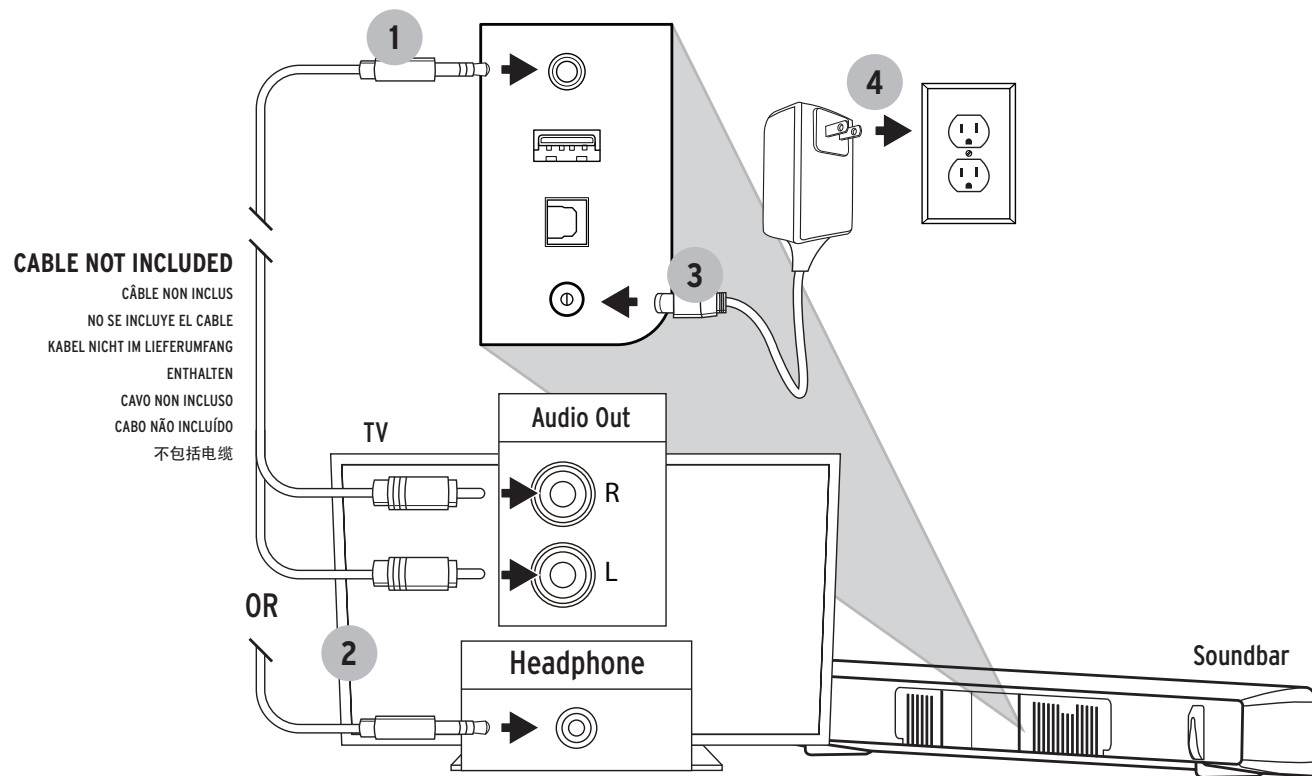

# SUBWOOFER PLACEMENT

POSITIONNEMENT DU CAISSON DE GRAVES • UBICACIÓN DEL SUBWOOFER • SUBWOOFER-PLATZIERUNG • COLLOCAZIONE DEL SUBWOOFER • POSIÇÃO DO SUBWOOFER • 低音炮布置

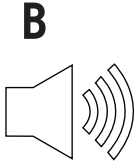
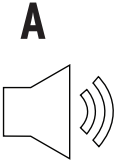
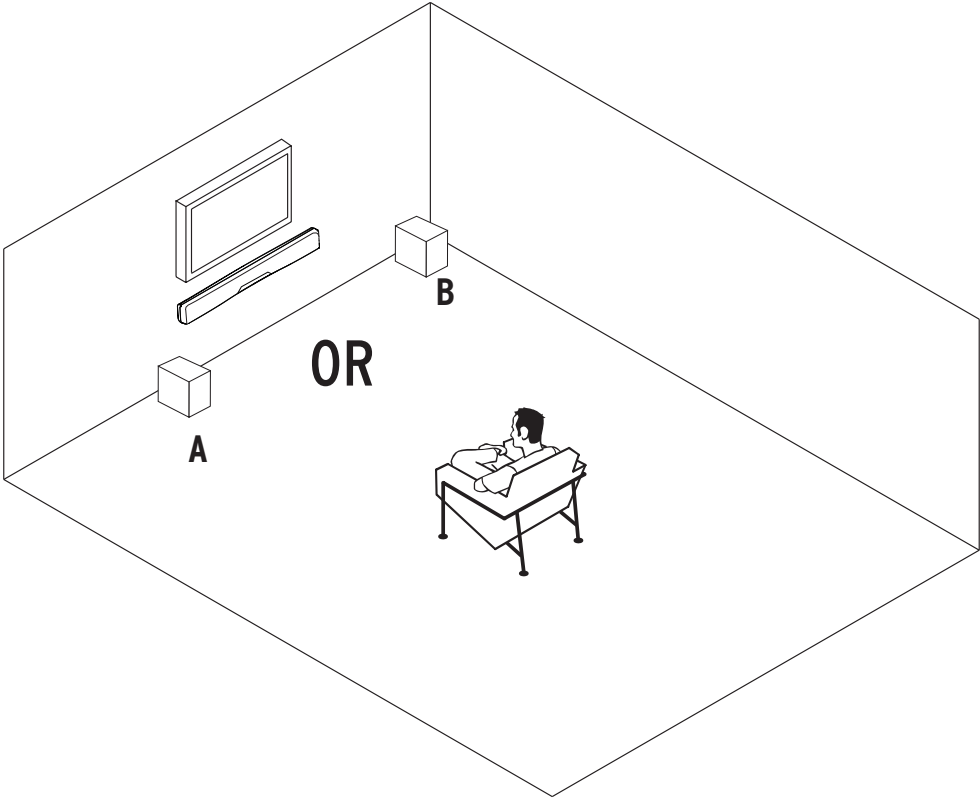

# SUBWOOFER WIRELESS CONNECTION

CONNEXION SANS FIL DU CAISSON DE GRAVES • CONEXIÓN INALÁMBRICA DEL SUBWOOFER • DRAHTLOSE VERBINDUNG ZUM SUBWOOFER • CONNESSIONE WIRELESS CON IL SUBWOOFER • CONEXÃO SEM FIO DO SUBWOOFER • 低音炮无线连接

1 Soundbar - Power On



30 ft. (9m)  
MAX

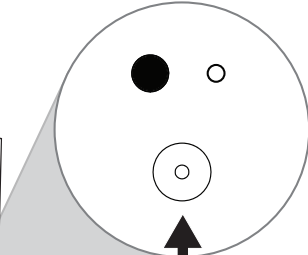
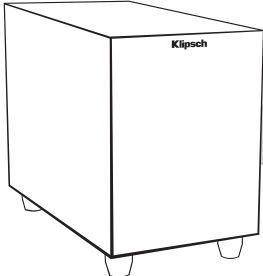

2

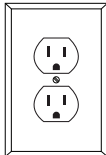

3



# SUBWOOFER RECONNECT

RECONNECTER • RECONECTAR • ERNEUT VERBINDEN • RICONNESSIONE • RECONECTAR • 重新连接

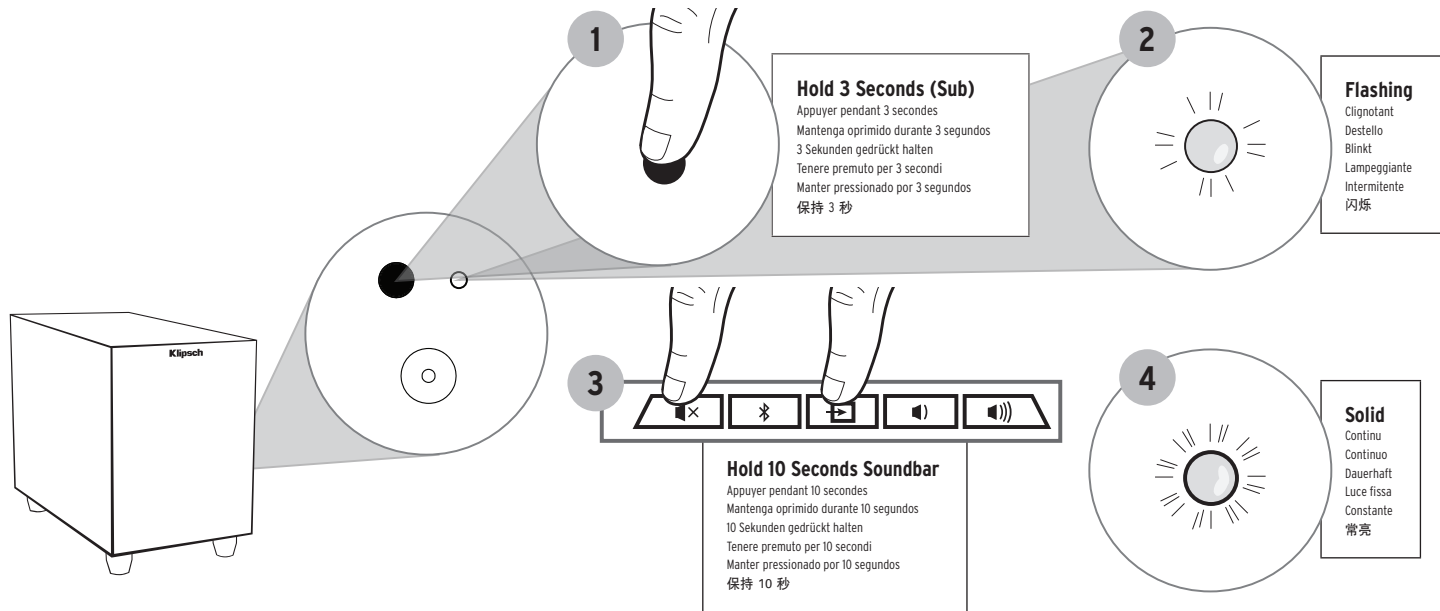

# REMOTE

TÉLÉCOMMANDE • CONTROL REMOTO • FERNBEDIENUNG • TELECOMANDO • CONTROLE REMOTO • 遙控器

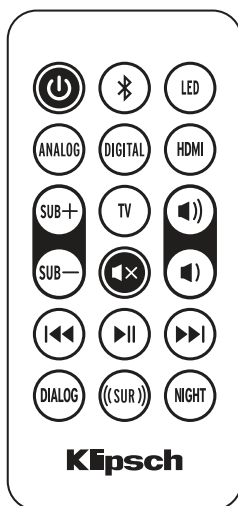

Bluetooth® Source Select



On/Off



LEDs On/Off (Soundbar)



Dialog Enhance Mode On/Off



Virtual Surround Mode On/Off



Night Mode On/Off



Analog Source Select



Digital Optical Source Select



TV Source Select (HDMI-ARC)



HDMI Source Select



Track Backward  
Play/Pause  
Track Forward



Subwoofer Level Down



Subwoofer Level Up



System Volume Up



System Volume Down



Mute

<p><b>Bluetooth® Source Select</b></p> <p>Sélection de la source Bluetooth®          Selección de fuente Bluetooth®          Bluetooth®-Quellenwahl          Selezione segnale Bluetooth®          Seleção de fonte Bluetooth®          蓝牙源选择</p>	<p><b>On / Off</b></p> <p>Sous tension / Hors tension          Encendido / Apagado          Ein / Aus          Acceso / Spento          Ligar / Desligar          开/关</p>	<p><b>LEDs On/Off (Soundbar)</b></p> <p>Volume haut - Caisson de graves          Subida de volumen - Subwoofer          Lauter - Subwoofer          Aumento volume - Subwoofer          Aumentar o volume- Subwoofer          音量增大</p>	<p><b>Analog Source Select</b></p> <p>Sélection de la source analogique          Selección de fuente analógica          Analog-Quellenwahl          Selezione segnale analogico          Seleção de fonte analógica          模拟源选择</p>	<p><b>Digital Optical Source Select</b></p> <p>Sélection de la source optique numérique          Selección de fuente óptica digital          Digital-optische Quellenwahl          Selezione segnale ottico digitale          Seleção de fonte ótica digital          数字光学源选择</p>	<p><b>TV Source Select</b></p> <p>Sélection de la source TV          Selección de fuente Televisor          TV-Quellenwahl          Selezione segnale TV          Seleção de fonte TV          电视源选择</p>
---	---	--	--	---	--

<p><b>Dialog Enhance Mode On/Off</b></p> <p>Marche/Arrêt Mode d'égalisation d'accentuation vocale          Activación/desactivación de eualización de mejoramiento de voz          EQ-Modus für verbesserte Stimmen Ein/Aus          Equalizzatore potenziamento vocale On/Off          Ativar/desativar o modo de EQ de melhoria de voz          音效增强均衡器开/关</p>	<p><b>Virtual Surround Mode On/Off</b></p> <p>Marche/Arrêt Mode ambiophonique virtuel          Activación/desactivación de modalidad de surround virtual          Virtueller Surroundmodus Ein/Aus          Modalità surround virtuale On/Off          Ativar/desativar o modo surround virtual          虚拟环绕声模式开/关</p>	<p><b>Night Mode On/Off</b></p> <p>Marche/Arrêt Mode nocturne          Activación/desactivación de modalidad nocturna          Nachtmodus Ein/Aus          Modalità notturna On/Off          Ativar/desativar o modo noturno          夜间模式开/关</p>	<p><b>HDMI Source Select</b></p> <p>Sélection de la source HDMI          Selección de fuente HDMI          HDMI Quellenwahl          Selezione segnale HDMI          Seleção de fonte HDMI          HDMI 源选择</p>
--	---	---	--

<p><b>Track Backward</b></p> <p>Reculer          Retroso de pista          Voriger Titel          Brano precedente          Retroceder          快退</p>	<p><b>Play/Pause</b></p> <p>Lecture/pause          Reproducción/pausa          Wiedergabe/Pause          Riproduzione / Pausa          Reproduzir/Pausar          播放/暂停</p>	<p><b>Track Foward</b></p> <p>Avancer          Avance de pista          Nächster Titel          Brano successivo          Avançar          快进</p>	<p><b>Subwoofer Level Down</b></p> <p>Volume bas - Caisson de graves          Bajada de volumen - Subwoofer          Leiser - Subwoofer          Riduzione volume - Subwoofer          Diminuir o volume - Subwoofer          音量减小</p>	<p><b>Subwoofer Level Up</b></p> <p>Volume haut - Caisson de graves          Subida de volumen - Subwoofer          Lauter - Subwoofer          Aumento volume - Subwoofer          Aumentar o volume- Subwoofer          音量增大</p>	<p><b>System Volume Up</b></p> <p>Volume haut          Subida de volumen          Lauter          Aumento volume          Aumentar o volume          音量增大</p>	<p><b>Mute</b></p> <p>Sourdiere          Silenciador          Stummschaltung          Disattivazione audio          Desativar áudio          静音</p>	<p><b>System Volume Down</b></p> <p>Volume bas          Bajada de volumen          Leiser          Riduzione volume          Diminuir o volume          音量减小</p>
--	---	---	--	--	---	---	--

# SURROUND MODES

MODES AMBIPHONIQUES • MODALIDADES SURROUND • SURROUND-MODI • MODALITÀ SURROUND • MODOS SURROUND • 环绕声模式



## DOLBY AUDIO™

- Only active if receiving a Dolby® Digital signal
- Manufactured under license from Dolby Laboratories. Dolby, Dolby Audio and the double-D symbol are trademarks of Dolby Laboratories

## DOLBY AUDIO™

- Actif seulement avec réception d'un signal Dolby Digital

## DOLBY AUDIO™

- Activa solo cuando hay señal Dolby Digital

## ((SUR))

### VIRTUAL SURROUND MODE

- Klipsch Custom DSP
- Independent of the EQ settings (Natural, Voice, Night)
- Can be **ON** regardless of Dolby Digital status

### MODE AMBIPHONIQUE VIRTUEL

- DSP personnalisé de Klipsch
- Indépendant des réglages d'égaliseur (Naturel, accentuation vocale, nocturne)
- Peut être en marche indépendamment du statut Dolby Digital

### MODALIDAD DE SURROUND VIRTUAL

- Procesador de Señal Digital (Digital Signal Processor, DSP) personalizado de Klipsch
- Independiente de las configuraciones de equalización (natural, mejoramiento de voz, nocturna)
- Puede estar activa independientemente del estado de Dolby Digital

## DIALOG

### DIALOG ENHANCE MODE

- Optimizes EQ for Dialog
- Can be **ON** regardless of Dolby Status or Virtual Surround Mode
- Only one EQ profile active at one time (Natural, Dialog Enhanced, or Night)

### MODE D'ÉGALISATION D'ACCENTUATION VOCALE

- Optimise l'égalisation pour les dialogues
- Peut être en marche indépendamment du statut Dolby Digital
- Seulement un profil d'égalisation actif à la fois (Naturel, accentuation vocale ou nocturne)

### MODALIDAD DE ECUALIZACIÓN DE MEJORAMIENTO DE VOZ

- Optimiza la equalización para el diálogo
- Puede estar activa independientemente del estado de Dolby Digital
- Puede haber solo un perfil de equalización activo a la vez (natural, mejoramiento de voz, nocturno)

## NIGHT

### NIGHT MODE

- Reduces Dynamic Range
- Subwoofer OFF
- Can be **ON** regardless of Dolby Status or Virtual Surround Mode
- Only one EQ profile active at one time (Natural, Voice Enhanced, or Night)

### MODE NOCTURNE

- Réduit la gamme dynamique
- Haut-parleur d'extrêmes graves désactivé
- Peut être en marche indépendamment du statut Dolby Digital
- Un seul profil d'égalisation actif à la fois (Naturel, accentuation vocale ou nocturne)

### MODALIDAD NOCTURNA

- Reduce el rango dinámico
- Subwoofer APAGADO
- Puede estar activa independientemente del estado de Dolby Digital
- Puede haber solo un perfil de equalización activo a la vez (natural, mejoramiento de voz, nocturno)





## DOLBY AUDIO™

- Nur bei Empfang eines Dolby-Digital-Signals aktiv

## DOLBY AUDIO™

- Attiva solo se viene ricevuto un segnale Dolby Digital

## DOLBY AUDIO™

- Ativo somente durante a recepção de um sinal Dolby Digital

## 杜比数字技术

- 仅当收到杜比数字信号时才有效

## ((SUR))

### VIRTUELLER SURROUNDMODUS

- Klipsch Spezial-DSP
- Unabhängig von EQ-Einstellungen (Natürlich, verbesserte Stimme, Nacht)
- Kann unabhängig vom Dolby-Digital-Status EIN sein

### MODALITÀ SURROUND VIRTUALE

- DSP personalizzato Klipsch
- Indipendente dalle impostazioni dell'equalizzatore (Naturale, Potenziamento vocale, Notturna)
- Può essere On indipendentemente dallo stato Dolby Digital

### MODO SURROUND VIRTUAL

- DSP personalizado da Klipsch
- Independente das configurações do EQ (Natural, Voz melhorada, Noturno)
- Pode estar ATIVADO independentemente do status do Dolby Digital

### 虚拟环绕声模式

- Klipsch 定制 DSP
- 独立于均衡器设置 (自然、音效增强、夜间)
- 不管杜比数字状态如何, 均可“打开”(ON)

## DIALOG

### EQ-MODUS VERBESSERTE STIMME

- Optimiert EQ für Dialog
- Kann unabhängig vom Dolby-Digital-Status EIN sein
- Es kann jeweils nur ein EQ-Profil aktiv sein (Natürlich, verbesserte Stimme, Nacht)

### MODALITÀ EQUALIZZATORE POTENZIAMENTO VOCALE

- Ottimizza l'equalizzatore per i dialoghi
- Può essere On indipendentemente dallo stato Dolby Digital
- Solo un profilo alla volta dell'equalizzatore è attivo (Naturale, Potenziamento vocale, Notturna)

### MODO DE EQ DE MELHORIA DE VOZ

- Otimiza a EQ para diálogos
- Pode estar ATIVADO independentemente do status do Dolby Digital
- Somente um perfil de EQ ativo de cada vez (Natural, Voz melhorada ou Noturno)

### 音效增强均衡器模式

- 优化均衡器, 以实现模拟效果
- 不管杜比数字状态如何, 均可“打开”(ON)
- 一次仅限一种均衡器模式有效 (自然、音效增强或夜间模式)

## NIGHT

### NACHTMODUS

- Reduziert Dynamikbereich
- Kann unabhängig vom Dolby-Digital-Status EIN sein
- Subwoofer aus
- Es kann jeweils nur ein EQ-Profil aktiv sein (Natürlich, verbesserte Stimme, Nacht)

### MODALITÀ NOTTURNA

- Riduce la gamma dinamica
- Subwoofer spento
- Può essere On indipendentemente dallo stato Dolby Digital
- Solo un profilo alla volta dell'equalizzatore è attivo (Naturale, Potenziamento vocale, Notturna)

### MODO NOTURNO

- Reduz a faixa dinâmica
- Subwoofer desligado
- Pode estar ATIVADO independentemente do status do Dolby Digital
- Somente um perfil de EQ ativo de cada vez (Natural, Voz melhorada ou Noturno)

### 夜间模式

- 缩小动态范围
- 低音炮关闭
- 不管杜比数字状态如何, 均可“打开”(ON)
- 一次仅限一种均衡器模式有效 (自然、音效增强或夜间模式)

# BLUETOOTH® WIRELESS TECHNOLOGY

TECNOLOGÍA INALÁMBRICA **BLUETOOTH®** • CONFIGURACIÓN DE TECNOLOGIA WIRELESS **BLUETOOTH®** • DRAHTLOSE **BLUETOOTH®**-TECHNOLOGIE-SETUP • CONFIGURAZIONE TECNOLOGIA WIRELESS **BLUETOOTH®** • CONFIGURAÇÃO DE TECNOLOGIA SEM FIO **BLUETOOTH®** • **BLUETOOTH®** 蓝牙无线电子技术

## PAIR

CONNEXION  
CONEXIÓN  
VERBINDEN  
COLLEGAMENTO  
CONECTAR  
连接

**1 Hold 3 Seconds**  
Appuyer pendant 3 secondes  
Mantenga oprimido durante 3 segundos  
3 Sekunden gedrückt halten  
Tenere premuto per 3 secondi  
Manter pressionado por 3 segundos  
保持 3 秒

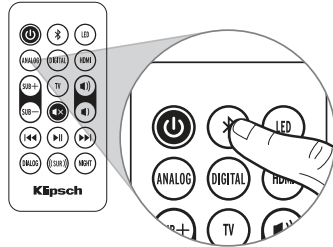

OR  
OU  
O BIEN  
ODER  
OPPURE  
OU  
或

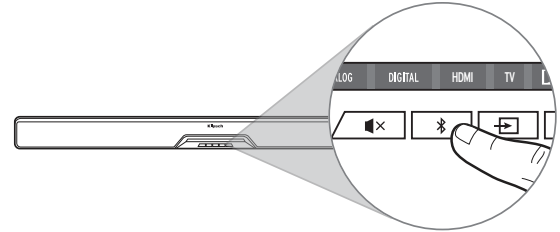

**2 Flashing**

**Flashing**  
Clignotant  
Destello  
Blinkt  
Lampeggiante  
Intermittente  
闪烁

**3**

**4**

**5 Solid**

**Solid**  
Continuo  
Continuo  
Dauerhaft  
Luce fissa  
Costante  
常亮

\* Example only. Your device may differ.

• À titre d'exemple seulement. Votre appareil peut être différent. • Este es solo un ejemplo. Es posible que su dispositivo sea diferente. • Nur als Beispiel. Ihr Gerät kann anders aussehen  
• Solo a titolo esemplificativo. Lo specifico dispositivo può essere diverso. • Apenas para exemplo. O dispositivo pode ser diferente. • 仅为示例。实际设备可能有所不同

# BLUETOOTH® WIRELESS TECHNOLOGY

TECNOLOGÍA INALÁMBRICA *BLUETOOTH*® • CONFIGURACIÓN DE TECNOLOGIA WIRELESS *BLUETOOTH*® • DRAHTLOSE *BLUETOOTH*®-TECHNOLOGIE-SETUP • CONFIGURAZIONE TECNOLOGIA WIRELESS *BLUETOOTH*® • CONFIGURAÇÃO DE TECNOLOGIA SEM FIO *BLUETOOTH*® • *BLUETOOTH*® 蓝牙无线电子技术

## RECONNECT

RECONNECTER  
 RECONNECTAR  
 ERNEUT VERBINDEN  
 RICONNESSIONE  
 RECONNECTAR  
 重新连接

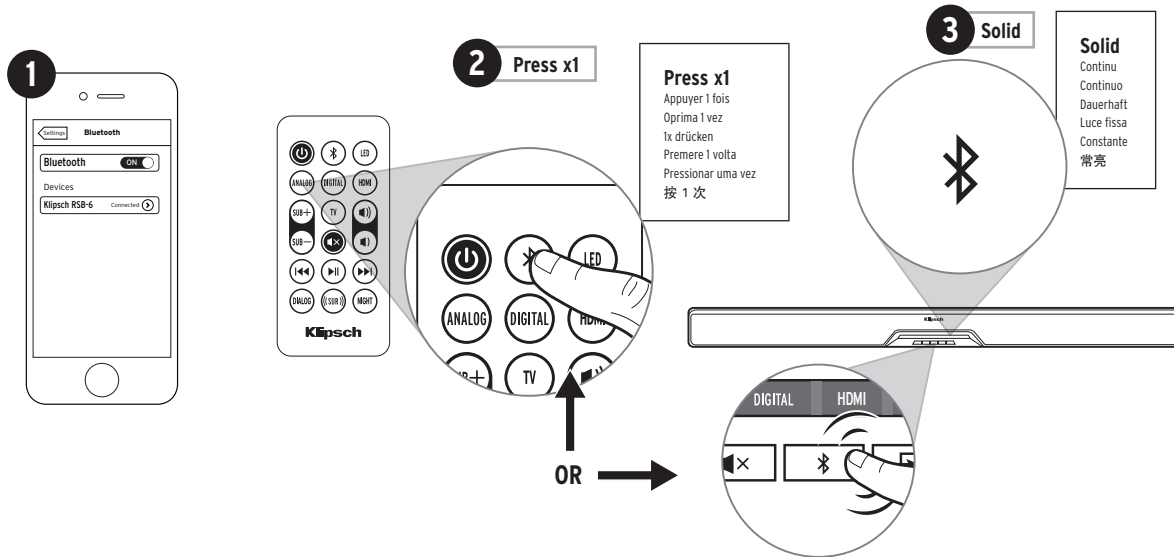

TECNOLOGIA WIRELESS *BLUETOOTH*® » ANALOG » DIGITAL » **BLUETOOTH** » ANALOG » DIGITAL

# TV REMOTE PROGRAMMING

PROGRAMMATION À DISTANCE DU TÉLÉVISEUR • PROGRAMACIÓN DEL CONTROL REMOTO DEL TELEVISOR • PROGRAMMIEREN DER TV-FERNBEDIENUNG • PROGRAMMAZIONE CON IL TELECOMANDO TV • PROGRAMAÇÃO DO CONTROLE REMOTO DA TV • 电视机遥控器编程

**If you want to use the TV remote to control the soundbar, you can program the soundbar to take commands from your TV remote**

Si vous souhaitez utiliser la télécommande du téléviseur pour contrôler la barre de son, vous pouvez programmer la barre de son pour recevoir des commandes depuis votre télécommande TV.

Si desea controlar la barra de sonido con el control remoto del televisor, puede programar la barra de sonido para que acepte los comandos del control remoto del televisor.

Wenn Sie die Soundbar mit der TV-Fernbedienung kontrollieren wollen, können Sie diese darauf programmieren, Befehle von Ihrer TV-Fernbedienung zu empfangen.

Se si desidera usare il telecomando del televisore per controllare il SoundBar, è possibile programmare appropriatamente il SoundBar.

É possível programar a barra de som para aceitar os comandos do controle remoto da TV.

如果您想要使用电视遥控器控制条形音箱，则可将条形音箱编程为从电视遥控器接收命令。

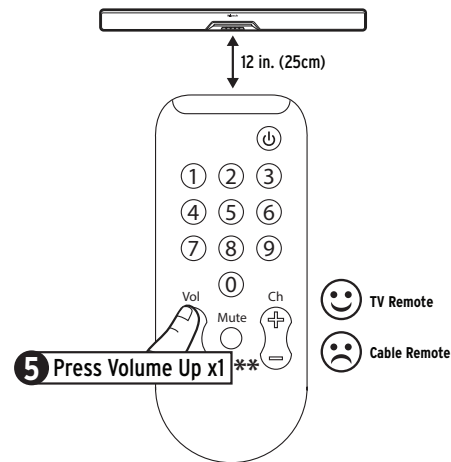
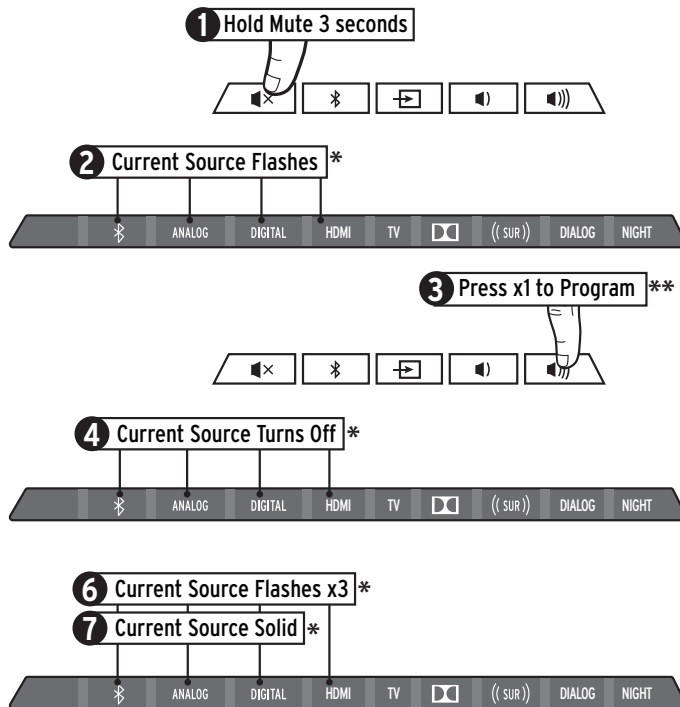

<p><b>1 Hold Mute 3 Seconds</b>  Appuyer sur la Sourdine pendant 3 secondes  Mantenga oprimido el silenciador durante 3 segundos  Stummschaltung 3 Sekunden gedrückt halten  Tenere premuto il pulsante Silenziamento per 3 secondi  Manter pressionado o botão desligar áudio por 3 segundos  按住“静音”按钮 3 秒钟</p>	<p><b>2 Current Source Flashes</b>  La source active clignote  La fuente activa destella  Aktuelle Quelle blinkt  La sorgente in funzione lampeggia  A fonte atual piscará  当前源闪烁</p>	<p><b>3 Press x1 to Program</b>  Appuyer 1 fois pour programmer  Oprima una vez para programar  1x drücken, um zu programmieren  Press una volta per programmare  Pressionar uma vez para programar  按一次进行编程</p>	<p><b>4 Current Source Turns Off</b>  La source active s'éteint  La fuente activa se apaga  Aktuelle Quelle abgeschaltet  La sorgente si disinserisce  A fonte atual desligará  当前源关闭</p>
--	---	--	---

<p><b>5 Press Volume Up x1</b>  Appuyer sur Volume haut 1 fois  Oprima la subida de volumen una vez  Lauter-Taste 1x drücken  Premere una volta il pulsante di aumento volume  Pressionar uma vez o botão Volume +  按“调高音量” (+) 按钮一次</p>	<p><b>6 Current Source Flashes x3</b>  La source active clignote 3 fois  La fuente activa destella 3 veces  Aktuelle Quelle blinkt 3x  La sorgente in funzione lampeggia tre volte  A fonte atual piscará 3 vezes  当前源闪烁 3 次</p>	<p><b>7 Current Source Solid</b>  Source active continue  La fuente activa brilla fijamente  Aktuelle Quelle leuchtet dauerhaft  La spia della sorgente in funzione rimane accesa  Fonte atual acesa  当前源常亮</p>
--	--	---

**\* Only Source LEDs active at the time will be effected**

Seules les DEL de sources actives à ce moment seront affectées  
Se efectúan solo las funciones de los indicadores LED activos en el momento  
Betrifft nur die momentan aktiven Quell-LEDs  
Solo i LED del segnale attivi al determinato istante segneranno  
Somente os LEDs das fontes ativos no momento serão afetados  
\*只有当时有效的源 LED 灯将受影响。

**\*\* To program Volume Down and Mute buttons repeat the steps shown and replace steps 3 and 5 with the button you want to program.**

Pour régler les boutons de Volume bas et de Sourdine, répéter les étapes indiquées et remplacez les étapes 3 et 5 par le bouton que vous souhaitez programmer.  
Para programar los botones de bajada de volumen y de silenciador, repita los pasos indicados y sustituya el botón de los pasos 3 y 5 por el botón que desea programar.  
Um die Leiser- und Stummschaltungs-Tasten zu programmieren, die gezeigten Schritte wiederholen und Schritte 3 und 5 mit der zu programmierenden Taste ersetzen.  
Per programmare i pulsanti Riduzione volume e Silenziamento, ripetere i passaggi illustrati e sostituire i passaggi 3 e 5 con il pulsante che si desidera programmare.  
Para programar os botões de diminuir o volume e desligar o áudio, repita os passos indicados e substitua as etapas 3 e 5 com o botão que deseja programar.  
要对“调低音量” (-) 与“静音”按钮进行编程, 请重复所示步骤, 然后用您想编程的按钮替换第 3 步和第 5 步。

## REMOTE CONTROL CODES (FOR UNIVERSAL OR CABLE REMOTES)

---

<b>RCA*</b>	41609 OR 43915
<b>DIRECTV</b>	31609 OR 31023
<b>XFINITY**</b>	31309 OR 31023
<b>BRIGHT HOUSE</b>	288
<b>AT&amp;T (SILVER)</b>	5156 OR 5023
<b>AT&amp;T (BLACK)</b>	5156

\* MUST HAVE AUDIO/AUX BUTTON OR AUDIO-SB BUTTON

\*\* RED CENTER BUTTON

NOTE: NOT ALL UNIVERSAL REMOTES ARE COMPATIBLE

<b>HEX CODES - SET 1</b>	
<b>VOLUME UP</b>	0x 856A 9F60
<b>VOLUME DOWN</b>	0x 856A 9E61
<b>MUTE</b>	0x 856A 9966

<b>HEX CODES - SET 3</b>	
<b>VOLUME UP</b>	0x A55A 0AF5
<b>VOLUME DOWN</b>	0x A55A 0BF4
<b>MUTE</b>	0x A55A 12ED

<b>HEX CODES - SET 4</b>	
<b>VOLUME UP</b>	0x 859A 817E
<b>VOLUME DOWN</b>	0x 859A 827D
<b>MUTE</b>	0x 859A 8778

# LED ON/OFF

DEL MARCHÉ/ARRÊT • ENCENDIDO/APAGADO DE INDICADORES LED • LED AN/AUS • LED ACCESO/SPENTO • LED LIGA/DESLIGA • LED 灯开/关

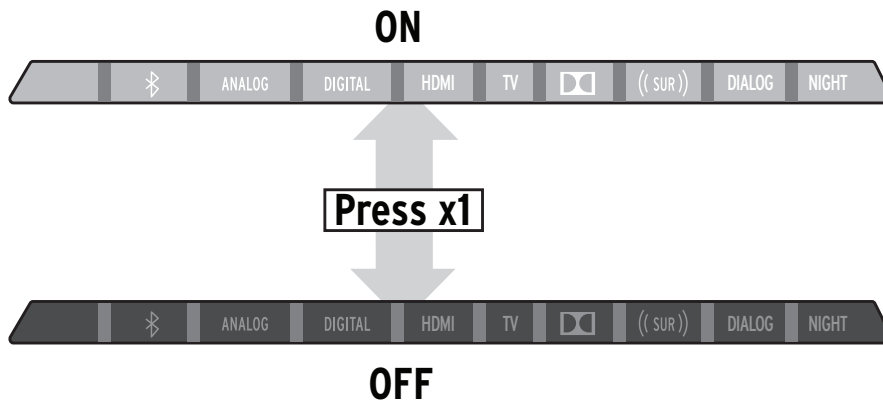
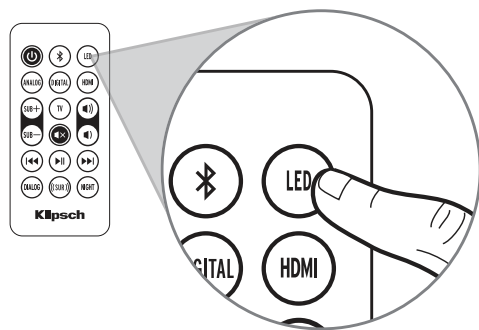

<p><b>Press x1</b>          Appuyer 1 fois          Oprima 1 vez          1x drücken          Premere 1 volta          Pressionar uma vez          按 1 次</p>	<p><b>ON / OFF</b>          Sous tension / Hors tension          Encendido / Apagado          Ein / Aus          Acceso / Spento          Ligar / Desligar          开/关</p>
--	---

**NOTE: LEDs will turn off after 5 seconds of inactivity**  
 REMARQUE : Les DEL s'éteindront après 5 secondes d'inactivité  
 NOTA: Los indicadores LED se apagan después de 5 segundos de inactividad  
 HINWEIS: LEDs schalten sich nach 5 Sekunden Inaktivität aus  
 NOTA: i LED si spegneranno dopo 5 secondi di inattività.  
 OBSERVAÇÃO: Os LEDs desligarão depois de 5 segundos de inatividade  
 注意: LED 灯休止 5 秒之后将关闭。

## FACTORY RESET

RÉINITIALISATION • RESTABLECIMIENTO DE FÁBRICA • RÜCKSETZUNG AUF WERKSEINSTELLUNG • RIPRISTINO IMPOSTAZIONI DI FABBRICA • RESTABECIMENTO DAS CONFIGURAÇÕES DE FÁBRICA • 恢复出厂设置

**Hold 10 Seconds**  
Appuyer pendant 10 secondes  
Mantenga oprimido durante 10 segundos  
10 Sekunden gedrückt halten  
Tenere premuto per 10 secondi  
Manter pressionado por 10 segundos  
保持 10 秒

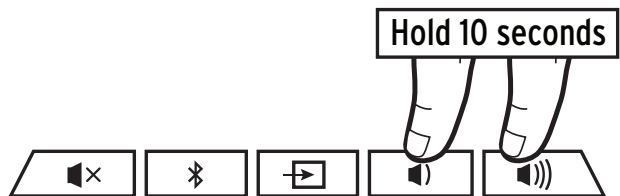

### Clears *Bluetooth®* pairing history and user programmed IR commands

Efface l'historique d'appariement Bluetooth® et les commandes IR programmées par l'utilisateur

Borra el historial de sincronización de Bluetooth® y los comandos programados por el usuario

Löscht Bluetooth®-Kupplungsdaten und benutzerprogrammierte IR-Befehle

Vengono cancellati la cronologia delle associazioni Bluetooth® e i comandi programmati dall'utente sul telecomando a infrarossi

Limpa o histórico de pareamento Bluetooth® e os comandos de IR programados pelo usuário

清除蓝牙® 配对历史记录及用户编程的 IR 指令。

## CARE AND CLEANING

ENTRETIEN ET NETTOYAGE • CUIDADO Y LIMPIEZA • PFLEGE UND REINIGUNG • CURA E PULIZIA • CUIDADOS E LIMPEZA • 保养与清洁

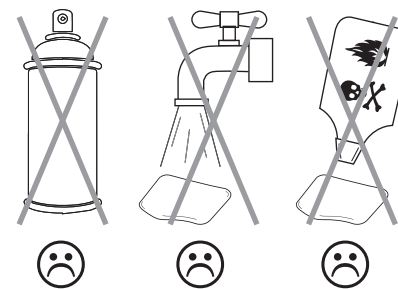









# Klipsch®

KEEPERS OF THE SOUND™

3502 WOODVIEW TRACE, INDIANAPOLIS, IN, USA

[KLIPSCH.COM](http://KLIPSCH.COM)

©2016, Klipsch Group, Inc. Klipsch Group, Inc. is a wholly-owned subsidiary of Vox International Corporation.

Klipsch and Keepers of the Sound are trademarks of Klipsch Group, Inc., registered in the United States and other countries.

The *Bluetooth*® word mark is a registered trademark owned by Bluetooth SIG, Inc. and any use of such mark by Klipsch Group, Inc. is under license.

Manufactured under license from Dolby Laboratories. Dolby, Dolby Audio and the double-D symbol are trademarks of Dolby Laboratories.

DTS and Play-Fi are registered trademarks of DTS, Inc.