

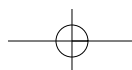

**Revel<sup>®</sup>**  
**CONCERT<sup>™</sup>**  
**B120 Subwoofer**

**Owner's Manual**  
**(120V)**



## IMPORTANT SAFETY PRECAUTIONS

### READ FIRST!

1. Read these instructions.
2. Keep these instructions.
3. Heed all warnings.
4. Follow all instructions.
5. Do not use this apparatus near water.
6. Clean only with a dry cloth.
7. Do not block any ventilation openings. Install in accordance with the manufacturer's instructions.
8. Do not install near any heat sources such as radiators, heat registers, stoves or other apparatus (including amplifiers) that produce heat.
9. Do not defeat the safety purpose of the polarized or grounding-type plug. A polarized plug has two blades with one wider than the other. A grounding-type plug has two blades and a third grounding prong. The wide blade or the third prong is provided for your safety. If the provided plug does not fit into your outlet, consult an electrician for replacement of the obsolete outlet.
10. Protect the power cord from being walked on or pinched, particularly at plugs, convenience receptacles and the point where they exit from the apparatus.
11. Only use attachments/accessories specified by the manufacturer.
12. Use only with the cart, stand, tripod, bracket or table specified by the manufacturer or sold with the apparatus. When a cart is used, use caution when moving the cart/apparatus combination to avoid injury from tip-over. 
13. Unplug this apparatus during lightning storms or when unused for long periods of time.
14. Refer all servicing to qualified service personnel. Servicing is required when the apparatus has been damaged in any way, such as power supply cord or plug is damaged, liquid has been spilled or objects have fallen into the apparatus, or the apparatus has been exposed to rain or moisture, does not operate normally or has been dropped.
15. Do not expose this apparatus to dripping or splashing and ensure that no objects filled with liquids, such as vases, are placed on the apparatus.
16. To completely disconnect this apparatus from the AC Mains, disconnect the power supply cord plug from the AC receptacle.
17. The mains plug of the power supply cord shall remain readily operable.
18. Do not expose batteries to excessive heat such as sunshine, fire or the like.



The lightning flash with arrowhead symbol, within an equilateral triangle, is intended to alert the user to the presence of uninsulated "dangerous voltage" within the product's enclosure that may be of sufficient magnitude to constitute a risk of electric shock to persons.



The exclamation point within an equilateral triangle is intended to alert the user to the presence of important operating and maintenance (servicing) instructions in the literature accompanying the product.  
**WARNING:** To reduce the risk of fire or electric shock, do not expose this apparatus to rain or moisture.

## FEDERAL COMMUNICATIONS COMMISSION INTERFERENCE STATEMENT

This equipment has been tested and found to comply with the limits for a Class B digital device, pursuant to Part 15 of the FCC Rules. These limits are designed to provide reasonable protection against harmful interference in a residential installation.

This equipment generates, uses and can radiate radio frequency energy and, if not installed and used in accordance with the instructions, may cause harmful interference to radio communications. However, there is no guarantee that interference will not occur in a particular installation. If this equipment does cause harmful interference to radio or television reception, which can be determined by turning the equipment off and on, the user is encouraged to try to correct the interference by one of the following measures:

- Reorient or relocate the receiving antenna.
- Increase the separation between the equipment and receiver.
- Connect the equipment into an outlet on a circuit different from that to which the receiver is connected.
- Consult the dealer or an experienced radio/TV technician for help.

**FCC Caution:** To assure continued compliance, any changes or modifications not expressly approved by the party responsible for compliance could void the user's authority to operate this equipment. (Example – use only shielded interface cables when connecting to computer or peripheral devices.)

### FCC Radiation Exposure Statement

This equipment complies with FCC RF radiation exposure limits set forth for an uncontrolled environment. This equipment should be installed and operated with a minimum distance of 20 centimeters between the radiator and your body.

This device complies with Part 15 of the FCC Rules. Operation is subject to the following two conditions:

1. This device may not cause harmful interference, and
2. This device must accept any interference received, including interference that may cause undesired operation.

## ABOUT THE REVEL® CONCERTA™ B120 SUBWOOFER

Thank you for purchasing the Revel Concerta B120, a high-performance powered subwoofer that perfectly augments Revel Concerta Series loudspeakers in stereo music or home theater entertainment systems. The B120's adjustable controls and multiple connection options also allow you to optimize the subwoofer's performance in any system and listening room.

Featuring a 12" (305mm) woofer with 1-1/2" (38.1mm) peak-to-peak excursion and powered by a 250-watt amplifier, the B120 subwoofer reproduces deep, realistic bass with very low distortion, even at the lowest frequencies and high output levels.

Combining superior form and function, the B120's proprietary woofer is constructed with an anodized-aluminum diaphragm for great strength at high output levels. The spider incorporates a superior-strength Nomex®/cotton blend with optimized geometry for increased linearity. The motor includes a large ceramic-magnet motor system. A 2" (50.8mm) copper voice coil is wound on a Kapton® bobbin for impressive power handling and freedom from compression. The vented center pole facilitates heat dissipation, allowing more efficient high-power handling and low compression.

The B120 cabinet consists of medium-density fiberboard (MDF) walls and extensive internal bracing to reduce cabinet-induced colorations. Rubber padded feet are attached to the bottom of the cabinet for optimal stability, accommodating installations on any floor surface.

Since 1996, the Revel brand has been at the forefront of loudspeaker design. Backed by Harman International's extensive research and design facilities, Revel Concerta Series speakers benefit from cutting-edge development tools, such as:

- A multichannel listening lab allows for double-blind listening tests.
- A laser interferometer enables detailed driver and cabinet analysis.
- Multiple large anechoic chambers provide for precise tests and measurements.
- Finite-element analysis allows for advanced loudspeaker modeling.
- A stereo lithography apparatus aids in achieving tight tolerances.

Adding to the proud lineage of Revel Ultima™ and Performa™ Series loudspeakers, the Concerta B120 subwoofer further substantiates the Revel reputation for high-quality, high-performance loudspeakers and subwoofers.

## B120 HIGHLIGHTS

- High-output capability with low distortion
- Proprietary 12" (305mm) anodized-aluminum diaphragm woofer
- Built-in 250W RMS amplifier
- Line-level RCA inputs
- Advanced woofer motor structure
- Large voice coil for wide dynamic range without compression
- Phase switch
- Low-pass frequency control
- Low-frequency level control
- Parametric room equalization controls
- Elegant cabinet design with vinyl finishes
- Wireless operation (with optional TX1 transmitter)

## PRODUCT REGISTRATION

### Important!

Please register your Concerta B120 subwoofer online at [www.revelspeakers.com](http://www.revelspeakers.com) within **15 days of purchase**. Retain the original, dated sales receipt as proof of warranty coverage.

## UNPACKING

The Concerta B120 subwoofer requires special care and handling during unpacking. Pay particular attention to the precautions that appear in this section and throughout this owner's manual.

### Warning!

Do not attempt to lift or move the B120 alone. Proper lifting requires at least two strong adults. When lifting the B120, stand as straight as possible, using the leg muscles to lift. Do not attempt to lift the B120 while bending at the waist. When moving the B120, rock it side to side into the desired position. Failure to follow these procedures may result in personal injuries and/or product damage.

Save all packaging materials for possible future shipping needs. Refer to the "Limited Warranty" section found later in this manual for more information.



## To Unpack the B120:

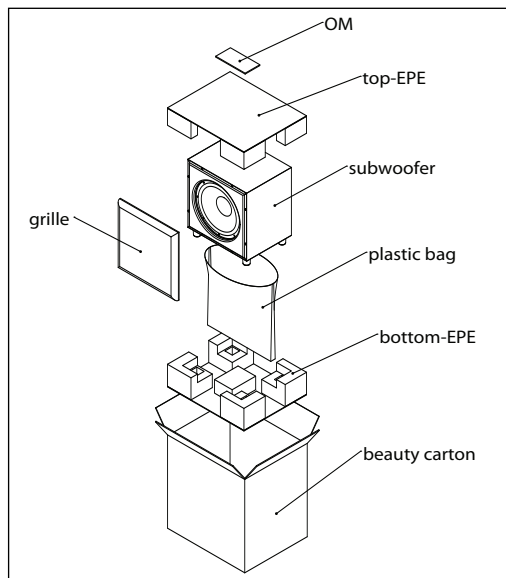

Figure 1: Unpacking the B120 subwoofer

1. Place the packing carton upright and fully open the top flaps. Refer to Figure 1.
2. Without allowing the top flaps to close, stand the packing carton upside down by carefully "rolling" the carton over on a soft surface, such as carpet.
3. Lift the packing carton off of the subwoofer. Use caution to avoid damaging the cabinet and objects located above the packing carton.
4. In addition to what is shown in Figure 1 above, the following is included with each B120:  
1 x 15' (4.6m) single-RCA LFE cable

## SUBWOOFER PLACEMENT

Below 300Hz, loudspeaker and listener locations have a profound impact on the way sound is reproduced. All rooms have "standing waves," by which certain frequencies are emphasized or diminished. Their complex patterns can combine to introduce tremendous sound coloration at low frequencies.

The Concerta B120's Equalization controls can help to compensate for these effects, but no electronic system alone can fully compensate for the dramatic effects of room acoustics. Every room has locations where "nulls" at specific frequencies occur. These cancellations of the sound are like "black holes," which no amount of equalization can fill. The best results are always achieved through careful placement of both the loudspeakers and the listening position. Preferable placement can be determined through the use of computer modeling programs, or by trial-and-error measurements. For optimal results, find the best loudspeaker and listener locations first, then use the B120 Equalization controls for fine-tune adjustments.

To help determine good locations for the subwoofer(s) and the listener(s), it is recommended that you make high-resolution in-room response measurements. Your authorized Revel dealer can make the appropriate measurements, using suitable equipment to ensure optimal results.

### Note

*Many sound-measurement devices are not accurate enough to properly measure low-frequency performance in a listening room, since room boundaries can often cause modes (standing waves) with very narrow-band peaks and dips. Check with your authorized Revel dealer to confirm that your measurement equipment is suitable for accurate, high-resolution measurements.*

## GENERAL PLACEMENT GUIDELINES

The following placement suggestions are followed by diagrams for recommended subwoofer locations. Due to the nature of room acoustics, the best approach is to experiment with different listening locations, as well as loudspeaker locations, to obtain the best sound at low frequencies.

Generally, it's best to place the Revel Concerta B120 subwoofer(s) near solid walls to reinforce bass response. Avoid placing the subwoofer(s) near windows, which can rattle and transmit sound to the outside world. Placing a subwoofer in the corner of a room, as shown in Figure 2, results in maximum reinforcement, which contributes to lower distortion. Most dips cannot be equalized, but they can be minimized through the optimal placement of the subwoofer(s) and listening position.

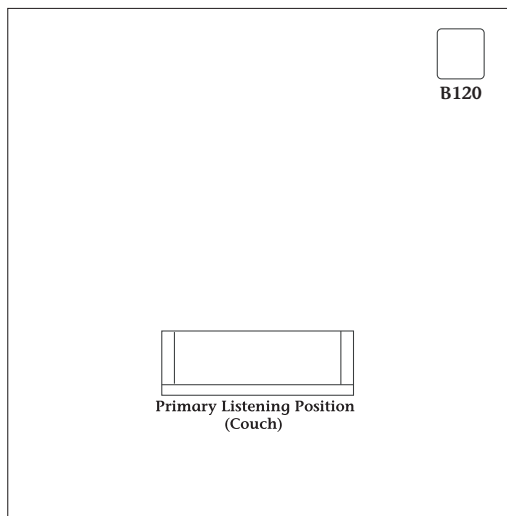

Figure 2: Single B120 subwoofer

Placing two Revel Concerta B120 subwoofers in opposite corners of the listening room, as shown in Figure 3, results in smoother low-frequency response and more consistent sound throughout the listening area.

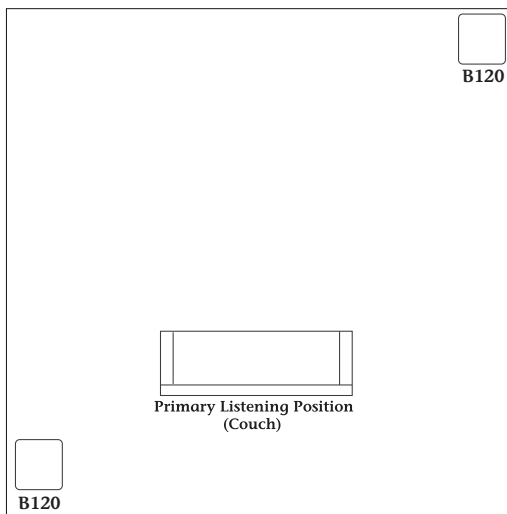

Figure 3: Two B120 subwoofers in opposite corners

If using two B120 subwoofers but corner placement is not an option, try placing the subwoofers at the midpoints of opposite walls, as shown in Figures 4 and 4a.

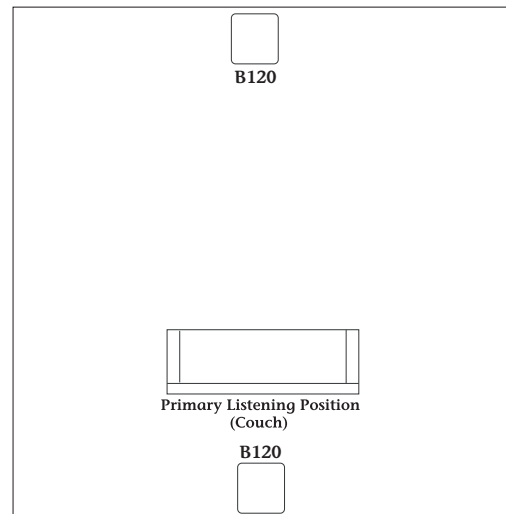

Figure 4: Two B120 subwoofers at opposite walls

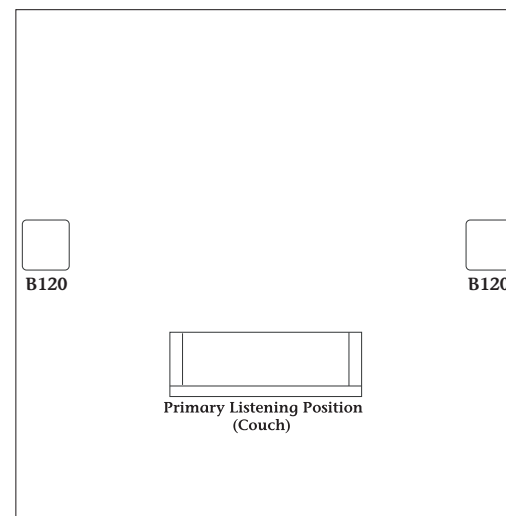

Figure 4a: Two B120 subwoofers at opposite walls

Use of a modeling program or trial-and-error measurements to further determine the best locations is recommended. Using precise measurements to determine subwoofer placement minimizes the response dips due to standing-wave cancellation that cannot be corrected by equalization. Ask your authorized Revel dealer for more information and assistance.



For large rooms (greater than 2000 to 3000 cubic feet, or 57 to 85 cubic meters), consider adding one or more additional B120 subwoofers for greater bass output and lower distortion.

Four properly placed Concerta B120 subwoofers achieve the smoothest low-frequency response with the most consistent sound throughout the listening area. When using four B120s, the flattest response is usually obtained by placing one pair at the midway point of the opposite front and back walls, and a second pair at the midway points of the side walls, as shown in Figure 5. Your authorized Revel dealer can use in-room measurements to fine-tune the locations, accounting for variation in construction among the room walls.

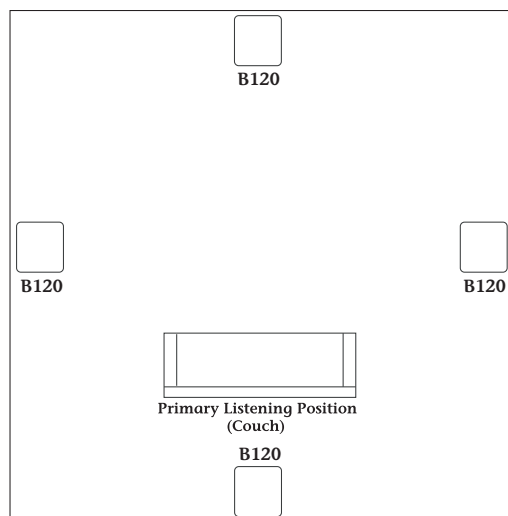

**Figure 5: Four B120 subwoofers at midpoints**

Another option is to place four Concerta B120 subwoofers in the corners of the listening room, as shown in Figure 6.

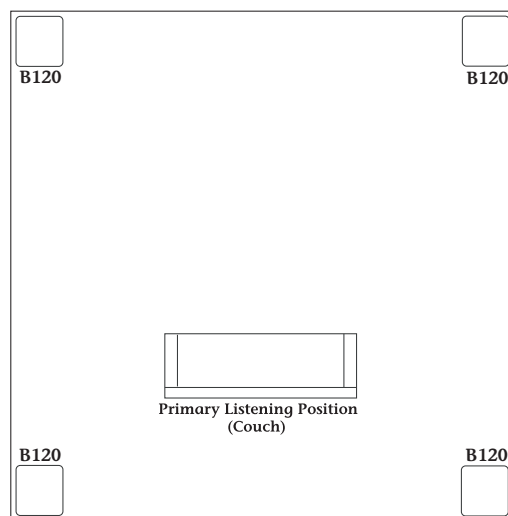

**Figure 6: Four B120 subwoofers in the corners**

A third alternative is to place the four B120s on the front and back walls at one-third of the distance into the room, as shown in Figure 7.

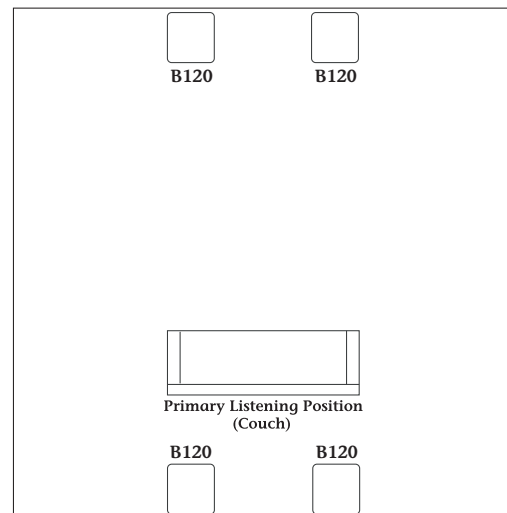

**Figure 7: Four B120 subwoofers at the front and back**

The placement of the other system loudspeakers in the listening room also affects the way sound (below 300Hz) is reproduced. Just as you would for the subwoofers, use a modeling program or trial-and-error measurements to determine the best locations.

Since listening and speaker locations are equally important, the trial-and-error process can be time-consuming. However, the sonic rewards are well worth the time spent determining the ideal placement locations. Remember that peaks (below the subwoofer crossover frequency) can be minimized or eliminated by the proper adjustment of the Concerta B120's Equalization controls, but dips cannot be corrected via equalization. Therefore, the most important objective is to find locations that result in the minimum number (and severity) of dips. Contact your authorized Revel dealer for assistance in determining the proper placement of your Revel loudspeakers and subwoofers.

After placing the B120 subwoofer(s), begin playback of a familiar music or film source that has substantial bass content. Listen from the primary listening position, increasing the overall volume of the system to a comfortable level. Adjust the Subwoofer Level (volume) control until you obtain the desired blend of bass. Also, test the subwoofer level by playing a recording of a deep male voice. Setting the subwoofer level (or crossover frequency) too high results in unnaturally "thick" or "boomy" vocal reproduction. Bass response should not overpower the room, and should be adjusted to achieve a harmonious blend across the entire audible range.

If you are using a multichannel receiver or processor with a subwoofer output, it's preferable to use the Subwoofer Level adjustment on the processor. Set the B120 Level control to the indicated "Nominal" position.

**Note**

Setting the level of the subwoofer in relation to the left and right front speakers is of critical importance because it is essential that the subwoofer integrate smoothly with the entire system. Setting the level too high results in an overpowering bass response. Setting the level too low negates the benefits of the B120 subwoofer.

## MAKING CONNECTIONS

### CAUTION!

Never make or break connections unless all system components are powered off.

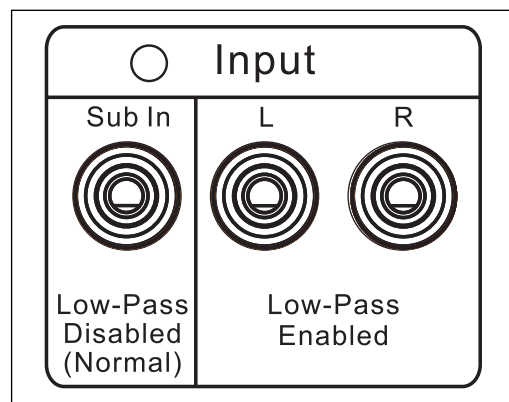

Figure 8: Rear-panel input connectors

This section provides typical examples of cable connections with different system configurations and devices. Review the owner's manuals for associated audio components to determine their connection requirements.

The B120 subwoofer input connectors are located on the rear panel. Two gold-plated RCA connector options are available – Sub In Low-Pass Disabled (Normal) and L/R Low-Pass Enabled – as shown in Figure 8.

In most cases, you'll use the Sub In connector, as it's designed for multichannel use. This input bypasses the low-pass filter, and is the appropriate input for most installations. This connector should be used when there is a dedicated subwoofer output available on the audio processor or receiver.

**Note**

Some processors incorrectly label the subwoofer output as LFE; others offer both an LFE and a Subwoofer output. If there is no labeled subwoofer output, use the LFE output. If the output has labeled connections for both LFE and Subwoofer, use the Subwoofer output.

The L (Left) and R (Right) connectors on the rear panel of the B120 are for use with 2-channel applications, where there is no dedicated subwoofer output available. These inputs are automatically crossed-over by the adjustable Low-Pass Crossover control on the rear panel. Having the low-pass filter enabled helps offset the fact that most 2-channel systems do not perform any high-pass filtering on the main speakers, minimizing the advantages of using a subwoofer. These connectors should be used in 2-channel applications where the receiver or preamplifier lacks a dedicated subwoofer or LFE output.

**Note**

The Concerta B120 subwoofer has a third connection option – wireless connection is also available when coupled with the optional TX1 transmitter. Refer to the "Wireless Connection" section found later in this manual for additional details regarding this option.

### Multichannel Applications – Typical Connection

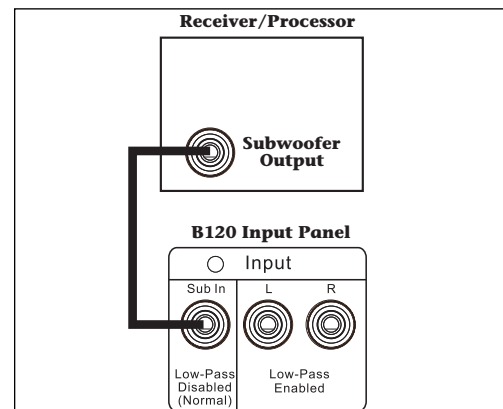

Figure 9: Typical connection

This configuration is for use with multichannel processors or receivers that have a single dedicated Subwoofer or LFE output connector.

Connect the supplied RCA patch cable from the Subwoofer or LFE output on the processor/receiver to the Sub In connector on the B120 rear panel, as shown in Figure 9.





## 2-Channel Applications – Connecting to the Main Outputs

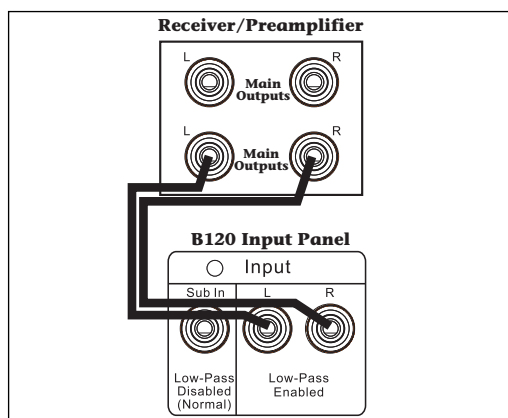

Figure 10: Connection to main outputs

This configuration is for use with 2-channel preamplifier/power amplifier combinations or 2-channel receivers that have full-range outputs for the left and right channels. The internal low-pass filter in the B120 is used to limit frequency range of the subwoofer, preventing undesirable overlap with the main loudspeakers.

1. Connect an RCA patch cable between the left main output on the receiver/preamplifier to the L(left) Low-Pass Enabled connector on the B120 rear panel, as shown in Figure 10.
2. Connect an RCA patch cable between the right main output on the receiver/preamplifier to the R(right) Low-Pass Enabled connector on the B120 rear panel.

### Note

*This configuration applies to receivers with preamplifier outputs or to preamplifier/power amplifier configurations in which there are two sets of Main outputs. If the receiver has jumpers from the Pre- or Main-Out to the Amp in connectors or if the preamplifier has only one set of Main-Out connectors, a Y-adapter should be used to send the same signal to both the main power amplifier and the subwoofer(s). Tape Out or Record Out connectors cannot be used.*

## Multichannel Applications – Multiple Subwoofer Connections

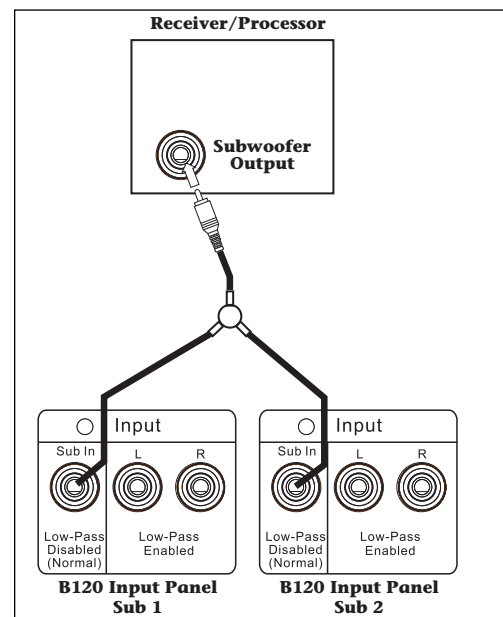

Figure 11: Connection to multiple B120 subwoofers

This configuration is for use with multiple B120 subwoofers and a multichannel processor or receiver.

### Note

*The supplied single-RCA patch cord can be used in any of the three connections described below, but you will need to purchase an RCA Y-adapter and possibly an additional single-RCA cable.*

1. Connect an RCA patch cable from the Subwoofer or LFE output on the processor/receiver to the single input on the Y-adapter, as shown in Figure 11.
2. Connect an RCA patch cable from one of the outputs of the Y-adapter to the Sub In connector on the first B120 rear panel.
3. Connect an RCA patch cable from the second output of the Y-adapter to the Sub In connector on the second B120 rear panel.

### Note

*Additional B120 subwoofers may be connected by using additional Y-adapters – by placing an additional Y-adapter input connector into one of the output connectors of the first Y-adapter.*



## Multichannel Applications – Multiple Subwoofer Outputs With a Single Subwoofer

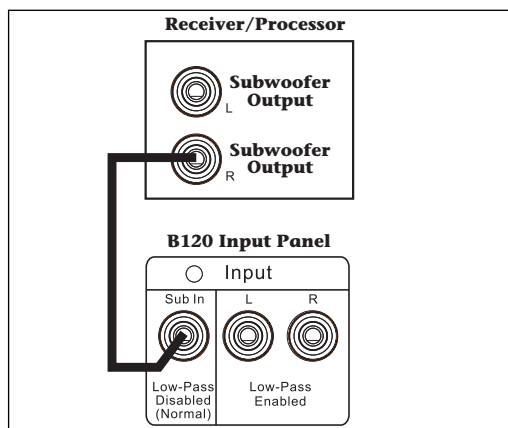

Figure 12: Typical connection with multiple subwoofer outputs

This configuration is for use with multichannel processors or receivers that have more than one dedicated Subwoofer or LFE output connector.

1. Set the processor or receiver to “Mono Subwoofer.”
2. Connect the supplied RCA patch cable from one of the Subwoofer or LFE outputs on the processor/receiver to the Sub In connector on the B120 rear panel, as shown in Figure 12.

### Note

*Additional B120 subwoofers may be connected by using additional Y-adapters – place the Y-adapter(s) in the processor/receiver Subwoofer or LFE output connector(s). Then connect the B120 Sub In connectors to the outputs of the Y-adapters.*

## Multichannel Applications – Multiple Subwoofer Outputs and Multiple Subwoofers

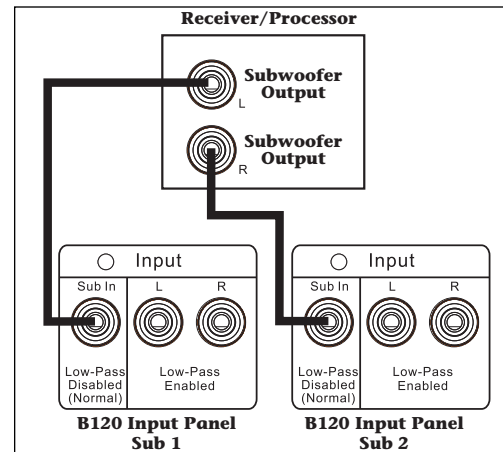

Figure 13: Multiple subwoofer connections

This configuration is for use with multiple B120 subwoofers and a multichannel processor or receiver that has more than one dedicated Subwoofer or LFE output connector.

1. Set the processor or receiver to “Mono Subwoofer.”
2. Connect the supplied RCA patch cable from one of the Subwoofer or LFE outputs on the processor/receiver to the Sub In connector on the first B120 rear panel, as shown in Figure 13.
3. Connect the RCA patch cable that was supplied with the second B120, from the second Subwoofer or LFE output on the processor/receiver to the Sub In connector on the second B120 rear panel.

### Note

*Additional B120 subwoofers may be connected by using additional Y-adapters – place the Y-adapter(s) in the processor/receiver Subwoofer or LFE output connector(s). Then connect the B120 Sub In connectors to the outputs of the Y-adapters.*

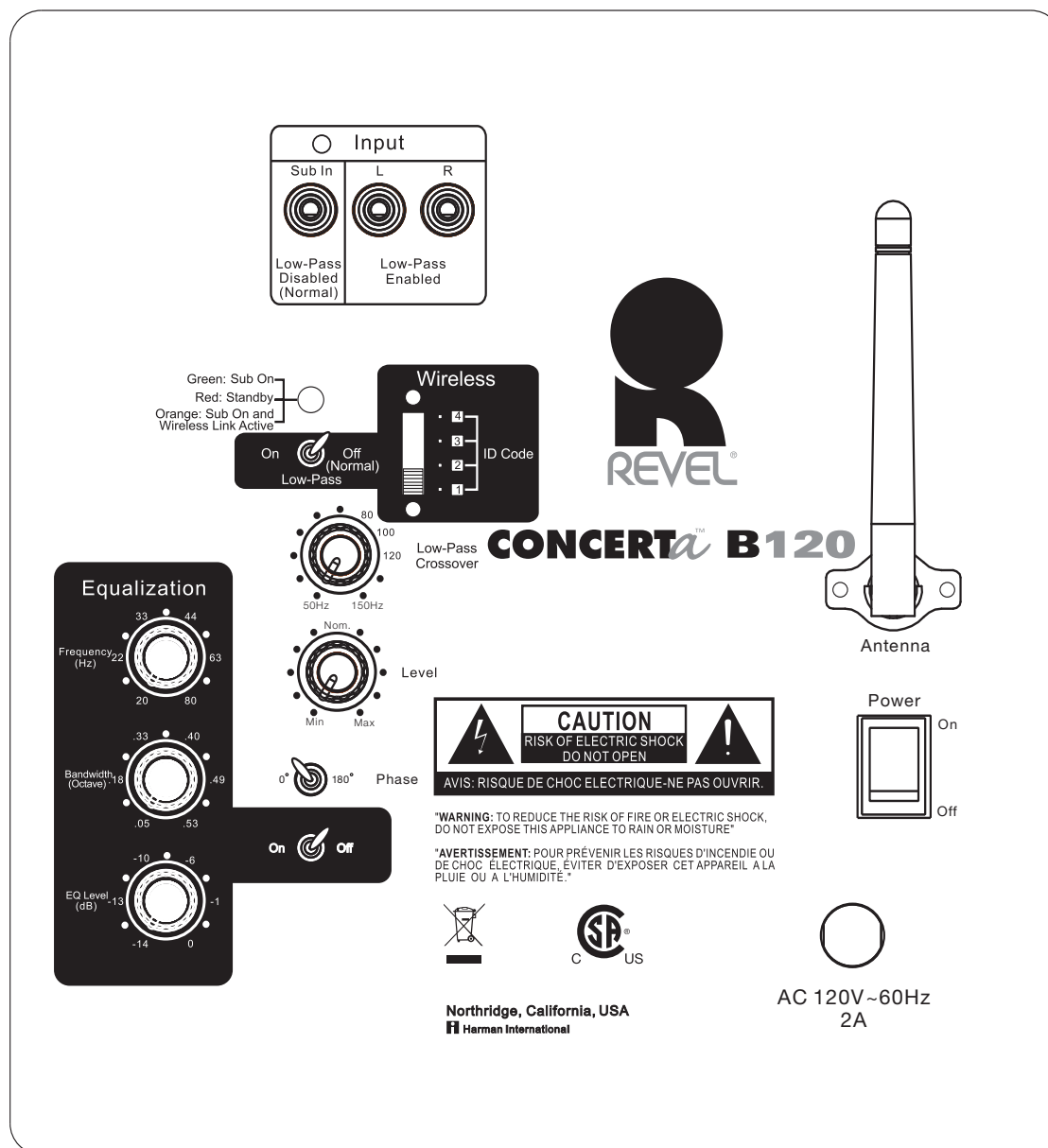

Figure 14: Rear-panel controls and connectors

## SUBWOOFER OPERATION

The rear panel of the Concerta B120 subwoofer, shown in Figure 14, contains all of the available connectors and controls. The Input section of the rear panel was discussed in the “Making Connections” section, earlier in this manual. The subwoofer controls are discussed in this section. For more information on the wireless connection option, refer to the “Wireless Connection” section found later in this manual.

### Power Indicator LED

The Power Indicator LED identifies the current state of the B120 subwoofer. The subwoofer has three different powered states – each identified by a different color. The Power Indicator LED reflects the color of the current power state. The color and the state each color indicates are:

**Red:** Standby – the B120 automatically enters Standby if no signal is detected from the system for 10 minutes.

**Green:** On – as soon as a signal is detected, the B120 powers on.

**Orange:** On – the B120 is powered on, and both the wireless link and transmitter are active.

## Subwoofer Level (Volume) Control

Provides basic volume adjustment for the subwoofer. Begin with this control set to the nominal "12 o'clock" position.

## Low-Pass Frequency Control

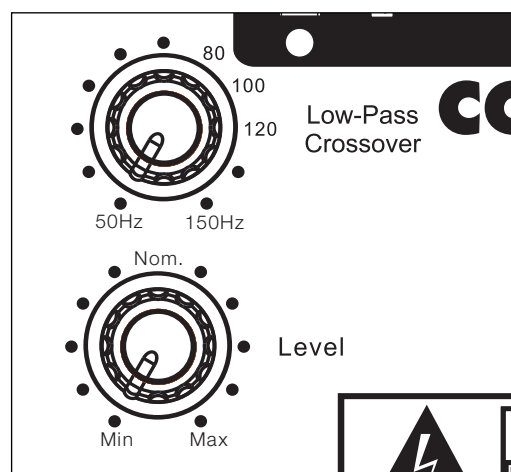

Figure 15: Rear-panel controls and connectors

Adjusts the variable 50Hz – 150Hz low-pass crossover, which determines the highest frequency at which the B120 reproduces sounds. Set the crossover to a lower frequency setting, between 50Hz and 100Hz, when using larger main loudspeakers that can comfortably reproduce some low-frequency sound.

With a lower frequency setting, the B120 subwoofer concentrates on reproducing the deep bass required by contemporary music and film soundtracks. Set the crossover to a higher frequency, between 100Hz and 150Hz, for smaller bookshelf loudspeakers that do not extend to the lower bass frequencies.

If the frequency control is set too high, the bass sounds "boomy" and can overpower the overall sound of the listening room. If the frequency control is set too low, some low frequency sound may be difficult to hear, or may be absent altogether.

This control has no effect when using the Sub In input or if the Low-Pass Switch, shown in Figure 17, is set to Off (Normal) while using the wireless input, because in both cases the receiver/processor sets the crossover frequency.

### Note

*This control does not limit the frequency range of the main speakers in the system. The objective of adjusting the Low-Pass Frequency control is to ensure that all frequencies are reproduced while minimizing any overlap between the subwoofers and the main speakers. Having both the subwoofer and main speakers reproduce the same frequencies should be avoided, as it results in very irregular response, since some frequencies are reinforced when they happen to be in phase while others are canceled because they are out of phase.*

## Phase Switch

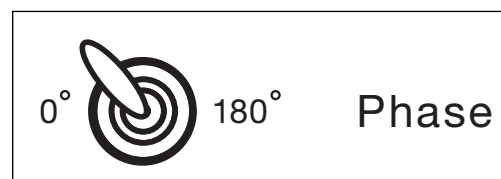

Figure 16: Phase switch

Compensates for the absolute phase of the subwoofer's output relative to the front speakers. Some associated electronics can invert the absolute phase. Use this switch to correct such occurrences. Proper phase adjustment can also depend on variables such as subwoofer placement and listener position. Use this switch, shown in Figure 16, to maximize bass output at the primary listening position.

- Select the 0° setting to set the B120 acoustic output in phase (0 degrees) with the input.
- Select the 180° setting to invert the B120 acoustic output (180 degrees) relative to the input.

## Low-Pass Filter Switch (Wireless Operation Only)



Figure 17: Low-pass switch

Activates or deactivates the Low-Pass Frequency Control when using an optional TX1 wireless transmitter. Refer to the "Wireless Connection" section found later in this manual for more details.

## Equalization Controls

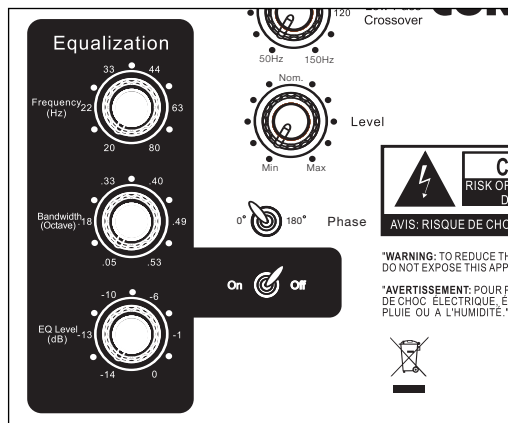

Figure 18: Equalization controls

Optimizes the subwoofer's response for your specific listening room. The parametric equalizer includes variable controls to adjust Frequency, Bandwidth and Level, as shown in Figure 18.

### Note

*Specific measurement equipment is required to properly adjust the Equalization controls. Your authorized Revel dealer can make the appropriate measurements, using suitable equipment to ensure optimal results.*

## Power Switch

Connects or disconnects power from the AC input cord. During periods of intermittent use, the Power Switch can be left on. Turn off the Power Switch for extended periods of nonuse.

## AC Input Cord

Provides power to the B120 through the power cord.

## WIRELESS CONNECTION

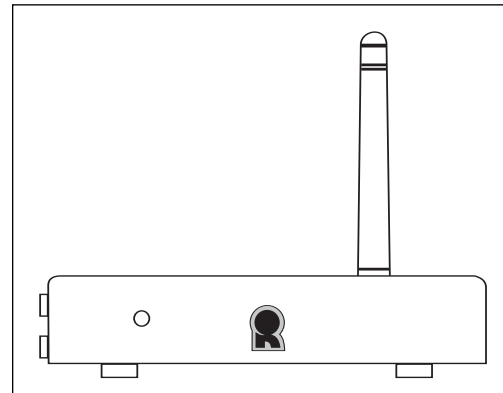

Figure 19: Wireless transmitter

The Concerta B120 subwoofer can be connected wirelessly by using the optional TX1 transmitter, shown in Figure 19. The TX1 transmitter utilizes advanced wireless transceivers which operate in the 2.4GHz frequency band – the same frequency band used for wireless home networks and high-quality cordless phones. This high-frequency band allows the wireless transmission of high-quality sound to remote locations.

One TX1 transmitter can support up to two B120 subwoofers. A third or fourth subwoofer may be connected by using an additional TX1 transmitter.

## The TX1 Package Includes:

- 1 x Transmitter module
- 1 x Power supply for transmitter
- 1 x 120V AC power cord for transmitter power supply
- 1 x 230V AC power cord for transmitter power supply – Shuko plug
- 1 x 230V AC power cord for transmitter power supply – UK plug
- 1 x 6' (1.8m) audio stereo cable, RCA-RCA
- 1 x Wall-mount bracket for transmitter
- 2 x Panhead M3 x 4 machine screws for attaching wall-mount bracket to transmitter
- 4 x Small, round, self-adhesive feet – to be attached on transmitter's left-side panel if transmitter is to be used vertically

## ID Codes

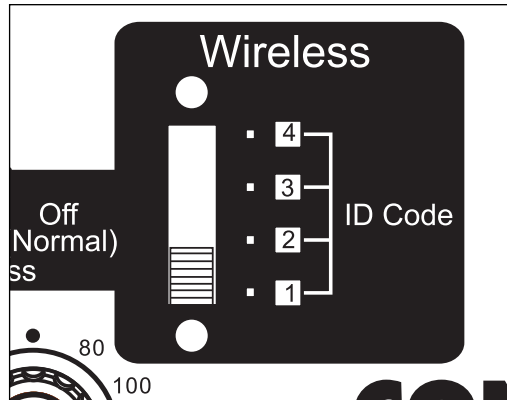

Figure 20: ID code selector

The ID Code identifies the channel in which the wireless system operates. This is particularly important if you have more than one set of subwoofer transmitters and receivers in operation, or in the unlikely event that the subwoofer(s) experience(s) interference with other wireless equipment.

Four different channels are available and can be set from the rear panels of the subwoofer and the TX1 transmitter. The subwoofer and transmitter **MUST** be set to the same channel; otherwise, the wireless system will not function.

### To Set the ID Code:

1. Adjust the four-position ID Code selector, shown in Figure 20, to the desired channel on the rear panel of the TX1 transmitter.
2. Then set the same channel on the ID Code selector on the rear panel of the subwoofer.

If you are using multiple sets of B120 subwoofers and TX1 transmitters, ensure that each subwoofer/TX1 transmitter pair are set to different ID Code channels.

## Connecting the TX1 Transmitter to the Subwoofer

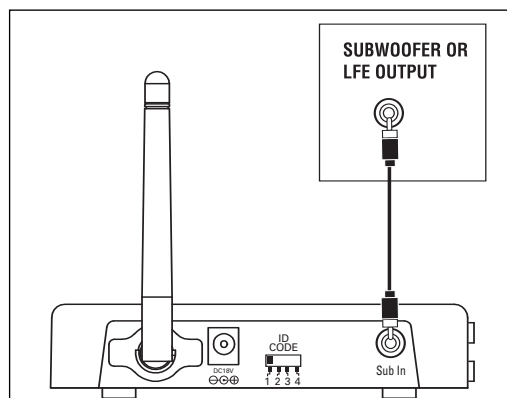

Figure 21: Wireless transmitter rear-panel connection

To use the wireless connection option with the B120 subwoofer, you must have at least one optional TX1 transmitter.

1. Connect an RCA patch cable from the Subwoofer or LFE output on the processor/receiver to the Sub In connector on the B120 rear panel, as shown in Figure 21.

### Note

*Some processors incorrectly label the subwoofer output as LFE; others offer both an LFE and a Subwoofer output. If there is no labeled subwoofer output, use the LFE output. If the output has labeled connections for both LFE and Subwoofer, use the Subwoofer output.*

2. Plug the supplied power cord of the TX1 transmitter between the power connector on the TX1 transmitter and an electrical wall outlet.
3. Set the ID Code on the transmitter and subwoofer to the same position, as described in the “ID Codes” section. When the ID Code is properly set, the LED on the rear panel of the B120 subwoofer lights in orange.
4. Set the Low-Pass switch on the rear panel of the B120 to the Off (Normal) position for most installations. See the following section, “Low-Pass Switch,” for more information about this switch.

## Low-Pass Switch

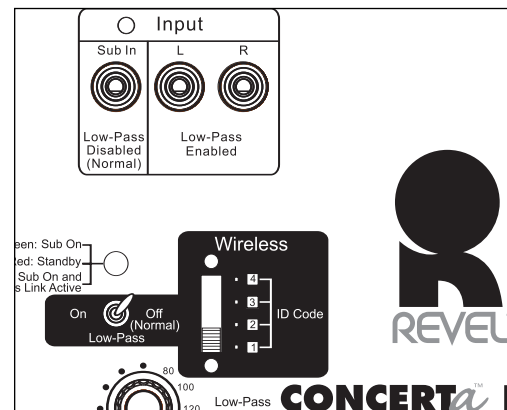

Figure 22: Low-pass switch and ID code selector

Activates or deactivates the Low-Pass Frequency Control when using an optional TX1 wireless transmitter.

It should be set to Off when the input of the TX1 transmitter is connected to the Subwoofer or LFE output of a processor or receiver. This is the recommended setting for most installations.

The Low-Pass filter should be set to the On position if the wireless connection option is in use AND the system does not include a dedicated subwoofer or LFE output. In most cases, this means that for multichannel systems, the switch will be set to the Off position, and for 2-channel systems, the switch will be set to the On position.



## Wall-Mounting the Transmitter Module

- Step 1. Insert the two M3 x 4 machine screws through the wall bracket and into the rear of the transmitter module, as shown.
- Step 2. Attach the transmitter module with wall bracket to the wall, using suitable hardware (and wall anchors, if necessary).

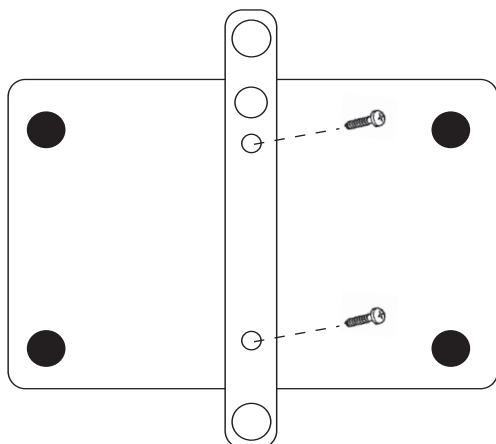

## LIMITED WARRANTY

A valid serial number is required for warranty coverage. This Revel warranty protects the original retail purchaser for a period of five (5) years (parts and labor) from any failure as a result of original manufacturing defects, so long as:

1. The Revel products were purchased within the 50 United States, its territories, or Canada.
2. The dealer from whom the Revel products were purchased was authorized to sell such products at the time of the original purchase.
3. The original, dated Bill of Sale is presented whenever service is required during the warranty period.

The balance of this warranty is transferable only if the used product is purchased from an authorized Revel dealer. This warranty is only valid for service within the United States, its territories, and Canada; please contact an authorized Revel dealer for warranty and service information.

Any Revel product not performing satisfactorily may be returned to the factory for evaluation. Return authorization must first be obtained by either calling or writing Customer Service prior to shipping the product. The customer is responsible for shipping charges to the factory. Customer Service will pay return shipping charges within the United States only in the event that

the product is found to be defective, as mentioned above. There are other stipulations that may apply to shipping charges.

There is no other express warranty on this product. Neither this warranty nor any other warranty, express or implied, including implied warranties of merchantability and fitness, shall extend beyond the warranty period. No responsibility is assumed for any incidental or consequential damages, so that the above exclusion or limitation may not apply.

This warranty provides specific legal rights. Other states may provide additional rights. This warranty is applicable in the United States, its territories, and Canada. Outside of the United States, its territories, and Canada, please contact an authorized Revel dealer for warranty and service information. The information this document contains is subject to change without notice. In the event that there are differences between this warranty and the provisions of any advertisements, documentation, product brochures or packaging cartons, the terms of this warranty will prevail.

For customer service and product shipment information, refer to [www.revelspeakers.com](http://www.revelspeakers.com).

## ROUTINE CARE & MAINTENANCE

The B120 cabinet's finish does not require routine maintenance. However, cabinet surfaces that have been marked with fingerprints, dust or other dirt can be cleaned using a soft cloth. Do not use any cleaning products or polishes on the cabinet or grille.

## CAUTION!

To prevent cabinet damage, **DO NOT** use a cloth made with steel wool or use metal polish to clean the cabinet.

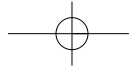

## SPECIFICATIONS

<b>B120 Subwoofer</b>	
<b>Frequency Response</b>	+/-0.5dB in the pass-band
<b>Low Frequency</b>	-3dB at 36Hz
<b>Extension (Anechoic)</b>	-6dB at 32Hz -10dB at 29Hz
<b>Maximum Amplifier Output</b>	20Hz – 150Hz with no more than 0.1% THD, 250W RMS, 300 dynamic
<b>Low-Pass Crossover Frequencies</b>	50Hz – 150Hz, 24dB/octave, continuously variable
<b>Power Requirements</b>	120V AC @ 60Hz, 2A
<b>Height</b>	17-3/4" (45.0cm), including feet
<b>Width</b>	15-3/4" (40.0cm)
<b>Depth</b>	14" (35.6cm) with grille
<b>Weight</b>	51 lb (23.15kg)

Features, specifications and appearance are subject to change without notice.

## NOTES

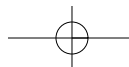



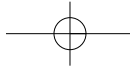

For customer service and product shipment information,  
refer to [www.revelspeakers.com](http://www.revelspeakers.com).

Part No. 406-000-05850-E

©2008 Harman International Industries, Incorporated.  
All rights reserved.

 Harman International

Revel, the Revel logo, Ultima, Performa and Concerta are  
trademarks of Harman International Industries, Incorporated,  
in the United States and/or other countries.

Nomex and Kapton are registered trademarks of  
E.I. du Pont de Nemours and Company.

This document should not be construed as a commitment  
on the part of Harman International Industries, Incorporated.  
The information it contains is subject to change without  
notice. Harman International Industries, Incorporated,  
assumes no responsibility for errors that may appear  
within this document.

