

MERITRC

6CH 2.4GHZ FHSS RADIO CONTROL SYSTEM

MT-602



SHANGHAI MERIT TECHNOLOGY CORP.

CONTENTS

TRANSMITTER **MT-602** (Front Panel)



ADJUSTMENT AND INSTALLATION

This section describes the installation method and adjustment method after installation when installing the receiver, servos, etc. to the plane.

Connections

Connection example is shown below.

The diagram shown is for aircraft models only. Additional servos may have to be purchased separately.

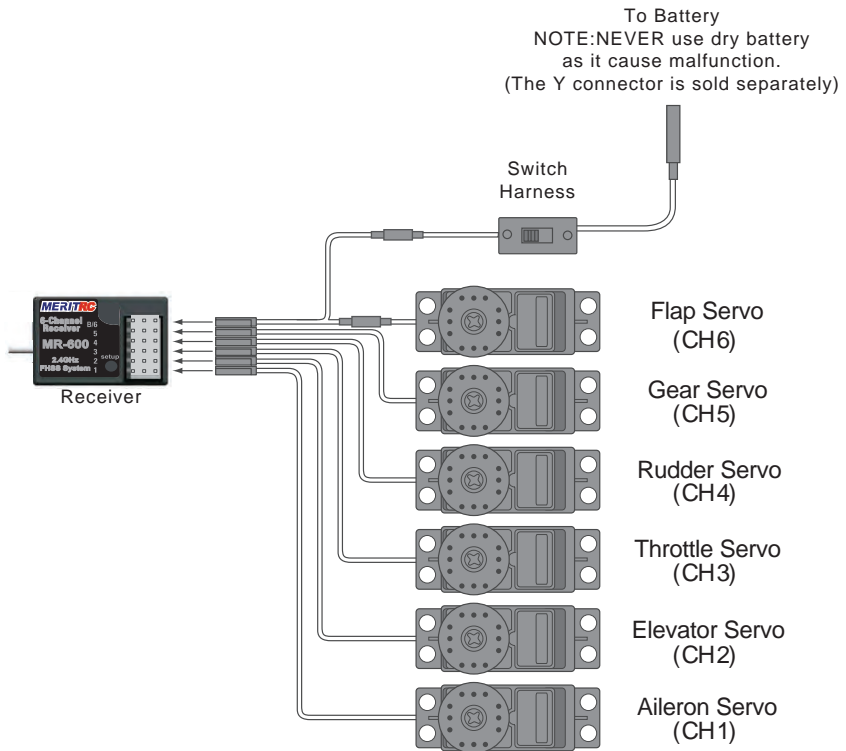

TRANSMITTER MT-602 (Rear and Side Panel)



Charging jack

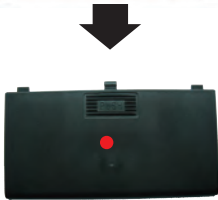

Battery cover

Use when replacing the battery .
Slide the cover downward while pressing the
part marked "  " .

RECEIVER MR-600

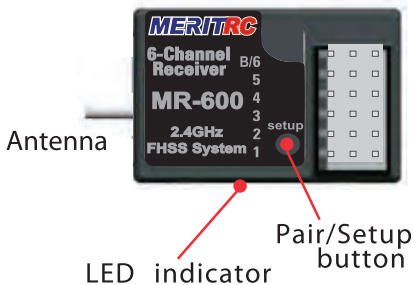

Channel Output

- "1": Aileron servo (CH1)
- "2": Elevator servo (CH2)
- "3": Throttle servo (CH3)
- "4": Rudder servo (CH4)
- "5": Gear servo (CH5)
- "6": Flap servo (CH6)

Special note for 2.4GHz FHSS radio system setup

Since the 2.4GHz have different characteristics than that of the conventional frequencies, please read this section carefully to enjoy safe flight with the 2.4GHz system.

Receiver 's Antenna installation

The wave length of the 2.4GHz is much shorter than that of the conventional frequencies, it is very susceptible to loss of signal which results in a receiving error.

To obtain the best results, please refer to the following instructions;

1. The antenna must be kept as straight as possible. Otherwise it will reduce the effective range.

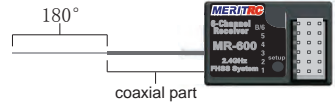

2. The antenna should be perpendicular to the fuselage. Larger models can have large metal objects that can attenuate the RF signal. In this case the antenna should be placed at side of the model. Then the best RF signal condition is obtained at any flying attitude.
3. The antenna must be kept away from conductive materials, such as metal and carbon by at least a half inch. The coaxial part of the antennas does not need to follow these guidelines, but do not bend it in a small radius.
4. Keep the antenna away from the motor, ESC, and other noise sources as much as possible.

- * The main purpose of the photo demonstrates how the antenna should be placed. For actual installation the receiver must be wrapped with a sponge or placed with floating material to protect it from vibration.

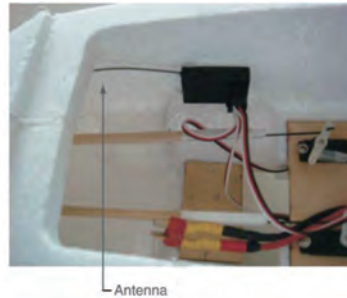

The receiver contains precision electronic parts. It is the most delicate radio component on-board the model and should be protected from vibration, shock and temperature extremes. To protect the receiver, wrap it in R/C foam rubber or other vibration-absorbing material. If appropriate, waterproof the receiver by placing it in a plastic bag and closing the open end with a rubber band before wrapping it in foam. If moisture enters the receiver, intermittent operation or a failure may result. Wrapping the receiver in a plastic bag also protects it from fuel and exhaust residue which, in some models, can work its way into the fuselage.

Transmitter antenna

1. The transmitter antenna is adjustable so please make sure that the antenna is never pointed directly at the model when flying as this creates a weak signal for the receiver.
2. Keep the antenna perpendicular to the transmitter's face to create a better RF condition for the receiver. Of course this depends on how you hold the transmitter, but in most cases, adjusting the transmitter antenna so that it is perpendicular to the face will give the best results. Please adjust the transmitter antenna to the way you hold the transmitter.
3. NEVER grip the antenna when flying as this degrades RF quality.



Binding Setup(Pair Procedure)

Programming a receiver to recognize the code of only one specific transmitter.



If you change transmitters or add a receiver, you must re-bind before operating your model.

1. Place the transmitter and the receiver close to each other (within one meter). Turn the power switch on the transmitter to the ON position.
2. Press and hold the receiver setup button, then turn the power switch to the ON position. The receiver LED will flash quickly. Release the setup button after 1 second.
3. Press and hold the binding/PDM button on the transmitter for 1 second until the green LED on the transmitter flash quickly then the LED on the transmitter and receiver are continuously lit.

Fail-Safe Setup

Please note the setup must be based on pair procedure well.

1. Turn the power switch on the transmitter & receiver to the ON position, the LED on transmitter & receiver are continuously lit.
2. Move the stick to the position where you want the servo to move, press and hold the receiver setup button for 2 seconds until the red LED on the receiver flash slowly, then press and hold the receiver setup button again within 5 seconds (Note: after 5 seconds F/S setup will reset, you have to start over at step one above) until the receiver LED is continuously lit, that means the F/S function has been correctly set.
3. Verify if the failsafe function has been correctly set. Turn off the transmitter, then check if the servos move to the position that you set.
4. Any new binding (pair procedure) will clear the preset Fail-Safe.

Range check the radio

A range check must be performed before the first flight of a new model. It is not necessary to do a range check before every flight (but is not a bad idea to perform a range check before the first flight of each day). A range check is the final opportunity to reveal any radio malfunctions, and to be certain the system has adequate operational range.

1. We have installed a special "Power Down Mode" for doing a ground range check. To activate the "Power Down Mode" please hold down the PDM key and then turn the transmitter switch on. During this mode, the RF power is reduced so the range test can be performed. When this mode is active the green LED starts blinking. In addition, when the mode is activated the transmitter gives users a warning with a beep sound every 1 second, and visual indication.

2. Walk away from the model while simultaneously operating the controls. Have an assistant stand by the model and signal what the controls are doing to confirm that they operate correctly. You should be able to walk approximately 30 - 50 paces from the model without losing control.
3. If everything operates correctly, return to the model. Set the transmitter in a safe, yet accessible location so it will be within reach after starting the engine. Be certain the throttle stick is all the way down, then start the engine. Perform another range check with your assistant holding the plane and the engine running at various speeds. If the servos jitter or move inadvertently, there may be a problem. Do not fly the plane! Look for loose servo connections or binding pushrods. Also be certain that the battery has been fully charged.
4. The "Power Down Mode" continues for 60 seconds and after that the power will go back to the normal level. To exit the "Power Down Mode" before the 60 seconds, turn the transmitter switch on again.
5. NEVER start flying when the "Power Down Mode" is active.

SERVO REVERSING

The direction of movement for any of the four channels can be reversed electronically.

To change the direction of movement for each main channel:

1. Switch off the TX power switch.
2. Press and hold one specific trim button for the channel to be reversed.
CH1 right trim button for CH1 reversing.
CH2 down trim button for CH2 reversing.
CH3 high trim button for CH3 reversing.
CH4 right trim button for CH4 reversing.
3. Switch the TX power switch on, the GREEN LED should flash then steady on to indicate the movement for that channel has been reversed.
4. Repeat steps 1-3 to reverse the direction of any other channel as needed.

CH1,CH2 DUAL RATE (D/R)

The travel Range of the servos for the aileron or elevator can be changed at any time by using the switch marked CH1 D/R or CH2 D/R, located above the stick. With the switch in UP position, the channel's servo will be capable of rotating through its full travel range(100%). Moving the switch to the opposite position(DOWN) will limit the rotational range of the channel's servo.

To adjust the D/R setting:

1. Switch the D/R switch to the DOWN position.
2. Adjust the trimmer located on the panel marked D/R CH1 or CH2, When the trimmer is turned counter-clockwise, the rotational range will decrease (Minimum 30%), conversely, the trimmer is turned clockwise, the rotational range will increase (Maximum 100%).

ELEVON & V-TAIL MIXING FUNCTIONS

The Elevon and V-tail mixing functions which can be turned on or off. Elevon control consists of a mixture between the elevator and aileron channels. V-tail control consists of a mixture between the elevator and rudder channels. The default setting for all mixing will be off the GREEN LED should be on steady.

To change the mix setting:

1. Switch off the TX power switch.
2. Press and hold CH2 and CH3 DOWN&HIGH trim button simultaneously.
3. Switch the TX power switch on, the GREEN LED should flash constantly to indicate the mixing function has been turned on.
4. Repeat steps 1-3 to change the mixing function from Elevon on, V-tail on then off in sequence.

MODE 1、MODE 2 STICK SETTING

This function changes the stick mode of transmitter。

Note: This will not change the throttle Ratchet etc. Those are mechanical changes that must be performed by specific technician。

To change the MODE setting:

- 1.Switch off the TX power switch。
- 2.Press and hold CH1 and CH4 LEFT&RIGHT trim button simultaneously。
- 3.Switch the TX power switch on, the GREEN LED should flash and accompanied by two audible tones indicate the MODE 2 function has been turned on. Conversely the GREEN LED flash and accompanied by one audible tone indicate the MODE 1 function has been turned on。
- 4.Repeat steps 1-3 to change the MODE function form MODE1 to MODE 2 in sequence。
- 5.Since TX power switch on then accompanied by one audible tone indicate the MODE 1 function has been turned on, if accompanied by two audible tones indicate the MODE 2 function has been turned on。

V-tail Mixing

Intended for V-tail aircraft,V-tail mixing allows the ruddervators to operate both as rudders and elevators.The same as the other mixes,V-tail mixing requires that each ruddervator be operated by a separate servo.

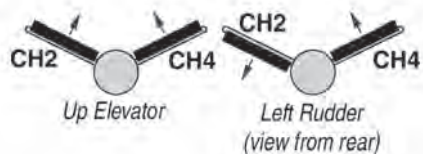

*If necessary,use the Servo Reversing function to achieve the correct direction of servo throws.

Delta Wing Mixing

Intended for tailless,“flying wing” models such as delta wings and flying wings,elevon mixing mixes channel 1 (aileron) to channel 2 (elevator) allowing the elevons to operate in unison (as elevators) or in opposition (as ailerons). This function requires that each elevon be operated by a separate servo.

*If necessary,use the Servo Reversing function to achieve the correct direction of servo throws.

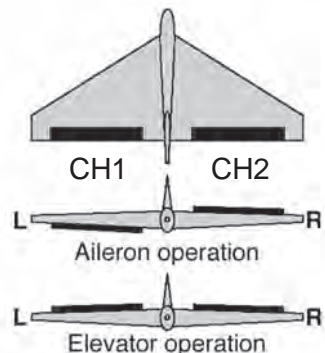

Transmitter Operation and Movement of Each Servo

Before making any adjustments, learn the operation of the transmitter and the movement of each servo. (In the following descriptions, the transmitter is assumed to be in the standby state.)

AILERON OPERATION

When the aileron stick is moved to the right, the right aileron is raised and the left aileron is lowered, relative to the direction of flight, and the plane turns to the right. When the aileron stick is moved to the left, the ailerons move in the opposite direction. To level the plane, the aileron stick must be moved in the opposite direction. When the aileron stick is tilted and held, the plane will roll.

Aileron(CH1)

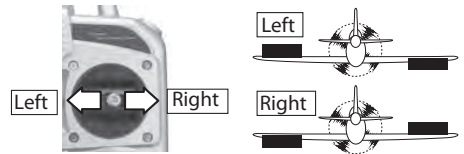

ELEVATOR OPERATION

When the elevator stick is pulled back, the tail elevator is raised and the tail of the plane is forced down, the air flow applied to the wings is changed, the lifting force is increased, and the plane climbs (UP operation). When the elevator stick is pushed forward, the elevator is lowered, the tail of the plane is forced up, the air flow applied to the wings is changed, the lifting force is decreased, and the plane dives (DOWN operation).

Elevator(CH2)

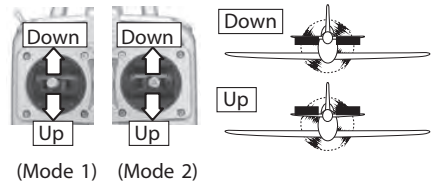

THROTTLE OPERATION

When the throttle stick is pulled back, the engine throttle lever arm moves to the SLOW (low speed) side. When the throttle stick is pushed forward, the throttle lever arm moves to the HIGH (high speed) side.

Throttle(CH3)

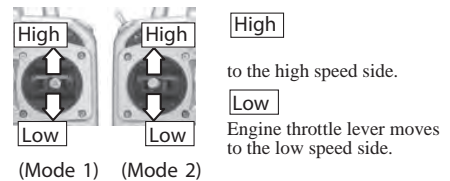

RUDDER OPERATION

When the rudder stick is moved to the right, the rudder moves to the right and the nose points to the right, relative to the direction of flight. When the rudder stick is moved to the left, the rudder moves to the left and the nose points to the left and the direction of travel of the plane changes.

Rudder(CH4)

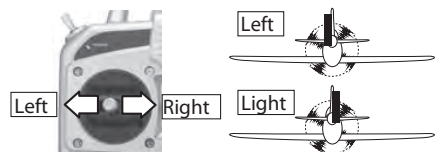

⚠ WARNING

Connector Connection

- ❗ Insert the receiver, servo, and battery connectors fully and firmly.

If vibration, etc. causes a connector to work loose during flight, the plane may crash.

Receiver Vibrationproofing / Waterproofing

- ❗ Vibrationproof the receiver by wrapping it in sponge rubber or some such material. If the receiver may get wet, waterproof it by placing it in a plastic bag.

If the receiver is subjected to strong vibration and shock, or gets wet, it may operate erroneously and cause a crash.

Receiver Antenna

- ⊘ Do not cut or bundle the receiver antenna. Also, do not bundle the antenna together with the servo lead wires.

Cutting or bundling the receiver antenna will lower the receiver sensitivity and shorten the flight range and cause a crash.

<Antenna installation>

For aircraft, attach the antenna to the top of the tail.

Attach the antenna with a rubber band, etc.

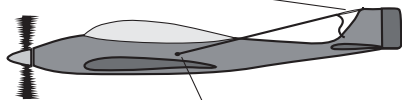

Use a rubber grommet, etc. at the part at which the antenna comes out of the fuselage so that it will not break. Also tie a knot in the antenna wire inside the fuselage so that the antenna cannot be pulled out.

Servo Throw

- ❗ Operate each servo horn over its full stroke and adjust so that the pushrod does not bind or is not too loose.

Unreasonable force applied to the servo horn will adversely affect the servo and drain the battery quickly.

Servo Installation

- ❗ Install the servos to the servo mount, etc. through a rubber grommet. Also install the servos so that the servo case does not directly touch the servo mount or other parts of the fuselage.

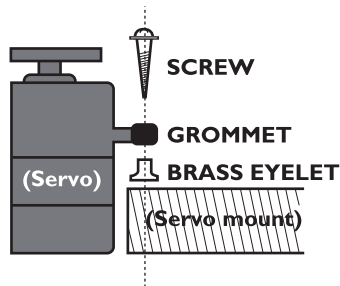

Power Switch Installation

When installing a receiver power switch to the fuselage, cut a rectangular hole somewhat larger than the full stroke of the switch knob and install the switch so it moves smoothly from ON to OFF.

Also install the switch where it will not come into direct contact with engine oil, dust, etc. Generally, install the switch to the fuselage at the side opposite the muffler exhaust.

FCC RF Exposure Information and Statement

This device complies with part 15 of the FCC rules. Operation is subject to the following two conditions: (1) this device may not cause harmful interference, and (2) this device must accept any interference received, including interference that may cause undesired operation.

NOTE: The manufacturer is not responsible for any radio or TV interference caused by unauthorized modifications to this equipment. Such modifications could void the user's authority to operate the equipment. NOTE: This equipment has been tested and found to comply with the limits for a Class B digital device, pursuant to part 15 of the FCC Rules. These limits are designed to provide reasonable protection against harmful interference in a residential installation. This equipment generates uses and can radiate radio frequency energy and, if not installed and used in accordance with the instructions, may cause harmful interference to radio communications. However, there is no guarantee that interference will not occur in a particular installation. If this equipment does cause harmful interference to radio or television reception, which can be determined by turning the equipment off and on, the user is encouraged to try to correct the interference by one or more of the following measures:

- Reorient or relocate the receiving antenna.
- Increase the separation between the equipment and receiver.
- Connect the equipment into an outlet on a circuit different from that to which the receiver is connected.
- Consult the dealer or an experienced radio/TV technician for help.

This smartphone meets the government's requirements for exposure to radio waves. The guidelines are based on standards that were developed by independent scientific organizations through periodic and thorough evaluation of scientific studies. The standards include a substantial safety margin designed to assure the safety of all persons regardless of age or health.

FCC RF Exposure information and Statement the SAR limit of USA (FCC) is 1.6W/kg averaged over one gram of tissue. Device type MT-602 (FCC ID: XJ6MT-602) has also been tested against this SAR limit. SAR information on this and other pad can be viewed on-line at <http://www.fcc.gov/oet/ea/fccid/>

To keep the device at least 0 mm away from your body to make sure the RF exposure level compliant or lower to the reported level.

.The use of belt clips, holsters and similar accessories should not contain metallic components in its assembly. The use of accessories that do not satisfy these requirements may not comply with FCC RF exposure requirements, and should be avoided.

changes or modifications not expressly approved by the party responsible for compliance could void the user's authority to operate the equipment.