

# **SYLVANIA**

MODEL NO. SCR1986BT

## BLUETOOTH CLOCK RADIO

### INSTRUCTION MANUAL

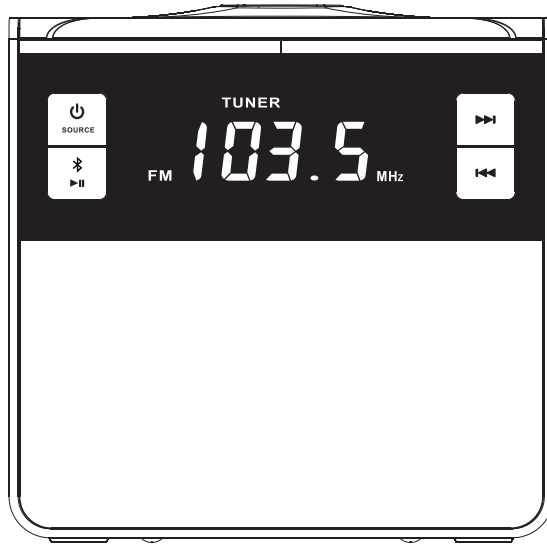

PLEASE READ BEFORE OPERATING THIS EQUIPMENT

## Warnings and Precautions

TO PREVENT FIRE OR SHOCK HAZARDS, DO NOT EXPOSE THIS UNIT TO RAIN OR MOISTURE.



This symbol, located on back or bottom of the unit, is intended to alert the user to the presence of uninsulated “dangerous voltage” within the product’s enclosure that may be of sufficient magnitude to constitute a risk of electric shock to persons.



This symbol, located on back or bottom of the unit, is intended to alert the user to the presence of important operating and maintenance (servicing) instructions in the literature accompanying the appliance.



This product utilizes a Class 1 laser to read Compact Discs. This laser Compact Disc Player is equipped with safety switches to avoid exposure when the CD door is open and the safety interlocks are defeated. Invisible laser radiation is present when the CD Player’s lid is open and the system’s interlock has failed or been defeated. It is very important that you avoid direct exposure to the laser beam at all times. Please do not attempt to defeat or bypass the safety switches.

**CAUTION:** TO PREVENT ELECTRIC SHOCK, MATCH WIDE BLADE OF PLUG TO WIDE SLOT, FULLY INSERT.

To reduce the risk of electric shock, do not remove cover (or back). There are no user-serviceable parts inside. Please refer any servicing to qualified service personnel.

**WARNING:** Changes or modifications to this unit not expressly approved by the party responsible for compliance could void the user’s authority to operate the equipment.

- Do not mix old and new batteries.
- Do not mix alkaline, standard (carbon-zinc), or rechargeable (ni-cad, ni-mh, etc) batteries.

**NOTE:** This equipment has been tested and found to comply with the limits for a Class B digital device, pursuant to Part 15 of the FCC Rules. These limits are designed to provide reasonable protection against harmful interference in a residential installation. This equipment generates, uses, and can radiate radio frequency energy and, if not installed and used in accordance with the instructions, may cause harmful interference to radio communications. However, there is no guarantee that interference will not occur in a particular installation. If this equipment does cause harmful interference to radio or television reception, which can be determined by turning the equipment off and on, the user is encouraged to try to correct the interference by one or more of the following measures:

- Reorient or relocate the receiving antenna.
- Increase the separation between the equipment and receiver.
- Connect the equipment into an outlet on a circuit different from that to which the receiver is connected.
- Consult the dealer or an experienced radio/TV technician for help.

# Important Safety Instructions

- Read Instructions** - All the safety and operating instruction should be read before the product is operated.
- Retain Instructions** - The safety and operating instruction should be retained for future reference.
- Heed Warnings** - All warning on the product and in the operating instructions should be adhered to.
- Follow instructions** - All operating and use instructions should be followed.
- Cleaning** - Unplug this product from the wall outlet before cleaning. Do not use liquid cleaners or aerosol cleaners. Clean only with a dry cloth.
- Attachments** - Do not use attachments not recommended by the product manufacturer as they may cause hazards.
- Water and Moisture** - Do not use this product near water - for example, near a bath tub, wash bowl, kitchen sink, or laundry tub; in a wet basement, or near a swimming pool, and the like. The apparatus shall not be exposed to dripping or splashing and that no objects filled with liquids, such as vases, shall be placed on apparatus.
- Accessories** - Do not place this product on an unstable cart, stand tripod, bracket, or table. The product may fall, causing serious injury to a child or adult, and serious damage to the product. Use only with a cart, stand, tripod, bracket, or table recommended by the manufacturer, or sold with the product. Any mounting of the product should follow the manufacturer's instructions, and should use a mounting accessory recommended by the manufacturer.
- A product and cart combination should be moved with care. Quick stops, excessive force, and uneven surfaces may cause the appliance and cart combination to overturn.

See figure:



- Ventilation** - Slots and openings in the cabinet are provided for ventilation and to ensure reliable operation of the product and to protect it from overheating, and these openings must not be blocked or covered. The openings should never be blocked by placing the product on a bed, sofa, rug, or other similar surface. This product should not be placed in a built-in installation such as a bookcase or rack unless proper ventilation is provided or the manufacturer's instruction have been adhered to.
- Power Sources** - This product should be operated only from the type of power source indicated on the marking label. If you are not sure of the type of power supply to your home, consult your product dealer or local power company. For products intended to operate from battery power, or other sources, refer to the operating instruction.
- Grounding or Polarization** - This product may be equipped with a polarized alternating-current line plug (a plug having one blade wider than the other). This plug will fit into the power outlet only one way. This is a safety

feature. If you are unable to insert the plug fully into the outlet, try reversing the plug. If the plug should still fail to fit, contact your electrician to replace your obsolete outlet. Do not defeat the safety purpose of the polarized plug.

**Alternate Warnings** - This product is equipped with a three-wire grounding-type plug, a plug having a third (grounding) pin. This plug will only fit into a grounding-type power outlet. This is a safety feature. If you are unable to insert the plug into the outlet, contact your electrician to replace your obsolete outlet. Do not defeat the safety purpose of the grounding-type plug.

- Power-Cord Protection** - Power supply cords should be routed so that they are not likely to be walked on or pinched by items placed upon or against them, paying particular attention to cords at plugs, convenience receptacles, and point where they exit from the product.
- Protective Attachment Plug** - The product is equipped with an attachment plug having overload protection. This is a safety feature. See Instruction Manual for replacement or resetting of protective device. If replacement of the plug is required, be sure the service technician has used a replacement plug specified by the manufacturer that has the same overload protection as the original plug.
- Outdoor Antenna Grounding** - If an outside antenna is connected to the receiver, be sure the antenna system is grounded so as to provide some protection against voltage surges and built-up static charges. Article 810 of the National Electrical Code, ANSI/NFPA 70, provides information with regard to proper grounding of the mast and supporting structure, grounding of the mast and supporting structure, grounding of the lead-in wire to an antenna-discharge unit, size of grounding conductors, location of antenna-discharge unit, connection to grounding electrodes, and requirements for the grounding electrode.

See figure:

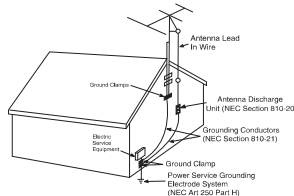

- Lightning** - For added protection for this product during a lightning storm, or when it is left unattended and unused for long periods of time, unplug it from the wall outlet and disconnect the antenna or cable system. This will prevent damage to the product due to lightning and power-line surges.
- Power Lines** - An outside antenna system should not be located in the vicinity of overhead power lines or other electric light or power circuits, or where it can fall into such power lines or circuits. When installing an outside antenna system, extreme care should be taken to keep from touching such power lines or circuits as contact with them might be fatal.
- Overloading** - Do not overload wall outlets, extension cords, or integral convenience

receptacles as this can result in a risk of fire or electric shock.

- Object and Liquid Entry** - Never push objects of any kind into this product through openings as they may touch dangerous voltage points or short-out parts that could result in a fire or electric shock. Never spill liquid of any kind on the product.
- Servicing** - Do not attempt to service this product yourself as opening or removing covers may expose you to dangerous voltage or other hazards. Refer all servicing to qualified service personnel.
- Damage Requiring Service** - Unplug this product from the wall outlet and refer servicing to qualified service personnel under the following conditions:
  - When the power-supply cord or plug is damaged,
  - If liquid has been spilled, or objects have fallen into the product,
  - If the product has been exposed to rain or water,
  - If the product does not operate normally by following the operating instructions. Adjust only those controls that are covered by the operating instructions as an improper adjustment of other controls may result in damage and will often require extensive work by a qualified technician to restore the product to its normal operation.
  - If the product has been dropped or damaged in any way, and
  - If the product exhibits a distinct change in performance - this indicates a need for service.
- Replacement Parts** - When replacement parts are required, be sure the service technician has used replacement parts specified by the manufacturer or have the same characteristics as the original part. Unauthorized substitutions may result in fire, electric shock, or other hazards.
- Safety Check** - Upon completion of any service or repairs to this product, ask the service technician to perform safety checks to determine that the product is in proper operating condition.
- Wall or Ceiling Mounting** - The product should be mounted to a wall or ceiling only as recommended by the manufacturer.
- Heat** - The product should be situated away from heat sources such as radiators, heat registers, stoves, or other products (including amplifiers) that produce heat. Battery shall not be exposed to excessive heat such as sunshine, fire, or the like.
- Main plug is used as disconnect device and it should remain readily operable during intended use. In order to disconnect the apparatus from the mains completely, the mains plug should be disconnected from the mains socket outlet completely.
- Excessive sound pressure from earphones and headphones can cause hearing loss.

## LOCATION OF CONTROLS

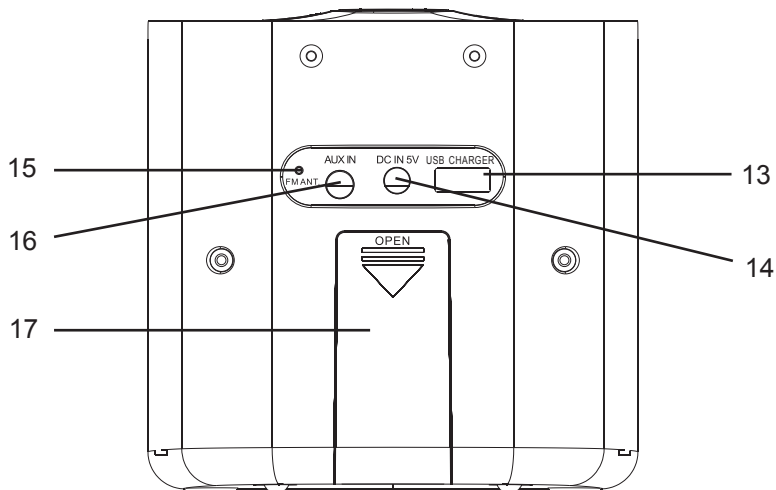
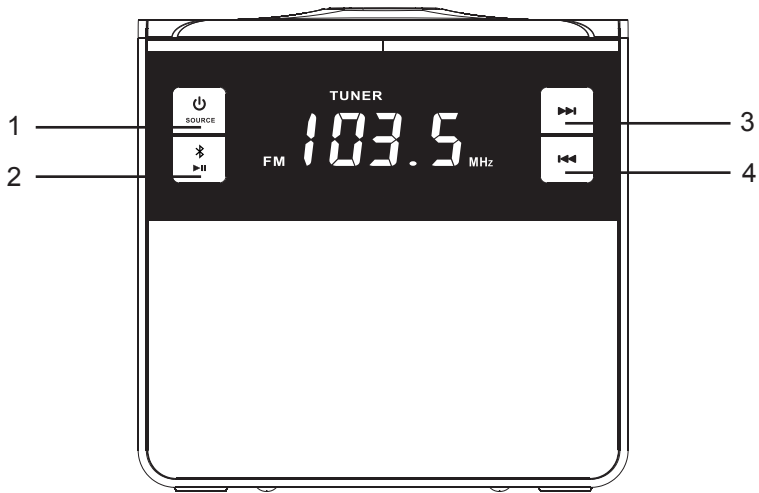
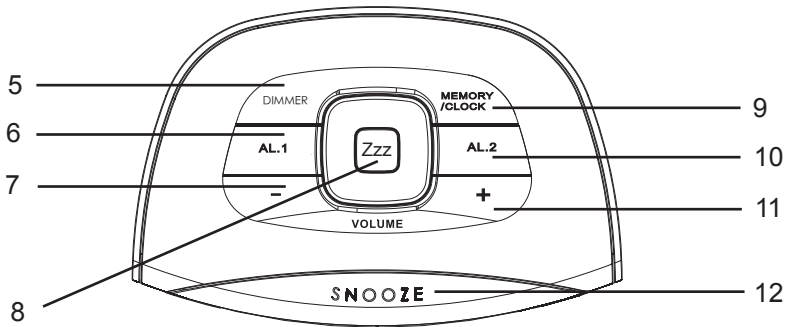

## LOCATION OF CONTROLS

1. POWER / SOURCE BUTTON
2. PAIR BLUETOOTH / PLAY / PAUSE BUTTON
3. SKIP / TUNE FORWARD BUTTON
4. SKIP / TUNE BACKWARD BUTTON
5. DIMMER BUTTON
6. ALARM ONE BUTTON
7. VOLUME DOWN BUTTON
8. SLEEP BUTTON
9. MEMORY / CLOCK BUTTON
10. ALARM TWO BUTTON
11. VOLUME UP BUTTON
12. SNOOZE BUTTON
13. USB CHARGING JACK
14. DC JACK
15. FM ANTENNA
16. AUX IN JACK
17. BACKUP BATTERIES COMPARTMENT

## POWER SOURCE

### A. DC Power

To power the unit, plug the DC Power adaptor into a standard wall outlet

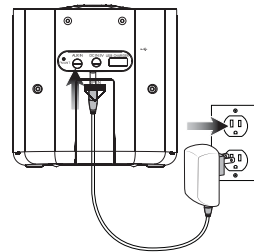

### B. Battery Backup

Requires 2 x AAA Size, batteries (not Include).  
The battery backup is intended for short power outages only. The unit's primary functions cannot run on the battery backup alone

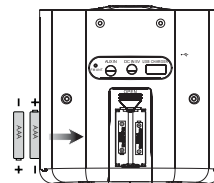

## CLOCK AND SLEEP

### Setting the Clock

1. With the power off, press and hold the MEMORY/CLOCK BUTTON. Press the SKIP/TUNE BUTTON to select 12HR or 24HR mode.
2. Press the SKIP/TUNE BUTTON to adjust the hour.
3. Press the MEMORY/CLOCK BUTTON again to adjust the minutes. The minutes on the display will begin flashing.
4. Press the SKIP/TUNE BUTTON to adjust the minutes.
5. Press the MEMORY/CLOCK BUTTON to finish setting the time, or wait for the display to stop flashing.

### SETTING SLEEP TIMER

When listening to radio, press SLEEP BUTTON to enter sleep mode. You can just adjust the sleep timer from 10 to 90 minutes by pressing the SLEEP BUTTON.

The unit will automatically turn off after the selected time expires.

## ALARM

### Setting the Alarm

1. If in radio mode, press and hold the POWER / SOURCE BUTTON to turn the unit off.
  2. Press and hold ALARM ONE BUTTON or ALARM TWO BUTTON.
  3. Press the SKIP/TUNE BUTTON repeatedly to switch between wake by bb (Buzzer), rad (Radio) or bt (Bluetooth) mode.
  4. Press the SKIP/TUNE BUTTON to adjust the hour.  
\*The PM indicator will light when the hour is set in the PM
  5. Press the SKIP/TUNE BUTTON to adjust the minute.  
\*The Alarm One or Alarm Two indicator will come on.
  6. Once the set alarm time is reached, the alarm will sound.
  7. To set the other alarm, follow the above steps and choose the alarm not currently set.
- Canceling the Alarm

*Note: In alarm wake by Bluetooth mode, if the clock radio cannot pair or playback the music from the Bluetooth device. It will automatic change to Buzzermode within 20 seconds.*

1. Follow the insurtcions for Setting the Alarm.
2. Press the ALARM ONE BUTTON or VALARM TWO BUTTON repeatedly until the indicator is no longer lit. When the Alarm sounds Press SNOOZE BUTTON to delay for an additional 9 minntes. Press POWER / SOURCE BUTTON to turn the alarm off until the set alarm time is reached again.

## RADIO

### Radio Reception

An FM antenna is built into the unit. To improve FM radio reception, adjust the position of the unit.

### Tuning the FM Radio

1. Press the POWER/SOURCE BUTTON to turn the unit on.
2. Press the POWER/SOURCE BUTTON to switch to FM Radio Mode.
3. Press SKIP / TUNE BUTTON to tune the radio manually
4. Hold down the SKIP / TUNE button to scan for available stations.

### Saving and Playing a Station as a Preset

1. Tune to the desired station
2. Press the MEMORY / CLOCK BUTTON. Preset number will appear on the displays
3. Press the SKIP / TUNE BUTTON to adjust to the desired preset number.
4. Press the MEMORY / CLOCK BUTTON to save the current radio station to the selected preset.
5. Press the MEMORY / CLOCK BUTTON to cycle through preset radio stations.

## BLUETOOTH AND LINE IN

### Pairing a Bluetooth Device for the First Time

1. Power on and the unit by pressing the POWER/SOURCE BUTTON .
2. Press the POWER/SOURCE BUTTON to switch to Bluetooth mode. The Pairing indicator will flash slowly.
3. Press the PAIR BLUETOOTH / PLAY / PAUSE BUTTON. The pairing indicator will flash quickly. When pairing remain within 3 feet of the unit.
4. Using the native controls on your Bluetooth device, select the SCR1986BT in your Bluetooth settings to pair.
5. If your device requests a password, enter the default password 0000.
- 6 . Refer to the user's manual for your specific device for instructions on pairing and connecting Bluetooth devices.
7. When successfully paired and connected, the Pairing indicator will be solid.
8. After initial pairing, the unit will stay paired unless unpaired manually by the user or erased due to the reset of the device
9. If your device should become unpaired or you find it is unable to connect, repeat the above steps or press the PAIR BLUETOOTH / PLAY / PAUSE BUTTON to start the pairing process again



### Playing Audio through Bluetooth

1. After successfully pairing to a device, use the native controls on the connected Bluetooth device to select a track
2. To play or pause the selected track, use the native controls on the connected Bluetooth device, or the PAIR BLUETOOTH / PLAY / PAUSE BUTTON on the unit.
3. To skip forward or back on the select track, use the native controls on the connected Bluetooth device or the SKIP / TUNE buttons on the unit.
4. Audio played through the connected Bluetooth device will now be heard through the speakers.

### Using the Audio Input

Require a 3.5mm audio cable (not include).

1. Connect a 3.5mm audio cable to the AUX IN JACK on the rear of the unit and the audio output on an audio device.
2. Press the POWER / SOURCE BUTTON to turn the unit on.
3. Press the POWER / SOURCE BUTTON to switch to AUX IN mode.
4. Use the native controls on the connected device to play your audio through the unit.

## USB CHARGE

1. Make sure the unit is plugged into the wall
2. Using the appropriate USB charging cable (not included), connect one end to the device and the other to the USB Charger on the unit.

Refer to the user's manual for your specific device for manufacturers required charging amperage as well as determining the appropriate cable for your device before charging.

Note: This device uses a USB charging port with a 1000mA maximum charging capacity, making it unsuitable for charging iPads.

3. The device will now charge.



# SYLVANIA

## LIMITED PRODUCT WARRANTY

This quality product is warranted to be free from manufacturer's defects in material and workman-ship, provided that the unit is used under the normal operating conditions intended by the manufacturer.

Should you have any problem with this product, please and it is highly recommended to visit our website at [www.curtisint.com](http://www.curtisint.com) before you take any other steps as we have additional copies of instruction manuals, operating manuals and trouble shooting tips on our website which gives you the answer on most of the questions you could have in operating the unit.

### TERMS OF WARRANTY

C.I. Service Dept. warrants this product to be free from defects in materials and workmanship for 90 days on parts and 90 days on labor. If you originally purchased your product more than 90 days ago, a repair fee may apply.

Nothing within this warranty shall imply that C.I. will be responsible or liable for any damage to any items placed in this product, whether due to any defect of the product, or its use, whether proper or improper.

### EXCLUSIONS

Save as herein provided, C.I. Service Dept. (Canada) or C.I. Service Dept. (USA), there are no other warranties, conditions, representations or guarantees, express or implied, made or intended by C.I. or its authorized distributors and all other warranties, conditions, representations or guarantees, including any warranties, conditions, representations or guarantees under any Sale of Goods Act or like legislation or statute is hereby expressly excluded. Save as herein provided, C.I. Service Dept. (Canada) or C.I. Service Dept. (USA), shall not be responsible for any damages to persons or property, including the unit itself, howsoever caused or any consequential damages arising from the malfunction of the unit and by the purchase of the unit, the purchaser does hereby agree to indemnify and save harmless C.I. from any claim for damages to persons or property caused by the unit.

### TO OBTAIN REPAIRS UNDER THE TERMS OF THIS WARRANTY

1. The original purchaser must present a copy of the original bill of sale and the service warranty card.
2. Any alterations, abuse, misuse, battery corrosion or accidental damage voids the warranty.
3. The warranty does not cover cabinets and accessories.
4. No warranty or insurance contained or set out shall apply when damage or repair is caused by power failure; damage in transit or when moving the unit; improper power supply; use for commercial or industrial purposes; service calls resulting in customer education, etc.
5. The defective product should be mailed to:

Canada  
C.I. Service Dept.  
315 Attwell Drive  
Toronto, ON  
M9W 5C1

U.S.A  
Curtis International Ltd  
c/o Liquidity Services/Liquidation.com  
1399 Perry Road  
Plainfield, IN  
46168

**For service assistance and product information, please call: 1-800-968-9853.**

If mailing the product, the freight must be prepaid and a money order for \$7.00 should be included to cover the cost of insurance and the return of the product.

6. C.I. reserves the right to repair or replace the parts which have become defective.

Model No. \_\_\_\_\_ Date Purchased \_\_\_\_\_ Serial No. \_\_\_\_\_