

# JukeBlox Networked Media Module CX Series

## Datasheet



- Complete audio networking system on a small module
- Integrated Ethernet + USB 2.0
- WiFi-certified 802.11b/g
- Built-in strip antenna
- Optional 2X Diversity Antenna
- Glueless audio, video and control ports
- FCC certified
- Ideal for enabling network and USB audio playback for iPod docks, audio systems, AV Receivers, active speaker systems, internet radios, network playback adaptors



80 ARKAY DRIVE, HAUPPAUGE, NY 11788 (631) 435-6000 or 1 (800) 443-SEMI

Copyright © 2011 SMSC or its subsidiaries. All rights reserved.

Circuit diagrams and other information relating to SMSC products are included as a means of illustrating typical applications. Consequently, complete information sufficient for construction purposes is not necessarily given. Although the information has been checked and is believed to be accurate, no responsibility is assumed for inaccuracies. SMSC reserves the right to make changes to specifications and product descriptions at any time without notice. Contact your local SMSC sales office to obtain the latest specifications before placing your product order. The provision of this information does not convey to the purchaser of the described semiconductor devices any licenses under any patent rights or other intellectual property rights of SMSC or others. All sales are expressly conditional on your agreement to the terms and conditions of the most recently dated version of SMSC's standard Terms of Sale Agreement dated before the date of your order (the "Terms of Sale Agreement"). The product may contain design defects or errors known as anomalies which may cause the product's functions to deviate from published specifications. Anomaly sheets are available upon request. SMSC products are not designed, intended, authorized or warranted for use in any life support or other application where product failure could cause or contribute to personal injury or severe property damage. Any and all such uses without prior written approval of an Officer of SMSC and further testing and/or modification will be fully at the risk of the customer. Copies of this document or other SMSC literature, as well as the Terms of Sale Agreement, may be obtained by visiting SMSC's website at <http://www.smsc.com>. SMSC is a registered trademark of Standard Microsystems Corporation ("SMSC"). Product names and company names are the trademarks of their respective holders.

**SMSC DISCLAIMS AND EXCLUDES ANY AND ALL WARRANTIES, INCLUDING WITHOUT LIMITATION ANY AND ALL IMPLIED WARRANTIES OF MERCHANTABILITY, FITNESS FOR A PARTICULAR PURPOSE, TITLE, AND AGAINST INFRINGEMENT AND THE LIKE, AND ANY AND ALL WARRANTIES ARISING FROM ANY COURSE OF DEALING OR USAGE OF TRADE. IN NO EVENT SHALL SMSC BE LIABLE FOR ANY DIRECT, INCIDENTAL, INDIRECT, SPECIAL, PUNITIVE, OR CONSEQUENTIAL DAMAGES; OR FOR LOST DATA, PROFITS, SAVINGS OR REVENUES OF ANY KIND; REGARDLESS OF THE FORM OF ACTION, WHETHER BASED ON CONTRACT; TORT; NEGLIGENCE OF SMSC OR OTHERS; STRICT LIABILITY; BREACH OF WARRANTY; OR OTHERWISE; WHETHER OR NOT ANY REMEDY OF BUYER IS HELD TO HAVE FAILED OF ITS ESSENTIAL PURPOSE, AND WHETHER OR NOT SMSC HAS BEEN ADVISED OF THE POSSIBILITY OF SUCH DAMAGES.**



# Table of Contents

<b>1</b>	<b>INTRODUCTION</b>	<b>4</b>
<b>2</b>	<b>BLOCK DIAGRAM</b>	<b>4</b>
<b>3</b>	<b>BOARD PICTURES</b>	<b>5</b>
3.1	TOP VIEW OF CX870	5
3.2	BOTTOM VIEW OF CX870	6
3.2.1	<i>CX870 Bottom View with 64-pin Low Density Connector</i>	6
3.2.2	<i>CX870 Bottom View with 120-pin Media Connector</i>	6
3.3	PRODUCTION MODULE WITH TOP AND RF SHIELDS IN PLACE – TOP VIEW	7
3.4	PRODUCTION MODULE WITH 64-PIN CONNECTOR OPTION – SIDE VIEW	7
3.5	EXAMPLE PRODUCTION MODULE SHOWING SOLDERED RF SHIELD	8
3.6	PRODUCTION MODULE WITH BOTTOM SHIELD (PART NUMBERS WITH A “B” AFTER THE CONFIGURATION LETTER)	9
3.6.1	<i>Including J3 Low Density 64-pin connector – Bottom View</i>	9
3.6.2	<i>Including J2 High Density 120-pin connector – Bottom View</i>	9
<b>4</b>	<b>ORDERING GUIDE</b>	<b>10</b>
4.1	PART NUMBER SYNTAX	11
<b>5</b>	<b>ELECTRICAL SPECIFICATIONS</b>	<b>12</b>
5.1	ABSOLUTE MAXIMUM RATINGS	13
5.2	OPERATING CONDITIONS	13
5.3	WiFi SPECIFICATION (CX870 ONLY)	14
<b>6</b>	<b>REGULATORY COMPLIANCE AND QUALITY</b>	<b>15</b>
6.0.1	<i>Antenna Considerations</i>	16
6.1	RoHS	17
6.2	ENVIRONMENTAL TEST	17
6.3	ESD AND TRANSIENT TEST (APPLIES TO LAN AND USB EXTERNAL CONNECTIONS ONLY)	17
6.4	MAGNETIC FIELD TEST	17
6.5	MTBF	17
6.6	MECHANICAL SPECIFICATIONS	17
6.7	MODULE QUALITY	17
<b>7</b>	<b>BOARD DIMENSIONS AND WEIGHT</b>	<b>18</b>
7.1	TOP & BOTTOM VIEW OF CX870 MODULE WITHOUT BOTTOM SHIELD	18
7.1.1	<i>Top &amp; Bottom View of CX870 Module with Bottom Shield</i>	18
7.2	SIDE VIEW OF CX870 MODULE WITHOUT BOTTOM SHIELD	19
7.2.1	<i>Side View of CX870 Module with Bottom Shield</i>	19
7.3	3D VIEW OF CX870 MODULE WITHOUT BOTTOM SHIELD	20
7.4	MODULE WEIGHT	20
<b>8</b>	<b>CONNECTORS AND CONNECTIONS</b>	<b>21</b>
8.1	WLAN UFL ANTENNA CONNECTOR (OPTIONAL)	21
8.2	MODULE CONNECTORS	21
8.2.1	<i>Pin Descriptions</i>	22
8.2.2	<i>Connector PIN Assignments</i>	27
8.2.3	<i>GPIO Assignments</i>	29
<b>9</b>	<b>APPLICATION GUIDELINES</b>	<b>29</b>
9.1	POWER SUPPLY SEQUENCING AND RESET TIMING	29
9.1.1	<i>Power up, Reset and Power Down Timing</i>	30
9.2	RF CONSIDERATIONS	30
<b>10</b>	<b>REVISION CONTROL</b>	<b>31</b>
<b>11</b>	<b>APPENDIX 1: CERTIFICATION NOTICES</b>	<b>38</b>



# 1 Introduction

The CX-series module is a single-board networked media player module, based on SMSC's DM860A and DM870A media processors, and enables fast product developments with Ethernet, USB and optional WiFi connectivity. The module connects to standard legacy components in various audio, video/LCD and control formats.

# 2 Block Diagram

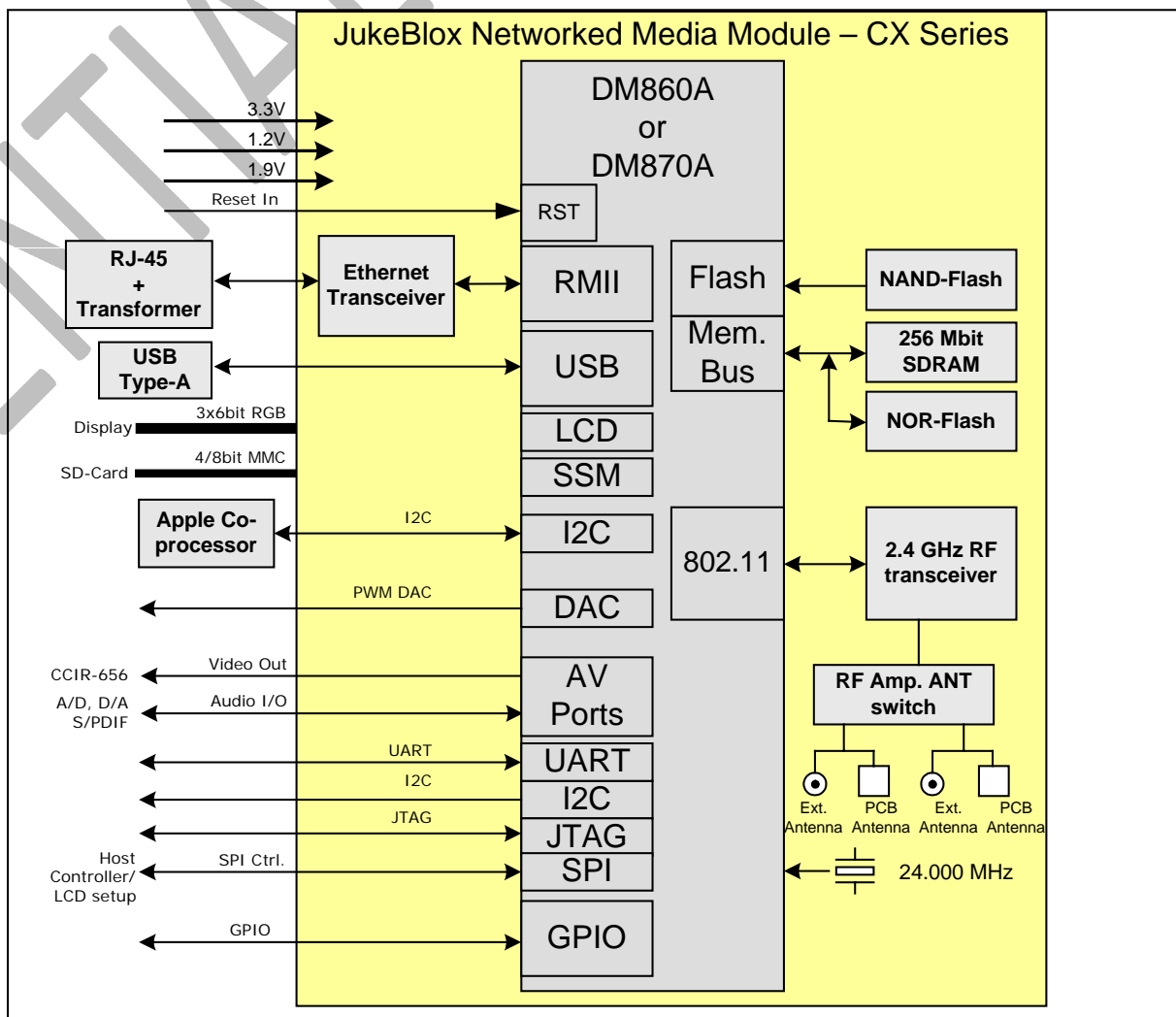

**Note:** Choice of antenna is a build option, see Ordering Guide.



### 3 Board Pictures

Please note that all production modules include the RF and top shield. The below top view has the shields temporarily removed to show the components. Also, please note that the 64-pin connector mounted on the module is the male gender.

#### 3.1 Top View of CX870

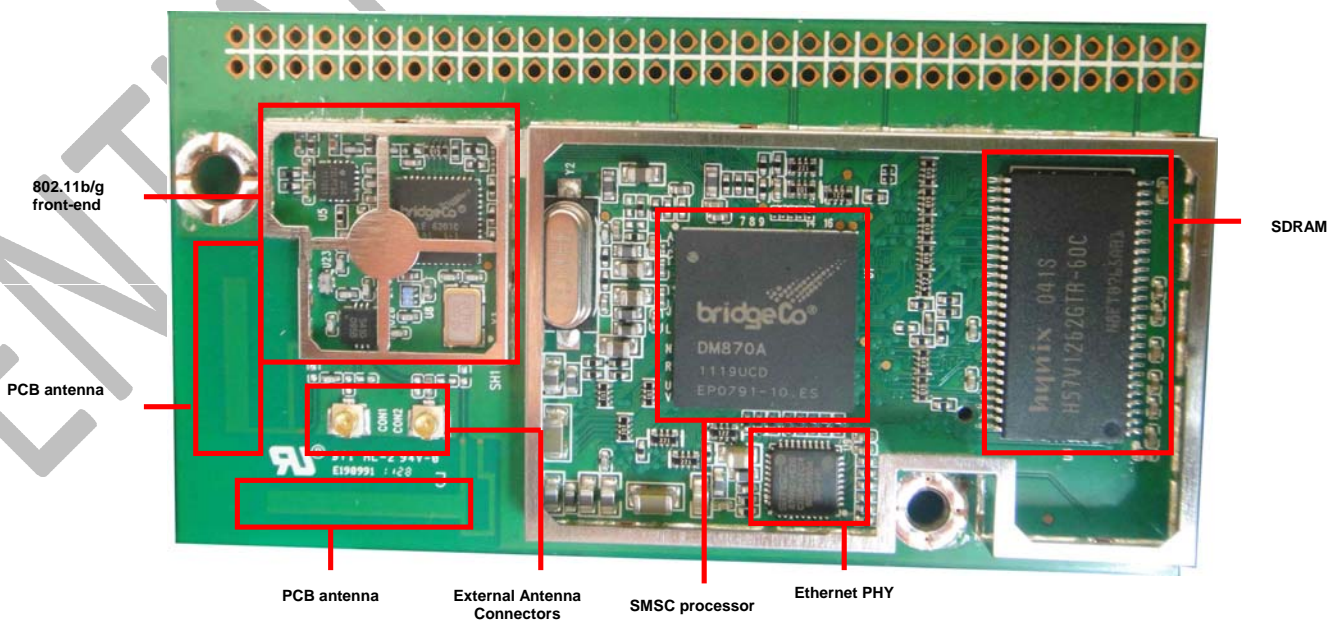



### 3.2 Bottom View of CX870

#### 3.2.1 CX870 Bottom View with 64-pin Low Density Connector

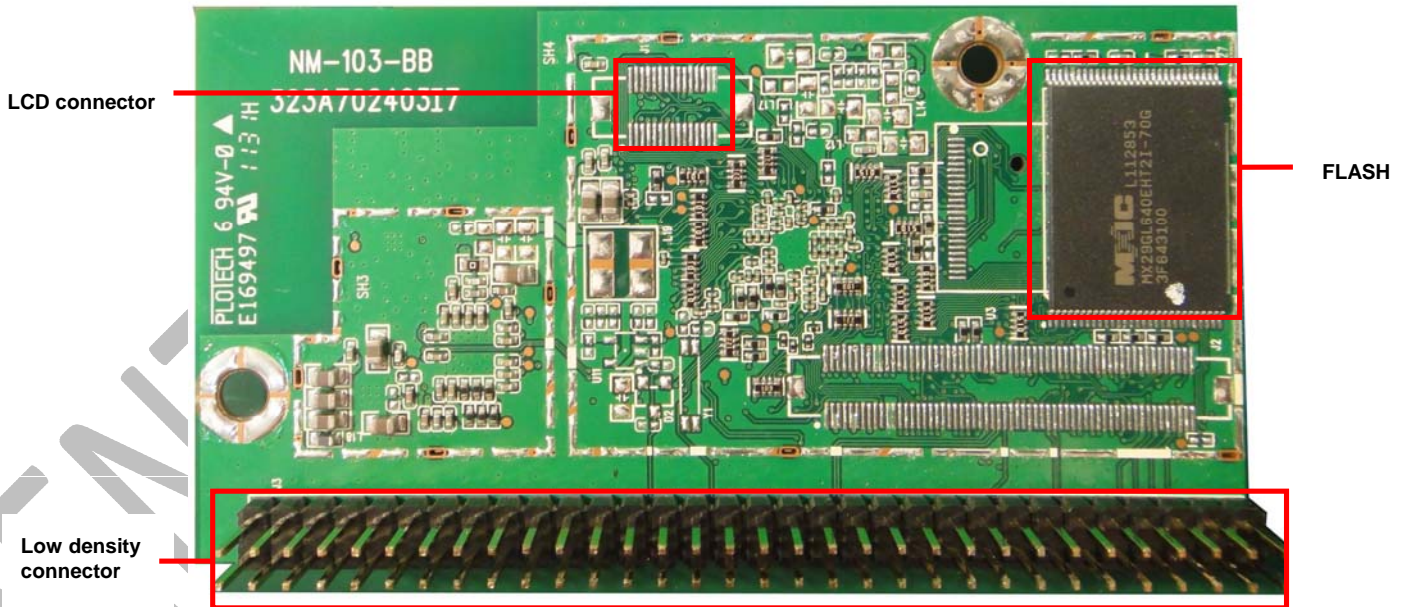

#### 3.2.2 CX870 Bottom View with 120-pin Media Connector

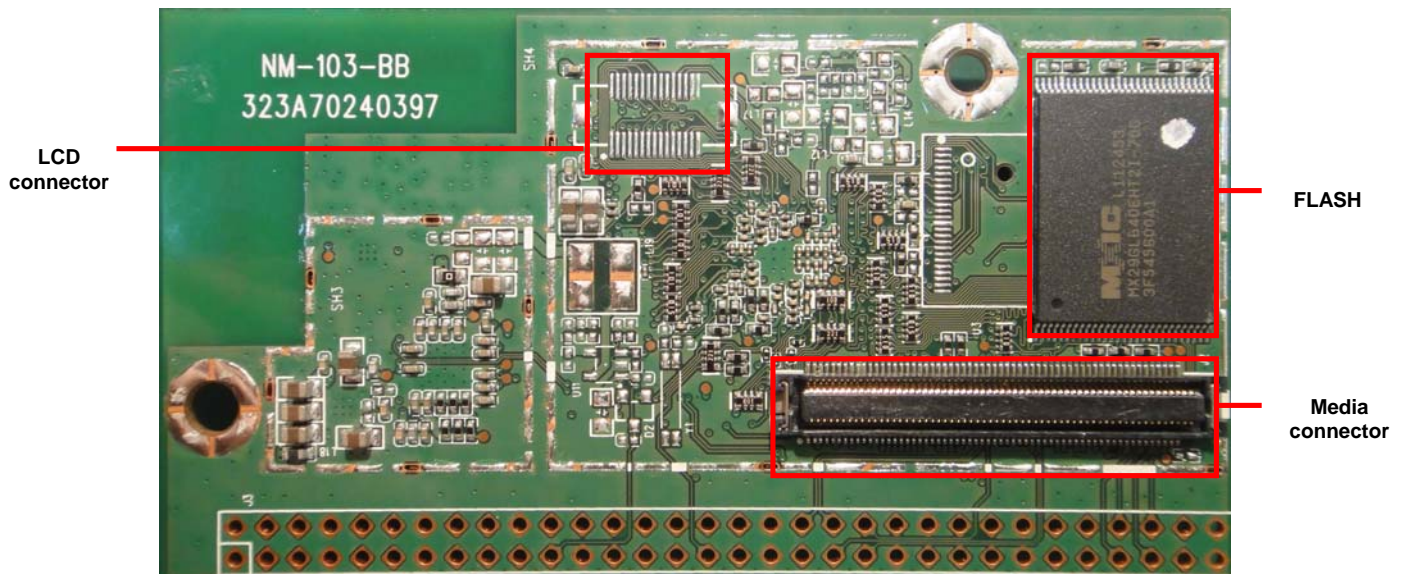

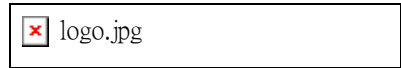

### 3.3 Production Module with Top and RF shields in place – Top View

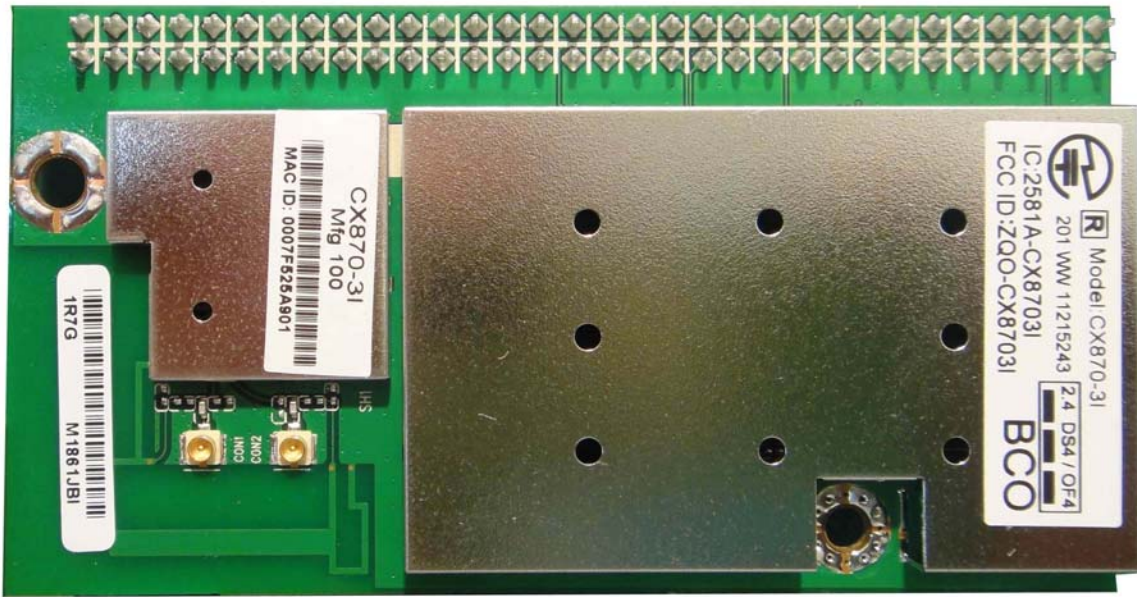

### 3.4 Production Module with 64-pin Connector Option – Side View

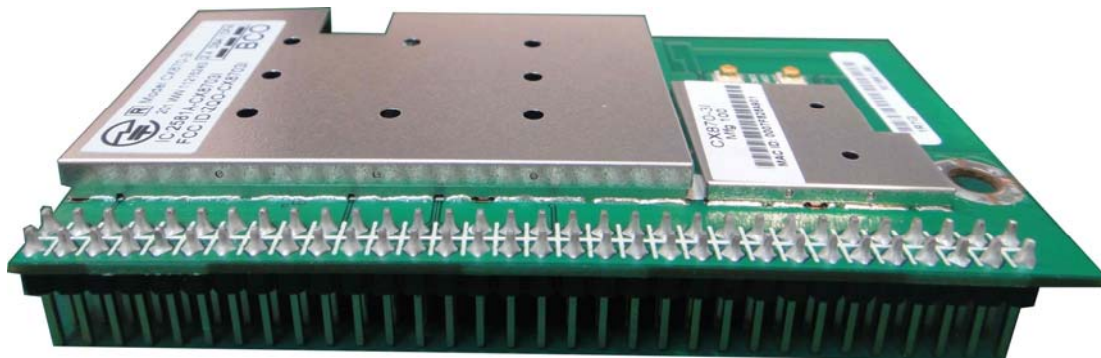



### 3.5 Example Production Module Showing Soldered RF Shield



IDENTITY





### 3.6 Production Module with Bottom Shield (Part Numbers with a “B” after the configuration letter)

#### 3.6.1 Including J3 Low Density 64-pin connector – Bottom View

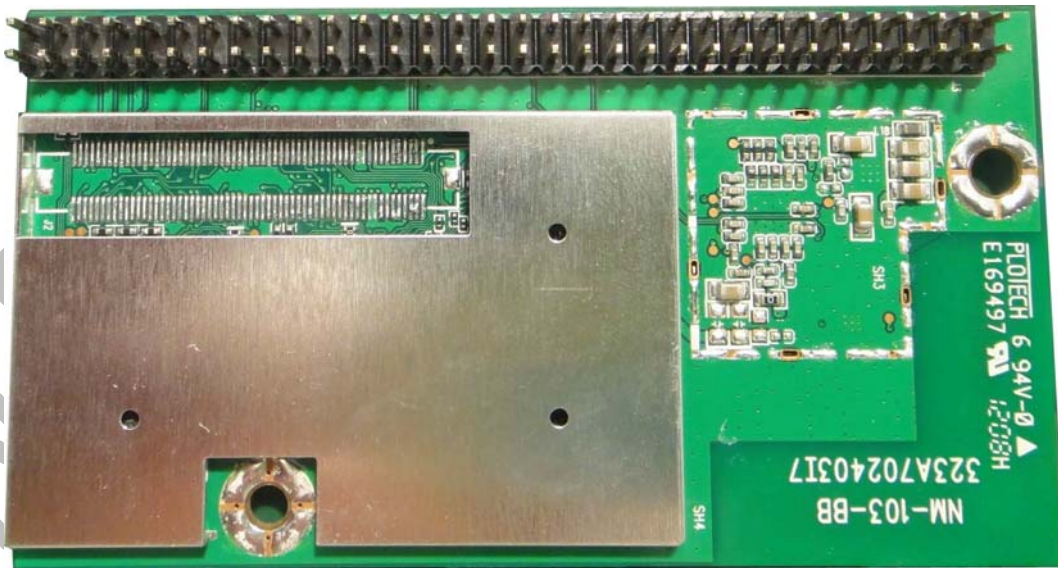

#### 3.6.2 Including J2 High Density 120-pin connector – Bottom View

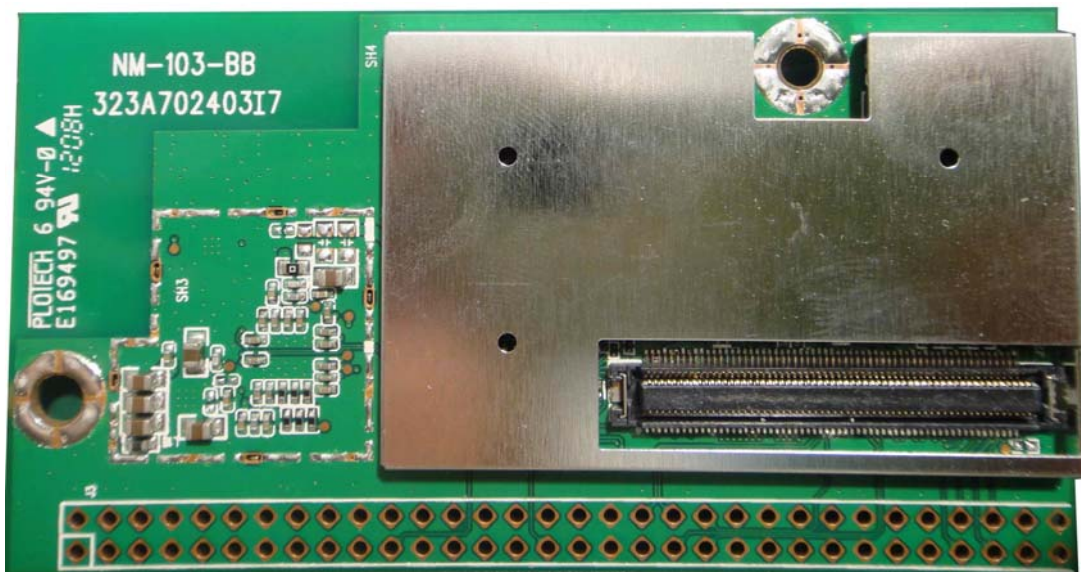

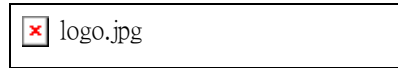

# 4 Ordering Guide

Part Number	SMSC IC's	Internal PCB Diversity Antennas	Ext. Diversity Antennas (UFL Conn.)*		Ethernet	USB Host	Low density 64-pin Conn.	Hi density 120-pin Conn.	Hi density LCD Conn.	64MB SDRAM	32MB SDRAM	16MB SDRAM	1Gb NAND	8MByte NOR	Top Module Shield	Bottom Module Shield
			One Ant.	Two Ant.												
CX870-3A	DM870A+T6201	X		(X)*	X	X		X	X		X		X	X	X	
CX870-3B	DM870A+T6201		X		X	X	X				X		X	X	X	
CX870-3D	DM870A+T6201			X	X	X		X				X	X	X	X	
CX870-3DS	% DM870A+T6201			X	X	X		X				X	X	X	X	
CX870-3F	DM870A+T6201	X			X	X	X					X		X	X	
CX870-3G	DM870A+T6201	X					X	X				X		X	X	
CX870-3H	DM870A+T6201			X	X	X	X					X		X	X	
CX870-3I	DM870A+T6201			X			X	X				X		X	X	
CX870-3J	DM870A+T6201			X			X		X			X		X	X	
CX870-3K	DM870A+T6201	X	X				X	X				X		X	X	
CX870-3BB	DM870A+T6201		X		X	X	X				X		X		X	X
CX870-3DB	DM870A+T6201			X	X	X		X				X	X		X	X
CX870-3DBS	DM870A+T6201			X	X	X		X				X	X		X	X
CX870-3HB	DM870A+T6201			X	X	X	X					X		X	X	X
CX870-3IB	DM870A+T6201			X			X	X				X		X	X	X
CX870-3JB	DM870A+T6201			X			X		X			X		X	X	X
CX870-3B-D	DM870A+T6201			X	X	X	X				X		X	X	X	X
CX870-3B-D60	DM870A+T6201			X	X	X	X			X			X	X	X	X

**Note:** Please note that the Apple Authentication Coprocessor will not be provided on the CX module. The Apple Authentication Coprocessor should be provided on the product motherboard, connected to the SDA, SCL signals from the CX module.

**Note:** Shaded rows indicate Custom or Obsolete configuration - NOT TO BE USED FOR NEW/STANDARD MP DESIGNS.

\* Connector on board, but requires board modification to enable the connector.

+ The position of the X in the One Ant. column indicates that there is one external antenna connector provided. The position of the X in the Two Ant. column indicates that there are two external antenna connectors provided. Do not use a module which has two external antenna connectors with only one external antenna connected. Leaving one antenna socket open will degrade WiFi performance. SMSC recommends always using modules with two external antennas for best performance.

% The CX870-3DS is the same as CX870-3D, except that the RF shield is soldered in place.

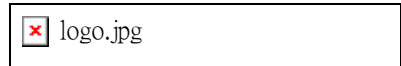

## 4.1 Part Number Syntax

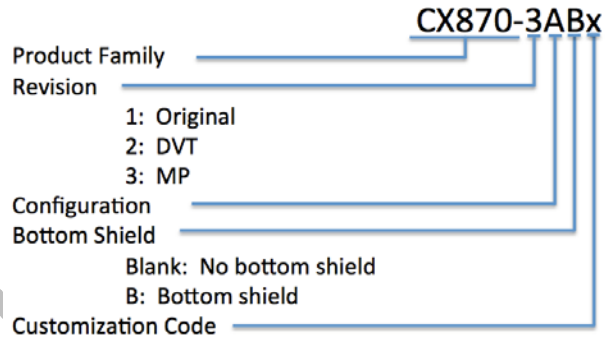

IDENTENTIAL

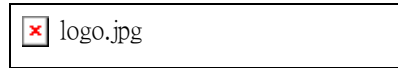

## 5 Electrical Specifications

Parameter	State	Model	Voltage	Symbol	min.	typ.	max.	Units
Power Supply Input Voltage				VIN	3.0	3.3	3.6	V
					1.08	1.2	1.32	V
					1.8	1.9	2.0	V
Logic Input high voltage				V <sub>IH</sub>	1.7		5.5	V
Logic Input low voltage				V <sub>IL</sub>	-0.3		0.7	V
Logic Input threshold voltage				V <sub>IT</sub>	1.29	1.39	1.5	V
Schmitt-trigger input low to high threshold voltage				V <sub>IT+</sub>	1.58	1.65	1.71	V
Schmitt-trigger input high to low threshold voltage				V <sub>IT-</sub>	0.95	1.01	1.06	V
Logic Output high voltage				V <sub>OH</sub>	2.4			V
Logic Output low voltage				V <sub>OL</sub>			0.4	V
Logic Low-level output current (V <sub>OL</sub> =0.4V)				I <sub>OL</sub>	-9.6	-15.6	-19.3	mA
Logic High-level output current (V <sub>OH</sub> =2.4V)				I <sub>OH</sub>	11.1	22.5	35.3	mA
Current Consumption	Reset State	CX870	3.3	I3.3		60	78	mA
			1.2	I1.2		32	42	mA
			1.9	I1.9		18	23	mA
	Operating in idle state		3.3	I3.3		185	241	mA
			1.2	I1.2		337	438	mA
			1.9	I1.9		257	334	mA
	Playback over WiFi high mips & rate condition		3.3	I3.3		240	312	mA
			1.2	I1.2		347	451	mA
			1.9	I1.9		258	335	mA

**Note:** The maximum current values are 30% larger than the typical values. The maximum values are intended to be used for power supply sizing calculations.



## 5.1 Absolute Maximum Ratings

Parameter	Component	Min	Max	Units
3.3V Supply Voltage	Main	-0.5	4.6	V
1.2V Supply Voltage		-0.5	1.8	V
1.9V Supply Voltage		-0.5	2.2	V
Logic Input Voltage		-0.5	6	V
Logic Output Voltage		-0.5	4.6	V

## 5.2 Operating Conditions

Parameter	Min	Max	Units
Operating Temperature	0	+70	°C
Operating Humidity	10	90 (non condensing)	%RH
Storage Temperature	-10	+75	°C
Storage Humidity	10	95 (non condensing)	%RH
Storage Temperature Cycle Test 24 hrs	-10	+75	°C



### 5.3 WiFi Specification (CX870 only)

Feature	Description
WLAN Standards	IEEE 802.11b IEEE 802.11g
Frequency Band	2.412 – 2.472 GHz (2.4GHz ISM Band, 13 Channels) Channel 1 - Channel 13 North America FCC, Japan Telec, Europe ETSI
Modulation	802.11b mode (DS-SS: IEEE 802.11b) 802.11g mode (OFDM: IEEE 802.11g)
Transmission Speed	802.11b mode 11Mbps, 5.5Mbps, 2Mbps, 1Mbps 802.11g mode 54Mbps, 48Mbps, 36Mbps, 24Mbps, 18Mbps, 12Mbps, 9Mbps, 6Mbps
Tx Power	802.11b mode: 16.5dBm, +/-1dB 802.11g mode: 15.0dBm, +/-1dB  Using nominal production settings as follows: Channel RF11 Rate: 11B = '3' (11Mbps), 11G = '8' (54Mbps) MIB: 11B=9, 11G=1 (Reference for Tx Power Tuning) Room temperature  The above TX Power specifications will apply to modules shipped from Liteon after 9 April 2012.
Power-on Ramp	< 2us
RF Carrier Suppression	< 15dBc
TX EVM	802.11b mode: <-22dB 802.11g mode: <-25dB
Rx Sensitivity (incl. CE2 Mother board)	802.11b mode: <=-82dBm @ 1Mbps, <=-81dBm @ 2Mbps, <=-81dBm @ 5.5Mbps, <=-78dBm @ 11Mbps 802.11g mode: <=-82dBm @ 9Mbps, <=-81dBm @ 18Mbps, <=-75dBm @ 36Mbps, <=-70dBm @ 54Mbps
Throughput Rate (measured for each module)	See factory test specification

**Note:** About Tx Power, different (higher/lower) RF output power settings may be used for specific regions, antennas and/or enclosures, in which case re-certification may be required.



## 6 Regulatory Compliance and Quality

Description	Country	Compliance	Module Versions Passed
Electromagnetic Compatibility (Prescan)	USA Europe	FCC CFR47 Part15B EN 55022 EN 55024 EN 61000-3-2 EN 61000-3-3 EN 61000-4-2 EN 61000-4-3 EN 61000-4-4 EN 61000-4-5 EN 61000-4-6 EN 61000-4-8 EN 61000-4-11	
Radio Regulations (CX870 only)	USA Japan Canada Europe New Zealand/Australia China Korea	FCC Part 15C Telec IC RSS-210 CE CE SRRC KCC	B, D, F, H, I, J B B, D, F, H, I, J B

SMSC does not certify all module variants for all countries. Please see above table for those module versions for which certain certifications have already been done.

Please contact your SMSC sales office for the latest information about which modules are certified for which countries, and arranging for additional certification for your chosen module if needed. Any additional certifications will need to be paid for by the customer.

Product manufacturers are responsible for the end product certification.

SMSC can help manufacturers to prepare for the WiFi Alliance tests by providing an example test plan and the required commands to enable special test modes. Please contact your SMSC sales office about WiFi Alliance logo certification assistance.

The CX module has received Limited Module Approval (LMA) from FCC. This is because the CX module does not have a built-in +1.9V regulator circuit. SMSC recommends that customers follow the +1.9V supply voltage requirements given in this data sheet, and follow the +1.9V power supply design given in “CX Module Power Supply\_V1.1.pdf” document or later version. If the power supply recommendations are followed, then customers will not need to go through formal certification of the product for WiFi related RF behavior for FCC. It is the product manufacturers responsibility to make sure that the power supply recommendations are followed, and that the RF behavior meets the certification requirements when the module is installed in the final product.

Please check the SMSC/BridgeCo Customer Portal at <https://portal.bridgeco.net/> for documents about WiFi certification and recommended interfacing and power supply schematics.



## 6.0.1 Antenna Considerations

Here are the antennas used for certification:

### **CX870-3B**

Dipole, WINiZEN, WIE-WO-08, 3.2 dBi for 2.4GHz

### **CX870-3D**

FCC&IC: Inverted-F, Tyco Electronics, 2174241, 2.19 dBi for 2.4 GHz

CE: Wanshih 01S0940-00, dipole, 1.59dBi@2.4GHz, 2.65dBi@2.45GHz, 1.76dBi@2.5GHz

### **CX870-3F**

Printed on PCB, Lite-On, N/A, 3.91 dBi for 2.4 GHz

### **CX870-3H**

Dipole, MAG.LAYERS, EDA-8709-2G4C1-A66, 2 dBi for 2.4GHz

### **CX870-3I**

Dipole, MAG.LAYERS, EDA-8709-2G4C1-A66, 2 dBi for 2.4GHz

### **CX870-3J**

Dipole, MAG.LAYERS, EDA-8709-2G4C1-A66, 2 dBi for 2.4GHz

### **Notes about antenna changes:**

- 1) Equivalent antennas from other manufacturers may be substituted, and then marketed without a Class II permissive change
- 2) Equivalent antennas must be of the same type (e.g. dipole, PIFA, etc.), must be of equal or less gain than the antennas listed and previously authorized under the same FCC ID, and must have similar in band and out of band characteristics (consult specification sheet for cutoff frequencies).
- 3) In case of new antenna types, or higher gain antennas, a Class II permissive change is required and compliance with FCC section 15.203 must be met.





## 6.1 RoHS

Uses only RoHS compliant components

## 6.2 Environmental Test

Withstands 4 hours at 70°C, 90% RH

## 6.3 ESD and Transient Test (Applies to LAN and USB external connections only)

ESD: +/- 2kV operation, +/- 4kV no destruction (part of CE test)

Fast electrical transients: +/- 500V operation, +/- 1000V no destruction (part of CE test)

## 6.4 Magnetic Field Test

Passes EN55022 and EN55024 (part of CE test)

## 6.5 MTBF

>10000 hours

## 6.6 Mechanical Specifications

Passes drop test according to I.E.C. 68-2-32, height 100 cm, 1 corner, 6 faces.

Passes vibration test with sine, vertical, 60 minutes, 600 to 18000 cpm, 1G

## 6.7 Module Quality

Defect Rate: < 1%

AQL CR=0, MA=0.4, MI=0.4



## 7 Board Dimensions and Weight

### 7.1 Top & Bottom View of CX870 Module without Bottom Shield

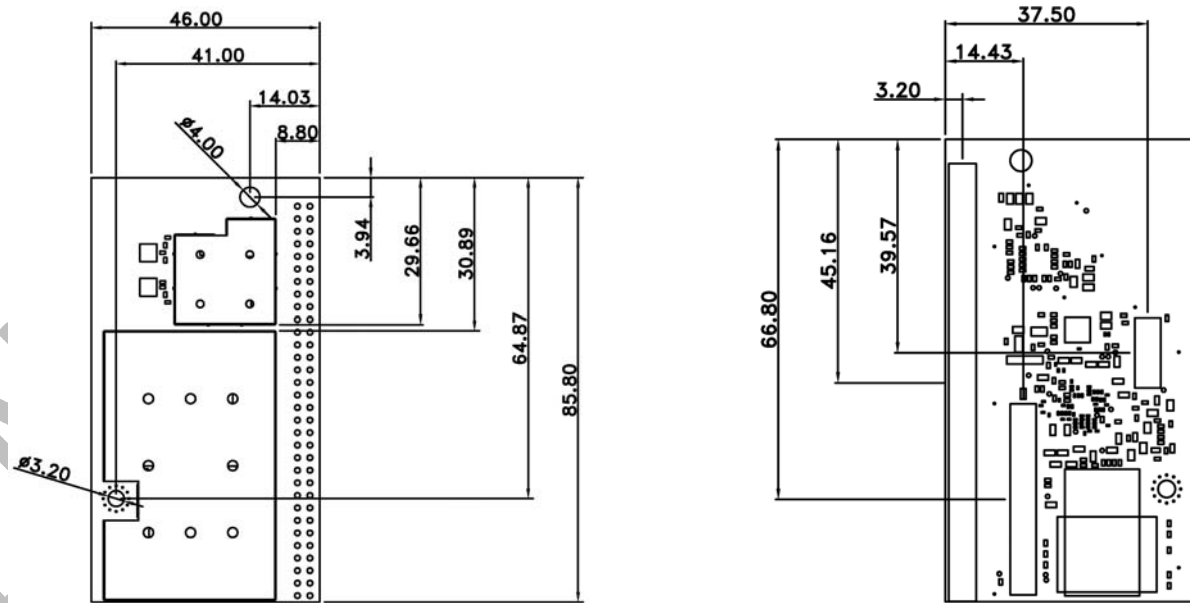

#### 7.1.1 Top & Bottom View of CX870 Module with Bottom Shield

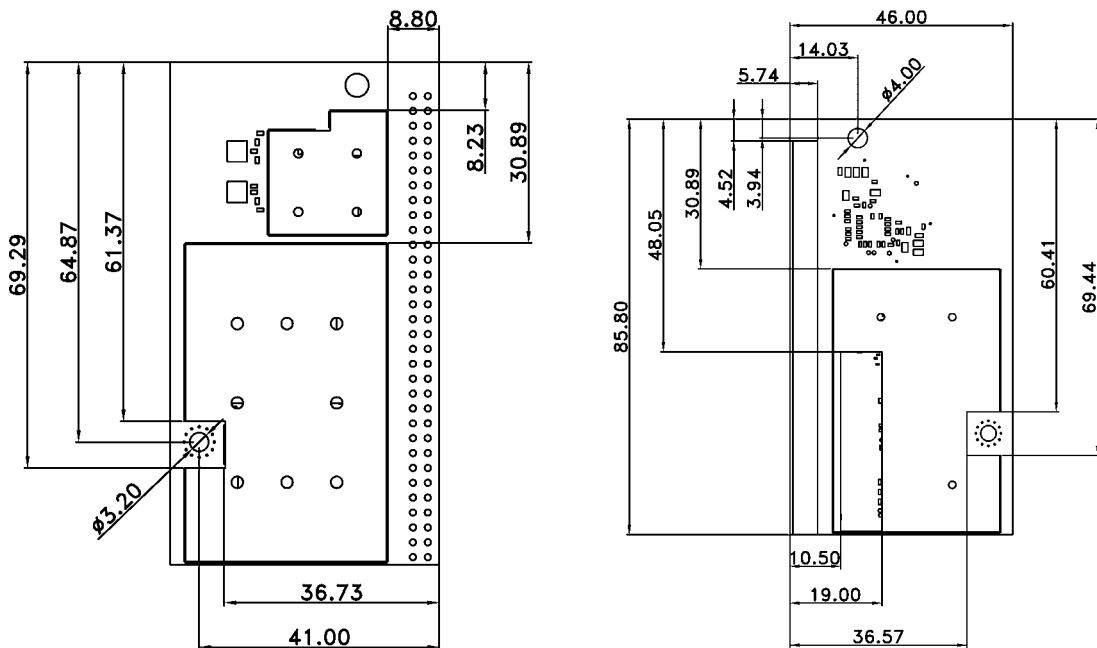



## 7.2 Side View of CX870 module without Bottom Shield

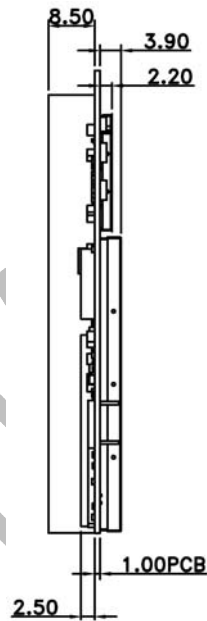

**Note:**

1. All dimensions are measured in **millimetres** (mm).
2. PCB's thickness: 1.00 +/- 0.10mm
3. Tolerance: +/-0.10mm
4. Outline Tolerance: +/-0.10mm
5. NPTH Hole: +/-0.05mm
6. PTH Hole: +/-0.075mm
7. Connector positions, board dimensions, mounting hole positions and sizes are the same for all module variants.
8. Connector position tolerance: +/- 0.38mm
9. The 64-pin connector mounted on the module along one edge is the male gender.
10. Not all module variants have all connectors. Please see the Ordering Guide table for details of connector options.

### 7.2.1 Side View of CX870 Module with Bottom Shield

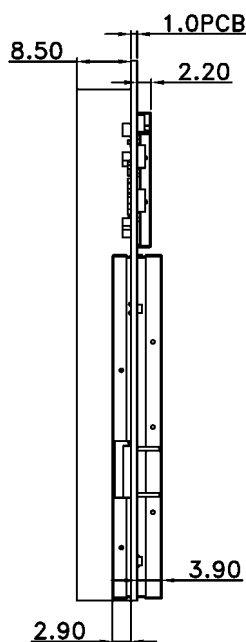

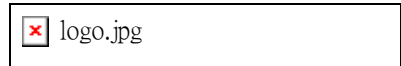

### 7.3 3D View of CX870 Module without Bottom Shield

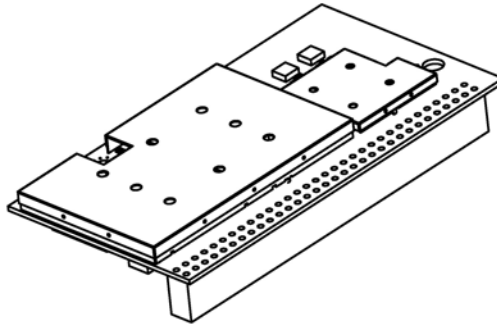

**Note:** A 3D file of the CX module in .stp format is available from the SMSC Customer Portal.

### 7.4 Module Weight

CX860: 20g  
CX870: 20g

**Note:** Module weight applies to all versions of the module.



## 8 Connectors and Connections

### 8.1 WLAN UFL Antenna Connector (optional)

The module includes two PCB strip antennas operated in diversity mode. Alternatively, one or two coaxial antenna connectors are provided for connecting external (to the module) antennas. The choice between using the strip antenna or using the coaxial sockets is a build option, determined by the position of surface mount capacitors on the module PCB. If the PCB antennas are chosen, then diversity mode is always used. If external (to the module) antenna sockets are used, then two external antennas should be used to provide 2X diversity operation.

If external antenna is used, please choose the proper part number indicating two external antenna sockets. Do not use a module which has two external antenna sockets with only one external antenna connected; this will result in reduced WiFi performance.

Please see ordering guide for build option details.

The surface-mount antenna socket used in the CX module is:

U.F.L type Ultra Small Surface Mount Coaxial Connector

### 8.2 Module Connectors

The CX860/870 module uses 3 board-to-board connectors as interfaces to the product main board. The part numbers for the connectors needed on the product main board, which mate with the connectors on the CX module, are shown in the table below.

Connector Number	Connector Purpose	Connector Type	Number of Pins	Pin Configuration	Mating Connector Part Numbers
J1	LCD	B2B Connector	30	2 x 15 x 0.5mm	14-5046-030-145-829+ (Kyocera)
J2	Media		120	2 x 60 x 0.5mm	14-5046-120-145-829+ (Kyocera)
J3	Low Density		64	2 x 32 x 2.54mm	CSHA201-3202A001A1AB



The pinout and signal names are shown on the next page. The following table provides an overview for the most important control and interface signals.

## 8.2.1 Pin Descriptions

Signal(s)	Type	Description
-----------	------	-------------

### POWER

VIN(+3.3V)	P	Power supply input ; +3.3V.
VIN (+1.2V)	P	Power supply input ; +1.2V.
VIN (+1.9V)	P	Power Supply input; +1.9V for powering RF section. Make sure this is a clean supply.
3V3RTC	P	The RTC function is no longer supported. This pin should be left open.
GND	P	Ground (GND) connection for power supply 0V, signal returns and shielding.

### SPI

SPI_DOUT	O	SPI data from DM870A to host controller.
SPI_DIN	I	SPI data from host controller to DM870A.
SPI_CLK	I	SPI clock from host controller to DM870A. Maximum recommended frequency is 2MHz, typical frequency is 1MHz. See Note 2 below.
SPI_NCS0	I	SPI chip select from host controller to DM870A.
PDOUT1	O	This signal is used as SPI_REQ, SPI request signal, from DM870A to host controller for eDMP applications. Logic 1 indicates that there is an SPI message waiting to be read, the host controller should start the SPI clock and read any changed registers. Logic 0 indicates that all changed register messages have been read and the message buffer is empty. Also GPIO-06.
SPI_NCS1	I	Not used. Leave open.

### UART

RXD1	I	UART1 input to the DM870A, used for shell access. SMSC recommends providing a connection to an external RS-232 transceiver and DB9 connector to connect to a PC COM port. Such a connection can be used for product development debugging, and for module programming control on the product manufacturing line and for module control during certification procedures.
TXD1	O	UART1 output from the DM870A, used for shell access. SMSC recommends providing a connection to an external RS-232 transceiver and DB9 connector to connect to a PC COM port. Such a connection can be used for product development debugging, and for module programming control on the product manufacturing line and for module control during certification procedures.
RXD0	I	UART0 input. Optionally used for controlling an iPod via UART.
TXD0	O	UART0 output. Optionally used for controlling an iPod via UART.



**AUDIO**

AV2DATA0	O	I2S or left justified audio data output. Typically connected to external D/A converter input or to external DSP for further audio processing. Used for main left and right channel audio output data. See Note 3.
AV2CTRL0	O	LRCK, audio data word clock at the audio sample rate (Fs). Maximum currently supported frequency is 192kHz.
AV2CTRL1	O	MCLK, audio master clock at 256Fs. This can be used to clock an external D/A converter or DSP.
AV2CLK	O	SCLK, audio data bit clock at 64Fs. Allows for up to 32 audio data bits per sample word.
AV4DATA1	O	SPDIF format output. Can support samples rates up to 192kHz, so the maximum instantaneous frequency on this pin is 24.576MHz.
AV4DATA0	I	SPDIF input. Not used at present. Leave open.
AV2DATA1	O	I2S or left justified audio data output. Not used at present. Leave open.
AOUTLP/AOUTLN, AOUTRP/AOUTRN	O	Differential stereo output from PWM-DAC, right and left channels. These signals require analog low pass filtering. SMSC is not recommending using the PWM-DAC outputs because of the potential for high out-of-band noise and uncharacterized audio quality. SMSC recommends using an external D/A converter connected to AV2DATA0.
AV2DATA2	I	I2S or left justified audio data input. Can be driven from an optional external A/D converter used to interface to iPod analog output or other analog audio sources. If not used, leave open.
AV2DATA3	I	I2S or left justified audio data input. Not used at present. Leave open.

**CONTROL**

NCS3	I	This signal is configured as GPIO-17 and is currently not used. DM870A-internal pull-up. Leave this pin open.
PDOUT0	I	Factory Reset. GPIO-04. Return the CnE to factory settings. High-active input, DM870A-internal pull-down. Pull to GND with a 10kohm resistor, unless return to factory settings from a hardware control is needed. Normally, return to factory settings is controlled from the host controller via SPI register. This pin is only monitored during the boot up process.
VCO0	I	Infrared sensor input. GPIO-05. This is a Schmitt-Trigger input and can handle inputs with slow slopes. Used for aDMP firmware builds for infrared remote control sensor output connection to DM870A. For applications with a host controller, pull this pin to +3.3V via a 10kohm resistor.
AV3CLK	O	ETH_NRESET Low-active reset for the on-board ethernet PHY. This output is driven by the DM870A. GPIO-12. Leave this pin open.
AV3CTRL0, AV3CTRL1	I/O	I2C_SCL, I2C_SDA bus created by GPIO-13 and GPIO-14. No internal pull-ups; Use 4.7kohm pull up resistor on each pin to +3.3V. Maximum frequency is 400kHz.
NRESET_MOD	I	Low-active input to reset the module. This signal must be driven by an external reset generator, or by a GPIO output from a host controller. See the application section of this data sheet for the timing requirements for NRESET_MOD. Includes internal 10K pull-up resistor to +3.3V.
NPD_RF	I	Active low input to shut down the power for the 802.11 RF section. Internal 10kohm pull-up resistor to +3.3V. Leave open if powering down the RF section is not required.



**ETHERNET**

ETH_RXN, ETH_RXP, ETH_TXN, ETH_TXP	M	Ethernet signals between the PHY on the module and the external magnetics (transformer). See Note 4. Maximum bit rate is 100Mbps.
ETH_LED_SPEED, ETH_LED_ACT	O	3.3V push-pull outputs (max. ±12mA) to drive the ethernet LEDs. 100Mbps speed mode and activity are indicated by the outputs being low. Connect to LEDs through 220ohm resistors.

**USB**

USB_DN, USB_DP	M	USB data signals, normally connected to type A connector, USB switch or iPod dock connector. Maximum bit rate is USB High Speed at 480Mbps.
USB_VBUS	M	Analog input for monitoring USB type A connector power. Connect to the +5V power which is driving the USB type A connector power pins. If this pin drops below 4.6V, then the DM870A will drive the USBVBUSDRV signal low to control an external power MOSFET to disconnect +5V power from the USB type A connector. See Note 5.
USBVBUSDRV	O	Logic output to control an external MOSFET that is in series with USB type A connector power. See USB_VBUS above and Note 5.

**JTAG**

TMS,TCK,TDI, TDO	I/O	JTAG port for DM870A. Leave open.
------------------	-----	-----------------------------------

**SSM**

SSMD4, SSMD5, SSMD6, SSMD7	I/O	Can be used to drive external shift registers to make extended GPIO signals (see Note 6), or as individual GPIO signals, or to make an SD card interface. SD card firmware is not supported at present in JB2. Can be mapped to GPIO #s 08,09,10,11. Leave open if not used.
SSMD0, SSMD1, SSMD2, SSMD3, SSMCLK, SSMCP, SSMCMD, SSMWP	I/O	Used to make an SD card interface. SD card firmware is not supported at present in JB2. Leave open.

**VIDEO**

AV0CLK, AV0CTRL0, AV0CTRL1, AV0CTRL2, AV0DATA0, AV0DATA1, AV0DATA2, AV0DATA3, AV1DATA0, AV1DATA1, AV1DATA2, AV1DATA3	O	ITU-R BT.656 digital video output signals. Optionally used to make a TVout menu display, or to display decoded album art. Can be connected to video D/A converter (see Note 7), or connected to a video DSP.
--	---	--





**GPIO (not already mentioned elsewhere in this table)**

A22	O	GPIO18 Reserved for NOR flash address A22. Leave open.
A23	O	GPIO-16 Reserved for NOR flash address A23. Leave open.
NWAIT	I/O	GPIO-15 Not currently assigned. Leave open.
NCS2	I	GPIO-19 Assigned to iPod dock connector iPod NDETECT. See Note 8.
VCO1	I/O	GPIO-07 Not currently assigned. Leave open.
MIICRS	I/O	GPIO-00 Not currently assigned. Leave open.
MIICOL	I/O	GPIO-01 Not currently assigned. Leave open.
MIITXER	I/O	GPIO-02 Not currently assigned. Leave open.
MIITXCLK	I/O	GPIO-03 iPod dock connector Accessory Power signal. See Note 8.

**MII**

MIITXD0, MIITXD1, MIIRXD0, MIIRXD1	I/O	Can be used, with GPIO signals above, to drive an external ethernet PHY. This is not supported by JB2 firmware. Leave open.
------------------------------------	-----	---

**LCD**

LCDD0, LCDD1, LCDD2, LCDD3, LCDD4, LCDD5, LCDD6, LCDD7, LCDD8, LCDD9, LCDD10, LCDD11, LCDD12, LCDD13, LCDD14, LCDD15, LCD16, LCD17, LCDCLK, LCDCTRL0, LCDCTRL1, LCDCTRL2, LCDCTRL3	O	Uses optional J1 LCD connector. Connect to local LCD display. See Note 9. Leave open if not used.
--	---	---



**Notes:**

1. Signal type codes:
  - I – 3.3V level Digital Logic Input into the DM870A
  - O – 3.3V level Digital Logic Output from the DM870A
  - IO – 3.3V level Digital Logic Input and Output (bi-directional) signal
  - M – Miscellaneous, see text for description
  - P – Power Supply
2. For SPI timing diagram for eDMP applications, please see:  
*BridgeCo\_JB2x - DeviceControlProtocol\_Registers\_v\_2\_1.pdf*, or later version.  
For detailed setup and hold timing details, see DM870A IC data sheet:  
*DM870A DS rev. 1.3\_12-15-11.pdf*, or later version.
3. For audio port timing diagrams, and for detailed setup and hold timing, please see DM870A IC data sheet:  
*DM870A DS rev. 1.3\_12-15-11.pdf*, or later version.
4. For example ethernet external schematic, see:  
*CX Module Ethernet (RJ45 + Ext.Magnetics)\_V1.2.pdf*, or later version.
5. For example USB schematics, see:  
*CX Module USB\_V1.2.pdf*, or later version.
6. For example use of extended GPIO shift registers, see CE2 schematic:  
*A EVMCE2-4\_schematic.pdf*, or later version.
7. For example connection to a video D/A converter, see CE2 schematic:  
*A EVMCE2-4\_schematic.pdf*, or later version.
8. iPod dock connector pin and GPIO assignments are under discussion. Please contact SMSC for recommendations for iPod dock connections to CX870 module.
9. For example connection to an LCD display, see CE2 schematic:  
*A EVMCE2-4\_schematic.pdf*, or later version.
10. All the above signals are brought out to J2 pins. Not all the above signals are brought out to J3, the 64-pin low density connector. The J3 pin assignments table shows which signals are brought out to the J3 pins.
11. SMSC has a set of example motherboard schematics that shows example external circuitry that is typically connected to the module. Please check the SMSC/BridgeCo customer portal at <https://portal.bridgeco.net/> for a copy of these example schematics.
12. Please check the SMSC/BridgeCo Customer Portal *Download* area for the latest version of the SMSC documents. Go to <https://portal.bridgeco.net/>. If you do not have an account, please contact SMSC.

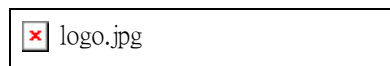

## 8.2.2 Connector PIN Assignments

### J2 – Media Connector

Function	GPIO	IC PIN	Signal	PIN Number	Signal	IC PIN	GPIO	Function
			GND	1	2			
			VIN (+3.3V)	3	4			
			VIN (+3.3V)	5	6			
			GND	7	8			
			VIN (+1.2V)	9	10			
			VIN (+1.2V)	11	12			
			GND	13	14			
			VIN (+1.9V)	15	16			
			GND	17	18			
			3V3RTC	19	20			
			GND	21	22			
			GND	23	24			
			SPI_DOUT	25	26	TMS	B15	JTAG
		D15	SPI_DIN	27	28	TCK	C14	
		D14	SPI_CLK	29	30	TDI	A16	
		B16	TXD0	31	32	TDO	A15	
		C13	RXD0	33	34	SPL_NCS0	C15	SPI
		B14	RXD0	35	36	SPL_NCS1	B17	
		A14	RXD1	37	38	NRESET_MOD		Module reset input
		B13	TXD1	39	40	SSMD6	C12	GPIO-10
			GND	41	42	SSMD4	A12	GPIO-08
			GND	43	44	SSMD2	C11	
			SSMD7	45	46	SSMD1	B11	
			SSMD5	47	48	SSMCMC	A13	
			SSMD3	49	50	SSMWP	D9	
			SSMD0	51	52	NCS3	H18	GPIO-17
			SSMCLK	53	54	NCS2	J17	BIST activate
			SSMCP	55	56	GND		GPIO-19
			GND	57	58	USB_VBUS	D2	iPod NDETECT
			USB_DN	59	60			USB
			USB_DP	61	62	GND		
			USBVBSDRV	63	64	AOUTRN	L3	
			GND	65	66	AOUTRP	L4	
			AOUTLP	67	68	GND		
			AOUTLN	69	70	PDOUT1	J1	GPIO-06
			GND	71	72	VCO1	J2	GPIO-07
			A23	73	74	PDOUT0	K1	GPIO-04
			A22	75	76	VCO0	K2	Factory reset
			AV3CTRL1	77	78	AV3CLK	R4	GPIO-05
			AV3CTRL0	79	80	AV0CTRL0	M1	IR input
			AV0CTRL2	81	82	AV1DATA3	N4	GPIO-12
			AV0CTRL1	83	84	AV1DATA2	P1	ETH NRESET
			AV0CLK	85	86	AV1DATA1	P2	
			AV0DATA3	87	88	AV1DATA0	P3	
			AV0DATA2	89	90	GND		
			AV0DATA1	91	92	AV2CTRL1	T1	MCLK
			AV0DATA0	93	94	GND		
			GND	95	96	AV2CLK	R1	SCLK
			AV2CTRL0	97	98	GND		
			AV2DATA3	99	100	AV4DATA1	U3	SPDIF output
			AV2DATA2	101	102	AV4DATA0	V2	SPDIF input
			AV2DATA1	103	104	GND		
			AV2DATA0	105	106	ETH_LED_ACT		
			GND	107	108	ETH_LED_SPEED		Ethernet
			ETH_RXN	109	110	MIICRS	R14	GPIO-00
			ETH_RXP	111	112	MIICOL	T13	GPIO-01
			ETH_TXN	113	114	MIITXER	T11	GPIO-02
			ETH_TXP	115	116	MIITXCLK	R12	GPIO-03
			GND	117	118	MIITXD0	U10	iPod Access Power
			NWAIT	119	120	MIITXD1	V10	
			NPD_RF			MIIRXD0	U12	
						MIIRXD1	V12	
						GND		

**Note:** The IC PIN column indicates the pin number on the DM860A or DM870A integrated circuit. This allows for easy cross-reference to the DM860A or DM870A data sheet information.

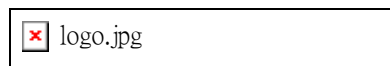

**J1 – LCD Connector**

Function	GPIO	IC PIN	Signal	PIN Number		Signal	IC PIN	GPIO	Function
			GND	1	2	GND			
LCD Interface		V8	LCDD0	3	4	LCDD1	U8	LCD Interface	
		T8	LCDD2	5	6	LCDD3	R8		
		V7	LCDD4	7	8	LCDD5	U7		
		T7	LCDD6	9	10	LCDD7	R7		
		V6	LCDD8	11	12	LCDD9	U6		
		T6	LCDD10	13	14	LCDD11	R6		
		V5	LCDD12	15	16	LCDD13	U5		
		T5	LCDD14	17	18	LCDD15	V4		
		V4	LCDD16	19	20	LCDD17	V3		
				GND	21	22	GND		
LCD Interface		T10	LCDCCLK	23	24	LCDCCTRL0	R9	LCD Interface	
		T9	LCDCCTRL1	25	26	LCDCCTRL2	U9		
		V9	LCDCCTRL3	27	28	GND			
			GND	29	30	GND			

**Note:** The IC PIN column indicates the pin number on the DM860A or DM870A integrated circuit. This allows for easy cross-reference to the DM860A or DM870A data sheet information.

**J3 – Low Density Connector**

Function	GPIO	IC PIN	Signal	PIN Number		Signal	IC PIN	GPIO	Function
			GND	1	2	GND			
			VIN (+3.3)	3	4	RXD0	B14		
			VIN (+3.3)	5	6	TXD0	C13		
			GND	7	8	GND			
			VIN (+1.9)	9	10	VIN (+1.2)			
			VIN (+1.9)	11	12	VIN (+1.2)			
			GND	13	14	GND			
Free	GPIO-15	K18	NWAIT	15	16	RXD1	A14	Debug UART	
iPod NDETECT	GPIO-19	J17	NCS2	17	18	TXD1	B13		
		D13	NRESET	19	20	GND			
			3V3RTC	21	22	AV2CTRL1	R2	MCLK LRCK SCLK A/D data 0 D/A data 0 SPDIF output SPDIF input	
			GND	23	24	AV2CTRL0	T1		
SPI		D14	SPI_DIN	25	26	AV2CLK	R1		
		D15	SPI_DOUT	27	28	AV2DATA2	R3		
		B16	SPI_CLK	29	30	AV2DATA0	U1		
		C15	SPI_NCS0	31	32	AV4DATA1	T2		
Free	GPIO-17	H18	NCS3	33	34	AV4DATA0	V2		
			GND	35	36	GND			
E-GPIO_NCS/TBA	GPIO-11	D12	SSMD7	37	38	USB_DN	A1	USB	
I2C SDA	GPIO-14	T3	AV3CTRL1	39	40	USB_DP	B1		
I2C SCL	GPIO-13	U2	AV3CTRL0	41	42	USBVBUSDRV	E3		
			GND	43	44	USB_VBUS	D2		
SPI_REQ	GPIO-06	J1	PDOUT1	45	46	GND			
Factory Reset	GPIO-04	K1	PDOUT0	47	48	SSMD5	B12	GPIO-09	E-GPIO_SDI/TBA
IR input	GPIO-05	K2	VCO0	49	50	SSMD4	A12	GPIO-08	E-GPIO_SDO/TBA
			GND	51	52	GND			
Ethernet			ETH_LED_SPEED	53	54	ETH_LED_ACT			Ethernet
iPod Access Power	GPIO-03	R12	MIITXCLK	55	56	SSMD6	C12	GPIO-10	E-GPIO_CLK/TBA
Ethernet			ETH_RXN	57	58	ETH_RXP			Ethernet
			ETH_TXN	59	60	ETH_TXP			Ethernet
Free	GPIO-00	R14	MIICRS	61	62	MIICOL	T13	GPIO-01	Free
			GND	63	64	GND			

**Note:** The IC PIN column indicates the pin number on the DM860A or DM870A integrated circuit. This allows for easy cross-reference to the DM860A or DM870A data sheet information.



## 8.2.3 GPIO Assignments

### GPIO Assignments for J3 64-pin Low Density Connector

GPIO	PIN Name	PIN Number	Function
00	MIICRS	61	Free
01	MIICOL	62	Free
03	MIITXCLK	55	iPOD Access Power
04	PDOUT0	47	Factory Reset
05	VCO0	49	IR Input
06	PDOUT1	45	Host NIREQ
08	SSMD4	50	E_GPIO_SDO/TBA
09	SSMD5	48	E_GPIO_SDI/TBA
10	SSMD6	56	E_GPIO_CLK/TBA
11	SSMD7	37	E_GPIO_NCS/TBA
13	AV3CTRL0	41	I2C_SCL
14	AV3CTRL1	39	I2C_SDA
15	NWAIT	15	Free
17	NCS3	33	Free
19	NCS2	17	IPOD NDETECT

**Note:** Not all 20 GPIO signals are brought out to J3 64-pin low density connector. For the CX870-3K, GPIOs 00, 01 and 03 are not brought out to J3 64-pin low density connector. J3 pin numbers 61, 62 and 55 are not connected to any signal in the CX870-3K module.

## 9 Application Guidelines

### 9.1 Power Supply sequencing and Reset Timing

There are strict power sequencing and reset timing requirements.

- Power up the I/O voltage (3.3V) first and hold NRESET\_MOD low.
- The core voltage (1.2V) must never be higher than (I/O voltage +0.5 V).
- The core voltage (1.2V) must be within the specified core voltage limits less than 300ms after the I/O voltage (3.3V) reaches the specified I/O voltage limits.
- Throughout the power down process, the 3.3V supply must maintain a higher voltage than the 1.2V supply, until both have reached ground potential.
- To assure a proper IC reset, the power supplies must be present for a minimum time of 2ms before NRESET\_MOD is de-asserted.

Please see the power and reset timing figure in Section 9.1.1 below.

About 1.9V, the arrival of 1.9V supply should lag behind the arrival of the 3.3V. The delay between the 1.9V and the 3.3V is not critical. Typical delay is approximately 10ms, for example using 10kohm resistor and 0.1uF capacitor on the enable pin of a 1.9V dc-to-dc converter.



### 9.1.1 Power up, Reset and Power Down Timing

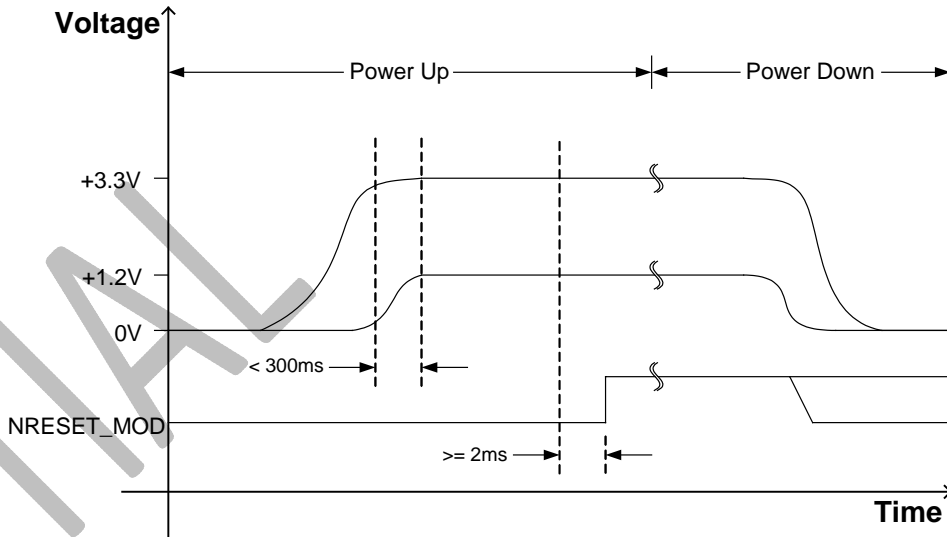

## 9.2 RF Considerations

Note that overall system, RF and WiFi performance is significantly affected by the product design, environment and the application. It is the responsibility of the product designer to ensure proper system level shielding (if required) and to verify performance and fitness for the given product features and applications.

The WiFi performance will be affected by the RF environment surrounding the CX module. Please ensure that the CX module is positioned in a “quiet” RF environment, as far away as possible from high frequency clock signals and any other sources of RF energy. Also, make sure the antenna is not shielded by any metal objects, for example loudspeakers or other metal parts. Please make sure that the power supplies, in particular the +1.9V supply, are quiet and free from noise.

SMSC recommends that systems implementing AirPlay should use a module configuration that includes on-module shielding, as well as paying particular attention to system configuration and shielding. In particular, SMSC is recommending the use of the Bottom Shield versions of the modules, which allows greater freedom in antenna positioning.

Also, please see the SMSC Application Note:  
*App Note Antenna Placement recommendation CX870 modules rev1.1.pdf*  
regarding antenna positioning guidelines.



# 10 Revision Control

Revision	Date / Author	Details of Change	Reason for Change
V2.5 (041112)	April 11, 2012	Added CX870-3B-D and CX870-3B-D60 option to Section 4 Ordering Guide	Added -3B-D and -3B-D60 option.
V2.4 (032312)	March 23, 2012 / SHs	Added IC PIN entry for MIICRS in J3 Low Density Connector table in Section 8.2.2 Connector PIN Assignments.	CX module uses DM870A.
		Changed "MMIICRS" to "MIICRS" in Section 8.2.3 GPIO Assignments.	Correction.
		Changed "MMIICRS" to "MIICRS" in J3 Low Density Connector table in Section 8.2.2 Connector PIN Assignments.	Correction.
		Changed "MMIICRS" to "MIICRS" in GPIO table in Section 8.2.1 Pin Descriptions.	Correction.
		Added important note text to Tx Power row in Section 5.3 WiFi Specification.	To indicate which modules the Tx Power specifications relate to.
V2.4 (031712)	March 17, 2012 / SHs	Removed the 'm' from "+/-1dBm" in the Tx Power row in Section 5.3 WiFi Specification.	Correction.
		In Section 5.3 WiFi Specifications, updated Transmission Speed entry	Add missing 2Mbps speed.
		In Section 4 Ordering Guide, changed all occurrences of DM870 to DM870A & DM860 to DM860A	CX module uses DM870A.
		In Section 2 Block Diagram, changed all occurrences of DM870 to DM870A & DM860 to DM860A	CX module uses DM870A.
		In Section 1 Introduction, changed all occurrences of DM870 to DM870A & DM860 to DM860A	CX module uses DM870A.
		In Section 8.2.1 Pin Descriptions, changed all occurrences of DM870 to DM870A	CX module uses DM870A.
		In the Notes for Section 8.2.1 Pin Descriptions, changed <i>dat_DM870_16_datasheet.pdf</i> to <i>DM870A DS rev. 1.3_12-15-11.pdf</i>	CX module uses DM870A.
		Changed all occurrences of DM870 to DM870A throughout the datasheet.	CX module uses DM870A.
		Updated J1, J2 & J3 tables in Section 8.2.2 Connector PIN Assignments, changing DM870 to DM870A.	CX module uses DM870A.
		Changed "WiFi (on-module PCB diversity)" column heading to "Internal PCB Diversity Antennas" in Section 4 Ordering Guide	Improve clarity of meaning.
		Added 'FCC' to North America in Frequency Band entry in Section 5.3 WiFi Specification	Specify North American WiFi regulatory certification body.
		Updated TX EVM entry in Section 5.3 WiFi Specifications	Update values to better reflect actual performance.
		Updated Rx Sensitivity entry in Section 5.3 WiFi Specifications	Update values to better reflect actual performance.
Updated Tx Power entry in Section 5.3 WiFi Specifications	Show test conditions.		



Revision	Date / Author	Details of Change	Reason for Change
V2.4 (031212)	March 12, 2012 / SHs	Added Section 3.6 Production Module with Bottom shield (Part Numbers with a "B" after the configuration letter)	Show module versions with bottom shield.
		Added Section 3.6.1 Including J3 Low Density 64-pin connector - Bottom View	Show bottom shield.
		Added Section 3.6.2 Including J2 High Density 120-pin connector - Bottom View	Show bottom shield.
V2.4 (031012)	March 10, 2012 / SHs	Updated Section 4 Ordering Guide & Section 4.1 Part Number Syntax drawing with bottom shield versions	Bottom shield versions added to table and Syntax drawing.
		Added another note to Section 8.2.3 GPIO Assignments	Document missing GPIOs for CX870-3K.
		Updated TX Power row in Section 5.3 WiFi Specification (CX870 only)	Show improved tolerances for TX power.
		Added Section 7.1.1 Top & Bottom View of CX870 Module with Bottom Shield	Show drawings of module with Bottom Shield.
		Added Section 7.2.1 Side View of CX870 Module with Bottom Shield	Show drawings of module with Bottom Shield.
		Added a note to Section 7.3 3D View of CX870 Module	To indicate availability of digital copy of 3D view of module.
V2.3 (112011)	November 20, 2011 / SHs	Added CX870-3DS option to Section 4 Ordering Guide	To indicate soldered shield version.
		V2.2 (110811)	November 8, 2011 / SHs
V2.1 (100711)	October 7, 2011 / SHs	Updated title of Section 6.1 from "1 RoHS" to "RoHS".	Correcting typo.
		In Section 10 Revision Control table, updated an entry for V2.0 b in the Reason for Change column from "RTV" to "RTC"	Correcting typo.
		Removed "Preliminary Datasheet" from the footer.	CX module is in production, so the datasheet is no longer preliminary.
		Removed the word "Preliminary" from the title page.	CX module is in production, so the datasheet is no longer preliminary.
V2.0 (100211)	October 2, 2011 / SHs	Updated Section 5.3 WiFi Specification "TX Power" entry for 802.11g	Correspond to actual production test limits.
		Updated Section 6.0.1 Antenna Considerations with updated module numbering scheme	Revert to original module numbering scheme.
		Updated Section 6.7 Module Quality with new Defect Rate	Data is now available.
		Updated Section 4.1 Part Number Syntax with removal of Antenna Configuration number and Note	Revert to original part numbering scheme.
		Updated Section 10 Revision Control with new Reason for Change column	Corporate standard.
V2.0 (092611)	Sept. 26, 2011 / SHs	Change from BridgeCo logos and disclaimer text to SMSC logos and disclaimer text	Corporate standard.
		Updated location of red boxes in Section 3.2.1 CX870 Bottom View with 64-pin Low density connector	Improve alignment of red box to photo.
		Updated location of red boxes in Section 3.2.2 CX870 Bottom View with 120-pin Media connector	Improve alignment of red box to photo.



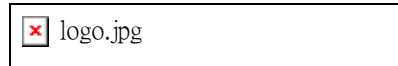

Revision	Date / Author	Details of Change	Reason for Change
		Moved Section 5.3 WiFi Specification on to one page Updated Customer Portal information in Section 6 Regulatory Compliance and Quality Reverted Antenna Considerations back to Section 6.0.1; subsequently all subsections in Section 6 reverted back to original numbering Updated Notes 11 & 12 in Section 8.2.1 Pin Descriptions with updated Customer Portal information Updated Table of Contents	Improve readability. Easier to access URL directly. Decided to keep original part numbering scheme to avoid unnecessary paper work and the need to redo certifications. Easier to access URL directly. Keep TOC aligned with actual content.
V2.0 c	Sept. 14, 2011 / SHs	Updated font styling of Table of Contents Update Section 2 Block Diagram : moved RJ45+Transformer & USB Type A boxes inside the drawing boundary Updated Section 5.3 WiFi Specification (CX870 only) TX Power Description entry Updated Section 5.3 WiFi Specification (CX870 only) Rx Sensitivity Description entry Updated Section 5.3 WiFi Specification (CX870 only) : add a Note underneath the table Updated Section 4 Ordering Guide : changed CX870-3D row Two Ant entry from (X)* to X Updated Section 4 Ordering Guide : removed the two blank rows	Easier to read. Improve accuracy of drawing. Align data with test limits. Align data with test limits. Clarification of the possible effect of changing the TX Power setting. Change to match final CX870-3D configuration. Improve readability.
V2.0 b	Sept. 10, 2011 / SHs	Updated the Description for pin NCS3 in Section 8.2.1 Pin Descriptions Updated Section 4 Ordering Guide : added gray background to CX870-3F & CX870-3G Updated Section 4 Ordering Guide : removed the 2 from A, H, I & J version Part Numbers Updated Section 4 Ordering Guide : split Ext. Diversity Antennas column into two, added two sub-columns "One Ant." & "Two Ant.", moved Xs to correspond with correct sub-column Updated Section 4 Ordering Guide : CX870-3D : removed X from WiFi column Updated Section 4 Ordering Guide : updated + Note text Updated Section 4 Ordering Guide : moved the + from Part Numbers column to Ext. Diversity Antennas column Updated Section 4 Ordering Guide : removed # Note completely Updated Section 4.1 Part Number Syntax : Updated graphic Updated Section 4.1 Part Number Syntax : Updated Note text Updated text in Section 8.1 WLAN UFL Antenna Connector Removed RTC elements from Section 2 Block Diagram Updated the Description for pin 3V3RTC in Section 8.2.1 Pin Descriptions	Update to align with actual use. Internal antenna versions are not available until performance issues are resolved. Decided to keep original part numbering scheme to avoid unnecessary paper work and the need to redo certifications. Show the number of external antenna connections. CX870-3D is not configured for internal antenna. Explained about one or two external antenna options. Proper link for "+" Note. Content now covered by "+" Note Explain antenna configuration field Explain about one or two antenna configuration. Remove references to part numbering scheme which includes the number of antennas, and repeat advice to use two external antennas. Support for RTC is removed. Support for RTC is removed.

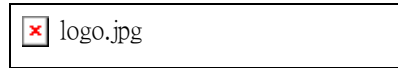

Revision	Date / Author	Details of Change	Reason for Change
V2.0 a	August 22, 2011 / SHs	Added Section 3.5 Example Production Module Showing Soldered RF Shield	Photo shows that RF shield is soldered, needed for Japan Telec certification.
V2.0	August 12, 2011 / SHs	Updated Note Section 4.1 Part number syntax  Updated all Section 3 Board Pictures to new versions + inserted new Sections 3.2.1 & 3.2.2 which show two different bottom views	Highlighted that CX870-3D does not follow the new part numbering scheme. This Note was subsequently deleted, so this is not relevant any more.  Improve accuracy of data sheet photos.
V1.9 c	August 2, 2011 / SHs	<ul style="list-style-type: none"> <li>Updated Key Features on Title page: removed (optional) from "WiFi-certified 802.11b/g" entry</li> <li>Updated Antenna Configuration entry in Section 4.1 Part number syntax</li> </ul>	
V1.9 b	July 28, 2011 / SHs	<ul style="list-style-type: none"> <li>Updated Section 4.1 Part number syntax                             <ul style="list-style-type: none"> <li>Updated graphic</li> <li>Added a Note</li> </ul> </li> <li>Changed intro text in Section 3 Board Pictures</li> <li>Updated Section 4 Ordering Guide                             <ul style="list-style-type: none"> <li>Changed CX870-3B1 to CX870-3B</li> <li>Updated the text for + note</li> <li>Added a note to CX870-3B Ext. Diversity Antenna column</li> <li>Added a new # note</li> </ul> </li> <li>Added Section 6.0.1 Antenna Considerations</li> </ul>	
V1.9 a	July 25, 2011 / SHs	<ul style="list-style-type: none"> <li>Inserted new photo for Section 3.1 Top View of CX870</li> <li>Inserted new photo for Section 3.2 Bottom View of CX870</li> <li>Added new Section 3.3 Production Module with Top &amp; RF shields</li> <li>Added new Section 3.4 Production Module with 64-pin Connector Option</li> <li>Updated Section 4 Ordering Guide                             <ul style="list-style-type: none"> <li>Added gray background to CX870-3D</li> <li>Changed CX870-3A to CX870-3A2</li> <li>Changed CX870-3B to CX870-3B1</li> <li>Changed CX870-3H to CX870-3H2</li> <li>Changed CX870-3I to CX870-3I2</li> <li>Changed CX870-3J to CX870-3J2</li> <li>Added a Note to the Part Number title</li> </ul> </li> <li>Updated Section 8.1 WLAN UFL Antenna Connector with new text</li> <li>Updated Section 5.3 WiFi Specification TX EVM entry to -9dB@6MHz</li> <li>Updated Section 6 Regulatory Compliance &amp; Quality with Module Versions Passed for Radio Regulations entries</li> </ul>	

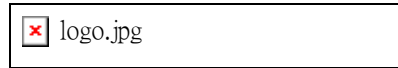

Revision	Date / Author	Details of Change	Reason for Change
		<ul style="list-style-type: none"> <li>Replaced the Note in Section 6 to be main body text and updated the text.</li> <li>Added new Section 4.1 Part number syntax</li> <li>Updated module weight to 20g</li> </ul>	
V1.8 a	July 10, 2011 / SHs	<ul style="list-style-type: none"> <li>Update section 8.1 WLAN UFL Antenna Connector</li> <li>Deleted section 8.1.1 Coaxial antenna connector dimensions</li> </ul>	
V1.8	July 5, 2011 / SHs	<ul style="list-style-type: none"> <li>Updated the acceptable surface-mount receptacle parts in Section 8.1 WLAN UFL Antenna Connector</li> <li>Added Appendix 1: Certification Notices</li> </ul>	
V1.7 c	May 13, 2011 / SHs	<ul style="list-style-type: none"> <li>Updated "Module Quality" Defect Rate field entry</li> <li>Updated "Board Dimensions &amp; Weight" drawings</li> <li>Updated the "Electrical Specifications" table</li> <li>Added another Note to the "Pin Descriptions" section</li> </ul>	
V1.7 b	May 11, 2011 / SHs	<ul style="list-style-type: none"> <li>Updated Note 8 in "Pin Descriptions" table</li> <li>Re-imported "Board Dimensions &amp; Weight" drawings</li> <li>Updated "Board Pictures" images</li> <li>Updated board photo on Cover page</li> <li>Updated the Feature list on Cover page</li> <li>Updated J1, J2 &amp; J3 "Connector PIN Assignments" tables: removed Power column &amp; re-organised columns</li> <li>Changed "Application Notes" title to "Application Guidelines"</li> <li>Updated Copyright date to "2011"</li> <li>Updated Table of Contents font styling</li> </ul>	
V1.7 a	May 6, 2011 / SHs	<ul style="list-style-type: none"> <li>Re-imported Block Diagram as a wmf file</li> <li>Updated "Power up, Reset &amp; Power down Timing" figure</li> <li>Updated "Pin Descriptions" table</li> <li>Re-organised text in "Power Supply sequencing &amp; Reset Timing"</li> <li>Re-imported J2 &amp; J3 Connector PIN Assignment tables</li> </ul>	
V1.7	May 4, 2011 / SHs	<ul style="list-style-type: none"> <li>Added note to Module Weight section</li> <li>Updated the Ordering Guide – Part Numbers &amp; added new J version</li> <li>Added new text to the Board Pictures section</li> <li>Updated all Mechanical Drawings and added &amp; removed Notes</li> <li>Updated the J3 Low Density Connector table</li> <li>Updated the GPIO Assignment table</li> <li>Added new Power Supply &amp; Timing figure</li> <li>Updated the text in the "Power Supply sequencing and Reset Timing" section</li> <li>Updated the Key Connections table</li> <li>Updated "Key Connections" section title to</li> </ul>	



Revision	Date / Author	Details of Change	Reason for Change
		"Pin Descriptions" <ul style="list-style-type: none"> <li>Updated "Detailed Connector PIN Descriptions" section title to "Connector PIN Assignments"</li> <li>Updated J2 Media Connector table</li> </ul>	
V1.6 d	March 3, 2011 / SHs	<ul style="list-style-type: none"> <li>Updated J3 Low Density Connector table</li> <li>Update GPIO Assignments section and table</li> </ul>	
V1.6 c	February 24, 2011 / SHs	<ul style="list-style-type: none"> <li>Updated all mechanical drawings in "Board Dimensions and Weights" section</li> <li>Deleted warning note in "Board Dimensions and Weights" section</li> </ul>	
V1.6 b	February 23, 2011 / SHs	<ul style="list-style-type: none"> <li>Updated "J3-Low density connector" pin description table</li> <li>Updated "GPIO Assignments" table</li> </ul>	
V1.6	February 11, 2011 / SHs	<ul style="list-style-type: none"> <li>Entirely updated the "Ordering Guide"</li> <li>Added a Note to the "Ordering Guide"</li> <li>Updated the subsection titles for the "Board Pictures" section</li> <li>Updated the Block Diagram – changed 'WiFi Antenna' to 'Ext. Antenna'</li> </ul>	
V1.5 b	January 27, 2011 / SHs	<ul style="list-style-type: none"> <li>Added Note to "Board Dimensions and Weight" section</li> </ul>	
V1.5 a	January 24, 2011 / SHs	<ul style="list-style-type: none"> <li>Updated the "Ordering Guide" – removed Mfg column and consolidated into one table</li> <li>Updated the Header to reflect Preliminary nature of datasheet</li> </ul>	
V1.5	January 22, 2011 / SHs	<ul style="list-style-type: none"> <li>Updated the datasheet to be a Preliminary Datasheet</li> <li>Added new feature to Summary on Front Page</li> <li>Updated "J3 - Low Density Connector" table</li> <li>Updated "GPIO Assignments" table</li> <li>Added note to "Board Dimensions &amp; Weight – Side Views of CX870 module" section</li> <li>Updated text in "Application Notes – Power Supply Sequencing &amp; Reset Timing" section</li> <li>Updated "Block Diagram"</li> <li>Updated text in "Connectors &amp; Connections – WLAN UFL Antenna Connector" section</li> </ul>	
V1.4 b	January 11, 2011 / SHs	<ul style="list-style-type: none"> <li>Updated the Application Notes, RF Considerations section</li> </ul>	
V1.4	January 3, 2011 / SHs	<ul style="list-style-type: none"> <li>Updated the module photo on the Title page</li> <li>Updated the Application Notes, RF Considerations section</li> </ul>	
V1.3	December 23, 2010 / SHs	<ul style="list-style-type: none"> <li>Updated Ordering Guide</li> <li>Added Notes to Ordering Guide</li> <li>Updated Block Diagram</li> <li>Updated "J3 – Low Density Connector" table</li> </ul>	



Revision	Date / Author	Details of Change	Reason for Change
		<ul style="list-style-type: none"> <li>• Updated “Electrical Specifications” table</li> <li>• Added Power Consumption data to “Electrical Specifications” table</li> <li>• Updated the Board Dimensions and Weight images</li> <li>• Updated the “GPIO Assignments” table</li> <li>• Added another Application Note</li> <li>• Added titles to Application Notes</li> </ul>	
V1.2	December 19, 2010 / SHs	<ul style="list-style-type: none"> <li>• Inserted CX860 and CX870 Module Weights</li> <li>• Updated module image on Front Page</li> </ul>	
V1.1	December 13, 2010 / SHs	<ul style="list-style-type: none"> <li>• Added the Ordering Guide.</li> <li>• Updated the Block Diagram.</li> <li>• Updated the “Electrical Specifications” table</li> <li>• Updated the “Absolute Maximum Ratings” table</li> <li>• Updated the Notes for “Regulatory Compliance and Quality” section</li> <li>• Updated “Key Connections” table</li> <li>• Updated “J2 – Media Connector” table</li> <li>• Updated “J3 – Low Density Connector” table</li> <li>• Updated “GPIO Assignments” table</li> <li>• Added Board Pictures</li> <li>• Replaced Mechanical Drawings in “Board Dimensions and Weight” section</li> </ul>	
V1.0	October 18, 2010 / SHs	<ul style="list-style-type: none"> <li>• Initial Version</li> </ul>	



# 11 Appendix 1: Certification Notices

## Federal Communications Commission Interference Statement

This equipment has been tested and found to comply with the limits for a Class B digital device, pursuant to part 15 of the FCC Rules. These limits are designed to provide reasonable protection against harmful interference in a residential installation. This equipment generates, uses and can radiate radio frequency energy and, if not installed and used in accordance with the instructions, may cause harmful interference to radio communications. However, there is no guarantee that interference will not occur in a particular installation. If this equipment does cause harmful interference to radio or television reception, which can be determined by turning the equipment off and on, the user is encouraged to try to correct the interference by one or more of the following measures:

- Reorient or relocate the receiving antenna.
- Increase the separation between the equipment and receiver.
- Connect the equipment into an outlet on a circuit different from that to which the receiver is connected.
- Consult the dealer or an experienced radio/ TV technician for help.

## CAUTION:

Any changes or modifications not expressly approved by the grantee of this device could void the user's authority to operate the equipment.

## Labeling requirements

This device complies with Part 15 of the FCC Rules. Operation is subject to the following two conditions: (1) this device may not cause harmful interference, and (2) this device must accept any interference received, including interference that may cause undesired operation.

## RF exposure warning

This equipment must be installed and operated in accordance with provided instructions and the antenna(s) used for this transmitter must be installed to provide a separation distance of at least 20 cm from all persons and must not be co-located or operating in conjunction with any other antenna or transmitter. End-users and installers must be provided with antenna installation instructions and transmitter operating conditions for satisfying RF exposure compliance.

## Information for the OEMs and Integrators

The following statement must be included with all versions of this document supplied to an OEM or integrator, but should not be distributed to the end user.

This device is intended for OEM integrators only. Please see the full Grant of Equipment document for other restrictions. This device must be operated and used with a locally approved access point.

## Information To Be Supplied to the End User by the OEM or Integrator

The following regulatory and safety notices must be published in documentation supplied to the end user of the product or system incorporating an adapter in compliance with local regulations.

Host system must be labeled with "Contains FCC ID:ZQO-CX870-3"X"", FCC ID displayed on the label. The label text should be updated according to the table shown in Ordering Guide section of this document. The proper letter shown in Ordering Guide Part Number column should be substituted for "X". For example, for the CX870-3B module, the label text should be "Contains FCC ID:ZQO-CX870-3B".

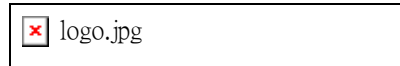

### Canada, Industry Canada (IC) Notices

This Class B digital apparatus complies with Canadian ICES-003 and RSS-210.

Operation is subject to the following two conditions: (1) this device may not cause interference, and (2) this device must accept any interference, including interference that may cause undesired operation of the device.

### Radio Frequency (RF) Exposure Information

The radiated output power of the Wireless Device is below the Industry Canada (IC) radio frequency exposure limits. The Wireless Device should be used in such a manner such that the potential for human contact during normal operation is minimized.

This device has also been evaluated and shown compliant with the IC RF Exposure limits under mobile exposure conditions. (antennas are greater than 20cm from a person's body).

This device has been certified for use in Canada. Status of the listing in the Industry Canada's REL (Radio Equipment List) can be found at the following web address:

<http://www.ic.gc.ca/app/sitt/reltel/srch/nwRdSrch.do?lang=eng>

Additional Canadian information on RF exposure also can be found at the following web address:

<http://www.ic.gc.ca/eic/site/smt-gst.nsf/eng/sf08792.html>

### Canada, avis d'Industry Canada (IC)

Cet appareil numérique de classe B est conforme aux normes canadiennes ICES-003 et RSS-210.

Son fonctionnement est soumis aux deux conditions suivantes : (1) cet appareil ne doit pas causer d'interférence et (2) cet appareil doit accepter toute interférence, notamment les interférences qui peuvent affecter son fonctionnement.

### Informations concernant l'exposition aux fréquences radio (RF)

La puissance de sortie émise par l'appareil de sans fil Dell est inférieure à la limite d'exposition aux fréquences radio d'Industry Canada (IC). Utilisez l'appareil de sans fil Dell de façon à minimiser les contacts humains lors du fonctionnement normal.

Ce périphérique a également été évalué et démontré conforme aux limites d'exposition aux RF d'IC dans des conditions d'exposition à des appareils mobiles (les antennes se situent à moins de 20 cm du corps d'une personne).

Ce périphérique est homologué pour l'utilisation au Canada. Pour consulter l'entrée correspondant à l'appareil dans la liste d'équipement radio (REL - Radio Equipment List) d'Industry Canada rendez-vous sur:

<http://www.ic.gc.ca/app/sitt/reltel/srch/nwRdSrch.do?lang=eng>

Pour des informations supplémentaires concernant l'exposition aux RF au Canada rendez-vous sur:

<http://www.ic.gc.ca/eic/site/smt-gst.nsf/eng/sf08792.html>