

Table of Content

1. Cylinder Installation	5
1.1 Package content	5
1.2 Tools required	5
1.3 Prior to installation	6
1.4 Cylinder & unit Installation	6
1.5 Magnet fitting	7
1.6 Cylinder to unit assembly (optional)	7
2. ENTR™ description	9
2.1 ENTR™ description	9
2.2 Indications	9
2.3 ON/OFF switch	10
2.3.1 Switching the ENTR™ ON	10
2.3.2 Switching the ENTR™ OFF	10
2.3.3 Low battery indication	10
2.4 Initiating the lock	11
2.5 Default PIN code	11
3. Operation	12
3.1 Changing PIN code	12
3.2 Door configuration	13
3.3 Pairing remote control	14
3.4 Deleting remote control	15
3.5 Setting the sound signal	16
3.6 Setting locking mode	17
3.7 Operated by knob	18
3.8 Operated by slide buttons	18

4. Touchpad Reader	19
4.1 Changing PIN code	19
4.2 Battery replacement	19
4.2.1 Low battery indication	19
5. Touchpad Reader operation	20
5.1 Operation	20
5.2 Pairing Touchpad Reader	20
5.3 Touchpad Reader master PIN code	22
5.4 Menu mode	22
5.5 Adding personal user code	22
5.6 Open door	23
5.7 Lock door	23
5.8 Delete personal user code	23
5.9 Delete all personal user codes	23
5.10 Factory reset	24
6. Fingerprint Reader	25
6.1 Mounting the Fingerprint Reader	25
6.2 Battery replacement	25
6.3 Initial configuration	25
6.3.1 Adjust Date & Time	25
6.4 Pairing fingerprint reader	26
6.4.1 Add master	27
6.4.2 Set finger	27
6.4.3 Set PIN code	27
6.5 Unlock the door	28

6.6	Lock Door	31
6.7	Low-battery Indication	31
6.8	Setting Menu	31
6.9	Add User	32
6.10	Delete User	33
6.11	Enable/Disable User	33
6.12	Delete all Users	34
6.13	Add Time Schedule	34
6.14	Edit Time Schedule	35
6.15	Volume Control	35
6.16	Double Security	36
6.17	Factory Reset	36
7.	Smartphone App	37
7.1	App Installation	37
7.2	Pairing Smartphone	38
8.	Remote Control Battery Change	39
8.1	Battery Removal	39
8.2	Battery Insertion	40
9.	Sabbath Mode	41
10.	Troubleshooting	42
10.1	Limitations and External Influences	42
10.2	Cases	42
	Limited warranty	45
	Federal Communications Commission (FCC) Statement	48

1. Cylinder Installation

1.1 Package content

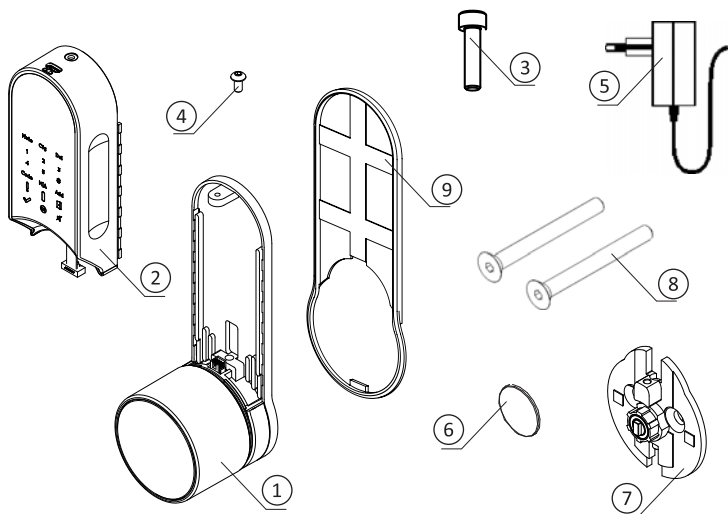

- 1 Base plate & Knob
- 2 Electrical unit
- 3 Mounting screw
- 4 Panel screw
- 9 Decorative spacer

- 5 Battery charger
- 6 Magnet
- 7 Inside drive adaptor
- 8 Mounting screws

1.2 Tools required

- 2mm Allen key
- 3mm Allen key
- 5/32" Allen key
- Small flat screwdriver

Note: Do not use power tools or any excessive force to assemble ENTR™ parts.

1.3 Prior to installation

Warning: Do not attempt to operate the unit until assembled into the door

- Remove knob screw using 1/16" Allen key and take the knob out.
- Use a flat screwdriver to remove the cover.
- Remove both Allen screws entirely and remove internal mechanism.

Note: While removing the internal mechanism secure the outside cylinder from falling. Consider using masking tape or similar.

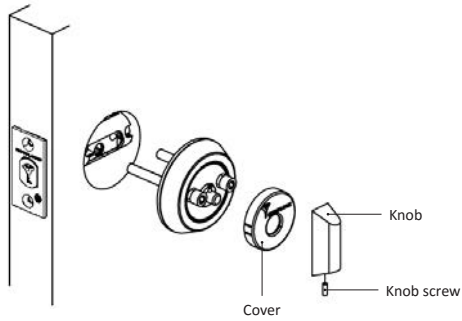

1.4 Unit installation

- Prior to installation check bolt locking direction.
- Verify that the bolt is in open position (bolt inside the door, unlocked).
- Rotate adaptor tail piece opposite to the bolt locking direction until stopped.
- Verify that the wide teeth is pointing up. If not rotate the external ring until the wide teeth will point up.

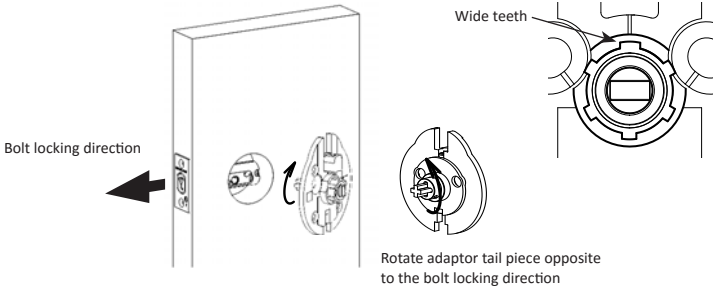

- Place the Inside drive adaptor and tighten the screws. Do not over tighten the screw or use power tools.

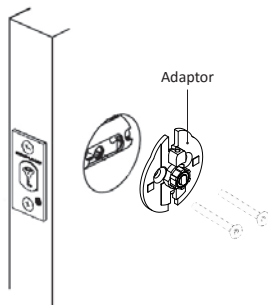

- Place decorative spacer over the Inside drive adaptor
- Assemble base plate (top housing & knob).
- Tighten cylinder mounting screw.

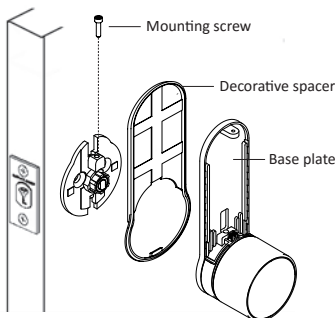

Note: In case the gear and the projecting rectangle are not aligned the unit will not be engaged to the knob.

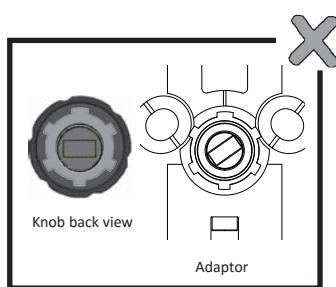
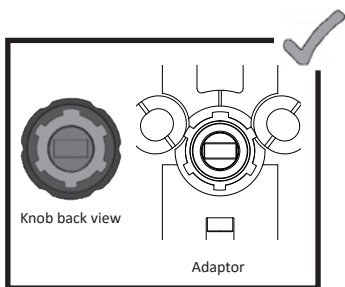

- Carefully connect data cable plug.
- Assemble electrical unit panel (battery housing). attache to base plate (1) and push down (2).
- Tighten electrical unit panel screw.

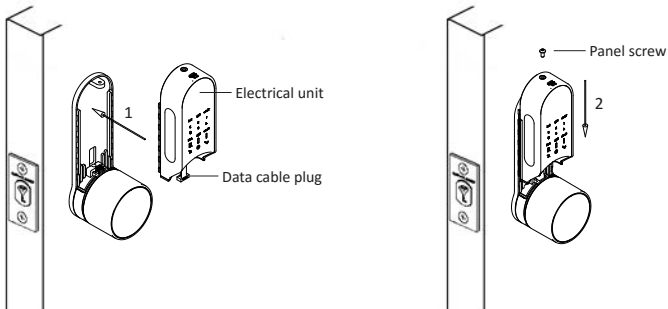

1.5 Magnet fitting

Magnet Fitting:

- Position the magnet on the frame moldings, as close as possible to the lock.
- The top point of the magnet should be aligned with the lower point of the slider (see illustration).

Note: The magnet area on frame molding should be clean and free from dust, peeling paint etc. Use alcohol if required. Wait until completely dry prior to sticking.

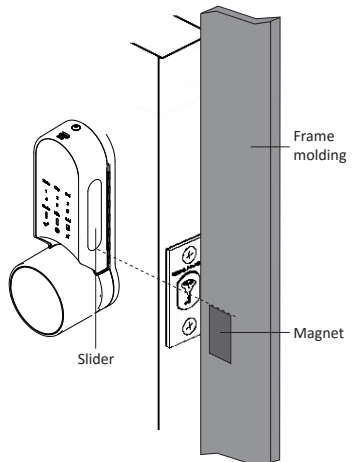

2. ENTR™ description

2.1 ENTR™ description

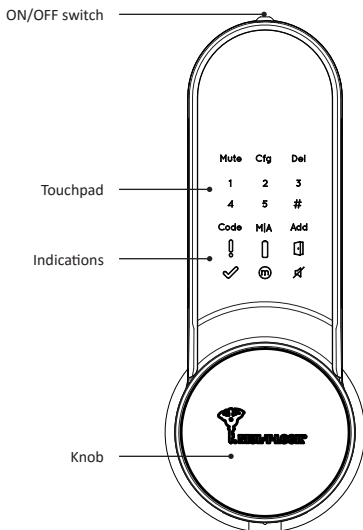

2.2 Indications

Mute (Green)

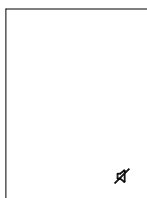

Manual Mode (Green)

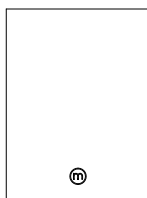

OK (Green)

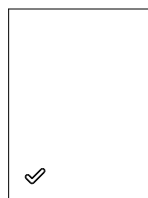

Door not closed (Red)

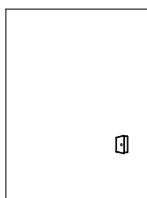

Battery status (Green/Red)

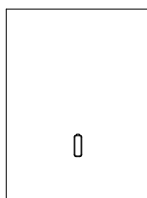

Error (Red)

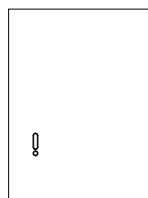

2.3 ON/OFF switch

- Turning the ENTR™ lock **ON** or **OFF**.

2.3.1 Switching the ENTR™ ON

Before turning ENTR™ **ON**, verify that the door is shut.

- Move the switch to the **ON** position. Make sure that the knob is in the zero position (see illustration).
- Function and numeric buttons will all blink once.
- Hazard beep sound will be emitted and error indication will blink once.
- ENTR™ is now in operating mode.

Note:

- After turning ENTR™ **ON**, avoid touching the front panel until beep sound ends.
- After turning ENTR™ **ON**, the door will be shut but not locked.

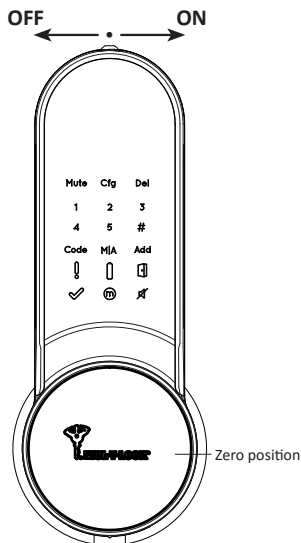

2.3.2 Switching the ENTR™ OFF

- Move the switch to **OFF** position.

2.3.3 Low battery indication

Battery red signal rapidly blinking and 2 long beeps will be emitted during every lock/unlock action, indicating that the battery is low and needs to be charged.

2.4 Initialization of the Lock

Initiate the lock by touching the screen with the palm of your hand or fingers for 3 seconds.

- Programming buttons and battery status indication light will illuminate for 15 seconds, waiting for user's action.
- After 15 seconds of inactivity, ENTR™ will idle.

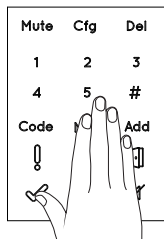

2.5 Default PIN Code

The lock's default factory PIN code is: **1 2 3 4 5 #**

Please note:

- Default PIN code must be changed before starting the configuration process.
- The PIN code must consist of 4-10 digits using numbers 1 through 5 in any sequence.
- Only the **Code** and **Mute** functions will operate until the default PIN code is changed

3. Operation

3.1 Changing PIN code

Warning: Do not attempt to operate the unit until assembled on the door.

1

Touch screen with palm or fingers for 3 seconds to activate.

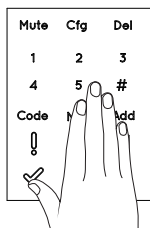

2

Press [Code]
Numeric buttons illuminated.

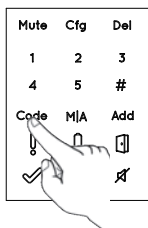

3

Type [Default PIN code]
(1 2 3 4 5) [Enter]

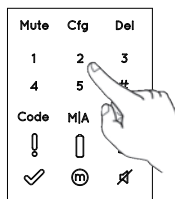

4

[OK] indication blinks once,
1 long beep emitted.
Illuminated buttons turn off.

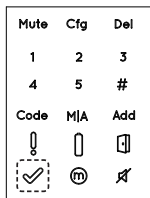

5

Numeric buttons illuminated Enter
[New PIN code] (4-10 digits) [Enter]
For example: 1231234#

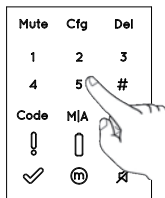

6

[OK] indication blinks once.
1 long beep emitted.
Illuminated buttons turns off.

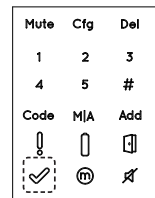

7

Numeric buttons illuminated Reenter
[New PIN code] [Enter] [Enter]
For example: 1231234#

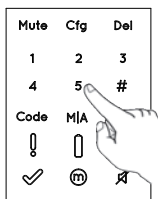

PIN codes match

[OK] indication illuminated.
2 short beep emitted.
New PIN code is set.

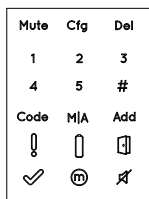

PIN Code doesn't match

[Error] indication illuminated.
2 long Beeps emitted for 1 second.
ENTR™ goes to menu mode.
Start the process from stage 1.

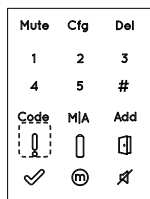

3.2 Door Configuration

The door configuration process sets your lock and door preferences.

This process should be done after successful installation of the lock. It will take 15-20 seconds to complete.

1

Important: Verify that the door is shut and no key is inserted into the cylinder during configuration steps.



2

Touch screen with palm or fingers for 3 seconds to activate.

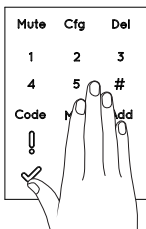

3

Press [Cfg]

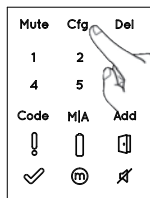

4

Numeric buttons illuminated, Type [PIN code] → [#] 1 long beep emitted.

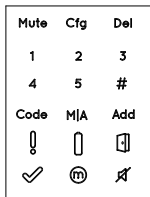

5

Press [1] or [3] to configure ENTR™ side (see illustration). Press [1] for ENTR™ on left side. Press [3] for ENTR™ on right side.

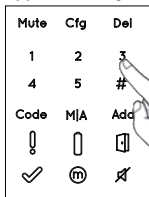

ENTR™ on left side of the door

Press [1]



ENTR™ on right side of the door

Press [3]



6

Hold the door shut to avoid opening.
The lock will carry out the configuration process.
It takes 15-20 seconds to complete.



Configuration OK

[Manual] indication illuminated.
[Cfg] indication blinks.
Note: If the configuration fails refer to [troubleshooting #1](#)

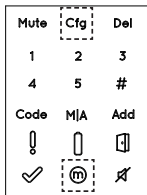

7

Open the door using the handle.
Bring the latch as close as possible to the door frame.
Note: Do not shut the door.

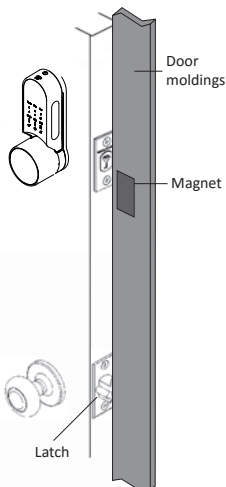

8

Press [Cfg]
The lock will carry out the configuration process.

Configuration OK

[OK] indication blinks once.
2 short beeps emitted,
Illuminated buttons turn off.

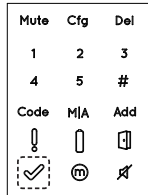
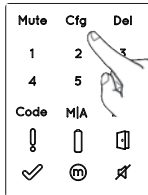

Troubleshooting #1







Lock configuration failed

1. Remove the mechanical key from the lock.
2. Check that the door was closed properly or if lock operation was interfered.

Configuration failed

[Error] indication illuminated,
2 long beeps emitted.

Refer to troubleshooting #2

Mute	Cfg	Del
1	2	3
4	5	#
Code	M/A	Add
		
		

Troubleshooting #2

Magnet configuration failed

1. You can still operate ENTR™ in Manual mode (w/o automatic locking).
2. Remove any other magnets from the door.
3. Place the magnet according to instructions.
4. Consult your installer or contact ENTR™ Technical Support.

Magnet Fitting:

- Position the magnet on the door moldings, as close as possible to the lock.
- The top point of the magnet should align with the lower point of the slider (see illustration).

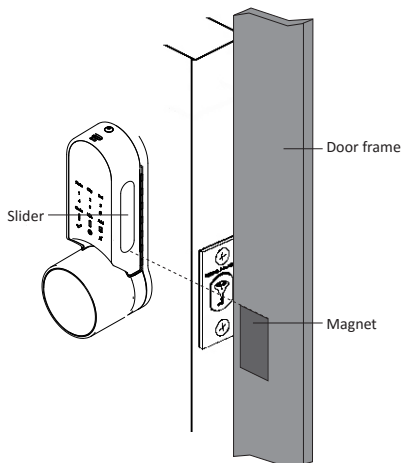

3.3 Pairing Remote Control

1

Touch screen with palm or fingers for 3 seconds to activate.

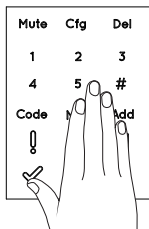

2

Press [Add]

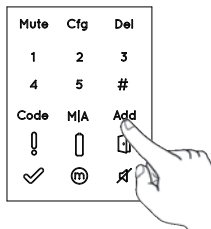

3

Numeric buttons illuminated.

Type [PIN code] → [#]

Numeric buttons blinking.

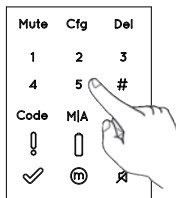

4

Press [1] to add remote control.

Illuminated buttons turn off.

[OK] indication blinks for 15 Seconds, waiting for remote control unit

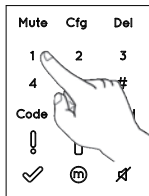

5

Press the remote control button.



Pairing OK

[OK] indication blinks once,
2 short beeps emitted.
Remote control unit added.

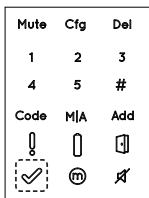

Pairing failed

[OK] indication blinks for 15 seconds,
No beeps emitted.
Start the process from stage 1.

Notes:

- To add more remote control units repeat this procedure.
- A remote control unit can be paired with only one single door unit.
- It is possible to add up to 20 remote control units.
- Only authorized dealer can reset a paired remote.

3.4 Deleting Remote Control

The deleting remote control process¹ will delete **all** remote control units including Touchpad and Fingerprint readers defined within the system.

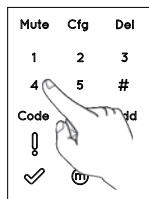
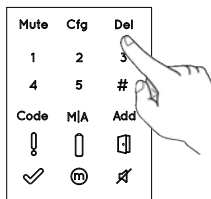
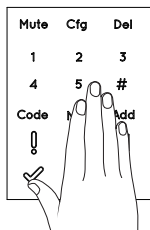
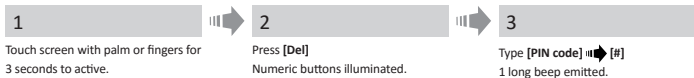

4

[Del] blinks for 30 seconds.

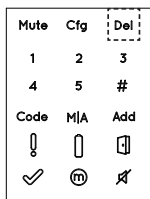

5

Press [Del] to confirm.

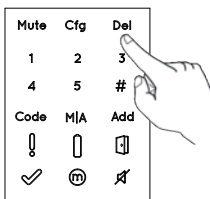

Deletion accomplished

[OK] indication blinks once.
2 short beeps emitted,
illuminated buttons turn off.

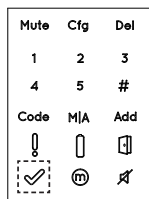

Note: Wall reader and smartphone connected to the ENTR™ lock will not be deleted.

3.5 Setting Sound Signal

Turn the sound signal to **OFF** or **ON**

1

Touch screen with palm or fingers for 3 seconds to activate.

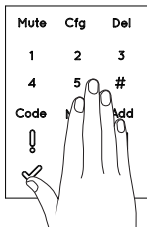

2

Press [Mute]

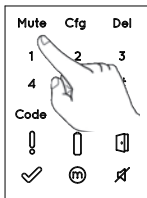

3

[Mute] indication illuminated.
Sound signal is off.

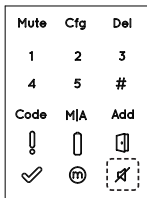

Notes:

- Setting the ENTR™ lock sound to **OFF** will mute the lock and unlock sounds, and the open door hazard signal. It will not mute the touchpad, mechanical override and low-battery sounds.
- Follow the same procedure to turn the sound back to **[ON]**.

3.6 Setting Locking Mode

Toggle between **Automatic** to **Manual** locking mode

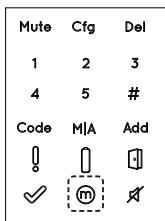
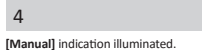
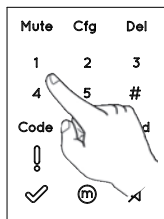
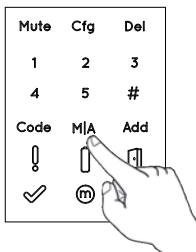
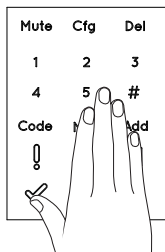

Notes:

- Setting the ENTR™ lock to **Manual** will disable automatic locking.
- Follow the same procedure to set the ENTR™ lock to **Automatic** locking.

3.7 Doorknob operation

Turn clockwise or counterclockwise to unlock.
Beep sound emitted during doorknob operation.

Important! When an active lock is opened by turning of the knob you must re-operate it by one of its automatic modes (i.e remote, phone, sliding your fingers, touch pad etc.) or else it will remain **UNLOCKED**.

Knob operation is meant solely for mechanical override in the rare event it will not otherwise unlock.

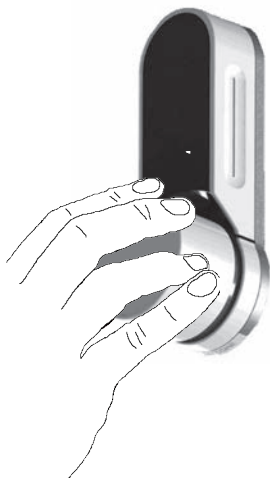

3.8 Slide Buttons Operation

Slide your fingers on the recessed grooves on both sides of the ENTR™ front panel:

- To open, slide fingers downwards on the recessed grooves on both sides.
- To lock, slide fingers upwards on the recessed grooves on both sides.

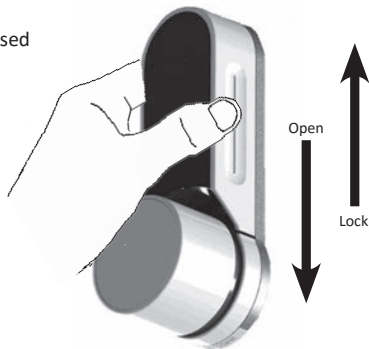

4. Touchpad Reader

4.1 Mounting the Touchpad Reader

Select the location where the Touchpad Reader will be mounted.

- Attach the Touchpad Reader baseplate to the wall.
- Use 4 screws and screw anchors, or double sided adhesive strip.

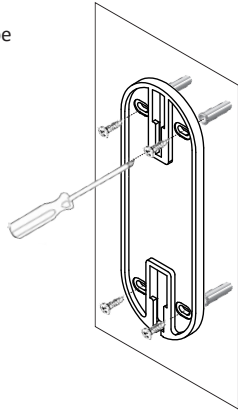

4.2 Battery Replacement

1. Release lid screw and open the lid.
2. Put in the batteries (2xAA) according to the "+" "-" signs.
3. Close the lid and tighten the screw.

Notes:

- After inserting the batteries the Touchpad Reader will turn on automatically.
- A short beep sound emitted and Green [OK] indication illuminated for 2 seconds.

Important: Do not touch the Touchpad during the self test procedure and until the lights are off.

4.2.1 Low battery indication

When batteries need replacement, a red warning signal will blink rapidly and long beep will sound during every lock/unlock action.



5. Touchpad Reader Operation

5.1 Operation

To turn the Touchpad Reader **ON** press [#] for 5 seconds. The reader will perform a self test followed by series of beeps. LED blinks Green, Red, Blue.

5.2 Pairing Touchpad Reader

This procedure is done via the ENTR™ lock. See also: Pairing Remote Control.

1

Touch **ENTR™ lock** screen with palm or fingers for 3 seconds to activate.

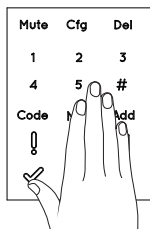

2

Press [Add]

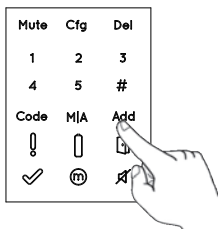

3

Numeric buttons illuminated.
Type [PIN code] → [#]
Numeric buttons blinking.

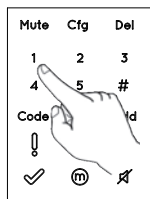

4

Press [1] to add Touchpad.
Illuminated buttons turn off.
[OK] indication blinks for 15 seconds
waiting for the Touchpad.

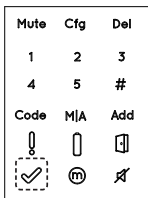

5



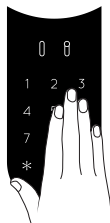



Touch the **Touchpad Reader** screen
with palm or fingers.
Press [77] → [#]
Blue LED blinking rapidly.



Pairing OK

[OK] indication blinks once,
2 short beeps emitted.

Touchpad Reader added.

Mute	Cfg	Del
1	2	3
4	5	#
Code	M/A	Add
		
		

Pairing failed

[OK] indication blinks for 15 seconds,
No beeps emitted.

In wall reader: Green LED illuminated
and 2 beeps emitted.

Start the process from stage 1.

- Hang the Touchpad Reader on the base plate.
- Tighten fixing screw.

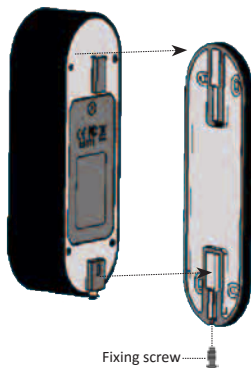

5.3 Touchpad Reader Master PIN Code

1



2

3

Touch screen with palm or fingers.
Press **[11]** → **[#]**

Enter **[New master PIN code]**
(4-10 digits) → **[#]**
For example: 1231234#

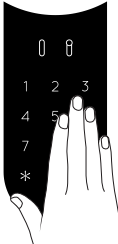
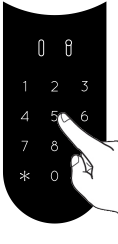
Reenter:
[New master PIN code] → **[#]**

Master PIN code added

Green **[OK]** illuminated for 1 second.
2 short beeps emitted.

Master PIN code not added

Red **[Error]** illuminated for 1 second.
1 long beep emitted.

5.4 Menu Mode

Entering menu mode: Press **[*]** → **[Master PIN code]** → **[#]**

5.5 Adding PIN Code (up to 20 different codes)

1

2

3

Touch Reader screen with palm or fingers.
Press **[*]** → **[Master PIN code]** → **[#]**
Press **[11]** → **[#]**

Enter **[Personal PIN code]**
(4-10 digits) → **[#]**
For example: 1231234#

Retype:
[Personal PIN code] → **[#]**

PIN code added

Green **[OK]** illuminated for 1 second,
2 short beeps emitted

PIN code not added

Red **[Error]** illuminated for 1 second,
1 long beep emitted.

5.6 Open Door



Touch Reader screen with palm or fingers.

Press [Personal PIN code] [#]

Not opening

Red [Error] illuminated for 1 second,
1 long beep emitted.

5.7 Lock Door



Touch Reader screen with palm or fingers.

Press [1] [#]

Not locking

Red [Error] illuminated for 1 second,
1 long beep emitted.

5.8 Delete PIN Code

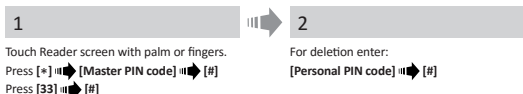

Touch Reader screen with palm or fingers.

Press [*] [#] [Master PIN code] [#]

Press [33] [#]

For deletion enter:

[Personal PIN code] [#]

Personal code deleted

Green [OK] illuminated for 1 second,
2 short beeps emitted.

Personal code not deleted

Red [Error] illuminated for 1 second,
1 long beep emitted.

5.9 Delete all PIN Codes



Touch Reader screen with palm or fingers.

Press [*] [#] [Master PIN code] [#]

Press [22] [#]

Enter [Master PIN code] [#]

Reenter: [Master PIN code] [#]

Personal PIN codes deleted

Green [OK] illuminated for 1 second,
2 short beeps emitted.

Note: Master PIN code can not be deleted.

Personal PIN codes not deleted

Red [Error] illuminated for 1 second,
1 long beep emitted.

5.10 Volume Control

1

Touch Reader screen with palm or fingers.
Press [*] → [Master PIN Code] → [#]
Press [55] → [#]



2

Press [2] to increase the volume, or [8] to decrease the volume.
Press [#] to confirm volume level.

5.11 Factory reset

The reset action will delete all PIN codes (master and personal) and will cut off the Touchpad Reader from the ENTR™ lock.

1

Touch Reader screen with palm or fingers.
Press [*] → [Master PIN code] → [#]
Press [99] → [#]



2

Enter [Master PIN code] → [#]

Personal and master PIN codes deleted

Green [OK] illuminated for 1 second.
2 short beeps emitted.
Device performing self test & is factory reset.

Personal and master PIN codes not deleted

Red [Error] illuminated for 1 second.
1 long beep emitted.

6. Fingerprint Reader

6.1 Mounting the Fingerprint Reader

Prior to starting, select the location where the Fingerprint Reader is to be mounted. Avoid direct sun light to the front panel.

- Attach the Fingerprint Reader base plate to the wall.
- Use 4 screws and screw anchors or double sided glued tape.

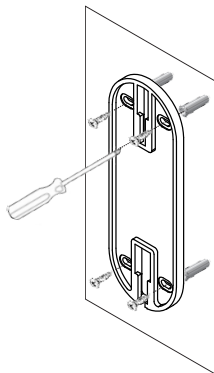

6.2 Battery Replacement

1. Using a 2mm Allen key release the lid screw and open the lid.
2. Insert batteries (2xAAA) according to the "+" "-" signs. Green LED will illuminate for 2 seconds.
3. Close the lid and tighten the screw.
4. Press on number #5 for 5 seconds.



The reader will self calibrate, which will be followed by a series of beeps and blinking LEDs.

6.3 Adjust Date & Time

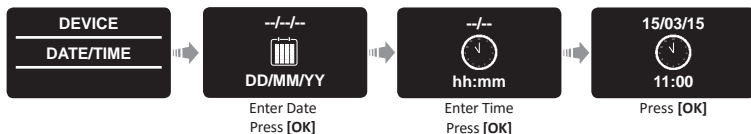

6.4 Pairing Fingerprint Reader

This procedure is done via the ENTR™ lock.

See also: Pairing Touchpad Reader.

- 1** Touch **ENTR™ lock** screen with palm or fingers for 3 seconds to activate.
- 2** Press **[Add]**
- 3** Numeric buttons illuminated. Type **[PIN code]** **[#]** Numeric buttons blinking.

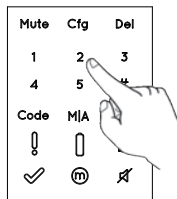
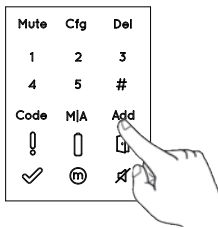
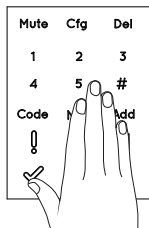

- 4** Press **[1]** to add the reader. Illuminated buttons turn off. **[OK]** indication blinks for 15 seconds waiting for the reader.
- 5** Touch Fingerprint Reader screen. 2 short beeps emitted. Press **[OK]** for YES or **[*]** to cancel.

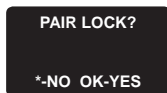
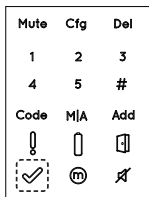

Pairing OK

[OK] indication blinks once.
2 short beeps emitted.
Fingerprint Reader added.



Pairing failed

1 long beep emitted.
Red LED illuminated for 2 seconds.



Note: At the end of the initial pairing process, a short notice will be displayed.



6.4.1 Add Master User

Setting a Master User requires both fingerprint and PIN code. It is possible to have up to two Master Users.

Note: At any stage you can press and hold the [*] key to move to standby mode.



Type in [Master name] [OK]

6.4.2 Set Finger

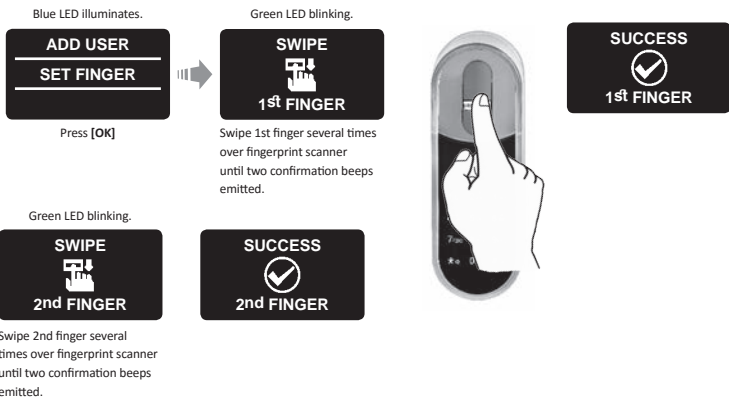

6.4.3 Set PIN Code

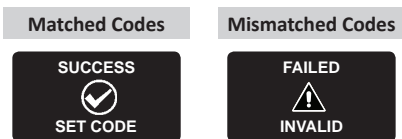

- Hang the reader on the base plate.
- Tighten fixing screw.

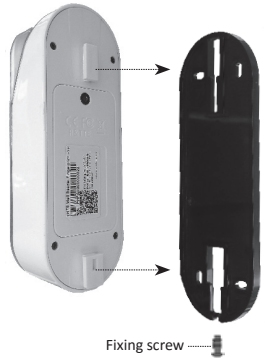

6.5 Unlock the Door

OPTION 1:

Place finger on fingerprint scanner.
Short beep emitted & white LED is on.
Swipe finger over fingerprint scanner

Fingerprint authorized: Blue LED blinking and unlock command is sent.

Fingerprint not authorized: Red LED is ON.
The device goes to standby.

OPTION 2:

Touch the Fingerprint Touchpad.
Screen shows user code.
Enter your code → [OK].

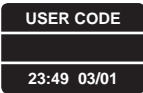

Note: In case ENTR™ lock hasn't succeed to unlock the door, unlock failed message appear on the screen.



6.6 Lock the Door

Touch the Fingerprint Touchpad

Press [1] → [#]

6.7 Low battery indication

Warning signal blinking.

Fingerprint Reader low battery indication

Red LED illuminate for 1s after wake-up,
2 long beeps emitted.



Door Unit low battery indication

Low battery: Red LED illuminate for 1s after wake-up.

Extremely low battery:

Red LED illuminate for 1s after wake-up,
2 long beeps emitted.



6.8 Setting Menu

Touch screen →



Press [*]

→















Enter [Master PIN code] → [OK] or
swipe finger over fingerprint scanner

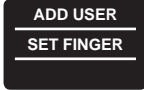

→

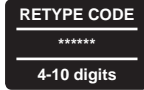

6.9 Add User

The unit allows adding up to 20 users. For each user two different fingerprints and one PIN code. Use different user name for each user.

1	2	3	4	User name added
				
Press [OK]	Press [OK]	Choose [OK] to add 2nd Master User or [*] to add a user. Note: This screen will not appear if two Master Users are defined.	User name added.	Type [USER NAME] [OK]
User name exist	5	6	1st finger added	7
				
Same user name. Choose different user name.	Press [OK]	Swipe 1st finger several times over fingerprint scanner until two confirmation beeps emitted.	1st finger added.	Swipe 2nd finger several times over fingerprint scanner until two confirmation beeps emitted.
2nd finger added	8	9	10	
				
	Press [OK] for YES or [*] for NO.	Type [CODE] [OK]	Retype [CODE] [OK]	

<div style="border: 1px solid black; padding: 5px; width: fit-content; margin: 0 auto;">Matched codes</div> 	<div style="border: 1px solid black; padding: 5px; width: fit-content; margin: 0 auto;">Mismatched codes</div> 
---	--

Process did not complete. All data typed in will be erased from memory.

6.10 Delete User

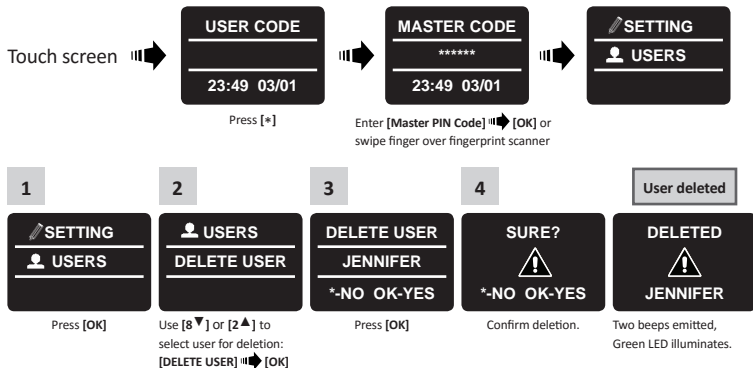

Note: The first Master User can't be deleted without doing a factory reset.

6.11 Enable/Disable User

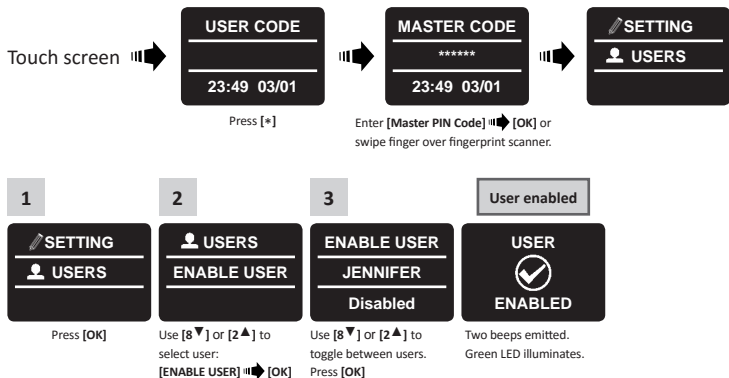

Note: Repeat this procedure to disable a user

6.12 Delete All Users

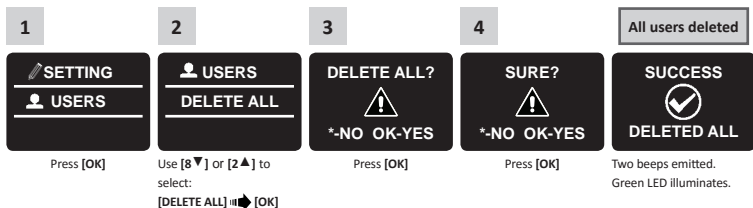
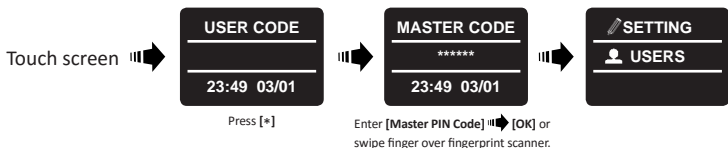

6.13 Add Time Schedule

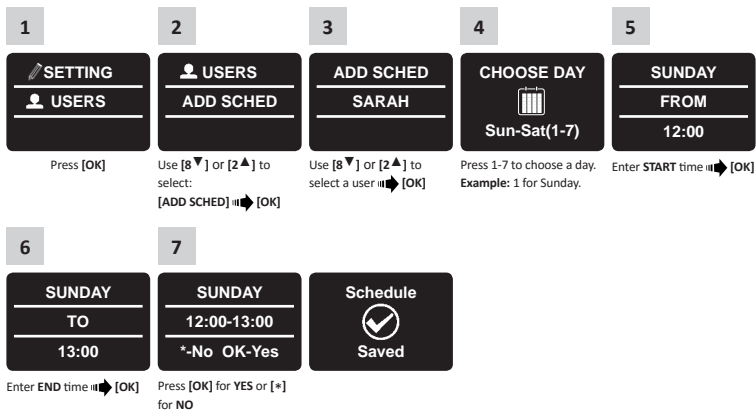

Notes:

1. Define up to 7 different time schedules for the same user.
2. Press [*] to go back on every menu.
3. Press [*] for 3 seconds to exit setting menu.

6.14 Edit Time Schedule

<p>1</p> <div style="border: 1px solid black; padding: 5px; background-color: #333; color: white;"> <p>SETTING</p> <hr/> <p>USERS</p> </div> <p>Press [OK]</p>	<p>2</p> <div style="border: 1px solid black; padding: 5px; background-color: #333; color: white;"> <p>USERS</p> <hr/> <p>EDIT SCHED</p> </div> <p>Use [8 ▼] or [2 ▲] to select: [EDIT SCHED] → [OK]</p>	<p>3</p> <div style="border: 1px solid black; padding: 5px; background-color: #333; color: white;"> <p>EDIT SCHED</p> <hr/> <p>SARAH</p> </div> <p>Use [8 ▼] or [2 ▲] to toggle between users → [OK]</p>	<p>4</p> <div style="border: 1px solid black; padding: 5px; background-color: #333; color: white;"> <p>SUNDAY</p> <hr/> <p>12:00-13:00</p> <hr/> <p>*-Back OK-Yes</p> </div> <p>Use [8 ▼] or [2 ▲] to choose the desired schedule to be edited. Pressing on [4 ◀] for 3 seconds shall delete the specific schedule.</p>	<p>5</p> <div style="border: 1px solid black; padding: 5px; background-color: #333; color: white;"> <p>FRIDAY</p> <hr/> <p>12:00-13:00</p> <hr/> <p>▼ DAY ▲</p> </div> <p>Use [8 ▼] or [2 ▲] to change schedule day → [OK]</p>
<p>6</p> <div style="border: 1px solid black; padding: 5px; background-color: #333; color: white;"> <p>FRIDAY</p> <hr/> <p>11:00-13:00</p> <hr/> <p>--:mm-HH:MM</p> </div> <p>Use [8 ▼] or [2 ▲] to change the START hour setting. Use [6 ▶] to move to START minutes.</p>	<p>7</p> <div style="border: 1px solid black; padding: 5px; background-color: #333; color: white;"> <p>FRIDAY</p> <hr/> <p>12:15-13:00</p> <hr/> <p>HH:--:HH:mm</p> </div> <p>Use [8 ▼] or [2 ▲] to change START minutes setting. Use [6 ▶] to move to the END hour.</p>	<p>8</p> <div style="border: 1px solid black; padding: 5px; background-color: #333; color: white;"> <p>FRIDAY</p> <hr/> <p>12:15-17:00</p> <hr/> <p>HH:mm--:mm</p> </div> <p>Use [8 ▼] or [2 ▲] to change END hour setting. Use [6 ▶] to move to the END minutes.</p>	<p>9</p> <div style="border: 1px solid black; padding: 5px; background-color: #333; color: white;"> <p>FRIDAY</p> <hr/> <p>12:15-17:45</p> <hr/> <p>HH:mm-HH:--</p> </div> <p>Use [8 ▼] or [2 ▲] to change END minutes setting.</p>	<p>10</p> <div style="border: 1px solid black; padding: 5px; background-color: #333; color: white;"> <p>FRIDAY</p> <hr/> <p>12:15-17:45</p> <hr/> <p>*-NO OK-Yes</p> </div> <p>Press [OK] for YES or [*] for NO.</p>

6.15 Volume Control

Touch screen →

USER CODE

23:49 03/01

→

MASTER CODE

23:49 03/01

→

SETTING

USERS

Press [*]

Enter [Master PIN Code] → [OK] or swipe finger over fingerprint scanner.

<p>1</p> <div style="border: 1px solid black; padding: 5px; background-color: #333; color: white;"> <p>SETTING</p> <hr/> <p>DEVICE</p> </div> <p>Use [8 ▼] or [2 ▲] to select: [DEVICE] → [OK]</p>	<p>2</p> <div style="border: 1px solid black; padding: 5px; background-color: #333; color: white;"> <p>DEVICE</p> <hr/> <p>VOLUME</p> </div> <p>Use [8 ▼] or [2 ▲] to select: [VOLUME] → [OK]</p>	<p>3</p> <div style="border: 1px solid black; padding: 5px; background-color: #333; color: white;"> <p>VOLUME</p> <hr/> <p>🔊</p> <hr/> <p>HIGH</p> </div> <p>Use [8 ▼] or [2 ▲] to toggle between HIGH, MEDIUM or LOW.</p>	<p>4</p> <div style="border: 1px solid black; padding: 5px; background-color: #333; color: white;"> <p>VOLUME</p> <hr/> <p>🔊</p> <hr/> <p>LOW</p> </div> <p>Press [OK]</p>	<p>SUCCESS</p> <hr/> <p>✔</p> <hr/> <p>SET VOLUME</p>
---	--	---	---	--

6.16 Double Security

After activating the double security option use both methods - swiping a fingerprint and inserting a PIN code to unlock the door.

Note: User set up with only one of the settings (fingerprint or PIN code) will not be able to unlock the door.

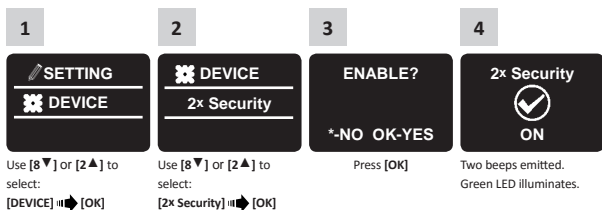
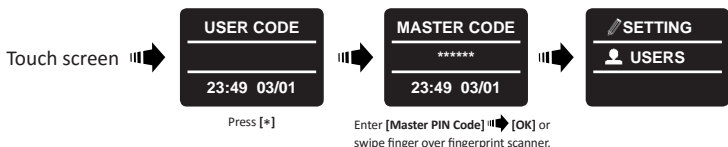

6.17 Factory Reset

Warning: A factory reset action will delete all information stored in the memory, including users and paired locks.

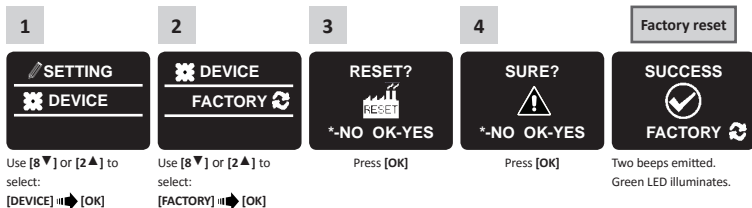
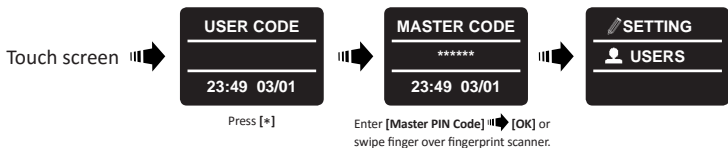

7. Smartphone App

7.1 App Installation

- Android smartphone users: go to Google Play to download the ENTR™ application.
System requirements: Android 4.4
- iOS (iPhone/iPad) users: go to the app store to download the ENTR™ application.
System requirements: iOS 7.0 or higher.
- Bluetooth low-energy compliant.

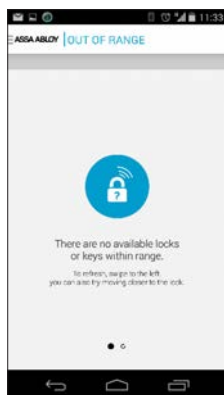

The below message will be displayed when opening the ENTR™ app prior to pairing it with your lock:
"There are no available locks or keys within range".

7.2 Pairing a Smartphone

This procedure is done via the ENTR™ lock door unit.

1

Touch the **Door Unit** screen with your palm or fingers for 3 seconds to activate.

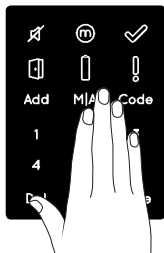

2

Press **[Add]**.

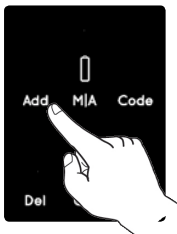

3

Numeric buttons illuminate.
Type **[PIN Code]** → **[#]**
Numeric buttons blink.

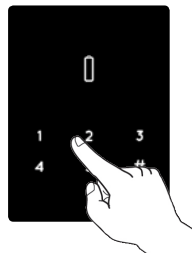

4

Press **[2]** to add a smartphone.
[OK] indication blinks for 3 seconds.
Illuminated buttons turn off,
ENTR™ will be visible for 5 min.



Open the ENTR™ app and follow the steps described in order to pair the smartphone with the ENTR™ lock.

ENTR™ App User Manual is available for download at: www.entrlock.com

8. Remote Control Battery Change

8.1 Battery Removal

- a. Release the lid by safely inserting a small tool into the notch (1), and press the lid clasp (2).

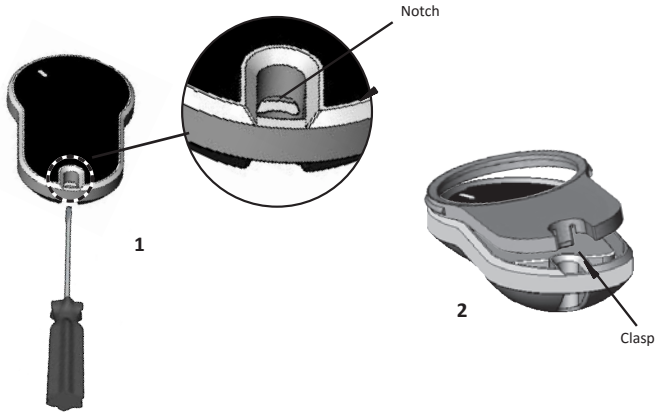

- b. Take out the push button and intermediate part.



- c. Take out the electronic board with the battery and remove battery.

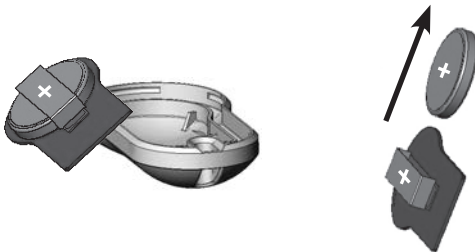

8.2 Battery Insertion

- a. Insert new battery (CR2032) into the electronic board according to the "+" "-" signs (1).
- b. Insert the electronic board into the remote control's housing (2).



- c. Reassemble the intermediate part and the push button and place over the electronic board.



- d. Place the lid and press until the clasp clicks into place.

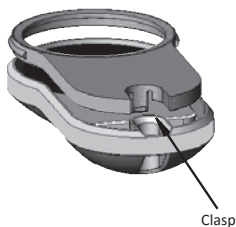

9. Sabbath Mode

Auto-locking and hazard beeps after knob operation are disabled. Battery indication LED blinks every 20 seconds.

1

Touch screen with palm or fingers for 3 seconds to activate.

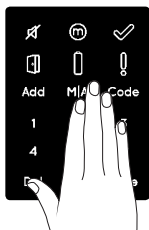

2

Press [Cfg]



3

Numeric buttons illuminated. Type [PIN Code] → [#], Numeric buttons blinking.

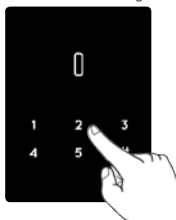

4

Press [5] to toggle between activation and deactivation of the Sabbath mode.

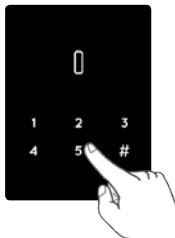

Sabbath mode
activated

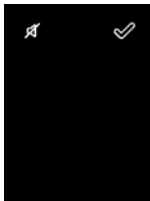

Sabbath mode
deactivated

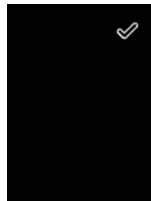

10. Troubleshooting

10.1 Limitations and External Influences

1. Door position sensor might be influenced by external electromagnetic interference.
2. After mechanical key operation, the user should unlock and lock the unit electronically.

10.2 Cases

New Unit Installation and Configuration		
Symptom	Corrective action	Page
The unit isn't accepting my administrative code.	Make sure the code you are using contains between 4-10 digits and is different from the "12345" factory code.	12
When I try to start the configuration (Cfg) process, I'm getting an error sound and light.	This could mean that the factory code hasn't been replaced with your administrative code. Go back and set your administrative code.	12
At the end of Step 1 of the configuration process, I'm getting an error sound	<ol style="list-style-type: none"> 1. Verify that you are able to lock and unlock the door using the key without issue. 2. Please contact your locksmith 	13
At the end of Step 2 of the configuration process, I'm getting an error sound.	<ol style="list-style-type: none"> 1. Verify that the magnet has been correctly positioned 2. Contact to your locksmith to replace the magnet with a stronger one. 	13
I turn the knob, but the lock isn't unlocking.	<ol style="list-style-type: none"> 1. Make sure that the mechanical key can operate the lock 2. Check that the electronic unit is properly attached to the cylinder. 3. Please consult with your locksmith/installer to ensure proper installation was completed. 	6
I've configured ENTR™, but when I slide my fingers down, the door locks; and when I slide my fingers up, it unlocks -- opposite actions of what should happen.	<ol style="list-style-type: none"> 1. Redo the configuration process. 2. Pay attention to the door's orientation, (Left = 1 and Right = 2). 	13

Remote Control		
Symptom	Corrective action	Page
I'm having trouble pairing the remote control.	<ol style="list-style-type: none"> 1. Please confirm that the LED on the remote control is ON when you press the button. 2. Repeat the pairing process again while standing closer to the door unit. 3. If after these steps are taken and pairing still isn't working, please contact your locksmith / installer. 	16
Sometimes the remote control doesn't open on the first attempt.	The remote control operates on RF signal, so you need to be within a certain proximity to the lock. Get closer and try again.	16

Constant Usage		
Symptom	Corrective action	Page
ENTR™ has started double beeping whenever I lock or unlock the door.	This is an indication your battery is low; it's time to charge the door unit.	31
The unit has started to beep constantly.	1. Place the knob in the zero position. 2. Please consult your locksmith or installer.	20
Sliders aren't responding as expected.	Turn the unit off, wait for 3 seconds, and then turn it back on to reset it.	20
The touch panel isn't responding as expected.	Turn the door unit off and wait for 3 seconds. When turning the power back on, avoid touching the front panel until the unit beeps.	12-19
The latch isn't moving fully into position.	1. Pull/push the door toward the frame and observe if the problem is solved. If so, consult your locksmiths to adjust the door or lock case. 2. Verify that the lock is operating smoothly when manually using the key.	6
When I lock or unlock the unit, an error sound occurs.	Please consult with your locksmith / installer to adjust the door or lock case.	6
The power adaptor is not charging the door unit.	Make sure you are using the dedicated ENTR™ power adaptor that was supplied with your lock. Standard 5V power adaptors WILL NOT charge the unit.	31
When I fully open the door the knob is touching the wall.	Place a doorstop at correct position to prevent the door from opening too widely and damaging the knob or nearby wall.	

Fingerprint/Touchpad Reader		
Symptom	Corrective action	Page
I'm having trouble pairing with the wall reader.	1. Repeat the pairing process until you hear double beep from both the door unit and the wall reader. 2. In some cases, if there are electro-magnetic interferences, there may be a need to repeat the pairing process several times until pairing is completed.	22
I'm having trouble pairing the wall reader with the door unit.	Set the door unit to pair mode, by pressing Add + Code + 1, then immediately set the wall reader to pair mode. You'll have a 30 second window until the door unit reverts back to standby mode.	22
The wall reader's blue LED is blinking, but the door unit isn't responding.	Verify that the wall reader is paired to the door unit by redoing the pairing process -- you will hear double beeps from both devices when completed.	25
The touchpad isn't accepting the PIN code I'm entering.	1. This specific code already exists within the device's memory. 2. Make sure that the PIN code is 4 - 10 digits.	25

Symptom	Corrective action	Page
I have replaced the batteries, but when I press on "5", nothing happens.	You need to first power-up the wall reader by pressing and holding the "#" button for 5 seconds.	27
My 5-year old son and his grandmother's fingerprints are no longer working with the fingerprint reader.	Both children and the elderly have fingerprints that change. If this occurs, you'll have to repeat the fingerprint learning process for them. Alternatively, they can use a PIN code.	30
The fingerprint Touchpad keys aren't functioning properly.	Please go to Setting mode --> Device --> Device, in order to get the product version. Contact your locksmith / installer for further information and next steps.	6

Mobile App		
Symptom	Corrective action	Page
The ENTR™ mobile app is disconnected from the door unit and/or I can't find my lock on the app.	<ol style="list-style-type: none"> 1. Make sure your phone is compatible with bluetooth 4.0, and that your phone model and OS version are approved for ENTR™. 2. Refresh the app. 3. Only one phone can connect to ENTR™ at the same time. It's possible that another user's phone is already connected to ENTR™. If so, close the app on any other user's phone. 4. Close the app, turn off your phone's Bluetooth. Then turn Bluetooth back on, and open the app. 5. Turn the door unit off, and then turn it on again. 	38
I've updated the OS on my mobile phone, but the ENTR™ app still isn't working properly.	If you are a lock owner, uninstall and then re-install the app. Then go to My Locks in the app and choose lock recovery. Use your owner password to recover the lock. If you are a user, please ask the lock owner to issue you a new key.	38
I'm unable to complete the 'Set Owner' process because I can't scan the QR on the ENTR™ package.	<ol style="list-style-type: none"> 1. Verify that you have a working internet connection. 2. Try to enter the unit's serial number manually (IFEU000xxx...). 3. Open a ticket on www.entrlock.com. 	38
I have created a key for a new user, but the user doesn't see that the key is available even though the user is within the lock's Bluetooth range.	<ol style="list-style-type: none"> 1. As only one phone can connect to the lock at the same time, please make sure you have closed your app. 2. Verify that you completed the key creation process by selecting the "active" button. 3. Verify that the new user did not exceed the expiration time you have set for this key. 	38
I'm unable to open the door from a distance of 10 meters / yards.	<ol style="list-style-type: none"> 1. The app works via a Bluetooth connection, which can be impacted by the environment. 2. For both security and functionality reasons, the ideal operating distance should not exceed 5m from the door. 3. Try moving as close as possible to the lock. 	38
I'm getting strange error messages and/or the app crashed during operation.	<ol style="list-style-type: none"> 1. Verify that you are using a supported mobile device and OS for ENTR™ app. 	37

LIMITED WARRANTY

Mul-T-Lock® hereby warrants, to the end user ("**Purchaser**") who purchased the genuine Mul-T-Lock® product ("**Product**"), from an authorized Mul-T-Lock® dealer ("**Dealer**"), that the Product will be free from defects in materials and workmanship ("**Defects**"), for a period of one year from the date the Product was purchased from Mul-T-Lock®'s authorized dealer. Subject to the terms and conditions indicated below, Mul-T-Lock® will repair or replace such Product or part thereof which, upon inspection by Mul-T-Lock®'s authorized dealer, is found to be defective, despite the Product not having been subjected to Improper Activity (as defined below).

Improper Activity shall render this warranty void. "Improper Activity" includes any and all of the following: installation by anyone other than a Dealer: improper installation; use/operation/maintenance other than in accordance with Mul-T-Lock®'s instructions and requirements (as directed below); tampering by Purchaser; neglect; damage by the application of force; bending; breaks; cracks; scratches; any other act of vandalism; repair or alteration by anyone other than a Dealer: use of keys, key blanks, cylinders, locks, approved batteries, accessories and/or other components that are not suitable and genuine Mul-T-Lock® products; all the foregoing as determined by Mul-T-Lock®, in its sole judgment.

Some basic instructions and recommendations for correct use of the Product are shown overleaf.

Mul-T-Lock®'s sole obligation under this limited warranty is to repair or replace, at Mul-T-Lock®'s sole discretion, at the venue of a Dealer, any Product and/or Product component found by Mul-T-Lock® to have Defects. This limited warranty does not grant any other rights or give rise to any other obligation, or absolve Purchaser of the responsibility to employ any other suitable measures, by whatever means, including insurance, against the risk of personal injury or damage to property. This limited warranty relate to product's defects only. Mul-T-Lock® shall be liable, in any event, for any labour costs associated with the product and its installation process.

In order to facilitate the warranty service and enable Mul-T-Lock® to determine entitlement under this warranty, Purchaser must first return the Product, with proof of purchase from a Dealer, to Mul-T-Lock®, either directly, or through the Dealer from whom Purchaser purchased the Product. All shipping, handling, travel, service call and/or other incidental and/or related charges are fully payable by Purchaser only and are not included in this limited warranty.

THE USE OF OTHER THAN SUITABLE, GENUINE MUL-T-LOCK® COMPONENTS MAY CAUSE SEVERE DAMAGE TO THE PRODUCT, AND WILL VOID THIS LIMITED WARRANTY. THIS LIMITED WARRANTY MAY NOT BE ASSIGNED OR OTHERWISE TRANSFERRED IN ANY WAY AND MAY NOT BE EXTENDED, ALTERED OR VARIED.

TO THE FULLEST EXTENT ALLOWABLE BY THE LAWS APPLYING HERETO, THIS LIMITED WARRANTY IS IN LIEU OF ANY OTHER WARRANTIES, EITHER EXPRESS OR IMPLIED, INCLUDING BUT NOT LIMITED TO ANY WARRANTIES OF MERCHANTABILITY OR FITNESS FOR A PARTICULAR PURPOSE, ALL OF WHICH ARE EXPRESSLY EXCLUDED AND DISCLAIMED. MUL-T-LOCK® WILL NOT BE LIABLE FOR LOSS OF PROFITS, ANY SPECIAL, INCIDENTAL, OR CONSEQUENTIAL DAMAGES, WHICH PURCHASER MAY SUSTAIN, OR PUNITIVE DAMAGES, EVEN IN THE EVENT OF NOTICE OF THE POSSIBILITY OF SUCH DAMAGES.



Some Basic Instructions and Requirements for Correct Use of ENTR™ Products

Protection of Keys:

- Keys should be used only for their original purpose, of operating the corresponding cylinder.
- Your key carries a code. Make sure you keep it concealed.
- Only genuine Mul-T-Lock® key blanks should be used.
- Duplicate keys must be performed by an authorized Mul-T-Lock® locksmith on Mul-T-Lock®'s key cutting machine.
- Keys must be inspected periodically and must be replaced when show physical wear.

Cylinders:

- Installation must be performed by an authorized Mul-T-Lock® dealer only.
- Cylinders must not be submerged in water, or exposed to any chemical wash, or be painted.
- Protect the cylinder from dirt & dust.
- Protect your cylinder from exposure to extreme temperatures. (External -20 C to +80C, Internal -10C to +50C)
- The cylinder's keyway should be lubricated at least once per year (preferably using lubricants authorized by Mul-T-Lock®, or light machinery oil). In any heavy use environments, extreme weather conditions, lubrication must be conducted every three months.

LEGAL NOTICES

Mobile phones

ENTR™ warranty should not cover any problem related with end user mobile phone/smartphone or its operation system, by connecting to ENTR™ lock or installing ENTR™ application. For any other limitation please refer to End User licence agreement.

Items excluded / limited from this warranty

- Screws
- Normal wear and tear
- Cleaning with cleaning detergents
- Warranty for ENTR™'s Main battery is limited for 1 year

Trademarks

Mul-T-Lock® and ENTR™ are trademarks/trade names belonging to Mul-T-Lock® Ltd. No unauthorised use may be made of these trademarks.

No Insurance

No security product can ever guarantee the safety of assets. The ENTR™ product is by no means a substitute for suitable insurance coverage protecting against loss or damage of your property. Mul-T-Lock® is not an insurance company and does not provide insurance services of any kind.

External Influences

- Services are subject to various external influences, outside our control, such as satellites and cellular or other communications networks, and may also be influenced by weather conditions, frequency jamming/interference, improper use or activity, interference, vandalism, destruction etc.
- Services may also be adversely affected, or rendered impossible when the ENTR™ product is located in places where a signal may not be available - for example, a garage, parking lot, tunnel or other such location.
- The fingerprint sensor may not work for certain members of the population, for physiological reasons

Limitations of Services and Liability

The Services will not always provide an accurate picture of whether or not assets have been subject to unauthorized access - for example, if the ENTR™ product is accessed using the original key or a duplicate key.

- Proper functioning of the ENTR™ product may be impaired if the ENTR™ product is not installed and maintained properly, in accordance with the instructions provided with the ENTR™ product. Installation and/or disassembly must be carried out only by authorised ENTR™ installation personnel.

For radio enclosure

Federal Communications Commission (FCC) Statement

Labelling requirement for small device statement (FCC15.19(3))

This device complies with part 15 of the FCC Rules. Operation is subject to the following two conditions: (1) This device may not cause harmful interference, and (2) this device must accept any interference received, including interference that may cause undesired operation.

Radio Frequency Interference (RFI) (FCC 15.105)

This equipment has been tested and found to comply with the limits for Class B digital devices pursuant to Part 15 of the FCC Rules. These limits are designed to provide reasonable protection against harmful interference in a residential environment.

This equipment generates, uses, and can radiate radio frequency energy, and if not installed and used in accordance with the instruction manual, may cause harmful interference to radio communications. However, there is no guarantee that interference will not occur in a particular installation. If this equipment does cause harmful interference to radio or television reception, which can be determined by turning the equipment off and on, the user is encouraged to try and correct the interference by one or more of the following measures:

- Reorient or relocate the receiving antenna.
- Increase the separation between the equipment and the receiver.
- Connect the equipment into an outlet on a circuit different from that to which the receiver is connected.
- Consult the dealer or an experienced radio/TV technician for help.

Labeling Requirements (FCC 15.19)

This device complies with Part 15 of FCC rules. Operation is subject to the following two conditions: (1) this device may not cause harmful interference, and (2) this device must accept any interference received, including interference that may cause undesired operation.

Modifications (FCC 15.21)

Changes or modifications to this equipment not expressly approved by Mul-T-Lock® may void the user's authority to operate this equipment.

RF Exposure info (FCC 2.1093)-for module radio

This equipment has been approved for mobile applications where the equipment should be used at distances greater than 20cm from the human body (with the exception of hands, wrists, feet and ankles). Operation at distances less than 20cm is strictly prohibited.