

Table of Content

1. Cylinder Installation	5
1.1 Package Content	5
1.2 Tools Requirements	5
1.3 Prior to Installation	6
1.4 Cylinder & Unit Installation	6
1.5 Magnet Fitting	8
2. ENTR® Description	9
2.1 ENTR® Description	9
2.2 Indications	9
2.3 ON/OFF Switch	10
2.3.1 Switching the ENTR® ON	10
2.3.2 Switching the ENTR® OFF	10
2.3.3 Low Battery Indication	10
2.4 Initiating the Lock	11
2.5 Default PIN Code	11
3. Operation	12
3.1 Changing PIN Code	12
3.2 Door Configuration	13
3.3 Pairing Remote Control	16
3.4 Deleting Remote Control	17
3.5 Setting the Sound Signal	18
3.6 Setting Locking Mode	19
3.7 Operated by Knob	20
3.8 Operated by Slide Buttons	20

4. Touchpad Reader	21
4.1 Changing PIN Code	21
4.2 Battery Replacement	21
4.2.1 Low Battery Indication	21
5. Touchpad Reader Operation	22
5.1 Operation	22
5.2 Pairing Touchpad Reader	22
5.3 Touchpad Reader Master PIN Code	24
5.4 Menu Mode	24
5.5 Adding Personal User Code	24
5.6 Open Door	25
5.7 Lock Door	25
5.8 Delete Personal User Code	25
5.9 Delete All Personal User Codes	25
5.10 Volume Control	26
5.11 Factory Reset	26
6. Fingerprint Reader	27
6.1 Mounting the Fingerprint Reader	27
6.2 Battery Replacement	27
6.3 Adjust Date & Time	27
6.4 Pairing Fingerprint Reader	28
6.4.1 Add Master	29
6.4.2 Set Finger	29
6.4.3 Set PIN Code	29
6.5 Unlock the Door	30

6.6	Lock Door	31
6.7	Low-battery Indication	31
6.8	Setting Menu	31
6.9	Add User	32
6.10	Delete User	33
6.11	Enable/Disable User	33
6.12	Delete all Users	34
6.13	Add Time Schedule	34
6.14	Edit Time Schedule	35
6.15	Volume Control	35
6.16	Double Security	36
6.17	Factory Reset	36
7.	Smartphone App	37
7.1	App Installation	37
7.2	Pairing Smartphone	38
8.	Remote Control Battery Change	39
8.1	Battery Removal	39
8.2	Battery Insertion	40
9.	Troubleshooting	41
10.1	Limitations and External Influences	41
10.2	Cases	41
	Limited warranty	44
	Federal Communications Commission (FCC) Statement	47

1. Cylinder Installation

1.1 Package Content

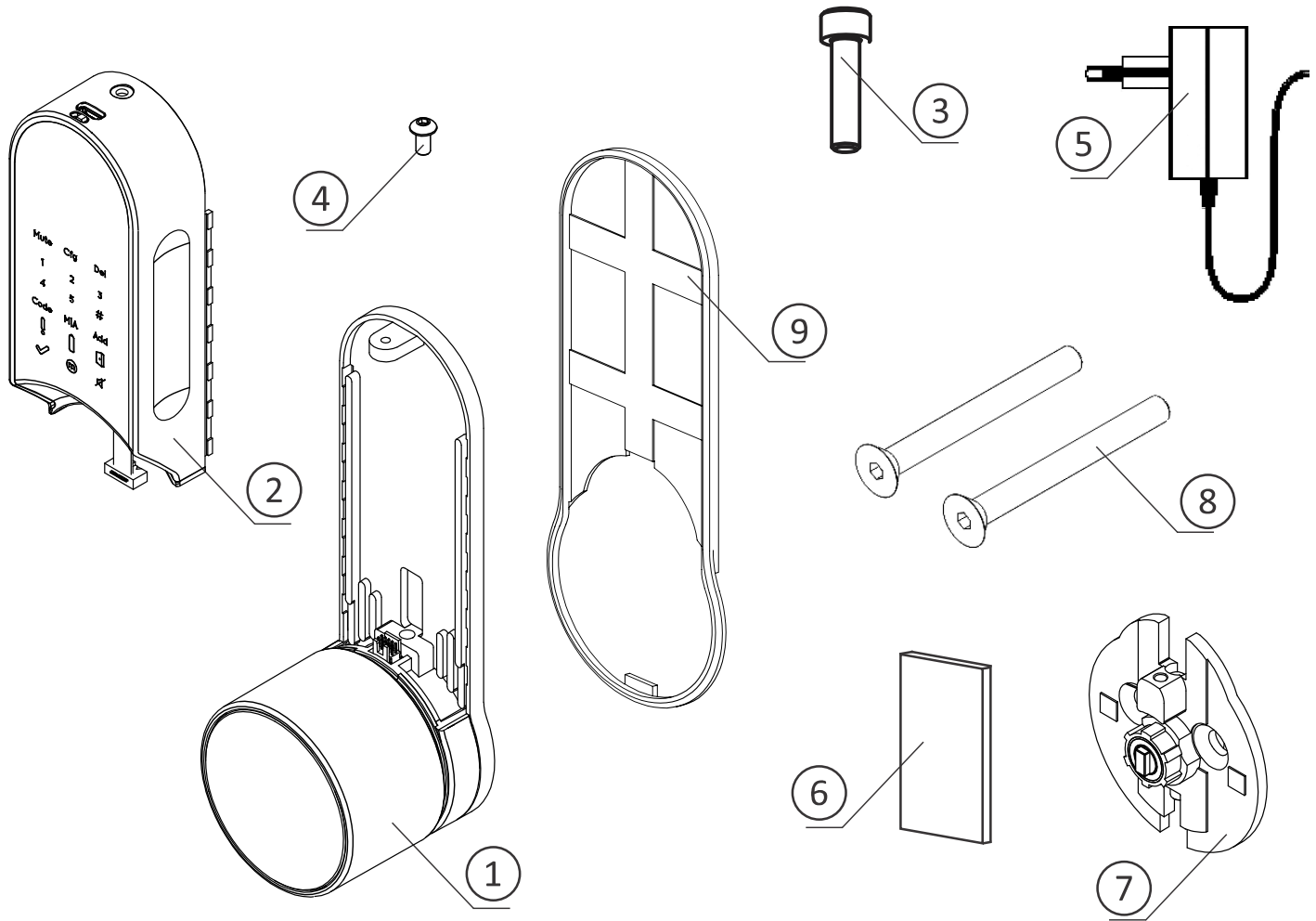

- 1 Base plate & Knob
- 2 Electrical unit
- 3 Mounting screw
- 4 Panel screw
- 9 Decorative spacer

- 5 Battery charger
- 6 Magnet
- 7 Inside drive adapter
- 8 Mounting screws
- 10 Allen key #3

1.2 Tools Requirements

- Small Phillips screwdriver

Note: Do not use power tools or any excessive force to assemble ENTR® parts.

1.3 Prior to Installation

⚠ Warning: Do not attempt to operate the unit until assembled into the door

- Remove knob screw using 1/16" Allen key and take the knob out.
- Use a flat screwdriver to remove the cover.
- Remove both Allen screws entirely and remove internal mechanism.

Note: While removing the internal mechanism secure the outside cylinder from falling. Consider using masking tape or similar.

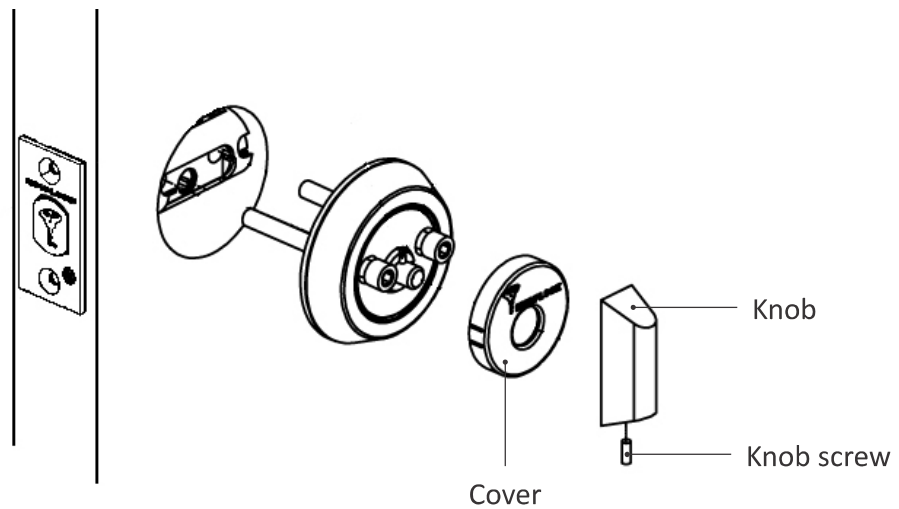

1.4 Unit Installation

- Prior to installation check bolt locking direction.
- Verify that the bolt is in open position (bolt inside the door, unlocked).
- Rotate adapter tail-piece opposite to the bolt locking direction until stopped (see below drawing #1).
- Verify that the wide teeth is pointing up. If not rotate the external ring until the wide teeth will point up (see below drawing #2).

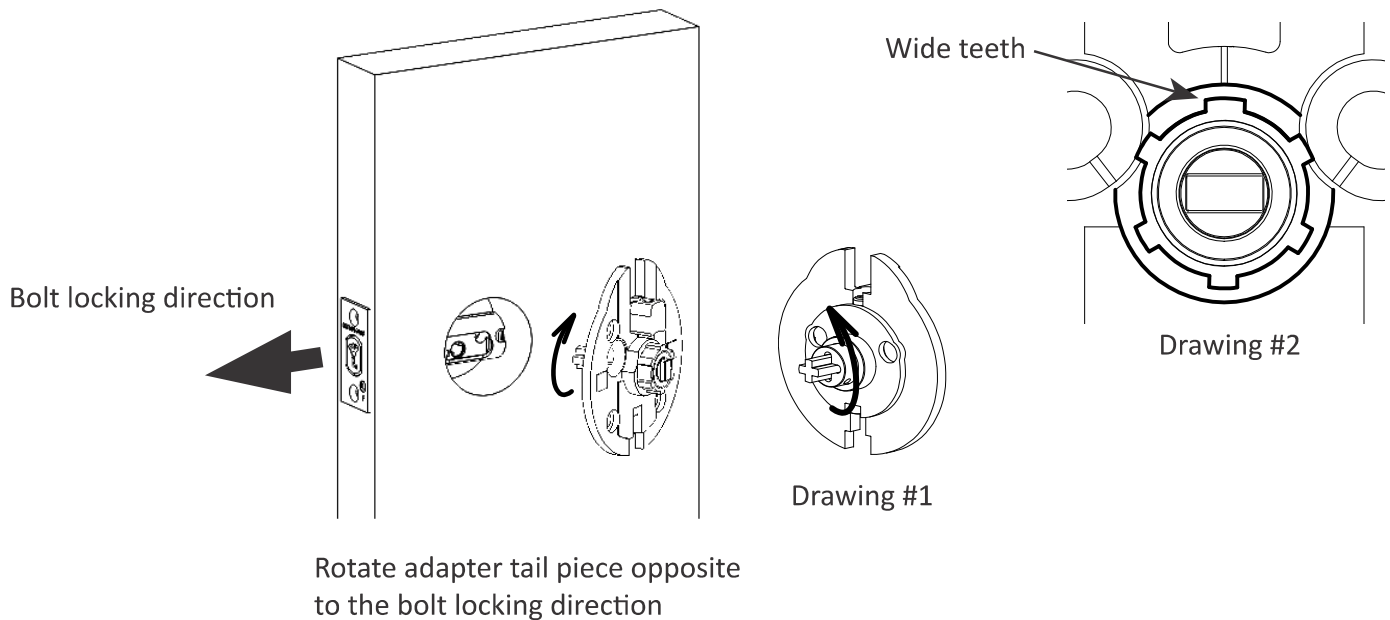

- Place the Inside drive adapter and tighten the screws. Do not over tighten the screws or use power tools.

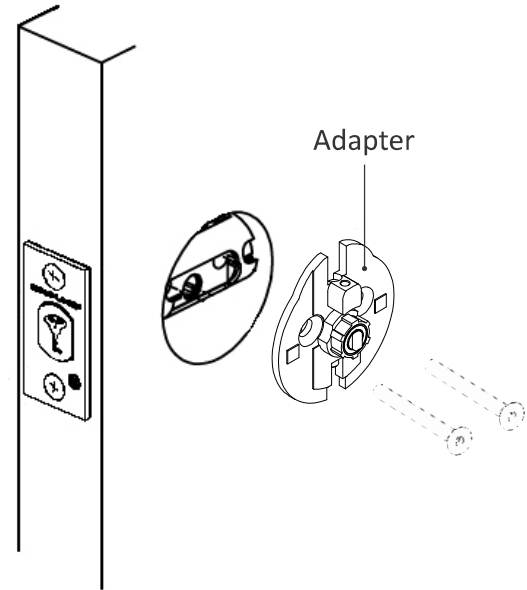

- Place decorative spacer over the Inside drive adapter.
- Assemble base plate (top housing & knob).
- Tighten cylinder mounting screw.

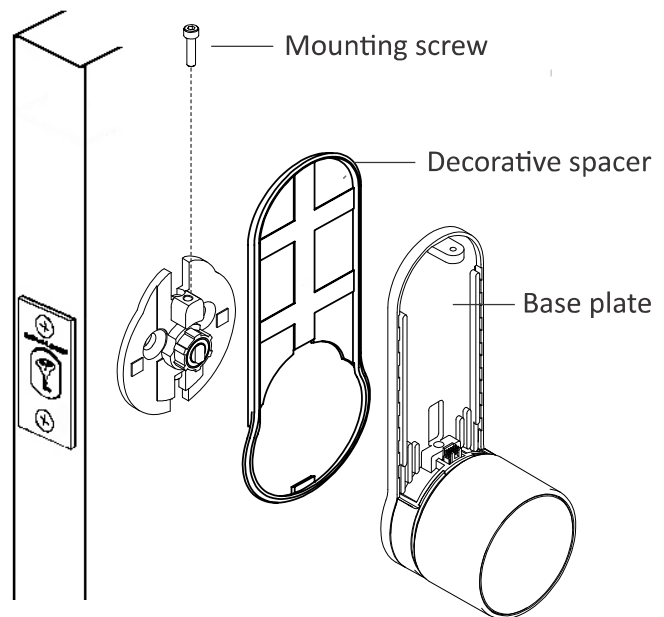

Note: In case the "Male rectangle" on the adapter is not aligned with the "Female rectangle" on the Knob, the unit will not engage properly and may cause to malfunction.

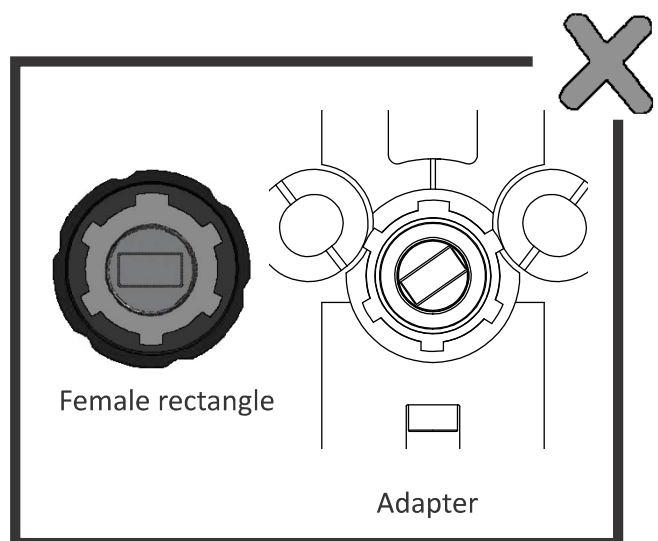
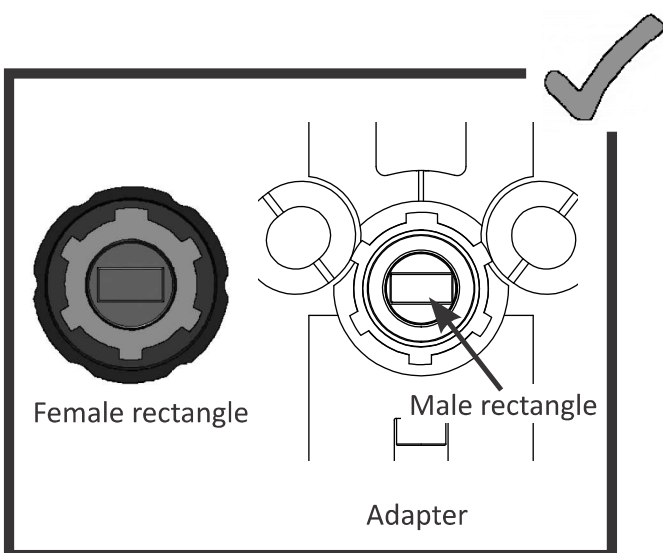

- Carefully connect data cable plug.
- Assemble electrical unit panel (battery housing). attache to base plate (1) and push down (2).
- Tighten electrical unit panel screw.

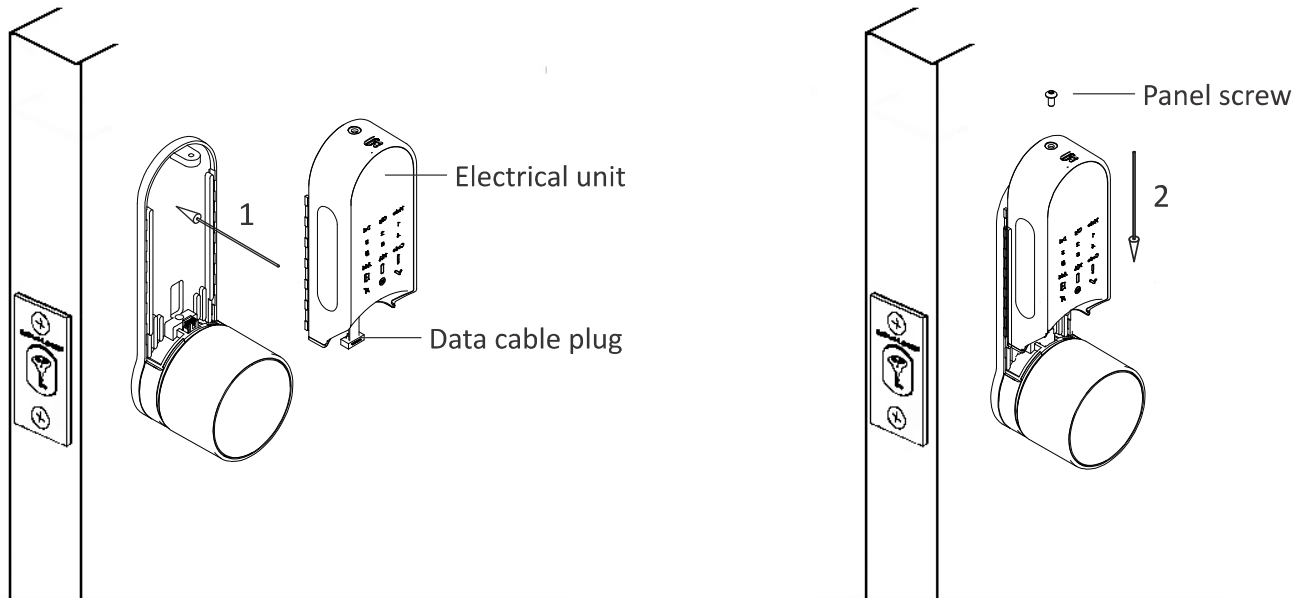

1.5 Magnet Fitting

Magnet Fitting:

- Mount the magnet on the frame moldings, as close as possible to the lock.
- The lower part of the magnet should align with the lower point of the slider (see illustration).

Note: The magnet area on frame molding should be clean and free from dust, peeling paint etc. Use alcohol if required. Wait until completely dry prior to sticking.

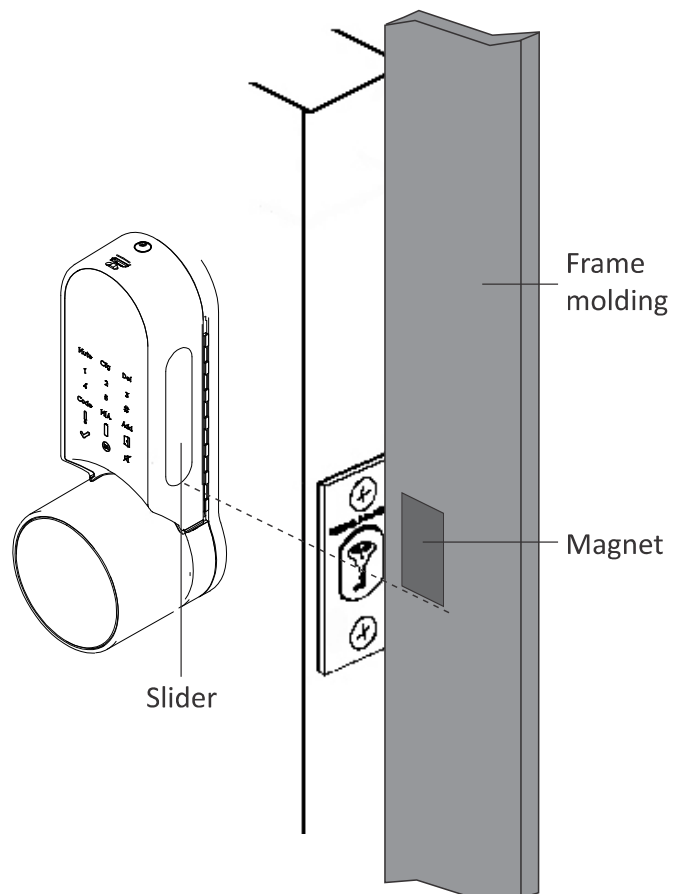

2. ENTR® Description

2.1 ENTR® Description

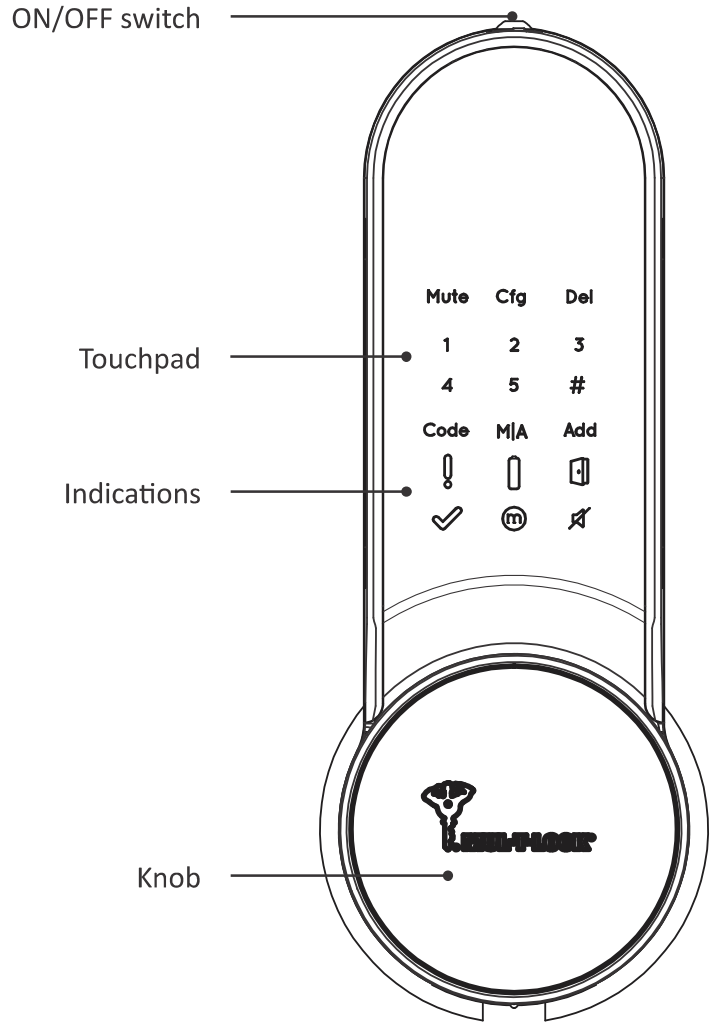

2.2 Indications

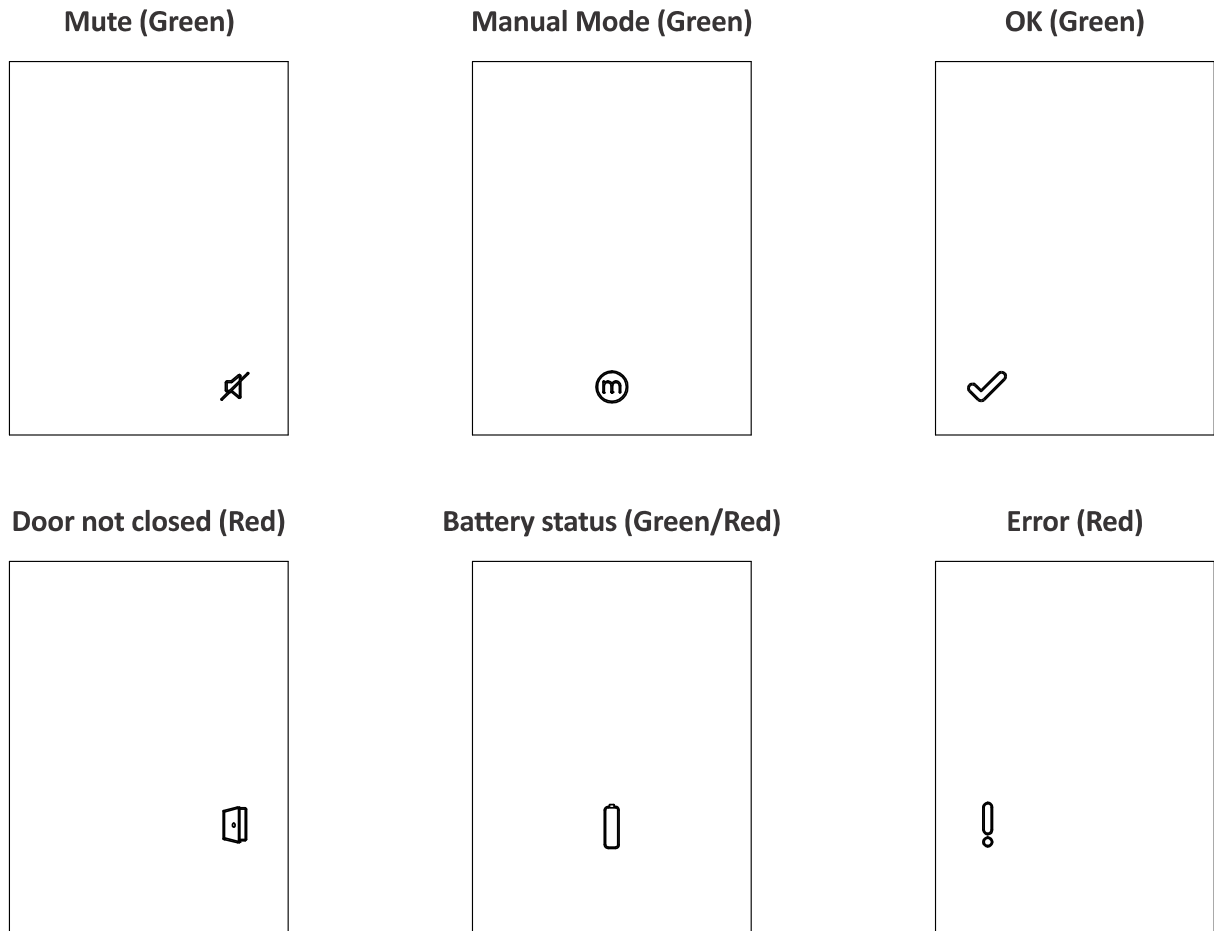

2.3 ON/OFF Switch

- Turning the ENTR® lock **ON** or **OFF**.

2.3.1 Switching the ENTR® ON

Before turning ENTR® **ON**, verify that the door is shut.

- Move the switch to the **ON** position. Make sure that the knob is in the zero position (see illustration).
- Function and numeric buttons will all blink once.
- Hazard beep sound will be emitted and error indication will blink once.
- ENTR® is now in operating mode.

Note:

- After turning ENTR® **ON**, avoid touching the front panel until beep sound ends.
- After turning ENTR® **ON**, the door will be shut but not locked.

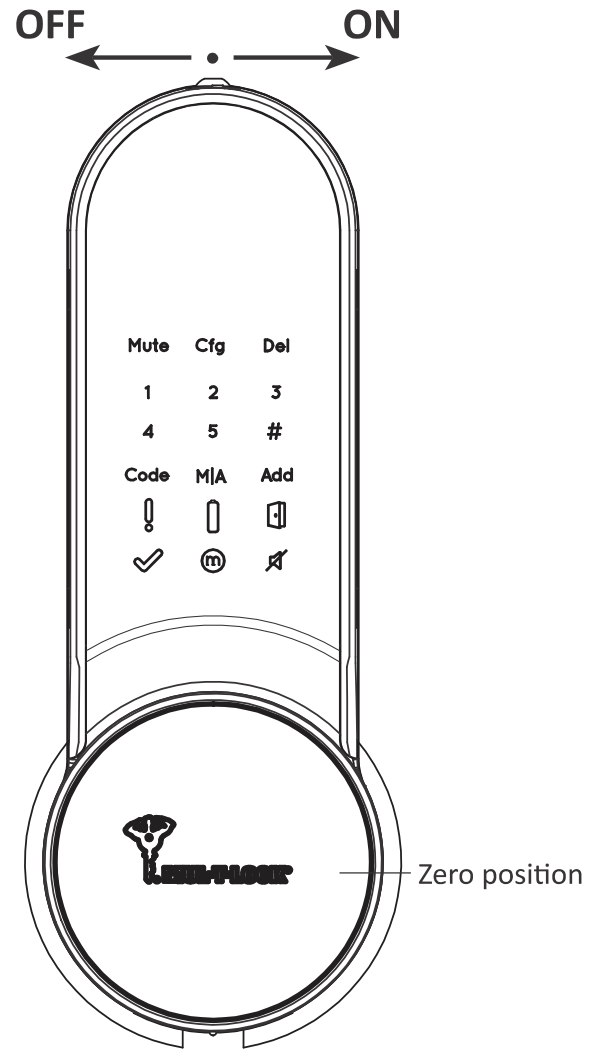

2.3.2 Switching the ENTR® OFF

- Move the switch to **OFF** position.

2.3.3 Low battery indication

Battery red signal rapidly blinking and 2 long beeps will be sounded during every lock/unlock action, indicating that the battery is low and needs to be charged.

2.4 Initialization of the Lock

Initiate the lock by touching the middle of the touch screen with the palm of your hand or fingers for 3 seconds.

- Programming buttons and battery status indication light will illuminate for 15 seconds, waiting for user's action.
- After 15 seconds of inactivity, ENTR® will idle.

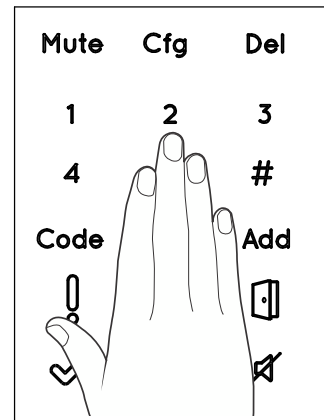

2.5 Default PIN Code

The lock's default factory PIN code is: **1 2 3 4 5 #**

Please note:

- Default PIN code must be changed before starting the configuration process.
- The PIN code must consist of 4-10 digits using numbers 1 through 5 in any sequence.
- Only the **Code** and **Mute** functions will operate until the default PIN code is changed.

 **Warning:** Don't forget/lose the PIN code once changed, otherwise you will be locked out. Keep your new PIN code in a safe place.

3. Operation

3.1 Changing PIN Code

Warning: Do not attempt to operate the unit until assembled on the door.



1
Touch screen with palm or fingers for 3 seconds to activate.

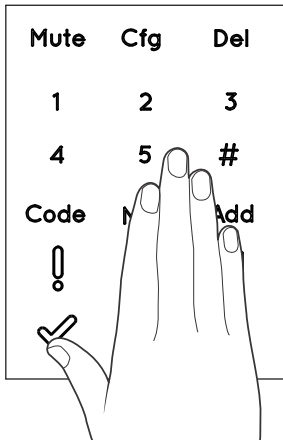

2
Press [Code]
Numeric buttons illuminated.

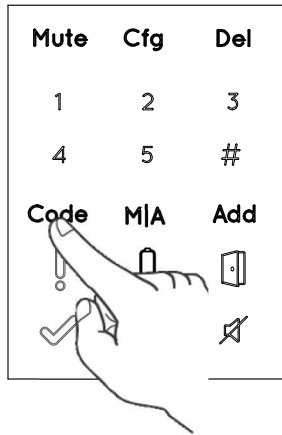

3
Type [Default PIN code]
(1 2 3 4 5) [#]

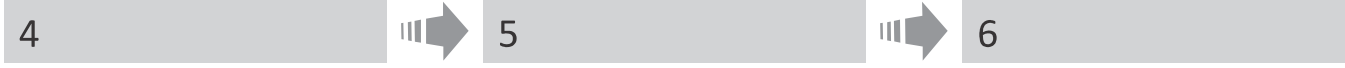
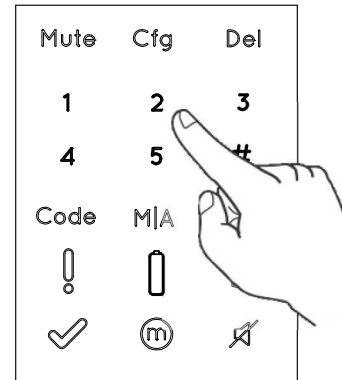

4
[OK] indication blinks once,
1 long beep emitted.
Illuminated buttons turn off.

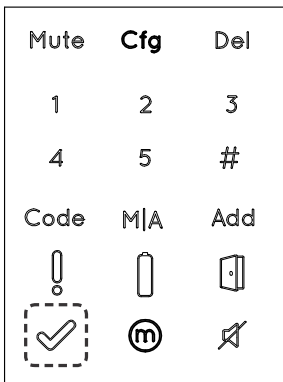

5
Numeric buttons illuminated Enter
[New PIN code] (4-10 digits) [#]
For example: 1231234#

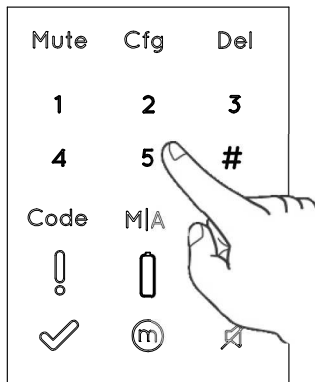

6
[OK] indication blinks once.
1 long beep emitted.
Illuminated buttons turns off.

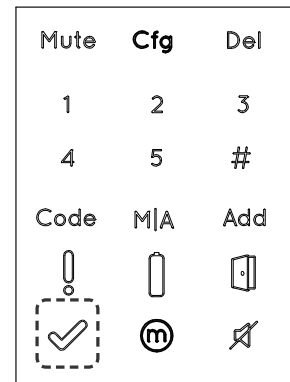

7
Numeric buttons illuminated.
Reenter [New PIN code] [#]
For example: 1231234#

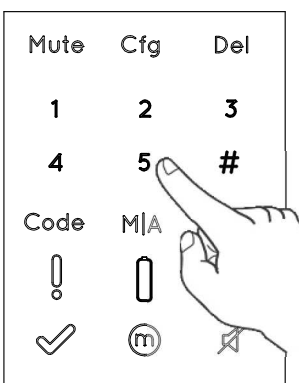

PIN codes match
[OK] indication illuminated.
2 short beep emitted.
New PIN code is set.

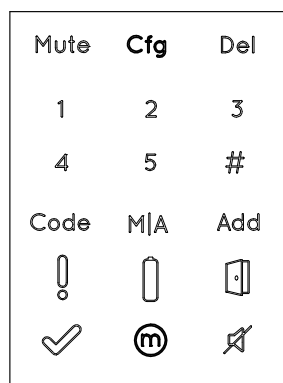

PIN Code doesn't match
[Error] indication illuminated.
2 long Beeps emitted for 1 second.
ENTR® goes to menu mode.
Start the process from stage 1.

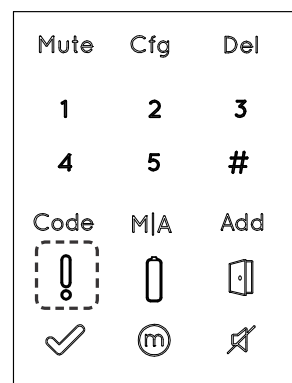

3.2 Door Configuration

The door configuration process sets your lock and door preferences.

This process should be done after successful installation of the lock. It will take 15-20 seconds to complete.



1
Important: Verify that the door is shut and no key is inserted into the cylinder during configuration steps.

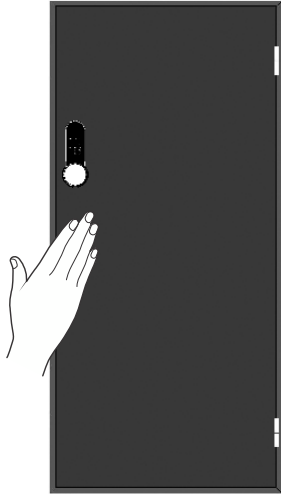

2
Touch screen with palm or fingers for 3 seconds to activate.

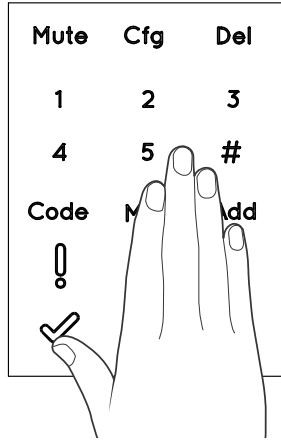

3
Press [Cfg]

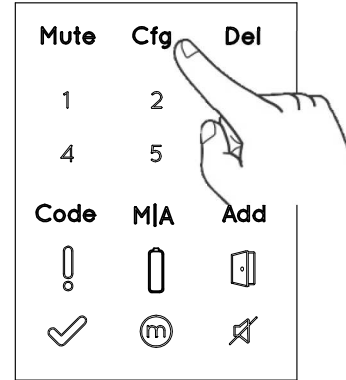

4
Numeric buttons illuminated, Type [PIN code] → [#] 1 long beep emitted.



5
Press [1] or [3] to configure ENTR® side (see illustration).
Press [1] for ENTR® on left side.
Press [3] for ENTR® on right side.

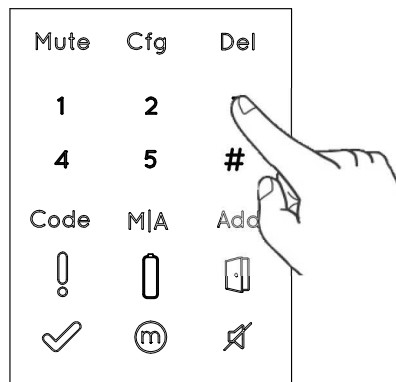

ENTR® on left side of the door

Press [1]

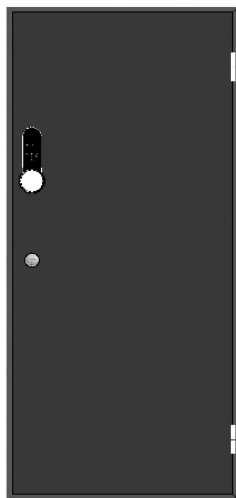

ENTR® on right side of the door

Press [3]

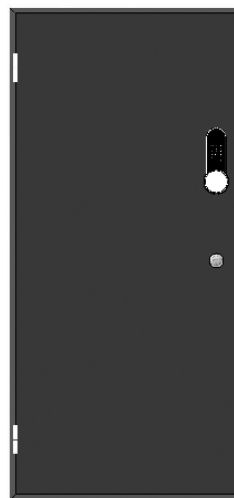

6

Hold the door shut to avoid opening.
The lock will carry out the configuration process.
It take's 15-20 seconds to complete.

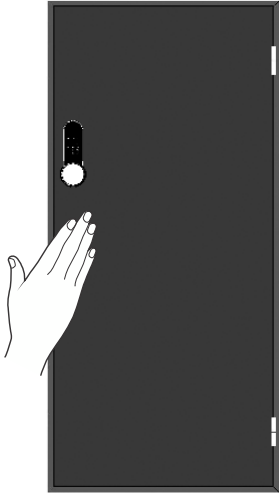

7

[Cfg] indication blinks.
Turn the knob manually to unlock position and keep the door closed.
Push on **[Cfg]**

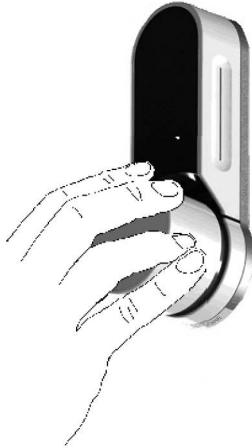

Configuration OK

[Manual] indication illuminated.
[Cfg] indication blinks.
Note: If the configuration fails refer to [troubleshooting #1](#)

Mute	Cfg	Del
1	2	3
4	5	#
Code	M A	Add
!	⏏	🚪
✓	Ⓜ	🔇

7

Open the door using the handle.
Bring the latch as close as possible to the door molding.
Note: Do not shut the door.

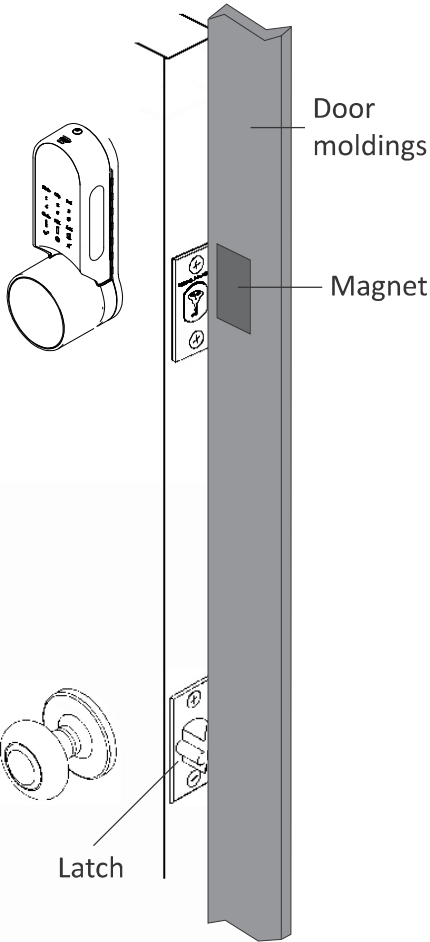

8

Press **[Cfg]**
The lock will carry out the configuration process.

Mute	Cfg	Del
1	2	3
4	5	#
Code	M A	Add
!	⏏	🚪
✓	Ⓜ	🔇

Configuration OK

[OK] Indication blinks once.
2 short beeps emitted,
Illuminated buttons turn off.

Mute	Cfg	Del
1	2	3
4	5	#
Code	M A	Add
!	⏏	🚪
✓	Ⓜ	🔇

Troubleshooting #1







Lock configuration failed

1. Remove the mechanical key from the lock.
2. Check that the door was closed properly or if lock operation was interfered.

Configuration failed

[Error] indication illuminated,
2 long beeps emitted.

Refer to troubleshooting #2

Mute	Cfg	Del
1	2	3
4	5	#
Code	M/A	Add
		
		

Troubleshooting #2

Magnet configuration failed

1. You can still operate ENTR® in Manual mode (w/o automatic locking).
2. Remove any other magnets from the door.
3. Place the magnet according to instructions.
4. Consult your installer or contact ENTR® Technical Support.

Magnet Fitting:

- Mount the magnet on the frame moldings, as close as possible to the lock.
- The lower part of the magnet should align with the lower point of the slider (see illustration).

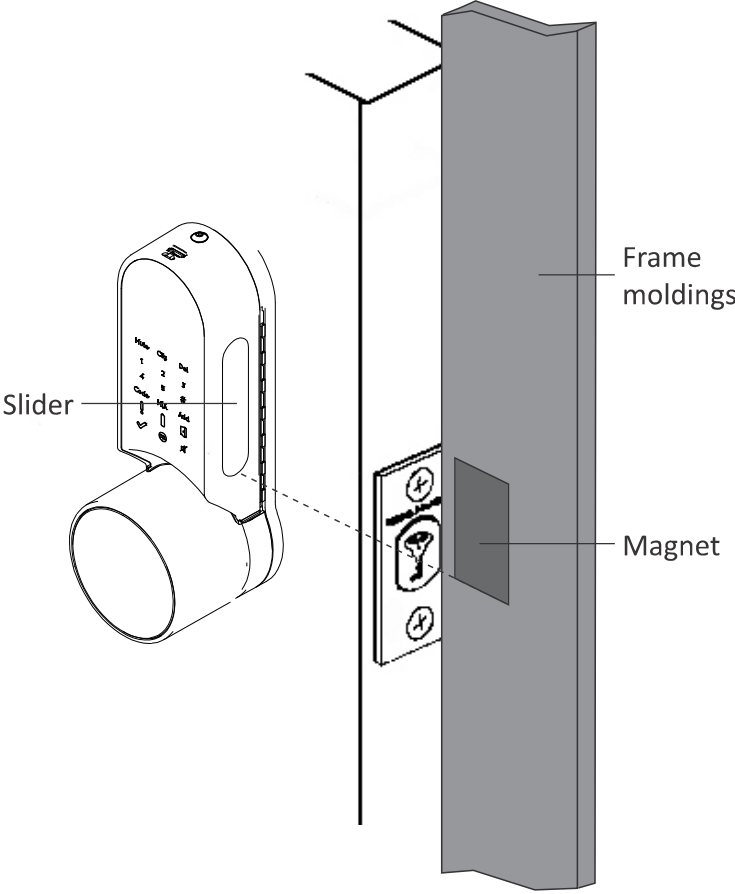

3.3 Pairing Remote Control

- 1** Touch screen with palm or fingers for 3 seconds to active.
- 2** Press **[Add]**
- 3** Numeric buttons illuminated. Type **[PIN code]** → **[#]**
Numeric buttons blinking.

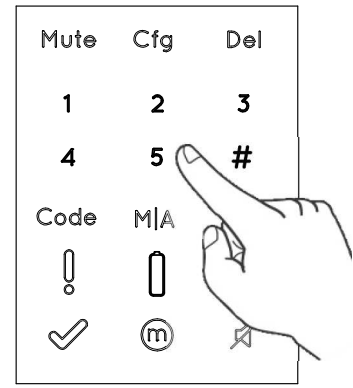
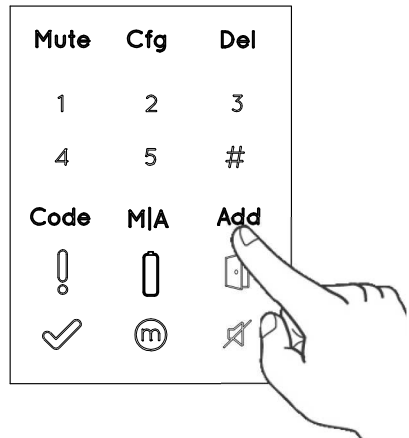
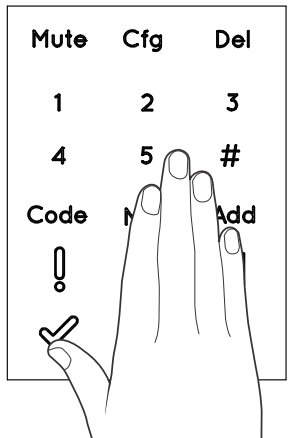

- 4** Press **[1]** to add remote control. Illuminated buttons turn off. **[OK]** indication blinks for 15 Seconds, waiting for remote control unit
- 5** Press the remote control button.

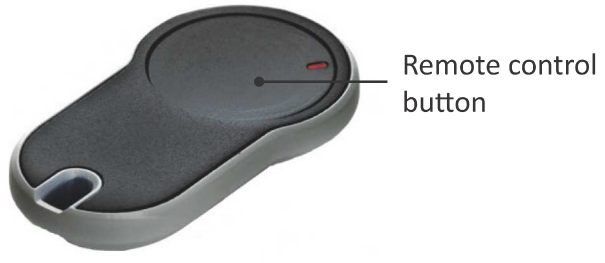
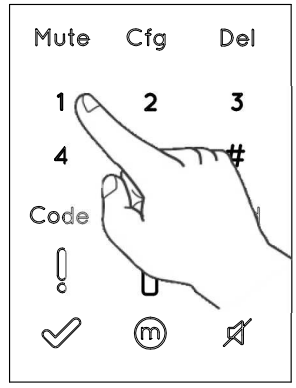

Pairing OK

[OK] indication blinks once,
2 short beeps emitted.
Remote control unit added.

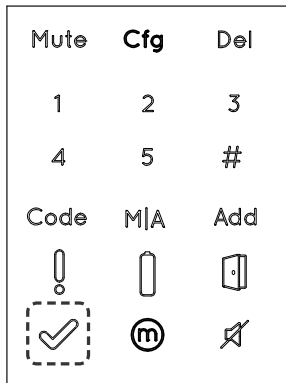

Pairing failed

[OK] indication blinks for 15 seconds,
No beeps emitted.
Start the process from stage 1.

Notes:

- To add more remote control units repeat this procedure.
- A remote control unit can be paired with only one single door unit.
- It is possible to add up to 20 remote control units.
- Only authorized dealer can reset a paired remote.

3.4 Deleting Remote Control

The deleting remote control process' will delete **all** remote control units including Touchpad and Fingerprint readers defined within the system.

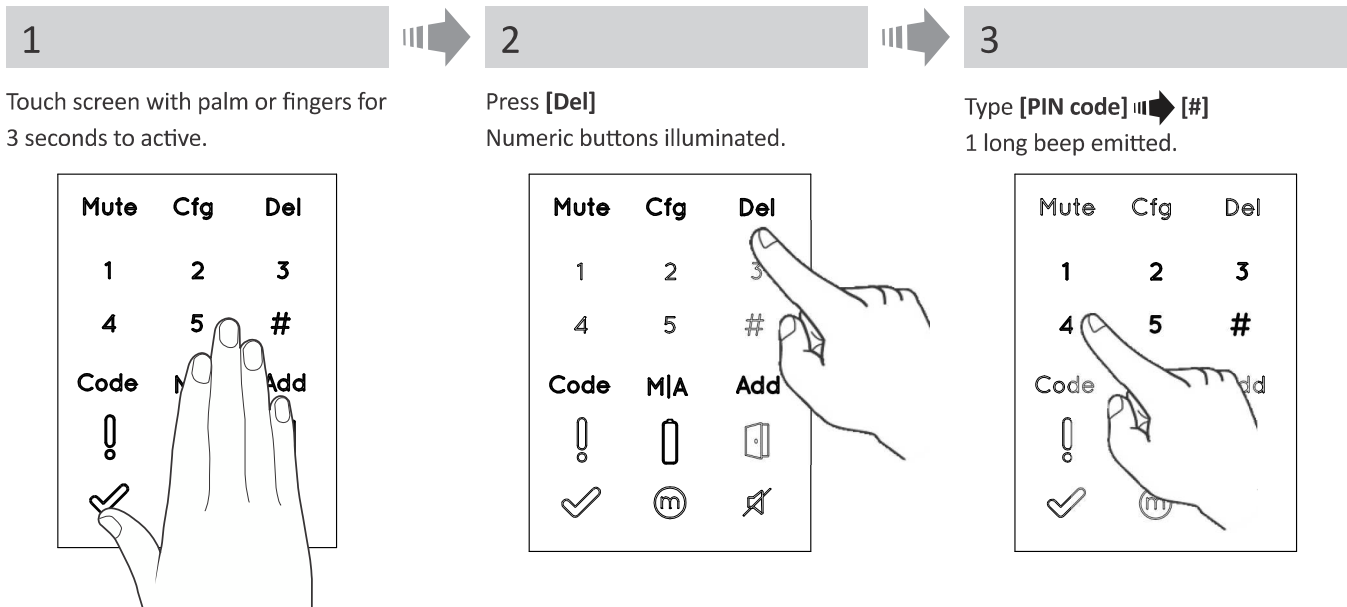

4

[Del] blinks for 30 seconds.

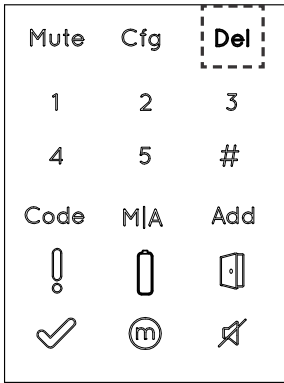

5

Press [Del] to confirm.

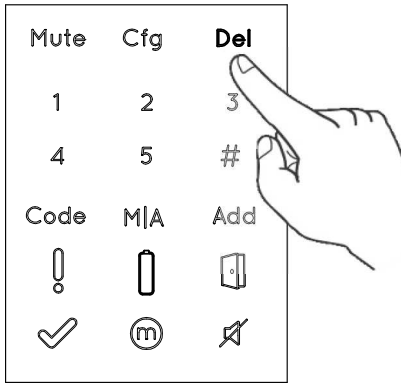

Deletion accomplished

[OK] indication blinks once.
2 short beeps emitted,
Illuminated buttons turn off.

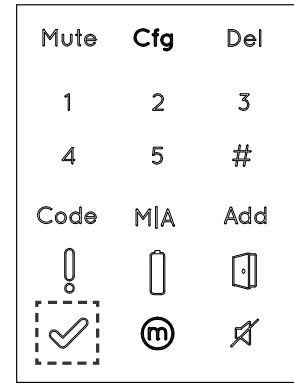

Note: Wall reader and smartphone connected to the ENTR® lock will not be deleted.

3.5 Setting Sound Signal

Turn the sound signal to **OFF** or **ON**

1

Touch screen with palm or fingers for 3 seconds to active.

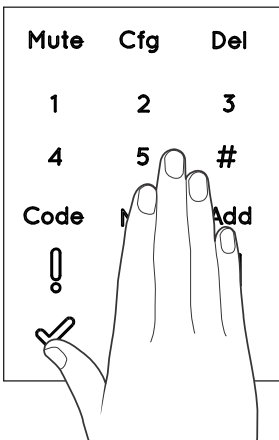

2

Press [Mute]

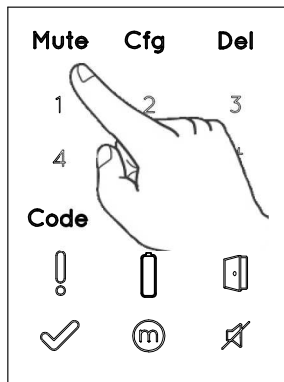

3

[Mute] indication illuminated.
Sound signal is off.

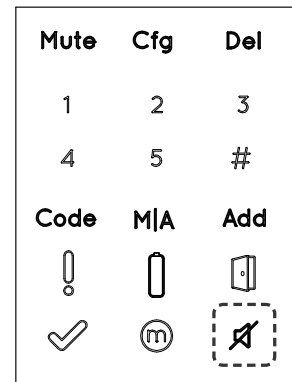

Notes:

- Setting the ENTR® lock sound to **OFF** will mute the lock and unlock sounds, and the open door hazard signal. It will not mute the touchpad, mechanical override and low-battery sounds.
- Follow the same procedure to turn the sound back to **ON**.

3.6 Setting Locking Mode

Toggle between **Automatic** to **Manual** locking mode



1
Touch screen with palm or fingers for 3 seconds to active.

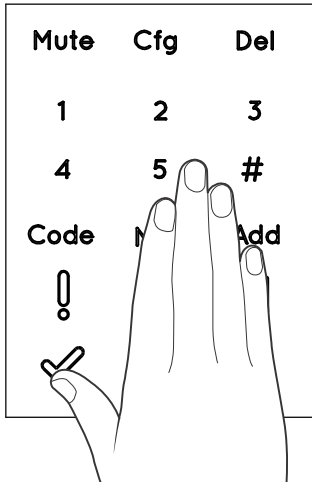

2
Press [M/A]

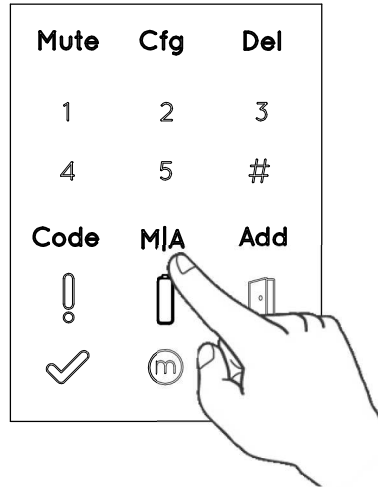

3
Type [PIN code] → [#]

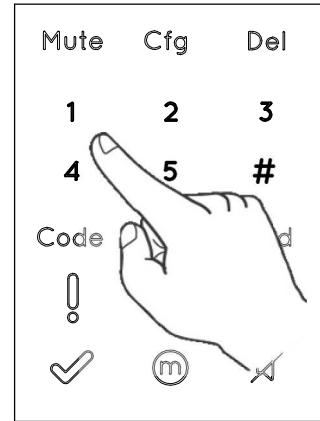

[Manual] indication illuminated.

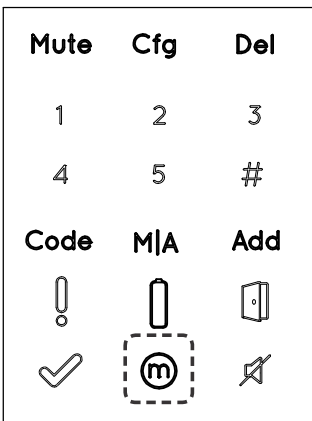

Notes:

- Setting the ENTR® lock to **Manual** will disable automatic locking.
- Follow the same procedure to set the ENTR® lock to **Automatic** locking.

3.7 Doorknob Operation

Turn clockwise or counterclockwise to unlock.
Beep sound emitted during doorknob operation.

Important! When an active lock is opened by turning of the knob you must re-operate it by one of its automatic modes (i.e remote, phone, sliding your fingers, touch pad etc.) or else it will remain **UNLOCKED**.

Knob operation is meant solely for mechanical override in the rare event it will not otherwise unlock.

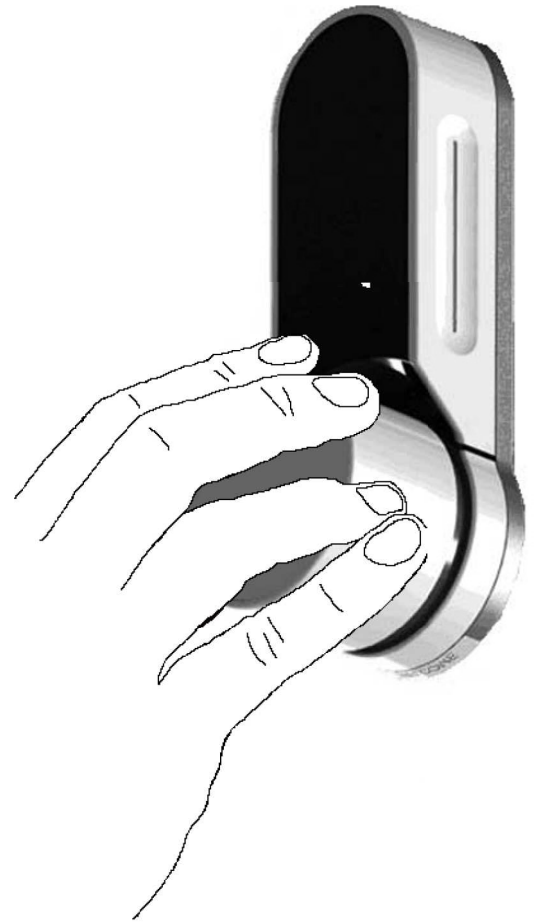

3.8 Slide Buttons Operation

Slide your fingers on the recessed grooves on both sides of the ENTR® front panel:

- To open, slide fingers downwards on the recessed grooves on both sides.
- To lock, slide fingers upwards on the recessed grooves on both sides.

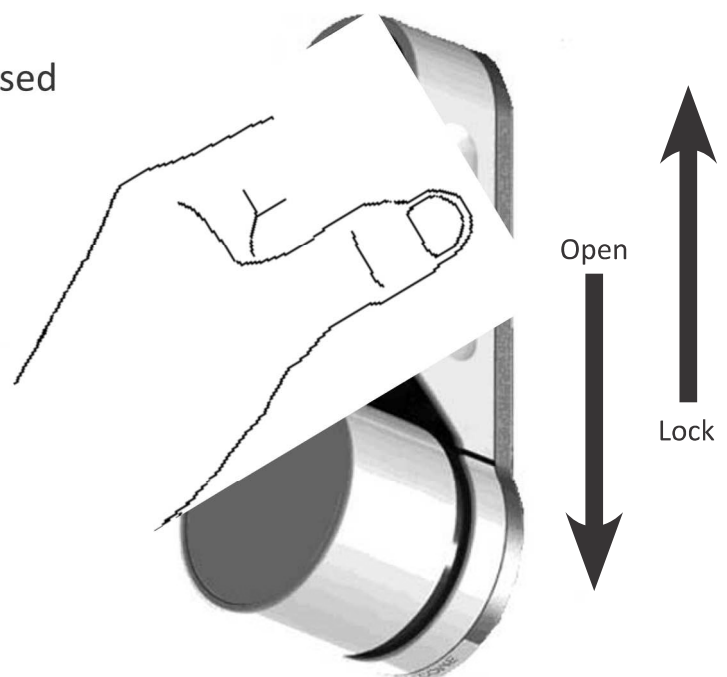

4. Touchpad Reader

4.1 Mounting the Touchpad Reader

Select the location where the Touchpad Reader will be mounted.

- Attach the Touchpad Reader baseplate to the wall.
- Use 4 screws and screw anchors, or double sided adhesive strip.

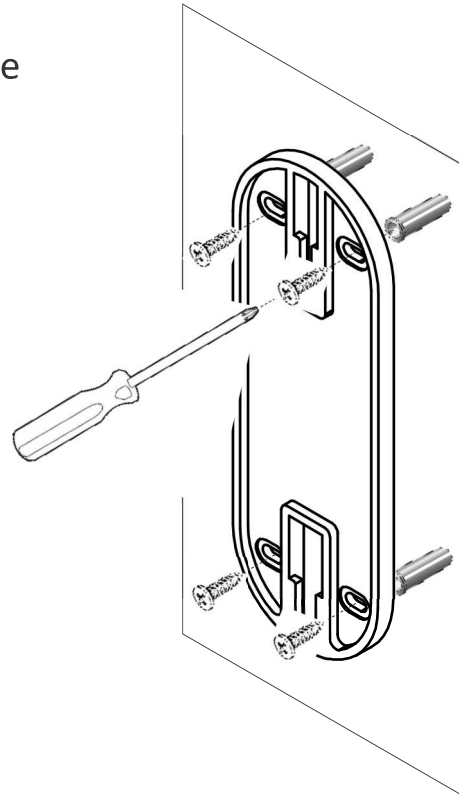

4.2 Battery Replacement

1. Release lid screw and open the lid.
2. Put in the batteries (2xAA) according to the "+" "-" signs.
3. Close the lid and tighten the screw.

Notes:

- After inserting the batteries the Touchpad Reader will turn on automatically.
- A short beep sound emitted and Green [OK] indication illuminated for 2 seconds.

Important: Do not touch the Touchpad during the self test procedure and until the lights are off.

4.2.1 Low Battery Indication

When batteries need replacement, a red warning signal will blink rapidly and long beep will sound during every lock/unlock action.

