

## X2 Transponder



## User Manual

Published by:  
MYLAPS B.V.  
Zuiderhoutlaan 4  
2012 PJ Haarlem  
The Netherlands

Copyright © 2016 No part of this document may be reproduced by any means without the written consent of the publisher. Whilst every care has been taken to ensure that the information in this document is correct, no liability can be accepted by MYLAPS for loss, damage or injury caused by any errors or omissions in this document. The sale of products, services of goods governed under this publication are covered by MYLAPS's standard Terms and Conditions of Sales. This product publication is provided solely for informational purposes. All hardware and software product names used in this document are likely to be registered trademarks and must be treated accordingly.

<b>Manual revision history</b>		
<b>Revision #</b>	<b>Date</b>	<b>Amendments</b>
Revision 1.00	09/12/14	This is the first version of this manual
Revision 2.00	09/06/15	New transponder model (rechargeable)
Revision 2.01	24/07/2015	Minor updates
Revision 2.20	23/09/2016	Compliance update



This device complies with part 15 of the FCC rules. Operation is subject to the following two conditions:

- (1) This device may not cause harmful interference, and
- (2) this device must accept any interference received, including interference that may cause undesired operation.



This device complies with the EMC directive 2004/108/EC and RTTE directive 1999/5/EC. A copy of the declaration of conformity can be obtained at:

MYLAPS B.V.  
Zuiderhoutlaan 4  
2012 PJ Haarlem  
The Netherlands

## Table of Contents

Table of Contents .....	3
1. Introduction.....	5
1.1. This manual.....	5
1.2. Intended use of the X2 Transponder.....	5
1.3. Description of the X2 Transponder and X2 System .....	5
1.4. Used symbols.....	5
2. Safety.....	6
2.1. Important safety instructions .....	6
2.2. UL Disclaimer .....	6
2.3. FCC compliance .....	7
3. Description.....	8
3.1. Components .....	8
3.2. Indicator light (LED) signals .....	10
3.2.1. X2 RaceKey (when docked on the direct power X2 RaceKey mount) .....	10
3.2.2. X2 RaceKey (when docked on the rechargeable X2 Transponder) .....	10
3.2.3. X2 Transponder Rechargeable.....	11
3.2.4. X2 Transponder Direct Power .....	12
4. How to use the product.....	13
4.1. Create an account.....	13
4.2. Register X2 Transponder .....	16
4.3. Activate the X2 Transponder using MYLAPS Connect .....	18
4.3.1. Install MYLAPS Connect .....	21
4.4. Reactivate the X2 RaceKey and X2 Transponder.....	23
5. Installation .....	23
5.1. Mounting direct power model .....	24

- 5.2. Mounting rechargeable model .....26
- 6. Maintenance.....27
  - 6.1. Periodic maintenance schedules .....27
  - 6.2. Cleaning .....27
  - 6.3. Charging (Rechargeable X2 Transponder only) .....28
- 7. Environment and disposal .....29
- 8. Troubleshooting .....30
- 9. Technical specifications.....30
  - 9.1. General X2 Transponder .....30
  - 9.2. Car/Bike .....31
  - 9.3. Kart .....31
  - 9.4. MX.....31
  - 9.5. X2 RaceKey .....31
  - 9.6. USB cable .....32
  - 9.7. Cable (X2 RaceKey mount to 12 VDC power supply).....32
  - 9.8. Cable (X2 RaceKey mount to transponder) .....33
  - 9.9. M8 cable power option .....33
  - 9.10. USB power option.....33
- 10. MYLAPS Support .....34

## 1. Introduction

### 1.1. This manual

This user manual describes how to install, use and maintain the X2 Transponder.

### 1.2. Intended use of the X2 Transponder

The main X2 Transponder components (X2 Transponder and X2 RaceKey) are mounted on a car, motorcycle, kart or bike to measure lap times.

### 1.3. Description of the X2 Transponder and X2 System

The track you are racing on has a MYLAPS system installed at the start and finish line and maybe at intermediate points along the track. The system picks up the signal sent out by the transponder mounted on your vehicle. This signal is picked up by a loop installed in the track and lap times are measured. This way the system calculates your lap times and your exact race position. This data used for creating official race results and can be published to mylaps.com in your personal MYLAPS account.

The X2 Transponder consists of two main components: The X2 Transponder and the X2 RaceKey. Two different X2 Transponder configurations are available:

- Rechargeable – no cabling between components (transponder – can be eventually charged by connecting the X2 RaceKey via a USB cable)
- Direct power (DP)– all components are connected via cabling to a vehicle 12 VDC supply

To activate the X2 Transponder, a subscription first needs to be downloaded onto the X2 RaceKey, and secondly the X2 RaceKey and transponder need to be physically connected to complete the activation. Beforehand, the X2 Transponder needs to be registered in your MYLAPS account.

### 1.4. Used symbols

This manual uses icons (see following examples) to highlight safety aspects during installation and operating steps.

**WARNING**

Indicates a hazardous situation which, if not avoided, could result in minor or moderate injury

**CAUTION**

For conditions that may cause damage to the equipment or interfere with the normal processing

**NOTE**

Indicates a situation which, if not avoided, could result in damage to the equipment or environment, or data loss.

**TIP**

A tip helps the user to perform certain tasks easier.

## 2. Safety

### 2.1. Important safety instructions

Read, follow, and retain for future reference all of the following safety instructions. Follow all warnings before operating the X2 Transponder equipment.

1. Clean only with a dry cloth. Do not use liquid cleaners or aerosol cleaners.
2. Do not install equipment near any heat sources, or other equipment that produce heat (the maximum operating temperature should not exceed 140°F/60°C).
3. Never spill liquid of any kind on the equipment.
4. Take precautions to protect the equipment from power and lightning surges.
5. Adjust only those controls specified in the operating instructions.
6. Operate the equipment only from the type of power source indicated on the label.
7. Unless qualified, do not attempt to service damaged equipment yourself. Refer all servicing to qualified service personnel.
8. Install in accordance with the manufacturer's instructions in accordance with applicable local codes.
9. Use only accessories specified by the manufacturer.
10. This equipment generates, uses, and can radiate radio frequency energy and, if not installed and used in accordance with this manual, may cause interference to radio communications.
11. Operation of this equipment in a residential area may cause transmission interference. Do not use the equipment in residential areas.
12. Keep the product out of reach of children



#### **CAUTION**

The Low Voltage power supply unit must comply with EN/UL 60950. The power supply must be a SELV-LPS unit or a SELV - Class 2 unit (Safety Extra Low Voltage - Limited Power Source)

### 2.2. UL Disclaimer

Underwriter Laboratories Inc. ("UL") has not tested the performance or reliability of the security or signaling aspects of this product. UL has only tested fire, shock and/or casualty hazards as outlined in Standard(s) for Safety for Information Technology Equipment, UL 60950-1. UL Certification does not cover the performance or reliability of the security or signaling aspects of this product.

UL MAKES NO REPRESENTATIONS, WARRANTIES, OR CERTIFICATIONS WHATSOEVER REGARDING THE PERFORMANCE OR RELIABILITY OF ANY SECURITY OR SIGNALING-RELATED FUNCTIONS OF THIS PRODUCT.

### 2.3. FCC compliance

This equipment has been tested and found to comply with the limits for a Class B digital device, pursuant to part 15 of the FCC Rules. These limits are designed to provide reasonable protection against harmful interference in a residential installation. This equipment generates, uses, and can radiate radio frequency energy and, if not installed and used in accordance with the instructions, may cause harmful interference to radio communications. However, there is no guarantee that interference will not occur in a particular installation. If this equipment does cause harmful interference to radio or television reception, which can be determined by turning the equipment off and on, the user is encouraged to try to correct the interference by one or more of the following measures:

- reorient or relocate the receiving antenna;
- increase the separation between the equipment and receiver;
- connect the equipment into an outlet on a circuit different from that to which the receiver is connected;
- Consult the dealer or an experienced electrical technician for help.

Intentional or unintentional modifications, not expressly approved by the party responsible for compliance, shall not be made. Any such modifications could void the user's authority to operate the equipment. If necessary, the user should consult the dealer or an experienced electrical technician for corrective action.

The user may find the following booklet, prepared by the Federal Communications Commission, helpful: How to Identify and Resolve Radio-TV Interference Problems. This booklet is available from the U.S. Government Printing Office, Washington, DC 20402, Stock No. 004-000-00345-4.





This device complies with part 15 of the FCC rules. Operation is subject to the following two conditions:

- (1) This device may not cause harmful interference, and
- (2) This device must accept any interference received, including interference that may cause undesired operation.





### 3. Description

#### 3.1. Components

X2 Transponder	 A black rectangular transponder with a white label. The label features the MYLAPS logo, a checkered flag, the text 'X2 TRANSPONDER', and the number '4361339'. It has a metal connector at the top and two mounting holes at the bottom.
X2 RaceKey	 A silver, rectangular RaceKey with a black face. It has a metal connector at the top, a circular button, and a wireless signal icon. The MYLAPS logo is visible at the top and bottom.
X2 Transponder Holder	 A black plastic holder designed to hold the X2 transponder. It has a central slot for the device, a small metal pin on the left side, and a mounting hole at the bottom.
USB cable	 A black USB cable with a standard USB-A connector on one end and a smaller, custom connector on the other.



**Extra components used for the Direct Power model**



<p>Transponder to RaceKey mount cable</p>	
<p>X2 RaceKey to 12VDC power source cable</p>	
<p>X2 RaceKey mount</p>	

### 3.2. Indicator light (LED) signals

#### 3.2.1. X2 RaceKey (when docked on the direct power X2 RaceKey mount)





When power is applied, the key will show a startup sequence where all the LED's will flash. After the start up sequence the indicators will light as described in the table below.

Symbol	Color	Direct Power
	n/a	n/a
	<b>GREEN</b> <b>RED</b>	Active Subscription: Solid for 2 seconds and then will flash 2 times and then go off Inactive Subscription: Solid for 2 seconds and then will flash 2 times and then go off
	n/a	n/a

#### 3.2.2. X2 RaceKey (when docked on the rechargeable X2 Transponder)



Symbol	Color	Direct Power
	Steady <b>GREEN</b> <b>GREEN</b> flashing Steady <b>BLUE</b> <b>RED</b> flashing	Powered and connected to a PC Communication Powered Upgrading X2 RaceKey firmware

	Steady <b>GREEN</b> Steady Red	Active Subscription Inactive Subscription
	Steady <b>GREEN</b> <b>RED</b> Flashing	Fully Charged Charging

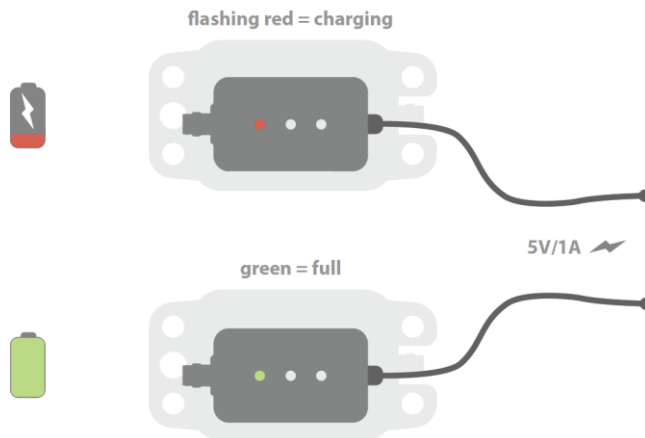

### 3.2.3. X2 Transponder Rechargeable



The X2 Transponder has an indicator LED in the M8 Connector.

LED indicator	Transmitting	Charging	Battery Full	Subscription Active	Comment
Steady <b>GREEN</b>	No	No	Yes	Yes	Connected to Power Source
Flashing <b>RED</b> once every second	No	Yes	No	Yes	Connected to Power Source
Flashing <b>GREEN</b> in a sequence	Yes	No	No	Yes	Indicates the number of days of charge remaining

Flashes <b>RED</b> every 5 seconds	Yes	No	No	Yes	Less than 1 day charge left
Flashes <b>RED</b> 5 times per second	No	See comment	See comment	No	Transponder <u>will charge</u> when connected to power source
Not lit	No	No	No	No	n/a

### 3.2.4. X2 Transponder Direct Power



The X2 Transponder has an indicator LED in the M8 Connector.

LED indicator	Transmitting	Charging	Battery Full	Subscription Active	Comment
Steady <b>GREEN</b>	Yes	Yes	n/a	Yes	Connected to Power Source
Flashing <b>GREEN</b> in a sequence	Yes	No	No	Yes	Indicates the number of days of charge remaining
Flashes <b>RED</b> every 5 seconds	Yes	No	No	Yes	Less than 1 day charge left, running on battery
Flashes <b>RED</b> 5 times per second	No	See comment	See comment	No	Transponder <u>will charge</u> when connected to power source
Not lit	No	No	No	No	n/a

## 4. How to use the product



Your X2 Transponder needs to be registered and activated before you can use it. Otherwise it will stop sending out its transponder number, and the subscription indicator light in the M8 Connector on the X2 Transponder will flash red 5 times per second.



During a race, keep the direct power X2 RaceKey in its mount to ensure the X2 Transponder stays activated.

To activate the X2 Transponder you will need a mylaps.com account (see section 4.1 to create a free account). If you already have an account, you can skip to the “Create Account” section 4.1 and then register and activate your transponder for the first time using MYLAPS Connect – see section 4.2 & section 4.3.

Once your X2 RaceKey and X2 Transponder are successfully installed, check the indicators lights on both products for correct operation – see section 3.2.

You must periodically reactivate the X2 Transponder and X2 RaceKey (at least every 5 days if the X2 RaceKey is removed from the X2 RaceKey mount) – see section 4.4.

### 4.1. Create an account

1. Go to mylaps.com and click “Sign up”.



2. Complete your signup details and click “Create account”.

MYLAPS SPORTS TIMING | RESULTS SOLUTIONS STORE NEWS COMPANY SUPPORT | Signup [Login](#)

☰ > Sign Up

## Sign up for your free MYLAPS account

- Overview**  
All your MYLAPS information in 1 place.
- Results**  
All your personal practice and event results in one overview.
- Manage**  
Manage your MYLAPS transponders and subscriptions.

**Name \***  
First name Last name

**Email \***

Subscribe me to the MYLAPS newsletter  
 I agree to the MYLAPS [terms and conditions](#)

[Login](#) [Create account](#)

3. An email will be sent to the email address provided in the sign up form and the following message appears.

MYLAPS SPORTS TIMING | RESULTS SOLUTIONS STORE NEWS COMPANY SUPPORT | Signup [Login](#)

☰ > Sign Up > Email Is Sent

## Thank you for signing up to MYLAPS

We have sent you an email. Click on the link to confirm your new account.

You might need to check the "junk" or "spam" folder of your email account in order to find this email.

[Need help?](#)

4. Open the email and click on the blue button “Confirm your new MYLAPS account” (if the email does not show up in your inbox, check your junk or spam filter as it may be there).

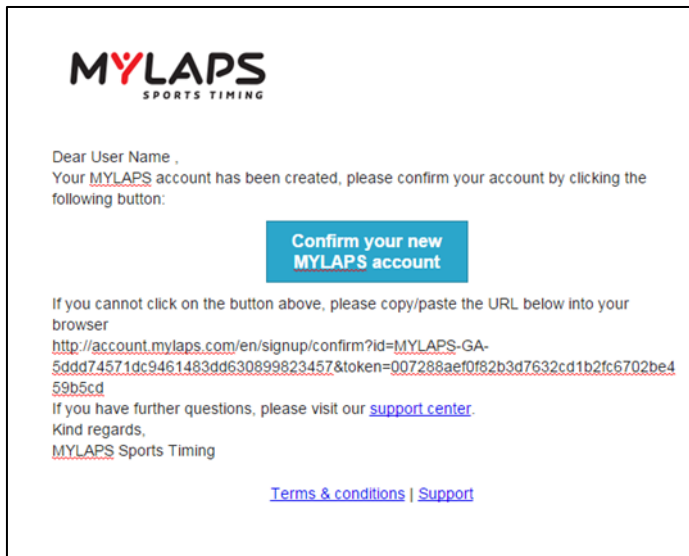

5. After clicking the link (blue button), the account activation page will open. Create and confirm your password.

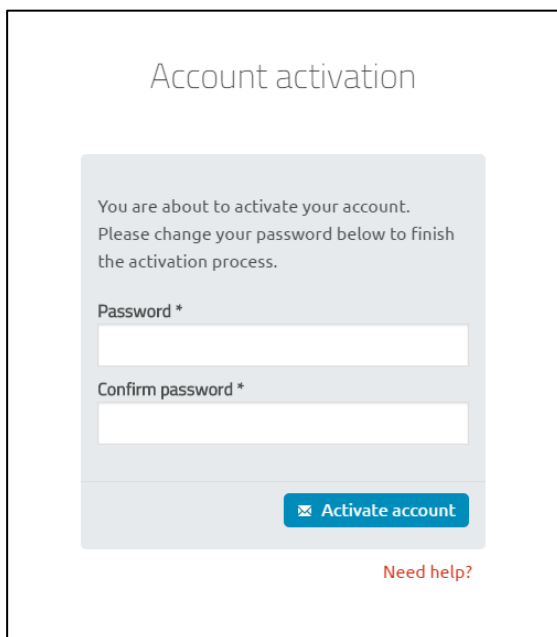

6. After clicking the Activate account button (blue button), a confirmation explains your account is active.

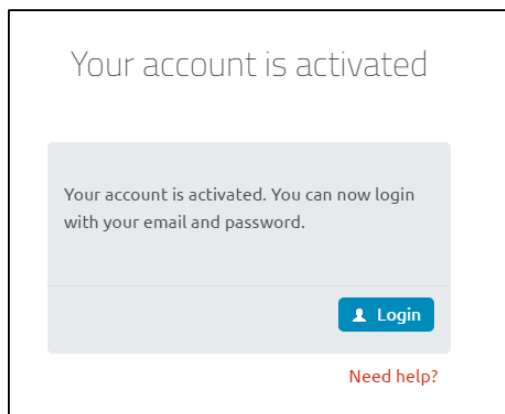

7. Click “Login” to go to the log in screen.
8. Proceed to section 4.2 (Register X2 Transponder) and section 4.3 (Activate the X2 Transponder).

## 4.2. Register X2 Transponder



- Make sure you follow all the registration steps. Your X2 Transponder is only success fully registered if you complete all steps.
- Make sure you do not disconnect the X2 RaceKey from your computer during registration and activation.

1. Visit [www.mylaps.com](http://www.mylaps.com) and login in to your personal MYLAPS account (if you do not yet have an account, refer to section 4.1).

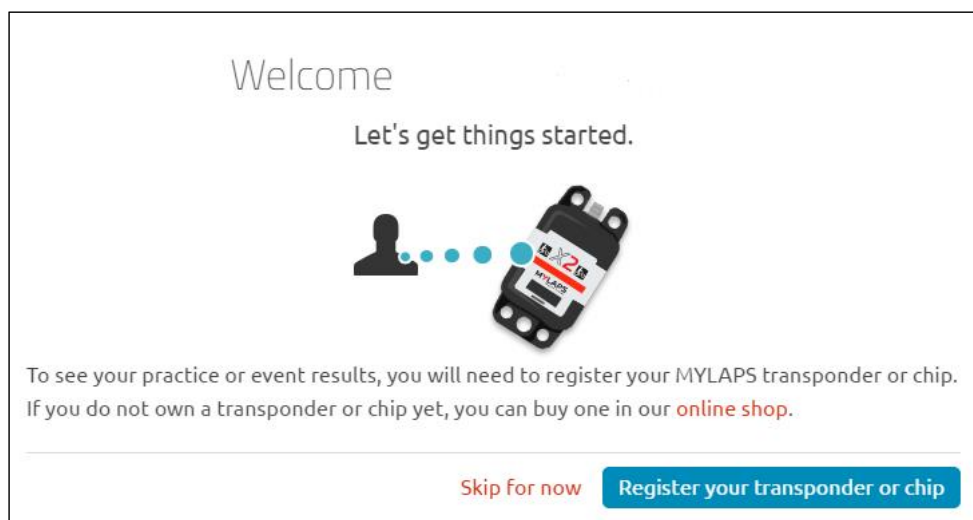

2. Click the “Register your transponder or chip” button. The Register dialog appears where you can enter the number on the label of your X2 Transponder into the “Transponder number” field.



**Register**  
Enter your transponder number and click Register



X2 MX Transponder  
Direct Power

Transponder number \*

+ Register



3. Click “Register” and check that the following confirmation screen appears.

Your transponder was successfully registered. ✕

Before you can use your transponder, you have to activate it.  
Click Download to download the MYLAPS Connect software and start the process.

[Already installed software](#) [Download MYLAPS Connect](#)

4. Here, you can click the “Download MYLAPS Connect” button to install the application onto your computer (needed to activate your X2 Transponder) – see section 4.3.1 for downloading MYLAPS Connect.

### 4.3. Activate the X2 Transponder using MYLAPS Connect

1. Ensure you have a current MYLAPS Connect application loaded on your computer – see section 4.3.1. Also make sure your computer is connected to the internet.
2. Startup MYLAPS Connect on your computer.
3. Login to MYLAPS Connect with your MYLAPS Email and Password.

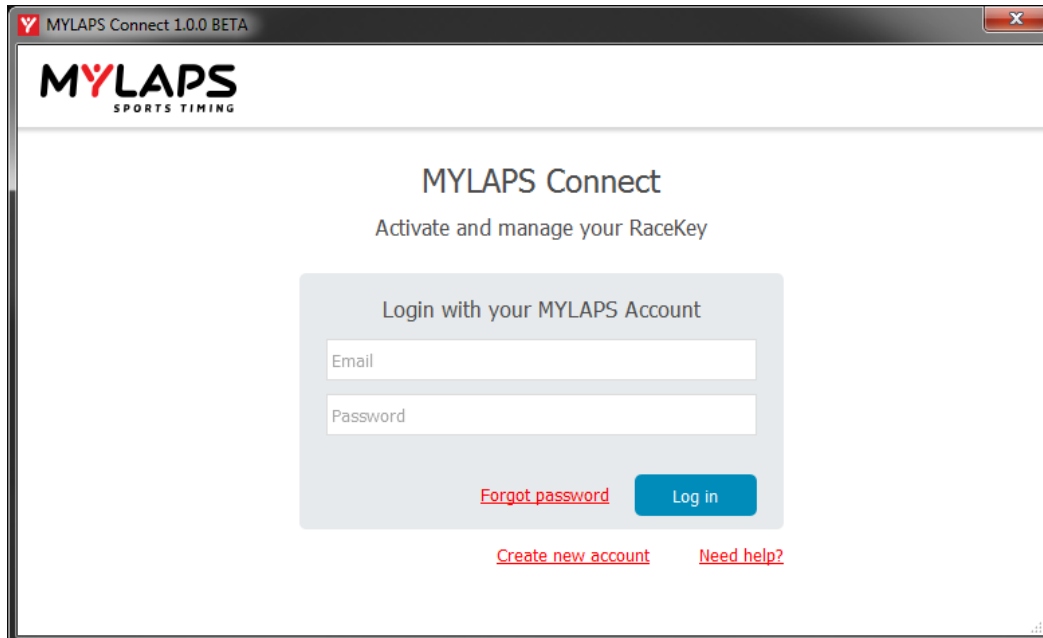

4. Wait until the “No X2 RaceKey detected. Searching for X2 RaceKey” message appears:

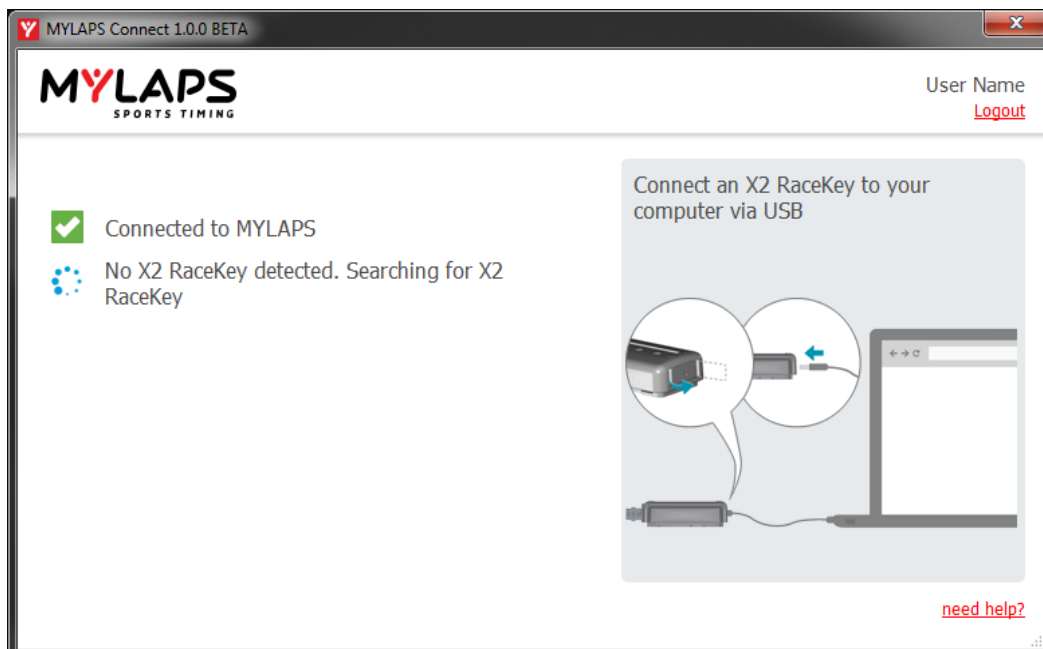

5. Attach your X2 RaceKey to your computer with the USB cable.

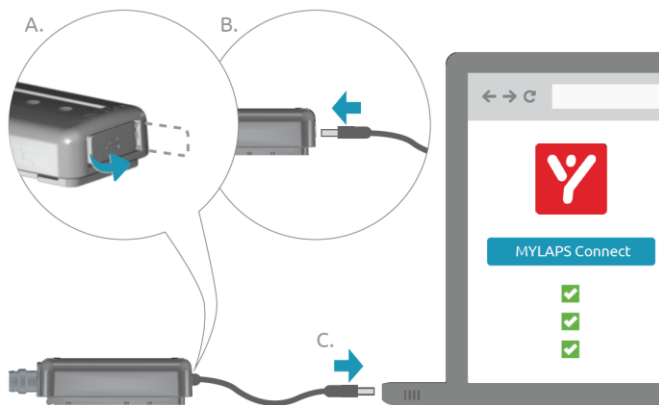

6. The activation process starts automatically and the following message appears:

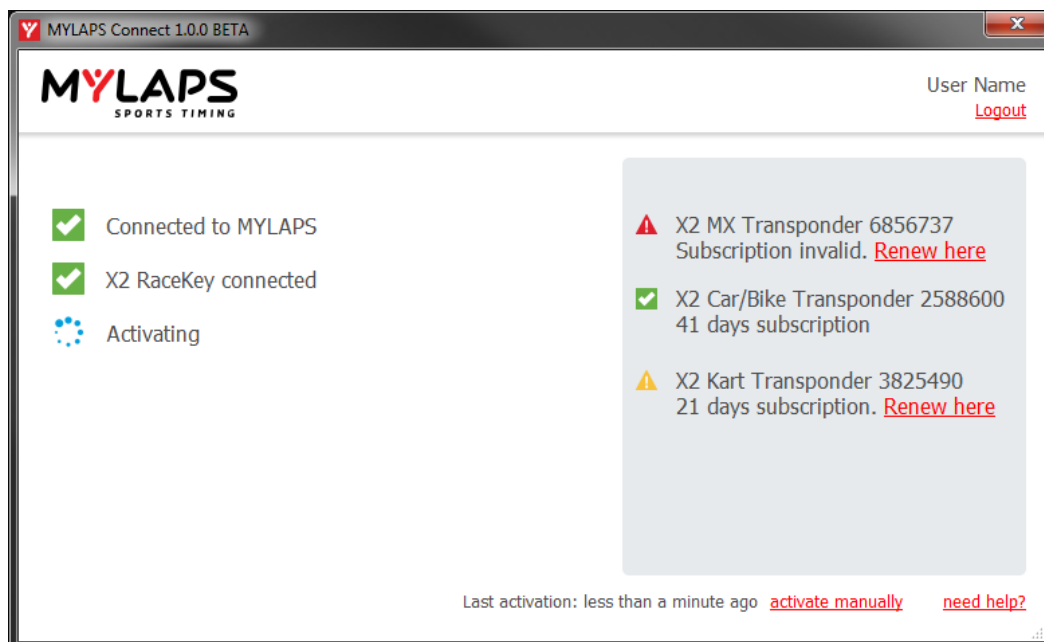

*Notice that the information on the right of the screen explains the current status of your transponder subscription (green tick = subscription is valid for more than 30 days; orange icon = subscription is valid for 1 to 30 days; red icon = subscription is expired and must be renewed).*

7. Wait until the activation is complete and the following message appears:

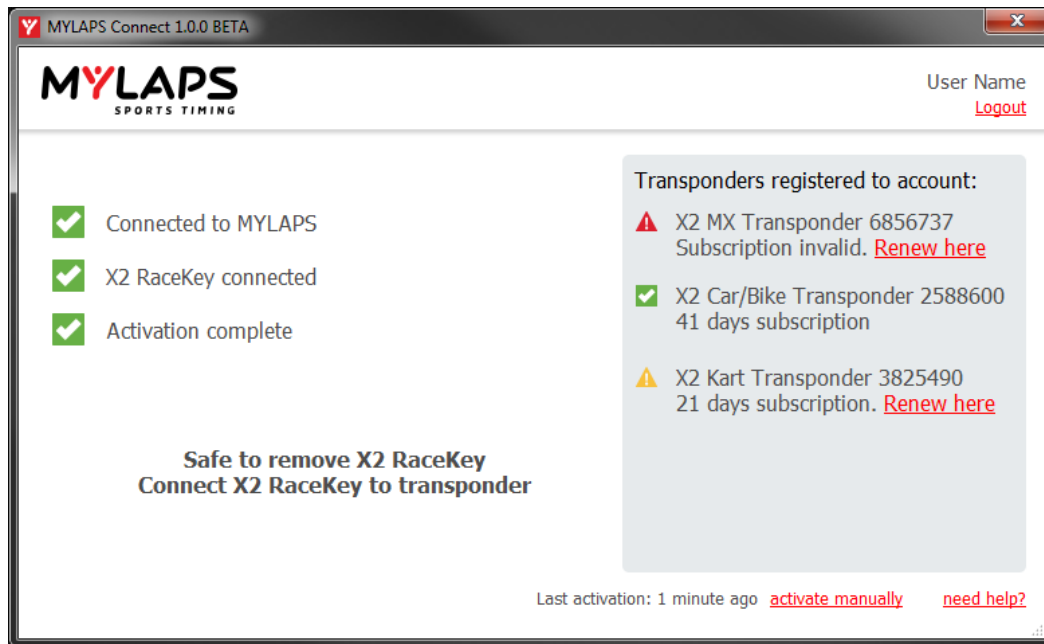

8. Connect the X2 RaceKey to the X2 Transponder (either directly to the back of the rechargeable transponder; or via the mount to the direct power transponder). The X2 Transponder is immediately activated (the lamp on the transponder blinks green).

For Rechargeable:

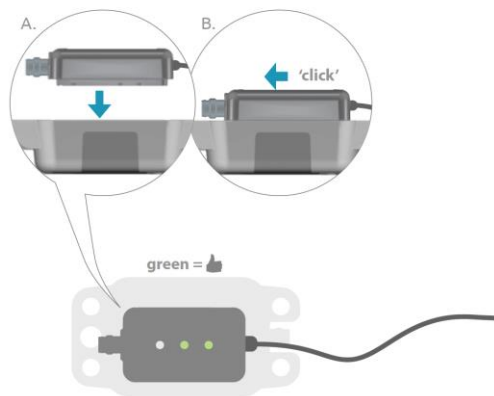

For Direct Power:

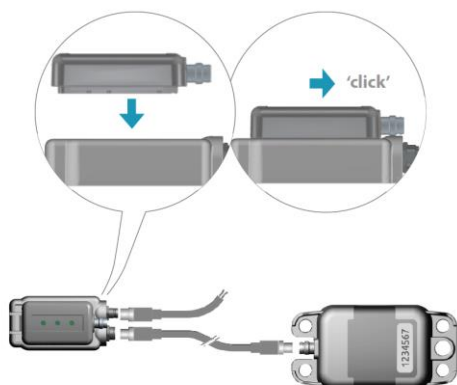

### 4.3.1. Install MYLAPS Connect

When you are activating your X2 Transponder for the first time, or when you use a new computer for activation, you will need to install the MYLAPS Connect application on the computer:

1. Visit [www.mylaps.com](http://www.mylaps.com) and access the download program directory or from your registration screen.
2. Double click the MYLAPS Connect Setup Wizard file and download the application onto your computer by following the setup wizard screen prompts.
3. Choose your language and click OK.

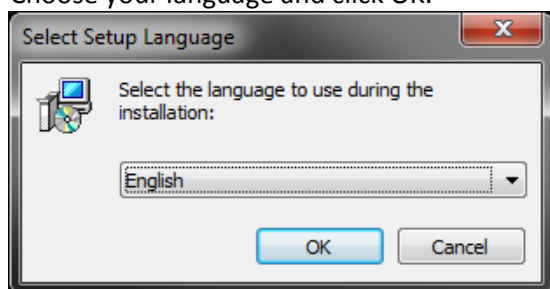

4. Click "Next".



5. Read and "Accept" the license agreement, and click "Next".

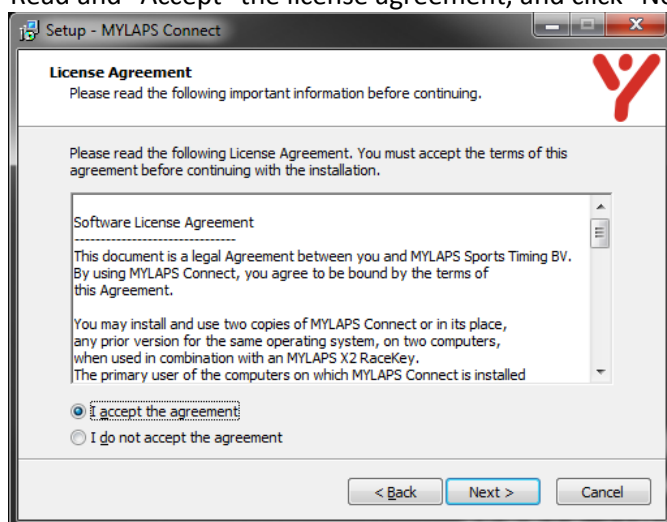

6. Choose a suitable location for the application and click "Next".

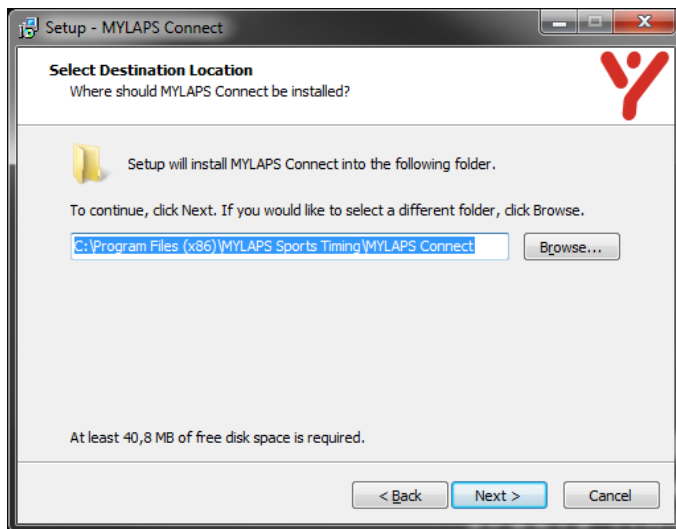

7. Select a suitable location for the program shortcut icon and click "Next".

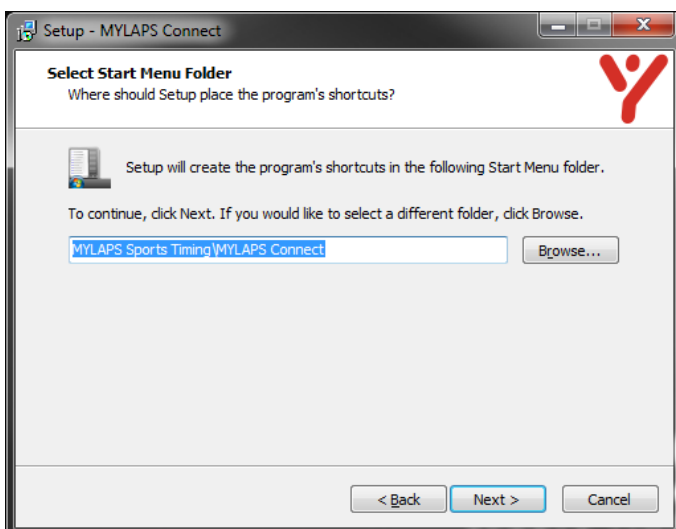

8. Check all settings are correct and click "Install".

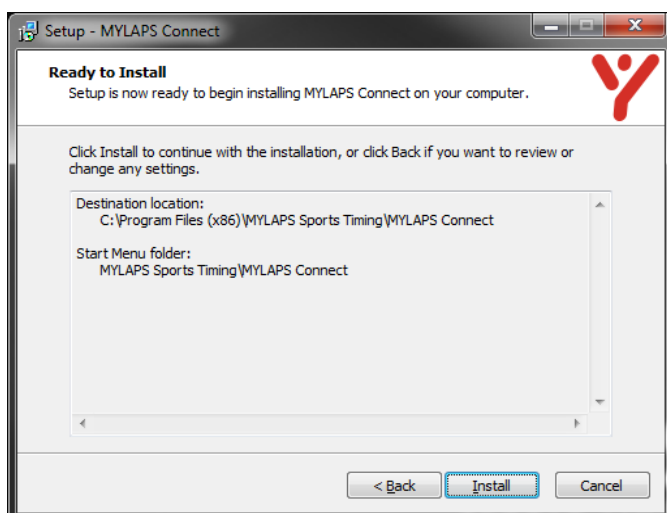

9. Click "Finish" to complete the installation.

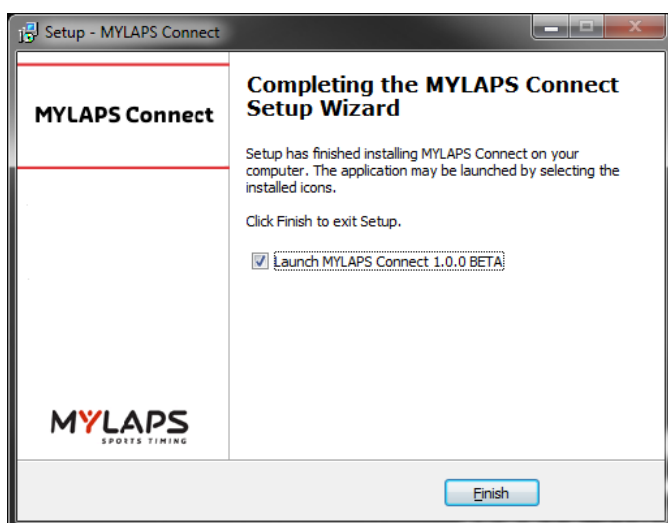

#### 4.4. Reactivate the X2 RaceKey and X2 Transponder



To ensure the functionality of your X2 Transponder, reactivate it periodically with the X2 RaceKey (at least once every 5 days). When the transponder is not reactivated, it will stop sending out its transponder number, and the subscription indicator light will flash red 5 times per second.



During a race, keep the direct power X2 RaceKey in its mount to ensure it stays activated.

Reactivate a rechargeable X2 Transponder by sliding the X2 RaceKey onto the back of the transponder and connect it with the USB cable to a computer (this is also how you recharge the transponder). For Direct Power transponders make sure you slide the X2 RaceKey into the RaceKey Mount before every race.

## 5. Installation

Before mounting the X2 Transponder components, always first register and activate your product - see section 4.



Make sure the X2 Transponder has a clear view to the track. Metal or carbon fibre underneath the transponder could block the signal.  
Do not attach the transponder near the engine or the exhaust due to heat and vibrations.  
Do not attach the transponder near high current AC wiring and/or systems e.g. KERS or other electric motors, xenon lights.

- i** The mounting position of the X2 Transponder must be identical on all vehicles competing in a race. The X2 Transponder components can be mounted to a car, motorcycle, MX or kart
- For the direct power model, see section 5.1
  - For the rechargeable model, see section 5.2

### 5.1. Mounting direct power model

1. Insert the vibration rubbers and attachment pins correctly in the X2 Transponder mounting holes.

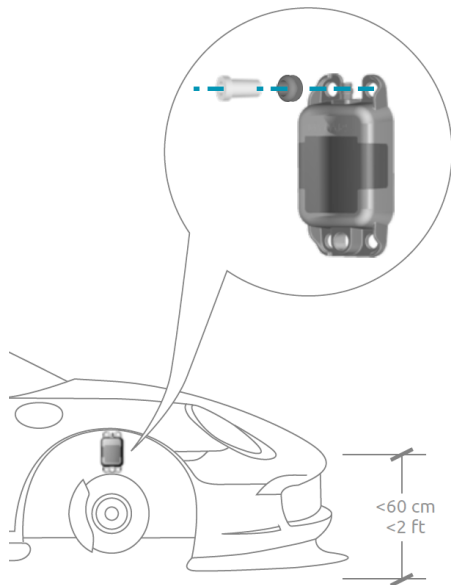

2. Mount the X2 Transponder in the car front wheel arch, or bike front forks, or kart lower chassis.

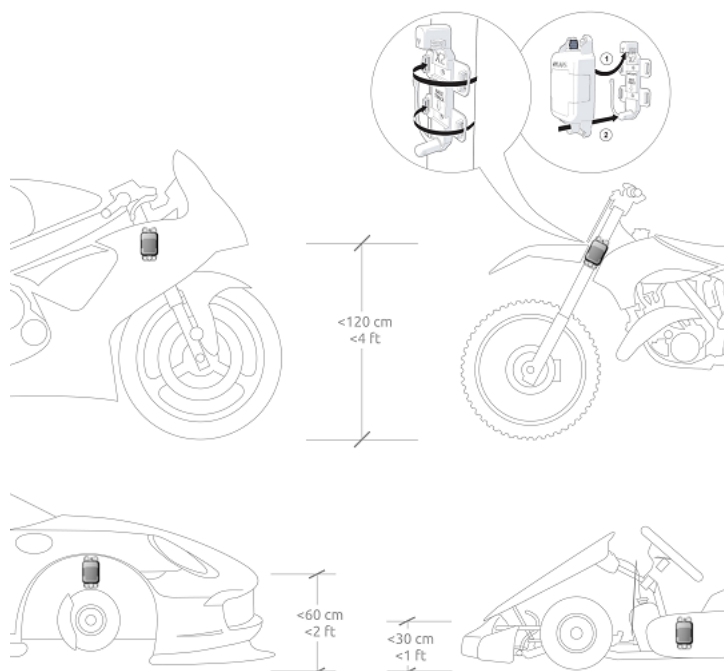



3. Connect the X2 RaceKey mount as follows:

- Connect power cable connector to the X2 RaceKey mount and connect the open end wires to a 12 VDC supply in your vehicle (check the cable and vehicle wiring specifications for correct connection). The brown cable is 12V and the Blue cable is Gnd. The black and white cable can be ignored.
- Connect the connector cable to the X2 Transponder and feed it to the connector on the RaceKey mount.
- Mount the X2 RaceKey mount in sight of the driver on the dashboard or steering.

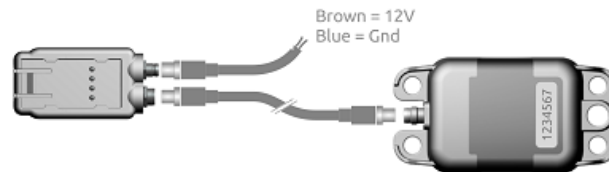

\* for direct power only

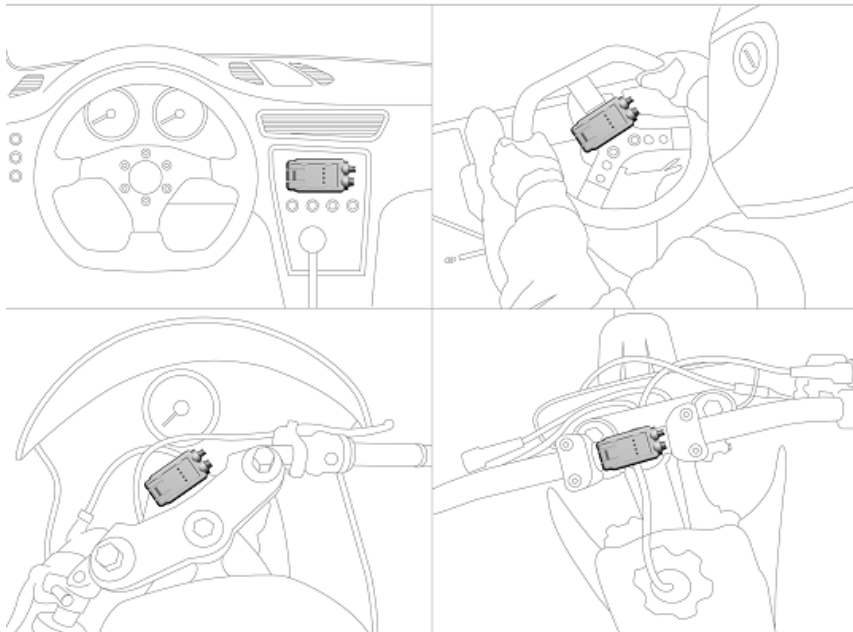

4. Insert the X2 RaceKey in the RaceKey Mount:

- During startup all three indicator lights will flash various colors.
- After startup the "Subscription" indicator light will blink green (or red if the subscription is not active) before it turns off.



## 5.2. Mounting rechargeable model

1. Before mounting the X2 Transponder, charge it as follows:
  - Slide the X2 RaceKey onto the X2 Transponder



- Connect the USB cable from a USB/wall adapter (e.g. laptop) to the X2 RaceKey.
  - The charge indicator light blinks red during charging. Wait till the light turns solid green (the transponder is fully charged).
  - Remove the USB cable and disconnect the X2 RaceKey from the X2 Transponder. The indicator lights (see section **Error! Reference source not found.**) on the transponder indicate how long the transponder can be used - there is no sleep mode.
2. Mount the X2 Transponder in the car front wheel arch, or bike front forks, or kart lower chassis.

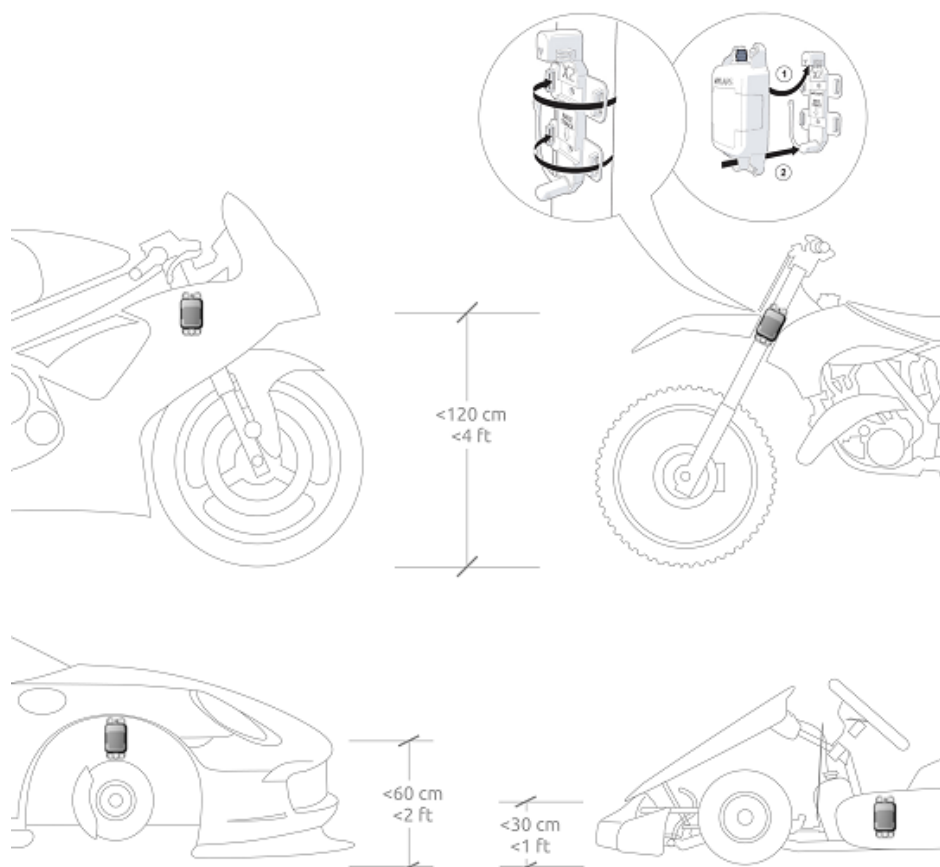

## 6. Maintenance

Maintenance can be described as, but not limited to:

- Checking and testing components;
- Cleaning the unit and individual components - accumulated dirt can hamper unit operations;
- Charging the unit;
- Troubleshooting any malfunctions that may occur on the unit during operation.

### 6.1. Periodic maintenance schedules

Type of maintenance	Daily	100 hours	300 hours	As required
Clean	X			X
Charging		X		
Replace parts and accessories				X

### 6.2. Cleaning

Take a clean soft cloth or brush and moisten it with clean water



- Do not use an abrasive cleaning liquid.
- Do not use high pressure waterguns or other (dish)washing machines to clean or rinse the transponders.
- Do not clean transponders with automotive cleaning products or other detergents.

- Use the moist cloth or brush to clean the X2 Transponder, paying particular attention to remove any dirt on the connector pins. Dry off any excess moisture.
- Take a fresh clean cloth and moisten it with clean water.
- Clean the X2 Transponder making sure not to get moisture on the electrical connector where the USB cable can be connected.
- Dry off any excess moisture.
- If necessary use clean cotton tips to clean any dirt off the connectors on the X2 RaceKey and the X2 Transponder.

### 6.3. Charging (Rechargeable X2 Transponder only)

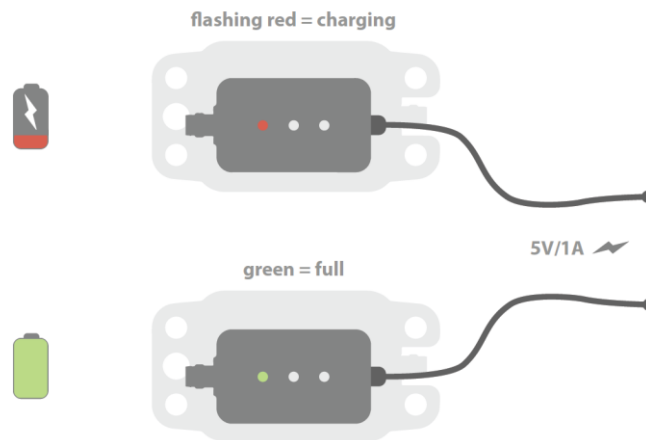

- Make sure the X2 Transponder is dry before charging.
- If the transponder is inactive for long periods, charge it once every three months.

1. Mount the X2 RaceKey on the X2 Transponder.
2. Connect the USB cable from a USB/wall adapter source (e.g. laptop) to the X2 RaceKey.
3. The charge indicator light blinks red during charging. Wait till the light turns solid green (the transponder is fully charged).
4. Remove the USB cable and disconnect the X2 RaceKey from the transponder. The indicator lights (see [section 3.2.3 X2 Transponder Rechargeable](#)) on the transponder indicates how long the transponder can be used.

## 7. Environment and disposal



**Do not dispose of electrical equipment in the household waste!**

The symbol on the material, accessories or packaging indicates that this product may not be discarded as household waste. Dispose of the equipment through a recycling centre that handles electronics and electrical appliances within the EU and in other European countries which use separate collection systems for used electronics and electrical appliances. By disposing of the equipment in the proper way, you will be helping to prevent possible risks to the environment and public health, which might otherwise be caused by improper handling of the discarded equipment.

Recycling of materials contributes to the conservation of natural resources. Therefore, please do not dispose of your old electronics and electrical appliances via household waste.

In accordance with European Directive 2012/19/EC relating to old electrical and electronic appliances and its translation into national law, used electrical equipment must be collected separately and recycled in an ecologically compatible way.

If you wish to part with the product, please dispose of it in accordance with the regulations applicable at such time. Advice is available from your local council.



**Environmental damage through incorrect disposal of the rechargeable batteries!**

Rechargeable batteries may not be disposed of with the usual domestic waste. They may contain toxic heavy metals and are subject to hazardous waste regulations. The chemical symbols of the heavy metals are: Cd = cadmium, Hg = mercury, Pb = lead. For this reason, dispose of used rechargeable batteries at a local collection point.

**i** The packaging materials may not be discarded as household waste, but must be collected separately and recycled in an ecologically compatible way.

## 8. Troubleshooting

This product contains delicate electronic components. This means that if it is placed near an object that transmits radio signals, it could cause interference. This could be, for example, mobile telephones, walkie talkies, CB radios, remote controls and microwaves. If interference occurs, move such objects away from the appliance. Electrostatic discharges can lead to malfunctions. In the event of such malfunctions briefly remove and reinsert the rechargeable batteries.

## 9. Technical specifications

### 9.1. General X2 Transponder

Dimensions	98x52x23 mm / 3.86x2.05x0.91 in
Weight	120 gr / 0.26 lb
Housing	Water and shock proof IP 67
Signal transfer	Magnetic induction
Operating temperature range	-20 to + 50 °C / -4 to +122°F
CAN bus	CAN 2.0A compliant
Baudrate	1 mbit/s
Termination resistor	120 Ohm
Connections	4 pin M8 sensor connector 4 pin docking
Internal battery	5 days
ID	Unique 7 digit number
Input voltage	8-17 VDC
Power consumption	Max. 140 mA 12 VDC (145 mA with X2 RaceKey)
Battery operating time	Min. 4 days (after full charge)
Battery Charging time	Min. 4 hours for full charge

## 9.2. Car/Bike

Timing resolution	2 ms
Max. Speed	260 km/h (162.5 mph)
Transponder position	Max. Height 120 cm (4 ft.) for bikes, 60 cm (2 ft.) for cars. Clear view to the asphalt

## 9.3. Kart

Timing resolution	3ms
Max. Speed	120 km/h (75 mph)
Transponder position	Max. Height 30 cm (2 ft.)

## 9.4. MX

Timing resolution	6ms
Max. Speed	120 km/h (75 mph)
Transponder position	Max. Height 120 cm (4 ft.)

## 9.5. X2 RaceKey

Dimensions	50x30x15 mm / 1.96x1.18x0.59 in
Weight	30 gr / 0.066 lb
Housing	Water and shock proof IP 65
Operating temperature range	0 - 60°C / 32 -140 °F
CAN bus	CAN 2.0A compliant
Baudrate	1 mbit/s
Termination resistor	120 Ohm
Connections	4 pin M8 sensor connector 4 spring docking Micro USB connector
Power Consumption	Max 450 mA at 5VDC (X2 Racekey & Transponder)

### 9.6. USB cable

Description	0.50M USB micro - USB A, black
Color of housing	Black
Type of plug	1x USB A male 1x USB micro
Length	0.5 m (19.7 inch)
Outer diameter	3 mm ((0.12 inch)

### 9.7. Cable (X2 RaceKey mount to 12 VDC power supply)

Type	Cable; Open end without connector
Material	PUR halogen free
Color of housing	Black
Number of contacts	4
Thread	M8
Type of plug	1x female (M8 female connector with snap-in joint, straight, 4-poles)
Length	1,5 m (59.1 inch)
Outer diameter	4.5 mm (0.17 inch)
Degree of protection (IP)	IP65, IP67 when mated
Environmental temperature	-40 - 90°C / -40 -194°F
Environmental protection	Oil and gasoline
EMC protection	No shielding
Rate current	4A
Nominal voltage	60V
Contact material	Gold plated pins



### 9.8. Cable (X2 RaceKey mount to transponder)

Type	Cable with double-ended connectors
Material	PUR halogen free
Color of housing	Black
Number of contacts	4
Thread	M8
Type of plug	1x female (M8 female connector with snap-in joint, straight, 4-poles) 1x male (M8 male connector with self-locking threaded joint, straight, 4-poles)
Length	2 m (78.7 inch)
Outer diameter	4.5 mm (0.17 inch)
Degree of protection (IP)	IP65, IP67 when mated
Environmental temperature	-40 - 90°C / -40 -194°F
Environmental protection	Oil and gasoline
EMC protection	No shielding
Rate current	4A
Nominal voltage	60V
Contact material	Gold plated pins

### 9.9. M8 cable power option

Input voltage	8-17 VDC
---------------	----------

### 9.10. USB power option

Input voltage	5 VDC
---------------	-------

## 10. MYLAPS Support

### MYLAPS EMEA Office

Haarlem

Tel: +31 23 7600 100

Email: [tech.support@mylaps.com](mailto:tech.support@mylaps.com)

### MYLAPS Japan Office

Tokyo

Tel: +81 3 5275 4600

Email: [info.japan@mylaps.com](mailto:info.japan@mylaps.com)

### MYLAPS Asia Office

Kuala Lumpur

Tel: +60 356131235

Email: [info.asia@mylaps.com](mailto:info.asia@mylaps.com)

### MYLAPS Americas Office

Atlanta

Tel: +1 678 216 4000

Email: [info.americas@mylaps.com](mailto:info.americas@mylaps.com)

### MYLAPS Asia Pacific Office

Sydney

Tel: +61 2 95462606

Email: [info.asia.pacific@mylaps.com](mailto:info.asia.pacific@mylaps.com)