

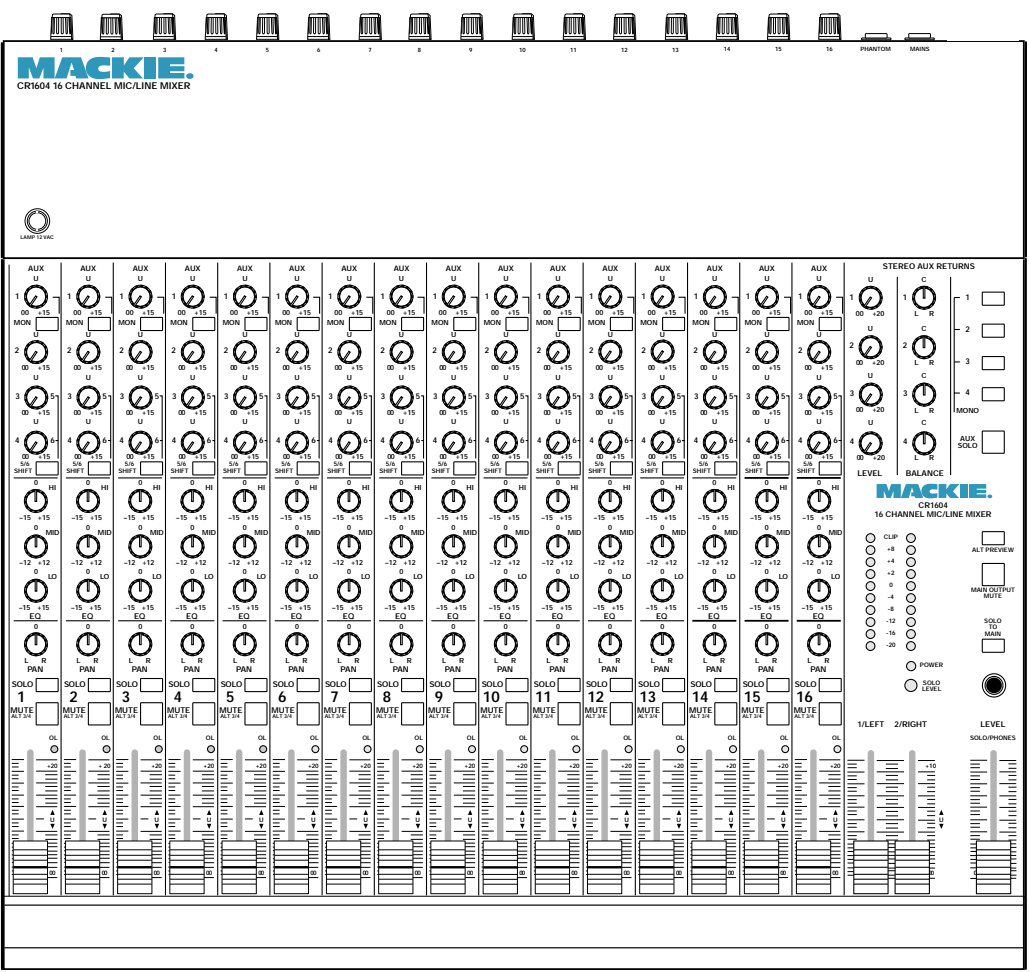

MACKIE™

CR-1604 OWNER'S MANUAL

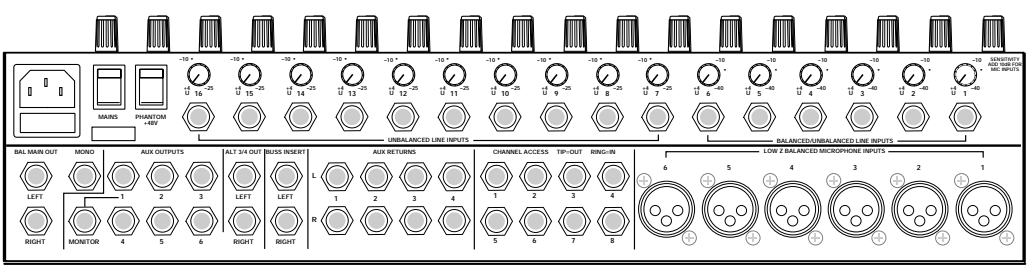



 The lightning flash with arrowhead symbol within an equilateral triangle is intended to alert the user to the presence of uninsulated "dangerous voltage" within the product's enclosure, that may be of sufficient magnitude to constitute a risk of electric shock to persons.
 Le symbole éclair avec point de flèche à l'intérieur d'un triangle équilatéral est utilisé pour alerter l'utilisateur de la présence à l'intérieur du coffret de "voltage dangereux" non isolé d'ampleur suffisante pour constituer un risque d'électrocution.

 The exclamation point within an equilateral triangle is intended to alert the user of the presence of important operating and maintenance (servicing) instructions in the literature accompanying the appliance.
 Le point d'exclamation à l'intérieur d'un triangle équilatéral est employé pour alerter les utilisateurs de la présence d'instructions importantes pour le fonctionnement et l'entretien (service) dans le livret d'instruction accompagnant l'appareil.

SAFETY INSTRUCTIONS

- 1. Read Instructions** — All the safety and operation instructions should be read before the CR-1604 is operated.
- 2. Retain Instructions and Packaging** — The safety and operating instructions should be kept for future reference. Also keep the box and end caps, in case the unit needs to be returned for service.
- 3. Heed Warnings** — All warnings on the CR-1604 and in these operating instructions should be followed.
- 4. Follow Instructions** — All operating and other instructions should be followed.
- 5. Water and Moisture** — The CR-1604 should not be used near water — for example, near a bathtub, washbowl, kitchen sink, laundry tub, in a wet basement, near a swimming pool, swamp or salivating St. Bernard dog, etc.
- 6. Heat** — The CR-1604 should be situated away from heat sources such as radiators, or other devices which produce heat.
- 7. Power Sources** — The CR-1604 should be connected to a power source only of the type described in these operation instructions or as marked on the CR-1604.
- 8. Power Cord Protection** — Power supply cords should be routed so that they are not likely to be walked upon or pinched by items placed upon or against them, paying particular attention to cords at plugs, convenience receptacles, and the point where they exit the CR-1604.

©1995 Mackie Designs™. All rights reserved.
 Printed in the USA.

V 4.1 2/95, Part No. 820-001-00

9. Object and Liquid Entry — Care should be taken so that objects do not fall into and liquids are not spilled into the inside of the CR-1604.

10. Damage Requiring Service — The CR-1604 should be serviced only by qualified service personnel when:

- Objects have fallen onto, or liquid has spilled into the CR-1604; or
- The CR-1604 has been exposed to rain; or
- The CR-1604 does not appear to operate normally or exhibits a marked change in performance; or
- The CR-1604 has been dropped, or its chassis damaged.

11. Servicing — The user should not attempt to service the CR-1604 beyond those means described in this operating manual. All other servicing should be referred to the Mackie Service Department. See page 21.

12. To prevent electric shock, do not use this polarized plug with an extension cord, receptacle or other outlet unless the blades can be fully inserted to prevent blade exposure.

Pour prévenir les chocs électriques ne pas utiliser cette fiche polarisée avec un prolongateur, un prise de courant ou une autre sortie de courant, sauf si les lames peuvent être insérées à fond sans laisser aucune partie à découvert.

13. Grounding or Polarization — Precautions should be taken so that the grounding or polarization means of the CR-1604 is not defeated.

This apparatus does not exceed the Class A/Class B (whichever is applicable) limits for radio noise emissions from digital apparatus as set out in the radio interference regulations of the Canadian Department of Communications.

ATTENTION — Le présent appareil numérique n'émet pas de bruits radioélectriques dépassant les limites applicables aux appareils numériques de class A/de class B (selon le cas) prescrites dans le règlement sur le brouillage radioélectrique édicté par les ministere des communications du Canada.

WARNING — To reduce the risk of fire or electric shock, do not expose this appliance to rain or moisture.

Thank you!!

There are a lot of makes and models of mixers out there today, all competing for your hard earned dough... but you have voted with your wallet for the folks in Woodinville who specialize in mixers.

And you are in good company !! The CR-1604 is the compact mixer of choice for some of the world's top performing groups, studio players, producers and soundtrack composers. Even when they could buy anything they wanted, they chose the CR-1604. So congratulations on joining the other

IF YOU IGNORE MANUALS OR ARE JUST HOT TO GET STARTED...

Please at least read the sections marked with these two icons:



Our Engineering Manager thinks this looks like a bomb. But actually it's a genuine Buck Rogers-style space ship.

They cover information that is absolutely critical or is unique to the CR-1604. But it's still a good idea to read the whole manual through at some point. We worked and slaved to make this manual readable, understandable and informative and it's bound to have a few nifty nuggets of knowledge you haven't picked up from the school of hard nox.



In particular, sections marked with A CLOSER LOOK icon include in-depth information...or at least our own opinions.

DESCRIPTION OF CONTROLS
BEGINS ON PG. 4

CONTROLS
& FEATURES

INPUT/OUTPUT "POD"
SECTION DESCRIPTION, PG. 11

INPUT
OUTPUT
POD

CONNECTION TIPS &
HOOKUP , PG. 15

HOOK
UP

DETAILED LEVEL-SETTING
PROCEDURE, PG. 19

LEVEL
SETTING
STEPS

POD ROTATION INSTRUCTIONS
PG. 20

CHANGING
THE POD

SERVICE, BLOCK DIAGRAM,
AND SPECS PG. 21-26

TECH
STUFF

discerning musicians/recordists who have found in this product the quality and performance that has long been considered unattainable in this class and price range.

Okay, enough stroking. Time to dig in! There are only two things that we ask:

Read this manual. Sounds obvious, but in all the excitement that goes along with the purchase of a new piece of gear the new owner often neglects to become as familiar as they should with the product, and as a result runs the risk of missing out on many of the cool features and convenience that it can offer.

If this is your first pro-mixer, please flip through the whole book. If you're a seasoned pro, at least read the sections with "QUICK START" or "VERY IMPORTANT" icons next to them. (However, we've found that truly experienced engineers usually read their owner's manuals cover-to-cover anyway... so they can continue to make those big bucks.)

The following chapters will take you on a guided tour of your new mixer and explain the inner workings of each control, as well as how it relates to the rest of the mixer and your particular application.

Part 1— A GUIDED TOUR OF THE CR-1604'S CONTROLS

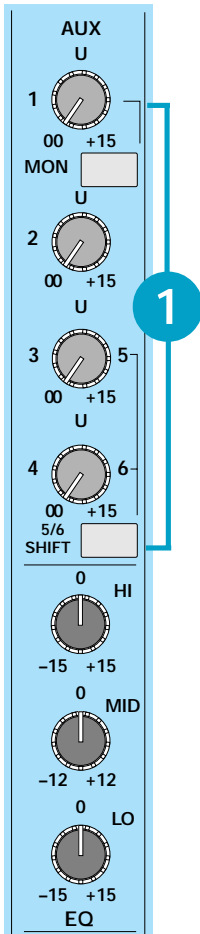

IMPORTANT SENSITIVITY ADJUSTMENT PROCEDURE

To fully achieve the CR-1604's impressive noise and headroom specs, you should "tune" channel sensitivity of each channel to your particular setup.

Can you run the mixer without this adjustment? Sure. Chances are that you'll get pretty good sound. But take a moment to adjust things properly and you'll get excellent sound. After all, it's your music.

Because we really want you to make this adjustment, we've included a slightly more detailed description of the process on page 19.

The basic procedure for adjustment is as follows.

- Set EQ controls approximately the way they'll be used for that channel. If you don't know in advance, just set them flat.
- Turn the channel's PAN control all the way to either the right or left.
- Set Channel Fader to Unity (center detent).
- Turn the channel's SENSITIVITY control fully counter clockwise (+4 UNITY).
- Press the channel's SOLO button *and* the SOLO TO MAIN button over on the main output section of the mixer.
- Play through the channel at the same volume and intensity that the channel is going to handle during use. Turn the channel's SENSITIVITY control clockwise until the level on the CR-1604 meter (left or right side, depending on which way you have the PAN set) reads around 0dB.
- Set the EQ the way you think you'll want it, then repeat step F.
- Turn the channel's SOLO button off and return the PAN control to center detent position.
- Repeat this procedure for each channel, using the appropriate kind of source which will be used with that channel.

All the knobs and buttons on the CR-1604's front panel can be broken down into sixteen identical input modules (channel strips) plus one Master Output section that's divided into Aux Return and General Output sections (see nifty diagram at right).

Each input channel strip can be divided into four specific sections:

- The AUX SENDS, with knobs color-coded RED
- EQUALIZATION, color-coded BLUE
- PAN control, color-coded black, and
- the channel LEVEL CONTROL faders

All modern mixing boards utilize some variation of this input module arrangement. Once you've mastered the CR-1604's input module layout, you should feel ready to take on that old 132-channel Neve mixing desk gathering dust in your Aunt Hattie's garage.

1 AUX SENDS

AUX 1, 2, 3 & 4

These controls are used to send the signal out to outboard parallel effects processors such as reverbs and delays. You may also use an Aux Send to create a separate monitor mix for stage monitors or headphone cues or generate separate mixes for recording.

There are a total of seven Aux Sends on each CR-1604 channel strip. A combination of four may be used at the same time.



NOTE: All of the CR-1604's Aux sends have a *very* wide range of gain. The first half of the control's rotation reaches from the off position to Unity Gain (0dB).

This half of the control's range corresponds to the full range of a conventional mixer. The second half of the control's rotation provides you with even more gain, from Unity to +15dB. For example, when you want a sound super-"wet" (mostly reverb), the extra gain allows you to bring the channel fader down (and the send way up) so that the sound is composed of predominantly reverb return with just a touch of "dry" signal.

AUX 1/MON

This particular Aux control could be viewed as the King of Sends, because of its varied functions.

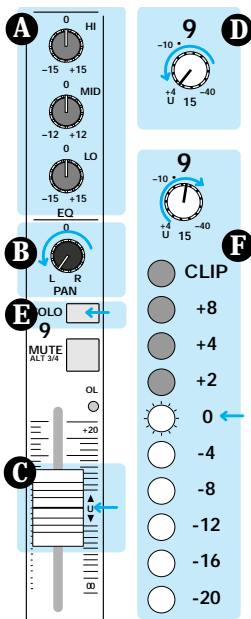

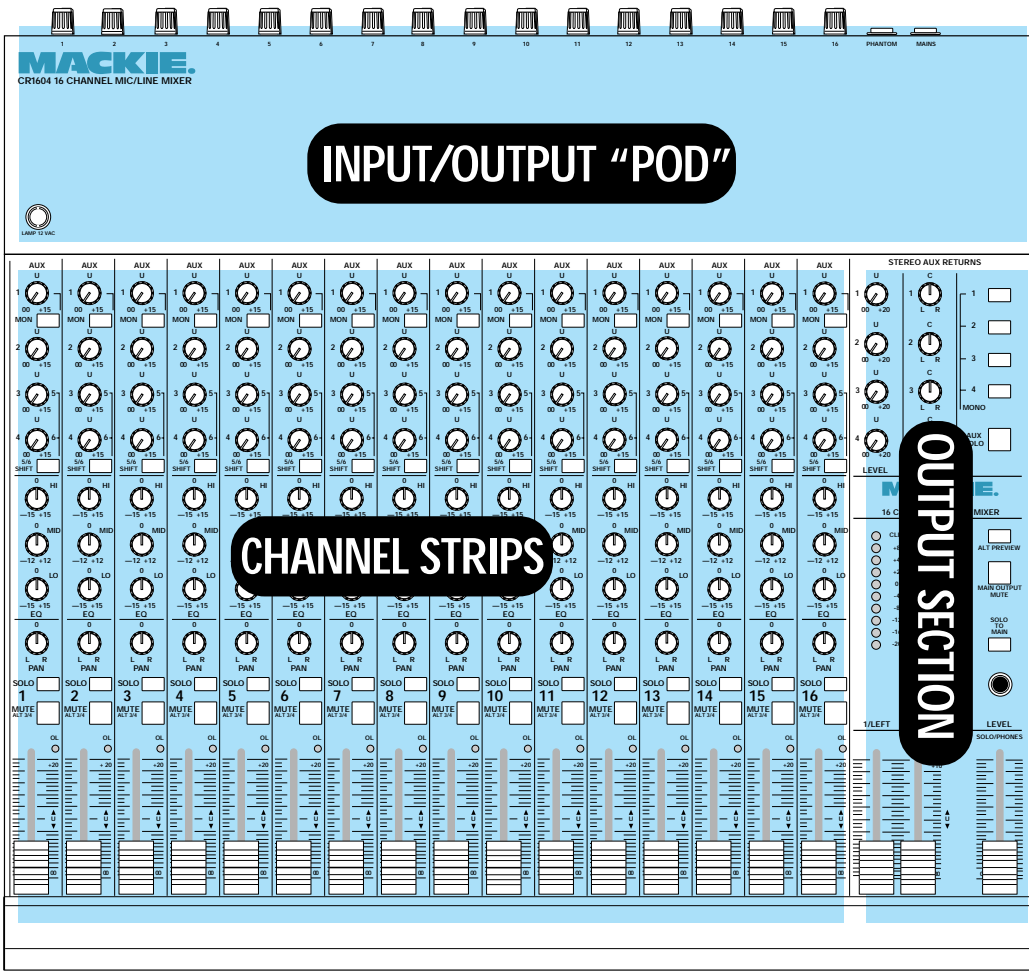

Send 1 may be routed to AUX OUT 1 which taps the signal downstream from the EQ circuitry and Channel Fader (we call this Post-Fader/Post-EQ, meaning that the signal will reflect any adjustments made to the fader or EQ controls.)

Send 1 can also be routed to the MONITOR OUT by pressing the MON button. This signal is intercepted ahead of the EQ circuitry and Channel Fader (known as pre-EQ/pre-Fader... the signal will be the same as it was when it first entered the input module, unaffected by the control adjustments made with the EQ or fader controls).

This arrangement allows for two separate sends. You can use Send 1 on Channels 1-6 as a stage monitor mix for vocals (with mic inputs), and Send 1 on Channels 7-16 as a reverb send (with synth inputs, for example).

AUX 2

This send is Post EQ and Post Fader. Since it's affected by EQ and gain adjustments, we recommend that it be used as your main reverb send.

AUX 3 & 4

These two sends are also post-EQ/post-Fader.

The "hidden" sends: 5 & 6

The 5/6 SHIFT button "converts" AUX 3 and 4 to AUX Sends 5 and 6. In other words, after you press this button, signal is sent to AUX 5 and AUX 6 but controlled by the AUX 3 and 4 Knobs. We did this to add the flexibility of extra sends without making the mixer so big that it looks like an airport landing strip.

To review

The CR-1604s Aux sends are used to route a portion of the signal out to another source for processing or sub-mixing. They allow you to control how much effect is mixed with each channel.

- All channel strips have four Aux sends feeding a total of seven outputs.
- All sends are fully off in the extreme counterclockwise position.



WUTZA DEEE-TENT?

Occasionally in this manual you will see a reference to detents. A detent is a simple but effective control feature that will aid in easy re-setting of your mixers controls. It's simply a notch in the movement of the control component, which determines a neutral setting, such as Unity on faders or center on the PAN control. This way you're either in de tent or out of de tent, as we say when camping up here in the Northwest.

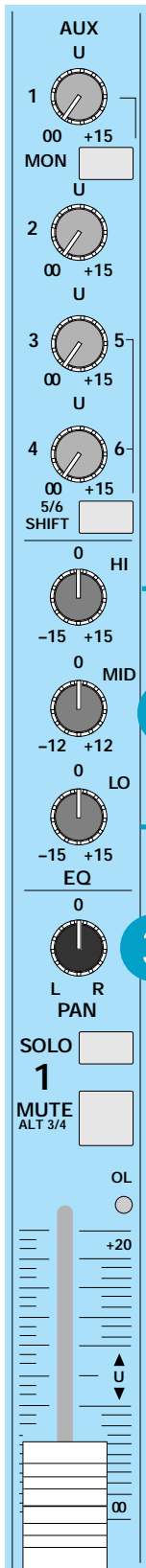

- We recommend going into a stereo reverb in mono and returning in stereo. We have found that most “stereo” reverbs’ second input just ties up an extra AUX send and adds little or nothing to the sound.
- All send buses are isolated from each other and have separate mix amps.



AUX SENDS AND LIVE MIXING

When using microphones in a live performance, we recommend that AUX 1 be set to MONITOR position.

In MONITOR mode, the signal is taken ahead of the EQ and Fader circuitry. When in AUX mode the signal will be taken downstream of the EQ and Fader circuitry. Remember that this means that the signal will reflect any changes brought about by settings made to EQ and channel fader controls, but still can be used.

2 Equalization Controls

These three controls offer you a surprising amount of control over the sonic personality of your mix (although they are not intended to take the place of a parametric or 1/3-octave graphic equalizer).

Through the creative use of the CR-1604’s EQ controls, samplers and other instruments can be contoured to better reflect the real world sound signature they are trying to emulate, mixes can be punched up, vocalists rescued from obscurity, etc.

We’ve carefully selected different points for our equalization and have used circuitry which provides an extremely “musical” effect. Some heavy-duty pros have complemented us on how useful they are. So before you immediately plug in an outboard equalizer, give the controls a chance. If all you’ve used are conventional small mixers, you’re in for a pleasant surprise.

EQ HI

15dB boost or cut at 12kHz. There is no effect at the center detent position. This shelving control will affect the higher frequencies of the incoming signal. By shelving, we mean that the circuitry boosts or cuts all frequencies past the specified point, instead of just creating a bump or dip in response the way a graphic equalizer would. Use this control to add sizzle to cymbals and vocals and give a sense of transparency or edge to keyboards and guitars. It can also be turned down a little to reduce sssssibilance.

EQ MID

12dB boost or cut at 2.5 kHz with a 3.3 octave bandwidth (this is NOT a shelving control). Because the majority of musical in-

formation is contained in this range, a little midrange EQ goes a long way. It can increase presence of a mix, enhance intelligibility of a vocal or back off a strident instrument.

EQ LO

15dB boost or cut at 80Hz. This control affects the lower frequencies of your input signal. It can be used to put punch in bass drums, bass guitar, fatten synth patches and add bottom end to male vocals. Cutting the LO EQ slightly can do wonders for muddy tracks and boomy room acoustics as well as helping fix poppy microphones.

3 PAN

This control positions a signal within the stereo sound field. Also a way to “assign” a channel to just left or right for sub-grouping to the mono or ALT-3/4 outputs.

The Mackie CR-1604 incorporates constant-power pan pots which maintain constant acoustic power as you move the channel’s signal to left or right. This is a way cool feature which is explained in detail on the next page.



LECTURE TIME: CONCERNING EQUALIZATION

MODERATION: Proper EQ can focus a mix. Improper EQ can cause distortion. Too much EQ results in mix mush.

The best EQ is none at all. In other words, in live recording situations, you should start by selecting the right mic, positioning it correctly and recording in the right acoustic environment. When mixing direct inputs, time spent on tweaking with the synth patch, boldly going where the tone module preset hasn’t been before or adjusting the instrument’s own tone controls beats the heck out of “saving it in the mix.”

Save the CR-1604’s EQ for solving problems you can’t work out in advance — particularly in live PA situations (where anything can happen and probably will) or final mix where you’re going for a particular overall sound.

EQ POINTS: Some of you may have probably noticed that the CR-1604 does not have its EQ points in the usual (Yawn) “standard” frequency locations.

Why? You may ask.

Well, the story goes that sometime in the Sixties, “Zoltan” (Bureaucratic High Moron from the Drumless planet of Vocal Frustration) descended upon the mixing board designers in Countries to the East and proclaimed the proper EQ points for mixers:

“10kHz for HF and 100Hz for LF”

We can’t figure out why. 100Hz is too high and 10kHz is too low. They might be holdovers from really ancient mixing boards or radio equipment back in the days when recording bandwidth was a lot narrower. It’s irrational and not founded on any particular acoustic or musical principle...but then, Zoltan never visited us.

Being musicians ourselves (and having cursed Zoltanesque EQ in other boards for years), we decided to start from scratch and determine the points which sounded best from a musical standpoint. It goes without saying that Zoltan was not pleased with the Rebels From The Rainforest.

But we trust that you will be.

4 SOLO

This control does just what its name implies. By pushing the SOLO button, you can listen in on only that channel while muting the rest of the mixer's output.

In order to make this function *really* useful, we have designed the CR-1604's SOLO section to allow for multiple inputs to be soloed together while retaining the original stereo placement of each channel in the mix. This feature is not often found outside of large mixing consoles, even though it adds significant application potential to the solo function.

- The effect of this button follows the setting of the SOLO TO MAIN button (i.e. if SOLO TO MAIN is pressed IN, the main and headphone outputs are replaced with the soloed signals. If it's left in the OUT position, only the headphones will get the soloed signals).

IMPORTANT: The master level of the SOLO signal is controlled by the HEADPHONE/SOLO fader, not the master faders.



WHAT CONSTANT POWER PAN POTS MEAN TO YOU

When you sit between a pair of monitors and pan from side to side, the apparent loudness at your ears should stay the same no matter where the source is positioned.

The CR-1604's constant power pan pots are so named because they incorporate special circuitry that maintains consistent acoustic power while panning center to side.

When the input module is set to the center detent, what you will hear is equal amounts of both left and right outputs.

When the module is panned away from center, you will begin to hear only one side. The side that you are panning into must therefore grow louder to make up for the loss of the other side. The effect is a more realistic shift in dimensional perception (*Ooooo... sounds pretty cosmic, doesn't it?*)

Here is an example of how stereo sound behaves in real life, why you would want to duplicate the same effect in your productions and how constant power pan pots help:

Imagine that a sax player was standing in front of you playing his horn. You get the same amount of sound at both ears and your ear-brain processing center sez, "This cat is right in front of me." Now the sax player moves to the left. More sound arrives at your left ear and your brain sez, "He's over on the left." But the total amount of sound arriving at your ears is still the same.

Constant power pan pots do the same thing. They move the sound, but don't reduce the overall amount of sound. Other small mixers don't have this feature. But like many other of the CR-1604's nifty-features, we wanted the mixer to perform to the demanding standards of higher priced gear, so that it could be used for professional recording, broadcasting, and film sound where the need for true panning integrity is often an unavoidable reality. And low and behold, the CR-1604 IS being used extensively by Hollywood pros for TV and film sound tracks. End of commercial.

- While a channel is in SOLO mode, its signal level is sent to the CR-1604 Level Meters in the Master Output section so you can observe its working level. This allows level setting for each individual channel using just one meter pair.
- The SOLO indicator LED will also blink to remind you that you are in the solo mode. We designed it to be so obnoxiously bright that you can get a suntan from it if you get too close for too long. If you've ever used a board with a tiny, obscure SOLO light, you know why we made ours large and rude.

5 MUTE-ALT 3/4 (3rd & 4th buses)

Think of this as a "mute button PLUS."

First, it works in the conventional way: push MUTE and that channel goes away, just like you'd expect. But, we reasoned, why send the channel's output into the ozone when it could go someplace *useful*? Such as another set of output buses.

So when you press MUTE, the signal is *reassigned to the ALT 3/LEFT and 4/RIGHT stereo outputs.*



NOTE: There is no master level control for the ALT-3/4 buses. With the channel set at Unity, the signal will come out at

Unity gain just as if you had a master fader at the center detent position.

There are lot of possibilities via the ALT 3/4 buses with the channel fader set at Unity. Especially combined with the ALT PREVIEW button over in the CR-1604's Master Output section. For example, you can create two stereo pairs for output to 4-track. Or bounce multiple tracks onto one or two more tracks. Or preview a sound source that hasn't been introduced into the mix yet.

One of the most common applications for ALT 3/4 is for creating submixes from various combinations of channels. By panning one set of channels hard left and another hard right, you can create two submixes (one from the LEFT ALT and one from the RIGHT ALT output) that can be routed back into spare channels on the board, or AUX returns. (See page 16 for more details.)

6 OL

The OverLoad LED is a visual indicator that warns you when you're overdriving the channel. Because it monitors multiple points in the channel's circuitry, it detects more than just input overload.

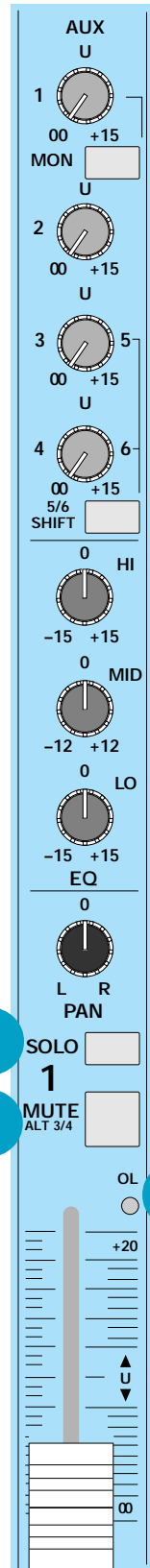

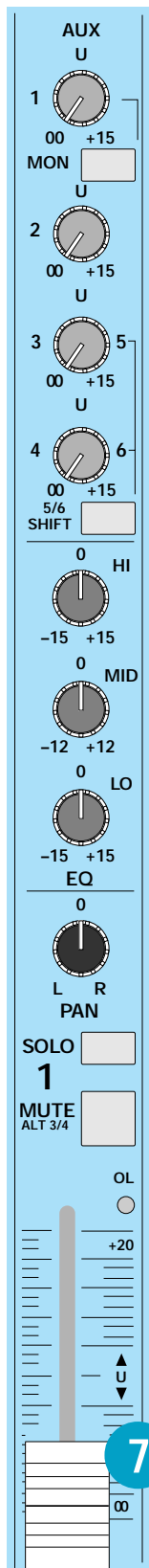

Basically, the OL lights should never blink. If they do, you're courting the potential of audible distortion.

- If you adjust the channel's input SENSITIVITY too high and compensate by pulling the faders down, the OL light will still flash — even though you're seeing conservative levels on the meters.
- If you set SENSITIVITY properly but add a LOT of EQ while mixing, you might also trigger the OL indicator. In this case, lowering the channel's SENSITIVITY trim pot will keep from over driving the EQ, which may be clipping.

7 CHANNEL FADER

Controls the overall output of the channel. All of the AUX SENDS with the exception of AUX 1/MON *in Monitor mode* are affected by this control (AUX 1/MON in Monitor mode is not affected because it is placed upstream of the Fader and EQ, remember?)

Most mixer channel faders are labeled with arbitrary and confusing ranges of digits (such as 1 thru 10) that don't correspond to anything. This often leads to mis-adjustment, as well as distortion, noise or all of the above.

On the CR-1604, proper gain settings are facilitated by the click-detent Unity Setting half way up the slider. When the channel's input control has been adjusted properly, Unity represents NO LOSS OR GAIN when panned left or right.

This means you have a known setting which is easily repeatable, even in the dark. Because levels can be set properly from this reference point, you can achieve very high headroom and low noise at the same time.

And, unlike any other mixer, you have 20dB MORE gain *above* Unity.

Part 2 — THE MAIN OUTPUT SECTION

Now that you have become more familiar with the CR-1604's channel strips, let's move our guided tour on to the Master control center.

We will start at the top of the section with the Stereo Aux Returns.

8 STEREO AUX RETURNS LEVEL

Located at the upper left of the Master Section, these four controls set the overall level for signals received via the four stereo Aux Returns from whatever effects you've connected from the Aux Sends.

As with the sends, these controls are designed to handle a very wide range of signal levels (which is a good thing considering the wildly varying output levels of many outboard signal processors). Remember how the gain was divided on the Aux Send controls? The same approach is used on these controls. The first half of the knob's rotation operates from off to Unity Gain (0dB) center position. The second half of the rotation provides gain from 0dB up to 20dB gain which can be very useful for bringing the level of some low output effects up to professional operating levels.

9 AUX RETURN BALANCE

The four Aux Return Balance controls are used to control the left/right balance of each return's signal (just like on your stereo) within the main mix.

10 AUX RETURN MONO

These four buttons are used to combine left and right Stereo Aux Return signals into a monaural signal, which is then sent on in equal proportions to the left and right Master Mix Buses.

NOTE: If all four Stereo Aux Returns are set to mono, a total of 8 separate mono feeds can be routed to the main mix.

If you are connecting an effects device which only has a mono out, pressing the AUX RETURN MONO button will route the effect to both the Left and Right main buses.

11 AUX RETURN SOLO

This button is used to solo the four Aux Returns for more detailed scrutiny. This function is the same as that of the Solo control on the individual channel strips, except that it solos all four AUX returns at the same time.

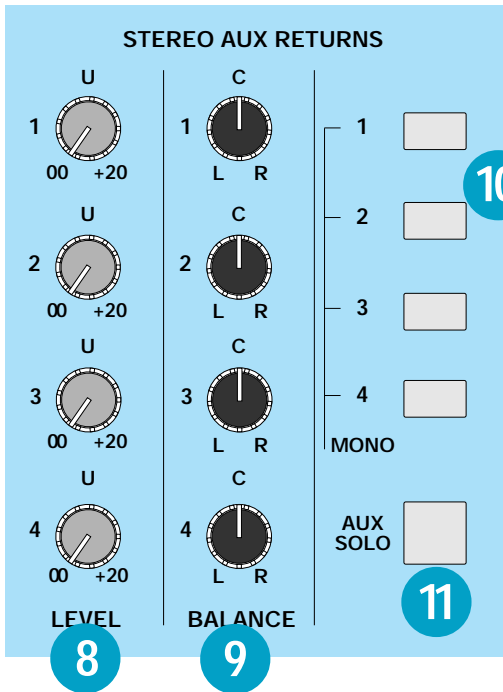

- The effect of this button follows the setting of the SOLO TO MAIN button (i.e. if SOLO TO MAIN is pressed IN, the phones *and the main output* are replaced with the Aux Return signals. If it's left in the OUT position, only the headphones will get the soloed Aux Return signals).

12 ALT PREVIEW

This button allows all channels assigned to the ALT 3/4 to be monitored through the headphone output.



This can come in very handy when you need to hear a cue from one of the tracks that is currently assigned to the ALT 3/4 Bus (Muted). All the inputs that are currently assigned to the ALT 3/4 output can be heard through your headphones when the ALT PREVIEW button is depressed.

You can also use this feature to monitor a second mix if you have decided to hook up a second tape deck to the ALT 3/4 outputs.

13 MAIN OUTPUT MUTE

This button mutes the main stereo and mono outputs of the CR-1604. All other outputs are blissfully unaffected.

- A useful application for this control is to help reduce perceived noise from your multitrack tape machine and musical instruments prior to the start of the song. Mute the mixer while monitoring the count

down or click track in your headphones, and then just before the down beat, UNmute the CR-1604.

- For live performance intermissions, use the MAIN OUTPUT MUTE to kill hum and noise from the room and prevent drunken head bangers from mounting the stage and screaming the name of a rival band.
- When recording at home and the telephone rings, hit the MAIN mute instead of pulling down your main faders. Now you can monitor that quality near field loudspeaker in your answering machine and decide whether or not to SOLO the caller.

14 SOLO TO MAIN

This switch determines what happens when you press channel or Aux Return SOLO buttons.

- IN — The CR-1604's Main output is interrupted whenever a Solo button is activated.
- OUT — Only the Headphone output is interrupted during solo monitoring. This is great for live work so that the sound person can solo into his phones without affecting the main mix. Sorry, but this button is not effective against poorly played or excessively lengthy guitar solos. If the problem persists, consult a physician or perhaps try the MUTE-ALT 3/4 on the offending player's channel.
- In the studio, SOLO TO MAIN can allow you to listen to your solo channels through the same speakers that you use for the mixdown if you are using the Main Outputs for your control room monitoring.

15 HEADPHONE JACK

The stereo PHONE jack will drive any standard headphones. Walk-Person-type mini phones can also be used with an appropriate adaptor.



WARNING:

When we say the headphone amp is loud, we're not kidding. Even intermediate levels may be unpleasantly loud with some headphones. *Be careful*, please!

INPUT
OUTPUT
POD



INPUT OUTPUT POD

Always turn the SOLO/PHONES LEVEL control down before you put the phone on. Then advance it for best levels with a typical sound source. Engineers who fry their ears find themselves with short careers.

You can also use the PHONES output to independently drive a separate tape recorder, PA system or studio monitor amp. Instead of using a low-cost “headphone amp” chip, we use a high-current version of our main output amplifier circuitry — which is why it can really clean out your cochlea if you crank it up too far. But that’s also what makes it a *very clean* signal source that’s, in fact, *identical* to the quality of the other outputs (see APPLICATIONS GUIDE for various hookups which use the PHONES output).

NOTE: When you press any SOLO button, a slight click will be heard in the headphones when a solo switch is activated.

16 SOLO/PHONES LEVEL

This control adjusts the Solo and Headphone levels simultaneously. The control range is from off to loud enough to cause a frontal lobotomy

(see warning on the previous page). Because SOLO/PHONES LEVEL is completely independent of the Master Faders, you can use it to preview your mix before fading up the main outputs.

CAUTION: To avoid speaker damage, this control should never be set higher than the Main Output (1/LEFT 2/RIGHT) level prior to activating the SOLO TO MAIN button.

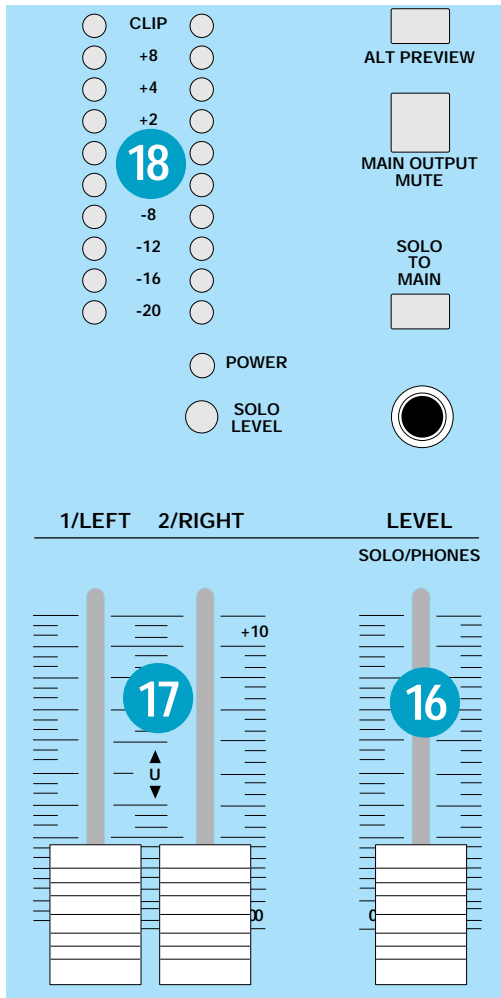

17 1/LEFT 2/RIGHT (MAIN OUTPUT LEVEL FADERS)



This gallant team stands guard over your precious main output level. They prefer to be stationed below or at the “U” (Unity) setting.

The outputs on the other end are capable of delivering up to +28dBm. Many amplifiers or other equipment inputs will go into clipping before that. Consult the specs on your amplifier/device. You may have to keep the CR-1604’s Main and Phone faders *below* the Unity gain level.

18 LEVEL

This 10-segment meter reflects the “unbalanced” output signal strength at the left and right main outputs.

- When the meter shows “0”, the unbalanced output level is 0dBu (0.775 VAC RMS).
- Remember that “balanced” output levels are 6dB hotter than the level indicated on the bar graph meter.

L BNC LAMP CONNECTOR

The CR-1604 includes a socket and power supply for a 12-volt goose-neck lamp. We recommend LittleLite lamps PN #12G or 12G-HI (with high-intensity bulb). Consult your dealer for the gory details.

NOTE: When the CR-1604 has been “Rotopodded” (pod jack to the front) the BNC lamp connector becomes inaccessible.

This concludes our guided tour of the CR-1604’s controls. After a short intermission, we will re-board the bus (*HA! Get it? Pun? bus.....? Oh well.*) and explore the CR-1604’s input/output “pod.”

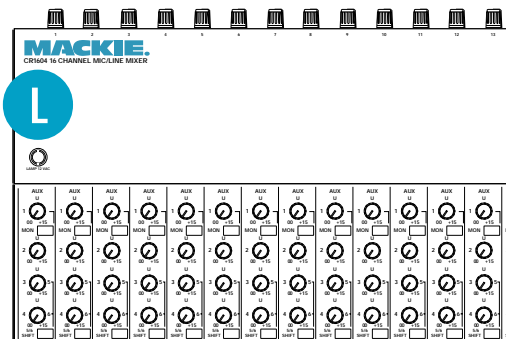

Part 3 — INPUT/OUTPUT POD

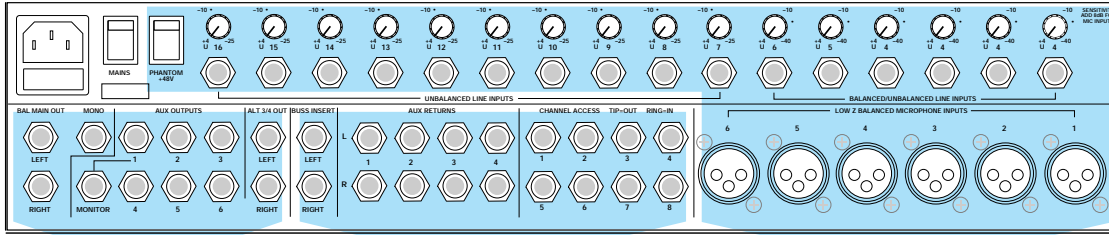

INPUT
OUTPUT
POD

OUTPUTS/SENDS RETURNS/INSERTS INPUTS

19 INPUT SENSITIVITY CONTROLS

The first set of items on our tour are the sensitivity controls for the 16 input channels. These knobs adjust the input sensitivity of the mic and line inputs so signals from the outside world are brought into the mixer at optimum internal operating levels. INPUT SENSITIVITY controls for channels 1–6 have up to 40dB of gain for line inputs and 50dB for XLR inputs; controls for channels 7–16 have 25dB of gain. Note that all SENSITIVITY controls are marked with a –10 setting. This is the amount of gain needed to raise –10dBv operating level equipment up to professional +4dB levels.

- When using microphone XLR input jacks, you will get 10dB more gain than what the SENSITIVITY trim marking indicates.

21 PHANTOM POWER SWITCH

What is Phantom Power? No, it's not the arch enemy of Captain America or anything like that. Most modern professional condenser mics are equipped for *Phantom Power*; which lets the mixer send DC power to the mic's electronics over the same wires that carry audio (hence "phantom" since the DC voltage is "unseen" by dynamic and ribbon mics which don't need external power and are unaffected by it anyway).

21

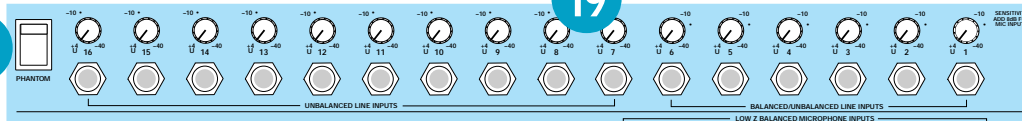

20 MICROPHONE INPUTS (Channels 1–6)

We use true *phantom-powered, balanced inputs* just like the big, studio mega-consoles for the same reason they do: This kind of circuit is excellent at rejecting hum and noise. You can plug in any kind of professional microphone that has a standard "XLR-type male" mic connector; an impedance of between 50 ohms and 600 ohms.

If you wire your own male XLR's, connect them like this:

- Pin 2 = Positive (+ or hot)**
- Pin 3 = Negative (– or cold)**
- Pin 1 = Shield (ground)**

Basically, Inputs 1–6 will handle any kind of mic level you can toss at them. Professional ribbon, dynamic and condenser mics will all sound excellent through these inputs — especially if you follow the Level Setting instructions on page 19. Lower-cost electret-type, unbalanced mics should be plugged into Inputs 7–16 but will require additional gain and thus not be as quiet.

20

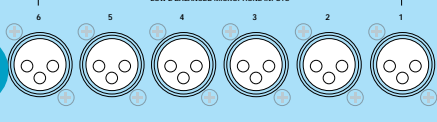

NEED MORE THAN SIX MIC INPUTS?



We have determined that six mic inputs takes care of most users' needs. But if you're miking a complex drum kit, lots of vocalists or a complete musical (our mixers have been used in several hit Broadway shows, by the way), you can add the XL10 Mic Input Expander. It adds 10 more high quality discrete, balanced preamplifiers just like the ones on the CR-1604's Channels 1–6. The unit installs in minutes and forms an integral, structural part of the mixer (in pod-to-back or tabletop configuration, it doesn't take up any more rack space either). Plus, you can still use the line inputs on the CR-1604's Channel's 7–16! Such a deal. Ask your Mackie dealer for more details.



- DC Power is applied to Pins 2 and 3. Maximum current is 10mA per microphone.
- When turned off, the phantom power circuitry takes a moment for voltage to bleed to zero. Do not attempt to adjust your set.
- There is only one “freak” way to damage a ribbon mic with phantom power. If the connector on the mic cable is worn, it may not make contact with both “hot” pins exactly at the same time when being plugged in. This could cause a momentary DC spike that could, in turn, damage or dislodge the ribbon. To avoid this remote possibility, always plug in ribbon mics *before* you turn the PHANTOM power switch on or off.

WARNING: If you’re connecting electret-type microphones, *plug them into Channel 7–16*. Avoid the temptation to use Channel 1–6 XLR sockets via 1/4"-to-XLR adaptors and then turn on the PHANTOM switch. If you do, the microphone will be toast. Also, *don’t* connect electronically balanced components such as CD players or the output of a tape deck to the XLR inputs. Use Channel 1–6 balanced 1/4" inputs instead.

22 BALANCED LINE INPUTS (Channels 1–6)

These six line inputs share circuitry (but not phantom power) with the six mic preamps, and can be driven by balanced and unbalanced devices. In other words, you can use these inputs for virtually any signal you’ll come across, from instrument levels to -10dBV to $+4\text{dBu}$, since there is 40dB of gain available.

- To connect these inputs to balanced sources, use a Tip-Ring-Sleeve (3-conductor) plug:
 - Tip** = Positive (+ or hot)
 - Ring** = Negative (– or cold)
 - Sleeve** = Shield (ground)
- To connect unbalanced sources to the balanced inputs, use a mono phone plug or standard instrument cable. The jack on the CR-1604 input will sense the plug and disable the balancing circuits.
- Line inputs 1–6 are a good place to connect instruments which have low output such as older keyboards. Or keyboards in general for that matter, since you can adjust the corresponding channel INPUT SENSITIVITY controls so the mixer has plenty of gain, but you can still keep the keyboard volume set around the halfway mark.

23 UNBALANCED INPUTS (Channels 7–16)

These inputs are designed for mono unbalanced signals from instrument level to -10dBV or $+4\text{dBu}$. They can be used with just about any pro or semipro instrument, effect or tape recorder.

24 MAINS

If you leave this switch in the OFF position, you won’t hear anything. You can leave the CR-1604’s MAINS power switch ON all the time since the mixer is conservatively designed so that heat buildup isn’t a problem, even in 24-hour-a-day operation. Or just plug everything into a good quality, grounded power strip for 1-button turn-on.

If you leave it on all the time, don’t worry about the top of the pod being warm to the touch. We use the pod chassis as a heatsink for the voltage regulators which in turn dissipates a very mild amount of heat constantly throughout the chassis. All is well.

25 AC RECEPTACLE

Look mom, no wall wart! Plug the AC power cord in here, and enjoy the convenience of the CR-1604’s built-in power supply. The other end goes to your power source. If some nasty

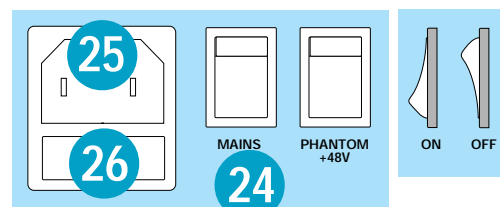

WHY NO WALL WART?

Building a power supply into the CR-1604 wasn’t any picnic. But we think that you’ll appreciate it for several reasons:

- The CR-1604 has separate regulated power supplies for the audio, meter, 12VAC lamp and microphone phantom circuits. That’s part of why it sounds so good. No wall wart can provide this kind of sophisticated power.
 - Wall warts and “line lumps” are inconvenient, generate huge hum fields, hog extra jacks on your power strip and get in the way when you move.
 - The thin cable coming out of a wall wart or in-line power supply breaks easily, especially on the road. Then you need a whole new one, possibly of some esoteric breed that’s only available from the manufacturer on alternate Thursdays via an unlisted phone number. If the rugged cord on the CR-1604 wears out, you can score one anywhere fast. Except maybe in the far reaches of the galaxy.

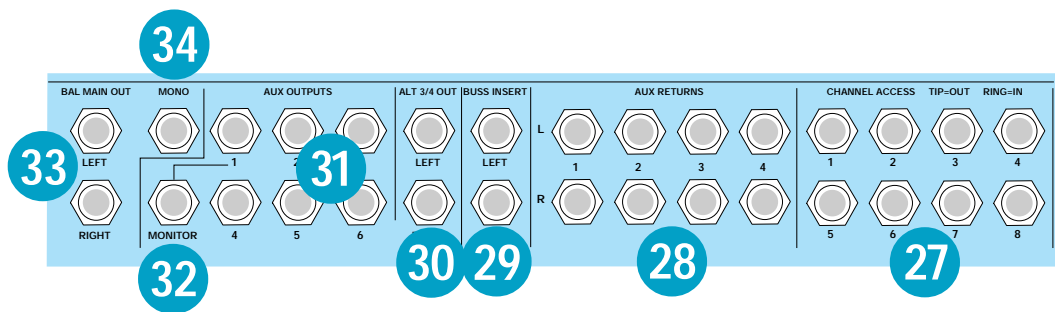

fate befalls the cord, you can use any standard IEC cord like those found on most professional recorders, musical instruments and computers (for example Radio Shack #278-1257 {6-ft.} or #278-1261 {12-ft.}). NOTE: Disconnecting the plug's ground pin can be dangerous. *Don't do it.*

26 FUSE

The CR-1604 is fused for your (and its own) protection. If you suspect a blown fuse, disconnect the power cord, pull the fuse drawer just below the AC receptacle and replace the fuse with a 1-amp SLO BLO fuse (or 1/2-amp SLO BLO fuse if the unit is a 230V model). 230V models have a bright red 230V sticker both on the shipping box and on the mixer itself. If two fuses in a row, something is very wrong. Call our toll-free number and find out what to do.

27 CHANNEL ACCESS, TIP=OUT, RING=IN

This is where you connect series processors such as compressors, equalizer, de-essers, or filters. Since most people don't have more than a few of these gadgets, we've included connections for just the first eight channels. If you want to use this kind of processing on Channels 9–16, simply plug into and out of the device before you plug into the CR-1604 channels. Connecting a processor here will affect only the associated channel.

- Tip=output (send to external device), Ring=input (return from external device)
- The insert points are after the mic preamps, channel faders and equalizers (Post-Fader/Post-EQ). This can be modified with a little technical knowledge found on pages 33–34.
- CHANNEL ACCESS outputs are low-impedance (120-ohm) and are capable of driving all processors (except Cuisinart food processors).
- For best results the device should be capable of at least +18dB input/output (any professional unit). Do not use "stomp box"-style devices. They simply can't keep up with the operating level needed to match CR-1604 performance.
- The CR-1604's CHANNEL ACCESS jacks are of a special design that gives more flexibility than regular jacks. What kind of plug you use and how far you plug it in varies the function of

CHANNEL ACCESS jacks For example, a mono plug inserted only to the first click does not interrupt the master (main outputs, headphone output, ALT-3/4 outputs). Plugged all the way in, it becomes a direct out and interrupts. This may seem weird at first, but it's the way. See page 16 for a picture describing the plug and inserts.

28 AUX RETURNS TO MASTER

This is where you connect the output of your effects devices or, in some cases, return the signal of a multitrack tape machine/mixdown deck.

Many mixers simply have a passive input circuit for AUX returns. We have active input gain circuitry which allows use of a wider range of external devices. The circuits will handle stereo or mono unbalanced signals at instrument level or -10dBV to +4dBu.

These eight inputs can be used for a variety of effects. (For more detailed information on functions and their relationships to practical application in the production of your music, see the *Applications Guide* in our *In Your Face* magazine.

29 BUS INSERT

These are the send and receive jacks for inserting an effect such as final compression, limiting or EQ into the Main Left/Right Buses. Inserting a processor here will affect your entire mix. See page 16 for a picture describing the plug and inserts.

The BUS INSERTS can also be used as an output with no interruption to signal.

NOTE: The BUS INSERTS are pre-main faders. If you are using them for output, make sure the connecting device has some way to adjust incoming level.

- Tip=output (send to external device), Ring=input (return from external device)
- The BUS INSERT is *before* the Master fader controls and *after* the main L/R mix amps.
- Inputs and outputs are unbalanced and designed to work with pro devices with at least 18dB of input/output.
- The BUS INSERT can also be used as a tape out if plugged in the first "click". Master adjustments will not affect level.

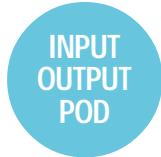

30 ALT 3/4 OUT

This is where the outputs appear from the channels that have been assigned via the MUTE/ALT switch. The post-EQ/post-fader/post-panpot/pre-aux send signals from all of the muted channels appear at these outputs. Output is low impedance unbalanced and is designed to drive *any* input from low to high impedance. Maximum output level is +22dBu with a nominal operating level of +4dBu.

NOTE: Engaging a channel's MUTE/ALT switch will deactivate its AUX sends. See the next section for several nifty ALT-3/4 OUT applications.

31 AUX OUTPUTS

These are low impedance unbalanced outputs for the signals sent from AUX sends 1 through 6 (post-fader/post-EQ). Output is low impedance and is designed to drive ANY input from low to high impedance. Maximum output level is +22dBu with a nominal operating level of +4dBu.

32 MONITOR OUT

This is a low impedance unbalanced output for the signals sent from the MON SEND (AUX1 pre fader/pre EQ). The output is designed to drive ANY input from low to high impedance. Maximum output level is +22dBu with a nominal operating level of +4dBu.

NEED MORE OF A GOOD THING?



You can create a 32 or 48-channel mixer with the Mackie Designs **MixerMixer** combiner. It connects all the outputs of up to three mixers without losing channels via "cascading." You can hook up two or three CR-1604s together, providing you with more of everything you love about our mixer as your budget and/or needs grow. The 1/LEFT and 2/RIGHT faders on each mixer become sub-mix faders. And we offer an optional 100mm **Remote Fader** to control the combined Main L/R outputs. Not satisfied with this stroke of flexibility, we've put together an ultra-affordable CordPack that includes all the cables necessary to interconnect three CR-1604s. This way, you won't go broke buying 36 mono and three stereo cables piecemeal, which could add up to almost as much as the MixerMixer itself.

33 BAL/UNBAL MAIN OUT – STEREO

These outputs are electronically balanced (since they have both polarities available and are capable of driving +4dBu lines with 28dB of headroom). They're also low impedance.

- For most music recording and PA applications, unbalanced outputs are perfectly acceptable. Use standard cables. For cables runs over 50 feet, you may need a balanced line to reject noise.
- Balanced output is 6dB hotter than the unbalanced outputs.
- To use these outputs in balanced applications, connect a stereo phone plug as follows:

Tip = - (cold)

Ring = + (hot)

Sleeve = Ground

This is NOT a typo!

Why is the tip cold and the ring hot?! Well if you *must* know there are quite a few manufacturers that use this polarity configuration. No, you cannot go inside the CR-1604 and merely flip the wires around; doing so would short out your meters and void your warranty. If you absolutely *must* change the polarity try internally modifying a TRS adaptor or use an external phase reverser.

34 MONO MAIN OUT

Same characteristics as the stereo MAIN OUTs except that the signal combines Right and Left Main Channels and the polarity is reversed (tip = hot, ring = cold).

ONE FINAL NOT-SO-OBVIOUS OUTPUT



The CR-1604's stereo PHONE jack. As you'll see from the **Applications Guide**, we recommend connecting your monitor power amp to this output in several cases.

Its output is HOT. First turn the PHONES fader all the way off. Then rotate the power amp's level controls to 12 o'clock. Now bring up the PHONES fader gently.

If in the past you've had to put up with conventional, grungy-sounding headphone amps, you may initially be reluctant to "trust" the CR-1604's headphone output. Not to worry. The sound quality is exactly the same as the main outputs and will not degrade your audio in any way.

Part 4 — CONNECTION TIPS

It's now time to begin hooking up all the cool stuff you want to mix together. At this point, you rack mounters may want to rotate the CR-1604's input/output pod to its jacks-to-back position. Pod rotation instructions start on page 20. If you want everything in yo' face, i.e. jacks on the same plane as the controls, get our RotoPod bracket (see details on page 20).

Instead of being included in this manual we have provided an incredibly detailed ***Applications Guide*** with much more detailed (and colorful) drawings than could be managed in a 2-color, letter-size manual. **NOTE: If you somehow lost the *Applications Guide* in the frenzied heat of unpacking your CR-1604, your Mackie dealer should have some extras stashed someplace. Or call 1-800-898-3211 and we'll send you a replacement, pronto.**

EFFECTS AND PROCESSORS

Most recording and PA setups use external signal processors to enhance the sound: reverb, delay, digital delay, equalizers and compressors are the most common, but perhaps you have a harmonizer or enhancer as well. All of these devices can be grouped into two categories — effects and processors, depending on what they do and how they're used.

EFFECTS (parallel processing)

These generate additional sounds that you add to the mix, usually by making two simultaneous mixes: one is of the unmodified dry signal that goes directly to the main outputs via the input channels; the other is an auxiliary mix that is sent to the effects device. The output of the effect is then mixed with the main output, usually through an AUX return. The most common effects are reverb and digital delay.

PROCESSORS (serial processing*)

These devices modify the signal and completely replace it with the processed version. Usually they are connected to only one microphone, instrument, or track at a time —

through a Channel Access or Stereo Bus insert or before/after the mixer. Processors include compressors, limiters, filters or *external* equalizers.

ODD DUCKS

Some newer, digital “Swiss Army Audio Knives” can be switched for compression, limiting and whatever else struck the whim of the product designer. Check their manuals for details. You'll probably want to connect them based on how you're using them in your mix.

CONNECTING AN EFFECT WITH STEREO OUTPUTS

Use two separate cables and plug into a LEFT/RIGHT pair of an AUX return. The corresponding stereo AUX RETURN Level knob will control both sides of the effect equally.

CONNECTING A MONO OUTPUT EFFECT

If you want a signal to return to just the right side, plug the effect output into just the RIGHT AUX RETURN.

SEPARATE MONO EFFECTS IN L & R

If you plug different mono effects into an AUX RETURN's left and right jacks and press the corresponding MONO button, you get up to eight mono returns.

CHANNEL INSERTS

To connect a processor using the CR-1604's CHANNEL ACCESS jacks, use tip-ring-sleeve plugs wired as shown. The “tip” plug goes to the processor INPUT; the “ring” plug goes to the processor's OUTPUT. If you're using these jacks as channel inserts, adjust the TRIM controls after you plug the processor in.

CHANNEL INSERTS AS DIRECT CHANNEL OUTS

You can also use the CHANNEL ACCESS jacks as direct outputs from the channels (post-fader/post EQ) to feed tape decks, DAT machines or other mixers. (See drawing on following page.)

HOOK
UP

* — as compared to CEREAL processing, wherein wheat, rice, oats, etc. are turned into strange, alien-colored breakfasts foods named after kiddie shows.

HOOK UP

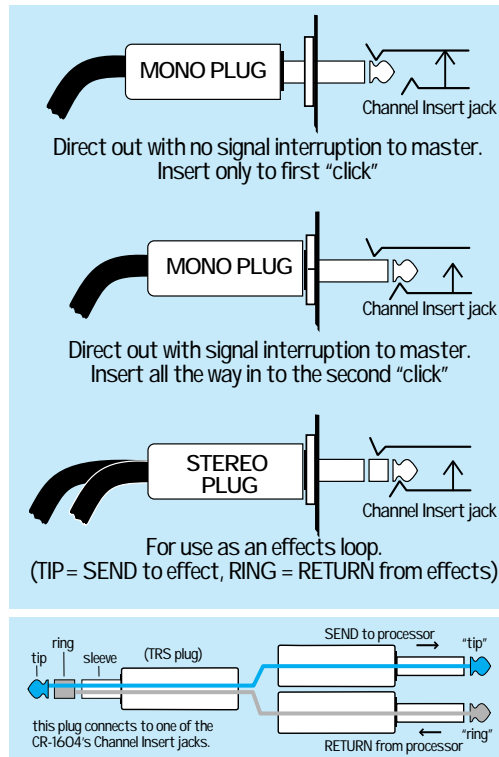

- **Direct out** with no signal interruption to mains. Push a MONO plug into a CHANNEL ACCESS jack until you feel it click once. In this configuration the channel access is acting as an independent direct out with no signal interruption to the master.
- **Direct out** with signal interruption to master: Push the plug all the way into the CHANNEL ACCESS jack. The signal will now be interrupted from the master and be available at the direct out only. Use this mode when connecting to the inputs of multi-track recorders.
- **Effects Loop.** A stereo plug wired as shown in the drawing above turns the CHANNEL ACCESS into a loop that will send and receive to and from an external device using the same channel access jack. Use this mode when connecting to the inputs of multi-track recorders.

CREATING SUB-MIXES USING THE ALT 3/4 OUT

Surprise! The CR-1604 really has FOUR buses, not just two! The following are working examples of how to effectively use the flexibility of the ALT 3/4 OUTPUT buses. In the first example, let's imagine that you want to create a separate drum sub-mix. This setup is used to control the level of all of the various channels that make up the drum

kit via two "sub master faders" (actually input channels 15 & 16 of the mixer). For purposes of this example, let's assume that you have already hooked up your drum mics or machine inputs to Channels 1 through 5.

EXAMPLE 1

1. Now press the MUTE ALT 3/4 buttons on these five input channels (They are no longer part of your main mix but are now destined for the sub-mix which in turn goes to the main mix.)
2. Next connect the rear panel ALT 3/4 outputs back into two other channels of the CR-1604, for example, Channels 15 and 16. These two channels become your sub-mix level controls.
3. Pan Channel 15 HARD LEFT and Channel 16 HARD RIGHT, respectively, so that the panning of Channels 1–5 will be reflected in your stereo sub-mix. DO NOT engage the mute/alt on these channels.
4. Adjust individual levels of the five drum channels that are part of the sub-mix by using their channel faders (1, 2, 3, 4, and 5).
5. Adjust the pan position of each drum channel with that channel's PAN pot.
6. Control the overall level of this drum sub-mix within the main mix via Channel Faders 15 and 16.
7. Add effects and EQ to the submix channels if desired.

EXAMPLE 2

You can also create sub-mixes without tying up additional CR-1604 channels.

1. As before, press the MUTE ALT 3/4 buttons on the five drum Channels (1–5). These channels are no longer part of your main mix.
2. Connect the CR-1604's ALT 3/4 Outputs to the LEFT and RIGHT jacks of an AUX return. In our diagram we've used AUX 1, LEFT. Stereo AUX RETURN 1 now controls the master drum sub-mix level.

In either of these two setups, you can instantly solo your sub-mix into your headphones (or monitor speakers if they are connected to the headphone output) by pressing the CR-1604's ALT/PREVIEW button or soloing the submaster channels.

SUBMIX HOOKUP EXAMPLE 1

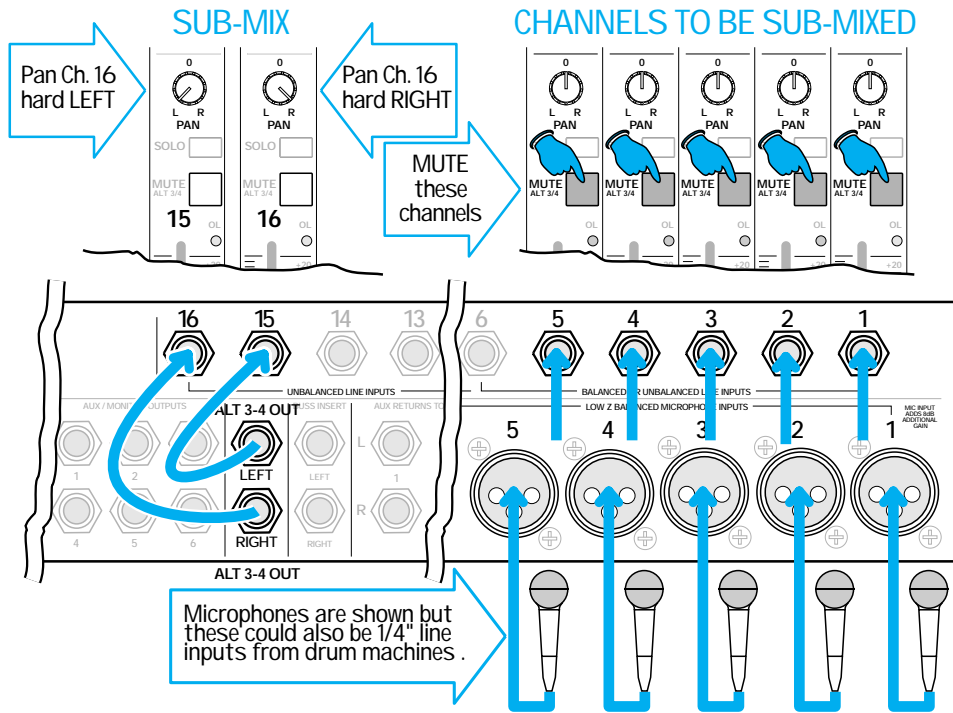

SUBMIX HOOKUP EXAMPLE 2

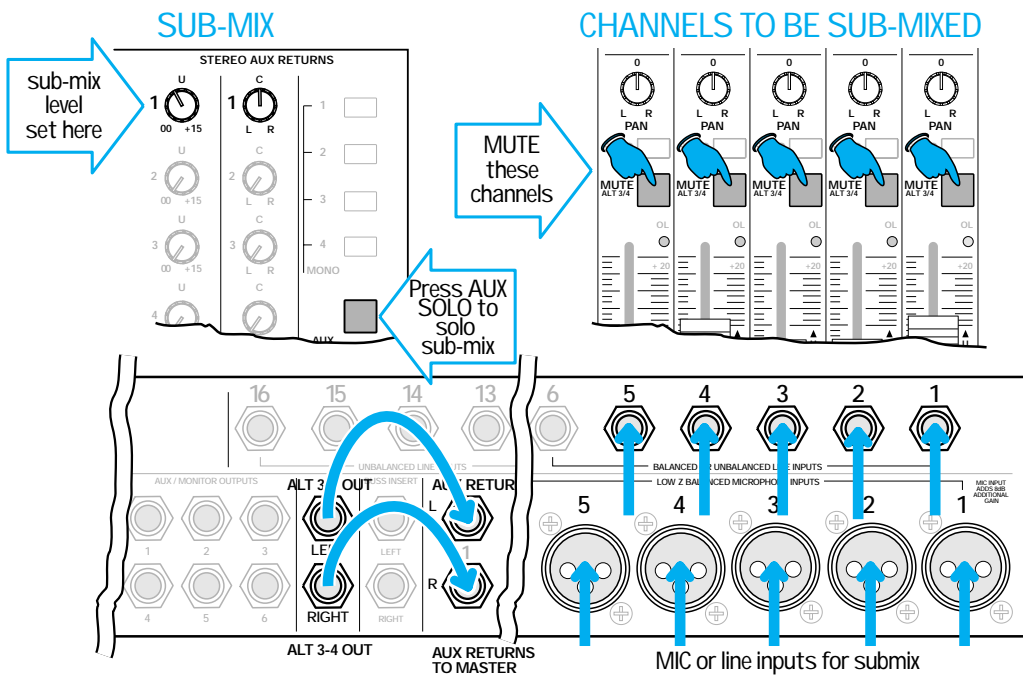

ASSORTED NUGGETS OF MONITORING WISDOM



CAN YOU TRUST YOUR EARS?

Even if you have perfect hearing, your ears will not always give you a true idea of what is being heard.

Especially if you like to really crank your monitors while mixing. As the session progresses, your ears will have a tendency to become accustomed and eventually numb to volume and EQ levels. We call this phenomenon *ear fatigue*. The longer your session, the more ear fatigue you'll encounter.

EXAMPLE : Have you ever spent an entire night working on a song trying to get the EQ and volume just right, only to find that when you listen to your results the next day you are horrified by the shrillness and lack of separation ?

This is a symptom of *ear fatigue*. By the end of the session, your ears had become accustomed to the EQ level...so you cranked in some more mid and highs. You also cranked the monitor amp level up every once in a while, so by the wee hours, things sounded distinct to you (after all, you *were* listening at a VERY high volume which tends to help definition...until you turn the level back down and discover mush at normal volume).

To avoid this, give your ears a break every hour or so they can recuperate. Also, it is a good idea to resist the temptation to start out mixing with a real high output level because this will speed up the process of ear fatigue.

Your mixer can become a victim of this vicious circle as well. Avoid inching up your levels in order to get better separation. Watch EQ levels, too. You may think you can get better results by adding a lot of EQ to a guitar or keyboard part to open up the mix. But eventually your CR-1604 can become overwhelmed by heavy-handed EQ and excessive output levels, creating what we call *mixer mush*.

Like we said, take a rest every once in a while. If things start getting out of hand in regards to the overall clarity of your mix, stop for awhile, go grab a soda or order in a pizza or both. What the heck. Big studios do it everyday !!

You'll find these rest times are a far better use of time than if you just bear down and twist some more knobs.

CAN YOU TRUST YOUR MONITORS?

Another common problem that many new engineers experience is the Big Studio Surprise . It happens when they take their tape to a larger studio with better monitors.

"Gee, the bass didn't sound that boomy at my studio"

"Where's the guitar solo?"

"The cymbals sound like garbage can lids !!"

If this has ever happened to you, don't feel bad.

You can't appreciate a color movie if all you have is a black and white TV. And just like having a good video monitor, the key to successful music production is an accurate idea of what your mix really sounds like.

In order to do this properly, several things must be present. The first and foremost is a quality set of control room monitors and a clean power amp with plenty of dynamic headroom.

These two components are indispensable if you are to achieve the album quality product that many of our professional users achieve with their CR-1604's (one recent album mixed on the CR-1604 was submitted for a Grammy nomination... in the classical category where they're sticklers for sound quality).

If your current monitors are an old set of POLY POOPALA liquid cooled monoliths that you bought off your roommate for a hundred bucks, and your amp is the stereo receiver you bought with your paper route money 15 years ago, you can be assured that whatever you create with your CR-1604 will most likely not sound right if played on any other system. Save cheap hi-fi speakers and wimpy 30-watt amps for your next garage sale.

Instead, spend the money on serious monitor speakers and a beefy amplifier.

Actually we recommend two or three sets of speakers: First, a good quality pair of *near field* monitors. This is a mandatory investment if you're serious. They're critical to accurate perception of what you're creating, since as you move close to true near field monitors, the room's acoustics no longer become as large a factor. You can then hear exactly what's happening. Next, get a pair of cheap mini-speakers. These simulate boom boxes, car radios, etc. Finally, if you're not out of room and money yet, get a pair of larger speakers with 10 or 12-inch woofers. They can be pro-style studio monitors or just quality stereo speakers with good bass response. This pair gives you the other end of the consumer spectrum and helps with adjust bass response to fit your potential audience's hi-fi systems.

"DO I HAVE TO?" Like we said at the beginning of this manual, it's your music. Good monitors and power amps don't have to cost a fortune.

DON'T DEVELOP TUNNEL HEARING

Even if you have ultra-accurate monitor speakers, remember, not everyone else does. Experiment with different systems to really hear what your music sounds like. Take your rough mixes to your friends house and play it on his stereo or pop a cassette of your mix into your car stereo. This will give you a wider feel for what your studio monitor system is really telling you. This is exactly why there are always at least two sets of monitors in big recording studios.

HOOK
UP

CARE AND FEEDING OF YOUR CR-1604

- If you're going to use the CR-1604 in a horizontal position (the mixer, not YOU!), cover it when not in use to prevent dust for settling in the faders.
- To clean grunge out of the channel faders, use "canned air" which is available at photo shops. It comes in compact spray cans.
- Just shove the nozzle into the fader slot and blast away. Do not use any solvents.
- To clean fingerprints, diet Pepsi and peanut butter off the surface of the mixer, spray Windex or other ammonia-based window cleaner on a rag and rub at will. Do not spray cleaner directly on the mixer lest it get into the faders.

SENSITIVITY/LEVEL ADJUSTMENT —

The long version



As we noted at the beginning of this manual achieving the CR-1604's impressive noise and headroom specs, requires adjusting channel sensitivity to your particular setup.

Can you run the mixer without this adjustment?

Sure. Chances are that you'll get pretty good sound. But take a moment to adjust things properly and you'll get excellent sound. After all, it's *your* music.

SENSITIVITY ADJUSTMENT STEPS (repeat for each channel being used)

1. If you have some idea of how the channel is going to be EQed, set it now. If not, it's no biggie. EQ will affect levels somewhat, but not enough to totally knock things out of whack.
 2. Rotate the channel's PAN control hard RIGHT or hard LEFT. Leaving PAN in the center position will reduce level indications by 6dB.
 3. Set the channel's Fader to the detent Unity position.
 4. Turn the channel's SENSITIVITY control fully counter clockwise (+4 UNITY). That's the small knob just above the channel line input on the CR-1604's input/output pod.
 5. Press the SOLO TO MAIN button on the CR-1604's output section. (Optional.)
 6. Press the SOLO button on the channel you're about to adjust. The level will appear on the CR-1604's LED output meters.
 7. Make some appropriate music through that channel. Don't just play one sustained note, but rather jam away as you would normally. If you're adjusting the level for a channel connected to a microphone, have the performer(s) sing/blow/strike/play at the level they're going to record or perform at.
 8. If you've set PAN hard left, view the level on the left LED row. If panned hard right, the level will appear on the right LED row.
 9. While the sound source is activated, turn the channel's SENSITIVITY control clockwise until the level on the CR-1604 meter reads about 0dB.
 10. Un-SOLO the channel and return the PAN control to center or however you're going to set it during use.
 11. **Repeat** this procedure for each channel, using the appropriate kind of source which will be used with that particular channel.
- When in actual use, avoid running the level into the CLIP range of the meter, as your sound quality may suffer. It's OK for the +2, +4, and +8 indicators to light up occasionally but only during peaks in the signal such as drum hits, or when the bass player accidentally gooses one of the backup singers with the neck of his Steinberger, etc.
 - Note that you must add 10dB to the markings on the SENSITIVITY control when using the and mic inputs.
 - Once you have performed this simple calibration, there should seldom be a need to readjust your input sensitivity unless a different kind of input is being used with that channel.
 - Adjusting the channel this way (with 0dB as maximum) is a conservative approach that assumes things could get louder later on. The sensitivity can be set just a tad higher, if you watch levels carefully during use.

LEVEL
SETTING
STEPS

CHANGING THE POD TO RACK MOUNT POSITION

It only takes about five minutes and a Phillips-head screwdriver to change the CR-1604's input/output pod from tabletop to jacks-to-back position.

1. Remove all cords and cables from the mixer, including a lamp if you've plugged one in.
2. Place the mixer gently face down on a clean, soft surface such as a blanket or very large dog.
3. Remove the four #6 screws securing the small slotted black plate on the bottom of the main part of the mixer. Keep track of which screws go where.
4. Remove the two #8 screws on each side of the mixer which secure the pod. Gently pull the pod away from the main chassis.
5. Lift the pod over the main part of the mixer. Replace the slotted plate but install it turned around 180° with the ribbon cables in the slot.
6. Lower the pod back onto the slots.
7. Reinstall two #8 screws on each side to secure the pod. DO NOT press hard while inserting these screws.
8. Install the rack "ears" on the sides of the mixer. DO NOT press hard while inserting these screws.

The BNC lamp socket is no longer accessible in this position.

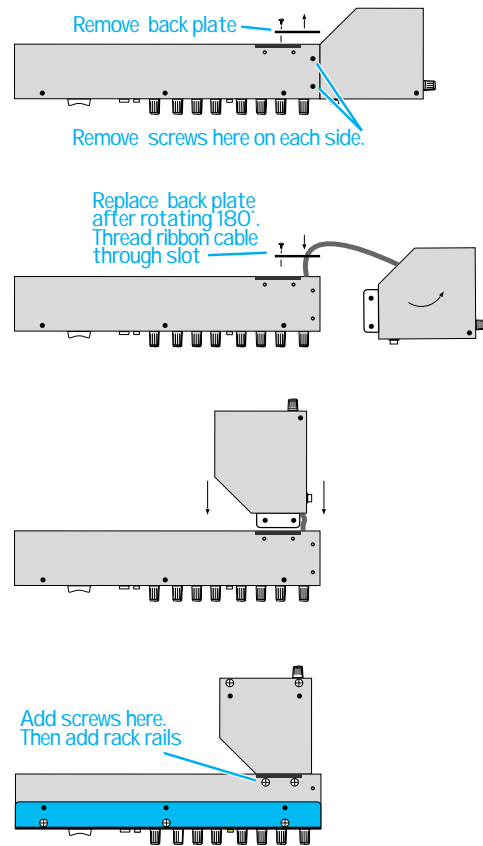

CHANGING THE POD

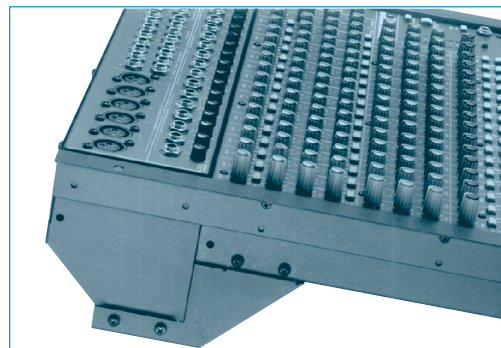

JACKS TO TOP?

You can also rotate the pod so that the inputs and outputs are on the same plane as the main CR-1604 controls. This requires our handy dandy **RotoPod** bracket. It comes with its own set of extended rack rails so that the mixer can be rack mounted in this configuration. Consult your dealer for exciting details.

WARRANTY SERVICE

The complete fine print of our Warranty is attached to the warranty card that came with your mixer. If you can't find it, call us and we'll send you another one.

Also make sure to save your sales receipt. It's useful in establishing when you bought the mixer and for insurance purposes if someone happens to borrow your entire studio while you were on vacation in Mazatlan.

TROUBLESHOOTING

We haven't included a gigantic troubleshooting chart with circles and arrows and captions on the back because our Service Department and support persons are here to handle that sort of thing. Still, there are some simple tests you can make before you call to determine if your CR-1604 is really the culprit. This saves time all around and prevents you from feeling sheepish when it turns out that it's really your Blort-Tronics Sonic Defrabulator that's creating the problem, and not our mixer.

Bad channel

Is the channel un-muted? Fader up? (Honest, this happens.)

Unplug all Bus Insert and Channel Access hookups.

Switch output cords. For example, if the left output is dead, switch the left and right output cords at the mixer. If the problem moves to the right, it's not the mixer.

Bad output

Is the output un-muted? Faders up?

Unplug all Bus Insert and Channel Access hookups.

Switch output cords. For example, if the left output is dead, switch the left and right output cords at the mixer. If the problem moves to the right, it's not the mixer.

Noise

Turn all faders and AUX returns down. If the noise goes away, bring levels back up one at a time, checking for noise at each step.

Unplug everything except the output where the noise was detected. If the noise goes away, plug everything back in one at a time, checking for noise at each connection.

Power

Check the CR-1604 fuse (see page 12).

REPAIR

Service for the CR-1604 is only available from the Mackie Designs factory in scenic Woodinville, Washington.

If there is a problem with your mixer:

1. Review the troubleshooting suggestions at left.
2. Call us to confirm that the CR-1604 needs repair and to get an RA number. **You must have a Return Authorization Number (RA)**. Call us at 1-800-258-6883, 8 AM to 5 PM Pacific time, Monday through Friday to get this number. **Products shipped to us without an RA number will be refused.**
3. If you have rotated the pod, **return it to its original position** (jacks pointing towards the back). If you've added a RotoPod, remove it and **return the pod to original position**. If you've added an XLR10, remove it.
4. Set aside the rack ears, manual and cord. We won't need these to repair the mixer (unless you have interharmonic underslewing bipolar crosstalk in your rack ears, a rare but particularly nasty problem...)
5. Pack the mixer in its original shipping carton with the foam end caps in place. This is VERY IMPORTANT. If you do not have the carton, just ask for one when you get your RA number and we'll ship it to you promptly.

TECH
STUFF

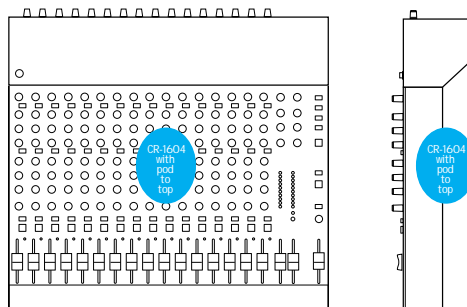

Be sure to return the CR-1604 in its original "desktop" mode and remove the rack ears!

6. Include a note stating:
 - a. Your return address and phone number
 - b. A brief description of the CR-1604's problem
7. Write the RA number in BIG PRINT on the outside of the shipping carton.
8. Send us the mixer. We recommend U.P.S. Remember to insure the mixer. U.P.S. will help you with this. Ship your CR-1604 to:

**Mackie Designs, attn: Service
16220 Wood-Red Rd. NE
Woodinville, WA 98072, U.S.A.**

9. We'll try to fix the mixer within three business days. We send everything back prepaid U.P.S. BLUE (Second Day Air) unless you have sent your CR-1604 to us for warranty service by NEXT DAY or SECOND DAY AIR. In that case, we figure you need it fixed ASAP, so we put it at the head of the line and ship the unit back U.P.S. RED (Next Day Air). This policy doesn't not apply to non-warranty service.

SPECIFICATIONS

Frequency Response:
20Hz–40kHz \pm 1dB

Distortion:
less than 0.025%, 20Hz–20kHz

Noise:
Mic E.I.N.
–129.0dBm, 150 Ω source
–133.7dBV input shorted
Main output noise: –86dBu
Working S/N ratio: 90dBu
(ref: +4dBu)

Max. Output:
+28dBu main output balanced
+22dBu all other outputs unbalanced

Dynamic Range:
108dB

Max Gain
Mic: 48dB
Lines 1–6: 40dB
Lines 7–16: 25dB
Mic in to balanced line out: 84dB
Mic in to unbalanced line out: 78dB
Channel faders : 20dB
AUX return: 20dB
L/R master: 10dB

Channel-to-Channel Crosstalk:
–85dB

Headphone Impedance/Output:
20–2000 ohms/200mW.

Equalization:
Hi: Shelving, \pm 15dB @12kHz
Mid: Peaking, \pm 12dB @2.5kHz (3.3 octave)
Lo: Shelving, \pm 15dB @80Hz

Phantom:
160mA, 10mA/CH.

Power Supply:
35 Watts

Weight:
18 lbs.

TECH
STUFF

CR-1604 DIMENSIONS

(including XLR10 & MixerMixer add-ons, RotoPod bracket)

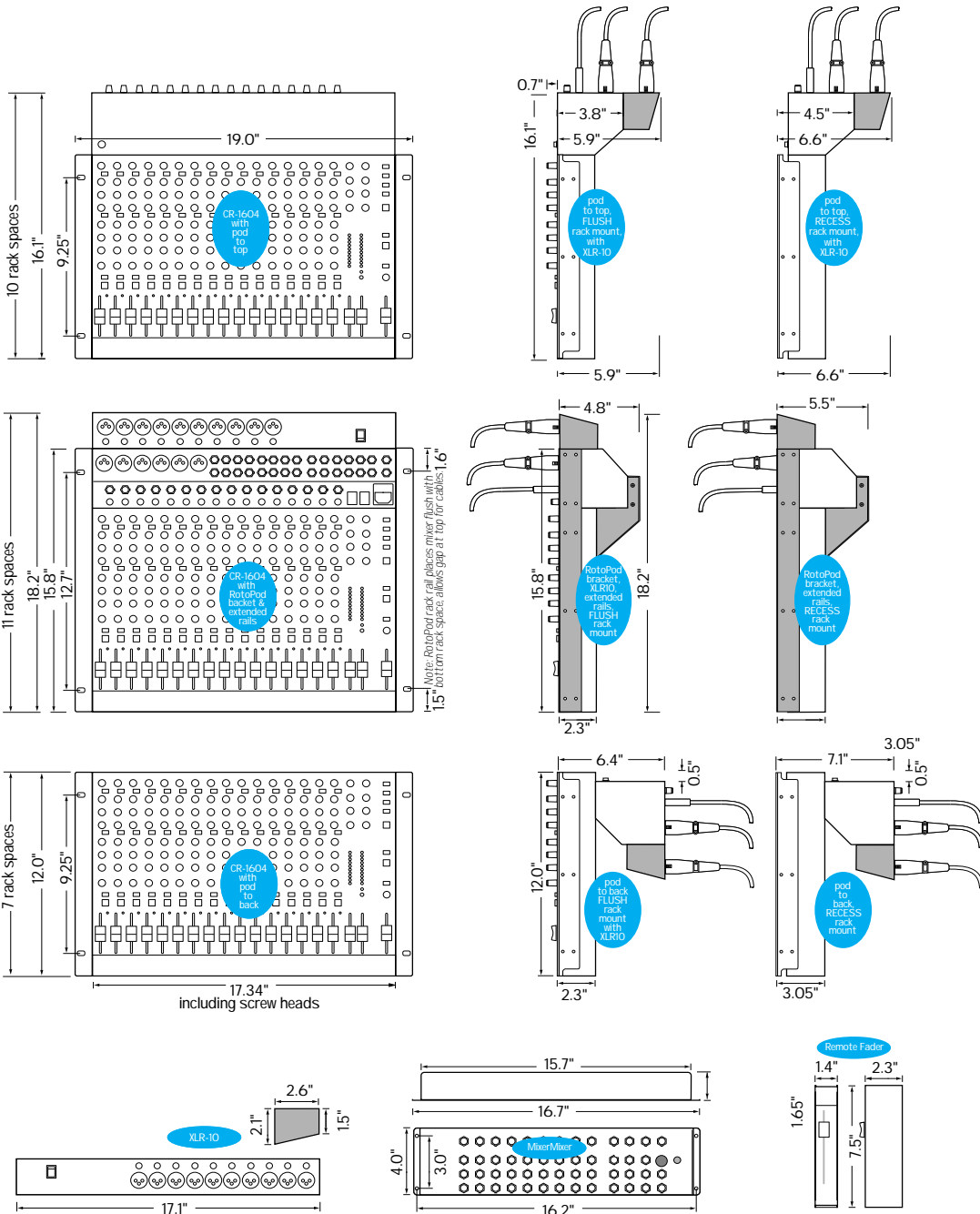

Note: Dimensional drawings are shown with optional XLR10 and RotoPod.

CR-1604 BLOCK DIAGRAM

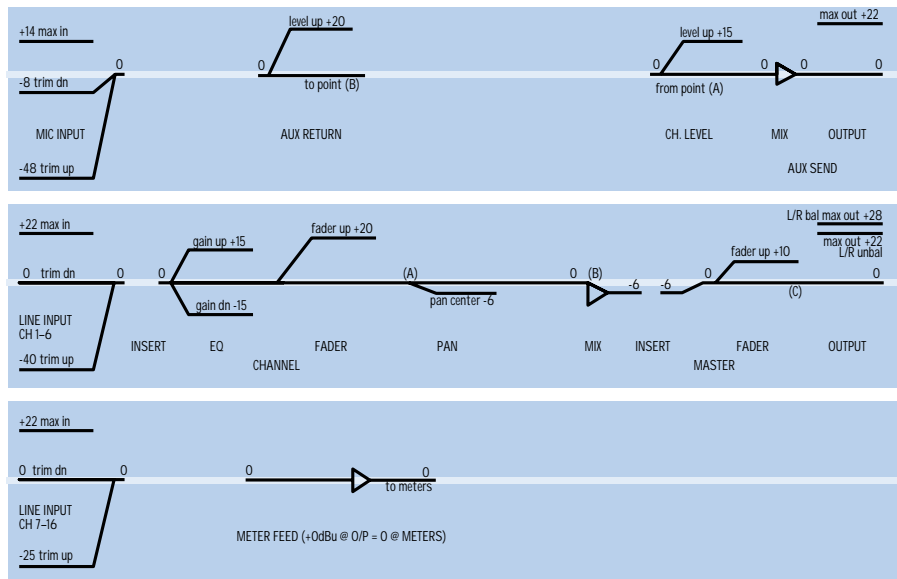
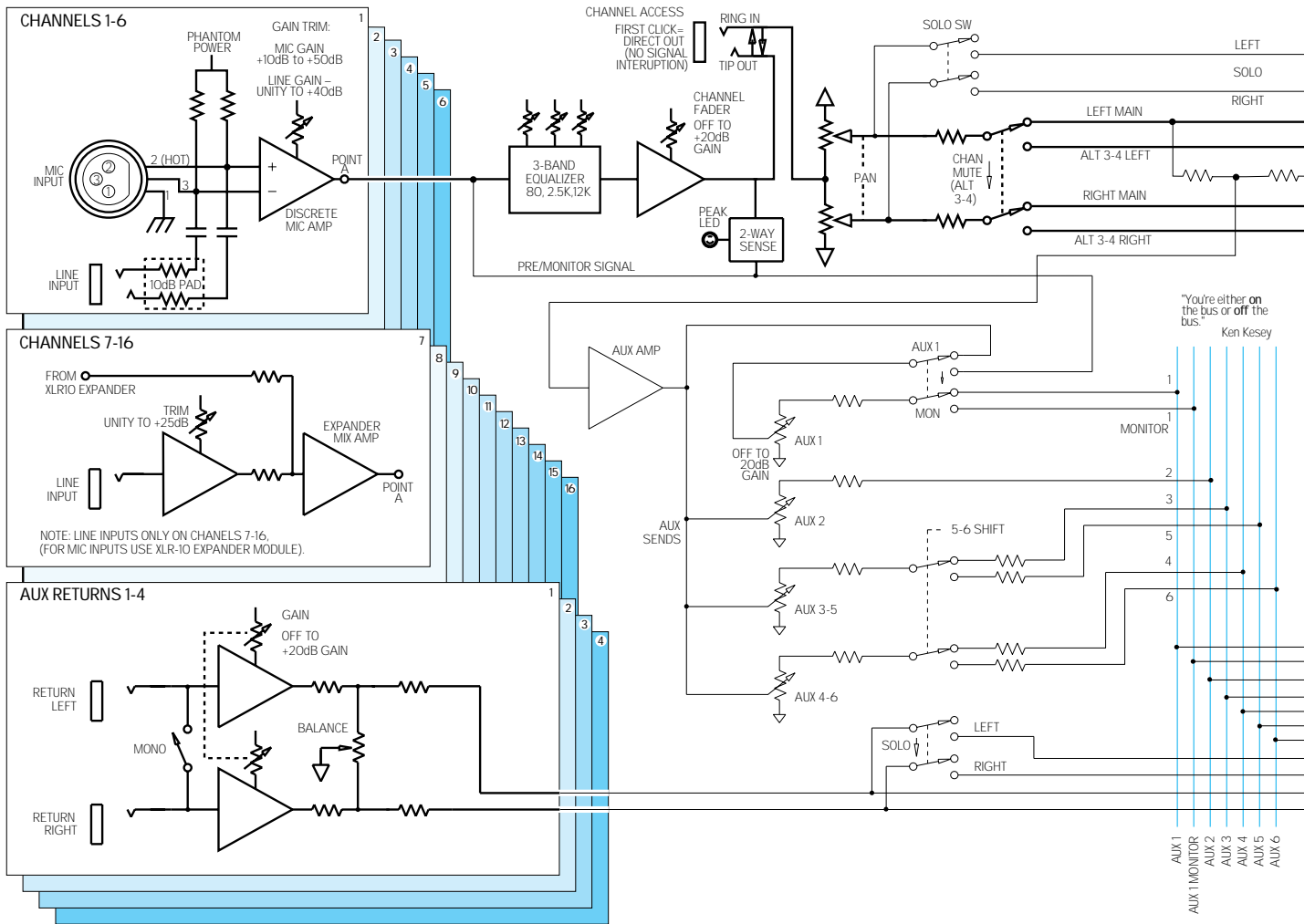

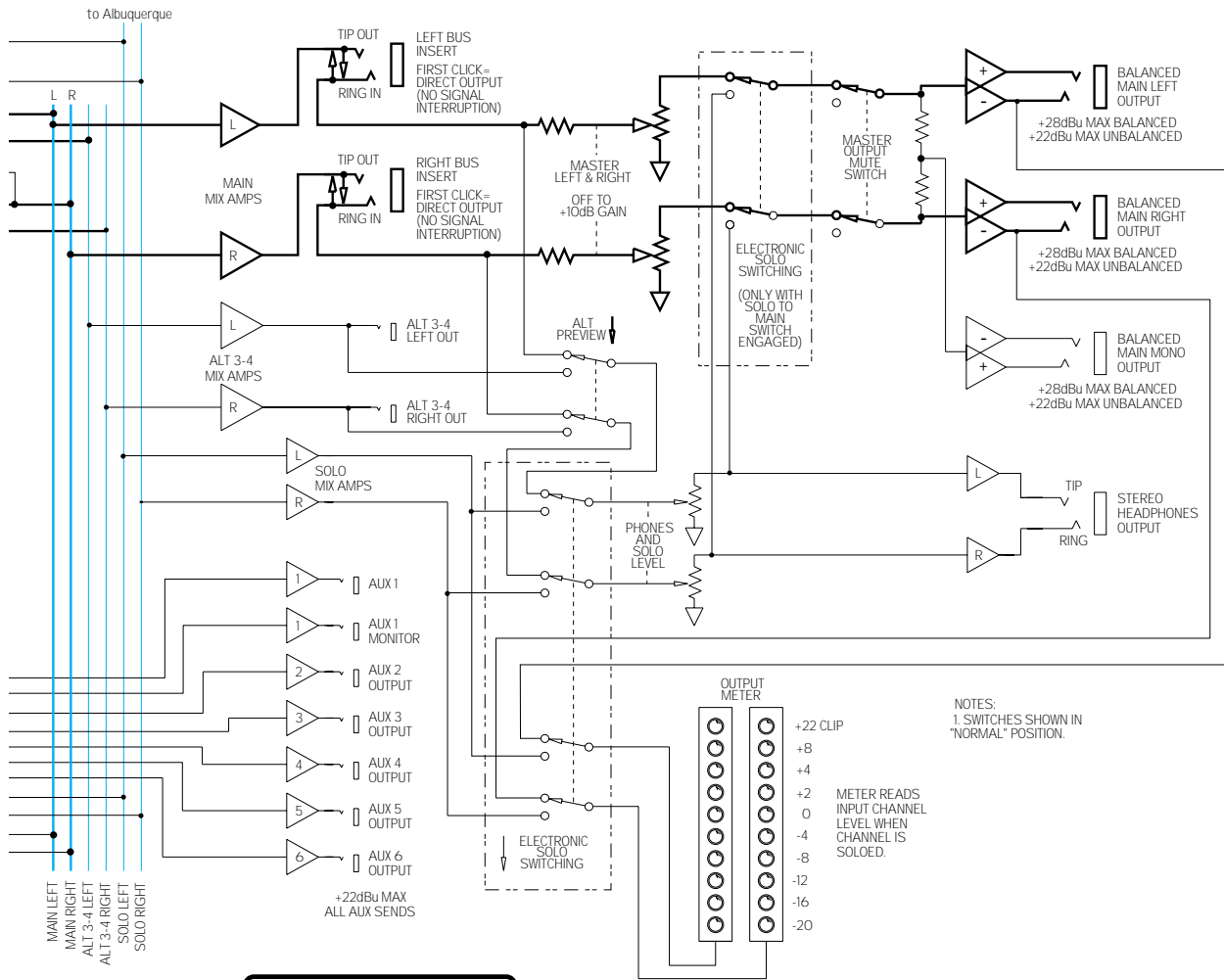

NOTES:
1. SWITCHES SHOWN IN "NORMAL" POSITION.

METER READS INPUT CHANNEL LEVEL WHEN CHANNEL IS SOLOED.

CR-1604
BLOCK DIAGRAM
Rev. ©1995 Mackie Designs



10 COMMON QUESTIONS

1. How do I get the effects into my monitors?
2. How do I get effects out the ALT 3/4 Bus?
3. How do I set up a monitor or auxiliary send master?
4. What modifications can be done to the mixer?
5. How do I perform the modifications to my mixer?
6. Can I use the Bal./Unbal. Main Outputs and Mono Output at the same time?
7. Can I split the Main Outputs with a Y-cord?
8. Can I use the XLR Mic Inputs for line inputs?
9. How do I record with effects?
10. Why are there really only 9 questions?

(1) Q: How do I get the effects into my monitors?

A: Instead of connecting the output (s) of an effect device to the AUX RETURN TO MASTER jacks, it should be connected to the line input (s) of unused channels. This would make the channel fader (s) the AUX RETURN to main output control. This channel or channels should be set up as if it were receiving any line input signal. This means setting the proper input trim level with the fader at unity and setting the pan control (stereo or mono). You now have the effect going to your main outputs.

Now to get the effect to the monitors simply turn up your monitor send on that channel (the one you have connected the output of the effect to). The AUX OUT is still connected to the input of the effect the same way and the individual channels are still sent to the effect the same way. The only difference is how you are controlling the return level of the effect.

Using this configuration you must remember one important point — NEVER turn up the AUX SEND level of the particular effect on the channel you are using as the AUX RETURN. This will give you a feedback loop. For example, if you are using AUX SEND 2 for a reverb send and you are using channels 15 and 16 as your stereo AUX RETURNS, you would NEVER want to turn up AUX SEND 2 on channels 15 and 16.

It may seem that you are losing inputs by configuring the aux returns this way but you are not. Your unused AUX RETURNS TO MASTER JACKS can now be used as inputs. By engaging the MONO switch on the AUX RETURNS you can have up to 8 mono inputs. Also, by returning the output of the effect to a channel you can now use the EQ to further enhance the effect.

(2) Q: How do I get effects out of the ALT 3/4 Bus?

A: You will need to perform option #1, 2, or 3 in the modification sheets in order for an individual channel to be muted (sent to the ALT 3/4 Bus) and still be capable of sending channel information out of the auxiliary sends.

Instead of connecting the output (s) of an effect device to the AUX RETURN TO MASTER jacks, it should be connected to the line input (s) of unused channels. This would make the channel fader the auxiliary return master.

TECH
STUFF

The channel should be set up as if it were receiving any line input signal. This means setting the proper input trim level with the fader at unity and setting the pan control (stereo or mono). Next you would MUTE the channel which would send the auxiliary returns out the ALT 3/4 Bus.

(3) Q: How do I set up a monitor or auxiliary send master?

A: There are two ways:

1) Insert a mono 1/4" cord into the auxiliary (monitor) output jack and return the other end of the cord to the line input of an unused channel. Engage the MUTE button on the channel which will send the signal out to the ALT 3/4 bus. Pan the channel hard left or right depending on which bus (3 or 4) you want to come out of. Connect another mono 1/4" cord from the corresponding ALT bus 3 or 4 output to the input of the monitor amplifier.

or

2) Insert a mono 1/4" cord into the auxiliary (monitor) output jack and return the other end of the cord to the line inputs on either of the channels 1–8. Connect another mono 1/4" cord from the corresponding channel access jack to the input of the effect device or monitor amplifier. Make sure to insert the plug all the way into the access jack on the mixer so the signal will not go to the main L/R outputs.

Either of these 2 ways will allow you to control the overall level of the auxiliary or monitor sends by using the channel fader as your master. Treat it as if it were any signal but be careful when you increase the individual channel send levels because this may eventually clip the input stage on the master send channel. If this happens, simply turn down the trim on the master send channel a little bit.

(4) Q: What modifications can be done to the mixer?

Auxiliaries:

- Option #1: Pre EQ, Pre Fader, Pre Mute/ALT
- Option #2: Post EQ, Pre Fader, Pre Mute/ALT
- Option #3: Post EQ, Post Fader, Pre Mute/ALT (STOCK: Post EQ, Post Fader, Post Mute/ALT)

Channel Access:

- Option #4: Pre EQ, Pre Fader
- Option #5: Post EQ, Pre Fader (STOCK: Post EQ, Post Fader)

(5) Q: How do I perform the modifications to my mixer?

A: Boy, are we glad you asked! Due to overwhelming demand we have included a section especially for Propeller-Head-Types on the next few pages called "MODIFICATIONS-O-RAMA".

(6) Q: Can I use the Bal/Unbal Main Outputs and Mono Output at the same time?

A: Yes! This will not degrade the signal in any way. Remember the polarities on the main and mono outputs when running balanced lines (see page 14 of the Owner's Manual).

This configuration can be very useful when an extra monitor send or a mono recording is needed. The mono output will be the summed output of the L/R Main Output.

It is important to remember that the Mono Output will be the same level as the Main Output but can be controlled at the monitor amplifier. It can also be controlled by connecting the Mono Output to the line input of an unused channel and Muted to the ALT 3/4 Bus and then connected to the monitor amplifier — this can be a little tricky because when the main output fader levels change so do the monitor levels.

(7) Q: Can I split the signal at the Main Outputs with Y-cords?

A: Yes! There is more than enough signal strength available at the Main Outputs to drive the high impedance inputs of two devices with no quality loss of the original signal. For example, if you wanted to record the Main Output to a cassette deck as well as a DAT, two Y-cords could be used to send an identical signal to both devices. This type of configuration could be very useful for many applications.

TECH
STUFF



(8) Q: Can I use the XLR Mic Inputs for balanced line inputs?

A: No and Yes. IMPORTANT!!!!!! The way the board is configured from the factory it is not meant to accept a line level signal at the Mic Inputs. Although the mic and line inputs pass through the same preamp stage, the line input has an internal 10dB pad. This 10dB pad can be accomplished externally by connecting two resistors into the XLR cord being plugged into the XLR jack.

The procedure for this is: solder one 4.7K (4,700 ohm) resistor in series with pin 2 (typically +) and one 4.7K (4,700 ohm) resistor in series with pin 3 (typically "-"). Solder the ground connection as normal.

The most important thing to remember about connecting line inputs to the XLR Mic Inputs is NEVER NEVER TURN ON THE PHANTOM POWER unless you put a 22µf 50V electrolytic capacitor in series with each resistor on pins 2 and 3. The positive leg of the capacitor should be at the mixer end.

(9) Q: How do I record with effects?

A: There are three ways:

1) During tracking or overdubbing, use the Main 1/2 outputs to feed your multitrack and keep the effects returns connected to the Aux Returns to Master jacks. This way the multitrack will get effects. Use the MUTE ALT 3/4 to feed the amp and speakers for monitoring purposes by muting (ALT 3/4) the multitrack returns. When it is time to mix simply connect the Main 1/2 Outputs to the amp for monitoring the mix.

2) When using direct outputs from the mixer to feed the multitrack inputs, the best way to record with effects is to place the effect device in between the mixer and the multitrack. You should use the "mix" potentiometer on the effect device to determine how much effects are wanted on the original signal. This would have to be done on a per channel basis.

3) Recording with effects can also be done using the ALT 3/4 outputs by muting the original signal and muting effects returned to channels. Connecting the ALT 3/4 outputs to the multitrack inputs gives you effects to tape. Mod #3 must be done first. (See question 2.)

(10) Q: Why are there really only 9 questions?

A: There are two reasons:

1) Due to an unforeseen space-time rift, the tenth answer slipped back in time before the question ever happened and cancelled out its own existence.

2) This is actually a trick question. The tenth question negates itself simply by being the tenth question. It's kind of like saying, "This statement is false." The statement is only true if it's false. But if it's false then it would be true... oh, nevermind. If you're not a student of logic, just pretend like this question never really happened in the first place.

MODIFICATIONS-O-RAMA

The CR-1604 can be modified to move the position of AUX Sends and Channel Inserts in the signal flow. Unless you have the right tools and have tweaked with circuitry before, leave these mods to a pro. Our Official Word on modifications is: **“Any internal modification of the CR-1604 MUST be performed by a competent technician. Mackie Designs accepts no responsibility in the event of improperly performed modifications or other damages and, in such cases, may declare warranty privileges void.”** Be VERY careful!

Here are the most common CR-1604 modifications, six of which are detailed on the following pages.

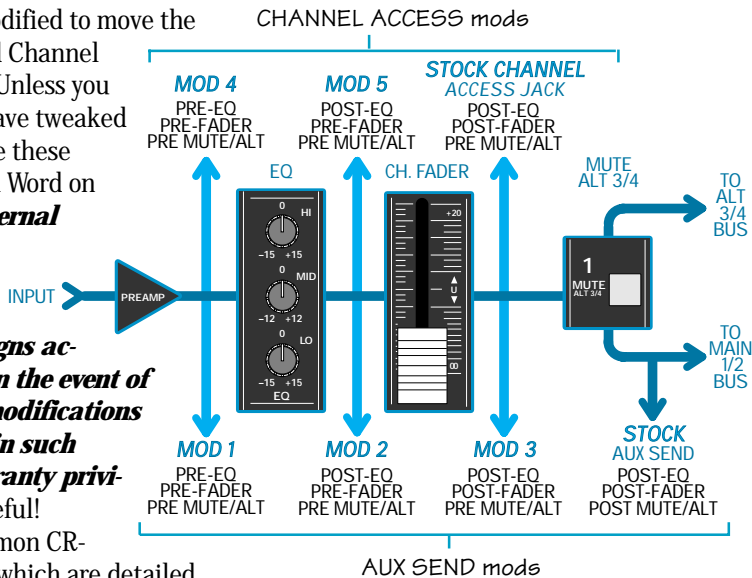

1. CONVERT AUX SENDS TO MONITOR SENDS (Pre-EQ, Pre-Fader, Pre-Mute/ALT Switch).

Can be done on any or all of channel strips 1 to 16. Each channel modification requires cutting one or more circuit traces and adding a small jumper wire. On each strip, you can modify Sends 2, 3, 4 or any combination thereof. Note: Converting AUX 3 will also convert AUX 5; converting AUX 4 will also convert AUX 6. See the next page.

2. CONVERT AUX SENDS INTO MONITOR SENDS WITH EQ (Post-EQ, Pre-Fader, Pre-Mute/ALT Switch).

Can be done on any or all of channel strips 1 to 16. Each channel modification requires cutting one or more circuit traces and adding a small jumper wire. On each strip, you can modify Sends 2, 3, 4 or any combination thereof. Note: Converting AUX 3 will also convert AUX 5; converting AUX 4 will also convert AUX 6. See pg. 31.

3. CONVERT AUX SENDS TO IGNORE MUTE/ALT STATUS (Post-EQ, Post-Fader, Pre-Mute/ALT Switch).

Can be on any or all of channel strips 1–16. Converts ALL AUX sends on each channel strip. Requires cutting a circuit trace, and adding both a small jumper wire and a 20,000Ω resistor. See pg.32 of this section.

4. CONVERT CHANNEL ACCESS (INSERTS) TO PRE-EQ / PRE-FADER.

Can be performed on any or all of the first eight CR-1604 channel strips. Requires cutting three circuit traces and adding both a small jumper wire and a 22μf/16V electrolytic cap on each channel strip. See pg. 33 of this section.

5. CONVERT CHANNEL ACCESS (INSERTS) TO POST-EQ / PRE-FADER.

Can be performed on any or all of the first eight CR-1604 channel strips. Requires cutting three circuit traces and adding both a small jumper wire and a 22μf/16V electrolytic cap on each channel strip. See pg. 34 of this section.

6. TIE SOLO TOGETHER ON TWO OR MORE CR-1604s.

See pg. 35 of this section.

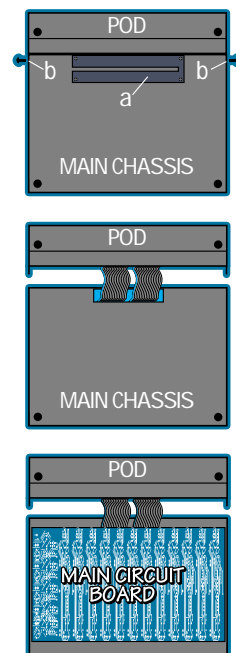

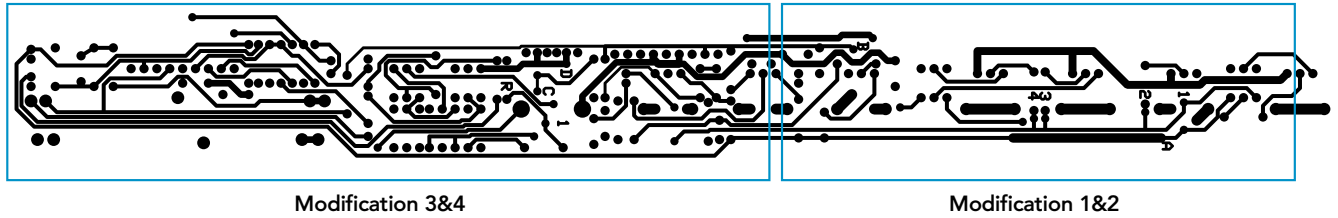

PRE-EQ • PRE-FADER • PRE-ALT/MUTE MODIFICATION

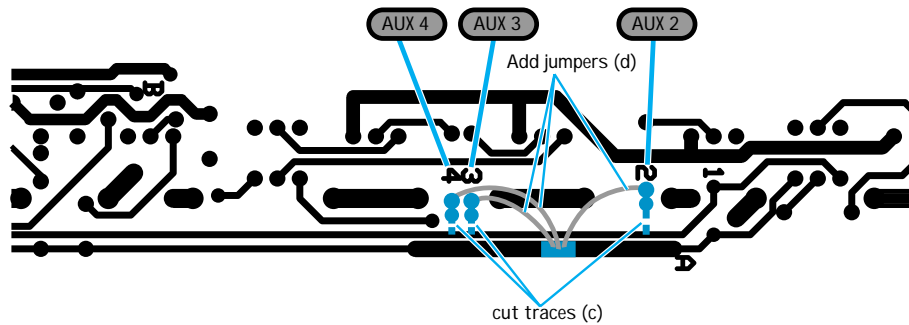

TECH STUFF

Modification 1 — AUX SEND
PRE-EQ • PRE-FADER • PRE-ALT/MUTE

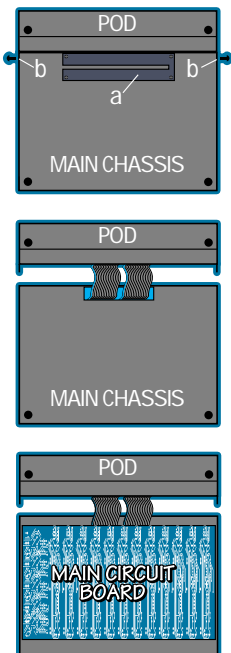

This modification converts AUX Sends into pre-EQ/pre-fader/pre-ALT/mute Monitor Sends. You can modify AUX 2, AUX 3 and/or AUX 4 on any or all of the CR-1604's 16 channels. Converting AUX 3 also converts AUX 5; converting AUX 4 also converts AUX 6.

1. Remove all cords from the CR-1604 and place it face down.
2. Remove ribbon cable plate cover (a). Keep track of what screws go where!
3. Remove pod mounting bolts (b) and separate pod from main chassis.
4. Remove bottom and side screws from main chassis.
5. Remove main chassis cover and set it aside.
6. Cut traces to selected AUX Sends (c).
7. Add jumper wires [shown as grey lines (d) in illustration] for those AUX Sends with cut traces. Don't smash the wires down tight onto the circuit board. Let them "arch" above if possible.

8. Replace main chassis cover and reattach top and side screws.
9. Reconnect main chassis and pod; replace side screws.
10. Gently nudge any slack ribbon cable into the main chassis and replace ribbon cable cover.

Any internal modification of the CR-1604 must be performed by a competent electronic technician. Mackie Designs accepts no responsibility in the event of improperly performed modifications or other damages and, in such cases, may declare warranty privileges void.

* Note: Traces on different channels may vary slightly from the drawing. (Engineering sez channel strips are like snowflakes).

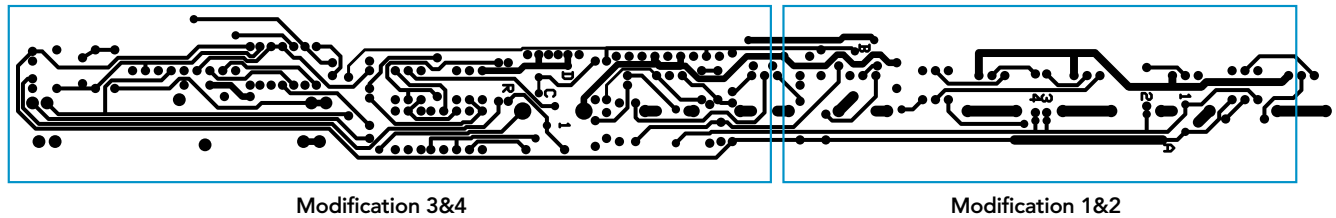

POST-EQ • PRE-FADER • PRE-ALT/MUTE MODIFICATION

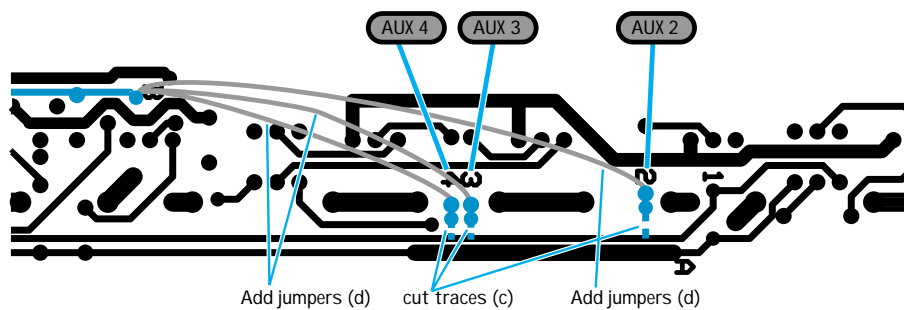

Modification 2 — AUX SEND
POST-EQ • PRE-FADER • PRE-ALT/MUTE

This modification converts AUX Sends into post-EQ / pre-fader / pre-ALT/mute Monitor Sends. You can modify AUX 2, AUX 3 and/or AUX 4 on any or all of the CR-1604's 16 channels. Converting AUX 3 also converts AUX 5; converting AUX 4 also converts AUX 6.

1. Remove all cords from the CR-1604 and place it face down.
2. Remove ribbon cable plate cover (a). Keep track of what screws go where!
3. Remove pod mounting bolts (b) and separate pod from main chassis.
4. Remove bottom and side screws from main chassis.
5. Remove main chassis cover and set it aside.
6. Cut traces to selected AUX Sends (c).
7. Add jumper wires [shown as grey lines (d) in illustration] for those AUX Sends with cut traces. Don't smash the wires down tight onto the circuit board. Let them "arch" above if possible.

8. Replace main chassis cover and reattach top and side screws.
9. Reconnect main chassis and pod; replace side screws.
10. Gently nudge any slack ribbon cable into the main chassis and replace ribbon cable cover.

Any internal modification of the CR-1604 must be performed by a competent electronic technician. Mackie Designs accepts no responsibility in the event of improperly performed modifications or other damages and, in such cases, may declare warranty privileges void.

* Note: Traces on different channels may vary slightly from the drawing. (Engineering sez channel strips are like snowflakes).

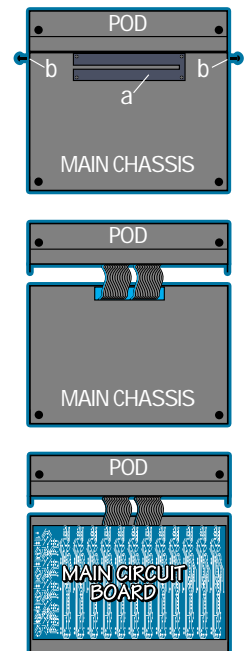

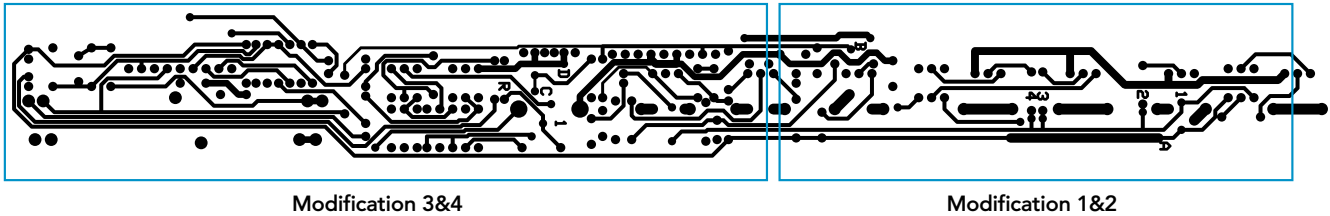

POST-EQ • POST-FADER • PRE-ALT/MUTE MODIFICATION

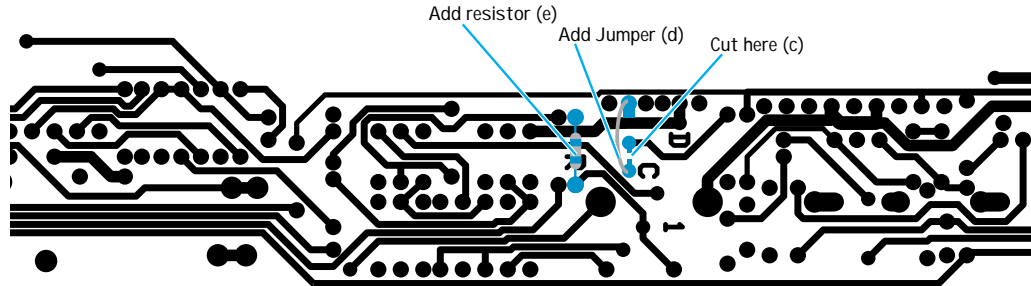

TECH STUFF

Modification 3 — AUX SEND
POST-EQ • POST-FADER • PRE-ALT/MUTE

This modification converts AUX Sends into post-EQ/post-fader/pre-ALT mute Monitor Sends. You can modify any or all of the CR-1604's 16 channels. **NOTE:** The conversion affects ALL AUX Sends per channel.

1. Remove all cords from the CR-1604 and place it facedown.
2. Remove ribbon cable plate cover (a). Keep track of what screws go where!
3. Remove pod mounting bolts (b) and separate pod from main chassis.
4. Remove bottom and side screws from main chassis.
5. Remove main chassis cover and set it aside.
6. Cut trace (c).
7. Add jumper wire (d). Don't smash the jumper down onto the circuit board. Let it "arch above," if possible.

8. Add 20,000Ω (20K), 1/4-watt resistor (e).
9. Replace main chassis cover and reattach top and side screws.
10. Reconnect main chassis and pod, and replace side screws.
11. Gently nudge any slack ribbon cable into the main chassis and replace ribbon cable cover.

Any internal modification of the CR-1604 must be performed by a competent electronic technician. Mackie Designs accepts no responsibility in the event of improperly performed modifications or other damages and, in such cases, may declare warranty privileges void.

* Note: Traces on different channels may vary slightly from the drawing. (Engineering sez channel strips are like snowflakes).

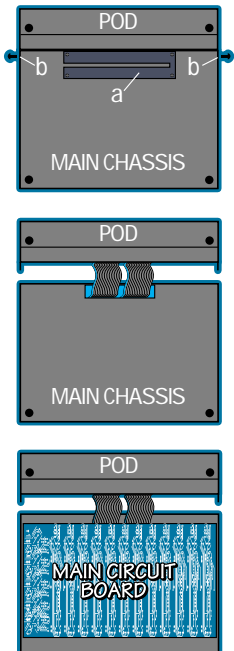

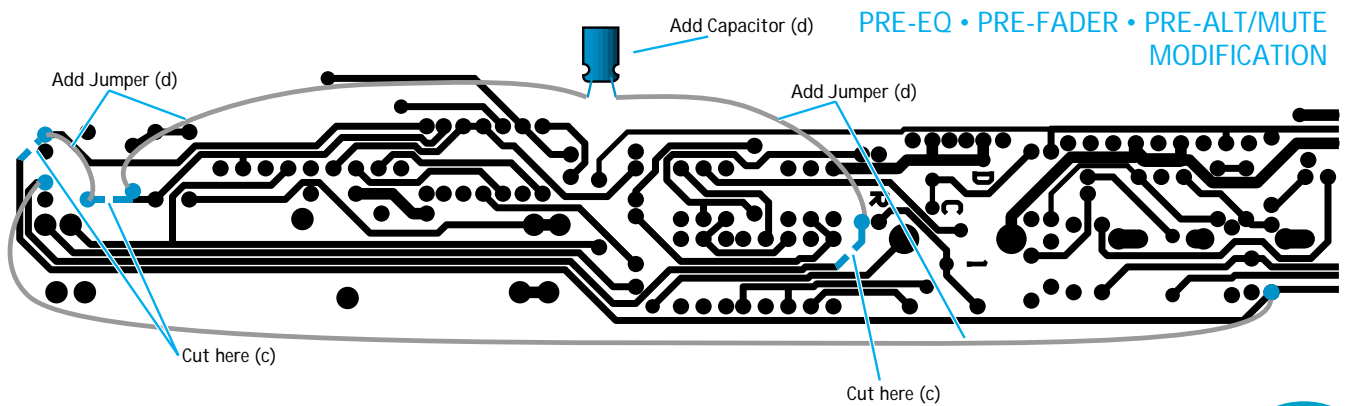
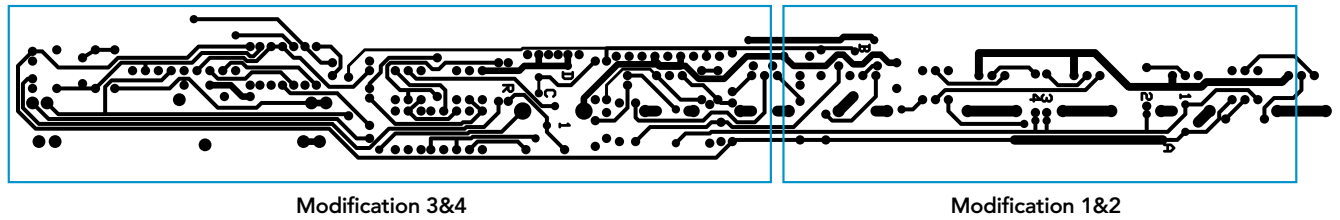

Modification 4 — Channel Insert PRE-EQ • PRE-FADER • PRE-ALT/MUTE

This modification moves the CR-1604's Channel Access points to pre-EQ/pre-fader. You can modify any or all of the CR-1604's first 8 channels. **WARNING:** This is an Advanced Deadly, Expert Level Modification. Don't try this one at home!

1. Follow steps 1 through 5 at the bottom of page 31.
2. Cut traces as shown at points (a), (b) and (c) in the upper drawing at left.
3. Add jumpers (d) & (e). Don't smash the jumper down onto the circuit board. Let it "arch" above.
4. Add a 22-microfarad/25-volt electrolytic capacitor as shown (f) — polarity doesn't matter. You will need to solder a wire onto one or both ends.
5. Follow steps 9 to 11 at the bottom of page 31.

Any internal modification of the CR-1604 must be performed by a competent electronic technician. Mackie Designs accepts no responsibility in the event of improperly performed modifications or other damages and, in such cases, may declare warranty privileges void.

* Note: Traces on different channels may vary slightly from the drawing. (Engineering sez channel strips are like snowflakes).

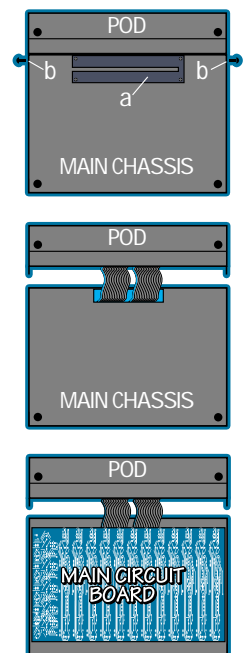

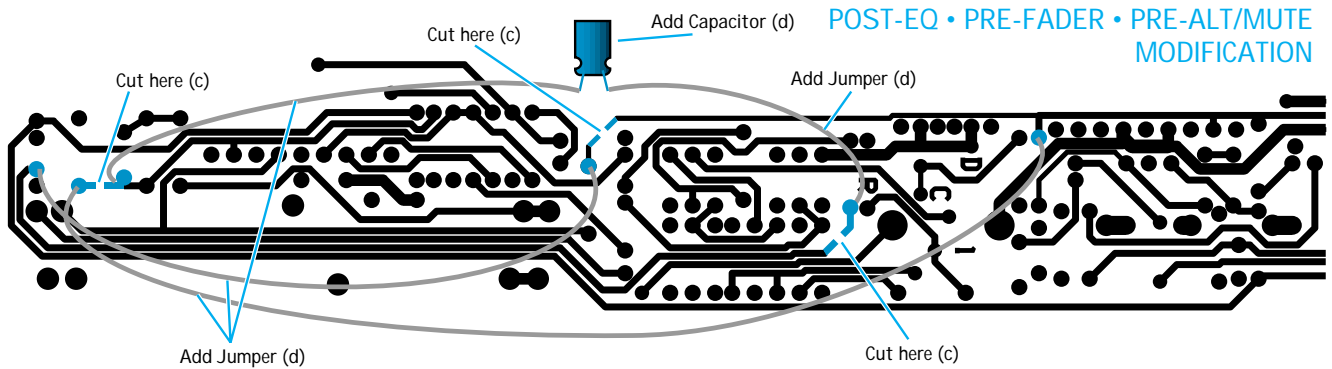
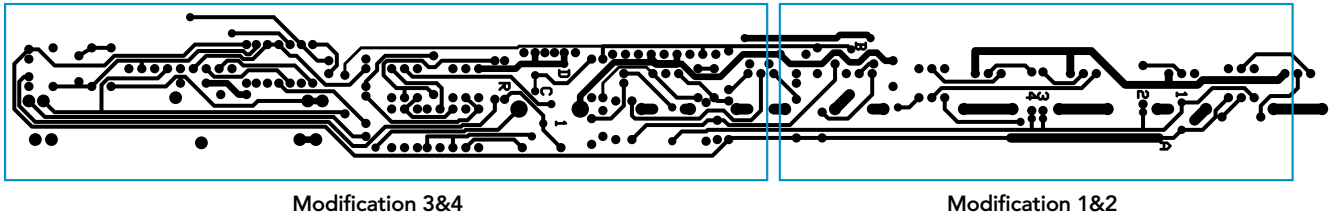

TECH STUFF

Modification 5 — Channel Insert
POST-EQ • PRE-FADER • PRE-ALT/MUTE

This modification moves the CR-1604's Channel Access points to post-EQ/pre-fader. You can modify any or all of the CR-1604's first 8 channels. **WARNING:** This is an Advanced Deadly, Expert Level Modification. Don't try this one at home!

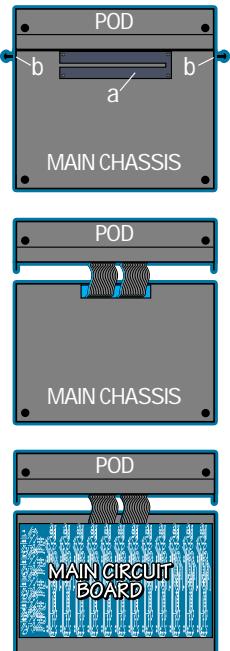

1. Follow steps 1 through 5 at the bottom of page 31.
2. Cut traces as shown at points (a), (b) and (c) in the lower drawing .
3. Add jumpers (d) & (e). Don't smash the jumper down onto the circuit board. Let it "arch" above.
4. Add a 22-microfarad/16-volt electrolytic capacitor as shown (f) polarity doesn't matter. You'll need to solder a wire onto one or both ends.
5. Follow steps 9 to 11 at the bottom of page 31.

Any internal modification of the CR-1604 must be performed by a competent electronic technician. Mackie Designs accepts no responsibility in the event of improperly performed modifications or other damages and, in such cases, may declare warranty privileges void.

* Note: Traces on different channels may vary slightly from the drawing. (Engineering sez channel strips are like snowflakes).

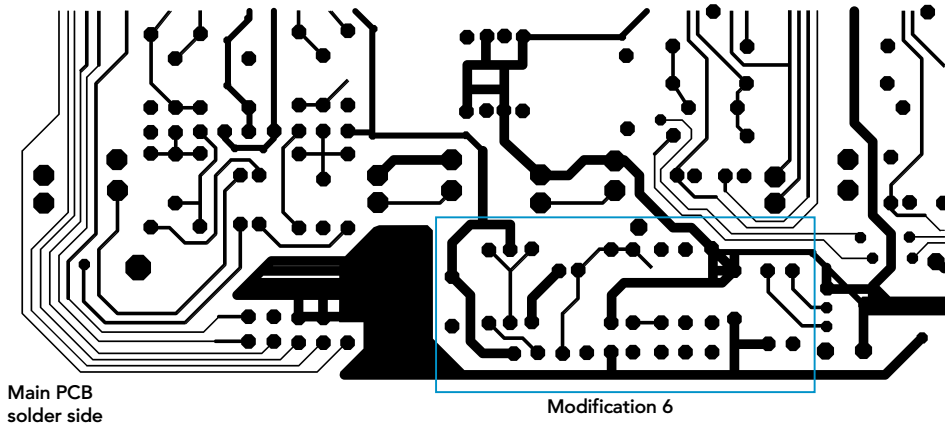

SOLO TIE FOR MIXERMIXER APPLICATION

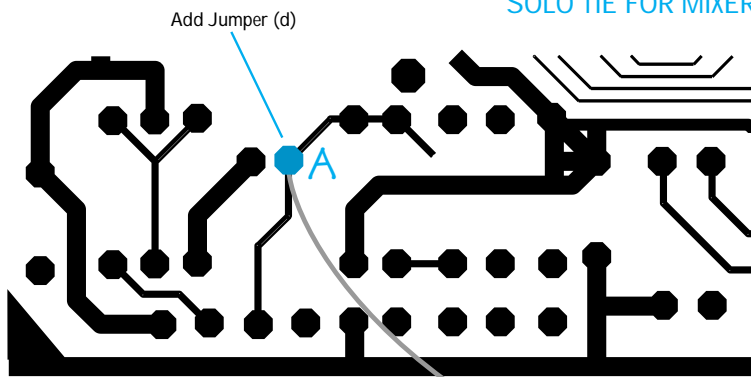

Modification 6 — Solo Tie FOR MIXERMIXER APPLICATION

This modification connects the solo function of multiple CR-1604's.

1. Follow steps 1 through 5 at the bottom of page 31.
2. Solder an insulated wire (d) from one mixer to another at point A
3. Follow steps 9 to 11 at the bottom of page 31.

Any internal modification of the CR-1604 must be performed by a competent electronic technician. Mackie Designs accepts no responsibility in the event of improperly performed modifications or other damages and, in such cases, may declare warranty privileges void.

To same point on other CR-1604

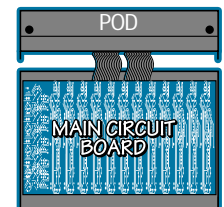
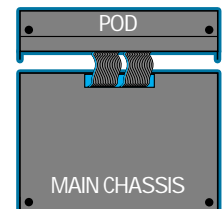
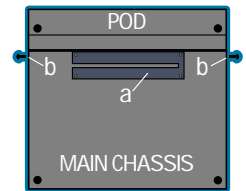

CR-1604 ARCHITECTS' & ENGINEERS' SPECIFICATIONS

(What the heck! You might run into an inquisitive, musical architect or engineer some day...)

1. The mixing console shall have a 2-part main frame which accommodates 10 Unbalanced and 6 Balanced Line Inputs, 6 Balanced Microphone Inputs, 1 Balanced/Unbalanced Main Left Output, 1 Balanced/Unbalanced Main Right Output, 1 Balanced/Unbalanced Main Mono Output, 1 Monitor Output, 6 AUX Outputs, 2 ALT Outputs, 2 Bus Inserts, 4 Stereo AUX Returns, 8 Channel Access Jacks and 1 Stereo Headphone Output. The main frame shall be capable of mounting on a table or in a standard 19-inch rack mount and shall be entirely self-contained.

2. The main frame shall include two 10-LED meters for monitoring Main L/R Outputs or channel level during solo, one each Overload Clipping LED's for each of 16 channels, Solo On LED and Power LED.

3. The main frame shall include on its rear panel electronically balanced mic inputs using female XLR-3-type connectors to accept nominal levels of from -50dBu to +14dBu. The main frame shall also have 16 line inputs consisting of standard 1/4" phone jacks which shall accept nominal levels of from -40dBu to +22dBu on Channels 1 through 6 and -25dBu to +22dBu on Channels 7 through 16. Each of 16 channels shall have a rotary Sensitivity Control adjustable from +4dB to -40dB on Channels 1 through 6 and +4dB to -25dB on Channels 7 through 16. The main frame shall have Stereo Bus Inserts, 4 Stereo Aux Returns and 8 tip-out/ring-in Channel Access Inserts. There shall be a phantom power supply with separate switch to provide DC power to all mic input connectors for remote powering of condenser microphones.

4. The mixer outputs shall be 1/4" phone jack; there shall be 1 Left and 1 Right Main Outputs, 1 Mono Main Output, 1 Monitor Output, 6 AUX Outputs, Alternate Outputs on buses 3 and 4, and 1 Stereo Headphone Output. Maximum Main Output level shall be +28dBu balanced (+22dBu unbalanced); all other Outputs shall be capable of +22dBu maximum output level.

5. The main frame shall be grey-black, consisting of two parts: a Main Mixing Board with steel chassis, and an Input/Output Pod with aluminum/steel chassis which shall be mechanically connected by metal screws and electrically connected by ribbon cables. The Pod shall be designed in such a way that it may be attached in one of two ways: 1) With input/outputs to the top of the mixing console or 2) with input/outputs to the rack of the mixing console.

Additionally, the mixer shall accommodate the RotoPod Bracket Set which shall allow the Input/Output Pod to be rotated in such a way the input/outputs are on the same plane with the Main Mixing Board controls.

The mixer's dimensions shall be 16.1" tall by 17.34" wide (including screw heads) by 4.1" deep with the Input/Output Pod rotated to top, or 15.8" tall by 17.34" wide by 4.8" deep with the Input/Output Pod rotated to back. The rack rails shall be adjustable to allow flush mounting which shall add an extra 0.7" to respective depth measurements. The weight in either case shall be 18 pounds.

The Input/Output Pod shall include a female BNC connector for 12V AC powering and physical attachment of a gooseneck lamp, LittleLite PN #12G or 12G-HI.

The mixer shall exactly accommodate the XLR10 add-on mic preamplifier section via mechanical and electronic connections.

6. Each mixer Input Section shall include the following features: 4 AUX send controls shall feed 7 separate outputs, a Monitor button shall change AUX 1 to either pre (monitor) or post effects; a Shift button shall change AUX 3 and 4 to AUX 5 and 6; 3 rotary equalization controls (± 15 dB LO shelving at 80Hz, ± 12 dB MID peaking at 2.5kHz, ± 15 dB HI shelving at 12kHz), L/R rotary Pan control, stereo in-place Solo switch, Mute ALT-3/4 switch, overload clipping LED, and dB-calibrated 45mm Channel Fader with center-detent unity gain position. The Solo switch shall maintain stereo perspective for all soloed channels and returns. The Mute switch shall cause muted channels to be unassigned from main left/right output and reassigned to ALT Outputs 3 & 4.

7. The mixer Main Output Section shall have 4 Stereo AUX Returns (consisting of 4 rotary Level controls, L/R Balance controls and 4 mono push switches), AUX Solo switch, ALT Preview switch, Main Output Mute switch, Solo to Main switch, Left/Right Master dB-calibrated 45mm Master Fader with center-detent unity gain position, 10-step LED meter (calibrated -20 to +8, plus CLIP), Power LED, flashing Solo LED, Stereo Headphone/Solo Output Jack and 45mm Solo/Headphone Level Control. The ALT Preview switch shall allow listening to all muted channels via headphones. The Headphone Solo Level Control shall regulate the output level of signals appearing at the Headphone Output jack and Solo as it appears at the Main Outputs.

The mixer shall be a Mackie Designs CR-1604.

TECH
STUFF

MACKIE CR-1604 TRACK SHEET

Chs _____ to _____ Session _____ Date ____/____/____

1	1	1	1	1	1	1	1
00 +15	00 +15	00 +15	00 +15	00 +15	00 +15	00 +15	00 +15
MON <input type="checkbox"/>	MON <input type="checkbox"/>	MON <input type="checkbox"/>	MON <input type="checkbox"/>	MON <input type="checkbox"/>	MON <input type="checkbox"/>	MON <input type="checkbox"/>	MON <input type="checkbox"/>
2	2	2	2	2	2	2	2
00 +15	00 +15	00 +15	00 +15	00 +15	00 +15	00 +15	00 +15
3	3	3	3	3	3	3	3
00 +15	00 +15	00 +15	00 +15	00 +15	00 +15	00 +15	00 +15
4	4	4	4	4	4	4	4
00 +15	00 +15	00 +15	00 +15	00 +15	00 +15	00 +15	00 +15
5/6 SHIFT <input type="checkbox"/>	5/6 SHIFT <input type="checkbox"/>	5/6 SHIFT <input type="checkbox"/>	5/6 SHIFT <input type="checkbox"/>	5/6 SHIFT <input type="checkbox"/>	5/6 SHIFT <input type="checkbox"/>	5/6 SHIFT <input type="checkbox"/>	5/6 SHIFT <input type="checkbox"/>
0 HI	0 HI	0 HI	0 HI	0 HI	0 HI	0 HI	0 HI
-15 +15	-15 +15	-15 +15	-15 +15	-15 +15	-15 +15	-15 +15	-15 +15
0 MID	0 MID	0 MID	0 MID	0 MID	0 MID	0 MID	0 MID
-12 +12	-12 +12	-12 +12	-12 +12	-12 +12	-12 +12	-12 +12	-12 +12
0 LO	0 LO	0 LO	0 LO	0 LO	0 LO	0 LO	0 LO
-15 +15	-15 +15	-15 +15	-15 +15	-15 +15	-15 +15	-15 +15	-15 +15
EQ	EQ	EQ	EQ	EQ	EQ	EQ	EQ
0	0	0	0	0	0	0	0
L R	L R	L R	L R	L R	L R	L R	L R
PAN	PAN	PAN	PAN	PAN	PAN	PAN	PAN
SOLO <input type="checkbox"/>	SOLO <input type="checkbox"/>	SOLO <input type="checkbox"/>	SOLO <input type="checkbox"/>	SOLO <input type="checkbox"/>	SOLO <input type="checkbox"/>	SOLO <input type="checkbox"/>	SOLO <input type="checkbox"/>
Ch # <input type="text"/>	Ch # <input type="text"/>	Ch # <input type="text"/>	Ch # <input type="text"/>	Ch # <input type="text"/>	Ch # <input type="text"/>	Ch # <input type="text"/>	Ch # <input type="text"/>
MUTE <input type="checkbox"/>	MUTE <input type="checkbox"/>	MUTE <input type="checkbox"/>	MUTE <input type="checkbox"/>	MUTE <input type="checkbox"/>	MUTE <input type="checkbox"/>	MUTE <input type="checkbox"/>	MUTE <input type="checkbox"/>
ALT 3/4	ALT 3/4	ALT 3/4	ALT 3/4	ALT 3/4	ALT 3/4	ALT 3/4	ALT 3/4
OL <input type="checkbox"/>	OL <input type="checkbox"/>	OL <input type="checkbox"/>	OL <input type="checkbox"/>	OL <input type="checkbox"/>	OL <input type="checkbox"/>	OL <input type="checkbox"/>	OL <input type="checkbox"/>
+20	+20	+20	+20	+20	+20	+20	+20
0	0	0	0	0	0	0	0

This is the back of a master track sheet, which
came in the Mackie CR-1604 Manual

If you find this sheet in a copy machine, please
return it to the engineer/owner of the console,

MACKIE. CR-1604 OUTPUT, INPUTS, TRIM LEVELS

Session _____ Date ____/____/____

STEREO AUX RETURNS

1	U	1	C	1	<input type="checkbox"/>
	00 +15		L R		
2	U	2	C	2	<input type="checkbox"/>
	00 +15		L R		
3	U	3	C	3	<input type="checkbox"/>
	00 +15		L R		
4	U	4	C	4	<input type="checkbox"/>
	00 +15		L R		

LEVEL BALANCE

<input type="radio"/>	CLIP	<input type="checkbox"/>	ALT PREVIEW
<input type="radio"/>	+8	<input type="checkbox"/>	
<input type="radio"/>	+4	<input type="checkbox"/>	MAIN OUTPUT MUTE
<input type="radio"/>	+2	<input type="checkbox"/>	
<input type="radio"/>	0	<input type="checkbox"/>	SOLO TO MAIN
<input type="radio"/>	-4	<input type="checkbox"/>	
<input type="radio"/>	-8	<input type="checkbox"/>	
<input type="radio"/>	-12	<input type="checkbox"/>	
<input type="radio"/>	-16	<input type="checkbox"/>	
<input type="radio"/>	-20	<input type="checkbox"/>	
<input type="radio"/>	POWER	<input type="checkbox"/>	
<input type="radio"/>	SOLO LEVEL	<input type="checkbox"/>	

1/LEFT 2/RIGHT LEVEL

SOLO/PHONES

BAL / UNBAL MAIN OUTPUTS

AUX / MONITOR OUTPUTS

16 15 14 13 12 11 10 9 8 7 6 5 4

RIGHT LEFT RIGHT LEFT

ALTS 3-4 OUT BUS INSERT

AUX RETURNS TO MASTER

CHANNEL ACCESS

NOTES

- Band members wanted bass EQ turned up to +15
- Monitor speakers toasted themselves at 3AM
- Band members thrown out of control room
- Ordered gut-bomb pizza
- Ad Jingle: Client was a real drunk
- Vocalist barfed on the Neumann
- Songwriter had electronic amnesia
- Ran out of patch cards

This is the back of a master track sheet, which
came in the Mackie CR-1604 Manual

If you find this sheet in a copy machine, please
return it to the engineer/owner of the console,



SEMIOFFICIAL LAST PAGE

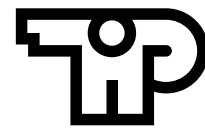

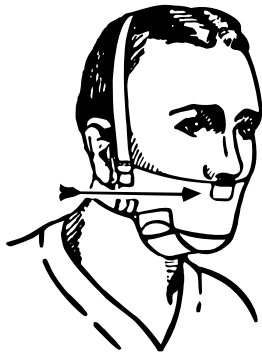

Whaddya say on the last page of a manual? Well, we'd like to roll the credits.

Film output by Artworks of Woodinville.

Set in ITC Century Condensed and Adobe Futura Condensed via

PageMaker® 5.0 for the Macintosh®.

The bulk of this manual was written by Ron Koliha. Technical revisions by Keith Medley, Paul Larson, Scott Garside, Jason Hill, Brian McCully, Sara Drake and Jeff Gilbert.

Page layout and Adobe Illustrator® 5.5 technical drawings by Bobby Hougham, Bruce Yunker, Ron Koliha, Sara Drake and Gene Endicott.

Additional "help" from P.D., the Mackie Corporate Chihuahua who shredded several drawings at various points during the development of this manual.

We appreciate users who take the time to write us with suggestions and corrections to this manual. It is in a steady state of revision and we DO read and listen to the comments. Send them to the Mackie Communications Department, c/o James Fowler, Minister of Propaganda (yes, that's really his title), 16220 Wood-Red Rd. NE, Woodinville, WA 98072.



MACKIE.

16220 Wood-Red Rd. NE • Woodinville • WA • 98072 • USA

Phone 800/258-6883 • FAX 206/487-4337 • Outside the U.S. call 206/487-4333

For literature requests only, 800/898-3211