



Magellan® RoadMate™

Reference Manual



Instructions for Operating the Magellan RoadMate 3000T

IMPORTANT SAFETY WARNINGS

The Magellan RoadMate 3000T is a vehicle-navigation aid designed to assist you in arriving to your selected destinations. When using the Magellan RoadMate 3000T, these safety rules must be followed to prevent accidents that can result in injury or death to yourself or others:

- California law prohibits mounting any item to your windshield. Please check with your state or local law enforcement for applicable regulations regarding windshield mounting. Go to www.magellanGPS.com for alternate mounting solutions.
- When driving, the need to view the display is minimal. Voice prompts will guide you to your destination. The driver should enter data or program the Magellan RoadMate 3000T only when the vehicle is stopped. Only a vehicle passenger should enter data or program the Magellan RoadMate 3000T while the vehicle is moving.
- It is your responsibility to comply with all traffic laws.
- Every attempt is made to ensure that the database is accurate. However, roadways, points of interest (POIs), and business and service locations may change over time. The database does not include, analyze, process, consider, or reflect any of the following: legal restrictions (such as vehicular type, weight, height, width, load and speed restrictions); road slope or grade; bridge height, width, weight, or other limits; population density; neighborhood quality or safety; availability or proximity of law enforcement, emergency rescue, medical, or other assistance; construction work zones or hazards; road or lane closures; road, traffic, or traffic facilities' safety or condition; weather conditions; pavement characteristics or conditions; special events; traffic congestion. It is your responsibility to disregard any unsafe, hazardous, or illegal route suggestions.
- Keep the Magellan RoadMate 3000T safe from extreme temperature conditions. For example, do not leave it exposed to direct sunlight for an extended period of time.
- Take care when mounting the Magellan RoadMate 3000T in your vehicle, whether using the windshield mount or other mount or accessories, that it does not obstruct the driver's view of the road, interfere with the operation of the vehicle's safety devices such as air bags, or present a hazard to occupants of the vehicle should the Magellan RoadMate 3000T be dislodged while driving. You assume the risks associated with damage to your vehicle or vehicle occupants as the result of your choices in mounting the Magellan RoadMate 3000T.
- Laws in some states prohibit wearing stereo headphones while operating a motor vehicle. Please contact your state's Department of Motor Vehicles for information.
- The battery in the Magellan RoadMate 3000T is rechargeable and should not be removed. In the event it should need to be replaced, please contact Magellan Technical Support.
- Extreme temperatures may cause the Magellan RoadMate 3000T to stop working. Do not leave it exposed to extreme heat or cold for long periods of time.

About Charging the Magellan RoadMate 3000T

- Use only the AC adapter (Pihong: PSC11R-050) approved for your Magellan RoadMate 3000T. Use of another type of AC adapter will result in malfunction and/or danger.
- Use only the car charger approved for / supplied with your Magellan RoadMate 3000T. Use of another type of car charger will result in malfunction and/or danger.
- The Magellan RoadMate 3000T is intended to be supplied with a LISTED Power Unit marked with "LPS", "Limited Power Source" and output rated + 5 V dc / 2.0 A".
- Use the USB cable approved for / supplied with your Magellan RoadMate 3000T.
- Use the battery provided with your Magellan RoadMate 3000T or its identical replacement approved for the Magellan RoadMate 3000T
- For safety reasons, the battery in your Magellan RoadMate 3000T will stop charging when the ambient temperature is less than 32°F (0°C) or more than 113°F (45°C)

IMPORTANT SAFETY WARNINGS

About the AC Adapter

- Do not use the adapter in a high moisture environment. Never touch the adapter when your hands or feet are wet.
- Allow adequate ventilation around the adapter when using it to operate the device or charging the battery. Do not cover the AC adapter with paper or other objects that will reduce cooling. Do not use the AC adapter while it is inside a carrying case.
- Connect the adapter to a proper power source. The voltage and grounding requirements are found on the product case and/or packaging.
- Do not use the adapter if the cord becomes damaged.
- Do not attempt to service the Magellan RoadMate 3000T. There are no serviceable parts inside. Replace the Magellan RoadMate 3000T if it is damaged or exposed to excess moisture.

About the Battery

- Do not attempt to replace the battery. Please contact Magellan Technical Support for issues related to the battery.
- Use the charger approved for your Magellan RoadMate 3000T.

IMPORTANT INSTRUCTIONS FOR SERVICE PERSONNEL ONLY:

- **Caution:** Risk of explosion if battery is replaced by an incorrect type. Dispose of used batteries according to the instructions.
- Replace only with the same or equivalent type recommended by Magellan.
- The battery must be recycled or disposed of properly.
- Use the battery only in the specified equipment.

INSTRUCTION TO THE USER:

This equipment has been tested and found to comply with the limits for a class B digital device, pursuant to part 15 of the FCC Rules. These limits are designed to provide reasonable protection against harmful interference in a residential installation. This equipment generates, uses and can radiate radio frequency energy and if not installed and used in accordance with the instructions, may cause harmful interference to radio communications. However, there is no guarantee that interference will not occur in a particular installation. If this equipment does cause harmful interference to radio or television reception, which can be determined by turning the equipment off and on, the user is encouraged to try to correct the interference by one or more of the following measures:

- Reorient or relocate the receiving antenna.
- Increase the separation between the equipment and receiver.
- Connect the equipment into an outlet on a circuit different from that to which the receiver is connected.
- Consult the dealer or an experienced radio/TV technician for help.

IMPORTANT SAFETY WARNINGS

In order to maintain compliance with FCC regulations, shielded cables must be used with this equipment. Operation with non-approved equipment or unshielded cables is likely to result in interference to radio and TV reception. The user is cautioned that changes and modifications made to the equipment without the approval of manufacturer could void the user's authority to operate this equipment.

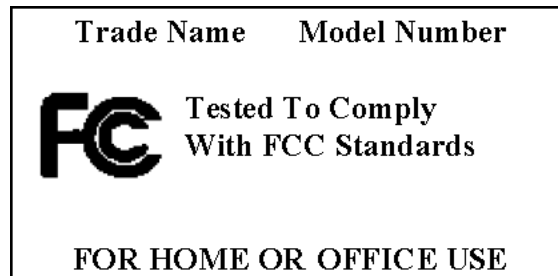

This Class B digital apparatus meets all requirements of the Canadian Interference-Causing Equipment Regulations.

Cet appareil numérique de la classe B respecte toutes les exigences du Règlement sur le matériel brouilleur du Canada.

© 2006 Thales Navigation, Inc. All rights reserved. The Magellan Logo, Magellan, Magellan RoadMate 3000T, Turn it on and go, TrueView, QuickSpell, SmartDetour, and SmartVolume are trademarks of Thales. No part of this user manual may be reproduced or transmitted in any form or by any means, electronic or mechanical, including photocopying and recording, for any purpose other than the purchaser's personal use, without the prior written permission of Thales.

631312-01 A

TABLE OF CONTENTS

Magellan® RoadMate™	1
Instructions for Operating the Magellan RoadMate 3000T	1
About Charging the Magellan RoadMate 3000T	1
IMPORTANT SAFETY WARNINGS	1
About the AC Adapter	2
About the Battery	2
Important instructions for service personnel only:	2
INSTRUCTION TO THE USER:	2
TABLE OF CONTENTS	i
Chapter 1: Contact Information	1
Technical Support	1
Warranty Service	1
Customer Service	1
Registration	1
Chapter 2: GPS Information	2
About Satellite Navigation	2
How Satellite Navigation Works	2
Line of Sight	2
A Word on the Safe Usage of GPS Maps	3
From Source to Destination	3
Placement of Your GPS Receiver for Optimal Satellite Reception	3
Signal Acquisition Time	3
GPS Maps and Your Safety	4
Chapter 3: Magellan RoadMate 3000T	5
Front View	5
Rear View	6
Top View	6
Bottom View	7
Right Side View	7
Left Side View	8
Car Holder	8
Using Removable Memory Cards	9
To Insert the Storage Card:	9
To Remove the Storage card:	9
Chapter 4: Vehicle Installation	10
Installing the Windshield Mount	10
Chapter 5: Navigation Basic Operation	12
Turning the Magellan RoadMate 3000T On Out of the Box	12
Power Off versus “Sleep” Mode	12
Power Management	12
Resetting the Magellan RoadMate 3000T	12
Adjusting the Volume	12
Repeating the Last Command	12
Making Selections	13
Inputting Text Characters	13
Additional Characters (“More” Button)	13
Numerical Characters (“123” Button)	14
What Is QuickSpell?	14
Help with Address Entry	15
Chapter 6: Traveling	16
Guidance Information Screens	16
Map Screen	17

TABLE OF CONTENTS

Changing from 2D to 3D Map View	17
Changing the Map Zoom Levels	18
Maneuver List Screen	18
TrueView Screen	19
Choosing the Route Method	20
Changing the Route Method	20
Cancelling a Planned Route	20
Detouring from the Planned Route	21
Excluding a Maneuver in the Planned Route	21
Displaying Information About Your Present Location	22
Saving Your Current Location to Your Address Book	22
Finding POIs Along Your Route	22
Finding a Detour Along Your Route	23
Chapter 7: Selecting Destinations	25
Destination Screen	25
Country Selection (Globe Button)	25
Entering and Routing to Your Home Address	25
Selecting a Destination Using Select Address	26
Search By City.....	27
Search by Zip Code	27
Search By State	28
Previous City.....	29
Selecting a Destination Using the Address Book	30
Previous Destinations	30
Saving a Previous Destination to the Address Book	31
Deleting A Previous Destination	32
Favorites	32
Editing a Favorite	33
Deleting A Favorite	33
List Addresses	34
Editing an Address	34
Deleting an Address	35
Create New Entry	35
Search by City	35
Search by Zip Code	36
Search by State	37
Previous City	38
Trip Planner	39
New	39
Optimizing a Trip	41
Guide Me	42
Edit	42
Delete and Rename	43
Selecting a Point of Interest as a Destination	45
Spell Name	46
Nearest	46
List By City	46
Select Category	47
Select Category.....	47
Nearest	48
List by City	48
Spell Name	48
Cuisine Type	49
Custom POIs	49
Selecting an Intersection as a Destination	51

TABLE OF CONTENTS

Search by City.....	51
Search by Zip Code.....	52
Search by State.....	52
Previous City.....	53
Chapter 8: Navigation Options	55
Configuration	55
POI Selection.....	55
Custom POIs	55
Map Options	60
TrueView Options	60
Select Map Color.....	60
Route Preferences.....	61
Detour Options.....	62
Menu Colors.....	63
Tone Options.....	63
GPS Options.....	63
GPS Status	63
Set GPS Position	64
Simulator Mode.....	64
Automatic Volume.....	65
Backup and Restore.....	65
Backup	65
Restore	65
Map Information	66
Trip Computer	66
Current Trip	66
Stopping or Starting the Trip Computer	67
Saving the Current Trip Report	67
Resetting the Trip Computer	68
Viewing a Saved Trip Report	68
Deleting a Trip Report	68
Chapter 9: System Settings	70
Brightness	70
Power Management	70
Password	70
Set Password	70
Change Password.....	71
Delete Password	71
Language	71
Chapter 10: System Status	72
Product Information	72
User Storage	72
Diagnostics	72
Audio Test.....	72
Touchscreen Test	72
Keypad Test	72
Video Test	72
Contact Us	73
Chapter 11: Magellan RoadMate Tools Installation	74
Installing the Software	74
Chapter 12: Magellan RoadMate Music Manager	75
Chapter 13: Music Player	76
Single Song Play	76
Multiple Song Play	76

TABLE OF CONTENTS

Play.....	77
Create.....	77
Modify.....	77
Delete.....	77
Rename.....	78
Play Mode.....	78
List Songs.....	78
Equalizer.....	79
Help.....	79
Chapter 14: Magellan RoadMate Photo Manager.....	80
Chapter 15: Photo Viewer.....	81
View Single Photo.....	81
Previous Image (left arrow).....	81
Zoom.....	81
Slideshow.....	82
Pan.....	82
Rotate Image.....	82
Next Image (right arrow).....	82
ESC.....	82
Manage Photos.....	82
List View.....	82
Thumbnail.....	82
Rename.....	82
Properties.....	83
Tools.....	83
Preferences.....	83
Delete Files.....	83
About.....	83
Chapter 16: Magellan RoadMate POI Manager.....	84
Latitude.....	84
Longitude.....	84
Altitude.....	85
Opening a POI File.....	85
Creating a New POI File.....	86
Adding Individual POI's.....	86
Importing a Data File.....	88
Appendix.....	89
POI Categories.....	89
Specifications.....	91
PC Requirements.....	91
GPS Status Screen.....	92
GPS STATUS Screen Structure-first page.....	92
Bad fix code.....	92
GPS STATUS Screen Structure - second page.....	93
Typical GPS STATUS Screen Display.....	94
Frequently Asked Questions.....	95

Chapter 1: Contact Information

If you need support for your Magellan RoadMate 3000T and you wish to contact Thales, please use the following information to direct your questions/comments to the proper person.

1.1 Technical Support

If you need technical assistance or “how-to” help, or if you have a technical question about the functionality of your Magellan product, please contact us on the Internet at **www.magellangps.com** or reach us by fax or by phone.

Our Technical Support phone representatives are available Monday through Friday, 6:00 a.m. to 5:00 p.m. PST/PDT. After hours, you may leave a detailed voice mail message that will be returned within the next business day.

Telephone: **(866) 868-2259** or **(909) 394-5000** (outside the United States)

You may also reach Technical Support by Fax: **(909) 494-7777** [Attn: Tech. Support]; or E-Mail: **magellansupport@thalesnavigation.com**

1.2 Warranty Service

To obtain warranty service on your Magellan RoadMate 3000T, you must contact us for a return authorization (RA) before you ship the product. Packages arriving at our dock without an RA will be refused.

To obtain an RA, simply contact our Technical Support group at: Telephone: **(866) 868-2259** or **(909) 394-5000** (outside the United States); Fax: **(909) 394-7050** [Attn: Tech. Support]; or E-Mail: **magellansupport@thalesnavigation.com**

1.3 Customer Service

If you need to order accessories or obtain unlock codes, you can call our Customer Service Department Monday through Friday, 6:00 a.m. to 5:00 p.m. PST/PDT, or visit our Web site at **www.magellangps.com**.

Telephone: **(866) 339-0488** or **(909) 394-5000** (outside the United States); Fax: **(909) 394-7078**.

1.4 Registration

Please make sure to register your Magellan RoadMate 3000T at **www.magellangps.com**. By registering, you will be informed of the latest product updates.

Chapter 2: GPS Information

2.1 About Satellite Navigation

Global satellite navigation is an exciting technology, providing enhanced productivity and accuracy in a vast number of industries. It adds a new level of enjoyment and safety to a wide range of navigation, sports, and recreational activities.

A Global Navigation Satellite System (GNSS) is a network of satellites that transmit high-frequency radio signals containing time and distance data that can be picked up by a receiver, allowing users to pinpoint their precise locations anywhere around the globe.

There are two Global Navigation Satellite Systems in operation: the U.S. Global Positioning System (GPS) and the Russian GLObal NAVigation Satellite System (GLONASS). These systems are constantly being upgraded to meet higher standards of reliability. A third GNSS named GALILEO, after the Italian astronomer of the early 1600s, is being developed in Europe specifically to provide a higher standard of integrity and reliability, required to ensure the safety of lives during transport by air, land and sea, without the use of additional augmentation systems.

While the GPS and GLONASS satellite networks are being developed to achieve maximum performance, Satellite-Based Augmentation Systems (SBAS) have been established to provide improved accuracy. SBAS provides differential signal corrections for GPS and GLONASS transmissions with the use of ground stations and geostationary satellites in specific regions. This is GNSS-1, the first phase in establishing the required integrity for high-precision satellite navigation.

GNSS-2 requires the launching of new satellites into orbit and a complete upgrade of the existing satellite systems. This second phase is already well underway. GALILEO, scheduled to begin service in 2008, is being developed to meet the standards of GNSS-2 for rapid and reliable, certified precision positioning.

2.2 How Satellite Navigation Works

Global navigation satellites continuously transmit time and distance information as they orbit Earth in a precise formation. Navigation satellite receivers use this information to calculate an exact location through triangulation. Every point on Earth is identified by two sets of numbers called coordinates. These coordinates represent the exact point where a horizontal line, known as latitude, crosses a vertical line, known as longitude. The receiver locks on to at least three satellites and uses the information received to determine the coordinates of the receiving device.

By comparing the time the signals were transmitted from the satellites and the time they were recorded, the receiver calculates how far away each satellite is. The distance of the receiver from three or more satellites reveals its position on the surface of the planet. With these distance measurements, the receiver might also calculate speed, bearing, trip time, distance to destination, altitude, and more.

The satellite-navigation device may display its position as longitude/latitude, Universal Transverse Mercator (UTM), Military Grid (MG), or simply as a point on an electronic map. Many Thales Navigation receivers provide comprehensive mapping data, making satellite navigation an easy tool to enhance your recreational and industrial activities.

2.2.1 Line of Sight

Satellite-navigation receivers operate by line of sight with global-positioning satellites. This means that at least three satellites must be in "view" of a receiver in order to calculate longitude and latitude. A fourth satellite must also be within line of sight to calculate altitude. On average, eight satellites are continuously within line of sight of every position on Earth; the more satellites in view, the more accurate the positioning.

Though the radio signals of navigation satellites will pass through clouds, glass, plastic, and other lightweight materials, satellite-navigation receivers will not work underground or in other enclosed spaces.

Chapter 2: GPS Information

2.3 A Word on the Safe Usage of GPS Maps

Just like paper maps, maps on GPS devices vary greatly in terms of information included and visual presentation. Whether topographical maps, roadmaps or marine charts, each map and the data it presents is designed for a specific purpose. For example, marine charts will often present only a minimal representation of roadways and are not a substitute for street maps. Topographic maps usually provide minimal detail about bodies of water and do not contain marine navigational markers.

Maps also vary widely in scale: the smaller the scale, the more detailed the map. Therefore, when using GPS maps (just as with paper maps) it is important to consider what type of map you are using in your explorations and to use common sense.

2.3.1 From Source to Destination

Thales Navigation, maker of Magellan GPS products, is not a cartography company. We do not create the maps that are used on our GPS devices. We seek to acquire map data from the best public and private sources available at the time of publication. Thales Navigation licenses* topographical maps, roadmaps, marine charts and points of interest (POI) data from commercial and governmental cartographic sources that provide raw map data. Thales Navigation processes and compresses the raw data into a format that makes it presentable and manageable to work on our GPS devices. And to ensure that our map data is as robust as possible, data from multiple sources are often combined to provide a better user experience for our customers. This processing does not alter the landforms, coordinates or other spatial data that comes in the raw data. The accuracy of the maps is fundamentally dependent on the source data used to create them. Map data changes frequently due to both natural and man-made causes. As a result, governmental and commercial cartography companies must continuously review, correct, and improve upon their map data. We release new versions of our maps on a regular basis to reflect these changes.

After processing the data, we test the compatibility of the map with our GPS devices to ensure that the products we release work properly on our GPS devices. We also beta-test our products to get customer feedback prior to release.

2.4 Placement of Your GPS Receiver for Optimal Satellite Reception

Firstly, before considering signal reception, it is important to understand that your GPS receiver is a sensitive piece of equipment. You should never place it in an area of your vehicle where it may be struck by other items, or where vibration may cause it to strike other items or parts of the vehicle. The windshield mount included in the box allows you to place the receiver in such a way that the antenna can receive the satellite signal through the windshield without being obstructed by other parts of the vehicle. However, tinted windows or other reflective coatings may interfere with reception. In this case, it may be required to attach an external antenna (optional). An external antenna provides faster satellite fix times and greater signal strength. Because it is mounted outside of the vehicle, it is not affected by reflective coatings on windows and has an unobstructed line of sight to the satellites. Other mounting solutions are available but may require an external antenna.

External conditions also affect GPS signal reception. Although weather conditions do not affect the signal, tall buildings and trees, driving through canyons, wooded areas, or tunnels, and sitting in a garage or covered parking area will affect the GPS signal. The GPS receiver constantly monitors and updated the GPS signal status and will reacquire the signal once it is clear of any obstructions.

2.5 Signal Acquisition Time

The first time you use your Magellan RoadMate 3000T, or if you travel over 500 miles with it off, there may be a delay in receiving the initial satellite fix; depending on your position and the position of the satellites, this could take 15 minutes or more. Normal usage will receive the satellite fix much faster, but still may take several minutes. It is important to have your antenna rotated upward and an unobstructed view of the sky to receive the best possible satellite signal.

Chapter 2: GPS Information

2.6 GPS Maps and Your Safety

Remember, your GPS device is an aid to navigation. It must be used with common sense, and it is important that users interpret GPS map data with a critical eye. Landscapes and roads change or may be impassable, trees and tall buildings can obscure GPS signals, and your GPS device may not always reflect the complete picture. When using GPS, you must combine the information provided by your GPS map with your relevant local knowledge, road signage, buoys, depth soundings and changing local conditions to generate a complete understanding of your situation.

It is your responsibility to ensure compliance to all traffic laws, including pedestrian observance of crosswalks, and to use good judgment while operating the Magellan GPS receiver. Safety must be your primary concern. The Magellan GPS receiver must not be used while engaged in any activity requiring the user's full attention to the environment. For instance, the Magellan RoadMate 3000T GPS receiver should be operated only by vehicle passengers or by the driver when the vehicle has come to a complete stop. The driver must not attempt to view the display while driving. Disregard any unsafe, hazardous or illegal route suggestions.

Magellan maps do not include, analyze, process, consider or reflect any of the following: legal restrictions (such as weight, height, width, load and speed restrictions); road slope or grade; bridge height, width, weight or other limits; population density; neighborhood quality or safety; availability or proximity of law enforcement, emergency rescue, medical or other assistance; construction work zones or hazards; road, sidewalk, or waterway closures or conditions; weather conditions; pavement characteristics or conditions; special events; traffic congestion; time of day.

*Thales Navigation licenses map data from governmental sources such as, but not limited to, U.S. Geological Survey (USGS), the National Oceanic and Atmospheric Administration (NOAA-NOS) and the Canadian Hydrographic Service (CHS). Thales Navigation also licenses map data from commercial cartography companies such as Navigation Technologies, Navionics, DMTI and C-Map.

Chapter 3: Magellan RoadMate 3000T

3.1 Front View

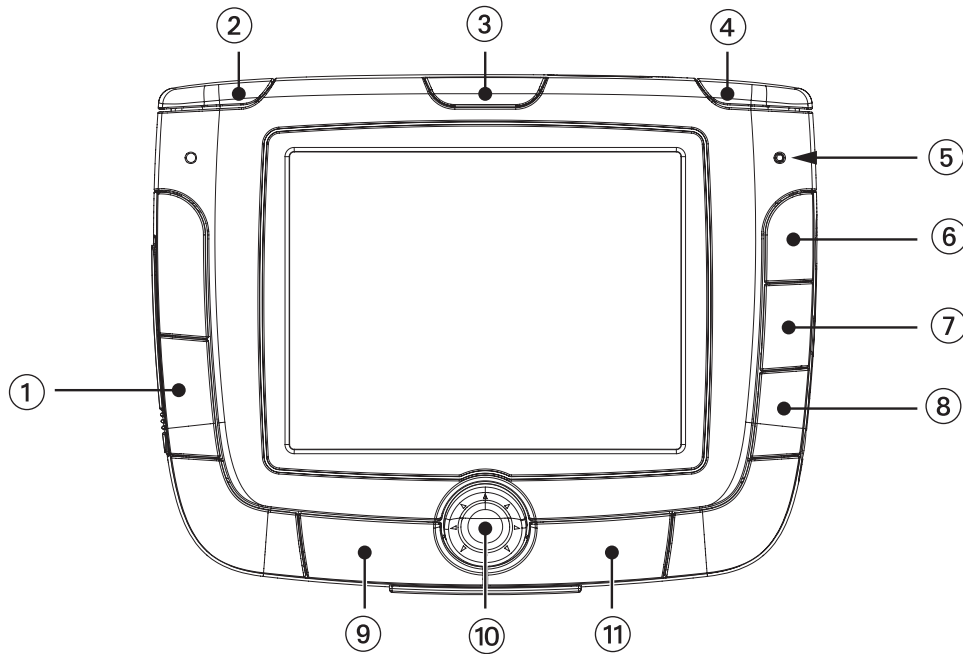

1	Mute Speaker	Press to disable sound from the speaker and the headphone jack.
2	Zoom Out Button	While viewing the map, press to zoom the map display out. The Zoom Out Button can also be used with long lists to scroll one page at a time.
3	Power/Sleep Button	Press and hold to turn the power on or off. <i>Turning on:</i> Hold for 2-3 seconds if in sleep mode. Hold for 10 seconds if first time use or not in sleep mode. <i>Turning off:</i> Hold for 2-3 seconds to put unit into sleep mode; 10 seconds to turn unit off completely.
4	Zoom In Button	While viewing the map, press to zoom in to the center of the display. The Zoom In Button can also be used with long lists to scroll one page at a time.
5	Charging Indicator	LED indicates the battery charging status of the Magellan RoadMate 3000T. Orange - Charging; Green - Fully charged.
6	Locate Button	Press to display current location details and save it to your address book.
7	Destination Menu/View	While not navigating, switches between the map display and the Destination Menu. While navigating, switches between the map display, the maneuver list and the TrueView screen.
8	Main Menu	Press to go to the Application Selection Menu.
9	Enter	Press to confirm an entry.
10	Navigation Key	Use to scroll through lists one item at a time, menus, or to pan the Map screen.
11	Escape	Press to cancel an entry or goes back to the previous screen..

Chapter 3: Magellan RoadMate 3000T

3.2 Rear View

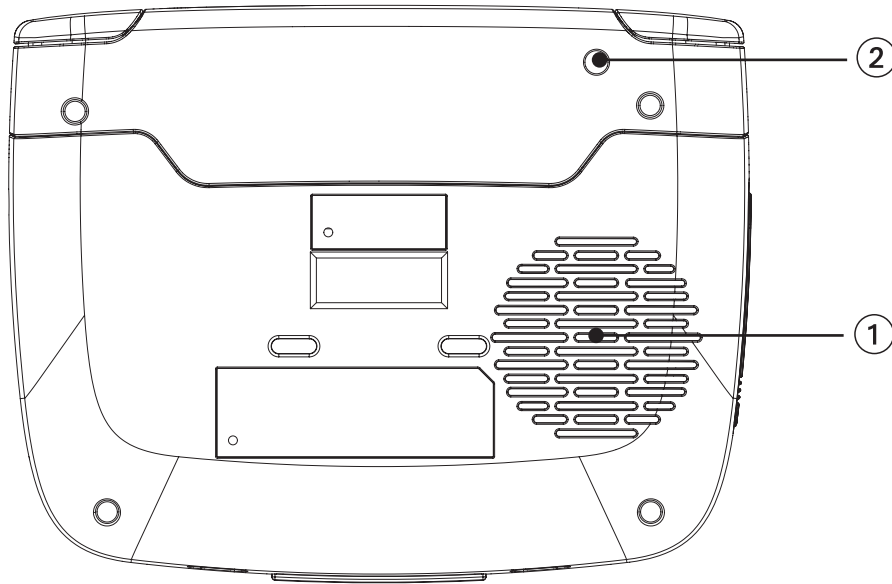

1	Speaker	Used for audible maneuvering instructions and music playback.
2	External Antenna Connector	Provides access by an optional external antenna.

3.3 Top View

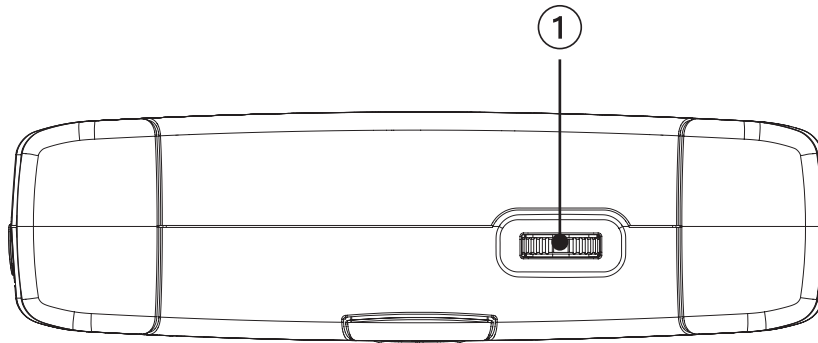

1	Volume Adjustment	Increases (slide right) or decreases (slide left) the volume level. Press to repeat the last voice prompt.
---	-------------------	--

Chapter 3: Magellan RoadMate 3000T

3.4 Bottom View

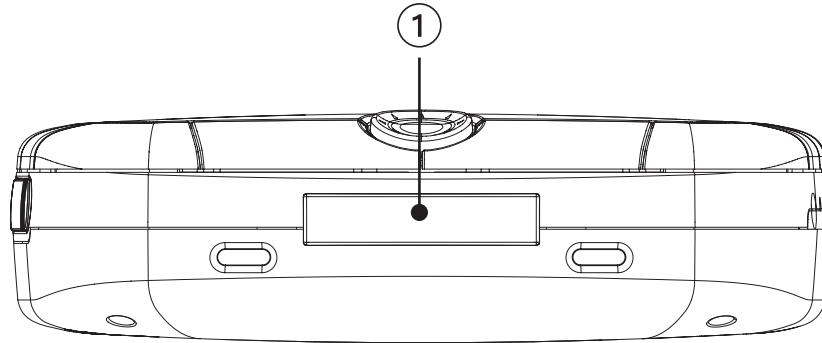

1	16-pin Connection	For future expansion.
---	-------------------	-----------------------

3.5 Right Side View

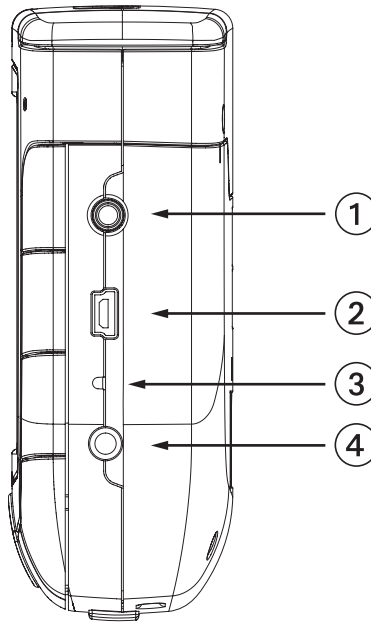

1	Stereo Headphone Connection	Used to connect stereo headphones.
2	USB Connection	Plug the Magellan RoadMate 3000T into your PC to upload music, photos, and custom POI's.
3	Reset Button	In the event the Magellan RoadMate 3000T should fail to respond, press the reset button to reboot.
4	Power Connection	Insert the vehicle power adapter or optional AC adapter to charge the battery.

Chapter 3: Magellan RoadMate 3000T

3.6 Left Side View

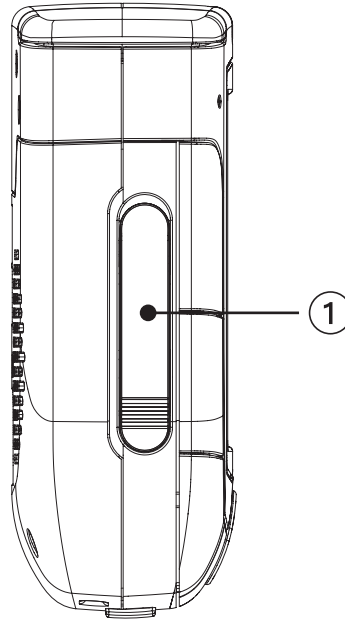

1	Memory Card slot	To listen to music or view files stored on a SD/MMC Card.
---	------------------	---

3.7 Car Holder

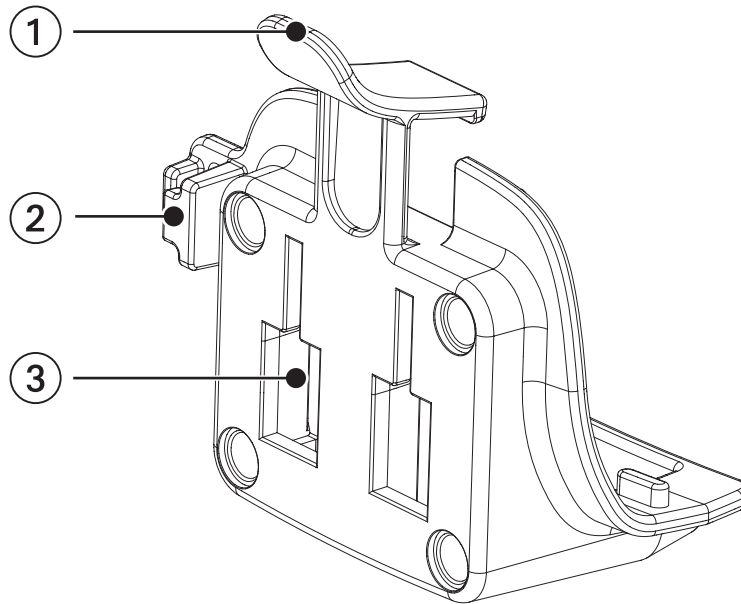

1	Car holder Release	Press to release Magellan RoadMate 3000T from car holder.
2	Wire Catcher	Used to secure the power cable.
3	Windshield Mount connection	Insert the notches of the windshield mount here.

Chapter 3: Magellan RoadMate 3000T

3.8 Using Removable Memory Cards

The Magellan RoadMate 3000T is equipped with a memory card slot on the left side (see “Left Side View” on page 8) that accepts Secure Digital (SD) cards and Multimedia Cards (MMC). These cards are used to backup navigation data or to store music and photos. The memory card slot on your Magellan RoadMate 3000T employs what is called a “push-push” method of locking and releasing. In other words, when you insert the card you must push it to lock it in, and to release it you must push it also. Storage cards come in a variety of sizes and manufacturers.

3.8.1 To Insert the Storage Card:

Peel back the rubber gasket to expose the memory card slot. Do not completely remove the rubber gasket.

The memory card can only be inserted in one direction. Do not force the card into the slot.

Insert the memory card into the slot with the metal contacts going in first and the beveled edge down and the label facing front.

Push the memory card until you hear a click.

Close the rubber gasket.

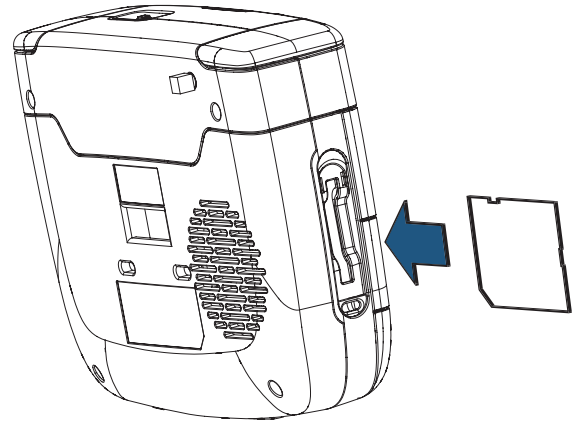

3.8.2 To Remove the Storage card:

Peel back the rubber gasket to expose the memory card slot. Do not completely remove the rubber gasket.

Push the memory card until you hear a click. Do not attempt to pull the card out of the slot

Remove the memory card from the slot.

Close the rubber gasket.

Chapter 4: Vehicle Installation

Take care when mounting the Magellan RoadMate 3000T in your vehicle, whether using the windshield mount or other mount, that it does not obstruct the driver's view of the road. Make sure that the placement of the Magellan RoadMate 3000T and cable does not interfere with the operation of vehicle safety devices, such as air bags. You assume the risks associated with damage to your vehicle or vehicle's occupants as a result of how you choose to mount the Magellan RoadMate 3000T.

4.1 Installing the Windshield Mount

Attach the car holder to the back of the Magellan RoadMate 3000T. Insert the bottom of the Magellan RoadMate 3000T first then snap the car holder clip at the top into place.



Slide the windshield mount onto the back of the car holder.



Press the windshield mount to the glass and slide the locking lever toward the glass.



Plug the power cable into the Magellan RoadMate 3000T as shown. This step is optional but ensures the battery remains charged.



Chapter 4: Vehicle Installation

Plug the power adapter into your vehicles cigarette lighter or 12 volt receptacle.



Installation is complete, and you are ready to turn the Magellan RoadMate 3000T on and go.

Chapter 5: Navigation Basic Operation

5.1 Turning the Magellan RoadMate 3000T On Out of the Box

Press the power button for approximately ten seconds (see “Front View” on page 5). If power is connected properly or if the battery is charged sufficiently, the Magellan screen will appear followed by the Warning screen. To comply with the warnings, press **OK**. Next, the Quick Tips screen will appear. It is recommended to view the Quick Tips to better familiarize yourself with the functionality of the Magellan RoadMate 3000T. Otherwise, select **ESC** to skip viewing the Quick Tips at this time. By default, the navigation application will launch and the Destination screen will appear.



5.1.1 Power Off versus “Sleep” Mode

The Magellan RoadMate 3000T can be put into “sleep” mode. This mode is a limited power mode that saves battery power. When “waking up” from sleep mode, the time to acquire a satellite fix is significantly shorter than when the Magellan RoadMate 3000T is powered up after being completely turned off.

To enable sleep mode, press and hold the Power button for 2-3 seconds. The display will shut off and the power indicator light will be on dimly.

To power off completely, press and hold the Power button for 10 seconds. The Magellan RoadMate will be fully shut off.

To power up the Magellan RoadMate 3000T from sleep mode, press and hold the power button for 2-3 seconds. The Warning screen will appear. Select **OK** and you will be taken to the last screen you were viewing.

5.1.2 Power Management

The Magellan RoadMate 3000T can be configured to automatically go into “sleep” mode after 20 minutes of no keys or touchscreen being pressed. Press the **MENU** key on the Magellan RoadMate 3000T then, select **System Settings** and select **Power Management**. Select the **Auto Power Off** time and then, select **OK**. For more information on Power Management, see “Power Management” on page 70.

5.2 Resetting the Magellan RoadMate 3000T

In the event the Magellan RoadMate 3000T should stop responding, press **RESET** button. If a route was active at the time the Magellan RoadMate 3000T was reset, powering the Magellan RoadMate 3000T back on will prompt you to resume, or cancel the active route.

5.3 Adjusting the Volume

The **VOLUME CONTROL** lever is located at the top of the Magellan RoadMate 3000T (see “Top View” on page 6). Use the lever to set the volume of the speaker to a desired level. The volume level indicator will appear on screen.

5.4 Repeating the Last Command

While routing to a destination, if you missed the last verbal command, you can repeat it by pressing the **VOLUME CONTROL** lever down.

Chapter 5: Navigation Basic Operation

5.5 Making Selections

The Magellan RoadMate 3000T comes equipped with a touch screen. To make a menu selection, or enter characters, simply touch the screen in the location of the item you wish to select.

You can also use the **NAVIGATION** key (see “Front View” on page 5) to scroll around the screen and highlight the item to select. When the desired item is highlighted, press the **ENTER** key (see “Front View” on page 5) to select the item.

5.6 Inputting Text Characters

Whenever you need to input names, street addresses, etc., the Magellan RoadMate 3000T will display a keyboard. Touch the letter you want and, if you make a mistake, use the Backspace key to go back one character at a time. The Spacebar is used to insert spaces between characters or words.

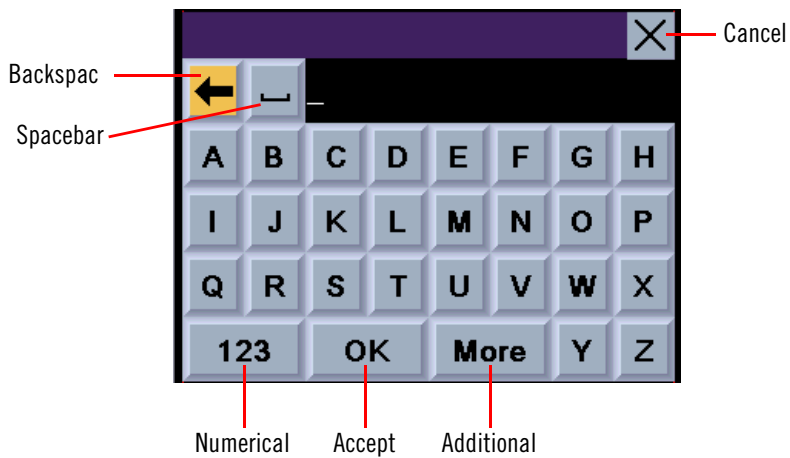

5.7 Additional Characters (“More” Button)

When you are entering characters, you may need to add punctuation or other special characters. When available, pressing the **More** button brings up a keypad with the characters shown here.



Chapter 5: Navigation Basic Operation

5.8 Numerical Characters (“123” Button)

When available, pressing the **123** button brings up a keypad with the numeric characters shown here.



5.9 What Is QuickSpell?

The Magellan RoadMate 3000T uses QuickSpell technology to provide you with the fastest method possible to enter characters. QuickSpell eliminates the possibility of a misspelled word or looking for a city or street that is not in the loaded database. As you begin entering characters, the QuickSpell feature of the Magellan RoadMate 3000T dims out those characters which that are not available, thereby speeding up the process of entering data.

Example:

Suppose that you need to input the name of a city--in this case, San Francisco.

Select “S”.



Select “A”.



Select “N”.



Chapter 5: Navigation Basic Operation

Select the spacebar.

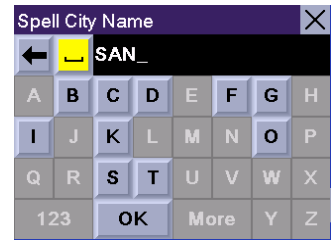

When enough characters have been entered, the Magellan RoadMate 3000T will automatically display the list of cities; or, if you feel that enough characters have been entered, select **OK**.

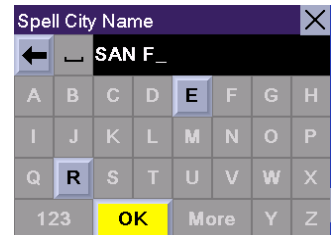

Use the Navigation key to scroll the list up or down and select "San Francisco, CA" from the list.

The list of items found in the database is limited to 100 items. When over 100 items have been found, "Matches: > 100" will be displayed shown in the bottom right corner of the display; you may need to press the **CANCEL** key (see "Front View" on page 5) and enter additional characters.

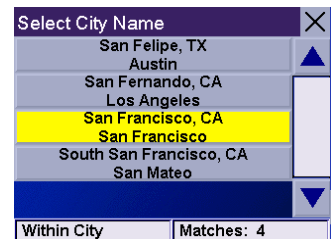

5.10 Help with Address Entry

When entering street names, please follow these simple guidelines to help you find your selection:

- Do not enter prefixes such as "N" or "North".
- Do not enter the street type such as "Ave." or "Avenue" except in some cases where the street type is included before the street name (e.g. "Via Calle", "Avenue 378", or "Rue Andre").
- When entering a numbered street (e.g. "4th Street"), use the numeric keypad to enter "4" and go back to the alpha keypad to enter "th".
- For streets with multiple words such as "Overland Heights", you must enter the first word. Entering the word "Heights" will not return the desired street.

Chapter 6: Traveling

6.1 Guidance Information Screens

The Magellan RoadMate 3000T has three screens you can use to assist you in traveling to your destination: the Map screen, the Maneuver List screen, and the TrueView/Split TrueView screen.

Map: When a new destination is selected and calculated, the Map screen is displayed. This screen displays a map of your surrounding area along with the planned route (if calculated) and information about the route. This screen can be accessed when no route has been calculated by selecting **Map** or by pressing the **VIEW** key (see “Front View” on page 5.) while at the Destination screen.

Maneuver List: This screen is available only when a route has been calculated. This screen displays a list of maneuvers to follow in order to arrive at the destination. It can also be used to exclude a maneuver and then recalculate the route. To access the Maneuver List screen, press the **VIEW** key (see “Front View” on page 5.) while viewing the Map screen.

TrueView: This screen is available only when a route has been calculated. This screen displays the next maneuver as a 3D graphic. It will help you to know which lane to be in and provides you with an easy-to-follow picture of the next maneuver. To access the TrueView screen, press the **VIEW** key (see “Front View” on page 5.) while viewing the Maneuver List. You can also show the TrueView in split mode (see “TrueView Options” on page 60). This view shows the TrueView screen on the left side and the Map on the right side.

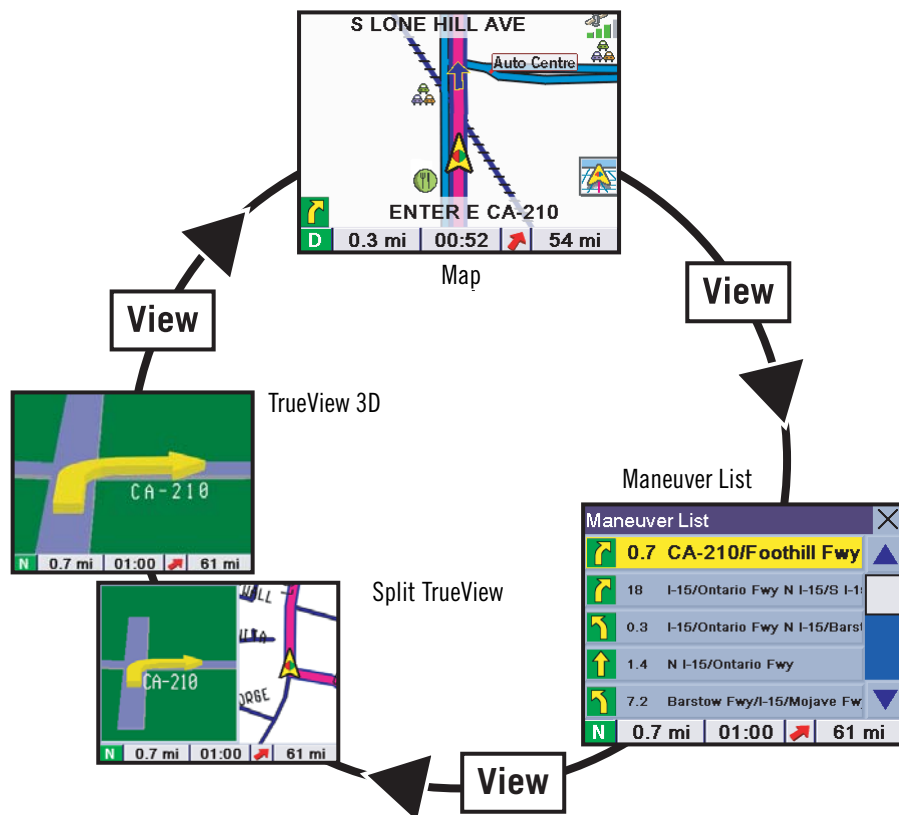

Chapter 6: Traveling

6.2 Map Screen

The Map screen is the most commonly used screen in the Magellan RoadMate 3000T and provides you with detailed information about where you are and where you are going.

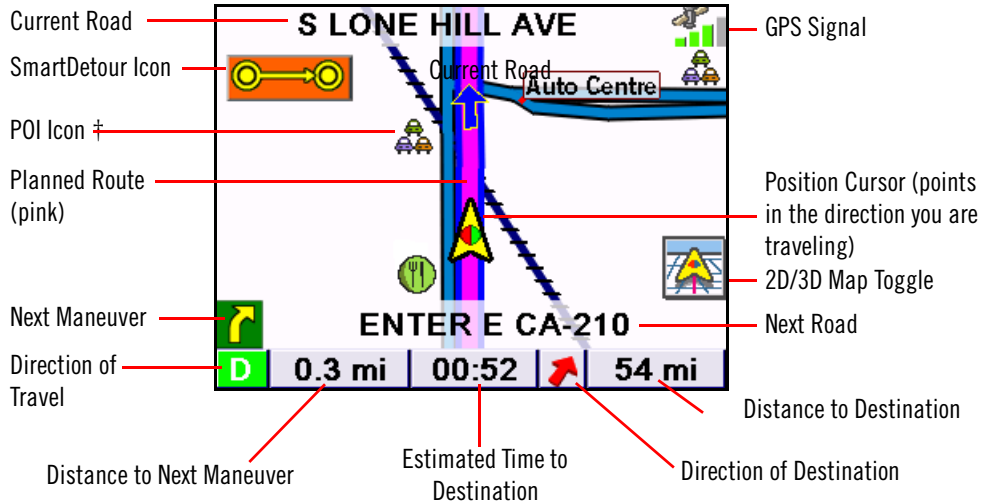

† By touching the POI icon on the screen, you can get information and route to it.

As you travel, the Map screen constantly updates your location and provides you with not only a map but a visual indication of where you are on the map.

6.3 Changing from 2D to 3D Map View

The Map screen can be changed between 2D (view overhead of the position cursor, and 3D (view overhead and slightly behind). The 3D view offers a more realistic view showing a perspective of the roads ahead. While in 3D Map mode, you can still touch icons on the screen to route to them while driving, and you can zoom in and out. You cannot however, scroll the map, and the map orientation is set at Heading Up. When in Split TrueView, the map portion of the screen will be in 2D mode.

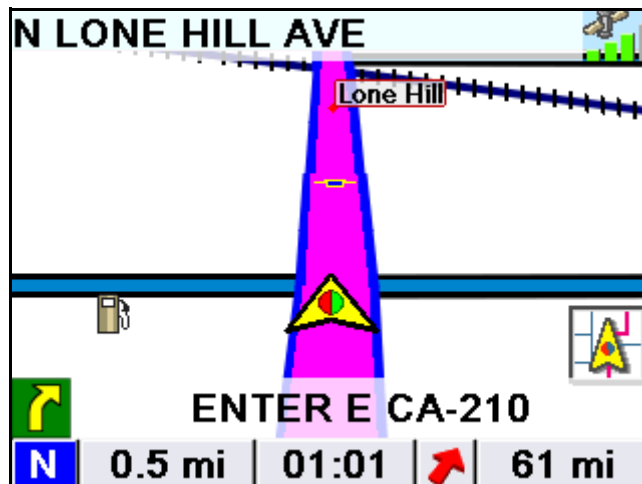

Chapter 6: Traveling

6.4 Changing the Map Zoom Levels

While viewing the Map screen, you can zoom in (enlarge the map) by pressing the **+** (**plus**) key or zoom out (shrink the map) by pressing the **-** (**minus**) key (see “Front View” on page 5.).

Note: The Zoom In and Zoom Out keys can also be used to scroll through long lists. While viewing a list, press the Zoom Out key to scroll the list down one page at a time and press the Zoom In key to scroll the list up one page at a time.

6.5 Maneuver List Screen

The Maneuver List screen can be viewed only after a route has been calculated. From the Map screen, press the **VIEW** key to bring up a list of all of the maneuvers along the route. When you are done viewing the Maneuver List screen, press the **VIEW** key twice to return to the Map screen, or wait a few moments and it will return automatically.

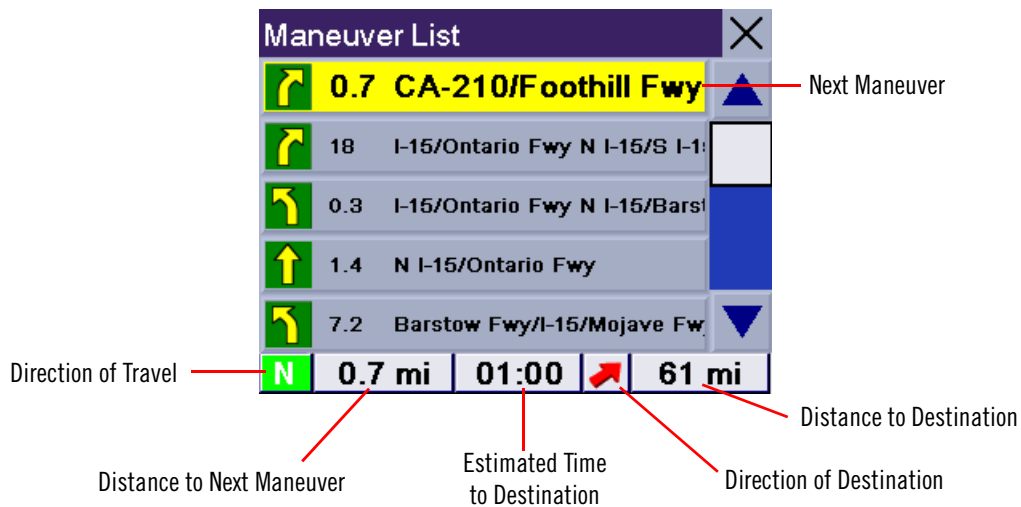

Chapter 6: Traveling

6.6 TrueView Screen

The Magellan RoadMate 3000T uses TrueView technology to display a three-dimensional picture of the next maneuver. The TrueView screen can be viewed only after a route has been calculated. From the Map screen, press the **VIEW** key twice to view the TrueView screen.

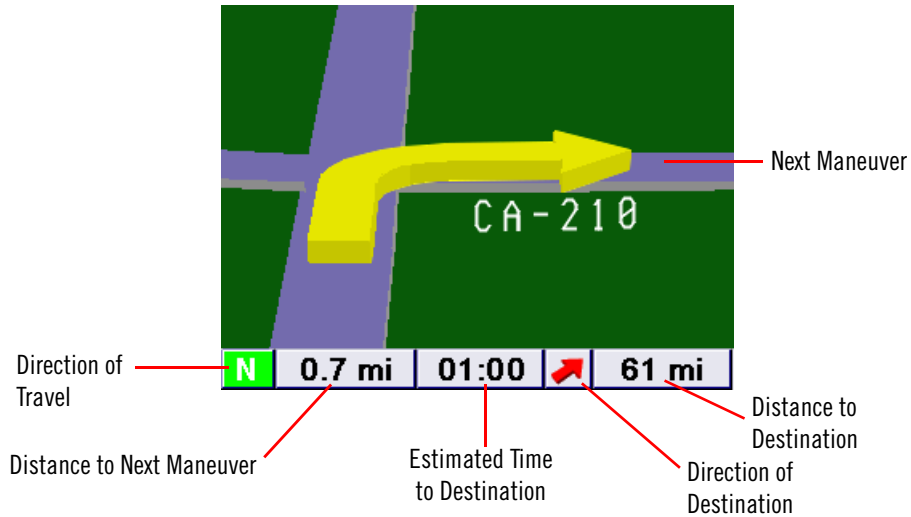

In split mode, the left half of the screen shows TrueView, while the right half of the screen shows the Map.

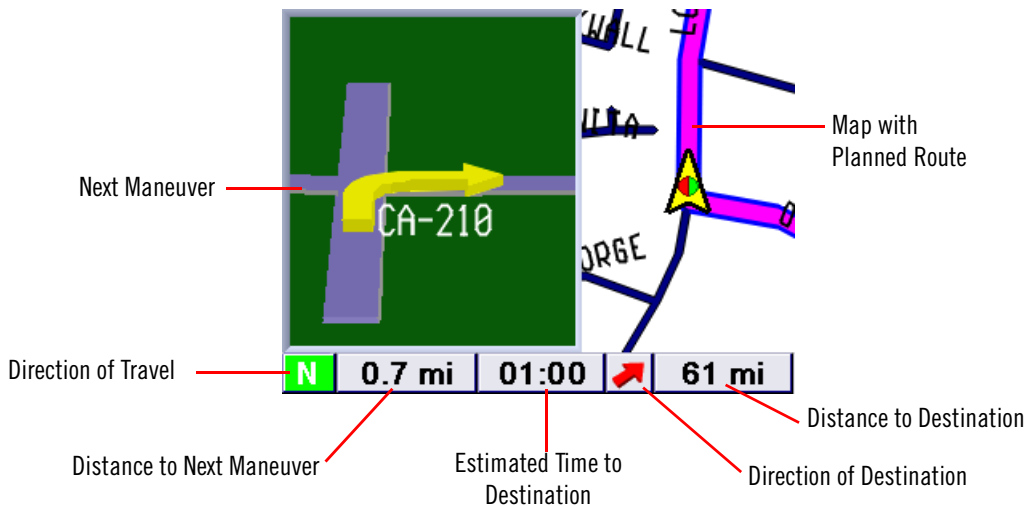

Chapter 6: Traveling

6.7 Choosing the Route Method

Every route is calculated based on the Route Method criteria selected. Every time a new destination is selected, the Magellan RoadMate 3000T prompts you for the method that will be used to calculate the route.

Shortest Time: This selection calculates a route that should take the least amount of time using speed limits and other information in the database. Other factors, such as traffic conditions, cannot be used in the calculation of shortest time.

Shortest Distance: This option calculates the route using the most direct route to the destination. This route may not be the fastest due to lower speed limits, left turns or other factors.

Least Use of Freeways: This selection calculates the route avoiding freeways whenever possible.

Most Use of Freeways: This selection calculates the route using freeways as much as possible. This option will use toll roads unless specified. See “Route Preferences” on page 61.

View Destination on Map: Before you select your Route Method, you can see where you are going.

Avoid Toll Roads: Check this option to calculate your route without using toll roads.

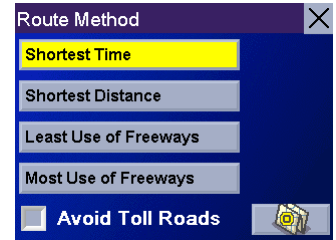

6.8 Changing the Route Method

While routing and viewing the Map screen, the Maneuver List screen, or the TrueView screen, press the **ESCAPE** key.

Select **Route**, then select the new route method.

The route will be re-calculated using the new Route Method chosen and the Map screen will be displayed. Press the **VIEW** key to see the Maneuver List with the new route.

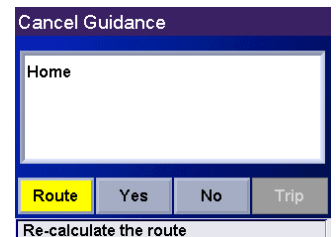

6.9 Cancelling a Planned Route

While viewing the Map screen, the Maneuver List screen, or the TrueView screen, press the **ESCAPE** key.

Select **Yes** to cancel the route and display the Destination screen.

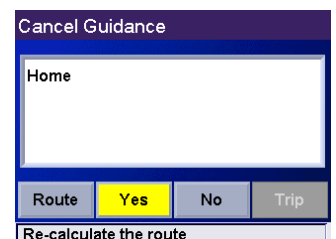

Chapter 6: Traveling

6.10 Detouring from the Planned Route

If you exit the planned route, the Magellan RoadMate 3000T will get you back on course in one of three ways.

1. If, while driving, you detour from the planned route, the Magellan RoadMate 3000T will automatically recalculate the route based on your new vehicle position.
2. If you exit the planned route before its completion and turn off your vehicle, the Magellan RoadMate 3000T will switch to battery power, unless your cigarette lighter maintains constant power. In either situation, the Magellan RoadMate 3000T will automatically suspend power when enabled through customization. While in “sleep” mode, navigation functions will be suspended and guidance will resume when the Magellan RoadMate 3000T wakes up.
3. If while routing, the Magellan RoadMate 3000T fails to respond, reset the Magellan RoadMate 3000T as described on page 12. The Resume Guidance screen will appear.
Select **Resume** to continue the route to the selected destination.
Select **Cancel** to clear the route and display the Destination screen.

6.11 Excluding a Maneuver in the Planned Route

While traveling or setting up your destination you may find it necessary to exclude one of the maneuvers in the Maneuver List. This could be due to an accident or street maintenance you want to avoid. The Magellan RoadMate 3000T provides you with tools to select a specific maneuver, exclude it from the planned route and reroute the trip.

Press the **VIEW** key to get to the Maneuver List. Select the maneuver you wish to exclude.



The details for the maneuver are displayed. Select **Exclude**.

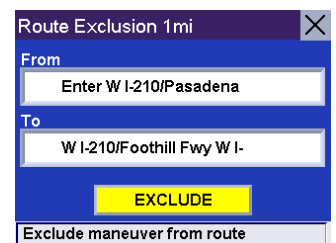

The trip will be recalculated, excluding the selected maneuver. This calculation is done using the same Route Method that was chosen originally. After the route is recalculated, the Map screen is displayed.

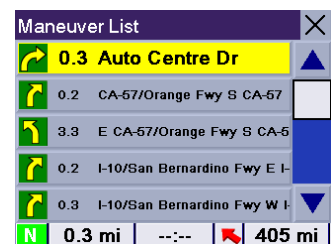

Chapter 6: Traveling

6.12 Displaying Information About Your Present Location

Anytime that you want to view information about your present location you can press the **LOCATE** key.

The first screen displays your heading and the street you are on, the state and city you are currently traveling in, the latitude and longitude of your present location, a compass, and your speed.

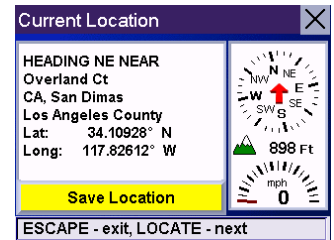

The next screen displays the street you are currently traveling on, the distance to and the next street on the map, and the distance from and the last street you passed.

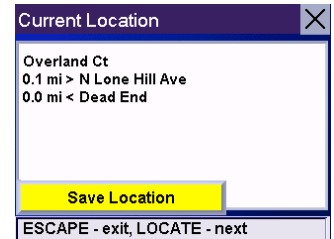

6.13 Saving Your Current Location to Your Address Book

While you are in the Locate screen, you can save your current location to your Address Book.

Select the **Save Location** button.

The information about your location is displayed. Select **Edit Name** and/or **Edit Information** and use the keypad to assign a name to the location and other information about it. If the point you are saving is off-road, the nearest road information will be used.

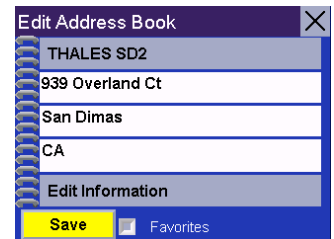

When you have finished, select **Save**. The location is saved to your Address Book and you are returned to the Locate screen.

6.14 Finding POIs Along Your Route

While driving along a route, if you need to find a gas station, ATM, or other POI, the Magellan RoadMate 3000T can find the nearest POI and route to it. Then, when you have completed the side route, resume guidance to your original destination.

While driving along a route, press the **ENTER** key.

Chapter 6: Traveling

Select **Dining, ATM, Gas....**

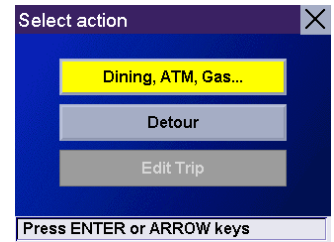

Select the desired POI category.

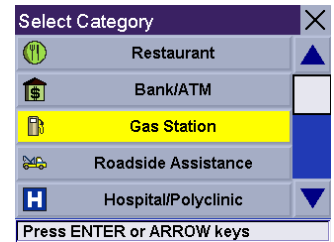

A list of the nearest POI's is displayed. Use the Navigation key to scroll the list up or down (if necessary) and select the desired POI.

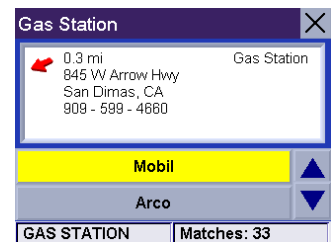

The Magellan RoadMate 3000T will calculate a new route to the selected POI from your current position. When you have arrived at the new destination, you will be prompted to resume guidance to your original destination. Select **Resume**. The Magellan RoadMate 3000T will calculate the route to your original destination using the Route Method previously selected.

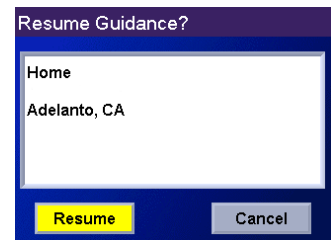

6.15 Finding a Detour Along Your Route

While driving along a route, if you encounter traffic, road construction, or other situation you might need to navigate around, the Magellan RoadMate 3000T can calculate an alternate route to your destination.

While driving along a route, press the **ENTER** key.

Select **Detour**.

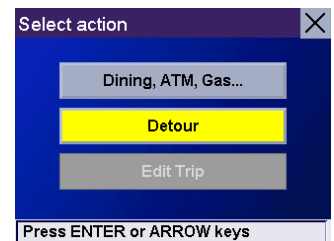

Chapter 6: Traveling

Select the distance of the detour. Select **3 miles**, **5 miles**, or **10 miles**.

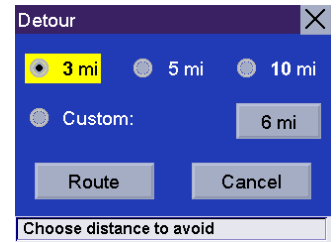

Or, you can enter a custom distance. Select **Custom** and select the custom distance.

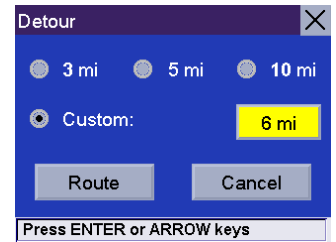

Enter the number of miles for your detour and then select **OK**.

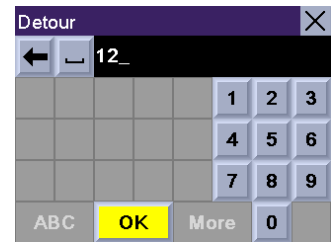

Select **Route**. The Magellan RoadMate 3000T will recalculate the alternate route to your destination.

You can also choose to have the Magellan RoadMate 3000T detour you around traffic automatically by enabling smart detour. See "Detour Options" on page 62.

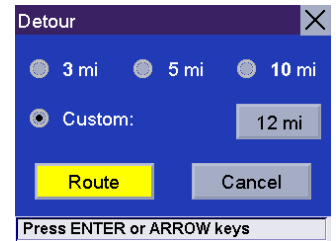

Chapter 7: Selecting Destinations

7.1 Destination Screen



7.2 Country Selection (Globe Button)

Country selection is used to help speed up searching by narrowing down the database. Before entering a destination, make sure you select the country where your destination is located. To select the country, select the **Globe** button then, select the country you wish to search. The current destination country is displayed at the top of the Destination screen.

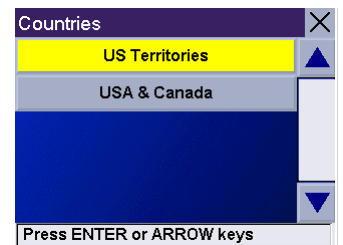

7.3 Entering and Routing to Your Home Address

The Magellan RoadMate 3000T enables you to enter an address to assign to your Home button. The Home button allows you one touch access to the address you route to most often. Select the **Home** button.

If this is the first time using this button, you will be prompted to enter an address. Select **Yes**.

Select either Search by City, Search by Zip Code, or Search by State. For this example select **Search by City**.

Enter the first few characters of the city name (see "Inputting Text Characters" on page 13). Select **OK**. Use the Navigation key to scroll the list up or down (if necessary) and select the desired city.

Enter the street name (see "Help with Address Entry" on page 15).

Enter the address. The acceptable range of street numbers is displayed at the top of the screen. Enter the street number and select **Done**.

At this point you can choose to edit the information or, if you are finished, select **Save**.

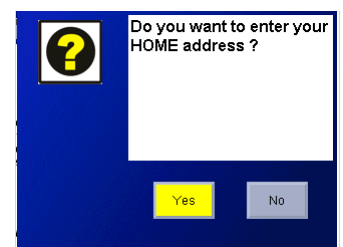

Chapter 7: Selecting Destinations

Now, when you press the Home button, you will be prompted to either route to or change the Home address.

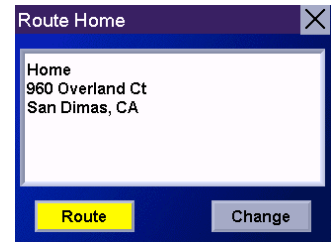

7.4 Selecting a Destination Using Select Address

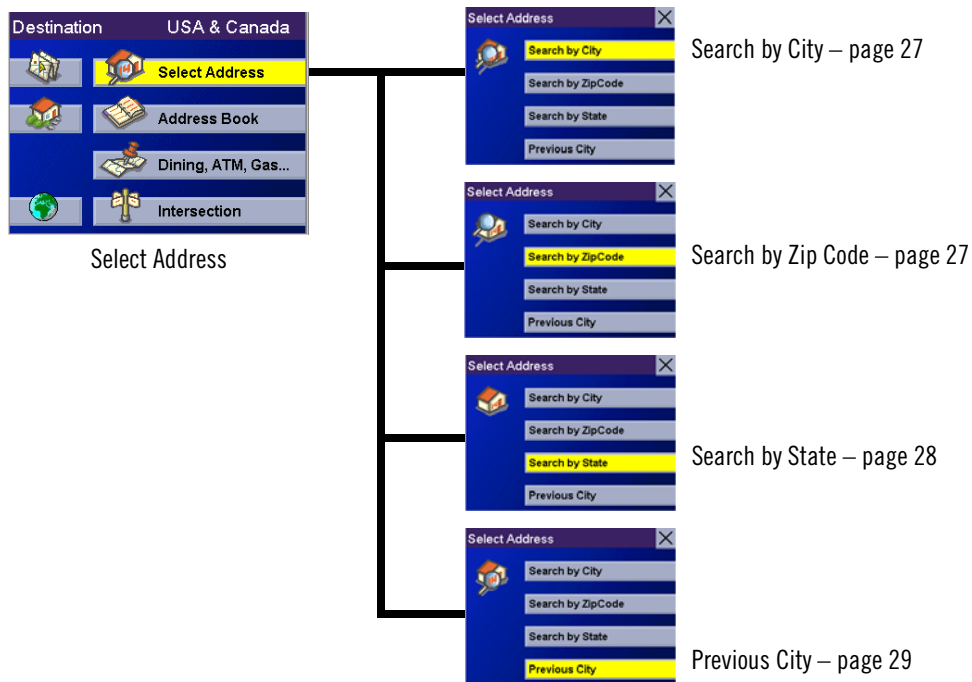

A destination can be created by entering the street address that you want to go to. This address is not automatically added your Address Book but is saved to your Previous Destinations list if you have routed to it. You have four options: Search By City, Search by Zip Code, Search By State, or Previous City. Use Search By City when you know the city that the address can be found in. Use Search by Zip Code if you aren't sure of how to spell the city, but know the zip code. Use Search By State when you don't know, or are unsure of the city name. You will be given a listing of all of the cities for the state you select that have the street name you are looking for. Use Previous City to speed up your search by not having to re-enter a city you have used before. Additionally, The Previous Cities list places your current city at the top of the list.

Chapter 7: Selecting Destinations

7.4.1 Search By City

From the Destination screen, select **Select Address** and then, select **Search By City**.

Enter the first few characters of the city name (see “Inputting Text Characters” on page 13). Select **OK**.

Use the Navigation key to scroll the list up or down (if necessary) and select the desired city.

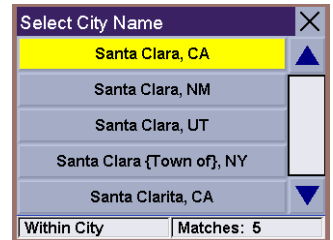

Enter the street name (see “Help with Address Entry” on page 15). Select **OK**.

Use the Navigation key to scroll the list up or down (if necessary) and select the desired street.

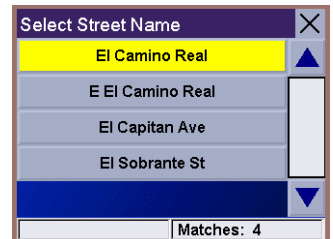

Enter the street address. The acceptable range of numbers is displayed at the top of the screen. Select **Done**.

Select the desired Route Method.

The Magellan RoadMate 3000T will calculate the route. When the calculations are complete, the Map screen will be displayed.

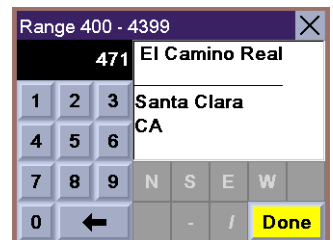

7.4.2 Search by Zip Code

From the Destination screen, select **Select Address** then, select **Search by Zip Code**.

Enter the zip code select **OK**, then select the city.

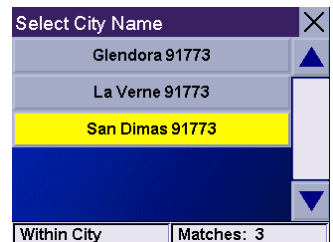

Enter the street name (see “Help with Address Entry” on page 15). Select **OK**.

Use the Navigation key to scroll the list up or down (if necessary) and select the desired street.

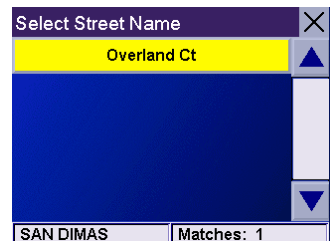

Chapter 7: Selecting Destinations

Enter the street address. The acceptable range of numbers is displayed at the top of the screen. Select **Done**.



Select the desired Route Method.

The Magellan RoadMate 3000T will calculate the route. When the calculations are complete, the Map screen will be displayed.

7.4.3 Search By State

From the Destination screen, select **Select Address** then, select **Search By State**.

Enter the first few characters for the state and select **OK**.

Select the state.

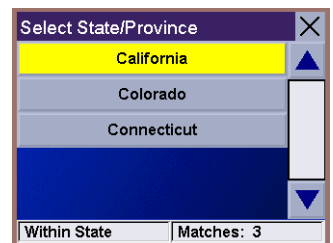

Enter the street name (see "Help with Address Entry" on page 15). Select **OK**.

Use the Navigation key to scroll the list up or down (if necessary) and select the desired street.

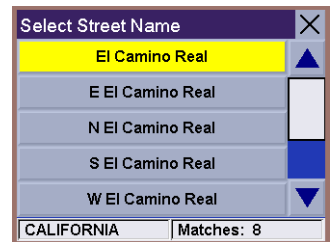

Select the desired city from the list. Only those cities that contain the street name and are within the state selected are displayed.

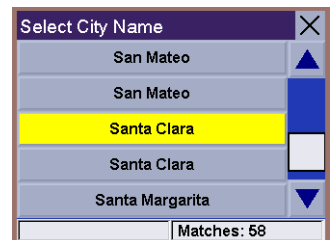

Enter the street address. The acceptable range of numbers is displayed at the top of the screen. Select **Done**.

Select the desired Route Method.

The Magellan RoadMate 3000T will calculate the route. When the calculations are complete, the Map screen will be displayed.

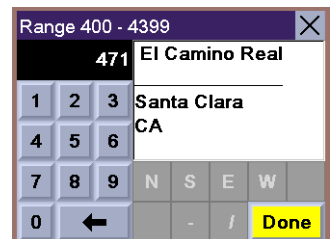

Chapter 7: Selecting Destinations

7.4.4 Previous City

From the Destination screen, select **Select Address** then, select **Previous City**.

Select the city from the list.

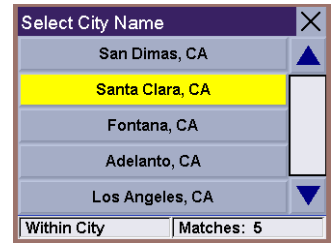

Enter the street name (see “Help with Address Entry” on page 15). Select **OK**.

Use the Navigation key to scroll the list up or down (if necessary) and select the desired street.

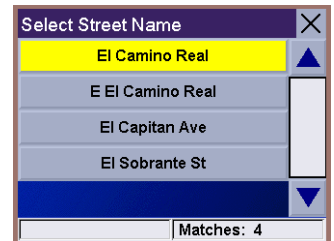

Enter the street address. The acceptable range of numbers is displayed at the top of the screen. Select **Done**.

Select the desired Route Method.

The Magellan RoadMate 3000T will calculate the route. When the calculations are complete, the Map screen will be displayed.

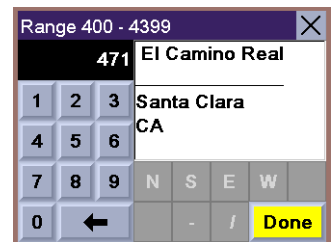

Chapter 7: Selecting Destinations

7.5 Selecting a Destination Using the Address Book

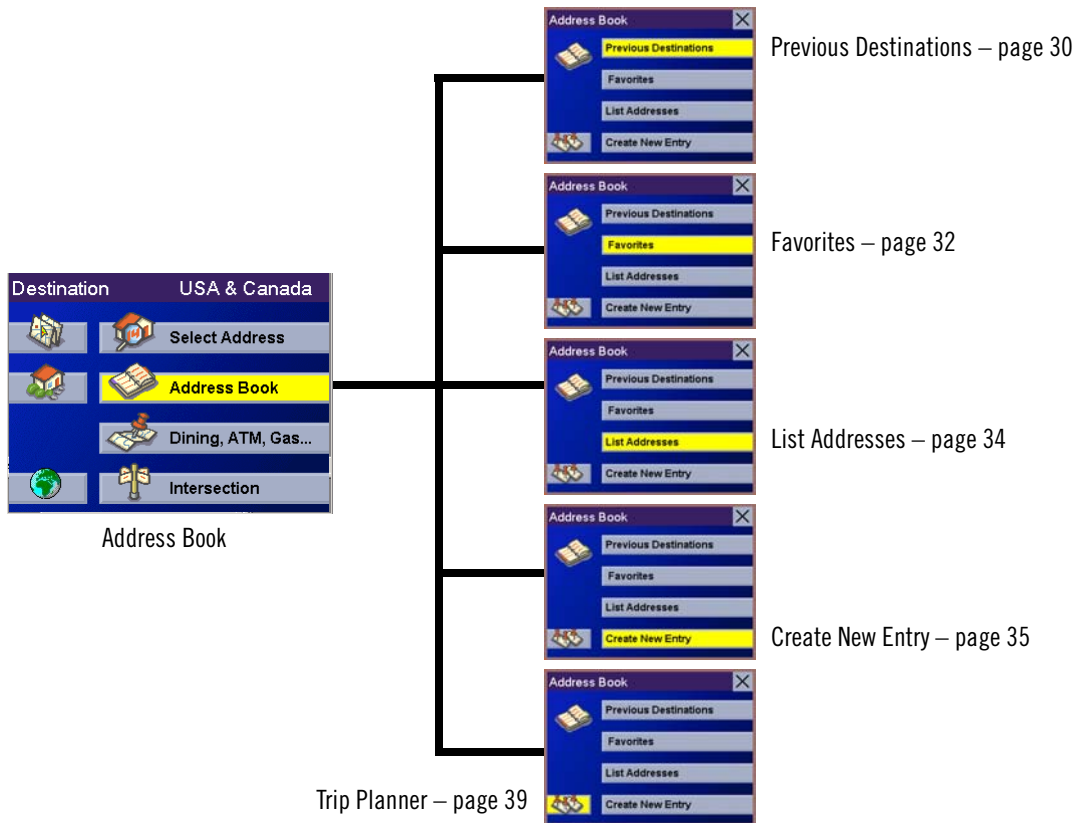

The Address Book can store up to 200 addresses. When you select Address Book you are given five options: **Previous Destinations** lets you select from a list of the last 50 destinations you routed to; **List Addresses** displays a list of all of the addresses you have stored in your Address Book; **Favorites** gives you a shortened list of entries from your Address Book marked as Favorites; **Create New Entry** lets you add a new address to your Address Book; and **Trip Planner** (indicated by the Trip button) lets you create a multi-destination trip from entries.

7.5.1 Previous Destinations

From the Destination screen, select **Address Book** then, select **Previous Destinations**.

Use the Navigation key to scroll the list up or down (if necessary) and select the desired previous destination.



Chapter 7: Selecting Destinations

Select **Route**.

Select the desired Route Method.

The Magellan RoadMate 3000T will calculate the route. When the calculations are complete, the Map screen will be displayed.

7.5.1.1 Saving a Previous Destination to the Address Book

From the Destination screen, select **Address Book**, then select **Previous Destinations**.

Use the Navigation key to scroll the list up or down (if necessary) and select the desired previous destination.

Select **Edit**.

The top line (Name) and the bottom line (Information) can be edited. The address cannot be changed. Select the line you want to modify. Use the keypad to enter the desired text and select **OK**.

When you have finished making changes, select **Save**, then press **ESCAPE**.

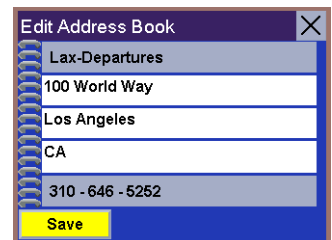
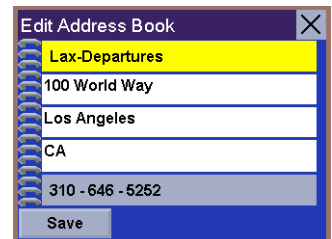
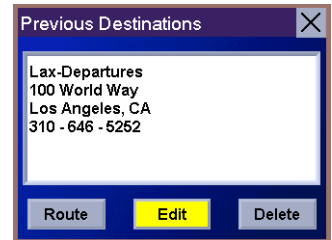
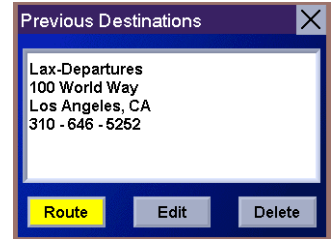

Chapter 7: Selecting Destinations

7.5.1.2 Deleting A Previous Destination

From the Destination screen, select **Address Book** then, select **Previous Destinations**.

Use the Navigation key to scroll the list up or down (if necessary) and select the desired previous destination.



Select **Delete**.

A dialog box will appear to confirm your selection. Select **Yes**.

The Previous Destination is deleted from the list.

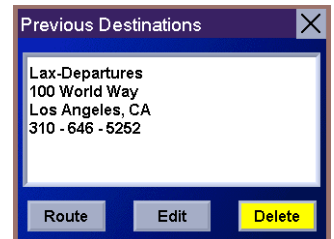

7.5.2 Favorites

You can add address book entries to your Favorites list by selecting the Favorites box at the bottom of the Edit Address Book screen. Only address book entries can be saved as Favorites, Previous Destinations must be saved to the Address Book first, and can then be designated as a favorite. The Favorites list is a shorter list of those address book entries that you travel to often.

From the Destination screen, select **Address Book**, then select **Favorites**.

Use the Navigation key to scroll the list up or down (if necessary) and select the destination from the list of addresses.



Select **Route**.

Select the desired Route Method.

The Magellan RoadMate 3000T will calculate the route. When the calculations are complete, the Map screen will be displayed.

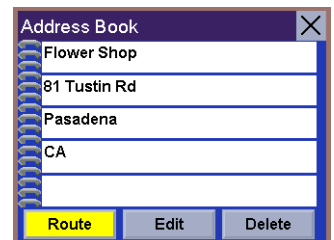

Chapter 7: Selecting Destinations

7.5.2.1 Editing a Favorite

From the Destination screen, select **Address Book** then, select **Favorites**.

Use the Navigation key to scroll the list up or down (if necessary) and select the desired favorite.



Select **Edit**.

The top line (Name) and the bottom line (Information) can be edited. The address cannot be changed. Select the line you want to modify. Use the keypad to enter the desired text and select **OK**.

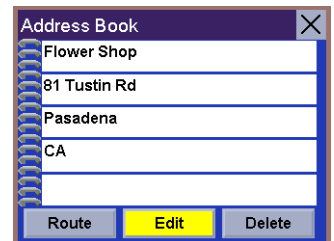

When you have finished making changes, select **Save** and then, press **ESCAPE**.

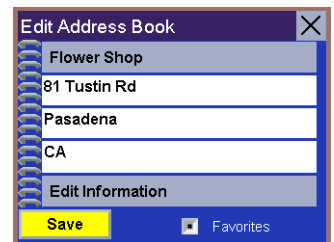

7.5.2.2 Deleting A Favorite

From the Destination screen, select **Address Book** then, select **Favorites**.

Use the Navigation key to scroll the list up or down (if necessary) and select the desired favorite.



Select **Delete**.

A dialog box will appear to confirm your selection. Select **Yes**.

The entry is deleted from the list.

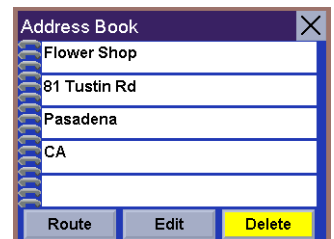

Chapter 7: Selecting Destinations

7.5.3 List Addresses

List Addresses shows all entries stored in your address book. It does not include previous destinations but does include those entries designated as Favorites.

From the Destination screen, select **Address Book** then, select **List Addresses**.

Use the Navigation key to scroll the list up or down (if necessary) and select the destination from the list of addresses.

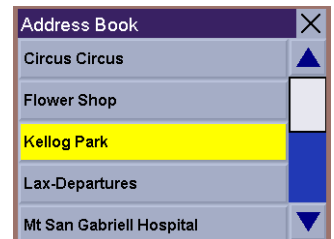

Select **Route**.

Select the desired Route Method.

The Magellan RoadMate 3000T will calculate the route. When the calculations are complete, the Map screen will be displayed.

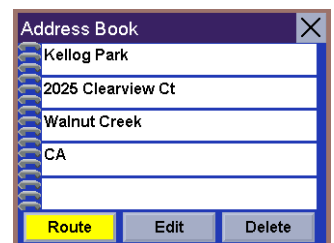

7.5.3.1 Editing an Address

From the Destination screen, select **Address Book** then, select **List Addresses**.

Use the Navigation key to scroll the list up or down (if necessary) and select the desired address.

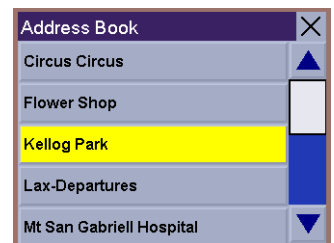

Select **Edit**.

The top line (Name) and the bottom line (Information) can be edited. The address cannot be changed. Select the line you want to modify. Use the keypad to enter the desired text and select **OK**. You can also designate the address as a favorite by checking the box at the bottom of the screen.

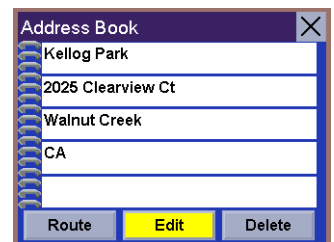

When you have finished making changes, select **Save** and then, press **ESCAPE**.

Chapter 7: Selecting Destinations

7.5.3.2 Deleting an Address

From the Destination screen, select **Address Book** then, select **List Addresses**.

Use the Navigation key to scroll the list up or down (if necessary) and select the desired address.

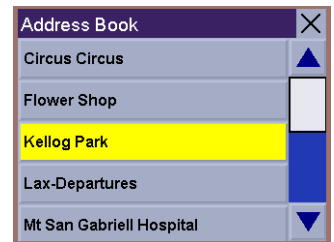

Select **Delete**.

A dialog box will appear to confirm your selection. Select **Yes**.

The address is deleted from the list and you are returned to the Address Book screen.

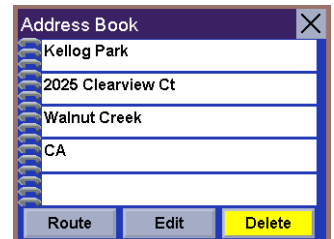

7.5.4 Create New Entry

Use Create New Entry to add entries to your address book. These entries can then be designated as Favorites to include in the Favorites list.

7.5.4.1 Search by City

From the Destination screen, select **Address Book** then, select **Create New Entry**.

Select **Search by City**.

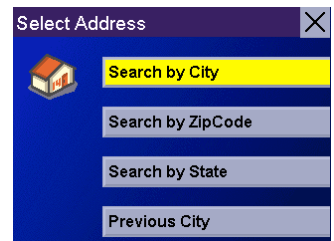

Enter the first few characters of the city name (see "Inputting Text Characters" on page 13). Select **OK**.

Use the Navigation key to scroll the list up or down (if necessary) and select the desired city.

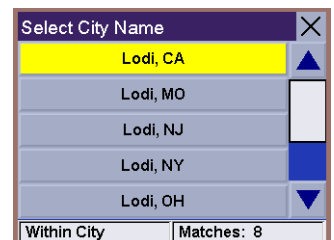

Chapter 7: Selecting Destinations

Enter the street name (see “Help with Address Entry” on page 15). Select **OK**.

Use the Navigation key to scroll the list up or down (if necessary) and select the desired street.



Enter the street address. The acceptable range of numbers is displayed at the top of the screen. Select **Done**.

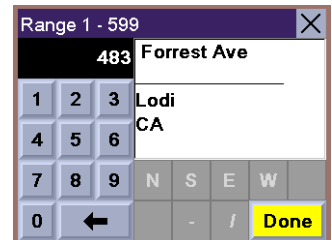

The top line (Name) and the bottom line (Information) can be edited. The address cannot be changed. Select the line you want to modify. Use the keypad to enter the desired text and select **OK**. You can also designate the address as a favorite by checking the box at the bottom of the screen.

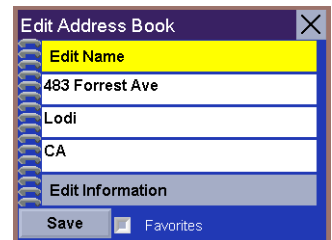

When you have finished making changes, select **Save** and then, press **ESCAPE**.

7.5.4.2 Search by Zip Code

From the Destination screen, select **Address Book** then, select **Create New Entry**.

Select **Search by Zip Code**.

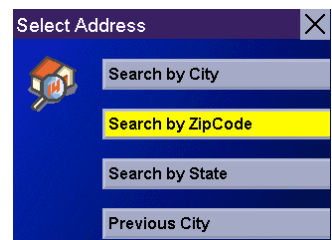

Enter the zip code and select **OK**, then select the city.

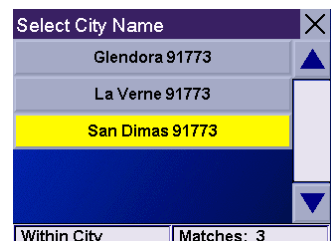

Chapter 7: Selecting Destinations

Enter the street name (see “Help with Address Entry” on page 15). Select **OK**.

Use the Navigation key to scroll the list up or down (if necessary) and select the desired street.

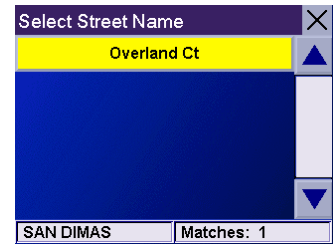

Enter the street address. The acceptable range of numbers is displayed at the top of the screen. Select **Done**.

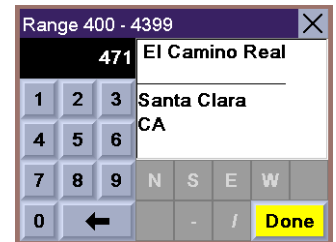

The top line (Name) and the bottom line (Information) can be edited. The address cannot be changed. Select the line you want to modify. Use the keypad to enter the desired text and select **OK**. You can also designate the address as a favorite by checking the box at the bottom of the screen.

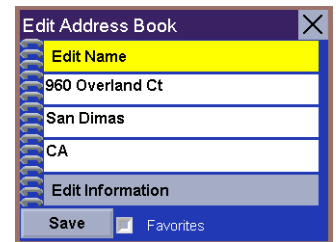

When you have finished making changes, select **Save** and then, press **ESCAPE**.

7.5.4.3 Search by State

From the Destination screen, select **Address Book** then, select **Create New Entry**.

Select **Search by State**.

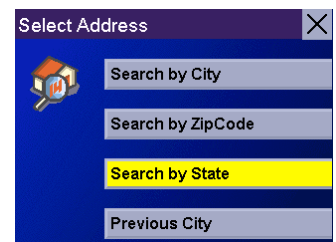

Use the keypad to enter the first few characters for the state and select **OK**.

Select the state.

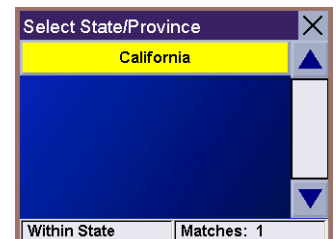

Chapter 7: Selecting Destinations

Enter the street name (see “Help with Address Entry” on page 15). Select **OK**.

Use the Navigation key to scroll the list up or down (if necessary) and select the desired street.

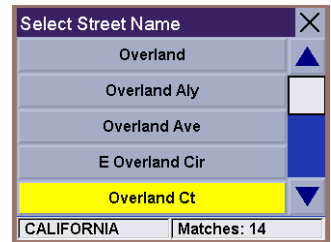

Use the Navigation key to scroll the list up or down and select the desired city. (These are all of the cities in your loaded database that have the street name you selected.)

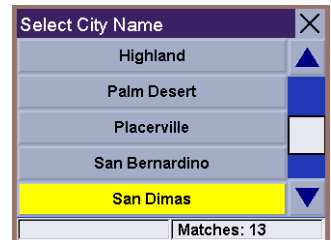

Enter the street address. The acceptable range of numbers is displayed at the top of the screen. Select **Done**.

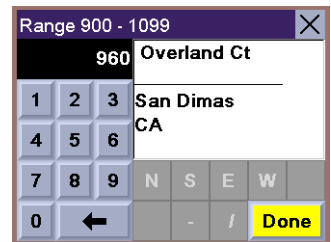

The top line (Name) and the bottom line (Information) can be edited. The address cannot be changed. Select the line you want to modify. Use the keypad to enter the desired text and select **OK**. You can also designate the address as a favorite by checking the box at the bottom of the screen.

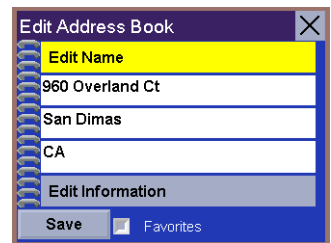

When you have finished making changes, select **Save** and then, press **ESCAPE**.

7.5.4.4 Previous City

From the Destination screen, select **Address Book**, then select **Create New Entry**.

Select **Previous City**.

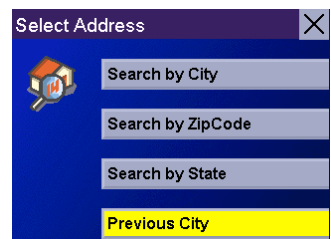

Chapter 7: Selecting Destinations

Use the Navigation key to scroll the list up or down (if necessary) and select the desired city.

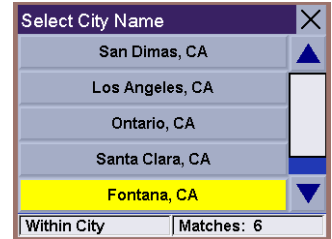

Enter the street name (see “Help with Address Entry” on page 15). Select **OK**.

Use the Navigation key to scroll the list up or down (if necessary) and select the desired street.

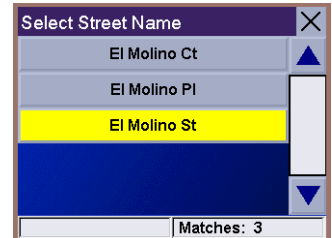

Enter the street address. The acceptable range of numbers is displayed at the top of the screen. Select **Done**.

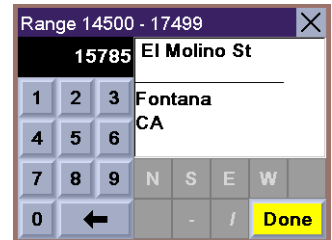

The top line (Name) and the bottom line (Information) can be edited. The address cannot be changed. Select the line you want to modify. Use the keypad to enter the desired text and select **OK**. You can also designate the address as a favorite by checking the box at the bottom of the screen.

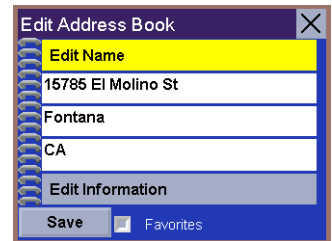

When you have finished making changes, select **Save** and then, press **ESCAPE**.

7.5.5 Trip Planner

Using the Trip Planner, you can enter multiple destinations for your “trip” and route to each one of them in order. Additionally, using the Trip Planner you can optimize your trip and route to arrive at your destinations in the most efficient manner.

7.5.5.1 New

From the Destination screen, select **Address Book**, then select **Trip** (Trip button).

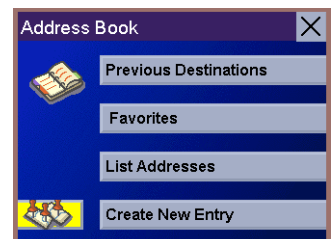

Chapter 7: Selecting Destinations

Select **New**.

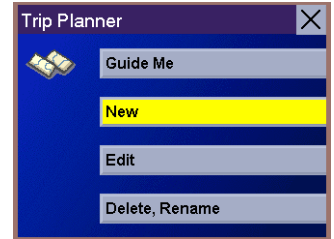

Use the keypad to enter a name for the new trip and select **OK**.



From the pop-up menu, select **Add**.

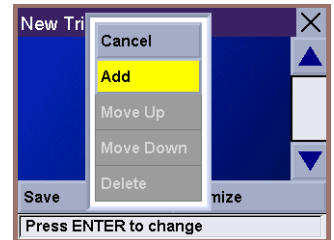

From the Select Trip Planner Address screen, select the method for adding a destination to your trip: **Map** (Map button) will add a destination by selecting a point on the map; **Select Address** will add a destination by creating a new address; **Address Book** will add a destination from a previous destination, Address Book, or favorites; **Dining, ATM, Gas...** will add a destination from the POI database; and **Intersection** will add a destination of two intersecting streets.

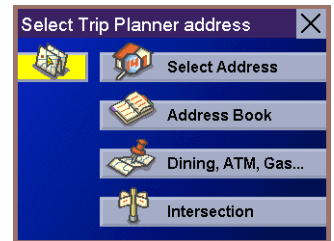

Continue adding destinations. When you are finished, select **Save**.

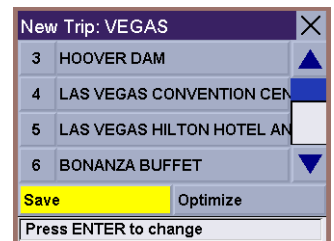

Chapter 7: Selecting Destinations

7.5.5.2 Optimizing a Trip

With Route Optimization, you can sort the destinations in your trip from closest to farthest.

From the Trip Planner screen, select **Edit**.

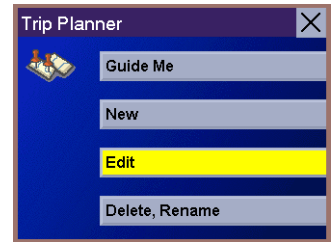

Select the trip to optimize.

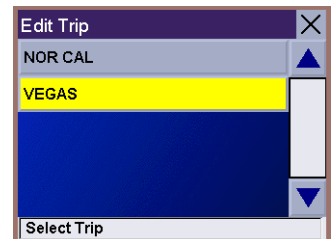

Select **Optimize**.

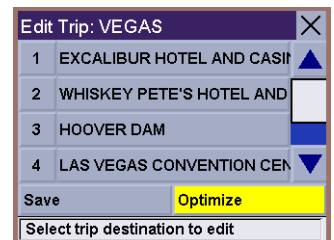

The destinations are sorted from closest to farthest from your current location.

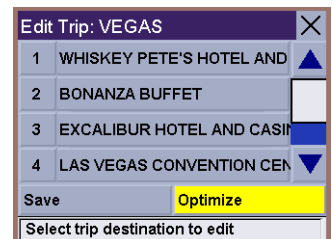

Select **Save**.

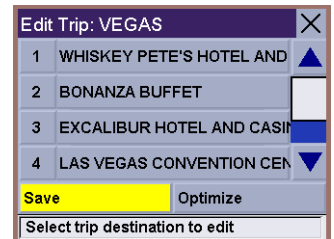

Chapter 7: Selecting Destinations

7.5.5.3 Guide Me

From the Destination screen, select **Address Book**, then select the **Trip** (Trip button).

Select **GuideMe**.



Select the Trip.

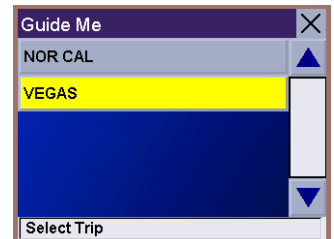

Select the first destination in the list you wish to route to.

Note: Selecting the second destination in the list will exclude the first destination, selecting the third destination in the list will exclude the first and second destinations, and so on.

Select the desired Route Method.



The Magellan RoadMate 3000T will calculate the route. When the calculations are complete, the Map screen will be displayed.

7.5.5.4 Edit

Destinations within a trip can be moved up or down, deleted, or added to.

From the Trip Planner screen, select **Edit**.

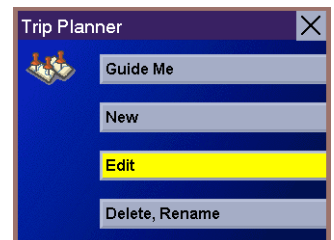

Chapter 7: Selecting Destinations

Select the trip to edit.

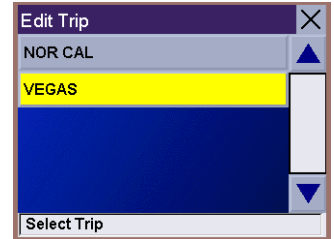

Select the destination you wish to delete, and select **Delete** from the pop-up menu.

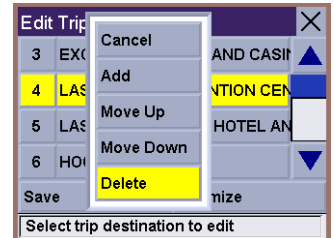

Select the destination you wish to change, and select **Move Up** from the pop-up menu.

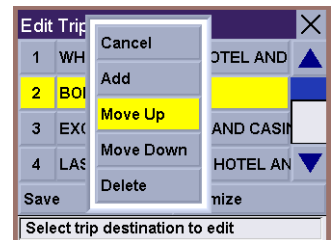

When you have finished, select **Save** and you are returned to the Trip Planner screen.

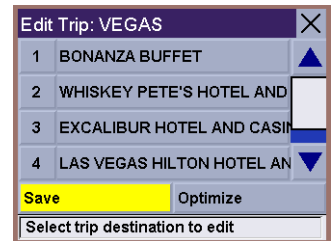

7.5.5.5 Delete and Rename

From the Trip Planner screen, select **Delete, Rename**.

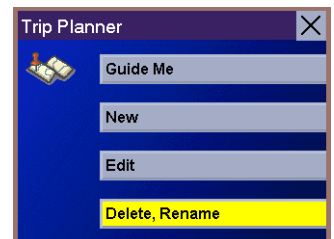

Chapter 7: Selecting Destinations

Select **Delete**.

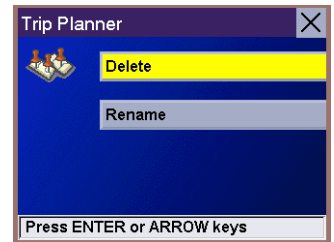

Select the trip you wish to delete.

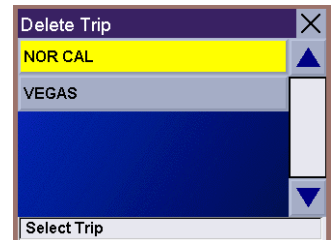

A dialog box will appear to confirm your selection. Select **Yes**.

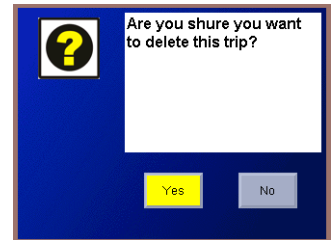

The trip has been deleted.

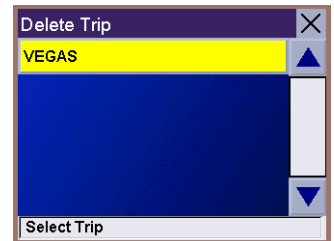

Select **Rename**.

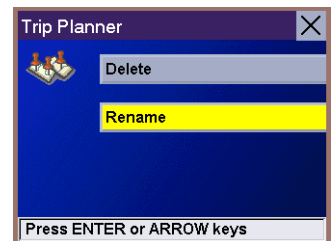

Select the trip to be renamed.

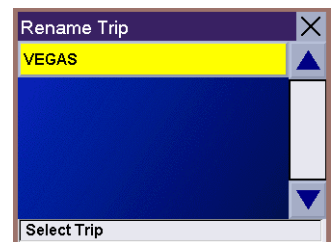

Chapter 7: Selecting Destinations

Use the backspace key to delete the old name; then, enter the new name for the trip. When you have finished, select **OK**.

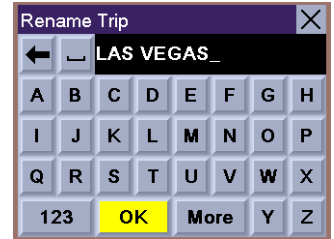

The trip has been renamed.

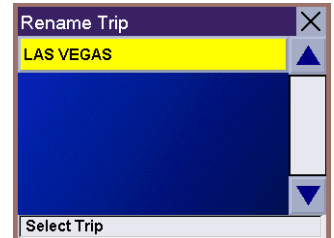

7.6 Selecting a Point of Interest as a Destination

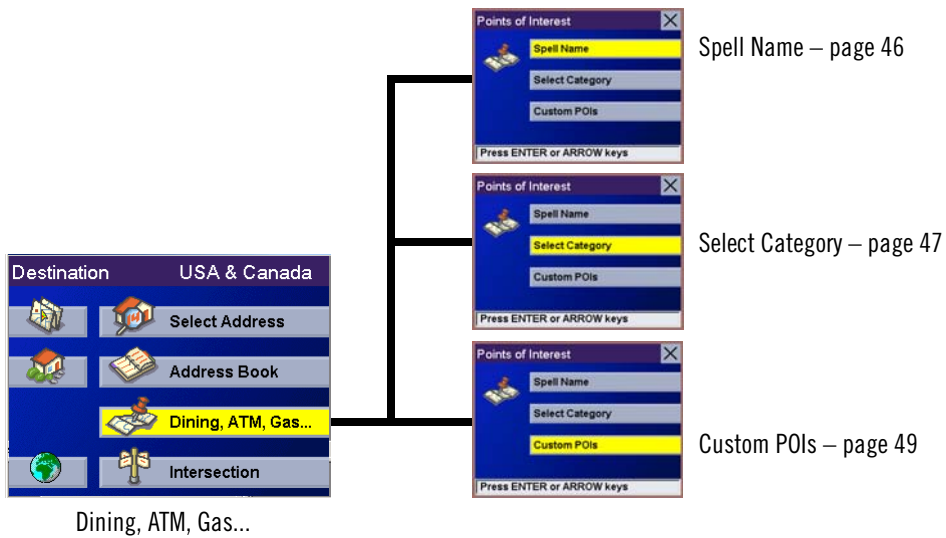

Points of Interest (or POIs) are commercial or recreational locations, landmarks, or services that are preloaded into the Magellan RoadMate 3000T database. There are over six million POI's in the database, which range from restaurants, parks, gas stations, and banks, to schools and police stations, and more. The purpose of the POI database (accessed through the Dining, ATM, Gas... menu option) is to provide you with a list of popular destinations without having to enter the address manually in order to route to them.

Chapter 7: Selecting Destinations

7.6.1 Spell Name

If you know the name of the POI you are looking for, find it using the Spell Name feature.

From the Destination screen, select **Dining, ATM, Gas..**, then select **Spell Name**.

Enter the name of the POI.



7.6.1.1 Nearest

Selecting Nearest will list the POIs matching the name you entered from closest to farthest from your current position. Select **Nearest**.

Use the Navigation key to scroll the list up or down (if necessary) and select the desired POI.

Select the desired Route Method.

The Magellan RoadMate 3000T will calculate the route. When the calculations are complete, the Map screen will be displayed.

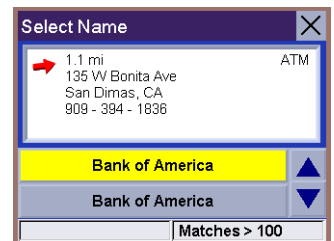
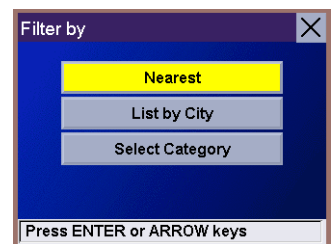

7.6.1.2 List By City

Selecting List by City will list the POIs matching the name you entered within a selected city sorted by distance from the city center. Select **List by City**.

Enter the city name (see "Help with Address Entry" on page 15). Select **OK**.

Use the Navigation key to scroll the list up or down (if necessary) and select the desired city.

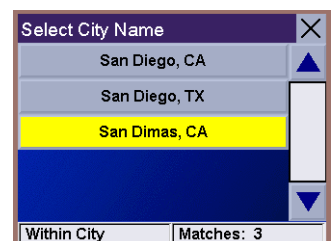
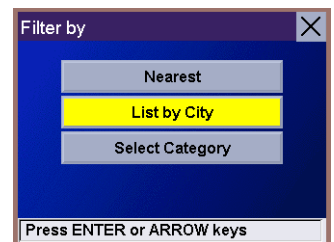

Chapter 7: Selecting Destinations

Use the Navigation key to scroll the list up or down (if necessary) and select the desired POI.

Select the desired Route Method.

The Magellan RoadMate 3000T will calculate the route. When the calculations are complete, the Map screen will be displayed.

7.6.1.3 Select Category

Selecting Select Category enables you to narrow the list of POIs by selecting the category of the name you spelled. Select **Select Category**.

Use the Navigation key to scroll the list up or down and select the desired POI category.

Use the Navigation key to scroll the list up or down (if necessary) and select the desired POI.

Select the desired Route Method.

The Magellan RoadMate 3000T will calculate the route. When the calculations are complete, the Map screen will be displayed.

7.6.2 Select Category

If you do not know the name of the POI you are looking for, but know the category (restaurant, bank, gas station, etc.), you can find it using Select Category

From the Destination screen, select **Dining, ATM, Gas...**, then select **Select Category**.

Select the POI category.

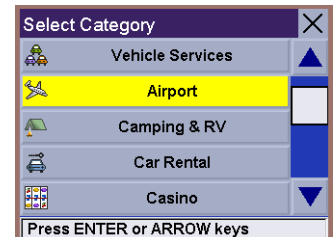
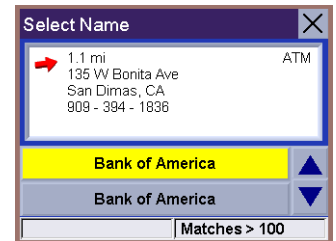
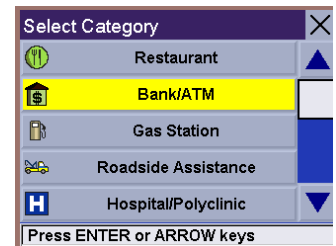
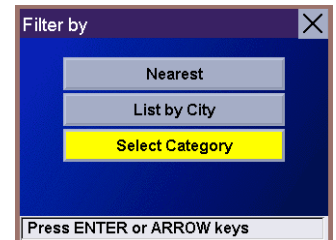

Chapter 7: Selecting Destinations

7.6.2.1 Nearest

Selecting Nearest will list the POIs in the category selected from closest to farthest from your current position. Select **Nearest**.

A list of all the POI's in the selected category nearest to your current position is displayed. Select the POI from the list.

Select the desired Route Method.

The Magellan RoadMate 3000T will calculate the route. When the calculations are complete, the Map screen will be displayed.



7.6.2.2 List by City

Selecting List by City will list the POIs in the category selected within a specified city. Select **List by City**.

Enter the name of the city you wish to search from. When you are finished, select **OK**.

Use the Navigation key to scroll the list up or down (if necessary) and select the desired city.

Use the Navigation key to scroll the list up or down (if necessary) and select the desired POI.

Select the desired Route Method.

The Magellan RoadMate 3000T will calculate the route. When the calculations are complete, the Map screen will be displayed.

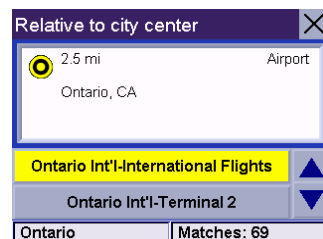
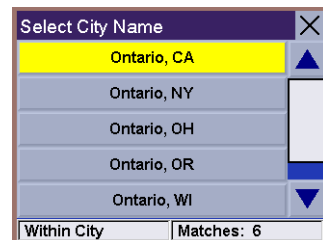
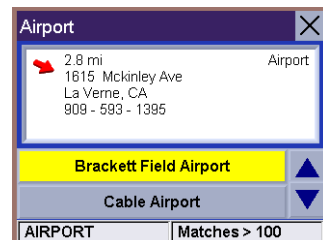

7.6.2.3 Spell Name

Selecting Spell Name will list the POIs in the category selected, matching the name you entered. Select **Spell Name**.



Chapter 7: Selecting Destinations

Enter the name of the POI. When you are finished, select **OK**.

Select Nearest to list the POIs matching the characters entered that are nearest to your current position.

Select List by City to list the POIs matching the characters entered that are nearest to a particular city. Enter the name of the city. When you are finished, select OK. Select the city from the list.

Use the Navigation key to scroll the list up or down (if necessary) and select the desired POI.

Select the desired Route Method.

The Magellan RoadMate 3000T will calculate the route. When the calculations are complete, the Map screen will be displayed.

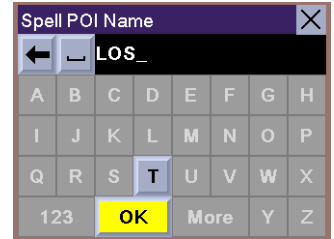

7.6.2.4 Cuisine Type

When selecting restaurants, you are presented with an additional method for finding POIs. Select Cuisine Type. Use the Navigation key to select the type of restaurant you prefer.

Use the Navigation key to scroll the list up or down (if necessary) and select the desired POI.

Select the desired Route Method.

The Magellan RoadMate 3000T will calculate the route. When the calculations are complete, the Map screen will be displayed.

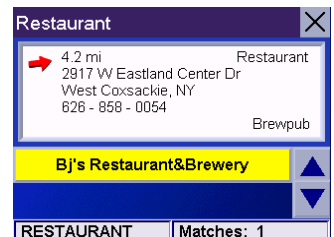
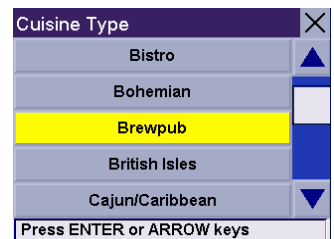

7.6.3 Custom POIs

Please refer to page 84 for information on creating and loading Custom POIs.

From the Destination screen, select **Dining, ATM, Gas...**, then select **Custom POIs**.

Chapter 7: Selecting Destinations

Select the category.

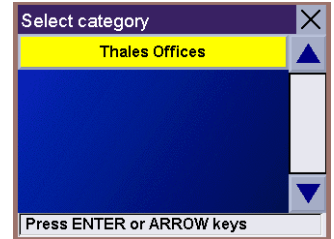

If the POI list has more than 15 returns, you can further narrow the search by selecting either Nearest or Spell Name. Select the desired POI from the list.

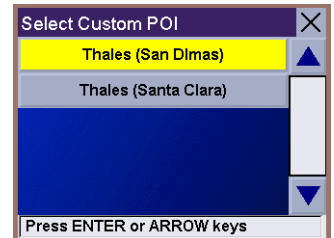

Select **Route** to go to the selected Address, or select **Cancel** to return to the Select Custom POI menu.

Select the desired Route Method.

The Magellan RoadMate 3000T will calculate the route. When the calculations are complete, the Map screen will be displayed.

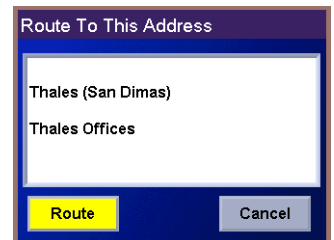

Chapter 7: Selecting Destinations

7.7 Selecting an Intersection as a Destination

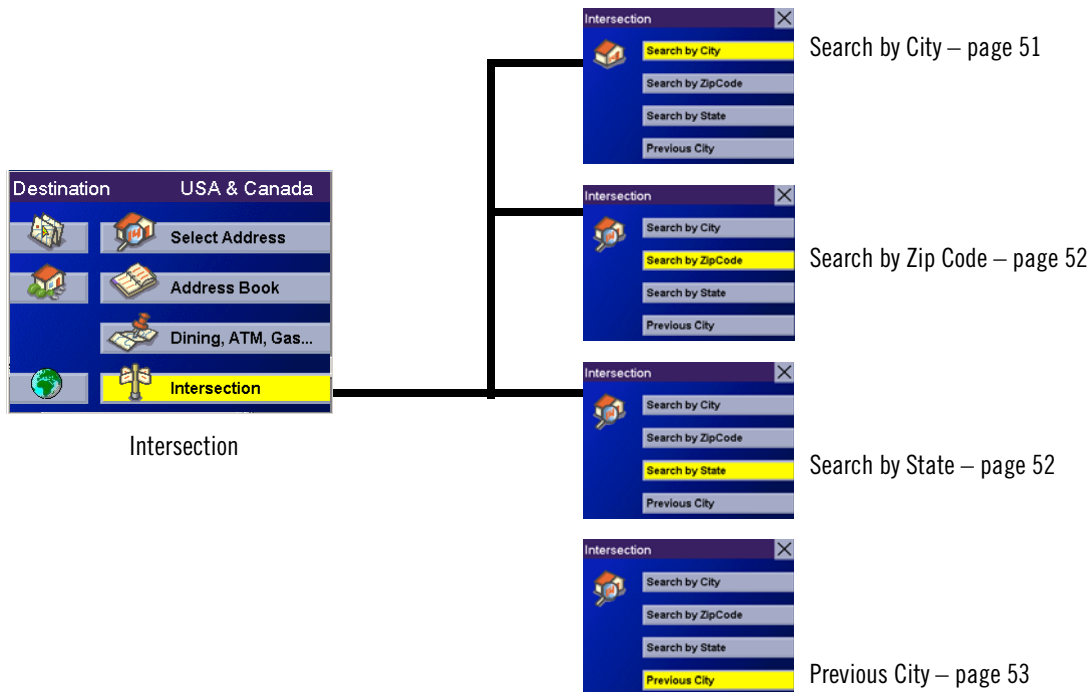

An intersection of two streets can be used as a destination. The search for the intersection can be done whether or not you know the city. If you know the city, you can start there; if you are unsure of the city, you can start with the state.

7.7.1 Search by City

From the Destination screen, select **Intersection** then, select **Search by City**.

Enter the first few characters of the city name (see “Inputting Text Characters” on page 13). Select **OK**.

Use the Navigation key to scroll the list up or down (if necessary) and select the desired city.

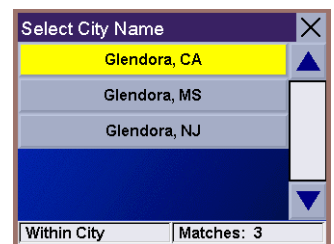

Enter the first street name (see “Help with Address Entry” on page 15). Select **OK**.

Use the Navigation key to scroll the list up or down and select the first street from the list.



Chapter 7: Selecting Destinations

Enter the second street name and select **OK**.

Use the Navigation key to scroll the list up or down (if necessary) and select the second street from the list.

Select the desired Route Method.

The Magellan RoadMate 3000T will calculate the route. When the calculations are complete, the Map screen will be displayed.



7.7.2 Search by Zip Code

From the Destination screen, select **Intersection** then, select **Search by Zip Code**.

Enter the zip code and select **OK**, then select the city.

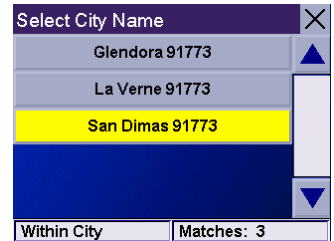

Enter the first street name (see “Help with Address Entry” on page 15). Select **OK**.

Use the Navigation key to scroll the list up or down and select the first street from the list.



Enter the second street and select **OK**.

Use the Navigation key to scroll the list up or down (if necessary) and select the second street from the list.

Select the desired Route Method.

The Magellan RoadMate 3000T will calculate the route. When the calculations are complete, the Map screen will be displayed.



7.7.3 Search by State

From the Destination screen, select **Intersection** then, select **Search by State**.

Chapter 7: Selecting Destinations

Enter the first few characters for the state and select **OK**.

Use the Navigation key to scroll the list up or down (if necessary) and select the state from the list.

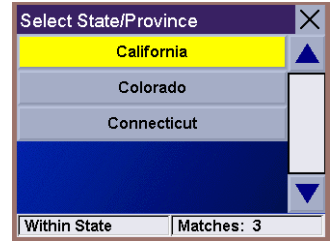

Enter the first street name (see "Help with Address Entry" on page 15). Select **OK**.

Use the Navigation key to scroll the list up or down (if necessary) and select the first street from the list.

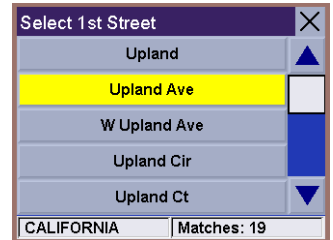

Enter the second street and select **OK**.

Use the Navigation key to scroll the list up or down (if necessary) and select the second street from the list.

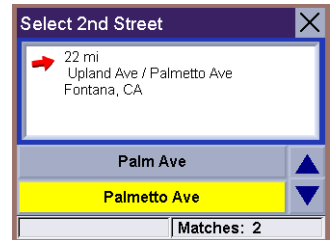

Select the desired Route Method.

The Magellan RoadMate 3000T will calculate the route. When the calculations are complete, the Map screen will be displayed.

7.7.4 Previous City

From the Destination screen, select **Intersection** then, select **Previous City**.

Use the Navigation key to scroll the list up or down (if necessary) and select the desired city.

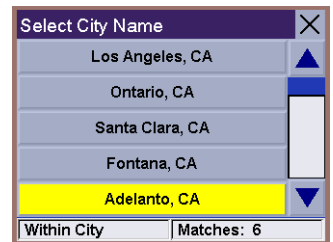

Enter the first street name (see "Help with Address Entry" on page 15). Select **OK**.

Use the Navigation key to scroll the list up or down (if necessary) and select the first street from the list.

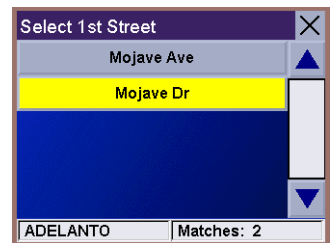

Chapter 7: Selecting Destinations

Enter the second street and select **OK**.

Use the Navigation key to scroll the list up or down (if necessary) and select the second street from the list.

Select the desired Route Method.

The Magellan RoadMate 3000T will calculate the route. When the calculations are complete, the Map screen will be displayed.



Chapter 8: Navigation Options

Navigation Options are only available when you are in Navigation Mode. When going to the Main Menu from the Music Player or from the Photo Viewer, this option will be grayed out.

To access these features, press the **MENU** key on the Magellan RoadMate 3000T and select **Navigation Options**.

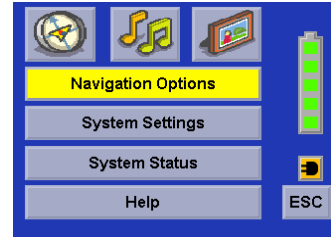

8.1 Configuration

Configuration enables you to customize the advanced navigation features of the Magellan RoadMate 3000T.

Select **Configuration**.

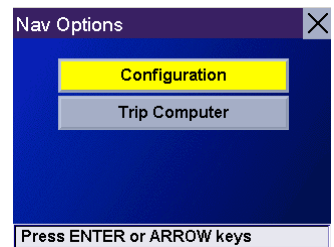

8.1.1 POI Selection

From the POI Selection menu, you can choose which icons to display on the Map screen. We recommend being selective about which icons you choose to display in order to prevent your map screen from being cluttered. For a list of POI Categories, see "POI Categories" on page 89.

Select **POI Selection**.

Select **Mark All** to display all POI icons on the Map screen.

Select **Clear All** if you wish not to have any POI icons displayed on the Map screen.

You can also select individual icons to display or hide on the Map screen. When you have finished, select **Save** to save your selection and return to the Configuration menu.



8.1.2 Custom POIs

The Custom POI menu enables you to select POIs previously loaded into your Magellan RoadMate 3000T using the Magellan RoadMate POI Manager software (see page 84). The following instructions are assuming that you have loaded one or more custom POIs into your Magellan RoadMate 3000T.

Select **Custom POIs**.

Chapter 8: Navigation Options

Select **Select a POI File**.

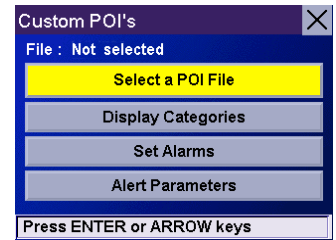

Use the Navigation key to scroll the list up or down (if necessary) and select a POI file. With the file selected, you are returned to the Custom POIs menu.

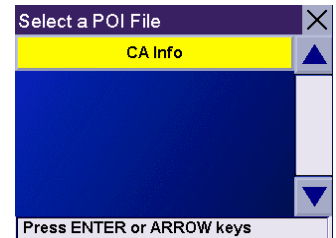

Select **Display Categories**.

The categories you created are displayed in the same way as the built-in POIs.

Select **Mark All** to display all POI icons on the Map screen. Select **Clear All** if you wish not to have any POI icons displayed on the Map screen. You can also select individual icons to display or hide on the Map screen.

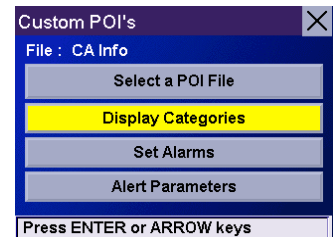

When you have finished, select **Save** to return to the Configuration menu

You can also be alerted when you approach a custom POI. The Set Alarm function works for Custom POIs only and only if the POI has been selected to show on the Map screen. Select **Set Alarms**.

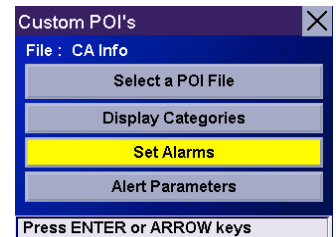

Again, you can select all, none, or individual POIs to have an alert set. Select **Mark All** to set an alert for all custom POI icons on the Map screen. Select **Clear All** if you wish not to have any alerts set for custom POI icons displayed on the Map screen. You can also select individual categories to have an alert set.



When you have finished, select **Save** to return to the Custom POIs menu.

With the POI alerts set, you can now choose at what point you will be alerted. Select **Alert Parameters**.

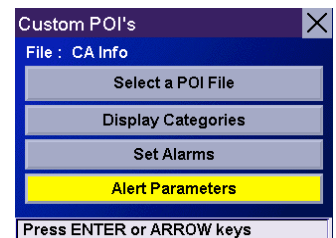

Chapter 8: Navigation Options

Select the POI category to customize.

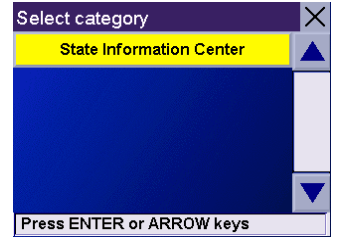

The Detection Angle is set to alert you when you are within so many degrees of the POI.

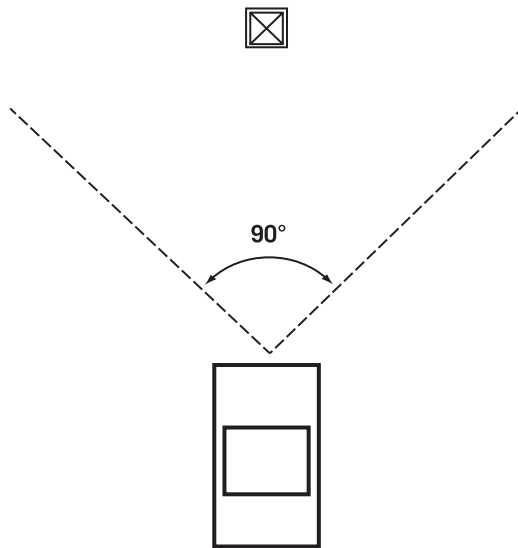

Select **Detection Angle**.

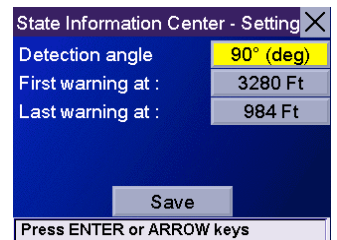

Use the numeric keypad to enter the number of degrees in which to set the alert. When you have finished, select **OK**.

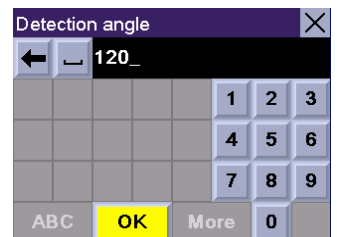

Chapter 8: Navigation Options

The First Warning is set to alert you when you are within a certain number of feet from the POI.

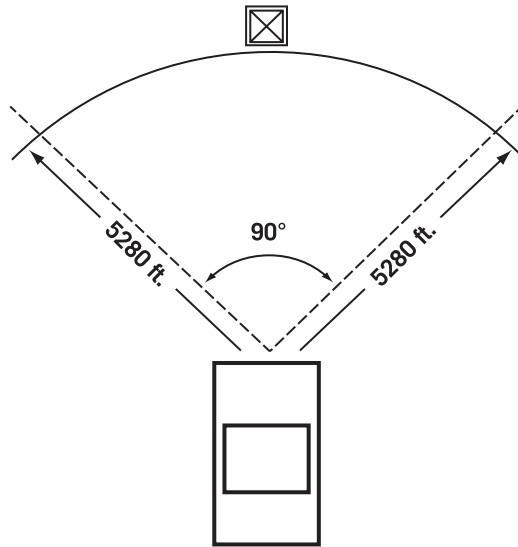

Select **First Warning**.

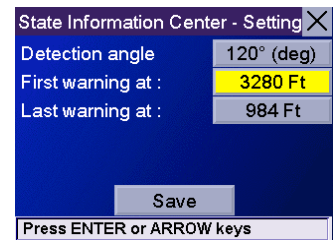

Use the numeric keypad to enter the number of feet in which to alert you. When you have finished, select **OK**.



Chapter 8: Navigation Options

The Last Warning is set as a final alert when you are within a certain number of feet from the POI.

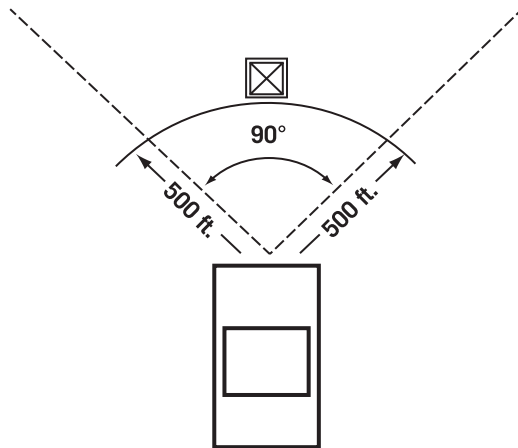

Select **Last Warning**.

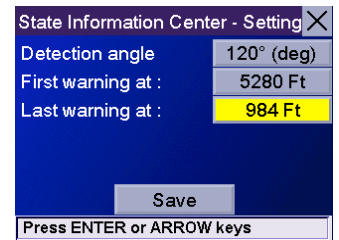

Use the numeric keypad to enter the number of feet in which to alert you. When you have finished, select **OK**.



When you have set the parameters as you like, select **Save**.

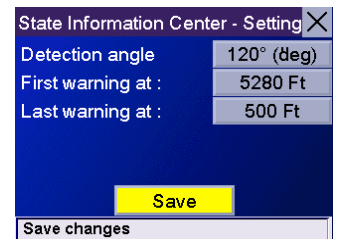

Chapter 8: Navigation Options

8.1.3 Map Options

Map Options enable you to determine the behavior of the Map while you are driving.

Select **Map Options**.

With **Scrolling** enabled, the vehicle position icon will always remain in the same position with the map scrolling, or moving as while the vehicle is in motion. With **Scrolling** disabled, the vehicle position icon will move forward slightly; then, the map will scroll down. Having Scrolling disabled allows for a faster display.

Heading Up sets the map display so that the direction of travel is always at the top of the screen. **North Up** sets the map display so that North is always at the top of the screen. North Up is only available in 2D Map mode.

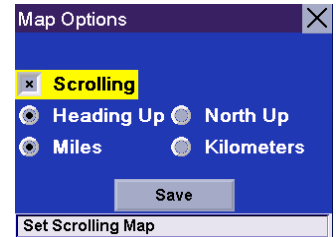

Select **Miles** or **Kilometers** as the unit of measure for distance.

When you have finished, select **Save**.

8.1.4 TrueView Options

TrueView options enable you to control how and when the TrueView screen is displayed. Select TrueView Options.

Select Split TrueView to enable the TrueView/Map Screen mode. See “TrueView Screen” on page 19.

Select Disable TrueView if you do not want the TrueView screen to appear during routing.

Select Manual TrueView to show the TrueView screen only by pressing the View key.

Select Auto TrueView to have the TrueView screen appear automatically when the next maneuver is approaching.

When you have finished, select **Save**.



8.1.5 Select Map Color

Select **Select Map Color**.

With **Automatic Night Mode** enabled, the Magellan RoadMate 3000T will switch between a Day screen and a Night screen based on sunrise and sunset times for your current location.

Select **Day Screen** to choose a color scheme for the map while you are driving during the day.

Select **Night Screen** to select a color scheme for driving at night.

When you have finished, select **Save**.

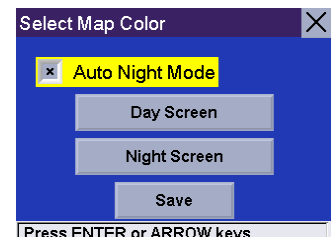

Chapter 8: Navigation Options

Select from nine available color schemes:

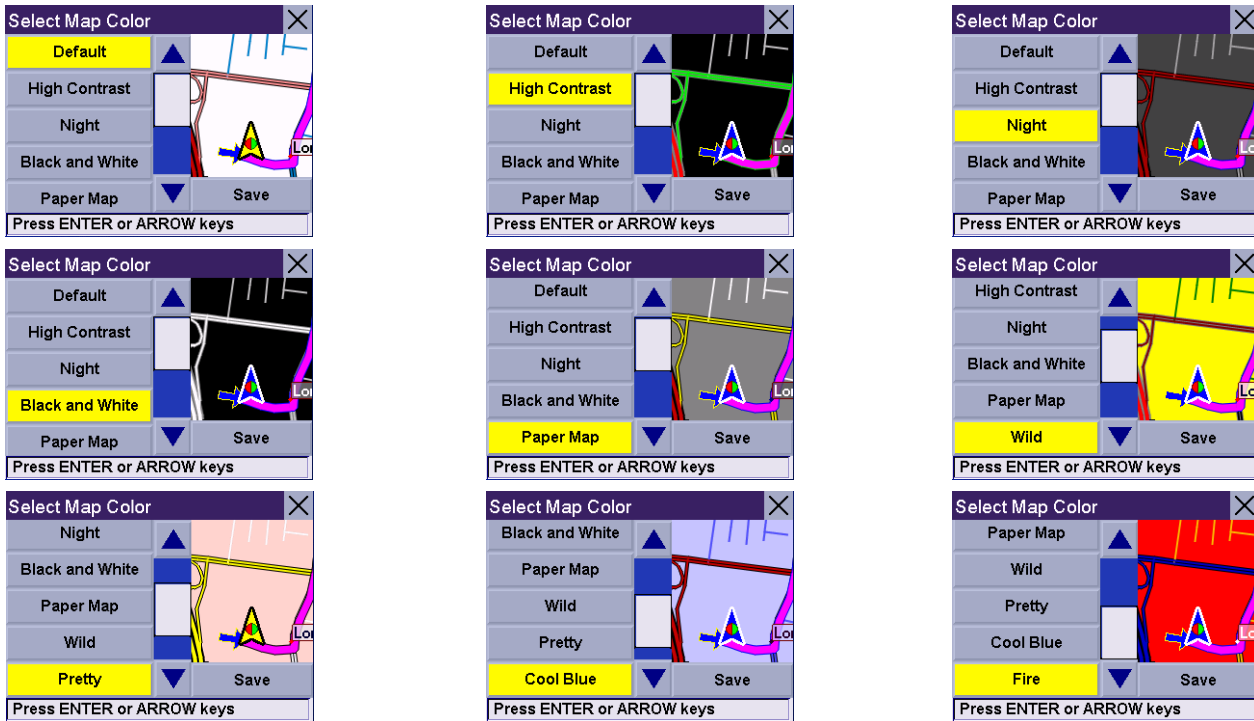

When you have finished, select **Save** and you will be returned to the Select Map Color menu.

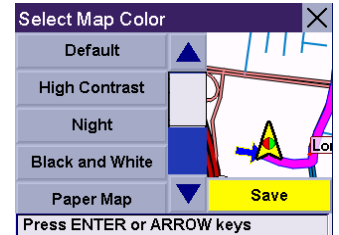

8.1.6 Route Preferences

Route Preferences enable you to set parameters for the Magellan RoadMate 3000T to follow when calculating a route. Select **Route Preferences**.

Automatic Re-Route will cause the Magellan RoadMate 3000T to try up to three times to automatically re-route to the destination when it has detected that the vehicle has deterred from the calculated route.

When you have finished, select **Save**.

Chapter 8: Navigation Options

8.1.7 Detour Options

The Magellan RoadMate 3000T comes equipped with SmartDetour. If you are driving on the freeway with SmartDetour enabled and your speed drops below 15 MPH, you may press the detour icon on the Map screen in order for the Magellan RoadMate 3000T to calculate an alternate route around traffic.

Select **Detour Options**.

Select the distance of the detour. You can select from a preset distance of three miles, five miles, or 10 miles.

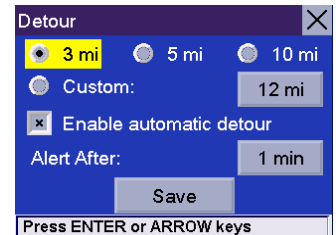

You can also select a custom distance. Select **Custom**, and then select the button to the right to enter a custom distance.

Enter the number of miles and select **OK**.

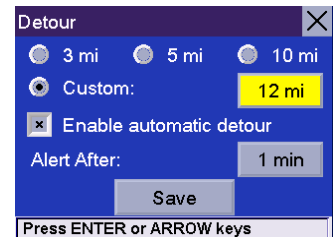

Next, select the amount of time the Magellan RoadMate 3000T will wait before alerting you. Select the **Time** button.

Enter the number of minutes and select **OK**.

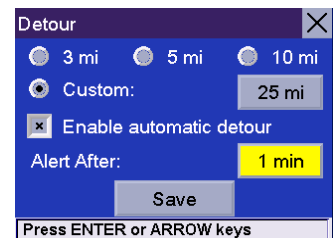

Enable Automatic Detour is selected by default as shown by the checkbox mark. To disable automatic detour, deselect **Enable Automatic Detour**.

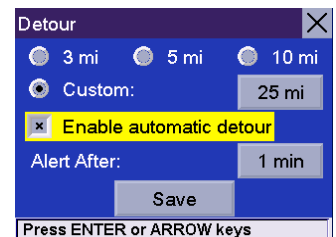

When you have finished, select **Save**.

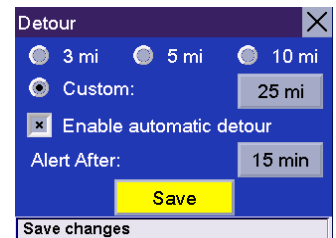

Chapter 8: Navigation Options

When you encounter traffic, and the set time has elapsed, the Detour icon will flash on the Map screen. Touch the icon on the screen to have the Magellan RoadMate 3000T calculate the detour. You can choose to ignore the Detour alert; and after one minute it will stop flashing until the set time has elapsed again when it will alert you once more.

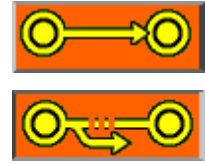

8.1.8 Menu Colors

You can change the color of the menu screens by selecting one of four color schemes.

Select **Menu Colors**.

Select the desired color scheme.

When you have finished, select **Save**.

8.1.9 Tone Options

As you approach a maneuver, an audible alert sounds to let you know to make the maneuver.

Select **Tone Options**.

Select either **Bell**, **Chime**, or **Beep**.

When you have finished, select **Save**.



8.1.10 GPS Options

GPS Options provide you with information on the satellite signal as well as the ability to speed up signal acquisition time.

8.1.10.1 GPS Status

The GPS Status screen is available by pressing the GPS Signal icon on the Map screen (see "Map Screen" on page 17) as well as through the GPS Options menu. GPS Status monitors the satellite signal. For more information on the GPS Status screens refer to "GPS Status Screen" on page 92.

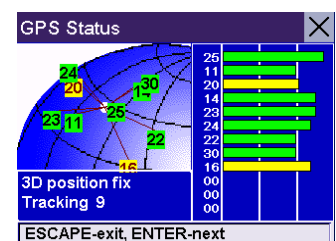

Chapter 8: Navigation Options

8.1.10.2 Set GPS Position

Set GPS Position enables you to manually set the location of the Current Position icon. If you have travelled a long distance with the Magellan RoadMate 3000T off, it may take some time for the Magellan RoadMate 3000T to reacquire a satellite signal. By manually setting the position of the Magellan RoadMate 3000T, you are telling the Magellan RoadMate 3000T where you are and will speed up the satellite signal acquisition. Make sure you first select the country you are in by pressing the Globe button on the Destination screen (see “Country Selection (Globe Button)” on page 25). Select **Set GPS Position**.

Enter the first few characters of the city name (see “Inputting Text Characters” on page 13). Select **OK**. Use the Navigation key to scroll the list up or down (if necessary) and select the desired city.

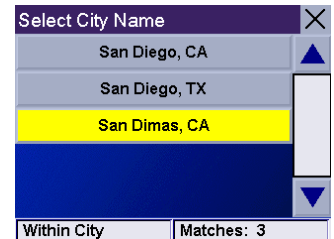

Enter the street name (see “Help with Address Entry” on page 15). Select **OK**. Use the Navigation key to scroll the list up or down (if necessary) and select the desired street.

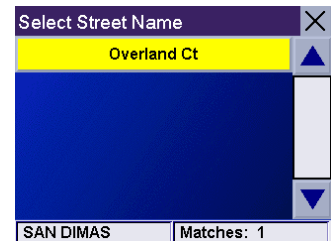

Enter the street address. The acceptable range of numbers is displayed at the top of the screen. If you do not know the exact address, just select **Done** and the Magellan RoadMate 3000T will use the lowest number in the range. Select **Done** to continue. You will be returned to the Configuration menu.

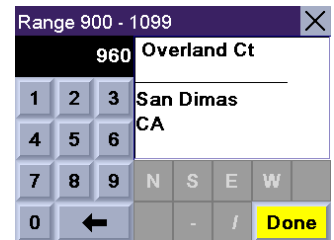

Go to the Map screen. Your current position is now set to the address you entered.

8.1.11 Simulator Mode

In Simulator Mode, you can demonstrate the capabilities of the Magellan RoadMate 3000T without actually driving. In order for the simulation to work, you must set a route first. Select **Simulator Mode**.

Select **Simulate** to begin the simulation.

Set the speed variance of the simulation: x1 will “drive” at normal speed using known speed limits; x1.5 will “drive” at one and a half times normal speed; x2 will “drive” at two times normal speed.

Return to the Map screen to view the simulation.

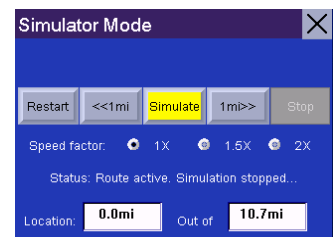

To disable Simulator Mode, select **Stop**, or when the power is turned off the Simulator will stop.

Chapter 8: Navigation Options

8.1.12 Automatic Volume

The Magellan RoadMate 3000T can be set to automatically increase the volume when the vehicle exceeds 45 MPH in order to compensate for road noise.

Select **Automatic Volume**.

Select the number increment by which to increase the volume.

Select **Enable**.

When you have finished, select **Save**.

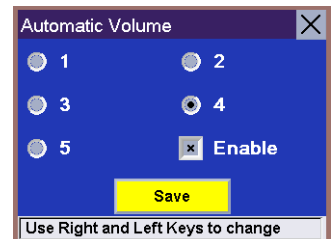

8.1.13 Backup and Restore

The Magellan RoadMate 3000T has the capability to back up your information (Address Book, Previous Destinations, etc.) to an optional memory card.

8.1.13.1 Backup

Select **Backup and Restore** then, select **Backup**.

If you do not have a card inserted, you will be prompted to insert a card. Make sure the card is unlocked to allow data to be copied to it. Insert a card and reselect **Backup**.

A dialog box will appear asking you to confirm your selection. Select **Yes**.

The files are copied to the memory card.

8.1.13.2 Restore

To restore the files to the hard disk, select **Backup and Restore** then, select **Restore**.

If you do not have a card inserted, you will be prompted to insert a card. Insert a card and reselect **Restore**.

A dialog box will appear asking you to confirm your selection. Select **Yes**.

The files are copied to the hard disk.

Chapter 8: Navigation Options

8.1.14 Map Information

Product Information displays information about the map and database installed in your Magellan RoadMate 3000T. This information aids our Technical Support Representative in finding a solution to whatever problem you may have.

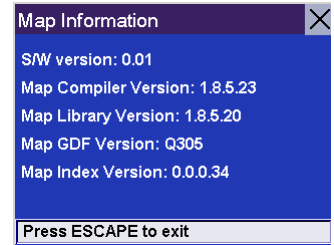

8.2 Trip Computer

The Trip Computer is a valuable tool for recording the mileage and time spent driving while on business or vacation. The information for the trip can be saved and viewed at any time, providing you easy access to information on your current trip, as well as previous trips.

To access these features, press the **MENU** key on the Magellan RoadMate 3000T and select **Navigation Options**.



Select **Trip Computer**.

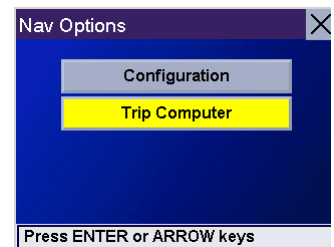

8.2.1 Current Trip

When you begin a new trip and you need to record the information, access the Trip Computer. There you can save the information displayed for the current trip (if needed) and reset the Trip Computer to zero in preparation for your new trip.

Select **Trip Computer**

Select **Current** from the list of saved Trip Reports.

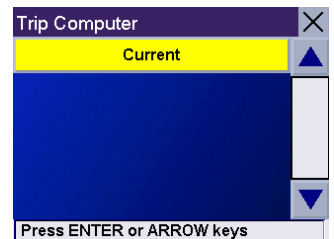

Chapter 8: Navigation Options

The Trip Computer is always in a “Running” state. The information for the current trip is displayed.

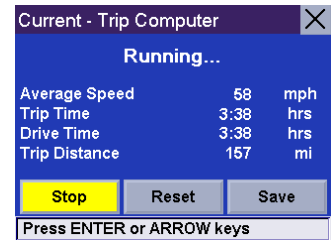

8.2.1.1 Stopping or Starting the Trip Computer

At any time the Trip Computer can be stopped and started. If the Trip Computer is currently running, select **Stop**. The Trip Computer will stop recording until restarted or reset.

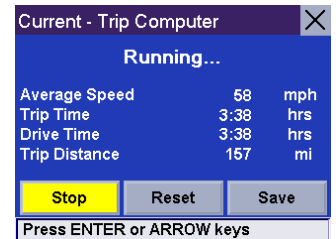

While the Trip Computer is in a “Stopped” state, select **Start** to continue recording the current trip or select reset to begin a new trip.

8.2.1.2 Saving the Current Trip Report

When you have finished with your trip, you can save the information for later viewing. Select **Save** at any time.

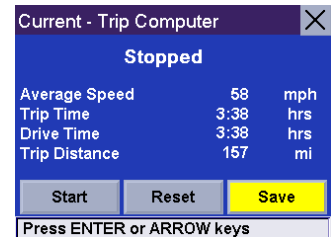
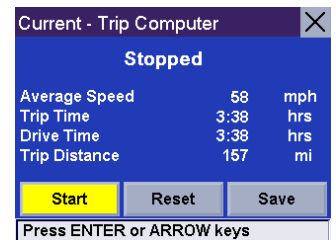

Use the keypad to enter a name for the Trip Report and select **OK** when you are finished.

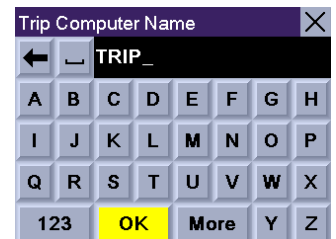

Chapter 8: Navigation Options

8.2.1.3 Resetting the Trip Computer

Before starting a new trip that you want to record, you need to reset the Trip Computer first. Select Reset and the information will be set to zero. The Trip Computer will remain in a “Running” state.

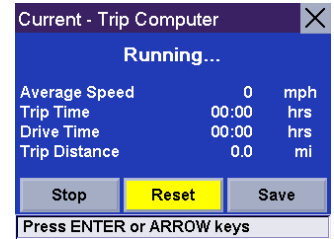

8.2.1.4 Viewing a Saved Trip Report

From the Trip Computer screen, select the Trip Report you wish to view.

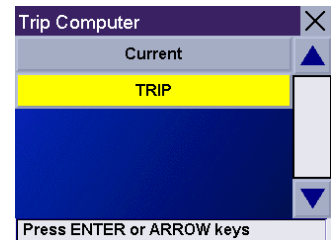

The saved Trip Report is displayed. Press the **ESCAPE** key when you are finished to view the trip and return to the Trip Computer screen.

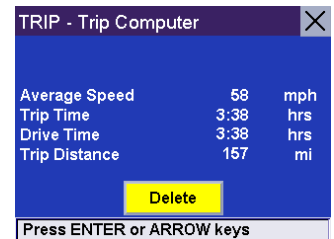

8.2.1.5 Deleting a Trip Report

Select the Trip Report to be deleted.

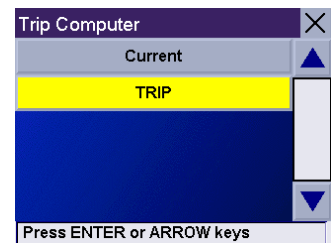

Select **Delete**.

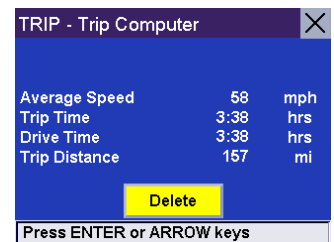

Chapter 8: Navigation Options

The trip is deleted and you are returned to the Trip Computer screen.

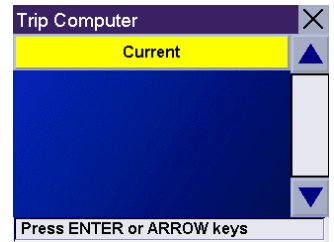

Chapter 9: System Settings

The System Settings Menu contains system wide customization features which include: Brightness, Power Management, Password, and Language.

To access these features, press the **MENU** key on the Magellan RoadMate 3000T and select **System Settings**.

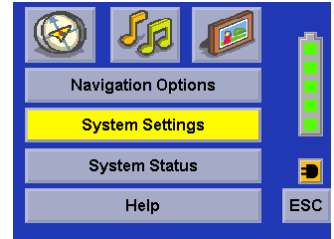

9.1 Brightness

To change how light the screen appears, select **Brightness**.

Use the right arrow to make the screen appear lighter, and use the left arrow make the screen appear darker.

With On-battery dimming enabled, the screen will decrease in brightness by 20% to save some battery power.

When you have finished, select **OK** to confirm or select **ESC** to cancel changes.

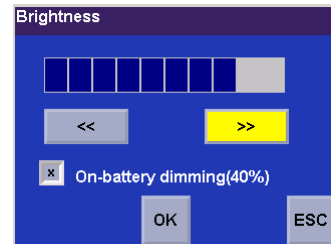

9.2 Power Management

The Power Management features enable you to customize the features that will conserve battery power and display life. Select **Power Management**.

Select the time period to put the Magellan RoadMate 3000T in “sleep” mode.

Select to enable or disable turning the screen off when music is being played.

When you have finished, select **OK** to confirm or select **ESC** to cancel changes.

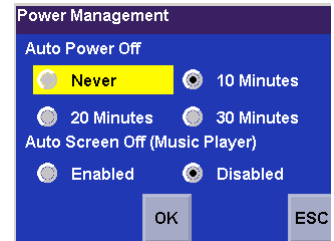

9.3 Password

9.3.1 Set Password

You can protect the Magellan RoadMate 3000T from unwanted use by enabling a password. Select **Password**.

Select **Set Password** to enter a password. Use the keypad to enter the desired password. When you have finished, select **OK**.

Re-enter the password to confirm. Use the keypad to re-enter the password exactly as you entered it the first time. When you have finished, select **OK**.

Select **OK** to activate the password. To return to the System Settings menu without setting the password, select **ESC**.

Once the password is enabled, you will be required to enter it when the Magellan RoadMate 3000T is turned on or when it wakes up from “sleep” mode.



Chapter 9: System Settings

9.3.2 Change Password

Select **Change Password**. Use the keypad to enter the desired password. When you have finished, select **OK**.

Re-enter the password to confirm. Use the keypad to re-enter the password exactly as you entered it the first time. When you have finished, select **OK**.

Select **OK** to activate the password. To return to the System Settings menu without setting the password, select **ESC**.

Once the password is enabled, you will be required to enter it when the Magellan RoadMate 3000T is turned on or when it wakes up from “sleep” mode.

9.3.3 Delete Password

Select **Delete Password** and use the keyboard to enter the password.

A dialog box will appear asking you to confirm your selection. Select **Yes**.

9.4 Language

To change the language for the menu text and voice prompts for navigation, select **Language**.

Select the desired language. A dialog box will appear asking you to confirm your selection. Select **Yes**.

The Magellan RoadMate 3000T will restart itself with the new language enabled.



Chapter 10: System Status

The System Status menu give you further options to check the performance of your Magellan RoadMate 3000T.

10.1 Product Information

Select Product Information to show the current application software versions. Also, the current hardware and firmware versions will be displayed.

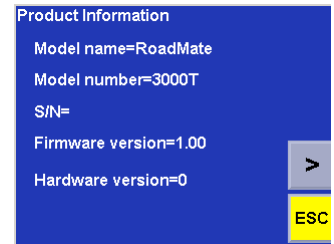

10.2 User Storage

Select **User Storage** to display the available space of the memory card if it is installed..

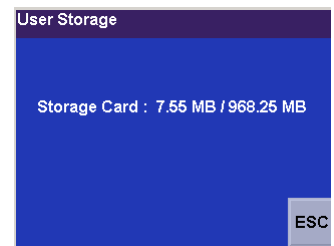

10.3 Diagnostics

Diagnostics enables you to test key performance elements of the Magellan RoadMate 3000T

10.3.1 Audio Test

The Audio Test will check the performance of the built-in speaker.

10.3.2 Touchscreen Test

The Touchscreen test will enable you to recalibrate the touchscreen should it not be tracking properly.

10.3.3 Keypad Test

The Keypad test will determine if the buttons on the Magellan RoadMate 3000T are functioning.

10.3.4 Video Test

The Video test will test to determine if the screen is displaying colors properly.

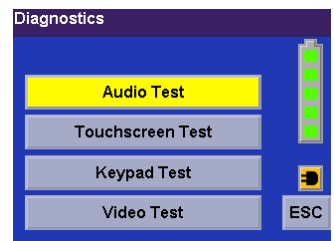

Chapter 10: System Status

10.4 Contact Us

If you experience problems using your Magellan RoadMate 3000T, you can contact us at the numbers displayed.



Contact Us

United States
Tel : (866) 868 - 2259

Canada
Tel : (909) 394 - 5000

Europe
Tel : 00 800 MAGELLAN
(00 800 62435526)

Website
<http://www.magellangps.com>

ESC

Chapter 11: Magellan RoadMate Tools Installation

The Magellan RoadMate Tools application enables you to create custom POI's and load them onto your Magellan RoadMate 3000T. Additionally, you can load pictures and music onto an SD or MMC card (sold separately) to view or play anytime. See "Using Removable Memory Cards" on page 9.

11.1 Installing the Software

Insert the Magellan RoadMate Tools PC Application CD into your PC's CD drive.

The setup application will begin automatically. If it does not, browse your computer's CD drive and double-click on the setup.exe file.

Select a default language for the Application.

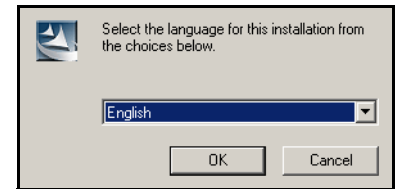

The Welcome screen will appear to begin the installation process.

Choose a destination for the application. Select **Next** to use the default location, or select **Browse** to choose a custom destination.

Next, choose a Program Folder to place the application icons.

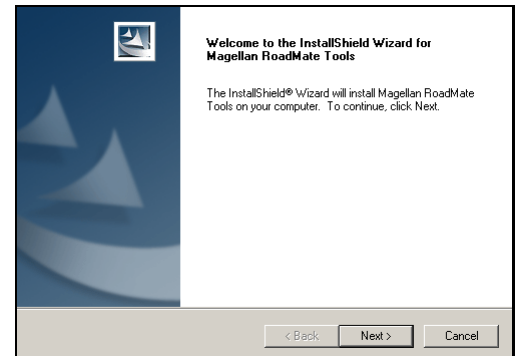

The Magellan RoadMate Tools software will be installed. After it has finished installing, a dialog box pertaining to Microsoft Digital Signatures may appear, select **OK**

When it has finished, you can have the installer launch the application automatically, or deselect to exit without launching the application. Select **Finish**.

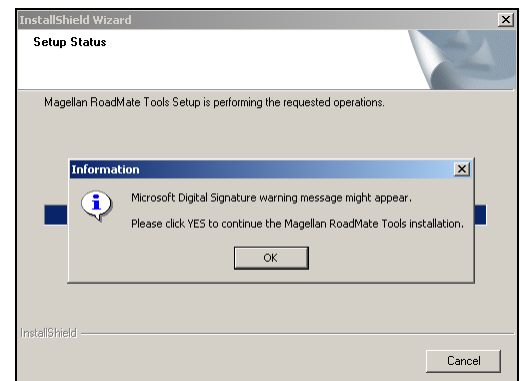

Chapter 12: Magellan RoadMate Music Manager

The Magellan RoadMate Music Manager enables you to transfer song files in MP3 or WMA format from your computer to an optional memory card (see “Using Removable Memory Cards” on page 9) installed in your Magellan RoadMate 3000T. The amount of music you can load depends on the size of the card.

Insert the memory card into the memory card slot as show on page 9. Turn on your Magellan RoadMate 3000T by pressing and holding the Power button for approximately 2-3 seconds if in sleep mode. (Ten seconds if not in sleep mode.) When the Warning screen appears, insert the small end of the USB cable into the USB port on your Magellan RoadMate 3000T and the large end into an available USB port on your computer.

Launch the Magellan RoadMate Tools application. From the Magellan RoadMate Tools screen, click on **Music**.

The left side of the window shows the contents of your computer and the right side of the window shows the contents of the memory card installed in your Magellan RoadMate 3000T.



Locate the song files you wish to load. When you have selected a file, the **Transfer** arrow will turn green. Click on the **Transfer** arrow to copy the file(s) to the memory card.

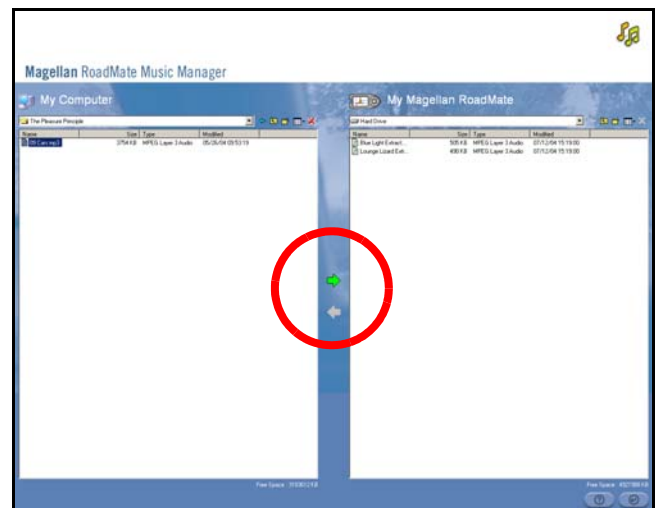

In the same way, if you have loaded song files onto a memory card from another computer, you can copy the files from the memory card to your computer.

When you have finished copying files, remove the USB cable from the Magellan RoadMate 3000T.

Chapter 13: Music Player

The Magellan RoadMate 3000T Music Player enables you to play music files in MP3, or WMA format, stored on an optional memory card installed in your Magellan RoadMate 3000T. If you have not already done so, you must install the Magellan RoadMate Tools application (page 74) and transfer files onto the card using the Magellan RoadMate Music Manager (page 75). You can also use a memory card that has been preloaded from a card reader.

Press the **MENU** key on the Magellan RoadMate 3000T (see page 5) and select the Music Player.



The Music Player control pad will appear.

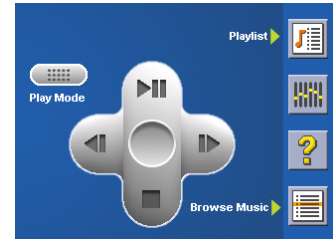

13.1 Single Song Play

Select **Browse Music**



Use the Navigation key or the Down arrow



to select the song file you wish to play and

press **OK**.



The song will begin playing automatically.

At the top of the screen is displayed the name of the song, the artist (if available), the selected play mode, the elapsed time, and the song duration.

Press the **Play/Pause** button to suspend song play. To resume song play, press the **Play/Pause** button again.

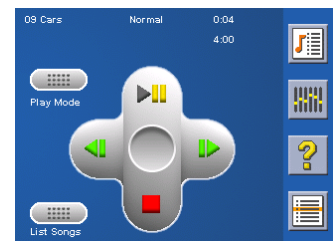

Press the **Stop** button to stop song play. Once a song has been stopped, pressing the **Play/Pause** button will start the song from the beginning.

13.2 Multiple Song Play

Multiple song play enables you to create a “playlist”. A playlist consists of one or more songs in a group that can be played continuously.

Chapter 13: Music Player

Select **Playlist**



The Playlist menu will appear. To exit from the playlist menu, select **ESC**.

13.2.1 Play

To hear a previously created playlist, select **Play**.

Use the Up or Down arrow to select the desired playlist. Select **OK**.

The songs will begin playing automatically in order.



13.2.2 Create

To make a new playlist, select **Create**.

Use the backspace key (<-) to erase the default name; and the keypad to enter a new name for your playlist. When you have finished, select **OK**.

The next screen to appear shows the song files stored on the memory card on the left side, and the playlist on the right side.

Use the arrow buttons on the left side of the screen to highlight the Music folder and then, select **List Files**.

Use the arrow buttons to highlight the song files you wish to add to the playlist. Select **Add to Playlist** (right arrow) to add the highlighted song to the playlist.

Continue adding files to the playlist. When you have finished, select **OK**.

13.2.3 Modify

Modify enables you to add or remove songs from the selected playlist. Select **Modify**.

To remove a song from the playlist, use the arrow keys on the right side of the screen to highlight the desired song and then select **Remove From Playlist** (left arrow).

Use the arrow buttons on the left side of the screen to highlight the song files you wish to add to the playlist. Select **Add to Playlist** (right arrow) to add the highlighted song to the playlist.

Continue adding files to the playlist. When you have finished, select **OK**.

13.2.4 Delete

To remove a playlist, select **Delete**.

Select the playlist you wish to delete and select **OK**.

A dialog box will appear asking to confirm your selection. Select **Yes** to delete the playlist.

Chapter 13: Music Player

13.2.5 Rename

If you want to change the name of a playlist, select **Rename**.

Select the playlist you wish to rename and then, select **OK**.

Use the backspace key (<-) to erase the name; and the keypad to enter a new name for your playlist. When you have finished, select **OK**.

13.3 Play Mode

While in single song play, select **Play Mode** for song play options.

Repeat All - Repeats all the songs in the current playlist starting at the beginning of the order. This function works only if there are two or more songs in the playlist.

Repeat - repeats the song that is currently playing.

Preview - Plays the first five seconds of each song in the current playlist.

Normal - Plays all songs in the current playlist in order.

Random - Plays the songs in the current playlist in random order.

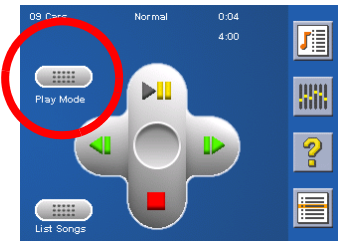

13.4 List Songs

Select **List Songs** to view the current playlist.

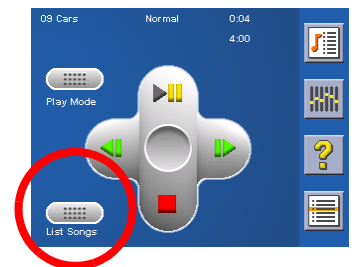

Chapter 13: Music Player

13.5 Equalizer

The Equalizer provides advanced sound options so you can customize the quality of the playback. The equalizer will only be available for MP3 format sound files. Select an equalizer preset from the following preconfigured options: Default (flat), Jazz, Classical, Rock, Techno, Dance Hall, Live, Full Bass, Full Treble, and Full Bass & Treble. You are not able to however, manually set the equalizer.

Select the **Equalizer**

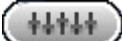

Select the equalizer preset by pressing the button at the top of the screen  .



When you are satisfied with your selection, select **OK**. To exit without setting the equalizer, select **ESC**.

13.6 Help

Select **Help**



for descriptions of the Music Player buttons.

Chapter 14: Magellan RoadMate Photo Manager

The Magellan RoadMate Photo Manager enables you to transfer image files in multiple formats from your computer to an optional memory card (see “Using Removable Memory Cards” on page 9) installed in your Magellan RoadMate 3000T. The number of images you can load depends on the size of the card. You can also use a memory card that has had images preloaded using a card reader.

Insert the memory card into the memory card slot as show on page 9. Turn on your Magellan RoadMate 3000T by pressing and holding the Power button for approximately 2-3 seconds (Ten seconds if the Magellan RoadMate 3000T is not in sleep mode.) When the Warning screen appears, insert the small end of the USB cable into the USB port on your Magellan RoadMate 3000T, and the large end into an available USB port on your computer.

Launch the Magellan RoadMate Tools application. From the Magellan RoadMate Tools screen, click on **Photo**.

The left side of the window shows the contents of your computer and the right side of the window shows the contents of the memory card installed in your Magellan RoadMate 3000T.



Locate the image files you wish to load. When you have selected a file, the **Transfer** arrow will turn green. Click on the **Transfer** arrow to copy the file(s) to the memory card.

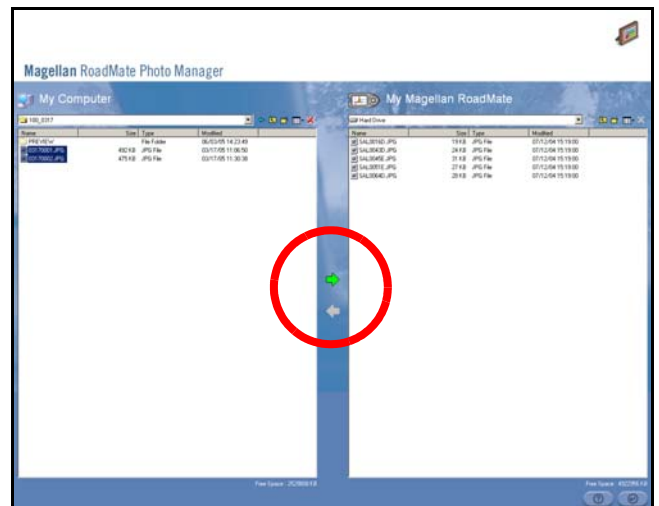

In the same way, if you have loaded image files onto a memory card from another computer, you can copy the files from the card to your computer.

When you have finished copying files, remove the USB cable from the Magellan RoadMate 3000T.

Chapter 15: Photo Viewer

The Magellan RoadMate Photo Viewer enables you to view image files in JPG and BMP format, stored on an optional memory card installed in your Magellan RoadMate 3000T. If you have not already done so, you must install the Magellan RoadMate Tools application (page 74) and transfer files onto the card using the Magellan RoadMate Photo Manager (page 75).

Press the **MENU** key on the Magellan RoadMate 3000T (see page 5). Select the **Photo Viewer**



The Photo Viewer screen will appear. The Photo viewer will show the contents of the SD or MMC card installed in your Magellan RoadMate 3000T..

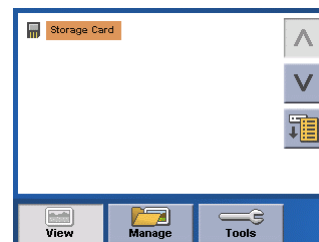

15.1 View Single Photo

The next screen to appear shows the file structure of the memory card. Select **List Files**



Use the Navigation key or the Down arrow  to highlight the photo you wish to view and select **View**.

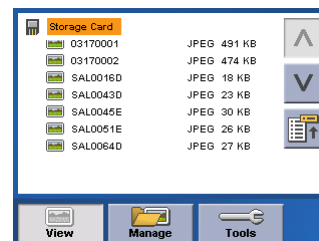

While viewing the image, double clicking on the image (that is tapping twice on the screen) will show the image in full screen. You can then cycle through the images by pressing left or right on the Navigation key.

15.1.1 Previous Image (left arrow)



Press the right arrow button to view the previous image in the folder. This button is grayed out (not functional) when viewing the first image in the folder.

15.1.2 Zoom



Press the Zoom button to reduce or enlarge the current photo. The top of the zoom menu shows the current zoom level. Select another zoom level from the list of presets. Select Best Fit to adjust the zoom to fit within the display boundaries; select Actual Size to display the image at 100%; select 25% to 150% to reduce or enlarge the image to the preset level.

Chapter 15: Photo Viewer

15.1.3 Slideshow



Press the Slideshow button to cycle through all the photos in the Pictures folder automatically.

15.1.4 Pan



If you enlarge an image beyond the screen boundaries, press the Pan button to enable image scrolling. While enabled, you can drag the image in any direction to view other areas of the image. Press the Pan button again to disable Pan mode.

15.1.5 Rotate Image



Press the Rotate Image button to rotate the image 90° counterclockwise, 90° clockwise, or 180°.

15.1.6 Next Image (right arrow)



Press the right arrow button to view the next image in the folder. This button is grayed out (not functional) when viewing the last image in the folder.

15.1.7 ESC



Press **ESC** to return to the folder list.

15.2 Manage Photos

15.2.1 List View

Press List view to show the files in a hierarchal list view.

15.2.2 Thumbnail

Press Thumbnail to show the files as thumbnails.

15.2.3 Rename

To change the name of the selected file or folder, press Rename.

Use the backspace key (<-) to erase the name; and the keypad to enter a new name for your file. When you have finished, select OK.

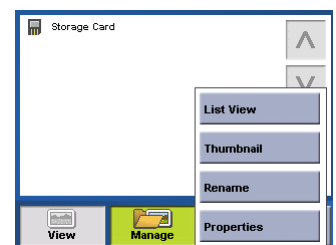

Chapter 15: Photo Viewer

15.2.4 Properties

To view information on the selected file or folder, press **Properties**. A thumbnail of the image will be displayed along with the width and height in pixels, the size, and the format (image type). When viewing the properties for folders, width, height, and format are not shown. Size shown is the combined size of all images in the selected folder.

When you are finished viewing the properties, select **OK**.

15.3 Tools

15.3.1 Preferences

General – The General preferences, you can set the default file view to either thumbnail or file list view.

Slideshow – The slideshow preferences enable you to set the view properties, the sequence of photos, the transition between photos, and the duration between photos.

Background – The background preferences enable you to set the color of the background behind the photo being viewed.

15.3.2 Delete Files

Use the arrow keys to select the file or folder you wish to delete. Press the **Delete** button (trash can).

A dialog box will appear asking to confirm your selection. Select **Yes** to delete the file.

15.3.3 About

This option will display the current version of the Photo Viewer software.

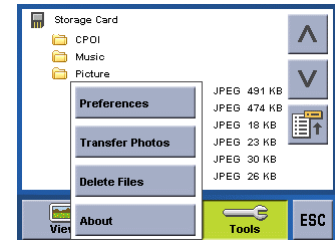

Chapter 16: Magellan RoadMate POI Manager

The Magellan RoadMate POI Manager enables you to transfer custom points of interest files from your computer to your Magellan RoadMate 3000T.

Before we add any custom POI's to the Magellan RoadMate 3000T, you should understand how the POI Manager plots POIs.

16.1 Latitude

Latitude can be expressed by dividing Earth into horizontal segments totalling 180 degrees. Starting at the Equator, or zero degrees Latitude, lines (or Parallels) are drawn in 10-degree increments 90 degrees to the north and 90 degrees to the south. If your location is below the Equator, you are at a South Latitude.

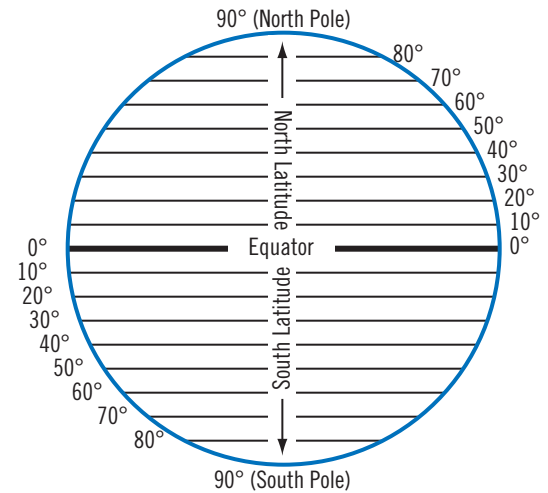

16.2 Longitude

Conversely, longitude lines can be expressed by dividing Earth into vertical segments totalling 360 degrees. Starting at the Prime Meridian (which is The Royal Observatory in Greenwich, England), or zero degrees Longitude, lines are drawn in 10-degree increments 180 degrees to the West and 180 degrees to the East. If your location is on the western hemisphere, you are at a West Longitude.

Additionally, to narrow down your location further, each 10-degree segment is divided into 60 smaller segments called minutes and, still further, each minute is divided into 60 segments called seconds.

To express this in coordinates, the city of Los Angeles is located at 34° (degrees) 03' (minutes) and 08 (seconds) North of the Equator, and 118° (degrees) 14' (minutes) and 42 (seconds) West of the Prime Meridian.

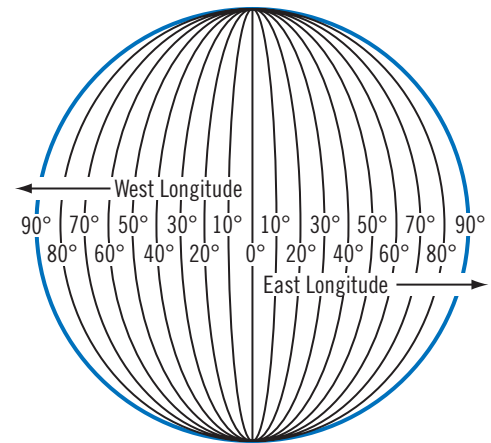

Chapter 16: Magellan RoadMate POI Manager

16.3 Altitude

Each location can also have an Altitude. Altitude is expressed by how far the point is above or below the level of the ocean, or Sea Level. For example, Los Angeles, California is about 300 feet above sea level. Death Valley, California is about 270 feet below sea level.

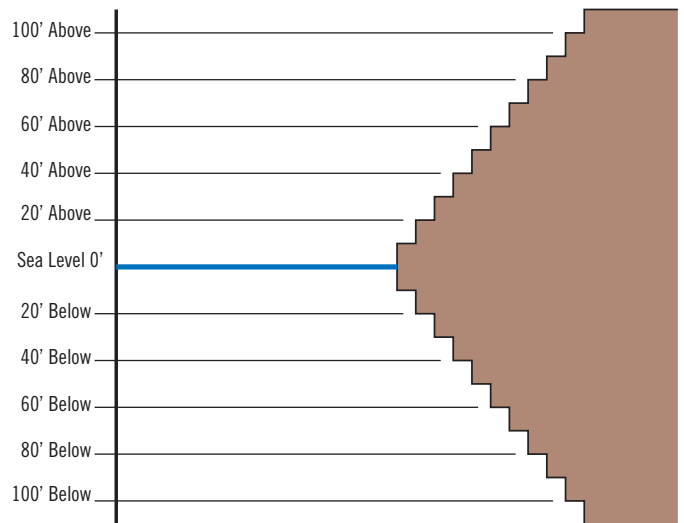

Turn on your Magellan RoadMate 3000T by pressing and holding the Power button for approximately 2-3 seconds, 10 seconds if not in sleep mode (see “Top View” on page 6). When the Warning screen appears, insert the small end of the USB cable into the USB port on your Magellan RoadMate 3000T, and the large end into an available USB port on your computer.

Launch the Magellan RoadMate Tools application. From the Magellan RoadMate Tools screen, click on **POI**.

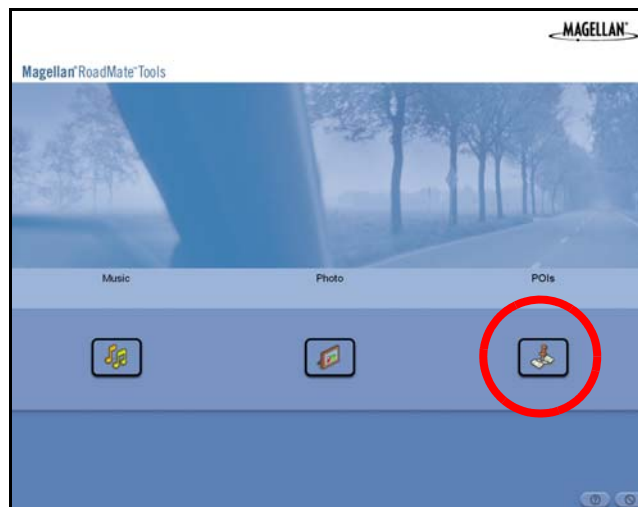

The left side of the window shows the contents of your computer and the right side of the window shows the contents of the Magellan RoadMate 3000T.

16.4 Opening a POI File

When you start the POI Manager the contents of your “My POI’s” folder will be displayed. This is the default location for storing custom POI files.

Chapter 16: Magellan RoadMate POI Manager

Locate the POI files you wish to load. When you have selected a file, the Copy To Unit arrow will turn green. Click on the arrow to copy the file to your Magellan RoadMate 3000T.

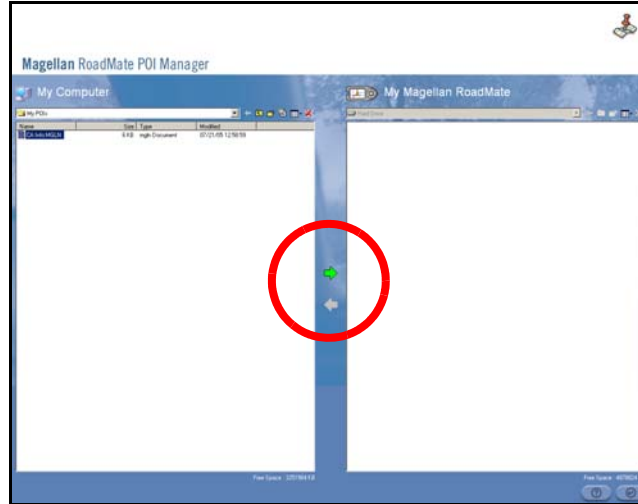

When you have finished copying files, remove the USB cable from the Magellan RoadMate 3000T.

16.5 Creating a New POI File

There are two ways to create a POI file. You can either add POI's individually, or you can import a character delimited file containing the information need to plot the POI's. To plot a POI, each item must have a name, longitude, and latitude. Longitude and latitude must be in decimal format.

16.6 Adding Individual POI's

Click on the **New POI File** Button to launch the POI Editor.

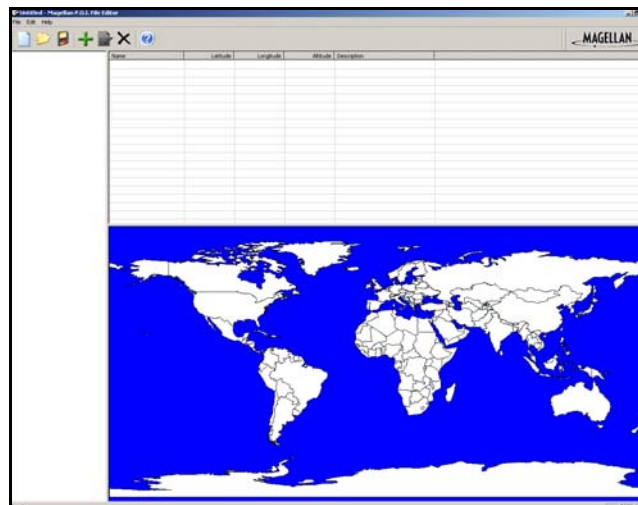

Click on the **Add** button  .

Enter the Name, the Latitude, and the Longitude. The Altitude and Description fields are optional.

Chapter 16: Magellan RoadMate POI Manager

Select the Category field and select **New**. A dialog box will appear to create a new POI category. Enter the Name and assign an Image (icon) for the POI. The Description field is optional.

The Alert feature is an audible alarm that lets you know when you are within a certain distance from the POI. You can set an initial reminder (Distance 1), a secondary reminder (Distance 2).

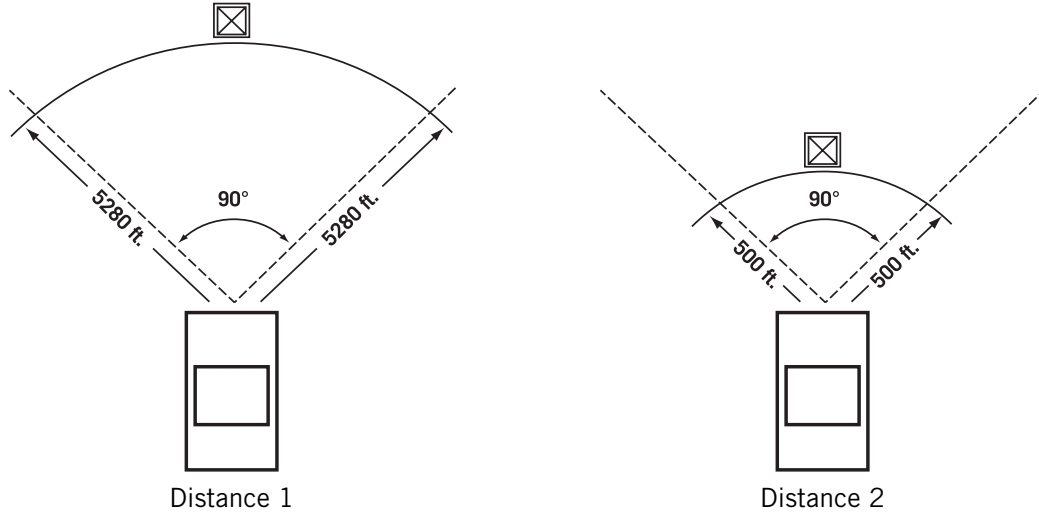

Select your preferred unit or measure (Meters or Feet).

The Detection angle sets the range of alert in degrees from the POI.

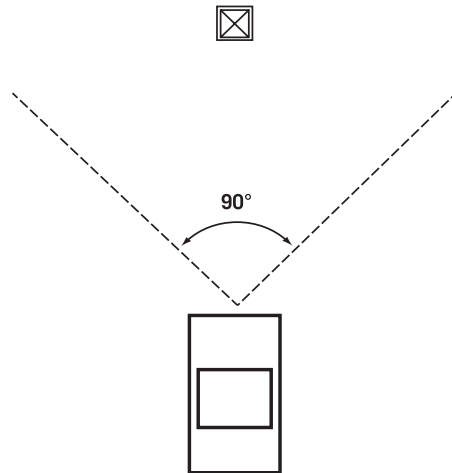

Select Activate alert for this category to enable the alert settings.

When you have finished, select **OK**.

Chapter 16: Magellan RoadMate POI Manager

16.7 Importing a Data File

The POI Manager software supports ASCII file format (.ASC,.CSV,.TXT); GPS Exchange file format (.GPS,.XML); Magellan Waypoint file format (.WPT,.RTE); and Garmin PCX5 Waypoint file format (.WPT,.RTE).

Click on the **Open** button  .

Select the file you wish to import and click **Open**.

Start by choosing which line in the data file to start importing data. If your data file has a header row, this row will generate an error so you should start at line two or below.

Next, choose how the data is separated and click on **Next**.

You now need to define the data columns. Click on the pull down menu and assign a field name to the appropriate column. Click on **Finish**.

Click on The **Save POI file** button. Assign a name to your file and click on **Save**.

Close the POI File Editor. Select the POI file you just created and click on the transfer button (right arrow) to upload the file to your Magellan RoadMate 3000T.

See page 55 for information on accessing custom POIs on your Magellan RoadMate 3000T.

Appendix

POI Categories

The Magellan RoadMate 3000T POI database has 37 different categories. The icons will appear on the Map screen (if enabled):

	Restaurant	Fast food, diners, and food marts
	Bank/ATM	Most financial services
	Gas Station	Most fuel services
	Roadside Assistance	Towing companies
	Hospital/Polyclinic	Most medical services
	Vehicle Services	Repair shops, tire stores, and oil changes
	Airport	International and Municipal airports
	Camping & RV	Campgrounds, camping areas, and RV parks
	Car Rental	Car rental companies
	Casino	Gambling venues
	City Center	The geographical center of a selected city
	Clothing	Clothing retail stores
	Convention Center	Major Convention Centers
	Education	Schools, Colleges, and other learning institutions
	Emergency Services	Police, Fire, and Emergency Rooms
	Entertainment	Movie theaters, live performance venues
	Golf Course	Private and public courses
	Grocery Store	Major chains and local markets
	Hair & Beauty	Salons and beauty parlors
	Health Care	Doctors' offices and pharmacies
	Home & Garden	Nurseries and do-it-yourself centers
	Hotel or Motel	Most overnight stay locations
	Marina	Docks and harbors
	Misc. Services	Other services not categorized
	Nightlife	Dance halls, pubs, nightclubs
	Open Parking Area	Parking lots and garages

Appendix

	Parks	County, regional, and local parks
	Professional Services	Business office locations
	Public Buildings	Libraries, museums, and government buildings
	Rest Area	Rest stops along major highways
	Shopping	Malls and other retail stores
	Ski Resorts	Most major ski resorts
	Sports & Recreation	Stadiums, parks, lakes
	Tourist Attraction	Places most visited by tourists
	Transportation	Bus and train stations
	Winery	Vinyards and tasting locations
	Worship	Churches, temples, mosques

When selecting restaurants, you can further narrow the search by cuisine type such as French, Italian, Greek, Mexican, etc.

Appendix

Specifications

Dimensions:	3.8" x 4.8" x 1.4" 9.6cm x 12.2cm x 3.5cm
Weight:	8.64 oz. 245 g
Display:	3.5" color touch screen display, 2.11" x 2.81" (53.64mm x 71.52mm)
Screen Resolution:	320 x 240 QVGA; 64,000 colors
Accepted Card Media:	Secure Digital (SD) or Multimedia Card (MMC)
Audio:	Integrated Speaker with integrated stereo headphone jack
GPS Antenna:	Integrated with optional external antenna connection
Battery:	2100mA LI-ION
USB Interface:	1.0
Operating Temperature:	32°F to 104°F 0°C to +40°C
Storage Temperature:	-4°F to 158°F -20°C to +70°C
Humidity:	50% ± 20% ambient room

PC Requirements

- IBM Compatible PC, Pentium or higher
- Microsoft ® Windows® 2000 or XP
- 128 MB RAM
- CD Drive for Software Installation
- DVD Drive for Map Upgrades
- USB Port

Appendix

GPS Status Screen

GPS STATUS Screen Structure-first page

CH	PRN	AZ	EL	SNR	U/N
01	d1	d2	d3	d4	c1
02	d1	d2	d3	d4	c1
03	d1	d2	d3	d4	c1
04	d1	d2	d3	d4	c1
05	d1	d2	d3	d4	c1
06	d1	d2	d3	d4	c1
07	d1	d2	d3	d4	c1
08	d1	d2	d3	d4	c1
09	d1	d2	d3	d4	c1
10	d1	d2	d3	d4	c1
11	d1	d2	d3	d4	c1
12	d1	d2	d3	d4	c1
13	d1	d2	d3	d4	c1
14	d1	d2	d3	d4	c1

It is ordered by the channel number from 1 to 12.

Where:

- d1: Satellite PRN number, with “e” or “E” to the right means got ephemeris data, “v” or “V” to the right means got verified ephemeris data (double check). “E” or “V” also means got satellite time for this channel.
- d2: Azimuth, in degrees
- d3: Elevation angle, in degrees
- d4: SNR (signal to noise ratio), it is ratio-Hz, not dB unit
- c1: U – Used for position fix, U – Not used for position fix

Bad fix code

- 0 PVT_OK :good fix
- 2 ILLEGAL_ALT: illegal altitude < -10km or > 17.5km
- 4 POSITION_JUMP: too big position jump between two epoch (300 miles)
- 5 ILLEGAL_VELOCITY_OR_ALT: max velocity 951mile
- 7 TOO_BIG_ACCELERATION max 15m around 1.5g
- 8 TOO_SMALL_ALTITUDE -10000 m
- 9 TOO_BIG_ALTITUDE 17,500 m
- 10 TOO_BIG_PDOP max PDOP 50
- 11 SATS_BELOW_MASK_ANGLE satellite elevation angle is below mask angle
- 16 ILL_DEFINED_3D_MATRIX 3X3 matrix can not be inverted in 3D fix

Appendix

- 17 ILL_DEFINED_2D_MATRIX 2X2 matrix can not be inverted in 2D fix
- 20 NO_SAT_TIME no satellite time
- 23 NOT_ENOUGH_SATS no enough satellite for 2D or 3D fix
- 24 CANNOT_SELECT_FIX_TYPE
- 30 VELOCITY_2D_ONLY 2 satellite fix only for velocity, no position fix
- 31 BAD_VELOCITY_PDOP 50 too big pdop for velocity
- 32 TOO_MANY_SATS_FOR_2D_VEL there are 4 or more satellites, but 2D fix provided
- 51 WRONG_NUMSAT number of satellite for fix > 12 or less 2
- 56 LOOP_3D_NOT_CONVERGING 3D initial fix is not convergent
- 57 MILLISECOND_ERROR millisecond jump happened
- 58 LOOP_2D_NOT_CONVERGING 2D initial fix is not convergent
- 59 BAD_RANGE_CHITEST; range post-fix residuals chi-test failed
- 60 BAD_DOPPLER_CHITEST doppler post-fix residuals chi-test failed
- 61 OSC_DRIFT_ERR too much clock drift 60HZ for XO, 7.5HZ for TCXO
- 62 BAD_DOPPLER_ERR too big Doppler errors 4m/s
- 63 BIG_RANGE_RESID 110m/40m depend on virtual ttagl/ DGPS factors
- 64 BIG_DOPPLER_RESID 0.7m/s
- 65 HUGE_RANGE_RESID 10km normal for postfit residuals for range
- 66 HUGE_DOPPLER_RESID 100m/s normal for postfit residuals for doppler

Usually, Bad code is 20 and 23. If fix is good, it would be 0.

GPS STATUS Screen Structure - second page

Heading XXX (degree) Speeding XX.X (meter per second)
Current Lat: DDD.DDDDD W/E (current latitude, degree)
Current Long: DDD.DDDDD N/S (current longitude, degree)
Current altitude XXXX (altitude in mean sea level meter) TTF XXXXs (Time-To-First-Fix in second)
#Satellite (U/T) XX/XX (the number of satellite used and tracked)
PDOP XX.X (Position Dilution Of Precision)
VDOP XX.X (Vertical Dilution of Precision)
TDOP XX.X (Time Dilution of Precision)
HDOP XX.X (Horizontal Dilution of Precision)
FOMS P/V/H (Figures Of Merits for position, velocity and heading in map matching)
UTC TIME MM/DD/YY HH:MM:SS(UTC time without local zone)

Appendix

Typical GPS STATUS Screen Display

First Page

CH	PRN	AZ	EL	SNR	U/N
01	27V	311	54	334	U
02	03E	078	29	135	U
03	13e	079	81	204	U
04	20e	175	06	90	N
05	31v	119	34	179	U
06	01V	120	53	316	U
07	28V	220	13	152	U
08	08V	282	29	182	U
09	02V	046	27	173	N
10	84	255	12	0	N
11	10	325	06	47	N
12	72	105	13	34	N
13	134	255	12	50	N
14	122	105	13	63	N

Second Page

Heading 0 Speed 0.0 m/s

Current Lat: 34.10939 N

Current Long:117.82599 W

GPS Version:

Current altitude 255 TTFF 116s

#Satellite (U/T) 11/12

PDOP 2.3

VDOP 1.7

TTFF 0.0

HDOP 1.3

FOMS P/V/H 2

UTC TIME 08/16/2004 22:56:53

Appendix

Frequently Asked Questions

Why is my street not showing up on the map?

The Magellan RoadMate 3000T uses the most current available map data. Chances are, your street is in a new housing development or the street is new. Map updates may be made available once per year.

I know there is a gas station on this street corner, why is there not icon for it on the map?

Check your POI settings and make sure you have the necessary POI checked to make it visible on the map. See “POI Selection” on page 55.

The Magellan RoadMate 3000T uses the latest POI data available. Chances are the POI you are looking for is relatively new and has not been added to the database. If this is not the case, it may have been overlooked or changed since the POI database was created. You can add custom POIs to your Magellan RoadMate 3000T to make up for those you route to often. See “Chapter 16: Magellan RoadMate POI Manager” on page 84., and “Custom POIs” on page 55.

The GPS signal is weak. What’s going on?

You may be driving through an area that has tall buildings or trees, or a canyon, or a tunnel. These conditions may interfere with satellite signals. Wait a few moments and the signal should get better as more satellites are acquired. If the problem persists, there may be a problem with the antenna. Contact Technical Support.

Why is an address I know I routed to not in the Previous Destinations list?

The Previous Destinations list stores the last 50 places you routed to. When you get to number 51, the first destination on the list is removed and each successive destination is moved up.

Can I play MP3's and Route at the same time?

No

Can I import a play list from Windows Media Player?

No. The Music Player does not support playlists from other applications.

Can I use any third party SD/MMC card with the Magellan RoadMate 3000T

The Magellan RoadMate 3000T is compatible with most major brands of SD/MMC card.