

ID Card Printer

User Manual



ReTransfer ID Card Printer – User Manual

CONTENTS

The information contained in this document is subject to change without notice	4
Safety Instructions:.....	4
CE Declaration:	4
FCC Declaration:	4
CCC Declaration:	4
CAUTION:	4
Printer installation.....	5
Welcome	5
IMPORTANT – Do not connect the USB yet!.....	6
Printer Environmental requirements:.....	6
Fitting the Printer accessories.....	7
Installing the Dye Film	8
Connect the Power Supply	9
Choosing the Correct Connector for your Region	10
installing the driver.....	11
The printer Driver settings.....	13
Using your ID Card Printer	14
Printer Main Components	14
Front Display Panel.....	15
Printer Menus.....	16
Main Homepage.....	16
Main Homepage (cont...).....	17
Tools Menu.....	17
Additional Settings Options	18
Help Menu	19
Cleaning Menu	20
The Internal Test Card	21
Available Encoder Modules	22
Choosing the Right dye film	23
Choosing the Right Cards.....	24
Card size	24
Card thickness.....	24
To obtain good quality prints the Cards must be... ..	24
Printable area of the Card	24
Using Magnetic Stripe Cards.....	25
In the event of a Card jamming in the printer	25

ReTransfer ID Card Printer – User Manual

Caring for your printer	26
MAINTAINING YOUR PRINTER IS IMPORTANT!!!	26
Cleaning Supplies	26
Cleaning the Printer Rollers using the Cleaning Kit	27
Replacing the Cleaning Roller	28
Cleaning the Print Head using the Cleaning Swab.....	29
Cleaning the Printer using the Cleaning Card	30
Upgrading to DUO Operation	31
Available consumables	32
Printer Error codes.....	33

ReTransfer ID Card Printer – User Manual

THE INFORMATION CONTAINED IN THIS DOCUMENT IS SUBJECT TO CHANGE WITHOUT NOTICE

Magicard Ltd. shall not be liable for errors contained herein or for incidental consequential damages in connection with the furnishing, performance or use of this material.

This document contains proprietary information belonging to Magicard Ltd. and may not be wholly or partially copied, stored in a data retrieval system, or used for any purpose other than that for which it was supplied, without the express written authority of Magicard Ltd. All rights are reserved.

The HoloKote feature is protected by US PATENT No: 5,990,918 and by EUROPEAN PATENT SPECIFICATION EP 0 817 726 B1.

Microsoft and Windows 2000, XP, Vista and Windows 7 and 8 are trademarks of Microsoft Corporation.

Copyright © 2011 Magicard Electronics Limited.

SAFETY INSTRUCTIONS:

To prevent electric shock do not remove covers.

Do not attempt to service the printer yourself.

There are no user serviceable parts inside. In the event of malfunction, refer servicing to your printer's supplier.

This product is only to be used with the Power Source supplied at point of purchase.

Take care not to spill any liquid on the printer.

Ensure that the power supply cord is no longer than 2 metres in length and includes a properly grounded connection.

If using this printer in Germany:

To provide adequate short-circuit protection and over-current protection for this printer, the building installation must be protected by a 16 Amp circuit breaker.

Bei Anschluß des Druckers an die Stromversorgung muß sichergestellt werden, daß die Gebäudeinstallation mit einem 16 A-Überstromschalter abgesichert ist.

When handling the printer avoid touching the thermal printing edge of the thermal print head. Any grease and contamination will shorten its life.

Before transporting the printer, remove the dye film & card hoppers and pack the printer in its original packaging.

CE DECLARATION:

FCC DECLARATION:

Information to the user.

NOTE:

This equipment has been tested and found to comply with the limits for a Class A digital device, pursuant to part 15 of the FCC Rules. These limits are designed to provide reasonable protection against harmful interference when the equipment is operated in a commercial environment. This equipment generates, uses, and can radiate radio frequency energy and, if not installed and used in accordance with the instruction manual, may cause harmful interference to radio communications. Operation of this equipment in a residential area is likely to cause harmful interference in which case the user will be required to correct the interference at his own expense.

CCC DECLARATION:

CAUTION:

Unapproved changes or modifications could void the Users authority to operate the equipment and affect any related warranty claim.

ReTransfer ID Card Printer – User Manual

PRINTER INSTALLATION

Welcome

Thank you for choosing a ReTransfer Card Printer

Before setting up your printer using the Driver CD-ROM, please follow the simple steps in this guide on installing your Printer. This guide helps you make your printing experience more enjoyable and secure.

Please ensure you have the following items before you begin the installation:

1. ReTransfer ID Card Printer
2. Card Hopper and Stacker
3. USB Cable
4. QuickStart Guide
5. Driver CD ROM
6. Cleaning Cards x2
7. Power Adaptor and Leads

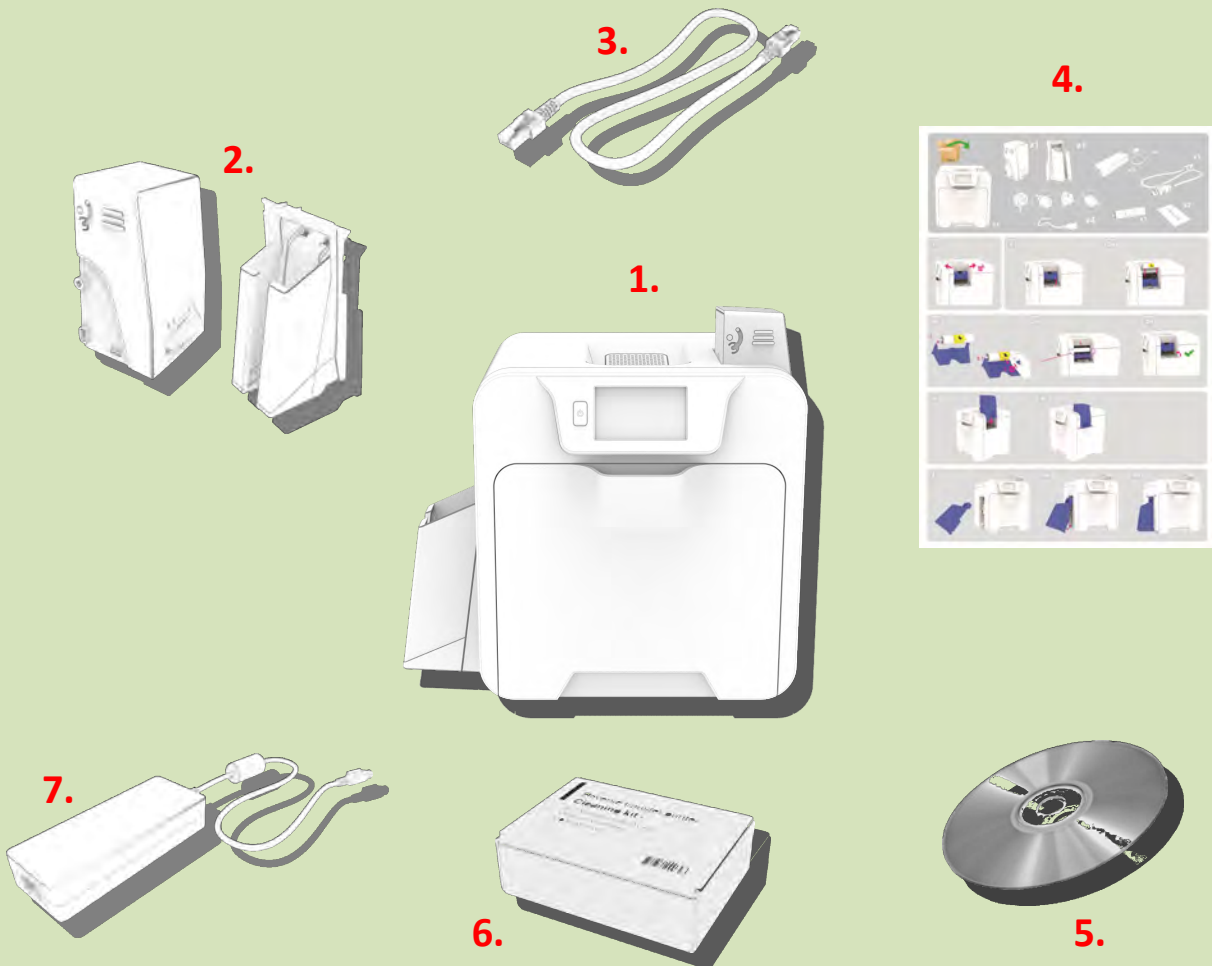

ReTransfer ID Card Printer – User Manual

IMPORTANT – Do not connect the USB yet!



IMPORTANT

Install the Driver software BEFORE connecting the USB Cable!

1.



2.

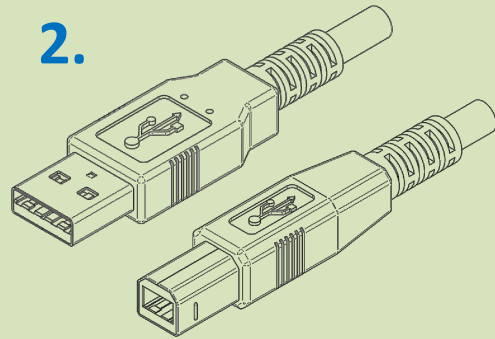

Printer Environmental requirements:



Normal Office environment with:

- A correctly Earthed Power Supply
- Ambient temperature +10 to 30°C (50 to 86°F)
- Protection from direct sunlight and chemicals
- Protection from sudden temperature changes
- Relative Humidity 20 - 70%
- Sufficient space for:
 - Opening the Front Cover
 - Cable access at the rear

FITTING THE PRINTER ACCESSORIES

Card Feed Hopper:

Insert the Hopper into the aperture on the right-side of the Printer and click into place.

Always fan the Cards to ensure these do not stick together due to a build-up of static electricity.

Try to handle the Cards as little as possible before printing.



Card Feed Hopper



Card Stacker:

Insert the Stacker into the aperture on the left-side of the Printer and click into place.

The Stacker can hold up to 200x 30 thou (0.76 – 1.02 mm) thick Cards.

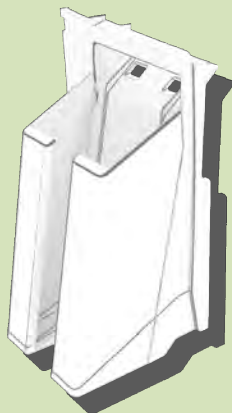

Card Stacker

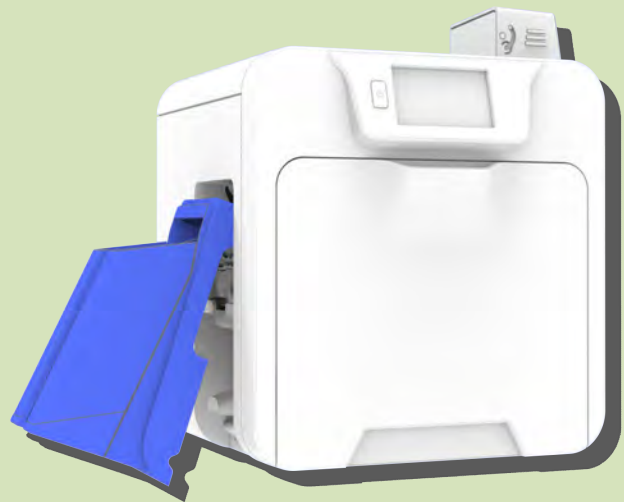

ReTransfer ID Card Printer – User Manual

Installing the Dye Film

3. Open the Printer's Front Cover and remove the Films from their Packaging.

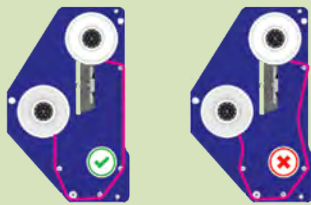
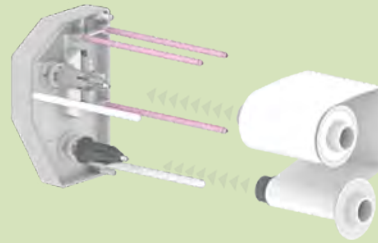
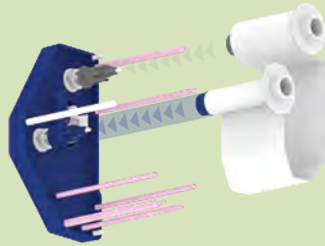

1. Inserting the Retransfer Film

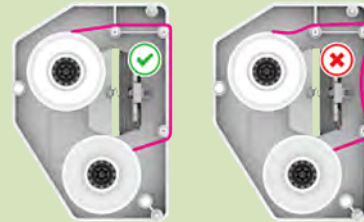

2. Inserting the Dye Film.

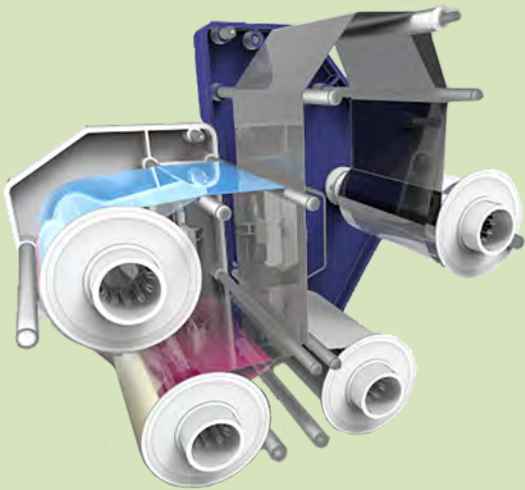

4. Films correctly inserted.

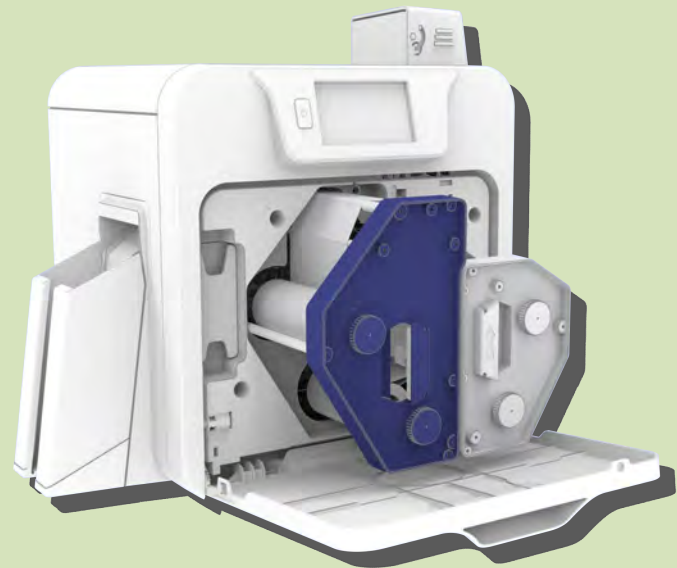

5. Close the Film Cartridge then insert the Cartridge into the Printer.

ReTransfer ID Card Printer – User Manual

Connect the Power Supply

Connect Mains Power Supply Unit (PSU) to the rear of the Printer but do not connect the USB cable at this stage.

Printers will despatch with the correct regional mains connector (which will include one of the following illustrated below).



IMPORTANT:

Do not connect the USB until the CD ROM Driver has been installed.

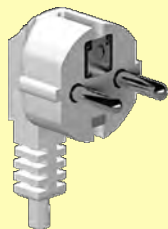
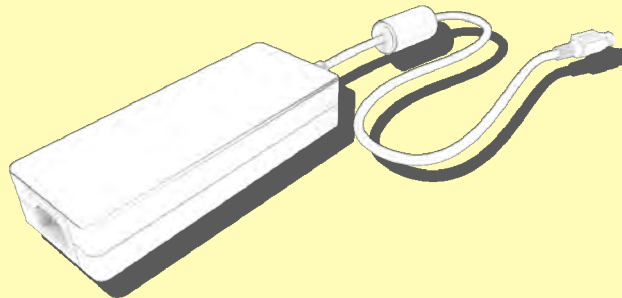
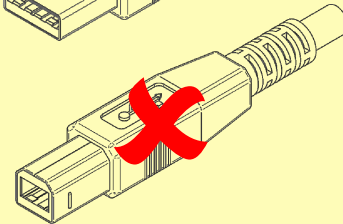
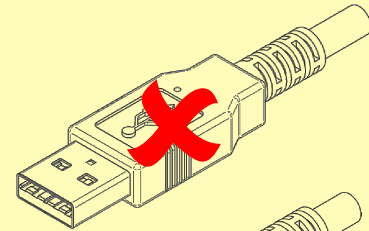

ReTransfer ID Card Printer – User Manual

Choosing the Correct Connector for your Region

INSTALLING THE DRIVER

1. Load the driver CD ROM into the PC.
Note: If the CD does not run automatically, click the “Start” Button, then click on “Run”. Type “D:\autorun”, where D is the drive letter for your CD Drive, then press the Return Key.
2. Now follow the on screen instructions to install the Printer Driver (please see below):

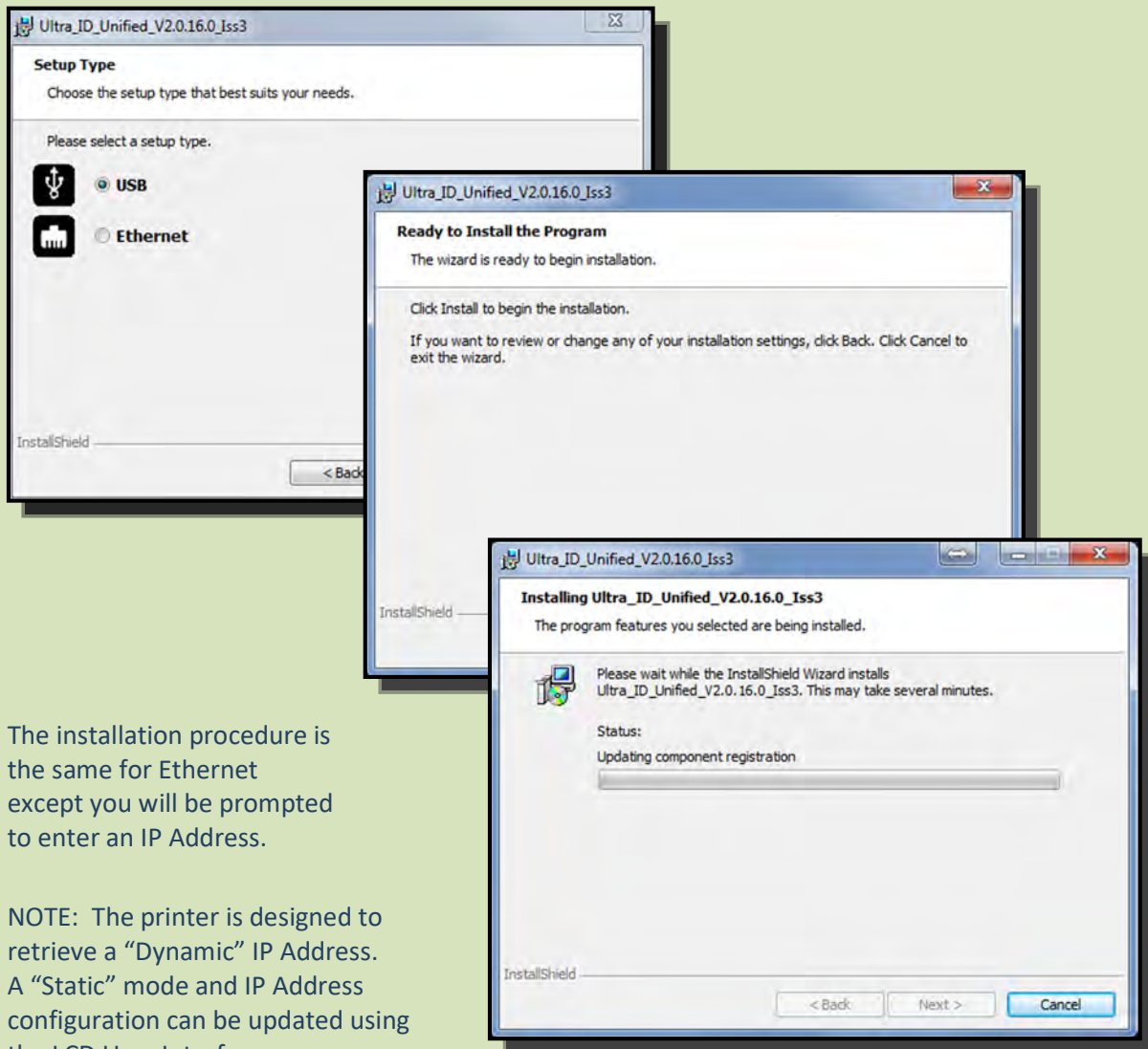
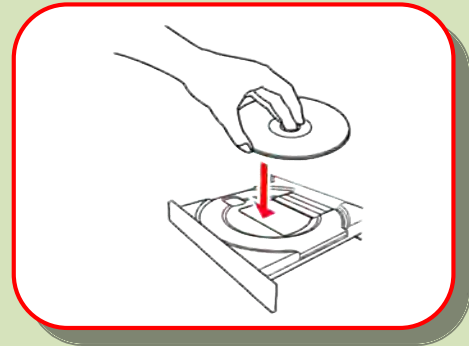

The installation procedure is the same for Ethernet except you will be prompted to enter an IP Address.

NOTE: The printer is designed to retrieve a “Dynamic” IP Address. A “Static” mode and IP Address configuration can be updated using the LCD User Interface.

INSTALLING THE DRIVER (Cont...)

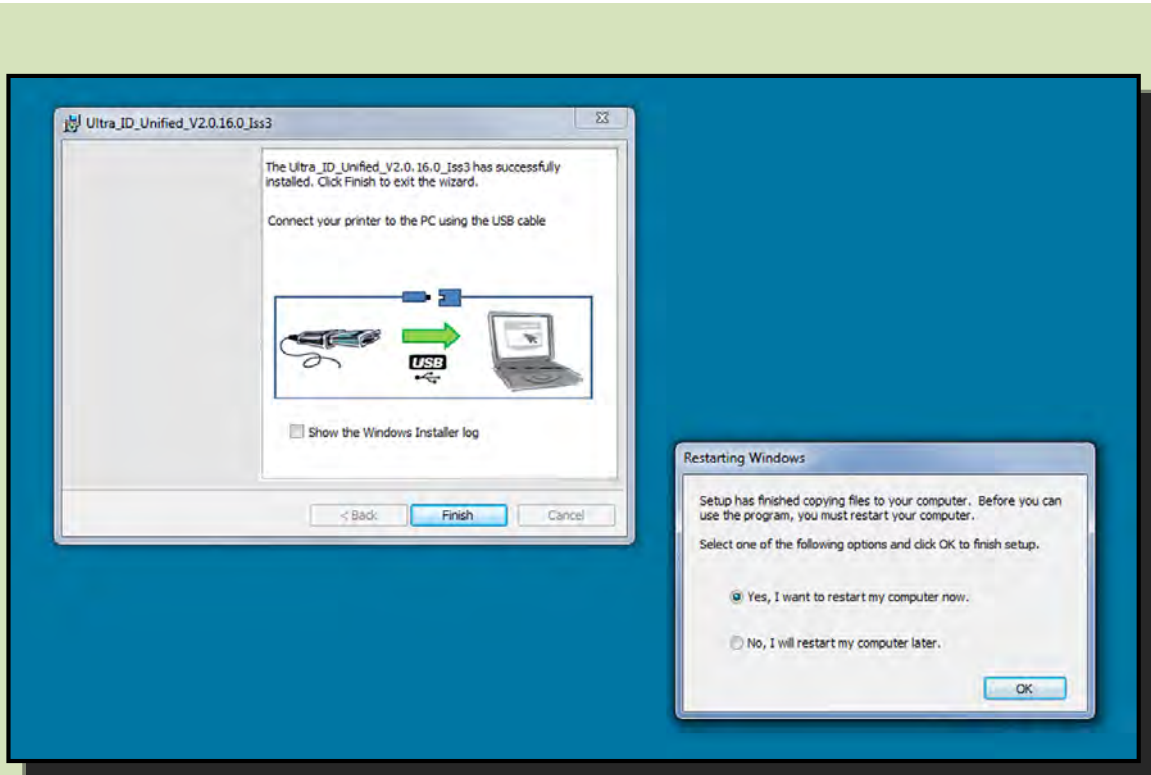

1. When the Driver has completed it's installation, connect the USB cable (shown below). Now restart the Computer.

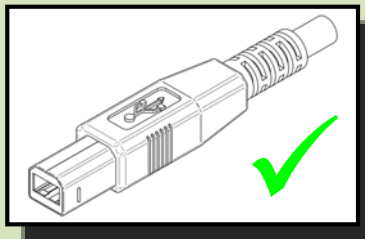

2. When complete you should now see the installed Driver icon on the **Devices and Printers** window on the Computer (this may take several seconds as the Computer needs to configure the USB Port in order to communicate with the Printer).
3. **Installation complete!**

THE PRINTER DRIVER SETTINGS

Accessing the Driver Preferences Settings:

Windows 7



Windows 8/8.1/10

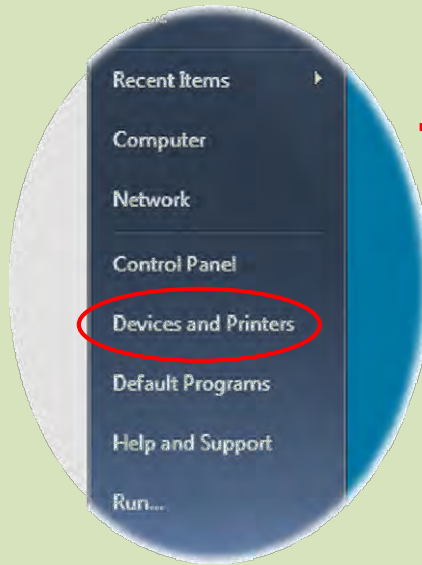

- Open the **Devices and Printers** Window.
- Right-click on the Printer icon.
- Select **Printing Preferences**.



Help with Driver Settings:

The Printer Driver contains a built-in help file (in HTML format) – this file gives an excellent, clear explanation of each Driver setting.

To view the Driver's help file, go to the **Printing Preferences** (as described above), and click on the "Help" Button.

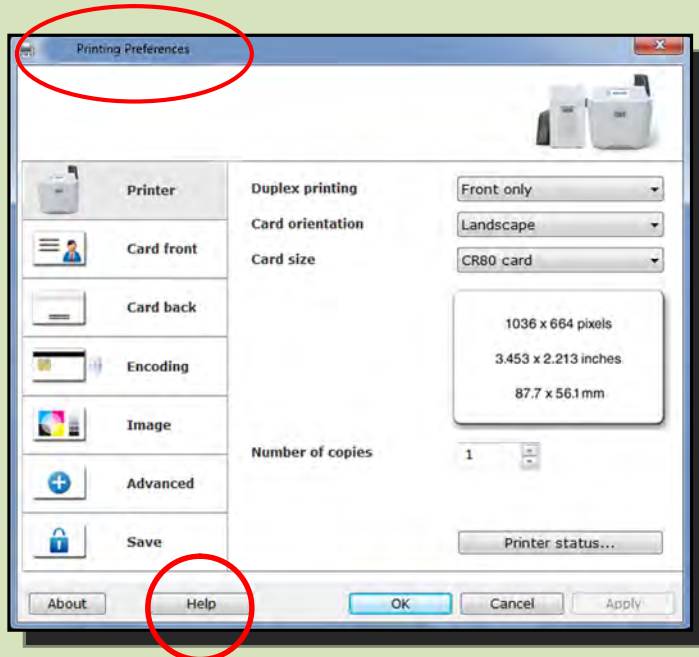

ReTransfer ID Card Printer – User Manual

Using your ID Card Printer

Printer Main Components

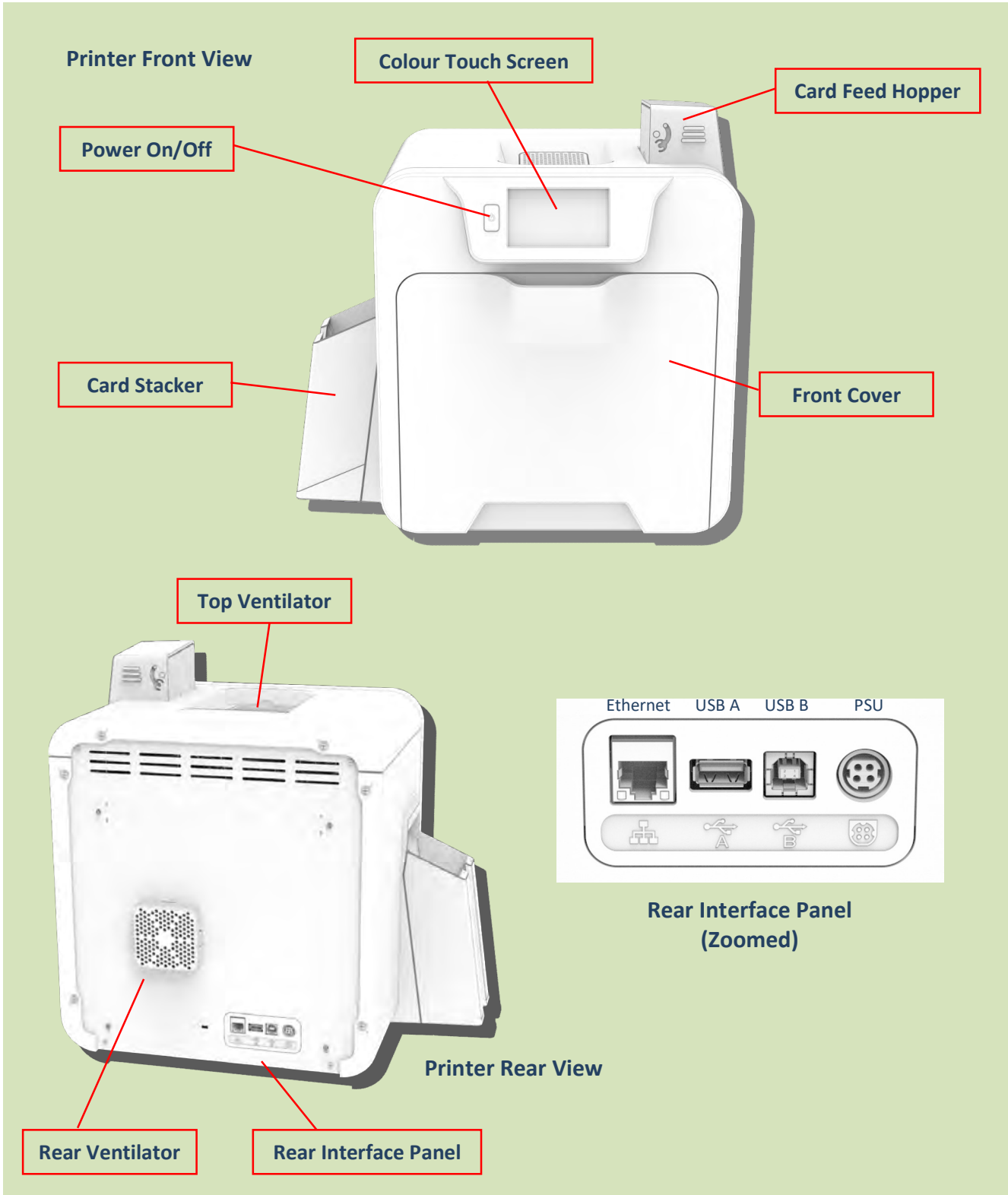

Front Display Panel

The front Display panel comprises a full colour touch-sensitive Liquid Crystal Display (LCD) capable of displaying 16.7 million colours at a resolution of 480 x 272 pixels (w x h).

Printer Menu Layout

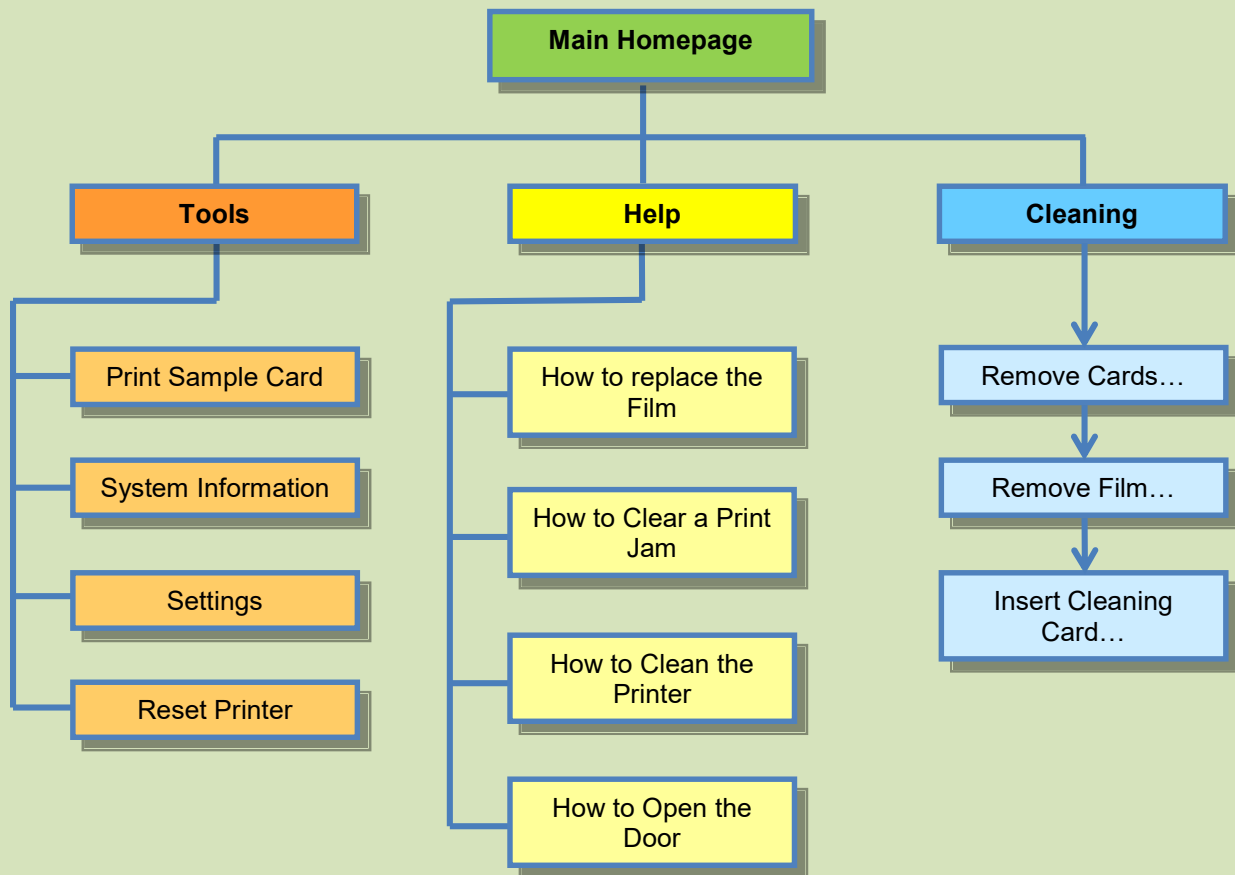

Printer Menus

Main Homepage

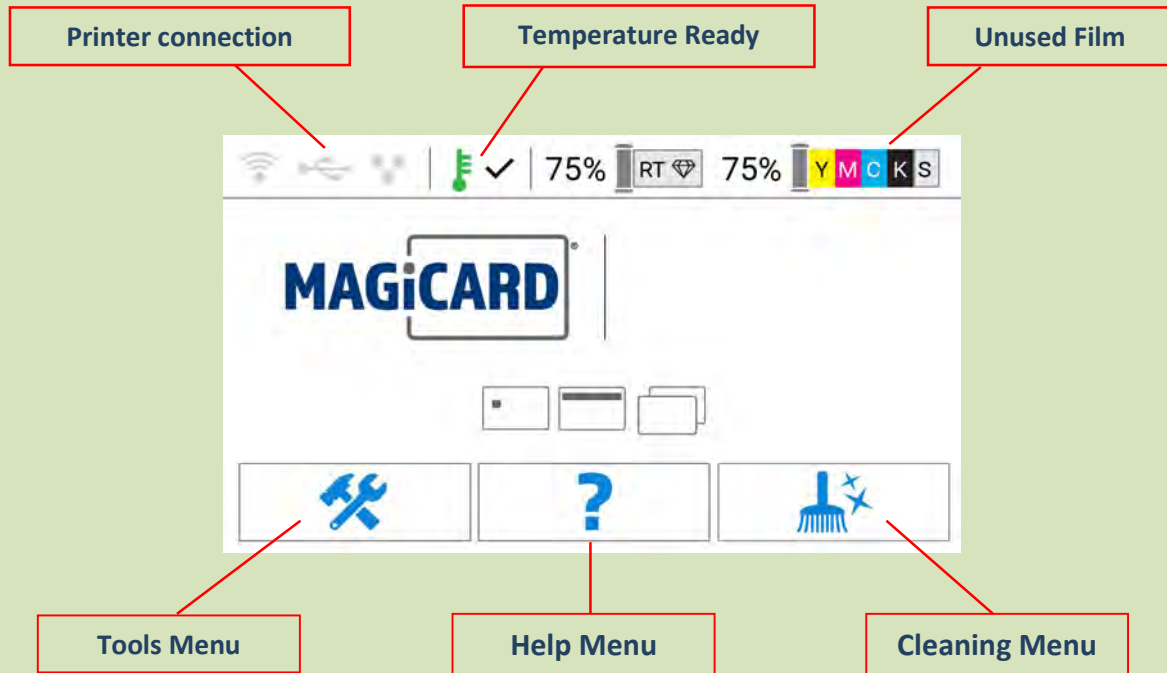

Printer Connection

Indicates the currently selected connection method to the Printer.

Temperature Ready

Indicates whether the Heated Roller temperature has reached the required temperature.

The operating temperature can be displayed by touching this icon.



Unused Film

Indicates the unused Film left on the Spool.

ReTransfer ID Card Printer – User Manual

Main Homepage (cont...)

Tools Menu

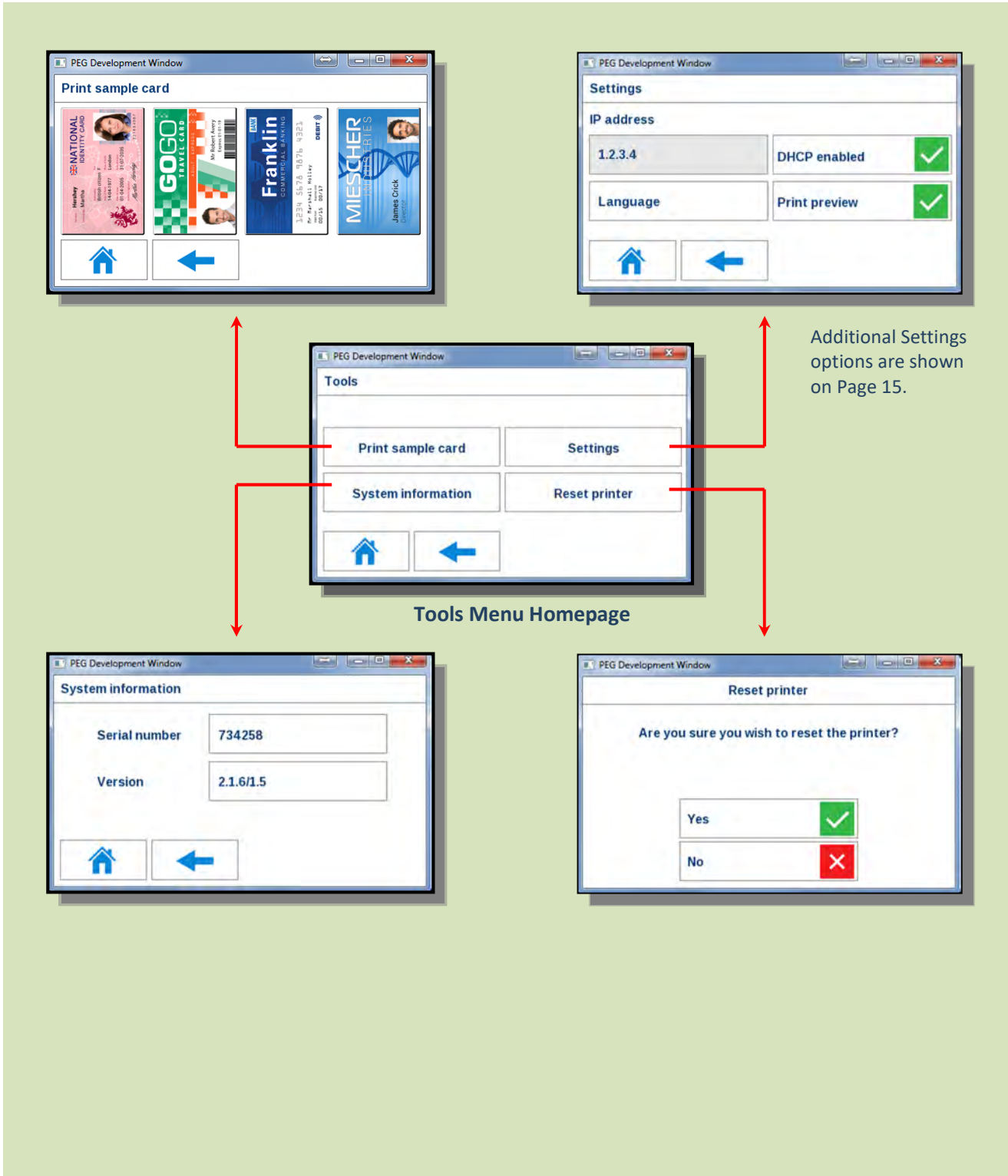

ReTransfer ID Card Printer – User Manual

Additional Settings Options

Additional settings are possible from the Settings Menu Homepage.

The Printer's IP Address can be set manually if required.

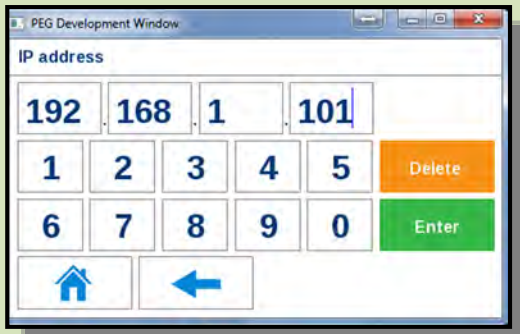

Manually enter the IP Address you wish to set and click "Enter".
If you make a mistake or wish to change the address, click "Delete".

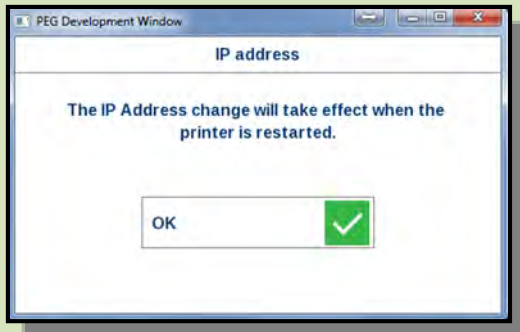

Any changes made will take effect after the printer is restarted.

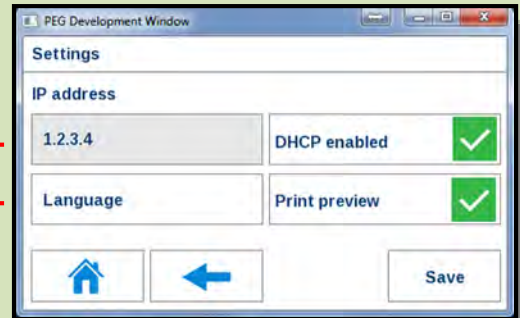

All settings in this window can be saved.



Additional Language options are also possible.

ReTransfer ID Card Printer – User Manual

Help Menu

Clicking any of the Help Menu Buttons will display a short animation showing the process selected.

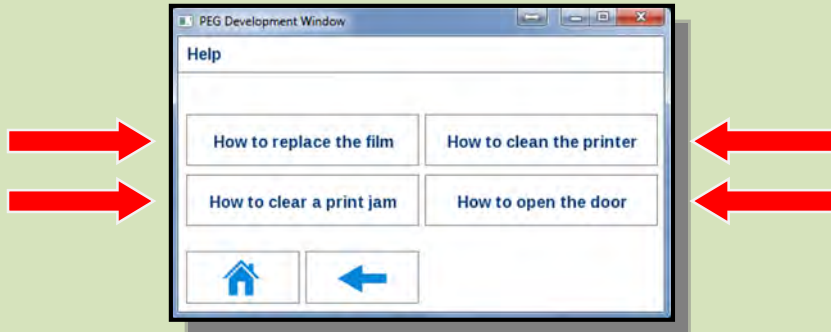

Help Menu Homepage

ReTransfer ID Card Printer – User Manual

Cleaning Menu

Cleaning the Printer is easy...

Simply select the Cleaning option from the Main Homepage and follow the On-Screen instructions.

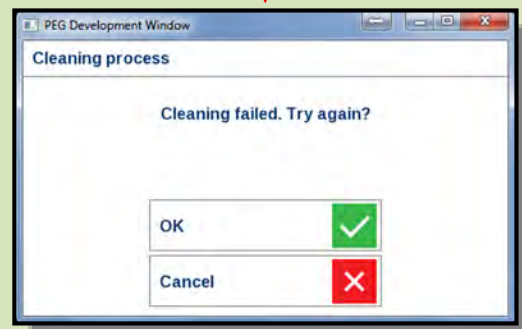
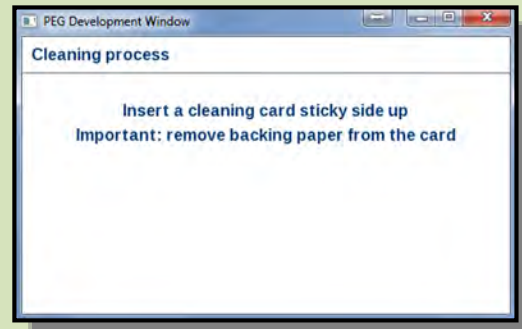
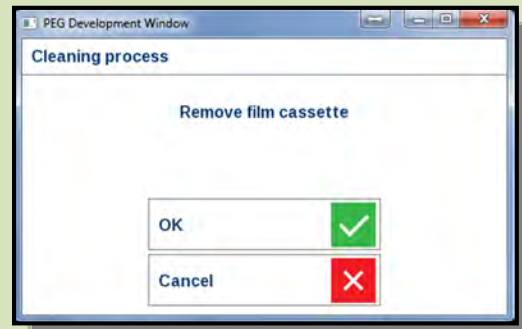

ReTransfer ID Card Printer – User Manual

The Internal Test Card

The internal Test Cards are essentially the same images that are accessible via the Tools Menu (clicking the “Print Sample Card” Button).



Each of the above images is stored and generated entirely within the Printer (making these independent of the Host PC).

ReTransfer ID Card Printer – User Manual

Available Encoder Modules

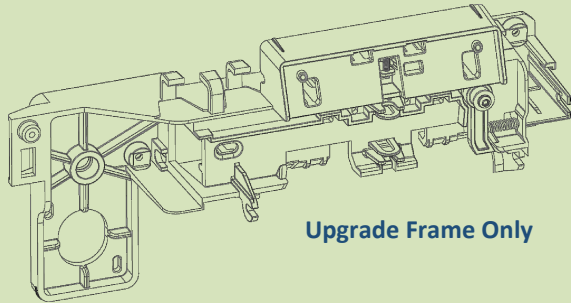

Upgrade Frame Only

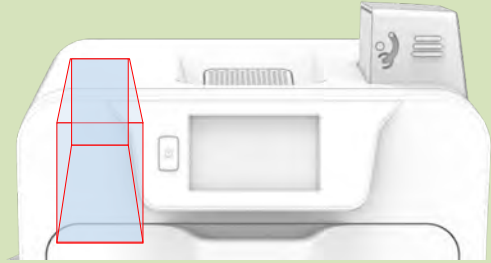

Approximate Encoder Location

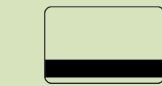
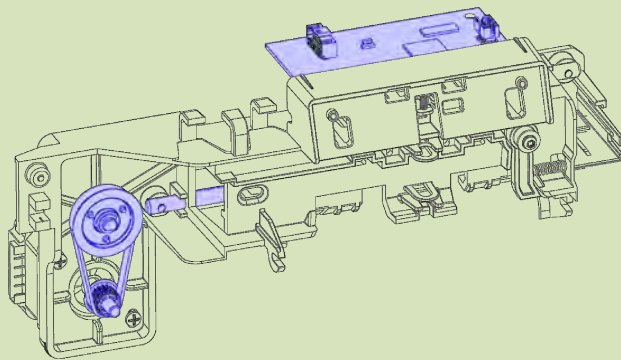

Upgrade Magnetic Only

Magnetic encoding is enabled by default if a Magnetic Encoder Module is fitted within the Printer. The Printer's Firmware is able to detect the Encoder and will make the necessary configuration changes accordingly.

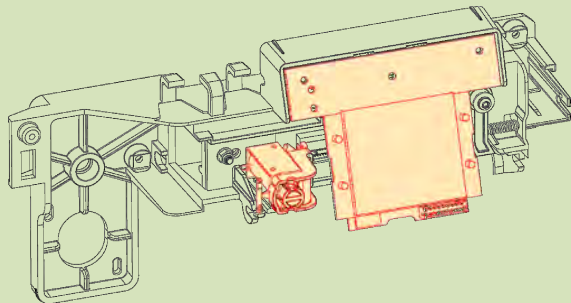

Upgrade Smart Only

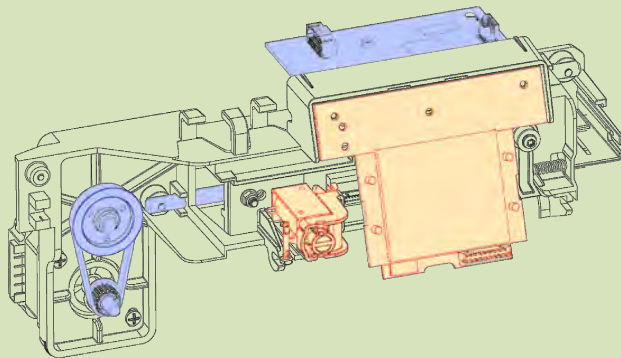

Upgrade Magnetic/Smart

Smart Encoder (Omnikey 5122)
Supported Cards: MIFARE, DESFire, iClass.

The OMNIKEY® 5122 Reader Board is a dual interface PC-linked reader that reads/writes to both a 13.56 MHz contactless smart card and virtually any contact smart card. The dual interface feature, implemented on a small PCB, economically supports end-user environments where both contactless and contact smart card technology may be in use. The reader supports contactless Smart cards with up to 424 kbps in ISO 14443 transmission mode.

ReTransfer ID Card Printer – User Manual

CHOOSING THE RIGHT DYE FILM

NOTE:

- The HE1000YMCK is generally the appropriate choice for colour printing with both single-sided (UNO) and double-sided (DUO) Printers.
- A HE750YMCKK Film is also more economical when printing a colour of the front of the Card and Black only (such as Barcodes etc.) on the rear of the Card.

Below is a general guide to selecting the most suitable Film for any typical application.

Dye Film	Typical Use
HE1000	YMCK Dye Film & RT Film Set – 1000 Prints
HE3000S	Holokote Film Set – 3000 Prints (4 YMCKK & 3 RT Films)
HE3000K	Holokote Film Set – 3000 Prints (4 YMCKS & 3 RT Films)
HE750YMCKK	YMCKK Dye Film - 750 Prints
HE750YMCKS	YMCKS Dye Film - 750 Prints
HE1000YMCK	YMCK Dye Film - 1000 Prints
HE1000RT	Re-transfer Film - 1000 Prints
HE3000K-BLACK	K Dye-Film BLACK – 3000 Prints

ReTransfer ID Card Printer – User Manual

CHOOSING THE RIGHT CARDS

Not all white PVC Cards are the same. For best image quality always use high grade PVC Cards.

Pure PVC Card stock or laminated PVC/Polyester Cards are available. The latter are more durable and better suited to heavy use and heat lamination when required. For access control and Smart Card applications, your Dealer should provide the appropriate type for Retransfer printing.

For consistent results, stick to a single variety of good quality Cards, such as those available from your ID Card Printer Supplier.

Card size

CR80 (Standard) = 3.375" x 2.125" (86.5 mm x 53.98 mm). (w x h)

Card thickness

Standard – 0.030" (0.76 mm).

Maximum – 0.063" (1.25 mm).



To obtain good quality prints the Cards must be...

- Glossy white.
- Free from contamination.
- Free from surface irregularities.
- Free from burrs at Card edges.

Printable area of the Card

The printable area of a standard CR80 Card is size of 1036 x 664 pixels to obtain "over the edge" print quality.

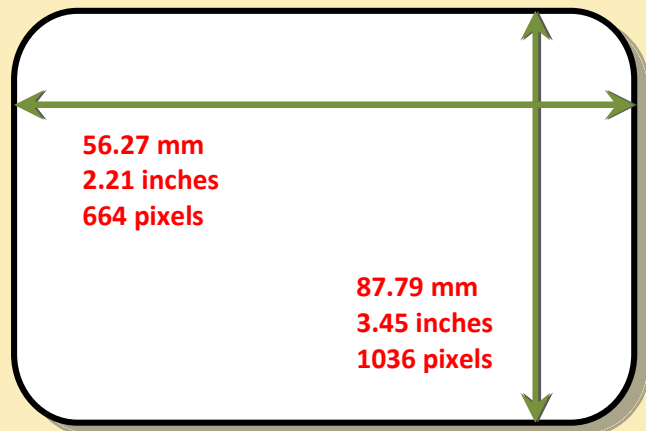

Using Magnetic Stripe Cards

If you have a Printer fitted with the optional Magnetic Encoding module, you can print and encode the magnetic stripe on the rear of a magnetic stripe Card in one operation.

Magnetic stripe formats:

- ISO 7811 (HiCo/LoCo)
- JIS2
- Custom formats

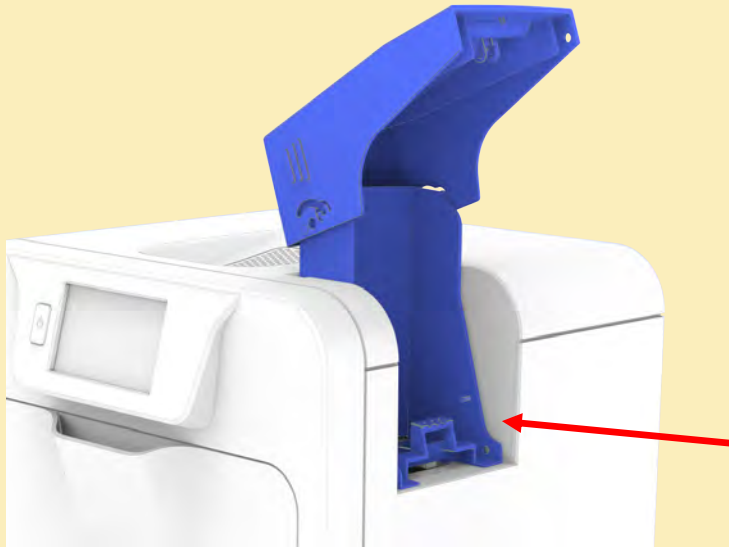

When loading Magnetic Stripe Cards, make sure the stripe is uppermost with the stripe closest to the body of the Printer.

In the event of a Card jamming in the printer

- Remove the card feed Hopper.
- Open the door and remove the film cassette. It may be necessary to turn the upper transfer film spool clockwise in order to free the film from the card if adhesion has occurred.
- Close the door. The printer will perform an initialisation routine and then attempt to eject the card.
- If this fails and another card jam error is reported, select the retry option on the LCD and the printer will perform an alternative card eject routine.
- If the card fails to eject and a card jam error is still displayed open the door and inspect the printer to locate the card position.
- If accessible from the card feed area, attempt to retrieve the card by hand.
- If this is not possible then use the 'Move card' feature which will turn the drive rollers in the required direction in order to free the card. **Important:** Using this method the card should be ejected from the **right hand side** of the printer (feed Hopper location).
- If the card still cannot be retrieved then please contact Technical Support for further assistance.

CARING FOR YOUR PRINTER

MAINTAINING YOUR PRINTER IS IMPORTANT!!!

- Maintenance is an important factor of your Printer's good operation and longevity.
- Maintaining a regular cleaning routine will give you optimum print quality and prevent down time. We recommend that you clean the Printer's rollers and Print Head each time you change Dye Films.
- A clean Printer will produce superior quality printed Cards and is less likely to require Factory maintenance and/or repair.
- In normal environments, regular maintenance should improve the longevity of the Print Head itself. (Remember... foreign particles can lodge under the Head and cause permanent damage!)
- Increased reliability when magnetic encoding.

Cleaning Supplies



ReTransfer ID Card Printer – User Manual

To prevent Cards slipping during printing, we recommend that you clean your Printer using a Cleaning Card each time you replace either Film.

Cleaning the Printer Rollers using the Cleaning Kit

What's in the Cleaning Kit?

Adhesive Cleaning Cards

Self-adhesive Cards with a paper peel-off backing – used for removing contamination From Feed Rollers.

Swabs

Alcohol soaked Swabs – used for cleaning the face of the Print Head and hard-to-reach transport areas.



Roller Wipes

Alcohol soaked wipes – used for cleaning Feed Rollers.

Replacing the Cleaning Roller

Replacing the Cleaning Roller:

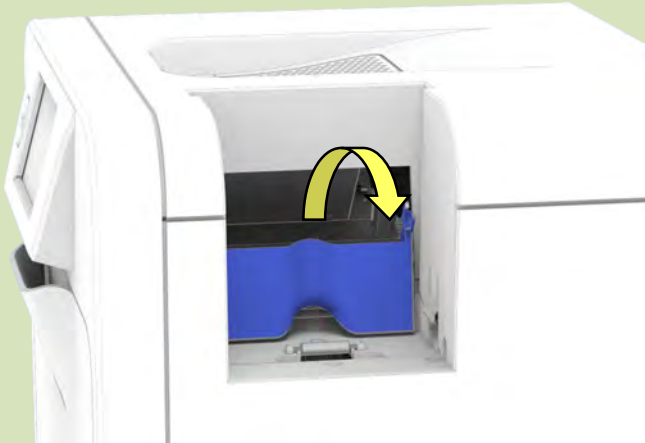

- Hinge the Roller Cover forward.
- Unclip the used Cleaning Roller and slide out the Steel Bar.
Do Not Discard this Bar.
- Discard the used Cleaning Roller.



- Slide the Steel Bar into the new Cleaning Roller.

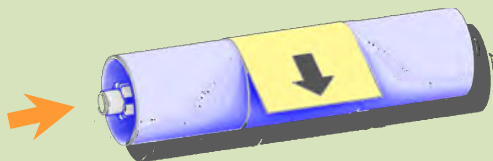

- Remove the paper wrapper protecting the sticky layer on this Roller.

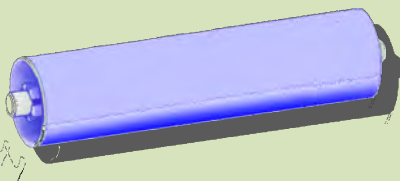

Unclip and Remove Cleaning Roller

- Clip the new Cleaning Roller (complete with Steel Bar) into the Printer.
- Close the Cleaning Roller Cover.
- **This completes the replacement process for the Cleaning Roller.**

Cleaning the Print Head using the Cleaning Swab

Using the Cleaning Swab:

1.

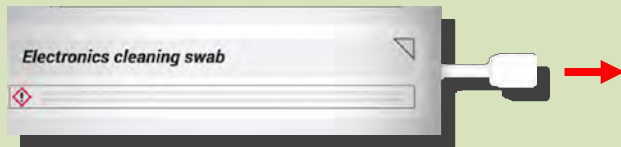

Remove the Cleaning Swab from its packaging.

2. Remove the Film Cartridge from the Printer.

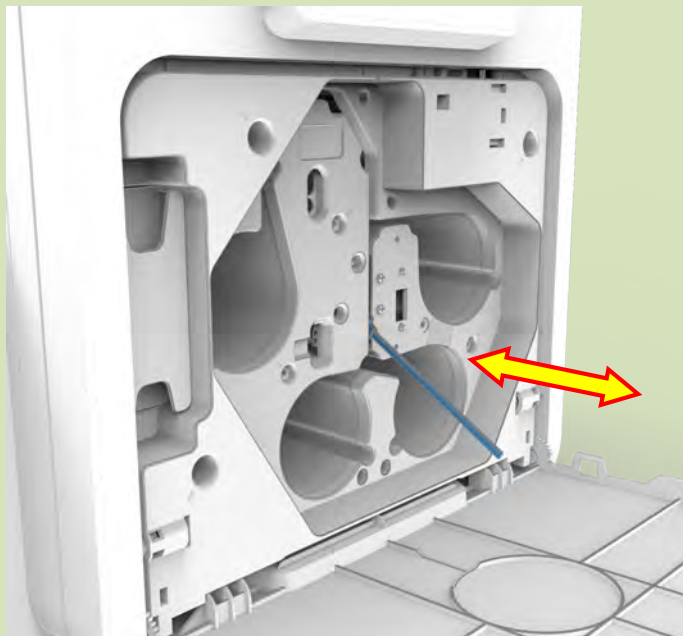
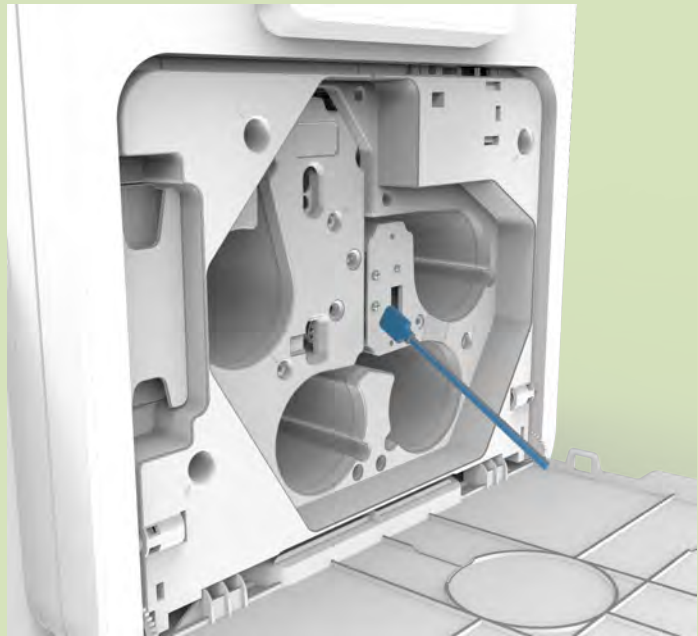

3. Run the Swab repeatedly along the front Face of the Print Head.

Cleaning the Printer using the Cleaning Card

Using the Cleaning Card:

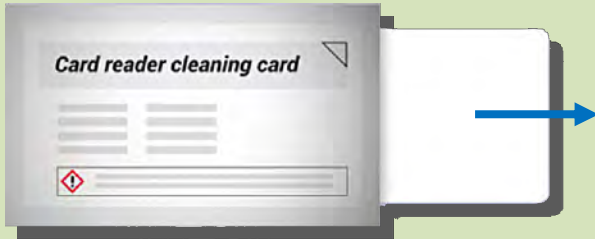

1. Remove the Cleaning Card from the packaging.

2. Peel off the backing paper from the Cleaning Card.

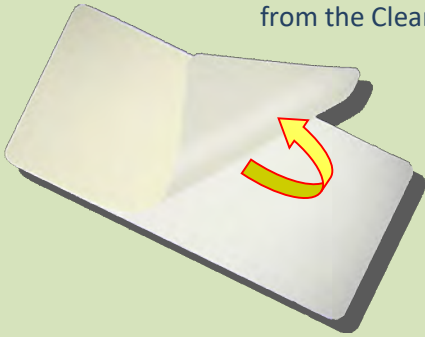

3. Select the cleaning option on the Printer.

4. Follow the instruction on the Printer display.

5. Feed the Cleaning Card into the Printer.



UPGRADING TO DUO OPERATION

The Retransfer printer can be supplied in two variants: UNO (single-sided) or DUO (double-sided).

All Retransfer printers are fitted as standard with a Card Rotation Unit (however in the UNO, the Rotation Unit is only used to rotate a Card in order to facilitate magnetic encoding. It is not possible to print two sides of a Card in one operation. However, the Retransfer printer UNO can be upgraded to a DUO variant as a retro-fit if required).

The upgrade will be available electronically via the Customer Support Portal and is downloaded to the Printer via the Driver.

ReTransfer ID Card Printer – User Manual

AVAILABLE CONSUMABLES

<u>Product Code</u>	<u>Description</u>
Dye Film	
HE1000	YMCK Dye Film & Re-transfer Film Set – 1000 Prints
HE3000S	Holokote Film Set – 3000 Prints (4 YMCKK & 3 Re-transfer Films)
HE3000K	Holokote Film Set – 3000 Prints (4 YMCKS & 3 Re-transfer Films)
HE750YMCKK	YMCKK Dye Film - 750 Prints
HE750YMCKS	YMCKS Dye Film - 750 Prints
HE1000YMCK	YMCK Dye Film - 1000 Prints
HE1000RT	Re-transfer Film - 1000 Prints
HE1000RTD	Durable Re-transfer Film – 1000 Prints
HE3000K-BLACK	K Dye-Film BLACK – 3000 Prints
Cleaning Kit	
E9887	Reverse Transfer Printer Cleaning Kit
Cards	
M9006-793	PVC CR80 Cards – Plain
M9006-794	PVC CR80 Cards – Magnetic Stripe Hi-Co
M9006-796	PVC CR80 Cards - Holopatch

PET or composite cards should be the recommended type used.

PRINTER ERROR CODES

Firmware Version FP-5 Dev-20

Error	Displayed message	Error Description
104	FPGA programming error	While preparing to update the FPGA, the device ID read from the fitted FPGA was not a recognised one. This is probably either due to a SPI comms failure between the processor and FPGA, or a faulty FPGA.
111	Firmware update failure	While attempting to verify a new firmware upgrade file was successfully saved to flash memory, the printer failed to allocate enough memory for the verification process. This may be because there are a large number of pending jobs in the printer's memory.
112	HoloKote update failure	While processing an incoming capability upgrade file, the printer was unable to write the new file to the SD card. This may be because the SD card is not plugged in correctly, or the SD card has developed a fault.
113	Capability update failure	While updating the printer's capabilities during boot-up, the printer failed to save the printer's identity information to the SD card. This may be because the SD card is not plugged in correctly, or the SD card has developed a fault.
114	HoloKote verification failure	While processing a HoloKote file, the printer detected that the file data was not of the correct format. This may be because the wrong file was sent, the file has become corrupted, or there was an error in the software which produced the file.
115	HoloKote slot empty	While attempting to retrieve a HoloKote file from the SD card, the printer was unable to read the SD card data. This is probably because the slot specified has no HoloKote bitmap installed, but could also be due to a fault with the SD card hardware.
116	Duplex Upgrade	The printer has been upgraded to Duplex. No Error – Information Only
117	Duplex Downgrade	The printer has had the duplex printing capability removed. No Error – Information Only
1024	Feature unavailable	The printer received a mag read job, but the printer has no detectable mag encoder module fitted. Either the job was sent to the wrong printer, or the printer has a mag module fitted which cannot be detected due to a hardware fault, or the printer has been set up as the wrong model.
1025	Out of cards	While trying to feed a new card from the input hopper to the point where it blocks the feed sensor, it took too many attempts to extract a card. This could be because the hopper was empty, or the card feed

ReTransfer ID Card Printer – User Manual

		motor was not functioning correctly, or the feed opto sensor was faulty.
1026	Card jam. Open door for more options	While feeding a new card from the hopper, and having already extracted the card far enough for it to block the feed sensor, the printer tried to feed the card further forwards to block the print position sensor. However, it took too long for the print position sensor to become blocked. This could be because the card was physically obstructed, or the card drive stepper motor was not functioning correctly, or the print position sensor was faulty.
1027	Flipper card jam	While initialising the flipper, the printer attempted to rotate the flipper clockwise until the flipper opto sensor unblocked, and it took too long for that sensor to unblock. This is probably due to either a faulty flipper opto sensor, the flip rotation motor not functioning correctly, or an obstruction preventing free rotation of the flipper.
1028	Invalid job option	The printer was sent a request to move a card, but the selected card destination was invalid. This may be because the job data was corrupted in transit, or because the job data was sent by a faulty application, or because the printer firmware needs to be updated to a version recognising the given destination.
1029	Heated roller timeout	During a print job, while waiting for the heated roller to reach its target temperature, it took too long to reach that target.
1030	Heated roller cam error	While carrying out a printer soak test, the printer was unable to lower the heated roller. This is possibly either because the heated roller cam opto sensor is faulty, or the cam motor is not functioning correctly, or the cam was physically obstructed.
1031	Print roller cam error	During a print job, while just about to print one of the colour planes onto the transfer film, the printer was unable to move the print roller to the closed position. This may be because the print roller cam mechanism has been obstructed, or the cam opto sensor is faulty, or the cam motor is not functioning correctly.
1032	Dye film panel timeout	While attempting to move the dye film to a particular panel, the printer was unable to find the requested panel. This could be because the film movement is being obstructed, or there is a problem with one or both of the film motors, or the dye panel sensor/LED is faulty.
1033	Dye film panel unavailable	While validating the print options at the start of a print job, the printer determined that the print job required a colour or security feature that was not available with the currently fitted dye film. This is probably because either the wrong type of film is fitted, or the wrong driver options were selected.

ReTransfer ID Card Printer – User Manual

1034	Transfer film panel timeout	During a print job, while printing onto the transfer film, the printer was unable to detect the index mark on the transfer film. This may be because the transfer film is beyond the end-of-film marker tape (i.e. has run out), or the index sensor needs to be recalibrated, or the index sensor is faulty, or the film cannot move due to an obstruction or motor fault.
1035	Mag head home timeout	While attempting to return the mag head to the home position, the printer first had to clear the head home opto sensor by moving the mag head a short distance towards the front of the printer. However, the head took too long to clear the head home opto sensor. This may be because there was a physical obstruction preventing the head from moving, or the head stepper motor is not working properly, or the head opto sensor is faulty.
1036	Mag head move timeout	While attempting to encode a mag card in the forwards direction, the printer had to wait for the mag head to unblock the head home opto sensor. However, the head took too long to do so. This may be because there was a physical obstruction preventing the head from moving, or the head stepper motor is not working properly, or the head opto sensor is faulty.
1037	Mag verify	The printer attempted to read data from a mag card in order to verify an encode operation, but no data was found, not even leading zeroes. This could mean that the card was loaded in the wrong orientation, the wrong type of card was used, the mag PCB was faulty, the head stepper motor was not functioning properly, or the head was physically obstructed.
1038	Cover open	The printer was about to start a print job, and detected that the cover was open. If the cover is not in fact open, it may be that the cover opto sensor is faulty.
1041	Transfer film expired	At the start of a print job, the printer determined that the transfer film currently fitted had run out of prints. A new roll of transfer film should be fitted before retrying the print job.
1042	Dye film expired	At the start of a print job, the printer determined that the dye film currently fitted had run out of prints. A new roll of dye film should be fitted before retrying the print job.
1043	Both films expired	At the start of a print job, the printer determined that the dye film and transfer film currently fitted had both run out of prints. New rolls of film should be fitted before retrying the print job.
1044	Index LED calibration failed	While attempting to calibrate the transfer index LED, the printer found that the required LED brightness setting was either too low or too high

ReTransfer ID Card Printer – User Manual

		to be considered trustworthy. This could either be due to a faulty or incorrectly fitted transfer index sensor or LED PCB. It could also be due to something physically obscuring the transfer index sensor/LED during calibration.
1045	Dye LED calibration failed	While attempting to calibrate the dye film LED, the printer found that one of the required LED brightness settings was either too low or too high to be considered trustworthy. This could either be due to a faulty or incorrectly fitted dye sensor or LED PCB. It could also be due to something physically obscuring the dye sensor/LED during calibration.
1046	Dye film not found	While validating the print options at the start of a print job, the printer determined that film was required, yet no dye film was fitted. If dye film is in fact fitted, it may be that the tag reader hardware is faulty, or that the tag on the dye film is faulty.
1047	Transfer film not found	While validating the print options at the start of a print job, the printer determined that film was required, yet no transfer film was fitted. If transfer film is in fact fitted, it may be that the tag reader hardware is faulty, or that the tags on the transfer film is faulty.
1048	Film is fitted. Please remove	The printer was requested to carry out a printer soak test, but detected that film was fitted. All film should be removed before retrying the soak test.
1049	No film is fitted	While initialising the print engine, the printer was unable to detect either of the film RFID tags. This is possibly because neither roll of film is fitted, or there is a problem with the RFID reader hardware.
1050	Printhead timeout	During a print job, while waiting for the Printhead to reach its target temperature, it took too long to reach that target.
1051	Failed to read the SD card	While processing a newly-inserted soak test dongle, the printer failed to open the dongle. This may be because the dongle was programmed incorrectly, was the wrong dongle, was corrupted, or was faulty. It may also be because the firmware needs to be updated to support the data format.
1052	Failed to write to the SD card	While attempting to update the printer's partner code, the printer was unable to save the updated identity information onto the SD card. This is probably because the SD card is either not fitted correctly, not programmed correctly, or faulty.
1053	Internal storage media absent	During boot-up initialisation, the printer's internal SD card failed the authentication check. This may be because the SD card was not programmed correctly, or was faulty.
1055	Partner code mismatch	While processing a request to reset the printer's partner code to 0 using a partner code dongle, the printer found that the dongle's partner code

ReTransfer ID Card Printer – User Manual

		did not match that of the printer. Therefore, the request was denied.
1056	Partner code programming dongle is corrupt	While processing a partner code dongle, the printer found that the dongle's partner code was 0, which is not allowed. This may be because the dongle is corrupt.
1057	File Read error	While preparing to print a demo card, the printer was unable to load the image data from the selected card's PRN file on the SD card. This is possibly because the SD card is either not programmed properly, or faulty.
2048	Cleaning is overdue	During printer boot-up initialisation, while attempting to check whether the printer needed to be cleaned, the printer determined that cleaning was overdue. This error message is a prompt to the user to carry out the cleaning routine.
2049	The printer has not been calibrated	During printer boot-up initialisation, while attempting to check whether printer calibration was required, the printer determined that calibration had not yet been performed. This error message is a prompt to the user to carry out the automatic calibration and soak test.
2051	The printer is too hot to soak test	The printer was requested to carry out a printer soak test, but detected that the heated roller was too hot (above 60 degrees Celsius). The printer should be switched off and allowed to cool, and then switched on without film fitted before retrying the soak test.
2052	No cleaning card	At the start of a roller cleaning routine, the printer was waiting for the cleaning card to be inserted into the print engine. However, it took too long for the cleaning card's leading edge to be detected at the print position opto sensor. This is probably because the cleaning card was not inserted, but if not then it could be that either the feed motor or card drive motor was not functioning correctly, or the print position opto sensor was faulty.
2053	Incorrect cleaning card type detected	At the start of a roller cleaning routine, and having already detected what should have been a cleaning card being inserted, the printer determined that the inserted card was shorter than expected and therefore probably not actually a proper roller cleaning card. This is probably because the wrong sort of card was inserted, or the card input hopper was not removed before initiating the cleaning cycle.
2054	Cleaning card jam	At the start of a roller cleaning routine, and having already detected that a cleaning card had been inserted, the printer was waiting for the cleaning card's leading edge to reach the eject opto sensor. However, it took too long for the eject sensor to become blocked. This is possibly

ReTransfer ID Card Printer – User Manual

		due to either the cleaning card was obstructed, or a faulty eject sensor.
2055	Cleaning card not ejected. Please remove card from rear of printer	While performing a roller cleaning cycle, and having already fed in a roller cleaning card as far as the flipper rollers and fed it back again to the point where the print position opto sensor was unblocked, it took too long for the feed opto sensor to become unblocked. This probably means that the cleaning card has become jammed, perhaps due to a physical obstruction or because the card is slipping on the rollers.
8191	General (miscellaneous) error	While attempting to retrieve a HoloKote file from the SD card, the printer found that an invalid parameter was supplied for selecting how the bitmap should be rotated. This indicates a bug in the firmware.
9000	The heater is over temperature	In the firmware module which controls the heated roller temperature, the printer detected that the heated roller temperature was above the maximum permitted level. This is either due to a fault in the control software, or a problem with the temperature measurement hardware.
9001	The Printhead is over temperature	In the firmware module which controls the Printhead temperature, the printer detected that the Printhead temperature was above the maximum permitted level. This is either due to a fault in the control software, or a problem with the temperature measurement hardware.
9002	The heater sensor is disconnected	In the firmware module which controls the heated roller temperature, the temperature sensor alarm was triggered and the temperatures sensor was reporting an unusually low temperature. This is almost always because the temperature sensor is not connected properly.
9003	The Printhead is disconnected	In the firmware module which controls the Printhead temperature, the temperature sensor was reporting an unusually low temperature. This is almost always because the Printhead is not connected properly.

