

Operation and Installation Manual

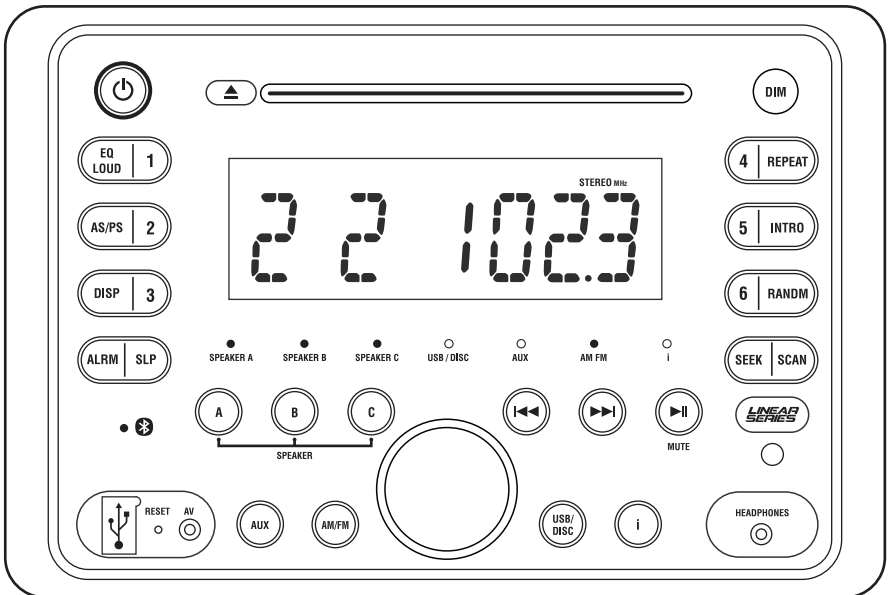

RV5090 AM / FM Stereo
Multi-Media Receiver
with Bluetooth

Introduction

Please take the time to read all of the information in this manual. Familiarity with operation and installation procedures will help you obtain the best possible performance from your new AM/FM Stereo Multi-Media Receiver.

WARNING! To prevent fire or electrical shock hazard, do not expose this product to moisture, or remove cover or bottom screws. No user-serviceable parts inside. Refer servicing to qualified personnel.

Index

Button Locations and Functions	3-4
Remote Control Button Locations and Functions	5
General Operation	6
Sound Controls	6-8
Speaker Selection	8
Setting the Clock	8-9
Sleep Timer Operation	9
Alarm Operation	10
Radio Operations	11-12
Disc Warnings	12
Music Disc Operation	13-15
MP3 Disc Operation	15-16
Movie Disc Operation	17-19
Setup Menu	19
IPOD Operations	20-22
USB Input	23
Bluetooth Operation	24
Audio/Video Input	25
Audio Input	25
Headphone Output	26
Reset Button	26
Additional Feature	26
Installation	27
Speaker Connections	28
Wiring and Auxiliary Connections	29-30
Safety Instructions	31
Warranty	32

Button Locations and Functions

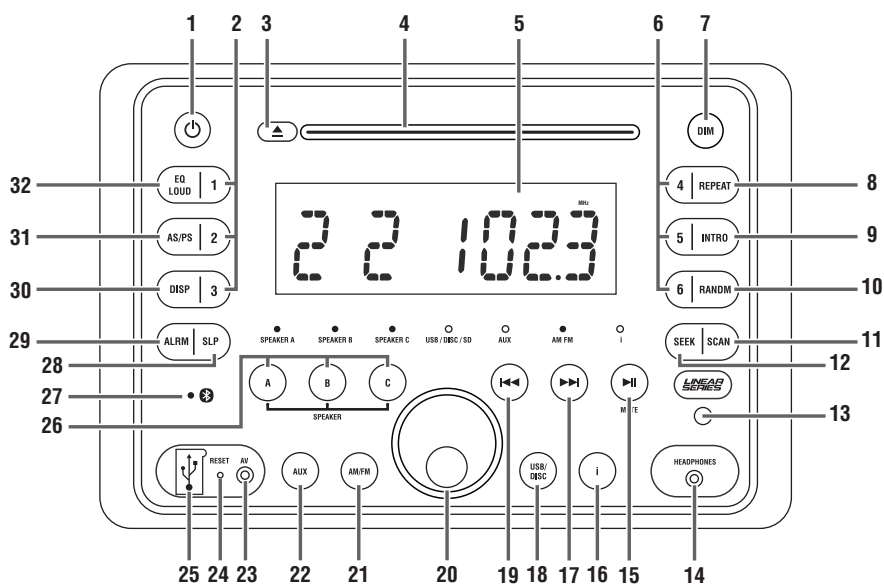

1. **Power On/Off:** Press to turn the unit on or off.
2. **Radio Station Recall Buttons (1-3):** Press and release when recalling preset radio stations. Press and hold until the preset number appears to memorize a radio station.
3. **Eject Button (▲):** Press to eject the disc.
4. **Disc Slot:** To play a disc, insert the disc into slot with label facing up.
5. **Display Area:** This area displays all function information for the radio, clock, disc player and auxiliary input devices.
6. **Radio Station Recall Buttons (4-6):** Press and release when recalling preset radio stations. Press and hold until the preset number appears to memorize a radio station.
7. **Display Dimmer Button (DIM):** Press to select the desired level of brightness of the display.
8. **Repeat Button:**
Disc Mode: Press to repeat a music disc track. Press again to cancel.
IPOD Mode: (See IPOD Operations section for more details).
9. **Music Disc Intro Button:** Press to preview each track on the music disc for 15 seconds. Press again to cancel.
10. **Music Disc Random Button:** Press to play all the tracks on the music disc in random order. Press again to cancel.
11. **Radio Scan Button:** Press this button and the tuner will scan up, pausing for 5 seconds at each strong station. Press the button again to cancel the scan function.
12. **Radio Seek Button:** Press this button and the tuner will seek up to the next strong station and stop.
13. **Infrared Eye:** Receives the signals from the remote control.
14. **Headphone Socket:** Accepts 3.5mm stereo headphone jacks.

Button Locations and Functions (Continued)

- 15. Play/Pause and Mute Button (▶||):**
 - Radio and Multimedia Input Modes:** Press to mute volume level. Press again to restore.
 - Disc Mode:** Press to pause disc play, press again to resume play.
 - IPOD Mode:** Press to pause play, press again to resume play.
 - Bluetooth:** Press to pause play, press again to resume play.
- 16. IPOD Selection Button:** Press to choose IPOD input mode.
- 17. Seek Up (▶▶|) Buttons:**
 - Radio Mode:** Press to tune the radio to a higher frequency.
 - Disc Mode:** Press to search for the beginning of next track or chapter.
 - IPOD Mode:** Press to search for the beginning of the next track.
 - Bluetooth Mode:** Press to search for the beginning of the next track.
- 18. USB/Disc Selection Button:** Press to choose between Disc and USB modes.
- 19. Seek Down (|◀◀) Buttons:**
 - Radio Mode:** Press to tune the radio to a lower frequency.
 - Disc Mode:** Press to search for the beginning or previous track or chapter.
 - IPOD Mode:** Press to search for the beginning of the previous track.
 - Bluetooth Mode:** Press to search for the beginning of the previous track.
- 20. Volume and Select Knob:** Rotate to increase or decrease the volume level. Press to select the sound controls: Bass, Treble and Balance.
- 21. AM/FM Radio Selection Button:** Press to choose Radio mode. Sequential presses will select radio bands: FM1, FM2, FM2 (MHz) and AM1, AM2 (KHz).
- 22. Auxiliary Input Selection Button (AUX):** Press to choose auxiliary input modes: Audio/Video input front, Audio/Video input rear, Audio input rear or Bluetooth.
- 23. Audio/Video Input Jack:** Press the **AUX** button until “AV IN F” appears in the display then plug in a device via the 3.5mm audio/video input plug.
 - Note:** The RV5090 does not control the device, it just allows the audio/video to be played through the system.
- 24. Reset Button:** Press to reset the unit to it's default settings.
- 25. USB Input:** Press the USB/DISC button until “DISC” appears in the display. Then plug in your USB device. “USB” will then appear in the display.
 - Note:** The RV5090 will control the USB audio device. (See “USB Input” for more details).
- 26. Speaker Selection Buttons (A, B and C):** Switches the speaker sets on and off. Refer to the LED indicators above the button to determine if the speaker set is on or off.
- 27. Bluetooth Indicator:** Indicates Bluetooth status. (See “Bluetooth Operation” for more details).
- 28. Sleep Button (SLP):** Sets the sleep timer. (See “Sleep Timer Operation” for more details).
- 29. Alarm Button (ALRM):** Sets the alarm. (See “Alarm Operation” for more details).
- 30. Display Button (DISP):** Press to display the clock or frequency in radio mode, track in music disc mode, chapter and elapse time in movie disc mode or track in IPOD mode. Press and hold to perform clock setting functions (See “Setting the Clock” for more details).
- 31. Radio AS/PS Button:** Automatic radio station memory storing (AS) and Preset radio station scanning (PS). (See “AM/FM Operation” for more details).
- 32. Equalizer and Loudness Button (EQ/LOUD):** Press to select between the preset sound equalization settings. Press and hold the button to boost high and low tones at low volume levels (loudness).

Remote Control Button Locations and Functions

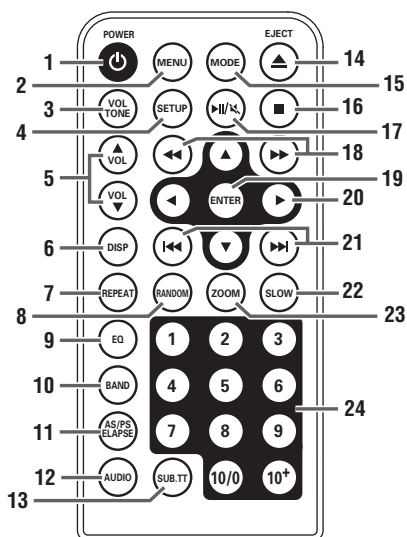

1. **Power On/Off Button (⏻):** Press to turn the unit on or off.
2. **Menu Button:** Press to access the Menu screen in movie mode.
3. **Sound Control Button (VOL/TONE):** Press to select the sound controls: Bass, Treble and Balance.
4. **Setup Button:** Displays the on-screen SETUP menu.
5. **Volume Buttons (VOL ▲ / VOL ▼):** Press VOL ▲ to increase or VOL ▼ decrease the volume level.
6. **Display Button (DISP):** Press to toggle through the available display information.
7. **Repeat Button:**
Disc: Press to repeat a music disc track or to repeat a movie disc title or chapter. Press again to cancel.
8. **Random Button:**
Disc: Press to play all the tracks on the music disc in random order. Press again to cancel.
9. **Equalizer Button (EQ):** Press to select between the preset sound equalization settings. Press and hold the button to boost high and low tones at low volume levels (loudness).
10. **Band Button:** Press to select the radio mode. Sequential presses will select radio band: FM1, FM2, FM2 (MHz) and AM1, AM2 (KHz).
11. **AS/PS Elapse Button:**
Radio: Automatic radio station memory storing (AS) and Preset radio station scanning (PS). (See "AM/FM Operation" for more details).
Disc: Press to display movie information.
12. **Audio Button:** Press to select appropriate movie audio/language setup.
13. **Subtitle Button (SUB.TT):** Press to access the movie disc's subtitle languages.
14. **Eject Button (⏏):** Press to eject the disc.
15. **Mode Button:** Press to select between the different modes: Radio, Disc, USB, Auxilliary Input or Bluetooth .
16. **Stop Button (■):** Press to stop disc play.
17. **Play/Pause and Mute Button (▶||/⏏):** Press to pause disc play, press again to resume play.
18. **Backwards (◀◀) or Fast Forward (▶▶) Disc Play:** Press ◀◀ and "BACKWARD X 2" appears in the display and the disc will play backwards at 2 times the normal speed. Press again and "BACKWARD X 4" will appear. X8 and X20 speeds can also be selected. Fast Forward ▶▶ button works the same way but fast forward. Press the ▶|| button at any time to resume normal play.
19. **Enter Button:** Executes the selected item.
20. **Navigation Buttons (▲, ▼, ◀, ▶):** Moves feature selection up, down, left or right.
21. **Down (◀◀), Up (▶▶) Buttons:**
Radio Mode: Press to manually tune the radio to a lower or higher frequency.
Disc Mode: Press to search for the beginning or next track or chapter.
Bluetooth Mode: Press to search for the beginning or next track.
22. **Slow Button:** Press to play the movie in slow motion.
23. **Zoom Button:** Press to enlarge or reduce the movie's on-screen image.
24. **Numeric Buttons (1, 2, 3, 4, 5, 6, 7, 8, 9, 10/0 and 10+)**

General Operations

Power On/Off:

Press the  button to turn the unit On/Off.

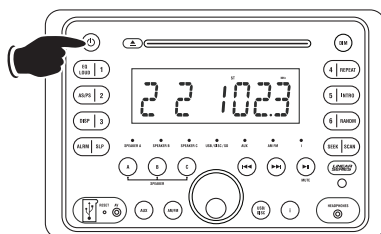

Selecting a Play Source:

To select a play source, press one of the following mode buttons:

AUX: Audio/Video Input Front (AV IN F),
Audio/Video Input Rear (AV IN R),
Audio Input Rear (AUX IN) or
Bluetooth (BT A2DP)

AM/FM: AM (KHz) or FM (Mhz) Radio Band (RADIO)

USB/DISC: Disc (DISC) or USB Input (USB)

i: IPOD Input (IPOD)



Dimming the Display:

Press the **DIM** button to select from the 4 levels of brightness for the display area.

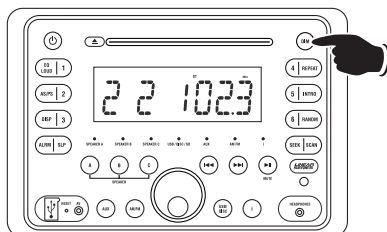

Display Selection:

Press the **DISP** button to display the clock.
Press again to return to previous display.

Press and hold to perform clock setting functions (See "Setting the Clock" for more details).

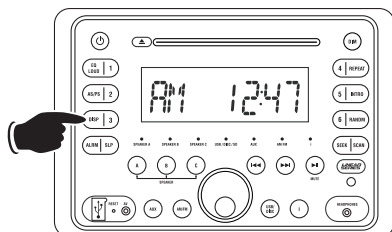

Sound Controls

Volume:

Increase the volume by rotating the **VOLUME** knob clockwise. Decrease the volume by rotating the Volume knob counterclockwise.

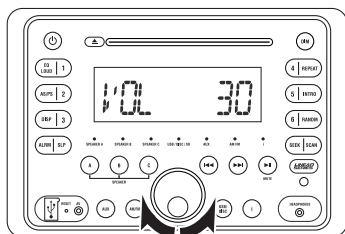

Sound Controls

Bass, Treble and Balance Control

Select the desired sound mode by pressing the **VOLUME** knob. The modes will be displayed in the following order: Bass, Treble, Balance and Volume.

Bass:

Select the Bass mode by pressing the **VOLUME** knob. Increase the Bass by rotating the knob clockwise. Decrease the Bass by rotating the knob counterclockwise. After 6 seconds control reverts back to volume control.

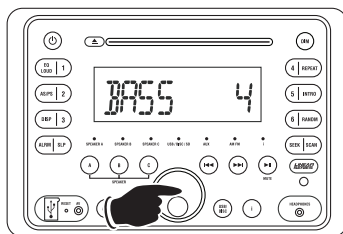

Treble:

Select the Treble mode by pressing the **VOLUME** knob. Increase the Treble by rotating the knob clockwise. Decrease the Treble by rotating the knob counterclockwise. After 6 seconds control reverts back to volume control.

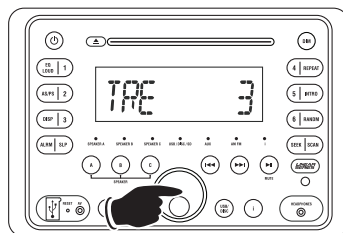

Balance:

Select the Balance mode by pressing the **VOLUME** knob. Adjust the Balance by rotating the knob.

R = L = Equal sound Right and Left

R 7 = Right speaker only

L 7 = Left speaker only

After 6 seconds control reverts back to volume control.

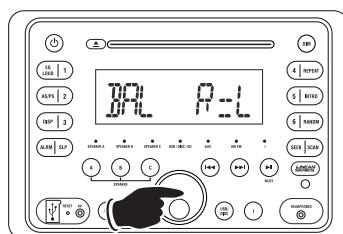

Equalizer (EQ):

Press the **EQ** button to choose between the preset equalizer settings: Normal, Classic, Rock, Pop and Jazz as indicated in the display area.

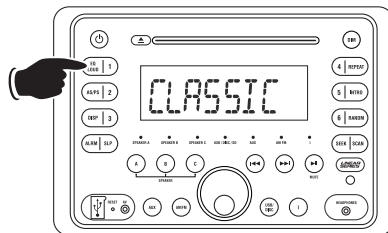

Loud:

To boost high and low tones at low volume levels, press and hold the **EQ** button until "LOUD ON" appears in the display. To deselect, press and hold the **EQ** button again until "LOUD OFF" appears in the display.

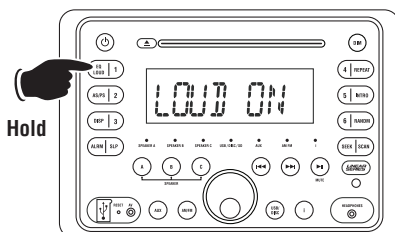

Sound Controls (Continued)

Mute:

Press the **MUTE** button to mute the volume level. Press the **MUTE** button again to restore the volume.

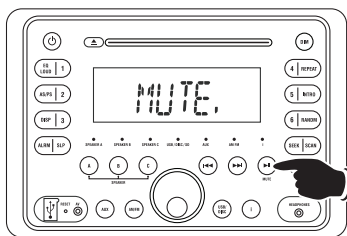

Speaker Selection

Selecting Speaker Sets:

- Press the **A** button to toggle speaker set A on and off. The LED above SPEAKER A lights up when speaker set A is on.
- Press the **B** button to toggle speaker set A on and off. The LED above SPEAKER B lights up when speaker set B is on.
- Press the **C** button to toggle speaker set A on and off. The LED above SPEAKER C lights up when speaker set C is on.

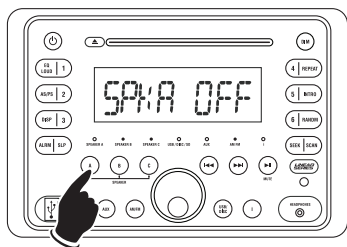

Setting the Clock

1. Press the **DISP** button until the clock appears in the display.

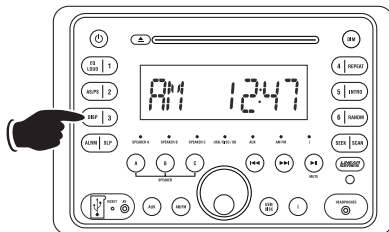

2. Press and hold the **DISP** button until the Hours number starts flashing.

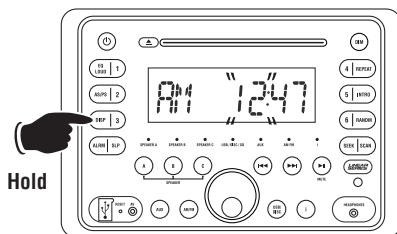

3. Rotate the **VOLUME** knob until the correct Hour appears in the display.

Note: When setting the clock make sure to select the correct AM or PM.

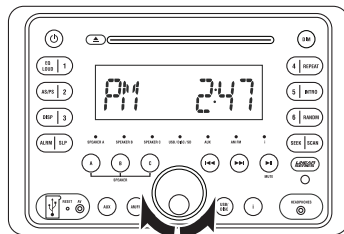

Setting the Clock (Continued)

4. Press the **VOLUME** knob and the Minute indicators will start flashing.

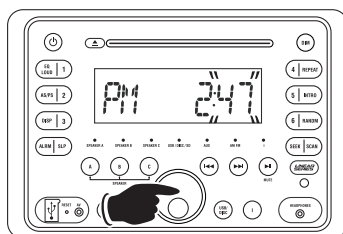

5. Rotate the **VOLUME** knob until the correct Minutes appears in the display. Wait 5 seconds and the colon between the hours and the minutes will start flashing indicating the clock is set.

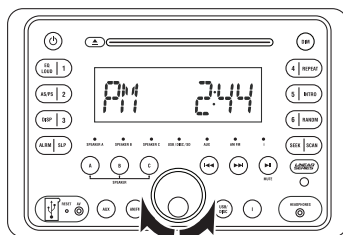

Sleep Timer Operation

Setting the Sleep Timer:

1. Press the **SLP** button and "SLEEP 10" appears in the display.
2. Keep pressing the **SLP** button again until the desired sleep time appears in the display (0, 10, 20, 30, 40, 50, 60, 70, 80 minutes).
3. Wait 5 seconds and the display will return to normal operation and "SLEEP" will appear in the display.
4. After the designated sleep timer has expired the unit will turn off automatically.

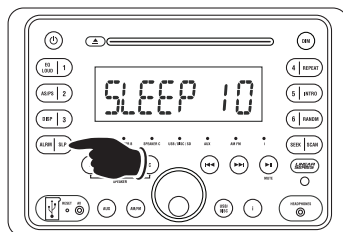

Canceling the Sleep Timer:

1. Press the **SLP** button until "0" is displayed.
2. Wait 5 seconds and the display will return to normal operation.

Alarm Operation

Setting the Alarm Timer:

1. Press the **ALM** button and the clock will appear in the display with the Hour number flashing.

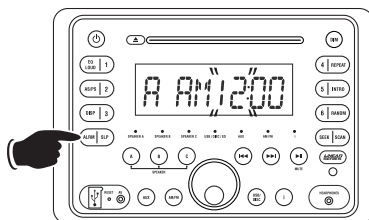

2. Rotate the **VOLUME** knob until the correct Hour appears in the display. "ALARM" will appear in the display indicating the alarm is activated.

Note 1: When setting the alarm clock make sure to select the correct AM or PM indicator.

Note 2: When setting the alarm DO NOT use 12:00 AM, because that time is used to cancel the alarm.

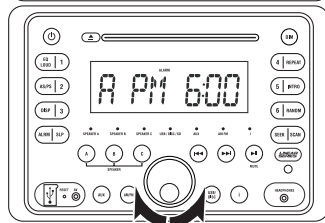

3. Press the **VOLUME** knob and the Minute indicators will start flashing.

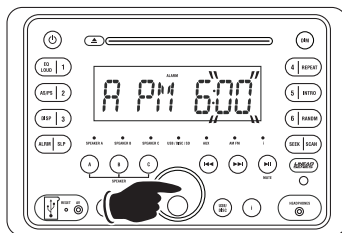

4. Rotate the **VOLUME** knob until the correct Minutes appears in the display. Wait 5 seconds and the colon between the hours and the minutes will start flashing. "ALARM" will appear in the display indicating the alarm is set.

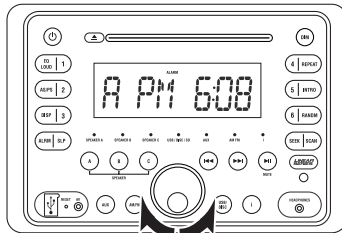

5. Press the **POWER** button to turn the unit off. The unit will automatically turn on when the set alarm time is reached.

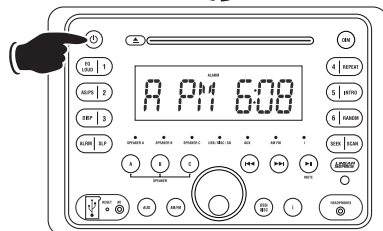

Cancelling the Alarm Timer:

Follow the procedures above except set the alarm time to "A AM 12:00". "ALARM" will disappear in the display indicating the alarm has been cancelled.

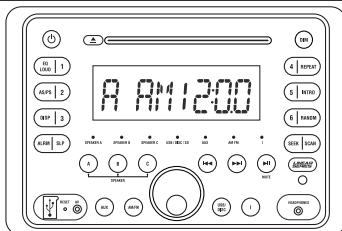

Radio Operations

Selecting the Play Source:

Press the **AM/FM** button and “RADIO” appears in the display. After a brief moment either KHZ (AM) or MHZ (FM) will appear in the display.

Selecting the AM or FM:

Press the **AM/FM** button repeatedly and select from MHZ (FM) 1, 2, 3, KHZ (AM) 1 or 2.

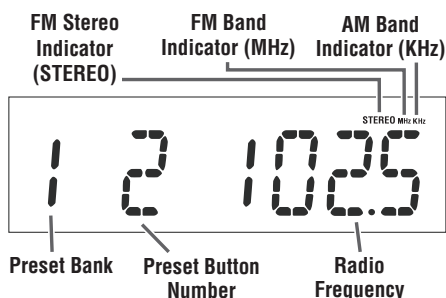
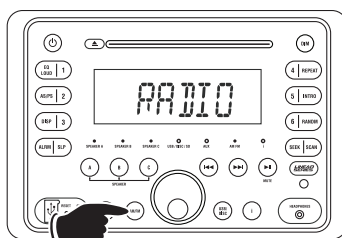

Manually Tuning in a Radio Station:

Press the **I◀◀** button to tune in a lower radio frequency. Press the **▶▶I** button to tune in a higher radio frequency.

Note: The unit will automatically switch from FM Mono to FM Stereo when the signal strength increases to a stereo level. If the stereo signal should become weak, the unit will switch back to Mono. FM stereo reception is indicated when “STEREO” appears in the display.

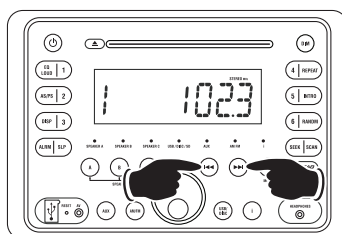

Tuning in a Radio Station Using Seek:

Press the **SEEK** button and the tuner will scan up to the next strong station and stop seeking, then start playing.

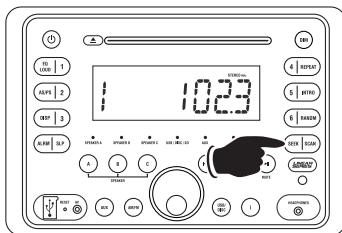

Tuning in a Radio Station Using Scan:

Press the **SCAN** button and the tuner will scan up to the next strong station and pause for 10 seconds, then scan for the next strong station. To cancel this function press the **SCAN** button again.

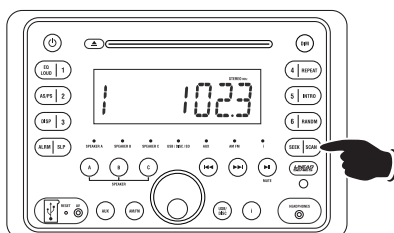

Radio Operation (Continued)

Memorizing Radio Stations:

1. Press the **AM/FM** button to select either the MHz (FM) 1, 2, 3, KHz (AM) 1 or 2 radio bank.
2. Tune-in the desired radio station.
3. To memorize the station press and hold any one of the six radio station recall buttons until the preset number appears.

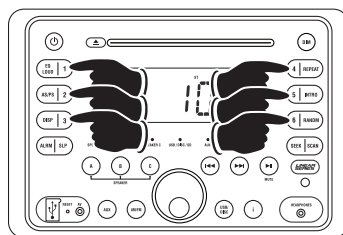

Automatically Store Radio Stations:

1. Press the **AM/FM** button to select either the MHz (FM) or KHz (AM) radio band.
2. Press and hold the **AS/PS** button then release. The tuner will search for the strongest stations and store them into memory. The new stations will replace stations that were previously stored in the current band.

Note: When the MHz (FM) band is selected the 18 strongest stations will be stored. When KHz (AM) band is selected the 12 strongest stations will be stored.

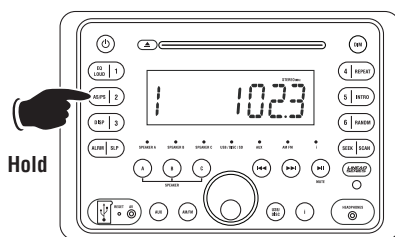

Scanning Stored Radio Stations:

1. Press the **AM/FM** button to select either the FM or AM radio band.
2. Press the **AS/PS** button then release. The tuner scans for preset stations stored in the current band and pauses for 6 seconds at each station. When a desired station is reached, press the **AS/PS** button again to stop scanning.

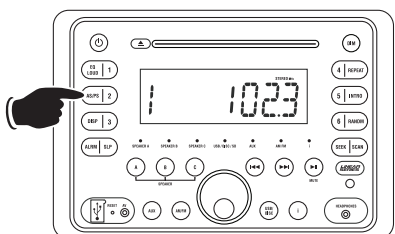

Disc Warnings

Handling and Cleaning:

- Dirt, dust, scratches and warping disc will cause non-operation.
- Do not place stickers on disc or scratch disc.
- Do not warp discs.
- A disc should always be kept in its case when not in use to prevent damage.
- Do not place discs in the following places: Direct sunlight, Dirty, dusty and damp areas, Near car heaters, Car seats or dashboard.

Disc Cleaning:

Use a dry soft cloth to wipe disc the surface. If the disc is quite dirty, use a soft cloth slightly moist with isopropyl (rubbing) alcohol. Never use solvents such as benzene, thinner or conventional record cleaners as they may mar the surface of the disc.

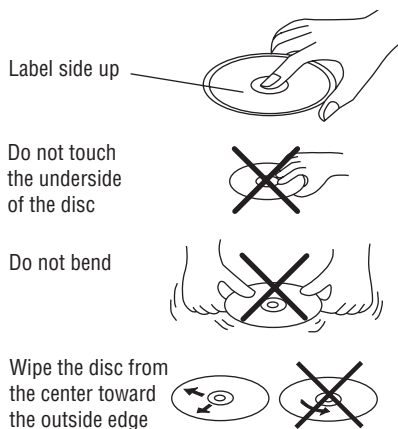

Music Disc Operation

General Operations:

Gently insert the disc into the slot with the label side up. The unit will automatically load the disc.

Note: If a disc does not auto-load DO NOT FORCE into the slot, as you may already have a disc loaded.

Label Side Up

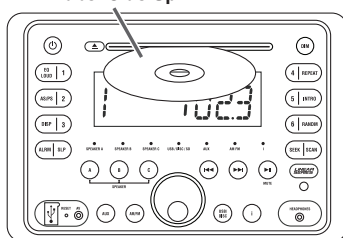

Music Track Selection:

Press the **I◀◀** button to select a lower track.
Press the **▶▶I** button to select a higher track.
The track number will appear in the display.

Tracks can also be selected by using the remote control. Press the track selection number button that corresponds to the track you want to play.

For example: If you want to play track 8, press button **8**. Track 8 will start playing and "8" will appear in the display.

If you want to play track 12, press button **10+**, followed immediately by button **2**. Track 12 will start playing and "12" will appear in the display.

Track Number

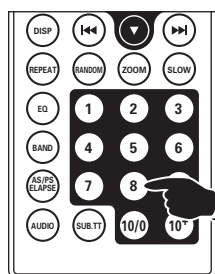
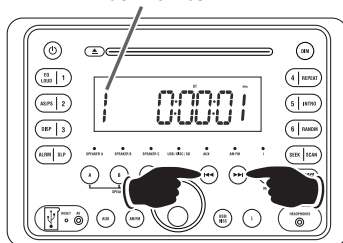

Pausing the Disc:

Press the **▶II** button to pause the disc and "PAUSE" will appear in the display. Press it again to resume play and "PAUSE" will disappear from the display.

Note: You can also press the **▶II** on the remote control.

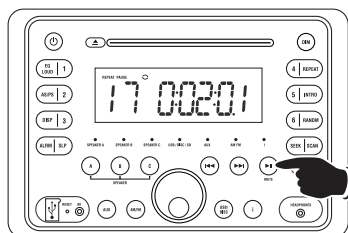

Music Disc Operation (Continued)

Stopping the Disc:

Press the **■** button to stop the disc. To resume play, press the **▶||** button.

Pressing the **■** button 2 times, then pressing the **▶||** button will play the disc from the beginning.



Ejecting the Disc:

Press the **▲** button to eject a disc.

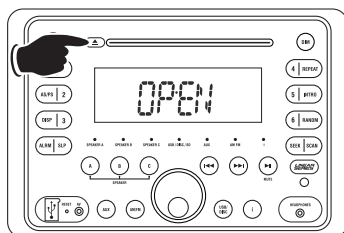

Repeating a Music Track or Entire Disc:

Select the desired track to repeat, then press the **REPEAT** button twice "REPEAT" and **⌂** will appear in the display. This track will play repeatedly.

Press the **REPEAT** button one more time "REPEAT" and **⌂** will appear in the display. The entire disc will now be repeated.

To cancel this feature press the **REPEAT** button again and nothing will appear in the display. The disc will stop playing when the end of the disc is reached.

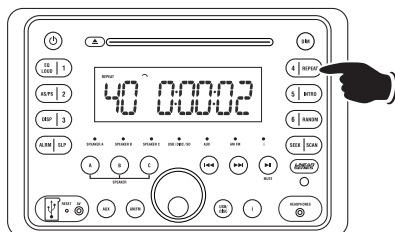

Preview Music Tracks:

Press the **INTRO** button to play the first 15 seconds of each track, "INTRO" will appear in the display. Press it again to stop introduction scan and listen to the track and "INTRO" will disappear from the display.

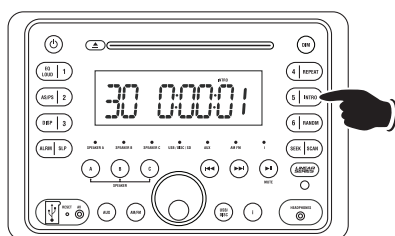

Random Music Track Play Order:

Press the **RANDM** button and the tracks on the disc will play in a random order, "RANDOM" will appear in the display. To cancel this feature press the **RANDM** button again and "RANDOM" will disappear from the display.

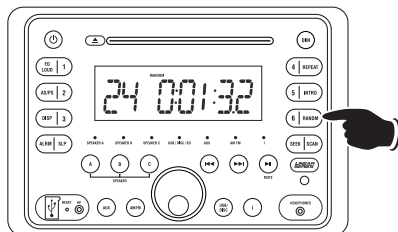

Music Disc Operation (Continued)

Elapse Times:

Continue to press the **AS/PS** button during music disc play to display the following disc information in this order:

Single Elapse, Single Remain, Total Elapse and Total Remain.

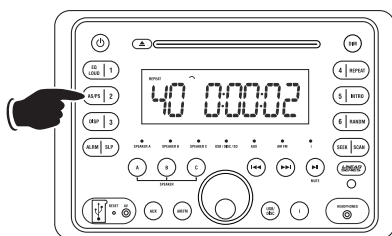

MP3 Disc Operation

General Operations:

Gently insert the disc into the slot with the label side up. The unit will automatically load the disc.

Note: If a disc does not auto-load DO NOT FORCE into the slot, as you may already have a disc loaded.

Label Side Up

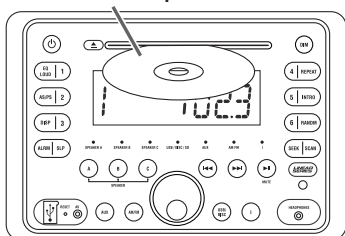

Disc File Selection:

Press the **I◀◀** button to select a lower file. Press the **▶▶I** button to select a higher file. The track number will appear in the display.

Files can also be selected by using the remote control. Press the file selection number button that corresponds to the file you want to play.

For example: If you want to play file 8, press button **8**. File 8 will start playing and "8" will appear in the display.

If you want to play file 12, press button **10+**, followed immediately by button **2**. File 12 will start playing and "12" will appear in the display.

File Number

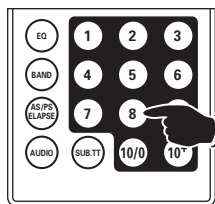
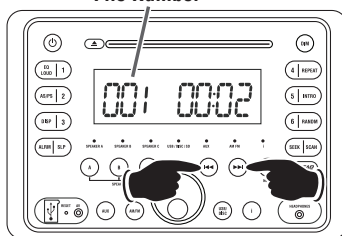

Pausing the Disc:

Press the **▶II** button to pause the disc and "PAUSE" will appear in the display. Press it again to resume play and "PAUSE" will disappear from the display.

Note: You can also press the **▶II** on the remote control.

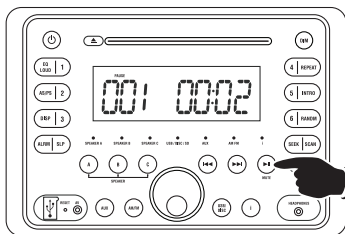

MP3 Disc Operation (Continued)

Stopping the Disc:

Press the **■** button to stop the disc. To resume play, press the **▶** button.

Pressing the **■** button 2 times, then pressing the **▶** button will play the disc from the beginning.

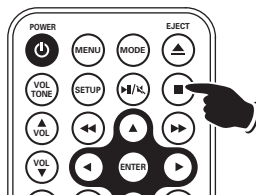

Ejecting the Disc:

Press the **▲** button to eject a disc.

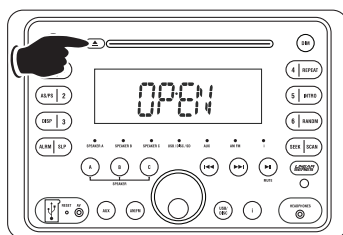

Repeating a Music File or Entire Disc:

Select the desired file to repeat, then press the **REPEAT** button "REPEAT" and **⌂** will appear in the display. This track will play repeatedly.

Press the **REPEAT** button one more time "REPEAT" and **⌂** will appear in the display. The entire disc will now be repeated.

To cancel this feature press the **REPEAT** button again and nothing will appear in the display. The disc will stop playing when the end of the disc is reached.

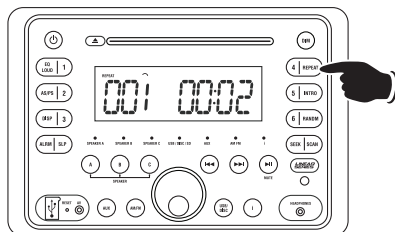

Random Music File Play Order:

Press the **RANDM** button and the files on the disc will play in a random order, "RANDOM" will appear in the display. To cancel this feature press the **RANDM** button again and "RANDOM" will disappear from the display.

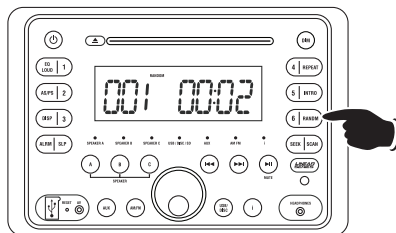

Movie Disc Operation (Continued)

Fast Forward / Backwards Movie Play:

Press the ►► (fast forward) or ◀◀ (backwards) button on the remote control during play. Each time the button is pressed the speed of fast forward/ backwards changes in the following order:

2X, 4X, 8X, 20X

To resume normal play, press the ►|| (Play) button.

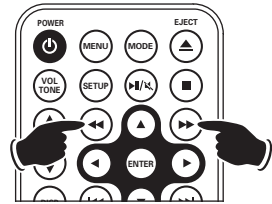

Slow Motion:

Continue to press the **SLOW** button to play the movie is slow motion in the following order:

SF 1/2, SF 1/3, SF 1/4, SF 1/5, SF 1/6, SF 1/7, SB 1/2, SB 1/3, SB 1/4, SB 1/5, SB 1/6, SB 1/7

To resume normal play, press the ►|| (Play) button.

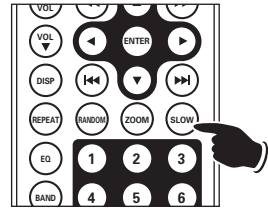

Zooming the Image:

To enlarge the on-screen image during disc play, press the **ZOOM** button. Each time the button is pressed, the magnification increment changes in the following order:

2X, 3X, 4X, 1/2, 1/3, 1/4.

Use the navigation buttons to move the image on the screen.

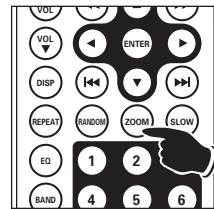

Repeat:

Continue to press the **REPEAT** button to select a repeat mode in the following order:

Repeat Chapter, Repeat Title, Off.



Elapse Times:

Continue to press the **AS/PS ELAPSE** button during movie play to display the following information in this order for most discs:

Title Elapse, Title Remain, Chapter Elapse, Chapter Remain and Display Off.

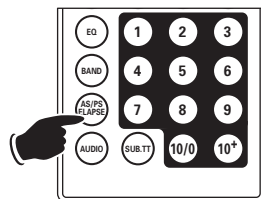

Subtitle Language Menu:

Press the **SUB.TT** button during playback. Each time the button is pressed, the subtitle language changes in sequential order.

- Some discs may only contain one subtitle language.
- Depending on the disc, the number of subtitle languages may be different.

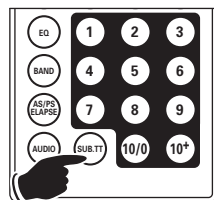

Movie Disc Operation (Continued)

Audio Language Menu:

Press the **AUDIO** button during playback to review the current setting. Most movies have their own audio setup. Go to the on-screen menu to select appropriate audio/language setup.

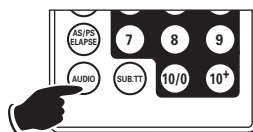

Setup Menu

Accessing the Movie Disc Setup Menu:

Press the **SETUP** button on the remote control to display the Setup Menu.

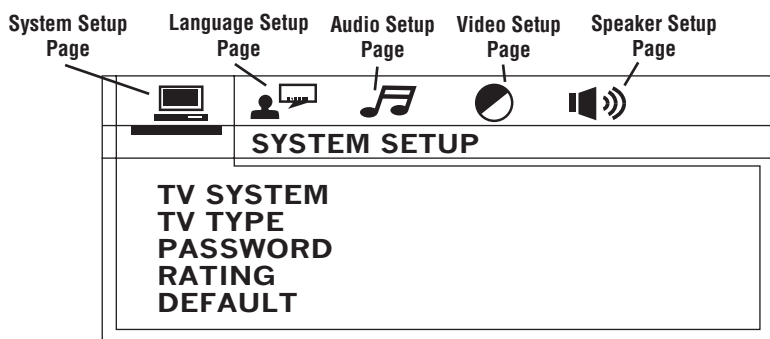
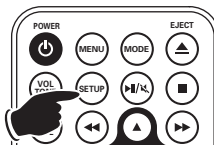

System Setup Page:

Use the navigation buttons to scroll between the menu items. Make a selection by pressing the **ENTER** button.

- TV System: NTSC, PAL or Auto.
- TV Type: 4:3PS, 4:3LB or 16:9.
- Password: _ _ _ _
- Rating: 1 Kid Safe, 2 G, 3 PG, 4 PG13, 5 PG-R, 6 R, 7 NC-17, 8 Adult.
- Default: Restore

Language Setup Page:

Use the navigation buttons to scroll between the menu items. Make a selection by pressing the **ENTER** button. Language Setup Options:

- OSD Language: English or Spanish.
- Audio Lang: Chinese, English, Japan, French, Spanish, Portuguese, Latin or German.
- Subtitle Lang: Chinese, English, Japan, French, Spanish, Portuguese, German or Off.
- Menu Lang: Chinese, English, Japan, French, Spanish, Portuguese, German or Latin.

Audio Setup Page:

Use the navigation buttons to scroll between the menu items. Make a selection by pressing the **ENTER** button. Audio Submenu Options:

- Audio Out: SPDIF/OFF, SPDIF/Raw or SPDIF/PCM.

Video Setup Page:

Use the navigation buttons to scroll between the menu items. Make a selection by pressing the **ENTER** button. Video Submenu Options:

- Brightness: 12, 10, 8, 6, 4, 2 or 0.
- Contrast: 12, 10, 8, 6, 4, 2 or 0.
- Hue: +6, +4, +2, 0, -2, -4 or -6.
- Saturation: 12, 10, 8, 6, 4, 2 or 0.
- Sharpness: 8, 6, 4, 2 or 0.

Digital Setup Page:

Use the navigation buttons to scroll between the menu items. Make a selection by pressing the **ENTER** button. Digital Submenu Options:

- Dynamic Range: Full, 6/8, 4/8, 2/8 or Off.
- Dual Mono: Stereo, Mono L, Mono R or Mix Mono.

IPOD Operation

General Operations:

1. Connect an IPOD to the cable attached to the RV5090.
2. The unit will automatically switch to the IPOD mode and start playing.

Note: The IPOD controls will become inoperable, and the RV5090 now controls the IPOD.

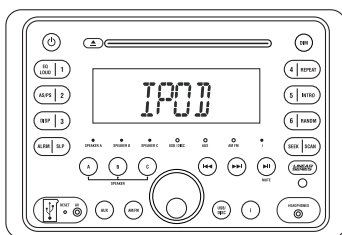

IPOD Mode Button Location and Functions:

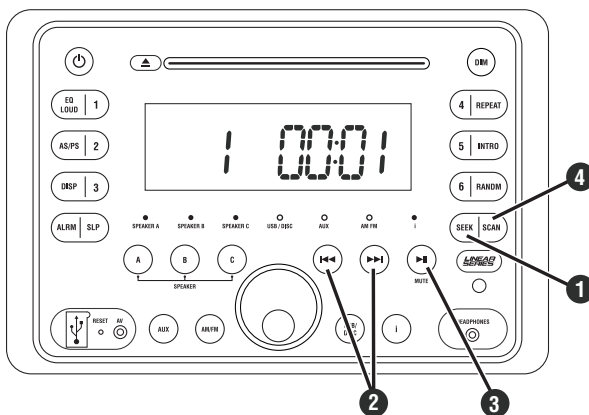

1. **Seek Button:** Same operation as the MENU button on an IPOD.
2. **Track Up/Down Buttons:** Press these buttons to scroll through the menu items, which is the same operation as the IPOD's Click Wheel.
3. **Play/Pause Button (▶||):** Same operation as the ▶|| button on an IPOD.
4. **Scan Button:** Same operation as the Center Select/Enter button on an IPOD.

Browse for a Song:

1. Press the **SEEK** button and "PLAYLIST" will appear in the display.



2. Press the **▶▶|** button to select the "SONGS" menu.

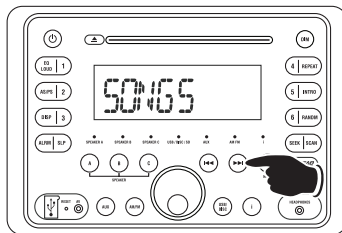

IPOD Operation (Continued)

3. Press the **SCAN** button to select the SONGS menu.

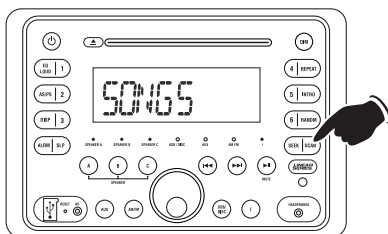

4. Press the **◀◀** or **▶▶** button to select the desired song from the menu. The selected song will automatically start playing.

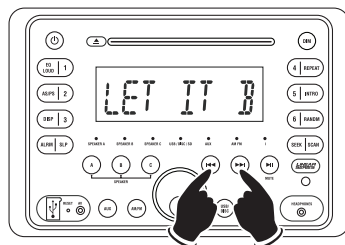

Pausing a Track:

Press the **⏸** button to pause the track. Press it again to resume play.

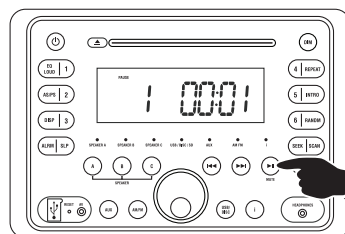

Repeating a Track:

Select the desired track to repeat, then press the **REPEAT** button once and "REPEAT" will appear in the display. This track will play repeatedly. To cancel this function press the **REPEAT** button one more time, and "REPEAT" will disappear from the display.

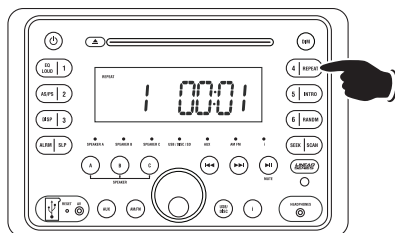

Preview Tracks:

Press the **INTRO** button and "INTRO" appears in the display. Each track on the IPOD will now play for 10 seconds. To cancel this feature press the **INTRO** button and "INTRO" disappears from the display.

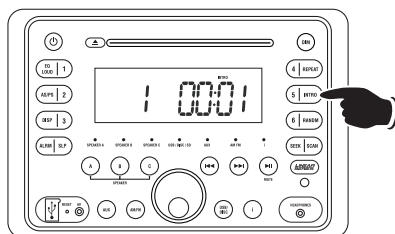

IPOD Operation (Continued)

Display Selection:

Press the **DISPLAY** button to display the following track information: Elapse Time, Artist, Album and Title.

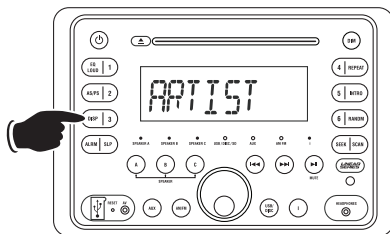

Manually Selecting the IPOD Source:

If a different source is playing and you wish to listen to the IPOD, press the **i** button until "IPOD AUT" appears in the display. The last song that was playing on the IPOD will resume.

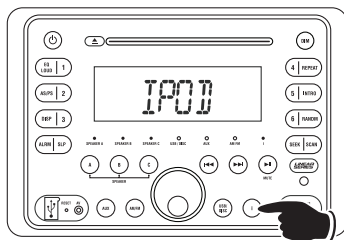

USB Input

Selecting USB Audio Play Source:

Press the **USB/DISC** button and “DISC” appears in the display. Remove the cover from the USB port. Insert the USB device and the files will automatically start playing.

Note: You can insert the USB device in any mode, the unit will automatically switch modes and start playing the USB device.

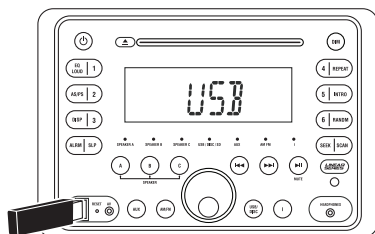

Disc File Selection:

Press the **▶▶1** button to select a lower file. Press the **1◀◀** button to select a higher file. The file number will appear in the display.

File selection can also be selected by using the remote control. Press the file selection number button that corresponds to the file you want to play then press the **ENTER** button.

For example: If you want to play file 8, press button **8**, then the **ENTER** button.

If you want to play file 28, press **10+**, then press button **2**, followed immediately by button **8** and finally press the **ENTER** button. File 28 will start playing and “28” will appear in the display.

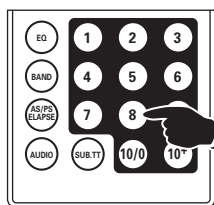
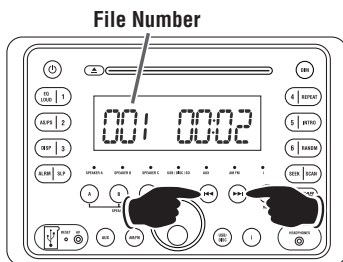

Pausing a MP3 Player:

Press the **▶||** button to pause the player, “PAUSE” will appear in the display. Press it again to resume play, and “PAUSE” will disappear from the display.

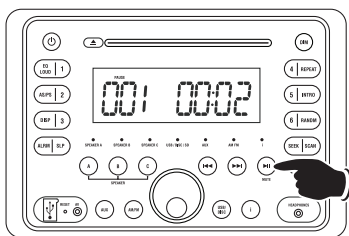

Stopping a MP3 Player:

Press the **■** button to stop play. To resume play, press the **▶||** button and play will begin from the first file.



Bluetooth Operation

Pairing Bluetooth Devices:

1. Press the **AUX** button until “BT A2DP” appears in the display.
2. Open the mobile device’s setup menu.
3. Open the Bluetooth setup program on the mobile device and activate the Bluetooth feature.
4. From your mobile device scan for available devices.
5. Select “WALL MOUNT RECEIVER” to connect to the unit. The “•” indicator next to the  on the RV5090 will flash quickly during pairing.

Note: If the mobile device requires a password enter “0000” as the password.

6. When phone has been paired the “•” will be illuminated continuously. When the unit starts streaming music the “•” indicator next to the  will flashes every 5 seconds.

Note 1: If the mobile device has been previously paired with the entertainment center, the unit will connect automatically to the Bluetooth mobile device when the unit is turned on.

Note 2: If the Bluetooth mobile device is already paired with the entertainment center, select “WALL MOUNT RECEIVER” on your phone and touch “Connect”.

Note 3: To directly select the Bluetooth mode press the **MODE** button on the remote controller until “BT A2DP” appears in the display.

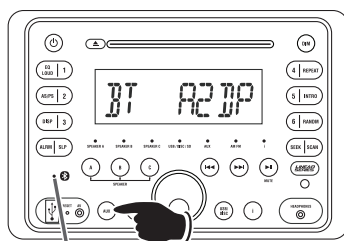

Bluetooth Indicator

Bluetooth Indicator “•” next to logo

- **is off** = RV5090 is not in Bluetooth mode.
- **is flashing quickly** = RV5090 is trying to pair with the device.
- **is on solid** = RV5090 is paired with the device but music is not streaming.
- **flashes every 5 seconds** = RV5090 is streaming music.

Bluetooth Operation:

Play/Pause Button: Press the  button to pause the Bluetooth playback. Press again to resume playback.

Note: The RV5090 display will not show the playback is pause. The mobile device will show that the playback is paused.

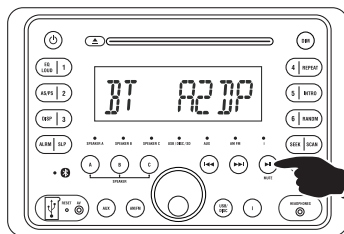

Changing the Track:

Press the  button to select a higher track.

Press the  button to select a lower track.

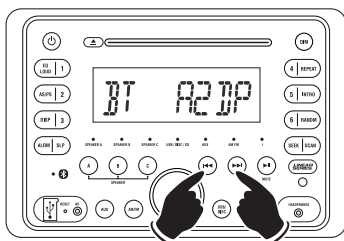

Sound Controls: Use the sound controls on the RV5090 to adjust the volume and sound quality.

Note: For optimum sound quality make sure the media volume on the device is set at 75% or greater.

Audio/Video Input

Selecting the Audio/Video Source:

Note: The RV5090 does not control the device, it just allows the audio/video to be played through the system.

Front Audio/Video Input:

Insert the 3.5mm jack from the audio/video device into the AV input socket on the front of the housing. Press the **AUX** button until “AV IN F” appears in the display. Refer to the audio/video device’s owner’s manual for proper operation.

Rear Audio/Video Input:

To select the rear input Audio/Video play source, press the **AUX** button until “AV IN R” appears in the display. Refer to the audio/video device’s owners manual for proper operation.

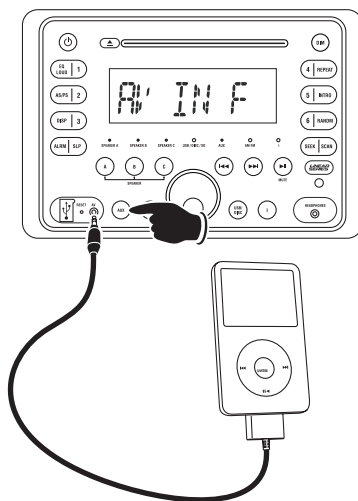

Audio Input

Selecting the Audio Source:

Note: The RV5090 does not control the device, it just allows the audio to be played through the system.

Dual RCA Rear Audio Input:

Press the **AUX** button until “AUX IN” appears in the display.

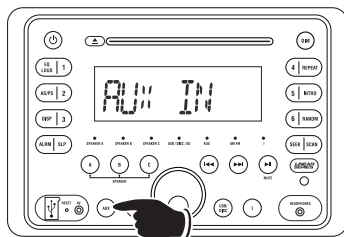

Headphone Output

Plugging in Headphone:

Insert a 3.5mm headphone jack into the Headphone Output socket. Use the Volume knob on the headphone to adjust the audio level.

Note: To make it so the sound only can be heard through the headphones press the **A**, **B**, **C** buttons once to deselected speaker sets A, B and C. The LED indicators for each speaker set will be off.

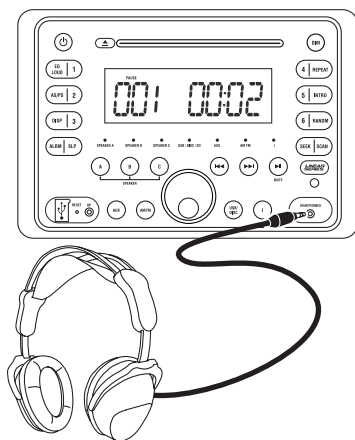

Reset Button

The LCD display may fail to function normally due to the vehicle's battery condition, and could require resetting the radio microprocessor if:

- The vehicle has been "jump started" from a dead battery condition.
- The vehicle battery becomes very low and is quick-charged.
- The vehicle battery is removed and replaced.

Should any of these conditions occur, simply press and release the **RESET** button on the radio front panel using the tip of a ball point pen. This will reset the radio microprocessor to the original factory settings. After pressing the **RESET** button you should recheck to see if the radio functions normally.

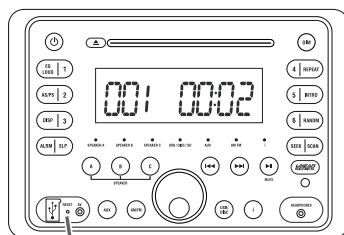

Reset Button

Additional Feature

Area Radio Frequency Adjustment:

Note: If operating the unit in the USA, do not change the area.

To Change the Area:

1. Press the **AM/FM** button and "RADIO" appears in the display.
2. Press and hold the **VOL/TONE** knob until "SETUP" appears in the display.
3. Press the **▶||** button and "US" or "OCEAN" will be displayed.
4. Press the **◀◀** or **▶▶** button to change the setting to US or OCEAN.
5. Press the **▶||** button to save the setting. The unit will clear all the station settings. After waiting a few seconds the unit exit programming.

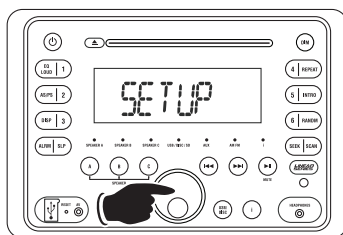

Installation

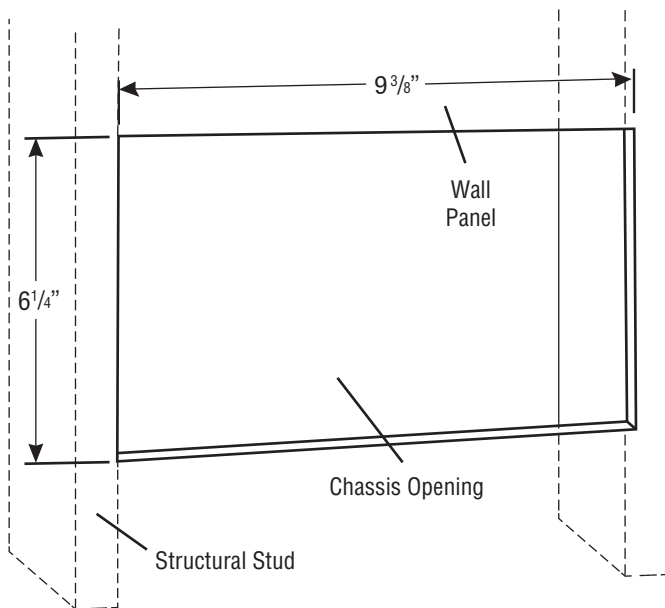

 Caution: Do not install radio without rear cover installed: No user-serviceable parts inside. Rear cover provides protection against potential fire hazard.

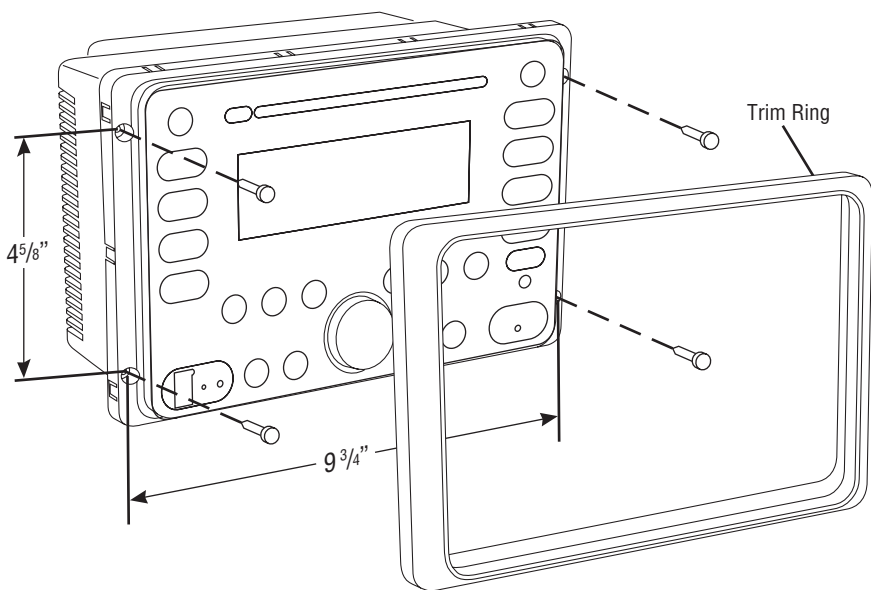

Speaker Connections

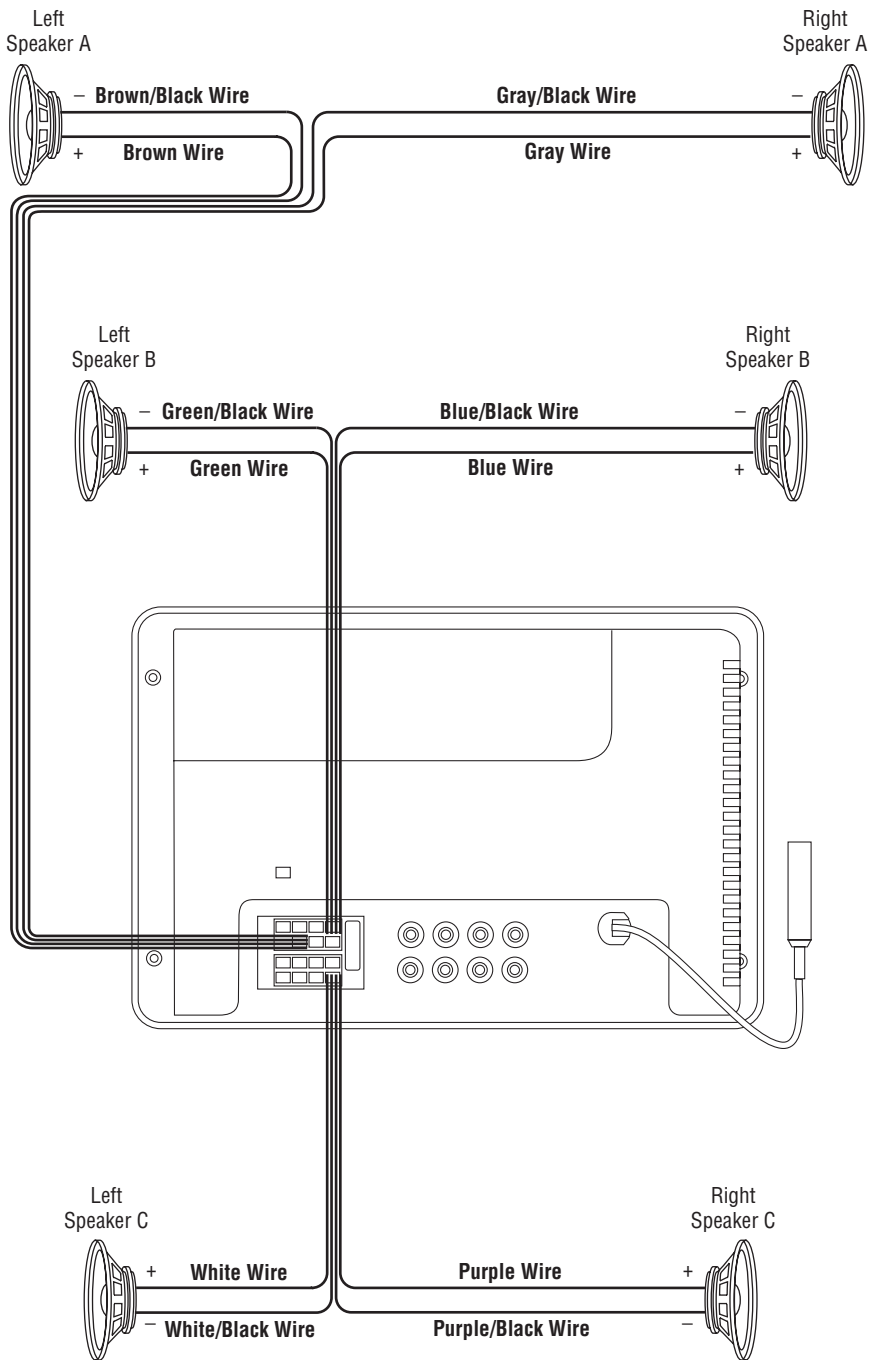

Wiring and Auxiliary Connections

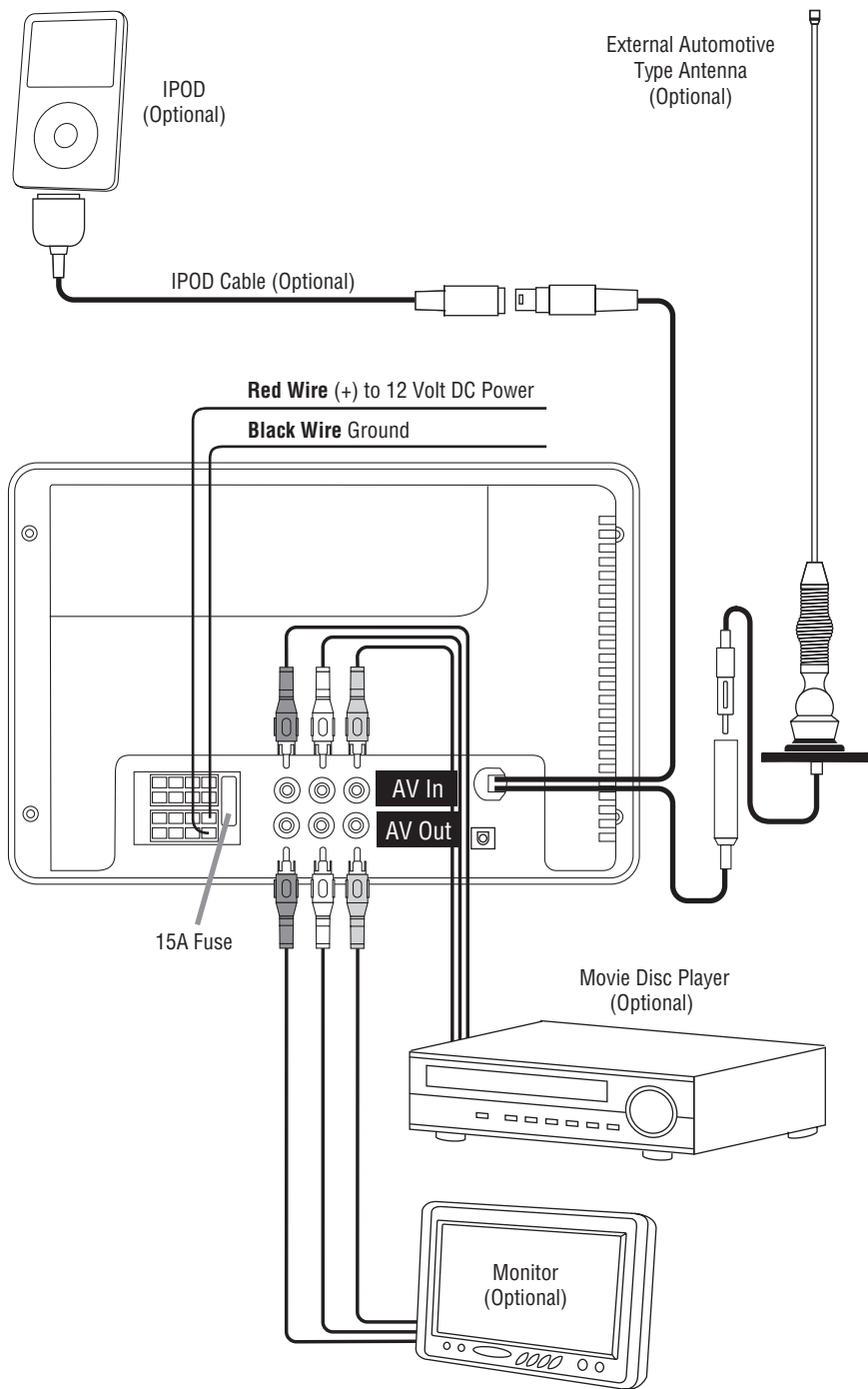

Wiring and Auxiliary Connections (Continued)

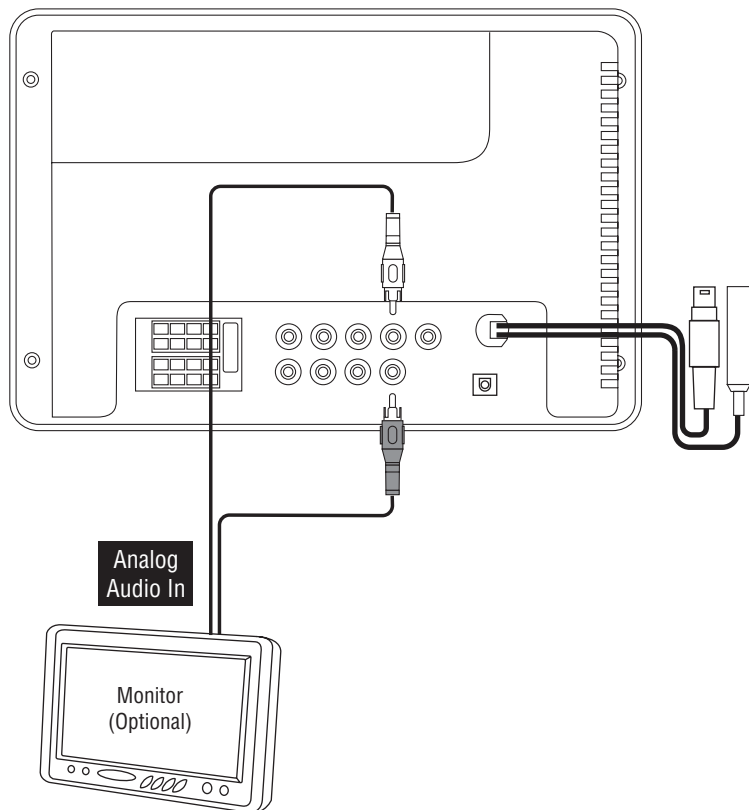

FCC Statement

This device complies with Part 15 of the FCC Rules. Operation is subject to the following two conditions:

1. This device may not cause harmful interference, and
2. This device must accept any interference received, including interference that may cause undesired operation.

Note: This equipment has been tested and found to comply with the limits for a Class B digital device, pursuant to part 15 of the FCC Rules. These limits are designed to provide reasonable protection against harmful interference in a residential installation. This equipment generates, uses and can radiate radio frequency energy and, if not installed and used in accordance with the instructions, may cause harmful interference to radio communications. However, there is no guarantee that interference will not occur in a particular installation. If this equipment does cause harmful interference to radio or television reception, which can be determined by turning the equipment off and on, the user is encouraged to try to correct the interference by one or more of the following measures:

- Reorient or relocate the receiving antenna.
- Increase the separation between the equipment and receiver.
- Connect the equipment into an outlet on a circuit different from that to which the receiver is connected.
- Consult the dealer or an experienced radio/TV technician for help.

Caution: Any changes or modifications not expressly approved by the party responsible for compliance could void the user's authority to operate this equipment.

RF Exposure: A distance of 20 cm shall be maintained between the antenna and users, and the transmitter module may not be co-located with any other transmitter or antenna.

Safety Instructions

- **Read Instructions:** All the safety and operating instructions should be read before the appliance is operated.
- **Retain Instructions:** The safety and operating instructions should be retained for future reference.
- **Heed Warnings:** All warnings on the appliance and in the operating instructions should be adhered to.
- **Follow Instructions:** All operating and use instructions should be followed.
- **Water and Moisture:** The appliance should not be used near water. For example, near a bathtub, wash-bowl, kitchen sink, laundry tub, in a wet basement, or near a swimming pool, etc.
- **Wall or Cabinet Mounting:** The appliance should be mounted to a wall or cabinet only recommended by the manufacturer.
- **Heat:** The appliance should be situated away from heat sources such as radiators, heat registers, stoves, or other appliances (including amplifiers) that produce heat.
- **Power Supply:** The appliance should be connected to a power supply only of the type described in the operating instructions or as marked on the appliance.
- **Power Lines:** An outdoor antenna should be located away from power lines.
- **Object and Liquid Entry:** Care should be taken so that objects do not fall, and liquids are not spilled into the enclosure through openings.

Outdoor Antenna Grounding:

If an outside antenna is connected to the receiver, be sure the antenna system is grounded, so as to provide some protection against voltage surges and built up static charges. Section 810 of the National Electrical Code, ANSI/NFPA No. 70-1983, provides information with respect to proper grounding of the mast and supporting structure, grounding of the lead-in wire to an antenna discharge unit, size of grounding conductors, location of antenna-discharge unit, connection to grounding electrodes, and requirements for the grounding electrode. See illustration below.

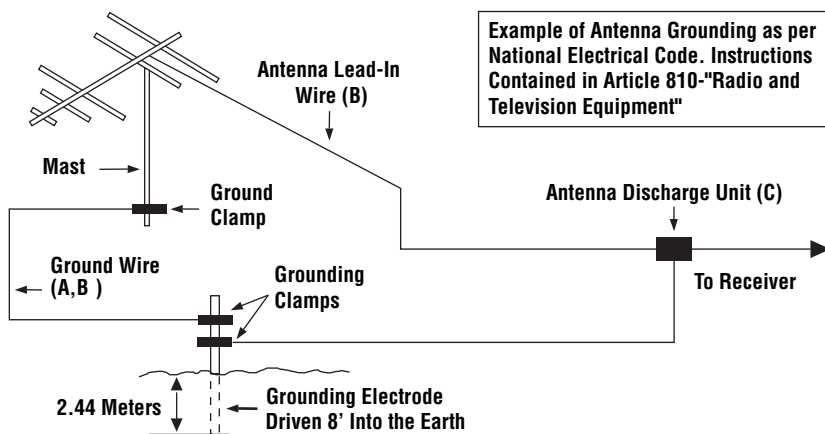

- A. Use No. 10 AWG (5.3mm²) copper, No. 8 AWG (8.4mm²) aluminum, No. 17 AWG (1.0mm²) copper clad steel or bronze wire, or larger as ground wire.
- B. Secure antenna lead-in and ground wires to house with stand-off insulators spaced from 4 feet (1.22m) to 6 feet (1.83m) apart.
- C. Mount antenna discharge unit as close as possible to where lead-in enters house.

ONE (1) YEAR LIMITED WARRANTY

Magnadyne Corporation or its authorized agents will within one year from the date of sale to you, repair, replace or refund the retail sales price of said product or any part thereof, at the option of the Magnadyne Corporation or its authorized agents, if said product or part is found defective in materials or workmanship, when properly connected and operating on the correct power requirements designated for the specific product. This warranty and Magnadyne Corporation or its authorized agent's obligations hereunder do not apply where the product was; damaged while in the possession of the consumer, subjected to unreasonable or unintended use, not reasonably maintained, utilized in commercial or industrial operations, or serviced by anyone other than Magnadyne Corporation or its authorized agents, or where the warning seal on the product is broken or the power and/or plugs are detached from the unit. Magnadyne Corporation or any of its authorized agents will not assume any labor costs for the removal and reinstallation of any product found to be defective, or the cost of transportation to Magnadyne Corporation or its authorized agents. Such cost are the sole responsibility of the purchaser.

This warranty does not cover the cabinet appearance items or accessories used in connection with this product, or any damage to recording or recording tape, or any damage to the products resulting from improper installation, alteration, accident, misuse, abuse or acts of nature.

MAGNADYNE CORPORATION OR ITS AUTHORIZED AGENTS SHALL NOT BE LIABLE TO ANYONE FOR CONSEQUENTIAL OR INCIDENTAL DAMAGES OR CLAIMS EXCEPT THOSE ACCORDED BY LAW. NO EXPRESSED WARRANTY OR IMPLIED WARRANTY IS GIVEN EXCEPT THOSE SET FORTH HEREIN. NO IMPLIED WARRANTY SHALL EXTEND BEYOND ONE YEAR FROM THE DATE OF SALE.

This warranty extends only to the original purchaser of the product and is not transferable. Some states do not allow limitations on how long an implied warranty lasts, and some states do not allow the exclusion or limitation of incidental or consequential damages, so the above limitations or exclusion may not apply to you. This warranty gives you specific legal rights, and you may have other rights that vary from state to state.

“NOTE: The manufacturer is not responsible for any radio or TV interference caused by unauthorized modifications to this equipment. Such modifications could void the User's authority to operate the equipment.”

Defective merchandise should be returned to the original point of purchase or secondly, to Magnadyne Corporation, 1111 W. Victoria Street, Compton CA 90220.

Return Authorization must be obtained before sending, or merchandise may be refused.