

# Owner's Manual

Please read before using this unit.

## DVD/CD Player

# DP170MW8

# MAGNAVOX

SMART. VERY SMART.

INSTRUCCIONES EN  
ESPAÑOL INCLUIDAS.

### Supplied Accessories

remote control  
(NA475UD)

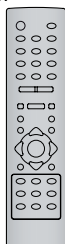

batteries  
(AAA x 2)



RCA audio/video cables  
(WPZ0102TM018 /  
WPZ0102LTE01)

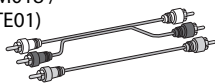

owner's manual  
(1VMN23650A)

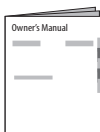

### Connecting to RF Modulator (Not Supplied)

If your TV has antenna in jack only, it is still possible to connect this unit to your TV by using an RF modulator. In this case, follow the instructions below.

- 1) Disconnect the power cords of the devices from the AC outlet.
- 2) Make the connection as illustrated below.
- 3) Set your RF modulator's channel 3/4 switch to either 3 or 4, whichever the TV channel is least used in your area. If your RF modulator has a modulator/antenna switch, set it according to the manual supplied with the RF modulator.
- 4) Plug in the power cords of the devices to the AC outlet.
- 5) Turn on your TV and choose the same channel as you set the RF modulator's channel 3/4 switch to. For more details, follow the manual supplied with the RF modulator.

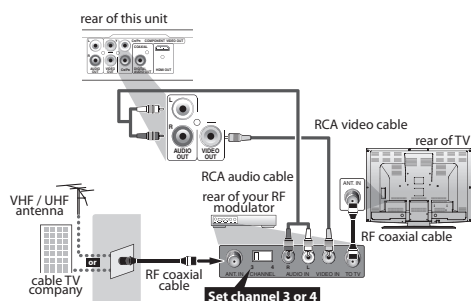

### Note:

- RF modulator is not supplied with this unit. You need to purchase it at your local store.
- The quality of picture may become poor if this unit is connected to an RF modulator.

If you need additional operating assistance after reading this owner's manual, please call

**TOLL FREE : 1-800-605-8610**

or visit our web site at

<http://www.funai-corp.com>

### Contents

#### PRECAUTIONS

Laser Safety .....	2
<b>Important Safeguards</b> .....	<b>3</b>
Location and Handling .....	4
Avoid the Hazards of Electrical Shock and Fire .....	4
Moisture Condensation Warning .....	4
About Copyright .....	4
Notice for Progressive Scan Outputs .....	4
Symbols Used in this Manual .....	4
Maintenance .....	4
<b>About the Discs</b> .....	<b>5</b>
Playable Discs .....	5
Unplayable Discs .....	5

#### SETUP

<b>Connections</b> .....	<b>6</b>
Connection to a TV .....	6
Connection to a TV with an HDMI Compatible Port .....	7
Connection to an Audio System .....	8
<b>Function Overview</b> .....	<b>9</b>
Rear Terminals .....	9
Front Panel Indicator .....	9
HDMI Setup .....	9
Remote Control .....	10
Installing the Batteries for the Remote Control .....	10

#### DVD FUNCTIONS

<b>Playback</b> .....	<b>11</b>
<b>MP3, JPEG Playback</b> .....	<b>12</b>
<b>Kodak Picture CD</b> .....	<b>12</b>
<b>Dual Playback</b> .....	<b>13</b>
<b>Transition Mode</b> .....	<b>13</b>
<b>Adjustment of Picture Size</b> .....	<b>13</b>
<b>Folder Playback</b> .....	<b>13</b>
<b>On-Screen Display</b> .....	<b>14</b>
<b>Search Functions</b> .....	<b>15</b>
Using Track Search .....	15
Using Title / Chapter Search .....	15
Using Time Search .....	15
Marker Setting .....	15
<b>Repeat / Random / Programmed Playback</b> .....	<b>16</b>
Repeat Playback .....	16
Repeat A-B Playback .....	16
Random Playback .....	16
Programmed Playback .....	16
<b>Special Settings</b> .....	<b>17</b>
Subtitle Language .....	17
Audio Language .....	17
Camera Angles .....	17
Black Level Setting .....	17
Stereo Sound Mode .....	17
Virtual Surround .....	17
<b>DVD Setting</b> .....	<b>18</b>
LANGUAGE Setting .....	18
DISPLAY Setting .....	19
AUDIO Setting .....	20
PARENTAL Setting .....	21
OTHERS Setting .....	22
Reset to the Default Setting (Except for PARENTAL Setting) .....	23

#### INFORMATION

<b>Troubleshooting Guide</b> .....	<b>23</b>
<b>Specifications</b> .....	<b>24</b>
<b>Language Code List</b> .....	<b>24</b>
<b>LIMITED WARRANTY</b> .....	<b>24</b>
<b>Español</b> .....	<b>27</b>
<b>Quick Use Guide</b> .....	<b>Back Cover</b>

PRECAUTIONS

SETUP

INFORMATION DVD FUNCTIONS

Español

# PRECAUTIONS

**WARNING:** TO PREVENT FIRE OR ELECTRICAL SHOCK, DO NOT EXPOSE THIS PRODUCT TO RAIN OR MOISTURE.



**CAUTION**  
**RISK OF ELECTRIC SHOCK**  
**DO NOT OPEN**



## CAUTION:

TO REDUCE THE RISK OF ELECTRIC SHOCK, DO NOT REMOVE COVER (OR BACK). NO USER SERVICEABLE PARTS INSIDE. REFER SERVICING TO QUALIFIED SERVICE PERSONNEL.



The lightning flash with arrowhead symbol, within an equilateral triangle, is intended to alert the user to the presence of uninsulated "dangerous voltage" within the product's enclosure that may be of sufficient magnitude to constitute a risk of electric shock to persons.



The exclamation point within an equilateral triangle is intended to alert the user to the presence of important operating and maintenance (servicing) instructions in the literature accompanying the appliance.

The caution marking is located on the rear of the cabinet.

## Laser Safety

This unit employs a laser. Only a qualified service person should remove the cover or attempt to service this device, due to possible eye injury.

**CAUTION:** USE OF CONTROLS OR ADJUSTMENTS OR PERFORMANCE OF PROCEDURES OTHER THAN THOSE SPECIFIED HEREIN MAY RESULT IN HAZARDOUS RADIATION EXPOSURE.

**CAUTION:** VISIBLE AND INVISIBLE LASER RADIATION WHEN OPEN AND INTERLOCK DEFEATED. DO NOT STARE INTO BEAM.

**LOCATION:** INSIDE, NEAR THE DECK MECHANISM.

**FCC WARNING - This equipment may generate or use radio frequency energy. Changes or modifications to this equipment may cause harmful interference unless the modifications are expressly approved in the manual. The user could lose the authority to operate this equipment if an unauthorized change or modification is made.**

## RADIO-TV INTERFERENCE

This equipment has been tested and found to comply with the limits for a Class B digital device, pursuant to Part 15 of the FCC Rules. These limits are designed to provide reasonable protection against harmful interference in a residential installation. This equipment generates, uses, and can radiate radio frequency energy and, if not installed and used in accordance with the instructions, may cause harmful interference to radio communications. However, there is no guarantee that interference will not occur in a particular installation. If this equipment does cause harmful interference to radio or television reception, which can be determined by turning the equipment off and on, the user is encouraged to try to correct the interference by one or more of the following measures:

- 1) Reorient or relocate the receiving antenna.
- 2) Increase the separation between the equipment and receiver.
- 3) Connect the equipment into an outlet on a circuit different from that to which the receiver is connected.
- 4) Consult the dealer or an experienced radio/TV technician for help.

**This Class B digital apparatus complies with Canadian ICES-003.**

**Cet appareil numérique de la classe B est conforme à la norme NMB-003 du Canada.**

**CAUTION: TO PREVENT ELECTRIC SHOCK, MATCH WIDE BLADE OF PLUG TO WIDE SLOT, FULLY INSERT.**

**ATTENTION: POUR ÉVITER LES CHOCs ÉLECTRIQUES, INTRODUIRE LA LAME LA PLUS LARGE DE LA FICHE DANS LA BORNE CORRESPONDANTE DE LA PRISE ET POUSSER JUSQU'AU FOND.**

## A NOTE ABOUT RECYCLING

This product's packaging materials are recyclable and can be reused. Please dispose of any materials in accordance with your local recycling regulations.

Batteries should never be thrown away or incinerated but disposed of in accordance with your local regulations concerning chemical wastes.

## Make your contribution to the environment!!!

- Used up batteries do not belong in the dust bin.
- You can dispose of them at a collection point for used up batteries or special wastes. Contact your council for details.



For Customer Use:

Read carefully the information located at the back of this unit and enter below the Model No. and the Serial No. Retain this information for future reference.

Model No. \_\_\_\_\_

Serial No. \_\_\_\_\_

# Important Safeguards

1. Read Instructions - All the safety and operating instructions should be read before the appliance is operated.
2. Retain Instructions- The safety and operating instructions should be retained for future reference.
3. Heed Warnings - All warnings on the appliance and in the operating instructions should be adhered to.
4. Follow Instructions - All operating and use instructions should be followed.
5. Cleaning - Unplug this video product from the wall outlet before cleaning. Do not use liquid cleaners or aerosol cleaners. Use a damp cloth for cleaning.  
EXCEPTION: A product that is meant for uninterrupted service and, that for some specific reason, such as the possibility of the loss of an authorization code for a CATV converter, is not intended to be unplugged by the user for cleaning or any other purpose, may exclude the reference to unplugging the appliance in the cleaning description otherwise required in item 5.
6. Attachments - Do not use attachments not recommended by the video product manufacturer as they may cause hazards.
7. Water and Moisture- Do not use this video product near water, for example, near a bath tub, wash bowl, kitchen sink, or laundry tub, in a wet basement, or near a swimming pool, and the like.
8. Accessories - Do not place this video product on an unstable cart, stand, tripod, bracket, or table. The video product may fall, causing serious injury to a child or adult, and serious damage to the appliance. Use only with a cart, stand, tripod, bracket, or table recommended by the manufacturer, or sold with the video product. Any mounting of the appliance should follow the manufacturer's instructions and should use a mounting accessory recommended by the manufacturer. An appliance and cart combination should be moved with care. Quick stops, excessive force, and uneven surfaces may cause the appliance and cart combination to overturn.
9. Ventilation - Slots and openings in the cabinet are provided for ventilation and to ensure reliable operation of the video product and to protect it from overheating, and these openings must not be blocked or covered.  
The openings should never be blocked by placing the video product on a bed, sofa, rug, or other similar surface. This video product should not be placed in a built-in installation such as a bookcase or rack unless proper ventilation is provided or the manufacturer's instructions have been adhered to.
10. Power Sources - This video product should be operated only from the type of power source indicated on the marking label. If you are not sure of the type of power supply to your home, consult your appliance dealer or local power company. For products intended to operate from battery power, or other sources, refer to the operating instructions.
11. Grounding or Polarization - This video product is equipped with a polarized alternating-current line plug (a plug having one blade wider than the other). This plug will fit into the power outlet only one way. This is a safety feature. If you are unable to insert the plug fully into the outlet, try reversing the plug. If the plug should still fail to fit, contact your electrician to replace your obsolete outlet. Do not defeat the safety purpose of the polarized plug.
12. Power Cord Protection - Power supply cords should be routed so that they are not likely to be walked on or pinched by items placed upon or against them, paying particular attention to cords at plugs, convenience receptacles, and the point where they exit from the appliance.
13. Lightning - For added protection for this video product during a lightning storm, or when it is left unattended and unused for long periods of time, unplug it from the wall outlet. This will prevent damage to the video product due to lightning and power-line surges.
14. Power Lines - An outside antenna system should not be located in the vicinity of overhead power lines or other electric light or power circuits, or where it can fall into such power lines or circuits. When installing an outside antenna system, extreme care should be taken to keep from touching such power lines or circuits as contact with them might be fatal.
15. Overloading - Do not overload wall outlets and extension cords as this can result in a risk of fire or electric shock.
16. Object and Liquid Entry - Never push objects of any kind into this video product through any openings as they may touch dangerous voltage points or short-out parts that could result in a fire or electric shock. Never spill liquid of any kind on the video product.
17. Servicing - Do not attempt to service this video product yourself as opening or removing covers may expose you to dangerous voltage or other hazards. Refer all servicing to qualified service personnel.
18. Damage Requiring Service - Unplug this video product from the wall outlet and refer servicing to qualified service personnel under the following conditions:
  - a. When the power-supply cord or plug is damaged.
  - b. If liquid has been spilled, or objects have fallen into the video product.
  - c. If the video product has been exposed to rain or water.
  - d. If the video product does not operate normally by following the operating instructions. Adjust only those controls that are covered by the operating instructions as an improper adjustment of other controls may result in damage and will often require extensive work by a qualified technician to restore the video product to its normal operation.
  - e. If the video product has been dropped or damaged in any way.
  - f. When the video product exhibits a distinct change in performance this indicates a need for service.
19. Replacement Parts - When replacement parts are required, be sure the service technician has used replacement parts specified by the manufacturer or have the same characteristics as the original part. Unauthorized substitutions may result in fire, electric shock or other hazards.
20. Safety Check - Upon completion of any service or repairs to this video product, ask the service technician to perform safety checks to determine that the video product is in proper operating condition.
21. Heat - This video product should be situated away from heat sources such as radiators, heat registers, stoves, or other products (including amplifiers) that produce heat.

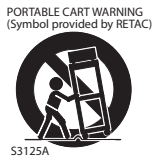

## Location and Handling

- Do not stand this unit up vertically. Install this unit in a horizontal and stable position. Do not place anything directly on top of this unit. Do not place this unit directly on top of the TV.
- Depending on the TV, noise or disturbance of the picture and/or sound may be generated if this unit is placed too close to your TV. In this case, please ensure enough space between your TV and this unit.
- Do not cover or place this unit in enclosed spaces to prevent excessive temperature build up.
- Do not place this unit in direct sunlight, or near heat sources.
- Depending on the environment, the temperature of this unit may increase slightly. This is not a malfunction.
- Keep this unit away from strong magnetic objects.
- Do not place any object containing water or other liquids on this unit. In the event that liquid should enter the cabinet, unplug this unit immediately and contact the retailer or an authorized service center immediately.
- Do not remove this unit cabinet. Touching parts inside the cabinet could result in electric shock and/or damage to this unit. For service and adjustment inside the cabinet, call a qualified dealer or an authorized service center.
- Be sure to remove disc and unplug the AC power cord from the output before carrying this unit.

## Avoid the Hazards of Electrical Shock and Fire

- Do not handle the power cord with wet hands.
- Do not pull on the power cord when disconnecting it from AC outlet. Grasp it by the plug.
- If, by accident, water is spilled on this unit, unplug the power cord immediately and take the unit to our authorized service center for servicing.

## Moisture Condensation Warning

Moisture may form inside this unit under the following conditions:

- Immediately after a heater is turned on.
- In a steamy or humid room.
- When this unit is suddenly moved from a cold to warm environment.

If moisture forms inside this unit, it may not operate properly or damage the disc. In such case, do not use this unit at least for 2 hours until its inside gets dry.

## About Copyright

Unauthorized copying, broadcasting, public performance and lending of discs are prohibited. This product incorporates copyright protection technology that is protected by U.S. patents and other intellectual property rights. Use of this copyright protection technology must be authorized by Macrovision, and is intended for home and other limited viewing uses only unless otherwise authorized by Macrovision. Reverse engineering or disassembly is prohibited.

## Notice for Progressive Scan Outputs

Consumers should note that not all high definition television sets are fully compatible with this product and may cause artifacts to be displayed in the picture. In case of picture problems with 525 progressive scan output, it is recommended that the user switch the connection to the 'standard definition' output. If there are questions regarding your TV set compatibility with this 525p DVD player, please contact our customer service center.

## Symbols Used in this Manual

The following symbols appear in some headings in this manual.

 : Description refers to DVD-video.

 : Description refers to audio CD.

 : Description refers to video CD.

 : Description refers to CD-RW/-R with MP3 files.

 : Description refers to CD-RW/-R with JPEG files.

## Maintenance

### Servicing

- Please refer to relevant topics on the "Troubleshooting Guide" on page 23 before returning the product.
- If this unit becomes inoperative, do not try to correct the problem by yourself. There are no user-serviceable parts inside. Turn off, unplug the power plug, and please call our toll free customer support line found on the cover of this manual to locate an authorized service center.

### Cleaning the Cabinet

- Use a soft cloth slightly moistened with a mild detergent solution. Do not use a solution containing alcohol, spirits, ammonia or abrasive.

### Cleaning Discs

- When a disc becomes dirty, clean it with a cleaning cloth. Wipe the disc from the center to out. Do not wipe in a circular motion.
- Do not use solvents such as benzene, thinner, commercially available cleaners, detergent, abrasive cleaning agents or anti-static spray intended for analog records.

### Cleaning the Disc Lens

- If this unit continues to perform improperly even after you have referred to the relevant sections and to the "Troubleshooting Guide" in this manual, the laser optical pickup unit may be dirty. Consult your dealer or an authorized service center for inspection and cleaning of the laser optical pickup unit.

### Disc Handling

- When you handle a disc, hold it by its edge and try not to touch the surface of the disc.
- Always store the disc in its protective case when not in use.

© 2007 Funai Electric Co., Ltd.

All rights reserved. No part of this manual may be reproduced, copied, transmitted, disseminated, transcribed, downloaded or stored in any storage medium, in any form or for any purpose without the express prior written consent of Funai. Furthermore, any unauthorized commercial distribution of this manual or any revision hereto is strictly prohibited.

Information in this document is subject to change without notice. Funai reserves the right to change the content herein without the obligation to notify any person or organization of such changes.

**FUNAI** with the  design is a registered trademark of Funai Electric Co., Ltd and may not be used in any way without the express written consent of Funai. All other trademarks used herein remain the exclusive property of their respective owners. Nothing contained in this manual should be construed as granting, by implication or otherwise, any license or right to use any of the trademarks displayed herein. Misuse of any trademarks or any other content in this manual is strictly prohibited. Funai shall aggressively enforce its intellectual property rights to the fullest extent of the law.



Manufactured under license from Dolby Laboratories. "Dolby" and the double-D symbol are trademarks of Dolby Laboratories.



Product that have earned ENERGY STAR® are designed to protect the environment through superior energy efficiency.

# About the Discs

## Playable Discs

Type of media	Mark (logo)	Region code	Recorded signals	Media size	Disc types
DVD-video *1, 2, 3, 5, 9		or	digital video (MPEG2)	5 inches (12 cm) or 3 inches (8 cm)	
DVD-RW DVD-R *1, 3, 4, 5, 6, 7, 8, 9, 10	 	—			
DVD+RW DVD+R *1, 3, 4, 5, 8, 9	 	—			
video CD *3, 5, 9, 11		—	digital video with audio	5 inches (12 cm) or 3 inches (8 cm)	video CD or audio CD e.g.) 
audio CD *3, 5, 9		—	digital audio		MP3 or JPEG e.g.) 
CD-RW CD-R *3, 4, 5, 8, 9	 	—	digital audio or MP3 or JPEG		
Kodak Picture CD *3, 4, 5, 8, 9		—	JPEG		

is a trademark of DVD Format/Logo Licensing Corporation.



is trademark of Eastman Kodak Company.

### If you cannot play back a disc which bears one of the marks above, check the following.

- \*1: This unit conforms to the NTSC color system. Discs recorded in other color systems such as PAL cannot be played back.
- \*2: Certain DVD-video does not operate as described in this manual due to the intentions of the disc's producers.
- \*3: Scratched or stained discs may not be played back.
- \*4: Some discs cannot be played back because of incompatible recording conditions, characteristics of the recorder or special properties of discs.
- \*5: You can play back discs which bear the marks above. If you use nonstandardized discs, this unit may not play them back. Even if they are played back, the sound or video quality will be compromised.
- \*6: You may play back the unfinalized DVD-RW/-R recorded in the video format on our brand's DVD recorder. However, depending on the recording status of a disc, the disc may not be played back at all or normally (the picture or sound may not be smooth, etc.). In this case, you need to finalize the disc with the DVD recorder. Refer to the manual accompanying the DVD recorder.
- \*7: Only discs recorded in the video format and finalized can be played back.  
Unfinalized discs cannot be played back. Depending on the recording status of a disc, the disc may not be played back at all (the picture or sound may not be smooth, etc.).
- \*8: If the recorded portion of the disc is too small (less than 2-3/16 inches (55 mm) across), it may not play back properly.
- \*9: Do not glue paper or put stickers on to the disc. These may damage the disc, and the unit may not read it correctly.
- \*10: Discs recorded in the VR (video recording) format cannot be played back
- \*11: This unit conforms to ver. 1.1 and ver. 2.0 of video CD standard with PBC function.  
Ver. 1.1 (without PBC function) : You can enjoy playback picture as well as music CD.  
Ver. 2.0 (with PBC function) : While using a video CD with PBC function, "PBC" appears on the TV screen.  
**NOTE :** When playing video CD with PBC function, some operations (e.g., track search and repeat tracks) cannot be performed. Cancel PBC function temporarily to perform those operations. (Refer to page 11.)

**What is PBC?** "PBC" stands for playback control.

You can play back interactive software using menu screens. Refer to instructions in the video CD.

## Unplayable Discs

### NEVER play back the following discs as malfunction may result!

DVD-RAM, DVD-audio, CD-i, photo CD, DVD with region codes other than 1 or ALL, DTS-CD, DVD-ROM for personal computers, CD-ROM for personal computers

### On the following disc, the sound MAY NOT be heard.

super audio CD

### Note:

- Only the sound recorded on the normal CD layer can be delivered. The sound recorded on the high density super audio CD layer cannot be delivered.

### Any other discs without compatibility indications

# SETUP

## Connections

### Connection to a TV

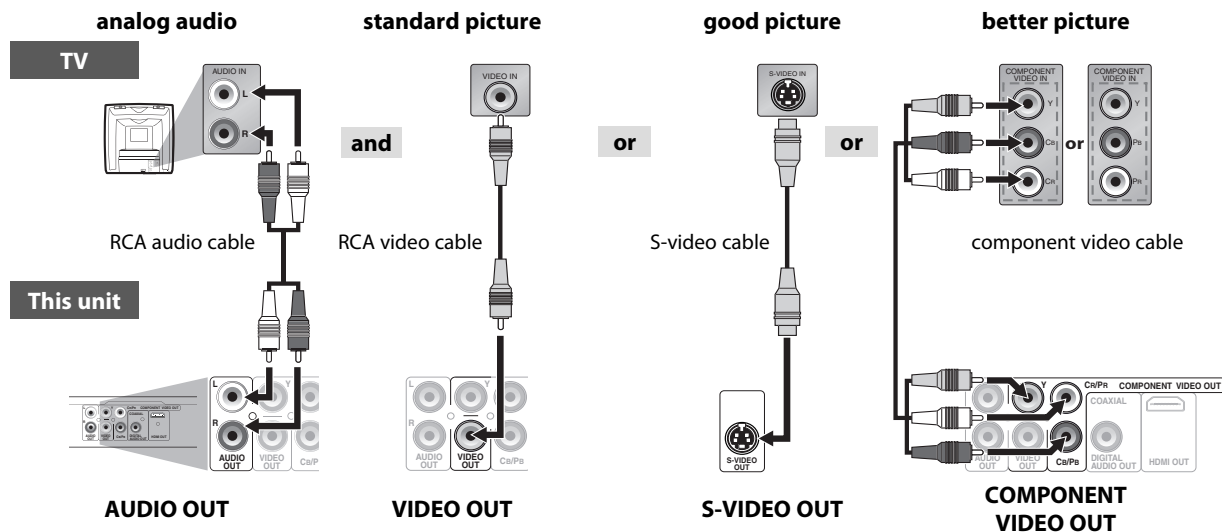

#### Supplied cables used in this connection are as follows:

- RCA audio cable (L/R) x 1
- RCA video cable x 1

Please purchase the rest of the necessary cables at your local store.

#### Note:

- Connect this unit directly to your TV. If RCA audio/video cables are connected to a VCR, pictures may be distorted due to the copy protection system.

#### If your TV is compatible with 525 (480) progressive scanning and you want to enjoy that high quality picture;

You must select the connection COMPONENT VIDEO OUT above and progressive scanning mode. To set the mode, set "PROGRESSIVE" to "ON" in "DISPLAY" menu. Refer to pages 18-20 for more details.

- When "PROGRESSIVE" is "ON", video signals from the unit's VIDEO OUT and S-VIDEO OUT jacks will be distorted or not be output at all.

#### If your TV is not compatible with progressive scanning;

Use this unit in interlace mode and set "PROGRESSIVE" to "OFF" either in "DISPLAY" menu or by pressing and holding [PLAY ►] on the front of the unit for more than 5 seconds.

#### After connecting to your TV:

You will need to switch to video input on your TV. This is usually marked TV/VIDEO, INPUT or AUX.

Please refer to your TV's owner's manual for details.

#### Input modes for common TV brands:

Listed below are inputs for common brand name TV's.

Admiral:	AUX	Panasonic:	TV/VIDEO
Curtis Mathis:	LINE1, LINE2, 00, 90, 91, 92, 93	RCA:	INPUT, TV/VCR, 00, 90, 91, 92, 93
GE:	INPUT, TV/VCR, 00, 90, 91, 92, 93	Samsung:	TV/VIDEO
Hitachi:	INPUT, AUX	Sanyo:	VIDEO
JVC:	VIDEO, VIDEO1, VIDEO2, VIDEO3	Sharp:	00
Kenwood:	AUX	Sony:	VIDEO1, VIDEO2, VIDEO3
LXI-Series:	00	Toshiba:	TV/GAME
Magnavox:	AUX CHANNEL	Zenith:	00



## Connection to a TV with an HDMI Compatible Port

A simple 1-cable connection with a device having an HDMI (High-Definition Multimedia Interface) connector allows digital transfer of the digital images of DVD-video and other devices.

best picture

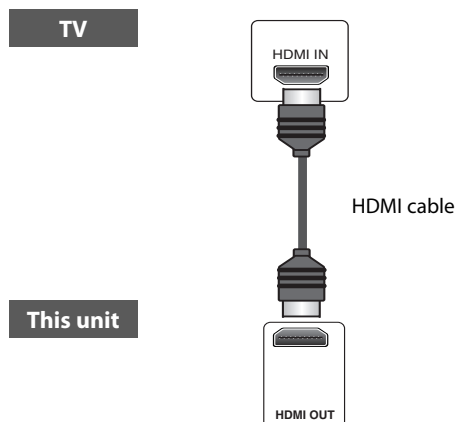

When connecting with an HDMI cable, the audio signal will be output as the digital audio signal simultaneously, so you do not need the analog audio connection described on page 6.

### Cables not included.

Please purchase the necessary cables at your local store.

### Actual output modes by media

		DOLBY DIGITAL Setting	
		BITSTREAM *1	PCM
DVD-video	Audio Recording Format		
	Dolby Digital	Dolby Digital	2channel PCM
	LPCM	2channel PCM	2channel PCM
audio CD		2channel PCM	2channel PCM
video CD		2channel PCM	2channel PCM
MP3		2channel PCM	2channel PCM

\*1 If the connected device is not compatible with HDMI BITSTREAM, signals are output on PCM.

### Copyright protection system

To play back the digital video images of a DVD via an HDMI connection, it is necessary that both the player and the display device (or an AV amplifier) support a copyright protection system called HDCP (high-bandwidth digital content protection system). HDCP is copy protection technology that comprises data encryption and authentication of the connected AV device. This unit supports HDCP. Please read the operating instructions of your display device (or AV amplifier) for more information.

\*HDMI: High Definition Multimedia Interface

### Note:

- When using an HDCP-incompatible display device, the image will not be viewed properly.
- Among the devices that support HDMI, some devices can control other devices via the HDMI connector; however, this unit cannot be controlled by another device via the HDMI connector.
- The audio signals from the HDMI connector (including the sampling frequency and bit length) may be limited by the device that is connected.
- Among the monitors that support HDMI, some do not support audio output (for example, projectors). In connections with device such as this, audio signals are not output from the HDMI output connector.
- When the set's HDMI connector is connected to a DVI-D compatible monitor (HDCP compatible) with an HDMI-DVI converter cable, the signals are output in digital RGB.



HDMI, the HDMI logo and High-Definition Multimedia Interface are trademarks or registered trademarks of HDMI Licensing LLC.

## Connection to an Audio System

### Analog Audio Connection

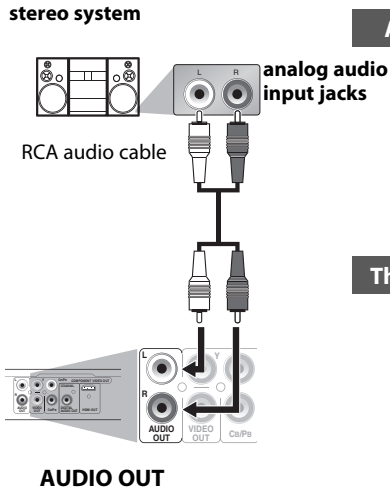

### Digital Audio Connection

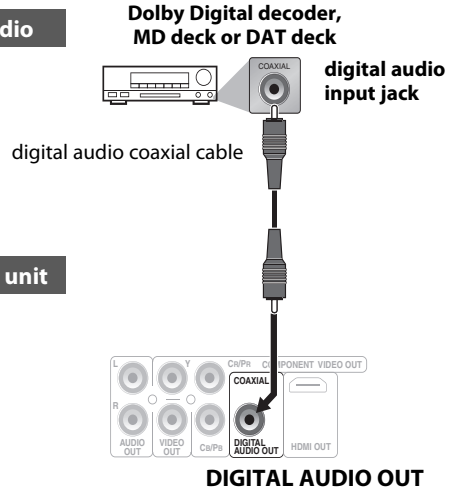

Supplied cables used in this connection are as follows:

- RCA audio cable (L/R) x 1
- Please purchase the rest of the necessary cables at your local store.

Connection	Setting	SETUP > QUICK > DOLBY DIGITAL
Connecting to a Dolby Digital decoder for Dolby Digital audio output.		BITSTREAM
Connecting to other device (an MD deck or DAT deck etc.) without Dolby Digital decoder.		PCM

\* To complete these settings, refer to pages 18-20.

#### Note:

- The audio source on a disc in a Dolby Digital multi channel surround format cannot be recorded as digital sound by an MD or DAT deck.
- By hooking this unit up to a Dolby Digital decoder, you can enjoy high-quality Dolby Digital multi channel surround sound as heard in the movie theaters.
- Playing back a DVD using incorrect settings may generate noise distortion and may also damage the speakers.



# Function Overview

## Rear Terminals

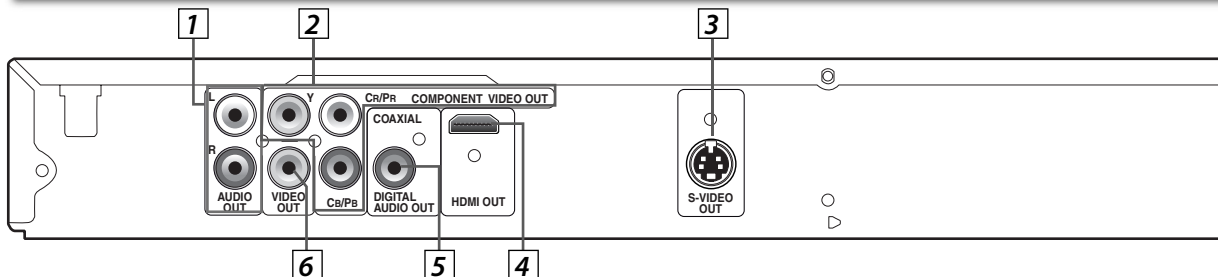

### 1: AUDIO OUT jacks

Connect an RCA audio cable from here to the audio input jack of your television or audio device.

### 2: COMPONENT VIDEO OUT jacks

Connect a component video cable from here to the component video input jacks of your television.

### 3: S-VIDEO OUT jack

Connect an S-video cable from here to the S-video input jack of your television.

### 4: HDMI OUT jack

Connect an HDMI cable from here to the HDMI compatible port of a television or other display device.

### 5: DIGITAL AUDIO OUT COAXIAL jack

Connect a digital audio coaxial cable from here to the digital audio input jack of your digital audio receiver.

### 6: VIDEO OUT jack

Connect an RCA video cable from here to the video input jack of your television.

### Note:

- Please purchase the necessary cables at your local store. (Refer to pages 6-8.)

## Front Panel Indicator

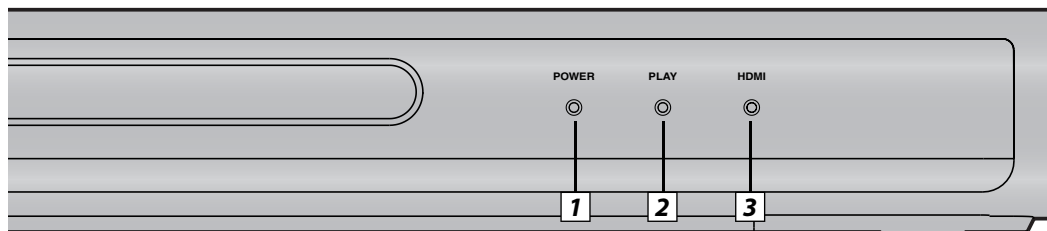

### 1 POWER indicator

Lights up when power is on.

### 2 PLAY indicator

Lights up when inserted disc is being played back. Blinks when an unplayable disc is inserted.

### 3 HDMI indicator

Lights up when there is video signal output from the HDMI OUT jack.

## HDMI Setup

Setting	SETUP > QUICK>
<b>Video Output Signal</b>	<b>HDMI MODE</b>
480 Progressive	480p
720 Progressive	720p
1080 Interlaced	1080i
1080 Progressive	1080p

\* To complete these settings, refer to pages 18-19.

### Note:

- Video and audio signals may distorted temporarily when changing to/from the HDMI output mode.
- Use a display with an HDMI-compatible port.
- You can check the HDMI connection status by pressing [DISPLAY] during playback with the HDMI output mode (refer to page 14).
- The HDMI mode that is not supported by display device is grayed in the settings.
- If the TV is not compatible with newly selected HDMI output mode, press and hold [PLAY ►] on the front of the unit for more than 5 seconds to reset the setting to default.

# Remote Control

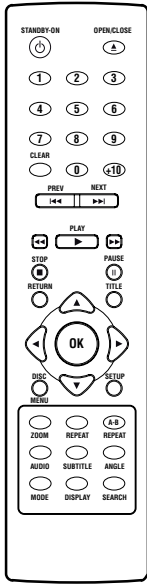

SETUP

## Installing the Batteries for the Remote Control

Install the batteries (AAAx2) matching the polarity indicated inside battery compartment of the remote control.

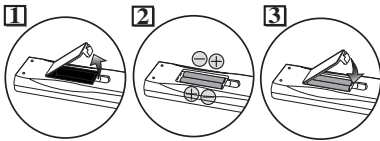

Keep in mind the following when using the remote control:

- Make sure that there are no obstacles between the remote control and the infrared sensor window on the unit.
- The maximum operable ranges from the unit are as follows.
  - **Line of sight:** approx. 23 feet (7m)
  - **Either side of center:**
    - approx. 16 feet (5m) within 30°
  - **Above:** approx. 16 feet (5m) within 15°
  - **Below:** approx. 10 feet (3m) within 30°

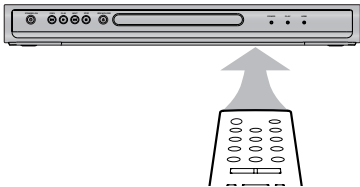

### Note:

- Do not mix alkaline and manganese batteries.
- Do not mix old and new batteries.
- Always remove batteries from remote control if they are dead or if the remote control is not to be used for an extended period of time. This will prevent battery acid from leaking into the battery compartment.

Button (Alphabetical order)	Disc	DVD	CD VCD MP3 JPEG
1 2 3 4 5 6 7 8 9 0		• To select chapter or title directly.	• To select track or file directly.
OK		• To move the cursor and determine its position.	• To move the cursor and determine its position. (CD/MP3/JPEG)
◀ ▶		• To search forward/backward through a disc. • To begin slow forward/reverse playback in the pause mode.	• To search forward/backward through a disc. • To begin slow forward playback in the pause mode. (VCD)
A-B REPEAT		• To repeat between your chosen point A and B.	• To repeat between your chosen point A and B. (CD/VCD)
ANGLE		• To select camera angles on a disc.	• To rotate a picture of JPEG files. (JPEG)
AUDIO		• To select audio languages on a disc.	• To select "STEREO", "L-ch" or "R-ch". (CD/VCD)
CLEAR		• To clear the markers. • To clear the numbers entered incorrectly. • To cancel the point for A-B repeat.	• To clear the markers. (CD/VCD) • To remove status number in program input. • To clear the numbers entered incorrectly. • To cancel the point for A-B repeat. (CD/VCD)
DISC MENU		• To call up the menu on a disc.	• To call up the file list. (MP3/JPEG)
DISPLAY		• To display the current disc or HDMI mode.	• To display the current disc or HDMI mode.
MODE		• To set black level on/off. • To set virtual surround on/off.	• To arrange the playing order or play randomly. (CD/MP3/JPEG) • To set virtual surround on/off. (CD/VCD/MP3) • To set black level on/off. (VCD) • To activate the slide show mode. (JPEG)
OPEN/CLOSE		• To open or close the disc tray. • To turn the unit on.	• To open or close the disc tray. • To turn the unit on.
PAUSE		• To pause disc playback. • To advance playback one frame at a time.	• To pause disc playback. • To advance playback one frame at a time. (VCD)
PLAY		• To begin disc playback. • To turn the unit on.	• To begin disc playback. • To turn the unit on.
PREV NEXT		• To skip chapters.	• To skip tracks or files.
REPEAT		• To play back a chapter or title repeatedly.	• To play back a track or disc repeatedly. (CD/VCD) • To play back a file, folder or disc repeatedly. (MP3/JPEG)
RETURN		• To return to the previous operation in menu.	• To return to the previous operation in menu.
SEARCH		• To search chapter, title or time. • To set or search the markers.	• To search track. • To search time. (CD/VCD) • To set or search the markers. (CD/VCD)
SETUP		• To call up the setup menu.	• To call up the setup menu.
STANDBY-ON		• To turn the unit on or off.	• To turn the unit on or off.
STOP		• To stop playback.	• To stop playback.
SUBTITLE		• To select subtitles on a disc.	—
TITLE		• To call up the top menu on a disc.	• To return to the top file of the highest hierarchy in the program and file list. (MP3/JPEG)
ZOOM		• To magnify part of a picture. (2x/4x)	• To magnify part of a picture. (2x) (VCD/JPEG)

# DVD FUNCTIONS

Please note : most instructions in this manual refer to remote control use.

## Playback

### Before:

Turn on the TV, amplifier and any other components which are connected to this unit. Make sure the TV and audio receiver (not supplied) are set to the correct channel.

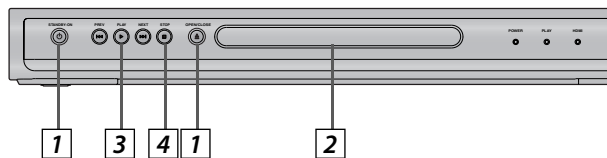
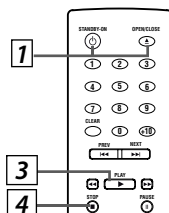

<b>1</b> To open the disc tray →	<b>2</b> Insert a disc with label facing up. 
<b>3</b> To start playback 	<b>4</b> To stop playback 

### Note:

- When you playback a CD-RW/R with MP3/JPEG files, details on page 12.
- "X" may appear at the top-right on the TV screen when the operation is prohibited by the disc or this unit.
- Some DVD may be played back from title 2 or 3 due to specific programs.
- During the playback of a 2-layered disc, pictures may stop for a moment. This happens while the 1st layer is being switched to the 2nd layer. This is not a malfunction.
- You can change the on-screen language for DVD function in "PLAYER MENU" menu. Refer to page 18.
- When the unit is connected with an HDMI cable, a revocation list update screen may appear when you try to playback the DVD-video containing a revocation list.
- If the unit is connected to the unauthorized display device with an HDMI cable, the audio/video signal may not be output when playing back a commercial DVD-video.

## Canceling and Calling Back PBC Function



- 1) Insert a video CD and press [STOP ■].
- 2) Press [the Number buttons] to enter the desired track number.
  - PBC function is now canceled and the playback of the video CD will start.
- 3) To call back PBC function, press [STOP ■] twice, and then press [PLAY ▶].
  - The title menu will appear.

## Disc Menu



Some discs contain menus which allow you to customize DVD playback. Use [▲ / ▼ / ◀ / ▶] to select an item, then press [OK] (or [PLAY ▶]).

## Calling Up a Menu Screen during Playback



- Press [DISC MENU] to call up the disc menu.
- Press [TITLE] to call up the title menu.

### Note:

- Menu operations may vary depending on the disc. Refer to the manual accompanying the disc for details.

## Resume Playback



Press [STOP ■] during playback. Resume message will appear on the TV screen. Press [PLAY ▶], playback will resume from the point at which playback was stopped.

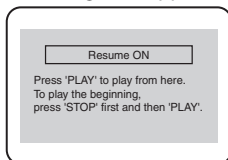

e.g.) DVD

### Note:

- To cancel resume, press [STOP ■] one more time in the stop mode.
- For MP3 and JPEG, playback will resume from the beginning of the track at which playback was stopped.
- The resume playback information stays on even when the power is turned off, as long as the disc stays in the unit.
- Some video CD with PBC function resume playback from the beginning of the track.

## Paused and Step-by-Step Playback



Press [PAUSE II] during playback. To continue playback, press [PLAY ▶].



The disc goes forward by one frame each time [PAUSE III] is pressed in the pause mode. To continue playback, press [PLAY ▶].

### Note:

- For DVD, set "STILL MODE" to "FIELD" in "DISPLAY" menu if pictures in the pause mode are blurred. Refer to pages 18-19.

## To use [PREV ◀◀], [NEXT ▶▶] on this unit



Press once to skip chapters, tracks or titles to a desired point.

## Fast Forward / Reverse Search



Press [▶▶] or [◀◀] repeatedly during playback to select the required forward or reverse speed.

### To use [PREV ◀◀], [NEXT ▶▶] on this unit

Pressing and holding [PREV ◀◀] or [NEXT ▶▶] on this unit will also change forward or reverse playback speed. To continue playback, press [PLAY ▶].

### Note:

- For DVD, fast forward or reverse search speed is different depending on the disc. Approximate speed is 1(2x), 2(8x), 3(20x), 4(50x), 5(100x).
- For audio CD, video CD and MP3, approximate speed is 1(2x), 2(8x), 3(30x).

## Slow Forward / Reverse Search



Press [▶▶] or [◀◀] repeatedly in the pause mode to select the required forward or reverse speed.

### To use [PREV ◀◀], [NEXT ▶▶] on this unit

Pressing and holding [PREV ◀◀] or [NEXT ▶▶] on this unit in the pause mode will also change forward or reverse playback speed. To continue playback, press [PLAY ▶].

### Note:

- Slow forward or reverse speed is different depending on the disc. Approximate speed is 1(1/16x), 2(1/8x), 3(1/2x).
- Set "STILL MODE" to "FIELD" in "DISPLAY" menu if pictures in the slow playback mode are blurred. Refer to pages 18-19.
- Only slow forward is available when playing back a video CD.

## Zoom



- 1) Press **[ZOOM]** during playback.
- 2) Press **[ZOOM]** repeatedly to select the required zoom factor: 2x, 4x or off.



- 3) Press **[▲ / ▼ / ◀ / ▶]** to slide the zoomed picture across the TV screen.
- 4) To exit zoom mode, press **[ZOOM]** to select off.

### Note:

- Zoom function does not work while the disc menu is displayed.
- 4x zoom is not available on some discs.
- Only 2x zoom is available on video CD and JPEG.
- You cannot slide the zoomed picture on some JPEG files.

## MP3, JPEG Playback

MP3 or JPEG is a method of compressing files. You can copy MP3 or JPEG files on CD-RW/-R from the computer and play back the files on this unit.



Insert a CD-RW/-R with MP3/JPEG files, the file list will automatically appear on the TV screen. Press **[DISC MENU]** when you want to call up the file list again while CD-RW/-R with MP3 files is already inserted.

- 1 When selecting the folder:

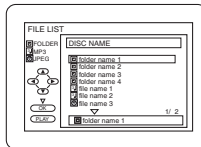
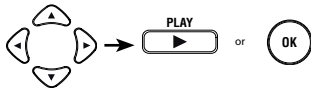

- Press **[▶]** when you want to go to the next hierarchy.
- Press **[◀]** when you want to go back to the previous hierarchy (except for the top hierarchy).

- 2 Press **[STOP ■]** once to stop playback temporarily.

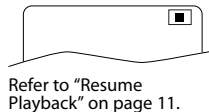

This unit recommends the files recorded under the following circumstances:

Applicable MP3 file	Remarks
Sampling frequency: 44.1 kHz or 48 kHz	• For MP3 file recorded in VBR (variable bit rate), the unit may not display the actual elapsed time.
Constant bit rate: 32 kbps ~ 320 kbps	

Applicable JPEG file	Remarks
<b>Normal playback</b> Upper limit: 6,300 x 5,100 Pixel lower limit: 32 x 32 pixel File size: Max. 7 MB	• A JPEG image that extends beyond the screen is reduced so that it will be displayed within the screen.
<b>Dual playback</b> Upper limit: 5,000 x 5,000 Pixel lower limit: 32 x 32 pixel File size: Max. 5 MB	

### Note:

- Depending on some sections, it may take a while to be recognized.
- Press **[TITLE]** to return to the first item.
- Folders and MP3 and JPEG files are displayed respectively as and .
- A maximum of 255 folders or 999 files may be recognized on one disc.
- Up to 8 hierarchies can be recognized in one folder. File in the 9th or deeper hierarchies cannot be played back.

## Kodak Picture CD



This unit can also run JPEG files stored on Kodak Picture CD. The picture CD is a service to convert photographs taken by a conventional film camera into digital data and write the data on a CD. The user can enjoy picture images on the television set by playing back the picture CD. For details of Kodak Picture CD, contact a shop that deals with developing service of Kodak Inc.

- 1 When selecting the file :



To play back

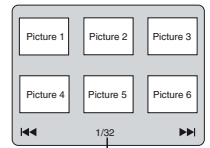

Current track number / the number of total tracks

- If a Kodak Picture CD file is selected, an image will be played back from the selected track and go to next one in turn.
- Press **[STOP ■]** to stop playback.
- If all menu items cannot be displayed in the TV screen, **[▶▶]** appears at the right bottom of the screen, indicating that the user can view remaining items on the next page. **[◀◀]** appears, it indicates that the user can view other items on the previous page. The track number of the currently highlighted item and the total tracks are shown at the center bottom of the screen.
- If **[▶▶]** is shown at the right bottom, use **[NEXT ▶▶]** to view the next page. If **[◀◀]** is shown at the left bottom, use **[PREV ◀◀]** to view the previous page.
- It may take some time until all menu items are displayed on the menu screen.

### Note:

- A track is displayed for 5 seconds and then the next track is displayed.
- Every press on **[ANGLE]** will turn the image clockwise by 90 degrees when an image is displayed.

## Dual Playback



This unit allows you to play back MP3 and JPEG files simultaneously. Available only when "DUAL PLAYBACK" is "ON". Refer to pages 18-22 on how to set "DUAL PLAYBACK" to "ON" or "OFF".

- 1 Press **[DISC MENU]** during MP3/JPEG playback.



- 2 To select a desired MP3 or JPEG file from the file list.



### Note:

- To cancel dual playback, press **[DISC MENU]** again at step 1.
- If you press **[PLAY ►]** directly after you inserted a disc which contains both MP3 and JPEG files and if the "DUAL PLAYBACK" setting is "ON", dual playback will start automatically.
- If you press **[►►]** or **[◄◄]** during dual playback, a JPEG file will be paused.
- Zooming or rotating a JPEG file during dual playback may cause an intermittent sound.
- Depending on the data size of each file, dual playback may not function properly. (Refer to "Applicable JPEG file" on page 12.)

## Transition Mode



You can switch to the transition mode for JPEG files during playback.

- 1 During playback, press **[MODE]** repeatedly until "JPG" appears.



- 2 To switch "CUT IN/OUT" or "FADE IN/OUT".



**CUT IN/OUT:**

The entire image appears in one time.

**FADE IN/OUT:**

The image appears gradually and then disappears.

- 3 Press **[RETURN]** to exit.



### Note:

- The transition mode cannot be switched when it is stopped, or from the file list screen or the picture CD menu screen.
- The default setting is "CUT IN/OUT".

## Adjustment of Picture Size



Depending on the TV connected to this unit, the overall picture cannot be displayed and the edge of the picture can be cut off. In this case, you can adjust the size of the JPEG playback image on screen.

- 1 During playback, press **[MODE]** repeatedly until "E" appears.



- 2 To switch "NORMAL" or "SMALL".



**NORMAL:**

To display the image at 100% of the picture size.

**SMALL:**

To display the image at 95% of the picture size.

- 3 Press **[RETURN]** to exit.



### Note:

- The setting screen will not be displayed while in the stop mode or from the file list.
- This feature may have no effect on some files (e.g. Files with small picture size).
- The default setting is "NORMAL".

## Folder Playback



This unit allows you to play back all the files and tracks contained in one selected folder automatically.

If the folder contains both MP3 and JPEG files, the dual playback will begin automatically within that folder.

Available only when "DUAL PLAYBACK" is "ON". Refer to pages 18-22 on how to set "DUAL PLAYBACK" to "ON" or "OFF".

- 1 Press **[STOP ■]** once to stop MP3 or JPEG playback.



File list will appear.

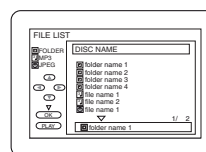

- 2 Press **[MODE]** once.



Folder list will appear.

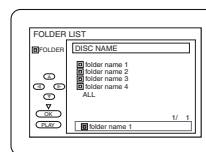

- 3 To select a desired folder from the folder list.

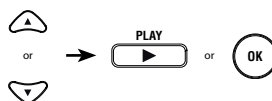

### Note:

- To cancel folder playback, press **[MODE]** again at step 2.
- If you press **[►►]** or **[◄◄]** during folder playback, a JPEG file will be paused.
- Zooming or rotating a JPEG file during folder playback may cause an intermittent sound.
- Depending on the data size of each file, folder playback may not function properly. (Refer to "Applicable JPEG file" on page 12.)

# On-Screen Display

You can check the information about the current disc by pressing **[DISPLAY]** on the remote control.

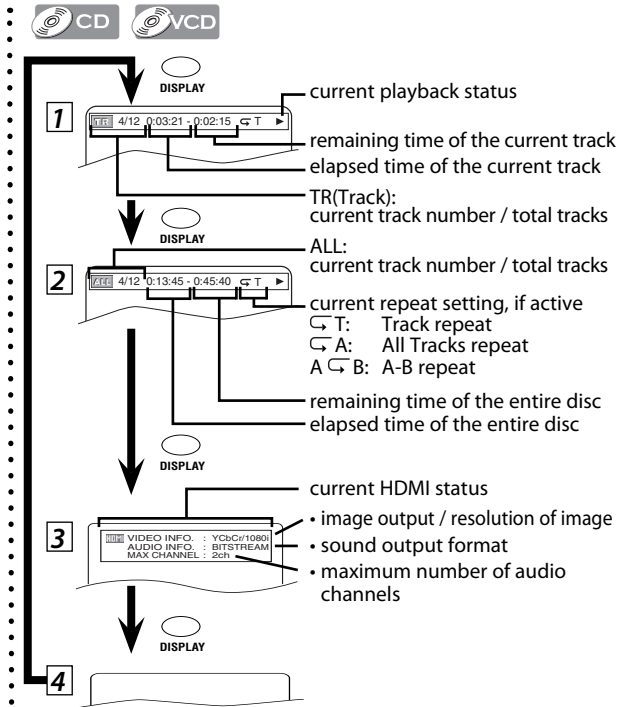
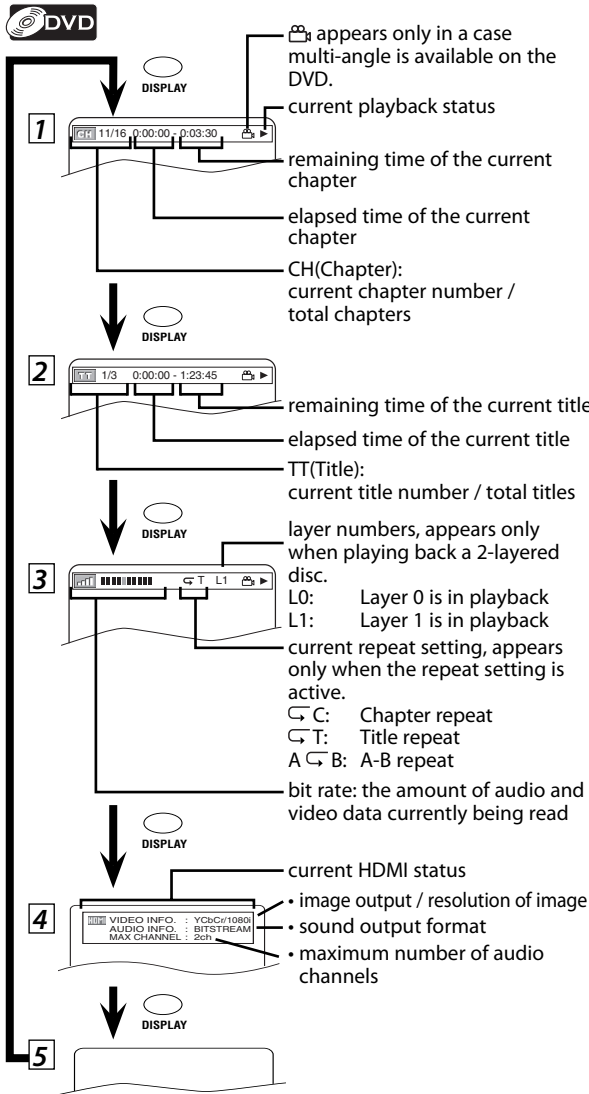

**Note:**

- For audio CD, when you are playing back a disc in program or random mode, **PROGRAM** (or **RANDOM**) will be displayed instead of **2**.
- **PBC** is displayed when you play back the video CD with PBC function.

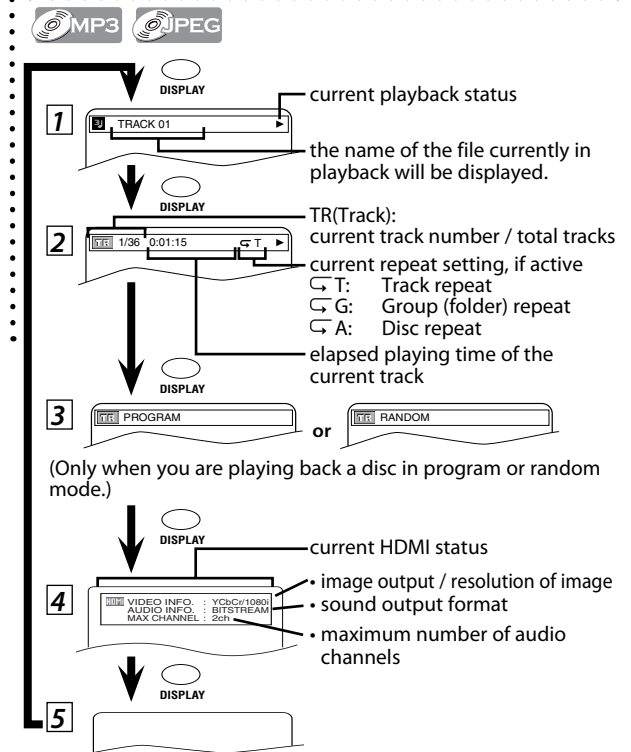

**Note:**

- When the "DUAL PLAYBACK" is "ON", MP3 and JPEG file name will be displayed.



# Search Functions

Search function does not work during programmed or random playback.

## Using Track Search



1 Press **[SEARCH]**.

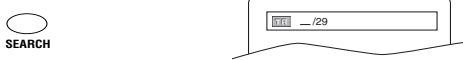

2 Select track number by using **[the Number buttons]** within 30 seconds.

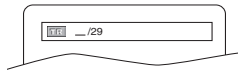

- For the disc with less than 10 tracks, press the track number directly.
- For discs with more than 10 but less than 99 tracks, to play back single-digit track, press **[0]** first, then the track number (e.g., for track 3, press **[0]**, **[3]**). To play back a double-digit track, press the track number.
- For discs with more than 100 tracks, to play back a single or a double-digit track, press **[0]** first, then the track number (e.g., for track 3, press **[0]**, **[0]**, **[3]**, and for track 26, press **[0]**, **[2]**, **[6]**). To play back a triple-digit track, press the track number.

## Using **[PREV|◀◀]**, **[NEXT|▶▶]**

1 Press **[PREV|◀◀]**, **[NEXT|▶▶]** during playback.



### Note:

- **[+10]** can also bring the track search display, except for the disc with less than 10 tracks. For such a disc, track search can be done by just pressing track number.
- For audio CD and MP3, track search is not available for programmed and random playback.
- Track search is not available when you play back the video CD with PBC function.

## Using Title / Chapter Search



1 Press **[SEARCH]** once for the chapter search. Press **[SEARCH]** twice for the title search.



2 Select title/chapter number by using **[the Number buttons]** within 30 seconds.

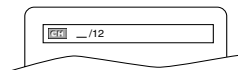

## Using **[PREV|◀◀]**, **[NEXT|▶▶]**

1 Press **[PREV|◀◀]**, **[NEXT|▶▶]** during playback.

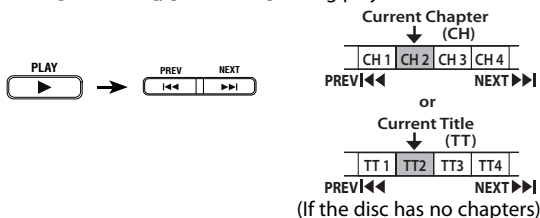

### Note:

- Depending on the disc being played back, this function can also be performed by directly entering the desired chapter number with **[the Number buttons]**. Refer to the manual accompanying the disc.

## Using Time Search



1 Press **[SEARCH]** repeatedly until the time search display appears.



2 Select a desired disc time by using **[the Number buttons]** within 30 seconds.



### Note:

- When there is no need to enter a number, "0" appears automatically. For example, "0: 0 : \_ \_" appears in the time search display if the total time of the title or track is less than 10 minutes.
- Press **[CLEAR]** to erase the incorrect input at step 2.
- For audio CD, time search is not available for programmed and random playback.
- Time search is not available when you play back the video CD with PBC function.

## Marker Setting



This function allows you to assign a specific point on a disc to be called back later.

### To set a marker

1 Press **[SEARCH]** repeatedly until the marker display appears.



2 Select a marker.

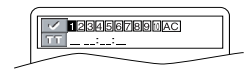
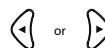

3 Press **[OK]**.



### To return to the marker later

1 Press **[SEARCH]** repeatedly until the marker display appears.

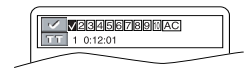

2 Select the marker.

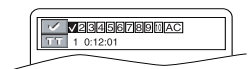
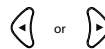

3 Press **[OK]** at the desired marker.

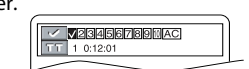

### To exit the marker screen

1 Press **[RETURN]**.



### Note:

- The marker display will disappear in about 30 seconds when there is no output.
- To clear a marker, select the marker to be cleared at step 2 in the section "To set a marker" or "To return to the marker later" and then press **[CLEAR]**.
- Opening the disc tray or turning off the power will erase all markers.
- Selecting "AC" at step 2 in the section "To set a marker" or "To return to the marker later" will also erase all markers.
- Marker search is not available when you play back the video CD with PBC function.



# Repeat / Random / Programmed Playback

## Repeat Playback



Repeat function is available only during playback.

- 1 Press **[REPEAT]** during playback.

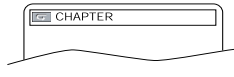
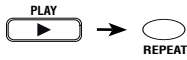

e.g.) DVD

Each time you press **[REPEAT]**, repeat function changes as example below.

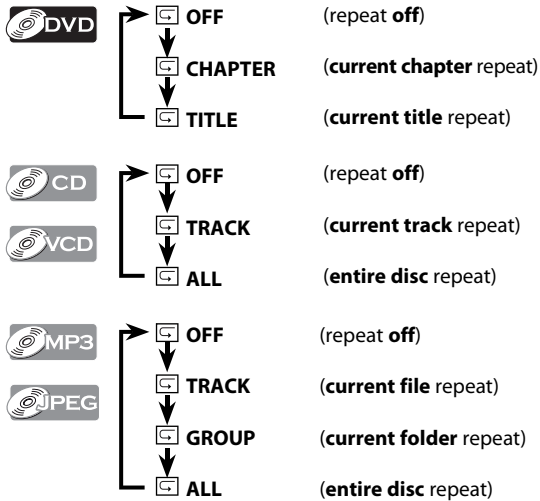

### Note:

- Repeat setting (except "ALL") will be cleared when moving to another title, chapter, track/file or folder.
- This function is not available with some discs or during repeat A-B playback.
- Repeat playback is not available when you play back the video CD with PBC function.

## Repeat A-B Playback



Repeat function is available only during playback.

- 1 Press **[A-B REPEAT]** at your desired starting point (A).

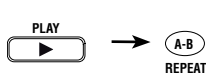

- 2 Press **[A-B REPEAT]** at your desired ending point (B).



- Point B should be in the same title or track as point A.

### Note:

- To exit the sequence, press **[A-B REPEAT]** so that "OFF" appears.
- To cancel point A, press **[CLEAR]** at step 1.
- This function is not available in the other repeat modes.

## Random Playback



This function shuffles the playing order of tracks instead of playback in sequence.

- 1 Press **[MODE]** twice.

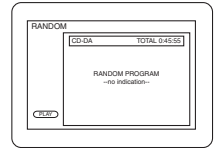
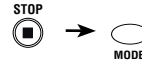

e.g.) CD

- 2 Press **[PLAY ▶]** to start random playback.

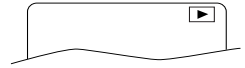

### Note:

- To repeat the current track in the random mode, press **[REPEAT]** repeatedly until "TRACK" appears during playback.
- To repeat the entire random selections, press **[REPEAT]** repeatedly until "ALL" appears during playback.
- During random playback, you cannot go back to the previous track.
- Random playback of MP3 or JPEG is not available while "DUAL PLAYBACK" is "ON".

## Programmed Playback



You may determine the order in which tracks will play back.

- 1 Press **[MODE]** once.

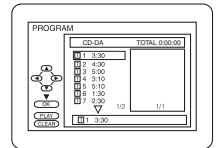
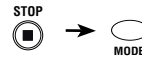

e.g.) CD

- 2 Using **[▲ / ▼]** to select desired track. Press **[OK]**.

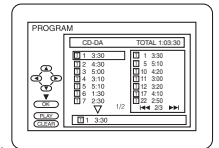

- Up to 99 tracks can be programmed.
- If eight or more tracks were in a program, use **[PREV ◀◀]**, **[NEXT ▶▶]** to see all the tracks.
- While an MP3 or JPEG folder is open:
  - Press **[▶]** when you want to go to the next hierarchy.
  - Press **[◀]** when you want to go back to the previous hierarchy (except for the top hierarchy).

- 3 Press **[PLAY ▶]** to start programmed playback.

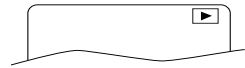

### Note:

- Press **[CLEAR]** at step 2 to erase the most recently entered track.
- To erase all programmed tracks at once, select "ALL CLEAR" and press **[OK]** at step 2.
- While a program is being played back, **[STOP ■]** works as follows:
  - Press **[STOP ■]** and **[PLAY ▶]** next, so that the programmed playback restarts. (CD playback restarts from the current point. MP3 or JPEG playback restarts from the beginning of the current file.)
  - Press **[STOP ■]** twice and **[PLAY ▶]** next, so that playback restarts from the first track in the original order. However, your programmed playback can be restarted when you follow the above steps. (Your programs are still stored until either the disc tray is open or power is turned off.)
- To repeat the current track in the program, press **[REPEAT]** repeatedly until "TRACK" appears during playback.
- To repeat the entire program, press **[REPEAT]** repeatedly until "ALL" appears during playback.
- Programmed playback of MP3 or JPEG is not available while "DUAL PLAYBACK" is "ON".

# Special Settings

## Subtitle Language



This unit allows you to select a subtitle language (if available) during DVD playback.

- 1 Press **[SUBTITLE]** during playback.



Each time you press **[SUBTITLE]**, subtitle language changes as example below.

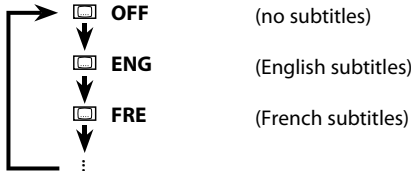

### To cancel subtitle

- 1 Press **[SUBTITLE]** during playback.

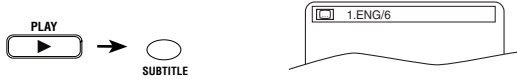

- 2 Press **[◀/▶]** to set subtitle to "OFF".



### Note:

- If your language is not shown after pressing **[SUBTITLE]** several times, the disc may not have that language. However, some discs have the subtitle language setting on the disc menu. (Operation varies depending on the discs, so refer to the manual along with the disc.)
- When "NOT AVAILABLE" appears on the TV screen, it means no subtitle is recorded on the scene.
- If you choose a language that has a 3-letter language code, the code will be displayed every time you change the subtitle language setting. If you choose any other languages, '---' will be displayed instead. Refer to page 24.
- Some discs will only allow you to change the subtitle from the disc menu. Refer to the manual accompanying the discs for details.

## Audio Language



This unit allows you to select an audio language (if multiple languages are available) during DVD playback.

- 1 Press **[AUDIO]** to change audio language.



Each time you press **[AUDIO]**, the audio language changes as example below.





### Note:

- If your language is not shown after pressing **[AUDIO]** several times, the disc may not have that language. However, some discs allow audio language setting on the disc menu. (Operation varies depending on the disc, so refer to the manual along with the disc.)
- When "OFF" appears on the TV screen, it means audio language is not available.
- Some discs will only allow you to change the audio setting from the disc menu. Refer to the manual accompanying the discs for details.

## Camera Angles



Some DVD may contain scenes which have been shot simultaneously from various angles. You can change the camera angle if  appears on the TV screen. If the "ANGLE ICON" is set to "OFF" in "OTHERS" menu,  will not appear. Refer to pages 18-22.

- 1 Press **[ANGLE]** during playback.



Each time you press **[ANGLE]** or **[◀/▶]**, camera angle changes.

## Black Level Setting



Adjust the black level to make the dark areas of the TV picture brighter.

- 1 Press **[MODE]** during playback.



- 2 Press **[OK]** to adjust the black level.



ON: makes the dark areas brighter.

OFF: shows the original picture as recorded.

- 3 Press **[RETURN]** to exit.



## Stereo Sound Mode



This unit allows you to select a sound mode during CD playback.

- 1 Press **[AUDIO]** during CD playback.



Each time you press **[AUDIO]**, sound mode changes as example below.

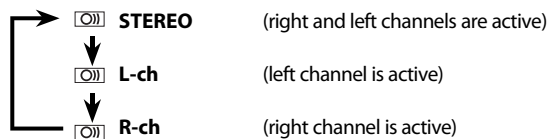

## Virtual Surround



You can enjoy stereophonic virtual world on your existing 2 channel stereo system.

- 1 Press **[MODE]** twice (once for CD and MP3) during playback.



- 2 Press **[OK]** for the desired effect.

1: natural effect

2: emphasized effect

OFF: no effects (original sound)



- 3 Press **[RETURN]** to exit.



### Note:

- For audio CD and video CD, virtual surround will not be effective if the sound mode is set to something other than "STEREO". Refer to "Stereo Sound Mode".
- For DVD, when playing back 96kHz with virtual surround function, the sound will be down sampled to 48kHz.

# DVD Setting

## QUICK Menu

You can select the "PLAYER MENU", "TV ASPECT", "PROGRESSIVE", "HDMI MODE" or "DOLBY DIGITAL" from "QUICK" menu quickly.

1 Press [SETUP] in the stop mode.



SETUP menu  
Confirm that "QUICK" is selected.

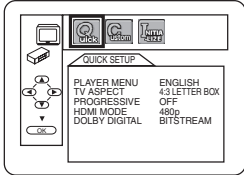

2 Select the desired item.

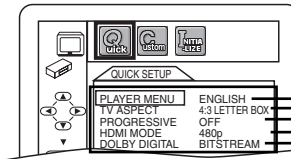
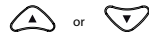

page 18 **A** Step 5

page 19 **B** Step 5

page 20 **C** Step 5



• Refer to the sections "PLAYER MENU", "TV ASPECT", "PROGRESSIVE", "HDMI MODE" or "DOLBY DIGITAL" section on pages 18-20.

## CUSTOM Menu

You can change the settings of the unit.

• **QUICK** on pages 18-20 indicates DVD setting menus also accessible from "QUICK" menu.

1 Press [SETUP] in the stop mode.



SETUP menu

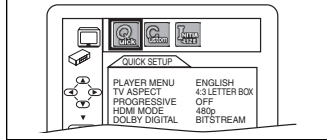

2 Select "CUSTOM".

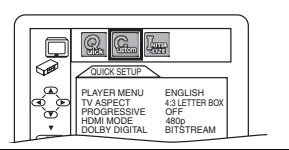
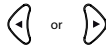

3 Select the desired item.

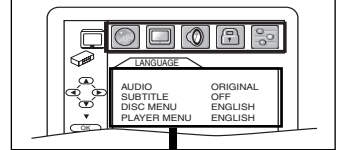
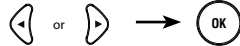

LANGUAGE menu

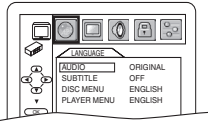

page 18 **A**

DISPLAY menu

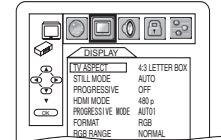

pages 19-20 **B**

AUDIO menu

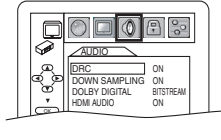

page 20 **C**

PARENTAL menu

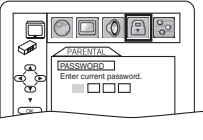

page 21 **D**

OTHERS menu

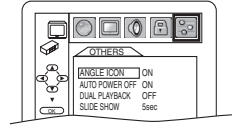

page 22 **E**

## **A** LANGUAGE Setting

Follow steps 1 to 3 in the "CUSTOM Menu" section above.

4 Select the desired item.

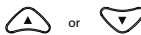

LANGUAGE menu

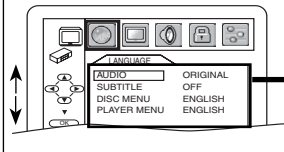

### Note:

• In "QUICK" menu, "PLAYER MENU", "TV ASPECT", "PROGRESSIVE", "HDMI MODE" or "DOLBY DIGITAL" are available. "QUICK" menu consists of the setting menu frequently used, and they are accompanied with **QUICK**. You can make all settings in "CUSTOM" menu.

5 Select the desired language.

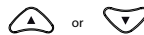

**AUDIO: \*1 \*2**  
(Default: ORIGINAL)  
Sets the audio language.

**SUBTITLE: \*1 \*2**  
(Default: OFF)  
Sets the subtitle language.

**DISC MENU: \*1**  
(Default: ENGLISH)  
Sets the language for DVD menu.

**PLAYER MENU: QUICK**  
(Default: ENGLISH)  
Sets the language for the on-screen display.

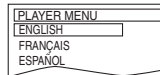
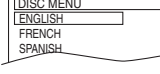
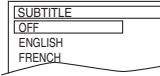
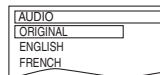

6 To exit the menu



### Note:

- \*1
  - Language options are not available with some discs.
  - If "OTHER" is selected on "AUDIO", "SUBTITLE" or "DISC MENU" screen, press 4-digit number to enter the code for the desired language. Refer to the "Language Code List" on page 24.
  - Only the languages supported by the disc can be selected.
- \*2
  - "LANGUAGE" setting for "AUDIO" and "SUBTITLE" are not available with some discs. Then use [AUDIO] and [SUBTITLE]. Refer to page 17.

## B DISPLAY Setting

You can change the display functions. Follow steps 1 to 3 in the "CUSTOM Menu" section on page 18.

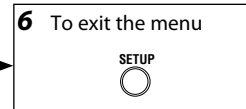
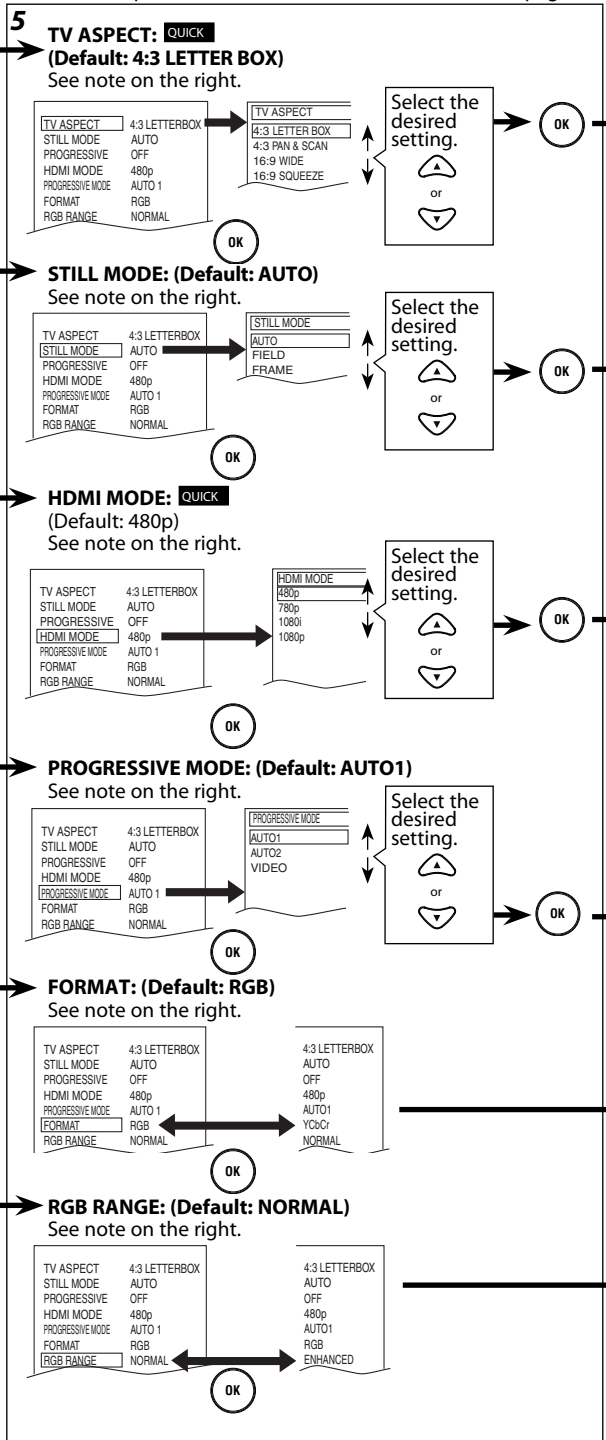
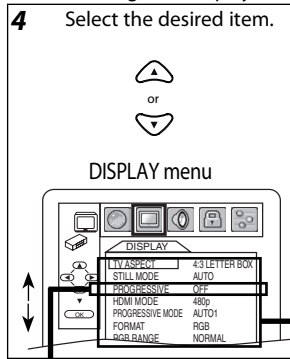

**Note:**

**TV ASPECT:**

- Select "4:3 LETTER BOX", so that black bars may appear on the top and bottom of the screen.
- Select "4:3 PAN & SCAN" for a full height picture with both sides adjusted.
- Select "16:9 WIDE" if a wide-screen TV is connected to this unit.
- Select "16:9 SQUEEZE" when the TV screen is too large horizontally at "16:9 WIDE" setting and when it is possible to adjust the screen size using the TV's controls.

**STILL MODE:**

- Select "AUTO" usually.
- If you select "AUTO", it automatically selects the best resolution setting ("FRAME" or "FIELD") based on the data characteristics of the pictures. (default)
- If you select "FIELD", the picture in the still mode will be stabilized.
- If you select "FRAME", the picture in the still mode will be highly defined.
- An individual picture on TV screen is called a "frame", which consists of two separate images called as "field".
- Some pictures may be blurred at the "AUTO" setting in the still mode due to their data characteristics.

**HDMI MODE:**

- 480p: Video output from the HDMI OUT jack at 480p
- 720p: Video output from the HDMI OUT jack at 720p
- 1080i: Video output from the HDMI OUT jack at 1080i
- 1080p: Video output from the HDMI OUT jack at 1080p
- When the HDMI/DVI video can be output, the setting change can be done.
- If the TV is not compatible with newly selected HDMI output mode, press and hold [PLAY ►] on the front of the unit for more than 5 seconds to reset the setting to default.

**PROGRESSIVE MODE:**

- You can select a mode below for the progressive scan output.
- AUTO1: mode suitable for images on the film material.
- AUTO2: mode for images on the material of 30-frame film.
- VIDEO: mode for video material.

**FORMAT:**

- Select an HDMI output mode between "YCbCr" and "RGB".
- When the connected device is not compatible with YCbCr, HDMI signal is output as RGB regardless of the setting.
- This setting is effective only when you use the HDMI connection.**

**RGB RANGE:**

- Select a HDMI picture mode between "NORMAL" and "ENHANCED".
- Select "ENHANCED" if the black-white contrast is not clear.
- This setting is effective only for HDMI RGB output.

DVD FUNCTIONS

Follow steps 1 to 3 in the "CUSTOM menu" section on page 18 and step 4 on page 19.

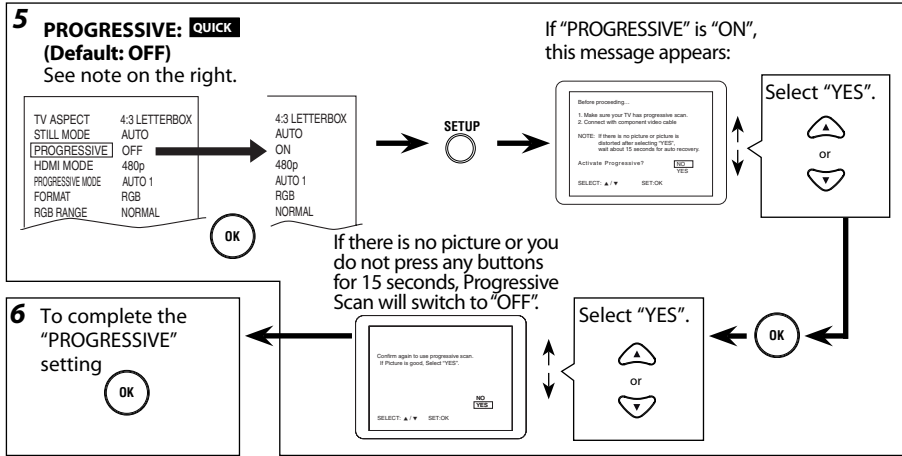

**Note:**  
**PROGRESSIVE:**

- You can set "PROGRESSIVE" to "OFF" either in the "DISPLAY" menu or by pressing and holding [PLAY] on the front of the unit for more than 5 seconds.
- When "PROGRESSIVE" is "ON", video signals from VIDEO OUT and S-VIDEO OUT jacks will be distorted or not be output at all.

## C AUDIO Setting

Choose the appropriate audio setting for your device. It only affects during the playback of DVD. Follow steps 1 to 3 in the "CUSTOM Menu" section on page 18.

DVD FUNCTIONS

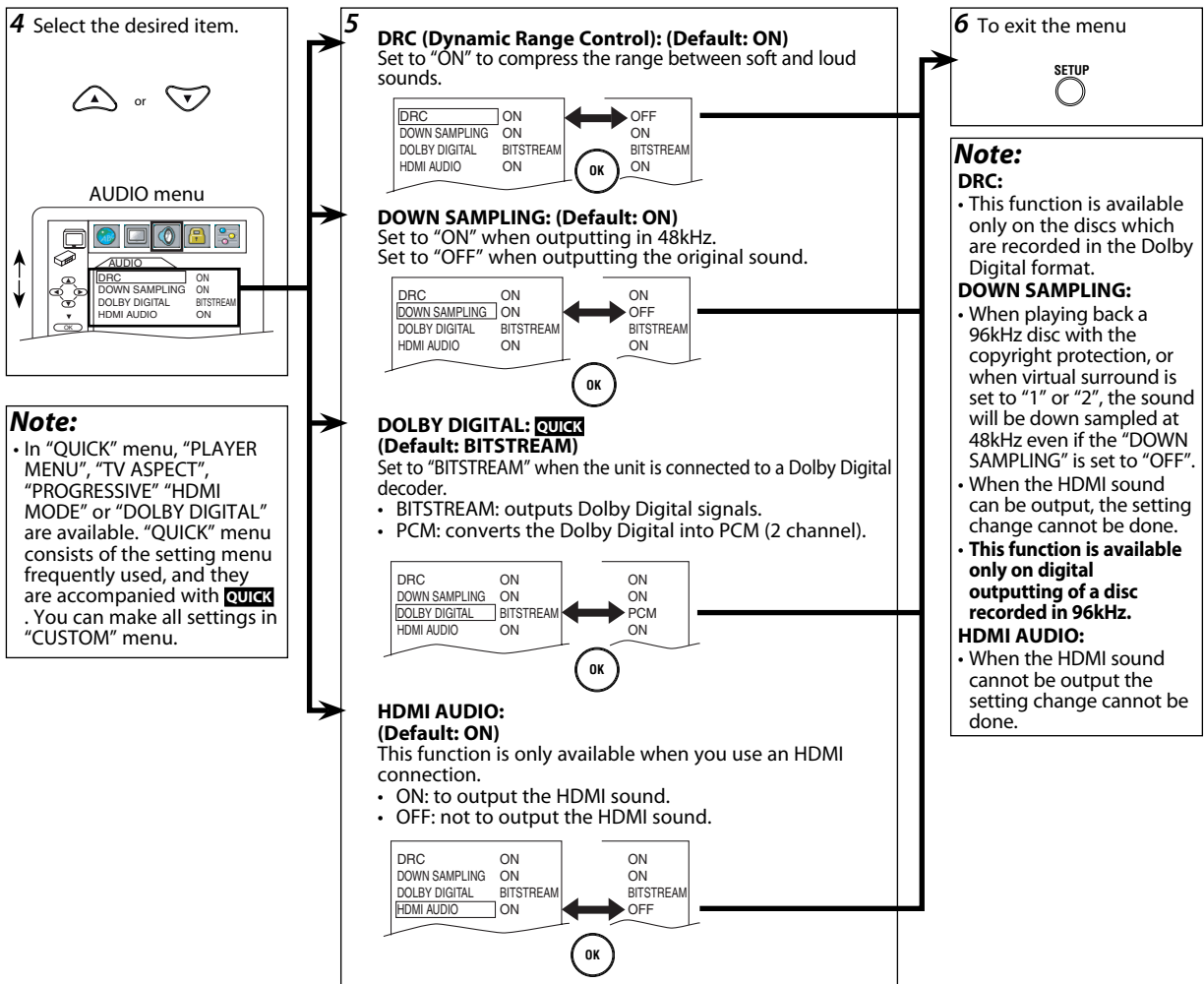

**Note:**  
**DRC:**

- This function is available only on the discs which are recorded in the Dolby Digital format.

**DOWN SAMPLING:**

- When playing back a 96kHz disc with the copyright protection, or when virtual surround is set to "1" or "2", the sound will be down sampled at 48kHz even if the "DOWN SAMPLING" is set to "OFF".
- When the HDMI sound can be output, the setting change cannot be done.
- This function is available only on digital outputting of a disc recorded in 96kHz.**

**HDMI AUDIO:**

- When the HDMI sound cannot be output the setting change cannot be done.

**Note:**

- In "QUICK" menu, "PLAYER MENU", "TV ASPECT", "PROGRESSIVE" "HDMI MODE" or "DOLBY DIGITAL" are available. "QUICK" menu consists of the setting menu frequently used, and they are accompanied with **QUICK**. You can make all settings in "CUSTOM" menu.

## D PARENTAL Setting

This function prevents unit from playing material inappropriate for children.

### Parental Levels

Parental level allows you to set the rating levels of your DVD software. Playback will stop if the ratings exceed the levels you set. Follow steps 1 to 3 in the "CUSTOM Menu" section on page 18.

**4** Enter your desired 4-digit password (except for 4737).

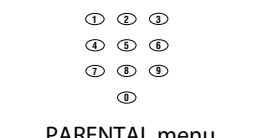

PARENTAL menu

or

If you have set a password already, enter the current 4-digit password.

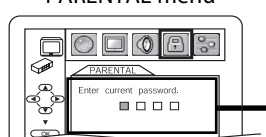

PARENTAL menu

**5** Select "PARENTAL LEVEL".

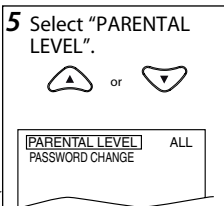

OK

**6** Select the desired level.

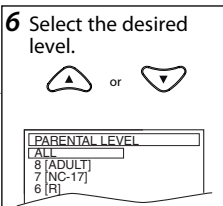

OK

**7** To exit the menu

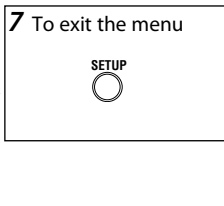

OK

**CONTROL LEVELS**

- ALL: all parental locks are canceled.
- Level 8: DVD software of any grades (adult/general/children) can be played back.
- Levels 7 to 2: only DVD software intended for general use and children can be played back.
- Level 1: only DVD software intended for children can be played back, with those intended for adult and general use prohibited.

**TIPS FOR LEVELS**

- 8 [ADULT]: DVD software of any grades (adult/general/children) can be played back.
- 7 [NC-17]: no one under 17 admitted
- 6 [R]: restricted; under 17 requires accompanying parent or adult guardian
- 5 [PGR]: parental guidance recommended
- 4 [PG13]: unsuitable for children under 13
- 3 [PG]: parental guidance suggested
- 2 [G]: general audience
- 1 [KID SAFE]: suitable for children

**Note:**

- Some DVD-video may not respond to "PARENTAL" setting. Make sure this function works with your DVD-video.
- The resume information will be cleared if you change the parental level when the resume information is on.

### To Change the Password for Parental Controls

You can change your password for parental controls. Follow steps 1 to 3 in the "CUSTOM Menu" section on page 18.

**4** Enter current 4-digit password.

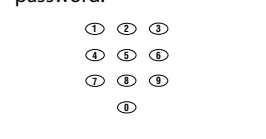

PARENTAL menu

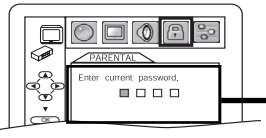

**5** Select "PASSWORD CHANGE".

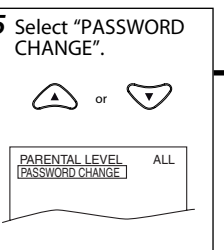

OK

**6** Enter your new 4-digit password (except for 4737).

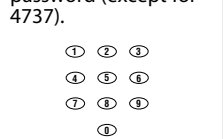

OK

**7** To exit the menu

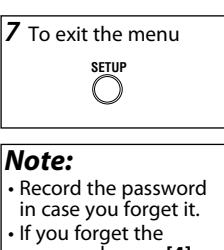

OK

**Note:**

- Record the password in case you forget it.
- If you forget the password, press [4], [7], [3], [7] at step 4, then enter your new password. Password will be cleared and parental levels will be set to "ALL".

## E OTHERS Setting

You can change the other functions. Follow steps 1 to 3 in the "CUSTOM Menu" section on page 18.

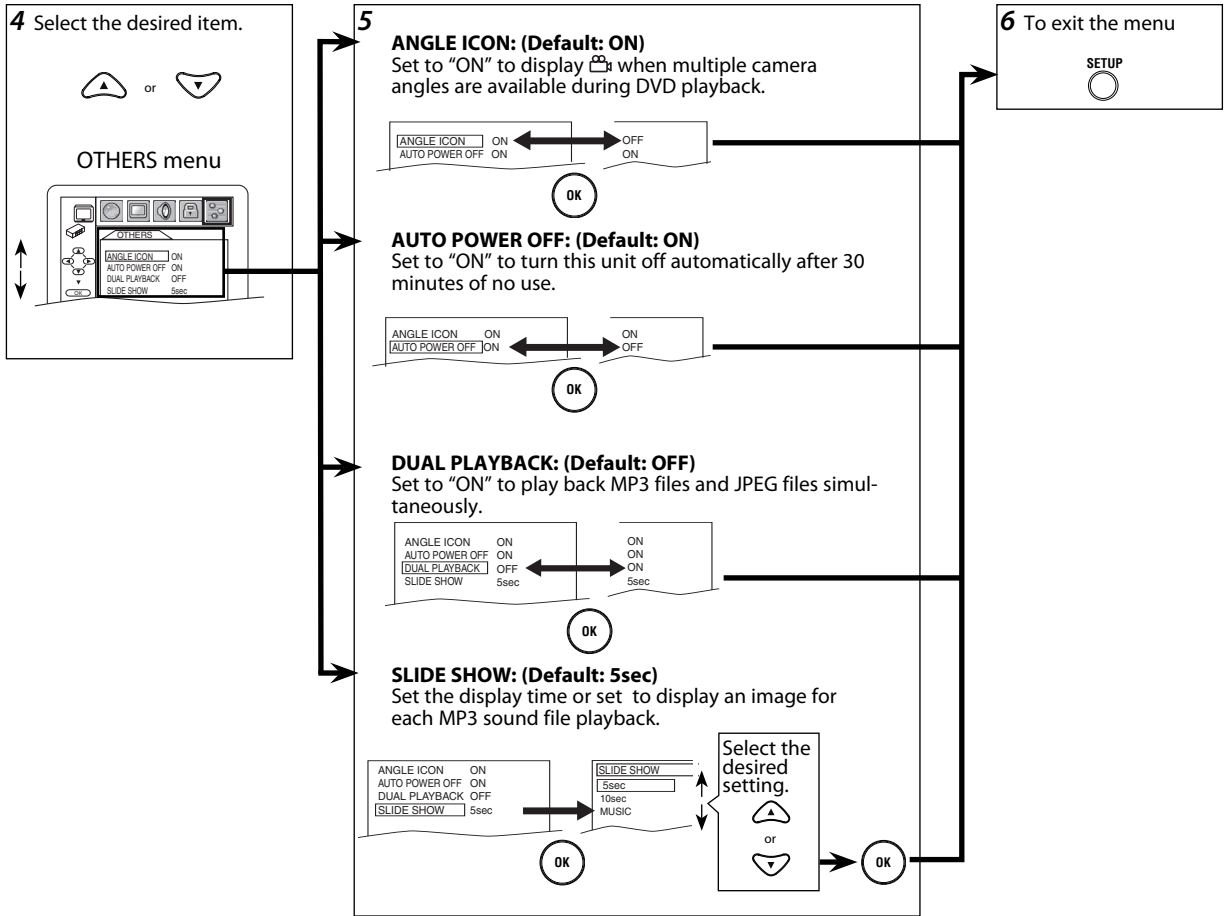



## Reset to the Default Setting (Except for PARENTAL Setting)

**1** Press [SETUP] in the stop mode.

**2** Select "INITIALIZE".

**3** Select "YES".

**4** To exit the menu

Press twice.

**Note:**

- When you do not wish to initialize, select "NO" at step 3.

## INFORMATION

### Troubleshooting Guide

If this unit does not perform properly when operated as instructed in this manual. Refer to the following:

Problem	Corrective action
No power.	<ul style="list-style-type: none"> <li>Make sure the power plug is connected to an AC outlet.</li> <li>Make sure the power is turned on.</li> </ul>
This unit does not respond to the remote control.	<ul style="list-style-type: none"> <li>Check if the power plug is connected to an AC outlet.</li> <li>Check the batteries in the remote control.</li> <li>Aim the remote control directly at the infrared sensor window. If necessary, remove all the obstacles between the sensor and the remote control.</li> <li>You have to be within 23 feet (7m) of this unit.</li> <li>Tune your radio to an empty AM station so that you hear a lot of static. Turn up the volume, then if you hear some signal sound from the radio in response to your pressing buttons on the remote control, the remote control is working.</li> <li>Press and hold any button on remote control toward a digital camera. The remote control is working if you confirm infrared light through the digital camera.</li> </ul>
Poor picture or noise.	<ul style="list-style-type: none"> <li>Interference signal may be received. Change the position and direction of the unit.</li> </ul>
No picture.	<ul style="list-style-type: none"> <li>Connect the video cable firmly.</li> <li>Insert a correct video disc that can be played back on this unit.</li> <li>Set "PROGRESSIVE" correctly in "DISPLAY" menu. Turn it on only if your TV has progressive scan and you are using the component video connections between the unit and the TV. Disable progressive scan for all other connections. Refer to pages 6-7.</li> </ul>
No sound/image from HDMI connection.	<ul style="list-style-type: none"> <li>Check the HDMI connection. (Check the status of the HDMI related indications.)</li> <li>Check whether the connected monitor device or other device supports HDCP. (This unit will not output a video signal unless the other device supports HDCP.)</li> <li>Check the setting of HDMI.</li> <li>Check whether the output format of this unit (HDMI FORMAT) matches the supported input format of other connected device.</li> <li>If the unit is connected to the unauthorized display device with an HDMI cable, the audio/video signal may not be output when playing back a commercial DVD-video.</li> </ul>
Distorted picture.	<ul style="list-style-type: none"> <li>Connect this unit directly to the TV.</li> <li>There are some cases where pictures may be slightly distorted, and those are not a sign of a malfunction.</li> <li>Although pictures may stop for a moment, this is not a malfunction. Refer to page 11.</li> <li>Check if "PROGRESSIVE" is set correctly according to your TV. Refer to pages 18-20.</li> </ul>
Disc cannot be played back.	<ul style="list-style-type: none"> <li>Insert the disc.</li> <li>Clean the disc.</li> <li>Place the disc correctly with the label side up.</li> <li>Cancel the parental lock or change the control levels.</li> <li>Handle a disc with special care so that it does not have fingerprints, scratches, or dusts on its surface.</li> </ul>
No sound.	<ul style="list-style-type: none"> <li>Connect the audio cables firmly.</li> <li>Turn on the power of the audio component.</li> <li>Correct the audio output settings.</li> <li>Correct the input settings on the audio component.</li> </ul>
No DTS audio is output.	<ul style="list-style-type: none"> <li>This unit does not support DTS audio.</li> <li>-This is not a malfunction.</li> </ul>
Audio or subtitle language does not match the setting.	<ul style="list-style-type: none"> <li>The selected language is not available for audio or subtitles on the DVD.</li> <li>-This is not a malfunction.</li> </ul>
The camera angle cannot be changed.	<ul style="list-style-type: none"> <li>The DVD does not contain sequences recorded from different camera angles.</li> <li>-This is not a malfunction.</li> </ul>
Audio or subtitle language cannot be changed.	<ul style="list-style-type: none"> <li>The DVD does not contain audio source or subtitles in the selected language.</li> <li>-This is not a malfunction.</li> </ul>
">" appears on the TV screen, prohibiting an operation.	<ul style="list-style-type: none"> <li>That operation is prohibited by this unit or the disc.</li> <li>-This is not a malfunction.</li> </ul>

- Some functions are not available in specific modes, but this is not a malfunction. Read the description in this manual for details on correct operations.
- Playback from a desired track and random playback are not available during programmed playback.
- Some functions are prohibited on some discs.
- When playing back video CD with PBC function, some operations (e.g. select and track repeat) cannot be performed.

# Specifications

Output signal format : NTSC color	Operating temperature : 41°F (5°C) to 104°F (40°C)	• Designs and specifications are subject to change without notice. • If there is a discrepancy between languages, the default language will be English.
Power source : 120 V AC +/- 10%, 60 Hz +/- 0.5%	Dimensions : W : 17.2" (435mm) H : 2.1" (51mm) D : 8.4" (211mm)	
Power consumption : 10W (standby : 0.8W)	Weight : Approx 3.8lbs (1.7kg)	

## Language Code List

Language	Code	Language	Code	Language	Code	Language	Code
	<b>A-B</b>	French [FRE]	5264	Macedonian	5957	Siswat	6565
Abkhazian	4748	Frisian	5271	Malagasy	5953	Slovak [SLO]	6557
Afar	4747	Galician	5358	Malay	5965	Slovenian	6558
Afrikaans	4752	Georgian	5747	Malayalam	5958	Somali	6561
Albanian	6563	German [GER]	5051	Maltese	5966	Spanish [SPA]	5165
Amharic	4759	Greek [GRE]	5158	Maori	5955	Sundanese	6567
Arabic	4764	Greenlandic	5758	Marathi	5964	Swahili	6569
Armenian	5471	Guarani	5360	Moldavian	5961	Swedish [SWE]	6568
Assamese	4765	Gujarati	5367	Mongolian	5960		<b>T</b>
Aymara	4771	Hausa	5447	Nauru	6047	Tagalog	6658
Azerbaijani	4772	Hebrew	5569	Nepali	6051	Tajik	6653
Bashkir	4847	Hindi	5455	Norwegian [NOR]	6061	Tamil	6647
Basque	5167	Hungarian [HUN]	5467		<b>O-R</b>	Tatar	6666
Bengali; Bangla	4860		<b>I-K</b>	Occitan	6149	Telugu	6651
Bhutani	5072	Icelandic [ICE]	5565	Oriya	6164	Thai	6654
Bihari	4854	Indonesian	5560	Oromo (Afan)	6159	Tibetan	4861
Bislama	4855	Interlingua	5547	Panjabi	6247	Tigrinya	6655
Breton	4864	Interlingue	5551	Pashto; Pushto	6265	Tonga	6661
Bulgarian [BUL]	4853	Inupiak	5557	Persian	5247	Tsonga	6665
Burmese	5971	Irish [IRI]	5347	Polish [POL]	6258	Turkish [TUR]	6664
Byelorussian	4851	Italian [ITA]	5566	Portuguese [POR]	6266	Turkmen	6657
	<b>C-E</b>	Japanese [JPN]	5647	Quechua	6367	Twi	6669
Cambodian	5759	Javanese	5669	Rhaeto-Romance	6459		<b>U-Z</b>
Catalan	4947	Kannada	5760	Romanian [RUM]	6461	Ukrainian	6757
Chinese [CHI]	7254	Kashmiri	5765	Russian [RUS]	6467	Urdu	6764
Corsican	4961	Kazakh	5757		<b>S</b>	Uzbek	6772
Croatian	5464	Kinyarwanda	6469	Samoan	6559	Vietnamese	6855
Czech [CZE]	4965	Kirghiz	5771	Sangho	6553	Volapuk	6861
Danish [DAN]	5047	Kirundi	6460	Sanskrit	6547	Welsh	4971
Dutch [DUT]	6058	Korean [KOR]	5761	Scots Gaelic	5350	Wolof	6961
English [ENG]	5160	Kurdish	5767	Serbian	6564	Xhosa	7054
Esperanto	5161		<b>L-N</b>	Serbo-Croatian	6554	Yiddish	5655
Estonian	5166	Laothian	5861	Sesotho	6566	Yoruba	7161
	<b>F-H</b>	Latin	5847	Setswana	6660	Zulu	7267
Faroese	5261	Latvian; Lettish	5868	Shona	6560		
Fiji	5256	Lingala	5860	Sindhi	6550		
Finnish [FIN]	5255	Lithuanian	5866	Singhalese	6555		

If you choose a language that has a 3-letter language code, the code will be displayed every time you change the audio or subtitle language setting on page 17. If you choose any other languages, '---' will be displayed instead. (3-letter language code is written in bracket.)

## MAGNAVOX LIMITED WARRANTY

FUNAI CORP. will repair this product, free of charge in the USA in the event of defect in materials or workmanship as follows:

### DURATION:

**PARTS:** FUNAI CORP. will provide parts to replace defective parts without charge for one (1) year from the date of original retail purchase. Certain parts are excluded from this warranty.

**LABOR:** FUNAI CORP. will provide the labor without charge for a period of ninety (90) days from the date of original retail purchase.

### LIMITS AND EXCLUSIONS:

This warranty is extended only to the original retail purchaser. A purchase receipt or other proof of original retail purchase will be required together with the product to obtain service under this warranty.

This warranty shall not be extended to any other person or transferee.

This warranty is void and of no effect if any serial numbers on the product are altered, replaced, defaced, missing or if service was attempted by an unauthorized service center. This limited warranty does not apply to any product not purchased and used in the United States.

This product is produced for home use and this warranty only covers failures due to defects in material or workmanship which occurs during normal use. It does not cover damage which occurs in shipment, or failures which are caused by repairs, alterations or product not supplied by FUNAI CORP., or damage which results from accident, misuse, abuse, mishandling, misapplication, alteration, faulty installation, improper maintenance, commercial use such as hotel, rental or office use of this product or damage which results from fire, flood, lightning or other acts of God.

THIS WARRANTY DOES NOT COVER PACKING MATERIALS, ANY ACCESSORIES (EXCEPT REMOTE CONTROL), ANY COSMETIC PARTS, COMPLETE ASSEMBLY PARTS, DEMO OR FLOOR MODELS.

FUNAI CORP. AND ITS REPRESENTATIVES OR AGENTS SHALL IN NO EVENT BE LIABLE FOR ANY GENERAL, INDIRECT OR CONSEQUENTIAL DAMAGES ARISING OUT OF OR OCCASIONED BY THE USE OF OR THE INABILITY TO USE THIS PRODUCT. THIS WARRANTY IS MADE IN LIEU OF ALL OTHER WARRANTIES, EXPRESS OR IMPLIED, AND OF ALL OTHER LIABILITIES ON THE PART OF FUNAI,

ALL OTHER WARRANTIES INCLUDING THE WARRANTY OF MERCHANTABILITY, AND FITNESS FOR A PARTICULAR PURPOSE, ARE HEREBY DISCLAIMED BY FUNAI AND ITS REPRESENTATIVES IN THE UNITED STATES. ALL WARRANTY INSPECTIONS AND REPAIRS MUST BE PERFORMED BY AN AUTHORIZED SERVICE CENTER. THIS WARRANTY IS VALID WHEN THE UNIT IS CARRIED-IN TO AN AUTHORIZED SERVICE CENTER.

### IMPORTANT:

THIS LIMITED WARRANTY GIVES YOU SPECIFIC LEGAL RIGHTS. YOU MAY HAVE OTHER RIGHTS THAT VARY FROM STATE TO STATE. IF, AT ANY TIME DURING THE WARRANTY PERIOD, YOU ARE UNABLE TO OBTAIN SATISFACTION WITH THE REPAIR OF THIS PRODUCT, PLEASE CONTACT FUNAI CORP.

### ATTENTION:

FUNAI CORP. RESERVES THE RIGHT TO MODIFY ANY DESIGN OF THIS PRODUCT WITHOUT PRIOR NOTICE.

### WARRANTY STATEMENT REGARDING NON AUTHORIZED REPAIRS:

To obtain warranty service, you must take the product, or deliver the product freight prepaid, in either its original packaging or packaging affording an equal degree of protection, to any AUTHORIZED SERVICE CENTER. FUNAI CORP. will not reimburse you for any service done by unauthorized service providers without prior written approval.

To locate your nearest AUTHORIZED SERVICE CENTER or for general service inquiries, please contact us at:

**FUNAI CORPORATION**  
Customer Service

Tel :1-800-605-8610

<http://www.funai-corp.com>

19900 Van Ness Avenue, Torrance, CA 90501





## 1 Conexiones

Si su televisor tiene entradas de audio/video vea la sección "Connection to a TV" en la página 6 en el manual de manejo. En caso contrario, vea la sección "Connecting to RF Modulator (Not Supplied)" en la página del frente en el manual de manejo.

## 2 Instalación de las pilas en el control remoto

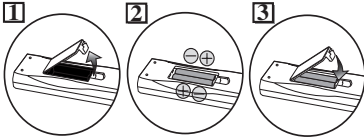

## 3 Para cambiar el idioma en la pantalla

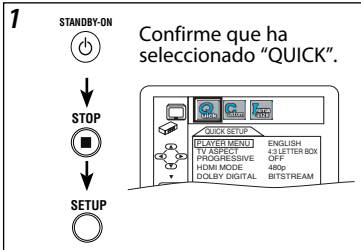

### 2 Confirme que ha seleccionado "PLAYER MENU".

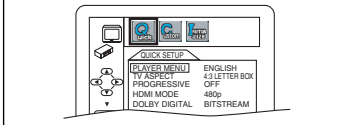

### 3 Seleccione el idioma deseado para las indicaciones en la pantalla.



### 4 Para salir del menú.



## 4 Reproducción

### Antes:

Encienda el televisor, amplificador y otros equipos que puedan estar conectados a esta unidad. Asegúrese que el televisor y el sintonizador de audio (no provisto) están en el canal correcto.

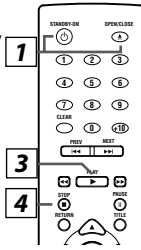

<p><b>1</b> Para abrir la bandeja del disco</p> →	<p><b>2</b> Ponga un disco con la etiqueta hacia arriba.</p>
<p><b>3</b> Para empezar la reproducción</p>	<p><b>4</b> Para parar la reproducción</p>

Botón (Orden alfabético)	Soporte	DVD	CD VCD MP3 JPEG
1 2 3			
4 5 6			
7 8 9			
0			
OK			
Left Arrow			
Right Arrow			
A-B REPEAT			
ANGLE			
AUDIO			
CLEAR			
DISC MENU			
DISPLAY			
MODE			
OPEN/CLOSE			
PAUSE			
PLAY			
PREV NEXT			
REPEAT			
RETURN			
SEARCH			
SETUP			
STANDBY-ON			
STOP			
SUBTITLE			
TITLE			
ZOOM			

corte aquí

Español

# Quick Use Guide

## 1 Connections

If your TV has audio/video input jacks, see the section "Connection to a TV" on page 6 of the owner's manual. If not, see the section "Connecting to RF Modulator (Not Supplied)" on the front page of the owner's manual.

## 2 Installing the Batteries for the Remote Control

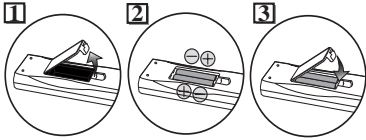

## 3 To Change the On-Screen Language

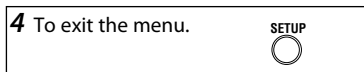
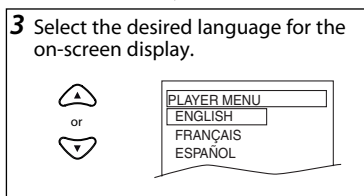
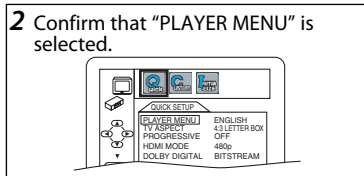
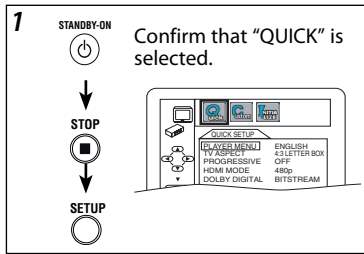

## 4 Playback

**Before:** Turn on the TV, amplifier and any other device which are connected to this unit. Make sure the TV and audio receiver (not supplied) are set to the correct channel.

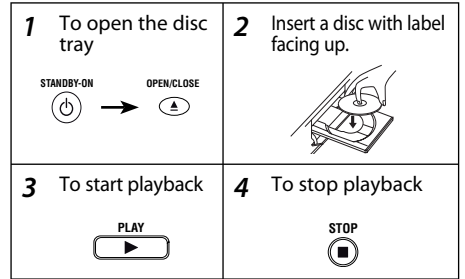
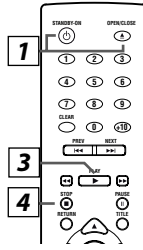

Button (Alphabetical order)	Disc	DVD	CD	VCD	MP3	JPEG
1 2 3 4 5 6 7 8 9 0		• To select chapter or title directly.				• To select track of file directly.
OK		• To move the cursor and determine its position.				• To move the cursor and determine its position. (CD/MP3/JPEG)
◀ ▶		• To search forward/backward through a disc. • To begin slow forward/reverse playback in the pause mode.				• To search forward/backward through a disc. • To begin slow forward playback in the pause mode. (VCD)
A-B REPEAT		• To repeat between your chosen point A and B.				• To repeat between your chosen point A and B. (CD/VCD)
ANGLE		• To select camera angles on a disc.				• To rotate a picture of JPEG files. (JPEG)
AUDIO		• To select audio languages on a disc.				• To select "STEREO", "L-ch" or "R-ch". (CD/VCD)
CLEAR		• To clear the markers. • To clear the numbers entered incorrectly. • To cancel the point for A-B repeat.				• To clear the markers. (CD/VCD) • To remove status number in program input. • To clear the numbers entered incorrectly. • To cancel the point for A-B repeat. (CD/VCD)
DISC MENU		• To call up the menu on a disc.				• To call up the file list. (MP3/JPEG)
DISPLAY		• To display the current disc or HDMI mode.				• To display the current disc or HDMI mode.
MODE		• To set black level on/off. • To set virtual surround on/off.				• To arrange the playing order or play randomly. (CD/MP3/JPEG) • To set virtual surround on/off. (CD/VCD/MP3) • To set black level on/off. (VCD) • To activate the slide show mode. (JPEG)
OPEN/CLOSE ▲		• To open or close the disc tray. • To turn the unit on.				• To open or close the disc tray. • To turn the unit on.
PAUSE ⏸		• To pause disc playback. • To advance playback one frame at a time.				• To pause disc playback. • To advance playback one frame at a time. (VCD)
PLAY ▶		• To begin disc playback. • To turn the unit on.				• To begin disc playback. • To turn the unit on.
PREV NEXT ◀ ▶		• To skip chapters.				• To skip tracks or files.
REPEAT		• To play back a chapter or title repeatedly.				• To play back a track or disc repeatedly. (CD/VCD) • To play back a file, folder or disc repeatedly. (MP3/JPEG)
RETURN		• To return to the previous operation in menu.				• To return to the previous operation in menu.
SEARCH		• To search chapter, title or time. • To set or search the markers.				• To search track. • To search time. (CD/VCD) • To set or search the markers. (CD/VCD)
SETUP		• To call up the setup menu.				• To call up the setup menu.
STANDBY-ON ⏻		• To turn the unit on or off.				• To turn the unit on or off.
STOP ⏹		• To stop playback.				• To stop playback.
SUBTITLE		• To select subtitles on a disc.				—
TITLE		• To call up the top menu on a disc.				• To return to the top file of the highest hierarchy in the program and file list. (MP3/JPEG)
ZOOM		• To magnify part of a picture. (2x/4x)				• To magnify part of a picture. (2x) (VCD/JPEG)

cut here