

**OWNER'S MANUAL**

**MAGNAVOX**  
SMART. VERY SMART.

## MDV410/MDV430 DVD PLAYER



**READ THIS MANUAL FIRST!**

CONGRATULATIONS ON PURCHASING THIS PRODUCT. WE'VE INCLUDED EVERYTHING YOU NEED TO GET STARTED. IF YOU HAVE ANY PROBLEMS, OUR REPRESENTATIVES CAN HELP YOU GET THE MOST FROM YOUR NEW PRODUCT BY EXPLAINING:

- HOOKUPS • FIRST TIME SETUP • FEATURE OPERATION

DO NOT ATTEMPT TO RETURN THIS PRODUCT TO THE STORE.

**FOR FAST HELP, CALL US FIRST!**

**1-800-705-2000**

THANK YOU FOR MAKING US A PART OF YOUR HOME!



**IMPORTANT!**

RETURN YOUR WARRANTY REGISTRATION CARD WITHIN 10 DAYS.

SEE WHY INSIDE.

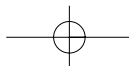
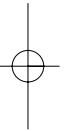
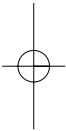

## Return your Warranty Registration card today to ensure you receive all the benefits you're entitled to.

Once your MAGNAVOX purchase is registered, you're eligible to receive all the privileges of owning a MAGNAVOX product. So complete and return the Warranty Registration Card enclosed with your purchase at once. And take advantage of these important benefits.

<b>Warranty Verification</b>	<b>Owner Confirmation</b>	<b>Model Registration</b>
Registering your product within 10 days confirms your right to maximum protection under the terms and conditions of your MAGNAVOX warranty.	Your completed Warranty Registration Card serves as verification of ownership in the event of product theft or loss.	Returning your Warranty Registration Card right away guarantees you'll receive all the information and special offers which you qualify for as the owner of your model.

**Congratulations on your purchase, and welcome to the "family!"**



**Dear MAGNAVOX product owner:**

Thank you for your confidence in MAGNAVOX. You've selected one of the best-built, best-backed products available today. And we'll do everything in our power to keep you happy with your purchase for many years to come.

As a member of the MAGNAVOX "family," you're entitled to protection by one of the most comprehensive warranties and outstanding service networks in the industry.

What's more, your purchase guarantees you'll receive all the information and special offers for which you qualify, plus easy access to accessories from our convenient home shopping network.

And most importantly you can count on our uncompromising commitment to your total satisfaction.

All of this is our way of saying welcome-and thanks for investing in a MAGNAVOX product.

**P.S. Remember, to get the most from your MAGNAVOX product, you must return your Warranty Registration Card within 10 days. So please mail it to us right now!**

Know these **safety** symbols



**⚡** This "bolt of lightning" indicates uninsulated material within your unit may cause an electrical shock. For the safety of everyone in your household, please do not remove product covering.

**⚠** The "exclamation point" calls attention to features for which you should read the enclosed literature closely to prevent operating and maintenance problems.

**WARNING:** TO PREVENT FIRE OR SHOCK HAZARD, DO NOT EXPOSE THIS EQUIPMENT TO RAIN OR MOISTURE.

**CAUTION:** To prevent electric shock, match wide blade of plug to wide slot, fully insert.

**ATTENTION:** Pour éviter les choc électriques, introduire la lame la plus large de la fiche dans la borne correspondante de la prise et pousser jusqu'au fond.

**For Customer Use**

Enter below the Serial No. which is located on the rear of the cabinet. Retain this information for future reference.

Model No. \_\_\_\_\_  
 Serial No. \_\_\_\_\_

Visit our World Wide Web Site at <http://www.magnavox.com>

## Table of Contents 3

### General Information

Table of Contents .....	3
Safety Information .....	4
Introduction .....	5
Playable Discs .....	6

### Getting Started

Remote Control Setup .....	7
Hookups .....	8-13
Remote Control Buttons .....	14-15
Front Panel .....	16
Display Panel .....	17
Rear Panel .....	18

### Disc Playback and Features

Playing a Disc .....	19
Menus .....	20
Paused and Step-by-Step Playback, Resume On .....	21
Fast Forward/Reverse Search .....	22
Slow Motion, Zoom .....	23
Specific Track Playback .....	24
Specific Title/Chapter Playback, Specific Time Playback .....	25
Repeat Playback .....	26
A-B Repeat Playback .....	27
Programmed Playback .....	28
Random Playback, MP3 Playback .....	29
MP3 Display Information, MP3 Track Selection .....	30
Random MP3 Playback, Programmed MP3 Playback .....	31
Audio Language, Stereo Sound Mode .....	32
Subtitle Language .....	33
Camera Angles .....	34

### DVD Player Setup and Features

On-Screen Display .....	35
Parental Controls Password .....	36
Parental Controls Levels .....	37
Marker Setup Screen .....	38
Audio Controls .....	39
Display Controls .....	40-41
Language Controls .....	42-43
Black Level Settings, TruSurround Setting .....	44

### Information You May Need

Care and Maintenance, Glossary .....	45
Helpful Hints .....	46-47
Limited Warranty .....	48
Specifications .....	49
Index .....	50
Supplied Accessories .....	51

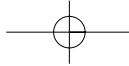

## 4 Safety Information

---

### Safety Precautions

**Warning:** To prevent fire or shock hazard, do not expose this equipment to rain or moisture.

**Federal Communications Commission (FCC) Warning:** Any unauthorized changes or modifications to this equipment void the user's authority to operate it.

### Laser Safety

This unit employs a laser. Only a qualified service person should remove the cover or attempt to service this device, due to possible eye injury.

CAUTION: USE OF CONTROLS OR ADJUSTMENTS OR PERFORMANCE OF PROCEDURES OTHER THAN THOSE SPECIFIED HEREIN MAY RESULT IN HAZARDOUS RADIATION EXPOSURE.

CAUTION: VISIBLE AND INVISIBLE LASER RADIATION WHEN OPEN AND INTERLOCK DEFEATED. DO NOT STARE INTO BEAM. THE BEAM IS LOCATED INSIDE, NEAR THE DECK MECHANISM.

### Special Information for Canadian Users

This Class B digital apparatus complies with Canadian ICES-003.

Cet appareil numérique de la classe B est conforme à la norme NMB-003 du Canada.

### Radio/TV Interference

This equipment has been tested and found to comply with the limits for a Class B digital device, pursuant to Part 15 of the FCC Rules. These limits are designed to provide reasonable protection against harmful interference in a residential installation. This equipment generates, uses, and can radiate radio frequency energy and, if not installed and used in accordance with the instructions, may cause harmful interference to radio communications. However, there is no guarantee that interference will not occur in a particular installation. If this equipment does cause harmful interference to radio or television reception, which can be determined by turning the equipment off and on, the user is encouraged to try to correct the interference by one or more of the following measures:

- 1) Reorient or relocate the receiving antenna.
- 2) Increase the separation between the equipment and the receiver.
- 3) Connect the equipment into an outlet on a circuit different from that to which the receiver is connected.
- 4) Consult the dealer or an experienced radio/TV technician for help.

### Copyright Protection

Unauthorized copying, broadcasting, public performance and lending of Discs are prohibited.

This product incorporates copyright protection technology that is protected by method claims of certain U.S. patents and other intellectual property rights owned by Macrovision Corporation and other rights owners. Use of this copyright protection technology must be authorized by Macrovision Corporation and is intended for home and other limited viewing uses only unless otherwise authorized by Macrovision Corporation. Reverse engineering or disassembly is prohibited.

### Declaration of Conformity

Model Number: MDV410, MDV430  
Trade Name: Magnavox  
Responsible Party: Philips Consumer Electronics  
P.O. Box 14810  
Knoxville, TN 37914-1810  
(865) 521-4316

Manufactured under license from Dolby Laboratories. "Dolby" and the double-D symbol are trademarks of Dolby Laboratories.

Copyright 2002 Magnavox. All rights reserved.

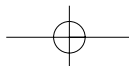
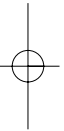
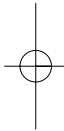

## Introduction 5

### Welcome!

This owner's manual describes two models: the MDV410 and the MDV430. The display panels of these two Players have a different appearance. Also, the MDV430 has COMPONENT VIDEO OUT jacks, but the MDV410 does not. Otherwise, the two models operate identically. Unless noted otherwise, the MDV430 is shown in this manual.

These Digital Video Disc Players provide high picture quality, clear sound, and endless playback features available on Digital Video Discs (DVDs). Add options to your DVD viewing - watch a director's cut of a movie, listen to the producer's comments, or play your favorite scene over and over again. The possibilities are limited only by your choices and the materials available on the DVD.

You can listen to Audio Compact Discs and MP3 files on this DVD Player as well.

To get the most enjoyment from the DVD Player, read this owner's manual carefully. It describes how to access the features listed below.

### Features

- Audio Language choices \*
- Camera Angles \*
- DVD Menus in a desired language \*
- Markers
- MP3 Playback
- Parental Controls\*
- Paused/Fast/Slow/Step-by-Step Playback
- Program Playback
- Random Playback
- Repeat, A-B Repeat
- Specific Time/Title/Chapter/Track Playback
- Subtitles \*
- Zoom

\* If available on the Disc

### When referring to this manual, remember...

**DVD** Indicates the feature described is available on some Digital Video Discs.

**AUDIO CD** Indicates the feature described is available on some Audio Compact Discs.

**MP3** Indicates the feature described is available with MP3 files.

### Disc Menus...

Some explanations in this manual describe the DVD Disc Menus. These menus are set by the movie producers and will vary among Discs. Not all Discs have menus. However, if the Disc has a menu, you can access the Disc Menu by pressing the MENU button on the remote control. *Details are on page 20.*

### DVD Player Setup Menus...

Some instructions explain how to use the DVD Player's Setup menu to set features of the DVD Player or the Disc. Access the DVD Player's Setup menu by pressing SETUP on the remote control when Disc playback is stopped. Even if a feature is set up in the DVD Player's menu, it may not be available if the current Disc does not include that feature.

### Available Disc Features...



All the features described in this manual may not be available on every Disc. If the feature is not available on the Disc, you cannot use the DVD Player to make the feature available. An "X" will appear in the top right corner of the TV screen if you try to access a feature that is not available on the current Disc or not available at the current time.

This unit employs TruSurround system

**TruSurround**  
by SRS (●) of SRS Labs, Inc. as virtual technology.

TruSurround and the (●) symbol are trademarks of SRS Labs, Inc.  
TruSurround technology is incorporated under license from SRS Labs, Inc.

## 6 Playable Discs

### Playable Discs

This DVD Player will play Digital Video Discs (DVDs) and Audio Compact Discs (CDs), and has limited playability of finalized Digital Video Discs Rewritable (DVD+RW) and Compact Discs Rewritable (CD-RW).

To play a DVD on this DVD Player, make sure the Disc meets the requirements for Region Codes and Color Systems as described below.

Discs that have the following logos will play on this DVD Player.



DVD



DVD



Audio CD

CD-RW  
(limited)DVD+RW  
(limited)

### Region Codes

DVDs must be labeled for ALL regions or for Region 1 in order to play on this DVD Player. You can not play DVDs that are labeled for other regions.

Look for the symbols below on your DVDs. If these region symbols do not appear on your DVD, you cannot play the DVD in this DVD Player.



The number inside the globe refers to a region of the world. Region 1 represents the United States, Canada, upper regions of North America, Bermuda, the U.S. Virgin Islands, and small regions near Australia.

A Disc encoded in a specific region format can only play on DVD Players with the same region code. For example, if a Disc is labeled for Region 2, you can not play the DVD on this DVD Player.

### Color Systems

Different color systems are available throughout the world. The most common color systems are NTSC, which is used primarily in the United States and North America, PAL, and SECAM.

This DVD Player uses the NTSC color system. Therefore, the Discs that you play must be recorded in the NTSC system. You cannot play Discs recorded in other formats. The color system of the DVD may be listed on the DVD or on the Disc case.

### Unacceptable Discs

If you insert an unacceptable type of disc, "Please insert a playable disc" will appear on the TV screen. (Also, "- - - -" will appear on the display panel of the MDV430. There is no indication on the front of the MDV410 if an unacceptable Disc is in the disc tray.) The following Discs will not play on this DVD Player.

- CD-ROM
- Compact Disc-Interactive (CD-I)
- DVD-RAM
- DVD-ROM
- Super Audio CD (SACD) (The Audio CD layer of a hybrid SACD may play.)
- Photo CD
- Video CD
- Video Single Disc (VSD)

Audio of the following discs might play, but video will not be accessible.

- Compact Disc-Graphic (CD-G)
- Compact Disc-Video (CD-V)

## Remote Control Setup 7

### Putting Batteries in the Remote Control

- 1** Remove the battery compartment lid on the bottom of the remote control by sliding the lid down and off, following the direction of the arrow on the lid.
- 2** Place two AA batteries inside the battery compartment with their + and – ends aligned as indicated.
- 3** Replace the battery compartment lid.

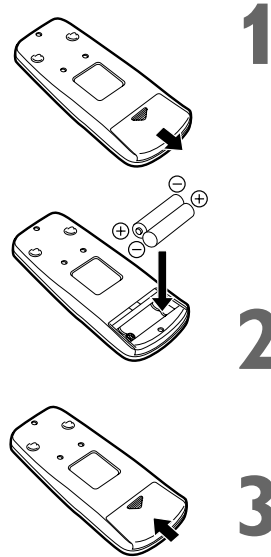

### Using the Remote Control

Point the remote control at the DVD Player's remote sensor (see page 16) when using the remote control to operate the DVD Player.

Do not put objects between the remote control and the DVD Player.

### Recycling Guidelines/Battery Safety

- Your new product and its packaging contain materials that can be recycled and reused. Specialized companies can recycle your product to increase the amount that needs to be properly disposed. Your product uses batteries that should not be thrown away when depleted but should be disposed of as small chemical waste. Please find out about the local regulations on disposal of your old product, batteries, and packaging whenever you replace existing equipment.
- Battery Usage CAUTION - To prevent battery leakage that may result in bodily injury or damage to the unit:
  - Install ALL batteries correctly, with the + and - markings on the battery aligned as indicated on the unit;
  - Do not mix batteries, for example, old with new or carbon with alkaline; and
  - Remove batteries when the unit will not be used for a long time.

## 8 Hookups

Depending on your TV and other equipment you wish to connect, there are various ways you could connect the DVD Player. Use only one of the connections described in the following pages.

### Before you begin...

- Refer to the manuals of your TV, Stereo or other devices as necessary. Note the style of jacks and connectors on the other equipment. Determine how to choose different Audio and Video In channels on your other equipment so you can see and hear the DVD Player on the TV, Stereo, etc.
- Disconnect all equipment from the power outlets. Connect the equipment to the power outlets only after you have finished hooking up everything. Never make or change connections with equipment connected to the power outlet.

### Determining the best possible connection...

Your hookup will be determined primarily by feature availability of your existing equipment. However, the following guidelines describe which options have the best picture and sound quality.

★★★★ COMPONENT VIDEO OUT jacks provide the best picture quality. These are available on the MDV430 only.

★★★ Use the S-VIDEO OUT jack for excellent picture quality.

★★ Use the yellow VIDEO OUT jack for good picture quality.

★★ **If your TV only has an RF-style jack, usually labelled Antenna In or 75 ohm, you will need an RF adapter in order to connect the DVD Player to the TV.** Ask your electronics retailer for details. The DVD picture still will exceed the quality of videotapes and other analog recordings.

★★★★ Digital audio connections provide the clearest sound. Connect the DVD Player's DIGITAL AUDIO OUT COAXIAL jack to your Stereo for the best sound quality.

★★★ If digital connections are not possible, connect the DVD Player's red and white AUDIO OUT jacks to the Audio In jacks of your Stereo or TV.

### Remember...

- Connect the DVD Player directly to the TV. For example, do not connect the DVD Player to a VCR, then connect the VCR to a TV. This type of connection may distort the picture and sound. Also, your VCR might have the copy protection system, which could further distort the DVD image.
- Set the TV to the correct Video In channel. Such channels may be called AUX or AUXILIARY IN, AUDIO/VIDEO or A/V IN, EXT1 or EXT2 or External In, etc. These channels often are located near channel 00. See your TV owner's manual for details. Or, keep changing channels at the TV until you see the DVD logo or DVD playback on the TV screen. (The DVD Player power must be on.)
- Set the Stereo to the correct channel or "source" mode.
- Do not connect the DVD Player's AUDIO OUT jacks to the PHONO IN jack of your Stereo.
- Depending on your connection, you may need to purchase additional cables.
- You only need one audio connection and one video connection.
- If you do not connect the DVD Player to a Dolby Digital-compatible Stereo, set DOLBY DIGITAL to OFF on the DVD Player. *Details are on pages 11 and 39.* Playing a Disc when the settings are wrong could distort the sound or damage the speakers.

**Once you determine the best option, find your choice on pages 9-13.**

**Follow the specific steps for the hookup you chose.**



## Hookups (cont'd) 9

### **Connecting the DVD Player to a TV only** **TV has AUDIO (red and white) and VIDEO (yellow) IN jacks**

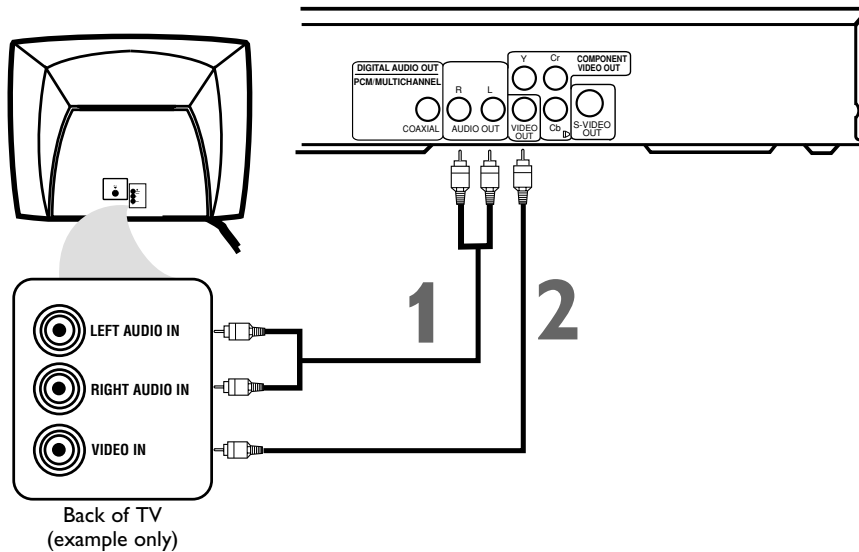

- 1** Connect the supplied red and white audio cables to the red and white **AUDIO OUT** jacks on the DVD Player and to the red and white **AUDIO IN** jacks on the TV, matching the cable colors to the jack colors.
- 2** Connect the supplied yellow video cable to the **VIDEO OUT** jack on the DVD Player and to the **VIDEO IN** jack on the TV.
- 3** Connect the TV's power cord to a power outlet.  
Turn on the TV and set it to the **Audio/Video In** channel, which also may be referred to as **A/V In** or **Auxiliary In**. This channel usually is near channel 00. See your TV owner's manual for details.
- 4** Connect the DVD Player's power cord to a power outlet.  
Press the **POWER** button to turn on the DVD Player.  
You should see the DVD logo on the TV screen. If you do not, check your connections and make sure the TV is set to the correct Audio/Video In channel.

## 10 Hookups (cont'd)

### ***Connecting the DVD Player to a TV only TV has AUDIO (red and white) and S-VIDEO IN jacks***

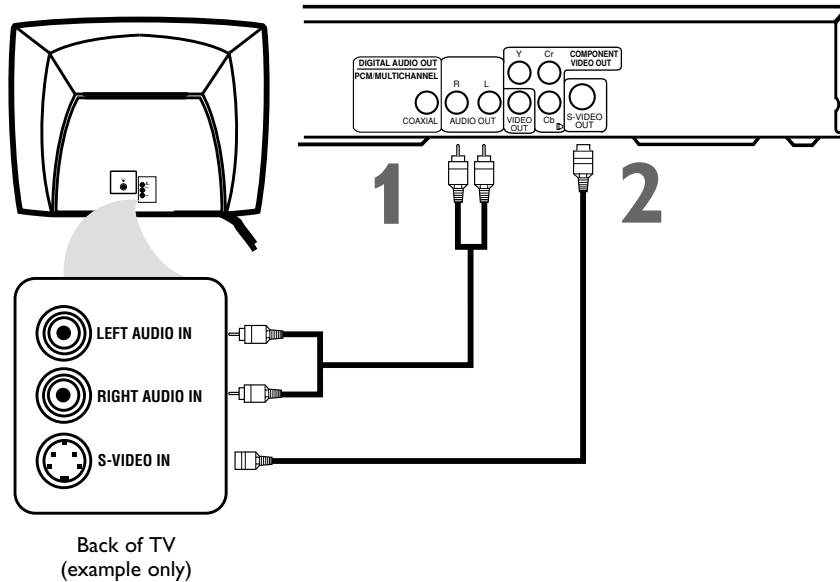

- 1** Connect the supplied red and white audio cables to the red and white **AUDIO OUT** jacks on the DVD Player and to the red and white **AUDIO IN** jacks on the TV, matching the cable colors to the jack colors.
- 2** Connect an S-Video cable (not supplied) to the **S-VIDEO OUT** jack on the DVD Player and to the **S-VIDEO IN** jack on the TV.
- 3** Connect the TV's power cord to a power outlet.  
Turn on the TV and set it to the **S-VIDEO IN** channel. This channel may be near channel 00. See your TV owner's manual for details.
- 4** Connect the DVD Player's power cord to a power outlet.  
Press the **POWER**  button to turn on the DVD Player.  
You should see the DVD logo on the TV screen. If you do not, check your connections and make sure the TV is on the correct S-Video In channel.

## Hookups (cont'd) 11

### **Connecting to a TV and a Stereo that is Dolby Digital or MPEG compatible**

Some Discs are recorded in a 5.1 channel Dolby Digital Surround format. These Discs will sound best if you connect the DVD Player to a Stereo that has Dolby Digital.

- Set DOLBY DIGITAL to ON if you connect the Player to a Dolby Digital-compatible Stereo. *Details are on page 39.*
- If you play an MPEG audio disc and connect the Player to an MPEG-compatible Stereo, set MPEG to ON. *Details are on page 39.*
- Select 5.1 channel Dolby Digital Surround sound if available in the DVD's menu.
- This DVD Player does not support the Digital Theater System (DTS).

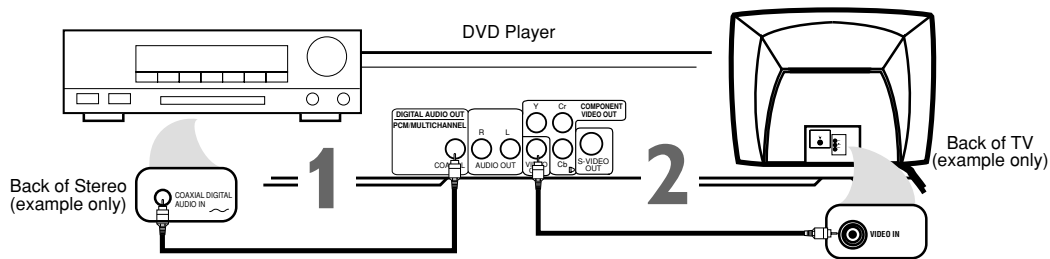

- 1** Connect a coaxial digital audio cable (not supplied) to the **COAXIAL** jack on the DVD Player and to the **COAXIAL DIGITAL AUDIO IN** jack on the Stereo.
- 2** Connect the supplied yellow video cable to the yellow **VIDEO OUT** jack on the DVD Player and to the **VIDEO IN** jack on the TV. You may use S-Video or Component Video (MDV430 only) if S-Video or Component Video is available on your TV. See pages 10 and 12 for these optional video connections. Remember, you only need one video connection between the TV and the DVD Player.
- 3** Plug in the Stereo's power cord. Turn on the Stereo and select the **Auxiliary IN** station. During Disc playback, you will adjust the volume at the Stereo. See your Stereo owner's manual for details.
- 4** Plug in the TV's power cord. Turn on the TV and set it to the correct **Video In** channel. During Audio CD playback, you may check the Disc status on your TV screen. During DVD playback, you will watch the program on the TV. See your TV owner's manual for details.
- 5** Connect the DVD Player's power cord to a power outlet. Press the **POWER** button to turn on the DVD Player. You should see the DVD logo on the TV screen. If you do not, check your connections and make sure the TV is on the correct channel.

## 12 Hookups (cont'd)

### **Connecting to a TV and a Stereo** **TV has Component Video In Jacks** **(possible only with MVD430)**

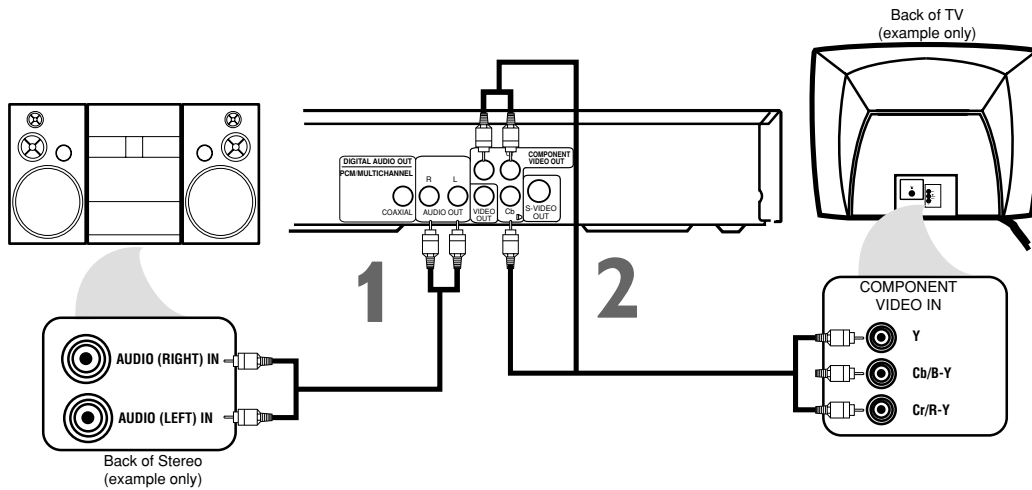

- 1** Connect the supplied red and white audio cables to the red and white **AUDIO OUT** jacks on the DVD Player and to the red and white **AUDIO IN** jacks on the Stereo, matching the cable colors to the jack colors.

You can use the Digital Audio Out Coaxial connection instead if your Stereo has a Coaxial In jack. Details are on pages 11 and 13. Remember, you only need one audio connection.
- 2** Connect component video cables (not supplied) to the **COMPONENT VIDEO OUT** jacks on the DVD Player and to the **COMPONENT VIDEO IN** jacks on the TV.
- 3** Plug in the Stereo's power cord. Turn on the Stereo and select the Stereo's **Auxiliary IN** station. During Disc playback, you will adjust the volume at your Stereo. See your Stereo owner's manual for details.
- 4** Plug in the TV's power cord. Turn on the TV and set it to the **Component Video In** channel, which may be near channel **00**. During Audio CD playback, you may check the status of Audio CDs on your TV screen. During DVD playback, you will watch the program on the TV. See your TV owner's manual for details.
- 5** Connect the DVD Player's power cord to a power outlet. Press the **POWER**  button to turn on the DVD Player. You should see the DVD logo on the TV screen. If you do not, check your connections and make sure the TV is on the correct Component Video In channel.

## Hookups (cont'd) 13

### Connecting to a TV and a Stereo with Digital Input jacks, Mini-Disc Deck or Digital Audio Tape Deck

- If the Disc is recorded in 5.1 channel Dolby Digital Surround, you cannot copy the Disc in digital sound using a Mini-Disc or Digital Audio Tape Deck.

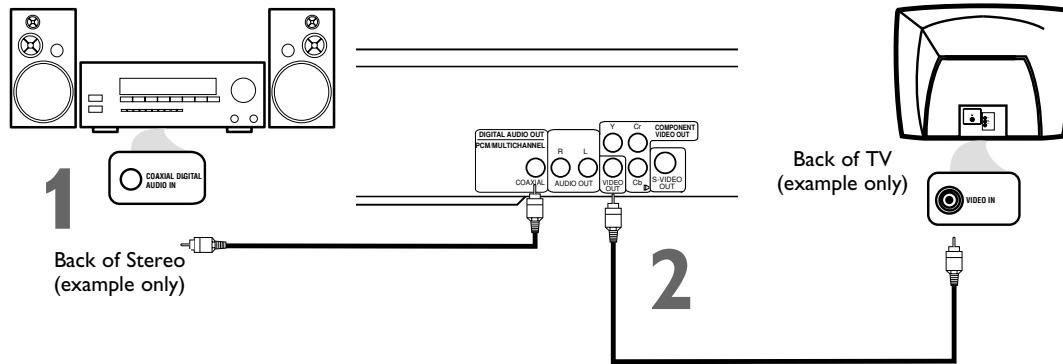

- 1** Connect a coaxial digital audio cable (not supplied) to the **COAXIAL** jack on the DVD Player and to the **COAXIAL DIGITAL AUDIO IN** jack on the Stereo.
- 2** Connect the supplied yellow video cable to the yellow **VIDEO OUT** jack on the DVD Player and to the **VIDEO IN** jack on the TV. You may use S-Video or Component Video (MDV430 only) if S-Video or Component Video is available on your TV. See *pages 10 and 12* for these optional video connections. Remember, you only need one video connection between the TV and the DVD Player.
- 3** Plug in the Stereo's power cord. Turn on the Stereo and select the **Auxiliary IN** station. During Disc playback, you will adjust the volume at the Stereo. See your Stereo owner's manual for details.
- 4** Plug in the TV's power cord. Turn on the TV and set it to the correct **Video In** channel. During Audio CD playback, you may check the status of the Disc on your TV screen. During DVD playback, you will watch the program on the TV. See your TV owner's manual for details.
- 5** Plug in the DVD Player's power cord. Press the **POWER** button to turn on the DVD Player. You should see the DVD logo on the TV screen. If you do not, check your connections and make sure the TV is on the correct channel.

## 14 Remote Control Buttons

- OPEN/CLOSE ▲ Button**  
Press to open or close the Disc tray.
- A-B REPEAT Button**  
Press to set up A-B Repeat Play, which repeatedly plays a specific segment of a Disc. *Details are on page 27.*
- REPEAT Button**  
Press to repeat playback of the current Disc or Track (Audio CD) or a Title or Chapter (DVD). *Details are on page 26.*
- POWER ⏻ Button**  
Press to turn the power on and off. P-ON or P-OFF appears briefly on the display panel of the MDV430. The red POWER light appears on the front of the MDV410 when the power is on.
- DISPLAY Button**  
Press to see the current status of the Disc on the TV screen during playback. Press repeatedly to remove the status display. *Details are on page 35.*
- Number Buttons**  
Press to directly select a Track (Audio CD) for playback. *Details are on page 24.*  
Use the Number buttons to program Tracks (Audio CD) for playback. *Details are on page 28.*
- CLEAR Button**  
Press to erase incorrect information when setting up features.
- MENU Button**  
Press to display the Disc menu. *Details are on pages 5 and 20.*
- SETUP Button**  
When Disc playback is stopped, press to access or remove the DVD Player's Setup menu.
- Arrow Buttons**  
Press to select an item in the DVD Player's Setup menu or in the Disc menu.
- MARKER Button**  
Press to set a Marker, which will give you quick access to points on a Disc that you select. *Details are on page 38.*
- ZOOM Button**  
Press to enlarge the DVD picture. *Details are on page 23.*
- MODE Button**  
When playback is stopped, press to set up programmed or random playback for an Audio CD or MP3 files. *Details are on pages 28-29.*  
During DVD playback, press to set up the black level setting or TruSurround setting. *Details are on page 44.*
- SEARCH MODE Button**  
Press to access or remove the Search display, which allows you to go directly to a specific Title/Chapter/Track/Time. *Details are on pages 24-25.*

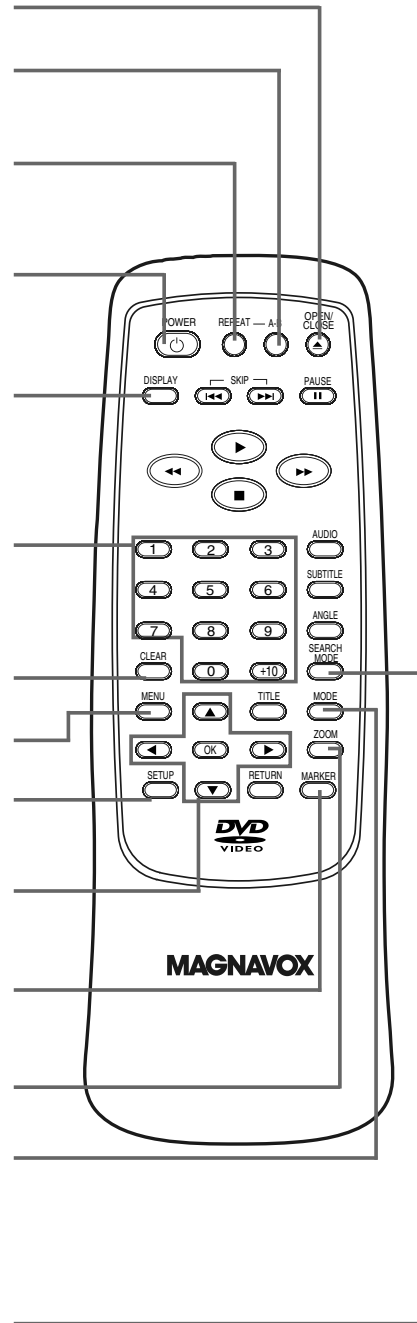



## Remote Control Buttons (cont'd) 15





**Pause  Button**  
Press to pause Disc playback. *Details are on page 21.* Press repeatedly to advance the DVD picture step by step (or one frame at a time). *Details are on page 21.*

**SKIP  and  Buttons**  
Press to skip Chapters or Tracks. *Details are on page 24-25.*

**Play  Button**  
Press to begin Disc play.

**Reverse  Button**  
Press to view the picture in fast reverse motion (DVD) or to reverse playback of an Audio CD. *Details are on page 22.*

**Stop  Button**  
Press to stop Disc play.

**Fast Forward  Button**  
Press to fast forward the Disc. *Details are on page 22.* On a DVD, press the Pause  button, then press the Fast Forward  button to begin slow motion playback. Press the Fast Forward  button repeatedly to change the forward speed of slow motion. *Details are on page 23.*

**TITLE Button**  
Press to display the Title menu of the DVD, if available. *Details are on page 20.*

**OK Button**  
Press to select, change, or confirm a setting in the DVD Player's Setup menu.  
Press to select a feature in the DVD Disc menu.

**RETURN Button**  
Press to return to the previous DVD Player Setup menu or to remove the Setup menu from the TV screen.

**ANGLE Button**  
Press to view the picture from a different angle (if available).  
Press to choose one of the available angles. *Details are on page 34.*

**SUBTITLE Button**  
Press to select a language for the subtitles (among those available) or to turn off the subtitles. *Details are on page 33.*

**AUDIO Button**  
Press to choose one of the audio languages available on a DVD or to choose a Stereo sound mode during Audio CD playback. *Details are on page 32.*

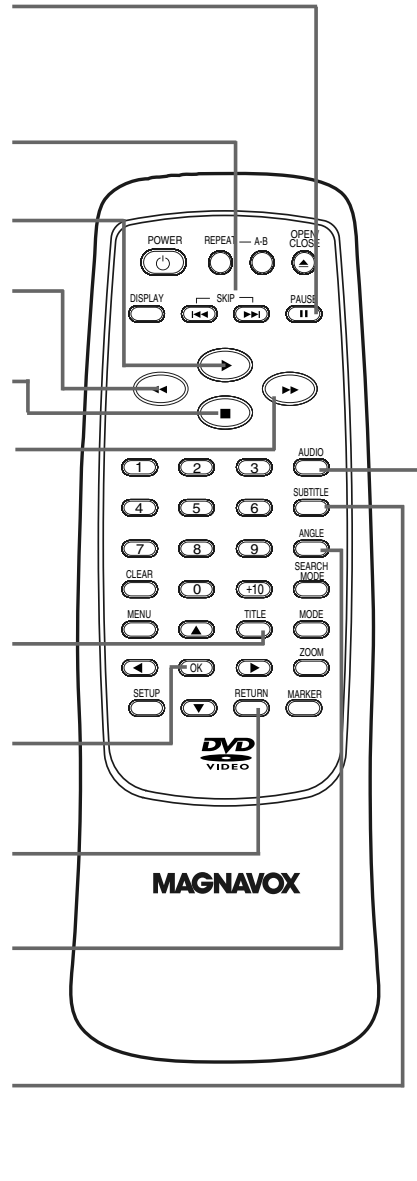

## 16 Front Panel

---

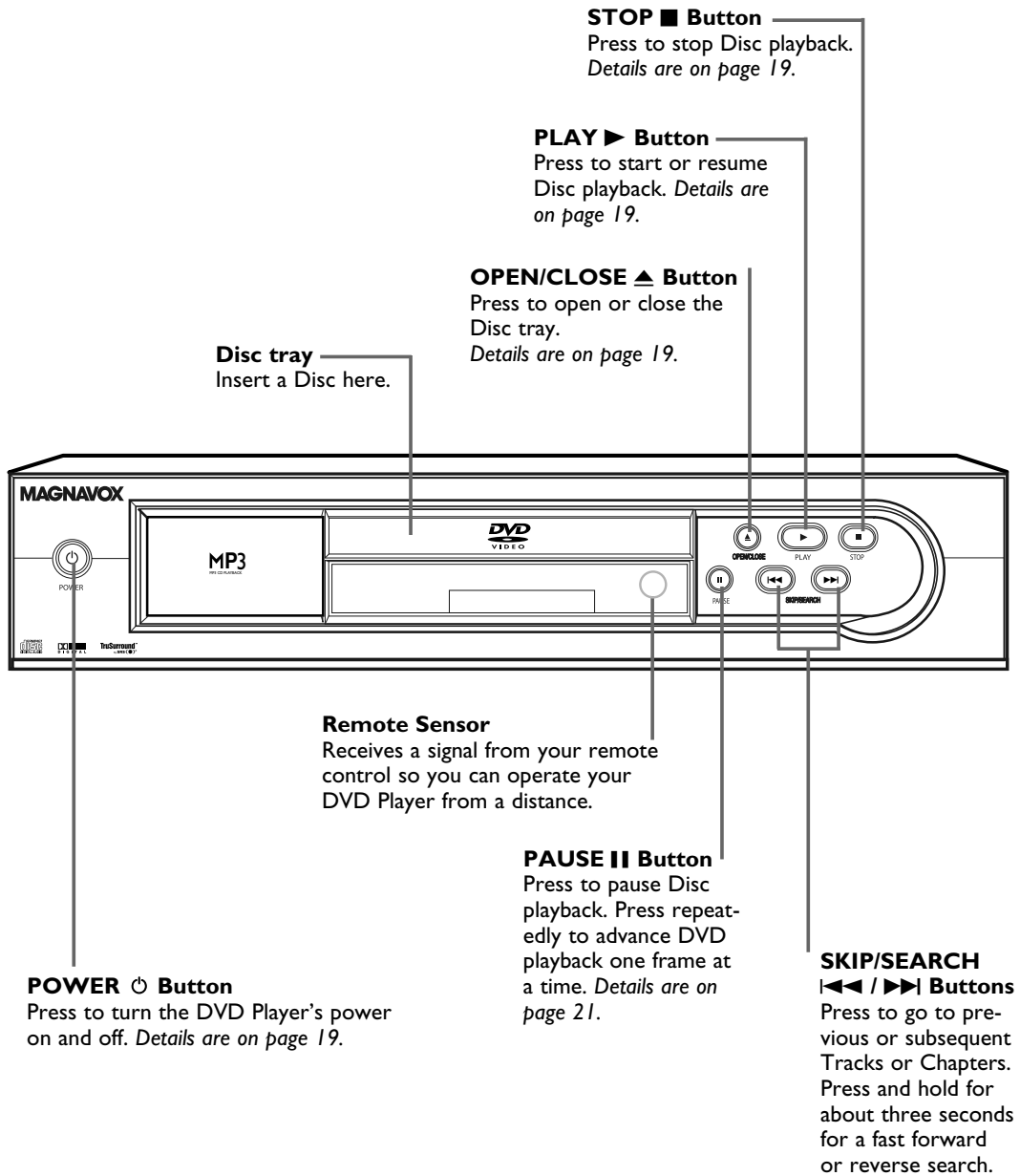



## Display Panel 17

### MDV430

#### Display with Dimmer

Messages about current DVD Player operations appear here. See Display Messages below. You can adjust the brightness of the display. Details are on pages 40-41.

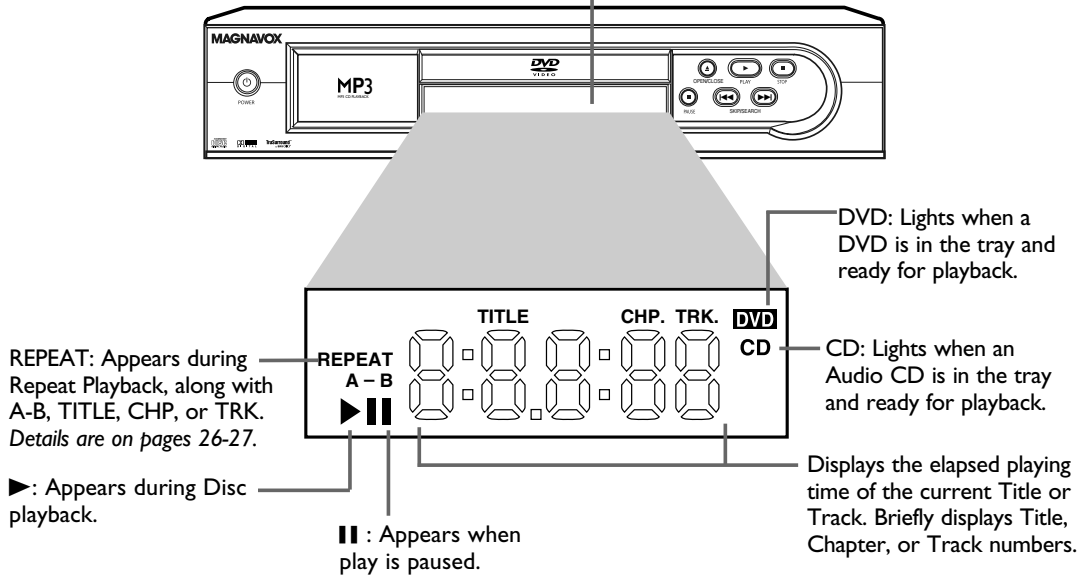

#### Display Messages (MDV430)

P-ON	Power is turning on.	CLOSE	Tray is closing.
- - - -	Appears after the disc tray closes if the tray is empty, if there is an error reading the disc, or if an unacceptable disc is installed.	Load	Disc is loading.
OPEN	Tray is opening or is open.	P-OFF	Power is turning off.

### MDV410

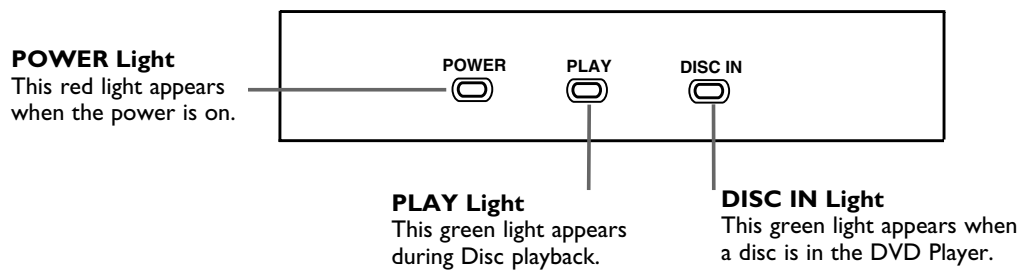

## 18 Rear Panel

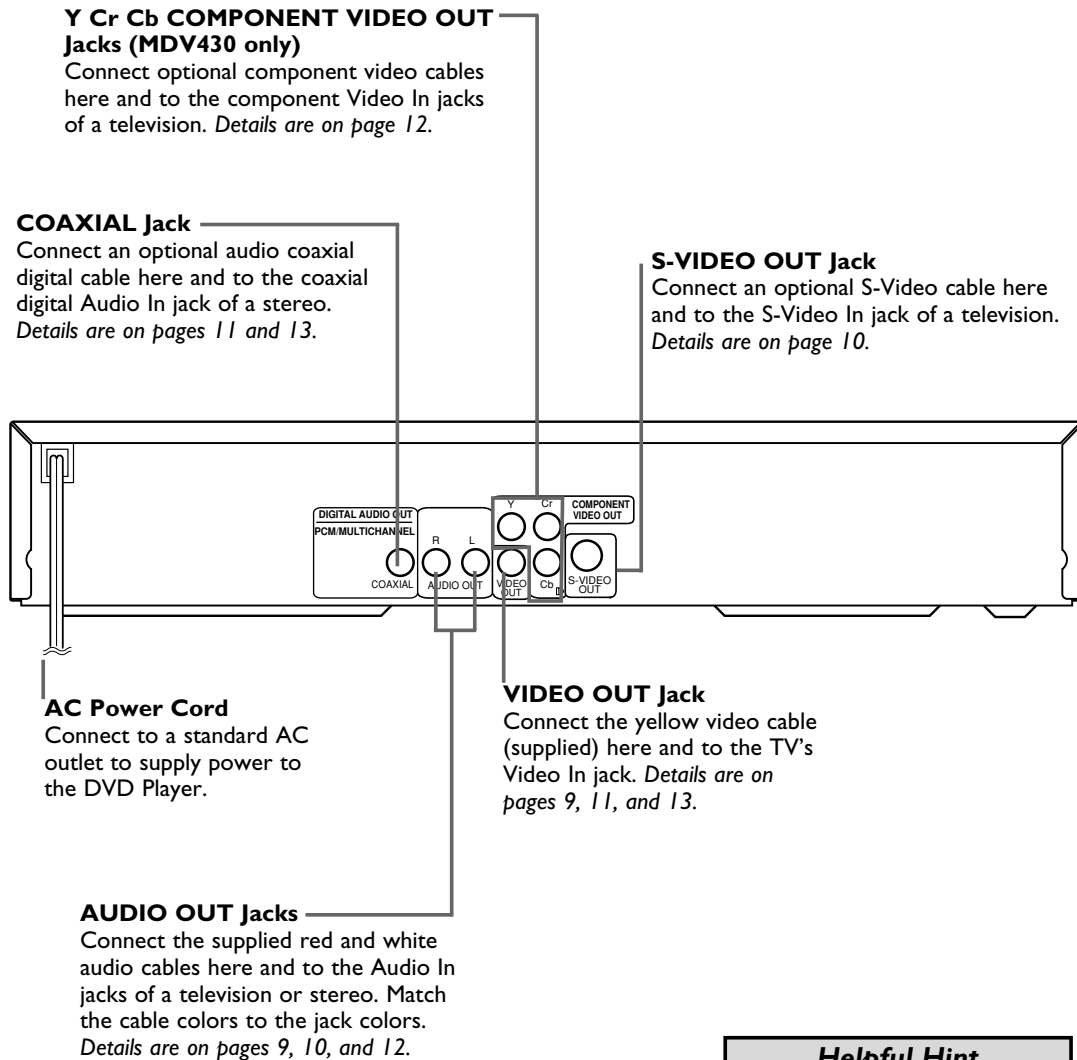

### Helpful Hint

- You only need one audio connection and one video connection, so you will not have a cable connected to every jack. For example, if you are using the S-VIDEO OUT jack, you will not use the yellow VIDEO OUT jack or the Y Cr Cb COMPONENT VIDEO OUT jacks.

## Playing a Disc 19

DVD

AUDIO CD

Before you begin, turn on the power of the TV, stereo, and any other equipment connected to the DVD Player. Make sure the TV and the stereo (if applicable) are set to the correct channel. *Details are on pages 8-13.*

- 1 Press POWER to turn on the DVD Player.**  
P-ON will appear briefly on the display panel of the MDV430. The red POWER light will appear on the front of the MDV410 when the power is on.
- 2 Press OPEN/CLOSE ▲ to open the Disc tray.**
- 3 Place a Disc into the tray.** Make sure the Disc is sitting properly in the recessed groove of the tray. Some DVDs are recorded on both sides. Make sure the side you want to play is facing up. Or, if the DVD is recorded on only one side, place the Disc in the tray with the label facing up (shiny side facing down).

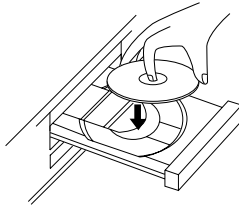

- 4 Press OPEN/CLOSE ▲ to close the tray.** Disc playback may start automatically. Or, if the DVD has a menu, the menu may appear on the screen instead. *Details are on page 20.*  
With some Audio CDs, playback will not begin until you press Play ►.
- 5 Press Stop ■ to stop playback.**

**Remember, this DVD Player will play only certain Discs. See page six for details.**

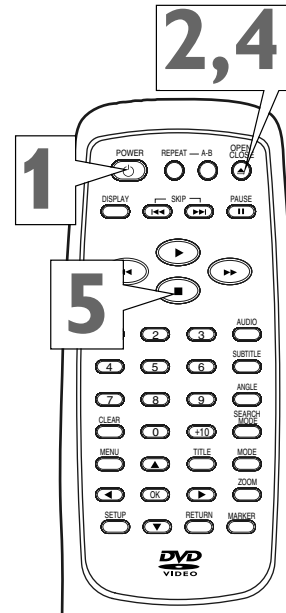

### Helpful Hints

- An "X" may appear in the top right corner of the TV screen when you try a feature. This means either the feature you tried is not available on the Disc, or the DVD Player can not access the feature at this time. This does not indicate a problem with the DVD Player.
- If a Disc is dirty or has scratches, the pictures may appear distorted and playback may stop. In such cases, remove the Disc and turn off the DVD Player. Unplug the power cord, then reconnect it to the power outlet. Clean the Disc, then turn on the DVD Player again and reinsert the Disc for playback.
- If a Disc has multiple layers, the picture may freeze occasionally. This happens when the first layer switches to the second layer. This is not a malfunction.

## 20 Menus

### DVD

#### DVD Disc Menus

Some DVDs contain menus that describe the contents of the Disc or allow you to customize Disc playback. For example, the menu may offer choices for subtitle languages, director's commentary, or soundtrack playback.

To use the DVD menu and select playback features, follow these steps.

- 1** Press **MENU**. The DVD's main menu will appear.
- 2** Press **▲▼◀▶** to select an item, then press **OK**. Continue this process to set up all the features you wish to see on the Disc or to start playback.

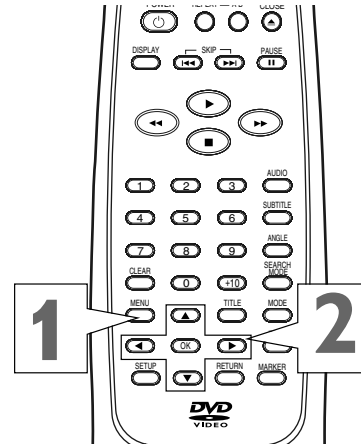

#### Title Menu

Some DVDs have a Title Menu, which lists the Titles available on the Disc. Use the Title Menu to start playback at a specific Title.

- 1** While playback is stopped, press **TITLE**. The Title Menu will appear.  
If a Title menu is not available, the "X" may appear on the TV screen. If the DVD only has a main menu, the main menu may appear when you press the **TITLE** button.
- 2** Press **▲▼◀▶** to select the desired Title, then press **OK**. Playback will begin at the Title you selected.

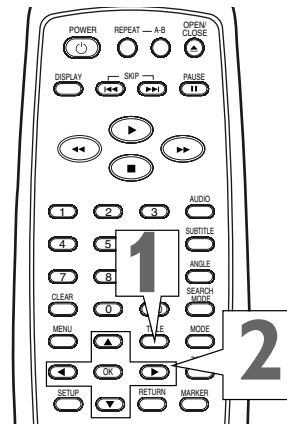

#### Helpful Hints

- Menus may vary among Discs. Refer to the literature accompanying the Disc for details.
- Not all DVDs have Title menus.
- Some DVDs may refer to Chapters as "scenes." Some DVDs may refer to the Title Menu as the "scene index."
- The **TITLE** button may not be active with all DVDs.

## Paused and Step-by-Step Playback, Resume On 21

DVD

AUDIO CD

### Paused and Step-by-Step Playback

**1** During playback of a DVD or Audio CD, press **PAUSE II**. Playback will pause and the sound will be mute. During DVD playback, press **PAUSE II** repeatedly to advance the picture one frame at a time.

**2** Press **Play ►** to resume playback.

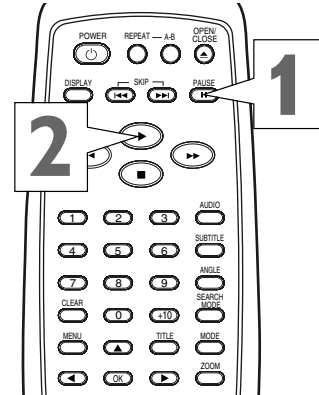

DVD

AUDIO CD

### Resume On

You may choose to resume playback from the point at which playback stopped last.

**1** Press **Stop ■** during playback. In a few seconds, the following Resume message will appear on the TV screen.

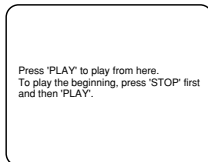

**2** Press **Play ►**. In a few seconds, playback will resume from the point at which playback stopped last.

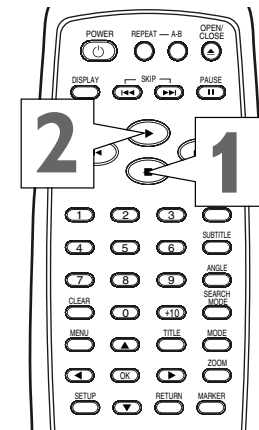

### Helpful Hints

- To cancel resume playback and start playing the Discs from the beginning, press **Stop ■** a second time while playback is stopped. The **■** will appear briefly at the top right corner of the TV screen. Press **Play ►** to play the Disc from the beginning.
- Resume On is retained when you turn off the DVD Player's power. When you turn on the power again later, **RESUME ON** will appear on the TV screen when the Disc is loaded and ready for playback. Press **Play ►** to resume play at the point you last stopped it.
- Opening the disc tray will cancel Resume On.

## 22 Fast Forward/Reverse Search

DVD

AUDIO CD

- 1** During playback, press **Fast Forward** **▶▶** or **Reverse** **◀◀** on the remote control.
- On a DVD, pressing Fast Forward **▶▶** or Reverse **◀◀** repeatedly will forward or reverse the picture at twice, eight times, 30 times, or 60 times the normal playback speed. Sound will be mute. Use Fast Forward **▶▶** for a forward search. Press Reverse **◀◀** for a reverse search.

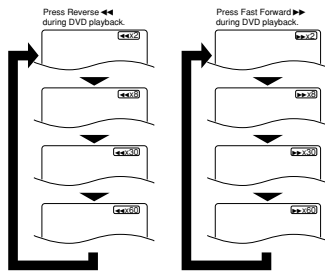

- On an Audio CD, you may search forward or backward at 16 times the normal playback speed (**◀◀x16** or **▶▶x16**). Pressing the Fast Forward **▶▶** or Reverse **◀◀** button repeatedly will not affect the speed of the search. Sound will be intermittent during searching on an Audio CD. Use Fast Forward **▶▶** for a forward search. Press Reverse **◀◀** for a reverse search.

Press the Reverse **◀◀** button during Audio CD playback.

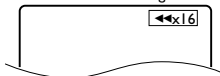

Press the Fast Forward **▶▶** button during Audio CD playback.



- 2** Press **Play** **▶** to return to normal playback.

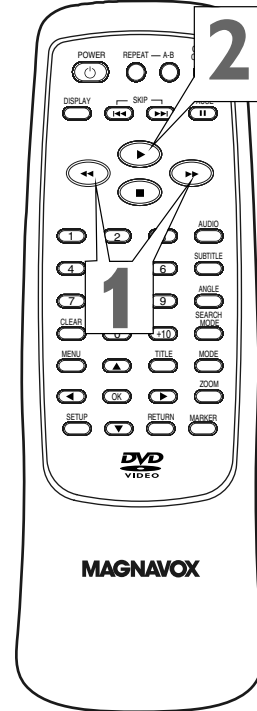

## Slow Motion, Zoom 23

DVD

### Slow Motion

- 1** Press **PAUSE** **||** during playback.
- 2** Press **Fast Forward** **▶▶**. Slow motion playback will begin. Press **Fast Forward** **▶▶** repeatedly during slow motion playback to vary the speed of slow motion playback. You may play the DVD at 1/16, 1/8, or 1/2 the normal playback speed.

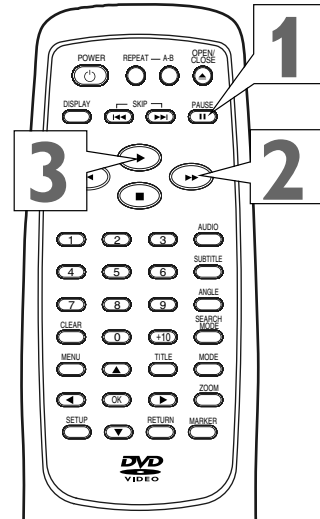
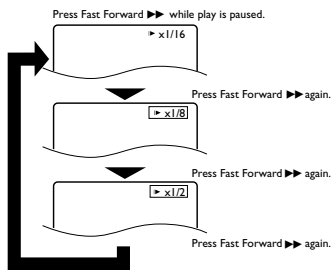

- 3** Press **Play** **▶** to return to normal playback.

DVD

### Zoom

You can enlarge the DVD picture during playback or when you have paused the picture. The picture can be two or four times larger than normal.

- 1** Press **ZOOM** during playback or when play is paused. The picture will appear twice as large. Press **ZOOM** again to make the picture four times as large as normal.
- 2** While the picture is enlarged, press **▲▼◀▶** to move the zoomed image up, down, left, or right. To remove the **■** from the lower right screen corner, press **OK**.



- 3** To return the picture to its normal size, press **ZOOM** so that **ZOOM [OFF]** appears briefly in the top right corner of the TV screen.

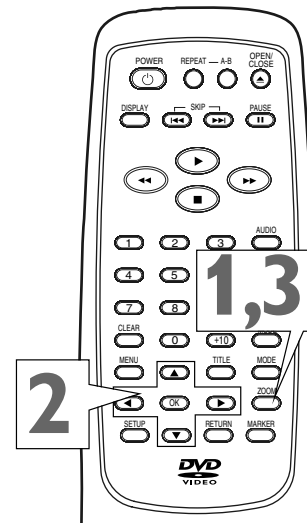

#### Helpful Hints

- The sound will be mute when playback is paused and during slow motion playback.
- You can not play the DVD in reverse slow motion.

## 24 Specific Track Playback

### AUDIO CD

There are three ways to begin playback on an Audio CD at a specific Track. You may use the Number buttons, the SEARCH MODE button, or the SKIP  $\lll$   $\ggg$  buttons.

**A** **Using the Number Buttons to Select a Track**  
**Press the Number buttons to enter the desired Track number.** Playback will start at the selected Track. You may select a Track with the Number buttons during playback or when playback is stopped.

For single-digit Tracks (1-9), press a single Number button. For example, to play Track three, press the Number 3 button.

For Tracks 10 and above, press the +10 button once so the Track Search display (TR) appears on the TV screen. Then press the Number button of the first digit, then press the Number button of the second digit.

For example, to play Track 26, press the +10 button, then press the Number 2 button, then press the Number 6 button.

If you enter a Track number that is not available on the Disc, playback will not begin (or the current Track will continue to play). An "X" will appear in the top right corner of the TV screen.

**B** **Using SEARCH MODE to Select a Track**  
**Press SEARCH MODE once so the Track Search display appears (TR). Within 30 seconds, press the Number buttons to select the Track number you desire. Playback will begin at the selected Track.**

For a single-digit Track (1-9), enter a zero first. For example, to play Track 5, press 0, 5.

For Tracks numbered 10 or above, use the Number buttons. For example, for Track 15, press the Number button 1, then the Number button 5. (You do not have to use the +10 button.)

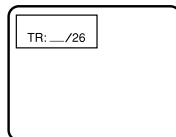

**C** **Using SKIP  $\lll$   $\ggg$  to Select a Track**  
**Press SKIP  $\ggg$  during playback to skip the current Track and move to the next Track. Press SKIP  $\ggg$  repeatedly to skip subsequent Tracks.**  
**Press SKIP  $\lll$  during playback to return to the beginning of the current Track. Press SKIP  $\lll$  repeatedly to go to previous Tracks.**

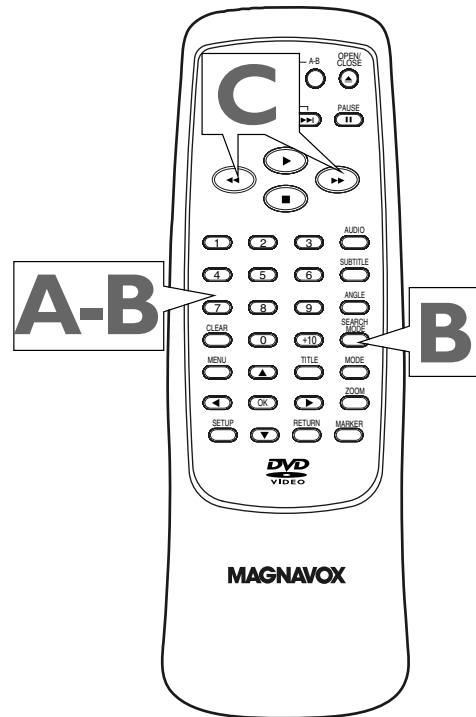

### Helpful Hints

- The SKIP  $\lll$   $\ggg$  buttons are not active when playback is stopped.
- You can not use SKIP  $\lll$   $\ggg$  to go from the last Track on the disc to the first Track.



## Specific Title/Chapter Playback, Specific Time Playback 25

DVD

### Specific Title/Chapter Playback

- 1** Press **SEARCH MODE** so the Title/Chapter Search display appears on the TV screen.
- 2** Within 30 seconds, press **▲** or **▼** to select the **TT (Title)** space, then press the **Number** buttons to enter the **Title number**. **CH (Chapter)** will be selected next automatically.
- 3** While **CH** is selected and within 30 seconds, press the **Number** buttons to enter the **Chapter number**. The DVD Player will begin playback at the selected Chapter.

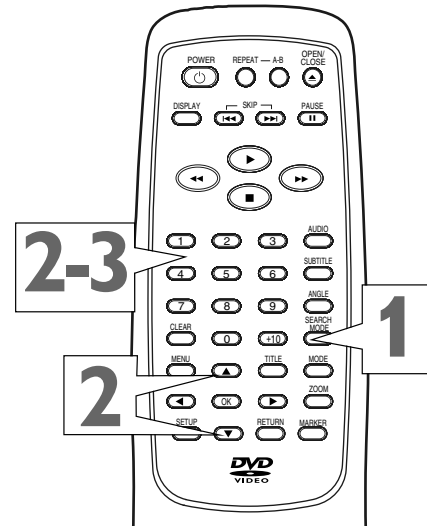
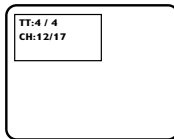

DVD

AUDIO CD

### Specific Time Playback

- 1** During playback, press **SEARCH MODE** repeatedly so the Time Search display appears on the TV screen.

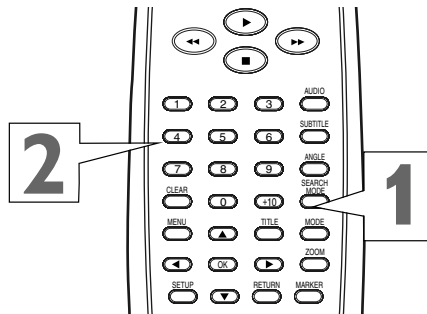
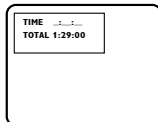

- 2** Within 30 seconds, use the **Number** buttons to enter the elapsed playing time at which you want playback to begin. Within a few seconds, playback will start at the specified time.
  - Example: 1 hour, 23 minutes and 30 seconds  
1 → 2 → 3 → 3 → 0
  - Make sure the time you enter is within the total time of the current Title or Track. If it is not, you must re-enter a valid time.
  - If you make a mistake, press **CLEAR**. Then, enter the correct information.

#### Helpful Hints

- Title/Chapter playback is not available with some DVDs.
- Press **SKIP ►►** during DVD playback to skip the current Chapter and move to the next Chapter. Press **SKIP ►►** repeatedly to skip subsequent Chapters. Press **SKIP ◄◄** during DVD playback to return to the beginning of the current Chapter. Press **SKIP ◄◄** repeatedly to go to previous Chapters.

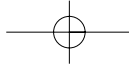

## 26 Repeat Playback

DVD

AUDIO CD

**1** Press **REPEAT** repeatedly until the repeat mode you want appears in the top left corner of the TV screen.

- On a DVD, repeatedly pressing REPEAT during playback lets you choose Repeat Chapter, Repeat Title, or Repeat Off.
- Selecting a new Chapter or Title will cancel repeat playback on a DVD.

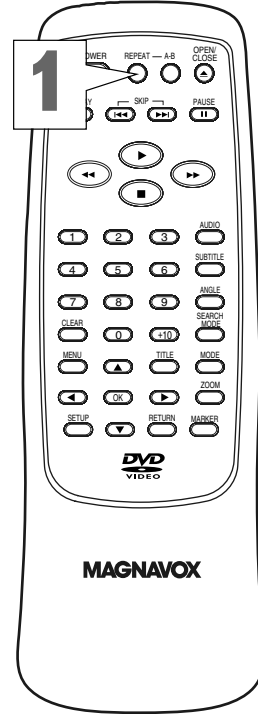
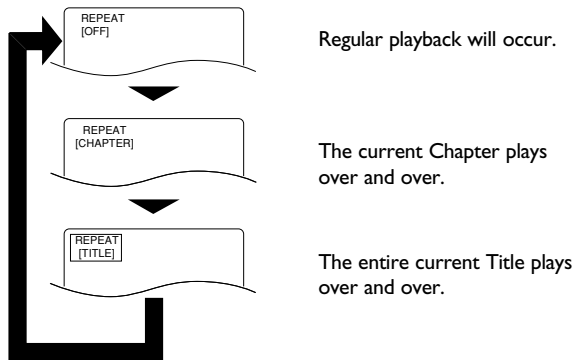

- On an Audio CD, repeatedly pressing REPEAT during playback lets you choose Repeat Track, Repeat All, or Repeat Off.
- Selecting a new Track will cancel repeat playback on an Audio CD.

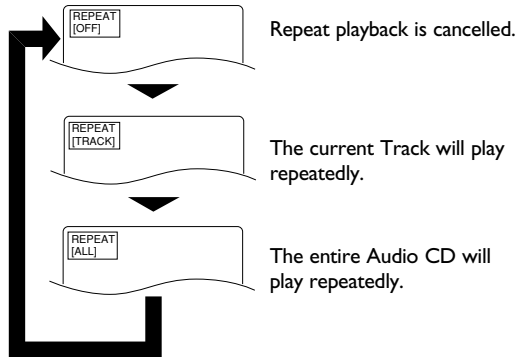

### Helpful Hint

- Repeat playback is not available with some Discs.

## A-B Repeat Playback 27

DVD

AUDIO CD

You can play a section of an Audio CD or DVD repeatedly. Follow these steps to set up the section that you want to play over and over.

- 1 Press **Play** ► to play the Disc to the point at which you want repeated playback to begin.
- 2 Press **A-B REPEAT** to set the starting point (A). If you make a mistake, press **CLEAR**. This will erase point A and let you start over. **REPEAT [OFF]** will appear briefly on the TV screen.

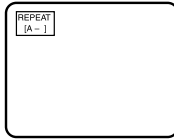

- 3 Play the Disc to the point at which you want repeated playback to end, then press **A-B REPEAT** again. Within a few seconds, the section will begin to play. The segment will play over and over until you cancel the A-B Repeat feature.

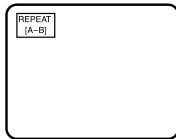

- 4 To cancel A-B Repeat Playback, press **A-B REPEAT** so **REPEAT [Off]** appears on the TV screen. Regular Disc playback will resume.

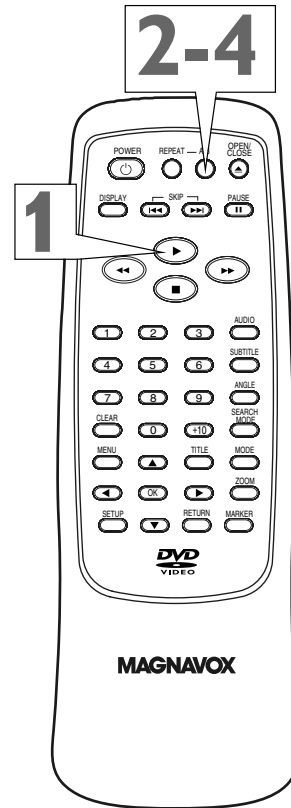

### Helpful Hints

- A-B Repeat playback is not available with some DVDs.
- With DVDs, the entire A-B repeat section must be within a single Title. The DVD Player will automatically set the end point (B) at the end of the Title if you do not set "B" before the end of the Title is reached.
- With Audio CDs, the A-B repeat section must be within a single Track. The DVD Player will automatically set the end point (B) at the end of the Track if you do not set "B" before the end of the Track is reached.
- Point B must be later on the Disc than Point A.
- You can not set up A-B Repeat Playback during Repeat playback (as described on page 26).

## 28 Programmed Playback

### AUDIO CD

You may determine the order in which Tracks will play. The order that you set is called the Program. To set up programmed playback, follow these steps.

- 1 While playback is stopped, press MODE.** The Program screen will appear.

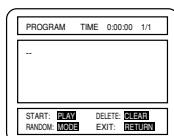

- 2 Press the Number buttons to enter the number of the first Track you want to play.**
  - Press CLEAR to erase the last Track in the Program.
  - Enter single-digit Tracks with a single Number button. For example, for Track three, press the Number 3 button.
  - For Tracks 10 and above, press the +10 button, then the Number button for the first digit, then the Number button for the second digit. For example, to play Track 26, press the +10 button, then press the Number 2 button, then press the Number 6 button.
  - The first Program screen can display 50 Tracks. Press ▼ to go to the next page, which can display 49 Tracks. Press ▲ to return to the first Program screen.

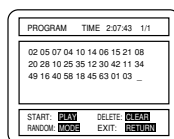

- 3 Repeat step 2 until you have selected all the Tracks you wish to play in the Program.** Make sure the Track numbers you enter are available on the Audio CD. If you enter an incorrect Track number, you must re-enter a valid Track number.
- 4 Press Play ►.** The Tracks will play in the order in which you programmed them. The Program will play once. Turning off the Player or opening the disc tray will erase the Program.

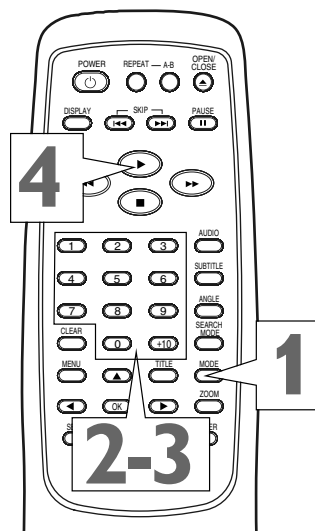

### Helpful Hints

- You can not use the Number buttons or SEARCH MODE to select another Track during programmed playback. You may use the SKIP ►► / ◀◀ buttons to select other Tracks within the Program. Details are on page 24.
- You can not combine random playback with programmed playback.
- You may play a Program or a Track within a Program repeatedly. During programmed playback, press REPEAT so REPEAT [ALL] or REPEAT [TRACK] appears. The entire Program or the current Track will play over and over.
- You can not alter a Program during program playback.
- While the Program is playing, press MODE to see the Program screen. The currently playing Track will appear in yellow. To remove the Program screen, press RETURN.
- A Program can have a maximum of 99 Tracks.

## Random Playback, MP3 Playback 29

### AUDIO CD

#### Random Playback

You may play the Tracks of an Audio CD in Random order instead of the order in which they are recorded (1,2,3...). To set up Random Playback, follow these steps.

- 1 While playback is stopped, press **MODE** twice so the **RANDOM** screen appears.

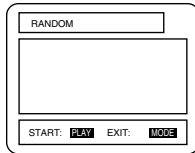

- 2 While the **RANDOM** screen appears, press **Play** ►. The Tracks will play in random order. After each Track plays once, playback will stop.

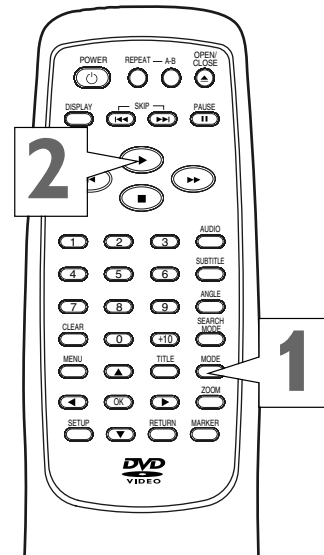

### MP3

#### MP3 Playback

- 1 When you put a CD-RW with MP3 files in the DVD Player, the MP3 menu will appear on the TV screen. While playback is stopped, press ▲ or ▼ to select the Album or Track you want to play.
  - If you choose a Track, press Play ► or OK. The tracks will play in the order in which they were recorded, i.e. 1, 2, 3, starting with the Track you selected.
  - If you select an Album and press OK, the Track selection screen will appear. Press ▲ or ▼ to select the Track you want to play, then press Play ► or OK.
  - Choose FIRST PLAY to start play from the first Track listed.
  - Press the TITLE button to go back to the first item on the first MP3 screen.

- 2 To stop playback, press **Stop** ■ .

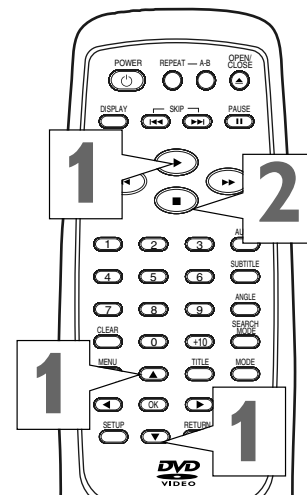

#### Helpful Hints

- Folders are known as Albums; files are known as Tracks.
- A "+" will appear at the start of the Album name.
- If all the Tracks can not appear on the screen at the same time, ▼ indicates more Tracks on the next screen; ▲ indicates previous screens. The current screen number and the total number of screens will appear on the screen.
- The player will recognize a total of 255 Albums and Tracks.

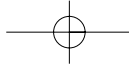

## 30 MP3 Display Information, MP3 Track Selection

MP3

### MP3 Display Information

You can check the MP3 files during playback.

- 1** Press **DISPLAY** during playback. The currently playing Track will be highlighted in yellow.
- 2** Press **DISPLAY** again. The elapsed playing time of the current track will appear at the top of the display.
  - D indicates Disc repeat
  - A indicates Album (folder) repeat
  - T indicates Track repeat.
- 3** Press **DISPLAY** again to remove the display.

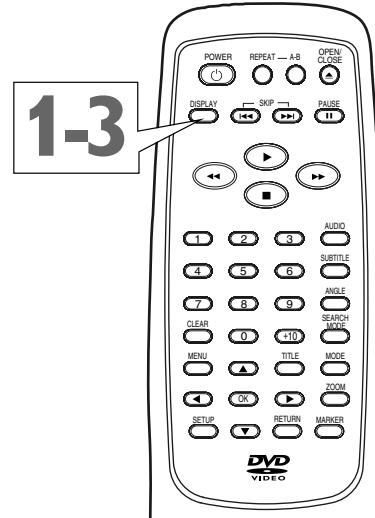

MP3

### MP3 Track Selection

- 1** Press the **SEARCH MODE** button.
  - The **SEARCH** menu will appear.
  - The current Track or the Track at which play will Resume (Resume On) will be highlighted. If Resume is off and playback is stopped, the first Track of the Disc will be highlighted.



- 2** Press **▲** or **▼** to select a Track you want to play. Press **Play ▶** to start playing the Track.
  - Press the **RETURN** or **SEARCH MODE** button to remove the **SEARCH** menu.

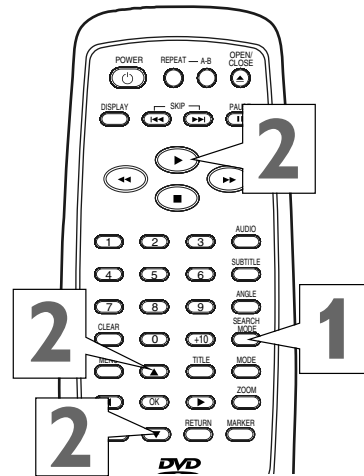

#### Helpful Hints

- During playback, press the Number buttons to select another Track, which will begin playing immediately. Or, press **SKIP** **◀◀** or **▶▶** to move to previous or subsequent Tracks.
- If the Track you chose is not available or can not be accessed, "X" will appear in the top right corner of the TV screen. Play may resume at a different Track.
- Specific Time playback is not possible with MP3 files.

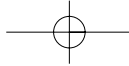

## Random MP3 Playback, Programmed MP3 Playback, 31

### MP3

#### Random MP3 Playback

**1** Press **MODE** twice while playback is stopped.

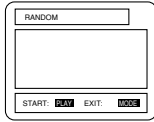

**2** Press **Play** ▶ to play the tracks in random order.

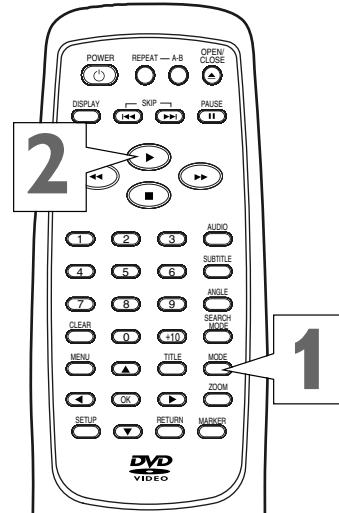

### MP3

#### Programmed MP3 Playback

**1** While playback is stopped, press **MODE**. The Program screen will appear.

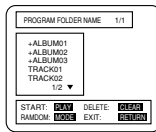

**2** Press **▲** or **▼** to select a track, then press **OK** to save it in the Program. The programmed track will appear on the right side of the Program screen. Press **▲** or **▼** if necessary to see additional Tracks. Repeat step 2 to enter all the Tracks you want.

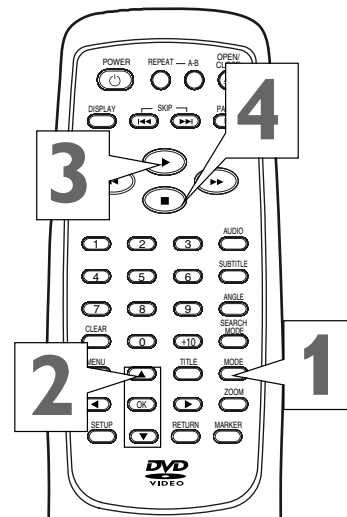
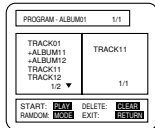

**3** Press **Play** ▶ to start programmed playback.

**4** Press **Stop** ■ to stop playing the Program.

#### Helpful Hints

- Press **CLEAR** to delete the last item in the Program.
- Turning off the DVD Player's power or opening the Disc tray will erase the entire Program.

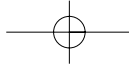

## 32 Audio Language, Stereo Sound Mode

### DVD

#### Audio Language

The DVD Player allows you to select a language for DVDs during playback. You can change the language only if multiple languages are available on the DVD.

- 1 Press **AUDIO** during playback so the audio display appears at the top of the TV screen. Press **AUDIO** repeatedly until you select your desired language.

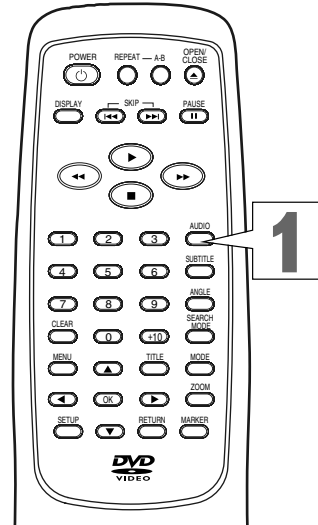
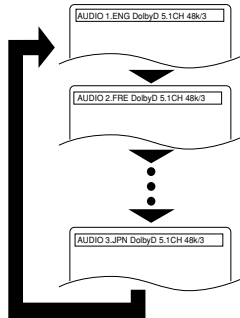

### AUDIO CD

#### Stereo Sound Mode

- 1 Press **AUDIO** repeatedly during playback to choose **AUDIO STEREO**, **AUDIO L-CH**, or **AUDIO R-CH**.

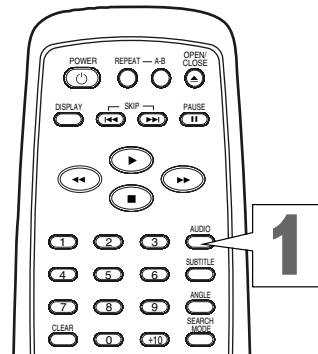
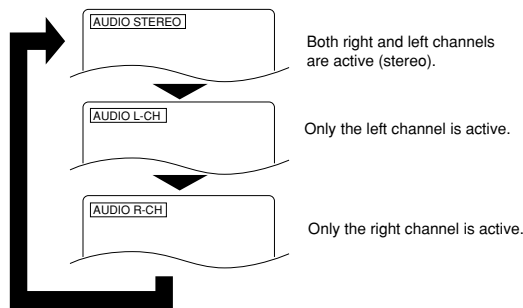

#### Helpful Hints

- If a desired language is not available after pressing **AUDIO** several times, the DVD does not have that language.
- The display will disappear after about five seconds.
- Some DVDs only allow you to change the language in the Disc menu.
- If you are using the **COAXIAL** jack, changing the sound mode is not applicable. Details are on pages 11 and 13.
- For some Audio languages, three dashes (- - -) may appear instead of a three-letter abbreviation for the language (ENG, FRE, etc.).



## Subtitle Language 33

### DVD

The DVD Player allows you to select a language for subtitles during playback. You may select only the subtitles that are available on the Disc.

- 1 **Press SUBTITLE repeatedly to select a subtitle language.** The subtitle display will appear at the top of the TV screen. The number of available languages appears at the right of the audio display. In this example, six languages are available (1/6). The display will disappear after about five seconds.

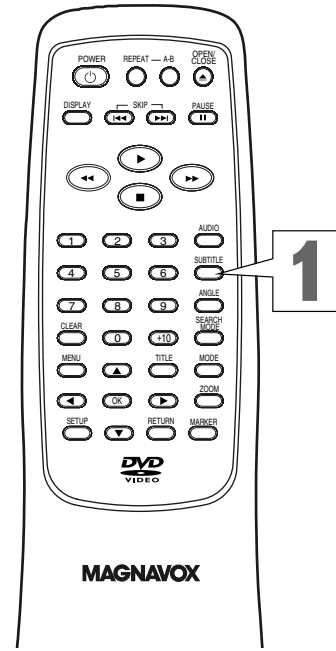
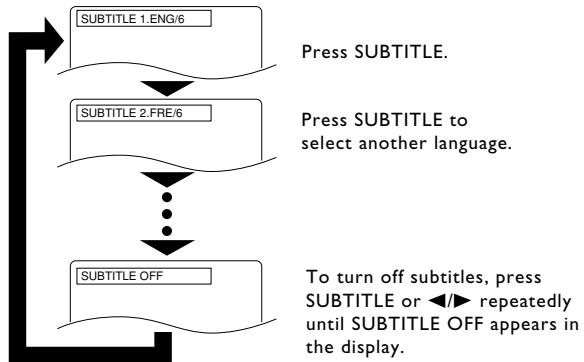

### Helpful Hints

- With some DVDs, you may select a subtitle language only in the Disc menu.
- If the desired language does not appear after pressing the SUBTITLE button several times, the Disc does not have subtitles in that language.
- The subtitles may be delayed for a few seconds.
- For some Subtitle languages, three dashes (---) may appear instead of a three-letter abbreviation for the language (ENG, FRE, etc.).

## 34 Camera Angles

### DVD

Some DVDs contain scenes that were recorded from different angles. You may select a camera angle with the DVD Player's remote control during playback.

- 1 **Press ANGLE repeatedly to select a different angle.** The Angle display will appear in the top left corner of the TV screen. The number of available angles appears at the right of the Angle display. In this example, eight angles are available (1/8). The Angle display will disappear after about five seconds. Playback will continue from the angle you selected, as long as it is available.

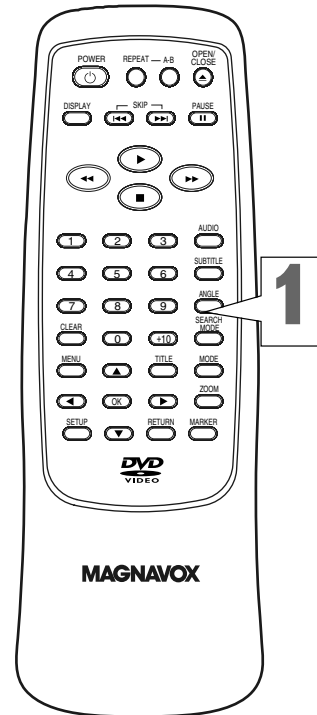
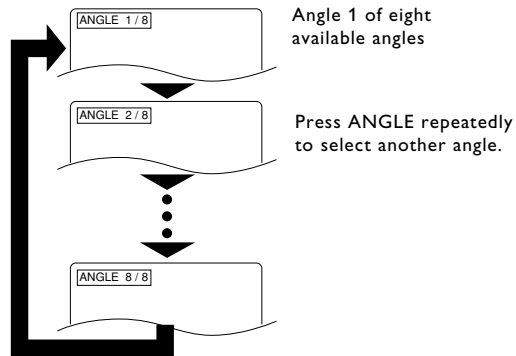

### Helpful Hints

- The current camera angle will appear when you first press ANGLE.
- If the Disc contains sequences recorded from different camera angles, the angle symbol will appear at the top right corner of the screen. You can change the camera angle when the symbol appears on the screen. ANGLE ICON must be ON. Details are on pages 40-41.
- The camera angle will not change if the Disc does not contain sequences recorded from different camera angles.

## Changing The On-Screen Display 35

### DVD

You can check information about the current Disc by pressing DISPLAY on the remote control.

#### 1 Press DISPLAY during playback.

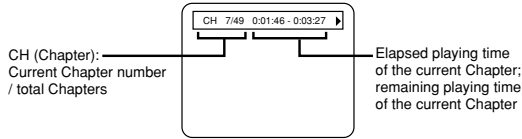

#### 2 Press DISPLAY again. If you want, you can press a Number button now to start playing a specific Chapter.



#### 3 Press DISPLAY again.

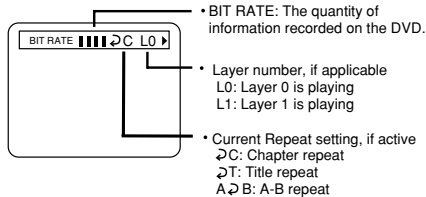

#### 4 Press DISPLAY or RETURN to remove the display.

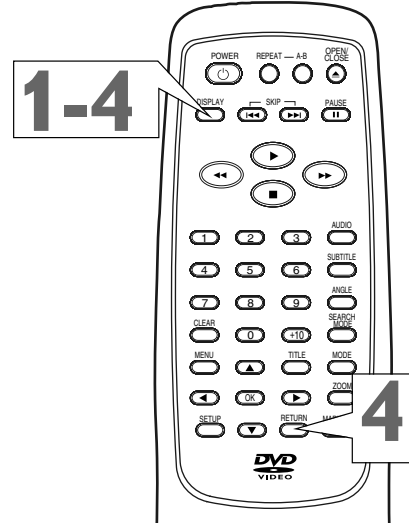

### AUDIO CD

#### 1 Press DISPLAY during playback.



#### 2 Press DISPLAY again. If you want, you can press a Number button now to start playing a specific Track.

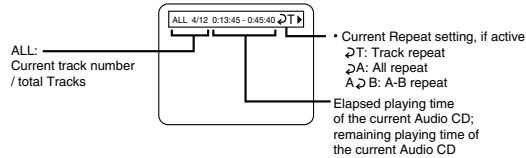

#### 3 Press DISPLAY or RETURN to remove the display.

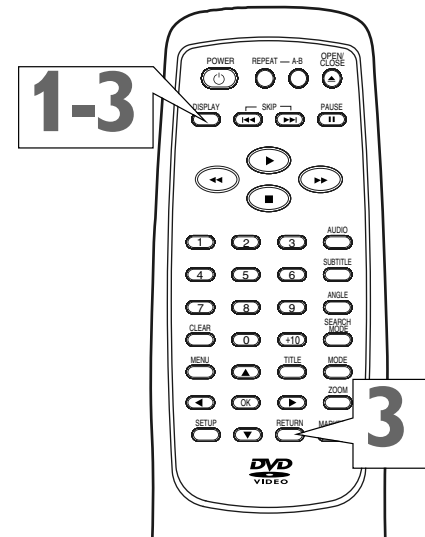

## 36 Parental Controls Password

Follow these steps to change your Parental Controls password. You will need a password to change the levels of the Parental Controls and to play Discs that are locked by Parental Controls.

- 1** While playback is stopped, press **SETUP**. The setup screen will appear.

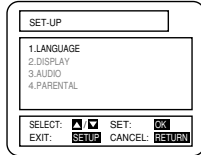

- 2** Press the **Number 4** button to select **Parental**. The **SET-UP PARENTAL CONTROLS PASSWORD** menu will appear.

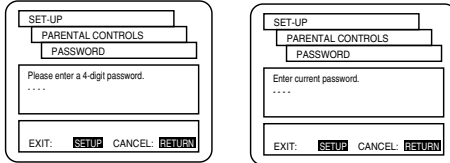

- 3** Press the **Number** buttons to enter your **four-digit password**. When doing this for the first time, enter any four digits, then press **OK**. That number will be used as the password from that point forward.

- 4** Press the **Number 2** button to select **CHANGE**.

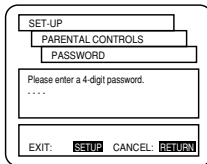

- 5** Press the **Number** buttons to enter your new **four-digit password**, then press **OK**.

- 6** Press **SETUP** to remove the menu.

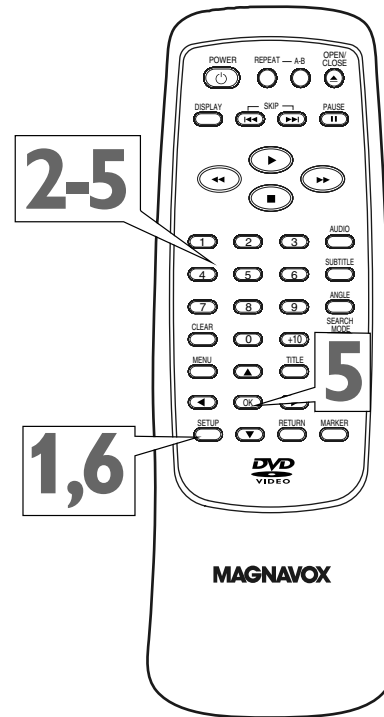

### Helpful Hints

- Write down your password in case you forget it.
- The default (factory preset) password is 4737. If you forget your password, press Number buttons 4, 7, 3, 7 at step 3. The Player immediately will ask you to enter a new four-digit code. Use the Number buttons to enter a new four-digit code, then press OK. PARENTAL LEVEL automatically will be reset to ALL. See page 37 to reset PARENTAL LEVEL as you desire.

## Parental Controls Levels 37

Follow these steps to set the rating level for Parental Controls. Discs whose ratings exceed the level you set will not play. See Helpful Hints below.

- 1** While playback is stopped, press **SETUP**. The setup screen will appear.

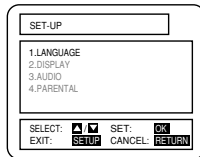

- 2** Press the **Number 4** button to select **Parental**. The **SET-UP PARENTAL CONTROLS PASSWORD** screen will appear.

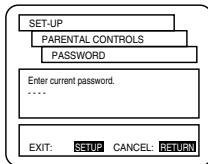

- 3** Press the **Number** buttons to enter your **four-digit password**. If your entry is incorrect, press **OK**, then enter the correct password as prompted by the on-screen message.

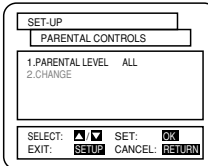

- 4** Press the **Number 1** button to select **Parental Level**.

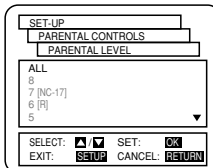

- 5** Press a **Number** button to select the level you desire. For example, if you want to play Discs rated PG-13, press the **Number 4** button. The level you select will appear on the screen beside **PARENTAL LEVEL** in the **SET-UP PARENTAL CONTROLS** screen.

- 6** Press **SETUP** to remove the menu.

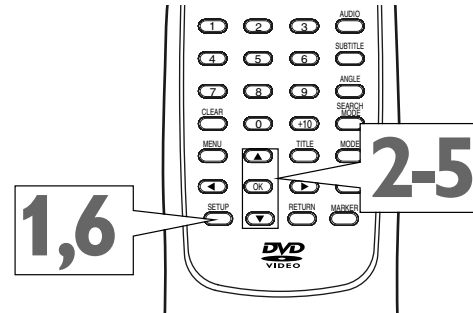

### RATING EXPLANATIONS

- ALL - Parental Controls is inactive. All discs can play.
- 8 - Adult material
- 7 - NC-17 Not appropriate for children under 17
- 6 - R - Restricted; parental approval required for viewers under 18.
- 4 - PG-13 - Unsuitable for children under 13.
- 3 - PG - Parental Guidance suggested.
- 1 - G - General Audience; recommended for audiences of all ages.

### Helpful Hints

- When you play a Disc whose rating exceeds the level you set, a message will appear on the screen, indicating the Disc cannot play. If this happens, remove the Disc, then select a level that allows playback. Or, select All to turn off Parental Controls. Load the Disc again and begin playback as usual. Some Discs may allow you to enter your four-digit password to begin playback. Refer to the instructions of the Disc.
- Some DVDs are not compatible with Parental Controls. Make sure the DVD plays according to the Parental Controls settings you have made before you allow children access to the DVD Player.
- You can not change Parental Level settings until you enter the correct password.

## 38 Marker Setup Screen

DVD

AUDIO CD

Use Markers to remember your favorite places on a Disc. To set the Markers, follow these steps. Before you begin, play the Disc to approximately the point at which you want to place the Marker.

- 1** During playback, press **MARKER**. The Marker display will appear in the top left corner of the screen.

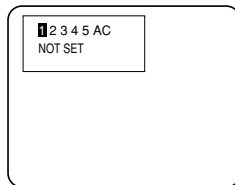

- 2** Within 30 seconds, press **◀** or **▶** to select **1, 2, 3, 4, or 5**. Make sure "NOT SET" appears in the display beneath the number you select.

- 3** Within 30 seconds, play the Disc to the point at which you want to set the Marker.

- 4** When the Disc reaches the point that you want to remember, press **OK**. The Title and elapsed playing time (DVD) or Track and its elapsed playing time (Audio CD) will appear in the display.

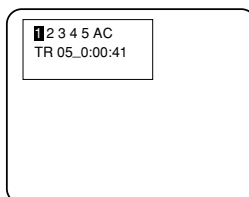
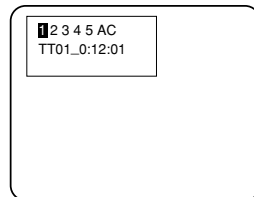

- 5** To return to the Marker later, press **MARKER** during playback. Press **◀** or **▶** to choose the Marker you want, then press **OK**. Disc play will continue from the marked point.

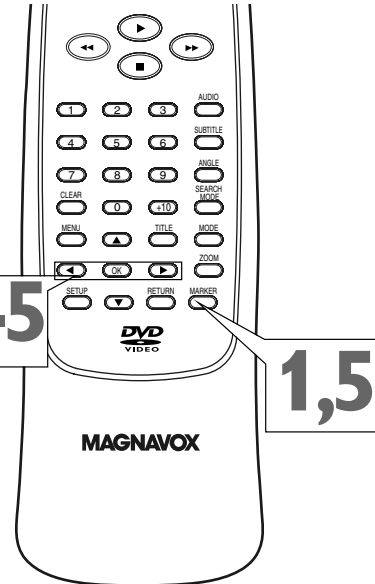

### Helpful Hints

- Opening the disc tray or turning off the DVD Player will erase all the Markers.
- To erase a single Marker, press **MARKER**, then press **◀** or **▶** to select your desired Marker. Press **CLEAR**. "NOT SET" will appear on the Marker display. Press **RETURN** or **MARKER** to remove the display.
- To erase all the Markers, press **MARKER**, then press **▶** repeatedly to select "AC." Press **OK**. Press **MARKER** to remove the display.

## Audio Controls 39

- 1** While playback is stopped, press **SETUP**. The setup screen will appear.

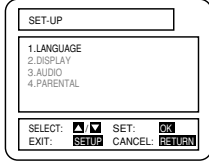

- 2** Press the Number 3 button to select Audio.

- 3** Press **▲** or **▼** to select an item, then follow step 4 accordingly.

- 4**
- If you selected DRC, press OK repeatedly to turn Dynamic Range Control (DRC) ON or OFF. This compresses the range of sound volume by suppressing loud sound and raising the volume of low sound.
  - If you selected DOLBY DIGITAL, press OK repeatedly to turn DOLBY DIGITAL ON or OFF. Select ON if you connected the DVD Player to a stereo that is Dolby Digital compatible. *Details are on page 11.*
  - If you selected MPEG, press OK repeatedly to turn MPEG ON or OFF. Select ON when the DVD Player is connected to an MPEG-compatible Stereo. *Details are on page 11.*
  - If you selected DOWN SAMPLING, press OK. Then, press **▲** or **▼** to select AUTO, 48 kHz, or 96 kHz, then press OK. The AUDIO CONTROLS menu will reappear.
- Select 96 kHz if the Disc was recorded in PCM 96 kHz. Otherwise, select 48 kHz.

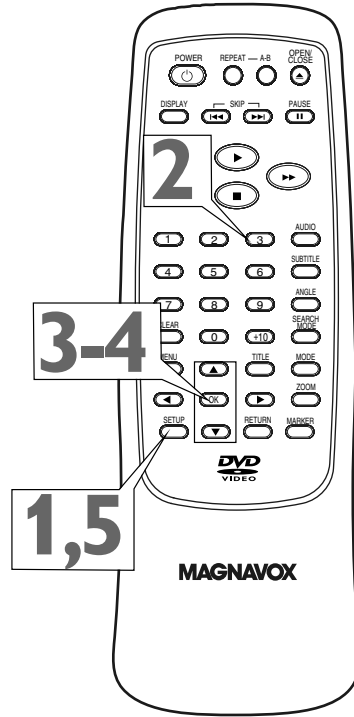

### DRC

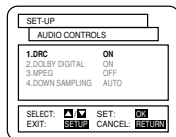

### DOLBY DIGITAL

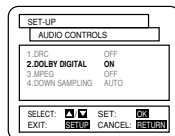

### MPEG

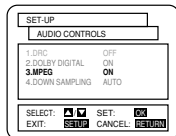

### DOWN SAMPLING

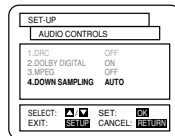

- 5** Press **SETUP** to remove the menu.

### Helpful Hint

- Selecting 96 kHz activates copyright protection and mutes the sound. Selecting AUTO sets downsampling to 48 kHz.

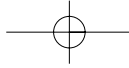

## 40 Display Controls

DVD

### Display Controls

- 1 Press **SETUP** while playback is stopped. The setup screen will appear.

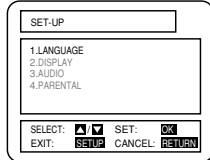

- 2 Press the **Number 2** button to select **DISPLAY**.

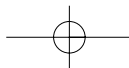
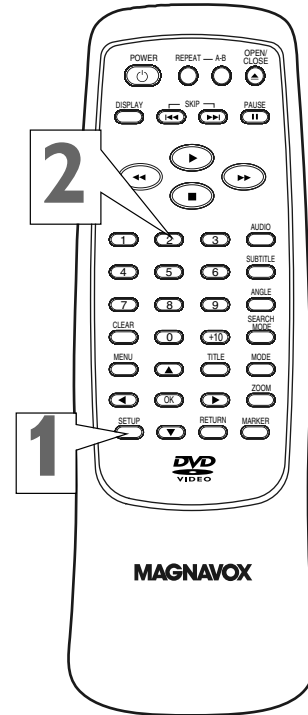
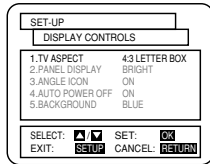



## Display Controls (cont'd) 41

- 3** Press **▲** or **▼** to select an item, then press **OK**.
- If you selected TV ASPECT, press **▲** or **▼** to select a setting, then press **OK**. Choose 4:3 LETTER BOX if you want black bars to appear at the top and bottom of the screen. Choose 4:3 PAN & SCAN for a full height picture, with both sides trimmed. Choose 16:9 WIDE : If a widescreen TV is connected to the DVD Player.
  - If you selected PANEL DISPLAY, press **▲** or **▼** to select BRIGHT, DIMMER, or AUTO, then press **OK**. This adjusts the brightness of the display panel. The default setting is BRIGHT. If you choose AUTO, the display dims only during playback.
  - If you selected ANGLE ICON, press **OK** repeatedly to turn ANGLE ICON ON or OFF. The default setting is ON. Choose ON to see the Angle icon when multiple camera angles are available. *Details are on page 34.* Choose OFF to disable the Angle icon.
  - If you selected AUTO POWER OFF, press **OK** repeatedly to turn AUTO POWER OFF ON or OFF. The default setting is ON. Choose ON if you want the DVD Player to turn itself off automatically after 35 minutes of no use. *Details are on page 47.*
  - If you selected BACKGROUND, press **OK** repeatedly to select BLUE or GRAY as the background color for the on-screen menus.

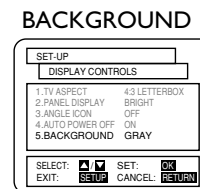
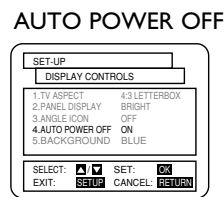
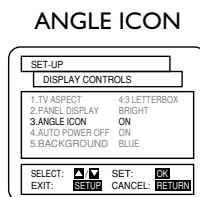
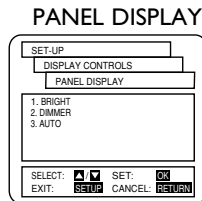
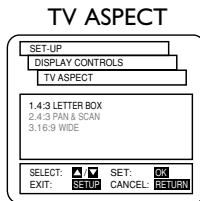
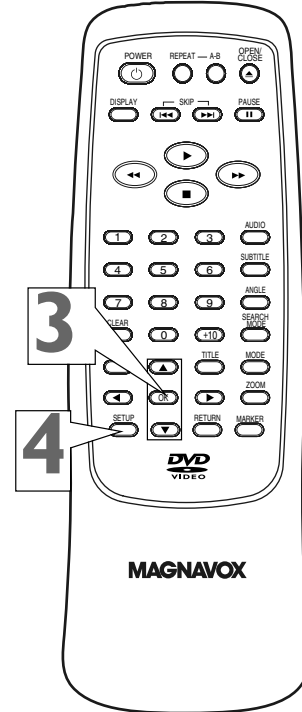

- 4** Press **SETUP** to remove the menus.

### Helpful Hints

- Selecting a different TV Aspect setting is only effective if it is available on the Disc.
- PANEL DISPLAY is not available in the menu on the MDV410.

## 42 Language Controls

### DVD

- 1** While playback is stopped, press **SETUP**. The setup screen appears.

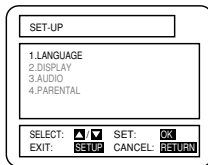

- 2** Press **▲** or **▼** to select **LANGUAGE**, then press **OK**.

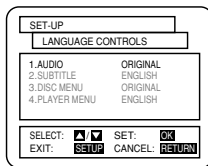

- 3** Press **▲** or **▼** to select **AUDIO**, **SUBTITLE**, **DISC MENU**, or **PLAYER MENU**. Then, press **OK**. The menu for the selected item will appear.

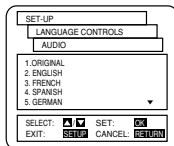

**AUDIO:** The DVD's audio plays in the selected language, if available on the Disc.

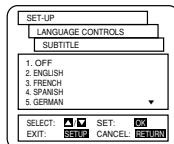

**SUBTITLE:** Subtitles appear in the chosen language, if available on the Disc.

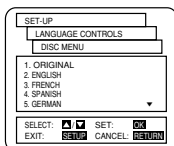

**DISC MENU:** A DVD's Disc menu appears in the chosen language, if available.

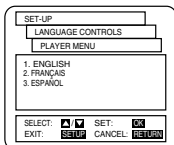

**PLAYER MENU:** The DVD Player's Setup menu appears in the selected language.

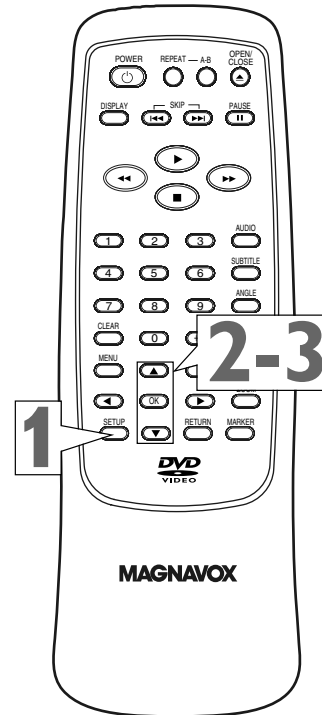

### Helpful Hints

- If the DVD's default settings for **Audio** and **Subtitle** are the same language, the subtitles may not show until you turn them on.
- Language options for **AUDIO**, **SUBTITLE**, and **DISC MENU** are not available with some Discs. Use the **AUDIO** and **SUBTITLE** buttons instead to select different languages for the audio and subtitles among those available on the Disc. Details are on pages 32-33.

## Language Controls (cont'd) 43

### 4 Press ▲ or ▼ to select a setting, then press OK.

● If you select OTHER at the AUDIO, SUBTITLE, or DISC MENU screen, press four Number buttons to enter the code for the language you desire. Refer to the list below.

● You can only select other languages for AUDIO, SUBTITLE, and DISC MENU if the language is available on the Disc.

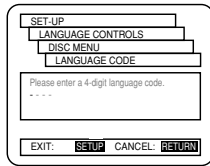

### 5 Press SETUP to remove the menu.

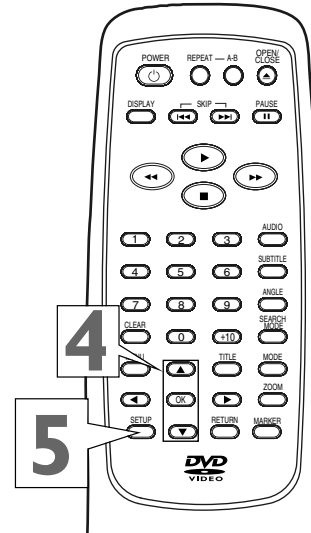

Language	Code	Language	Code	Language	Code	Language	Code	Language	Code
<b>A-B</b>		Dutch [DUT]	6058	Japanese [JPN]	5647	<b>O-R</b>		Sundanese	6567
Abkhazian	4748	English [ENG]	5160	Javanese	5669	Occitan	6149	Swahili	6569
Afar	4747	Esperanto	5161	Kannada	5760	Oriya	6164	Swedish [SWE]	6568
Afrikaans	4752	Estonian	5166	Kashmiri	5765	Oromo (Afan)	6159	<b>T</b>	
Albanian	6563	<b>F-H</b>		Kazakh	5757	Panjabi	6247	Tagalog	6658
Amharic	4759	Faroese	5261	Kinyarwanda	6469	Pashto	6265	Tajik	6653
Arabic	4764	Fiji	5256	Kirghiz	5771	Persian	5247	Tamil	6647
Armenian	5471	Finnish [FIN]	5255	Kirundi	6460	Polish	6258	Tatar	6666
Assamese	4765	French [FRE]	5264	Korean [KOR]	5761	Portugese [POR]	6266	Telugu	6651
Aymara	4771	Frisian	5271	Kurdish	5767	Pushto	6265	Thai	6654
Azerbaijani	4772	Gaelic (Scots)	5350	<b>L-N</b>		Quechua	6367	Tibetan	4861
Bangla	4860	Galician	5358	Laothian	5861	Rhaeto-Romance	6459	Tigrinya	6655
Bashkir	4847	Georgian	5747	Latin	5847	Romanian [RUM]	6461	Tonga	6661
Basque	5167	German [GER]	5051	Latvian	5868	Russian [RUS]	6467	Tsonga	6665
Bengali	4860	Greek [GRE]	5158	Lettish	5868	<b>S</b>		Turkish [TUR]	6664
Bhutani	5072	Greenlandic	5758	Lingala	5860	Samoan	6559	Turkmen	6657
Bihari	4854	Guarani	5360	Lithuanian	5866	Sangho	6553	Twi	6669
Bislama	4855	Gujarati	5367	Macedonian	5957	Sanskrit	6547	<b>U-Z</b>	
Breton	4864	Hausa	5447	Malagasy	5953	Serbian	6564	Ukrainian	6757
Bulgarian	4853	Hebrew	5569	Malay	5965	Serbo-Croatian	6554	Urdu	6764
Burmese	5971	Hindi	5455	Malayalam	5958	Sesotho	6566	Uzbek	6772
Byelorussian	4851	Hungarian [HUN]	5467	Maltese	5966	Setswana	6660	Vietnamese	6855
<b>C-E</b>		<b>I-K</b>		Maori	5955	Shona	6560	Volapuk	6861
Cambodian	5759	Icelandic [ICE]	5565	Marathi	5964	Sindhi	6550	Welsh	4971
Catalan	4947	Indonesian	5560	Moldavian	5961	Singhalese	6555	Wolof	6961
Chinese [CHI]	7254	Interlingua	5547	Mongolian	5960	Siswat	6565	Xhosa	7054
Corsican	4961	Interlingue	5551	Nauru	6047	Slovak	6557	Yiddish	5655
Croatian	5464	Inupiak	5557	Nepali	6051	Slovenian	6558	Yoruba	7161
Czech	4965	Irish [IRI]	5347	Norwegian [NOR]	6061	Somali	6561	Zulu	7267
Danish [DAN]	5047	Italian [ITA]	5566			Spanish [SPA]	5165		

## 44 Black Level Settings, TruSurround Setting

DVD

### Black Level Settings

Adjust the Black Level Settings to make the black parts of the picture as bright as you prefer.

- 1** Press **MODE** during playback.
- 2** Press **OK** repeatedly to choose **ON** or **OFF**. ON makes the dark parts brighter. OFF shows the original picture as recorded.

**BLACK LEVEL : ON**

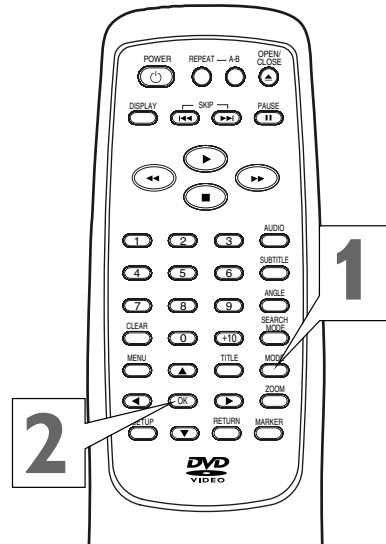

DVD

### SRS TruSurround Setting

You can enjoy improved stereo sound when you play Discs in Dolby Digital, PCM 48 kHz, or MPEG Audio.

- 1** Press **MODE** twice during playback.
- 2** Press **OK** repeatedly to choose **ON** or **OFF**. The default setting is OFF. Choose ON only if you connected the DVD Player to a stereo that has a Dolby Digital or MPEG decoder. *Details are on page 11.* Make sure the current DVD is recorded in Dolby Digital, PCM 48 kHz, or MPEG Audio.

**SRS TruSurround ON**

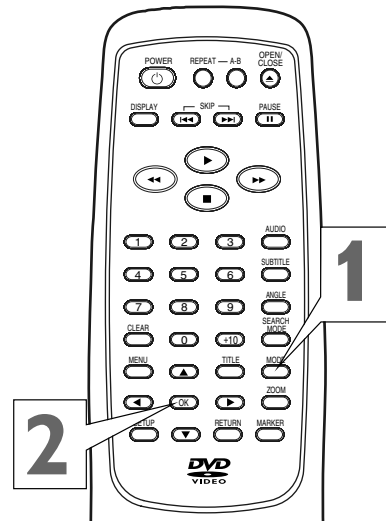

### Helpful Hints

- SRS TruSurround is available only when the DVD Player is connected to a TV or Stereo using the red and white AUDIO OUT jacks on the DVD Player.
- If you connected the DVD Player to a stereo using the COAXIAL DIGITAL AUDIO OUT jack as described on page 11, turn off SRS TruSurround; otherwise, there will be no sound.

## Care and Maintenance, Glossary 45

### Care and Maintenance

#### Cleaning the DVD Player

- Wipe the front panel and other exterior surfaces of the DVD Player with a soft, slightly damp cloth.
- Never use a solvent, thinner, benzene, or alcohol to clean the DVD Player. Do not spray insecticide liquid near the DVD Player. Such chemicals may discolor the surface or damage the DVD Player.

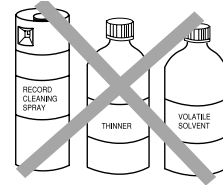

Don't use cleaners.

#### Cleaning a Disc

- Use a soft, dry cloth to wipe the Disc.
- Wipe the Disc in a straight line from the center to the edge. Never wipe the Disc in a circular motion.
- Do not use detergent or abrasive cleaning agents.
- Handle the Discs by the edges so fingerprints and dust do not adhere to the surfaces of the Discs.
- Always store the Disc in its protective case when it is not in use.

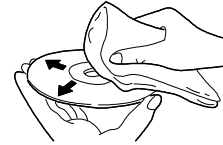

Wipe Discs from the center to the edge.

#### Checking the Laser

- If the DVD Player does not operate as described in this owner's manual, the laser may be dirty. Consult an Authorized Service Center for inspection and cleaning of the laser.



Handle Discs by the edges.

### Glossary

**AUDIO OUT Jacks:** Jacks on the back of the DVD Player that send audio to another system (TV or stereo).

**COAXIAL jack:** Sends digital audio to a stereo, allowing you to adjust the volume at the stereo. The stereo must have a Coaxial In jack. This connection provides the 5.1 channel surround sound as heard in movie theaters.

**COMPONENT VIDEO OUT Jacks (MDV430 only):** Jacks on the back of the DVD Player that send high-quality video to a TV that has Component Video In jacks.

**Dolby Digital:** A surround sound system that provides 5.1 channel sound as used in movie theaters.

**Letterbox:** A TV Aspect setting (4:3). Displays the video in full-width, with black bars at the top and bottom of the TV screen. This format is used often when you see a movie in a theater. If the Disc does not include a letterbox format, selecting Letterbox may have no effect. (For example, some DVD discs are two-sided, with one side playing in Letterbox and the other side playing in a normal format.)

**Pan & Scan:** A TV Aspect setting (4:3). Displays the video with full-height picture, with one or both sides of the picture trimmed to fit your screen.

**Remote Control:** The small electronic unit that came with your DVD Player; allows you to operate your DVD Player from a distance.

**S-Video:** Produces a clearer picture by sending separate signals for the luminance and the color. If you connect an optional S-Video cable, you will not need to use the supplied yellow video cable. You can use S-Video only if your TV has an S-Video In jack.

**VIDEO OUT Jack:** Jack on the back of the DVD Player that sends video to a TV. Use the supplied yellow video cable to make this connection.

**Wide:** A TV Aspect setting (16:9). Displays the video appropriately when you connect the DVD Player to a widescreen TV.

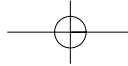

## 46 Helpful Hints

---

If you are having problems with your product, check this list of problems and possible solutions before requesting service. You may be able to solve the problem yourself. If you need to call a customer service representative, please know the model number and serial number of your product before you call. This information is on the back of the product. Also, please take a moment to identify the problem you are having, and be prepared to explain this to the representative. If you believe the representative will need to help you with operations, please stay near the product. Our representatives will be happy to assist you.

### **The DVD Player has no power.**

- Make sure the power cord is connected completely to an AC (alternating current) outlet.
- Press the POWER  button to turn on the DVD Player. "P-ON" will appear briefly on the display panel of the MDV430 as the power is turning on. The red POWER light will appear on the front of the MDV410 when the power is on.

### **The remote control will not operate the DVD Player.**

- Aim the remote control directly at the DVD Player's remote sensor. *Details are on page 16.*
- Remove all obstacles between the remote control and the DVD Player.
- Inspect and/or replace the batteries in the remote control. *Details are on page seven.*
- Use the remote control within 23 feet of the DVD Player.

### **No picture**

- Make sure the video cable is connected correctly. You may connect either the yellow video cable (supplied), an optional S-Video cable, or optional component video (MDV430 only) cables. You only need one video connection between the DVD Player and the TV. *Details are on pages 8-13.*
- Make sure the TV is set to the correct Video channel (usually the AUX IN, A/V IN, Auxiliary In, EXT or External In, Component Video In or S-Video In channel). These channels usually are located near channel 00. Check your TV owner's manual for details. Or, change channels at the TV until you see the DVD logo or DVD playback on the TV screen.
- Insert a Disc that is playable on this DVD Player. *Details are on page six.*

### **Disc cannot play.**

- Insert a playable Disc. *Details are on page six.*
- Place the Disc correctly in the recesses in the Disc tray. If the Disc is one-sided, place the Disc in the tray with the label facing up. If the Disc is two-sided, make sure the side you want to play is facing up.
- Clean the Disc. *Details are on page 45.*
- Check the Parental Controls and adjust if necessary. *Details are on pages 36-37.*

### **No sound**

- Connect the audio cables firmly. Make sure the cables are connected to the AUDIO IN jacks on the TV or audio equipment. *Details are on pages 8-13.*
- Check the Audio Settings of the DVD Player. *Details are on page 39.*
- Turn on the power of the audio equipment and make sure it is set to the correct channel, usually Auxiliary IN. Refer to the owner's manual of the audio equipment for details.
- Check the Audio Settings of the Disc. For example, you may have selected "sound-track" playback on a DVD. Only the music of the movie will play, not the characters' dialog; music might not be recorded throughout the entire DVD. *Details are on page 32.*

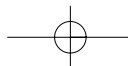
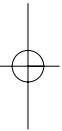
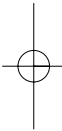

## Helpful Hints (cont'd) 47

---

### **Distorted picture**

- Connect the DVD Player directly to the TV. *Details are on page eight.*
- There are some cases where the picture may be distorted slightly and briefly; this is not a malfunction of the DVD Player.

### **You can not change the camera angle.**

- The DVD might not contain segments recorded from different camera angles. See if multiple angles are available by referring to the DVD case or menu for more information. *Details are on page 34.*

### **You can not change the audio or subtitle language.**

- The DVD does not contain audio or subtitles in the desired language. Not all DVDs contain audio or subtitles in multiple languages. See if other languages are available. *Details are on page 32-33.*

### **An "X" appears on the TV screen, prohibiting an operation.**

- You can not access the current operation at the current time or the feature is not available on the Disc. For example, some menus or features can be accessed or changed only when Disc play is stopped, while some are available only during playback. Check the instructions for accessing the feature before trying again. *Details are on page five.*

### **The DVD Player turns off after 35 minutes.**

- If AUTO POWER OFF is activated, the DVD Player turns off automatically if playback stops for more than 35 minutes and you press no buttons on the remote control or the DVD Player. When you receive the DVD Player, the factory has set AUTO POWER OFF to ON. *Details are on pages 40-41.*

### **A large DVD logo appears on the TV screen.**

- The DVD logo will appear on the TV screen if you stop Disc playback for more than five minutes and you do not press any buttons on the remote control or the DVD Player. The logo will appear on the screen for 35 minutes, then the Player will turn off automatically as described above. To prevent damage to your TV's picture tube, avoid leaving the DVD logo on the TV screen. Turn off the DVD Player when it is not in use. A prolonged still image, including TV station identification logos or video games, may damage your TV picture tube.

**RENEWED  
90 DAY  
LIMITED WARRANTY**



## 50 Specifications

---

### Product Type

Digital Video Disc Player

### Frequency Response

DVD (linear sound): 20 Hz to 22 kHz (sample rate: 48 kHz)  
20 Hz to 44 kHz (sample rate: 96 kHz)

Audio CD: 20 Hz to 20 kHz

### Signal-to-Noise Ratio (S/N Ratio)

Audio CD: 110 dB EIAJ (Electronic Industries Association of Japan)

### Dynamic Range

DVD (linear sound): 95 dB

Audio CD: 94 dB (EIAJ)

### Total Distortion Factor

Audio CD: 0.005% (EIAJ)

### Wow and Flutter

Below the measurement limitation ( $\pm 0.001\%$  W PEAK) (EIAJ)

### Power Requirement

120V AC  $\pm 10\%$ , 60 Hz  $\pm 0.5\%$

### Connections

S-Video output

Video output

Coaxial digital output

Analog audio output

Mini DIN 4-pin jack (75  $\Omega$ )

One pin jack, 1 Vpp (75  $\Omega$ )

One pin jack, 500m Vpp (75 $\Omega$ )

Two pin jacks

(one left channel, one right channel)

2 Vrms (47 k $\Omega$ )

Component video output  
(MDV430 only)

One pin jack (Y), 1 Vpp (75 $\Omega$ )

Two pin jacks (Cb and Cr), 700m Vpp (75 $\Omega$ )

### Power Consumption

Power on: 14 W

Power off: 1.2 W (MDV410)

2.2 W (MDV430)

### Operating Temperature

41°F (5°C) to 104°F (40°C)

### Relative Humidity

30% to 80%

### Dimensions

17-1/8" (W) x 2-15/16" (H) x 8-5/16" (D)

(360mm x 75mm x 211mm)

### Weight

4.42 lbs. (2.0 kg.)

*NOTE: Designs and specifications are subject to change without notice.*

## Index 51

- ac power cord .....18
- accessories .....51
- angle button .....15, 34
- arrow buttons .....14
- audio button .....15, 32
- audio cd .....6, 19
- audio controls .....39
- audio out jacks .....8-10, 15
- a-b repeat .....27
- a-b repeat button .....14, 27
- batteries .....7
- bit rate .....35
- black level settings .....34
- camera angle .....34
- chapters .....25
- clear button .....14
- coaxial jack .....11, 13, 18, 45
- color systems .....56
- component video out jacks (MDV430 only) 12, 18, 45
- connections .....8-13
- contents, table of .....3
- controls, remote .....14-15
- disc in light (MDV410 only) ...17
- disc menus .....20
- disc tray .....16
- display button .....14, 35
- display controls .....40-41
- display panel .....17
- display screens .....35
- dvd video .....6
- fast forward button .....15, 22
- front panel .....16
- glossary .....45
- helpful hints .....46-47
- hookups  
 amplifier with digital in jacks/  
 md deck/dat deck .....13  
 dolby digital/mpeg .....11  
 s-video .....10  
 stereo .....11-13  
 tv .....8-13
- language controls .....42-43
- maintenance .....45
- marker button .....14, 38
- markers .....38
- menu button .....14, 20
- menus .....5, 20
- mode button .....14, 28-29
- MP3 playback .....29-31
- number buttons .....14
- ok button .....15
- on-screen display .....35
- open/close button .....14, 16, 19
- parental controls .....36-37
- password .....36
- pause button .....15-16, 21, 23
- play button .....15-16, 19
- play light (MDV410 only) .....17
- playing .....19
- power  
 button .....14, 16  
 cord .....18  
 light (MDV410 only) .....17  
 program .....28, 31
- random .....29, 31
- rear panel .....18
- region codes .....6
- remote control  
 buttons .....14-15  
 sensor .....16  
 using .....7
- repeat button .....14, 26
- repeat playback .....26
- resume on .....21
- return button .....15
- reverse button .....15, 22
- safety precautions .....4
- search mode button ...14, 24-25
- searching .....22
- setup button ...14, 36-37, 39-43
- skip buttons .....15-16, 24-25
- slow motion .....23
- specifications .....50
- step-by-step playback .....21
- stereo sound mode .....32
- still picture .....21
- stop button .....15-16, 19
- subtitle button .....15, 33
- s-video out jack .....10, 18, 45
- table of contents .....3
- time search .....25
- title button .....15, 20
- title menu .....20
- titles .....20, 25
- tracks .....24
- trusurround .....44
- video out jack ...9, 11, 13, 18, 45
- warranty .....48
- “x” .....5, 47
- zoom button .....14, 23

## SUPPLIED ACCESSORIES

**The following items are supplied with your DVD Player;  
they are provided to help you use or set up your DVD Player.**

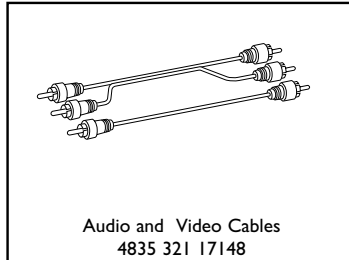
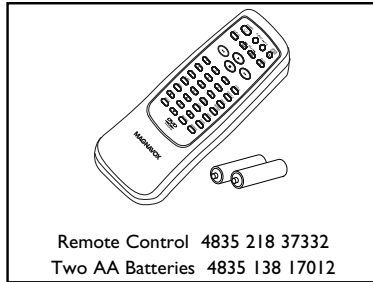

This owner's manual is made of recyclable materials.  
Remember to recycle!

IB8337E001  
Printed in China  
0VMN02956 / E56UD \*\*\*\*\*