

Owner's Manual

MAGNAVOX
SMART. VERY SMART.

Recordable disc

- We strongly recommend for good recording quality:
SONY DVD+RW 4x, MAXELL DVD+R 4x/8x/16x, SONY DVD+R 4x/8x/16x, TDK DVD+R 4x/8x/16x, MAXELL DVD-RW 4x, MAXELL DVD-R 8x/16x
- Discs that have been tested and are proven to be compatible with this recorder:
VERBATIM DVD+RW 4x VERBATIM DVD+R 8x
VERBATIM DVD-RW 2x VERBATIM DVD-R 8x JVC DVD-RW 4x MAXELL DVD-R 16x

DVD Recorder with Video Cassette Recorder

MWR20V6

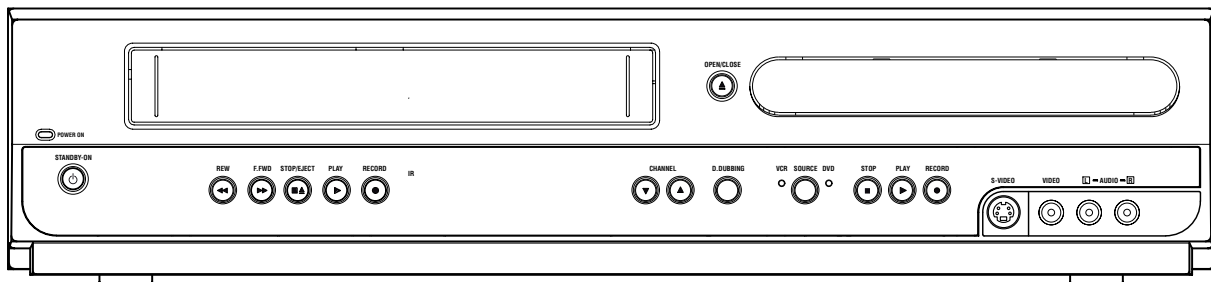

INSTRUCCIONES EN ESPAÑOL INCLUIDAS

Supplied Accessory

- Remote control (NB550UD) with two AAA batteries
- RF cable (WPZ0901TM002)
- Audio/Video cables (WPZ0102TM015 or WPZ0102LTE01)
- Owner's Manual (1VMN22213)
- Quick Guide (1VMN22214)

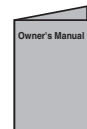
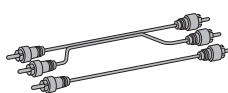
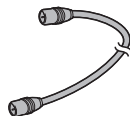
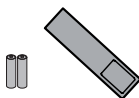

Please read before using this equipment.
If you need additional operating assistance after reading this owner's manual or to order replacement accessories, please call
TOLL FREE : 1-800-605-8453
or visit our web site at <http://www.funai-corp.com>

Before you use this unit, you need to complete connections. Refer to "Connections" on pages 14-16.

To record a program easily, refer to "Easy DVD recording" on pages 17-18 after connections are completed.
(You CANNOT record on any copyright protected DVD disc with this unit.)

Note

- Connect this unit directly to the TV. If the A/V cables are connected to a VCR, pictures may be distorted due to the copy protection system.

Before you start

Connections

Getting started

Recording

Playing discs

Editing

Changing the Setup menu

VCR functions

Others

Español

Before you start

Precautions

WARNING: TO REDUCE THE RISK OF FIRE OR ELECTRIC SHOCK, DO NOT EXPOSE THIS APPLIANCE TO RAIN OR MOISTURE.



CAUTION
RISK OF ELECTRIC SHOCK
DO NOT OPEN



CAUTION:

TO REDUCE THE RISK OF ELECTRIC SHOCK, DO NOT REMOVE COVER (OR BACK). NO USER SERVICEABLE PARTS INSIDE. REFER SERVICING TO QUALIFIED SERVICE PERSONNEL.



The lightning flash with arrowhead symbol, within an equilateral triangle, is intended to alert the user to the presence of uninsulated "dangerous voltage" within the product's enclosure that may be of sufficient magnitude to constitute a risk of electric shock to persons.



The exclamation point within an equilateral triangle is intended to alert the user to the presence of important operating and maintenance (servicing) instructions in the literature accompanying the appliance.

Laser Safety

This unit employs a laser. Only a qualified service person should remove the cover or attempt to service this device, due to possible eye injury.

CAUTION: USE OF CONTROLS OR ADJUSTMENTS OR PERFORMANCE OF PROCEDURES OTHER THAN THOSE SPECIFIED HEREIN MAY RESULT IN HAZARDOUS RADIATION EXPOSURE.

CAUTION: VISIBLE AND INVISIBLE LASER RADIATION WHEN OPEN AND INTERLOCK DEFEATED. DO NOT STARE INTO BEAM.

LOCATION: INSIDE, NEAR THE DECK MECHANISM.

FCC WARNING- This equipment may generate or use radio frequency energy. Changes or modifications to this equipment may cause harmful interference unless the modifications are expressly approved in the manual. The user could lose the authority to operate this equipment if an unauthorized change or modification is made.

RADIO-TV INTERFERENCE

This equipment has been tested and found to comply with the limits for a Class B digital device, pursuant to Part 15 of the FCC Rules. These limits are designed to provide reasonable protection against harmful interference in a residential installation. This equipment generates, uses, and can radiate radio frequency energy and, if not installed and used in accordance with the instructions, may cause harmful interference to radio communications. However, there is no guarantee that interference will not occur in a particular installation. If this equipment does cause harmful interference to radio or television reception, which can be determined by turning the equipment off and on, the user is encouraged to try to correct the interference by one or more of the following measures:

- 1) Reorient or relocate the receiving antenna.
- 2) Increase the separation between the equipment and receiver.
- 3) Connect the equipment into an outlet on a circuit different from that to which the receiver is connected.
- 4) Consult the dealer or an experienced radio/TV technician for help.

This Class B digital apparatus complies with Canadian ICES-003.

Cet appareil numérique de la classe B est conforme à la norme NMB-003 du Canada.

CAUTION: TO PREVENT ELECTRIC SHOCK, MATCH WIDE BLADE OF PLUG TO WIDE SLOT, FULLY INSERT.

ATTENTION:POUR ÉVITER LES CHOC ÉLECTRIQUES, INTRODUIRE LA LAME LA PLUS LARGE DE LA FICHE DANS LA BORNE CORRESPONDANTE DE LA PRISE ET POUSSER JUSQU'AU FOND.

A NOTE ABOUT RECYCLING

This product's packaging materials are recyclable and can be reused. Please dispose of any materials in accordance with your local recycling regulations.

Batteries should never be thrown away or incinerated but disposed of in accordance with your local regulations concerning chemical wastes.

Make your contribution to the environment!!!

- Used up batteries do not belong in the dust bin.
- You can dispose of them at a collection point for used up batteries or special waste. Contact your council for details.



For Customer Use:

Read carefully the information located at the back of this unit and enter below the Model No. and Serial No. Retain this information for future reference.

Model No. _____

Serial No. _____

IMPORTANT SAFEGUARDS

1. Read Instructions - All the safety and operating instructions should be read before the appliance is operated.
2. Retain Instructions- The safety and operating instructions should be retained for future reference.
3. Heed Warnings - All warnings on the appliance and in the operating instructions should be adhered to.
4. Follow Instructions - All operating and use instructions should be followed.
5. Cleaning - Unplug this product from the wall outlet before cleaning. Do not use liquid cleaners or aerosol cleaners. Use a damp cloth for cleaning.
EXCEPTION: A product that is meant for uninterrupted service and, that for some specific reason, such as the possibility of the loss of an authorization code for a CATV converter, is not intended to be unplugged by the user for cleaning or any other purpose, may exclude the reference to unplugging the appliance in the cleaning description otherwise required in item 5.
6. Attachments - Do not use attachments not recommended by the product manufacturer as they may cause hazards.
7. Water and Moisture- Do not use this product near water, for example, near a bath tub, wash bowl, kitchen sink, or laundry tub, in a wet basement, or near a swimming pool, and the like.
8. Accessories - Do not place this product on an unstable cart, stand, tripod, bracket, or table. The product may fall, causing serious injury to a child or adult, and serious damage to the appliance. Use only with a cart, stand, tripod, bracket, or table recommended by the manufacturer, or sold with the product. Any mounting of the appliance should follow the manufacturer's instructions and should use a mounting accessory recommended by the manufacturer. An appliance and cart combination should be moved with care. Quick stops, excessive force, and uneven surfaces may cause the appliance and cart combination to overturn.
9. Ventilation - Slots and openings in the cabinet are provided for ventilation and to ensure reliable operation of the product and to protect it from overheating, and these openings must not be blocked or covered. The openings should never be blocked by placing the product on a bed, sofa, rug, or other similar surface. This product should not be placed in a built-in installation such as a bookcase or rack unless proper ventilation is provided or the manufacturer's instructions have been adhered to.
10. Power Sources - This product should be operated only from the type of power source indicated on the marking label. If you are not sure of the type of power supply to your home, consult your appliance dealer or local power company. For products intended to operate from battery power, or other sources, refer to the operating instructions.
11. Grounding or Polarization - This product is equipped with a polarized alternating-current line plug (a plug having one blade wider than the other). This plug will fit into the power outlet only one way. This is a safety feature. If you are unable to insert the plug fully into the outlet, try reversing the plug. If the plug should still fail to fit, contact your electrician to replace your obsolete outlet. Do not defeat the safety purpose of the polarized plug.
12. Power Cord Protection - Power supply cords should be routed so that they are not likely to be walked on or pinched by items placed upon or against them, paying particular attention to cords at plugs, convenience receptacles, and the point where they exit from the appliance.
13. Outdoor Antenna Grounding - If an outside antenna or cable system is connected to the product, be sure the antenna or cable system is grounded so as to provide some protection against voltage surges and built-up static charges. Article 810 of the National Electrical Code, ANSI/

NFPA No. 70, provides information with regard to proper grounding of the mast and supporting structure, grounding of the lead-in wire to an antenna discharge unit, size of grounding conductors, location of antenna-discharge unit, connection to grounding electrodes, and requirements for the grounding electrode. (Fig. A)

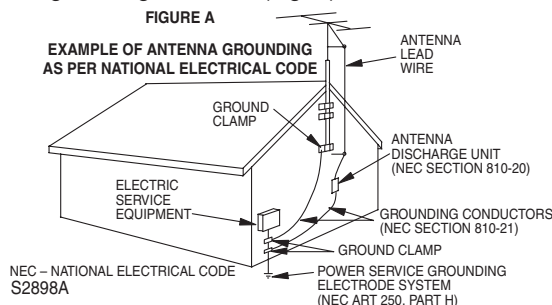

14. Lightning - For added protection for this product during a lightning storm, or when it is left unattended and unused for long periods of time, unplug it from the wall outlet and disconnect the antenna or cable system. This will prevent damage to the product due to lightning and power-line surges.
15. Power Lines - An outside antenna system should not be located in the vicinity of overhead power lines or other electric light or power circuits, or where it can fall into such power lines or circuits. When installing an outside antenna system, extreme care should be taken to keep from touching such power lines or circuits as contact with them might be fatal.
16. Overloading - Do not overload wall outlets and extension cords as this can result in a risk of fire or electric shock.
17. Object and Liquid Entry - Never push objects of any kind into this product through any openings as they may touch dangerous voltage points or short-out parts that could result in a fire or electric shock. Never spill liquid of any kind on the product.
18. Servicing - Do not attempt to service this product yourself as opening or removing covers may expose you to dangerous voltage or other hazards. Refer all servicing to qualified service personnel.
19. Damage Requiring Service - Unplug this product from the wall outlet and refer servicing to qualified service personnel under the following conditions:
 - a. When the power-supply cord or plug is damaged.
 - b. If liquid has been spilled, or objects have fallen into the product.
 - c. If the product has been exposed to rain or water.
 - d. If the product does not operate normally by following the operating instructions. Adjust only those controls that are covered by the operating instructions as an improper adjustment of other controls may result in damage and will often require extensive work by a qualified technician to restore the product to its normal operation.
 - e. If the product has been dropped or damaged in any way.
 - f. When the product exhibits a distinct change in performance this indicates a need for service.
20. Replacement Parts - When replacement parts are required, be sure the service technician has used replacement parts specified by the manufacturer or have the same characteristics as the original part. Unauthorized substitutions may result in fire, electric shock or other hazards.
21. Safety Check - Upon completion of any service or repairs to this product, ask the service technician to perform safety checks to determine that the product is in proper operating condition.
22. Heat - This product should be situated away from heat sources such as radiators, heat registers, stoves, or other products (including amplifiers) that produce heat.

PORTABLE CART WARNING
(Symbol provided by RETAC)



S3125A

Before you start

Precautions (cont'd)

Installation Location

For safety and optimum performance of this unit:

- Install the unit in a horizontal and stable position. Do not place anything directly on top of the unit. Do not place the unit directly on top of the TV.
- Shield it from direct sunlight and keep it away from sources of intense heat. Avoid dusty or humid places. Avoid places with insufficient ventilation for proper heat dissipation. Do not block the ventilation holes on the sides of the unit. Avoid locations subject to strong vibration or strong magnetic fields.

Avoid the Hazards of Electrical Shock and Fire

- Do not handle the power cord with wet hands.
- Do not pull on the power cord when disconnecting it from AC wall outlet. Grasp it by the plug.
- If, by accident, water is spilled on this unit, unplug the power cord immediately and take the unit to our Authorized Service Center for servicing.

Moisture Condensation Warning

Moisture condensation may occur inside the unit when it is moved from a cold place to a warm place or after heating a cold room or under conditions of high humidity. Do not use this unit at least for 2 hours until its inside gets dry.

About Copyright

Unauthorized copying, broadcasting, public performance and lending of discs are prohibited. This product incorporates copyright protection technology that is protected by U.S. patents and other intellectual property rights. Use of this copyright protection technology must be authorized by Macrovision, and is intended for home and other limited viewing uses only unless otherwise authorized by Macrovision. Reverse engineering or disassembly is prohibited.

Notice for progressive scan output

Consumers should note that not all high definition television sets are fully compatible with this product and may cause artifacts to be displayed in the picture. In case of picture problems with 525 progressive scan output, it is recommended that the user switch the connection to the 'standard definition' output. If there are questions regarding your TV set compatibility with this 525p DVD recorder, please contact our customer service center.

Before you start

Precautions (cont'd)

Maintenance

SERVICING

- Please refer to relevant topics on Troubleshooting on pages 77-80 before returning the product.
- If this unit becomes inoperative, do not try to correct the problem by yourself. There are no user-serviceable parts inside. Turn off, unplug the power plug and please call our help line mentioned on the front page to locate an Authorized Service Center.

CLEANING THE CABINET

- Use a soft cloth slightly moistened with a mild detergent solution. Do not use a solution containing alcohol, spirits, ammonia or abrasive.

CLEANING DISCS

- When a disc becomes dirty, clean it with a cleaning cloth. Wipe the disc from the center to out. Do not wipe in a circular motion.
- Do not use solvents such as benzene, thinner, commercially available cleaners, detergent, abrasive cleaning agents or antistatic spray intended for analogue records.

CLEANING THE DISC LENS

- If this unit still does not perform properly although you refer to the relevant sections and to “Troubleshooting” in this Owner’s Manual, the laser optical pickup unit may be dirty. Consult your dealer or an Authorized Service Center for inspection and cleaning of the laser optical pickup unit.

DISC HANDLING

- Handle the discs so that fingerprints and dust do not adhere to the surfaces of the discs.
- Always store the disc in its protective case when it is not used.

AUTO HEAD CLEANING

- Automatically cleans video heads as you insert or remove a cassette, so you can see a clear picture.
 - Playback picture may become blurred or interrupted while the TV program reception is clear. Dirt accumulated on the video heads after a long period of use, or the usage of rental or worn tapes can cause this problem. If a streaky or snowy picture appears during playback, the video heads in the unit may need to be cleaned.
1. Please visit your local Audio/Video store and purchase a good quality VHS Video Head Cleaner.
 2. If a Video Head Cleaner does not solve the problem, please call our help line mentioned on the front page to locate an Authorized Service Center.

NOTES:

- Remember to read the instructions along with the video head cleaner before use.
- Clean video heads only when problems occur.

IR SIGNAL CHECK

If the remote control does not work properly, you can test if the remote control sends out the infrared signal with AM radio or a digital camera (including built-in camera of cellular phone). It will help to define the cause of malfunction.

- **With an AM radio:**
Tune an AM radio to a band with no broadcasting. Press a button on remote control toward the radio. Sound will be fluttering when you press any key and the radio receives the signal. This means the remote control unit is working.
- **With a digital camera (including built-in camera of cellular phone):**
Direct a digital camera to remote control, press and hold a button on remote control. If infrared light appears through digital camera, the remote is working.

Manufactured under license from Dolby Laboratories. “Dolby” and the double-D symbol are trademarks of Dolby Laboratories.

Dolby Digital Recording

“Dolby® Digital Recording enables consumers to record high-quality video with stereo sound on recordable DVD discs. The technology, when utilized instead of PCM recording, also saves recordable disc space, allowing for higher video resolution or extended recording time on each DVD. DVDs created using Dolby Digital Recording will play back on all DVD-Video players.”

Note: This is true when the players are compatible with actual recordable DVD discs.

Before you start

Table of contents

Before you start	2	Skipping TV commercials during play.	45
Precautions	2	Rapid play	46
Table of contents	6	Step by step playback.	46
Features	7	Slow forward / Slow reverse play	46
Symbol in this Owner's Manual	7	Zoom	47
Functional overview	8	Marker Setup	47
Installing batteries in the remote control.	10	Search	48
Using a remote control	10	Title/Chapter search	48
The VCR/DVD recorder switching	10	Track search	49
Setup menus.	11	Time search	49
Display menu	12	Repeat/Random/Program playback	50
Connections	14	Repeat playback	50
Connection to a TV	14	Random playback	50
Connection to a cable box or satellite box	15	Program playback	51
Connection to an Audio System	16	Selecting the format of audio and video	51
Getting started	17	Switching subtitles	51
Easy DVD recording	17	Switching audio soundtrack	52
Initial setting	19	Switching virtual surround system	52
Channel setting	19	Switching camera angles	53
Getting channels automatically.	19	Reducing block noise	53
Adding/deleting channels	20	Editing	54
Selecting the TV stereo or SAP	21	Information on disc editing	54
Setting the clock	22	Guide to a title list	54
Auto Clock Setting	22	Editing discs	54
Manual Clock Setting	23	Editing discs (Setup menu).	54
Setting the Daylight Saving Time	24	Editing discs	55
Selecting the TV aspect ratio	24	Deleting titles	55
Recording	25	Putting names on titles	56
Information on DVD recording	25	Setting chapter marks	57
Information	25	Clearing chapter marks.	58
Recordable disc	25	Hiding chapters	59
Recording mode	25	Setting pictures for thumbnails	60
Making discs playable in other DVD player (Finalize/Make Edits Compatible)	26	Dividing a title	61
Before recording	27	Editing discs (Setup menu)	62
Replacing disc menu.	27	Putting name on disc	62
Setting for Auto Chapter	27	Setting or releasing disc protect	63
Basic recording	28	Erasing disc	65
One-touch Timer Recording (OTR)	29	Making edits compatible	65
Timer Recording	30	Changing the Setup menu	66
Hints for Timer Recording.	32	Tour of the Setup menu	66
Overwriting an existing title	33	Language setting	67
Overwriting from the beginning of the title	33	Display setting	68
Overwriting in the middle of the title	33	Audio setting	69
Hints for Overwriting	34	Video setting	71
Settings for an external source	35	Settings for Parental lock level	72
Connection to an external source.	35	Settings for PBC (Playback Control)	73
Recording from an external source.	36	VCR functions	74
Setting a disc to protect	36	Playback	74
Playing the discs in other DVD players	37	Playback	74
Finalizing a disc	37	Recording and One-touch Timer Recording	74
Auto finalizing	38	Recording	74
Dubbing Mode	39	One-touch Timer Recording (OTR)	75
Playing discs	41	Search	75
Information on DVD play	41	Index search	75
Basic playback	42	Time search	76
Playback	42	Other operations	76
Playing MP3 disc	43	Others	77
Playing discs using the disc menu	44	Troubleshooting	77
Playing discs using the title menu	44	RF output switch	80
Pause	44	Glossary	81
Special playback	45	Language code	81
Resume play	45	Frequently Asked Questions	82
Fast forward / Fast reverse.	45	Specifications	82
		Español	84
		Limited Warranty	Back Cover

Before you start

Features

This unit not only plays DVDs, CDs and VHS tapes but also offers features for you to record on DVD discs and edit them after that. The following features are offered with this unit.

Recording

DVD mode VCR mode

This unit is compatible with DVD+RW/DVD-RW, which is rewritable repeatedly and DVD+R/DVD-R, which is available for recording once. You can choose either one for your convenience. Even if you choose DVD-RW/R discs, these discs are formatted with DVD+VR mode.

Up to 8 program recording:

You can program the unit to record up to 8 programs, with in a month in advance. Daily or weekly program recordings are also available.

One-touch Timer Recording:

You can easily set a recording time as you prefer. Every time [RECORD ●], [DVD REC ●] or [VCR REC ●] is pressed during recording, the recording time will be increased by 30 minutes up to 8 hours. The unit will automatically turn off when the recording time you set is reached.

Dubbing mode:

You can copy a DVD disc to a videotape or copy a videotape to a DVD disc. This function will be possible only if the DVD disc or a videotape is not copy protected. You cannot record on a videotape when its record tab is removed.

Left channel stereo recording:

This unit can record the sound of the Left channel monaural input as Left and Right channels automatically.

Automatic Chapter mark setting:

Chapter marks will be put on recordings as you set in the Setup menu before attempting to record.

Automatic Title list making:

The unit makes a title list with the index automatically.

Automatic finalizing (DVD+R, DVD-RW/R only):

The unit can finalize discs automatically after finishing all Timer Recordings or when the disc runs out recordable space.

Play

DVD mode

Theater surround sound in your home:

When connecting the unit to an amplifier or a decoder which is compatible with Dolby Digital, you are allowed to experience the theater surround sound from discs with surround sound system.

Quick search for what you want to watch:

You can easily find the part you want to watch using the search function. Search for a desired point on a disc by title, chapter or time.

Virtual Surround System:

You can enjoy stereophonic space through your exciting 2 channel stereo system.

Playing back on MP3 disc:

You can enjoy MP3 files which are recorded on CD-RW/R.

VCR mode

Quick search for what you want to watch:

You can easily find the part you want to watch using the Index search/Time search functions. An index mark will be assigned at the beginning of each recordings you make. For Time search function, you can go to a specific point on a videotape by entering the exact amount of time you wish to skip.

Editing

DVD mode

Deleting titles:

You can delete titles which you do not need anymore.

Putting names on titles:

You can put your favorite names on titles.

Setting / Clearing chapter marks:

You can set/clear chapter marks on titles.

Hiding unwanted chapters:

To keep others from playing back some chapters without permission, you can hide chapters.

Setting pictures for thumbnails:

You can change pictures for thumbnails.

Dividing titles (DVD+RW/DVD-RW only):

You can divide a title into two or more.

Putting name on disc:

You can put your favorite disc name.

Compatibility

DVD mode

Available for playing discs on a regular DVD player:

Recorded discs can be played on regular DVD players, including computer DVD drives compatible with DVD-Video playback. You will need to finalize the discs recorded on DVD+R/DVD-RW/DVD-R discs to play in other DVD players.

Others

Progressive Scan system

Unlike conventional interlace scanning, the progressive scan system provides less flickering and images in higher resolution than that of traditional television signals.

Symbol in this Owner's Manual

To specify for what disc type each function is, we put the following symbols at the beginning of each item to operate. *DVD-RW (VR mode) disc is not played in this unit.

Symbol	Description
	Available to DVD-Video discs
	Available to DVD+RW discs
	Available to DVD+R discs
	Available to DVD+R DL discs
	Available to DVD-RW discs formatted with DVD+VR mode
	Available to DVD-R discs formatted with DVD+VR mode
	Available to DVD-RW discs (Video mode, Finalized)
	Available to DVD-R discs (Video mode, Finalized)
	Available to Audio CDs
	Available to CD-RW/R discs with MP3 files
	Available to Video CDs
	Available to VHS tapes Use only VHS tapes marked with this unit.

First: (Press:) Indicates that you need to select the DVD mode by pressing [DVD] on the remote control before proceeding next step.

First: (Press:) Indicates that you need to select the VCR mode by pressing [VCR] on the remote control before proceeding next step.

Before you start

Functional overview

Front Panel

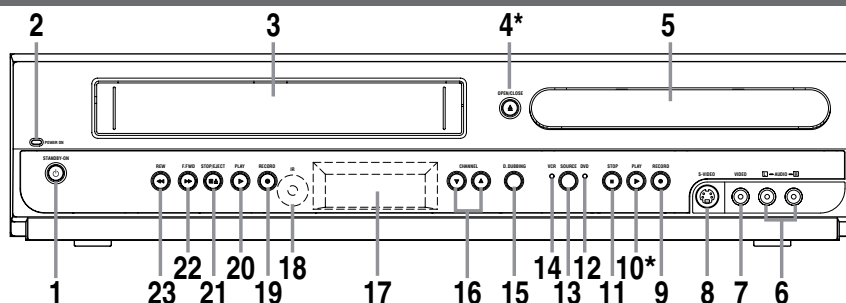

(*) The unit can also be turned on by pressing these buttons.

- 1. STANDBY-ON $\text{\textcircled{I}}$ button (DVD/VCR)**
Press to turn on and off the unit.
- 2. POWER ON indicator (DVD/VCR)**
Red LED lights up when power is on.
- 3. Cassette compartment (VCR)**
Insert a videotape here.
- 4. OPEN/CLOSE \blacktriangle button (DVD)***
Press to open or close the disc tray.
- 5. Disc tray (DVD)**
Place a disc when it is open.
- 6. AUDIO input jacks (EXT2) (DVD/VCR)**
Use to connect external equipment with a standard audio cable.
- 7. VIDEO input jack (EXT2) (DVD/VCR)**
Use to connect external equipment with a standard video cable.
- 8. S-VIDEO input jack (EXT2) (DVD/VCR)**
Use to connect the S-Video output of external equipment with an S-Video cable.
- 9. RECORD \bullet button (DVD)**
Press once to start recording. Press repeatedly to start a One-touch Timer Recording.
- 10. PLAY \blacktriangleright button (DVD)***
Press to start or resume play.
- 11. STOP \blacksquare button (DVD)**
Press to stop playback or recording. Press to stop the proceeding Timer Recording in DVD.
- 12. DVD indicator**
Lights up when the DVD output mode is selected.
- 13. SOURCE button (DVD/VCR)**
Press to select the component you wish to operate.
- 14. VCR indicator**
Lights up when the VCR output mode is selected.
- 15. D.DUBBING button (DVD/VCR)**
Press to start VCR to DVD (DVD to VCR) duplication which you set in the Setup menu.
- 16. CHANNEL \blacktriangledown / \blacktriangle button (DVD/VCR)**
Press to change the channel up and down.
- 17. Display**
Shows various information and messages.
- 18. Remote control sensor (DVD/VCR)**
Receive signals from your remote control so that you can control the unit from a distance.
- 19. RECORD \bullet button (VCR)**
Press once to start a recording. Press repeatedly to start a One-touch Timer Recording.
- 20. PLAY \blacktriangleright button (VCR)**
Press to start playback.
- 21. STOP \blacksquare / EJECT \blacktriangle button (VCR)**
EJECT \blacktriangle button
Press to remove the videotape from the cassette compartment when the power is on or off.
STOP \blacksquare button
Press to stop videotape playback or recording. Press to stop the proceeding Timer Recording in VCR.
- 22. F.FWD $\blacktriangleright\blacktriangleright$ button (VCR)**
Press to rapidly advance the videotape, or view the picture rapidly in forward during playback. (Forward Search)
- 23. REW $\blacktriangleleft\blacktriangleleft$ button (VCR)**
Press to rewind the videotape, or to view the picture rapidly in reverse during the playback mode. (Rewind Search)

Rear Panel

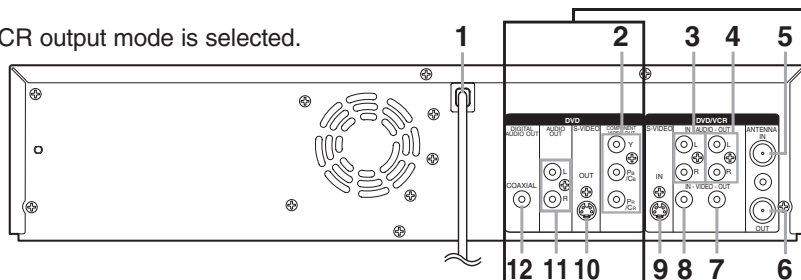

• These jacks are useful only in DVD mode.

- 1. AC Power Cord (DVD/VCR)**
Connect to a standard AC outlet to supply power to this unit.
- 2. COMPONENT VIDEO OUT jacks (DVD only)**
Use to connect a TV monitor with component video inputs with a component video cable.
- 3. AUDIO IN jacks (EXT1) (DVD/VCR)**
Use to connect external equipment with a standard audio cable.
- 4. AUDIO OUT jacks (DVD/VCR)**
Use to connect a TV monitor, AV receiver or other equipment with a standard audio cable.
- 5. TV ANTENNA IN jack (DVD/VCR)**
Use to connect an antenna.
- 6. TV ANTENNA OUT jack (DVD/VCR)**
Use to connect an antenna cable to pass the signal from the TV ANTENNA IN to your TV monitor.
- 7. VIDEO OUT jack (DVD/VCR)**
Use to connect a TV monitor, AV receiver or other equipment with a standard video cable.
- 8. VIDEO IN jack (EXT1) (DVD/VCR)**
Use to connect external equipment with a standard video cable.
- 9. S-VIDEO IN jack (EXT1) (DVD/VCR)**
Use to connect the S-Video output of external equipment with an S-Video cable.
- 10. S-VIDEO OUT jack (DVD only)**
Use to connect the S-Video input of a TV monitor, AV receiver or other equipment with an S-Video cable.
- 11. AUDIO OUT jacks (DVD only)**
Use to connect a TV monitor, AV receiver or other equipment with a standard audio cable.
- 12. COAXIAL DIGITAL AUDIO OUT jack (DVD only)**
Use to connect an AV receiver, Dolby Digital decoder or other equipment with a coaxial digital input jack with a digital coaxial cable.

Note

- Do not touch the inner pins of the jacks on the rear panel. Electrostatic discharge may cause permanent damage to the unit.

Functional overview (cont'd)

Remote Control

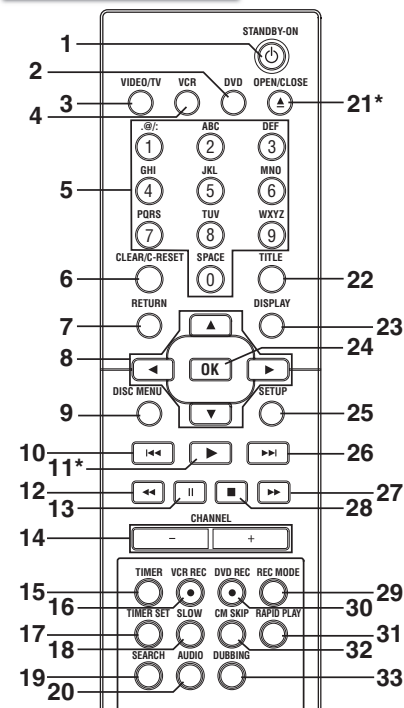

(*) In DVD mode, the unit can also be turned on by pressing these buttons.

1. **STANDBY-ON** button (DVD/VCR)
Press to turn on and off the unit.
2. **DVD** button
Press to activate the remote control in DVD mode (refer to page 10).
Press to select the DVD output mode.
3. **VIDEO/TV** button (DVD/VCR)
Press to select VIDEO or TV position.
4. **VCR** button
Press to activate the remote control in VCR mode (refer to page 10).
Press to select the VCR output mode.
5. **Number buttons** (DVD/VCR)
Press to select channel numbers.
Press to select a title / chapter / track on display.
Also press to enter values for the settings in the Setup menu.
Also press to start the index/time search in VCR mode.
6. **CLEAR/C-RESET** button (DVD/VCR)
• DVD mode
Press to clear the password entered, to cancel the programming for CD, to clear the highlighted marker number in the Edit menu or to clear the program once entered in the Timer Programming list, etc.
• VCR mode
Press to reset the tape counter.
7. **RETURN** button (DVD/VCR)
Press to return to the previously displayed menu screen.
8. **Cursor** buttons (DVD/VCR)
Press to select items or settings.
9. **DISC MENU** button (DVD)
Press to display the Disc menu.
Press to change Original and Playlist on the TV screen. (VR mode only)
10. **SKIP** button (DVD)
During playback, press to skip to the previous chapter or track.
Or when playback is paused, press to play back in reverse step by step.
11. **PLAY** button* (DVD/VCR)
Press to start or resume playback.
12. **REW** button (DVD/VCR)
• DVD mode
During playback, press to play back in fast reverse.
Or when playback is paused, press to play back in slow reverse.
• VCR mode
Press to rewind the videotape or to view the picture rapidly in reverse during the playback mode.
13. **PAUSE** button (DVD/VCR)
Press to pause playback or recording.
14. **CHANNEL** buttons (DVD/VCR)
• DVD mode
Press to change the channel up and down.
• VCR mode
Press to change the channel up and down.
Press to adjust the tracking during playback or in slow motion of the videotape. Also while playback is in Still Mode, you can adjust the picture blurred vertically.
15. **TIMER** button (DVD/VCR)
Press to display the Timer Programming list.
16. **VCR REC** button (VCR)
Press to activate the remote control in VCR mode (refer to page 10).
Press once to start a recording.
Press repeatedly to start a One-touch Timer Recording.
17. **TIMER SET** button (DVD/VCR)
Press to set the unit in the timer standby mode. In the timer standby mode, press to cancel the mode and to turn the unit on.
18. **SLOW** button (VCR)
During playback, press to view the videotape in slow motion.
19. **SEARCH** button (VCR)
Press to call up the index or time search menu.
20. **AUDIO** button (VCR)
During playback a HiFi videotape, press to change the AUDIO OUT setting "HiFi" and "MONO".
21. **OPEN/CLOSE** button (DVD/VCR)*
• DVD mode
Press to open or close the disc tray.
• VCR mode
Press to remove the videotape from the cassette compartment.
22. **TITLE** button (DVD)
Press to display the Title list.
23. **DISPLAY** button (DVD/VCR)
Press to display the Display menu on or off.
24. **OK** button (DVD/VCR)
Press to confirm or select menu items.
25. **SETUP** button (DVD/VCR)
Press to display the Setup menu. During DVD playback, press and hold for more than 3 seconds to switch the progressive scanning mode to the interlace mode.
26. **SKIP** button (DVD)
During playback, press to skip to the next chapter or track.
Or when playback is paused, press to play back in forward step by step.
27. **F.FWD** button (DVD/VCR)
• DVD mode
During playback, press to play back in fast forward.
Or when playback is paused, press to play back in slow forward.
• VCR mode
Press to rapidly advance the videotape or view the picture rapidly in forward during playback.
28. **STOP** button (DVD/VCR)
Press to stop playback or recording.
Press to exit from the title list.
29. **REC MODE** button (DVD/VCR)
Press to change the recording mode.
30. **DVD REC** button (DVD)
Press to activate the remote control in DVD mode (refer to page 10).
Press once to start a recording.
Press repeatedly to start a One-touch Timer Recording.
31. **RAPID PLAY** button (DVD)
During playback, press to playback in a slightly faster/slower speed with keeping the audio quality.
32. **CM SKIP** button (DVD)
During playback, press to skip to the 30 second advanced point.
33. **DUBBING** button (DVD/VCR)
Press to start VCR to DVD (DVD to VCR) duplication which you set in the Setup menu.

Before you start

Functional overview (cont'd)

Installing batteries in the remote control

Install two "AAA" size batteries (supplied) matching the polarity indicated inside battery compartment of the remote control.

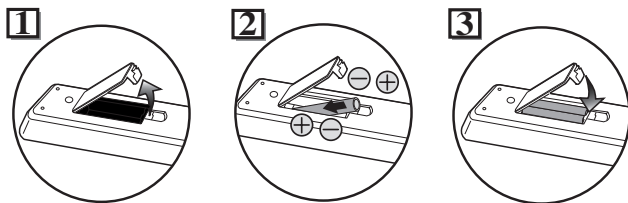

Note:

Incorrect use of batteries can result in hazards such as leakage and bursting. Please observe the following:

- Do not mix new and old batteries together.
- Do not use different kinds of batteries together, although they may look similar, different batteries may have different voltages.
- Make sure that the plus and minus ends of each battery match the indications in the battery compartment.
- Remove batteries from equipment that is not going to be used for a month or more.
- When disposing of used batteries, please comply with governmental regulations or environmental public instruction's rules that apply in your country or area.
- Do not recharge, short-circuit, heat, burn or disassemble batteries.

Using a remote control

Keep in mind the following when using the remote control:

- Make sure that there is no obstacle between the remote control and the remote sensor on the unit.
- Remote operation may become unreliable if strong sunlight or fluorescent light is shining on the remote sensor of the unit.
- Remote control for different devices can interfere with each other. Avoid using remote control for other equipment located close to the unit.
- Replace the batteries when you notice a fall off in the operating range of the remote control.
- The maximum operable ranges from the unit are as follows.
 - **Line of sight:** approx. 23 feet (7m)
 - **Either side of the center:** approx. 16 feet (5m) within 30°
 - **Above:** approx. 16 feet (5m) within 15°
 - **Below:** approx. 10 feet (3m) within 30°

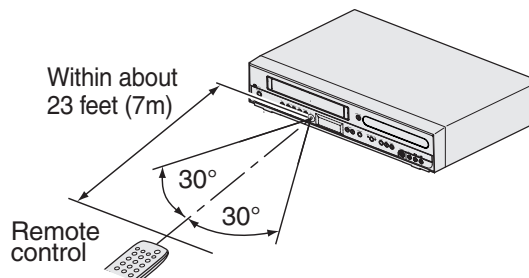

The VCR/DVD recorder switching

Because this product is a combination of a VCR and a DVD recorder, you must select first which component you wish to operate with **[SOURCE]**.

VCR MODE

Press **[VCR]** on the remote control.
(Verify that the VCR indicator is lit.)

DVD MODE

Press **[DVD]** on the remote control.
(Verify that the DVD indicator is lit.)

Note:

- Pressing only **[SOURCE]** on the front panel DOES NOT switch the mode of the remote control. You MUST select the correct mode on the remote control.
- You cannot switch to another mode (DVD or VCR) during in the timer-standby mode.
- Pressing **[DVD REC ●]** or **[VCR REC ●]** on the remote control switches immediately its respective mode so that you can start recording directly on the appropriate media.

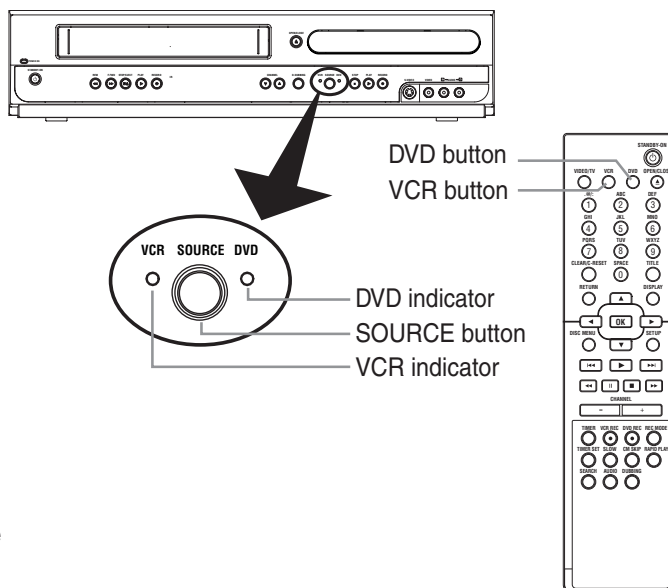

Functional overview (cont'd)

Guide to Displays On Screen menu

This unit uses the following On Screen menu for most operations: Setup menu and Title list, and Display menu. They allow you to change the playing status of the disc during play. The Display menu also gives you information on the status of the disc or a videotape.

Setup menus

Press **[SETUP]** to display the Setup menu, then press **[OK]** to display each menu, using **[▲ / ▼]**. These menus provide entries to all main functions of the unit.

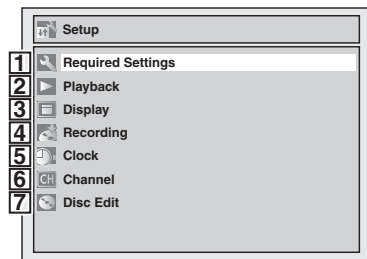

1.Required Settings:

To set up the required settings.

2.Playback:

To set up the unit to play discs as you prefer.

3.Display:

To set up the OSD screen and the front panel display of the unit as you prefer.

4.Recording:

To set up the unit to record on discs or tapes as you prefer.

5.Clock:

To set up the clock of the unit as you need.

6.Channel:

To adjust the channel setting of the unit as you prefer.

7.Disc Edit / CD Playback Mode:

When a DVD-Video disc (commercially available), a blank disc, and DVD-R formatted with other than DVD+VR is inserted into the unit, you cannot select "Disc Edit".

"CD Playback Mode" is available only when an Audio CD disc, a CD-RW/R disc with MP3 files or a Video CD is inserted into the unit.

<Disc Edit menu (DVD+RW)>

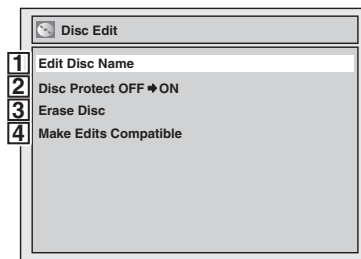

1.Edit Disc Name:

Allows you to rename the disc formatted with DVD+VR.

2.Disc Protect :

Allows you to protect a disc from accidental editing or recording.

3.Erase Disc (DVD+RW/DVD-RW only):

Allows you to erase all contents in the disc and format it.

4.Make Edits Compatible (DVD+RW only):

Allows you to make edits possible to play discs in other units after editing discs.

Finalize (DVD+R/DVD-R/DVD-R only):

Allows you to finalize a disc containing recorded titles.

<Disc Edit menu (DVD-RW)>

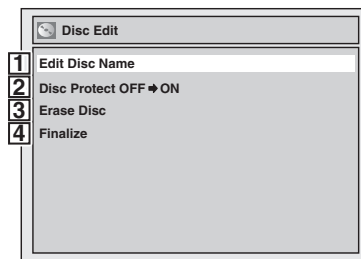

5.Random Play:

Allows you to activate the random playback feature.

6.Program Play (Audio CD/ Video CD only):

Allows you to activate the programmed playback feature.

7.PBC (Video CD only):

Allows you to select images or information on the menu screen by activation PBC (Playback control) function.

<Disc Edit menu (DVD+R/DVD-R)>

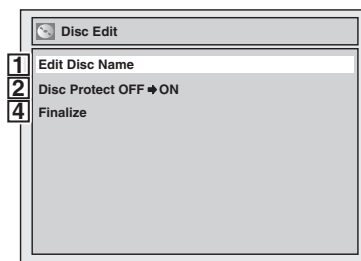

<CD Playback Mode menu>

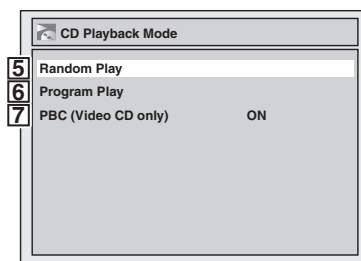

Before you start

Functional overview (cont'd)

Display menu

DVD mode





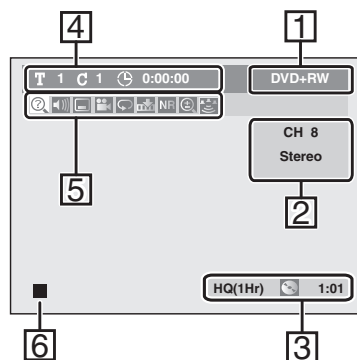



First: 

Press **[DISPLAY]** to call up the Display menu. This menu will give you the information on the disc. Some operations are available while disc is inserted in the unit.



1. Indicates a disc type and a format mode. (Format mode is displayed with DVD-RW/DVD-R (Video mode) discs inserted.)
NOTE: In some descriptions on this manual, only one disc type is indicated as an example.
2. Indicates a channel number and audio status.
3. Indicates a recording mode and possible recording time left.
4. Indicates a title number, chapter number and the time lapse of disc play.

5. Each icon means:

-  : Search
-  : Audio
-  : Subtitle
-  : Angle
-  : Repeat
-  : Marker
-  : Noise Reduction
-  : Zoom
-  : Surround

6. Indicates current disc status.

Note:

- This is an example screen only for explanation. Displayed items will change depending on the actual mode.
- DISPLAY function is not available when the disc is not inserted.

VCR mode

First: 

Press **[DISPLAY]** to display the On Screen display.

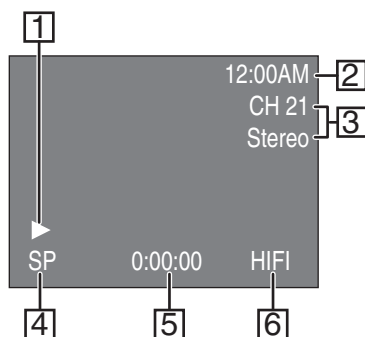

1. Indicates current video status.
2. Indicates the current time.
3. Indicates a current channel number and an audio status of the program.
4. Indicates a recording or playing mode.
5. Indicates a Tape Counter.
6. Audio status of the current videotape.

Note:

- This is an example screen only for explanation. Displayed items will change depending on the actual mode.

Before you start

Functional overview (cont'd)

Front Panel Display Guide

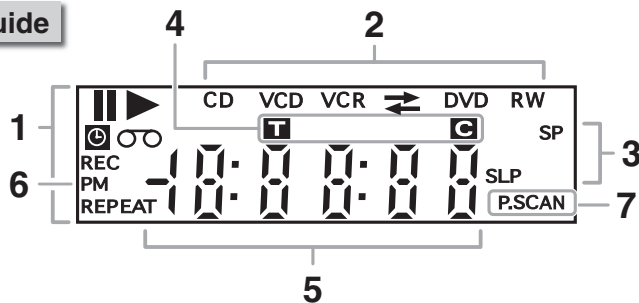

1. Current Status of the unit

|| :Appears when a disc or a videotape play is paused.

▶ :Appears when playing back a disc or a videotape.

⌚ :Appears when the timer programming or OTR has been set and is proceeding. Flashes when all Timer Recordings have been finished.

REC :Appears during recording process.
:Flashes when a recording pauses.

REPEAT

:Appears during repeat playback (disc playback only).

⌚ :Appears when a videotape is in the unit.

2. Disc type and Current status of the unit

CD :Appears when an Audio CD or a disc with MP3 files is on the disc tray.

VCD :Appears when a Video CD is on the disc tray.

DVD :Appears when a DVD disc is on the disc tray. Appears when the Timer Recording is proceeding in DVD.
:Appears when DVD is in the Timer Recording standby mode.
:Flashes when a program cannot be performed for some reasons.

DVD R :Appears when a DVD+R/DVD-R disc is on the disc tray.

DVD RW :Appears when a DVD+RW/DVD-RW disc is on the disc tray.

VCR :Appears when the Timer Recording is proceeding in VCR.
:Appears when VCR is in the Timer Recording standby mode.
:Flashes when a program cannot be performed for some reasons.

VCR → DVD

:Appears during VCR to DVD duplication process.

VCR ← DVD

:Appears during DVD to VCR duplication process.

3. Recording mode

Indicates the recording mode of a videotape.

4. Title/Track and Chapter mark

T :Appears when indicating a title/track number.

C :Appears when indicating a chapter number.

5. Displays the following

- Played-back time
- Current title / chapter / track number
- Recording time / remaining time
- Clock
- Channel number
- VCR tape counter
- Remaining time for a One-touch Timer Recording

6. PM

:Appears in the afternoon with the clock display.

7. P.SCAN

:Appears when the progressive scan system is activated.

Display message



Appears when the disc tray is opening.



Appears when the disc tray is closing.



Appears when a disc is loaded on the disc tray.



Appears when data is being recorded on a disc.



Appears when the PBC function is activated. (Video CD playback only. Refer to page 73.)

Connections

Connection to a TV (cont'd)

After you have completed connections

- Switch the input selector on your TV to an appropriate external input channel (usually near channel 0). Press a button on the TV's original remote control that selects an external input channel until the DVD recorder's picture appears. Check your TV owner's manual for details.

Input Mode Names for Common TV Brands (Example)

Admiral	AUX	Panasonic	TV/VIDEO
Curtis Mathis	LINE1, LINE2, 00, 90, 91, 92, 93	RCA	INPUT, TV/VCR, 00, 90, 91, 92, 93
GE	INPUT, TV/VCR, 00, 90, 91, 92, 93	Samsung	TV/VIDEO
Hitachi	INPUT, AUX	Sanyo	VIDEO
JVC	VIDEO, VIDEO 1, VIDEO 2, VIDEO 3	Sharp	00
Kenwood	AUX	Sony	VIDEO1, VIDEO2, VIDEO3
LXI-Series	00	Toshiba	TV/GAME
Magnavox	AUX CHANNEL	Zenith	00

To set progressive scan mode, refer to page 71

- This unit is compatible with the Progressive Scan System. The feature provides you with the higher definition images than the traditional output system does. To utilize this feature, you must set Progressive Scan mode to "ON".

Connection to a cable box or satellite box

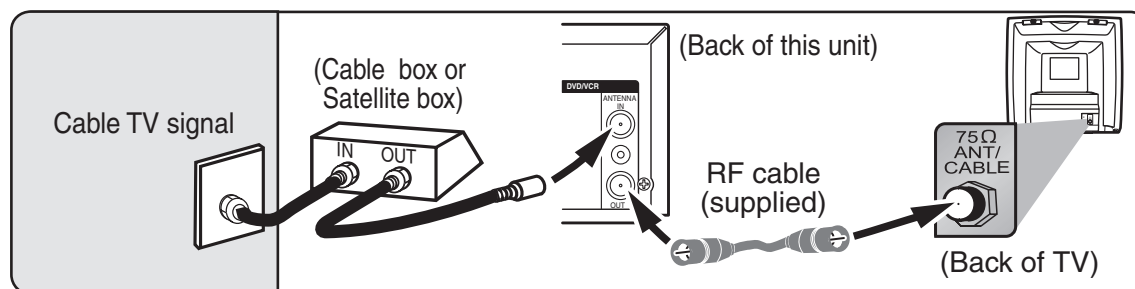

This connection allows you to view or record a scrambled channel. With this connection, channels cannot be changed on this unit. You can view or record ONLY the channels you have selected on the cable box or the satellite box.

- While you are recording, only the recorded channel can be viewed.

To select channels of the cable box or satellite box

- 1) Turn on this unit by pressing [STANDBY-ON - If noise appears on the TV screen, press [VIDEO/TV] on the remote control.
- If you use the channel 4, you will need to change this unit's RF output to channel 4. Refer to "RF output switch" on page 80.
- 2) At the TV, select channel 3 or 4 (the same channel as you have selected at step 1).
- 3) At the cable box or satellite box, select the channel you want to view or record.

Note to the Cable TV System Installer :

This reminder is provided to call the Cable TV system installer's attention to Article 820-40 of the National Electrical Code, which provides guidelines for proper grounding - in particular, specifying that the cable ground shall be connected to the grounding system of the building, as close to the point of cable entry as possible.

Connections

Connection to an Audio System

- When you change the connections, all devices should be turned off.
- Refer to the operation manual accompanying external devices for more information.

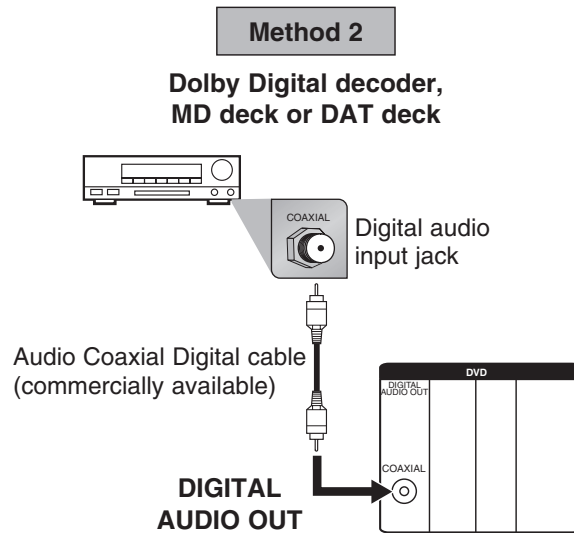
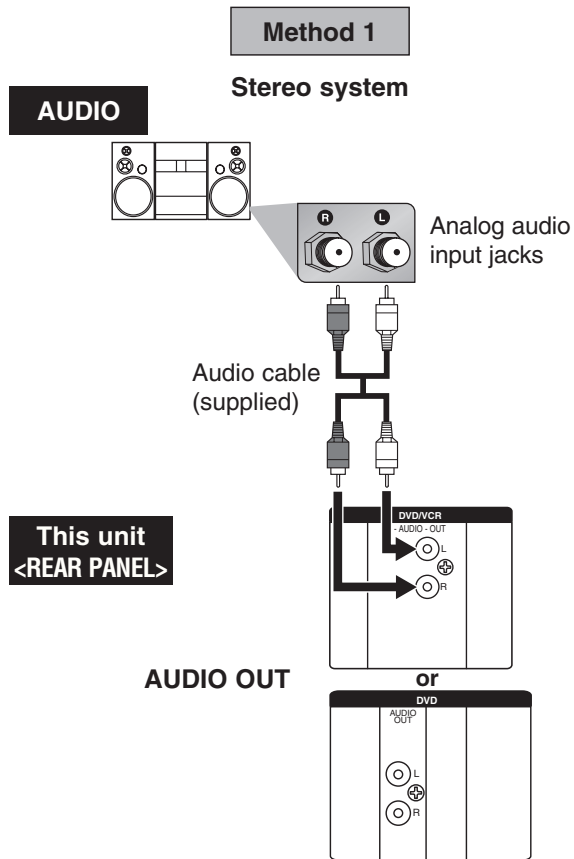

Connection	Setting	Setup>Playback>Disc Audio>Digital Out>	
		PCM	Dolby Digital
If output is Dolby Digital encoded audio, connect to a Dolby Digital decoder.		-	STREAM
Unless connected to a Dolby Digital decoder.		-	PCM
Connecting to an MD deck or DAT deck.		-	PCM

* To complete these settings, refer to pages 69-70.

Note

- Playing back a DVD using incorrect settings may generate noise distortion and may also damage the speakers.

Note

- By connecting this unit to a Multi-channel Dolby Digital decoder, you can enjoy high-quality Dolby Digital Multi-channel surround sound as heard in the movie theaters.
- The audio source on a disc in a Dolby Digital Multi-channel surround format cannot be recorded as digital sound by an MD or DAT deck.
- Playing back a DVD using incorrect settings may generate noise distortion and may also damage the speakers.

Getting started

Easy DVD recording

The following will help you to understand easily how to record to DVD discs.

Note:

Make sure batteries are in the remote control and you have connected this unit and the TV correctly.

Step 1: Choose a disc type.

There are several types of recordable DVD discs to choose from. This unit can record on the following type of discs.



For example, when you want to record repeatedly on the same disc, select the rewritable DVD+RW/DVD-RW type disc. When you want to save recordings without any alteration, a non-rewritable DVD+R/DVD-R can be your choice.

Step 2: Turn on the unit.

Remote Control

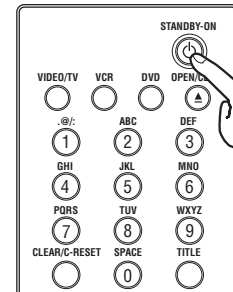

Select the input to which the unit is connected on your TV.

Step 3: Insert a blank disc.

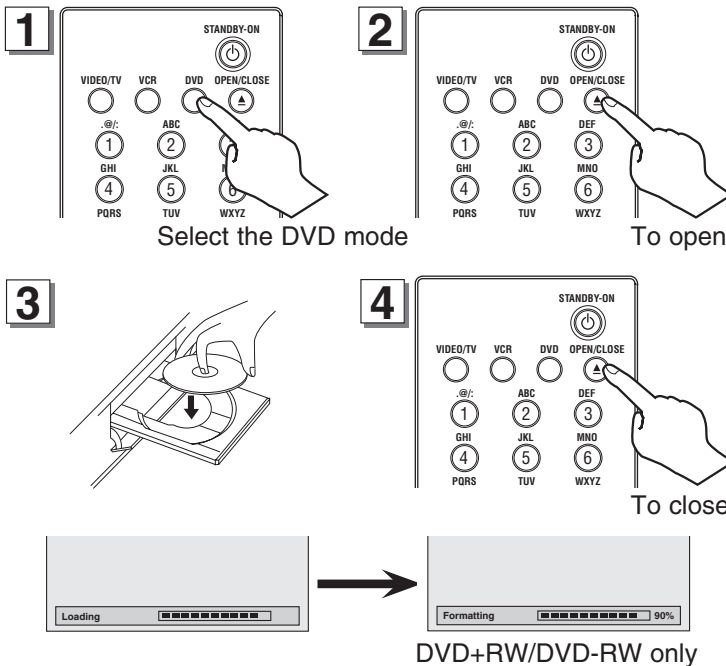

Step 4: Select the recording mode.

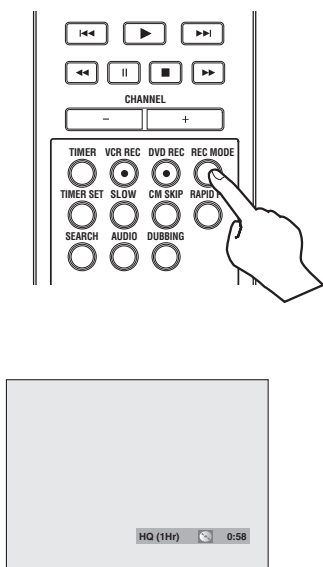

Getting started

Easy DVD recording (cont'd)

Step 5: Select the desired channel.

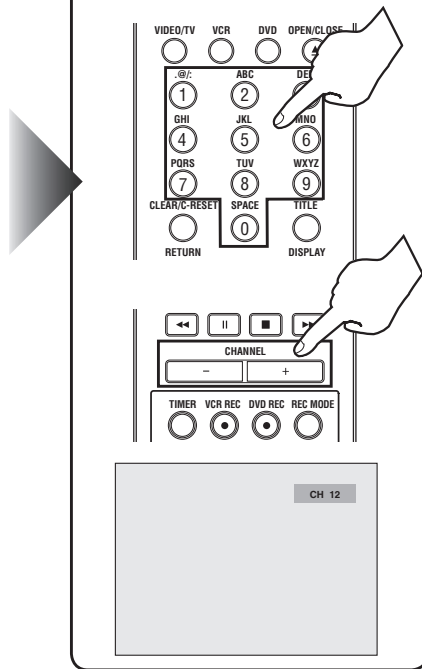

Step 6: Record on DVD disc.

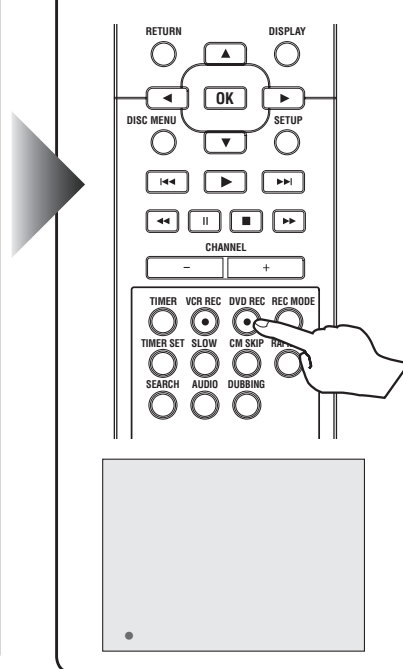

Step 7: Stop the recording.

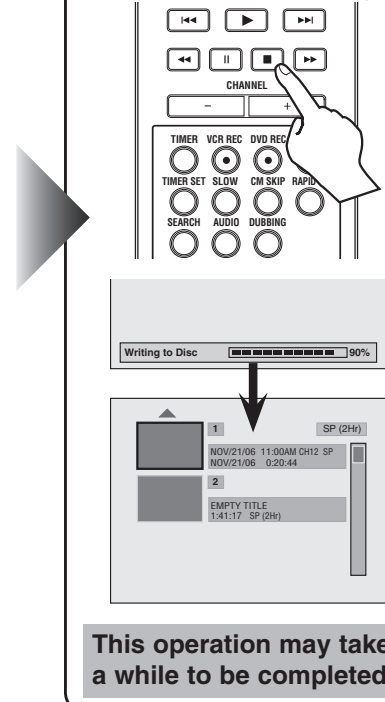

This operation may take a while to be completed.

Hint 1: Play the recorded contents

You can select the title you want to play from a displayed title list, and immediately start to play. Recorded contents are easily accessible, with simple procedure of choosing a title on a chapter in the menu screen.

What are titles and chapters?

The contents of the DVD disc are generally divided into titles. Titles may be further divided into chapters.

Hint 2: Edit the recorded disc

You will find editing discs is easy. This unit offers convenient edit functions to discs formatted with DVD+VR mode.

You can edit the following from a title list or setup menu.

- Deleting titles
- Putting names on titles
- Setting / Clearing chapter marks
- Hiding chapters
- Setting pictures for thumbnails
- Dividing a title (DVD+RW/DVD-RW only)
- Putting name on disc

Finalizing a Disc

- This will allow DVD+R/DVD-RW/DVD-R discs recorded on this unit to be played back on a different DVD player — **without finalization it will not be playable on other units.**
- After finalizing a disc, you cannot edit contents on that disc.
- DVD+RW discs is not required to finalize but to “Make Edits Compatible” to play on other units. You can edit the disc after “Make Edits Compatible”.

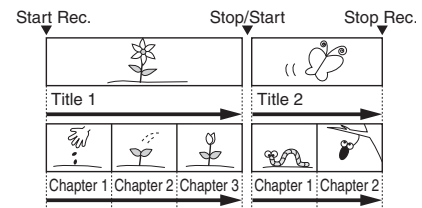

Getting started

Initial setting

Turn on this unit for the first time, you need to follow these steps.

1

Press [STANDBY-ON].

2

Turn the TV on. Select the input to which the unit is connected. Refer to the table on page 15.

“Initial Setup” will automatically appear.

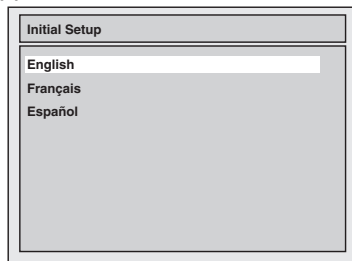

3

Using [▲ / ▼], select your desired language On Screen menu. Then press [OK] to set language.

“Channel Preset” will automatically appear.

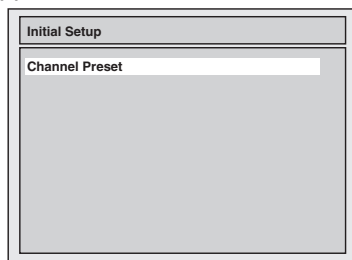

4

Press [OK] to start Channel Preset.

The unit will start getting channels available in your area.

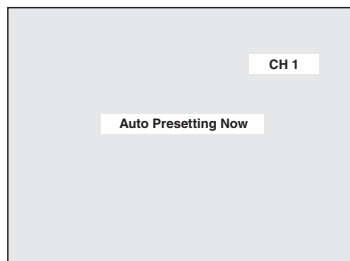

After channel setting is finished, “Clock Setting” will appear. Then press [OK].

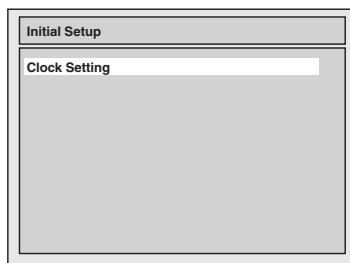

5

Follow to step 3 to “Manual Clock Setting” on page 23.

- If a Public Broadcasting Station (PBS) is available in your area, follow “Auto Clock Setting” on page 22.

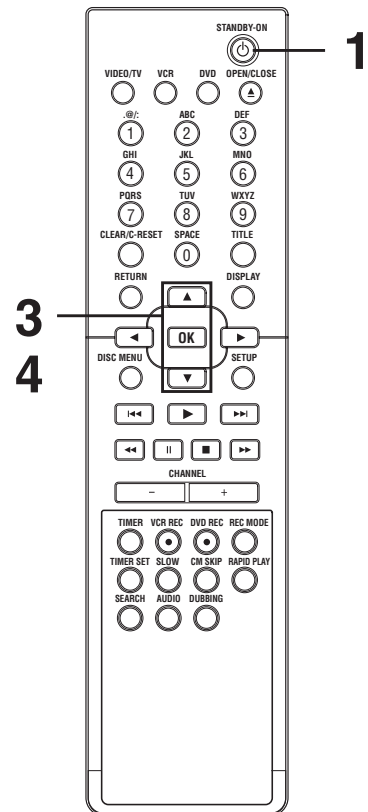

Channel setting

If you have changed antenna connection, we recommend you to program available channels in your area with the following procedures.

Getting channels automatically

1

Press [SETUP].

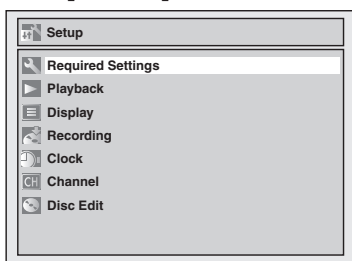

2

Using [▲ / ▼], select “Channel”. Press [OK].

Channel menu will appear.

3

Using [▲ / ▼], select “Auto Channel Preset”. Press [OK].

The unit will start getting channels available in your area.

Wait for several minutes to finish channel scanning.

4

Press [SETUP] to exit.

- You can select only the channels memorized in this unit by using [CHANNEL ▼ / ▲] on the front panel or [CHANNEL - / +].

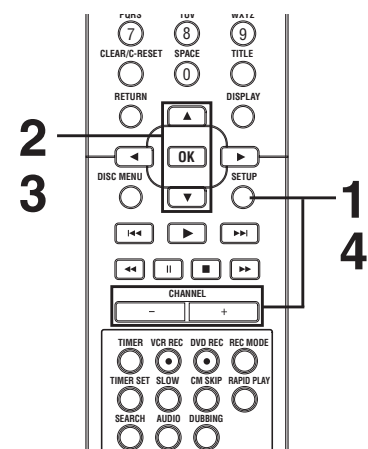

Before you start

Connections

Getting started

Recording

Playing discs

Editing

Changing the Setup menu

VCR functions

Others

Español

Getting started

Channel setting (cont'd)

To select a channel

You can select a channel by directly entering channel using the **Number buttons** on the remote control.

Notes for using the Number buttons:

- When selecting cable channels which are higher than 99, enter channel numbers as a three-digit number. (For example: 117, press [1], [1], [7])
- You must precede single-digit channel numbers with a zero (For example: 02, 03, 04 and so on).
- You can select the line input mode ("E1" or "E2"). To select "E1" by pressing [0], [0], [1]. To select "E2" by pressing [0], [0], [2]. Details are on pages 35-36.

Note

- You cannot change the channel when one of the components of the unit (VCR or DVD) is in the recording, OTR or Timer Recording mode.
- **If the auto presetting is cancelled during presetting, some of the channels not yet preset may not be received.**
- The selection will depend on how you receive the TV channels.
Press [RETURN] or [SETUP] to cancel the auto presetting during scanning.

Adding/deleting channels

The channels you no longer receive or seldom watch can be deleted from the memory. You also may add channels into memory.

1

Press [SETUP].

2

Using [▲ / ▼], select "Channel". Press [OK].

Channel menu will appear.

3

Using [▲ / ▼], select "Manual Channel Preset". Press [OK]. Manual Channel Preset menu will appear.

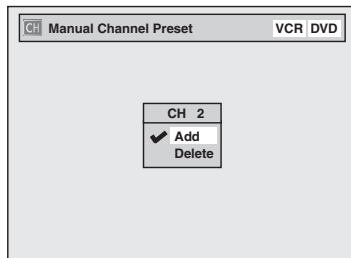

4

Select the channel number to add or delete.

Press [◀] or [CHANNEL -] to move to a lower channel number. Press [▶] or [CHANNEL +] to move to a higher channel number. Press the **Number buttons** to select a channel number directly.

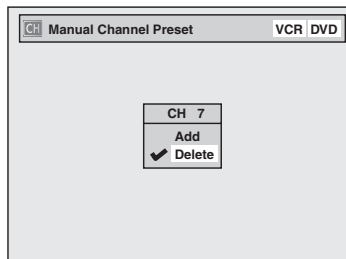

5

Using [▲ / ▼], select "Add" or "Delete". Press [OK].

The channel number will be added or deleted from the channel memory. Then the next channel number will appear so that you can continue adding or deleting channels.

6

Press [SETUP] to exit.

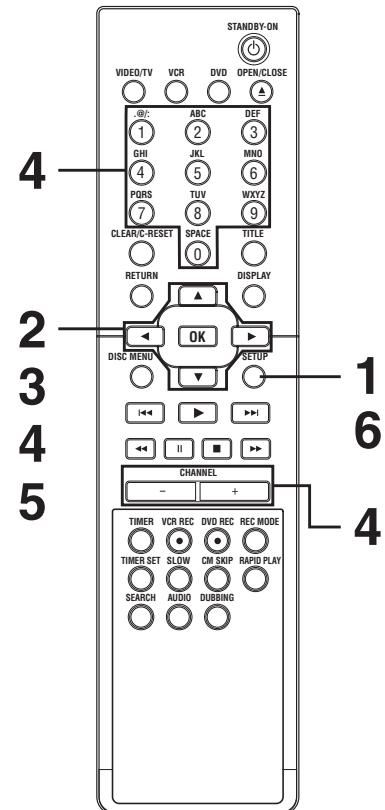

Note

- [CHANNEL - / +] works on the memorized channel in this unit.
- [◀ / ▶] works on all of channel numbers.

Getting started

Selecting the TV stereo or SAP

You can select a sound channel to output from TV. "Stereo" has been selected as the default.

1

Press [SETUP].

2

Using [▲ / ▼], select "Required Settings". Press [OK].

Required Settings menu will appear.

3

Using [▲ / ▼], select "TV Audio Select". Press [OK].

Option window will appear.

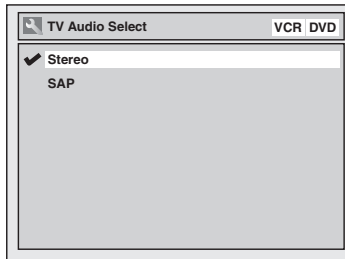

4

Using [▲ / ▼], select "Stereo" or "SAP". Press [OK].

Stereo:

Outputs main-audio.

SAP (Secondary Audio Program):

Outputs sub-audio.

5

Press [SETUP] to exit.

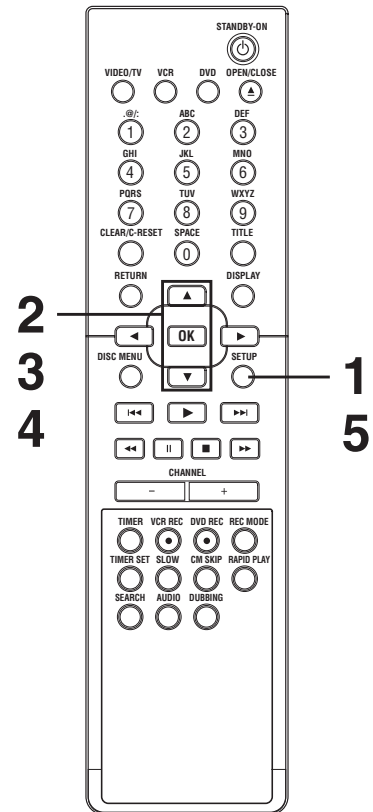

Notes on TV channel audio

- When you record a TV program available in second audio or stereo, you have to select either Stereo or SAP in "Required Settings" beforehand. Refer to the following table to check an appropriate setting.

Selected audio	Broadcast audio	Disc (Videotape) recording	Audio output
Stereo	STEREO+SAP	STEREO	STEREO
	STEREO	STEREO	STEREO
	MONO+SAP	MONO	MONO
	MONO	MONO	MONO
SAP	STEREO+SAP	SAP	SAP
	STEREO	STEREO	STEREO
	MONO+SAP	SAP	SAP
	MONO	MONO	MONO

- You can only play the disc in second audio if a TV program is available in second audio and you set "TV Audio Select" to "SAP".

Before you start

Connections

Getting started

Recording

Playing discs

Editing

Changing the Setup menu

VCR functions

Others

Español

Getting started

Setting the clock

Set the clock before you try the Timer Programming. If a Public Broadcasting Station (PBS) is available in your area, follow "Auto Clock Setting" below. If not, follow "Manual Clock Setting" on page 23.

Auto Clock Setting

Make sure

- The antenna/Cable TV connections are correct.
- If this unit is connected to a Cable Box or Satellite Box, select the local PBS station on them to set the clock automatically.

1

Press [SETUP].

2

Using [▲ / ▼], select "Clock". Press [OK].

Clock menu will appear.

3

Using [▲ / ▼], select "Auto Clock Setting". Press [OK].

Option window will appear.

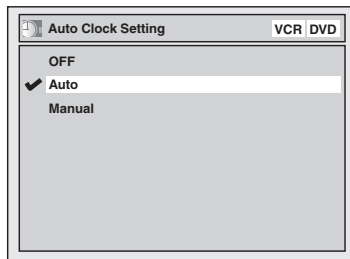

4

- If you do not know your PBS channel number:

Using [▲ / ▼], select "Auto". Press [OK].

The setting will be activated.

- If you know your PBS channel number:

Using [▲ / ▼], select "Manual". Press [OK].

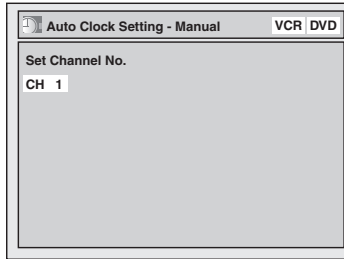

Using the Number buttons or [▲ / ▼], enter your PBS channel number. Press [OK].

The setting will be activated.

- If you want to set the clock manually and cancel the Auto Clock Setting function: Using [▲ / ▼], select "OFF" in "Auto Clock Setting". Press [OK].

The Auto Clock Setting function will be canceled.

5

Press [SETUP] to exit.

6

Press [STANDBY-ON] to turn off the unit.

This unit will search for the time only when the power is off. Leave it off for several minutes to give this unit time to set the clock on the front panel display.

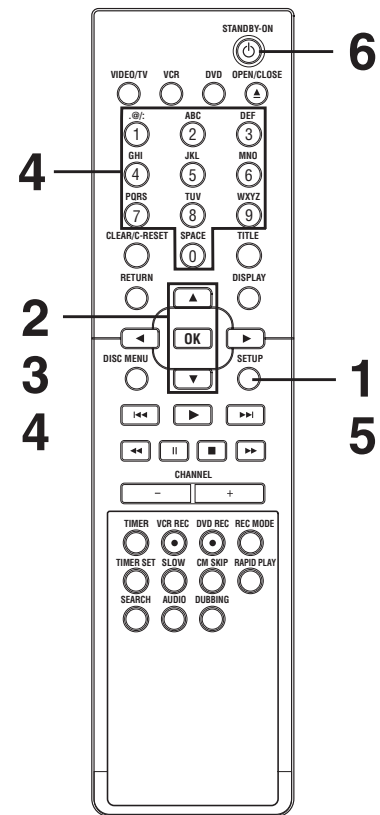

Note

- The clock may set itself automatically after you connect the antenna/cable signal to this unit and plug in the power cord. In this case, the current time will appear on the front panel display.
- If the current time is not displayed or the displayed clock is not correct, set the clock manually.

Getting started

Setting the clock (cont'd)

Manual Clock Setting

1

Press [SETUP].

2

Using [▲ / ▼], select “Clock”. Press [OK].

3

Using [▲ / ▼], select “Clock Setting”. Press [OK].
Clock Setting menu will appear.

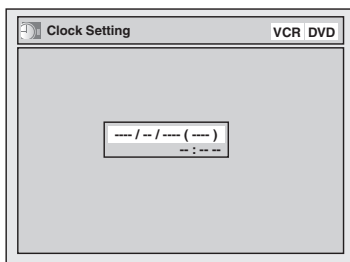

Press [OK] again.
Default date will appear.

4

Using [▲ / ▼], enter the date (month / day / year). Press [◀ / ▶] to move the cursor.

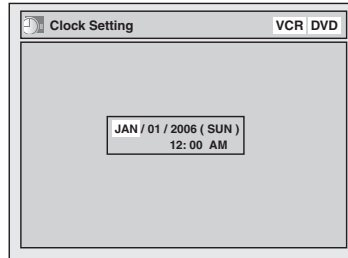

5

Using [▲ / ▼], enter the time (hour / minute). Press [◀ / ▶]. A cursor will move on AM.

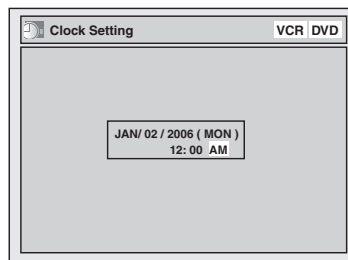

6

Press [▲ / ▼] to select “AM” or “PM”. Press [OK].
The settings will be activated. Although seconds are not displayed, they begin counting from zero.

7

Press [SETUP] to exit, if Clock menu appears.

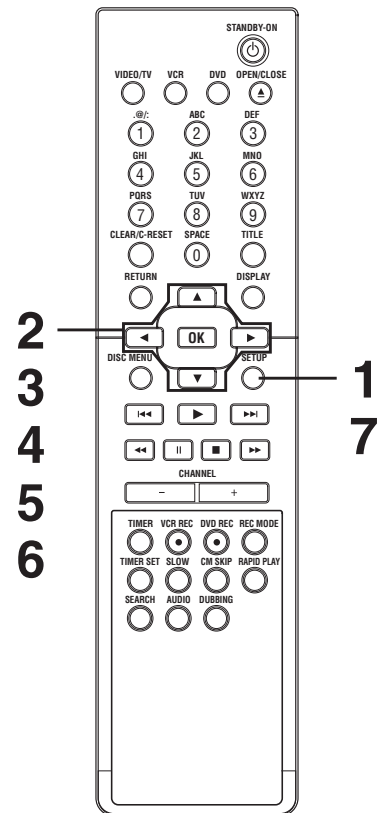

Note

- Your clock setting will be lost if either there is a power failure or this unit has been unplugged for more than 30 seconds when you set the clock manually.

Getting started

Setting the clock (cont'd)

Setting the Daylight Saving Time

When “Daylight Saving Time” is “ON”, the unit clock will automatically move forward one hour on the first Sunday in April and move back one hour on the last Sunday in October.
“ON” has been selected as the default.

1

Press [SETUP].

2

Using [▲ / ▼], select “Clock”. Press [OK].

Clock menu will appear.

3

Using [▲ / ▼], select “Daylight Saving Time”. Press [OK].

Option window will appear.

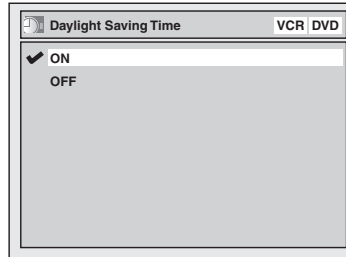

4

Using [▲ / ▼], select “ON” or “OFF”. Press [OK].

Choose “ON” when currently utilizing the daylight saving time.

5

Press [SETUP] to exit.

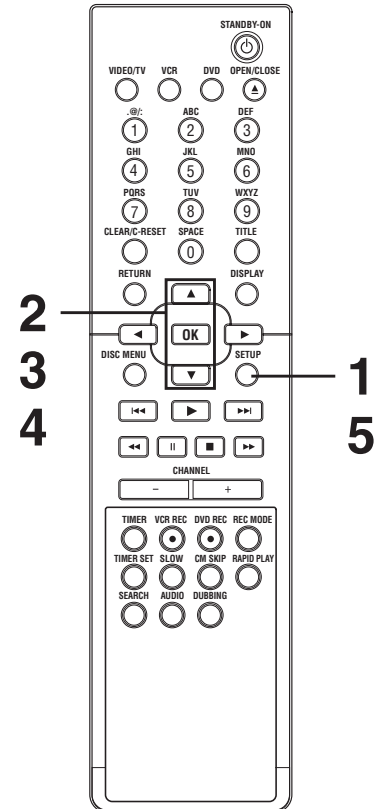

Selecting the TV aspect ratio

You can select the TV aspect ratio to match the formats of what you are playing with the unit and your TV screen (4:3 standard or 16:9 widescreen TV).
“4:3 Letter Box” has been selected as the default.

1

Press [SETUP].

2

Using [▲ / ▼], select “Required Settings”. Press [OK].

Required Settings menu will appear.

3

Using [▲ / ▼], select “TV Aspect”. Press [OK].

Option window will appear.

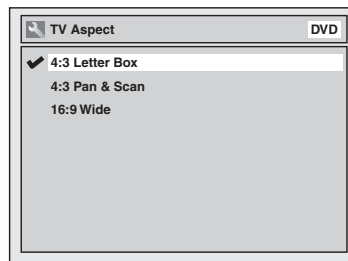

Refer to the Note on this page.

4

Using [▲ / ▼], select a desired option. Press [OK].

5

Press [SETUP] to exit.

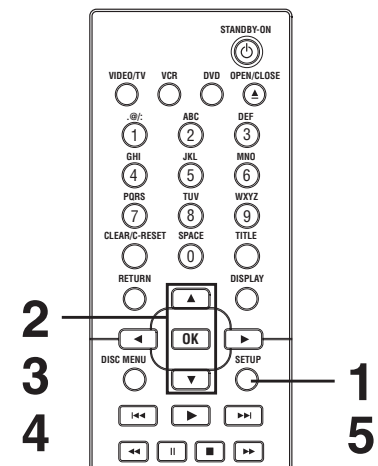

Note

If you have a standard TV:

Select “4:3 Letter Box”, so that black bars appear on the top and bottom of the screen. Select “4:3 Pan & Scan” for a full height picture with both sides trimmed.

If you have a widescreen TV:

Select “16:9 Wide”.

Information on DVD recording







Information

This unit can record to DVD+RW/DVD-RW/DVD+R/DVD-R discs.

DVD+R/DVD-R discs can only be recorded to once. DVD+RW/DVD-RW discs can be recorded to and erased many times.

These discs are formatted with DVD+VR mode automatically.

Discs other than DVD+VR mode cannot be recorded in this unit.

Logo	Attributes
	8cm/12cm, single-sided, single layer disc
	Approx. max. recording time (SLP mode): 360 minutes (4.7GB) (for 12cm) 108 minutes (1.4GB) (for 8cm)
	
	
	
	8cm/12cm, single-sided, single layer disc
	Approx. max. recording time (SLP mode): 360 minutes (4.7GB) (for 12cm) 108 minutes (1.4GB) (for 8cm)
	
	

Recordable disc

- We strongly recommend for good recording quality:
SONY DVD+RW 4x
TDK DVD+R 4x/8x/16x
SONY DVD+R 4x/8x/16x
MAXELL DVD+R 4x/8x/16x
MAXELL DVD-RW 4x
MAXELL DVD-R 8x/16x
- DVD+RW 1x-4x, DVD+R 1x-16x, DVD-RW 4x and DVD-R 8x/16x discs can be used in this recorder.
- Discs that have been tested and are proven to be compatible with this recorder:
VERBATIM DVD+RW 4x VERBATIM DVD+R 8x
VERBATIM DVD-RW 2x VERBATIM DVD-R 8x
JVC DVD-RW 4x MAXELL DVD-R 16x
- You can play DVD+RW in most DVD players without finalizing. To play discs other than DVD+RW in other DVD players, you will need to finalize.

Recording mode

You can select a recording mode among 6 options, and the recording time will depend on the recording mode you select as follows.

Disc Size	Recording mode	Recording time	Video/Sound Quality
8cm Disc	HQ (1Hr)	18 min	☆☆☆☆☆☆ (good)
	SP (2Hr)	36 min	☆☆☆☆☆
	SPP (2.5Hr)	45 min	☆☆☆☆
	LP (3Hr)	54 min	☆☆☆
	EP (4Hr)	72 min	☆☆
	SLP (6Hr)	108 min	☆ (poor)
12cm Disc	HQ (1Hr)	60 min	☆☆☆☆☆☆ (good)
	SP (2Hr)	120 min	☆☆☆☆☆
	SPP (2.5Hr)	150 min	☆☆☆☆
	LP (3Hr)	180 min	☆☆☆
	EP (4Hr)	240 min	☆☆
	SLP (6Hr)	360 min	☆ (poor)

- The recording time are estimates and actual recording time may differ.
- The audio and video quality is getting poorer as the Recording time becomes longer.
- Each time [REC MODE] is pressed, recording mode and its allowed recording time will be displayed.

Note

- This recorder cannot record CD-RW or CD-R discs.
- DVD+RW/R, DVD-RW/R and CD-RW/R discs recorded on a personal computer or a DVD or CD recorder may not play if the disc is damaged or dirty or if there is dirt of condensation on the player's lens.
- If you record a disc using a personal computer, even if it is recorded in a compatible format, there are cases in which it may not play because of the settings of the application software used to create the disc. (Check with the software publisher for more detailed information.)
- DVD-RW/R discs recorded in Video mode cannot be recorded additionally using the unit.
- Since the recording is made by the variable bit rate (VBR) method, depending on the picture you are recording, the actual remaining time for recording may be a little shorter than the remaining time displayed on the OSD.
- You cannot record copy-protected video using this unit. (Copy-protected video includes DVD-Video discs and some satellite broadcasts.)
- You cannot record videos that includes "copy-once only" signal.

Recording

Information on DVD recording (cont'd)

Making discs playable in other DVD player (Finalize/Make Edits Compatible)

After recording on DVD+R/DVD-RW/DVD-R, you must finalize the disc in order to play on other units. (Refer to page 37.)

There is no need to finalize DVD+RW discs but to “Make Edits Compatible” (refer to page 65) for playing on other units after editing.

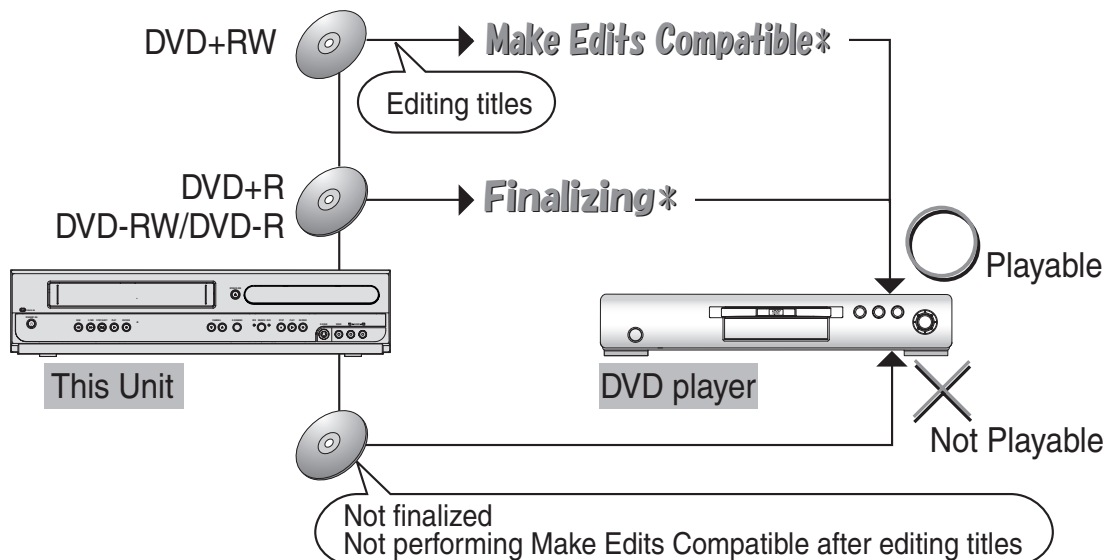

***You cannot finalize or Make Edits Compatible in other DVD recorders.**

- Once DVD+R/DVD-RW/DVD-R discs are finalized, you cannot record additionally or edit.
- You cannot record additionally or edit on finalized DVD-RW discs unless the DVD-RW discs are performed "Undo Finalize".

Recording

Before recording

Replacing disc menu



It can be used to prohibit recording additionally or to replace the title list after recording when inserting the disc includes titles and a different type of title list recorded by other units. "OFF" has been selected as the default.

1

Press [SETUP].

2

Using [▲ / ▼], select "Recording". Press [OK].
Recording menu will appear.

3

Using [▲ / ▼], select "Replace Disc Menu". Press [OK].
Option window will appear.

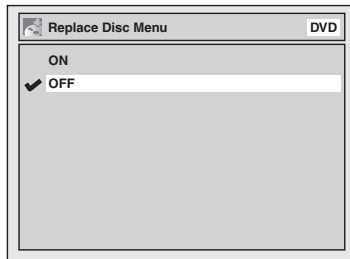

4

Using [▲ / ▼], select "ON" or "OFF". Press [OK].
ON: Replacing the title list
OFF: Prohibiting additional record

5

Press [SETUP] to exit.

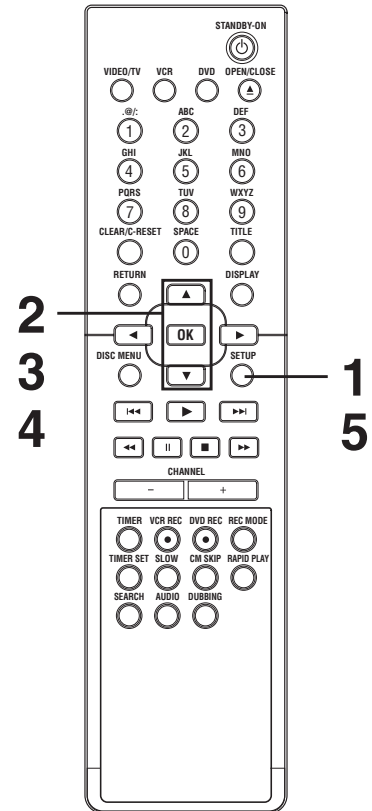

Setting for Auto Chapter



You can set a specified time for chapter marks. "10 minutes" has been selected as the default.

1

Press [SETUP].

2

Using [▲ / ▼], select "Recording". Press [OK].

3

Using [▲ / ▼], select "Auto Chapter". Press [OK].

Option window will appear.

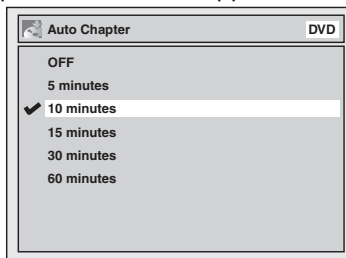

4

Using [▲ / ▼], select a desired time option. Press [OK].

5

Press [SETUP] to exit.

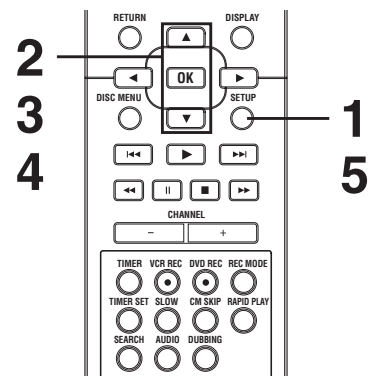

Note

- The interval for auto chapter marks may slightly deviate from the one you specified on the Auto chapter screen.
- A blank chapter may be created depending on the remaining time of the disc.

Before you start

Connections

Getting started

Recording

Playing discs

Editing

Changing the
Setup menu

VCR functions

Others

Español

Recording

Basic recording



Follow the steps below to record TV programs.

1

Press **[STANDBY-ON ⏻]**.
Turn the TV on and be sure to select the input to which the unit is connected.

Press:

2

Press **[OPEN/CLOSE ▲]**.
The disc tray will open.

3

Insert your disc with its label facing up. Align the disc to the disc tray guide.

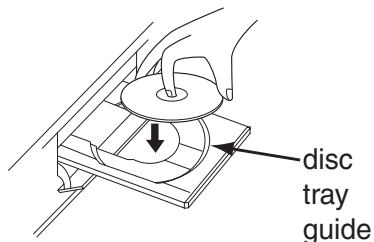

4

Press **[OPEN/CLOSE ▲]** to close the disc tray.

- When inserting a brand-new DVD+RW/DVD-RW disc, the unit automatically starts to format.
- If titles have been recorded on the disc, the title list is displayed. Press **[STOP ■]** to exit the title list.

This operation may take a while to be recognized.

5

Using **[REC MODE]**, select a recording mode.
Refer to "Recording mode" on page 25.

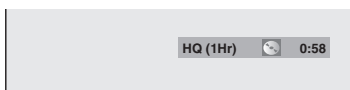

6

Using **[CHANNEL - / +]** or the **Number** buttons, select a desired channel to record.



7

Press **[DVD REC ●]** to start recording.
"●" mark will be displayed for 5 seconds.

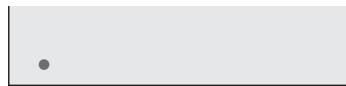

Press **[PAUSE II]** to pause recording. Press **[PAUSE II]** or **[DVD REC ●]** again to restart recording.

8

Press **[STOP ■]** to stop recording.
The recorded title will be on the displayed title list. (Refer to "Guide to a title list" on page 54.)

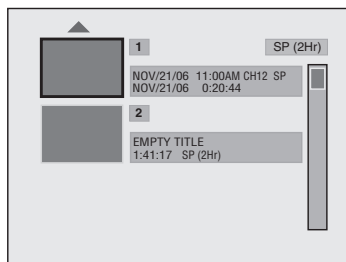

- Press **[STOP ■]** to exit the title list.

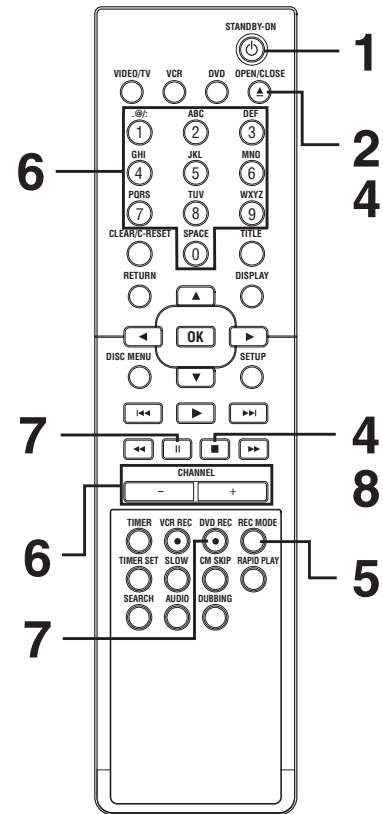

Note

- The portion bar in the light side of the title list may not indicate the precise position of the disc.
- Recording starts immediately and continues until the disc is full or you stop recording.
- When the clock setting has not been made, the space for a date and time of title names will be blank.
- When you record a TV program which has Stereo and SAP audio, you have to select the TV channel audio (Stereo or SAP) beforehand. Only the selected channel audio will be recorded. Refer to "Selecting the TV stereo or SAP" on page 21 for more details.
- You cannot change the recording mode during the REC pause mode.
- You can change a channel during the REC pause mode.

Recording

One-touch Timer Recording (OTR)



This is a simple way to set the recording time in blocks of 30 minutes. Check that the disc you are recording onto has enough space for the time you set. When the recording finishes the recorder automatically goes into standby mode.

First:

1

Turn on the unit and load a recordable disc.

Make sure that the TV input is set on the unit.

This operation may take a while to be recognized.

2

Using [REC MODE], select a recording mode.

Refer to "Recording mode" on page 25.

3

Using [CHANNEL - / +] or the Number buttons, select a desired channel to record.

4

Press [DVD REC ●] repeatedly to select desired recording time. Recording times appear on the TV screen (30 minutes to 8 hours). Recording will start.

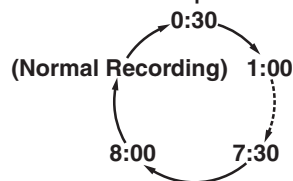
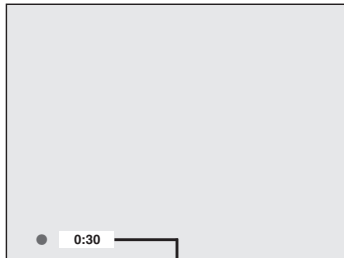

When the unit reaches the specified time, it will be turned off automatically.

To change the recording length during the One-touch Timer Recording, press [DVD REC ●] repeatedly until the desired length appear.

To cancel the One-touch Timer Recording within the specified time, press [STOP ■].

This operation may take a while to be completed.

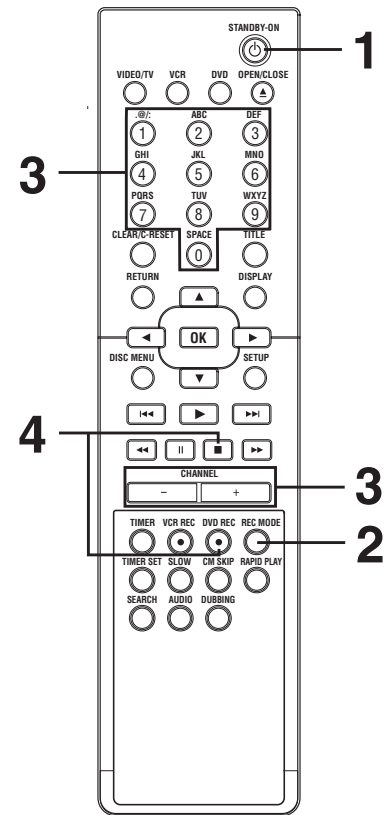

Note

- The remaining recording time will appear on the display panel during a One-touch Timer Recording, press [DISPLAY] to see the remaining recording time on the TV screen.
- You cannot pause a One-touch Timer Recording.
- Unlike a Timer Recording, you can perform the following operations during a One-touch Timer Recording.
 - Turning the power off.
 - Using [DVD REC ●] and [STOP ■].
- The unit will be turned off automatically under the following conditions.
 - 1) No space remained on the disc.
 - 2) When a power failure occurs.
- If OTR is finished in DVD during playback or REC mode in VCR, the DVD will be in STOP mode and the VCR keeps the current mode.
- When OTR is finished and the power is turned off, the unit will switch to the standby mode automatically if a Timer Recording has been programmed. Press [TIMER SET] to cancel the standby mode for using the unit continuously.

Before you start

Connections

Getting started

Recording

Playing discs

Editing

Changing the Setup menu

VCR functions

Others

Español

Recording

Timer Recording



You can program the unit to record up to 8 programs within a month in advance. Daily or weekly program recordings are also available.

- Be sure to set the clock before setting a timer programming.
- Insert a recordable disc or a videotape with a record tab.

1

Press [TIMER].

Timer Programming list will appear.

Timer Programming						VCR DVD
Date	Start	End	CH	DVD VCR	Mode	
1. ---						
2. ---						
3. ---						

2

Using [▲ / ▼], select a program number. Press [OK].

3

Using [▲ / ▼], enter the Date. Press [▶].

Timer Programming						VCR DVD
Date	Start	End	CH	DVD VCR	Mode	
1. JAN/01	--:--	--:--	E1	DVD		
2. ---						
3. ---						

When pressing [▼] at the current date, the Date will change as follows.

e.g. January 1st

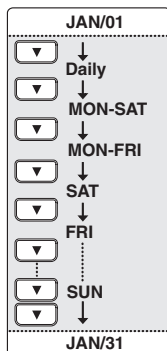

4

Using [▲ / ▼], enter the Start and End time. Press [▶].

Timer Programming						VCR DVD
Date	Start	End	CH	DVD VCR	Mode	
1. JAN/01	12:57AM	--:--	E1	DVD		
2. ---						

5

Using [▲ / ▼], select the channel number to record. Press [▶].

Timer Programming						VCR DVD
Date	Start	End	CH	DVD VCR	Mode	
1. JAN/01	12:57AM	1:57AM	8	DVD		
2. ---						
3. ---						

To record from external input, select E1 or E2.

6

Using [▲ / ▼], select a recording media. Press [▶].

Timer Programming						VCR DVD
Date	Start	End	CH	DVD VCR	Mode	
1. JAN/01	12:57AM	1:57AM	8	DVD		
2. ---						
3. ---						

- To record on a videotape, select VCR.
- To record on a disc, select DVD.

7

Using [▲ / ▼], select a recording mode.

Timer Programming						VCR DVD
Date	Start	End	CH	DVD VCR	Mode	
1. JAN/01	12:57AM	1:57AM	8	DVD	HQ	
2. ---						
3. ---						

Refer to “Recording mode” on page 25 for DVD or page 74 for VCR.

When “Auto” (DVD only) is selected as a recording mode, the unit determines how much time is available on the disc and record in the appropriate recording mode to complete recording the program.

Timer Programming						VCR DVD
Date	Start	End	CH	DVD VCR	Mode	
1. JAN/01	12:57AM	1:57AM	8	DVD	Auto	
2. ---						
3. ---						

8

Press [OK] when information is entered.

Your program setting will be stored.

- To set another program, repeat steps 2 to 8.
- To exit, press [TIMER] or [SETUP].
- When programs are overlapped, “Overlap” and the overlapped program numbers will appear on the TV screen.

9

Press [TIMER SET] to set a Timer Programming.

Ⓢ will appear on the front panel display.



- “VCR” will appear if VCR Timer Recording have been set.

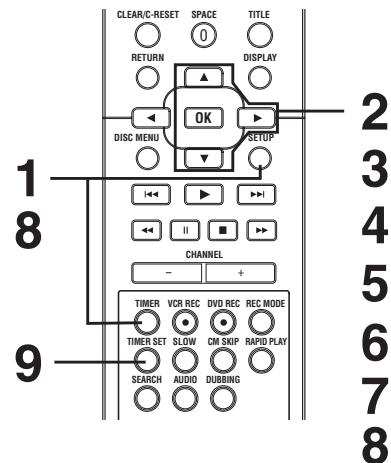

Note

- **If you have not set the clock yet:**

A manual clock setting menu will appear instead of the Timer Programming list at step 1. Continue with step 3 in “Manual Clock Setting” on page 23 before setting a timer programming.

- Press [◀ / ▶] to move the cursor to the left and the right in the timer programming list.
- After step 9, you can use the other component (VCR or DVD) which is not currently programmed by turning the power on. Note that the programmed device will start to capture the selected channel 2 minutes before the start time and at the moment, if the other device still stays in recording, recording pause or OTR mode turning a different channel, the current mode will be canceled and you cannot change the channel. When both devices capture the same channel, the current mode continues to function.

Recording

Timer Recording (cont'd)

Checking, canceling, or correcting the timer programming information

1

Press [TIMER SET].

☼ disappears from the front panel display.

2

Press [TIMER].

Timer Programming list will appear.

Timer Programming						VCR DVD
Date	Start	End	CH	Mode		
1. JAN/01	12:57AM	1:57AM	8	DVD	HQ	
2.	---					
3.	---					

3

Check the information on the list you will need.

4

To clear the timer programming: Using [▲ / ▼], select your desired program. Press [CLEAR/C-RESET].

To correct the timer programming: Using [▲ / ▼], select your desired program. Press [OK].

Next, correct the timer programming by using [▲ / ▼ / ◀ / ▶]. Finally, press [OK] again.

5

Press [TIMER] to exit.

6

Press [TIMER SET] to return to the timer standby mode.

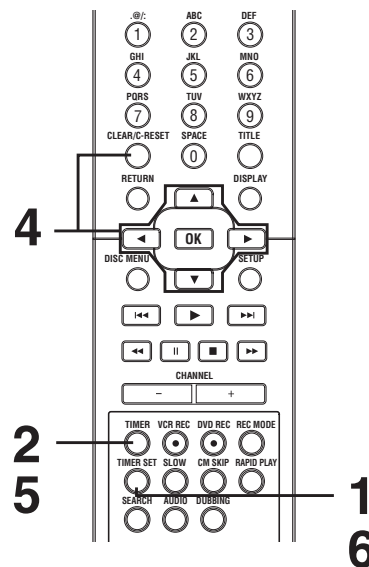

Note

- Press [TIMER] to check the Timer Recording in process.
- When the Timer Recording is in progress, that program will be highlighted in red.
- While using the side of the unit that is free from Timer Recording (either DVD or VCR) during timer standby mode, no programs will be highlighted even if you press [TIMER] to confirm the program information. In this case, you cannot select other program either for correction or add any new programs.
- The unit will be turned on automatically before the recording time.

To stop the Timer Recording in process

Press [STOP ■] to stop the disc recording or [STOP ■ / EJECT ▲] to stop the videotape recording on the front panel of the main unit. [STOP ■] on the remote control is not effective.

If the timer program did not complete correctly, the error number appears in the Timer Programming list.

Timer Programming						VCR DVD
Date	Start	End	CH	Mode		
* JAN/01	12:57AM	1:57AM	8	DVD	E22	
2.	---					
3.	---					
4.	---					
5.	---					
6.	---					
7.	---					
8.	---					

Press [CLEAR/C-RESET] to erase the selected program.

Each error number means:

E1-22	Recording error other than below	E41	Power failed
E37-39	Unrecordable disc	E42	No disc when recording
E23-24	Copy prohibited program	E43	Already 49 titles recorded
E25-26	Disc protected	E44	Already 254 chapters recorded
E29	Disc full	E45	Copy prohibited program
E30	No space for Control information	E46	It is impossible to record additionally on a disc recorded by other units when setting Replace Disc Menu to OFF.
E34	PCA full		
E35	Already finalized Video format disc		
E36	Some portion has not been recorded because of program overlapping. Recording did not start at the start time.		
E40			

- E27, E28, E31, E32 and E33 are not displayed.

- A program with the error number is grayed and asterisked in the Timer Programming list.
- Once the Timer Programming list with error line(s) is displayed, or after canceling and setting again the timer standby mode, the program line(s) with error will be cleared.

Recording

Timer Recording (cont'd)

Hints for Timer Recording

- If there is a power failure or this unit has been unplugged for more than 30 seconds, the clock setting and all timer settings will be lost.
- If a recordable disc is not on the tray or an unrecordable disc is on the tray, "DVD" on the front panel display flashes and Timer Recording cannot be performed. In some cases, "DVD" flashes momentarily around the Timer starting time as the unit attempts to record. Please insert a recordable disc.
- If a videotape with a record tab is not in the cassette compartment or there is no videotape in the compartment, "VCR" on the front panel display flashes and timer recording cannot be performed. Please insert a recordable videotape.
- If you press [STANDBY-ON] and turn on the unit while either DVD or VCR is in timer standby mode, the [RECORD] indicator disappears. In this case, you cannot change the mode between DVD and VCR. You cannot change any settings using [SETUP] or edit discs.
- After step 9 on page 30, you can turn on the power to use the side of the unit that is free from Timer Recording (either DVD or VCR) for another recording by pressing [STANDBY-ON] during timer standby. During Timer Recording, press [SOURCE] on the front panel, or [DVD] or [VCR] on the remote control. Note that you cannot change channels after Timer Recording started. You can use all recording/recording pause/OTR functions. However, the unit will begin receiving channel signals for Timer Recording 2 minutes before the programmed starting time. Unless the program that you are currently recording using the Timer Recording free side of the unit is on the same channel with the one programmed for Timer Recording, the unit prioritizes Timer Recording and the current recording will be automatically stopped. If the channels set for Timer recording and the current recording are same, the current recording will continue without interruption.
- When all the Timer Recording is completed, the [RECORD] indicator flashes. To play or eject the recorded disc, press [STANDBY-ON] first, and then press [PLAY] or [OPEN/CLOSE].
- If both DVD and VCR are timer programmed, you cannot use any functions for either unit during timer standby or Timer Recording. If you want to use functions other than recording under such condition, cancel Timer Recording by pressing [TIMER SET] during timer standby or stop recording by pressing [STOP] on the front panel during Timer Recording.
- When the starting and ending time are same, the recording will be set for 24 hours. When the disc or tape reaches the end during the recording, the unit turns itself off. If you want to continue the recording, cancel timer standby by pressing [TIMER SET], insert a new disc or tape, and then press [TIMER SET] again. If you are recording on a tape, the unit automatically ejects the tape when it reaches the end. You can continue the recording by inserting a new tape.
- When the programmed starting and ending time are earlier than the current time, the setting will not be accepted and be cleared for redoing.
- If the starting time is earlier and the ending time is later than the current time, the recording will start right after you press [TIMER SET].
- The Timer Recording cannot be performed in DVD and VCR at the same time. If you set two programming with the same channel and time in both units, the program with a lower program number will be recorded.

The priority of overlapped settings

This unit records the programs according to priority if the timer programmings are overlapped. The timer programming set previously has priority.

A Timer Recording of lower priority will be canceled, start from the middle or stop on the way.

Check the overlapped timer programmings and change the priority if necessary.

A programming set previously has priority

When the starting time is the same:

A program set previously (PROG. A) has priority.

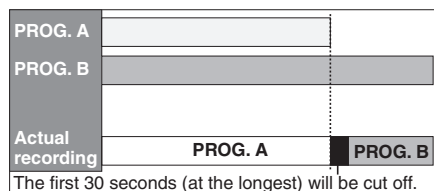

When the recording time is partially overlapped:

PROG. A will start after PROG. B is complete to be recorded.

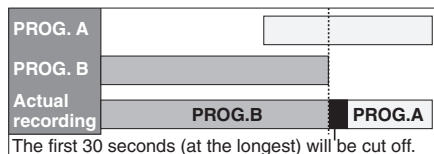

When some programming have been made at the end time of the programming currently being recorded:

A program set previously (PROG. B) has priority.

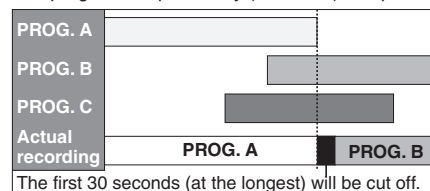

When the recording time is entirely overlapped:

PROG. A will not be recorded.

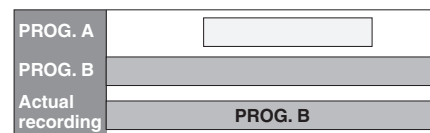

Note for DVD recording

- When the recording time of two programs are overlapped, or the End time of a program and the Start time of another is the same, the first 30 seconds (at the longest) of the subsequent program will be cut off.
- If the cut-off portion comes up to one minute or more, this program will be displayed with error number E40 in the timer programming list.

When the End time of the programming currently being recorded and the Start time of the subsequent program are same:

If PROG. A is a DVD recording program, the beginning of the PROG. B may be cut off.

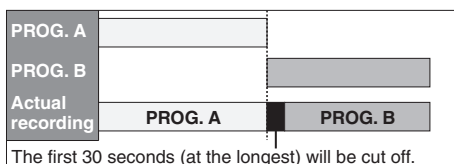

Recording

Overwriting an existing title

Overwriting from the beginning of the title



You can overwrite the existing title from the beginning.

1

Press [STANDBY-ON].
Make sure that the TV input is set on the unit.

Press:

2

Load the disc that includes a title to be overwritten.

Title list will appear.
If the title list does not appear, press [DISC MENU].

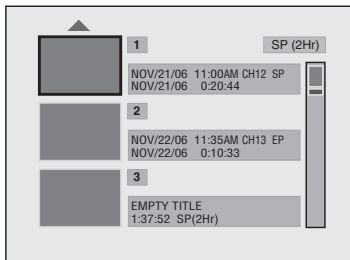

This operation may take a while to be recognized.

3

Using [REC MODE], select a recording mode.

Refer to "Recording mode" on page 25.

4

Using [\blacktriangle / \blacktriangledown], select a title to be overwritten. Press [OK].

Overwriting in the middle of the title



You can overwrite the existing title from the selected position.

1

Proceed to steps 1 to 2 above.

2

Using [\blacktriangle / \blacktriangledown], select a title to be overwritten. Press [OK].

3

Using [\blacktriangle / \blacktriangledown], select "Play". Press [OK].

Playback will start.

4

Press [PAUSE] at the point from which you want to start overwriting.

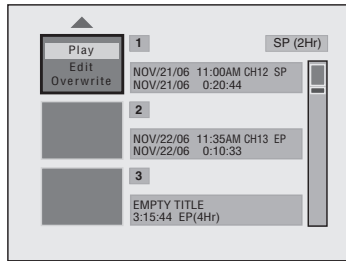

5

Using [\blacktriangle / \blacktriangledown], select "Overwrite". Press [OK].

Channel can be changed.

Selected title number to be overwritten

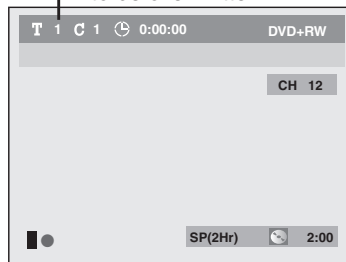

6

Press [DVD REC].

Overwriting recording starts.
The elapsed-time counter starts running.

7

Press [STOP] to stop recording.

Title name is also overwritten.

This operation may take a while to be recognized.

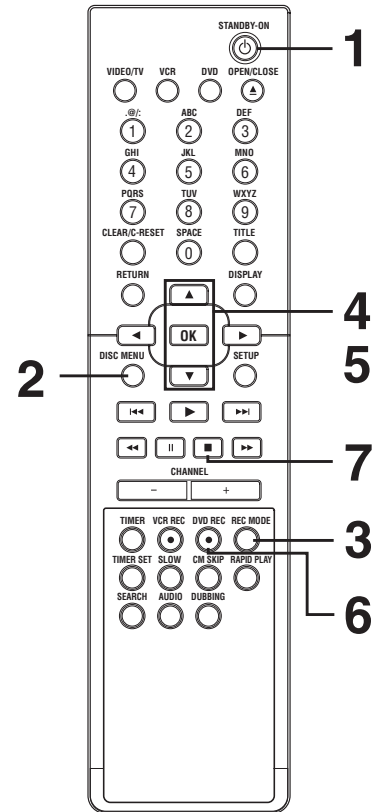

Note

- Remaining time, which is displayed on the bottom right corner of the screen during overwriting, indicates the remaining time at the time of starting overwriting.

5

Press [DVD REC].

"" mark, Display menu, CH, and the time lapse will be displayed as stated above.

Channel can be changed.

6

Press [DVD REC] again.

Overwriting recording starts.

7

Press [STOP] to stop recording.

Title name is not overwritten.

This operation may take a while to be recognized.

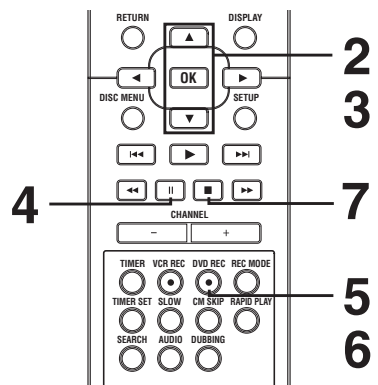

Note

- Recording mode of the overwriting title is the same as that of the original (overwritten) title when overwriting in the middle of the title.

Before you start

Connections

Getting started

Recording

Playing discs

Editing

Changing the Setup menu

VCR functions

Others

Español

Recording

Overwriting an existing title (cont'd)

Hints for Overwriting

When an existing title is overwritten, the title name may be changed according to the overwriting situations. Before overwriting, read the following cases and Note.

- When overwriting title is shorter than the existing title:**
(Overwriting from the beginning of the title)

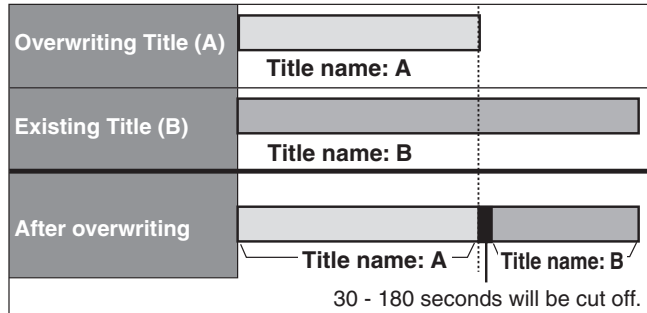

- When overwriting title is longer than the existing title:**
(Overwriting from the beginning of the title)

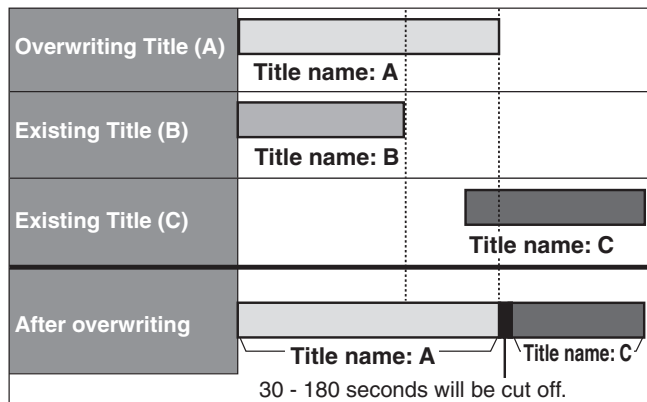
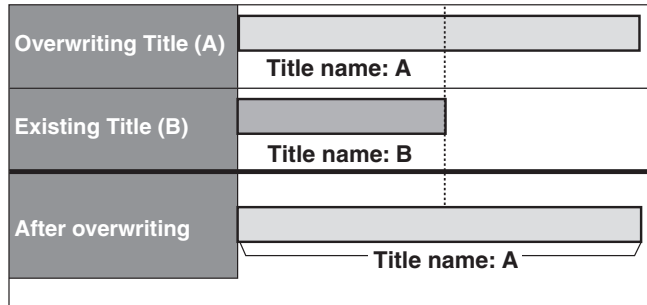

- When overwriting in the middle of the title:**

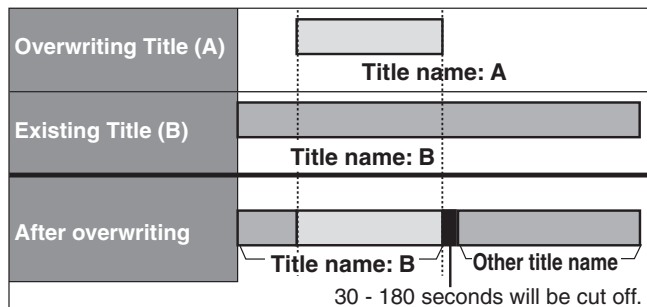

Note

- When a title name is overwritten, its thumbnail is also overwritten.
- When existing title is longer than overwriting title, overwriting title is divided into 2 titles. If this is the case, there may be an unrecorded portion between titles.
- A chapter mark is put between titles when overwriting in the middle of the title.
- “Auto Chapter” interval time is reset at the overwriting start point.

Settings for an external source

Connection to an external source



Connect the external source properly to the unit by using input jacks either EXT2 (Front) or EXT1 (Rear). When connecting an external equipment of monaural output to this unit, use AUDIO L jack of EXT2 (Front). Use commercially available S-Video or Video cable and an Audio cable for this connection.

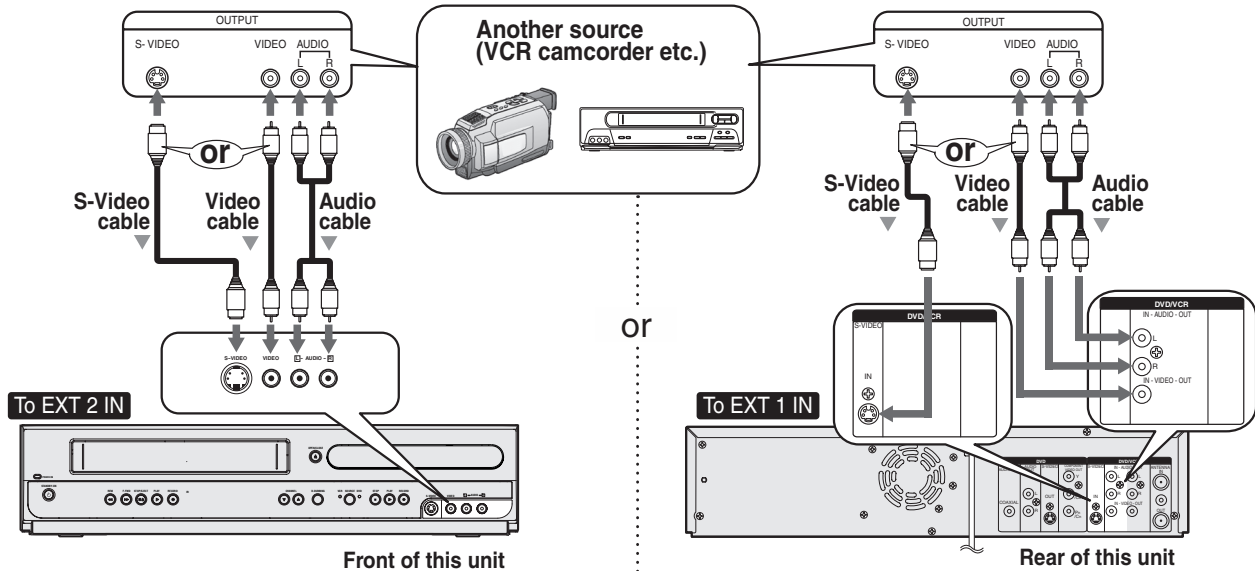

1. Press [SETUP].
2. Using [▲ / ▼], select "Required Settings". Press [OK].
3. Using [▲ / ▼], select "Video Input". Press [OK].

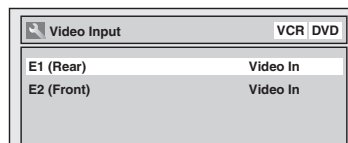

4. Using [▲ / ▼], select "E2 (Front)". Press [OK].

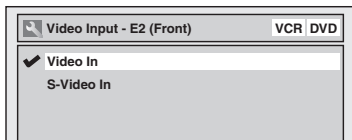

5. Using [▲ / ▼], select the input jack type to connect. Press [OK].
If you want to use S-VIDEO input jack, select "S-Video In".
If you want to use VIDEO input (Composite) jack, select "Video In".

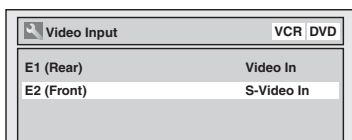

6. Press [SETUP] to exit.

4. Using [▲ / ▼], select "E1 (Rear)". Press [OK].

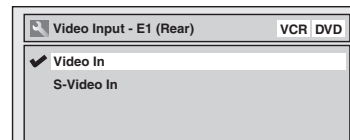

5. Using [▲ / ▼], select the input jack type to connect. Press [OK].
If you want to use S-VIDEO IN jack, select "S-Video In".
If you want to use VIDEO IN (Composite) jack, select "Video In".

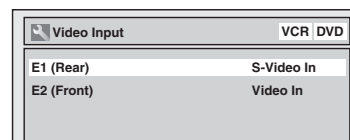

6. Press [SETUP] to exit.

Recording

Settings for an external source (cont'd)

Recording from an external source



Before recording from an external source, see the instructions for the connection on page 35.

1. Turn on the TV and press [STANDBY-ON] and be sure to select the input of the TV to which the unit is connected.

Refer to the table on page 15.

2. When you want to record to the disc: Press:

Press [OPEN/CLOSE] to open the disc tray. Place the disc to record properly.

3. Press [OPEN/CLOSE] to close the disc tray.

This operation may take a while to be recognized.

When you want to record to a videotape: Press:

Insert the videotape with a record tab into the cassette compartment.

4. Select the input of the unit which the external equipment is connected. (E2 or E1)

- To use the input jacks on the back of this unit, select "E1" position by pressing [0], [0], [1] with the Number buttons or using [CHANNEL - / +] on the remote control, or [CHANNEL ∇ / \blacktriangle] on the front panel.

- To use the input jacks on the front of this unit, select "E2" position by pressing [0], [0], [2] with the Number buttons or using [CHANNEL - / +] on the remote control, or [CHANNEL ∇ / \blacktriangle] on the front panel.

5. Select a recording mode by pressing [REC MODE].

Refer to "Recording mode" on page 25 for DVD or page 74 for VCR.

6. Press [DVD REC] ([VCR REC]) on the remote control or [RECORD] (DVD/VCR) on the front panel to start recording.

7. Press "Play" on the external source to record from.

8. For disc:

Press [STOP] on the remote control or on the front panel to stop recording.

This operation may take a while to be completed.

For videotape:

Press [STOP] on the remote control or [STOP] / [EJECT] on the front panel to stop recording.

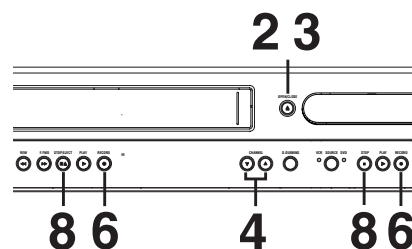
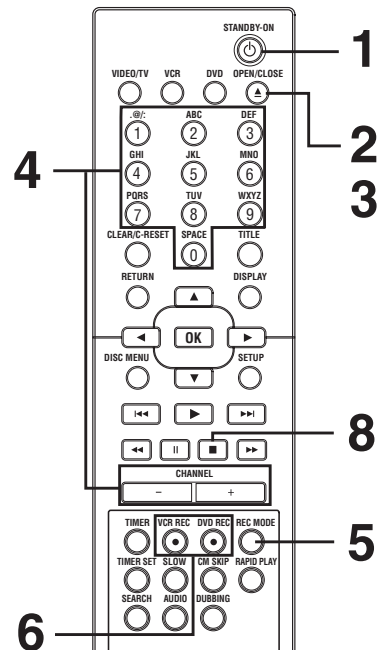

Setting a disc to protect



To prevent accidental recording, editing or erasing the titles, you can protect them from the Setup menu.

1

Press [SETUP].

2

Using [\blacktriangle / \blacktriangledown], select "Disc Edit". Press [OK].

Disc menu will appear.

3

Using [\blacktriangle / \blacktriangledown], select "Disc Protect OFF \rightarrow ON". Press [OK].

Confirmation window will appear.

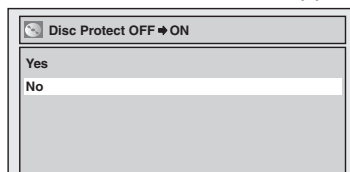

4

Using [\blacktriangle / \blacktriangledown], select "Yes". Press [OK].

A disc will be protected.

This operation may take a while to be completed.

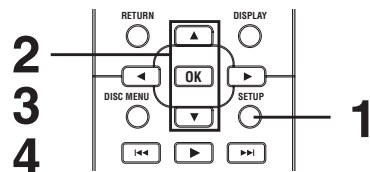

Note

To cancel the disc protect:

- When you insert a disc protected with this unit, "Disc Protect ON \rightarrow OFF" will appear instead of "OFF \rightarrow ON".

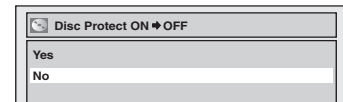

To release the protect for the disc, select "Disc Protect ON \rightarrow OFF" at step 3, then select "Yes".

Finalizing a disc



You will need to finalize discs to play in other DVD players.

Finalizing may take several minutes up to an hour.

A shorter recording period on the disc will require a longer time period for finalization. Do not unplug the power cord during finalization.

Details are on pages 25-26.

1

Press [SETUP].

2

Using [▲ / ▼], select “Disc Edit”. Press [OK].

Disc menu will appear.

3

Using [▲ / ▼], select “Finalize”. Press [OK].

Confirmation window will appear.

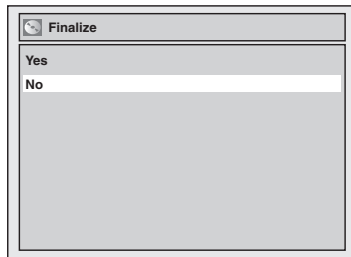

4

Using [▲ / ▼], select “Yes”. Press [OK].

Finalizing will start.



To cancel finalizing...

(DVD-RW only)

- To cancel finalizing at step 4, press [STOP ■], select “Yes” with [◀ / ▶], then press [OK]. Finalizing is cancelled and the unit will be in stop mode.

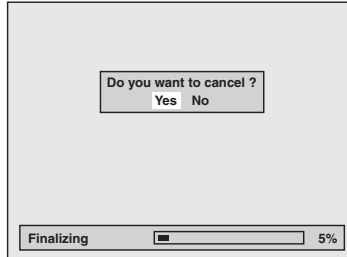

- If Ⓞ appears when pressing [STOP ■], you cannot cancel finalizing because the finalizing has been in certain progress.
- When selecting “No” and press [OK] or [RETURN], finalizing will be continued.
- You cannot cancel finalizing the DVD+R/DVD-R disc once it has started.

This operation may take a while to be completed.

5

Finalizing is completed.

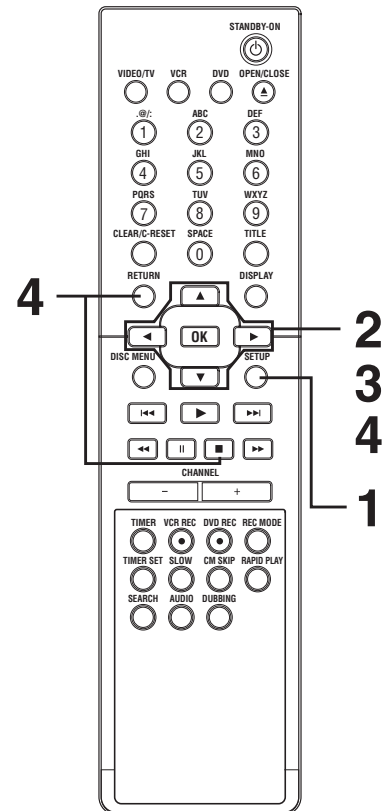
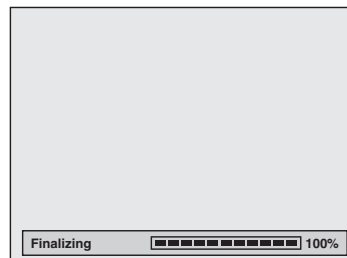

Note

- Once you have finalized a disc recorded on DVD+R/ DVD-R, you cannot edit or record anything else on that disc.
- There is no need to finalize DVD+RW discs.
- When you insert a DVD-RW disc finalized with this unit, “Undo Finalize” will appear instead of “Finalize”.

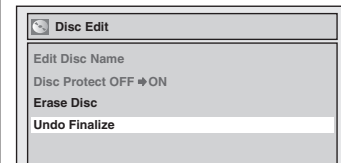

To release the finalizing for the disc, select “Undo Finalize” at step 3.

* DO NOT power off during finalization, this will result in malfunction.

Recording

Playing the discs in other DVD players (cont'd)

Auto finalizing



You can finalize discs automatically using Auto Finalize function. You can use this function to finalize discs after finishing all Timer Recordings and at the end of the disc space.

1

Press [SETUP].

2

Using [▲ / ▼], select “Recording”. Press [OK].
Recording menu will appear.

3

Using [▲ / ▼], select “Auto Finalize”. Press [OK].
Auto Finalize menu will appear.

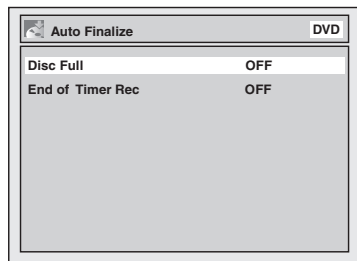

4

Using [▲ / ▼], select “Disc Full” or “End of Timer Rec”. Press [OK].

Option window will appear.

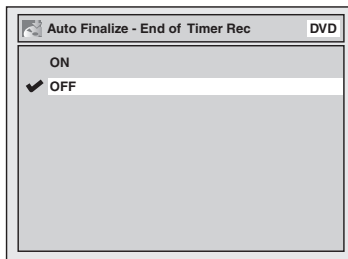
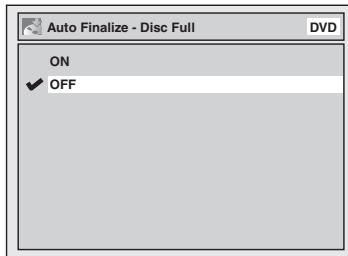

5

Using [▲ / ▼], select “ON”. Press [OK].

Your setting will be activated.

6

Press [SETUP] to exit.

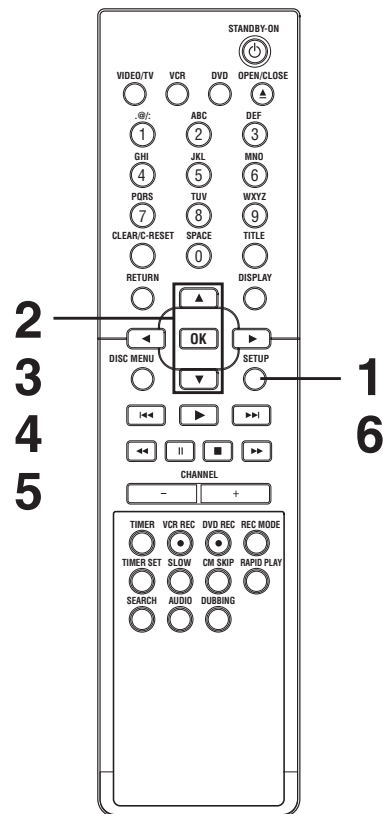

Recording

Dubbing Mode



You can copy a DVD disc to a videotape or copy a videotape to a DVD disc. This function will be possible only if the DVD disc or the videotape is not copy protected.

Before starting this function, prepare for the recording on the DVD+RW/R, DVD-RW/R disc or the videotape. Refer to pages 28 and 74.

Make sure:

- Insert a recordable disc and a videotape with a record tab.

Note for recording to a videotape:

- The videotape's record tab is intact.
- The remaining time of the videotape is long enough.

Note for recording to a disc:

- Make sure that the disc is recordable. Refer to pages 25-26.

3

Using [▲ / ▼], select “Dubbing Mode”. Press [OK].
Option window will appear.

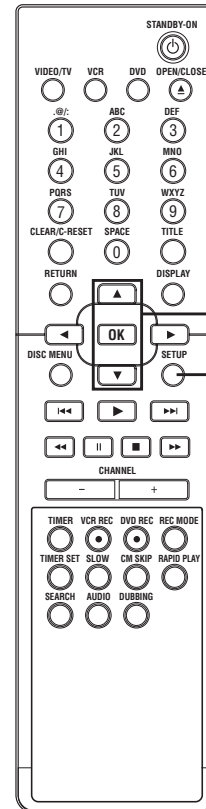
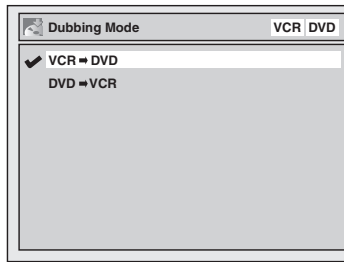

1

Press [SETUP].

2

Using [▲ / ▼], select “Recording”. Press [OK].
Recording menu will appear.

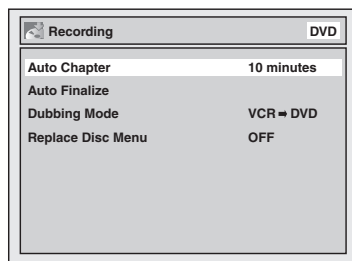

Note

For VCR to DVD duplication:

- After starting VCR to DVD duplication, the picture may be distorted because of the auto tracking function. This is not a malfunction. Be advised to playback the videotape until the picture is stabilized, then set the starting point which you wish to start recording, and start VCR to DVD duplication.

Recording

Dubbing Mode (cont'd)

VCR to DVD

- 4**
Using [\blacktriangle / \blacktriangledown], select “VCR \rightarrow DVD”. Press [OK].

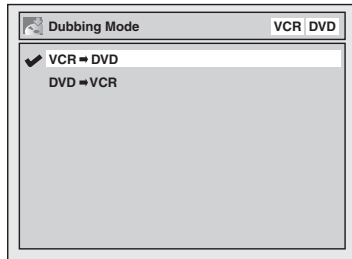

- 5**
Press [SETUP] to exit.

Press:

Make sure to select a recording mode using [REC MODE].

Press:

- 6**
Press [PLAY \blacktriangleright]. Then press [PAUSE \parallel] at the point you wish to start recording.

- Since it takes about a few seconds before the actual dubbing begins, please allow extra 5 seconds when selecting the starting point.

- 7**
Press [DUBBING].
VCR to DVD duplication will start.

- 8**
Press [STOP \blacksquare] to stop the recording.

DVD to VCR

- 4**
Using [\blacktriangle / \blacktriangledown], select “DVD \rightarrow VCR”. Press [OK].

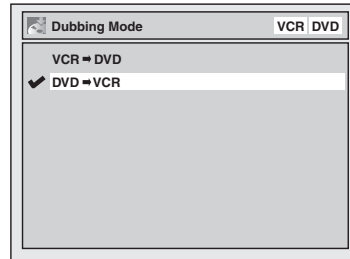

- 5**
Press [SETUP] to exit.

Press:

Make sure to select a recording mode using [REC MODE].

Press:

- 6**
Press [PLAY \blacktriangleright]. Then press [PAUSE \parallel] at the point you wish to start recording.

- 7**
Press [DUBBING].
DVD to VCR duplication will start.

- 8**
Press [STOP \blacksquare] to stop the recording.

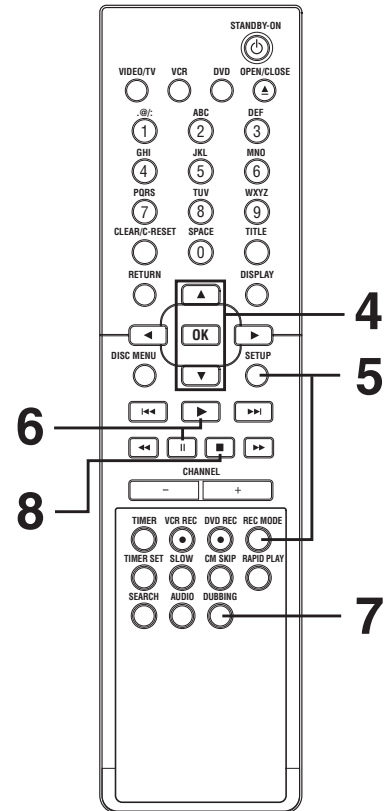

Note

- When you turn off the unit after setting the Dubbing Mode to **DVD \rightarrow VCR**, the setting will be set to **VCR \rightarrow DVD** automatically.
- Dubbing Mode is available only if the videotape or disc is not copy protected.
- You cannot change the output mode during VCR to DVD or DVD to VCR duplication.

For Audio CD to VCR duplication:

- This function is available on Audio CDs, not MP3 files.

For VCR to DVD duplication:

- The playback sound mode is followed by the setting of VCR playback sound mode on page 76. Set the playback sound mode to which you wish to record to the DVD.
- This unit will automatically stop the duplication if playback with no image is for more than 3 minutes during VCR to DVD duplication.

Playing discs

Information on DVD play

Before you play DVD discs, read the following information.

Playable discs

This unit is compatible to play the following discs. To play a DVD, make sure that it meets the requirements for Region Codes and Color Systems as described below. Discs that have the following logos will play on the unit. Other disc types are not guaranteed to play.

Disc	Logo
DVD-VIDEO	
DVD+RW	
DVD+R	
DVD+R Double Layer	
DVD-RW (VIDEO mode, Finalized)	
DVD-R (VIDEO mode, Finalized)	
CD-DA (AUDIO CD)	
VCD (VIDEO CD)	
CD-RW (CD-DA FORMAT, MP3 files)	
CD-R (CD-DA FORMAT, MP3 files)	

is a trademark of DVD Format/Logo Licensing Corporation.

Color systems

DVDs are recorded in different color systems throughout the world. The most common color system is NTSC (which is used primarily in the United States and Canada).

This unit uses NTSC, so DVDs you play must be recorded in the NTSC system. You cannot play DVDs recorded in other color system.

Region codes

This unit has been designed to play DVD discs with Region One (1). DVDs must be labeled for ALL regions or for Region 1 in order to play on the unit. You cannot play DVDs that are labeled for other regions. Look for the symbols below on your DVDs. If these region symbols do not appear on your DVD, you cannot play the DVD in this unit.



The number inside the globe refers to region of the world.

A DVD labeled for a specific region can only play on the unit with the same region code.

PBC (Playback Control) for Video CD

This unit conforms to ver.1.1 and ver.2.0 of Video CD standard with PBC function.

Ver.1.1 (without PBC function): You can enjoy playback picture as well as music CD.

Ver.2.0 (with PBC function): While using a Video CD with PBC function, "PBC" appears on the screen and the display.

Note: When playing Video CDs with PBC function, some operations (e.g., track search and repeat tracks) cannot be performed. Cancel PBC function temporarily to perform those operations (refer to page 73).

You can play interactive software using menu screens. Refer to instructions in the Video CD.

Hint for DVD playback

The contents of DVD disc are generally divided into titles. Titles may be further subdivided into chapters.

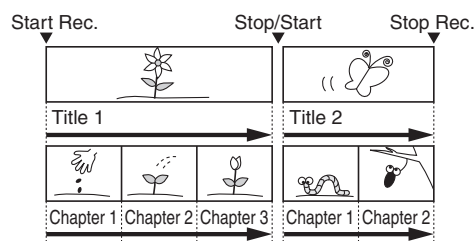

Playing discs

Basic playback

Playback



1

Press [STANDBY-ON].
Turn the TV on and be sure to select the input to which the unit is connected.

Press:

2

Press [OPEN/CLOSE].
The disc tray will open.

3

Insert your disc with its label facing up. Align the disc to the disc tray guide.

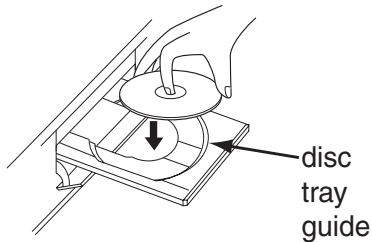

4

Press [OPEN/CLOSE] to close the disc tray.

This operation may take a while to be recognized.

Title list will appear automatically.

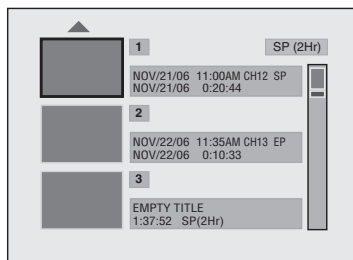

If you want to return to the playback while you are stopping temporarily, press [TITLE] to resume play.

To exit the title list, press [STOP].

5

Using [/ , select a desired title. Press [OK].

Pop-up window will appear.



If you want to see Disc information, press [] when the first page of the title list is displayed or press [] when the first title is selected but "Play", "Edit" or "Overwrite" is not highlighted.

<DVD+RW>

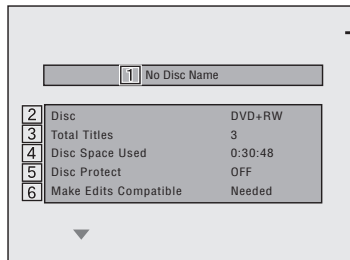

<DVD+R, DVD-RW, DVD-R>

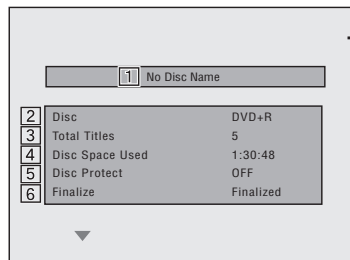

6

Using [/ , select "Play". Press [OK].

Playback will start.

7

Press [STOP] to stop playback.

To eject the disc, press [OPEN/CLOSE] to open the disc tray, then remove the disc before turning the unit off.

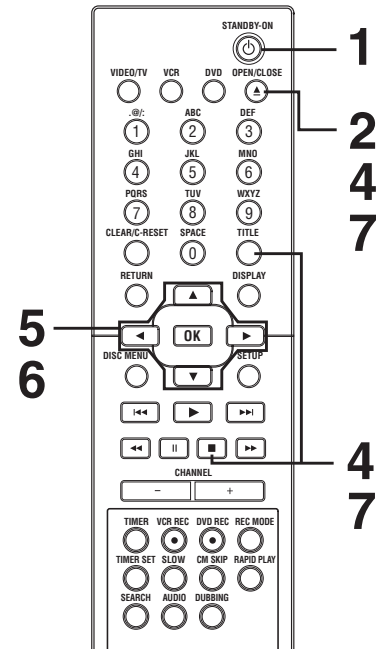

1. Disc name
(Default "No Disc Name")
2. Disc Type
(DVD+RW/DVD+R/DVD-RW/
DVD-R)
3. Total number of title
(include "Empty Title")
4. Total time of recorded disc space
5. Status of disc protection
(“ON” is protected disc.)
6. Making edits compatible /
Finalize
 - When DVD+RW disc is inserted:
If edit for which “Make Edits Compatible” is necessary is done, “Needed” is displayed. “Not Needed” is not necessary.
 - When DVD+R, DVD-RW or DVD-R disc is inserted:
If “Finalize” is done, “Finalized” is displayed. Otherwise, “Unfinalized” is displayed.

Note

- Some discs may start playback automatically.
- You can also start playback by pressing [PLAY] instead of [OK] at step 5.
- Press [] to display the next page, and press [] to display the previous page.

Playing discs

Basic playback (cont'd)



1

Press **[STANDBY-ON]**.
Turn the TV on and be sure to select the input to which the unit is connected.

Press:

2

Press **[OPEN/CLOSE]** to open the disc tray.
The disc tray will open.

3

Insert your disc with its label facing up. Align the disc to the disc tray guide.

4

Press **[PLAY ▶]** to start playback.
Playback will start.

If you are playing a DVD-Video disc or Video CD with PBC function, a menu may appear. Refer to page 42 for details about a disc menu.

If you are playing a finalized DVD-R/DVD-RW disc, a title list will appear.

5

Press **[STOP ■]** to stop playback.

Note

- Some discs may start playback automatically.
- You can select images or information on the menu screen by activating PBC (Playback control) function (page 73).

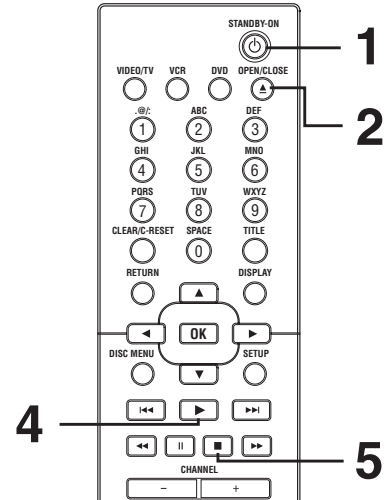

Playing MP3 disc



First:

1

In stop mode, press **[TITLE]** to call up the MP3 menu.

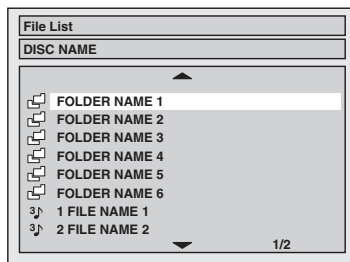

- To exit the menu, press **[TITLE]** again.

2

Press **[▲ / ▼]** to select a desired folder (group) or track. Press **[OK]**.

When selecting track:
Playback will start.

When selecting the folder:
The files in folder will appear.
Press **[▲ / ▼]** to select the track or folder you want, then press **[OK]**.

- Press **[PLAY ▶]**, **[OK]** or **[▶]** to move to the lower hierarchies.
- Press **[◀]** or **[RETURN]** to the previous hierarchy.

Hints for MP3 files:

- Folders are known as Groups, files are known as Tracks.
- Folders are accompanied by
- MP3 files are accompanied by
- Reproduction will start from the selected track and go to the next one in turn.
- The system can recognize up to 255 groups (or folders) and up to 999 tracks.
- The name of group and track can be displayed in up to 29 characters. Unrecognizable characters will be replaced with asterisks.
- If there are no files in the folder, "No Files" will be displayed.

This unit recommends the files recorded under the following circumstances:

- Sampling frequency: 44.1kHz or 48kHz.
- Constant bit rate: 112kbps - 320kbps.

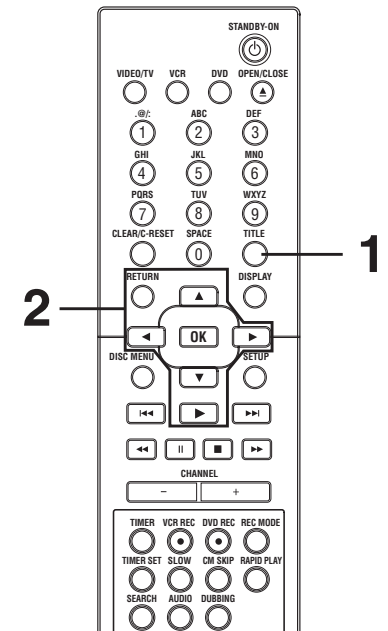

Note

- The audio source of MP3 files cannot be recorded as digital sound by an MD or DAT deck.
- Files whose extension is other than ".mp3(MP3)" will not be listed in the MP3 menu.
- Some unplayable folders or tracks may be listed in the MP3 menu due to the recording status.

Playing discs

Basic playback (cont'd)

Playing discs using the disc menu



A DVD disc contains a disc menu that describes the contents or allows you to customize the playback. For example, the menu may offer choices for subtitle languages, special features, or chapter selection.

Sometimes these are displayed automatically when you start playback, otherwise only appear when you press [DISC MENU].

First:

1
Press [DISC MENU].

Disc menu will appear. If the feature is not available, may appear on the TV screen.

2
Using [▲ / ▼ / ◀ / ▶], select an item. Press [OK] to confirm. Continue this step to set up all the features you want or to start playing the disc from the menu.

DISC MENU button:
Displays a DVD disc menu which varies with the disc and may be the same as the 'Title list'.

Cursor ▲ / ▼ / ◀ / ▶ buttons:
Moves the cursor around screen.

OK button:
Selects the currently highlighted menu option.

Number buttons:
Selects a numbered menu option (some discs only). (Press [OK] after.)

3
Press [DISC MENU] to exit the disc menu.

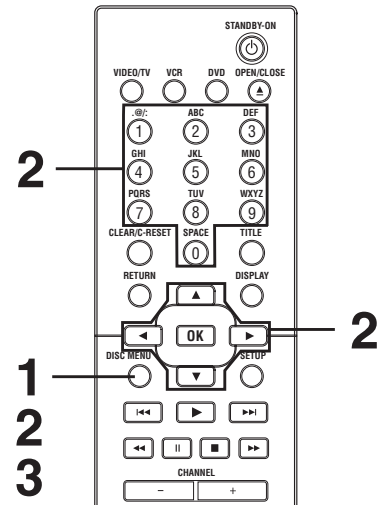

Note

- Menus vary among discs. Refer to the information accompanying the disc for details.

Playing discs using the title menu



Some DVDs have a title menu, which lists the titles available on them. It helps you to start playback at a specific title.

First:

1
Press [TITLE].

Title menu will appear. If the feature is not available, may appear on the TV screen.

2
Using [▲ / ▼ / ◀ / ▶], select a title to play. Press [OK]. Play will begin at the title you selected.

TITLE button:
Displays the 'Title menu' of a DVD disc which varies with the disc.

Cursor ▲ / ▼ / ◀ / ▶ buttons:
Moves the cursor around screen.

OK button:
Selects the currently highlighted menu option.

Number buttons:
Selects a numbered menu option (some discs only). (Press [OK] after.)

3
Press [TITLE] to exit the title menu.

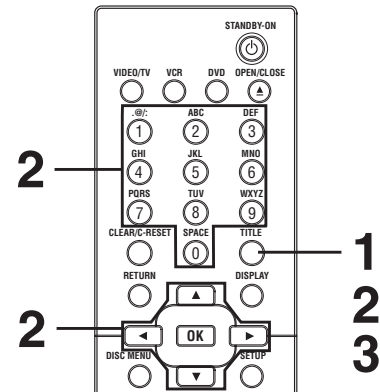

Note

- [TITLE] will not always be active with all DVDs.
- Menus vary among discs. Refer to the information accompanying the disc for details.

Pause



1
During playback, press [PAUSE II]. Play will pause and sound will be muted.

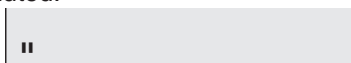

2
Press [PLAY ▶] to resume play.

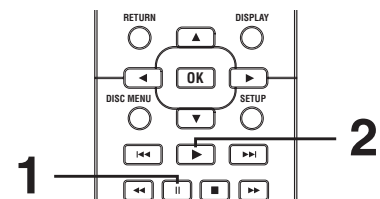

Note

- On DVDs, set "Still Mode" to "Field" in the Setup menu if pictures in the pause mode are blurred. (Refer to page 71.)

Playing discs

Special playback

Resume play



You can resume play from where you stopped playing the disc last.

1

During playback, press [STOP ■]. The resume message will appear.

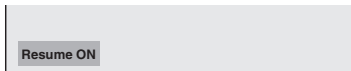

2

Press [PLAY ►].

In a few seconds, play will resume from the point at which it stopped last. You can resume play at the same point even if you turn off the unit.

To cancel the resume play and start playing the disc from the beginning, press [STOP ■] the second time while the play is stopped.

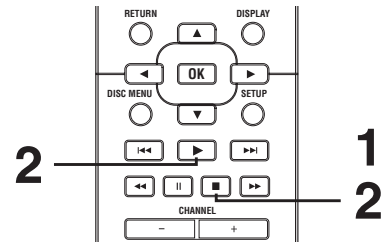

Note

- For MP3 files, playback will resume from the beginning of the track at which playback was stopped.
- Some Video CDs with the PBC function resume playback from the beginning of the track.

Fast forward / Fast reverse



1

During playback, press [F.FWD ►►] or [REW ◀◀].

Every time you press [F.FWD ►►] or [REW ◀◀], approximate speed will be changed as follows.

Fast forward or fast reverse playback across titles (for DVD discs) or tracks (for MP3) is not possible.

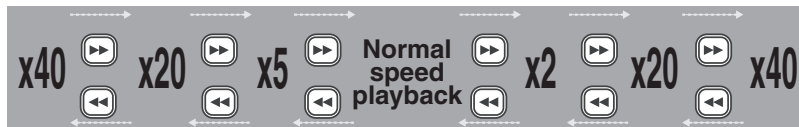

For Video CDs, approximate forward/reverse speeds are x2, x8, x16. For Audio CDs and MP3 files approximate speed is fixed at x8 with sound.

To return to the normal play, press [PLAY ►].

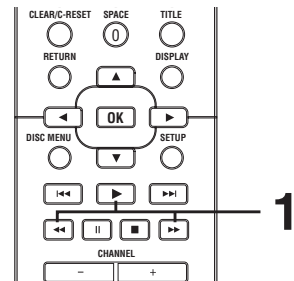

Note

- Forward/reverse speed will be indicated with icons as follows.
Forward (Approx. Speed)
x2: [two right arrows]
x20: [four right arrows]
x40: [eight right arrows]
Reverse (Approx. Speed)
x5: [two left arrows]
x20: [four left arrows]
x40: [eight left arrows]

Skipping TV commercials during play



You can skip TV commercials by pressing [CM SKIP], so that you can enjoy the recorded programs without interrupting.

1

During playback, press [CM SKIP].

Normal play will start at 30 seconds ahead from the point you press [CM SKIP].

Every time you press [CM SKIP], the searching point will be extended by 30 seconds ahead.

You can press up to 6 times (180 seconds).

e.g. Press [CM SKIP] once.

(forwarding 30 seconds)

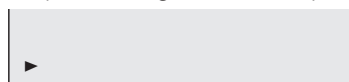
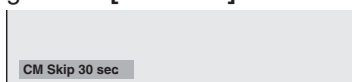

Playback will restart automatically.

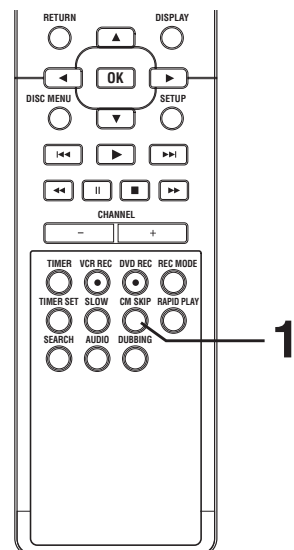

Playing discs

Special playback (cont'd)

Rapid play



Rapid play function is available only during playback.

Available only on discs recorded in the Dolby Digital format, Rapid play plays back in a slightly faster/slower speed while keeping the sound quality just as normal playback.

1

During playback, press [RAPID PLAY].

- ▶ : Press [RAPID PLAY] once during playback. Plays back approximately at 0.8 times of normal playback.
- ▶ : Press [RAPID PLAY] twice during playback. Plays back approximately at 1.3 times of normal playback.
- ▶ : Press [RAPID PLAY] three times to play back in normal speed. No effects.

2

Press [PLAY ▶] to continue the normal playback.

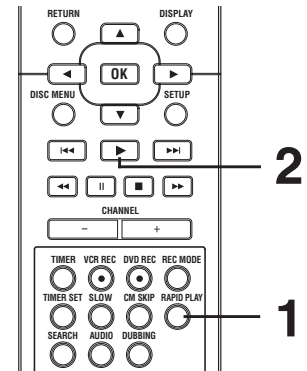

Note

- Audio (language) setting cannot be changed while using this mode.
- This feature may not work at some point in a disc.
- Audio is PCM during Rapid play mode.

Step by step playback



1

During playback, press [PAUSE II]. Play will pause and sound will be muted.

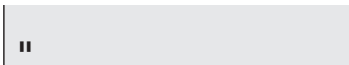

To play step by step backward: Press [SKIP I◀◀] repeatedly. Every time you press the button, the play will go backward by one frame.

- Press and hold [SKIP I◀◀ / ▶▶] to reverse/advance continuously.

2

Press [SKIP ▶▶] repeatedly. The play will advance one frame (or step) at a time when you press [SKIP ▶▶] with the sound muted.

3

Press [PLAY ▶] to continue the normal playback.

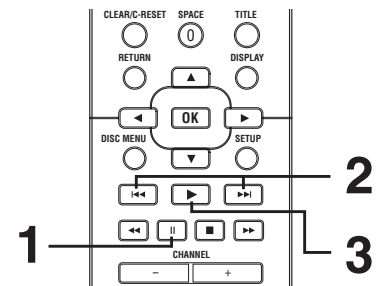

Note

- Only step by step forward playback is available for playing back Video CDs.

Slow forward / Slow reverse play



1

During playback, press [PAUSE II]. Then press [F.FWD ▶▶▶] or [REW ◀◀]. Every time you press [F.FWD ▶▶▶] or [REW ◀◀], approximate speed will be changed as follows. (The sound will remain muted.)



To return to the normal play, press [PLAY ▶].

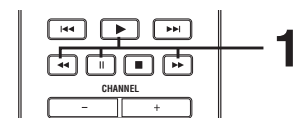

Note

- Forward/reverse speed will be indicated with icons as follows.
 Forward (Approx. Speed)
 x1/16:
 x1/8:
 x1/3:
 Reverse (Approx. Speed)
 x1/16:
 x1/8:
 x1/4:
- Only slow forward playback is available for playing back Video CDs.

Playing discs

Special playback (cont'd)

Zoom



1

During playback, press [DISPLAY].

Display menu will appear.

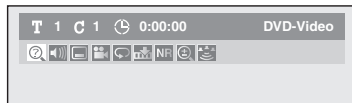

2

Using [◀/▶], select . Press [OK].

Zoom menu will appear.

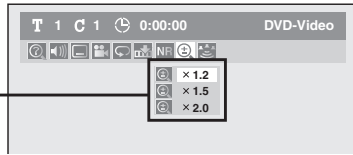

There are four options (x1.0, x1.2, x1.5 and x2.0), these are displayed excluding the current zoom rate.

3

Using [▲/▼], select a desired zoom factor to zoom. Press [OK].

The zoom area will be displayed.

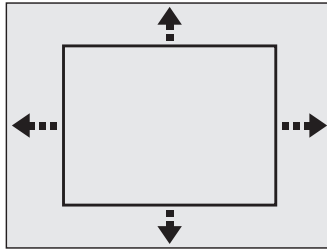

4

Using [▲/▼/◀/▶], select a desired zoom position. Press [OK].

The zoom play will start.

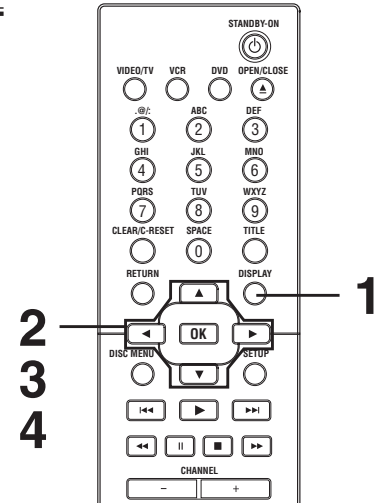

Note

- When selecting a smaller factor than the current one, the zoom area will not be displayed.
- To exit the zoom menu, press [DISPLAY] again at step 1.
- To cancel the zoom function, select "x1.0" using [▲/▼], then press [OK].

Marker Setup



This feature allows you to assign a specific point on a disc to be called back later.

1

During playback, press [DISPLAY].

Display menu will appear.

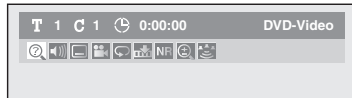

2

Using [◀/▶], select . Press [OK].

Marker setup menu will appear.

<DVD-Video>

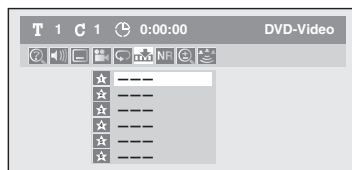

<Audio CD>

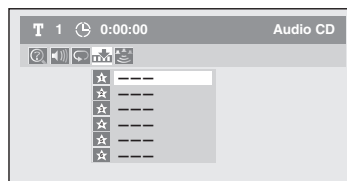

3

Using [▲/▼], select a desired marker number. When it reaches the desired point, press [OK].

The title (track) number and the time will be displayed.

4

To return to the marker later: Using [▲/▼], select the desired marker number. Press [OK].

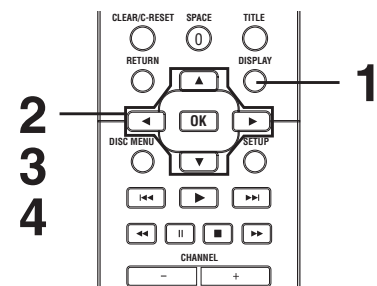

Note

- To clear a marker, select the marker number to be cleared, then press [CLEAR/C-RESET].
- All markers will be erased when you operate these operations listed below.
 - Opening the disc tray
 - Turning off the power
 - Recording to a recordable disc
- You can mark up to 6 points.
- Marker Setup is not available when you play the Video CD with PBC function.

Playing discs

Search

Title/Chapter search



Using [SKIP <<< / >>>]

1

During playback, press [SKIP >>>] to skip the current title or chapter and move to the next.

The title or chapter will move forward by one at a time.

- If there is no chapter in one title, the current title will be skipped.

To go back to the beginning of the current title or chapter, press [SKIP <<<].

Press it repeatedly to go to the previous title or chapter. The title or chapter will move backward one title at a time.

Using [DISPLAY]

1

During playback, press [DISPLAY].

Display menu will appear.

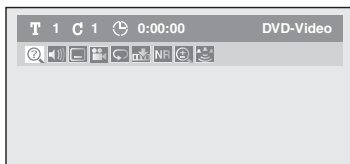

2

Using [◀ / ▶], select [?]. Press [OK].

The number next to **T** will be highlighted.

Title:

Using [▲ / ▼] or the Number buttons, enter a desired title number to search. Press [OK].

Title search will start.

Chapter:

Press [▶] to move to the number next to **C** for chapter.

Using [▲ / ▼] or the Number buttons, enter a desired chapter number to search. Press [OK].

Chapter search will start.

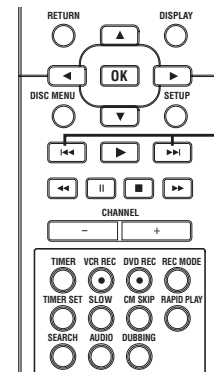

1

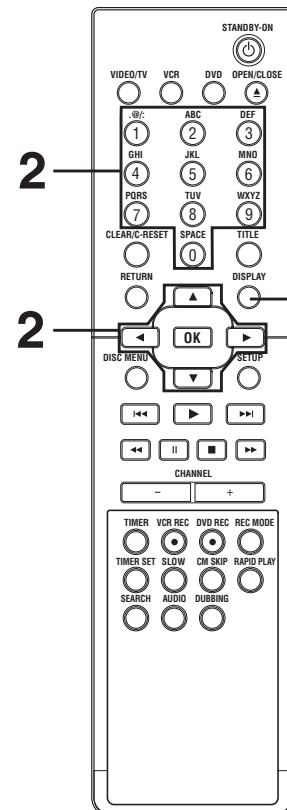

2

2

1

Note

- In search mode display, total numbers of each search contents (title/chapter/time) are shown as a denominator.

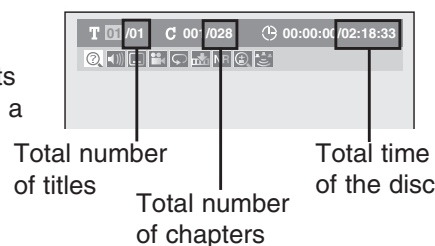

Playing discs

Search (cont'd)

Track search



Using [SKIP <<< / >>>]

1

During playback, press [SKIP >>>] to skip the current track and move to the next.

The track will move forward one at a time.

To go back to the beginning of the current track, press [SKIP <<<].

Press it repeatedly to go to the previous track. The track will move backward one at a time.

Using [DISPLAY]

1

During playback, press [DISPLAY].

Display menu will appear.

<Audio CD>

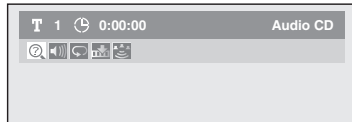

<MP3 files>

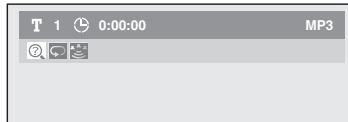

2

Using [◀ / ▶], select . Press [OK].

The number next to **T** will be highlighted.

3

Using [▲ / ▼] or the Number buttons, enter a desired track number to search. Press [OK].

Track search will start.

Time search



1

During playback, press [DISPLAY].

Display menu will appear.

<DVD-Video>

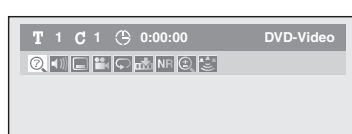

<Audio CD>

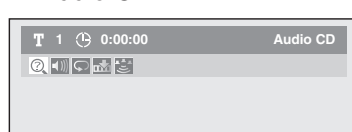

2

Using [◀ / ▶], select . Press [OK].

The number next to **T** will be highlighted.

To move to the number next to , press [▶].

When time search is not available, and time counter are not displayed.

3

Using [▲ / ▼] or the Number buttons, enter a desired time to search. Press [OK].

Time search will start.

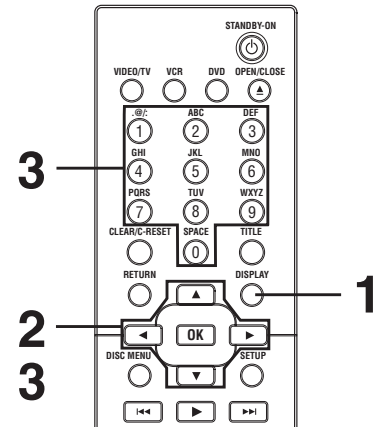
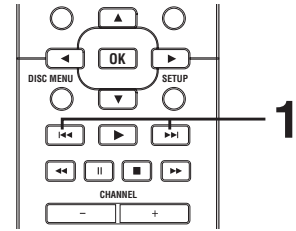

Note

- During CD playback you can enter a track number directly using the **Number buttons** for track search without displaying the menu.
- Track search is not available when you play the Video CD with PBC function.

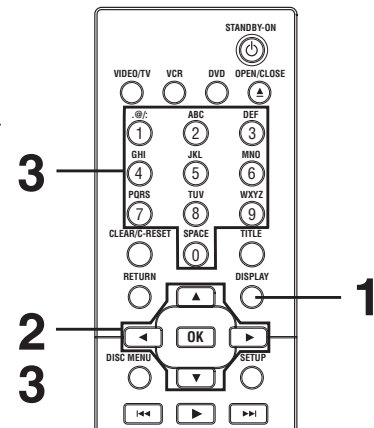

Note

- Time search function is available only in the same track or title.
- Time search is not available when you play the Video CD with PBC function.

Before you start

Connections

Getting started

Recording

Playing discs

Editing

Changing the Setup menu

VCR functions

Others

Español

Playing discs

Repeat/Random/Program playback

Repeat playback



1
During playback, press [DISPLAY].
Display menu will appear.

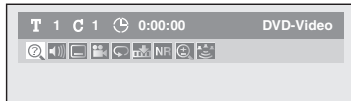

2
Using [◀/▶], select . Press [OK].
Repeat menu will appear.

<DVD-Video>

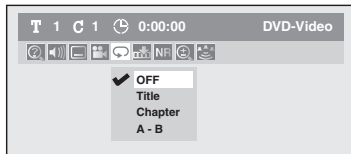

<Audio CD / Video CD>

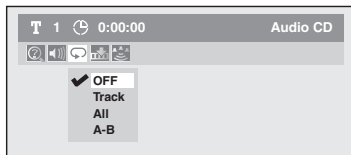

<MP3 files>

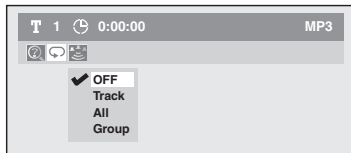

3
Using [▲ / ▼], select a desired option to repeat. Press [OK].
The selected repeat play will start.

Title:
The current title will be played repeatedly. (DVD only)

Chapter:
The current chapter will be played repeatedly. (DVD only)

All:
The current disc will be played repeatedly. (Audio CD, MP3, Video CD)

A-B:
The A-B point will be played repeatedly.
When pressing [OK] while A-B is highlighted, A-B repeat is set. Press [OK] again to decide the starting point (A). Press [OK] after setting point A to select the ending point (B).

Track:
The current track will be played repeatedly. (Audio CD, MP3, Video CD)

Group:
The current group will be played repeatedly. (MP3 only)

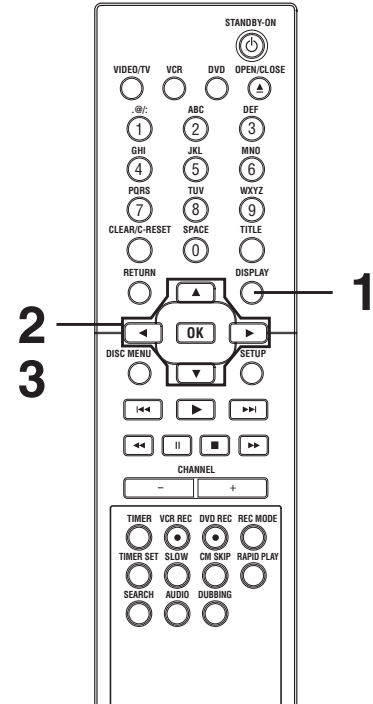

Note

- The A-B Repeat playback can only be set with in the current title (for DVDs), or current track (for Audio CDs).
- To cancel the repeat playback, select “OFF” at the step 2. The repeat setting will also be cancelled when you stop playback.
- You cannot select “Group” during the random playback of MP3 files.
- Repeat playback is not available when you play the Video CD with PBC function.

Random playback



With this function, you can play a disc randomly instead of playing in the original order.

First:

1
Press [SETUP].

2
Using [▲ / ▼], select “CD Playback Mode”. Press [OK].
CD Playback Mode menu will appear.

3
Using [▲ / ▼], select “Random Play”. Press [OK].
Random playback will start.

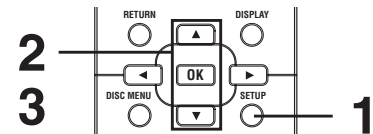

Note

- To cancel random playback, press [STOP ■] twice during random playback. “Play mode OFF” appears on the TV screen.
- For Video CDs with PBC function, the PBC setting will be switched to off automatically when you start random playback.

Playing discs

Repeat/Random/Program playback (cont'd)

Program playback



You can program the disc to play in your desired order.

First:

1

Press [SETUP].

2

Using [▲ / ▼], select “CD Playback Mode”. Press [OK].

CD Playback Mode menu will appear.

3

Using [▲ / ▼], select “Program Play”. Press [OK].

Program play list will appear.

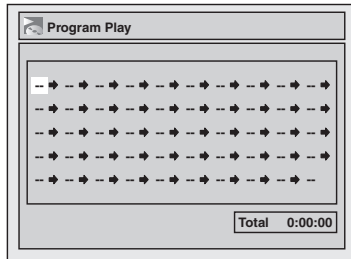

4

Using [▲ / ▼], select a desired track. Press [OK] or [▶].

A cursor will move to next.

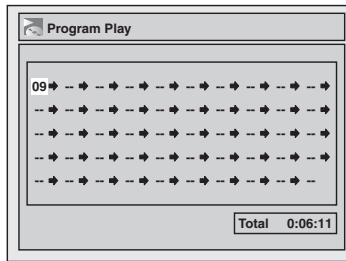

5

Press [PLAY ▶].

Program playback will start.

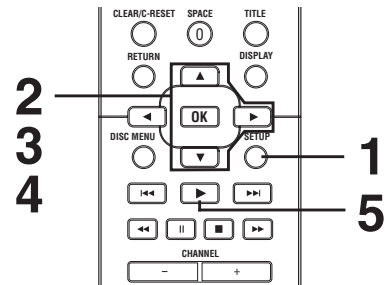

Note

- To erase tracks you selected, press [CLEAR/C-RESET].
- You can make program settings up to 50.
- To cancel program playback, press [STOP ■] twice during program playback. “Play mode OFF” appears on the TV screen.
- You may also select a desired track using the **Number buttons** at step 4.
- For Video CDs with PBC function, the PBC setting will be switched to off automatically when you start program playback.

Selecting the format of audio and video

You can select the format of audio and video as you prefer depending on the contents of the disc you are playing.

Switching subtitles



Many DVD-Video discs have subtitles in one or more languages – the case usually tells you which subtitle languages are available. You can switch subtitle languages anytime during playback.

1

During playback, press [DISPLAY].

Display menu will appear.

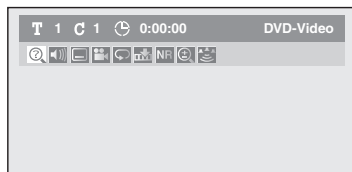

2

Using [◀ / ▶], select . Press [OK].

Subtitle menu will appear.

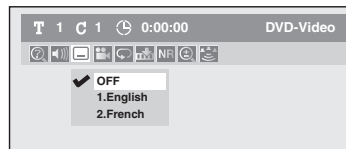

3

Using [▲ / ▼], select a desired subtitle language. Press [OK].

Subtitle will be displayed in the selected language.

When selecting “OFF”, subtitle will disappear.

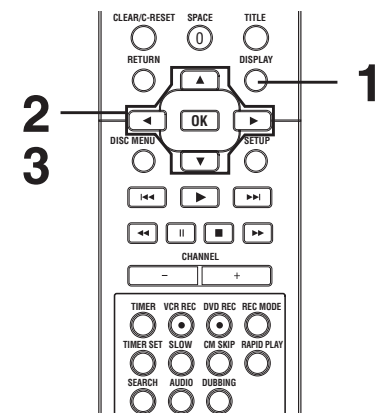

Note

- Some discs will only allow you to change the subtitle from the disc menu. Press [TITLE] or [DISC MENU] to display the disc menu.
- If a 4-digit language code appears in the subtitle menu at step 2, refer to the Language code on page 81.

Playing discs

Selecting the format of audio and video (cont'd)

Switching audio soundtrack



When playing a DVD-Video disc recorded with two or more soundtracks (these are often in different languages), you can switch them during playback. When playing Audio CDs or Video CDs you can switch between stereo, just the left channel or just the right channel.

1

During playback, press [DISPLAY].

Display menu will appear.

2

Using [◀/▶], select . Press [OK].

Audio menu will appear.

<DVD-Video>

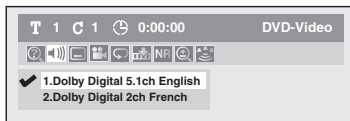

<Audio CD>

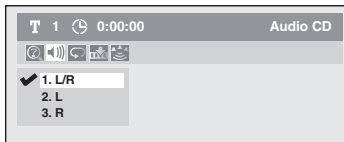

3

Using [▲/▼], select a desired audio soundtrack or audio channel. Press [OK].

<DVD-Video>
Audio soundtrack will switch.

<Audio CD/Video CD>
Audio channel will switch.

4

Using [▲/▼], select a desired audio channel. Press [OK].

Audio channel will switch.

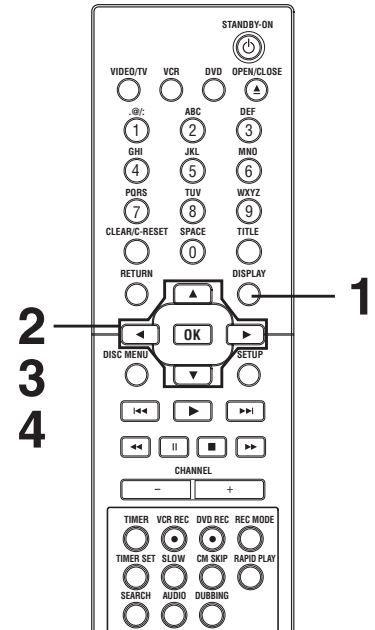

Note

- Some discs will only allow you to change the soundtrack from the disc menu. Press [TITLE] or [DISC MENU] to display the disc menu.
- This unit CANNOT record in both stereo and SAP (Secondary Audio Program) at the same time.

Switching virtual surround system



You can enjoy stereophonic virtual space through your exciting 2 channel stereo system.

1

During playback, press [DISPLAY].

Display menu will appear.



2

Using [◀/▶], select . Press [OK].

Virtual Surround menu will appear.

<DVD-Video>

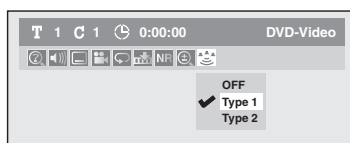

<DVD+RW>

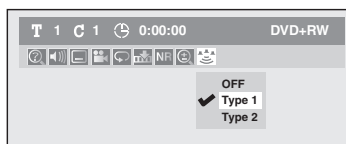

<Audio CD/MP3 files>

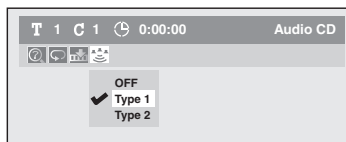

3

Using [▲/▼], to select "OFF", "Type1" or "Type2", then press [OK].

- OFF: no effect
- Type1: natural effect
- Type2: emphasized effect

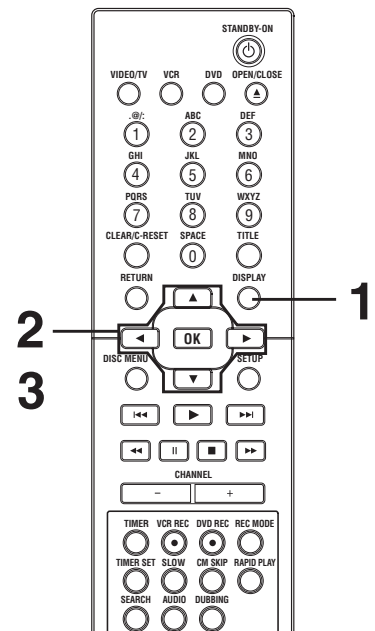

Note

- Select Virtual Surround to "OFF" in a case sound is dissorted.
- The setting will be kept "OFF" when the unit is turned off.

Playing discs

Selecting the format of audio and video (cont'd)

Switching camera angles



Some DVD-Video discs feature scenes shot from two or more angles, check the case for details: it should be marked with Angle icon if it contains multi-angle scenes.

1

During playback, press [DISPLAY].

Display menu will appear.

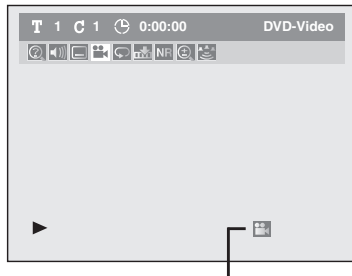

Angle icon appears when a switching camera angle is available.

2

Using [◀/▶], select . Press [OK].

Angle will switch each time you press [OK].

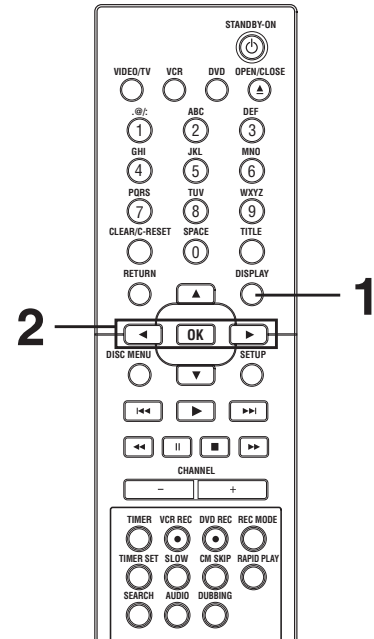

Note

Angle icon does not appear on the screen in a case you have selected Angle as "OFF" in the Display setting. Refer to pages 68-69.

Reducing block noise



1

During playback, press [DISPLAY].

Display menu will appear.

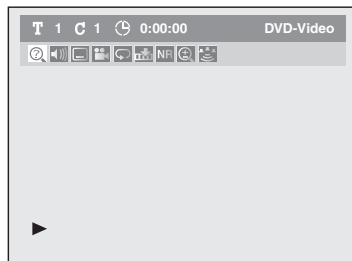

2

Using [◀/▶], select . Press [OK].

Noise Reduction menu will appear.

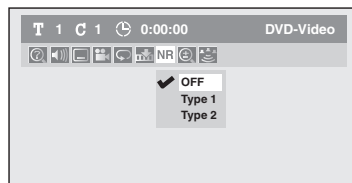

3

Using [▲/▼], select a desired option. Press [OK].

Your setting will be activated.

This function reduces noise in the playback picture. When playing back discs recorded in long time mode such as EP or SLP mode, select "Type 1" or "Type 2". ("Type 2" is more effective.) When playing back discs with a few noises such as DVD-Video discs, select "OFF".

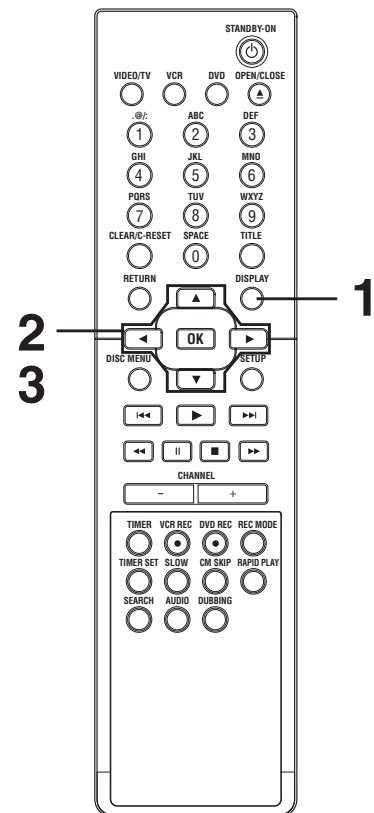

Guide to a title list

Title list allows you to check the titles recorded on the disc easily. You can choose a title to play from this list and easily edit the titles as you prefer.

Press [TITLE].

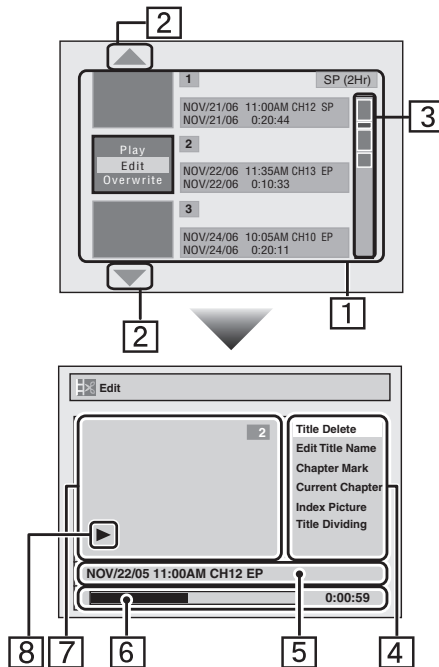

1. Titles recorded on the disc can be selected to edit by pressing [OK] with the cursor on the title. Using [▲ / ▼], select "Edit". Press [OK].
2. The arrow icon, which means the title list includes a next or a previous page. Press [▲ / ▼] by following direction of the icon. You can also use [◀ / ▶] to go to the next / previous page.
3. The portion bar, which indicates the position of the disc.
4. The menus in here for editing as you prefer. The available menus depend on the disc type and the format type. An item which is not available is grayed.
5. The details of the title, which can be changed to the title name you will edit.
6. Time status bar of the title
Time status will be held even after exiting the edit mode, and you can resume playback from that point.
7. The selected title thumbnail from the title list
8. Playback status of the current title

Editing discs

You can edit discs for the following items. Be sure that once you edit titles, they will not remain as original.

- Deleting titles (Refer to page 55)
- Putting names on titles (Refer to page 56)
- Setting / Clearing chapter marks (Refer to pages 57-58)
- Hiding chapters (Refer to page 59)
- Setting pictures for thumbnails (Refer to page 60)
- Dividing a title (DVD+RW/DVD-RW only) (Refer to page 61)

Note

- When selecting "Edit" on Pop-up menu of the title list and edit the title, the title list is displayed after writing the edited contents onto the disc. Press [STOP ■] to exit the title list.

Editing discs (Setup menu)

- Putting name on disc (Refer to page 62)
- Setting or releasing disc protect (Refer to pages 63-64)
- Erasing disc (Refer to page 65)
- Making edits compatible (Refer to page 65)

Note

- The portion bar in the right side of the title list may not indicate the precise position in the disc.
- The portion bar may not indicate the position for the titles of which recording time is short.
- Once a disc is finalized, editing the disc or recording to the disc will not be available.

Deleting titles



You can delete titles which you do not need anymore.

Be advised that the titles once deleted cannot be brought back to the disc.

When the last title, which is recorded in the disc, in the title list is deleted, the disc space to recorded will be increased. For DVD+R and DVD-R disc, the disc space to record will not be changed.

First:

1

Press [TITLE].

Title list will appear.

<DVD+RW/DVD-RW>

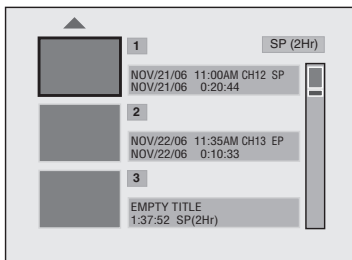

2

Using [▲ / ▼], select a desired title. Press [OK].

Pop-up window will appear.



3

Using [▲ / ▼], select "Edit". Press [OK].

Edit menu will appear.

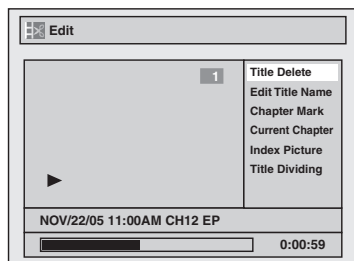

4

Using [▲ / ▼], select "Title Delete". Press [OK].

Confirmation window will appear.

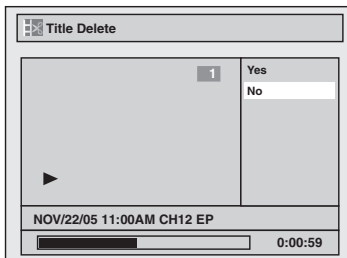

5

Using [▲ / ▼], select "Yes". Press [OK].

After that, "Are you sure?" will appear, select "Yes" and then press [OK].

Title will be deleted.

Data will be written onto the disc momentarily.



Title list will appear.

<DVD+RW/DVD-RW>

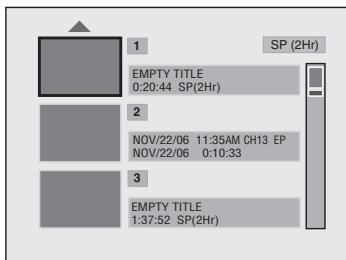

<DVD+R/DVD-R>

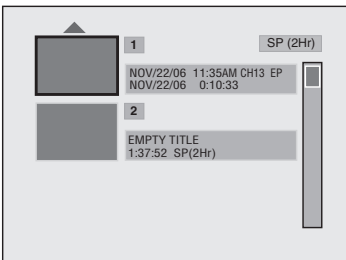

This operation may take a while to be completed.

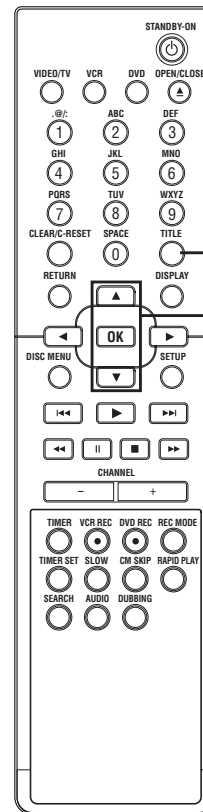

1
2
3
4
5

Before you start

Connections

Getting started

Recording

Playing discs

Editing

Changing the Setup menu

VCR functions

Others

Español

Note

- Deleted part of the titles in the portion bar changes in color.

Putting names on titles



You can put title names on the titles and change the names from this menu.

The names you put on the titles will be displayed on a title list.

First:

1

Follow steps 1 to 3 on page 55 to display the Edit menu.

2

Using **[▲ / ▼]**, select “Edit Title Name”. Press **[OK]**.

A window for entering a title name will appear.

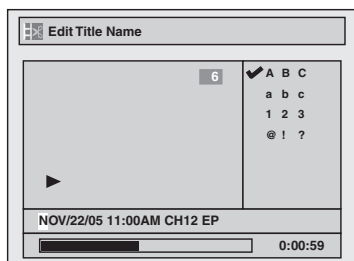

3

To enter a title name, follow the steps of “Guide to edit title name” on this page.

character set

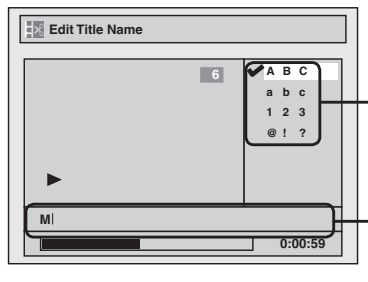

area for entering title names

When you finish entering a title name, press **[OK]**. Confirmation window will appear.

4

Using **[▲ / ▼]**, select “Yes”. Press **[OK]**.

The name you entered will be activated for the title.



5

After this operation is completed, press **[RETURN]** to exit.

Data will be written onto the disc momentarily.

This operation may take a while to be completed.

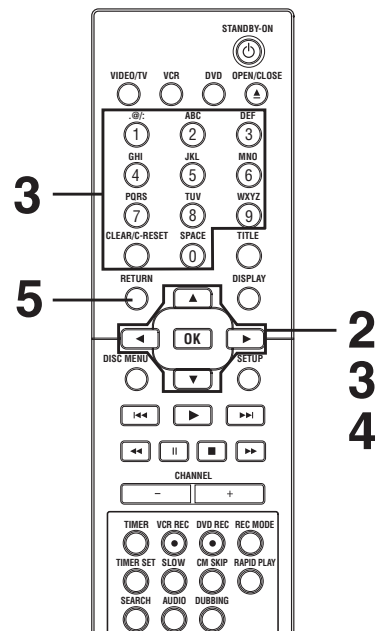

[Guide to edit title name]

[Step1]: Select a desired character set using **[▲/▼]**, then press **[OK]**.

A B C
a b c
1 2 3
@ ! ?

[Step2]: Follow the list below, press the **Number buttons** repeatedly until the desired letter appears.
e.g. character set : A B C

Select Press	ABC	abc	123	@ ! ?
0	<space>	<space>	0	<space>
1	(*1)	(*1)	1	! " # \$ % & ' () * + , - . / : ; < = > ? @ [] ^ _ { }
2	ABC	abc	2	(*2)
3	DEF	def	3	(*2)
4	GHI	ghi	4	(*2)
5	JKL	jkl	5	(*2)
6	MNO	mno	6	(*2)
7	PQRS	pqrs	7	(*2)
8	TUV	tuv	8	(*2)
9	WXYZ	wxyz	9	(*2)

Note:

Undefined letters in a title name are shown by “*”. If you delete them, adjoining letters may change to “*” or other.

*1 Press **①**, character set will be changed to the “@!?” mode automatically.

*2 Press **②** to **⑨**, character set will be changed to the previous input mode automatically.

- To delete letters, press **[CLEAR]** repeatedly. Holding **[CLEAR]** to delete all letters.
- Press **[◀/▶]** to move the cursor to the left or right.
- You can enter up to 30 letters.

Setting chapter marks



You can put chapter marks in each title. Once a chapter is marked, you can use it for the chapter search feature.

First:

1

Follow steps 1 to 3 on page 55 to display the Edit menu.

2

Using **[▲ / ▼]**, select “Chapter Mark”. Press **[OK]**.

Option window will appear.

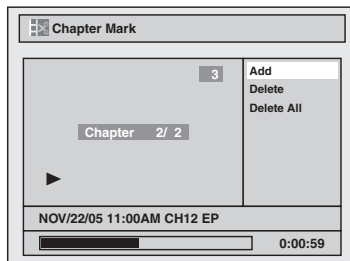

3

Press **[PLAY ►]** and then **[PAUSE II]** to decide the point at which you will create a new chapter mark.

- It is convenient to use **[SKIP ◀◀ / ▶▶]**, **[REW ◀◀]** and **[F.FWD ▶▶]** for finding the point to be added a new chapter mark.

4

Using **[▲ / ▼]**, select “Add”. Press **[OK]**.

Confirmation window will appear.

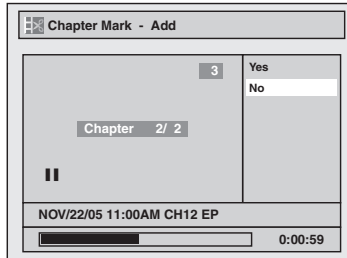

5

Using **[▲ / ▼]**, select “Yes”. Press **[OK]**.

A new chapter mark will be added.

6

Press **[RETURN]** to exit.

Data will be written onto the disc momentarily.

This operation may take a while to be completed.

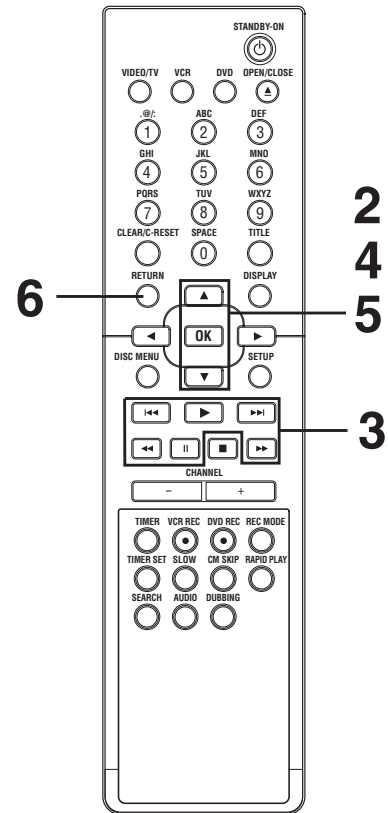

Note

- When the number of chapter marks in a title is 99 and the number of chapter marks in a disc is 254, chapter marks cannot be added.
- Besides the above-mentioned, it is not likely to be able to add according to recorded time and number of chapters.
- Remaining time of the disc may decrease when adding chapter marks or increase when clearing chapter marks depending on the recording time or edited contents.

Editing discs (cont'd)

Clearing chapter marks



First:

1

Follow steps 1 to 3 on page 55 to display the Edit menu.

2

Using [\blacktriangle / \blacktriangledown], select "Chapter Mark". Press [OK].

Option window will appear as illustrated step 2 on page 57.

3

Using [SKIP \lll / \ggg], select a chapter mark to be deleted.

4

Using [\blacktriangle / \blacktriangledown], select "Delete". Press [OK].

Confirmation window will appear.

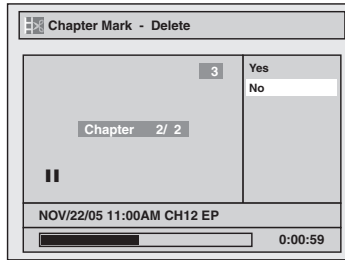

5

Using [\blacktriangle / \blacktriangledown], select "Yes". Press [OK].

The selected chapter mark will be deleted.

6

Press [RETURN] to exit.

Data will be written onto the disc momentarily.

This operation may take a while to be completed.

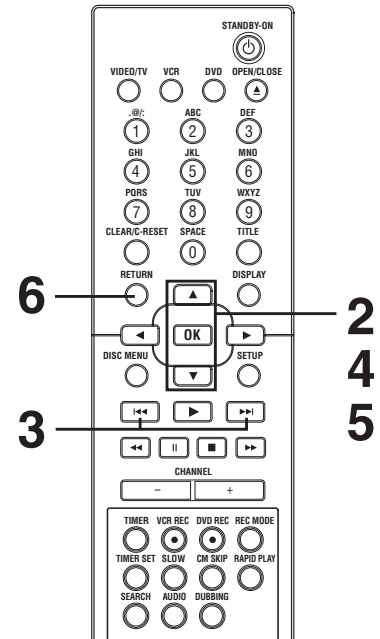

Note

- Remaining time of the disc may decrease when adding chapter marks or increase when clearing chapter marks depending on the recording time or edited contents.

To delete all chapter marks:



1

Follow steps 1 to 3 on page 55 to display the Edit menu.

2

Using [\blacktriangle / \blacktriangledown], select "Chapter Mark". Press [OK].

Option window will appear as illustrated step 2 on page 57.

3

Using [\blacktriangle / \blacktriangledown], select "Delete All". Press [OK].

Confirmation window will appear.

4

Using [\blacktriangle / \blacktriangledown], select "Yes". Press [OK].

Final confirmation window will appear.

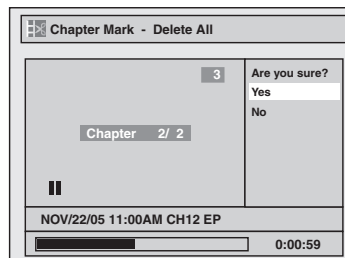

5

Using [\blacktriangle / \blacktriangledown], select "Yes". Press [OK].

All chapter marks will be deleted.

6

Press [RETURN] to exit.

Data will be written onto the disc momentarily.

This operation may take a while to be completed.

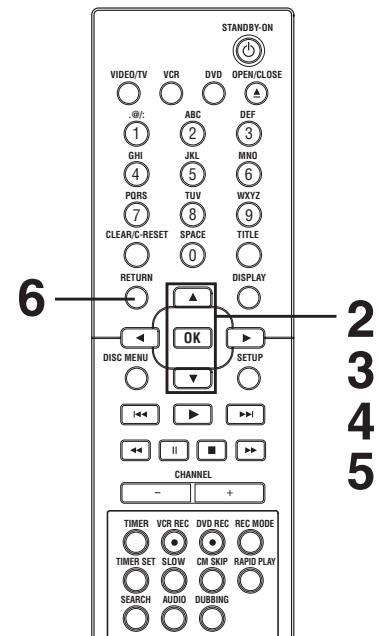

Note

- Remaining time of the disc may decrease when adding chapter marks or increase when clearing chapter marks depending on the recording time or edited contents.

Hiding chapters



You can hide chapters from the title list.

Hidden chapters are skipped during playback.

First:

1

Follow steps 1 to 3 on page 55 to display the Edit menu.

2

Using [\blacktriangle / \blacktriangledown], select “Current Chapter”. Press [OK].

Option window will appear.

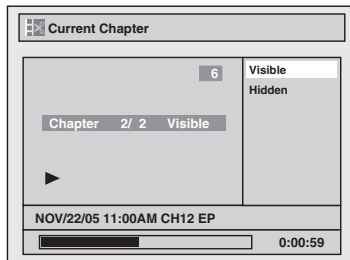

3

Using [SKIP \lll / \ggg], [PLAY \blacktriangleright] and [PAUSE II], decide the chapter to be hidden.

4

Using [\blacktriangle / \blacktriangledown], select “Hidden”. Press [OK].

“Hidden” is displayed in the middle of the preview screen on Current chapter window.

“Hidden” is also displayed on the lower right corner of the preview screen on Edit menu option window other than Current chapter window.

5

After this operation is completed, press [RETURN] twice to exit.

Data will be written onto the disc momentarily.

This operation may take a while to be completed.

If you want to return “Visible”, select the chapter to be shown. Then using [\blacktriangle / \blacktriangledown], select “Visible” at the step 4 on this page.

Data will be written onto the disc momentarily.

After that Title list is displayed.

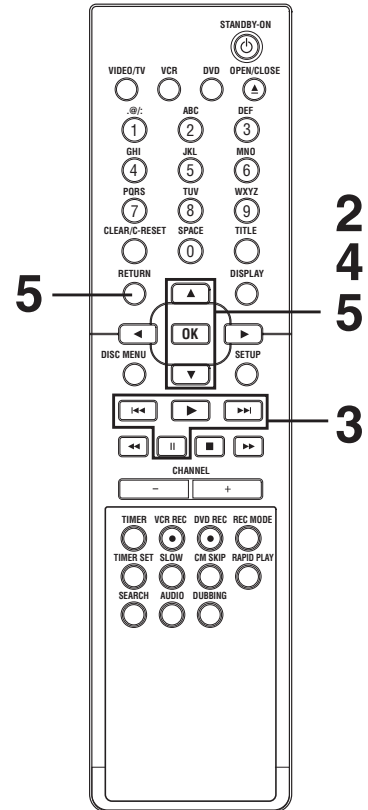

5

2
4
5

3

Note

- When you make all chapters in the title to “Hidden”, “Hidden” is displayed in a thumbnail of the title list.

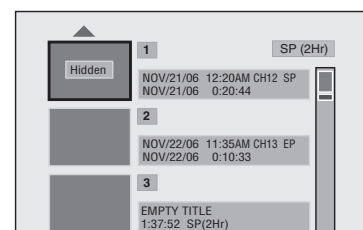

Setting pictures for thumbnails



You can set a picture to each title for a thumbnail. It helps you to remember the contents of the title you are playing. The beginning picture has been selected as the default.

First:

1

Follow steps 1 to 3 on page 55 to display the Edit menu.

2

Using [\blacktriangle / \blacktriangledown], select “Index Picture”. Press [OK].

3

Press [PLAY \blacktriangleright] and then [PAUSE II] to decide the picture to be set as the thumbnail.

- It is convenient to use [SKIP $\text{I} \lll / \ggg$], [REW \lll] and [F.FWD \ggg] for finding the thumbnail picture.

Press [OK].

Confirmation window will appear.

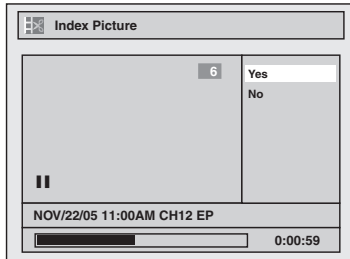

4

Using [\blacktriangle / \blacktriangledown], select “Yes”. Press [OK].

A picture for thumbnail will be set.

5

Press [RETURN] to exit.

Data will be written onto the disc momentarily.

This operation may take a while to be completed.

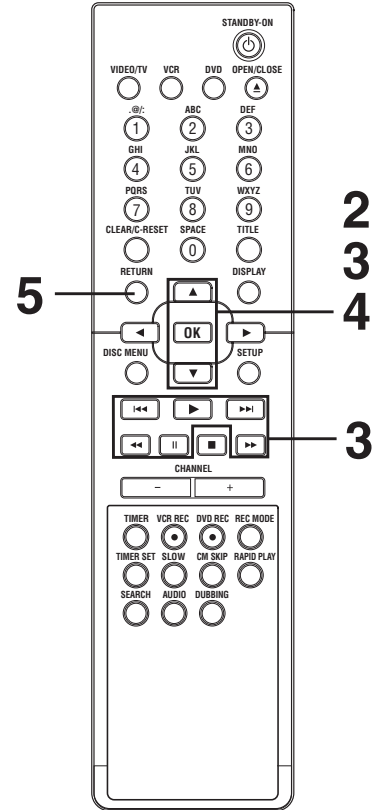

Note

- If the selected picture for a thumbnail is overwritten, the index picture is reset to the first scene of the title.

Dividing a title



You can divide one title into two new titles.

First:

1

Follow steps 1 to 3 on page 55 to display the Edit menu.

2

Using [\blacktriangle / \blacktriangledown], select “Title Dividing”.

3

Press [PLAY \blacktriangleright] and then [PAUSE II] to decide the point at which you will divide the title.

- It is convenient to use [SKIP $\text{I} \lll / \ggg \text{I}$], [REW \lll] and [F.FWD \ggg] for finding the point to be divided.

Press [OK].

Confirmation window will appear.

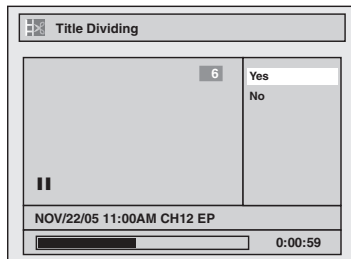

4

Using [\blacktriangle / \blacktriangledown], select “Yes”. Press [OK].

The title will be divided into two new titles.

Both title names are identical, and index pictures are reset to the first scene at this point.

Data will be written onto the disc momentarily.

This operation may take a while to be completed.

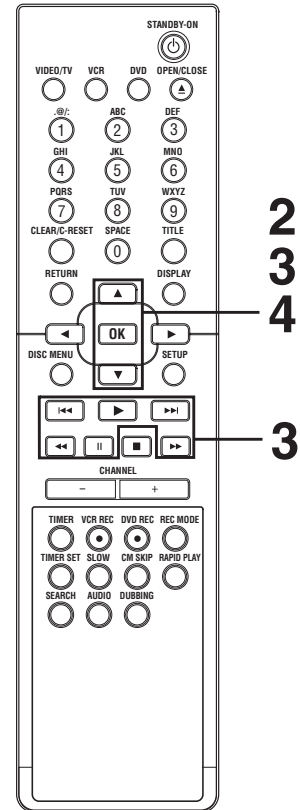

Note

- You cannot divide a title of the disc on which the number of recording title comes up to the maximum (49), and the number of recording chapter comes up to the maximum (254).

Editing discs (Setup menu)

Putting name on disc



You can put title names on the titles and change the names from this menu.

Press **[STOP ■]** if you are playing a disc.

First:

1

Press **[SETUP]**.

2

Using **[▲ / ▼]**, select “Disc Edit”. Press **[OK]**.

Disc Edit menu will appear.

<DVD+RW>

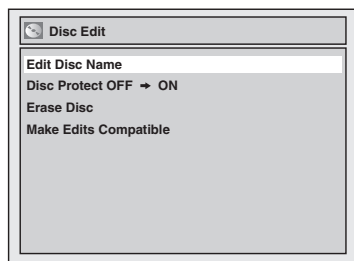

<DVD+R/DVD-R>

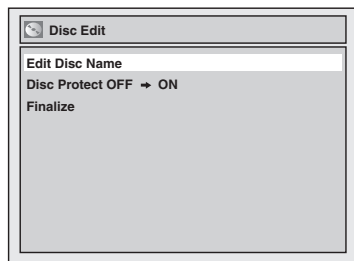

<DVD-RW>

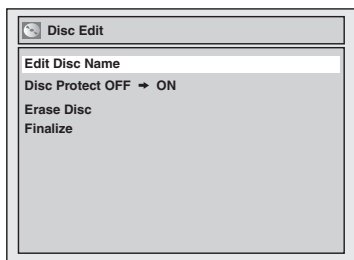

3

Using **[▲ / ▼]**, select “Edit Disc Name”. Press **[OK]**.

A window for entering a title name will appear.

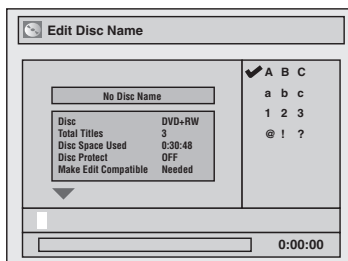

4

To enter a disc name, follow the steps of “Guide to edit title name” on page 56.

When you finish entering a title name, press **[OK]**.

Confirmation window will appear.

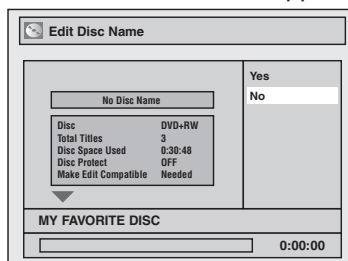

5

Using **[▲ / ▼]**, select “Yes”. Press **[OK]**.

The name you entered will be activated for the title.

Data will be written onto the disc momentarily.

This operation may take a while to be completed.

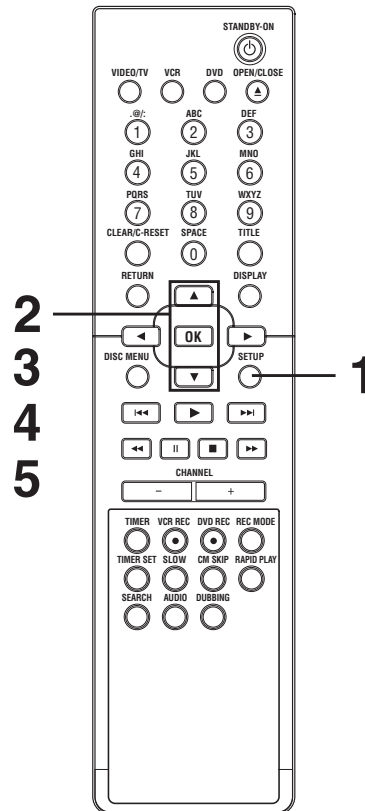

Note

- You cannot select “Disc Edit” when finalized DVD disc is inserted (DVD+R/DVD-R).

Setting or releasing disc protect



To prevent accidental editing, or erasing the titles, you can protect them.

Setting disc to protect

First:

1

Follow steps 1 to 2 on page 62 to display the Disc Edit menu.

<DVD+RW>

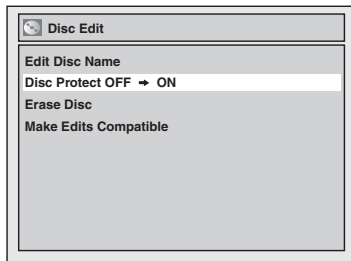

<DVD+R/DVD-R>

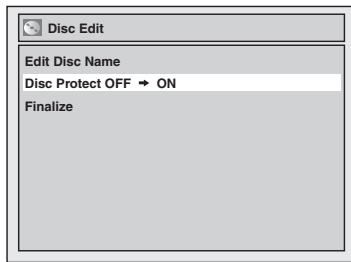

<DVD-RW>

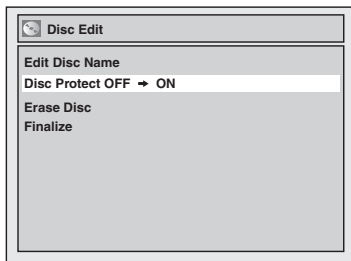

2

Using [▲ / ▼], select “Disc Protect OFF → ON”. Press [OK].

Confirmation window will appear.



3

Using [▲ / ▼], select “Yes”. Press [OK].

Data will be written onto the disc momentarily.

This operation may take a while to be completed.

2
3

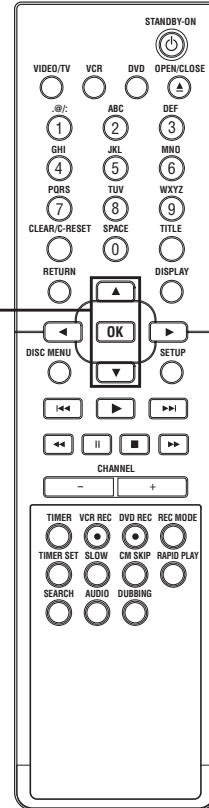

Editing discs (Setup menu) (cont'd)

Setting or releasing disc protect (cont'd)

Releasing disc from protect

First: 

1

Follow steps 1 to 2 on page 62 to display the Disc Edit menu.

<DVD+RW>

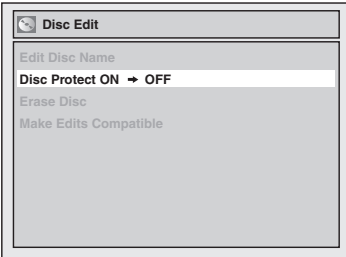

<DVD+R/DVD-R>

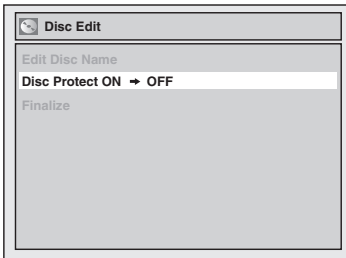

<DVD-RW>

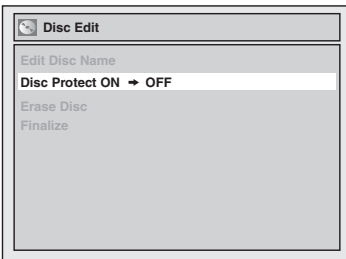

2

Using [▲ / ▼], select “Disc Protect”. Press [OK].

Confirmation window will appear.

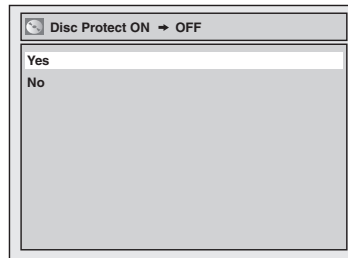

3

Using [▲ / ▼], select “Yes”. Press [OK].

This operation may take a while to be completed.

Data will be written onto the disc momentarily.

2
3

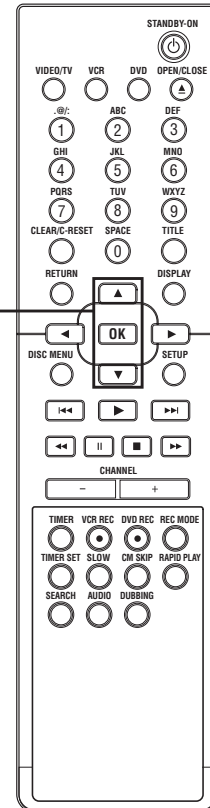

Editing discs (Setup menu) (cont'd)

Erasing disc



You can erase all titles on a disc. If you want to record on DVD-RW formatted with other than DVD+VR mode, erase all contents on the disc and format it.

Press **[STOP ■]** if you are playing a disc.

First:

1

Follow steps 1 to 2 on page 62 to display the Disc Edit menu.

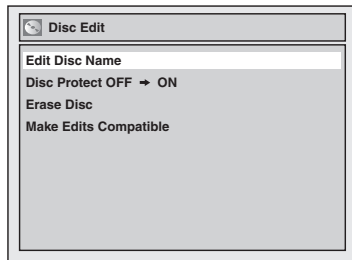

2

Using **[▲ / ▼]**, select “Erase Disc”. Press **[OK]**.

Confirmation window will appear.

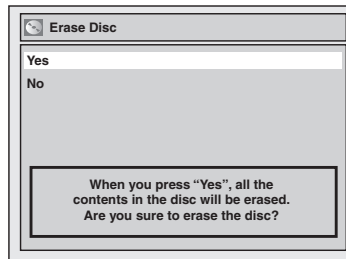

3

Using **[▲ / ▼]**, select “Yes”. Press **[OK]**.

Data will be written onto the disc momentarily.

This operation may take a while to be completed.

2
3

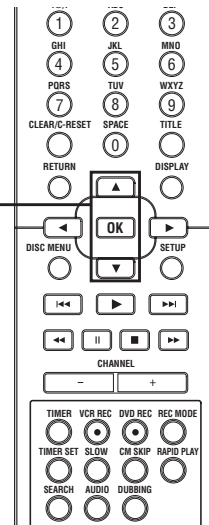

Note

- When you press “Yes”, all contents of the disc will be erased.
- When you erase the disc, the contents of the disc will be erased. (Its format is changed to DVD+VR mode.)
- If you want to cancel erasing the disc at step 2, select “No”.

Making edits compatible



You will need to perform “Make Edit Compatible” to play in other DVD players.

Press **[STOP ■]** if you are playing a disc.

First:

1

Follow steps 1 to 2 on page 62 to display the Disc Edit menu.

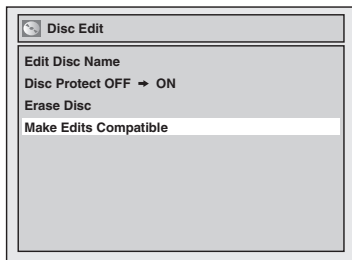

2

Using **[▲ / ▼]**, select “Make Edits Compatible”. Press **[OK]**.

Confirmation window will appear.

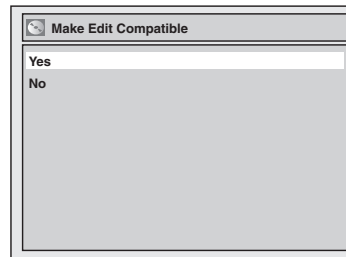

3

Using **[▲ / ▼]**, select “Yes”. Press **[OK]**.

Data will be written onto the disc momentarily.

This operation may take a while to be completed.

2
3

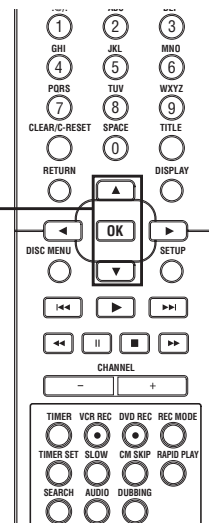

Note

- If “Make Edits Compatible” is not selectable in “Disc Edit” menu, you do not need to perform “Make Edits Compatible” to play in other DVD players.

Changing the Setup menu

Tour of the Setup menu

The following table is the contents which you can set and the default settings.
Refer to the following table for useful operation.

Setup	Items (highlight is the default)	Contents	
1.Language setting ➔ Pages 67-68	Disc Menu Language	English French Spanish ⋮	Set the language for disc menu.
	Audio Language	Original English French ⋮	Set the language for audio.
	Subtitle Language	OFF English French ⋮	Set the language for subtitle.
2.Display setting ➔ Pages 68-69	OSD Language	English Français Español	Set the language for OSD (On Screen Display).
	Angle Icon	ON OFF	Set the display or undisplay of multi-angle icon in a case the DVD in playback mode contains multi-angle scene.
	Screen Saver	OFF 5 minutes 10 minutes ⋮	Set the time to work the screen saver on the screen.
	FL Dimmer	Auto Bright Dark	Set the brightness of the front panel display.
3.Audio setting ➔ Pages 69-70	Digital Out	PCM 48kHz 96kHz	Set whether the sound recorded in 96kHz will be down sampled in 48kHz.
		Dolby Digital PCM Stream	Set the type of sound signal which outputs from the digital audio output jack.
	Dynamic Range Control	ON OFF	Compressing the range of sound volume.
4.Video setting ➔ Page 71	Progressive Scan	ON OFF	Set to the progressive scan mode (set to "ON") or to the interlace scan mode (set to "OFF").
	Still Mode	Auto Field Frame	Set the type of still image in pausing playback.
5.Parental setting ➔ Pages 72-73	Parental Lock	All level 8 to 1	Set the parental level of your DVD discs.
	(Change password)	Enter the current four-digit password	Set and change the password.
6.PBC setting ➔ Page 73	PBC (Video CD only)	ON OFF	Set the Playback Control. (Video CD only)

Note

- If you change the setting in the Setup menu, the information of contents stays on even when the power is switched off.
- An item which is not currently available is grayed in the Setup menus.

Changing the Setup menu

Language setting

Press [STOP ■] if you are playing a disc.

1

Press [SETUP].

2

Using [▲ / ▼], select “Playback”. Press [OK].
Playback menu will appear.

3

Using [▲ / ▼], select “Language”. Press [OK].
Language menu will appear.

4

Using [▲ / ▼], desired item. Press [OK].

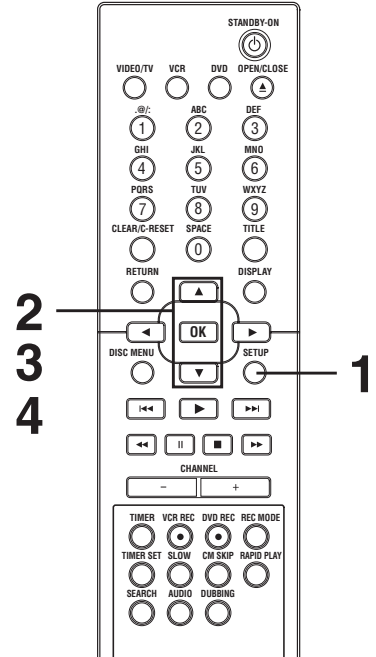

Disc Menu Language (Default : English)
Set the language for Disc Menu.

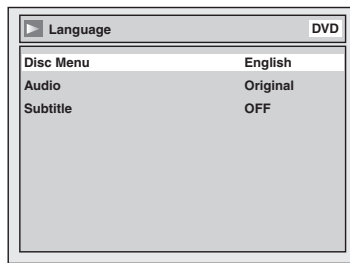

- Using [▲ / ▼], select a setting. Press [OK].
Your setting will be activated.

Audio Language (Default : Original)
Set the Audio language.

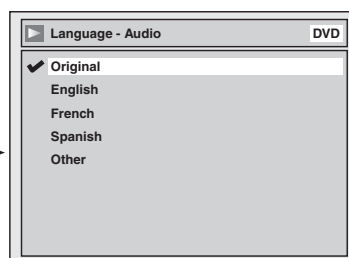
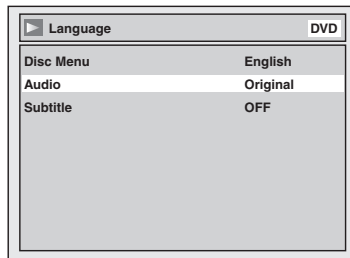

- Using [▲ / ▼], select a setting. Press [OK].
Your setting will be activated.
- When Original is selected, the audio language will be in the disc's default language.

Subtitle Language (Default : OFF)
Set the Subtitle language.

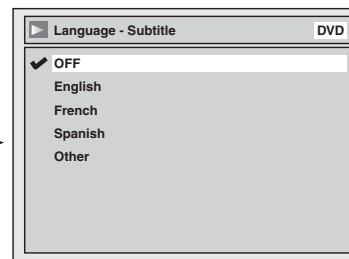
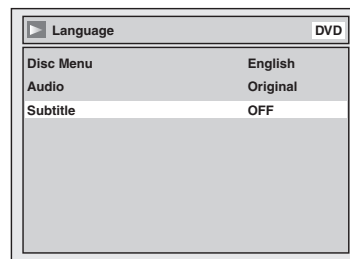

- Using [▲ / ▼], select a setting. Press [OK].
Your setting will be activated.

Changing the Setup menu

Language setting (cont'd)

If "Other" is selected, press 4-digit code using the **Number buttons**.

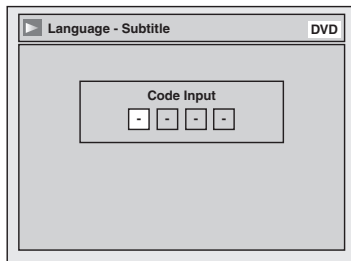

- When you finish entering the code, press [OK]. Refer to the language code table on page 81.

Note

- Only the languages supported by the disc can be selected.
- Audio Language setting may not be available to some discs.
- You can change or switch off the subtitles on a DVD disc also from the disc menu if it is available.
- Press [CLEAR/C-RESET] or [◀] to erase numbers entered incorrectly.

5

Press [SETUP] to exit.

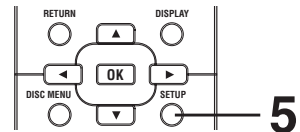

Display setting

Press [STOP ■] if you are playing a disc.

1

Press [SETUP].

2

Using [▲ / ▼], select "Display". Press [OK].
Display menu will appear.

3

Using [▲ / ▼], select a desired item. Press [OK].

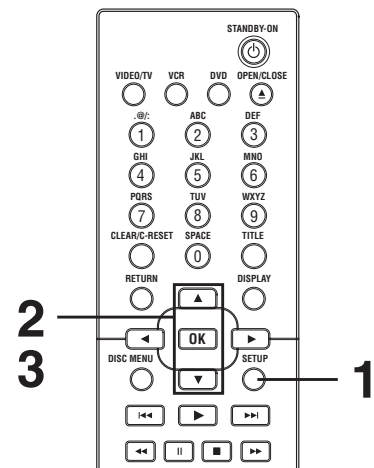

OSD Language (Default : English)

Set the language for the On Screen display.

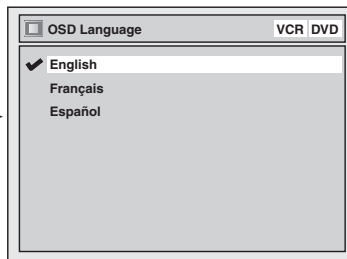
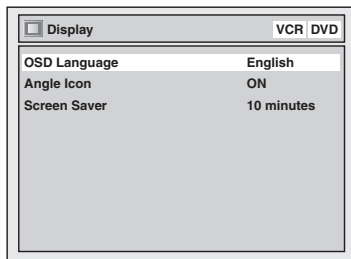

- Using [▲ / ▼], select a setting. Press [OK].
Your setting will be activated.

Angle Icon (Default : ON)

Set to "ON" to show the Angle Icon during the playback.

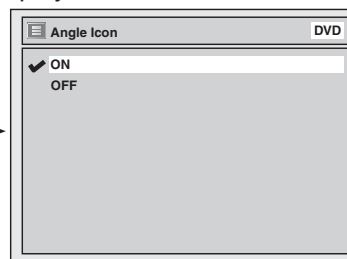
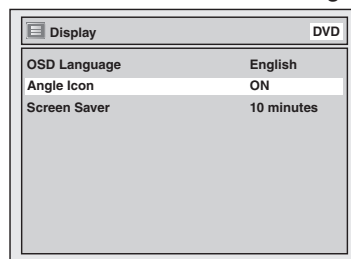

- Using [▲ / ▼], select a setting. Press [OK].
Your setting will be activated.

Changing the Setup menu

Display setting (cont'd)

Screen Saver (Default : 10 minutes)

Set the time to work the screen saver function on the screen.

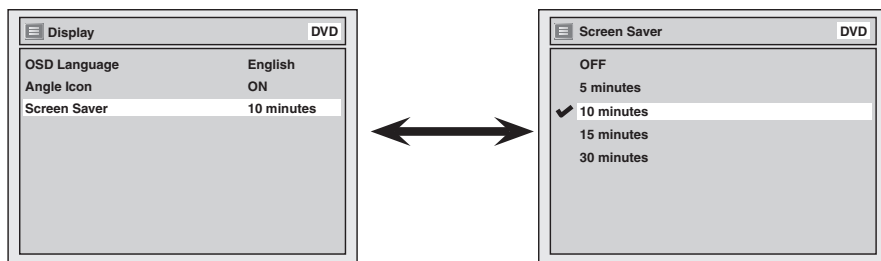

- Using **[▲ / ▼]**, select a setting. Press **[OK]**. Your setting will be activated.

FL Dimmer (Default : Bright)

Set the brightness of front panel display. You can choose one among "Auto", "Bright" and "Dark".

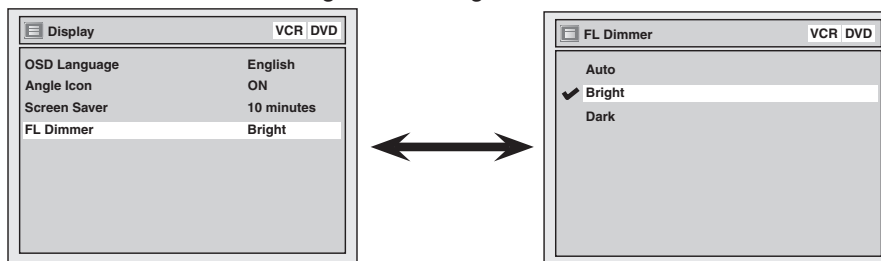

- Using **[▲ / ▼]**, select a setting. Press **[OK]**. Your setting will be activated.
- If "Auto" is selected, the display is shown brighter when the power is on, darker when the power is off.

4

Press **[SETUP]** to exit.

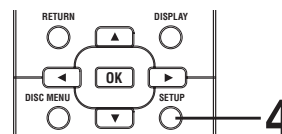

Audio setting

Choose the appropriate Audio settings for your external equipment.

It will only affect a disc playback.

Press **[STOP ■]** if you are playing a disc.

1

Press **[SETUP]**.

2

Using **[▲ / ▼]**, select "Playback". Press **[OK]**. Playback menu will appear.

3

Using **[▲ / ▼]**, select "Disc Audio". Press **[OK]**.

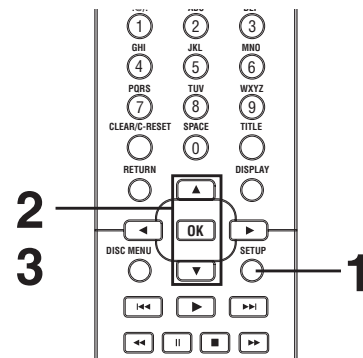

Note

- Dynamic Range Control function is available only on the discs which are recorded in the Dolby Digital format.

Digital Out

Set the digital audio output.

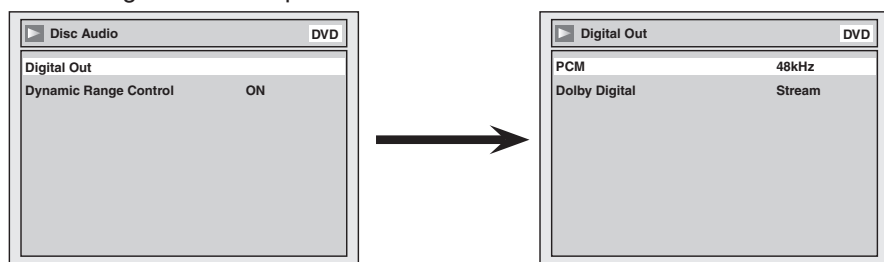

- Using **[▲ / ▼]**, select a setting. Press **[OK]**. Option window will appear. Proceed to step A or B.

Changing the Setup menu

Audio setting (cont'd)

A Settings for PCM (Default : 48kHz)

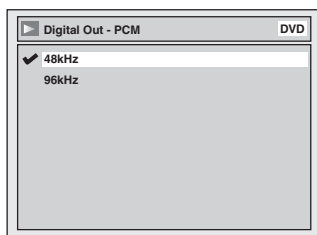

- Using [▲ / ▼], select a setting. Press [OK].
Your setting will be activated.
- 48kHz :If your amplifier/decoder is NOT compatible with 96kHz PCM, select "48kHz". 96kHz sound will be output in 48kHz.
- 96kHz :If your amplifier/decoder is compatible with 96kHz PCM, select "96kHz". 96kHz sound will be output.

Note
When playing disc with copyright protection

- Even if you select "96kHz", the sound will be down sampled at 48kHz.

B Settings for Dolby Digital (Default : Stream)

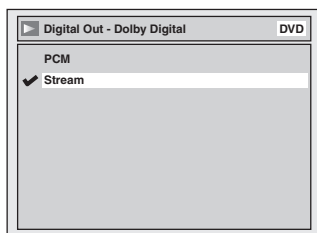

- Using [▲ / ▼], select a setting. Press [OK].
Your setting will be activated.
- PCM :Convert the Dolby Digital into PCM(2 channel).
When your amplifier/decoder is NOT compatible with Dolby Digital, set to "PCM".
- Stream :Outputs Dolby Digital signals
When your amplifier/decoder is compatible with Dolby Digital, set to "Stream".

Dynamic Range Control (Default : ON)

Set to "ON" to compress the range between soft and loud sounds.

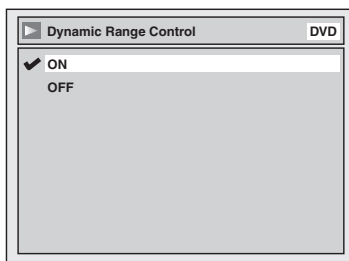
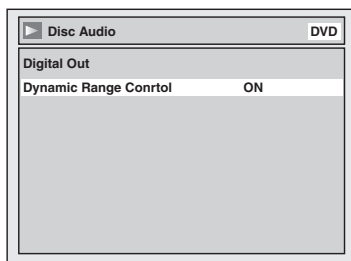

- Using [▲ / ▼], select a setting. Press [OK].
Your setting will be activated.

4

Press [SETUP] to exit.

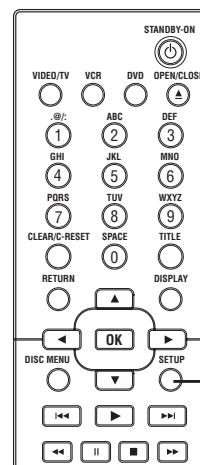

Changing the Setup menu

Video setting

Progressive Scan (Default : OFF)

This unit is compatible with the Progressive Scan System. The feature provides you with the higher definition images than the traditional output system does. To utilize this feature, you must set Progressive Scan mode to "ON".

1

Press [SETUP].

2

Using [▲ / ▼], select "Playback". Press [OK].

3

Using [▲ / ▼], select "Video". Press [OK].

4

Using [▲ / ▼], select "Progressive Scan". Press [OK].

5

Using [▲ / ▼], select "ON".

Press [OK].

Confirmation window will appear.

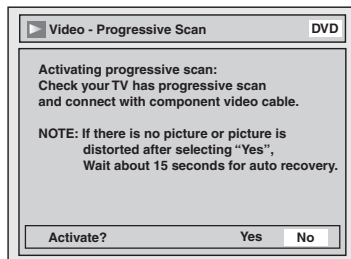

6

Using [◀ / ▶], select "Yes". Press [OK].

7

Using [▲ / ▼], select "Yes" in 15 seconds. Press [OK].

Your setting will be activated.

8

Press [SETUP] to exit.

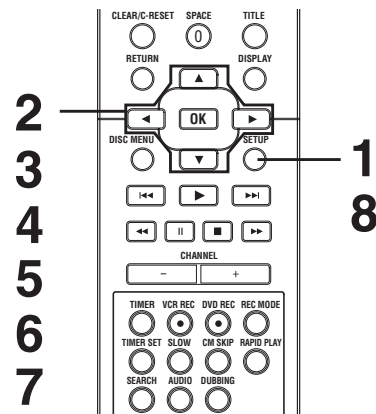

Note

- If your TV is compatible with Progressive Scan (525p / 480p), you must use the Component Video cable (commercially available) to connect this unit to the TV. (See Method 3 on page 14.) Make sure the "P.SCAN" appears on the front panel display. If not, use the video cable and set the Progressive scan mode to "OFF" or press and hold [SETUP] for more than 3 seconds during DVD playback, so that the "P.SCAN" on the front panel display disappears.
- When selecting "No" or not pressing any keys on the unit or remote control within 15 seconds at step 7, Progressive Scan remains to be "OFF" (interlace scan).

Still Mode (Default : Auto)

Set the type of still image in pausing playback. Select "Auto" usually.

Press [STOP ■] if you are playing a disc.

1

Proceed to steps 1 to 3 above.

2

Using [▲ / ▼], select "Still Mode". Press [OK].

3

Using [▲ / ▼], select a setting. Press [OK].

Your setting will be activated.

Auto : Optimum resolution setting (Field of Frame) will be selected.

Field : Images in the still mode will be stabilized.

Frame : Images in the still mode will be highly defined.

4

Press [SETUP] to exit.

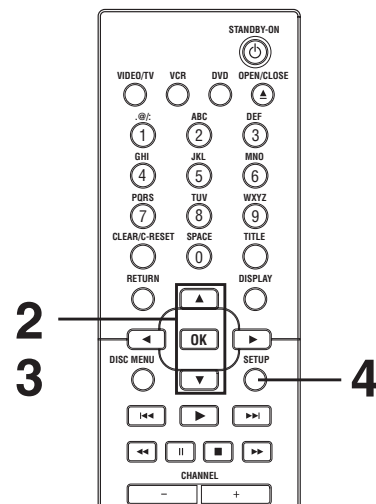

Note

- Frame is 1 completed video image made up of 2 fields (There are 30 frame per second of NTSC video).

Changing the Setup menu

Settings for Parental lock level

Some DVD-Video discs feature a Parental Lock level. Playback will stop if the ratings exceed the levels you set, it will require you to enter a password before the disc will playback. This feature prevents your children from viewing inappropriate material.

Press **[STOP ■]** if you are playing a disc.

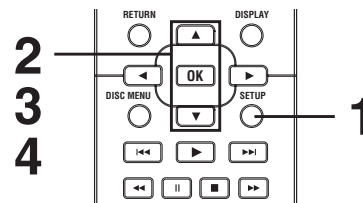

1

Press **[SETUP]**.

2

Using **[▲ / ▼]**, select “Playback”. Press **[OK]**.

Playback menu will appear.

3

Using **[▲ / ▼]**, select “Parental Lock”. Press **[OK]**.

4

Using **[▲ / ▼]**, select the desired level. Press **[OK]**.

Note

- Parental lock function may not be available to some discs.
- With some DVDs, it may be difficult to find if they are compatible with parental lock. Be sure to check if the parental lock function operates in the way that you have set.
- Record the password in case you forget it.

Parental Lock (Default : All)

Set the Parental Lock level.

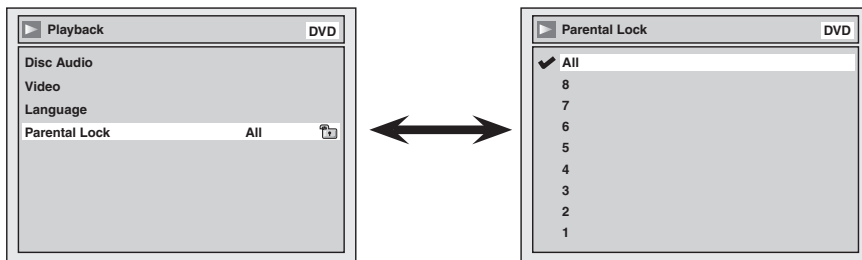

- Using **[▲ / ▼]**, change the parental level. Press **[OK]**. Option window will appear. Proceed to step A or B.

A

A password has not been set yet.

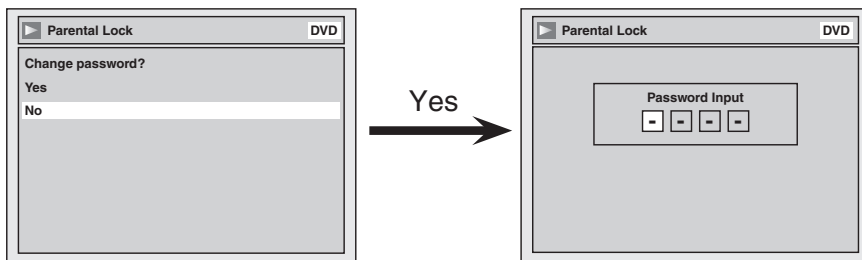

- Using **[▲ / ▼]**, select “Yes”. Press **[OK]**. If you select “No”, proceed to step 5.

- Using the Number buttons, enter a new password. Press **[OK]**. Your setting will be activated.

B

A password has been set already.

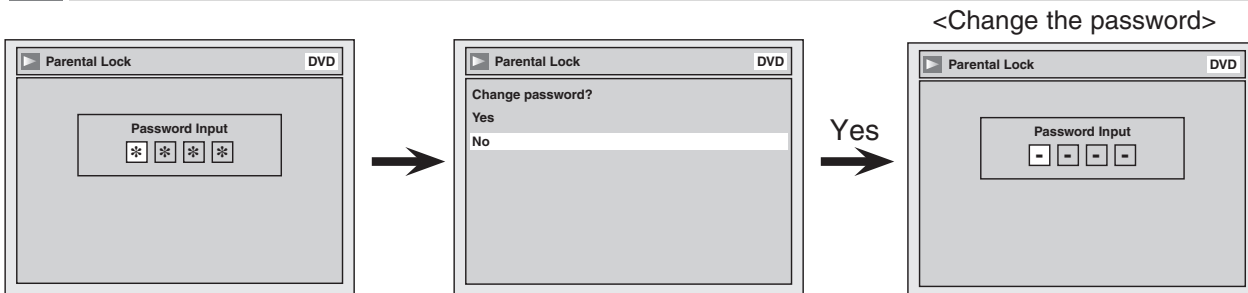

- Using the Number buttons, enter the current password.

- Using **[▲ / ▼]**, select “Yes”. Press **[OK]**. If you select “No”, proceed to step 5.

- Using the Number buttons, enter a new password. Press **[OK]**. Your setting will be activated.

Changing the Setup menu

Settings for Parental lock level (cont'd)

5

Press [SETUP] to exit.

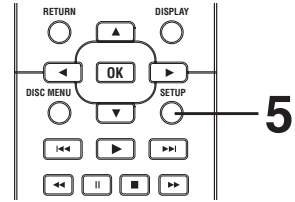

Note

- Press [CLEAR/C-RESET] to erase numbers entered incorrectly.
- When you forget the password or you want to clear all settings in Parental lock, enter **4,7,3,7** using the **Number buttons** in Password Input window. Password will be cleared and parental levels will be set to "All".

Settings for PBC (Playback Control)

PBC (Video CD only) (Default : ON)

You can select images or information on the menu screen by activation PBC (Playback Control) function of Video CD.

Press [STOP ■] if you are playing a disc.

1

Press [SETUP].

2

Using [▲ / ▼], select "CD Playback Mode". Press [OK].
CD Playback menu will appear.

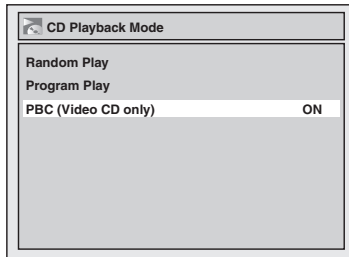

3

Using [▲ / ▼], select "PBC (Video CD only)". Press [OK].

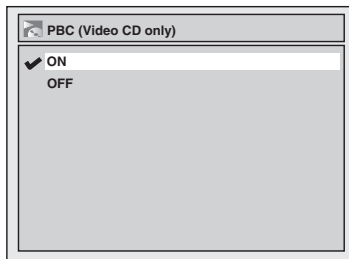

4

Using [▲ / ▼], select "ON" or "OFF". Press [OK].
Your setting will be activated.

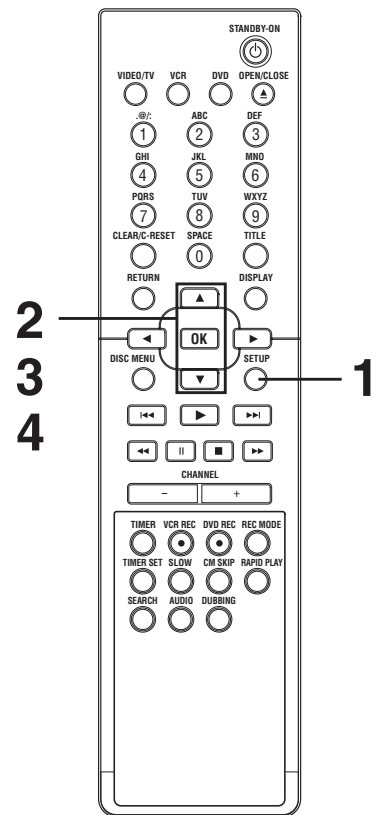

Note

- When playing Video CDs with PBC function, some operations (e.g. select and track repeat) cannot be performed. Select PBC function "OFF" to perform those operations.
- PBC setting turns to "ON" when loading Video CDs with PBC function, thus, even after setting PBC to "OFF" and ejecting the Video CD then reloading the Video CD, this setting turns to "ON" automatically.

Before you start

Connections

Getting started

Recording

Playing discs

Editing

Changing the Setup menu

VCR functions

Others

Español

VCR functions

Playback

Playback



1
Press [STANDBY-ON ] on the remote control or the front panel of the unit.

When you are playing a videotape, turn the TV on and be sure to select the input to which the unit is connected.

Press: 

2
Insert a prerecorded videotape. Press [PLAY ] to begin playback.

3
During playback, press [PAUSE ]. Playback will pause and sound will be muted.



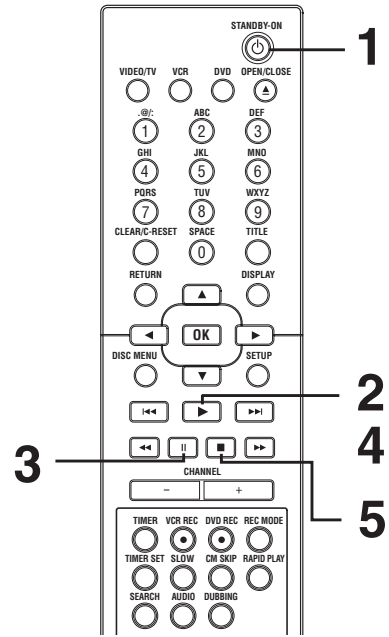

4
Press [PLAY ] to resume play.

5
Press [STOP ] to stop playback.

6
Press [STOP  / EJECT ] on the front panel of the unit to eject the videotape.



Note

- When a videotape without record tab is inserted, the unit will start playback automatically.
- Tracking will be automatically adjusted upon playback. To adjust the tracking manually, press [CHANNEL  / ] on the front panel of the unit or [CHANNEL  / ] on the remote control.





Recording and One-touch Timer Recording

Recording



First: 

Before recording, make sure:

- The desired channel is selected by pressing the **Number buttons** or [CHANNEL  / ] on the remote control or [CHANNEL  / ] on the front panel of the unit.
- There is a videotape with a record tab in the unit.
- The desired recording mode is selected in SP (standard play) or SLP (super long play) mode by pressing [REC MODE] on the remote control.

Recording mode:

Tape speed	Recording/Playback Time		
Type of tape	T60	T120	T160
SP mode	1hour	2hours	2-2/3hours
SLP mode	3hours	6hours	8hours

- Stereo or SAP is selected. Refer to page 21.
- Refer to page 30 for instructions on Timer Recording.

1
Press [VCR REC ] to begin the recording.

To temporarily stop recording or to resume it, press [PAUSE ]. After the unit has been in Pause mode for 5 minutes, it will stop automatically to protect the videotape and the video head from damage.

2
Press [STOP ] when the recording is completed.

Accidental erasure prevention

To prevent accidental recording on a recorded videotape, remove its record tab. To record on it later, cover the hole with cellophane tape.

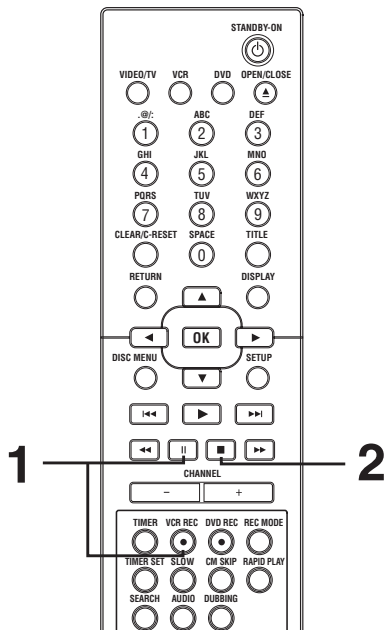
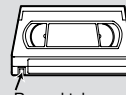

Note

- To view one channel while recording another
 - 1) While you are recording on the unit, press [VIDEO/TV].
 - 2) At the cable box or satellite box, select the channel you want to view.
 If you have connected the unit to a cable box or satellite box, refer to "Connection to a cable box or satellite box" section on page 15.

VCR functions

Recording and One-touch Timer Recording (cont'd)

One-touch Timer Recording (OTR)



This feature allows you to set the recording length simply by pressing [VCR REC ●] on the remote control or [RECORD ●] (VCR) on the front panel of the unit.

1 During normal recording, press [VCR REC ●] to begin One-touch Timer Recording. You can select a fixed recording time by pressing [VCR REC ●] repeatedly.

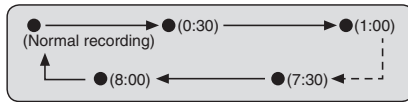

When One-touch Timer Recording is finished, the unit will turn off automatically.

To change the recording length during the One-touch Timer Recording, press [VCR REC ●] repeatedly until the desired length appear.

To cancel the One-touch Timer Recording within the specified time, press [STOP ■].

Note

- The remaining recording time will appear on the display panel during an One-touch Timer Recording. Press [DISPLAY] to see it on the TV screen.
- You cannot pause a One-touch Timer Recording.
- If OTR is finished in VCR during playback or REC mode in DVD, the VCR will be in STOP mode and the DVD keeps the current mode.

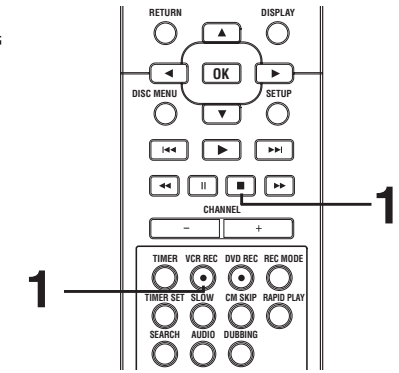

- Unlike a Timer Recording, you can perform the following operations during a One-touch Timer Recording.
 - Turning the power off
 - Using [VCR REC ●] or [STOP ■].
- When OTR is finished and the power is turned off, the unit will switch to the standby mode automatically if a Timer Recording has been programmed. Press [TIMER SET] to cancel the standby mode for using the unit continuously.

Search

Index search



An index mark will be assigned at the beginning of each recording you make. You may skip to a specific marked point by following the steps below.

First:

1 Press [SEARCH] so that the INDEX SEARCH menu appears.

2 Using the Number buttons, enter the number of recordings you wish to skip within 30 seconds.

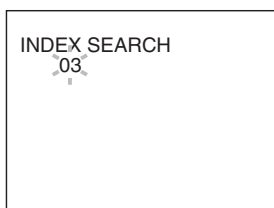

3 Press [REW ◀◀], [F.FWD ▶▶] to start index search.

If you want to go in the forward direction, press [F.FWD ▶▶].

If you want to go in the reverse direction, press [REW ◀◀].

After index search, the VCR will play the videotape automatically.

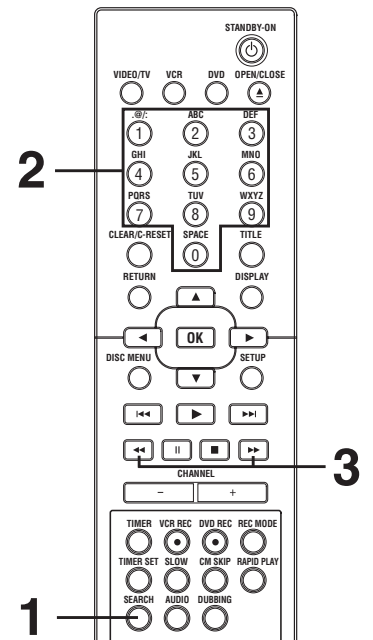
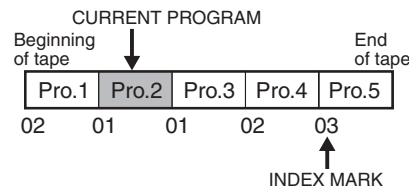

Note

- Every time a videotape is recorded, an index mark is written on the videotape.
- You can make the index mark up to 20.

Before you start

Connections

Getting started

Recording

Playing discs

Editing

Changing the Setup menu

VCR functions

Others

Español

VCR functions

Search (cont'd)

Time search



This feature allows you to go to a specific point on a videotape by entering the exact amount of time you wish to skip in order to reach the point.

First:

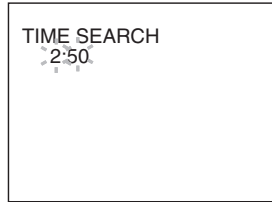

1
Press [SEARCH] repeatedly so that the TIME SEARCH menu appears.

2
Using the Number buttons, enter your desired time to skip within 30 seconds.

You can set the time up to 9:59.

3
Press [REW ◀◀], [F.FWD ▶▶] to start time search.

If you want to go in the forward direction, press [F.FWD ▶▶].

If you want to go in the reverse direction, press [REW ◀◀].

After time search, the unit will play the videotape automatically.

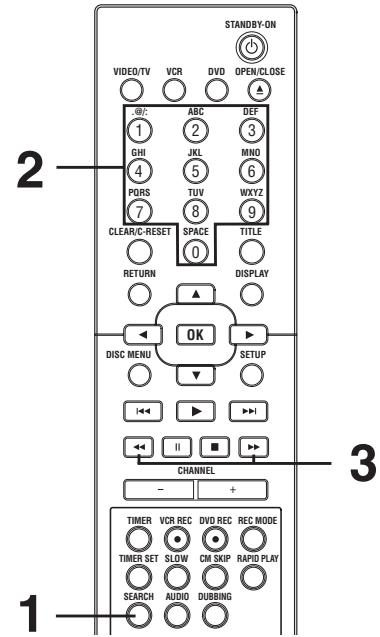

Note

- Index search and Time search are not available during recording.
- Press [STOP ■] to stop the search.
- If the end of the videotape is reached during Search, this unit will cancel the search and rewind the videotape.

Other operations



First:

Fast forward:

When the unit is in stop mode, press [F.FWD ▶▶] to fast forward the videotape.

Rewind:

When the unit is in stop mode, press [REW ◀◀] to rewind the videotape.

To cue or review picture during playback (Picture Search):

Press [REW ◀◀], [F.FWD ▶▶] during playback.

Press it again and the unit will search in super high speed. (in the SLP mode only)

To freeze the picture on TV screen during playback (Still Mode):

Press [PAUSE II]. Each time you press the button, the picture will be forwarded by one frame.

If the picture begins to vibrate vertically during the Still Mode, stabilize the picture by pressing [CHANNEL ▼ / ▲] on the front panel or [CHANNEL - / +].

If the picture is distorted or rolling vertically, adjust the vertical hold control on your TV, if equipped.

Counter Reset:

Press [CLEAR/C-RESET].

To playback in slow motion:

Press [SLOW] during playback or the Still Mode.

If the noise bars appear on the TV screen, you can reduce it by pressing [CHANNEL ▼ / ▲] on the front panel or [CHANNEL - / +].

Automatic Rewind:

When a videotape is played or fast forwarded to its end, the videotape will rewind to the beginning, stop and eject itself.

When you playback a videotape recorded in Hi-Fi stereo:

Press [AUDIO] on the remote control to select Hi-Fi or MONO for playback sound mode.

- If you have connected a stereo TV to this unit, select "HIFI".
- If you have connected a monaural TV to this unit, select "MONO".

Your Selection Type of recorded tape	HIFI		MONO
	L-channel	R-channel	
non Hi-Fi tapes	Monaural	Monaural	Monaural
Hi-Fi tapes recorded in Hi-Fi stereo	L	R	L+R
Hi-Fi tapes recorded main audio program	Main audio program	Main audio program	Main audio program
Hi-Fi tapes recorded second audio program	Second audio program	Second audio program	Second audio program

Note

- Still/Slow/Pause mode will be automatically cancelled after 5 minutes to prevent damage to the videotape and the video head.
- To return to playback from the Picture Search/Still/Slow mode, press [PLAY ▶].

Troubleshooting

Before requesting service for this unit, check the table below for a possible cause of the problem you are experiencing. Some simple checks or a minor adjustment on your part may eliminate the problem and restore proper performance.

Symptom	Remedy
The power does not turn on.	<ul style="list-style-type: none"> • Check that the AC power cord is connected securely. • (In case of power failure) Check the breaker. • Press [TIMER SET] to cancel the timer standby mode.
There is no picture.	<ul style="list-style-type: none"> • Re-connect the connecting cord securely. • Check if the connecting cords are damaged. • Check the connection to your TV (page 14). • Check the RF output channel when you view a TV program using RF connection. • Switch the input selector on your TV (such as to "EXT1") so that the signal from this unit appears on the TV screen.
TV program reception does not fill the screen.	<ul style="list-style-type: none"> • Try to set the channels with "Auto Channel Preset" or "Manual Channel Preset" in the Setup menu (pages 19-20). • Select a channel of any TV program using the [CHANNEL - / +]. • Press [VIDEO/TV] if necessary.
TV program pictures are distorted.	<ul style="list-style-type: none"> • Adjust TV antenna. • Adjust the picture (see the TV's instruction manual). • Place the unit and TV farther apart. • Place the TV and any bunched antenna cables farther apart.
TV channels cannot be changed.	<ul style="list-style-type: none"> • Switch the input to TV. • Connect the antenna cable correctly (page 14).
Playback picture is distorted.	<ul style="list-style-type: none"> • Keep the equipment which may cause electrical disturbances, such as a cellular phone, away.
The playback picture or TV program from the equipment connected through the unit is distorted.	<ul style="list-style-type: none"> • If the playback picture output from a DVD player, VCR or tuner goes through the unit before reaching your TV, the copy-protection signal applied to some programs could affect picture quality. Disconnect the playback equipment in question and connect it directly to your TV.
There is no sound.	<ul style="list-style-type: none"> • Re-connect all connections securely. • The connecting cord is damaged. • Check the connections to the amplifier input. • The input source setting on the amplifier is incorrect. • The unit is in pause mode or in Slow forward / Slow reverse play. • The unit is in fast forward or fast reverse mode.
The channel cannot be changed from the channel you are recording.	<ul style="list-style-type: none"> • Set the TV's input to "TV".
Nothing was recorded even though you set the timer setting correctly.	<ul style="list-style-type: none"> • There was a power failure during recording. • The internal clock of the unit stopped due to a power failure that lasted for more than 30 seconds. Reset the clock (pages 22-24). • Disconnect the AC power cord from the AC outlet, and connect it again. • The program contains copy protection signals that restricts copying. • The timer setting overlapped with another setting that has priority.
Timer Recording is not completed or did not start from the beginning.	<ul style="list-style-type: none"> • The timer setting overlapped with another setting that has priority (page 32). • Disc space was not enough.
Timer Recording is impossible.	<ul style="list-style-type: none"> • Make sure Ⓢ appears on the front panel display of this unit. If not, press [TIMER SET].
The remote control does not work.	<ul style="list-style-type: none"> • Check the antenna or cable connection to the main unit. • Check the battery life of the remote control. • Check if there is an obstacle between the sensor and the remote control. • Test the signal output. If OK, then possible remote sensor trouble. (Refer to "IR SIGNAL CHECK" on page 5.) • Press [DVD] or [VCR], whichever you need. Then, try again. • Press [TIMER SET] to cancel the timer standby mode.
The unit does not operate properly.	<ul style="list-style-type: none"> • When static electricity, etc., causes the unit to operate abnormally, unplug the unit and then plug it again.

DVD • VCR

Before you start

Connections

Getting started

Recording

Playing discs

Editing

Changing the Setup menu

VCR functions

Others

Español

Troubleshooting (cont'd)

Symptom	Remedy
There is no picture.	<ul style="list-style-type: none"> • If Setup menu appears on the TV screen, press [RETURN] (or [SETUP]) to exit.
Picture noise appears.	<ul style="list-style-type: none"> • The disc is dirty or flawed. • If the picture output signal from the unit passes through your VCR before reaching your TV, or if you are connected to a combination TV/VIDEO player, the copy-protection signal applied to some DVD programs could affect picture quality. If you still experience this problem even when you connect the unit directly to your TV, try connecting the unit to your TV's S-VIDEO input.
There is no sound.	<ul style="list-style-type: none"> • If the audio signal does not come through the DIGITAL OUT (COAXIAL) jack, check the Audio settings (pages 69-70). • The disc is dirty or flawed.
Sound is noisy.	<ul style="list-style-type: none"> • The disc is dirty or flawed.
No DTS sound is output.	<ul style="list-style-type: none"> • This unit is not compatible with DTS sound.
The unit does not play back the disc.	<ul style="list-style-type: none"> • No disc is inserted. • A blank disc is inserted. • The disc is upside down. Insert the disc with the labeled side facing up. • The disc is not correctly inserted. • The unit cannot playback certain discs (such as a CD-ROM) (page 41). • The region code on the DVD-Video does not match the ones on the unit (page 41). • Moisture has condensed inside the unit. Remove the disc and leave the unit turned on for about two hours until the moisture evaporates (page 4). • If the disc was recorded on another recorder, the unit cannot play back the disc unless it is finalized (pages 26, 37).
Playback image freezes for a second.	<ul style="list-style-type: none"> • During the playback of two layered disc, picture may freeze for a moment when the 1st layer switches to the 2nd layer. This is not a malfunction.
The disc does not start playback from the beginning.	<ul style="list-style-type: none"> • Resume play was activated (page 45). Press [STOP ■] twice. • You have inserted a disc whose Title menu or DVD menu automatically appears on the TV screen when it is first insert.
The unit starts playing back the disc automatically.	<ul style="list-style-type: none"> • The DVD-Video features an auto playback function.
Some functions such as Stop, Search, or Slow-motion Play cannot be performed.	<ul style="list-style-type: none"> • Depending on the disc, you may not be able to do some of those operations. See the instruction manual supplied with the disc.
The language for the sound track cannot be changed.	<ul style="list-style-type: none"> • Multilingual tracks are not recorded on the DVD-Video, DVD-R or DVD-RW being played back. • The DVD-Video prohibits the changing of the language for the sound track. • Try changing the language using the DVD-Video's menu.
The subtitle language cannot be changed or turned off.	<ul style="list-style-type: none"> • Multilingual subtitle are not recorded on the DVD-Video. • The DVD-Video prohibits changing of the subtitles. • Try changing the subtitles using the DVD-Video's menu.
The angles cannot be changed.	<ul style="list-style-type: none"> • Multi-angles are not recorded on the DVD-Video being played back. • The angle-change operation is possible as long as the disc contains a multi-angle portion. Actual change can be performed when the portion has come up. • The DVD-Video prohibits changing angles. • Try changing the angles using the DVD-Video's menu.
Recording does not stop immediately after you press [STOP ■] .	<ul style="list-style-type: none"> • It will take a few seconds for the unit to input disc data before recording can stop.
Recording does not start immediately after you press [DVD REC ●] .	<ul style="list-style-type: none"> • A brand-new DVD+RW/DVD-RW has been inserted. It takes a while for the unit to automatically format a DVD+RW/DVD-RW.
The disc tray does not open when you press [OPEN/CLOSE ▲] .	<ul style="list-style-type: none"> • It may take a few seconds for the disc tray to open after you have recorded or edited a disc. This is because the unit is adding disc data to the disc.

Troubleshooting (cont'd)

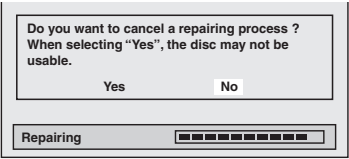
Symptom	Remedy
<p>D V D</p> <p>“Repairing” appears on the TV screen.</p>  <p>In a case you intend to cancel the Repairing process.</p> 	<ul style="list-style-type: none"> • If there is a power failure or unplugging during recording, finalizing, formatting or editing (even after “Wait for a moment.” message is disappeared), a Repairing process will begin automatically just after turning the unit on again. It may take several minutes up to about four hours. • If you intend to cancel the Repairing process, press [OPEN/CLOSE ▲] on the front panel, then select “Yes” with [◀/▶] and press [OK]. After that, the disc tray will automatically open. In case the Repairing process is canceled, the disc MAY NOT work.
<p>V C R</p> <p>Picture noise appears.</p> <p>The tape does not play.</p> <p>Recording does not start immediately after you press [VCR REC ●].</p> <p>The remote control does not function.</p> <p>The motor rotates even when playback / recording is stopped.</p>	<ul style="list-style-type: none"> • Head cleaning for VCR may be necessary. Refer to “AUTO HEAD CLEANING”. • Adjust tracking control for better picture by pressing [CHANNEL ▼ / ▲] on the front panel or [CHANNEL - / +] while you are playing a videotape. • No videotape is inserted. • Make sure the videotape has a record tab when you record to a videotape. If needed, cover the hole with cellophane tape. • Check if a videotape is in this unit. • The motor may rotate for the duration of approximately 5 minutes for efficient operation. This is not a malfunction.

Error message	Cause	Solution
<div style="border: 1px solid black; padding: 2px; text-align: center;">Disc Error</div> <p>--- Please eject the disc. --- Playback feature may not be available on this Disc.</p>	<ul style="list-style-type: none"> • Unplayable disc is inserted in the unit. • The disc is upside down. 	<ul style="list-style-type: none"> • Insert the standardized disc which bear the marks on page 41. • Insert the disc with the labeled side facing up.
<div style="border: 1px solid black; padding: 2px; text-align: center;">Region Error</div> <p>--- Please eject the disc. --- Playback is not authorized in your region.</p>	<ul style="list-style-type: none"> • The region of the DVD-Video disc does not match the ones on the unit. 	<ul style="list-style-type: none"> • Insert the DVD-Video disc with region codes 1 or ALL.
<div style="border: 1px solid black; padding: 2px; text-align: center;">Parental Lock On</div> <p>The current selected parental level prohibits playback.</p>	<ul style="list-style-type: none"> • The current selected parental level in the Setup menu prohibits playback. 	<ul style="list-style-type: none"> • Check the “Parental Lock” setting (pages 72-73).
<div style="border: 1px solid black; padding: 2px; text-align: center;">Recording Error</div> <p>This program is not allowed to be recorded.</p>	<ul style="list-style-type: none"> • The recording function encountered the copy prohibited program. 	<ul style="list-style-type: none"> • You cannot record copy prohibited programs.
<div style="border: 1px solid black; padding: 2px; text-align: center;">Recording Error</div> <p>This program is not recordable in +VR mode.</p>	<ul style="list-style-type: none"> • You are trying to record the copy-once program. 	<ul style="list-style-type: none"> • You cannot record the copy-once program.
<div style="border: 1px solid black; padding: 2px; text-align: center;">Recording Error</div> <p>Can not record on this disc.</p>	<ul style="list-style-type: none"> • You are trying to record onto the disc which is unrecordable, or the disc status is unable to record. • The disc is dirty. • The disc is damaged. 	<ul style="list-style-type: none"> • Insert the recordable disc, and ensure the disc status satisfies the recording requirements (pages 25-26). • Clean the disc with a cleaning cloth. • Replace the disc.
<div style="border: 1px solid black; padding: 2px; text-align: center;">Recording Error</div> <p>This disc is protected and not recordable.</p>	<ul style="list-style-type: none"> • You are trying to record on to the protected disc which is set in the Disc Edit menu. 	<ul style="list-style-type: none"> • Release the disc protect setting in the Disc Edit menu (pages 36, 64).
<div style="border: 1px solid black; padding: 2px; text-align: center;">Recording Error</div> <p>Disc is full. (No area for new recording)</p>	<ul style="list-style-type: none"> • You are trying to record onto the disc which has no space for recording. 	<ul style="list-style-type: none"> • Insert the recordable disc with enough recording space.

Others

Troubleshooting (cont'd)

Error message	Cause	Solution
<p>Recording Error</p> <p>You cannot record more than 49 titles on one disc. (The maximum is 49)</p>	<ul style="list-style-type: none"> You are trying to record onto the disc on which the number of recording titles comes up to the maximum (99). 	<ul style="list-style-type: none"> Delete unnecessary titles (page 55).
<p>Recording Error</p> <p>You cannot record more than 254 chapters on one disc. (The maximum is 254)</p>	<ul style="list-style-type: none"> You are trying to record onto the VR mode DVD-RW disc on which the number of recording chapters comes up to the maximum (254). 	<ul style="list-style-type: none"> This unit cannot delete the original chapter. Delete unnecessary chapter mark using other DVD recorders. Delete unnecessary chapter marks (page 58).
<p>Recording Error</p> <p>You cannot record on this disc as Control Information is full.</p>	<ul style="list-style-type: none"> This disc has no space to write the Control Information when recording or deleting contents. When editing has been repeatedly performed, the control Information area may come up to be full even the recording area has enough space. 	<ul style="list-style-type: none"> Delete unnecessary titles (page 55).
<p>Recording Error</p> <p>You cannot record on this disc as Power Calibration Area is full.</p>	<ul style="list-style-type: none"> When recordings are performed repeatedly onto an unstable disc, this area may come up to be full. Every time you insert a disc for recording, the disc's working area will be taken up. And if you repeat this frequently, it will be used up sooner and you may not be able to record full 99 titles. 	<ul style="list-style-type: none"> Insert a new disc.
<p>Recording Error</p> <p>This disc is already finalized.</p>	<ul style="list-style-type: none"> You are trying to record onto the disc already finalized. 	<ul style="list-style-type: none"> Release the finalizing for this disc (page 37).
<p>Recording Error</p> <p>The disc has a different menu layout. (Set "Replace Disc Menu" to ON to rewrite the menu.)</p>	<ul style="list-style-type: none"> You are trying to record onto the +VR formatting disc that had been recorded by the other recorder. 	<ul style="list-style-type: none"> Set "Replace Disc Menu" to "ON" to rewrite the menu, after that you will record to disc (page 27).

- If you are still having trouble with this unit after checking Troubleshooting, write down the error code and the error description, and call our helpline mentioned on the front page to locate an Authorized Service Center.

RF output switch

You can watch the TV programs with the tuner of the unit. (Usually channel 3 or 4 of the TV is available for the RF converter setting.) Be sure to connect the unit to a TV using the RF cable. Refer to page 14.

1

Select channel 3 on your TV.

2

Press [VIDEO/TV] on the remote control.

- If noise appears, change the RF output channel of the unit to CH 4 by pressing [VIDEO/TV] for 3 seconds. The RF output channel will alternate between CH3 and CH4 as follows.

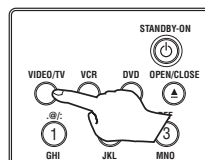

for more than
3 seconds

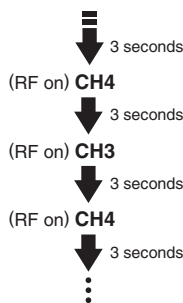

- Each time the RF output channel is changed, CH3 or CH4 will appear on the front panel display.

Glossary

Analog audio

An electrical signal that directly represents sound. In contrast, digital audio which can be an electrical signal, but is an indirect representation of sound. See also Digital audio.

Aspect ratio

The width of a TV screen relative to its height. Conventional TVs are 4:3 (in other words, the screen is almost square); widescreen models are 16:9 (the screen is almost twice as wide as it is high).

Chapter

Just as a book is split up into several chapters, a title on a DVD disc is usually divided into chapters. See also Title.

Component video output

This is a video signal format that conveys each of three principal colors of light (red, blue and green) through different signal lines. This allows the viewers to experience picture colors as original as it is. There are several signal formats, including Y/PB/PR and Y/CB/CR.

Digital audio

An indirect representation of sound by numbers. During recording, the sound is measured at discrete intervals (44, 100 times a second for CD audio) by an analog-to-digital converter, generating a stream of numbers. On playback, a digital-to-analog converter generates an analog signal based on these numbers. See also Sampling frequency and Analog audio.

Dolby Digital

The system developed by Dolby Laboratories to compress digital sound. It offers you sound of stereo(2ch) or multi-channel audio (up to 5.1ch).

Finalize

To make recorded contents on DVD discs possible to be played back on DVD players. With this unit, it is possible to finalize DVD+R/DVD-RW/DVD-R discs.

MP3 (MPEG Audio Layer 3)

MP3 is a method of compressing files. You can copy MP3 files on CD-RW/R discs from the computer and play back the files on this unit.

PBC (Playback Control)

(Video CD only)

This function enables you to play back interactive software using a menu screen. See also Video CD.

PCM (Pulse Code Modulation)

PCM is a format that converts audio into digital data. It is mainly used for Audio CDs and DAT. This unit can play back sounds as realistic as possible by converting even compressed Dolby Digital and MPEG audio to PCM.

Progressive Scan (525p/480p)

A type of display that does not split each frame into fields, and instead scans directly through all the scanlines of each frame in order. Progressive Scan provides less flickering and higher image resolution than traditional (525i/480i) TV signals. Refer to page 71 for instructions on selective Progressive Scan mode.

Regions code

Regions associate discs and players with particular areas of the world. This unit will only play back discs that have compatible region codes. You can find the region code of your unit by looking at the rear panel. Some discs are compatible with more than one region (or all regions).

Sampling frequency

The rate which sound is measured by a specified interval to turn it into digital audio data. The numbers of sampling in one second defines as sampling frequency. The higher the rate, the better the sound quality is.

SAP (Secondary Audio Program)

Sub audio channel which is delivered separately from main-audio channel. This audio channel is used as an alternate in bilingual broadcasting.

S-Video output

It delivers independently each signal of color(C) and luminance(Y) to TV as video signals, so that higher-quality picture will be materialized.

Title (DVD only)

A collection of chapters on DVD disc. See also chapter.

Track

Audio CDs use tracks to divide the content of a disc. The DVD equivalent is called a chapter. See also Chapter.

Video CD

The contents of a Video CD. When playing back a Video CD with the PBC function, the title menu will appear automatically.

Language code

Language	Code	Language	Code	Language	Code	Language	Code
Abkhazian	4748	French	5264	Lithuanian	5866	Sindhi	6550
Afar	4747	Frisian	5271	Macedonian	5957	Singhalese	6555
Afrikaans	4752	Galician	5358	Malagasy	5953	Siswat	6565
Albanian	6563	Georgian	5747	Malay	5965	Slovak	6557
Amharic	4759	German	5051	Malayalam	5958	Slovenian	6558
Arabic	4764	Greek	5158	Maltese	5966	Somali	6561
Armenian	5471	Greenlandic	5758	Maori	5955	Spanish	5165
Assamese	4765	Guarani	5360	Marathi	5964	Sundanese	6567
Aymara	4771	Gujarati	5367	Moldavian	5961	Swahili	6569
Azerbaijani	4772	Hausa	5447	Mongolian	5960	Swedish	6568
Bashkir	4847	Hebrew	5569	Nauru	6047	Tagalog	6658
Basque	5167	Hindi	5455	Nepali	6051	Taiik	6653
Bengali; Bangla	4860	Hungarian	5467	Norwegian	6061	Tamil	6647
Bhutani	5072	Icelandic	5565	Occitan	6149	Tatar	6666
Bihari	4854	Indonesian	5560	Oriya	6164	Telugu	6651
Bislama	4855	Interlingua	5547	Oromo (Afan)	6159	Thai	6654
Breton	4864	Interlingue	5551	Panjabi	6247	Tibetan	4861
Bulgarian	4853	Inupiak	5557	Pashto; Pushto	6265	Tigrinya	6655
Burmese	5971	Irish	5347	Persian	5247	Tonga	6661
Byelorussian	4851	Italian	5566	Polish	6258	Tsonga	6665
Cambodian	5759	Japanese	5647	Portuguese	6266	Turkish	6664
Catalan	4947	Javanese	5669	Quechua	6367	Turkmen	6657
Chinese	7254	Kannada	5760	Rhaeto-Romance	6459	Twi	6669
Corsican	4961	Kashmiri	5765	Romanian	6461	Ukrainian	6757
Croatian	5464	Kazakh	5757	Russian	6467	Urdu	6764
Czech	4965	Kinyarwanda	6469	Samoan	6559	Uzbek	6772
Danish	5047	Kirghiz	5771	Sangho	6553	Vietnamese	6855
Dutch	6058	Kirundi	6460	Sanskrit	6547	Volapuk	6861
English	5160	Korean	5761	Scots Gaelic	5350	Welsh	4971
Esperanto	5161	Kurdish	5767	Serbian	6564	Wolof	6961
Estonian	5166	Laothian	5861	Serbo-Croatian	6554	Xhosa	7054
Faroese	5261	Latin	5847	Sesotho	6566	Yiddish	5655
Fiji	5256	Latvian; Lettish	5868	Setswana	6660	Yoruba	7161
Finnish	5255	Lingala	5860	Shona	6560	Zulu	7267

Frequently Asked Questions

- Can I record on CD-RW/R?
No, this unit records only DVDs.
- Can I play back DVD-Video that is bought in another country?
Possible only if the region code of the disc is 1 and ALL.
- Is this unit JPEG compatible?
No.
- Can I connect the unit to my PC?
No, you cannot control the unit by PCs.

Specifications

General			
System	DVD-Video, DVD+RW/R, DVD-RW/R, CD-DA, CD-RW/R, Video Cassette Tape	Dimensions (width x height x depth)	17 3/16" x 3 15/16" x 10 5/16" (435 x 99.5 x 262 mm)
VCR video heads	Four heads	Operating temperature	41F° to 104F° (5°C to 40°C)
Power requirements	AC120 V, 60 Hz	Operating humidity	Less than 80% (no condensation)
Power consumption	30 W (standby: 3.0 W)	TV format	NTSC
Weight	9.5 lbs (4.3 kg)		
Recording			
Recording format	Video Recording format (DVD+RW, DVD+R, DVD-RW, DVD-R), Video format (DVD+RW, DVD+R, DVD-RW, DVD-R)	Video recording format	Sampling frequency 13.5MHz Compression format MPEG
Recordable discs	DVD+Rewritable, DVD+Recordable, DVD-Rewritable, DVD-Recordable	Audio recording format	Sampling frequency 48kHz Compression format Dolby Digital
Tuner			
Receivable channels		RF Converter	Built-in VHF converter
VHF	2-13ch	Converter output	VHF channel 3 or 4
UHF	14-69ch		
CATV	C1-C125ch		
Input / Output			
Video input	Input 1 (rear), 2 (front)	Video output	
Input level	1 Vp-p (75Ω)	Output level	1 Vp-p (75Ω)
Jacks	RCA jacks	Jack	RCA jack
S-Video input	Input 1 (rear), 2 (front)	S-Video output	
Y (luminance)	- Input level 1 Vp-p (75Ω)	Y (luminance)	- Output level 1 Vp-p (75Ω)
C (color)	- Input level 286 mVp-p (75Ω)	C (color)	- Output level 286 mVp-p (75Ω)
Jacks	4 pin mini DIN	Jack	4 pin mini DIN
Audio input	Input 1 (rear), 2 (front) L/R	Audio output	Output 1, 2 L/R
During audio input	2V rms (47kΩ)	During audio output	2V rms (47kΩ)
Jacks	RCA jacks	Jacks	RCA jacks
Component video output		Digital audio output	
Output level	Y: 1.0 Vp-p (75Ω), P _B /C _B , P _R /C _R : 0.7 Vp-p (75Ω)	Output level	500 mVp-p (75Ω)
Jacks	RCA jacks	Jack	RCA jack
		VHF/UHF antenna input/output terminal	VHF/UHF set 75Ω

Note:

The specifications and design of this product are subject to change without notice.

Fácil grabación de DVD

Estas instrucciones le ayudarán a entender fácilmente cómo grabar discos DVD.

Nota:

Asegúrese que las pilas están en el mando a distancia y que ha conectado correctamente esta unidad y el TV.

Paso 1: Elija un tipo de disco.

Puede elegir entre distintos tipos de discos DVD grabables. Este grabador de DVD puede grabar los siguientes tipos de discos.

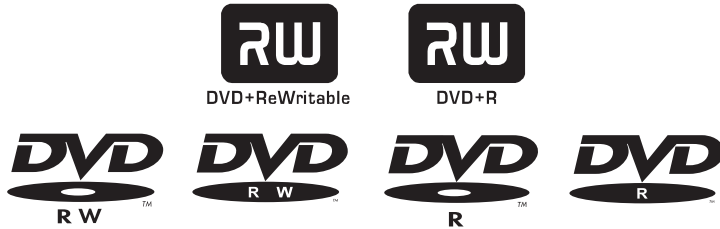

Por ejemplo, cuando desea grabar repetidamente en el mismo disco, seleccione el disco de tipo regrabable DVD+RW/DVD-RW. Cuando desea guardar grabaciones sin alterarlos, un DVD no regrabable DVD+R/DVD-R puede ser más conveniente.

Paso 2: Encienda la unidad.

Mando a distanci

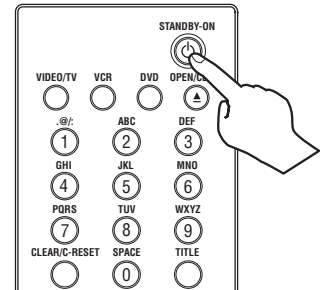

Seleccione la entrada a la que se conectará la unidad en su TV.

Paso 3: Coloque un disco en blanco.

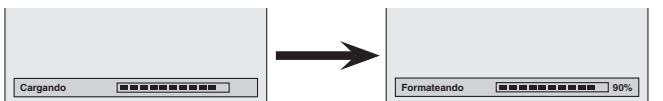
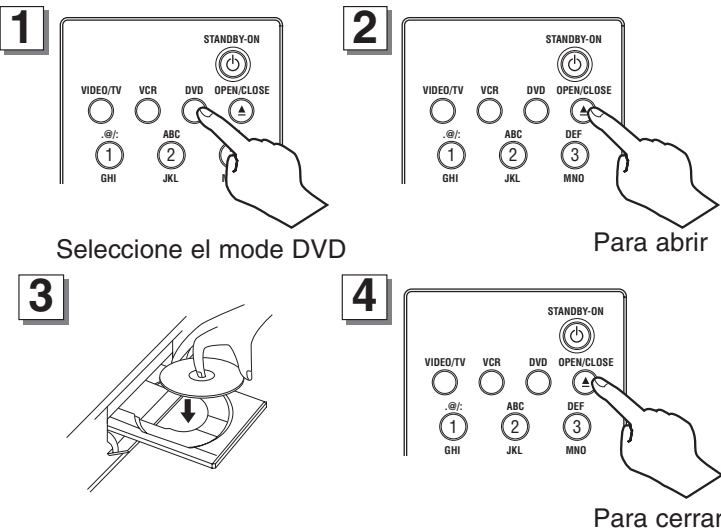

DVD+RW/DVD-RW solamente

Esta operación puede demorar en reconocerse.

Paso 4: Seleccione la velocidad de grabación.

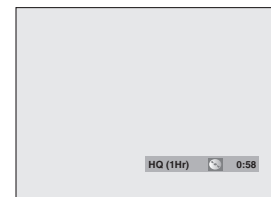
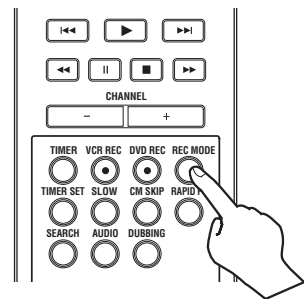

Paso 5: Eleccione el canal deseado.

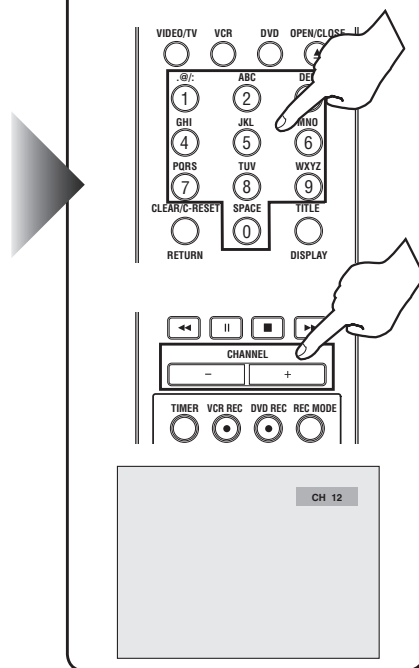

Paso 6: Grabe en discos DVD.

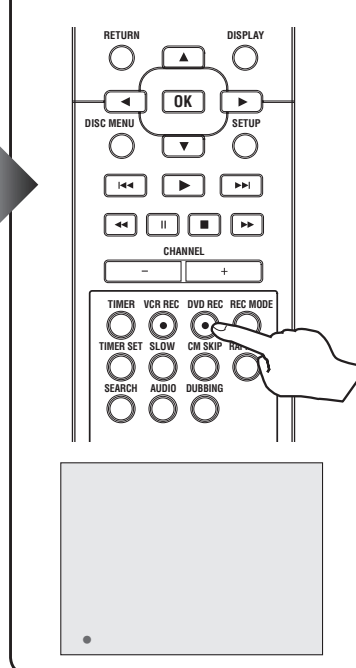

Paso 7: Pare la grabación.

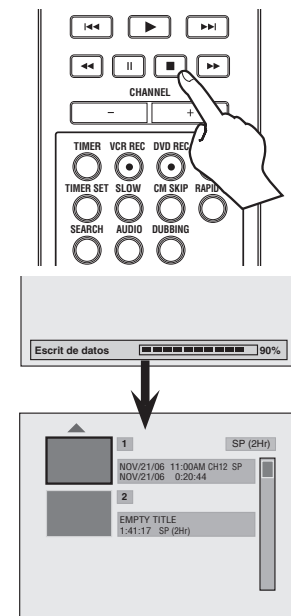

Esta operación puede demorar en completarse.

Sugerencia 1: Reproduzca el contenido grabado

Puede seleccionar el título que desea reproducir de un menú indicado y empiece a reproducir inmediatamente. El contenido grabado se puede acceder fácilmente con un simple procedimiento de elegir un título en la pantalla del menú.

¿Qué son títulos y capítulos?

El contenido de un disco DVD se divide generalmente en títulos. Los títulos pueden dividirse a su vez en capítulos.

Sugerencia 2: Edite el disco grabado

La edición de discos es fácil. Esta unidad ofrece convenientes funciones de edición para discos formateados en el modo DVD+VR.

Puede editar lo siguiente desde el menú del título o el menú de ajuste.

- Borrado de títulos
- Poniendo nombres en títulos
- Seleccionando / Borrando marcas de capítulos
- Ocultando capítulos
- Seleccionando imágenes para índices
- División de un título (DVD+RW/DVD-RW solamente)
- Poniendo un nombre en disco

Finalización de un disco

- Esto permitirá que un disco DVD+R/DVD-RW/DVD-R que se grabe en nuestra unidad pueda ser reproducido en un reproductor DVD diferente. Un disco sin finalizar no se podrá reproducir en otro reproductor.
- Después de finalizar un disco, no puede editar los contenidos en ese disco.
- Los discos DVD+RW no requieren finalización, pero sí "Compatibilizar edic." para reproducirse en otras unidades después de ediciones. Puede editar el disco después de "Compatibilizar edic." .

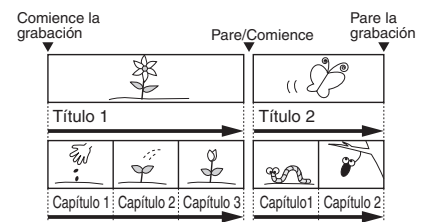

Reproducción con videgrabadora



1

Presione [STANDBY-ON ] en el mando a distancia o el panel frontal de la unidad.

Cuando reproduzca una cinta, conecte el TV y asegúrese de seleccionar la entrada donde se conecta la unidad.

Presione: 

2

Coloque una cinta pregrabada y presione [PLAY ] para empezar la reproducción.

3

Durante la reproducción, presione [PAUSE ].

Se hará una pausa de reproducción y se silenciará el sonido.

4

Presione [PLAY ] para continuar la reproducción.

5

Presione [STOP ] para detener la reproducción.

6

Presione [STOP  / EJECT ] en el panel frontal de la unidad para expulsar la cinta.

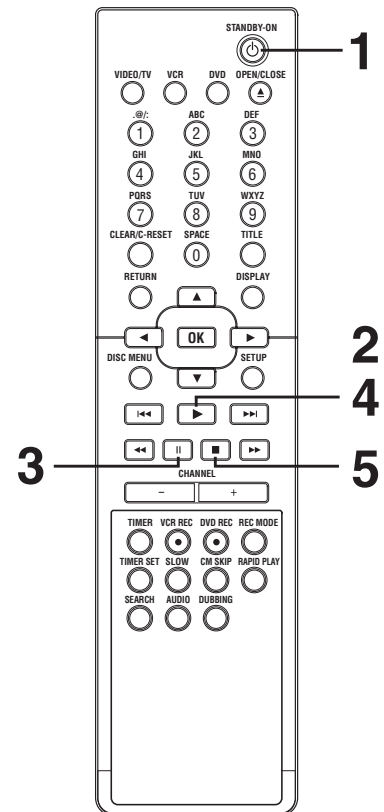

Nota

- Cuando se coloca una cinta sin la lengüeta de grabación, la unidad empezará a reproducir automáticamente.
- El seguimiento se ajustará automáticamente para la reproducción. Para ajustar manualmente el seguimiento, presione [CHANNEL  / ] en el panel frontal de la unidad o los botones [CHANNEL - / +] en el mando a distancia.

Grabación y grabación con temporizador de un toque (VCR)

Grabación



Antes de grabar, asegúrese de que:

- Se seleccionó el canal deseado presionando los **botones numéricos** en el mando a distancia o los botones **[CHANNEL - / +]** en el mando a distancia o **[CHANNEL ▼ / ▲]** en el panel frontal de la unidad.
- Hay una cinta con la lengüeta para grabación intacta en la unidad.
- Se seleccionó la velocidad de grabación deseada en SP (reproducción estándar) o SLP (reproducción de super larga duración) presionando **[REC MODE]** en el mando a distancia.

Velocidad de grabación:

Velocidad de la cinta	Tiempo de grabación/reproducción		
	Tipo de cinta	T60	T120
Modo SP	1 hora	2 horas	2-2/3 horas
Modo SLP	3 horas	6 horas	8 horas

- Se selecciona Estéreo o SAP.

1
Presione **[VCR REC ●]** para **empezar la grabación.**

Para detener temporalmente la grabación o continuarla, presione **[PAUSE ■]**. Después de que la unidad haya estado en el modo de pausa durante 5 minutos, se detendrá automáticamente para proteger al cinta y el cabezal de video contra cambios.

2
Presione **[STOP ■]** cuando se **complete la grabación.**

Prevención contra borrado accidental

Para evitar una grabación por accidente en un casete grabado, rompa la lengüeta de grabación. Para volver a grabar posteriormente, cubra el orificio con cinta adhesiva.

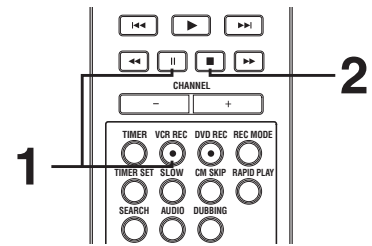

Nota

- Para ver un canal mientras graba en otro
 - 1) Mientras está grabando en la unidad, presione **[VIDEO/TV]**.
 - 2) En la caja de cable o caja de satélite, seleccione el canal que desea ver. Si se conectó la unidad a una caja de cable o caja de satélite, consulte la sección de "Connection to a cable box or satellite box" en la página 15.

Grabación con temporizador de un toque (OTR)



Esta función permite seleccionar la longitud de la grabación simplemente presionando **[VCR REC ●]** en el mando a distancia o **[RECORD ●]** (VCR) en el panel frontal de la unidad.

1
Durante la grabación normal, presione **[VCR REC ●]** para **empezar la grabación con temporizador de un toque.**

Puede seleccionar un tiempo de grabación determinado presionando repetidamente **[VCR REC ●]**.

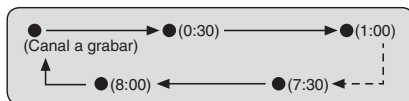

Cuando termina la grabación con temporizador de un toque, la unidad se desconectará automáticamente.

Para cambiar la longitud de tiempo durante la grabación con temporizador de un toque, presione repetidamente **[VCR REC ●]** hasta que aparezca la longitud deseada.

Para cancelar la grabación con temporizador de un toque dentro del tiempo especificado, presione **[STOP ■]**.

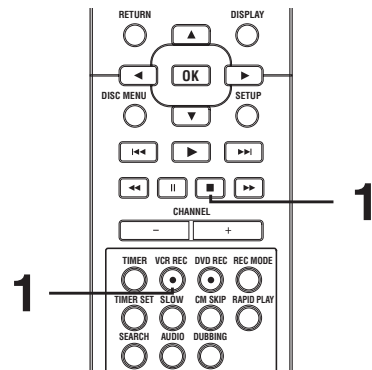

Nota

- El tiempo de grabación remanente aparecerá en la pantalla durante una grabación con temporizador de un toque. Presione **[DISPLAY]** para que aparezca en la pantalla de TV.
- **No puede hacer una pausa en una grabación con temporizador de un toque.**
- Si se termina el OTR en la videograbadora durante el modo de reproducción o REC en DVD, la videograbadora estará en el modo STOP y la DVD se mantiene en el modo actual.
- A diferencia de una grabación con temporizador, durante una grabación con temporizador de un toque usted puede realizar las operaciones siguientes.
 - Desconectar la alimentación
 - Utilizar **[VCR REC ●]** o **[STOP ■]**.



LIMITED WARRANTY

FUNAI CORP. will repair this product, free of charge in the USA in the event of defect in materials or workmanship as follows:

DURATION:

PARTS: FUNAI CORP. will provide parts to replace defective parts without charge for one (1) year from the date of original retail purchase. Certain parts are excluded from this warranty.

LABOR: FUNAI CORP. will provide the labor without charge for a period of ninety (90) days from the date of original retail purchase.

LIMITS AND EXCLUSIONS:

This warranty is extended only to the original retail purchaser. A purchase receipt or other proof of original retail purchase will be required together with the product to obtain service under this warranty.

This warranty shall not be extended to any other person or transferee.

This warranty is void and of no effect if any serial numbers on the product are altered, replaced, defaced, missing or if service was attempted by an unauthorized service center. This limited warranty does not apply to any product not purchased and used in the United States.

This product is produced for home use and this warranty only covers failures due to defects in material or workmanship which occurs during normal use. It does not cover damage which occurs in shipment, or failures which are caused by repairs, alterations or product not supplied by FUNAI CORP, or damage which results from accident, misuse, abuse, mishandling, misapplication, alteration, faulty installation, improper maintenance, commercial use such as hotel, rental or office use of this product or damage which results from fire, flood, lightning or other acts of God.

THIS WARRANTY DOES NOT COVER PACKING MATERIALS, ANY ACCESSORIES (EXCEPT REMOTE CONTROL), ANY COSMETIC PARTS, COMPLETE ASSEMBLY PARTS, DEMO OR FLOOR MODELS.

FUNAI CORP. AND ITS REPRESENTATIVES OR AGENTS SHALL IN NO EVENT BE LIABLE FOR ANY GENERAL, INDIRECT OR CONSEQUENTIAL DAMAGES ARISING OUT OF OR OCCASIONED BY THE USE OF OR THE INABILITY TO USE THIS PRODUCT. THIS WARRANTY IS MADE IN LIEU OF ALL OTHER WARRANTIES, EX OR IMPLIED, AND OF ALL OTHER LIABILITIES ON THE PART OF FUNAI, ALL OTHER WARRANTIES INCLUDING THE WARRANTY OF MERCHANTABILITY AND FITNESS FOR A PARTICULAR PURPOSE, ARE HEREBY DISCLAIMED BY FUNAI AND ITS REPRESENTATIVES IN THE UNITED STATES. ALL WARRANTY INSPECTIONS AND REPAIRS MUST BE PERFORMED BY AN AUTHORIZED SERVICE CENTER. THIS WARRANTY IS ONLY VALID WHEN THE UNIT IS CARRIED-IN TO AN AUTHORIZED SERVICE CENTER.

IMPORTANT:

THIS LIMITED WARRANTY GIVES YOU SPECIFIC LEGAL RIGHTS. YOU MAY HAVE OTHER RIGHTS THAT VARY FROM STATE TO STATE. IF, AT ANY TIME DURING THE WARRANTY PERIOD, YOU ARE UNABLE TO OBTAIN SATISFACTION WITH THE REPAIR OF THIS PRODUCT, PLEASE CONTACT FUNAI CORP.

ATTENTION:

FUNAI CORP. RESERVES THE RIGHT TO MODIFY ANY DESIGN OF THIS PRODUCT WITHOUT PRIOR NOTICE.

To locate your nearest AUTHORIZED SERVICE CENTER or for general service inquires, please contact us at:

**FUNAI CORPORATION
Customer Service**

Tel :1-800-605-8453

<http://www.funai-corp.com>

19900 Van Ness Avenue, Torrance, CA 90501

Quick Guide

DVD Recorder with Video Cassette Recorder MWR20V6

Playable discs

This unit is compatible to play the following discs.

Disc	Logo	Disc	Logo
DVD-VIDEO		DVD-R (VIDEO mode, Finalized)	
DVD+RW		CD-DA (AUDIO CD)	
DVD+R		CD-RW (CD-DA FORMAT, MP3 files)	
DVD+R Double Layer		CD-R (CD-DA FORMAT, MP3 files)	
DVD-RW (VIDEO mode, Finalized)		Video CD	

DVD is a trademark of DVD Format/Logo Licensing Corporation.

Region codes



The number inside the globe refers to region of the world. This unit can play DVDs that are labeled for ALL regions or for Region 1.

Recordable discs

This unit can record to the following disc types.

- This unit formats discs with DVD+VR mode.
- DVD-R/DVD+R discs can only be recorded once. DVD+RW/DVD-RW discs can be recorded to and erased many times.
- We strongly recommend for good recording quality: SONY DVD+RW 4x, MAXELL DVD+R 4x/8x/16x, SONY DVD+R 4x/8x/16x, TDK DVD+R 4x/8x/16x, MAXELL DVD-RW 4x, MAXELL DVD-R 8x/16x
- Discs that have been tested and are proven to be compatible with this recorder: VERBATIM DVD+RW 4x, VERBATIM DVD+R 8x, VERBATIM DVD-RW 2x, VERBATIM DVD-R 8x, JVC DVD-RW 4x, MAXELL DVD-R 16x

Logo	Attributes	Logo	Attributes
	8cm/12cm, single-sided, single layer disc Approx. max. recording time (SLP mode): 360 minutes (4.7GB) (for 12cm) 108 minutes (1.4GB) (for 8cm)		8cm/12cm, single-sided, single layer disc Approx. max. recording time (SLP mode): 360 minutes (4.7GB) (for 12cm) 108 minutes (1.4GB) (for 8cm)

1 Connections

(Back of TV) Connect Video cable (supplied) and Audio cable (supplied) to the back of the unit. Connect RF cable (supplied) to the back of the unit. Connect Cable Box or Satellite Box to the back of the unit. Connect Indoor or Outdoor Antenna or Cable Company (No Cable Box) to the back of the unit.

Remote Control

● You can use either AV or RF cables to connect to TV for operation.

2 Setup

2-1 Watching on TV

Press [STANDBY-ON] to turn the unit on.

1. Switch the input selector on your TV to an appropriate external input channel (usually near channel 0).
2. Press a button on the TV's original remote control (see the table below) to select an external input channel until the DVD recorder's picture appears.

Brand	Input Mode	Brand	Input Mode
Admiral	AUX	Panasonic	TV/VIDEO
Curtis Mathis	LINE1, LINE2, 00, 90, 91, 92, 93	RCA	INPUT, TV/VCR, 00, 90, 91, 92, 93
GE	INPUT, TV/VCR, 00, 90, 91, 92, 93	Samsung	TV/VIDEO
Hitachi	INPUT, AUX	Sanyo	VIDEO
JVC	VIDEO, VIDEO1, VIDEO2, VIDEO3	Sharp	00
Kenwood	AUX	Sony	VIDEO1, VIDEO2, VIDEO3
LXI-Series	00	Toshiba	TV/GAME
Magnavox	AUX CHANNEL	Zenith	00

2-2 Initial Setup

Set up the following items when turning on the unit for the first time.

Using [▲/▼], select your desired language and press [OK].

Press [OK] to Channel Preset. Then the unit will start getting available channels in your area.

Press [OK] to Clock Setting.

Press [OK] again.

Using [▲/▼], enter the date (month / day / year). Press [◀/▶] to move the cursor. Press [OK]. TV Program will automatically appear. (usually near channel 0)

Follow to the back side of this sheet.

3

DVD Recording

3-1 Easy Recording

First:

Select the recording mode.

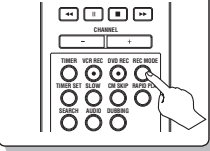

Select the desired channel.

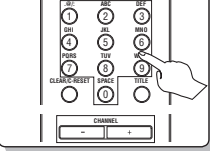

Record!

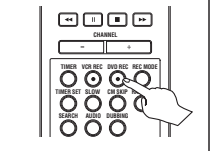

Stop recording.

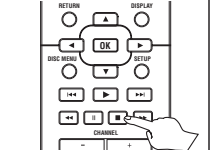

How to select the recording mode:

Disc Size	Recording mode	Recording time	Video/Sound Quality
8cm Disc	HQ (1Hr)	18 min	★★★★★ (good)
	SP (2Hr)	36 min	★★★★★
	SPP (2.5Hr)	45 min	★★★★
	LP (3Hr)	54 min	★★★
	EP (4Hr)	72 min	★★
	SLP (6Hr)	108 min	★
12cm Disc	HQ (1Hr)	60 min	★★★★★ (good)
	SP (2Hr)	120 min	★★★★★
	SPP (2.5Hr)	150 min	★★★★
	LP (3Hr)	180 min	★★★
	EP (4Hr)	240 min	★★
	SLP (6Hr)	360 min	★ (poor)

Press repeatedly to select desired recording time.

Recording times appear on the TV screen (30 minutes to 8 hours). Recording will start.

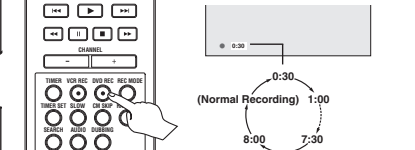

When the unit reaches the specified time, the unit will be turned off automatically.

After all recordings, finalize your disc!

Finalize DVD-RW/-R/+R discs after recording. Make edits compatible on DVD+RW discs after editing.

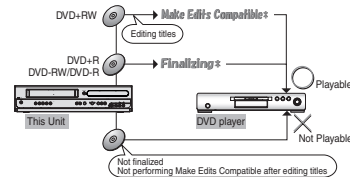

*You cannot finalize or Make Edits Compatible in other DVD recorders.

3-2 Timer Recording

- You can set up to 8 programs (once, daily or weekly).
- Be sure to set the clock before starting a timer programming.

Press [TIMER].

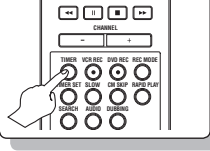

Timer Programming list appears. Select any blank line with [▲/▼] and press [OK].

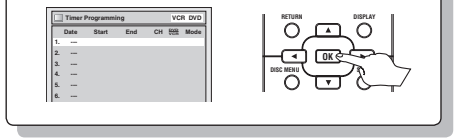

ENTER!

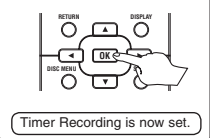

Timer Recording is now set.

Set the date.

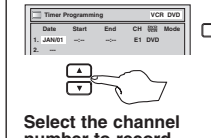

Set start and end time.

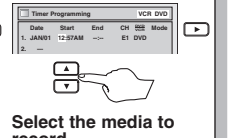

Select the channel number to record.

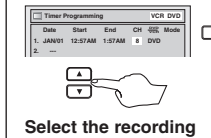

Select the media to record.

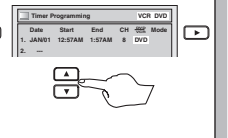

Select the recording mode.

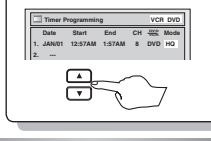

Set the Timer Standby mode.

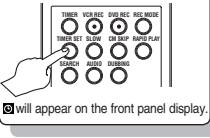

will appear on the front panel display.

4

Playback

First:

Open the disc tray.

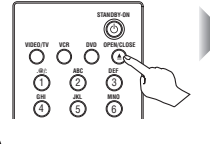

Insert a disc.

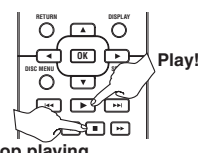
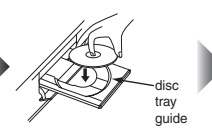

If the title menu appears, using [▲/▼], select a title and press [OK]. (Then select "Play" with [▲/▼] when playing titles recorded by this unit.)

Stop playing.

Play!