

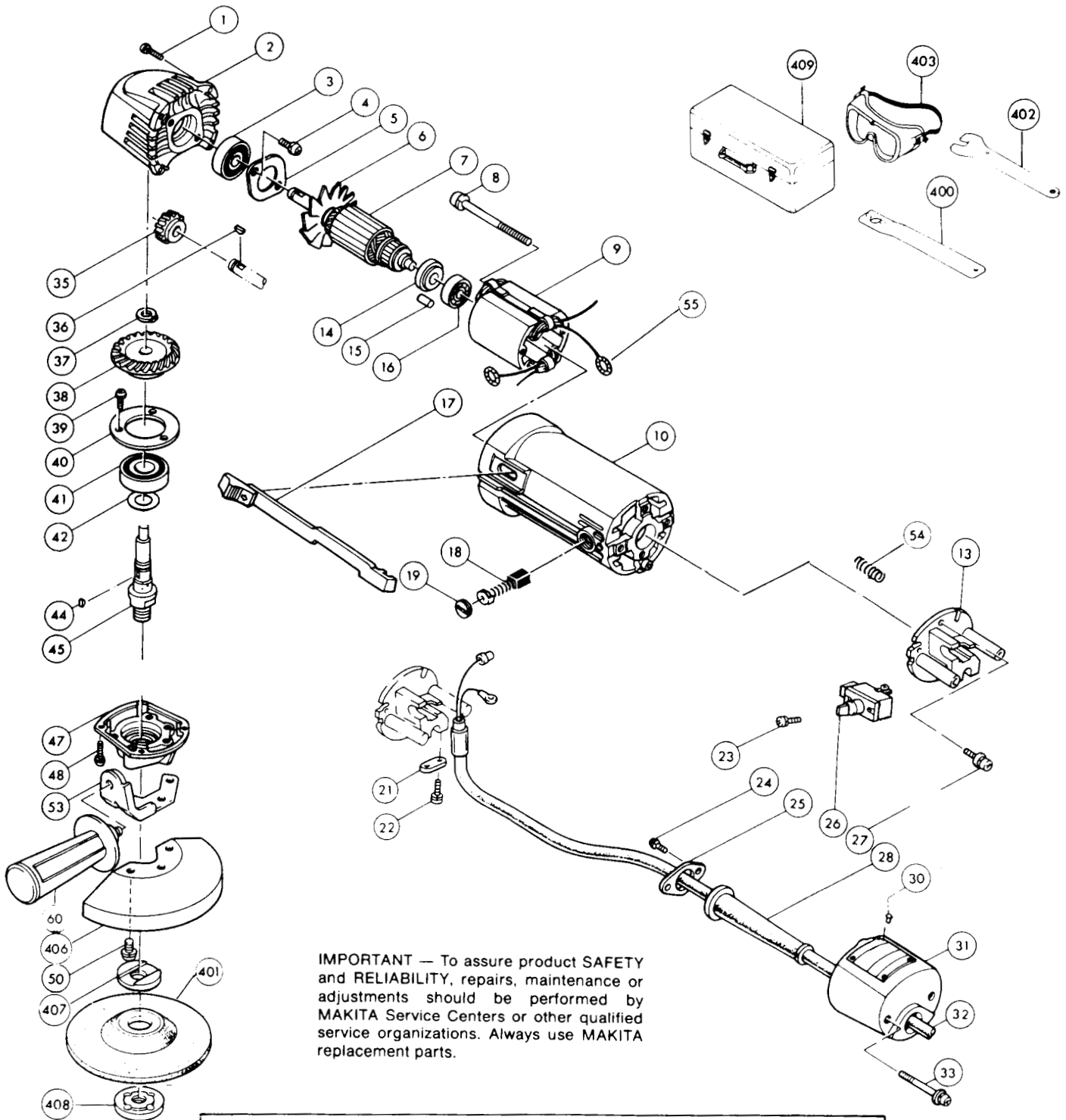

# 4" DISC GRINDER

MODEL 9501B  
MODEL 9501BKIT



**IMPORTANT** — To assure product **SAFETY** and **RELIABILITY**, repairs, maintenance or adjustments should be performed by **MAKITA** Service Centers or other qualified service organizations. Always use **MAKITA** replacement parts.

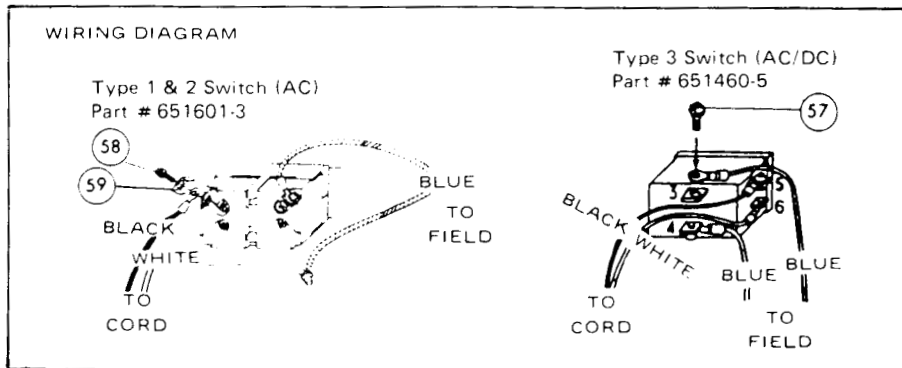

Fig.	Part No.	Qty. Used	Description	Fig.	Part No.	Qty. Used	Description
1	911136-9	4	SCREW M4X20	35	221229-7	1	SPIRAL BEVEL GEAR 15
2	156050-4	1	GEAR HOUSING (WITH PLANE BEARING 6, 214006-4)	36	254002-0	1	WOODRUFF KEY 3
3	211088-7	1	BALL BEARING 6000DDW	37	961006-2	1	RETAINING RING S-10
4	911216-1	2	SCREW M5X14	38	221232-8	1	SPIRAL BEVEL GEAR 35
5	285604-1	1	BEARING RETAINER 35	39	911121-2	3	SCREW M4X14
6	241068-9	1	FAN	40	285616-4	1	BEARING RETAINER 40
7	*****	1	ARMATURE ASSEMBLY (ASSEMBLED FIG.'S 6,7,14 & 16)	41	211129-9	1	BALL BEARING 6201DDW
8	911200-6	2	SCREW M4X70	42	253055-6	1	WASHER
9	*****	1	FIELD ASSEMBLY (WITH FIG. 55)	44	254002-0	1	WOODRUFF KEY 3
10	***	1	MOTOR HOUSING (WITH 2 EA. BRUSH HOLDER, 643557-4)	45	****	1	SPINDLE
11	*	1	STOP RING E-2.3 (TYPE 2 & 3)	47	312629-3	1	BEARING BOX
12	*	1	SWITCH ROD	48	911121-2	4	P.H. SCREW M4X14
13	*	1	SWITCH HOLDER	50	911221-8	3	SCREW M5X16
14	681614-0	1	INSULATION WASHER	53	164329-9	1	GRIP HOLDER
15	263002-9	1	RUBBER PIN 4	54	231223-1	1	COMPRESSION SPRING 6
16	211026-9	1	BALL BEARING 627LLB	55	654018-9	2	GARTER SPRING
17	*	1	SWITCH LEVER	56	*	1	SCREW M2.6X8 (TYPE 1)
18	*****	2	CARBON BRUSH	57	652021-4	4	TERMINAL SCREW
19	643550-8	2	BRUSH CAP	58	652007-8	2	TERMINAL SCREW
21	687001-1	1	STRAIN RELIEF	59	652250-9	2	CLAMP WASHER
22	911123-8	2	SCREW M4X14	60	273485-5	1	AUXILIARY HANDLE
23	911006-2	1	SCREW M3X8 (TYPE 1 & 2)	<u>ACCESSORIES</u>			
24	911106-8	2	SCREW M4X8	400	782401-1		LOCK NUT WRENCH 20
25	687637-6	1	SET PLATE	401	741402-8		4" DEPRESSED CENTER WHEEL, #24
26	*	1	SWITCH	402	781007-2		WRENCH
27	911133-5	2	SCREW M4X18	403	191686-2		SAFETY GOGGLES
28	682502-4	1	CORD GUARD	406	342554-4		WHEEL COVER
30	953106-2	4	RIVET	407	****		INNER FLANGE
31	411218-2	1	REAR COVER	408	****		LOCK NUT
32	664013-1	1	CORD WITH PLUG (2X18X8,SJ)	409	181717-5		STEEL TOOL CASE
33	911188-0	2	SCREW M4X60				

**SERVICE CHANGE**

1) Change on Switch and Switch Lever.

- \* SEE SERVICE CHANGE 1
- \*\* SEE SERVICE CHANGE 2
- \*\*\* SEE SERVICE CHANGE 3
- \*\*\*\* SEE SERVICE CHANGE 4
- \*\*\*\*\* SEE SERVICE CHANGE 5
- \*\*\*\*\* SEE SERVICE CHANGE 6

**TYPE 1**

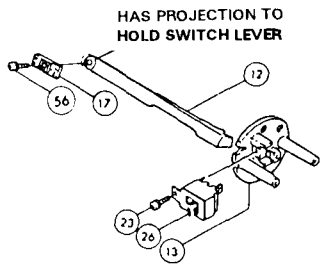

**TYPE 2**

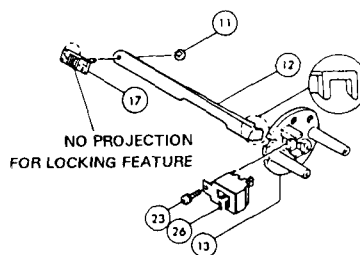

**TYPE 3**

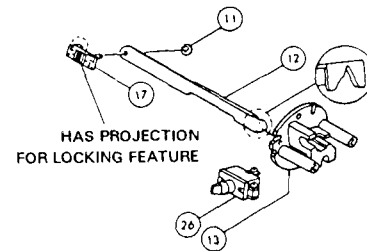

Fig.	Description	Type 1	Type 2	Type 3
11	Stop Ring	-----	Part #257903-1	
12	Switch Rod	Part #411178-8 (Discontinued)	Part #411328-5	Part #411491-4 (See Service Change 2)
13	Switch Holder	Part #411179-6		Part #411490-6
17	Switch Lever	Part #682044-6 (Discontinued)	Part #411508-3	Part #411492-2 (See Service Change 2)
23	Screw M3x8	Part #911006-2		
26	Switch	Part #651601-3		Part #651460-5
56	Screw M2.6x8	Part #912854-1 (Discontinued)	-----	

The above parts are completely interchangeable as a set.

5) Change on Motor from Serial Number 1,706,374E.

TYPE 1

TYPE 2

ARMATURE

WHITE WEDGES  
Part #611252-4

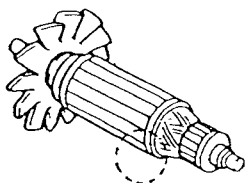

GREEN WEDGES  
Part #618819-9

FIELD

1-11/16" (43mm)  
Part #621092-2

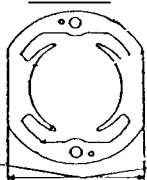

1-7/8" (48mm)  
Part #633131-6

CARBON BRUSH

13/64" (5mm) THICK  
BY 5/16" (8mm)  
CB-72  
Part #643072-8



15/64" (6mm) THICK  
BY 23/64" (9mm)  
CB-408  
Part #643408-1

GARTER SPRING

1" (25.8mm)  
Part #654018-9

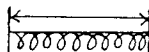

1-3/16" (30mm)  
Part #654100-4

Fig.	Description	Type 1	Type 2
7	Armature	Part #611252-4	Part #618819-9
9	Field	Part #621092-2 (w/Garter Spring 654018-9)	Part #633131-6 (w/Garter Spring 654100-4)
10	Motor Housing	Part #159175-3 (w/Brush Holder 643557-4)	Part #159283-0 (w/Brush Holder 643917-0)
18	Carbon Brush	Part #643072-8	Part #643408-1

The above parts are completely interchangeable as a set.  
Type 2 Armature replaces Type 1 Armature individually.

NOTE

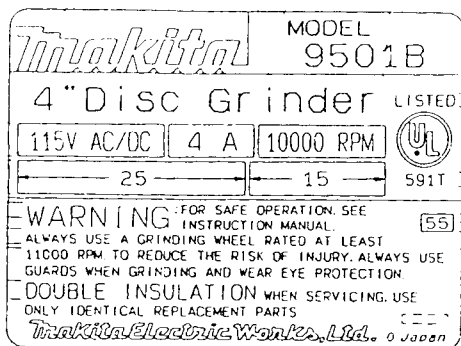

Type 2 tools have 55 marking on the name plate.

4) Change on Flange and Lock Nut from Serial Number 1,672,683E.

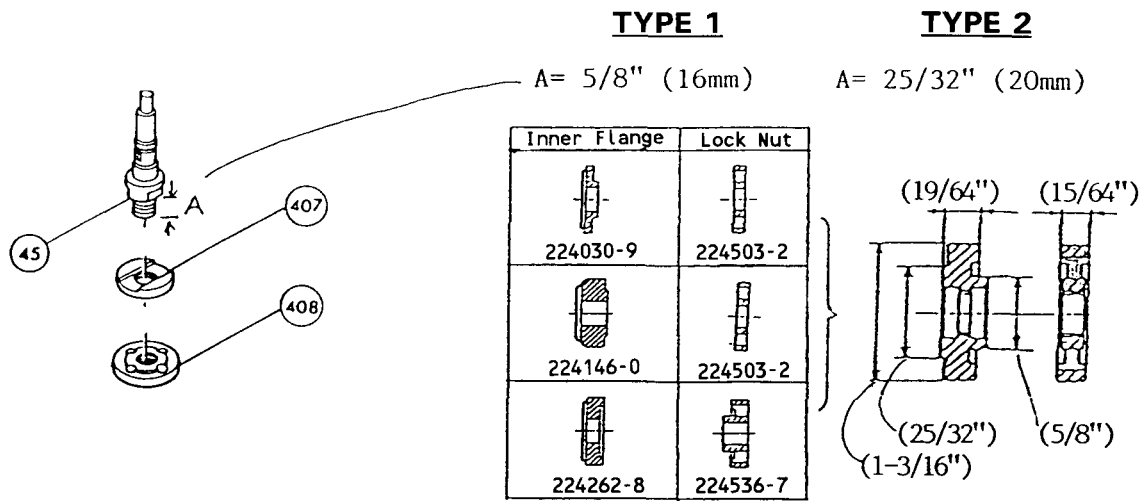

Fig.	Description	Type 1	Type 2
45	Spindle	Part #325329-6 (Discontinued)	Part #322423-5
407	Inner Flange (Depressed center wheel)	Part #224030-9	Part #224278-3  (See Service Change 6)
	Inner Flange (Diamond wheel)	Part #224146-0	
	Inner Flange (Abrasive cut-off wheel)	Part #224262-8	
408	Lock Nut (Depressed center wheel) (Diamond wheel)	Part #224503-2	Part #224541-4  (See Service Change 6)
	Lock Nut (Abrasive cut-off wheel)	Part #224536-7	

When using Diamond wheel, flip over the Inner Flange to face 25/32" (20mm) Diameter side to the Diamond wheel.

**INTERCHANGEABILITY OF CURRENT PARTS AND THE NEW PARTS.**

Model	Combination		Depressed center wheel	Abrasive cut-off wheel	Diamond wheel	Flex wheel	Multi-disc
	Spindle	Flange & Lock Nut					
9501B	(T1)	(T2)	no	yes	yes	no	no
	(T2)	(T1)	yes	yes*	yes**	yes	yes

1. \* mark indicates Inner Flange (Part #224262-8) and Lock Nut (Part #224536-7) should be used; \*\* mark indicates Inner Flange (Part #224146-0) and Lock Nut (Part #224503-2) should be used.
2. Never use the tool under the condition of "No". The accessory installed on the tool may come loose and fly out dangerously during operation.

2) Change on Switch Lever.

**TYPE 3**

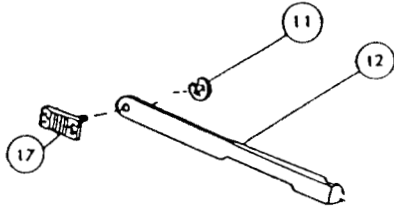

**TYPE 4**

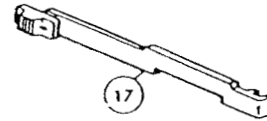

ONE-PIECE UNIT

Fig.	Description	Type 3	Type 4
11	Stop Ring	Part #257903-1	_____
12	Switch Rod	Part #411491-4	_____
17	Switch Lever	Part #411492-2	Part #414524-4 (See Service Change 3)

The above items are completely interchangeable as a set.

3) Change on Switch Lever and Motor Housing.

**TYPE 4**

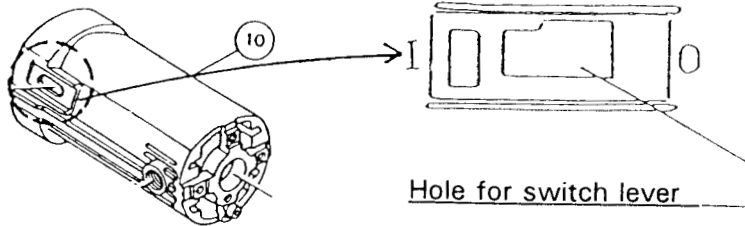

**TYPE 5**

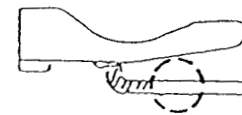
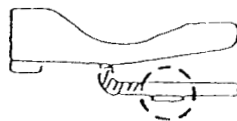
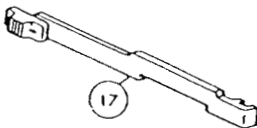
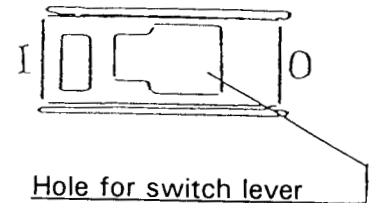
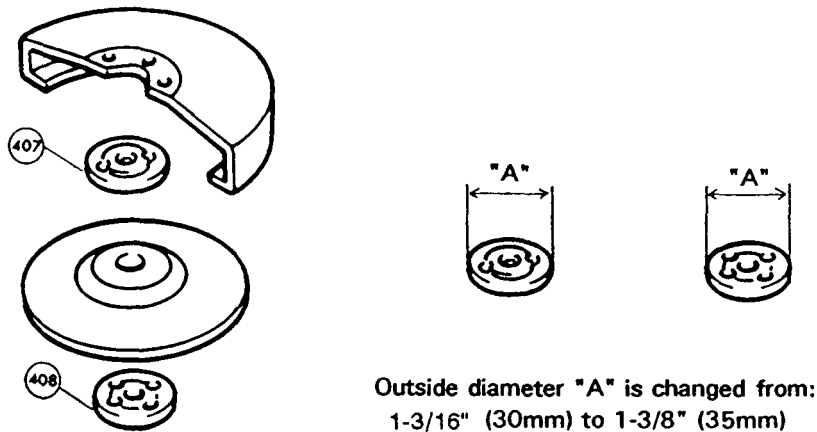

Fig.	Description	Type 4	Type 5
10	Motor Housing	Part #156096-0 (Discontinued)	Part #159175-3 (See Service Change 5)
17	Switch Lever	Part #414524-4 (Discontinued)	Part #414660-6

The above parts are completely interchangeable as a set.

6) Change on Inner Flange & Lock Nut from serial number 1,845,053E.



Outside diameter "A" is changed from:  
1-3/16" (30mm) to 1-3/8" (35mm)

FIG.	DESCRIPTION	TYPE 2	TYPE 3
407	Inner Flange	Part # 224278-3	Part # 224291-1
408	Lock Nut	Part # 224541-4	Part # 224545-6

The above parts are completely interchangeable as a set.

**NOTE:** Standard equipment will change to Type 3 Inner Flange and Lock Nut. They fit all accessories. (Grinding Wheel, cut-off, Diamond Wheel, Multi Disc.) Except Type 2 will remain used for Flex Wheel application, Sanding Disc uses Lock Nut 224501-6.