

Mamiya *MF*

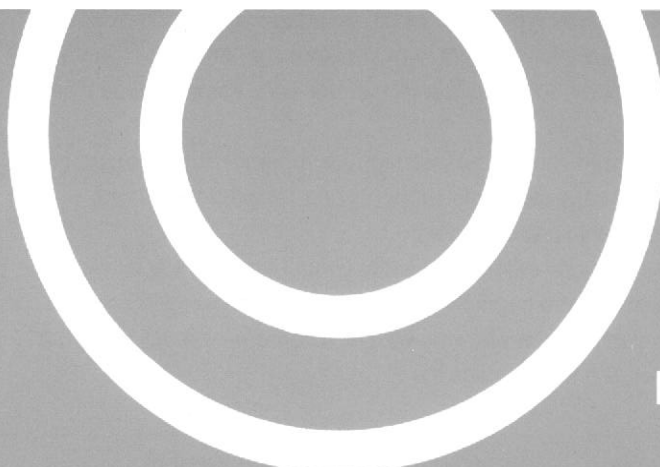

Instructions

Congratulations on your purchase of the Mamiya 6 MF,

Succeeding the New Mamiya 6, the Mamiya 6 MF is the latest addition to the Mamiya 6 x 6cm format series which has become the world's standard in the medium format field thanks to Mamiya's stress on "originality and reliability" -two qualities that have become synonymous with the very name Mamiya.

A combination of Mamiya's traditional precision workmanship and modern aesthetics, the 6 MF can take photos in any of three formats (6 x 6cm, 6 x 4.5cm and the wide panoramic format using an adapter with 135 film).

Featuring automatic exposure (AE) control, the 6 MF is compact, light weight and exhibits the versatility of a 35mm camera, while assuring high quality medium format pictures, The retractable lens mount, which allows the lens to be partially recessed into the camera body, further adds to the camera's compactness while protecting the lens.

The 6 MF also comes with three types of high performance interchangeable lenses - the standard (75mm), wide angle (50mm), and telephoto (150mm) - to satisfy a variety of photographic prerequisites.

While the 6 MF has undergone extensive quality control checks, it is extremely important that this manual be read carefully before attempting to use the camera. A thorough understanding of just how and why your new camera work will eliminate potential misuse and ensure a long service life.

Contents

Special Features of the Mamiya 6 MF	3	Manual Photography	24
Nomenclature and Functional Parts	5	Self-Timer	24
Preparatory Steps for Use	9	Depth-of-Field	25
Mounting/Removing Lenses	10	Exposure Compensation	26
How to Retract the Lens Mount	11	Time Exposures	26
Inserting Batteries	11	Flash Photography	27
Opening/Closing Light Shield Curtain	13	Infrared Photography	27
Releasing the Shutter	14	Emergency Winding-Stop Release Button	28
Before Loading the Film	15	How to Hold the Camera	28
Loading the Film	16	Photography with the 6 x 4.5 Format	29
Shutter Speed	18	Lenses	30
Shutter Release Button	19	Accessories	31
LED Indicators in the Viewfinder	19	Specifications	32
Focusing the Lens	21	Trouble Shooting	33
Taking Photographs	22	Camera Care	33
AE (Automatic Exposure) Photography	23	Camera Storage and Maintenance	34
AE Lock (AEL) Photography	23		

Three Size Multiple Formats

In addition to the attractive 6 x 6cm square format which assures multifaceted composition, the Mamiya 6 MF is also capable of using the 6 x 4.5cm format frame mask and the wide 24 x 54mm panoramic format using 35mm film with the optional Panoramic adapter Set. Thus, these multipurpose formats greatly enhance the photographer's potential creations.

Compact and Light Weight 6 x 6 Format / Versatile and Quick

Although the Mamiya 6 MF is a 6 x 6cm format camera, its versatility is comparable to that of a 35mm camera and allows for fast operation, thus serving particularly well for covering wedding, parties, sports as well as a host of other photographic venues.

Innovative Retractable Lens Mount/Compact and Safe

The interchangeable lenses fit on a retractable lens mount which reduces storage depth by 31 mm.

The lens barrels and mount are made of a tough, durable light weight aluminum alloy that promises a long service life even under the roughest professional use.

Automatic Exposure(AE)/Simplicity at Your Fingertips

Utilizing the latest in electronic technology, the Mamiya 6 MF aperture- priority AE control guarantees simplicity in all camera operations. Simply by focusing the lens and actuating the shutter with a soft touch of the electromagnetic release, every photographer can avail himself of a negative area that is a significant 3.6X larger than the 35mm format.

Double-Image Superimposing Rangefinder/Precise and Accurate

Focusing has been enhanced and errors substantially eliminated due to the rangefinder's long 60mm base, while the precision ground pentaprism guarantees the clearest and most crisp photos possible. When mounting any one of the three lenses, the corresponding frames in the field of view in the viewfinder are automatically selected, and parallax is automatically compensated for.

LED Display/A Variety of Safety Features

The user will find all relevant data on LED display - correct shutter speed, as well as over or under exposure indication. A blinking red LED signals when an erroneous photographic step has been taken.

A self-timer with a 10 second delay and electronic flash synchronization at all shutter speeds are additional features.

Wide Angle, Standard and Telephoto Lenses

The high contrast, color balance and resolving power of Mamiya multi-coated, high performance lenses reflect the latest optical discoveries. The short flange focal distance design of these lenses contributes substantially to their outstanding quality.

The wide angle lens, in particular, transmits large amounts of peripheral light, resulting in corner to corner sharpness. The image quality produced by these new Mamiya lenses is unsurpassed, regardless of the subject matter - be it landscape, aerial, industrial, scientific, fashion or portrait photography.

Retractable lens mount



The retractable lens mount greatly reduces the profile of the Mamiya 6 MF. making it more convenient to store and carry.

When not in use the lens mount, retracts into the body for storage and reduces the overall size of the camera.

(The mount slides 31mm into and out of the body - depending on its being in the operational or storage mode.)



("A" retracts first, then "B" coupled with the lens retracts)

Nomenclature and Functional Parts

Exposure compensation scale

Exposure counter window

"S" appears automatically when opening the back cover. (Any other numeral indicates that the film is loaded. Do not open the back cover under this condition.)

Exposure compensation lever

Cable release socket

Emergency advance/stop release button

Used when advance/stop is suspended when battery power drops or the power on/off lever is turned off during long exposures.

Shutter release button

Power on/off lever

Turn off after use

Self-timer pilot lamp

Lights for 8 seconds when the shutter release button is pressed, then blinks for 2 seconds, after which the shutter is released.

Lens release button

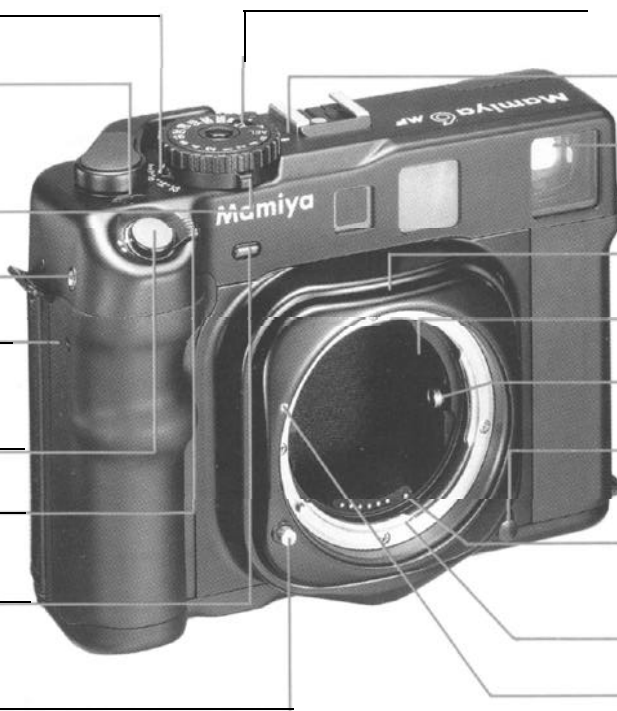

- Film speed window (ISO)

Shutter speed indicator

Rangefinder window

Shows the field of view within the bright frame and the double-image superimposed rangefinder.

Retractable lens mount

Internal bellows

Rangefinder coupling pin

Retraction/extension button

Press this button to retract the lens for storage, or pull it out for operation.

Electronic contacts

(Do not touch contacts and keep them clean in order not to impair good electrical contact.)

Bayonet mount

Lens alignment dot

Align with the dot on the lens to mount/ remove the lens.

Hot Shoe for mounting electronic flash

Light shield curtain
(Built-in darkslide)

Shutter speed dial

When A or AEL on the shutter speed dial is aligned with the indicator on the camera body, the dial will lock in place. To unlock it, rotate the dial while pushing in the AE lock (AEL) release button located in the center.

Film advance lever

Advance some 185° until it stops – the shutter is then cocked.

AEL release button

Film selector

Exposure compensation lock release button

Film holder roller

Film starting indicator

Be sure to align the film starting indicator "▼" on the camera with the arrow on the film. (Incorrect alignment may result in the film loading failure.)

Film type (120 or 220/135)

Position the pressure plate with either the 120, 220 or 135 roll film index mark.

Pressure plate

Set the pressure plate position according to the film type (120 or 220/135) used.

Spool release lever

When replacing the film, be sure to push this lever to the side to lower the spool stud.

Film spool stud

Film holder spring

Back cover latch

Back cover lock release button

Nomenclature and Functional Parts

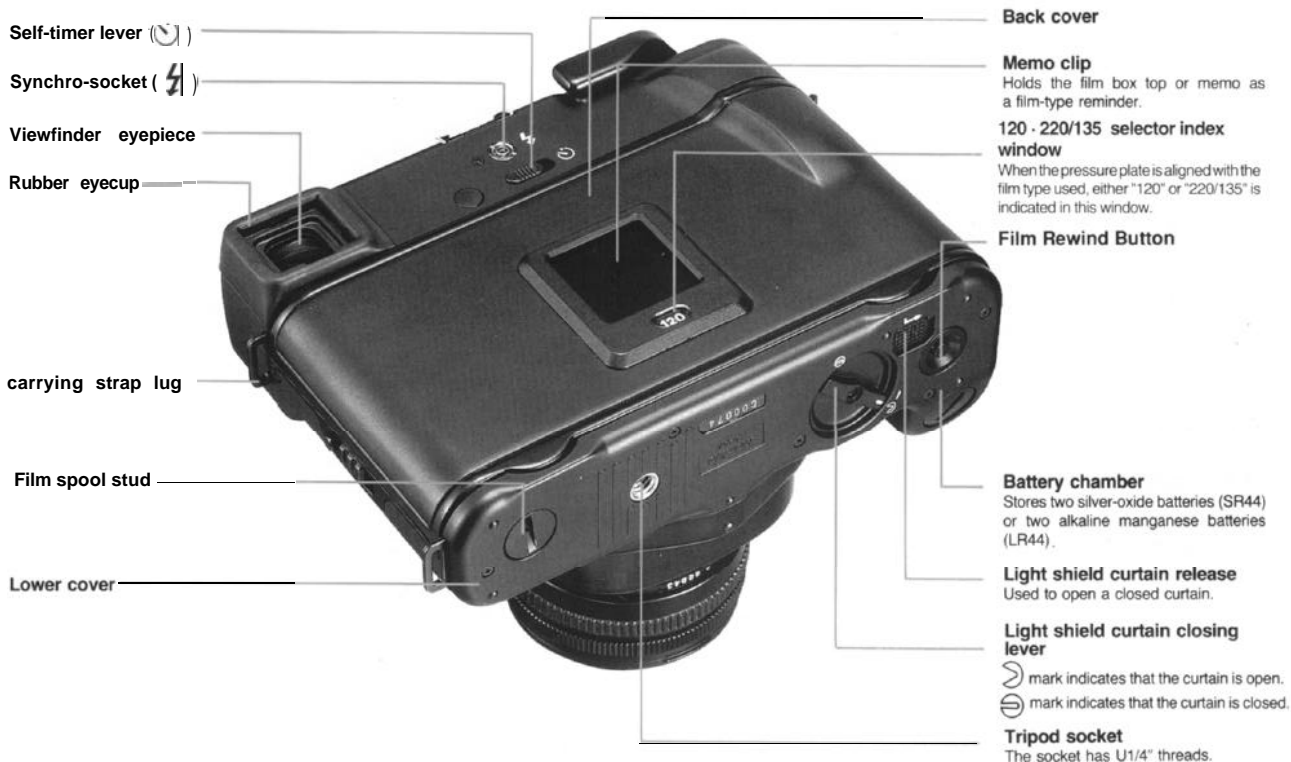

Aperture scale _____

Focusing ring _____

Used to focus the lens.

Depth-of-field scale _____

Allows the aperture (f-stop) to be checked in relation to the correct focusing range.

Lens alignment dot _____

When mounting or changing a lens, align this dot with the dot on the camera body.



Aperture ring

Distance scale (m · ft)

Used to set the subject-to-lens distance.

Infrared index mark

When engaged in infrared photography, use this mark to align lens according to usual focusing position.

Body cap



Spare battery case

4 batteries can be stored inside.

Preparatory Steps for Use

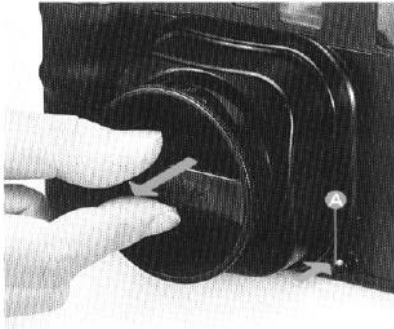

In order to attach the lens, first pull out the lens mount and remove the camera body cap. To do this, while pressing the retraction/extension button (A) in, pull the lens mount out by gripping the cross bar of the lens cap.

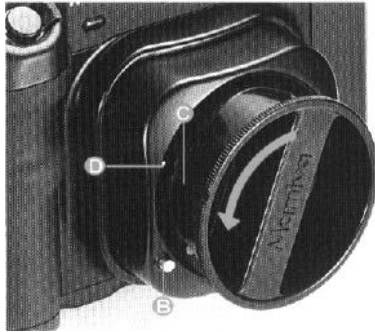

Then, while pressing the lens release button (B) in, rotate the cap counterclockwise, and align the groove (C) on the cap's side with the lens alignment dot (D) on the body. The body cap can then be pulled out.

*The lens release button cannot be pressed when the light shield curtain is open. So make sure the curtain is closed. For curtain opening/closing see page 13.

Mounting/Removing Lenses

[Mounting lens]



Remove the front and rear lens caps.

- The front lens cap can be removed by pressing in the tabs on the right and left with your fingers and pulling the cap towards you.

- The rear lens cap can be removed by rotating it counterclockwise.

Align Lens Alignment Dot (E) With the Camera Alignment Dot (D). Insert the lens into the camera body. Then turn the lens in the direction of the arrow until it clicks and locks into place.

[Removing lens]



Like removing the camera body cap, while pressing in the lens release button (B), rotate the lens in the direction of the arrow until the lens alignment dot is lined up with the white alignment dot (D) on the camera body.

Changing lens

When changing lens, pull out the retractable mount and proceed to the action mode.

- Through mounting the lens is possible with the mount retracted, removing it is not possible. (Interlocks!)

- When the mount is retracted, or if the light baffle is open when trying to remove the lens, the lens release button will not work, preventing lens release.

- Particularly when mounting the 50mm lens, take care so that the rear rim of the lens does not touch the body's rangefinder coupling cam.

- *When the lens has been removed and film remains in the camera body, avoid exposure to direct sunlight as film fogging may result.

[CAUTION]

Gold Plated Electronic contacts are provided inside the retractable mount and at the rear of each lens. If oil, dirt, or other foreign matter collects on the contacts poor electronic information transfer may result. When soiled, use a piece of clean cloth to wipe them thoroughly before installing the lens. Also, use the utmost care so as not to touch them. (Position the front face of the lens which has been removed as shown in the photo.)



How to Retract the Lens Mount

[Pulling out the retractable lens mount]



1. While pressing in the retraction button (A) on the camera body in the direction of the arrow, pull out the lens and lens mount until it clicks.
2. When both have been pulled out, take your fingers off the retraction button, and make sure that both are completely pulled out.

The camera is a precision instrument. When working the retractable lens mount, be sure to avoid abusive handling.

[Retracting (storing) the lens]

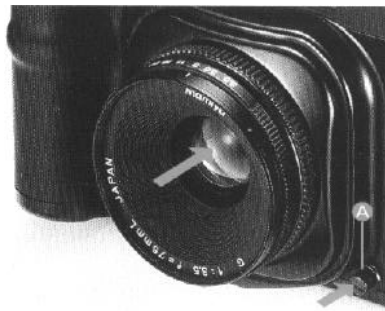

1. While pressing in the retraction button (A) on the camera body in the direction of the arrow, push the lens straight in towards the camera body.
2. When the lens mount has been retracted in place, take your fingers off the button and make sure that the lens is securely seated in the camera body.

*Once the lens mount is retracted, a safety mechanism is actuated to prevent the lens from being removed and the shutter released.

+ When the shutter release button is touched slightly (when the batteries are in the chamber) a red LED lights in the upper right corner of the viewfinder, indicating that the lens mount has been pulled out.

Inserting Batteries



The camera will not function without batteries.

1. Remove the battery chamber cover on the bottom of the camera with a coin or screwdriver.
2. "+" is indicated on the inside of the battery, chamber cover. Insert the two batteries, being sure to properly place each battery with the "+" side up, facing the cover.

[Batteries]

The Mamiya 6 MF uses either two SR44 silver oxide batteries or two LR44 alkaline manganese batteries.

[Battery check]



1. Power can be turned on/off with the small lever beside the shutter release button.
(ON) Align the white dot on the lever with the white dot on the camera body.
(OFF) Align the white dot on the lever with the red dot on the camera body.

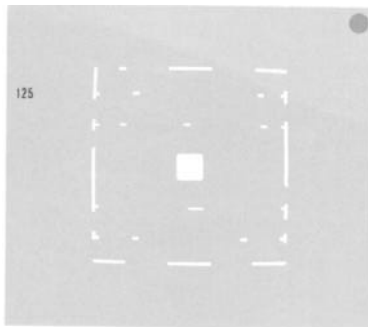

2. When the power is turned ON and the shutter release button is touched slightly, the shutter speed is indicated on the left side of the viewfinder and a red LED indicator lights on the upper right side indicating that power is normal.

- When battery power drops below normal, or when the batteries have been inserted improperly, the shutter speed does not show and the red LED does not light.

* When the shutter release button is lightly touched.

CAUTION:

- Be sure to confirm proper polarity of the batteries before inserting them.
- Do not contaminate the battery surface with oil, sweat, or other foreign matter. Failure to insert clean batteries could result in poor electrical contact.

When contaminated, carefully wipe with a dry cloth, or clean lens tissue.

* After the camera has been used for many hours of photographing, or has been inactive for a long time, insert new batteries.

*When the camera is used in low temperatures, battery performance deteriorates: below 0°C| use new batteries as needed.

[Spare batteries]

Can be stored inside the body cap.

If the power on/off lever is left ON, the LED lights up when the shutter release button is pressed, resulting in early battery depletion. Be sure to keep the on/off lever OFF.

Opening/Closing Light Shield Curtain

Before opening/closing the light shield curtain, be sure to cock the shutter, otherwise, it will not open/close.

[Opening the light shield curtain]

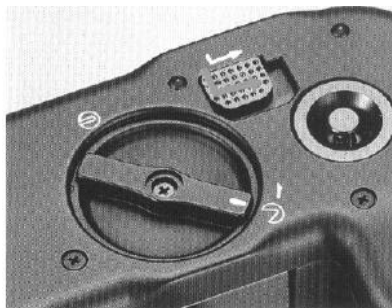

To open the light shield curtain, slide the light shield curtain release lever along to follow the arrow "→" down and right. This will cause curtain to snap open. The light shield lever indicator - (a white line) is then aligned with "☺"

[Closing the light shield curtain]

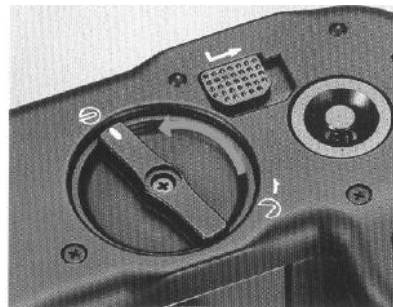

Rotate the light shield closing lever in the direction of the arrow, away from the open position "☺" and align the white indicator on the lever with "☹" to close.

- When the light shield curtain is open, the lens Cannot be removed. Close the curtain to remove the lens.

* When the light shield curtain is closed, the shutter cannot be released.

When taking a picture, open the light shield curtain.

(If the light shield curtain is closed, a red LED will indicate that it is closed.)

CAUTION:

Never touch the light shield curtain or the bellows. If touched, light leakage or a malfunction may result.

Releasing the Shutter



Before using the camera, it is advisable to understand how it works

- ① Power on/off lever Set to ON.
(See page 12)
- ② Film advance lever . . . Wind the lever to
cock the shutter.
(See page 13)
- ③ Light shield curtain Open.
(See page 13)
- ④ Retractable lens mount Pull out.
(Photographing position) (See page 11)
- ⑤ Back cover Open.
(See page 15)
- ⑥ Release the shutter . . . (See page 19)

Note:

If the shutter is not released, a red (LED) in the viewfinder will light; repeat steps ② to ⑤ again.

Before Loading the Film

[Setting the film speed]



Set the film speed of the film being used by lifting up the outer rim of the shutter speed dial and rotate it until the correct ISO value appears in the window.

Be sure to set the exact film speed, as otherwise incorrect exposure will result.

ISO 25 • 32 40 • 50 • 64 80 • 100 • 125 160 • 200 • 250 320 • 400 • 500 640 • 800 • 1000 1250 • 1600

[Opening/closing the back cover]

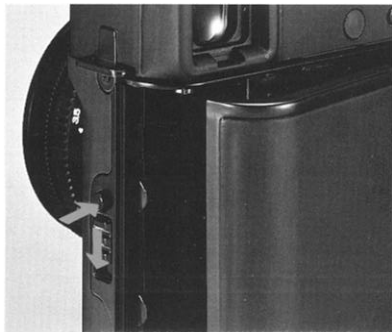

While depressing the back cover lock button, simultaneously push down the lock lever in the direction of the arrow and the back will open. When closing the back cover, securely press both corners until it clicks.

[Setting the film type]

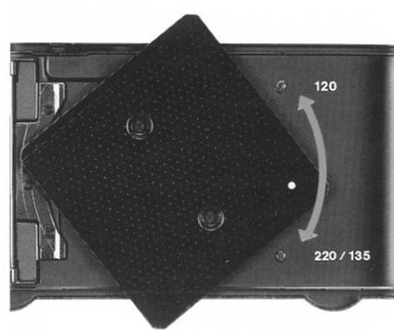

This camera can use either 120 or 220/135 film. To set the type of film used, simply rotate the pressure plate in the direction of the arrow until the white dot is at "120" or "220/135". When set, "120" or "220/135" will appear in the small window under the memo clip.

* The number of exposures on the film counter is automatically set at 12 for 120 film and 24 for 220 film, according to the position of the pressure plate.

If pressure plate position is not matched to the type of film used, a picture can be taken but it might be out of focus.

Loading the Film

[Memo clip]



The memo clip on the back cover is used to hold the film box to serve as a convenient reminder of the type of film in the camera or for recording the date.

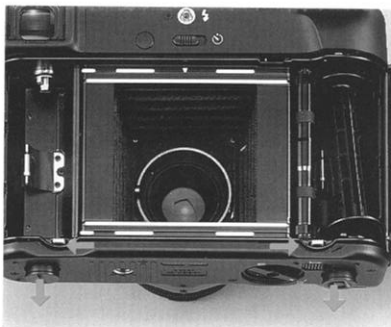

1. Push the spool release lever of right side to the right, and install the take-up spool in the take-up spool chamber, then push the lower spool stud up.



2. Like installing the take-up spool, push the spool release lever of left side to the left, place a roll of film in the film chamber, making sure it seats properly. Make sure the backing paper is in the position illustrated above.

* The product identification number, and other data are printed on the back side of the backing paper. If no visible, the film has been loaded incorrectly. Simply remove and position properly.

* When loading film or installing the take-up spool, carefully place the spool in the stud and make sure it is seated properly by gently turning to the right or left so that it engages smoothly.

Loading the Film

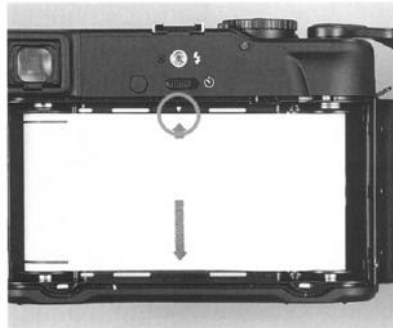

3. When the new roll has been inserted, be sure to reset the lower spool stud by pressing it in. (Also, be sure to reset the take-up spool stud in a similar manner.)

4. Pull out the backing paper, and insert the tip into the slot on the take-up spool as pictured.

5. Wind the film advance lever until the small arrow (the starting indicator on the backing paper) aligns with the film starting indicator (▼) on the camera body. Then close the back cover.

6. Wind the film advance until it stops and "1" appears in the exposure counter window.

- Make sure backing paper advances evenly between the spool flanges and does not begin to slant. If it advances unevenly, remove the backing paper from the take-up spool and refeed, starting again.

- If the film is not properly aligned with the "▼" indicator, the film may be improperly loaded.

- When any numeral other than "S" appears in the exposure counter window, it is an indication that the film is loaded. So do not open!

- Do not pull excessively on the backing paper, and do not load/unload the film in direct sunlight: bright light may fog the film.

- * Tightly wind the backing paper around the spool a couple of times. If this is not done, light may enter from the spool flanges when the film is unloaded.

Shutter Speed

[Determining the shutter speed]



The Mamiya 6 MF has an aperture-priority, AE lens shutter. Once the aperture and film speed are set, the AE meter selects a proper shutter speed in relation to the set aperture. Under the manual photographic mode, proper shutter speed is indicated by a red LED within the viewfinder.

1. To set the diaphragm to a desired aperture, rotate the aperture ring (A) until the appropriate figure is aligned with the central red index line (B). (Click stops are provided at each engraved aperture number but the diaphragm can be set also for intermediate stops.)

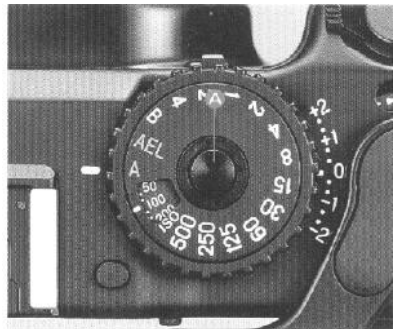

2. Rotate the shutter speed dial and select either the A(AE) or manual mode for photographing.

Rotate the dial to align it with the white index line (-) on the camera body.

* At A or AEL, the dial is locked. The lock can be released by pressing the AE lock release button (A) in the center of dial.

* In any position other than A or AEL, the shutter speed dial moves freely from click-stop to click-stop: it must be set on a specific click-stop and cannot be used at an in between setting.

* Intermediate Diaphragm settings (between click stops) are possible Intermediate Shutter Speeds (between engraved numbers) are not possible

Shutter speed dial:

A; Automatic exposure

Based on the aperture setting, the camera automatically selects the shutter speed.

AEL; AE lock

The camera memorizes the aperture when shutter release button is touched slightly so that, even when the position of the subject or camera changes, a picture can be taken with the initial aperture setting and is not affected by changes in light.

B. Bulb exposure

At this position, the shutter will remain open as long as the shutter release button is pressed.

Shutter controls

On the shutter speed dial the yellow numbers indicate the number of whole seconds while the white numbers indicate fractions of seconds.

Example: "4" indicates 4 seconds while 125 indicates 1/125 seconds.

Shutter Release Button

LED Indicators in the Viewfinder



The shutter release button is designed so that pressure can be applied in two stages. When it is lightly touched, correct metering data is displayed on the left side of the view finder. When it is depressed all the way, the shutter is released and an exposure is made.

*The LED's are located at the very left margin of the finder in order not to interfere with the field of view of the wide angle lens.

Viewfinder display

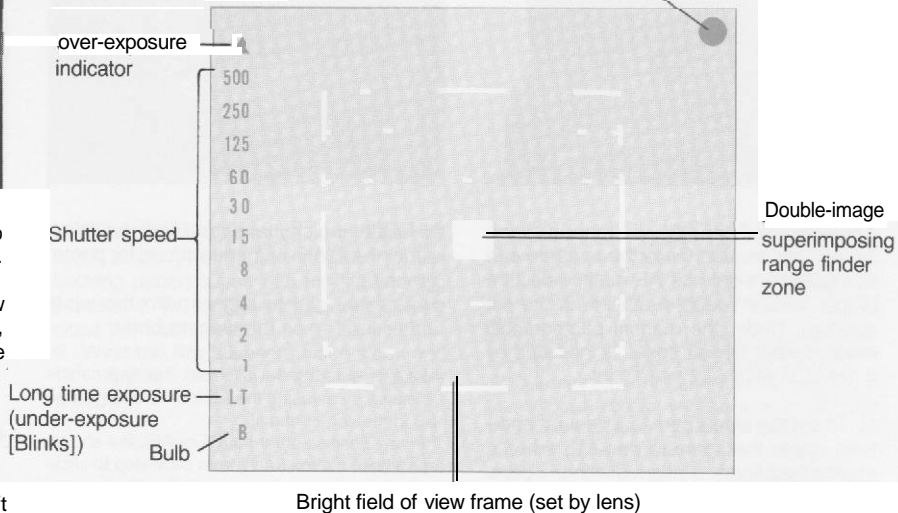

*When the lens mount is retracted, the viewfinder frame (i.e. the bright frame) selected is the widest frame for all lenses.

LED Indicators in the Viewfinder

AE photography

Proper speed
Illuminates

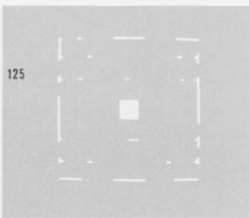

Lock speed
Illuminates



AEL photography

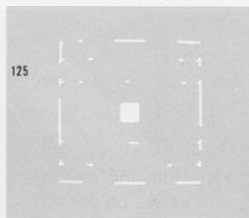

Set speed
Illuminates

Proper speed
Blinks



Manual mode

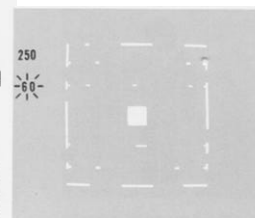

- The set speed has been adjusted to illuminate

Over-exposure
Blinks

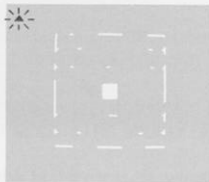

Battery capacity drops in the AE mode
Blinks

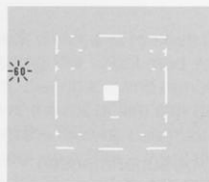

Long time exposure
Illuminates

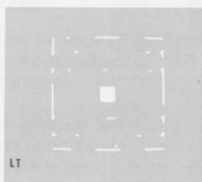

Under-exposure
Blinks

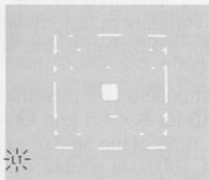

Battery capacity drops in the manual mode
• At both set speed and proper speed
Blinks

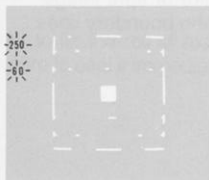

Focusing the Lens



When the lens has been focused, the doubleimage superimposing rangefinder produces two superimposed images with in the square □ of the viewfinder.

How To:

1. Position the subject within the central square □ of the viewfinder. As on the top left the subject will appear as a double images.
2. Rotate the focusing ring until the two images converge and are superimposed as on the figure on the left. The lens is now focused.



The two images can also be superimposed by using the boundary line between the viewfinder and the square or split image. Adjust the images until the boundary lines converge.

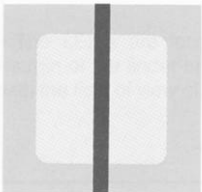
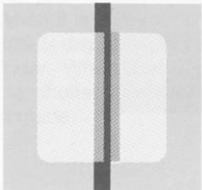

Photographic area covered

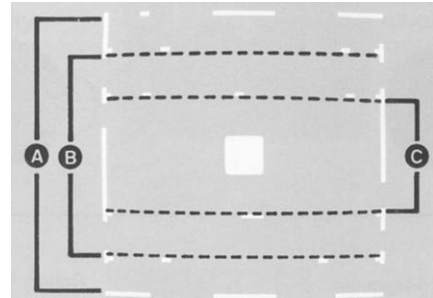

Within the viewfinder the photographic area covered is indicated by the visible bright frame. Parallax is automatically compensated for according to the subject-to-lens distance.

The composition will be within the line A for 6 x 6, B for 6 x 4.5 and C for panoramic format. 83% of the field of view is visible at ∞ , and 100% is visible at the minimum focusing distance. The appropriate bright frame area is automatically selected upon lens interchange.

Taking Photographs

[Unloading the film]

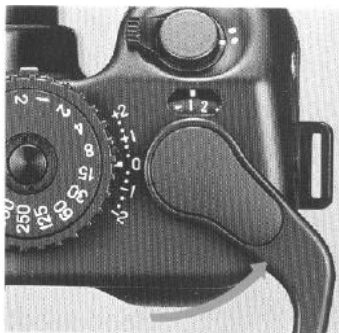

1. Press the shutter release button when you have focused and determined composition.
2. Advance the film by winding the film advance lever until it stops. (The shutter is then cocked.)
3. After completing the last exposure, wind the advance lever several times, until the film with its backing paper is completely wound onto the take-up spool. The advance lever will become easier to actuate when the film has been completely wound on the spool.

* When the shutter release button is pressed and the film is exposed, a red LED will light on the upper right side of the viewfinder.

1. Open the back cover and remove the roll of film. By pushing the spool stud release lever to the right, disengage and remove the spool. As shown, the roll of film can be easily removed from the take-up chamber if you push the spool up a little-it will then lift out. When the back cover is opened, the exposure counter will automatically return to 'S' (start).
2. Be careful not to let the roll of exposed film unwind. Be sure to seal it immediately.

- To prepare for another roll, remove the empty spool from the film chamber, and place it in the take-up chamber.

- Wind the advance lever until it stops. (Otherwise a red LED in the viewfinder will signal that it is impossible to press the shutter release button.)

- Do not advance the film too quickly, as this might adversely affect film flatness, or frame spacing.

*To remove the film before exposing the entire roll, cap the lens and press the shutter release button and wind the film onto the take-up spool frame by frame.

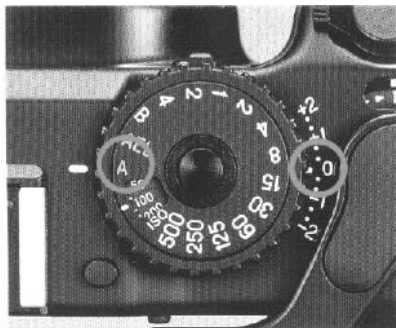

1. Align "A" on the shutter speed dial with the white line index mark on the camera body.
2. Be sure to set the exposure compensation scale to 0.
3. Set the aperture to the desired "f" number according to conditions
4. When the shutter release button is slightly touched, an LED indicating proper exposure will automatically light in the viewfinder. When "A" LED blinks, it indicates over-exposure. Rotate the aperture ring to stop down to a smaller exposure until an LED indicates proper exposure.

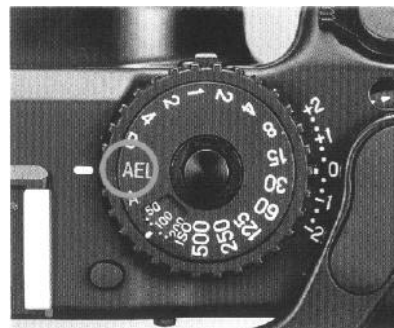

- Blinking "LT" indicates under-exposure: rotate the aperture ring until the LED stops blinking to increase exposure.

* Illuminating "LT" indicates that the shutter is set for a relatively long exposure from between 1 to 4 seconds.

When taking pictures at such slow speeds, be careful not to move or vibrate the camera. Either open the aperture for a higher shutter speed, or use a tripod, or use a flash.

- Under AE (automatic exposure) or AEL (AE lock), the LED display in the viewfinder will continue to operate as long as the shutter release button is touched slightly. When you take your finger off the button, the LEDs will go out.

Rotate the shutter speed dial until "AEL" aligns with the white index mark on the camera body.

Position the important part of your subject in the central square of the viewfinder – this will establish the correct exposure. Then touch the shutter release button slightly and an LED will light indicating the correct exposure. After making any necessary adjustments to the aperture, press completely for your exposure. Even when light quality is variable, an optimum exposure is possible. If you cannot get close enough to your subject for another meter reading, make substitute measurements by pointing the camera to light and dark areas and calculate a mean exposure value or try taking a reading off your palm.

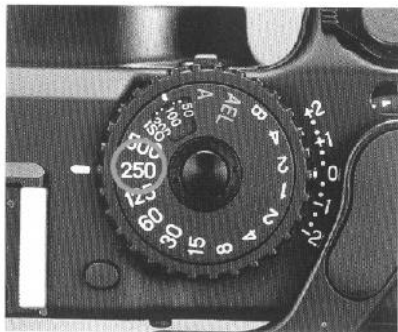

You may over-ride the AE mode and select the aperture and shutter speed manually. Simply set the shutter speed against the white line index mark and also set the lens aperture to the desired "f" stop.

As noted previously when the shutter release button is touched slightly, the proper shutter speed will be indicated by a blinking LED. A non-blinking LED will indicate the set shutter speed. Adjust the exposure accordingly. To do this, turn the shutter speed dial and/or aperture ring to align the two LEDs or until they become one. The single LED indicates proper shutter speed.

* When on manual, and the shutter release button is touched slightly, the LED indicators will light for ten seconds. They can be illuminated in ten second increments by simply pressing the button again.



1. Shift the self-timer lever in the direction of the arrow to "⌚" .
2. The shutter is released about 10 seconds after pressing the shutter release button. The LED on the front of the camera illuminates for about 8 seconds, then blinks for about 2 seconds, and then the shutter is released.
3. Be sure to return the self-timer lever to its normal position after use.

- The self-timer can be reset by simply following the above steps.
- * Under the self-timing mode make sure a tripod or other secure method is used to steady the camera.
- When the shutter is set to "B" (bulb), the self-timer does not operate.

Depth-of-Field

[F8]



The depth-of-field varies according to the aperture. The smaller the aperture ($f/8$, $f/11$, $f/16$...) the greater the depth-of-field; the larger the aperture ($f/8$, $f/5$...) the smaller the depth-of-field. To take pictures which are sharp from foreground to infinity or when taking snap shots, the focusing range is extended or depth increased by using a smaller aperture. When the subject is to stand out, with the background out of focus, a larger aperture is appropriate.

[F16]



The depth-of-field scale on the lens indicates depth-of-field in terms of the distance between subjects on both sides of the scale. For example, when a 75mm lens is stopped down to $f/8$ and $f/16$, respectively, everything photographed within the ranges shown in the photo at the left will be sharp.

- Refer to the instructions attached to individual lenses for specific depth-of-field tables..

[Diopter Correction]

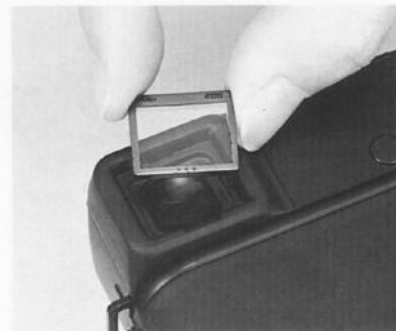

Six types of diopter correcting lenses are available for near/far-sighted people. Mount as indicated above. Powers available are: +3, +2, +1, -1, -2 and -3.

Exposure Compensation

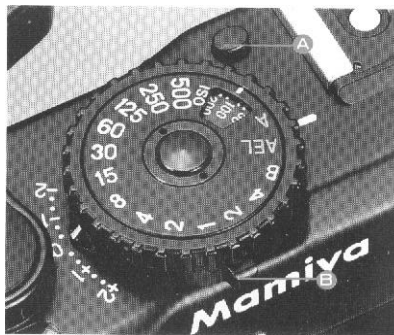

The exposure compensator functions in a number of important ways. It can be used to correct exposure values (EVs) or the differences in brightness between a primary subject and its background -especially when over or under-exposures occur. It can also be used when filters are employed or when engaged in available light photography — or under high contrast conditions (i.e. low or high key).

To set, press the compensator lock release button (A), and move lever (B) to select the desired EV: graduations are 1/3 EV.

[When a filter is used]

Whether using the AE or manual mode simply compensate for the filter exposure factor as indicated in the table below.

* After using exposure compensation, be sure to reset to "0".

Filter exposure factor	×1	×1.2	×1.5	×1.7	×2	×2.5	×3	×4
Exposure compensation value (EV)	0	+1/3	+2/3	+1	+1 1/3	+1 2/3	+2	

Time Exposures

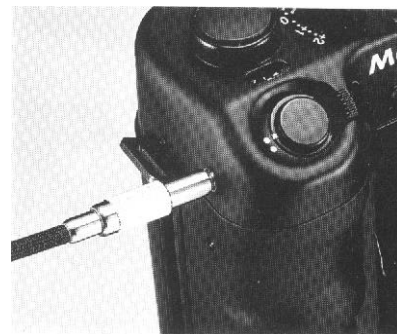

When taking an exposure longer than 4 seconds, set shutter to "B" (bulb). While the button is pressed down, the shutter will remain open. In order to prevent camera movement, it is best to use a cable release and tripod.

When set at "B" the self-timer does not work.

The cable release can be screwed in the release socket beside the shutter release button as pictured above.

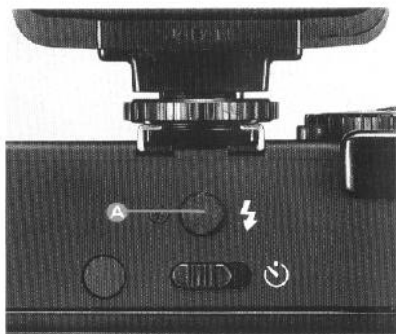

The Mamiya 6 MF features an X synchro flash terminal and its lens shutter system permits flash synchronization at all shutter speeds.

Shoe-mounted flash units can be attached directly to the hot-shoe, while flash brackets can be attached to the tripod socket for larger flash guns.

Remove safety cover (A) to attach sync cord in the socket.

[Determining the aperture]

When using automatic flash units, refer to the instructions on the flash unit for correct aperture settings.

When using a manual electronic flash, the guide number divided by subject distance gives the correct aperture.

$$\frac{\text{Guide number (48)}}{\text{Subject distance (6 m)}} = \text{Correct aperture setting (8)}$$

* Charged electronic flash units sometimes fire when they are attached to the camera. This does not indicate a defective circuit.

* When using electronic flash, be sure to read its manual carefully.

CAUTION:

When an electronic flash is connected to the hot-shoe, current moves through the X contact. So, be sure to put the safety cover supplied with the camera on the X contact so that you will not receive an electric shock.

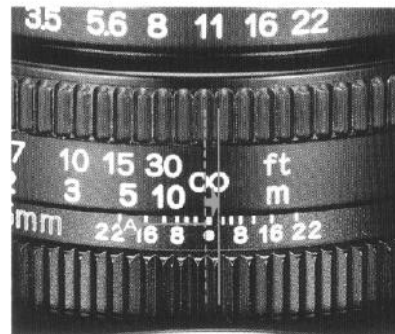

When using infrared film, it is necessary to make a focusing adjustment in order to achieve accurate focus. This is because the focus position of the image deviates from normal since the infrared ray wavelength is longer. After focusing in the usual manner, check the distance on the distance scale that is aligned with the center reference mark of the lens. Make the focusing adjustment by turning the focusing ring in the direction of the arrow in the accompanying photograph so that the distance just observed is aligned with the infrared mark.

When using infrared film, be sure to read the instructions with the film.

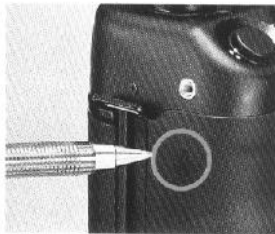

If the batteries have been depleted — especially when the power on-off lever has been set to the OFF position during long exposures (at "B" ; 4 seconds or 2 seconds) — the winding-stop prevents the film from being wound.

If this happens, push the emergency advance/stop release button with a pen or other pointed object as shown above. The advance/stop is then released, allowing the film to be wound. Please note that that particular frame will be poorly exposed.

* When the batteries have been depleted, immediately replace them.

- The emergency winding-stop release button should not be used for any other purposes.



Since the Mamiya 6 MF has a 6 x 6 format, it is not necessary to adjust for vertical and horizontal composition. Because most out of focus pictures are the result of camera movement, make sure not to move when pressing the shutter button. Hold the camera with your elbows close to your body: pressing part of the camera on your forehead will help stabilize it. Then gently release the shutter.

When making exposures longer than 1/30 sec., it is advisable to use a tripod with a cable release.

[Neck strap]

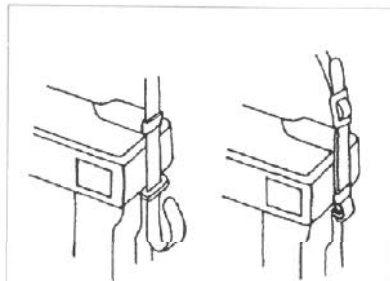

Pass the neck strap through the carrying strap lug, and fasten it as shown.

[Using a tripod]

When using the camera with a large tripod head, the head may interfere with the spool stud, preventing film from being loaded. To prevent this, use the optional tripod adapter N.

- The threaded tripod screw hole is 5.5mm deep and the use of a longer tripod screw might result in the damage or breakage of internal working parts. So be careful not to apply unnecessary pressure when mounting the camera.

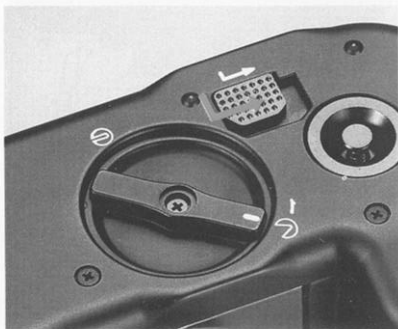

Before taking photos, insert the 6X4.5 frame under the film guide rails, making sure to open the light shield curtain first. If it is inserted when the curtain is closed, your fingers may come in contact with the curtain and light may leak in or other malfunctions may result.

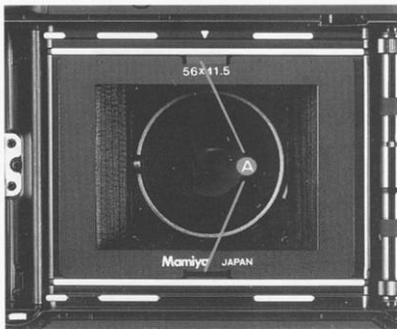

Gently bend the 6x4.5 frame [with the ivlarmya name visible as pictured (A)] under the film guide rails, making sure that it is flat.

[Loading/Unloading the Film]

The film can be loaded/unloaded in the same manner as the 6x6cm standard size.

[6x4.5 Picture Area and the Number of Exposures for each Film Type]

When using the 75mm lens at ∞ :

- Picture area: 56 x 41.5mm
 - Visible field of view: 83% at ∞ , 100% 1 m
- Number of exposures : 120 roll film . . . 12
220 rollfilm . . . 24

[Determining the Field of View in the Viewfinder]

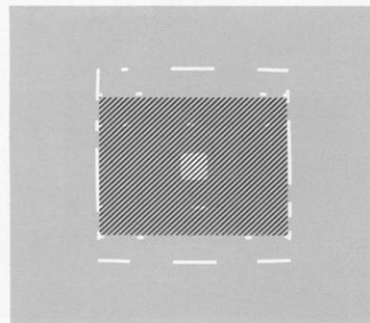

When the 6x4.5 frame is used, the shaded area in the illustration is the field of view in the viewfinder.

- * Depending on the lens type being used, the bright frame is automatically selected and parallax is automatically corrected according to subject distance.
- * Before taking photos, be sure to change the position of the pressure plate according to the film type being used.
- * When panoramic photography using the 6x4.5 frame has been completed, be sure to remove the frame from under the film guide rails.
- * The subject is pictured on two small unexposed parts on the upper and lower sides of the developed film.

G4/50L (50mm f/4)



Lens construction: 8 elements in 5 groups
Angle of view: 75°
Minimum aperture: 22
35mm equivalent: 28mm
Minimum focusing distance: 1m
Minimum magnification: 0.059
Area covered: 945 x 945mm
Filter size: 58mm
Hood: Bayonet type
Dimensions: 55 (length) x 64mm (diameter)
Weight: 335g

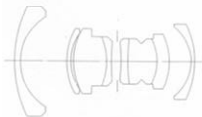

G3.5/75L (75mm f/3.5)



Lens construction 6 elements in 4 groups
Angle of view: 55°
Minimum aperture: 22
35mm equivalent: 41mm
Minimum focusing distance: 1m
Minimum magnification: 0.089
Area covered 632 x 632mm
Filter size: 58mm
Hood: Bayonet type
Dimensions: 43 (length) x 64mm
Weight: 250g

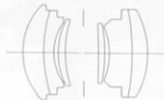

G4.5/150L (150mm f/4.5)

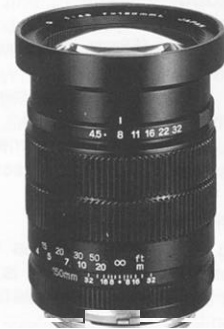

Lens construction: 6 elements in 5 groups
Angle of view: 30°
Minimum aperture: 32
35mm equivalent: 82mm
Minimum focusing distance: 1.8m
Minimum magnification: 0.0996
Area covered 562 x 562mm
Filter size: 67mm
Hood: Screw-in type
Dimensions: 86 (length) x 70mm (diameter)
Weight: 480g



[Lens hood]

For 50mm f/4: Bayonet type
(58mm in diameter)

For 75mm f/3.5: Bayonet type
(58mm in diameter)

For 150mm f/4.5 Screw-in type
(67mm in diameter)

All are supplied with the lenses.

[Diopter correcting lens]

Focusing accuracy diminishes when the eye diopter is incorrect. So, it is advisable that near and far sighted people use diopter correcting lenses.

Fit the proper diopter correcting lens to the eyepiece.

6 types are available: +3, +2, +1 -1, -2, -3.]

[Tripod adapter N]

This is used to mount the camera to the tripod head.

Even when the tripod has a large head, the adapter allows film to be loaded, while the camera is attached to the tripod.



[Auto Close up Lens]

The close-up adapter "Auto Close up Lens" is designed for use with standard 75mm/f3.5 lens.

It will be very convenient for taking close-ups of portraits, plants, flowers and insects, as well as for the reproduction of books, and similar items.

It can be simply mounted on or removed from the camera, without special adjustments. It easily couples with the rangefinder, and allows close-ups to 50cm.

Subject distance	From the film 110-61.7 (cm)
	From the front frame of the auto close up lens 100-50 (cm)
Magnification	×0.07 (100cm)-0.17 (50cm)
Area covered	75×75~34×34 (cm)
Percentage of the field of view visible	90%~100%



[Lens case] Type A

The lens case is made of special material which is very soft but tough. Dimension: bottom diameter is 90mm and it is 160mm in length.



Specifications;

[Panoramic Adapter Set]

When using the Panoramic Adapter, a wide panoramic photography can be taken by using 35mm film.

The 135 panoramic Adapter Set is composed of the following:

1. 135 Panoramic Frame
2. Winding Spool
3. Magazine Holder
4. Rewind Crank Unit
(Unit Weight: 60 g)

• 135 Panoramic Picture Area and the Number of Exposures.

Picture area: 24mm x 54mm (with wide angle 50mm lens; subject distance at ∞)

Number of exposures:

135 Film 36EXP20
135 Film 24EXP12
135 Film 20EXP10
135 Film 12EXP5

The picture area (24 x 54mm) provided by the Mamiya 6 MF panoramic photography is about three (exactly 2.78) times as wide as that provided by 35mm panoramic format (13 x36mm). Sharp panoramic images are also assured by the highly reputed wide angle 50mm lens.

Camera Type	: Multiple format (6 x 6, 6 x 4.5 and 35mm Panorama). Interchangeable lens, rangefinder camera
Film Type	120 Roll Film (12 exposures with both 6 x 6 and 6 x 4.5) 220 Roll Film (24 exposures with both 6 x 6 and 6 x 4.5) 135 Roll Film (up to 20 exposures)
Actual Negative Size	: 56 x 56mm with 6 x 6, 56 x 41.5mm with 6 x 4.5 56 x 24 mm with panoramic format with using Panoramic Adapter Set
Lens Type	Wide Angle : 50mm f/4 Standard : 75mm f/3.5 Telephoto :150mm f/4.5
Film Winding	A single 185° stroke
Shutter	#00 electronic shutter, B,4-1/500sec., electro-magnetic release; X contact synchronizing at all speed with hot-shoe and synch. socket; electronic self-timer (10 sec. delay)
Exposure Control	: Aperture priority AE,SPD receptor in viewfinder; metering range: EV3.5-EV18 with 75mm Lens, ISO 100); exposure compensa- tion: +2 to -2 EV (in 1/3 EV steps)
Film Speed Range	: ISO 25 - 1600
Rangefinder	: Lens declination, double image superimposing system; base lens 60mm (effective base length 34.8mm)
Viewfinder	: Coupled with rangefinder; automatic bright line frame selection (50, 75, 150mm); parallax compensation: magnification ratio 0.56X; 83% of the field of view visible at infinity; built-in shutter speed and exposure display, safety interlock warning LED
Internal "Dark Slide" Curtain	: For Interchangeable lens function
Safety Mechanism	: 1. Double exposure prevention 2. Exposure prevention when internal dark slide engaged 3. Exposure prevention when lens mount is retracted
Power Supply	: Two (2) 1.5V batteries (MS 76, SR44 or LR44)
Dimensions Weight	: Camera body : 155 x 109 x 69mm : 900g
Panoramic Adapter Set	: Panoramic frame mask, Take-up spool, Film magazine holder, Rewinding dial unit Weight: 60g

*Specifications and design are subject to change without notice.

Uniquely designed to prevent mistakes, the New Mamiya 6 incorporates numerous safety features. If the shutter will not function, it is very likely due to user error rather than camera malfunction. Should something appear to go wrong, be sure to review the following points.

● When the shutter will not function.

- ① Is the power on/off lever set to the ON position?
- ② Has the film been completely advanced to the next frame?
Have all the exposures already been made (12 with 120, 24 with 220)?
- ③ Has the film advance lever been wound until it stops?
- ④ Is the lens mount retracted?
- ⑤ Is the light shield curtain closed?
(In the case of examples ②~⑤, the red LED will flash a warning on the upper right side of the viewfinder.)

● When the lens cannot be removed:

- ① Is the light shield curtain open?
- ② Is the lens mount retracted or stored in the body?

[Photographing at low temperatures]

- Be sure to use new batteries.
 - Expose the camera to cold air only when in use.
- Batteries which will not function at low temperatures may be used when returned to use at normal temperatures.

Avoid quick heating or cooling as unstable voltage may result.

[Batteries]

An automatic circuit will signal battery depletion.

When the shutter release button is touched slightly, an LED blinks to indicate a suitable shutter speed. A few exposures can be made, but replace the batteries as soon as possible. When the batteries are depleted, the LED ceases to light and the shutter cannot be released.

[Batteries Care]

- Replace both batteries at the same time. Avoid using old batteries with new ones, and avoid mixing different types of batteries.
- * When inserting batteries in the battery chamber, verify correct polarity. If contaminated with oil, sweat or other foreign matter, be sure to wipe clean with a dry cloth or lens tissue.

Camera Storage and Maintenance

- If the camera is not to be used for a long time, remove the batteries and film.
- Do not store the camera at temperatures exceeding 40°C or below - 10°C. Also avoid storing in a damp or sea air environment.

When stored in the vicinity of gaseous chemicals, such as naphthaline and formalin, the camera and film may be adversely affected. Read the instructions on the film carefully for proper handling procedures.

- As your camera is a precision instrument, avoid exposing it to vibrations or severe shocks.

When handholding your camera, always use a neck strap and exercise extreme caution when removing lenses and adjusting the mount.

- Prolonged disuse does not lengthen camera life, but shortens it. So, when storing for a long time, periodically take the camera and release the shutter several times to keep it in good condition.
- Do not touch either the front or the back of the lens surfaces. If either needs cleaning use blower or lens tissue to remove dust particles. A fingerprint can be removed with a drop of lens cleaner and wiped off with lens tissue.
- Carefully read all instructions in the manual.

Periodic Examination

In order to maintain the camera in its best condition, it is advisable to periodically check all functions.

When the camera has not been used for a long time, or when it is to be used for very important photographs, check the camera or take some trial pictures beforehand. **(Be sure to check the batteries, electronic flash synchronization, film advance, upper and lower images in the rangefinder, correct position, and shutter function.)**

For a general overhaul, cleaning, or repairs, take the camera to your nearest authorized Mamiya Service Center or ask your camera shop for advice.

This product employs a protective circuit for prevention of electrostatic electrification. Should an electrostatic trouble occur, be sure to turn off power to this Product before using it again. Be careful not to touch the electrical contact of this Product.

In rare cases, this Product may be affected by a strong external electromagnetic wave. In such cases, carefully use this Product.