

C 230 Kompressor Sport

C 240

C 240 4MATIC

C 320

C 320 4MATIC

C 320 Sport

C 320 4MATIC Sport

C 32 AMG

Our company and staff congratulate you on the purchase of your new Mercedes-Benz.

Your selection of our product is a demonstration of your trust in our company name. Further, it exemplifies your desire to own an automobile that will be as easy as possible to operate and provide years of service.

Your Mercedes-Benz represents the efforts of many skilled engineers and craftsmen. To help assure your driving pleasure, and also the safety of you and your passengers, we ask you to make a small investment of time:

- Please read this manual carefully before putting it aside. Then return it to your vehicle where it will be handy for your reference.
- Please follow the recommendations contained in this manual. They are designed to acquaint you with the operation of your Mercedes-Benz.

- Please pay attention to the warnings and cautions contained in this manual. They are designed to help improve the safety of the vehicle operator and occupants.

We extend our best wishes for many miles of safe, pleasurable driving.

Mercedes-Benz USA, LLC  
A DaimlerChrysler Company

<b>Introduction</b> .....	9
Product information .....	9
Operator's Manual .....	10
Service and warranty information ..	10
Important notice for California retail buyers and lessees of Mercedes-Benz automobiles .....	11
Maintenance .....	12
Roadside Assistance .....	12
Change of address or ownership....	12
Operating your vehicle outside the USA or Canada.....	13
Where to find it.....	14
Symbols.....	15
Operating safety .....	16
Proper use of the vehicle .....	16
Problems with your vehicle.....	17
Reporting safety defects.....	18
Reporting Safety Defects .....	18

<b>At a glance</b> .....	19
Cockpit.....	20
Instrument cluster .....	22
Multifunction steering wheel .....	24
Center console .....	25
Upper part .....	25
Lower part .....	26
Overhead control panel .....	27
Door control panel.....	28

<b>Getting started</b> .....	29
Unlocking .....	30
Unlocking with SmartKey.....	30
Adjusting.....	32
Seats .....	32
Steering wheel.....	37
Mirrors.....	39
Driving.....	41
Fastening the seat belt .....	41
Starting the engine .....	44
Switching on headlamps.....	47
Turn signals and high beam .....	47
Windshield wipers.....	48
Problems while driving.....	49
Parking and locking.....	51
Parking brake .....	51
Switching off headlamps.....	52
Turning off engine .....	53

<b>Safety and Security</b> .....	55
Occupant safety .....	56
Airbags .....	57
Seat belts .....	61
Children in the vehicle .....	65
Blocking of rear door window operation .....	71
Panic alarm* .....	72
Activating .....	72
Deactivating .....	72
Driving safety systems .....	73
ABS .....	73
BAS .....	74
ESP .....	75
Four wheel electronic traction system (4MATIC*) with the ESP .....	78
Anti-theft systems .....	79
Immobilizer .....	79
Anti-theft alarm system .....	79
Tow-away alarm .....	80

<b>Controls in detail</b> .....	83
Locking and unlocking .....	84
Keys .....	84
Opening the doors from the inside .....	87
Opening the trunk from the inside .....	88
Opening the trunk .....	88
Closing the trunk .....	89
Trunk lid emergency release .....	89
Separately locking the trunk .....	90
Separately unlocking the trunk .....	91
Automatic central locking .....	91
Locking and unlocking from the inside .....	92
Seats .....	93
Easy-entry/exit feature* .....	93
Head restraints .....	94
Multicontour seat* .....	96
Heated seats* .....	97
Memory function* .....	98
Storing positions into memory .....	99
Recalling positions from memory ... ..	99
Storing exterior rear view mirror parking position .....	100

Lighting .....	101
Exterior lamp switch .....	101
Combination switch .....	104
Hazard warning flasher .....	104
Interior lighting .....	105
Door entry lamps .....	106
Trunk lamp .....	106
Instrument cluster .....	107
Instrument cluster illumination ....	107
Coolant temperature display .....	108
Trip odometer .....	109
Tachometer .....	109
Outside temperature indicator .....	110
Control system .....	111
Multifunction display .....	111
Multifunction steering wheel .....	112
Menus .....	114
Standard display menu .....	116
AUDIO menu .....	116
NAVI menu .....	118
Malfunction memory menu .....	118
Settings menu .....	119
Trip computer menu .....	132
TEL menu* .....	134
Manual transmission .....	137
Shifting into reverse .....	137

Automatic transmission* .....	138	Automatic climate control* .....	156	Power windows .....	187
One-touch gearshifting.....	139	Setting the temperature.....	158	Opening and closing the windows	187
Gear ranges .....	140	Adjusting air distribution.....	159	Synchronizing power windows.....	189
Gear selector lever position .....	141	Adjusting air volume .....	159	Sliding/pop-up roof* .....	190
Program mode selector switch.....	142	Maximum cooling MAXCOOL .....	160	Opening and closing the	
Accelerator position.....	143	Defrosting .....	160	sliding/pop-up roof.....	190
Emergency operation		Air recirculation mode .....	160	Synchronizing the	
(Limp Home Mode) .....	143	Charcoal filter .....	161	sliding/pop-up roof.....	192
Good visibility .....	144	Rear window defroster.....	162	Driving systems.....	193
Rear view mirror.....	144	Air conditioning.....	163	Cruise control .....	193
Headlamp cleaning system* .....	146	Residual heat and ventilation* .....	163	Loading .....	196
Sun visors .....	146	Rear passenger compartment		Roof rack* .....	196
Rear window sunshade* .....	147	adjustable air vents.....	164	Ski sack* .....	196
Climate control.....	148	Audio system.....	165	Split rear bench seat*.....	199
Setting the temperature.....	150	Audio and telephone, operation....	165	Loading instructions .....	202
Adjusting air distribution and		Operating safety .....	165	Useful features.....	203
volume .....	151	Operating and display elements....	166	Interior storage spaces .....	203
Defrosting .....	151	Button and soft key operation.....	168	Ashtrays.....	207
Air recirculation mode.....	152	Operation.....	168	Cigarette lighter.....	208
Rear window defroster.....	153	Radio mode.....	171	Telephone* .....	208
Deactivating the climate control		Cassette mode.....	174	Tele Aid* .....	209
system .....	153	CD changer* operating mode .....	178	Garage door opener.....	217
Air conditioning.....	154	Telephone* operation .....	182		
Ventilated storage compartment .	155				
Rear passenger compartment					
adjustable air vents.....	155				

# Contents

<b>Operation</b> .....	221	At the gas station .....	233	Maintenance.....	247
The first 1 000 miles (1 500 km).....	222	Check regularly and before		Clearing the service indicator .....	247
Driving instructions.....	223	a long trip.....	234	Service term exceeded .....	247
Drive sensibly – save fuel .....	223	Engine compartment .....	235	Calling up the service indicator....	248
Drinking and driving .....	223	Hood .....	235	Resetting the service indicator ....	248
Pedals .....	223	Engine oil .....	236	Vehicle care.....	249
Power assistance .....	224	Transmission fluid level.....	238	Cleaning and care of vehicle .....	249
Brakes .....	224	Coolant level .....	238		
Driving off.....	225	Battery .....	240		
Parking.....	225	Windshield washer system and			
Tires .....	226	headlamp cleaning* system.....	241		
Hydroplaning.....	227	Tires and wheels.....	242		
Tire traction.....	227	Important guidelines .....	242		
Tire speed rating .....	227	Life of tire.....	243		
Winter driving instructions .....	228	Direction of rotation .....	243		
Standing water .....	229	Checking tire inflation pressure ...	243		
Passenger compartment .....	230	Rotating wheels .....	244		
Driving abroad.....	230	Winter driving .....	245		
Control and operation of		Winter tires .....	245		
radio transmitter .....	230	Block heater (Canada only) .....	246		
Catalytic converter.....	231	Snow chains.....	246		
Emission control.....	231				
Coolant temperature .....	232				

<b>Practical hints</b> .....	255	Replacing wiper blades.....	296	<b>Technical data</b> .....	315
What to do if ... ..	256	Removing.....	296	Spare parts service .....	316
Lamps in instrument cluster .....	256	Installing.....	296	Warranty coverage .....	317
Lamp in center console.....	260	Flat tire.....	297	Loss of Service and Warranty	
Messages in the display.....	261	Preparing the vehicle .....	297	Information Booklet.....	317
Where will I find ...? .....	279	Mounting the spare wheel .....	297	Identification labels .....	318
First aid kit.....	279	Battery.....	303	Layout of poly-V-belt drive.....	319
Vehicle tool kit.....	279	Disconnecting the battery.....	304	C 230 Kompressor Sport.....	319
Spare wheel .....	281	Removing the battery.....	304	C 240 / C 320 (all models).....	319
Unlocking/locking in an emergency..	285	Charging and reinstalling		C 32 AMG .....	319
Unlocking the vehicle.....	285	the battery .....	304	Engine .....	320
Locking the vehicle .....	286	Reconnecting the battery.....	305	Rims and Tires.....	322
Changing batteries.....	286	Jump starting.....	306	Same size tires .....	323
Fuel filler flap .....	287	Towing the vehicle .....	308	Mixed size tires.....	324
Manually unlocking the		Installing towing eye bolt .....	311	Spare wheel.....	325
transmission selector lever .....	288	Fuses.....	312	Electrical system .....	326
Opening/closing in an emergency.....	289	Fuse box in passenger		Main dimensions .....	327
Sliding/pop-up roof* .....	289	compartment .....	312	Weights .....	328
Replacing bulbs .....	290	Fuse box in engine			
Bulbs.....	290	compartment .....	312		
Replacing bulbs for front lamps ...	292	Auxiliary fuse box in trunk.....	313		
Side marker lamp bulb.....	294				
Replacing bulbs for rear lamps.....	295				

## Contents

Fuels, coolants, lubricants etc. ....	329	
Capacities .....	329	<b>Technical terms</b> ..... 341
Engine oils.....	332	
Engine oil additives .....	332	
Air conditioning refrigerant .....	332	<b>Index</b> ..... 347
Brake fluid.....	332	
Premium unleaded gasoline .....	333	
Fuel requirements .....	333	
Gasoline additives .....	334	
Flexible Fuel Vehicles .....	334	
Coolants.....	336	
Windshield washer and headlamp cleaning* system.....	338	
Consumer information .....	339	
Uniform tire quality grading.....	339	



## Product information

Please observe the following in your own best interest:

We recommend using Mercedes-Benz original parts as well as conversion parts and accessories explicitly approved by us for your vehicle model.

We have tested these parts to determine their reliability, safety and their special suitability for Mercedes-Benz vehicles.

We are unable to make an assessment for other products and therefore cannot be held responsible for them, even if in individual cases an official approval or authorization by governmental or other agencies should exist. Use of such parts and accessories could adversely affect the safety, performance or reliability of your vehicle. Please do not use them.

Mercedes-Benz original parts as well as conversion parts and accessories approved by us are available at your authorized Mercedes-Benz Center where you will receive comprehensive information, also on permissible technical modifications, and where proper installation will be performed.

### Operator's Manual

#### Operator's Manual

This Operator's Manual contains a great deal of useful information. We urge you to read it carefully and familiarize yourself with the vehicle before driving.

For your own safety and longer service life of the vehicle, we urge you to follow the instructions and warnings contained in this manual. Ignoring them could result in damage to the vehicle or personal injury to you or others. Vehicle damage caused by failure to follow instructions is not covered by the Mercedes-Benz Limited Warranty.

Your vehicle may have some or all of the equipment described in this manual. Therefore, you may find explanations for optional equipment not installed in your vehicle. If you have any questions about the operation of any equipment, your authorized Mercedes-Benz Center will be glad to demonstrate the proper procedures.

We continuously strive to improve our product, and ask for your understanding that we reserve the right to make changes in design and equipment. Therefore, information, illustrations and descriptions in this Operator's Manual might differ from your vehicle.

Optional equipment is also described in this manual, including operating instructions wherever necessary. Since they are special-order items, the descriptions and illustrations herein may vary slightly from the actual equipment of your vehicle.

If there are any equipment details that are not shown or described in this Operator's Manual, your authorized Mercedes-Benz Center will be glad to inform you of correct care and operating procedures.

The Operator's Manual and Service Booklet are important documents and should be kept with the vehicle.

### Service and warranty information

The Service and Warranty Information Booklet contains detailed information about the warranties covering your Mercedes-Benz, including:

- New Car Limited Warranty
- Emission System Warranty
- Emission Performance Warranty
- California, Maine, Massachusetts, and Vermont Emission Control System Warranty (California, Maine, Massachusetts, and Vermont only)
- State Warranty Enforcement Laws (Lemon Laws)

### **Important notice for California retail buyers and lessees of Mercedes-Benz automobiles**

Under California law you may be entitled to a replacement of your vehicle or a refund of the purchase price or lease price, if Mercedes-Benz USA, LLC and / or its authorized repair or service facilities fail to fix one or more substantial defects or malfunctions in the vehicle that are covered by its express warranty after a reasonable number of repair attempts. During the period of 18 months from original delivery of the vehicle or the accumulation of 18 000 miles (approx. 29 000 km) on the odometer of the vehicle, whichever occurs first, a reasonable number of repair attempts is presumed for a retail buyer or lessee if one or more of the following occurs:

- (1) the same substantial defect or malfunction results in a condition that is likely to cause death or serious bodily injury if the vehicle is driven, that defect or malfunction has been subject to repair two or more times, and you have directly notified Mercedes-Benz USA, LLC in writing of the need for its repair,
- (2) the same substantial defect or malfunction of a less serious nature than category (1) has been subject to repair four or more times and you have directly notified us in writing of the need for its repair, or
- (3) the vehicle is out of service by reason of repair of the same or different substantial defects or malfunctions for a cumulative total of more than 30 calendar days. Written notification should be sent to us, not a dealer, at Mercedes-Benz USA, LLC, Customer Assistance Center, One Mercedes Drive, Montvale, NJ 07645-0350.

### Maintenance

---

The Service Booklet describes all the necessary maintenance work which should be performed at regular intervals.

Always have the Service Booklet with you when you take the vehicle to your authorized Mercedes-Benz Center for service. The service advisor will record each service in the booklet for you.

### Roadside Assistance

---

The Mercedes-Benz Roadside Assistance Program provides factory-trained technical help in the event of a breakdown. Calls to the toll-free Roadside Assistance number

**1-800-FOR-MERCEdes (in the USA)**  
**1-800-387-0100 (in Canada)**

will be answered by Mercedes-Benz Customer Assistance Representatives 24 hours a day, 365 days a year.

For additional information refer to the Mercedes-Benz Roadside Assistance Program brochure in your glove box.

### Change of address or ownership

---

If you change your address, be sure to send in the "Change of Address Notice" found in the Service and Warranty Information Booklet, or simply call the Mercedes-Benz Customer Assistance Center (in the USA) at 1-800-FOR-MERCEdes, or Customer Service (in Canada) at 1-800-387-0100. It is in your own interest that we can contact you should the need arise.

If you sell your Mercedes, please leave all literature with the vehicle to make it available to the next operator.

If you bought this vehicle used, be sure to send in the "Notice of Purchase of Used Car" found in the Service and Warranty Information Booklet, or call the Mercedes-Benz Customer Assistance Center (in the USA) at 1-800-FOR-MERCEdes, or Customer Service (in Canada) at 1-800-387-0100.

## Operating your vehicle outside the USA or Canada

---

If you plan to operate your vehicle in foreign countries, please be aware that

- service facilities or replacement parts may not be readily available.
- unleaded gasoline for vehicles with catalytic converters may not be available; the use of leaded fuels will damage the catalyts.
- gasoline may have a considerably lower octane rating, and improper fuel can cause engine damage.

Certain Mercedes-Benz models are available for delivery in Europe under our European Delivery Program. For details, consult your authorized Mercedes-Benz Center or write to:

- in the USA:

Mercedes-Benz USA, LLC  
European Delivery Department  
One Mercedes Drive  
Montvale, NJ 07645-0350

- in Canada:

Mercedes-Benz Canada, Inc.  
European Delivery Department  
849 Eglinton Avenue East  
Toronto, Ontario M4G 2L5

### Where to find it

#### Where to find it

This Operator's Manual is designed to provide comprehensive support information for you, the vehicle operator. For you to find information quickly each section has its own reference color:

#### At a glance

Here you will find an overview of all the controls that can be operated from the driver's seat.

#### Getting started

Here you will find all the information you need for your first drive. You should read this section first if this is your first Mercedes-Benz vehicle or if you are renting or borrowing this vehicle.

#### Safety and Security

Here you will find descriptions of the safety features of your vehicle.

#### Controls in detail

Here you will find detailed information about the equipment installed in your vehicle. This section expands on the "Getting started" section and also describes technical innovations. If you are already familiar with the basic functions of your vehicle, this section will be of particular interest to you.

#### Operation

Here you will find all the information you need for the proper operation of your vehicle.

#### Practical hints

This section provides fast assistance for dealing with problems you may encounter.

#### Technical data

All important technical data for your vehicle can be found in this section.

#### Indexes

The glossary provides explanations of the most important technical terms.

The table of contents and the index are designed to help you find information quickly and easily.

The following publications are part of your vehicle documentation:

- this Operator's Manual
- the Service Booklet

Separate operating instructions will be provided as required depending on the equipment options installed in your vehicle.

## Symbols

The following symbols are found in this Operator's Manual:

- \* Optional equipment is identified with an asterisk. Since standard equipment varies between models, the descriptions and illustrations in this manual may differ slightly from the actual equipment of your vehicle.

### Warning!



Warning notices draw your attention to hazards that may endanger your health or life, or the health or life of others.



Highlights hazards that may result in damage to your vehicle.



Helpful hints or further information you may find useful.

- ▶ This symbol points to instructions for you to follow.
- ▶ A number of these symbols appearing in succession indicates a multiple-step procedure.
- ▷ Page This symbol tells you where to look for further information on a topic.
- ▷▷ This continuation symbol marks an interrupted procedure which will be continued on the next page.
- > In the glossary of technical terms, this symbol is used to cross-reference term definitions.
- Display Words appearing in the multi-function display are printed in the type shown here.

### Operating safety

### Operating safety

#### Warning!



Work improperly carried out on electronic components and associated software could cause them to cease functioning. Because the vehicle's electronic components are interconnected, any modification made may produce an undesired effect on other systems.

Electronic system malfunctions could seriously impair the operating safety of your vehicle.

Ensure that any repairs or modifications to electronic components are carried out by an authorized Mercedes-Benz Center.

Other improper work or modifications on the vehicle could also have a negative impact on the operating safety of the vehicle.

Some safety systems only function while the engine is running. You should therefore never turn off the engine while driving.

### Proper use of the vehicle

---

Proper use of the vehicle requires that you are familiar with the following information and rules:

- the safety precautions in this manual
- the “Technical data” section in this manual
- traffic rules and regulations
- motor vehicle laws and safety standards



**Problems with your vehicle**

If you should experience a problem with your vehicle, particularly one that you believe may affect its safe operation, we urge you to immediately contact your authorized Mercedes-Benz Center to have the problem diagnosed and corrected if required. If the matter is not handled to your satisfaction, please discuss the problem with the Mercedes-Benz Center management, or if necessary contact us at one of the following addresses:

In the USA:

Customer Assistance Center  
Mercedes-Benz USA, LLC  
One Mercedes Drive  
Montvale, NJ 07645-0350

In Canada:

Customer Relations Department  
Mercedes-Benz Canada, Inc.  
849 Eglinton Avenue East  
Toronto, Ontario, M4G 2L5

### **Reporting safety defects**

#### **Reporting safety defects**

For the USA only:

The following text is published as required of manufacturers under Title 49, Code of U.S. Federal Regulations, Part 575 pursuant to the “National Traffic and Motor Vehicle Safety Act of 1966”.

#### **Reporting Safety Defects**

---

If you believe that your vehicle has a defect which could cause a crash or could cause injury or death, you should immediately inform the National Highway Traffic Safety Administration (NHTSA) in addition to notifying Mercedes-Benz USA, LLC.

If NHTSA receives similar complaints, it may open an investigation, and if it finds that a safety defect exists in a group of vehicles, it may order a recall and remedy campaign. However, NHTSA cannot become involved in individual problems between you, your dealer, or Mercedes-Benz USA, LLC.

To contact NHTSA, you may either call the Auto Safety Hotline toll-free at 1-888-327-4236 (or 366-0123 in Washington, D.C. area) or write to: NHTSA, U.S. Department of Transportation, Washington, D.C. 20590. You can also obtain other information about motor vehicle safety from the Hotline.

## At a glance

Cockpit

Instrument cluster

Multifunction steering wheel

Center console

Overhead control panel

Door control panel



Cockpit

Cockpit

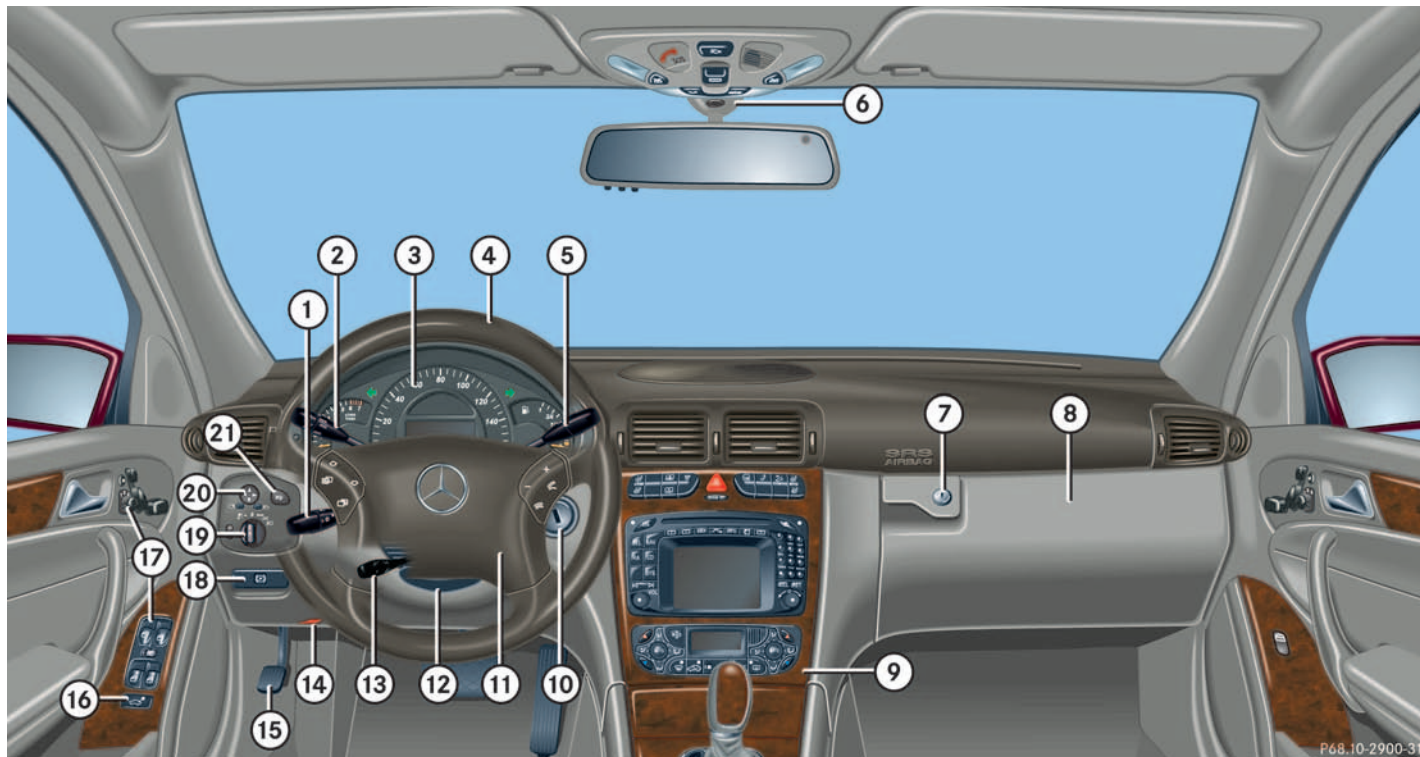

P68.10-2900-31

Item	Page
<b>1</b> Combination switch	
• Turn signals	47
• Windshield wipers	48
• High beam	47
<b>2</b> Cruise control lever	193
<b>3</b> Instrument cluster	22, 107
<b>4</b> Multifunction steering wheel	24, 112
<b>5</b> Lever for voice control system*, see separate operating instructions	

Item	Page
<b>6</b> Overhead control panel	27
<b>7</b> Glove box lid release, glove box lock	203
<b>8</b> Glove box	203
<b>9</b> Center console	25
<b>10</b> Starter switch	31
<b>11</b> Horn	
<b>12</b> Steering wheel adjustment handle (manual)	37
<b>13</b> Steering wheel adjustment stalk (electrical)*	38



Item	Page
<b>14</b> Hood lock release	235
<b>15</b> Parking brake pedal	45, 51
<b>16</b> Trunk lid release switch	88
<b>17</b> Door control panel	28
<b>18</b> Parking brake release	45
<b>19</b> Exterior lamp switch	101
<b>20</b> Exterior rear view mirror adjustment	39
<b>21</b> Headlamp washer switch*	146



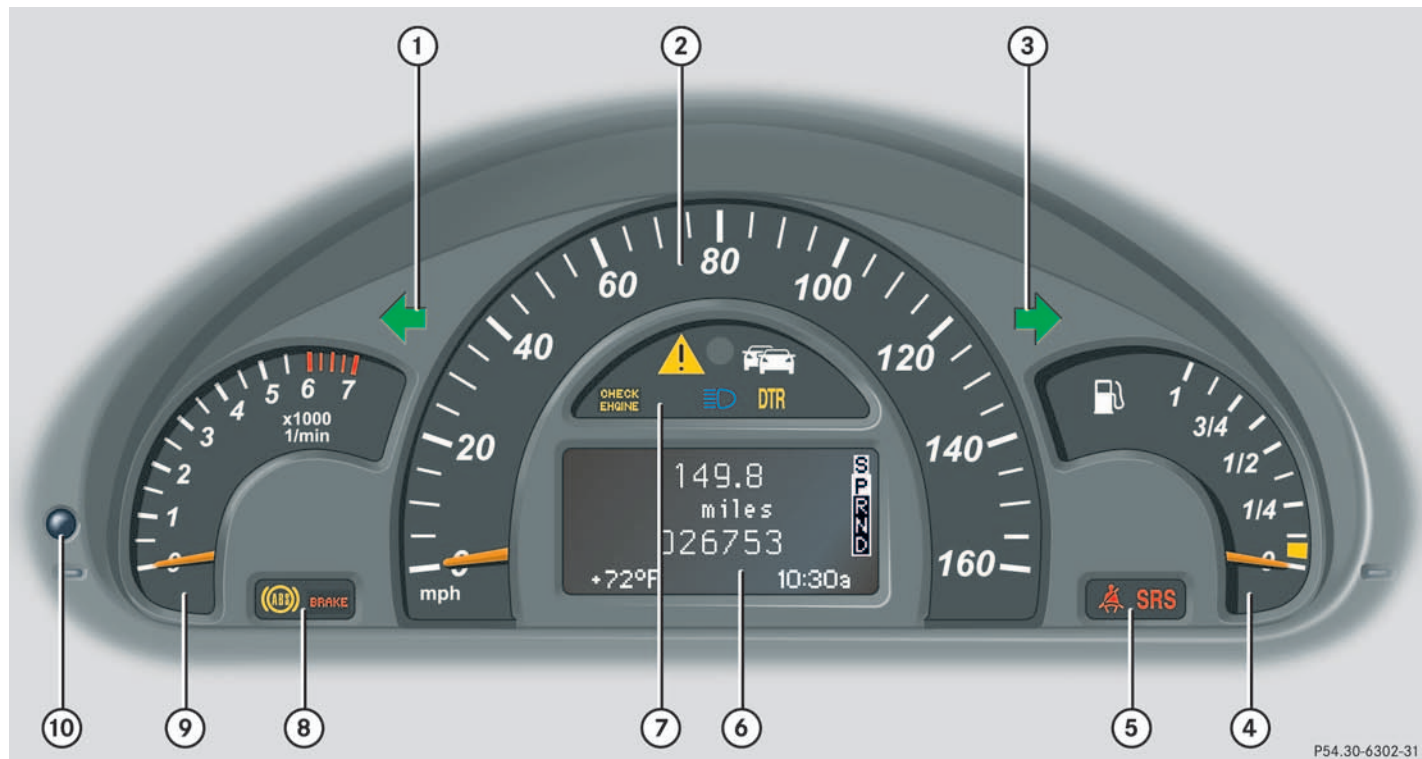

Instrument cluster

Instrument cluster





P54.30-6302-31

Item	Page
1 Turn signal indicator lamp, left	47
2 Speedometer	
3 Turn signal indicator lamp, right	47
<b>4 Fuel gauge with:</b>	
Fuel reserve warning lamp	259
5  Seat belt nonusage warning lamp	61, 259
 Supplemental restraint system indicator lamp	56, 257
<b>6 Multifunction display with:</b>	111
Trip odometer	109
Main odometer	111

Item	Page
Selector lever position	140, 141
Program mode	142
Outside temperature display	110
Digital clock	111
7  Engine malfunction indicator lamp	259
 Electronic Stability Program (ESP) warning lamp	75, 256
 High beam headlamp indicator	47, 104
 Indicator lamp without function <sup>1</sup>	
<b>DTR</b> Indicator lamp without function <sup>1</sup>	

<sup>1</sup> The indicator lamp illuminates briefly when you turn the key in the starter switch to position 2.





Item	Page
8  Antilock Brake System (ABS) malfunction indicator lamp	73, 257
 Brake warning lamp, USA only	45, 51, 258
 Brake warning lamp, Canada only	45, 51, 258
9 Tachometer	109
<b>10 Reset knob for:</b>	
• Resetting trip odometer	109
• Resetting individual settings	120
• Instrument cluster illumination	107

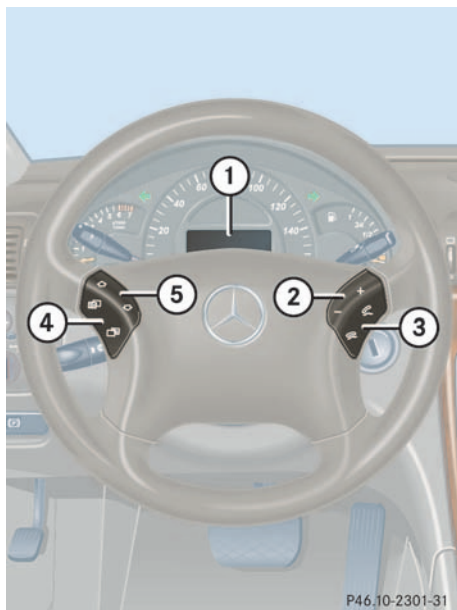



## Multifunction steering wheel

## Multifunction steering wheel



P46.10-2301-31

Item	Page
1 Multifunction display in speedometer	111
<b>Operating control system</b>	111
2 Selecting the submenu or setting the volume	
 down/to decrease	
 up/to increase	
3 Telephone*: Press button	
 to take a call	
 to end a call	

Item	Page
4 Menu systems: Press button	
 for next system	
 for previous system	
5 Moving within a menu: Press button	
 for next display	
 for previous display	



## Center console

### Upper part

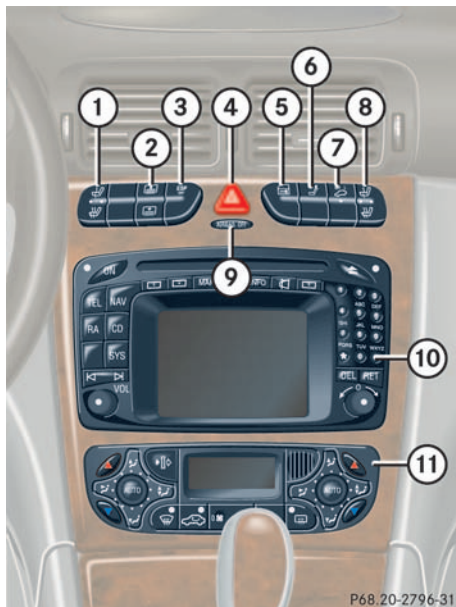

P68.20-2796-31

Item	Page
1 Seat heater*, driver's side	97
2 Rear window sunshade switch	147
3 ESP control switch	75
4 Hazard warning flasher switch - switching on/off	104
5 Central locking switch	92
6 Rear seat head restraints switch	36
7 Anti-theft alarm system indicator lamp	79
Tow-away alarm switch	80

Item	Page
8 Seat heater*, passenger side	97
9 Indicator lamp 	67, 260
10 Audio system, or COMAND* (see separate operating instructions)	165
11 Climate control	148
Automatic climate control*	156
Rear window defroster	153, 162

## Center console

### Lower part



	Item	Page
1	Ashtray	207
2	Selector lever for automatic transmission*	44, 138
	Gearshift lever for manual transmission	44, 137
3	Storage compartment	205
	Cup holder	204
	Cigarette lighter	208
4	Armrest	206
5	Program mode selector for automatic transmission	142

## Overhead control panel



Item	Page
1 Rear interior lighting on/off	105
2 Sliding/pop-up roof*	190
3 Right reading lamp on/off	106
4 Interior lighting control	105
5 Hands-free microphone for Tele Aid* (emergency call system), telephone* and voice control system* (see separate operating instructions)	134, 182, 209
6 Rear view mirror	39, 144
7 Garage door opener	217
8 Left reading lamp on/off	106
9 Tele Aid* (emergency call system) button	209

### Door control panel

### Door control panel

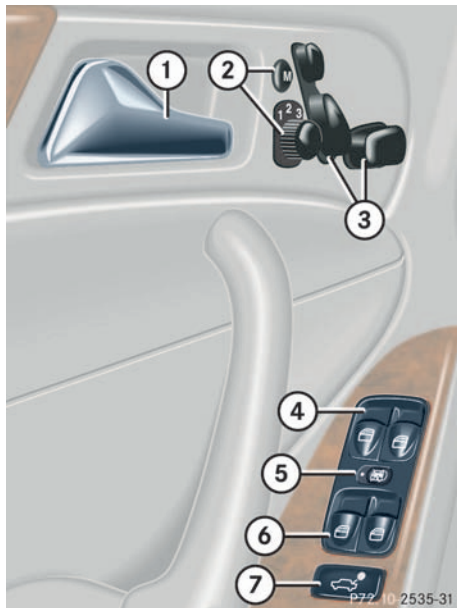

	Item	Page
1	Door handle	87
2	Memory function (for storing seat, mirror and steering wheel settings)	98
3	Seat adjustment*	32, 34, 93
4	Switches for opening/closing front door windows	187
5	Switch for rear door window override	71
6	Switches for opening/closing rear door windows	187
7	Remote trunk lid release switch	88

## Getting started

Unlocking

Adjusting

Driving

Parking and locking



### Unlocking

The “Getting started” section provides an overview of the vehicle’s most basic functions. First-time Mercedes-Benz owners should pay special attention to the information given here.



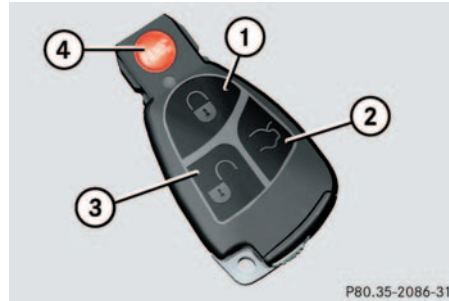

If you are already familiar with the basic functions described here, the “Controls in detail” section will help you with further information. The corresponding page references are at the end of each segment.

### Unlocking

#### Unlocking with SmartKey



#### SmartKey with remote control

- 1  Lock button
- 2  Opening button for trunk
- 3  Unlock button for doors
- 4  Panic button\* (▷ page 72)

- ▶ Press unlock button  on the key.

All turn signal lamps blink once. The locking knobs in the doors move up.

- ▶ Get in the vehicle and insert the key in the starter switch.



Canada only:  
Only vehicles equipped with an anti-theft alarm system\* have SmartKeys with integrated panic button\* 4.

More information can be found in the “Controls in detail” section (▷ page 84).

## Starter switch positions

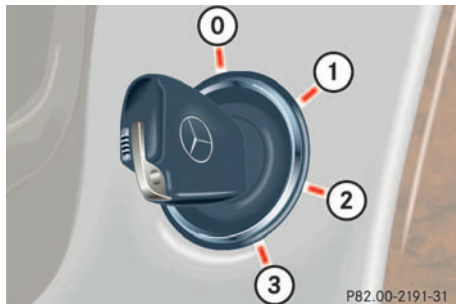

### Starter switch

#### 0 For removing key

The steering is locked when the key is removed from the starter switch. If necessary, move steering wheel slightly to allow the locking mechanism to engage.

#### 1 Power supply to some electrical consumers, such as seat adjustment

#### 2 Ignition (power supply for all electrical consumers) and driving position

#### 3 Starting position

### Warning!



When leaving the vehicle, always remove the SmartKey from the starter switch and lock the vehicle. Do not leave children unattended in the vehicle, or with access to an unlocked vehicle. Unsupervised use of vehicle equipment may cause an accident and/or serious personal injury.



Vehicles with automatic transmission: The SmartKey can only be removed from the starter switch with the gear selector lever in position **P**.



If the key is left in starter switch position **0** for an extended period of time, it can no longer be turned in the starter switch.

- Remove the key from the starter switch and reinsert.

If the key can still not be turned, the battery may not be sufficiently charged.

- Check the battery and charge it if necessary (▷ page 240).
- Get a jump start (▷ page 306).

To prevent accelerated battery discharge and a possible dead battery, always remove the key from the starter switch.

### Adjusting Adjusting

#### Warning!



All seat, head restraint, steering wheel, and rear view mirror adjustments, as well as fastening of seat belts, must be done before the vehicle is put into motion.

#### Seats

The seats can be adjusted either manually or electrically, depending on the vehicle's equipment.

#### Warning!



Do not adjust the driver's seat while driving. Adjusting the seat while driving could cause the driver to lose control of the vehicle.

Never ride in a moving vehicle with the seat back reclined. Sitting in an excessively reclined position can be dangerous. You could slide under the seat belt in a collision. If you slide under it, the belt would apply force at the abdomen or neck.

That could cause serious or fatal injuries. The seat back and seat belts provide the best restraint when the wearer is in an upright position and belts are properly positioned on the body. Your seat must be adjusted so that you can correctly fasten your seat belt (▷ page 41).

Never place hands under the seat or near any moving parts while a seat is being adjusted.

#### Warning!



When leaving the vehicle, always remove the key from the starter switch, and lock your vehicle.

The power seats\* can also be operated with the driver's or front passenger door open. Do not leave children unattended in the vehicle, or with access to an unlocked vehicle. Unsupervised use of vehicle equipment may cause an accident and/or serious personal injury.

#### Warning!



Children 12 years old and under must never ride in the front seat, except in a Mercedes-Benz authorized BabySmart™ compatible child seat, which operates with the BabySmart™ system installed in the vehicle to deactivate the passenger side front airbag when it is properly installed. Otherwise they will be struck by the airbag when it inflates in a crash. If this happens, serious or fatal injury will result.

According to accident statistics, children are safer when properly restrained in the rear seating positions than in the front seating positions. Infants and small children must ride in back seats and be seated in an appropriate infant or child restraint system, which is properly secured with the vehicle's seat belt and top tether strap, or secured via lower anchors and top tether strap, fully in accordance with the child seat manufacturer's instructions.



A child's risk of serious or fatal injuries is significantly increased if the child restraints are not properly secured in the vehicle and the child is not properly secured in the child restraint.

### Manual seat

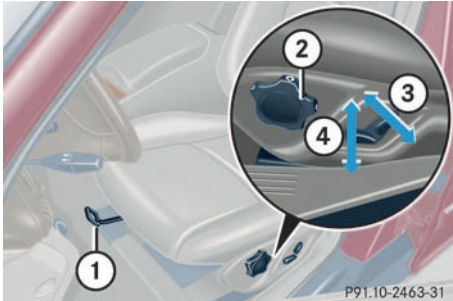

- 1 Seat fore and aft adjustment
- 2 Seat cushion tilt
- 3 Backrest tilt
- 4 Seat height

### Seat fore and aft adjustment

- ▶ Lift handle **1**.
- ▶ Slide seat to the desired position.
- ▶ Allow handle **1** to reengage.
- ▶ Check for proper engagement before driving.

Adjust to a comfortable seating position that still allows you to reach the accelerator/brake pedal safely. The position should be as far rearward as possible, consistent with ability to properly operate controls.



When moving the seat, be sure that there are no items in the footwell or behind the seats. Otherwise you could damage the seats.

### Seat cushion tilt

- ▶ Turn handwheel **2** forward or backward until your upper legs are lightly supported

### Backrest tilt

- ▶ Press switch **3** in direction of arrow until your arms are slightly angled when holding the steering wheel.

### Seat height

- ▶ Press switch **4** in direction of arrow until your legs are lightly supported.

### Head restraint height

#### Warning!



For your protection, drive only with properly positioned head restraints.

Adjust head restraint to support the back of the head approximately at ear level.

Do not drive the vehicle without the seat head restraints. Head restraints are intended to help reduce injuries during an accident.

### Adjusting

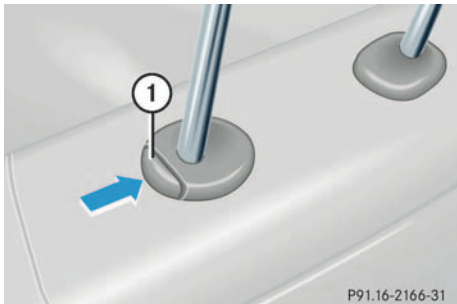

#### 1 Release knob

- ▶ Manually adjust the height of the head restraint by pulling it upward. To lower the head restraint, push release knob **1** and push down on the head restraint.

#### Head restraint tilt

- ▶ Manually adjust the angle of the head restraint. Push or pull on the lower edge of the head restraint cushion.

More information can be found in the “Controls in detail” section (▷ page 93).

#### Power seat\*

- ▶ Turn the key in the starter switch to position **1** or **2**.  
or
- ▶ Open the driver’s or front passenger door.

The seat adjustment switches are located in each front door.

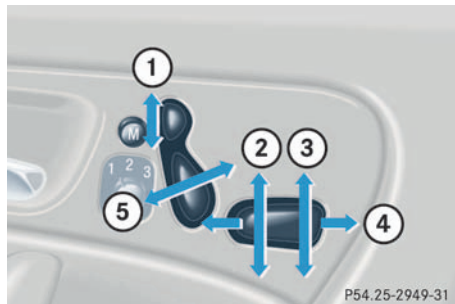

- 1 Head restraint height
- 2 Seat height
- 3 Seat cushion tilt
- 4 Seat fore and aft adjustment
- 5 Backrest tilt

#### Seat fore and aft adjustment

- ▶ Press the switch forward or backward in the direction of arrow **4**.

Adjust to a comfortable seating position that still allows you to reach the accelerator/brake pedal safely. The position should be as far rearward as possible, consistent with ability to properly operate controls.



When moving the seat, be sure that there are no items in the footwell or behind the seat. Otherwise you could damage the seat.

With the memory function\* (▷ page 98), you can store seat positions together with settings for the steering wheel and the exterior rear view mirrors.

**Seat height**

- ▶ Press the switch up or down in the direction of arrow **2**.

**Seat cushion tilt**

- ▶ Press the switch up or down in the direction of arrow **3** until your upper legs are lightly supported.

**Backrest tilt**

- ▶ Press the switch forward or back in direction of arrow **5** until your arms are slightly angled when holding the steering wheel.

**Head restraint height**

- ▶ Press the switch up or down in the direction of arrow **1**.

**Warning!**

For your protection, drive only with properly positioned head restraints.

Adjust head restraint to support the back of the head approximately at ear level.

Do not drive the vehicle without the seat head restraints. Head restraints are intended to help reduce injuries during an accident.

**Head restraint tilt**

- ▶ Manually adjust the angle of the head restraint. Push or pull on the lower edge of the head restraint cushion.

More information can be found in the “Controls in detail” section (▶ page 93).

**Rear seat head restraints**

The rear seat head restraints can be folded backward for increased visibility.

**Warning!**

For safety reasons, always drive with the rear head restraints in the upright position when the rear seats are occupied.

Keep the area around head restraints clear of articles (e.g. clothing) to not obstruct the folding operation of the head restraints.



The center rear seat head restraint cannot be adjusted.

### Adjusting

#### *Folding head restraints back in the rear passenger compartment*

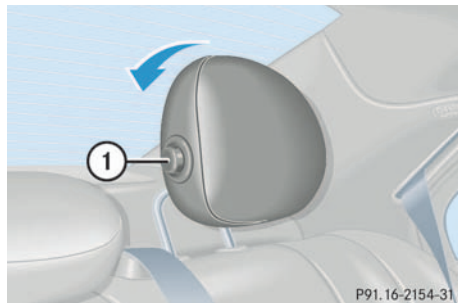

**1** Lock button

- ▶ Push lock button **1**.  
The head restraints will fold backward.



You can also fold the head restraints back using the switch in the center console (▷ page 36).

#### *Folding head restraints back with switch in the center console*



**1** Releasing head restraints

- ▶ Turn the key in starter switch to position **1** or **2**.
- ▶ Press the symbol-side on the rocker switch **1** to release the head restraints.  
The head restraints will fold backward.

#### *Placing head restraints upright*

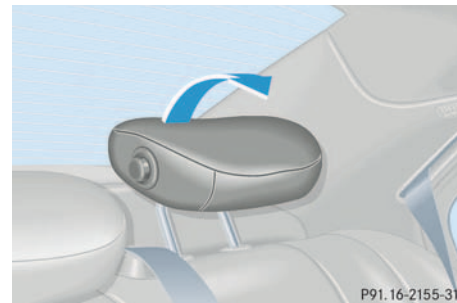

- ▶ Pull the head restraint forward until it locks into position.

#### *Head restraint tilt*

Two different head restraint angle positions are available.

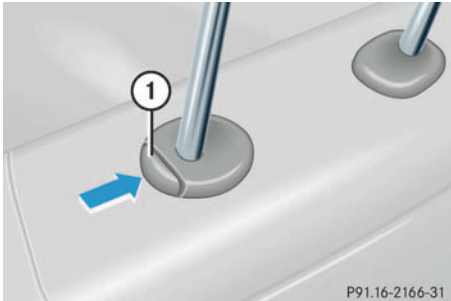
**Head restraint height (rear outer seats)**

Raising:

- ▶ Pull up on head restraint.

Lowering:

- ▶ Push button 1.
- ▶ Push down on head restraint.

**Warning!**

For your protection, drive only with properly positioned head restraints.

Adjust head restraint to support the back of the head approximately at ear level.

**Steering wheel****Warning!**

Do not adjust the steering wheel while driving. Adjusting the steering wheel while driving, or driving without the adjustment locked could cause the driver to lose control of the vehicle.

When leaving the vehicle always remove the key from the starter switch and lock your vehicle.

The electrical steering wheel adjustment feature\* can also be operated with the driver's door open. Do not leave children unattended in the vehicle, or with access to an unlocked vehicle. Unsupervised use of vehicle equipment may cause an accident and/or serious personal injury.

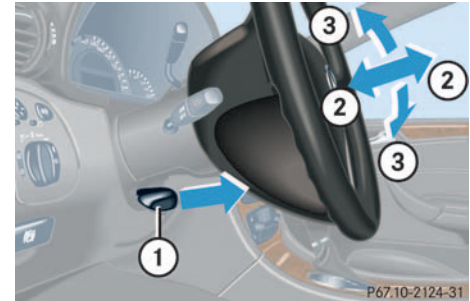
**Steering wheel adjustment, manual**

- 1 Release lever
- 2 Steering column, lengthen or shorten
- 3 Steering column, height

- ▶ To unlock the steering column, pull lever 1 out until its stop limit.
- ▶ Adjust the steering wheel to the desired position.
- ▶ To lock, press lever 1 all the way in until it engages.

The steering wheel is once again locked into position.

### Adjusting



Do not drive the vehicle until you have properly locked the steering column.

If the warning message **STEERING WHEEL ADJUST - LOCK !** is displayed while the engine is running, the steering column is not locked properly (> page 276).

#### Steering wheel adjustment, electrical\*

The stalk is located on the steering column (lower left).



- 1 Steering column, lengthen or shorten
- 2 Steering column, height

- ▶ Turn the key in the starter switch to position **1** or **2**.  
or
- ▶ Open the driver's door.

#### Steering column, lengthen or shorten

- ▶ Move stalk forward or backward in the direction of arrow **1** until a comfortable steering wheel position is reached with your arms slightly bent at the elbow.

#### Steering column, height

- ▶ Move stalk up or down in the direction of arrow **2**. Make sure that your legs can move freely and that all the displays (including malfunction and indicator lamps) on the instrument cluster are clearly visible.



With the memory function\* (> page 98), you can store steering wheel positions together with settings for the seats and the exterior rear view mirrors.

## Mirrors

Adjust the inside and exterior rear view mirrors before driving so that you have a good view of the road and traffic conditions.

### Warning!



In the case of an accident liquid electrolyte may escape the mirror housing if the mirror glass breaks.

Electrolyte has an irritating effect. Do not allow the liquid to come into contact with eyes, skin, clothing, or respiratory system. In case it does, immediately flush affected area with water, and seek medical help if necessary.

### Inside rear view mirror

- ▶ Manually adjust the inside rear view mirror.

More information can be found in the “Controls in detail” section (▷ page 144).

### Exterior rear view mirror

### Warning!



Exercise care when using the passenger side exterior rear view mirror. The mirror surface is convex (outwardly curved surface for a wider field of view). Objects in mirror are closer than they appear. Check your inside rear view mirror or glance over your shoulder before changing lanes.



Electrolyte drops coming into contact with the vehicle paint finish can only be completely removed while in their liquid state by applying plenty of water.

The buttons are located above the exterior lamp switch.

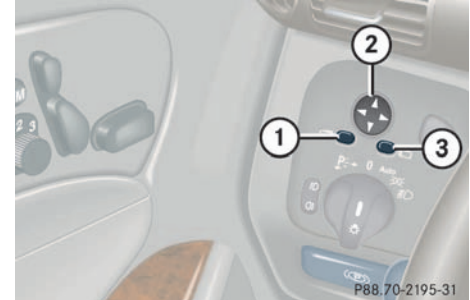

- 1 Driver's side mirror
- 2 Adjustment button
- 3 Passenger side mirror

- ▶ Make sure that the ignition is switched on.

All the lights in the instrument cluster light up.



### Adjusting

- ▶ Press button **1** for the left mirror or button **3** for the right mirror.
- ▶ Push adjustment button **2** up, down, left or right according to the setting desired.



If an exterior rear view mirror housing is forcibly pushed forward or backward, reposition it by applying firm pressure until it snaps into place. The mirror housing is now properly positioned and you can adjust the mirror normally.



With the memory function\* (▷ page 98), you can store exterior rear view mirror positions together with settings for the seats and the steering wheel.

More information can be found in the “Controls in detail” section (▷ page 144).



## Driving

### Warning!



Do not lay any objects in the driver's footwell. Be careful that floor mats or carpets in the driver's footwell have sufficient clearance for the pedals.

During sudden driving or braking maneuvers the objects could get caught between the pedals. You could then no longer brake or accelerate.

### Fastening the seat belt

### Warning!



Always fasten your seat belt before driving off. Always make sure your passengers are properly restrained, even those sitting in the rear and pregnant women.

Failure to wear and properly fasten and position your seat belt greatly increases your risk of injuries and their likely severity in an accident. You and your passenger should always wear seat belts.

If you are ever in an accident, your injuries can be considerably more severe without your seat belt properly buckled. Without your seat belt buckled, you are much more likely to hit the interior of the vehicle or be ejected from it. You can be seriously injured or killed.

In the same crash, the possibility of injury or death is lessened if you are wearing your seat belt. The airbags can only protect as expected if the occupants are using their seat belts (▷ page 61).

### Warning!



Children 12 years old and under must never ride in the front seat, except in a Mercedes-Benz authorized BabySmart™ compatible child seat, which operates with the BabySmart™ system installed in the vehicle to deactivate the passenger side front airbag when it is properly installed. Otherwise they will be struck by the airbag when it inflates in a crash. If this happens, serious or fatal injury will result.

According to accident statistics, children are safer when properly restrained in the rear seating positions than in the front seating positions. Infants and small children must ride in back seats and be seated in an appropriate infant or child restraint system, which is properly secured with the vehicle's seat belt and top tether strap, or secured via lower anchors and top tether strap, fully in accordance with the child seat manufacturer's instructions.

A child's risk of serious or fatal injuries is

### Driving

significantly increased if the child restraints are not properly secured in the vehicle and the child is not properly secured in the child restraint.

#### Warning!



Never ride in a moving vehicle with the seat backrest reclined. Sitting in an excessively reclined position can be dangerous. You could slide under the seat belt in a collision. If you slide under it, the belt would apply force at the abdomen or neck. That could cause serious or even fatal injuries. The seat backrest and seat belt provide the best restraint when the wearer is in an upright position and the belt is properly positioned on the body.

#### Warning!



Never let more people ride in the vehicle than there are seat belts available. Be sure everyone riding in the vehicle is correctly restrained with a separate seat belt - even those in the rear.

#### Warning!



Read and observe the additional warning notices printed in the “Safety and Security” section (▷ page 61).

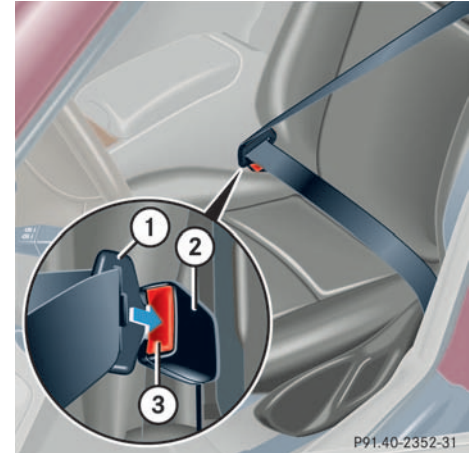

- 1 Latch plate
- 2 Buckle
- 3 Release button

- ▶ With a smooth motion, pull the belt from the belt outlet.
- ▶ Place the belt over your shoulder.
- ▶ Push latch plate **1** into buckle **2** until it clicks.



- ▶ If necessary, tighten the lap portion to a snug fit by pulling shoulder portion up.

### Seat belt height adjustment

Adjust seat belt so that shoulder portion is located as close as possible to the middle of your shoulder (it should not touch the neck).

### Front seats

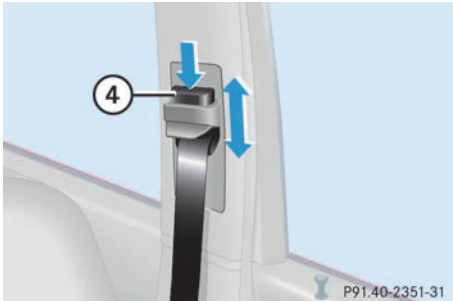

**4** Button for belt outlet height adjustment

- ▶ Press button **4** and slide belt outlet upward or downward.

### Proper use of seat belts

- Do not twist the belt when fastening.
- Adjust seat belt so that the shoulder portion is located as close as possible to the middle of the shoulder (it should not touch the neck or pass under the arm). For this purpose, you can adjust the height of the belt outlet.
- Position the lap belt as low as possible on your hips (over hip joint) and not across the abdomen.
- Place the seat backrest in a nearly upright position.
- Never use a seat belt for more than one person at a time.
- Do not fasten a seat belt around a person and another object at the same time.
- Check your seat belt during travel to ensure that it is properly positioned.

- Ensure that the seat belt is always fitted snugly. You should avoid wearing bulky clothing, such as winter coats, when traveling in the vehicle.

### Warning!



Do not pass belts over sharp edges. They could tear.

Do not allow the belt to get caught in the door or in the seat adjustment mechanism. This could damage the belt.

Never attempt to make modifications to seat belts. This could impair the effectiveness of the belts.

Damaged seat belts or belts that were highly stressed in an accident must be replaced by an authorized Mercedes-Benz Center.

### Starting the engine

#### Warning!



Inhalation of exhaust gas is hazardous to your health. All exhaust gas contains carbon monoxide, and inhaling it can cause unconsciousness and lead to death.

Do not run the engine in confined areas (such as garage) which are not properly ventilated. If you think that exhaust gas fumes are entering the vehicle while driving, have the cause determined and corrected immediately. If you must drive under these conditions, drive only with at least one window fully open.

### Manual transmission

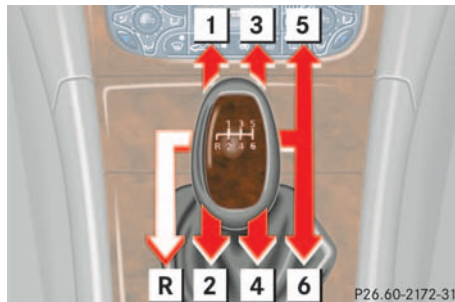

#### Gearshift pattern for manual transmission

- ▶ Make sure that the gearshift lever is in Neutral position.
- ▶ Do not depress accelerator.
- ▶ Fully depress clutch pedal.

Otherwise the engine cannot be started due to the integrated safety interlock.

- ▶ Turn the key in the starter switch to position **3**. Release only when the engine is firing regularly (▷ page 31).

More information can be found in the “Controls in detail” section (▷ page 137).

### Automatic transmission\*



#### Gearshift pattern for automatic transmission

- P** Park position with selector lever lock
- R** Reverse gear
- N** Neutral
- D** Drive position

- ▶ Make sure that the gear selector lever is set to **P**.
- ▶ Do not depress accelerator.
- ▶ Turn the key in the starter switch to position **3**. Release only when the engine is firing regularly (▷ page 31).



**i**

You can also use the “touch-start” function. Turn the key to position **3** and release it again immediately. The engine then starts automatically.

- ▶ Depress the brake pedal.

The selector lever lock is released.

More information can be found in the “Controls in detail” section (▷ page 138).

For information on turning off the engine, see “Turning off engine” (▷ page 53).

**Starting difficulties**

If the engine does not start as described, carry out the following steps:

- ▶ Turn key in starter to position **0** and repeat starting procedure (▷ page 44).
- ▶ Remember that extended starting attempts can drain the battery.
- ▶ Get a jump start (▷ page 306).

If the engine does not start after several starting attempts, there could be a malfunction in the engine electronics or in the fuel supply system.

- ▶ Notify an authorized Mercedes-Benz Center.

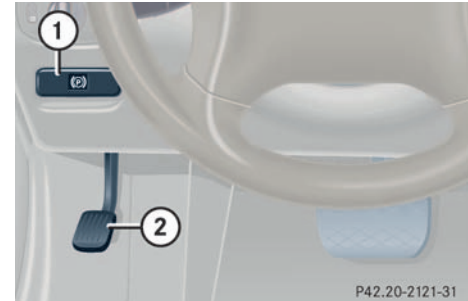
**Parking brake**



- 1 Release handle
- 2 Parking brake

**Warning!**

When leaving the vehicle, always remove the key from the starter switch and lock the vehicle. Do not leave children unattended in the vehicle, or with access to an unlocked vehicle. Children could release the parking brake, which could result in an accident and/or serious injury.

### Driving

- ▶ Release the parking brake by pulling on handle **2**.

The indicator lamp  (USA only) or  (Canada only) in the instrument cluster goes out.

### Driving

- ▶ Depress the brake pedal.
- ▶ Move selector lever to position **D** or **R** (manual transmission: first or reverse gear).



Vehicles with automatic transmission: Wait for the gear selection process to complete before setting the vehicle in motion.

- ▶ Release the brake pedal.
- ▶ Carefully depress the accelerator.  
Once the vehicle is in motion, the automatic central locking system engages and the locking knobs drop down.



You can open a locked door from the inside. Open door only when conditions are safe to do so.



Simultaneously depressing the accelerator pedal and applying the brake reduces engine performance and causes premature brake and drivetrain wear.



If you hear a warning signal when driving off, you have forgotten to release the parking brake.

Release the parking brake.

After a cold start, the automatic transmission engages at a higher revolution. This allows the catalytic converter to reach its operating temperature earlier.

### Warning!



On slippery road surfaces, never downshift in order to obtain braking action. This could result in drive wheel slip and reduced vehicle control. Your vehicle's ABS will not prevent this type of loss of control.

### Warning!



Vehicles with automatic transmission: It is dangerous to shift the selector lever out of **P** or **N** if the engine speed is higher than idle speed. If your foot is not firmly on the brake pedal, the vehicle could accelerate quickly forward or in reverse. You could lose control of the vehicle and hit someone or something. Only shift into gear when the engine is idling normally and when your right foot is firmly on the brake pedal.

More information on driving can be found in the "Operation" section (> page 223).

## Switching on headlamps



### Exterior lamp switch

- 1 Off
- 2 Low beam headlamps on

► Turn the switch to .

More information can be found in the "Controls in detail" section (► page 101).

## Turn signals and high beam

The combination switch is on the left of the steering column.

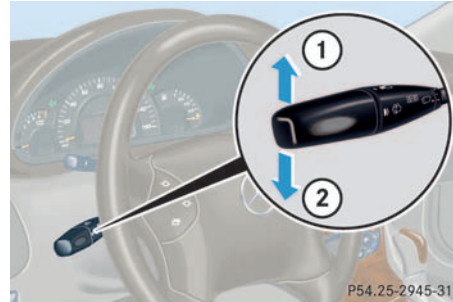

### Combination switch

- 1 Turn signals, right
- 2 Turn signals, left

► Press the combination switch up **1** or down **2**.



To signal minor directional changes, move combination switch to point of resistance only and release. The turn signal blinks three times.

### High beam

► Push the combination switch forward.

The high beam symbol  in the instrument cluster lights up.

More information can be found in the "Controls in detail" section (► page 104).

#### Windshield wipers

The combination switch is on the left of the steering column.



#### Combination switch

- 1 Single wipe
- 2 Switching on windshield wipers

- ▶ Make sure that the ignition is switched on.

#### Switching on windshield wipers

- ▶ Turn the combination switch to the desired position depending on the intensity of the rain.

- 0 Windshield wipers off
- I Intermittent wiping
- II Normal wiper speed
- III Fast wiper speed



Vehicles without rain sensor\*:  
Fast wiper speed III goes to setting II when the vehicle is standing still.

Vehicles with rain sensor\*:  
Intermittent wiping interval dependent on wetness of windshield. Wiping will not occur with a front door open.



Vehicles with rain sensor\*:  
Do not leave in intermittent setting when vehicle is taken to an automatic car wash or during windshield cleaning. Wipers will operate in presence of water sprayed on the windshield, and wipers may be damaged as a result.

The switch should not be left in intermittent setting as the wipers will wipe the windshield once every time the engine is started. Dust that accumulates on the windshield might scratch the glass when wiping occurs on a dry windshield.



### Single wipe

- ▶ Press switch briefly in the direction of arrow 1.

The windshield wipers wipe one time without washer fluid.

### Wiping with windshield washer fluid

- ▶ Press switch in the direction of arrow 1 past the resistance point.

The windshield wiper operates with washer fluid.

Information on filling up the washer reservoir can be found in the “Operation” section (▶ page 241).



If leaves, snow, etc. block the windshield wipers, switch off the wipers.

- For safety reasons, withdraw key from starter switch. Remove blockage.
- Turn the windshield wipers on again.

If windshield wipers fail to function at all in switch position I,

- set the combination switch to the next highest wiper speed.
- have the windshield wipers checked at the nearest authorized Mercedes-Benz Center.

### Problems while driving

---

#### The engine runs erratically and misfires

- An ignition cable may be damaged.
  - The engine electronics may not be operating properly.
  - Unburned gasoline may have entered the catalytic converter and damaged it.
- ▶ Give very little gas.
  - ▶ Have the problem repaired by an authorized Mercedes-Benz Center as soon as possible.

#### **The coolant temperature is over 248°F (120°C)**

The coolant is too hot and is no longer cooling the engine.

- ▶ Stop the vehicle as soon as possible and turn off the engine. Allow engine and coolant to cool.
- ▶ Check the coolant level and add coolant if necessary (▷ page 238).

#### **In case of accident**

If the vehicle is leaking gasoline:

- ▶ Do not start the engine under any circumstances.
- ▶ Notify local fire and/or police authorities.

If the extent of the damage cannot be determined:

- ▶ Notify an authorized Mercedes-Benz Center.

If no damage can be determined on the

- major assemblies
  - fuel system
  - engine mount:
- ▶ Start the engine in the usual manner.

## Parking and locking

You have now completed your first drive. You have properly stopped and parked your vehicle. End your drive as follows.

### Warning!



Wait until the vehicle is stationary before removing the key from the starter switch. The vehicle cannot be steered when the key is removed.

### Warning!



With the engine not running, there is no power assistance for the brake and steering system. In this case, it is important to keep in mind that a considerably higher degree of effort is necessary to stop or steer the vehicle.

### Warning!



Do not park this vehicle in areas where combustible materials such as grass, hay or leaves can come into contact with the hot exhaust system, as these materials could be ignited and cause a vehicle fire.

To reduce the risk of personal injury as a result of vehicle movement, before turning off the engine and leaving the vehicle always:

- Keep right foot on brake pedal.
- Firmly depress parking brake pedal.
- Move the selector lever to position **P** (manual transmission: first or reverse gear).
- Slowly release brake pedal.
- When parked on an incline, turn front wheels towards the road curb.
- Turn the key to starter switch position **0** and remove.
- Take the key and lock vehicle when leaving.

## Parking brake

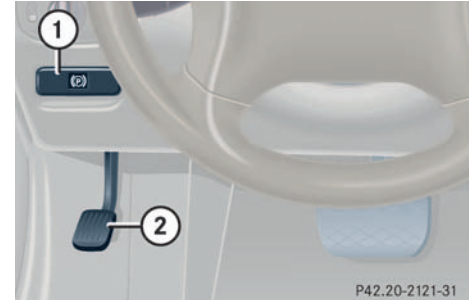

- 1 Release handle
- 2 Parking brake

- ▶ Step firmly on parking brake **2**.

When the engine is running, the indicator lamp **BRAKE** (USA only) or  (Canada only) in the instrument cluster will be illuminated.

#### Warning!



When leaving the vehicle, always remove the key from the starter switch and lock the vehicle. Do not leave children unattended in the vehicle, or with access to an unlocked vehicle. Children could release the parking brake and/or move the gear selector lever from position **P**, either of which could result in an accident and/or serious injury.

#### Warning!



Getting out of your vehicle with the selector lever not fully engaged in position **P** is dangerous. Also, when parked on an incline, position **P** alone may not prevent your vehicle from moving, possibly hitting people or objects.

Always set the parking brake in addition to shifting to position **P** (manual transmission: first or reverse gear).

When parked on an incline, turn front wheel towards the road curb.

#### Switching off headlamps

- ▶ Turn the exterior lamp switch to **0** (▷ page 47).

More information can be found in the “Controls in detail” section (▷ page 101).

## Turning off engine

- ▶ Place the gear selector lever in position **P** (manual transmission: first or reverse gear).



Always set the parking brake in addition to shifting to position **P** (manual transmission: first or reverse gear).

On steep slopes, turn the front wheels towards the road curb.

- ▶ Turn the key in the starter switch to position **0** and remove it. The immobilizer is activated.



Vehicles with automatic transmission: The SmartKey can only be removed from the starter switch with the gear selector lever in position **P**.

- ▶ Press the seat belt release button (▷ page 42).



With the SmartKey removed and the driver's door open, a warning sounds if the vehicle's exterior lamps are not switched off.

### Warning!



To prevent possible personal injury, always keep hands and fingers away from the door openings when closing the doors. Be especially careful when small children are around.

Before closing doors, make sure that there is no possibility of someone getting caught in a door during closing.

- ▶ After exiting the vehicle press the lock button  on the key (▷ page 30).

The locking knobs on the doors move down.

### Warning!



When leaving the vehicle, always remove the key from the starter switch, and lock your vehicle. Do not leave children unattended in the vehicle, or with access to an unlocked vehicle. Unsupervised use of vehicle equipment may cause an accident and/or serious personal injury.

More information can be found in the "Controls in detail" section (▷ page 84).





## **Safety and Security**

**Occupant safety**

**Panic alarm\***

**Driving safety systems**

**Anti-theft systems**

**lass**

### Occupant safety

In this section you will learn the most important facts about the restraint systems of the vehicle.

The restraint systems are

- Seat belts
- Emergency tensioning device
- Airbags
- Child seats
- Child seat recognition
- Lower anchors and tethers for children (LATCH)

As independent systems their protective effects work in conjunction with each other.



For information on infants and children traveling with you in the vehicle and restraint systems for infants and children, see “Children in the vehicle” (> page 65).

### Occupant safety

The **SRS** warning lamp in the instrument cluster (> page 22) lights up:

- for about four seconds when you turn the key in the starter switch to position **1**.
- for about four seconds when you start the engine by turning the key.



The warning lamp remains lit if the key is turned to position **2** and left there.

The warning lamp will go out when you start the engine.

The warning lamp goes out shortly after you start the engine. This shows that the restraint systems are operational.

A malfunction in the system has been detected if the **SRS** warning lamp:

- fails to extinguish after approximately four seconds.
- does not come on at all.
- comes on after the engine was started or while driving.

For safety reasons, we strongly recommend that you visit an authorized Mercedes-Benz Center immediately to have the system checked.

More information can be found in the “Practical hints” section (> page 257).



**Warning!**

In the event that the SRS malfunction indicator lamp lights up during driving or does not come on at all, the SRS may not be operational. For your safety, we strongly recommend that you visit an authorized Mercedes-Benz Center immediately to have the system checked; otherwise the SRS may not be activated when needed in an accident, which could result in serious or fatal injury, or it might deploy unexpectedly and unnecessarily which could also result in injury.

Improper work on the restraint systems, including incorrect installation and removal, can lead to possible injury through an unintended activation of the SRS.

In addition, through improper work there is a risk of rendering the SRS inoperative or causing unintended airbag deployment. Work on the SRS must therefore only be performed by an authorized Mercedes-Benz Center.

**Airbags****Warning!**

Airbags are designed to reduce the potential of injury in certain frontal (front airbags) impacts, or side (side impact and head protection window curtain airbags) impacts which may cause significant injuries. However, no system available today can totally eliminate injuries and fatalities.

The activation of the SRS temporarily releases a small amount of dust from the airbags. This dust, however, is neither injurious to your health, nor does it indicate a fire in the vehicle. The dust might cause some temporary breathing difficulty for people with asthma or other breathing trouble. To avoid this, you may wish to get out of the vehicle as soon as it is safe to do so. If you have any breathing difficulty but cannot get out of the vehicle after the airbag inflates, then get fresh air by opening a window or door.

**Warning!**

To reduce the risk of injury when the front airbags inflate, it is very important for the driver and front passenger to always be in a properly seated position and to wear your seat belts.

For maximum protection in the event of a collision always be in normal seated position with your back against the backrest. Fasten your seat belt and ensure that it is properly positioned on your body.

Since the airbag inflates with considerable speed and force, a proper seating and hands on steering wheel position will help to keep you at a safe distance from the airbag. Occupants who are unbelted, out of position or too close to the airbag can be seriously injured by an airbag as it inflates with great force in the blink of an eye:

### Occupant safety

- Sit properly belted in an upright position with your back against the seat backrest.
- Adjust the driver seat as far as possible rearward, still permitting proper operation of vehicle controls. The distance from the center of the driver's breastbone to the center of the airbag cover on the steering wheel must be at least ten inches (25 cm) or more. You should be able to accomplish this by a combination of adjustments to the seat and steering wheel. If you have any problems, please see your authorized Mercedes-Benz Center.
- Do not lean with your head or chest close to the steering wheel or dashboard.
- Keep hands on the outside of steering wheel rim. Placing hands and arms inside the rim can increase the risk and potential severity of hand/arm injury when driver front airbag inflates.
- Adjust the front passenger seat as far as possible rearward from the dashboard when the seat is occupied.

- Occupants, especially children, should never lean their heads in the area of the door where the side airbag inflates. This could result in serious injuries or death should the airbag be triggered. Always sit upright, properly use the seat belts and appropriate size infant or child restraint system.
- Children 12 years old and under must never ride in the front seat, except in a Mercedes-Benz authorized BabySmart™ compatible child seat, which operates with the BabySmart™ system installed in the vehicle to deactivate the passenger side front airbag when it is properly installed. Otherwise they will be struck by the airbag when it inflates in a crash. If this happens, serious or fatal injury will result.

Failure to follow these instructions can result in severe injuries to you or other occupants.

If you sell your vehicle you are responsible to make the buyer aware of these points. Be sure to give the buyer this Operator's Manual.

#### Warning!



Accident research shows that the safest place for children in an automobile is in the rear seat. Should you choose to place a child 12 years old or under in the front passenger seat of your vehicle, you must properly use a BabySmart™ child restraint which will turn off the passenger side front airbag. BabySmart™ will not, however, turn off any side impact airbag.

It should be noted that with respect to both front and rear side impact airbags there is a possibility for a side airbag related injury if occupants, especially children, are not properly seated or restrained when next to a side airbag which needs to deploy rapidly in a side impact in order to do its job.

To help avoid the possibility of injury, please follow these guidelines:

- (1) Occupants, especially children, should never place their bodies or lean their heads in the area of the door where the side airbag inflates. This could

result in serious injuries or death should the side airbag be activated.

- (2) Always sit upright, properly use the seat belts and use an appropriately sized infant or child restraint system for all children 12 years old or under.
- (3) Always wear seat belts properly.

If you believe that, even with the use of these guidelines, it would be safer for your rear seat occupants to have both rear door mounted side airbags deactivated, then deactivation can be accomplished upon your written request to do so at your authorized Mercedes-Benz Center at an additional cost.

Please contact your local authorized Mercedes-Benz Center or call our Customer Assistance Center at 1-800-FOR-MERCEdes (1-800-367-6372) for details.



Airbags are designed to activate only in certain frontal (front airbags) impacts, or side (side impact and head protection window curtain airbags) impacts which exceed preset thresholds.

Only during these types of impacts, if of sufficient severity to meet the deployment thresholds, will they provide their supplemental protection.

The driver and passenger should always wear their seat belts. Otherwise it is not possible for the airbags to provide their supplemental protection.

In cases of other frontal impacts, angled impacts, roll-overs, other side impacts, rear collisions, or other accidents, the airbags will not be activated. The driver and passengers will then be protected by the fastened seat belts.

We caution you not to rely on the presence of the airbags in order to avoid wearing your seat belt.

Your vehicle was originally equipped with airbags that are designed to activate in certain impacts exceeding a preset threshold to reduce the potential and severity of injury. It is important to your safety and that of your passenger that you replace deployed airbags and repair any malfunctioning airbags to ensure that the vehicle will continue to provide supplemental crash protection for occupants.

#### **Safety guidelines for the seat belt, emergency tensioning device and airbag**

##### **Warning!**



- Damaged seat belts or belts that were highly stressed in an accident must be replaced and their anchoring points must also be checked. Use only belts installed or supplied by an authorized Mercedes-Benz Center.
- Airbags and ETDs are designed to function on a one-time-only basis. An airbag

### Occupant safety

or emergency tensioning device (ETD) that was activated must be replaced.

- No modifications of any kind may be made to any components or wiring of the SRS. This includes changing or removing any component or part of the SRS, the installation of additional trim material, badges etc. over the steering wheel hub, front passenger airbag cover, door trim panels, or door frame trims, and installation of additional electrical/electronic equipment on or near SRS components and wiring. Keep area between airbags and occupants free from objects (e.g. packages, purses, umbrellas, etc.).
- Do not pass belts over sharp edges. They could tear.
- Do not make any modification that could change the effectiveness of the belts.
- Do not hang items such as coat hangers from the coat hooks or handles over the door. These items may turn into projectiles and cause head and other injuries when curtain airbag is deployed.

- An airbag system component within the steering wheel gets hot after the airbag has inflated. Do not touch.
- Improper work on the system, including incorrect installation and removal, can lead to possible injury through an unintended activation of the SRS.
- In addition, through improper work there is a risk of rendering the SRS inoperative or causing unintended airbag deployment. Work on the SRS must therefore only be performed by an authorized Mercedes-Benz Center.
- For your protection and the protection of others, when scrapping the airbag unit or emergency tensioning device, our safety instructions must be followed. These instructions are available from your authorized Mercedes-Benz Center.
- Given the considerable deployment speed and the textile structure of the airbags, there is the possibility of abrasions or other injuries resulting from airbag deployment.

When you sell your vehicle we strongly urge you to give notice to the subsequent owner that it is equipped with an SRS by alerting them to the applicable section in the Operator's Manual.

### Front airbags

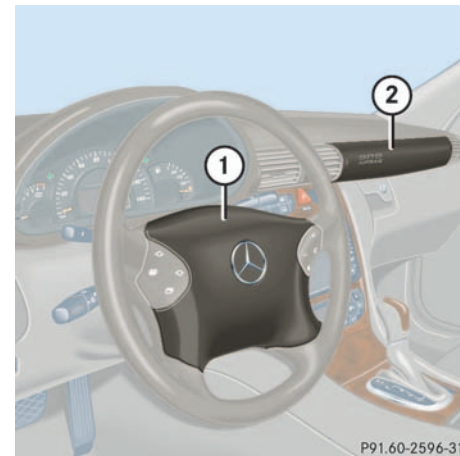

1 Driver airbag

2 Passenger airbag

Driver and passenger airbags are deployed

- in the event of a frontal impact
- if impact exceeds a preset deployment threshold
- independently of the side impact airbags

The airbags will not deploy in impacts which do not exceed the system's deployment thresholds. You will then be protected by the fastened seat belts.

The front passenger airbag will only be deployed if

- the front passenger seat is occupied
- the **AIRBAG OFF** indicator lamp in the center console is not lit (▷ page 67)



Do not place objects heavier than 20 lbs (9 kg) on the front passenger seat. This could cause the front or side impact airbag on the front passenger side to deploy in a crash which exceeds the system's deployment threshold.

### Side impact airbags, window curtain airbags

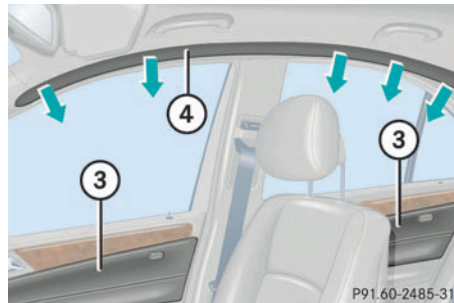

**3** Side impact airbags

**4** Window curtain airbag

The side impact airbags and window curtain airbags are deployed

- on the impacted side of the vehicle
- in impacts exceeding a preset deployment threshold
- independently of the front airbags

The front passenger side airbag will only deploy if the system senses that the front passenger seat is occupied.

The side impact airbags are not deployed in impacts which do not exceed the system's deployment threshold.

### Seat belts

The seat belt nonusage warning lamp  in the instrument cluster lights up and a warning sounds for a short time when you turn the key in the starter switch to position **2** and the driver's seat belt is not fastened.

After starting the engine the seat belt nonusage warning lamp blinks for a brief period to remind the driver and passengers to fasten the seat belts.

### Occupant safety

The use of seat belts and infant and child restraint systems is required by law in most states and all Canadian provinces. Even where this is not the case, all vehicle occupants should have their seat belts fastened whenever the vehicle is in motion.

Information on fastening seat belts is found in the “Getting started” section (▷ page 41).



For information on infants and children traveling with you in the vehicle and restraint systems for infants and children, see “Children in the vehicle” (▷ page 65).

#### Warning!



Always fasten your seat belt before driving off. Always make sure your passengers are properly restrained, even those sitting in the rear and pregnant women.

Failure to wear and properly fasten and position your seat belt greatly increases your risk of injuries and their likely severity in an accident. You and your passengers should always wear seat belts.

If you are ever in an accident, your injuries can be considerably more severe without your seat belt properly buckled. Without your seat belt buckled, you are much more likely to hit the interior of the vehicle or be ejected from it. You can be seriously injured or killed.

In the same crash, the possibility of injury or death is lessened if you are properly wearing your seat belt. Airbags can only protect as they are designed if the occupants are properly wearing their seat belts.

#### Warning!



Never ride in a moving vehicle with the seat backrest reclined. Sitting in an excessively reclined position can be dangerous. You could slide under the seat belt in a collision. If you slide under it, the belt would apply force at the abdomen or neck. That could cause serious or even fatal injuries. The seat backrest and seat belt provide the best restraint when the wearer is in an upright position and the belt is properly positioned on the body.

#### Warning!



Never let more people ride in the vehicle than there are seat belts available. Be sure everyone riding in the vehicle is correctly restrained with a separate seat belt.

**Warning!**

Damaged seat belts or belts that were highly stressed in an accident must be replaced and their anchoring points must also be checked.

Only use seat belts which have been approved by Mercedes-Benz.

Do not make any modifications to the seat belts. This can lead to unintended activation or to failure.

Have all work carried out only by an authorized Mercedes-Benz Center.

**Warning!****USE SEAT BELTS PROPERLY**

- Seat belts can only work when used properly. Never wear seat belts in any other way than as described in this section, as that could result in serious injuries in case of an accident.
- Each occupant should wear their seat belt at all times, because seat belts help reduce the likelihood of and potential severity of injuries in accidents, including rollovers. The integrated restraint system includes SRS (driver airbag, front passenger airbag, side impact airbags, head protection window curtain airbags for side windows), ETD (seat belt emergency tensioning device), and front seat knee bolsters. The system is designed to enhance the protection offered to properly belted occupants in certain frontal (front airbags) and side (side impact airbags and window curtain airbags) impacts which exceed preset deployment thresholds.

- Never wear the shoulder belt under your arm, against your neck or off your shoulder. In a crash, your body would move too far forward. That would increase the chance of head and neck injuries. The belt would also apply too much force to the ribs or abdomen, which could severely injure internal organs such as your liver or spleen.
- Never wear belts over rigid or breakable objects in or on your clothing, such as eyeglasses, pens, keys etc., as these might cause injuries.
- Position the lap belt as low as possible on your hips and not across the abdomen. If the belt is positioned across your abdomen, it could cause serious injuries in a crash.
- Never use a seat belt for more than one person at a time. Do not fasten a seat belt around a person and another person or other objects.
- Belts should not be worn twisted. In a crash, you wouldn't have the full

### Occupant safety

width of the belt to manage impact forces. The twisted belt against your body could cause injuries.

- Pregnant women should also use a lap-shoulder belt. The lap belt portion should be positioned as low as possible on the hips to avoid any possible pressure on the abdomen.
- Never place your feet on the instrument panel or on the seat. Always keep both feet on the floor in front of the seat.

#### Emergency tensioning device (ETD), seat belt force limiter

The seat belts for the front and rear outer seats are equipped with emergency tensioning devices and belt force limiters.

The ETD is designed to activate in the following cases when the seat belts are fastened:

- in frontal or rear-end impacts exceeding a preset severity level
- if the restraint systems are operational and functioning correctly.  
See **SRS** indicator lamp (▷ page 56).

In an impact, emergency tensioning devices remove slack from the belts in such a way that the seat belts fit more snugly against the body. Belt force limiters reduce the force exerted by the seat belts on occupants during a crash.

#### Warning!



An emergency tensioning device (ETD) that was activated must be replaced.

When scrapping the emergency tensioning device, our safety instructions must be followed. These are available at your authorized Mercedes-Benz Center.



Do not place objects heavier than 20 lbs (9 kg) on the front passenger seat. This could cause the front or side impact airbag on the front passenger side to deploy in a crash which exceeds the system's deployment threshold.



## Children in the vehicle

If an infant or child is traveling with you in the vehicle:

- Secure the child using an infant or child restraint appropriate to the age and size of the child and recommended for use by Mercedes-Benz.
- Ensure that the infant or child is properly secured by a belt at all times while the vehicle is in motion.

Infant and child restraint seats and information on choosing an appropriate restraint system can be obtained from any Mercedes-Benz Center.

### Infant and child restraint systems

Use only a BabySmart™ compatible child restraint for the front passenger seat in this vehicle.

We recommend all infants and children be properly restrained at all times while the vehicle is in motion. All lap-shoulder belts except the driver's seat belt have special seat belt retractors for secure fastening of child restraints.

To fasten a child restraint, follow child restraint instructions for mounting. Then pull the shoulder belt out completely and let it retract. During the seat belt retraction, a ratcheting sound can be heard to indicate that the special seat belt retractor is activated. The belt is now locked. Push down on child restraint to take up any slack.

To deactivate, release seat belt buckle and let seat belt retract completely. The seat belt can again be used in the usual manner.



Information on child seats with anchor fittings for tether anchorages (▷ page 68).

For information on child seat anchors - "LATCH" type (▷ page 69).

### Warning!



Never release the seat belt buckle while the vehicle is in motion, since the special seat belt retractor will be deactivated.



The use of infant or child restraints is required by law in all 50 states, the District of Columbia, the U.S. territories, and all Canadian provinces.

Infants and small children should be seated in an appropriate infant or child restraint system properly secured by a lap-shoulder belt or, if so equipped, a child restraint lower anchorage system that complies with U.S. Federal Motor Vehicle Safety Standards 213 and 225 and Canadian Motor Vehicle Safety Standards 213 and 210.2.

A statement by the child restraint manufacturer of compliance with this standard can be found on the instruction

### Occupant safety

label on the restraint and in the instruction manual provided with the restraint.

When using any infant or child restraint system, be sure to carefully read and follow all manufacturer's instructions for installation and use.

Please read and observe warning labels affixed to inside of vehicle and to infant or child restraints.

#### Warning!



Children 12 years old and under must never ride in the front seat, except in a Mercedes-Benz authorized BabySmart™ compatible child seat, which operates with the BabySmart™ System installed in the vehicle to deactivate the passenger front airbag when it is properly installed. Otherwise they will be struck by the airbag when it inflates in a crash. If this happens, serious or fatal injury can result.

According to accident statistics, children are safer when properly restrained in the rear seating positions than in the front seating positions. Infants and small children must ride in back seats and be seated in an appropriate infant or child restraint system, which is properly secured with the vehicle's seat belt and top tether strap, or secured via lower anchors and top tether strap, fully in accordance with the child seat manufacturer's instructions.

Infants and small children should never share a seat belt with another occupant. During an accident, they could be crushed between the occupant and seat belt.

A child's risk of serious or fatal injuries is significantly increased if the child restraints are not properly secured in the vehicle and the child is not properly secured in the child restraint.

#### Warning!



Children too big for child restraint systems must ride in back seats using regular seat belts. Position shoulder belt across chest and shoulder, not face or neck. A booster seat may be necessary to achieve proper belt positioning for children from 41 lbs. until they reach a height where a lap/shoulder belt fits properly without a booster.

When the child restraint is not in use, remove it from the vehicle or secure it with the seat belt to prevent the child restraint from becoming a projectile in the event of an accident.

Do not leave children unattended in the vehicle; even if the children are secured in a child restraint system. Unsupervised children in a child restraint system may use vehicle equipment and may cause an accident and/or serious personal injury.

## BabySmart™ airbag deactivation system



Special BabySmart™ compatible child seats, designed for use with the Mercedes-Benz system and available at any authorized Mercedes-Benz Center are required for use with the BabySmart™ airbag deactivation system. With the special child seat properly installed, the passenger front airbag will not deploy.

BabySmart™ is a trademark of Siemens Automotive Corp.

The **AIRBAG OFF** indicator lamp located in the center console will be illuminated, except with the key removed or in the starter switch position **0**.



The system does not deactivate the side impact airbag.

### Self-test BabySmart™ without special child seat installed

After turning the key in the starter switch to position **1** or **2**, the **AIRBAG OFF** indicator lamp located in the center console lights up for approx. six seconds and then goes out.

If the indicator lamp should not come on or is continuously lit, the system is not functioning. You must see an authorized Mercedes-Benz Center before seating any child on the passenger seat.

More information can be found in the “Practical hints” section (> page 260).

### Warning!



The BabySmart™ airbag deactivation system will **ONLY** work with a special child seat designed to operate with it. It will not work with child seats which are not BabySmart™ compatible.

Never place anything between seat cushion and child seat (e.g. pillow), since it reduces the effectiveness of the deactivation system. The bottom of the child seat must make full contact with the passenger seat cushion. An incorrectly mounted child seat could cause injuries to the child in case of an accident, instead of protecting the child.

Follow the manufacturer’s instructions for installation of special child seats.

When using a BabySmart™ compatible child seat on the front passenger seat, the front passenger airbag will not deploy only if the **AIRBAG OFF** indicator lamp remains illuminated.

### Occupant safety

#### Warning!



Please be sure to check the indicator every time you use the special system child seat. Should the light go out while the restraint is installed, please check installation. If the light remains out, do not use the BabySmart™ restraint to transport children on the front passenger seat until the system has been repaired.

#### Warning!



Do not place powered-on laptops, cell phones and like electronic devices on the front passenger seat. Signals from such devices may interfere with the BabySmart™ system. Such signal interference may cause the  indicator lamp not to come on during self-test or be continuously lit, indicating that the system is not functioning.

#### Installation of infant and child restraint systems

This vehicle is equipped with tether anchorages for a top tether strap at each of the rear seating positions.

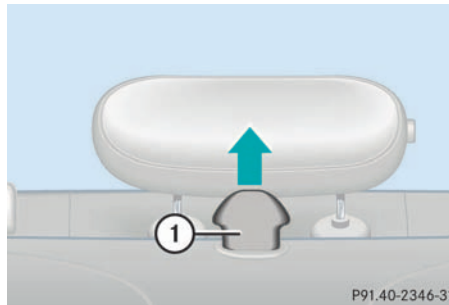

#### 1 Cover of top anchorage ring

- ▶ Make sure that the rear backrest is locked in its upright position (▷ page 200).

#### Warning!



Always lock backrest in its upright position when rear seat bench is occupied by passengers, or the extended cargo area is not in use. Check for secure locking by pushing and pulling on the backrest.

- ▶ Remove cover **1** from anchorage ring **3**.
- ▶ Guide tether strap between head restraint and top of seat back.

Head restraint must be installed (if removable) and positioned such that the top tether strap can pass freely between the head restraint and top of seat back.

Make sure that the tether strap is not twisted.



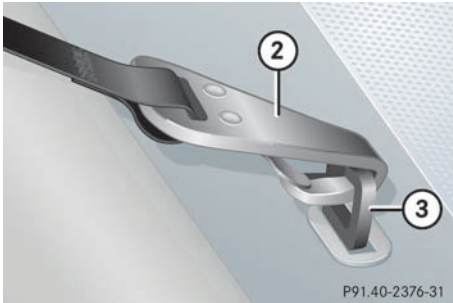

- 2** Hook
- 3** Anchorage ring

- ▶ Securely fasten the hook **2** to the anchorage ring **3**.



For safety, make sure that the hook has attached to the ring beyond the safety catch, as illustrated.

- ▶ Reinstall cover **1** after removing the tether strap.

### Child seat anchors – “LATCH” type

This vehicle is equipped with two “LATCH” (Lower Anchors and Tethers for Children) type anchors (at each of the outer rear seats) for the installation of a “LATCH” child seat with the matching mounting fittings.

If a child seat is not installed, the “LATCH” anchors can be folded back between the seat cushion and the backrest.

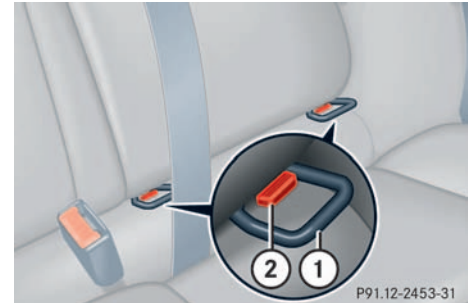

- 1** Anchors
- 2** Button

- ▶ Grip inner side of anchors **1** and fold forward until they lock in place.
- ▶ Install child seat according to the manufacturer’s instructions and attach it firmly in the right and left anchors **1**.

### Occupant safety



With a child seat installed in the left rear seat, the seat belt for the center seat occupied by a passenger must operate freely. Guide seat belt between its seat cushion mount and backrest mount along outside of right side child seat anchor.

#### *To fold anchors back*

- ▶ Press down button **2** on each anchor and return anchor **1** to its catch.



Non-“LATCH” type child seats may also be used and can be installed using the vehicle’s seat belt system. Install child seat according to the manufacturer’s instructions.

#### Warning!



Children too big for child restraint systems must ride in back seats using regular seat belts. Position shoulder belt across chest and shoulder, not face or neck. A booster seat may be necessary to achieve proper belt positioning for children from 41 lbs. until they reach a height where a lap/shoulder belt fits properly without a booster.

Before installing the child seat, make sure anchors **1** are folded out and locked in place.

Install child seat according to manufacturer’s instructions.

The child seat must be firmly attached in the right and left side anchors **1**.

An incorrectly mounted child seat may come loose during an accident which could result in serious injury or death to your child.

Damaged or impact-damaged child seats or child seat anchors **1** must be replaced.

Do not leave children unattended in the vehicle, even if the children are secured in a child restraint system.

### Blocking of rear door window operation

The override switch is located on the door control panel of the driver's door.



#### 1 Override switch

- ▶ Slide override switch 1 to the right.

The rear door windows can no longer be operated using the switch located in the rear doors.



Operation of the rear door windows with the switches located on the door control panel of the driver's door is still possible.

### Warning!



Activate the override switch when children are riding in the back seats of the vehicle. The children may otherwise injure themselves, e.g. by becoming trapped in the window opening.

When leaving the vehicle, always remove the key from the starter switch, and lock the vehicle. Do not leave children unattended in the vehicle, or with access to an unlocked vehicle. Unsupervised use of vehicle equipment can cause an accident and/or serious personal injury.

For more information on power windows, see the “Controls in detail” section (▶ page 187).

### Panic alarm\*

#### Panic alarm\*

An audible alarm and blinking exterior lamps will operate for approximately 2<sup>1</sup>/<sub>2</sub> minutes.

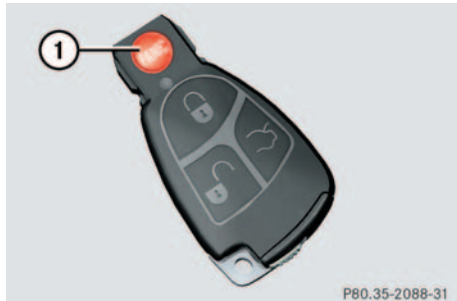

1 **PANIC** button



Canada only:

Only vehicles equipped with an anti-theft alarm system\* have SmartKeys with integrated panic button 1.

#### Activating

- ▶ Press and hold button 1 for at least one second.

#### Deactivating

- ▶ Press button 1 again  
or
- ▶ Insert key in starter switch.



For operation in the USA only:

This device complies with Part 15 of the FCC Rules. Operation is subject to the following two conditions:

- (1) This device may not cause harmful interference, and
- (2) this device must accept any interference received, including interference that may cause undesired operation.

Any unauthorized modification to this device could void the user's authority to operate the equipment.



## Driving safety systems

In this section you will find information on the following driving safety systems:

- ABS (Antilock Brake System)
- BAS (Brake Assist System)
- ESP (Electronic Stability Program)
- 4MATIC\* (Four Wheel Electronic Traction System)



In winter operation, the maximum effectiveness of the ABS, ESP and 4MATIC\* is only achieved with winter tires (M+S tires), or snow chains as required.

### Warning!



The following factors increase the risk of accidents:

- Excessive speed, especially in turns
- Wet and slippery road surfaces
- Following another vehicle too closely

The ABS, BAS, ESP and 4MATIC\* cannot reduce this risk.

Always adjust your driving style to the prevailing road and weather conditions.

## ABS

### Warning!



Do not pump the brake pedal. Use firm, steady brake pedal pressure instead. Pumping the brake pedal defeats the purpose of the ABS and significantly reduces braking effectiveness.

The ABS regulates the brake pressure so that the wheels do not lock during braking. This allows you to maintain the ability to steer your vehicle.

The ABS is functional above a speed of approximately 5 mph (8 km/h) independent of road surface conditions.

At the instant one of the wheels is about to lock up, a slight pulsation can be felt in the brake pedal, indicating that the ABS is in the regulating mode. Keep firm and steady pressure on the brake pedal while experiencing the pulsation.

### Driving safety systems

Continuous steady brake pedal pressure yields the advantages provided by the ABS, namely braking power and ability to steer the vehicle.

On slippery road surfaces, the ABS will respond even with light brake pressure. The pulsating brake pedal can be an indication of hazardous road conditions and functions as a reminder to take extra care while driving.



To alert following vehicles to slippery road conditions you discover, operate your hazard warning flashers as appropriate.

#### Warning!



The ABS cannot prevent the natural laws of physics from acting on the vehicle, nor can it increase braking or steering efficiency beyond that afforded by the condition of the vehicle brakes and tires or the traction. The ABS cannot prevent accidents, including those resulting from excessive speed in turns, following another vehicle too closely, or aquaplaning. Only a safe, attentive, and skillful driver can prevent accidents. The capabilities of an ABS equipped vehicle must never be exploited in a reckless or dangerous manner which could jeopardize the user's safety or the safety of others.

#### ABS control

The  malfunction indicator lamp in the speedometer lights up when you turn the key in the starter switch to position **2**. It goes out when the engine is running.

More information can be found in the “Practical hints” section (▷ page 257).

#### BAS

The Brake Assist System (BAS) operates in emergency situations. If you apply the brakes very quickly, the BAS automatically provides full brake boost, thereby potentially reducing the braking distance. Apply continuous full braking pressure until the emergency braking situation is over. The ABS will prevent the wheels from locking.

When you release the brake pedal, the brakes function again as normal. The BAS is then deactivated.

**Warning!**

The BAS cannot prevent the natural laws of physics from acting on the vehicle, nor can it increase braking efficiency beyond that afforded by the condition of the vehicle brakes and tires or the traction. The BAS cannot prevent accidents, including those resulting from excessive speed in turns, following another vehicle too closely, or hydroplaning. Only a safe, attentive, and skillful driver can prevent accidents. The capabilities of a BAS equipped vehicle must never be exploited in a reckless or dangerous manner which could jeopardize the user's safety or the safety of others.

**ESP**

The Electronic Stability Program (ESP) monitors the vehicle's traction (force of adhesive friction between the tires and the road surface) and handling.

The ESP recognizes when a wheel is spinning or if the vehicle starts to skid. By applying brakes to the appropriate wheel and by limiting engine output, the ESP works to stabilize the vehicle. The ESP is especially useful while driving off and on wet or slippery road surfaces.

The ESP warning lamp  in the speedometer dial flashes when the ESP is engaged.

The ESP warning lamp  in the speedometer dial lights up when you turn the key in the starter switch to position **2**. It goes out when the engine is running.

**Warning!**

Never switch off the ESP when you see the ESP warning lamp  flashing in the speedometer dial. In this case proceed as follows:

- While driving off, apply as little throttle as possible.
- While driving ease up on the accelerator.
- Adapt your speed and driving style to the prevailing road conditions.

Failure to observe these guidelines could cause the vehicle to skid.

The ESP cannot prevent accidents resulting from excessive speed.

### Driving safety systems

#### Warning!



The ESP cannot prevent the natural laws of physics from acting on the vehicle, nor can it increase the traction afforded. The ESP cannot prevent accidents, including those resulting from excessive speed in turns, following another vehicle too closely, or hydroplaning. Only a safe, attentive, and skillful driver can prevent accidents. The capabilities of a ESP equipped vehicle must never be exploited in a reckless or dangerous manner which could jeopardize the user's safety or the safety of others.



Because of the ESP's automatic operation, the engine must be shut off (key in starter switch position **0** or **1**) when

- the parking brake is being tested on a brake test dynamometer
- the vehicle is being towed with the front axle raised

Active braking action through the ESP may otherwise seriously damage the rear axle brake system.

The ESP will only function properly if you use wheels of the recommended tire size.

More information can be found in the "Practical hints" section (▷ page 256).

#### Switching off the ESP

#### Warning!



The ESP should not be switched off during normal driving other than in the circumstances described below. Disabling of the system will reduce vehicle stability in standard driving maneuvers.

To improve the vehicle's traction, turn off the ESP in driving situations where it would be advantageous to have the drive wheels spin and thus cut into surfaces for better grip such as:

- starting out on slippery surfaces and in deep snow in conjunction with snow chains
- in sand or gravel

The switch is located on the center console.



1 ESP off

2 ESP on

- ▶ Press upper half 1 of the ESP switch until the ESP warning lamp  in the speedometer lights up.

ESP is deactivated.

If one or more drive wheels are spinning, the ESP warning lamp  in the speedometer flashes, regardless of the speed.

Traction control brakes a spinning wheel even when ESP is deactivated.

ESP always operates when you are braking, even when it has been deactivated.



Avoid spinning of a drive wheel for an extended period with the ESP switched off. This may cause serious damage to the drive train which is not covered by the Mercedes-Benz Limited Warranty.

### Warning!



When the ESP warning lamp  is illuminated continuously, the ESP is switched off.

Adapt your speed and driving to the prevailing road conditions and to the non-operating status of the ESP.

### Switching on the ESP

- ▶ Press lower half 2 of the ESP switch until the ESP warning lamp  in the speedometer goes out.

You are now again in normal driving mode.

### Driving safety systems

#### Four wheel electronic traction system (4MATIC\*) with the ESP

Models with all-wheel-drive\* only.

The 4MATIC improves vehicle's ability to use available traction, e.g. during winter operation in mountains under snowy conditions, by applying power to all four wheels.

#### Warning!



If you see the ESP warning lamp  flashing in the speedometer dial, proceed as follows:

- While driving off, apply as little throttle as possible
- While driving ease up on the accelerator
- Adapt your speed and driving style to the prevailing road conditions

Failure to observe these guidelines could cause the vehicle to skid.

The ESP cannot prevent accidents resulting from excessive speed.



Do not tow with one axle raised.

Otherwise the transfer case can be damaged, which is not covered by the Mercedes-Benz Limited Warranty.



Performance testing must only be conducted on a two-axle dynamometer.

Otherwise the transfer case can be damaged, which is not covered by the Mercedes-Benz Limited Warranty.



Because of ESP's automatic operation, the engine must be shut off (key in starter switch position **0** or **1**) when the parking brake is being tested on a brake test dynamometer

Active braking action through ESP may otherwise seriously damage the front or rear axle brake system.

Operational tests with the engine running can only be conducted on a two-axle dynamometer.

## Anti-theft systems

### Immobilizer

The immobilizer prevents unauthorized persons from starting your vehicle.

### Activating

- Removing the key from the starter switch activates the immobilizer.

### Deactivating

- Inserting the key in the starter switch deactivates the immobilizer.



In case the engine cannot be started (yet the vehicle's battery is charged), the system is not operational. Contact an authorized Mercedes-Benz Center or call 1-800-FOR-MERCEdes (in the USA), or 1-800-387-0100 (in Canada).

### Anti-theft alarm system

Once the alarm system has been armed, a visual and audible alarm is triggered when someone opens

- a door
- the trunk
- the hood

The alarm system will also be triggered when

- someone attempts to raise the vehicle
- the vehicle is opened with the mechanical key



If the alarm stays on for more than 20 seconds, an emergency call is initiated automatically by the Tele Aid system\* (> page 209) provided Tele Aid service was subscribed to and properly activated, and that necessary cellular service and GPS coverage are available.

### Arming the alarm system

The alarm system is armed after locking the vehicle with the remote control. The turn signal lamps blink three times to indicate that the alarm system is activated. A red indicator lamp in the switch for the tow-away alarm (> page 80) will blink after approximately ten seconds when the alarm system is completely armed.



If the turn signal lamps do not blink three times, the tow-away sensor\* is malfunctioning or one of the following elements may not be properly closed:

- a door
- the trunk lid
- the hood

Close the respective element and lock the vehicle again.

### Anti-theft systems



#### Disarming the alarm system

The alarm system is disarmed when you unlock your vehicle with the remote control. The turn signal lamps blink once to indicate that the alarm system is deactivated.



The alarm system will rearm automatically again after approximately 40 seconds if one of the doors or the trunk lid is not opened.

#### Canceling the alarm

- ▶ Insert the key in the starter switch.  
or
- ▶ Press the  or  button on the key.

#### Tow-away alarm

Once the tow-away alarm is armed, a visual and audible alarm will be triggered when someone attempts to raise the vehicle.



The tow-away protection alarm is triggered, for example, if the vehicle is lifted on one side.

If the alarm stays on for more than 20 seconds, an emergency call is initiated automatically by the Tele Aid system\* (> page 209) provided Tele Aid service was subscribed to and properly activated, and that necessary cellular service and GPS coverage are available.

#### Arming tow-away alarm

When you lock your vehicle, the tow-away alarm is automatically armed after about 30 seconds.

When you unlock your vehicle, the tow-away protection disarms automatically.

#### Disarming tow-away alarm

To prevent triggering the tow-away alarm feature, switch off the tow-away alarm before towing the vehicle, or when parking on a surface subject to movement, such as a ferry or auto train.



The switch is located on the center console.



1 Tow-away alarm off switch

2 Indicator lamp

- ▶ Turn off the ignition and remove the key.



You cannot disarm the tow-away alarm if the ignition is turned on.

- ▶ Press upper half **1** of the switch.



Indicator lamp **2** in the switch lights up briefly.

The tow-away alarm remains disarmed until you lock your vehicle again.

### Canceling the alarm

- ▶ Insert the key in the starter switch.

or

- ▶ Press the  or  button on the key.



## Controls in detail

Locking and unlocking

Seats

Memory function\*

Lighting

Instrument cluster

Control system

Manual transmission

Automatic transmission\*

Good visibility

Climate control

Automatic climate control\*

Audio system

Power windows

Sliding/pop-up roof\*

Driving systems

Loading

Useful features



### Locking and unlocking

In the “Controls in detail” section you will find detailed information on how to operate the equipment installed on your vehicle. If you are already familiar with the basic functions of your vehicle, this section will be of particular interest to you.

To quickly familiarize yourself with the basic functions of the vehicle, refer to the “Getting started” section of this manual. The corresponding page numbers are given at the beginning of each segment.

### Locking and unlocking

Information on locking and unlocking can be found in the “Getting started” section on (▷ page 30) and (▷ page 51).

#### Keys

Your vehicle comes supplied with two SmartKeys with remote controls and a removable mechanical key. The locking tabs for the mechanical key portion of the two keys are a different color to help distinguish each key unit.

The SmartKey provides an extended operating range. To prevent theft, however, it is advisable to only unlock the vehicle when you are in close proximity to it.

The Smartkey centrally locks and unlocks:

- the doors
- the trunk
- the fuel filler flap



You can also open and close the power windows (▷ page 188) and sliding/pop-up roof\* (▷ page 191) using the SmartKey.

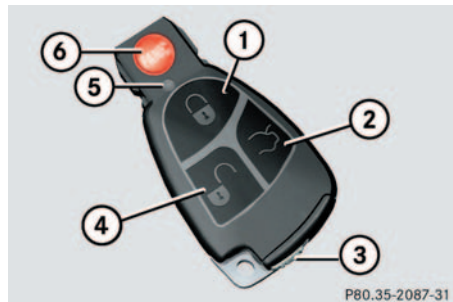

P80.35-2087-31

#### SmartKey with remote control

- 1 Lock button
- 2 Unlock button for the trunk lid
- 3 Mechanical key locking tab
- 4 Unlock button
- 5 Battery check lamp
- 6 PANIC button\* (▷ page 72).



Canada only:

Only vehicles equipped with an anti-theft alarm system\* have SmartKeys with integrated panic button\* **6**.



To prevent possible malfunction, avoid exposing the key to high levels of electromagnetic radiation.

## Factory setting

### Global unlocking

- ▶ Press button

All turn signal lamps blink once. The locking knobs in the doors move up.

The vehicle will lock again automatically within approximately 40 seconds of unlocking if neither door nor trunk is opened, the SmartKey is not inserted in the starter switch, or the central locking switch is not activated.

### Global locking

- ▶ Press button

All turn signal lamps blink three times. The locking knobs in the doors move down.

### Selective setting

If you frequently travel alone, you may wish to reprogram the key so that pressing only unlocks the driver's door and the fuel filler flap.

- ▶ Press and hold buttons and simultaneously for about five seconds until battery check lamp **5** blinks twice.

The key will then function as follows:

Unlocking driver's door and fuel filler flap

- ▶ Press button once.

Global unlocking

- ▶ Press button twice.

Global locking

- ▶ Press button

### Restoring to factory setting

- ▶ Press and hold buttons and simultaneously for about six seconds until battery check lamp **5** blinks twice.

### Warning!



When leaving the vehicle, always remove the key from the starter switch, take it with you and lock the vehicle. Do not leave children unattended in the vehicle, or with access to an unlocked vehicle. It is possible for children to open a locked door from the inside, which could result in an accident and/or serious injury.

### Locking and unlocking





If you can no longer lock or unlock the vehicle with the key, then either the batteries in the SmartKey are discharged, the key is malfunctioning or the vehicle battery is drained.

- Check the batteries in the key (▷ page 86) and replace them if necessary (▷ page 286).
- Use the mechanical key to lock and unlock the doors (▷ page 285) and the trunk lid (▷ page 91) as required.
- Check the vehicle battery (▷ page 303)

If the key is malfunctioning, contact an authorized Mercedes-Benz Center.

#### Checking the batteries

- ▶ Press button  or .

Battery check lamp **5** lights up briefly to indicate that the key batteries are in order.



If battery check lamp **5** does not light up briefly during check, then the key batteries are discharged.

Replace the batteries (▷ page 286).

You can obtain the required batteries at any authorized Mercedes-Benz Center.

#### Unlocking the trunk lid

You can unlock the trunk separately.

A minimum height clearance of 5.75 ft. (1.75 m) is required to open the trunk lid.

- ▶ Press button  until trunk opens.



The trunk lid swings open upwards automatically. Always make sure that there is sufficient overhead clearance.

The trunk can also be opened from its inside in an emergency, see “Trunk lid emergency release” (▷ page 89).



If the vehicle was previously centrally locked, the trunk lid will lock automatically when closed (▷ page 89). The turn signals will flash three times to confirm locking.

If the trunk lid was previously separately locked (▷ page 90), the trunk lid will remain locked.

### Loss of SmartKey or mechanical key

If you lose a SmartKey or mechanical key, you should do the following:

- ▶ Have the SmartKey deactivated by an authorized Mercedes-Benz Center.
- ▶ Report the loss of the SmartKey or the mechanical key immediately to your car insurance company.
- ▶ If necessary, have the mechanical lock replaced.

Your authorized Mercedes-Benz Center will be glad to supply you with a replacement.

### Opening the doors from the inside

You can open a locked door from the inside. Open door only when conditions are safe to do so.

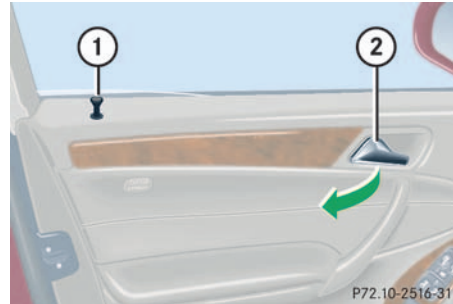

- 1 Locking knob
- 2 Inside door handle



- ▶ Pull on door handle 2.

If door was locked, locking knob 1 will move up.



If the vehicle has previously been locked from the outside, opening a door from the inside will trigger the anti-theft alarm system.

To cancel the alarm, do one of the following:

- Press button  or  on the SmartKey.
- Insert the SmartKey in the starter switch.

### Locking and unlocking

#### Opening the trunk from the inside

You can open the trunk from the inside if the vehicle is stationary.

A minimum height clearance of 5.75 ft. (1.75 m) is required to open the trunk lid.

The switch is located on the driver's door.



**1** Remote trunk lid release switch with indicator lamp

- ▶ Press remote trunk lid release switch **1**.

The trunk lid opens. The indicator lamp in the switch remains lit as long as the trunk is open.



The trunk lid swings open upwards automatically. Always make sure that there is sufficient overhead clearance.

The trunk can also be opened using the SmartKey (▶ page 86) or from its inside in an emergency, see “Trunk lid emergency release” (▶ page 89).



If the vehicle was previously centrally locked, the trunk lid will lock automatically when closed (▶ page 89). The turn signals will flash three times to confirm locking.

If the vehicle was previously separately locked (▶ page 90) or locked with the SmartKey (▶ page 85), the trunk lid will remain locked.

#### Opening the trunk

A minimum height clearance of 5.75 ft. (1.75 m) is required to open the trunk lid.

The handle is located above the rear license plate recess.

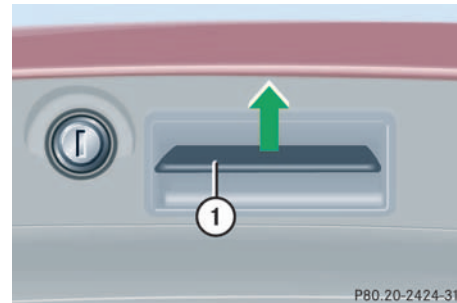

**1** Handle

- ▶ Pull handle **1** to open the trunk lid.

The trunk lid swings open upwards automatically. Always make sure that there is sufficient overhead clearance.



The vehicle must be unlocked.



### Closing the trunk

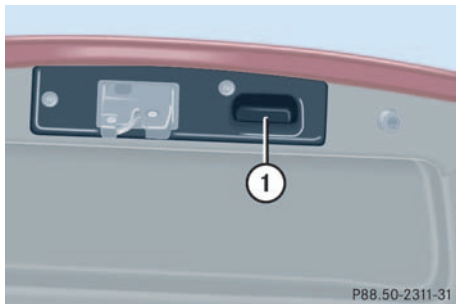

1 Handle

- ▶ Lower trunk lid using the handle 1.

### Warning!



To prevent possible personal injury, always keep hands and fingers away from the trunk opening when closing the trunk. Be especially careful when small children are around.

### Warning!



Only drive with the trunk closed as, among other dangers such as visibility blockage, exhaust fumes may enter the vehicle interior.



To prevent an inadvertent lockout, do not place the key in the trunk.

### Trunk lid emergency release

The emergency release button is located on the inside of the trunk lid.

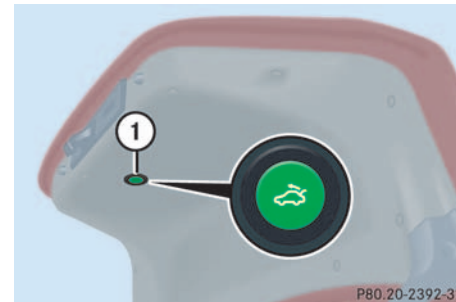

1 Emergency release button

- ▶ Briefly press the emergency release button.

The trunk unlocks and the trunk lid opens.



The emergency release button unlocks and opens the trunk while the vehicle is standing or driving.

### Locking and unlocking

Illumination of the emergency release button:



- The button will blink for 30 minutes after opening the trunk.
- The button will blink for 60 minutes after closing the trunk.



The emergency release button does not open the trunk lid, if the vehicle battery is discharged or disconnected.



If the emergency release button is pressed and the vehicle was centrally locked, the exterior lamps will flash and the alarm will sound as the trunk lid opens.

To cancel the alarm, insert the key in the starter switch or press button  or  on the key.

### Separately locking the trunk



To deny any unauthorized person access to the trunk, lock it separately with the mechanical key. Leave only the SmartKey less its mechanical key with the vehicle.

The lock is located next to the recessed handle.

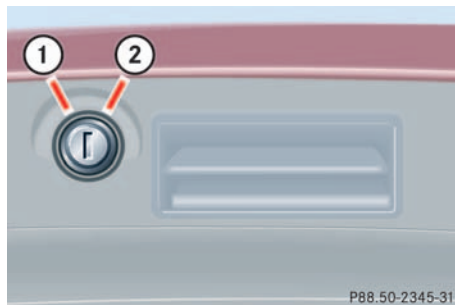

1 Unlocked

2 Locked

- ▶ Close the trunk lid (▷ page 89).
- ▶ Pull the mechanical key out of the SmartKey (▷ page 285).
- ▶ Insert the mechanical key in the trunk lid lock.
- ▶ Turn the key completely to the right to position **2**.

The trunk remains locked even when the vehicle is centrally unlocked.



You can only cancel the separate trunk locking mode by means of the mechanical key.



### Separately unlocking the trunk

- ▶ Pull the mechanical key out of the SmartKey (▷ page 285).
- ▶ Insert the mechanical key in the trunk lid lock.
- ▶ Turn the key completely to the left to position **1**, see above.

You can now open the trunk (▷ page 88).



Unlocking the trunk with the mechanical key will trigger the anti-theft alarm system. To cancel the alarm, do one of the following:

- Press button  or  on the SmartKey.
- Insert the SmartKey in the starter switch.

### Automatic central locking

The doors and the trunk automatically lock when the ignition is switched on and the wheels are turning at vehicle speeds of approximately 9 mph (15 km/h) or more.

You can open a locked door from the inside. Open door only when conditions are safe to do so.



The doors unlock automatically after an accident if the force of the impact exceeds a preset threshold.

The vehicle automatically locks when the ignition is switched on and the wheels are turning at vehicle speeds of approximately 9 mph (15 km/h) or more. You could therefore lock yourself out when the vehicle

- is pushed
- is on a test stand

You can deactivate the automatic locking using the control system (▷ page 129).

### Locking and unlocking

#### Locking and unlocking from the inside

You can lock or unlock the doors and the trunk from inside using the central locking switch. This can be useful, for example, if you want to lock the vehicle before starting to drive.

The fuel filler flap cannot be locked or unlocked with the central locking switch.

#### Warning!



When leaving the vehicle, always remove the key from the starter switch, take it with you and lock the vehicle. Do not leave children unattended in the vehicle, or with access to an unlocked vehicle. Unsupervised use of vehicle equipment may cause an accident and/or serious personal injury.

The switch is located in the center console.



#### Central locking switch

- 1 Locking
- 2 Unlocking

#### Locking

- ▶ Press upper half **1** of the central locking switch.

If both front doors are closed, the vehicle locks.

#### Unlocking

- ▶ Press lower half **2** of the central locking switch.

The vehicle unlocks.



You can open a locked door from the inside. Open door only when conditions are safe to do so.

If the vehicle was previously centrally locked using the SmartKey, it will not unlock using the central locking switch.

If the vehicle was previously locked with the central locking switch

- while in the selective remote control mode, only the door opened from the inside is unlocked.
- while in the global remote control mode, the complete vehicle is unlocked when a door is opened from the inside.

## Seats

Information on seat adjustment can be found in the “Getting started” section (▷ page 32).

### Easy-entry/exit feature\*

With the easy-entry/exit feature activated, the steering wheel tilts upwards and the driver’s seat moves to the rear.

This allows easier entry into and exit from the vehicle when the driver’s door is opened. However, the engine must be turned off.

When the SmartKey is inserted in the starter switch and the driver’s door is closed, the steering wheel and the driver’s seat return to their last set positions.

### Warning!



You must make sure that no one can become trapped or injured by the moving steering wheel and the driver’s seat when the easy-entry/exit feature\* is activated, the driver’s door is being opened and the engine is turned off or the SmartKey is removed from the starter switch. Do not leave children unattended in the vehicle, or with access to an unlocked vehicle. Unsupervised use of vehicle equipment may cause an accident and/or serious personal injury.

Do not leave children unattended in the vehicle, or with access to an unlocked vehicle. Children could open the driver’s door and unintentionally activate the easy-entry/exit feature\*, which could result in an accident and/or serious personal injury.

You can activate the following functions:

- **Steering column:**  
Only the steering column is adjusted.
- **Steering column and seat:**  
The steering column and the seat are adjusted.

The easy-entry/exit feature can be switched on or off in the individual setting menu **CONVENIENCE - EASY-ENTRY FEATURE ACTIVATE** (▷ page 129).



To cancel seat/steering wheel movement, do one of the following:

- press seat adjustment switch (▷ page 28)
- move steering column stalk (▷ page 32)
- press memory switch (▷ page 28)

## Seats

### Head restraints

Information on head restraint adjustment can be found in the “Getting started” section (▷ page 32).

#### Warning!



For your protection, drive only with properly positioned head restraints.

Adjust head restraint to support the back of the head approximately at ear level.

Do not drive the vehicle without the seat head restraints. Head restraints are intended to help reduce injuries during an accident.



Tilt the backrest to the rear for easier removal and installation of the head restraints.

### Front seat head restraints, manual seat

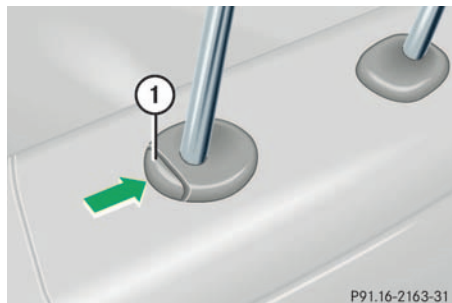

#### Removing front head restraints

- ▶ Pull head restraint to its highest position.
- ▶ Push button **1** and pull out head restraint.

#### Installing front head restraints

- ▶ Insert head restraint and push it down to the stop.
- ▶ Push button **1** and adjust head restraint to desired position.

### Front seat head restraints, power seat\*

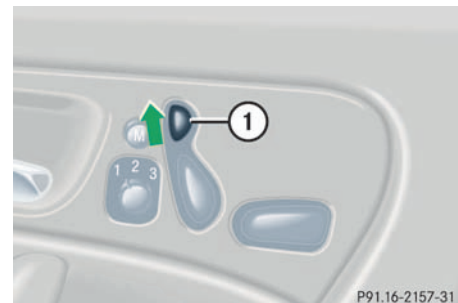

#### Removing front head restraints

- ▶ Press switch **1** upwards and hold until the head restraint is fully extended.
- ▶ Pull out head restraint.

#### Installing front head restraints

- ▶ Press switch **1** upwards and hold for about five seconds.
- ▶ Push the head restraint down until it engages.
- ▶ Adjust head restraint to desired position (▷ page 34).

**Rear seat head restraints (outer seats)****Warning!**

For safety reasons, always drive with the rear head restraints in the upright position when the rear seats are occupied.

Keep the area around head restraints clear of articles (e.g. clothing) to not obstruct the folding operation of the head restraints.

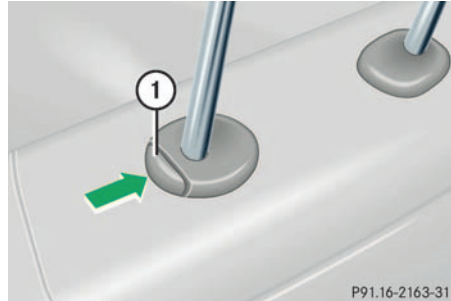

The center rear seat head restraint cannot be removed.

**Removing rear head restraints**

- ▶ Pull head restraint to its highest position.
- ▶ Push button **1** and pull out head restraint.

**Installing rear head restraints**

- ▶ Insert head restraint and push it down until it engages.
- ▶ Push button **1** and adjust head restraint to desired position.

#### Multicontour seat\*

Some models may be equipped with driver's multicontour seat. This seat has a movable seat cushion and inflatable air cushions built into the backrest to provide additional lumbar and side support.

The seat cushion movement, backrest cushion height and curvature can be continuously varied with regulators on the right side of the seat after turning the SmartKey in the starter switch to position **2**.

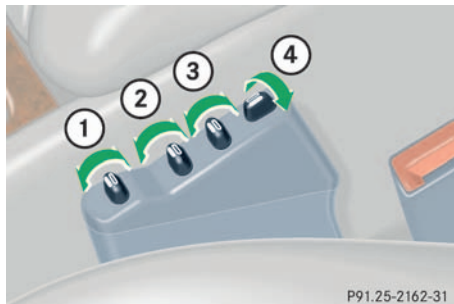

- 1 Seat cushion depth
- 2 Backrest bottom
- 3 Backrest center
- 4 Side bolster adjustment

Adjusting the multicontour seat in the order listed above is recommended.

- ▶ Check that the ignition is switched on.  
All lamps in the instrument cluster light up.

The seat cushion movement, backrest cushion height and curvature can be continuously varied with regulators **1**, **2** and **3**.

The side bolsters of the backrest can be adjusted with rocker switch **4**.

- ▶ Press to the left.  
Side support will be increased.
- ▶ Press to the right.  
Side support will be decreased.



When the engine is turned off, the last cushion setting is retained in memory, and the cushion is automatically adjusted to this setting when the engine is restarted.



### Heated seats\*

Both switches for the front seats are located in the center console.



**1** Normal heating

**2** Rapid heating

- ▶ Make sure that the ignition is switched on.

All the lamps in the instrument cluster light up.

### Switching on seat heating

- ▶ Press upper switch position **1**.

A red indicator lamp on the switch lights up.

### Switching on rapid seat heating

- ▶ Press lower switch position **2**.

Both red indicator lamps on the switch light up.



If one or both of the lamps on the seat heater switch are blinking, there is insufficient voltage available since too many electrical consumers are turned on. The seat heater switches off automatically.

The seat heater will switch back on again automatically as soon as sufficient voltage is available.



The system switches over to normal heating mode after approximately five minutes. Only one indicator lamp remains lit.

### Switching off seat heating

- ▶ If one indicator lamp is on, press upper switch position **1**.
- ▶ If both indicator lamps are on, press lower switch position **2**.



The seat heater will be automatically switched off after approximately 30 minutes.

### Memory function\*

#### Memory function\*



Prior to operating the vehicle, the driver should check and adjust the seat height, seat position fore and aft, and seat backrest angle if necessary, to ensure adequate control, reach and comfort. The head restraint should also be adjusted for proper height. Also see airbag section (▷ page 57) for proper seat positioning.

In addition, adjust the steering wheel to ensure adequate control, reach, operation and comfort. Both the inside and outside rear view mirrors should be adjusted for adequate rear vision.

Fasten seat belts. Infants and small children should be seated in a properly secured restraint system that complies with U.S. Federal Motor Vehicle Safety Standards 213 and 225 and Canadian Motor Vehicle Safety Standards 213 and 210.2.

You can store up to three different settings per key.

The following settings are saved for each stored position:

- Driver's seat and backrest position
- Steering wheel position
- Driver's side exterior rear view mirror position
- Passenger side exterior rear view mirror position
- Front passenger seat position

These key-dependent memory settings can be deactivated if desired (▷ page 99).

#### Warning!



Do not activate the memory function while driving. Activating the memory function while driving could cause the driver to lose control of the vehicle.

The memory button and stored position button are located on the door.

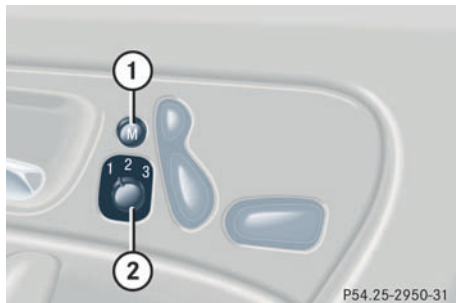

**1** Memory button

**2** Stored position button

- ▶ Make sure that the ignition is switched on or the relevant door is open and the SmartKey is inserted in the starter switch.

### Storing positions into memory

- ▶ Adjust the seats, steering wheel and rear view mirrors to the desired position (▷ page 32).
- ▶ Turn button **2** to selected memory position.
- ▶ Press memory button **1**.
- ▶ Release memory button and push button **2** within three seconds.

All the settings are stored at the selected position.

### Recalling positions from memory

- ▶ Turn button **2** to selected memory position.
- ▶ Press and hold button **2** until the seat, steering wheel and rear view mirrors have fully moved to the stored positions.



Releasing the button immediately stops movement to the stored positions.

### Warning!



Do not operate the power seats using the memory button if the seat backrest is in an excessively reclined position. Doing so could cause damage to front or rear seats.

First move backrest to an upright position.

### Memory function\*

#### Storing exterior rear view mirror parking position

For easier parking, you can adjust the passenger-side exterior rear view mirror so that you can see the right rear wheel as soon as you engage reverse gear **R**.

You can store a parking position for the passenger exterior rear view mirror for each key using the memory button.

For information about activating the parking position, see “Activating exterior rear view mirror parking position” (▷ page 145).



- 1 Memory button
- 2 Adjustment button
- 3 Passenger side exterior rear view mirror

- ▶ Stop the vehicle.
- ▶ Switch ignition on (if not already on).
- ▶ Press button **3**.

The passenger side exterior rear view mirror is selected.

- ▶ Adjust the exterior rear view mirror with button **2** so that you see the rear wheel and the road curb.
- ▶ Press memory button “M” **1** on the door.
- ▶ Within three seconds press bottom of adjustment button **2** above the exterior lamp switch.

The parking position is stored if the mirror does not move.



If the mirror does move, repeat the above steps. After the setting is stored you can move the mirror again.

## Lighting

For notes on how to switch on the headlamps and use the turn signals, see the “Getting started” section (▷ page 47).

### Exterior lamp switch

The exterior lamp switch is located on the dashboard to the left of the steering wheel.



- 0** Off
- AUTO** Automatic headlamp mode
- ☾☽** Parking lamps (also side marker lamps, tail lamps, license plate lamps, instrument panel lamps)  
Canada only:  
When engine is running, the low beam is also switched on.
- ☾☽** Low beam plus parking lamps or high beam headlamps (combination switch pushed forward).
- P ←** Standing lamps, right (turn left one stop)
- ← P** Standing lamps, left (turn left two stops)



If you remove the key and open the driver's door while the parking lamps or low beam headlamps are switched on, then

- a warning sounds
- **☾☽** appears in the multifunction display
- the message **TURN OFF LAMPS!** appears in the multifunction display



With the daytime running lamp mode activated and the engine running, the low beam headlamps cannot be switched off manually.

### Lighting

#### Manual headlamp mode

The low beam headlamps and parking lamps can be switched on and off with the exterior lamp switch. For exterior lamp switch, see above.

#### Automatic headlamp mode

The parking lamps, low beam headlamps and license plate lamps switch on and off automatically depending on the brightness of the ambient light.

- ▶ Turn the exterior lamp switch to **AUTO**.

#### Warning!



In automatic headlamp mode, the headlamps will not be automatically switched on under foggy conditions. To minimize risk to you and to others, activate headlamps by turning exterior lamp switch to .

The driver is responsible for the operation of the vehicle's lights at all times. The automatic headlamp feature is only an aid to the driver. Switch on the vehicle lights manually when driving or when traffic conditions require you to do so.



With the daytime running lamp mode activated, the low beam headlamps will not be switched off automatically.



Front fog lamps and rear fog lamp can not be switched on manually with exterior lamp switch in position **AUTO**. To activate the fog lamps, turn exterior lamp switch to position .



If you drive in countries where vehicles drive on the other side of the road than the country where the vehicle is registered, you must have the headlamps modified for symmetrical low beams. Relevant information can be obtained at your authorized Mercedes-Benz Center.

### Daytime running lamp mode

- ▶ Turn exterior lamp switch to position **0** or **AUTO**.

When the engine is running, the low beam headlamps are automatically switched on. In low ambient light conditions the parking lamps will also switch on.

### Canada only

When you shift from a driving position to position **N** or **P**, the low beam switches off (with a three-minute delay).

For nighttime driving you should turn the exterior lamp switch to position  to permit activation of the high beam headlamps.

### USA only

The high beam headlamps can also be activated when driving with the daytime running lamp mode activated and exterior lamp switch in position **0**.

To activate the daytime running lamp mode, see “Setting daytime running lamp mode (USA only)” (▷ page 125).



See notes on the exterior lamp switch (▷ page 101).

### Locator lighting and night security illumination

Locator lighting and night security illumination are described in the control system section under “Setting locator lighting” (▷ page 126) and “Setting night security illumination” (▷ page 126).

### Switching on front fog lamps

- ▶ Make sure that the low beam headlamps are switched on.
- ▶ Pull out exterior lamp switch to first stop.

The green indicator lamp  in the lamp switch lights up.



Fog lamps will operate with the parking lamps and/or the low beam headlamps on. Fog lamps should only be used in conjunction with low beam headlamps. Consult your State or Province Motor Vehicle Regulations regarding allowable lamp operation.

### Switching on rear fog lamp

- ▶ Make sure that the low beam headlamps are switched on.
- ▶ Pull out exterior lamp switch to second stop.

The yellow indicator lamp  in the lamp switch lights up.

### Lighting

#### Combination switch

The combination switch is located on the left side of the steering column.

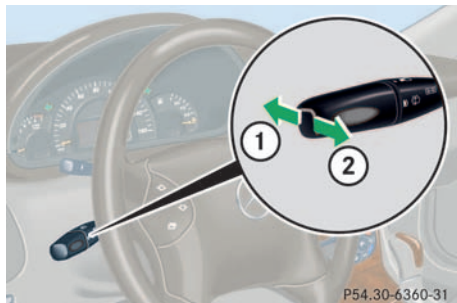

- 1 High beam
- 2 High beam flasher

#### Switching on high beams

- ▶ Turn exterior lamp switch to position  or to **AUTO** (▷ page 101).
- ▶ Push the combination switch in direction 1.

The high beam symbol is illuminated on the instrument cluster.

#### High beam flasher

- ▶ Pull the combination switch briefly in direction 2.

#### Hazard warning flasher

The hazard warning flasher can be activated with the ignition switched on or off. It is activated automatically when an airbag is deployed.

The switch is located on the center console.



- 1 Hazard warning flasher switch

#### Switching on the hazard warning flasher

- ▶ Press the hazard warning flasher switch.

All turn signals will blink.



With the hazard warning flasher activated and the combination switch set for either left or right turn, only the respective left or right turn signals will operate when the key in the starter switch is in position 1 or 2.

#### Switching off the hazard warning flasher

- ▶ Press hazard warning flasher switch again.



## Interior lighting

The controls are located in the overhead control panel.

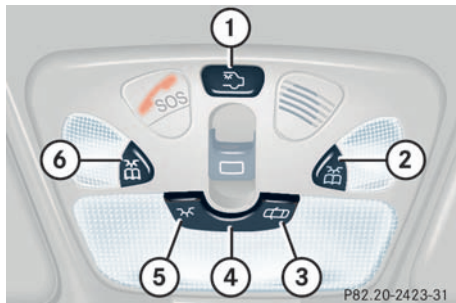

- 1 Rear interior lights
- 2 Right front reading lamp
- 3 Rocker switch: Automatic control off
- 4 Rocker switch: Automatic control on
- 5 Rocker switch: Front interior lights on
- 6 Left front reading lamp



If the door remains open, the interior lamps switch off automatically after approximately five minutes, when the key is removed or in the starter switch position **0**.

An interior lamp switched on manually does not go out automatically.

### Activating automatic control

- ▶ Press the rocker switch to the center position **4**.

Interior lamps are switched on in darkness, when

- unlocking the vehicle
- opening a door
- removing the SmartKey from starter switch

The interior lamps are switched off following an adjustable time delay (▷ page 127).

### Deactivating automatic control

- ▶ Press the rocker switch to the right position **3**.

The interior lighting remains switched off, even when

- centrally unlocking the vehicle
- opening a door
- removing the SmartKey from the starter switch

### Manual control

#### Switching rear interior lights on and off

- ▶ Press button **1**.

The lights in the rear passenger compartment go on.

- ▶ Press button **1** again.

The lights in the rear passenger compartment go out.

### Lighting

#### *Switching right front reading lamp on and off*

- ▶ Press button **2**.  
The right reading lamp goes on.
- ▶ Press button **2** again.  
The right reading lamp goes off.

#### *Switching left front reading lamp on and off*

- ▶ Press button **6**.  
The left reading lamp goes on.
- ▶ Press button **6** again.  
The left reading lamp goes off.

#### *Switching all front interior lights on and off*

- ▶ Press rocker switch in position **5**.  
The interior lighting stays on while the rocker switch is pressed in.
- ▶ Press rocker switch to position **3** or **4**.  
The interior lighting goes out.

#### Door entry lamps

---

The appropriate door entry lamp switches on if a door is opened in darkness and if the interior lighting is switched to automatic function.

The entry lamp switches off automatically when the door is closed.



If you turn the key in the starter switch to position **0** and switch off the exterior headlamps, the door entry lamps will remain lit for approximately five minutes.

#### Trunk lamp

---

The trunk lamp switches on if the trunk lid is opened.

If you leave the trunk open for an extended period of time, the trunk lamp will switch off automatically after approximately ten minutes.

## Instrument cluster

A full view illustration of the instrument cluster can be found in the “At a glance” section of this manual (▷ page 22).

The instrument cluster is activated when you

- open a door
- turn on the ignition
- press the reset knob (▷ page 22)
- switch on the exterior lamps

You can change the instrument cluster settings in the Instrument cluster submenu of the control system (▷ page 122).

## Instrument cluster illumination

Use the reset knob (▷ page 22) to adjust the illumination brightness for the instrument cluster.



The instrument cluster illumination is dimmed or brightened automatically to suit ambient light conditions.

The instrument cluster illumination will also be adjusted automatically when you switch on the vehicle's exterior lamps.

## To brighten illumination

- ▶ Turn the reset knob in the instrument cluster clockwise (▷ page 22).

The instrument cluster illumination will brighten.

## To dim illumination

- ▶ Turn the reset knob in the instrument cluster counterclockwise (▷ page 22).

The instrument cluster illumination will dim.

### Coolant temperature display

#### Warning!







- Driving when your engine is badly overheated can cause some fluids which may have leaked into the engine compartment to catch fire. You could be seriously burned.
- Steam from an overheated engine can cause serious burns and can occur just by opening the engine hood. Stay away from the engine if you see or hear steam coming from it.

Turn off the engine, get out of the vehicle and do not stand near the vehicle until it cools down.



Turn the SmartKey in the starter switch to position **1** or **2**.

- ▶ Call up the trip odometer and main odometer by pressing button  or  on the multifunction steering wheel (▷ page 112).
- ▶ Press button  or  until the coolant temperature display appears.



Excessive coolant temperatures trigger a warning in the multifunction display.

During severe operating conditions and stop-and-go city traffic, the coolant temperature may rise close to 248°F (120°C).

The engine should not be operated with the coolant temperature above 248°F (120°C). Doing so may cause serious engine damage which is not covered by the Mercedes-Benz Limited Warranty.

### Trip odometer

---

- ▶ Make sure you are viewing the trip odometer and main odometer (▷ page 111) in the multifunction display.
- ▶ Press and hold the reset knob on the instrument cluster (▷ page 22) until the trip odometer is reset.

### Tachometer

---

The red marking on the tachometer denotes excessive engine speed.



Avoid driving at excessive engine speeds, as it may result in serious engine damage that is not covered by the Mercedes-Benz Limited Warranty.

To help protect the engine, the fuel supply is interrupted if the engine is operated within the red marking.

### C 32 AMG

On the C 32 AMG, there is no red marking denoting excessive engine speed.

To help protect the engine, the fuel supply is interrupted if the engine is operated at an excessive speed.

#### Outside temperature indicator

---

##### Warning!



The outside temperature indicator is not designed to serve as an ice-warning device and is therefore unsuitable for that purpose.

Indicated temperatures just above the freezing point do not guarantee that the road surface is free of ice. The road may still be icy, especially in wooded areas or on bridges.

The temperature sensor is located in the front bumper area. Due to its location, the sensor can be affected by road or engine heat during idling or slow driving. This means that the accuracy of the displayed temperature can only be verified by comparison to a thermometer placed next to the sensor, not by comparison to external displays (e.g. bank signs etc.).

When moving the vehicle into colder ambient temperatures (e.g. when leaving your garage), you will notice a delay before the lower temperature is displayed.

A delay also occurs when ambient temperatures rise. This prevents inaccurate temperature indications caused by heat radiated from the engine during idling or slow driving.

## Control system

The control system is activated as soon as the key in the starter switch is turned to position **1**. The control system enables you to

- call up information about your vehicle
- change vehicle settings

For example, you can use the control system to find out when your vehicle is next due for service, to set the language for messages in the instrument cluster display, and much more.



The displays for the audio systems (radio, CD player, cassette player) will appear in English, regardless of the language selected.

### Warning!



A driver's attention to the road and traffic conditions must always be his/her primary focus when driving.

For your safety and the safety of others, selecting features through the multifunction steering wheel should only be done by the driver when traffic and road conditions permit it to be done safely.

Bear in mind that at a speed of just 30 mph (approximately 50 km/h), your vehicle is covering a distance of 44 feet (approximately 13.5 m) every second.

The control system relays information to the multifunction display.

## Multifunction display

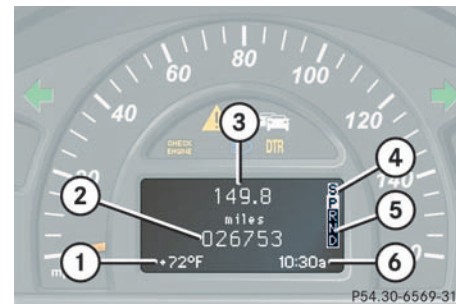

- 1 Outside temperature
- 2 Main odometer
- 3 Trip odometer
- 4 Automatic transmission program mode
- 5 Current gear selector lever position
- 6 Digital clock

## Control system

### Multifunction steering wheel

The displays in the multifunction display and the settings in the control system (▷ page 111) are controlled by the buttons on the multifunction steering wheel.

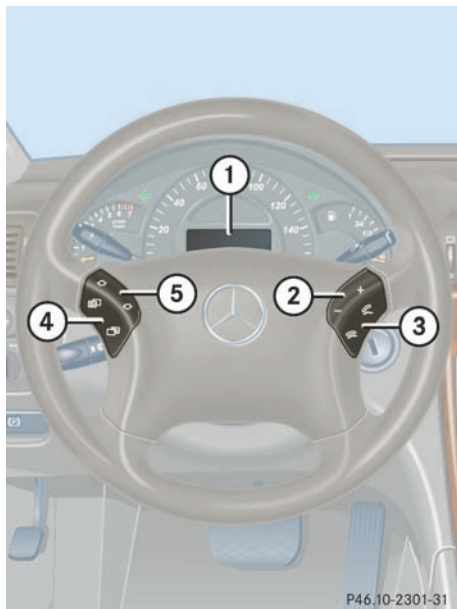

1 Multifunction display in the speedometer

#### Operating the control system

2 Selecting the submenu or setting the volume

 down / to decrease

 up / to increase

3 Telephone\*

 to take a call

 to end a call

4 Menu systems

 for next menu

 for previous menu

5 Moving within a menu

 for next display

 for previous display





Pressing any of the buttons on the multifunction steering wheel will alter what is shown in the multifunction display.

The information available in the multifunction display is arranged in menus, each containing a number of functions or submenus.

The individual functions are then found within the relevant menu (radio or CD operations under AUDIO, for example). These functions serve to call up relevant information or to customize the settings for your vehicle.



It is helpful to think of the menus, and the functions within each menu, as being arranged in a circular pattern.

- If you press button  or  repeatedly, you will pass through each menu one after the other.
- If you press button  or  repeatedly, you will pass through each function display, one after the other, in the current menu.

In the **SETTINGS** menu, instead of functions you will find a number of submenus for calling up and changing settings. For instructions on using these submenus, see the “Settings menu” section (▷ page 120).

The number of menus available in the system depends on which optional equipment is installed in your vehicle.

The menus are described on the following pages.

### Menus

This is what you will see when you scroll through the menus.

The table on the next page provides an overview of the individual menus.

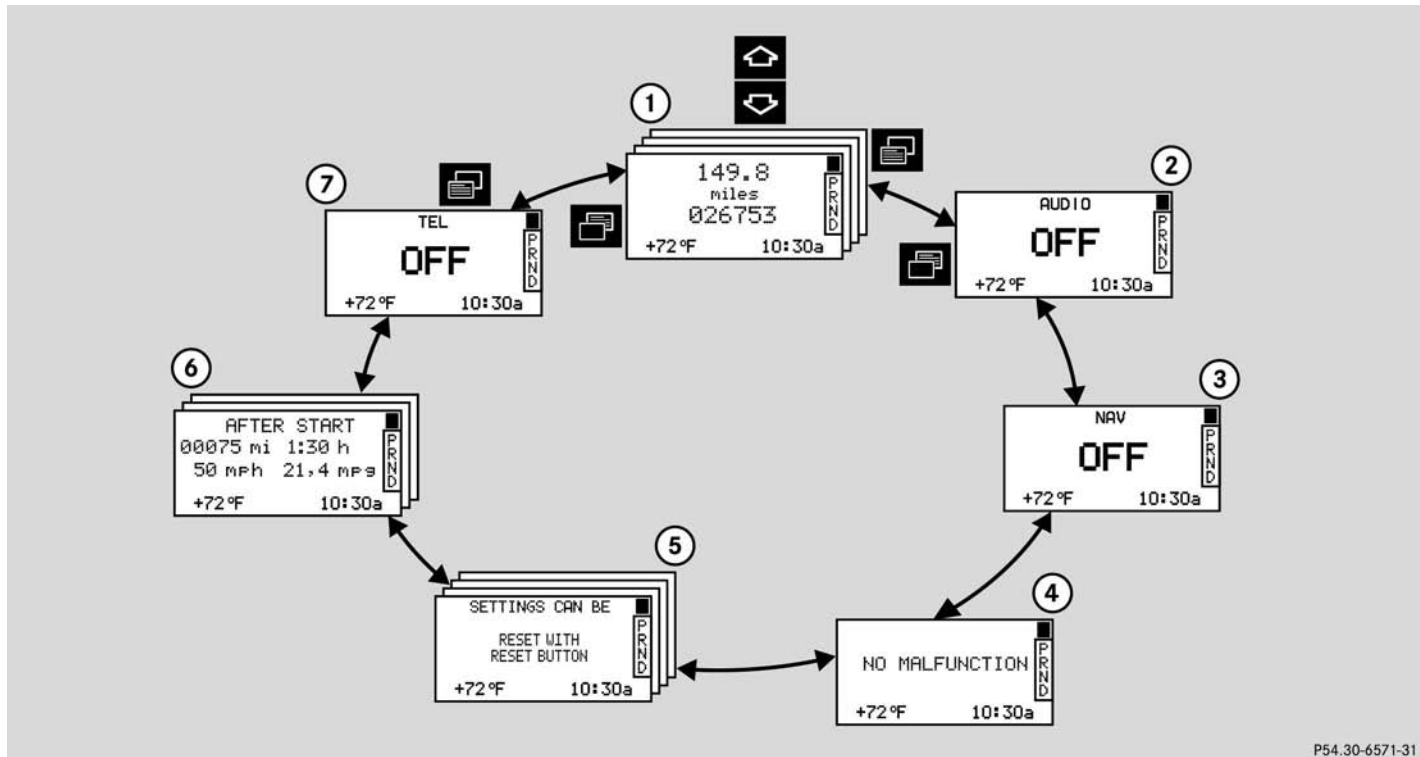

P54.30-6571-31

Menus, submenus and functions

	Menu 1	Menu 2	Menu 3	Menu 4	Menu 5	Menu 6	Menu 7
	Standard display	AUDIO	NAVI*	Malfunction memory	Settings	Trip computer	Telephone*
Commands/submenus	Coolant temperature display	Select radio station	Activate route guidance	Call up malfunction messages	Reset to factory settings	Fuel consumption statistics after start	Load phone book
	Digital speedometer	Operate CD player*			Instrument cluster submenu	Fuel consumption statistics since the last reset	Search for name in phone book
	Call up FSS	Operate cassette player			Lighting submenu	Call up range	
	Check engine oil level				Vehicle submenu Convenience submenu		



### Control system



The headings used in the menus table are designed to facilitate navigation within the system and are not necessarily identical to those shown in the control system displays.

The first function displayed in each menu will automatically show you which part of the system you are in.

#### Standard display menu

You can select the functions in the standard display menu with button  or .

The following functions are available:

Function	Page
Call up coolant temperature display	108
Call up digital speedometer	see below
Call up FSS	247
Check engine oil level	236

#### Display digital speedometer

- ▶ Press button  twice.

The current vehicle speed is shown in the multifunction display.

#### AUDIO menu



The functions in the **AUDIO** menu operate the audio equipment which you currently have turned on.

If no audio equipment is currently turned on, the message **AUDIO OFF** is shown in the display.

The following functions are available:

Function	Page
Select radio station	117
Operate CD player*	117
Operate cassette player	118

### Select radio station

- ▶ Turn on the radio (▷ page 168).  
Vehicles with COMAND\*:  
Refer to separate operating instructions.
- ▶ Press button  or  repeatedly until you see the currently tuned station in the display.



- 1 Station frequency
- 2 Waveband setting
- 3 Setting for station selection using memory

- ▶ Press button  or  repeatedly until the desired station is found.

The type of search depends on the setting for the station tuning (▷ page 128):

- The next stored station is selected (SP)
- Station search





You can only store new stations using the corresponding feature on the radio (▷ page 173).

Vehicles with COMAND\*:  
Refer to separate operating instructions.

You can also operate the radio in the usual manner.

### Operate the CD player\*

- ▶ Turn on the radio and select the CD player (▷ page 178).  
Vehicles with COMAND\*:  
Refer to separate operating instructions.
- ▶ Press button  or  repeatedly until the settings for the CD currently being played are shown in the display.



- 1 Current track
- 2 Current CD (for CD changer\*)



- ▶ Press button  or  repeatedly until the desired track is selected.



To select a CD from the magazine, press a number on the audio system or the COMAND\* system key pad located in the center dashboard.



### Control system

#### Operate the cassette player

- ▶ Turn on the radio and select the Cassette player (▷ page 174). Vehicles with COMAND\*: Refer to separate operating instructions.
- ▶ Press button  or  repeatedly until the settings for the cassette currently being played are shown in the display.



#### 1 Current side



- ▶ Press button  to fast forward to the next track.
- ▶ Press button  to rewind the cassette to the beginning of the current track.



To select the reverse side of the tape, press button below track number on the audio system display, or enter request on the COMAND\* system located in the center dashboard.

#### NAVI menu

The NAVI menu contains the functions needed to operate your navigation system.

- ▶ Press button  or  repeatedly until you see the message NAV in the display.
- If the navigation system is switched off, the message NAV OFF is shown in the display.
- If the navigation system is on, the message NAV ACTIVE is shown in the display.

Please refer to the COMAND\* manual for instructions on how to activate the route guidance system\*.



#### Malfunction memory menu

Use the malfunction memory menu to scan malfunction and warning messages that may be stored in the system. What information is shown in the display depends on whether malfunctions have actually occurred.

#### Warning!



Malfunction and warning messages are only indicated for certain systems and are intentionally not very detailed. The malfunction and warning messages are simply a reminder with respect to the operation of certain systems and do not replace the owner's and/or driver's responsibility to maintain the vehicle's operating safety by having all required maintenance and safety checks performed on the vehicle and by bringing the vehicle to an authorized Mercedes-Benz Center to address the malfunction and warning messages (▷ page 261).

- ▶ Press button  or  repeatedly until you see the malfunction message memory in the display.

### No malfunction messages

If no malfunctions have occurred, the message in the display is:



NO MALFUNCTION

### Malfunctions have occurred

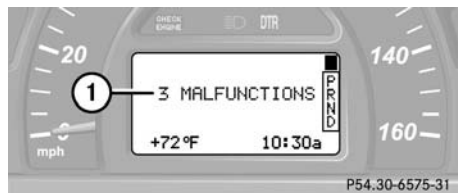
If malfunctions have occurred, you will see the number of malfunctions in the display:



1 Number of malfunctions

- ▶ Press button  or .

The stored messages will now be displayed in order. See the “Practical hints” section for malfunction and warning messages (▶ page 261).



Should any malfunctions occur while driving, the number of malfunctions will reappear in the display when the key in the starter switch is turned to position **0** or removed from the starter switch.



The message memory will be cleared when you turn the key in the starter switch to position **1** or **2**. You will then only see high-priority messages in the multifunction display (▶ page 261).

### Settings menu

In the **SETTINGS** menu there are two functions:

- The function **RESET TO FACTORY SETTINGS**, with which you can reset all the settings to the original factory settings.
  - A collection of submenus with which you can make individual settings for your vehicle.
- ▶ Press button  or  repeatedly until the **SETTINGS** menu is seen in the display.



### Control system

#### Resetting all settings

You can reset all the functions of all submenus to the factory settings.

- ▶ Press the reset knob in the instrument cluster (> page 22) for approximately three seconds.

In the display you will see the request to press the reset knob again to confirm.



- ▶ Press the reset knob again.

The functions of all the submenus will reset to factory settings.



The settings you have changed will not be reset unless you confirm the action by pressing the reset knob a second time.

#### Submenus in the Settings menu

- ▶ Press button or .

In the display you see the collection of the submenus.



- ▶ Press button .

The selection marker moves to the next submenu.

The submenus are arranged by hierarchy. Scroll down with the button, scroll up with the button.

Move within the submenus with the or button to the individual functions.

The settings themselves are made with button or .

#### Resetting the functions of a submenu

For each submenu you can reset all the functions to the factory settings.

- ▶ Move to a function in the submenu.
  - ▶ Press the reset knob (> page 22) in the instrument cluster for approximately three seconds.
- In the display you will see the request to press the reset knob again to confirm.
- ▶ Press the reset knob again.

All functions of the submenu will reset to factory settings.



The table below shows what settings can be changed within the various menus. Detailed instructions on making individual settings can be found on the following pages.

INSTRUMENT CLUSTER	LIGHTING	VEHICLE	CONVENIENCE
Set time (hours)	Set daytime running lamp mode (USA only)	Set station selection mode (radio)	Activate easy-entry/exit feature
Set time (minutes)	Set locator lighting	Set automatic locking	Set key dependency
Select time display mode	Exterior lamps delayed shut-off		Set parking position for exterior rear view mirror
Select temperature display mode	Interior lighting delayed shut-off		
Select speedometer display mode			
Select language			
Select display (speed display or outside temperature)			

## Control system

### Instrument cluster submenu

Access the INSTRUMENT CLUSTER submenu via the SETTINGS menu. Use the INSTRUMENT CLUSTER submenu to change the instrument cluster display settings. The following functions are available:

Function	Page
Set time (hours)	see below
Set time (minutes)	see below
Select time display mode	123
Select temperature display mode	123
Select speedometer display mode	123
Select language	124
Select display (speed display or outside temperature)	124

### Set time (hours)

- ▶ Move the selection marker with the **+** or **-** button to the INSTRUMENT CLUSTER submenu.
- ▶ Press button **▲** or **▼** repeatedly until you see this message in the display: TIME SETTINGS - HOURS.

The selection marker is on the hour setting.



- ▶ Press **+** or **-** to set the hour.

### Set time (minutes)

- ▶ Move the selection marker with the **+** or **-** button to the INSTRUMENT CLUSTER submenu.
- ▶ Press button **▲** or **▼** repeatedly until you see this message in the display: TIME SETTINGS - MINUTES.

The selection marker is on the minute setting.



- ▶ Press **+** or **-** to set the minutes.

### Selecting time display mode

- ▶ Move the selection marker with the **+** or **-** button to the INSTRUMENT CLUSTER submenu.
- ▶ Press button **↶** or **↷** repeatedly until you see this message in the display: 12/24 HOUR.

The selection marker is on the current setting.

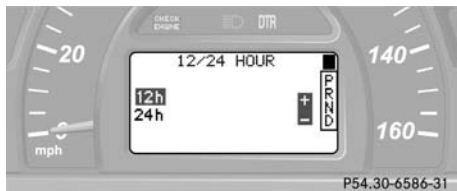

- ▶ Press **+** or **-** to set the 12h or 24h time display mode.

### Selecting temperature display mode

- ▶ Move the selection marker with the **+** or **-** button to the INSTRUMENT CLUSTER submenu.
- ▶ Press button **↶** or **↷** repeatedly until you see this message in the display: TEMP. INDICATOR.

The selection marker is on the current setting.

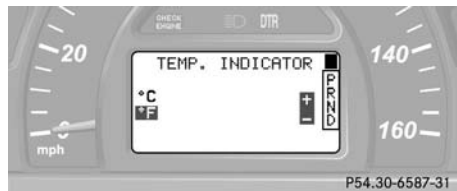

- ▶ Press **+** or **-** to set temperature unit to degrees Celsius (°C) or degrees Fahrenheit (°F).

### Selecting speedometer display mode

- ▶ Move the selection marker with the **+** or **-** button to the INSTRUMENT CLUSTER submenu.
- ▶ Press button **↶** or **↷** repeatedly until you see this message in the display: DISPLAY VALUES IN.

The selection marker is on the current setting.



- ▶ Press **+** or **-** to set speedometer unit to km or miles.

### Control system

#### Selecting language

- ▶ Move the selection marker with the **+** or **-** button to the INSTRUMENT CLUSTER submenu.
- ▶ Press button **↶** or **↷** repeatedly until you see this message in the display: TEXT.

The selection marker is on the current setting.



- ▶ Press **+** or **-** to select the language to be used for the multifunction display messages.

Available languages:

- German
- English
- French
- Italian
- Spanish

#### Selecting display (speed display or outside temperature)

- ▶ Move the selection marker with the **+** or **-** button to the INSTRUMENT CLUSTER submenu.
- ▶ Press button **↶** or **↷** repeatedly until you see this message in the display: SELECT DISPLAY.

The selection marker is on the current setting.

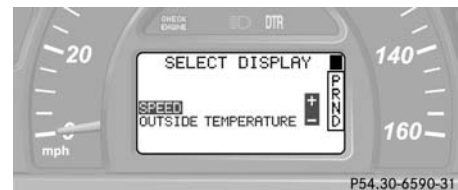

- ▶ Press **+** or **-** to select the display permanently shown in the multifunction display.

### Lighting submenu

Access the LIGHTING submenu via the SETTINGS menu. Use the LIGHTING submenu to change the lamp and lighting settings on your vehicle. The following functions are available:

Function	Page
Set daytime running lamp mode (USA only)	see below
Set locator lighting	126
Exterior lamps delayed shut-off	126
Interior lighting delayed shut-off	127

### Setting daytime running lamp mode (USA only)

- ▶ Move the selection marker with the **+** or **-** button to the LIGHTING submenu.
- ▶ Press button **↶** or **↷** repeatedly until you see this message in the display: LAMP CIRCUIT HEADLAMP MODE. The selection marker is on the current setting.

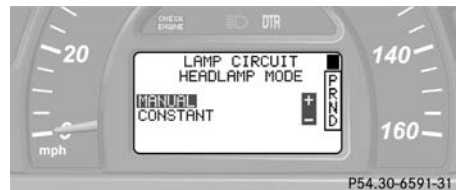

- ▶ Press **+** or **-** to select manual or daytime running lamp (constant) mode. This function is not available in countries where daytime running lamps are mandatory.

With daytime running lamp mode selected and the exterior lamp switch at position **0**, the following lamps will come on automatically when the engine is turned on:

- Parking lamps and low beam headlamps
- License plate lamps (in low ambient light conditions)



If you turn the exterior lamp switch to another position, the corresponding lamp(s) will switch on.

For safety reasons, resetting the LIGHTING submenu to factory settings (▷ page 120) will not reset the daytime running lamp mode.

In the display you will then see the message: LIGHTING - CANNOT BE COMPLETELY RESET TO FACTORY SETTINGS WHILE DRIVING!.

### Control system

#### Setting locator lighting

During darkness, the following lamps will come on when the exterior lamp switch is in position **AUTO**, the locator lighting feature is activated, and the vehicle is unlocked by remote control:

- Parking lamps
- Tail lamps
- License plate lamps
- Front fog lamps

The locator lighting switches off when the driver's door is opened. It switches off automatically after a period of approximately 40 seconds.

- ▶ Move the selection marker with the **+** or **-** button to the **LIGHTING** submenu.
- ▶ Press button **↶** or **↷** repeatedly until you see this message in the display: **LOCATOR LIGHTING**.

The selection marker is on the current setting.



- ▶ Press **+** or **-** to select the desired setting.

The locator lighting will be switched on or off.

#### Setting night security illumination

(Exterior lamps delayed shut-off)

Use the **HEADLAMPS DELAYED SHUT-OFF** function to set whether and for how long you would like the exterior lamps to illuminate during darkness after all doors are closed. When the delayed shut-off feature is activated and the exterior lamp switch is in position **AUTO**, the following lamps will remain lit after you remove the key from the starter switch:

- Parking lamps
- Tail lamps
- License plate lamps
- Front fog lamps



You can reactivate this function within ten minutes by opening a door.

If you do not open a door after removing the key, the lamps will automatically switch off after 60 seconds.

- ▶ Move the selection marker with the **+** or **-** button to the LIGHTING submenu.
- ▶ Press button **↶** or **↷** repeatedly until you see this message in the display: HEADLAMPS DELAYED SHUT-OFF.

The selection marker is on the current setting.

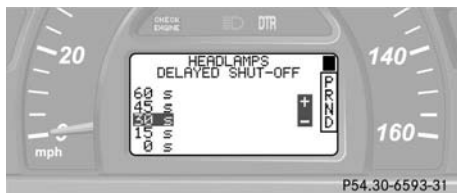

- ▶ Press **+** or **-** to select the desired lamp-on period.

You can select:

- 0 s, the delayed shut-off feature is deactivated
- 15 s, 30 s, 45 s or 60 s, the delayed shut-off feature is activated

You can temporarily deactivate the delayed shut-off feature:

- ▶ Before leaving the vehicle turn the key in the starter switch to position **0**.
- ▶ Then turn it to position **2** and back to **0**.

The delayed shut-off feature is deactivated. It will reactivate as soon as you reinsert the key in the starter switch.

### *Interior lighting delayed shut-off*

Use this function to set whether and for how long you would like the interior lighting to remain lit during darkness after the key is removed from the starter switch.

- ▶ Move the selection marker with the **+** or **-** button to the LIGHTING submenu.
- ▶ Press button **↶** or **↷** repeatedly until you see this message in the display: INT. LIGHTING DELAYED SHUT OFF.



## Control system

The selection marker is on the current setting.



- ▶ Press **+** or **-** to select the desired lamp-on time period. You can select:
  - 0 s, the delayed shut-off feature is deactivated
  - 5 s, 10 s, 15 s or 20 s, the delayed shut-off feature is activated

### Vehicle submenu

Access the VEHICLE submenu via the SETTINGS menu. Use the VEHICLE submenu to make general vehicle settings. The following functions are available:

Function	Page
Set station selection mode (radio)	see below
Set automatic locking	129

### Setting station selection mode

Use the PRESS BUTTON IN AUDIO MODE function to select the manual or memory station selection mode for the radio (▷ page 117).

- ▶ Move the selection marker with the **+** or **-** button to the VEHICLE submenu.

- ▶ Press button **▲** or **▼** repeatedly until you see this message in the display: PRESS BUTTON IN AUDIO MODE.

The selection marker is on the current setting.



- ▶ Press **+** or **-** to select the desired station selection mode. You can select:
  - STATION SEARCH
  - MEMORY selects next stored station



### Setting automatic locking

Use this function to activate or deactivate the automatic central locking. With the automatic central locking system activated, the vehicle is centrally locked at vehicle speeds of approximately 9 mph (15 km/h).

- ▶ Move the selection marker with the **+** or **-** button to the VEHICLE submenu.
- ▶ Press button **↶** or **↷** repeatedly until you see this message in the display: AUTOMATIC DOOR LOCK.

The selection marker is on the current setting.



- ▶ Press **+** or **-** to switch AUTOMATIC DOOR LOCK ON or OFF.

### Convenience submenu

Access the CONVENIENCE submenu via the SETTINGS menu. Use the CONVENIENCE submenu to change the settings for a number of convenience features. The following functions are available:

Function	Page
Activate easy-entry/exit feature*	see below
Set key dependency	131
Set parking position for exterior rear view mirror	131

### Activating easy-entry/exit feature\*

Use this function to activate and deactivate the easy-entry/exit feature. When the feature is activated, the steering wheel and driver's seat will move back to facilitate exiting when you

- remove the key from the starter switch
- open the driver's door

However, the engine must be turned off.

### Warning!



You must make sure that no one can become trapped or injured by the moving steering wheel and the driver's seat when the easy-entry/exit feature\* is activated and the driver's door is being opened and the engine is turned off or the SmartKey is removed from the starter switch. Do not leave children unattended in the vehicle, or with access to an unlocked vehicle. Unsupervised use of vehicle equipment may cause an accident and/or serious personal injury.

Do not leave children unattended in the vehicle, or with access to an unlocked vehicle. Children could open the driver's door and unintentionally activate the easy-entry/exit feature\*, which could result in an accident and/or serious personal injury.

### Control system

After entering the vehicle the steering wheel and seat will move into the position stored in memory when

- the driver's door is closed
- you put the key in the starter switch and
- press the appropriate stored position button on the memory switch (▷ page 99)



To cancel seat/steering wheel movement, do one of the following:

- press the seat adjustment switch\* (▷ page 34)
- move the steering column stalk\* (▷ page 38)
- press the memory switch\* (▷ page 99)

- ▶ Move the selection marker with the **+** or **-** button to the CONVENIENCE submenu.
- ▶ Press button or repeatedly until you see this message in the display: EASY-ENTRY FEATURE ACTIVATE.

The selection marker is on the current setting.



- ▶ Press **+** or **-** to change the easy-entry/exit setting.

The following settings are available for the easy-entry/exit feature:

OFF	The easy-entry/exit feature is deactivated
STEERING COLUMN	Only the steering column is moved
STEERING COLUMN + SEAT	Both the steering column and the seat are moved

### Setting key dependency

Use this function to set whether the memory settings for the seats, the steering wheel and the mirrors should be stored separately for each key (▷ page 84).

- ▶ Move the selection marker with the **+** or **-** button to the CONVENIENCE submenu.
- ▶ Press button **↶** or **↷** repeatedly until you see this message in the display: SETTINGS KEY-DEPENDENT.

The selection marker is on the current setting.

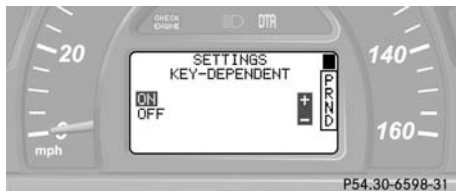

- ▶ Press **+** or **-** to set key dependency to ON or OFF.

### Setting parking position for exterior rear view mirror

Use the MIRROR SETTING WHEN PARKING function to select whether the passenger-side exterior rear view mirror should be turned downward during parking maneuvers, when reverse gear is engaged. For additional information, see “Activating exterior rear view mirror parking position” (▷ page 145).

- ▶ Move the selection marker with the **+** or **-** button to the CONVENIENCE submenu.
- ▶ Press button **↶** or **↷** repeatedly until you see this message in the display: MIRROR SETTING WHEN PARKING.

The selection marker is on the current setting.



- ▶ Press **+** or **-** to switch function ON or OFF.





## Control system

### Trip computer menu

Use the trip computer menu to call up statistical data on your vehicle. The following information is available:

Function	Page
Fuel consumption statistics after start	see below
Fuel consumption statistics since last reset	see below
Call up range (distance to empty)	133





### Fuel consumption statistics after start

- ▶ Press button  or  repeatedly until you see the first function of the Trip computer menu.
- ▶ Press button  or  repeatedly until you see this message in the display: AFTER START.



- 1 Distance driven since start
- 2 Time elapsed since start
- 3 Average fuel consumption since start
- 4 Average speed since start

### Fuel consumption since last reset

- ▶ Press button  or  repeatedly until you see the first function of the Trip computer menu.
- ▶ Press button  or  repeatedly until you see this message in the display: AFTER RESET.



- 1 Distance driven since last reset
- 2 Time elapsed since last reset
- 3 Average fuel consumption since last reset
- 4 Average speed since last reset



All statistics stored since the last engine start will be reset approximately four hours after the key in the starter switch is turned to position **0** or removed from the starter switch.

Resetting will not occur if you turn the key back to position **1** or **2** within this time period.

### Resetting fuel consumption statistics

- ▶ Press button or repeatedly until you see the first function of the Trip computer menu.
- ▶ Press button or repeatedly until you see the reading that you want to reset in the display.
- ▶ Press and hold the reset knob in the instrument cluster (▷ page 22) until the value is reset to 0.

### Call up range (distance to empty)

- ▶ Press button or repeatedly until you see the first function of the Trip computer menu.
- ▶ Press button or repeatedly until you see this message in the display: RANGE.

In the display you will see the calculated range based on the current fuel tank level.



### Control system

#### TEL menu\*

##### Warning!





A driver's attention to the road must always be his/her primary focus when driving. For your safety and the safety of others, we recommend that you pull over to a safe location and stop before placing or taking a telephone call. If you choose to use the telephone while driving, please use the hands-free device and only use the telephone when weather, road and traffic conditions permit.

Some jurisdictions prohibit the driver from using a cellular telephone while driving a vehicle.

Bear in mind that at a speed of just 30 mph (approximately 50 km/h), your vehicle is covering a distance of approximately 44 feet (approximately 13.5 m) every second.

Never operate radio transmitters equipped with a built-in or attached antenna (i.e. without being connected to an external antenna) from inside the vehicle while the engine is running. Doing so could lead to a malfunction of the vehicle's electronic system, possibly resulting in an accident and personal injury.

You can use the functions in the TEL menu to operate your telephone, provided it is connected to a hands-free system and switched on.

- ▶ Switch on the telephone and COMAND\*.
- ▶ Press button  or  on the steering wheel repeatedly until you see the TEL menu in the display.

Which messages will appear in the display field depends on whether your telephone is switched on or off:

- If the telephone is off, the message in the multifunction display is: TEL OFF.
- If the telephone is on:

The telephone will then search for a network. During this time the display is empty.

As soon as the telephone has found a network, READY is indicated in the display.



1 Signal strength

This standby message indicates that your telephone is ready for use and you can operate it using the control system.



Vehicles with audio system:

In top right corner; the higher the number, the stronger the signal received from the net.

Vehicles with COMAND\*:

In top left corner; the higher the number of bars, the stronger the signal received from the net.

### Answering a call

When your telephone is ready to receive calls, you can answer a call at any time. In the display you will then see the message:



- ▶ Press button

You have answered the call. In the display you see the length of the call.

### Ending a call

- ▶ Press button

You have ended the call. In the display you will again see the standby message.

### Dialing a number from the phone book

If your telephone is ready to receive calls, you may select and dial a number from the phone book at any time.

- ▶ Press button or repeatedly until you see the TEL menu in the display.
- ▶ Press button or .

The control system reads the phone book which is stored in the telephone. This may take up to 30 seconds. In the display you will see the message PLEASE WAIT!.

When the message PLEASE WAIT! disappears, the phone book has been loaded.

- ▶ Press button or repeatedly until the desired name appears in the display.

The stored names are displayed in increasing or decreasing alphabetical order.



### Control system



If you press and hold or for longer than one second, the system scrolls rapidly through the list of names until you release the button again.

Cancel the quick search mode by pressing .

- ▶ Press button .

The system dials the selected phone number.

- If connection is successful, the name of the party you called and the duration of the call will appear in the display.



- If no connection is made, the control system stores the dialed number in the redial memory.

### Redialing

The control system stores the most recently dialed phone numbers. This eliminates the need to search through your entire phone book.

- ▶ Press button or repeatedly until you see the TEL menu in the display.

- ▶ Press button .

In the display you see the first number in the redial memory.

- ▶ Press button or repeatedly until the desired name appears in the display.

- ▶ Press button .

The control system dials the selected phone number.



## Manual transmission

Information for driving with a manual transmission is found in the “Getting started” section (▷ page 44).

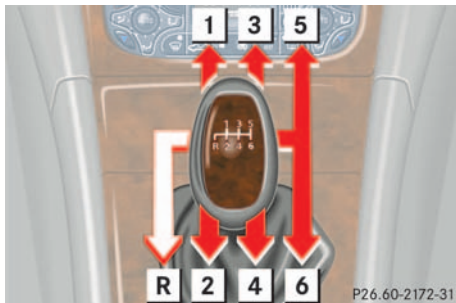

### Gearshift lever

Do not exceed the maximum speed in the individual gears. Refer to tachometer (▷ page 109) for engine speeds.

#### Warning!



For vehicles equipped with a manual transmission, getting out of your vehicle with the gearshift lever not engaged in first or reverse gear and parking brake engaged is dangerous.

Also, when parked on an incline, an engaged first or reverse gear alone may not prevent your vehicle from moving, possibly hitting people or objects.

Always set the parking brake in addition to engaging first or reverse gear (▷ page 51).

When parked on an incline, turn front wheels towards the road curb.

#### Warning!



When leaving the vehicle, always remove the key from the starter switch, take it with you and lock the vehicle. Do not leave children unattended in the vehicle, or with access to an unlocked vehicle. Children could move the gearshift lever, which could result in an accident and/or serious injury.

#### Warning!



On slippery road surfaces, never downshift in order to obtain braking action.

This could result in drive wheel slip and reduced vehicle control. Your vehicle’s ABS will not prevent this type of loss of control.



Downshifting gears leading to overrevving the engine can result in engine damage that is not covered by the Mercedes-Benz Limited Warranty.

Never hold the vehicle stopped on a hill by using the clutch pedal. The clutch may be damaged which is not covered by the Mercedes-Benz Limited Warranty.

Do not exceed the engine speed limits (▷ page 109).

### Shifting into reverse

- ▶ Stop the vehicle completely.
- ▶ Pull gearshift lever up and shift in R reverse.

### Automatic transmission\*

#### Automatic transmission\*

Information for driving with an automatic transmission is found in the “Getting started” section (▷ page 44).

Your transmission adapts its gear shifting process to your individual driving style by continually adjusting the shift points up or down. These shift point adjustments are performed based on current operating and driving conditions.

If the operating conditions change the automatic transmission reacts by adjusting its gear shift program.



During the brief warm-up the transmission upshifting is delayed. This allows the catalytic converter to heat up more quickly to operating temperatures.

The automatic transmission selects individual gears automatically, depending on

- the selector lever position **D** with gear ranges **4, 3, 2, 1** (▷ page 140)
- the selected shift program (**W/S**) (▷ page 142)
- the position of the accelerator pedal (▷ page 143)
- the vehicle speed

The current selector lever position and shift program (**W/S**) appear in the speedometer display (▷ page 111).

An additional indication of the current selector lever position can be found on the cover of the shifting-gate. The indicators come on when you activate a switch (e.g. unlocking the vehicle or opening a door) and go out after approximately 15 minutes.

#### Warning!



It is dangerous to shift the selector lever out of **P** or **N** if the engine speed is higher than idle speed. If your foot is not firmly on the brake pedal, the vehicle could accelerate quickly forward or reverse. You could lose control of the vehicle and hit someone or something. Only shift into gear when the engine is idling normally and when your right foot is firmly on the brake pedal.

When the selector lever is in position **D**, you can influence transmission shifting by

- limiting the gear range
- changing gears yourself

## One-touch gearshifting

Even with an automatic transmission you can change the gears yourself when the selector lever is in position **D**.

## Downshifting

- ▶ Briefly press the selector lever to the left in the **D-** direction.

The transmission will shift from the current gear to the next lower gear. This action simultaneously limits the gear range of the transmission (▷ page 140).

### Warning!



On slippery road surfaces, never downshift in order to obtain braking action. This could result in drive wheel slip and reduced vehicle control. Your vehicle's ABS will not prevent this type of loss of control.



To avoid overrevving the engine when the selector lever is moved to the **D-** direction, the transmission will not shift to a lower gear if the engine's max. speed would be exceeded.

## Upshifting

- ▶ Briefly press the selector lever to the right in the **D+** direction.

The transmission will shift from the current gear to the next higher gear as permitted by the shift program. This action simultaneously extends the gear range of the transmission.

## Canceling gear range limit

- ▶ Press and hold the selector lever in the **D+** direction until **D** reappears in the tachometer display field.

The transmission will shift from the current gear range directly to gear range **D**.

## Shifting into optimal gear range

- ▶ Press and hold the gear selector lever in the **D-** direction.

The transmission will automatically select the gear range suited for optimal acceleration and deceleration. This will involve shifting down one or more gears.

### Automatic transmission\*

#### Gear ranges

With the selector lever in position **D**, you can limit the transmission's gear range by pressing the lever to the left (**D-**), and reverse the gear range limit by pressing the lever to the right (**D+**).

The selected gear range will appear in the tachometer display field. If you press on the accelerator when the engine has reached its rpm limit, the transmission will upshift beyond any gear range limit selected.

Gear range	Effect
<b>4</b>	The transmission shifts through fourth gear only.
<b>3</b>	The transmission shifts through third gear only.  With this selection you can use the braking effect of the engine.

Gear range	Effect
<b>2</b>	The transmission shifts through second gear only.  Allows the use of engine's braking power when driving <ul style="list-style-type: none"><li>• on steep downgrades</li><li>• in mountainous regions</li><li>• under extreme operating conditions</li></ul>
<b>1</b>	The transmission operates only in first gear.  For maximum use of engine's braking effect on very steep or lengthy downgrades.

### Gear selector lever position

	Effect
<b>P</b>	<p><b>Park position</b></p> <p>Selector position when the vehicle is parked. Only place selector lever in position <b>P</b> when vehicle is stopped. The park position is not intended to serve as a brake when the vehicle is parked. Rather, the driver should always set the parking brake in addition to placing the selector lever in position <b>P</b> to secure the vehicle.</p> <p>The key can only be removed from the starter switch with the selector lever in position <b>P</b>. With the key removed the selector lever is locked in position <b>P</b>.</p>

	Effect
<b>R</b>	<p><b>Reverse gear</b></p> <p>Place selector lever in position <b>R</b> only when vehicle is stopped.</p>
<b>N</b>	<p><b>Neutral</b></p> <p>No power is transmitted from the engine to the drive axle. When the brakes are released, the vehicle can be moved freely (pushed or towed).</p> <p>To avoid damage to the transmission, never engage <b>N</b> while driving.</p> <p>If ESP is deactivated or malfunctioning: Only move selector lever to <b>N</b> if the vehicle is in danger of skidding (e.g. on icy roads).</p>
<b>D</b>	<p><b>Drive</b></p> <p>The transmission shifts automatically. All five forward gears are available.</p>



Coasting the vehicle, or driving for any other reason with selector lever in **N** can result in transmission damage that is not covered by the Mercedes-Benz Limited Warranty.

### Warning!



Getting out of your vehicle with the selector lever not fully engaged in position **P** is dangerous. Also, position **P** alone is not intended to or capable of preventing your vehicle from moving, possibly hitting people or objects.

Always set the parking brake in addition to shifting to position **P** (▷ page 51).

When parked on an incline, turn the front wheels towards the road curb.

#### Warning!



When leaving the vehicle, always remove the key from the starter switch, take it with you and lock the vehicle. Do not leave children unattended in the vehicle, or with access to an unlocked vehicle. Children could move the selector lever from position **P**, which could result in an accident and/or serious injury.

#### Program mode selector switch

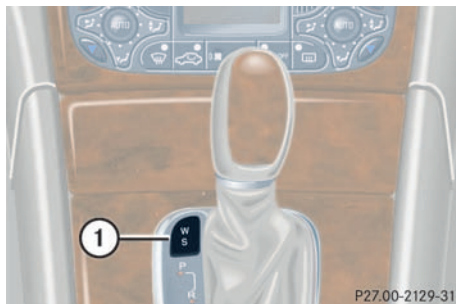

**1** Program mode selector switch

**S** Standard For regular driving

**W** Winter For winter driving



Never change the program mode when the selector lever is out of position **P**. It could result in a change of driving characteristics for which you may not be prepared.

- ▶ Press the program mode selector switch repeatedly until the letter of the desired shift program appears in the multifunction display (▷ page 111).

Select **W** for winter driving:

- The vehicle starts out in second gear (both forward and reverse) for gentler starts. This does not apply if full throttle is applied or gear range **1** is selected.
- Traction and driving stability are improved on icy roads.
- Upshifts occur earlier even when you give more gas. The engine then operates at lower rpms and the wheels are less likely to spin.
- The power transmission ratio for selector lever position **R** changes depending on the program mode selected (**W** or **S**).

### Accelerator position

---

Your driving style influences the transmission's shifting behavior:

Less throttle	Earlier upshifting
More throttle	Later upshifting

### Kickdown

Use kickdown when you want maximum acceleration.

- ▶ Press the accelerator past the point of resistance.

The transmission shifts into a lower gear.

- ▶ Ease on the accelerator when you have reached the desired speed.

The transmission shifts up again.

### Emergency operation (Limp Home Mode)

---

If vehicle acceleration worsens or the transmission no longer shifts, the transmission is most likely operating in limp home (emergency operation) mode. In this mode only second gear and reverse gear can be activated.

- ▶ Stop the vehicle.
- ▶ Move selector lever to **P**.
- ▶ Turn off the engine.
- ▶ Wait at least ten seconds before restarting.
- ▶ Restart the engine.
- ▶ Move selector lever to position **D** (for second gear) or **R**.
- ▶ Have the transmission checked at an authorized Mercedes-Benz Center as soon as possible.

### Good visibility

#### Good visibility

Information on the windshield wipers (▷ page 48) and for setting the rear view mirrors (▷ page 39) is found in the “Getting started” section.

#### Rear view mirror

##### Inside rear view mirror, antiglare position

Tilt the mirror to the antiglare night position using the lever at its lower edge.

##### Automatic antiglare rear view mirror\*

The reflection brightness of the exterior rear view mirror on the driver’s side and the inside rear view mirror will respond automatically to glare when

- the ignition is switched on, and
- incoming light from headlamps falls on the sensor in the inside rear view mirror.

The rear view mirror will not react if

- reverse gear is engaged
- the interior lighting is turned on

#### Warning!



The automatic antiglare function does not react if incoming light is not aimed directly at sensors in the inside rear view mirror.

The inside rear view mirror and the exterior rear view mirror on the driver’s side do not react, for example, if the rear window sunshade is in raised position.

Glare can endanger you and others.

#### Warning!



In the case of an accident liquid electrolyte may escape from the mirror housing if the mirror glass breaks.

Electrolyte has an irritating effect. Do not allow the liquid to come into contact with eyes, skin, clothing, or respiratory system. In case it does, immediately flush affected area with water, and seek medical help if necessary.

#### Warning!



Exercise care when using the passenger side exterior rear view mirror. The mirror surface is convex (outwardly curved surface for a wider field of view). Objects in mirror are closer than they appear. Check your inside rear view mirror or glance over your shoulder before changing lanes.





Electrolyte drops coming into contact with the vehicle paint finish can be completely removed only while in the liquid state by applying plenty of water.

### Activating exterior rear view mirror parking position

Follow these steps to activate the mirror parking position so that the passenger-side exterior rear view mirror will be turned downward to the stored position.

- ▶ Make sure you stored a parking position for the passenger-side exterior rear view mirror (▷ page 100).

- ▶ Make sure that the MIRROR SETTING WHEN PARKING function, found under the CONVENIENCE submenu in the control system, is switched to ON (▷ page 131).
- ▶ Switch on ignition.
- ▶ Press button **3** (▷ page 39) for the passenger-side exterior rear view mirror.
- ▶ Place the gear selector lever in reverse gear **R**.

The passenger-side exterior rear view mirror will be turned downward to the stored position.

The exterior rear view mirror returns to its previously stored driving position:

- ten seconds after you put the gear selector lever out of position **R**
- immediately once you exceed a vehicle speed of approx. 6 mph (10 km/h)
- immediately when you press the button for driver's side mirror (▷ page 39)

### Good visibility

#### Headlamp cleaning system\*

The switch is located on the left side of the dashboard.



#### 1 Headlamp washer switch

- ▶ Switch on ignition.
- ▶ Press switch 1.

The headlamps are cleaned with a high-pressure water jet.

Information on filling up the washer reservoir can be found in the “Operation” section (▷ page 241).

#### Sun visors

The sun visors protect you from sun glare while driving.

#### Warning!



Do not use the vanity mirror while driving. Keep the mirrors in the sun visors closed while vehicle is in motion. Reflected glare can endanger you and others.

- ▶ Swing sun visors down when you experience glare.

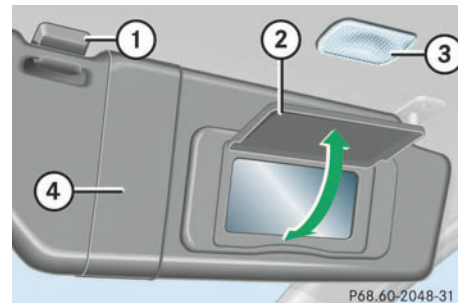

- 1 Mounting
- 2 Mirror cover
- 3 Mirror lamp
- 4 Sun visor

- ▶ To use illuminated mirror, lift up cover 2.



If sunlight enters through a side window, disengage sun visor from mounting 1 and pivot to the side.

The mirror lamp 3 will switch off.

### Rear window sunshade\*

The switch is located in the center console.



- ▶ Turn the key to starter switch position **1** or **2**.
- ▶ Press the switch briefly at **1** to raise the sunshade.
- ▶ Press the switch briefly at **2** to lower the sunshade.

Always raise the sunshade fully for its support against the window frame.

### Warning!



When operating the rear window sunshade, make sure that there is no danger of anyone being harmed by the raising or lowering procedure.

The raising or lowering procedure can be immediately halted by briefly pressing the upper or lower half of the switch.

Briefly press upper or lower half of the switch again to raise or lower the rear window sunshade completely.

### Warning!



When leaving the vehicle, always remove the SmartKey from starter switch, and lock your vehicle. Do not leave children unattended in the vehicle, or with access to an unlocked vehicle. Unsupervised use of vehicle equipment can cause an accident and/or serious personal injury.

### Climate control

### Climate control

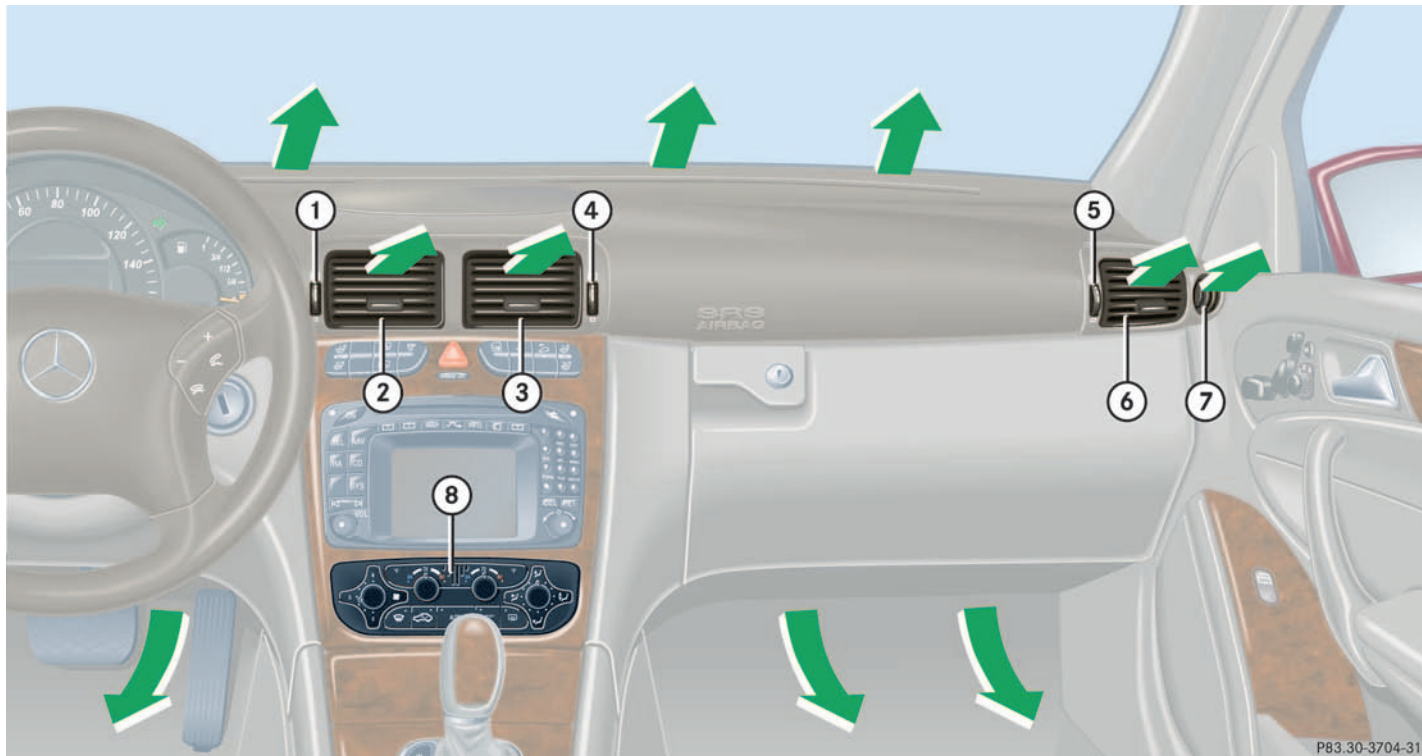

P83.30-3704-31

Item
1 Air volume control for left center air vent
2 Left center air vent, adjustable
3 Right center air vent, adjustable
4 Air volume control for right center air vent
5 Air volume control for side air vent
6 Side air vent, adjustable
7 Side defroster vent, fixed
8 Climate control panel

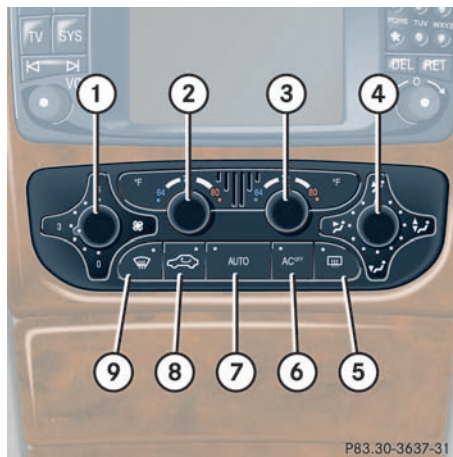

Climate control panel

Item
1 Air volume control
2 Left-side temperature control
3 Right-side temperature control
4 Air distribution control switch
5 Rear window defroster
6 AC cooling on/off (AC <sup>OFF</sup> )
7 Air distribution and air volume (automatic)
8 Air recirculation
9 Defrosting



For draft-free ventilation, move the sliders for the center air vents to the middle position.

The storage compartment between the front seats can be ventilated (▷ page 155).

Information about “Rear passenger compartment adjustable air vents” (▷ page 155).

### Climate control

The climate control is operational whenever the engine is running. You can operate the climate control system in either the automatic or manual mode. The system cools or heats the interior depending on the selected interior temperature and the current outside temperature.

Nearly all dust particles, pollutants and odors are filtered out before outside air enters the passenger compartment through the air distribution system.

The air conditioning will not engage (no cooling) if the **AC<sup>OFF</sup>** mode is selected (▷ page 154).

#### Warning!



Follow the recommended settings for heating and cooling given on the following pages. Otherwise the windows could fog up, impairing visibility and endangering you and others.



If the vehicle interior is hot, ventilate the interior before driving off.

Keep the air intake grille in front of the windshield free of snow and debris.

Do not obstruct air flow by placing objects on the air flow-through exhaust slots below the rear window.

#### Setting the temperature

Use the temperature controls **2** and **3** (▷ page 149) to separately adjust the air temperature on each side of the passenger compartment. You should raise or lower the temperature setting in small increments, preferably starting at 72°F (22°C).

#### Increasing





- ▶ Turn the control slightly to the right.  
The climate control system will correspondingly adjust the interior air temperature.

#### Decreasing

- ▶ Turn the control slightly to the left.  
The climate control system will correspondingly adjust the interior air temperature.

## Adjusting air distribution and volume

Use the air distribution control 4 (▷ page 149) to adjust the air distribution. The following symbols are found on the controls:

Symbol	Function
	Directs air through the center, side and rear passenger compartment air vents
	Directs air to the windows
	Directs air into the entire vehicle interior
	Directs air to the footwells



## Adjusting manually

- ▶ Press the **AUTO** button.  
The indicator lamp on the button goes out.
- ▶ Select any of the six air volume speeds using the air volume control 1 (▷ page 149) and the air distribution.

## Adjusting automatically

- ▶ Press the **AUTO** button.  
The indicator lamp on the button comes on. The air distribution and volume is adjusted automatically.

## Windshield fogged on the outside



- ▶ Switch the windshield wipers on.
- ▶ Switch to manual mode.
- ▶ Turn the air distribution control to  or .

## Defrosting



These settings should only be selected for a short time.

## Activating

- ▶ Press button .  
The indicator lamp on the button comes on.
- or
- ▶ Switch off air recirculation, if selected. Press button .  
The indicator lamp on the button goes out.
  - ▶ Close center air vents.
  - ▶ Open left and right side air vents and adjust side air vents upwards.

### Climate control

#### Deactivating

- ▶ Press button .

The indicator lamp on the button goes out. Defrosting is turned off.

#### Air recirculation mode

Switch to air recirculation mode to prevent unpleasant odors from entering the vehicle from the outside. This setting cuts off the intake of outside air and recirculates the air in the passenger compartment.

#### Warning!



When the outside temperature is below 41°F (5°C), only switch to air recirculation mode for short periods to prevent window fogging.

#### Activating

- ▶ Press button .

The indicator lamp on the button comes on.



If you keep button  pressed the side windows and sliding/pop-up roof\* will be closed.

The air recirculation mode is activated automatically at high outside temperatures.

If you have turned off the air conditioning (▷ page 154) or the outside temperature is below 41°F (5°C), the air recirculation mode will not switch on automatically.

#### Deactivating

- ▶ Press button .

The indicator lamp on the button goes out.



If you keep button  pressed the side windows and sliding/pop-up roof\* will be returned to their previous position.

The air recirculation mode is deactivated automatically:

- after five minutes if the outside temperature is below approximately 41°F (5°C)
- after five minutes if the air conditioning is turned off
- after 30 minutes if the outside temperature is above approximately 41°F (5°C)

At outside temperatures above 79°F (26°C) the system will not automatically switch back to outside air. A quantity of outside air is added after approximately 30 minutes.



## Rear window defroster

---

The rear window defroster uses a large amount of power. To keep the battery drain to a minimum, switch off the defroster as soon as the rear window is clear. The defroster is automatically deactivated after approximately 6 to 17 minutes of operation depending on the outside temperature.

### Activating

- ▶ Press button .

The indicator lamp on the button lights up.

### Deactivating

- ▶ Press button  again.

The indicator lamp on the button goes out.

### Warning!



Any accumulation of snow and ice should be removed from the rear window before driving. Visibility could otherwise be impaired, endangering you and others.



If the rear window defroster switches off too soon and the indicator lamp starts blinking, this means that too many electrical consumers are operating simultaneously and there is insufficient voltage in the battery. The system responds automatically by deactivating the rear window defroster.

As soon as the battery has sufficient voltage, the rear window defroster automatically turns itself back on.

## Deactivating the climate control system

---

### Deactivating

- ▶ Set the air volume control (▷ page 149) to position **0**.

### Reactivating

- ▶ Set the air volume control (▷ page 149) to any speed.

### Climate control

#### Air conditioning

The air conditioning is operational while the engine is running and cools the interior air to the temperature set by the operator.



Condensation may drip out from underneath the vehicle. This is normal and not an indication of a malfunction.

#### Deactivating

It is possible to deactivate the air conditioning (cooling) function of the climate control system. The air in the vehicle will then no longer be cooled or dehumidified.

- ▶ Press button **AC<sup>OFF</sup>** (▷ page 149).

The indicator lamp on the button **AC<sup>OFF</sup>** lights up.

#### Activating

Moist air can fog up the windows. You can dehumidify the air with the air conditioning.

- ▶ Press **AC<sup>OFF</sup>** again (▷ page 149).

The indicator lamp on the button **AC<sup>OFF</sup>** goes out.

The air conditioning uses the refrigerant R134a. This refrigerant is free of CFC's which are harmful to the ozone layer.



If the air conditioning cannot be turned on again, this indicates that the air conditioning is losing refrigerant. The compressor has turned itself off.

Have the air conditioning checked at the nearest authorized Mercedes-Benz Center.

### Ventilated storage compartment

The front center console storage compartment has its own air vent that allows for cooling ventilation when the automatic climate control system is activated.



You should keep this air vent closed when outside temperatures are low.

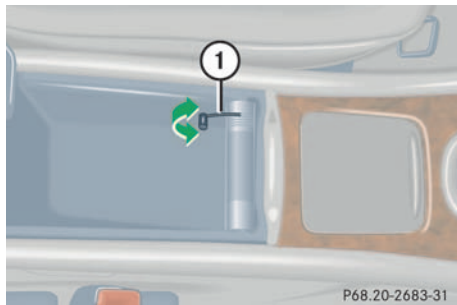

1 Lever

### Opening the air vent

- ▶ Raise lever 1.

### Closing the air vent

- ▶ Lower lever 1.



The compartment can get very warm due to its confined space. When storing heat sensitive objects in the compartment, close the air vent while heating the passenger compartment.



Do not obstruct the air vent in the storage compartment.

### Rear passenger compartment adjustable air vents

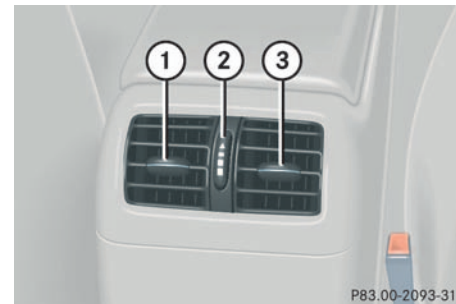

- 1 Center air vent, left
- 2 Thumbwheel for air volume control for center air vents
- 3 Center air vent, right

To open center air vents:

- ▶ Turn thumbwheel 2 upward.



The temperature at the air vents for the rear passenger compartment 1 and 3 is the same as at the dashboard center air vents.

## Controls in detail

**Automatic climate control\***

**Automatic climate control\***

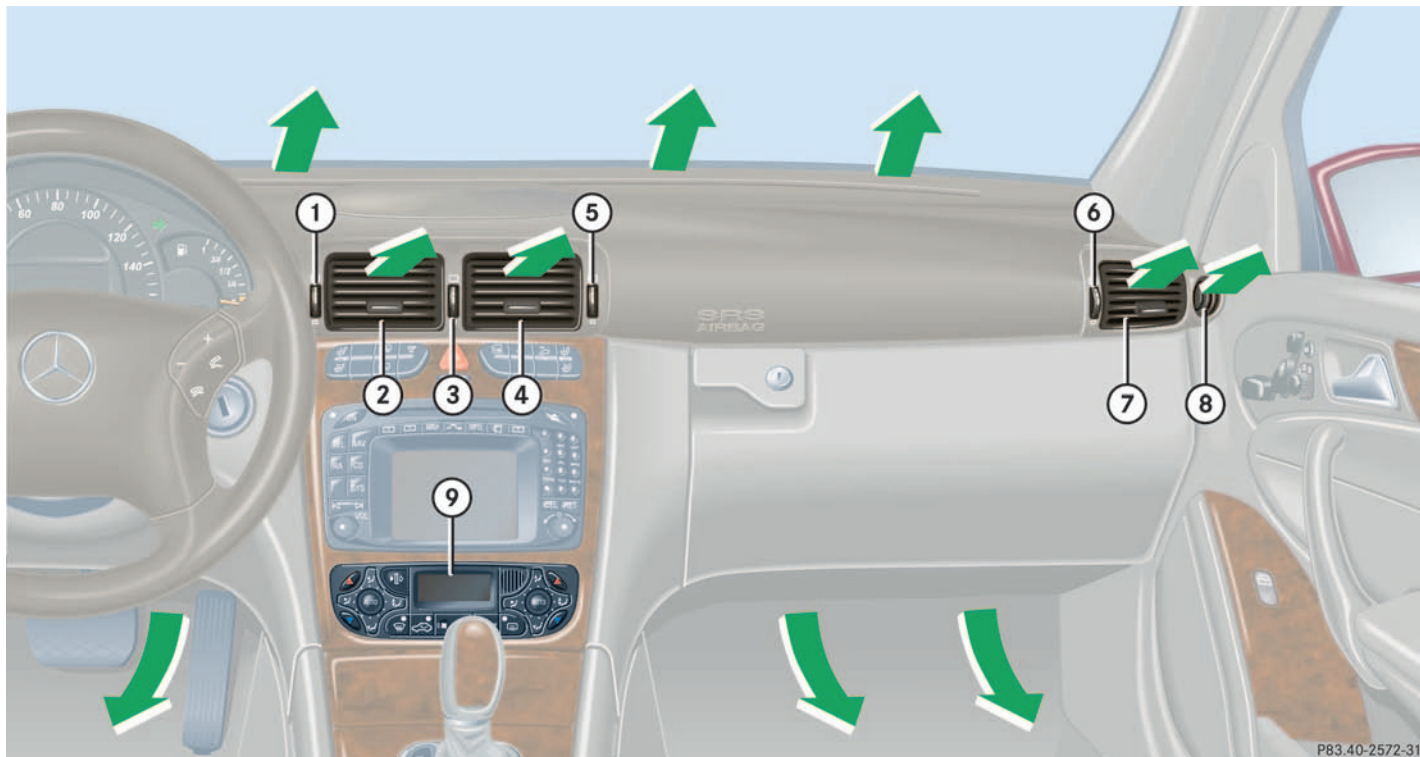

### Automatic climate control\*

Item
1 Air volume control for left center air vent
2 Left center air vent, adjustable
3 Thumbwheel for adding outside air
4 Right center air vent, adjustable
5 Air volume control for right center air vent
6 Air volume control for side air vent
7 Side air vent, adjustable
8 Side defroster vent, fixed
9 Automatic climate control panel

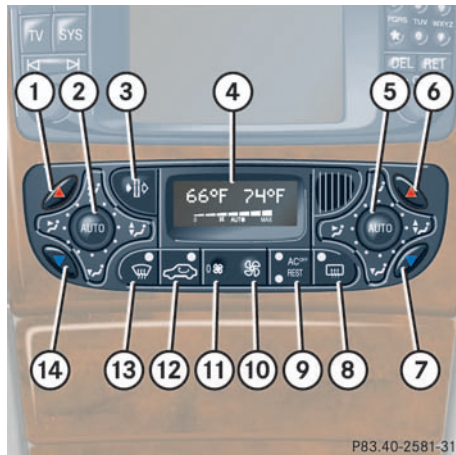

Automatic climate control panel



For draft-free ventilation, move the sliders for the center air vents to the middle position.

Item
1 Temperature control, left, raising
2 Left-side air distribution control (automatic or manual operation)
3 Activated charcoal filter
4 Display
5 Right-side air distribution control (automatic or manual operation)
6 Temperature control, right, raising
7 Temperature control, right, lowering
8 Rear window defroster
9 AC cooling on/off (AC <sup>OFF</sup> ) Residual heat/ventilation
10 Air volume control
11 Automatic climate control on/off (complete system)
12 Air recirculation
13 Defrosting
14 Temperature control, left, lowering

### Automatic climate control\*

The automatic climate control is operational whenever the engine is running. You can operate the climate control system in either the automatic or manual mode. The system cools or heats the interior depending on the selected interior temperature and the current outside temperature.

Nearly all dust particles, pollutants and odors are filtered out before outside air enters the passenger compartment through the air distribution system.

The air conditioning will not engage (no cooling) if the **AC<sup>OFF</sup>** mode is selected (▷ page 149).

#### Warning!



Follow the recommended settings for heating and cooling given on the following pages. Otherwise the windows could fog up, impairing visibility and endangering you and others.



If the vehicle interior is hot, ventilate the interior before driving off.

Keep the air intake grille in front of the windshield free of snow and debris.

Do not obstruct air flow by placing objects on the air flow-through exhaust slots below the rear window.

#### Setting the temperature

Use temperature controls **1** and **14** for the left side or **6** and **7** for the right side to separately adjust the air temperature on each side of the passenger compartment. You should raise or lower the temperature setting in small increments, preferably starting at 72°F (22°C).



When operating the climate control system in automatic mode, you will only rarely need to adjust the temperature, air volume and air distribution.

#### Increasing

- ▶ Push temperature control **1** and/or **6**.

The automatic climate control system will correspondingly adjust the interior air temperature.

#### Decreasing

- ▶ Push temperature control **7** and/or **14**.





The automatic climate control system will correspondingly adjust the interior air temperature.

#### Adding outside air

- ▶ Turn thumbwheel **3** in dashboard (▷ page 156) to increase airflow of outside air through air vents for center, left and right sides and rear passenger compartment.

### Adjusting air distribution

Use air distribution controls **2** and **5** (▷ page 157) to separately adjust the air distribution on each side of the passenger compartment. The following symbols are found on the controls:

Symbol	Function
	Directs air through the center, side and rear passenger compartment air vents
	Directs air to the windows
	Directs air into the entire vehicle interior
	Directs air to the footwells

### Adjusting manually

- ▶ Press left or right **AUTO** button.

The indicator lamp on the button goes out.

The air distribution can be adjusted manually.



### Adjusting automatically

- ▶ Press left or right **AUTO** button.

The indicator lamp on the button comes on.

The air distribution is adjusted automatically.

### Windshield fogged on the outside

- ▶ Switch the windshield wipers on.
- ▶ Switch to manual mode.
- ▶ Turn the air distribution control to  or .

### Adjusting air volume

#### Adjusting manually

Seven blower speeds are available.

- ▶ Press left **0** or right  side of air volume control switch until the requested blower speed is attained.

The display “Auto” disappears and the automatic mode is switched off. The selected blower speed is shown in the display.

#### Adjusting automatically

- ▶ Press left or right **AUTO** button.

The indicator lamp on the button comes on.

The air volume is adjusted automatically.

### Automatic climate control\*

#### Maximum cooling MAXCOOL

If the left and right air distribution controls as well as the airflow volume control are set to **AUTO** and there is a high need for cooling, the display “AUTO MAXCOOL” appears.

This provides the fastest possible cooling of the vehicle interior (when windows and sliding/pop-up roof\* are closed).

#### Defrosting



These settings should only be selected for a short time.

#### Activating

- ▶ Press button

The indicator lamp on the button lights up.

- ▶ Switch off air recirculation, if selected.
- ▶ Press button

The indicator lamp on the button goes out.

- ▶ Close center air vents.
- ▶ Adjust side air vents upwards.

#### Deactivating

- ▶ Press button

The indicator lamp on the button goes out. Defrosting is turned off.

#### Air recirculation mode

Switch to air recirculation mode to prevent unpleasant odors from entering the vehicle from the outside. This setting cuts off the intake of outside air and recirculates the air in the passenger compartment.

#### Warning!



When the outside temperature is below 41 °F (5 °C), only switch to air recirculation mode for short periods to prevent window fogging.

#### Activating

- ▶ Press button

The indicator lamp on the button lights up.





If you keep button  pressed, the side windows and the sliding/pop-up roof\* will be closed.

The air recirculation mode is activated automatically:

- at high outside temperatures
- if the concentration of carbon monoxide and nitrogen oxide in the outside air increases, for example in a tunnel

Please note that the charcoal filter must be activated (see below) for the air recirculation mode to be activated automatically.

If you have turned off the air conditioning (▷ page 163) or the outside temperature is below 41 °F (5 °C), the air recirculation mode will not switch on automatically.

### Deactivating

- ▶ Press button .

The indicator lamp on the button goes out.



If you keep button  pressed the side windows and the sliding/pop-up roof\* will be returned to their previous position.

The air recirculation mode is deactivated automatically:

- after five minutes if the outside temperature is below approximately 41 °F (5 °C)
- after five minutes if the air conditioning is turned off
- after 30 minutes if the outside temperature is above approximately 41 °F (5 °C)

At outside temperatures above 79 °F (26 °C) the system will not automatically switch back to outside air. A quantity of outside air is added after approximately 30 minutes.

### Charcoal filter

An activated charcoal filter markedly reduces bad odors and removes pollutants from air entering the passenger compartment.

### Activating

- ▶ Press button .

The indicator lamp on the button lights up.

The system switches automatically to the air recirculation mode if the carbon monoxide (CO) or nitrogen oxide (NO<sub>x</sub>) concentration of the outside air increases beyond a predetermined level.

### Automatic climate control\*



If you keep button pressed, the side windows and the sliding/pop-up roof\* will be closed.

#### Deactivating

- ▶ Press button .

The indicator lamp on the button goes out.



If you keep button pressed, the side windows and the sliding/pop-up roof\* will be returned to their previous position.

The automatic air recirculation mode does not function if the **AC<sup>OFF</sup>** mode is selected or if the outside temperature has fallen below 41 °F (5 °C).

The activated charcoal filter should be switched off when windows fog up on the inside, or if the passenger compartment needs to be quickly heated or cooled down.

#### Rear window defroster

The rear window defroster uses a large amount of power. To keep the battery drain to a minimum, switch off the defroster as soon as the rear window is clear. The defroster is automatically deactivated after approximately 6 to 17 minutes of operation depending on the outside temperature.

#### Activating

- ▶ Press button .

The indicator lamp on the button lights up.

#### Deactivating

- ▶ Press button again.

The indicator lamp on the button goes out.

#### Warning!



Any accumulation of snow and ice should be removed from the rear window before driving. Visibility could otherwise be impaired, endangering you and others.



If the rear window defroster switches off too soon and the indicator lamp starts blinking, this means that too many electrical consumers are operating simultaneously and there is insufficient voltage in the battery. The system responds automatically by deactivating the rear window defroster.

As soon as the battery has sufficient voltage, the rear window defroster automatically turns itself back on.

## Air conditioning

The air conditioning is operational while the engine is running and cools the interior air to the temperature set by the operator.



Condensation may drip out from underneath the vehicle. This is normal and not an indication of a malfunction.

## Deactivating

It is possible to deactivate the air conditioning (cooling) function of the automatic climate control system. The air in the vehicle will then no longer be cooled or dehumidified.

- ▶ Press button **AC<sup>OFF</sup>**.

The indicator lamp on the button **AC<sup>OFF</sup>** lights up.

## Activating

Moist air can fog up the windows. You can dehumidify the air with the air conditioning.

- ▶ Press **AC<sup>OFF</sup>** again.

The indicator lamp on the button **AC<sup>OFF</sup>** goes out.

The air conditioning uses the refrigerant R134a. This refrigerant is free of CFCs which are harmful to the ozone layer.



If the air conditioning cannot be turned on again, this indicates that the air conditioning is losing refrigerant. The compressor has turned itself off.

Have the air conditioning checked at the nearest authorized Mercedes-Benz Center.

## Residual heat and ventilation\*

With the engine switched off, it is possible to continue to heat or ventilate the interior for up to 30 minutes. This feature makes use of the residual heat produced by the engine.

## Activating

- ▶ Turn the key in the starter switch to position **1** or remove it from the starter switch.
- ▶ Press button **REST**.

The indicator lamp on button **REST** comes on.

## Deactivating

- ▶ Press button **REST**.

The indicator lamp on button **REST** goes off.

### Automatic climate control\*

The residual heat is automatically turned off

- when the ignition is switched on
- after about 30 minutes
- if the battery voltage drops



How long the system will provide heating depends on the coolant temperature and the temperature set by the operator. The blower will run at speed setting **1** regardless of the air distribution control setting.

### Rear passenger compartment adjustable air vents

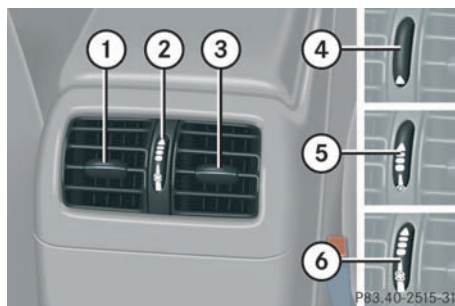

- 1 Center air vent, left
- 2 Thumbwheel for air volume control for center air vents
- 3 Center air vent, right
- 4 Closing center air vents
- 5 Opening center air vents
- 6 Switching on blower

### Adjusting the air volume

- ▶ Turn thumbwheel **2**.



Four blower speeds are available.

The temperature at the air vents for rear passenger compartment **1** and **3** is the same as at the dashboard center air vents.

## Audio system

### Audio and telephone, operation

These instructions are intended to help you become acquainted with your Mercedes-Benz car radio. They contain useful tips and a detailed description of the user functions.

#### Warning!



In order to avoid distraction which could lead to an accident, system settings should be entered with the vehicle at standstill and systems should be operated by the driver only when traffic conditions permit. Always pay full attention to traffic conditions first before operating system controls while driving.

Bear in mind that at a speed of just 30 mph (approximately 50 km / h), your car is covering a distance of approximately 44 feet (approximately 13.5 m) every second.<sup>1</sup>

<sup>1</sup> The right to correct errors and make technical amendments is reserved.

### Operating safety

#### Warning!



Any alterations made to electronic components can cause malfunctions.

The radio, cassette deck, CD changer\*, telephone\* and voice control system\* are interconnected. When one of the components is not operational or has not been removed / replaced properly, the function of other components may be impaired.

This condition might seriously impair the operating safety of your vehicle.

We recommend that you have any service work on electronic components carried out by an authorized Mercedes-Benz Center.

## Audio system

### Operating and display elements

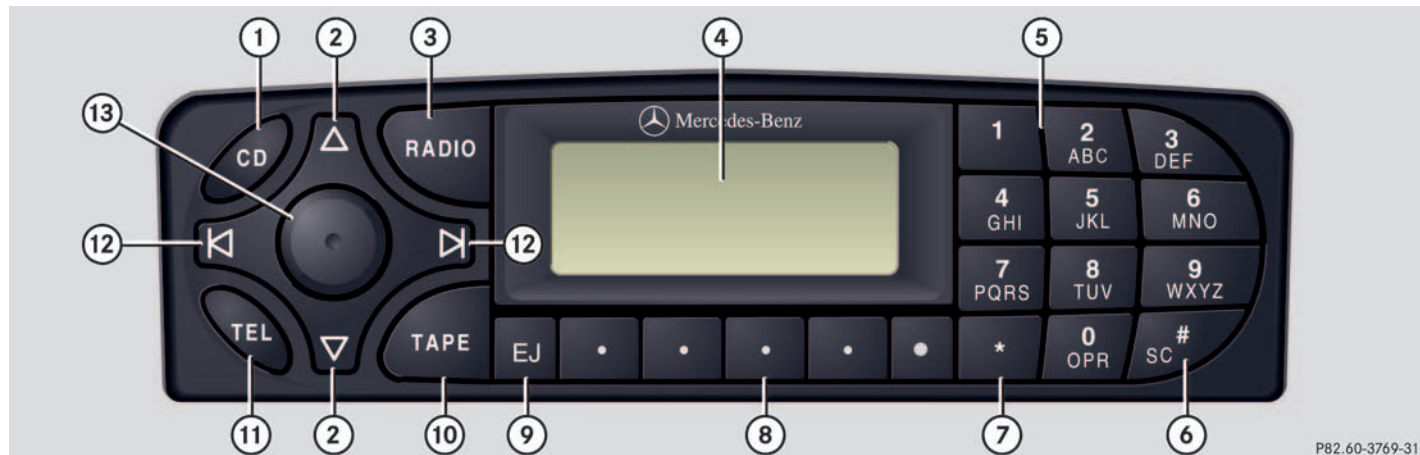

P82.60-3769-31

Item	Page
<b>1</b> CD mode selector	178
<b>2</b> Manual tuning (radio)	172
Fast forward/reverse (cassette, CD)	176, 180
Speed dialing memory (telephone*)	185
<b>3</b> Radio mode selector	171
<b>4</b> Display	

Item	Page
<b>5</b> Alpha-numeric keypad	
Band selection, station buttons (radio)	171
CD selection (CD)	179
Telephone number entry, retrieving speed dialing memory (telephone*)	182
<b>6</b> Scanning (radio, cassette, CD)	173, 176, 180
<b>7</b> Function button	172
<b>8</b> Soft keys	168

Item	Page
<b>9</b> Cassette eject	175
<b>10</b> Cassette mode selector	174
<b>11</b> Telephone* mode selector	182
<b>12</b> Seek tuning (radio)	172
Track search (cassette, CD)	175, 180
Speed dialing memory (telephone*)	185
<b>13</b> On /off	168
Volume	168

### Audio system

#### Button and soft key operation

In these instructions, the alpha-numeric keypad (right side of radio face) and the function buttons (left side of the radio face) are referred to as “buttons” and the four keys under the display are referred to as “soft keys”.



Do not press directly on the radio display face.

#### Operation

##### Switching on/off

Switching on:

- ▶ Turn the key to position **1** or **2** in the starter switch.

or

- ▶ Turn control knob .



If the radio is turned on without the key in the ignition, it will automatically turn off again after approx. 30 minutes.

Switching off:

- ▶ Remove the key from the starter switch.

or

- ▶ Turn control knob .

##### Adjusting the volume

- ▶ Turn control knob .

The volume will increase or decrease according to the direction turned.



If your vehicle was equipped with a telephone\* and voice control system\*, and both are connected to the car radio, their volume can be adjusted separately while the telephone\* is being used or voice control system\* is activated.

##### Adjusting audio functions

In radio, cassette and CD mode, press the AUD key to call up the bass, treble, balance and fader functions.

Settings for bass and treble are stored separately for the AM (medium wave, long wave, short wave) and FM (ultra-short wave) frequency bands, cassette mode and CD mode.



### Bass

- ▶ In radio, cassette and CD mode, press the **AUD** key repeatedly until **BASS** appears on the display.



- ▶ Press the **+** or **-** key to increase or decrease the tone level accordingly.  
or
- ▶ Press both the **+** and **-** keys simultaneously to reset the bass tones to the center (flat) level.

### Treble

- ▶ In radio, cassette and CD mode, press the **AUD** key repeatedly until **TREBLE** appears on the display.



- ▶ Press the **+** or **-** key to increase or decrease the tone level accordingly.  
or
- ▶ Press both the **+** and **-** keys simultaneously to reset the treble tones to their center (flat) level.

### Fader



Your vehicle may or may not have the fader function, depending on the vehicle equipment and model.

- ▶ In radio, cassette and CD mode, press the **AUD** key repeatedly until **FADER** appears on the display.



- ▶ Press the **F** or **R** key to shift the sound accordingly.  
or
- ▶ Press both the **F** and **R** keys simultaneously to reset the fader to its center level.

### Audio system

#### Balance

- ▶ In radio, cassette and CD mode, press the **AUD** key repeatedly until **BALANCE** appears on the display.

```
FM BALANCE
.....|.....
<L EXT AUD R>
```

- ▶ Press the **L** or **R** key to shift the sound accordingly.  
or
- ▶ Press both the **L** and **R** keys simultaneously to reset the balance to its center level.

#### Returning audio functions to factory settings

```
RESET
```

- ▶ In radio, cassette and CD mode, press and hold the **AUD** key longer than two seconds. **RESET** will appear on the display.

All settings for bass, treble and balance are returned to center and the volume is set to a predefined level.

#### Audio system sound selection (EXT)\*

- ▶ In radio, cassette and CD mode, press the **AUD** key.

The sound settings menu appears on the display.

- ▶ Press the **EXT** key.

```
SOUND
DRIVER
DRV SP AMB OFF
```

- ▶ Press one of the function keys.

You can select from among the following settings:

- **DRV**: The tone level is set to the “Driver” position, sound is directed toward the passengers.

- **SP:** The tone level is set for “Speech”, optimizing the sound for spoken language.
- **AMB:** The tone level is set for “Ambience”, producing a three-dimensional sound.
- **OFF:** The audio system sound selection is turned off.

### Telephone\* muting

If a telephone has been installed in the vehicle, the radio will switch to telephone mode when a call is received. The current audio source is muted.

### Radio mode

#### Selecting radio mode

- ▶ Press the **RADIO** button.

#### Selecting the band

You can select from among FM, AM or WB frequency bands.

FM frequency band:

FM (ultra-short wave) 87.9.....107.9 MHz

AM frequency bands:

MW (medium wave) 530.....1710 KHz

WB (long wave) approx. 162 KHz

#### Selecting FM band

- ▶ Press the **FM** function button.

FM appears in the upper right-hand corner of the display.

#### Selecting AM band

- ▶ Press the **AM** function button.

AM appears in the upper right-hand corner of the display.

#### Selecting a station

The following options are available for selecting a station:

- Direct frequency band input
- Manual tuning
- Automatic seek tuning
- Scan tuning
- Station buttons
- Automatic station memory (Autostore)

### Audio system

#### *Direct frequency input (AM and FM only)*

Select the desired frequency band.

```
FM5 ST
 95.5 MHz
AM WB AUD AS
```

- ▶ Press the **\*** button.
- ▶ Enter the desired frequency with the buttons **1** to **0**.



You can only enter frequencies within the respective waveband.

If a button is not pressed within four seconds, the radio will return to the last tuned station.

#### *Manual tuning*

- ▶ Select the desired band.

```
FM1
 95.5 MHz
AM WB AUD AS
```

- ▶ Press and hold either the **▲** or **▼** button until the desired frequency is reached.

Step-by-step station tuning takes place in ascending or descending order of frequency. The first three tuning steps will take place without muting. Afterward, the radio will be muted and high-speed tuning will take place until the button is released.

#### *Automatic seek tuning*

- ▶ Select the desired frequency band.

```
FM
SEARCH
AM WB AUD AS
```

- ▶ Press either the **▶** or **◀** button.  
The radio will tune to the next receivable station at a higher or lower frequency.

### Scan tuning

- Starting scan tuning
  - ▶ Select the desired frequency band.

FM1  
95.5 MHz  
AM WB AUD AS

- ▶ Press the **SC#** button.  
SC will appear on the display. The radio briefly tunes into all receivable stations on the band selected. The first scan will tune only the stations with a strong signal. The second scan will tune every receivable station.
- Ending scan tuning
  - ▶ Press the **SC#** button or the **▲**, **▼**, **▶** or **◀** button.  
SC disappears from the display.

### Station memory

You can store ten AM and ten FM stations.

- Storing stations
  - ▶ Tune in the desired station.
  - ▶ Press and hold the desired station button **1** to **0** until a brief signal tone is heard.  
The frequency is stored on the selected station button.
- Retrieving a station from memory
  - ▶ Press the desired station button **1** to **0**.

### Storing stations automatically (Autostore)

The Autostore memory function provides an additional memory level. The station memory for manually stored stations is not erased.

- Calling up the Autostore memory level
  - ▶ Briefly press the **AS** key.  
AS appears on the display in inversed-color format.  
The radio finds the ten stations with the strongest signals. These stations are stored on the station buttons **1** to **0** in the order of signal strength.
- Retrieving a station from memory
  - ▶ Press the desired station button **1** to **0**.
- Leaving the Autostore memory level
  - ▶ Press the **AS** key.  
AS appears on the display in inversed-color format.

### Audio system

#### Weather band

- ▶ Press the **WB** key.

The last weather band station is tuned in.

- ▶ Select the desired weather band station with buttons **1** to **7**.

If a station cannot be tuned in, a scan is automatically started.

- ▶ Press the **▶** or **◀** button. The next receivable weather band station is tuned in.

#### Cassette mode

##### Playing cassettes

- ▶ Press the **EJ** button.

The display folds down and the cassette slot becomes visible.

- ▶ Press the cassette into the slot until it engages and tap it gently.

The cassette will be pulled in automatically. The system switches to cassette mode (TAPE). Track 1 will be played and **SIDE 1** appears in the display. Track 1 is the side of the cassette which is facing upward. The cassette deck will automatically detect the type of tape.

- ▶ Fold the display back up and press gently on the display frame to lock in place.



Do not press directly on the display face.

or

- ▶ If a cassette is already in the mechanism, press the **TAPE** button.



A warning signal will sound after 20 seconds if the display is left in the down position. If the display is not closed, a warning signal will sound and the radio will be muted.

#### Track selection

TAPE  
SIDE 1  
TRK NR AUD SB

- ▶ Press the **TRK** key.

Upon selection of the track, the display shows **SIDE 1** or **SIDE 2** correspondingly.

- ▶ You can switch track sides at any time. The track side will be changed automatically at the end of the tape.

**Cassette eject**

- ▶ Press the eject button .

The display will fold down and the cassette will be ejected. The system will switch back to radio mode automatically.

- ▶ Fold the display back up.



The cassette will not be ejected when the system is switched off or switched to another operating mode.

**Track search****Track search forward**

```
TAPE
SEEK FWD
TRK NR AUD SB
```

- ▶ Press the  button.

SEEK FWD will appear in the display. The track search will run the tape forward to the start of the next track and switch to play.



The cassette will not be ejected when the system is switched off or switched to another operating mode.

**Track search backward**

- ▶ Press the  button.

SEEK RWD will appear on the display. The track search will run the tape backward to the start of the track currently playing and switch to play.

**Stopping track search**

- ▶ Press the , ,  or  button.

The cassette will switch over to Play.

### Audio system

#### Scanning

```
TAPE SC
SEEK FWD
TRK NR AUD SB
```

- ▶ Press the **SC#** button.

SC will appear on the display.

Each track on the cassette will be played briefly in ascending order.

Stopping scan:

- ▶ Press the **SC#**, **▲**, **▼**, **▶** or **◀** button.

The system will switch to Play.

#### Fast forward/reverse

Starting cassette fast forward mode:

```
TAPE
FORWARD
TRK NR AUD SB
```

- ▶ Press the **▲** button.

FORWARD will appear on the display.

Starting cassette fast reverse mode:

- ▶ Press the **▼** button.

REWIND will appear on the display.

The cassette will automatically switch over to the play mode at the end or beginning of the tape.

Stopping the cassette fast forward/reverse mode:

- ▶ Press the **▲**, **▼**, **▶** or **◀** button.

The cassette will switch over to the play mode.



**Skipping blank sections (skip blank)****Switching on the skip blank function**

TAPE  
SIDE 1  
TRK NR AUD SB

- ▶ Press the SB key.

SB appears on the display in inverted-color format.

If the system does not detect a sound signal, the cassette will automatically fast forward to the next sound signal.

**Switching off the skip blank function**

- ▶ Press the SB key.

The inverted-color SB display disappears.

**Dolby NR<sup>1</sup> (noise reduction system)**

To enable optimum sound reproduction of cassettes recorded using Dolby B NR<sup>1</sup>, the Dolby NR<sup>1</sup> system should be switched on.



The Dolby NR<sup>1</sup> function should be switched off when playing cassettes not recorded with Dolby B NR<sup>1</sup>.

**Switching on**

- ▶ Press the NR key.

NR appears on the display in inverted-color format.

**Switching off**

- ▶ Press the NR key again.

The inverted-color NR display disappears.

<sup>1</sup> DOLBY and the double-D symbol  are trademarks of Dolby Laboratories Licensing Corporation.

The Dolby noise reduction system is manufactured under license from Dolby Laboratories Licensing Corporation.

### Audio system

#### CD changer\* operating mode

##### General notes

Should excessively high temperatures occur while in CD mode, CD TEMP HIGH will appear on the display and muting will take place. The unit will then switch back to the last operating mode used until the temperature has decreased to a safe operating level.

Should excessively low temperatures occur while in CD mode, CD TEMP LOW will appear on the display, but the CD will continue to play.

Handle CDs carefully to prevent interference during playback. Avoid fingerprints and dust on CDs. Do not write on CDs or apply any label or other material to them.

Use only original CDs. Using copied CDs may create problems during playback.

Clean CDs from time to time with a commercially available cleaning cloth. No solvents, anti-static sprays, etc. should be used for cleaning. Replace the CD in its case after use. Protect CDs from heat and direct sunlight.



Only use CDs, which bear the label shown and that conform to the compact disc digital audio standard (IEC 60908).

Use of CDs which do not meet this standard may cause damage to the CD changer. Do not play single-CDs (80 mm) with an adapter.

#### Warning!



The CD changer\* is a Class 1 laser product. There is a danger of invisible laser radiation if the cover is opened or damaged. Do not remove the cover. The CD changer\* does not contain any parts which can be serviced by the user. For safety reasons, have any service work which may be necessary performed only by qualified personnel.

#### Operational readiness of CD changer

If a CD changer has been installed in the system, it can be operated from the front control panel of the radio. A loaded magazine must be installed for CD playing.

#### Loading/unloading the CD magazine

- ▶ Slide the changer door to the right and press the eject button .
- ▶ The magazine will be ejected.



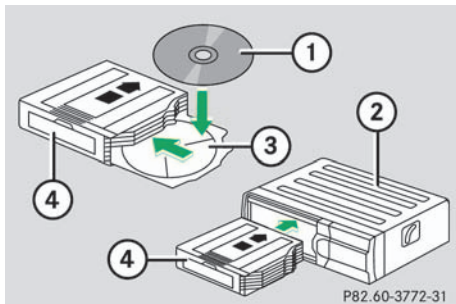

- 1 CD
- 2 CD changer
- 3 CD tray
- 4 CD magazine

- ▶ Remove the magazine and pull the CD tray fully out.
- ▶ Place the CD in the recess of the tray, label side up.
- ▶ Push the tray into the magazine in the direction shown by the arrow.



CDs which have been inserted improperly or are unreadable will not be played.

- ▶ Push the magazine into the CD changer in the direction shown by the arrow and close the sliding door.

### Playing CDs

- ▶ Press the **CD** button.

CD will appear on the display.

The CD most recently listened to will then start playing at the point where it was last switched off.

After the last track on a CD has finished, the next CD is automatically played.

### Selecting CDs

```
CD1
NO CD3
RDM RPT AUD
```

- ▶ You can select from among the CDs in the CD magazine using buttons 1 to 6.

CD and the magazine slot number of the selected CD appear on the display. The number of the current track is displayed after TRACK.

If there is no CD in the selected magazine slot, NO CD appears on the display with the corresponding slot number.

### Audio system

#### *Skipping tracks forward/backward*

Skipping tracks forward:



- ▶ Press the  button.

The next track will be played.

Skipping tracks backward:

- ▶ Press the  button.

If the track has been playing for more than ten seconds, it will revert to the start of that track. If it has been playing for less than ten seconds, it will revert to the preceding track.

Repeated pressing of the  or  button will result in multiple tracks being skipped.

#### *Fast forward/reverse*

Fast forward:

- ▶ Press and hold the  button until the desired location has been reached.

Reverse:

- ▶ Press and hold the  button until the desired location has been reached.



The relative time of the track is shown on the display during search.

#### *Scanning*





Starting scan:

- ▶ Press the  button.

SC appears in the display.

Each track on the current CD will be played for approx. eight seconds in ascending order.

Ending scan:

- ▶ Press the , , ,  or  button.

**Random play**

The random play function (RDM) plays the tracks on the current CD in random order.

Switching on random play:

```
CD1
TRACK 10
RDM RPT AUD T
```

- ▶ Press the RDM key.

RDM appears on the display in inverted-color format.

Switching off random play:

- ▶ Press the RDM key again.

The inverted-color RDM display disappears.

**Repeat**

The repeat function (RPT) repeats the current track.

Switching on repeat:

```
CD1
TRACK 1
RDM RPT AUD T
```

- ▶ Press the RPT key.

RPT appears on the display in inverted-color format.

Switching off repeat:

- ▶ Press the RPT key again.

The inverted-color RPT display disappears.



The Random play and Repeat function cannot be used simultaneously.

**Track and time display**

```
CD3
T01 / 02:46
RDM RPT AUD T
```

- ▶ Press the T key.

The number of the track being played and the elapsed playing time appear in the display.

- ▶ Press the T key again.

The total number of tracks and the total playing time of the CD appear in the display.

The CD main menu appears again after eight seconds.

### Audio system

#### Telephone\* operation

Various car telephone functions and operating steps for the car telephone can be performed and displayed via the audio system.

Further operating instructions not covered here can be found in the operating instructions for the multifunction steering wheel, voice control system\* and the car telephone.

#### Switching on the telephone

- ▶ Press the **TEL** button.
- ▶ If you have programmed an unlock code for the telephone, you must input the code now.
- ▶ Press the **OK** key.

The telephone is unlocked. If you enter the wrong code, you must re-enter the correct code.

#### Switching off the telephone

- ▶ Press the **TEL** button repeatedly until **PHONE OFF** appears in the display.

The receiving symbol in the display disappears.

#### Adjusting the volume

- ▶ Turn control knob  during telephone operation.

The volume increases or decreases depending on the direction in which the knob is turned.



The volume can be adjusted separately for the telephone, voice control system\* and radio.

#### Placing a call

##### *Entering a telephone number and starting the dialing process*



- ▶ Enter the desired telephone number using buttons **1** to **0**.





The number can have up to 32 digits, but only 17 of these are visible on the display.

- ▶ If necessary, correct the number entered with the **CLR** key. Press the key briefly to delete the last digit entered, press the key and hold to delete the complete number.
- ▶ After the correct telephone number has been entered, press the **SND** key.

### Telephone book

The numbers stored in the telephone book can be called up by either name or number.

#### Calling up the telephone book

- ▶ Press either the , ,  or  button.

#### Switching between name search and number search

```
S_... M12
7248711353
SND ABC CLR END
```

- ▶ Press the ABC key.

The name search is called up.

or

```
S_...
BAUER
SND NUM CLR END
```

- ▶ Press the NUM key.

The number search is called up.

#### Searching and calling up telephone book entries by name

```
S_...
BAUER
SND NUM CLR END
```

- ▶ Press the ABC key.

The current name is marked on the display.

- ▶ Press either the  or  button.

The stored entries are selected according to alphabetical order of initial letters.

or

- ▶ Press the  or  button.

The stored entries are selected in increments of four.

or

- ▶ Press the desired numerical key **2** to **9**.

The stored entries are selected according to alphabetical initial letters (e.g. for B -Brown, press button **2** twice).



A number of characters and symbols cannot be shown on the display for technical reasons, they have been replaced with spaces.

### Audio system

#### Searching and selecting telephone book entries by number



S [signal strength] M12  
7248711353  
SND ABC CLR END

- ▶ Press the NUM key.

The current number is marked in the display.

- ▶ Press either the  or  button.

The stored entries are selected according to numerical order.

or

- ▶ Press the  or  button.

The stored entries are selected in increments of four (e.g. Entry M1, Entry M5, etc.).

#### Starting dialing process

- ▶ Once you have selected a number, press the SND key.

#### Repeat dialing

If, for example, the number dialed is busy, you can again place calls to the last ten telephone numbers dialed using the repeat dialing function.





#### Manual repeat dialing (redial)



S [signal strength] M12  
7248711353  
SND ABC CLR END

- ▶ Press the SND key.

The last number dialed is shown in the display.

- ▶ Select the desired telephone number using the , ,  or  button.

The abbreviation L and the number of the entry are shown in the top line of the display.

- ▶ When you have selected a number, press the SND key.

The call will then be placed.

#### Automatic repeat dialing (redial)

If a call cannot be connected, press the SND key.

REDIAL will appear on the display and repeated attempts to place the call will be made for the next four minutes.

#### Quick dialing



S [signal strength] 153  
SND RCL CLR END

- ▶ Enter the previously selected three-digit (1-999) number of the entry using the number keys **1** to **0**.

- ▶ Press the RCL key.

The telephone number stored under that entry will be dialed.

- ▶ Press the SND key.

The call will be placed.



### Speed dialing

- ▶ Input the desired entry number using the number keys **1** to **0**.

A maximum of two digits can be entered.

If necessary, correct the last number entered with the CLR key.

- ▶ Press the **SND** key.

The telephone number stored under that entry will be dialed. The number, **L** and the full entry number will be shown in the display.

### Express dialing

- ▶ Press one of the desired number buttons **1** to **0** longer than one second.

The telephone number saved under that number will be dialed.



Please be aware that button **1** might already be reserved for an emergency call number.

### Emergency call

- ▶ Press button **1** longer than one second.
- ▶ A call will be placed to the saved number (e.g. 911).



Please be aware that the 911 emergency call system is a public service. Using it without due cause is a criminal offense.

You can make an emergency call to an emergency rescue station with a mobile communications network.

The emergency call will be placed as long as the corresponding mobile communications network is available. To do this, switch the telephone on if not already done so.

The call will also be placed if the unlock-code is not entered.

Emergency calls may not be possible with all telephone networks or if certain network services and/or telephone functions are active. Check with your local network operation company. It may take some time to set up an emergency call.

To use this function you must ensure that the number stored in memory location 1 is the number to be dialed in case of emergency.

```

S  [signal bars] ROAM
SYSTEM BUSY
SND          END
  
```

If an emergency call cannot be connected, the message **SYSTEM BUSY** appears.

### Audio system

#### Accepting an incoming call

##### *Accepting an incoming call in telephone mode*

With an incoming call, a ringing tone can be heard and the caller's telephone number, or the name under which this telephone number has been saved in the telephone book, appear on the display. If the caller's number is not transmitted, CALL will appear in the display.

- ▶ Press the SND key to accept the call.

##### *Accepting an incoming call in cassette, CD or radio mode*

If the telephone is activated in the background (receiving symbol S visible on display), the audio source is muted when a call is received. The ringing tone is heard and the caller's telephone number or the name under which this telephone number has been saved in the telephone book appear on the display.

If the caller's number is not transmitted, CALL appears in the display.

- ▶ Press the SND key to accept the call.

#### Muting a call

It is possible to silence a call, the caller is then no longer able to hear you.

##### *Muting*

- ▶ Press the MUT key.

##### *Unmuting*

- ▶ Press the MUT key again.

#### Terminating a call

- ▶ Press the END key.
- ▶ The current call is disconnected.

#### Call waiting

If you receive another call during an already active call, you can accept the second call and switch between the two.

##### *Accepting a second call*

- ▶ Press the SND key.

You are connected with the second caller, the first call is muted.

##### *Switching between the calls*

- ▶ Press the SND key again.

#### Terminating the second call

- ▶ Press the END key.

The current call will be terminated. You are connected with the muted call again.

## Power windows

### Opening and closing the windows

The side windows can be opened and closed electrically. The switches for all the side windows are on the driver's door. The switches for the respective windows are on the front passenger and the rear doors.



- 1 Left front window
- 2 Right front window
- 3 Switch for rear door window override  
(▷ page 71)
- 4 Right rear window
- 5 Left rear window

### Warning!



When closing the windows, make sure that there is no danger of anyone being harmed by the closing procedure.

The closing of the door windows can be immediately halted by releasing the switch or, if switch was pulled past the resistance point and released, by either pressing or pulling the respective switch.

If the window encounters an obstruction that blocks its path in a circumstance where you pulled the switch past the resistance point and released it to close the window, the automatic reversal function will stop the window and open it slightly.

If the window encounters an obstruction that blocks its path in a circumstance where you are closing the window by pulling the switch and holding it there, or by pressing and holding button  on the SmartKey, the automatic reversal function will not operate.

When leaving the vehicle, always remove the key from starter switch, take it with you, and lock your vehicle. Do not leave children unattended in the vehicle, or with access to an unlocked vehicle. Unsupervised use of vehicle equipment can cause an accident and/or serious personal injury.

- ▶ Turn key in the starter switch to position **1** or **2**.

### Opening the windows

- ▶ Press switch to resistance point.

The window will move downwards until you release the switch.

### Closing the windows

- ▶ Pull on switch.

The window will move upwards until you release the switch.

### Power windows

If you pull and hold the switch up when closing the window, and upward movement of the window is blocked by some obstruction including but not limited to arms, hands, fingers etc., the automatic reversal will not operate.

#### Fully opening windows

- ▶ Press switch past resistance point and release.

The window opens completely.

#### Fully closing windows

- ▶ Pull switch past resistance point and release.

The window closes completely.

If the upward movement of the window is blocked during the closing procedure, the window will stop and open slightly.

#### Warning!



Driver's door only:



If within five seconds the switch **1** is again pulled past the resistance point and released, the automatic reversal will not operate.

#### Stopping windows

- ▶ Press or pull respective switch again.



You can also open or close the windows using the

- SmartKey (summer opening/convenience feature), see below
- button  in the control panel of the climate control (▷ page 149) or automatic climate control (▷ page 157)
- button  in the control panel of the automatic climate control (▷ page 157)



#### Opening and closing the windows with the Smartkey

The sliding/pop-up roof\* will also be opened or closed when the power windows are operated with the key (▷ page 191).

#### Warning!



Never operate the windows or sliding/pop-up roof\* if there is the possibility of anyone being harmed by the opening or closing procedure.

In case the procedure causes potential danger, the procedure can be immediately halted by releasing the control button. To reverse direction of movement, press button  for opening or  for closing.

- ▶ Aim transmitter eye at the front door handle.

### ***Opening (Summer opening feature)***

- ▶ Press and hold button  after unlocking the vehicle.

The windows and sliding/pop-up roof\* begin to open after approximately one second.

- ▶ Release transmit button to interrupt procedure.

### ***Closing (Convenience feature)***

- ▶ Press and hold button  after locking the vehicle.

The windows and sliding/pop-up roof\* begin to close after approximately one second.

- ▶ Release transmit button to interrupt procedure.

Ensure that all side windows and the sliding/pop-up roof\* are properly closed before leaving the vehicle.

### ***Synchronizing power windows***

---

The power windows must be resynchronized each time after the battery has been disconnected.

- ▶ Pull the power window switches until the side windows are closed and hold the switches for approximately one second.

### Sliding/pop-up roof\*

### Sliding/pop-up roof\*

#### Opening and closing the sliding/pop-up roof

The sliding/pop-up roof can be opened and closed electrically. The switch for the sliding/pop-up roof is on the overhead control panel.

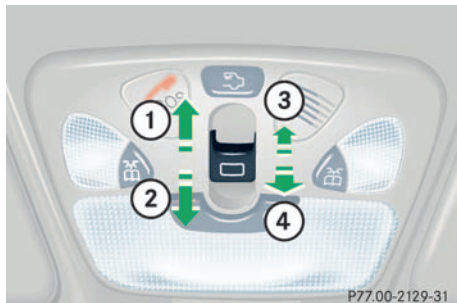

- 1 Push back to slide roof open
- 2 Push forward to slide roof closed
- 3 Push up to raise roof at rear
- 4 Pull down to lower roof at rear

With the roof closed or tilted open, a screen can be slid into the roof opening to guard against sun rays. When sliding the roof open, the screen will also retract.

#### Warning!



When closing the sliding/pop-up roof, make sure that there is no danger of anyone being harmed by the closing procedure.

The closing procedure of the sliding/pop-up roof can be immediately reversed by either moving the switch in any direction, or pressing button  on the key and holding it.

When leaving the vehicle, always remove the key from starter switch, take it with you, and lock your vehicle. Do not leave children unattended in the vehicle, or with access to an unlocked vehicle. Unsupervised use of vehicle equipment can cause an accident and/or serious personal injury.

- ▶ Turn the key in the starter switch to position **1** or **2**.

#### Opening and closing the sliding/pop-up roof

- ▶ To open, close, raise or lower the sliding/pop-up roof, move the switch to resistance point in the required direction.  
Release the switch when the roof has reached the required position.

#### Opening and closing the sliding/pop-up roof automatically

- ▶ Move the switch past resistance point in the direction required and release.  
The sliding/pop-up roof opens or closes completely.



## Stopping the sliding /pop-up roof

- ▶ Move the switch in any direction.

If the movement of the sliding/pop-up roof is blocked during the closing procedure, the roof will stop and reopen slightly.



You can also open or close the sliding/pop-up roof using the

- SmartKey, see below
- button  in the control panel of the climate control (▷ page 149) or automatic climate control (▷ page 157)
- button  in the control panel of the automatic climate control (▷ page 157)



To avoid damaging the seals, do not transport any objects with sharp edges which can stick out of the sliding/pop-up roof.

Open the sliding/pop-up roof only if the roof is clear of snow or ice.

The sliding/pop-up roof can be opened or closed manually should an electrical malfunction occur (▷ page 289).



## Opening and closing the sliding/pop-up roof with the SmartKey

The power windows will also be opened or closed when the sliding/pop-up roof is operated with the key (▷ page 188).

### Warning!



Never operate the windows or sliding/pop-up roof if there is the possibility of anyone being harmed by the opening or closing procedure.

In case the procedure causes potential danger, the procedure can be immediately halted by releasing the remote control button. To reverse direction of movement, press button  for opening or  for closing.

- ▶ Aim transmitter eye at the front door handle.

### Sliding/pop-up roof\*

#### *Opening (Summer opening feature)*

- ▶ Press and hold button  after unlocking the vehicle.

The windows and sliding/pop-up roof begin to open after approximately one second.

- ▶ Release transmit button to interrupt procedure.

#### *Closing (Convenience feature)*

- ▶ Press and hold button  after locking the vehicle.

The windows and sliding/pop-up roof begin to close after approximately one second.

- ▶ Release transmit button to interrupt procedure.

Ensure that all side windows and the sliding/pop-up roof are properly closed before leaving the vehicle.

#### **Synchronizing the sliding / pop-up roof**

The power sliding/pop-up roof must be re-synchronized each time

- after the battery has been disconnected,
- the sliding/pop-up roof has been closed manually (▷ page 289) or
- the sliding/pop-up roof does not open smoothly or malfunctions.

#### **Synchronizing**

- ▶ Turn the key in the starter switch to position **1** or **2**.
- ▶ Press the switch in the “raise” direction until the sliding/pop-up roof is fully raised at the rear (▷ page 190).  
Hold the switch for approximately one second.



## Driving systems

The cruise control driving system of your vehicle is described on the following pages.

The BAS, ABS and ESP driving systems are described in the “Safety and Security” section (▷ page 73).

### Cruise control

Cruise control automatically maintains the speed you set for your vehicle.

Use of cruise control is recommended for driving at a constant speed for extended periods of time. You can set any speed over 20 mph (30 km/h).

The cruise control function is operated by means of the cruise control lever.

The cruise control lever is the uppermost lever found on the left-hand side of the steering column (▷ page 24).

### Warning!



Cruise control is a convenience system designed to assist the driver during vehicle operation. The driver is and must remain at all times responsible for the vehicle speed and for safe brake operation.

Only use cruise control if the road, traffic and weather conditions make it advisable to travel at a steady speed.

- The use of cruise control can be dangerous on winding roads or in heavy traffic because conditions do not allow safe driving at a steady speed.
- The use of cruise control can be dangerous on slippery roads. Rapid changes in tire traction can result in wheel spin and loss of control.
- Deactivate cruise control when driving in fog.

The “Resume” function should only be operated if the driver is fully aware of the previously set speed and wishes to resume this particular preset speed.

### Driving systems

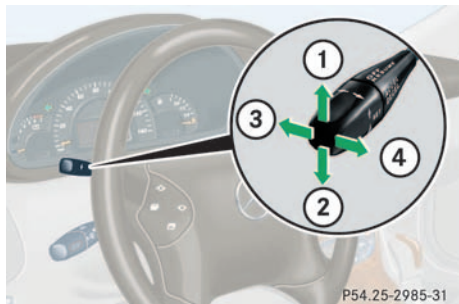

- 1 Set current or higher speed
- 2 Set current or lower speed
- 3 Cancel cruise control
- 4 Resume at previously set speed

#### Saving current speed

- ▶ Accelerate or decelerate to the desired speed.
- ▶ Briefly lift **1** or depress **2** the cruise control lever.

The current speed is set.

- ▶ Remove your foot from the accelerator pedal.

Cruise control is activated.



On uphill or downhill grades, cruise control may not be able to maintain the set speed. Once the grade eases, the set speed will be resumed.

#### Canceling cruise control

There are several ways to cancel cruise control:

- ▶ Step on the brake pedal.
- or
- ▶ Briefly push the cruise control lever to position **3**.

Cruise control will be canceled. The last speed set will be stored for later use.



Vehicles with automatic transmission: Moving gear selector lever to position **N** while driving also cancels cruise control. However, the gear selector lever should not be moved to position **N** while driving except to coast when the vehicle is in danger of skidding (e.g. on icy roads).



Vehicles with manual transmission: The set cruise controlled speed is switched off when declutching exceeds four seconds during downshifting a gear.



The last stored speed is canceled when you turn off the engine.

## Setting stored speed (“Resume” function)

### Warning!



The speed stored in memory should only be set again if prevailing road conditions permit. Possible acceleration or deceleration differences arising from returning to preset speed can cause an accident and/or serious personal injury to you and others.

- ▶ Briefly push the cruise control lever to position **4**.

The cruise control will resume the last previously set speed.

- ▶ Remove your foot from the accelerator pedal.

## Setting a higher speed

- ▶ Lift the cruise control lever to position **1** and hold it up until the desired speed is reached.
- ▶ Release the cruise control lever.  
The new speed is set.



Depressing the accelerator pedal does not deactivate cruise control. After brief acceleration (e.g. for passing), cruise control will resume the last speed set.

## Setting a lower speed

- ▶ Depress the cruise control lever to position **2** and hold it down until the desired speed is reached.
- ▶ Release the cruise control lever.  
The new speed is set.



Vehicles with automatic transmission:  
When you use the cruise control lever to decelerate, the transmission will automatically downshift if the engine's braking power does not brake the vehicle sufficiently.

## Fine adjustment in 1 mph (1 km/h) increments

### *Faster*

- ▶ Briefly tip the cruise control lever in the direction of arrow **1**.

### *Slower*

- ▶ Briefly tip the cruise control lever in the direction of arrow **2**.

### Loading

### Loading

#### Roof rack\*

##### Warning!



Use only those roof racks approved by Mercedes-Benz for your vehicle model to avoid damage to the vehicle. Follow manufacturer's installation instructions.

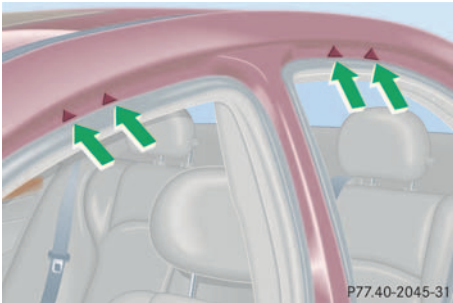

Only mount the approved roof rack to the fastening bolts (see arrows) located under the door weatherstrips.



Be sure to stack a load on the roof rack so that the vehicle cannot be damaged while driving.

Make sure that

- you can fully raise the sliding/pop-up roof\*.
- you can fully open the trunk.

#### Ski sack\*



#### Unfolding and loading

- ▶ Fold armrest down (arrow).
- ▶ Swing cover **1** down.



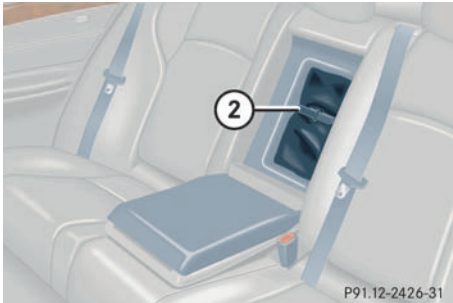

- ▶ Open hook and loop strap **2**.
- ▶ Pull ski sack into passenger compartment and unfold.

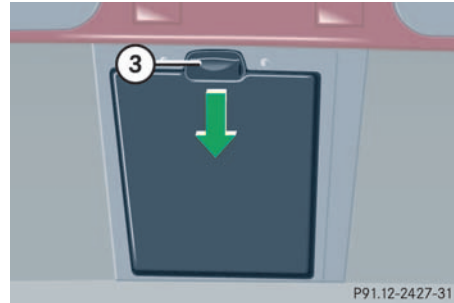

- ▶ Open flap in trunk by pulling handle **3**.

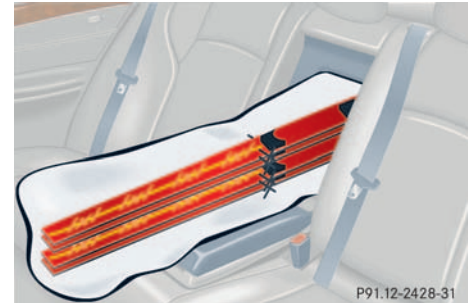

- ▶ From trunk, slide skis into ski sack.

### Warning!



The ski sack is designed for up to four pairs of skis. Do not load the ski sack with other objects.

Always fasten the ski sack securely. In an accident, an unfastened ski sack can cause injury to vehicle occupants.



### Loading

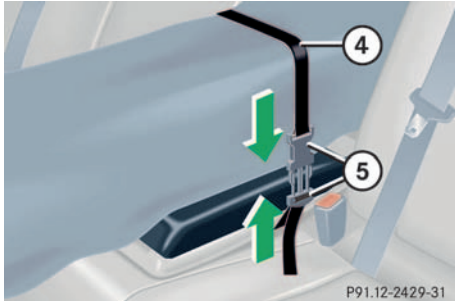

- ▶ Wrap strap **4** around ski sack and armrest.
- ▶ Close clasp **5** (arrows) and pull strap tight to immobilize skis.

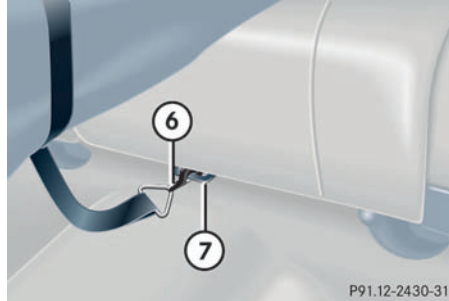

- ▶ Connect snap hook **6** of front strap to eye **7** located on center tunnel in front of rear seat bench.

### Unloading and folding

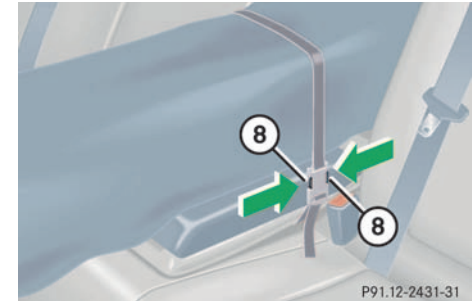

- ▶ Loosen strap, open clasp by pressing tabs **8** together (arrows).
- ▶ Unload skis.
- ▶ Close flap in trunk.
- ▶ Disconnect snap hook **6** from eye **7**.
- ▶ Fold and flatten ski sack lengthwise and place folded ski sack inside recess of backrest.





- Close ski sack compartment cover 1.

### Removal of ski sack

For removal of the ski sack we recommend that you contact an authorized Mercedes-Benz Center.

### Warning!



Never drive vehicle with trunk lid open while the ski sack is removed. Deadly carbon monoxide (CO) gases may enter vehicle interior, resulting in unconsciousness and death.



To prevent unauthorized persons from access to the trunk, always close the cover.

### Split rear bench seat\*

The two sections can be folded down separately to enlarge the cargo area.

### Warning!



When expanding the luggage area, always fold the seat cushions fully forward.

Unless you are transporting cargo, the backrests must remain properly locked in the upright position.

In an accident, during hard braking or sudden maneuvers, loose items will be thrown around inside the vehicle, and cause injury to vehicle occupants unless the items are securely fastened in the vehicle.

### Loading

#### Folding the backrest forward

The release handle **1** is located in the trunk.

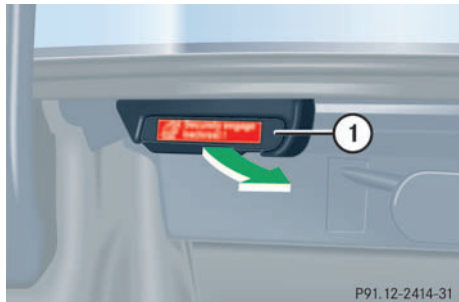

- ▶ Pull release handle **1**.
- ▶ Retract head restraints fully and fold rearward (▷ page 36).

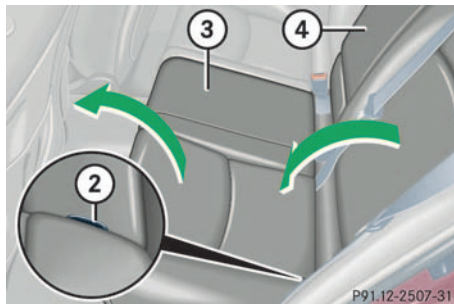

- ▶ Pull release handle **2** on the left or right\* backrest as required.
- ▶ Fold seat cushion **3** forward.
- ▶ Fold backrest **4** forward.

#### Setting up rear seat bench

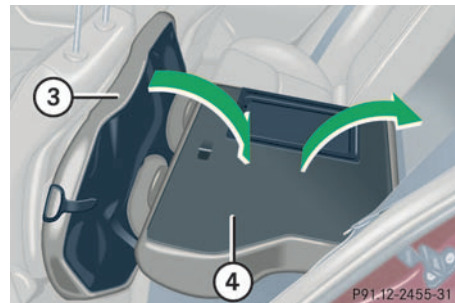

- ▶ Fold the backrest **4** rearward until it engages.
- ▶ Fold the seat cushions **3** rearward until they lock into position.





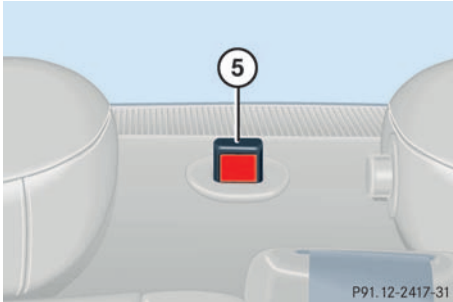

If the backrest is not locked into position, a red indicator **5** will be visible.

- ▶ Check for secure locking by pushing and pulling on the backrest.

### Warning!



If a red indicator is visible with the backrest up, then the backrest is not properly locked into position.

Always lock backrest in its upright position when rear seat bench is occupied, cargo is being carried in the trunk, or the extended cargo compartment is not in use. Check for secure locking by pushing and pulling on the backrest.

In an accident, during hard braking or sudden maneuvers, loose items will be thrown around inside the vehicle, and cause injury to vehicle occupants unless the items are securely fastened in the vehicle.

To help avoid personal injury during a collision or sudden maneuver, exercise care when transporting cargo.



To prevent unauthorized persons from access to the trunk, always lock backrest in its upright position.

### Loading

#### Loading instructions

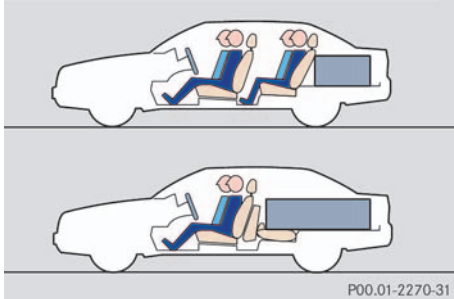

The total load weight including vehicle occupants and luggage/cargo should not exceed the vehicle capacity weight indicated on the certification tag which can be found on the left door pillar.

The handling characteristics of a fully loaded vehicle depend greatly on the load distribution. It is therefore recommended to load the vehicle according to the illustrations shown, with the heaviest items being placed towards the front of the vehicle.

Always place items being carried against front or rear seat backrests, and fasten them as securely as possible.

The heaviest portion of the cargo should always be kept as low as possible since it influences the handling characteristics of the vehicle.

#### Warning!



Always fasten items being carried as securely as possible.

In an accident, during hard braking or sudden maneuvers, loose items will be thrown around inside the vehicle and can cause injury to vehicle occupants unless the items are securely fastened in the vehicle.

To help avoid personal injury during a collision or sudden maneuver, exercise care when transporting cargo.

Never drive vehicle with trunk open. Deadly carbon monoxide (CO) gases may enter vehicle interior resulting in unconsciousness and death.



The trunk is the preferred place to carry objects.

The enlarged cargo area should only be used for items which do not fit in the trunk alone.

## Useful features

### Interior storage spaces

#### Warning!



To help avoid personal injury during a collision or sudden maneuver, exercise care when stowing objects in the vehicle. Put luggage or cargo in the trunk if possible. Do not pile luggage or cargo higher than the seat backs. Do not place anything on the shelf below the rear window.

Luggage nets cannot secure hard or heavy objects.

Keep compartment lids closed. This will help to prevent stored objects from being thrown about and injuring vehicle occupants during an accident.

### Glove box

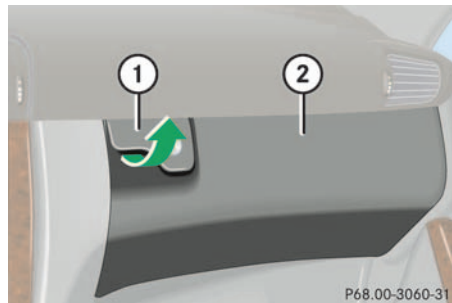

- 1 Glove box lid release
- 2 Glove box

#### Opening the glove box

- ▶ Pull lid release 1.  
The glove box lid opens downward.

#### Closing the glove box

- ▶ Push lid up to close.



Prior to closing the glove box, close the compartment for glasses first.

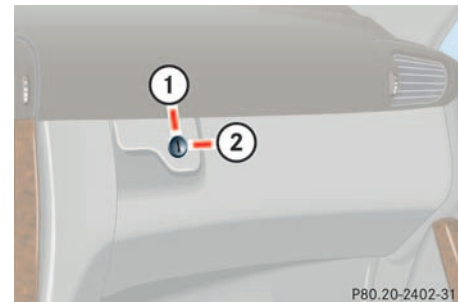

#### Locking the glove box

- ▶ Insert mechanical key (▷ page 285) into the glove box lock and turn it to position 2.

#### Unlocking the glove box

- ▶ Turn mechanical key (▷ page 285) in the glove box lock to position 1.

### Useful features

#### Cup holder in front of seat armrest

##### Warning!



When not in use, keep the cup holder closed. Place only containers that fit into the cup holder to prevent spills. Use lids on open containers and do not fill containers to a height where the contents, especially hot liquids, could spill during vehicle maneuvers.

#### Opening cup holder

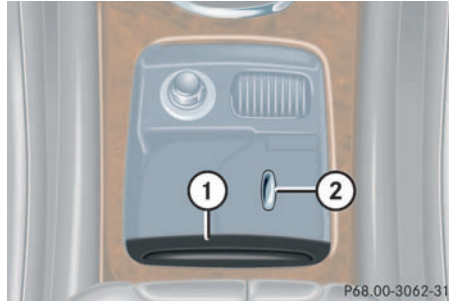

- ▶ Slide cover **1** rearward.
- ▶ Push button **2**.

The cup holder opens automatically.

#### Closing cup holder

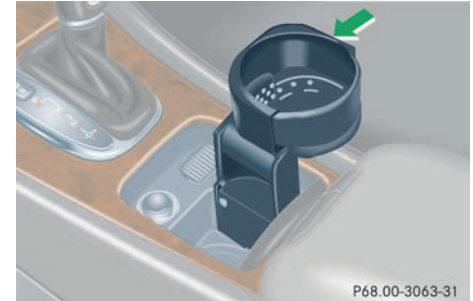

- ▶ Fold in direction of arrow until cup holder engages.

## Cup holder in rear seat armrest

**Warning!**

When not in use, keep the cup holder closed. Place only containers that fit into the cup holder to prevent spills. Use lids on open containers and do not fill containers to a height where the contents, especially hot liquids, could spill during vehicle maneuvers.

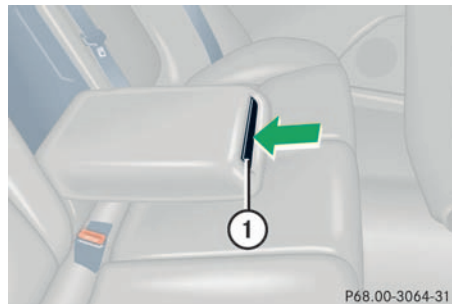
**Opening cup holder**

- ▶ Push front of sliding compartment **1**.  
The cup holder slides out.

**Closing cup holder**

- ▶ Push the sliding compartment **1** back until it engages.

## Storage compartment in front of armrest

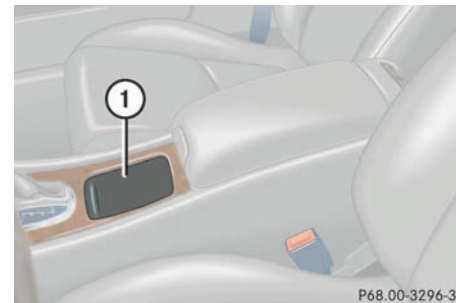
**Opening**

- ▶ Slide cover **1** rearward.

The compartment contains a cigarette lighter (▷ page 208), a coin holder and a cup holder (▷ page 204).

**Closing**

- ▶ Slide cover **1** forward.

### Useful features

#### Armrest storage spaces

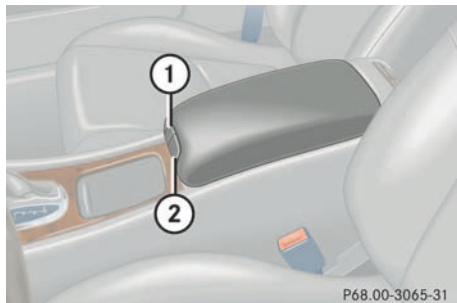

#### **Opening compartment in armrest**

- ▶ Lift armrest by handle 1.

#### **Opening compartment under armrest**

- ▶ Lift armrest by handle 2.

#### **Closing**

- ▶ Lower armrest until it engages in lock.

#### **Changing inclination of armrest**

- ▶ Pull up on armrest.

#### **Lowering armrest**

- ▶ Pull handle 2 to lower armrest.



The storage compartment can be heated or cooled.

The compartment can get very warm due to its confined space. When storing heat sensitive objects in the compartment, close the air vent (▷ page 155) while heating the passenger compartment.



Do not obstruct the air vent in the storage compartment.

#### **Parcel net in front passenger footwell**

A small convenience parcel net is located in the front passenger footwell. It is for small and light items, such as road maps, mail, etc.

#### **Warning!**



Do not place heavy or fragile objects, or objects having sharp edges, in the parcel net.

In an accident, during hard braking or sudden maneuvers, they could be thrown around inside the vehicle, and cause injury to vehicle occupants.

## Ashtrays

### Center console ashtray

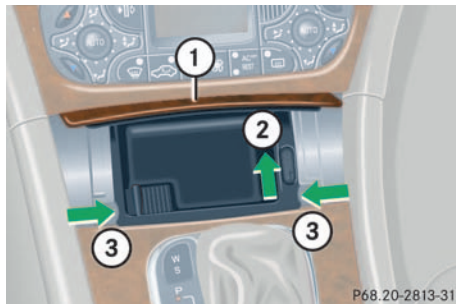

#### Opening ashtray

- ▶ Briefly touch cover plate 1.  
The ashtray opens automatically.

### Removing ashtray insert

#### Warning!



Remove front ashtray only with vehicle standing still. Set the parking brake to secure vehicle from movement. Move gear selector lever to position **N**. With gear selector lever in position **N**, turn off the engine.

- ▶ Secure vehicle from movement by setting the parking brake. Move the selector lever to position **N**.  
Now you have more room to take out the insert.
- ▶ Slide ashtray insert in direction of arrow 2 until it disengages.
- ▶ Grip ashtray at indents (arrows 3) and remove insert from ashtray frame.

#### Reinstalling ashtray insert

- ▶ Install insert by pushing back into frame until it engages again.

### Rear seat ashtray

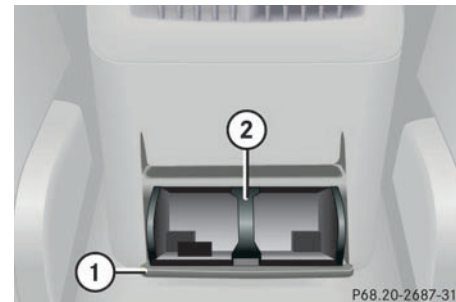

#### Opening ashtray

- ▶ Pull at top of cover 2 to open ashtray.

#### Removing ashtray insert

- ▶ Press latch 1 to disengage ashtray insert and remove it.

#### Reinstalling the ashtray insert

- ▶ Install ashtray insert.
- ▶ Close the ashtray.

### Useful features

#### Cigarette lighter

The cigarette lighter is located in the center console compartment in front of the armrest (▷ page 25).

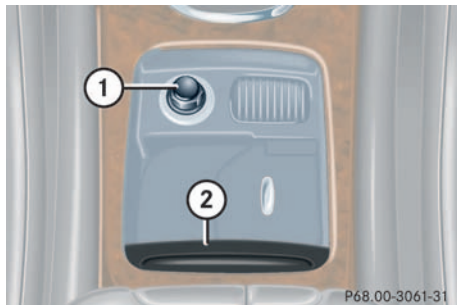

- 1 Cigarette lighter
- 2 Cover

- ▶ Turn key in the starter switch to position **1** or **2**.
- ▶ Slide cover **2** rearward.
- ▶ Push in cigarette lighter **1**.

The lighter will pop out automatically when hot.

#### Warning!



Never touch the heating element or sides of the lighter; they are extremely hot. Hold the knob only.

When leaving the vehicle, always remove the key from the starter switch, and lock your vehicle. Do not leave children unattended in the vehicle, or with access to an unlocked vehicle. Unsupervised use of vehicle equipment may cause an accident and/or serious personal injury.



The lighter socket can be used to accommodate electrical accessories up to a maximum 85 W.

#### Telephone\*

#### Warning!



Never operate radio transmitters equipped with a built-in or attached antenna (i.e. without being connected to an external antenna) from inside the vehicle while the engine is running. Doing so could lead to a malfunction of the vehicle's electronic system, possibly resulting in an accident and personal injury.

Radio transmitters, such as a portable telephone or a citizens band unit, should only be used inside the vehicle if they are connected to an antenna that is installed on the outside of the vehicle.

The external antenna must be approved by Mercedes-Benz. Please contact an authorized Mercedes-Benz Center for information on the installation of an approved external antenna. Refer to the radio transmitter operation instructions regarding use of an external antenna.



**Warning!**



Please do not forget that your primary responsibility is to drive the vehicle. A driver's attention to the road must always be his/her primary focus when driving. For your safety and the safety of others, we recommend that you pull over to a safe location and stop before placing or taking a telephone call.

If you choose to use the telephone<sup>1</sup> while driving, please use the hands-free device and only use the telephone when road, weather and traffic conditions permit. Some jurisdictions prohibit the driver from using a cellular telephone while driving a vehicle.

Only operate the COMAND\* (Cockpit Management and Data System)<sup>1</sup> if road, weather and traffic conditions permit.

Bear in mind that at a speed of just 30 mph (approximately 50 km/h), your vehicle is covering a distance of approx. 44 feet (approximately 13.5 m) every second.

<sup>1</sup> Observe all legal requirements.

You can take and place telephone calls using the  and  buttons on the steering wheel. To carry out other telephone functions, use the control system (▷ page 111).

See separate operating manual for instructions on how to use the telephone.

**Warning!**

Some jurisdictions prohibit the driver from using a cellular telephone while driving a vehicle. Whether or not prohibited by law, for safety reasons, the driver should not use the cellular telephone while the vehicle is in motion.

Stop the vehicle in a safe location before answering or placing a call.

**Tele Aid\***

The initial activation of the Tele Aid system may only be performed by completing the subscriber agreement and placing an acquaintance call using the SOS button. Failure to complete either of these steps will result in a system that is not activated. If the system is not activated, the indicator lamp in the SOS button stays on after turning key in starter switch to position **2** and the message **TELE AID - NOT ACTIVATED** will be shown in the multifunction display for approx. ten seconds.

If you have any questions regarding activation, please call the Response Center at 1-800-756-9018 (in the USA) or 1-888-923-8367 (in Canada).

### Useful features



#### The Tele Aid system



(Telematic Alarm Identification on Demand)

The Tele Aid system consists of three types of response:

- automatic and manual emergency
- roadside assistance and
- information



The Tele Aid system is operational providing that the vehicle's battery is charged, properly connected, not damaged and cellular and GPS coverage is available.

The speaker volume of a Tele Aid call can be adjusted when using the volume control on the multifunction steering wheel. To raise, press button  and to lower, press button .

- ▶ To activate, press the SOS button, the Roadside Assistance button  or the Information button , depending on the type of response required.



The SOS button is located above the inside rear view mirror.



The Roadside Assistance button  and the Information button  are located below the center armrest cover.

Shortly after the completion of your Acquaintance Call, you will receive a user ID and password via first call mail. By visiting [www.mbusa.com](http://www.mbusa.com) and selecting "Tele Aid" (USA only), you will have access to account information, remote door unlock and more.



The Tele Aid system utilizes the cellular network for communication and the GPS (Global Positioning System) satellites for vehicle location. If either of these signals are unavailable, the Tele Aid system may not function and if this occurs, assistance must be summoned by other means.

#### System self-check

Initially, after turning the key in starter switch to position **2**, malfunctions are detected and indicated (the indicator lamps in the SOS button, the Roadside Assistance button  and the Information button  stay on longer than ten seconds or do not come on). The message TELE AID - VISIT WORKSHOP! appears for approx. ten seconds in the multifunction display.

**Warning!**

If the indicator lamps in the SOS button, in the Roadside Assistance button and/or in the Information button do not come on during the system self-check or if any of these indicators remain illuminated constantly in red and/or the message **TELE AID - VISIT WORKSHOP!** is displayed in the multifunction display after the system self-check, a malfunction in the system has been detected.

If a malfunction is indicated as outlined above, the system may not operate as expected. Have the system checked at the nearest Mercedes-Benz Center as soon as possible.

**Emergency calls**

An emergency call is initiated automatically

- following an accident in which the emergency tensioning devices (ETDs) or airbags deploy
- if the anti-theft alarm or the tow-away alarm stays on for more than 20 seconds. See anti-theft alarm system (▷ page 79) and tow-away alarm (▷ page 80)

An emergency call can also be initiated manually by opening the cover next to the inside rear view mirror labeled SOS, then briefly pressing the button located under the cover. See below for instructions on initiating an emergency call manually.

Once the emergency call is in progress, the indicator lamp in the SOS button will begin to flash. The message **EMERGENCY CALL - CONNECTING CALL** appears in the multifunction display. When the connection is established, the message **EMERGENCY CALL - CALL CONNECTED** appears in the multifunc-

tion display. All information relevant to the emergency, such as the location of the vehicle (determined by the GPS satellite location system), vehicle model, identification number and color are generated.

A voice connection between the Response Center and the occupants of the vehicle will be established automatically soon after the emergency call has been initiated. When a voice connection is established the audio system mutes and the message **TELE AID - EMERGENCY CALL ACTIVE** appears in the multifunction display. The Response Center will attempt to determine more precisely the nature of the accident provided they can speak to an occupant of the vehicle.

### Useful features

The Tele Aid system is available if

- it has been activated and is operational. Activation requires a subscription for monitoring services, connection and cellular air time
- the relevant cellular phone network and GPS signals are available and pass the information on to the response center



Location of the vehicle on a map is only possible if the vehicle is able to receive signals from the GPS satellite network and pass the information on to the response center.

#### Warning!



If the indicator lamp in the SOS button is illuminated continuously and there was no voice connection to the Response Center established, then the Tele Aid system could not initiate an emergency call (e.g. the relevant cellular phone network is not available). The message **EMERGENCY CALL - CALL FAILED** appears in the multifunction display for approx. ten seconds.

Should this occur, assistance must be summoned by other means.

#### Initiating an emergency call manually



- 1 Cover
- 2 SOS button

- ▶ Briefly press on cover **1**.  
The cover will open.
- ▶ Press SOS button **2** briefly.  
The indicator lamp in the SOS button **2** will flash until the emergency call is concluded.
- ▶ Wait for a voice connection to the Response Center.
- ▶ Close cover **1** after the emergency call is concluded.

**Warning!**

If you feel at any way in jeopardy when in the vehicle (e.g. smoke or fire in the vehicle, vehicle in a dangerous road location), please do not wait for voice contact after you have pressed the emergency button. Carefully leave the vehicle and move to a safe location. The Response Center will automatically contact local emergency officials with the vehicle's approximate location if they receive an automatic SOS signal and cannot make voice contact with the vehicle occupants.

**Roadside Assistance button** 

Located below the center armrest cover is the Roadside Assistance button

- ▶ Press and hold the button (for longer than two seconds).

A call to a Mercedes-Benz Roadside Assistance dispatcher will be initiated. The button will flash while the call is in progress. The message **ROADSIDE ASSISTANCE - CONNECTING CALL** will appear in the multifunction display.

When the connection is established, the message **ROADSIDE ASSISTANCE - CALL CONNECTED** appears in the multifunction display. The Tele Aid system will transmit data generating the vehicle identification number, model, color and location (subject to availability of cellular and GPS signals).

A voice connection between the Roadside Assistance dispatcher and the occupants of the vehicle will be established. When a voice connection is established the audio

system mutes and the message **TELE AID - ROADSIDE ASSISTANCE CALL ACTIVE** appears in the multifunction display.

- ▶ Describe the nature of the need for assistance.



The Mercedes-Benz Roadside assistance dispatcher will either dispatch a qualified Mercedes-Benz technician or arrange to tow your vehicle to the nearest Mercedes-Benz Center. For services such as labor and/or towing, charges may apply. Refer to the Roadside Assistance manual for more information.

These programs are only available in the USA:

- Sign and Drive services: Services such as jump start, a few gallons of fuel or the replacement of a flat tire with the vehicle spare tire are obtainable.
- Remote Vehicle Diagnostics: This function permits the Mercedes-Benz Roadside Assistance dispatcher to download malfunction codes and actual vehicle data.

### Useful features



The indicator lamp in the Roadside Assistance button  remains illuminated in red for approx. ten seconds during the system self-check after turning the key in the starter switch to position **2** (together with the SOS button and the Information button ).

See system self-check (▷ page 210) when the indicator lamp does not light up in red or stays on longer than approximately ten seconds.

If the indicator lamp in the Roadside Assistance button  is illuminated continuously and there was no voice connection to the Response Center established, then the Tele Aid system could not initiate a Roadside Assistance call (e.g. the relevant cellular phone network is not available). The message **ROADSIDE ASSISTANCE - CALL FAILED** appears in the multifunction display.

Roadside Assistance calls can be terminated using the  button on the multifunction steering wheel.

#### Information button

Located below the center armrest cover is the Information button .

- ▶ Press and hold the button (for longer than two seconds).



A call to the Customer Assistance Center will be initiated. The button will flash while the call is in progress. The message **INFO - CONNECTING CALL** will appear in the multifunction display.

When the connection is established, the message **INFO - CALL CONNECTED** appears in the multifunction display. The Tele Aid system will transmit data generating the vehicle identification number, model, color and location (subject to availability of cellular and GPS signals).

A voice connection between the Customer Assistance Center representative and the occupants of the vehicle will be established. When a voice connection is established the audio system mutes and the message **TELE AID - INFO CALL ACTIVE** appears in the multifunction display. Information regarding the operation of your vehicle, the nearest Mercedes-Benz Center or Mercedes-Benz USA products and services is available to you.

For more details concerning the Tele Aid system, please visit [www.mbusa.com](http://www.mbusa.com) and use your ID and password (sent to you separately) to learn more (USA only).



The indicator lamp in the Information button  remains illuminated in red for approx. ten seconds during the system self-check after turning key in the starter switch to position **2** (together with the SOS button and the Roadside Assistance button .

See system self-check (▷ page 210) when the indicator lamp does not light up in red or stays on longer than approximately ten seconds.

If the indicator lamp in the Information button  is illuminated continuously and there was no voice connection to the Response Center established, then the Tele Aid system could not initiate an Information call (e.g. the relevant cellular phone network is not available). The message INFO - CALL FAILED appears in the multifunction display.

Information calls can be terminated using the  button on the multifunction steering wheel.



If the indicator lamps do not start flashing after pressing one of the buttons or remain illuminated (in red) at any time, the Tele Aid system has detected a fault or the service is not currently active, and may not initiate a call. Visit your Mercedes-Benz Center and have the system checked or contact the Response Center at 1-800-756-9018 (in the USA) or 1-888-923-8367 (in Canada) as soon as possible.

### Upgrade signals

The Tele Aid system processes calls using the following priority:

- Automatic emergency – First priority
- Manual emergency – Second priority
- Roadside assistance – Third priority
- Information – Fourth priority

Should a higher priority call be initiated while you are connected, an upgrade (alternating) tone will be heard, and the appropriate indicator lamp will flash. If certain information such as vehicle identification number or customer information is not available, the operator may need to retransmit.

During this time you will hear a beep and voice contact will be interrupted. Voice contact will resume once the retransmission is completed. Once a call is concluded, a beep will be heard and the appropriate indicator lamp will stop flashing. The COMAND\* system operation will resume.

### Useful features



If the indicator lamp continues to flash or the system does not reset, contact the Response Center at 1-800-756-9018 (in the USA) or 1-888-923-8367 (in Canada), or Mercedes-Benz Customer Assistance at 1-800-FOR-MERCEdes (1-800-367-6372) in the USA or Customer Service at 1-800-387-0100 in Canada.



The indicator lamp in the respective button flashes until the call is concluded. Calls can only be terminated by a Response Center or Customer Assistance Center representative except Roadside Assistance and Information calls, which can also be terminated by pressing button  on the multifunction steering wheel.



When a Tele Aid call has been initiated, the audio system or the COMAND\* system audio is muted and the selected mode (radio, tape or CD) pauses. The optional cellular phone (if installed) switches off. If you must use this phone, the vehicle must be parked. Disconnect the coiled cord and place the call. The COMAND\* navigation system (if engaged) will continue to run. The display in the instrument cluster is available for use and spoken commands are only available by pressing the RPT button on the COMAND\* unit. A pop-up window will appear in the COMAND\* display to indicate that a Tele Aid call is in progress.

### Remote door unlock

In case you have locked your vehicle unintentionally (e.g. key inside vehicle), and the reserve key is not handy:

- ▶ Contact the Mercedes-Benz Response Center at 1-800-756-9018 (in the USA) or 1-888-923-8367 (in Canada).

You will be asked to provide your password which you provided when you completed the subscriber agreement.

- ▶ Then return to your vehicle and pull the trunk recessed handle for minimum of 20 seconds until the SOS button is flashing.

The message **EMERGENCY CALL - CALL CONNECTED** appears in the multifunction display.

As an alternative, you may unlock the vehicle via Internet using the ID and password sent to you shortly after the completion of your Acquaintance Call.



The Response Center will then unlock your vehicle with the remote door unlocking feature.



The remote door unlock feature is available if the relevant cellular phone network is available.

The SOS button will flash and the message **EMERGENCY CALL - CALL CONNECTED** will appear in the multifunction display to indicate receipt of the door unlock command.

Once the vehicle is unlocked, a Response Center specialist will attempt to establish voice contact with the vehicle occupants.

If the trunk recessed handle was pulled for more than 20 seconds before door unlock authorization was received by the Response Center, you must wait 15 minutes before pulling the trunk recessed handle again.

### Stolen vehicle tracking services

In the event your vehicle was stolen:

- ▶ Report the incident to the police.  
The police will issue a numbered incident report.
- ▶ Pass this number on to the Mercedes-Benz Response Center along with your password issued to you when you subscribed to the service.

The Response Center will then attempt to covertly contact the vehicle's Tele Aid system. Once the vehicle is located, the Response Center will contact the local law enforcement and you. The vehicle's location will only be provided to law enforcement.

### Garage door opener

The built-in remote control is capable of operating up to three separately controlled objects.

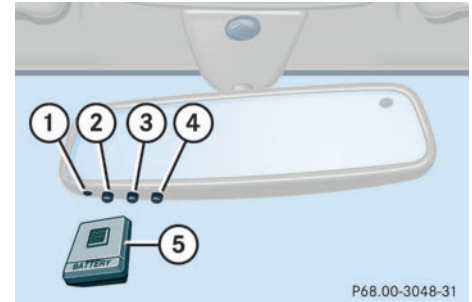

- 1 Indicator lamp
- 2, 3, 4 Signal transmitter key
- 5 Hand-held remote control transmitter

### Useful features

#### Warning!



When programming a garage door opener, the door moves up or down.

When programming or operating the remote control make sure there is no possibility of anyone being injured by the moving door.



Certain types of garage door openers are incompatible with the integrated opener. If you should experience difficulties with programming the transmitter, contact your authorized Mercedes-Benz Center, or call Mercedes-Benz Customer Assistance Center (in the USA only) at 1-800-FOR-MERCEdes, or Customer Service (in Canada) at 1-800-387-0100.



For operation in the USA only: This device complies with Part 15 of the FCC Rules. Operation is subject to the following two conditions:

- (1) This device may not cause harmful interference, and
- (2) this device must accept any interference received, including interference that may cause undesired operation.

Any unauthorized modification to this device could void the user's authority to operate the equipment.

#### Programming or reprogramming the integrated remote control

- ▶ Turn key in the starter switch to position **1** or **2**.
- ▶ Hold the end of the hand-held transmitter of the device you wish to train approximately 2 in to 5 in (5 cm to 12 cm) away from the surface of the integrated remote control located on the inside rear view mirror, keeping the indicator lamp in view.
- ▶ Using both hands, simultaneously push the hand-held transmitter button and the desired integrated remote control button. Do not release the buttons until completing next step.
- ▶ The indicator lamp on the integrated remote control will flash, first slowly and then rapidly. The rapid flashing lamp indicates successful programming of the new frequency signal.
- ▶ When the indicator lamp flashes rapidly, release both buttons.



- ▶ To program the remaining two buttons, repeat the above steps.



If, after several attempts, you do not successfully program the integrated remote control device to learn the signal of the hand-held transmitter, the garage door opener could be equipped with the “rolling code feature”.

### ***Rolling code programming***

To train a garage door opener (or other rolling code devices) with the rolling code feature, follow these instructions after completing the “Programming” portion of this text. (A second person may make the following training procedures quicker and easier.)

- ▶ Locate training button on the garage door opener motor head unit.

Exact location and color of the button may vary by garage door opener brand. If there is difficulty locating the transmitting button, refer to garage door opener operator’s manual.

- ▶ Press “training” button on the garage door opener motor head unit.

The “training light” is activated.

You have 30 seconds time to initiate the following step.

- ▶ Firmly press and release the programmed integrated remote control transmit button.
- ▶ Press and release same button a second time to complete the training process.

Some garage door openers may require you to do this procedure a third time to complete the training.

- ▶ Confirm the garage door operation by pressing the programmed button on the integrated remote control transmitter.

### ***Canadian programming***

During programming, your hand-held transmitter may automatically stop transmitting.

- ▶ Continue to press and hold the integrated remote control transmitter button (refer to steps two through four in the “Programming” portion) while you press and re-press (“cycle”) your hand-held transmitter every two seconds until the frequency signal has been learned.

Upon successful training, the indicator lamp will flash slowly and then rapidly after several seconds.

### Useful features

#### Operating the remote control

- ▶ Turn key in starter switch to position **1** or **2**.
- ▶ Select and press the appropriate button to activate the remote controlled device.

The integrated remote control transmitter continues to send the signal as long as the button is pressed – up to 20 seconds.

#### Erasing the remote control memory

- ▶ Turn key in starter switch to position **1** or **2**.
- ▶ Simultaneously hold down the left and right side buttons for approximately 20 seconds, or until the indicator lamp blinks rapidly.

The codes of all three channels are erased.



If you sell your vehicle, erase the codes of all three channels.

## Operation

The first 1000 miles (1500 km)

Driving instructions

At the gas station

Engine compartment

Tires and wheels

Winter driving

Maintenance

Vehicle care



### The first 1 000 miles (1 500 km)

In the “Operation” section you will find detailed information on operating, maintaining and caring for your vehicle.

#### The first 1 000 miles (1 500 km)

The more cautiously you treat your vehicle during the break-in period, the more satisfied you will be with its performance later on.

- Drive your vehicle during the first 1 000 miles (1 500 km) at varying but moderate vehicle and engine speeds.
- During this period, avoid heavy loads (full throttle driving) and excessive engine speeds (no more than  $\frac{2}{3}$  of maximum rpm in each gear).
- Shift gears in a timely manner.
- Avoid accelerating by kick-down.
- Do not attempt to slow the vehicle down by shifting to a lower gear using the selector lever.
- Select positions **3**, **2** or **1** only when driving at moderate speeds (for hill driving).

After 1 000 miles (1 500 km) you may gradually increase vehicle and engine speeds to the permissible maximum.



Additional instructions for AMG vehicles:

- During the first 1 000 miles (1 500 km), do not exceed a speed of 85 mph (140 km/h).
- During this period, avoid engine speeds above 4 500 rpm in each gear.

All of the above instructions, as may apply to your vehicle type, also apply when driving the first 1 000 miles (1 500 km) after the engine or the rear differential has been replaced



Always obey applicable speed limits.

## Driving instructions

### Drive sensibly – save fuel

Fuel consumption, to a great extent, depends on driving habits and operating conditions.

To save fuel you should:

- Keep tires at the recommended inflation pressures.
- Remove unnecessary loads.
- Remove roof rack when not in use.
- Allow engine to warm up under low load use.
- Avoid frequent acceleration and deceleration.
- Have all maintenance work performed at regular intervals by an authorized Mercedes-Benz Center.

Fuel consumption is also increased by driving in cold weather, in stop-and-go traffic, on short trips and in hilly country.

### Drinking and driving

#### Warning!



Drinking and driving and/or taking drugs and driving are very dangerous combinations. Even a small amount of alcohol or drugs can affect your reflexes, perceptions and judgement.

The possibility of a serious or even fatal accident is sharply increased when you drink or take drugs and drive.

Please don't drink or take drugs and drive or allow anyone to drive after drinking or taking drugs.

### Pedals

#### Warning!



Keep driver's foot area clear at all times. Objects stored in this area may impair pedal movement.

### Driving instructions

#### Power assistance

##### Warning!



When the engine is not running, the brake and steering systems are without power assistance. Under these circumstances, a much greater effort is necessary to stop or steer the vehicle

#### Brakes

##### Warning!



After driving in heavy rain for some time without applying the brakes or through water deep enough to wet brake components, the first braking action may be somewhat reduced and increased pedal pressure may be necessary to obtain expected braking effect. Maintain a safe distance from vehicles in front.

Resting your foot on the brake pedal will cause excessive and premature wear of the brake pads.

It can also result in the brakes overheating, thereby significantly reducing their effectiveness. It may not be possible to stop the vehicle in sufficient time to avoid an accident.

To help prevent brake disk corrosion after driving on wet road surfaces (particularly salted roads), it is advisable to brake the vehicle with considerable force prior to parking. The heat generated serves to dry the brakes.

If your brake system is normally only subject to moderate loads, you should occasionally test the effectiveness of the brakes by applying above-normal braking pressure at higher speeds. This will also enhance the grip of the brake pads.



Be very careful not to endanger other road users when you apply the brakes.

Refer to the description of the Brake Assist System (BAS) (▷ page 74).

If the parking brake is released and the brake warning lamp in the instrument cluster stays on, the brake fluid level in the reservoir is too low.

Brake pad wear or a leak in the system may be the reason for low brake fluid in the reservoir.

Have the brake system inspected at an authorized Mercedes-Benz Center immediately.

All checks and service work on the brake system should be carried out by an authorized Mercedes-Benz Center.

Only install brake pads and brake fluid recommended by Mercedes-Benz.



**Warning!**

If other than recommended brake pads are installed, or other than recommended brake fluid is used, the braking properties of the vehicle can be degraded to an extent that safe braking is substantially impaired. This can result in an accident.



When driving down long and steep grades, relieve the load on the brakes by shifting into a lower gear to use the engine's braking power. This helps prevent overheating of the brakes and reduces brake pad wear.

After hard braking, it is advisable to drive on for some time, rather than immediately parking, so that the air stream will cool down the brakes faster.

**Driving off**

Apply the brakes to test them briefly after driving off. Perform this procedure only when the road is clear of other traffic.

Warm up the engine smoothly. Do not place full load on the engine until the operating temperature has been reached.

When starting off on a slippery surface, do not allow one drive wheel to spin for an extended period with the ESP switched off. Doing so may cause serious damage to the drive train which is not covered by the Mercedes-Benz Limited Warranty.



Simultaneously depressing the accelerator pedal and applying the brake reduces engine performance and causes premature brake and drivetrain wear.

**Parking**

Set the parking brake whenever parking or leaving the vehicle. In addition, move selector lever to position **P** (manual transmission: first or reverse gear). In addition, when parking on hills, always turn front wheels towards road curb.

### Driving instructions

#### Warning!



Do not park this vehicle in areas where combustible materials such as grass, hay or leaves can come into contact with the hot exhaust system, as these materials could be ignited and cause a vehicle fire.

To reduce the risk of personal injury as a result of vehicle movement, before turning off the engine and leaving the vehicle always:

- Keep right foot on brake pedal.
- Firmly depress parking brake pedal.
- Move the selector lever to position **P** (manual transmission: first or reverse gear).
- Slowly release brake pedal.
- When parked on an incline, turn front wheels towards the road curb.
- Turn the key to starter switch position **0**.
- Take the key and lock vehicle when leaving.

### Tires

#### Warning!



If you feel a sudden significant vibration or ride disturbance, or you suspect that possible damage to your vehicle has occurred, you should turn on the hazard warning flashers, carefully slow down, and drive with caution to an area which is a safe distance from the road.

Inspect the tires and the vehicle underbody for possible damage. If the vehicle or tires appear unsafe, have it towed to the nearest Mercedes-Benz Center or tire dealer for repairs.

Tread wear indicators (TWI) are required by law. These indicators are located in six places on the tread circumference and become visible at a tread depth of approximately  $\frac{1}{16}$  in (1.5 mm), at which point the tire is considered worn and should be replaced.

The tread wear indicator appears as a solid band across the tread.

#### Warning!



Do not allow your tires to wear down too far. As tread depth approaches  $\frac{1}{16}$  in (1.5 mm), the adhesion properties on a wet road are sharply reduced.

Depending upon the weather and/or road surface (conditions), the tire traction varies widely.

Specified tire pressures must be maintained. This applies particularly if the tires are subject to high loads (e.g. high speeds, heavy loads, high ambient temperatures).

**Warning!**

Do not drive with a flat tire. A flat tire affects the ability to steer or brake the vehicle. You may lose control of the vehicle. Continued driving with a flat tire or driving at high speed with a flat tire will cause excessive heat build-up and possibly a fire.

**Hydroplaning**

Depending on the depth of the water layer on the road, hydroplaning may occur, even at low speeds and with new tires. Reduce vehicle speed, avoid track grooves in the road and apply brakes cautiously in the rain.

**Tire traction**

The safe speed on a wet, snow covered or icy road is always lower than on a dry road.

You should pay particular attention to the condition of the road whenever the outside temperatures are close to the freezing point.

**Warning!**

If ice has formed on the road, tire traction will be substantially reduced. Under such weather conditions, drive, steer and brake with extreme caution.

Mercedes-Benz recommends M+S rated radial-ply tires for the winter season for all four wheels to insure normal balanced handling characteristics. On packed snow, they can reduce your stopping distance compared to summer tires. Stopping distance, however, is still considerably greater than when the road is not covered with snow or ice. Exercise appropriate caution.

**Tire speed rating**

Additional information on winter tires can be found under “Winter tires” (▷ page 245).

**Warning!**

Even when permitted by law, never operate a vehicle at speeds greater than the maximum speed rating of the tires.

Exceeding the maximum speed for which tires are rated can lead to sudden tire failure, causing loss of vehicle control and possibly resulting in an accident and/or personal injury and possible death, for you and for others.

### Driving instructions

#### **C 240, C 240 4MATIC, C 320, and C 320 4MATIC**

Your vehicle is factory equipped with “H”-rated tires, which have a speed rating of 130 mph (210 km/h).

An electronic speed limiter prevents your vehicle from exceeding a speed of 130 mph (210 km/h).

#### **C 230 Kompressor Sport, C 320 Sport, and C 320 4MATIC Sport**

Your vehicle is factory equipped with “W”-rated tires, which have a speed rating of 168 mph (270 km/h).

An electronic speed limiter prevents your vehicle from exceeding a speed of 130 mph (210 km/h).

#### **C 32 AMG**

Your vehicle is factory equipped with “Y”-rated tires, which have a speed rating of 188 mph (300 km/h).

An electronic speed limiter prevents your vehicle from exceeding a speed of 155 mph (250 km/h).

Regardless of the tire speed rating, local speed limits should be obeyed. Use prudent driving speeds appropriate to prevailing conditions.

#### **Winter driving instructions**

The most important rule for slippery or icy roads is to drive sensibly and to avoid abrupt acceleration, braking and steering maneuvers. Do not use the cruise control system under such conditions.

When the vehicle is in danger of skidding, move selector lever to position **N** or in case of manual transmission declutch. Try to keep the vehicle under control by corrective steering action.



Information on driving with snow chains, see “Snow chains” (> page 246).

#### **Warning!**



On slippery road surfaces, never downshift in order to obtain braking action. This could result in drive wheel slip and reduced vehicle control. Your vehicle’s ABS will not prevent this type of control loss.

Road salts and chemicals can adversely affect braking efficiency. Increased pedal force may become necessary to produce the normal braking effect.

We therefore recommend depressing the brake pedal periodically when traveling at length on salt-strewn roads.

This can bring road salt impaired braking efficiency back to normal. Be very careful that you carry out these braking maneuvers without endangering any other road users.

If the vehicle is parked after being driven on salt treated roads, the braking efficiency should be tested as soon as possible after driving is resumed while observing the safety rules in the previous paragraph.

**Warning!**

If the vehicle becomes stuck in snow, make sure that snow is kept clear of the exhaust pipe and from around the vehicle with the engine running. Otherwise, deadly carbon monoxide (CO) gases may enter vehicle interior resulting in unconsciousness and death.

To assure sufficient fresh air ventilation, open a window slightly on the side of the vehicle not facing the wind

**Warning!**

The outside temperature indicator is not designed to serve as an ice-warning device and is therefore unsuitable for that purpose. Indicated temperatures just above the freezing point do not guarantee that the road surface is free of ice.

For more information, see “Winter driving” (▷ page 245).

**Standing water**

Do not drive through flooded areas or water of unknown depth.

If you must drive through standing water, drive slowly to prevent water from entering the passenger compartment or the engine compartment. Water in these areas could cause damage to electrical components or wiring of the engine or transmission, or could result in water being ingested by the engine through the air intake causing severe internal engine damage. Any such damage is not covered by the Mercedes-Benz Limited Warranty.

### Driving instructions

#### Passenger compartment

##### Warning!



Always fasten items being carried as securely as possible.

In an accident, during hard braking or sudden maneuvers, loose items will be thrown around inside the vehicle, and cause injury to vehicle occupants unless the items are securely fastened in the vehicle.

The trunk is the preferred place to carry objects.

#### Driving abroad

Abroad, there is a widely-spread Mercedes-Benz service network at your disposal. If you plan to drive into areas which are not listed in the index of your Mercedes-Benz Center directory, you should request pertinent information from your authorized Mercedes-Benz Center.

#### Control and operation of radio transmitter

##### COMAND\*, radio and telephone\*

##### Warning!



Please do not forget that your primary responsibility is to drive the vehicle safely. Only operate the COMAND (Cockpit Management and Data System), radio or telephone<sup>1</sup> if road, weather and traffic conditions permit.

Bear in mind that at a speed of just 30 mph (approximately 50 km/h), your vehicle is covering a distance of approximately 44 feet (approximately 13.5 m) every second.

<sup>1</sup> Observe all legal requirements

#### Telephones and two-way radios

##### Warning!



Never operate radio transmitters equipped with a built-in or attached antenna (i.e. without being connected to an external antenna) from inside the vehicle while the engine is running. Doing so could lead to a malfunction of the vehicle's electronic system, possibly resulting in an accident and personal injury.

Radio transmitters, such as a portable telephone or a citizens band unit should only be used inside the vehicle if they are connected to an antenna that is installed on the outside of the vehicle.

Refer to the radio transmitter operation instructions regarding use of an external antenna.

## Catalytic converter

---

Your Mercedes-Benz is equipped with monolithic type catalytic converters, an important element in conjunction with the oxygen sensors to achieve substantial control of the pollutants in the exhaust emissions. Keep your vehicle in proper operating condition by following our recommended maintenance instructions as outlined in your Service Booklet.



To prevent damage to the catalytic converters, use only premium unleaded gasoline in this vehicle.

Any noticeable irregularities in engine operation should be repaired promptly. Otherwise, excessive unburned fuel may reach the catalytic converter, causing it to overheat and start a fire.

### Warning!



As with any vehicle, do not idle, park or operate this vehicle in areas where combustible materials such as grass, hay or leaves can come into contact with the hot exhaust system, as these materials could be ignited and cause a vehicle fire.

## Emission control

---

Certain systems of the engine serve to keep the toxic components of the exhaust gases within permissible limits required by law.

These systems, of course, will function properly only when maintained strictly according to factory specifications. Any adjustments on the engine should, therefore, be carried out only by qualified Mercedes-Benz Center authorized technicians. Engine adjustments should not be altered in any way. Moreover, the specified service jobs must be carried out regularly according to Mercedes-Benz servicing requirements. For details refer to the Service Booklet.

### Driving instructions

#### Warning!



Inhalation of exhaust gas is hazardous to your health. All exhaust gas contains carbon monoxide, and inhaling it can cause unconsciousness and lead to death.

Do not run the engine in confined areas (such as a garage) which are not properly ventilated. If you think that exhaust gas fumes are entering the vehicle while driving, have the cause determined and corrected immediately. If you must drive under these conditions, drive only with at least one window fully open at all times.

#### Coolant temperature

During severe operating conditions and stop-and-go city traffic, the coolant temperature may rise close to approx. 248°F (120°C).

The engine should not be operated with the coolant temperature over 248°F (120°C). Doing so may cause serious engine damage which is not covered by the Mercedes-Benz Limited Warranty.

#### Warning!



- Driving when your engine is badly overheated can cause some fluids, which may have leaked into the engine compartment, to catch fire. You could be seriously burned.
- Steam from an overheated engine can cause serious burns and can occur just by opening the engine hood. Stay away from the engine if you see or hear steam coming from it.

Turn off the engine, get out of the vehicle and do not stand near the vehicle until it cools down.



At the gas station

Warning!



Gasoline is highly flammable and poisonous. It burns violently and can cause serious injury. Whenever you are around gasoline, avoid inhaling fumes and skin contact, extinguish all smoking materials. Never allow sparks, flame or smoking materials near gasoline!

Warning!



Flexible Fuel Vehicles (MY 2003 Mercedes-Benz C 320 models, except those equipped with manual transmission or 4MATIC\*) only:  
Ethanol fuel (E85) and its vapors are highly flammable, poisonous and burn easily. Ethanol fuel can cause serious injuries if ignited or if you come into contact with it or inhale fumes of it. Avoid inhalation of Ethanol fumes and skin contact with Ethanol. Extinguish all open flames before fueling. Never smoke or create sparks close to Ethanol.

The fuel filler flap is located on the right-hand side of the vehicle towards the rear. Locking/unlocking the vehicle with the remote control automatically locks/unlocks the fuel filler flap.

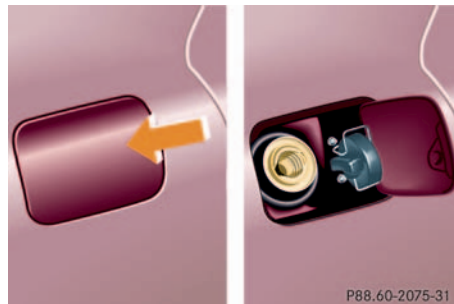

- ▶ Remove the key from the starter switch.
- ▶ Open the fuel filler flap by pushing at the point indicated by the arrow.  
The fuel filler flap springs open.
- ▶ Turn the fuel cap to the left and hold on to it until possible pressure is released.

- ▶ Take off the cap and set it in the recess on the fuel filler flap.

To prevent fuel vapors from escaping into open air, fully insert filler nozzle unit.

- ▶ Only fill your tank until the filler nozzle unit cuts out – do not top up or overfill.

Warning!



Overfilling of the fuel tank may create pressure in the system which could cause a gas discharge. This could cause the gas to spray back out when removing the fuel pump nozzle, which could cause personal injury.

- ▶ Replace the fuel cap by turning it to the right.  
You will hear when the fuel cap is tightened.
- ▶ Close the fuel filler flap.

### At the gas station



Use only premium unleaded gasoline with a minimum Posted Octane Rating of 91 (average of 96 RON / 86 MON). Information on gasoline quality can normally be found on the fuel pump.

More information on gasoline can be found in the Factory Approved Service Products pamphlet.

Flexible Fuel Vehicles (MY 2003 Mercedes-Benz C 320 models, except those equipped with manual transmission or 4MATIC\*):

More information on Flexible Fuel Vehicles can be found in the “Technical data” section (▷ page 334).



Leaving the engine running and the fuel cap open can cause the **CHECK ENGINE** lamp to illuminate.

See also “Practical hints” section (▷ page 259).

### Check regularly and before a long trip

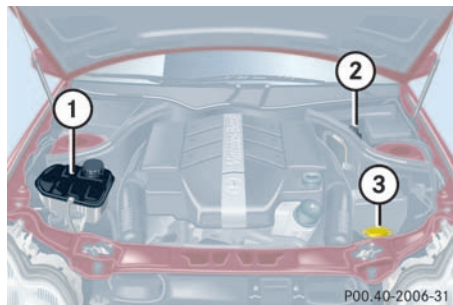

- 1 Coolant level**  
More information on the coolant level can be found in the “Operation” section (▷ page 238).
- 2 Brake fluid (fuse box cover removed)**  
More information on brake fluid can be found in the “Technical data” section (▷ page 332).  
Removing fuse box cover (▷ page 312).
- 3 Windshield washer and headlamp cleaning system\***  
For more information on refilling the reservoir, see the “Operation” section (▷ page 241).

### Engine oil level

More information on engine oil can be found in the “Operation” section (▷ page 236).

Opening hood (▷ page 235).

### Coolant

For normal replenishing, use water (potable water quality). More information on coolant can be found in the “Operation” section (▷ page 238).

### Vehicle lighting

Check function and cleanliness. For more information on replacing light bulbs, see the “Practical hints” section (▷ page 290).

Exterior lamp switch (▷ page 101).

### Tire inflation pressure

More information on tire inflation pressure can be found in the “Operation” section (▷ page 243).

## Engine compartment

### Hood

#### Warning!



Do not pull the release lever while the vehicle is in motion. Otherwise the hood could be forced open by passing air flow.

### Opening

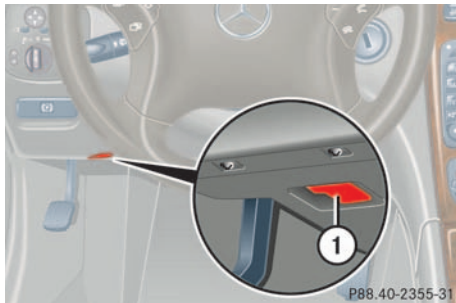

#### 1 Hood release

- ▶ Pull lever **1** downwards.

The hood is unlocked and handle **2** will extend out of the radiator grill.



To avoid damage to the windshield wipers or hood, never open the hood if the wiper arms are folded forward away from the windshield.



#### 2 Handle for opening the hood

- ▶ Pull handle **2** to its stop out of radiator grill.
- ▶ Pull up on the hood (do not pull up on the handle) and then release it.

The hood will be automatically held open at shoulder height by gas-filled struts.

#### Warning!



To help prevent personal injury, stay clear of moving parts when the hood is open and the engine is running. Make sure the hood is properly closed before driving. When closing the hood, use extreme caution not to catch hands or fingers.

The radiator fan may continue to run for approximately 30 seconds or even restart after the engine has been turned off. Stay clear of fan blades.

#### Warning!



If you see flames or smoke coming from the engine compartment, or if the coolant temperature gauge indicates that the engine is overheated, do not open the hood. Move away from vehicle and do not open the hood until the engine has cooled. If necessary, call the fire department.

### Engine compartment

#### Warning!



The engine is equipped with a transistorized ignition system. Because of the high voltage it is dangerous to touch any components (ignition coils, spark plug sockets, diagnostic socket) of the ignition system

- with the engine running
- while starting the engine
- if ignition is “on” and the engine is turned manually

#### Closing

#### Warning!



Be careful that you do not close the hood on anyone.

- ▶ Let the hood drop from a height of approximately 1 ft (30 cm).

The hood will lock audibly.

- ▶ Check to make sure that the hood is fully closed.

If you can raise the hood at a point above the headlamps, then it is not properly closed. Open it again and let it drop with somewhat greater force.

#### Engine oil

The amount of oil your engine needs will depend on a number of factors, including driving style. Higher oil consumption can occur when

- the vehicle is new
- the vehicle is driven frequently at higher engine speeds

Engine oil consumption checks should only be made after the vehicle break-in period.

#### Checking engine oil level



When checking the oil level the vehicle must

- be parked on level ground
- be at normal operating temperature
- have been stationary for at least five minutes with the engine turned off

You can check the engine oil level on the multifunction display.

- ▶ Turn the key in the starter switch to position **2**.

The standard display (▷ page 116) should appear in the multifunction display.

- ▶ Press button  or , on the steering wheel until the following message is seen in the multifunction display:

ENGINE OIL LEVEL - MEASUREMENT IN PROCESS!  
CORRECT MEASUREMENT ONLY IF VEH. LEVEL



After about three seconds this message is displayed:

ENGINE OIL LEVEL - MEASURING NOW

One of the following messages will subsequently appear in the indicator:

- ENGINE OIL LEVEL - OK
- ENGINE OIL LEVEL - ADD 1 QUART (1.0 LITER)!
- ENGINE OIL LEVEL - ADD 1.5 QUARTS (1.5 LITERS)!
- ENGINE OIL LEVEL - ADD 2 QUARTS (2.0 LITERS)!

### Adding engine oil

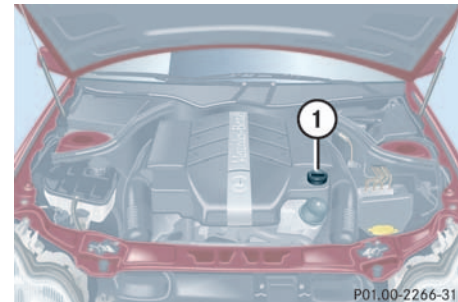

#### 1 Filler neck

- ▶ Unscrew the cap from filler neck **1**. Be careful not to overfill with oil.

Be careful not to spill any oil when adding. Avoid environmental damage caused by oil entering the ground or water.

- ▶ Screw the cap back on the filler neck.



Excessive oil must be siphoned or drained off. It could cause damage to the engine and catalytic converter not covered by the Mercedes-Benz Limited Warranty.

### Engine compartment

#### Other display messages

If there is excessive engine oil with the engine at normal operating temperature, the following message will appear:

ENGINE OIL LEVEL-REDUCE OIL LEVEL

- ▶ Have excess oil siphoned.

If the key is not turned to position **2** in the starter switch:

FOR ENGINE OIL LEVEL IGNITION ON PLEASE!

- ▶ Switch on the ignition.

If you see the message:

OBSERVE WAITING PERIOD

- ▶ Wait five minutes before repeating check procedure.

If you see the message:

ENGINE OIL LEVEL-NOT WHEN ENGINE ON!

- ▶ Turn off the engine. If engine is at normal operating temperature, wait five minutes before checking oil. If the engine is not yet at normal operating temperature, you must wait 30 minutes before checking oil.

If a proper oil level check cannot be performed, the following message will appear: MEASURING NOT POSSIBLE

- ▶ Repeat the engine oil level check after a short while.

See “Practical hints” (▷ page 270) if an engine oil level indicator appears on the display when the engine is running.

More information on engine oil can be found in the “Technical data” section (▷ page 332).

#### Transmission fluid level

---

The transmission fluid level does not need to be checked. If you notice transmission fluid loss or gear shifting malfunctions, have an authorized Mercedes-Benz Center check the transmission.

#### Coolant level

---

The engine coolant is a mixture of water and anticorrosion/antifreeze. To check the coolant level, the vehicle must be parked on level ground and the engine must be cool.

The coolant expansion tank is located on the passenger side of the engine compartment.

**Warning!**

In order to avoid any possibly serious burns:

- Use extreme caution when opening the hood if there are any signs of steam or coolant leaking from the cooling system, or if the coolant temperature gauge indicates that the coolant is overheated.
- Do not remove pressure cap on coolant reservoir if engine temperature is above 194°F (90°C). Allow engine to cool down before removing cap. The coolant reservoir contains hot fluid and is under pressure.
- Using a rag, slowly open the cap approximately  $\frac{1}{2}$  turn to relieve excess pressure. If opened immediately, scalding hot fluid and steam will be blown out under pressure.
- Do not spill antifreeze on hot engine parts. Antifreeze contains ethylene glycol which may burn if it comes into contact with hot engine parts.

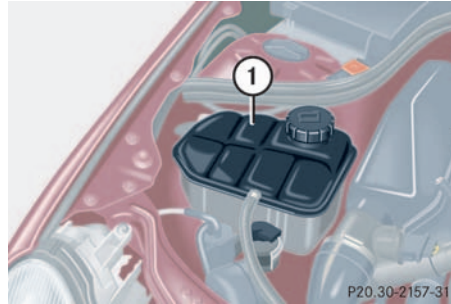

### 1 Coolant expansion tank

- ▶ Using a rag, turn the cap slowly approximately one half turn to the left to release any excess pressure.
- ▶ Continue turning the cap to the left and remove it.

The coolant level is correct if the level

- for cold coolant: reaches the black top part of the reservoir
- for warm coolant: is approx. 0.6 in (1.5 cm) higher

- ▶ Add coolant as required.
- ▶ Replace and tighten cap.

More information on coolant can be found in the “Technical data” section (▶ page 336).

### Engine compartment

#### Battery

Your vehicle's battery is located in the engine compartment (▷ page 303).

The battery should always be sufficiently charged in order to achieve its rated service life.

If you use your vehicle mostly for short distance trips, you will need to have the battery charge checked more frequently.

When replacing the battery, always use batteries approved by Mercedes-Benz.

If you do not intend to operate your vehicle for an extended period of time, consult an authorized Mercedes-Benz Center about steps you need to observe.



Observe all safety instructions and precautions when handling automotive batteries.



Risk of explosion



Keep flames or sparks away from battery. Do not smoke.



Battery acid is caustic. Do not allow it to come into contact with skin, eyes or clothing.

In case it does, immediately flush affected area with clear water and seek medical help if necessary.



Wear eye protection.



Keep children away.



Follow the instructions in this Operator's Manual.

Batteries contain materials that can harm the environment if disposed of improperly. Recycling of batteries is the preferred method of disposal. Many states require sellers of batteries to accept old batteries for recycling.



## Windshield washer system and headlamp cleaning\* system

Fluid for the windshield washer system and the headlamp cleaning system is supplied from the windshield washer reservoir. It has a capacity of

- Vehicles without headlamp cleaning system: approx. 3.2 US qt. (3.0 l).
- Vehicles with headlamp cleaning system\*: approx. 6.4 US qt. (6.0 l).

During all seasons, add MB Windshield Washer Concentrate “S” to water. Premix the windshield washer fluid in a suitable container.

- ▶ Refill the reservoir with MB Windshield Washer Concentrate and water (or commercially available premixed windshield washer solvent / antifreeze, depending on ambient temperatures).

Always use washer solvent/antifreeze where temperatures may fall below freezing. Failure to do so could result in damage to the washer system/reservoir.

### Warning!



Washer solvent / antifreeze is highly flammable. Do not spill washer solvent / antifreeze on hot engine parts, because it may ignite. You could be seriously burned.

More information can be found in the “Technical data” section (▷ page 338).

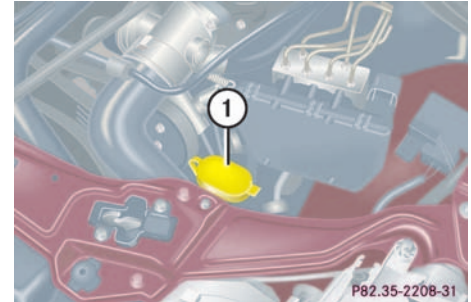

1 Washer fluid reservoir



Only use washer fluid which is suitable for plastic lenses. Improper washer fluid can damage the plastic lenses of the headlamps.

### Tires and wheels

#### Tires and wheels

See your authorized Mercedes-Benz Center for information on tested and recommended rims and tires for summer and winter operation. They can also offer advice concerning tire service and purchase.

#### Warning!



Replace rims or tires with the same designation, manufacturer and type as shown on the original part. See your authorized Mercedes-Benz Center for further information. If incorrectly sized rims and tires are mounted:

- The wheel brakes or suspension components can be damaged
- The correct operating clearance of the wheels and the tires are no longer guaranteed

#### Warning!



Worn, old tires can cause accidents. If the tire tread is badly worn, or if the tires have sustained damage, replace them.

When replacing rims, use only genuine Mercedes-Benz wheel bolts specified for the particular rim type. Failure to do so can result in the bolts loosening and possibly an accident.

Retread tires are not tested or recommended by Mercedes-Benz, since previous damage cannot always be recognized on retreads. Mercedes-Benz can therefore not assure the operating safety of the vehicle when such tires are used.

See your authorized Mercedes-Benz Center for information on tested and recommended rims and tires for summer and winter operation.

#### Important guidelines

- Use only sets of tires and rims of the same type and make.
- Tires must be of the correct size for the rim.
- Break in new tires for approximately 60 miles (100 km) at moderate speeds.
- Regularly check the tires and rims for damage.
- If vehicle is heavily loaded, check tire pressure and correct as required.
- Do not allow your tires to wear down too far. Adhesion properties on wet roads are sharply reduced at tread depths under  $\frac{1}{8}$  in (3 mm).
- When replacing individual tires, you should mount new tires on the front wheels first (on vehicles with same-sized wheels all around).

## Life of tire

The service life of a tire is dependent upon varying factors including but not limited to:

- Driving style
- Tire pressure
- Distance driven

### Warning!



Tires and spare tire should be replaced after six years, regardless of the remaining tread.



Keep unmounted tires in a cool, dry place with as little exposure to light as possible. Protect tires from contact with oil, grease and gasoline.

## Direction of rotation

Unidirectional tires offer added advantages, such as better aquaplaning performance. To benefit, however, you must ensure that the tires rotate in the direction specified.

An arrow on the sidewall indicates the intended direction of tire rotation.

## Checking tire inflation pressure

### Warning!



If the tire pressure repeatedly drops

- check the tires for punctures from foreign objects
- check to see whether air is leaking from the valves or from around the rim

Regularly check your tire pressure at intervals of no more than 14 days.

Correct the tire pressure only when tires are cold.

If the tires are warm you should only correct the tire pressure if it is too low for current operating conditions.

A table on the fuel filler flap lists the specified tire inflation pressures for warm and cold tires as well as for various operating conditions.



The pressures listed for light loads are minimum values offering high driving comfort.

Increased inflation pressures listed for heavier loads may also be used for light loads. These higher pressures produce favorable handling characteristics. The ride of the vehicle, however, will be somewhat harder. Never exceed the max. values or inflate tires below the min. values listed in the fuel filler flap.

Tire pressure changes by approx. 1.5 psi (0.1 bar) per 18°F (10°C) of air temperature change.

### Tires and wheels

Keep this in mind when checking tire pressure where the temperature is different from the outside temperature.

Tire temperature and tire pressure are also increased while driving, depending on the driving speed and the tire load.

Check the spare tire periodically for condition and inflation. Spare tires will age and become worn over time even if never used, and thus should be inspected and replaced when necessary.

#### Warning!



Follow recommended inflation pressures.

Do not overinflate tires. Overinflated tires can result in sudden deflation (blowout) because they are more likely to become punctured or damaged by road debris, potholes, etc.

Do not underinflate tires. Underinflated tires wear unevenly, adversely affect handling and fuel economy, and are more likely to fail from being overheated.

Do not overload the tires by exceeding the specified vehicle capacity weight (as indicated by the label on the pillar in the driver's door opening). Overloading the tires can overheat them, possibly causing a blowout.

#### Rotating wheels

#### Warning!



Rotate front and rear wheels only if they are of the same size.

On vehicles with the same wheel size all around, wheels can be rotated every 3000 to 6000 miles (5000 to 10000 km), or sooner if necessary, according to the degree of tire wear. The same direction of tire rotation must be retained.

Rotate the wheels before the characteristic tire wear pattern becomes visible (shoulder wear on front wheels and tread center wear on rear wheels).

Thoroughly clean the inner side of the wheels after each rotation. Check and ensure proper tire inflation pressure.

#### Warning!



Have the tightening torque checked after changing a wheel. Wheels could become loose if not tightened with a torque of 80 ft.lb. (110 Nm).

Use only genuine Mercedes-Benz wheel bolts specified for your vehicle's rims.

## Winter driving

Before the onset of winter have your vehicle winterized at an authorized Mercedes-Benz Center. This service includes:

- Check of anticorrosion and antifreeze concentration.
- Addition of cleaning concentrate to the water of the windshield and headlamp cleaning system. Add MB Concentrate “S” to a premixed windshield washer solvent / antifreeze which is formulated for below freezing temperatures (▷ page 338).
- Battery test. Battery capacity drops with decreasing ambient temperature. A well charged battery helps to ensure that the engine can be started, even at low ambient temperatures.
- Tire change. We recommend M+S rated radial-ply tires on all four wheels for the winter season.

### Winter tires

Always use winter tires at temperatures below 39°F (4°C) and whenever wintry road conditions prevail. Use of winter tires is the only way to achieve the maximum effectiveness of ABS, ESP and 4MATIC\* in winter operation.

For safe handling, ensure that all mounted winter tires are of the same make and have the same tread design.

#### Warning!



Winter tires with a tread depth under 0.16 in (4 mm) must be replaced. They are no longer suitable for winter operation.

Always observe the speed rating of the winter tires installed on your vehicle. If the maximum speed for which your tires are rated is below the speed rating of your vehicle, you must place a notice to this effect where it will be seen by the driver. Such notices are available from your tire dealer or from any authorized Mercedes-Benz Center.

#### Warning!



If you use your spare tire when winter tires are fitted on the other wheels, be aware that the difference in tire characteristics may very well impair turning stability and that overall driving stability may be reduced. Adapt your driving style accordingly.

Have the spare tire replaced with a winter tire at the nearest authorized Mercedes-Benz Center.

### Winter driving

#### Block heater (Canada only)

The engine is equipped with a block heater.

The electrical cable may be installed at your authorized Mercedes-Benz Center.

#### Snow chains

Snow chains should only be driven on snow-covered roads at speeds not to exceed 30 mph (50 km/h). Remove chains as soon as possible when driving on roads without snow.



When driving with snow chains, you may wish to deactivate the ESP (▷ page 75) before setting the vehicle in motion. This will improve the vehicle's traction.

Please observe the following guidelines when using snow chains:

- Use of snow chains is not permissible with all wheel/tire combinations.
- Chains should only be used on the rear wheels. Follow the manufacturer's mounting instructions.
- Use only snow chains that are approved by Mercedes-Benz. Your authorized Mercedes-Benz Center will be glad to advise you on this subject.



Even on vehicles with all-wheel-drive use snow chains on rear tires only.

Use of snow chains is not permissible with tire sizes:

- 225/45 R17 91 H M+S
- 225/45 R17 91 W
- 245/40 R17 91 Y
- T 125/90 R16 M 98

## Maintenance

We strongly recommend that you have your vehicle serviced by your authorized Mercedes-Benz Center, in accordance with the Service Booklet at the times called for by the FSS (Flexible Service System).

Failure to have the vehicle maintained in accordance with the Service Booklet at the designated times/mileage called for by the FSS may result in vehicle damage not covered by the Mercedes-Benz Limited Warranty.

FSS will notify you when your next service is due.

Approximately one month before your next service is due, one of the following messages will appear in the multifunction display while you are driving or when you switch on the ignition (example service A):

SERVICE A IN XX DAYS  
 SERVICE A IN XX MILES (KM)  
 SERVICE A DUE NOW!

The type of service due is indicated in the speedometer display field:

 Minor service (A)

 Major service (B)



The interval between services depends on your driving habits. A gentle driving style, moderate engine speeds and the avoidance of short distance trips will lengthen the interval between services.

## Clearing the service indicator

The service indicator is automatically cleared

- after ten seconds when you switch on the ignition or when reaching the service threshold while driving
- after 30 seconds, once the suggested service term has passed

You can also clear it yourself.

- ▶ Press the reset knob on the instrument cluster (▷ page 22).

## Service term exceeded

If you have exceeded the suggested service term, you will see the following message in the multifunction display:



SERVICE A EXCEEDED BY XX DAYS  
 SERVICE A EXCEEDED BY XX MILES (KM)

The Mercedes-Benz Center will reset the service indicator following a completed service.

### Calling up the service indicator

- ▶ Switch ignition on.

The standard display of the control system appears (▷ page 116).

- ▶ Press button  or  on the multifunction steering wheel until the FSS indicator appears in the multifunction display.



If the battery is disconnected, the days of disconnection will not be included in the count shown by the service indicator. To arrive at the true service deadline, you will need to subtract these days from the days shown in the service indicator.



Do not confuse the service indicator with the engine oil level indicator .

### Resetting the service indicator

In the event that the service on your vehicle is not carried out by an authorized Mercedes-Benz Center, you can reset the service indicator yourself.

- ▶ Switch ignition on.

The standard display of the control system appears (▷ page 116).

- ▶ Press button  or  on the multifunction steering wheel until the FSS indicator appears in the multifunction display.
- ▶ Press the reset knob for about four seconds.

This message appears in the tachometer:

DO YOU WANT TO RESET SERVICE INTERVAL? CONFIRM BY PRESSING RESET (R) BUTTON

- ▶ To confirm, hold down the reset knob until you hear a signal.

The service indicator now displays the reset interval.



If the service indicator was inadvertently reset, have a Mercedes-Benz Center correct it.

Only reset if the proper service has been performed. Resetting the system without performing proper service as called for by the FSS will cause the FSS to incorrectly determine the next service interval which will result in engine damage not covered by the Mercedes-Benz Limited Warranty.



## Vehicle care

### Cleaning and care of vehicle

#### Warning!



Many cleaning products can be hazardous. Some are poisonous, others are flammable. Always follow the instructions on the particular container. Always open your vehicle's doors or windows when cleaning the inside.

Never use fluids or solvents that are not designed for cleaning your vehicle.

While in operation, even while parked, your vehicle is subject to varying external influences which, if gone unchecked, can attack the paintwork as well as the underbody and cause lasting damage.

Such damage is caused not only by extreme and varying climatic conditions, but also by:

- Air pollution
- Road salt
- Tar, gravel and stone chipping

To avoid paint damage, you should immediately remove:

- Grease and oil
- Fuel
- Coolant
- Brake fluid
- Insects
- Tree resins etc.

Frequent washing reduces and /or eliminates the aggressiveness and potency of the above adverse influences.

More frequent washings are necessary to deal with unfavorable conditions:

- Near the ocean
- In industrial areas (smoke, exhaust emissions)
- During winter operation

You should check your vehicle from time to time for stone chipping or other damage. Any damage should be repaired as soon as possible to prevent corrosion.

In doing so, do not neglect the underbody of the vehicle. A prerequisite for a thorough check is a washing of the underbody followed by a thorough inspection. Damaged areas need to be re-undercoated.

Your vehicle has been treated at the factory with a wax-base rustproofing in the body cavities which will last for the lifetime of the vehicle. Post-production treatment is neither necessary nor recommended by Mercedes-Benz because of the possibility of incompatibility between materials used in the production process and others applied later.

We have selected car-care products and compiled recommendations which are specially matched to our vehicles and which always reflect the latest technology. You can obtain Mercedes-Benz approved car-care products at your authorized Mercedes-Benz Center.

### Vehicle care

Scratches, corrosive deposits, corrosion or damage due to negligent or incorrect care cannot always be removed or repaired with the car-care products recommended here. In such cases it is best to seek aid at your authorized Mercedes-Benz Center.

The following topics deal with the cleaning and care of your vehicle and give important “how-to” information as well as references to Mercedes-Benz approved car-care products.

Additional information can be found in the booklet “Vehicle Care Guide”.

#### Power washer

When using a power washer for cleaning the vehicle always observe manufacturer’s operating instructions.



Never use a round nozzle to power wash tires. The intense jet of water can result in damage to the tire.

Always replace a damaged tire.

Always keep the jet of water moving across the surface. Do not aim directly at electrical parts, electrical connectors, seals, or other rubber parts.

#### Tar stains

Quickly remove tar stains before they dry and become more difficult to remove. A tar remover is recommended.

#### Paintwork, painted body components

Mercedes-Benz approved Paint Care should be applied when water drops on the paint surface do not “bead up”, normally every three to five months, depending on climate and washing detergent used.

Mercedes-Benz approved Paint Cleaner should be applied if the paint surface shows signs of embedded dirt (i.e. loss of gloss).

Do not apply any of these products or wax if your vehicle is parked in the sun or if the hood is still hot.

Use the appropriate MB-Touch-Up Stick for quick and provisional repairs of minor paint damage (i.e. chips from stones, vehicle doors etc.).

#### Engine cleaning

Prior to cleaning the engine compartment make sure to protect electrical components and connectors from contact with water and cleaning agents.

Corrosion protection, such as MB Anticorrosion Wax should be applied to the engine compartment after every engine cleaning. Before applying, all control linkage bushings and joints should be lubricated. The poly-V-belt and all pulleys should be protected from any wax.

## Vehicle washing

Do not use hot water or wash your vehicle in direct sunlight. Use only a mild car wash detergent, such as Mercedes-Benz approved Car Shampoo.

Thoroughly spray the vehicle with a diffused jet of water. Direct only a very weak spray towards the ventilation intake. Use plenty of water and rinse the sponge and chamois frequently.

Rinse with clear water and thoroughly dry with a chamois. Do not allow cleaning agents to dry on the finish.

Due to the width of the vehicle, fold in outside mirrors prior to running the vehicle through an automatic car wash to prevent damage to the mirrors.

In the winter, thoroughly remove all traces of road salt as soon as possible.

When washing the underbody, do not forget to clean the inner sides of the wheels.

## Ornamental moldings

For regular cleaning and care of very dirty chrome-plated parts, use a chrome cleaner.

## Headlamps, tail lamps, turn signal lenses

Use a mild car wash detergent, such as Mercedes-Benz approved Car Shampoo, with plenty of water.

To prevent scratches, never apply strong force and use only a soft, non-scratchy cloth when cleaning the lenses. Do not attempt to wipe dirty lenses with a dry cloth or sponge.

## Wiper blades

Clean the wiper blade inserts with a clean cloth and detergent solution.



For safety reasons, switch off wipers and remove key from starter switch before cleaning the wiper blades, otherwise the wiper motor can suddenly turn on and cause injury.



Fold the windshield wiper arms back onto the windshield before turning the key in the starter switch.

## Window cleaning

Use a window cleaning solution on all glass surfaces. An automotive glass cleaner is recommended.



For safety reasons, switch off wipers and remove key from starter switch before cleaning the windshield, otherwise the wiper motor can suddenly turn on and cause injury.

### Vehicle care

#### Light alloy wheels

Mercedes-Benz approved Wheel Care should be used for regular cleaning of the light alloy wheels.

If possible, clean wheels once a week with Mercedes-Benz approved Wheel Care, using a soft bristle brush and a strong spray of water.

Follow instructions on container.



Use only acid-free cleaning materials. Acid could lead to corrosion.

#### Instrument cluster

Use a gentle dishwashing detergent or mild detergent for delicate fabrics as a washing solution. Wipe with a cloth moistened in lukewarm solution. Do not use scouring agents.

#### Steering wheel and gear selector lever

Wipe with a damp cloth and dry thoroughly or clean with Mercedes-Benz approved Leather Care.

#### Cup holder

Use a gentle dishwashing detergent or mild detergent for delicate fabrics as a washing solution. Wipe with a cloth moistened in lukewarm solution. Do not use scouring agents.

#### Hard plastic trim items

Pour Mercedes-Benz approved Interior Care onto soft lint-free cloth and apply with light pressure.

#### Plastic and rubber parts

Do not use oil or wax on these parts.

#### Headliner and shelf below rear window

Clean with soft bristle brush, or use a dry-shampoo cleaner in case of excessive dirt.

#### Seat belts

The webbing must not be treated with chemical cleaning agents. Use only clear, lukewarm water and soap. Do not dry the webbing at temperatures above 176°F (80°C) or in direct sunlight.

#### Warning!



Do not bleach or dye seat belts as this may severely weaken them. In a crash they may not be able to provide adequate protection.

**Leather upholstery**

Using aftermarket seat covers or wearing clothing that have the tendency to give off coloring (e.g. when wet etc.) may cause the upholstery to become permanently discolored. By lining the seats with a proper intermediate cover, contact-discoloration will be prevented.

Wipe leather upholstery with a damp cloth and dry thoroughly or clean with Mercedes-Benz approved Leather Care. Exercise particular care when cleaning perforated leather as its underside should not become wet.

**MB Tex upholstery**

Pour Mercedes-Benz approved Interior Care onto soft lint-free cloth and apply with light pressure.



**What to do if ...**

**Where will I find ...?**

**Unlocking/locking in an emergency**

**Opening/closing in an emergency**

**Replacing bulbs**

**Replacing wiper blades**

**Flat tire**

**Battery**

**Jump starting**

**Towing the vehicle**

**Fuses**

### What to do if ...



### What to do if ...

#### Lamps in instrument cluster



General information:

If a bulb in the instrument cluster fails to light up during the bulb self-check when

turning the SmartKey in the starter switch to position **2**, have it checked and replaced if necessary.

Problem	Possible cause	Suggested solution
 The yellow ESP warning lamp lights up while driving.	The ESP is deactivated. Risk of accident! Adapt your speed and driving to the prevailing road conditions.	<ul style="list-style-type: none"> <li>▶ Turn the ESP back on (▷ page 75).</li> </ul> If the ESP cannot be turned back on, have the system checked at an authorized Mercedes-Benz Center as soon as possible.
 The yellow ESP warning lamp flashes while driving.	The ESP or traction control has come into operation because of detected traction loss in at least one tire.	<ul style="list-style-type: none"> <li>▶ When driving off apply as little throttle as possible.</li> <li>▶ While driving ease up on the accelerator.</li> <li>▶ Adapt your speed and driving to the prevailing road and weather conditions.</li> <li>▶ Do not deactivate the ESP. Exceptions: (▷ page 75).</li> </ul> Failure to follow these instructions increases the risk of accidents.



Problem	Possible cause	Suggested solution
<p> The yellow ABS malfunction indicator lamp comes on while driving.</p>	<p>The ABS has detected a malfunction and has switched off. The BAS and the ESP are also switched off (see messages in display).</p> <p>The brake system is still functioning normally but without the ABS available.</p> <p>The charging voltage has fallen below 10 volts and the ABS has switched off.</p>	<ul style="list-style-type: none"> <li>▶ Continue driving with added caution. Wheels may lock during hard braking reducing steering capability.</li> <li>▶ Have the system checked at an authorized Mercedes-Benz Center as soon as possible.</li> </ul> <p>Failure to follow these instructions increases the risk of an accident.</p> <ul style="list-style-type: none"> <li>▶ When the voltage is above this value again, the ABS is operational again.</li> <li>▶ If necessary, have the generator and battery checked.</li> </ul>
<p> The red SRS indicator lamp lights up while driving.</p>	<p>There is a malfunction in the restraint systems. The airbags or emergency tensioning device (ETDs) could deploy unexpectedly or fail to activate in an accident.</p>	<ul style="list-style-type: none"> <li>▶ Drive with added caution to the nearest authorized Mercedes-Benz Center.</li> </ul>

**Warning!**





In the event a malfunction of the SRS is indicated as outlined above, the SRS may not be

operational. For your safety, we strongly recommend that you visit an authorized Mercedes-Benz Center immediately to have the system checked; otherwise the SRS may not be activated when needed in an

accident, which could result in serious or fatal injury, or it might deploy unexpectedly and unnecessarily which could result in an accident and/or injury to you or to others.

### What to do if ...

Problem		Possible cause	Suggested solution
 (Canada only)	The red brake warning lamp lights up while driving and you hear a warning sound.	You are driving with the parking brake set.	▶ Release the parking brake (▷ page 51).
 (USA only)			
	The red brake warning lamp lights up while driving.	There is insufficient brake fluid in the reservoir.	▶ Risk of accident! Carefully stop the vehicle and notify an authorized Mercedes-Benz Center. Do not add brake fluid! This will not solve the problem.

#### Warning!



Driving with the brake warning lamp illuminated can result in an accident. Have your brake system checked immediately if the brake warning lamp stays on. Don't add brake fluid before checking the brake system. Overfilling the brake fluid reservoir can result in spilling brake fluid on hot engine parts and the brake fluid catching fire. You can be seriously burned.





If you find that the brake fluid in the brake fluid reservoir has fallen to the minimum mark or below, have the brake system checked for brake pad thickness and leaks.

Problem	Possible cause	Suggested solution
<p><b>CHECK ENGINE</b></p> <p>The yellow “CHECK ENGINE” malfunction indicator lamp comes on while driving.</p>	<p>There is a malfunction in:</p> <ul style="list-style-type: none"> <li>• The fuel management system</li> <li>• The ignition system</li> <li>• The emission control system</li> <li>• Systems which affect emissions</li> </ul> <p>Such malfunctions may result in excessive emissions values and may switch the engine to its limp-home (emergency operation) mode.</p>	<p>▶ Have the vehicle checked as soon as possible by an authorized Mercedes-Benz Center. An on-board diagnostic connector is used by the service station to link the vehicle to the shop diagnostics system. It allows the accurate identification of system malfunctions through the readout of diagnostic trouble codes. It is located in the front left area of the footwell next to the parking brake pedal.</p>
	<p>The fuel cap is not closed tight.</p>	<p>▶ Check the fuel cap.</p>
	<p>Your gas tank is empty.</p>	<p>▶ After refuelling start the engine three or four times in succession.</p> <p>The limp-home mode is canceled. You do not need to have your vehicle checked.</p>
<p> The red seat belt warning lamp blinks for a brief period after starting the engine.</p>	<p>The warning lamp reminds you to fasten seat belts.</p>	<p>▶ Fasten your seat belt.</p>
<p>The yellow fuel tank reserve warning lamp lights while driving.</p>	<p>The fuel level has gone below the reserve mark.</p>	<p>▶ Refuel at the next gas station (▷ page 233).</p>

### What to do if ...

#### Lamp in center console

Problem	Possible cause	Suggested solution
 The indicator lamp lights up.	<p>A BabySmart™ child seat is installed on the front passenger seat. Therefore the front passenger airbag is switched off.</p> <p>The system is malfunctioning when there is no BabySmart™ child seat installed on the front passenger seat.</p>	<p>▶ Have the system checked as soon as possible by an authorized Mercedes-Benz Center.</p>
 The indicator lamp does not light up with a BabySmart™ child seat properly installed on the front passenger seat.	<p>The system is malfunctioning.</p>	<p>▶ Make sure that there is nothing between seat cushion and child seat and check installation of the child seat.</p> <p>▶ If the light remains out, have the system checked as soon as possible by an authorized Mercedes-Benz Center.</p> <p>Do not use the BabySmart™ restraint to transport children on the front passenger seat until the system has been repaired.</p>

## Messages in the display

The control system shows warning and malfunction messages in the multifunction display.

Certain warning and malfunction messages are accompanied by an audible signal.

Address these messages accordingly and follow the additional instructions given in this Operator's Manual.

Selecting the malfunction memory menu in the control system (▷ page 118) displays both cleared and uncleared messages.

High-priority messages appear in the multifunction display in red color.

Certain messages of high priority cannot be cleared from the multifunction display using the reset knob.

Other messages of high priority and messages of less immediate priority can be cleared from the multifunction display using the reset knob (▷ page 22) and are then stored in the malfunction message memory (▷ page 118).

### Warning!



All categories of messages contain important information which should be taken note of and, where a malfunction is indicated, addressed as soon as possible at an authorized Mercedes-Benz Center.

Failure to repair condition noted may cause damage not covered by the Mercedes-Benz Limited Warranty, or result in property damage or personal injury.

### Warning!



No messages will be displayed if either the instrument cluster or the multifunction display is inoperative.

Contact your nearest authorized Mercedes-Benz Center.



Turning the key in starter switch to position **2**, causes all lamps as well as the multifunction display to come on. Ensure that they are all in working order before starting your journey.



On the pages that follow, you will find a compilation of all the messages that may appear in the display.

### What to do if ...



Display	Possible cause	Suggested solution
 <p>ABS SYSTEM VISIT WORKSHOP!</p>	<p>The ABS has detected a malfunction and has switched off. The ESP and the BAS are also deactivated. The brake system is still functioning normally but without the ABS available.</p>	<ul style="list-style-type: none"> <li>▶ Continue driving with added caution. Wheels will lock in hard braking reducing steering capability.</li> <li>▶ Have the system checked at an authorized Mercedes-Benz Center as soon as possible.</li> </ul> <p>Failure to follow these instructions increases the risk of accident.</p>
<p>DISPLAY DEFECTIVE VISIT WORKSHOP!</p>	<p>The ABS or the ABS display is malfunctioning.</p>	<ul style="list-style-type: none"> <li>▶ Continue driving with added caution. Wheels will lock in hard braking reducing steering capability.</li> <li>▶ Have the system checked at an authorized Mercedes-Benz Center as soon as possible.</li> </ul> <p>Failure to follow these instructions increases the risk of accident.</p>
<p>BAS</p> <p>BRAKE ASSIST NOT AVAILABLE!</p>	<p>The charging voltage has fallen below ten volts and the BAS has switched off.</p>	<ul style="list-style-type: none"> <li>▶ When the voltage is above this value again, the BAS is operational again.</li> <li>▶ If necessary, have the generator and battery checked.</li> </ul>

Display	Possible cause	Suggested solution
BAS BRAKE ASSIST VISIT WORKSHOP!	The BAS has detected a malfunction and switched off. The brake system is still functioning normally but without the BAS available.	<ul style="list-style-type: none"> <li>▶ Continue driving with added caution.</li> <li>▶ Have the system checked at an authorized Mercedes-Benz Center as soon as possible.</li> </ul> Failure to follow these instructions increases the risk of accident.
DISPLAY DEFECTIVE VISIT WORKSHOP!	The BAS or the BAS display is malfunctioning.	<ul style="list-style-type: none"> <li>▶ Continue driving with added caution.</li> <li>▶ Have the system checked at an authorized Mercedes-Benz Center as soon as possible.</li> </ul> Failure to follow these instructions increases the risk of accident.
 BATTERY/ALTERNATOR VISIT WORKSHOP!	The battery was charged with a battery charger or jump started.	<ul style="list-style-type: none"> <li>▶ Have the battery checked at a service station.</li> </ul>

### What to do if ...

Display	Possible cause	Suggested solution
 <p>BATTERY/ALTERNATOR VISIT WORKSHOP!</p>	<p>The battery is no longer charging. Possible causes:</p> <ul style="list-style-type: none"> <li>• alternator malfunctioning</li> <li>• broken poly-V-belt</li> </ul>	<p>▶ Stop immediately and check the poly-V-belt.</p> <p>If it is broken:</p> <p>▶ Do not continue to drive. Otherwise the engine will overheat due to an inoperative water pump which may result in damage to the engine. Notify an authorized Mercedes-Benz Center.</p> <p>If it is intact:</p> <p>▶ Drive immediately to the nearest authorized Mercedes-Benz Center.</p>
<p> (Canada only) PARKING BRAKE RELEASE PARKING BRAKE!</p> <p> (USA only)</p>	<p>You are driving with the parking brake set.</p>	<p>▶ Release the parking brake (▷ page 51).</p>



Display	Possible cause	Suggested solution
 (Canada only) BRAKE PAD WEAR VISIT WORKSHOP!  (USA only)	The brake pads have reached their wear limit.	▶ Have the brake pads replaced as soon as possible.
BRAKE FLUID VISIT WORKSHOP!	There is insufficient brake fluid in the reservoir.	▶ Risk of accident! Stop the vehicle and notify an authorized Mercedes-Benz Center. Do not add brake fluid! This will not solve the problem.

**Warning!**



Driving with this message displayed can result in an accident. Have your brake system checked immediately. Don't add brake fluid before checking the brake system. Overfilling the brake fluid reservoir can result in spilling brake fluid on hot engine parts and the brake fluid catching fire. You can be seriously burned.



If you find that the brake fluid in the brake fluid reservoir has fallen to the minimum mark or below, have the brake system checked for brake pad thickness and leaks.



Brake pad thickness must be visually checked by a qualified technician at the intervals specified in the Service booklet.

### What to do if ...

Display	Possible cause	Suggested solution
 <p>COOLANT CHECK LEVEL!</p>	The coolant level is too low.	<ul style="list-style-type: none"> <li>▶ Add coolant (▷ page 238).</li> <li>▶ If you have to add coolant frequently, have the cooling system checked by an authorized Mercedes-Benz Center.</li> </ul>

#### Warning!



Do not spill antifreeze on hot engine parts. Antifreeze contains ethylene glycol which may burn if it comes into contact with hot engine parts. You can be seriously burned.



Do not ignore the low engine coolant level warning. Extended driving with the message and symbol displayed may cause serious engine damage not covered by the Mercedes-Benz Limited Warranty.

Do not drive without sufficient amount of coolant in the cooling system. The engine will overheat causing major engine damage.

Display	Possible cause	Suggested solution
 <p>COOLANT STOP, ENGINE OFF!</p>	<p>The coolant is too hot.</p>	<ul style="list-style-type: none"> <li>▶ Stop the vehicle and turn off the engine.</li> <li>▶ Only start the engine again after the message disappears. You could otherwise damage the engine.</li> </ul>

**Warning!**



Driving when your engine is badly overheated can cause some fluids which may have leaked into the engine compartment to catch fire. You could be seriously burned.

Steam from an overheated engine can cause serious burns and can occur just by opening the engine hood. Stay away from the engine if you see or hear steam coming from it.

Turn off the engine, get out of the vehicle and do not stand near the vehicle until it cools down.

During severe operating conditions and stop-and-go city traffic, the coolant temperature may rise close to 248°F (120°C).



The engine should not be operated with the coolant temperature above 248°F (120°C). Doing so may cause serious engine damage which is not covered by the Mercedes-Benz Limited Warranty.

## What to do if ...

Display	Possible cause	Suggested solution
 <p>COOLANT STOP, ENGINE OFF!</p>	<p>The poly-V-belt could be broken.</p>	<ul style="list-style-type: none"> <li>▶ Stop immediately and check the poly-V-belt.</li> </ul> <p>If it is broken:</p> <ul style="list-style-type: none"> <li>▶ Do not continue to drive. Otherwise the engine will overheat due to an inoperative water pump which may result in damage to the engine. Notify an authorized Mercedes-Benz Center.</li> </ul> <p>If it is intact:</p> <ul style="list-style-type: none"> <li>▶ Do not continue to drive the vehicle with this message displayed. Doing so could result in serious engine damage that is not covered by the Mercedes-Benz Limited Warranty.</li> </ul>
<p>COOLANT VISIT WORKSHOP!</p>	<p>The cooling fan for the coolant is malfunctioning.</p>	<ul style="list-style-type: none"> <li>▶ Observe the coolant temperature display.</li> <li>▶ Have the fan replaced as soon as possible.</li> </ul>

Display	Possible cause	Suggested solution
ESP ESP NOT AVAILABLE!	The ESP is deactivated because of a malfunction or interrupted power supply. The ABS might not be operational.	<ul style="list-style-type: none"> <li>▶ With vehicle stationary and the engine running, turn the steering wheel completely to the left and then to the right to synchronize the ESP.</li> </ul> If the ESP message does not go out: <ul style="list-style-type: none"> <li>▶ Continue driving with added caution.</li> <li>▶ Visit an authorized Mercedes-Benz Center as soon as possible.</li> </ul> Failure to follow these instructions increases the risk of accident.
	The self-diagnosis has not been completed.	The display will clear itself after driving a short distance at more than 12 mph (20 km/h).
	The charging voltage has fallen below ten volts and the ESP has switched off.	<ul style="list-style-type: none"> <li>▶ When the voltage is above this value again, the ESP is operational again.</li> <li>▶ If necessary, have the generator and battery checked.</li> </ul>

## What to do if ...

Display	Possible cause	Suggested solution
ESP ESP VISIT WORKSHOP!	The ESP is deactivated because of a malfunction.	<ul style="list-style-type: none"> <li>▶ Continue driving with added caution.</li> <li>▶ Visit an authorized Mercedes-Benz Center as soon as possible.</li> </ul> <p>Failure to follow these instructions increases the risk of accident.</p>
DISPLAY DEFECTIVE VISIT WORKSHOP!	The ESP or the ESP display is malfunctioning.	<ul style="list-style-type: none"> <li>▶ Continue driving with added caution.</li> <li>▶ Visit an authorized Mercedes-Benz Center as soon as possible.</li> </ul> <p>Failure to follow these instructions increases the risk of accident.</p>
 ENGINE OIL LEVEL STOP, ENGINE OFF!	There is no oil in the engine. There is a danger of engine damage.	<ul style="list-style-type: none"> <li>▶ Carefully bring the vehicle to a halt as soon as possible.</li> <li>▶ Turn off the engine.</li> <li>▶ Add engine oil.</li> </ul>
ENGINE OIL LEVEL CHECK LEVEL!	The engine oil level is too low.	▶ Check the engine oil level (▷ page 236) and add oil as required.
ENGINE OIL LEVEL REDUCE OIL LEVEL!	You have added too much engine oil. There is a risk of damaging the engine or the catalytic converter.	▶ Have oil siphoned. Observe all legal requirements with respect to its disposal.

Display	Possible cause	Suggested solution
 ENGINE OIL VISIT WORKSHOP!	The engine oil has dropped to a critical level.	<ul style="list-style-type: none"> <li>▶ Check the engine oil level (▷ page 236) and add oil as required.</li> <li>▶ If you must add engine oil frequently, have the engine checked for possible leaks.</li> </ul>
	There is water in the oil.	▶ Have the oil checked.
ENGINE OIL LEVEL VISIT WORKSHOP!	The measuring system is malfunctioning.	▶ Have the measuring system checked by an authorized Mercedes-Benz Center.

When the ENGINE OIL LEVEL - CHECK LEVEL! message appears while the engine is running and at operating temperature, the engine oil level has dropped to approximately the minimum mark on the dipstick.







When this occurs, the warning will first come on intermittently and then stay on if the oil level drops further.

If no oil leaks are noted, continue to drive to the nearest service station where the engine oil should be topped to the “full” mark on the dipstick with an approved oil.



The engine oil level warnings should not be ignored. Extended driving with the symbol displayed could result in serious engine damage that is not covered by the Mercedes-Benz Limited Warranty.

### What to do if ...



Display	Possible cause	Suggested solution
 RESERVE FUEL VISIT FILLING STATION!	The fuel level has dropped below the reserve mark.	▶ Refuel at the next gas station (▷ page 233).
 DOOR OPEN!	You are attempting to drive with one or more doors open.	▶ Close the doors.
 HOOD OPEN!	You are driving with the hood open.	▶ Close the hood (▷ page 235).
 TRUNK OPEN!	This message will appear whenever the trunk lid is open.	▶ Close the trunk lid.
 REPLACE KEY VISIT WORKSHOP!	No additional code available for SmartKey.	▶ Visit an authorized Mercedes-Benz Center as soon as possible.
AUTOM. LIGHT ON REMOVE KEY!	You have forgotten to remove the key.	▶ Remove the key from the starter switch.
 LAMP SENSOR VISIT WORKSHOP!	The lamp sensor is malfunctioning. The headlamps switch on automatically.	▶ In the control system, set lamp operation to manual (▷ page 119). ▶ Switch on headlamps using the exterior lamp switch.
LOW BEAM, L CHECK LAMPS!	The left low beam lamp is malfunctioning.	▶ Visit an authorized Mercedes-Benz Center as soon as possible.
LOW BEAM, R CHECK LAMPS!	The right low beam lamp is malfunctioning.	▶ Visit an authorized Mercedes-Benz Center as soon as possible.
DISPLAY DEFECTIVE VISIT WORKSHOP!	The display for the lamps or the system is malfunctioning.	▶ Visit an authorized Mercedes-Benz Center as soon as possible.





Display	Possible cause	Suggested solution
 TURN SIGNAL, LR CHECK LAMPS!	The left rear turn signal lamp is malfunctioning.	▶ Replace the bulb as soon as possible.
TURN SIGNAL, RR CHECK LAMPS!	The right rear turn signal lamp is malfunctioning.	▶ Replace the bulb as soon as possible.
TURN SIG. IN MIRROR L CHECK LAMPS!	The left turn signal in the side mirror is malfunctioning. This message will only appear if all light emitting diodes have stopped working.	▶ Have the LEDs replaced as soon as possible.
TURN SIG. IN MIRROR R CHECK LAMPS!	The right turn signal in the side mirror is malfunctioning. This message will only appear if all light emitting diodes have stopped working.	▶ Have the LEDs replaced as soon as possible.
TURN SIGNAL, LF CHECK LAMPS!	The left front turn signal lamp is malfunctioning.	▶ Replace the bulb as soon as possible.
TURN SIGNAL, RF CHECK LAMPS!	The right front turn signal lamp is malfunctioning.	▶ Replace the bulb as soon as possible.
BRAKE LAMP VISIT WORKSHOP!	Brake lamp illumination is delayed or lamp is permanently on.	▶ Visit an authorized Mercedes-Benz Center as soon as possible.
BRAKE LAMP, L CHECK LAMPS!	The left brake lamp is malfunctioning.	▶ Visit an authorized Mercedes-Benz Center as soon as possible.
BRAKE LAMP, R CHECK LAMPS!	The right brake lamp is malfunctioning.	▶ Visit an authorized Mercedes-Benz Center as soon as possible.

### What to do if ...

Display	Possible cause	Suggested solution
 3RD BRAKE LAMP CHECK LAMPS!	The high mounted brake lamp is malfunctioning.	▶ Visit an authorized Mercedes-Benz Center as soon as possible.
HIGH BEAM, L CHECK LAMPS!	The left high beam lamp is malfunctioning.	▶ Replace the bulb as soon as possible.
HIGH BEAM, R CHECK LAMPS!	The right high beam lamp is malfunctioning.	▶ Replace the bulb as soon as possible.
LICENSE PLATE LAMP, L CHECK LAMPS!	The left license plate lamp is malfunctioning.	▶ Replace the bulb as soon as possible.
LICENSE PLATE LAMP, R CHECK LAMPS!	The right license plate lamp is malfunctioning.	▶ Replace the bulb as soon as possible.
FRONT FOG LAMP, L CHECK LAMPS!	The left front fog lamp is malfunctioning.	▶ Replace the bulb as soon as possible.
FRONT FOG LAMP, R CHECK LAMPS!	The right front fog lamp is malfunctioning.	▶ Replace the bulb as soon as possible.
REAR FOG LAMP CHECK LAMPS!	The rear fog lamp is malfunctioning.	▶ Replace the bulb as soon as possible.
REVERSE LAMP, L CHECK LAMPS!	The left backup lamp is malfunctioning.	▶ Replace the bulb as soon as possible.
REVERSE LAMP, R CHECK LAMPS!	The right backup lamp is malfunctioning.	▶ Replace the bulb as soon as possible.

Display	Possible cause	Suggested solution	
 <p>TAIL LAMP, L CHECK LAMPS! SUBSTITUTE LAMP ON!</p>	The left tail lamp is malfunctioning. A backup bulb is being used.	▶ Visit an authorized Mercedes-Benz Center as soon as possible.	
	TAIL LAMP, R CHECK LAMPS! SUBSTITUTE LAMP ON!	The right tail lamp is malfunctioning. A backup bulb is being used.	▶ Visit an authorized Mercedes-Benz Center as soon as possible.
	SIDE MARKER LAMP, LF CHECK LAMPS! SUBSTITUTE LAMP ON!	The left parking lamps are malfunctioning. A backup bulb is being used.	▶ Visit an authorized Mercedes-Benz Center as soon as possible.
	SIDE MARKER LAMP, RF CHECK LAMPS! SUBSTITUTE LAMP ON!	The right parking lamps are malfunctioning. A backup bulb is being used.	▶ Visit an authorized Mercedes-Benz Center as soon as possible.
	AUTOM. LIGHT ON REMOVE KEY!	Key in the starter switch position <b>1</b> or <b>2</b> .	▶ Remove key from the starter switch.
	LIGHTS TURN OFF LAMPS!	This display appears if the driver's door is opened with the engine shut off and no key in the starter switch.	▶ Insert key in the starter switch. ▶ Switch off lights.
 <p>SEAT BELT SYSTEM VISIT WORKSHOP!</p>	The seat belt system is malfunctioning.	▶ Visit an authorized Mercedes-Benz Center as soon as possible.	
	DRIVER'S SEAT BELT FASTEN SEAT BELT!	The display reminds you and your passengers to fasten seat belts.	▶ Fasten the seat belts.

### What to do if ...

Display	Possible cause	Suggested solution
 PASSENGER SEAT BELT FASTEN SEAT BELT!	The display reminds you and your passengers to fasten seat belts.	▶ Fasten the seat belts.
 STEERING WHEEL ADJUST LOCK!  POWER STEERING FLUID VISIT WORKSHOP!	The steering column is not properly locked .  The steering gear oil level is too low. There is a danger of steering gear damage.	▶ Lock steering column (▷ page 37).  ▶ Have the system checked by an authorized Mercedes-Benz Center.





#### Warning!



If the level of steering gear oil in reservoir is too low, the steering power assistance could fail. Much greater effort will then be needed to turn the steering wheel.

Do not add steering oil without checking the steering system.

Do not drive the vehicle. Have the system checked at your authorized Mercedes-Benz Center as soon as possible.





Display	Possible cause	Suggested solution
 TELE AID VISIT WORKSHOP!	One or more main functions of the Tele Aid system* are malfunctioning.	▶ Have the Tele Aid system* checked by an authorized Mercedes-Benz Center.
 FUNCTION NOT AVAILABLE!	This display appears if button  or  on the multifunction steering wheel is pressed and the vehicle is not equipped with a telephone*.	
 RESTRAINT SYSTEM VISIT WORKSHOP!	The system is malfunctioning.	▶ Drive with added caution to the nearest authorized Mercedes-Benz Center.

Warning!



In the event a malfunction of the SRS is indicated as outlined above, the SRS may not be operational. For your safety, we strongly recommend that you visit an authorized Mercedes-Benz Center immediately to have the system checked; otherwise the SRS may not be activated when needed in an accident, which could result in serious or fatal injury, or it might deploy unexpectedly and unnecessarily which could also result in injury.

### What to do if ...

Display	Possible cause	Suggested solution
 <p>UNDERSVOLTAGE ENGINE ON!</p>	The battery has insufficient voltage and can no longer supply the convenience functions such as seat heater*.	▶ Start the engine (▷ page 44).
<p>UNDERSVOLTAGE SWITCH CONSUMERS OFF!</p>	The battery is malfunctioning.	▶ Have the battery checked at a service station.
 <p>VISIT WORKSHOP! DISPLAY DEFECTIVE</p>	The instrument cluster display is malfunctioning.	<p>▶ Continue driving with added caution.</p> <p>▶ Visit an authorized Mercedes-Benz Center as soon as possible.</p>
 <p>VISIT WORKSHOP! DISPLAY DEFECTIVE</p>	<p>Certain electronic systems are unable to relay information to the control system. The following systems may have failed:</p> <ul style="list-style-type: none"> <li>• Coolant temperature display</li> <li>• Tachometer</li> <li>• Cruise control display</li> </ul>	▶ Have the electronic systems checked by an authorized Mercedes-Benz Center (▷ page 259).
 <p>WASHER FLUID CHECK LEVEL!</p>	The fluid level has dropped to about $\frac{1}{3}$ of total reservoir capacity.	▶ Add washer fluid (▷ page 241).

## Where will I find ...?

### First aid kit

The first aid kit is stored in the trunk on the left side secured by a velcro strap.



- ▶ Unfasten velcro strap.
- ▶ Remove first aid kit.



Check expiration dates and contents for completeness at least once a year and replace missing/expired items.

### Vehicle tool kit

The following is included:

- Vehicle tool kit
- Towing eye bolt
- Wheel wrench
- Alignment bolt
- Vehicle jack
- Wheel bolts
- Special fuse extractor
- Spare fuses

### Removing the vehicle tool kit

#### *Vehicles with full size tire spare wheel*

The vehicle tool kit is stored in the space underneath the trunk floor in the storage tray (▷ page 281).

#### *Vehicles with Minispare wheel*

- ▶ Lift up the trunk floor cover.
- ▶ Loosen retaining screw **1** in the middle of storage well casing **2**.
- ▶ Remove storage well casing **2**.

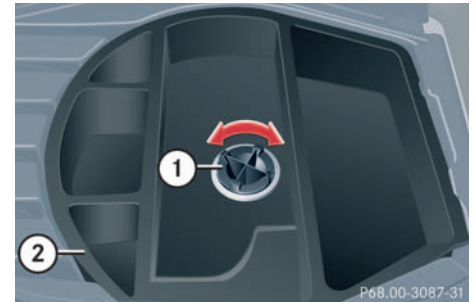

- 1 Retaining screw
- 2 Storage well casing



### Where will I find ...?

- ▶ Remove vehicle tool kit storage well casing 5.

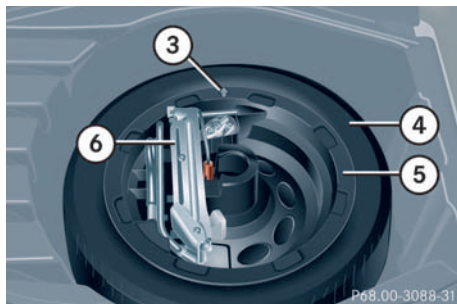

- 3 Arrow
- 4 Minispare wheel
- 5 Vehicle tool kit storage well casing
- 6 Vehicle tool kit  
Wheel wrench  
Vehicle jack



Arrow **3** on vehicle tool kit storage well casing **5** must point in the direction of travel. Otherwise you cannot place the storage well casing on top and secure the Minispare wheel with retaining screw **1** (▷ page 279).

### Vehicle jack

#### Warning!



The jack is designed exclusively for jacking up the vehicle at the jack take-up brackets built into both sides of the vehicle. To help avoid personal injury, use the jack only to lift the vehicle during a wheel change. Never get beneath the vehicle while it is supported by the jack. Keep hands and feet away from the area under the lifted vehicle. Always firmly set parking brake and block wheels before raising vehicle with jack.

Do not disengage parking brake while the vehicle is raised. Be certain that the jack is always vertical (plumb line) when in use, especially on hills. Always try to use the jack on level surface. Make sure that the jack arm is fully seated in the jack take-up bracket. Always lower the vehicle onto sufficient capacity jackstands before working under the vehicle.

### Vehicles with full size tire spare wheel

The vehicle jack is stored in the space underneath the trunk floor together with the vehicle tool kit in the storage tray (▷ page 281).

### Vehicles with Minispare wheel

The vehicle jack is stored in the space underneath the trunk floor together with the vehicle tool kit in the vehicle tool kit storage well casing (▷ page 279).

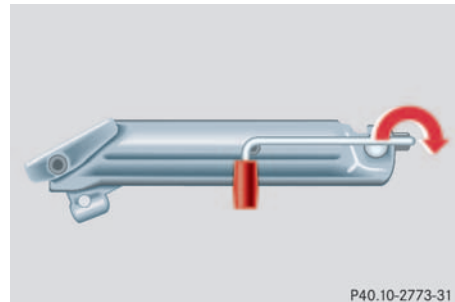

#### Storage position

- ▶ Remove the vehicle jack from its compartment.





- ▶ Push the crank handle up.

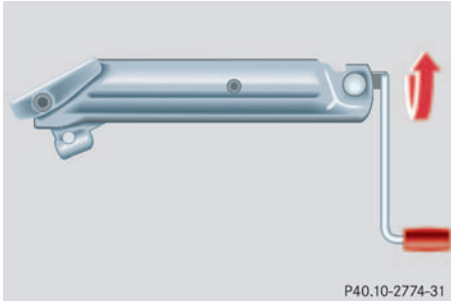

**Operational position**

- ▶ Turn the crank handle clockwise until it engages (operational position).

Before storing the vehicle jack in its compartment:

- The vehicle jack should be fully collapsed.
- The handle must be folded in (storage position).

**Spare wheel**

Your vehicle is equipped with either a spare wheel with full size tire or a Minispare wheel. Full size spare tire has marking “205/55 R16” or “225/45 R17” on sidewall. Minispare has marking “T 125/90 R16” on sidewall. Identify the spare tire in your vehicle and follow appropriate instructions.

**Vehicles with full size tire spare wheel**

The spare wheel is located in the compartment underneath the trunk floor.

- ▶ Lift trunk floor cover and engage trunk floor handle in upper edge of trunk.

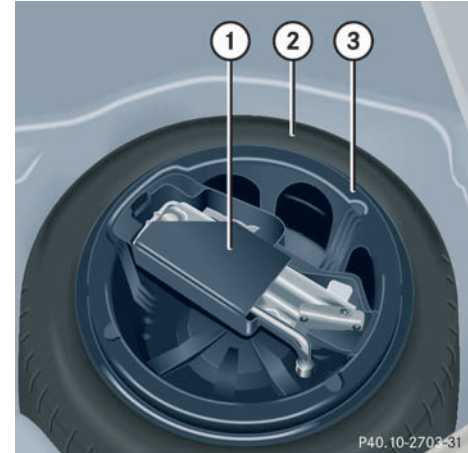

- 1 Tool kit
- 2 Spare wheel
- 3 Storage tray

**Removing the spare wheel**

- ▶ Remove tool kit 1.
- ▶ Turn storage tray 3 counterclockwise.
- ▶ Remove spare wheel 2.

### Where will I find ...?

#### Storing the spare wheel

- ▶ Place spare wheel **2** in wheel well.
- ▶ Turn storage tray **3** clockwise to its stop to secure the spare wheel.
- ▶ Insert toolkit **1**.



To prevent damage, always disengage trunk floor handle from upper edge of trunk and lower trunk floor before closing the trunk lid.

#### Spare wheel bolts

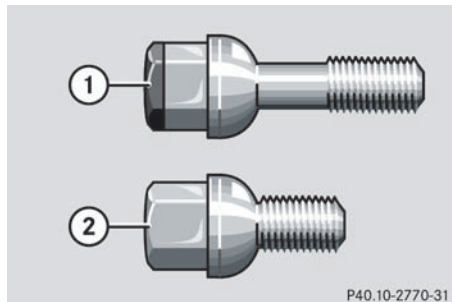

- 1** Wheel bolt for light alloy rims
- 2** Wheel bolt for steel rims



Wheel bolts **2** must be used when mounting steel wheel rim. The use of any wheel bolts other than wheel bolts **2** for steel wheel rims can cause physical damage to the vehicle.

#### Warning!



Be sure to use the original length wheel bolts when remounting the original wheel after it has been repaired.

#### Vehicles with Minispare wheel

The Minispare wheel is located in the compartment underneath the trunk floor.

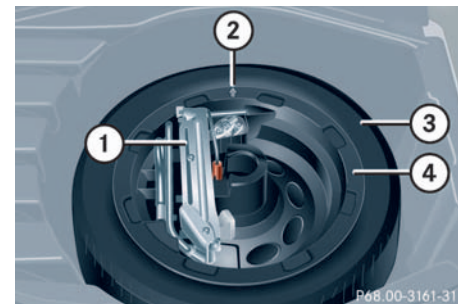

- 1** Vehicle tool kit  
Wheel wrench  
Jack
- 2** Arrow
- 3** Minispare wheel
- 4** Vehicle tool kit storage well casing

**Removing the Minispare wheel**

- ▶ Lift trunk floor cover and engage trunk floor handle in upper edge of trunk.
- ▶ Loosen the retaining screw (▷ page 279) in the middle of storage well casing.
- ▶ Remove the storage well casing.
- ▶ Remove vehicle tool kit storage well casing **4**.
- ▶ Remove Minispare wheel **3**.

**Storing the Minispare wheel**

- ▶ Place Minispare wheel **3** in wheel well.
- ▶ Place vehicle tool kit storage well casing **4** over the Minispare wheel. Be sure that the arrow **2** on storage well casing **4** points in the direction of travel.

- ▶ Place storage well casing (▷ page 279) over the vehicle tool kit storage well casing **4** and turn the retaining screw (▷ page 279) clockwise to its stop to secure the Minispare wheel.



The arrow **2** on vehicle tool kit storage well casing **4** must point in the direction of travel, otherwise you cannot place the storage well casing (▷ page 279) on top and secure the Minispare wheel with the retaining screw (▷ page 279).



To prevent damage, always disengage trunk floor handle from upper edge of trunk and lower trunk floor before closing the trunk lid.

**Warning!**

The dimensions of the Minispare wheel are different from those of the road wheels. As a result, the vehicle handling characteristics change when driving with a Minispare wheel mounted.

The Minispare wheel should only be used temporarily, and should be replaced with a regular road wheel as quickly as possible.

### Where will I find ...?

In the case of a flat tire, you may temporarily use the Minispare wheel when observing the following restrictions:

- Do not exceed a vehicle speed of 50 mph (80 km/h).
- Drive to the nearest tire repair facility to have the flat tire repaired or replaced as appropriate.
- Do not operate vehicle with more than one Minispare wheel mounted.

### Minispare wheel bolts

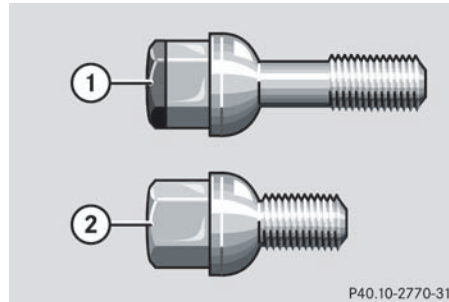

- 1 Wheel bolt for light alloy rims
- 2 Wheel bolt for Minispare wheel or other steel rims



Wheel bolts **2** must be used when mounting the Minispare wheel. The use of any wheel bolts other than wheel bolts **2** for the Minispare wheel can cause physical damage to the vehicle.

### Warning!



Be sure to use the original length wheel bolts when remounting the original wheel after it has been repaired.

Unlocking/locking in an emergency

Unlocking/locking in an emergency

Unlocking the vehicle

In case of a malfunction in the central locking system you can unlock the trunk separately (▷ page 91).

Unlocking the driver's door

If you are unable to unlock the driver's door using the SmartKey, open the door using the mechanical key.

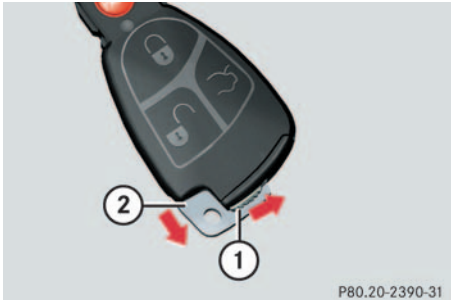

- 1 Mechanical key locking tab
- 2 Mechanical key

- ▶ Move locking tab 1 in direction of arrow and slide the mechanical key 2 out of the housing.

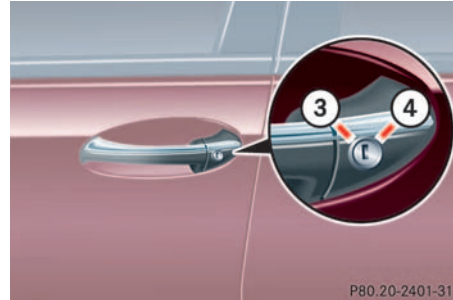

- 3 Unlocked
- 4 Locked

- ▶ Unlock the door with the mechanical key. To do so, push the mechanical key in the lock until it stops and turn it to the left 3.



Unlocking your vehicle with the mechanical key will trigger the anti-theft alarm system. To cancel the alarm, do one of the following:

- Press button or on the SmartKey.
- Insert the key in the starter switch.

### Unlocking/locking in an emergency

#### Locking the vehicle

If you are unable to lock the vehicle with the SmartKey, lock it with the mechanical key as follows:

- ▶ Close the passenger doors and the trunk.
- ▶ Press the central locking switch in the cockpit (▷ page 92).
- ▶ Check to see whether the locking knobs on the passenger doors are still visible. If necessary push them down manually.
- ▶ Lock the driver's door with the mechanical key (▷ page 285).
- ▶ Check if the trunk is locked. If necessary lock the trunk with the mechanical key (▷ page 90).

#### Changing batteries

If the batteries in the SmartKey are discharged, the vehicle can no longer be locked or unlocked. It is recommended to have the batteries replaced at an authorized Mercedes-Benz Center.

#### Warning!



Keep the batteries out of reach of children.

If a battery is swallowed, seek medical help immediately.

Batteries contain materials that can harm the environment if disposed of improperly. Recycling of batteries is the preferred method of disposal. Many states require sellers of batteries to accept old batteries for recycling.



When changing batteries, always replace both batteries.

The required replacement batteries are available at any Mercedes-Benz Center.

Unlocking/locking in an emergency

SmartKey

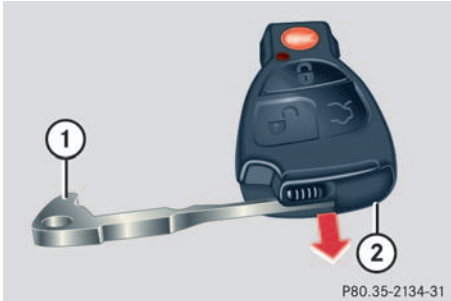

- 1 Mechanical key
- 2 Battery compartment

Replacement batteries: Lithium, type CR 2025 or equivalent.

- ▶ Remove mechanical key 1 (▷ page 285).
- ▶ Insert the mechanical key in side opening and push gray slide.

The battery compartment 2 is unlatched.

- ▶ Pull the battery compartment 2 out of the key housing in direction of arrow.

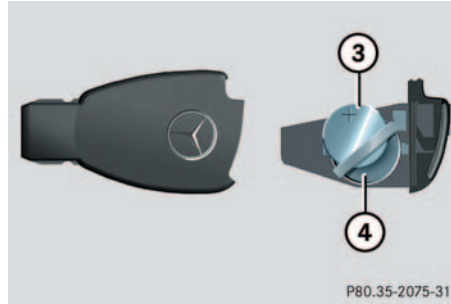

- 3 Battery
- 4 Contact spring

- ▶ Remove the batteries.
- ▶ Using a lint-free cloth, insert new batteries under the contact spring with the plus (+) side facing up.
- ▶ Return battery compartment into housing until it locks into place.

Fuel filler flap

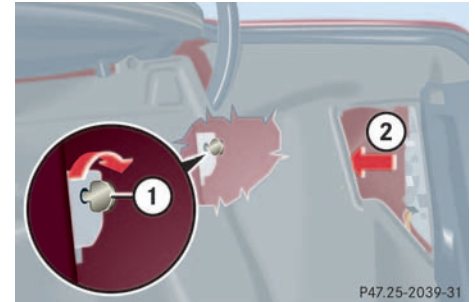

- ▶ Open trunk lid.
- ▶ Fold away right-side tail lamp trim.
- ▶ Reach inside through opening 2.
- ▶ Turn release knob 1 clockwise (arrow).  
The fuel filler flap can now be opened.

### Unlocking/locking in an emergency

#### Manually unlocking the transmission selector lever

In the case of power failure the transmission selector lever can be manually unlocked, e.g. to tow the vehicle.

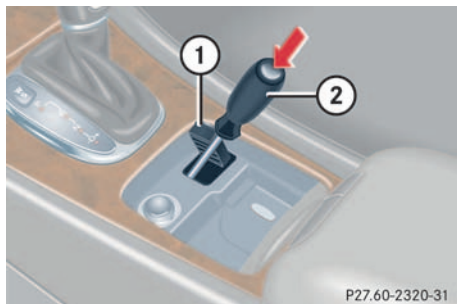

- 1 Coin holder
- 2 Tool

- ▶ Open the storage compartment in front of the center armrest (▷ page 205).
- ▶ Release coin holder **1** (e.g. using a small coin).
- ▶ Swing coin holder **1** aside.
- ▶ Insert a tool **2** (e.g. flat blade screwdriver) into the opening.
- ▶ Perform the following two steps simultaneously:
  - ▶ Push the tool down.
  - ▶ Move selector lever from position **P**.
- ▶ Reinstall the coin holder **1** after removing the tool **2** from the opening.



The selector lever is locked again when moving it to position **P**.



Opening/closing in an emergency

Opening/closing in an emergency

Sliding/pop-up roof\*

You can open or close the sliding/pop-up roof manually should an electrical malfunction occur.

The sliding/pop-up roof drive is located behind the lens 1 of the interior overhead light.



- ▶ Pry of lens 1 using a flat blade screwdriver.



- ▶ Slide both locking tabs 2 in direction of arrow.
- ▶ Lower rear of cover and remove.
- ▶ Remove cover.



Do not disconnect electrical connectors.

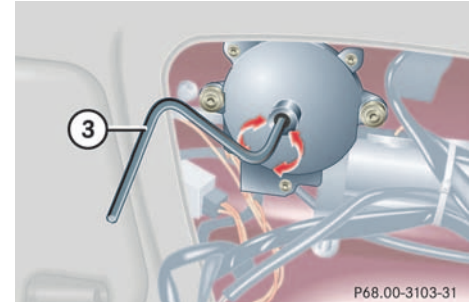

- ▶ Obtain crank 3.
- ▶ Insert crank 3 through hole.
- ▶ Turn crank 3 clockwise to:
  - slide roof closed
  - raise roof at the rear
- ▶ Turn crank 3 counterclockwise to:
  - slide roof open
  - lower roof at the rear

The sliding/pop-up roof must be resynchronized after being operated manually (▷ page 192).

### Replacing bulbs

#### Replacing bulbs

Safe vehicle operation depends on proper exterior lighting and signaling. It is therefore essential that all bulbs and lamp assemblies are in good working order at all times.

Correct headlamp adjustment is extremely important. Have headlamps checked and readjusted at regular intervals and when a bulb has been replaced. See your authorized Mercedes-Benz Center for headlamp adjustment.



Backup bulbs will be brought into use when the following lamps malfunction:

- Standing lamps
- Tail lamps
- Rear fog lamp

#### Bulbs



#### Front lamps

Lamp	Type
1 Additional turn signal lamps	LED
2 Turn signal lamp Halogen	1156 A
Turn signal lamp Bi-Xenon*	2357 A
3 Low beam Halogen	H7 (55 W)
Low and high beam	Bi-Xenon*
4 High beam	H7 (55 W)
Parking and standing lamps	W 5 W
5 Fog lamp	HB4/9006 (55 W)
6 Side marker lamp	W 5 W

Rear lamps

Lamp	Type
7 High mounted brake lamp	LED
8 Brake lamp	P 21 W
9 Turn signal lamp	PY 21 W
10 Backup lamp	P 21 W
11 Tail, parking, standing and side marker lamp	R 5 W
12 License plate lamps	C 5 W
13 Rear fog lamp, driver's side	P 21 W

Notes on bulb replacement

Warning!



Keep bulbs out of reach of children.

Bulbs and bulb sockets can be very hot. Allow the lamp to cool down before changing a bulb.

Halogen lamps contain pressurized gas. A bulb can explode if you

- touch or move it when hot
- drop the bulb
- scratch the bulb

Wear eye and hand protection.

Because of high voltage in Xenon lamps, it is dangerous to replace the bulb or repair the lamp and its components. We recommend that you have such work done by a qualified technician.

- Use only 12 volt bulbs of the same type and with the specified watt rating.
- Switch lights off before changing a bulb to prevent short circuits.
- Always use a clean lint-free cloth when handling bulbs.
- Your hands should be dry and free of oil and grease.
- If the newly installed bulb does not light up, visit an authorized Mercedes-Benz Center.
- Have the LEDs and bulbs for the following lamps replaced by an authorized Mercedes-Benz Center:
  - Additional turn signal lamps in the exterior rear view mirrors
  - High mounted brake lamp
  - Xenon lamps
  - Front fog lamps

### Replacing bulbs

#### Replacing bulbs for front lamps

##### Halogen headlamps

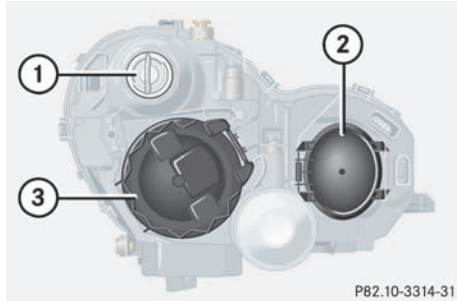

- 1 Bulb socket for turn signal lamp
- 2 Headlamp cover for high beam headlamp, parking and standing lamp
- 3 Headlamp cover for low beam headlamp

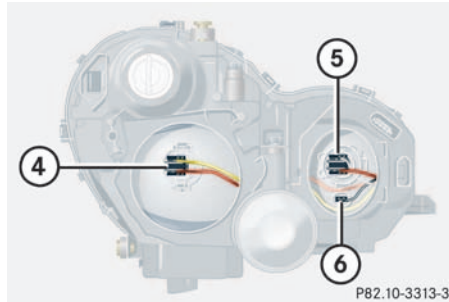

- 4 Low beam headlamp bulb
- 5 High beam headlamp bulb
- 6 Bulb socket for parking and standing lamp bulb

##### *Low and high beam bulb*

- ▶ Switch off the lights.
- ▶ Open the hood (▷ page 235).
- ▶ Press the clamp and remove headlamp cover **2** or **3**.
- ▶ Pull electrical connector off.
- ▶ Unclip the retainer springs and take out the bulb.

- ▶ Insert the new bulb so that the base locates in the recess on the holder.
- ▶ Clip the retainer springs and plug the connector onto the bulb.
- ▶ Align headlamp cover **2** or **3** and click into place.

##### *Front turn signal lamp bulb*

- ▶ Switch off the lights.
- ▶ Open the hood (▷ page 235).
- ▶ Twist bulb socket **1** counterclockwise and pull out.
- ▶ Push bulb into socket, turn counterclockwise and remove.
- ▶ Insert new bulb in socket, push in and twist clockwise.
- ▶ Reinsert bulb socket in lamp and twist clockwise.

**Parking and standing lamp bulb**

- ▶ Switch off the lights.
- ▶ Open the hood (▷ page 235).
- ▶ Press the clamp and remove headlamp cover **2**.
- ▶ Pull out the bulb socket **6** with the bulb.
- ▶ Pull the bulb out of the bulb socket.
- ▶ Insert a new bulb in the socket.
- ▶ Reinstall the bulb socket.
- ▶ Align headlamp cover **2** and click into place.

**Bi-Xenon\* headlamps**

**Warning!**



Do not remove the cover **3** for the Bi-Xenon headlamp. Because of high voltage in Bi-Xenon lamps, it is dangerous to replace the bulb or repair the lamp and its components. We recommend that you have such work done by a qualified technician.

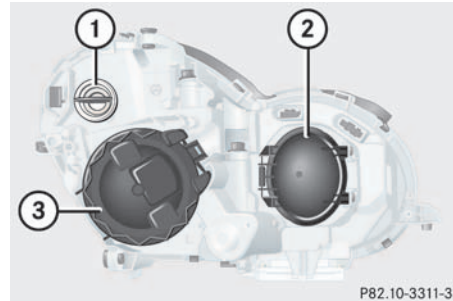

- 1** Bulb socket for turn signal lamp
- 2** Headlamp cover for high beam headlamp, parking and standing lamp
- 3** Headlamp cover for Bi-Xenon lamp

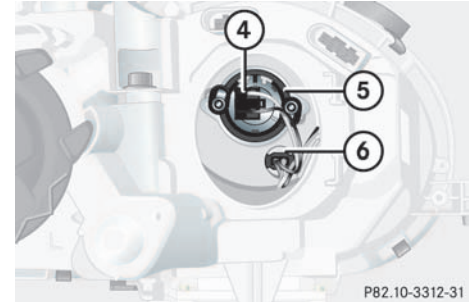

- 4** High beam headlamp bulb
- 5** Bayonet socket for high beam headlamp bulb
- 6** Bulb socket for parking and standing lamp bulb

**High beam bulb**

- ▶ Switch off the lights.
- ▶ Open the hood (▷ page 235).
- ▶ Press the clamp and remove headlamp cover **2**.
- ▶ Pull electrical connector **4** off.



### Replacing bulbs

- ▶ Twist bayonet socket **5** counterclockwise to the stop (do not remove).
- ▶ Pull the bulb out of the socket.
- ▶ Insert the new bulb so that the base locates in the recess in the bayonet socket **5**.
- ▶ Twist bayonet socket clockwise until you hear it snap into place.
- ▶ Plug the connector onto the bulb.
- ▶ Align headlamp cover **2** and click into place.

#### *Front turn signal lamp bulb*

- ▶ Switch off the lights.
- ▶ Open the hood (▷ page 235).
- ▶ Twist bulb socket **1** counterclockwise and pull out.
- ▶ Push bulb into socket, turn counterclockwise and remove.

- ▶ Insert new bulb in socket, push in and twist clockwise.
- ▶ Reinsert bulb socket in lamp and twist clockwise.

#### *Parking and standing lamp bulb*

- ▶ Switch off the lights.
- ▶ Open the hood (▷ page 235).
- ▶ Press the clamp and remove headlamp cover **2**.
- ▶ Pull out the bulb socket **6** with the bulb.
- ▶ Pull the bulb out of the bulb socket.
- ▶ Insert a new bulb in the socket.
- ▶ Reinstall the bulb socket.
- ▶ Align headlamp cover **2** and click into place.

#### **Side marker lamp bulb**

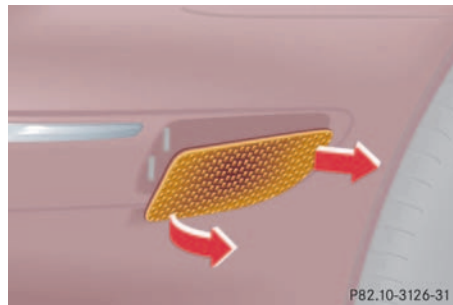

- ▶ Switch off the lights.
- ▶ Carefully slide lamp towards rear.
- ▶ Remove front end first.
- ▶ Twist bulb socket counterclockwise and pull out.
- ▶ Pull bulb out of the bulb socket.
- ▶ Insert new bulb in socket.
- ▶ Reinstall bulb socket, push in and twist clockwise.
- ▶ To reinstall lamp, set rear end in bumper and let front end snap into place.

## Replacing bulbs for rear lamps

### Tail lamp assemblies

- ▶ Switch off lights.
- ▶ Open trunk lid.



1 Locking lever

- ▶ Fold trim to the side.
- ▶ Turn locking lever 1 to vertical position and remove bulb carrier.

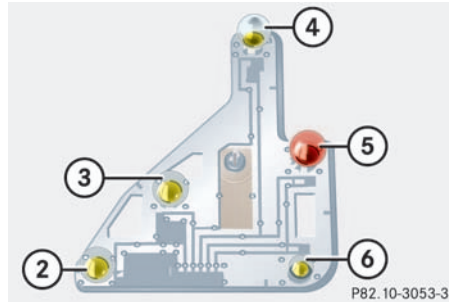

- 2 Rear fog lamp, driver's side
- 3 Back up lamp
- 4 Stop lamp
- 5 Turn signal lamp
- 6 Tail, parking, standing and side marker lamp

- ▶ Gently push bulb into socket, turn counterclockwise and remove.
- ▶ Insert new bulb and turn clockwise.
- ▶ Reinstall bulb socket.
- ▶ Reinstall bulb holder and close trim panel.

### License plate lamp

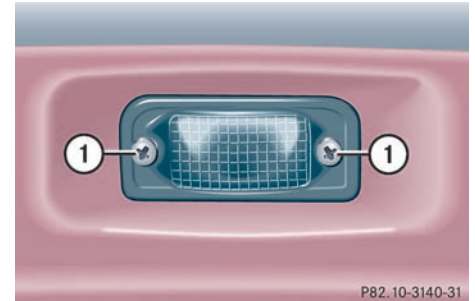

1 Screw

- ▶ Switch off the lights.
- ▶ Loosen both screws 1 and remove lamp.
- ▶ Replace the tubular lamp and reinstall lamp.
- ▶ Retighten the screws.

### Replacing wiper blades

### Replacing wiper blades

#### Warning!



For safety reasons, remove key from starter switch before replacing a wiper blade, otherwise the motor could suddenly turn on and cause injury.

#### Removing

- ▶ Fold wiper arm forward.

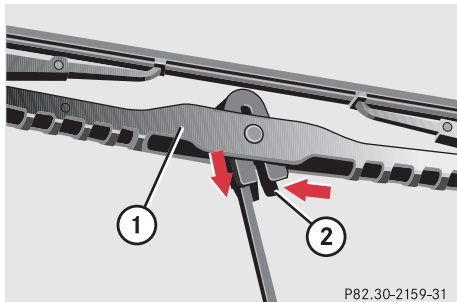

- ▶ Press safety tab down **2**.
- ▶ Push wiper blade downward **1** and remove.

#### Replacing wiper blade inserts

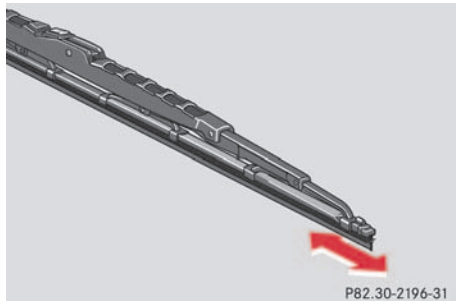

- ▶ Place wiper blade on firm support.
- ▶ Press down both tabs.
- ▶ Slide (direction of arrow) the wiper blade insert out of the retainer claws.
- ▶ Slide (direction of arrow) the new wiper blade insert into retainer claws until tabs are engaged.

#### Installing

- ▶ Slide wiper blade onto wiper arm until it locks in place.



Never open the hood when the wiper arm is folded forward.

Do not allow the wiper arms to contact the windshield glass without a wiper blade inserted.

Make certain that the wiper blades are properly installed. Improperly installed wiper blades may cause windshield damage.

For your convenience, we recommend that you have this work carried out by an authorized Mercedes-Benz Center.



## Flat tire

### Preparing the vehicle

- ▶ Park the vehicle as far as possible from moving traffic on a hard surface.
- ▶ Turn on the hazard warning flashers.
- ▶ Engage the steering wheel lock in the straight ahead position and set the parking brake.
- ▶ Move the selector lever to **P** (manual transmission to first or reverse gear).
- ▶ Have any passenger exit the vehicle at a safe distance from the roadway.

### Mounting the spare wheel

- ▶ Prepare the vehicle as described under "Preparing the vehicle" on this page.
- ▶ Take the spare wheel out of the trunk as described on (▷ page 281) (full size tire spare wheel) or (▷ page 282) (Minispare wheel).

### Lifting the vehicle

- ▶ Prevent the vehicle from rolling away by blocking wheels with wheel chocks (not included) or other sizable objects.

When changing wheel on a level surface:

- ▶ Place one chock in front of and one behind the wheel that is diagonally opposite to the wheel being changed.

When changing wheel on a hill:

- ▶ Place chocks on the downhill side blocking both wheels of the other axle.
- ▶ Take the two-piece wheel wrench and the jack out of the trunk (▷ page 279). Assemble wheel wrench.

### Warning!



The jack is designed exclusively for jacking up the vehicle at the jack take-up brackets built into both sides of the vehicle. To help avoid personal injury, use the jack only to lift the vehicle during a wheel change. Never get beneath the vehicle while it is supported by the jack. Keep hands and feet away from the area under the lifted vehicle. Always firmly set parking brake and block wheels before raising vehicle with jack.

Do not disengage parking brake while the vehicle is raised. Be certain that the jack is always vertical (plumb line) when in use, especially on hills. Always try to use the jack on level surface. Make sure that the jack arm is fully seated in the jack take-up bracket. Always lower the vehicle onto sufficient capacity jackstands before working under the vehicle.



### Flat tire

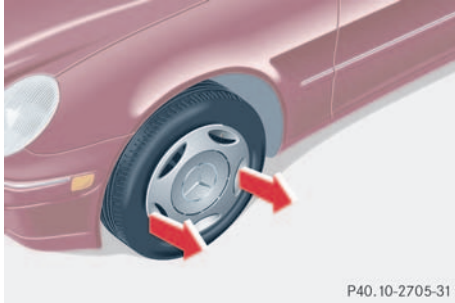

#### Wheel cover on vehicles with steel rims (Canada only)

- ▶ On wheel to be changed, remove wheel cover by reaching into two openings of the wheel cover and pulling away from the wheel.

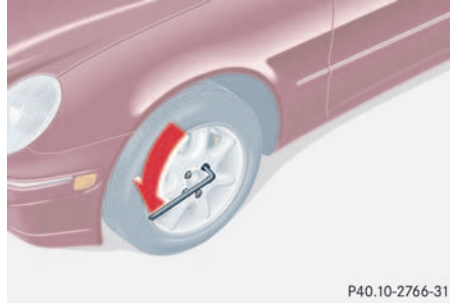

- ▶ On wheel to be changed, loosen but do not yet remove the wheel bolts (approximately one full turn with wrench).

The jack take-up brackets are located directly behind the front wheel housings and in front of the rear wheel housings.

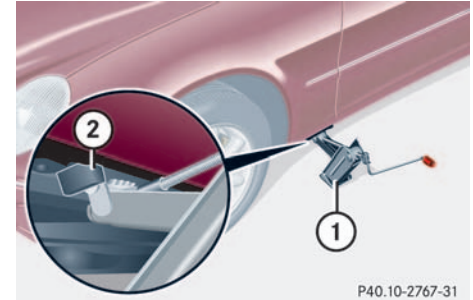

- ▶ Place jack on firm ground.
- ▶ Position jack **1** under the take-up bracket **2** so that it is always vertical (plumb-line) as seen from the side, even if the vehicle is parked on an incline.
- ▶ Jack up the vehicle until the wheel is a maximum of 1.2 in (3 cm) from the ground. Never start engine while vehicle is raised.

### Removing the wheel

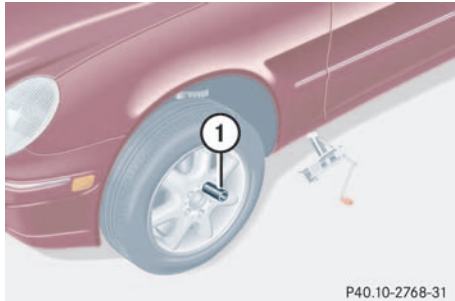

#### 1 Alignment bolt

- ▶ Unscrew upper-most wheel bolt and remove.
- ▶ Replace this wheel bolt with the alignment bolt **1** supplied in the tool kit.
- ▶ Remove the remaining bolts.



Do not place wheel bolts in sand or dirt. This could result in damage to the bolt and wheel hub threads.

- ▶ Remove the wheel.

### Mounting the new wheel

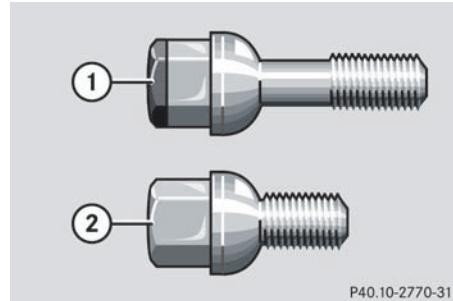

#### 1 Wheel bolt for light alloy rims

#### 2 Wheel bolt for Minispare wheel or other steel rims

- ▶ Clean contact surfaces of wheel and wheel hub.
- ▶ Guide the spare wheel onto the alignment bolt and push it on.
- ▶ Insert wheel bolts and tighten them slightly.



Wheel bolts **2** must be used when mounting steel wheel rims or the Minispare wheel. The use of any wheel bolts other than wheel bolts **2** for steel wheel rims or the Minispare wheel can cause physical damage to the vehicle.



To avoid paint damage, place wheel flat against hub and hold it there while installing first wheel bolt.



### Flat tire

#### Warning!



Always replace wheel bolts that are damaged or rusted.

Never apply oil or grease to wheel bolts.

Damaged wheel hub threads should be repaired immediately. Do not continue to drive under these circumstances! Contact an authorized Mercedes-Benz Center or call Roadside Assistance.

Incorrect mounting bolts or improperly tightened mounting bolts can cause the wheel to come off. This could cause an accident. Be sure to use the correct mounting bolts.

#### Warning!



Use only genuine equipment Mercedes-Benz wheel bolts. They are identified by the Mercedes star. Other wheel bolts may come loose.

Do not tighten the wheel bolts when the vehicle is raised. Otherwise the vehicle could tip over.

- ▶ Unscrew the alignment bolt, install last wheel bolt and tighten slightly.

### *Minispare wheel*

#### Warning!



The dimensions of the Minispare wheel are different from those of the road wheels. As a result, the vehicle handling characteristics change when driving with a Minispare wheel mounted.

The spare wheel should only be used temporarily, and replaced with a regular road wheel as quick as possible.

In the case of a flat tire, you may temporarily use the Minispare wheel when observing the following restrictions:

- Do not exceed vehicle speed of 50 mph (80 km/h).
- Drive to the nearest tire repair facility to have the flat tire repaired or replaced as appropriate.
- Do not operate vehicle with more than one spare wheel mounted.

### Lowering the vehicle

- ▶ Lower vehicle by turning crank counterclockwise until vehicle is resting fully on its own weight.
- ▶ Remove the jack.

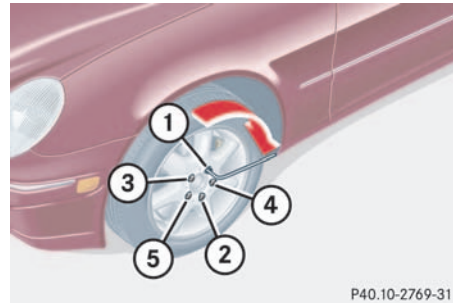

### 1 - 5 Wheel bolts

- ▶ Tighten the five wheel bolts evenly, following the diagonal sequence illustrated (1 to 5), until all bolts are tight. Observe a tightening torque of 80 ft lb (110 Nm).

### Warning!



Have the tightening torque checked after changing a wheel. The wheels could come loose if they are not tightened to a torque of 80 ft lb (110 Nm).

- ▶ Before storing the jack in the trunk, it should be fully collapsed, with handle folded in (storage position) (▷ page 280).

### Flat tire

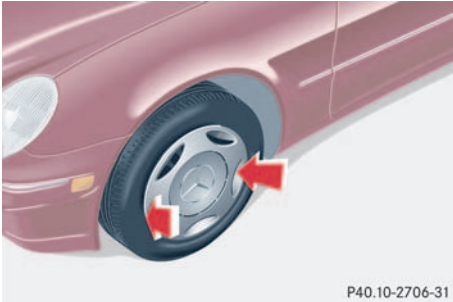

#### **Wheel cover on vehicles with steel rims (Canada only)**

- ▶ Position small wheel cover opening over tire valve and press wheel cover against wheel rim.
- ▶ Now press (do not hit) opposite side of wheel cover against wheel rim until seated.

Make certain that the springs of the wheel cover are firmly seated in the outer rim of the steel wheel.

## Battery

The battery is located in the engine compartment on the right hand side.

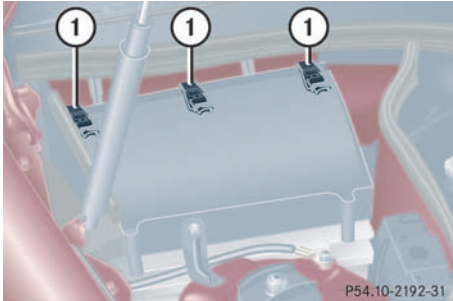

Removal of filter box:

- ▶ Release the three clamps **1**.
- ▶ Remove filter box.

Installation of filter box:

- ▶ Insert filter box properly.
- ▶ Secure it with the three clamps **1**.

### Warning!



Failure to follow these instructions can result in severe injury or death.

Never lean over batteries while connecting, you might get injured.

Battery fluid contains sulfuric acid. Do not allow this fluid to come in contact with eyes, skin or clothing. In case it does, immediately flush affected area with water and seek medical help if necessary.

A battery will also produce hydrogen gas, which is flammable and explosive. Keep flames or sparks away from battery, avoid improper connection of jumper cables, smoking etc.



Never loosen or detach battery terminal clamps while the engine is running or the key is in the starter switch. Otherwise the alternator and other electronic components could be severely damaged.

Have the battery checked regularly by an authorized Mercedes-Benz Center.

Refer to Service Booklet for maintenance intervals or contact your authorized Mercedes-Benz Center for further information.

### Warning!



Do not place metal objects on the battery as this could result in a short circuit.

Use leak-proof battery only to avoid the risk of acid burns in the event of an accident.

### Battery

#### Warning!



With a disconnected battery

- you will no longer be able to turn the key in the starter switch will have no effect
- the selector lever will remain locked in position **P**

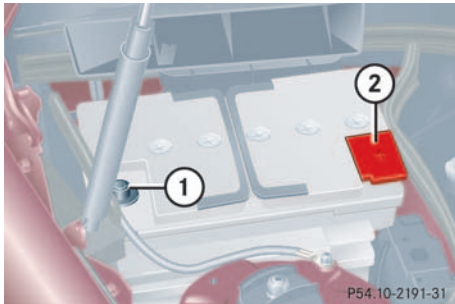

- 1 Negative terminal
- 2 Positive terminal cover

#### Disconnecting the battery

- ▶ Turn off all electrical consumers.
- ▶ Open the hood (> page 235).
- ▶ Remove the filter box.
- ▶ Disconnect the battery negative lead **1**.
- ▶ Remove the cover **2** from the positive terminal.
- ▶ Disconnect the battery positive lead.

#### Removing the battery

- ▶ Remove the screw-nuts securing the battery.
- ▶ Remove the battery bracket.
- ▶ Take out the battery.

#### Charging and reinstalling the battery

- ▶ Charge battery in accordance with the instructions of the battery charger manufacturer.
- ▶ Reinstall the charged battery. Follow the previously described steps in reverse order.

#### Warning!



Never charge a battery while still installed in the vehicle. Gases may escape during charging and cause explosions that may result in paint damage, corrosion or personal injury.



## Reconnecting the battery

- ▶ Turn off all electrical consumers.
- ▶ Connect the positive lead and fasten its cover.
- ▶ Connect the negative lead.



NEVER invert the terminal connections!

- ▶ Reinstall the filter box (▷ page 303).



The battery, its filler caps and the vent tube must always be securely installed when the vehicle is in operation.



The following procedures must be carried out following any interruption of battery power (e.g. due to reconnection):

- Set the clock (▷ page 120)  
Vehicles with COMAND\*:  
see COMAND operator's manual.
- Resynchronize the front seat head restraints (▷ page 94).
- Resynchronize the ESP  
(▷ page 75).
- Resynchronize side windows  
(▷ page 189).
- Resynchronize sliding/pop-up roof\* (▷ page 191).

Batteries contain materials that can harm the environment if disposed of improperly. Large 12 volt storage batteries contain lead. Recycling of batteries is the preferred method of disposal. Many states require sellers of batteries to accept old batteries for recycling.

### Jump starting

### Jump starting

#### Warning!



Failure to follow these directions will cause damage to the electronic components, and can lead to a battery explosion and severe injury or death.

Never lean over batteries while connecting or jump starting, you might get injured.

Battery fluid contains sulfuric acid. Do not allow this fluid to come in contact with eyes, skin or clothing. In case it does, immediately flush affected area with water, and seek medical help if necessary.

A battery will also produce hydrogen gas, which is flammable and very explosive. Keep flames or sparks away from battery, avoid improper connection of jumper cables, smoking etc.

Read all instructions before proceeding.

If the battery is discharged, the engine can be started with jumper cables and the battery of another vehicle. Observe the following:

- Jump starting should only be performed when the engine and catalytic converter are cold.
- Do not start the engine if the battery is frozen. Let the battery thaw out first.
- Only jump start from batteries with the same voltage rating (12 V). Jump starting with a more powerful battery could damage the vehicle's electrical system, which will not be covered by the Mercedes-Benz Limited Warranty.
- Only use jumper cables with sufficient cross-section and insulated terminal clamps.
- Always make sure that the jumper cables are not on or near pulleys, fans, or other parts that move when an engine is started or running.



Jump starting may only be performed on the battery installed in the engine compartment.

Avoid repeated and lengthy starting attempts.

Do not attempt to start the engine using a battery quick charge unit.

If engine does not run after several unsuccessful starting attempts, have it checked at the nearest authorized Mercedes-Benz Center.

Excessive unburned fuel generated by repeated failed starting attempts may damage the catalytic converter and may present a fire risk.

Make sure the jumper cables do not have loose or missing insulation.

Make sure the cable clamps do not touch any other metal part while the other end is still attached to a battery.

### Warning!



Keep flames or sparks away from battery. Do not smoke.

Observe all safety instructions and precautions when handling automotive batteries (> page 240).

The battery is located in the engine compartment on the right hand side. The terminals for jump starting are located in front of the battery.

- ▶ Make sure that the two vehicles do not touch.
- ▶ Turn off all electrical consumers.
- ▶ Apply parking brake.
- ▶ Shift selector lever to position **P** (manual transmission to Neutral).

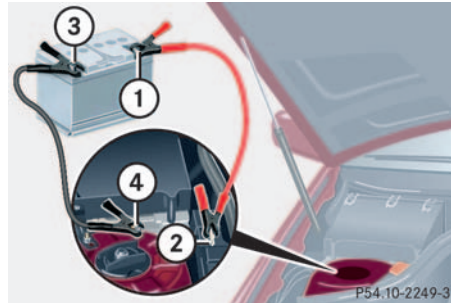

- 1 Positive terminal of charged battery
  - 2 Positive under hood terminal in front of discharged battery
  - 3 Negative terminal of charged battery
  - 4 Negative under hood terminal in front of discharged battery
- ▶ Connect positive terminal **1** of the charged battery with the under hood terminal **2** in front of the discharged battery with the jumper cables. Clamp cable to charged battery **1** first.
  - ▶ Start engine of the vehicle with the charged battery and run at idle speed.

- ▶ Connect negative terminal **3** of the charged battery with the under hood terminal **4** of the discharged battery with the jumper cables. Clamp cable to charged battery **3** first.
- ▶ Start the engine of the disabled vehicle.

Now you can again turn on the electrical consumers. Do not turn on the lights under any circumstances.

- ▶ Remove the jumper cables first from negative terminals **3** and **4** and then from positive terminals **1** and **2**.
- ▶ Have the battery checked at the nearest authorized Mercedes-Benz Center.



Vehicles with automatic transmission and/or 4MATIC\*:  
Do not tow-start the vehicle.

### Towing the vehicle

#### Towing the vehicle

Mercedes-Benz recommends that the vehicle be transported with all wheels off the ground using flatbed or appropriate wheel lift/dolly equipment. This method is preferable to other types of towing.



Use flatbed or wheel lift/dolly equipment with key in starter switch turned to position **0**.

Do not tow with sling-type equipment. Towing with sling-type equipment over bumpy roads will damage radiator and supports.

To prevent damage during transport, do not tie down vehicle by its chassis or suspension parts.

Switch off the tow-away alarm (▷ page 80) and deactivate the automatic central locking (▷ page 129).

When circumstances do not permit the recommended towing methods, the vehicle may be towed with all wheels on the ground or front wheels raised (except vehicles with 4MATIC\*) only so far as necessary to have the vehicle moved to a safe location where the recommended towing methods can be employed.



Vehicles with automatic transmission and/or 4MATIC\*:  
Do not tow-start the vehicle.



Vehicles with 4MATIC\*:  
Do not tow with one axle raised. Doing so could damage the transfer case, which is not covered by the Mercedes-Benz Limited Warranty.

All wheels must be on or off the ground. Observe instructions for towing the vehicle with all wheels on the ground.



If the vehicle is towed with the front axle raised (not permissible for vehicles with 4MATIC\*), the engine must be shut off (key in starter switch position **0** or **1**). Otherwise the ESP will immediately be engaged and will apply the rear wheel brakes.

When towing the vehicle with all wheels on the ground, the selector lever must be in position **N** (manual transmission: gears disengaged) and the key must be in starter switch position **2**.

When towing the vehicle with all wheels on the ground or the front axle raised, the vehicle may be towed only for distances up to 30 miles (50 km) and at a speed not to exceed 30 mph (50 km/h).



To be certain to avoid a possibility of damage to the drive train, however, we recommend the drive shaft be disconnected at the rear axle drive flange (vehicles with 4MATIC\*: disconnected at the front and rear axle drive flanges) for any towing beyond a short tow to a nearby garage.

**Warning!**

If circumstances require towing the vehicle with all wheels on the ground, always tow with a tow bar if:

- the engine will not run
- there is a malfunction in the power supply or in the vehicle's electrical system

as that will be necessary to adequately control the towed vehicle.

Prior to towing the vehicle with all wheels on the ground, make certain that the key is in starter switch position **2**.

If the key is left in starter switch position **0** for an extended period of time, it can no longer be turned in the switch. In this case, the steering is locked. To unlock, remove key from starter switch and reinsert.



To signal turns while being towed with the hazard warning flasher in use, turn key in starter switch to position **2** and activate the combination switch for the left or right turn signal in the usual manner – only the selected turn signal will operate.

Upon canceling the turn signal, the hazard warning flasher will operate again.

### Towing the vehicle

#### Warning!



With the engine not running, there is no power assistance for the braking and steering systems. In this case, it is important to keep in mind that a considerably higher degree of effort is necessary to brake and steer the vehicle. Adapt your driving accordingly.



When towing the vehicle with all wheels on the ground, please note the following:

With the automatic central locking activated and the key in starter switch position **2**, the vehicle doors lock if the left front wheel as well as the right rear wheel are turning at vehicle speeds of approx. 9 mph (15 km/h) or more.

Switch off the tow-away alarm (▷ page 80).

To prevent the vehicle doors from locking, deactivate the automatic central locking (▷ page 129).

Towing of the vehicle should only be done using the properly installed towing eye bolt. Never attach tow cable, tow rope or tow rod to vehicle chassis, frame or suspension parts.



If the battery is disconnected or discharged

- the key will not turn in the starter switch. See notes on the battery (▷ page 240) or on jump starting (▷ page 306).
- the selector lever will remain locked in position **P**. See notes on manual unlocking of gear selector lever (▷ page 288).

### Installing towing eye bolt

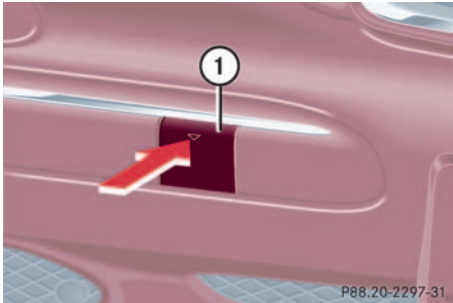

1 Cover on right side of front bumper.

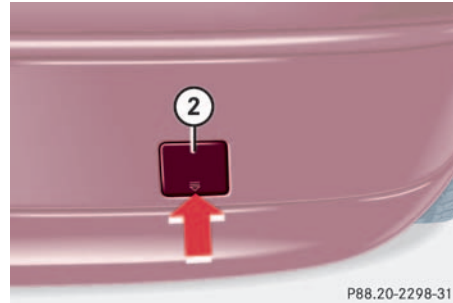

2 Cover on right side of rear bumper.

### Removing cover

- ▶ Press mark on cover in direction of arrow.
- ▶ Lift cover off to reveal threaded hole for towing eye bolt.

The towing eye bolt is supplied with the tool kit (located behind the left hand trim panel in cargo area).

- ▶ Screw towing eye bolt in to its stop and tighten with lug wrench.

### Reinstalling cover

- ▶ Fit cover and snap into place.

### Fuses

#### Fuses



Only install fuses that have been tested and approved by Mercedes-Benz and that have the specified amperage rating.

Never attempt to repair or bridge a blown fuse. Have the cause determined and remedied by an authorized Mercedes-Benz Center.

#### Fuse box in passenger compartment

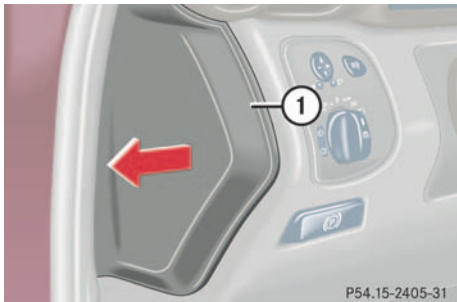

1 Cover

#### Opening

- ▶ Pull cover **1** open with a screw driver or similar tool.
- ▶ Remove cover **1** rearward.

#### Closing

- ▶ Attach the cover **1** in the front.
- ▶ Fold the cover **1** in until it engages.

#### Fuse chart

The fuse chart is found in the fuse box in the passenger compartment. The amperages of the fuses are also given there.

#### Fuse box in engine compartment

The fuse box is located in the engine compartment on the left hand side.

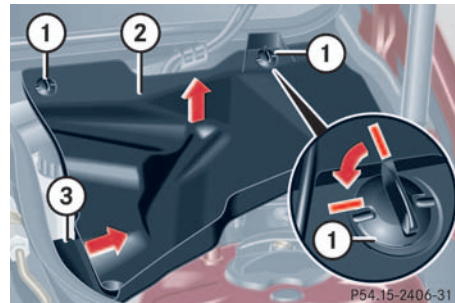

- 1 Screw
- 2 Cover
- 3 Retainer

#### Removing/installing cover

- ▶ Twist screws **1** 90° counterclockwise.
- ▶ Pull up cover **2**.
- ▶ Slide out retainer **3** and remove cover by pulling towards front.
- ▶ Install cover **2** in reverse order.



### Opening fuse box

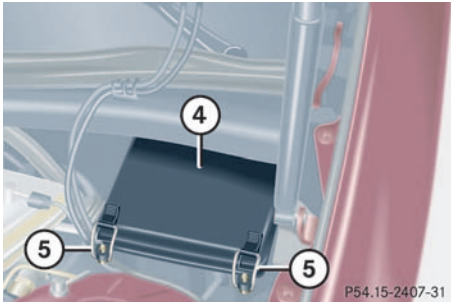

- 4 Fuse box cover
- 5 Clamps

- ▶ Release clamps **5**.
- ▶ Remove cover **4**.

### Closing fuse box

- ▶ Ensure that the sealing rubber is properly positioned.
- ▶ Press the cover **4** down and secure with clamps **5**.

### Auxiliary fuse box in trunk

The auxiliary fuse box is located in the trunk.

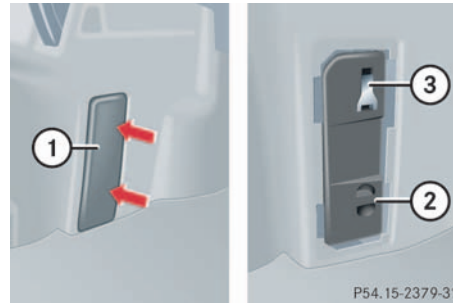

- 1 Trim panel
- 2 Cover of auxiliary fuse box
- 3 Special fuse extractor

### Opening

- ▶ Pull away trim panel **1**.
- ▶ Remove cover **2**.

### Spare fuses

Spare fuses are found in the vehicle tool kit in the spare wheel well.





## Technical data

Spare parts service

Warranty coverage

Identification labels

Layout of poly-V-belt drive

Engine

Rims and Tires

Electrical system

Main dimensions

Weights

Fuels, coolants, lubricants etc.

Consumer information

### Spare parts service

The “Technical data” section provides the necessary technical data for your vehicle.

#### Spare parts service

All authorized Mercedes-Benz Centers maintain a stock of original spare parts required for maintenance and repair work. In addition, strategically located parts distribution centers provide quick and reliable parts service.

More than 300 000 different spare parts for Mercedes-Benz models are available.

Mercedes-Benz original spare parts are subject to stringent quality inspections. Each part has been specifically developed, manufactured or selected for and adapted to Mercedes-Benz vehicles.

Therefore, Mercedes-Benz original spare parts should be installed.



The use of non-genuine parts and accessories not authorized by Mercedes-Benz could damage the vehicle, which is not covered by the Mercedes-Benz Limited Warranty, or could compromise the vehicle's durability or safety.

## Warranty coverage

Your vehicle is covered under the terms of the “warranties” printed in the Service and Warranty Information booklet. Your authorized Mercedes-Benz Center will exchange or repair any defective parts originally installed in the vehicle in accordance with the terms of the following warranties:

- New Vehicle Limited Warranty
- Emission System Warranty
- Emission Performance Warranty
- California, Maine, Massachusetts, and Vermont Emission Control Systems Warranty

Replacement parts and accessories are covered by the Mercedes-Benz Spare Parts and Accessories warranties, copies of which are available at any Mercedes-Benz Center.

## Loss of Service and Warranty Information Booklet

---

Should you lose your Service and Warranty Information booklet, have your authorized Mercedes-Benz Center arrange for a replacement. It will be mailed to you.

### Identification labels

### Identification labels

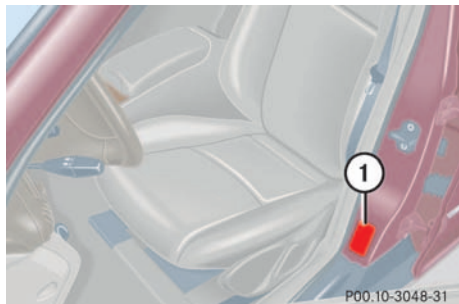

1 Certification label

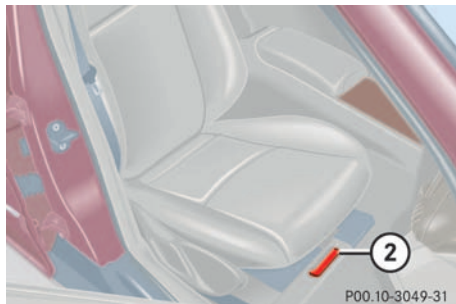

2 Vehicle Identification Number (VIN)

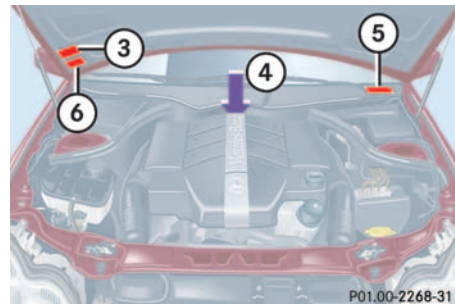

- 3 Information label, California version  
Vacuum line routing for emission control system
- 4 Engine number (engraved on engine)
- 5 VIN, visible (lower edge of windshield)
- 6 Emission control label

When ordering spare parts, please specify vehicle identification and engine numbers.

Layout of poly-V-belt drive

Layout of poly-V-belt drive

C 230 Kompressor Sport

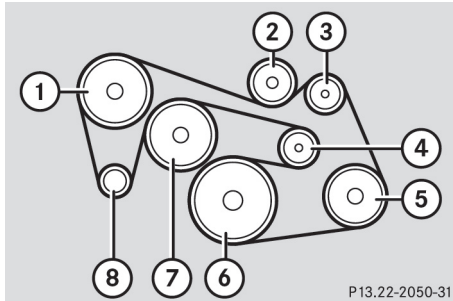

- 1 Power steering pump
- 2 Idler pulley
- 3 Mechanical loader
- 4 Automatic belt tensioner
- 5 Air conditioning compressor
- 6 Crankshaft
- 7 Coolant pump
- 8 Generator (alternator)

C 240 / C 320 (all models)

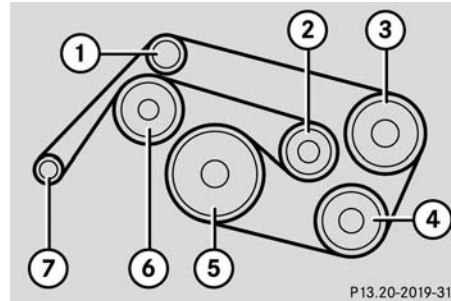

- 1 Idler pulley
- 2 Automatic belt tensioner
- 3 Power steering pump
- 4 Air conditioning compressor
- 5 Crankshaft
- 6 Coolant pump, fan
- 7 Generator (alternator)

C 32 AMG

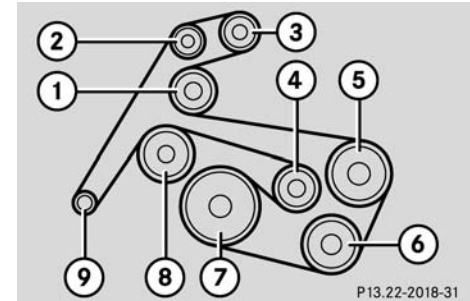

- 1 Idler pulley
- 2 Idler pulley
- 3 Supercharger
- 4 Automatic belt tensioner
- 5 Power steering pump
- 6 Air conditioning compressor
- 7 Crankshaft
- 8 Coolant pump, fan
- 9 Generator (alternator)

**Engine**
**Engine**

Model	C 230 Kompressor Sport (203.040) <sup>1</sup>	C 240 (203.061) <sup>1</sup> C 240 4MATIC (203.081) <sup>1</sup>
Engine	271	112
Mode of operation	4-stroke engine, gasoline injection	4-stroke engine, gasoline injection
No. of cylinders	4	6
Bore	3.23 in (82.00 mm)	3.54 in (89.90 mm)
Stroke	3.35 in (85.00 mm)	2.68 in (68.20 mm)
Total piston displacement	109.6 cu.in. (1 796 cm <sup>3</sup> )	158.5 cu.in. (2 597 cm <sup>3</sup> )
Compression ratio	8.5:1	10.5:1
Output acc. to SAE J 1349	189 hp / 5 800 rpm (141 kW / 5 800 rpm)	167 hp / 6 000 rpm (125 kW / 6 000 rpm)
Maximum torque acc. to SAE J 1349	192 ft.lb / 3 500 rpm (260 Nm / 3 500 rpm)	177 ft.lb / 4 500 rpm (240 Nm / 4 500 rpm)
Maximum engine speed	6 000 rpm	6 200 rpm
Firing order	1-3-4-2	1-4-3-6-2-5
Poly-V-belt	7 ft 11 in (2 420 mm)	7 ft 10 in (2 390 mm)

<sup>1</sup> The quoted data apply only to the standard vehicle. See an authorized Mercedes-Benz Center for the corresponding data of all special bodies and special equipment.



Model	C 320 (203.064) <sup>1</sup> C 320 4MATIC (203.084) <sup>1</sup> C 320 Sport (203.064) <sup>1</sup> C 320 4MATIC Sport (203.084) <sup>1</sup>	C 32 AMG (203.065) <sup>1</sup>
Engine	112	112
Mode of operation	4-stroke engine, gasoline injection	4-stroke engine, gasoline injection
No. of cylinders	6	6
Bore	3.54 in (89.90 mm)	3.54 in (89.90 mm)
Stroke	3.31 in (84.00 mm)	3.31 in (84.00 mm)
Total piston displacement	195.2 cu.in. (3 199 cm <sup>3</sup> )	195.2 cu.in. (3 199 cm <sup>3</sup> )
Compression ratio	10:1	9:1
Output acc. to SAE J 1349	214 hp / 5700 rpm (160 kW / 5700 rpm)	348 hp / 6 100 rpm (260 kW / 6 100 rpm)
Maximum torque acc. to SAE J 1349	229 ft.lb / 3000 rpm (310 Nm / 3000 rpm)	333 ft.lb / 4 400 rpm (450 Nm / 4 400 rpm)
Maximum engine speed	6 000 rpm	6 200 rpm
Firing order	1-4-3-6-2-5	1-4-3-6-2-5
Poly-V-belt	7 ft 10 in (2 390 mm)	9 ft 6 in (2 902 mm)

<sup>1</sup> The quoted data apply only to the standard vehicle. See an authorized Mercedes-Benz Center for the corresponding data of all special bodies and special equipment.

### Rims and Tires

#### Rims and Tires

Use only tires and rims which have been specifically developed for your vehicle and tested and approved by Mercedes-Benz. Other tires and rims can have detrimental effects, such as

- poor handling characteristics
- increased noise
- increased fuel consumption



Moreover, tires and rims not approved by Mercedes-Benz may, under load, exhibit dimensional variations and different tire deformation characteristics under load that could cause them to come into contact with the vehicle body or axle parts. Damage to the tires or the vehicle may be the result.



Further information on tires and rims is available at any authorized Mercedes-Benz Center. A tire inflation pressure table is located on the fuel filler cap of the vehicle. The tire pressure should be checked regularly and should only be adjusted on cold tires. Follow tire manufacturer's maintenance recommendation included with vehicle.

Same size tires

	<b>C 240 C 240 4MATIC C 320 C 320 4MATIC</b>	<b>C 230 Kompressor Sport C 320 Sport C 320 4MATIC Sport</b>	<b>C 32 AMG</b>
<b>Rims (light alloy)</b>	7J x 16 H2	7 <sup>1</sup> / <sub>2</sub> J x 17	-
<b>Rims (steel - Canada only)</b>	7J x 16 H2	-	-
<b>Wheel offset</b>	1.46 in (37 mm)	1.46 in (37 mm)	-
<b>All season tires (radial-ply tires)</b>	205/55 R16 91 H	-	-
<b>Summer tires (radial-ply tires)</b>	-	225/45 R17 91 W <sup>1</sup>	-
<b>Winter tires (radial-ply tires)</b>	205/55 R16 91 H M+S	205/55 R16 91 H M+S	205/50 R17 89 H M+S <sup>2</sup> or 225/45 R17 91 H M+S <sup>1, 2</sup>

<sup>1</sup> Must not be used with snow chains.

<sup>2</sup> Only on rim 7<sup>1</sup>/<sub>2</sub> Jx17 H2 ET 37

## Rims and Tires

### Mixed size tires

<b>C 32 AMG</b>	
<b>Front axle:</b>	
<b>Rims (light alloy)</b>	7 <sup>1</sup> / <sub>2</sub> J x 17 H2
<b>Wheel offset</b>	1.46 in (37 mm)
<b>Summer tires (radial-ply tires)</b>	225/45 R17 91 Y <sup>1</sup>
<b>Rear axle:</b>	
<b>Rims (light alloy)</b>	8 <sup>1</sup> / <sub>2</sub> J x 17 H2
<b>Wheel offset</b>	1.34 in (34 mm)
<b>Summer tires (radial-ply tires)</b>	245/40 R17 91 Y <sup>2, 3</sup>

<sup>1</sup> Also permissible: 225/45 ZR17 91 Y

<sup>2</sup> Also permissible: 245/40 ZR17 91 Y

<sup>3</sup> Must not be used with snow chains.

### Spare wheel

Your vehicle is equipped with either a spare wheel with full size tire or Minispare wheel.

#### Spare wheel with full size tire

	C 230 Kompressor Sport C 240 (all models) C 320 (all models)	C 32 AMG
Rim (light alloy)	-	7 <sup>1</sup> / <sub>2</sub> J x 17 H2
Rim (steel)	7J x 16 H2	-
Wheel offset	1.46 in (37 mm)	1.42 in (36 mm)
All season tire (radial-ply tire)	205/55 R16 91 H	225/45 R17 91 Y

#### Minispare wheel

	C 230 Kompressor Sport C 240 (all models) C 320 (all models)
Rim (steel)	3.5B x 16 H2
Wheel offset	0.67 in (17 mm)
All season tire (radial-ply tire)	T 125/90 R16 M 98 <sup>1</sup>

<sup>1</sup> Must not be used with snow chains.

**Electrical system****Electrical system**

	<b>C 230 Kompressor Sport</b>	<b>C 240 / C 320 (all models)</b>	<b>C 32 AMG</b>
<b>Generator (alternator)</b>	14 V/120 A	14 V/120 A	14 V/120 A
<b>Starter motor</b>	12 V/1.1 kW	12 V/1.7 kW	12 V/1.7 kW
<b>Battery</b>	12 V/100 Ah	12 V/100 Ah	12 V/100 Ah
<b>Spark plugs</b>	Bosch F 6 MPP 332	Bosch F 8 DPP332 NGK PFR 5 R-11	NGK IFR 6 D 10
<b>Electrode gap</b>	0.031 in (0.8 mm)	0.039 in (1.0 mm)	0.039 in (1.0 mm)
<b>Tightening torque</b>	18 – 22 ft.lb (25 – 30 Nm)	15 – 22 ft.lb (20 – 30 Nm)	15 – 22 ft.lb (20 – 30 Nm)

Main dimensions

	C 230 Kompressor Sport	C 240 C 320 C 320 Sport	C 240 4MATIC C 320 4MATIC C 320 4MATIC Sport	C 32 AMG
<b>Overall vehicle length</b>	178.2 in (4526 mm)	178.2 in (4526 mm)	178.2 in (4526 mm)	178.2 in (4526 mm)
<b>Overall vehicle width</b>	68.0 in (1728 mm)	68.0 in (1728 mm)	68.0 in (1728 mm)	68.0 in (1728 mm)
<b>Overall vehicle height</b>	56.4 in (1433 mm)	56.3 in (1429 mm)	56.0 in (1422 mm)	56.1 in (1426 mm)
<b>Wheelbase</b>	106.9 in (2715 mm)	106.9 in (2715 mm)	106.9 in (2715 mm)	106.9 in (2715 mm)
<b>Track, front</b>	58.8 in (1493 mm)	58.8 in (1493 mm)	58.8 in (1493 mm)	58.8 in (1493 mm)
<b>Track, rear</b>	57.6 in (1464 mm)	57.6 in (1464 mm)	57.6 in (1464 mm)	58.0 in (1474 mm)

### Weights

### Weights

Roof load max.	220 lb (100 kg)
Trunk load max.	220 lb (100 kg)



**Fuels, coolants, lubricants etc.**

**Fuels, coolants, lubricants etc.**

**Capacities**

Vehicle components and their respective lubricants must match.

Therefore use only brands tested and recommended by Mercedes-Benz.

Please refer to the Factory Approved Service Products pamphlet, or inquire at your Mercedes-Benz Center.

	Model	Capacity	Fuels, coolants, lubricants etc.
<b>Engine with oil filter</b>	C 230 Kompressor Sport	5.8 US qt (5.5 l)	Recommended engine oils
	C 240	7.9 US qt (7.5 l)	
	C 320	7.9 US qt (7.5 l)	
	C 320 Sport	7.9 US qt (7.5 l)	
	C 240 4MATIC	7.4 US qt (7.0 l)	
	C 320 4MATIC	7.4 US qt (7.0 l)	
	C 320 4MATIC Sport	7.4 US qt (7.0 l)	
C 32 AMG	8.5 US qt (8.0 l)		
<b>Automatic transmission</b>		8.5 US qt (8.0 l)	MB Automatic Transmission Oil <sup>1</sup>
<b>Manual transmission</b>		1.3 US qt (1.2 l)	MB Manual Transmission Oil <sup>2</sup>
<b>Rear axle</b>	C 230 Kompressor Sport	1.2 US qt (1.1 l)	Hypoid gear oil SAE 85 W 90
	C 240 (all models)	1.2 US qt (1.1 l)	
	C 320 (all models)	1.2 US qt (1.1 l)	
	C 32 AMG	1.5 US qt (1.4 l)	

<sup>1</sup> MB part no. 001 989 21 03 10

<sup>2</sup> MB part no. 001 989 26 03 10

**Fuels, coolants, lubricants etc.**

	<b>Model</b>	<b>Capacity</b>	<b>Fuels, coolants, lubricants etc.</b>
<b>Front axle</b>	C 240 4MATIC C 320 4MATIC C 320 4MATIC Sport	0.5 US qt (0.46 l)	Hypoid gear oil SAE 85 W 90
<b>Transfer case</b>	C 240 4MATIC C 320 4MATIC C 320 4MATIC Sport	approx. 0.62 US qt (0.59 l)	MB Automatic Transmission Oil <sup>1</sup>
<b>Power steering</b>		approx. 1.1 US qt (1.0 l)	MB Power Steering Fluid (Pentosin CHF 11S)
<b>Front wheel hubs</b>		approx. 2.1 oz (60 g) each	High temperature roller bearing grease
<b>Brake system</b>		0.5 US qt (0.5 l)	MB Brake Fluid (DOT 4+)
<b>Cooling system</b>	C 230 Kompressor Sport C 240 (all models) C 320 (all models) C 32 AMG	approx. 8.5 US qt (8.0 l) approx. 6.8 US qt (6.4 l) approx. 6.8 US qt (6.4 l) approx. 15.3 US qt (14.5 l)	MB 325.0 Anticorrosion / antifreeze agent
<b>Fuel tank including a reserve of</b>		16.4 US gal (62.0 l) 2.1 US gal (8.0 l)	Premium unleaded gasoline: Posted Octane 91 (Avg. of 96 RON / 86 MON)  Flexible Fuel Vehicle (MY 2003 Mercedes-Benz C 320 models, except those equipped with manual transmission or 4MATIC*): Alternative fuel – Ethanol fuel (E85)

<sup>1</sup> MB part no. 001 989 21 03 10

Fuels, coolants, lubricants etc.

	Model	Capacity	Fuels, coolants, lubricants etc.
<b>Air conditioning system</b>			R-134a refrigerant and special PAG lubricant oil (never R-12)
<b>Windshield washer system:</b>			MB Windshield Washer Concentrate <sup>1</sup>
<b>Without headlamp cleaning system</b>		3.2 US qt (3.0 l)	
<b>With headlamp cleaning system*</b>		6.4 US qt (6.0 l)	

<sup>1</sup> Use MB Windshield Washer Concentrate “S” and water for temperatures above freezing or MB Windshield Washer Concentrate “S” and commercially available premixed windshield washer solvent/antifreeze for temperatures below freezing. Follow suggested mixing ratios (> page 338).

### Fuels, coolants, lubricants etc.

#### Engine oils

---

Engine oils are specifically tested for their suitability in our engines. Therefore, use only engine oils recommended by Mercedes-Benz. Information on recommended brands is available in the Factory Approved Service Products pamphlet, or at your authorized Mercedes-Benz Center.

Please follow FSS recommendations for scheduled oil changes. Failure to do so could result in engine damage not covered by the Mercedes-Benz Limited Warranty.

#### Engine oil additives

---

Do not blend oil additives with engine oil. They may be harmful to the engine operation.

Damage or malfunctions resulting from blending oil additives are not covered by the Mercedes-Benz Limited Warranty.

#### Air conditioning refrigerant

---

R-134a (HFC) refrigerant and special PAG lubricating oil is used in the air conditioning system.

Never use R-12 (CFC) or mineral-based lubricating oil, otherwise damage to the system will occur.

#### Brake fluid

---

During vehicle operation, the boiling point of the brake fluid is continuously reduced through the absorption of moisture from the atmosphere. Under extremely strenuous operating conditions, this moisture content can lead to the formation of bubbles in the system, thus reducing the system's efficiency.

Therefore, the brake fluid must be replaced every two years, preferably in the spring.

Only brake fluid approved by Mercedes-Benz is recommended. Your authorized Mercedes-Benz Center will provide you with additional information.

## Premium unleaded gasoline



To maintain the engine's durability and performance, premium unleaded gasoline must be used. If premium unleaded is not available and low octane fuel is used, follow these precautions:

- Have the fuel tank only partially filled with unleaded regular and fill up with premium unleaded as soon as possible.
- Avoid full throttle driving and abrupt acceleration.
- Do not exceed an engine speed of 3000 rpm if the vehicle is loaded with a light load such as two persons and no luggage.
- Do not exceed  $\frac{2}{3}$  of maximum accelerator pedal position if the vehicle is fully loaded or operating in mountainous terrain.

## Fuel requirements



Flexible Fuel Vehicles (MY 2003 Mercedes-Benz C 320 models, except those equipped with manual transmission or 4 - MATIC system\*) are designed to operate on premium unleaded gasoline or Ethanol fuel (E85) or any mixture of these two.

See notes on Flexible Fuel Vehicles (▷ page 334).

Use only premium unleaded meeting ASTM standard D 439:

- The octane number (posted at the pump) must be 91 min. It is an average of both the Research (R) octane number and the Motor (M) octane number:  $(R+M) / 2$ . This is also known as the ANTI-KNOCK INDEX.

Unleaded gasoline containing oxygenates such as Ethanol, IPA, IBA and TBA can be used provided the ratio of any one of these oxygenates to gasoline does not exceed 10%; MTBE not to exceed 15%.

The ratio of Methanol to gasoline must not exceed 3% plus additional cosolvents.

Using mixtures of Ethanol and Methanol is not allowed. Gasohol, which contains 10% Ethanol and 90% unleaded gasoline, can be used.

These blends must also meet all other fuel requirements, such as resistance to spark knock, boiling range, vapor pressure etc.

### Fuels, coolants, lubricants etc.

#### Gasoline additives

---

A major concern among engine manufacturers is carbon build-up caused by gasoline. Mercedes-Benz recommends only the use of quality gasoline containing additives that prevent the build up of carbon deposits.

After an extended period of using fuels without such additives, carbon deposits can build up especially on the intake valves and in the combustion area, leading to engine performance problems such as:

- Warm-up hesitation
- Unstable idle
- Knocking/pinging
- Misfire
- Power loss

Do not blend any specific fuel additives with fuel. This only results in unnecessary cost and may be harmful to engine operation.

Damage or malfunctions resulting from poor fuel quality or from blending specific fuel additives are not covered by the Mercedes-Benz Limited Warranty.

#### Flexible Fuel Vehicles

---

MY 2003 Mercedes-Benz C 320 models, except those equipped with manual transmission or 4MATIC\*, are Flexible Fuel Vehicles.

These vehicles are designed to operate on premium unleaded gasoline or Ethanol fuel (E85), or on any mixture of these two.

Ethanol fuel (E85) is a mixture of approximately 85% Ethanol and 15% unleaded gasoline.

#### Warning!



Ethanol fuel (E85) and its fumes are highly flammable, poisonous and burn easily. Ethanol fuel can cause serious injuries if ignited or if you come into contact with it or inhale fumes of it. Avoid inhalation of Ethanol fumes and skin contact with Ethanol. Extinguish all open flames before fueling. Never smoke or create sparks close to Ethanol.

#### Switching fuels

For best performance and driveability it is recommended to use either one or the other fuel. A refueling pattern that alternates between the two different fuels should be avoided if possible.

When switching fuels, make sure that:

- Fuel level is below half full.
- Fuel level is above reserve (reserve warning lamp is not lit).
- Amount of added fuel is more than 5 gallons (20 liters).
- Ignition is off during refill.
- Immediately after refueling engine is started and operated for at least five minutes.

These precautions and recommendations are supposed to prevent any difficulties when starting and operating the engine which otherwise may be experienced before the engine has fully adapted to the different fuel.

If in spite of these recommendations the engine does not perform properly, adding more gasoline [at least 3 gallons (12 liters)] to the fuel may improve the engine behavior.

### Cold weather performance

It is possible that starting times will significantly increase at temperatures below 32°F (0°C). At low temperatures the use of a block heater is recommended (see your authorized Mercedes-Benz Center for further information). Rough idling may also be experienced at such temperatures before the engine is fully warmed up.



E85 fuel is unsuitable for use when ambient temperatures fall below 14°F (-10°C).

### Hot weather performance

At ambient temperatures above 95°F (35°C) start times may increase and be accompanied by a rough idle following the start.

### Cruising range

E85 fuel contains less energy per gallon than gasoline. To ensure that engine performance with Ethanol fuel is similar to that when using gasoline, the engine must burn more Ethanol fuel. As a result, it is to be expected that the fuel consumption will increase when using E85 compared to gasoline operation.



Use of E85 may reduce your driving range.

### Maintenance

Please inform your Mercedes-Benz Center if you use or have used E85 fuel when your vehicle is delivered for maintenance or repairs.

### Fuels, coolants, lubricants etc.

#### Coolants

---

The engine coolant is a mixture of water and anticorrosion / antifreeze, which provides:

- Corrosion protection
- Freeze protection
- Boiling protection (by increasing the boiling point)

The cooling system was filled at the factory with a coolant providing freeze protection to approximately  $-22^{\circ}\text{F}$  ( $-30^{\circ}\text{C}$ ) and corrosion protection.

If the antifreeze mixture is effective to  $-22^{\circ}\text{F}$  ( $-30^{\circ}\text{C}$ ), the boiling point of the coolant in the pressurized cooling system is reached at approximately  $266^{\circ}\text{F}$  ( $130^{\circ}\text{C}$ ).

The coolant solution must be used year-round to provide the necessary corrosion protection and increase boil-over protection. You should have it replaced every 15 years or 150 000 miles (250 000 km), whichever comes first. Coolant system design and coolant used stipulate the replacement interval. The above replacement interval is only applicable if MB 325.0 anticorrosion / antifreeze solution or other Mercedes-Benz approved products of equal specification (see Factory Approved Service Products pamphlet) are used to renew the coolant concentration or bring it back up to the proper level.

To provide important corrosion protection, the solution must be at least 45% anticorrosion / antifreeze [equivalent to freeze protection to approx.  $-22^{\circ}\text{F}$  ( $-30^{\circ}\text{C}$ )].

If you use a solution that is more than 55% anticorrosion / antifreeze [freeze protection to approx.  $-49^{\circ}\text{F}$  ( $-45^{\circ}\text{C}$ )], the engine temperature will increase due to the lower heat transfer capability of the solution. Therefore, do not use more than this amount of anticorrosion / antifreeze.

If the coolant level is low, water and MB 325.0 anticorrosion / antifreeze should be used to bring it up to the proper level (have cooling system checked for signs of leakage). Please make sure that the mixture is in accordance with label instructions.

The water in the cooling system must meet minimum requirements, which are usually satisfied by normal drinking water. If you are not sure about the water quality, consult your authorized Mercedes-Benz Center.



**Anticorrosion/antifreeze**

Your vehicle contains a number of aluminum parts. The use of aluminum components in motor vehicle engines necessitates that anticorrosion/antifreeze coolant used in such engines be specifically formulated to protect the aluminum parts.

Failure to use such anticorrosion/antifreeze coolant will result in a significantly shortened service life.

Therefore, the following product is strongly recommended for use in your vehicle: Mercedes-Benz 325.0 Anticorrosion/Antifreeze Agent.

Before the start of the winter season (or once a year in hot southern regions), you should have the anticorrosion/antifreeze concentration checked. The coolant is also regularly checked each time you bring your vehicle to your authorized Mercedes-Benz Center for service.

***Anticorrosion/antifreeze quantity***

Model	Approx. freeze protection	
	-35°F (-37°C)	-49°F (-45°C)
<b>C 230 Kompressor Sport</b>	4.2 US qt (4.0 l)	4.7 US qt (4.4 l)
<b>C 240 / C 320 (all models)</b>	4.8 US qt (4.5 l)	5.3 US qt (5.0 l)
<b>C 32 AMG</b>	7.7 US qt (7.3 l)	8.5 US qt (8.0 l)

### Fuels, coolants, lubricants etc.

#### Windshield washer and headlamp cleaning\* system

Both the windshield and headlamp washer systems are supplied from the windshield washer fluid reservoir.

The washer fluid reservoir has a capacity of approx.

- 6.4 US qt (6.0 l) in vehicles with headlamp cleaning system\*
- 3.2 US qt (3.0 l) in vehicles without headlamp cleaning system

- ▶ Refill the reservoir with MB Windshield Washer Concentrate “S” and water (or concentrate and commercially available premixed windshield washer solvent/antifreeze, depending on ambient temperatures).

#### Warning!



Washer solvent/antifreeze is highly flammable. Do not spill washer solvent/antifreeze on hot engine parts, because it may burn. You can be seriously burned.

#### Washer fluid mixing ratio

For temperatures above freezing use MB Windshield Washer Concentrate “S” and water:

- 1 part “S” to 100 parts water  
[40 ml “S” to 1 gallon (4 l) water]

For temperatures below freezing use MB Windshield Washer Concentrate “S” and commercially available premixed windshield washer solvent/antifreeze:

- 1 part “S” to 100 parts solvent  
[40 ml “S” to 1 gallon (4 l) solvent]

### Consumer information

The following text is published as required of all manufacturers of passenger cars under Title 49, Code of U.S. Federal Regulations, Part 575 pursuant to the “National Traffic and Motor Vehicle Safety Act of 1966”.

#### Uniform tire quality grading

Quality grades can be found, where applicable, on the tire sidewall between tread shoulder and maximum section width. For example:

Tread wear	Traction	Temperature
200	AA	A

All passenger car tires must conform to federal safety requirements in addition to these grades.

### Tread Wear

The tread wear grade is a comparative rating based on the wear rate of the tire when tested under controlled conditions on a specified government test course. For example, a tire graded 150 would wear one and one-half ( $1\frac{1}{2}$ ) times as well on the government course as a tire graded 100. The relative performance of tires depends upon the actual conditions of their use, however, and may depart significantly from the norm due to variations in driving habits, service practices and differences in road characteristics and climate.

### Traction

The traction grades, from highest to lowest are AA, A, B, and C. Those grades represent the tire’s ability to stop on wet pavement as measured under controlled conditions on specified government test surfaces of asphalt and concrete. A tire marked C may have poor traction performance.

#### Warning!



The traction grade assigned to this tire is based on straight ahead braking traction tests, and does not include acceleration, cornering, hydroplaning, or peak traction characteristics.

### Consumer information

#### Temperature

The temperature grades are A (the highest), B, and C, representing the tire's resistance to the generation of heat and its ability to dissipate heat when tested under controlled conditions on a specified indoor laboratory test wheel. Sustained high temperature can cause the material of the tire to degenerate and reduce tire life, and excessive temperature can lead to sudden tire failure. Grade C corresponds to a level of performance which all passenger car tires must meet under the Federal Motor Vehicle Safety Standard No. 109.

Grades B and A represent higher levels of performance on the laboratory test wheel than the minimum required by law.

#### Warning!



The temperature grade for this tire is established for a tire that is properly inflated and not overloaded. Excessive speed, underinflation, or excessive loading, either separately or in combination, can cause excessive heat build-up and possible tire failure.

**ABS**

(Antilock Brake System)

Prevents the wheels from locking up during braking so that the vehicle can continue to be steered.

**Alignment bolt**

Metal pin with thread. The centering pin is an aid used when changing a tire to align the wheel with the wheel hub.

**BabySmart™ airbag deactivation system**

This system detects if a special system compatible child restraint seat is installed on the front passenger seat. The system will automatically deactivate the passenger front airbag when such a seat is properly installed (indicator lamp  located in the center console lights up). See your authorized Mercedes-Benz Center for availability.

**BabySmart™ compatible child seats**

Special restraint system for children. The sensor system for the passenger seat prevents deployment of the passenger side airbag if a BabySmart™ compatible child seat is installed.

**BAS**

(Brake Assist System)

System for potentially reducing braking distances in emergency braking situations. The system is activated when it senses an emergency based on how fast the brake is applied.

**Bi-Xenon headlamps\***

Headlamps which use an electric arc as the light source and produce a more intense light than filament headlamps. Bi-Xenon headlamps produce low beam and high beam.

**CAC**

(Customer Assistance Center)

Mercedes-Benz customer service center, which can help you with any questions about your vehicle and provide assistance in the event of a breakdown.

**CAN system**

(Controller Area Network)

Data bus network serving to control vehicle functions such as door locking or windshield wiping.

**Cockpit**

All instruments, switches, buttons and indicator/warning lamps in the passenger compartment needed for vehicle operation and monitoring.

### **COMAND\***

(Cockpit Management and Data System)

Information and operating center for vehicle sound and communications systems, including the radio and navigation system, as well as for other optional equipment (CD changer, telephone, etc.).

### **Control system**

The control system is used to call up vehicle information and to change component settings. Information and messages appear in the multifunction display. The driver uses the buttons on the multifunction steering wheel to navigate through the system and to adjust settings.

### **Cruise control**

Driving convenience system for automatically maintaining the vehicle speed set by the driver.

### **Engine number**

The number set by the manufacturer and placed on the cylinder block to uniquely identify each engine produced.

### **Engine oil viscosity**

Measurement for the inner friction (viscosity) of the oil at different temperatures. The higher the temperature an oil can tolerate without becoming thin, or the lower the temperature it can tolerate without becoming viscous, the better the viscosity.

### **ESP**

(Electronic Stability Program)  
Improves vehicle handling and directional stability.

### **ETD**

(Emergency Tensioning Device)  
Device which deploys in certain frontal and rear collisions exceeding the system's threshold to tighten the seat belts.  
->SRS

### **FSS**

(Flexible Service System)  
Service indicator in the multifunction display that informs the driver when the next vehicle maintenance service is due.

### **Gear range**

Number of gears which are available to the automatic transmission for shifting. The automatic gear shifting process can be adapted to specific operating conditions using the selector lever.

### **GPS**

(Global Positioning System)  
Satellite-based system for relaying geographic location information to and from vehicles equipped with special receivers. Employs CD digital maps for navigation.

### **Instrument cluster**

The displays and indicator/warning lamps in the driver's field of vision, including the tachometer, speedometer and fuel gauge.

**Kickdown**

Depressing the accelerator past the point of resistance shifts the transmission down to the lowest possible gear. This very quickly accelerates the vehicle and should not be used for normal acceleration needs.

**Lock button**

Button on the door which indicates whether the door is locked or unlocked. Pushing the lock button down on an individual door from inside will lock that door.

**Memory function\***

Used to store three individual seat, steering wheel and mirror positions for each key.

**Menu**

The control system displays are arranged in menus. Each menu contains a number of commands for particular systems. In the Audio menu, for example, you will find the commands `SELECT RADIO STATION` or `OPERATE CD PLAYER`. Using commands you can directly change the settings for your vehicle.

**MON**

(Motor Octane Number)  
 The Motor Octane Number for gasoline as determined by a standardized method. It is an indication of a gasoline's ability to resist undesired detonation (knocking). The average of both the MON (Motor Octane Number) and →RON (Research Octane Number) is posted at the pump, also known as ANTI-KNOCK INDEX.

**Multifunction display**

The display field in the instrument cluster used to present information provided by the control system.

**Multifunction steering wheel**

Steering wheel with buttons for operating the control system.

**Overspeed range**

Engine speeds within the red marking of the tachometer dial. Avoid this engine speed range, as it may result in serious engine damage that is not covered by the Mercedes-Benz Limited Warranty.

### **Poly-V-belt drive**

Drives engine-components (alternator, AC compressor, etc.) from the engine.

### **Power train**

Collective term designating all components used to generate and transmit motive power to the drive axles, including

- engine
- clutch/torque converter
- transmission
- transfer case\*
- drive shaft
- axle shafts/axles

### **Program mode selector switch**

Used to switch the automatic transmission between standard operation **S** and winter operation **W**.

### **Remote Vehicle Diagnostics**

Transmission of vehicle data and current location to the Mercedes-Benz Customer Assistance Center for subscribers to Tele Aid service.

### **Restraint systems**

Seat belts, belt tensioners, airbags and child restraint systems. As independent systems, their protective functions complement one another.

### **RON**

(Research Octane Number)

The Research Octane Number for gasoline as determined by a standardized method. It is an indication of a gasoline's ability to resist undesired detonation (knocking). The average of both the →MON (Motor Octane Number) and RON (Research Octane Number) is posted at the pump, also known as ANTI-KNOCK INDEX.

### **Shift lock**

When the vehicle is parked, this lock prevents the transmission selector lever from being moved out of position **P** without key turned and brake pedal depressed.

### **SRS**

(Supplemental Restraint System)

Seat belts, emergency tensioning device and airbags. Though independent systems, they are closely interfaced to provide effective occupant protection.



**Tele Aid System**

(Telematic Alarm Identification on Demand)

The Tele Aid system consists of three types of response: automatic and manual emergency, roadside assistance and information. Tele Aid is initially activated by completing a subscriber agreement and placing an acquaintance call.

The Tele Aid system is operational providing that the vehicle’s battery is charged, properly connected, not damaged and cellular and GPS coverage is available.

**Telematics\***

A combination of the terms “telecommunications” and “informatics”.

**Tightening torque**

Force times lever arm (e.g. a lug wrench) with which threaded fasteners such as wheel bolts are tightened.

**Tire speed rating**

Part of tire designation; indicates the speed range for which a tire is approved.

**Traction**

Force exerted by the vehicle on the road via the tires.

**VIN**

(Vehicle Identification Number)

The number set by the manufacturer and placed on the body to uniquely identify each vehicle produced.

**Voice control system\***

Voice control system for car phones, portable cell phones and audio systems (radio, CD, etc.).



- A**
- ABS 23, 73, 341
    - ABS control 74
    - Malfunction indicator lamp 257
    - Messages in display 262
    - Warning lamp 257
  - Accelerator position, automatic transmission 143
  - Accident
    - In case of 50
  - Activating
    - Air conditioning (cooling) 154, 163
    - Air recirculation mode 152, 160
    - Anti-theft alarm system 79
    - Automatic climate control\* 157
    - Central locking (control system) 129
    - Charcoal filter 161
    - Climate control 149
    - Climate control system 153
    - Defrosting 151
    - Easy-entry/exit feature\* 129
    - ESP 77
    - Exterior headlamps 47
    - Exterior lamps 102
    - Exterior rear view mirror parking position\* 145
    - Hazard warning flasher 104
    - Headlamps 47
    - High beams 104
    - Ignition 31
    - Immobilizer 53, 79
    - Rear fog lamp 102
    - Rear window defroster 153, 162
    - Residual heat 163
    - Seat heater\* 97
    - Tow-away alarm 80
    - Windshield wipers 48
  - Adding
    - Coolant 239
    - Engine oil 237
  - Additional turn signals 290
  - Adjustable air vents, rear passenger compartment 155, 164
  - Adjusting 32
    - Air distribution 151, 159
    - Air volume 151, 159
    - Backrest tilt 33, 35
    - Exterior rear view mirror 39
    - Head restraint height 33, 35, 37
    - Head restraint tilt 34, 35, 36
    - Head restraints 36
    - Inside rear view mirror 39
  - Instrument cluster illumination 107
  - Manual seat 33
  - Mirrors 39
  - Multicontour seat\* 96
  - Power seat\* 34
  - Rear seat head restraints 35
  - Seat belt height 43
  - Seat cushion depth 96
  - Seat cushion tilt 33, 35
  - Seat fore and aft adjustment 33, 34
  - Seat height 33, 35
  - Seats 32, 33
  - Steering column height 37, 38
  - Steering column length 37, 38
  - Steering wheel 37
  - Air conditioner (cooling)
    - Turning off 154, 163
    - Turning on 154, 163
  - Air conditioning refrigerant 332
  - Air distribution
    - Adjusting 151, 159
  - Air pressure
    - see Tire inflation pressure 243
  - Air recirculation mode 152, 160
    - Activating 152, 160
    - Deactivating 152, 161

- Air vents, rear passenger compartment
  - Adjustable 155, 164
- Air volume
  - Adjusting 151, 159
- AIRBAG OFF indicator lamp 260
- Airbags 57
  - BabySmart™ deactivation system 67, 341
  - Children 58
  - Front 60
  - Passenger 61
  - Safety guidelines 59
  - Side impact 61
  - Window curtain 61
- Alarm
  - Audible 72, 80
  - Canceling 80
  - Visual 79
- Alarm system
  - Anti-theft 79
  - Tow-away 80
- Alignment bolt (vehicle tool kit) 299, 341
- Anticorrosion/antifreeze 337
- Antiglare
  - Automatic\* 144
  - Manual 144
- Antilock brake system (ABS) 341
- Anti-theft alarm system
  - Arming 79
  - Canceling alarm 80
  - Disarming 80
- Anti-theft systems 79
  - Anti-theft alarm system 79
  - Immobilizer 79
  - Tow-away alarm 80
- Aquaplaning see Hydroplaning 227
- Armrest
  - Storage compartment in front of 205
  - Storage spaces 206
- Ashtray 207
- ATF (automatic transmission fluid) 238
- AUDIO menu 116
  - Selecting radio station 117
- Audio system 165
  - Audio and telephone, operation 165
  - Button and soft key operation 168
  - Cassette mode 174
  - CD mode 178
  - Operating and display elements 166
  - Operating safety 165
  - Operation 168
  - Radio mode 171
  - Switching off 168
  - Switching on 168
  - Telephone operation 182
- Automatic antiglare\*
  - for rear view mirror 144
- Automatic central locking
  - Activating/deactivating (control system) 129
- Automatic climate control\* 156
  - Activating 157
  - Adjusting air distribution 159
  - Adjusting air volume 159
  - Air recirculation mode 160
  - Deactivating 157
  - Defrosting 160
  - Rear window defroster 153, 162
  - Residual heat utilization 163
  - Residual ventilation 163
  - Setting the temperature 158
- Automatic headlamp mode 102
- Automatic lighting control
  - Activating 105
  - Deactivating 105
- Automatic locking when driving 91

- Automatic transmission 138
  - Accelerator position 143
  - Emergency operation (Limp Home Mode) 143
  - Fluid level 238
  - Gear ranges 140
  - Gear selector lever position 141
  - Gear shifting malfunctions 143
  - Kickdown 143
  - Manual shifting 139
  - One-touch gearshifting 139
  - Program mode selector switch 142
  - Selector lever position 138
  - Starting with 44
  - Transmission fluid 238
  - Winter program mode 142
- Auxiliary fuse box 313
- B**
- BabySmart™
  - Airbag deactivation system 67, 341
  - Compatible child seats 67, 341
  - Self-test 67
- Backrest
  - Folding forward 200
  - Folding rearward 200
- Backrest tilt 33
- Backup lamps 291, 295
  - Bulbs 291
- BAS 74, 341
  - Messages in display 263
- Batteries, SmartKey
  - Changing 286, 287
  - Check lamp 85
  - Checking 86
- Battery discharged
  - Jump starting 306
- Battery, vehicle 240, 303
  - Charging 304
  - Disconnecting 304
  - Messages in display 278
  - Reconnecting 305
  - Reinstalling 304
  - Removing 304
- Bi-Xenon headlamps\* 341
- Bi-Xenon type\*
  - Front lamp bulbs 293
- Block heater 246
- Blocking
  - Rear door window operation 71
- Bolts
  - For Minispare wheel 284
  - For spare wheel 282
- Brake assist system (BAS) 341
- Brake fluid 332
  - Checking 234
- Brake lamp bulbs 291
- Brake lamp, high mounted 291
- Brake pads
  - Message in display 265
- Brakes 224
  - Warning lamp 258
- Break-in period 222
- Bulbs, replacing 290
  - Additional turn signals 290
  - Backup lamps 291
  - Brake lamps 291
  - Fog lamps 290
  - Front lamps 290
  - High beam 290
  - High mounted brake lamp 291
  - License plate lamps 291, 295
  - Low beam 290
  - Parking lamps 290, 291, 293, 294
  - Rear fog lamp 291, 295
  - Side marker lamps 290, 294
  - Standing lamps 290, 291, 293, 294
  - Tail lamp assemblies 291, 295
  - Turn signal lamps 290, 291

- Button
  - Audio system 168
- C**
- CAC (Customer Assistance Center) 341
- California
  - Important notice 11
- Calling up
  - Range (distance to empty) 133
  - Service indicator 248
- CAN system 341
- Capacities
  - Fuels, coolants, lubricants, etc. 329
- Cargo area see Trunk 86
- Cassette mode
  - Playing cassettes 174
- Cassette player
  - Operating 118
- Catalytic converter 231
- CD changer\* 178
- CD mode 178
- CD player\*
  - Operating 117
- Center console 25
  - AIRBAG OFF indicator lamp 260
  - Lower part 26
  - Upper part 25
- Centigrade
  - Setting temperature units 123
- Central locking
  - Automatic 91
  - From inside 92
  - Switch 92
  - Switching on/off (control system) 129
  - Unlocking from inside 92
- Central locking switch 92
- Certification label 318
- Changing
  - Batteries (SmartKey) 287
  - Key setting 129
- Changing CDs 178
- Charcoal filter 161
- Charging
  - Vehicle battery 304
- CHECK ENGINE malfunction indicator lamp 259
- Checking
  - Brake fluid 234
  - Coolant level 234, 238
  - Oil level 234, 236
  - Tire inflate pressure 234
  - Vehicle lighting 234
- Child safety 65
  - Airbags 58
  - Infant and child restraint systems 62, 65
  - LATCH child seat anchors 69
- Child safety switch see Blocking of rear door window operation 71
- Child seat anchors
  - see LATCH child seat anchors 70
- Cigarette lighter 208
- Cleaning
  - Cup holder 252
  - Gear selector lever 252
  - Hard plastic trim items 252
  - Headlamps 146
  - Headliner 252
  - Instrument cluster 252
  - Leather upholstery 253
  - Light alloy wheels 252
  - MB Tex upholstery 253
  - Plastic and rubber parts 252
  - Seat belts 252
  - Steering wheel 252
  - Windows 251
  - Windshield 49
  - Wiper blades 251

- Climate control 148
  - Adjusting 151
  - Defogging windshield 151
  - Defrosting 151
  - Setting the temperature 150
- Clock 23, 122
- Closing
  - Glove box 203
  - Hood 236
  - Side windows 187
  - Sliding/pop-up roof\* 190, 289
  - Sliding/pop-up roof\*
    - with SmartKey 191
  - Trunk lid 89
  - Windows 187
  - Windows with SmartKey 188
- Closing sliding/pop-up roof\*
  - In an emergency 289
- Cockpit 20, 341
- Cockpit management and data system (COMAND\*) 342
- COMAND\* see separate operating instructions
- Combination switch 104
  - High beam flasher 47
  - Turn signals 47
  - Windshield wipers 48
- Consumer information 339
- Control and operation of radio transmitters 230
- Control system 111, 342
  - AUDIO menu 116
  - Convenience submenu 129
  - Display digital speedometer 116
  - Functions 112, 115
  - Instrument cluster submenu 122
  - Lighting submenu 125
  - Malfunction memory menu 118
  - Menus 114, 115, 343
  - Multifunction display 111
  - Multifunction steering wheel 112
  - NAVI menu\* 118
  - Selecting radio system 117
  - Settings menu 119
  - Standard display menu 116
  - Submenus 113, 115
  - TEL\* menu 134
  - Trip computer menu 132
  - Vehicle submenu 128
- Convenience submenu 129
  - Activating easy-entry/exit feature\* 129
  - Setting key dependency 131
  - Setting parking position\* for exterior rear view mirror 131
- Coolant 238, 336
  - Adding 239
  - Anticorrosion/antifreeze quantity 336
  - Capacities 329
  - Checking level 238
  - Messages in display 266, 267
  - Temperature 232
  - Temperature display 108
  - Warning lamp 267
- Coolant level
  - Checking 234, 238
- Cruise control 193, 342
  - Canceling 194
  - Driving downhill 194
  - Driving uphill 194
  - Fine adjustment 195
  - Saving current speed 194
  - Setting speeds 195
- Cruise control lever 193

- Cruising range, fuel 335
- Cup holder
  - Cleaning 252
  - In front seat armrest 204
  - In rear seat armrest 205
  - Opening 204
- Customer Assistance Center (CAC) 341
- D**
- Daytime running lamp mode 103
  - Setting 125
- Deactivating
  - Air conditioner 154
  - Air recirculation mode 152, 161, 162
  - Alarm 80
  - Anti-theft alarm system 80
  - Automatic climate control\* 157
  - Central locking (control system) 129
  - Climate control 149
  - Climate control system 153
  - Cruise control 194
  - Defrosting 152, 160
  - Engine with the key 53
  - ESP 76
  - Exterior lamps 102
  - Exterior lamps delayed shut-off 126
  - Front fog lamps 126
  - Hazard warning flasher 104
  - Headlamps 52
  - Interior lighting delayed shut-off 127
  - Rear window defroster 153, 162
  - Seat heater\* 97
  - Tow-away alarm 80
- Deep water see Standing water 229
- Defogging
  - Windshield 151, 159
- Defrosting 151, 160
- Delayed shut-off
  - Exterior lamps 126
  - Interior lighting 127
- Dialing
  - A number (telephone) 135
- Difficulties
  - While driving
    - see Problems while driving 49
  - With starting 45
- Digital speedometer 116
- Direction of rotation (tires) 243
- Discharged battery
  - Jump starting 306
- Disconnecting
  - Vehicle battery 304
- Display elements
  - Audio system 166
- Displays
  - Digital speedometer 116
  - Messages 238, 261
  - Selecting 124
  - Service indicator 247
  - Showing malfunctions 119
- Distance to empty (range)
  - Calling up 132
- Door control panel 28
- Door entry lamps 106
- Door handle 28
- Door unlock
  - With Tele Aid\* 216
- Doors
  - Message in display 272
  - Opening from inside vehicle 87
  - Opening from outside 85
- Downhill driving
  - Cruise control 194
- Downshifting 137, 139
- Drink holder see Cup holder 204
- Drinking and driving 223



- Driving
  - Driving abroad 230
  - General instructions 41, 223
  - Hydroplaning 227
  - In winter 228
  - Problems 49
  - Safety systems 73
  - Through standing water 229
- Driving abroad 230
- Driving instructions 223
- Driving off 225
- Driving safety systems
  - 4MATIC 78
  - ABS 73
  - BAS 74
  - ESP 75
- Driving systems 193
  - Cruise control 193
  - Driving safety systems 73
- E**
- Easy-entry/exit feature\* 93
  - Activating 129
  - Interrupting movement 93, 130
- Electrical fuses 312
- Electrical system
  - Technical data 326
- Electronic Stability Program
  - see ESP 23, 75, 342
- Emergency call system\* 210
- Emergency calls
  - Initiating an emergency call 212
  - Telephone\* 185
  - With Tele Aid\* 211
- Emergency operation (Limp Home Mode) 143
- Emergency operations
  - Closing sliding/pop-up roof\* 289
  - Locking the vehicle 286
  - Opening sliding/pop-up roof\* 289
  - Releasing trunk lid from inside 89
  - Remote door unlock 216
  - Unlocking the vehicle 285
- Emergency tensioning device
  - see ETD 64, 342
- Emission control 231
- Emission control label 318
- Ending
  - A call (telephone) 135
- Engine 320
  - Compartment 235
  - Message in display 259
- Starting with automatic transmission 44
- Starting with manual transmission 44
- Starting with the key 44
- Turning off with the key 53
- Engine cleaning 250
- Engine compartment 235
  - Fuse box in 312
  - Hood 235
- Engine malfunction indicator lamp 23, 259
- Engine number 342
- Engine oil 236, 332
  - Adding 237
  - Additives 332
  - Checking level 236
  - Consumption 236
  - Display messages 270
  - Filler neck 237
  - Messages in display 238, 270
  - Viscosity 342
- Engine oil level see Oil level 234
- ESP 23, 75, 342
  - Four wheel electronic traction system with ESP 78

- Messages in display 269
- Switching off 76
- Switching on 77
- Warning lamp 256
- ETD 64, 342
  - Safety guidelines 59
- Ethanol fuel
  - At the gas station 233
  - Requirements 334
  - Switching fuels 334
- Exterior lamp switch 47, 101
- Exterior lamps
  - Delayed shut-off 126
- Exterior rear view mirrors
  - Adjusting 39
  - Parking position\* for 131
- F**
- Fahrenheit
  - Setting temperature units 123
- Fastening the seat belts 41
- Fine adjustment
  - Cruise control 195
- First aid kit 279
- Flat tire 297
  - Lowering the vehicle 301
  - Mounting the spare wheel 297
- Preparing the vehicle 297
- Spare wheel 281
- Flexible fuel vehicles 334
  - At the gas station 233
  - Switching fuels 334
- Flexible Service System (FSS) 247, 342
- Fog lamp, rear 103, 291
- Fog lamps
  - Replacing bulbs 290
- Fog lamps, front 103
  - Messages in display 274
  - Replacing bulbs 291
  - Switching on 103
- Four wheel electronic traction system (4MATIC) with ESP 78
- 4MATIC 78
- Front airbags 60
- Front lamps
  - Bi-Xenon type\* 293
  - Halogen-type 292
  - Messages in display 272–275
  - Replacing bulbs 290, 292
  - Switching on 101
- Front seat head restraints
  - Installing 94
  - Manual seat 94
- Power seat\* 94
  - Removing 94
- Front seats
  - Heater\* 97
- FSS (Flexible Service System) 247, 342
- Fuel 234
  - Additives 334
  - Cruising range 335
  - E85 (Ethanol fuel) 335
  - Fuel reserve warning lamp 259
  - Gasoline additives 334
  - Premium unleaded
    - gasoline 234, 330, 333
  - Requirements 333, 334
  - Reserve warning 23
  - Switching (Flexible fuel vehicle) 334
  - Technical data 329
- Fuel additives 334
- Fuel consumption statistics
  - After start 132
  - Since last reset 132, 133
- Fuel filler flap 233
  - Locking 233
  - Opening 287
  - Unlocking 233

- Fuel requirements 333
  - For ethanol fuel 334
- Fuel reserve tank
  - Message in display 272
- Fuel tank
  - Capacity 330
  - Filler flap 233
- Fuels, coolants, lubricants etc.
  - Capacities 329
- Functions (control system) 112, 115
  - Resetting 120
- Fuse box 312
- Fuse chart 312
- Fuse extractor 313
- Fuses 312
  - Auxiliary fuse box in the trunk 313
  - Fuse box in engine compartment 312
  - Fuse box in passenger compartment 312
  - Fuse chart 312
  - Fuse extractor 313
  - Spare fuses 313
- G**
- Garage door opener 27, 217
  - Erasing in remote control 220
  - Integrated remote control 218
  - Rolling code programming 219
- Gasoline see Fuel 234
  - Gasoline additives 334
- Gear range 342
  - Automatic transmission 140
  - Limiting 140
  - Shifting into optimal 139
- Gear range limit
  - Canceling 139
- Gear selector lever
  - Cleaning 252
  - Position 141
- Global
  - Locking 85
  - Unlocking 85
- Global Positioning System (GPS) 342
- Glove box 21, 203
  - Closing 203
  - Opening 203
- Good visibility 144
- GPS 342
- GPS see COMAND\* 210
- H**
- Halogen-type
  - Front lamp bulbs 292
- Hand-held transmitter
  - Programming integrated remote control 218
- Hands-free microphone 27
- Hard plastic trim items
  - Cleaning 252
- Hazard warning flasher 104
  - Switching off 104
  - Switching on 104
- Head restraints 94
  - Manual seats 33
  - Power seats\* 35
  - Rear seats 35
- Headlamp cleaning system\* 241
- Headlamp shut-off delay
  - see Delayed shut-off, exterior lamps
- Headlamps
  - Automatic control 102
  - Bi-Xenon type\*
    - Replacing bulbs 293
  - Bi-Xenon\* 341
  - Cleaning 251
  - Cleaning system\* 146, 241, 338

- Halogen-type
    - Replacing bulbs 292
    - Refilling washer fluid 241
    - Switching off 52
    - Switching on 47
    - Washer fluid 338
  - Headliner
    - Cleaning 252
  - Heated seats\* 97
  - Height adjustment
    - Head restraints 33, 35, 37
    - Seat belts 43
    - Steering wheel 37
  - High beam flasher 47, 104
  - High beam headlamps
    - Messages in display 274
    - Replacing bulbs 290, 292
    - Switching on 104
  - High beam headlamps xenon type\*
    - Replacing bulbs 293
  - High mounted brake lamp 291
  - Hood 235
    - Closing 236
    - Message in display 272
    - Opening 235
  - Hydroplaning 227
- I**
- Identification labels 318
    - Certification label 318
    - Vehicle identification number (VIN) 318
  - Ignition 31
    - Switching on 44
  - Immobilizer 79
    - Activating 79
    - Deactivating 79
  - Indicator lamps
    - see Lamps, indicator and warning
  - Infant and child restraint systems 65
    - Installing 68
    - LATCH child seat anchors 69
  - Information
    - About service and warranty 10
    - Button for Tele Aid\* 214
  - Inside rear view mirror
    - Adjusting 39
    - Antiglare 144
  - Installing
    - Infant and child restraint systems 68
    - Towing eye bolt 311
    - Wiper blades 296
  - Instrument cluster 22, 107, 342
    - Cleaning 252
    - Coolant temperature display 108
    - Illumination 107
    - Lamps in 256–259
    - Multifunction display 111
    - Outside temperature indicator 110
    - Selecting language 124
  - Instrument lighting 107, 108
  - Instruments and controls see Cockpit 20
  - Integrated remote control
    - Canadian programming 219
    - Erasing memory 220
    - Hand-held transmitter 218
    - Operating 220
    - Rolling code programming 219
  - Interior lighting 105
    - Activating automatic control 105
    - Deactivating automatic control 105
    - Delayed shut-off 127
    - Manual operation 105
  - Interior storage spaces 203
    - Armrest 206
    - Cup holder 204, 205
    - Glove box 203

- Parcel net in front passenger
  - footwell 206
- Storage compartment in front of
  - armrest 205
- J**
- Jack 279
- Jump starting 306
- K**
- Key dependency memory
  - Settings 131
- Key positions in starter switch 31
- Key, mechanical 285
- Key, SmartKey
  - Battery check lamp 85
  - Changing the batteries 287
  - Checking the batteries 86
  - Factory setting 85
  - Global locking 85
  - Global unlocking 85
  - Loss of 87
  - Positions in starter switch 31
  - Remote control 84
  - Restoring to factory setting 85
  - Selective setting 85
  - Starting the engine 44
- Turning off the engine 53
- Unlocking the trunk lid 86
- Unlocking with 30
- Keys 84
- Kickdown 143, 343
- Kilometers/miles in speedometer 123
- Km/h or mph in speedometer 123
- L**
- Labels, identification 318
- Lamp bulbs, exterior 290
- Lamps, exterior
  - Front 290
  - Light sensor 272
  - Messages in display 272–275
  - Rear 291
- Lamps, indicator and warning
  - ABS 257
  - Airbag Off 61
  - Battery (SmartKey) 85
  - Brakes 258
  - CHECK ENGINE 259
  - Coolant 266
  - Engine diagnostics 257, 259
  - ESP 256
  - Fuel reserve 259
  - Instrument cluster 256–259
- Seat belts 259
- Service indicator 247
- SRS 57
- Turn signals 23
- Language
  - Multifunction display 124
  - Setting 124
- LATCH child seat anchors 69
  - Folding back 70
- Layout of poly-V-belt drive 319
- Leather upholstery
  - Cleaning 253
- License plate lamps
  - Messages in display 274
  - Replacing bulbs 291, 295
- Light alloy wheels
  - Cleaning 252
  - Technical data 323
- Light sensor 272
- Lighter see Cigarette lighter 208
- Lighting 101
  - Automatic headlamp mode 102
  - Combination switch 104
  - Daytime running lamp mode 103
  - Door entry lamps 106

- Exterior lamp switch 101
- Front fog lamps 103
- High beams 104
- Instrument cluster illumination 107
- Instruments 107, 108
- Interior 105
- Locator lighting 103
- Low beam 101
- Manual headlamp mode 102
- Night security illumination 103
- Parking lamps 101
- Rear fog lamp 103
- Settings (control system) 125
- Trunk lamp 106
- Limiting the gear range 140
- Limp Home Mode 143
- Loading 196
  - Instructions 202
  - Roof rack\* 196
  - Ski sack\* 196
  - Split rear bench seat\* 199
- Locator lighting 103
  - Setting 126
- Lock button 343
- Locking 51, 84
  - Automatic while driving 91
  - Centrally from inside 92
  - Fuel filler flap 233
  - Global, SmartKey 85
  - Separately the trunk 90
  - Vehicle in an emergency 286
- Loss of keys 87
- Loss of Service and Warranty Information Booklet 317
- Low beam headlamps
  - Messages in display 272
  - Replacing bulbs 290, 292
- Lowering
  - Vehicle 301
- Lubricants
  - Technical data 329
- M**
- Main dimensions 327
- Maintenance 12, 247
  - Vehicles with E85 fuel 335
- Malfunction
  - Displaying 119
- Malfunction memory 118
  - Calling up 118
  - Clearing 119
- Manual headlamp mode 102
- Manual operations
  - Fuel filler flap 287
  - Interior lighting control 105
  - Locking the trunk 90
  - Locking the vehicle 286
  - Sliding/pop-up roof\* 289
  - Unlocking the driver's door 285
  - Unlocking the trunk 91
  - Unlocking transmission selector lever 288
- Manual seat
  - Adjusting 33
  - Adjusting backrest tilt 33
  - Adjusting head restraint height 33
  - Adjusting head restraint tilt 34
  - Adjusting seat cushion tilt 33
  - Adjusting seat height 33
  - Front seat head restraints 94
  - Seat fore and aft adjustment 33
- Manual transmission 137
  - Shifting into reverse 137
  - Starting with 44
- MAXCOOL Maximum cooling 160
- MB Tex upholstery
  - Cleaning 253

- Mechanical key 285
- Memory function\* 98, 343
  - Recalling positions from memory 99
  - Storing exterior rear view mirror parking positions 100
  - Storing key dependent settings 99
- Menus 112
  - AUDIO 116
  - Control system 343
  - In control system 114, 115
  - Malfunction memory 118
  - NAVI\* 118
  - Settings menu 119
  - Standard display 116
  - Submenus 113
  - TEL\* 134
  - Trip computer 132
- Microphone
  - Hands-free microphone 27
- Miles/kilometers in speedometer
  - Setting 123
- Minispare wheel 300
  - Bolts 284
  - Removing 283
- Mirrors
  - Activating exterior rear view mirror parking position\* 145
  - Adjusting 39
  - Automatic antiglare\* for inside mirror 144
  - Automatic antiglare\* for rear view mirror 144
  - Exterior rear view mirror 39
  - Exterior rear view mirror parking positions 131
  - Inside rear view mirror 39
  - Storing exterior rear view mirror parking position\* 100
- MON (Motor Octane Number) 234, 343
- Mph or km/h in speedometer 123
- Multicontour seat\* 96
- Multifunction display 111, 343
  - Selecting language 124
  - Standard display 115
- Multifunction display messages
  - ABS 262
  - BAS 263
  - Battery 278
  - Brake fluid 265
  - Brake pads 265
  - Check engine 259
  - Coolant 267
  - Coolant level 266
  - Display 278
  - Doors 272
  - Engine 259
  - Engine oil level 270
  - ESP 269
  - Fuel reserve tank 272
  - Hood 272
  - Key 272
  - Lamps 272-275
  - Parking brake 264
  - Steering column not properly locked 276
  - Steering gear oil level 276
  - Tele Aid\* 277
  - Telephone\* 277
  - Trunk lid 272
  - Washer fluid 278
- Multifunction steering wheel 24, 112, 343
  - Buttons 112

**N**

- Navigation system
  - See separate COMAND\* operating instructions
- Navigation system\*
  - Operating 118
- Night security illumination 103
  - Setting 126

**O**

- Occupant safety 56
  - Airbags 57
  - Children and airbags 58
  - Children in the vehicle 65
  - Fastening the seat belt 41
  - Infant and child restraint systems 65
  - LATCH child seat anchors 69
  - Seat belts 41, 59
- Odometer, main 23
- Oil
  - Adding 237
  - Checking level 236
  - Consumption 236
  - Dipstick 236
  - Filler neck 237
  - Viscosity 342

- Oil level
  - Checking 234
- One-touch gearshifting 139
  - Canceling gear range limit 139
  - Downshifting 139
  - Upshifting 139
- Opening
  - Ashtray 207
  - Cup holders 204
  - Doors from the inside 87
  - Fuel filler flap 233
  - Fuel filler flap manually 287
  - Glove box 203
  - Hood 235
  - Side windows 188
  - Sliding/pop-up roof\* 190, 289
  - Sliding/pop-up roof\* in an emergency 289
  - Sliding/pop-up roof\* with SmartKey 191
  - Trunk 86, 88
  - Trunk from the inside 88
  - Windows 187
  - Windows with SmartKey 188

**Operating**

- Audio system 165
- Cassette player 118
- CD player\* 117
- COMAND\* see separate operating instructions
- Garage door opener 220
- Integrated remote control 220
- Navigation system\* 118
- Radio 115, 117
- Radio transmitters 230
- Safety 16
- Telephone\* 134, 165, 182
- Vehicle outside the USA and Canada 13
- Operating safety 16
  - Audio system 165
- Operator's Manual 10
- Ornamental moldings 251
- Outer seats
  - Rear seat head restraints 95
- Outside temperature indicator 110
- Overdue service 247
- Overhead control panel 27
- Overspeed range 343



- P**
- Paintwork 250
  - Panic alarm 72
    - Panic button on SmartKey 72
  - Parcel net
    - In front passenger footwell 206
  - Parking 51, 225
  - Parking brake 45, 51
    - Engaging 51
    - Message in display 264
    - Releasing 45
  - Parking lamps
    - Replacing bulbs 290, 291, 293, 294
    - Switching on 101
  - Parking position\*
    - Exterior rear view
      - mirrors 100, 131, 145
  - Parts see Spare parts service 316
  - Passenger compartment 230
    - Fuse box in 312
    - Inside rear view mirror 39
    - Interior lighting 105
    - Parcel net in front passenger
      - footwell 206
  - Passenger safety
    - see Occupant safety 56
  - Pedals 223
  - Performance
    - In cold weather 335
    - In hot weather 335
  - Phone book\*
    - Loading 135
    - Quick search 136
  - Phone number\*
    - Dialing 135
    - Redialing 136
  - Plastic and rubber parts
    - Cleaning 252
  - Playing
    - CDs 179
  - Poly-V-belt drive 344
    - Layout 319
  - Positions (Memory function\*)
    - Recalling from memory 99
    - Storing into memory 99
  - Power assistance 224
  - Power seat\*
    - Adjusting backrest tilt 35
    - Adjusting head restraint height 35
    - Adjusting head restraint tilt 35
    - Adjusting seat cushion tilt 35
  - Adjusting seat height 35
  - Memory function 98
  - Removing/installing head
    - restraints 94
  - Seat fore and aft adjustment 34
  - Power train 344
  - Power washer 250
  - Power windows 187
    - Blocking of rear door window
      - operation 71
    - Side windows 187
    - Synchronizing 189
  - Practical hints
    - First aid kit 279
    - Fuses 312
    - Lamp in center console 260
    - Lamps in instrument cluster 256
    - Messages in the display 261
    - Minispare wheel bolts 284
    - Spare wheel 281
    - Spare wheel bolts 282
    - Towing the vehicle 308
    - Vehicle jack 280
    - Vehicle tool kit 279
  - Premium unleaded gasoline 333

## Problems

- While driving 49
- With vehicle 17
- Product information 9
- Program mode selector switch 344
  - Automatic transmission 142

**Q**

## Quick search

- Phone book\* 136

**R**

## Radio

- Selecting stations 117
- Station search 117
- Station selection setting 128
- Radio mode 171
- Radio see Radio mode
- Radio transmitters, control and operation 230
- Range (distance to empty)
  - Calling up 133
- Rapid seat heating\*
  - Switching on 97
- Reading lamp 27
- Rear bench seat
  - Foldable\* 199

## Rear door window

- Blocking operation 71
- Rear fog lamp 291
  - Bulb 291
  - Switching on 103
- Rear lamp bulbs
  - Replacing 295
- Rear lamps see Tail lamps
- Rear outer seats
  - Adjusting head restraint height 37
- Rear passenger compartment
  - Adjustable air vents 155, 164
- Rear seat head restraints
  - Adjusting 35
  - Adjusting tilt 36
  - Folding back 36
  - Folding back with switch 36
  - Installing 95
  - Outer seats 95
  - Placing upright 36
  - Removing 95
- Rear view mirror automatic
  - antiglare\* 144
- Rear view mirrors see Mirrors
- Rear window defroster 153, 162
- Rear window sunshade\* 147

## Reconnecting

- Vehicle battery 305

## Refrigerant

- Air conditioning 332

## Regular checks 234

## Reinstalling vehicle battery 304

## Remote control

- Integrated 218
- SmartKey 84

## Remote door unlock

- With Tele Aid\* 216

## Remote Vehicle Diagnostics 344

## Removing

- Minispare wheel 283
- Spare wheel 281
- Vehicle battery 304
- Vehicle tool kit 279
- Wheel 299
- Wiper blade insert 296
- Wiper blades 296

## Replacing

- Backup lamp bulbs 295
- Brake lamp bulbs 295
- Bulbs 290
- Front lamp bulbs 292
- Front turn signal bulbs 292, 293

- Fuses 313
- High beam bulbs 292
- High beam bulbs (xenon-type\* headlamps) 293
- License plate lamp bulbs 295
- Low beam bulbs 292
- Parking lamp bulbs 293, 294
- Rear fog lamp bulb 295
- Rear lamp bulbs 291, 295
- Rear turn signal bulbs 295
- Side marker lamp bulbs 294
- Standing lamp bulbs 293, 294
- Wiper blade insert 296
- Wiper blades 296
- Reporting
  - Safety defects 18
- Reset knob in the instrument cluster 23, 120
- Resetting
  - All functions (control system) 120
  - All functions of a submenu 120
  - Fuel consumption 132, 133
  - Service indicator (FSS) 248
  - Trip odometer 109
- Residual heat utilization 163
- Residual ventilation 163
- Restraint system see Infant and child restraint systems 65, 68, 344
- Reverse (manual transmission)
  - Shifting into 137
- Rims 322
- Roadside Assistance 12
- Rolling code programming 219
- RON (Research Octane Number) 234, 344
- Roof rack\* 196
- Rotating wheels 244
- Rubber parts
  - Cleaning 252
- S**
- Safety
  - Occupant 56
- Safety belts see Seat belts 41
- Safety defects
  - Reporting 18
- Safety systems
  - Driving 73
- Saving current speed 194
- Searching
  - Radio station 117
- Seat belt force limiter 64
- Seat belt height adjustment 43
- Seat belts 61
  - Cleaning 252
  - Fastening 41
  - Height adjustment 43
  - Proper use of 43, 63
  - Safety guidelines 59
  - Warning lamp 259
- Seat cushion depth
  - Adjusting 96
- Seat heater\*
  - Switching off 97
  - Switching on 97
- Seats 93
  - Adjusting 32, 33
  - Easy entry/exit feature\* 93
  - Heater\* 97
  - Manual seat 33
  - Multicontour seat\* 96
  - Power seat\* 34
  - Rapid seat heating\* 97
  - Split rear bench seat\* 199
- Selecting
  - Display 124

- Selector lever 23
  - Lock 44
  - Position
    - (automatic transmission) 23, 138
- Self-test
  - BabySmart™ airbag deactivation
    - system 67
  - Tele Aid\* 210
- Service
  - Calling up the service indicator 248
  - Major service (Service B) 247
  - Minor service (Service A) 247
  - Overdue 247
  - Spare parts 316
  - Types 247
  - When due 247
- Service and Warranty Booklet
  - Loss of 317
- Service and warranty information 10
- Service indicator 247
  - Calling up 248
  - Clearing 247, 248
- Service life (tires) 243
- Service see maintenance 247
- Service System see FSS 247
- Setting
  - Convenience functions 121, 129
  - Cruise control 194
  - Daytime running lamp mode 125
  - Higher speed in cruise control 195
  - Hours (clock) 122
  - Individual vehicle settings 119
  - Instrument lighting 107, 108
  - Interior lighting delayed shut-off 127
  - Key dependent memory 131
  - Lamps and lighting
    - (control system) 125
  - Language, multifunction display 124
  - Locator lighting 126
  - Lower speed in cruise control 195
  - Miles/kilometers in
    - speedometer 123
  - Minutes (clock) 122
  - Night security illumination 126
  - Parking position\* for exterior rear
    - view mirrors 131
  - Slower speed in cruise control 195
  - Speed in cruise control 195
  - Speedometer display mode 123
  - Station selection mode 128
  - Temperature (Interior) 158
  - Temperature (interior) 150
  - Temperature indicator 123
  - Time display mode (Clock) 123
  - Units
    - Speedometer 123
    - Temperature 123
- Settings
  - Convenience functions 129
  - Factory, SmartKey 85
  - Individual (SmartKey) 131
  - Lighting (control system) 125
  - Menus and submenus 113
  - Resetting all (control system) 120
  - Resetting in the submenu 120
  - Selective 85
- Settings menu
  - Functions in 119
  - Individual vehicle settings 119
  - Submenus 120
- Shift lock 344
- Shifting
  - Gear selector lever positions 141
  - Gearshift lever 137
  - Into optimal gear range
    - (automatic transmission) 139

- Into reverse
  - (manual transmission) 137
- Side impact airbags 61
- Side marker lamps
  - Replacing bulbs 290, 291, 294
- Side windows
  - Automatic opening 188
  - Cleaning 251
  - Closing 187, 188
  - Closing with SmartKey 188
  - Opening 187, 188
  - Opening fully 188
  - Opening with SmartKey 188
  - Stopping 188
  - Synchronizing power windows 189
- Signal strength (telephone\*) 134
- Simultaneous wiping and washing
  - Windshield wipers 49
- Single wipe 49
- Ski sack\* 196
  - Removing 199
  - Unfolding and loading 196
  - Unloading and folding 198
- Sliding/pop-up roof\* 190
  - Closing 190, 289
  - Closing with SmartKey 191
  - Opening 190, 289
  - Opening with SmartKey 191
  - Stopping 191
  - Synchronizing 192
- SmartKey
  - Changing battery 286
  - Locking and unlocking 84
  - Opening and closing
    - the sliding/pop-up roof\* with 191
  - Opening and closing
    - windows with 188
  - Unlocking with 30
- Snow chains 246
- Soft keys
  - Audio system 168
- Spare fuses 313
- Spare parts service 316
- Spare wheel 281
  - Bolts 282
  - Minispare 300
  - Mounting 297
  - Removing 281
- Speed
  - Saving current 194
- Speed settings
  - Cruise control 195
- Speedometer 23
  - Settings units 123
- Speedometer display mode
  - Selecting 123
- Split rear bench seat\* 199
- SRS 63, 344
  - Indicator lamp 257
- Standing lamps 101
  - Replacing bulbs 290, 291, 293, 294
- Standing water
  - Driving instructions 229
- Starter switch 21, 31
  - Positions 31
- Starting difficulties 45
- Starting position 31
- Starting the engine 44
- Station (radio)
  - Search 117
- Station selection
  - Setting 128
- Steel rims
  - Technical data 323
- Steering column
  - Height adjustment 37, 38
  - Length adjustment 37, 38
  - Messages in display 276

- Steering gear oil
  - Message in display 276
- Steering wheel
  - Adjusting 37
  - Buttons 24
  - Cleaning 252
  - Electrical adjustment\* 38
  - Height adjustment 38
  - Manual adjustment 37
- Stolen vehicle
  - Tracking services 217
- Stopping
  - Sliding/pop-up roof\* 191
  - Windows 188
- Storage compartments
  - Armrest 205
  - Glove box 203
  - Ventilated compartments 155
- Storage spaces
  - Cup holder 204
- Storing (Memory function\*)
  - Positions into memory 99
- Submenus 115
  - Convenience 129
  - For settings 113
  - In control system 115
- Instrument cluster 122
- Lighting 125
- Resetting functions in
  - Control system 120
- Selecting 120
- Settings menu 120
- Vehicle 128
- Sun visors 146
- Sunshade\* 147
- Supplemental Restraint System (SRS) 344
- Switching
  - Fuel (Flexible fuel vehicle) 334
- Switching off
  - Audio system 168
  - Automatic central locking (control system) 129
  - Delayed (exterior lamps) 126
  - Engine 53
  - ESP 76
  - Hazard warning flasher 104
  - Headlamps 52
  - Seat heating\* 97
- Switching on
  - Audio system 168
  - Automatic central locking (control system) 129
  - ESP 77
  - Front fog lamps 103
  - Hazard warning flasher 104
  - Headlamps 47
  - High beams 104
  - Rapid seat heating\* 97
  - Rear fog lamp 103
  - Seat heating\* 97
  - Windshield wipers 48
- Symbols 15
- Synchronizing
  - Power windows 189
  - Sliding/pop-up roof\* 192
- T**
- Tachometer 23, 109
  - Displaying gear range 140
  - Overspeed range 109
- Tail lamps
  - Cleaning 251
  - Replacing bulbs 291, 295
- Tar stains 250

- Technical data 332
  - Brake fluid 332
  - Coolant 329
  - Coolants 336
  - Electrical system 326
  - Engine oil 332
  - Engine oil additives 332
  - Flexible fuel vehicles 334
  - Fuel requirements 333
  - Fuels 329
  - Gasoline additives 334
  - Lubricants 329
  - Main dimensions 327
  - Premium unleaded gasoline 333
  - Rims and tires 322
  - Weights 328
  - Windshield washer and headlamp cleaning\* system 331, 338
- Tele Aid\* 209
  - Emergency calls 211
  - Information 214
  - Initiating an emergency call manually 212
  - Messages in display 277
  - Remote door unlock 216
  - Roadside assistance 213
- SOS button 212
- Stolen vehicle tracking services 217
- System self-check 210
- Tele Aid System 210, 345
- Upgrade signals 215
- Telematics\* 345
- Telephone\* 24, 208
  - Answering a call 135
  - Dialing a number from the phone book 135
  - Emergency call 185
  - Ending a call 135
  - Hands-free microphone 27
  - Loading phone book\* 135
  - Messages in display 277
  - Operation 134, 182
  - Redialing 136
  - Signal strength 134
- Temperature
  - Display mode 123
  - Grades of tires 340
  - Setting interior temperature 150, 158
  - Setting units in display 123
  - Tires 244
- Tightening torque (Wheel bolts) 301, 345
- Tilt
  - Head restraint 34
- Time
  - Setting hours 122
  - Setting minutes 122
- Time display
  - Setting 123
- Tire inflation pressure
  - Checking 234, 243
- Tire speed rating 227, 345
- Tire traction 227
- Tires 242, 322, 339
  - Consumer information 339
  - Direction of rotation 243
  - Driving instructions 226
  - Retreads 242
  - Rims and tires 322
  - Service life 243
  - Temperature 244
  - Temperature grades 340
  - Tread depth 245
  - Wear pattern 244
  - Winter 245
- Tools 279

- Tow-away alarm 25, 80
  - Arming 80
  - Disarming 80
  - Disarming for transport 80
- Towing eye bolt (vehicle tool kit)
  - Installing 311
- Towing the vehicle 308
- Tracking services
  - For stolen vehicle 217
- Traction 142, 339, 345
- Transmission see Automatic or manual transmission 238
- Transmission selector lever 288
  - Unlocking manually 288
- Tread depth (tires) 245
- Tread Wear 339
- Trip computer 132
- Trip odometer
  - Resetting 109
- Trunk
  - Auxiliary fuse box 313
  - Closing the lid 89
  - Lamp 106
  - Opening 86, 88
  - Opening from inside vehicle 88
  - Separately locking 90
  - Separately unlocking 91
  - Trunk lid emergency release 89
- Trunk lid
  - Closing 89
  - Message in display 272
- Turn signal lamps
  - Replacing bulbs 290, 291
- Turn signals 47
  - Additional in mirrors 290
  - Cleaning lenses 251
  - Front bulbs 290, 292, 294
  - Indicator lamps 23
  - Rear bulbs 291, 295
- Turning off
  - Engine 53
- U**
- Units
  - Setting speedometer units 123
  - Setting temperature units 123
- Unlocking 30, 84
  - Centrally from inside 92
  - Driver's door in an emergency 285
  - Fuel filler flap 233
  - Global 85
  - In an emergency 285
  - Selective settings 85
  - Separately the trunk 91
  - Transmission selector lever manually 288
  - Vehicle in an emergency 216
  - With the SmartKey 30
- Upgrade signals
  - Tele Aid\* 215
- Uphill driving
  - Cruise control 194
- Upshifting 139
- Useful features 203
  - Ashtrays 207
  - Cigarette lighter 208
  - Garage door opener 217
  - Tele Aid\* 209
  - Telephone\* 208
- V**
- Vehicle
  - Individual settings 119, 121
  - Locking 25
  - Locking in an emergency 286
  - Lowering 301
  - Performance in cold weather 335
  - Performance in hot weather 335
  - Proper use of 16



- Service battery 303
  - Towing 308
  - Unlocking 25
  - Unlocking in an emergency 285
    - With flexible fuel 334
  - Vehicle battery 303
  - Vehicle care 249
    - Cup holder 252
    - Engine cleaning 250
    - Gear selector lever 252
    - Hard plastic trim items 252
    - Headlamps 251
    - Instrument cluster 252
    - Leather upholstery 253
    - Light alloy wheels 252
    - MB Tex upholstery 253
    - Ornamental moldings 251
    - Paintwork 250
    - Plastic and rubber parts 252
    - Power washer 250
    - Seat belts 252
    - Steering wheel 252
    - Tail lamps 251
    - Tar stains 250
    - Turn signals 251
  - Vehicle washing 251
  - Window cleaning 251
  - Wiper blades 251
  - Vehicle identification number (VIN) 318
  - Vehicle jack 280
  - Vehicle lighting
    - Checking 234
  - Vehicle tool kit 279
    - Alignment bolt 279
    - Removing 279
    - Spare fuses 279
    - Special fuse puller 279
    - Towing eye bolt 279
    - Vehicle jack 279
    - Wheel bolts 279
    - Wheel wrench 279
  - Vehicle washing 251
  - Ventilated storage compartment 155
  - Ventilation
    - Storage compartment 155
  - VIN (Vehicle Identification Number) 318, 345
  - Voice control system\* 345
    - Hands-free microphone 27
- W**
- Warning lamps
    - see Lamps, indicator and warning
  - Warning sounds
    - Drivers seat belts 61
    - Parking brake 46
  - Warranty coverage 317
  - Washer fluid see Windshield washer fluid
  - Washing the vehicle 249
  - Wear pattern (tires) 244
  - Weights 328
  - Wheel change
    - Tightening torque 301
  - Wheels
    - Rotating 244
    - Tires and wheels 242
  - Window curtain airbags 61
  - Windows see Side windows
  - Windshield
    - Defogging 151, 159
    - Refilling washer fluid 241
    - Replacing wiper blades 296
    - Washer fluid 241, 338
    - Washer system 338

- Windshield washer fluid 338
    - Message in display 278
    - Mixing ratio 338
    - Refilling 241
    - Wiping with 49
  - Windshield washer system 338
  - Windshield wipers 48
    - Fast wiper speed 48
    - Replacing wiper blades 296
    - Single wipe 49
    - Switching on 48
    - Wiping with windshield washer fluid 49
  - Winter driving 245
    - Block heater 246
    - Snow chains 246
    - Tires 245
    - Transmission program mode 142
  - Winter driving instructions 228
  - Winter tires 245
  - Wiper blades
    - Cleaning 251
    - Installing 296
    - Removing 296
    - Replacing 296
    - Replacing insert 296
  - Wiping
    - Interval 48
    - With windshield washer fluid 49
- X**
- Xenon headlamps
    - Bi-Xenon\* 341









## Service and Literature

Your authorized Mercedes-Benz Center has trained technicians and original Mercedes-Benz parts to service your vehicle properly.  
For expert advice and quality service, see your authorized Mercedes-Benz Center.

If you are interested in obtaining service literature for your vehicle, please contact your authorized Mercedes-Benz Center.  
We consider this the best way for you to obtain accurate information for your vehicle.

For further information you can find us on the Mercedes-Benz web-site [www.mbusa.com](http://www.mbusa.com) or [www.mercedes-benz.ca](http://www.mercedes-benz.ca).

### Warning!



To help avoid personal injury, be extremely careful when performing any service work or repairs. Improper or incomplete service or the use of incorrect or inappropriate parts or materials may damage the vehicle or its equipment, which may in turn result in personal injury.

If you have any question about carrying out some service, turn to the advice of an authorized Mercedes-Benz Center.

We reserve the right to modify the technical details of the vehicle as given in the data and illustrations of this Operator's Manual.  
Reprinting, translation and copying, even of excerpts, is not permitted without our prior authorization in writing.

Title illustration no. P00.01-2283-31

Press time 10/24/02

GSP/SIP

Printed in Germany

