

CL 500

CL 600

CL 55 AMG

Our company and staff congratulate you on the purchase of your new Mercedes-Benz.

Your selection of our product is a demonstration of your trust in our company name. Furthermore, it exemplifies your desire to own an automobile that will be as easy as possible to operate and provide years of service.

Your Mercedes-Benz represents the efforts of many skilled engineers and craftsmen. To help assure your driving pleasure, as well as your and your passengers' safety, we ask you to make a small investment of time:

- Please read this manual carefully before putting it aside. Then return it to your vehicle where it will be handy for your reference.
- Please follow the recommendations contained in this manual. They are designed to acquaint you with the operation of your Mercedes-Benz.
- Please pay attention to the warnings and cautions contained in this manual. They are designed to help improve the safety of the vehicle operator and occupants.

We extend our best wishes for many miles of safe, pleasurable driving.

Mercedes-Benz USA, LLC
A DaimlerChrysler Company

Introduction	9
Product information	9
Operator's Manual	10
Service and Warranty Information..	10
Important notice for California retail buyers and lessees of	
Mercedes-Benz automobiles	11
Maintenance	12
Roadside Assistance	12
Change of address or ownership....	12
Operating your vehicle outside the USA or Canada	13
Where to find it	14
Symbols	15
Operating safety	16
Proper use of the vehicle	16
Problems with your vehicle	17
Reporting safety defects	18
Reporting safety defects	18

At a glance	19
Cockpit	20
Instrument cluster	22
Multifunction steering wheel	24
Center console	25
Upper part	25
Lower part	26
Overhead control panel	27
Door control panel	28

Getting started	29
Unlocking	30
Unlocking with the SmartKey	30
Unlocking with KEYLESS-GO*	32
Adjusting	34
Seats	34
Steering wheel	37
Mirrors	38
Driving	40
Fastening the seat belts	40
Starting the engine	42
Switching on headlamps	46
Turn signals and high beam	46
Windshield wipers	47
Problems while driving	48
Parking and locking	49
Parking brake	50
Switching off headlamps	50
Turning off engine	51

Safety and Security	53
Occupant safety	54
Airbags	55
Seat belts	60
Children in the vehicle	63
Blocking of rear window operation ..	69
Panic alarm	70
Activating	70
Deactivating	70
Driving safety systems	71
ABS	71
BAS	73
ESP	73
Anti-theft systems	76
Immobilizer	76
Anti-theft alarm system	77
Tow-away alarm	78

Controls in detail	79
Locking and unlocking	80
SmartKey	80
KEYLESS-GO card*	83
Opening the doors	
from the inside	87
Opening the trunk lid	
from the inside	88
Opening the trunk lid	
from the outside	89
Trunk lid emergency release	89
Closing the trunk lid	90
Separately locking the trunk	90
Separately unlocking the trunk	91
Trunk lid	
opening / closing system*	91
Power closing assist	
for doors and trunk lid	94
Automatic central locking	94
Locking and unlocking	
from the inside	95

Seats	96
Lumbar support	96
Easy-entry / exit feature	96
Head restraints	97
Multicontour seat*	99
Folding forward	
front seat backrests	100
Seat ventilation*	102
Seat heating	103
Memory function	105
Storing positions into memory	106
Recalling positions	
from memory	106
Storing exterior rear	
view mirror parking position	107
Lighting	108
Exterior lamp switch	108
Combination switch	111
Hazard warning flasher	111
Interior lighting	112
Courtesy lighting	113

Instrument cluster	114	Automatic transmission.....	143	Automatic climate control	157
Instrument cluster illumination	114	One-touch gearshifting	144	Setting the temperature	160
Coolant temperature gauge	115	Gear ranges	145	Adjusting air distribution	161
Trip odometer	115	Gear selector lever position	146	Adjusting air volume	162
Tachometer	115	Program mode selector switch	147	Maximum cooling MAXCOOL.....	162
Outside temperature indicator	116	Accelerator position.....	148	Defrosting.....	162
Control system	117	Emergency operation		Air recirculation mode	163
Multifunction display.....	117	(Limp home mode).....	148	Charcoal filter	164
Multifunction steering wheel.....	118	Steering wheel gearshift control		Rear window defroster.....	165
Menus	120	(Speedshift) and manual		Deactivating the climate	
Standard display menu	122	shift program CL 55 AMG	149	control system.....	166
AUDIO menu	122	Good visibility	151	Air conditioning	166
CD changer operating mode	123	Rear view mirror	151	Residual heat and ventilation.....	167
TEL menu*	125	Windshield wipers.....	154	Ventilated storage compartment	
NAVI menu	127	Headlamp cleaning system	154	under armrest.....	167
Distronic* menu.....	128	Sun visors	155	Rear passenger compartment	
Trip computer menu.....	129	Rear window sunshade	156	adjustable air vents	168
Malfunction memory menu	130				
Settings menu.....	131				

Contents

Power windows	169	Useful features	199	Driving off	227
Opening and closing		Interior storage spaces	199	Parking.....	227
the windows	169	Ashtrays.....	206	Tires.....	228
Synchronizing power windows	172	Cigarette lighter	207	Hydroplaning.....	229
Sliding / pop-up roof.....	173	Heated steering wheel*	208	Tire traction	229
Opening and closing the		Telephone*	208	Tire speed rating.....	229
sliding / pop-up roof	173	Tele Aid	209	Winter driving instructions	230
Synchronizing the		Garage door opener	217	Standing water.....	231
sliding / pop-up roof	175	Infrared reflecting windshield.....	221	Passenger compartment.....	231
Driving systems	176			Driving abroad	231
Cruise control.....	176			Control and operation	
Distronic*	179	Operation	223	of radio transmitters	232
Active Body Control (ABC).....	190	The first 1000 miles (1500 km)	224	Catalytic converter.....	232
Parktronic system*		Driving instructions.....	225	Emission control	233
(Parking assist).....	193	Drive sensibly – save fuel.....	225	Coolant temperature.....	234
Loading.....	197	Drinking and driving	225	At the gas station	235
Roof rack*	197	Pedals	225	Check regularly	
Loading instructions.....	197	Power assistance	225	and before a long trip.....	236
Cargo tie-down hooks	198	Brakes.....	226		

Engine compartment	237	Maintenance.....	254	Opening/closing in an emergency	301
Hood	237	Clearing the service indicator	254	Sliding/pop-up roof	301
Engine oil	238	Service term exceeded	254	Replacing bulbs.....	302
Transmission fluid level.....	242	Calling up the service indicator.....	255	Bulbs.....	302
Active Body Control (ABC)		Resetting the service indicator	255	Replacing bulbs for front lamps	304
fluid level.....	242	Vehicle care.....	256	Replacing bulbs for rear lamps	305
Coolant	242	Cleaning and care of vehicle	256	Replacing wiper blades	307
Battery	243			Removing.....	307
Windshield washer system and				Installing.....	307
headlamp cleaning system.....	244	Practical hints	263	Flat tire.....	308
Tires and wheels.....	246	What to do if ...?	264	Preparing the vehicle	308
Important guidelines	246	Lamps in instrument cluster	264	Mounting the spare wheel	308
Life of tires	247	Lamp in center console.....	269	Battery	313
Direction of rotation.....	247	Messages in the display.....	270	Disconnecting the battery	314
Checking tire inflation pressure ...	247	Where will I find...?	295	Removing the battery	314
Rotating wheels	251	First aid kit.....	295	Charging and reinstalling	
Winter driving	252	Vehicle jack, vehicle tool kit,		the battery.....	314
Winter tires	252	luggage bowl, spare wheel.....	295	Reconnecting the battery	315
Block heater*	253	Unlocking/locking in an emergency...	297	Jump starting.....	316
Snow chains.....	253	Unlocking the vehicle.....	297	Towing the vehicle.....	318
		Locking the vehicle	298	Installing towing eye bolt.....	321
		Changing batteries.....	299		
		Fuel filler flap	300		

Contents

Fuses	322	Engine.....	330	Consumer information.....	345
Fuse boxes in passenger compartment.....	322	Rims and Tires	331	Uniform tire quality grading	345
Fuse boxes in engine compartment.....	324	Same size tires.....	332		
Emergency engine shut-down	324	Mixed size tires	333		
		Spare wheel	333	Technical terms	347
		Electrical system	334		
		Main Dimensions	335		
		Weights.....	336	Index	353
Technical data	325	Fuels, coolants, lubricants etc.	337		
Spare parts service	326	Capacities	337		
Warranty coverage.....	327	Engine oils.....	339		
Loss of Service and Warranty Information Booklet.....	327	Engine oil additives	339		
Identification labels.....	328	Air conditioning refrigerant	339		
Layout of poly-V-belt drive	329	Brake fluid.....	340		
CL 500	329	Premium unleaded gasoline	340		
CL 55 AMG.....	329	Fuel requirements	340		
CL 600	329	Gasoline additives	341		
		Coolants.....	342		
		Windshield and headlamp washer system	344		

Product information

Please observe the following in your own best interest:

We recommend using Mercedes-Benz original parts as well as conversion parts and accessories explicitly approved by us for your vehicle model.

We have tested these parts to determine their reliability, safety and special suitability for Mercedes-Benz vehicles.

We are unable to make an assessment for other products and therefore cannot be held responsible for them, even if in individual cases an official approval or authorization by governmental or other agencies should exist. Use of such parts and accessories could adversely affect the safety, performance or reliability of your vehicle. Please do not use them.

Mercedes-Benz original parts as well as conversion parts and accessories approved by us are available at your authorized Mercedes-Benz Center where you will receive comprehensive information, including permissible technical modifications, and where proper installation will be performed.

Operator's Manual

Operator's Manual

This Operator's Manual contains a great deal of useful information. We urge you to read it carefully and familiarize yourself with the vehicle before driving.

For your own safety and longer service life of the vehicle, we urge you to follow the instructions and warnings contained in this manual. Ignoring them could result in damage to the vehicle or personal injury to you or others. Vehicle damage caused by failure to follow instructions is not covered by the Mercedes-Benz Limited Warranty.

Your vehicle may have some or all of the equipment described in this manual. Therefore, you may find explanations for optional equipment not installed in your vehicle. If you have any questions about the operation of any equipment, your authorized Mercedes-Benz Center will be glad to demonstrate the proper procedures.

We continuously strive to improve our product, and ask for your understanding that we reserve the right to make changes in design and equipment. Therefore, information, illustrations and descriptions in this Operator's Manual might differ from your vehicle.

Optional equipment is also described in this manual, including operating instructions wherever necessary. Since they are special-order items, the descriptions and illustrations herein may vary slightly from the actual equipment of your vehicle.

If there are any equipment details that are not shown or described in this Operator's Manual, your authorized Mercedes-Benz Center will be glad to inform you of correct care and operating procedures.

The Operator's Manual and Service Booklet are important documents and should be kept with the vehicle.

Service and Warranty Information

The Service and Warranty Information Booklet contains detailed information about the warranties covering your Mercedes-Benz, including:

- New Car Limited Warranty
- Emission System Warranty
- Emission Performance Warranty
- California, Maine, Massachusetts, and Vermont Emission Control System Warranty (California, Maine, Massachusetts, and Vermont only)
- State Warranty Enforcement Laws (Lemon Laws)

Important notice for California retail buyers and lessees of Mercedes-Benz automobiles

Under California law you may be entitled to a replacement of your vehicle or a refund of the purchase price or lease price, if Mercedes-Benz USA, LLC and / or its authorized repair or service facilities fail to fix one or more substantial defects or malfunctions in the vehicle that are covered by its express warranty after a reasonable number of repair attempts. During the period of 18 months from original delivery of the vehicle or the accumulation of 18000 miles (approx. 29000 km) on the odometer of the vehicle, whichever occurs first, a reasonable number of repair attempts is presumed for a retail buyer or lessee if one or more of the following occurs:

- (1) the same substantial defect or malfunction results in a condition that is likely to cause death or serious bodily injury if the vehicle is driven, that defect or malfunction has been subject to repair two or more times, and you have directly notified Mercedes-Benz USA, LLC in writing of the need for its repair,
- (2) the same substantial defect or malfunction of a less serious nature than category (1) has been subject to repair four or more times and you have directly notified us in writing of the need for its repair, or
- (3) the vehicle is out of service by reason of repair of the same or different substantial defects or malfunctions for a cumulative total of more than 30 calendar days. Written notification should be sent to us, not a dealer, at Mercedes-Benz USA, LLC, Customer Assistance Center, One Mercedes Drive, Montvale, NJ 07645-0350.

Maintenance

The Service Booklet describes all the necessary maintenance work which should be performed at regular intervals.

Always have the Service Booklet with you when you take the vehicle to your authorized Mercedes-Benz Center for service. The service advisor will record each service in the booklet for you.

Roadside Assistance

The Mercedes-Benz Roadside Assistance Program provides factory trained technical help in the event of a breakdown. Calls to the toll-free Roadside Assistance number

1-800-FOR-MERCEdes (in the USA)
1-800-387-0100 (in Canada)

will be answered by Mercedes-Benz Customer Assistance Representatives 24 hours a day, 365 days a year.

For additional information refer to the Mercedes-Benz Roadside Assistance Program brochure in your glove box.

Change of address or ownership

If you change your address, be sure to send in the "Change of Address Notice" found in the Service and Warranty Information Booklet, or simply call the Mercedes-Benz Customer Assistance Center (in the USA) at 1-800-FOR-MERCEdes, or Customer Service (in Canada) at 1-800-387-0100. It is in your own interest that we can contact you should the need arise.

If you sell your Mercedes, please leave all literature with the vehicle to make it available to the next operator.

If you bought this vehicle used, be sure to send in the "Notice of Purchase of Used Car" found in the Service and Warranty Information Booklet, or call the Mercedes-Benz Customer Assistance Center (in the USA) at 1-800-FOR-MERCEdes, or Customer Service (in Canada) at 1-800-387-0100.

Operating your vehicle outside the USA or Canada

If you plan to operate your vehicle in foreign countries, please be aware that:

- Service facilities or replacement parts may not be readily available.
- Unleaded gasoline for vehicles with catalytic converters may not be available; the use of leaded fuels will damage the catalyysts.
- Gasoline may have a considerably lower octane rating, and improper fuel can cause engine damage.

Certain Mercedes-Benz models are available for delivery in Europe under our European Delivery Program. For details, consult your authorized Mercedes-Benz Center or write to:

In the USA:

Mercedes-Benz USA, LLC
European Delivery Department
One Mercedes Drive
Montvale, NJ 07645-0350

In Canada:

Mercedes-Benz Canada, Inc.
European Delivery Department
849 Eglinton Avenue East
Toronto, Ontario M4G 2L5

Where to find it

Where to find it

This Operator's Manual is designed to provide comprehensive support information for you, the vehicle operator. Each section has its own reference color so you can find information quickly.

At a glance

Here you will find an overview of all the controls that can be operated from the driver's seat.

Getting started

Here you will find all the information you need for your first drive. You should read this section first if this is your first Mercedes-Benz vehicle or if you are renting or borrowing this vehicle.

Safety and Security

Here you will find descriptions of the safety features of your vehicle.

Controls in detail

Here you will find detailed information about the equipment installed in your vehicle. This section expands on the "Getting started" section and also describes technical innovations. If you are already familiar with the basic functions of your vehicle, this section will be of particular interest to you.

Operation

Here you will find all the information you need for the proper operation of your vehicle.

Practical hints

This section provides fast assistance for dealing with problems you may encounter.

Technical data

All important technical data for your vehicle can be found in this section.

Indexes

The glossary provides explanations of the most important technical terms.

The table of contents and the index are designed to help you find information quickly and easily.

The following publications are part of your vehicle documentation:

- this Operator's Manual
- the Service Booklet

Separate operating instructions will be provided as required depending on the equipment options installed in your vehicle.

Symbols

The following symbols are found in this Operator's Manual:

- * Optional equipment is identified with an asterisk. Since standard equipment varies between models, the descriptions and illustrations in this manual may differ slightly from the actual equipment of your vehicle.

Warning!



Warning notices draw your attention to hazards that may endanger your health or life, or the health or life of others.



Highlights hazards that may result in damage to your vehicle.



Helpful hints or further information you may find useful.

- ▶ This symbol points to instructions for you to follow.
- ▶ A number of these symbols appearing in succession indicates a multiple-step procedure.
- ▷ Page This symbol tells you where to look for further information on a topic.
- ▷▷ This continuation symbol marks an interrupted procedure which will be continued on the next page.
- > In the glossary of technical terms, this symbol is used to cross-reference term definitions.
- DISPLAY Words appearing in the multi-function display are printed in the type shown here.

Operating safety

Operating safety

Warning!



Work improperly carried out on electronic components and associated software could cause them to malfunction or cease functioning completely. Because the vehicle's electronic components are interconnected, any modification made may produce an undesired effect on other systems.

Electronic system malfunctions could seriously impair the operating safety of your vehicle.

Make sure that any repairs or modifications to electronic components are carried out by an authorized Mercedes-Benz Center.

Other improper work or modifications on the vehicle could also have a negative impact on the operating safety of the vehicle.

Some safety systems only function while the engine is running. You should therefore never turn off the engine while driving.

Proper use of the vehicle

Proper use of the vehicle requires that you are familiar with the following information and rules:

- The safety precautions in this manual
- The “Technical data” section in this manual
- Traffic rules and regulations
- Motor vehicle laws and safety standards

Problems with your vehicle

If you should experience a problem with your vehicle, particularly one that you believe may affect its safe operation, we urge you to immediately contact your authorized Mercedes-Benz Center to have the problem diagnosed and corrected if required. If the matter is not handled to your satisfaction, please discuss the problem with the Mercedes-Benz Center management, or if necessary contact us at one of the following addresses:

In the USA:

Customer Assistance Center
Mercedes-Benz USA, LLC
One Mercedes Drive
Montvale, NJ 07645-0350

In Canada:

Customer Relations Department
Mercedes-Benz Canada, Inc.
849 Eglinton Avenue East
Toronto, Ontario, M4G 2L5

Reporting safety defects

Reporting safety defects

For the USA only:

The following text is published as required of manufacturers under Title 49, Code of U.S. Federal Regulations, Part 575 pursuant to the “National Traffic and Motor Vehicle Safety Act of 1966.”

Reporting safety defects

If you believe that your vehicle has a defect which could cause a crash or could cause injury or death, you should immediately inform the National Highway Traffic Safety Administration (NHTSA) in addition to notifying Mercedes-Benz USA, LLC.

If NHTSA receives similar complaints, it may open an investigation, and if it finds that a safety defect exists in a group of vehicles, it may order a recall and remedy campaign. However, NHTSA cannot become involved in individual problems between you, your dealer, or Mercedes-Benz USA, LLC.

To contact NHTSA, you may either call the Auto Safety Hotline toll-free at 1-888-327-4236 (or 366-0123 in Washington, D.C. area) or write to: NHTSA, U.S. Department of Transportation, Washington, D.C. 20590. You can also obtain other information about motor vehicle safety from the Hotline.

At a glance

Cockpit

Instrument cluster

Multifunction steering wheel

Center console

Overhead control panel

Door control panel

Cockpit

Cockpit

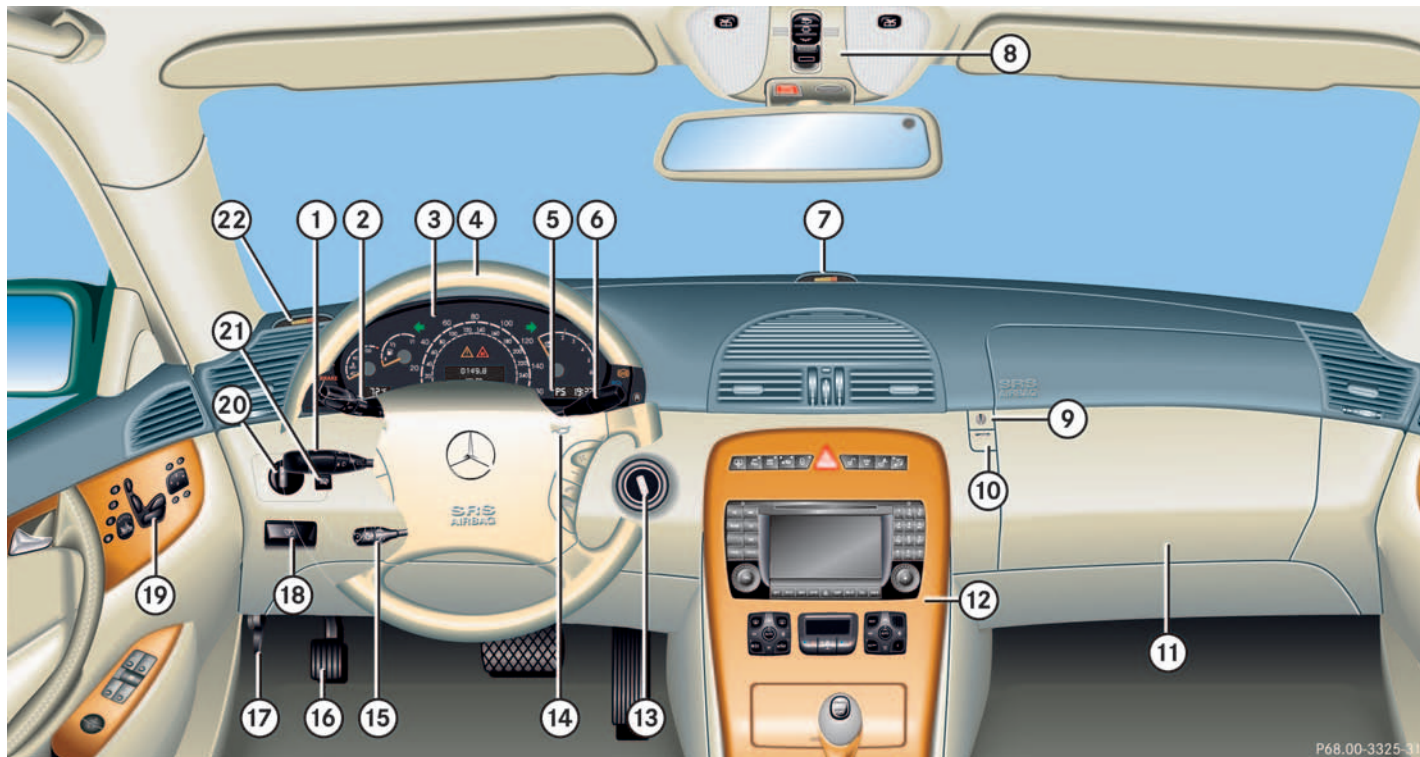

P68.00-3325-31

Item	Page
1 Combination switch	
• Turn signals	46
• Windshield wipers	47
• High beam	111
2 Cruise control lever	
• Cruise control	176
• Distronic*	179
3 Instrument cluster	22, 111
4 Multifunction steering wheel	24, 118
5 Gear range indicator, clock	22

Item	Page
6 Lever for voice control system* (see separate operating instructions)	
7 Parking assist* (Parktronic) right front area warning indicator	195
8 Overhead control panel	27
9 Glove box lock	199
10 Glove box lid release	199
11 Glove box	199
12 Center console	25, 26
13 Starter switch	31
14 Horn	



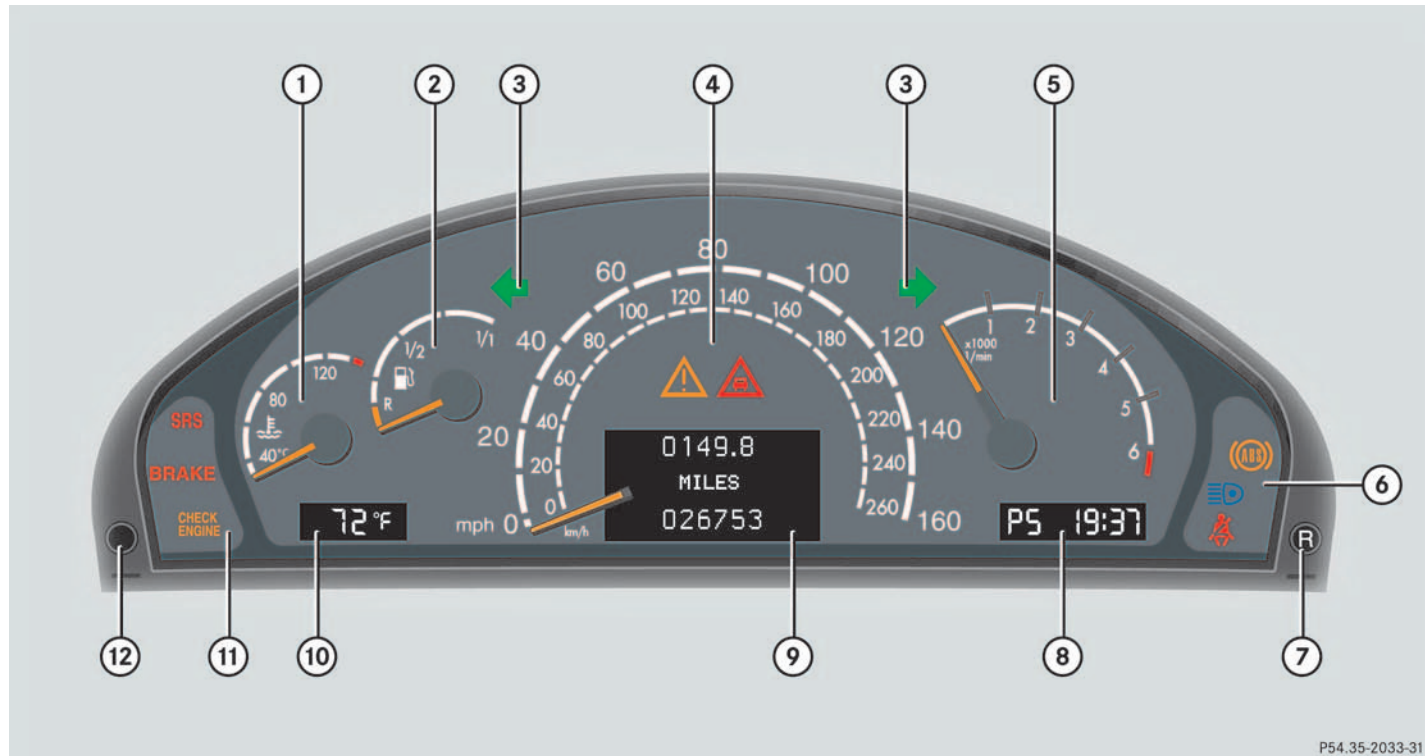

Item	Page
15 Steering wheel adjustment stalk	37
Heated steering wheel*	208
16 Parking brake pedal	44
17 Hood lock release	237
18 Parking brake release	44
19 Door control panel	28
20 Exterior lamp switch	46, 108
21 Headlamp washer button	154
22 Parking assist* (Parktronic) left front area warning indicator	195

Instrument cluster





Instrument cluster







P54.35-2033-31

Item	Page
1 Coolant temperature gauge	115
2 Fuel gauge with:	
Fuel reserve warning lamp	268
3  Left turn signal indicator lamp	46
 Right turn signal indicator lamp	46
4 Speedometer with:	
 Electronic Stability Program (ESP) warning lamp	264
 Distance warning lamp ¹	265
5 Tachometer	115

¹ Vehicles without DISTRONIC*: Warning lamp without function. It illuminates with SmartKey in starter switch position **2**. It should go out when the engine is running.







Item	Page
6 Right display with:	
 Antilock Brake System (ABS) malfunction indicator lamp	265
 High beam headlamp indicator	111
 Seat belt nonusage warning lamp	266
7  Reset button	114
8 Display with:	
Program mode	147
Gear range indicator	145
Digital clock (see COMAND operating instructions)	
9 Multifunction display with:	
Trip odometer	117
Main odometer	117





Item	Page
Stored speed for:	
Cruise control or DISTRONIC*	176
10 Outside temperature indicator	115
11 Left display with:	
 Supplemental restraint system indicator lamp	266
 Brake warning lamp, except Canada	267
 Brake warning lamp, Canada only	267
 Engine malfunction indicator lamp	268
12 Knob for instrument cluster illumination	114

Multifunction steering wheel

Multifunction steering wheel



	Item	Page
1	Multifunction display	117
	Operating control system	118
2	Selecting the submenu or setting the volume	
	 down / to decrease	
	 up / to increase	
3	Telephone*: Press button	
	 to take a call	
	 to dial a call	
	 to end a call	
	 to reject an incoming call	

	Item	Page
4	Menu systems: Press button	
	 for next system	
	 for previous system	
5	Scrolling within a menu: Press button	
	 for next display	
	 for previous display	

Center console

Upper part

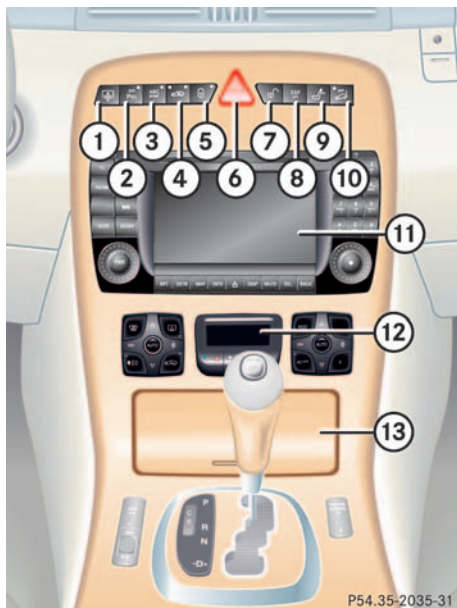

P54.35-2035-31

Item	Page
1 Rear window sunshade	156
2 Parking assist* (Parktronic system) deactivation switch	193
3 Active Body Control (ABC)	190
4 Level control switch	191
5 Central locking switch	95
Anti-theft alarm system indicator lamp	77
6 Hazard warning flasher on/off switch	111
7 Central unlocking switch	95

Item	Page
8 Electronic Stability Program (ESP) control switch	75
9 Rear seat head restraints, switch for folding down	97
10 Tow-away alarm switch	78
11 COMAND (see separate operating instructions)	
12 Automatic climate control	157
13 Ashtray	206
Lighter	207

Center console

Lower part

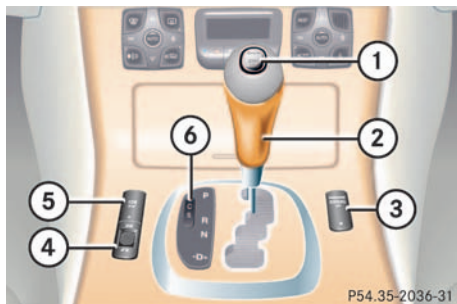

	Item	Page
1	KEYLESS-GO* start / stop button	33, 43
2	Selector lever for automatic transmission	43, 145
3	PASSENGER AIRBAG OFF indicator lamp	65
4	Thumbwheel for setting distance in DISTRONIC*	187
5	Distance warning function* on / off switch	187
6	Program mode selector for automatic transmission	147

Overhead control panel

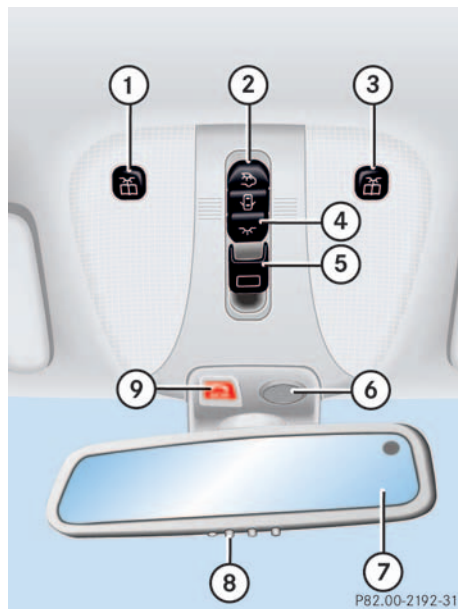

P82.00-2192-31

	Item	Page
1	Left reading lamp on / off	112
2	Rear interior lighting on / off	112
3	Right reading lamp on / off	112
4	Interior lighting control	112
5	Sliding / pop-up roof	173
6	Hands-free microphone for Tele Aid (emergency call system), telephone* and voice control system* (see separate operating instructions)	
7	Rear view mirror	38, 151
8	Garage door opener	217
9	Tele Aid (emergency call system) button	209

Door control panel

Door control panel

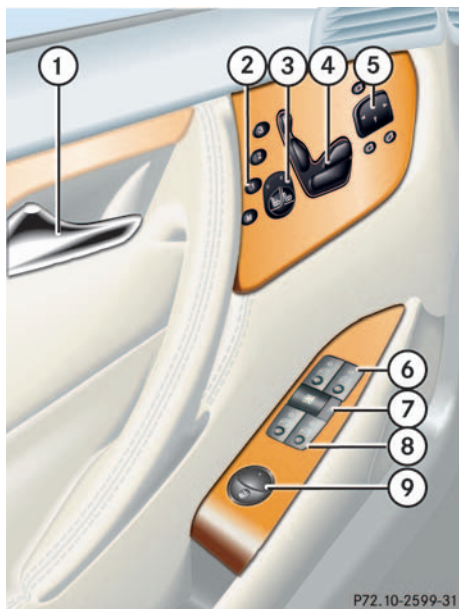

P72.10-2599-31

	Item	Page
1	Door handle	87
2	Memory function (for storing seat, mirror and steering wheel settings)	105
3	Seat heating	103
	Seat ventilation*	102
4	Seat adjustment	34, 96
5	Exterior mirror adjustment	38, 151

	Item	Page
6	Switches for opening / closing front door windows	169
7	Rear window override switch	69
8	Switches for opening / closing rear windows	169
9	Remote trunk lid release switch	88
	Trunk lid opening / closing system* switch	91

Getting started

Unlocking

Adjusting

Driving

Parking and locking



Unlocking

The “Getting started” section provides an overview of the vehicle’s most basic functions. First-time Mercedes-Benz owners should pay special attention to the information given here.

If you are already familiar with the basic functions described here, the “Controls in detail” section will help you with further information. The corresponding page references are at the end of each segment.

Unlocking

Unlocking with the SmartKey

Your vehicle comes equipped with two SmartKeys with integrated remote controls and removable mechanical key.

The locking tabs for the mechanical key portion of the two keys are a different color to help distinguish each key unit.

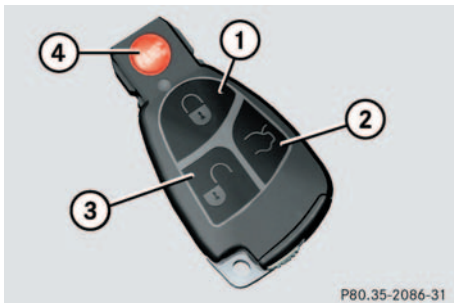

SmartKey with remote control

- 1 Lock button
- 2 Unlock button for trunk lid
- 3 Unlock button
- 4 PANIC (▷ page 70)

- ▶ Press unlock button on the key.

All turn signal lamps blink once. The locking knobs in the doors move up.

- ▶ Get in the vehicle and insert the key in the starter switch.



Opening a door causes the windows on that side of the car to open slightly. They will return to the up position when the door is closed.

Starter switch positions

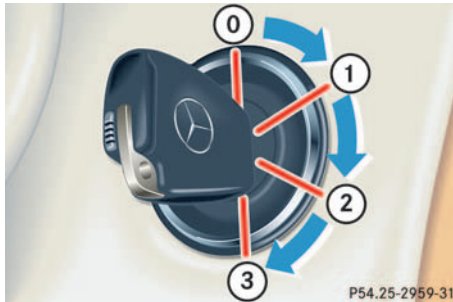

Starter switch

- 0** For removing key
- 1** Power supply for some electrical consumers, such as seat adjustment
- 2** Ignition (power supply for all electrical consumers) and driving position
- 3** Starting position

Warning!



When leaving the vehicle, always remove the key from the starter switch, take the KEYLESS-GO* card with you and lock the vehicle. Do not leave children unattended in the vehicle, or with access to an unlocked vehicle. Unsupervised use of vehicle equipment may cause an accident and/or serious personal injury.



The SmartKey can only be removed from the starter switch with the gear selector lever in position **P**.



If the key is left in starter switch position **0** for an extended period of time, it can no longer be turned in the starter switch.

- ▶ Remove the key from the starter switch and reinsert.

If the key can still not be turned, the battery may not be sufficiently charged.

- ▶ Check the battery and charge it if necessary (▶ page 313).
- ▶ Get a jump start (▶ page 316).

To prevent accelerated battery discharge or a completely discharged battery, always remove the key from the starter switch.

Unlocking

Unlocking with KEYLESS-GO*

Vehicles with KEYLESS-GO*: in addition to the two SmartKeys with remote controls and removable mechanical key, your vehicle comes equipped with two KEYLESS-GO* cards.

The function of the SmartKey overrides the KEYLESS-GO function.



If you have the KEYLESS-GO function, your vehicle checks whether the KEYLESS-GO card is valid when you grasp the door handle. If your KEYLESS-GO card is valid, the doors will unlock, and you can open them.



To unlock the vehicle, the KEYLESS-GO card must be outside the vehicle, no further than approx. 3 feet (1 meter) away from the door.

Warning!



When leaving the vehicle, always take the key and the KEYLESS-GO card with you, and lock the vehicle. Do not leave children unattended in the vehicle, or with access to an unlocked vehicle. Unsupervised use of vehicle equipment may cause an accident and/or serious personal injury.

- ▶ Grasp the door handle.

All turn signal lamps blink once. The locking knobs on the doors move up.

Pressing the KEYLESS-GO start/stop button on the selector lever corresponds to turning the key to the various starter switch positions.

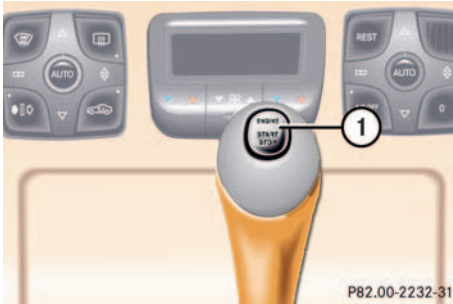

1 KEYLESS-GO start/stop button

Before you press the KEYLESS-GO start/stop button, the vehicle's on-board electronics have status **0** (as with key removed).

Make sure the gear selector lever is set to **P**.

Do not depress the brake pedal.

Position 1

- ▶ Press the KEYLESS-GO start/stop button once.

This supplies power to some electrical consumers, such as seat adjustment.



If you now press the KEYLESS-GO start/stop button twice, the power supply is switched off.

Ignition (or position 2)

- ▶ Press the KEYLESS-GO start/stop button twice in immediate succession.

This supplies power to all electrical consumers. All the lights in the instrument cluster light up.



If you now press the KEYLESS-GO start/stop button once, the power supply is again switched off.

More information can be found in the “Controls in detail” section (▶ page 83). For information on starting the engine using the KEYLESS-GO start/stop button, see “Starting with KEYLESS-GO*” (▶ page 43).

Adjusting Adjusting

Warning!



All seat, head restraint, steering wheel, and rear view mirror adjustments, as well as fastening of seat belts, must be done before the vehicle is put into motion.

Seats

Warning!



Do not adjust the driver's seat while driving. Adjusting the seat while driving could cause the driver to lose control of the vehicle.

Never ride in a moving vehicle with the seat back reclined. Sitting in an extremely reclined position can be dangerous. You could slide under the seat belt in a collision. If you slide under it, the belt would apply force at the abdomen or neck. That could cause serious or fatal injuries. The seat back and seat belts provide the best restraint when the wearer is in an upright position and belts are properly positioned on the body.

Your seat must be adjusted so that you can correctly fasten your seat belt.

Never place hands under the seat or near any moving parts while a seat is being adjusted.

Warning!



When leaving the vehicle, always remove the key from the starter switch, take the KEY-LESS-GO* card with you, and lock your vehicle.

The power seats can also be operated with the driver's or passenger door open. Do not leave children unattended in the vehicle, or with access to an unlocked vehicle. Unsupervised use of vehicle equipment may cause an accident and/or serious personal injury.

Warning!



Children 12 years old and under must never ride in the front seat, except in a Mercedes-Benz authorized BabySmart™ compatible child seat, which operates with the BabySmart™ system installed in the vehicle to deactivate the front passenger airbag when it is properly installed. Otherwise they will be struck by the airbag when it inflates in a crash. If this happens, serious or fatal injury will result.

According to accident statistics, children are safer when properly restrained in the rear seating positions than in the front seating positions. Infants and small children must ride in back seats and be seated in an appropriate infant or child restraint system, which is properly secured with the vehicle's seat belt and top tether strap, or secured via lower anchors and top tether strap, fully in accordance with the child seat manufacturer's instructions.

A child's risk of serious or fatal injuries is significantly increased if the child restraints are not properly secured in the vehicle and the child is not properly secured in the child restraint.

Seat adjustment

The seat adjustment switches are located in each door.

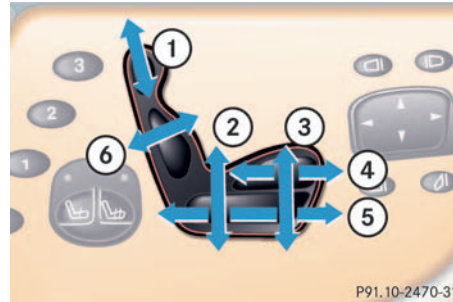

- 1 Head restraint height
- 2 Seat height
- 3 Seat cushion tilt
- 4 Seat cushion depth
- 5 Seat fore and aft adjustment
- 6 Seat backrest tilt

- ▶ Turn the key in the starter switch to position **1** or **2**.
or
- ▶ Press the KEYLESS GO* start/stop button once or twice.
or
- ▶ Open the driver's or passenger door.

Adjusting

Head restraint height

Warning!



For your protection, drive only with properly positioned head restraints.

Adjust head restraint to support the back of the head approximately at ear level.

Do not drive the vehicle without the seat head restraints. Head restraints are intended to help reduce injuries during an accident.

- ▶ Press the switch up or down in the direction of arrow 1.

Seat height

- ▶ Press the switch up or down in the direction of arrow 2.

Seat cushion tilt

- ▶ Press the switch up or down in the direction of arrow 3 until your upper legs are lightly supported.

Seat cushion depth

- ▶ Press the switch forward or backward in the direction of arrow 4 until your legs are supported comfortably.

Seat fore and aft adjustment

- ▶ Press the switch forward or backward in the direction of arrow 5.

Adjust to a comfortable seating position that still allows you to reach the accelerator / brake pedal safely. The position should be as far to the rear as possible, corresponding to the driver's ability to properly operate the controls.



When moving the seat, be sure that there are no items in the footwell or behind the seats. Otherwise you could damage the seats.

Seat backrest tilt

- ▶ Press the switch forward or backward in the direction of arrow 6 until your arms are slightly angled when holding the steering wheel.

Head restraint tilt

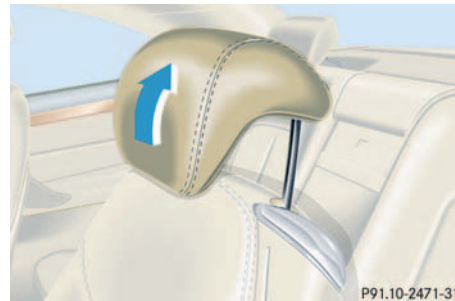

- ▶ Manually adjust the angle of the head restraint. Push or pull on the lower edge of the head restraint cushion.

i

The front passenger seat head restraint automatically lowers after a few seconds when the front passenger seat is not occupied. This improves the driver's outward view as well as the forward view from the rear passenger compartment.

When the front passenger seat is occupied again, the front passenger head restraint returns to the last set position within a few seconds.

If the front passenger seat was moved fore or aft while not being occupied, the front passenger seat head restraint returns to a position that corresponds best with the seat's axial position when the seat is occupied again.

More information can be found in the "Controls in detail" section (▷ page 97).

Steering wheel**Warning!**

Do not adjust the steering wheel while driving. Adjusting the steering wheel while driving could cause the driver to lose control of the vehicle.

When leaving the vehicle, always remove the key from the starter switch, and take the KEYLESS-GO* card with you.

The steering wheel adjustment feature can also be operated with the driver's door open. Do not leave children unattended in the vehicle, or with access to an unlocked vehicle. Unsupervised use of vehicle equipment may cause an accident and/or serious personal injury.

Steering wheel adjustment

The stalk for steering wheel adjustment is located on the steering column (lower left).

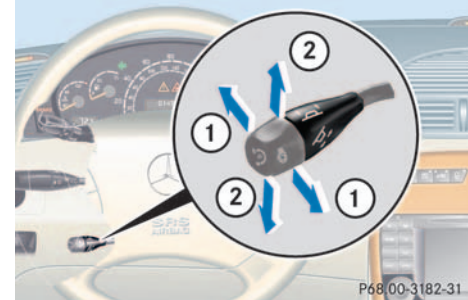

- 1** Steering column, lengthen or shorten
- 2** Steering column, height

- ▶ Turn the key in the starter switch to position **1** or **2**.
or
- ▶ Press the KEYLESS GO* start/stop button once or twice.
or
- ▶ Open the driver's or passenger door.

Adjusting

Steering column, lengthen or shorten

- ▶ Move stalk forward or backward in the direction of arrow **1** until a comfortable steering wheel position is reached with your arms slightly bent at the elbow.

Steering column, height

- ▶ Move the stalk up or down in the direction of arrow **2**. Make sure that your legs can move freely and that all the displays (including malfunction and indicator lamps) on the instrument cluster are clearly visible.

Please refer to “Controls in detail” for information on the heated steering wheel* (▷ page 208).

Mirrors

Adjust the inside and exterior rear view mirrors before driving so that you have a good view of the road and traffic conditions.

Warning!



In the case of an accident liquid electrolyte may escape the mirror housing if the mirror glass breaks.

Electrolyte has an irritating effect. Do not allow the liquid to come into contact with eyes, skin, clothing, or respiratory system. In case it does, immediately flush affected area with water, and seek medical help if necessary.

Inside rear view mirror

- ▶ Manually adjust the inside rear view mirror.

Exterior rear view mirror

Warning!



Exercise care when using the passenger side exterior rear view mirror. The mirror surface is convex (outwardly curved surface for a wider field of view). Objects in mirror are closer than they appear. Check your inside rear view mirror or glance over your shoulder before changing lanes.



Electrolyte drops coming into contact with the vehicle paint finish can only be completely removed while in their liquid state and by applying plenty of water.

The buttons are located on the driver's door.

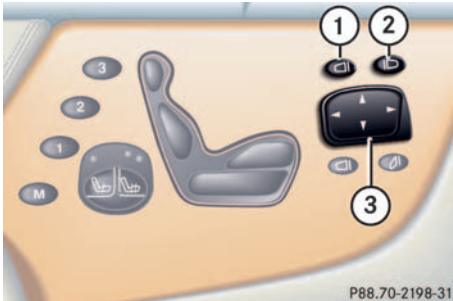

- 1 Driver's side mirror
- 2 Passenger side mirror
- 3 Adjustment button

- ▶ Make sure that the ignition is switched on.
All the lights in the instrument cluster light up.
- ▶ Press button **1** for the left mirror or button **2** for the right mirror.
- ▶ Push adjustment button **3** up, down, left or right according to the desired setting.



Information on how to reposition the exterior mirror housing when it was forcibly pushed forward (hit from the rear) or forcibly pushed rearward (hit from the front) can be found in the "Controls in detail" section (▷ page 153)



At low ambient temperatures, the mirrors will be heated automatically.

Information on the electrically folding exterior rear view mirrors can be found in the "Controls in detail" section (▷ page 152).

Driving Driving

Warning!



Do not lay any objects in the driver's footwell. Be careful that floor mats or carpets in the driver's footwell leave sufficient clearance for the pedals.

During sudden driving or braking maneuvers the objects could get caught between or underneath the pedals. You could then no longer brake or accelerate.

Fastening the seat belts

Warning!



Always fasten your seat belt before driving off. Always make sure your passengers are properly restrained, even those sitting in the rear and pregnant women.

Failure to wear and properly fasten and position your seat belt greatly increases your risk of injuries and their likely severity in an accident. You and your passengers should always wear seat belts.

If you are ever in an accident, your injuries can be considerably more severe without your seat belt properly buckled. Without your seat belt buckled, you are much more likely to hit the interior of the vehicle or be ejected from it. You can be seriously injured or killed.

In the same crash, the possibility of injury or death is lessened if you are wearing your seat belt. The airbags can only protect as expected if the occupants are using their seat belts (> page 54).

Warning!



Children 12 years old and under must never ride in the front seat, except in a Mercedes-Benz authorized BabySmart™ compatible child seat, which operates with the BabySmart™ system installed in the vehicle to deactivate the passenger front airbag when it is properly installed. Otherwise they will be struck by the airbag when it inflates in a crash. If this happens, serious or fatal injury will result.

According to accident statistics, children are safer when properly restrained in the rear seating positions than in the front seating positions. Infants and small children must ride in back seats and be seated in an appropriate infant or child restraint system, which is properly secured with the vehicle's seat belt and top tether strap, or secured via lower anchors and top tether strap, fully in accordance with the child seat manufacturer's instructions.

A child's risk of serious or fatal injuries is significantly increased if the child restraints are not properly secured in the vehicle and the child is not properly secured in the child restraint.

Warning!

Never let more people ride in the vehicle than there are seat belts available. Be sure everyone riding in the vehicle is correctly restrained with a separate seat belt.

Warning!

Never ride in a moving vehicle with the seat backrest reclined. Sitting in an extremely reclined position can be dangerous. You could slide under the seat belt in a collision. If you slide under it, the belt would apply force at the abdomen or neck. That could cause serious or even fatal injuries. The seat backrest and seat belt provide the best restraint when the wearer is in an upright position and the belt is properly positioned on the body.

Warning!

Read and observe the additional warning notices printed in the "Safety and Security" section (▷ page 58).

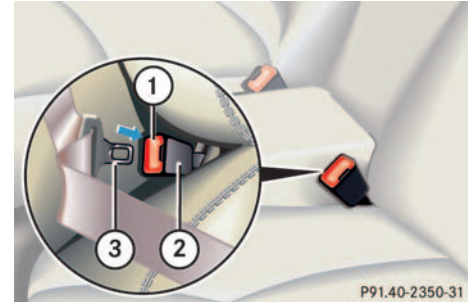

- 1** Release button
- 2** Buckle
- 3** Latch plate

- ▶ With a smooth motion, pull the belt out of the seat belt outlet.
- ▶ Place the belt over your shoulder.
- ▶ Push latch plate **3** into buckle **2** until it clicks.
- ▶ If necessary, tighten the lap portion to a snug fit by pulling shoulder portion up.

Driving

Proper use of seat belts

- Do not twist the belt when fastening.
- Adjust seat belt so that the shoulder portion is located as close as possible to the middle of the shoulder (it should not touch the neck or pass under the arm).
- Position the lap belt as low as possible on your hips (over hip joint) and not across the abdomen.
- Place the seat backrest in a nearly upright position.
- Never use a seat belt for more than one person at a time.
- Do not fasten a seat belt around a person and another object at the same time.
- Check your seat belt during travel to ensure that it is properly positioned.
- Ensure that the seat belt is always fitted snugly. You should avoid wearing bulky clothing, such as winter coats, when traveling in the vehicle.

Warning!



Do not pass belts over sharp edges. They could tear.

Do not allow the belt to get caught in the door or in the seat adjustment mechanism. This could damage the belt.

Never attempt to make modifications to seat belts. This could impair the effectiveness of the belts.

Damaged seat belts or belts that were highly stressed in an accident must be replaced by an authorized Mercedes-Benz Center.

Starting the engine

Warning!



Inhalation of exhaust gas is hazardous to your health. All exhaust gas contains carbon monoxide, and inhaling it can cause unconsciousness and lead to death.

Do not run the engine in confined areas (such as a garage) which are not properly ventilated. If you think that exhaust gas fumes are entering the vehicle while driving, have the cause determined and corrected immediately. If you must drive under these conditions, drive with at least one window fully open.

Automatic transmission

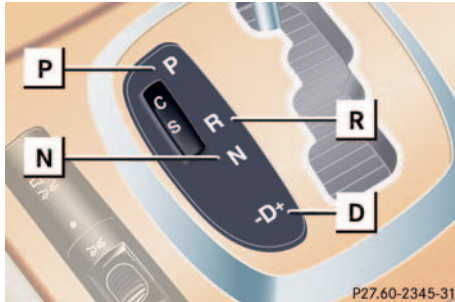

Gearshift pattern for automatic transmission

- P** Park position with selector lever lock
- R** Reverse gear
- N** Neutral
- D** Drive position

- ▶ Make sure that the gear selector lever is set to **P**.

Starting with the SmartKey

- ▶ Turn the key in the starter switch to position **3** and hold until the engine starts (▷ page 31).



You can also use the “touch-start” function. Turn the key to position **3** and release it again immediately. The engine then starts automatically.

- ▶ Firmly depress the brake pedal.
The selector lever lock is released.

For information on turning off the engine with the SmartKey, see “Turning off engine with the SmartKey” (▷ page 51).

Starting with KEYLESS-GO*

You can start your vehicle without a key using the KEYLESS-GO start/stop button on the gear selector lever.

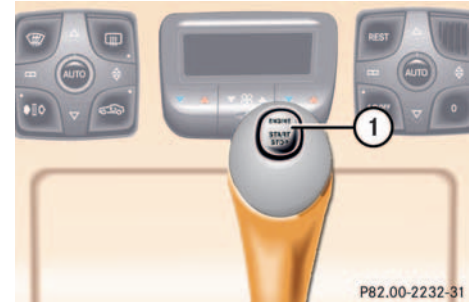

1 KEYLESS-GO start/stop button

- ▶ Firmly depress the brake pedal during the starting procedure. Do not depress accelerator.
The selector lever lock is released.
- ▶ Press KEYLESS-GO start/stop button **1** once.
The engine starts automatically.

For information on turning off the engine with KEYLESS-GO, see “Turning off engine with KEYLESS-GO” (▷ page 51).

Driving

Starting difficulties

If the engine does not start as described above, carry out the following steps:

- ▶ If you are starting the engine with the SmartKey, turn key in starter switch to position **0** and repeat starting procedure.
- ▶ If you are starting the engine with KEYLESS-GO: Close all doors to allow for better detection of the KEYLESS-GO card.
Or:
Start the engine with the key as radio signals from another source may be interfering with the KEYLESS-GO card.
- ▶ Repeat the starting procedure (▷ page 42). Remember that extended starting attempts can drain the battery.
- ▶ Get a jump start (▷ page 316).

If the engine does not start after several starting attempts, there could be a malfunction in the engine electronics or in the fuel supply system.

- ▶ Notify an authorized Mercedes-Benz Center.

Parking brake

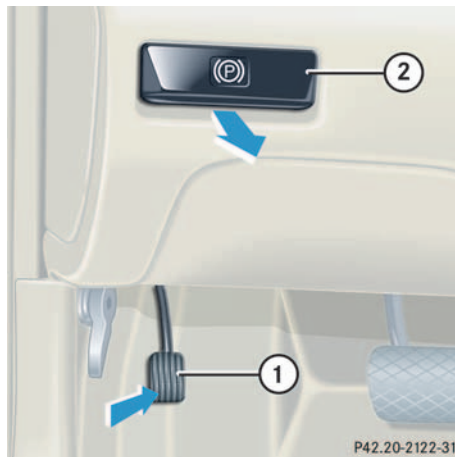

- 1 Parking brake pedal
- 2 Parking brake release handle

Warning!



When leaving the vehicle, always remove the key from the starter switch, take the KEYLESS-GO* card with you and lock the vehicle. Do not leave children unattended in the vehicle, or with access to an unlocked vehicle. Children could release the parking brake, which could result in an accident and/or serious injury.

- ▶ Release the parking brake by pulling on handle **2**.

The indicator lamp **BRAKE** (USA only) or  (Canada only) in the instrument cluster goes out.

Driving

- ▶ Firmly depress the brake pedal.
- ▶ Move selector lever in position **D** or **R**.
- ▶ Release the brake pedal.
- ▶ Carefully depress the accelerator pedal.

Once the vehicle is in motion, the automatic central locking system engages and the locking knobs drop down.



You can open a locked door from the inside. Open door only when conditions are safe to do so.

You can deactivate the automatic locking using the control system (▷ page 139).



If you hear a warning signal when driving off, you have forgotten to release the parking brake.

Release the parking brake.

After a cold start the automatic transmission engages at a higher engine speed. This allows the catalytic converter to reach its operating temperature faster.



Wait for the gear selection process to complete before setting the vehicle in motion.

Warning!



It is dangerous to shift the selector lever out of **P** or **N** if the engine speed is higher than idle speed. If your foot is not firmly on the brake pedal, the vehicle could accelerate quickly forward or in reverse. You could lose control of the vehicle and hit someone or something. Only shift into gear when the engine is idling normally and when your right foot is firmly on the brake pedal.



Simultaneously depressing the accelerator pedal and applying the brake reduces engine performance and causes premature brake and drivetrain wear.

Driving

Warning!



On slippery road surfaces, never downshift in order to obtain braking action. This could result in drive wheel slip and reduced vehicle control. Your vehicle's ABS will not prevent this type of loss of control.

Switching on headlamps

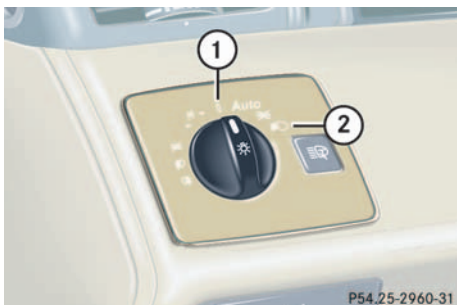

Exterior lamp switch

- 1 Off
 - 2 Low beam headlamps on
- Turn the switch to .

More information can be found in the “Controls in detail” section (► page 108).

Turn signals and high beam

The combination switch is on the left of the steering column.

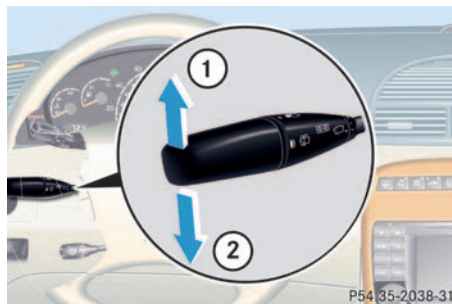

Combination switch

- 1 Turn signals, right
 - 2 Turn signals, left
- Press the combination switch up **1** or down **2**.



To signal minor directional changes, e.g. passing or changing lanes, move combination switch to point of resistance only and release. The turn signal blinks three times.

High beam

- Push the combination switch forward.
- The high beam headlights are switched on.
- The high beam symbol  in the tachometer lights up.

More information can be found in the “Controls in detail” section (► page 111).

Windshield wipers

The combination switch is on the left of the steering column.



Combination switch

- 1 Single wipe
- 2 Switching on windshield wipers

- ▶ Make sure that the ignition is switched on.

Switching on windshield wipers

- ▶ Turn the combination switch to the desired position depending on the intensity of the rain.

- 0 Windshield wipers off
- I Intermittent wiping
- II Normal wiper speed
- III Fast wiper speed



The intermittent wiping interval is dependent on wetness of windshield. Wiping will not occur with a door open.



Do not leave windshield wipers in intermittent setting when vehicle is taken to an automatic car wash or during windshield cleaning. Wipers will operate in the presence of water sprayed on the windshield, and wipers may be damaged as a result.

The switch should not be left in intermittent setting as the wipers will wipe the windshield once every time the engine is started. Dust that accumulates on the windshield might scratch the glass when wiping occurs on a dry windshield.

Single wipe

- ▶ Press switch briefly in the direction of arrow 1.

The windshield wipers wipe one time without washer fluid.

Wiping with windshield washer fluid

- ▶ Press switch in the direction of arrow 1 past the resistance point.

The windshield wiper operates with washer fluid.





If leaves, snow, etc. block the windshield wipers, switch off the wipers.

- For safety reasons, withdraw key from starter switch. Remove blockage.
- Turn the windshield wipers on again.

If windshield wipers fail to function at all in switch position I:

- Set the combination switch to the next highest wiper speed.
- Have the windshield wipers checked at the nearest authorized Mercedes-Benz Center.

Problems while driving

The engine runs erratically and misfires

- An ignition cable may be damaged.
- The engine electronics may not be operating properly.
- Unburned gasoline may have entered the catalytic converter and damaged it.
 - ▶ Give very little gas.
 - ▶ Have the problem repaired by an authorized Mercedes-Benz Center as soon as possible.

The coolant temperature is over 248°F (120°C)

The coolant is too hot and is no longer cooling the engine.

- ▶ Stop the vehicle as soon as possible and turn off the engine. Allow engine and coolant to cool.
- ▶ Check the coolant level and add coolant if necessary (▷ page 242).

In case of accident

If the vehicle is leaking gasoline:

- ▶ Do not start the engine under any circumstances.
- ▶ Notify local fire and / or police authorities.

If the extent of the damage cannot be determined:

- ▶ Notify an authorized Mercedes-Benz Center.

If no damage can be determined on the

- major assemblies
- fuel system
- engine mount
 - ▶ Start the engine in the usual manner.

Parking and locking

You have now completed your first drive. You have properly stopped and parked your vehicle. End your drive as follows:

Warning!



Wait until the vehicle is stationary before removing the key from the starter switch. The vehicle cannot be steered when the key is removed.

Warning!



With the engine not running, there is no power assistance for the brake and steering systems. In this case, it is important to keep in mind that a considerably higher degree of effort is necessary to brake or steer the vehicle.

Warning!



Do not park this vehicle in areas where combustible materials such as grass, hay or leaves can come into contact with the hot exhaust system, as these materials could be ignited and cause a vehicle fire.

To reduce the risk of personal injury as a result of inadvertent vehicle movement, before turning off the engine and leaving the vehicle always:

- Keep right foot firmly on brake pedal.
- Firmly depress parking brake pedal.
- Move the selector lever to position **P**.
- Slowly release brake pedal.
- When parked on an incline, turn front wheels towards the road curb.

- Turn the key to starter switch position **0** and remove, or press start / stop button (vehicles with KEYLESS-GO*).
- Take the key or the KEYLESS-GO* card and lock vehicle when leaving.

Parking and locking

Parking brake

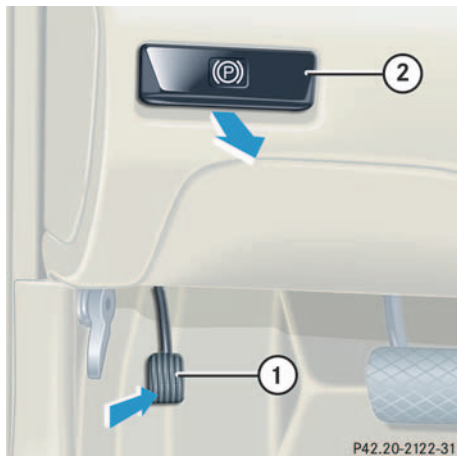

- 1 Parking brake
- 2 Release handle

- ▶ Step firmly on parking brake 1.

When the engine is running, the indicator lamp **BRAKE** (USA only) or **(P)** (Canada only) in the instrument cluster will be illuminated.

Warning!



When leaving the vehicle, always remove the key from the starter switch, take the KEY-LESS-GO* card with you and lock the vehicle. Do not leave children unattended in the vehicle, or with access to an unlocked vehicle. Children could release the parking brake and/or move the gear selector lever from position **P**, either of which could result in an accident and/or serious injury.

Warning!



Getting out of your vehicle with the selector lever not fully engaged in position **P** is dangerous. Also, when parked on an incline, position **P** alone may not prevent your vehicle from moving, possibly hitting people or objects.

Always set the parking brake in addition to shifting to position **P** (▷ page 43).

When parked on an incline, turn front wheels towards the road curb.

Switching off headlamps

- ▶ Turn the exterior lamp switch to **0** (▷ page 46).

More information can be found in the “Controls in detail” section (▷ page 108).

Turning off engine

- ▶ Place the gear selector lever in position **P**.



Always set the parking brake in addition to shifting to position **P**.

On steep slopes, turn the front wheels towards the curb.

Turning off engine with the SmartKey

- ▶ Turn the key in the starter switch (▷ page 31) to position **0** and remove it.
The immobilizer is activated.
- ▶ Press the seat belt release button (▷ page 41).



The SmartKey can only be removed from the starter switch with the gear selector lever in position **P**.



With the SmartKey removed and the driver's door open, a warning sounds if the vehicle's exterior lamps are not switched off.

Warning!



To prevent possible personal injury, always keep hands and fingers away from the door openings when closing the doors. Be especially careful when small children are around.

Before closing doors, make sure that there is no possibility of someone getting caught in a door during closing.

- ▶ After exiting the vehicle press the lock button  on the SmartKey (▷ page 30).

The locking knobs on the doors move down. The turn signal indicators light up briefly.

Warning!



When leaving the vehicle, always remove the key from the starter switch and lock your vehicle. Do not leave children unattended in the vehicle, or with access to an unlocked vehicle. Unsupervised use of vehicle equipment may cause an accident and/or serious personal injury.

More information can be found in the "Controls in detail" section (▷ page 80).

Turning off engine with KEYLESS-GO*

- ▶ Place the gear selector lever in **P**.
- ▶ Press the KEYLESS-GO start/stop button until the engine shuts off.

With the driver's door closed, the starter switch is now in position **1**. With the driver's door opened, the starter switch is set to position **0**, same as key removed from starter switch. The immobilizer is activated (▷ page 31).



Parking and locking

- ▶ Press the seat belt release button (▷ page 41).



If you hear a warning signal you have either

- forgotten to turn off the lights, or
- not put the gear selector lever in **P** before opening the driver's door.

Turn off the lights or place the gear selector lever in **P**.

Warning!



To prevent possible personal injury, always keep hands and fingers away from the door openings when closing the doors. Be especially careful when small children are around.

Before closing doors, make sure that there is no possibility of someone getting caught in a door during closing.



Opening a door causes the windows on that side of the car to open slightly. They will return to the up position when the door is closed.

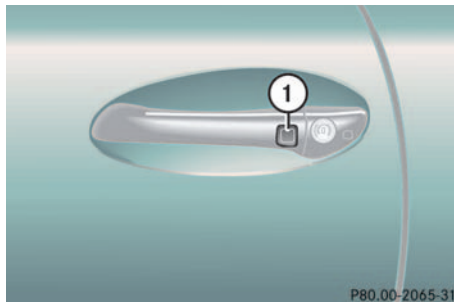

1 Lock button on the door handle

- ▶ After exiting the vehicle, press lock button **1** on the door handle or on the trunk lid (▷ page 86).

The locking knobs on the doors move up. The turn signal indicators light up briefly.

Warning!



When leaving the vehicle, always remove the key from the starter switch, take the KEY-LESS-GO* card with you, and lock your vehicle. Do not leave children unattended in the vehicle, or with access to an unlocked vehicle. Unsupervised use of vehicle equipment may cause an accident and/or serious personal injury.

More information can be found in the “Controls in detail” section (▷ page 80).

Safety and Security

Occupant safety

Panic alarm

Driving safety systems

Anti-theft systems



Occupant safety

In this section you will learn the most important facts about the restraint systems of the vehicle.

The restraint systems are:

- Seat belts
- Emergency tensioning device
- Airbags
- Child seats
- Child seat recognition
- Lower anchors and tethers for children (LATCH)

As independent systems their protective effects work in conjunction with each other.



For information on infants and children traveling with you in the vehicle and restraint systems for infants and children, see “Children in the vehicle” (▷ page 63).

Occupant safety

The **SRS** indicator lamp in the instrument cluster lights up

- for about four seconds when you turn the key in the starter switch to position **1** or press the KEYLESS-GO* start/stop button once. It then goes out briefly, lights up again and remains lit until you start the engine.
- for about four seconds when you start the engine by turning the key or pressing the KEYLESS-GO* start/stop button.



The **SRS** indicator lamp lights up and remains lit if the key is turned to position **2** and left there or the KEYLESS-GO* start/stop button is pressed twice. The indicator lamp will go out when you start the engine.

The restraint systems are fully operational if the **SRS** indicator lamp is not lit when the engine is running.

A malfunction in the system has been detected, if the **SRS** indicator lamp:

- fails to go out after approximately four seconds.
- does not come on at all.
- comes on after the engine was started or while driving.

For safety reasons, we strongly recommend that you visit an authorized Mercedes-Benz Center immediately to have the system checked.

More information can be found in the “Practical hints” section (▷ page 266).

Warning!

In the event that the **SRS** malfunction indicator lamp lights up during driving or does not come on at all, the SRS may not be operational. For your safety, we strongly recommend that you visit an authorized Mercedes-Benz Center immediately to have the system checked; otherwise the SRS may not be activated when needed in an accident, which could result in serious or fatal injury, or it might deploy unexpectedly and unnecessarily which could also result in injury.

Improper work on the restraint systems, including incorrect installation and removal, can lead to possible injury through an unintended activation of the SRS.

In addition, through improper work there is a risk of rendering the SRS inoperative or causing unintended airbag deployment. Work on the SRS must therefore only be performed by an authorized Mercedes-Benz Center.

Airbags**Warning!**

Airbags are designed to reduce the potential of injury and fatality in certain frontal impacts (front airbags), side impacts (side impact airbags and head protection window curtain airbags) or rollovers (head protection window curtain airbags). However, no system available today can totally eliminate injuries and fatalities.

The activation of the SRS temporarily releases a small amount of dust from the airbags. This dust, however, is neither injurious to your health, nor does it indicate a fire in the vehicle. The dust might cause some temporary breathing difficulty for people with asthma or other breathing trouble. To avoid this, you may wish to get out of the vehicle as soon as it is safe to do so. If you have any breathing difficulty but cannot get out of the vehicle after the airbag inflates, then get fresh air by opening a window or door.

Warning!

To reduce the risk of injury when the front airbags inflate, it is very important for the driver and front passenger to always be in a properly seated position and to wear your seat belts.

For maximum protection in the event of a collision always be in normal seated position with your back against the seat backrest. Fasten your seat belt and ensure that it is properly positioned on your body.

Since the airbag inflates with considerable speed and force, a proper seating and hands on steering wheel position will help to keep you at a safe distance from the airbag. Occupants who are unbelted, out of position or too close to the airbag can be seriously injured by an airbag as it inflates with great force in the blink of an eye:

- Sit properly belted in an upright position with your back against the seat backrest.

Occupant safety

- Adjust the driver's seat as far as possible rearward, still permitting proper operation of vehicle controls. The distance from the center of the driver's breastbone to the center of the airbag cover on the steering wheel must be at least 10 inches (25 cm) or more. You should be able to accomplish this by a combination of adjustments to the seat and steering wheel. If you have any problems, please see your authorized Mercedes-Benz Center.
- Do not lean with your head or chest close to the steering wheel or dashboard.
- Keep hands on the outside of steering wheel rim. Placing hands and arms inside the rim can increase the risk and potential severity of hand/arm injury when driver front airbag inflates.
- Adjust the front passenger seat as far as possible rearward from the dashboard when the seat is occupied.

- Occupants, especially children, should never lean their heads in the area of the door where the side airbag inflates. This could result in serious injuries or death should the airbag be triggered. Always sit upright, properly use the seat belts and appropriate size infant or child restraint system.
- Children 12 years old and under must never ride in the front seat, except in a Mercedes-Benz authorized BabySmart™ compatible child seat, which operates with the BabySmart™ system installed in the vehicle to deactivate the passenger front airbag when it is properly installed. Otherwise they will be struck by the airbag when it inflates in a crash. If this happens, serious or fatal injury will result.

Failure to follow these instructions can result in severe injuries to you or other occupants.

If you sell your vehicle you are responsible to make the buyer aware of these points. Be sure to give the buyer this Operator's Manual.

Warning!



Accident research shows that the safest place for children in an automobile is in the rear seat. Should you choose to place a child 12 years old or under in the front passenger seat of your vehicle, you must properly use a BabySmart™ child restraint which will turn off the passenger front airbag. BabySmart™ will not, however, turn off any side impact airbag.

It should be noted that with respect to both front and rear side impact airbags there is a possibility for a side airbag related injury if occupants, especially children, are not properly seated or restrained when next to a side airbag which needs to deploy rapidly in a side impact in order to do its job.

To help avoid the possibility of injury, please follow these guidelines:

- (1) Occupants, especially children, should never place their bodies or lean their heads in the area of the door where the side airbag inflates. This could result in

serious injuries or death should the side airbag be activated.

- (2) Always sit upright, properly use the seat belts and use an appropriately sized infant or child restraint system for all children 12 years old or under.
- (3) Always wear seat belts properly.

If you believe that, even with the use of these guidelines, it would be safer for your rear seat occupants to have both rear side airbags deactivated, then deactivation can be accomplished upon your written request to do so at your authorized Mercedes-Benz Center at an additional cost.

Please contact your local authorized Mercedes-Benz Center or call our Customer Assistance Center at 1-800-FOR-MERCEdes (1-800-367-6372) for details.



Airbags are designed to activate only in certain frontal impacts (front air bags), side impacts (side impact and head protection window curtain airbags) which exceed preset thresholds and in certain rollovers (head protection window curtain airbags). Only during these events will they provide their supplemental protection.

The driver and passengers should always wear their seat belts. Otherwise it is not possible for airbags to provide their supplemental protection.

In case of other types of impacts and impacts below airbag deployment thresholds, airbags will not be activated. The driver and passenger will then be protected to the extent possible by a properly fastened seat belt. A properly fastened seat belt is also needed to provide the best possible protection in a rollover.

We caution you not to rely on the presence of the airbags in order to avoid wearing your seat belt.

Your vehicle was originally equipped with airbags that are designed to activate in certain impacts exceeding a preset threshold to reduce the potential and severity of injury. It is important for your safety and the safety of your passengers that you replace deployed airbags and repair any malfunctioning airbags to ensure that the vehicle will continue to provide supplemental crash protection for occupants.

Occupant safety

Safety guidelines for the seat belt, emergency tensioning device and airbag

Warning!



- Damaged seat belts or belts that were highly stressed in an accident must be replaced and their anchoring points must also be checked. Use only belts installed or supplied by an authorized Mercedes-Benz Center.
- Airbags and ETDs are designed to function on a one-time-only basis. An airbag or emergency tensioning device (ETD) that was activated must be replaced.

- No modifications of any kind may be made to any components or wiring of the SRS. This includes changing or removing any component or part of the SRS, the installation of additional trim material, badges etc. over the steering wheel hub, front passenger airbag cover, door trim panels, or door frame trims, and installation of additional electrical/electronic equipment on or near SRS components and wiring. Keep area between airbags and occupants free from objects (e.g. packages, purses, umbrellas, etc.).
- Do not pass belts over sharp edges. They could tear.
- Do not make any modification that could change the effectiveness of the belts.
- Do not hang items such as coat hangers from the coat hooks or handles over the door. These items may turn into projectiles and cause head and other injuries when curtain airbag is deployed.

- An airbag system component within the steering wheel gets hot after the airbag has inflated. Do not touch.
- Improper work on the system, including incorrect installation and removal, can lead to possible injury through an unintended activation of the SRS.
- In addition, through improper work there is a risk of rendering the SRS inoperative or causing unintended airbag deployment. Work on the SRS must therefore only be performed by an authorized Mercedes-Benz Center.
- For your protection and the protection of others, when scrapping the airbag unit or emergency tensioning device, our safety instructions must be followed. These instructions are available from your authorized Mercedes-Benz Center.
- Given the considerable deployment speed and the textile structure of the airbags, there is the possibility of abrasions or other injuries resulting from airbag deployment.

When you sell your vehicle we strongly urge you to give notice to the subsequent owner that it is equipped with an SRS by alerting them to the applicable section in the Operator's Manual.

Front airbags

Driver and passenger airbags are deployed:

- in the event of a frontal impact
- if impact exceeds a preset deployment threshold
- independently of the side impact airbags

The airbags will not deploy in impacts which do not exceed the system's deployment thresholds. You will then be protected by the fastened seat belts.

The front passenger airbag will only be deployed if:

- the front passenger seat is occupied.
- the PASSENGER AIRBAG OFF indicator lamp in the center console is not lit (▷ page 65).
- the impact exceeds a preset deployment threshold

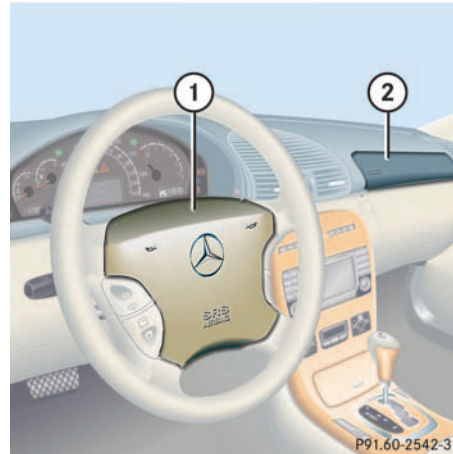

- 1 Driver's airbag
- 2 Passenger airbag



Do not place objects heavier than 20 lbs (9 kg) on the front passenger seat. This could cause the front or side impact airbag on the front passenger side to deploy in a crash which exceeds the system's deployment threshold.

Side impact airbags, window curtain airbags

The side impact airbags and window curtain airbags are deployed:

- on the impacted side of the vehicle
- in impacts exceeding a preset deployment threshold
- independently of the front airbags

In addition, the window curtain airbags **1** are deployed:

- in certain vehicle rollovers

The side impact airbags **2** and **3** are not deployed in impacts which do not exceed the system's deployment threshold.

Occupant safety

The front passenger side impact airbag **2** will only deploy if the system senses that the front passenger seat is occupied.

The window curtain airbags fill up the area between the A and C pillars (see arrows).

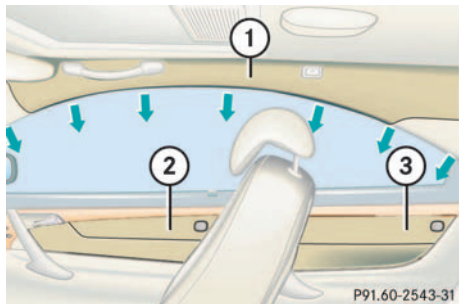

- 1 Window curtain airbag
- 2 Front side impact airbags
- 3 Rear side impact airbags

Seat belts

The seat belt nonusage warning lamp  in the instrument cluster lights up and a warning sounds for a short time when you turn the key in the starter switch to position **2** or press the KEYLESS-GO* start/stop button twice and the drivers seat belt is not fastened.

After starting the engine, the seat belt nonusage warning lamp blinks for a brief period to remind the driver and passengers to fasten the seat belts.

The use of seat belts and infant and child restraint systems is required by law in most states, the District of Columbia and all Canadian provinces. Even where this is not the case, all vehicle occupants should have their seat belts fastened at all times when driving or riding in the vehicle.

Information on fastening seat belts is found in the “Getting started” section (▷ page 40).



For information on infants and children traveling with you in the vehicle and restraint systems for infants and children, see “Children in the vehicle” (▷ page 63).

Warning!

Always fasten your seat belt before driving off. Always make sure your passengers are properly restrained, even those sitting in the rear and pregnant women.

Failure to wear and properly fasten and position your seat belt greatly increases your risk of injuries and their likely severity in an accident. You and your passengers should always wear seat belts.

If you are ever in an accident, your injuries can be considerably more severe without your seat belt properly buckled. Without your seat belt buckled, you are much more likely to hit the interior of the vehicle or be ejected from it. You can be seriously injured or killed.

In the same crash, the possibility of injury or death is lessened if you are properly wearing your seat belt. Airbags can only protect as they are designed if the occupants are properly wearing their seat belts.

Warning!

Never ride in a moving vehicle with the seat backrest reclined. Sitting in an extremely reclined position can be dangerous. You could slide under the seat belt in a collision. If you slide under it, the belt would apply force at the abdomen or neck. That could cause serious or even fatal injuries. The seat backrest and seat belt provide the best restraint when the wearer is in an upright position and the belt is properly positioned on the body.

Warning!

Never let more people ride in the vehicle than there are seat belts available. Be sure everyone riding in the vehicle is correctly restrained with a separate seat belt.

Warning!

Damaged seat belts or belts that were highly stressed in an accident must be replaced and their anchoring points must also be checked.

Only use seat belts which have been approved by Mercedes-Benz.

Do not make any modifications to the seat belts. This can lead to unintended activation or to failure.

Have all work carried out only by an authorized Mercedes-Benz Center.

Occupant safety

Warning!



USE SEAT BELTS PROPERLY

- Seat belts can only work when used properly. Never wear seat belts in any other way than as described in this section, as that could result in serious injuries in case of an accident.
- Each occupant should wear their seat belt at all times, because seat belts help reduce the likelihood of and potential severity of injuries in accidents, including rollovers. The integrated restraint system includes SRS (driver's airbag, front passenger airbag, side impact airbags, head protection window curtain airbags for side windows), ETB (seat belt emergency tensioning device), and front seat knee bolsters. The system is designed to enhance the protection offered to properly belted occupants in certain frontal (front airbags) and side (side impact and window curtain airbags) impacts which exceed preset deployment thresholds and in

certain rollovers (window curtain airbags).

- Never wear the shoulder belt under your arm, against your neck or off your shoulder. In a crash, your body would move too far forward. That would increase the chance of head and neck injuries. The belt would also apply too much force to the ribs or abdomen, which could severely injure internal organs such as your liver or spleen.
- Never wear belts over rigid or breakable objects in or on your clothing, such as eyeglasses, pens, keys etc., as these might cause injuries.
- Position the lap belt as low as possible on your hips and not across the abdomen. If the belt is positioned across your abdomen, it could cause serious injuries in a crash.

- Never use a seat belt for more than one person at a time. Do not fasten a seat belt around a person and another person or other objects.
- Belts should not be worn twisted. In a crash, you wouldn't have the full width of the belt to manage impact forces. The twisted belt against your body could cause injuries.
- Pregnant women should also use a lap-shoulder belt. The lap belt portion should be positioned as low as possible on the hips to avoid any possible pressure on the abdomen.
- Never place your feet on the instrument panel or on the seat. Always keep both feet on the floor in front of the seat.

Emergency tensioning device (ETD), seat belt force limiter

The seat belts for the front and rear outer seats are equipped with emergency tensioning devices and belt force limiters.

The ETD is designed to activate in the following cases when the seat belts are fastened:

- in frontal or rear-end impacts exceeding a preset severity level
- in certain vehicle rollovers
- if the restraint systems are operational and functioning correctly. See **SRS** indicator lamp (▷ page 54).

In an impact, emergency tensioning devices remove slack from the belts in such a way that the seat belts fit more snugly against the body. Belt force limiters reduce the force exerted by the seat belts on occupants during a crash.

Warning!



An emergency tensioning device (ETD) that was activated must be replaced.

When scrapping the emergency tensioning device, our safety instructions must be followed. These are available at your authorized Mercedes-Benz Center.



Do not place objects heavier than 20 lbs (9 kg) on the front passenger seat. This could cause the front or side impact airbag on the front passenger side to deploy in a crash which exceeds the system's deployment threshold.

Automatic comfort-fit feature seat belt

An automatic comfort-fit feature for front seats reduces the retracting force of the seat belts when they are in normal use.

Children in the vehicle

If an infant or child is traveling with you in the vehicle:

- Secure the child using an infant or child restraint appropriate to the age and size of the child and recommended for use by Mercedes-Benz.
- Ensure that the infant or child is properly secured at all times while the vehicle is in motion.

Infant and child restraint seats and information on choosing an appropriate restraint system can be obtained from any Mercedes-Benz Center.

Infant and child restraint systems

Use only a BabySmart™ compatible child restraint for the front passenger seat in this vehicle.

We recommend all infants and children be properly restrained at all times while the vehicle is in motion.

Occupant safety

All lap-shoulder belts except the driver's seat belt have special seat belt retractors for secure fastening of child restraints.

To fasten a child restraint, follow child restraint instructions for mounting. Then pull the shoulder belt out completely and let it retract. During seat belt retraction, a ratcheting sound can be heard to indicate that the special seat belt retractor is activated. The belt is now locked. Push down on child restraint to take up any slack.

To deactivate, release seat belt buckle and let seat belt retract completely. The seat belt can again be used in the usual manner.



Information on child seats with mounting fittings for tether anchorages (> page 67).

For information on "LATCH"-type child seat mounts (> page 68).

Warning!



Never release the seat belt buckle while the vehicle is in motion, since the special seat belt retractor will be deactivated.



The use of infant or child restraints is required by law in all 50 states, the District of Columbia, the U.S. territories and all Canadian provinces.

Infants and small children should be seated in an appropriate infant or child restraint system properly secured by a lap-shoulder belt or, if so equipped, a child restraint lower anchorage system that complies with U.S. Federal Motor Vehicle Safety Standards 213 and 225 and Canadian Motor Vehicle Safety Standards 213 and 210.2.

A statement by the child restraint manufacturer of compliance with this standard can be found on the instruction label on the restraint and in the instruction manual provided with the restraint.

When using any infant or child restraint system, be sure to carefully read and follow all manufacturer's instructions for installation and use.

Please read and observe warning labels affixed to inside of vehicle and to infant or child restraints.

Warning!



Children 12 years old and under must never ride in the front seat, except in a Mercedes-Benz authorized BabySmart™ compatible child seat, which operates with the BabySmart™ system installed in the vehicle to deactivate the passenger front airbag when it is properly installed. Otherwise they will be struck by the airbag when it inflates in a crash. If this happens, serious or fatal injury will result.

According to accident statistics, children are safer when properly restrained in the rear seating positions than in the front seating positions. Infants and small children must ride in back seats and be seated in an appropriate infant or child restraint system, which is properly secured with the vehicle's seat belt and top tether strap, or secured via lower anchors and top tether strap, fully in accordance with the child seat manufacturer's instructions.

Infants and small children should never share a seat belt with another occupant. During an accident, they could be crushed between the occupant and seat belt.

Children too big for child restraint systems must ride in back seats using regular seat belts. Position shoulder belt across chest and shoulder, not face or neck. A booster seat may be necessary to achieve proper belt positioning for children from 41 lbs. until they reach a height where a lap/shoulder belt fits properly without a booster.

A child's risk of serious or fatal injuries is significantly increased if the child restraints are not properly secured in the vehicle and the child is not properly secured in the child restraint.

When the child restraint is not in use, remove it from the vehicle or secure it with the seat belt to prevent the child restraint from becoming a projectile in the event of an accident.

Do not leave children unattended in the vehicle; even if the children are secured in a child restraint system. Unsupervised children in a child restraint system may use vehicle equipment and may cause an accident and/or serious personal injury.

BabySmart™ airbag deactivation system

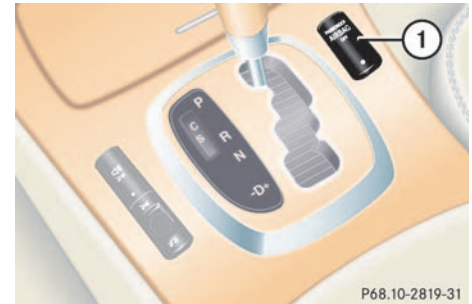

1 Indicator lamp

BabySmart™ is a trademark of Siemens Automotive Corp.

Occupant safety

Special BabySmart™ compatible child seats, designed for use with the Mercedes-Benz system and available at any authorized Mercedes-Benz Center are required for use with the BabySmart™ airbag deactivation system. With the special child seat properly installed, the passenger front airbag will not deploy.

The PASSENGER AIRBAG OFF indicator lamp **1** located in the center console will be illuminated, except with the key removed or in the starter switch position **0**.



The system does not deactivate the side impact airbag and the emergency tensioning device.

Self-test BabySmart™ without special child seat installed

After turning the key in the starter switch to position **1** or **2** or pressing the KEYLESS-GO* start/stop button once or twice, the PASSENGER AIRBAG OFF indi-

cator lamp **1** located in the center console lights up for approx. 6 seconds and then goes out.

If the indicator lamp should not come on or is continuously lit, the system is not functioning. You must see an authorized Mercedes-Benz Center before seating any child on the passenger seat.

More information can be found in the “Practical hints” section (> page 269).

Warning!



The BabySmart™ airbag deactivation system will ONLY work with a special child seat designed to operate with it. It will not work with child seats which are not BabySmart™ compatible.

Never place anything between seat cushion and child seat (e.g. pillow), since it reduces the effectiveness of the deactivation system. The bottom of the child seat must make full contact with the passenger seat cushion. An incorrectly mounted child seat

cushion. An incorrectly mounted child seat could cause injuries to the child in case of an accident, instead of protecting the child.

Follow the manufacturer's instructions for installation of special child seats.

Warning!



When using a BabySmart™ compatible child seat on the front passenger seat, the passenger front airbag will not deploy only if the PASSENGER AIRBAG OFF indicator lamp remains illuminated.

Please be sure to check the indicator every time you use the special system child seat. Should the light go out while the restraint is installed, please check installation. If the light remains out, do not use the BabySmart™ restraint to transport children on the front passenger seat until the system has been repaired.

Warning!



Do not place powered-on laptops, cell phones and like electronic devices on the front passenger seat. Signals from such devices may interfere with the BabySmart™ system. Such signal interference may cause the PASSENGER AIRBAG OFF indicator lamp not to come on during self-test or be continuously lit, indicating that the system is not functioning.

Installation of infant and child restraint systems

This vehicle is equipped with tether anchorages for a top tether strap at each of the rear seating positions.

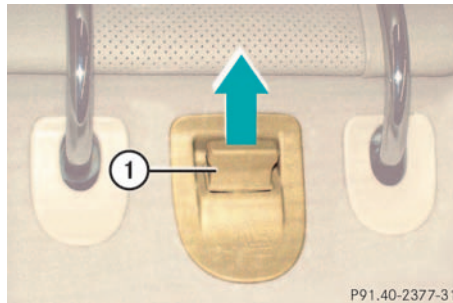

1 Cover of top anchorage ring

- ▶ Remove cover **1** from anchorage ring.
- ▶ Store cover **1** in a convenient place (e.g. glove box).
- ▶ Guide tether strap between head restraint and top of seat back.

Head restraint must be positioned such that the top tether strap can pass freely between the head restraint and the top of seat back.

Make sure that the tether strap is not twisted.

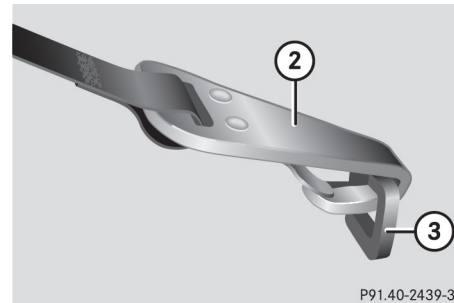

2 Hook

3 Anchorage ring

- ▶ Securely fasten hook **2**, which is part of the tether strap, to anchorage ring **3**.



For safety, please make sure that the hook has attached to the ring beyond the safety catch, as illustrated.

- ▶ Reinstall cover after removing the tether strap.

Occupant safety

Child seat anchors – “LATCH” type

This vehicle is equipped with two LATCH (Lower Anchors and Tethers for Children) type anchors (at each of the outer rear seats) for the installation of a “LATCH” child seat with the matching anchor fittings.

If you have not installed a child seat, the “LATCH” mounting anchor fittings are covered with an upholstery blend.

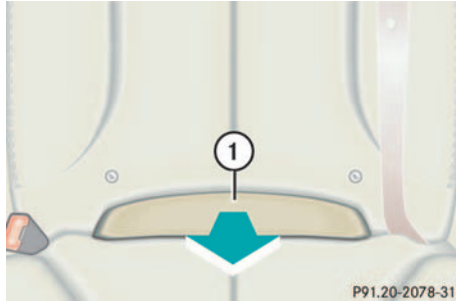

1 Upholstery blend.

- ▶ Remove upholstery blend 1 and store it in the rear center armrest.



- 2 Indicates the position of the anchors
- 3 Anchors

- ▶ Install child seat according to the manufacturer's instructions.



The child seat must be firmly attached in the right and left side anchor fittings.

Non-“LATCH” type child seats may also be used and can be installed using the vehicle's seat belt system. Install child seat according to the manufacturer's instructions.

Warning!

Children too big for child restraint systems must ride in back seats using regular seat belts. Position shoulder belt across chest and shoulder, not face or neck. A booster seat may be necessary to achieve proper belt positioning for children from 41 lbs. until they reach a height where a lap/shoulder belt fits properly without a booster.

Install child seat according to manufacturer's instructions.

The child seat must be firmly attached in the right and left side anchors **3**.

An incorrectly mounted child seat may come loose during an accident which could result in serious injury or death to your child.

Damaged or impact damaged child seats or child seat mounting fittings must be replaced.

Do not leave children unattended in the vehicle, even if the children are secured in a child restraint system.

Blocking of rear window operation

The override switch is located on the driver's door.

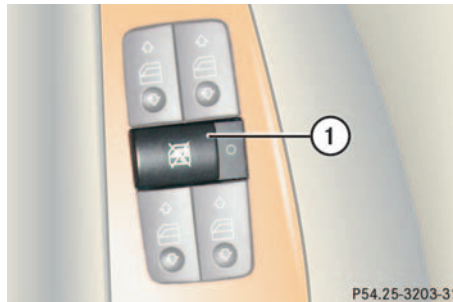

1 Override switch

Activating override switch

- ▶ Slide override switch **1** to the right.
The functions in the rear are disabled.

Deactivating override switch

- ▶ Slide override switch **1** to the left.
The functions in the rear are enabled again.



Operation of the rear windows with the switches located in the driver's door is still possible.

Warning!

Activate the override switch when children are riding in the back seats of the vehicle. The children may otherwise injure themselves, e.g. by becoming trapped in the window opening.

When leaving the vehicle, always remove the key from the starter switch, take the KEY-LESS-GO* card with you, and lock your vehicle. Do not leave children unattended in the vehicle, or with access to an unlocked vehicle. Unsupervised use of vehicle equipment can cause an accident and/or serious personal injury.

For more information on power windows, see the "Controls in detail" section (▷ page 169).

Panic alarm

Panic alarm

An audible alarm and blinking exterior lamps will operate for approximately 2½ minutes.



1 **PANIC** button

Activating

- ▶ Press and hold button **1** for at least one second.

Deactivating

- ▶ Press button **1** again
- or
- ▶ Insert key in the starter switch.



For operation in the USA only: This device complies with Part 15 of the FCC Rules. Operation is subject to the following two conditions:

- (1) This device may not cause harmful interference, and
- (2) this device must accept any interference received, including interference that may cause undesired operation.

Any unauthorized modification to this device could void the user's authority to operate the equipment.

Driving safety systems

In this section you will find information on the following driving safety systems:

- ABS (Antilock Brake System)
- BAS (Brake Assist System)
- ESP (Electronic Stability Program)



In winter operation, the maximum effectiveness of the ABS and the ESP is only achieved with winter tires (M+S tires), or snow chains as required.

Warning!



The following factors increase the risk of accidents:

- Excessive speed, especially in turns
- Wet and slippery road surfaces
- Following another vehicle too closely

The ABS, BAS and ESP cannot reduce this risk.

Always adjust your driving style to the prevailing road and weather conditions.

ABS

Warning!



Do not pump the brake pedal. Use firm, steady brake pedal pressure instead. Pumping the brake pedal defeats the purpose of the ABS and significantly reduces braking effectiveness.

The ABS regulates the brake pressure so that the wheels do not lock during braking. This allows you to maintain the ability to steer your vehicle.

The ABS is functional above a speed of approximately 5 mph (8 km/h) independent of road surface conditions.

At the instant one of the wheels is about to lock up, a slight pulsation can be felt in the brake pedal, indicating that the ABS is in the regulating mode. Keep firm and steady pressure on the brake pedal while experiencing the pulsation.

Driving safety systems

Continuous steady brake pedal pressure yields the advantages provided by the ABS, namely braking power and the ability to steer the vehicle.

On slippery road surfaces, the ABS will respond even with light brake pressure. The pulsating brake pedal can be an indication of hazardous road conditions and functions as a reminder to take extra care while driving.



To alert following vehicles to slippery road conditions you discover, operate your hazard warning flashers as appropriate.

Warning!



The ABS cannot prevent the natural laws of physics from acting on the vehicle, nor can it increase braking or steering efficiency beyond that afforded by the condition of the vehicle brakes and tires or the traction. The ABS cannot prevent accidents, including those resulting from excessive speed in turns, following another vehicle too closely, or hydroplaning. Only a safe, attentive, and skillful driver can prevent accidents. The capabilities of an ABS equipped vehicle must never be exploited in a reckless or dangerous manner which could jeopardize the user's safety or the safety of others.

ABS control

The  indicator lamp in the instrument cluster lights up when you turn the key in the starter switch to position **2** or press the KEYLESS-GO* start/stop button twice. It goes out when the engine is running.

More information can be found in the “Practical hints” section (▷ page 265).

BAS

The Brake Assist System (BAS) operates in emergency situations. If you apply the brakes very quickly, the BAS automatically provides full brake boost, thereby potentially reducing the braking distance. Apply continuous full braking pressure until the emergency braking situation is over. The ABS will prevent the wheels from locking.

When you release the brake pedal, the brakes function again as normal. The BAS is then deactivated.

Warning!



The BAS cannot prevent the natural laws of physics from acting on the vehicle, nor can it increase braking efficiency beyond that afforded by the condition of the vehicle brakes and tires or the traction. The BAS cannot prevent accidents, including those resulting from excessive speed in turns, following another vehicle too closely, or hydroplaning. Only a safe, attentive, and skillful driver can prevent accidents. The capabilities of a BAS equipped vehicle must never be exploited in a reckless or dangerous manner which could jeopardize the user's safety or the safety of others.

More information can be found in the “Practical hints” section (▷ page 273).

ESP

The Electronic Stability Program (ESP) monitors the vehicle's traction (force of adhesive friction between the tires and the road surface) and handling.

The ESP recognizes when a wheel is spinning or if the vehicle starts to skid. By applying brakes to the appropriate wheel and by limiting engine output, the ESP works to stabilize the vehicle. The ESP is especially useful while driving off and on wet or slippery road surfaces.

The ESP warning lamp  in the instrument cluster flashes when the ESP is engaged.

The warning lamp  in the instrument cluster lights up when you turn the key in the starter switch to position **2** or press the KEYLESS-GO* start/stop button twice. It goes out when the engine is running.

Driving safety systems

Warning!



Never switch off the ESP when you see the ESP warning lamp  flashing in the instrument cluster. In this case proceed as follows:

- While driving off, apply as little throttle as possible
- While driving ease up on the accelerator
- Adapt your speed and driving style to the prevailing road conditions

Failure to observe these guidelines could cause the vehicle to skid.

The ESP cannot prevent accidents resulting from excessive speed.

Warning!



The ESP cannot prevent the natural laws of physics from acting on the vehicle, nor can it increase the traction afforded. The ESP cannot prevent accidents, including those resulting from excessive speed in turns, or hydroplaning. Only a safe, attentive, and skillful driver can prevent accidents. The capabilities of an ESP equipped vehicle must never be exploited in a reckless or dangerous manner which could jeopardize the user's safety or the safety of others.



Distronic* is switched off when ESP is activated.



Because of the ESP's automatic operation, the engine must be shut off (key in starter switch position **0** or **1**) when

- the parking brake is being tested on a brake test dynamometer
- the vehicle is being towed with the front / rear axle raised.

Active braking action through the ESP may otherwise seriously damage the brake system.

The ESP will only function properly if you use wheels of the recommended tire size (▷ page 331).

More information can be found in the "Practical hints" section (▷ page 264).

Switching off the ESP

Warning!



The ESP should not be switched off during normal driving other than in the circumstances described below. Disabling of the system will reduce vehicle stability in standard driving maneuvers.

To improve the vehicle's traction, turn off the ESP in driving situations where it would be advantageous to have the drive wheels spin and thus cut into surfaces for better grip such as:

- starting out on slippery surfaces and in deep snow in conjunction with snow chains
- sand or gravel



Distronic* cannot be activated when ESP has been deactivated.

The switch is located on the center console.



1 ESP off / on

- ▶ Press the ESP switch **1** until the ESP warning lamp in the speedometer lights up.

ESP is deactivated.

If one or more wheels are spinning, the ESP warning lamp in the speedometer flashes, regardless of the speed.

Traction control brakes a spinning wheel even when ESP is deactivated.

ESP always operates when you are braking, even when it has been deactivated.



Avoid spinning of a drive wheel for an extended period with the ESP switched off. This may cause serious damage to the drivetrain which is not covered by the Mercedes-Benz Limited Warranty.

Warning!



When the ESP warning lamp is illuminated continuously, the ESP is switched off.

Adapt your speed and driving to the prevailing road conditions and to the non-operating status of the ESP.

Switching on the ESP

- ▶ Press the ESP switch **1**.

The ESP warning lamp in the instrument cluster goes out. You are now again in normal driving mode.

Anti-theft systems

Anti-theft systems

Immobilizer

The immobilizer prevents unauthorized persons from starting your vehicle.

Activating

- With the SmartKey: Removing the key from the starter switch activates the immobilizer.
- With KEYLESS-GO*: Turning off the engine by means of the KEYLESS-GO start/stop button on the gear selector lever activates the immobilizer.

Deactivating

- With the SmartKey: Inserting the key in the starter switch deactivates the immobilizer.
- With KEYLESS-GO*: Starting the engine by means of the KEYLESS-GO start/stop button on the gear selector lever deactivates the immobilizer.



In case the engine cannot be started (yet the vehicle's battery is charged), the system is not operational. Contact an authorized Mercedes-Benz Center or call 1-800-FOR-MERCEdes (in the USA), or 1-800-387-0100 (in Canada).

Anti-theft alarm system

Once the alarm system has been armed, a visual and audible alarm is triggered when someone opens

- a door
- the trunk
- the hood

The alarm system will also be triggered when

- someone attempts to raise the vehicle
- the vehicle is opened with the mechanical key



If the alarm stays on for more than 20 seconds, an emergency call is initiated automatically by the Tele Aid system provided Tele Aid service was subscribed to and properly activated, and that necessary cellular service and GPS coverage are available.

Arming the alarm system

The alarm system is armed after locking the vehicle with the remote control or KEYLESS-GO*. The turn signal lamps blink three times to indicate that the alarm system is activated. The indicator lamp in the central locking switch will blink after approximately 10 seconds when the alarm system is completely armed (▷ page 95).



If the turn signal lamps do not blink three times one of the following elements may not be properly closed:

- a door
- the trunk lid
- the hood

Close the respective element and lock the vehicle again.



Disarming the alarm system

The alarm system is disarmed when you unlock your vehicle with the remote control or KEYLESS-GO*. The turn signal lamps blink once to indicate that the alarm system is deactivated.

Canceling the alarm

To cancel the alarm:

With the SmartKey

- ▶ Insert the key in the starter switch.
- or
- ▶ Press the  or  button.

*With KEYLESS-GO**

- ▶ Grasp the outside door handle.
- or
- ▶ Press the KEYLESS-GO* start/stop button.

Anti-theft systems

Tow-away alarm

Once the tow-away alarm is armed, a visual and audible alarm will be triggered when someone attempts to raise the vehicle.



The tow-away protection alarm is triggered, for example, if the vehicle is lifted on one side.

If the alarm stays on for more than 20 seconds, an emergency call is initiated automatically by the Tele Aid system provided Tele Aid service was subscribed to and properly activated, and that necessary cellular service and GPS coverage are available.

Arming tow-away alarm

When you lock your vehicle, the tow-away alarm is automatically armed after about 30 seconds.

When you unlock your vehicle, the tow-away protection disarms automatically.

Disarming tow-away alarm

To prevent triggering the tow-away alarm feature, switch off the tow-away alarm before towing the vehicle, or when parking on a surface subject to movement, such as a ferry or auto train.

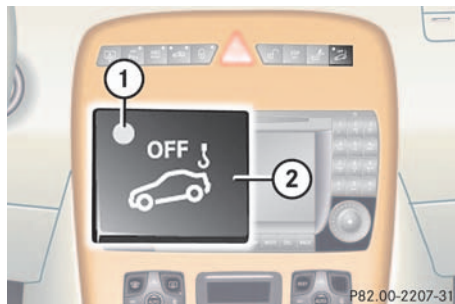

- 1 Indicator lamp
- 2 Tow-away alarm off switch

The switch is located on the center console.

- ▶ Turn off the ignition and remove the key.



You cannot disarm the tow-away alarm if the ignition is turned on.

- ▶ Press switch **2**.

Indicator lamp **1** in the switch lights up briefly.

- ▶ Exit vehicle and lock your vehicle with the key or (vehicles with KEY-LESS-GO*) the lock button at each door handle.

The tow-away alarm remains disarmed until you lock your vehicle again.



Controls in detail

Locking and unlocking

Seats

Memory function

Lighting

Instrument cluster

Control system

Automatic transmission

Good visibility

Automatic climate control

Power windows

Sliding / pop-up roof

Driving systems

Loading

Useful features

Locking and unlocking

In the “Controls in detail” section you will find detailed information on how to operate the equipment installed on your vehicle. If you are already familiar with the basic functions of your vehicle, this section will be of particular interest to you.

To quickly familiarize yourself with the basic functions of the vehicle, refer to the “Getting started” section of this manual. The corresponding page numbers are given at the beginning of each segment.

Locking and unlocking

Information on locking and unlocking can be found in the “Getting started” section on (▷ page 30) and (▷ page 49).

SmartKey

Your vehicle comes supplied with two SmartKeys with remote controls and a removable mechanical key. The locking tabs for the mechanical key portion of the two SmartKeys are a different color to help distinguish each SmartKey unit.





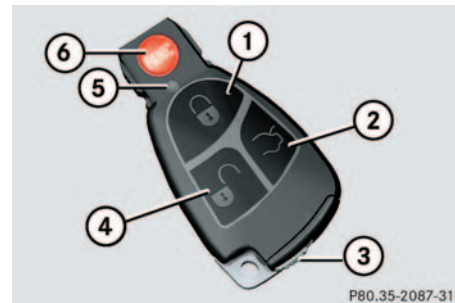

The SmartKey provides an extended operating range. To prevent theft, however, it is advisable to only unlock the vehicle when you are in close proximity to it.

The SmartKey centrally locks and unlocks:

- the doors
- the trunk
- the fuel filler flap



SmartKey with remote controls

- 1  Lock button
- 2  Unlock button for trunk lid
- 3  Mechanical key locking tab
- 4  Unlock button
- 5  Battery check lamp
- 6  PANIC (▷ page 70)



You can also open and close the power windows (▷ page 171) and sliding / pop-up roof using the SmartKey (▷ page 174).



To prevent possible malfunction, avoid exposing the key to high levels of electromagnetic radiation.

Factory setting

Global unlocking

- ▶ Press button .

All turn signal lamps blink once. The locking knobs in the doors move up.

The anti-theft alarm system is switched off. If it is dark, the locator lighting switches on.

The vehicle will lock again automatically within approximately 40 seconds of unlocking if:

- neither door nor trunk is opened
- the SmartKey is not inserted in the starter switch
- the central locking switch is not activated



Global locking

- ▶ Press button .

All turn signal lamps blink three times. The locking knobs in the doors move down. The anti-theft alarm system is activated.

Selective setting

If you frequently travel alone, you may wish to reprogram the key so that pressing  only unlocks the driver's door and the fuel filler flap.

- ▶ Press and hold buttons  and  simultaneously for about five seconds until battery check lamp **5** blinks twice.

The key will then function as follows:
Unlocking driver's door and fuel filler flap

- ▶ Press button  once.



Global unlocking

- ▶ Press button  twice.

Global locking

- ▶ Press button .

Restoring to factory setting

- ▶ Press and hold buttons  and  simultaneously for about six seconds until battery check lamp **5** blinks twice.

Warning!



When leaving the vehicle, always remove the key from the starter switch, take the KEYLESS-GO* card with you and lock the vehicle. Do not leave children unattended in the vehicle, or with access to an unlocked vehicle. It is possible for children to open a locked door from the inside, which could result in an accident and/or serious injury.

Locking and unlocking





If you can no longer lock or unlock the vehicle with the key, then either the batteries in the SmartKey are discharged or the key is malfunctioning.

- Check the batteries in the key and replace them if necessary (▷ page 299).
or
- Use the mechanical key to unlock the doors (▷ page 297) and trunk (▷ page 298) as required. Lock the vehicle using the mechanical key (▷ page 298).

If the key is malfunctioning, contact an authorized Mercedes-Benz Center.

Checking the batteries

- ▶ Press button  or .

Battery check lamp **5** lights up briefly to indicate that the key batteries are in order.



If battery check lamp **5** does not light up briefly during check, then the key batteries are discharged.

Replace the batteries (▷ page 299).

You can obtain the required batteries at any authorized Mercedes-Benz Center.

Unlocking the trunk lid

You can unlock the trunk separately.

A minimum height clearance of 6.1 ft (1.90 m) is required to open the trunk lid.

- ▶ Press and hold button  until trunk unlocks.



The trunk lid swings open automatically. Always make sure that there is sufficient overhead clearance.



If the vehicle was previously centrally locked with the SmartKey, the trunk lid will lock automatically after closing it.

The turn signals will flash three times to confirm locking.

If the trunk was previously separately locked (▷ page 90), the trunk lid will remain locked.

Loss of SmartKey or mechanical key

If you lose a SmartKey or mechanical key, you should do the following:

- ▶ Have the SmartKey deactivated by an authorized Mercedes-Benz Center.
- ▶ Report the loss of the SmartKey or the mechanical key immediately to your car insurance company.
- ▶ If necessary, have the mechanical lock replaced.

Your authorized Mercedes-Benz Center will be glad to supply you with a replacement.

KEYLESS-GO card*

Specially equipped vehicles come with two KEYLESS-GO cards. On these vehicles, the validity of the KEYLESS-GO card is checked every time you grasp a door handle.

If the card is valid, your vehicle unlocks

- the doors
- the trunk lid
- the fuel filler flap

Warning!

When leaving the vehicle, always remove the key from the starter switch, take the KEYLESS-GO card with you and lock the vehicle. Do not leave children unattended in the vehicle, or with access to an unlocked vehicle. Unsupervised use of vehicle equipment may cause an accident and/or serious personal injury.



To prevent possible malfunction, avoid exposing the KEYLESS-GO card to high levels of electromagnetic radiation.

Important notes on using KEYLESS-GO

- Always carry the KEYLESS-GO card with you.
- Never store the KEYLESS-GO card together with:
 - Electronic items such as a cellular phone or another KEYLESS-GO card
 - Metallic objects such as coins or metal foil

Doing so could impair the function of the KEYLESS-GO system.

- Always take an electronic SmartKey with you in case of a malfunction of the KEYLESS-GO system.
- To lock or unlock the vehicle, the card must be located outside the vehicle within approximately 3 ft. (1 m) of a door or the trunk lid.

- In order to start the engine with the KEYLESS-GO card:
 - The KEYLESS-GO card must be located in the vehicle.
 - All the doors must be closed.
- If you have started the engine with the KEYLESS-GO start / stop button, you can only turn it off again with this button, even if you have put the key in the starter switch in the meantime.
- This does not apply if, after starting, the selector lever is still in position **P**. The key will then have priority over the card and the vehicle's electrical system will operate according to the position of the key in the starter switch, even stopping the engine.
- If the KEYLESS-GO card is positioned farther away from the vehicle (e.g. inside clothing or briefcase) and can no longer be recognized by the system, the vehicle cannot be locked or the engine started via the KEYLESS-GO system.

Locking and unlocking

- If the KEYLESS-GO card is removed from the vehicle while the ignition is switched on (e.g. if passenger exits the vehicle with the card), the message **CHIP CARD NOT RECOGNIZED!** will appear in the multifunction display.

Find the card or change its present location immediately (e.g. place it on the front passenger seat or insert it in shirt pocket).

- Remember that the engine can be started by anyone with a KEYLESS-GO card that is left inside the vehicle. If you leave the card behind when exiting and locking the vehicle, the message **CHIP CARD DETECTED IN VEHICLE!** will appear in the multifunction display.

Factory setting

Global unlocking

- ▶ Grasp the door handle.

The vehicle will lock again automatically within approximately 40 seconds of unlocking if neither door nor trunk is opened.



The vehicle could inadvertently unlock if the KEYLESS-GO card is within 3 ft. (1 m) of the vehicle and

- the door handle is splashed with water, or
- you attempt to clean the door handle.

Global locking

- ▶ Press lock button at door handle (▷ page 52) or trunk (▷ page 86) and (▷ page 93).

Individual setting

If you frequently travel alone, you may wish to reprogram the KEYLESS-GO card so that grasping a door handle only unlocks the driver's door, interior lockable storage compartments and the fuel filler flap.



- 1 Programming button
- 2 “Driver’s door” symbol
- 3 “Global unlock” symbol

- ▶ Press and hold the programming button **1** until the “Driver’s door” symbol **2** lights up.

The KEYLESS-GO card will then function as follows:

Unlocking the driver’s door

- ▶ Grasp the driver’s door handle.

Global unlocking

- ▶ Grasp the door handle on the passenger side.

Global locking

- ▶ Press lock button at door handle or trunk.

Restoring to factory setting

- ▶ Press and hold the programming button **1** until the “Global unlock” symbol **3** lights up.



If you cannot lock or unlock the vehicle with the KEYLESS-GO card, then either the batteries of the KEYLESS-GO card are discharged or the KEYLESS-GO card is malfunctioning or the vehicle battery is drained.

- Check the batteries of the KEYLESS-GO card (▷ page 85) and replace them if necessary (▷ page 299).
- or
- Use the mechanical key to unlock the doors (▷ page 297) and trunk (▷ page 298) as required. Lock the vehicle using the mechanical key (▷ page 298).

If your KEYLESS-GO card is malfunctioning, contact your authorized Mercedes-Benz Center.

Checking the batteries

- ▶ Briefly press the programming button **1**.

The KEYLESS-GO card batteries are in order if the indicator lamp for either the “Driver’s door” **2** or “Global unlock” **3** comes on red or green.



If the symbols **2** or **3** do not light up during the check, then the batteries of the KEYLESS-GO card are discharged.

- Change the batteries (▷ page 299).

You can obtain the batteries at any authorized Mercedes-Benz Center.

Locking and unlocking

Checking vehicle lock status

If you cannot remember whether you have locked the vehicle, you can check the lock status using the KEYLESS-GO card.

- ▶ Briefly press programming button **1**.

The indicator lamp for “Driver’s door” **2** or “Global unlock” **3** lights up in red or green.

Vehicle lock status:

Red Vehicle is locked

Green Vehicle is unlocked



When the vehicle is unlocked and the anti-theft alarm system is switched off, the turn signals illuminate briefly. If it is dark, the locator lighting also switches on (▷ page 137).

When the vehicle is locked and the anti-theft alarm system is activated, the the turn signals flash three times.

Locking the vehicle

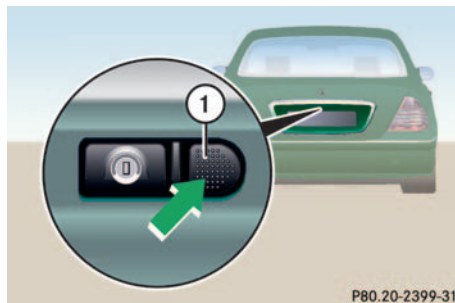

1 Trunk lock button

- ▶ Press the lock button at door (▷ page 52) or trunk **1**.

Closing the side windows and the sliding / pop-up roof

- ▶ Press and hold lock button at door (▷ page 52) until the side windows and the sliding / pop-up roof are closed.

Warning!



When closing the windows and the sliding / pop-up roof, make sure that there is no danger of anyone being harmed by the closing procedure.

If potential danger exists, proceed as follows:

- Release the lock button.
- Pull on the door handle and hold firmly. The side windows and the sliding / pop-up roof will open for as long as the door handle is held but the door not opened.

Unlocking the trunk lid

The trunk lid lock is located in the rear license plate recess.

A minimum height clearance of 6.1 ft (1.90 m) is required to open the trunk lid.

- ▶ Press trunk lid lock **1** (▷ page 89)



The trunk lid swings open automatically. Always make sure that there is sufficient overhead clearance.



If the vehicle was previously centrally locked, the trunk lid will lock automatically after closing it. The turn signal will flash three times to confirm locking.

To prevent a possible inadvertent lock-out, the trunk lid will open automatically if a KEYLESS-GO card is recognized in the area of the rear shelf or inside the trunk.

Loss of the KEYLESS-GO card

If you lose your KEYLESS-GO card, you should do the following:

- ▶ Have the KEYLESS-GO card deactivated by an authorized Mercedes-Benz Center.
- ▶ Report the loss immediately to your car insurance company.
- ▶ Have the mechanical lock replaced if necessary.

Your authorized Mercedes-Benz Center will be glad to supply you with a replacement.

Opening the doors from the inside

You can open a locked door from the inside. Open door only when conditions are safe to do so.

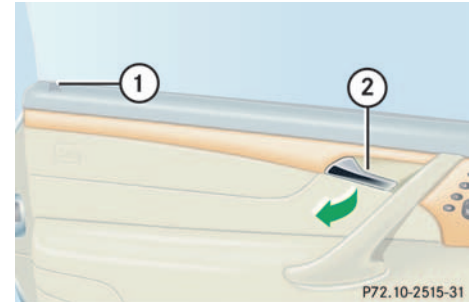

- 1** Locking knob
- 2** Inside door handle

- ▶ Pull on door handle **2**.



If door was locked, locking knob **1** will move up.

Locking and unlocking



If the vehicle has previously been locked from the outside with the SmartKey, opening a door from the inside will trigger the anti-theft alarm system.

To cancel the alarm, do one of the following:

- Press button  or  on the SmartKey.
- Insert the SmartKey in the starter switch.



If you open a door, the side windows on that side of the vehicle will lower slightly. The windows close again when you close the door.

Opening the trunk lid from the inside

You can open the trunk from the inside if the vehicle is stationary.

A minimum height clearance of 6.1 ft (1.90 m) is required to open the trunk lid.

The switch is located on the driver's door.

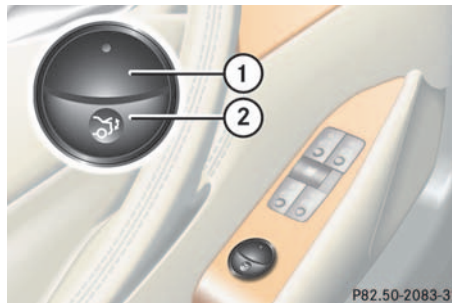

- 1 Indicator lamp
- 2 Remote trunk lid release switch

- ▶ Pull remote trunk lid release switch **2**.

The trunk opens. The indicator lamp **1** comes on. It remains lit until you close the trunk again.



The trunk lid swings open automatically. Always make sure that there is sufficient overhead clearance.

The trunk can also be opened from the inside in an emergency, see “Trunk lid emergency release” (▷ page 89).

Opening the trunk lid from the outside

The trunk lid lock is located in the rear license plate recess.

A minimum height clearance of 6.1 ft (1.90 m) is required to open the trunk lid.

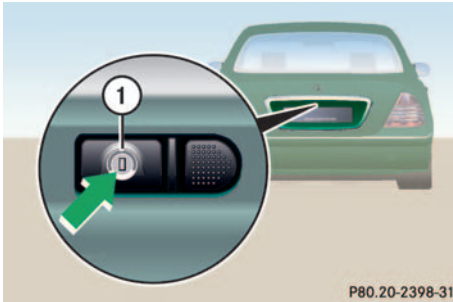

- ▶ Press trunk lid lock **1**.

The trunk lid swings open. Always make sure that there is sufficient overhead clearance.



The vehicle must be unlocked.

The trunk can also be opened from the inside of the trunk in an emergency, see “Trunk lid emergency release” (▶ page 89).

Trunk lid emergency release



The emergency release button is located in the trunk lid.

Illumination of the emergency release button:

- The button will blink for 30 minutes after opening the trunk.
- The button will blink for 60 minutes after closing the trunk.

- ▶ Briefly press the emergency release button.



The trunk unlocks and the trunk lid opens.



The emergency release button does not open the trunk lid if the vehicle battery is discharged or disconnected.



If the emergency release button is pressed and the vehicle was centrally locked, the exterior lamps will flash and the alarm will sound as the trunk lid opens.

To cancel the alarm, insert the key in the starter switch or press button  or  on the key.

Locking and unlocking

Closing the trunk lid



1 Handle

- ▶ Lower trunk lid by pulling firmly on handle 1.
- ▶ Push the trunk lid closed from the outside with hands placed flat on trunk lid.

The power closing assist automatically ensures that the lid is pulled completely closed (▶ page 94).

Warning!



To prevent possible personal injury, always keep hands and fingers away from the trunk lid opening when closing the trunk. Be especially careful when small children are around.

Warning!



Only drive with the trunk closed as, among other dangers such as visibility blockage, exhaust fumes may enter the vehicle interior.



To prevent an inadvertent lockout, do not place the key in the trunk.

Vehicles with KEYLESS-GO*: To prevent a possible inadvertent lockout, the trunk lid will open automatically if a KEYLESS-GO card is recognized in the area of the rear shelf or inside the trunk.

Separately locking the trunk

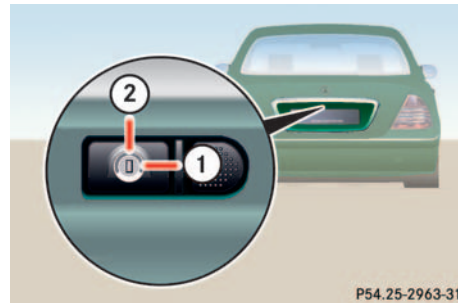

1 Locked

2 Unlocked

- ▶ Close the trunk lid.



- ▶ Pull the mechanical key out of the SmartKey (▷ page 297).
- ▶ Insert the mechanical key into the trunk lid lock.
- ▶ Turn the key completely to the right to position **1**.

The trunk remains locked even when the vehicle is centrally unlocked.



You can only cancel the separate trunk locking mode by means of the mechanical key.

Separately unlocking the trunk

- ▶ Turn the key completely to the left to position **2**.
You can now open the trunk.

Trunk lid opening/closing system*

You can open or close the trunk lid from the inside if the vehicle is stationary.

A minimum height clearance of 6.1 ft (1.90 m) is required to open the trunk lid.

Opening from the inside

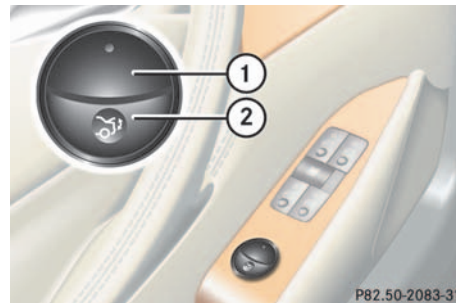

- 1** Indicator lamp
- 2** Remote trunk lid switch

- ▶ Pull remote trunk lid switch **2**.

The trunk opens. The indicator lamp **1** comes on. It remains lit until you close the trunk again.



The trunk lid swings open automatically. Always make sure that there is sufficient overhead clearance.



The vehicle must be unlocked.

If the trunk lid does not open, it is still locked separately (▷ page 91).

The trunk can also be opened from the inside in an emergency, see “Trunk lid emergency release” (▷ page 89).

You can stop the opening procedure as follows:

- ▶ Press the remote trunk lid switch **2**.

The trunk lid stops moving.

Locking and unlocking

Closing from the inside

- ▶ Press the remote control switch **2** until the indicator lamp in the switch goes out and the trunk lid is closed.

To interrupt the closing procedure:

- ▶ Release remote trunk lid switch **2**.

Warning!



Maintain sight of trunk area while operating the door mounted switch. Monitor the closing procedure carefully to ensure that no one is in danger of being injured.

To interrupt the closing procedure, release the door mounted remote trunk lid switch.

If the trunk lid comes into contact with an object while closing (e.g. luggage that has been piled too high) in the upper motion sequence, the closing procedure is stopped and the trunk re-opens slightly.

Closing from the outside

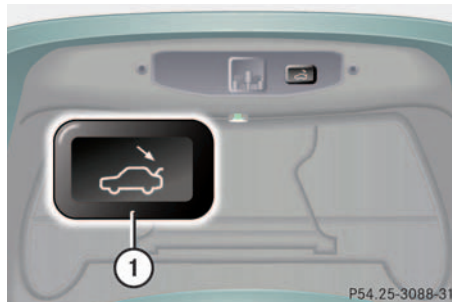

1 Trunk lid closing switch

- ▶ Press the trunk lid closing switch **1** briefly.

The trunk lid closes automatically.

If the trunk lid comes into contact with an object while closing (e.g. luggage that has been piled too high) in the upper motion sequence, the closing procedure is stopped and the trunk re-opens slightly.

Warning!



Monitor the closing procedure carefully to ensure that no one is in danger of being injured. To prevent possible personal injury, always keep hands and fingers away from the trunk opening when closing the trunk. Be especially careful when small children are around. To stop the closing procedure, press the remote trunk lid switch (on driver's door control panel), the trunk lid closing switch **1** or the  button on the Smart-Key.



Do not place the key in the open trunk. You may lock yourself out.

Vehicles with KEYLESS-GO*: To prevent a possible inadvertent lockout, the trunk lid will open automatically if a KEYLESS-GO card is recognized in the area of the rear shelf or inside the trunk.

Closing and locking the trunk lid with KEYLESS-GO*

On vehicles with trunk lid opening/closing system and KEYLESS-GO, you can close the trunk lid and lock the vehicle simultaneously.

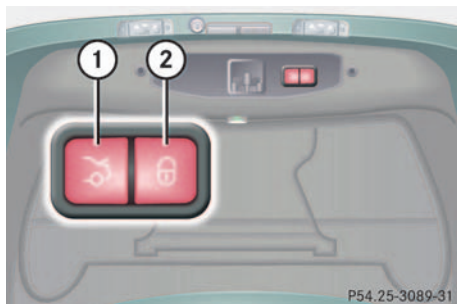

- 1 Trunk lid closing switch
- 2 KEYLESS-GO switch

- ▶ Make sure that you have the SmartKey and the KEYLESS-GO card with you.
- ▶ Press switch **2** in the trunk lid.

The trunk lid closes automatically and the vehicle is locked. The turn signals flash three times to confirm locking.



To prevent a possible inadvertent lock-out, the trunk lid will open automatically if a KEYLESS-GO card is recognized in the area of the rear shelf or inside the trunk.

Warning!



Monitor the closing procedure carefully to ensure that no one is in danger of being injured. To prevent possible personal injury, always keep hands and fingers away from the trunk opening when closing the trunk. Be especially careful when small children are around. To stop the closing procedure, press the trunk lid closing switch **1** in the trunk lid, the  button on the SmartKey or the remote trunk lid switch (on driver's door control panel).

Limiting opening height of trunk lid

The trunk lid opening height can be limited when transporting goods on a roof rack

(e.g. presence of an MB sport luggage container). When activated, the trunk lid opens to approximately the height of the roof edge.

- ▶ With the trunk lid closed, press the remote trunk lid switch and hold for at least five seconds (▷ page 91).

Depending on its previous status, the opening height restriction is then switched on or off.



If the trunk lid comes into contact with an object while closing (e.g. luggage that has been piled too high), the closing procedure is stopped and the trunk re-opens slightly.

The closing procedure can be stopped at anytime by once again pressing the trunk lid closing switch in the trunk lid or the remote control switch in the driver's door or the  button on the SmartKey.

Locking and unlocking

Power closing assist for doors and trunk lid

Power closing assist for doors

- ▶ Press the doors gently past the initial engage position into the lock.

The doors close automatically.

Power closing assist for trunk lid

- ▶ Press the trunk lid gently into its lock.

The trunk closes automatically.

It is not necessary to slam the door or trunk lid closed. A pneumatic power-assisted mechanism draws doors and trunk lid closed quietly and automatically once the door or trunk lid has been latched. When the pneumatic power-assist and mechanism has stopped, doors and /or trunk can be re-opened.

Warning!



To prevent possible personal injury, always keep hands and fingers away from the door or trunk opening when closing a door or the trunk lid. Be especially careful when small children are around.

The pneumatic power closing assist mechanism cannot be stopped once it has been engaged.

To prevent personal injury, never activate the closing assist mechanism by tampering with the door or trunk lid latch.

Automatic central locking

The doors and the trunk automatically lock when the ignition is switched on and the wheels are turning at speeds of approximately 9 mph (15 km/h) or more.

You can open a locked door from the inside. Open door only when conditions are safe to do so.



The doors unlock automatically after an accident if the force of the impact exceeds a preset threshold.

The vehicle automatically locks when the ignition is switched on and the wheels are turning at speeds of approximately 9 mph (15 km/h) or more. You could therefore lock yourself out when the vehicle

- is pushed
- is on a test stand

You can deactivate the automatic locking using the control system (▷ page 139).

Locking and unlocking from the inside

You can lock or unlock the doors and the trunk from inside using the central locking switch. This can be useful, for example, if you want to lock the vehicle before starting to drive.

The fuel filler flap cannot be locked or unlocked with the central locking switch.

Warning!



When leaving the vehicle, always remove the key from the starter switch, take the KEYLESS-GO* card with you and lock the vehicle. Do not leave children unattended in the vehicle, or with access to an unlocked vehicle. Unsupervised use of vehicle equipment may cause an accident and/or serious personal injury.

The switches are located in the center console.



Central locking/unlocking switches

- 1 Central locking switch
- 2 Central unlocking switch

Locking

- ▶ Press central locking switch **1**.
If both doors are closed, the vehicle locks.

Unlocking

- ▶ Press central unlocking switch **2**.
The vehicle unlocks.



You can open a locked door from the inside. Open door only when conditions are safe to do so.

If the vehicle was previously centrally locked with the SmartKey or the KEYLESS-GO* card it will not unlock using the central locking switch.

If the vehicle was previously locked with the central locking switch:

- While in the global remote control mode, the complete vehicle is unlocked when a door is opened from the inside.
- While in the selective remote control mode, only the door opened from inside is unlocked.

Seats

Seats

Information on seat adjustment can be found in the “Getting started” section (▷ page 34).

Lumbar support

You can adjust the contour of the seat’s lumbar support to best support your back.

The thumbwheels for the driver’s and front passenger’s seat are on the inner side of the seat.

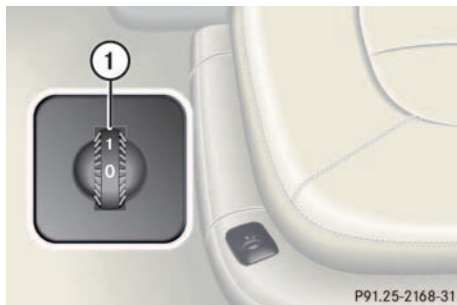

1 Thumbwheel

- ▶ Make sure the ignition is switched on. All the lamps in the instrument cluster should light up.
- ▶ Set the lumbar support between 0 and 5.

Easy-entry / exit feature

With the easy-entry / exit feature activated, the steering wheel tilts upwards and the driver’s seat moves to the rear.

This allows easier entry into and exit from the vehicle when the driver’s door is opened. However, the engine must be turned off.

When the SmartKey is inserted in the starter switch or you have pressed the KEYLESS-GO* start / stop button once and the driver’s door is closed, the steering wheel and the driver’s seat return to their last set positions.

Warning!



You must make sure that no one can become trapped or injured by the moving steering wheel and driver’s seat when the easy-entry / exit feature is activated, the driver’s door is being opened, and the engine is turned off or the SmartKey removed from the starter switch. Do not leave children unattended in the vehicle, or with access to an unlocked vehicle. Unsupervised use of vehicle equipment may cause an accident and/or serious personal injury.

You can activate the following functions:

- Steering column:
 - Only the steering column is adjusted.
- Steering column and seat:
 - Both the steering column and the seat are adjusted.

The easy-entry / exit feature can be switched on or off in the in the settings menu of the control system (▷ page 140).

Head restraints

Information on head restraint adjustment can be found in the “Getting started” section (▷ page 36).

Warning!



For your protection, drive only with properly positioned head restraints.

Adjust head restraint to support the back of the head approximately at ear level.

Do not drive the vehicle without the seat head restraints. Head restraints are intended to help reduce injuries during an accident.



Tilt the seat backrest to the rear for easier removal and installation of the head restraints.

Front seat head restraints

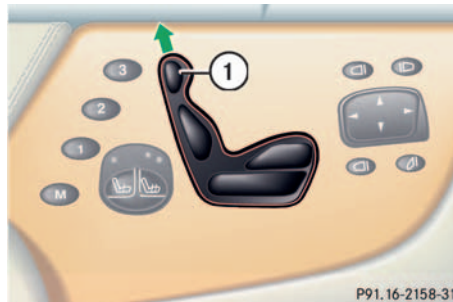

Removing front head restraints

- ▶ Press switch **1** upwards and hold until the head restraint is fully extended.
- ▶ Pull out head restraint.

Installing front head restraints:

- ▶ Press switch **1** upwards and hold for about five seconds.
- ▶ Push the head restraint down until it engages.
- ▶ Adjust head restraint to desired position (▷ page 35).

Rear seat head restraints

Warning!



For safety reasons, always drive with the rear head restraints in the upright position when the rear seats are occupied.

Keep the area around head restraints clear of articles (e.g. clothing) to not obstruct the folding operation of the head restraints.



You can adjust the angle manually by pulling or pushing the head restraints by hand.

Folding rear head restraints back

- ▶ Make sure the ignition is switched on.
- All the lamps in the instrument cluster should light up. ▷▷

Seats



- ▶ Press switch **1**.

The rear head restraints will fold backward.

Placing rear head restraints upright

- ▶ Pull the rear head restraint upright until it locks into position.



Make sure that the head restraints engage when adjusting them manually. Otherwise, their protective function cannot be assured.

Head restraint tilt

The rear head restraint angle can be adjusted manually.

Power head restraints, rear*

You can fold the rear head restraints backward or upright using the head restraint folding switch. The switch is located:

- on the front center console:
 - ▶ Make sure the ignition is switched on.
All the lamps in the instrument cluster should light up
 - ▶ Press switch **1** briefly.
The rear head restraints will fold backward.
 - ▶ Press switch **1** and hold.
The rear head restraints will fold upright.

- on the rear center console:

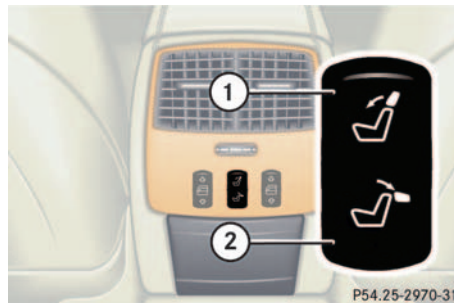

- ▶ Make sure the ignition is switched on.
All the lamps in the instrument cluster should light up
- ▶ Push upper half **1** of switch.
The rear head restraints will fold upright.
- ▶ Push lower half **2** of switch.
The rear head restraints will fold down.

Multicontour seat*

The multicontour seat has a movable seat cushion and inflatable air cushions built into the seat backrest to provide additional lumbar and side support.

The seat cushion movement, seat backrest cushion height and curvature can be continuously varied with regulators on the right side of the seat after turning the SmartKey in the starter switch to position **2** or pressing the KEYLESS-GO* start / stop button twice.

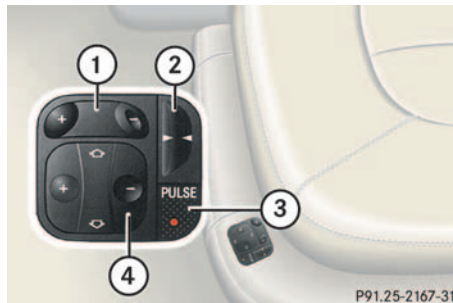

- 1 Shoulder region support
- 2 Side bolster adjustment
- 3 Massage function (PULSE)
- 4 Lumbar region support

Adjusting the multicontour seat in the order listed above is recommended.

- ▶ Make sure the ignition is switched on.
All lamps in the instrument cluster light up.

Shoulder region support

- ▶ Press **+** or **-** on switch 1.
The air cushion inflates or deflates.

Lumbar region support

- ▶ Press **↙** or **↘** on rocker switch 4.

This selects the air cushion you wish to adjust.

- ▶ Press **+** or **-** on rocker switch 4.

The air cushion inflates or deflates.

Side bolsters adjustment

- ▶ Adjust the side bolsters so that they provide good lateral support using switch 2.



When the engine is turned off, the last cushion setting is retained in memory, and the cushion is automatically adjusted to this setting when the engine is restarted.

Seats

Massage function (PULSE)

You can reduce muscle tension during long trips by periodically using the massage function.

- ▶ Press button **3**.

The indicator lamp on button **3** lights up. The air cushions in the lumbar region inflate and deflate rhythmically.



The massage function switches off automatically after approximately eight minutes. The indicator lamp goes out.

Folding forward front seat backrests

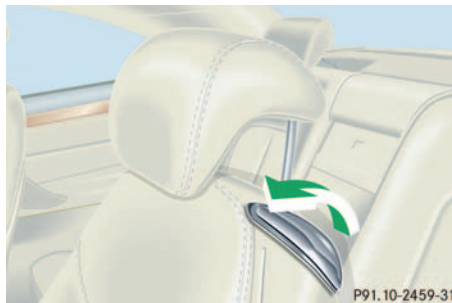

Folding seat backrests forward

- ▶ Lift release lever and fold backrest forward.

The seat will automatically slide forward and the head restraint will move down.



The head restraint is automatically lowered.

Folding seat backrests to the rear

- ▶ Lift release lever and fold backrest back.

The seat and head restraint return to their previous positions.

To interrupt the procedure, activate the seat adjustment switch (▷ page 35).



When moving the seat, be sure that there are no items in the footwell or behind the seats. Otherwise you could damage the seats.

Warning!



Always ensure that no one can become trapped or injured when the seat is moving. In case potential danger exists, the procedure can be interrupted by moving the seat adjustment switch (▷ page 35) in the door control panel.

Warning!

The seat belts provide protection only with the backrest locked in place and, therefore, must be locked in place with the vehicle in motion. Do not drive the vehicle when the backrest is not locked in place. If the warning message SEAT BACKREST, RIGHT - LOCK or SEAT BACKREST, LEFT - LOCK is displayed in the multifunction display, then the respective backrest is not engaged in its lock. Carefully slow down, and drive with caution to an area which is in a safe distance from the roadway. Always provide sufficient room behind the backrest and fold the backrest all the way back until it locks in place.

Keep the area around head restraints clear of articles (e.g. clothing) to not obstruct the folding operation of the head restraints.

The warning message is no longer displayed as soon as the backrest is locked in place. If both backrests are locked in place and the warning message is still displayed, have the

system checked at your authorized Mercedes-Benz Center immediately.

When leaving the vehicle, always remove the electronic key from the starter switch, take the KEYLESS-GO* card with you, and lock your vehicle.

The power seats can also be operated with the driver's or passenger door open. Do not leave children unattended in the vehicle or with access to an unlocked vehicle. Unsupervised use of vehicle equipment may cause an accident and/or serious personal injury.

Never place hands under seat or near any moving parts during a seat adjustment procedure.



The automatic seat slide is provided with a safety feature.

The automatic process is interrupted, if the backrest of the sliding seat is pushed against an occupant or object. The seat will slide forward and stop.

Investigate and correct the cause of interruption.

Now use memory button (▷ page 105) or seat adjustment switch (▷ page 35) to bring seat into desired position.

When folding the backrest forward from a reclined position, and then folding it back, the backrest stops in a more upright position for the safety of any rear-seat passenger. Adjust the backrest until your arms are slightly angled when holding the steering wheel (▷ page 35).

Seats

Seat ventilation*

The switch is located on the door. Seat ventilation can be activated manually with the electronic key in starter switch position 1 or 2, or by the summer opening feature (▷ page 171). The blue indicator lamps on the switch show the ventilation level selected:

Level	
3	Three indicator lamps on
2	Two indicator lamps on
1	One indicator lamp on
off	No indicator lamp on

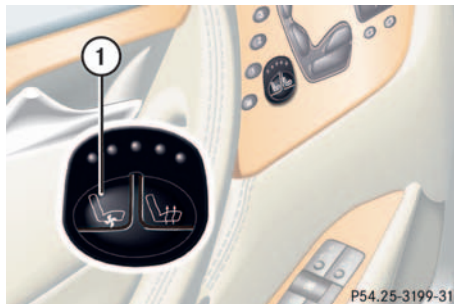

1 Seat ventilation switch

- ▶ Make sure the ignition is switched on.
All lamps in the instrument cluster light up.

Switching on seat ventilation

- ▶ Press switch **1**.
Three blue indicator lamps above the switch light up.
- ▶ Continue pressing switch **1** until the desired seat ventilation level is reached.

Switching off seat ventilation

- ▶ Press switch **1** repeatedly until all indicator lamps go out.



The seat ventilation is automatically set to the highest level if activated via summer opening feature (▷ page 171).



If one or all of the lamps blink on the seat ventilation switch, there is insufficient voltage due to too many electrical consumers being switched on. The seat ventilation switches off automatically.

The seat ventilation will switch back on again automatically as soon as sufficient voltage is available.

Seat heating

Vehicles without seat ventilation*

The switch is located on the door.

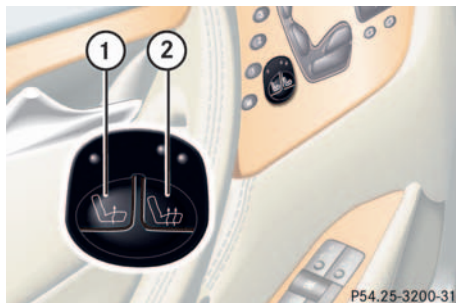

1 Normal heating

2 Rapid heating

- ▶ Make sure the ignition is switched on.
All the lamps in the instrument cluster light up.

Switching on seat heating

- ▶ Press switch **1**.

A red indicator lamp above the switch lights up.

Switching off seat heating

- ▶ Press switch **1** again.



The seat heating will be automatically switched off after approximately 30 minutes.

Rapid seat heating mode

- ▶ Press switch **2**.

Both red indicator lamps above the switch light up.



The system switches over to normal heating mode after approximately five minutes. Only the right-hand indicator lamp remains lit.

Switching off rapid seat heating mode

- ▶ Press switch **2** again.



If one or both of the lamps on the seat heating switch are blinking, there is insufficient voltage due to too many electrical consumers being turned on. The seat heating switches off automatically.

The seat heating will switch back on again automatically as soon as sufficient voltage is available.

Seats

Vehicles with seat ventilation*

The switch is located on the door. The red indicator lamps on the switch show the heating level selected:

Level	
2	Two indicator lamps on
1	One indicator lamp on
off	No indicator lamp on

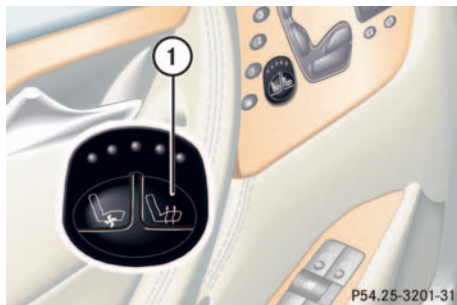

1 Seat heating switch

- ▶ Make sure the ignition is switched on.
All the lamps in the instrument cluster light up.

Switching on seat heating

- ▶ Press switch 1 twice.

A red indicator lamp above the switch lights up.

Switching off seat heating

- ▶ Press switch 1 again.



The seat heating will be automatically switched off after approximately 30 minutes.

Rapid seat heating

- ▶ Press switch 1 once.

Both indicator lamps above the switch light up.



The system switches over to normal heating mode after approximately five minutes. Only the right-hand indicator lamp remains lit.

Switching off rapid seat heating mode

- ▶ Press switch position 1 twice.



If one or both of the lamps on the seat heating switch are blinking, there is insufficient voltage due to too many electrical consumers are turned on. The seat heating switches off automatically.

The seat heating will switch back on again automatically as soon as sufficient voltage is available.

Memory function



Prior to operating the vehicle, the driver should check and adjust the seat height, seat position fore and aft, and seat backrest angle if necessary, to ensure adequate control, reach and comfort. The head restraint should also be adjusted for proper height. Also see “Airbag” section (▷ page 55) for proper seat positioning.

In addition, adjust the steering wheel to ensure adequate control, reach, operation and comfort. Both the inside and outside rear view mirrors should be adjusted for adequate rear vision.

Fasten seat belts. Infants and small children should be seated in a properly secured restraint system that complies with U.S. Federal Motor Vehicle Safety Standards 213 and 225 and Canadian Motor Vehicle Safety Standards 213 and 210.2.

The memory button and stored position switch are located on the door.

You can store up to three different settings per SmartKey or KEYLESS-GO* card.

The following settings are saved for each stored position:

- Driver’s seat and seat backrest position
- Settings for multicontour seat*
- Steering wheel position
- Inside rear view mirror position
- Exterior rear view mirror position
- Automatic climate control

These key dependent memory settings can be deactivated if desired (▷ page 140).

Warning!



Do not activate the memory function while driving. Activating the memory function while driving could cause the driver to lose control of the vehicle.



1, 2, 3 Stored position button

M Memory button

- ▶ Make sure that the ignition is switched on or the relevant door is open and the SmartKey is inserted in the starter switch.

Memory function

Storing positions into memory

- ▶ Adjust the seats, steering wheel and mirrors to the desired position (▷ page 34).
- ▶ Press memory button **M**.
- ▶ Release memory button **M** and push position button **1**, **2** or **3** within three seconds.

All the settings are stored at the selected position.

Recalling positions from memory

- ▶ Press and hold position button **1**, **2** or **3** until the seat, steering wheel and mirrors have fully moved to the stored positions.



Releasing the button immediately stops movement to the stored positions.

Warning!



Do not operate the power seats using the memory button if the seat backrest is in an extremely reclined position. Doing so could cause damage to front or rear seats.

First move seat backrest to an upright position.

Storing exterior rear view mirror parking position

For easier parking you can adjust the passenger exterior rear view mirror so that you can see the right rear wheel as soon as you engage reverse gear **R**.

For information on activating the parking position, see “Setting parking position for exterior rear view mirror” (▷ page 142).



You can store a parking position for the passenger-side exterior rear view mirror for each key or KEYLESS-GO* card.

The buttons are located on the driver’s door.

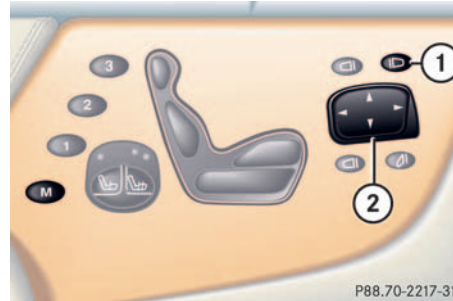

- 1 Exterior rear view mirror
- 2 Adjustment button
- M Memory button

- ▶ Stop the vehicle.
- ▶ Switch ignition on (if not already on).
- ▶ Press button 1.

The passenger-side exterior rear view mirror is selected.

- ▶ Adjust the exterior rear view mirror with button **2** so that you see the rear wheel and the road curb.
- ▶ Press memory button **M**.
- ▶ Within three seconds, press bottom of adjustment button **2**.

The parking position is stored if the mirror does not move.



If the mirror does move, repeat the above steps. After the setting is stored you can move the mirror again.

Lighting



Lighting

For notes on how to switch on the headlamps and use the turn signals, see the “Getting started” section (▷ page 46).

Exterior lamp switch

The exterior lamp switch is located on the dashboard to the left of the steering wheel.



- 0** Off
- AUTO** Automatic headlamp mode
-  Parking lamps (also side marker lamps, tail lamps, license plate lamps, instrument panel lamps)
Canada only: When engine is running, the low beams are also switched on.
-  Low beam plus parking lamps or high beam headlamps (combination switch pushed forward).
- P** → Standing lamps, right (turn left one stop)
- ← P** Standing lamps, left (turn left two stops)

i

If you remove the key and open the driver's door while the parking lamps or low beam headlamps are switched on, then

- a warning sounds
-  appears in the multifunction display
- the message **TURN OFF LIGHTS!** appears in the multifunction display

i

With the daytime running lamp mode activated and the engine running, the low beam headlamps cannot be switched off manually.

Manual headlamp mode

The low beam headlamps and parking lamps can be switched on and off with the exterior lamp switch. For exterior lamp switch, see (▷ page 108).

Automatic headlamp mode

The parking lamps, low beam headlamps and license plate lamps switch on and off automatically depending on the brightness of the ambient light.

- ▶ Turn the exterior lamp switch to **AUTO**.



With the daytime running lamp mode activated, the low beam headlamps will not switch off automatically.



Front fog lamps and rear fog lamp can not be switched on manually with exterior lamp switch in position **AUTO**. To activate the fog lamps, turn exterior lamp switch to position  and pull the exterior lamp switch to first or second stop (▷ page 110).

Warning!



In automatic headlamp mode, the headlamps will not be automatically switched on under foggy conditions. To minimize risk to you and to others, activate headlamps by turning exterior lamp switch to .

The driver is responsible for the operation of the vehicle's lights at all times. The automatic headlamp feature is only an aid to the driver. Switch on the vehicle lights manually when driving or when traffic conditions require you to do so.



If you drive in countries where vehicles drive on the other side of the road than the country where the vehicle is registered, you must have the headlamps modified for symmetrical low beams. Relevant information can be obtained at your authorized Mercedes-Benz Center.

Lighting

Daytime running lamp mode

- ▶ Turn exterior lamp switch to position **0** or **AUTO**.

When the engine is running, the low beam headlamps are automatically switched on. In low ambient light conditions the parking lamps will also switch on.

Canada only

When you shift from a driving gear to position **N** or **P**, the low beam switches off (with a three-minute delay).

For nighttime driving you should turn the exterior lamp switch to position  to permit activation of the high beam headlamps.

USA only

The high beam headlamps can also be activated when driving with the daytime running lamp mode activated and exterior lamp switch in position **0**.

To activate the daytime running lamp mode, see “Setting daytime running lamp mode” (▷ page 136).



See notes on the exterior lamp switch (▷ page 108).

Locator lighting and night security illumination

Locator lighting and night security illumination are described in the control system section under “Setting locator lighting” (▷ page 136) and “Setting night security illumination” (▷ page 137).

Switching on front fog lamps

- ▶ Make sure that the low beam headlamps are switched on.
- ▶ Pull out exterior lamp switch to first stop.

The green indicator lamp  in the lamp switch lights up.



Fog lamps will operate with the parking lamps and / or the low beam headlamps on. Fog lamps should only be used in conjunction with low beam headlamps. Consult your State or Province Motor Vehicle Regulations regarding permissible lamp operation.

Switching on rear fog lamp

- ▶ Make sure that the low beam headlamps are switched on.
- ▶ Pull out exterior lamp switch to second stop.

The yellow indicator lamp  in the lamp switch lights up.

Combination switch

The combination switch is located on the left side of the steering column.

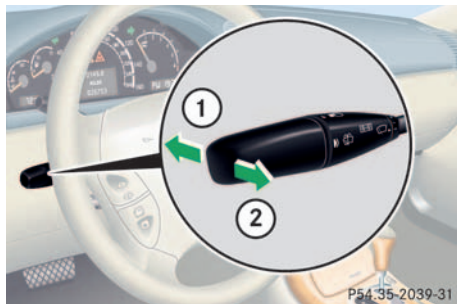

- 1 High beam
- 2 High beam flasher

Switching on high beams

- ▶ Turn exterior lamp switch to position  (▷ page 108).
- ▶ Push the combination switch in direction 1.

The high beam symbol  is illuminated on the instrument cluster.

High beam flasher

- ▶ Pull the combination switch briefly in direction 2.

Hazard warning flasher

The hazard warning flasher can be activated with the ignition switched on or off. It is activated automatically when an airbag is deployed.

The switch is located on the center console.



- 1 Hazard warning flasher switch

Switching on the hazard warning flasher

- ▶ Press the hazard warning flasher switch.

All turn signals will blink.



With the hazard warning flasher activated and the combination switch set for either left or right turn, only the respective left or right turn signal will operate when the key in the starter switch is in position 1 or 2.

Switching off the hazard warning flasher

- ▶ Press hazard warning flasher switch again.



If the hazard warning flasher was activated automatically, press switch 1 twice.

Lighting

Interior lighting

The controls are located in the overhead control panel.

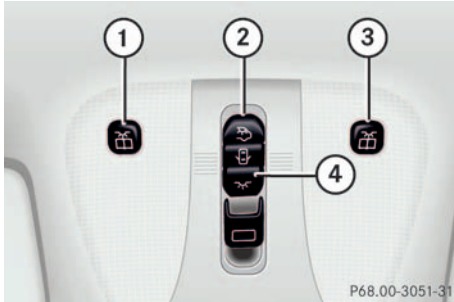

- 1 Left front reading lamp
- 2 Rear interior lights
- 3 Right front reading lamp
- 4 Rocker switch for automatic control system

Automatic control

Activating

- ▶ Press the rocker switch to the center position 4.

Interior lamps are switched on in darkness, when

- the vehicle is unlocked
- a door is opened
- the key is removed from the starter switch

The interior lamps are switched off after a set time (▶ page 138).



If the door remains open, the interior lamps switch off automatically after approximately five minutes.

Deactivating

- ▶ Press the  symbol on rocker switch 4.

The interior lighting remains switched off in darkness, even when you

- unlock the vehicle
- open a door
- remove the key from the starter switch

Manual control

Switching lamps on

- ▶ Press the  symbol on rocker switch 4.

The front interior lighting switches on.

Switching lamps off

- ▶ Press the  symbol on rocker switch 4.

The interior lighting switches off. The automatic control function is switched on.

Switching rear interior lights on

- ▶ Press switch 2.

The rear compartment lighting is switched on.

Switching rear interior lights off

- ▶ Press switch 2.

The rear compartment lighting is switched off.

Front reading lamps

Switching on

- ▶ Press switch 1 or 3.

The corresponding reading lamp is switched on.

Switching off

- ▶ Press switch 1 or 3.

The corresponding reading lamp is switched off.

Courtesy lighting

For better orientation in the dark, courtesy lamps will illuminate the interior of your vehicle as follows:

With parking lamps switched on:

- the door entry lamps
- the driver and passenger footwells

With key in starter switch position 1:

- the door entry lamps
- the center console



If you turn the key in the starter switch to position 0 and switch off the exterior headlamps, the door entry lamps will remain lit for approximately five minutes.

Instrument cluster

Instrument cluster

A full view illustration of the instrument cluster can be found in the “At a glance” section of this manual (▷ page 22).

The instrument cluster is activated when you

- open a door
- turn on the ignition
- press the reset button **R** (▷ page 22)
- switch on the exterior lamps

You can change the instrument cluster settings in the Instrument cluster submenu of the control system (▷ Seite 134).

Instrument cluster illumination

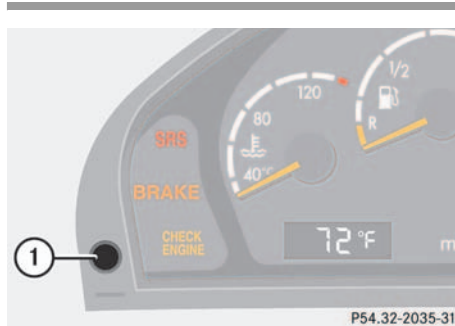

- 1** Knob for adjusting instrument cluster illumination

Use knob **1** to adjust the illumination brightness for the instrument cluster.



The instrument cluster illumination is dimmed or brightened automatically to suit ambient light conditions.

The instrument cluster illumination will also be adjusted automatically when you switch on the vehicle's exterior lamps.

- ▶ Press the knob **1**.
The knob will pop out.

To brighten illumination

- ▶ Turn the knob **1** clockwise.
The instrument cluster illumination will brighten.

To dim illumination

- ▶ Turn the knob **1** in the instrument cluster counterclockwise.
The instrument cluster illumination will dim.

Coolant temperature gauge

Warning!



- Driving when your engine is badly overheated can cause some fluids which may have leaked into the engine compartment to catch fire. You could be seriously burned.
- Steam from an overheated engine can cause serious burns and can occur just by opening the engine hood. Stay away from the engine if you see or hear steam coming from it.

Turn off the engine, get out of the vehicle and do not stand near the vehicle until it cools down.



During severe operating conditions and stop-and-go city traffic, the coolant temperature may rise close to 248° F (120°C), i.e. close to the red zone of the coolant temperature gauge.

The engine should not be operated with the coolant temperature above 248° F (120°C), i.e. in the red zone of the coolant temperature gauge. Doing so may cause serious engine damage which is not covered by the Mercedes-Benz Limited Warranty.



Excessive coolant temperatures trigger a warning in the multifunction display (▷ page 278).

Trip odometer

- ▶ Make sure you are viewing the trip odometer display.
- ▶ Press button  or  on the multifunction steering wheel repeatedly until the trip odometer appears if it is not displayed (▷ page 117).
- ▶ Press and hold the reset button  (▷ page 22) in the instrument cluster until the trip odometer is reset.

Tachometer

The red marking on the tachometer denotes excessive engine speed.



Avoid driving at excessive engine speeds, as it may result in serious engine damage that is not covered by the Mercedes-Benz Limited Warranty.

To help protect the engine, the fuel supply is interrupted if the engine is operated within the red marking.

CL 55 AMG

The tachometer of the CL 55 AMG does not have a red marking denoting excessive engine speed.

To help protect the engine, the fuel supply is interrupted if the engine is operated at an excessive engine speed.

Outside temperature indicator

Warning!



The outside temperature indicator is not designed to serve as an ice-warning device and is therefore unsuitable for that purpose.

Indicated temperatures just above the freezing point do not guarantee that the road surface is free of ice. The road may still be icy, especially in wooded areas or on bridges.

The temperature sensor is located on the lower left-hand side of the instrument cluster (▷ page 22). Due to its location, the sensor can be affected by road or engine heat during idling or slow driving. Therefore, the accuracy of the displayed temperature can only be verified by comparison to a thermometer placed next to the sensor, not by comparison to external displays (e.g. bank signs etc.).

When moving the vehicle into colder ambient temperatures (e.g. when leaving your garage), you will notice a delay before the lower temperature is displayed.

A delay also occurs when ambient temperatures rise. This prevents inaccurate temperature indications caused by heat radiated from the engine during idling or slow driving.

Control system

The control system is activated as soon as the key in the starter switch is turned to position **1**. The control system enables you to

- call up information about your vehicle
- change vehicle settings

For example, you can use the control system to find out when your vehicle is next due for service, to set the language for messages in the instrument cluster display, and much more.



The displays for the audio systems (radio, CD player) will appear in English, regardless of the language selected.

Warning!



A driver's attention to the road and traffic conditions must always be his / her primary focus when driving.

For your safety and the safety of others, selecting features through the multifunction steering wheel should only be done by the driver when traffic and road conditions permit it to be done safely.

Bear in mind that at a speed of just 30 mph (approximately 50 km/h), your vehicle is covering a distance of 44 feet (approximately 13.5 m) every second.

The control system relays information to the multifunction display.

Multifunction display

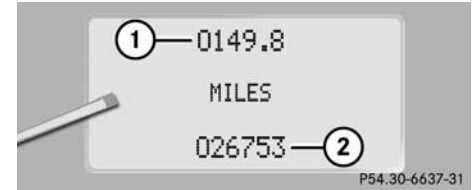

- 1 Trip odometer
- 2 Main odometer

Control system

Multifunction steering wheel

The displays in the multifunction display and the settings in the control system are controlled by the buttons on the multifunction steering wheel.



- 1 Multifunction display in the speedometer

Operating the control system

- 2 Selecting the submenu or setting the volume

 down / to decrease

 up / to increase

- 3 Telephone*

 to take a call

 to end a call

- 4 Menu systems

 for next menu

 for previous menu

- 5 Moving within a menu

 for next display





 for previous display

Pressing any of the buttons on the multifunction steering wheel will alter what is shown in the multifunction display.

The information available in the multifunction display is arranged in menus, each containing a number of functions or submenus.

The individual functions are then found within the relevant menu (radio or CD operations under **AUDIO**, for example). These functions serve to call up relevant information or to customize the settings for your vehicle.

It is helpful to think of the menus, and the functions within each menu, as being arranged in a circular pattern.

- If you press button  or  repeatedly, you will pass through each menu one after the other.
- If you press button  or  repeatedly, you will pass through each function display, one after the other, in the current menu.

In the **SETTINGS** menu, instead of functions you will find a number of submenus for calling up and changing settings. For instructions on using these submenus, see the “Settings menu” section (▷ page 131).

The number of menus available in the system depends on which optional equipment is installed in your vehicle.

The menus are described on the following pages.

Menus

This is what you will see when you scroll through the menus.

The table on the next page provides an overview of the individual menus.

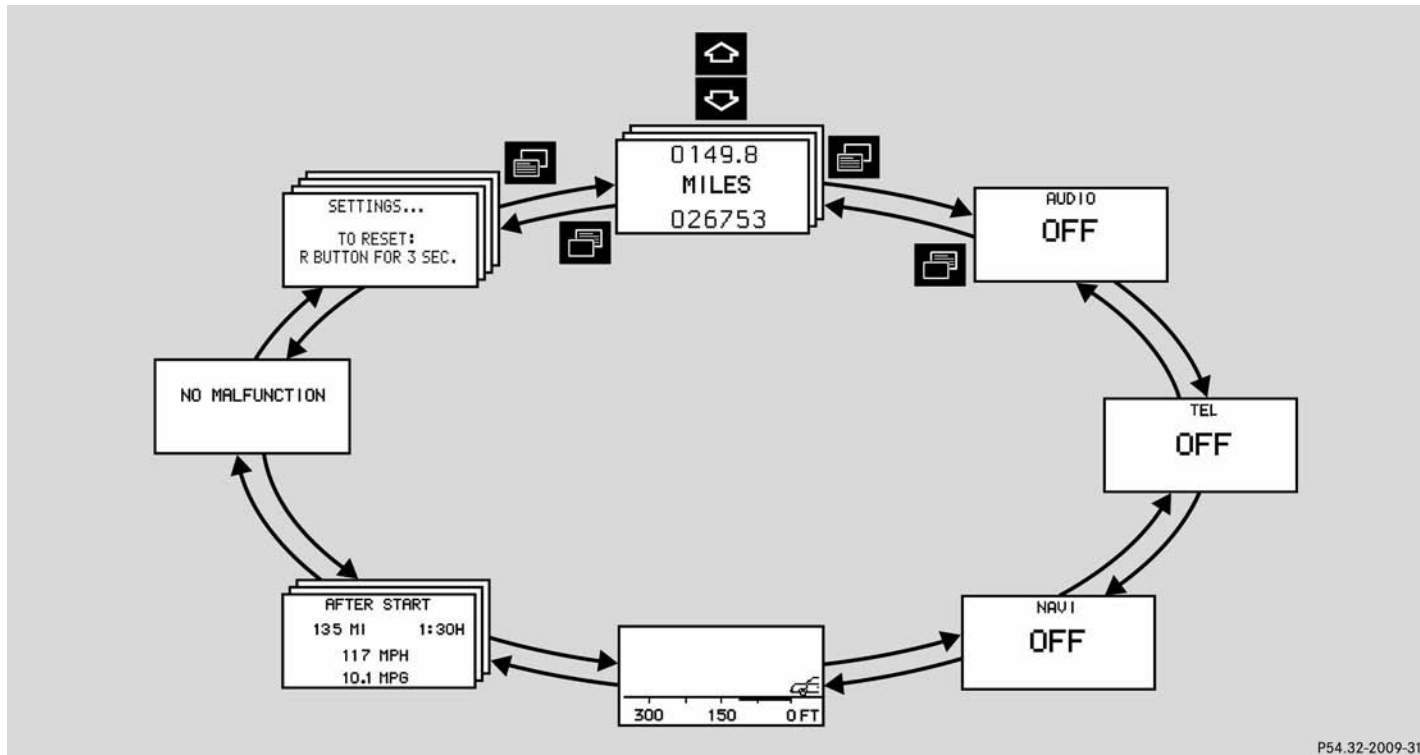

P54.32-2009-31

Menus, submenus and functions

	Menu 1	Menu 2	Menu 3	Menu 4	Menu 5	Menu 6	Menu 7	Menu 8
Commands / submenus	Standard display	AUDIO	Telephone	NAVI	Distronic*	Trip computer	Malfunction memory	Settings
	Call up FSS	Select radio station	Load phone book	Activate route guidance	Call up settings	Fuel consumption statistics after start	Call up malfunction messages	Reset to factory settings
	Check tire pressure*	Operate CD player	Search for name in phone book			Fuel consumption statistics since the last reset		Instrument cluster submenu
	Check engine oil level					Call up range		Lighting submenu
	Digital speedometer							Vehicle submenu Convenience submenu





The headings used in the menus table are designed to facilitate navigation within the system and are not necessarily identical to those shown in the

control system displays.

The first function displayed in each menu will automatically show you which part of the system you are in.

Control system



Standard display menu

You can select the functions in the standard display menu with button  or .

The following functions are available:

Function	Page
Call up FSS	255
Check tire pressure*	248
Check engine oil level	238
Call up digital speedometer	see below

Display digital speedometer

- ▶ Press the  or  button repeatedly until you see the digital speedometer appear in the display.

The current vehicle speed is shown in the multifunction display.

AUDIO menu



The functions in the AUDIO menu operate the audio equipment which you currently have turned on.

If no audio equipment is currently turned on, the message AUDIO OFF is shown in the display.

The following functions are available:



Function	Page
Select radio station	122
Operate CD player	123

Select radio station

- ▶ Turn on the radio. Refer to the separate COMAND operating instructions.
- ▶ Press button  or  repeatedly until you see the currently tuned station in the display.



- 1 Waveband
- 2 Setting for station selection using memory
- 3 Station frequency

- ▶ Press button  or  repeatedly until the desired station is found.

The type of search depends on the setting for the station tuning (▷ page 139):

- Frequency
- Memory



You can only store new stations using the designated feature on the radio. Refer to separate COMAND operating instructions.

You can also operate the radio in the usual manner.

Operate the CD player

- ▶ Turn on the radio and select the CD player. Refer to separate COMAND operating instructions.
- ▶ Press button or repeatedly until the settings for the CD currently being played are shown in the display.

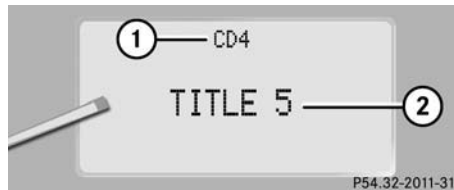

- 1 Current CD, for CD changer (▶ page 123)
- 2 Current track



CD changer: To select a CD from the magazine, press a number on the COMAND system key pad located in the center dashboard.

- ▶ Press button or repeatedly until the desired track is selected.

CD changer operating mode

General notes

Should excessively high temperatures occur while in CD mode, CD TEMP HIGH will appear on the display and muting will take place. The unit will then switch back to the last operating mode used until the temperature has decreased to a safe operating level.

Should excessively low temperatures occur while in CD mode, CD TEMP LOW will appear on the display, but the CD will continue to play.

Handle CDs carefully to prevent interference during playback. Avoid fingerprints and dust on CDs. Do not write on CDs or apply any label or other material to them.

Use only original CDs. Using copied CDs may create problems during playback.

Control system

Clean CDs from time to time with a commercially available cleaning cloth. No solvents, anti-static sprays, etc. should be used for cleaning. Replace the CD in its case after use. Protect CDs from heat and direct sunlight.



Only use CDs, which bear the label shown and that conform to the compact disc digital audio standard (IEC 60908).

Use of CDs which do not meet this standard may cause damage to the CD changer. Do not play single-CDs (80 mm) with an adapter.

For information operating the CD changer refer to the separate COMAND operating instructions.

Warning!



The CD changer is a Class 1 laser product. There is a danger of invisible laser radiation if the cover is opened or damaged.

Do not remove the cover. The CD changer does not contain any parts which can be serviced by the user. For safety reasons, have any service work which may be necessary performed only by qualified personnel.

Operational readiness of CD changer

If a CD changer has been installed in the system, it can be operated from the COMAND system key pad located in the center dashboard. A loaded magazine must be installed for CD playing.

Loading/unloading the CD magazine

The CD changer is located behind the cover on the left hand side in the trunk.

- ▶ Remove the CD changer cover.

- ▶ Slide the CD changer door to the right and press the eject button **EJ**.
- ▶ The magazine is ejected.

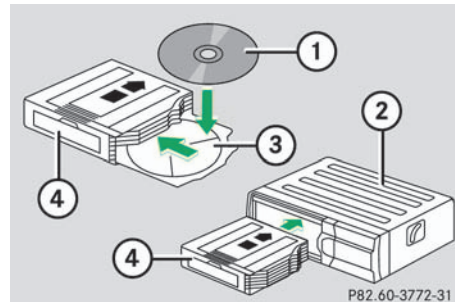

- 1 CD
- 2 CD changer
- 3 CD tray
- 4 CD magazine

- ▶ Remove the magazine and completely pull out the CD tray.
- ▶ Place the CD in the recess of the tray, label side up.
- ▶ Push the tray into the magazine in the direction shown by the arrow.



CDs which have been inserted improperly or are unreadable will not be played.

- ▶ Push the magazine into the CD changer in the direction shown by the arrow and close the CD changer door.

TEL menu*

Warning!



A driver's attention to the road and traffic conditions must always be his / her primary focus when driving. For your safety and the safety of others, we recommend that you pull over to a safe location and stop before making or taking a telephone call. If you choose to use the telephone while driving, please use the hands-free device and only use the telephone when weather, road and traffic conditions permit.

Some jurisdictions prohibit the driver from using a cellular telephone while driving a vehicle.

Bear in mind that at a speed of just 30 mph (approximately 50 km/h), your vehicle is covering a distance of approximately 44 feet (approximately 13.5 m) every second.

Never operate radio transmitters equipped with a built-in or attached antenna (i.e. without being connected to an external antenna) from inside the vehicle while the engine is running. Doing so could lead to a malfunction of the vehicle's electronic system, possibly resulting in an accident and / or personal injury.

You can use the functions in the TEL menu to operate your telephone, provided it is connected to a hands-free system and switched on.

- ▶ Switch on the telephone and COMAND.

- ▶ Press button or on the steering wheel repeatedly until you see the TEL menu in the display.

Which messages will appear in the display field depends on whether your telephone is switched on or off:

- If the telephone is off, the message in the multifunction display is: TEL OFF.
- If the telephone is on:

The telephone will then search for a network. During this time the display reads NO SERVICE.

As soon as the telephone has found a network, READY is indicated in the display.



The standby message indicates that your telephone is ready for use and you can operate it using the control system.

Control system

Answering a call

When your telephone is ready to receive calls, you can answer a call at any time. In the display you will then see the message:



- ▶ Press button .

You have answered the call. In the display you see the length of the call positioned above the number.



If you do not wish to accept a call, press button .





Ending a call

- ▶ Press button .

You have ended the call. In the display you will again see the standby message.



Dialing a number from the phone book

If your telephone is ready to receive calls, you may select and dial a number from the phone book at any time.

- ▶ Press button  or  repeatedly until you see the TEL menu in the display.
- ▶ Press button  or .



The control system reads the phone book which is stored in the telephone. This may take up to 30 seconds. In the display you will see the message PLEASE WAIT!.

When the message PLEASE WAIT! disappears, the phone book has been loaded.

- ▶ Press button  or  repeatedly until the desired name appears in the display.

The stored names are displayed in increasing or decreasing alphabetical order.



If you press and hold  or  for longer than one second, the system scrolls rapidly through the list of names until you release the button again.

Cancel the quick search mode by pressing .

- ▶ Press button .

The system dials the selected phone number.

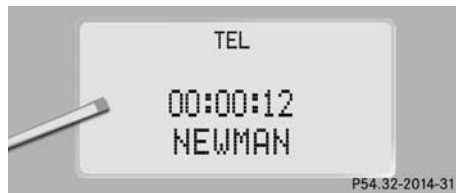

- If connection is successful, the name of the party you called and the duration of the call will appear in the display.



- If no connection is made, the control system stores the dialed number in the redial memory.



Redialing

The control system stores the most recently dialed phone numbers. This eliminates the need to search through your entire phone book.

- ▶ Press button  or  repeatedly until you see the TEL menu in the display.

- ▶ Press button .

In the display you see the first number in the redial memory.

- ▶ Press button  or  repeatedly until the desired name appears in the display.





If you do not want to use the telephone, press button .

- ▶ Press button .

The control system dials the selected phone number.

NAVI menu

The NAVI menu contains the functions needed to operate your navigation system.

- ▶ Press button  or  repeatedly until you see the message NAVI in the display.
- If the navigation system is switched off, the message NAVI OFF is shown in the display.
- If the navigation system is on, the message NAVI ACTIVE is shown in the display.

Please refer to the COMAND manual for instructions on how to activate the route guidance system.



Control system

Distronic* menu

Use the DISTRONIC menu to display the current settings for your DISTRONIC system. What information is shown in the display depends on whether the DISTRONIC system is active or inactive.

Please refer to the “Driving systems” section of this manual (▷ page 179) for instructions on how to activate DISTRONIC.

Please refer to the “Driving systems” section of this manual (▷ page 179) for instructions on how to activate DISTRONIC.

- ▶ Press button  or  repeatedly until you see one of the following two pictures in the display.

Distronic deactivated

When DISTRONIC is deactivated you will see the standard display.

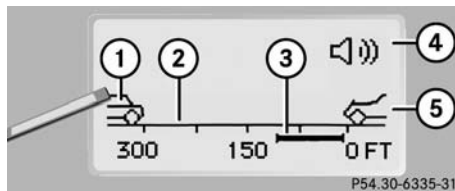

- 1 Vehicle ahead, if detected
- 2 Actual distance to vehicle ahead
- 3 Desired distance to vehicle ahead
- 4 Symbol for activated distance warning function
- 5 Your vehicle

Distronic activated

When DISTRONIC is activated, DISTRONIC and the set speed are seen in the display.

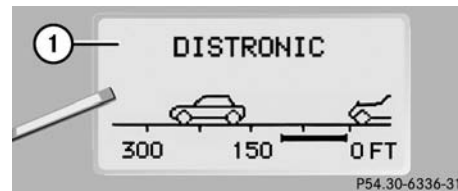





- 1 DISTRONIC activated

Trip computer menu

Use the trip computer menu to call up statistical data on your vehicle. The following information is available:

Function	Page
Fuel consumption statistics after start	129
Fuel consumption statistics since last reset	129
Call up range (distance to empty)	130

Fuel consumption statistics after start

- ▶ Press button  or  repeatedly until you see the first function of the Trip computer menu.
- ▶ Press button  or  repeatedly until you see this message in the display: AFTER START.

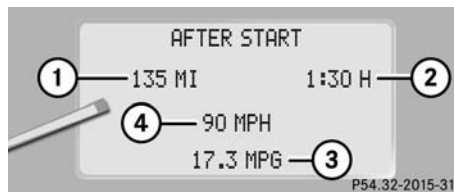





- 1 Distance driven since start
- 2 Time elapsed since start
- 3 Average fuel consumption since start
- 4 Average speed since start



The AFTER START display will flash until a distance of approximately 1 mile (1.6 km) has been covered or two minutes have elapsed since the engine was restarted. During this period, you can incorporate the values for the previous journey by pressing button  in the instrument cluster.

If button  is not pressed, the AFTER START values are set to "0".

Fuel consumption since last reset



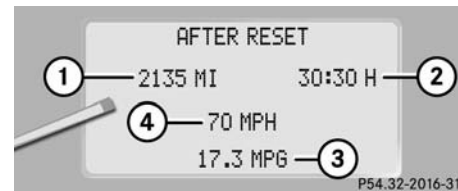

- ▶ Press button  or  repeatedly until you see the first function of the Trip computer menu.
- ▶ Press button  or  repeatedly until you see this message in the display: AFTER RESET.







- 1 Distance driven since last reset
- 2 Time elapsed since last reset
- 3 Average fuel consumption since last reset
- 4 Average speed since last reset

Control system

Resetting fuel consumption statistics

- ▶ Press button  or  repeatedly until you see the first function of the Trip computer menu.
- ▶ Press button  or  repeatedly until you see the reading that you want to reset in the display.
- ▶ Press and hold the reset button  (▷ page 22) in the instrument cluster until the value is reset to 0.

Call up range (distance to empty)

- ▶ Press button  or  repeatedly until you see the first function of the Trip computer menu.
- ▶ Press button  or  repeatedly until you see this message in the display: RANGE.

In the display you will see the calculated range based on the current fuel tank level.





Malfunction memory menu

Use the malfunction memory menu to scan malfunction and warning messages that may be stored in the system. The information shown in the display depends on whether malfunctions have actually occurred.

Warning!



Malfunction and warning messages are only indicated for certain systems and are intentionally not very detailed. The malfunction and warning messages are simply a reminder with respect to the operation of certain systems and do not replace the owner's and / or driver's responsibility to maintain the vehicle's operating safety by having all required maintenance and safety checks performed on the vehicle and by bringing the vehicle to an authorized Mercedes-Benz Center to address the malfunction and warning messages (▷ page 270).

- ▶ Press button  or  repeatedly until you see the malfunction message memory in the display.

No malfunction messages

If no malfunctions have occurred, the message in the display is:



NO MALFUNCTION

Malfunctions have occurred

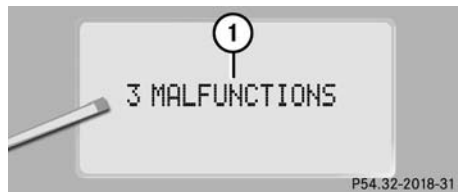
If malfunctions have occurred, you will see the number of malfunctions in the display:



1 Number of malfunctions

- ▶ Press button  or .

The stored messages will now be displayed in order. See the “Practical hints” section for malfunction and warning messages (> page 270).



Should any malfunctions occur while driving, the number of malfunctions will reappear in the display when the key in the starter switch is turned to position **0** or removed from the starter switch.



The message memory will be cleared when you turn the key in the starter switch to position **1** or **2**. You will then only see high priority malfunctions (> page 270).

Settings menu

In the **SETTINGS** menu there are two functions:

- The function **TO RESET: R BUTTON FOR 3 SEC.**, with which you can reset all the settings to the original factory settings.
 - A collection of submenus with which you can make individual settings for your vehicle.
- ▶ Press button  or  repeatedly until the **SETTINGS** menu appears in the display.



Control system

Resetting all settings

You can reset all the functions of all submenus to the factory settings.

- ▶ Press the reset button **R** (▷ page 22) in the instrument cluster for approximately three seconds.

In the display you will see the request to press the reset button **R** again to confirm.

- ▶ Press the reset button **R** again.

The functions of all the submenus will reset to factory settings.



The settings you have changed will not be reset unless you confirm the action by pressing the reset button **R** a second time.

Due to safety reasons, resetting all of the settings while driving will not reset all of the values in the LIGHTING or the VEHICLE menu.

Submenus in the Settings menu

- ▶ Press button or .

In the display you see the collection of the submenus.



- ▶ Press button or .

The selection marker moves to the next submenu.

The submenus are arranged by hierarchy. Scroll down with the button, scroll up with the button.

Move within the submenus with the or button to the individual functions.

The settings themselves are made with button or .

Resetting the functions of a submenu

For each submenu you can reset all the functions to the factory settings.

- ▶ Move to a function in the submenu.
- ▶ Press the reset button **R** (▷ page 22) in the instrument cluster for approximately three seconds.

In the display you will see the request to press the reset button **R** again to confirm.

- ▶ Press the reset button **R** again.

All functions of the submenu will reset to factory settings.

The table below shows what settings can be changed within the various menus. Detailed instructions on making individual settings can be found on the following pages.

INSTRUMENT CLUSTER	LIGHTING	VEHICLE	CONVENIENCE
Select temperature display mode	Set daytime running lamp mode (USA only)	Set station selection mode (radio)	Set key dependency
Select speedometer display mode	Set locator lighting	Set automatic locking	Activate easy-entry / exit feature
Select language	Exterior lamps delayed shut-off		Set parking position for exterior rear view mirrors
	Interior lighting delayed shut-off		Set fold-in function for exterior rear view mirrors

Control system

Instrument cluster submenu

Access the **INST. CLUSTER** submenu via the **SETTINGS** menu. Use the **INST. CLUSTER** submenu to change the instrument cluster display settings. The following functions are available:

Function	Page
Select temperature display mode	135
Select speedometer display mode	134
Select language	135

Selecting temperature display mode

- ▶ Move the selection marker with the **+** or **-** button to the **INST. CLUSTER** submenu.
- ▶ Press button **▲** or **▼** repeatedly until you see this message in the display: **TEMP. INDICATOR**.

The selection marker is on the current setting.

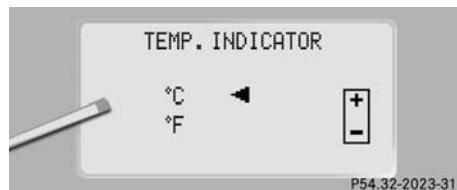

- ▶ Press **+** or **-** to set the temperature unit to degrees Celsius (°C) or degrees Fahrenheit (°F).

Selecting speedometer display mode

- ▶ Move the selection marker with the **+** or **-** button to the **INST. CLUSTER** submenu.
- ▶ Press button **▲** or **▼** repeatedly until you see this message in the display: **DISPLAY VALUES IN**.

The selection marker is on the current setting.



- ▶ Press **+** or **-** to set speedometer unit to **MILES** or **KM**.

Selecting language

► Move the selection marker with the **+** or **-** button to the INST. CLUSTER submenu.

► Press button **↶** or **↷** repeatedly until you see this message in the display: TEXT

The selection marker is on the current setting.



► Press **+** or **-** to select the language to be used for the multifunction display messages.

Available languages:

- German
- English
- Italian
- French
- Spanish

Lighting submenu

Access the LIGHTING submenu via the SETTINGS menu. Use the LIGHTING submenu to change the lamp and lighting settings on your vehicle. The following functions are available:

Function	Page
Set daytime running lamp mode (USA only)	136
Set locator lighting	136
Exterior lights delayed shut-off	137
Interior lighting delayed shut-off	138

Control system

Setting daytime running lamp mode (USA only)

- ▶ Move the selection marker with the **+** or **-** button to the LIGHTING submenu.
- ▶ Press button **↶** or **↷** repeatedly until you see this message in the display: LIGHT CIRCUIT HEADLIGHT MODE. The selection marker is on the current setting.



- ▶ Press **+** or **-** to select manual or daytime running lamp (constant) mode. This function is not available in countries where daytime running lamps are mandatory.

With daytime running lamp mode selected and the exterior lamp switch at position **0**, the following lamps will come on automatically when the engine is turned on:

- Parking lamps and low beam headlights
- License plate lamps (in low ambient light conditions)



If you turn the exterior lamp switch to another position, the corresponding lamp(s) will switch on.

For safety reasons, resetting the LIGHTING submenu to factory settings (▷ page 132) will not reset the daytime running lamp mode.

In the display you will then see the message: LIGHTING - CANNOT BE TOTALLY RESET TO FACTORY SETTINGS WHILE DRIVING!.



Setting locator lighting

During darkness, the following lamps will come on when the exterior lamp switch is in position **AUTO**, the locator lighting feature is activated and the vehicle is unlocked by remote control:

- Parking lamps
- Tail lamps
- License plate lamps
- Front fog lamps



The locator lighting switches off when the driver's door is opened. It switches off automatically after a period of approximately 40 seconds.

- ▶ Move the selection marker with the **+** or **-** button to the LIGHTING submenu.

- ▶ Press button  or  repeatedly until you see this message in the display: LOCATOR LIGHTING.

The selection marker is on the current setting.



- ▶ Press  or  to select the desired setting.

The locator lighting will be switched on or off.

Setting night security illumination (Exterior lights delayed shut-off)

Use the HEADLIGHTS DELAYED SHUT-OFF function to set whether and for how long you would like the exterior lamps to illuminate during darkness after all doors are closed. When the delayed shut-off feature is activated and the exterior lamp switch is in position **AUTO**, the following lamps will remain lit after you remove the key from the starter switch:

- Parking lamps
- Tail lamps
- License plate lamps
- Front fog lamps



You can reactivate this function within ten minutes by opening a door.



If you do not open a door after removing the key, the lamps will automatically shut off after 60 seconds.

To select delayed shut-off period:

- ▶ Move the selection marker with the  or  button to the LIGHTING submenu.
- ▶ Press button  or  repeatedly until you see this message in the display: HEADLIGHTS DELAYED SHUT-OFF.

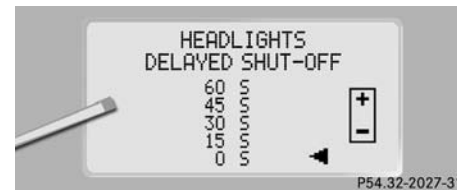
The selection marker is on the current setting.



- ▶ Press  or  to select the desired lamp-on period.

You can select:

- 0 S, the delayed shut-off feature is deactivated
- 15 S, 30 S, 45 S, or 60 S, the delayed shut-off feature is activated

Control system

You can temporarily deactivate the delayed shut-off feature:

- ▶ Before leaving the vehicle, turn the key in the starter switch to position **0**.
- ▶ Turn the key in the starter switch to position **2** and back to **0**.

The delayed shut-off feature is deactivated. It will reactivate as soon as you reinsert the key in the starter switch.

Vehicles with KEYLESS-GO*:

- ▶ Press the KEYLESS-GO start/stop button on the gear selector lever (▷ page 33).

Interior lighting delayed shut-off

Use this function to set whether and for how long you would like the interior lighting to remain lit during darkness after the key is removed from the starter switch.

- ▶ Move the selection marker with the **+** or **-** button to the LIGHTING submenu.
- ▶ Press button **▲** or **▼** repeatedly until you see this message in the display: INT. LIGHTING DELAYED SHUT-OFF.

The selection marker is on the current setting.

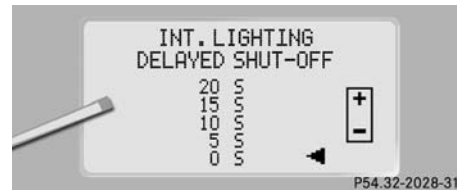

- ▶ Press **+** or **-** to select the desired lamp-on time period. You can select:
 - 0 S, the delayed shut-off feature is deactivated.
 - 5 S, 10 S, 15 S, or 20 S, the delayed shut-off feature is activated.

Vehicle submenu

Access the VEHICLE submenu via the SETTINGS menu. Use the VEHICLE submenu to make general vehicle settings. The following functions are available:

Function	Page
Set station selection mode (radio)	see below
Set automatic locking	139

Setting station selection mode

Use the STATION SEARCH USING function to select the manual or memory station selection mode for the radio (▷ page 122).

- ▶ Move the selection marker with the **+** or **-** button to the VEHICLE submenu.
- ▶ Press button **⬆** or **⬇** repeatedly until you see this message in the display: STATION SEARCH USING.

The selection marker is on the current setting.



- ▶ Press **+** or **-** to select the desired station selection mode. You can select:
 - FREQUENCY
 - MEMORY selects next stored station

Setting automatic locking

Use this function to activate or deactivate the automatic central locking. With the automatic central locking system activated, the vehicle is centrally locked at vehicle speeds of approximately 9 mph (15 km/h).

- ▶ Move the selection marker with the **+** or **-** button to the VEHICLE submenu.

- ▶ Press button **⬆** or **⬇** repeatedly until you see this message in the display: AUTOMATIC DOOR LOCK.

The selection marker is on the current setting.



- ▶ Press **+** or **-** to switch AUTOMATIC DOOR LOCK ON or OFF.

Control system



Convenience submenu

Access the CONVENIENCE submenu via the SETTINGS menu. Use the CONVENIENCE submenu to change the settings for a number of convenience features. The following functions are available:

Function	Page
Set key dependency	140
Activate easy-entry / exit feature	140
Set parking position for exterior rear view mirrors	142
Set fold-in function for exterior rear view mirrors	142

Setting key dependency

Use this function to set whether the memory settings for the seats, the steering wheel, the mirrors, and the automatic climate control should be stored separately for each key (▷ page 105).

- ▶ Move the selection marker with the **+** or **-** button to the CONVENIENCE submenu.
- ▶ Press button  or  repeatedly until you see this message in the display: SETTINGS KEY-DEPENDENT.

The selection marker is on the current setting.



- ▶ Press **+** or **-** to set key dependency to ON or OFF.

Activating easy-entry / exit feature

Use this function to activate and deactivate the easy-entry / exit feature. When the feature is activated, the steering wheel and driver's seat will move back to facilitate exiting when you

- remove the key from the starter switch
- open the driver's door.

However, the engine must be turned off.



- ▶ Press **+** or **-** to change the easy-entry / exit setting.

The following settings are available for the easy-entry / exit feature:

OFF	The easy-entry / exit feature is deactivated.
STEER. COL.	Only the steering column is moved.
ST. COL + SEAT	Both the steering column and the seat are moved.

Warning!



You must make sure that no one can become trapped or injured by the moving steering wheel and the driver's seat when the easy-entry / exit feature is in operation and the driver's door is being opened or the key is removed from the starter switch. Do not leave children unattended in the vehicle, or with access to an unlocked vehicle. Unsupervised use of vehicle equipment may cause an accident and / or serious personal injury.

Do not leave children unattended in the vehicle, or with access to an unlocked vehicle. Children could open the driver's door and unintentionally activate the easy-entry / exit feature, which could result in an accident and / or serious personal injury.

After entering the vehicle, the steering wheel and seat will move into the position stored in memory when

- the driver's door is closed

- you put the key in the starter switch
- press the appropriate stored position button on the memory switch (▷ page 105).



To cancel seat / steering wheel movement, do one of the following:

- Press seat adjustment switch (▷ page 35)
 - Move the steering column stalk (▷ page 37)
 - Press the memory switch (▷ page 105)
- ▶ Move the selection marker with the **+** or **-** button to the CONVENIENCE submenu.
 - ▶ Press button **▲** or **▼** repeatedly until you see this message in the display: EASY-ENTRY FEATURE ACTIVATE. The selection marker is on the current setting.

Control system

Setting parking position for exterior rear view mirror

Use the MIRROR SETTING WHEN PARKING function to select whether the passenger side exterior rear view mirror should be turned downward during parking maneuvers when reverse gear is engaged. For additional information see “Setting parking position for exterior rear view mirror” (▷ page 142).

- ▶ Move the selection marker to the CONVENIENCE submenu using the **+** or **-** button.
- ▶ Press the **▲** or **▼** button repeatedly until the message MIRROR SETTING WHEN PARKING appears in the display.

The selection marker is on the current setting.



- ▶ Press **+** or **-** to switch function ON or OFF.

Setting fold-in function for exterior rear view mirrors

Using this function, you can set the exterior or rear view mirrors to be automatically folded in when you lock your vehicle (▷ page 152).

- ▶ Move the selection marker to the CONVENIENCE submenu using the **+** or **-** button.

- ▶ Press the **▲** or **▼** button repeatedly until the message FOLD MIRRORS WHEN LOCKING appears in the display.

The selection marker is on the current setting.



- ▶ Press the **+** or **-** button to switch the automatic fold-in setting for the mirrors ON or OFF when the vehicle is locked.

Automatic transmission

Information on driving with an automatic transmission is found in the “Getting started” section (▷ page 43).

Your transmission adapts its gear shifting process to your individual driving style by continually adjusting the shift points up or down. These shift point adjustments are performed based on current operating and driving conditions.

If the operating conditions change the automatic transmission reacts by adjusting its gear shift program.



During the brief warm-up the transmission upshifting is delayed. This allows the catalytic converter to heat up more quickly to operating temperature.

The automatic transmission selects individual gears automatically, depending on:

- the selector lever position **D** with gear ranges **4, 3, 2, 1** (▷ page 145)
- the selected shift program (**C/S**) (▷ page 147)
- the position of the accelerator pedal (▷ page 148)
- the vehicle speed

The current selector lever position and shift program (C/S) appear in the tachometer display (▷ page 22).

Warning!



It is dangerous to shift the selector lever out of **P** or **N** if the engine speed is higher than idle speed. If your foot is not firmly on the brake pedal, the vehicle could accelerate quickly forward or reverse. You could lose control of the vehicle and hit someone or something. Only shift into gear when the engine is idling normally and when your right foot is firmly on the brake pedal.

When the selector lever is in position **D**, you can influence transmission shifting by:

- limiting the gear range
- changing gears manually

Automatic transmission

One-touch gearshifting

Even with an automatic transmission you can change the gears manually when the selector lever is in position **D**.

Downshifting

- ▶ Briefly press the selector lever to the left in the **D-** direction.

The transmission will shift from the current gear to the next lower gear. This action simultaneously limits the gear range of the transmission (▷ page 145).

Warning!



On slippery road surfaces, never downshift in order to obtain braking action. This could result in drive wheel slip and reduced vehicle control. Your vehicle's ABS will not prevent this type of loss of control.



To avoid overrevving the engine when the selector lever is moved to the **D-** direction, the transmission will not shift to a lower gear if the engine's max. speed would be exceeded.

Upshifting

- ▶ Briefly press the selector lever to the right in the **D+** direction.

The transmission will shift from the current gear to the next higher gear as permitted by the shift program. This action simultaneously extends the gear range of the transmission.

Canceling gear range limit

- ▶ Press and hold the selector lever in the **D+** direction until **D** reappears in the tachometer display.

The transmission will shift from the current gear range directly to gear range **D**.

Shifting into optimal gear range

- ▶ Press and hold the gear selector lever in the **D-** direction.

The transmission will automatically select the gear range suited for optimal acceleration and deceleration. This will involve shifting down one or more gears.

Gear ranges

With the selector lever in position **D**, you can limit the transmission's gear range by pressing the lever to the left (**D-**), and reverse the gear range limit by pressing the lever to the right (**D+**).

The selected gear range will appear in the tachometer display. If you press on the accelerator when the engine has reached its rpm limit, the transmission will upshift beyond any gear range limit selected.

Gear range	Effect
4	The transmission shifts through fourth gear only.
3	The transmission shifts through third gear only. With this selection you can use the braking effect of the engine.

Gear range	Effect
2	The transmission shifts through second gear only. Allows the use of engine's braking power when driving <ul style="list-style-type: none"> • on steep downgrades • in mountainous regions • under extreme operating conditions
1	The transmission operates only in first gear. For maximum use of engine's braking effect on very steep or lengthy downgrades.

Automatic transmission

Gear selector lever position

	Effect
P	<p>Park position</p> <p>Selector position when the vehicle is parked. Only place selector lever in position P when vehicle is stopped. The park position is not intended to serve as a brake when the vehicle is parked. Rather, the driver should always set the parking brake in addition to placing the selector lever in position P to secure the vehicle.</p> <p>The key can only be removed from the starter switch with the selector lever in position P. With the key removed the selector lever is locked in position P.</p>

	Effect
R	<p>Reverse gear</p> <p>Place selector lever in position R only when vehicle is stopped.</p>
N	<p>Neutral</p> <p>No power is transmitted from the engine to the drive axle. When the brakes are released, the vehicle can be moved freely (pushed or towed).</p> <p>To avoid damage to the transmission, never engage N while driving.</p> <p>If the ESP is deactivated or malfunctioning: Only move selector lever to N if the vehicle is in danger of skidding (e.g. on icy roads).</p>
D	<p>Drive</p> <p>The transmission shifts automatically. All five forward gears are available.</p>



Coasting the vehicle, or driving for any other reason with selector lever in **N** can result in transmission damage that is not covered by the Mercedes-Benz Limited Warranty.

Warning!



Getting out of your vehicle with the selector lever not fully engaged in position **P** is dangerous. Also, position **P** alone is not intended to or capable of preventing your vehicle from moving, possibly hitting people or objects.

Always set the parking brake in addition to shifting to position **P** (▷ page 44).

When parked on an incline, turn the front wheels towards the road curb.

Warning!



When leaving the vehicle, always remove the key from the starter switch, take the KEYLESS-GO* card with you and lock the vehicle. Do not leave children unattended in the vehicle, or with access to an unlocked vehicle. Children could move the selector lever from position **P**, which could result in an accident and / or serious personal injury.

Program mode selector switch

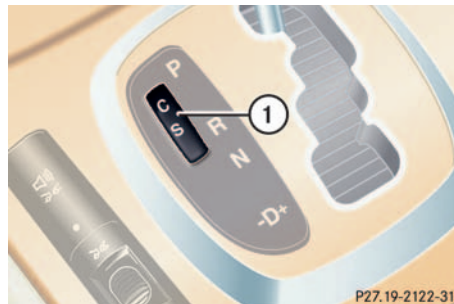

1 Program mode selector switch

S Sport For standard driving

C Comfort For comfort driving



Never change the program mode when the selector lever is out of position **P**. This could result in a change of driving characteristics for which you may not be prepared.

- ▶ Press the program mode selector switch repeatedly until the letter of the desired shift program appears in the tachometer display (▷ page 22).

Select **C** for comfort driving:

- The vehicle starts out in second gear (both forward and reverse) for gentler starts. This does not apply if full throttle is applied or gear range **1** is selected.
- Traction and driving stability are improved on icy roads.
- Upshifts occur earlier even when you give more gas. The engine then operates at lower rpms and the wheels are less likely to spin.
- The power transmission ratio for selector lever position **R** changes depending on the program mode selected (**C** or **S**).

Automatic transmission

Accelerator position

Your driving style influences the transmission's shifting behavior:

Less throttle	Earlier upshifting
More throttle	Later upshifting

Kickdown

Use kickdown when you want maximum acceleration.

- ▶ Press the accelerator past the point of resistance.

The transmission shifts into a lower gear.

- ▶ Ease up on the accelerator when you have reached the desired speed.

The transmission shifts up again.

Emergency operation (Limp home mode)

If vehicle acceleration worsens or the transmission no longer shifts, the transmission is most likely operating in Limp-Home Mode (emergency operation). In this mode, only second gear and reverse gear can be activated.

- ▶ Stop the vehicle.
- ▶ Move selector lever to **P**.
- ▶ Turn off the engine.
- ▶ Wait at least ten seconds before re-starting.
- ▶ Restart the engine.
- ▶ Move selector lever to position **D** (for second gear) or **R**.
- ▶ Have the transmission checked at an authorized Mercedes-Benz Center as soon as possible.

Steering wheel gearshift control (Speedshift) and manual shift program CL 55 AMG

The CL 55 AMG can be driven in both the automatic and manual shift program modes. In the manual shift program mode you can change the gears manually on the steering wheel or by using the selector lever.

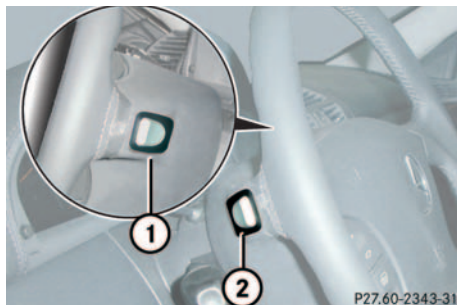

- 1 Right button: upshift
- 2 Left button: downshift

To do so, you must first select the manual shift program **M** on the program mode selector switch.

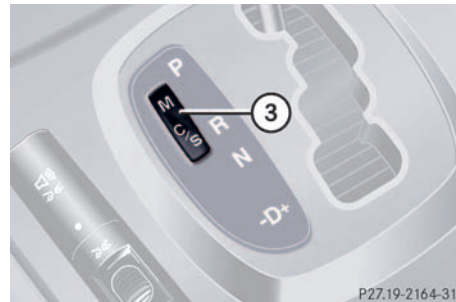

3 Program mode selector switch

- S** Sport For standard driving
- C** Comfort For comfort driving
- M** Manual For manual gear shifting



Never change the program mode when the selector lever is out of position **P**. It could result in a change of driving characteristics for which you may not be prepared.

Activating steering wheel gearshift control

- ▶ Press the program mode selector switch repeatedly until the **M** for manual shift program appears in the tachometer display.

Automatic gear shifting is activated.

Automatic transmission

Upshifting

- ▶ Press the button located on the right side of the steering wheel.

or

- ▶ Briefly press the selector lever to the right in the **D+** direction.

The transmission shifts to the next higher gear.

Warm up the engine smoothly. Do not place full load on the engine until the operating temperature has been reached. Shift into reverse gear only when the vehicle is stopped.



Avoid spinning of a drive wheel for an extended period when driving off on slippery surface. This may cause serious damage to the drivetrain which is not covered by the Mercedes-Benz Limited Warranty.

Downshifting

- ▶ Press the button located on the left side of the steering wheel.

or

- ▶ Briefly press the selector lever to the right in the **D-** direction.

The transmission shifts to the next lower gear.

Warm up the engine smoothly. Do not place full load on the engine until the operating temperature has been reached. Shift into reverse gear only when the vehicle is stopped.

Warning!



On slippery road surfaces, never downshift in order to obtain braking action. This could result in drive wheel slip and reduced vehicle control. Your vehicle's ABS will not prevent this type of loss of control.

Deactivating steering wheel gearshift control

- ▶ Press the program mode selector switch repeatedly until the **S** or **C** for automatic shift program appears in the tachometer display.

Automatic gear shifting is activated.



At each engine start, the transmission will go into the last automatic shift program mode selected (**S** or **C**). Program mode **M** is not stored and will not be recalled when engine is restarted.

Good visibility

Information on the windshield wipers (▷ page 47) and for setting the rear view mirrors (▷ page 38) is found in the “Getting started” section.

Rear view mirror

Automatic antiglare rear view mirror

The reflection brightness of the exterior rear view mirror on the driver’s side and the inside rear view mirror will respond automatically to glare when

- the ignition is switched on, and
- incoming light from headlamps falls on the sensor in the inside rear view mirror.

The rear view mirror will not react if

- reverse gear is engaged
- the interior lighting is turned on

Warning!



The automatic antiglare function does not react if incoming light is not aimed directly at sensors in the inside rear view mirror.

The inside rear view mirror and the exterior rear view mirror on the driver’s side do not react, for example, if the rear window sunshade is in raised position.

Glare can endanger you and others.

Warning!



In the case of an accident liquid electrolyte may escape from the mirror housing if the mirror glass breaks.

Electrolyte has an irritating effect. Do not allow the liquid to come into contact with eyes, skin, clothing, or respiratory system. In case it does, immediately flush affected area with water, and seek medical help if necessary.

Warning!



Exercise care when using the passenger side exterior rear view mirror. The mirror surface is convex (outwardly curved surface for a wider field of view). Objects in mirror are closer than they appear. Check your inside rear view mirror or glance over your shoulder before changing lanes.



Electrolyte drops coming into contact with the vehicle paint finish can be completely removed only while in the liquid state by applying plenty of water.

Good visibility

Activating exterior rear view mirror parking position

The buttons are located on the driver's door.

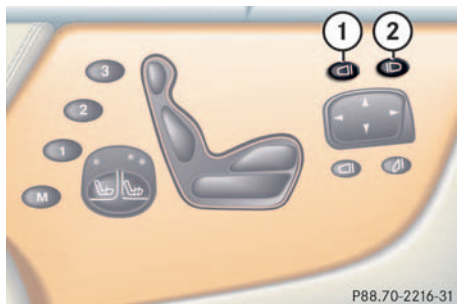

- 1 Driver's side exterior rear view mirror
- 2 Passenger-side exterior rear view mirror

Follow these steps to activate the mirror parking position so that the passenger-side exterior rear view mirror will be turned downward to the stored position.

- ▶ Make sure you have stored a parking position for the passenger-side exterior rear view mirror (▷ page 107).

- ▶ Make sure that the MIRROR SETTING WHEN PARKING function in the CONVENIENCE submenu in the control system, is switched to ON (▷ page 142).
- ▶ Switch on ignition (if not already on).
- ▶ Press button **2** for passenger-side exterior rear view mirror.
- ▶ Place the gear selector lever in reverse gear **R**.

The passenger-side exterior rear view mirror will be turned downward in the stored position.

The exterior rear view mirror returns to its previously stored driving position:

- 10 seconds after you put the gear selector lever out of position **R**
- immediately once you exceed a vehicle speed of approx. 6 mph (10 km/h)
- immediately when you press button **1** for driver's side exterior rear view mirror

Electrically folding exterior rear view mirrors

Folding the exterior rear view mirrors in and out automatically

When the corresponding function in the control system is activated (▷ page 142):

- The exterior rear view mirrors automatically fold in as soon as the vehicle is locked from the outside.
- The exterior rear view mirrors automatically fold out as soon as the vehicle is unlocked and the driver's or passenger door are subsequently opened.

Folding the exterior rear view mirrors in and out manually

The exterior rear view mirrors can vibrate if they are not completely folded out.

The buttons are located on the driver's door.

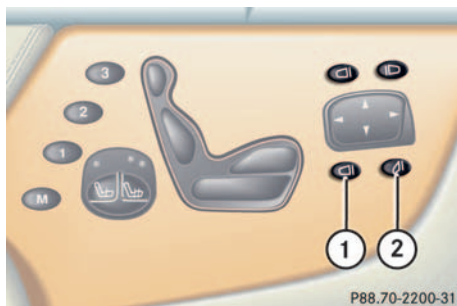

1 Folds the exterior mirrors out

2 Folds the exterior mirrors in

- ▶ Make sure the ignition is switched on.

All the lamps in the instrument cluster should light up.

Folding in

- ▶ Briefly press button **2**.

The mirrors fold in.



Before you drive the vehicle through an automatic car wash, fold the exterior mirrors in, otherwise they may get damaged.



If you are driving at more than 9 mph (15 km/h), you will not be able to fold the exterior mirrors in.

Folding out

- ▶ Briefly press button **1**.

The mirrors fold out.



If an exterior mirror housing is forcibly pushed forward (hit from the rear), reposition it manually by applying firm pressure until it snaps back into place.

If an exterior mirror is forcibly pushed rearward (hit from the front) press button **2** to fold mirrors in, then press button **1** to fold mirrors out. Do not force mirror by hand as it may damage the adjustment mechanism.

The mirror housing is now properly positioned and you can adjust the mirror normally.

Good visibility

Windshield wipers

Information on the windshield wipers is found in the “Getting started” section (▷ page 47).



Intermittent wiping is interrupted when the vehicle is at a standstill and a front door is opened.

A rain sensor automatically controls the windshield wipers depending on how wet the windshield is.

- ▶ Switch on ignition.
- ▶ Set the wiper switch to position **I** (▷ page 47).

After the initial wipe, pauses between wipes are automatically controlled by the rain sensor which monitors the wetness of the windshield.



To prevent the windshield wipers from being damaged, do not leave the wiper switch in intermittent setting when the vehicle is taken to an automatic car wash or when cleaning the windshield.

The switch should not be left in intermittent setting as the wipers will wipe the windshield once every time the engine is started. Dust that accumulates on the windshield might scratch the glass when wiping occurs on a dry windshield.



If intermittent wiping is on and you turn the key in the steering lock from position **1** to position **2** (▷ page 31) and keep the key in that position longer than 2 seconds, the wipe interval will be set to approx. 5 seconds.

Headlamp cleaning system

The switch is located on the left side of the dashboard.



1 Headlamp washer switch

- ▶ Switch on ignition.
- ▶ Press switch **1**.

Sun visors

The sun visors protect you from sun glare while driving.

Warning!



Do not use the vanity mirror while driving. Keep the mirrors in the sun visors closed while vehicle is in motion. Reflected glare can endanger you and others.

- Swing sun visors down when you experience glare.

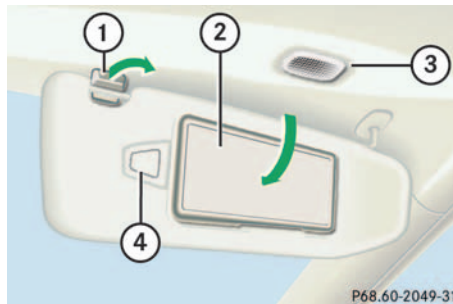

- 1 Mounting
- 2 Mirror cover
- 3 Mirror lamp
- 4 Document holder

- To use mirror, lift up cover **2**.
Mirror lamp **3** lights up.

If sunlight enters through a side window:

- Disengage sun visor from mounting **1**.
- Pivot sun visor to the side.



If you disengage the sun visor from mounting **1**, mirror lamp **3** will switch off.

Document holder

You can use the plastic tab of the document holder to hold admission tickets, parking passes or similar items in place.

Adjusting the vanity mirror



- Slide the mirror to the left or to the right.

Images in the mirror appear in normal size or larger, depending on the position of the mirror.

Good visibility

Rear window sunshade

The switch is located in the center console.



- ▶ Turn the key to starter switch position **1** or **2**. Vehicles with KEYLESS-GO*: press the start / stop button once or twice.
- ▶ Press the switch briefly at **1** to raise the sunshade.
- ▶ Press the switch briefly at **1** to lower the sunshade.

Always raise the sunshade fully for its support against the window frame.

Warning!



When operating the rear window sunshade, make sure that there is no danger of anyone being harmed by the raising or lowering procedure.

The raising or lowering procedure can be immediately reversed by pressing switch **1**.

Warning!



When leaving the vehicle, always remove the SmartKey from starter switch, and lock your vehicle. Do not leave children unattended in the vehicle, or with access to an unlocked vehicle. Unsupervised use of vehicle equipment may cause an accident and / or serious personal injury.

Automatic climate control

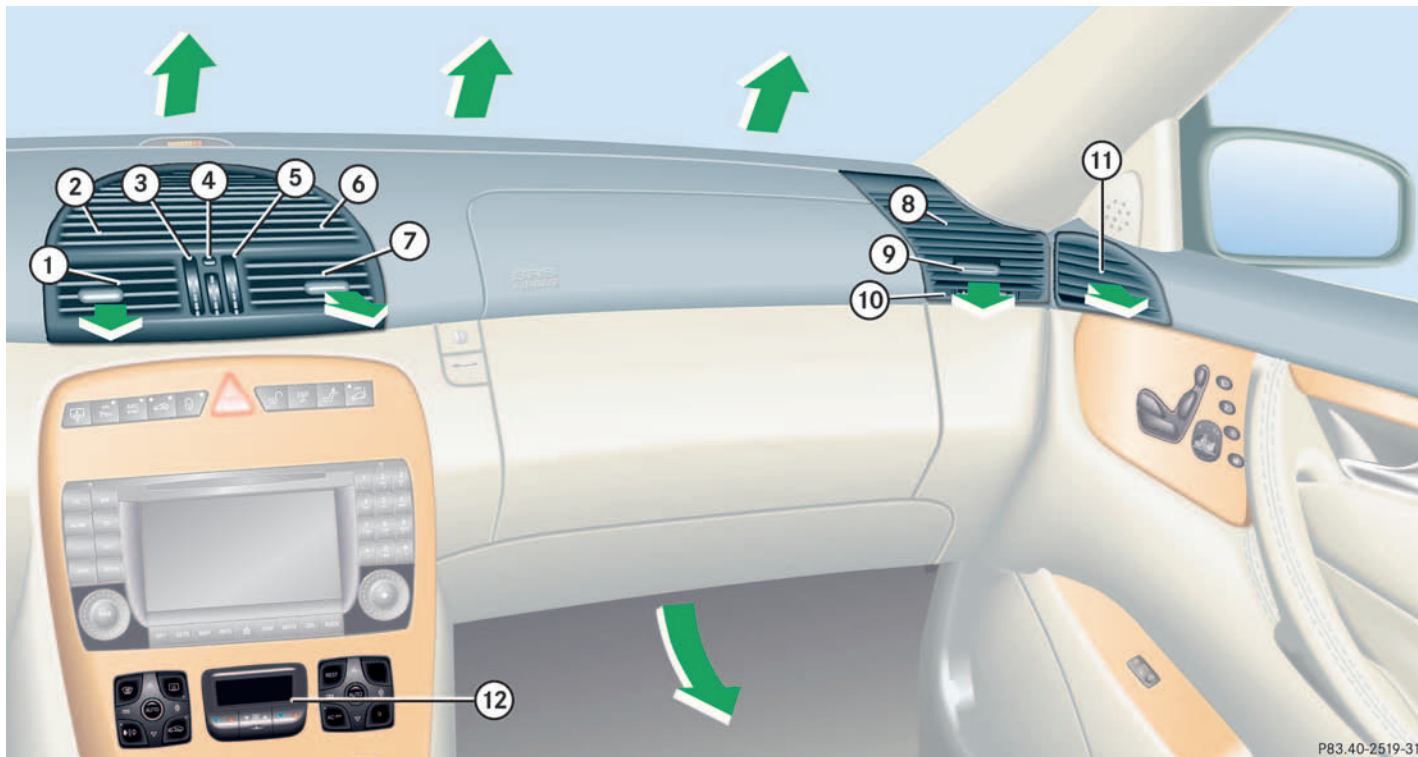

P83.40-2519-31

Automatic climate control

	Item
1	Center air vent, left, adjustable
2	Fixed air vent, left
3	Air volume control for left center air vent
4	Air temperature control for center air vents
5	Air volume control for right center air vent
6	Fixed air vent, right
7	Center air vent, right, adjustable
8	Side defroster vent, left and right, fixed
9	Side air vent, left and right, adjustable
10	Air volume control for side air vents
11	Door air vent, left and right
12	Automatic climate control panel

Warning!



When operating the automatic climate control, the air that enters the passenger compartment through the air vents in the footwell can be very hot or very cold (depending on the set temperature). This may cause burn or frostbite to unprotected skin in the immediate area of the air vents. Always keep sufficient distance between unprotected parts of the body and the footwell air vents. If necessary, change the air flow using the air distribution controls to direct the air away from the footwell air vents (▷ page 161).



For draft-free ventilation, move the sliders for the center air vents to the middle position.

Automatic climate control

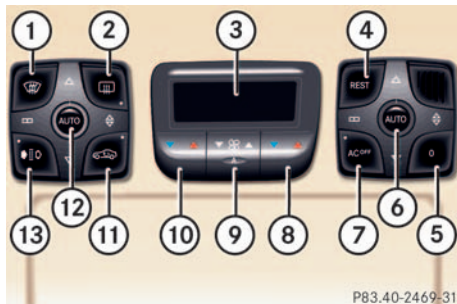

Automatic climate control panel

	Item
1	Windshield defroster
2	Rear window defroster
3	Display
4	Residual engine heat utilization
5	Automatic climate control on / off
6	Air distribution, right
7	AC cooling on / off
8	Temperature control, right
9	Air volume (automatic, manual)
10	Temperature control, left
11	Air recirculation
12	Air distribution, left
13	Activated charcoal filter

The automatic climate control is operational whenever the engine is running. You can operate the climate control system in either the automatic or manual mode. The system cools or heats the interior depending on the selected interior temperature and the current outside temperature.

Nearly all dust particles, pollutants and odors are filtered out before outside air enters the passenger compartment through the air distribution system.

The air conditioning will not engage (no cooling) if the **AC^{OFF}** mode is selected (▷ page 166).

Warning!



Follow the recommended settings for heating and cooling given on the following pages. Otherwise the windows could fog up, impairing visibility and endangering you and others.

Automatic climate control



The current climate control settings (ON / OFF, temperature, air volume, activated charcoal filter, etc.) are stored for each electronic key before it is removed from the starter switch or when the vehicle is locked using the KEYLESS-GO* card (▷ page 105).

If the vehicle interior is hot, ventilate the interior before driving off.

Keep the air intake grille in front of the windshield free of snow, leaves, sticks and any other debris.

Do not obstruct air volume by placing objects on the air volume-through exhaust slots below the rear window.

Setting the temperature

Use temperature controls (▷ page 159) **10** for the left side or **8** for the right side to separately adjust the air temperature on each side of the passenger compartment. You should raise or lower the temperature setting in small increments, preferably starting at 72°F (22°C).



When operating the climate control system in automatic mode, you will only rarely need to adjust the temperature, air volume and air distribution.

Increasing / decreasing

- ▶ Press button **10** or **8** repeatedly up or down until the display shows the desired temperature.

The automatic climate control system will accordingly adjust the interior air temperature.

Adjusting the temperature for center air vents

When outside temperatures are low, you can manually raise the air temperature for the center and side air vents. The thumbwheel **4** is located between the center air vents (▷ page 157).

Automatic temperature control

- ▶ Turn thumbwheel **4** to **A**.

The indicator lamp above the thumbwheel lights up. The temperature is automatically adjusted to the set value.

Turning on warm air

- ▶ Turn thumbwheel **4** in the direction of the white marking.

Warm air will enter from the center air vent.





Turning on cooler air

- ▶ Turn thumbwheel **4** in the direction of the blue marking.

Cooler air will enter from the center air vent.





Adjusting air distribution

Use the air distribution controls **12** and **6** (▷ page 159) to separately adjust the air distribution on each side of the passenger compartment. The following symbols are found on the controls:

Symbol	Function
	Directs air through the center air vents
	Directs air to the windows
	Directs air into the entire vehicle interior
	Directs air to the footwells

Adjusting manually

- ▶ Press button **AUTO**.





The button emerges and the , ,  and  symbols become visible.

- ▶ Turn the marking on the regulator to the desired symbol.

The air will be directed to the vents corresponding to this symbol.

Adjusting automatically

- ▶ Press button **AUTO** until it clicks in.

The , ,  and  symbols are no longer visible. The air distribution is adjusted automatically.

Windows fogged on the inside

- ▶ Press button AC^{OFF} to switch on the air conditioning (▷ page 159).

The indicator lamp in the button goes out.

- ▶ Press button  to switch off the air recirculation (▷ page 159).



The indicator lamp on the button goes out.

- ▶ Adjust left and right air vents **1** and **6** upwards (▷ page 157).
- ▶ Set blower to the maximum speed.
- ▶ Increase temperature setting.
- ▶ Open the side air vents **9** and direct them onto the side windows (▷ page 157).

Automatic climate control

Windshield fogged on the outside

- ▶ Switch the windshield wipers on.
- ▶ Press on both **AUTO** buttons until they click in.

The , ,  and  symbols are no longer visible.

- ▶ Press button  to switch off the air recirculation (▷ page 159).

The indicator lamp on the button goes out.

- ▶ Set blower to the maximum speed.

Adjusting air volume

Use air volume control **9** (▷ page 159) for both automatic and manual air volume adjustment.

Adjusting automatically

- ▶ Press **A** on air volume switch **9** (▷ page 159).

The display shows “AUTO”. The air volume is adjusted automatically.

Adjusting manually

Reducing air volume

- ▶ Press switch **9** down until the desired air volume is reached.

The display shows the current level.

Increasing air volume

- ▶ Press switch **9** up until the desired air volume is reached.

The display shows the current level.

Maximum cooling MAXCOOL

If the left and right air distribution controls as well as the air volume control are set to **AUTO** and there is a high need for cooling, the display “AUTO MAXCOOL” appears.

This provides the fastest possible cooling of the vehicle interior (when windows and sliding / pop-up roof are closed).

Defrosting



These settings should only be selected for a short time.

Activating

- ▶ Press button  (▷ page 159).

The indicator lamp on the button lights up.

Switch off air recirculation, if selected.

- ▶ Press button  (▷ page 159).

The indicator lamp on the button goes out.

- ▶ Close center air vents.
- ▶ Adjust side air vents upwards.

Deactivating

- ▶ Press button  (▷ page 159).

The indicator lamp on the button goes out. Defrosting is turned off.

Air recirculation mode

Switch to air recirculation mode to prevent unpleasant odors from entering the vehicle from the outside. This setting cuts off the intake of outside air and recirculates the air in the passenger compartment.

Warning!



When the outside temperature is below 41 °F (5°C), only switch to air recirculation mode for short periods to prevent window fogging.

Activating

- ▶ Press button (▷ page 159).

The indicator lamp on the button lights up.



If you keep button pressed, the side windows and the sliding / pop-up roof will be closed.

Warning!



Never operate the side windows and the sliding / pop-up roof if there is the possibility of anyone being harmed by the closing procedure.

In the event that the procedure causes potential danger, the closing of the side windows can be immediately halted by releasing the button or by pressing the respective window switch. The closing of the sliding / pop-up roof can be immediately halted by releasing the button or by moving the sliding / pop-up roof switch in the overhead control panel in any direction.



The air recirculation mode is activated automatically:

- at high outside temperatures
- if the concentration of carbon monoxide and nitrogen oxide in the outside air increases beyond a predetermined level, for example in a tunnel.

Please note that the charcoal filter must be activated (▷ page 164) for the air recirculation mode to be activated automatically.

If you have turned off the air conditioning (▷ page 166) or the outside temperature is below 41 °F (5°C), the air recirculation mode will not switch on automatically.

Automatic climate control

Deactivating

- ▶ Press button  (▷ page 159).

The indicator lamp on the button goes out.



If you keep button  pressed, the side windows and the sliding / pop-up roof will be returned to their previous position.

The air recirculation mode is deactivated automatically:

- after five minutes if the outside temperature is below approximately 41 °F (5 °C)
- after five minutes if the air conditioning is turned off
- after 30 minutes if the outside temperature is above approximately 41 °F (5 °C)

At outside temperatures above 79 °F (26 °C) the system will not automatically switch back to outside air. A quantity of outside air is added after approximately 30 minutes.

Charcoal filter

An activated charcoal filter markedly reduces bad odors and removes pollutants from air entering the passenger compartment.

Activating

- ▶ Press button  (▷ page 159).

The indicator lamp on the button lights up.





If you keep button  pressed, the side windows and the sliding / pop-up roof will be closed.

Warning!



Never operate the side windows and the sliding / pop-up roof if there is the possibility of anyone being harmed by the closing procedure.

In the event that the procedure causes potential danger, the procedure can be immediately halted by releasing the  button or by pressing the respective window switch. The closing of the sliding / pop-up roof can be immediately halted by releasing the  button or by moving the sliding / pop-up roof switch in the overhead control panel in any direction.

Deactivating

- ▶ Press button  (▷ page 159).

The indicator lamp on the button goes out.



If you keep button  pressed, the side windows and the sliding / pop-up roof will be returned to their previous positions.

The system switches automatically to the air recirculation mode if the carbon monoxide (CO) or nitrogen oxide (NO_x) concentration of the outside air increases beyond a predetermined level, for example in a tunnel.

The automatic air recirculation mode does not function if **AC^{OFF}** mode is selected or if the outside temperature has fallen below 41°F (5°C).

The activated charcoal filter should be switched off when windows fog up on the inside, or if the passenger compartment needs to be quickly heated or cooled down.

Rear window defroster

The rear window defroster uses a large amount of power. To keep battery drain to a minimum, switch off the defroster as soon as the rear window is clear. The defroster is automatically deactivated after approximately 6 to 17 minutes of operation depending on the outside temperature.

Activating

- ▶ Press button  (▷ page 159).
The indicator lamp on the button lights up.

Deactivating

- ▶ Press button  (▷ page 159) again.
The indicator lamp on the button goes out.

Warning!



Any accumulation of snow and ice should be removed from the rear window before driving. Visibility could otherwise be impaired, endangering you and others.



If the rear window defroster switches off too soon and the indicator lamp starts blinking, this means that too many electrical consumers are operating simultaneously and there is insufficient voltage in the battery. The system responds automatically by deactivating the rear window defroster.

As soon as the battery has sufficient voltage, the rear window defroster automatically turns itself back on.

Automatic climate control

Deactivating the climate control system

Deactivating

It is possible to completely deactivate the automatic climate control system.

- ▶ Press button **0** (▷ page 159).

The display shows “0”

Reactivating

There are several ways to reactivate the automatic climate control system:

- ▶ Press one of the following buttons, **0**, , **AUTO**, a temperature control switch (▷ page 159) or air volume switch **9** on the climate control panel.

Air conditioning

The air conditioning is operational while the engine is running and cools the interior air to the temperature set by the operator.



Condensation may drip out from underneath the vehicle. This is normal and not an indication of a malfunction.

Deactivating

It is possible to deactivate the air conditioning (cooling) function of the automatic climate control system. The air in the vehicle will then no longer be cooled or dehumidified.

- ▶ Press button **AC^{OFF}** (▷ page 159).

The indicator lamp on the button **AC^{OFF}** lights up.

Activating

Moist air can fog up the windows. You can dehumidify the air with the air conditioning.

- ▶ Press **AC^{OFF}** again (▷ page 159).

The indicator lamp on the button **AC^{OFF}** goes out.

The air conditioning uses the refrigerant R134a. This refrigerant is free of CFCs which are harmful to the ozone layer.



If the **AC^{OFF}** button on the automatic climate control panel starts to blink, this indicates that the air conditioning is losing refrigerant. The compressor has turned itself off. The air conditioning cannot be turned on again.

Have the air conditioning checked at the nearest authorized Mercedes-Benz Center.

Residual heat and ventilation

With the engine switched off, it is possible to continue to heat or ventilate the interior for up to 30 minutes. This feature makes use of the residual heat produced by the engine.

Activating

- ▶ Turn the key in the starter switch to position **1** or remove it from the starter switch.
- ▶ Press button **REST** (▷ page 159).

The indicator lamp on button **REST** comes on.

Deactivating

- ▶ Press button **REST** (▷ page 159).

The indicator lamp on button **REST** goes off.

The residual heat is automatically turned off:

- when the ignition is switched on
- after about 30 minutes
- if the battery voltage drops



How long the system will provide heating depends on the coolant temperature and the temperature set by the operator. The blower will run at speed setting **1** regardless of the air distribution control setting.

Ventilated storage compartment under armrest

The storage compartment under the armrest (▷ page 200) can be ventilated when the automatic air conditioning is switched on. The switch is located inside the storage compartment in the front. The air temperature is about the same as that of the center air vents.

The air volume is dependent on the setting of:

- Air distribution control
- Air volume control
- Air vents in the dashboard

The air temperature is about the same as that of the dashboard air vents. It cannot be regulated separately.

Automatic climate control

Switching ventilation on

- ▶ Push upper portion of switch.

Switching ventilation off

- ▶ Push lower portion of switch.



The compartment can get very warm due to its confined space. When storing heat sensitive objects in the compartment, close the air vent while heating the passenger compartment.



Do not obstruct the air vent in the storage compartment.

Rear passenger compartment adjustable air vents

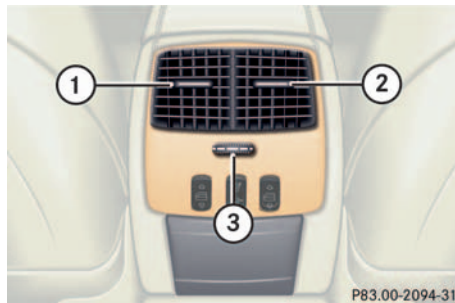

- 1 Left center air vent
- 2 Right center air vent
- 3 Thumbwheel for center air vents with adjustable booster blower

To open center air vents and to adjust the booster blower:

- ▶ Turn thumbwheel **3**.



The booster blower allows air volume speed to the rear passenger compartment to be increased at four different levels.

The temperature at the air vents for rear passenger compartment **1** and **2** is the same as at the dashboard center air vents.

Power windows

Opening and closing the windows

The side windows can be opened and closed electrically. The switches for all the side windows are on the driver's door. The switches for the respective windows are on the passenger door and on the rear center console.

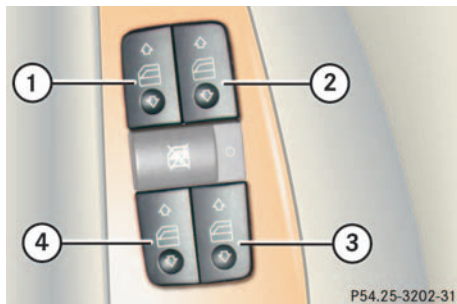

- 1 Left front window
- 2 Right front window
- 3 Right rear window
- 4 Left rear window

Additional switches for the rear windows are located on the rear center console.



- 1 Left rear window
- 2 Right rear window

Warning!



When closing the windows, make sure that there is no danger of anyone being harmed by the closing procedure.

The closing of the door windows can be immediately halted by releasing the switch or, if switch was pressed past the resistance point and released, by pressing the respective switch.

If the window encounters an obstruction that blocks its path in a circumstance where you pressed the switch past the resistance point and released it to close the window, the automatic reversal function will stop the window and open it slightly.

If the window encounters an obstruction that blocks its path in a circumstance where you are closing the window by pressing and holding the switch, by pressing and holding button  on the SmartKey, or by pressing and holding the lock button (vehicles with KEYLESS-GO*) on the door handle, the automatic reversal function will not operate.

When leaving the vehicle, always remove the key from starter switch, take the SmartKey with KEYLESS-GO* with you, and lock your vehicle. Do not leave children unattended in the vehicle, or with access to an unlocked vehicle. Unsupervised use of vehicle equipment can cause an accident and/or serious personal injury.

Power windows

- ▶ Turn key in the starter switch to position **1** or **2**.

Opening the windows

- ▶ Lightly press switch  to resistance point.

The window will move downwards until you release the switch.

Closing the windows

- ▶ Lightly press switch  to resistance point.

The window will move upwards until you release the switch.

If you pull and hold the switch up when closing the window, and upward movement of the window is blocked by some obstruction including but not limited to arms, hands, fingers etc., the automatic reversal will not operate.

Fully opening the windows

- ▶ Press switch  past the resistance point and release.

Fully closing the windows

- ▶ Press switch  past the point of resistance and release.



If the upward movement of the window is blocked during the closing procedure, the window will stop and open slightly.

Remove the obstruction, press the switch  again past the resistance point and release.

If the window still does not close when there is no obstruction, then hold the switch  down. The side window will then close without the obstruction sensor function.

Warning!



Driver's door only:



If within five seconds you again press the switch past the resistance point and release, the automatic reversal will not function.

Stopping windows

- ▶ Press respective switch again.



You can also open or close the windows using the:

- SmartKey, see below
- button  in the control panel of the automatic climate control (▶ page 159).
- button  in the control panel of the automatic climate control (▶ page 159).



Opening and closing the windows with the SmartKey

The sliding/pop-up roof will also be opened or closed when you operate the power windows with the key.

Warning!



Never operate the windows or sliding/pop-up roof if there is the possibility of anyone being harmed by the opening or closing procedure.

In the event that the procedure causes potential danger, the procedure can be immediately halted by releasing the remote control button. To reverse direction of movement, press  for opening or  for closing.

Opening (Summer opening feature)

- ▶ Press and hold button  after unlocking the vehicle.

The windows and sliding/pop-up roof begin to open after approximately one second.

- ▶ Release the  button to stop procedure.

Closing (Convenience feature)

- ▶ Press and hold button  after locking the vehicle.

The windows and sliding/pop-up roof begin to close after approximately one second.

- ▶ Release the  button to stop procedure.

Make sure that all side windows and the sliding/pop-up roof are properly closed before leaving the vehicle.

Power windows

Closing the side windows and sliding / pop-up roof with KEYLESS-GO*

- ▶ Press and hold lock button at door (▷ page 52) until the side windows and the sliding / pop-up roof are closed.

Warning!





When closing the windows and the sliding / pop-up roof, make sure that there is no danger of anyone being harmed by the closing procedure.

The windows will not automatically re-open if blocked during convenience closing.

If potential danger exists, proceed as follows:

SmartKey

- Release the  button.
- Press and hold the  button until the windows and the sliding / pop-up roof open again.

KEYLESS-GO*

- Release the lock button.
- Pull on the door handle and hold firmly. The side windows and the sliding / pop-up roof will open for as long as the door handle is held but the door not opened.

Synchronizing power windows

The power windows must be resynchronized each time after the battery has been disconnected:

- ▶ Push the power window switches until the side windows are closed and hold the switches for approximately one second.

Sliding/pop-up roof

Opening and closing the sliding/pop-up roof



- 1 Push up to raise roof at rear
- 2 Pull down to lower roof at rear
- 3 Push forward to slide roof closed
- 4 Push back to slide roof open

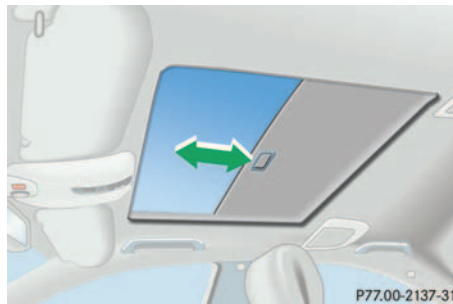

With the roof closed or tilted open, a screen can be slid into the roof opening to guard against sun rays. When sliding the roof open, the screen will also retract.

Warning!



When closing the sliding/pop-up roof, make sure that there is no danger of anyone being harmed by the closing procedure.

The closing procedure of the sliding/pop-up roof can be immediately halted by releasing the switch or, if the switch was moved past the resistance point and released, by moving the switch in any direction.

When leaving the vehicle, always remove the key from starter switch, take the KEYLESS-GO* card with you, and lock your vehicle. Do not leave children unattended in the vehicle, or with access to an unlocked vehicle. Unsupervised use of vehicle equipment may cause an accident and/or serious personal injury.

Opening and closing the sliding/pop-up roof

- ▶ Turn the key in the starter switch to position **1** or **2** or press the KEYLESS-GO* start/stop button.
- ▶ To open, close, raise or lower the sliding/pop-up roof, move the switch to resistance point in the required direction.

Release the switch when the roof has reached the required position.

Sliding / pop-up roof

Opening the sliding / pop-up roof automatically

- ▶ To select a sunroof opening position, press the switch to the resistance point and release it when the sunroof has reached the required position.

The sliding / pop-up roof now opens to the position set if the switch is pressed past the resistance point in the “open” direction.

Closing the sliding / pop-up roof automatically

- ▶ Press the switch past the resistance point in the “close” direction and release.

The sliding / pop-up roof closes completely.



Stopping the sliding / pop-up roof

- ▶ Move the switch in any direction.

If the movement of the sliding / pop-up roof is blocked during the closing procedure, the roof will stop and reopen slightly.



You can also open or close the sliding / pop-up roof using the:

- SmartKey (▷ page 171)
- button  in the control panel of the automatic climate control (▷ page 159)
- button  in the control panel of the automatic climate control (▷ page 159)



To avoid damaging the seals, do not transport any objects with sharp edges which can stick out of the sliding / pop-up roof.

The sliding / pop-up roof can be opened or closed manually should an electrical malfunction occur (▷ page 301).



Opening and closing the sliding / pop-up roof with the SmartKey

The power windows will also be opened or closed when you operate the sliding / pop-up roof with the key.

Warning!



Never operate the windows or sliding / pop-up roof if there is the possibility of anyone being harmed by the opening or closing procedure.

In case the procedure causes potential danger, the procedure can be stopped immediately by releasing the remote control button. To reverse direction of movement, press  for opening or  for closing

- ▶ Aim transmitter eye at the front door handle.

Opening (Summer opening feature)

- ▶ Press and hold button  after unlocking the vehicle.

The windows and sliding / pop-up roof begin to open after approximately one second.

- ▶ Release the  button to stop procedure.

Closing (Convenience feature)

- ▶ Press and hold button  after locking the vehicle.

The windows and sliding / pop-up roof begin to close after approximately one second.

- ▶ Release the  button to stop procedure.

Make sure that all side windows and the sliding / pop-up roof are properly closed before leaving the vehicle.

Closing the side windows and sliding / pop-up roof with KEYLESS-GO* (Convenience feature)

- ▶ Press and hold lock button at door (▷ page 52) until the side windows and the sliding / pop-up roof are closed.

Warning!

When closing the windows and the sliding / pop-up roof, make sure that there is no danger of anyone being harmed by the closing procedure.

If potential danger exists, proceed as follows:

- Release the lock button.
- Pull on the door handle and hold firmly. The side windows and the sliding / pop-up roof will open for as long as the door handle is held but the door not opened.

Synchronizing the sliding / pop-up roof

The power sliding / pop-up roof must be re-synchronized each time after:

- the battery has been disconnected
 - the sliding / pop-up roof has been closed manually
 - the sliding / pop-up roof does not open smoothly
 - a malfunction
- ▶ Press the switch in direction 1 (▷ page 173).
 - ▶ Wait until the sliding / pop-up roof is raised and hold the switch down for approx. one second.

Driving systems

Driving systems

The driving systems of your vehicle are described on the following pages:

- Cruise control and DISTRONIC*, with which the vehicle can maintain a preset speed
- ABC with vehicle level control systems, with which you can change vehicle suspension characteristics.
- Parktronic system*, which serves as a parking assistant.

The BAS, ABS and ESP driving systems are described in the “Safety and Security” section (▷ page 71).

Cruise control

Cruise control automatically maintains the speed you set for your vehicle.

Use of cruise control is recommended for driving at a constant speed for extended periods of time. You can set any speed over 20 mph (30 km/h).

The cruise control function is operated by means of the cruise control lever.

The cruise control lever is the uppermost lever found on the left-hand side of the steering column (▷ page 20).

Warning!



Cruise control is a convenience system designed to assist the driver during vehicle operation. The driver is and must remain at all times responsible for the vehicle speed and for safe brake operation.

Only use cruise control if the road, traffic and weather conditions make it advisable to travel at a steady speed.

- The use of cruise control can be dangerous on winding roads or in heavy traffic because conditions do not allow safe driving at a steady speed.
- The use of cruise control can be dangerous on slippery roads. Rapid changes in tire traction can result in wheel spin and loss of control.
- Deactivate cruise control when driving in fog.

The “Resume” function should only be operated if the driver is fully aware of the previously set speed and wishes to resume this particular preset speed.

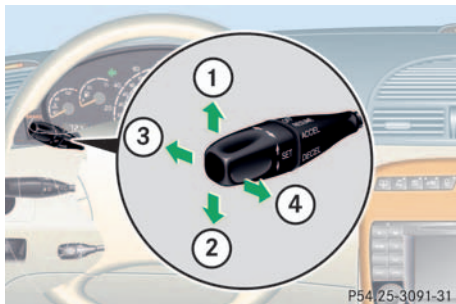

- 1 Set current or higher speed
- 2 Set current or lower speed
- 3 Cancel cruise control
- 4 Resume at previously set speed

Setting current speed

- ▶ Accelerate or decelerate to the desired speed.
- ▶ Briefly lift **1** or depress **2** the cruise control lever.

The current speed is set.

- ▶ Remove your foot from the accelerator pedal.

Cruise control is activated.

The selected speed appears in the multi-function display for approximately 5 seconds, and the corresponding speedometer segments from the selected speed to the vehicle maximum speed are illuminated.



On uphill or downhill grades, cruise control may not be able to maintain the set speed. Once the grade eases, the set speed will be resumed.

Canceling cruise control

There are several ways to cancel cruise control:

- ▶ Step on the brake pedal.
- or
- ▶ Briefly push the cruise control lever to position **3**.

Cruise control will be canceled. The last speed set will be stored for later use.



Moving gear selector lever to position **N** while driving also cancels cruise control. However, the gear selector lever should not be moved to position **N** while driving except to coast when the vehicle is in danger of skidding (e.g. on icy roads).



The last stored speed is canceled when you turn off the engine.

Driving systems

Setting to last stored speed (“Resume” function)

Warning!



The speed stored in memory should only be set again if prevailing road conditions permit. Possible acceleration or deceleration differences arising from returning to preset speed could cause an accident and /or serious injury to you and others.

- ▶ Briefly push the cruise control lever to position **4**.

The cruise control will resume the last set speed.

- ▶ Remove your foot from the accelerator pedal.

The selected speed appears in the multi-function display for approximately 5 seconds, and the corresponding speedometer segments from the selected speed to the vehicle maximum speed are illuminated.

Setting a higher speed

- ▶ Lift the cruise control lever to position **1** and hold it until the desired speed is reached.
- ▶ Release the cruise control lever.

The new speed is set.



Depressing the accelerator pedal does not deactivate cruise control. After brief acceleration (e.g. for passing), cruise control will resume the last speed set.

Setting a lower speed

- ▶ Depress the cruise control lever to position **2** and hold it until the desired speed is reached.
- ▶ Release the cruise control lever.

The new speed is set.



When you use the cruise control lever to decelerate, the transmission will automatically downshift if the engine's braking power does not slow the vehicle sufficiently.

Fine adjustment in 1 mph (Canada: 1 km/h) increments

Faster

- ▶ Briefly tip the cruise control lever in the direction of arrow **1**.

Slower

- ▶ Briefly tip the cruise control lever in the direction of arrow **2**.

Distronic*

When activated, the DISTRONIC adaptive cruise control system increases driving convenience afforded by the cruise control during travel on expressways and other major roads.

- If the DISTRONIC distance sensor detects a slower moving vehicle directly ahead, your vehicle speed will be reduced so that you follow that vehicle at a preset distance.
- If there is no vehicle directly ahead of you, DISTRONIC will function in the same way as cruise control (▷ page 176).

Warning!

DISTRONIC adaptive cruise control is no substitute for active driving involvement. It does not react to stationary objects, nor recognize or predict the curvature and lane layout or the movement of vehicles ahead. DISTRONIC can only apply a maximum of 20% of the vehicle's braking power.

It is the driver's responsibility at all times to be attentive to traffic and road conditions and to provide the steering, braking and other driving inputs necessary to retain control of the vehicle.

Warning!

DISTRONIC is a convenience system. Its speed adjustment reduction capability is intended to make cruise control more effective and usable when traffic speeds vary. However, it is not intended to, nor does it, replace the need for extreme care. The responsibility for the vehicle speed and the distance to the vehicle ahead, including most importantly brake operation to assure safe stopping distance, always rests with the driver.

DISTRONIC cannot take street and traffic conditions into account.

Warning!

DISTRONIC requires familiarity with its operational characteristics. We strongly recommend that you review the following information carefully before operating the system.



For operation in the USA only: This device complies with Part 15 of the FCC Rules. Operation is subject to the following two conditions:

- This device may not cause harmful interference, and
- this device must accept any interference received, including interference that may cause undesired operation.

Any unauthorized modification to this device could void the user's authority to operate the equipment.

Driving systems

Warning!



Distronic cannot take street and traffic conditions into account. Only use Distronic if the road, weather and traffic conditions make it advisable to travel at a steady speed.

Warning!



Use of Distronic can be dangerous on slippery roads. Rapid changes in tire traction can result in wheel spin and loss of control.

Distronic does not act upon adverse sight distance conditions. Do not use Distronic during conditions of fog and heavy rain, snow or sleet.

Warning!



Close attention to road and traffic conditions is imperative at all times, regardless of whether or not Distronic is activated.

Use of Distronic can be dangerous on winding roads or in heavy traffic because conditions do not allow safe driving at a steady speed.

Distronic will not react to stationary objects in the roadway (e.g. a stopped vehicle in a traffic jam or a disabled vehicle). Distronic will also not respond to oncoming vehicles.

Switch off Distronic:

- when changing from the left to the right lane if vehicles are moving more slowly in the left lane
- when entering a turn lane or highway off ramp
- in complex driving situations, such as in highway construction zones

In these situations, Distronic will continue to maintain the set speed unless deactivated.

Distronic is designed and intended only to maintain a set speed and keep a set distance from moving objects in front of it.

Warning!



The “Resume” function should only be operated if the driver is fully aware of the previously set speed and wishes to resume this particular preset speed.

Distronic displays in the speedometer dial

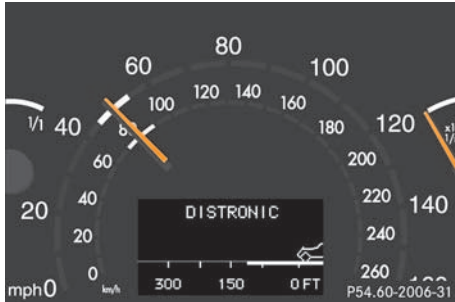

Set speed

If DISTRONIC is activated, one or two segments light up around the set speed.



The vehicle speed displayed on the speedometer can briefly vary from the speed setting on the DISTRONIC system.

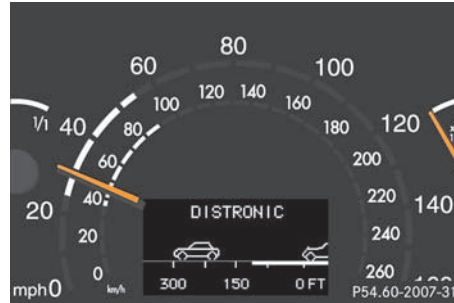

Segments

If DISTRONIC detects a vehicle directly ahead, the segments from the speed of the vehicle ahead to set speed light up.

If DISTRONIC calculates that there is a danger of collision

- the distance warning lamp  in the instrument cluster lights up red
- an intermittent warning sounds

- ▶ Immediately brake the vehicle to avoid a collision.

Under no circumstances should the driver await the intermittent warning sound before braking. See warning note on the next page.

The intermittent warning sound ceases and the red distance warning lamp  goes out when the necessary distance to the vehicle ahead is again established.



Warning!



An intermittent warning sounds and the distance warning lamp  in the instrument cluster is illuminated if the Distronic system calculates that the distance to the vehicle ahead and your vehicle's current speed indicate that Distronic will not be capable of slowing the vehicle sufficiently to maintain the preset following distance, which creates a danger of a collision.

Immediately brake the vehicle to increase the distance between your vehicle and the vehicle in front of you. The warning sound is intended as a final caution that you have not interceded with your own braking inputs to avoid a potentially dangerous situation. Do not wait for the operation of the warning signal to intercede with your own braking, as that will result in potentially dangerous emergency braking which will not always result in an impact being avoided.

Tailgating increases the risk of an accident.

Warning!



Distronic brakes your vehicle with a maximum of 6.5 ft/s^2 (2 m/s^2). This corresponds to about 20% of the maximum deceleration ability of your vehicle.



Distronic brakes the vehicle in an effort to restore the preset distance or to maintain the speed. The brake pedal is automatically applied as this happens which results in the brake pedal moving.

Keep driver's foot area clear at all times, including the area under the brake pedal. Objects stored in this area may impair pedal movement which could interfere with the braking ability of the Distronic system.

Do not place your foot under the brake pedal – your foot could become caught.

Distronic menu in the control system

In the Distronic menu you can read the current settings for Distronic. What appears in the display depends on whether Distronic and the distance warning function are turned on or off.

- ▶ Press button  or  repeatedly until you see one of the following displays.

Distronic deactivated

If DISTRONIC is deactivated, you can see the standard display of DISTRONIC in the multifunction display.

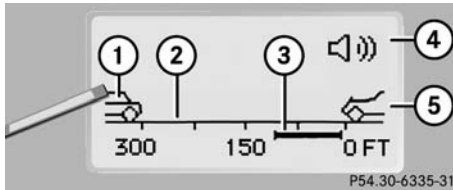

- 1 Vehicle ahead, if detected
- 2 Actual distance to vehicle ahead
- 3 Desired distance to vehicle ahead
- 4 Symbol for activated distance warning function
- 5 Your vehicle

Distronic activated

If you turn DISTRONIC on, you will see the set speed in the multifunction display for about five seconds. If DISTRONIC is activated, you can see the following display in the multifunction display.

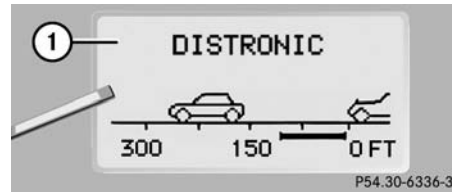

- 1 DISTRONIC activated

Cruise control lever

The DISTRONIC system is operated by means of the cruise control lever.

The cruise control lever is the uppermost lever found on the left-hand side of the steering column.

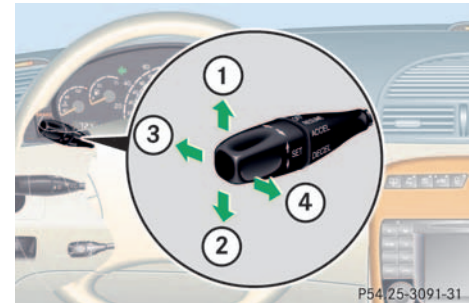

- 1 Set current or higher speed
- 2 Set current or lower speed
- 3 Deactivate DISTRONIC
- 4 Resume at previously set speed

Driving systems

Activating Distronic

You can activate Distronic if

- you are driving between 25 mph (40 km/h) and 110 mph (180 km/h)
- the ESP is activated (▷ page 73)

If Distronic has not been activated after pressing the cruise control lever you will see the message --- in the multifunction display.

In the following cases you cannot activate Distronic:

- up to two minutes after starting the engine
- when you brake
- if you have set the parking brake
- if the gear selector lever is in position **P**, **R** or **N**
- if the ESP is switched off

Setting the current speed

- ▶ Accelerate or decelerate to the desired speed.
- ▶ Briefly lift or depress the cruise control lever.

Distronic is activated and the current speed is set.

- ▶ Remove your foot from the accelerator pedal.



If you do not take your foot off of the accelerator completely, the following message will appear in the multifunction display:

DISTRONIC OVERRIDE.

Distronic will not work to maintain the distance to slower moving vehicle in front of you. Your vehicle speed will then be determined only by the accelerator pedal position.

Setting a higher speed

- ▶ Briefly tip the cruise control lever in the direction of arrow 1 (▷ page 183) to increase vehicle speed in increments of 5 mph (Canada: 10 km/h).

The new speed is set.

The stored speed is displayed in the multifunction display for approximately five seconds (▷ page 183), and one or two segments around the stored speed light up on the speedometer (▷ page 181).



Depressing the accelerator pedal does not deactivate Distronic. After brief acceleration (e.g. for passing), the cruise control will resume the last speed set.

Setting a lower speed

- ▶ Briefly tip the cruise control lever in the direction of arrow **2** (▷ page 183) to decrease vehicle speed in increments of 5 mph (Canada: 10 km/h).

The new speed is set.

The stored speed is displayed in the multifunction display for approximately five seconds (▷ page 183), and one or two segments around the stored speed light up on the speedometer (▷ page 181).



When you use the cruise control lever to decelerate, the transmission will automatically downshift if the rate of deceleration is too low.

Fine adjustment in 1 mph (Canada: 1 km/h) increments

Faster

- ▶ Briefly tip the cruise control lever in the direction of arrow **4** (▷ page 183).

Setting to last stored speed ("Resume" function)

Warning!



The speed stored in memory should only be set again if prevailing road conditions permit. Possible acceleration or deceleration differences arising from returning to preset speed could cause an accident and / or serious injury to you and others.

- ▶ Briefly tip the cruise control lever in the direction of arrow **4** (▷ page 183).
Distronic is set to the last stored speed.
- ▶ Remove your foot from the accelerator pedal.

Driving systems

Deactivating Distronic

There are several ways to deactivate the Distronic system:

- ▶ Briefly tip the cruise control lever in the direction of arrow **3** (▷ page 183).

or

- ▶ Step on the brake pedal.

Distronic will be deactivated. The last speed set will be stored into memory.



The following message will appear in the multifunction display for approximately five seconds: **DISTRONIC OFF**.

The last stored speed is deleted when you turn off the engine.

Distronic deactivates automatically when:

- You set the parking brake.
- You drive slower than 25 mph (40 km/h).
- The ESP is active (▷ page 73) or you deactivate the ESP.
- You move the transmission selector lever into position **N**.

A signal will sound. The **DISTRONIC OFF** message appears in the multifunction display for approximately five seconds.

Warning!



Distronic switches off and releases the brakes when the vehicle decelerates below the minimum speed of approx. 25 mph (40 km/h) by operation of the system. At that time the driver must apply the brakes in order to reduce vehicle speed further or bring it to a stop.

Setting the following distance in Distronic

You can set the specified following distance for Distronic by varying the time setting between 1.0 and 2.0 seconds. Using this time setting and the current speed of your vehicle, Distronic calculates and sets the required following distance to the vehicle ahead. The set distance will be shown in the multifunction display field.

The thumbwheel for making the time setting is located on the lower section of the center console.

Warning!



It is up to the driver to exercise discretion to select the appropriate setting given road conditions, traffic, driver's preferred driving style and applicable laws and driving recommendations for safe following distance.



- 1 Distance warning function on / off switch
- 2 Thumbwheel for setting distance

Increasing distance

Increasing the distance setting tells DISTRONIC to maintain a greater following distance to the vehicle ahead.

- ▶ Turn thumbwheel **2** towards .

Decreasing distance

Decreasing the distance setting tells DISTRONIC to maintain a shorter following distance to the vehicle ahead.

- ▶ Turn thumbwheel **2** towards .

Distance warning function

When DISTRONIC is deactivated, this function will continue to warn you when recognizing a stationary obstacle or a slower vehicle moving in the vehicle's path and the danger of a collision exists:

- The distance warning lamp  in the instrument cluster lights up
- An intermittent warning sounds.

If these warnings are issued, you must brake manually to maintain a safe distance and avoid a collision with the vehicle ahead.

When pressing the brake pedal, the warning sound stops. The warning sound also stops when the distance to the vehicle ahead is sufficient again without applying the brake pedal. In this case the distance warning lamp  also extinguishes.

Warning!



If the distance warning lamp  in the instrument cluster lights up while driving and / or an intermittent warning sounds, immediate attention on the part of the driver is required.

As required by the traffic situation, apply the brakes and navigate around a possible obstacle. However, do not drive by relying on the distance warning function, as this will result in an emergency braking application. Especially depending on road surface conditions and driver reaction, this will not always enable you to avoid a collision.

Driving systems



Complex driving situations are not always fully recognized by DISTRONIC. This could result in wrong or missing distance warnings.

Activating

- ▶ Press switch 1.

Indicator lamp on the switch lights up. A loudspeaker symbol appears in the multifunction display (▷ page 183).

Deactivating

- ▶ Press switch 1.

Indicator lamp on the switch goes out. No loudspeaker symbol appears in the multifunction display.

Driving with DISTRONIC

This section describes a number of driving situations where special precaution is required on the part of the driver. Be prepared to brake in such situations. This will deactivate the DISTRONIC system.

Warning!



DISTRONIC works to maintain the speed selected by the driver unless a moving obstacle proceeding directly ahead of it in the same travel direction is detected (e.g. following another vehicle ahead of you at a distance set by DISTRONIC). This means that:

- Your vehicle can pass another vehicle after you change lanes.
- While in a sharp turn or if the vehicle in front is in a sharp turn, DISTRONIC could lose sight of a vehicle traveling in front of it, then your vehicle could accelerate to the previously selected speed.

DISTRONIC regulates only the distance between your vehicle and those directly ahead of it, but does not register stationary objects in the road, e.g.:

- a stopped vehicle in a traffic jam
- a disabled vehicle
- an oncoming vehicle

The driver must always be on the alert, observe all traffic and intercede as required by steering or braking the vehicle.

Warning!



DISTRONIC should not be used in snowy or icy road conditions.

The most likely cause for a malfunctioning system is a dirty sensor (located behind the hood grill), especially at times of snow and ice or heavy rain. In such a case, Distronic will switch off, and the message **DISTRONIC - CLEAN SENSOR! SEE OPERATOR'S MAN.** appears in the multifunction display.

For cleaning and care of the Distronic sensor, see “Cleaning the Distronic system sensor” (▷ page 259).



If the message **DISTRONIC - CLEAN SENSOR! SEE OPER. MANUAL** disappears during driving and the last speed stored flashes for approximately five seconds, the dirt (e.g. slush) has dissolved; Distronic is again operational.

Turns and bends

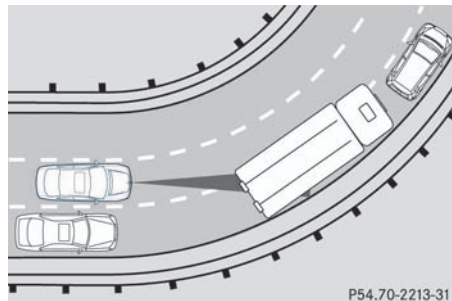

In turns or bends, Distronic may not detect a moving vehicle in front, or it may detect one too soon. This may cause your vehicle to brake late or unexpectedly.

Offset driving

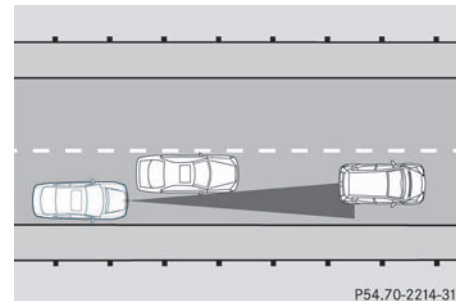

A vehicle traveling in your lane but offset from your direct line of travel may not be detected by Distronic. There will be insufficient distance to the vehicle ahead.

Lane changing

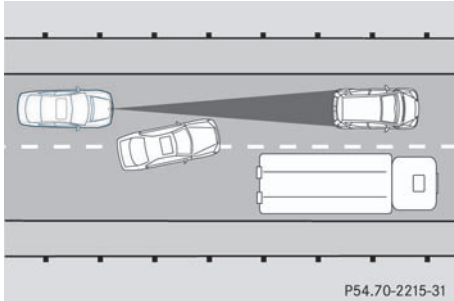

Distronic has not yet detected the vehicle changing lanes. There will be insufficient distance to the lane changing vehicle.

Narrow vehicles

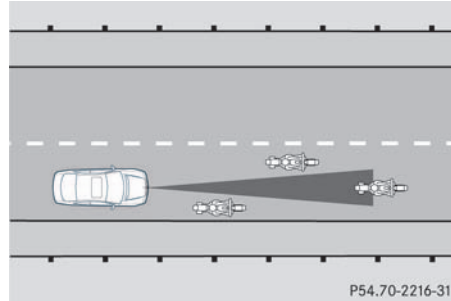

Because of their narrow profiles, the vehicles traveling near the outer edges of the lane have not yet been detected by Distronic. There will be insufficient distance to the vehicle ahead.

Active Body Control (ABC)

The ABC system automatically selects the optimum suspension tuning and ride height for your vehicle.

Suspension tuning

The suspension tuning is set according to:

- your driving style
- road surface conditions
- the vehicle loading
- your choice of suspension style, “sporty” or “regular”, which you select using the ABC switch

The selected suspension style is stored in memory, even after the key is removed from the starter switch.



- 1 ABC switch
2 Indicator lamp

- ▶ Start the engine.

Suspension for sporty driving

The setting for sporty driving is selected when indicator lamp **2** is illuminated.

- ▶ Press ABC switch **1** to change from regular suspension to sporty driving suspension.

Indicator lamp **2** comes on.

Suspension for regular driving

The setting for regular driving is selected when indicator lamp **2** is off.

- ▶ Press ABC switch **1** to change from sporty driving suspension to regular suspension.

Indicator lamp **2** goes out.

Vehicle level control

Your vehicle automatically adjusts its ride height to

- reduce fuel consumption
- increase vehicle safety

The vehicle chassis ride height is raised or lowered according to the selected level setting and to the vehicle speed:

- With increasing speed, ride height is reduced by up to a maximum of 0.95 inches (24 mm).
- With decreasing speed, the ride height is again raised to the selected vehicle level.



These height adjustments are so small that you may not notice any change.

Select the level 1 and 2 settings only when required by current driving conditions. Otherwise

- fuel consumption may increase
- handling may be impaired

Warning!



To help avoid personal injury, keep hands and feet away from wheel housing area, and stay away from under the vehicle when lowering the vehicle chassis.

Driving systems

The following vehicle level settings can be selected when the vehicle is stationary:

Vehicle level when stationary	Use for	Ride height increase over normal	Automatic lowering	Indicator lamps (▷ page 192)
Normal level	Normal operation	None	Max. approx. 0.4 in (11 mm)	Both lamps off
Raised level 1	Driving with snow chains (▷ page 253)	Max. 0.55 in (14 mm) ¹	Max. approx. 0.55 in (14 mm)	One lamp on
Raised level 2	Very rough road surface conditions	Max. 0.95 in (24 mm) ¹	Max. approx. 0.95 in (24 mm)	Both lamps on

¹ Dependent on load

The switch and the indicator lamps are located in the upper part of the center console.

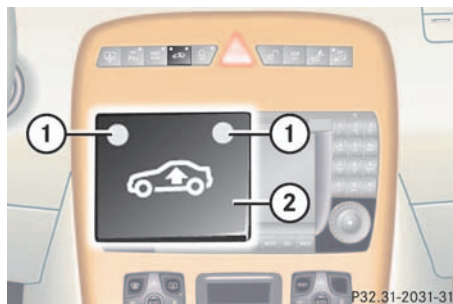

- 1 Indicator lamps
- 2 Vehicle level control switch

- ▶ Briefly press switch **2** to change from one level setting to the next. When vehicle is at raised level 2, pressing the switch will return the vehicle to normal level.

The message:

ACTIVE BODY CONTROL
VEHICLE RISING!

appears in the multifunction display. The display switches off when the vehicle is raised.



Pressing the switch twice in quick succession will cause the vehicle to immediately raise or lower according to the starting level.

The selected vehicle level setting remains stored in memory even if the engine is turned off and restarted.

Normal level (see table)

Speed dependent lowering of vehicle chassis (approximate values):

- between 0 mph (0 km/h) and 40 mph (65 km/h) – none
- between 40 mph (65 km/h) and 87 mph (140 km/h) – lowered progressively by approx. 0.4 in (11 mm).

Raised level 1 (see table)

Speed dependent lowering of vehicle chassis (approximate values)

- between 0 mph (0 km/h) and 38 mph (60 km/h) – raised by approx. 0.55 in (14 mm)
- between 38 mph (60 km/h) and 100 mph (160 km/h) – lowered progressively by approx. 0.55 in (14 mm)

Raised level 2 (see table)

Speed dependent lowering of vehicle chassis (approximate values):

- between 0 mph (0 km/h) and 18 mph (30 km/h) – raised by approx. 0.95 in (24 mm)
- between 18 mph (30 km/h) and 38 mph (60 km/h) – lowered progressively by approx. 0.4 in (10 mm)
- between 38 mph (60 km/h) and 100 mph (160 km/h) – lowered progressively by additional approx. 0.55 in (14 mm).

Parktronic system* (Parking assist)

Warning!



Parktronic is a supplemental system. It is not intended to, nor does it replace, the need for extreme care. The responsibility during parking and other critical maneuvers always rests with the driver.

Special attention must be paid to objects with smooth surfaces or low silhouettes (e.g. trailer couplings, painted posts, or road curbs). Such objects may not be detected by the system and can damage the vehicle.

The operational function of the Parktronic can be affected by dirty sensors, especially at times of snow and ice, see “Cleaning the Parktronic system sensors” (▷ page 259).

Interference caused by other ultrasonic signals (e.g. working jackhammers or the air brakes of trucks) can cause the system to send erratic indications, and should be taken into consideration.

Warning!



Make sure that no persons or animals are in the area in which you are maneuvering. You could otherwise injure them.

The Parktronic system is an electronic aid designed to assist the driver during parking maneuvers. It visually and audibly indicates the relative distance between the vehicle and an obstacle.

The Parktronic system is automatically activated when you switch on the ignition and release the parking brake. The Parktronic system deactivates at speeds over 11 mph (18 km/h). At lower speeds the Parktronic system turns on again.

The Parktronic system monitors the surroundings of your vehicle with six sensors in the front bumper and four sensors in the rear bumper.

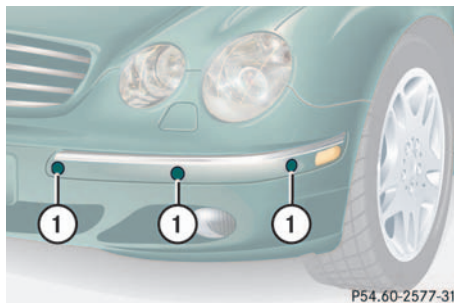

P54.60-2577-31

1 Sensors in the front bumper

Range of the sensors

To function properly, the sensors must be free of dirt, ice, snow and slush. Clean the sensors regularly, being careful not to scratch or damage the sensors.

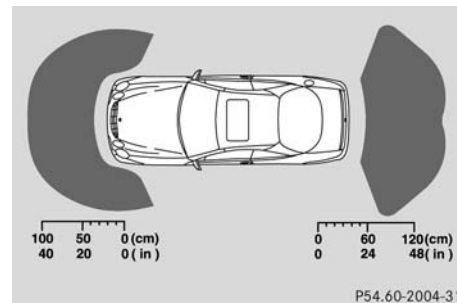

P54.60-2004-31

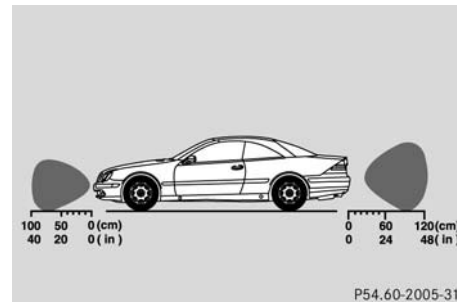

P54.60-2005-31

Front sensors

Center	approx. 40 in (100 cm)
Corners	approx. 24 in (60 cm)

Rear sensors

Center	approx. 48 in (120 cm)
Corners	approx. 32 in (80 cm)



During parking maneuvers, pay special attention to objects located above or below the height of the sensors (e.g. planters or trailer hitches). The Parktronic system will not detect such objects at close range and damage to your vehicle or the object may result.

Ultrasonic signals from outside sources (e.g. truck air brakes or jackhammers) may impair the operation of the Parktronic system.

Minimum distance

Center	approx. 8 in (20 cm)
Corners	approx. 6 in (15 cm)

If the system detects an obstacle in this range, all the warning lamps light up and you hear a warning signal. If the obstacle is closer than the minimum distance, the actual distance might no longer be indicated by the system.

Warning indicators

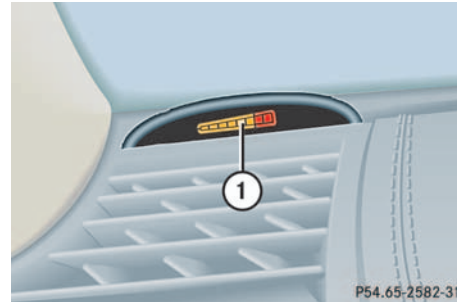

1 Left front area warning indicator

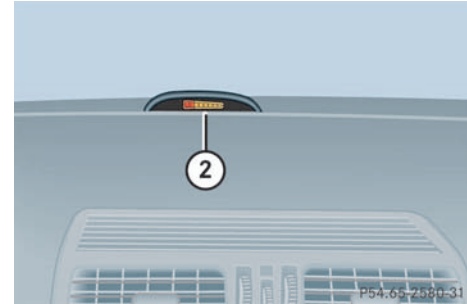

2 Right front area warning indicator

Visual signals indicate to the driver the relative distance between the sensors and an obstacle. The warning indicators for the front area are located above the left air vents **1** and center air vents **2** in the dashboard. The warning indicator for the rear area is integrated in the rear trim.

Each warning indicator is divided into six yellow and two red segments for either side of the vehicle. The Parktronic system is ready when the border around the indicator is illuminated.

Driving systems

The position of the gear selector lever determines which warning indicators will be activated.

Selector lever position	Warning indicator
D	Front area activated
R or N	Rear and front area activated
P	Neither activated

As your vehicle approaches an object, one or more segments will light up, depending on the distance between your vehicle and the object. When the eighth segment lights up, you have reached the minimum distance.

- **Front area:** An intermittent acoustic warning will sound as the first red segment lights up and a constant acoustic warning, both lasting a maximum of three seconds, will sound for the eighth segment, i.e. the second red segment. The signal is canceled when the gear selector lever is placed in position **P**.

- **Rear area:** An intermittent acoustic warning will sound as the first red segment lights up and a constant acoustic warning, both lasting a maximum of three seconds, will sound for the eighth segment, i.e. the second red segment. The signal is canceled when the gear selector lever is placed in position **D** or **P**.

Switching the Parktronic system on/off

You can switch off the Parktronic system manually.

The Parktronic switch is located in the upper section of the center console.

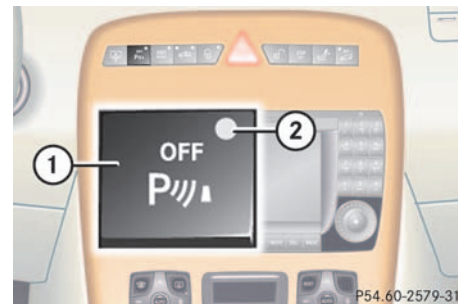

- 1 Parktronic on/off
- 2 Indicator lamp

Switching off the Parktronic system

- ▶ Press switch **1**.
Indicator lamp **2** comes on.

Switching on the Parktronic system

- ▶ Press switch **1** again.
Indicator lamp **2** goes out.

Loading

Roof rack*

Warning!



Use only roof racks approved by Mercedes-Benz for your vehicle model to avoid damage to the vehicle. Follow manufacturer's installation instructions.

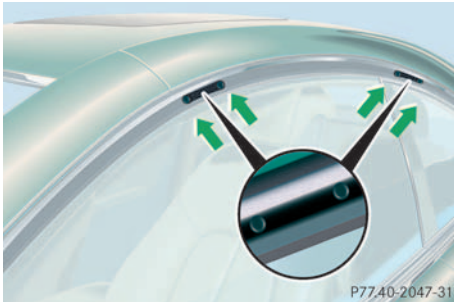

P77,40-2047-31

Preparing roof rack installation

- ▶ Open trim at the trim strips in the roof.
- ▶ Secure the roof rack according to manufacturer's instructions for installation.



Load the roof rack in such a way that the vehicle cannot be damaged while driving.

Make sure that

- you can fully raise the sliding / pop-up roof
- you can fully open the trunk

Loading instructions

The total load weight including vehicle occupants and luggage/cargo should not exceed the vehicle capacity weight indicated on the certification tag which can be found on the left door pillar.

Loading

Warning!



Always fasten items being carried as securely as possible.

In an accident, during hard braking or sudden maneuvers, loose items will be thrown around inside the vehicle and can cause injury to vehicle occupants unless the items are securely fastened in the vehicle.

To help avoid personal injury during a collision or sudden maneuver, exercise care when transporting cargo. Put luggage or cargo in the trunk if possible. Do not pile luggage or cargo higher than the seat backs. Do not place anything on the rear-window shelf.

Never drive vehicle with trunk open. Deadly carbon monoxide (CO) gases may enter vehicle interior resulting in unconsciousness and death.

Cargo tie-down hooks

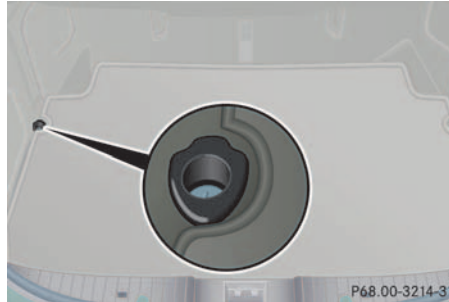

Six hooks are located in the trunk.

- ▶ Carefully secure cargo by applying even load on all hooks with rope of sufficient strength to hold down the cargo.

Useful features

Interior storage spaces

Warning!



To help avoid personal injury during a collision or sudden maneuver, exercise care when stowing objects in the vehicle. Put luggage or cargo in the trunk if possible. Do not pile luggage or cargo higher than the seat backs.

Luggage nets cannot secure hard or heavy objects.

Keep compartment lids closed. This will help to prevent stored objects from being thrown about and injuring vehicle occupants during an accident.

Glove box

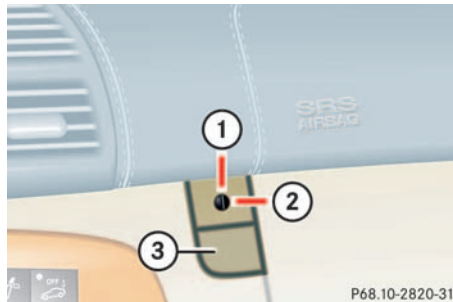

- 1 Unlocked position
- 2 Locked position
- 3 Glove box lid release

Opening the glove box

- ▶ Press button 3.

The glove box lid opens downward.



The glove box can be locked and unlocked with the mechanical key.

Closing the glove box

- ▶ Push lid up to close.

Useful features

Storage compartment in the glove box

A storage compartment is located in the cover of the glove box. It can be used to store check cards, pens, a flashlight, etc.

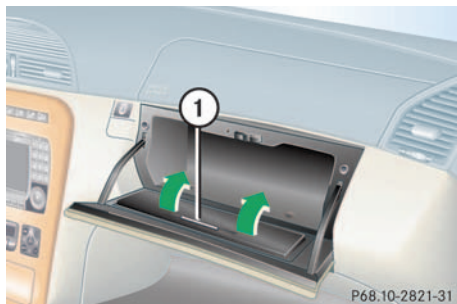

1 Storage compartment in glove box

- ▶ Lightly press the marking on the lid of storage compartment **1**.

The lid opens upward.

An AUX socket is located in the glove box. Portable audio devices can be plugged in here.

Storage compartment in front of armrest

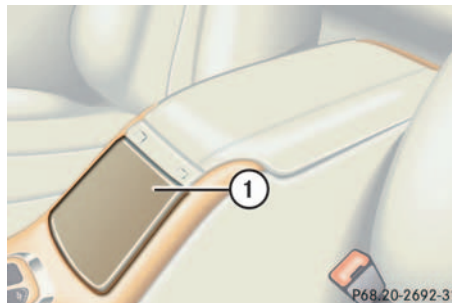

Opening

The compartment contains a cup holder (▷ page 202).

- ▶ Lightly touch cover plate **1**.

The cover opens automatically.

Closing

- ▶ Lightly push the cover plate **1** up until it engages in lock.

Storage compartment below the front armrest

The buttons are located under the cushion of the armrest.

The storage compartment below the front armrest is illuminated with the exterior lamps switched on.

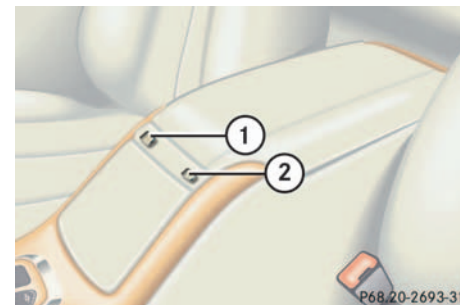

1 Button to open storage compartment

2 Button to open storage tray

Opening storage compartment

The compartment contains a coin holder.

- ▶ Press button **1** and lift the armrest.



The storage compartment can be heated or cooled.

The compartment can get very warm due to its confined space. When storing heat-sensitive objects in the compartment, close the air vent while heating the passenger compartment.



Do not obstruct the air vent in the storage compartment.

Opening storage tray

- ▶ Press button **2** and lift up the armrest.



Do not let bank cards, credit cards or other cards with a magnetic strip come near the storage tray as a magnet built into the tray could erase or change the information on the card.

Storage compartment between rear seats

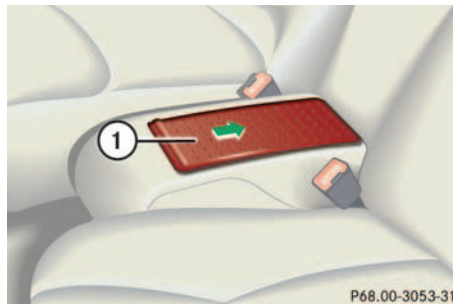

1 Cover

Opening

- ▶ Slide cover **1** rearward.

Closing

- ▶ Slide cover **1** forward.

Storage compartments under the front seats

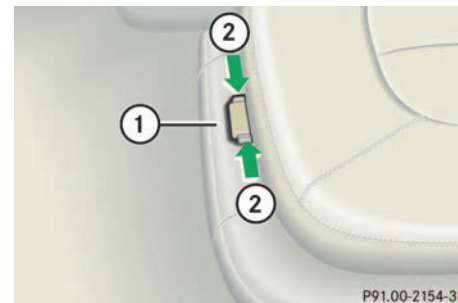

1 Lid
2 Buttons

Opening

- ▶ Press the buttons **2** together and fold the lid **1** down.

Closing

- ▶ Close the lid **1** until both buttons **2** of lock engage.

Useful features

Cup holder in front of seat armrest

Warning!



When not in use, keep the cup holder closed while traveling. Place only containers that fit into the cup holder to prevent spills. Use lids on open containers and do not fill containers to a height where the contents, especially hot liquids, could spill during vehicle maneuvers.

Folding cup holder out

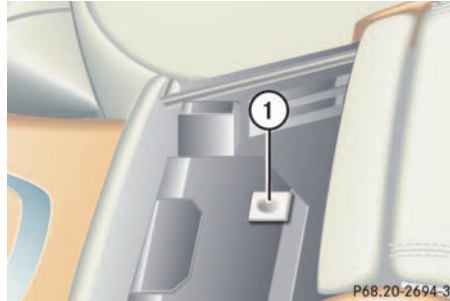

- ▶ Open the storage compartment in front of the armrest (▷ page 200).
- ▶ Push button **1**.

The cup holder opens automatically.

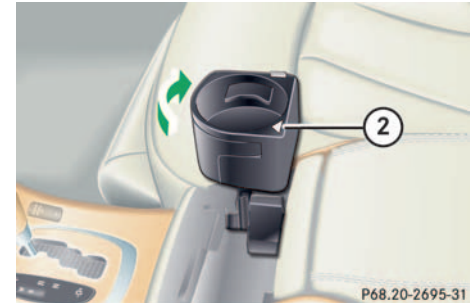

- ▶ Push button **2**.

The second cup holder folds out in the direction indicated by the arrow.

Folding cup holder in

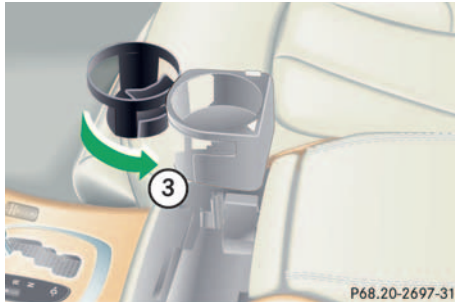

- ▶ Press the second cup holder in the direction of arrow **3** until it engages.

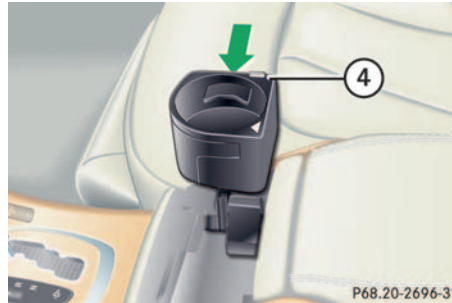

- ▶ Press release button **4** and fold the cup holder into the storage compartment until it engages.
- ▶ Close the storage compartment.

Cup holder in rear seat armrest

Warning!



When not in use, keep the cup holder closed while traveling. Place only containers that fit into the cup holder to prevent spills. Use lids on open containers and do not fill containers to a height where the contents, especially hot liquids, could spill during vehicle maneuvers.

Useful features

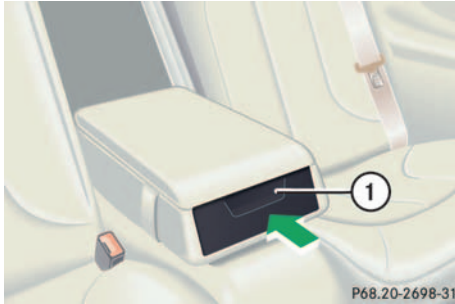

Opening cup holder

- ▶ Push front of sliding compartment **1**.
The cup holder slides out.

Closing cup holder

- ▶ Push sliding compartment **1** back until it engages.

Auxiliary cup holder

You can fasten the auxiliary cup holder onto the left front side of the passenger seat.

Inserting the auxiliary cup holder

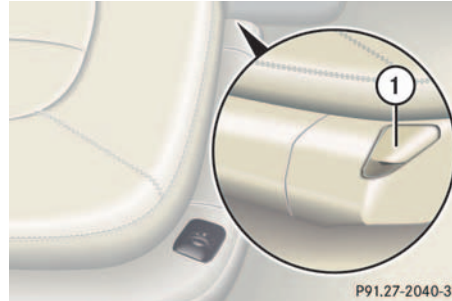

- 1** Cover
- ▶ Pull up the cover and place it in a storage compartment.

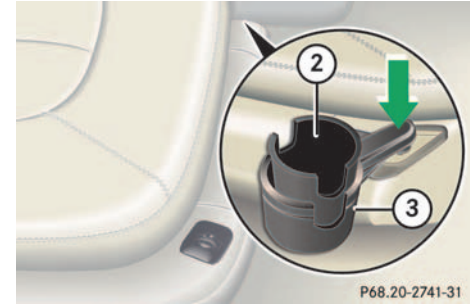

- 2** Insert
- 3** Auxiliary cup holder

- ▶ Press auxiliary cup holder **3** in the direction of the arrow until it snaps in place.

You can now place a larger container in the holder. For even larger containers you can remove insert **2**. Make sure that the container does not press against the glove box.

Warning!

When not in use, remove the auxiliary cup holder. Place only containers that fit into the auxiliary cup holder to prevent spills. Use lids on open containers and do not fill containers to a height where the contents, especially hot liquids, could spill during vehicle maneuvers.



When you move the seat forward, the auxiliary cup holder turns to the side.

When you move the seat back, turn the auxiliary cup holder back until it stops in its original position.

Removing the auxiliary cup holder

- ▶ Pull the auxiliary cup holder **3** (▷ page 204) up and out of the receptacle and place it in a storage compartment.
- ▶ Install cover **1** (▷ page 204) on the opening. Press cover down until it snaps in place.

Parcel net in front passenger footwell

A small convenience parcel net is located in the front passenger footwell. It is for small and light items, such as road maps, mail, etc.

Warning!

Do not place heavy or fragile objects, or objects having sharp edges, in the parcel net.

In an accident, during hard braking or sudden maneuvers, they could be thrown around inside the vehicle and cause injury to vehicle occupants.

Useful features

Parcel net in trunk

You can hang a parcel net in the trunk. The hooks and the parcel net in the trunk can hold a load of up to 29.8 lbs (13.5 kg).

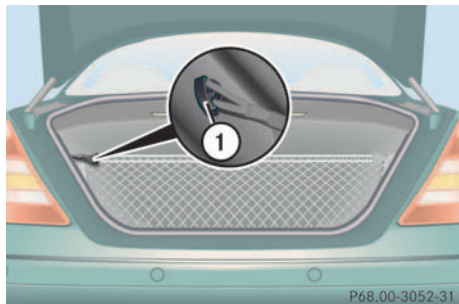

- ▶ Hang the parcel net on hooks **1** on the left and right sides of the trunk.



The parcel net cannot protect or sufficiently secure goods in the event of an accident.

Ashtrays

Center console ashtray



Opening ashtray

- ▶ Briefly touch cover plate.
The ashtray opens automatically.

Removing ashtray insert

Warning!



Remove front ashtray only with vehicle standing still. Set the parking brake to secure vehicle from movement. Move gear selector lever to position **N**. With gear selector lever in position **N**, turn off the engine.

- ▶ Prevent vehicle from moving by setting the parking brake. Move the selector lever to position **N**.
- ▶ Now you have more room to remove the insert.
- ▶ Push sliding button **1** to the right.
The ashtray is disengaged and slides out a short way out.
- ▶ Remove insert from ashtray frame.

Reinstalling the ashtray insert

- ▶ Install insert by pushing back into frame until it engages again.

Rear seat ashtray

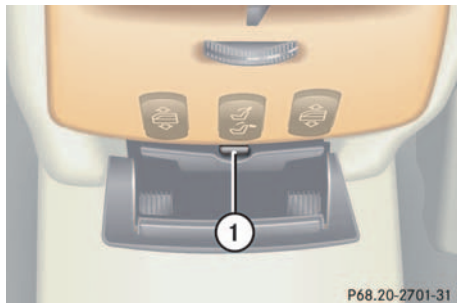

Opening ashtray

- ▶ Pull at top of cover to open ashtray.

Removing ashtray insert

- ▶ Press latch **1** to disengage ashtray insert and remove it.

Reinstalling the ashtray insert

- ▶ Install ashtray insert.
- ▶ Close the ashtray.

Cigarette lighter



1 Cigarette lighter

- ▶ Make sure the ignition is switched on.
All the lamps in the instrument cluster should light up.
- ▶ Push in cigarette lighter **1**.
The lighter will pop out automatically when hot.

Warning!



Never touch the heating element or sides of the lighter; they are extremely hot. Hold the knob only.

When leaving the vehicle, always remove the key from the starter switch, take the KEYLESS-GO* card with you and lock the vehicle. Do not leave children unattended in the vehicle, or with access to an unlocked vehicle. Unsupervised use of vehicle equipment may cause an accident and/or serious personal injury.



The lighter socket can be used to accommodate electrical accessories up to a maximum 85 W.

Useful features

Heated steering wheel*

The steering wheel heating warms up the leather area of the steering wheel.

The lever is on the lower left-hand side of the steering wheel.

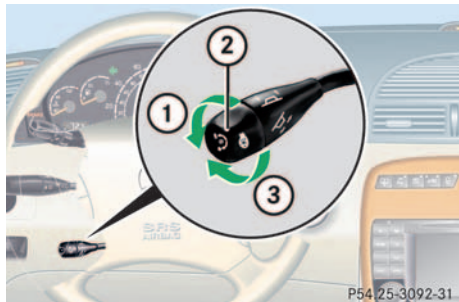

- 1 Switching on
- 2 Indicator lamp
- 3 Switching off

Switching on

- ▶ Make sure the ignition is switched on.

All the lamps in the instrument cluster should light up.

- ▶ Turn lever in direction of arrow **1**.

The steering wheel is heated. Indicator lamp **2** lights up.

Switching off

- ▶ Turn the lever in direction of arrow **3**.

The steering wheel heating is turned off. Indicator lamp **2** goes out.



The steering wheel heating does not turn off automatically.

Telephone*

Warning!



Never operate radio transmitters equipped with a built-in or attached antenna (i.e. without being connected to an external antenna) from inside the vehicle while the engine is running. Doing so could lead to a malfunction of the vehicle's electronic system, possibly resulting in an accident and / or serious personal injury.

Radio transmitters, such as a portable telephone or a citizens band unit, should only be used inside the vehicle if they are connected to an antenna that is installed on the outside of the vehicle.

The external antenna must be approved by Mercedes-Benz. Please contact an authorized Mercedes-Benz Center for information on the installation of an approved external antenna. Refer to the radio transmitter operation instructions regarding use of an external antenna.

Warning!



Please do not forget that your primary responsibility is to drive the vehicle. A driver's attention to the road must always be his/her primary focus when driving. For your safety and the safety of others, we recommend that you pull over to a safe location and stop before placing or taking a telephone call.

If you choose to use the telephone¹ while driving, please use the hands-free device and only use the telephone when road, weather and traffic conditions permit. Some jurisdictions prohibit the driver from using a cellular telephone while driving a vehicle.

Only operate the COMAND (Cockpit Management and Data System)¹ if road, weather and traffic conditions permit.

¹ Observe all legal requirements.

Bear in mind that at a speed of just 30 mph (approximately 50 km/h), your vehicle is covering a distance of approx. 44 feet (approximately 13.5 m) every second.

You can take and make telephone calls using the  and  buttons on the steering wheel. To carry out other telephone functions, use the control system (▷ page 117).

See separate operating manual for instructions on how to use the telephone.

Tele Aid

The initial activation of the Tele Aid system may only be performed by completing the subscriber agreement and placing an acquaintance call using the SOS button. Failure to complete either of these steps will result in a system that is not activated. If the system is not activated, the indicator lamp in the SOS button stays on after turning key in starter switch to position **2** or pressing KEYLESS-GO* start/stop button twice to position **2** (▷ page 33). The message TELE AID - NOT ACTIVATED will be shown in the multifunction display for approx. 10 seconds.

If you have any questions regarding activation, please call the Response Center at 1-800-756-9018 (in the USA) or 1-888-923-8367 (in Canada).

Useful features



The Tele Aid system



(Telematic Alarm Identification on Demand)

The Tele Aid system consists of three types of response:

- Automatic and manual emergency
- Roadside Assistance and
- Information



The Tele Aid system is operational providing that the vehicle's battery is charged, properly connected, not damaged and cellular and GPS coverage is available.

The speaker volume of a Tele Aid call can be adjusted using the volume control on the multifunction steering wheel. To raise, press button  and to lower, press button .

- ▶ To activate, press the SOS button, the Roadside Assistance button  or the Information button , depending on the type of response required.



The SOS button is located above the interior rear view mirror.



The Roadside Assistance button  and the Information button  are located below the center armrest cover.

Shortly after the completion of your Acquaintance Call, you will receive a user ID and password via first call mail. By visiting www.mbusa.com and selecting "Tele Aid" (USA only), you will have access to account information, remote door unlock, profile and more.



The Tele Aid system utilizes the cellular network for communication and the GPS (Global Positioning System) satellites for vehicle location. If either of these signals are unavailable, the Tele Aid system may not function and if this occurs, assistance must be summoned by other means.

System self-check

Initially, after turning the key in starter switch to position **2**, malfunctions are detected and indicated (the indicator lamps in the SOS button, the Roadside Assistance button  and the Information button  stay on longer than 10 seconds or do not come on). The message TELE AID - VISIT WORKSHOP! appears for approx. 10 seconds in the multifunction display.

Warning!

If the indicator lamps in the SOS button, in the Roadside Assistance button and/or in the Information button do not come on during the system self-check or if any of these indicators remain illuminated constantly in red and/or the message **TELE AID - VISIT WORKSHOP!** is displayed in the multifunction display after the system self-check, a malfunction in the system has been detected.

If a malfunction is indicated as outlined above, the system may not operate as expected. Have the system checked at the nearest Mercedes-Benz Center as soon as possible.

Emergency calls

An emergency call is initiated automatically:

- following an accident in which the emergency tensioning devices (ETDs) or airbags deploy
- if the anti-theft alarm or the tow-away alarm stays on for more than 20 seconds. See anti-theft alarm system (▷ page 76) and tow-away alarm (▷ page 78)

An emergency call can also be initiated manually by opening the cover next to the inside rear view mirror labeled **SOS**, then briefly pressing the button located under the cover. See below for instructions on initiating an emergency call manually.

Once the emergency call is in progress, the indicator lamp in the SOS button will begin to flash. The message **EMERGENCY CALL - CONNECTING CALL** appears in the multifunction display. When the connection is established, the message **EMERGENCY CALL - CALL CONNECTED** appears in the multifunc-

tion display. All information relevant to the emergency, such as the location of the vehicle (determined by the GPS satellite location system), vehicle model, identification number and color are generated.

A voice connection between the Response Center and the occupants of the vehicle will be established automatically soon after the emergency call has been initiated. When a voice connection is established the audio system mutes and the message **TELE AID - CALL CONNECTED** appears in the multifunction display. The Response Center will attempt to determine more precisely the nature of the accident provided they can speak to an occupant of the vehicle.

Useful features

The Tele Aid system is available if:

- It has been activated and is operational. Activation requires a subscription for monitoring services, connection and cellular air time
- The relevant cellular phone network and GPS signals are available and pass the information on to the response center



Location of the vehicle on a map is only possible if the vehicle is able to receive signals from the GPS satellite network and pass the information on to the response center.

Warning!



If the indicator lamp in the SOS button is illuminated continuously and there was no voice connection to the Response Center established, then the Tele Aid system could not initiate an emergency call (e.g. the relevant cellular phone network is not available). The message **EMERGENCY CALL - CALL FAILED** appears in the multifunction display for approx. 10 seconds.

Should this occur, assistance must be summoned by other means.

Initiating an emergency call manually

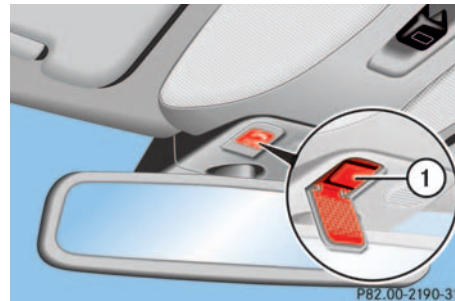

1 SOS button

- ▶ Briefly press on the cover of the emergency call button with the inscription **SOS** above the inside rear view mirror.
The cover will open.
- ▶ Press SOS button **1** briefly.
The indicator lamp in SOS button **1** will flash until the emergency call is concluded.
- ▶ Wait for a voice connection to the Response Center.

- ▶ Close cover **1** after the emergency call is concluded.

Warning!

If you feel at any way in jeopardy when in the vehicle (e.g. smoke or fire in the vehicle, vehicle in a dangerous road location), please do not wait for voice contact after you have pressed the emergency button. Carefully leave the vehicle and move to a safe location. The Response Center will automatically contact local emergency officials with the vehicle's approximate location if they receive an automatic SOS signal and cannot make voice contact with the vehicle occupants.

Roadside Assistance button 

Located below the center armrest cover is the Roadside Assistance button .

- ▶ Press and hold the button (for longer than 2 seconds).

A call to a Mercedes-Benz Roadside Assistance dispatcher will be initiated. The button will flash while the call is in progress. The message **ROADSIDE ASSISTANCE - CONNECTING CALL** will appear in the multifunction display.

When the connection is established, the message **ROADSIDE ASSISTANCE - CALL CONNECTED** appears in the multifunction display. The Tele Aid system will transmit data generating the vehicle identification number, model, color and location (subject to availability of cellular and GPS signals).

A voice connection between the Roadside Assistance dispatcher and the occupants of the vehicle will be established. When a voice connection is established the audio

system mutes and the message **TELE AID - ROADSIDE ASSISTANCE CALL CONNECTED** appears in the multifunction display.

- ▶ Describe the nature of the need for assistance.



The Mercedes-Benz Roadside Assistance dispatcher will either dispatch a qualified Mercedes-Benz technician or arrange to tow your vehicle to the nearest Mercedes-Benz Center. For services such as labor and /or towing, charges may apply. Refer to the Roadside Assistance manual for more information.

These programs are only available in the USA:

- **Sign and Drive services:** Services such as jump start, a few gallons of fuel or the replacement of a flat tire with the vehicle spare tire are obtainable.
- **Remote Vehicle Diagnostics:** This function permits the Mercedes-Benz Roadside Assistance dispatcher to download malfunction codes and real time vehicle data.

Useful features



The indicator lamp in the Roadside Assistance button  remains illuminated in red for approx. 10 seconds during the system self-check after turning the key in the starter switch to position **2** (together with the SOS button and the Information button ).

See system self-check (▷ page 210) when the indicator lamp does not light up in red or stays on longer than approximately 10 seconds.

If the indicator lamp in the Roadside Assistance button  is illuminated continuously and there was no voice connection to the Response Center established, then the Tele Aid system could not initiate a Roadside Assistance call (e.g. the relevant cellular phone network is not available). The message **ROADSIDE ASSISTANCE - CALL FAILED** appears in the multifunction display.

Roadside Assistance calls can be terminated using the  button on the multifunction steering wheel.

Information button

Located below the center armrest cover is the Information button .

- ▶ Press and hold the button (for longer than 2 seconds).



A call to the Customer Assistance Center will be initiated. The button will flash while the call is in progress. The message **INFO - CONNECTING CALL** will appear in the multifunction display.

When the connection is established, the message **INFO - CALL CONNECTED** appears in the multifunction display. The Tele Aid system will transmit data generating the vehicle identification number, model, color and location (subject to availability of cellular and GPS signals).

A voice connection between the Customer Assistance Center representative and the occupants of the vehicle will be established. When a voice connection is established the audio system mutes and the message **TELE AID - INFO CALL ACTIVE** appears in the multifunction display. Information regarding the operation of your vehicle, the nearest Mercedes-Benz Center or Mercedes-Benz USA products and services is available to you.

For more details concerning the Tele Aid system, please visit www.mbusa.com and use your ID and password (sent to you separately) to learn more (USA only).



The indicator lamp in the Information button  remains illuminated in red for approx. 10 seconds during the system self-check after turning key in the starter switch to position **2** (together with the SOS button and the Roadside Assistance button .

See System self-check (▷ page 210) when the indicator lamp does not light up in red or stays on longer than approximately 10 seconds.

If the indicator lamp in the Information button  is illuminated continuously and no voice connection to the Response Center has been established, then the Tele Aid system could not initiate an Information call (e.g. the relevant cellular phone network is not available). The message INFO - CALL FAILED appears in the multifunction display.

Information calls can be terminated using the  button on the multifunction steering wheel.



If the indicator lamps do not start flashing after pressing one of the buttons or remain illuminated (in red) at any time, the Tele Aid system has detected a fault or the service is not currently active, and may not initiate a call. Visit your Mercedes-Benz Center and have the system checked or contact the Response Center at 1-800-756-9018 (in the USA) or 1-888-923-8367 (in Canada) as soon as possible.

Upgrade Signals

The Tele Aid system processes calls using the following priority:

- Automatic emergency – First priority
- Manual emergency – Second priority
- Roadside Assistance – Third priority
- Information – Fourth priority

Should a higher priority call be initiated while you are connected, an upgrade (alternating) tone will be heard, and the appropriate indicator lamp will flash. If certain information such as vehicle identification number or customer information is not available, the operator may need to retransmit.

During this time you will hear a beep and voice contact will be interrupted. Voice contact will resume once the retransmission is completed. Once a call is concluded, a beep will be heard and the appropriate indicator lamp will stop flashing. The COMAND system operation will resume.

Useful features



If the indicator lamp continues to flash or the system does not reset, contact the Response Center at 1-800-756-9018 (in the USA) or 1-888-923-8367 (in Canada), or Mercedes-Benz Customer Assistance at 1-800-FOR-MERCEdes (1-800-367-6372) in the USA or Customer Service at 1-800-387-0100 in Canada.



The indicator lamp in the corresponding button flashes until the call is concluded. Calls can only be terminated by a Response Center or Customer Assistance representative except Roadside Assistance and Information calls, which can also be terminated by pressing button  on the multifunction steering wheel.



When a Tele Aid call has been initiated, the audio system or the COMAND system audio is muted and the selected mode (radio, tape or CD) pauses. The optional cellular phone (if installed) switches off. If it is necessary for you to use this phone, then the vehicle must be at a standstill. Disconnect the coiled cord and place the call. The COMAND navigation system (if engaged) will continue to run. The display in the instrument cluster is available for use and spoken commands are only available by pressing the RPT button on the COMAND unit. A pop-up window will appear in the COMAND display to indicate that a Tele Aid call is in progress.

Remote door unlock

In the event that you have locked your vehicle unintentionally (e.g. key inside vehicle), and the reserve key is not handy:

- ▶ Contact the Mercedes-Benz Response Center at 1-800-756-9018 (in the USA) or 1-888-923-8367 (in Canada).

You will be asked to provide your password which you provided when you completed the subscriber agreement.

- ▶ Then return to your vehicle and press the trunk lock for a minimum of 20 seconds until the SOS button is flashing.

The message **EMERGENCY CALL - CALL CONNECTED** appears in the multifunction display.

As an alternative, you may unlock the vehicle via Internet using the ID and password sent to you shortly after the completion of your Acquaintance Call.

The Response Center will then unlock your vehicle with the remote door unlocking feature.



The remote door unlocking feature is available if the relevant cellular phone network is available.

The SOS button will flash and the message **EMERGENCY CALL - CALL CONNECTED** will appear in the multifunction display to indicate receipt of the door unlock command.

Once the vehicle is unlocked, a Response Center specialist will attempt to establish voice contact with the vehicle occupants.

If the trunk button was pressed for more than 20 seconds before door unlock authorization was received by the Response Center, you must wait 15 minutes before pressing the trunk lock again.

Stolen vehicle tracking services

In the event your vehicle was stolen:

- ▶ Report the incident to the police.
The police will issue a numbered incident report.
- ▶ Give this number to the Mercedes-Benz Response Center along with the password which was issued to you when you subscribed to the service.

The Response Center will then attempt to covertly contact the vehicle's Tele Aid system. Once the vehicle is located, the Response Center will contact the local law enforcement and you. The vehicle's location will only be provided to law enforcement.

Garage door opener

The built-in remote control is capable of operating up to three separately controlled objects.

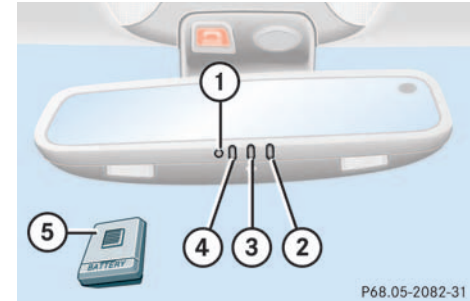

- 1 Indicator lamp
- 2, 3, 4 Signal transmitter key
- 5 Hand-held remote control transmitter (not part of vehicle equipment)

Useful features

Warning!



When programming a garage door opener, the door moves up or down.

When programming or operating the remote control, make sure there is no possibility of anyone being injured by the moving door.



Certain types of garage door openers are incompatible with the integrated opener. If you should experience difficulties with programming the transmitter, contact your authorized Mercedes-Benz Center, or call Mercedes-Benz Customer Assistance Center (in the USA only) at 1-800-FOR-MERCEdes, or Customer Service (in Canada) at 1-800-387-0100.



For operation in the USA only: This device complies with Part 15 of the FCC Rules. Operation is subject to the following two conditions:

- (1) This device may not cause harmful interference.
- (2) This device must accept any interference received, including interference that may cause undesired operation.

Any unauthorized modification to this device could void the user's authority to operate the equipment.

Programming or reprogramming the integrated remote control

- ▶ Turn key in the starter switch to position **1** or **2**.
- ▶ Hold the end of the hand-held transmitter of the device you wish to train approximately 2 to 5 inches (5 cm to 12 cm) away from the surface of the integrated remote control located on the inside rear view mirror, keeping the indicator lamp in view.
- ▶ Using both hands, simultaneously push the hand-held transmitter button and the desired integrated remote trunk lid switch. Do not release the buttons until completing next step.

- ▶ The indicator lamp on the integrated remote control will flash, first slowly and then rapidly. The rapid flashing lamp indicates successful programming of the new frequency signal.
- ▶ When the indicator lamp flashes rapidly, release both buttons.
- ▶ To program the remaining two buttons, repeat the above steps.



If, after several attempts, you do not successfully program the integrated remote control device to learn the signal of the hand-held transmitter, the garage door opener could be equipped with the “rolling code feature”.

Rolling code programming

To train a garage door opener (or other rolling code devices) with the rolling code feature, follow these instructions after completing the “Programming” portion of this text. (A second person may make the following training procedures quicker and easier.)

- ▶ Locate training button on the garage door opener motor head unit.
Exact location and color of the button may vary by garage door opener brand. If there is difficulty locating the transmitting button, refer to garage door opener operator’s manual.
- ▶ Press “training” button on the garage door opener motor head unit.
The “training light” is activated.

You have 30 seconds time to initiate the following step.

- ▶ Firmly press and release the programmed integrated remote control transmit button.
- ▶ Press and release same button a second time to complete the training process.

Some garage door openers may require you to do this procedure a third time to complete the training.

- ▶ Confirm the garage door operation by pressing the programmed button on the integrated remote control transmitter.

Useful features

Canadian programming

During programming, your hand-held transmitter may automatically stop transmitting.

- ▶ Continue to press and hold the integrated remote control transmitter button (refer to steps two through four in the “Programming” portion) while you repeatedly press (“cycle”) your hand-held transmitter every two seconds until the frequency signal has been learned.

Upon successful training, the indicator lamp will flash slowly and then rapidly after several seconds.

Operating the remote control

- ▶ Turn key in starter switch to position **1** or **2**.
- ▶ Select and press the appropriate button to activate the remote controlled device.

The integrated remote control transmitter continues to send the signal as long as the button is pressed – up to 20 seconds.

Erasing the remote control memory

- ▶ Turn key in ignition to position **1** or **2**.
- ▶ Simultaneously hold down the left and right side buttons for approximately 20 seconds, or until the indicator lamp blinks rapidly.

The codes of all three channels are erased.



If you sell your vehicle, erase the codes of all three channels.

Infrared reflecting windshield

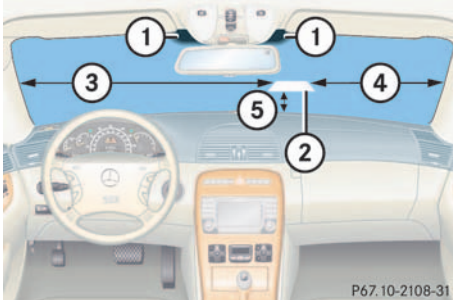

- 1** Mounting location for electronic toll collection devices (infrared transparent)
- 2** Infrared transparent area (pass-through for electronic signals)
- 3** 31.5 in (80 cm)
- 4** 19.0 in (48 cm)
- 5** 1.75 in (4.5 cm)

Your vehicle is equipped with infrared reflecting glass which reduces the amount of radiated heat entering the interior through the windows.

The infrared reflecting glass also prevents the transmission of signals through the glass by in-vehicle electronic devices (e.g. electronic toll collection devices).

To allow the use of these devices in the vehicle, two infrared transparent areas (**1** and **2**) are placed in the windshield.

Operation

The first 1000 miles (1500 km)

Driving instructions

At the gas station

Engine compartment

Tires and wheels

Winter driving

Maintenance

Vehicle care



The first 1000 miles (1500 km)

In the “Operation” section you will find detailed information on operating, maintaining and caring for your vehicle.

The first 1000 miles (1500 km)

The more cautiously you treat your vehicle during the break-in period, the more satisfied you will be with its performance later on.

- Drive your vehicle during the first 1000 miles (1500 km) at varying but moderate vehicle and engine speeds.
- During this period, avoid heavy loads (full throttle driving) and excessive engine speeds (no more than $\frac{2}{3}$ of maximum rpm in each gear).
- Avoid accelerating by kick-down.
- Do not attempt to slow the vehicle down by shifting to a lower gear using the selector lever.
- Select gear positions **3**, **2** or **1** only when driving at moderate speeds (for hill driving).

After 1000 miles (1500 km), you may gradually increase vehicle and engine speeds to the permissible maximum.



Additional instructions for AMG vehicles:

- During the first 1000 miles (1500 km) do not exceed a speed of 85 mph (140 km/h).
- During this period, avoid engine speeds above 4500 rpm in each gear.



All of the above instructions, as may apply to your vehicle type, also apply when driving the first 1000 miles (1500 km) after the engine or the rear differential has been replaced.



Always obey applicable speed limits.

Driving instructions

Drive sensibly – save fuel

Fuel consumption, to a great extent, depends on driving habits and operating conditions.

To save fuel you should:

- Keep tires at the recommended inflation pressures.
- Remove unnecessary loads.
- Remove roof rack when not in use.
- Allow engine to warm up under low load use.
- Avoid frequent acceleration and deceleration.
- Have all maintenance work performed at regular intervals by an authorized Mercedes-Benz Center.

Fuel consumption is also increased by driving in cold weather, in stop-and-go traffic, on short trips and in hilly country.

Drinking and driving

Warning!



Drinking and driving and/or taking drugs and driving are very dangerous combinations. Even a small amount of alcohol or drugs can affect your reflexes, perceptions and judgement.

The possibility of a serious or even fatal accident is sharply increased when you drink or take drugs and drive.

Please don't drink or take drugs and drive or allow anyone to drive after drinking or taking drugs.

Pedals

Warning!



Keep driver's foot area clear at all times. Objects stored in this area may impair pedal movement.

Power assistance

Warning!



With the engine not running, there is no power assistance for the brake and steering systems. In this case, it is important to keep in mind that a considerably higher degree of effort is necessary to brake and steer the vehicle.

Driving instructions

Brakes

Warning!



After driving in heavy rain for some time without applying the brakes or through water deep enough to wet brake components, the first braking action may be somewhat reduced and increased pedal pressure may be necessary to obtain expected braking effect. Maintain a safe distance from vehicles in front.

Resting your foot on the brake pedal will cause excessive and premature wear of the brake pads.

It can also result in the brakes overheating, thereby significantly reducing their effectiveness. It may not be possible to stop the vehicle in sufficient time to avoid an accident.

To help prevent brake disk corrosion after driving on wet road surfaces (particularly salted roads), it is advisable to brake the vehicle with considerable force prior to parking. The heat generated serves to dry the brakes.

If your brake system is normally only subjected to moderate loads, you should occasionally test the effectiveness of the brakes by applying above-normal braking pressure at higher speeds. This will also enhance the grip of the brake pads.



Be very careful not to endanger other road users when you apply the brakes.

Refer to the description of the Brake Assist System (BAS) (▷ page 73).

If the parking brake is released and the brake warning lamp in the instrument cluster stays on, the brake fluid level in the reservoir is too low.

Brake pad wear or a leak in the system may be the reason for low brake fluid in the reservoir.

Have the brake system inspected at an authorized Mercedes-Benz Center immediately.

All checks and service work on the brake system should be carried out by an authorized Mercedes-Benz Center.

Install only brake pads and brake fluid recommended by Mercedes-Benz.

Warning!

If other than recommended brake pads are installed, or other than recommended brake fluid is used, the braking properties of the vehicle can be degraded to an extent that safe braking is substantially impaired. This could result in an accident.



When driving down long and steep grades, relieve the load on the brakes by shifting into a lower gear to use the engine's braking power. This helps prevent overheating of the brakes and reduces brake pad wear.

After hard braking, it is advisable to drive on for some time, rather than immediately parking, so that the air stream can cool down the brakes faster.

Driving off

Apply the brakes to test them briefly after driving off. Perform this procedure only when the road is clear of other traffic.

Warm up the engine smoothly. Do not place full load on the engine until the operating temperature has been reached.

When starting off on a slippery surface, do not allow one drive wheel to spin for an extended period with the ESP switched off. Doing so may cause serious damage to the drive train which is not covered by the Mercedes-Benz Limited Warranty.



Simultaneously depressing the accelerator pedal and applying the brake reduces engine performance and causes premature brake and drivetrain wear.

Parking

Set the parking brake whenever parking or leaving the vehicle. In addition, move selector lever to position **P**.

In addition, when parking on hills, turn front wheel towards the curb.

Warning!

Do not park this vehicle in areas where combustible materials such as grass, hay or leaves can come into contact with the hot exhaust system, as these materials could be ignited and cause a vehicle fire.

Driving instructions

To reduce the risk of personal injury as a result of inadvertent vehicle movement, before turning off the engine and leaving the vehicle always:

- Keep right foot firmly on brake pedal.
- Firmly depress parking brake pedal.
- Move the selector lever to position **P**.
- Slowly release brake pedal.
- When parked on an incline, turn front wheel towards the road curb.
- Turn the key to starter switch position **0** and remove, or press KEYLESS-GO* start/stop button (vehicles with KEYLESS-GO*).
- Take the key or the KEYLESS-GO* card with you and lock vehicle when leaving.

Tires

Warning!



If you feel a sudden significant vibration or ride disturbance, or you suspect that possible damage to your vehicle has occurred, you should turn on the hazard warning flashers, carefully slow down, and drive with caution to an area which is a safe distance from the road.

Inspect the tires and the vehicle underbody for possible damage. If the vehicle or tires appear unsafe, have it towed to the nearest Mercedes-Benz Center or tire dealer for repairs.

Tread wear indicators (TWI) are required by law. These indicators are located in six places on the tread circumference and become visible at a tread depth of approximately $\frac{1}{16}$ in (1.5 mm), at which point the tire is considered worn and should be replaced.

The tread wear indicator appears as a solid band across the tread.

Warning!



Do not allow your tires to wear down too far. As tread depth approaches $\frac{1}{16}$ in (1.5 mm), the adhesion properties on a wet road are sharply reduced.

Depending upon the weather and/or road surface (conditions), the tire traction varies widely.

Specified tire pressures must be maintained. This applies particularly if the tires are subject to extreme operating conditions (e.g. high speeds, heavy loads, high ambient temperatures).

Warning!

Do not drive with a flat tire. A flat tire affects the ability to steer or brake the vehicle. You may lose control of the vehicle. Continued driving with a flat tire or driving at high speed with a flat tire will cause excessive heat build-up and possibly a fire.

Hydroplaning

Depending on the depth of the water layer on the road, hydroplaning may occur, even at low speeds and with new tires. Reduce vehicle speed, avoid track grooves in the road and apply brakes cautiously in the rain.

Tire traction

The safe speed on a wet, snow covered or icy road is always lower than on a dry road.

You should pay particular attention to the condition of the road whenever the outside temperatures are close to the freezing point.

Warning!

If ice has formed on the road, tire traction will be substantially reduced. Under such weather conditions, drive, steer and brake with extreme caution.

Mercedes-Benz recommends M+S rated radial-ply tires for the winter season for all four wheels to insure normal balanced handling characteristics. On packed snow, they can reduce your stopping distance in comparison to summer tires. Stopping distance, however, is still considerably greater than when the road is not covered with snow or ice. Exercise appropriate caution.

Tire speed rating

Regardless of the tire rating, local speed limits should be obeyed. Use prudent driving speeds appropriate to prevailing conditions.

Warning!

Even when permitted by law, never operate a vehicle at speeds greater than the maximum speed rating of the tires.

Exceeding the maximum speed for which tires are rated can lead to sudden tire failure, causing loss of vehicle control and possibly resulting in an accident and/or personal injury and possible death, for you and for others.

CL 500 and CL 600

An electronic speed limiter prevents your vehicle from exceeding a speed of 130 mph (210 km/h).

Driving instructions

CL500 (without Sport Package*)

Your vehicle is factory equipped with “H”-rated tires, which have a speed rating of 130 mph (210 km/h).

CL 600 (without Sport Package*)

Your vehicle is factory equipped with “Y”-rated tires, which have a speed rating of 188 mph (300 km/h).

Vehicles with Sport Package*

Your vehicle is factory equipped with “Y”-rated tires, which have a speed rating of 188 mph (300 km/h).

CL 55 AMG

Your vehicle is factory equipped with “Y”-rated tires, which have a speed rating of 188 mph (300 km/h).

An electronic speed limiter prevents your vehicle from exceeding a speed of 155 mph (250 km/h).

Information on tire speed rating for winter tires (▷ page 252)

Winter driving instructions

The most important rule for slippery or icy roads is to drive sensibly and to avoid abrupt acceleration, braking and steering maneuvers. Do not use the cruise control system under such conditions.

When the vehicle is in danger of skidding, move selector lever to position **N**. Try to keep the vehicle under control by corrective steering action.



Information on driving with snow chains (▷ page 253).

Warning!



On slippery road surfaces, never downshift in order to obtain braking action. This could result in drive wheel slip and reduced vehicle control. Your vehicle’s ABS will not prevent this type of control loss.

Road salts and chemicals can adversely affect braking efficiency. Increased pedal force may become necessary to produce the normal braking effect.

We therefore recommend depressing the brake pedal periodically when traveling at length on salt-strewn roads.

This can bring road salt impaired braking efficiency back to normal. Be very careful that you carry out these braking maneuvers without endangering any other road users.

If the vehicle is parked after being driven on salt treated roads, the braking efficiency should be tested as soon as possible after driving is resumed while observing the safety rules in the previous paragraph.

Warning!

If the vehicle becomes stuck in snow, make sure that snow is kept clear of the exhaust pipe and from around the vehicle with the engine running. Otherwise, deadly carbon monoxide (CO) gases may enter vehicle interior resulting in unconsciousness and death.

To assure sufficient fresh air ventilation, open a window slightly on the side of the vehicle not facing the wind.

Warning!

The outside temperature indicator is not designed to serve as an ice-warning device and is therefore unsuitable for that purpose. Indicated temperatures just above the freezing point do not guarantee that the road surface is free of ice.

For more information on winter driving (▷ page 252).

Standing water

Do not drive through flooded areas or water of unknown depth.

If you must drive through standing water, drive slowly to prevent water from entering the passenger compartment or the engine compartment. Water in these areas could cause damage to electrical components or wiring of the engine or transmission, or could result in water being ingested by the engine through the air intake causing severe internal engine damage. Any such damage is not covered by the Mercedes-Benz Limited Warranty.

Passenger compartment**Warning!**

Always fasten items being carried as securely as possible.

In an accident, during hard braking or sudden maneuvers, loose items will be thrown around inside the vehicle, and cause injury to vehicle occupants unless the items are securely fastened in the vehicle.

The trunk is the preferred place to carry objects.

Driving abroad

Abroad, there is a widely-spread Mercedes-Benz service network at your disposal. If you plan to drive into areas which are not listed in the index of your Mercedes-Benz Center directory, you should request pertinent information from your authorized Mercedes-Benz Center.

Driving instructions

Control and operation of radio transmitters

COMAND, radio and telephone*

Warning!



Please do not forget that your primary responsibility is to drive the vehicle safely. Only operate the COMAND (Cockpit Management and Data System), radio or telephone¹ if road, weather and traffic conditions permit.

Bear in mind that at a speed of just 30 mph (approximately 50 km/h), your vehicle is covering a distance of approximately 44 feet (approximately 13.5 m) every second.

¹ Observe all legal requirements.

Telephones and two-way radios

Warning!



Never operate radio transmitters equipped with a built-in or attached antenna (i.e. without being connected to an external antenna) from inside the vehicle while the engine is running. Doing so could lead to a malfunction of the vehicle's electronic system, possibly resulting in an accident and/or personal injury.

Radio transmitters, such as a portable telephone or a citizens band unit should only be used inside the vehicle if they are connected to an antenna that is installed on the outside of the vehicle.

Refer to the radio transmitter operation instructions regarding use of an external antenna.

Catalytic converter

Your Mercedes-Benz is equipped with monolithic type catalytic converters, an important element in conjunction with the oxygen sensors to achieve substantial control of the pollutants in the exhaust emissions. Keep your vehicle in proper operating condition by following our recommended maintenance instructions as outlined in your Service Booklet.



To prevent damage to the catalytic converters, use only premium unleaded gasoline in this vehicle.

Any noticeable irregularities in engine operation should be dealt with promptly. Otherwise, excessive unburned fuel may reach the catalytic converter, causing it to overheat and start a fire.

Warning!

As with any vehicle, do not idle, park or operate this vehicle in areas where combustible materials such as grass, hay or leaves can come into contact with the hot exhaust system, as these materials could be ignited and cause a vehicle fire.

Emission control

Certain systems of the engine serve to keep the toxic components of the exhaust gases within legal limits.

These systems, of course, will function properly only when maintained strictly according to factory specifications. Any adjustments to the engine should therefore be carried out only by qualified Mercedes-Benz Center authorized technicians.

Engine adjustments should not be altered in any way. Moreover, the specified service jobs must be carried out regularly according to Mercedes-Benz servicing requirements. For details refer to the Service Booklet.

Warning!

Inhalation of exhaust gas is hazardous to your health. All exhaust gas contains carbon monoxide, and inhaling it can cause unconsciousness and lead to death.

Do not run the engine in confined areas (such as a garage) which are not properly ventilated. If you think that exhaust gas fumes are entering the vehicle while driving, have the cause determined and corrected immediately. If you must drive under these conditions, drive with at least one window fully open at all times.

Driving instructions

Coolant temperature

During severe operating conditions and stop-and-go city traffic, the coolant temperature may rise close to approx. 248°F (120°C).

The engine should not be operated with the coolant temperature over 248°F (120°C). Doing so may cause serious engine damage which is not covered by the Mercedes-Benz Limited Warranty.

Warning!



- Driving when your engine is badly overheated can cause some fluids, which may have leaked into the engine compartment, to catch fire. You could be seriously burned.
- Steam from an overheated engine can cause serious burns and can occur just by opening the engine hood. Stay away from the engine if you see or hear steam coming from it.

Turn off the engine, get out of the vehicle and do not stand near the vehicle until it cools down.

At the gas station

Warning!



Gasoline is highly flammable and poisonous. It burns violently and can cause serious injury. Whenever you are around gasoline, avoid inhaling fumes and skin contact, extinguish all smoking materials. Never allow sparks, flame or smoking materials near gasoline!

The fuel filler flap is located on the right-hand side of the vehicle towards the rear. Locking/unlocking the vehicle with the SmartKey or the KEYLESS-GO* card automatically locks/unlocks the fuel filler flap.

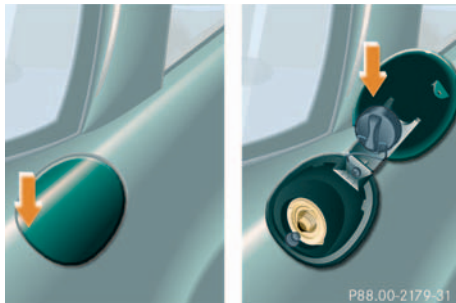

- ▶ Remove the key from the starter switch.
- ▶ Open the fuel filler flap by pushing at the point indicated by the arrow.
The fuel filler flap springs open.
- ▶ Turn the fuel cap to the left and hold on to it until possible pressure is released.
- ▶ Take off the cap and set it in the recess on the fuel filler flap.
To prevent fuel vapors from escaping into open air, fully insert filler nozzle unit.
- ▶ Only fill your tank until the filler nozzle unit cuts out – **do not top up or overfill.**

Warning!



Overfilling of the fuel tank may create pressure in the system which could cause a gas discharge. This could cause the gas to spray back out when removing the fuel pump nozzle, which could cause personal injury.

- ▶ Replace the fuel cap by turning it to the right.
You will hear when the fuel cap is tightened.
- ▶ Close the fuel filler flap.



CL 600: Use only premium unleaded gasoline with a minimum Posted Octane Rating of 93 (average of 98 RON / 88 MON).

CL 500 and CL 55 AMG: Use only premium unleaded gasoline with a minimum Posted Octane Rating of 91 (average of 96 RON / 86 MON).

Information on gasoline quality can normally be found on the fuel pump.

More information on gasoline can be found in the Factory Approved Service Products pamphlet.

At the gas station



Leaving the engine running and the fuel cap open can cause the **CHECK ENGINE** lamp to illuminate.

More information can be found in the “Practical hints” section (▷ page 268).

Check regularly and before a long trip

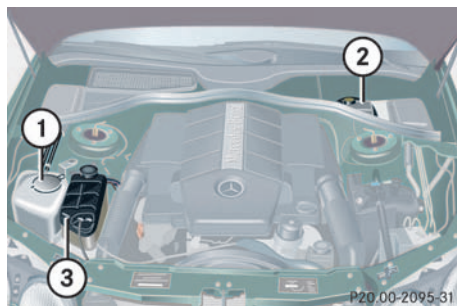

1 Windshield washer and headlamp cleaning system
More information on refilling the reservoir (▷ page 244).

2 Brake fluid
More information on brake fluid can be found in the “Technical data” section on (▷ page 340).

3 Coolant level
More information on coolant (▷ page 242).

Engine oil level

More information on engine oil (▷ page 238).

Vehicle lighting

Check function and cleanliness. More information on replacing light bulbs can be found in the “Practical hints” section on (▷ page 302).

Tire inflation pressure

More information on tire inflate pressure (▷ page 247).

Opening hood (▷ page 237).

Exterior lamp switch (▷ page 108).

Engine compartment

Hood

Warning!



Do not pull the release lever while the vehicle is in motion. Otherwise the hood could be forced open by passing air flow.

Opening

The hood lock release lever is located in the driver's footwell to the left of the parking brake pedal.

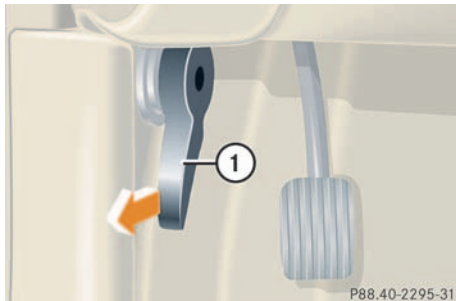

1 Hood lock release

- ▶ Pull lever **1** towards you in the direction of the arrow.

The hood is unlocked and handle **2** will extend out of the radiator grill.



To avoid damage to the windshield wipers or hood, never open the hood if the wiper arms are folded forward away from the windshield.

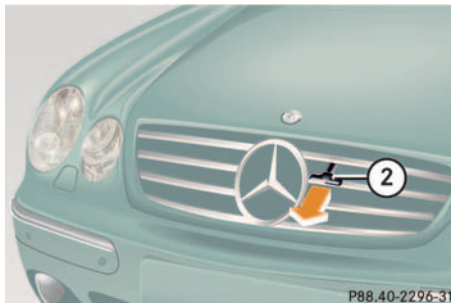

2 Handle for opening the hood

- ▶ Pull handle **2** to its stop out of radiator grill.
- ▶ Pull up on the hood (do not pull up on the handle) and then release it.

The hood will be automatically held open at shoulder height.

Warning!



To help prevent personal injury, stay clear of moving parts when the hood is open and the engine is running. Make sure the hood is properly closed before driving. When closing the hood, use extreme caution not to catch hands or fingers.

The radiator fan may continue to run for approximately 30 seconds or even restart after the engine has been turned off. Stay clear of fan blades.



Engine compartment

Warning!



If you see flames or smoke coming from the engine compartment, or if the coolant temperature gauge indicates that the engine is overheated, do not open the hood. Move away from vehicle and do not open the hood until the engine has cooled. If necessary, call the fire department.

Warning!



The engine is equipped with a transistorized ignition system. Because of the high voltage it is dangerous to touch any components (ignition coils, spark plug sockets, diagnostic socket) of the ignition system

- with the engine running
- while starting the engine
- if ignition is “on” and the engine is turned manually

Closing

Warning!



Be careful that you do not close the hood on anyone.

- ▶ Let the hood drop from a height of approximately 1 ft (30 cm).

The hood will lock audibly.

- ▶ Check to make sure that the hood is fully closed.

If you can raise the hood at a point above the headlamps, then it is not properly closed. Open it again and let it drop with somewhat greater force.

Engine oil

The amount of oil your engine needs will depend on a number of factors, including driving style. Higher oil consumption can occur when

- the vehicle is new
- the vehicle is driven frequently at higher engine speeds

Engine oil consumption checks should only be made after the vehicle break-in period.

Checking engine oil level

When checking the oil level the vehicle must



- be parked on level ground
- be at normal operating temperature
- have been stationary for at least five minutes with the engine turned off

Checking the engine oil level with the control system

You can check the engine oil level on the multifunction display.

- ▶ Turn the key in the starter switch to position **2**.

The standard display (▷ page 122) should appear in the multifunction display.

- ▶ Press button  or  on the steering wheel until the following message is seen in the multifunction display:

```
ENGINE OIL LEVEL
MEASURING NOW
MEASURE. CORRECT
ONLY IF VEH. LEVEL
```

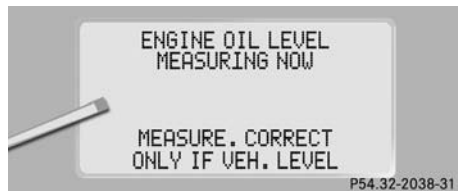

One of the following messages will subsequently appear in the indicator:

- ENGINE OIL LEVEL
OK
 - ADD 1.0 QT. TO
REACH MAX. OIL LEVEL!
(Canada: 1.0 LITER)
 - ADD 1.5 QTS. TO
REACH MAX. OIL LEVEL!
(Canada: 1.5 LITERS)
 - ADD 2.0 QTS. TO
REACH MAX. OIL LEVEL!
(Canada: 2.0 LITERS)
- ▶ If necessary, add engine oil.

For adding oil see (▷ page 241).

Other display messages

If the key is not turned to position **2** in the starter switch, the following message will appear:

```
FOR ENGINE OIL LEVEL
SWITCH ON IGNITION!
```

- ▶ Switch on the ignition.

If you see the message:
OBSERVE WAITING PERIOD

- ▶ Wait five minutes before repeating check procedure.

If you see the message:
ENGINE OIL LEVEL
NOT WHEN ENGINE ON!

- ▶ Turn off the engine. If engine is at normal operating temperature, wait five minutes before checking oil. If the engine is not yet at normal operating temperature, you must wait 30 minutes before checking oil.





Engine compartment

If there is excessive engine oil with the engine at normal operating temperature, the following message will appear:

ENGINE OIL LEVEL
REDUCE OIL LEVEL

- ▶ Have excess oil siphoned.



If you want to stop the checking procedure, press the  or  button on the multifunction steering wheel.

See “Practical hints” (▷ page 281) if the engine oil level indicator lights up in the display while the engine is running.

More information on engine oil can be found in the “Technical data” (▷ page 339).

Checking the engine oil level with the oil dipstick (CL 500, CL 55 AMG only)

The engine oil level can be checked by either oil dipstick **1** or via the multifunction display in the instrument cluster (▷ page 239). The amount of engine oil needed is shown more precisely on the operating system display.

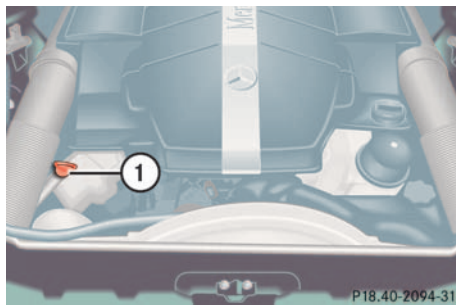

1 Oil dipstick

- ▶ Open the hood (▷ page 237).
- ▶ Pull out oil dipstick **1** (▷ page 241).
- ▶ Wipe oil dipstick **1** clean.
- ▶ Fully insert oil dipstick **1** into the dipstick guide tube, and remove after approximately three seconds to obtain an accurate reading.

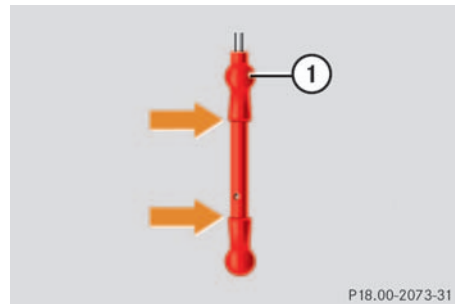

1 Oil dipstick

The oil level is acceptable when it leaves a line between the upper and lower marks of oil dipstick **1**.



Fill quantity between upper and lower oil dipstick marking level is approximately 2.1 US qt (2.0 l).

For adding oil see (▷ page 241).

See “Practical hints” (▷ page 281) if the engine oil level indicator lights up in the display while the engine is running.

More information on engine oil can be found in the “Technical data” (▷ page 339).

Adding engine oil

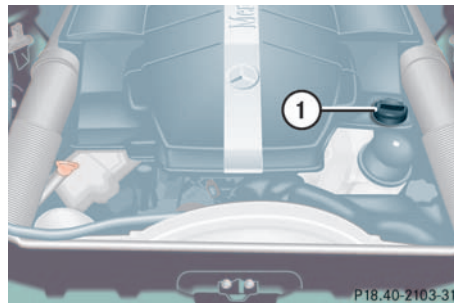

CL 500, CL 55 AMG

1 Filler neck cap

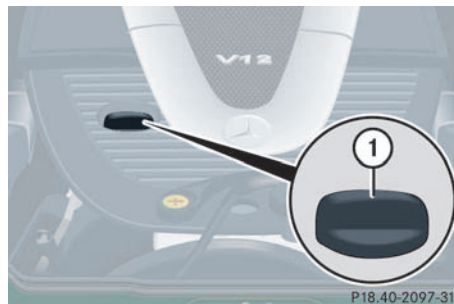

CL 600

1 Filler neck cap

- ▶ Unscrew the filler neck cap **1** from filler neck.
- ▶ Add engine oil as required. Be careful not to overfill with oil.

Be careful not to spill any oil when adding. Avoid environmental damage caused by oil entering the ground or water.



Excessive oil must be siphoned or drained off. It could cause damage to the engine and catalytic converter not covered by the Mercedes-Benz Limited Warranty.

- ▶ Screw the filler neck cap **1** back on the filler neck.

More information on engine oil can be found in the “Technical data” (▷ page 339).

Engine compartment

Transmission fluid level

The transmission fluid level does not need to be checked. If you notice transmission fluid loss or gear shifting malfunctions, have an authorized Mercedes-Benz Center check the automatic transmission.

Active Body Control (ABC) fluid level

Regular fluid level check is not required. If you notice fluid leaks or malfunction messages in the multifunction display, have an authorized Mercedes-Benz Center check the ABC system.

Coolant

The engine coolant is a mixture of water and anticorrosion / antifreeze. To check the coolant level, the vehicle must be parked on level ground and the engine must be cool.

Warning!



In order to avoid any possibly serious burns:

- Use extreme caution when opening the hood if there are any signs of steam or coolant leaking from the cooling system, or if the coolant temperature gauge indicates that the coolant is overheated.
- Do not remove pressure cap on coolant reservoir if engine temperature is above 194°F (90°C). Allow engine to cool down before removing cap. The coolant reservoir contains hot fluid and is under pressure.
- Using a rag, slowly open the cap approximately 1/2 turn to relieve excess pressure. If opened immediately, scalding hot fluid and steam will be blown out under pressure.
- Do not spill antifreeze on hot engine parts. Antifreeze contains ethylene glycol which may burn if it comes into contact with hot engine parts.

The coolant expansion tank is located on the passenger side of the engine compartment.

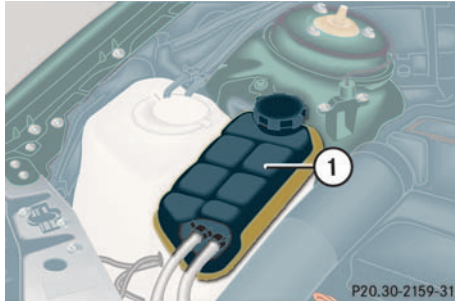

1 Coolant expansion tank

- ▶ Using a rag, turn the cap slowly approximately one half turn to the left to release any excess pressure.
- ▶ Continue turning the cap to the left and remove it.

The coolant level is correct if the level

- for cold coolant: reaches the black top part of the reservoir
- for warm coolant: is approx. 0.6 in (1.5 cm) higher
- ▶ Add coolant as required.
- ▶ Replace and tighten cap.

More information on coolant can be found in the “Technical data” section (▶ page 342).

Battery

Your vehicle’s battery is located in the trunk under the right hand wheel well cover panel (▶ page 313).

The battery should always be sufficiently charged in order to achieve its rated service life. Refer to Service Booklet for battery maintenance intervals.

If you use your vehicle mostly for short distance trips, you will need to have the battery charge checked more frequently.

When replacing the battery, always use batteries approved by Mercedes-Benz.

If you do not intend to operate your vehicle for an extended period of time, consult an authorized Mercedes-Benz Center about steps you need to observe.

Engine compartment



Observe all safety instructions and precautions when handling automotive batteries.



Risk of explosion



Keep flames or sparks away from battery. Do not smoke.



Battery acid is caustic. Do not allow it to come into contact with skin, eyes or clothing.

In case it does, immediately flush affected area with clear water and seek medical help if necessary.



Wear eye protection.



Keep children away.



Follow the instructions in this Operator's Manual.

Batteries contain materials that can harm the environment if disposed of improperly. Recycling of batteries is the preferred method of disposal. Many states require sellers of batteries to accept old batteries for recycling.

Windshield washer system and headlamp cleaning system

Fluid for the windshield washer system and the headlamp cleaning system is supplied from the windshield washer reservoir. It has a capacity of approx. 7.1 US qt. (6.7 l).

During all seasons, add MB Windshield Washer Concentrate “S” to water. Premix the windshield washer fluid in a suitable container.

- ▶ Refill the reservoir with MB Windshield Washer Concentrate and water (or commercially available pre-mixed windshield washer solvent / antifreeze, depending on ambient temperatures).

Always use washer solvent / antifreeze where temperatures may fall below freezing. Failure to do so could result in damage to the washer system / reservoir.

The windshield washer system on this vehicle is heated, so a fluid mixture produced for temperatures of approximately 14°F (-10°C) should be sufficient.

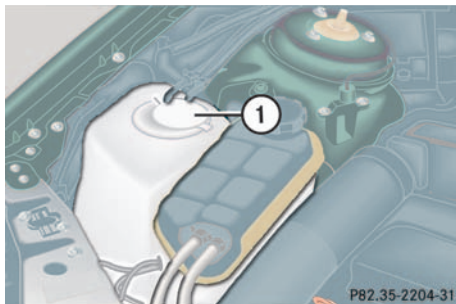

1 Washer fluid reservoir

More information can be found in the “Technical data” section (▷ page 344).

Warning!



Washer solvent / antifreeze is highly flammable. Do not spill washer solvent / antifreeze on hot engine parts, because it may ignite. You could be seriously burned.



Only use washer fluid which is suitable for plastic lenses. Improper washer fluid can damage the plastic lenses of the headlamps.

Tires and wheels

Tires and wheels

See your authorized Mercedes-Benz Center for information on tested and recommended rims and tires for summer and winter operation. They can also offer advice concerning tire service and purchase.

Warning!



Replace rims or tires with the same designation, manufacturer and type as shown on the original part. See your authorized Mercedes-Benz Center for further information. If incorrectly sized rims and tires are mounted:

- The wheel brakes or suspension components can be damaged
- The correct operating clearance of the wheels and the tires are no longer guaranteed

Warning!



Worn, old tires can cause accidents. If the tire tread is badly worn, or if the tires have sustained damage, replace them.

When replacing rims, use only genuine Mercedes-Benz wheel bolts specified for the particular rim type. Failure to do so can result in the bolts loosening and possibly an accident.

Retreaded tires are not tested or recommended by Mercedes-Benz, since previous damage cannot always be recognized on retreads. Mercedes-Benz can therefore not assure the operating safety of the vehicle when such tires are used.

Important guidelines

- Use only sets of tires and rims of the same type and make.
- Tires must be of the correct size for the rim.
- Break in new tires for approximately 60 miles (100 km) at moderate speeds.
- Regularly check the tires and rims for damage.
- If vehicle is heavily loaded, check tire pressure and correct as required.
- Do not allow your tires to wear down too far. Adhesion properties on wet roads are sharply reduced at tread depths under $1/8$ in (3 mm).
- When replacing individual tires, you should mount new tires on the front wheels first (on vehicles with same-sized wheels all around).

Life of tires

The service life of a tire is dependent upon varying factors including but not limited to:

- Driving style
- Tire pressure
- Distance driven

Warning!



Tires and spare tire should be replaced after six years, regardless of the remaining tread.



Keep unmounted tires in a cool, dry place with as little exposure to light as possible. Protect tires from contact with oil, grease and gasoline.

Direction of rotation

Unidirectional tires offer added advantages, such as better hydroplaning performance. To benefit, however, you must make sure that the tires rotate in the direction specified.

An arrow on the sidewall indicates the intended direction of tire rotation.

Checking tire inflation pressure

Warning!



If the tire pressure repeatedly drops:

- Check the tires for punctures from foreign objects.
- Check to see whether air is leaking from the valves or from around the rim.

Correct the tire pressure only when tires are cold.

Regularly check your tire pressure at intervals of no more than 14 days.

If the tires are warm, you should only correct the tire pressure if it is too low for current operating conditions.

A table on the fuel filler flap lists the specified tire inflation pressures for warm and cold tires as well as for various operating conditions.

Tires and wheels



The pressures listed for light loads are minimum values offering high driving comfort.

Increased inflation pressures listed for heavier loads may also be used for light loads. These higher pressures produce favorable handling characteristics. The ride of the vehicle, however, will be somewhat harder. Never exceed the max. values or inflate tires below the min. values listed on the fuel filler flap.

Tire pressure changes by approximately 1.5 psi (0.1 bar) per 18°F (10°C) of air temperature change. Keep this in mind when checking tire pressure where the temperature is different from the outside temperature.

Tire temperature and tire pressure also increase while driving, depending on the driving speed and the tire load.

Warning!



Follow recommended inflation pressures.

Do not overinflate tires. Overinflated tires can result in sudden deflation (blowout) because they are more likely to become punctured or damaged by road debris, potholes etc.

Do not underinflate tires. Underinflated tires wear unevenly, adversely affect handling and fuel economy, and are more likely to fail from being overheated.

Do not overload the tires by exceeding the specified vehicle capacity weight (as indicated by the label on the pillar in the driver's door opening). Overloading the tires can overheat them, possibly causing a blowout.

Check the spare tire periodically for condition and inflation pressure. Spare tires will age and become worn over time even if never used, and thus should be inspected and replaced when necessary or after a maximum of six years.

Checking tire pressure electronically*





The tire inflation pressure monitor only functions on wheels that are equipped with the proper electronic sensors. It monitors the tire inflation pressure, as selected by the driver, in all four tires. A warning is issued to alert you to a decrease in pressure in one or more of the tires.

Tire pressure inquiries are made using the multifunction display (> page 117). The inflation pressures are displayed only after a few minutes' travel time.

You can select the unit of measure used for the tire inflation pressure by changing the setting in the control system (> page 117).



Possible differences between the readings of a tire pressure gauge of an air hose, e.g. gas station equipment, and the vehicle's control system can occur. The readings issued by the control system are more precise.

- ▶ Switch on the ignition.
- ▶ Press button  or  on the multifunction steering wheel repeatedly until the standard display menu appears in the multifunction display (▷ page 118).
- ▶ Press the  or  button repeatedly until you see the current inflation pressures for each tire appear in the display.

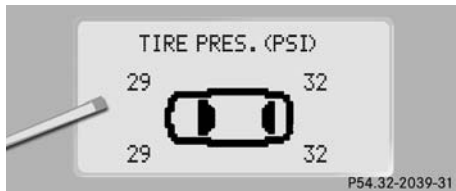

Warning!



The tire inflation pressure monitor does not indicate a warning for wrongly selected inflation pressures. Always adjust tire inflation pressure according to the label affixed on the fuel filler flap.

The tire inflation pressure monitor is not able to issue a warning due to a sudden loss of pressure (e.g. tire puncture caused by a foreign object). In this case bring the vehicle to a halt by carefully applying the brakes and avoiding abrupt steering maneuvers.

Warning!



Follow recommended inflation pressures.

Do not overinflate tires. Overinflated tires can result in a sudden deflation (blowout) because they are more likely to become punctured or damaged by road debris, potholes etc.

Do not underinflate tires. Underinflated tires wear unevenly, adversely affect handling and fuel economy, and are more likely to fail from being overheated.

Do not overload the tires by exceeding the specified vehicle capacity weight (as indicated by the label on the pillar in the driver's door opening). Overloading the tires can overheat them, possibly causing a blowout.







Operating radio transmission equipment (e.g. wireless headsets, two-way radios) in or near the vehicle could cause the tire inflation pressure monitor to malfunction.

Tires and wheels

Activating the tire inflation pressure monitor

You must activate the tire inflation pressure monitor in the following cases:

- If you have changed the tire pressure
 - If you have replaced the wheels or tires
 - If you have installed new wheels or tires
- ▶ Make sure that the tire pressure is correctly set.
- ▶ Press button  or  on the multifunction steering wheel repeatedly until the standard display menu appear in the in the multifunction display (▷ page 118).

- ▶ Press the  or  button repeatedly until you see the current inflation pressures for each tire appear in the display or the following message appears in the display
- TIRE PRES. MONITOR
PRES. DISPLAY AFTER DRIVING A FEW
MINS. REACTIVATE USING R BUTTON



If transporting a deflated road wheel or additional wheel sensors in the vehicle, the tire inflation pressure monitor should not be reactivated until the deflated wheel or additional wheel sensors have been removed from the vehicle. Otherwise, the deflated wheel or additional sensors could cause the tire inflation pressure monitor system to malfunction.

- ▶ Press the reset button  (▷ page 22).

The following message will appear in the multifunction display:
CHECK CURRENT TIRE PRES.?

- ▶ Press the  button.

The following message will appear in the multifunction display field:
TIRE PRES. MONITOR ACTIVATED

The tire inflation pressure monitor will now monitor the tire inflation pressure values of all four tires.

The following message will appear in the multifunction display field:
TIRE PRES. MONITOR
PRES. DISPLAY AFTER DRIVING A FEW
MINS. REACTIVATE USING R BUTTON

This display appears until the individual inflation pressure values are matched with the tires. The individual values are then displayed.

If you wish to cancel activation:

- ▶ Press the  button.

If the following message appears in the multifunction display field:

REACTIVATE TIRE
PRES. MONITOR

or

TIRE PRES.
CHECK TIRES!

- ▶ Check the tire inflation pressures and correct them if necessary.
- ▶ Reactivate the tire inflation pressure monitor.

Rotating wheels

Warning!



Rotate front and rear wheels only if they are of the same size.

On vehicles with the same wheel size all around, wheels can be rotated every 3000 to 6000 miles (5000 to 10000 km), or sooner if necessary, according to the degree of tire wear. The same direction of tire rotation must be retained.

Rotate the wheels before the characteristic tire wear pattern becomes visible (shoulder wear on front wheels and tread center wear on rear wheels).

Thoroughly clean the inner side of the wheels after each rotation. Check and ensure proper tire inflation pressure. It is necessary to activate the tire inflation pressure monitor*.



If your vehicle is equipped with a tire inflation pressure monitor*, there are electronic components built into the wheel.

Do not use mounting tools in the area of the valve as they could damage the electronic components.

To prevent damage or incorrect installation, have the tires changed at an authorized Mercedes-Benz Center.

Warning!



Have the tightening torque checked after changing a wheel. Wheels could become loose if not tightened with a torque of 110 ft.lb. (150 Nm).

Use only genuine Mercedes-Benz wheel bolts specified for your vehicle's rims.

Winter driving

Winter driving

Before the onset of winter have your vehicle winterized at an authorized Mercedes-Benz Center. This service includes:

- Check of anticorrosion and antifreeze concentration.
- Addition of cleaning concentrate to the water of the windshield and headlamp cleaning system. Add MB Concentrate “S” to a pre-mixed windshield washer solvent / antifreeze which is formulated for temperatures below freezing point (▷ page 343)
- Battery test. Battery capacity drops with decreasing ambient temperature. A well-charged battery helps to ensure that the engine can be started even at low ambient temperatures.
- Tire change. We recommend M+S rated radial-ply tires on all four wheels for the winter season.

Winter tires

Always use winter tires at temperatures below 39°F (4°C) and whenever wintry road conditions prevail. Use of winter tires is the only way to achieve the maximum effectiveness of the ABS and the ESP in winter operation.

For safe handling, ensure that all mounted winter tires are of the same make and have the same tread design.

Warning!



Winter tires with a tread depth under 0.16 in (4 mm) must be replaced. They are no longer suitable for winter operation.

Always observe the speed rating of the winter tires installed on your vehicle. If the maximum speed for which your tires are rated is below the speed rating of your vehicle, you must place a notice to this effect where it will be seen by the driver. Such notices are available from your tire dealer or from any authorized Mercedes-Benz Center.

Warning!



If you use your spare tire when winter tires are fitted on the other wheels, be aware that the difference in tire characteristics may very well impair turning stability and that overall driving stability may be reduced. Adapt your driving style accordingly.

Have the spare tire replaced with a winter tire at the nearest authorized Mercedes-Benz Center.

Block heater*

(Canada only)

The engine is equipped with a block heater.

The electrical cable may be installed at your authorized Mercedes-Benz Center.

Snow chains

When using snow chains, the vehicle should only be driven at vehicle height 1 (▷ page 191).

Snow chains should only be driven on snow-covered roads at speeds not to exceed 30 mph (50 km/h). Remove chains as soon as possible when driving on roads without snow.



When driving with snow chains, you may wish to deactivate the ESP (▷ page 75) before setting the vehicle in motion. This will improve the vehicle's traction.

Please observe the following guidelines when using snow chains:

- Using snow chains is not permissible with all wheel/tire combinations.
- Chains should only be used on the rear wheels. Follow the manufacturer's mounting instructions.
- Use only snow chains that are approved by Mercedes-Benz. Your authorized Mercedes-Benz Center will be glad to advise you on this subject.



Do not use snow chains with tire sizes 245 / 45 R18 on 8½J x 18 rim and 265 / 40 R18 in general (▷ page 331).

Do not use snow chains on tires mounted on AMG rims.

Maintenance

Maintenance

We strongly recommend that you have your vehicle serviced by your authorized Mercedes-Benz Center, in accordance with the Service Booklet at the times called for by the FSS (Flexible Service System).

Failure to have the vehicle maintained in accordance with the Service Booklet at the designated times/mileage called for by the FSS may result in vehicle damage not covered by the Mercedes-Benz Limited Warranty.

FSS will notify you when your next service is due.

Approximately one month before your next service is due, one of the following messages will appear in the multifunction display while you are driving or when you switch on the ignition (example service A):

SERVICE A IN XXXXX MILES (KM)
SERVICE A IN XXX DAYS
SERVICE A IN X DAY
SERVICE A DUE NOW!



The type of service due is indicated in the multifunction display:



Minor service (A)



Major service (B)



The interval between services depends on your driving habits. A gentle driving style, moderate engine speeds and the avoidance of short distance trips will lengthen the interval between services.

Clearing the service indicator

The service indicator is automatically cleared after 30 seconds. You can also clear it yourself.

- ▶ Press the reset button **R** (> page 22) in the instrument cluster.

Service term exceeded

If you have exceeded the suggested service term, you will see the following message in the multifunction display:

SERVICE A EXCEEDED BY XXXX MILES (KM)
SERVICE A EXCEEDED BY XXX DAYS
SERVICE A EXCEEDED BY X DAY





An acoustic signal will also sound.

The Mercedes-Benz Center will reset the service indicator following a completed service.

Calling up the service indicator

- ▶ Switch on the ignition.

The standard display of the control system appears (▷ page 117).

- ▶ Press button  or  on the multifunction steering wheel until FSS indicator with the service symbol  or  and the service deadline appears in the multifunction display.



If the battery is disconnected, the days of disconnection will not be included in the count shown by the service indicator. To arrive at the true service deadline, you will need to subtract these days from the days shown in the service indicator.





Do not confuse the service indicator with the engine oil level indicator .

Resetting the service indicator

In the event that the service on your vehicle is not carried out by an authorized Mercedes-Benz Center, you can reset the service indicator yourself.

- ▶ Switch on the ignition.

The standard display of the control system appears (▷ page 117).

- ▶ Press button  or  on the multifunction steering wheel until the FSS indicator with the service symbol  or  and the service deadline appears in the multifunction display.
- ▶ Press the reset button  (▷ page 22) in the instrument cluster for about four seconds.

This message appears in the multifunction display:

SERVICE INTERVAL?
RESET WITH R BUTTON

- ▶ To confirm, hold down the reset button until you hear a signal.

The service indicator now displays the reset interval.



If the service indicator was inadvertently reset, have a Mercedes-Benz Center correct it.

Only reset if the proper service has been performed. Resetting the system without performing proper service as called for by the FSS will cause the FSS to incorrectly determine the next service interval which will result in engine damage not covered by the Mercedes-Benz Limited Warranty.

Vehicle care

Vehicle care

Cleaning and care of vehicle

Warning!



Many cleaning products can be hazardous. Some are poisonous, others are flammable. Always follow the instructions on the particular container. Always open your vehicle's doors or windows when cleaning the inside. Never use fluids or solvents that are not designed for cleaning your vehicle.

While in operation, even while parked, your vehicle is subjected to varying external influences which, if gone unchecked, can attack the paintwork as well as the underbody and cause lasting damage.

Such damage is caused not only by extreme and varying climatic conditions, but also by:

- Air pollution
- Road salt
- Tar, gravel and stone chipping

To avoid paint damage, you should immediately remove:

- Grease and oil
- Fuel
- Coolant
- Brake fluid
- Insects
- Tree resins etc.

Frequent washing reduces and /or eliminates the aggressiveness and potency of the above adverse influences.

More frequent washings are necessary to deal with unfavorable conditions:

- Near the ocean
- In industrial areas (smoke, exhaust emissions)
- During winter operation

You should check your vehicle from time to time for stone chipping or other damage. Any damage should be repaired as soon as possible to prevent corrosion.

In doing so, do not neglect the underbody of the vehicle. A prerequisite for a thorough check is a washing of the underbody followed by a thorough inspection. Damaged areas need to be re-undercoated.

Your vehicle has been treated at the factory with a wax-base rustproofing in the body cavities which will last for the lifetime of the vehicle. Post-production treatment is neither necessary nor recommended by Mercedes-Benz because of the possibility of incompatibility between materials used in the production process and others applied later.

We have selected car-care products and compiled recommendations which are specially matched to our vehicles and which always reflect the latest technology. You can obtain Mercedes-Benz approved car-care products at your authorized Mercedes-Benz Center.

Scratches, corrosive deposits, corrosion or damage due to negligent or incorrect care cannot always be removed or repaired with

the car-care products recommended here. In such cases it is best to seek aid at your authorized Mercedes-Benz Center.

The following topics deal with the cleaning and care of your vehicle and give important “how-to” information as well as references to Mercedes-Benz approved car-care products.

Additional information can be found in the booklet “Vehicle Care Guide”.

Power washer

When using a power washer for cleaning the vehicle always observe the manufacturer’s operating instructions.



Vehicles with KEYLESS-GO*:

If a door handle is hit by a strong jet of water, and a KEYLESS-GO* card is in close proximity, i.e. within approx. 3 ft. (approx. 1 m), the vehicle could be inadvertently locked or unlocked.



Never use a round nozzle to power wash tires. The intense jet of water can result in damage to the tire.

Always replace a damaged tire.

Always keep the jet of water moving across the surface. Do not aim directly at electrical parts, electrical connectors, seals, or other rubber parts.

Tar stains

Quickly remove tar stains before they dry and become more difficult to remove. A tar remover is recommended.

Paintwork, painted body components

Mercedes-Benz approved Paint Care should be applied when water drops on the paint surface do not “bead up”, normally every 3 to 5 months, depending on climate and washing detergent used.

Mercedes-Benz approved Paint Cleaner should be applied if the paint surface shows signs of embedded dirt (i.e. loss of gloss).

Do not apply any of these products or wax if your vehicle is parked in the sun or if the hood is still hot.

Use the appropriate MB-Touch-Up Stick for quick and provisional repairs of minor paint damage (i.e. chips from stones, vehicle doors etc.).

Engine cleaning

Prior to cleaning the engine compartment make sure to protect electrical components and connectors from contact with water and cleaning agents.

Vehicle care

Corrosion protection, such as MB Anticorrosion Wax should be applied to the engine compartment after every engine cleaning. Before applying, all control linkage bushings and joints should be lubricated. The poly-V-belt and all pulleys should be protected from any wax.

Vehicle washing

Do not use hot water or wash your vehicle in direct sunlight. Use only a mild car wash detergent, such as Mercedes-Benz approved Car Shampoo.

Thoroughly spray the vehicle with a diffused jet of water. Direct only a very weak spray towards the ventilation intake. Use plenty of water and rinse the sponge and chamois frequently.

Rinse with clear water and thoroughly dry with a chamois. Do not allow cleaning agents to dry on the finish.

Due to the width of the vehicle, fold in outside mirrors prior to running the vehicle through an automatic car wash to prevent damage to the mirrors.

In the winter, thoroughly remove all traces of road salt as soon as possible.

When washing the underbody, do not forget to clean the inner sides of the wheels.



Vehicles with KEYLESS-GO*:

If a door handle is hit by a strong jet of water, and a KEYLESS-GO* card is in close proximity, i.e. within approx. 3 ft. (approx. 1 m), the vehicle could be inadvertently locked or unlocked.

Ornamental moldings

For regular cleaning and care of very dirty chrome-plated parts, use a chrome cleaner.

Headlamps, tail lamps, turn signal lenses

Use a mild car wash detergent, such as Mercedes-Benz approved Car Shampoo, with plenty of water.

To prevent scratches, never apply strong force and use only a soft, non-scratchy cloth when cleaning the lenses. Do not attempt to wipe dirty lenses with a dry cloth or sponge.

Cleaning the DISTRONIC* system sensor cover



1 DISTRONIC* system sensor cover

Use a mild car wash detergent, such as Mercedes-Benz approved Car Shampoo, with plenty of water to clean sensor cover 1.

To prevent scratches, never apply strong force and use only a soft, non-scratchy cloth when cleaning the sensor cover. Do not attempt to wipe dirty sensors with a dry cloth or sponge.



Restart the engine after cleaning sensor cover 1.

Cleaning the Parktronic system sensors

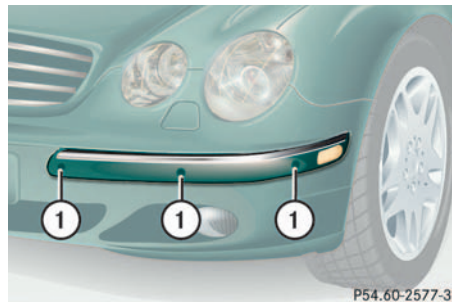

1 Parktronic sensors

Use a mild car wash detergent, such as Mercedes-Benz approved Car Shampoo with plenty of water.

When using a steam cleaner or power washer, aim nozzle only briefly from a minimum distance of 4 in (10 cm) at sensors 1.

To prevent scratches, never apply strong force and use only a soft, non-scratchy cloth when cleaning the sensor. Do not attempt to wipe dirty sensors with a dry cloth or sponge.

Wiper blades

Clean the wiper blade inserts with a clean cloth and detergent solution.

Warning!



For safety reasons, switch off wipers and remove key from starter switch before cleaning the wiper blades, otherwise the wiper motor might suddenly turn on and cause injury.

Vehicle care



Fold the windshield wiper arms away from the windshield in a vertical position only. They could otherwise damage the hood (▷ page 237).

Fold the windshield wiper arms back onto the windshield before turning the key in the starter switch.

Window cleaning

Use a window cleaning solution on all glass surfaces. An automotive glass cleaner is recommended.

Warning!



For safety reasons, switch off wipers and remove key from starter switch before cleaning the windshield, otherwise the wiper motor might suddenly turn on and cause injury.



Fold the windshield wiper arms away from the windshield in a vertical position only. They could otherwise damage the hood (▷ page 237).

Fold the windshield wiper arms back onto the windshield before turning the key in the starter switch.

Light alloy wheels

Mercedes-Benz approved Wheel Care should be used for regular cleaning of the light alloy wheels.

If possible, clean wheels once a week with Mercedes-Benz approved Wheel Care, using a soft bristle brush and a strong spray of water.

Follow instructions on container.



Use only acid-free cleaning materials. Acid could lead to corrosion.

Instrument cluster

Use a gentle dishwashing detergent or mild detergent for delicate fabrics as a washing solution. Wipe with a cloth moistened in lukewarm solution. Do not use scouring agents.

Steering wheel and gear selector lever

Wipe with a damp cloth and dry thoroughly or clean with Mercedes-Benz approved Leather Care.

Cup holder

Use a gentle dishwashing detergent or mild detergent for delicate fabrics as a washing solution. Wipe with a cloth moistened in lukewarm solution. Do not use scouring agents.

Hard plastic trim items

Pour Mercedes-Benz approved Interior Care onto soft lint-free cloth and apply with light pressure.

Headliner

Clean with soft bristle brush, or use a dry-shampoo cleaner in case of excessive dirt.

Seat belts

The webbing must not be treated with chemical cleaning agents. Use only clear, lukewarm water and soap. Do not dry the webbing at temperatures above 176°F (80°C) or in direct sunlight.

Warning!



Do not bleach or dye seat belts as this may severely weaken them. In a crash they may not be able to provide adequate protection.

Leather upholstery

Using aftermarket seat covers or wearing clothing that have the tendency to give off coloring (e.g. when wet etc.) may cause the upholstery to become permanently discolored. By lining the seats with a proper intermediate cover, contact-discoloration will be prevented.

Wipe leather upholstery with a damp cloth and dry thoroughly or clean with Mercedes-Benz approved Leather Care. Exercise particular care when cleaning perforated leather as its underside should not become wet.

Plastic and rubber parts

Do not use oil or wax on these parts.

Practical hints

What to do if ...?

Where will I find...?

Unlocking/locking in an emergency

Opening/closing in an emergency

Replacing bulbs

Replacing wiper blades

Flat tire

Battery

Jump starting

Towing the vehicle

Fuses



What to do if ...?



What to do if ...?



Lamps in instrument cluster

General information:

If a bulb in the instrument cluster fails to light up during the bulb self-check when

turning the SmartKey in the starter switch to position **2**, have it checked and replaced if necessary.

Problem	Possible cause	Suggested solution
 The yellow ESP warning lamp lights up while driving.	<p>The ESP is deactivated.</p> <p>Risk of accident!</p> <p>Adapt your speed and driving to the prevailing road, weather and traffic conditions.</p>	<p>▶ Turn the ESP back on (▷ page 75).</p> <p>If the ESP cannot be turned back on, have the system checked at an authorized Mercedes-Benz Center as soon as possible.</p>
 The yellow ESP warning lamp flashes while driving.	<p>The ESP or traction control has come into operation because of detected traction loss in at least one tire.</p> <p>DISTRONIC* is deactivated.</p>	<p>▶ When driving off apply as little throttle as possible.</p> <p>▶ While driving, ease up on the accelerator.</p> <p>▶ Adapt your speed and driving to the prevailing road, weather conditions.</p> <p>▶ Do not deactivate the ESP. Exceptions: (▷ page 75).</p> <p>Failure to follow these instructions increases the risk of an accident.</p>

Problem	Possible cause	Suggested solution
 The red distance indicator lamp lights up while driving.	You are too close to the vehicle in front of you to maintain selected speed.	<ul style="list-style-type: none"> ▶ Apply the brakes immediately to increase the following distance.
 The red distance indicator lamp comes on while driving and you hear a warning sound.	<ul style="list-style-type: none"> • You are gaining too rapidly on the vehicle ahead of you. • The distance warning system has recognized a stationary obstacle on your probable line of travel. 	<ul style="list-style-type: none"> ▶ Apply the brakes immediately. ▶ Carefully observe the traffic situation. You may need to brake or maneuver to avoid hitting an obstacle.
 The yellow ABS malfunction indicator lamp comes on while driving.	<p>The ABS has detected a malfunction and has switched off. The BAS and the ESP are also switched off (see messages in display).</p> <p>The brake system is still functioning normally but without the ABS available.</p> <p>If the ABS control unit control unit is malfunctioning, other systems such as Parktronic*, DISTRONIC*, the navigation system and the automatic transmission can also malfunction.</p> <p>The charging voltage has fallen below 10 volts and the ABS has switched off.</p>	<ul style="list-style-type: none"> ▶ Continue driving with added caution. Wheels may lock during hard braking, reducing steering capability. ▶ Have the system checked at an authorized Mercedes-Benz Center as soon as possible. <p>Failure to follow these instructions increases the risk of an accident.</p> <ul style="list-style-type: none"> ▶ When the voltage is above this value again, the ABS is operational again. ▶ If necessary, have the generator and battery checked.



What to do if ...?

Problem	Possible cause	Suggested solution
 The red seat belt warning lamp blinks for a brief period after starting the engine.	The warning lamp reminds you to fasten seat belts.	▶ Fasten your seat belt.
SRS The red SRS indicator lamp lights up while driving.	There is a malfunction in the restraint systems. The airbags or emergency tensioning device (ETDs) could deploy unexpectedly or fail to activate in an accident.	▶ Drive with added caution to the nearest authorized Mercedes-Benz Center.

Warning!



In the event that a malfunction of the SRS is indicated as outlined above, the SRS may not be operational. For your safety, we strongly recommend that you visit an authorized Mercedes-Benz Center immediately to have the system checked; otherwise the SRS may not be activated when needed in an accident, which could result in serious or fatal injury, or it might deploy unexpectedly and unnecessarily which could result in an accident and/or injury to you or to others.

Problem	Possible cause	Suggested solution
Except Canada:  Canada only: 	The red brake warning lamp lights up while driving and you hear a warning sound.	You are driving with the parking brake set.
	The red brake warning lamp lights up while driving.	There is insufficient brake fluid in the reservoir.
		▶ Release the parking brake. ▶ Risk of accident! Carefully stop the vehicle and notify an authorized Mercedes-Benz Center. Do not add brake fluid! This will not solve the problem.

Warning!



Driving with the brake warning lamp illuminated can result in an accident. Have your brake system checked immediately if the brake warning lamp stays on. Don't add brake fluid before checking the brake system.

Overfilling the brake fluid reservoir can result in spilling brake fluid on hot engine parts and the brake fluid catching fire. You can be seriously burned.



If you find that the brake fluid in the brake fluid reservoir has fallen to the minimum mark or below, have the brake system checked for brake pad thickness and leaks.

What to do if ...?

Problem	Possible cause	Suggested solution
<p>CHECK ENGINE</p> <p>The yellow “CHECK ENGINE” malfunction indicator lamp comes on while driving.</p>	<p>There is a malfunction in:</p> <ul style="list-style-type: none"> • The fuel management system • The ignition system • The emission control system • Systems which affect emissions <p>Such malfunctions may result in excessive emissions values and may switch the engine to its Limp-Home Mode (emergency operation).</p> <p>Your gas tank is empty.</p>	<p>► Have the vehicle checked as soon as possible by an authorized Mercedes-Benz Center. An on-board diagnostic connector is used by the service station to link the vehicle to the shop diagnostics system. It allows the accurate identification of system malfunctions through the readout of diagnostic trouble codes. It is located in the front left area of the footwell next to the parking brake pedal.</p> <p>► After refuelling start the engine three or four times in succession.</p> <p>The Limp-Home Mode is canceled. You do not need to have your vehicle checked.</p>
<p>The yellow fuel tank reserve warning lamp lights up while driving.</p>	<p>The fuel level has dropped below the reserve mark.</p> <p>The fuel cap not closed tight.</p>	<p>► Refuel at the next gas station (▷ page 235).</p> <p>► Check the fuel cap (▷ page 235).</p>

Lamp in center console

Problem	Possible cause	Suggested solution
<p>The PASSENGER AIRBAG OFF indicator lamp lights up.</p>	<p>A BabySmart™ child seat is installed on the front passenger seat. Therefore the front passenger airbag is switched off.</p> <p>The system is malfunctioning if there is no BabySmart™ child seat installed on the front passenger seat.</p>	<ul style="list-style-type: none"> ▶ Have the system checked as soon as possible by an authorized Mercedes-Benz Center.
<p>The PASSENGER AIRBAG OFF indicator lamp does not light up with a BabySmart™ child seat properly installed on the front passenger seat.</p>	<p>The system is malfunctioning.</p>	<ul style="list-style-type: none"> ▶ Make sure that there is nothing between seat cushion and child seat and check installation of the child seat. ▶ If the light remains out, have the system checked as soon as possible by an authorized Mercedes-Benz Center. <p>Do not use the BabySmart™ restraint to transport children on the front passenger seat until the system has been repaired.</p>

What to do if ...?

Messages in the display

The control system shows warning and malfunction messages in the multifunction display.

Certain warning and malfunction messages are accompanied by an audible signal.

Address these messages accordingly and follow the additional instructions given in this Operator's Manual.

Selecting the malfunction memory menu in the control system (▷ page 130) displays both cleared and uncleared messages.

High-priority messages appear in the multifunction display in red color.

Certain messages of high priority cannot be cleared from the multifunction display using the reset button **R**.

Other messages of high priority or messages of less immediate priority (regular display colors) can be cleared from the multifunction display using the reset button **R**.

These are then stored in the malfunction message memory (▷ page 130).

Warning!



All categories of messages contain important information which should be taken note of and, where a malfunction is indicated, addressed as soon as possible at an authorized Mercedes-Benz Center.

Failure to repair condition noted may cause damage not covered by the Mercedes-Benz Limited Warranty, or result in property damage or personal injury.

Warning!



No messages will be displayed if either the instrument cluster or the multifunction display is inoperative.

Contact your nearest authorized Mercedes-Benz Center.



Turning the key in the starter switch to position **2**, or pressing the KEY-LESS-GO* start/stop button twice to position **2** causes all lamps as well as the multifunction display to come on. Ensure that they are all in working order before starting your journey.

On the pages that follow, you will find a compilation of all the messages that may appear in the display.

High priority messages appear on a red background.

Display	Possible cause	Possible solution
<p>ABC</p> <p>ACTIVE BODY CONTROL DRIVE CAREFULLY!</p>	<p>The capability of the ABC system is restricted. This can impair the handling.</p>	<ul style="list-style-type: none"> ▶ Do not exceed a speed of 50 mph (80 km/h). ▶ Visit a service center as soon as possible.
	<p>The vehicle is losing oil.</p>	<ul style="list-style-type: none"> ▶ Stop your vehicle as soon as it is safe to do so.
<p>ACTIVE BODY CONTROL STOP, CAR TOO LOW!</p>	<p>The vehicle is parked on an extremely uneven surface.</p>	<ul style="list-style-type: none"> ▶ Press the vehicle level control button to select raised level 2 (▷ page 192).
	<p>ABC is malfunctioning.</p>	<ul style="list-style-type: none"> ▶ Stop and press the vehicle level control button to select a higher vehicle level (▷ page 192). ▶ Do not turn steering wheel too far to avoid damaging the front fenders. ▶ Listen for scraping noises. ▶ Do not exceed a speed of 50 mph (80 km/h). ▶ Visit a service center as soon as possible.
<p>DISPLAY MALFUNCTION VISIT WORKSHOP!</p>	<p>The display for ABC or the ABC system itself is malfunctioning.</p>	<ul style="list-style-type: none"> ▶ Visit an authorized Mercedes-Benz Center as soon as possible.



What to do if ...?

Display	Possible cause	Possible solution
ABC VISIT WORKSHOP!	The capability of the ABC system is restricted.	<ul style="list-style-type: none"> ▶ Do not exceed a speed of 50 mph (80 km/h). ▶ Visit a service center as soon as possible.
ABS MALFUNCTION! VISIT WORKSHOP!	<p>The ABS has detected a malfunction and has switched off. The ESP and the BAS are also deactivated.</p> <p>The brake system is still functioning normally but without the ABS available.</p>	<ul style="list-style-type: none"> ▶ Continue driving with added caution. Wheels may lock during hard braking, reducing steering capability. ▶ Have the system checked at an authorized Mercedes-Benz Center as soon as possible. <p>Failure to follow these instructions increases the risk of an accident.</p>
DISPLAY MALFUNCTION VISIT WORKSHOP!	The ABS or the ABS display is malfunctioning.	<ul style="list-style-type: none"> ▶ Continue driving with added caution. Wheels may lock during hard braking, reducing steering capability. ▶ Have the system checked at an authorized Mercedes-Benz Center as soon as possible. <p>Failure to follow these instructions increases the risk of an accident.</p>

Display	Possible cause	Possible solution
AIR FILTER CHANGE CARTRIDGE VISIT WORKSHOP!	The air filter is clogged.	<ul style="list-style-type: none"> ▶ Have the air filter checked by an authorized Mercedes-Benz Center.
BAS MALFUNCTION! VISIT WORKSHOP!	The BAS has detected a malfunction and switched off. The ESP is switched off, too. The ABS may still be operational.	<ul style="list-style-type: none"> ▶ Continue driving with added caution. ▶ Have the system checked at an authorized Mercedes-Benz Center as soon as possible. <p>Failure to follow these instructions increases the risk of an accident.</p>
DISPLAY MALFUNCTION VISIT WORKSHOP!	The BAS or the BAS display is malfunctioning.	<ul style="list-style-type: none"> ▶ Continue driving with added caution. ▶ Have the system checked at an authorized Mercedes-Benz Center as soon as possible. <p>Failure to follow these instructions increases the risk of an accident.</p>

What to do if ...?

Display	Possible cause	Possible solution
 <p>BATTERY/ALTERNATOR VISIT WORKSHOP!</p>	<p>The battery was charged with a battery charger or jump started.</p> <p>The battery is no longer charging. Possible causes:</p> <ul style="list-style-type: none"> • Alternator malfunctioning • Broken poly-V-belt <p>Do not forget that the brake system requires electrical energy and may be operating with restricted capability. Considerably greater brake pedal force is required and the stopping distance is longer.</p>	<p>► Have the battery checked at a service station.</p> <p>► Stop immediately and check the poly-V-belt.</p> <p>If it is broken:</p> <p>► Do not continue to drive. Otherwise the engine will overheat due to an inoperative water pump which may result in damage to the engine. Notify an authorized Mercedes-Benz Center.</p> <p>If it is intact:</p> <p>► Drive immediately to the nearest authorized Mercedes-Benz Center. Adjust driving to be consistent with reduced braking responsiveness.</p>

Display	Possible cause	Possible solution
 BRAKE WEAR VISIT WORKSHOP!	The brake pads have reached their wear limit.	▶ Have the brake pads replaced as soon as possible.
Except Canada:  BRAKE FLUID VISIT WORKSHOP! Canada only: 	There is insufficient brake fluid in the reservoir.	▶ Risk of accident! Stop the vehicle and notify an authorized Mercedes-Benz Center. Do not add brake fluid! This will not solve the problem.



Brake pad thickness must be visually checked by a qualified technician at the intervals specified in the Service Booklet.

Warning!





Driving with this message displayed can result in an accident. Have your brake system checked immediately. Don't add brake fluid before checking the brake system. Overfilling the brake fluid reservoir can result in spilling brake fluid on hot engine parts and the brake fluid catching fire. You can be seriously burned.



If you find that the brake fluid in the brake fluid reservoir has fallen to the minimum mark or below, have the brake system checked for brake pad thickness and leaks.

What to do if ...?

Display	Possible cause	Possible solution
 <p>CHIP CARD CHECK BATTERY</p>	KEYLESS-GO*card batteries are discharged.	▶ Change the batteries (▷ page 299).
<p>CHIP CARD NOT RECOGNIZED!</p>	<p>KEYLESS-GO*card is not recognized while the engine is running because</p> <ul style="list-style-type: none"> • the card is not in the vehicle • there is strong radio-frequency interference 	<p>▶ Stop the vehicle as soon as it is safe to do so.</p> <p>▶ Search for the card.</p> <p>Otherwise the vehicle cannot be centrally locked nor can the engine be started again after it has been stopped.</p>
	KEYLESS-GO*card is momentarily not recognized.	<p>▶ Change the position of the card in the vehicle.</p> <p>▶ Operate the vehicle with the key in the starter switch if necessary.</p>
<p>CHIP CARD DETECTED IN VEHICLE</p>	KEYLESS-GO*card left in the vehicle was recognized while locking the vehicle from the outside.	▶ Take the card out of the vehicle.
<p>CHIP CARD VISIT WORKSHOP!</p>	The KEYLESS-GO* system is malfunctioning.	▶ Visit an authorized Mercedes-Benz Center as soon as possible.

Display	Possible cause	Possible solution
 <p>CHIP CARD DO NOT FORGET</p>	<p>This display appears (for a maximum of 60 seconds) if the driver's door is opened with the engine shut off and no key in the starter switch. Message is only a reminder.</p>	<ul style="list-style-type: none"> ▶ Insert key in the starter switch. ▶ Take the KEYLESS-GO*card with you when leaving the vehicle.
 <p>COOLANT CHECK LEVEL!</p>	<p>The coolant level is too low.</p>	<ul style="list-style-type: none"> ▶ Add coolant (▷ page 242). ▶ If you have to add coolant frequently, have the cooling system checked by an authorized Mercedes-Benz Center.

Warning!



Do not spill antifreeze on hot engine parts. Antifreeze contains ethylene glycol which may burn if it comes into contact with hot engine parts. You can be seriously burned.



Do not ignore the low engine coolant level warning. Extended driving with the message and symbol displayed may cause serious engine damage not covered by the Mercedes-Benz Limited Warranty.

Do not drive without a sufficient amount of coolant in the cooling system. The engine will overheat, causing major engine damage.

What to do if ...?

Display	Possible cause	Possible solution
 <p>COOLANT STOP, ENGINE OFF!</p>	The coolant is too hot.	<ul style="list-style-type: none"> ▶ Stop the vehicle and turn off the engine. ▶ Only start the engine again after the message disappears. You could otherwise damage the engine.

Warning!



Driving when your engine is badly overheated can cause some fluids which may have leaked into the engine compartment to catch fire. You could be seriously burned.



Steam from an overheated engine can cause serious burns and can occur just by opening the engine hood. Stay away from the engine if you see or hear steam coming from it.

Turn off the engine, get out of the vehicle and do not stand near the vehicle until it cools down.



During severe operating conditions and stop-and-go city traffic, the coolant temperature may rise close to 248°F (120°C).



The engine should not be operated with the coolant temperature above 248°F (120°C). Doing so may cause serious engine damage which is not covered by the Mercedes-Benz Limited Warranty.

Display	Possible cause	Possible solution
 <p>COOLANT STOP, ENGINE OFF!</p>	<p>The poly-V-belt could be broken.</p>	<ul style="list-style-type: none"> ▶ Stop immediately and check the poly-V-belt. <p>If it is broken:</p> <ul style="list-style-type: none"> ▶ Do not continue to drive. Otherwise the engine will overheat due to an inoperative water pump which may result in damage to the engine. Notify an authorized Mercedes-Benz Center. <p>If it is intact:</p> <ul style="list-style-type: none"> ▶ Do not continue to drive the vehicle with this message displayed. Doing so could result in serious engine damage that is not covered by the Mercedes-Benz Limited Warranty.
 <p>COOLANT VISIT WORKSHOP!</p>	<p>The cooling fan for the coolant is malfunctioning.</p>	<ul style="list-style-type: none"> ▶ Observe the coolant temperature display. ▶ Have the fan replaced as soon as possible.

What to do if ...?

Display	Possible cause	Possible solution
 DISPLAY MALFUNCTION VISIT WORKSHOP!	The instrument cluster display is malfunctioning.	<ul style="list-style-type: none"> ▶ Continue driving with added caution. ▶ Visit an authorized Mercedes-Benz Center as soon as possible.
DISTRONIC EXTERNAL INTERFERENCE REACTIVATE! CLEAN SENSOR! SEE OPERATOR'S MAN. VISIT WORKSHOP!	DISTRONIC* is switched off and is temporarily unavailable.	▶ Try activating DISTRONIC* again later.
	DISTRONIC* is switched off because the DISTRONIC* cover in the radiator grille is dirty.	<ul style="list-style-type: none"> ▶ Clean the DISTRONIC* cover in the radiator grille (▷ page 259). ▶ Restart the vehicle.
	DISTRONIC* is malfunctioning or the display is malfunctioning.	▶ Visit an authorized Mercedes-Benz Center as soon as possible.
 DOOR OPEN!	You are attempting to drive with one or more doors open.	▶ Close the doors.
P SHIFT TO P	You have turned off the engine with the KEYLESS-GO* start/stop button and opened the driver's door.	▶ Place the selector lever in position P .
 VISIT WORKSHOP!	There may be a malfunction in the: <ul style="list-style-type: none"> • Fuel injection system • Ignition system • Exhaust system • Fuel system 	▶ Visit an authorized Mercedes-Benz Center as soon as possible.

Display	Possible cause	Possible solution
 <p>ENGINE OIL LEVEL STOP, ENGINE OFF!</p>	<p>There is no oil in the engine. There is a danger of engine damage.</p>	<ul style="list-style-type: none"> ▶ Carefully bring the vehicle to a halt as soon as possible. ▶ Turn off the engine. ▶ Add engine oil.
<p>ENGINE OIL LEVEL REDUCE OIL LEVEL</p>	<p>You have added too much engine oil. There is a risk of damaging the engine or the catalytic converter.</p>	<ul style="list-style-type: none"> ▶ Have oil siphoned. Observe all legal requirements with respect to its disposal.
<p>ENGINE OIL VISIT WORKSHOP!</p>	<p>The engine oil has dropped to a critical level.</p>	<ul style="list-style-type: none"> ▶ Check the engine oil level (▷ page 238) and add oil as required. ▶ If you must add engine oil frequently, have the engine checked for possible leaks.
	<p>There is water in the oil.</p>	<ul style="list-style-type: none"> ▶ Have the oil checked.

What to do if ...?

Display	Possible cause	Possible solution
 ENGINE OIL LEVEL VISIT WORKSHOP!	The measuring system is malfunctioning.	▶ Have the measuring system checked by an authorized Mercedes-Benz Center.
ENGINE OIL LEVEL CHECK LEVEL!	The engine oil level is too low.	▶ Check the engine oil level (▷ page 238) and add oil as required.

When the ENGINE OIL LEVEL - CHECK LEVEL! message appears while the engine is running and at operating temperature, the engine oil level has dropped to approximately the minimum mark on the dipstick.

When this occurs, the warning will first come on intermittently and then stay on if the oil level drops further.



If no oil leaks are noted, continue to drive to the nearest service station where the engine oil should be topped to the “full” mark on the dipstick with an approved oil.



The engine oil level warnings should not be ignored. Extended driving with the symbol displayed could result in serious engine damage that is not covered by the Mercedes-Benz Limited Warranty.

Display	Possible cause	Possible solution
ESP MALFUNCTION! VISIT WORKSHOP!	The ESP has detected a malfunction and switched off. The ABS may still be operational.	<ul style="list-style-type: none"> ▶ Continue driving with added caution. ▶ Visit an authorized Mercedes-Benz Center as soon as possible. Failure to follow these instructions increases the risk of an accident.
DISPLAY MALFUNCTION VISIT WORKSHOP!	The ESP or the ESP display is malfunctioning.	<ul style="list-style-type: none"> ▶ Continue driving with added caution. ▶ Visit an authorized Mercedes-Benz Center as soon as possible. Failure to follow these instructions increases the risk of an accident.
NOT AVAILABLE! SEE OPER. MANUAL	The ESP was deactivated because the power supply has been interrupted. The ABS is still operational.	<ul style="list-style-type: none"> ▶ With the vehicle stationary and the engine running, turn the steering wheel completely to the left and then to the right to synchronize the ESP. If the ESP message does not go out: <ul style="list-style-type: none"> ▶ Continue driving with added caution. ▶ Visit an authorized Mercedes-Benz Center as soon as possible. Failure to follow these instructions increases the risk of an accident.

What to do if ...?

Display	Possible cause	Possible solution
 RESERVE FUEL	The fuel level has dropped below the reserve mark.	▶ Refuel at the next gas station (▷ page 235).
 HOOD OPEN!	You are driving with the hood open.	▶ Close the hood (▷ page 238).
 REMOVE KEY!	You have forgotten to remove the key.	▶ Remove the key from the starter switch.
REPLACE KEY! VISIT WORKSHOP!	There is no additional code available for SmartKey.	▶ Visit an authorized Mercedes-Benz Center as soon as possible.
AUTOM. LIGHT ON REMOVE KEY!		▶ Remove the key from the starter switch.
SEAT BACKREST, RIGHT LOCK!	The driver seat backrest is not engaged.	▶ Fold back and push the seat backrest until the seat cushion and seat backrest audibly engage into the driving position.
SEAT BACKREST, LEFT LOCK!	The passenger seat backrest is not engaged.	▶ Fold back and push the seat backrest until the seat cushion and seat backrest audibly engage into the driving position.



Display	Possible cause	Possible solution
 LIGHT SENSOR VISIT WORKSHOP!	The lamp sensor is malfunctioning. The headlamps switch on automatically.	<ul style="list-style-type: none"> ▶ In the control system, set lamp operation to manual (▷ page 136). ▶ Switch on headlamps using the exterior lamp switch.
BRAKE LIGHT VISIT WORKSHOP!	Brake lamp illumination is delayed or lamp is permanently on.	▶ Visit an authorized Mercedes-Benz Center as soon as possible.
DISPLAY MALFUNCTION VISIT WORKSHOP!	The display for the lamps or the system is malfunctioning.	▶ Visit an authorized Mercedes-Benz Center as soon as possible.
TURN OFF LIGHTS!	Lamps have been turned on although the key in the starter switch is in position 0.	▶ Turn off the lights.
TURN SIG. MIRROR, L CHECK LIGHT!	The left turn signal in the side mirror is malfunctioning. This message will only appear if all light emitting diodes have stopped working.	▶ Visit an authorized Mercedes-Benz Center as soon as possible.
TURN SIG. MIRROR, R CHECK LIGHT!	The right turn signal in the side mirror is malfunctioning. This message will only appear if all light emitting diodes have stopped working.	▶ Visit an authorized Mercedes-Benz Center as soon as possible.
TURN SIG., LF CHECK LIGHT! BACK-UP LIGHT ON!	The left front turn signal lamp is malfunctioning. A back-up bulb is being used.	▶ Replace the bulb as soon as possible.



What to do if ...?

Display	Possible cause	Possible solution
 TURN SIG., RF CHECK LIGHT! BACK-UP LIGHT ON!	The right front turn signal lamp is malfunctioning. A back-up bulb is being used.	▶ Replace the bulb as soon as possible.
HIGH BEAM, L CHECK LIGHT!	The left high beam flasher lamp is malfunctioning.	▶ Replace the bulb as soon as possible.
HIGH BEAM, R CHECK LIGHT!	The right high beam lamp flasher is malfunctioning.	▶ Replace the bulb as soon as possible.
MARKER LIGHT, FL CHECK LIGHT!	The front left side marker lamp is malfunctioning.	▶ Replace the bulb as soon as possible.
MARKER LIGHT, FR CHECK LIGHT!	The front right side marker lamp is malfunctioning.	▶ Replace the bulb as soon as possible.
FR. L. PARK. LAMP CHECK LIGHT! BACK-UP LIGHT ON!	The left parking lamps are malfunctioning. A back-up bulb is being used.	▶ Replace the bulb as soon as possible.
FR. R. PARK. LAMP CHECK LIGHT! BACK-UP LIGHT ON!	The right parking lamps are malfunctioning. A back-up bulb is being used.	▶ Replace the bulb as soon as possible.
STANDING LIGHT, L CHECK LIGHT! BACK-UP LIGHT ON!	The left standing lamp is malfunctioning. A back-up bulb is being used.	▶ Replace the bulb as soon as possible.

Display	Possible cause	Possible solution
 STANDING LIGHT, R CHECK LIGHT! BACK-UP LIGHT ON!	The right standing signal lamp is malfunctioning. A back-up bulb is being used.	▶ Replace the bulb as soon as possible.
FRONT FOGLIGHT, L CHECK LIGHT!	The left front fog lamp is malfunctioning.	▶ Visit an authorized Mercedes-Benz Center as soon as possible.
FRONT FOGLIGHT, R CHECK LIGHT!	The right front fog lamp is malfunctioning.	▶ Visit an authorized Mercedes-Benz Center as soon as possible.
LOW BEAM, L CHECK LIGHT!	The left low beam lamp is malfunctioning.	▶ Visit an authorized Mercedes-Benz Center as soon as possible.
LOW BEAM, R CHECK LIGHT!	The right low beam lamp is malfunctioning.	▶ Visit an authorized Mercedes-Benz Center as soon as possible.
3RD BRAKE LIGHT CHECK LIGHT!	The high mounted brake lamp is malfunctioning.	▶ Visit an authorized Mercedes-Benz Center as soon as possible.
BRAKE LIGHT, L CHECK LIGHT! BACK-UP LIGHT ON!	The left brake lamp is malfunctioning. A back-up bulb is being used.	▶ Visit an authorized Mercedes-Benz Center as soon as possible.
BRAKE LIGHT, R CHECK LIGHT! BACK-UP LIGHT ON!	The right brake lamp is malfunctioning. A back-up bulb is being used.	▶ Visit an authorized Mercedes-Benz Center as soon as possible.
REVERSE LIGHT, L CHECK LIGHT!	The left backup lamp is malfunctioning.	▶ Replace the bulb as soon as possible.

What to do if ...?

Display	Possible cause	Possible solution
 REVERSE LIGHT, R CHECK LIGHT!	The right backup lamp is malfunctioning.	▶ Replace the bulb as soon as possible.
REAR FOGLIGHT CHECK LIGHT!	The rear fog lamp is malfunctioning.	▶ Replace the bulb as soon as possible.
LICENSE PLATE LIGHT, L CHECK LIGHT!	The left license plate lamp is malfunctioning.	▶ Replace the bulb as soon as possible.
LICENSE PLATE LIGHT, R CHECK LIGHT!	The right license plate lamp is malfunctioning.	▶ Replace the bulb as soon as possible.
TAIL LIGHT, L CHECK LIGHT! BACK-UP LIGHT ON!	The left tail lamp is malfunctioning. A back-up bulb is being used.	▶ Replace the bulb as soon as possible.
TAIL LIGHT, R CHECK LIGHT! BACK-UP LIGHT ON!	The right tail lamp is malfunctioning. A back-up bulb is being used.	▶ Replace the bulb as soon as possible.
TURN SIG., LR CHECK LIGHT! BACK-UP LIGHT ON!	The left rear turn signal lamp is malfunctioning. A back-up bulb is being used.	▶ Replace the bulb as soon as possible.
TURN SIG., RR CHECK LIGHT! BACK-UP LIGHT ON!	The right rear turn signal lamp is malfunctioning. A back-up bulb is being used.	▶ Replace the bulb as soon as possible.
 PARK. BRAKE RELEASE BRAKE!	You are driving with the parking brake engaged.	▶ Release the parking brake (▷ page 44).

Display	Possible cause	Possible solution
 SEAT BELT SYSTEM VISIT WORKSHOP!	The seat belt system is malfunctioning.	▶ Visit an authorized Mercedes-Benz Center as soon as possible.
 TIRE PRES. MONITOR PRES. DISPLAY AFTER DRIVING A FEW MINS. RE- ACTIVATE USING R BUTTON	The tire pressure is being checked.	
TIRE PRES. MONITOR REACTIVATE!	The tire inflation pressure monitor* is de-activated.	▶ Activate the tire inflation pressure monitor* (▷ page 248).

Warning!



Do not drive with a flat tire. A flat tire affects the ability to steer or brake the vehicle.

You may lose control of the vehicle. Continued driving with a flat tire will cause excessive heat build-up and possibly a fire.

What to do if ...?

Display	Possible cause	Possible solution
 <p>TIRE PRES. MONITOR NOT ACTIVE</p>	<p>The tire inflation pressure monitor* is unable to monitor the tire pressure due to</p> <ul style="list-style-type: none"> • the presence of several wheel sensors in the vehicle. • excessive wheel sensor temperatures. • a nearby radio interference source. • unrecognized wheel sensors mounted. 	<p>▶ Check the tire pressure at the next service station.</p>
<p>TIRE PRES. MONITOR VISIT WORKSHOP!</p>	<p>The tire inflation pressure monitor* is malfunctioning.</p>	<p>▶ Have the tire inflation pressure monitor* checked by an authorized Mercedes-Benz Center.</p> <p>▶ Change the wheel (▷ page 308).</p>
	<p>A wheel without proper sensor was installed.</p>	<p>▶ Check and correct tire pressure as required (▷ page 248).</p>

Warning!



Do not drive with a flat tire. A flat tire affects the ability to steer or brake the vehicle.

You may lose control of the vehicle. Continued driving with a flat tire will cause excessive heat build-up and possibly a fire.

Display	Possible cause	Possible solution
 TIRE PRES. CAUTION, TIRE DEFECT!	One or more tires is rapidly deflating.	<ul style="list-style-type: none"> ▶ Carefully bring the vehicle to a halt, avoiding abrupt steering and braking maneuvers. ▶ Change the wheel (▷ page 308).
TIRE PRES. CHECK TIRES!	<p>The tire pressure in one or more tires is already below the minimum value.</p> <p>The tire pressure in one or more tires is low.</p>	<ul style="list-style-type: none"> ▶ Carefully bring the vehicle to a halt, avoiding abrupt steering and braking maneuvers. ▶ Change the wheel (▷ page 308).
TIRE PRES., RF CAUTION, TIRE DEFECT!	The right front tire is rapidly deflating.	<ul style="list-style-type: none"> ▶ Carefully bring the vehicle to a halt, avoiding abrupt steering and braking maneuvers. ▶ Change the wheel (▷ page 308).
TIRE PRES., RF CHECK TIRES!	The right front tire pressure is low.	<ul style="list-style-type: none"> ▶ Carefully bring the vehicle to a halt. ▶ Check the tire pressure. ▶ Change the wheel (▷ page 308).

Warning!



Do not drive with a flat tire. A flat tire affects the ability to steer or brake the vehicle.

You may lose control of the vehicle. Continued driving with a flat tire will cause excessive heat build-up and possibly a fire.

What to do if ...?

Display	Possible cause	Possible solution
 TIRE PRES., LF CAUTION, TIRE DEFECT!	The left front tire is rapidly deflating.	<ul style="list-style-type: none"> ▶ Carefully bring the vehicle to a halt, avoiding abrupt steering and braking maneuvers. ▶ Change the wheel (▷ page 308).
TIRE PRES., LF CHECK TIRES!	The left front tire pressure is low.	<ul style="list-style-type: none"> ▶ Carefully bring the vehicle to a halt. ▶ Check the tire pressure. ▶ Change the wheel (▷ page 308).
TIRE PRES., RR CAUTION, TIRE DEFECT!	The right rear tire is rapidly deflating.	<ul style="list-style-type: none"> ▶ Carefully bring the vehicle to a halt, avoiding abrupt steering and braking maneuvers. ▶ Change the wheel (▷ page 308).
TIRE PRES., RR CHECK TIRES!	The right rear tire pressure is low.	<ul style="list-style-type: none"> ▶ Carefully bring the vehicle to a halt. ▶ Check the tire pressure. ▶ Change the wheel (▷ page 308).

Warning!



Do not drive with a flat tire. A flat tire affects the ability to steer or brake the vehicle.

You may lose control of the vehicle. Continued driving with a flat tire will cause excessive heat build-up and possibly a fire.

Display	Possible cause	Possible solution
 <p>TIRE PRES., LR CAUTION, TIRE DEFECT!</p>	The left rear tire is rapidly deflating.	<ul style="list-style-type: none"> ▶ Carefully bring the vehicle to a halt, avoiding abrupt steering and braking maneuvers. ▶ Change the wheel (▷ page 308).
<p>TIRE PRES., LR CHECK TIRES!</p>	The left rear tire pressure is low.	<ul style="list-style-type: none"> ▶ Carefully bring the vehicle to a halt. ▶ Check the tire pressure. ▶ Change the wheel (▷ page 308).

Warning!











Do not drive with a flat tire. A flat tire affects the ability to steer or brake the vehicle.

You may lose control of the vehicle. Continued driving with a flat tire will cause excessive heat build-up and possibly a fire.

Display	Possible cause	Possible solution
 <p>TELE AID MALFUNCTION VISIT WORKSHOP!</p>	One or more main functions of the Tele Aid system are malfunctioning.	▶ Have the Tele Aid system checked by an authorized Mercedes-Benz Center.
<p>TELE AID BATTERY VISIT WORKSHOP!</p>	The emergency power battery for the Tele Aid system is malfunctioning. If the vehicle battery is also discharged, Tele Aid will not be operational.	▶ Have the Tele Aid system checked by an authorized Mercedes-Benz Center.

What to do if ...?

Display	Possible cause	Possible solution
 <p>FUNCTION NOT AVAILABLE!</p>	<p>This display appears if button  or  on the multifunction steering wheel is pressed and the vehicle is not equipped with a telephone.</p>	
 <p>TRUNK OPEN!</p>	<p>This message will appear whenever the trunk lid is open.</p>	<p>▶ Close the trunk lid.</p>
 <p>WASHER FLUID CHECK LEVEL!</p>	<p>The fluid level has dropped to about $\frac{1}{3}$ of total reservoir capacity.</p>	<p>▶ Add washer fluid (▷ page 244).</p>
 <p>CRUISE CONTROL VISIT WORKSHOP!</p>	<p>Cruise control or Distronic* is malfunctioning.</p>	<p>▶ Have cruise control or Distronic* checked by an authorized Mercedes-Benz Center.</p>
 <p>ENTRY POSITION DO NOT DRIVE!</p>	<p>Seat, mirrors and steering wheel have not yet moved to their preset driving positions.</p>	<p>▶ Wait until the seat, mirrors and steering wheel have moved to their driving positions. The message will disappear.</p>
 <p>DISPLAY MALFUNCTION VISIT WORKSHOP!</p>	<p>Certain electronic systems are unable to relay information to the control system. The following systems may have failed:</p> <ul style="list-style-type: none"> • Coolant temperature display • Tachometer • Cruise control display 	<p>▶ Have the electronic systems checked by an authorized Mercedes-Benz Center.</p>

Where will I find...?

First aid kit

The first aid kit is stored in the rear center armrest.

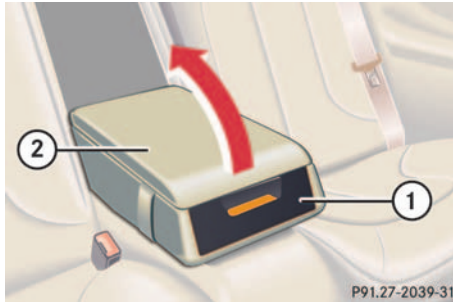

- ▶ Fold rear arm rest down **1**.
- ▶ Press handle **1** upwards.
- ▶ Fold lid **2** up.
- ▶ Remove first aid kit.



Check expiration dates and contents for completeness at least once a year and replace missing/expired items.

Vehicle jack, vehicle tool kit, luggage bowl, spare wheel

The spare wheel, the vehicle tool kit and the luggage bowl are stored in the compartment underneath the trunk floor.

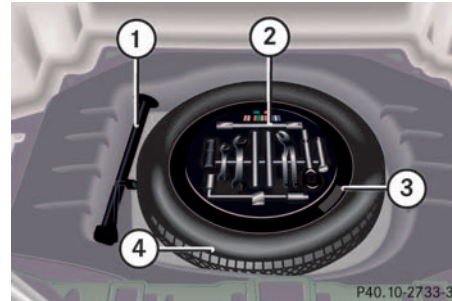

- 1** Vehicle jack
 - 2** Vehicle tool kit
 - 3** Luggage bowl
 - 4** Spare wheel
- ▶ Lift up the trunk floor cover and engage trunk floor handle in upper edge of trunk.
- You can now remove the tools and accessories.



To prevent damage, always disengage trunk floor handle from trunk edge and lower trunk floor before closing the trunk lid.

The vehicle tool kit includes:

- One pair of universal pliers
- Two open-end wrenches
- One hex-socket wrench
- One interchangeable slot/Phillips screwdriver
- One towing eye bolt
- One wheel wrench
- One alignment bolt
- One fuse extractor
- One fuse chart for the main fuse box
- Spare fuses

Where will I find...?

Vehicle jack

To prepare the vehicle jack for use

- ▶ Remove the vehicle jack from the spare wheel well under the trunk floor.
- ▶ Push the crank handle up.
- ▶ Turn the crank handle clockwise until it engages (operational position).



Storing the vehicle jack in the trunk

- ▶ Retract the vehicle jack arm to the base of the vehicle jack.
- ▶ Push the crank handle up.

- ▶ Turn the crank handle counterclockwise to the end of the stop (storage position).

Warning!



The jack is designed exclusively for jacking up the vehicle at the jack take-up brackets built into both sides of the vehicle. To help avoid personal injury, use the jack only to lift the vehicle during a wheel change. Never get beneath the vehicle while it is supported by the jack. Keep hands and feet away from the area under the lifted vehicle. Always firmly set parking brake and block wheels before raising vehicle with jack.

Do not disengage parking brake while the vehicle is raised. Be certain that the jack is always vertical (plumb line) when in use, especially on hills. Always try to use the jack on level surface. Make sure that the jack arm is fully seated in the jack take-up bracket. Always lower the vehicle onto sufficient capacity jackstands before working under the vehicle.

Spare wheel

Removing the spare wheel

- ▶ Take out vehicle tool kit tray **2**.
- ▶ Turn the luggage bowl **3** counterclockwise.
- ▶ Remove the spare wheel **4**.

Storing the spare wheel

- ▶ Place spare wheel **4** in wheel well and secure it with luggage bowl **3**.
- ▶ Turn the luggage bowl **3** clockwise to its stop.
- ▶ Place vehicle tool kit tray **2** in luggage bowl **3**.

Unlocking/locking in an emergency

Unlocking/locking in an emergency

Unlocking the vehicle

Unlocking the driver's door

If you are unable to unlock the driver's door using the SmartKey, open the door using the mechanical key.

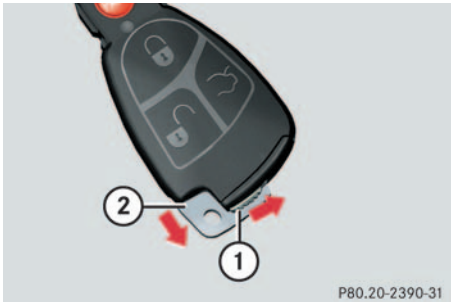

1 Mechanical key locking tab

2 Mechanical key

- ▶ Move locking tab **1** in direction of arrow and slide the mechanical key out of the housing.

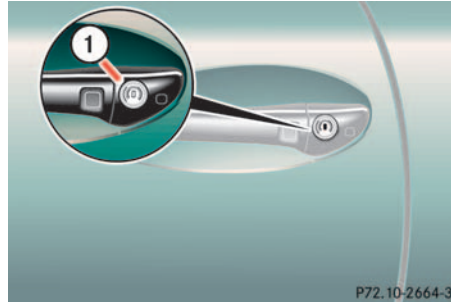

- ▶ Unlock the door with the mechanical key. To do so, push the mechanical key in the lock until it stops and turn it to the left (position **1**).



Unlocking your vehicle with the mechanical key will trigger the anti-theft alarm system. To cancel the alarm, do one of the following:

- Press button or on the SmartKey.
- Insert the key in the starter switch.
- If KEYLESS-GO* card present, press the KEYLESS-GO* start/stop button.

Unlocking/locking in an emergency

Unlocking the trunk

If you are unable to unlock the trunk with the SmartKey, open the trunk with the mechanical key as follows:

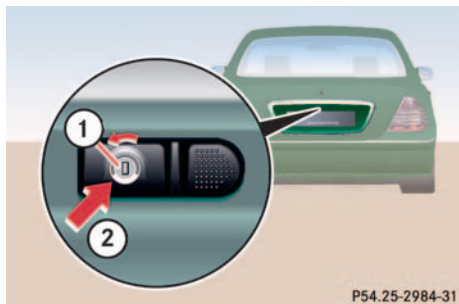

Trunk lock

- ▶ Insert the mechanical key into the trunk lid lock.
- ▶ Turn the key counterclockwise to position **1**.
- ▶ Press trunk lid lock **2**.



The trunk lid swings open.



The trunk lid swings open automatically. Always make sure that there is sufficient overhead clearance. A minimum height clearance of 6.1 ft (1.90 m) is required to open the trunk lid.



Unlocking your vehicle with the mechanical key will trigger the anti-theft alarm system. To cancel the alarm, do one of the following:

- Press button  or  on the SmartKey.
- Insert the key in the starter switch.
- If KEYLESS-GO* card present, press the KEYLESS-GO* start/stop button (▷ page 33).

Locking the vehicle

If you are unable to lock the vehicle with the SmartKey, lock it with the mechanical key as follows:

- ▶ Close the passenger door and the trunk lid.
- ▶ Press the central locking switch in the center console (▷ page 95).
- ▶ Check to see whether the locking knob on the passenger door is still visible. If necessary push it down manually.
- ▶ Lock the driver's door with the mechanical key.
- ▶ Lock the trunk lid if necessary with the mechanical key (▷ page 90).

Unlocking/locking in an emergency

Changing batteries

If the batteries in the SmartKey or the KEYLESS-GO* card are discharged, the vehicle can no longer be locked or unlocked. It is recommended to have the batteries replaced at an authorized Mercedes-Benz Center.

Warning!



Keep the batteries out of reach of children.
If a battery is swallowed, seek medical help immediately.

Batteries contain materials that can harm the environment if disposed of improperly. Recycling of batteries is the preferred method of disposal. Many states require sellers of batteries to accept old batteries for recycling.



When changing batteries, always replace both batteries.

The required replacement batteries are available at any Mercedes-Benz Center.

SmartKey

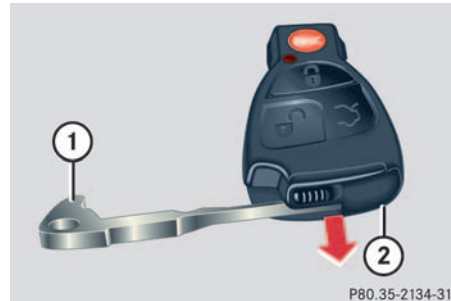

- 1 Mechanical key
- 2 Battery compartment

Replacement batteries: Lithium, type CR 2025 or equivalent.

- ▶ Remove mechanical key 1 (▷ page 297).

- ▶ Insert the mechanical key 1 in side opening and push gray slide 2. The battery compartment is unlatched.
- ▶ Pull the battery compartment out of the key housing in direction of arrow.
- ▶ Remove the batteries.

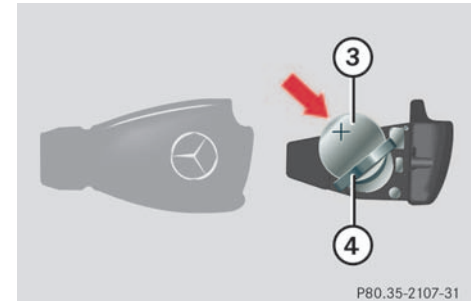

- 3 Battery
- 4 Contact spring

- ▶ Using a lint-free cloth, insert new batteries 3 under the contact spring 4 with the plus (+) side facing up.
- ▶ Return battery compartment into housing until it locks into place.

Unlocking/locking in an emergency

KEYLESS-GO* card

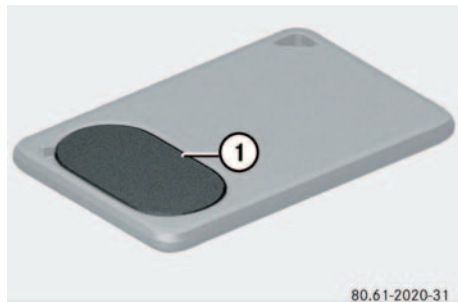

1 Battery cover

Replacement batteries: Lithium, type CR 2025 or equivalent.

- ▶ Pry open cover **1** (e.g. by using a narrow blade screw driver).
- ▶ Remove the batteries.
- ▶ Install new batteries as indicated by the “+” and “-” markings in the KEYLESS-GO card.
- ▶ Replace battery cover **1**.

Fuel filler flap

In an emergency, the fuel filler flap can only be opened from the trunk. The release knob is located on the right-hand side in the trunk.

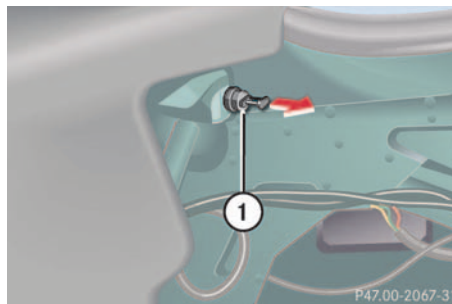

1 Release knob

- ▶ Open the trunk with the mechanical key (▷ page 298).
- ▶ Remove the battery cover and the trim inside the trunk on the right-hand side.
- ▶ Pull release knob **1** (arrow) flap.
The fuel filler flap can be opened.

Opening/closing in an emergency

Opening/closing in an emergency

Sliding/pop-up roof

The sliding/pop-up roof drive is located behind the lens of the interior overhead light.

You can open or close the sliding/pop-up roof manually should an electrical malfunction occur.



1 Lens

- ▶ Pry off lens 1 using a screwdriver.

- ▶ Turn the key in the starter switch to position 1 or 2.
- ▶ Remove the crank from the Operator's Manual pouch.



2 Crank

- ▶ Insert crank 2 through hole.
- ▶ Turn crank 2 clockwise to:
 - slide roof closed
 - raise roof at the rear
- ▶ Turn crank 2 counterclockwise to:
 - slide roof open
 - lower roof at the rear

The sliding/pop-up roof must be resynchronized after being operated manually (▷ page 175).

Replacing bulbs

Replacing bulbs

Safe vehicle operation depends on proper exterior lighting and signaling. It is therefore essential that all bulbs and lamp assemblies are in good working order at all times.

Correct headlamp adjustment is extremely important. Have headlamps checked and readjusted at regular intervals and when a bulb has been replaced. See your authorized Mercedes-Benz Center for headlamp adjustment.



Back-up bulbs will be brought into use when the following lamps malfunction:

- Turn signal lamps
- Brake lamps
- Parking lamps
- Tail lamps

Bulbs

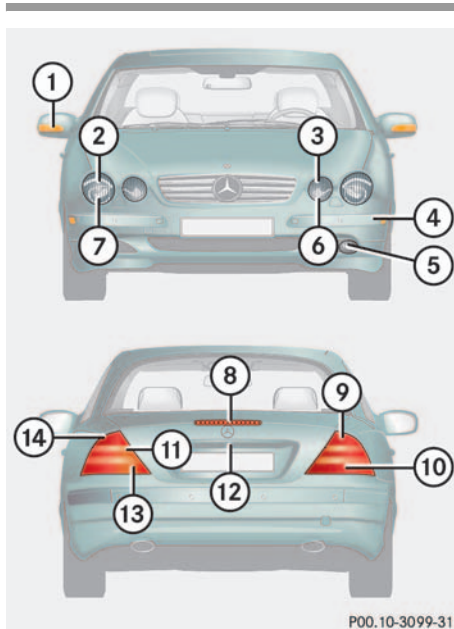

Front lamps

Lamp	Type
1 Additional turn signal lamps	LED
2 Turn signal lamp	1156 A
3 High beam flasher	H7-55 W
4 Side marker lamp	W 5 W
5 Fog lamp	HB4-55 W
6 Parking and standing lamps	H 6 W
7 Low beam and high beam	Xenon ¹ D2S-35 W

¹ Bi-Xenon headlamps: For safety reasons (high voltage), do not replace the xenon bulb yourself. See your authorized Mercedes-Benz Center.

Rear lamps

Lamp	Type
8 High mounted brake lamp	LED
9 Brake lamp	LED
10 Tail, parking and standing lamp	P 21/4 W
Side marker lamp	LED
11 Backup lamp	P 21 W
12 License plate lamps	C 5 W
13 Rear fog lamp, driver's side	P 21/4 W
14 Turn signal lamp	PY 21 W

Notes on bulb replacement

Warning!



Keep bulbs out of reach of children.

Bulbs and bulb sockets can get very hot. Allow the lamp to cool down before changing a bulb.

Halogen lamps contain pressurized gas. A bulb can explode if you

- touch or move it when hot
- drop the bulb
- scratch the bulb

Wear eye and hand protection.

Because of high voltage in Bi-Xenon lamps, it is dangerous to replace the bulb or repair the lamp and its components. We recommend that you have such work done by a qualified technician.

- Use only 12 volt bulbs of the same type and with the specified watt rating.
- Switch lights off before changing a bulb to prevent short circuits.
- Always use a clean lint-free cloth when handling bulbs.
- Your hands should be dry and free of oil and grease.
- If the newly installed bulb does not light up, visit an authorized Mercedes-Benz Center.
- Have the LEDs and bulbs for the following lamps replaced by an authorized Mercedes-Benz Center:
 - Additional turn signal lamps in the exterior rear view mirrors
 - Bi-Xenon lamps
 - Front fog lamps
 - High mounted brake lamp
 - Brake lamp
 - Rear side marker

Replacing bulbs

Replacing bulbs for front lamps

Warning!



Do not remove the cover for the Bi-Xenon headlamp. Because of high voltage in xenon lamps, it is dangerous to replace the bulb or repair the lamp and its components. We recommend that you have such work done by a qualified technician at an authorized Mercedes-Benz Center.

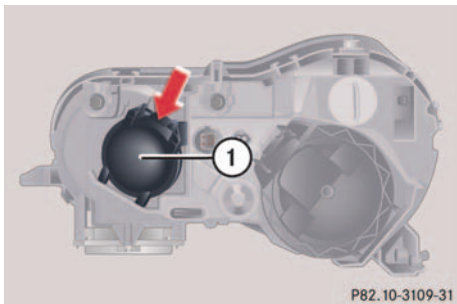

1 Housing cover for high beam flasher bulb, parking and standing lamp

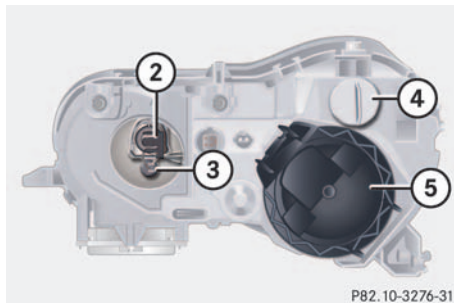

- 2 Electrical connector for high beam flasher housing bulb
- 3 Parking and standing lamp
- 4 Bulb socket for turn signal lamp
- 5 Low beam and high beam (Bi-Xenon) housing cover

High beam flasher bulb

- ▶ Switch off the lights.
- ▶ Open the hood (▷ page 237).
- ▶ Press ends of housing cover **1** tab together and remove cover.
- ▶ Press connector **2** downward.
- ▶ Remove connector **2** with the bulb.

- ▶ Insert the new bulb so that the base locates in the recess on the holder.
- ▶ From below, press connector **2** with bulb upward onto the reflector.
- ▶ Align housing cover **1** and click into place.

Front turn signal bulb

- ▶ Switch off the lights.
- ▶ Open the hood (▷ page 237).
- ▶ Twist bulb socket **4** counterclockwise and pull out.
- ▶ Push bulb into socket, turn counterclockwise and remove.
- ▶ Insert new bulb in socket, push in and twist clockwise.
- ▶ Reinsert bulb socket in lamp and twist clockwise.

Parking and standing lamp bulb

- ▶ Switch off the lights.
- ▶ Open the hood (▷ page 237).
- ▶ Press ends of housing cover 1 tab together and remove cover.
- ▶ Pull out the bulb socket with the bulb.
- ▶ Pull the bulb out of the bulb socket.
- ▶ Insert a new bulb in the socket.
- ▶ Reinstall the bulb socket.
- ▶ Align housing cover and click into place.

Side marker lamp bulb

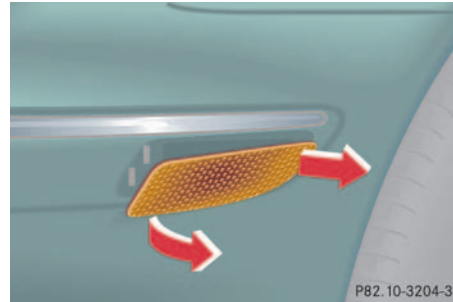

- ▶ Switch off the lights.
- ▶ Carefully slide lamp towards rear.
- ▶ Remove front end first.
- ▶ Twist bulb socket counterclockwise and pull out.
- ▶ Pull bulb out of the bulb socket.
- ▶ Insert new bulb in socket.
- ▶ Reinstall bulb socket, push in and twist clockwise.
- ▶ To reinstall lamp, set rear end in bumper and let front end snap into place.

Replacing bulbs for rear lamps

Tail lamp assemblies

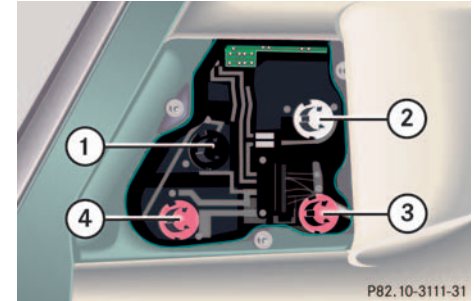

- 1 Backup lamp (black socket)
- 2 Turn signal lamp (white socket)
- 3 Tail, standing and parking lamp (red socket)
- 4 Driver's side: tail, parking and rear fog lamp
Passenger's side: tail and parking lamp (red socket)

Replacing bulbs

- ▶ Switch off the lights.
- ▶ Open trunk.
- ▶ Turn lock counterclockwise and move the trim to the side.
- ▶ Turn bulb socket counterclockwise and pull out.
- ▶ Gently twist bulb counterclockwise and pull out of bulb holder.
- ▶ Insert new bulb into the holder and turn it clockwise.
- ▶ Reinstall bulb socket.
- ▶ The bulb socket should audibly click.
- ▶ Replace trim and secure with lock.

License plate lamp

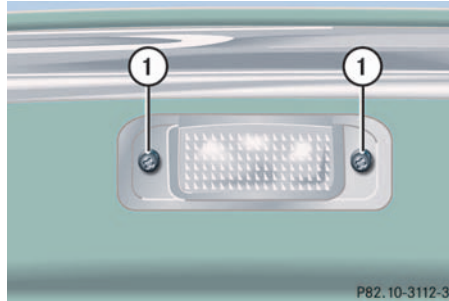

1 Screws

- ▶ Switch off the lights.
- ▶ Loosen both screws **1** and remove lamp.
- ▶ Replace the tubular lamp and reinstall lamp.
- ▶ Retighten the screws.

Replacing wiper blades



To avoid damage to the hood, the wiper arms should only be folded forward when in the vertical position.



Removing

- ▶ Turn key in starter switch to position **1**.
- ▶ Turn combination switch to wiper setting **II** (▷ page 47).
- ▶ With wiper arm in the vertical position (see above), turn key in starter switch to position **0**.

Warning!



For safety reasons, remove key from starter switch before replacing a wiper blade, otherwise the motor could suddenly turn on and cause injury.

- ▶ Fold the wiper arm forward.
You should hear it snap into place.

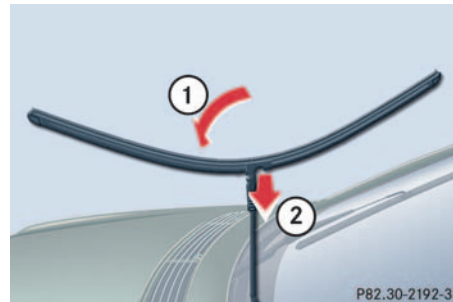

- ▶ Turn the wiper blade at a right angle to wiper arm (arrow **1**).
- ▶ Slide the wiper blade sideways out of the retainer in the direction of arrow **2**.

Installing

- ▶ Slide the wiper blade into the cutout on the wiper arm.
- ▶ Rotate wiper blade into position parallel to wiper arm.
- ▶ Fold the wiper arm backward to rest on the windshield.



Never open the hood when the wiper arm is folded forward.

Do not allow the wiper arms to contact the windshield glass without a wiper blade inserted.

Make certain that the wiper blades are properly installed. Improperly installed wiper blades may cause windshield damage.

For your convenience, we recommend that you have this work carried out by an authorized Mercedes-Benz Center.

Flat tire

Flat tire

Preparing the vehicle

- ▶ Park the vehicle as far as possible from moving traffic on a hard surface.
- ▶ Turn on the hazard warning flashers.
- ▶ Engage the steering wheel lock in the straight ahead position and set the parking brake.
- ▶ Move the selector lever to **P**.
- ▶ Have any passenger exit the vehicle at a safe distance from the roadway.

Mounting the spare wheel

Spare wheel

Spare wheel CL 500 and CL 600 (except Sport Package)*

The spare wheel rim is mounted with a full sized tire of the same type as on the vehicle, and it is fully functional.

However, that spare wheel rim is weight optimized and has a limited service life of 12 000 miles (20 000 km) use before a standard wheel rim must replace it.

Warning!



The spare wheel rim is for temporary use only. Use for over a total of 12 000 miles (20 000 km) (aggregate of all uses) may cause wheel rim failure leading to an accident and possible injuries.

Drive to the nearest Mercedes-Benz-Center as soon as possible to have the spare wheel replaced with a regular road wheel.

Never operate the vehicle with more than one spare wheel mounted.

More information can be found in the “Technical data” section (> page 333).

*Spare wheel CL 55 AMG and Sport Package**

Warning!



The dimensions of the spare wheel are different from those of the road wheels. As a result, the vehicle handling characteristics change when driving with a mounted spare wheel. Adapt your driving style accordingly.

The spare wheel rim is for temporary use only. Use for over a total of 12 000 miles (20 000 km) (aggregate of all uses) may cause wheel rim failure leading to an accident and possible injuries.

Never operate the vehicle with more than one spare wheel mounted.

When driving with spare wheel mounted, ensure proper tire pressure and do not exceed vehicle speed of 50 mph (80 km).

Drive to the nearest Mercedes-Benz-Center as soon as possible to have the spare wheel replaced with a regular road wheel.

More information can be found in the “Technical data” section (▷ page 333).

Preparing the vehicle

- ▶ Take vehicle tool kit tray and vehicle jack out of trunk.
- ▶ Take the spare wheel out of wheel well (▷ page 296).

Lifting the vehicle

- ▶ Prevent the vehicle from rolling away by blocking wheels with wheel chocks (not included) or other sizable, heavy objects.

When changing wheel on a level surface:

- ▶ Place one chock in front of and one behind the wheel that is diagonally opposite to the wheel being changed.

When changing wheel on a hill:

- ▶ Place chocks behind the downhill sides of both wheels of the axle not being worked on.

- ▶ Take the two-piece wheel wrench out of the vehicle tool kit tray. Assemble wheel wrench.

Warning!



The jack is designed exclusively for jacking up the vehicle at the jack take-up brackets built into both sides of the vehicle. To help avoid personal injury, use the jack only to lift the vehicle during a wheel change. Never get beneath the vehicle while it is supported by the jack. Keep hands and feet away from the area under the lifted vehicle. Always firmly set parking brake and block wheels before raising vehicle with jack.

Do not disengage parking brake while the vehicle is raised. Be certain that the jack is always vertical (plumb line) when in use, especially on hills. Always try to use the jack on level surface. Make sure that the jack arm is fully seated in the jack take-up bracket. Always lower the vehicle onto sufficient capacity jackstands before working under the vehicle.



- ▶ On wheel to be changed, loosen but do not yet remove the wheel bolts (approximately one full turn with wrench).

The tube openings are located directly behind the front wheel housings and in front of the rear wheel housings. ▷▷

Flat tire

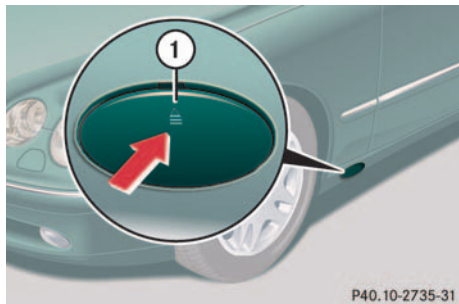

1 Jack support tube cover

- ▶ Move cover 1 toward rear by pressing at point indicated by arrow.
- ▶ Remove cover 1 carefully to avoid damage to the locking tabs.

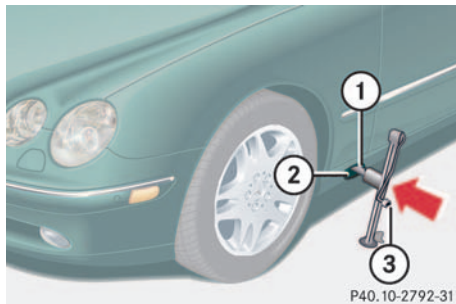

- 1 Jack arm
- 2 Jack support tube hole
- 3 Crank

- ▶ Insert jack arm 1 fully into tube hole 2 up to the stop.

Warning!



Insert the jack arm fully into the jack support tube hole up to the stop. Otherwise the vehicle may fall from the jack and cause personal injury or damage to the vehicle.

- ▶ Keeping jack in this position, turn crank 3 clockwise until the jack base meets the ground. Make sure the jack is vertical (plumb line).
- ▶ Continue to turn the crank until the tire is a maximum of 1.2 in (3 cm) from the ground.

Warning!



The jack is intended only for lifting the vehicle briefly for wheel changes. It is not suited for performing maintenance work under the vehicle.

- Never start the engine when the vehicle is raised.
- Never lie down under the raised vehicle.

Removing the wheel

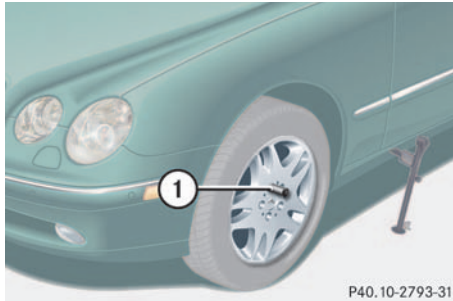

1 Alignment bolt

- ▶ Unscrew upper-most wheel bolt and remove.
- ▶ Replace this wheel bolt with alignment bolt **1** supplied in the tool kit.
- ▶ Remove the remaining bolts.



Do not place wheel bolts in sand or dirt. This could result in damage to the bolt and wheel hub threads.

- ▶ Remove the wheel.

Mounting the new wheel

- ▶ Clean contact surfaces of wheel and wheel hub.



To avoid paint damage, place wheel flat against hub and hold it there while installing first wheel bolt.

Warning!



Always replace wheel bolts that are damaged or rusted.

Never apply oil or grease to wheel bolts.

Damaged wheel hub threads should be repaired immediately. Do not continue to drive under these circumstances! Contact an authorized Mercedes-Benz Center or call Roadside Assistance.

Incorrect mounting bolts or improperly tightened mounting bolts can cause the wheel to come off. This could cause an accident. Make sure you are using the correct mounting bolts.

- ▶ Guide the spare wheel onto the alignment bolt and push it on.
- ▶ Insert wheel bolts and tighten them slightly.
- ▶ Unscrew the alignment bolt, install last wheel bolt and tighten slightly.

Warning!



Use only genuine equipment Mercedes-Benz wheel bolts. They are identified by the Mercedes star. Other wheel bolts may come loose.

Do not tighten the wheel bolts when the vehicle is raised. Otherwise the vehicle could tip over.

Flat tire

Lowering the vehicle

- ▶ Lower vehicle by turning crank counterclockwise until vehicle is resting fully on its own weight.
- ▶ Remove the jack.

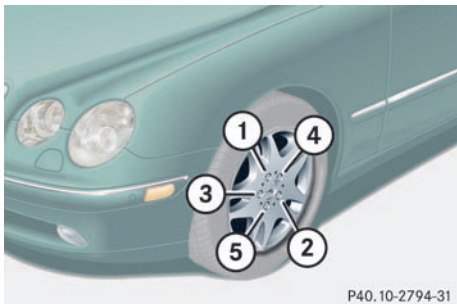

1 - 5 Wheel bolts

- ▶ Tighten the five wheel bolts evenly, following the diagonal sequence illustrated (1 to 5), until all bolts are tight. Observe a tightening torque of 110 ft lb (150 Nm).

Warning!



Have the tightening torque checked after changing a wheel. The wheels could come loose if they are not tightened to a torque of 110 ft lb (150 Nm).

- ▶ Before storing the jack in the trunk, it should be fully collapsed, with handle folded in.
- ▶ Place the wheel bolt wrench, alignment bolt and jack back in the vehicle tool kit in the trunk and close the covering lid.

Replacing jack support tube cover

- ▶ Slide tongue of cover under the upper edge of the tube opening.
- ▶ Applying even pressure, press cover until it snaps into place. Be careful not to damage the locking tabs or clamp the plastic retaining strap.



You can also screw the faulty wheel down into the spare wheel well in the trunk.

Do not activate the tire inflation pressure monitor* until the depressurized tire is no longer in the vehicle.

Battery

Warning!



Failure to follow these instructions can result in severe injury or death.

Never lean over batteries while connecting, you might get injured.

Battery fluid contains sulfuric acid. Do not allow this fluid to come in contact with eyes, skin or clothing. In case it does, immediately flush affected area with water and seek medical help if necessary.

A battery will also produce hydrogen gas, which is flammable and explosive. Keep flames or sparks away from battery, avoid improper connection of jumper cables, smoking etc.



Never loosen or detach battery terminal clamps while the engine is running or the key is in the starter switch. Otherwise the alternator and other electronic components could be severely damaged.

Have the battery checked regularly by an authorized Mercedes-Benz Center. Refer to Service Booklet for maintenance intervals or contact your authorized Mercedes-Benz Center for further information.

Warning!



Do not place metal objects on the battery as this could result in a short circuit.

Use leak-proof battery only to avoid the risk of acid burns in the event of an accident.

Warning!



With a disconnected battery

- you will no longer be able to turn the key in the starter switch and pressing the KEYLESS-GO* start/stop button on the selector lever will have no effect
- the selector lever will remain locked in position **P**

Battery

The battery is located in the trunk under the right hand wheel well cover panel.

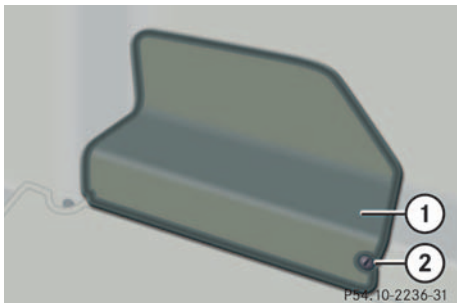

- 1 Battery cover
- 2 Locking knob

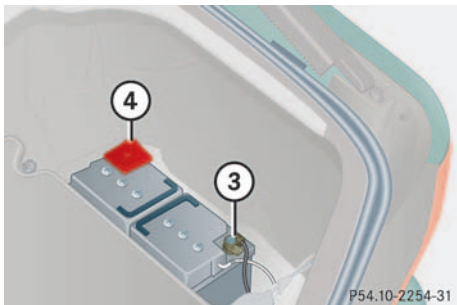

- 3 Negative terminal
- 4 Cover over positive terminal

Disconnecting the battery

- ▶ Turn off all electrical consumers.
- ▶ Depress the parking brake firmly or move the gear selector lever to position **P**.
- ▶ Open the trunk lid (▷ page 88) or (▷ page 89).
- ▶ Turn locking knob **2** and remove battery cover **1**.
- ▶ Detach negative terminal **3** of the battery with the 10 mm open-end wrench from the vehicle tool kit.
- ▶ Remove cover **4** from the positive terminal.
- ▶ Disconnect the battery positive lead.

Removing the battery

- ▶ Remove the screw securing the battery.
- ▶ Remove the battery support and bracket. Take out the battery.

Charging and reinstalling the battery

- ▶ Charge battery in accordance with the instructions of the battery charger manufacturer.
- ▶ Reinstall the charged battery. Follow the previously described steps in reverse order.

Warning!



Never charge a battery while still installed in the vehicle. Gases may escape during charging and cause explosions that may result in paint damage, corrosion or personal injury.

Reconnecting the battery

- ▶ Turn off all electrical consumers.
- ▶ Connect the positive lead and fasten its cover **4**.
- ▶ Connect negative lead **3**.



Never invert the terminal connections.



The battery, its filler caps and the vent tube must always be securely installed when the vehicle is in operation.



The following procedures must be carried out following any interruption of battery power (e.g. due to reconnecting):

- Set the clock. Refer to the separate COMAND operating instructions.
- Resynchronize the ESP (▷ page 283).
- Resynchronize side windows (▷ page 172).
- Resynchronize sliding/pop-up roof (▷ page 175).

Batteries contain materials that can harm the environment if disposed of improperly. Large 12-volt storage batteries contain lead. Recycling of batteries is the preferred method of disposal. Many states require sellers of batteries to accept old batteries for recycling.

Jump starting

Jump starting

Warning!



Failure to follow these directions will cause damage to the electronic components, and can lead to a battery explosion and severe injury or death.

Never lean over batteries while connecting or jump starting, you might get injured.

Battery fluid contains sulfuric acid. Do not allow this fluid to come in contact with eyes, skin or clothing. In case it does, immediately flush affected area with water, and seek medical help if necessary.

A battery will also produce hydrogen gas, which is flammable and very explosive. Keep flames or sparks away from battery, avoid improper connection of jumper cables, smoking etc.

Attempting to jump start a frozen battery can result in it exploding, causing personal injury.

Read all instructions before proceeding.

If the battery is discharged, the engine can be started with jumper cables and the battery of another vehicle. Observe the following:

- Jump starting should only be performed when the engine and catalytic converter are cold.
- Do not start the engine if the battery is frozen. Let the battery thaw out first.
- Only jump start from batteries with the same voltage rating (12V). Jump starting with a more powerful battery could damage the vehicle's electrical system, which will not be covered by the Mercedes-Benz Limited Warranty.
- Use only jumper cables with sufficient cross-section and insulated terminal clamps.
- Always make sure that the jumper cables are not on or near pulleys, fans or other parts that move when an engine is started or running.



Avoid repeated and lengthy starting attempts.

Do not attempt to start the engine using a battery quick charge unit.

If engine does not run after several unsuccessful starting attempts, have it checked at the nearest authorized Mercedes-Benz Center.

Excessive unburned fuel generated by repeated failed starting attempts may damage the catalytic converter and may present a fire risk.

Make sure the jumper cables do not have loose or missing insulation.

Make sure the cable clamps do not touch any other metal part while the other end is still attached to a battery.

Warning!



Keep flames or sparks away from battery. Do not smoke.

Observe all safety instructions and precautions when handling automotive batteries (▷ page 243).

The battery is located on the right side of the trunk under the battery cover (▷ page 313).

- ▶ Make sure that the two vehicles do not touch.
- ▶ Turn off all electrical consumers.
- ▶ Apply parking brake.
- ▶ Shift gear selector lever to position **P**.
- ▶ Open the trunk lid.
- ▶ Remove battery cover.
- ▶ Connect positive terminals **1** and **3** of the batteries with the jumper cable. Clamp cable to charged battery **3** first.

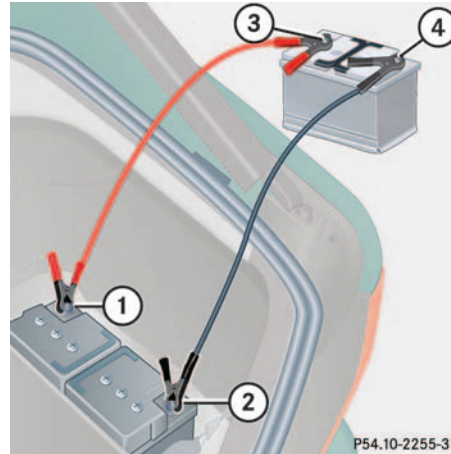

- 1** Positive terminal of discharged battery
- 2** Negative terminal of discharged battery
- 3** Positive terminal of charged battery
- 4** Negative terminal of charged battery



Never invert the terminal connections.

- ▶ Start engine of the vehicle with the charged battery and run at idle speed.

- ▶ Connect negative terminals **2** and **4** of the batteries with the jumper cable. Clamp cable to charged battery **4** first.
- ▶ Start the engine of the disabled vehicle.

You can now turn on the electrical consumers. Do not turn on the lights under any circumstances.

- ▶ Remove the jumper cables first from negative terminals **2** and **4** and then from positive terminals **1** and **3**.

You can now turn on the lights.

- ▶ Have the battery checked at the nearest authorized Mercedes-Benz Center.



Do not tow-start the vehicle.

Towing the vehicle

Towing the vehicle

Mercedes-Benz recommends that the vehicle be transported with all wheels off the ground using flatbed or appropriate wheel lift/dolly equipment.



Use flatbed or wheel lift/dolly equipment with key in starter switch turned to position **0**.

Do not tow with sling-type equipment. Towing with sling-type equipment over bumpy roads will damage radiator and supports.

Do not tow-start the vehicle.

To prevent damage during transport, do not tie down vehicle by its chassis or suspension parts.

Switch off the tow-away alarm (▷ page 78) and the automatic central locking (▷ page 139).

When circumstances do not permit the recommended towing methods, the vehicle may be towed with all wheels on the ground or front wheels raised only so far as necessary to have the vehicle moved to a safe location where the recommended towing methods can be employed.



If the vehicle is towed with the front axle raised, the engine must be shut off (key in starter switch position **0** or **1**). Otherwise, the ESP will immediately be engaged and will apply the rear wheel brakes.

When towing the vehicle with all wheels on the ground, the selector lever must be in position **N** and the key must be in starter switch position **2**.

When towing the vehicle with all wheels on the ground or the front axle raised, the vehicle may be towed only for distances up to 30 miles (50 km) and at a speed not to exceed 30 mph (50 km/h).



To be certain to avoid a possibility of damage to the transmission, however, we recommend the drive shaft be disconnected at the rear axle drive flange for any towing beyond a short tow to a nearby garage.

Warning!

Prior to towing the vehicle with all wheels on the ground, make certain that the key is in starter switch position **2**.

If the key is left in starter switch position **0** for an extended period of time, it can no longer be turned in the switch. In this case, the steering is locked. To unlock, remove key from starter switch and reinsert.

If circumstances require towing the vehicle with all wheels on the ground, always tow with a tow bar if:

- the engine will not run
- there is a malfunction in the power supply or in the vehicle's electrical system

as that will be necessary to adequately control the towed vehicle.

Warning!

With the engine not running, there is no power assistance for the brake and steering systems. In this case, it is important to keep in mind that a considerably higher degree of effort is necessary to brake and steer the vehicle. Adapt your driving accordingly.

Towing the vehicle



To signal turns while being towed with the hazard warning flasher in use, turn key in starter switch to position **2** and activate the combination switch for the left or right turn signal in the usual manner – only the selected turn signal will operate.

Upon canceling the turn signal, the hazard warning flasher will operate again.



When towing the vehicle with all wheels on the ground, please note the following:

With the automatic central locking activated and the key in starter switch position **2**, or KEYLESS-GO* start/stop button in position **2**, the vehicle doors lock if the left front wheel as well as the right rear wheel are turning at vehicle speeds of approx. 9 mph (15 km/h) or more.

Switch off the tow-away alarm (▷ page 78).

To prevent the vehicle door locks from locking, deactivate the automatic central locking (▷ page 139).

Towing of the vehicle should only be done using the properly installed towing eye bolt. Never attach tow cable, tow rope or tow rod to the vehicle chassis, frame or suspension parts.



The selector lever will remain locked in position **P** and the key will not turn in the starter switch if the battery is disconnected or discharged. See notes on the battery (▷ page 313) or on jump starting (▷ page 316).

Installing towing eye bolt

Front of vehicle

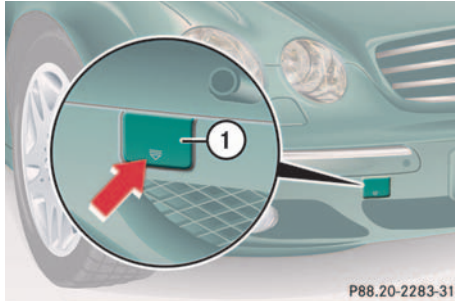

1 Cover on right side of front bumper

Removing cover

- ▶ Press mark on cover in direction of arrow.
- ▶ Lift cover off to reveal threaded hole for towing eye bolt.

The towing eye bolt is supplied with the tool kit (located in the storage compartment under the trunk floor).

- ▶ Screw towing eye bolt in to its stop and tighten with lug wrench.

Reinstalling cover

- ▶ Fit cover and snap into place.

Rear of vehicle

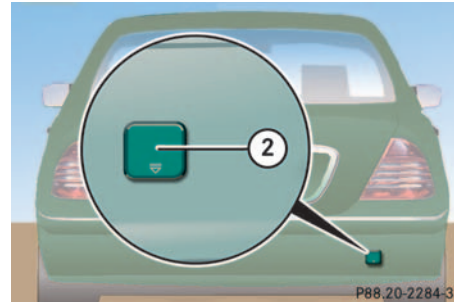

2 Cover on right side of rear bumper

Removing cover

- ▶ Pull cover in the direction of the arrow.
- ▶ Fold cover down to reveal threaded hole for the towing eye bolt.

The towing eye bolt is supplied with the tool kit (located in the storage compartment under the trunk floor).

- ▶ Screw towing eye bolt in to its stop and tighten with lug wrench.

Reinstalling cover

- ▶ Fit cover and snap into place.

Fuses

Fuses

Your vehicle's electrical fuses are located in various fuse boxes:

- In the dashboard on the passenger side
- In the rear passenger compartment under the right rear seat
- In the engine compartment on the driver's side
- In the engine compartment on the passenger side

The following implements are located in the vehicle tool kit in the trunk

(▷ page 295):

- The fuse chart. The amperages of the fuses are also given there.
- Spare fuses
- Special fuse extractor



Only install fuses that have been tested and approved by Mercedes-Benz and that have the specified amperage rating.

Never attempt to repair or bridge a blown fuse. Have the cause determined and remedied by an authorized Mercedes-Benz Center.

Fuse boxes in passenger compartment

There are two fuse boxes in the passenger compartment. One fuse box is located in the dashboard on the front passenger side. An additional fuse box is located under the right rear seat.

Fuse box in the dashboard

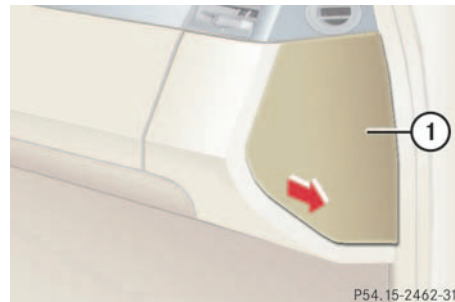

1 Cover



Do not use sharp objects such as a screw driver to open the fuse box in the dashboard, as this could damage it.

Opening

- ▶ Open the passenger door.
 - ▶ Using the flat of your hand, press on the middle of the cover.
- The edge of cover 1 lifts up slightly from the dashboard.
- ▶ Insert flat, blunt object into the edge of the cover as a lever.
 - ▶ Loosen cover 1 from the dashboard using lever.
 - ▶ Using your hands, pull cover 1 in the direction of the arrow and remove.

Closing

- ▶ Press cover 1 back on.

Fuse box in the rear passenger compartment

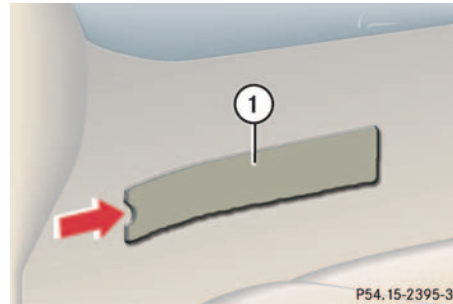

1 Cover

Opening

- ▶ Pull cover 1 away from fuse box (arrow).
- ▶ Remove cover rearward.

Closing

- ▶ Press cover back on until it engages.

Fuses

Fuse boxes in engine compartment

There are two fuse boxes located in the engine compartment on both the driver's and front passenger side in front of the firewall (dividing wall between engine compartment and passenger compartment).

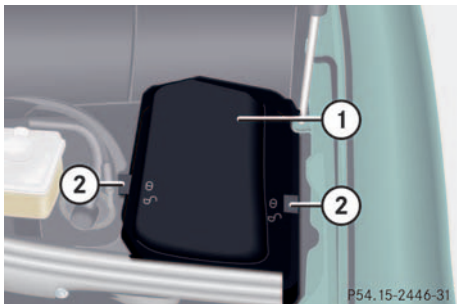

- 1 Fuse box cover, driver's side
- 2 Slide

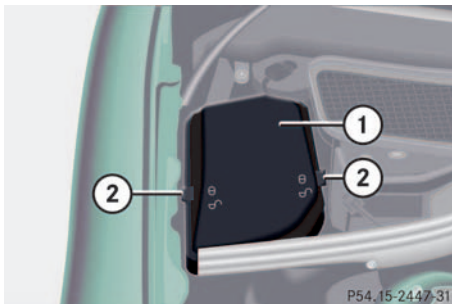

- 1 Fuse box cover, front passenger side
- 2 Slide

Opening

- ▶ Push both slides **2** to the  symbol.
- ▶ Remove cover **1**.

Closing

- ▶ Replace cover **1** and press it down by hand.
- ▶ Push both slides **2** to the  symbol.



The cover must fit properly and the slide must be positioned at the  symbol, as moisture or dirt may impair the functionality of the fuses.

Emergency engine shut-down

If the engine can no longer be stopped using the SmartKey or the KEYLESS-GO* start/stop button, the engine can be turned off by withdrawing two fuses.

For easy removal of fuses, use the fuse extractor (supplied with vehicle tool kit) to pull out the fuses marked on the fuse chart as "ENGINE EMERGENCY STOP".

The fuse chart is also located in the vehicle tool kit (▷ page 295).



Technical data

Spare parts service

Warranty coverage

Identification labels

Layout of poly-V-belt drive

Engine

Rims and Tires

Electrical system

Main Dimensions

Weights

Fuels, coolants, lubricants etc.

Consumer information

Spare parts service

The “Technical data” section provides the necessary technical data for your vehicle.

Spare parts service

All authorized Mercedes-Benz Centers maintain a stock of original spare parts required for maintenance and repair work. In addition, strategically located parts distribution centers provide quick and reliable parts service.

More than 300 000 different spare parts for Mercedes-Benz models are available.

Mercedes-Benz original spare parts are subjected to stringent quality inspections. Each part has been specifically developed, manufactured or selected for and adapted to Mercedes-Benz vehicles.

Therefore, Mercedes-Benz original spare parts should be installed.



The use of non-genuine parts and accessories not authorized by Mercedes-Benz could damage the vehicle, which is not covered by the Mercedes-Benz Limited Warranty, or could compromise the vehicle's durability or safety.

Warranty coverage

Your vehicle is covered under the terms of the warranties printed in the Service and Warranty Information booklet. Your authorized Mercedes-Benz Center will exchange or repair any defective parts originally installed in the vehicle in accordance with the terms of the following warranties:

- New Vehicle Limited Warranty
- Emission System Warranty
- Emission Performance Warranty
- California, Maine, Massachusetts, and Vermont Emission Control Systems Warranty

Replacement parts and accessories are covered by the Mercedes-Benz Spare Parts and Accessories warranties, copies of which are available at any Mercedes-Benz Center.

Loss of Service and Warranty Information Booklet

Should you lose your Service and Warranty Information booklet, have your authorized Mercedes-Benz Center arrange for a replacement. It will be mailed to you.

Identification labels

Identification labels

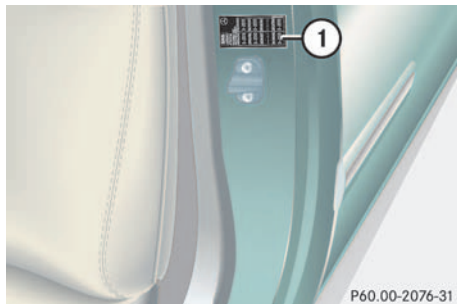

1 Certification label
(on driver's B pillar)

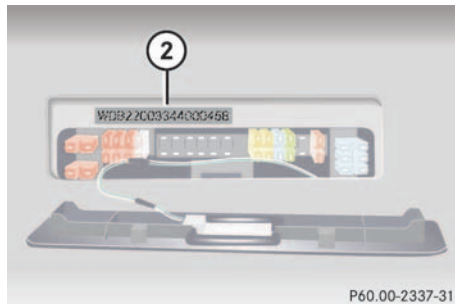

2 Vehicle Identification Number (VIN)
(below right rear passenger seat)

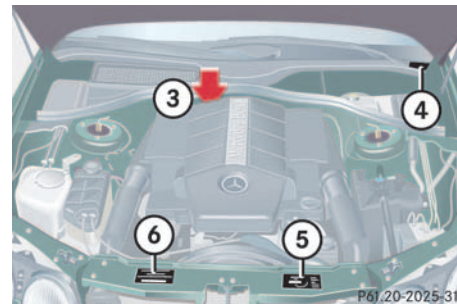

- 3** Engine number (engraved on engine)
- 4** VIN, visible (lower edge of windshield)
- 5** Information label, California version
Vacuum line routing for emission control system
- 6** Emission control label

When ordering spare parts, please specify vehicle identification and engine numbers.

Layout of poly-V-belt drive

CL 500

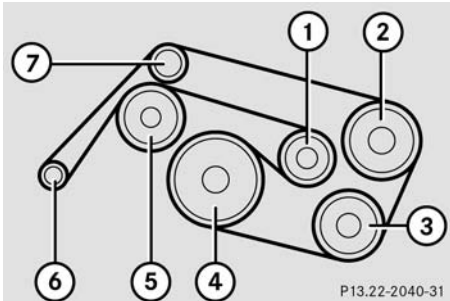

- 1 Automatic belt tensioner
- 2 Power steering pump
- 3 Air conditioning compressor
- 4 Crankshaft
- 5 Coolant pump
- 6 Generator (alternator)
- 7 Idler pulley

CL 55 AMG

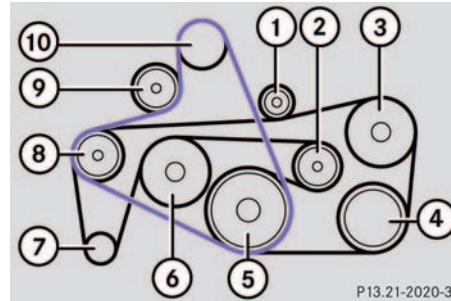

The CL 55 AMG has two poly-V-belts (belt one shown in purple/belt two shown in black).

- 1 Idler pulley
- 2 Automatic belt tensioner
- 3 Power steering pump
- 4 Air conditioning compressor
- 5 Crankshaft
- 6 Coolant pump
- 7 Generator (alternator)
- 8 Idler pulley
- 9 Automatic belt tensioner
- 10 Super charger

CL 600

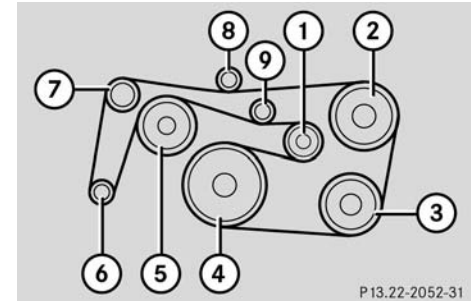

- 1 Automatic belt tensioner
- 2 Power steering pump
- 3 Air conditioning compressor
- 4 Crankshaft
- 5 Coolant pump
- 6 Generator (alternator)
- 7 Idler pulley
- 8 Idler pulley
- 9 Idler pulley

Engine
Engine

Model	CL 500 (215.375) ¹	CL 55 AMG (215.374) ¹	CL 600 (215.376) ¹
Engine	113	113	275
Mode of operation	4-stroke engine, gasoline injection	4-stroke engine, gasoline injection	4-stroke engine, gasoline injection
No. of cylinders	8	8	12
Bore	3.82 in (97.00 mm)	3.82 in (97.00 mm)	3.23 in (82.00 mm)
Stroke	3.31 in (84.00 mm)	3.60 in (92.00 mm)	3.43 in (87.00 mm)
Total piston displacement	303.5 cu.in. (4966 cm ³)	331.8 cu.in. (5439 cm ³)	336.4 cu.in. (5513 cm ³)
Compression ratio	10:1	9:1	9:1
Output acc. to SAE J 1349	302 hp / 5500 rpm (225 kW / 5500 rpm)	493 hp / 6100 rpm (368 kW / 6100 rpm)	493 hp / 5000 rpm (368 kW / 5000 rpm)
Maximum torque acc. to SAE J 1349	339 ft.lb / 2700 rpm (460 Nm / 2700 rpm)	517 ft.lb / 2750–4000 rpm (700 Nm / 2750–4000 rpm)	590 ft.lb / 1800–3500 rpm (800 Nm / 1800–3500 rpm)
Maximum engine speed	6000 rpm	6500 rpm	5950 rpm
Firing order	1-5-4-2-6-3-7-8	1-5-4-2-6-3-7-8	1-12-5-8-3-10-6-7-2-11-4-9
Poly-V-belt	7 ft 10 in (2390 mm)	Belt one: 4 ft 3 in (1289 mm) Belt two: 8 ft 1 in (2462 mm)	7 ft 8 in (2335 mm)

¹ The quoted data apply only to the standard vehicle. See an authorized Mercedes-Benz Center for the corresponding data of all special bodies and special equipment.

Rims and Tires

Use only tires and rims which have been specifically developed for your vehicle and tested and approved by Mercedes-Benz. Other tires and rims can have detrimental effects, such as

- poor handling characteristics
- increased noise
- increased fuel consumption



Moreover, tires and rims not approved by Mercedes-Benz may, under load, exhibit dimensional variations and different tire deformation characteristics that could cause them to come into contact with the vehicle body or axle parts. Damage to the tires or the vehicle can be the result.



Further information on tires and rims is available at any authorized Mercedes-Benz Center. A tire inflation pressure table is located on the fuel filler cap of the vehicle. The tire pressure should be checked regularly and should only be adjusted on cold tires. Follow tire manufacturer's maintenance recommendation included with vehicle.

Rims and Tires

Same size tires

	CL 500 (except Sport Package*)	CL 600 (except Sport Package*)	CL 55 AMG
Rims (light alloy)	7½J x17 H2	8J x18 H2 ¹	8J x18 H2 or 8½J x18 EH2 ²
Wheel offset	1.81 in (46 mm)	1.73 in (44 mm)	1.73 in (44 mm)
Summer tires (radial-ply tires)	-	245 / 45 R18 96Y ¹	-
All season tires (radial-ply tires)	225 / 55 R17 97H M+S AS	-	-
Winter tires (radial-ply tires)	225 / 55 R17 97H M+S	245 / 45 R18 100V XL M+S ¹ or 245 / 45 R18 96H M+S ¹	245 / 45 R18 100V XL M+S or 245 / 45 R18 96H M+S

¹ For use with snow chains contact an authorized Mercedes-Benz Center

² Must not be used with snow chains

Mixed size tires

		CL 500 and CL 600 (Sport Package*)	CL 55 AMG
Front axle	AMG light alloy rims	8½J x 18 EH2 ¹	8½J x 18 EH2 ¹
	Wheel offset	1.73 in (44 mm)	1.73 in (44 mm)
	Summer tires (radial-ply tires)	245 / 45 R18 100Y XL	245 / 45 R18 100Y XL ¹
Rear axle	AMG light alloy rims	9J x 18 EH2 ¹	9J x 18 EH2 ¹
	Wheel offset	1.73 in (44 mm)	1.73 in (44 mm)
	Summer tires (radial-ply tires)	265 / 40 R18 101Y XL ¹ or 265/40 R18 97Y ¹	265 / 40 R18 101Y XL ¹

¹ Must not be used with snow chains

Spare wheel

	CL 500 (except Sport Package)	CL 600 (except Sport Package*) CL 500 and CL 600 (Sport Package*) CL 55 AMG
Rims (light alloy)	7½J x 17 H2	8J x 18 H2
Wheel offset	2.0 in (51 mm)	1.73 in (44 mm)
Summer tires (radial-ply tires)	-	245 / 45 R18 96Y
All season tires (radial-ply tires)	225 / 55 R17 97H M+S AS	-

Electrical system**Electrical system**

Model	CL 500	CL 55 AMG	CL 600
Generator (alternator)	14 V / 150 A	14 V / 180 A	14 V / 180 A
Starter motor	12 V / 1.7 kW	12 V / 1.8 kW	12 V / 1.7 kW
Battery	12 V / 95 Ah	12 V / 95 Ah	12 V / 95 Ah
Spark plugs	Bosch F 8 DPP332 NGK PFR 5 R-11	NGK ILFR 6 A	NGK NFR 6Q-G
Electrode gap	0.039 in (1.0 mm)	0.031 in (0.8 mm)	0.028 in (0.7 mm)
Tightening torque	15 – 22 ft.lb (20 – 30 Nm)	15 – 22 ft.lb (20 – 30 Nm)	15 – 22 ft.lb (20 – 30 Nm)

Main Dimensions

Model	CL 500	CL 55 AMG	CL 600
Overall vehicle length	196.4 in (4989 mm)	196.4 in (4989 mm)	196.4 in (4989 mm)
Overall vehicle width	73.1 in (1857 mm)	73.1 in (1857 mm)	73.1 in (1857 mm)
Overall vehicle height	55.4 in (1408 mm)	55.4 in (1408 mm)	55.4 in (1408 mm)
Wheelbase	113.6 in (2885 mm)	113.6 in (2885 mm)	113.6 in (2885 mm)
Track, front	62.1 in (1577 mm)	62.2 in (1581 mm)	62.1 in (1577 mm)
Track, rear	62.1 in (1578 mm)	62.1 in (1578 mm)	62.1 in (1578 mm))

Weights

Weights

Roof load max.	220 lb (100 kg)
----------------	-----------------

Trunk load max.	220 lb (100 kg)
-----------------	-----------------

Fuels, coolants, lubricants etc.

Fuels, coolants, lubricants etc.

Capacities

Vehicle components and their respective lubricants must match. Therefore use only brands tested and recommended by us.

Please refer to the Factory Approved Service Products pamphlet, or inquire at your Mercedes-Benz Center.

	Model	Capacity	Fuels, coolants, lubricants etc.
Engine with oil filter	CL 500	8.5 US qt (8.0 l)	Recommended engine oils
	CL 55 AMG	7.9 US qt (7.5 l)	
	CL 600	9.5 US qt (9.0 l)	
Automatic transmission	CL 500	9.1 US qt (8.6 l)	MB Automatic Transmission Oil ¹
	CL 55 AMG	9.1 US qt (8.6 l)	
	CL 600	8.1 US qt (7.7 l)	
Rear axle		1.7 US qt (1.6 l)	Hypoid gear oil SAE 85 W 90
Hydraulic system for ABC		approx. 4.2 US qt (4.0 l)	MB Hydraulic fluid
Power steering		approx. 1.1 US qt (1.0 l)	MB Power Steering Fluid (Pentosin CHF 11S)
Front wheel hubs		approx. 2.1 oz (60 g) each	High temperature roller bearing grease
Brake system		0.7 US qt (0.7 l)	MB Brake Fluid (DOT 4+)
Cooling system	CL 500	approx. 12.1 US qt (11.5 l)	MB 325.0 Anticorrosion / Antifreeze
	CL 55 AMG	approx. 15.3 US qt (14.5 l)	
	CL 600	approx. 15.85 US qt (15 l)	

¹ MB part no. 001 989 21 03 10

Fuels, coolants, lubricants etc.

	Model	Capacity	Fuels, coolants, lubricants etc.
Low temperature cooling system	CL 600	2.43 US qt (2.3 l)	MB 325.0 Anticorrosion / Antifreeze
Fuel tank including a reserve of	CL 500	23.2 US gal (88.0 l)	Premium unleaded gasoline: Posted Octane Rating of min 91 (average of 96 RON / 86 MON)
	CL 55 AMG	2.9 US gal (11.0 l)	
Fuel tank including a reserve of	CL 600	23.2 US gal (88.0 l) 2.9 US gal (11.0 l)	Premium unleaded gasoline: Posted Octane Rating of min 93 (average of 98 RON / 88 MON)
Air conditioning system			R-134a refrigerant and special PAG lubricant oil (never R-12)
Windshield washer and headlamp cleaning system:		7.1 US qt (6.7 l)	MB Windshield Washer Concentrate ¹

¹ Use MB Windshield Washer Concentrate “S” and water for temperatures above freezing or MB Windshield Washer Concentrate “S” and commercially available pre-mixed windshield washer solvent / antifreeze for temperatures below freezing. Follow suggested mixing ratios (▷ page 344).

Engine oils

Engine oils are specifically tested for their suitability in our engines. Therefore, use only engine oils recommended by Mercedes-Benz. Information on recommended brands is available in the Factory Approved Service Products pamphlet, or at your authorized Mercedes-Benz Center.

Please follow FSS recommendations for scheduled oil changes. Failure to do so could result in engine damage not covered by the Mercedes-Benz Limited Warranty.

Engine oil additives

Do not blend oil additives with engine oil. They may be harmful to the engine operation.

Damage or malfunctions resulting from blending oil additives are not covered by the Mercedes-Benz Limited Warranty.

Air conditioning refrigerant

R-134a (HFC) refrigerant and special PAG lubricating oil is used in the air conditioning system.

Never use R-12 (CFC) or mineral-based lubricating oil, otherwise damage to the system will occur.

Fuels, coolants, lubricants etc.

Brake fluid

During vehicle operation, the boiling point of the brake fluid is continuously reduced through the absorption of moisture from the atmosphere. Under extremely strenuous operating conditions, this moisture content can lead to the formation of bubbles in the system, thus reducing the system's efficiency.

Therefore, the brake fluid must be replaced every two years, preferably in the spring.

Only brake fluid approved by Mercedes-Benz is recommended. Your authorized Mercedes-Benz Center will provide you with additional information.

Premium unleaded gasoline



To maintain the engine's durability and performance, premium unleaded gasoline must be used. If premium unleaded is not available and low octane fuel is used, follow these precautions:

- Have the fuel tank only partially filled with unleaded regular and fill up with premium unleaded as soon as possible.
- Avoid full throttle driving and abrupt acceleration.
- Do not exceed an engine speed of 3000 rpm if the vehicle is loaded with a light load such as two persons and no luggage.
- Do not exceed 2 / 3 of maximum accelerator pedal position if the vehicle is fully loaded or operating in mountainous terrain.

Fuel requirements

Use only premium unleaded gasoline meeting ASTM standard D 439:

- The octane number (posted at the pump) must be min. 91 for CL 500 and CL 55 AMG and min. 93 for CL 600. It is an average of both the Research (R) octane number and the Motor (M) octane number: $(R+M) / 2$. This is also known as the ANTI-KNOCK INDEX.

Unleaded gasoline containing oxygenates such as ethanol, IPA, IBA and TBA can be used provided the ratio of any one of these oxygenates to gasoline does not exceed 10%; MTBE not to exceed 15%.

The ratio of methanol to gasoline must not exceed 3% plus additional cosolvents.

Using mixtures of ethanol and methanol is not allowed. Gasohol, which contains 10% ethanol and 90% unleaded gasoline, can be used.

These blends must also meet all other fuel requirements, such as resistance to spark knock, boiling range, vapor pressure etc.

Gasoline additives

A major concern among engine manufacturers is carbon build-up caused by gasoline. Mercedes-Benz recommends only the use of quality gasoline containing additives that prevent the build up of carbon deposits.

After an extended period of using fuels without such additives, carbon deposits can build up especially on the intake valves and in the combustion area, leading to engine performance problems such as:

- Warm-up hesitation
- Unstable idle
- Knocking/pinging
- Misfire
- Power loss

Do not blend any specific fuel additives with fuel. This only results in unnecessary costs and may be harmful to the engine operation.

Damage or malfunctions resulting from poor fuel quality or from blending specific fuel additives are not covered by the Mercedes-Benz Limited Warranty.

Fuels, coolants, lubricants etc.

Coolants

The engine coolant is a mixture of water and anticorrosion / antifreeze, which provides:

- Corrosion protection
- Freeze protection
- Boiling protection (by increasing the boiling point)

The cooling system was filled at the factory with a coolant providing freeze protection to approximately -22°F (-30°C) and corrosion protection.

If the antifreeze mixture is effective to -22°F (-30°C), the boiling point of the coolant in the pressurized cooling system is reached at approximately 266°F (130°C).

The coolant solution must be used year round to provide the necessary corrosion protection and increase in the boil-over protection. You should have it replaced every 15 years or 150000 miles (250000 km), whichever comes first.

Coolant system design and coolant used stipulate the replacement interval. The above replacement interval is only applicable if MB 325.0 anticorrosion / antifreeze solution or other Mercedes-Benz approved products of equal specification (see Factory Approved Service Products pamphlet) are used to renew the coolant concentration or bring it back up to the proper level.

To provide important corrosion protection, the solution must be at least 45% anticorrosion / antifreeze [equivalent to freeze protection to approx. -22°F (-30°C)]. If you use a solution that is more than 55% anticorrosion / antifreeze [freeze protection to approx. -49°F (-45°C)], the engine temperature will increase due to the lower heat transfer capability of the solution. Therefore, do not use more than this amount of anticorrosion / antifreeze.

If the coolant level is low, water and MB 325.0 anticorrosion / antifreeze should be used to bring it up to the proper level (have cooling system checked for signs of leakage). Please make sure that the mixture is in accordance with label instructions.

The water in the cooling system must meet minimum requirements, which are usually satisfied by normal drinking water. If you are not sure about the water quality, consult your authorized Mercedes-Benz Center.

Anticorrosion/antifreeze

Your vehicle contains a number of aluminum parts. The use of aluminum components in motor vehicle engines necessitates that anticorrosion/ antifreeze coolant used in such engines be specifically formulated to protect the aluminum

parts. (Failure to use such anticorrosion/ antifreeze coolant will result in a significantly shortened service life.)

Therefore, the following product is strongly recommended for use in your vehicle: Mercedes-Benz 325.0 Anticorrosion/ Antifreeze Agent.

Before the start of the winter season (or once a year in hot southern regions), you should have the anticorrosion/ antifreeze concentration checked. The coolant is also regularly checked each time you bring your vehicle to your authorized Mercedes-Benz Center for service.

Anticorrosion/antifreeze quantity

Model	Approx. freeze protection	
	- 35°F (- 37°C)	- 49°F (- 45°C)
CL 500	6.1 US qt (5.75 l)	6.7 US qt (6.3 l)
CL 55 AMG	7.7 US qt (7.25 l)	8.5 US qt (8.0 l)
CL 600	6.3 US qt (6.0 l)	7.0 US qt (6.6 l)

Fuels, coolants, lubricants etc.

Windshield and headlamp washer system

Both the windshield and headlamp washer systems are supplied from the windshield washer fluid reservoir.

The washer fluid reservoir has a capacity of approx. 7.1 US qt. (6.7 l).

- ▶ Refill the reservoir with MB Windshield Washer Concentrate and water (or concentrate and commercially available pre-mixed windshield washer solvent / antifreeze, depending on ambient temperatures).

Warning



Washer solvent / antifreeze is highly flammable. Do not spill washer solvent / antifreeze on hot engine parts, because it may burn. You can be seriously burned.

Windshield and headlamp washer fluid mixing ratio

For temperatures above freezing use MB Windshield Washer Concentrate “S” and water:

- 1 part “S” to 100 parts water [40 ml “S” to 1 gallon (4 liters) water].

For temperatures below freezing use MB Windshield Washer Concentrate “S” and commercially available pre-mixed windshield washer solvent / antifreeze:

- 1 part “S” to 100 parts solvent [40 ml “S” to 1 gallon (4 liters) solvent].

Consumer information

The following text is published as required of all manufacturers of passenger cars under Title 49, Code of U.S. Federal Regulations, Part 575 pursuant to the “National Traffic and Motor Vehicle Safety Act of 1966.”

Uniform tire quality grading

Quality grades can be found, where applicable, on the tire sidewall between tread shoulder and maximum section width. For example:

Tread wear	Traction	Temperature
200	AA	A

All passenger car tires must conform to federal safety requirements in addition to these grades.

Tread wear

The tread wear grade is a comparative rating based on the wear rate of the tire when tested under controlled conditions on a specified government test course. For example, a tire graded 150 would wear one and one-half (1½) times as well on the government course as a tire graded 100. The relative performance of tires depends upon the actual conditions of their use, however, and may depart significantly from the norm due to variations in driving habits, service practices and differences in road characteristics and climate.

Traction

The traction grades, from highest to lowest are AA, A, B, and C. Those grades represent the tire’s ability to stop on wet pavement as measured under controlled conditions on specified government test surfaces of asphalt and concrete. A tire marked C may have poor traction performance.

Warning



The traction grade assigned to this tire is based on straightedge braking traction tests, and does not include acceleration, cornering, hydroplaning, or peak traction characteristics.

Consumer information

Temperature

The temperature grades are A (the highest), B, and C, representing the tire's resistance to the generation of heat and its ability to dissipate heat when tested under controlled conditions on a specified indoor laboratory test wheel. Sustained high temperature can cause the material of the tire to degenerate and reduce tire life, and excessive temperature can lead to sudden tire failure. Grade C corresponds to a level of performance which all passenger car tires must meet under the Federal Motor Vehicle Safety Standard No. 109. Grades B and A represent higher levels of performance on the laboratory test wheel than the minimum required by law.

Warning



The temperature grade for this tire is established for a tire that is properly inflated and not overloaded. Excessive speed, underinflation, or excessive loading, either separately or in combination, can cause excessive heat build-up and possible tire failure.

ABC

(Active Body Control)

Active, computer-controlled system that hydraulically adjusts the suspension at all four wheels in response to various driving situations.

ABS

(Antilock Brake System)

Prevents the wheels from locking up during braking so that the vehicle can continue to be steered.

Alignment bolt

Metal pin with thread. The centering pin is an aid used when changing a tire to align the wheel with the wheel hub.

BabySmart™ airbag deactivation system

This system detects if a special system compatible child restraint seat is installed on the front passenger seat. The system will automatically deactivate the passenger front airbag when such a seat is properly installed (PASSENGER AIRBAG OFF indicator lamp in the center console lights up). See your authorized Mercedes-Benz Center for availability.

BabySmart™ compatible child seats

Special restraint system for children. The sensor system for the passenger seat prevents deployment of the passenger side airbag if a BabySmart™ compatible child seat is installed.

BAS

(Brake Assist System)

System for potentially reducing braking distances in emergency braking situations. The system is activated when it senses an emergency based on how fast the brake is applied.

Bi-Xenon headlamps

Headlamps which use an electric arc as the light source and produce a more intense light than filament headlamps. Bi-Xenon headlamps produce low beam and high beam.

CAC

(Customer Assistance Center)

Mercedes-Benz customer service center, which can help you with any questions about your vehicle and provide assistance in the event of a breakdown.

CAN system

(Controller Area Network)

Data bus network serving to control vehicle functions such as door locking or windshield wiping.

Cockpit

All instruments, switches, buttons and indicator/warning lamps in the passenger compartment needed for vehicle operation and monitoring.

COMAND

(Cockpit Management and Data System)

Information and operating center for vehicle sound and communications systems, including the radio and navigation, as well as for other optional equipment (CD changer, telephone, etc.).

Control system

The control system is used to call up vehicle information and to change component settings. Information and messages appear in the multifunction display. The driver uses the buttons on the multifunction steering wheel to navigate through the system and to adjust settings.

Cruise control

A driving convenience system for automatically maintaining the vehicle speed set by the driver.

Distronic*

A driving convenience cruise control system which helps the driver maintain a pre-selected speed:

- If there is no vehicle directly ahead, the system operates in the same way as conventional ->cruise control.
- If a slower moving vehicle is ahead, Distronic will reduce your vehicle speed to the extent permitted by reduced throttle and up to 20% braking power to maintain the preset minimum following distance.

Engine number

The number set by the manufacturer and placed on the cylinder block to uniquely identify each engine produced.

Engine oil viscosity

Measurement for the inner friction (viscosity) of the oil at different temperatures. The higher the temperature an oil can tolerate without becoming thin, or the lower the temperature it can tolerate without becoming viscous, the better the viscosity.

ESP

(Electronic Stability Program)

Improves vehicle handling and directional stability.

ETD

(Emergency Tensioning Device)

Device which deploys in certain frontal and rear collisions exceeding the system's threshold to tighten the seat belts.

->SRS

FSS

(Flexible Service System)

Service indicator in the multifunction display that informs the driver when the next vehicle maintenance service is due.

Gear range

Number of gears which are available to the automatic transmission for shifting. The automatic gear shifting process can be adapted to specific operating conditions using the selector lever.

GPS

(Global Positioning System)

Satellite-based system for relaying geographic location information to and from vehicles equipped with special receivers. Employs CD digital maps for navigation.

Instrument cluster

The displays and indicator/warning lamps in the driver's field of vision, including the tachometer, speedometer, engine temperature and fuel gauge.

KEYLESS-GO*

System for entering and operating the vehicle without the use of a key.

Kickdown

Depressing the accelerator past the point of resistance shifts the transmission down to the lowest possible gear. This very quickly accelerates the vehicle and should not be used for normal acceleration needs.

Line of fall

The direct line that an object moves downhill when influenced by the force of gravity alone.

Lock button

Button on the door which indicates whether the door is locked or unlocked. Pushing the lock button down on an individual door from inside will lock that door.

Memory function

Used to store three individual seat, steering wheel and mirror positions for each key or, if so equipped, KEYLESS-GO* feature.

Menu

The control system displays are arranged in menus. Each menu contains a number of commands for particular systems. In the Audio menu, for example, you will find the commands SELECT RADIO STATION or OPERATE CD player. Using commands you can directly change the settings for your vehicle.

MON

(Motor Octane Number)

The Motor Octane Number for gasoline as determined by a standardized method. It is an indication of a gasoline's ability to resist undesired detonation (knocking). The average of both the MON (Motor Octane Number) and ->RON (Research Octane Number) is posted at the pump, also known as ANTI-KNOCK INDEX.

Multifunction display

Display field in the speedometer used to present information provided by the control system.

Multifunction steering wheel

Steering wheel with buttons for operating the control system.

Overspeed range

Engine speeds within the red marking of the tachometer dial. Avoid this engine speed range, as it may result in serious engine damage that is not covered by the Mercedes-Benz Limited Warranty.

Parktronic*

System which uses visual and acoustic signals to assist the driver during parking maneuvers.

Poly-V-belt drive

Drives engine-components (alternator, AC compressor, etc.) from the engine.

Power train

Collective term designating all components used to generate and transmit motive power to the drive axles, including:

- Engine
- Clutch/torque converter
- Transmission
- Transfer case
- Drive shaft
- Differential
- Axle shafts/axles

Program mode selector switch

Used to switch the automatic transmission between sport operation **S** and comfort operation **C**.

CL 55 AMG with steering wheel gearshift control and manual shift program: in addition to **S** and **C** (see above), you can use the **M** for manual operation.

Remote Vehicle Diagnostics

Transmission of vehicle data and current location to the Mercedes-Benz Customer Assistance Center for subscribers to Tele Aid service.

REST

(Residual engine heat utilization)
Feature that uses the engine heat stored in the coolant to heat the vehicle interior for a short time after the engine has been turned off.

Restraint systems

Seat belts, belt tensioners, airbags and child restraint systems. As independent systems, their protective functions complement one another.

RON

(Research Octane Number)

The Research Octane Number for gasoline as determined by a standardized method. It is an indication of a gasoline's ability to resist undesired detonation (knocking). The average of both the →MON (Motor Octane Number) and RON (Research Octane Number) is posted at the pump, also known as ANTI-KNOCK INDEX.

Shift lock

When the vehicle is parked, this lock prevents the transmission selector lever from being inadvertently moved out of position **P** without key turned and brake pedal depressed.

Speedshift

Steering wheel gearshift control and manual shift program. In the manual shift program mode you can change the gears yourself on the steering wheel or by using the selector lever.

SRS

(Supplemental Restraint System)

Seat belts, emergency tensioning device and airbags. Though independent systems, they are closely interfaced to provide effective occupant protection.

Tele Aid System

(Telematic Alarm Identification on Demand)

The Tele Aid system consists of three types of response: automatic and manual emergency, roadside assistance and information. Tele Aid is initially activated by completing a subscriber agreement and placing an acquaintance call.

The Tele Aid system is operational providing that the vehicle's battery is charged, properly connected, not damaged and cellular and GPS coverage is available.

Telematics

A combination of the terms “telecommunications” and “informatics”.

Tightening torque

Force times lever arm (e.g. a lug wrench) with which threaded fasteners such as wheel bolts are tightened.

Tire speed rating

Part of tire designation; indicates the speed range for which a tire is approved.

Traction

Force exerted by the vehicle on the road via the tires.

VIN

(Vehicle Identification Number)

The number set by the manufacturer and placed on the body to uniquely identify each vehicle produced.

Voice control system*

Voice control system for car phones, portable cell phones and audio systems (radio, CD, etc.).

- A**
- ABC 190, 347
 - Messages in display 271
 - Setting vehicle level 191
 - ABS 23, 71, 347
 - ABS control 72
 - Malfunction indicator lamp 265
 - Messages in display 272
 - Warning lamp 265
 - Accelerator position, automatic transmission 148
 - Accident
 - In case of 48
 - Activating
 - Air conditioner (cooling) 166
 - Air recirculation mode 163
 - Anti-theft alarm system 77
 - Central locking (control system) 139
 - Charcoal filter 164
 - Distance warning function* 188
 - Distronic* 184
 - Easy-entry/exit feature 140
 - ESP 75
 - Exterior headlamps 46
 - Exterior lamps 109
 - Exterior rear view mirror parking position 152
 - Front and rear fog lamp 109
 - Hazard warning flasher 111
 - Headlamps 46
 - High beams 111
 - Ignition 31
 - Ignition with KEYLESS-GO* start/stop button 33
 - Immobilizer 51, 76
 - Rear window defroster 165
 - Residual heat 167
 - Seat heater 103, 104
 - Seat ventilation* 102
 - Tow-away alarm 78
 - Windshield wipers 47
 - Activating steering wheel gearshift control 149
 - Downshifting 150
 - Upshifting 150
 - Adding
 - Coolant 243
 - Engine oil 241
 - Additional turn signals 302
 - Adjustable air vents, rear passenger compartment 168
 - Adjusting 34
 - Air distribution 161
 - Air volume 162
 - Backrest tilt 36
 - Exterior rear view mirror 38
 - Folding forward front seat backrests 100
 - Head restraint height 36
 - Head restraint tilt 36
 - Inside rear view mirror 38
 - Instrument cluster illumination 114
 - Lumbar support 96
 - Mirrors 38
 - Multicontour seat* 99
 - Seat cushion depth 36, 99
 - Seat cushion tilt 36
 - Seat fore and aft adjustment 36
 - Seat height 36
 - Seat in the lumbar region 99
 - Seat in the shoulder region 99
 - Seats 34
 - Steering column height 38
 - Steering column length 38
 - Steering wheel 37

- Air conditioner (cooling)
 - Turning off 166
- Air pressure see Tire inflation pressure 247
- Air recirculation mode 163
 - Activating 163
 - Deactivating 164
- Air vents, rear passenger compartment
 - Adjustable 168
- Air volume
 - Adjusting 162
- AIRBAG OFF indicator lamp 269
- Airbags 55
 - BabySmart™ deactivation system 65, 347
 - Children 56
 - Front 59
 - Passenger 59
 - Safety guidelines 58
 - Side impact 59
 - Window curtain 59
- Alarm
 - Audible 70, 77
 - Canceling 77
 - Visual 77
- Alarm system
 - Anti-theft 77
 - Anti-theft alarm system indicator lamp 25
- Alignment bolt 311
- Alignment bolt (vehicle tool kit) 295, 347
- Antiglare
 - Automatic 151
- Antilock brake system (ABS) 347
- Antilock Brake System see ABS 23
- Anti-theft alarm system
 - Activating 77
 - Canceling alarm 77
 - Deactivating 77
- Anti-theft systems 76
 - Anti-theft alarm system 77
 - Anti-theft alarm system indicator lamp 25
 - Immobilizer 76
 - Tow-away alarm 78
- Armrest
 - Storage compartment in front of 200, 201
 - Storage compartment in front of armrest 200
- Ashtray 206
- At the gas station 235
- ATF (automatic transmission fluid) 242
- AUDIO menu 122
 - Selecting radio station 122
- Audio system
 - CD mode 123
- Automatic antiglare for rear view mirror 151
- Automatic central locking
 - Activating/deactivating (control system) 139
- Automatic climate control 157
 - Air recirculation mode 163
 - Defrosting 162
 - Rear window defroster 165
 - Setting the temperature 160
- Automatic headlamp mode 109
- Automatic lighting control
 - Activating 112
 - Deactivating 112
- Automatic locking when driving 94

- Automatic transmission 143
 - Accelerator position 148
 - Activating steering wheel gearshift control 149
 - Deactivating steering wheel gearshift control 150
 - Emergency operation (Limp Home Mode) 148
 - Fluid level 242
 - Gear ranges 145
 - Gear selector lever position 146
 - Gear shifting malfunctions 148
 - Kickdown 148
 - One-touch gearshifting 144
 - Program mode selector switch 147
 - Selector lever position 143
 - Starting the engine 43
 - Steering wheel gearshift control (Speedshift) and manual shift program S 55 AMG 149
 - Transmission fluid 242
 - Winter program mode 147, 149
- Auxiliary cup holder 204
 - Inserting 204
 - Removing 205

B

- BabySmart™
 - Airbag deactivation system 65, 347
 - Compatible child seats 65, 347
 - Self-test 66
- Backrest supports
 - Lumbar region 99
 - Shoulder region 99
- Backup lamps 303, 305
 - Bulbs 303
- BAS 73, 347
 - Messages in display 273, 283
- Batteries, KEYLESS-GO* card
 - Changing 300
 - Check lamp 85
 - Checking 85
- Batteries, SmartKey
 - Changing 299
 - Check lamp 81
 - Checking 82
- Batteries, SmartKey with KEYLESS-GO*
 - Checking 82
- Battery discharged
 - Jump starting 316
- Battery, vehicle 243, 313
 - Charging 314
 - Disconnecting 314
 - Reconnecting 315
 - Reinstalling 314
 - Removing 314
- Bi-Xenon headlamps 347
- Block heater* 253
- Blocking
 - Rear window operation 69
- Brake assist system (BAS) 347
- Brake fluid 236, 340
- Brake lamp bulbs 303
- Brake lamp, high mounted 303
- Brake pads
 - Message in display 275
- Brakes 226
 - Warning lamp 267
- Break-in period 224

- Bulbs, replacing 302
 - Additional turn signals 302
 - Backup lamps 303
 - Brake lamps 303
 - Fog lamps 302
 - Front lamps 302
 - High beam 302
 - High mounted brake lamp 303
 - License plate lamps 303, 306
 - Low beam 302
 - Parking lamps 302, 303, 305
 - Rear fog lamp 303, 305
 - Side marker lamps 302, 305
 - Standing lamps 302, 303, 305
 - Tail lamp assemblies 303, 305
 - Turn signal lamps 302, 303
- C**
- CAC (Customer Assistance Center) 347
- California
 - Important notice 11
- Calling up
 - Distronic* settings 128
 - Range (distance to empty) 130
 - Service indicator 255
- CAN system 347
- Cargo tie-down hooks 198
- Catalytic converter 232
- CD changer* 123
- CD mode 123
- CD player
 - Operating 123
- Center console 25
 - AIRBAG OFF indicator lamp 269
 - Lower part 26
 - Upper part 25
- Centigrade
 - Setting temperature units 134
- Central locking
 - Automatic 94
 - From inside 95
 - Switch 95
 - Switching on/off (control system) 139
 - Unlocking from inside 95
- Central locking switch 95
- Changing
 - Batteries (KEYLESS-GO* card) 300
 - Batteries (SmartKey) 299
 - Key setting 140
 - KEYLESS-GO* card setting 84
 - Vehicle level 192
- Changing CDs 123
- Charcoal filter 164
 - Activating 164
 - Deactivating 164
- Charging
 - Vehicle battery 314
- CHECK ENGINE malfunction indicator lamp 268
- Checking
 - Batteries (KEYLESS-GO* card) 85
 - Coolant level 242
 - Oil level 236, 238
 - Oil level with the oil dipstick 240
 - Tire inflate pressure 236
 - Vehicle lighting 236
 - Vehicle lock status (KEYLESS-GO* card) 86
- Child safety 63
 - Airbags 56
 - Infant and child restraint systems 60, 63
 - LATCH child seat mounts 68
- Child safety switch see Blocking of rear window operation 69
- Cigarette lighter 207

- Cleaning
 - Cup holder 260
 - Distronic* system sensor cover 259
 - Gear selector lever 260
 - Hard plastic trim items 260
 - Headlamps 154
 - Headliner 261
 - Instrument cluster 260
 - Leather upholstery 261
 - Light alloy wheels 260
 - Parktronic* system sensor 259
 - Plastic and rubber parts 261
 - Seat belts 261
 - Steering wheel 260
 - Windows 260
 - Windshield 47
 - Wiper blades 259
- Clock 23
- Closing
 - Cup holder 204
 - Glove box 199
 - Hood 238
 - Side windows 170
 - Side windows with KEYLESS-GO* 86
 - Sliding/pop-up roof 173, 301
 - With SmartKey 174
 - Sliding/pop-up roof with
 - KEYLESS-GO* 86, 172, 175
 - Trunk 90
 - Windows 169
 - Windows with
 - KEYLESS-GO* 172, 175
 - Windows with SmartKey 171
- Closing sliding/pop-up roof
 - In an emergency 301
- Cockpit 20, 347
- Cockpit management and data system (COMAND) 348
- COMAND 348
- COMAND see separate operating instructions
- Combination switch 111
 - High beam flasher 46, 111
 - Turn signals 46
 - Windshield wipers 47
- Consumer information 345
- Control and operation of radio transmitters 232
- Control system 117, 348
 - AUDIO menu 122
 - Convenience submenu 140
 - Display digital speedometer 122
 - Distronic* menu 128
 - Functions 119, 121
 - Instrument cluster submenu 134
 - Lighting submenu 135
 - Malfunction memory menu 130
 - Menus 120, 121, 349
 - Multifunction display 117
 - Multifunction steering wheel 118
 - NAVI menu 127
 - Operating
 - CD player 123
 - Selecting radio system 122
 - Settings menu 131
 - Standard display menu 122
 - Submenus 119, 121
 - TEL* menu 125
 - Trip computer menu 129
 - Vehicle submenu 139
- Convenience submenu 140
 - Activating easy-entry/exit feature 140
 - Setting automatic locking 139
 - Setting fold-in function for exterior rear view mirrors 142
 - Setting parking position for exterior rear view mirror 142

- Coolant 242
 - Adding 243
 - Checking level 242
 - Messages in display 277, 278
 - Temperature 234
 - Temperature gauge 115
 - Warning lamp 278
- Coolant level 236
 - Checking 242
- Courtesy lighting 113
- Cruise control 176, 348
 - Canceling 177
 - Driving downhill 177
 - Driving uphill 177
 - Fine adjustment 178
 - Lever 183
 - Saving current speed 177
 - Setting speeds 178
- Cruise control lever 176
- Cup holder
 - Cleaning 260
 - Closing 204
 - In front seat armrest 202
 - In rear seat armrest 203
 - Opening 204
- Customer Assistance Center (CAC) 347

- D**
- Daytime running lamp mode 110
 - Setting 136
- Deactivating
 - Air conditioner (cooling) 166
 - Air recirculation mode 164
 - Alarm 77
 - Anti-theft alarm system 77
 - Automatic climate control 166
 - Central locking (control system) 139
 - Cruise control 177
 - Defrost 162
 - Distance warning function* 188
 - Distrionic* 186
 - Engine with KEYLESS-GO* 51
 - Engine with the key 51
 - ESP 75
 - Exterior lamps 109
 - Hazard warning flasher 111
 - Headlamps 50
 - Immobilizer 76
 - Interior lighting delayed
 - switch-off 138
 - Rear window defroster 165
 - Residual heat 167
 - Seat heater 103, 104
 - Seat ventilation* 102
 - Tow-away alarm 78
- Deactivating steering wheel gearshift control 150
- Deceleration
 - With Distrionic* 182
- Deep water see Standing water 231
- Defrosting 162
- Delayed switch-off
 - Interior lighting 138
- Dialing
 - A number (telephone) 126
- Difficulties
 - While driving see Problems while driving 48
 - With starting 44
- Digital speedometer 122
- Direction of rotation (tires) 247
- Discharged battery
 - Jump starting 316
- Disconnecting
 - Vehicle battery 314

- Displays
 - Digital speedometer 122
 - DISTRONIC* 181
 - Messages 239, 270
 - Service indicator 254
 - Showing malfunctions 131
- Distance
 - Decreasing in DISTRONIC* 187
 - Increasing in DISTRONIC* 187
 - Setting in DISTRONIC* 186
 - Warning function 187
- Distance to empty (range)
 - Calling up 129
- Distance warning function* 187
 - Activating 188
 - Deactivating 188
 - DISTRONIC* warning lamp 187
 - Intermittent warning sound 187
 - Symbol in multifunction display 128
- DISTRONIC* 179, 348
 - Activated 183
 - Activating 184
 - Calling up settings 128, 182
 - Cleaning system sensor 259
 - Cruise control lever 183
 - Deactivated 183
 - Deactivating 186
 - Deceleration 182
 - Decreasing distance 187
 - Decreasing time interval 186
 - Displays in the speedometer dial 181
 - Distance warning function 187
 - Driving hints 188
 - Fine adjustment 185
 - Increasing distance 187
 - Increasing time interval 186
 - Intermittent signal tone 181
 - Malfunction indicator lamp 265
 - Menu 182
 - Messages in display 280
 - Resetting stored speed 185
 - Sensor cover 259
 - Setting a higher speed 184
 - Setting a lower speed 185
 - Setting following distance 186
 - Setting the current speed 184
 - Warning and indicator lamps 181
 - Warning lamp 265
- Door control panel 19, 28
- Door handle 28
- Door unlock
 - With Tele Aid 216
- Doors
 - Message in display 280
 - Opening from inside vehicle 87
 - Opening from outside 81
- Downhill driving
 - Cruise control 177
- Downshifting 144, 150
- Drink holder see Cup holder 202
- Drinking and driving 225
- Driving
 - Abroad 231
 - General instructions 40, 225
 - Hydroplaning 229
 - In winter 230
 - Problems 48
 - Safety systems 71
 - Through standing water 231
 - With DISTRONIC* 188
- Driving abroad 231
- Driving instructions 225
- Driving off 227
- Driving safety systems
 - ABS 71
 - BAS 73
 - ESP 73

- Driving systems 176
 - ABC 190
 - Cruise control 176
 - Distronic* 179
 - Driving safety systems 71
 - Parktronic* 193
 - Vehicle level control 191
- E**
- Easy-entry/exit feature 96
 - Activating 140
- Electrical fuses 322
- Electrical system 334
- Electronic Stability Program see ESP 23, 73, 348
- Emergency calls
 - Initiating an emergency call 212
 - With Tele Aid 211
- Emergency engine shut-down 324
- Emergency operation (Limp Home Mode) 148
- Emergency operations
 - Closing sliding/pop-up roof 301
 - Locking the vehicle 298
 - Opening sliding/pop-up roof 301
 - Remote door unlock 216
 - Unlocking the trunk lid 298
- Unlocking the vehicle 297
- Emergency tensioning device see ETD 63, 349
- Emission control 233
- Ending
 - A call (telephone) 126
- Engine 330
 - Compartment 237
 - Message in display 268
 - Starting 43
 - Starting with KEYLESS-GO* 43
 - Starting with the key 43
 - Turning off with the key 51
- Engine cleaning 257
- Engine compartment 237
 - Fuse box in 324
 - Hood 237
- Engine malfunction indicator lamp 23, 268
- Engine number 348
- Engine oil 238
 - Adding 241
 - Additives 339
 - Checking level 238
 - Consumption 238
 - Display messages 281
 - Filler neck 241
 - Messages in display 239, 282
 - Viscosity 348
- Engine oil level
 - see Oil level 236, 238, 240
- Entry position
 - Messages in display 294
- ESP 23, 73, 348
 - Switching off 75
 - Switching on 75
 - Warning lamp 264
- ETD 349
 - Safety guidelines 58
- ETD (Emergency tensioning device) 63
- Exterior lamp switch 108
- Exterior rear view mirrors
 - Adjusting 38
 - Folding 152
 - Parking position for 142

- F**
- Fahrenheit
 - Setting temperature units 134
 - Fastening the seat belts 40
 - Fine adjustment
 - Cruise control 178
 - Distronic* 185
 - First aid kit 295
 - Flat tire 308
 - Lowering the vehicle 312
 - Mounting the Spare wheel 308
 - Preparing the vehicle 308, 309
 - Flexible Service System (FSS) 254, 349
 - Fog lamp, rear 110, 303
 - Replacing bulb 305
 - Fog lamps
 - Replacing bulbs 302
 - Fog lamps, front
 - Messages in display 287
 - Switching on 110
 - Folding
 - Exterior rear view mirrors 152
 - Front airbags 59
 - Front lamps
 - Messages in display 286–287
 - Replacing bulbs 302, 304
 - Switching on 108
 - Front seat
 - Head restraints 97
 - Head restraints installing 97
 - Head restraints removing 97
 - FSS (Flexible Service System) 254, 349
 - Fuel 235
 - Fuel reserve warning lamp 268
 - Premium unleaded gasoline 235
 - Reserve warning lamp 23
 - Fuel consumption statistics
 - After start 129
 - Since last reset 129
 - Fuel filler flap 235
 - Locking 235
 - Opening 300
 - Unlocking 235
 - Fuel reserve tank
 - Message in display 284
 - Fuel tank
 - Filler flap 235
 - Fuels, coolants, lubricants etc. 337
 - Functions (control system) 119, 121
 - Resetting 132
 - Fuse box 322, 324
 - Fuse chart 295
 - Fuses 322
 - Fuse box in dashboard 322
 - Fuse box in engine compartment 324
 - Fuse box in passenger compartment 322
 - Fuse box in the rear passenger compartment 323
 - Fuse chart 295
 - Fuse extractor 295
 - Spare fuses 295
- G**
- Garage door opener 27, 217
 - Erasing in remote control 220
 - Integrated remote control 218
 - Rolling code programming 219
 - Gasoline see Fuel 235
 - Gear range 349
 - Automatic transmission 145
 - Limiting 145
 - Shifting into optimal 144
 - Gear range limit
 - Canceling 144

- Gear selector lever
 - Cleaning 260
 - Position 146
- Gearshift pattern for automatic transmission 43
- Global
 - Locking 81
 - Unlocking 81
- Global Positioning System (GPS) 349
- Glove box 21, 199
 - Closing 199
 - Opening 199
- Good visibility 151
- GPS 210, 349
- H**
- Hand-held transmitter
 - Programming integrated remote control 218
- Hands-free microphone 27
- Hard plastic trim items
 - Cleaning 260
- Hazard warning flasher 111
 - Switching off 111
 - Switching on 111
- Head restraints 97
- Headlamp cleaning system 236
- Headlamps
 - Automatic control 109
 - Bi-Xenon 347
 - Cleaning 258
 - Cleaning system 154, 244, 344
 - Refilling washer fluid 244
 - Switching off 50
 - Switching on 46
- Headliner
 - Cleaning 261
- Heated steering wheel* 208
- Height adjustment
 - Head restraints 36
 - Steering wheel 37
- Height adjustments
 - Vehicle level 191
- High beam flasher 46, 111
- High beam headlamps
 - Messages in display 286
 - Replacing bulbs 302
 - Switching on 111
- High mounted brake lamp 303
- Hood 237
 - Closing 238
 - Message in display 284
 - Opening 237
- Hydroplaning 229
- I**
- Identification labels
 - Certification label 328
 - Emission control label 328
 - Engine number 328
 - Information label, California version
 - Vacuum line routing for emission control system 328
 - VIN (vehicle identification number) 328
 - VIN, visible 328
- Ignition 31
- Immobilizer 76
 - Activating 76
 - Deactivating 76
- Indicator lamps see Lamps, indicator and warning
- Infant and child restraint systems 63
 - Installing 67
 - LATCH child seat mounts 68
- Information
 - About service and warranty 10
 - Button for Tele Aid 214

- Inside rear view mirror
 - Adjusting 38
 - Antiglare 151
- Installing
 - Infant and child restraint systems 67
 - Wiper blades 307
- Instrument cluster 21, 22, 114, 349
 - Cleaning 260
 - Coolant temperature gauge 115
 - Illumination 114
 - Multifunction display 117
 - Outside temperature indicator 116
 - Selecting language 135
- Instruments and controls see Cockpit 20
- Integrated remote control
 - Canadian programming 220
 - Erasing memory 220
 - Hand-held transmitter 218
 - Operating 220
 - Rolling code programming 219
- Interior lighting 112
 - Activating automatic control 112
 - Deactivating automatic control 112
 - Delayed switch-off 138
 - Manual operation 113
- Interior storage spaces 199
 - Cup holder 202
 - Glove box 199
 - Parcel net 205
 - Storage compartment in front of armrest 200, 201
- J**
 - Jump starting 316
- K**
 - Key positions in starter switch 31
 - Key, KEYLESS-GO* card
 - Changing the batteries 300
 - Key, mechanical 297
 - Key, SmartKey
 - Battery check lamp 81
 - Changing the batteries 299
 - Checking the batteries 82
 - Factory setting 81
 - Global locking 81
 - Global unlocking 81
 - Loss of 82
 - Positions in starter switch 31
 - Remote controls 80
 - Restoring to factory setting 81
 - Selective setting 81
 - Starting the engine 43
 - Turning off the engine 51
 - Unlocking with 30
- KEYLESS-GO start/stop button* 33
- KEYLESS-GO* 349
 - Activating ignition with 33
 - Closing side windows 86
 - Closing sliding/pop-up roof 86
 - Closing sliding/pop-up roof with 172, 175
 - Closing windows with 172, 175
 - Locking the vehicle 86
 - Messages in display 276
 - Starting the engine 43
 - Turning off engine 51
 - Unlocking with 32

- KEYLESS-GO* card 83
 - Central locking 84
 - Changing the batteries 299
 - Checking the batteries 82, 85
 - Checking vehicle lock status 86
 - Factory setting 84
 - Locking the vehicle 86
 - Loss of 87
 - Messages in display 276
 - Reprogramming 84
 - Restoring to factory setting 81
 - Turning off the engine 51
 - Unlocking 83
 - Unlocking with 32
- Keys 80
- Kickdown 148, 349
- Kilometers/miles in speedometer 134
- Km/h or mph in speedometer 134
- L**
- Lamp bulbs, exterior 302
- Lamps, exterior
 - Front 302
 - Light sensor 285
 - Messages in display 287
 - Rear 303
- Lamps, indicator and warning
 - ABS 265
 - Battery (SmartKey) 81
 - Brakes 267
 - CHECK ENGINE 268
 - Coolant 277
 - Distronic*
 - DTR* 181, 265
 - Engine diagnostics 268
 - ESP 75, 264
 - Fuel reserve 268
 - Instrument cluster 264–268
 - PASSENGER AIRBAG OFF 65, 269
 - Seat belts 266
 - Service indicator 254
 - SRS 55
 - Tow-away alarm 78
 - Turn signals 23
- Language
 - Multifunction display 135
 - Setting 135
- LATCH child seat anchors 68
- LATCH child seat mounts 68
- Layout of poly-V-belt drive 329
- Leather upholstery
 - Cleaning 261
- Lever
 - For cruise control 183
- License plate lamps
 - Replacing bulbs 303, 306
- Light alloy wheels
 - Cleaning 260
- Light sensor 285
- Lighter see Cigarette lighter 207
- Lighting 108
 - Automatic headlamp mode 109
 - Combination switch 111
 - Daytime running lamp mode 110
 - Exterior lamp switch 108
 - Front fog lamps 110
 - High beam flasher 111
 - High beams 111
 - Instrument cluster illumination 114
 - Interior 112
 - Locator lighting 110
 - Low beam 108
 - Manual headlamp mode 109
 - Night security illumination 110
 - Parking lamps 108
 - Rear fog lamp 110
 - Settings (control system) 135
- Limiting the gear range 145

- Limp Home Mode 148
- Line of fall 349
- Loading 197
 - Cargo tie-down hooks 198
 - Instructions 197
 - Roof rack 197
- Locator lighting 110
 - Setting 136
- Lock button 349
 - Door handle (KEYLESS-GO*) 52
 - SmartKey 30, 80
 - Trunk 86
- Locking 49, 80
 - Central (KEYLESS-GO* card) 84
 - Fuel filler flap 235
 - Global, SmartKey 81
 - The vehicle with KEYLESS-GO* 86
 - Trunk lid, separately 90
 - Vehicle in an emergency 298
- Loss of
 - KEYLESS-GO* card 87
 - Mechanical key 82
 - SmartKey 82
- Low beam headlamps
 - Messages in display 286, 287
 - Replacing bulbs 302
- Lowering
 - Vehicle 312
- Lumbar support adjustment 96
- M**
- Main Dimensions 335
- Maintenance 12, 254
- Malfunction memory 130
 - Calling up 130
 - Displaying 131
- Manual headlamp mode 109
- Manual operations
 - Fuel filler flap 300
 - Interior lighting control 113
 - Locking the vehicle 298
 - Sliding/pop-up roof 301
 - Unlocking the driver's door 297
 - Unlocking the trunk lid 298
- Massage function 100
- MAXCOOL maximum cooling 162
- Mechanical key 297
- Memory function 105, 349
 - Recalling positions from memory 106
 - Storing exterior rear view mirror parking positions 107
 - Storing key dependent settings 106
- Menus 119
 - AUDIO 122
 - Control system 349
 - Distronic* 128, 182
 - In control system 120, 121
 - Malfunction memory 130
 - NAVI 127
 - Operating
 - CD player 123
 - Settings menu 131
 - Standard display 122
 - Submenus 119
 - TEL* 125
 - Trip computer 129
- Microphone
 - Hands-free microphone 27
- Miles/kilometers in speedometer
 - Setting 134

- Mirrors
- Activating exterior rear view mirror parking position 152
 - Adjusting 38
 - Automatic antiglare for rear view mirror 151
 - Exterior rear view mirror 38
 - Exterior rear view mirror parking position 142
 - Exterior rear view mirror parking positions 142
 - Inside rear view mirror 38
 - Storing exterior rear view mirror parking position 107
- MON (Motor Octane Number) 235, 350
- Mph or km/h in speedometer 134
- Multicontour seat* 99
- Multifunction display 24, 117, 350
- Selecting language 135
 - Standard display 121
- Multifunction display messages
- ABC 271
 - ABS 272
 - BAS 273, 283
 - Brake fluid 275
 - Brake pads 275
 - Check engine 268
 - Coolant 278
 - Coolant level 277
 - Distronic* 280
 - Doors 280
 - Engine 268
 - Engine oil level 282
 - Entry position 294
 - Fuel reserve tank 284
 - Hood 284
 - Key 284
 - KEYLESS-GO* card 276
 - Lamps 287
 - Parking brake 288
 - Selector lever 280
 - Tele Aid 293
 - Telephone* 294
 - Tires 291
 - Trunk 294
 - Washer fluid 294
- Multifunction
- steering wheel 24, 118, 350
 - Buttons 118
- N**
- Navigation system
- Operating 127
 - See separate COMAND* operating instructions
- Night security illumination 110
- O**
- Occupant safety 54
- Airbags 55
 - Children and airbags 56
 - Children in the vehicle 63
 - Fastening the seat belt 40
 - Infant and child restraint systems 63
 - LATCH child seat mounts 68
 - Seat belts 40, 58
- Odometer, main 23
- Odometer, trip 23

- Oil
 - Adding 241
 - Checking level 238
 - Consumption 238
 - Filler neck 241
 - Viscosity 348
 - Oil level
 - Checking 236, 238, 240
 - One-touch gearshifting 144
 - Canceling gear range limit 144
 - Downshifting 144
 - Upshifting 144
 - Opening
 - Ashtray 206
 - Cup holder 204
 - Doors from the inside 87
 - Fuel filler flap 235
 - Fuel filler flap manually 300
 - Glove box 199
 - Hood 237
 - Side windows 170
 - Sliding/pop-up roof 173, 301
 - In an emergency 301
 - With SmartKey 174
 - Storage space in the armrest 201
 - Storage space in the center console 201
 - Trunk 89
 - Trunk from the inside 88
 - Windows 169, 170
 - Windows with SmartKey 171
 - Operating
 - CD player 123
 - COMAND* see separate operating instructions
 - Garage door opener 220
 - Integrated remote control 220
 - Navigation system 127
 - Radio 122
 - Radio transmitters 232
 - Safety 16
 - Telephone* 125
 - Vehicle outside the USA and Canada 13
 - Operating safety 16
 - Operator's Manual 10
 - Ornamental moldings 258
 - Outside temperature indicator 116
 - Overdue service 254
 - Overhead control panel 27
 - Overspeed range 350
- P**
- Paintwork 257
 - Panic alarm 70
 - Panic button on SmartKey 70
 - Parcel net in front passenger footwell 205
 - Parcel net in trunk 206
 - Parking 49, 227
 - Parking brake 44, 50
 - Message in display 288
 - Releasing 44
 - Parking lamps
 - Replacing bulbs 302, 303, 305
 - Switching on 108
 - Parking position
 - Exterior rear view mirrors 107, 142, 152
 - Parktronic* 193, 350
 - Cleaning sensors 259
 - Warning indicators 195
 - PASSENGER AIRBAG OFF
 - Warning lamp 269

- Passenger compartment 231
 - Fuse box in 322
 - Inside rear view mirror 38
 - Interior lighting 112
 - Parcel net in front passenger footwell 205
 - Passenger safety see Occupant safety 54
 - Pedals 225
 - Phone book*
 - Loading 126
 - Quick search 126
 - Phone number*
 - Dialing 126
 - Redialing 127
 - Plastic and rubber parts
 - Cleaning 261
 - Pliers, universal (vehicle tool kit) 295
 - Poly-V-belt drive 350
 - Positions (Memory function)
 - Recalling from memory 106
 - Positions (Memory function*)
 - Storing into memory 106
 - Power assistance 225
 - Power closing assist
 - for doors and trunk lid 94
 - Power seat
 - Adjusting backrest tilt 36
 - Adjusting head restraint height 36
 - Adjusting head restraint tilt 36
 - Adjusting seat cushion depth 36
 - Adjusting seat cushion tilt 36
 - Adjusting seat height 36
 - Folding forward front seat backrests 100
 - Front seat head restraints 97
 - Seat fore and aft adjustment 36
 - Power train 350
 - Power washer 257
 - Power windows 169
 - Blocking of rear window operation 69
 - Side windows 169
 - Synchronizing 172
 - Practical hints
 - First aid kit 295
 - Fuses 322
 - Lamp in center console 269
 - Lamps in instrument cluster 264
 - Messages in the display 270
 - Vehicle tool kit 295
 - Problems
 - While driving 48
 - With vehicle 17
 - Product information 9
 - Program mode selector switch 350
 - Automatic transmission 147
 - PULSE function (Massage function) 100
- Q**
- Quick search
 - Phone book* 126
- R**
- Radio
 - Selecting stations 122
 - Station selection setting 139
 - Radio transmitters, control and operation 232
 - Range (distance to empty)
 - Calling up 130
 - Reading lamp 27
 - Rear fog lamp 303
 - Bulb 303
 - Switching on 110
 - Rear lamp bulbs
 - Replacing 305
 - Rear lamps see Tail lamps

- Rear passenger compartment
 - Adjustable air vents 168
- Rear seat head restraints
 - Folding back with switch 92, 97
 - Placing upright 98
- Rear seats
 - Head restraints 97
- Rear view mirror automatic antiglare 151
- Rear view mirrors see Mirrors
- Rear window
 - Blocking operation 69
- Rear window defroster 165
 - Activating 165
 - Deactivating 165
- Rear window sunshade* 156
- Reconnecting
 - Vehicle battery 315
- Regular checks 236
- Regular driving style 191
- Reinstalling vehicle battery 314
- Remote controls
 - Integrated 218
 - SmartKey 80
- Remote door unlock
 - With Tele Aid 216
- Remote Vehicle Diagnostics 350
- Removing
 - Vehicle battery 314
 - Wheel 311
- Replacing
 - Backup lamp bulbs 305
 - Brake lamp bulbs 305
 - Bulbs 302
 - Front lamp bulbs 304
 - License plate lamp bulbs 306
 - Parking lamp bulbs 305
 - Rear fog lamp bulb 305
 - Rear fog lamp bulbs 305
 - Rear lamp bulbs 303, 305
 - Rear turn signal bulbs 305
 - Side marker lamp bulbs 305
 - Standing lamp bulbs 305
 - Wiper blades 307
- Reporting
 - Safety defects 18
- Reset button in the instrument cluster 132
- Resetting
 - All functions (control system) 132
 - All functions of a submenu 132
 - Fuel consumption 129
 - Service indicator (FSS) 255
 - Stored speed in Distronic* 185
 - Trip odometer 115
- Residual heat utilization 167, 350
- Residual ventilation 167
- REST (Residual engine heat utilization) 350
- Restraint system see Infant and child restraint systems 63, 67
- Rims and Tires 331
- Roadside Assistance
 - Tele Aid 213
- Roadside assistance 12
- Rolling code programming 219
- RON (Research Octane Number) 235, 351
- Roof rack 197
- Rotating wheels 251
- Rubber parts
 - Cleaning 261

S

- Safety
 - Occupant 54
 - Safety belts see Seat belts 40
 - Safety defects
 - Reporting 18
 - Safety systems
 - Driving 71
 - Saving current speed 177
 - Screwdriver (vehicle tool kit) 295
 - Seat belt force limiter 63
 - Seat belts 60
 - Cleaning 261
 - Fastening 40
 - Proper use of 42, 62
 - Safety guidelines 58
 - Warning lamp 266
 - Seat cushion depth
 - Adjusting 99
 - Seat heater
 - Switching off 103
 - Switching on 103
 - Seat ventilation*
 - Switching off 102
 - Switching on 102
- Seats 96
 - Adjusting 34
 - Adjusting lumbar support 99
 - Adjusting shoulder support 99
 - Easy entry/exit feature 96
 - Heater 103
 - Massage function 100
 - Multicontour seat* 99
- Securing cargo
 - Cargo tie-down hooks 198
- Selector lever
 - Message in display 280
 - Position 143
- Self-test
 - BabySmart™ airbag deactivation system 66
 - Tele Aid 210
- Service
 - Calling up the service indicator 255
 - Major service (Service B) 254
 - Minor service (Service A) 254
 - Overdue 254
 - Types 254
 - When due 254
- Service (maintenance) 254
- Service and warranty information 10
- Service indicator 254
 - Calling up 255
 - Clearing 254, 255
- Service life (tires) 247
- Service System see FSS 254
- Setting
 - Convenience functions 140
 - Cruise control 177
 - Daytime running lamp mode 136
 - Distronic* time interval 186
 - Exterior rear view mirror parking position 142
 - Following distance in DISTRONIC* 186
 - Higher speed in cruise control 178
 - Higher speed in DISTRONIC* 184
 - Individual vehicle settings 131
 - Interior lighting delayed switch-off 138
 - Lamps and lighting (control system) 135
 - Language, multifunction display 135
 - Locator lighting 136
 - Lower speed in cruise control 178
 - Lower speed in DISTRONIC* 185
 - Miles/kilometers in speedometer 134

- Parking position for exterior rear view mirrors 142
- Slower speed in cruise control 178
- Speed in cruise control 178
- Speed in DISTRONIC* 184
- Speedometer display mode 134
- Station selection mode 139
- Suspension tuning 190
- Temperature (interior) 160
- Temperature indicator 134
- Units
 - Speedometer 134
 - Temperature 134
- Vehicle level control 191
- Settings
 - Calling up DISTRONIC* 128, 182
 - Convenience functions 140
 - Factory, SmartKey 81
 - Lighting (control system) 135
 - Menus and submenus 119
 - Resetting all (control system) 132
 - Resetting in the submenu 132
 - Selective 81
- Settings menu
 - Functions in 131
 - Individual vehicle settings 131
 - Submenus 132
- Shift lock 351
- Shifting
 - Gear selector lever positions 146
 - Into optimal gear range (automatic transmission) 144
- Shoulder support
 - Seat adjustment 99
- Side impact airbags 59
- Side marker lamps
 - Replacing bulbs 302, 303, 305
- Side windows
 - Automatic closing 170
 - Automatic opening 170
 - Cleaning 260
 - Closing 169, 170, 171
 - Closing fully 170
 - Closing with KEYLESS-GO* 86, 172, 175
 - Closing with SmartKey 171
 - Opening 169, 170, 171
 - Opening fully 170
 - Opening with SmartKey 171
- Stopping 171
 - Synchronizing power windows 172
- Simultaneous wiping and washing
 - Windshield wipers 47
- Single wipe 47
- Sliding/pop-up roof 173
 - Closing 173, 301
 - Closing with
 - KEYLESS-GO* 86, 172, 175
 - Closing with SmartKey 174
 - Opening 173, 301
 - Opening with SmartKey 174
 - Stopping 174
 - Synchronizing 175
- SmartKey
 - Changing the batteries 299
 - Global locking and unlocking 81
 - Lock button 30, 80
 - Locking and unlocking 80
 - Opening and closing the sliding/pop-up roof 174
 - Opening and closing windows 171
 - Unlock button 30, 80
 - Unlocking with 30
- Snow chains 253
- Spare fuses 295

- Spare parts service 326
- Spare wheel
 - Mounting 308
- Speed
 - Resetting stored speed in
 - Distronic* 185
 - Saving current 177
- Speed settings
 - Cruise control 178
 - Distronic* 184, 185
- Speedometer 23
 - Displaying gear range 145
 - Displays 181
 - Settings units 134
- Speedometer display mode
 - Selecting 134
- Sporty driving suspension 191
- SRS 62, 351
 - Indicator lamp 266
- SRS indicator lamp 54
- Standing lamps 108
 - Replacing bulbs 302, 303, 305
- Standing water
 - Driving instructions 231
- Starter switch 21, 31
 - Positions 31
 - Switching on 43
- Starting difficulties 44
- Starting position 31
- Starting the engine 42
- Station selection
 - Setting 139
- Steering column
 - Height adjustment 38
 - Length adjustment 38
- Steering wheel
 - Adjusting 37
 - Buttons 24
 - Cleaning 260
 - Electrical adjustment 37
 - Heated steering wheel* 208
 - Height adjustment 38
- Stolen vehicle
 - Tracking services 217
- Stopping
 - Sliding/pop-up roof 174
 - Windows 171
- Storage compartments
 - Armrest 200, 201
 - Glove box 199
- Storage spaces
 - Cup holder 204
 - Storage tray 201
- Storing (Memory function*)
 - Positions into memory 106
- Submenus
 - Convenience 140
 - For settings 119
 - In control system 121
 - Instrument cluster 134
 - Lighting 135
 - Resetting functions in Control system 132
 - Selecting 132
 - Settings menu 132
 - Vehicle 139
- Sun visors 155
- Supplemental Restraint System (SRS) 351
- Suspension tuning
 - For regular driving style 191
 - For sporty driving style 191
 - Setting 190

- Switching off
 - Automatic central locking (control system) 139
 - Engine 51
 - ESP 75
 - Hazard warning flasher 111
 - Headlamps 50
 - Switching on
 - Automatic central locking (control system) 139
 - ESP 75
 - Front fog lamps 110
 - Front lamps 108
 - Hazard warning flasher 111
 - Headlamps 46
 - High beams 111
 - Parking lamps 108
 - Rear fog lamp 110
 - Windshield wipers 47
 - Symbol (Distronic*)
 - Distance warning function* 128
 - Synchronizing
 - Power windows 172
 - Sliding/pop-up roof 175
- T**
- Tachometer 23, 115
 - Overspeed range 115
 - Tail lamps
 - Cleaning 258
 - Replacing bulbs 303, 305
 - Tar stains 257
 - Tele Aid 209
 - Emergency calls 211
 - Information 214
 - Initiating an emergency call manually 212
 - Messages in display 293
 - Remote door unlock 216
 - Roadside Assistance 213
 - Stolen vehicle tracking services 217
 - System self-check 210
 - Upgrade signals 215
 - Tele Aid System 351
 - Telematics* 351
 - Telephone* 24, 208
 - Answering a call 126
 - Dialing a number from the phone book 126
 - Ending a call 126
 - Hands-free microphone 27
 - Loading phone book* 126
 - Messages in display 294
 - Operating 125
 - Redialing 127
 - Temperature
 - Display mode 134
 - Setting interior temperature 160
 - Setting units in display 134
 - Tires 248
 - Tie-down hooks (Trunk) 198
 - Tightening torque 351
 - Tightening torque (Wheel bolts) 312
 - Tire inflation pressure
 - Checking 236, 247
 - Tire speed rating 229, 351
 - Tire traction 229
 - Tires 246, 345
 - Direction of rotation 247
 - Driving instructions 228
 - Messages in display 291
 - Retreads 246
 - Service life 247
 - Temperature 248
 - Tread depth 252
 - Wear pattern 251
 - Winter 252

- Tools 295
- Tow-away alarm 25, 78
 - Arming 78
 - Disarming 78
 - Disarming for transport 78
- Towing eye bolt (vehicle tool kit) 295
 - Installing 321
- Towing the vehicle 318
- Tracking services
 - For stolen vehicle 217
- Traction 147, 351
- Transmission see Automatic transmission 242
- Tread depth (tires) 252
- Trip computer 129
- Trip odometer
 - Resetting 115
- Trunk
 - Closing 90
 - Lock button 86
 - Lock button, KEYLESS-GO* 86
 - Locking separately 90
 - Message in display 294
 - Opening 89
 - Opening from inside vehicle 88
 - Parcel net 206
 - Tie-down hooks 198
 - Trunk lid 89
 - Trunk lock 298
 - Unlocking in an emergency 298
 - Unlocking separately 91
 - Unlocking with SmartKey 82
- Trunk lid emergency release 89
- Turn signal lamps
 - Replacing bulbs 302, 303
- Turn signals 46
 - Additional in mirrors 302
 - Cleaning lenses 258
 - Front bulbs 302, 304
 - Indicator lamps 23
 - Rear bulbs 303, 305
- Turning off
 - Engine 51
- U**
- Units
 - Setting speedometer units 134
 - Setting temperature units 134
- Unlock button
 - SmartKey 30, 80
 - Trunk lid 80
- Unlocking 30, 80
 - Central (KEYLESS-GO* card) 84
 - Driver's door in an emergency 297
 - Fuel filler flap 235
 - Global 81
 - In an emergency 297
 - Selective settings 81
 - Trunk in an emergency 298
 - Trunk lid 80
 - Trunk lid with SmartKey 82
 - Trunk lid, separately 91
 - Vehicle in an emergency 216
 - With KEYLESS-GO* card 32
 - With the KEYLESS-GO* card 83
 - With the SmartKey 30
- Unlocking the trunk lid 87
- Upgrade signals
 - Tele Aid 215
- Uphill driving
 - Cruise control 177
- Upshifting 144, 150

- Useful features 199
 - Ashtrays 206
 - Cigarette lighter 207
 - Garage door opener 217
 - Interior storage spaces 199
 - Tele Aid 209
 - Telephone* 208
- V**
- Vehicle
 - Individual settings 131, 133
 - Locking 25
 - Locking in an emergency 298
 - Lowering 312
 - Proper use of 16
 - Service battery 313
 - Towing 318
 - Unlocking 25
 - Unlocking in an emergency 297
- Vehicle battery 313
- Vehicle care 256
 - Cup holder 260
 - Distronic* system sensor cover 259
 - Engine cleaning 257
 - Gear selector lever 260
 - Hard plastic trim items 260
 - Headlamps 258
 - Instrument cluster 260
 - Leather upholstery 261
 - Light alloy wheels 260
 - Ornamental moldings 258
 - Paintwork 257
 - Parktronic* system sensor 259
 - Plastic and rubber parts 261
 - Power washer 257
 - Seat belts 261
 - Steering wheel 260
 - Tail lamps 258
 - Tar stains 257
 - Turn signals 258
 - Vehicle washing 258
 - Window cleaning 260
 - Wiper blades 259
- Vehicle level 191
 - Changing 192
 - Setting 192
 - Automatic 192
 - Manual 192
- Vehicle lighting
 - Checking 236
- Vehicle lock status
 - Checking (KEYLESS-GO*) 86
- Vehicle tool kit 295
 - Alignment bolt 295
 - Fuse chart 295
 - Fuse extractor 295
 - Hex-socket wrench 295
 - Open-end wrench 295
 - Screwdriver 295
 - Spare fuses 295
 - Universal pliers 295
 - Wheel wrench 295
- Vehicle washing 258
- VIN (Vehicle Identification Number) 351
- Voice control system* 351
 - Hands-free microphone 27
- W**
- Warning indicators
 - Parktronic* 195
- Warning lamps see Lamps, indicator and warning
- Warning sounds
 - Distance warning function* 187
 - Distronic* 181
 - Drivers seat belts 60
 - Parking brake 45
- Warranty coverage 327
- Washing the vehicle 256

- Wear pattern (tires) 251
 - Weights 336
 - Wheel change
 - Tightening torque 312
 - Wheels
 - Rotating 251
 - Tires and wheels 246
 - Window curtain airbags 59
 - Windows see Side windows
 - Windshield
 - Refilling washer fluid 244
 - Replacing wiper blades 307
 - Washer fluid 244, 344
 - Windshield washer 236
 - Windshield washer fluid
 - Message in display 294
 - Refilling 244, 344
 - Wiping with 47
 - Windshield wipers 47, 154
 - Fast wiper speed 47
 - Intermittent wiping 47
 - Replacing wiper blades 307
 - Single wipe 47
 - Switching on 47
 - Wiping with windshield washer fluid 47
 - Winter driving 252
 - Block heater* 253
 - Snow chains 253
 - Tires 252
 - Transmission program mode 147, 149
 - Winter driving instructions 230
 - Winter tires 252
 - Wiper blades
 - Cleaning 259
 - Installing 307
 - Replacing 307
 - Wiping
 - And washing simultaneously 47
 - Interval 47
 - With windshield washer fluid 47
 - Wrench, hex-socket (vehicle tool kit) 295
 - Wrench, open-end (vehicle tool kit) 295
 - Wrench, wheel (vehicle tool kit) 295
- X**
- Xenon headlamps
 - Bi-Xenon 347

Service and Literature

Your authorized Mercedes-Benz Center has trained technicians and original Mercedes-Benz parts to service your vehicle properly. For expert advice and quality service, see your authorized Mercedes-Benz Center.

If you are interested in obtaining service literature for your vehicle, please contact your authorized Mercedes-Benz Center. We consider this the best way for you to obtain accurate information for your vehicle.

For further information you can find us on the Mercedes-Benz website www.mbusa.com or www.mercedes-benz.ca.

Warning!



To help avoid personal injury, be extremely careful when performing any service work or repairs. Improper or incomplete service or the use of incorrect or inappropriate parts or materials may damage the vehicle or its equipment, which may in turn result in personal injury.

If you have any questions about service, maintenance and the carrying out thereof, seek the advice of an authorized Mercedes-Benz Center.

We reserve the right to modify the technical details of the vehicle as given in the data and illustrations of this Operator's Manual. Reprinting, translation and copying, even of excerpts, is not permitted without our prior authorization in writing.

Title illustration no. P00.01-2397-31

Press time 17 / 01 / 03

GSP / SIP

Printed in Germany

