

TABLE OF CONTENTS

SECTION		PAGE
1	INTRODUCTION	3
2	THINGS TO KNOW BEFORE STARTING YOUR VEHICLE	7
3	UNDERSTANDING THE FEATURES OF YOUR VEHICLE	49
4	UNDERSTANDING YOUR INSTRUMENT PANEL	97
5	STARTING AND OPERATING	129
6	WHAT TO DO IN EMERGENCIES	171
7	MAINTAINING YOUR VEHICLE	195
8	MAINTENANCE SCHEDULES	247
9	IF YOU NEED CONSUMER ASSISTANCE	257
10	INDEX	273

INTRODUCTION

CONTENTS

■ Introduction	4	■ Warnings And Cautions	6
■ How To Use This Manual	4	■ Vehicle Identification Number	6

4 INTRODUCTION

INTRODUCTION

This manual has been prepared with the assistance of service and engineering specialists to acquaint you with the operation and maintenance of your Crossfire. It is supplemented by a Warranty Information Booklet and various customer-oriented documents. You are urged to read these publications carefully. Following the instructions and recommendations in this manual will help assure safe and enjoyable operation of your vehicle.

NOTE: After you read the manual, it should be stored in the vehicle for convenient reference and remain with the vehicle when sold.

When it comes to service, remember that your authorized dealer knows your vehicle best, has the factory-trained technicians and genuine Mopar® parts, and is interested in your satisfaction.

WARNING!



















Engine exhaust, some of its constituents, and certain vehicle components contain or emit chemicals known to the State of California to cause cancer and birth defects or other reproductive harm.

HOW TO USE THIS MANUAL

Consult the table of contents to determine which section contains the information you desire.

The detailed index, at the rear of this manual, contains a complete listing of all subjects.

Consult the following table for a description of the symbols that may be used on your vehicle or throughout this owner's manual:

			BRAKE BRAKE SYSTEM WARNING PARKING BRAKE						
			 FAILURE OF ANTI-LOCK BRAKING SYSTEM						
									
									
									BAS ESP BRAKE ASSIST SYSTEM / ELECTRONIC STABILITY PROGRAM
									
CHECK ENGINE ENGINE		SRS AIRBAG SUPPLEMENTAL RESTRAINT SYSTEM							
									

6 INTRODUCTION

WARNINGS AND CAUTIONS

This manual contains **WARNINGS** against operating procedures which could result in an accident or bodily injury. It also contains **CAUTIONS** against procedures which could result in damage to your vehicle. If you do not read this entire manual you may miss important information. Observe all Warnings and Cautions.

VEHICLE IDENTIFICATION NUMBER

The vehicle identification number (VIN) is located beneath the left front corner of the instrument panel, visible through the windshield. This number also appears on the Automobile Information Disclosure Label affixed to a window on your vehicle. Save this label as a convenient record of your vehicle identification number and optional equipment.

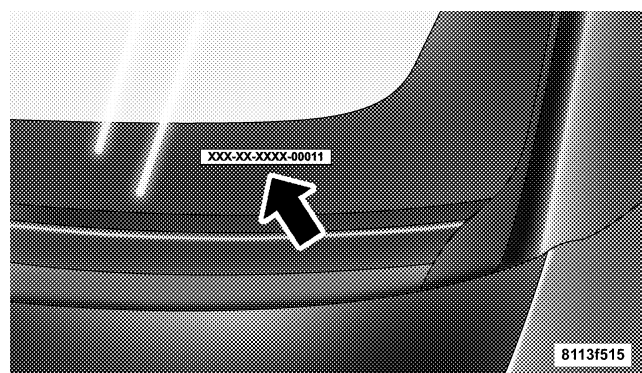

THINGS TO KNOW BEFORE STARTING YOUR VEHICLE

CONTENTS

■ A Word About Your Keys	9	□ Start Lockout14
□ Keys	9	■ Remote Keyless Entry14
□ Obtaining Replacement Keys10	□ To Unlock The Doors14
□ Ignition Key Removal10	□ To Lock The Doors15
□ Key-In-Ignition Reminder10	□ Panic Alarm15
■ Glove Compartment Lock11	□ To Use The Panic Alarm16
■ Door Locks11	□ General Information16
□ Central Locking Switch12	□ Transmitter Battery Service16
□ Automatic Central Locking13	■ Security Alarm System17
□ General Notes On The Central Locking System13	□ Tow-Away Alarm18
□ Emergency Unlocking Feature14	■ Decklid Internal Emergency Release - Roadster19

8 THINGS TO KNOW BEFORE STARTING YOUR VEHICLE

■ Power Windows20	□ Child Restraint39
□ Power Window Operation With The Convertible Top Switch (Roadster Only)21	■ Engine Break-In Recommendations46
■ Rear Liftgate/Decklid Release21	■ Safety Tips46
■ Occupant Restraints21	□ Exhaust Gas46
□ Lap/Shoulder Belts22	□ Safety Checks You Should Make Inside The Vehicle47
□ Seat Belts And Pregnant Women27	□ Periodic Safety Checks You Should Make Outside The Vehicle47
□ Seat Belt Extender27		
□ Supplemental Restraint System (SRS) - Airbag28		

A WORD ABOUT YOUR KEYS

You can insert the double-sided keys into the locks with either side up.

The dealer that sold you your new vehicle has the key code numbers for your vehicle locks. These numbers can be used to order duplicate keys only from an authorized dealer. Ask your dealer for these numbers and keep them in a safe place.

CAUTION!

An unlocked car is an invitation to thieves. Always remove the key from the ignition and lock all the doors when leaving the vehicle unattended.

NOTE: To avoid discharging the battery, the key must be removed from the ignition when the vehicle is parked.

Keys

Included with your vehicle are two remote controls with folding keys. The remote control operates all locks on the vehicle, including the locking fuel filler door.

To release the key from the folded position, press the button. The key unfolds from the fob.

The transmitter for the remote control is located in the key fob.

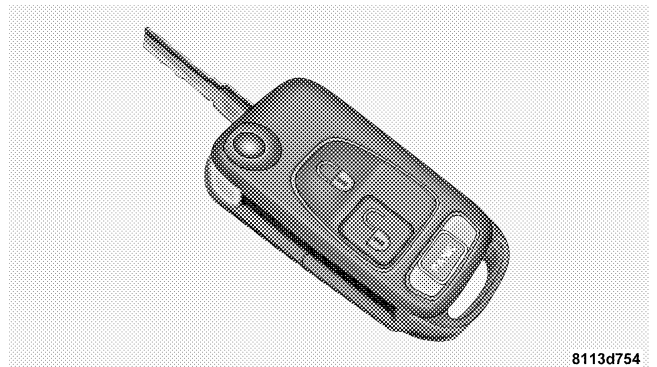

8113d754

10 THINGS TO KNOW BEFORE STARTING YOUR VEHICLE

Obtaining Replacement Keys

Your vehicle is equipped with a theft deterrent locking system requiring a special key manufacturing process. For security reasons, replacement keys can only be obtained from your authorized dealer.

Important!

Removing the key from the steering lock activates the start lock-out. The engine cannot be started.

Turning the key in the steering lock to the ON/RUN position deactivates the start lock-out.

NOTE: In case the engine cannot be started, and START and ERROR are shown in the odometer display field, the system is not operational. Contact an authorized dealer.

Ignition Key Removal

Turn the key to the LOCK position and remove the key.

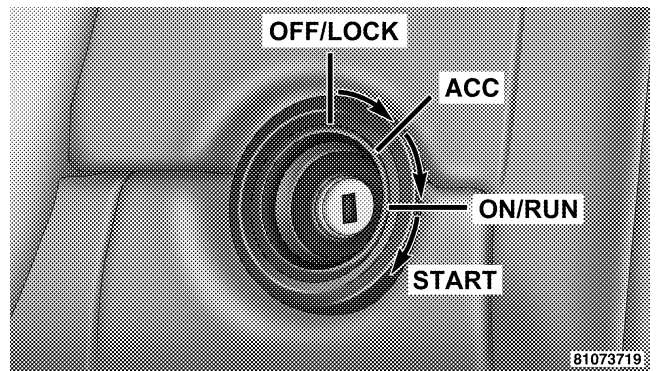

NOTE: For vehicles with automatic transmissions, if you try to remove the key before you place the shift lever in PARK, the key may become trapped temporarily in the key cylinder. If this occurs, turn the key clockwise slightly, then remove the key as described.

Key-In-Ignition Reminder

Opening the driver's door when the key is in the ignition sounds a signal to remind you to remove the key.

GLOVE COMPARTMENT LOCK

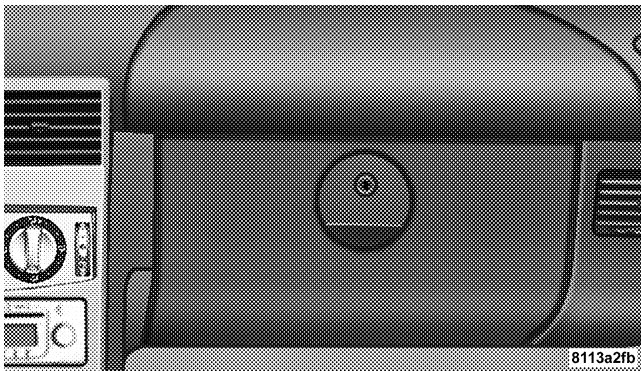

The glove compartment can be locked by turning the key straight up to the vertical or right position, and then removing the key.

To unlock the glove compartment, turn the key to the horizontal or left position, and then remove the key.

DOOR LOCKS

The vehicle doors can be locked when the doors are closed by either manually pressing the button down at the top of the door panel, pressing and releasing the bottom portion of the central locking switch located in the console, or by pressing and releasing the Lock transmit button on the key fob. Also, by turning the key clockwise in the driver's door, both doors, liftgate/decklid, fuel filler door, and center console (roadster only) will lock.

2

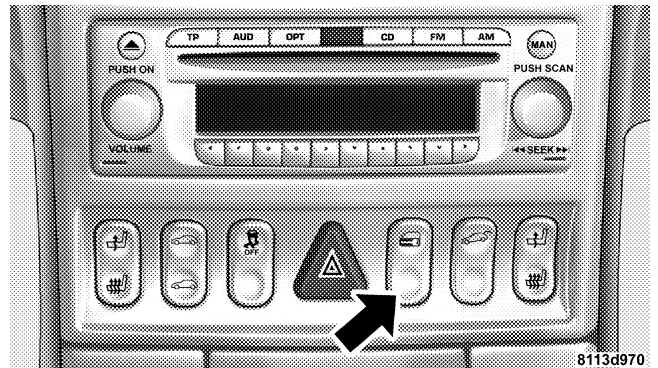

12 THINGS TO KNOW BEFORE STARTING YOUR VEHICLE

The doors can be unlocked by pulling on the inside door handle, pressing and releasing the top portion of the central locking switch located in the console, or by pressing and releasing the Unlock transmit button on the key fob. Both doors can also be unlocked by turning the key counterclockwise in the driver's door.

NOTE: If the key in the ignition switch is in the ON/RUN position, the vehicle cannot be locked or unlocked with the remote control.

When you lock the vehicle, both door lock buttons should move down. If either one stays up, the respective door is not properly closed. You should then unlock the vehicle, open and reclose the door, and lock the vehicle again.

Each individual door can be locked with the respective door lock button - the driver's door can only be locked when it is closed. If the vehicle has previously been locked from the outside, only the door being opened from the inside will unlock, and the alarm will come on. The other door, the rear liftgate/decklid, fuel filler door, and center console (roadster only) will remain locked.

NOTE: In case of a malfunction in the central locking system, the doors can be locked and unlocked individually. To lock, turn the key in the driver's door lock clockwise, or push down the lock buttons. To unlock, turn the key in the driver's door lock counterclockwise, or pull the inside door handles.

WARNING!

For personal security and safety in the event of an accident, lock the vehicle doors as you drive and when you park and leave the vehicle.

Central Locking Switch

The central locking switch is located in the console. The doors and rear liftgate/decklid can only be locked with the central locking switch if both doors are closed.

If the vehicle was previously locked with the remote control or key, the doors and rear liftgate/decklid cannot be unlocked with the central locking switch. If the vehicle was previously locked with the central locking switch, the complete vehicle is unlocked when a door is opened from the inside.

NOTE: The fuel filler door and center console (roadster only) cannot be locked or unlocked with the central locking switch.

Automatic Central Locking

The central locking switch also operates the automatic central locking feature. With the automatic central locking feature activated, the doors and rear liftgate/decklid are locked at vehicle speeds of approximately 9 mph (15 km/h) or more; however, the fuel filler door remains unlocked.

To activate this feature, turn the key to the ON/RUN position and hold the upper portion of the switch for a minimum of five seconds. To deactivate, turn the key to the ON/RUN position and hold the lower portion of the switch for a minimum of five seconds.

NOTE: If the doors are unlocked with the central locking switch after activating the automatic central locking feature and neither door is opened, the doors remain unlocked even at vehicle speeds of approximately 9 mph (15 km/h) or more.

NOTE: If you attempt to lock the doors with the key in the ignition and the driver's door open, the doors will not lock.

General Notes On the Central Locking System

If the key in the ignition switch is in the ON/RUN position, the vehicle cannot be locked or unlocked with the remote control.

If the vehicle cannot be locked or unlocked at any time with the remote control, it may be necessary to change the batteries in the remote.

NOTE: To help prevent the vehicle battery from discharging during short periods of inactivity, perform the following:

1. Make sure that the rear liftgate/decklid, hood and doors are completely closed.
2. Make sure that remote transmitter is operating and that the battery is good.
3. Make sure that the hood, rear liftgate/decklid and door switches are in adjustment.

14 THINGS TO KNOW BEFORE STARTING YOUR VEHICLE

Perform the quick system check which follows: Use the remote transmitter to set the alarm. If the parking lamps flash three times, the system is operating properly. If not, there is a problem with a switch or the system. See your authorized dealer for service.

Emergency Unlocking Feature

In the case of an accident, the doors unlock automatically a short time after a strong deceleration is detected, such as in a collision (this is intended to aid rescue and exit). However, the key must still be in the ignition.

Start Lockout

Removing the key from the ignition switch activates the start lockout. The engine cannot be started. Turning the key to the ON/RUN position deactivates the start lockout. If the engine cannot be started, and the messages START and ERROR are shown in the odometer display field, the system is not operational. Contact an authorized dealer.

REMOTE KEYLESS ENTRY

This feature allows you to lock or unlock the vehicle from remote locations using a hand-held transmitter located in the key fob. You don't have to point the transmitter at the vehicle to activate the system. The vehicle doors, rear liftgate/decklid, fuel filler door, and center console (roadster only) can be locked and unlocked using the remote control.

To Unlock the Doors:

Press and release the unlock button on the key fob.

NOTE: If within 40 seconds of unlocking with the key fob, neither door is opened, the key is not inserted in the ignition switch, or the central locking switch is not activated, the vehicle will automatically lock.

Press the Unlock transmit button on the key fob once to unlock driver's door, rear liftgate/decklid, fuel filler door, and center console (roadster only). Press the Unlock transmit button twice to unlock both doors, rear liftgate/decklid, fuel filler door, and center console (roadster only).

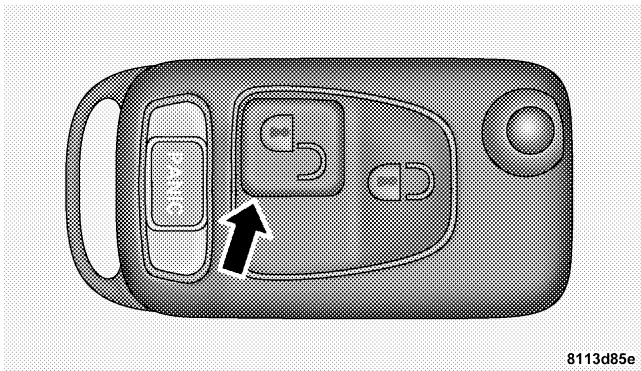

8113d85e

To Lock The Doors:

Press the Lock button on the key fob once. All turn signal lights blink three times to indicate that the vehicle is locked. If the turn signal lights do not blink, a door or rear liftgate/decklid is not closed properly.

The entire vehicle, including the fuel filler door, may be locked or unlocked by using the key in the driver's door. The doors and liftgate/decklid can be locked or unlocked by pressing the central locking switch located in the center console.

If the vehicle cannot be locked or unlocked by pressing the transmit button, then it may be necessary to change the batteries in the remote control.

2

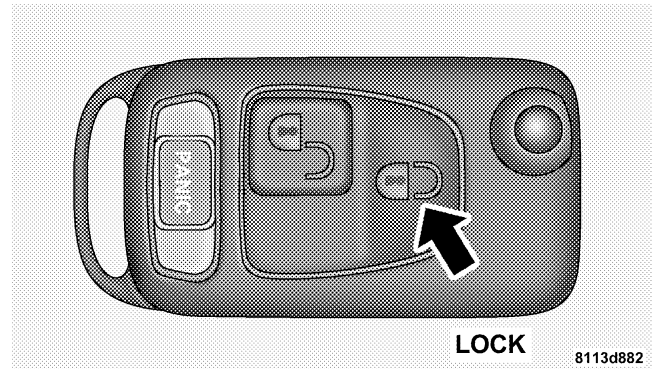

8113d882

Panic Alarm

The panic alarm unlocks the driver's door, turns on the interior lights, flashes the foglights and sounds the horn for about three minutes or until the alarm is turned off. The vehicle can be driven while in the Panic mode.

To Use the Panic Alarm:

Press and hold the Panic button to activate the alarm. Press and hold the Panic button or unlock the door with the key to deactivate the alarm. The alarm will also shut off after three minutes or when vehicle speed reaches 15 mph (24 km/h).

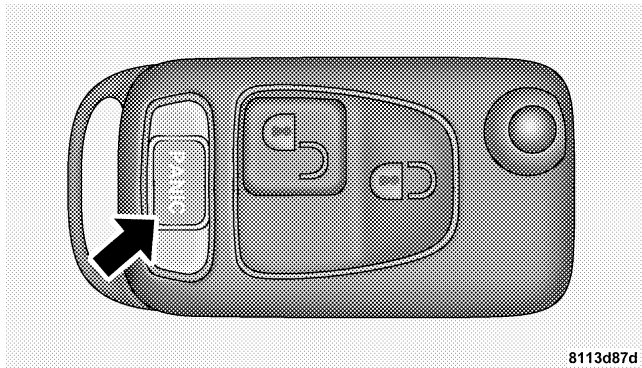

8113d87d

General Information

This transmitter complies with FCC rules part 15. Operation is subject to the following conditions:

1. This device may not cause harmful interference.

2. This device must accept any interference that may be received, including interference that may cause undesired operation.

Transmitter Battery Service

The recommended replacement Lithium battery is Panasonic® CR 2025 or equivalent.

To change the batteries:

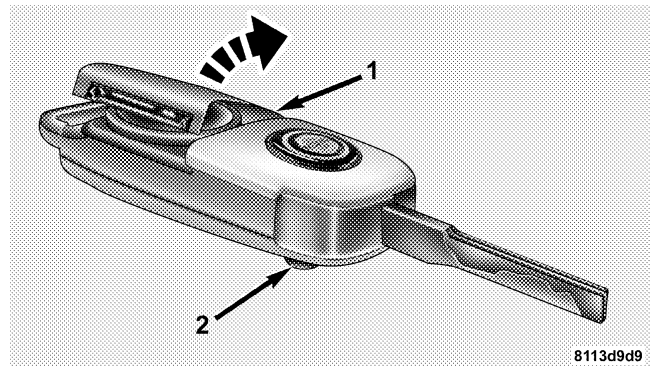

8113d9d9

- Press release button (2) on the key fob. The key folds out.
- Press the battery cover (1) in the direction of the arrow.

- Remove the old batteries.

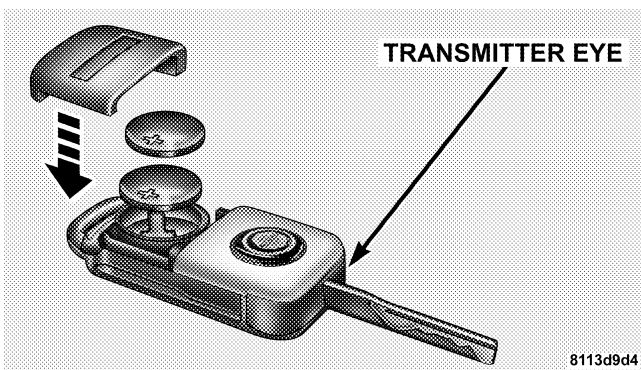

- Insert the new batteries in the direction of the arrow with the positive symbol facing upwards.
- Replace the battery cover and press on it until you feel it engage.

NOTE: Only replace the batteries in pairs.

The system may have to be resynchronized if the transmitter is without voltage for several minutes. To synchronize, aim the transmitter eye at the vehicle and briefly press either the Lock or the Unlock button twice. Within

approximately 30 seconds, insert the key in the ignition and turn it to the ON/RUN position. The remote control should once again be operational.

SECURITY ALARM SYSTEM

The system monitors the doors, rear liftgate/decklid, hood, and ignition for unauthorized operation. The security alarm system is automatically armed or disarmed with the remote control or any of your vehicle's keys by locking or unlocking the vehicle.

The antitheft alarm is armed within approximately 10 seconds after locking the vehicle. A blinking light in the tow away alarm switch indicates that the alarm is armed. Once the alarm system has been armed, the exterior vehicle lights will flash and an alarm will sound when a door, the rear liftgate/decklid, the hood, or the glove compartment is opened, or if someone attempts to raise the vehicle for towing. The alarm will flash the exterior lamps for approximately three minutes and sound an audible alarm for 30 seconds. The alarm will stay on even if the activating element is immediately closed.

18 THINGS TO KNOW BEFORE STARTING YOUR VEHICLE

Tow-Away Alarm

The tow-away alarm switch is located on the console. To deactivate for towing or jacking up the vehicle, press and release the upper portion of the switch. Press and release the upper portion to activate it again.

After the alarm system has been armed, the exterior vehicle lights will flash and an alarm will sound when someone attempts to raise the vehicle. The alarm will flash the exterior lamps for approximately three minutes and sound an audible alarm for 30 seconds. The alarm will stay on even if the vehicle is immediately lowered.

To cancel the alarm, insert the key into the ignition switch or press a transmit button on the key fob.

To prevent triggering the tow-away alarm feature when parking on a surface subject to movement (such as a ferry), switch off the tow-away alarm. To do so, turn the key in the ignition switch to the OFF/LOCK or ACC position, or remove the key from the ignition switch. Press the tow-away alarm switch and the indicator light will illuminate briefly. Exit the vehicle, and lock the vehicle with the key or the remote control.

The tow-away alarm remains switched off until the vehicle is locked again with the key or the remote control, at which time it is automatically reactivated.

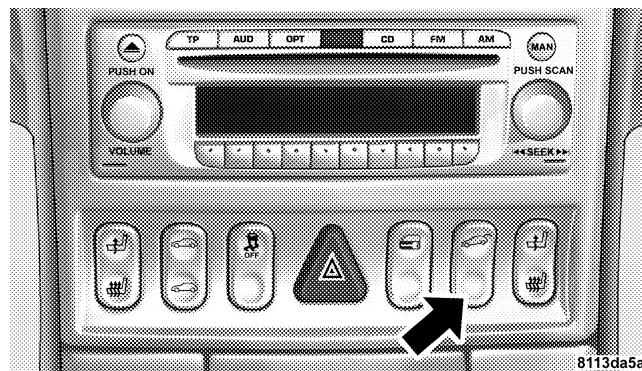

DECKLID INTERNAL EMERGENCY RELEASE - ROADSTER

WARNING!

Do not allow children to have access to the trunk by climbing into the trunk from outside. Always close the decklid when your vehicle is unattended. Once in the trunk, young children may not be able to escape. If trapped in the trunk, children can die from suffocation or heat stroke.

WARNING!

If the battery voltage drops below the minimum threshold during the convertible top operation, the Trunk Internal Emergency Release will not function.

WARNING!

The Trunk Internal Emergency Release will not function during the convertible top operation.

2

NOTE: As a security measure, a Decklid Internal Emergency Release lever is built into the decklid latching mechanism. In the event of an individual being locked inside the trunk, the decklid can be easily opened by pulling on the glow-in-the-dark handle attached to the decklid latching mechanism. See picture.

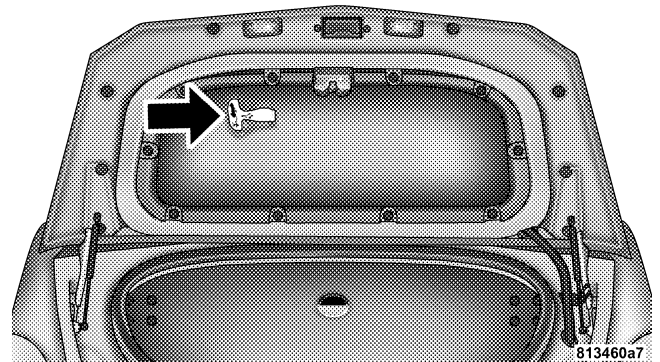

813460a7

POWER WINDOWS

The power window switches are located in the console.

To operate, turn the key in the ignition switch to the ACC or ON/RUN position. Press the switch in to the resistance point to open; release the switch when the window is in the desired position.

For express opening of windows, press the switch past the resistance point and release; the window lowers to the fully open position. To interrupt the procedure, briefly press the switch again and release.

When closing the windows, be sure that there is no danger of anyone being harmed by the closing procedure.

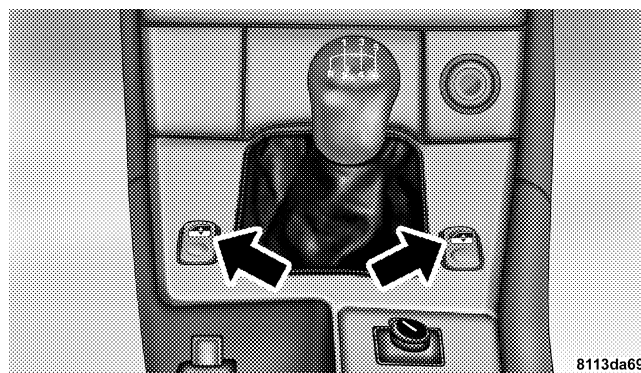

WARNING!

When leaving the vehicle, always remove the key from the ignition switch, and lock the vehicle. Do not leave children unattended in the vehicle, or with access to an unlocked vehicle. Unsupervised use of vehicle equipment can cause serious personal injury.

Power Window Operation With The Convertible Top Switch (Roadster Only)

The power windows can also be operated by using the convertible top switch.

To operate, turn the key in the ignition switch to the ON/RUN position. Press down on the rear of the convertible top switch twice to open the windows.

Press down on the front of the convertible top switch twice to close the windows.

REAR LIFTGATE/DECKLID RELEASE

You can open the rear liftgate/decklid by using the handle located on the liftgate/decklid just above the rear license plate pocket.

WARNING!

Do not allow children to have access to the rear cargo area by climbing into the rear cargo area from outside. Always close the liftgate/decklid when your vehicle is unattended. Once in the cargo area, young children may have difficulty leaving the vehicle. If trapped in the cargo area, children can die from suffocation or heat stroke.

2**OCCUPANT RESTRAINTS**

Some of the most important safety features in your vehicle are the restraint systems. These include the lap/shoulder seat belts for the driver and passenger, emergency tensioning retractors for the seat belts, and front and side airbags for the driver and passenger. If you will be carrying children too small for adult-size belts, the passenger side seat belt also can be used to hold infant and child restraint systems.

22 THINGS TO KNOW BEFORE STARTING YOUR VEHICLE

Please pay close attention to the information in this section. It tells you how to use your restraint system properly to keep you and your passengers as safe as possible.

WARNING!

In a collision, you and your passengers can suffer much greater injuries if you are not properly buckled up. You can strike the interior of your vehicle or other occupants, or you can be thrown out of the vehicle. Always be sure you and others in your vehicle are buckled up properly.

Buckle up even though you are an excellent driver, even on short trips. Someone on the road may be a poor driver and cause a collision that includes you. This can happen far away from home or on your street.

Research has shown that seat belts save lives. They also can reduce the seriousness of injuries in a collision. Some of the worst injuries happen when people are thrown from the vehicle. Seat belts provide protection from that, and they reduce the risk of injury caused by striking the inside of the vehicle. **Everyone** in a motor vehicle needs to be buckled up all the time.

Lap/Shoulder Belts

Each seating position is equipped with a combined lap/shoulder belt system.

The belt webbing retractor will lock only during very sudden stops or impacts. This feature allows the shoulder part of the belt to move freely with you under normal conditions. But, in a collision, the belt will lock and reduce the risk of your striking the inside of the vehicle or being thrown out. The seat belts are also equipped with emergency tensioning retractors. These tensioning retractors are located in each belt's inertia reel and become operationally ready with the key in the ignition switch turned to the ACC or ON/RUN positions. The emergency tensioning retractors are designed to activate during frontal and rear impacts. They remove slack from the belts in such a way that the seat belts fit more snugly against the body, restricting its forward movement as much as possible.

In cases of other frontal impacts, rollovers, certain side impacts, rear collisions or other accidents without sufficient frontal or rear impact forces, the emergency tensioning retractors will not be activated. The driver and passenger will then be protected by the fastened seat belts and inertia reel in the usual manner.

WARNING!

- **Wearing a seat belt incorrectly is dangerous. Seat belts are designed to go around the large bones of your body. These are the strongest parts of your body and can take the forces of a collision the best. Wearing your belt in the wrong place could make your injuries in a collision much worse. You might suffer internal injuries, or you could even slide out of part of the belt. Follow these instructions to wear your seat belt safely and to keep your passengers safe, too.**
- **Two people should never be belted into a single seat belt. People belted together can crash into one another in an accident, hurting one another badly. Never use a lap/shoulder belt or a lap belt for more than one person, no matter what their size.**

Lap/Shoulder Belt Operating Instructions

1. Enter the vehicle and close the door. Sit back and adjust the seat.

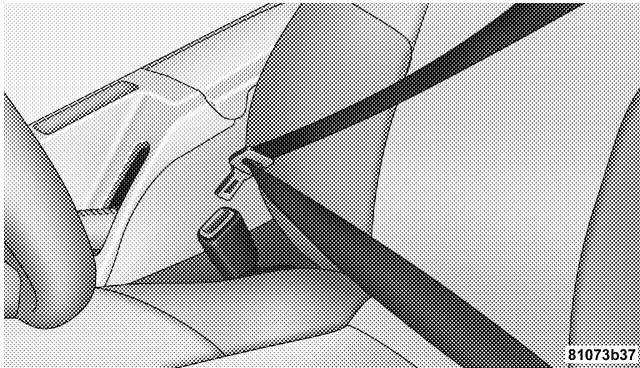

2. The seat belt latch plate is above the back of your seat. Grasp the latch plate and pull out the belt. Slide the latch plate up the webbing as far as necessary to make the belt go around your lap.

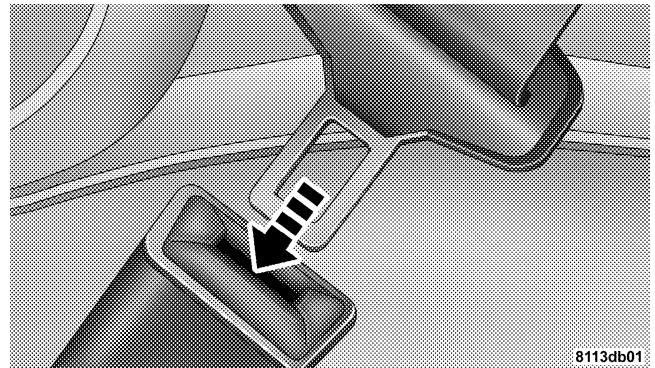

3. When the belt is long enough to fit, insert the latch plate into the buckle until you hear a "click."

4. Position the lap belt across your thighs, below your abdomen. To remove slack in the lap belt portion, pull up a little on the shoulder belt, as shown.

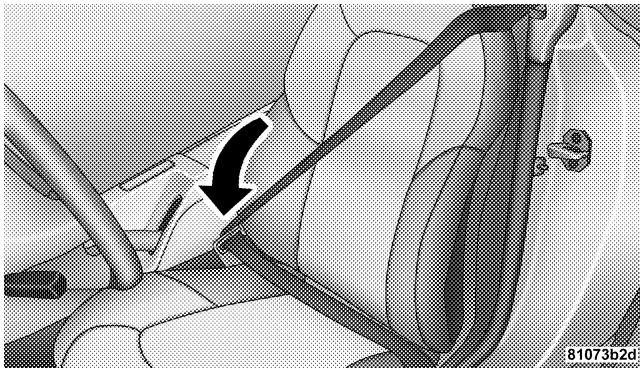

5. To loosen the lap belt if it is too tight, tilt the latch plate away from you and pull on the lap belt. Remember that a snug belt reduces the risk of sliding under the belt in a collision.

2

6. Position the shoulder belt on your chest so that it is comfortable and not resting on your neck. The retractor will withdraw any slack in the belt.

7. To release the belt, push the red button on the buckle. The belt will automatically retract to its stowed position. If necessary, slide the latch plate down the webbing to allow it to retract fully.

WARNING!

- A belt that is buckled into the wrong buckle will not protect you properly. The lap portion could ride too high on your body, possibly causing internal injuries. Always buckle your belt into the buckle nearest you.
- A belt that is too loose will not protect you as well. In a sudden stop you could move too far forward, increasing the possibility of injury. Wear your seat belt snugly.
- A belt that is worn under your arm is very dangerous. Your body could strike the inside surfaces of the vehicle in a collision, increasing head and neck injury. A belt worn under the arm can cause internal injuries. Ribs aren't as strong as shoulder bones. Wear the belt over your shoulder so that your strongest bones will take the force in a collision.
- A shoulder belt placed behind you will not protect you from injury during a collision. You are more likely to hit your head in a collision if you do not wear your shoulder belt. The lap and shoulder belt are meant to be used together.

WARNING!

- A lap belt worn too high can increase the risk of internal injury in a collision. The belt forces won't be at the strong hip and pelvic bones, but across your abdomen. Always wear the lap belt as low as possible and keep it snug.
- A twisted belt can't do its job as well. In a collision it could even cut into you. Be sure the belt is straight. If you can't straighten a belt in your vehicle, take it to an authorized dealer and have it fixed.

WARNING!

Seat belt systems must always be replaced after an impact severe enough to fire the emergency locking retractors. If there is any question about the condition of your seat belt system, take the vehicle to an authorized dealer for an inspection.

WARNING!

A frayed or torn belt could rip apart in a collision and leave you with no protection. Inspect the belt system periodically, checking for cuts, frays, or loose parts. Damaged parts must be replaced immediately. Do not disassemble or modify the system. Seat belt assemblies must be replaced after an accident if they have been damaged (bent retractor, torn webbing, etc.)

Seat Belts and Pregnant Women

We recommend that pregnant women use the seat belts throughout their pregnancy. Keeping the mother safe is the best way to keep the baby safe.

Pregnant women should wear the lap part of the belt across the thighs and as snug across the hips as possible. Keep the belt low so that it does not come across the abdomen. That way the strong bones of the hips will take the force if there is a collision.

Seat Belt Extender

If a seat belt is too short even when fully extended, an authorized dealer can provide you with a seat belt extender. This extender should be used only if the existing belt is not long enough. When it is not required, remove the extender and store it.

2**WARNING!**

Using a seat belt extender when not needed can increase the risk of injury in a collision. Only use the extender when the lap belt is not long enough when it is worn low and snug, and in the recommended seating positions. Remove and store the extender when not needed.

Supplemental Restraint System (SRS) - Airbag

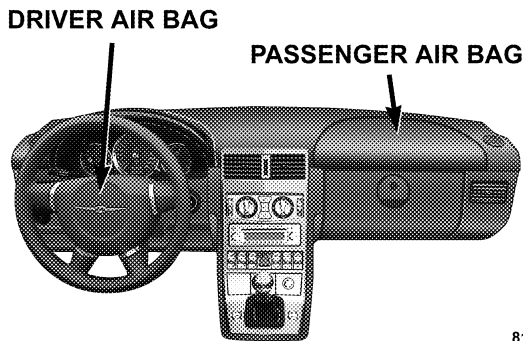

81159dba

This vehicle has airbags for the driver and passenger as a supplement to the seat belt restraint systems. The driver's airbag is mounted in the steering wheel. The passenger frontal airbag is mounted in the instrument panel, under a cover marked SRS/AIRBAG.

These airbags inflate in higher speed frontal impacts. They work with the instrument panel knee bolster and the seat belts to provide improved protection for the driver and passenger.

The vehicle is also equipped with side airbags, located in the driver and passenger doors. Side airbags also work with seat belts to improve occupant protection.

WARNING!

- Do not put anything on or around the front airbag covers or attempt to manually open them. You may damage the airbags and you could be injured because the airbags are not there to protect you. These protective covers are designed to open only when the airbags are inflated.
- Do not place objects between you and the side airbags; the performance could be adversely affected and/or objects could be pushed into you, causing serious injury.
- Do not attach cup holders or any other objects on or around the door. The inflating side airbag could drive objects into occupants, causing serious injury.

The seat belts are designed to protect you in many types of collisions. The front airbags deploy only in moderate to severe front collisions. In certain types of collisions, both the front and side airbags may be triggered. But even in collisions where the airbags work, you need the seat belts to keep you in the right position for the airbags to protect you properly.

Here are some simple steps you can take to minimize the risk of harm from a deploying airbag.

1. Infants in rear-facing child safety seats should **NEVER** ride in the front seat of a vehicle with a passenger frontal airbag unless the airbag is shut OFF. See "Passenger Airbag On/Off Switch" and "To Shut Off the Passenger Airbag." The rear-facing seat places them too close to the passenger air bag in the event of a crash. An airbag deployment can cause severe injury or death to infants in this position.

Children that are not big enough to properly wear the vehicle seat belt (see section on "Child Restraint") should be secured in child safety seats or booster seats that are appropriate for the child's age, height, and weight.

Older children who do not use child safety seats or booster seats should ride properly buckled. Never allow children to place the shoulder belt behind them or under the arm.

If a child from 1 to 12 years old must ride in the vehicle, move the seat as far back as possible, shut off the passenger airbag, and use the proper child restraint. See the section on "Child Restraint."

You should read the instructions provided with your child restraint or belt-positioning booster seat to make sure that you are using it properly.

2. All occupants should wear their lap and shoulder belts properly.
3. The driver and passenger seats should be moved back as far as practical to allow the front airbags room to inflate.
4. Do not lean against the door, as the side airbags will inflate forcefully into the space between you and the door. (See the section on "Side Airbags.")

WARNING!

- Relying on the airbags alone could lead to more severe injuries in a collision. The airbags work with your seat belt to restrain you properly. In some collisions the airbags won't deploy at all. Always wear your seat belts even though you have airbags.
- Being too close to the steering wheel or instrument panel during airbag deployment could cause serious injury.
- Airbags need room to inflate. Sit back, comfortably extending your arms to reach the steering wheel or instrument panel.
- The side airbags also need room to inflate. Do not lean against the door. Sit upright in the center of the seat.

Airbag System Components

The airbag system consists of the following:

- Airbag control module and internal crash sensor
- AIRBAG readiness light
- Driver and passenger frontal airbag/inflator units
- Driver and passenger side airbag/inflator units
- Passenger airbag On/Off switch and indicator light
- Unique steering wheel and column
- Unique instrument panel
- Interconnecting wiring
- Knee impact bolster
- Side impact sensors

How the Front Airbag System Works

- A crash sensor in the occupant compartment determines if a frontal impact is severe enough to require the airbag. The sensor will not detect side, roll over, or rear impacts. The sensor is connected to the diagnostic unit and to the airbag/inflator unit.
- The Occupant Restraint Controller monitors the readiness of the electronic parts of the system whenever the ignition switch is in the START or ON/RUN positions. These include all of the items listed above except the knee bolster, the instrument panel, and the steering wheel and column.
- The Occupant Restraint Controller also turns on the AIRBAG light in the instrument panel for four seconds when the ignition is first turned on, then turns the light off. If it detects a malfunction in any part of the system, it turns on the light either momentarily or continuously depending on the condition that is present at the time.

- The airbag/inflator units are in the center of the steering wheel and in the instrument panel. The words SRS/AIRBAG are embossed on the airbag covers.

2

WARNING!

Ignoring the AIRBAG light in your instrument panel could mean you won't have the airbags to protect you in a collision. If the light does not come on, stays on after you start the vehicle, or if it comes on as you drive, have the airbag system checked right away.

WARNING!

Do not put anything on or around the airbag covers or attempt to manually open them. You may damage the airbags and you could be injured because the airbags are not there to protect you. These protective covers are designed to open only when the airbags are inflated.

32 THINGS TO KNOW BEFORE STARTING YOUR VEHICLE

- When the crash sensor detects an impact requiring the airbags, it signals the inflator units. A large quantity of nontoxic nitrogen gas is generated to inflate the airbags. The airbag covers separate and fold out of the way as the airbags inflate to their full size. The airbags then quickly deflate while helping to restrain the driver and passenger. The airbag gas is vented through the airbag material towards the instrument panel. In this way the airbags do not interfere with your control of the vehicle.
- The knee impact bolster helps protect the knees and working with the seat belts, position you for the best interaction with the airbags.

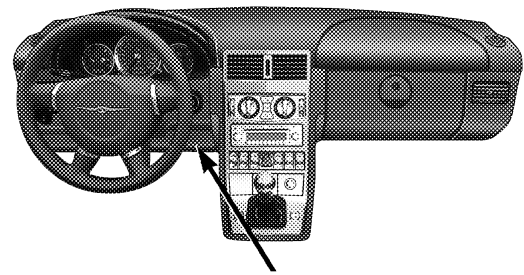

KNEE BOLSTER

8113e94b

If a Deployment Occurs

WARNING!

Deployed airbags can't protect you in another collision. Have the airbags replaced by an authorized dealer as soon as possible.

The airbag system is designed to deploy when the impact sensors detect a moderate-to-severe frontal collision, to help restrain the driver and passenger, and then to immediately deflate.

NOTE: A frontal collision that is not severe enough to need airbag protection will not activate the system. This does not mean something is wrong with the airbag system.

If you do have a collision which deploys the airbags, any or all of the following may occur:

- The nylon airbag material may sometimes cause abrasions and/or skin reddening to the driver and passenger as the airbags deploy and unfold. The abrasions are similar to friction rope burns or those you might get sliding along a carpet or gymnasium floor. They are not caused by contact with chemicals. They are not permanent and normally heal quickly. However, if you haven't healed significantly within a few days, or if you have any blistering, see your doctor immediately.
- As the airbags deflate, you may see some smoke-like particles. The particles are a normal by-product of the

process that generates the nontoxic nitrogen gas used for airbag inflation. These airborne particles may irritate the skin, eyes, nose, or throat. If you have skin or eye irritation, rinse the area with cool water. For nose or throat irritation, move to fresh air. If the irritation continues, see your doctor. If these particles settle on your clothing, follow the garment manufacturer's instructions for cleaning.

- It is not advisable to drive your vehicle after the airbags have been deployed. If you are involved in another collision, the airbags will not be in place to protect you.

How the Side Impact Airbag System Works

- The side impact airbags are located in the doors above the armrest.
- Separate crash sensors in the vehicle determine if a side impact is severe enough to require the airbag on the side of the vehicle subjected to an impact. As with the frontal system, the sensors are connected to the diagnostic unit and the airbag/inflator units.

34 THINGS TO KNOW BEFORE STARTING YOUR VEHICLE

- When a side impact above a predetermined threshold occurs, the sensors signal the inflator on the impacted side of the vehicle. A large quantity of nontoxic nitrogen gas is generated to inflate the airbag. The door panel opens to allow the airbag to inflate to its full size.

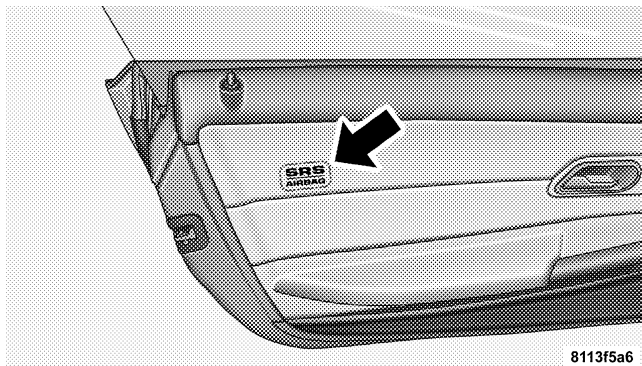

WARNING!

- Do not put anything on or around the airbag covers or attempt to manually open them. You may damage the airbags and you could be injured because the airbags are not there to protect you. These protective covers are designed to open only when the airbags are inflated.
- Do not attach cup holders or any other objects on or around the door. The inflating side airbag could drive the objects into occupants, causing serious injury.

- The operational readiness of the side airbag system is verified by the airbag indicator light in the instrument cluster when turning the key in the ignition switch to the ON/RUN position. If no fault is detected, the light will go out after approximately four seconds. After the light goes out, the system continues to monitor the components and circuitry of the airbag system and will indicate a malfunction by coming on again. If the light does not come on at all, or if it fails to go out after the four seconds, or if it comes on thereafter, a malfunction in the system has been detected. See your authorized dealer for service.

WARNING!

- **The door mounted side airbag deploys with considerable force. Being too close to the door panel during airbag deployment could cause serious injury or death.**
- **All occupants must be in the appropriate restraint for their size and age, especially children 12 and under.**
- **To help avoid the potential for serious injury and death should the side airbag be activated, please follow these guidelines:**
 1. **Occupants, especially children, should never lean against the door in the area where the side airbag inflates;**
 2. **Occupants need to sit upright in the center of the seat to give the side airbag room to inflate;**
 3. **Always use the appropriate restraint for the occupant and ensure it is properly used.**

36 THINGS TO KNOW BEFORE STARTING YOUR VEHICLE

Passenger Front Airbag On/Off Switch

The on/off switch is located at the right end of the instrument panel and is accessible by opening the passenger door.

The on/off switch is to be used only when the passenger is:

- an infant (less than 1 year old),
- a child, age 1 to 12,
- an adult with a medical condition which makes passenger airbag inflation (deployment) a greater risk for the passenger than the risk of hitting the dashboard (instrument panel) or windshield in a crash.

If the airbag is turned off when there is any other occupant at that position, the supplemental restraint provided by the airbag will not be available.



To turn OFF the passenger front airbag, use the on/off switch located on the instrument panel.

NOTE: When the passenger airbag is turned off, the yellow airbag off light will illuminate.

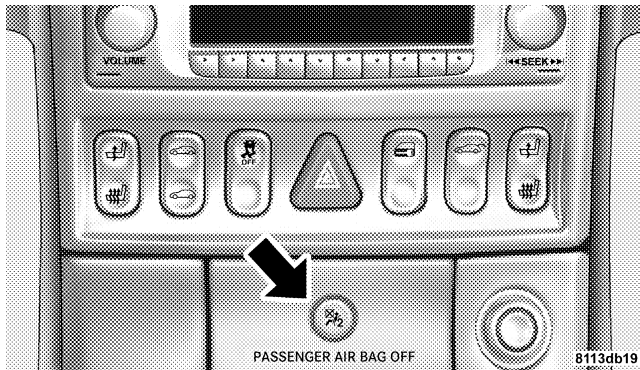

- The air bag will remain off until the switch is turned back to the ON position.
- The switch does NOT turn off the side airbag.

2

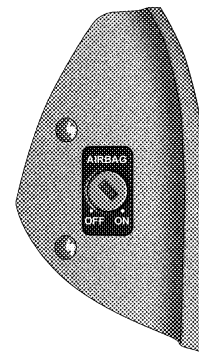

810d7a6f

To Shut Off the Passenger Airbag:

- Place the ignition key in the on/off switch, turn the key clockwise, and remove the key from the switch. This will shut off the passenger front airbag.

To Turn On the Passenger Airbag:

- Place the ignition key in the on/off switch, turn the key counterclockwise, and remove the key from the switch. This will turn on the passenger airbag. The Passenger Airbag Off light on the console will turn off, or will not be illuminated when the ignition is turned to the ON position.

WARNING!

The airbag may malfunction and serious injury could result if key is left in the airbag shut off switch. Always remove the key.

Maintaining Your Airbag System

WARNING!

- Modifications to any part of the airbag system could cause it to fail when you need it. You could be injured because the airbag is not there to protect you. Do not modify the components or wiring, including adding any kind of badges or stickers to the airbag covers. Do not modify the front bumper or vehicle body structure.
- You need proper knee impact protection in a collision. Do not mount or locate any aftermarket equipment on or behind the knee impact bolster.
- You can be injured if you are too close to either airbag cover when the airbags inflate. It is dangerous to try to repair any part of the airbag system yourself. Don't try to repair the airbag system. Be sure to tell anyone who works on your vehicle that it has airbags.

Airbag Light

You will want to have the airbags ready for your protection in case of a collision. While the airbag Supplemental Restraint System (SRS) is designed to be maintenance free, if any of the following occurs, have an authorized dealer service the system immediately.

- The AIRBAG light does not come on or flickers during the four seconds when the ignition switch is first turned on.
- The light remains on or flickers after the four second interval.
- The light flickers or comes on and remains on while driving.

Child Restraint

Everyone in your vehicle needs to be buckled up all the time, babies and children, too. Every state in the United States and all Canadian provinces require that small children ride in proper restraint systems. This is the law, and you can be prosecuted for ignoring it.

WARNING!

In a collision, an unrestrained child, even a tiny baby, can become a missile inside the vehicle. The force required to hold even an infant on your lap could become so great that you could not hold the child, no matter how strong you are. The child and others could be badly injured. Any child riding in your vehicle should be in a proper restraint for the child's size.

2**Infants and Child Restraints**

There are different sizes and types of restraints for children from newborn size to the child almost large enough for an adult safety belt. Always check the child seat Owner's Manual to ensure you have the right seat for your child. Use the restraint that is correct for your child:

40 THINGS TO KNOW BEFORE STARTING YOUR VEHICLE

- Safety experts recommend that children ride rearward-facing in the vehicle until they are at least one year old and weigh at least 9 kg (20 lbs.). Two types of child restraints can be used rearward-facing: infant carriers and “convertible” child seats.
- The infant carrier is only used rearward-facing in the vehicle. It is recommended for children who weigh up to about 20 lbs. (9 kg). “Convertible” child seats can be used either rearward-facing or forward-facing in the vehicle. Convertible child seats often have a higher weight limit in the rearward-facing direction than infant carriers do, so they can be used rearward-facing by children who weigh more than 20 lbs. (9 kg) but are less than one year old. Both types of child restraints are held in the vehicle by the lap/shoulder belt or the LATCH child restraint anchorage system. (See the LATCH - Child Seat Anchorage System section.)
- Rearward-facing child seats must **NEVER** be used in the front seat of a vehicle with the front passenger airbag unless the airbag is turned off. An airbag deployment could cause severe injury or death to infants in this position.

WARNING!

- A rearward facing infant restraint must not be used unless the passenger airbag has been shut off. A rearward facing infant restraint may be struck by a deploying passenger airbag which may cause severe or fatal injury to the infant.
- Improper installation can lead to failure of a child restraint. It could come loose in a collision. The child could be badly injured or killed. Follow the manufacturer’s directions exactly when installing a child restraint.

Here are some tips on getting the most out of your child restraint:

- Before buying any restraint system, make sure that it has a label certifying that it meets all applicable Safety Standards. We also recommend that you make sure that you can install the child restraint in the vehicle where you will use it before you buy it.

- The restraint must be appropriate for your child's weight and height. Check the label on the restraint for weight and height limits.
- Carefully follow the instructions that come with the restraint. If you install the restraint improperly, it may not work when you need it.
- Buckle the child into the seat according to the seat manufacturer's directions.
- When your child restraint is not in use, secure it in the vehicle with the seat belt or remove it from the vehicle. Do not leave it loose in the vehicle. In a sudden stop or collision, it could strike the occupants and cause serious personal injury.

NOTE: For additional information refer to www.seatcheck.org or call 1-866-SEATCHECK.

Older Children and Child Restraints

Children who weigh more than 20 lbs. (9 kg) and who are older than one year can ride forward-facing in the vehicle. Forward-facing child seats and convertible child seats used in the forward-facing direction are for children who weigh 20 to 40 lbs. (9 to 18 kg) and who are older

than one year. These child seats are also held in the vehicle by the lap/shoulder belt or the LATCH child restraint anchorage system. (See LATCH - Child Seat Anchorage System section.)

The belt-positioning booster seat is for children weighing more than 40 lbs. (18 kg), but who are still too small to fit the vehicle's seat belts properly. If the child cannot sit with knees bent over the vehicle's seat cushion while the child's back is against the seat back, they should use a belt-positioning booster seat. The child and belt-positioning booster seat are held in the vehicle by the lap/shoulder belt.

Children Too Large For Booster Seats

Children who are large enough to wear the shoulder belt comfortably, and whose legs are long enough to bend over the front of the seat when their back is against the seat back, should use the lap/shoulder belt.

- Make sure that the child is upright in the seat.
- The lap portion should be low on the hips and as snug as possible.

42 THINGS TO KNOW BEFORE STARTING YOUR VEHICLE

- Check belt fit periodically. A child's squirming or slouching can move the belt out of position.
- If the shoulder belt contacts the face or neck, move the child closer to the center of the vehicle. Never allow a child to put the shoulder belt under an arm or behind their back.

LATCH - Child Seat Anchorage System (Lower Anchors and Tether for Children)

Your vehicle's passenger seat is equipped with the child restraint anchorage system called LATCH. The LATCH system provides for the installation of the child restraint without using the vehicle's belts, instead securing the child restraint using lower anchorages and upper tether straps from the child restraint to the vehicle structure. LATCH-compatible child restraints are now available.

Installing the LATCH-Compatible Child Restraint System

We urge that you carefully follow the directions of the manufacturer when installing your child restraint. These

are general instructions, and not all child restraint systems will be installed exactly as described here. Again, carefully follow the installation instructions that were provided with the child restraint system.

The passenger seat lower anchorages are round bars, located at the rear of the seat cushion where it meets the seat back, and are just visible when you lean in to install the child restraint. You will easily feel them if you run your finger along the intersection of the seat back and seat cushion surfaces.

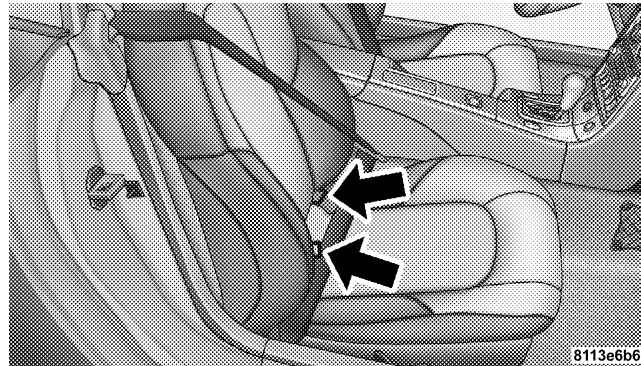

The passenger seat tether anchorage is located on the back of the seat cushion frame. It is visible by moving the passenger seat forward in the vehicle.

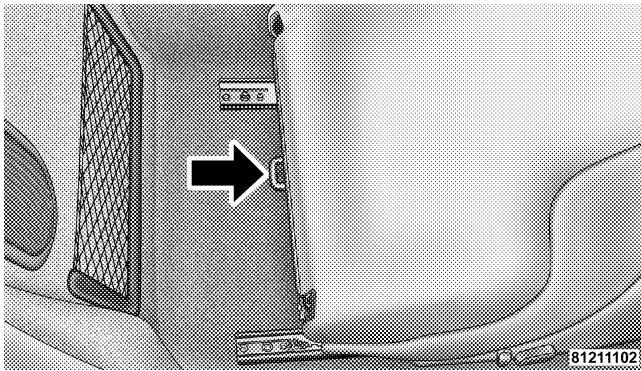

Many, but not all LATCH-Compatible child restraint systems will be equipped with separate straps on each side, with each having a hook or connector for attachment to the lower anchorage and a means of adjusting the tension in the strap. Forward-facing toddler restraints and some rear-facing infant restraints will also be

equipped with a tether strap, a hook for attachment to the tether strap anchorage and a means of adjusting the tension of the strap.

2

You will first loosen the adjusters on the lower straps and on the tether strap so that you can more easily attach the hooks or connectors to the vehicle anchorages. Next, you can attach the tether strap to the anchor by moving the passenger seat forward. Route the child restraint tether directly over the top of the seat, through the strap near the top of the seat back, and attach the hook to the anchor bar. Recline the seat back and move the passenger seat as far rearward as possible. Next, attach the lower hooks to the passenger seat lower anchor bars by pushing aside the seat cover material. Finally, tighten all three straps as you push the child restraint rearward and downward into the seat, removing slack in the straps according to the child restraint manufacturer's instructions.

WARNING!

Improper installation of a child restraint to the LATCH anchorages can lead to failure of an infant or child restraint. The child could be badly injured or killed. Follow the manufacturer's directions exactly when installing an infant or child restraint.

Installing Child Restraints Using the Vehicle Seat Belt

Child restraints can be securely fastened in the passenger seat using the seat belts. For this purpose, the passenger seat belt retractor provides two modes of operation - normal emergency locking and automatic locking. For child restraint installation, the retractor switches to automatic locking when the belt is pulled out to the full extent of its travel. As the belt retracts, the retractor locks to prevent the belt from being pulled out again. Pulling the belt snugly over the child restraint toward the retractor secures the restraint in place. When the belt retracts fully after child restraint removal, normal (emergency locking)

retractor action is restored. Any seat belt system will loosen with time, so check the belt occasionally and pull it tight if necessary.

If your child restraint is equipped with a tether strap, attach it to the vehicle by first moving the seat back fully forward. Next, route the child restraint tether directly over the top of the seat, through the strap near the top of the seat back, and attach the hook to the anchor bar. Recline the seat back and move the passenger seat as far rearward as possible. Remove slack in the tether strap as you push the child restraint downward and rearward, following the child restraint manufacturer's instructions.

Child Restraint Tether Anchor - General Information

Child restraints having tether straps and hooks for connection to tether anchors have been available for some time. In fact, many child restraint manufacturers will provide add-on tether strap kits for certain of their older products. There is a tether strap anchor behind the passenger seat.

To attach the tether strap to the anchor, move the seatback fully forward. Pass the child restraint tether hook over the top of the seat, through the strap near the top of the seat back, and attach it to the anchor bar behind the passenger seat, below the seatback. After securing the tether hook to the bar, recline the seatback fully rearward and move the seat to its most rearward position.

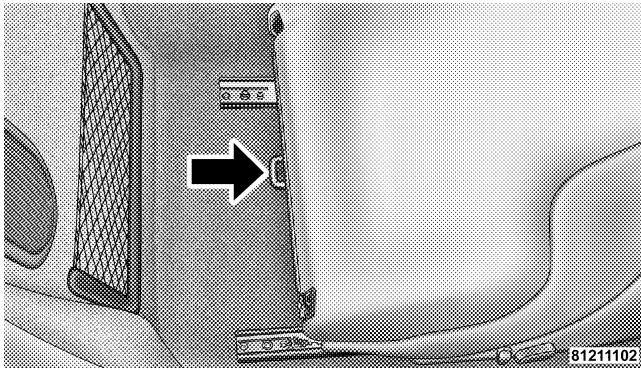

Install the child restraint and return the seatback to an upright position. Remove slack from the tether strap according to the child restraint manufacturer's directions.

2

WARNING!

An incorrectly anchored tether strap could lead to increased head motion and possible injury to the child. Use only the anchor position directly behind the child seat to secure a child restraint top tether strap.

Transporting Pets

Deploying airbags could harm your pet. An unrestrained pet will be thrown about and possibly injured, or injure a passenger during panic braking or in a collision.

Pets should be restrained in pet harnesses or pet carriers that are secured by seat belts.

ENGINE BREAK-IN RECOMMENDATIONS

The engine in your new Crossfire does not require a long break-in period. Following these few simple guidelines is all that is necessary for a good break-in.

- Drive your vehicle at moderate vehicle and engine speeds during the first 1,000 miles (1,600 km).
- Do not make any full throttle starts and avoid full throttle acceleration.
- Use the proper transmission gear for your speed range.
- Avoid excessive idling.
- Check the engine oil level at every fuel fill.

NOTE: A new engine may consume some oil during the first few thousand miles of operation. This should be considered as a normal part of the break-in and not an indication of a problem.

SAFETY TIPS

Exhaust Gas

WARNING!

Exhaust gases can injure or kill. They contain carbon monoxide (CO) which is colorless and odorless. Breathing it can make you unconscious and can eventually poison you. To avoid breathing (CO) follow the safety tips below.

- Do not run the engine in a closed garage or in confined areas any longer than needed to move your vehicle in or out of the area.
- If it is necessary to sit in a parked vehicle with the engine running, adjust your heating or cooling controls to force outside air into the vehicle. Set the blower at high speed.
- To avoid drawing exhaust gases into the vehicle, close the rear liftgate/decklid while driving. However, if for some reason it must remain open, close all windows. Adjust the heating or cooling system to force outside air into the vehicle. Set the blower at high speed.

Safety Checks You Should Make Inside the Vehicle

Seat Belts

Inspect the belt system periodically, checking for cuts, frays and loose parts. Damaged parts must be replaced immediately. Do not disassemble or modify the system.

Seat belt assemblies must be replaced after an accident if they have been damaged (bent retractor, torn webbing, etc.). If there is any question regarding belt or retractor condition, see your authorized dealer.

Airbag Light



The light should come on and remain on for four seconds as a bulb check when the ignition switch is first turned ON. If the bulb is not lit during starting, have it replaced. If the light stays on or comes on while driving, have the system checked by an authorized dealer.

Defrosters

Check operation by pressing the A/C control button, selecting the defrost mode and placing the blower control on high speed. You should be able to feel the air directed against the windshield.

Periodic Safety Checks You Should Make Outside the Vehicle

Tires

Examine tires for excessive tread wear or uneven wear patterns. Check for stones, nails, glass, or other objects lodged in the tread. Inspect for tread cuts or sidewall cracks. Check wheel nuts for tightness and tires for proper pressure.

Lights

Have someone observe the operation of exterior lights while you work the controls. Check turn signal and high beam indicator lights on the instrument panel.

Fluid Leaks

Check area under vehicle after overnight parking for fuel, water, oil, or other fluid leaks. Also, if gasoline fumes are present, the cause should be corrected immediately.

NOTE: Use of the air conditioning may cause puddles of water to form under the vehicle.

UNDERSTANDING THE FEATURES OF YOUR VEHICLE

CONTENTS

■ Convertible Top Operation52	■ Mirrors66
□ To Lower The Top53	□ Inside Day/Night Mirror66
□ To Raise The Top57	□ Exterior Mirrors Folding Feature66
□ Convertible Top Lamp And Audible Signal Chart60	□ Heated Remote Control Mirrors66
■ Console Features61	□ Outside Mirrors66
□ Storage Compartments62	□ Power Remote Control Outside Mirrors67
□ Ashtray63	□ Vanity Mirrors68
□ Coin Holder64	■ Seats68
□ Power Outlet/Cigar Lighter64	□ Driver Eight-Way Power Seat68
□ Glove Compartment65	□ Passenger Four-Way Power Seat69
■ Cupholder65	□ Heated Seats70

50 UNDERSTANDING THE FEATURES OF YOUR VEHICLE

■ To Open And Close The Hood70	□ Mist Function78
■ Interior Lights71	■ Telescoping Steering Column79
□ Front Map/Reading Lights72	■ Tire Pressure Monitor System80
□ Battery Saver Feature72	■ Rear Spoiler82
□ Instrument Panel Lighting72	■ Brake Assist System (BAS)85
□ Night Security Illumination72	■ Electronic Stability Program (ESP)86
■ Exterior Lights73	□ Synchronizing ESP88
□ Headlights And Parking Lights73	■ Electronic Speed Control88
□ Daytime Running Lights (Where Applicable) . .	.73	□ To Vary The Speed Setting90
□ Fog Lights74	□ To Deactivate90
□ Standing Lights74	□ To Resume Speed91
■ Multifunction Control Lever75	□ Using Speed Control On Hills91
□ Turn Signals75	■ Garage Door Opener92
□ Headlight Dimmer Switch76	□ Programming The Universal Transceiver92
□ Passing Light76	□ Gate Operator/Canadian Programming95
□ Windshield Wipers And Washer77	□ Using The Universal Transceiver95

UNDERSTANDING THE FEATURES OF YOUR VEHICLE		51	
□ Erasing Universal Transceiver Buttons95	□ Security96
□ Reprogramming a Single Button96	■ Umbrella Hook96

CONVERTIBLE TOP OPERATION

WARNING!

The convertible top does not provide the structural protection that a reinforced metal roof does and the fabric top cannot be expected to prevent the ejection of the occupants of a vehicle in a collision. Therefore, it is important that all occupants wear their seat belts at all times when riding in a convertible. Studies have shown that it is generally safer to remain inside a vehicle during a collision than to be ejected from the vehicle.

For safety reasons, the convertible top should only be opened and closed when the vehicle is standing still. Top operation is allowed up to a maximum of 9 mph (15 km/h). Above this speed, top operation will cease and an audible warning will sound. The top operation can be resumed after the vehicle is below the maximum speed by pressing the convertible top switch again.

WARNING!

Before operating the switch for the convertible top, make sure that no persons can be injured by the moving parts (convertible top frame and tonneau cover).

Hands must never be placed near the sport bar, convertible top frame, upper windshield area, shelf behind sport bar, or convertible top storage compartment while the convertible top is being raised or lowered. Serious personal injury may occur.

If potential danger exists, release the convertible top switch. This immediately interrupts the raising or lowering procedure. You then can operate the convertible top switch to raise or lower the convertible top away from the danger zone.

CAUTION!

When opening and closing the convertible top, make sure that:

- There is sufficient clearance of at least 6 ft. (1.8m) for the convertible top to move up.
- Nothing is placed on the tonneau cover.
- The outside temperature is above 32°F (0°C).

Otherwise the convertible top and other parts of the vehicle could be damaged.

To Lower The Top:

WARNING!

Top operation can be suspended for a maximum of 10 minutes. Thirty seconds before the end of this period an audible warning will begin to sound continuously. At the end of this period, hydraulic pressure will be released and the top and tonneau cover will slowly collapse. In order to re-initialize the top cycle, the tonneau cover must be lowered to its full open position manually. Hands should be kept away from moving parts of the top compartment mechanism to avoid injury as hydraulic pressure is reestablished. The hydraulic pressure can be reestablished by turning the ignition to the ON/RUN position and pushing down on the convertible top switch twice. Refer to Convertible Top Emergency Operation in the What To Do In Emergencies section of this manual.

CAUTION!

To avoid possible damage to the tonneau cover and convertible top, do not allow the convertible top to remain in the suspended position. After approximately 10 minutes in the suspended position, the hydraulic pressure will be released which will allow the top and the tonneau cover to lower. The convertible top switch can be pressed to cancel this operation.

CAUTION!

To avoid damage to either the top or the rear window, check the tonneau cover area at the rear of the vehicle interior to be sure that it is clear of debris or other items. Do not use the tonneau cover area for other storage purposes.

CAUTION!

To fully insure that no damage occurs, be sure that the vehicle is at a complete stop before attempting to lower or raise the top.

NOTE: If the top stops during the raising or lowering procedure, start the engine and continue operation.

1. Make sure the rear cargo compartment divider is unfolded and secured in the vertical position.

If the divider is in its stowed position, first unfold the panels towards the rear of the vehicle. Pull up on the vertical panel using the center cutout shown, and hook the pins at the top into the brackets mounted to the cargo compartment trim on each side near the forward edge of the decklid opening. The pins must be hooked in these brackets in order for the top to operate.

NOTE: See label attached to underside of decklid.

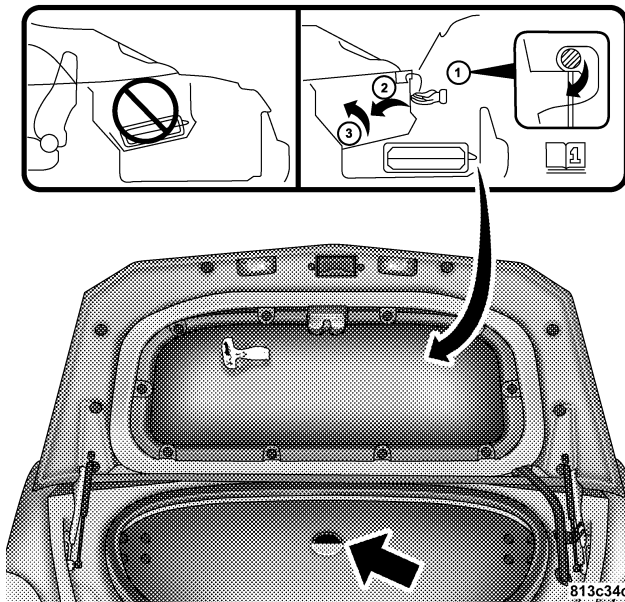

2. Make sure the decklid is closed.

CAUTION!

Be sure to turn the ignition to the "ON/RUN" position before releasing the top from the windshield header. The windows will not go down if the top is released from the header without the ignition turned "ON". The side windows can be damaged if the doors are opened or closed with the windows up and the top released from the windshield header.

3

3. Turn the ignition key to the ON/RUN position.
4. Unlock the top from the windshield header by pushing the latch handle release button, pulling the latch handle down and turning it clockwise one quarter turn.

NOTE: Once the release handle is rotated, the windows will automatically go down.

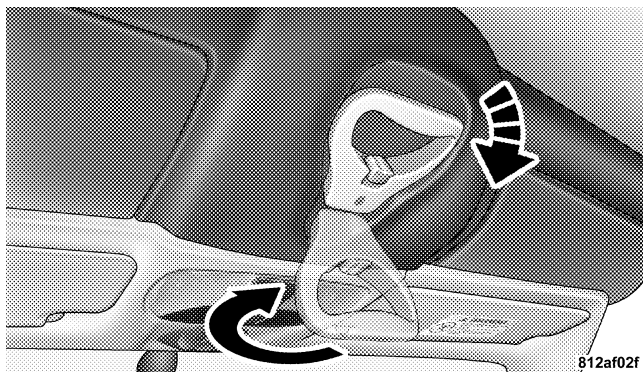

5. Push up on the convertible top latch handle to create a gap between the header and top of approximately 8 inches (200 mm). As soon as the top is free, rotate the latch handle counterclockwise just over one quarter turn and push it up into the stored position.

NOTE: Failure to perform any of these steps will prevent the top from operating with the convertible top switch and will cause an audible information signal to sound.

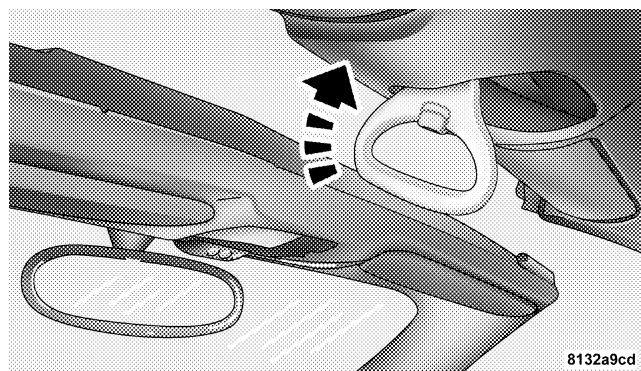

6. Push down on the rear of the convertible top switch to begin top operation. The rear of the top will unlatch and the tonneau cover will open before the top begins to fold. Hold the switch down until the convertible top is completely lowered into its storage compartment and the tonneau cover is closed and latched. A single audible signal will sound to indicate completion of the top opening operation.

NOTE: Once the top is lowered and the audible signal is heard, you can continue to push the convertible top switch down or push it within 2 seconds to raise the windows.

The windows can also be closed/opened later using the power window switches.

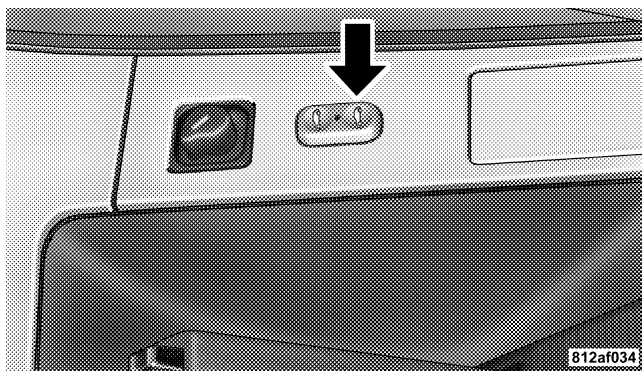

CAUTION!

To prevent mildew, the convertible top must be dry before lowering it into the storage compartment.
Do not lower a frozen convertible top until thawed and dry. Doing so may result in damage not covered by the DaimlerChrysler Limited Warranty.

3

CAUTION!

Do not place anything on the tonneau cover.
The tonneau cover must never be used as a seating area.

To Raise The Top:

1. Make sure the rear cargo compartment divider is still secured in the vertical position.
2. Make sure the decklid is closed.

58 UNDERSTANDING THE FEATURES OF YOUR VEHICLE

3. Turn the ignition key to the ON/RUN position and press down on the front of the convertible top switch.

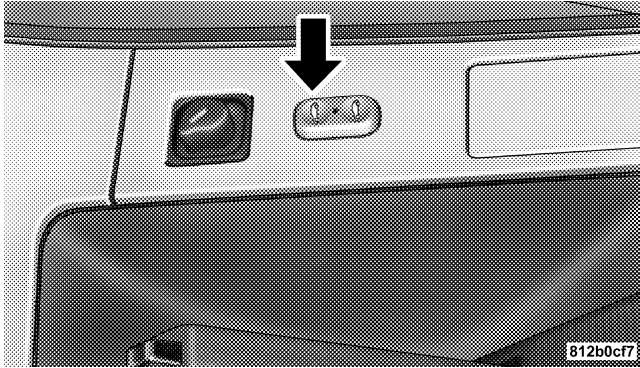

4. If the windows are raised, they will lower as soon as the convertible switch is pressed down. The tonneau cover will open, and the top will then close until it reaches approximately 8 inches (200 mm) from the header. The tonneau cover will then close and the rear of the top will close and latch. At the completion of this cycle, a single audible signal will sound.

NOTE: If the top is latched to the windshield header before the rear of the top is properly latched, an audible warning will sound.

5. Push the latch handle release button, pull the latch handle down from the storage position and turn it clockwise just over one quarter turn.

6. Pull the latch handle and convertible top down to engage the top with the header.

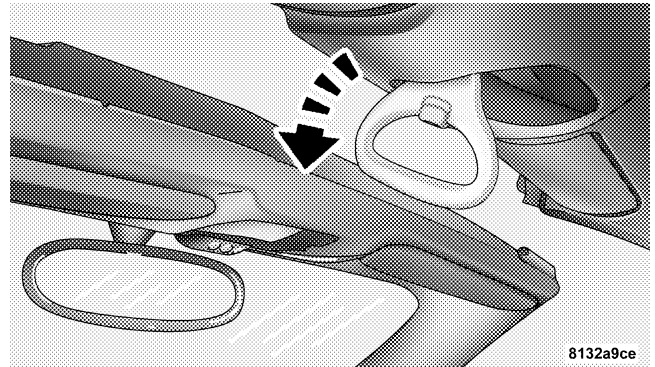

7. When the top engages to the header, turn the latch handle counterclockwise just over one quarter turn to the lock position and push the latch handle up to the stored position. The top is now secured in the closed position.

NOTE: The convertible top switch indicator will light up and an audible warning will be heard if you start driving the vehicle without the top fully locked in the closed position.

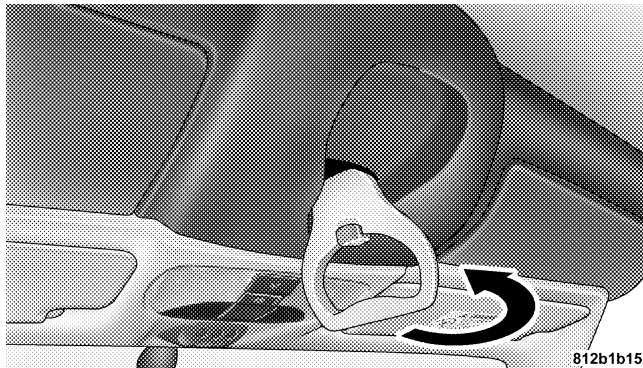

812b1b15

WARNING!

To prevent possible accidents, drive the vehicle only with the convertible top either completely closed and locked, or fully lowered into its storage compartment.

3

8. Once the top has been raised and locked, the cargo compartment divider can be unhooked and folded forward to increase the cargo compartment capacity. Follow the steps shown on the label affixed to the decklid trim.

CAUTION!

Once the cargo compartment divider is folded forward to increase the cargo compartment capacity, the tonneau cover flaps are exposed and can be damaged by long items being put into the cargo compartment.

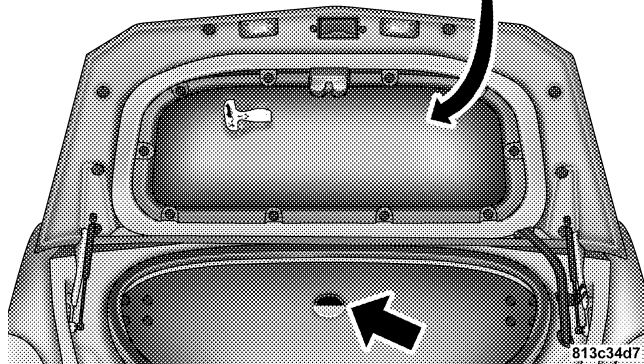
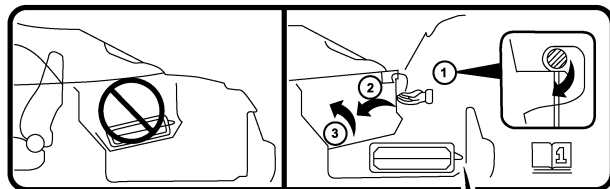

Convertible Top Lamp and Audible Signal Chart

Below is a table containing all of the visual and audible signals that can be seen or heard during the tops operation or if a fault is present.

Visual and Audible Signals	Operation Mode or Fault
Single audible signal is heard	Roof reaches fully open position
	Roof reaches fully closed position
Convertible top switch lamp flashes slowly and a slow audible beep is heard	Decklid open
	Cargo compartment divider not secured in vertical position
	Top latched at windshield header
	Top unlatched but not released from windshield header
	Vehicle speed greater than 9 mph (15 km/h) while trying to operate the top
	Battery voltage less than 10.6 Volts

Convertible top switch lamp flashes quickly and a quick audible beep is heard	Maximum hydraulic pump run-time reached
	Power window motor(s) or rear spoiler inoperative
	Vehicle speed greater than 9 mph (15 km/h) during top operation
	Top operation suspended longer than 10 minutes
Convertible top switch lamp flashes rapidly	General top control module fault

Operating controls for the heating and air conditioning systems, power windows, power mirrors, convertible top switch (if equipped), and the automatic transmission program mode selector switch (if equipped) are also located in the console.

3

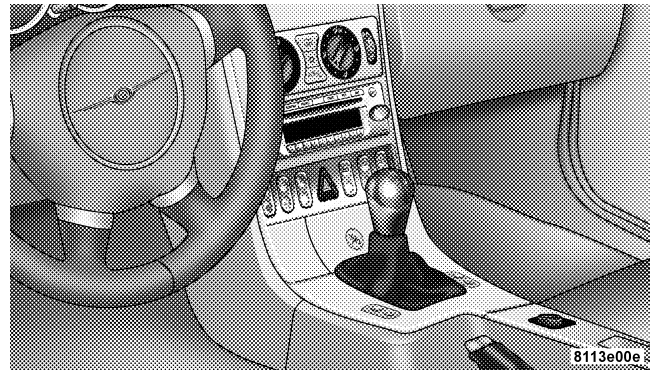

CONSOLE FEATURES

The console has a power outlet/cigar lighter, an ash tray with a coin holder, a cupholder, and the passenger airbag light. In addition, there are switches to control the heated seats, rear spoiler, electronic stability program (ESP), hazard flashers, central locking, rear defroster and towing alarm.

Storage Compartments

There is a storage compartment in the console. To open the storage compartment, lift the lid with the finger depressions on either side. To close, lower the lid until the lock engages.

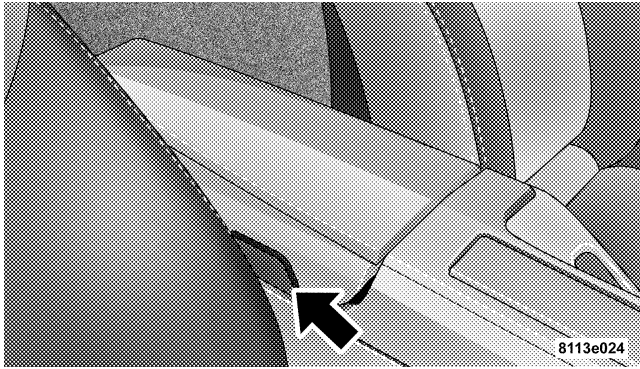

A cargo net for storage is located in the footwell area on the passenger side.

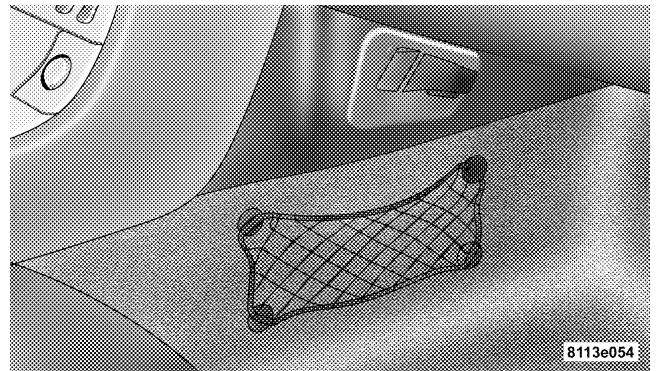

Additionally, storage pockets are located on the wall behind each seat and on each door panel.

A storage pouch is located on the rear wall between the seats, and the driver's sunvisor has a document strap.

WARNING!

Keep compartment lids closed. This will help to prevent stored objects from being thrown about and injuring vehicle occupants during an accident.

Ashtray

Lightly touch the bottom of the ashtray cover. The ashtray will open automatically.

To remove the ashtray insert, pull the ashtray past the detent. Hold both sides of the insert, and pull up. To install the ashtray, place it in the frame and push down to engage.

WARNING!

Remove the ashtray only with the vehicle stopped and the ignition off. Otherwise, the vehicle might move unexpectedly as a result of unintended contact with the gear selector lever.

3

Coin Holder

With the ashtray open, folding down the cover plate reveals the coin holder, which can accommodate nine coins in various sizes up to a U.S. quarter. The coin slots are shaped to retain the coins, and the cover plate ensures that the coins remain in the coin holder.

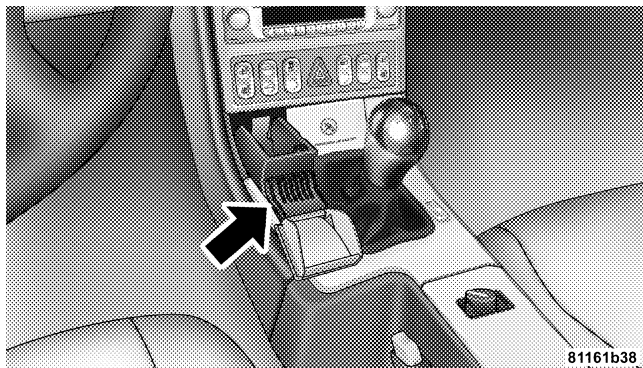

Power Outlet/Cigar Lighter

The dual-purpose power outlet is located in the console, next to the passenger airbag off warning light. The power outlet can accommodate a lighter or electrical accessories

up to a maximum of 15 amps. The outlet is protected by a 15 amp fuse, located behind the fuse cover on the left end of the instrument panel.

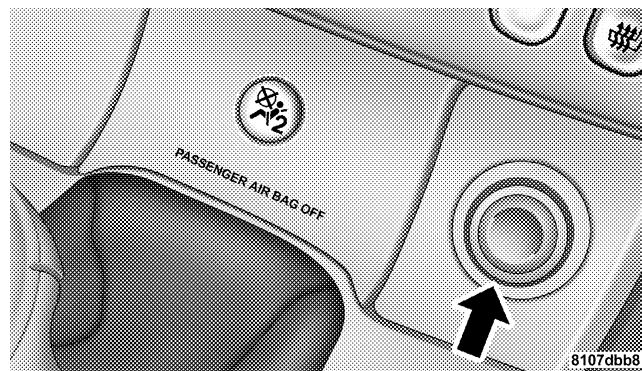

The lighter will operate only when the ignition switch is in the ON/ACC position. It heats up when pushed in and pops out automatically when ready for use. To preserve the heating element, do not hold the lighter in the heating position.

Glove Compartment

To lock the glove compartment, turn the key to the right and remove. To unlock, turn the key to the left and remove.

Pull on the handle to open the glove compartment.

CUPHOLDER

The cupholder is located in the console. To open the cupholder, gently press downward on the front edge of the top panel, and then release. The cupholder will open automatically.

When the cupholder is no longer needed, push forward on the top edge of the door and rotate it down into the console until it engages.

The cupholder is designed to hold beverage containers up to 20 oz. (1 L).



CAUTION!

Only use containers that fit into the cupholder. Overfilled containers could spill during vehicle maneuvers.

MIRRORS

Inside Day/Night Mirror

Adjust the mirror to center on the view through the rear window. A two point pivot system allows for horizontal and vertical mirror adjustment.

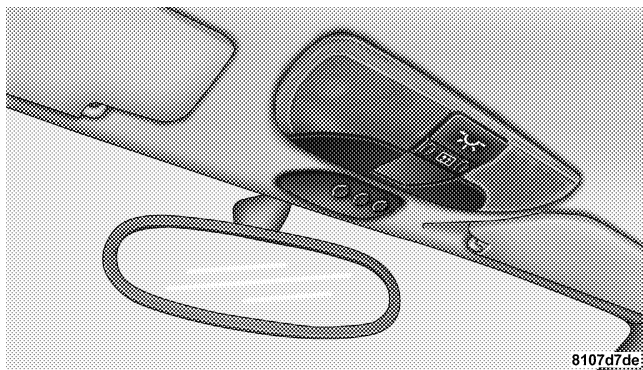

Annoying headlight glare can be reduced by moving the small control under the mirror to the night position (toward rear of vehicle) The mirror should be adjusted with the glare control set in the day position (toward windshield).

Exterior Mirrors Folding Feature

All exterior mirrors are hinged to move forward or rearward to resist damage. The hinges have three detent positions: full forward, full rearward, and normal.

Heated Remote Control Mirrors

Both outside mirrors are heated to melt frost or ice when the Rear Window Defroster switch is depressed.

Outside Mirrors

Adjust the outside mirrors to center on the adjacent lane of traffic, with a slight overlap of the view seen in the inside mirror.

WARNING!

Vehicles and other objects seen in the passenger side convex mirror will look smaller and farther away than they actually are. Relying too much on your passenger side mirror could cause you to collide with another vehicle or other object. Use your inside mirror to judge the size or distance of objects seen in the convex mirror.

Power Remote Control Outside Mirrors

The mirrors can be adjusted by using the remote control located in the console. Rotate the switch to the right to select the right mirror, rotate to the left to select the left mirror. Then use the switch to adjust the selected mirror to the desired direction.

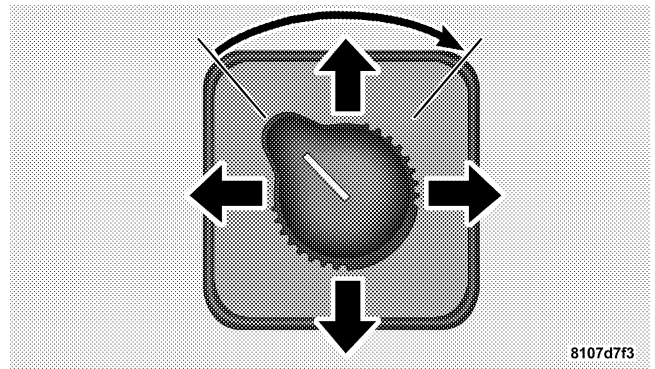
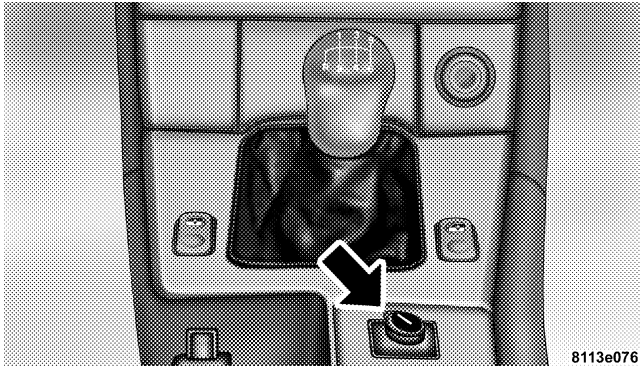

Vanity Mirrors

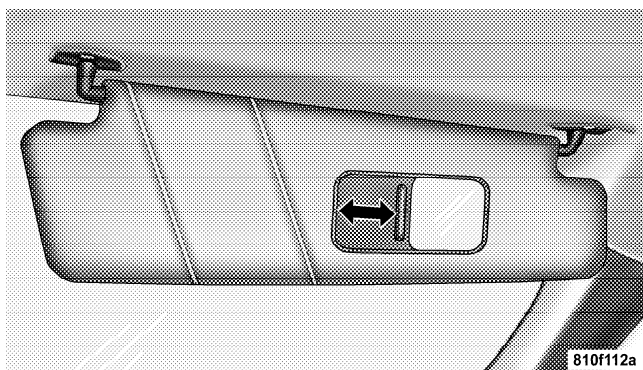

A vanity mirror is on each sun visor. To use the mirror, rotate the sun visor down and slide open the mirror cover.

SEATS

Driver Eight-Way Power Seat

The switches to adjust the power seats are located on the outboard side of each seat. The driver's seat features eight-way power adjustment - horizontal, vertical, cushion tilt and back angle.

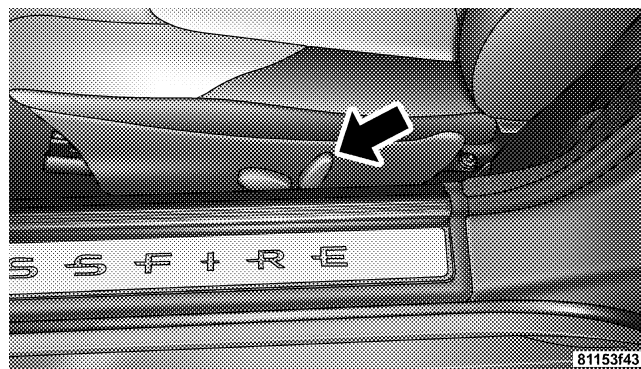

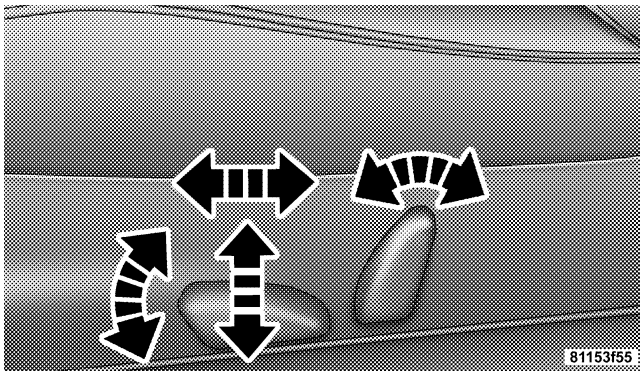

Passenger Four-Way Power Seat

The switches to adjust the passenger seat are also on the outboard side of the seat. The passenger seat provides four-way adjustment - horizontal and back angle.

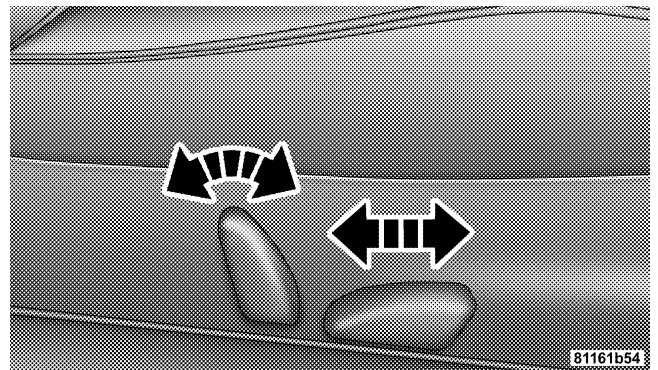

Heated Seats

This feature heats the driver and passenger seats. The controls for the heated seats are located on the instrument panel, below the radio.

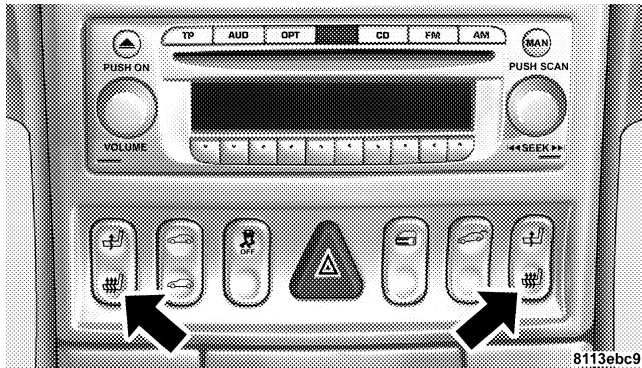

After turning the ignition switch ON, you can choose the HI, LO, or OFF setting. Indicators on the switches show which setting has been selected.

The heated seats setting will automatically switch from HI to LO after approximately 5 minutes.

TO OPEN AND CLOSE THE HOOD

To open the hood, pull the release lever located inside your vehicle, below the instrument panel.

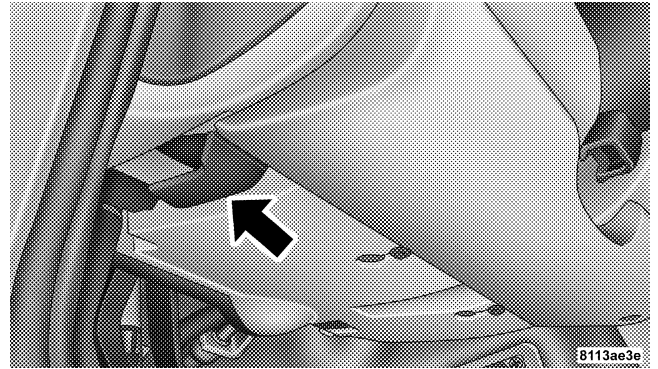

Then, reach under the hood and pull upward on the safety latch and lift the hood.

To prevent possible damage, close the hood by dropping it from approximately 12 inches (30 cm).

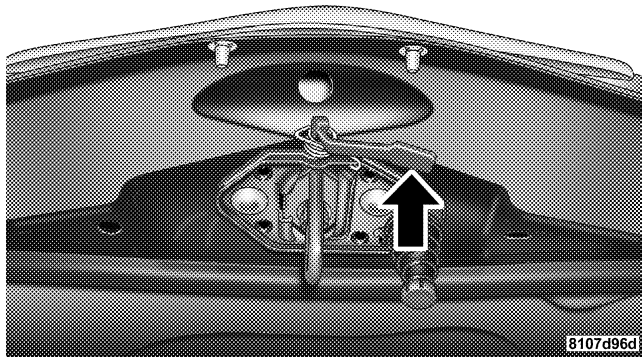

WARNING!

If the hood is not fully latched, it could fly up when the vehicle is moving, and block your forward vision. You could have a collision. Be sure all hood latches are fully latched before driving.

INTERIOR LIGHTS

A two-position mode selector switch controls the interior lights located in the overhead console.

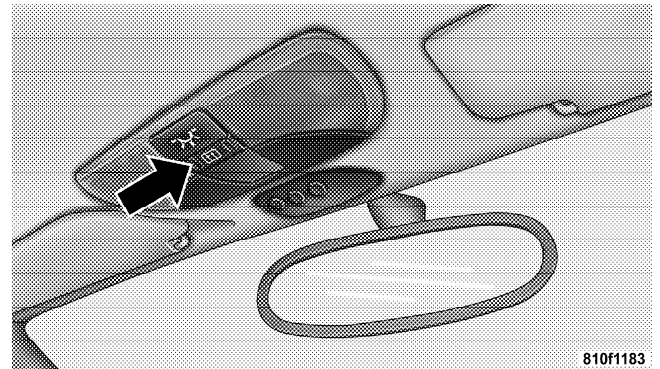

3

The AUTO mode turns the lights on when a door is open or ajar, or when locking or unlocking the vehicle. AUTO mode also has a "fade to off" feature. When the doors are closed or locked, they gradually "fade" off.

The OFF position turns off the interior lights feature.

Front Map/Reading Lights

These lights are located between the sun visors. A single centrally located switch operates both lights.

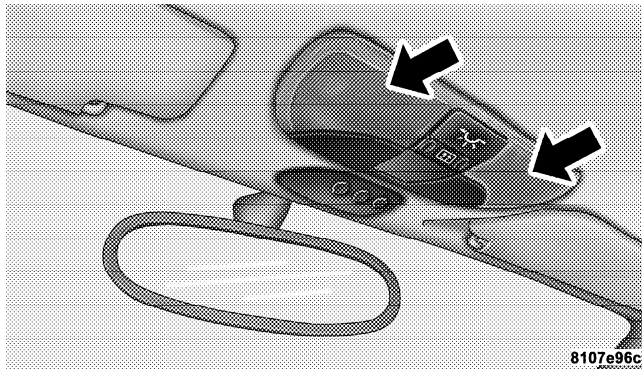

Battery Saver Feature

To prevent battery drain if a door is left open or ajar, the interior lights will turn off automatically after 15 minutes. After the door is closed, the interior lights will return to their normal function.

Instrument Panel Lighting

With the parking lights or headlights on, rotate the dimmer control to the left of the speedometer to increase or decrease brightness of the instrument panel.

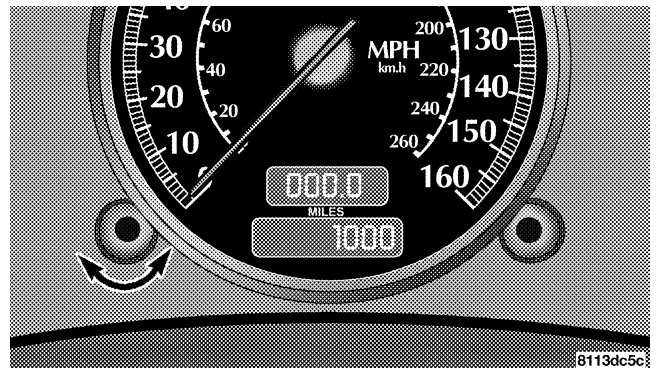

Night Security Illumination

For added security when exiting the vehicle after driving with the exterior lights on, the lights will switch on again for approximately 30 seconds after closing the last door. The lights-on timing can be changed at your authorized dealer.

EXTERIOR LIGHTS

Headlights and Parking Lights

When the headlight switch is turned clockwise from OFF to the first position, the parking lights, taillights, side marker lights, license plate lights and instrument panel lights are all illuminated.

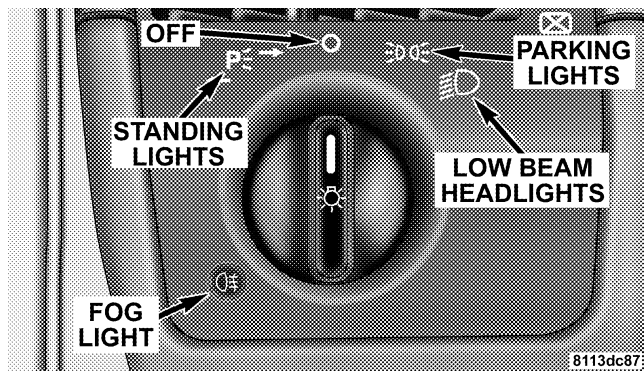

The headlights turn on when the switch is turned to the second position.

Lights-On Reminder

If the headlights or parking lights are left on after the ignition is turned off, a warning will sound if the driver's door is opened.

Daytime Running Lights (Where Applicable)

VEHICLES WITH AUTOMATIC TRANSMISSION

The low beam headlights, parking lights, side marker lights, taillights and license plate lights are automatically switched on whenever the vehicle is started and the transmission gear selector is in a driving position.

VEHICLES WITH MANUAL TRANSMISSION

The low beam headlights, parking lights, side marker lights, taillights, and license plate lights are automatically switched on whenever the vehicle is started and the parking brake is released.

For nighttime driving, the exterior lights switch should be in the low beam position to permit activation of the high beam headlights.

Fog Lights



To operate the fog lights, pull the headlight switch out one stop, with the parking lights and/or low beam headlights on. A light to the lower left of the headlight switch will illuminate when the fog lights are on.

To turn off the fog lights, push the headlight switch in fully. Selecting high beam headlights will also turn off the fog lights.

Standing Lights

When the vehicle is parked on the street, the standing lights (left or right side parking lights) can be turned on, making your vehicle more visible to passing vehicles.

To operate the standing lights, turn the headlight switch counterclockwise one stop (right lamps) or two stops (left lamps) from the OFF position. To turn off the standing lights, return the headlight switch to the OFF position.

The standing lights cannot be operated when the ignition switch is in the ON/RUN position.

CAUTION!

Standing lamps are intended for short term use when parking. If these lights are left on for a long period of time, your car's battery may drain, causing a possible starting problem. Assure that the headlamp switch is in the OFF position when leaving the vehicle.

MULTIFUNCTION CONTROL LEVER

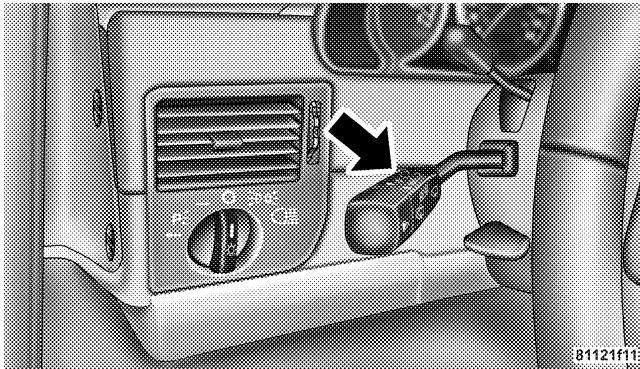

Turn Signals

Move the multifunction control lever up to activate the right turn signal; move the lever down to activate the left turn signal. An arrow on the inside of the speedometer will flash to indicate operation.

To signal minor directional changes, such as changing lanes, move the control lever just to the point of resistance, and hold it there.

To operate the turn signals continuously, move the control lever up or down past the point of resistance. The operation is automatically canceled when the steering wheel is turned to a large enough degree.

If one of the turn signal lights fail, the turn signal indicator system flashes and sounds at a faster than normal rate. If an indicator fails to light when the control lever is moved, it may mean that the fuse or indicator bulb is defective.

3

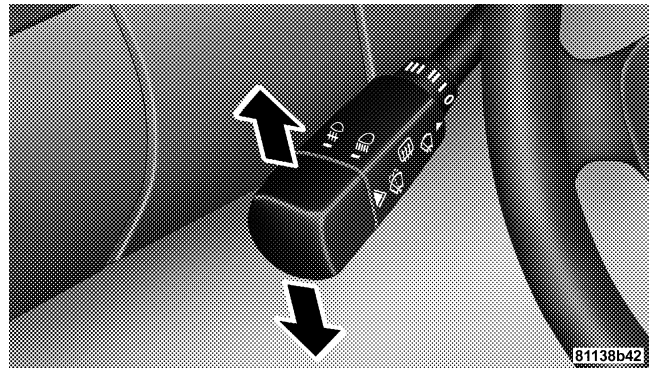

Headlight Dimmer Switch

Push the multifunction control lever toward the instrument panel to turn the headlights to high beam. Pull the lever toward you to switch to low beam.

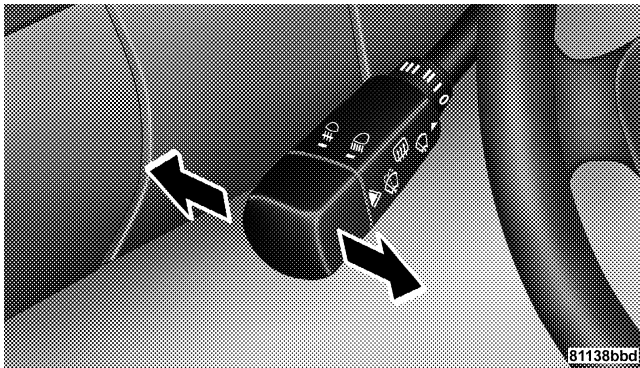

Passing Light

You can signal another vehicle with your headlights by lightly pulling the multifunction control lever toward the steering wheel. This will cause the headlight to turn on at high beam and remain on until the control lever is released.

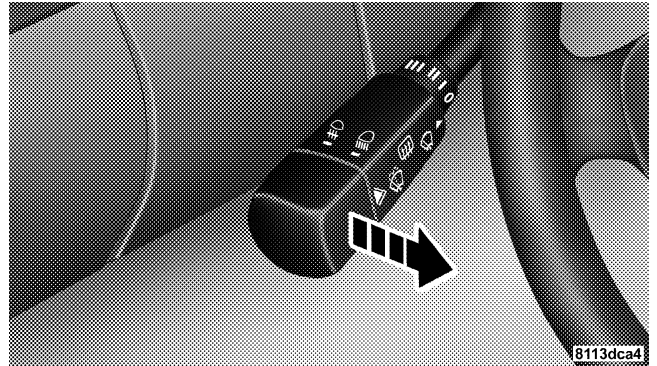

Windshield Wipers And Washer

The wipers and washer are operated by a switch in the multifunction control lever. Turn the end of the lever to select desired wiper speed: off, intermittent, normal, or fast.

Push the end of the lever inward and hold it to activate the wiper and washer together.

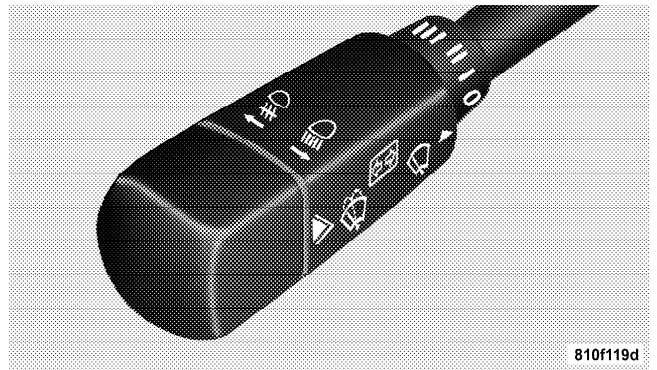
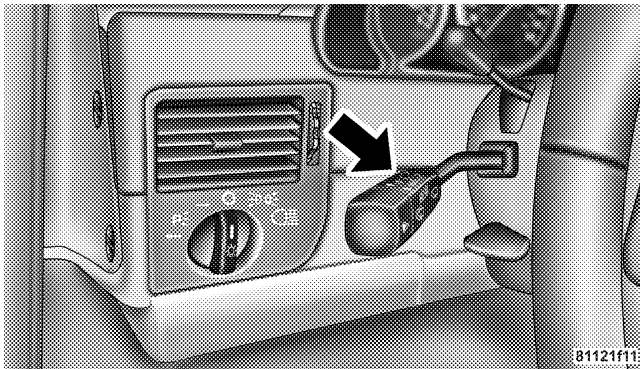

Mist Function

Push the end of the multifunction control lever inward briefly for a single wipe without adding washer fluid. Use this feature only when the windshield is wet.

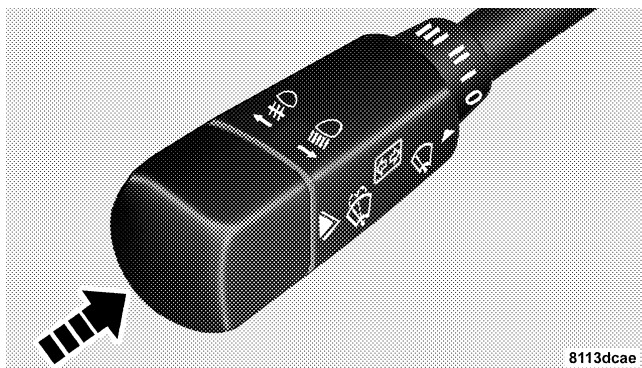

8113dcae

WARNING!

Sudden loss of visibility through the windshield could lead to an accident. You might not see other vehicles or other obstacles. To avoid sudden icing of the windshield during freezing weather, warm the windshield with the defroster before and during windshield washer use.

TELESCOPING STEERING COLUMN

Unlock the steering column by pulling out the handle located directly below the column. The indicator light located in the instrument cluster will come on. To lengthen or shorten the steering column, pull out or push in the steering wheel. Lock the steering column in position by pushing the handle in until it engages. The indicator light in the instrument cluster will go out.

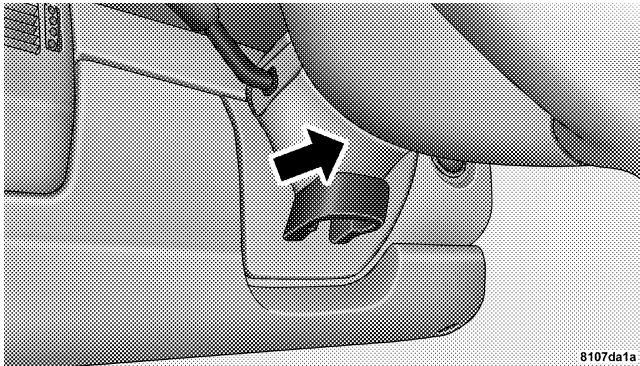
**WARNING!**

Do not adjust the steering wheel while driving. The telescoping adjustment must be locked while driving. Adjusting the steering wheel while driving, or driving without the telescoping adjustment locked could cause the driver to lose control of the vehicle.

NOTE: If the indicator light in the instrument cluster does not go out after starting the engine, the telescoping column is not locked properly. Do not drive the vehicle until you have properly locked the steering column.

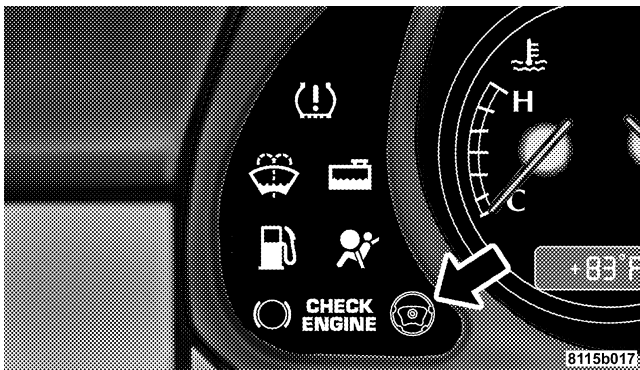

TIRE PRESSURE MONITOR SYSTEM

The Tire Pressure Monitor (TPM) system uses wireless technology to monitor tire pressure levels. Sensors mounted to each wheel as part of the valve stem transmit tire pressure readings to a receiver located inside the vehicle.

NOTE: The TPM system can inform you about a low tire pressure condition, but it does not replace normal tire maintenance. The TPM system is not intended to provide you with notification of rapid tire pressure loss.

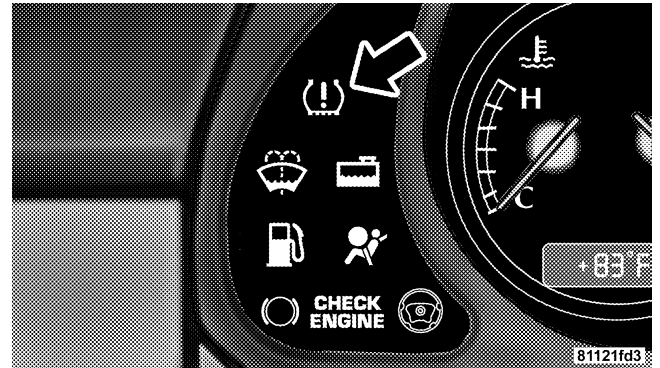

CAUTION!

The TPM system is designed to monitor your tire pressure and will not function as a tire pressure gauge. After adjusting the air pressure in a tire, there will be a delay before the system updates the display.

The TPM system will cause the indicator lamp in the instrument cluster to illuminate whenever the pressure in one tire falls 25% below the recommended pressure shown on the vehicle's tire label.

NOTE: The pressure in your tires changes with temperature. A significant decrease in temperature could reduce cold inflation pressure below the TPM setpoint. For example, tires inflated to the proper cold inflation pressure on a warm day or in a warm garage could illuminate the TPM indicator lamp on the following day if the temperature is very cold. **ALWAYS** check the pressure in your tires if the TPM lamp is illuminated.

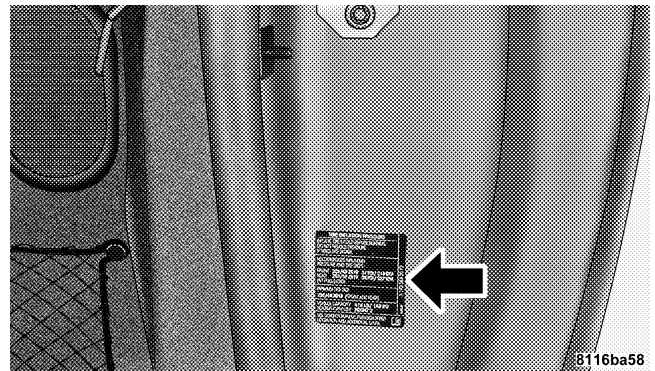
**3****CAUTION!**

The TPM system has been optimized for the original equipment tires and wheels. TPM system pressures have been established for the tire size equipped on your vehicle. Undesirable operation or sensor damage may result when using replacement equipment that is not of the same size, type, and/or style. Aftermarket wheels can cause sensor damage. Do not use aftermarket tire sealant or balance beads, as damage to the sensors may result.

NOTE: The standard TIREFIT system (refer to What To Do In Emergencies for more information) is specifically designed to operate in conjunction with the TPM system, and will not damage the sensors.

If your tire pressure is low, you should correct your tire inflation pressure as soon as possible and inspect all of your tires. Low tire pressure will cause the tire pressure light to illuminate and the alert will sound. They will remain on for the rest of the driving cycle, or until the tire pressure is corrected.

In addition to monitoring tire pressures, the TPM system also monitors faults within the system. If the TPM light and alarm continue after the tire pressure has been corrected, see your authorized dealer.

This device complies with part 15 of FCC rules and with RSS-210 of Industry Canada. Operation is subject to the following conditions:

1. This device may not cause harmful interference.
2. This device must accept any interference that may be received, including interference that may cause undesired operation.

NOTE: Changes and modifications not expressly approved by the party responsible for compliance could void the user's authority to operate the equipment.

REAR SPOILER

CAUTION!

Do not push or pull on the spoiler when deployed. Damage to the spoiler could result.

A rear spoiler enhances vehicle stability. The rear spoiler deploys automatically when vehicle speed reaches approximately 62 mph (100 km/h). The spoiler begins to retract at 39 mph (62 km/h). When retracted, the spoiler fits between the quarter panels, and aft of the liftgate window or tonneau cover.

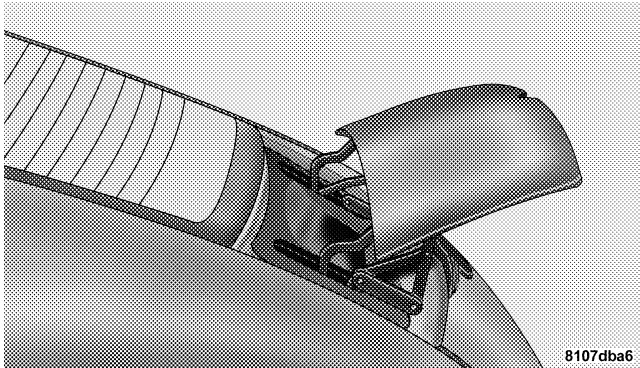

The spoiler can also be deployed at lower speeds using an override switch mounted in the center console.

Once manually deployed, the spoiler will only retract by pressing the bottom of the spoiler switch. The spoiler will then retract in steps as long as the switch is depressed. If the switch is depressed until the spoiler is fully retracted, a short beep will be heard, and automatic control will be reestablished.

The spoiler control also incorporates an emergency stop feature. If, for any reason, spoiler motion needs to be stopped, pressing either the top or bottom of the switch will stop the spoiler motion. Once the deployment speed is reached, however, the spoiler deploys to its full up position.

The spoiler will deploy as a safety precaution if the ESP system detects a large difference in wheel speed between the front and rear wheels. This could occur as a result of a speed signal malfunction, or could occur if the vehicle is attempting to accelerate on a low friction surface causing the rear wheels to spin. The spoiler will remain deployed and the warning light in the spoiler switch will blink until the vehicle is restarted. If the spoiler continues to deploy in this fashion below the normal deployment speed, see your authorized dealer.

84 UNDERSTANDING THE FEATURES OF YOUR VEHICLE

Should a malfunction occur that prevents the spoiler from deploying automatically, a red warning light will illuminate in the override switch and an audible warning will sound.

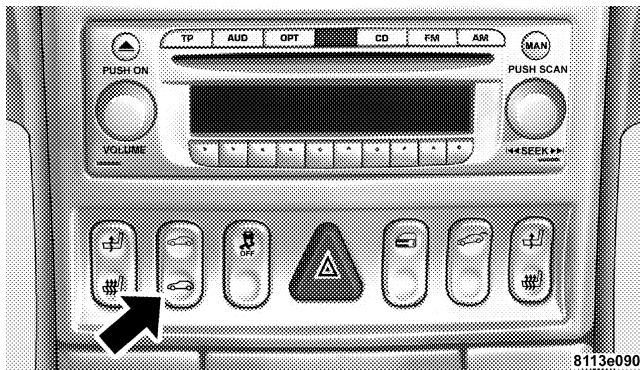

WARNING!

Do not drive the vehicle at speeds above 62 mph (100 km/h) if the red spoiler warning indicator is illuminated. You could have reduced vehicle stability and control.

WARNING!

Keep hands and fingers away from the spoiler and spoiler linkage when the spoiler is deploying or retracting. The linkage could pinch your fingers and cause serious injury.

BRAKE ASSIST SYSTEM (BAS)

WARNING!

BAS cannot prevent the natural laws of physics from acting on the vehicle, nor can it increase braking efficiency beyond that afforded by the condition of the vehicle brakes and tires or the traction afforded. The BAS cannot prevent accidents, including those resulting from excessive speed in turns, following another vehicle too closely, or hydroplaning. Only a safe, attentive, and skillful driver can prevent accidents. The capabilities of a BAS-equipped vehicle must never be exploited in a reckless or dangerous manner which could jeopardize the user's safety or the safety of others.

The BAS is designed to maximize the vehicle's braking capability during emergency braking maneuvers. The system applies maximum power boost to the brakes more quickly in emergency braking conditions than might otherwise be afforded solely by the driver's braking style. This can help reduce braking distances. The

BAS complements the antilock brake system (ABS). Applying the brakes very quickly results in maximum BAS assistance. To receive the benefit of the system, you must apply continuous full braking power during the stopping sequence. Do not reduce brake pedal pressure.

Once the brake pedal is released, the BAS is deactivated.

3

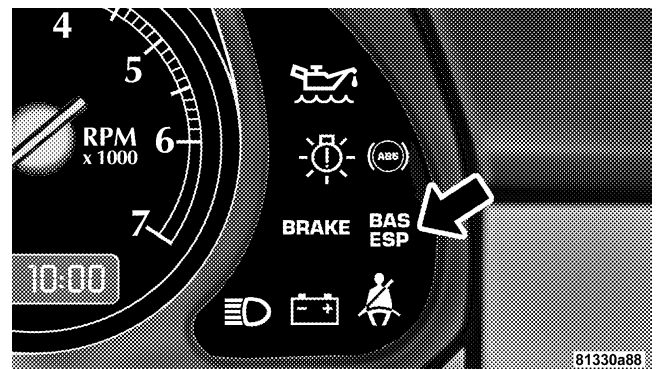

The malfunction indicator lamp for the Electronic Stability Program is combined with the BAS. The yellow BAS/ESP malfunction indicator light in the instrument cluster and the yellow ESP warning light in the speedometer dial come on with the key in the ignition switch

86 UNDERSTANDING THE FEATURES OF YOUR VEHICLE

turned to the ON/RUN position. They should go out with the engine running. If the BAS/ESP malfunction indicator light comes on continuously with the engine running, a malfunction has been detected in either system.

If the malfunction indicator light stays illuminated, have the BAS and ESP checked at your authorized dealer as soon as possible.

ELECTRONIC STABILITY PROGRAM (ESP)

WARNING!

ESP cannot prevent the natural laws of physics from acting on the vehicle, nor can it increase the traction afforded. The ESP cannot prevent accidents, including those resulting from excessive speed in turns, or hydroplaning. Only a safe, attentive, and skillful driver can prevent accidents. The capabilities of an ESP-equipped vehicle must never be exploited in a reckless or dangerous manner which could jeopardize the user's safety or the safety of others.

The ESP enhances directional control and reduces driving wheel spin of the vehicle under various driving conditions.

The ESP system corrects for over/understeering of the vehicle by applying brakes to the appropriate wheel. Engine torque is also limited. The ESP warning light, located in the instrument cluster, starts to flash as soon as the tires lose traction and the wheels begin to spin.

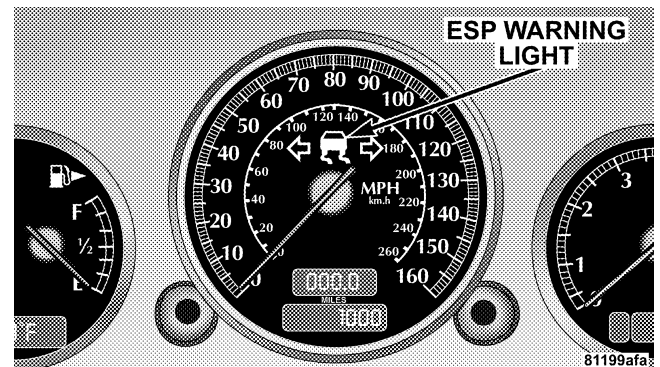

To improve the vehicle's traction when driving with snow chains, or starting off in deep snow, sand or gravel, switch off the ESP system by pressing the upper half of the ESP switch.

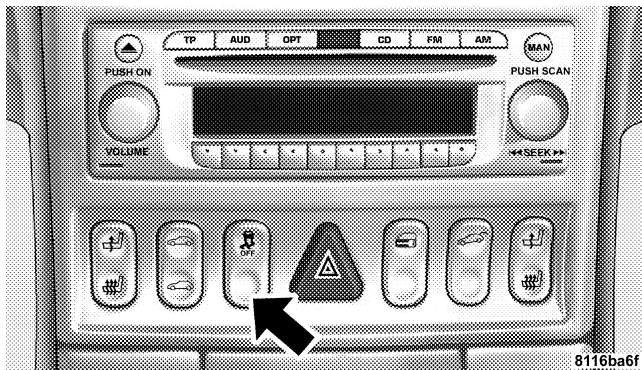

With the ESP system switched off, the engine torque reduction feature is cancelled. Therefore, the enhanced vehicle stability offered by ESP is unavailable. ESP always operates under braking, even with the switch in the OFF position. If one drive wheel loses traction and begins to spin, the brake is applied by the ESP system until the

wheel regains sufficient traction. The traction control engages at approximately 24 mph (40 km/h), and switches off at 50 mph (80 km/h).

If the ESP warning light begins to flash during acceleration, ease up on the accelerator and apply as little throttle as possible. Be sure to adapt your speed and driving to the prevailing road conditions. When the ESP warning light is illuminated continuously, the ESP is switched off. To return to the enhanced vehicle stability offered by ESP, press the lower half of the switch (the ESP warning light in the speedometer dial goes out). Avoid spinning one drive wheel. This may cause serious damage to the drive train and is not covered by the DaimlerChrysler warranty.

3

CAUTION!

If the vehicle is towed with the front axle raised, the engine must be shut off (key in the ignition switch to the OFF/LOCK or ACC position). Otherwise the ESP will immediately be engaged and will apply the rear wheel brakes.

Synchronizing ESP

If the power supply was interrupted (battery disconnected or discharged), the BAS/ESP malfunction indicator light may be illuminated with the engine running. To re-synchronize the ESP, and cancel the malfunction indicator light, the steering angle sensor will need to be recalibrated.

1. Turn the ignition switch to the ON/RUN position.
2. Rotate the steering wheel to the center position.
3. Rotate the steering wheel completely to the left, and then rotate the steering wheel completely to the right.
4. Bring the steering wheel back to the center position.
5. The BAS/ESP malfunction indicator light will go out.

If the BAS/ESP malfunction indicator light is still illuminated, the vehicle should be serviced at an authorized dealer.

ELECTRONIC SPEED CONTROL

The electronic speed control automatically maintains the set speed by actively regulating the throttle setting. Any speed above approximately 20 mph (30 km/h) can be maintained with the electronic speed control by operating the lever.

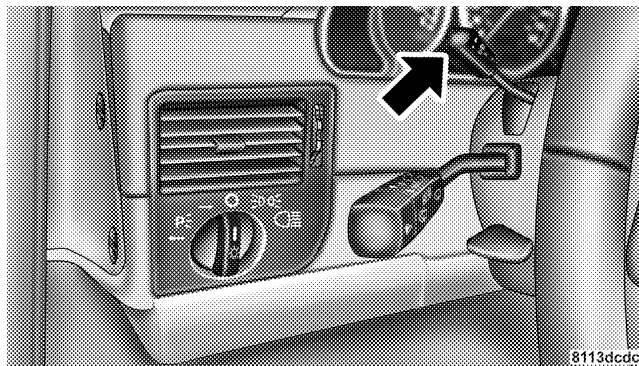

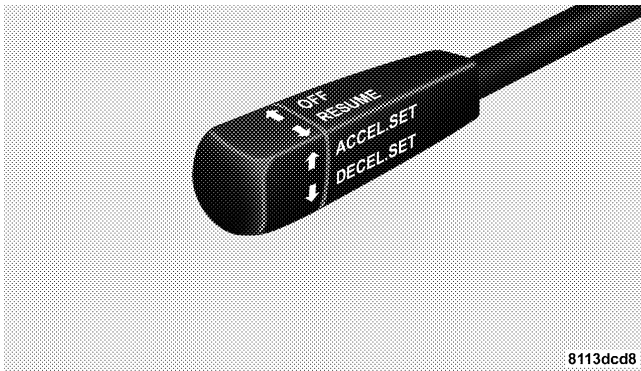

8113dcd8

To accelerate and set a speed, lift the lever up. Lift and hold the lever to accelerate, or lift and release to set a speed. To decelerate and set a speed, press the lever down. Press down and hold the lever to decelerate, or press down and release to set a speed.

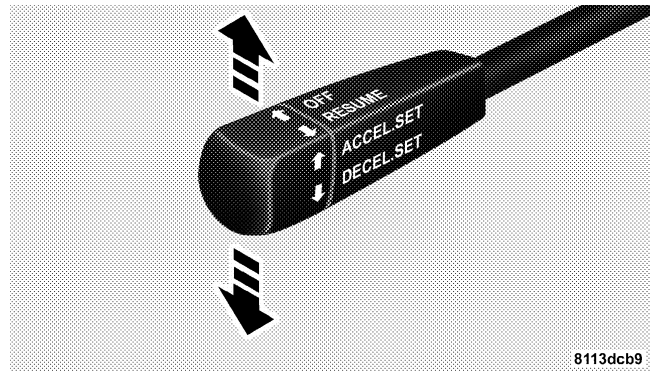

8113dcb9

3

WARNING!

Leaving the electronic speed control system on when not in use is dangerous. You could accidentally set the system or cause it to go faster than you want. You could lose control and have an accident. Always leave the system OFF when you are not using it.

To Vary The Speed Setting

If a set speed needs to be adjusted slightly, lift up or hold down the speed control lever briefly until the desired speed is reached. A single tap on the lever up or down will change the speed in 0.6 mph (1 km/h) increments. When the lever is released, the newly set speed remains.

To increase the speed for passing, use the accelerator. After the accelerator is released, the previously set speed will resume automatically.

To Deactivate

A soft tap on the brake pedal, or normal brake pressure while slowing the vehicle, will deactivate the speed control without erasing the memory. Pushing the speed control lever forward or turning the key in the ignition switch to the OFF/LOCK position will turn off the speed control and erase the memory.

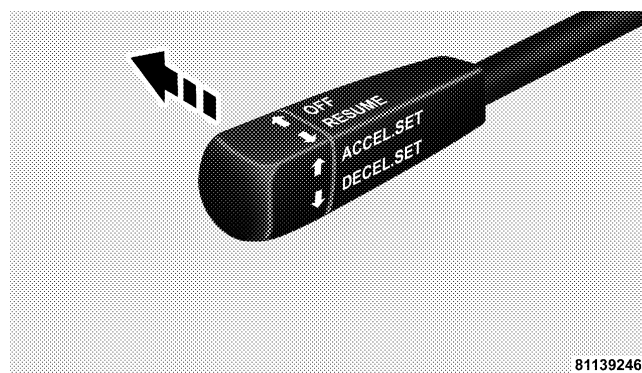

To Resume Speed

To resume a previously set speed, pull the speed control lever toward you, and then release. The resume feature can be used at any speed above 20 mph (30 km/h).

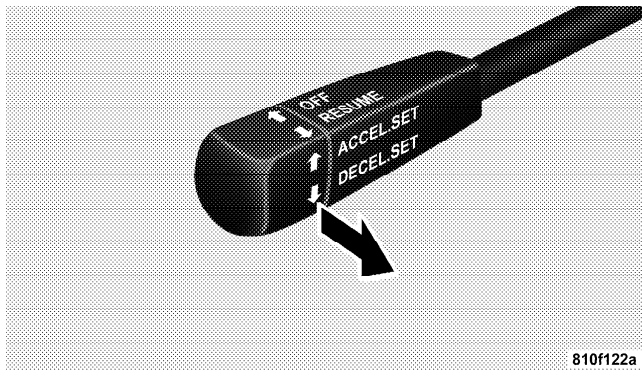

NOTE: Moving the gear selector lever to the “N” position will switch the speed control off.

Using Speed Control On Hills

Your vehicle is equipped with interactive speed control. This feature activates when driving up or down hills with the speed control engaged and the driver’s foot off the accelerator.

3

WARNING!
<p>Speed control can be dangerous where the system can’t maintain a constant speed. Your vehicle could go too fast for the conditions, and you could lose control. An accident could be the result. Don’t use speed control in heavy traffic or on roads that are winding, icy, snow-covered, or slippery.</p>

For vehicles with automatic transmission:

On a downgrade or an upgrade, downshifting will occur automatically to allow the engine’s braking power to maintain the set speed. When more level roadway is reached, the transmission will automatically upshift to fifth gear.

For vehicles with manual transmission:

The set speed control is switched off when declutching exceeds four seconds during downshifting. In some cases, you may have to step on the brake pedal to slow down sufficiently to achieve the desired speed.

NOTE: On very steep hills, a greater speed loss or gain may occur. It may be preferable to drive without speed control.

GARAGE DOOR OPENER

The HomeLink® Universal Transceiver replaces up to three remote controls (hand-held transmitters) that operate devices such as garage door openers, motorized gates, or home lighting. The transceiver triggers these devices at the push of a button. The transceiver operates off your vehicle's battery and charging system: no batteries are needed.

For additional information on HomeLink®, call 1-800-355-3515, or on the internet at www.homelink.com.

WARNING!

A moving garage door can cause injury to people and pets in the path of the door. People or pets could be seriously or fatally injured. Only use this transceiver with a garage door opener that has a "stop and reverse" feature, as required by federal safety standards. This includes most garage door opener models manufactured after 1982. Do not use a garage door opener without these safety features, as it could cause injury or death. Call toll-free 1-800-355-3515 or, on the internet at www.homelink.com for safety information and assistance.

Programming The Universal Transceiver

For best results, install a new battery in the hand-held transmitter before programming. If your garage door opener (located in the garage) is equipped with an antenna, make sure that the antenna is hanging straight down.

1. Turn off the engine.

WARNING!

Vehicle exhaust contains carbon monoxide, a dangerous gas. Do not run the vehicle's engine while programming the transceiver. Exhaust gas can cause serious injury or death.

WARNING!

Your motorized door or gate will open and close while you are programming the universal transceiver. Do not program the transceiver if people or pets are in the path of the door or gate. A moving door or gate can cause serious injury or death to people and pets or damage to objects.

2. Turn the ignition to the ON/RUN position.
3. Erase the factory test codes by pressing the two outside buttons. Release the buttons when the light in the overhead console display begins to flash (about 20 seconds).

NOTE: Step 3 does not have to be followed to program additional hand-held transmitters.

4. Choose one of the three buttons to program. Place the hand-held controller 1–3 inches (25–76 mm) from the universal transceiver while keeping its indicator light in view.

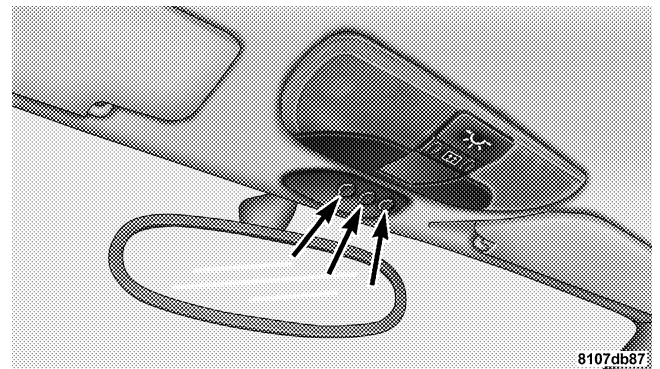

5. Using both hands, press the hand-held transmitter button and the desired universal transceiver button. Do not release the buttons until Step 6 has been completed.

NOTE: Some gate operators and garage door openers may require you to replace this Programming Step 5 with procedures noted in the "Gate Operator/Canadian Programming" section.

6. The indicator light in the universal transceiver will begin to flash, first slowly and then rapidly. Release both buttons after the indicator light changes from slow to rapid flash. If, after 90 seconds, the indicator does not flash rapidly or goes out, return to Step 1 and repeat the procedure.

7. Press and hold the just programmed universal transceiver button and observe the indicator light. If the indicator stays on constantly, programming is complete and your device should activate when the universal transceiver button is pressed and released.

NOTE: To program the remaining two universal transceiver buttons, begin with Programming Step 4. Do not repeat Steps 1, 2, and 3.

If the indicator light blinks rapidly for two seconds and then turns to a constant light, continue with

Programming Steps 8-10 to complete programming of a rolling code equipped device (most commonly a garage door opener).

8. At the garage door opener receiver (motor-head unit) in the garage, locate the "learn" or "smart" button. This can usually be found where the hanging antenna wire is attached to the motor-head unit.

9. Firmly press and release the "learn" or "smart" button. (The name and color of the button may vary by manufacturer.)

NOTE: There are 30 seconds in which to initiate Step 10.

10. Return to the vehicle and firmly press, hold for two seconds and release the programmed universal transceiver button. Repeat the "press/hold/release" sequence a second time, and, depending on the brand of the garage door opener (or other rolling code equipped device), repeat this sequence a third time to complete the programming.

The universal transceiver should now activate your rolling code equipped device.

If you do not successfully program the universal transceiver to learn the signal of your hand-held transmitter, call toll free for customer assistance at 1-800-355-3515, or on the internet at www.homelink.com.

Gate Operator/Canadian Programming

Canadian radio-frequency laws require transmitter signals to “time-out” (or quit) after several seconds of transmission. This may not be long enough for the universal transceiver to pick up the signal during programming. Similar to this Canadian law, some U.S. gate operators are designed to “time-out” in the same manner.

If you live in Canada or you are having difficulties programming a gate operator by using the programming procedures (regardless of where you live), replace Programming Step 5 with the following:

NOTE: If programming a garage door opener or gate operator, it is advised to unplug the device during the “cycling” process to prevent possible overheating.

5. Continue to press and hold the universal transceiver button while you press and release every two seconds (“cycle”) your hand-held transmitter until the frequency

signal has successfully been accepted by the universal transmitter. (The indicator light will flash slowly and then rapidly.) Proceed with Programming Step 6 to complete.

Using the Universal Transceiver

To operate the universal transceiver, simply press and release the programmed button. Activation will now occur for the programmed device (i.e. garage door opener, gate operator, security system, entry door lock, home/office lighting, etc.) For convenience, the hand-held transmitter of the device may also be used at any time.

Erasing Universal Transceiver Buttons

To erase programming from the three buttons (individual buttons cannot be erased but can be reprogrammed – see below), follow this procedure:

- Press and hold the two outer universal transceiver buttons until the indicator light begins to flash after 20 seconds. Release both buttons. Do not hold for longer than 30 seconds. The universal transceiver is now in the program (or learning) mode and can be programmed at any time beginning with Programming Step 4.

Reprogramming a Single Button

To program a device using a universal transceiver button previously programmed, follow these steps:

1. Press and hold the desired universal transceiver button. DO NOT release the button.
2. The indicator light will begin to flash after 20 seconds. Without releasing the universal transceiver button, proceed with Programming Step 4.

Security

If you sell your vehicle, be sure to erase the frequencies.

To erase all of the previously programmed frequencies, hold down both outside buttons until the light begins to flash.

This device complies with part 15 of FCC rules and with RS-210 of Industry Canada. Operation is subject to the following conditions:

1. This device may not cause harmful interference.

2. This device must accept any interference that may be received, including interference that may cause undesired operation.

NOTE: Changes or modifications not expressly approved by the party responsible for compliance could void the user's authority to operate the equipment.

HomeLink® is a trademark owned by Johnson Controls, Inc.

UMBRELLA HOOK

Your Crossfire is equipped with an umbrella hook. This feature is located behind and between the two seats, just above the map pocket.

UNDERSTANDING YOUR INSTRUMENT PANEL

CONTENTS

■ Instruments And Controls98	□ Driver – L/R	119
■ Instrument Cluster99	□ Telephone Mute Characteristics	119
■ Instrument Cluster Description99	■ Compact Disc Maintenance	120
■ “Infinity Modulus” AM/FM Stereo Radio With Single-Disc CD Player And GPS Navigation . .	112	■ Radio Antenna	120
■ “Infinity Modulus” AM/FM Stereo Radio With Single-Disc CD Player	112	■ Radio Operation And Cellular Phones	120
□ Infinity Modulus Entertainment Systems	112	■ Climate Controls	121
□ CD Player Operation	116	□ Temperature Control	121
□ User Menu	118	□ Fan Control	122
□ User Memory (User – 1, 2, 3)	118	□ Basic Setting - Heater	122
□ Mono/Stereo	118	□ Basic Setting - Air Conditioner	122
		□ Dust Filter	126
		□ Operating Tips	127

INSTRUMENTS AND CONTROLS

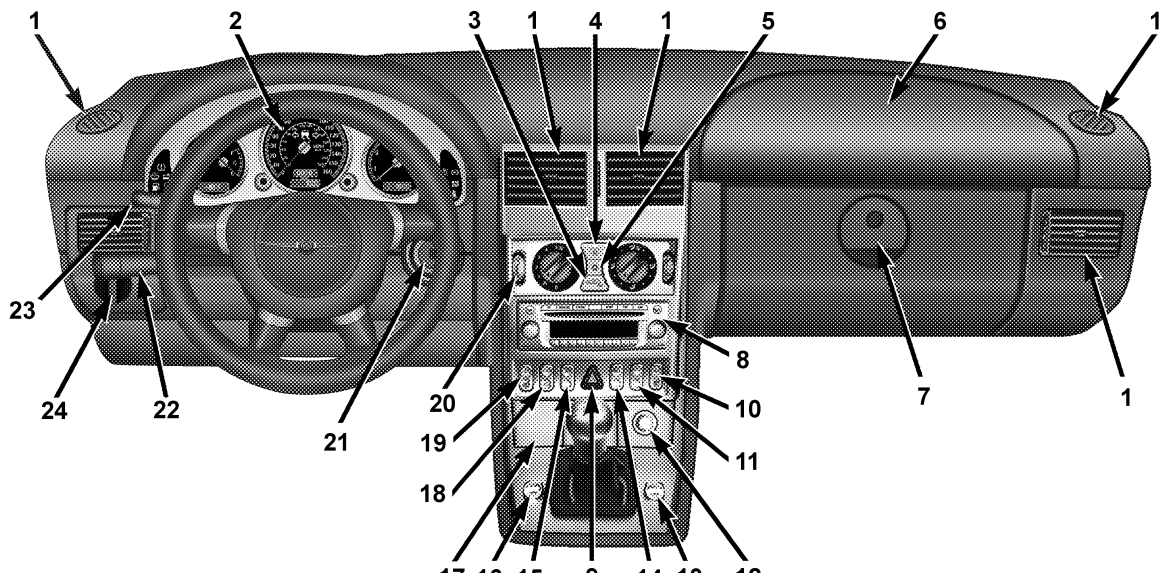

- | | | | |
|--------------------------|--------------------------------|------------------------|---------------------------------|
| 1. Air Outlets | 6. Passenger Airbag | 17. Ashtray/Coinholder | 21. Ignition Switch |
| 2. Instrument Cluster | 7. Glove Compartment | 18. Spoiler Control | 22. Multifunction Control Lever |
| 3. Air Recirculation | 8. Audio System | 19. Driver Heated Seat | 23. Speed Control Lever |
| 4. Rear Window Defroster | 9. Hazard Warnings | 20. Climate Control | 24. Headlight Switch |
| 5. Air Conditioning | 10. Passenger Heated Seat | | |
| | 11. Anti-Towing Protection | | |
| | 12. Power Outlet/Cigar Lighter | | |
| | 13. Passenger Power Window | | |
| | 14. Central Locking | | |
| | 15. ESP Off | | |
| | 16. Driver Power Window | | |

8113e19b

INSTRUMENT CLUSTER

The instrument cluster displays are activated by either opening the door, pressing the left button within the cluster, or turning the key in the ignition switch to the ON/RUN position.

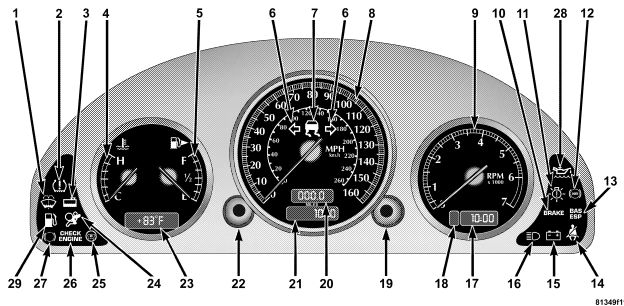

INSTRUMENT CLUSTER DESCRIPTION

1. Low Windshield Washer System Fluid Level Warning Light



With the key in the ignition switch turned to the ON/RUN position, the indicator light comes on. It should go out when the engine is running.

If the indicator light does not go out after starting the engine, or if it comes on while driving, the fluid reservoir is less than 1/4 filled.

The reservoir should be refilled at the next opportunity with commercially available premixed windshield washer solvent/antifreeze or water, depending on ambient temperature.

The reservoir for the windshield washer system is located in the engine compartment and the cap is marked with the above symbol.

WARNING!

Do not overfill the washer reservoir. Do not attempt to fill to the top of the filler neck. Fluid may leak out onto the floor or driveway causing a potential slip and fall hazard. When the indicator light first illuminates, the maximum fill amount is 1 Gallon (4 Liters).

CAUTION!

The TPM system is designed to monitor your tire pressure and will not function as a tire pressure gauge. After adjusting the air pressure in a tire, there will be a delay before the system updates the display.

2. *Low Tire Pressure Indicator Light*



The tire pressure monitor (TPM) system uses wireless technology to monitor tire pressure levels. Sensors, mounted to each wheel as part of the valve stem, transmit tire pressure readings to a receiver located in the vehicle.

If the light is illuminated, the pressure in one of the tires on the vehicle has dropped to at least 25% below the recommended pressure on the vehicle's tire label. Additionally, the indicator light will illuminate if a fault has been detected in the TPM system.

NOTE: The TPM system can inform you about a low tire pressure condition, but it does not replace normal tire maintenance. The TPM system is not intended to provide you with notification of rapid pressure loss.

NOTE: The pressure in your tires changes with temperature. A significant decrease in temperature could reduce cold inflation pressure below the TPM setpoint. **ALWAYS** check the pressure in your tires if the TPM lamp is illuminated.

3. Coolant Indicator Light



This indicator illuminates when the engine coolant has dropped below the required level in the reservoir or the coolant temperature is too high (see the Temperature gauge section).

To check the coolant level, the vehicle must be parked on level ground and the engine stopped.

Check coolant level only when the coolant is cold.

WARNING!
<p>You or others can be badly burned by hot coolant or steam from your radiator. If you see or hear steam coming from under the hood, don't open the hood until the radiator has had time to cool. Never try to open a cooling system pressure cap when the radiator or coolant bottle is hot.</p>

4. Engine Coolant Temperature Gauge

This gauge shows engine coolant temperature. Any reading between the Hot and Cold gauge marks show that the engine cooling system is operating properly. The gauge pointer may show a higher temperature when driving in hot weather, up mountain grades, or in heavy stop-and-go-traffic.

If the pointer rises to the red (Hot) area, stop the vehicle and turn off the engine until the problem is corrected.

4

CAUTION!
<p>Continuing to drive with an overheated engine cooling system can cause damage to the engine or other components.</p>

5. Fuel Gauge

When the ignition is in the ON/RUN position, the pointer will show the level of fuel remaining in the tank. The arrow to the right of the gas pump symbol shows which side of the vehicle the fuel filler door is located on.

6. Turn Signal Indicators



To signal minor directional changes, such as changing lanes, move the multifunction control lever to the point of resistance only and hold it there. The arrows will flash in unison with the corresponding exterior turn signal.

To operate the turn signals continuously, move the multifunction control lever past the point of resistance up or down. The switch is automatically canceled when the steering wheel is turned to a large enough degree.

The arrows in the instrument cluster will flash in unison with the respective exterior turn signal.

7. Electronic Stability Program (ESP) Indicator Light



The yellow ESP indicator light in the speedometer dial comes on with the key in the ignition switch turned to the ON/RUN position. It should go out with the engine running.

If the ESP indicator light flashes during acceleration, apply as little throttle as possible. While driving, ease up on the accelerator. Adapt your speed and driving to the prevailing road conditions, and do not switch off the ESP.

8. Speedometer

The speedometer shows the vehicle speed in miles-per-hour and kilometers-per-hour.

9. Tachometer

This gauge shows engine speed in revolutions-per-minute (RPM) times 1,000.

The red markings on the tachometer indicate excessive engine speed. Ease off on the accelerator before reaching the red area.

10. Brake System Warning Light

BRAKE The dual brake system provides a reserve braking capability if a failure occurs in a portion of the hydraulic system.

This light monitors both the brake fluid level and the parking brake. If the light comes on, it indicates either that the parking brake is on or there is a low fluid level in the brake master cylinder. Since this vehicle is equipped with anti-lock brakes (ABS), the brake light may also indicate reduced braking performance due to the loss of electronic brake proportioning. If the parking brake is off and the light remains on, have the brake system inspected as soon as possible.

The warning light should be checked frequently to assure that it is operating properly. This can be done by turning the ignition switch to START. The light should come on. If the red brake light does not come on when the ignition is turned to the ON/RUN position, have the brake light repaired promptly.

WARNING!

Driving a vehicle with the brake light on is dangerous. Part of the brake system may have failed. It will take longer to stop the vehicle. You could have an accident. Have the vehicle checked immediately.

NOTE: This light shows only that the parking brake is on. It does not show the degree of brake application.

The brake warning light will come on if the ABS light is not functioning and there is an ABS system malfunction.

11. Light Outage Indicator



With the key in the ignition switch turned to the ON/RUN position, an indicator light comes on. It should go out when the engine is running. If the indicator light does not go out after starting the engine, or if it comes on while driving, it indicates a failure in the parking light, taillight, stoplight, or low beam headlight.

The indicator light will come on when the exterior light fails. If a brake light fails, the light outage indicator will come on when applying the brake and stays on until the engine is turned off.

NOTE: If additional lighting equipment is installed (e.g., auxiliary headlights, etc.) be certain to connect into the fuse before the failure indicator monitoring unit in order to avoid damaging the system.

12. Antilock Warning Indicator Light



The ABS warning indicator light comes on with the key in the ignition switch turned to the ON/RUN position, and should go out with the engine running.

If the ABS warning indicator light comes on while the engine is running, it indicates that the ABS has detected a malfunction and has switched off. In this case, the brake system functions in the usual manner, but without antilock assistance.

If the ABS light is on, have the system checked at your authorized dealer as soon as possible.

13. Brake Assist Indicator Light

BAS
ESP The indicator light for the Brake Assist System (BAS) is combined with the Electronic Stability Program (ESP). This yellow indicator light in the instrument cluster comes on with the key in the ignition switch turned to the ON/RUN position. The BAS/ESP warning indicator light also comes on when a malfunction is detected in either the Brake Assist System or the Electronic Stability Program. It should go out with the engine running. If the BAS/ESP indicator light comes on continuously, see an authorized dealer as soon as possible.

14. Seat Belt Indicator Light



With the key in the ignition, the light comes on, and a warning sounds for a short time if the driver's seat belt is not fastened.

After starting the engine, the seat belt indicator light blinks and a chime sounds periodically for up to 90 seconds to remind the driver and passenger to fasten the seat belts. Fastening the seat belts will extinguish the light and silence the chime.

The seat belt indicator light will remain lit until the seat belts are fastened.

15. Charging System Indicator Light



Should the charging system indicator light fail to come on prior to starting when the key is in the ignition switch in the ON/RUN position, or should it fail to go out after starting or during operation, it indicates a malfunction that must be repaired immediately at an authorized dealer.

If the charging system indicator light comes on, or a loss of power steering assistance is noticeable while the engine is running, this may indicate that the accessory drive belt has broken. Should this condition occur, the belt must be replaced before continuing to operate the vehicle.

CAUTION!

The accessory drive belt also drives the water pump. Operating the vehicle with a failed belt can cause engine overheating and possible severe engine damage.

16. High Beam Indicator Light

 This indicator will illuminate when the headlights are in the high beam setting.

To activate the high beams, push the multifunction control lever past the point of resistance, toward the instrument panel.

17. Electronic Digital Clock

A digital readout in the instrument cluster shows the time in hours and minutes whenever the ignition switch is in the ON/RUN or ACC position.

When the ignition switch is in the OFF/LOCK position, timekeeping is accurately maintained.

The display can be adjusted with the knob/button located to the left of the clock.

18. Gear Indicator

For automatic transmission vehicles, the current gear shift selector range is indicated in the gear range indicator display.

19. Push Button for Time Setting

To adjust the time display, turn the key in the ignition switch to the ON/RUN or ACC position. The knob/button located just to the left of the clock is used to change the time. Pull out the knob and turn it to the left for hour adjustment; pull out the knob and turn it to the right for minute adjustment.

20. Trip Odometer, Flexible Service System (FSS) Indicator

This display shows the distance traveled since last reset.

To reset:

- Press the button to the left of the display once (with the key in the ON/RUN position).
- Press the button twice (with the key removed or in the OFF/LOCK or ACC position).

21. Main Odometer, Flexible Service System (FSS)

This shows the total distance the vehicle has been driven.

U.S. Federal regulations require that upon transfer of vehicle ownership, the seller certify to the purchaser the correct distance that the vehicle has been driven. Therefore, if the odometer reading is changed during repair or replacement be sure to keep a record of the reading before and after service so that the correct distance can be determined.

22. Push Button for Activating the Instrument Cluster, Intensity of Instrument Lights, for Resetting Trip Odometer and Flexible Service System (FSS) Indicator

Press the knob/button to illuminate the display. To vary the intensity of the instrument cluster lights, rotate the knob/button.

To reset the trip odometer, press the knob/button once with the key in the ON/RUN position. Press the knob/button twice with the key removed or in the OFF/LOCK or ACC position.

The FSS permits a flexible service schedule that is directly related to the operating conditions of the vehicle.

There are two symbols which will appear in the main odometer display field prior to the next suggested service. This symbol represents Service A.



This second symbol represents Service B.



Depending on operating conditions throughout the year, the next service is calculated and displayed next to this symbol in days remaining before the next service is required.



Likewise, the next service may be calculated and displayed next to this symbol as distance remaining before the next service is required.

The counter can also be reset by any individual after the indicated service has been performed. To do so:

1. Turn key to the ON/RUN position.
2. Within one second press the knob/button twice.
3. The present status for days or distance is displayed. Within 10 seconds turn the key to OFF/LOCK.
4. Press and hold the knob/button, while turning the key to ON/RUN again. The present status for days or distance is displayed once more. Continue to hold the knob/button.

After approximately 10 seconds, a signal sounds and the display shows 7,000 miles (Canada: 11,000 km) for approximately 10 seconds.

5. Release the knob/button.

If the FSS counter was inadvertently reset, have an authorized dealer correct it.

The message is displayed for approximately 10 seconds when turning the key to the ON/RUN position, or while driving when reaching the service warning threshold. It can be canceled manually by pressing the knob/button.

Once the suggested term has passed, the message plus either the symbol for Service A or the symbol for Service B preceded by a – (minus symbol) blinks for approximately 30 seconds and a signal sounds every time when turning the key to the ON/RUN position.

The FSS display can also be called up for approximately 10 seconds with the display illuminated by pressing the knob/button twice within one second.

Following a completed A or B service your authorized dealer sets the counter to 7,000 miles (Canada: 11,000 km).

NOTE: When disconnecting vehicle battery for one or more days at a time, such days will not be counted. Any such days not counted by FSS can be added by your authorized dealer.

The interval between services is determined by the type of vehicle operation. Driving at extreme speeds, and cold starts combined with short distance driving in which the engine does not reach normal operating temperature, reduce the interval between services.

However you choose to set your reference numbers, the scheduled services as posted in the Service Booklet must be followed to properly care for your vehicle.

23. Outside Temperature Display

The temperature display is located on the left side of the instrument cluster, below the fuel and engine temperature gauges.

The sensor for the outside temperature indicator is located in the front fascia area. Due to its location, the sensor can be affected by road or engine heat during idling or slow driving. This means that the accuracy of the displayed temperature can only be verified by comparison to a thermometer placed next to the sensor, not by comparison to external displays (e.g., bank signs, etc.).

Adaptation to ambient temperature takes place in steps and depends on the prevailing driving conditions (stop-and-go or moderate, constant driving) and amount of temperature change.

WARNING!

The outside temperature indicator is not designed to serve as an ice-warning device and is unsuitable for that purpose. Indicated temperatures just above the freezing point do not guarantee that the road surface is free of ice.

24. Airbag Light



The operational readiness of the airbag system is verified by the airbag indicator light in the instrument cluster when turning the key in the ignition switch to the ACC or ON/RUN position. If no fault is detected, the light will go out after approximately 4 seconds. After the lamp goes out, the system continues to monitor the components and circuitry of the airbag system and will indicate a malfunction by coming on again.

The light will come on and remain on for 4 seconds as a bulb check when the ignition switch is first turned ON. If the bulb is not lit during starting, have it replaced. If the light stays on, or comes on while driving, have the system checked by an authorized dealer.

WARNING!

In the event a malfunction of the airbag is indicated, the airbag may not be operational. For your safety, we strongly recommend that you visit an authorized dealer immediately to have the system checked; otherwise the airbag may not be activated when needed in an accident, which could result in serious or fatal injury, or it might deploy unexpectedly and unnecessarily which could also result in injury.

4

25. Telescoping Wheel Indicator Light



With the key in the ignition and turned to the ON/RUN position, the indicator light in the instrument cluster comes on. It should go out when the engine is running. If the indicator light does not go out after starting the engine, the telescoping steering column is not locked properly.

WARNING!

Do not drive the vehicle until you have properly locked the steering column.

26. Check Engine Light

CHECK ENGINE This light is part of an onboard diagnostic system that monitors the emissions and engine control systems. If a problem is detected in one of these systems, the Check Engine light will come on. The light comes on and stays on briefly as a bulb check when the ignition is first turned on.

Certain conditions, such as a loose or missing gas cap, or poor fuel quality may illuminate the light after the engine is started. Be sure the gas cap is tightened every time you refuel.

If the Check Engine light remains on continuously and the vehicle is driving normally, you may still drive the vehicle. In most situations, the vehicle will not require towing. However, we recommend that you have the system checked at an authorized dealer as soon as possible.

If the vehicle is not driving normally, and the Check Engine light flashes or remains on continuously, it is an alert to serious conditions that could lead to loss of power or severe catalytic converter damage. The vehicle should be serviced at an authorized dealer as soon as possible.

27. Brake Wear Indicator Light

With the key in the ignition and turned to the ON/RUN position, the brake wear indicator light comes on. The light goes out when the engine is running.

If the indicator light comes on during braking, this indicates the brake pads are worn down.

Have the brake system checked at your authorized dealer as soon as possible.

28. Oil Level Indicator Light

With the key in the ignition switch turned to the ON/RUN position, the oil level indicator light comes on. It should go out immediately when the engine is running. If the light does not go out, or comes on while driving, the engine oil level has dropped to approximately the minimum mark on the dipstick.

CHECKING ENGINE OIL LEVEL

A sensor in the oil pan allows oil level to be checked without opening the hood. It provides an accurate measurement of oil level, whereas the low engine oil level indicator warns that oil level is definitely too low. With the vehicle parked on a level surface, the engine is warmed up and shut off for approximately five minutes. When the ignition switch is turned to the ON/RUN position, an ISO oil level icon appears in the trip odometer window and a "clock" icon in the cumulative odometer display. Pressing the knob to the left of the speedometer twice within one second displays one of the following messages:

- OK
- -1.0 Q (-1.0L)
- -1.5 Q (-1.5L)
- -2.0 Q (-2.0L)
- HI

The indicated amount of oil must be added to the engine if the message -2.0 Q (-2.0L) blinks and a signal sounds. The HI message indicates that the excess oil must be removed from the pan to avoid possible engine or catalytic converter damage. If the ISO oil level icon and "clock" icon remain on when attempting to check oil level and no message follows, or if the low engine oil level warning lamp comes on, a malfunction in the engine oil level system is indicated. A conveniently located dipstick allows manual checking of the oil level.

If no leaks are noted, continue to drive to the nearest service station where the engine oil should be topped to the "full" mark on the dipstick with an approved oil.

29. *Low Fuel Warning Light*



When the fuel level drops to about 2 gallons (7.5 liters), this symbol will light and remains lit until fuel is added.

**“INFINITY MODULUS” AM/FM STEREO RADIO
WITH SINGLE-DISC CD PLAYER AND GPS
NAVIGATION**

(OPTIONAL - See separate User’s Manual)

**“INFINITY MODULUS” AM/FM STEREO RADIO
WITH SINGLE-DISC CD PLAYER**

INFINITY MODULUS Entertainment Systems

A premium Infinity Modulus AM/FM stereo, single-disc CD audio system is standard equipment in your Cross-fire. It feeds a six-channel, 240-watt amplifier with dual subwoofers mounted in the back panel behind the seats, and four door-mounted speakers.

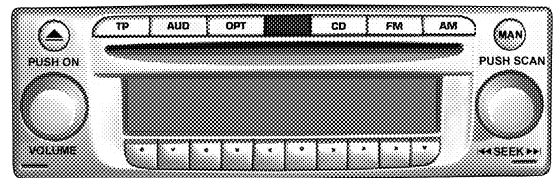

810aecb6

Power/Volume Control

To activate the audio system, press the ON/OFF knob on the left. If the unit was switched off using the ignition switch, it will switch on again with the ignition switch.

Press the ON/OFF knob within three seconds of turning the ignition switch off to prevent the radio from switching off.

The unit can also be operated without the ignition switch turned on by pressing the ON/OFF knob, but it will switch off automatically after one hour.

The volume is controlled by rotating the ON/OFF knob to the left or right.

Audio (AUD) Settings

- Bass (BASS)

Press the AUD button repeatedly until BASS appears. Rotate the right rotary control for the desired level (from -9 to +9).

- Treble (TREB)

Press the AUD button repeatedly until TREB appears. Rotate the right rotary control for the desired level (from -9 to +9).

- Balance (BAL)

Press the AUD button repeatedly until BAL appears. Rotate the right rotary control for the desired level (from -9 to +9).

- Linear adjustment (LINEAR)

The tone values for the set signal source (e.g., radio/FM) are set to "0" (mean value). Press and hold the

AUD button for more than 4 seconds until FM LINEAR appears (which affects FM only). Press and hold the AUD button for more than eight seconds until ALL LINEAR appears (which affects both radio and CD).

- Mute function (MUTE)

To activate the mute function in all modes and wavebands, press the TP button. The mute function is cancelled by either pressing the TP button again, or by turning the volume control.

NOTE: After six seconds without any action, or by pressing OPT, CD, AM, FM, or TP, the current setting is cancelled, and the new setting is stored.

FM1 – FM2 – FM AS – BEST FM

The system has four FM memory modes that can be selected by repeatedly pressing the FM button.

FM1 – One of ten memorized FM station frequencies can be selected by pressing a multifunction button.

FM2 – A second set of ten memorized FM station frequencies can be selected by pressing a multifunction button.

FM AS – An autostore feature will store the 9 current stations with the strongest signal on station buttons 1-9 in the order of their signal quality.

Press the FM button repeatedly until FM AS is displayed to perform an autostore scan. Press the multifunction button labeled AS repeatedly until AS-SEEK is displayed. To select the stored stations, press the 1-9 buttons.

BEST FM – The BEST FM function automatically memorizes and continuously updates the frequencies of stations in order of their signal strength.

The strongest station comes up first when BEST FM is selected. Stations with stronger or weaker signals are selected by turning the right rotary knob.

To select the displayed station, press the right rotary control/push button.

Tuning FM stations – Rotating the right rotary control to the right or left will change the FM frequency to the next higher or lower station with a strong signal. To manually step through each frequency or tune in a station with a weaker signal, press the MAN button first, and then rotate the rotary control right or left.

Storing FM stations – 10 frequencies can be stored on FM 1 and on FM 2 by pressing a multifunction button for three seconds; a tone will confirm that the selection was set.

Scan Search FM (SC) – To activate, press the right rotary control/push button until SC is displayed.

Beginning with the currently set frequency, the next station scanned will be heard for eight seconds. Press the right rotary control/push button if you wish to keep the current station. Once the scan begins, it will continue until either a station or program is retained or until another mode is selected.

Radio Data System (RDS) Stations

PTY (Program Type)

The program type of the selected station can be displayed for 10 seconds, or scanned in order of ascending frequency for eight seconds each.

To activate, press the OPT button in FM mode, then press the multifunction PT button. You can pre-select one of the

currently available PTY by turning the right rotary control/push button and the program type scan search begins.

Press the button again to keep the received program. If the selected station does not transmit a PTY identification, the display will show NO PTY. If all criteria for evaluating RDS are not met, the unit will only display the frequency.

The following are examples of program types displayed:

- NEWS – News Service
- SOFT – Soft Music
- INFORM – Information Programs
- NOSTALGA – Nostalgia
- SPORTS – Sports Reports
- JAZZ – Jazz Music
- TALK – Talk Programs
- CLASSICL – Classical
- ROCK – Rock Music
- R B – R&B
- CLS ROCK – Classic Rock
- SOFT R B – Soft R&B
- ADLT HIT – Adult Hits
- LANGUAGE – Language Program
- SOFT RCK – Soft Rock
- REL MUSC – Religious Music
- TOP 40 – Top 40
- REL TALK – Religious Talk
- COUNTRY – Country Music
- PERSNLTY – Personality
- OLDIES – Oldies Format
- PUBLIC – Public Radio
- WEATHER – Weather Forecast
- PTY 24-28 – Not Specified
- NO PTY – No Program Type

AM-AM AS

The system has two AM modes available. Press the AM button repeatedly until the band or operation mode is selected. To search in this mode, press the right rotary control/push button and the abbreviation SC is displayed. Receivable stations can be heard for eight seconds. Press the control again to keep the received station.

Once the scan search begins, it will continue until either a station is retained or until another mode is selected.

Tuning AM stations – Rotating the right rotary control to the right or left will change the AM frequency to the next higher or lower station with a strong signal. To manually step through each frequency or tune in a station with a weaker signal, press the MAN button first, and then rotate the rotary control right or left.

Storing AM stations – 10 frequencies can be stored on AM by pressing a multifunction button for three seconds; a tone will confirm that the selection was set.

AM AS – An autostore feature will store the 9 current stations with the strongest signal on station buttons 1-9 in the order of their signal quality. Press the AM button

repeatedly until AM AS is displayed to perform an autostore scan. Press the multifunction button labeled AS repeatedly until AS-SEEK is displayed. To select the stored stations, press the 1-9 buttons.

General Information

This radio complies with Part 15 of FCC rules and with RSS-210 of Industry Canada. Operation is subject to the following conditions:

1. This device may not cause harmful interference,
2. This device must accept any interference received, including interference that may cause undesired operation.

NOTE: Changes or modifications not expressly approved by the party responsible for compliance could void the user's authority to operate the equipment.

CD Player Operation

To activate the CD function, press the CD button; CDS is shown in the display. If no CD disc is present, the display briefly shows NO CDS and the radio mode remains active.

Insert the CD into the slot with the printed side up. The unit will display the number of tracks and total playback time. After the last track has been played back, the unit automatically begins to play the first track again.



To eject a disc, briefly press and release the EJT button.

If the power is turned off, the disc will remain in the CD slot for protection.

Features of the CD player:

- **Skipping Tracks**

Turn the right rotary control/push button. Turn further to the left or right to skip multiple tracks. If a track was played for less than eight seconds, the system will skip to the next track.

- **Scan Tracks (SC)**

Push the right rotary control/push button until the display shows SC. All tracks are played back for eight seconds each. Press the button again to cancel this feature.

- **Fast Forward/Rewind (<<, >>)**

Press and hold the multifunction button >> for audible fast forward play. Press and hold the multifunction button << for audible fast rewind play. The relative time is displayed during this operation and continues for an additional eight seconds after releasing the function button.

- **Relative Time Display (T)**

Press the multifunction button T for the time of the currently playing track to be displayed for approximately eight seconds.

- **Random Play (RP)**

Press the multifunction button RP for random generation of the next track to be played. Press the button again to cancel the feature.

NOTE: To protect the unit from excessive heat, a temperature protection device has been integrated into the circuitry. When a high operating temperature is detected, CD TEMP is displayed for eight seconds and the unit switches back to the last source (AM or FM). Allow sufficient cool down time and retry.

User Menu

The following functions can be customized to your personal needs in the user menu:

- USER – User Memory
- M/S – Mono/Stereo Setting
- DRIVER – Left/Right Hand Drive Setting
- PHONE – Telephone Characteristics
- LED – LED Setting

To enter the USER menu, press the OPT button for more than three seconds. USER then appears on the display, and another user action must be entered within six seconds or this menu is exited automatically. Your current setting can be cancelled and the selections made will be saved by pressing either the CD, AM, FM or TP buttons momentarily.

User Memory (USER – 1, 2, 3)

You can program up to three user memories, which saves the sound settings, and the last received station when the unit is switched off. To activate, first enter the user menu. One of the three users can now be selected by turning the right rotary/push button. You can also call up the Mono/Stereo setting by pressing the right rotary/push button at this time.

Mono/Stereo

In order to suppress reception-related interference, three different parameters can be set to optimize reception.

To activate, call up the user menu, then press the right rotary control/push button repeatedly until STEREO, STO AUTO or MONO is displayed (depending on the currently selected setting, you may need to turn the knob also for your selection).

- STO AUTO – Setting for normal operation. The unit switches from stereo to mono and back, depending on the reception conditions (for nearly all reception areas, this is the optimal setting).

- STEREO – Setting for exceptional conditions. The unit is constantly set for stereo reception (primarily for private broadcasters in urban areas).
- MONO – Setting for receptions with constant reflection, the unit is constantly set for monaural reception.

You can also call up the Setting DRIVER mode by pressing the right rotary/push button at this time.

Driver – L/R

If a telephone with hands-free operation is installed, the call is routed through the speaker system. The setting DRIVER is used to set the appropriate speaker side (left or right).

To activate, call up the user menu, then press the right rotary control/push button repeatedly until DRIVER L or DRIVER R is displayed (depending on the currently selected setting, you may need to turn the knob also for your selection). You can also call up the Telephone mute characteristics mode by pressing the right rotary/push button at this time.

Telephone mute characteristics

If a telephone with hands-free operation is installed, the call may be routed through the speaker system. This eliminates the need for an additional speaker (if the signal lines are connected to the unit). The following settings are available:

- PH MUTE – Switching radio to mute.
- AUDIO PH – Telephone call via the car radio.

Call up the user menu, then press the right rotary control/push button repeatedly until AUDIO PH or PH MUTE is displayed (depending on the currently selected setting, you may need to turn the knob also for your selection).

COMPACT DISC MAINTENANCE

To keep the compact discs in good condition, take the following precautions:

1. Handle the disc by its edge; avoid touching the surface.
2. If the disc is stained, clean the surface with a soft cloth, wiping from center to edge.
3. Do not apply paper or tape to the disc; avoid scratching the disc.
4. Do not use solvents such as benzine, thinner, cleaners, or antistatic sprays.
5. Store the disc in its case after playing.
6. Do not expose the disc to direct sunlight.
7. Do not store the disc where temperatures may become too high.

RADIO ANTENNA

The radio antenna is located in the rear liftgate glass on the coupe vehicles and mounted on the left rear body panel on the roadster vehicles. The antenna requires no maintenance.

RADIO OPERATION AND CELLULAR PHONES

Under certain conditions, the operation of a cellular phone in your vehicle can cause erratic or noisy performance from your radio. This condition may be lessened or eliminated by relocating the cellular phone antenna. This condition is not harmful to the radio. If your radio performance does not satisfactorily "clear" by the repositioning of the antenna, it is recommended that the radio volume be turned down or off during cellular phone operation.

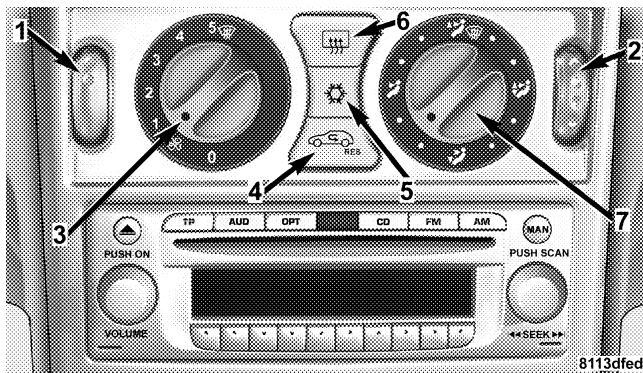
CLIMATE CONTROLS

1. Driver Temperature Control
2. Passenger Temperature Control
3. Fan Speed Control
4. Air Recirculation/REST
5. Air Conditioning ON/OFF
6. Rear Window Defroster
7. Air Distribution (Mode) Control

The climate control system allows you to balance the temperature, amount and direction of the air circulating throughout the vehicle.

The system is always at operational readiness, except when manually switched off. The climate control only operates with the engine running.

The climate control removes a considerable amount of moisture from the air during operation in the air conditioning mode, therefore it is considered normal operation for water to drip on the ground through ducts in the underbody.

The settings and controls are as follows:

Temperature Control

Use the driver or passenger temperature control to regulate the temperature of the air inside the passenger compartment. The blue area of the control indicates cooler temperatures, while the red area indicates warmer temperatures.

The temperature selector should be left at the desired temperature setting so that the system can automatically reach that selection as quickly as possible. The inside temperature will not heat or cool any quicker by setting the selector higher or lower upon initial start up.

Fan Control



Use this control to regulate the amount of air volume moving through the system in any mode you select. Turn the control clockwise to increase fan speed; counterclockwise to decrease fan speed.

Basic Setting - Heater



Select a temperature for each side of the passenger compartment. Select air volume with the fan control switch and set the fan control at least to position 2 to prevent windows from fogging up. Set the air distribution control switch to the tri-level setting. Turn the defroster outlets for the side windows to the detent positions. Open center air outlets as desired.



Select a temperature for each side of the passenger compartment. Select air volume with the fan control switch. Then select the panel setting on the air distribution control switch to force air from the panel outlets.



Select a temperature for each side of the passenger compartment. Select air volume with the fan control switch. Then select the Bi-Level setting on the air distribution control switch to force air from both the upper panel outlets and the floor outlets.

Basic Setting - Air Conditioner



Press the air conditioning ON/OFF switch. The light in the switch will illuminate. Select a temperature for each side of the passenger compartment. Select the air volume with the fan control switch, at least to position 1. Set the air distribution control switch to one of the positions shown above. Open center air outlets. Open left and right side air outlets.

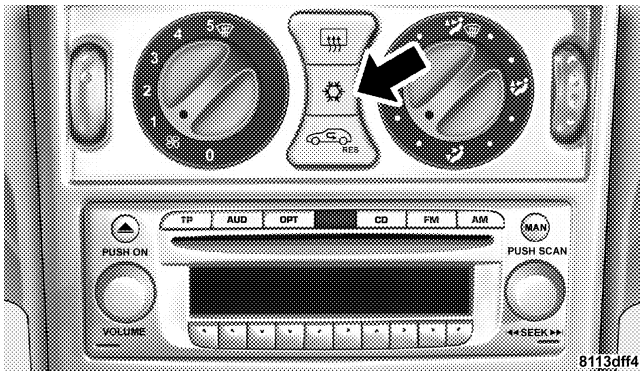

NOTE: The dot between the air distribution control icons is a mix position between the two modes.

Slight changes in engine speed or power may be noticed when the compressor is on. This is a normal occurrence, since the compressor will cycle on and off to maintain comfort and increase fuel economy.

NOTE: If your air conditioning performance seems lower than expected, check the front of the A/C condenser for an accumulation of dirt or insects.

4

Defrosting

 Set the temperature selectors to the maximum heating position, set the fan control to position 5, and the air distribution to the defrost position. Close the center air outlets. Close the left and right side air outlets. Turn the defroster outlets for the side windows to the detent position.

Defogging Windows Fogged Up On Inside

Press the A/C button; the indicator light should illuminate. Switch off the air recirculation; the indicator light should go out. Set the air distribution control switch to the defrost position. Increase air volume with the fan control switch. Close the center, left, and right side air outlets. Turn the defroster outlets for the side windows to the detent position.

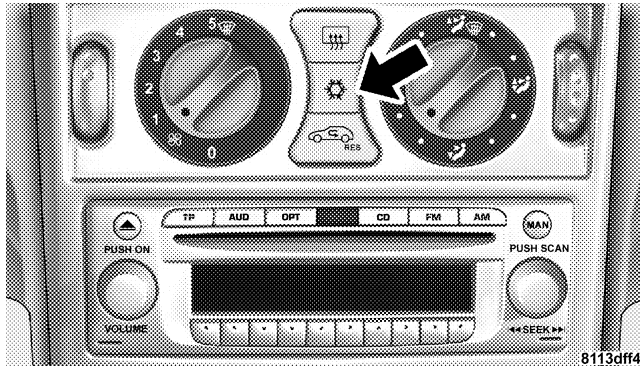
**Windshield Fogged Up On Outside**

Switch on the windshield wipers. Set the air distribution control switch to the defrost position. Increase air volume

with the fan control switch. Close the center and right side air outlets. Turn the defroster outlets for the side windows to the detent position.

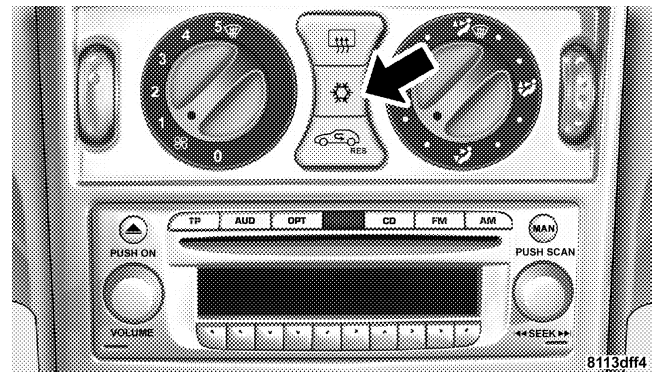
Ventilation

To receive outside air through the panel outlets, turn off the Air Conditioning ON/OFF switch. The light in the switch should be off. Set the controls as above for basic air conditioning.

Climate Control - OFF

To switch the climate control off, set the air volume control switch to position 0. The fresh air supply to the vehicle interior is shut off. While driving, use this setting only temporarily, otherwise the windshield could fog up.

Rear Window Defroster



Turn the key in the ignition switch to the ON/RUN position. To select, press the rear window defroster button once and release. The indicator light in the switch should illuminate.

To cancel, press the rear window defroster button again and release.

NOTE: Heavy accumulation of snow and ice should be removed before activating the defroster. The rear window defroster uses a large amount of power. To keep the battery drain to a minimum, turn off the defroster as soon as the window is clear. The defroster is automatically turned off after a maximum of 12 minutes of operation.

If several components in the vehicle are consuming power simultaneously, or the battery is only partially charged, it is possible that the defroster will automatically turn itself off. When this happens, the indicator light

inside the switch starts blinking. As soon as the battery has sufficient voltage, the defroster automatically turns itself back on.

CAUTION!
To avoid damaging the electrical conductors, do not use scrapers, sharp instruments, or abrasive window cleaners on the interior surface of the rear window. Labels can be peeled off by soaking with warm water.

Air Recirculation/REST



This mode can be selected to temporarily reduce the entry of annoying odors or dust into the vehicle's interior. Outside air does not flow into the vehicle's interior. To select, press the recirculation button. To cancel, press the recirculation button again.

The system will automatically switch from recirculated air to fresh air after approximately five minutes at outside temperatures below approximately 40°F (5°C);

after approximately 30 minutes, at outside temperatures above approximately 40°F (5°C); after approximately five minutes, if the A/C button is pressed.

At high outside temperatures, the system automatically engages the recirculated air mode for approximately 30 minutes, thereby increasing the cooling capacity performance. Press the recirculation button again to extend the recirculated air mode.

Residual Engine Heat Utilization (REST)



With the engine switched off, it is possible to continue heating the interior for a short while.

Air volume is controlled automatically. Select a temperature for each side of the passenger compartment. Set the air distribution control switch to the desired position.

To select, turn the key in the ignition switch to the ACC or the OFF/LOCK position or remove. Press the recirculation button. The indicator light in the button illuminates. This function selection will not activate if the battery charge level is insufficient.

To cancel, press the recirculation button. The indicator light in the button goes out. The system will automatically shut off if you turn the key in the ignition switch to the ON/RUN position, after approximately 30 minutes, or if the battery voltage drops.













NOTE: This vehicle is equipped with an air conditioner system that uses R-134a (HFC: hydrofluorocarbon) as a refrigerant. Repairs should always be performed by a qualified technician, and refrigerant should be collected in a recovery system for recycling.

Dust Filter

Nearly all dust particles and pollen are filtered out before outside air enters the passenger compartment through the air distribution system.

NOTE: Keep the air intake grille in front of windshield free of snow and debris.

Operating Tips

WEATHER	CONTROL SETTINGS
<p>HOT WEATHER AND VEHICLE INTERIOR IS VERY HOT</p> 	<p>Start vehicle and press Air Recirculation button  and turn on A/C. Set Fan Control to High. Roll windows down to flush out hot air. Roll windows up after hot air is flushed out. Turn Mode Control to  and set Fan and Temp Knobs as desired once car has cooled.</p>
<p>WARM WEATHER</p> 	<p>Set the Mode Control to  position and turn A/C on in sunny weather. Choose the  position for cloudy or dark conditions with A/C on.</p>
<p>COOL OR COLD HUMID CONDITIONS</p> 	<p>Set the Mode Control to  position and turn the A/C on in sunny weather. Choose the  position and turn on the A/C in cloudy or dark conditions.</p>
<p>COLD DRY CONDITIONS</p> 	<p>Use the  position in sunny weather, the  position in cloudy or dark weather, and the  Mode Knob setting for snowy or very cold weather that requires extra heat to the windshield.</p>

8118231d

STARTING AND OPERATING

CONTENTS

■ Starting Procedures	131	□ Park Position	137
□ Normal Starting	131	□ Reverse	138
□ Extremely Cold Weather (Below -20°F Or -29°C)	132	□ Neutral	138
□ If Engine Fails To Start	132	□ Drive	139
□ After Starting	133	□ AutoStick® Gear Selection	139
■ Transmission Shifting	133	□ Gear Ranges	140
□ Manual Transmission	133	□ Program Mode Selector Switch	140
□ Recommended Shift Speeds	134	□ Emergency Operation (Limp Home Mode)	141
□ Automatic Transmission	135	■ Parking Brake	142
□ Stopping	136	■ Brake System	144
□ Maneuvering	137	□ Brake Assist System (BAS)	144

130 STARTING AND OPERATING

□ Electronic Stability Program (ESP)	146	□ Tread Wear Indicators	160
□ Synchronizing ESP	147	□ Replacement Tires	160
□ ESP Control Switch	148	□ Tire Rotation Recommendations	162
□ Anti-Lock Brake System (ABS)	149	□ Alignment And Balance	163
□ Brake Pad Break-In	152	■ Fuel Requirements	164
■ Power Steering	152	□ Reformulated Gasoline	164
■ Tires	153	□ Gasoline/Oxygenate Blends	165
□ Tire Pressure	153	□ MMT In Gasoline	165
□ Tire Inflation Pressures	154	□ Materials Added To Fuel	166
□ Radial-Ply Tires	156	□ Sulfur In Gasoline	166
□ Tire Spinning	156	■ Adding Fuel	166
□ Tire Pressure Monitor System	157	□ Fuel Filler Cap (Gas Cap)	166
□ Tire Chains	158	■ Vehicle Loading	168
□ Original Equipment Tires	158	□ Roof Luggage Rack	168
□ Snow Tires	159	■ Trailer Towing	169

STARTING PROCEDURES

WARNING!

Do not leave animals or children inside parked vehicles in hot weather; interior heat build up may cause serious injury or death.

Be sure that the parking brake is engaged and that selector lever is in the NEUTRAL or PARK position (gearshift lever in Neutral). Turn the key in the ignition switch to the ON/RUN position. Apply the brakes before shifting into any driving gear.

Normal Starting

Vehicles with automatic transmissions:

Do not depress the accelerator. Simply turn the key in the ignition switch clockwise to the START position and release when the engine starts. If the engine will not run, turn the key counterclockwise to the OFF/LOCK position and repeat the starting procedure. If there are several unsuccessful attempts, have the system checked at the nearest authorized dealer.

Vehicles with manual transmissions:

Do not depress the accelerator. Fully depress the clutch pedal, otherwise the engine cannot be started due to the integrated safety interlock. Simply turn the key in the ignition switch clockwise to the START position and release when the engine starts. The starter will engage until the engine is running. If the engine will not run, turn the key counterclockwise to the OFF/LOCK position and repeat the starting procedure. If there are several unsuccessful attempts, have the system checked at the nearest authorized dealer.

NOTE: Due to the starter non-repeat feature, the key must be turned completely to the left before attempting to start the engine again.

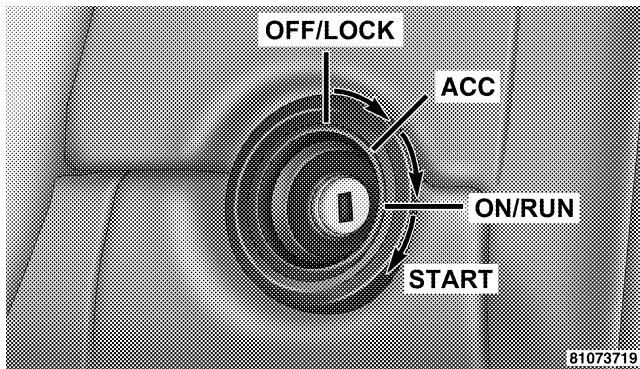

Extremely Cold Weather (below -20°F or -29°C)

For reliable starting in areas where temperatures frequently drop below -20°F (-29°C), we recommend the use of an externally powered battery and an electric engine block heater. Advice on these items and installation is available at your authorized dealer.

If Engine Fails to Start

CAUTION!

Do not try to push or tow your vehicle to get it started. Your vehicle cannot be started this way. Pushing with another vehicle may damage the transmission or the rear of your vehicle. See Section 6 of this manual for proper jump-starting procedures.

WARNING!

Never pour fuel or other flammable liquid into the throttle body air inlet opening in an attempt to start the vehicle. This could result in a flash fire, causing serious personal injury.

If the engine fails to start after you have followed the Normal Starting procedure, it may be flooded. Push the accelerator pedal all the way to the floor and hold it there while cranking the engine. This should clear any excess fuel in case the engine is flooded.

CAUTION!

To prevent damage to the starter, do not crank the engine for more than 15 seconds at a time. Wait 10 to 15 seconds before trying again.

If the engine has been flooded, it may start to run, but not have enough power to continue running when the key is released. If this occurs, continue cranking with the accelerator pedal pushed all the way to the floor. Release the accelerator pedal and the key once the engine is running smoothly.

If the engine shows no sign of starting after two 15-second periods of cranking with the accelerator pedal held to the floor, the Normal Starting procedure should be repeated.

After Starting

The idle speed will automatically decrease as the engine warms up.

TRANSMISSION SHIFTING

Manual Transmission

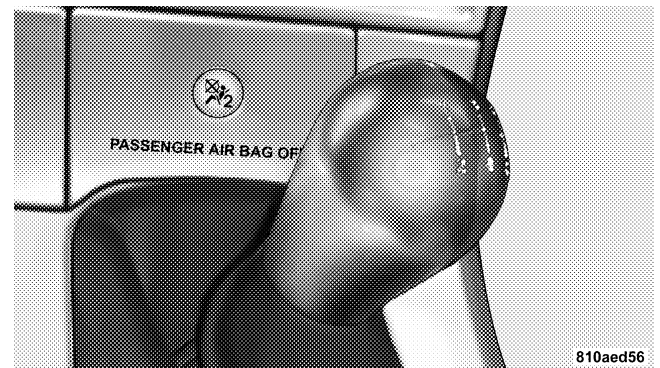

NOTE: The parking brake should be engaged and the gear selector placed in REVERSE before leaving the vehicle, especially on an incline. To place the transmission in REVERSE, lift up on the shifter knob, push it to the left and pull it back.

Fully depress the clutch pedal before you shift gears. As you release the clutch pedal, lightly depress the accelerator pedal.

Be sure the transmission is in **FIRST** gear, (not **THIRD**), when starting from a stopped position. Damage to the clutch can result from starting in **THIRD**.

NOTE: If there is a need to restart your engine, you must recycle your ignition switch to the **OFF** position before restarting the engine.

For most city driving, you will find it easier to use only the lower gears. For steady highway driving with light accelerations, sixth gear is recommended.

Never drive with your foot resting on the clutch pedal, or try to hold the vehicle on a hill with the clutch pedal partially engaged. This will cause abnormal wear on the clutch.

Never shift into **REVERSE** until the vehicle has come to a complete stop.

NOTE: During cold weather, until the transmission lubricant has warmed, you may have difficulty shifting. This is normal and not harmful to the transmission.

Recommended Shift Speeds

To use your manual transmission for both fuel economy and performance, it should be upshifted as shown in the chart. Shift at the vehicle speeds listed for acceleration.

Earlier upshifts during cruise conditions (relatively steady speeds) will result in increased fuel economy, and may be used as indicated.

Higher upshift speeds may be used to obtain a desired acceleration rate.

MANUAL TRANSMISSION RECOMMENDED SHIFT SPEEDS					
	1-2	2-3	3-4	4-5	5-6
MPH	15	25	40	45	50
(km/h)	(24)	(40)	(64)	(72)	(80)

WARNING!

When leaving the vehicle, always remove the key from the ignition switch, and lock the vehicle. Do not leave children unattended in the vehicle, or with access to an unlocked vehicle. Children could move the gearshift lever, which could result in an accident or serious injury.

WARNING!

Skipping more than one gear while downshifting could cause you to lose control of your vehicle. You could have an accident.

CAUTION!

If you skip more than one gear while downshifting or downshift at too high an engine speed, you could damage the engine, transmission, or clutch.

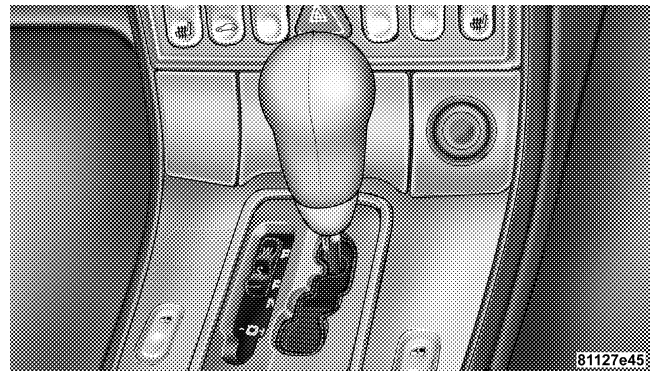
Automatic Transmission

The automatic transmission selects individual gears automatically, dependent upon:

- Selector lever position
- Program mode selector switch
- Accelerator position
- Vehicle speed

The gear shifting process is continuously adapted, dependent on the driving style, the driving situation and the road characteristics.

The selector lever is automatically locked while in the PARK position. To move the selector lever out of the PARK position, the brake pedal must be firmly depressed before the shift lock will release.

Shift the selector lever to the desired position only when the engine is idling normally and the brake pedal is applied. Do not release the brake until ready to drive. The vehicle may otherwise accelerate quickly when the selector lever is in DRIVE or REVERSE position.

NOTE: After selecting any driving position, wait a moment to allow the gear to fully engage before accelerating, especially when the engine is cold.

WARNING!

It is dangerous to shift the selector lever out of PARK or NEUTRAL if the engine speed is higher than idle speed. If your foot is not firmly on the brake pedal, the vehicle could accelerate quickly forward or in reverse. You could lose control of the vehicle and hit someone or something. Only shift into gear when the engine is idling normally and when your foot is firmly on the brake pedal.

Stopping

For brief stops, leave the transmission in gear and hold the vehicle with the brake pedal. For longer stops with the engine idling, shift into the NEUTRAL or PARK position and hold the vehicle with the parking brake. When stopping the vehicle uphill, do not hold it with the accelerator; use the brake. This avoids unnecessary transmission heat build-up.

Maneuvering

To maneuver in tight areas, control the vehicle speed by gradually releasing the brakes. Accelerate gently and never abruptly step on the accelerator.

To rock a vehicle out of soft ground (mud or snow), alternately shift from forward to reverse, while applying only slight acceleration. Rocking a vehicle free in this manner may cause the ABS or traction system malfunction indicator light to come on. Turn off the engine and restart the engine to clear the malfunction indication.

Park Position

The PARK position is to be used when parking the vehicle. Engage only with the vehicle stopped. The PARK position is not intended to serve as a brake when the vehicle is parked. Rather, the driver should always use the parking brake in addition to placing the selector lever in PARK to secure the vehicle.

NOTE: The key can be removed from the ignition switch only with the selector lever in the PARK position. With the key removed, the selector lever is locked in the PARK position.

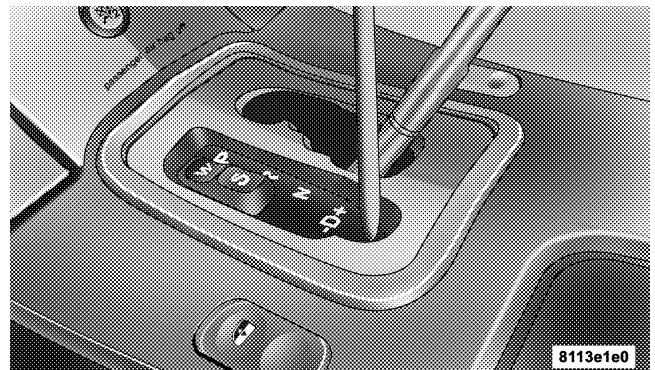

With a malfunction in the vehicle's electrical system, the selector lever could remain locked in the PARK position. To unlock the selector lever manually, insert the end of the multipurpose tool from the glove box (or ball point pen) into the covered opening below the position "D" of the shift pattern. While pushing the tool down, move the selector lever out of the PARK position. After removal of the tool from the opening, the cover will not close fully. Only after moving the selector lever to the "D+" and "D-" positions does the cover return to its closed position.

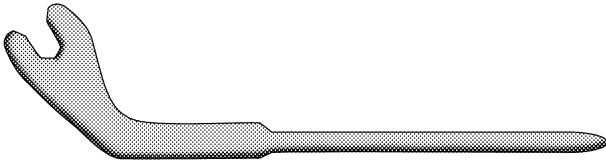

8119a19e

Reverse

Shift into REVERSE gear only when the vehicle is completely stopped.

Dependent on the program mode selector switch position "S" or "W," the maximum speed in the REVERSE gear is different. However, it is not possible to change the program mode while in REVERSE.

Neutral

No power is transmitted from the engine to the drive axle. When the brakes are released, the vehicle can be moved freely (pushed or towed). Do not engage in NEUTRAL position while driving except to coast when the vehicle is in danger of skidding (e.g., on icy roads).

NOTE: Coasting the vehicle, or driving for any other reason with selector lever in NEUTRAL can result in transmission damage that is not covered by the Limited Warranty.

Drive

The transmission automatically upshifts through fifth gear. The DRIVE position provides optimum driving characteristics under all normal operating conditions.

AutoStick® Gear selection

The transmission gear can be selected by pressing the selector lever to the right or the left with the selector lever in the DRIVE position. The gear currently selected is indicated in the instrument cluster display. Briefly press selector lever in the “D-” direction. The transmission will shift from the current gear to the next lower gear. Shifting into another gear that allows for quicker acceleration or to slow the vehicle down is possible. Downshifts can also be performed.

Press and hold the selector lever in the “D-” direction. The transmission will shift from the current gear directly to the best gear for acceleration.

NOTE: To avoid overrevving the engine when the selector lever is moved in “D-” direction, the transmission will not shift to a lower gear if the engine’s revolutions per minute limit would be exceeded.

Briefly press the selector lever in the “D+” direction. The transmission will shift from the current gear to the next higher gear.

Press and hold the selector lever in the “D+” direction. The transmission will shift from the current gear directly to gear “D.”

WARNING!

On slippery road surfaces, never downshift in order to obtain braking action. This could result in drive wheel slip and reduced vehicle control. Your vehicle’s ABS will not prevent this type of loss of control. You could lose control of your vehicle and have an accident.

NOTE: With transmission in gear “D,” “4,” or “3,” upshifting from FIRST to SECOND to THIRD gear may be delayed, depending on vehicle speed and engine temperature. This allows the catalytic converter to heat up more quickly to operating temperatures.

The delayed upshift is effective with vehicle speeds below 31 mph (50 km/h) at partial throttle and engine temperatures below 95°F (35°C). To prevent the engine from laboring at low RPM when driving uphill or with your vehicle heavily loaded, the automatic transmission will downshift when necessary to maintain engine RPM within the best torque range.

Gear Ranges

“P” PARK

NOTE: If the key is in the ON/RUN position, you must press the brake pedal to shift out of the PARK position.

PARK supplements the parking brake by locking the transmission. The engine can be started in this range. Never attempt to use PARK while the vehicle is in motion.

Apply the parking brake when leaving the vehicle in this range.

“R” REVERSE

Shift into this range only after the vehicle has come to a complete stop.

“N” NEUTRAL

The engine may be started in this range. Use this range for starting your vehicle if it is moving or being towed.

“D” OVERDRIVE

This range should be used for most city and highway driving. It provides the smoothest upshifts and downshifts and best fuel economy.

Program mode selector switch

The transmission is provided with a selector switch for Standard “S” and Winter/Wet “W” (snow and ice) program modes.

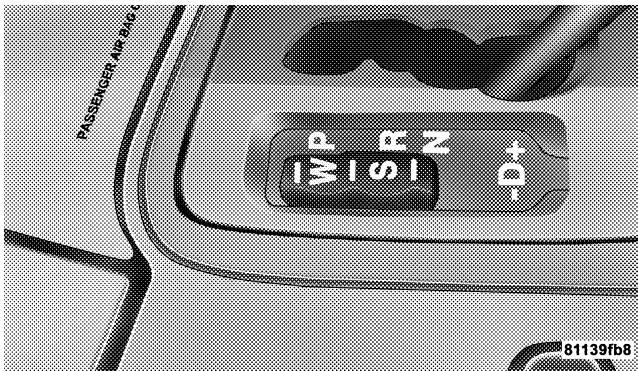

For standard mode, press the “S” symbol on the switch. Use this mode for all regular driving. The vehicle starts out in FIRST gear.

Depressing the accelerator pedal rapidly or nearly to the floor while driving (kickdown position), rather than depressing the accelerator pedal in slow, small movements, will cause the automatic transmission to shift down into a lower gear. Rapid release of the accelerator pedal will normally result in an upshift. This gear shifting process is dependent on the current vehicle speed.

For Winter/Wet (snow and ice) mode, press the “W” symbol on the switch. The vehicle starts out in SECOND gear, unless FIRST gear has been selected, or the accelerator pedal is in the kickdown position. The “W” mode helps to improve traction and driving stability of the vehicle. The gear shifting process occurs at lower vehicle and engine speeds than in the “S” program mode.

CAUTION!

Never change the program mode when the selector lever is out of the PARK position. It could result in a change of driving characteristics for which you may not be prepared.

5

Emergency Operation (Limp Home Mode)

If vehicle acceleration worsens, or the transmission no longer shifts, the transmission is most likely operating in Limp Home Mode which engages when there is a malfunction of the transmission.

This condition may be accompanied by the CHECK ENGINE light in the instrument cluster coming on.

In this mode only the SECOND gear or REVERSE gear can be activated.

To engage SECOND gear or REVERSE:

1. Stop the vehicle.
2. Move the selector lever to the PARK position.
3. Turn off the engine.
4. Wait approximately 10 seconds.
5. Restart the engine.
6. Move the selector lever to the DRIVE position (for SECOND gear), or move the selector lever to the REVERSE position (for REVERSE gear).

Have the transmission checked at your authorized dealer as soon as possible.

PARKING BRAKE

BRAKE When you apply the parking brake with engine running, the brake system warning light in the instrument cluster will come on.

NOTE: This light, when illuminated with parking brake application, shows only that the parking brake is on. It does not show the degree of brake application.

NOTE: If the light remains on with the parking brake released, a brake system malfunction is indicated. Have the brake system serviced by an authorized dealer immediately.

Before leaving the vehicle, make sure that the parking brake is fully applied. For manual transmission vehicles, place the gear selector in REVERSE. For vehicles equipped with automatic transmissions, place the gear selector in the PARK position.

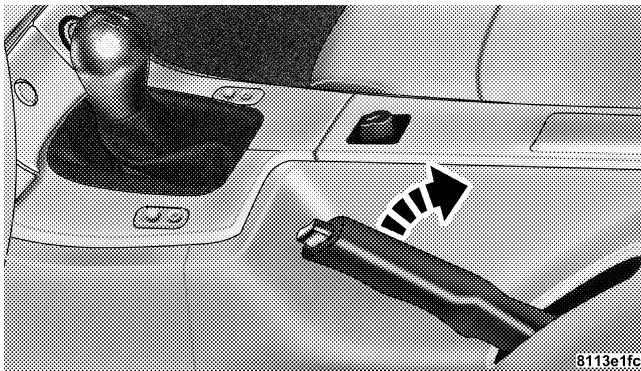

To release the parking brake, slightly pull up the handle while pushing the lock button, and guide the lever downward to its stop. The brake warning light in the instrument cluster should go out.

A warning sounds if you start to drive without having released the parking brake.

When parking on a hill, you must set the parking brake **before** placing the gear selector in PARK. If you don't, the load on the transmission locking mechanism may make it difficult to move the selector out of PARK. As an added precaution, turn the front wheels toward the curb on a downhill grade and away from the curb on an uphill grade.

The parking brake should always be applied when the driver is not in the vehicle.

5

WARNING!

Be sure the parking brake is fully disengaged before driving; failure to do so can lead to brake failure and an accident.

WARNING!

Do not leave children unattended in a vehicle. A child could be injured, or could injure others, if left unattended.

BRAKE SYSTEM

Your vehicle is equipped with power brakes as standard equipment. In the event power assist is lost for any reason (for example, repeated brake applications with the engine off), the brakes will still function. The effort required to brake the vehicle will be much greater than that required with the power system operating.

If either the front or rear hydraulic system loses normal capability, the remaining system will still function with some loss of overall braking effectiveness. This will be evident by increased pedal travel during application, greater pedal force required to slow or stop, and activation of the brake warning light during brake use.

Brake Assist System (BAS)

The BAS is designed to maximize the vehicle's braking capability during emergency braking maneuvers. Maximum power boost is applied to the brakes more quickly in emergency braking conditions. This can help reduce braking distances relative to what ordinary driving and braking style might do.

The BAS complements the antilock brake system (ABS). Applying the brakes very quickly results in maximum BAS assistance. To receive the benefit of the system you must apply continuous, full braking power during the stopping sequence. Do not reduce brake pedal pressure.

WARNING!

BAS cannot prevent the natural laws of physics from acting on the vehicle, nor can it increase braking efficiency beyond that afforded by the condition of the vehicle brakes and tires or the traction afforded. The BAS cannot prevent accidents, including those resulting from excessive speed in turns, following another vehicle too closely, or hydroplaning. Only a safe, attentive, and skillful driver can prevent accidents. The capabilities of a BAS-equipped vehicle must never be exploited in a reckless or dangerous manner which could jeopardize the user's safety or the safety of others.

Once the brake pedal is released, the BAS is deactivated.

The malfunction indicator light for the BAS is combined with the Electronic Stability Program (ESP) malfunction indicator light.

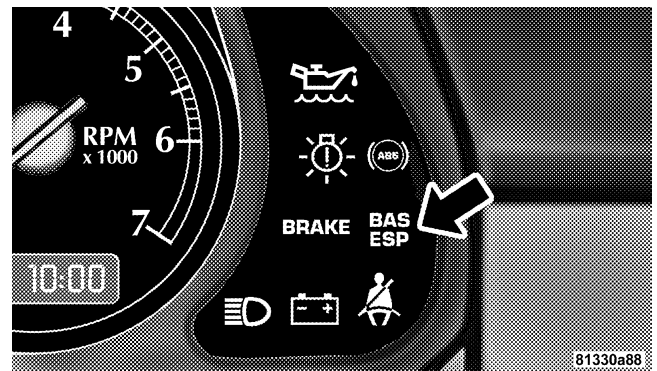

The BAS/ESP malfunction indicator light in the instrument cluster comes on with the key in the ignition switch turned to the ON/RUN position and should go out with the engine running. If the BAS/ESP malfunction indicator light comes on steadily while the engine is running, a malfunction has been detected in either the BAS or ESP system. As a result, it is possible that only partial engine output will be available, and pressing the accelerator pedal will require more effort.

If the BAS malfunctions, the brake system functions in the usual manner, but without BAS.

With the ABS malfunctioning, the BAS and ESP will be disabled. In this condition, both malfunction indicator lights come on while the engine is running. If the malfunction indicator light stays illuminated, have the BAS and ESP checked at your authorized dealer as soon as possible.

Electronic Stability Program (ESP)

The ESP enhances directional control and reduces wheel-spin under various driving conditions. When ESP is active, engine torque is limited and the ESP warning light starts to flash.

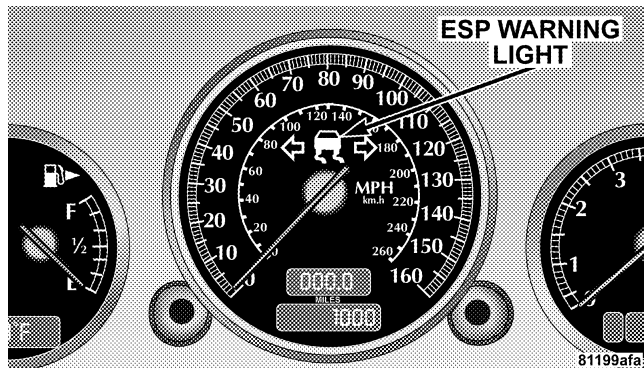

In winter operation, the effectiveness of the ESP can be enhanced by equipping the vehicle with DaimlerChrysler recommended mud and snow (M+S) rated radial-ply tires and/or snow chains.

WARNING!

ESP cannot prevent the natural laws of physics from acting on the vehicle, nor can it increase the traction afforded. The ESP cannot prevent accidents, including those resulting from excessive speed in turns, or hydroplaning. Only a safe, attentive, and skillful driver can prevent accidents. The capabilities of an ESP equipped vehicle must never be exploited in a reckless or dangerous manner which could jeopardize the user's safety or the safety of others.

The ESP warning light starts to flash at any vehicle speed as soon as the tires lose traction and the wheels begin to spin.

If the ESP warning light flashes during acceleration, ease up on the accelerator and apply as little throttle as possible. While driving, adapt your speed to the prevailing road conditions.

CAUTION!

If the vehicle is towed with the front axle raised (see the What To Do In Emergencies section in this manual), the engine must be shut off (key in the ignition switch turned to the OFF/LOCK or ACC position). Otherwise, the ESP will immediately be engaged and will apply the rear wheel brakes.

NOTE: When the ESP warning light is illuminated continuously, the ESP is switched off. Adapt your speed and driving to the prevailing road conditions.

NOTE: Avoid spinning of one drive wheel. This may cause serious damage to the drivetrain which is not covered by the DaimlerChrysler Limited Warranty.

NOTE: If the ESP warning light flashes during acceleration, ease up on the accelerator.

NOTE: ESP should not be switched off during normal driving. Disabling of the system under normal operating conditions will eliminate the benefits of the ESP system.

Synchronizing ESP

If the power supply was interrupted (battery disconnected or discharged), the BAS/ESP malfunction indicator light may be illuminated with the engine running. To re-synchronize the ESP, and cancel the malfunction indicator light, the steering angle sensor will need to be recalibrated.

1. Turn the ignition switch to the ON/RUN position.
2. Rotate the steering wheel to the center position.
3. Rotate the steering wheel completely to the left, and then rotate the steering wheel completely to the right.
4. Bring the steering wheel back to the center position.
5. The BAS/ESP malfunction indicator light will go out.

If the BAS/ESP malfunction indicator light is still illuminated, the vehicle should be serviced at an authorized dealer.

ESP Control switch

The ESP control switch is located in the center console. When the ESP is switched off, the warning light in the instrument cluster comes on. When the ESP is switched on, the warning light goes out.

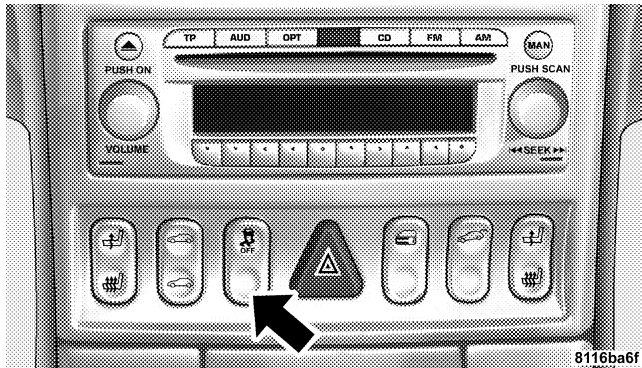

To improve the vehicle's traction when driving with snow chains, or starting off in deep snow, sand, or gravel, switch off the ESP by pressing the upper half of the ESP

switch. The ESP warning light will then be continuously illuminated. With the ESP system switched off, the engine torque reduction feature is cancelled. Therefore, the enhanced vehicle stability offered by ESP is unavailable.

CAUTION!

Snow chains should never be used without the recommended mud and snow (M+S) rated radial-ply tires. Damage to your vehicle may result from such usage.

ESP always operates under braking, even with the switch in the OFF position.

If one drive wheel loses traction and begins to spin, the ESP system will apply the brake at the affected wheel until the wheel regains sufficient traction. The traction control engages at approximately 24 mph (40 km/h), and switches off at 50 mph (80 km/h).

To return to the enhanced vehicle stability offered by ESP, press the lower half of the switch (the ESP warning light goes out).

Anti-Lock Brake System (ABS)

The ABS gives increased vehicle stability and brake performance under most braking conditions. The system automatically “pumps” the brakes during severe braking conditions to prevent wheel lock-up. The system operates to prevent wheel lock-up and help avoid skidding on slippery surfaces.

NOTE: The ABS improves steering control of the vehicle during hard braking maneuvers.

The ABS prevents the wheels from locking up above a vehicle speed of approximately 5 mph (8 km/h) independent of road surface conditions.

At the instant one of the wheels is about to lock up, a slight pulsation can be felt in the brake pedal, indicating that the ABS is in the regulating mode.

Keep firm and steady pressure on the brake pedal while experiencing the pulsation. Continuous, steady

brake pedal pressure results in optimal braking power while maintaining the ability to steer the vehicle.

In the case of an emergency brake maneuver, keep continuous full pressure on the brake pedal. In this manner only can the ABS be most effective.

On slippery road surfaces, the ABS will respond even with light brake pedal pressure because of the increased likelihood of locking wheels. The pulsating brake pedal can be an indication of hazardous road conditions and functions as a reminder to take extra care while driving.

WARNING!

Significant over- or under-inflation of tires, or mixing sizes of front or rear tires or wheels on the vehicle can reduce braking effectiveness. Maintain proper tire pressure and always use the tires and wheels specified in this manual for your vehicle.

The anti-lock brake system conducts a low-speed self-test at about 12 mph (20 km/h). If you have your foot lightly on the brake while this test is occurring, you may feel slight pedal movement. The movement can be more apparent on ice and snow. The anti-lock brake system pump motor makes a low humming noise during operation, which is normal.

WARNING!

Pumping of the brake pedal will diminish the effectiveness of the anti-lock brakes and may lead to an accident. Pumping makes the stopping distance longer. Just press firmly on your brake pedal when you need to slow down or stop.

NOTE: During severe braking conditions, a pulsing sensation may occur and a clicking noise will be heard. This is normal, indicating that the anti-lock brake system is functioning.

The ABS malfunction indicator light in the instrument cluster comes on with the key in the ignition switch turned to the ON/RUN position, and should go out with the engine running. If the ABS light does not illuminate briefly during this procedure, or remains on after the engine is running, have the system checked by an authorized dealer.

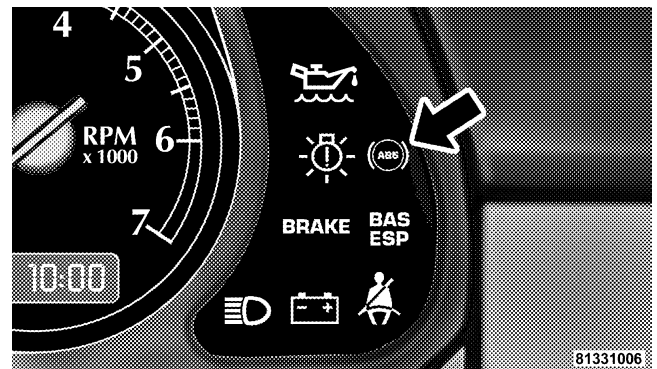

When the ABS malfunction indicator light in the instrument cluster comes on while the engine is running, it indicates that the ABS has detected a malfunction and has switched off. In this case, the brake system functions in the usual manner, but without antilock assistance. With the ABS malfunctioning, the BAS and ESP are also switched off. Both malfunction indicator lights come on with the engine running. If the charging voltage falls below 10 volts, the malfunction indicator light comes on and the ABS is switched off. When the voltage is above this value again, the malfunction indicator light should go out and the ABS is operational. If the malfunction indicator light stays illuminated, have the system checked at your authorized dealer as soon as possible.

WARNING!

ABS cannot prevent the natural laws of physics from acting on the vehicle, nor can it increase braking or steering efficiency beyond that afforded by the condition of the vehicle brakes and tires or the traction afforded. The ABS cannot prevent accidents, including those resulting from excessive speed in turns, following another vehicle too closely, or hydroplaning. Only a safe, attentive, and skillful driver can prevent accidents. The capabilities of an ABS-equipped vehicle must never be exploited in a reckless or dangerous manner which could jeopardize the user's safety or the safety of others.

WARNING!

To use your brakes and accelerator more safely, follow these tips:

- Do not “ride” the brakes by resting your foot on the pedal. This could overheat the brakes and result in unpredictable braking action, longer stopping distances, or brake damage.
- When descending mountains or hills, repeated braking can cause brake fade with loss of braking control. Avoid repeated heavy braking by downshifting the transmission whenever possible.
- Do not drive too fast for road conditions, especially when roads are wet or slushy. A wedge of water can build up between the tire tread and the road. This hydroplaning action can cause loss of traction, braking ability, and control.
- After going through deep water or a car wash, brakes may become wet, resulting in decreased performance and unpredictable braking action. Dry the brakes by gentle, intermittent pedal action while driving at very slow speeds.

Brake Pad Break-In

The brakes on your vehicle do not require a long break-in period, but avoid repeated hard brake applications from high speeds during initial break-in. Also avoid severe brake loading such as may be encountered when descending long mountain grades.

POWER STEERING

The power-assisted steering system of your vehicle provides mechanical steering capability in the event power assist is lost.

If, for some reason, the hydraulic pressure is interrupted, it will still be possible to steer your vehicle. Under these conditions, you will observe a substantial increase in steering effort.

TIRES

Please take the time to read the tire warranty booklet in your Owner's Manual package. It contains valuable information on tire maintenance.

Specific recommendations on guidelines for long-term tire storage should be requested of the tire manufacturer. Please refer to the tire warranty booklet for contact information.

Tire Pressure

Proper tire inflation pressure is essential to the safe and satisfactory operation of your vehicle. Three primary areas are affected by improper tire pressure:

1. Safety

WARNING!

Improperly inflated tires are dangerous and can cause accidents.

- Under inflation increases tire flexing and can result in tire failure.
- Over inflation reduces a tire's ability to cushion shock. Objects on the road and chuck holes can cause damage that results in tire failure.
- Unequal tire pressures can cause steering problems. You could lose control of your vehicle.
- Over inflated or under inflated tires can affect vehicle handling and can fail suddenly, resulting in loss of vehicle control.
- Unequal tire pressures from one side of the vehicle to the other can cause the vehicle to drift to the right or left.

Always drive with each tire inflated to the recommended cold tire inflation pressure.

2. Economy

Improper inflation pressures can cause uneven wear patterns to develop across the tire tread. These abnormal wear patterns will reduce tread life resulting in a need for earlier tire replacement. Underinflation also increases tire rolling resistance and results in higher fuel consumption.

3. Ride Comfort And Vehicle Stability

Proper tire inflation contributes to a comfortable ride. Overinflation produces a jarring and uncomfortable ride.

Tire Inflation Pressures

The proper cold tire inflation pressure for passenger cars is listed on the face of the driver's door latch pillar.



The pressure should be checked and adjusted as well as inspecting for signs of tire wear or visible damage at least once a month. Use a good quality pocket-type gauge to check tire pressure. Do not make a visual judgement when determining proper inflation. Radial tires may look properly inflated even when they are underinflated.

CAUTION!

After inspecting or adjusting the tire pressure always reinstall the valve stem cap—if equipped. This will prevent moisture and dirt from entering the valve stem, which could damage the valve stem.

Inflation pressures specified on the placard are always “cold tire inflation pressure.” Cold tire inflation pressure is defined as the tire pressure after the vehicle has not been driven for at least 3 hours, or driven less than 1 mile (1.6 km) after a 3 hour period. The cold tire inflation pressure must not exceed the maximum inflation pressure molded into the tire side wall.

Check tire pressures more often if subject to a wide range of outdoor temperatures, as tire pressures vary with temperature changes.

Tire pressures change by approximately 1 psi (7 kPa) per 12°F (7°C) of air temperature change. Keep this in mind when checking tire pressure inside a garage especially in the winter.

Example: If garage temperature = 68°F (20°C) and the outside temperature = 32°F (0°C) then the cold tire inflation pressure should be increased by 3 psi (21 kPa), which equals 1 psi (7 kPa) for every 12°F (7°C) for this outside temperature condition.

Tire pressure may increase from 2 to 6 psi (13 to 40 kPa) during operation. DO NOT reduce this normal pressure build up or your tire pressure will be too low.

Tire Pressures for High Speed Operation

The manufacturer advocates driving at safe speeds within posted speed limits. Where speed limits or conditions are such that the vehicle can be driven at high speeds, maintaining correct tire inflation pressure is very important. Increased tire pressure and reduced vehicle loading may be required for high speed vehicle operation. Refer elsewhere in this section for recommended safe operating speeds, loading and cold tire inflation pressures.

WARNING!

High speed driving with your vehicle under maximum load is dangerous. The added strain on your tires could cause them to fail. You could have a serious accident. Don't drive a vehicle loaded to the maximum capacity at continuous speeds above 75 mph (120 km/h).

Radial-Ply Tires**WARNING!**

Combining radial ply tires with other types of tires on your vehicle will cause your vehicle to handle poorly. The instability could cause an accident. Always use radial tires in sets of four. Never combine them with other types of tires.

Cuts and punctures in radial tires are repairable only in the tread area because of sidewall flexing. Consult your authorized tire dealer for radial tire repairs.

Tire Spinning

When stuck in mud, sand, snow, or ice conditions, do not spin your vehicle's wheels above 35 mph (55 km/h).

See the paragraph on Freeing A Stuck Vehicle in Section 6 of this manual.

WARNING!

Fast spinning tires can be dangerous. Forces generated by excessive wheel speeds may cause tire damage or failure. A tire could explode and injure someone. Do not spin your vehicle's wheels faster than 35 mph (55 km/h) when you are stuck. And don't let anyone near a spinning wheel, no matter what the speed.

Tire Pressure Monitor System



The Tire Pressure Monitor System (TPM) monitors the pressure in all tires. The TPM system uses wireless technology to monitor tire pressure levels. Sensors, mounted to each wheel as part of the valve stem, transmit tire pressure readings to a computer which monitors for low pressure. If low pressure is measured, the TPM Indicator Light will illuminate.

The TPM system informs you of a low tire pressure condition. If this occurs, correct your tire inflation pressure as soon as possible, and inspect all of your tires. Be sure to use a high quality gauge when adjusting pressure. The TPM system is designed to periodically monitor your tire pressure but cannot be expected to function as a tire pressure gauge. There can be a delay between the instant you adjust the air pressure in a tire and when the system updates the display. The TPM system is not intended to provide you with notification of rapid air loss.

The TPM system will cause the indicator lamp in the instrument cluster to illuminate whenever the pressure in one tire falls 25% below the recommended pressure shown on the tire label.

NOTE: A TPM system does not replace normal tire maintenance.

CAUTION!

The TPM system has been optimized for the original equipment tires and wheels. TPM system pressures have been established for the tire size equipped on your vehicle. Undesirable operation or sensor damage may result when using replacement equipment that is not of the same size, type, and/or style. Aftermarket wheels can cause sensor damage. Do not use aftermarket tire sealant or balance beads as damage to the sensors may result. The standard TIREFIT system (see Tirefit Tire Repair and Jacking Instructions in the What To Do In Emergencies section) is specifically designed to operate in conjunction with the TPM system, and will not damage the sensors.

NOTE: The pressure in your tires changes with temperature. A significant decrease in temperature could reduce cold inflation pressure below the TPM setpoint. For example, tires inflated to the proper cold inflation pressure on a warm day or in a warm garage could illuminate the TPM indicator lamp on the following day if the temperature is very cold. **ALWAYS** check the pressure in your tires if the TPM lamp is illuminated.

Tire Chains

The RUD-matic® DISC is the only tire chain system approved for use on the Chrysler Crossfire.

Chains should only be used on the rear wheels and only with the recommended winter mud and snow (M+S) tires and wheels. Follow the manufacturer's mounting instructions.

Tire chains should only be driven on snow-covered roads at speeds not to exceed 30 mph (48 km/h). Remove chains as soon as possible when driving on roads without snow.

When driving with tire chains, press the ESP control switch to OFF.

CAUTION!

Damage to the vehicle may result if unapproved tire chains are used.

Original Equipment Tires

Your vehicle is equipped with either sport performance tires or all-season performance tires. The sport performance tires offer the maximum road handling capability in dry and wet weather conditions. The all-season performance tires, while offering slightly less road handling capability, are able to provide traction capability in snow and ice conditions. Both types of tires are rated for high speed operation. It is important that you know what type of tires your vehicle is equipped with so that you understand their traction and handling characteristics for various road conditions. Replacement tires should be of the same size and speed rating to continue to provide the same level of performance you are accustomed to.

Snow Tires

Some areas of the country require the use of snow tires during winter. See the recommended snow type winter tire applications in this section.

WARNING!

Your vehicle may be equipped with sport performance tires that are optimized for driving in dry and wet weather conditions. However, these tires have reduced traction capability in snow and ice. When driving your Crossfire in these conditions with these tires, you must take special care to maintain control and avoid accidents. We recommend that you equip your vehicle with "SNOW" or "ALL SEASON" tires on all four wheels for driving in snowy and icy conditions.

If you need snow tires, the recommended size for the front and rear tires is the same size as the original equipment front tires. This size tire on the rear allows the use of tire chains on the rear wheels. Selection of this size tire also requires the purchase of two additional wheels with the same size specification as the original equipment front wheels.

Snow tires may have a lower speed rating than factory equipped tires and may not match the maximum vehicle speed.

Snow tires should not be operated at sustained speeds over 75 mph (120 km/h).

Tread Wear Indicators

Tread wear indicators are in the original equipment tires to help you in determining when your tires should be replaced.

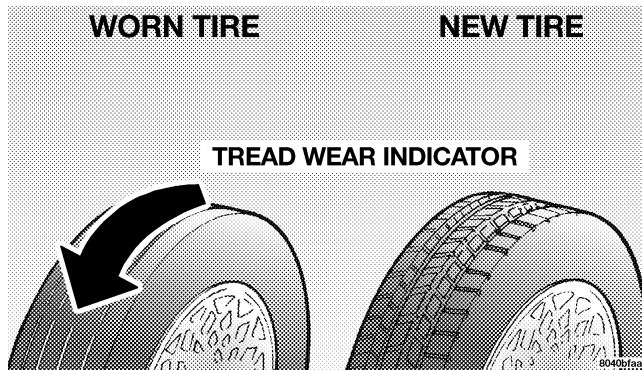

These indicators are molded into the bottom of the tread grooves and will appear as bands when the tread depth becomes 1/16 inch (2 mm). When the indicators appear in two or more adjacent grooves, the tire should be replaced.

Many states have laws requiring tire replacement at this point.

Replacement Tires

The tires on your new vehicle provide a balance of many characteristics. They should be inspected regularly for wear and correct cold tire inflation pressure. The manufacturer strongly recommends that you use tires equivalent to the originals in size, quality and performance when replacement is needed (see the paragraph on tread wear indicators). Refer to the Tire and Loading Information placard for the size designation of your tire. The service description and load identification will be found on the original equipment tire. Failure to use equivalent replacement tires may adversely affect the safety, handling, and ride of your vehicle. We recommend that you contact your original equipment or an authorized tire dealer with any questions you may have on tire specifications or capability.

Sport Performance (Y speed rating) tires and All-Season Performance (W speed rating) tires

Front 225/40 ZR18	32 psi (221 kPa)
Rear 255/35 ZR19.	33 psi (227 kPa)

Sport Performance (Y speed rating) tires and All-Season Performance (W speed rating) tires above 100 mph (161 km/h)

Front 225/40 ZR18	36 psi (248 kPa)
Rear 255/35 ZR19.	36 psi (248 kPa)

Winter tires

Front 225/40 VR18 M+S	33 psi (227 kPa)
Rear 225/40 VR18 M+S.	36 psi (248 kPa)

WARNING!

- Do not use a tire, wheel size or rating other than that specified for your vehicle. Some combinations of unapproved tires and wheels may change suspension dimensions and performance characteristics, resulting in changes to steering, handling, and braking of your vehicle. This can cause unpredictable handling and stress to steering and suspension components. You could lose control and have an accident resulting in serious injury or death. Use only the tire and wheel sizes with load ratings approved for your vehicle.
- Never use a tire with a smaller load index or capacity, other than what was originally equipped on your vehicle. Using a tire with a smaller load index could result in tire overloading and failure. You could lose control and have an accident.
- Failure to equip your vehicle with tires having adequate speed capability can result in sudden tire failure and loss of vehicle control.

CAUTION!

Replacing original tires with tires of a different size may result in false speedometer and odometer readings. Check with your authorized dealer before replacing tires with a different size.

Tire Rotation Recommendations

Tires on the front and rear axles of vehicles operate at different loads and perform different steering, driving and braking functions. For these reasons, they wear at unequal rates, and tend to develop irregular wear patterns.

These effects can be reduced by timely rotation of tires. The benefits of rotation are especially worthwhile with aggressive tread designs such as those on all season type tires. Rotation will increase tread life, help to maintain mud, snow and wet traction levels, and contribute to a smooth, quiet ride.

Rotate your tires at intervals shown on the maintenance schedules. More frequent rotation is permissible if desired. The reasons for any rapid or unusual wear should be corrected before rotating.

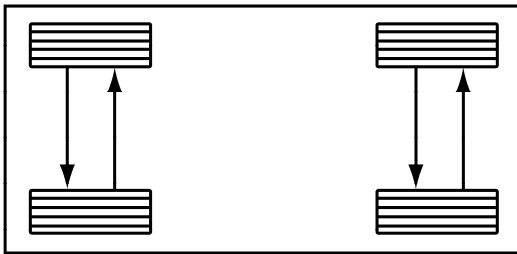
TIRE ROTATION PATTERN← **FRONT OF VEHICLE****4 TIRE ROTATION****Alignment And Balance**

The suspension components of your vehicle should be inspected and aligned when needed to obtain full tire tread mileage.

Poor suspension alignment may result in:

- Fast tire wear
- Uneven tire wear, such as feathering and one-sided wear
- Vehicle pull to right or left

Tires may also cause vehicle to pull to the left or right. Alignment will not correct this condition. See your authorized dealer for proper diagnosis.

Improper alignment will not cause vehicle vibration. Vehicle vibration may be a result of tire and wheel out-of-balance. Proper balancing will reduce vibration and avoid tire cupping and spotty wear.

810B4335

FUEL REQUIREMENTS

Your engine is designed to meet all emissions regulations and provide satisfactory fuel economy and optimum performance when using high quality unleaded gasoline having an octane rating of 91 or higher. DaimlerChrysler Corporation requires the use of 91 octane or higher premium fuel to minimize the potential for engine damage.

Light spark knock at low engine speeds is not harmful to your engine. However, continued heavy spark knock at high speeds can cause damage and should be reported to your authorized dealer immediately. Engine damage resulting from operating with a heavy spark knock may not be covered by the new vehicle warranty.

Poor quality gasoline can cause problems such as hard starting, stalling and stumble. If you experience these problems, try another brand of gasoline before considering service for the vehicle.

Over 60 automobile manufacturers around the world have issued and endorsed consistent gasoline specifications (the World Wide Fuel Charter, WWFC) to define fuel properties necessary to deliver enhanced emissions, engine performance, and durability for your vehicle. DaimlerChrysler Corporation recommends the use of gasolines that meet the WWFC specifications if they are available.

Reformulated Gasoline

Many areas of the country require the use of cleaner burning fuel, referred to as "Reformulated Gasoline".

Reformulated gasolines contain oxygenates and are specially blended to reduce vehicle emissions and improve air quality.

DaimlerChrysler Corporation supports the use of reformulated gasolines. Properly blended reformulated gasolines will provide excellent performance and durability of engine and fuel system components.

Gasoline/Oxygenate Blends

Some fuel suppliers blend unleaded gasoline with materials called oxygenates such as 10% ethanol, MTBE and ETBE. Oxygenates are required in some areas of the country during the winter months to reduce carbon monoxide emissions. Fuels blended with these oxygenates may be used in your vehicle.

CAUTION!

DO NOT use gasolines containing Methanol. Use of these blends may result in starting and drivability problems and may damage critical fuel system components.

Problems that result from using methanol/gasoline blends are not the responsibility of DaimlerChrysler Corporation and may not be covered by the Limited Warranty. While MTBE is an oxygenate made from Methanol, it does not have the negative effects of Methanol.

MMT in Gasoline

MMT is a manganese containing metallic additive that is blended into some gasolines to increase the octane number. Gasolines blended with MMT offer no performance advantage beyond gasolines of the same octane number without MMT. Gasolines blended with MMT have shown to reduce spark plug life and reduce emission system performance in some vehicles. DaimlerChrysler Corporation recommends using gasolines without MMT. Since the MMT content of gasoline may not be indicated on the pump, you should ask your gasoline retailer whether or not his/her gasoline contains MMT.

MMT is prohibited in both Federal and California reformulated gasolines.

In Canada, MMT can be used at levels higher than those allowed in the United States. For this reason, it is even more important to look for gasolines without MMT in Canada.

Materials Added to Fuel

All gasoline sold in the United States is required to contain effective detergent additives. Use of additional detergents or other additives is not needed under normal conditions and would result in unnecessary cost. Therefore, you should not have to add anything to the fuel.

Sulfur in Gasoline

If you live in the Northeast United States, your vehicle may have been designed to meet California low emission standards with cleaner burning California reformulated gasoline with low sulfur. If such fuels are not available in states adopting California emission standards, your vehicle will operate satisfactorily on fuels meeting Federal specifications, but emission control system performance may be adversely affected.

Gasoline sold outside of California is permitted to have higher sulfur levels, which may affect the performance of the vehicle's catalytic converter. This may cause the CHECK ENGINE light to illuminate. DaimlerChrysler Corporation recommends that you try a different brand of unleaded gasoline having lower sulfur to determine if the problem is fuel-related prior to returning your vehicle to an authorized dealer for service.

CAUTION!

If the CHECK ENGINE Light is flashing, immediate service is required. See the Onboard Diagnostic System (OBDII) paragraph in the Maintaining Your Vehicle section of this manual.

ADDING FUEL**Fuel Filler Cap (Gas Cap)**

The gas cap is located under the fuel filler door, on the passenger's side of the vehicle. To open the door, be sure it is unlocked, then gently press the rear edge of the door until a click can be heard, then release. The door rear edge will spring open enough to grasp and pull it completely open. If the central locking system does not release the fuel filler door, see your authorized dealer for service. If the gas cap is lost or damaged, be sure the replacement cap has been designed for use with this vehicle.

CAUTION!

Damage to the fuel system or emission control system could result from using an improper gas cap. A poorly fitting cap could let impurities into the fuel system. The CHECK ENGINE light will come on if the gas cap is not properly secured.

NOTE: The fuel tank filler tube has a restricting door about 2 inches (50 mm) down from the opening. If fuel is poured from a portable container, the container should have a flexible nozzle long enough to force open the restricting door.

CAUTION!

To avoid fuel spillage and overfilling, do not “top off” the fuel tank after filling.

With the key in the ignition switch turned to the ON/RUN position, the fuel reserve warning light comes on. It should go out immediately when the engine is running.

If the warning light does not go out after starting the engine, or if it comes on while driving, it indicates that the fuel level is down to the reserve quantity of approximately 2.1 gallons (8 liters).

Leaving the engine running and the fuel cap open can cause the CHECK ENGINE light to illuminate.

NOTE:

- When the fuel nozzle “clicks” or shuts off, the fuel tank is full.
- Tighten the gas cap until you hear a single click. This is an indication that the gas cap is properly tightened. The CHECK ENGINE light will come on if the gas cap is not properly secured. Make sure that the gas cap is tightened each time the vehicle is refueled.

WARNING!
<ul style="list-style-type: none"> • Never have any smoking materials lit in or near the vehicle when the gas cap is removed or the tank is filled. • Never add fuel to the vehicle when the engine is running. • A fire may result if gasoline is pumped into a portable container that is inside of a vehicle. You could be burned. Always place gas containers on the ground outside the vehicle while filling.

VEHICLE LOADING

The load carrying capacity of your vehicle is in the following chart and on the tire pressure label attached to the driver door pillar.

Vehicle Loading Capacities	
Front Seat Occupants	2
Cargo Capacity (with two persons)	115 lbs. (52 kg)
Rated Vehicle Capacity	415 lbs. (188 kg)

Roof Luggage Rack

Convertible Top Vehicles

CAUTION!
<p>To prevent damage to the convertible top, DO NOT carry any loads on the convertible top.</p>

Coupe Vehicles

External racks do not increase the total load carrying capacity of the vehicle. Be sure that the total occupant and luggage load inside the vehicle, plus the load on the roof luggage rack, do not exceed the rated vehicle capacity. The maximum recommended roof load for your vehicle is 110 lbs. (50 kg).

CAUTION!

- To prevent damage to the roof of your vehicle, **DO NOT** carry any loads on the roof luggage rack which may come in contact with the roof panel. The load should be secured and placed on top of the rack, not directly on the roof. If it is necessary to place some part of the load on the roof, place a blanket or some other protection between the load and the roof surface.
- To avoid damage to the roof luggage rack and vehicle, do not exceed the rated load capacity of your roof luggage rack system maximum load capacity. Always distribute heavy loads as evenly as possible and secure the load appropriately.
- Long loads which extend over the windshield, such as wood panels or surfboards, should be carefully secured to both the front and rear of the vehicle.
- Travel at reduced speeds and turn corners carefully when carrying large or heavy loads on the roof luggage rack. Wind forces, due to natural causes or nearby truck traffic, can add sudden upward loads. This is especially true on large flat loads and may result in damage to the cargo or your vehicle.

WARNING!

Cargo must be securely tied before driving your vehicle. Improperly secured loads can fly off the vehicle, particularly at high speeds, resulting in personal injury or property damage. Follow the roof luggage rack "Cautions" when carrying cargo on your roof rack.

TRAILER TOWING

Trailer towing with your Crossfire is not recommended.

5

WHAT TO DO IN EMERGENCIES

CONTENTS

■ Hazard Warning Flasher	172	□ Traction	184
■ If Your Engine Overheats	172	■ Freeing A Stuck Vehicle	184
■ TIREFIT Tire Repair And Jacking	174	■ Towing A Disabled Vehicle	185
□ TIREFIT	174	□ Towing Eyes	186
□ Preparations For Jacking	177	□ Tow-Away Alarm	188
□ Jack Location And Instructions	178	■ Convertible Top Emergency Operation	189
■ Jump-Starting The Battery	181	□ Relieving Hydraulic Pressure	190
■ Driving On Slippery Surfaces	183		

HAZARD WARNING FLASHER

The flasher switch is located in the console. Push in the flasher switch and all front and rear directional signals will flash. Press the flasher switch a second time to turn the flashers off.

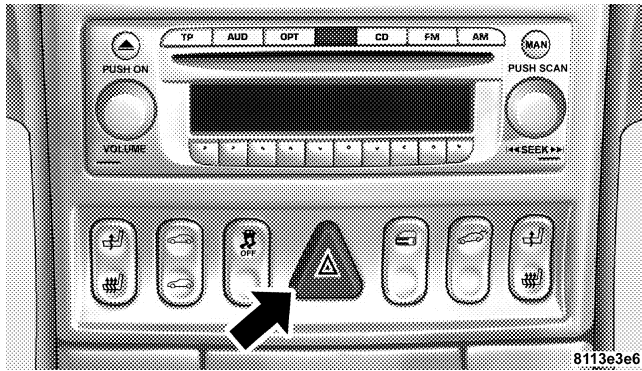

Do not use this emergency warning system when the vehicle is in motion. Use it when your vehicle is disabled and is creating a safety hazard for other motorists.

If it is necessary to leave the vehicle to go for service, the flasher system will continue to operate with the ignition key removed and the vehicle locked.

NOTE: With extended use, the flasher may run down your battery.

IF YOUR ENGINE OVERHEATS

During severe operating conditions and stop-and-go city traffic, the coolant temperature may rise close to the red area on the gauge.

The engine should not be operated with the coolant temperature in the red area. Doing so may cause serious damage which is not covered by the DaimlerChrysler Limited Warranty.

In any of the following situations, you can reduce the potential for overheating by taking the appropriate action.

- **On the highways** – Slow down and use the highest gear possible.
- **In city traffic** – While stopped, put the transmission in Neutral, but do not increase engine idle speed.
- **In city traffic** – While moving, shift into the highest gear possible to reduce engine RPM.

NOTE: There are steps that you can take to slow down an impending overheating condition. If your air conditioner is on, turn it off. The air conditioning system adds heat to the cooling system and turning off the A/C removes this heat. You can also turn the temperature control to maximum heat, the mode control to floor, and the fan control to high. This allows the heater core to act as a supplement to the radiator and aids in removing heat from the cooling system.

CAUTION!

Driving with a hot cooling system could damage your vehicle. If temperature gauge reads "H," pull over and stop the vehicle. Idle the vehicle with the air conditioner turned off until the pointer drops back into the normal range. If the pointer remains on the "H," turn the engine off immediately, and call for service.

WARNING!

A hot cooling system is dangerous. You or others could be badly burned by steam or boiling coolant. If your temperature gauge pointer is in the red area, turn off the engine immediately. You may want to call an authorized dealer for service. If you decide to look under the hood yourself, see Section 7 of this manual. Follow the warnings under the Cooling System Pressure Cap paragraph.

TIREFIT TIRE REPAIR AND JACKING

TIREFIT

Small punctures, particularly those in the tread, can be sealed with TIREFIT. Foreign objects (e.g., screws or nails) should not be removed from the tire. TIREFIT can be used in outside temperatures down to approximately -4°F (-20°C).

1. TIREFIT sealant bottle
2. Air pump flap
3. Recess in air pump
4. Power plug and cable
5. Air pump hose with pressure gauge
6. Hose connection on sealant bottle

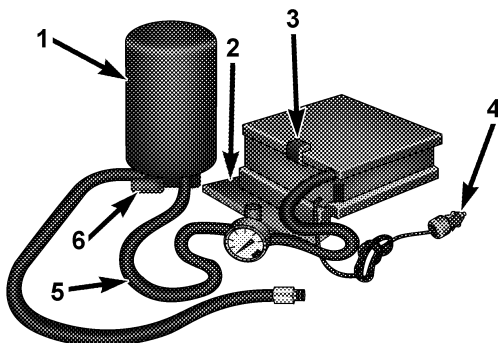

810b5640

WARNING!

Cuts or punctures larger than approximately 0.16 in. (4 mm), tire damage caused by driving with extremely low tire pressure or on a flat tire, or a damaged wheel can pose a hazard while driving. TIREFIT should not be used in such circumstances. Do not drive the vehicle under such circumstances. Contact your nearest authorized dealer for assistance.

Take care not to allow the contents of TIREFIT to come in contact with hair, eyes or clothing. TIREFIT is harmful if inhaled, swallowed or absorbed through the skin: It causes skin, eye and respiratory irritation. Any contact with eyes or skin should be flushed immediately with plenty of water. If clothing comes in contact with TIREFIT, change clothing as soon as possible.

In case of allergic reaction or rash, consult a physician immediately. Keep TIREFIT out of reach of children. If swallowed, rinse mouth immediately with plenty of water and drink plenty of water. Do not induce vomiting! Consult a physician immediately.

Keep away from open flame or heat source.

Sealing tire with TIREFIT

1. Set the parking brake and turn on the hazard warning flashers.
2. Move the transmission selector lever to the PARK position (manual transmission to FIRST or REVERSE gear) and turn off the engine.
3. Remove the TIREFIT kit and electric air pump from the area below the cargo compartment carpet.
4. Open flap (2) on the electric air pump.
5. Pull the power plug (4) and air hose (5) along with the pressure gauge out of the air pump housing.
6. Screw the air hose (5) onto the hose connection on the TIREFIT sealant bottle (1).
7. Holding the sealant bottle by the top, insert it downwards into the recess (3) on the air pump.
8. Unscrew the valve cap from the valve on the deflated tire.
9. Screw the filler hose from the sealant bottle on the tire valve.

10. Insert the power plug (4) into the power point on the instrument panel.
 11. Turn the ignition key to the ON/RUN position.
 12. Press the switch on the air pump to 1. The air pump should start to inflate the tire.
 13. After five minutes, the tire should be inflated to at least 26 psi (180 kPa) on the pressure gauge.
 14. If the tire doesn't inflate to this level, press the air pump switch to 0, disconnect the TIREFIT system from the tire, and drive the vehicle back and forth approximately 30 feet (9.1 m) to distribute the sealant more evenly within the tire.
 15. Attach the air pump hose directly to the tire, press the switch to 1, and inflate the tire again. **NOTE:** If a tire pressure of 26 psi (180 kPa) is not reached after five minutes, the tire is too badly damaged. Do not attempt to drive the vehicle further, and call for assistance.
 16. If a tire pressure of 26 psi (180 kPa) is obtained, press the air pump switch to 0, turn the ignition switch to the OFF/LOCK position, and disconnect the TIREFIT system.
 17. Drive the vehicle for about 10 minutes to ensure optimum distribution of the tire sealant within the tire.
 18. Check the pressure in the tire. If the pressure is above 19 psi (130 kPa), inflate the tire to the pressure indicated on the tire pressure label on the driver side latch pillar.
 19. Have the tire inspected at the earliest opportunity at an authorized dealer or tire service center.
- NOTE:** Do not exceed 50 mph (80 km/h) until the tire has been inspected.
- NOTE:** If a pressure of at least 19 psi (130 kPa) cannot be maintained in the tire, the tire is too badly damaged. Do not attempt to drive the vehicle further, and call for assistance.

NOTE: Do not operate the electric air pump for more than eight minutes to avoid overheating. The air pump may be used again once it has cooled down.

NOTE: Replace the TIREFIT sealant bottle once every four years to assure optimum operation of the system.

NOTE: If TIREFIT is liquid, clean water and a damp cloth will remove the material from the vehicle or tire and wheel components. Once TIREFIT sealing material has dried, it can easily be peeled off and properly discarded.

Preparations for Jacking

WARNING!

Getting under a jacked-up vehicle is dangerous. The vehicle could slip off the jack and fall on you. You could be crushed. Never get any part of your body under a vehicle that is on a jack. Never start or run the engine while the vehicle is on a jack. If you need to get under a raised vehicle, take it to a service facility where it can be raised on a lift.

WARNING!

Do not attempt to repair a tire on the side of the vehicle close to traffic. Pull far enough off the road to avoid the danger of being hit when operating the jack or repairing a tire.

Jacking the vehicle should only be necessary in the event that a tire has been severely damaged, and must be replaced. (See TIREFIT Tire Repair section for a description of cuts and punctures that may be repairable with TIREFIT.)

6

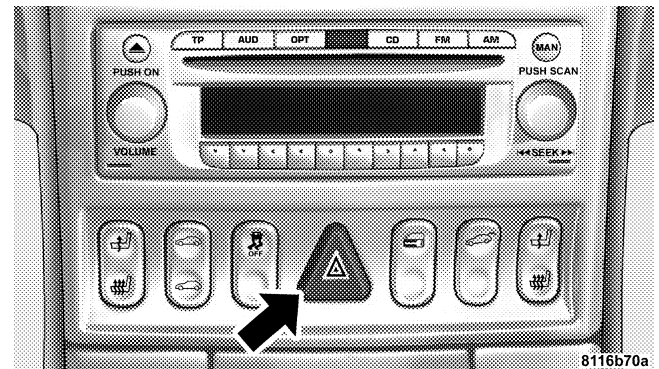

178 WHAT TO DO IN EMERGENCIES

- Turn on the hazard warning flashers and park the vehicle on a firm, level surface; avoid ice or slippery areas.
- Firmly set the parking brake and shift the transmission selector lever into PARK (manual transmission to FIRST or REVERSE gear).
- Turn off the engine.
- Block the wheel diagonally opposite the flat tire.

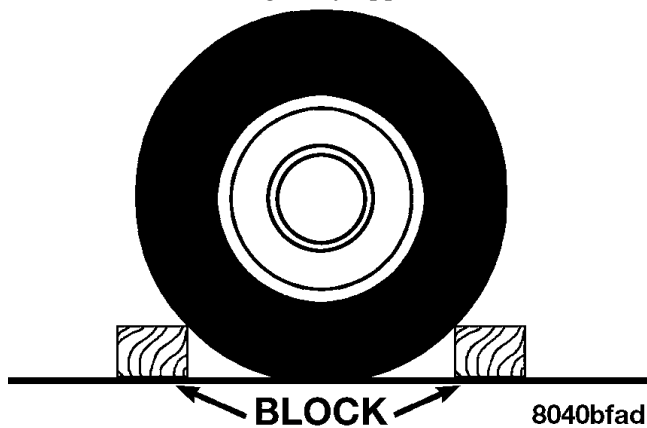

- Passengers must not remain in the vehicle when the vehicle is jacked.

NOTE: The jack is designed exclusively for jacking up the vehicle at the specified jack location points built beneath either side of the vehicle.

Jack Location and Instructions

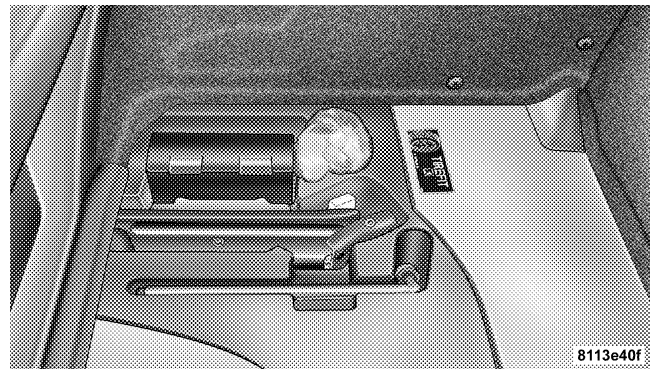

1. Remove the jack and jack handle from stowage beneath the cargo compartment carpet.

2. The lifting points for the jack are located beneath the outer edge of the body side, directly behind the front wheel housings, and in front of the rear wheel housings.

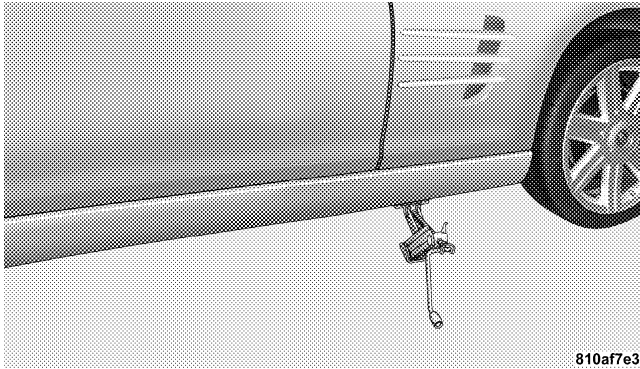

NOTE: Do not raise the vehicle until you are sure the jack is securely engaged, as shown.

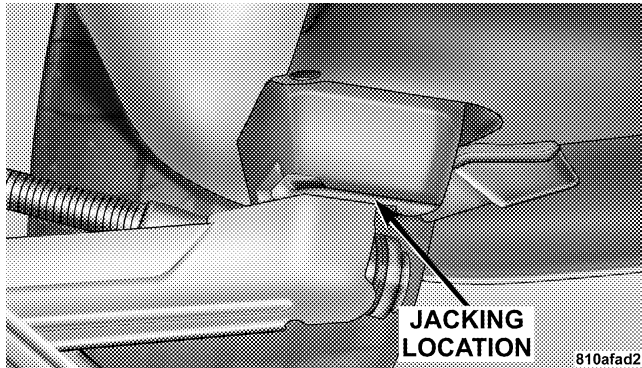

3. Holding the jack, insert the cradle under the lifting points. Crank the handle clockwise until the jack base meets the ground. Place the jack on firm ground. Position the jack so that it is always level, even if the vehicle is parked on an incline. Raise the vehicle only until the tire just clears the surface. Minimum tire lift provides maximum stability.

4. Replace the tire.

5. Lower the vehicle by cranking the handle counter-clockwise, then remove the jack assembly.

NOTE: Before storing the jack, it should be fully collapsed.

6. Ensure proper tire pressure.

WARNING!

Raising the vehicle higher than necessary can make the vehicle less stable. It could slip off the jack and hurt someone near it. Raise the vehicle only enough to make the necessary repair.

WARNING!

A loose jack or tool thrown forward in a collision or hard stop could endanger the occupants of the vehicle. Always stow the jack parts and tools in the places provided.

JUMP-STARTING THE BATTERY**WARNING!**

Take care to avoid the radiator cooling fan whenever the hood is raised. It can start any time the ignition switch is on. You can be hurt by the fan.

CAUTION!

Do not try to push or tow your vehicle to get it started. Your vehicle cannot be started this way. Pushing with another vehicle may damage the transmission or the rear of your vehicle. If your vehicle has a discharged (dead) battery, booster cables may be used to obtain a start from another vehicle. This type of start can be dangerous if done improperly, so follow the procedure carefully.

WARNING!

Battery fluid is a corrosive acid solution; do not allow battery fluid to contact eyes, skin or clothing. Don't lean over battery when attaching clamps or allow the clamps to touch each other. If acid splashes in eyes or on skin, flush contaminated area immediately with large quantities of water.

A battery generates hydrogen gas that is flammable and explosive. Keep flame or spark away from the vent holes. Do not use a booster battery or any other booster source with an output that exceeds 12 volts.

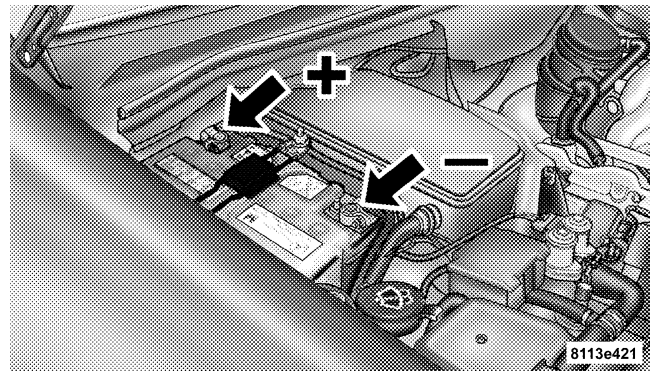

1. Wear eye protection and remove any metal jewelry such as watch bands or bracelets that might make an inadvertent electrical contact.
2. When boost is provided by a battery in another vehicle, park that vehicle within booster cable reach but without letting the vehicles touch. Set the parking brake, place the transmission in Neutral and turn the ignition OFF for both vehicles.

3. Turn off the heater, radio and all unnecessary electrical loads.

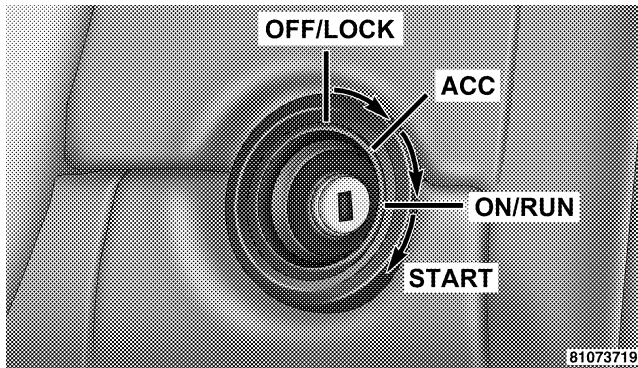

4. Connect one end of a jumper cable to the positive jump-start attachment of the booster battery. Connect the other end of the same cable to the positive jump-start attachment of the discharged battery.

5. Connect the other cable, first to the negative jump-start attachment of the booster battery and then to the engine of the vehicle with the discharged battery. Make sure you have good contact on the engine.

6. Start the engine in the vehicle which has the booster battery, let the engine idle a few minutes, then start the engine in the vehicle with the discharged battery.

7. When removing the jumper cables, reverse the above sequence exactly. Be careful of the moving belts and fans.

NOTE: If engine does not run after several unsuccessful starting attempts, have it checked at the nearest authorized dealer.

DRIVING ON SLIPPERY SURFACES

WARNING!

Rapid acceleration on slippery surfaces is dangerous. You could lose control of the vehicle and possibly have an accident. Accelerate slowly and carefully whenever there is likely to be poor traction (ice, snow, rain, mud, loose sand, etc.).

Traction

When driving on wet or slushy roads, it is possible for a wedge of water to build up between the tire and road surface. This is hydroplaning and may cause partial or complete loss of vehicle control and stopping ability. To reduce this possibility, the following precautions should be observed:

1. Slow down during rainstorms or when roads are slushy.
2. Slow down if the road has standing water or puddles.
3. Replace tires when tread wear indicators first become visible.
4. Keep tires properly inflated.
5. Maintain enough distance between your vehicle and the vehicle in front to avoid a collision in a sudden stop.

FREEING A STUCK VEHICLE

In order to free a stuck vehicle you must turn off the Electronic Stability Program (ESP) before attempting to “rock” the vehicle.

If your vehicle becomes stuck in mud, sand or snow, it can often be moved by a rocking motion. Turn your steering wheel right and left to clear the area around the front wheels. Then shift back and forth between Reverse and Drive. Usually the least accelerator pedal pressure to maintain the rocking motion without spinning the wheels is most effective.

NOTE: ESP should be turned on again after freeing the vehicle from a stuck condition.

CAUTION!

Racing the engine or spinning the wheels too fast may lead to transmission/axle overheating and failure. It can also damage the tires. Do not spin the wheels above 30 mph (48 km/h).

TOWING A DISABLED VEHICLE

We recommend that the vehicle be transported using flat bed equipment. This method is preferable to other types of towing.

CAUTION!

Important! If towing the vehicle, please note the following: With the automatic central locking activated and the key in the ignition switch turned to the ON/RUN position, the vehicle doors lock if the left front wheel and the right rear wheel are turning at vehicle speeds of approximately 9 mph (15 km/h) or more. To prevent the vehicle door locks from locking, deactivate the automatic central locking.

CAUTION!

If the vehicle is towed with the front wheels raised, the engine must be shut off (key in the ignition switch turned to the OFF/LOCK or ACC positions). Otherwise, the ESP will immediately be engaged and will apply the rear wheel brakes. Switch off the tow-away alarm as well as the automatic central locking system.

Towing restrictions for vehicles with automatic transmission: The vehicle may be towed with all wheels on the ground and the transmission selector lever in the Neutral position for distances up to 30 miles (48 km) and at a speed not to exceed 30 mph (48 km/h). The key must be turned to the ON/RUN position in the ignition. To be certain to avoid a possibility of damage to the transmission, however, we recommend the drive shaft be disconnected at the rear axle drive flange for any towing beyond a short tow to a nearby garage.

Always comply with applicable state or local towing ordinances.

CAUTION!

- Do not attempt to tow this vehicle from the front with sling-type towing equipment. Damage to the front fascia will result.
- Always use wheel lift equipment when towing from the front. The only other approved method of towing is with a flatbed truck.
- Do not tow the vehicle from the rear. Damage to the rear sheet metal and fascia will occur.
- Do not push or tow this vehicle with another vehicle as damage to the bumper fascia and transmission may result.

Towing Eyes

The vehicle is equipped with front and rear towing eyes to allow towing with the wheels on the ground or to allow the vehicle to be easily drawn up on a flatbed tow truck. The rear towing eye is located on the right side of the vehicle below the rear fascia. The front hook is

located behind the lower grille in the fascia. For access, a snap-in grille must be removed using the multifunction tool from the glovebox.

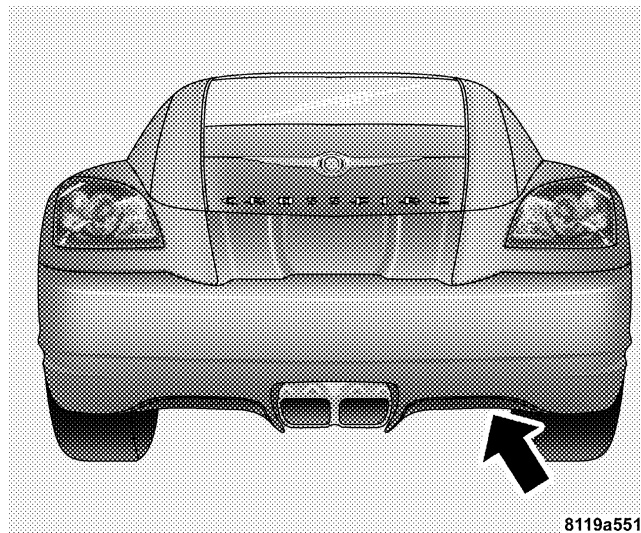

8119a551

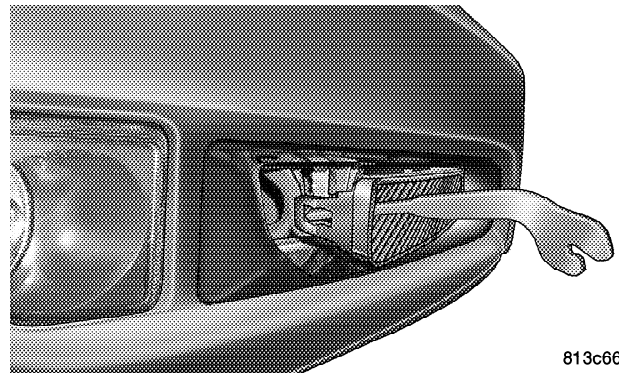
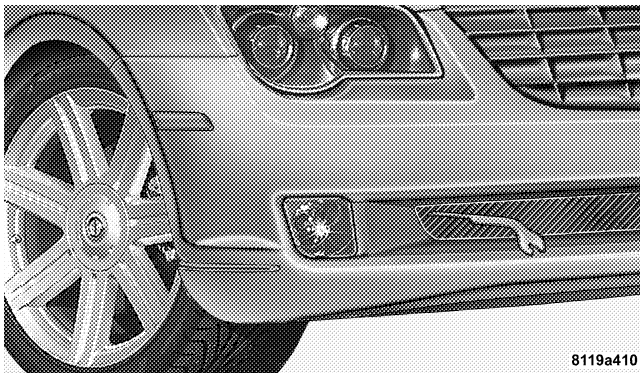

Insert the tool (or similar sized screwdriver) into the slot in the grille as shown (the tool must be inserted far enough to engage the clip on the left side of the grille). Push the tool to the left to disengage the clip and detach the grille. The front towing eye is now accessible.

Tow-Away Alarm

Once the alarm system has been armed, the exterior vehicle lights will flash and an alarm will sound when anyone attempts to raise the vehicle for towing. The alarm will last approximately three minutes in the form of flashing exterior lights. At the same time, an alarm will sound for 30 seconds. The alarm will stay on even if the vehicle is immediately lowered. To cancel the alarm, insert the key in the ignition switch or press the transmit button on the key fob.

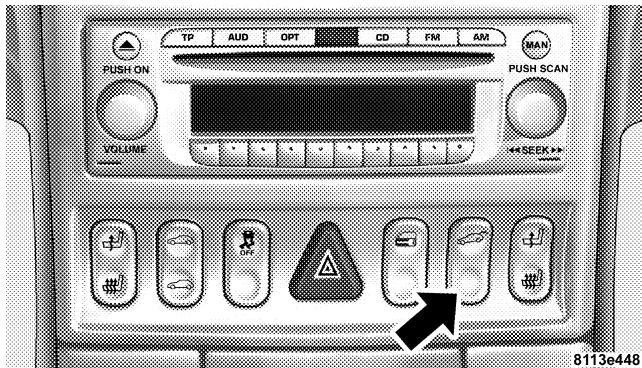

To prevent triggering the tow-away alarm feature, press the tow-away alarm switch to turn off the tow-away alarm before towing the vehicle, or when parking on a surface subject to movement, such as a ferry or auto train. To do so, turn the key in the ignition switch to the OFF/LOCK or ACC positions, or remove key from the ignition switch. Press the upper half of the tow-away alarm switch. The indicator light will illuminate briefly. Then, exit the vehicle and lock with a key or the remote control. The tow-away alarm remains switched off until the vehicle is locked again with a key or the remote control, at which time it is automatically reactivated.

CONVERTIBLE TOP EMERGENCY OPERATION

If the convertible top cannot be closed using the convertible top switch, check the following:

- Is the decklid closed properly?
- Is there sufficient battery voltage? Start the engine if necessary.
- Is the rear cargo compartment divider secured in the vertical position?

If the power convertible top operation does not function properly, you can close the convertible top manually.

NOTE: The multifunction tool from the glovebox is required for this job.

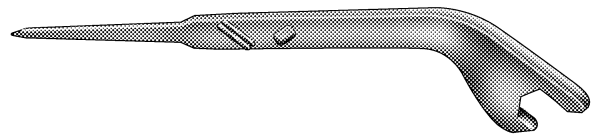

812b1b23

6

CAUTION!

Manually closing the convertible top is a complicated and technically demanding procedure. Closing the convertible top manually should be performed with great care by two people. Close the convertible top manually in emergency cases only. Otherwise, visit an authorized DaimlerChrysler Dealer.

Relieving Hydraulic Pressure

NOTE: The hydraulic pressure must be relieved before the top can manually be raised or lowered.

1. Turn the ignition to the "ON" position.
2. Push down on the convertible top switch and hold in that position.
3. Turn the ignition "OFF" and continue to push down on the switch for 5 seconds.
4. After 5 seconds the hydraulic system pressure will be relieved.

WARNING!

It is important that a second person assist you to close the convertible top manually to prevent injuries.

1. Lower the windows and open the doors.
2. Turn the ignition key off.

CAUTION!

Ensure that the decklid is closed while raising the convertible top manually to prevent the possibility of contact between the decklid and the tonneau cover.

WARNING!

Do not place your hands near the convertible top frame, upper windshield area, or the convertible top storage compartment while the convertible top is being raised and locked. Serious personal injury may occur.

3. Unlock the storage compartment by placing the tool on the bolt between the backrest and the tonneau cover. Turn the wrench in the direction of the arrow to its stop and remove the tool.

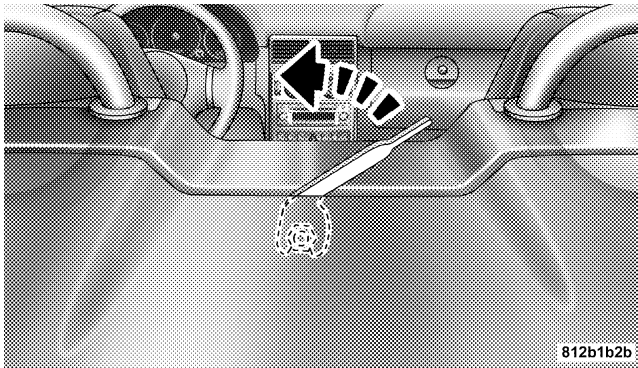

4. Open the tonneau cover and secure it in the upright position.

5. Pull up hard on the upper section of the convertible top to move it out of its storage compartment.

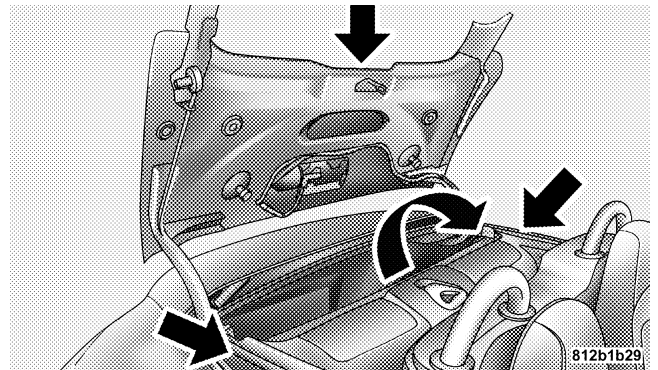

NOTE: Do not let go of the convertible top as it may fall back into the convertible top storage compartment.

6. Move the convertible top toward the windshield header.

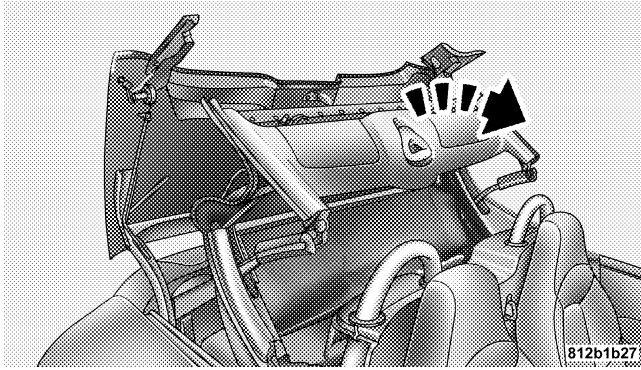

WARNING!

Do not place your hands in the convertible top frame areas. Serious personal injury may occur.

7. Do not place the convertible top frame onto windshield header.

8. Place the rear window section of the convertible top in its vertical position.

9. Close the tonneau cover by placing hands near the edges (arrows) and slowly lowering it. The tonneau cover must lock in the first notch of the compartment cover catch.

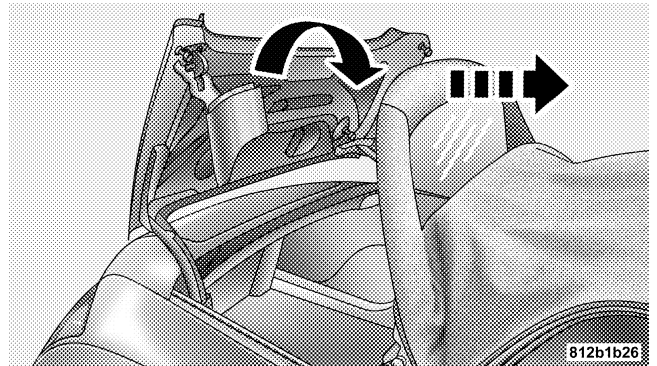

10. Lock the convertible top storage compartment by placing the tool on the bolt between the backrest and the tonneau cover. Turn the wrench in the direction of the arrow to its stop and remove the tool.

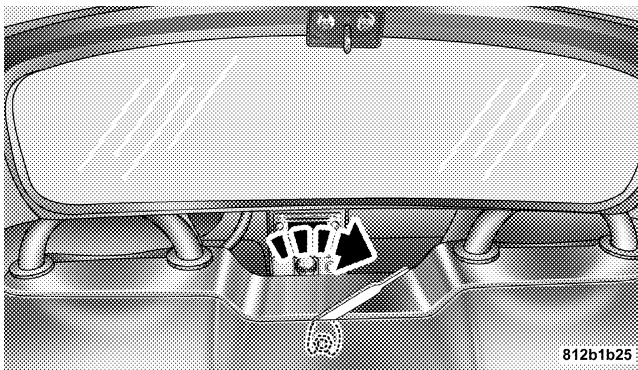

11. Lower the rear window section of the convertible top down and lock into the tonneau cover.

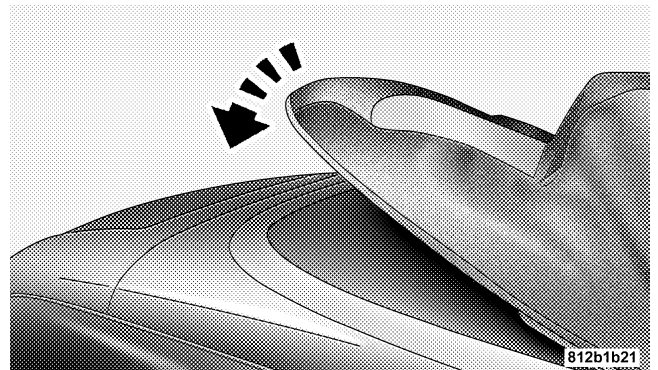

12. Press latch handle release button and fold down the locking latch handle.

13. Turn the latch handle just past one quarter turn clockwise and pull the convertible top frame carefully down until it meets the windshield header attachment points.

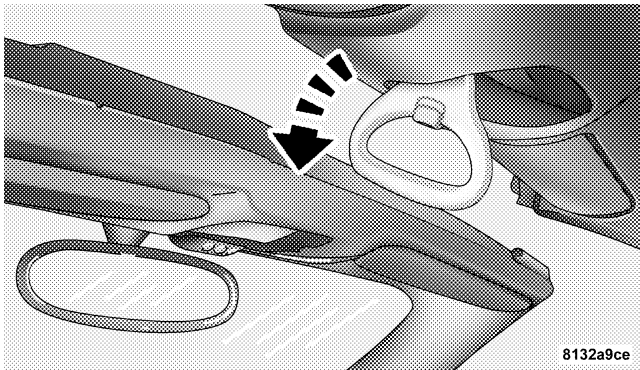

14. Turn the latch handle counterclockwise to the stop in order to lock the convertible top.

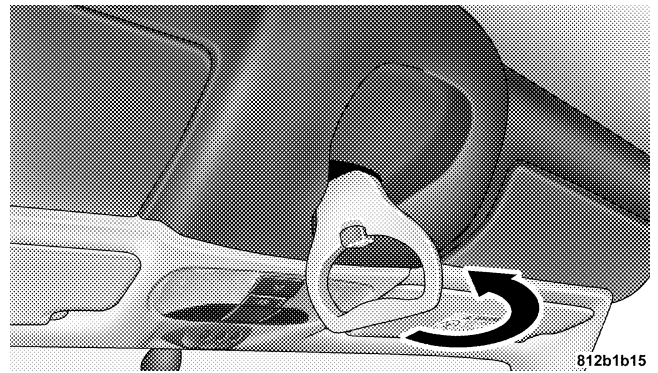

15. Fold the latch handle up until the release button engages.

The convertible top is now locked onto the windshield header.

NOTE: Have the convertible top operation checked at your authorized DaimlerChrysler Dealer as soon as possible.

MAINTAINING YOUR VEHICLE

CONTENTS

■ 3.2L Engine	197	□ Power Steering Fluid	209
■ Onboard Diagnostic System (OBD II)	198	□ Chassis Lubrication	210
■ Emissions Inspection And Maintenance Programs	199	□ Body Lubrication	211
■ Replacement Parts	200	□ Windshield Wiper Blades	211
■ Dealer Service	200	□ Windshield Wiper Blade Replacement	212
■ Maintenance Procedures	201	□ Windshield Washer Reservoir	212
□ Engine Oil	201	□ Exhaust System	213
□ Ignition Wiring System	207	□ Cooling System	214
□ Crankcase Emission Control System	207	□ Hoses And Vacuum/Vapor Harnesses	217
□ Maintenance-Free Battery	207	□ Brakes	217
□ Air Conditioner	208	□ Automatic Transmission	220

196 MAINTAINING YOUR VEHICLE

□ Manual Transmission	221	□ Headlights	235
□ Appearance Care And Protection From Corrosion	222	□ Front Turn Signal And Parking/Standing Lights	236
■ Convertible Top Care	226	□ Front And Rear Sidemarker Lights	236
□ Washing	227	□ Tail, Stop, Back Up And Turn Signal Lights . . .	237
□ General Cleaning	227	□ License Plate Light	238
□ Weather Strip Care	228	□ Headlight Aiming	238
■ Fuses	228	■ Vehicle Storage	239
□ Underhood Accessory Fuse Block Fuses	228	■ Specifications	241
□ Relay Control Module Fuses	232	■ Fluid Capacities	243
□ Interior Fuses	233	■ Recommended Fluids, Lubricants And Genuine Parts	244
■ Replacement Bulbs	235	□ Engine	244
□ Interior Light Bulbs	235	□ Chassis	245
□ Exterior Light Bulbs	235	□ Body	246
■ Exterior Light Bulb Service	235		

3.2L ENGINE

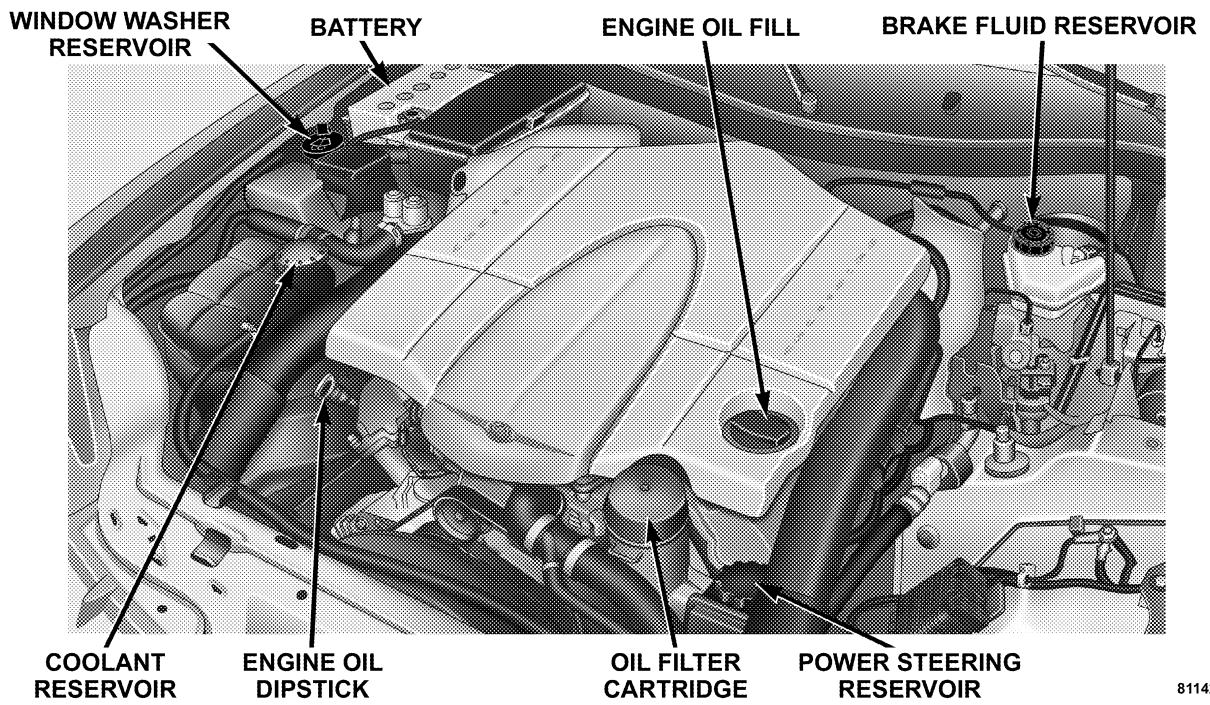

81142f34

ONBOARD DIAGNOSTIC SYSTEM (OBD II)

To meet new government regulations and promote cleaner air, your Crossfire is equipped with a sophisticated onboard diagnostic system called OBD II. This system monitors the performance of the emissions and engine control systems. When these systems are operating properly, your vehicle will provide excellent performance and fuel economy, as well as engine emissions well within current government regulations.

If any of these systems require service, the OBD II system will turn on the CHECK ENGINE Light. It will also store diagnostic codes and other information to assist your service technician in making repairs. Although your vehicle will usually be drivable and not need towing, see your authorized dealer for service as soon as possible.

CAUTION!

Prolonged driving with the CHECK ENGINE light on could cause further damage to the emission control system. It could also affect fuel economy and drivability. The vehicle must be serviced before any state emissions tests can be performed.

If the CHECK ENGINE light is flashing, severe catalytic converter damage and power loss will soon occur. Immediate service is required.

If the gas cap is not tightened properly, the CHECK ENGINE light may come on. Be sure the gas cap is tightened every time you add fuel. Tighten the cap until you hear it "click" once.

EMISSIONS INSPECTION AND MAINTENANCE PROGRAMS

In some localities, it may be a legal requirement to pass an inspection of your vehicle's emissions control system. Failure to pass could prevent vehicle registration.

CHECK ENGINE For states which have an I/M (Inspection and Maintenance) requirement, this check verifies the following: the CHECK ENGINE Light is functioning and is not on when the engine is running, and that the OBD (Onboard Diagnostic) system is ready for testing.

Normally, the OBD system will be ready. The OBD system may **not** be ready if your vehicle was recently serviced, if you recently had a dead battery, or a battery replacement. If the OBD system should be determined not ready for the I/M test, your vehicle may fail the test.

Your vehicle has a simple ignition key actuated test which you can use prior to going to the test station. To check if your vehicle's OBD system is ready, you must do the following:

1. Insert your ignition key into the ignition switch.
2. Turn the ignition to the ON/RUN position, but do not crank or start the engine.
3. If you crank or start the engine, you will have to start this test over.
4. As soon as you turn your key to the ON/RUN position, you will see your CHECK ENGINE light come on as part of a normal bulb check.
5. Approximately 15 seconds later, one of two things will happen:
 - a. The CHECK ENGINE light will flash for about 10 seconds and then return to being fully illuminated until you turn off the ignition key or start the engine. This means that your vehicle's OBD system is **not ready** and you should **not** proceed to the I/M station.
 - b. The CHECK ENGINE light will not flash at all and will remain fully illuminated until you turn off the ignition key or start the engine. This means that your vehicle's OBD system is **ready** and you can proceed to the I/M station.

If your OBD system is **not ready**, you should see your authorized dealer or repair facility. If your vehicle was recently serviced or had a battery failure or replacement, you may need to do nothing more than drive your vehicle as you normally would in order for your OBD system to update. A recheck with the above test routine may then indicate that the system is now ready.

Regardless of whether your vehicle's OBD system is ready or not ready, if the CHECK ENGINE light is illuminated during normal vehicle operation, you should have your vehicle serviced before going to the I/M station. The I/M station can fail your vehicle because the CHECK ENGINE light is on with the engine running.

REPLACEMENT PARTS

Use of genuine Mopar® parts for normal/scheduled maintenance and repairs is highly recommended to insure the designed performance. Damage or failures caused by the use of non-Mopar® parts for maintenance and repairs will not be covered by the warranty offered by DaimlerChrysler Corporation.

DEALER SERVICE

Your dealer has the qualified service personnel, special tools and equipment to perform all service operations in an expert manner. Service Manuals are available which include detailed service information for your Crossfire. Refer to these manuals before attempting any procedure yourself.

NOTE: Intentional tampering with emissions control systems can result in civil penalties being assessed against you.

WARNING!

You can be badly injured working on or around a motor vehicle. Do only that service work for which you have the knowledge and the proper equipment. If you have any doubt about your ability to perform a service job, take your vehicle to a competent technician.

MAINTENANCE PROCEDURES

The pages that follow contain the maintenance service recommended by the engineers who designed your vehicle.

Besides the maintenance items for which there are fixed maintenance intervals, there are other items that should operate satisfactorily without periodic maintenance. However, if a malfunction of these items does occur, it could adversely affect the engine or vehicle performance. These items should be inspected if a malfunction is observed or suspected.

Engine Oil**Checking Oil Level**

To assure proper engine lubrication, the engine oil must be maintained at the correct level. Check the oil level at regular intervals, such as every fuel stop.

You can check the oil level using the procedure described in Checking Engine Oil Level in the Understanding Your Instrument Panel section, or by checking the engine oil dipstick.

The best time to check the engine oil level is about 5 minutes after a fully warmed engine is shut off, or before starting the engine after it has sat overnight.

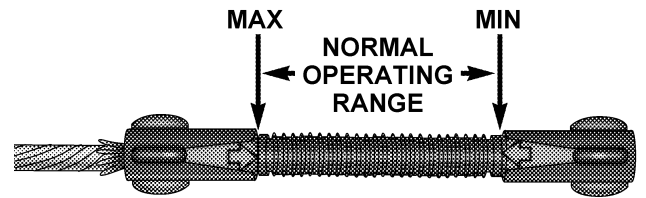
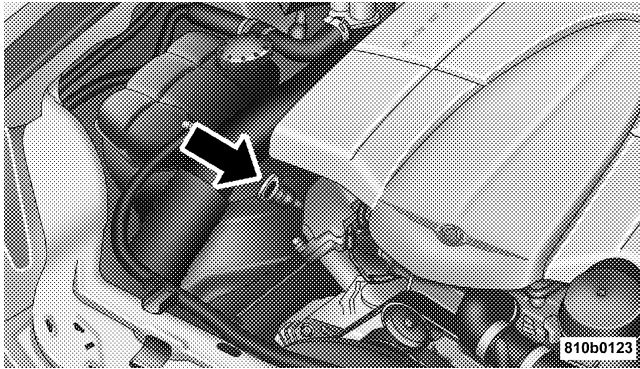

81073c4c

Checking the oil while the vehicle is on level ground will improve the accuracy of the oil level readings. Maintain the oil level between the MIN and MAX markings on the dipstick. Adding one quart of oil when the reading is at the MIN mark will result in a MAX reading on this engine.

Change Engine Oil

The oil change interval for your Crossfire is initially set at 7,000 miles (Canada: 11,000 km).

The Flexible Service System (FSS) in your vehicle evaluates engine temperature, oil level, vehicle speed, engine speed, distance driven, and the time elapsed since your last service. It determines when your vehicle needs maintenance service and alerts you in advance. The next necessary service is indicated by the FSS in your instrument cluster.

NOTE: Also see the FSS system details in the Understanding Your Instrument Panel section of this manual.

Very light duty driving cycles (most trips more than 10 miles [16 km] at moderate speeds in moderate temperature conditions) can extend the service interval beyond 7,000 miles (Canada: 11,000 km).

If **ANY** of the following apply to your driving, the oil change interval can be reduced significantly:

- Day and night temperatures are below 32°F (0°C)
- Stop-and-go driving
- Extensive engine idling

- Driving in dusty conditions
- Short trips of less than 10 miles (16 km)
- More than 50% of your driving is at sustained high speeds during hot weather, above 90°F (32°C)
- Taxi, Police, or delivery service (commercial service)

Observe the oil change interval indicated by your FSS system. This system will monitor the driving conditions seen by your vehicle, and will recommend the best interval for servicing your vehicle to maintain it in top condition.

CAUTION!

Overfilling or underfilling the crankcase will cause oil aeration or loss of oil pressure. This could damage your engine.

Engine Oil Selection

For best performance and maximum protection under all types of operating conditions, only use synthetic engine oils, approved to MB 229.3 or MB 229.5, such as Mobil 1 SAE 0W-40. The FSS may not alert for an oil change at the proper interval if an unapproved engine oil is used; engine damage and reduced engine life may result.

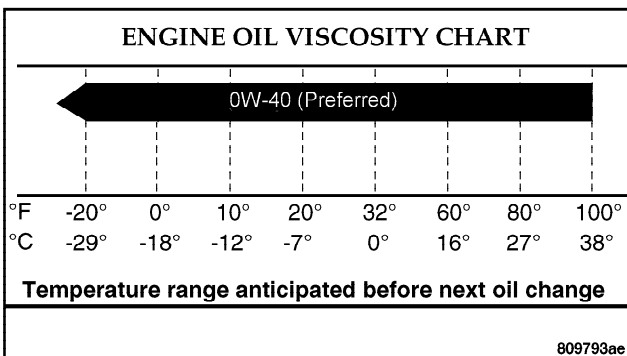

Materials Added To Engine Oils

Do not add materials (other than leak detection dyes) to engine oil. Engine oil is an engineered product and its performance may be impaired by supplemental additives.

Disposing of Used Engine Oil

Care should be taken in disposing of used engine oil from your vehicle. Used oil, indiscriminately discarded, can present a problem to the environment. Contact your dealer, service station, or governmental agency for advice on how and where used oil can be safely discarded in your area.

Engine Oil Filter

The engine oil filter should be replaced at every engine oil change.

Engine Oil Filter Selection

All DaimlerChrysler Corporation engines have a full-flow type disposable oil filter. Use a filter of this type for replacement. The quality of replacement filters varies considerably. Only high quality filters should be used to assure most efficient service. Mopar® Engine Oil Filters are high quality oil filters and are recommended.

Drive Belts - Check Condition and Tension

At the distance shown in the maintenance schedules, check all drive belts for condition and proper tension. Improper belt tension can cause belt slippage and failure.

Inspect the drive belts for evidence of cuts, cracks, or glazing and replace them if there is any sign of damage which could result in belt failure. If adjustment is required, adjust the belts according to the specifications and procedures shown in the Service Manual.

Special tools are required to properly measure tension and to restore belt tension to factory specifications. Also, check belt routing to make sure there is no interference between the belts and other engine components.

Spark Plugs

Spark plugs must fire properly to assure engine performance and emission control. New plugs should be installed at the distance specified in the appropriate maintenance chart. The entire set should be replaced if there is any malfunction due to a faulty spark plug. Check the specifications section for the proper type of spark plug for use in your vehicle.

Engine Air Cleaner Filter

Under normal driving conditions, replace the air filter at each interval called out by FSS.

WARNING!

The air cleaner can provide a measure of protection in the case of engine backfire. Do not remove the air cleaner unless such removal is necessary for repair or maintenance. Make sure that no one is near the engine compartment before starting the vehicle with the air cleaner removed. Failure to do so can result in serious personal injury.

7

Engine Fuel Filter

A plugged fuel filter can cause hard starting or limit the speed at which a vehicle can be driven. Should an excessive amount of dirt accumulate in the fuel tank, frequent filter replacement may be necessary. See your authorized dealer for service.

Catalytic Converter

The catalytic converter requires the use of unleaded fuel only. Leaded gasoline will destroy the effectiveness of the catalyst as an emission control device.

Under normal operating conditions, the catalytic converter will not require maintenance. However, it is important to keep the engine properly serviced to assure proper catalyst operation and prevent possible catalyst damage.

If the CHECK ENGINE light is flashing, immediate service is required.

CAUTION!

Damage to the catalytic converter can result if your vehicle is not kept in proper operating condition. In the event of engine malfunction, particularly involving engine misfire or other apparent loss of performance, have your vehicle serviced promptly. Continued operation of your vehicle with a severe malfunction could cause the converter to overheat, resulting in possible damage to the converter and the vehicle.

WARNING!

A hot exhaust system can start a fire if you park over materials that can burn. Such materials might be grass or leaves coming into contact with your exhaust system. Do not park or operate your vehicle in areas where your exhaust system can contact anything that can burn.

In unusual situations involving grossly malfunctioning engine operation, a scorching odor may suggest severe and abnormal catalyst overheating. If this occurs, stop the vehicle, turn off the engine and allow it to cool. Service, including a tune up to DaimlerChrysler Corporation's specifications, should be obtained immediately.

To minimize the possibility of catalyst damage:

- Do not shut off the engine or interrupt the ignition when the transmission is in gear and the vehicle is in motion.
- Do not try to start the engine by pushing or towing the vehicle.
- Do not idle the engine with any spark plug wires disconnected for a prolonged period.

Ignition Wiring System

The ignition cables should be kept clean and properly connected. Terminals should be fully seated. Cracked, damaged, or faulty cables should be replaced.

Crankcase Emission Control System

Proper operation of this system depends on freedom from sticking or plugging due to deposits.

Check ventilation hose for indication of damage or plugging deposits. Replace if necessary.

Maintenance-Free Battery

The top of the maintenance-free battery is permanently sealed. You will never have to add water, nor is periodic maintenance required.

WARNING!

Battery posts, terminals and related accessories contain lead and lead compounds. Wash hands after handling.

Battery fluid is a corrosive acid solution and can burn or even blind you. Don't allow battery fluid to contact your eyes, skin or clothing. Don't lean over a battery when attaching clamps. If acid splashes in eyes or on skin, flush the area immediately with large amounts of water.

Battery gas is flammable and explosive. Keep flame or sparks away from the battery. Don't use a booster battery or any other booster source with an output greater than 12 volts. Don't allow cable clamps to touch each other.

CAUTION!

It is essential when replacing the cables on the battery that the positive cable is attached to the positive post and the negative cable is attached to the negative post. Battery posts are marked positive (+) and negative (-) and identified on the battery case. Cable clamps should be tight on the terminal posts and free of corrosion. Apply grease to posts and clamps after tightening.

If a "fast charger" is used while the battery is in the vehicle, disconnect both vehicle battery cables before connecting the charger to battery. Do not use a "fast charger" to provide starting voltage as battery damage can result.

Air Conditioner

Check the air conditioning system at the start of the warm weather season.

NOTE: If your air conditioning performance seems lower than expected, check the front of the A/C condenser for an accumulation of dirt or insects. Clean with a gentle water spray from behind the radiator and through the condenser as required. Fabric front fascia protectors may reduce air flow to the condenser, reducing air conditioning performance.

WARNING!

The air conditioning system contains refrigerant under high pressure. To avoid risk of personal injury or damage to the system, adding refrigerant or any repair requiring lines to be disconnected should be done by an experienced repair person.

Refrigerant Recovery And Recycling

The air conditioning system of your vehicle contains R-134a, a refrigerant that does not deplete the ozone layer in the upper atmosphere. The DaimlerChrysler Corporation recommends that air conditioning service be done by facilities using refrigerant recycling and recovery equipment that meets SAE standard J1991.

Power Steering Fluid

No power steering fluid service is required. The system is filled at the factory with Pentosin CHF 11S. Steering noise and reduced component life may result if an unapproved fluid is used.

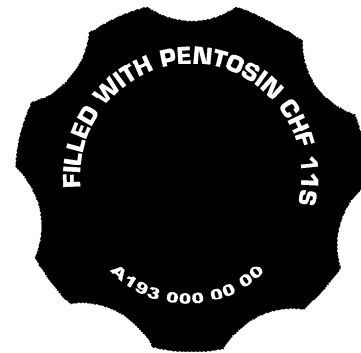

8118c2cf

During scheduled maintenance, check the power steering fluid level at the power steering fluid reservoir. Normally, it will not be necessary to add power steering fluid.

Before removing the reservoir cap, wipe the outside of the cap and reservoir so that no dirt can fall into the reservoir.

The power steering pump has a dipstick. Fluid level should be maintained at the proper level indicated on the dipstick. If necessary, add fluid to restore to the proper indicated level. With a clean cloth, wipe any spilled fluid from all surfaces.

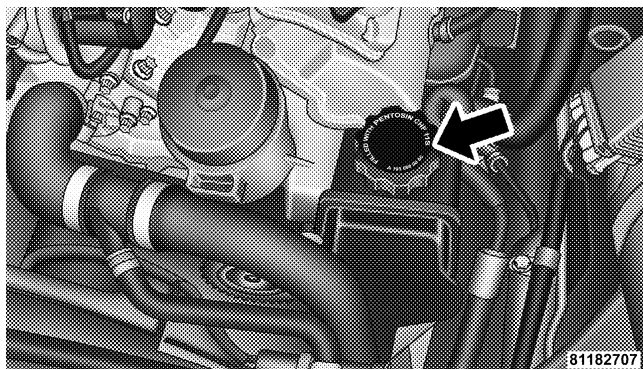

Chassis Lubrication

Front Suspension Ball Joints

There are two front suspension lower ball joints that are permanently lubricated. Inspect these ball joints whenever under-vehicle service is done.

Steering Linkage

Inspect tie rod ends whenever the vehicle is serviced. They are permanently lubricated and do not require periodic lubrication.

Drive Shaft Universal Joints

Your vehicle has four constant velocity universal joints. Periodic lubrication of these joints is not required. However, the joint boots should be inspected for external leakage or damage when other maintenance is performed.

If leakage or damage is evident, replace the universal joint boot and grease immediately.

Continued operation could result in failure of the universal joint due to water and dirt contamination of the grease. This would require complete replacement of the joint assembly.

Body Lubrication

Locks and all body pivot points, including such items as seat tracks, doors, and rear liftgate / decklid hinges, should be lubricated periodically to assure quiet, easy operation and to protect against rust and wear.

Hood Latch

When performing other under hood services, the hood latch release mechanism and safety catch should be inspected, cleaned, and lubricated.

It is important to maintain proper lubrication to insure that the hood mechanisms work properly and safely. Multi-Purpose Lubricant, NLGI Grade 2, should be applied sparingly to all pivot and sliding contact areas.

Driver's Door Lock Cylinder

The driver's door lock cylinder should be lubricated twice a year, preferably in the fall and spring. Apply a small amount of a high quality lubricant, such as Mopar® Lock Cylinder Lubricant directly into the lock cylinder (avoid excess lubricant).

Insert the key into the lock cylinder and rotate from the unlocked to the locked position without adding more lubricant. Repeat this procedure three or four times. Wipe all the lubricant off the key with a clean cloth, to avoid soiling clothing.

Windshield Wiper Blades

Clean the rubber edges of the wiper blades and the windshield periodically with a sponge or soft cloth and a mild non-abrasive cleaner, or use the washer solvent. This will remove accumulations of salt or road film and help reduce streaking and smearing.

Operation of the wipers on dry glass for long periods may cause deterioration of the wiper blades. Always use washer fluid when using the wipers to remove salt or dirt from a dry windshield. Avoid using the wiper blades to remove frost or ice from the windshield. Make sure that they are not frozen to the glass before turning them on to avoid damaging the blade. Keep the blade rubber out of contact with petroleum products such as engine oil, gasoline, etc.

Windshield Wiper Blade Replacement

1. Lift the wiper arm away from the glass.
2. Rotate the blade 45 degrees to gain access to the release tab.
3. Push the release tab as shown in the illustration and slide the wiper blade assembly down along the arm. Gently place the wiper arm on the windshield.

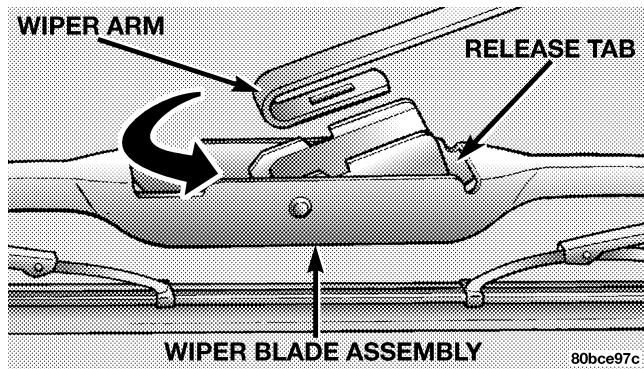

4. Install the new blade assembly onto the wiper arm tip until it locks in place.

Windshield Washer Reservoir

The washer fluid reservoir is located in the engine compartment and should be checked for fluid level at regular intervals. Fill the reservoir with windshield washer solvent (not radiator antifreeze) rated not to freeze at -25°F (-31°C). Operate the system for a few seconds to flush out the residual water.

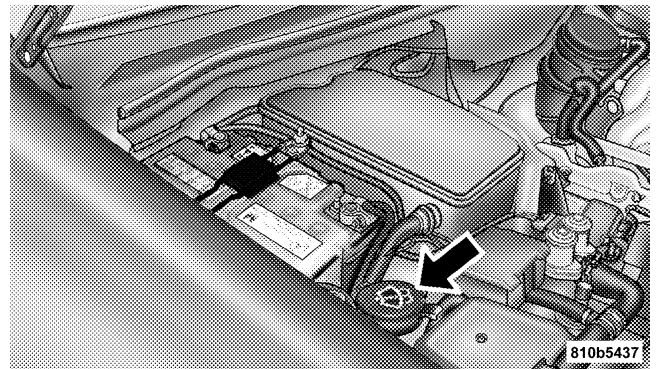

WARNING!

Do not overfill the washer reservoir. Do not attempt to fill to the top of the filler neck. Fluid may leak out onto the floor or driveway causing a potential slip and fall hazard. When the indicator light first illuminates, the maximum fill amount is 1 gallon or 4 liters.

WARNING!

Commercially available windshield washer solvents are flammable. They could ignite and burn you. Care must be exercised when filling or working around the washer solution.

Exhaust System

The best protection against carbon monoxide entry into the vehicle body is a properly maintained engine exhaust system.

If you notice a change in the sound of the exhaust system, or if exhaust fumes can be detected inside the vehicle, or when the underside or rear of the vehicle is damaged, have a competent technician inspect the complete exhaust system and adjacent body areas for broken, damaged, deteriorated, or mispositioned parts. Open seams or loose connections could permit exhaust fumes to seep into the passenger compartment. In addition, inspect the exhaust system each time the vehicle is raised for lubrication or oil change. Replace as required.

WARNING!

Exhaust gases can injure or kill. They contain carbon monoxide which is colorless and odorless. Breathing it can make you unconscious and can eventually poison you. Follow the above precautions to keep your exhaust system as safe as possible.

Cooling System

WARNING!

- When working near the radiator cooling fan, disconnect the fan motor lead or turn the ignition switch to the OFF position. The fan is temperature controlled and can start at any time the ignition key is in the ON position.
- You or others can be badly burned by hot coolant or steam from your radiator. If you see or hear steam coming from under the hood, don't open the hood until the radiator has had time to cool. Never try to open a cooling system pressure cap when the radiator is hot.

Coolant Checks

Check coolant protection every 12 months (before the onset of freezing weather, where applicable). If the coolant is dirty or rusty in appearance, the system should be drained, flushed and refilled with fresh coolant.

Check the front of the radiator and condenser for an accumulation of bugs, leaves, etc. Clean the radiator and condenser by gently spraying water from a garden hose at the back of the radiator core.

Check the recovery bottle tank tubing for condition and tightness of connection at the bottle and radiator. Inspect the entire system for leaks.

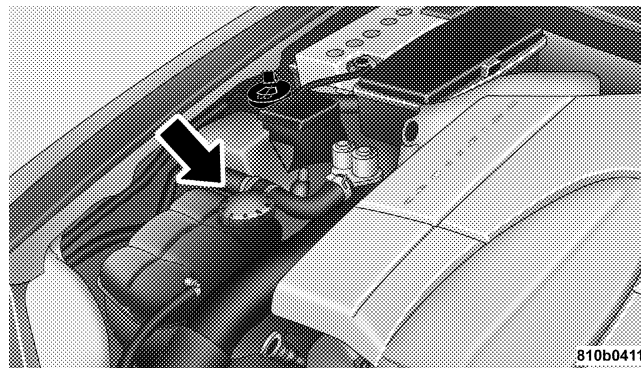

Cooling System - Drain, Flush and Refill

At the intervals shown on the Maintenance Schedules, the system should be drained, flushed and refilled.

If the solution is dirty and contains a considerable amount of sediment, clean and flush with a reliable cooling system cleaner. Follow with a thorough rinsing to remove all deposits and chemicals.

Engine Coolant Disposal

Used ethylene glycol based engine coolant is a regulated substance requiring proper disposal. Check with your local authorities to determine the disposal rules for your community. Do not store ethylene glycol based engine coolant in open containers or allow it to remain in puddles on the ground. Prevent ingestion by animals or children. If ingested by a child, contact a physician immediately.

Selection Of Coolant

Use only coolant approved to MB 325.0, such as Valvoline GO5, or an equivalent extended life coolant. Refer to the recommended Fluids, Lubricants and Genuine Parts for correct coolant type.

CAUTION!

Failure to use the proper antifreeze could cause radiator plugging and engine overheating. Do not mix antifreeze brands or types. Do not use plain water alone or alcohol base antifreeze products. Do not use additional rust inhibitors or antirust products, as they may not be compatible with the radiator coolant and may plug the radiator.

Adding Coolant

When adding coolant, a minimum solution of 50% ethylene glycol antifreeze coolant and water should be used. Use higher concentrations (not to exceed 70%) if temperatures below -34°F (-37°C) are anticipated.

Use only high purity water, such as distilled or deionized water when mixing the water/antifreeze solution. The use of lower quality water will reduce the amount of corrosion protection in the engine cooling system.

NOTE: Mixing coolant types other than Mopar® products will decrease the life of the engine coolant and will require more frequent coolant changes.

Please note that it is the owner's responsibility to maintain the proper level of protection against freezing, according to the temperatures occurring in the area where the vehicle is operated.

Cooling System Pressure Cap

The cap must be fully tightened to prevent loss of coolant, and to insure that coolant will return to the radiator from the coolant reserve tank.

The cap should be inspected and cleaned if there is any accumulation of foreign material on the sealing surfaces.

WARNING!

The warning words "DO NOT OPEN WHEN HOT" near the cooling system reservoir cap are a safety precaution. Never add coolant when the engine is overheated. Do not loosen or remove the cap to cool an overheated engine. Heat causes pressure to build up in the cooling system. To prevent scalding or injury, do not remove the pressure cap while the system is hot or under pressure.

WARNING!

Do not use a pressure cap other than the one specified for your vehicle. Personal injury or engine damage may result.

Points to Remember

NOTE: When the vehicle is stopped after a few miles/kilometers of operation, you may observe vapor coming from the front of the engine compartment. This is normally a result of moisture from rain, snow, or high humidity accumulation on the radiator and being vaporized when the thermostat opens, allowing hot water to enter the radiator.

If an examination of your engine compartment shows no evidence of radiator or hose leaks, the vehicle may be safely driven. The vapor will soon dissipate.

- Do not overfill the coolant bottle.
- Check coolant freeze point in the system.

- If frequent coolant additions are required, or if the level in the recovery bottle does not drop when the engine cools, the cooling system should be pressure tested for leaks.
- Maintain a coolant concentration of a minimum of 50% ethylene glycol Extended Life Coolant and high quality water with recommended antifreeze for proper corrosion protection of your engine cooling system that contains aluminum components.
- Make sure that the radiator and coolant bottle hoses are not kinked or obstructed.
- Keep the front of the radiator clean. If your vehicle has air conditioning, keep the front of the condenser clean, also.
- Do not change the thermostat for summer or winter operation. If replacement is ever necessary, install **ONLY** the correct type thermostat. Other designs may result in unsatisfactory coolant performance, poor fuel economy, and increased emissions.

Hoses And Vacuum/Vapor Harnesses

Inspect surfaces of hoses and nylon tubing for evidence of heat and mechanical damage. Hard or soft spots, brittle rubber, cracking, checking, tears, cuts, abrasions, and excessive swelling indicate deterioration of the rubber.

Pay particular attention to the hoses nearest to high heat sources such as the exhaust manifold. Inspect hose routing to be sure hoses do not touch any heat source or moving component that may cause heat damage or mechanical wear.

Insure nylon tubing in these areas has not melted or collapsed. Inspect all hose connections such as clamps and couplings to make sure they are secure and no leaks are present. Components should be replaced immediately if there is any evidence of degradation that could cause failure.

Brakes

In order to assure brake system performance, all brake system components should be inspected periodically. Suggested service intervals can be found in the Maintenance section.

WARNING!

Riding the brakes can lead to brake failure and possibly an accident. Driving with your foot resting or riding on the brake pedal can result in abnormally high brake temperatures, excessive lining wear, and possible brake damage. You wouldn't have your full braking capacity in an emergency.

Brake and Power Steering System Hoses

When servicing the vehicle for scheduled maintenance, inspect surface of hoses and nylon tubing for evidence of heat and mechanical damage. Hard and brittle rubber, cracking, checking, tears, cuts, abrasions, and excessive swelling suggest deterioration of the rubber. Particular attention should be made to examining those hose surfaces nearest to high heat sources, such as the exhaust manifold.

Inspect all hose clamps and couplings to make sure they are secure and no leaks are present.

Insure nylon tubing in these areas has not melted or collapsed.

NOTE: Often, fluids such as oil, power steering fluid, and brake fluid are used during assembly plant operations to ease the assembly of hoses to couplings. Therefore, oil wetness at the hose-coupling area is not necessarily an indication of leakage. Actual dripping of hot fluid when systems are under pressure (during vehicle operation) should be noted before a hose is replaced based on leakage.

NOTE: Inspection of brake hoses should be done whenever the brake system is serviced and at every engine oil change.

WARNING!

Worn brake hoses can burst and cause brake failure. You could have an accident. If you see any signs of cracking, scuffing, or worn spots, have the brake hoses replaced immediately.

Brake Master Cylinder

The fluid level in the master cylinder should be checked when performing under hood services, or immediately if the brake system warning light is on.

Be sure to clean the top of the master cylinder area before removing the cap. If necessary, add fluid to bring the fluid level up to the requirements described on the brake fluid reservoir. Fluid level can be expected to fall as the brake pads wear. Brake fluid level should be checked when pads are replaced. However, low fluid level may be caused by a leak and a checkup may be needed.

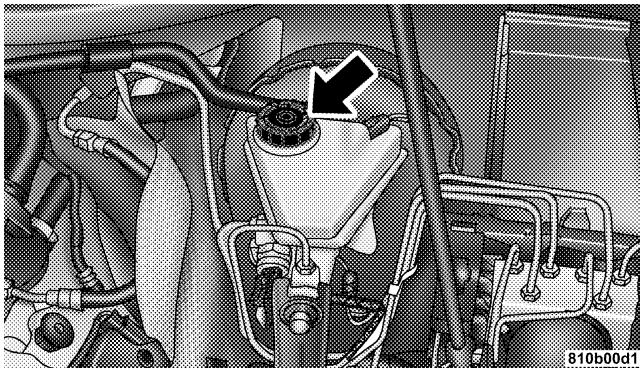

Use brake fluid approved to MB 331.0, or a DOT 4 brake fluid with: minimum dry boiling point (ERBP) 500°F, minimum wet boiling point (WERBP) 356°F, maximum viscosity 1500 mm²/s, conforming to FMVSS 116 and ISO 4925.

WARNING!

Use of a brake fluid that may have a lower initial boiling point or unidentified as to specification, may result in sudden brake failure during hard prolonged braking. You could have an accident.

WARNING!

Use only brake fluid that has been in a tightly closed container to avoid contamination from foreign matter. Use of contaminated fluid may result in reduced brake performance or a sudden brake failure. You could have an accident.

CAUTION!

Do not allow petroleum-based fluid to contaminate the brake fluid as seal damage will result!

Automatic Transmission

The fluid in the automatic transmission should be changed at 80,000 miles (129,000 km), along with the transmission fluid filter. After that, the transmission fluid is filled for life.

Selection of Lubricant

It is important that the proper lubricant is used in the transmission to assure optimum transmission performance. Use only ATF approved to MB 236.10, MB 236.12. Synthetic Dexron III® Automatic Transmission Fluid may be substituted. Refer to the Recommended Fluids, Lubricants and Genuine Parts section for the correct fluid type. It is important that the transmission fluid be maintained at the prescribed level using the recommended fluid.

CAUTION!

Using a transmission fluid other than the fluid recommended by DaimlerChrysler Corporation may cause deterioration in transmission shift quality and/or torque converter shudder. Using a transmission fluid other than that recommended by the DaimlerChrysler Corporation will result in more frequent fluid and filter changes. Refer to the Recommended Fluids, Lubricants and Genuine Parts section for correct fluid type.

Fluid Level Check

Regular automatic transmission fluid level checks and changes are not required. For this reason the dipstick is omitted.

If you notice fluid loss or gear shift malfunction, have your authorized dealer check the transmission fluid level.

Fluid and Filter Changes

Automatic transmission fluid and filter should be changed at 80,000 miles (129,000 km). The fluid is then filled for life.

NOTE: Refer to Section 8 of this manual for Maintenance Schedules.

Manual Transmission**Selection of Lubricant**

No fluid service is required. Use only fluid approved to MB 236.2. SAE 5W-20 engine oil, meeting API SL or GF-3, may be substituted. Refer to the Recommended Fluids, Lubricants and Genuine Parts section for the correct fluid type.

Fluid Level Check

Check the fluid level by removing the fill plug. The fluid level should be between the bottom of the fill hole and a point not more than 3/16 inch (4.76 mm) below the bottom of the hole.

CAUTION!

Do not overfill. Dirt and water in the transmission can cause serious damage. To prevent dirt and water from entering the transmission after checking or replenishing fluid, make certain that the dipstick cap is seated properly.

Add fluid, if necessary, to maintain the proper level.

Frequency of Fluid Change

Under normal operation conditions, the fluid installed at the factory will give satisfactory lubrication for the life of the vehicle. Fluid changes are not necessary unless the lubricant has become contaminated with water. If contaminated with water, the fluid should be changed immediately.

Special Additives

Do not add any fluid additives to the transmission. The only exception to this policy is the use of special dyes to aid in detecting fluid leaks. The use of transmission sealers should be avoided as this may adversely affect seals.

Appearance Care and Protection from Corrosion

Protection of Body and Paint from Corrosion

Vehicle body protection requirements vary according to geographic locations and usage. Chemicals that make roads passable in snow and ice, and those that are sprayed on trees and road surfaces during other seasons, are highly corrosive to the metal in your vehicle. Outside parking, which exposes your vehicle to airborne contaminants, road surfaces on which the vehicle is operated, extreme hot or cold weather and other extreme conditions will have an adverse effect on paint, metal trim, and underbody protection.

The following maintenance recommendations will enable you to obtain maximum benefit from the corrosion resistance built into your vehicle.

What Causes Corrosion?

Corrosion is the result of deterioration or removal of paint and protective coatings from your vehicle.

The most common causes are:

- Road salt, dirt and moisture accumulation.

- Stone and gravel impact.
- Insects, tree sap and tar.
- Salt in the air near seacoast localities.
- Atmospheric fallout/industrial pollutants.
- Bird droppings.

Washing

- Wash your vehicle regularly. Always wash your vehicle in the shade using a mild car wash soap, and rinse the panels completely with clear water.
- If insects, tar or other similar deposits have accumulated on your vehicle, wash it as soon as possible.
- Use Mopar® auto polish to remove road film and stains and to polish your vehicle. Take care never to scratch the paint.
- Avoid using abrasive compounds and power buffing that may diminish the gloss or thin out the paint finish.

CAUTION!

Do not use abrasive or strong cleaning materials such as steel wool or scouring powder, which will scratch metal and painted surfaces.

Special Care

- If you drive on salted or dusty roads or if you drive near the ocean, hose off the undercarriage at least once a month.
- It is important that the drain holes in the lower edges of the doors, rocker panels and rear liftgate / decklid be kept clear and open.
- If you detect any stone chips or scratches in the paint, touch them up immediately. The cost of such repairs is considered the responsibility of the owner.
- Use Mopar® touch-up paint on scratches or chips as soon as possible. Your dealer has touch-up paint to match the color of your vehicle.

- If your vehicle is damaged due to an accident or similar cause which destroys the paint and protective coating, have your vehicle repaired as soon as possible. The cost of such repairs is considered the responsibility of the owner.
- If you carry special cargo such as chemicals, fertilizers, deicer salt, etc., be sure that such materials are well packaged and sealed.
- Aluminum wheels should be cleaned regularly with mild soap and water to prevent corrosion. To remove heavy soil, select a non-abrasive, non-acidic cleaner. Do not use scouring pads or metal polishes. Avoid automatic car washes that use acidic solutions or harsh brushes that may damage the wheels' protective finish.

Wheel And Wheel Trim Care

All wheels and wheel trim, especially Aluminum, should be cleaned regularly, using mild soap and water to maintain their luster and to prevent corrosion. Wash them with the same soap solution as the body of your vehicle. Rinse the wheels thoroughly.

When cleaning extremely dirty wheels, care must be taken in the selection of tire and wheel cleaning chemicals and equipment to prevent damage to the wheels. Only Mopar® Wheel Cleaners are recommended. Any of the "DO NOT USE" items listed below can damage wheels and wheel trim.

DO NOT USE:

- Any abrasive cleaner
- Any abrasive cleaning pad (such as steel wool) or abrasive brush
- Any cleaner that contains an acid which can react with and discolor the chrome surface.
- Oven cleaner
- A car wash that uses carbide-tipped wheel cleaning brushes or acidic solutions.

CAUTION!

Many wheel cleaners contain acids that may harm the wheel surface.

Interior Care

Use Mopar® Fabric Cleaner to clean fabric upholstery and carpeting.

Use Mopar® Vinyl Cleaner to clean vinyl upholstery. Mopar® Vinyl Cleaner is specifically recommended for vinyl trim.

Leather Seat Care and Cleaning

Leather is best preserved by regular cleaning with a damp soft cloth. Small particles of dirt can act as an abrasive and damage the leather surface and should be removed immediately with a damp cloth. Stubborn soils can be removed easily with a soft cloth and Mopar® Total Clean. Care should be taken to avoid soaking your leather upholstery with any liquid. Please do not use polishes, oils, cleaning fluids, solvents, detergents, or

ammonia based cleaners to clean your leather upholstery. Application of a leather conditioner is not required to maintain the original condition.

CAUTION!

The use of vinyl, leather or plastic protectants may cause excessive gloss and/or discoloration of interior trim parts.

WARNING!

Do not use volatile solvents for cleaning purposes. Many are potentially flammable, and if used in closed areas they may cause respiratory harm.

Cleaning Headlights

Your vehicle has plastic headlights that are lighter and less susceptible to stone breakage than glass headlights.

Plastic is not as scratch resistant as glass and therefore different lens cleaning procedures must be followed.

To minimize the possibility of scratching the lenses and reducing light output, avoid wiping with a dry cloth. To remove road dirt, wash with a mild soap solution followed by rinsing.

Do not use abrasive cleaning components, solvents, steel wool or other aggressive material to clean the lenses.

Glass Surfaces

All glass surfaces should be cleaned on a regular basis with any commercial household-type glass cleaner. Never use an abrasive-type cleaner. Use caution when cleaning inside rear windows equipped with electric defrosters. Do not use scrapers or other sharp instruments which may scratch the elements.

Instrument Panel Cover

The instrument panel cover has a low glare surface which minimizes reflections in the windshield. Do not use protectants or other products which may cause undesirable reflections. Use soap and warm water to restore the low glare surface.

Cleaning Plastic Instrument Cluster Lenses

The lenses in front of the instruments in the vehicle are molded in clear plastic. When cleaning the lenses, care must be taken to avoid scratching the plastic.

- Clean with a wet soft rag. A mild soap solution may be used, but do not use high alcohol content or abrasive cleaners. If soap is used, wipe clean with a clean damp rag.
- Dry with a soft tissue.

Seat Belt Maintenance

Do not bleach, dye or clean the belts with chemical solvents or abrasive cleaners. This will weaken the fabric.

If the belts need cleaning, use a mild soap solution or lukewarm water. Do not remove the belts from the vehicle to wash them.

Replace the belts if they appear frayed or worn or if the buckles do not work properly.

CONVERTIBLE TOP CARE**CAUTION!**

Due not use sharp-edged instruments to remove snow or ice from the soft top.

NOTE: Place a suitable cover over the top if your are going to park the vehicle outside for a extended period of time.

Immediate removal of any contaminant is recommended. Regular washing of the top will enhance its life and appearance, and make successive cleanings easier. Do not subject the top to excessive heat. Frequently vacuum the top and cargo compartment divider.

Washing

CAUTION!
<ul style="list-style-type: none"> • Remove bird droppings immediately. The organic acid can damage the material and cause the top to leak. • Never use a power washer to clean the top, as you may damage the top material. • If an automatic car wash is used, never use hot-wax.

Hand washing is highly recommended. Automatic car washing equipment can damage the top material. If you must use an automatic car wash, soft cloth systems are preferred.

General Cleaning

CAUTION!
<p>Do not use any of the following to clean the top:</p> <ul style="list-style-type: none"> • Gasoline • Paint Thinner • Tar and Stain Removers • Glass Cleaner • Similiar Organic Solvents • Abrasive Type Cleaners or Bleaches

The following methods are sufficient if the top is only lightly soiled:

Dry Cleaning

Brush the dry top with a soft-bristled brush from front to rear of the vehicle.

Wet Cleaning

Wash with clear water or with a mild detergent and an ample supply of luke warm water by wiping with a soft-bristled brush or sponge from front to rear. Then rinse thoroughly with clear water.

Allow the top to dry before lowering. Vacuuming the top with a wet/dry shop vacuum will decrease the top's drying time, ensure removal of all dirt, and delete streaks in the material. Multiple cleanings may be necessary to remove stubborn stains. If stains persist, contact your local dealership for further suggestions.

Weather Strip Care

Lubricate all top and door glass weather strips periodically with Mopar Weather Strip Lubricant (part number 4773427), to keep them soft and pliable.

FUSES**Underhood Accessory Fuse Block Fuses**

The underhood accessory fuse block fuses are located under the hood on the driver's side, between the brake master cylinder and the left front fender.

To remove the lid, squeeze the tabs together located at the front of the fusebox. Then lift the lid up by the tabs. The lid will then slide off the top of the fuse box. To replace the lid, place the two hinge-like tabs at the rear of the lid under the tabs on the fusebox. Push down on the front of the lid until the tabs at the front click.

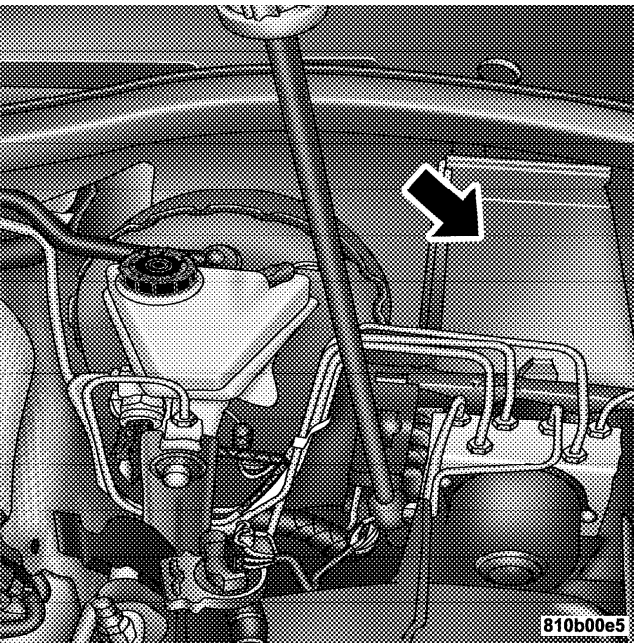
**CAUTION!**

When replacing a blown fuse, it is important to use only a fuse having the correct amperage rating. The use of a fuse with a rating other than indicated may result in a dangerous electrical system overload. If a properly rated fuse continues to blow, it shows a problem in the circuit that must be corrected.

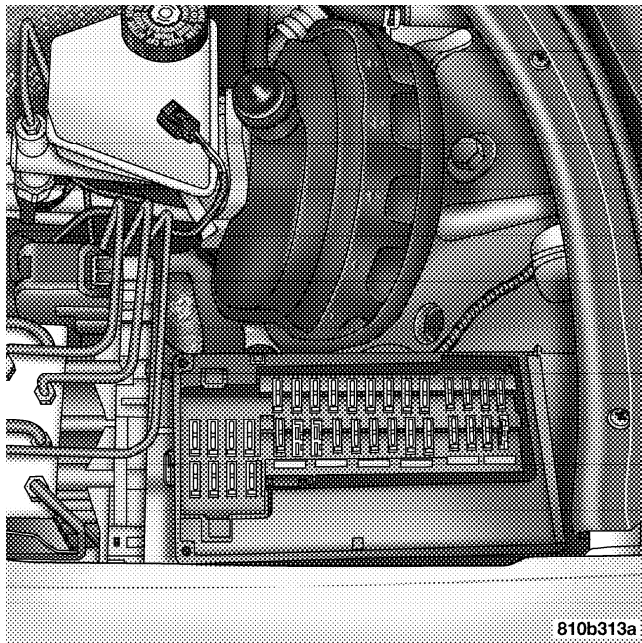

Underhood Accessory Fuse Block Fuses

Cavity	Fuse	Circuits
1	5 Amp Beige	Garage Door Opening Signal, TPM and Seat Heater
2	5 Amp Beige	Occupant Restraint Controller Passenger Airbag Off
3	5 Amp Beige	Indicator, Safety Restraint System and Indicator, Passenger Airbag Off
4	7.5 Amp Brown	Heated Mirror
5	15 Amp Blue	Radio (Coupe)
5	20 Amp Yellow	Roof Control Module (Roadster)
6	5 Amp Beige	Exterior Mirror Adjustment, Left And Right (Coupe)
6	40 Amp Orange	Roof Hydraulic Unit (Roadster)
7	5 Amp Beige	Electronic Transmission Control (Park/Reversing Lock) and BCM
8	15 Amp Blue	Radio

Cavity	Fuse	Circuits
9	10 Amp Red	Roof Light, Horn, Anti-Theft Alarm, Cargo Lamp and Tire Pressure Control
10	5 Amp Beige	Speed Control
11	15 Amp Blue	Ignition Coil 6 Cyl.
12	10 Amp Red	Heated Washer Nozzles
13		Spare
14	10 Amp Red	Diagnostic Socket
15	5 Amp Beige	Residual Engine Heat Utilization
16	30 Amp Green	Wiper Motor
17	40 Amp Orange	Electronic Stability Program
18	40 Amp Orange	Electronic Stability Program

Cavity	Fuse	Circuits
19	40 Amp Orange	Power Window, Front
20	10 Amp Red	Spoiler Motor
21	30 Amp Green	Seat Adjustment Right Side
22	30 Amp Green	Seat Adjustment Left Side
23	15 Amp Blue	Sound Booster (Amplifier)
24	30 Amp Green	Seat Heater
25	20 Amp Yellow	Pneumatic Control Unit, Rear Window Defroster
26	20 Amp Yellow	Central Locking
30		Spare (Coupe)
30	15 Amp Blue	Radio (Roadster)
31	15 Amp Blue	Cigar Lighter, Glove Compartment Light

Cavity	Fuse	Circuits
32	15 Amp Blue	Wiper, Washer Pump, Headlight Flasher
33	5 Amp Beige	Residual Engine Heat Utilization
34		Spare (Coupe)
34	30 Amp Green	Climate Control (Roadster)
35	15 Amp Blue	Radio Frequency Remote Control, Hazard Warning Flasher, Instrument Cluster, Residual Engine Heat Utilization
36	30 Amp Green	Climate Control (Coupe)
36	5 Amp Beige	Exterior Mirror Adjustment (Roadster)
37	5 Amp Beige	Circulating Air, Instrument Cluster, Radio Frequency Remote Control, Residual Engine Heat Utilization

Relay Control Module Fuses

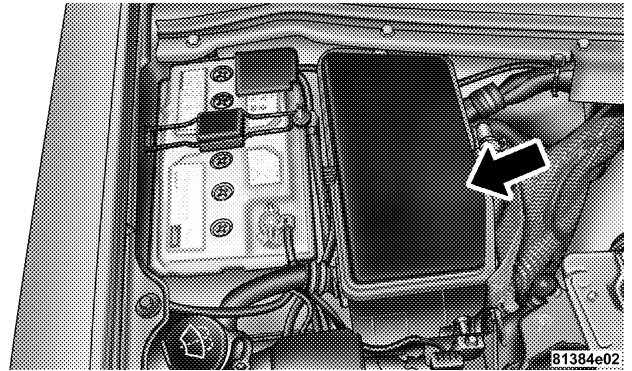

The relay control module fuses are located in the Control Module Box next to the battery in the engine compartment. Slide the control module box cover retaining clips forward and lift the cover from the control module box to gain access to the relay control module fuses.

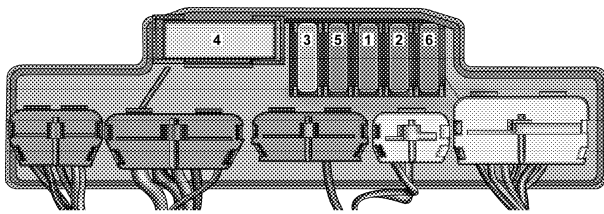

8138904f

Relay Control Module Fuses

Cavity	Fuse	Circuits
1	15 Amp Blue	Traction System
2	15 Amp Blue	Engine Control 2
3	15 Amp Blue	Engine Control 1
4	40 Amp Orange	Air Pump

Cavity	Fuse	Circuits
5	15 Amp Blue	Fuel Pump
6	15 Amp Blue	Horn

Interior Fuses

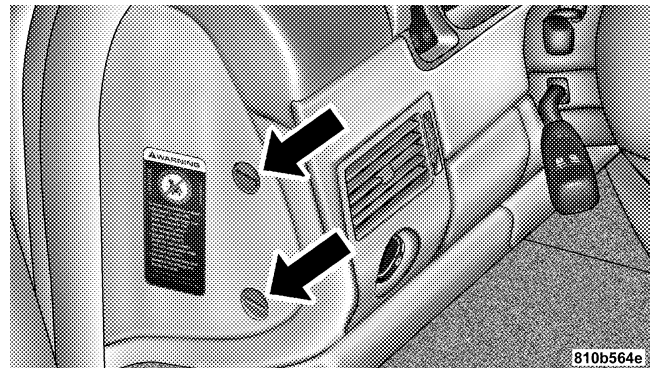

810b564e

234 MAINTAINING YOUR VEHICLE

The fuse access door is located on the end of the instrument panel on the driver's side behind the trim panel cover. Use a coin or flat blade screwdriver to open and close this access door.

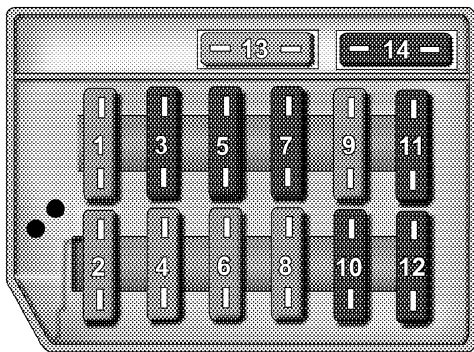

8113fcb2

Interior Fuses

Cavity	Fuse	Circuits
1		Not Assigned
2	15 Amp Blue	Brake Lamp/Speed Control
3	7.5 Amp Brown	Right High Beam, High Beam Indicator Light

Cavity	Fuse	Circuits
4	15 Amp Blue	Reverse/Turn signal Light
5	7.5 Amp Brown	Left High Beam
6	15 Amp Blue	Right Low Beam
7	7.5 Amp Brown	Right Parking/Tail Light Side Marker
8	15 Amp Blue	Left Low Beam
9	15 Amp Blue	Fog Light
10	7.5 Amp Brown	Left Parking/Tail Light Side Marker
11	7.5 Amp Brown	License Plate/Instrument Cluster Lighting/Symbol Lighting
12	7.5 Amp Brown	Rear Fog Light (European Markets Only)
13		Not Used - Spare Fuse
14		Not Used - Spare Fuse

REPLACEMENT BULBS

Interior Light Bulbs

For lighted switches and interior lights, see your authorized dealer for servicing requirements.

Exterior Light Bulbs

Bulb	Bulb No.
Headlight - High and Low Beam	12V55W H7U
Front Turn Signal	Y21W
Front Parking/Standing Light	W5W
Front Side Marker Light	W5W
Rear Marker Light	W5W
Center High-Mounted Stop Light (CHMSL)	LED
Front Fog Lights	HB455W
Rear Turn Signal Light	Y21W
Rear Tail and Stop Light	21/5W
Backup Light	21W
License	168

EXTERIOR LIGHT BULB SERVICE

Headlights

WARNING!

Halogen lamps contain pressurized gas. A bulb can explode if you:

- touch or move it when hot,
- drop the bulb,
- scratch the bulb

Wear eye and hand protection.

NOTE: To prevent a possible electrical short circuit, switch off light prior to replacing a bulb.

1. Push the tab down at the top end of the cover and remove.
2. Disconnect the electrical connector.

3. Release the spring clamps holding the bulb in place, and pull out the bulb. Replace the bulb and reverse the removal procedure exactly.

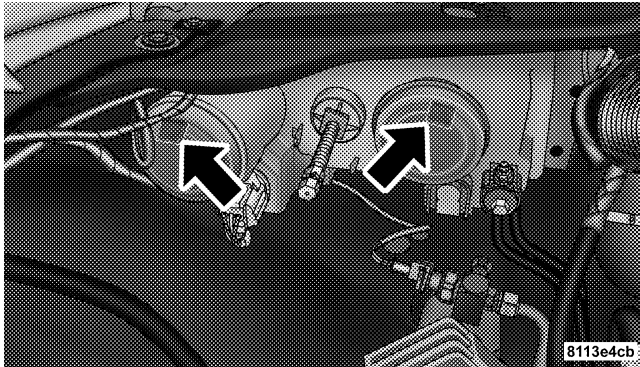

CAUTION!

Do not touch the new bulb with your fingers. Oil contamination will severely shorten bulb life. If the bulb comes in contact with an oily surface, clean the bulb with rubbing alcohol.

Front Turn Signal and Parking/Standing Lights

- Twist the bulb socket counterclockwise and pull out. Push the bulb into the socket, turn counterclockwise and remove.
- Replace the bulb, push in and twist clockwise. Reinstall the socket, and turn clockwise.

Front and Rear Sidemarkers Lights

1. Push the front sidemarker assembly in and slide it forward. Push the rear sidemarker assembly in and slide rearward. The assembly will release from the fascia.
2. Twist the bulb socket counterclockwise and pull out. Push the bulb into the socket, turn counterclockwise and remove.
3. Replace the light, push in and twist clockwise.

4. Realign the two tabs and push the light in until it engages into the lock.

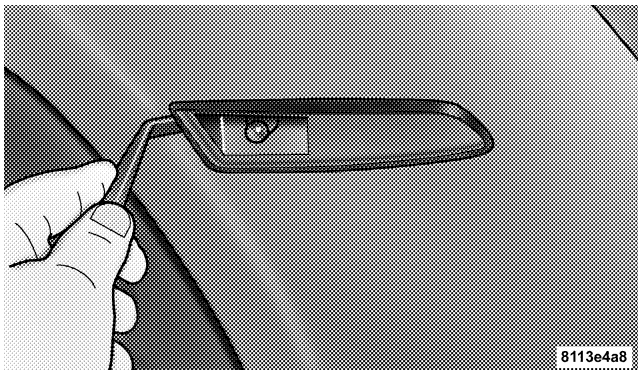

8113e4a8

3. Replace the light and return to open socket, turn clockwise until it stops.

4. Replace the access door in the trim panel.

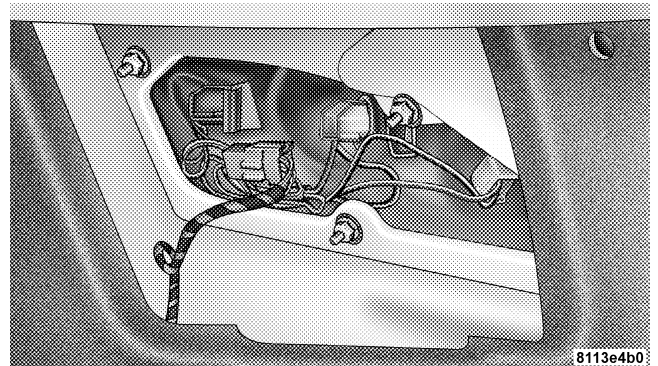

8113e4b0

Tail, Stop, Back Up and Turn Signal Lights

1. Open the rear liftgate / decklid and remove the access door in the trim panel.
2. Twist the bulb socket counterclockwise and pull out.

License Plate Light

1. Remove the two lens assembly mounting screws.
2. Pull the bulb out of the socket.
3. Replace the bulb and reattach the lens assembly.
4. Align and resecure the two lens assembly mounting screws.

NOTE: Be sure not to over-torque the mounting screws or permanent damage to the lens may occur.

NOTE: Always test the operation of all lights after service operations have been performed to validate an effective repair.

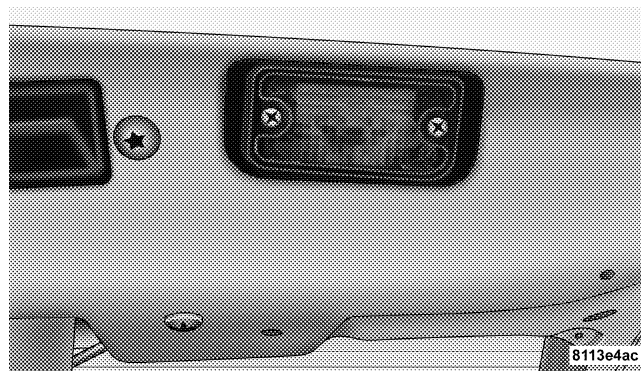

Headlight Aiming

The headlights on your new vehicle were aimed at the factory. The factory setting was made at a no load setting. A great increase in weight will change the aiming and it may be necessary to readjust the headlights if carrying an excessive amount of weight in the rear cargo area. To readjust the headlights first mark the position of the headlights on a wall prior to loading the vehicle. Load the vehicle and then readjust the headlights to the

original position. If any further adjustments are necessary contact your manufacturer's dealer. A detailed service procedure is contained in the manufacturer's Service Manual. Information on purchasing a Service Manual can be found at the back of this Owner's Manual.

VEHICLE STORAGE

We recommend that you follow these guidelines before storing your Crossfire for extended periods.

- Fill the gas tank. This will prevent water condensation inside the tank. If you plan on storing your vehicle more than two months, add an anti-oxidant fuel stabilizer to the gas tank.
- Change the oil to remove any corrosive combustion-related acids in the crankcase.
- Wash and wax the vehicle to protect the finish.
- Cover the vehicle whenever possible to prevent accidental damage to the finish.

- Store the vehicle in a dry, well-ventilated location.
- If the vehicle will be subjected to freezing temperatures, remove the battery and store it in a dry, well-ventilated place. If the vehicle is not going to be driven in the next three weeks, follow the battery recharge procedure in the Service Manual, then disconnect the battery at the negative terminal.

CAUTION!

Use care when disconnecting the remote positive cable. It is connected to the battery and can short out to any metal on the vehicle. Always tape or wrap the exposed cable end to prevent electrical shorts.

Disconnecting the battery causes the engine control system to lose memory of some "learned" functions. The engine may run rough when first started after a battery disconnect until the control module "relearns" these functions.

Check the battery every four to six weeks to ensure that the voltage is above 12.40. Voltage will drop more rapidly in hot temperatures. If battery voltage drops below 12.40, follow the battery recharge procedure in the Service Manual.

- Check that the radiator coolant level of protection is to at least -20°F (-29°C).
- Block the wheels. Do not apply the parking brake.
- Make sure that all tires are inflated to the optimum pressure.
- Cut blocks of plywood about the same size of the tires. Cover each block with indoor/outdoor carpeting and place them between the tires and concrete. This will prevent tire flat spotting.
- For long term storage, remove the tires and put the vehicle up on blocks. Stack the tires on plywood and cover with a tarp to prevent flat spotting.

- Move the wiper blades away from the windshield.

NOTE: To help prevent the battery from discharging during shorter periods of inactivity, perform the following:

1. Make sure that the rear liftgate/decklid, hood, and doors are completely closed.
2. Make sure that the remote transmitter is operating and that the battery is good.
3. Make sure that the hood, rear liftgate and door switches are in adjustment.
4. Use the remote transmitter to set the alarm.

SPECIFICATIONS

Engine Specifications

Engine Size	195.2 CID (3.2 Liters)
Mode of Operation	4-stroke engine, gasoline injection
No. of Cylinders	6
Horsepower (SAE J 1349)	215 hp (160 kW) @ 5700 rpm
Bore	3.54 in. (89.90 mm)
Stroke	3.30 in. (84.00 mm)
Torque (SAE J 1349)	229 ft. lbs. (310 N·m) @ 3000 rpm
Firing Order	1-4-3-6-2-5
Compression Ratio	10:1
Spark Plugs	Bosch F 8 DPER/ NGK PFR 5-11
Spark Plug Gap	0.039 in. (1.0 mm)
Tightening Torque	15-22 ft. lbs. (20-30 N·m)
Maximum Engine Speed	6000 rpm
Accessory Drive Belt	94.1 in. (2390 mm)

Performance Specifications (approximate)

Maximum Speed	150 mph (242 km/h)
Acceleration 0-60 mph	6.5 seconds
1/4 mile time	14.9 seconds at 96 mph (154 km/h)

Gear Ratios - 6-Speed Manual Transmission

First	4.459
Second	2.614
Third	1.723
Fourth	1.245
Fifth	1.000
Sixth	0.838
Reverse	4.062

Gear Ratios - 5-Speed Automatic Transmission

First	3.95
Second	2.423
Third	1.486
Fourth	1.00
Fifth	0.833
Reverse	3.147/1.93

Body Specifications

Overall Length	159.8 in. (4058 mm)
Maximum Width	69.5 in. (1766 mm)
Maximum Width With Mirrors	76.9 in. (1954 mm)
Overall Height	
Coupe:	51.5 in. (1307 mm)
Roadster:	51.8 in. (1315 mm)
Front Track	58.8 in. (1493 mm)
Rear Track	59.1 in. (1502 mm)
Wheelbase	94.5 in. (2400 mm)
Front Overhang	32.4 in. (822 mm)
Rear Overhang	32.9 in. (836 mm)

Front Ground Clearance	5.0 in. (127 mm)
Rear Ground Clearance	5.8 in. (147 mm)
Turning Radius	32.2 ft. (9.8 m)
Weight	
Coupe:	3061 lbs. (1388 kg)
Roadster:	3140 lbs. (1424 kg)
Maximum Vehicle Load	415 lbs. (188 kg)
Luggage Capacity	
Coupe:	7.7 cu. ft. (215 l)
Roadster:	6.5 cu. ft. (190 l) - Top Up 3.6 cu. ft. (104 l) - Top Down

FLUID CAPACITIES

	U.S.	Metric
Fuel (Approximate)	15.8 Gallons	60.0 Liters
Fuel Tank Reserve	2.1 Gallons	8.0 Liters
Engine Oil (with filter)		
3.2 L Engine	8.5 Qts.	8.0 Liters
Cooling System *		
3.2 L Engine	11.8 Qts.	11.2 Liters
Manual Transmission	1.9 Qts.	1.8 Liters
Automatic Transmission	8.5 Qts.	8.0 Liters
Rear Axle	1.4 Qts.	1.3 Liters
Power Steering Reservoir	1.1 Qts.	1.0 Liters
Brake Reservoir	.5 Qts.	.5 Liters
Windshield Washer Reservoir (MAX fill when empty)	7.4 Qts.	7.0 Liters

* Includes heater and coolant recovery bottle filled to MAX level.

RECOMMENDED FLUIDS, LUBRICANTS AND GENUINE PARTS**Engine**

Component	Fluids, Lubricants and Genuine Parts
Engine Coolant	Use coolant approved to MB 325.0, such as Valvoline GO5, or an equivalent extended life coolant.
Engine Oil	Only use synthetic engine oils, approved to MB 229.3 or MB 229.5, such as Mobil 1 SAE 0W-40. The FSS may not alert for an oil change at the proper interval if an unapproved engine oil is used; engine damage and reduced engine life may result.
Engine Oil Filter	Mopar® 5102905AA or equivalent
Spark Plugs	Bosch F 8 DPER/NGK PFR 5-11
Spark Plug Gap	0.039 in (1.0 mm)
Fuel Selection	Premium Unleaded 91 Octane

Chassis

Component	Fluids, Lubricants and Genuine Parts
Automatic Transmission	Only use ATF approved to MB 236.10, MB 236.12. Synthetic Dexron III® Transmission Fluid may be substituted.
Brake Master Cylinder	Use brake fluid approved to MB 331.0, or a DOT 4 brake fluid with: minimum dry boiling point (ERBP) 500°F (260°C), minimum wet boiling point (WERBP) 356°F (180°C), maximum viscosity 1500 mm ² /s, conforming to FMVSS 116 and ISO 4925.
Clutch Fluid	Use brake fluid approved to MB 331.0, or a DOT 4 brake fluid with: minimum dry boiling point (ERBP) 500°F (260°C), minimum wet boiling point (WERBP) 356°F (180°C), maximum viscosity 1500 mm ² /s, conforming to FMVSS 116 and ISO 4925.
Manual Transmission Fluid	No fluid service required. Only use fluid approved to MB 236.2. SAE 5W-20 engine oil, meeting API SL or GF-3, may be substituted.
Power Steering Reservoir	No fluid service required. Filled at the factory with Pentosin CHF 11S. Steering noise and reduced component life may result if an unapproved fluid is used.
Rear Axle Fluid	Only use synthetic SAE 75W-85 axle lubricant that meets MB 231.1. Reduced axle durability may result if an unapproved product is used.
Tire Pressure	Refer to label on driver's door frame.

Body

Component	Fluids, Lubricants and Genuine Parts
Hinges:	
Door	Mopar® Spray White Lube
Liftgate / Decklid	Mopar® Multi-Purpose Lube NLGI Grade 2 EP, GC-LB
Hood Springs and Links	Mopar® Spray White Lube
Latches:	
Liftgate/Decklid	Mopar® Spray White Lube
Hood/Safety Catch	Mopar® Multi-Purpose Lube NLGI Grade 2 EP, GC-LB
Door	Mopar® Spray White Lube
Seat Regulator and Track	Mopar® Multi-Purpose Lube NLGI Grade 2 EP, GC-LB
Window System Components	Mopar® Spray White Lube
Lock Cylinders	Mopar® Lock Cylinder Lube
Spoiler	Mopar® Spray White Lube

MAINTENANCE SCHEDULES

CONTENTS

<ul style="list-style-type: none"> ■ Introduction248 ■ Warranty248 ■ Emission Control System Maintenance249 ■ Maintenance Schedules249 <ul style="list-style-type: none"> □ Scope Of Work For "A" Schedule Maintenance Service250 □ Scope Of Work For "B" Schedule Maintenance Service251 ■ FSS System252 	<ul style="list-style-type: none"> ■ Regular Check-Ups254 <ul style="list-style-type: none"> □ Additional Periodic Maintenance255 ■ Special Maintenance Requirements256 <ul style="list-style-type: none"> □ Coolant256 □ Dust Filter For Heating/Ventilation Replacement256 ■ Engine Oil Change And Filter Replacement . . .256
---	--

INTRODUCTION

This is intended as a guide to the service requirements of your vehicle.

It contains all necessary instructions concerning service intervals and operations which have to be carried out.

Scope and frequency of maintenance work primarily depend on the vehicle's operating conditions. In the interest of maintaining the vehicle's operating safety, the specified work should be performed regularly and in good time.

Our vehicles are subject to ongoing development. Technical progress may also affect the scope of service work performed.

"Daily vehicle checks" before starting a journey are the responsibility of the driver.

WARRANTY

The DaimlerChrysler Corporation Dealer network is at your disposal for maintenance work. Each of these workshops has the equipment and tools, the specially trained, skilled and experienced personnel and receives regular technical instruction from DaimlerChrysler Corporation to ensure that your vehicle is inspected and maintained thoroughly and in accordance with the latest procedures.

Please follow the instructions given in this Owner's Manual and ensure that they are observed, even if you hand the vehicle over to a third party for use or care. By not observing these instructions you may void your warranty rights.

If the specified oil and maintenance services are not carried out regularly or at the time intervals specified, a decision as to the validity of a warranty claim can only be made after DaimlerChrysler Corporation has investigated your claim.

The use of Special lubricant additives is not recommended. The use of such additives may affect your warranty rights. With regard to legal stipulations concerning emissions control, please note that engines have to be serviced and adjusted in accordance with special instructions and using special measuring equipment. Modifications to or interference with the emissions control systems are not permissible.

All DaimlerChrysler Corporation dealers are familiar with the relevant and applicable regulations.

EMISSION CONTROL SYSTEM MAINTENANCE

The "Scheduled" maintenance services, listed in **bold type** must be done at the times or mileages specified to assure the continued proper functioning of the emission control system. These, and all other maintenance services included in this manual, should be done to provide best vehicle performance and reliability. More frequent maintenance may be needed for your Crossfire in severe operating conditions such as dusty areas and very short trip driving.

Inspection and service also should be done any time a malfunction is suspected.

NOTE: Maintenance, replacement, or repair of the emission control devices and systems on your vehicle may be performed by any automotive repair establishment or individual using any automotive part which has been certified pursuant to U.S. EPA or, in the State of California, California Air Resources Board regulations.

MAINTENANCE SCHEDULES

There are two maintenance schedules that show the **required** service for your vehicle.

Schedule "A" typically rotates with Schedule "B." Follow Schedule "A" after the first service interval, Schedule "B" after the second service interval, and so on. In some cases where the service interval has been extended due to very light duty driving, a Schedule "B" service may be indicated following a previous Schedule "B" service. There are additional service tasks required under Schedule "B."

250 MAINTENANCE SCHEDULES

Your Flexible Service System (FSS) — see Understanding Your Instrument Panel section — should give you an exact indication of when your vehicle should be scheduled for service and which schedule to follow.

Additional Periodic Maintenance items should also be performed beyond the items listed in the following charts to assure the optimum performance of your Crossfire.

SCOPE OF WORK FOR “A” SCHEDULE MAINTENANCE SERVICE

Oil Change

- Change oil and replace filter

Maintenance

- Lubricate hood hinges, latch, and secondary latch
- Reset FSS Display

Function Check

- Horn, hazard warning flashers, turn signals, and indicator lamps
- Headlamps and exterior lighting

- Windshield wipers and washer system

Inspection

- Check front and rear brake pads for lining thickness
- Check tires for damage and general condition
- Check tire inflation pressures and correct if necessary

Fluid Levels

Check fluid levels for the following systems and correct if necessary. Should there be a loss of fluid that cannot be explained by regular use, trace and eliminate the cause.

- Engine cooling system (check corrosion inhibitor/antifreeze)
- Hydraulic brake system
- Power steering system
- Windshield washer system

SCOPE OF WORK FOR "B" SCHEDULE MAINTENANCE SERVICE

Oil Change

- Change oil and replace filter

Maintenance

- Rotate tires
- Replace dust filter
- Lubricate hood hinges, latch, and secondary latch
- Reset FSS Display

Function Check

- Horn, hazard warning flashers, turn signals, and indicator lamps
- Headlamps and exterior lighting
- Windshield wipers and washer system
- Check seat belts for damage and proper function
- Test hydraulic brakes and check parking brake function

Inspection

- Check front and rear brake pads for lining thickness
- Check condition of front and rear brake discs
- Check tires for damage and general condition
- Check tire inflation pressures and correct if necessary
- Check major underbody components for leakage or damage (if there are signs of leakage, determine cause and repair)
- Check condition of front axle ball joints and rubber boots
- Check condition of steering components and rubber boots
- Check underhood components for leakage or damage (if there are signs of leakage determine cause and repair)
- Check condition of accessory drive belt
- Check headlamp aiming, adjust if necessary
- Check windshield wiper blades, replace if necessary

252 MAINTENANCE SCHEDULES

Fluid Levels

Check fluid levels for the following systems and correct if necessary. Should there be a loss of fluid that cannot be explained by regular use, trace and eliminate the cause.

- Engine cooling system (check corrosion inhibitor/antifreeze)
- Hydraulic brake system
- Power steering system
- Windshield washer system

FSS SYSTEM

The Flexible Service System (FSS) permits a flexible service schedule that is directly related to the operating conditions of the vehicle. See the Understanding Your Instrument Panel section for details on how to use the FSS.

The oil change interval for your Crossfire is initially set at 7,000 miles (Canada: 11,000 km). Very light duty driving cycles (most trips more than 10 miles [16 km] at moderate speeds in moderate temperature conditions) can extend the service interval beyond 7,000 miles (Canada: 11,000 km). If **ANY** of the following apply to your driving, the oil change interval can be reduced significantly:

- Day or night temperatures are below 32°F (0°C).
- Stop and go driving.
- Extensive engine idling.
- Driving in dusty conditions.
- Short trips of less than 10 miles (16 km).
- More than 50% of your driving is at sustained high speeds during hot weather, above 90°F (32°C).

There are two symbols which will appear in the main odometer display field prior to the next suggested service.



This symbol represents Service A.



This second symbol represents Service B. Service B rotates with Service A and includes additional service tasks.



The next service is normally calculated and displayed next to the Service A or Service B symbol as distance remaining before the next service is required.



Depending on operating conditions throughout the year, a clock symbol may appear next to the service symbol. When this occurs, the next service is calculated and displayed in days remaining before the next service is required.

You should have the maintenance performed within the stated time period or distance.

Following a completed A or B service your authorized dealer sets the counter to 7,000 miles (Canada: 11,000 km).

NOTE: When disconnecting vehicle battery for one or more days at a time, such days will not be counted. Any such days not counted by FSS can be added by your authorized dealer.

The interval between services is determined by the type of vehicle operation. Driving at extreme speeds, and cold starts combined with short distance driving in which the engine does not reach normal operating temperature, reduce the interval between services.

Regardless of the service interval determined by your FSS, the scheduled services as posted in this manual must be followed to properly care for your vehicle.

REGULAR CHECK-UPS

To maintain the safe operation of your vehicle, it is recommended that you perform the following tasks on a regular basis (i.e., weekly or whenever the vehicle is refueled).

CAUTION!

Failure to perform the required maintenance items may result in damage to the vehicle.

At Each Stop for Fuel

- Check the engine oil level about 5 minutes after a fully warmed engine is shut off. Checking the oil level while the vehicle is on level ground will improve the accuracy of the oil level reading. See the procedure described in Checking Your Engine Oil in the Understanding Your Instrument Panel section or under Engine Oil in the Maintaining Your Vehicle section. Add oil only when the level is at or below the ADD or MIN mark.

- Check the windshield washer solvent and add if required.
- Inspect wiper blade condition.
- Check operation of lighting systems.
- Inspect tires for unusual wear, damage, and pressure (at least every 14 days).
- Mechanical assemblies (e.g., engine, transmission, etc.) - check for leaks.

Once a Month

- Inspect the battery and clean and tighten the terminals as required.
- Check the fluid levels of coolant reservoir, brake master cylinder and power steering and add as needed.
- Check all lights and all other electrical items for correct operation.

Additional Periodic Maintenance

The following maintenance items should be performed during the scheduled maintenance nearest the time elapsed and/or distance shown. Follow the interval that occurs first.

Every 2 years:

- Inspect body for paint damage.
- Check chassis and supporting body parts for damage and corrosion.

At approximately every 50,000 miles (80,000 km) or 4 years:

- Check condition of driveshaft flex discs.
- Retighten locking bolts for steering (observe torque).

At approximately every 60,000 miles (96,000 km) or 4 years:

- Replace fuel filter.
- Replace air cleaner filter element.

At approximately 80,000 miles (129,000 km):

- Change the automatic transmission fluid and filter. Use the recommended automatic transmission fluid. After this change it is filled for life. The manual transmission comes filled for life from the factory.

At approximately every 100,000 miles (161,000 km) or 5 years:

- Replace spark plugs.

Every 100,000 miles (161,000 km) or 5 years:

- Replace engine coolant using coolant approved to MB 325.0, such as Valvoline GO5, or an equivalent extended life coolant.

WARNING!

You can be badly injured working on or around a motor vehicle. Do only that service work for which you have the knowledge and the right equipment. If you have any doubt about your ability to perform a maintenance service, take your vehicle to a competent technician.

SPECIAL MAINTENANCE REQUIREMENTS**Coolant**

Have the corrosion inhibitor/antifreeze concentration in the coolant checked before the onset of winter (once a year in countries with high prevailing temperatures). Have the coolant replaced every five years or 100,000 miles (161,000 km).

Dust Filter for Heating/Ventilation Replacement

The dust filter is replaced during routine maintenance service. The filter element must be replaced with "B" Schedule service or every 18,500 miles (30,000 km) to maintain effectiveness. However, if operating conditions are dusty, these filters should be replaced more frequently. A cover in the HVAC unit that can be reached from the passenger foot well provides access to the filter element.

ENGINE OIL CHANGE AND FILTER REPLACEMENT

The recommended oil and filter change interval is based on FSS or 1 year. Please refer to the heading FSS System in this section for a full description of the use and interpretation of symbols in the FSS system. Only use synthetic engine oils, approved to MB 229.3 or MB 229.5, such as Mobil 1 SAE 0W-40. The FSS may not alert for an oil change at the proper interval if an unapproved engine oil is used; engine damage and reduced engine life may result. Information is available from your authorized dealer. The oil filter should always be changed when the oil is changed.

IF YOU NEED CONSUMER ASSISTANCE

CONTENTS

■ Suggestions For Obtaining Service For Your Vehicle	258	■ Reporting Safety Defects	262
□ Prepare For The Appointment	258	□ In Canada	262
□ Prepare A List	258	■ Publication Order Forms	263
□ Be Reasonable With Requests	258	■ Tire Safety Information	264
■ If You Need Assistance	258	□ Tire Markings	264
■ Warranty Information	261	□ Tire Identification Number (TIN)	266
■ Mopar® Parts	262	□ Tire Loading And Tire Pressure	267

SUGGESTIONS FOR OBTAINING SERVICE FOR YOUR VEHICLE**Prepare For The Appointment**

If you're having warranty work done, be sure to have the right papers with you. Take your warranty folder. All work to be performed may not be covered by the warranty; discuss additional charges with the service manager. Keep a maintenance log of your vehicle's service history. This can often provide a valuable clue to the current problem.

Prepare A List

Make a written list of your vehicle's problems or the specific work you want done. If you've had an accident, or work done that is not on your maintenance log, let the service advisor know.

Be Reasonable With Requests

If you list a number of items, and you must have your vehicle by the end of the day, discuss the situation with the service advisor and list the items in order of priority. At many dealers you may obtain a rental vehicle at a

minimal daily charge. If you need a rental, it is advisable to make these arrangements when you call for an appointment.

IF YOU NEED ASSISTANCE

DaimlerChrysler and its dealers are vitally interested in your satisfaction. We want you to be happy with our products and services.

Your selling dealer is best equipped and most anxious to provide prompt resolution for any warranty issue or related matter that you may experience. Authorized dealers have the facilities, factory-trained technicians, special tools, and the latest information to assure your vehicle is fixed correctly and in a timely manner. DaimlerChrysler has empowered its dealers to make warranty and repair decisions that ensure you are not inconvenienced. There is no need for you to wait for a decision from the DaimlerChrysler Corporation. If a special circumstance occurs that requires information from the DaimlerChrysler Corporation, we have asked the dealer's service management to make the contact on your behalf.

This is why you should always talk to your dealer's service manager first. Most matters can be resolved with this process.

- If for some reason you are still not satisfied, talk to the general manager or owner of the dealership. They want to know if you need assistance.
- If your dealership is unable to resolve the concern, you may contact the DaimlerChrysler Corporation's Customer Center.

Any communication to the DaimlerChrysler Corporation's Customer Center should include the following information:

- Owner's name and address
- Owner's telephone number (home and office)
- Dealership name
- Vehicle identification number
- Vehicle delivery date and mileage

DaimlerChrysler Motors Corporation Customer Center

P.O. Box 21-8004
 Auburn Hills, MI 48321-8004
 Phone: (800) 992-1997

DaimlerChrysler Canada Inc. Customer Center

P.O. Box 1621
 Windsor, Ontario N9A 4H6
 Phone: (800) 465-2001

In Mexico contact:

A.V. Prolongacion Paseo de la Reforma, 1240
 Sante Fe C.P. 05109
 Mexico, D.F.
 In Mexico (915) 729-1248 or 729-1240
 Outside Mexico (525) 729-1248 or 729-1240

Customer Assistance For The Hearing Or Speech Impaired (TDD/TTY)

To assist customers who have hearing difficulties, the DaimlerChrysler Corporation has installed special TDD (Telecommunication Devices for the Deaf) equipment at its Customer Center. Any hearing or speech impaired customer who has access to a TDD or a conventional teletypewriter (TTY) in the United States can communicate with the DaimlerChrysler Corporation by dialing 1-800-380-CHRY.

Service Contract

You may have purchased a service contract for your vehicle to help protect you from the high cost of unexpected repairs after your DaimlerChrysler Corporation's new vehicle limited warranty expires. The DaimlerChrysler Corporation stands behind only the DaimlerChrysler Corporation's Service Contracts. If you purchased a DaimlerChrysler Corporation Service Contract, you will receive Plan Provisions and an Owner Identification Card in the mail within three weeks of your vehicle delivery date. If you have any questions about your service contract, call the

DaimlerChrysler Corporation Service Contract National Customer Hotline at 1-800-521-9922.

The DaimlerChrysler Corporation will not stand behind any service contract that is not the DaimlerChrysler Corporation's Service Contract. It is not responsible for any service contract other than the DaimlerChrysler Corporation's Service Contract. If you purchased a service contract that is not a DaimlerChrysler Corporation Service Contract, and you require service after your DaimlerChrysler Corporation's new vehicle limited warranty expires, please refer to your contract documents, and contact the person listed in those documents.

We appreciate that you have made a major investment when you purchased your new Crossfire. Your dealer has also made a major investment in facilities, tools, and training to assure that you are absolutely delighted with your ownership experience. You'll be pleased with their sincere efforts to resolve any warranty issues or related concerns.

WARRANTY INFORMATION

See your DaimlerChrysler Corporation Warranty Information Booklet for more information on warranty coverage and transfer of warranty.

DESCRIPTION	1 Yr/ 12,000	2 Yr/ 24,000	3 Yr/ 36,000	3 Yr/ 50,000	3 Yr/ Unlmtd	5 Yr/ 100,000	7 Yr/ 70,000	8 Yr/ 80,000
Basic Limited Warranty Coverage	████████████████████							
Special Extended Warranty Coverage								
Powertrain Limited Warranty (\$100 deductible)	████████████████████			1st Owner & 2nd Owner with Paid Powertrain Transfer				
	2nd Owner if Powertrain Not Transferred and 3rd (And After) Owners							
Anti-Corrosion Perforation Limited Warranty: All Panels	████████████████████							
Outer Panels	████████████████████							
Federal Emission Warranty	████████████████████							
Federal Emission Warranty - Specified Components	████████████████████							
California Emission Warranty	████████████████████							
California Emission Warranty - Specified Components	████████████████████							

NOTE: Vehicles used as a police vehicle, taxi, limousine, postal delivery vehicle, ambulance or rental vehicle are covered only under the 3 year/36,000 mile Basic Limited Warranty. 8132c269

MOPAR® PARTS

Mopar® fluids, lubricants, parts, and accessories are available from your authorized dealer. They will help you keep your vehicle operating at its best.

REPORTING SAFETY DEFECTS

In the 50 states of the United States and Washington, D.C.: If you believe that your vehicle has a defect which could cause a crash or cause injury or death, you should immediately inform the National Highway Traffic Safety Administration (NHTSA) in addition to notifying the DaimlerChrysler Corporation.

If NHTSA receives similar complaints, it may open an investigation, and if it finds that a safety defect exists in a group of vehicles, it may order a recall and remedy campaign. However, NHTSA cannot become involved in individual problems between you, your dealer, and the DaimlerChrysler Corporation.

To contact NHTSA, you may either call the Auto Safety Hotline toll-free at 1-800-424-9393 (or 366-0123 in Washington, D.C. area) or write to: NHTSA, U.S. Dept. of Transportation, Washington, D.C. 20590. You can also obtain other information about motor vehicle safety from the Hotline.

In Canada:

If you believe that your vehicle has a safety defect, you should contact the Customer Service Department immediately. Canadian customers who wish to report a safety defect to the Canadian government should write to Transport Canada, P.O. Box 8880, Ottawa Postal Station, Ottawa, Ontario K1G 3J2.

PUBLICATION ORDER FORMS

To order the following manuals, you may use either the website or the phone numbers listed below. Visa, Mastercard, American Express, and Discover orders are accepted. If you prefer mailing your payment, please call for an order form.

NOTE: A street address is required when ordering manuals. (No P.O. Boxes).

- *Service Manuals.*

These comprehensive service manuals provide the information that students and professional technicians need in diagnosing/troubleshooting, problem solving, maintaining, servicing and repairing DaimlerChrysler Corporation vehicles. A complete working knowledge of the vehicle, system and/or components is written in straightforward language with illustrations, diagrams and charts.

- *Owner's Manuals.*

These manuals have been prepared with the assistance of service and engineering specialists to acquaint you with specific Chrysler group vehicles. Included are starting, operating, emergency and maintenance procedures as well as specifications, capabilities and safety tips.

Call Toll Free at **1-800-890-4038 (U.S.)** or **1-800-387-1143 (Canada)**

Or

Visit us on the World Wide Web at:

www.techauthority.daimlerchrysler.com or
www.daimlerchrysler.ca/manuals

TIRE SAFETY INFORMATION

Tire Markings

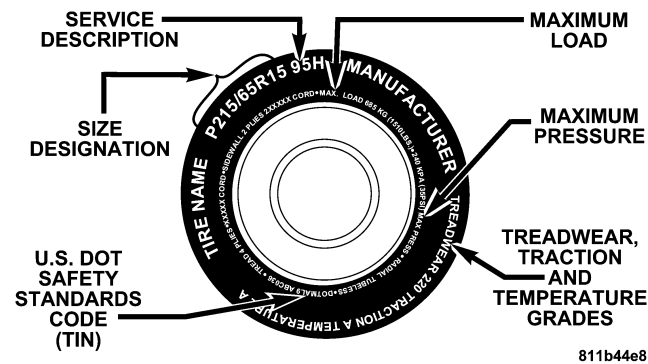

Tire Sizing Chart

NOTE: P(Passenger)-Metric tire sizing is based on U.S. design standards. P-Metric tires have the letter "P" molded into the sidewall preceding the size designation. Example: P215/65R15 95H.

NOTE: European Metric tire sizing is based on European design standards. Tires designed to this standard have the tire size molded into the sidewall beginning with the section width. The letter "P" is absent from this tire size designation. Example: 215/65R15 96H.

NOTE: LT(Light Truck)-Metric tire sizing is based on U.S. design standards. The size designation for LT-Metric tires is the same as for P-Metric tires except for the letters "LT" that are molded into the sidewall preceding the size designation. Example: LT235/85R16.

NOTE: Temporary Spare tires are high pressure compact spares designed for temporary emergency use only. Tires designed to this standard have the letter "T" molded into the sidewall preceding the size designation. Example: T145/80D18 103M.

NOTE: High Flotation tire sizing is based on U.S. design standards and begins with the tire diameter molded into the sidewall. Example: 31x10.5 R15 LT.

EXAMPLE:**Size Designation:**

- P** = Passenger car tire size based on U.S. design standards
- "...blank..."** = Passenger car tire based on European design standards
- LT** = Light Truck tire based on U.S. design standards
- T** = Temporary Spare tire
- 31** = Overall Diameter in Inches (in)
- 215** = Section Width in Millimeters (mm)
- 65** = Aspect Ratio in Percent (%)
 - Ratio of section height to section width of tire.
- 10.5** = Section Width in Inches (in)
- R** = Construction Code
 - "R" means Radial Construction.
 - "D" means Diagonal or Bias Construction.
- 15** = Rim Diameter in Inches (in)

Service Description:
<p>95 = Load Index —A numerical code associated with the maximum load a tire can carry.</p>
<p>H = Speed Symbol —A symbol indicating the range of speeds at which a tire can carry a load corresponding to its load index under certain operating conditions. —The maximum speed corresponding to the Speed Symbol should only be achieved under specified operating conditions. i.e. tire pressure, vehicle loading, road conditions and posted speed limits.)</p>
Load Identification:
<p>"...blank..." = Absence of any text on sidewall of the tire indicates a Standard Load (SL) Tire</p>
<p>Extra Load (XL) = Extra Load (or Reinforced) Tire</p>
<p>Light Load = Light Load Tire</p>
<p>C,D,E = Load range associated with the maximum load a tire can carry at a specified pressure</p>
<p>Maximum Load — Maximum Load indicates the maximum load this tire is designed to carry.</p>
<p>Maximum Pressure — Maximum Pressure indicates the maximum permissible cold tire inflation pressure for this tire.</p>

Tire Identification Number (TIN)

The TIN may be found on one or both sides of the tire however the date code may only be on one side. Tires with white sidewalls will have the full TIN including date code located on the white sidewall side of the tire.

Look for the TIN on the outboard side of black sidewall tires as mounted on the vehicle. If the TIN is not found on the outboard side then you will find it on the inboard side of the tire.

EXAMPLE:
DOT MA L9 ABCD 0301
<p>DOT = Department of Transportation —This symbol certifies that the tire is in compliance with the U.S. Department of Transportation tire safety standards, and is approved for highway use.</p>
<p>MA = Code representing the tire manufacturing location. (2 digits)</p>
<p>L9 = Code representing the tire size. (2 digits)</p>
<p>ABCD = Code used by tire manufacturer. (1 to 4 digits)</p>
<p>03 = Number representing the week in which the tire was manufactured. (2 digits) —03 means the 3rd week.</p>
<p>01 = Number representing the year in which the tire was manufactured. (2 digits) —01 means the year 2001. —Prior to July 2000, tire manufacturers were only required to have 1 number to represent the year in which the tire was manufactured. Example: 031 could represent the 3rd week of 1981 or 1991.</p>

Tire Loading and Tire Pressure

Tire Placard Location

NOTE: Some vehicles have a “Tire and Loading Information” placard located on the driver’s side “B” pillar.



8116ba58

Tire and Loading Information Placard

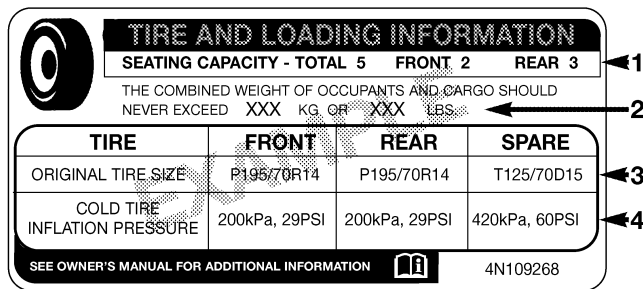

The placard is a rectangular label with a tire icon on the left. It contains the following information:

- TIRE AND LOADING INFORMATION**
- SEATING CAPACITY - TOTAL 5 FRONT 2 REAR 3** (indicated by arrow 1)
- THE COMBINED WEIGHT OF OCCUPANTS AND CARGO SHOULD NEVER EXCEED **XXX** KG OR **XXX** LBS. (indicated by arrow 2)
- A table with columns: **TIRE**, **FRONT**, **REAR**, **SPARE**.

TIRE	FRONT	REAR	SPARE
ORIGINAL TIRE SIZE	P195/70R14	P195/70R14	T125/70D15
COLD TIRE INFLATION PRESSURE	200kPa, 29PSI	200kPa, 29PSI	420kPa, 60PSI

 (indicated by arrow 3)
- SEE OWNER'S MANUAL FOR ADDITIONAL INFORMATION (indicated by arrow 4)
- 4N109268

811b5a9a

This placard tells you important information about the,

1. number of people that can be carried in the vehicle
2. the total weight your vehicle can carry
3. the tire size designed for your vehicle
4. the cold tire inflation pressures for the front, rear and spare tires.

Loading

The vehicle maximum load on the tire must not exceed the load carrying capacity of the tire on your vehicle. You will not exceed the tire's load carrying capacity if you adhere to the loading conditions, tire size and cold tire inflation pressures specified on the Tire and Loading Information placard and the Vehicle Loading section of this manual.

NOTE: Under a maximum loaded vehicle condition, gross axle weight ratings (GAWR's) for the front and rear axles must not be exceeded. For further information on GAWR's, vehicle loading and trailer towing, see the Vehicle Loading section of this manual.

To determine the maximum loading conditions of your vehicle, locate the statement "The combined weight of occupants and cargo should never exceed XXX kg or XXX lbs." or "Vehicle Capacity" on the Tire and Loading Information placard. The combined weight of occupants, cargo/luggage and trailer tongue weight (if applicable) should never exceed the weight referenced here.

Steps for Determining Correct Load Limit

1. Locate the statement "The combined weight of occupants and cargo should never exceed XXX pounds" or "Vehicle Capacity" on your vehicle's placard.
2. Determine the combined weight of the driver and passengers that will be riding in your vehicle.
3. Subtract the combined weight of the driver and passengers from XXX kilograms or XXX pounds.
4. The resulting figure equals the available amount of cargo and luggage load capacity. For example, if "XXX" amount equals 1400 lbs. and there will be five 150 lb. passengers in your vehicle, the amount of available cargo and luggage load capacity is 650 lbs. (1400–750 (5 x 15) = 650 lb.)
5. Determine the combined weight of luggage and cargo being loaded on the vehicle. That weight may not safely exceed the available cargo and luggage load capacity calculated in step 4.

6. If your vehicle will be towing a trailer, load from your trailer will be transferred to your vehicle. Consult this manual to determine how this reduces the available cargo and luggage load capacity of your vehicle.

NOTE: The following table shows examples on how to calculate total load, cargo/luggage and towing capacities of your vehicle with varying seating configurations and number and size of occupants. This table is for illustration purposes only and may not be accurate for the seating and load carry capacity of your vehicle.

NOTE: For the following example the combined weight of occupants and cargo should never exceed 865 lbs. (392 Kg).

270 IF YOU NEED CONSUMER ASSISTANCE

Occupants			Combined weight of occupants and cargo from Tire Placard	MINUS	Combined Occupant's weight	=	AVAILABLE Cargo/Luggage and Trailer Tongue Weight
TOTAL	FRONT	REAR					
EXAMPLE 1			865 lbs	minus	Occupant 1: 200 lbs Occupant 2: 130 lbs Occupant 3: 160 lbs Occupant 4: 100 lbs Occupant 5: 80 lbs TOTAL WEIGHT: 670 lbs	=	195 lbs
5	2	3					
EXAMPLE 2			865 lbs	minus	Occupant 1: 210 lbs Occupant 2: 180 lbs Occupant 3: 150 lbs TOTAL WEIGHT: 540 lbs	=	325 lbs
3	2	1					
EXAMPLE 3			865 lbs	minus	Occupant 1: 200 lbs Occupant 2: 200 lbs TOTAL WEIGHT: 400 lbs	=	465 lbs
2	2	0					

811a4d11

WARNING!

Overloading of your tire is dangerous. Overloading can cause tire failure, affect vehicle handling, and increase your stopping distance. Use tires of the recommended load capacity for your vehicle-never overload them.

INDEX

ABS (Anti-Lock Brake) System	103	Fluid and Filter Changes	221
Adding Engine Coolant (Antifreeze)	215	Fluid Level Check	220
Adding Fuel	166	Fluid Type	220
Aiming Headlights	238	Special Additives	221
Air Cleaner, Engine	205	Autostick	139
Air Conditioning	121,208	Ball Joints	210
Air Conditioning Filter	256	Battery	104,207
Air Conditioning Refrigerant	209	Saving Feature	72
Air Conditioning System	208	Belts, Drive	205
Air Pressure, Tires	153,154	Belts, Seat	21
Airbag	28	Body Mechanism Lubrication	211
Airbag Deployment	32	Brake Assist System	85
Airbag Light	31,109	Brake, Parking	142
Airbag Maintenance	38	Brake System	144,217
Airbag On/Off Switch	36,40	Anti-Lock	144
Alignment and Balance	163	Hoses	218
Antenna	120	Master Cylinder	219
Antifreeze (Engine Coolant)	243	Break-In Recommendations, New Vehicle	46,152
Anti-Lock Warning Light	103	Bulbs, Light	235
Appearance Care	222	Capacities, Fluid	241
Ashtrays and Lighter	63	Capacity, Cargo Weight	168
Automatic Door Locks	13		
Automatic Transmission	135,220		

Carbon Monoxide Warning	46	Convertible	52
Cargo Compartment		Convertible Top	52
Capacity	168	Convertible Top Maintenance	226
Catalytic Converter	206	Convertible Top Manual Override	189
CD Player	112,116	Coolant	215,256
Chains, Tire	158	Cooling System	214
Changing A Flat Tire	174	Adding Coolant (Antifreeze)	215
Charging System Light	104	Coolant Level	214
Checks, Safety	46	Disposal of Used Coolant	215
Child Restraint	39	Drain, Flush, and Refill	215
Child Restraint Tether Anchors	44	Points to Remember	216
Cigar Lighter	64	Pressure Cap	216
Circuit Breakers	228	Rubber and Plastic Components	217
Clean Air Gasoline	164	Selection of Coolant	215
Cleaning		Corrosion Protection	222
Glass	225	Crankcase Emission Control System	207
Headlights	225	Cup Holder	65
Climate Control	121	Customer Assistance	258
Coin Holder	64	Cylinders, Lock	211
Compact Disc Maintenance	120	Dealer Service	200
Console	61	Deck Lid	19
Contract, Service	260	Defroster, Windshield	47
Converter, Catalytic	177		

Disposal	
Engine Oil	204
Door Locks, Automatic	13
Drive Belts	205
Drive Shaft Universal Joints	210
Driving	
On Slippery Surfaces	156,183
Electronic Speed Control	88
Electronic Stability Program	86
Emergency, In Case of	
Hazard Warning Flasher	172
Jump Starting	181
Overheating	172
Towing	185
Emergency Trunk Release	19
Emission Control System Maintenance	199,249
Engine	
Break-In Recommendations	46
Checking Oil Level	201
Compartment	197
Oil	201,243
Oil Change Interval	202
Oil Selection	204
Exhaust Gas Caution	46
Exhaust System	213
Exterior Lights	235
Filters	
Air Cleaner	205
Air Conditioning	256
Engine Fuel	205
Engine Oil	204
Fluid Capacities	241,243
Fluid Leaks	47
Fluid Level Checks	
Manual Transmission	221
Four-Way Hazard Flasher	172
Freeing A Stuck Vehicle	184
Fuel	164
Adding	166
Additives	166
Filler Cap	166
Filter	205
Octane Rating	164
Fuses	228

Garage Door Opener	92	Inside Rearview Mirror	66
Gas Cap	166	Instrument Cluster	99
Gasoline	243	Instrument Panel and Controls	98
Gasoline/Oxygenate Blends	165	Instrument Panel Cover	225
Gear Ratios	241	Instrument Panel Lens Cleaning	226
Glass Cleaning	225	Interior Appearance Care	224
Glove Compartment	65	Introduction	4
Hazard Warning Flasher	172	Jack Location	178
Headlights		Jack Operation	174
Aiming	238	Jump Starting	181
Cleaning	225		
Dimmer Switch	76	Key-In Reminder	10
Heater	121	Keyless Entry System	14
Hood Latch Maintenance	211	Keys	9
Hood Release	70	Knee Bolster	28
Hoses	217		
 		Lap/Shoulder Belts	22
Ignition		Light Bulbs	235
Key	9	Lights	
Wiring System	207	Airbag	31,109
Illuminated Entry	72	Anti-Lock Warning	103
Infant Restraint	39	Back-Up	237

Daytime Running	73	Maintenance Schedules	249
Exterior	73	Malfunction Indicator Light	110,199
Exterior Check	47	Manual Override, Convertible Top	189
Fog	74	Manual, Service	263
Hazard Warning Flasher	172	Manual Transmission	133,221
Headlights	73	Fluid Level Check	221
Instrument Cluster	72	Frequency of Fluid Change	221
Interior	71,235	Lubricant Selection	221
License	238	Marker Lights, Side	236
Lights On Reminder	73	Master Cylinder	219
Malfunction Indicator	110	Mirrors	66
Map Reading	72	Electric Powered	67
Park	73,236	Electric Remote	66
Rear Tail	237	Exterior Folding	66
Seat Belt Reminder	104	Heated	66
Turn Signal	236,237	Outside	66
Loading Vehicle	268	Rearview	66
Capacities	168	Vanity	68
Tires	268	Monitor, Tire Pressure System	80,157
Lubrication, Body	211	Mopar Parts	200,262
Maintenance Free Battery	207	Multi-Function Control Lever	75
Maintenance Procedures	201	Occupant Restraints	21

Oil, Engine	201	Program Mode Selector Switch	140
Change Interval	202	Programming Transmitters	95,96
Checking	201	Radial Ply Tires	156
Disposal	204	Radio	112
Filter	204	Radio Antenna	120
Materials Added to	204	Radio Operation	120
Recommendation	204	Rear Liftgate	21
Oil Filter, Selection	204	Rear Spoiler	82
Onboard Diagnostic System	198,199	Recommended Fluids, Lubricants and Genuine Parts	244
Overheating, Engine	172	Reformulated Gasoline	164
Owner's Manual	263	Refrigerant	209
Paint Care	222	Remote Keyless Entry	14
Parking Brake	142	Replacement Tires	160
Passing Light	76	Reporting Safety Defects	262
Pets	45	Residual Engine Heat Utilization (REST)	125,126
Pets, Transporting	45	Restraints, Child	39
Power		Restraints, Infant	39
Outlet	64	Restraints, Occupant	21
Steering	152,209	Rotation, Tires	162
Steering, Checking	209	Safety Checks Inside Vehicle	47
Windows	20		
Pregnant Women and Seat Belts	27		

Safety Checks Outside Vehicle	47	Starting	131
Safety Tips	46	Cold Weather	132
Schedule, Maintenance	249	Emergency (Jump Starting)	181
Seat Belts	21	Engine Fails to Start	132
And Pregnant Women	27	Steering	
Extender	27	Linkage	210
Inspection	47	Power	152
Maintenance	226	Storage	239
Operating Instructions	24	Storage Bin	62
Reminder	104	Stuck, Freeing	184
Seats	68	Sulfur in Gasoline	166
Cleaning	224	Supplemental Restraint System - Airbag	28
Service Assistance	258	Telescoping Steering Column	79
Service Contract	260	Temperature Gauge, Engine Coolant	173
Service Manuals	263	Theft Alarm	17
Shift Speeds	133,134	Theft System	17
Slippery Surfaces, Driving On	183	TIREFIT	174
Snow Chains	158	Tires	153,264
Snow Tires	159	Air Pressure	154
Soft Top	52	Alignment	163
Spark Plugs	205	Balancing	163
Specifications	241	Chains	158
Standing Lights	74		

Changing	174,178	Shifting	133,134
Inflation Pressures	267	Transporting Pets	45
Load Capacity	267	Tread Wear Indicators	160
Pressure Label	154	Trunk Release, Emergency	19
Pressure Monitor System	80,157	Turn Signals	75
Quality Grading	264	Umbrella Hook	96
Replacement	160	Uniform Tire Quality Grades	264
Rotation	162	Universal Transmitter	92,95
Safety	47	Vacuum/Vapor Harnesses	217
Sizes	264	Vehicle Identification Number	6
Snow Tires	159	Vehicle Loading	168
Tread Wear Indicators	160	Vehicle Storage	239
Tow-Away Alarm	18,188	Vehicle Theft Alarm	17
Towing	185	Warnings and Cautions	6
Disabled Vehicle	185	Warranty Information	261
Trailer	169	Washer, Adding Fluid	212
Towing Eyes	186	Washing Vehicle	222
Traction	184	Wheel and Wheel Trim Care	223
Trailer Towing	169	Windows	
Transmission		Power	20
Automatic	135,220		
Fluid	220		
Manual	133,221		

282 INDEX

Windshield Defroster	47	Windshield Wipers	77
Windshield Washers	77	Wiper Blade Replacement	212
Windshield Wiper Blades	211	Wiring, Ignition	207

NOTES

NOTES

NOTES

NOTES

NOTES

NOTES
