



2155847483

Order No. 6515 2192 13 Part No. 215 584 74 83 USA Edition A 2006

Operator's Manual CL-Class



Operator's Manual
CL-Class



Mercedes-Benz

CL 500

CL 55 AMG

CL 600

CL 65 AMG

Our company and staff congratulate you on the purchase of your new Mercedes-Benz.

Your selection of our product is a demonstration of your trust in our company name. Furthermore, it exemplifies your desire to own an automobile that will be as easy as possible to operate and provide years of service.

Your Mercedes-Benz represents the efforts of many skilled engineers and craftsmen. To help assure your driving pleasure, and also the safety of you and your passengers, we ask you to make a small investment of time:

- Please read this manual carefully, then return it to your vehicle where it will be handy for your reference.
- Please follow the recommendations contained in this manual. They are designed to acquaint you with the operation of your Mercedes-Benz.
- Please pay attention to the warnings and cautions contained in this manual. They are designed to help improve the safety of the vehicle operator and occupants.

We extend our best wishes for many miles of safe, pleasurable driving.

Mercedes-Benz USA, LLC
A DaimlerChrysler Company

Introduction	9
Product information	9
Operator's Manual	10
Service and warranty information ..	10
Important notice for California retail buyers and lessees of Mercedes-Benz automobiles	11
Maintenance	12
Roadside Assistance	12
Change of address or ownership....	12
Operating your vehicle outside the USA or Canada.....	13
Where to find it.....	14
Symbols.....	15
Operating safety	16
Proper use of the vehicle	16
Problems with your vehicle.....	17
Reporting safety defects.....	18
Reporting safety defects	18
Vehicle data recording.....	19
Information regarding electronic recording devices.....	19

At a glance	21
Cockpit.....	22
Instrument cluster	24
Multifunction steering wheel	26
Center console	27
Upper part	27
Lower part	28
Overhead control panel	29
Door control panel.....	30

Getting started	31
Unlocking	32
Unlocking with the SmartKey	32
Unlocking with KEYLESS-GO*	33
Starter switch positions.....	34
Adjusting.....	37
Seats	37
Steering wheel.....	42
Mirrors.....	43
Driving.....	45
Fastening the seat belts	45
Starting the engine	48
Parking brake	50
Driving	51
Switching on headlamps.....	52
Turn signals	53
Windshield wipers.....	54
Problems while driving.....	56
Parking and locking.....	57
Parking brake	58
Switching off headlamps.....	58
Turning off the engine.....	58
Releasing seat belts.....	59
Locking.....	60

Safety and Security	61
Occupant safety	62
Air bags	63
Seat belts	68
Children in the vehicle	72
Blocking of rear side windows operation	78
Panic alarm	79
Activating	79
Deactivating	79
Driving safety systems	80
ABS	80
BAS	81
ESP®	82
Anti-theft systems	85
Immobilizer	85
Anti-theft alarm system	85
Tow-away alarm	87

Controls in detail	89
Locking and unlocking	90
SmartKey	90
SmartKey with KEYLESS-GO*	94
Opening the doors from the inside	100
Opening the trunk	101
Closing the trunk	103
Trunk emergency release	109
Power closing assist for doors and trunk lid	110
Automatic central locking	110
Locking and unlocking from the inside	111
Seats	112
Easy-entry/exit feature	112
Removing and installing front seat head restraints	114
Rear seat head restraints	115
Lumbar support	117
Multicontour seats*	117
Seat heating	119
Seat ventilation*	121

Memory function	122
Storing positions into memory	123
Recalling positions from memory	123
Storing exterior rear view mirror parking position	124
Lighting	125
Exterior lamp switch	125
Combination switch	129
Hazard warning flasher	130
Interior lighting	131
Courtesy lighting	133
Door entry lamps	133
Trunk lighting	133
Instrument cluster	134
Instrument cluster illumination	134
Coolant temperature gauge	135
Trip odometer	135
Tachometer	136
Outside temperature indicator	136
Clock	136

Control system	137	Manual shift program		Ventilated storage compartment ..	195
Multifunction display	137	CL 55 AMG and CL 65 AMG.....	175	Rear passenger compartment	
Multifunction steering wheel.....	138	Emergency operation		adjustable air vents	196
Menus	140	(Limp Home Mode)	177	Power windows	197
Standard display menu	142	Good visibility	178	Opening and closing the power	
AUDIO menu	142	Headlamp cleaning system	178	windows.....	197
CD changer operating mode	145	Rear view mirrors.....	178	Synchronizing the power	
TEL menu*	147	Power folding exterior rear		windows.....	199
NAVI menu	149	view mirrors	180	Summer opening feature	200
Distronic* menu.....	150	Sun visors	181	Convenience closing feature.....	200
Trip computer menu.....	151	Rear window sunshade*	182	Power tilt/sliding sunroof	202
Vehicle status message		Automatic climate control	184	Opening and closing the power	
memory menu	153	Deactivating the climate		tilt/sliding sunroof.....	202
Settings menu.....	154	control system	187	Synchronizing the power	
Automatic transmission.....	165	Setting the temperature.....	187	tilt/sliding sunroof.....	204
Gear selector lever position	167	Adjusting air distribution.....	188	Driving systems.....	205
Driving tips.....	169	Adjusting air volume	189	Cruise control	205
Gear ranges	170	Maximum cooling MAXCOOL	189	Distronic*	208
Automatic shift program	171	Defrosting	189	Active Body Control (ABC)	220
Gear selector lever one-touch		Air recirculation mode	190	Parktronic system*	
gearshifting	172	Charcoal filter	191	(Parking assist)	223
Steering wheel gearshift control		Rear window defroster	193		
one-touch gear shifting		Air conditioning.....	193		
CL 55 AMG and CL 65 AMG.....	173	Residual heat and ventilation.....	194		

Contents

Loading.....	228		
Roof rack*.....	228		
Loading instructions.....	229		
Cargo tie-down hooks.....	229		
Useful features.....	230		
Vanity mirrors.....	230		
Storage compartments.....	231		
Cup holders.....	235		
Ashtrays.....	237		
Cigarette lighter.....	238		
Heated steering wheel* (CL 500 and CL 600).....	239		
Telephone*.....	240		
Tele Aid.....	241		
Garage door opener.....	249		
Infrared reflecting windshield.....	256		
Operation.....	257		
The first 1000 miles (1500 km).....	258		
Driving instructions.....	259		
Drive sensibly – save fuel.....	259		
Drinking and driving.....	259		
Pedals.....	259		
Power assistance.....	259		
Brakes.....	260		
Driving off.....	262		
Parking.....	262		
Tires.....	263		
Hydroplaning.....	263		
Tire traction.....	264		
Tire speed rating.....	264		
Winter driving instructions.....	265		
Standing water.....	266		
Passenger compartment.....	267		
Driving abroad.....	267		
Control and operation of 'radio transmitters.....	267		
Catalytic converter.....	268		
Emission control.....	268		
Coolant temperature.....	269		
		At the gas station.....	270
		Refueling.....	270
		Check regularly and before a long trip.....	271
		Engine compartment.....	273
		Hood.....	273
		Engine oil.....	274
		Transmission fluid level.....	279
		Active Body Control (ABC) fluid level.....	279
		Coolant level.....	280
		Battery.....	281
		Windshield washer system and headlamp cleaning system.....	282
		Tires and wheels.....	283
		Important guidelines.....	283
		Tire care and maintenance.....	284
		Direction of rotation.....	286
		Loading the vehicle.....	286
		Recommended tire inflation pressure.....	292
		Checking tire inflation pressure...	294
		Tire labeling.....	299
		Load identification.....	303

DOT, Tire Identification Number (TIN)	304		
Maximum tire load	305		
Maximum tire inflation pressure ..	306		
Uniform Tire Quality Grading Standards (U.S. vehicles)	306		
Tire ply material	308		
Tire and loading terminology	309		
Rotating tires	312		
Winter driving	313		
Winter tires	313		
Block heater (Canada only)	314		
Snow chains	314		
Maintenance	315		
Maintenance service indicator message	315		
Calling up the maintenance service indicator	316		
Resetting the maintenance service indicator	317		
Vehicle care	318		
Cleaning and care of vehicle	318		
		Practical hints	327
		What to do if ...?	328
		Lamps in instrument cluster	328
		Lamp in center console	336
		Vehicle status messages in the multifunction display	337
		Where will I find ...?	369
		First aid kit	369
		Vehicle jack, vehicle tool kit, luggage bowl, spare wheel	370
		Unlocking/locking in an emergency ...	372
		Unlocking the vehicle	372
		Locking the vehicle	373
		Fuel filler flap	374
		Opening/closing in an emergency	375
		Tilt/sliding sunroof	375
		Replacing SmartKey batteries	376
		SmartKey	376
		SmartKey with KEYLESS-GO*	377
		Replacing bulbs	378
		Bulbs	379
		Replacing bulbs for front lamps	381
		Replacing bulbs for rear lamps	382
		Replacing wiper blades	384
		Removing wiper blades	384
		Installing wiper blades	385
		Flat tire	386
		Preparing the vehicle	386
		Mounting the spare wheel	386
		Battery	391
		Disconnecting the battery	392
		Removing the battery	392
		Charging and reinstalling the battery	392
		Reconnecting the battery	393
		Jump starting	394
		Towing the vehicle	396
		Installing towing eye bolt	398
		Fuses	399
		Aids for replacing fuses	399
		Fuse boxes in passenger compartment	400
		Fuse boxes in engine compartment	401

Contents

Technical data	403	Fuels, coolants, lubricants, etc.	418	Technical terms	427
Parts service	404	Capacities	418		
Warranty coverage.....	405	Engine oils.....	420		
Loss of Service and Warranty		Engine oil additives	420	Index	433
Information Booklet.....	405	Air conditioning refrigerant	420		
Identification labels.....	406	Brake fluid.....	420		
Layout of poly-V-belt drive	407	Premium unleaded gasoline	421		
CL 500	407	Fuel requirements	421		
CL 55 AMG.....	407	Gasoline additives	422		
CL 600 and CL 65 AMG	407	Coolants.....	422		
Engine.....	408	Windshield washer system and			
Rims and Tires	410	headlamp cleaning system.....	425		
Same size tires	412				
Mixed size tires	414				
Spare wheel	415				
Electrical system.....	416				
Main dimensions and weights.....	417				
Main dimensions	417				
Weights	417				

▼ Product information

Please observe the following in your own best interest:

We recommend using Genuine Mercedes-Benz parts as well as conversion parts and accessories explicitly approved by us for your vehicle model.

We have tested these parts to determine their reliability, safety and special suitability for Mercedes-Benz vehicles.

We are unable to make an assessment for other products and therefore cannot be held responsible for them, even if in individual cases an official approval or authorization by governmental or other agencies should exist. Use of such parts and accessories could adversely affect the safety, performance or reliability of your vehicle. Please do not use them.

Genuine Mercedes-Benz parts as well as conversion parts and accessories approved by us are available at your authorized Mercedes-Benz Center where you will receive comprehensive information, also on permissible technical modifications, and where proper installation will be performed.

Operator's Manual

This Operator's Manual contains a great deal of useful information. We urge you to read it carefully and familiarize yourself with the vehicle before driving.

For your own safety and longer service life of the vehicle, we urge you to follow the instructions and warnings contained in this manual. Ignoring them could result in damage to the vehicle or personal injury to you or others. Vehicle damage caused by failure to follow instructions is not covered by the Mercedes-Benz Limited Warranty.

Your vehicle may have some or all of the equipment described in this manual. Therefore, you may find explanations for optional equipment not installed in your vehicle. If you have any questions about the operation of any equipment, your authorized Mercedes-Benz Center will be glad to demonstrate the proper procedures.

We continuously strive to improve our product, and ask for your understanding that we reserve the right to make changes in design and equipment. Therefore, information, illustrations and descriptions in this Operator's Manual might differ from your vehicle.

Optional equipment is also described in this manual, including operating instructions wherever necessary. Since they are special-order items, the descriptions and illustrations herein may vary slightly from the actual equipment of your vehicle.

If there are any equipment details that are not shown or described in this Operator's Manual, your authorized Mercedes-Benz Center will be glad to inform you of correct care and operating procedures. The Operator's Manual and Maintenance Booklet are important documents and should be kept with the vehicle.

Service and warranty information

The Service and Warranty Information Booklet contains detailed information about the warranties covering your Mercedes-Benz, including:

- New Car Limited Warranty
- Emission System Warranty
- Emission Performance Warranty
- California, Maine, Massachusetts, and Vermont Emission Control System Warranty (California, Maine, Massachusetts, and Vermont only)
- State Warranty Enforcement Laws (Lemon Laws)

Important notice for California retail buyers and lessees of Mercedes-Benz automobiles

Under California law you may be entitled to a replacement of your vehicle or a refund of the purchase price or lease price, if Mercedes-Benz USA, LLC and/or its authorized repair or service facilities fail to fix one or more substantial defects or malfunctions in the vehicle that are covered by its express warranty after a reasonable number of repair attempts. During the period of 18 months from original delivery of the vehicle or the accumulation of 18 000 miles (approx. 29 000 km) on the odometer of the vehicle, whichever occurs first, a reasonable number of repair attempts is presumed for a retail buyer or lessee if one or more of the following occurs:

- (1) the same substantial defect or malfunction results in a condition that is likely to cause death or serious bodily injury if the vehicle is driven, that defect or malfunction has been subject to repair two or more times, and you have directly notified Mercedes-Benz USA, LLC in writing of the need for its repair,
- (2) the same substantial defect or malfunction of a less serious nature than category (1) has been subject to repair four or more times and you have directly notified us in writing of the need for its repair, or
- (3) the vehicle is out of service by reason of repair of the same or different substantial defects or malfunctions for a cumulative total of more than 30 calendar days.

Written notification should be sent to us, not a dealer, at Mercedes-Benz USA, LLC, Customer Assistance Center, One Mercedes Drive, Montvale, NJ 07645-0350.

Maintenance

The Maintenance Booklet describes all the necessary maintenance work which should be performed at regular intervals.

Always have the Maintenance Booklet with you when you take the vehicle to your authorized Mercedes-Benz Center for service. The service advisor will record each service in the booklet for you.

Roadside Assistance

The Mercedes-Benz Roadside Assistance Program provides factory trained technical help in the event of a breakdown. Calls to the toll-free Roadside Assistance number

1-800-FOR-MERCEdes (in the USA)
1-800-387-0100 (in Canada)

will be answered by Mercedes-Benz Customer Assistance Representatives 24 hours a day, 365 days a year.

For additional information refer to the Mercedes-Benz Roadside Assistance Program brochure in your vehicle literature portfolio.

Change of address or ownership

If you change your address, be sure to send in the "Change of Address Notice" found in the Service and Warranty Information Booklet, or simply call the Mercedes-Benz Customer Assistance Center (in the USA) at 1-800-FOR-MERCEdes, or Customer Service (in Canada) at 1-800-387-0100. It is in your own interest that we can contact you should the need arise.

If you sell your Mercedes, please leave all literature with the vehicle to make it available to the next operator.

If you bought this vehicle used, be sure to send in the "Notice of Purchase of Used Car" found in the Service and Warranty Information Booklet, or call the Mercedes-Benz Customer Assistance Center (in the USA) at 1-800-FOR-MERCEdes, or Customer Service (in Canada) at 1-800-387-0100.

Operating your vehicle outside the USA or Canada

If you plan to operate your vehicle in foreign countries, please be aware that:

- service facilities or replacement parts may not be readily available,
- unleaded gasoline for vehicles with catalytic converters may not be available; the use of leaded fuels will damage the catalyts,
- gasoline may have a considerably lower octane rating, and improper fuel can cause engine damage.

Certain Mercedes-Benz models are available for delivery in Europe under our European Delivery Program. For details, consult your authorized Mercedes-Benz Center or write to:

In the USA:

Mercedes-Benz USA, LLC
European Delivery Department
One Mercedes Drive
Montvale, NJ 07645-0350

In Canada:

Mercedes-Benz Canada, Inc.
European Delivery Department
98 Vanderhoof Avenue
Toronto, Ontario M4G 4C9

Where to find it

This Operator's Manual is designed to provide comprehensive support information for you, the vehicle operator. Each section has its own reference color.

At a glance

Here you will find an overview of all the controls that can be operated from the driver's seat.

Getting started

Here you will find all the information you need for your first drive. You should read this section first if this is your first Mercedes-Benz vehicle or if you are renting or borrowing this vehicle.

Safety and Security

Here you will find descriptions of the safety and security features of your vehicle.

Controls in detail

Here you will find detailed information about the equipment installed in your vehicle. This section expands on the "Getting started" section and also describes technical innovations. If you are already familiar with the basic functions of your vehicle, this section will be of particular interest to you.

Operation

Here you will find all the information you need for the proper operation of your vehicle.

Practical hints

This section provides fast assistance for dealing with problems you may encounter.

Technical data

All important technical data for your vehicle can be found in this section.

Indexes

The glossary provides explanations of the most important technical terms.

The table of contents and the index are designed to help you find information quickly and easily.

The following publications are part of your vehicle documentation:

- this Operator's Manual
- the Maintenance Booklet

Separate operating instructions will be provided as required depending on the equipment options installed in your vehicle.

▼ Symbols

Trademarks:

- ESP® is a registered trademark of DaimlerChrysler.
- HomeLink® is a registered trademark of Prince, a Johnson Controls Company.
- BabySmart™ is a trademark of Siemens Automotive Corp.

The following symbols are found in this Operator's Manual:

- * Optional equipment is identified with an asterisk. Since standard equipment varies between models, the descriptions and illustrations in this manual may differ slightly from the actual equipment of your vehicle.

Warning!



Warning notices draw your attention to hazards that may endanger your health or life, or the health or life of others.



Highlights hazards that may result in damage to your vehicle.



Helpful hints or further information you may find useful.

- ▶ This symbol points to instructions for you to follow.
- ▶ A number of these symbols appearing in succession indicates a multiple-step procedure.
- ▷ Page This symbol tells you where to look for further information on a topic.
- ▷▷ This continuation symbol marks an interrupted procedure which will be continued on the next page.
- > In the glossary of technical terms, this symbol is used to indicate cross-references to term definitions.
- DISPLAY Words appearing in the multi-function display are printed in the type shown here.

Warning!



Work improperly carried out on electronic components and associated software could cause them to cease functioning. Because the vehicle's electronic components are interconnected, any modifications made may produce an undesired effect on other systems. Electronic malfunctions could seriously impair the operating safety of your vehicle.

See an authorized Mercedes-Benz Center for repairs or modifications to electronic components.

Other improper work or modifications on the vehicle could also have a negative impact on the operating safety of the vehicle.

Some safety systems only function while the engine is running. You should therefore never turn off the engine while driving.

Warning!



Heavy blows against the vehicle underbody or tires/wheels, for example when running over an obstacle, road debris or a pothole, may cause serious damage and impair the operating safety of your vehicle. If you feel a sudden significant vibration or ride disturbance, or you suspect that damage to your vehicle has occurred, you should turn on your hazard warning flashers, carefully slow down, and drive with caution to an area which is a safe distance from the road.

Inspect the vehicle underbody and tires/wheels for possible damage. If the vehicle appears unsafe, have it towed to the nearest authorized Mercedes-Benz Center or other qualified maintenance or repair facility for further inspection or repairs.

Proper use of the vehicle

Proper use of the vehicle requires that you are familiar with the following information and rules:

- the safety precautions in this manual
- the “Technical data” section in this manual
- traffic rules and regulations
- motor vehicle laws and safety standards

Warning!



Various warning labels are attached to your vehicle. These warning labels are intended to make you and others aware of various risks. You should not remove any of these warning labels unless explicitly instructed to do so by information on the label itself. Removal of any of these labels may cause you and others to be unaware of certain risks which may result in an accident and/or personal injury.

▼ Problems with your vehicle

If you should experience a problem with your vehicle, particularly one that you believe may affect its safe operation, we urge you to immediately contact an authorized Mercedes-Benz Center to have the problem diagnosed and corrected if required. If the matter is not handled to your satisfaction, please discuss the problem with the Mercedes-Benz Center management, or if necessary contact us at one of the following addresses:

In the USA:

Customer Assistance Center
Mercedes-Benz USA, LLC
One Mercedes Drive
Montvale, NJ 07645-0350

In Canada:

Customer Relations Department
Mercedes-Benz Canada, Inc.
98 Vanderhoof Avenue
Toronto, Ontario, M4G 4C9

Reporting safety defects

For the USA only:

The following text is published as required of manufacturers under Title 49, Code of U.S. Federal Regulations, Part 575 pursuant to the “National Traffic and Motor Vehicle Safety Act of 1966.”

Reporting safety defects

If you believe that your vehicle has a defect which could cause a crash or could cause injury or death, you should immediately inform the National Highway Traffic Safety Administration (NHTSA) in addition to notifying Mercedes-Benz USA, LLC.

If NHTSA receives similar complaints, it may open an investigation, and if it finds that a safety defect exists in a group of vehicles, it may order a recall and remedy campaign. However, NHTSA cannot become involved in individual problems between you, your dealer, or Mercedes-Benz USA, LLC.

To contact NHTSA, you may either call the Auto Safety Hotline toll-free at 1-888-327-4236 (or 366-0123 in Washington, D.C. area) or write to: NHTSA, U.S. Department of Transportation, Washington, D.C. 20590. You can also obtain other information about motor vehicle safety from the Hotline.

▼ Vehicle data recording

Information regarding electronic recording devices

(Including notice pursuant to California Code § 9951)

Please note that your vehicle is equipped with devices that can record vehicle systems data and, if equipped with the Tele Aid system, may transmit some data in certain accidents.

This information helps, for example, to diagnose vehicle systems after a collision and to continuously improve vehicle safety. DaimlerChrysler may access the information and share it with others

- for safety research or vehicle diagnosis purposes
- with the consent of the vehicle owner or lessee
- in response to an official request by law enforcement or other government agency
- for use in dispute resolution involving DaimlerChrysler, its affiliates or sales/service organization and/or
- as otherwise required or permitted by law.

Please check the Tele Aid subscription service agreement for details regarding the information that may be recorded or transmitted via that system.

At a glance

Cockpit

Instrument cluster

Multifunction steering wheel

Center console

Overhead control panel

Door control panel



Cockpit



P68.00-3746-31

Item	Page
① Combination switch	
• Turn signals	53
• Windshield wipers	54
• High beam	129
② Cruise control lever	212
• Cruise control	205
• Distronic*	208
③ Instrument cluster	24
④ Multifunction steering wheel	26
⑤ Steering wheel gearshift control (CL 55 AMG and CL 65 AMG only)	175





Item	Page
⑥ Lever for voice control system*, see separate operating instructions	
⑦ Front Parktronic* warning indicator for right front area	225
⑧ Overhead control panel	29
⑨ Glove box lock	231
⑩ Glove box lid release	231
⑪ Glove box	231
⑫ Center console	27, 28
⑬ Starter switch	34
⑭ Horn	

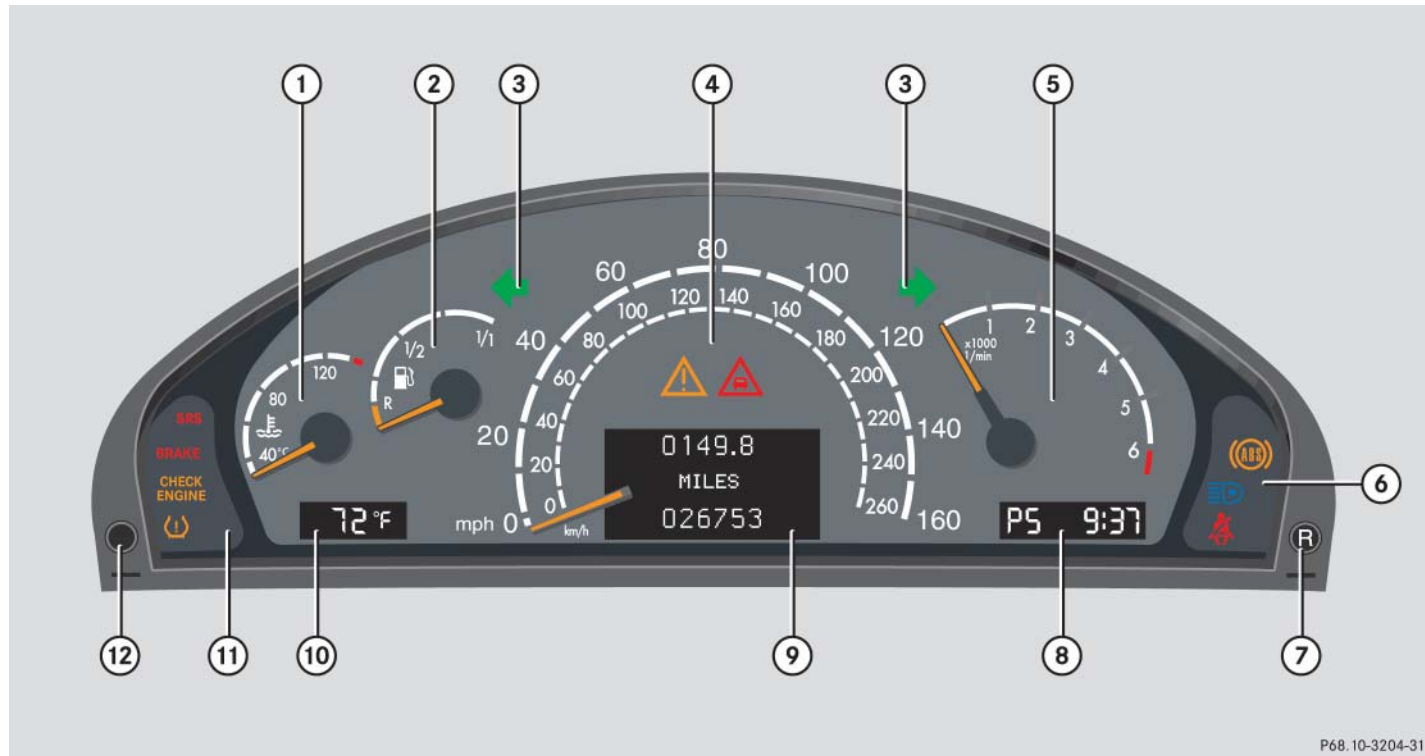



Item	Page
⑮ Steering wheel adjustment stalk	42
Heated steering wheel*	239
⑯ Parking brake pedal	50
⑰ Hood lock release	273
⑱ Parking brake release	50
⑲ Door control panel	30
⑳ Exterior lamp switch	125
㉑ Headlamp washer button	178
㉒ Front Parktronic* warning indicator for left front area	225







Instrument cluster



P68.10-3204-31



Item	Page
① Coolant temperature gauge	135
② Fuel gauge with fuel tank reserve warning lamp	331
③  Left turn signal indicator lamp	53
 Right turn signal indicator lamp	53
④ Speedometer with:	
 Electronic Stability Program (ESP®) warning lamp	333
 Distance warning lamp	332
Vehicles without DISTRONIC*: Warning lamp without function. It illuminates when the ignition is on. It should go out when the engine is running.	
⑤ Tachometer	136





Item	Page
⑥ Right display with:	
 Seat belt telltale	333
 High beam headlamp indicator lamp	52
 Antilock Brake System (ABS) indicator lamp	328
⑦  Reset button	134
⑧ Display with:	
• Gear selector lever position	166
• Program mode	166
• Digital clock (see COMAND operating instructions)	
⑨ Multifunction display with:	
• Trip odometer	137
• Main odometer	137

Item	Page
⑩ Outside temperature indicator	136
⑪ Left display with:	
 Supplemental Restraint System (SRS) indicator lamp	335
 Brake warning lamp, USA only	329
 Brake warning lamp, Canada only	329
 Engine malfunction indicator lamp, USA only	330
 Engine malfunction indicator lamp, Canada only	330
 Tire inflation pressure warning lamp	334
⑫ Knob for instrument cluster illumination	134

Multifunction steering wheel



	Item	Page
①	Multifunction display	137
	Operating control system	138
②	Selecting the submenu or setting the volume: Press button	138
	+ up/to increase	
	- down/to decrease	
③	Telephone*: Press button	147
	 to take a call to dial a call	
	 to end a call to reject an incoming call	

	Item	Page
④	Menu systems: Press button	138
	 for next menu	
	 for previous menu	
⑤	Moving within a menu: Press button	138
	 for next display	
	 for previous display	

▼ Center console

Upper part



P68.20-2860-31

Item	Page
① Button for rear window sunshade	182
② Parktronic* deactivation button	223
③ Active Body Control (ABC) button	220
④ Level control button	221
⑤ Central locking switch	111
Anti-theft alarm system indicator lamp	85
⑥ Hazard warning flasher on/off switch	130

Item	Page
⑦ Central unlocking switch	111
⑧ Electronic Stability Program (ESP®) control switch	84
⑨ Rear head restraints, button for folding down and placing upright*	115
⑩ Tow-away alarm button	87
⑪ COMAND system, see separate operating instructions	
⑫ Automatic climate control	184

Center console

Lower part

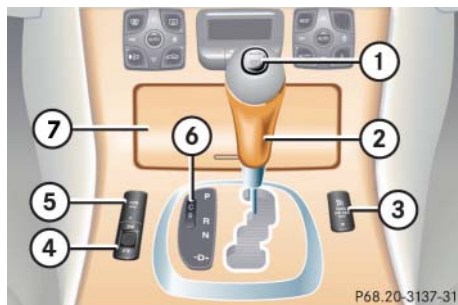

P68.20-3137-31

	Item	Page
①	KEYLESS-GO* start/stop button	35
②	Gear selector lever for automatic transmission	49
③	Front passenger front air bag off indicator lamp	74
④	Thumbwheel for setting distance in Distronic*	216
⑤	Distance warning function* on/off button	216
⑥	Program mode selector for automatic transmission	171
⑦	Cover of compartment with: <ul style="list-style-type: none"> • Ashtray • Lighter 	237 238

▼ Overhead control panel

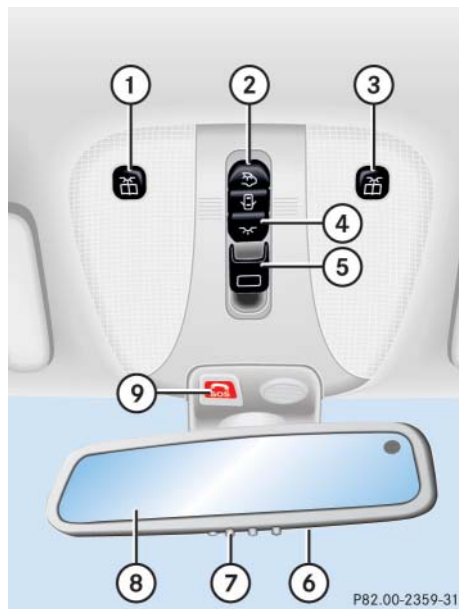

Item	Page
① Left reading lamp on/off	132
② Rear interior lighting on/off	132
③ Right reading lamp on/off	132
④ Interior lighting control	131
⑤ Tilt/sliding sunroof	202
⑥ Hands-free microphone for Tele Aid (emergency call system), telephone*, and voice control system* (see separate operating instructions)	241
⑦ Garage door opener	249
⑧ Rear view mirror	43
⑨ Tele Aid (emergency call system) button	241

Door control panel

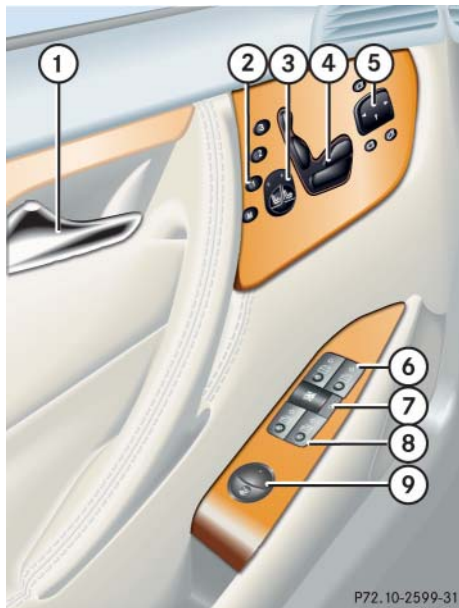

P72.10-2599-31

	Item	Page
①	Door handle	100
②	Memory function (for storing seat, exterior mirror and steering wheel settings)	122
③	Seat heating	119
	Seat ventilation*	121
④	Seat adjustment	37

	Item	Page
⑤	Exterior mirror adjustment	43, 178
	Mirror folding function	181
⑥	Switches for opening/closing front door windows	197
⑦	Override switch for rear passenger compartment	78
⑧	Switches for opening/closing rear side windows	197
⑨	Remote trunk opening/closing* switch	102

Unlocking

Adjusting

Driving

Parking and locking



Unlocking



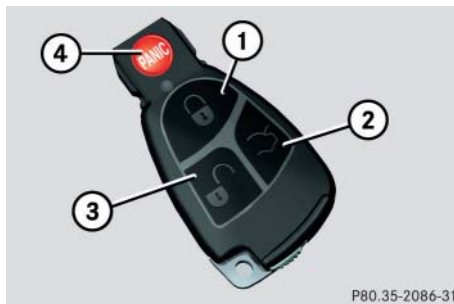

The “Getting started” section provides an overview of the vehicle’s most basic functions. First-time Mercedes-Benz owners should pay special attention to the information given here.

If you are already familiar with the basic functions described here, the “Controls in detail” section will provide you with further information. The corresponding page references are located at the end of each segment.

Unlocking with the SmartKey



SmartKey with remote control

- ①  Lock button
- ②  Opening button for trunk
- ③  Unlock button
- ④  Panic button (▷ page 79)



Opening a door causes the windows on that side of the car to open slightly. They will return to the up position when the door is closed.

Warning!



When leaving the vehicle, always remove the SmartKey from the starter switch, take it with you, and lock the vehicle. Do not leave children unattended in the vehicle, or with access to an unlocked vehicle. Unsupervised use of vehicle equipment may cause an accident and/or serious personal injury.

- ▶ Press unlock button  on the SmartKey.

All turn signal lamps flash once. The locking knobs in the doors move up. The anti-theft alarm system is disarmed.

- ▶ Get in the vehicle and insert the SmartKey in the starter switch.

For more information, see “Locking and unlocking” (▷ page 90).

Unlocking with KEYLESS-GO*

With the KEYLESS-GO function, you can lock and unlock the vehicle without using the remote control buttons on the SmartKey and start the engine without inserting the SmartKey in the starter switch.



To unlock the vehicle, the SmartKey with KEYLESS-GO must be outside the vehicle, no further than approx. 3 feet (1 meter) away from the door.



Opening a door causes the windows on that side of the car to open slightly. They will return to the up position when the door is closed.

Warning!



When leaving the vehicle, always take the SmartKey with KEYLESS-GO* with you and lock the vehicle. Do not leave children unattended in the vehicle, or with access to an unlocked vehicle. Unsupervised use of vehicle equipment may cause an accident and/or serious personal injury.

- ▶ Grasp an outside door handle.

All turn signal lamps flash once. The locking knobs in the doors move up. The anti-theft alarm system is disarmed.



If the vehicle has been parked for more than 72 hours, you must pull an outside door handle in order to activate the KEYLESS-GO function.

- ▶ Get in the vehicle.

For more information, see “Locking and unlocking” (▷ page 94).

Unlocking

Starter switch positions

Warning!



When leaving the vehicle, always remove the SmartKey or SmartKey with KEYLESS-GO* from the starter switch, take it with you, and lock the vehicle. Do not leave children unattended in the vehicle, or with access to an unlocked vehicle. Unsupervised use of vehicle equipment may cause an accident and/or serious personal injury.

SmartKey

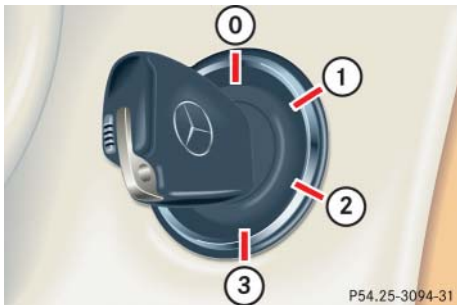

Starter switch

- 0 For removing SmartKey
- 1 Power supply for some electrical consumers, such as seat adjustment
- 2 Ignition (power supply for all electrical consumers) and driving position. All lamps (except high beam headlamp indicator lamp and turn signal indicator lamps unless activated) in the instrument cluster come on. If a lamp in the instrument cluster fails to come on when the ignition is switched on, have it checked and replaced if necessary. If a lamp in the instrument cluster remains on after starting the engine or comes on while driving, refer to “Lamps in instrument cluster” (▷ page 328).
- 3 Starting position



When you switch on the ignition, the indicator and warning lamps (except high beam headlamp indicator lamp and turn signal indicator lamps unless activated) in the instrument cluster come on. The indicator and warning lamps (except high beam headlamp indicator lamp and turn signal indicator lamps if activated) should go out when the engine is running. This indicates that the respective systems are operational.



The SmartKey can only be removed from the starter switch with the gear selector lever in position **P**.



If the SmartKey cannot be turned in the starter switch, the vehicle battery may not be sufficiently charged.

- Check the vehicle battery and charge it if necessary (▷ page 391).
- Get a jump start (▷ page 394).

To prevent accelerated vehicle battery discharge or a completely discharged vehicle battery, always remove the SmartKey from the starter switch when the engine is not in operation.

For information on starting the engine using the SmartKey, see “Starting with the SmartKey” (▷ page 48).

SmartKey with KEYLESS-GO*

Pressing the KEYLESS-GO start/stop button on the gear selector lever corresponds to turning the SmartKey to the various starter switch positions.

If you firmly depress the brake pedal during pressing KEYLESS-GO start/stop button, the engine starts automatically.



The function of the SmartKey overrides the KEYLESS-GO function.

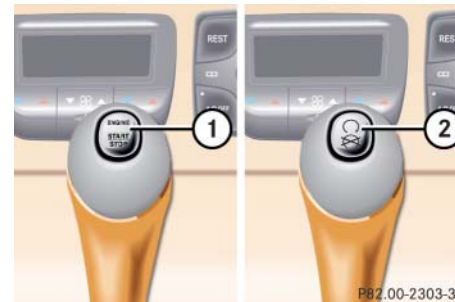

KEYLESS-GO start/stop button

- ① USA only
- ② Canada only

The SmartKey with KEYLESS-GO must be located in the vehicle.

- ▶ Make sure the gear selector lever is set to **P**.
- ▶ Do not depress the brake pedal.

Unlocking

Position 0

Before you press the KEYLESS-GO start/stop button, the vehicle's on-board electronics have status **0** (as with SmartKey removed).

Position 1

- ▶ Press KEYLESS-GO start/stop button once.

This supplies power for some electrical consumers, such as seat adjustment.



If you now press the KEYLESS-GO start/stop button

- once again, the ignition (position **2**) is switched on
- twice, the power supply is again switched off

Ignition (or position 2)

- ▶ Press KEYLESS-GO start/stop button twice.

This supplies power for all electrical consumers.

All lamps (except high beam headlamp indicator lamp and turn signal indicator lamps unless activated) in the instrument cluster come on. If a lamp in the instrument cluster fails to come on when the ignition is switched on, have it checked and replaced if necessary. If a lamp in the instrument cluster remains on after starting the engine or comes on while driving, refer to "Lamps in instrument cluster" (▷ page 328).



If you now press the KEYLESS-GO start/stop button once, the power supply is again switched off.



When you switch on the ignition, the indicator and warning lamps (except high beam headlamp indicator lamp and turn signal indicator lamps unless activated) in the instrument cluster come on. The indicator and warning lamps (except high beam headlamp indicator lamp and turn signal indicator lamps if activated) should go out when the engine is running. This indicates that the respective systems are operational.

For information on starting the engine using the KEYLESS-GO start/stop button, see "Starting with KEYLESS-GO*" (▷ page 49).

▼ Adjusting

Warning!



All seat, head restraint, steering wheel, and rear view mirror adjustments, as well as fastening of seat belts, must be done before the vehicle is put into motion.

Seats

Warning!



Do not adjust the driver's seat while driving. Adjusting the seat while driving could cause the driver to lose control of the vehicle.

Never ride in a moving vehicle with the seat back in an excessively reclined position as this can be dangerous. You could slide under the seat belt in a collision. If you slide under it, the belt would apply force at the abdomen or neck. That could cause serious or fatal injuries. The seat backrest and seat belts provide the best restraint when the wearer is in a nearly upright position and

belts are properly positioned on the body.

Your seat must be adjusted so that you can correctly fasten your seat belt (▷ page 45).

Never place hands under the seat or near any moving parts while a seat is being adjusted.

Warning!



When leaving the vehicle, always remove the SmartKey or SmartKey with KEYLESS-GO* from the starter switch, take it with you, and lock the vehicle.

Even with the SmartKey or SmartKey with KEYLESS-GO* removed from the starter switch or the SmartKey with KEYLESS-GO* removed from the vehicle, the power seats can be operated when the respective door is open. Therefore, do not leave children unattended in the vehicle, or with access to an unlocked vehicle. Unsupervised use of vehicle equipment may cause an accident and/or serious personal injury.

Warning!



Children 12 years old and under must never ride in the front seat, except in a Mercedes-Benz authorized BabySmart™ compatible child seat, which operates with the BabySmart™ system installed in the vehicle to deactivate the passenger front air bag when it is properly installed. Otherwise they will be struck by the air bag when it inflates in a crash. If this happens, serious or fatal injury will result.

According to accident statistics, children are safer when properly restrained in the rear seating positions than in the front seating positions. Infants and small children must ride in the back seats and be seated in an appropriate infant or child restraint system, which is properly secured with the vehicle's seat belt and top tether strap, or secured via lower anchors and top tether strap, fully in accordance with the child seat manufacturer's instructions.



Adjusting

- ▷▷ A child's risk of serious or fatal injuries is significantly increased if the child restraints are not properly secured in the vehicle and the child is not properly secured in the child restraint.

Seat adjustment

The seat adjustment switches are located in each door.

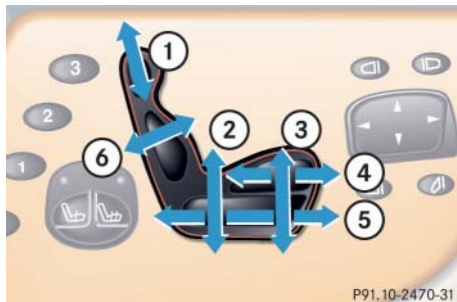

- ① Head restraint height
- ② Seat height
- ③ Seat cushion tilt
- ④ Seat cushion depth
- ⑤ Seat fore and aft adjustment
- ⑥ Seat backrest tilt

- ▶ Switch on the ignition (▷ page 34).
- or
- ▶ Open the respective door.



The memory function (▷ page 122) lets you store the settings for the seat position together with the settings for the steering wheel and the exterior rear view mirrors.

Seat fore and aft adjustment

- ▶ Press the switch forward or backward in the direction of arrow ⑤.

Adjust seat to a comfortable seating position that still allows you to reach the accelerator/brake pedal safely. The position should be as far to the rear as possible, consistent with ability to properly operate controls.



When moving the seat, make sure there are no items in the footwell or behind the seats. Otherwise you could damage the seats.

Seat cushion tilt

- ▶ Press the switch up or down in the direction of arrow ③ until your upper legs are lightly supported.

Seat cushion depth

- ▶ Press the switch forward or backward in the direction of arrow ④ until your legs are supported comfortably.

Seat backrest tilt

- ▶ Press the switch forward or backward in the direction of arrow ⑥ until your arms are slightly angled when holding the steering wheel.

Seat height

- ▶ Press the switch up or down in the direction of arrow ②.

Head restraint height

- ▶ Press the switch up or down in the direction of arrow ①.

Warning!

For your protection, drive only with properly positioned head restraints.

Adjust head restraint so that the center of the head restraint supports the back of the head at eye level. This will reduce the potential for injury to the head and neck in the event of an accident or similar situation.

Do not drive the vehicle without the seat head restraints. Head restraints are intended to help reduce injuries during an accident.

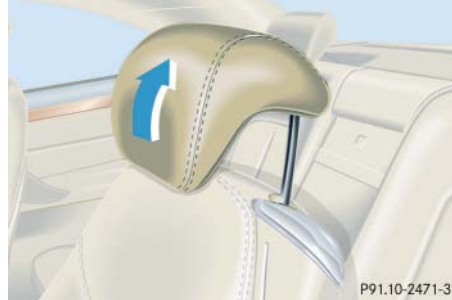
Head restraint tilt

Manually adjust the angle of the head restraint.

- ▶ Push or pull on the lower edge of the head restraint cushion.



Adjust the head restraint in such a way that it is as close to the head as possible.

For more information, see “Seats” (▶ page 112).



The feature below is deactivated at the factory for U.S. vehicles. If you wish to have it activated, contact an authorized Mercedes-Benz Center.

The front passenger seat head restraint automatically lowers after a few seconds when the front passenger seat is not occupied. This improves the driver’s outward view as well as the forward view from the rear passenger compartment.

When the front passenger seat is occupied again, the front passenger head restraint returns to the last set position within a few seconds.

If the front passenger seat was moved fore or aft while not being occupied, the front passenger seat head restraint returns to a position that corresponds best with the seat’s axial position when the seat is occupied again.

Adjusting

Folding front seat backrest forward

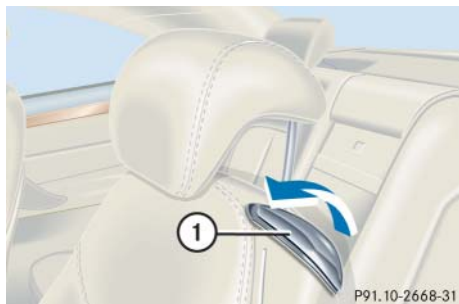

① Release lever

Folding backrest forward

- ▶ Lift release lever ① and fold the seat backrest forward.

The seat will automatically slide forward and the head restraint will move down.

Folding backrests back

- ▶ Lift release lever ① and fold backrest back.

The seat and head restraint return to their previous positions.



To interrupt the procedure, activate the seat adjustment switch (▷ page 38) or move the release lever again.



When moving the seat, make sure there are no items in the footwell or behind the seats. Otherwise you could damage the seats.

Warning!



Always ensure that no one can become trapped or injured when the seat is moving. In case potential danger exists, the procedure can be interrupted by moving the seat adjustment switch (▷ page 38) in the door control panel or by moving the release lever again.

Warning!



The seat belts provide protection only with the backrest locked in place. Therefore, the backrest must be locked in place with the vehicle in motion. Do not drive the vehicle when the backrest is not locked in place. If the warning message:

SEAT BACKREST, RIGHT
LOCK

or

SEAT BACKREST, LEFT
LOCK

is displayed in the multifunction display, then the respective backrest is not engaged in its lock. Carefully slow down, and drive with caution to an area which is in a safe distance from the roadway. Always provide sufficient room behind the backrest and fold the backrest all the way back until it locks in place.

The warning message is no longer displayed as soon as the backrest is locked in place. If both backrests are locked in place and the warning message is still displayed, have the system checked at an authorized Mercedes-Benz Center immediately.

When leaving the vehicle, always remove the SmartKey or SmartKey with KEYLESS-GO* from the starter switch, take it with you, and lock the vehicle.

The power seats can also be operated with the driver's or passenger door open. Do not leave children unattended in the vehicle or with access to an unlocked vehicle. Unsupervised use of vehicle equipment may cause an accident and/or serious personal injury.

Never place hands under seat or near any moving parts during a seat adjustment procedure.



The automatic seat slide is provided with a safety feature.

The automatic process is interrupted if the backrest of the sliding seat is pushed against an occupant or object. The seat will slide forward and stop.

Investigate and correct the cause of interruption.

Now use memory button (▷ page 123) or seat adjustment switch (▷ page 38) to bring the seat into the desired position.

When folding the backrest forward from a reclined position, and then folding it back, the backrest stops in a more upright position for the safety of any rear-seat passenger. Adjust the backrest until your arms are slightly angled when holding the steering wheel (▷ page 38).

For information on additional convenience features permitting easy entry and exit, see "Easy-entry/exit feature" (▷ page 112).

Adjusting

Steering wheel

Warning!



Do not adjust the steering wheel while driving. Adjusting the steering wheel while driving could cause the driver to lose control of the vehicle.

When leaving the vehicle, always remove the SmartKey or SmartKey with KEYLESS-GO* from the starter switch, take it with you, and lock the vehicle.

Even with the SmartKey or SmartKey with KEYLESS-GO* removed from the starter switch or the SmartKey with KEYLESS-GO* removed from the vehicle, the steering wheel adjustment feature can be operated when the driver's door is open. Therefore, do not leave children unattended in the vehicle, or with access to an unlocked vehicle. Unsupervised use of vehicle equipment may cause an accident and/or serious personal injury.

Steering wheel adjustment

The stalk for steering wheel adjustment is located on the steering column (lower left).

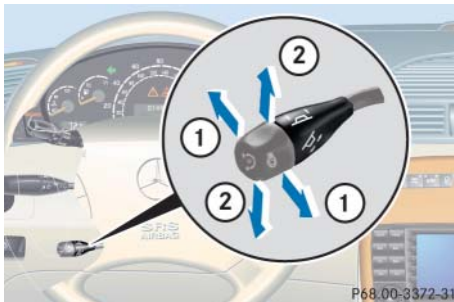

- ① Adjusting steering column, in or out
- ② Adjusting steering column, up or down

- ▶ Switch on the ignition (▷ page 34).
- or
- ▶ Open the driver's door.

Adjusting steering column in or out

- ▶ Move stalk forward or back in the direction of arrow ① until a comfortable steering wheel position is reached with your arms slightly bent at the elbow.

Adjusting steering column up or down

- ▶ Move stalk up or down in the direction of arrow ②.

Make sure your legs can move freely and all the displays (incl. malfunction and indicator lamps) on the instrument cluster are clearly visible.



The memory function (▷ page 122) lets you store settings for the steering wheel together with the settings for the exterior rear view mirrors and the seat position.

For more information, see “Heated steering wheel* (CL 500 and CL 600)” (▷ page 239).

Mirrors

Adjust the interior and exterior rear view mirrors before driving so that you have a good view of the road and traffic conditions.

Warning!



In case of an accident, liquid electrolyte may escape the mirror housing if the mirror glass breaks.

Electrolyte has an irritating effect. Do not allow the liquid to come into contact with eyes, skin, clothing, or the respiratory system. In case it does, immediately flush affected area with water, and seek medical help if necessary.



Electrolyte drops coming into contact with the vehicle paint finish can only be completely removed while in their liquid state and by applying plenty of water.

Interior rear view mirror

- ▶ Manually adjust the interior rear view mirror.

For more information, see “Rear view mirrors” (> page 178).

Exterior rear view mirrors

Warning!



Exercise care when using the passenger side exterior rear view mirror. The mirror surface is convex (outwardly curved surface for a wider field of view). Objects in mirror are closer than they appear. Check your interior rear view mirror or glance over your shoulder before changing lanes.

Adjusting

The buttons are located on the driver's door.

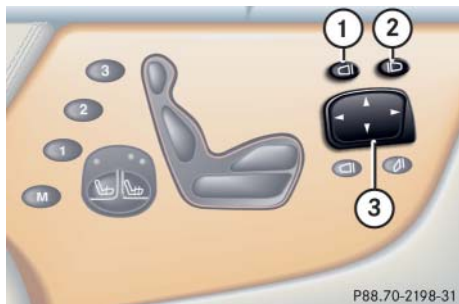

- ① Driver's side exterior rear view mirror button
- ② Passenger-side exterior rear view mirror button
- ③ Adjustment button

- ▶ Switch on the ignition (▷ page 34).
- ▶ Press button ① for the left mirror or button ② for the right mirror.
- ▶ Push adjustment button ③ up, down, left or right according to the desired setting.



For information on how to reposition the exterior mirror housing when it was forcibly pushed forward (hit from the rear) or forcibly pushed rearward (hit from the front), see “Folding exterior rear view mirrors in and out manually” (▷ page 181).



The memory function (▷ page 122) lets you store the setting for the exterior rear view mirrors together with the setting for the steering wheel and the seat position.

At low ambient temperatures, the mirrors will be heated automatically.

For more information, see “Folding exterior rear view mirrors in and out automatically” (▷ page 180).

▼ Driving

Warning!



Do not lay any objects in the driver's footwell. Be careful that floor mats or carpets in the driver's footwell leave sufficient clearance for the pedals.

During sudden driving or braking maneuvers the objects could get caught between or underneath the pedals. You could then no longer brake or accelerate.

Fastening the seat belts

Warning!



Always fasten your seat belt before driving off. Always make sure your passengers are properly restrained, even those sitting in the rear and pregnant women.

Failure to wear and properly fasten and position your seat belt greatly increases your risk of injuries and their likely severity in an accident. You and your passengers should always wear seat belts.

If you are ever in an accident, your injuries can be considerably more severe without your seat belt properly buckled. Without your seat belt buckled, you are much more likely to hit the interior of the vehicle or be ejected from it. You can be seriously injured or killed.

In the same crash, the possibility of injury or death is lessened if you are wearing your seat belt. The air bags can only provide the protection they were designed to afford if the occupants are using their seat belts (▷ page 62).

Warning!



Children 12 years old and under must never ride in the front seat, except in a Mercedes-Benz authorized BabySmart™ compatible child seat, which operates with the BabySmart™ system installed in the vehicle to deactivate the passenger front air bag when it is properly installed. Otherwise they will be struck by the air bag when it inflates in a crash. If this happens, serious or fatal injury will result.





According to accident statistics, children are safer when properly restrained in the rear seating positions than in the front seating positions. Infants and small children must ride in back seats and be seated in an appropriate infant or child restraint system, which is properly secured with the vehicle's seat belt and top tether strap, or secured via lower anchors and top tether strap, fully in accordance with the child seat manufacturer's instructions.

A child's risk of serious or fatal injuries is significantly increased if the child restraints are not properly secured in the vehicle and the child is not properly secured in the child restraint.

Warning!



Never ride in a moving vehicle with the seat backrest in an excessively reclined position as this can be dangerous. You could slide under the seat belt in a collision. If you slide under it, the belt would apply force at the abdomen or neck. That could cause serious or even fatal injuries. The seat backrest and seat belt provide the best restraint when the wearer is in a nearly upright position and the belt is properly positioned on the body.

Warning!



Never let more people ride in the vehicle than there are seat belts available. Be sure everyone riding in the vehicle is correctly restrained with a separate seat belt. Never use a seat belt for more than one person at a time.

Warning!



Read and observe the additional warning notices printed in the "Safety and Security" section (▷ page 66).

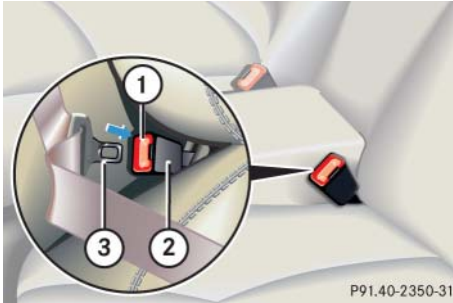

P91.40-2350-31

- ① Release button
- ② Buckle
- ③ Latch plate

- ▶ With a smooth motion, pull the belt from the seat belt outlet.
- ▶ Place the shoulder portion of the belt across the top of your shoulder and the lap portion across your hips.
- ▶ Push latch plate ③ into buckle ② until it clicks.
- ▶ If necessary, tighten the lap portion to a snug fit by pulling shoulder portion up.

Proper use of seat belts

- Do not twist the belt when fastening.
- Adjust seat belt so that the shoulder portion is located as close as possible to the middle of the shoulder (it should not touch the neck). Never pass the shoulder portion of the belt under your arm.
- Position the lap belt as low as possible on your hips (over hip joint) and not across the abdomen.
- Place the seat backrest in a nearly upright position.
- Never use a seat belt for more than one person at a time.
- Do not fasten a seat belt around a person and another object at the same time.
- When using a seat belt to secure infant or toddler restraints or children in booster seats, always follow the child seat manufacturer's instructions.

- Check your seat belt during travel to make sure it is properly positioned.
- Make sure the seat belt is always fitted snugly. Take special care of this when wearing loose clothing.

Warning!



Do not pass belts over sharp edges. They could tear.

Do not allow the belt to get caught in the door or in the seat adjustment mechanism. This could damage the belt.

Never attempt to make modifications to seat belts. This could impair the effectiveness of the belts.

Do not bleach or dye seat belts as this may severely weaken them. In a crash, they may not be able to provide adequate protection.

Damaged seat belts or belts that were highly stressed in an accident must be replaced. Contact an authorized Mercedes-Benz Center.

Starting the engine

Warning!



Inhalation of exhaust gas is hazardous to your health. All exhaust gas contains carbon monoxide, and inhaling it can cause unconsciousness and possible death.

Do not run the engine in confined areas (such as a garage) which are not properly ventilated. If you think that exhaust gas fumes are entering the vehicle while driving, have the cause determined and corrected immediately. If you must drive under these conditions, drive with at least one window fully open.

Automatic transmission

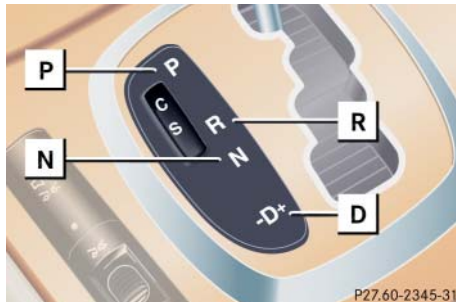

Gearshift pattern for automatic transmission

- P** Park position with gear selector lever lock
- R** Reverse gear
- N** Neutral position
- D** Drive position

For more information, see the “Controls in detail” section (▷ page 165).

Starting with the SmartKey

- ▶ Make sure the gear selector lever is set to **P**.
- ▶ Do not depress accelerator.
- ▶ Turn the SmartKey in the starter switch to position **3** and hold until the engine starts (▷ page 34).



You can also use the “touch-start” function. Turn the SmartKey to position **3** and release it again immediately. The engine then starts automatically.

For information on turning off the engine with the SmartKey, see “Turning off with the SmartKey” (▷ page 59).

Starting with KEYLESS-GO***Warning!**

As long as the SmartKey with KEYLESS-GO is in your vehicle, the vehicle can be started. Therefore, never leave children unattended in the vehicle, as they could otherwise accidentally start the engine.

When leaving the vehicle, always take the SmartKey with KEYLESS-GO with you and lock the vehicle. Do not leave children unattended in the vehicle, or with access to an unlocked vehicle.

You can start your vehicle without the SmartKey in the starter switch using the KEYLESS-GO start/stop button on the gear selector lever.

The SmartKey with KEYLESS-GO must be located in the vehicle.

**KEYLESS-GO start/stop button**

- ① USA only
- ② Canada only

- ▶ Make sure the gear selector lever is set to **P**.
 - ▶ Depress the brake pedal during the starting procedure. Do not depress accelerator.
- The gear selector lever lock is released.
- ▶ Press KEYLESS-GO start/stop button once.
- The engine starts automatically if the SmartKey with KEYLESS-GO is in the vehicle.

For information on turning off the engine with KEYLESS-GO, see “Turning off the engine with KEYLESS-GO*” (▷ page 59).

Driving

Starting difficulties

If the engine does not start as described, carry out the following steps:

- ▶ If you are starting the engine with the SmartKey: Turn SmartKey in starter switch to position **0** and repeat starting procedure.
- ▶ If you are starting the engine with KEYLESS-GO*: Close any doors that may be open to allow for better detection of the SmartKey with KEYLESS-GO*.

or

- ▶ Start the engine with the SmartKey as radio signals from another source may be interfering with the SmartKey with KEYLESS-GO*.
- ▶ Repeat the starting procedure (▷ page 48). Remember that extended starting attempts can drain the vehicle battery.
- ▶ Get a jump start (▷ page 394).

If the engine does not start after several starting attempts, there could be a malfunction in the engine electronics or in the fuel supply system.

- ▶ Notify an authorized Mercedes-Benz Center.

Parking brake

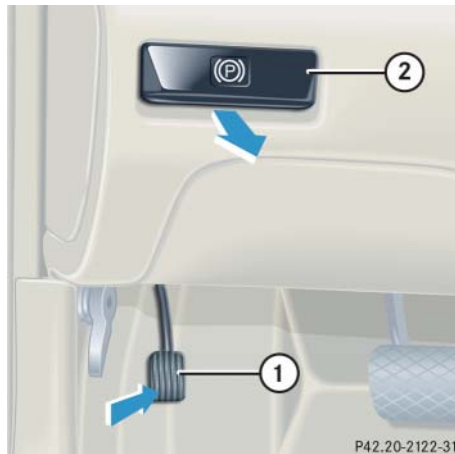

- ① Parking brake pedal
- ② Release handle

Warning!



When leaving the vehicle, always remove the SmartKey or SmartKey with KEYLESS-GO* from the starter switch, take it with you, and lock the vehicle. Do not leave children unattended in the vehicle, or with access to an unlocked vehicle. Children could release the parking brake, which could result in an accident and/or serious injury.

- ▶ Release the parking brake by pulling on handle ②.

The warning lamp **BRAKE** (USA only) or **(P)** (Canada only) in the instrument cluster goes out.

Driving

- ▶ Depress the brake pedal.
The gear selector lever lock is released.
- ▶ Move gear selector lever in position **D** or **R**.

Warning!



It is dangerous to shift the gear selector lever out of **P** or **N** if the engine speed is higher than idle speed. If your foot is not firmly on the brake pedal, the vehicle could accelerate quickly forward or in reverse. You could lose control of the vehicle and hit someone or something. Only shift into gear when the engine is idling normally and when your right foot is firmly on the brake pedal.

Warning!



On slippery road surfaces, never downshift in order to obtain braking action. This could result in drive wheel slip and reduced vehicle control. Your vehicle's ABS will not prevent this type of loss of control.



In order to avoid damaging the transmission,

- wait for the gear selection process to complete before setting the vehicle in motion.
 - place the gear selector lever in position **P** or **R** only when the vehicle is stopped.
- ▶ Release the brake pedal.
 - ▶ Carefully depress the accelerator pedal.

Once the vehicle is in motion, the automatic central locking system engages and the locking knobs drop down.



If you hear a warning signal and the message:

RELEASE
PARKING BRAKE

appears in the multifunction display when driving off, you have forgotten to release the parking brake.

Release the parking brake.

After a cold start, the automatic transmission shifts at a higher engine revolution. This allows the catalytic converter to reach its operating temperature faster.



Do not run cold engine at high engine speeds. Running a cold engine at high engine speeds may shorten the service life of the engine.

Driving



Simultaneously depressing the accelerator pedal and applying the brake reduces engine performance and causes premature brake and drivetrain wear.



You can open a locked door from the inside. Open doors only when conditions are safe to do so.

You can deactivate the automatic locking using the control system (▷ page 162).

For more information, see “Driving instructions” (▷ page 259).

Switching on headlamps

Low beam headlamps

The exterior lamp switch is located on the dashboard to the left of the steering wheel.

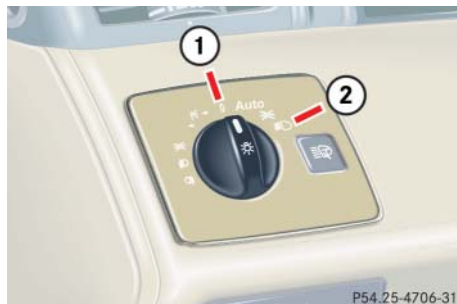

Exterior lamp switch

- ① Off
- ② Low beam headlamps on

▶ Turn the exterior lamp switch to .

The green indicator lamp  in the exterior lamp switch comes on.

For more information, see “Exterior lamp switch” (▷ page 125).

High beam

The combination switch is located on the left of the steering column.



Combination switch

- ① High beam
- ② High beam flasher

- ▶ Push combination switch in the direction of arrow ①.

The high beam headlamps are switched on.

The high beam headlamp indicator  in the tachometer comes on.

For more information, see “Lighting” (▷ page 125).

Turn signals

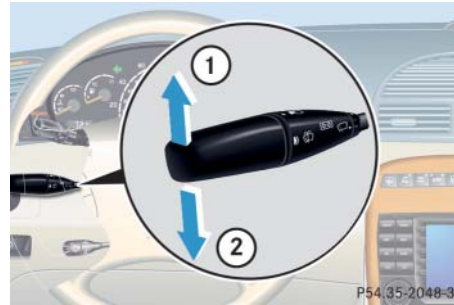

The combination switch is located on the left of the steering column.



Combination switch

- ① Turn signals, right
- ② Turn signals, left

- ▶ Press the combination switch up ① or down ②.

The corresponding turn signal indicator lamp  or  flashes in the instrument cluster (▷ page 24).

The combination switch resets automatically after major steering wheel movements.



To signal minor directional changes, e.g. passing or changing lanes, move combination switch to point of resistance only and release. The turn signal flashes three times.

Windshield wipers

The combination switch is located on the left of the steering column.



Combination switch

- ① Single wipe
Wiping with windshield washer fluid
 - ② Switching on windshield wipers
- ▶ Switch on the ignition (▷ page 34).



Do not operate the windshield wipers when the windshield is dry. Dust that accumulates on a windshield might scratch the glass and/or damage the windshield wipers blades when wiping occurs on a dry windshield. If it is necessary to operate the windshield wipers in dry weather conditions, always operate the windshield wipers with windshield washer fluid (▷ page 55).

Switching on windshield wipers

- ▶ Turn the combination switch to the desired position depending on the intensity of the rain.
- 0 Windshield wipers off
 - I Intermittent wiping
 - II Normal wiper speed
 - III Fast wiper speed

Intermittent wiping



Do not leave windshield wipers in intermittent setting when the vehicle is taken to an automatic car wash or during windshield cleaning. Windshield wipers will operate in the presence of water sprayed on the windshield, and windshield wipers may be damaged as a result.

Intermittent wiping interval is dependent on wetness of windshield.

- ▶ Turn the combination switch to position I.

After the initial wipe, pauses between wipes are automatically controlled by the rain sensor.



Intermittent wiping is interrupted when the vehicle is at a standstill and a front door is opened. This protects persons getting into or out of the vehicle from being sprayed.

Intermittent wiping will be continued when

- all doors are closed
- and
- the gear selector lever is in position **D** or **R**
- or
- the wiper setting is changed using the combination switch

Single wipe

- ▶ Press the combination switch briefly in the direction of arrow ① to the resistance point.

The windshield wipers wipe one time without washer fluid.

Wiping with windshield washer fluid

- ▶ Press the combination switch in the direction of arrow ① past the resistance point.

The windshield wiper operates with washer fluid.



To prevent smears on the windshield, wipe with windshield washer fluid every now and then even when it is raining.



If anything blocks the windshield wipers (leaves, snow, etc.), switch them off immediately.

- For safety reasons, stop the vehicle in a safe location,
 - remove SmartKey from the starter switch
- or
- turn off the engine by pressing the KEYLESS-GO* start/stop

button (▷ page 35) and open the driver's door (with the driver's door open, starter switch is in position **0**, same as with SmartKey removed from the starter switch)

before attempting to remove any blockage.

- Remove blockage.
- Turn the windshield wipers on again.

If windshield wipers fail to function at all in the combination switch position **I**:

- Set the combination switch to the next higher wiper speed.
- Have the windshield wipers checked at the nearest authorized Mercedes-Benz Center.

For information on filling up the washer reservoir, see "Windshield washer system and headlamp cleaning system" (▷ page 282).

Problems while driving

The engine runs erratically and misfires

- An ignition cable may be damaged.
- The engine electronics may not be operating properly.
- Unburned gasoline may have entered the catalytic converter and damaged it.
- ▶ Give very little gas.
- ▶ Have the problem repaired by an authorized Mercedes-Benz Center as soon as possible.

The coolant temperature is above 248°F (120°C)

The coolant is too hot and is no longer cooling the engine.

- ▶ Stop the vehicle in a safe location as soon as possible and turn off the engine. Allow engine and coolant to cool.
- ▶ Check the coolant level and add coolant if necessary (▷ page 280).



Excessive coolant temperature triggers a warning message in the multifunction display (▷ page 348).

In case of accident

If the vehicle is leaking gasoline:

- ▶ Do not start the engine under any circumstances.
- ▶ Notify local fire and/or police authorities.

If the extent of the damage cannot be determined:

- ▶ Notify an authorized Mercedes-Benz Center.

If no damage can be determined on the

- major assemblies
- fuel system
- engine mount:
- ▶ Start the engine in the usual manner.

▼ Parking and locking

You have now completed your first drive. You have properly stopped and parked your vehicle. End your drive as follows:

Warning!



With the engine not running, there is no power assistance for the brake and the steering systems. In this case, it is important to keep in mind that a considerably higher degree of effort is necessary to brake and steer the vehicle.

Warning!



Do not park this vehicle in areas where combustible materials such as grass, hay or leaves can come into contact with the hot exhaust system, as these materials could be ignited and cause a vehicle fire.

To reduce the risk of personal injury as a result of vehicle movement, before turning off the engine and leaving the vehicle always:

- Keep right foot on brake pedal.
- Firmly depress parking brake pedal.

- Move the gear selector lever to position **P**.
- Slowly release brake pedal.
- When parked on an incline, turn front wheels towards the road curb.
- Turn the SmartKey to starter switch position **0** and remove, or press KEYLESS-GO* start/stop button (> page 35).
- Take the SmartKey or the SmartKey with KEYLESS-GO* with you and lock vehicle when leaving.

Parking and locking

Parking brake

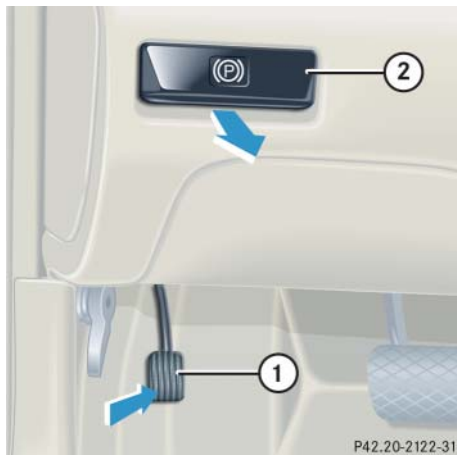

- ① Parking brake pedal
- ② Release handle

- ▶ Step firmly on parking brake ①.

When the engine is running, the indicator lamp **BRAKE** (USA only) or **(P)** (Canada only) in the instrument cluster will be illuminated.

Warning!



When leaving the vehicle, always remove the SmartKey or SmartKey with KEYLESS-GO* from the starter switch, take it with you, and lock the vehicle. Do not leave children unattended in the vehicle, or with access to an unlocked vehicle. Children could release the parking brake and/or move the gear selector lever to position **P**, either of which could result in an accident and/or serious injury.

Warning!



Getting out of your vehicle with the gear selector lever not fully engaged in position **P** is dangerous. Also, when parked on an incline, position **P** alone may not prevent your vehicle from moving, possibly hitting people or objects.

Always set the parking brake in addition to shifting to position **P** (▷ page 48).

When parked on an incline, turn front wheels towards the road curb.

Switching off headlamps

- ▶ Turn the exterior lamp switch to **0** (▷ page 52).

For more information, see “Exterior lamp switch” (▷ page 125).

Turning off the engine

- ▶ Place the gear selector lever in position **P**.



Always set the parking brake in addition to shifting to position **P**.

On slopes, turn the front wheels towards the curb.

Turning off with the SmartKey

- ▶ Turn the SmartKey in the starter switch (▷ page 34) to position **0** and remove it.

The immobilizer is activated.



The SmartKey can only be removed from the starter switch with the gear selector lever in position **P**.



With the SmartKey removed and the driver's door open, a warning sounds if the vehicle's exterior lamps are not switched off.

Turning off the engine with KEYLESS-GO*

- ▶ Place the gear selector lever in position **P**.
- ▶ Press the KEYLESS-GO start/stop button (▷ page 35) to shut off the engine.

With the driver's door closed, the starter switch is now in position **1**. With the driver's door opened, the starter switch is set to position **0**, same as SmartKey removed from starter switch (▷ page 34).



If you hear a warning signal, you have either

- forgotten to turn off the lights before opening the driver's door
- or
- tried to turn off the engine while the gear selector lever is not in **P**.

Turn off the lights or place the gear selector lever in **P**.

Releasing seat belts

- ▶ Press the seat belt release button (▷ page 47).

Allow the retractor to completely rewind the seat belt by guiding the latch plate.



Make sure the seat belt retracts fully so that the seat belt and/or latch plate cannot get caught or pinched in the door or in the seat mechanism. This can damage the seat belt and impair the effectiveness of the seat belt, and/or cause damage to the door and/or door trim panel. Such damage is not covered by the Mercedes-Benz Limited Warranty.

Damaged seat belts must be replaced. Contact an authorized Mercedes-Benz Center.

Parking and locking

Locking

Warning!



To prevent possible personal injury, always keep hands and fingers away from the door openings when closing the doors. Be especially careful when small children are around.

Before closing doors, make sure there is no possibility of someone getting caught in a door during closing.

Warning!



When leaving the vehicle, always remove the SmartKey or SmartKey with KEYLESS-GO* from the starter switch, take it with you, and lock the vehicle. Do not leave children unattended in the vehicle, or with access to an unlocked vehicle. Unsupervised use of vehicle equipment may cause an accident and/or serious personal injury.



Opening a door causes the windows on that side of the car to open slightly. They will return to the up position when the door is closed.

Locking with the SmartKey

- ▶ After exiting the vehicle, press the lock button  on the SmartKey ([▷ page 32](#)).

With the trunk and all doors closed, all turn signal lamps flash three times. The locking knobs in the doors move down. The anti-theft alarm system is armed.

For more information, see “Locking and unlocking” ([▷ page 90](#)).

Locking with KEYLESS-GO*

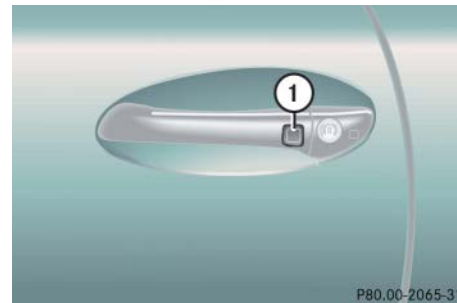

① Lock button

- ▶ After exiting the vehicle, take the SmartKey with KEYLESS-GO with you and press lock button ① on an outside door handle or on the trunk lid ([▷ page 99](#)).

With the trunk and all doors closed, all turn signal lamps flash three times. The locking knobs in the doors move down. The anti-theft alarm system is armed.

For more information, see “Locking and unlocking” ([▷ page 94](#)).

Safety and Security

Occupant safety

Panic alarm

Driving safety systems

Anti-theft systems



Occupant safety

In this section you will learn the most important facts about the restraint systems of the vehicle.

The restraint systems are:

- Seat belts
- Emergency tensioning device
- Air bags
- Child seats
- Child seat recognition
- Lower anchors and tethers for children (LATCH)

As independent systems, their protective effects work in conjunction with each other.



For information on infants and children traveling with you in the vehicle and restraint systems for infants and children, see “Children in the vehicle” (▷ page 72).

The **SRS** indicator lamp in the instrument cluster comes on

- for about 4 seconds when you turn the SmartKey in the starter switch to position **1** or press the KEYLESS-GO* start/stop button (▷ page 35) once. It then goes out briefly, comes on again and remains lit until you start the engine.
- for about 4 seconds when you start the engine by turning the SmartKey or pressing the KEYLESS-GO* start/stop button.



The **SRS** indicator lamp remains lit if the SmartKey is turned to position **2** and left there or the KEYLESS-GO* start/stop button is pressed twice. The indicator lamp will go out when you start the engine.

The restraint systems are fully operational if the **SRS** indicator lamp is not lit when the engine is running.

A malfunction in the system has been detected if the **SRS** indicator lamp:

- fails to extinguish after approximately 4 seconds
- does not come on at all
- comes on after the engine was started
- comes on while driving

For safety reasons, we strongly recommend that you visit an authorized Mercedes-Benz Center immediately to have the system checked.

For more information, see “Practical hints” (▷ page 335).

Warning!

In the event that the **SRS** indicator lamp comes on during driving or does not come on at all, the SRS self-check has detected a malfunction. For your safety, we strongly recommend that you visit an authorized Mercedes-Benz Center immediately to have the system checked; otherwise the SRS may not be activated when needed in an accident, which could result in serious or fatal injury, or it might deploy unexpectedly and unnecessarily which could also result in injury.

In addition, improper repair work on the SRS creates a risk of rendering the SRS inoperative or causing unintended air bag deployment. Work on the SRS must therefore only be performed by qualified technicians. Contact an authorized Mercedes-Benz Center.

Air bags**Warning!**

Air bags are designed to reduce the potential of injury and fatality in certain frontal impacts (front air bags), side impacts (side impact air bags and head protection window curtain air bags) or rollovers (head protection window curtain air bags). However, no system available today can totally eliminate injuries and fatalities.

The activation of the air bags temporarily releases a small amount of dust from the air bags. This dust, however, is neither injurious to your health, nor does it indicate a fire in the vehicle. The dust might cause some temporary breathing difficulty for people with asthma or other breathing trouble. To avoid this, you may wish to get out of the vehicle as soon as it is safe to do so. If you have any breathing difficulty but cannot get out of the vehicle after the air bag inflates, then get fresh air by opening a window or door.

Warning!

To reduce the risk of injury when the front air bags inflate, it is very important for the driver and front passenger to always be in a properly seated position and to wear your seat belts.

For maximum protection in the event of a collision always be in normal seated position with your back against the seat backrest. Fasten your seat belt and make sure it is properly positioned on your body.

Since the air bag inflates with considerable speed and force, a proper seating and hands on steering wheel position will help to keep you at a safe distance from the air bag. Occupants who are unbelted, out of position or too close to the air bag can be seriously injured or killed by an air bag as it inflates with great force in the blink of an eye:

- Sit properly belted in a nearly upright position with your back against the seat backrest.



Occupant safety



- Adjust the driver's seat as far as possible rearward, still permitting proper operation of vehicle controls. The distance from the center of the driver's breastbone to the center of the air bag cover on the steering wheel must be at least 10 in (25 cm) or more. You should be able to accomplish this by a combination of adjustments to the seat and steering wheel. If you have any problems, please see an authorized Mercedes-Benz Center.
- Do not lean with your head or chest close to the steering wheel or dashboard.
- Keep hands on the outside of steering wheel rim. Placing hands and arms inside the rim can increase the risk and potential severity of hand/arm injury when driver front air bag inflates.
- Adjust the front passenger seat as far as possible rearward from the dashboard when the seat is occupied.
- Occupants, especially children, should never lean their heads in the area of the door where the side air bag inflates.

This could result in serious injuries or death should the air bag be triggered. Always sit nearly upright, properly use the seat belts and appropriate size infant or child restraint system.

- Children 12 years old and under must never ride in the front seat, except in a Mercedes-Benz authorized BabySmart™ compatible child seat, which operates with the BabySmart™ system installed in the vehicle to deactivate the passenger front air bag when it is properly installed. Otherwise they will be struck by the air bag when it inflates in a crash. If this happens, serious or fatal injury will result.

Failure to follow these instructions can result in severe injuries to you or other occupants.

If you sell your vehicle, it is important that you make the buyer aware of this safety information. Be sure to give the buyer this Operator's Manual.

Warning!



Accident research shows that the safest place for children in an automobile is in the rear seat. Should you choose to place a child 12 years old or under in the front passenger seat of your vehicle, you must properly use a BabySmart™ child restraint which will turn off the passenger front air bag. BabySmart™ will not, however, turn off any side impact air bag.

It should be noted that with respect to both front and rear side impact air bags there is a possibility for a side air bag related injury if occupants, especially children, are not properly seated or restrained when next to a side air bag which needs to deploy rapidly in a side impact in order to do its job.

To help avoid the possibility of injury, please follow these guidelines:

- (1) Occupants, especially children, should never place their bodies or lean their heads in the area of the door where the side air bag inflates. This could result in

serious injuries or death should the side air bag be activated.

- (2) Always sit nearly upright, properly use the seat belts and use an appropriately sized infant or child restraint system for all children 12 years old or under.
- (3) Always wear seat belts properly.

If you believe that, even with the use of these guidelines, it would be safer for your rear seat occupants to have the rear mounted side air bags deactivated, then deactivation can be accomplished upon your written request to do so at your authorized Mercedes-Benz Center at an additional cost.

Please contact your local authorized Mercedes-Benz Center or call our Customer Assistance Center at 1-800-FOR-MERCEdes (1-800-367-6372) for details.



Air bags are designed to activate only in certain frontal (front air bags) impacts, side impacts (side impact and head protection window curtain air bags) which exceed preset thresholds and in certain rollovers (head protection window curtain air bags). Only during these events will they provide their supplemental protection.

The driver and passengers should always wear their seat belts. Otherwise it is not possible for air bags to provide their supplemental protection.

In case of other types of impacts and impacts below air bag deployment thresholds, air bags will not be activated. The driver and passenger will then be protected to the extent possible by a properly fastened seat belt. A properly fastened seat belt is also needed to provide the best possible protection in a rollover.

We caution you not to rely on the presence of the air bags in order to avoid wearing your seat belt.

Your vehicle was originally equipped with air bags that are designed to activate in certain impacts exceeding a preset threshold to reduce the potential and severity of injury. It is important for your safety and that of your passengers that you replace deployed air bags and repair any malfunctioning air bags to make sure the vehicle will continue to provide supplemental crash protection for occupants.

Occupant safety

Safety guidelines for the seat belt, emergency tensioning device and air bag

Warning!



- Damaged seat belts or belts that were highly stressed in an accident must be replaced and their anchoring points must also be checked. Use only belts installed or supplied by an authorized Mercedes-Benz Center.
- Air bags and emergency tensioning devices (ETDs) are designed to function on a one-time-only basis. An air bag or ETD that was activated must be replaced.
- No modifications of any kind may be made to any components or wiring of the SRS. This includes changing or removing any component or part of the SRS, the installation of additional trim material, badges, etc. over the steering wheel hub, passenger front air bag

cover, outboard sides of the front seat backrests, door trim panels, or door frame trims, and installation of additional electrical/electronic equipment on or near SRS components and wiring. Keep area between air bags and occupants free from objects (e.g. packages, purses, umbrellas, etc.).

- Do not pass belts over sharp edges. They could tear.
- Do not make any modification that could change the effectiveness of the belts.
- Do not bleach or dye seat belts as this may severely weaken them. In a crash they may not be able to provide adequate protection.
- Do not hang items such as coat hangers from the coat hooks or handles over the door. These items may turn into projectiles and cause head and other injuries when curtain air bag is deployed.
- Never place your feet on the instrument panel, dashboard, or on the seat. Always keep both feet on the floor in front of the seat.

- Air bag system components will be hot after the air bag has inflated. Do not touch.
- In addition, improper repair work on the SRS creates a risk of rendering the SRS inoperative or causing unintended air bag deployment. Work on the SRS must therefore only be performed by qualified technicians. Contact an authorized Mercedes-Benz Center.
- For your protection and the protection of others, when scrapping the air bag unit or emergency tensioning device, our safety instructions must be followed. These instructions are available from your authorized Mercedes-Benz Center.
- Given the considerable deployment speed and the textile structure of the air bags, there is the possibility of abrasions or other injuries resulting from air bag deployment.

When you sell your vehicle, we strongly urge you to give notice to the subsequent owner that it is equipped with an SRS by alerting them to the applicable section in the Operator's Manual.

Front air bags

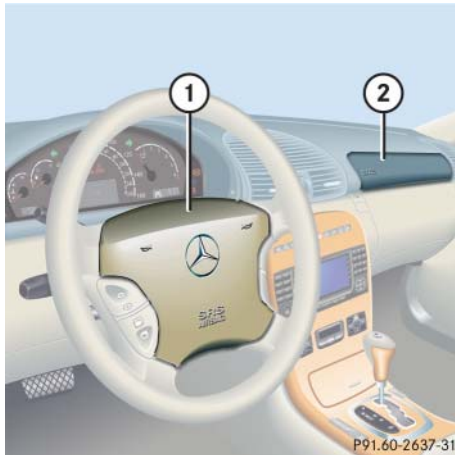

- ① Driver's front air bag
- ② Passenger front air bag

Driver's and passenger front air bags are deployed:

- in the event of certain frontal impacts
- if impact exceeds a preset deployment threshold
- independently of the side impact air bags

The air bags will not deploy in impacts which do not exceed the system's deployment thresholds. You will then be protected by the fastened seat belts.

The passenger front air bag will only be deployed if:

- the front passenger seat is occupied
- the  indicator lamp in the lower part of the front center console is not lit (▷ page 74)
- the impact exceeds a preset deployment threshold



Do not place objects heavier than 20 lbs (9 kg) on the front passenger seat. This could cause the front or side impact air bag on the front passenger side to deploy in a crash which exceeds the system's deployment threshold.

Side impact air bags

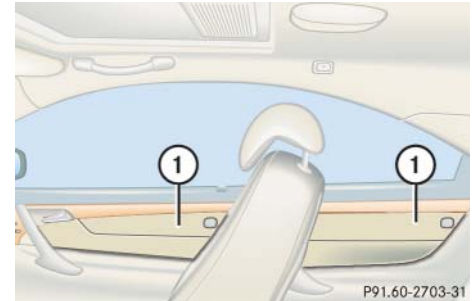

- ① Side impact air bags

Occupant safety

The side impact air bags are deployed:

- in impacts exceeding a preset deployment threshold
- on the impacted side of the vehicle
- independently of the front air bags

The side impact air bags are not deployed in impacts which do not exceed the system's deployment threshold.

The front passenger side impact air bag will only deploy if the system senses that the front passenger seat is occupied.

Window curtain air bags

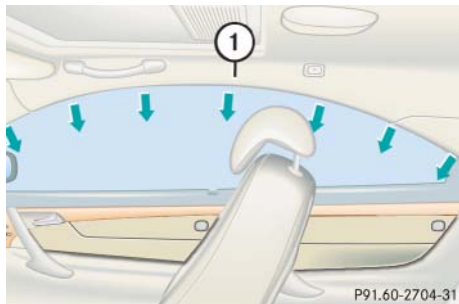

① Window curtain air bag



The side window curtain air bags are deployed:

- in impacts exceeding a preset deployment threshold
- on the impacted side of the vehicle
- independently of the front air bags
- in certain vehicle rollovers

The side window curtain air bags are not deployed in impacts which do not exceed the system's deployment threshold.

The window curtain air bags fill up the area indicated by the arrows.

Seat belts

When the engine is started, the seat belt telltale  illuminates to remind you and your passengers to fasten your seat belts. If the driver's seat belt is not fastened before the engine is started, the seat belt telltale  illuminates and a warning chime sounds for approximately 6 seconds when the engine is started.

Always wear your seat belt. All vehicle occupants always need to have their seat belts fastened and wear them properly.

In addition, applicable motor vehicle safety laws require you to wear seat belts. Even where this is not the case, we strongly recommend that all vehicle occupants have their seat belts fastened and wear them properly.

For more information, see “Fastening the seat belts” (▷ page 45).



For information on infants and children traveling with you in the vehicle and restraint systems for infants and children, see “Children in the vehicle” (> page 72).

Warning!

Always fasten your seat belt before driving off. Always make sure your passengers are properly restrained, even those sitting in the rear and pregnant women.

Failure to wear and properly fasten and position your seat belt greatly increases your risk of injuries and their likely severity in an accident. You and your passengers should always wear seat belts.

If you are ever in an accident, your injuries can be considerably more severe without your seat belt properly buckled. Without your seat belt buckled, you are much more likely to hit the interior of the vehicle or be ejected from it. You can be seriously injured or killed.

In the same crash, the possibility of injury or death is lessened if you are properly wearing your seat belt. Air bags can only protect as they are designed if the occupants are properly wearing their seat belts.

Warning!

Never ride in a moving vehicle with the seat backrest in an excessively reclined position as this can be dangerous. You could slide under the seat belt in a collision. If you slide under it, the belt would apply force at the abdomen or neck. That could cause serious or even fatal injuries. The seat backrest and seat belt provide the best restraint when the wearer is in a nearly upright position and the belt is properly positioned on the body.

Warning!

Never let more people ride in the vehicle than there are seat belts available. Be sure everyone riding in the vehicle is correctly restrained with a separate seat belt. Never use a seat belt for more than one person at a time.

Occupant safety

Warning!



Damaged seat belts or belts that were highly stressed in an accident must be replaced and their anchoring points must also be checked.

Only use seat belts which have been approved by Mercedes-Benz.

Do not make any modifications to the seat belts. This can lead to failure of the seat belts.

Do not bleach or dye seat belts as this may severely weaken them. In a crash, they may not be able to provide adequate protection.

Have all work carried out only by qualified technicians. Contact an authorized Mercedes-Benz Center.

Warning!



USE SEAT BELTS PROPERLY

- Seat belts can only work when used properly. Never wear seat belts in any other way than as described in this section, as that could result in serious injuries in case of an accident.
- Each occupant should wear their seat belt at all times, because seat belts help reduce the likelihood of and potential severity of injuries in accidents, including rollovers. The integrated restraint system includes SRS (driver's air bag, passenger front air bag, side impact air bags, head protection window curtain air bags for side windows), ETD (seat belt emergency tensioning device), and front seat knee bolsters. The system is designed to enhance the protection offered to properly belted occupants in certain frontal (front air bags and ETD) and side (side impact, window curtain air bags and ETD) impacts which exceed preset deployment thresholds and in certain rollovers

(window curtain air bags and ETD).

- Never wear the shoulder belt under your arm, against your neck or off your shoulder. In a crash, your body would move too far forward. That would increase the chance of head and neck injuries. The belt would also apply too much force to the ribs or abdomen, which could severely injure internal organs such as your liver or spleen.
- Never wear belts over rigid or breakable objects in or on your clothing, such as eyeglasses, pens, keys, etc., as these might cause injuries.
- Position the lap belt as low as possible on your hips and not across the abdomen. If the belt is positioned across your abdomen, it could cause serious injuries in a crash.
- Never use a seat belt for more than one person at a time. Do not fasten a seat belt around a person and another person or other objects.

- Belts should not be worn twisted. In a crash, you wouldn't have the full width of the belt to manage impact forces. The twisted belt against your body could cause injuries.
- Pregnant women should also use a lap-shoulder belt. The lap belt portion should be positioned as low as possible on the hips to avoid any possible pressure on the abdomen.
- Never place your feet on the instrument panel, dashboard or on the seat. Always keep both feet on the floor in front of the seat.

Emergency tensioning device (ETD), seat belt force limiter

The seat belts for the front and rear outer seats are equipped with emergency tensioning devices and belt force limiters.

The ETD is designed to activate in the following cases:

- in frontal or rear-end impacts exceeding a preset severity level

- in certain vehicle rollovers
- if the restraint systems are operational and functioning correctly, see **SRS** indicator lamp (▷ page 62).



The ETDs for the front seats will only activate if the respective front seat belt is fastened (latch plate properly inserted into buckle).

The ETDs for the rear outer seats will activate with or without the respective seat belt fastened.

In an impact, emergency tensioning devices remove slack from the belts in such a way that the seat belts fit more snugly against the body. Belt force limiters reduce the force exerted by the seat belts on occupants during a crash.

Warning!



An emergency tensioning device (ETD) that was activated must be replaced.

When disposing of the emergency tensioning device, our safety instructions must be followed. These are available at your authorized Mercedes-Benz Center.



Do not place objects heavier than 20 lbs (9 kg) on the front passenger seat. This could cause the front or side impact air bag on the front passenger side and, with the seat belt fastened to secure the object, the ETD to deploy in a crash which exceeds the system's deployment threshold.

Automatic comfort-fit feature seat belt

An automatic comfort-fit feature for front seats reduces the retracting force of the seat belts when they are in normal use.

Occupant safety

Children in the vehicle

If an infant or child is traveling with you in the vehicle:

- Secure the child using an infant or child restraint appropriate to the age and size of the child.
- Make sure the infant or child is properly secured at all times while the vehicle is in motion.

Infant and child restraint seats and information on choosing an appropriate restraint system can be obtained from any Mercedes-Benz Center.

Infant and child restraint systems

Use only a BabySmart™ compatible child restraint for the front passenger seat in this vehicle.

We recommend all infants and children be properly restrained at all times while the vehicle is in motion.

All lap-shoulder belts except the driver's seat belt have special seat belt retractors for secure fastening of child restraints.

To fasten a child restraint, follow child restraint instructions for mounting. Then pull the shoulder belt out completely and let it retract. During seat belt retraction, a ratcheting sound can be heard to indicate that the special seat belt retractor is activated. The belt is now locked. Push down on child restraint to take up any slack.

To deactivate, release seat belt buckle and let seat belt retract completely. The seat belt can again be used in the usual manner.



For more information on child seats with mounting fittings for tether anchorages, see “Installation of infant and child restraint systems” (▷ page 76).

For information on LATCH-type child seat mounts (▷ page 77).

Warning!



Never release the seat belt buckle while the vehicle is in motion, since the special seat belt retractor will be deactivated.



The use of infant or child restraints is required by law in all 50 states, the District of Columbia, the U.S. territories and all Canadian provinces.

Infants and small children should be seated in an appropriate infant or child restraint system properly secured by

a lap-shoulder belt or, if so equipped, a child restraint lower anchorage system that complies with U.S. Federal Motor Vehicle Safety Standards 213 and 225 and Canadian Motor Vehicle Safety Standards 213 and 210.2.

A statement by the child restraint manufacturer of compliance with this standard can be found on the instruction label on the restraint and in the instruction manual provided with the restraint.

When using any infant or child restraint system, be sure to carefully read and follow all manufacturer's instructions for installation and use.

Please read and observe warning labels affixed to inside of vehicle and to infant or child restraints.

Warning!

Children 12 years old and under must never ride in the front seat, except in a Mercedes-Benz authorized BabySmart™ compatible child seat, which operates with BabySmart™ System installed in the vehicle to deactivate the passenger front air bag when it is properly installed. Otherwise they will be struck by the air bag when it inflates in a crash. If this happens, serious or fatal injury will result.

According to accident statistics, children are safer when properly restrained in the rear seating positions than in the front seating positions. Infants and small children must ride in back seats and be seated in an appropriate infant or child restraint system, which is properly secured with the vehicle's seat belt and top tether strap, or secured via lower anchors and top tether strap, fully in accordance with the child seat manufacturer's instructions.

Infants and small children should never share a seat belt with another occupant. During an accident, they could be crushed between the occupant and seat belt.

Children too big for child restraint systems must ride in back seats using regular seat belts. Position shoulder belt across chest and shoulder, not face or neck. A booster seat may be necessary to achieve proper belt positioning for children from 41 lbs until they reach a height where a lap/shoulder belt fits properly without a booster.

A child's risk of serious or fatal injuries is significantly increased if the child restraints are not properly secured in the vehicle and the child is not properly secured in the child restraint.

When the child restraint is not in use, remove it from the vehicle or secure it with the seat belt to prevent the child restraint from becoming a projectile in the event of an accident.



Occupant safety

▷▷ Do not leave children unattended in the vehicle; even if the children are secured in a child restraint system. Unsupervised children in a child restraint system may use vehicle equipment and cause an accident and/or serious personal injury.

BabySmart™ air bag deactivation system

The  indicator lamp is located on the lower part of the center console.



①  indicator lamp

Special BabySmart™ compatible child seats, designed for use with the Mercedes-Benz system and available at any authorized Mercedes-Benz Center are required for use with the BabySmart™ air bag deactivation system. With the special child seat properly installed, the passenger front air bag will not deploy.

The  indicator lamp ① located on the lower part of the front center console will be illuminated, except with the SmartKey removed or in starter switch position 0.



The system does not deactivate the side impact air bag and the emergency tensioning device.

Self-test BabySmart™ without special child seat installed

After turning the SmartKey in the starter switch to position 1 or 2 or pressing the KEYLESS-GO* start/stop button (▷ page 35) once or twice, the  indicator lamp comes on for approximately 6 seconds and then goes out.

If the  indicator lamp should not come on or is continuously lit, the system is not functioning. You must see an authorized Mercedes-Benz Center before seating any child on the front passenger seat.

For more information, see “Practical hints” (▷ page 336).

Warning!



The BabySmart™ air bag deactivation system will **ONLY** work with a special child seat designed to operate with it. It will not work with child seats which are not BabySmart™ compatible.

Never place anything between seat cushion and child seat (e.g. pillow), since it reduces the effectiveness of the deactivation system. The bottom of the child seat must make full contact with the passenger seat cushion. An incorrectly mounted child seat could cause injuries to the child in case of an accident, instead of protecting the child.

Follow the manufacturer's instructions for installation of special child seats.

Warning!

When using a BabySmart™ compatible child seat on the front passenger seat, the passenger front air bag will not deploy only if the  indicator lamp remains illuminated.

Make sure to check the  indicator lamp every time you use the special system child seat. Should the  indicator lamp go out while the restraint is installed, please check installation. If the  indicator lamp remains out, do not use the BabySmart™ restraint to transport children on the front passenger seat until the system has been repaired.

Warning!

Do not place powered-on laptops, cell phones, electronic tags such as those used in ski passes and like electronic devices on the front passenger seat. Signals from such devices may interfere with the BabySmart™ system. Such signal interference, for example, may cause the  indicator lamp not to come on or be continuously lit during self-test, indicating that the system is not functioning.

Occupant safety

Installation of infant and child restraint systems

This vehicle is equipped with tether anchorages for a top tether strap at each of the rear seating positions.

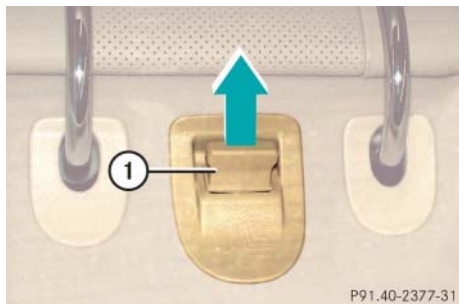

① Cover of top anchorage ring

- ▶ Remove cover ① from anchorage ring.
- ▶ Store cover ① in a convenient place (e.g. glove box).
- ▶ Guide tether strap between head restraint and top of seat back.

Head restraint must be positioned such that the top tether strap can pass freely between the head restraint and the top of seat back.

- ▶ Make sure the tether strap is not twisted.

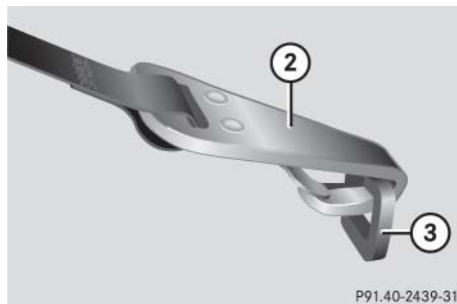

② Hook

③ Anchorage ring

- ▶ Securely fasten hook ②, which is part of the tether strap, to anchorage ring ③.

i

For safety, make sure the hook ② has attached to the ring ③ beyond the safety catch, as illustrated.

Once the top tether anchorage hook is attached, the child restraint itself can be secured. Tighten the top tether strap according to the child restraint manufacturer's instructions.

- ▶ Reinstall cover after removing the tether strap.

Child seat anchors – LATCH type

This vehicle is equipped with two LATCH (Lower Anchors and Tethers for Children) type anchors (at each of the rear seats) for the installation of a LATCH child seat with the matching anchor fittings.

If you have not installed a child seat, the LATCH mounting anchor fittings are covered with an upholstery blend.

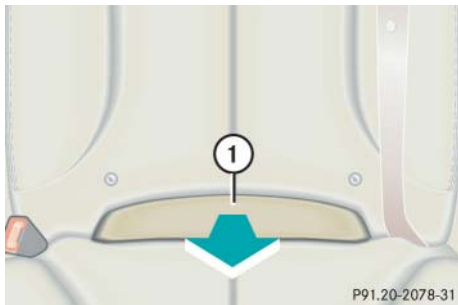

① Upholstery blend

- ▶ Remove upholstery blend ① and store it in the rear center armrest.



- ② Indicates the position of the anchors
- ③ Anchors

- ▶ Install child seat according to the manufacturer's instructions.

i

The child seat must be firmly attached in the right and left side anchor fittings.

Non-LATCH type child seats may also be used and can be installed using the vehicle's seat belt system. Install child seat according to the manufacturer's instructions.

Warning!



Children too big for child restraint systems must ride in back seats using regular seat belts. Position shoulder belt across chest and shoulder, not face or neck. A booster seat may be necessary to achieve proper belt positioning for children from 41 lbs until they reach a height where a lap/shoulder belt fits properly without a booster.

Install child seat according to manufacturer's instructions.

The child seat must be firmly attached in the right and left side anchors ③.



Occupant safety

▷▷ An incorrectly mounted child seat may come loose during an accident which could result in serious injury or death to the child.

Damaged or impact damaged child seats or child seat mounting fittings must be replaced.

Do not leave children unattended in the vehicle, even if the children are secured in a child restraint system.

Blocking of rear side windows operation

The override switch is on the driver's door.

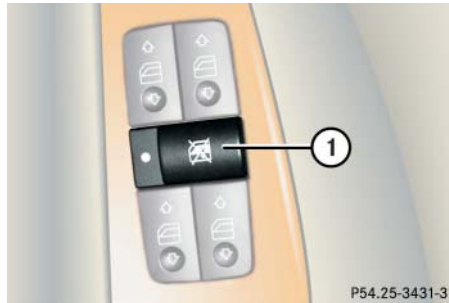

① Override switch

Activating override switch

- ▶ Slide override switch ① to the right.

A dot becomes visible. The functions in the rear are disabled.



Operation of the rear side windows with the switches located in the driver's door is still possible.

Warning!



Activate the override switch when children are riding in the back seats of the vehicle. The children may otherwise injure themselves, e.g. by becoming trapped in the side window opening.

When leaving the vehicle, always remove the SmartKey or SmartKey with KEYLESS-GO* from the starter switch, take it with you, and lock the vehicle. Do not leave children unattended in the vehicle, or with access to an unlocked vehicle. Unsupervised use of vehicle equipment may cause an accident and/or serious personal injury.

Deactivating override switch

- ▶ Slide override switch ① to the left.

The functions in the rear are enabled again.

▼ Panic alarm

An audible alarm and blinking exterior lamps will operate for approximately 2¹/₂ minutes.



① **PANIC** button

Activating

- ▶ Press and hold button ① for at least 1 second.

Deactivating

- ▶ Press button ① again.
- or
- ▶ Insert the SmartKey or the SmartKey with KEYLESS-GO* in starter switch.

or

- ▶ Press the KEYLESS-GO* start/stop button (▷ page 35).

The SmartKey with KEYLESS-GO* must be inside the vehicle.



USA only:

This device complies with Part 15 of the FCC Rules. Operation is subject to the following two conditions:

- (1) This device may not cause harmful interference, and

- (2) this device must accept any interference received, including interference that may cause undesired operation.

Any unauthorized modification to this device could void the user's authority to operate the equipment.



Canada only:

This device complies with RSS-210 of Industry Canada. Operation is subject to the following two conditions:

- (1) This device may not cause interference, and
- (2) this device must accept any interference received, including interference that may cause undesired operation of the device.

Any unauthorized modification to this device could void the user's authority to operate the equipment.

Driving safety systems

In this section you will find information on the following driving safety systems:

- ABS (Antilock Brake System)
- BAS (Brake Assist System)
- ESP® (Electronic Stability Program)



In winter operation, the maximum effectiveness of the ABS, BAS, and the ESP® is only achieved with winter tires (> page 313), or snow chains as required.

Warning!



The following factors increase the risk of accidents:

- Excessive speed, especially in turns
- Wet and slippery road surfaces
- Following another vehicle too closely

The ABS, BAS and ESP® cannot reduce this risk.

Always adjust your driving style to the prevailing road and weather conditions.

ABS

Warning!



Do not pump the brake pedal. Use firm, steady brake pedal pressure instead. Pumping the brake pedal defeats the purpose of the ABS and significantly reduces braking effectiveness.

The Antilock Brake System (ABS) regulates the brake pressure so that the wheels do not lock during braking. This allows you to maintain the ability to steer your vehicle.

The ABS is functional above a speed of approximately 5 mph (8 km/h) independent of road surface conditions.

On slippery road surfaces, the ABS will respond even to light brake pressure.

The  indicator lamp in the instrument cluster (▷ page 24) comes on when you switch on the ignition (▷ page 34). It goes out when the engine is running.

Braking

At the instant one of the wheels is about to lock up, a slight pulsation can be felt in the brake pedal, indicating that the ABS is in the regulating mode.

- ▶ Keep firm and steady pressure on the brake pedal while experiencing the pulsation.

Continuous steady brake pedal pressure yields the advantages provided by the ABS, namely braking power and the ability to steer the vehicle.

The pulsating brake pedal can be an indication of hazardous road conditions and functions as a reminder to take extra care while driving.

Emergency brake maneuver

- ▶ Keep continuous full pressure on the brake pedal.

Warning!



The ABS cannot prevent the natural laws of physics from acting on the vehicle, nor can it increase braking or steering efficiency beyond that afforded by the condition of the vehicle brakes and tires or the traction afforded. The ABS cannot prevent accidents, including those resulting from excessive speed in turns, following another vehicle too closely, or hydroplaning. Only a safe, attentive, and skillful driver can prevent accidents. The capabilities of an ABS equipped vehicle must never be exploited in a reckless or dangerous manner which could jeopardize the user's safety or the safety of others.

For more information, see "Practical hints" (▷ page 328).

BAS

The Brake Assist System (BAS) operates in emergency situations. If you apply the brakes very quickly, the BAS automatically provides full brake boost, thereby potentially reducing the braking distance.

- ▶ Apply continuous full braking pressure until the emergency braking situation is over.

The ABS will prevent the wheels from locking.

When you release the brake pedal, the brakes function again as normal. The BAS is then deactivated.

Warning!



If the BAS is malfunctioning, the brake system is still functioning normally, but without the additional brake boost available that BAS would normally provide in an emergency braking maneuver. Therefore, the braking distance may increase.

Warning!



The BAS cannot prevent the natural laws of physics from acting on the vehicle, nor can it increase braking efficiency beyond that afforded by the condition of the vehicle brakes and tires or the traction afforded. The BAS cannot prevent accidents, including those resulting from excessive speed in turns, following another vehicle too closely, or hydroplaning. Only a safe, attentive, and skillful driver can prevent accidents. The capabilities of a BAS equipped vehicle must never be exploited in a reckless or dangerous manner which could jeopardize the user's safety or the safety of others.

For more information, see the “Practical hints” (▷ page 328).

ESP®

The Electronic Stability Program (ESP®) is operational as soon as the engine is running and monitors the vehicle's traction (force of adhesive friction between the tires and the road surface) and handling.

The ESP® recognizes when a wheel is spinning or if the vehicle starts to skid. By applying brakes to the appropriate wheel and by limiting the engine output, the ESP® works to stabilize the vehicle. The ESP® is especially useful while driving off and on wet or slippery road surfaces. The ESP® also stabilizes the vehicle during braking maneuvers.

The ESP® warning lamp  in the instrument cluster flashes when the ESP® is engaged.

The ESP® warning lamp  in the instrument cluster comes on when you switch on the ignition (▷ page 34). It goes out when the engine is running.

Warning!



Never switch off the ESP® when you see the ESP® warning lamp  flashing in the instrument cluster. In this case proceed as follows:

- While driving off, apply as little throttle as possible.
- While driving ease up on the accelerator.
- Adapt your speed and driving style to the prevailing road conditions.

Failure to observe these guidelines could cause the vehicle to skid.

The ESP® cannot prevent accidents resulting from excessive speed.

Warning!

The ESP® cannot prevent the natural laws of physics from acting on the vehicle, nor can it increase the traction afforded. The ESP® cannot prevent accidents, including those resulting from excessive speed in turns, or hydroplaning. Only a safe, attentive, and skillful driver can prevent accidents. The capabilities of an ESP® equipped vehicle must never be exploited in a reckless or dangerous manner which could jeopardize the user's safety or the safety of others.



Distronic* is switched off when the ESP® engages.



The ESP® will only function properly if you use wheels of the recommended tire size (▷ page 410).



Because of the ESP's® automatic operation, the engine and ignition must be shut off (SmartKey in starter switch position **0** or **1** or KEYLESS-GO* start/stop button in position **0** or **1**) when

- the parking brake is being tested on a brake test dynamometer
- the vehicle is being towed with the front/rear axle raised

Active braking action through the ESP® may otherwise seriously damage the brake system.

For more information, see “Practical hints” (▷ page 332).

Switching off the ESP®**Warning!**

The ESP® should not be switched off during normal driving other than in the circumstances described below. Disabling of the system will reduce vehicle stability in standard driving maneuvers.

To improve the vehicle's traction, switch off the ESP® in driving situations where it would be advantageous to have the drive wheels spin and thus cut into surfaces for better grip such as:

- when driving with snow chains
- in deep snow
- in sand or gravel



Distronic* cannot be activated when the ESP® has been switched off.

Driving safety systems

When you switch off the ESP®

- the ESP® does not stabilize the vehicle
- the engine output is not limited, which allows the drive wheels to spin and thus cut into surfaces for better grip
- the traction control will still brake a spinning wheel
- the ESP® continues to operate when you are braking



When the ESP® is switched off and one or more drive wheels are spinning, the ESP® warning lamp  in the instrument cluster flashes. However, the ESP® will then not stabilize the vehicle.

The switch is located on the upper part of the center console.



① ESP® on/off

- ▶ Press ESP® switch ① until the ESP® warning lamp  in the speedometer comes on.

The ESP® is switched off.

Warning!



When the ESP® warning lamp  is illuminated continuously, the ESP® is switched off.

Adapt your speed and driving to the prevailing road conditions and to the non-operating status of the ESP®.



Avoid spinning of a drive wheel for an extended period with the ESP® switched off. This may cause serious damage to the drivetrain which is not covered by the Mercedes-Benz Limited Warranty.

Switching on the ESP®

- ▶ Press ESP® switch ①.

The ESP® warning lamp  in the instrument cluster goes out.

You are now again in normal driving mode with the ESP® switched on.

▼ Anti-theft systems

Immobilizer

The immobilizer prevents unauthorized persons from starting your vehicle.

Activating

With the SmartKey

- ▶ Remove the SmartKey from the starter switch.

The immobilizer is activated.

*With KEYLESS-GO**

- ▶ Turn off the engine by means of the KEYLESS-GO start/stop button (▷ page 35).
- ▶ Open the driver's door.

The immobilizer is activated.

Deactivating

With the SmartKey

- ▶ Insert the SmartKey in the starter switch.

The immobilizer is deactivated.

*With KEYLESS-GO**

- ▶ Start the engine by means of the KEYLESS-GO start/stop button (▷ page 35).

The immobilizer is deactivated.



In case the engine cannot be started (yet the vehicle's battery is charged), the system is not operational. Contact an authorized Mercedes-Benz Center or call 1-800-FOR-MERCEdes (in the USA), or 1-800-387-0100 (in Canada).

Anti-theft alarm system

Once the alarm system has been armed, a visual and audible alarm is triggered when someone opens:

- a door
- the trunk
- the hood

The alarm will stay on even if the activating element (a door, for example) is immediately closed.

The alarm system will also be triggered when

- someone attempts to raise the vehicle
- the vehicle is opened using the mechanical key
- someone opens a door from the inside
- someone opens the trunk with the emergency release button

Anti-theft systems



If the alarm stays on for more than 30 seconds, a call to the Response Center is initiated automatically by the Tele Aid system (▷ page 24 1) provided Tele Aid service was subscribed to and properly activated, and that necessary cellular service and GPS coverage are available.

Arming the alarm system

The indicator lamp located in the central locking switch in on the upper part of the front center console.



① Indicator lamp

- ▶ Lock your vehicle with the SmartKey or KEYLESS-GO*.

The turn signal lamps flash three times to indicate that the alarm system is activated. The indicator lamp ① flashes to indicate that the alarm system is armed.



If the turn signal lamps does not flash three times one of the following elements may not be properly closed:

- a door
- the trunk

Close the respective element and lock the vehicle again.

Disarming the alarm system

- ▶ Unlock your vehicle with the SmartKey or the KEYLESS-GO*.

The turn signal lamps flash once to indicate that the alarm system is disarmed.



The alarm system will rearm automatically again after approximately 40 seconds if no door was opened.



Canceling the alarm

To cancel the alarm:

With the SmartKey

- ▶ Insert the SmartKey in the starter switch.

or

- ▶ Press the  or  button on the SmartKey.

The alarm is canceled.

With KEYLESS-GO*

- ▶ Grasp an outside door handle.

The SmartKey with KEYLESS-GO must be within 3 ft. (1 m) of the vehicle.

or

- ▶ Press the KEYLESS-GO start/stop button (▷ page 35).

The SmartKey with KEYLESS-GO must be inside the vehicle.

The alarm is canceled.

Tow-away alarm

Once the tow-away alarm is armed, a visual and audible alarm will be triggered when someone attempts to raise the vehicle.



The tow-away protection alarm is triggered, for example, if the vehicle is lifted on one side.

If the alarm stays on for more than 30 seconds, a call to the Response Center is initiated automatically by the Tele Aid system (▷ page 241) provided Tele Aid service was subscribed to and properly activated, and that necessary cellular service and GPS coverage are available.

Arming tow-away alarm

- ▶ Lock your vehicle with the SmartKey or KEYLESS-GO*.

The tow-away alarm is automatically armed after about 30 seconds.

Disarming tow-away alarm

To prevent triggering the tow-away alarm, switch off the tow-away alarm feature before towing the vehicle, or when parking on a surface subject to movement, such as a ferry or auto train.



Anti-theft systems

- ▷▷ The button is located on the upper part of the front center console.



- ① Indicator lamp
- ② Tow-away alarm off button

- ▶ Switch off the ignition and remove the SmartKey from the starter switch.



You cannot disarm the tow-away alarm if the ignition is switched on.

- ▶ Press button ②.

Indicator lamp ① in the button comes on briefly.

- ▶ Exit and lock your vehicle with the SmartKey or (vehicles with KEYLESS-GO*) with the lock button on each outside door handle or trunk lid.

The tow-away alarm remains disarmed until you lock your vehicle again.



Canceling the alarm

To cancel the alarm:

With the SmartKey

- ▶ Insert the SmartKey in the starter switch.

or

- ▶ Press the  or  button on the SmartKey.

The alarm is canceled.

With KEYLESS-GO*

- ▶ Grasp an outside door handle.

The SmartKey with KEYLESS-GO must be within 3 ft. (1 m) of the vehicle.

or

- ▶ Press the KEYLESS-GO start/stop button (▷ page 35).

The SmartKey with KEYLESS-GO must be inside the vehicle.

The alarm is canceled.

Locking and unlocking

Seats

Memory function

Lighting

Instrument cluster

Control system

Automatic transmission

Good visibility

Automatic climate control

Power windows

Power tilt/sliding sunroof

Driving systems

Loading

Useful features

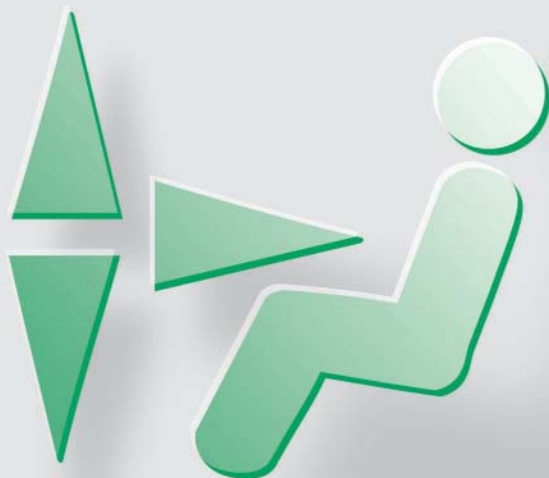

Locking and unlocking

In the “Controls in detail” section you will find detailed information on how to operate the equipment installed in your vehicle. If you are already familiar with the basic functions of your vehicle, this section will be of particular interest to you.

To quickly familiarize yourself with the basic functions of the vehicle, refer to the “Getting started” section of this manual. The corresponding page numbers are given at the beginning of each segment.

For more information on locking and unlocking, see “Getting started” (▷ page 32) and (▷ page 60).

SmartKey

Your vehicle comes supplied with two SmartKeys, each with remote control and a removable mechanical key.

The locking tabs for the mechanical key portion of the two SmartKeys are a different color to help distinguish each SmartKey unit.

The SmartKey provides an extended operating range. To prevent theft, however, it is advisable to only unlock the vehicle when you are in close proximity to it.





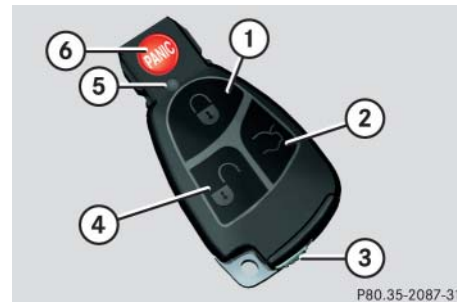

The SmartKey centrally locks and unlocks:

- the doors
- the trunk
- the fuel filler flap



P80.35-2087-31

SmartKey with remote controls

- ①  Lock button
- ②  Opening button for trunk
- ③  Locking tab for mechanical key
- ④  Unlock button
- ⑤  Battery check lamp
- ⑥  PANIC (▷ page 79)

Warning!

When leaving the vehicle, always remove the SmartKey or SmartKey with KEYLESS-GO* from the starter switch, take it with you, and lock the vehicle. Do not leave children unattended in the vehicle, or with access to an unlocked vehicle. It is possible for children to open a locked door from the inside, which could result in an accident and/or serious personal injury.



To prevent possible malfunction, avoid exposing the SmartKey to high levels of electromagnetic radiation.



USA only:

This device complies with Part 15 of the FCC Rules. Operation is subject to the following two conditions:

- (1) This device may not cause harmful interference, and
- (2) this device must accept any interference received, including interference that may cause undesired operation.

Any unauthorized modification to this device could void the user's authority to operate the equipment.



Canada only:

This device complies with RSS-210 of Industry Canada. Operation is subject to the following two conditions:

- (1) This device may not cause interference, and
- (2) this device must accept any interference received, including interference that may cause undesired operation of the device.

Any unauthorized modification to this device could void the user's authority to operate the equipment.



You can also open and close the windows and tilt/sliding sunroof using the SmartKey, see “Summer opening feature” (▷ page 200) and “Convenience closing feature” (▷ page 200).

Locking and unlocking

Factory setting

Global unlocking

- ▶ Press button .

All turn signal lamps flash once. The locking knobs in the doors move up. The anti-theft alarm system is disarmed.

The vehicle will lock again automatically and reactivate the anti-theft alarm system within approximately 40 seconds of unlocking if:

- neither a door nor the trunk is opened
- the SmartKey is not inserted in the starter switch
- the central locking switch is not activated



Global locking

- ▶ Press button .

With the trunk and all doors closed, all turn signal lamps flash three times. The locking knobs in the doors move down. The anti-theft alarm system is armed.

Selective setting

If you frequently travel alone, you may wish to reprogram the SmartKey so that pressing  only unlocks the driver's door and the fuel filler flap.

- ▶ Press and hold buttons  and  simultaneously for about 5 seconds until battery check lamp  flashes twice.

The SmartKey will then function as follows:

Unlocking driver's door and fuel filler flap

- ▶ Press button  once.

All turn signal lamps flash once. The locking knob in the driver's door moves up. The anti-theft alarm system is disarmed.

Global unlocking

- ▶ Press button  twice.



All turn signal lamps flash once. The locking knobs in the doors move up. The anti-theft alarm system is disarmed.

Global locking

- ▶ Press button .

With the trunk and all doors closed, all turn signal lamps flash three times. The locking knobs in the doors move down. The anti-theft alarm system is armed.

Restoring to factory setting

- ▶ Press and hold buttons  and  simultaneously for about 6 seconds until battery check lamp  flashes twice.





If you can no longer lock or unlock the vehicle with the SmartKey, then either the batteries in the SmartKey are discharged, the SmartKey is malfunctioning or the vehicle battery is drained.

- Check the batteries in the SmartKey and replace them if necessary (▷ page 376).
- Use the mechanical key to unlock the driver's door (▷ page 372) and the trunk (▷ page 373).
- Use the mechanical key to lock the driver's door (▷ page 372).
- Have the vehicle battery and the battery connections checked (▷ page 391).

If the SmartKey is malfunctioning, contact an authorized Mercedes-Benz Center.

Checking the batteries

- ▶ Press button  or .

Battery check lamp  comes on briefly to indicate that the SmartKey batteries are in order.





If battery check lamp  does not come on briefly during check, then the SmartKey batteries are discharged.

Replace the batteries (▷ page 376).

You can obtain the required batteries at any authorized Mercedes-Benz Center.



If the batteries are checked within signal range of the vehicle, pressing the button  or  will lock or unlock the vehicle accordingly.

Unlocking and opening the trunk

You can unlock and open the trunk separately.

A minimum height clearance of 6.3 ft (1.90 m) is required to open the trunk lid.

- ▶ Press and hold button  until trunk unlocks and begins to open.



The trunk lid swings open upwards automatically. Always make sure that there is sufficient overhead clearance.

Vehicles with trunk opening/closing system*: To stop the opening procedure, press button . The trunk lid stops moving.

Locking and unlocking

Loss of SmartKey or mechanical key

If you lose a SmartKey or mechanical key, you should do the following:

- ▶ Have the SmartKey deactivated by an authorized Mercedes-Benz Center.
- ▶ Report the loss of the SmartKey or the mechanical key immediately to your car insurance company.
- ▶ If necessary, have the mechanical lock replaced.

Your authorized Mercedes-Benz Center will be glad to supply you with a replacement.

SmartKey with KEYLESS-GO*

Vehicles equipped with KEYLESS-GO come with two SmartKeys with KEYLESS-GO, each with remote control and a removable mechanical key.

The locking tabs for the mechanical key portion of the two SmartKeys with KEYLESS-GO are a different color to help distinguish each SmartKey with KEYLESS-GO unit.



The KEYLESS-GO function is integrated into the SmartKey. On these vehicles, the validity of the SmartKey with KEYLESS-GO is checked every time you grasp an outside door handle.

If the SmartKey with KEYLESS-GO is valid, your vehicle unlocks:

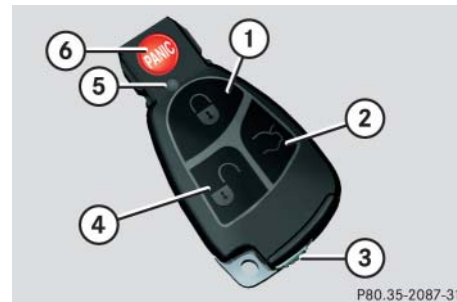
- the doors
- the trunk
- the fuel filler flap



SmartKey with KEYLESS-GO

- ①  Lock button
- ②  Opening button for trunk
- ③ Locking tab for mechanical key
- ④  Unlock button
- ⑤ Battery check lamp
- ⑥  PANIC (▶ page 79)



When the passenger outside door handle is grasped, the vehicle is centrally unlocked.

Warning!

When leaving the vehicle, always take the SmartKey with KEYLESS-GO with you and lock the vehicle. Do not leave children unattended in the vehicle, or with access to an unlocked vehicle. Unsupervised use of vehicle equipment may cause an accident and/or serious personal injury.



To prevent possible malfunction, avoid exposing the SmartKey with KEYLESS-GO to high levels of electromagnetic radiation.



USA only:

This device complies with Part 15 of the FCC Rules. Operation is subject to the following two conditions:

- (1) This device may not cause harmful interference, and
- (2) this device must accept any interference received, including interference that may cause undesired operation.

Any unauthorized modification to this device could void the user's authority to operate the equipment.



Canada only:

This device complies with RSS-210 of Industry Canada. Operation is subject to the following two conditions:

- (1) This device may not cause interference, and
- (2) this device must accept any interference received, including interference that may cause undesired operation of the device.

Any unauthorized modification to this device could void the user's authority to operate the equipment.



You can also open and close the windows and tilt/sliding sunroof using the SmartKey with KEYLESS-GO, see “Summer opening feature” (▷ page 200) and “Convenience closing feature” (▷ page 200).

Locking and unlocking

Important notes on using KEYLESS-GO

- You can also use the SmartKey with KEYLESS-GO like a normal SmartKey (▷ page 90).
- You can combine KEYLESS-GO functions with normal SmartKey functions (e.g. unlocking with KEYLESS-GO and locking with the  button).
- Always carry the SmartKey with KEYLESS-GO with you.
- Never store the SmartKey with KEYLESS-GO together with:
 - Electronic items such as a cellular phone or another SmartKey with KEYLESS-GO
 - Metallic objects such as coins or metal foil

Doing so could impair the function of the KEYLESS-GO system.

- To lock or unlock the vehicle, the SmartKey with KEYLESS-GO must be located outside the vehicle within approximately 3 ft. (1 m) of a door or the trunk lid.
- In order to start the engine with the SmartKey with KEYLESS-GO:
 - The SmartKey with KEYLESS-GO must be located in the vehicle.
 - All doors must be closed.
 - The brake pedal must be firmly depressed. Do not depress the accelerator.

- If you have started the engine with the KEYLESS-GO start/stop button (▷ page 35), you can only turn it off again with this button, even if you have put the SmartKey in the starter switch in the meantime.

This does not apply if, after starting, the gear selector lever is still in position **P** and the SmartKey is then inserted in the starter switch. The SmartKey will then have priority over the KEYLESS-GO function and the vehicle's electrical system will operate according to the position of the SmartKey in the starter switch, even stopping the engine.

- If the SmartKey with KEYLESS-GO is positioned farther away from the vehicle, the system may no longer recognize the SmartKey with KEYLESS-GO. The vehicle then cannot be locked or the engine started via the KEYLESS-GO system.

- If the SmartKey with KEYLESS-GO is removed from the vehicle while the ignition is switched on (e.g. if passenger exits the vehicle with the SmartKey with KEYLESS-GO), the message

KEY
NOT RECOGNIZED

will appear in the multifunction display while driving off.

Find the SmartKey or change its present location immediately (e.g. place it on the front passenger seat or insert it in shirt pocket).

- Remember that the engine can be started by anyone with a SmartKey with KEYLESS-GO that is left inside the vehicle. If you leave the SmartKey with KEYLESS-GO behind when exiting and locking the vehicle, the message

KEY
STILL IN VEHICLE

will appear in the multifunction display.

Factory setting

Global unlocking

- ▶ Grasp an outside door handle.

All turn signal lamps flash once. The locking knobs in the doors move up. The anti-theft alarm system is disarmed.



If the vehicle has been parked for more than 72 hours, you must pull an outside door handle in order to activate the KEYLESS-GO function.

The vehicle will lock again automatically and reactivate the anti-theft alarm system within approximately 40 seconds of unlocking if:

- neither a door nor the trunk is opened
- the central locking switch is not activated



The vehicle could inadvertently be unlocked if the SmartKey with KEYLESS-GO is within 3 ft. (1 m) of the vehicle and:

- an outside door handle is splashed with water, or
- you attempt to clean an outside door handle.

Global locking



- ▶ Press lock button on an outside door handle (> page 60) or trunk lid (> page 99).

With the trunk and all doors closed, all turn signal lamps flash three times. The locking knobs in the doors move down. The anti-theft alarm system is armed.

Locking and unlocking

Selective setting

If you frequently travel alone, you may wish to reprogram the SmartKey with KEYLESS-GO so when you, grasp the driver's outside door handle only the driver's door and the fuel filler flap unlocks.

- ▶ Press and hold buttons  and  simultaneously for about 6 seconds until battery check lamp  flashes twice.

The SmartKey with KEYLESS-GO will then function as follows:

Unlocking driver's door and fuel filler flap

- ▶ Grasp the driver's outside door handle.

All turn signal lamps flash once. The locking knob in the driver's door moves up. The anti-theft alarm system is disarmed.

Global unlocking

- ▶ Grasp the outside door handle on the passenger side.

All turn signal lamps flash once. The locking knobs in the doors move up. The anti-theft alarm system is disarmed.

Global locking



- ▶ Press lock button on an outside door handle (▷ page 60).

With the trunk and all doors closed, all turn signal lamps flash three times. The locking knobs in the doors move down. The anti-theft alarm system is armed.



You can also lock the vehicle using the lock button on the trunk lid (▷ page 99) or, vehicles with trunk opening/closing system*, KEYLESS-GO locking/closing switch (▷ page 107).

Restoring to factory setting

- ▶ Press and hold buttons  and  simultaneously for about 6 seconds until battery check lamp  flashes twice.





If you can no longer lock or unlock the vehicle with the SmartKey with KEYLESS-GO, then the battery of the SmartKey with KEYLESS-GO is discharged, the SmartKey with KEYLESS-GO is malfunctioning or the vehicle battery is drained.

- Check the battery of the SmartKey with KEYLESS-GO and replace them if necessary (▷ page 377).
- Use the mechanical key to unlock the driver's door (▷ page 372) and the trunk (▷ page 373).
- Use the mechanical key to lock the driver's door (▷ page 372).

- Have the vehicle battery and the battery connections checked (▷ page 391).

If the SmartKey with KEYLESS-GO is malfunctioning, contact an authorized Mercedes-Benz Center.

Checking the battery

- ▶ Press button  or .

Battery check lamp  comes on briefly to indicate that the SmartKey with KEYLESS-GO battery is in order.





If battery check lamp  does not come on briefly during check, the SmartKey with KEYLESS-GO battery is discharged.

Replace the battery (▷ page 377).

You can obtain the required battery at any authorized Mercedes-Benz Center.



If the battery is checked within signal range of the vehicle, pressing the button  or  will lock or unlock the vehicle accordingly.

Global locking using the lock button on the trunk lid



To prevent a possible inadvertent lock-out, the trunk will open automatically if a SmartKey with KEYLESS-GO is recognized inside the vehicle or in the trunk.

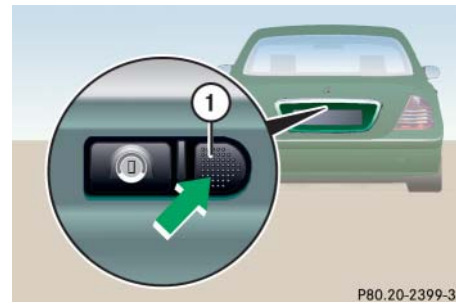

P80.20-2399-31

Lock button

- ▶ Press lock button  on the trunk lid.

All turn signal lamps flash three times. The locking knobs in the doors move down. The anti-theft alarm system is armed.



You can also lock the vehicle using the lock button on an outside door handle (▷ page 60) or, vehicles with trunk opening/closing system*, KEYLESS-GO locking/closing switch (▷ page 107).

Locking and unlocking

Unlocking and opening the trunk

You can unlock and open the trunk separately.

A minimum height clearance of 6.3 ft (1.90 m) is required to open the trunk lid.

- ▶ Press and hold button  until trunk unlocks and begins to open.



The trunk lid swings open upwards automatically. Always make sure that there is sufficient overhead clearance.

Vehicles with trunk opening/closing system*: To stop the opening procedure, press button . The trunk lid stops moving.

Loss of the SmartKey with KEYLESS-GO

If you lose your SmartKey with KEYLESS-GO or mechanical key you should do the following:

- ▶ Have the SmartKey with KEYLESS-GO deactivated by an authorized Mercedes-Benz Center.
- ▶ Report the loss of the SmartKey with KEYLESS-GO or the mechanical key immediately to your car insurance company.
- ▶ Have the mechanical lock replaced if necessary.

Your authorized Mercedes-Benz Center will be glad to supply you with a replacement.

Opening the doors from the inside

You can open a locked door from the inside. Open door only when conditions are safe to do so.

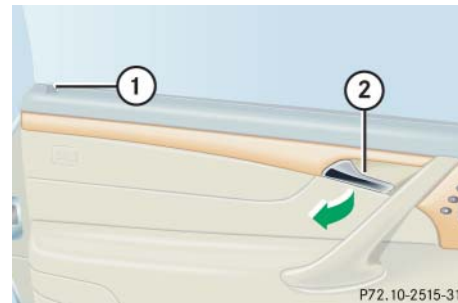

- ① Locking knob
- ② Inside door handle

- ▶ Pull on door handle ②.

If door was locked, locking knob ① will move up.



If you open a door, the windows on that side of the vehicle will lower slightly. The windows close again when you close the door.



If the vehicle has previously been locked with the SmartKey or KEYLESS-GO*, opening a door from the inside will trigger the anti-theft alarm system.

To cancel the alarm, do one of the following:

- Insert the SmartKey in the starter switch.
- Press button or on the SmartKey.

In vehicles with KEYLESS-GO*:

- Grasp an outside door handle.
The SmartKey with KEYLESS-GO must be within 3 ft. (1 m) of the vehicle.
- Press the KEYLESS-GO* start/stop button (▷ page 35).
The SmartKey with KEYLESS-GO must be inside the vehicle.

Opening the trunk

Opening the trunk from the outside

A minimum height clearance of 6.3 ft (1.90 m) is required to open the trunk lid.

The trunk lock button is located in the rear license plate recess.

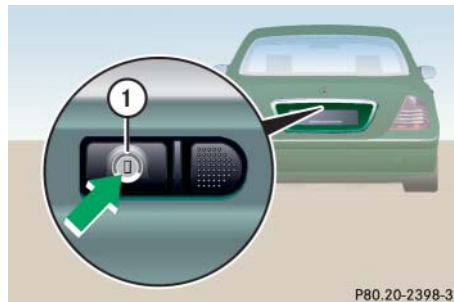

① Trunk lock

In vehicles without KEYLESS-GO*: The vehicle must be unlocked.

- ▶ Press trunk lock ①.
The trunk opens.



The trunk lid swings open upwards automatically. Always make sure that there is sufficient overhead clearance.

Vehicles with trunk opening/closing system*: To stop the opening procedure, press button on the SmartKey or SmartKey with KEYLESS-GO*.



The trunk can also be opened using button on the SmartKey or SmartKey with KEYLESS-GO* or from its inside in an emergency, see “Trunk emergency release” (▷ page 109).

Locking and unlocking

Opening the trunk from the inside

You can open the trunk from the inside if the vehicle is stationary.

A minimum height clearance of 6.3 ft (1.90 m) is required to open the trunk lid.

The remote trunk opening/closing* switch is located on the driver's door.

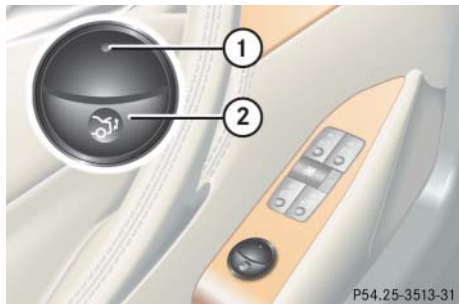

① Indicator lamp

② Remote trunk opening/closing* switch

- ▶ Pull switch ② until trunk begins to open.

The trunk opens. The indicator lamp ① comes on and remains lit until the trunk is closed.



The trunk lid swings open upwards automatically. Always make sure there is sufficient overhead clearance.

Vehicles with trunk opening/closing system*: To stop the opening procedure, press or pull remote trunk opening/closing* switch ②.



The trunk can also be opened using button  on the SmartKey or SmartKey with KEYLESS-GO* or from its inside in an emergency, see “Trunk emergency release” (▷ page 109).

Limiting opening height of trunk lid*

Vehicles with trunk opening/closing system*:

The trunk lid opening height can be limited when transporting goods on a roof rack (e.g. presence of an accessory MB sport luggage container*). When activated, the trunk lid opens to approximately the height of the roof edge.

- ▶ Activate the limiting opening height of trunk lid using the control system (▷ page 163).

Closing the trunk

Closing the trunk from the inside automatically*

In vehicles with trunk opening/closing system* you can close the trunk from the inside using the remote trunk opening/closing* switch.

- ▶ Press the remote trunk opening/closing* switch (▷ page 102) until the indicator lamp in the switch goes out and trunk lid is closed.

To interrupt the closing procedure:

- ▶ Release the remote trunk opening/closing* switch.



You can also close the trunk by hand (▷ page 104).

Warning!



Maintain sight of trunk area while operating the door mounted remote trunk opening/closing* switch. Monitor the closing procedure carefully to make sure no one is in danger of being injured.

To interrupt the closing procedure, release the door mounted remote trunk opening/closing* switch.

Even with the SmartKey or the SmartKey with KEYLESS-GO* removed from the starter switch or the SmartKey with KEYLESS-GO* removed from the vehicle, the remote trunk opening/closing* switch can be operated. Therefore, do not leave children unattended in the vehicle, or with access to an unlocked vehicle. Unsupervised use of vehicle equipment may cause an accident and/or serious personal injury.

Warning!



Only drive with the trunk closed as, among other dangers such as blocked visibility, exhaust fumes may enter the vehicle interior.

If the trunk lid comes into contact with an object while closing (e.g. luggage that has been piled too high) in the upper motion sequence, the closing procedure is stopped and the trunk reopens slightly.

Locking and unlocking

Closing the trunk from the outside manually



① Handle

- ▶ Lower trunk lid by pulling firmly on handle ①.
- ▶ Push the trunk lid closed from the outside with hands placed flat on trunk lid.

The power closing assist automatically ensures that the lid is pulled closed completely (▷ page 110).

Warning!



To prevent possible personal injury, always keep hands and fingers away from the trunk lid opening when closing the trunk. Be especially careful when small children are around.

When leaving the vehicle, always remove the SmartKey or the SmartKey with KEYLESS-GO* from the starter switch, take it with you, and lock the vehicle. Do not leave children unattended in the vehicle, or with access to an unlocked vehicle. Unsupervised use of vehicle equipment may cause an accident and/or serious personal injury.

Warning!



Only drive with the trunk closed as, among other dangers such as blocked visibility, exhaust fumes may enter the vehicle interior.



Do not place the SmartKey in the open trunk. You may lock yourself out.

Vehicles with KEYLESS-GO*:

To prevent a possible inadvertent lock-out, the trunk will open automatically if a SmartKey with KEYLESS-GO is recognized inside the vehicle or in the trunk.



If the vehicle was previously centrally locked, the trunk will lock automatically after closing it. All turn signal lamps flash three times to confirm locking.

Closing the trunk from the outside (vehicles without KEYLESS-GO*)

In vehicles with trunk opening/closing system* you can close the trunk separately.

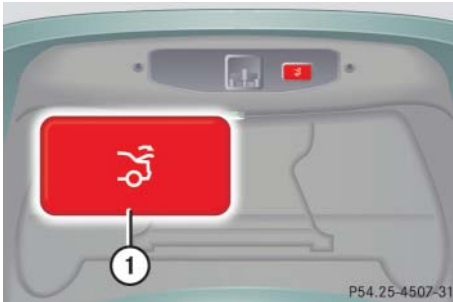

① Trunk closing switch

► Press switch ① briefly.

The trunk closes.



You can also close the trunk by hand
(▷ page 104).

If the trunk lid comes into contact with an object while closing (e.g. luggage that has been piled too high), the closing procedure is stopped and the trunk reopens slightly.

Warning!



Monitor the closing procedure carefully to make sure no one is in danger of being injured. To prevent possible personal injury, always keep hands and fingers away from the trunk opening when closing the trunk. Be especially careful when small children are around. To stop the closing procedure, do one of the following:

- press trunk closing switch ①
- press the  button on the SmartKey
- press the remote trunk opening/closing* switch (on the driver's door)

Even with the SmartKey removed from the starter switch, the trunk closing switch can be operated. Therefore, do not leave children unattended in the vehicle, or with access to an unlocked vehicle. Unsupervised use of vehicle equipment may cause an accident and/or serious personal injury.



Locking and unlocking



Warning!



Only drive with the trunk closed as, among other dangers such as blocked visibility, exhaust fumes may enter the vehicle interior.



Do not place the SmartKey in the open trunk. You may lock yourself out.



If the vehicle was previously centrally locked, the trunk will lock automatically after closing it. All turn signal lamps flash three times to confirm locking.

Closing the trunk from the outside (vehicles with KEYLESS-GO*)

In vehicles with trunk opening/closing system* you can close the trunk separately.

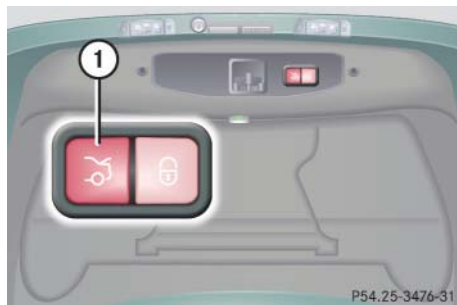

① Trunk closing switch

- ▶ Make sure you have the SmartKey with KEYLESS-GO with you.
- ▶ Press switch ① briefly.

The trunk closes.



You can also close the trunk by hand (▷ page 104).

If the trunk lid comes into contact with an object while closing (e.g. luggage that has been piled too high), the closing procedure is stopped and the trunk reopens slightly.



To prevent a possible inadvertent lock-out, the trunk will open automatically if a SmartKey with KEYLESS-GO is recognized inside the vehicle or in the trunk.

Closing the trunk and locking the vehicle from the outside (vehicles with KEYLESS-GO*)

In vehicles with trunk opening/closing system* and KEYLESS-GO, you can close the trunk lid and lock the vehicle simultaneously.

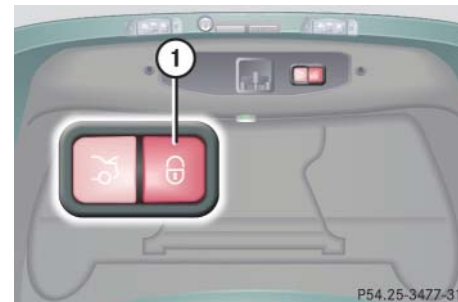

① KEYLESS-GO locking/closing switch

- ▶ Make sure you have the SmartKey with KEYLESS-GO with you. ▷▷

Warning!



Monitor the closing procedure carefully to make sure no one is in danger of being injured. To prevent possible personal injury, always keep hands and fingers away from the trunk opening when closing the trunk. Be especially careful when small children are around. To stop the closing procedure, do one of the following:

- press trunk closing switch ①
- press KEYLESS-GO locking/closing switch
- press the  button on the SmartKey with KEYLESS-GO
- press the remote trunk opening/closing* switch (on the driver's door)

Even with the SmartKey with KEYLESS-GO removed from the vehicle, the trunk closing switch can be operated. Therefore, do not leave children unattended in the vehicle, or with access to an unlocked vehicle. Unsupervised use of vehicle equipment may cause an accident and/or serious personal injury.

Warning!



Only drive with the trunk closed as, among other dangers such as blocked visibility, exhaust fumes may enter the vehicle interior.



If the vehicle was previously centrally locked, the trunk will lock automatically after closing it. All turn signal lamps flash three times to confirm locking.

Locking and unlocking

▷▷ Press switch ① briefly.

The vehicle is locked and the trunk closes automatically.

With the hood and all doors closed, All turn signal lamps flash three times to confirm locking. The locking knobs in the doors move down. The anti-theft alarm system is activated.



You can also close the trunk by hand (▷ page 104).

If the trunk lid comes into contact with an object while closing (e.g. luggage that has been piled too high), the closing procedure is stopped and the trunk reopens slightly.



To prevent a possible inadvertent lock-out, the trunk will open automatically if a SmartKey with KEYLESS-GO is recognized inside the vehicle or in the trunk.

Warning!



Monitor the closing procedure carefully to make sure no one is in danger of being injured. To prevent possible personal injury, always keep hands and fingers away from the trunk opening when closing the trunk. Be especially careful when small children are around. To stop the closing procedure, do one of the following:

- press KEYLESS-GO locking/closing switch ①
- press trunk closing switch
- press the  button on the SmartKey with KEYLESS-GO
- press the remote trunk opening/closing* switch (on the driver's door)

Even with the SmartKey with KEYLESS-GO removed from the vehicle, the KEYLESS-GO locking/closing switch can be operated. Therefore, do not leave children unattended in the vehicle, or with access to an unlocked vehicle. Unsupervised use of vehicle equipment may cause an accident and/or serious personal injury.

Warning!



Only drive with the trunk closed as, among other dangers such as blocked visibility, exhaust fumes may enter the vehicle interior.

Trunk emergency release

With the emergency release button, the trunk can be opened from inside the trunk.

The emergency release button is located on the inside of the trunk lid.



① Emergency release button

- ▶ Briefly press emergency release button ①.

The trunk opens.



The emergency release button unlocks and opens the trunk while the vehicle is standing still or in motion.

Illumination of the emergency release button:

- The button will flash for 30 minutes after opening the trunk.
- The button will flash for 60 minutes after closing the trunk.





The emergency release button does not open the trunk if the vehicle battery is discharged or disconnected.



If the vehicle has previously been locked using the SmartKey or KEYLESS-GO*, opening the trunk from the inside using the emergency release button will trigger the anti-theft alarm system.

To cancel the alarm, do one of the following:

- Insert the SmartKey in the starter switch.
- Press button  or  on the SmartKey.

In vehicles with KEYLESS-GO*:

- Grasp an outside door handle.
The SmartKey with KEYLESS-GO must be within 3 ft. (1 m) of the vehicle.
- Press the KEYLESS-GO* start/stop button (▶ page 35).

The SmartKey with KEYLESS-GO must be inside the vehicle.

Locking and unlocking

Power closing assist for doors and trunk lid

It is not necessary to slam the door or trunk lid closed. A pneumatic power-assisted mechanism draws doors and trunk lid closed quietly and automatically once door and trunk lid has been latched. When the pneumatic power-assisted mechanism has stopped, doors and/or trunk can be re-opened.

Warning!



To prevent possible personal injury, always keep hands and fingers away from the door or trunk opening when closing a door or the trunk. Be especially careful when small children are around.

In case of danger, pull the inside or outside door handle, or press the trunk lid lock.

To prevent personal injury, never actuate the closing assist mechanism by tampering with the door or trunk lid latch.

Power closing assist for doors

- ▶ Press the doors gently past the initial engage position into the lock.

The doors close automatically.

Warning!



Only drive with the doors closed. Otherwise, one or more of the doors could open while the vehicle is in motion, putting you and/or others at risk.

Power closing assist for trunk lid

- ▶ Press the trunk lid gently into its lock.

The trunk closes automatically.

Warning!



Only drive with the trunk closed as, among other dangers such as blocked visibility, exhaust fumes may enter the vehicle interior.

Automatic central locking

The doors and the trunk automatically lock when the ignition is switched on and the wheels are turning at speeds of approximately 9 mph (15 km/h) or more.

You can open a locked door from the inside. Open door only when conditions are safe to do so.



The doors unlock automatically after an accident if the force of the impact exceeds a preset threshold. The vehicle locks automatically when the ignition is switched on and the wheels are turning at vehicle speeds of approximately 9 mph (15 km/h) or more. You could therefore lock yourself out when the vehicle

- is pushed or towed
- is on a test stand

You can deactivate the automatic locking using the control system (▷ page 162).

Locking and unlocking from the inside

You can lock or unlock the doors and the trunk from inside using the central locking or unlocking switch. This can be useful, for example, if you want to lock the vehicle before starting to drive.

The fuel filler flap cannot be locked or unlocked with the central locking or unlocking switch, respectively.

Warning!



When leaving the vehicle, always remove the SmartKey or SmartKey with KEYLESS-GO* from the starter switch, take it with you, take the SmartKey with KEYLESS-GO* with you and lock the vehicle. Do not leave children unattended in the vehicle, or with access to an unlocked vehicle. Unsupervised use of vehicle equipment may cause an accident and/or serious personal injury.

The switches are located on the upper part of the front center console.



Central locking/unlocking switches

- ① Central locking switch
- ② Central unlocking switch

Locking

- ▶ Press central locking switch ①.
If both doors are closed, the vehicle locks.

Unlocking

- ▶ Press central unlocking switch ②.
The vehicle unlocks.



You can open a locked door from the inside. Open door only when conditions are safe to do so.

If the vehicle was previously centrally locked with the SmartKey or the SmartKey with KEYLESS-GO*, it will not unlock using the central unlocking switch ②.

If the vehicle was previously locked with the central locking switch ①:

- While in the global remote control mode, the vehicle is unlocked completely when a door is opened from the inside.
- While in the selective remote control mode, only the door opened from inside is unlocked.

Seats

For more information on seat adjustment, see “Adjusting” (▷ page 37).

Easy-entry/exit feature

This feature allows for easier entry into and exit from the vehicle. When entering and exiting the vehicle, the driver’s seat is in its maximum forward position and the steering wheel is in its uppermost position.

The easy-entry/exit feature can be activated or deactivated in the **CONVENIENCE** sub-menu of the control system (▷ page 163).

Warning!



You must make sure no one can become trapped or injured by the moving steering wheel and driver’s seat when the easy-entry/exit feature is activated.

To cancel seat/steering wheel movement, do one of the following:

- Press seat adjustment switch (▷ page 38).

- Move steering column stalk (▷ page 42).
- Press one of the memory position buttons or the memory button **M** (▷ page 123).

Do not leave children unattended in the vehicle, or with access to an unlocked vehicle. Children could open the driver’s door and unintentionally activate the easy-entry/exit feature, which could result in an accident and/or serious personal injury.

With the easy-entry/exit feature activated, the steering wheel or, depending on your selection, the steering wheel and driver’s seat will return to their last set memory position or a factory-set maximum forward position when you:

- close the driver’s door with the ignition switched on
- insert the SmartKey into the starter switch or press the **KEYLESS-GO*** start/stop button (▷ page 35) once with the driver’s door closed.



For safety reasons, the driver’s seat will not return to its last set position with the easy-entry/exit feature activated if the system recognizes the last set position as an extreme forward position. Instead, the driver’s seat will remain at or move to a factory-set maximum forward position. To again fully return the driver’s seat to your last set position or to memory position, adjust the seat to the desired position or press and hold the respective memory position button (▷ page 123).



The last set driver’s seat and steering wheel positions are stored when

- the ignition is switched off
- the position is stored in memory (▷ page 123)

With the easy-entry/exit feature activated and depending on your selection, the steering wheel tilts upwards and/or the driver's seat moves a few inches to the rear when you:

- remove the SmartKey from the starter switch,
or
- open the driver's door with the SmartKey in starter switch position **0** or **1** or the KEYLESS-GO* start/stop button (▷ page 35) in position **1**.



If the current position for the steering wheel is in the uppermost tilt position, the steering wheel will no longer be able to move upward when the easy-entry/exit feature is activated.

If the current seat position falls into a factory-set position range and the system recognizes the current seat position to be rearward enough for easy entry and exit, the driver's seat will not move to the rear when the easy-entry/exit feature is activated.

The adjustment procedure is briefly interrupted when the engine is started.

Warning!



Let the system complete the adjustment procedure before setting the vehicle in motion. All driver's seat and steering wheel adjustments must be completed before setting the vehicle in motion. Driving off with the driver's seat/steering wheel still adjusting could cause the driver to lose control of the vehicle.

Removing and installing front seat head restraints

For information on head restraint adjustment, see “Seats” (▷ page 37).

Warning!



For your protection, drive only with properly positioned head restraints.

Adjust head restraint so that the center of the head restraint supports the back of the head at eye level. This will reduce the potential for injury to the head and neck in the event of an accident or similar situation.

Do not drive the vehicle without the seat head restraints. Head restraints are intended to help reduce injuries during an accident.



Tilt the seat backrest to the rear for easier removal and installation of the head restraints.

Front seat head restraints

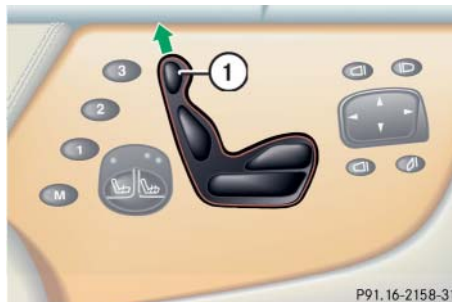

① Head restraint height switch

- ▶ Switch on the ignition (▷ page 34).

or

- ▶ Open the respective door.

Removing front seat head restraints

- ▶ Press switch ① upwards and hold until the head restraint is fully extended.
- ▶ Pull out head restraint.

Installing front seat head restraints

- ▶ Press switch ① upwards and hold for about 5 seconds.
- ▶ Push the head restraint down until it engages.
- ▶ Adjust head restraint to desired position (▷ page 38).

Rear seat head restraints



The rear head restraints cannot be removed.

Folding rear head restraints back

The rear seat head restraints and the rear seat power head restraints* can be folded backward for increased visibility.

The button is located on the upper part of the front center console.



① Button in the front center console

- ▶ Switch on the ignition (▷ page 34).
- ▶ Press button ① in the front center console briefly.

The rear head restraints will fold backward.

Warning!



For safety reasons, always drive with the rear head restraints in the upright position when the rear seats are occupied.

Keep the area around head restraints clear of articles (e.g. clothing) to not obstruct the folding operation of the head restraints.

Placing rear power head restraints upright

- ▶ Switch on the ignition (▷ page 34).
- ▶ Press and hold button ① (▷ page 115) in the front center console and hold.

The rear head restraints will place upright.

Seats

Folding down and placing upright rear power head restraints with the switch in the rear center console

You can fold the rear power head restraints backward or place them upright using the rear head restraint switch in the rear center console.



- ① Place rear head restraint upright
- ② Fold rear head restraint down

- ▶ Switch on the ignition (▷ page 34).
- ▶ Push upper half ① of switch to place the head restraints upright.
- ▶ Push lower half ② of switch to fold the head restraints down.

Warning!



For safety reasons, always drive with the rear head restraints in the upright position when the rear seats are occupied.

Keep the area around head restraints clear of articles (e.g. clothing) to not obstruct the folding operation of the head restraints.

Head restraint tilt

You can adjust the angle manually by pulling or pushing the head restraints by hand.



Adjust the head restraint in such a way that it is as close to the head as possible.

Lumbar support

You can adjust the contour of the seat's lumbar support to help enhance support to your spine.

The thumbwheels for the driver's and front passenger's seat are located on the outer side of the seat.

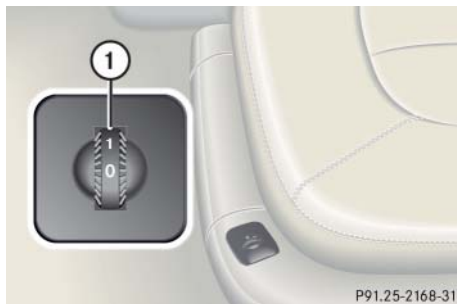

① Thumbwheel

- ▶ Switch on the ignition (▷ page 34).
- ▶ Set the lumbar support between 0 and 5.

Multicontour seats*

The multicontour seat has inflatable air cushions built into the seat backrest to provide additional lumbar and side support.

The seat backrest cushion height and curvature can be adjusted with switches on the right side of the seat after switching on ignition.

The switches for the driver and front passenger seat are located on the inner side of the seat.

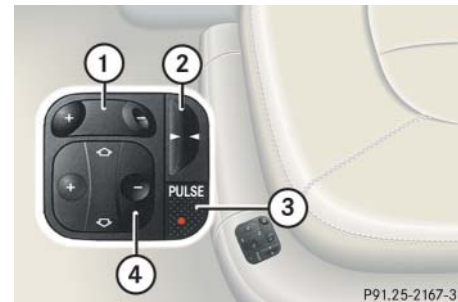

- ① Shoulder region support
- ② Side bolster adjustment
- ③ Massage function (PULSE)
- ④ Lumbar region support



- ▶ Switch on the ignition (▷ page 34).

Shoulder region support



- ▶ Press **+** or **-** on switch ①.
The air cushion inflates or deflates.

Seats

Lumbar region support

- ▶ Press  or  on rocker switch ④.

This selects the air cushion you wish to adjust.

- ▶ Press  or  on rocker switch ④.

The air cushion inflates or deflates.

Side bolsters adjustment

- ▶ Adjust the side bolsters so that they provide good lateral support using switch ②.



When the engine is turned off, the last cushion setting is retained in memory, and the cushion is automatically adjusted to this setting when the engine is restarted.

Massage function (PULSE)

You can reduce muscle tension during long trips by periodically using the massage function.

- ▶ Press button ③.

The indicator lamp on button ③ comes on. The air cushions in the lumbar region inflate and deflate rhythmically.



The massage function switches off automatically after approximately 8 minutes. The indicator lamp extinguishes.

Seat heating

Vehicles without seat ventilation*

The switch is located on the door.

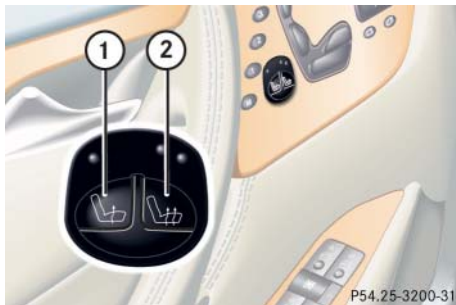

- ① Normal heating
- ② Rapid heating

The red indicator lamps above the switches show the heating level selected:

Level	
off	No indicator lamp on.
1	One left indicator lamp on.
2	Two right indicator lamps on.

- ▶ Switch on the ignition (▷ page 34).

Switching on seat heating

- ▶ Press switch ①.

A red indicator lamp above the switch comes on.

Switching off seat heating

- ▶ Press switch ① again.

The indicator lamp above the switch goes out.



The seat heating will be automatically switched off after approximately 30 minutes.

Switching on rapid seat heating

- ▶ Press switch ②.

Both red indicator lamps above the switch come on.



The system switches over to normal heating mode after approximately 5 minutes. Only the right-hand indicator lamp remains lit.

Switching off rapid seat heating

- ▶ Press switch ② again.

Both indicator lamps above the switch go out.



If one or both of the lamps on the seat heating switch are flashing, there is insufficient voltage available since too many electrical consumers are turned on. The seat heating switches off automatically.

The seat heating will switch back on again automatically as soon as sufficient voltage is available.

Seats

Vehicles with seat ventilation*

The switch is located on the door.

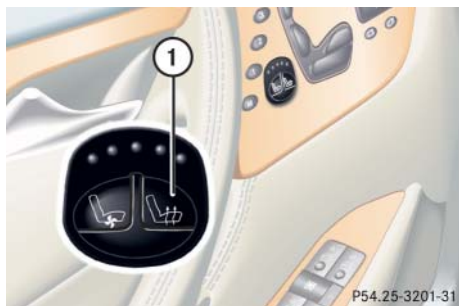

① Seat heating switch

The red indicator lamps above the switch show the heating level selected:

Level	
off	No indicator lamp on.
1	One indicator lamp on.
2	Two indicator lamps on.

- ▶ Switch on the ignition (▷ page 34).

Switching on seat heating

- ▶ Press switch ① twice.

A red indicator lamp above the switch comes on.

Switching off seat heating

- ▶ Press switch ① again.

The indicator lamp above the switch goes out.



The seat heating will be automatically switched off after approximately 30 minutes.

Switching on rapid seat heating

- ▶ Press switch ① once.

Both indicator lamps above the switch come on.



The system switches over to normal heating mode after approximately 5 minutes. Only the right-hand indicator lamp remains lit.

Switching off rapid seat heating

- ▶ Press switch ① twice.

Both indicator lamps above the switch go out.



If one or both of the lamps on the seat heating switch are flashing, there is insufficient voltage available since too many electrical consumers are turned on. The seat heating switches off automatically.

The seat heating will switch back on again automatically as soon as sufficient voltage is available.

Seat ventilation*

The switch is located on the door. Seat ventilation can be activated manually with the SmartKey in starter switch position **1** or **2**. The driver's seat ventilation can be activated automatically by the summer opening feature (▷ page 200).

The blue indicator lamps on the switch show the ventilation level selected:

Level	
3	Three indicator lamps on (highest level)
2	Two indicator lamps on
1	One indicator lamp on (lowest level)
off	No indicator lamp on

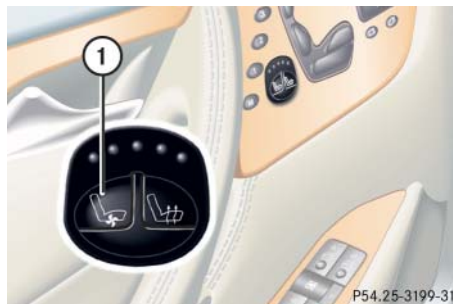

① Seat ventilation switch

- ▶ Switch on the ignition (▷ page 34).

Switching on seat ventilation

- ▶ Press switch ①.
Three blue indicator lamps above the switch come on.
- ▶ Continue pressing switch ① until the desired seat ventilation level is reached.

Switching off seat ventilation

- ▶ Press switch ① repeatedly until all indicator lamps go out.



The seat ventilation for the driver's seat is automatically set to the highest level if activated via summer opening feature (▷ page 200).



If one or all of the lamps on the seat ventilation switch are flashing, there is insufficient voltage due to too many electrical consumers being switched on. The seat ventilation switches off automatically.

The seat ventilation will switch back on again automatically as soon as sufficient voltage is available.

Memory function

Prior to operating the vehicle, the driver should check and adjust the seat height, seat position fore and aft, and seat backrest angle if necessary, to ensure adequate control, reach and comfort. The head restraint should also be adjusted for proper height. See also the section on air bags (▷ page 63) for proper seat positioning.

In addition, adjust the steering wheel to ensure adequate control, reach, operation and comfort. Both the inside and outside rear view mirrors should be adjusted for adequate rear vision.

Fasten seat belts. Infants and small children should be seated in a properly secured restraint system that complies with U.S. Federal Motor Vehicle Safety Standards 213 and 225 and Canadian Motor Vehicle Safety Standards 213 and 210.2.

With the memory function you can store up to four different settings.

The following settings are stored when using the buttons on the driver's door:

- Driver's seat and seat, backrest and head restraint position
- Settings for multicontour seat*
- Steering wheel position
- Exterior rear view mirror position

The following settings are stored when using the buttons on the passenger door:

- Front passenger seat, backrest and head restraint position
- Settings for multicontour seat*

Warning!



Do not activate the memory function while driving. Activating the memory function while driving could cause the driver to lose control of the vehicle.

The memory button and stored position switch are located on the door.

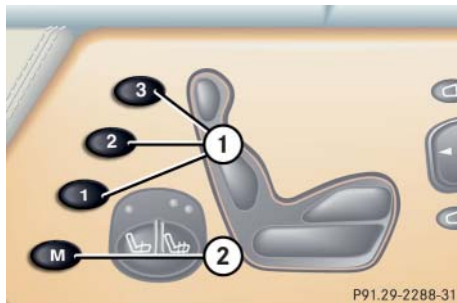

① Stored position button

M Memory button **M**

▶ Switch on the ignition (▷ page 34).

or

▶ Open the respective door.

Storing positions into memory

- ▶ Adjust the seats, steering wheel and exterior mirrors to the desired position (▷ page 37).
- ▶ Press memory button **M**.
- ▶ Release memory button **M** and push one of the position buttons ① within 3 seconds.

All the settings are stored with the selected position.

Recalling positions from memory



Do not operate the power seats using the memory button if the seat backrest is in an extremely reclined position. Doing so could cause damage to front or rear seats.

First move seat backrest to an upright position.

- ▶ Press and hold one of the position buttons ① until the seat, steering wheel and exterior mirrors have fully moved to the stored positions.



Releasing the button immediately stops movement to the stored positions.

Memory function

Storing exterior rear view mirror parking position

For easier parking, you can adjust the passenger-side exterior rear view mirror so that you can see the right rear wheel as soon as you engage reverse gear **R**.

For information on activating the parking position, see “Activating exterior rear view mirror parking position” (▷ page 180).

The buttons are located on the driver’s door.



① Passenger-side exterior rear view mirror button

② Adjustment button

M Memory button **M**

- ▶ Stop the vehicle in a safe location.
- ▶ Make sure the ignition is switched on (▷ page 34).

- ▶ Press button ①.

The passenger-side exterior rear view mirror is selected.

- ▶ Adjust the passenger-side exterior rear view mirror with button ② so that you see the rear wheel and the road curb.

- ▶ Press memory button **M**.

- ▶ Within 3 seconds, press bottom of adjustment button ② on **▼**.

The parking position is stored if the mirror does not move.



If the mirror does move, repeat the above steps. After the setting is stored, you can move the mirror again.

▼ **Lighting**

For information on how to switch on the headlamps and use the turn signals, see “Switching on headlamps” (▷ page 52) and “Turn signals” (▷ page 53).



If you drive in countries where vehicles drive on the other side of the road than the country in which the vehicle is registered, you must have the headlamps modified for symmetrical low beams. Relevant information can be obtained at your authorized Mercedes-Benz Center.

Exterior lamp switch

The exterior lamp switch is located on the dashboard to the left of the steering wheel.



- 0** Off
Daytime running lamp mode (▷ page 127)
- AUTO** Automatic headlamp mode
Daytime running lamp mode (▷ page 127)
- Parking lamps (also side marker lamps, tail lamps, license plate lamps, instrument panel lamps)
- Low beam headlamps (or high beam headlamps when the combination switch is pushed forward) and parking lamps.
- P** Standing lamps, right (turn left one stop)
- ←P** Standing lamps, left (turn left two stops)
- Indicator lamp for parking lamps
- Indicator lamp for front fog lamps
- Indicator lamp for rear fog lamp

Lighting



With the SmartKey removed from the starter switch or the engine turned off with KEYLESS-GO* and the driver's door open, a warning sounds if the parking lamps or low beam headlamps are switched on.

The message **TURN OFF LIGHTS** appears in the multifunction display.

Manual headlamp mode

The low beam headlamps and parking lamps can be switched on and off with the exterior lamp switch. For exterior lamp switch, see (▷ page 125).

Automatic headlamp mode

The following lamps switch on and off automatically depending on the brightness of the ambient light:

- Low beam headlamps
- Tail and parking lamps
- License plate lamps
- Side marker lamps



Warning!



If the exterior lamp switch is set to **AUTO**,

- the headlamps may switch off unexpectedly when the system senses bright ambient light, for example light from oncoming traffic.
- the headlamps will not be automatically switched on under foggy conditions.

To minimize risk to you and to others, activate headlamps by turning exterior lamp switch to  when driving or when traffic and/or ambient lighting conditions require you to do so.

In low ambient lighting conditions, only switch from position **AUTO** to  with the vehicle at a standstill in a safe location. Switching from **AUTO** to  will briefly switch off the headlamps. Doing so while driving in low ambient lighting conditions may result in an accident.

The automatic headlamp feature is only an aid to the driver. The driver is responsible for the operation of the vehicle's lights at all times.



The front fog lamps and rear fog lamp cannot be switched on manually with exterior lamp switch in position **AUTO**. To activate the fog lamps, turn exterior lamp switch to position  and pull the exterior lamp switch to first or second stop (▷ page 128).

- ▶ Turn the exterior lamp switch to **AUTO**.

With the SmartKey in starter switch position **1** or the KEYLESS-GO* start/stop button pressed once, only the parking lamps will switch on and off automatically.

When the engine is running, the low beam headlamps, the tail and parking lamps, the license plate lamps, and the side marker lamps will switch on and off automatically.

Daytime running lamp mode

- ▶ Turn exterior lamp switch to position **0** or **AUTO**.

When the engine is running, the low beam headlamps are switched on. In low ambient light conditions, the following lamps will switch on additionally:

- tail and parking lamps
- license plate lamps
- side marker lamps



For nighttime driving you should turn the exterior lamp switch to position  to permit activation of the high beam headlamps.

Canada only

The daytime running lamp mode is mandatory and therefore in a constant mode.

When the engine is running, and you shift from a driving position to position **N** or **P**, the low beam headlamps will switch off with a 3-minute delay.



When the engine is running, and you

- turn the exterior lamp switch to position , the parking lamps switch on additionally.
- turn the exterior lamp switch to position , the manual headlamp mode has priority over the daytime running lamp mode.

The corresponding exterior lamps switch on (▷ page 379).

USA only

By default, the daytime running lamp mode is deactivated. Activate the daytime running lamp mode using the control system, see “Setting daytime running lamp mode (USA only)” (▷ page 159).

When the engine is running, and you turn the exterior lamp switch to position  or , the manual headlamp mode has priority over the daytime running lamp mode.

The corresponding exterior lamps switch on (▷ page 379).

Locator lighting and night security illumination



Locator lighting and night security illumination are described in the control system section under “Setting locator lighting” (▷ page 160) and “Setting night security illumination” (▷ page 160).

Lighting

Switching on fog lamps

Warning!



In low ambient lighting or foggy conditions, only switch from position **AUTO** to  with the vehicle at a standstill in a safe location. Switching from **AUTO** to  will briefly switch off the headlamps. Doing so while driving in low ambient lighting conditions may result in an accident.



Fog lamps will operate with the parking lamps and/or the low beam headlamps on. Fog lamps should only be used in conjunction with low beam headlamps. Consult your State or Province Motor Vehicle Regulations regarding permissible lamp operation.



Fog lamps cannot be switched on with exterior lamp switch in position **AUTO**. For switching on the fog lamps, turn exterior lamp switch to position .

Switching on front fog lamps

- ▶ Switch on the low beam headlamps (▷ page 52).
- ▶ Pull out exterior lamp switch to first stop.

The front fog lamps are switched on.

The green indicator lamp  in the lamp switch comes on (▷ page 125).

- ▶ Push in the exterior lamp switch.

The front fog lamps are switched off.

The green indicator lamp  in the lamp switch goes out (▷ page 125).

Switching on rear fog lamp (driver's side only)

- ▶ Switch on the front fog lamps (▷ page 128).
- ▶ Pull out exterior lamp switch to second stop.

The rear fog lamp is switched on.

The yellow indicator lamp  in the lamp switch comes on (▷ page 125).

- ▶ Push in the exterior lamp switch to first stop.

The rear fog lamp is switched off.

The green indicator lamp  in the lamp switch goes out (▷ page 125).

The front fog lamps remain lit.

Combination switch

The combination switch is located on the left side of the steering column.



- ① High beam
- ② High beam flasher

High beam

- ▶ Turn exterior lamp switch to position  or to **AUTO** (▷ page 125).
- ▶ Push the combination switch in the direction of arrow ① to switch on the high beam.

The high beam indicator  on the instrument cluster comes on (▷ page 24).

- ▶ Pull the combination switch back to its original position to switch off the high beam.

The high beam indicator  on the instrument cluster goes out.

High beam flasher

- ▶ Pull the combination switch briefly in the direction ②.

Lighting

Hazard warning flasher

The hazard warning flasher can be switched on at all times, even with the SmartKey removed from the starter switch or with the SmartKey with KEYLESS-GO* removed from the vehicle.

The hazard warning flasher switches on automatically when an airbag deploys.

The hazard warning flasher switch is located on the upper part of the front center console.



① Hazard warning flasher switch

Switching on the hazard warning flasher

- ▶ Press hazard warning flasher switch.
All turn signals will flash.



With the hazard warning flasher activated and the combination switch set for either left or right turn, only the respective left or right turn signals will operate when the SmartKey in the starter switch is in position **1** or **2** or the KEYLESS-GO* start/stop button (▷ page 35) is pressed once or twice.

Switching off the hazard warning flasher

- ▶ Press hazard warning flasher switch again.



If the hazard warning flasher was activated automatically, also press hazard warning flasher switch ① to switch off the hazard warning flasher.

Interior lighting

The controls are located in the overhead control panel.

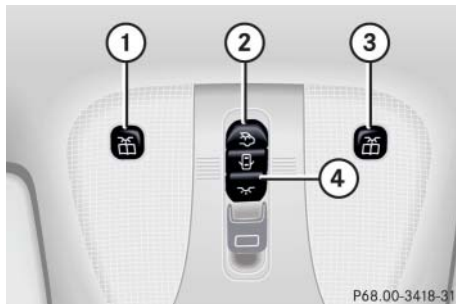

- ① Left reading lamp on/off
- ② Rear interior lamps on/off
- ③ Right reading lamp on/off
- ④ Rocker switch for automatic control on/off



Leaving an interior light switch in the ON position for extended periods of time with the engine turned off could result in a discharged battery.

Automatic control

Activating

- ▶ Press rocker switch ④ to the center position.

The interior lighting switches on in darkness when you:

- unlock the vehicle
- remove the SmartKey from the starter switch
- open a door
- open the trunk

The interior lighting switches off automatically following an adjustable time delay.

For more information, see “Interior illumination delayed switch-off” (▷ page 161).



If the door remains open, the interior lighting switches off automatically after approximately 5 minutes.

Deactivating

- ▶ Press the  symbol on rocker switch ④.

The interior lighting remains switched off in darkness, even when you:

- unlock the vehicle
- remove the SmartKey from the starter switch
- open a door
- open the trunk

Lighting

Manual control

Front interior lighting

- ▶ Press the  symbol on rocker switch ④.

The front interior lighting switches on.

- ▶ Press the  symbol on rocker switch ④ again.



The front interior lighting switches off.
The automatic control function is activated.



The setting selected for the interior lighting is used for the trunk lighting as well.

If the trunk remains open, the trunk lighting switches off automatically after approximately 10 minutes.

Rear interior lighting

- ▶ Press switch ② on the  symbol.
The rear compartment lighting switches on.
- ▶ Press switch ② on the  symbol again.
The rear compartment lighting switches off.

Reading lamps

The reading lamps are integrated into the interior rear view mirror.

- ▶ Press reading lamp switch ① or ③ to switch on the desired reading lamp.
- ▶ Press reading lamp switch ① or ③ again to switch off the respective reading lamp.

Courtesy lighting

For better orientation in the dark, courtesy lamps will illuminate the interior of your vehicle as follows:

With parking lamps switched on:

- the door handles
- the driver and passenger footwells

With the SmartKey in the starter switch position **1**:

- the door handles
- the center console



If you turn the SmartKey in the starter switch to position **0** and switch off the exterior headlamps, the door handle lamps will remain lit for approximately 5 minutes.

Door entry lamps

For better orientation in the dark, the corresponding door entry lamps will switch on in darkness when you open a door and the automatic control is activated.

The door entry lamps switch off when the corresponding door is closed.



If you turn the SmartKey in the starter switch to position **0** and switch off the exterior headlamps, the door entry lamps will remain lit for approximately 5 minutes.

Trunk lighting

The trunk lighting switches on if the trunk is opened.

If you leave the trunk open for an extended period of time, the trunk lighting will switch off automatically after approximately 10 minutes.

Instrument cluster

A full view illustration of the instrument cluster can be found in the “At a glance” section of this manual (▷ page 24).



① Reset button **R**

The instrument cluster is activated when you:

- open a door
- switch on the ignition (▷ page 34)
- press reset button **R** ①
- switch on the exterior lamps

You can change the instrument cluster settings in the instrument cluster submenu of the control system (▷ page 157).

Instrument cluster illumination



① Knob for adjusting instrument cluster illumination

Use knob ① to adjust the illumination brightness for the instrument cluster.



The instrument cluster illumination is dimmed or brightened automatically to suit ambient light conditions.

The instrument cluster illumination will also be adjusted automatically when you switch on the vehicle's exterior lamps.

- ▶ Press knob ①.
The knob will pop out.

To brighten illumination

- ▶ Turn knob ① in the instrument cluster clockwise.

The instrument cluster illumination will brighten.

To dim illumination

- ▶ Turn knob ① in the instrument cluster counterclockwise.

The instrument cluster illumination will dim.

Coolant temperature gauge

Warning!



- Driving when your engine is badly overheated can cause some fluids which may have leaked into the engine compartment to catch fire. You could be seriously burned.
- Steam from an overheated engine can cause serious burns and can occur just by opening the hood. Stay away from the engine if you see or hear steam coming from it.

Turn off the engine, get out of the vehicle and do not stand near the vehicle until the engine has cooled down.



Excessive coolant temperature triggers a warning in the multifunction display (▷ page 348).

During severe operating conditions, e.g. stop-and-go traffic, the coolant temperature may rise close to 248°F (120°C), i.e. close to the red zone of the coolant temperature gauge.

The engine should not be operated with the coolant temperature above 248°F (120°C), i.e. in the red zone of the coolant temperature gauge. Doing so may cause serious engine damage which is not covered by the Mercedes-Benz Limited Warranty.

Trip odometer

- ▶ Make sure you are viewing the trip odometer display.
- ▶ If it is not displayed, press the or button on the multifunction steering wheel repeatedly until the trip odometer appears (▷ page 137).
- ▶ Press and hold reset button in the instrument cluster (▷ page 134) until the trip odometer is reset.

Tachometer

The red marking on the tachometer denotes excessive engine speed.



Avoid driving at excessive engine speeds, as it may result in serious engine damage that is not covered by the Mercedes-Benz Limited Warranty.

To help protect the engine, the fuel supply is interrupted if the engine is operated within the red marking.

CL 55 AMG and CL 65 AMG

The tachometer of the CL 55 AMG and CL 65 AMG does not have a red marking denoting excessive engine speed.

To help protect the engine, the fuel supply is interrupted if the engine is operated at an excessive engine speed.

Outside temperature indicator

Warning!



The outside temperature indicator is not designed to serve as an ice-warning device and is therefore unsuitable for that purpose.

Indicated temperatures just above the freezing point do not guarantee that the road surface is free of ice. The road may still be icy, especially in wooded areas or on bridges.

The outside temperature is displayed in the instrument cluster (▷ page 24). For information on how to select the unit of the displayed temperature, i.e. degrees Celsius (°C) or degrees Fahrenheit (°F), see “Selecting temperature display mode” (▷ page 157).

The temperature sensor is located in the front bumper area. Due to its location, the sensor can be affected by road or engine heat during idling or slow driving. Therefore, the accuracy of the displayed temper-

ature can only be verified by comparison to a thermometer placed next to the sensor, not by comparison to external displays (e.g. bank signs, etc.).

When moving the vehicle into colder ambient temperatures (e.g. when leaving your garage), you will notice a delay before the lower temperature is displayed.

A delay also occurs when ambient temperatures rise. This prevents inaccurate temperature indications caused by heat radiated from the engine during idling or slow driving.

Clock

The time is indicated in the instrument cluster in the tachometer display.

You can adjust the clock using the COMAND system. Refer to separate COMAND operating instructions.

▼ Control system

The control system is activated as soon as the SmartKey in the starter switch is turned to position **1** or as soon as the KEYLESS-GO* start/stop button (▷ page 35) is in position **1**. The control system enables you to:

- call up information about your vehicle
- change vehicle settings

For example, you can use the control system to find out when your vehicle is next due for service, to set the language for messages in the instrument cluster display, and much more.



The displays for the audio systems (radio, CD player etc.) will appear in English, regardless of the language selected.

Warning!



A driver's attention to the road and traffic conditions must always be his/her primary focus when driving.

For your safety and the safety of others, selecting features through the multifunction steering wheel should only be done by the driver when traffic and road conditions permit it to be done safely.

Bear in mind that at a speed of just 30 mph (approximately 50 km/h), your vehicle is covering a distance of 44 feet (approximately 14 m) every second.

The control system relays information to the multifunction display.

Multifunction display

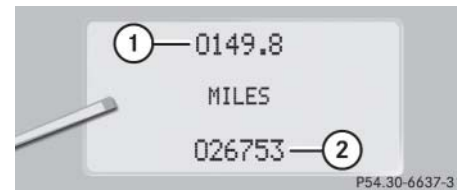

- ① Trip odometer
- ② Main odometer

Control system

Multifunction steering wheel

The displays in the multifunction display and the settings in the control system are controlled by the buttons on the multifunction steering wheel.



- ① Multifunction display in the speedometer

Operating the control system

- ② Selecting the submenu or setting the volume

 up/to increase

 down/to decrease

- ③ Telephone*

 to take a call

 to end a call

- ④ Menu systems

 for next menu

 for previous menu

- ⑤ Moving within a menu

 for next display





 for previous display

Pressing any of the buttons on the multifunction steering wheel will alter what is shown in the multifunction display.

The information available in the multifunction display is arranged in menus, each containing a number of functions or submenus.

The individual functions are then found within the relevant menu (radio or CD operations under **AUDIO**, for example). These functions serve to call up relevant information or to customize the settings for your vehicle.

It is helpful to think of the menus, and the functions within each menu, as being arranged in a circular pattern.

- If you press button  or  repeatedly, you will pass through each menu one after the other.
- If you press button  or  repeatedly, you will pass through each function display, one after the other, in the current menu.

In the **SETTINGS** menu, instead of functions you will find a number of submenus for calling up and changing settings. For instructions on using these submenus, see “Settings menu” (▷ page 154).

The number of menus available in the system depends on which optional equipment is installed in your vehicle.

The menus are described on the following pages.

Control system

Menus

This is what you will see when you scroll through the menus.

The table on the next page provides an overview of the individual menus.

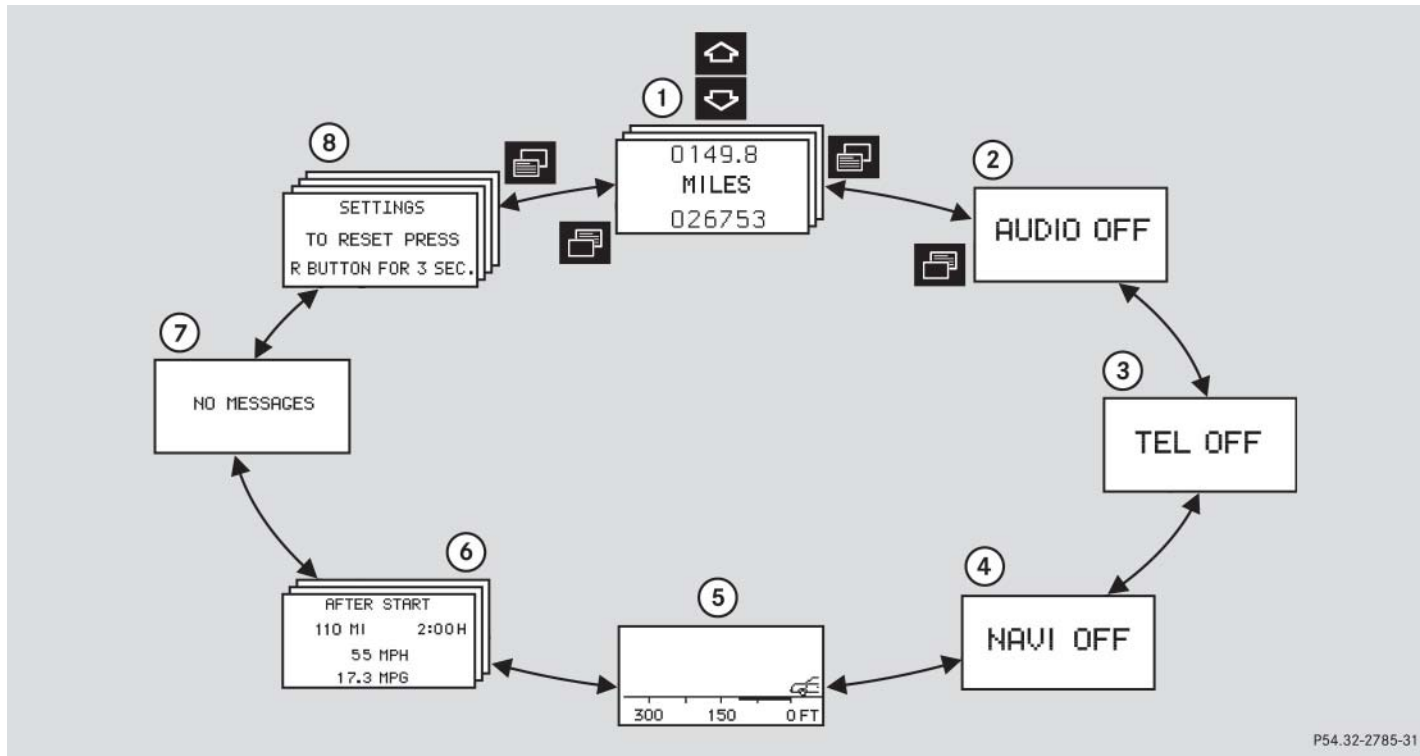

P54.32-2785-31

Menus, submenus and functions

	Menu ①	Menu ②	Menu ③	Menu ④	Menu ⑤	Menu ⑥	Menu ⑦	Menu ⑧
	Standard display	AUDIO	TEL*	NAVI	Distronic*	Trip computer	Vehicle status message memory	Settings
	(▷ page 142)	(▷ page 142)	(▷ page 147)	(▷ page 149)	(▷ page 150)	(▷ page 151)	(▷ page 153)	(▷ page 154)
Commands/submenus	Call up maintenance service display	Select radio station	Load phone book	Show route guidance instructions, current direction traveled	Call up settings	Fuel consumption statistics after start	Call up vehicle malfunction, warning and system status messages stored in memory	Reset to factory settings
	Check tire inflation pressure*	Select satellite radio station* (USA only)	Search for name in phone book			Fuel consumption statistics since the last reset		Instrument cluster submenu
	Check engine oil level	Select CD track	Select number last dialed			Call up range		Lighting submenu
	Digital speedometer	Select MP3-CD track						Vehicle submenu Convenience submenu

Control system



The headings used in the menus table are designed to facilitate navigation within the system and are not necessarily identical to those shown in the control system displays.

The first function displayed in each menu will automatically show you which part of the system you are in.

Standard display menu

In the standard display, the trip odometer and main odometer are shown in the multifunction display.

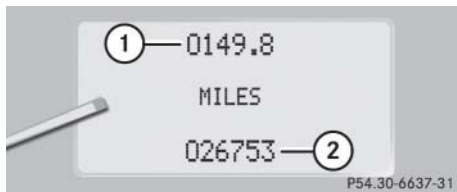

- ① Trip odometer
- ② Main odometer

- ▶ If you see another display, press button or until the standard display appears.
- ▶ Press button or repeatedly to select the functions in the standard display menu.

The following functions are available:

Function	Page
Call up maintenance service display	316
Check tire inflation pressure*	294
Check engine oil level	275
Call up digital speedometer	142

Display digital speedometer

- ▶ Press button or repeatedly until the digital speedometer appears in the multifunction display.

AUDIO menu



The functions in the AUDIO menu operate the audio equipment which you currently have turned on.

If no audio equipment is currently turned on, the message AUDIO OFF is shown in the multifunction display.

The following functions are available:

Function	Page
Select radio station	143
Select satellite radio* station (USA only)	143
Select CD track	144
Select MP3-CD track	144

Select radio station

- ▶ Turn on COMAND and select radio. Refer to separate COMAND operating instructions.
- ▶ Press button  or  repeatedly until you see the currently tuned station in the multifunction display.



- ① Waveband
- ② Station frequency

- ▶ Press button  or  repeatedly until the desired station is found.





You can only store new stations using the corresponding feature on the radio. Refer to separate COMAND operating instructions.

You can also operate the radio in the usual manner.



Select satellite radio* station (USA only)

The satellite radio is treated as a radio application.

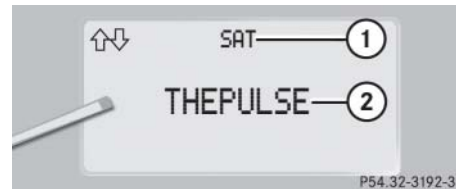
- ▶ Turn on COMAND and select satellite radio with the corresponding key on the COMAND control panel (SAT).
- ▶ Press button  or  repeatedly until you see the currently tuned station in the multifunction display.



- ① SAT mode and preset number
- ② Channel name or number

- ▶ Press button  or  repeatedly until the desired channel is found.





Additional optional satellite radio equipment and a subscription to satellite radio service provider are required for satellite radio operation. Contact an authorized Mercedes-Benz Center for details and availability for your vehicle.

For more information, refer to separate COMAND operating instructions.

Control system

Select CD track

- ▶ Turn on COMAND and select CD. Refer to separate COMAND operating instructions.
- ▶ Press button  or  repeatedly until the settings for the CD currently being played appear in the multifunction display.





- ① Current CD, for CD changer (▷ page 145)
- ② Current track



CD changer: To select a CD from the magazine, press a number on the COMAND system key pad located in the center dashboard.

- ▶ Press button  or  repeatedly until the desired track is selected.

Select MP3-CD track

- ▶ Turn on COMAND and select MP3-CD. Refer to separate COMAND operating instructions.
- ▶ Press button  or  repeatedly until the settings for the MP3-CD currently being played in the multifunction display.



- ① Indicates MP3-CD mode
- ② Current track

- ▶ Press button  or  repeatedly until the desired track is selected.



Level of information displayed will vary depending on the information contained on the MP3-CD.

CD changer operating mode

General notes

Should excessively high temperatures occur while in CD mode, CD TEMP HIGH will appear on the multifunction display and muting will take place. The unit will then switch back to the last operating mode used until the temperature has decreased to a safe operating level.

Should excessively low temperatures occur while in CD mode, CD TEMP LOW will appear on the multifunction display, but the CD will continue to play.

Handle CDs carefully to prevent interference during playback. Avoid fingerprints and dust on CDs. Do not write on CDs or apply any label or other material to them.

Only use original CDs. Using copied CDs may create problems during playback.

Clean CDs from time to time with a commercially available cleaning cloth. No solvents, anti-static sprays, etc. should be used for cleaning. Replace the CD in its case after use. Protect CDs from heat and direct sunlight.



Only use CDs which bear the label shown and that conform to the compact disc digital audio standard (IEC 60908).

Use of CDs which do not meet this standard may cause damage to the CD changer. Do not play single-CDs (80 mm) with an adapter.



Your CD drive has been designed to play CDs which correspond to the IEC 60908 standard.

If you insert thicker data carriers, e.g. ones that have data on both sides (one side with DVD data, the other side with audio data), they cannot be ejected and will damage the drive.

For information on operating the CD changer, refer to separate COMAND operating instructions.

Control system

Warning!



The CD changer is a Class 1 laser product. There is a danger of invisible laser radiation if the cover is opened or damaged. Do not remove the cover. The CD changer does not contain any parts which can be serviced by the user. For safety reasons, have any service work which may be necessary performed only by qualified personnel.

Operational readiness of CD changer

If a CD changer has been installed in the system, it can be operated from the COMAND system key pad located in the center dashboard. A loaded magazine must be installed for CD playing.

Loading/unloading the CD magazine

The CD changer is located behind the cover on the left hand side in the trunk.

- ▶ Remove the CD changer cover.
- ▶ Slide the CD changer door to the right and press the eject button .
- ▶ The magazine is ejected.

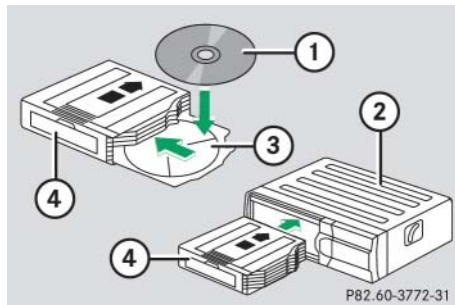

- ① CD
- ② CD changer
- ③ CD tray
- ④ CD magazine

- ▶ Remove the magazine ④ and completely pull out the CD tray ③.
- ▶ Place the CD ① in the recess of the tray ③, label side up.
- ▶ Push the tray ③ into the magazine ④ in the direction shown by the arrow.



CDs which have been inserted improperly or are unreadable will not be played.

- ▶ Push the magazine ④ into the CD changer ② in the direction shown by the arrow and close the CD changer door.

TEL menu*

Warning!



A driver's attention to the road and traffic conditions must always be his/her primary focus when driving. For your safety and the safety of others, we recommend that you pull over to a safe location and stop before making or taking a telephone call. If you choose to use the telephone while driving, please use the hands-free device and only use the telephone when weather, road and traffic conditions permit.

Some jurisdictions prohibit the driver from using a cellular telephone while driving a vehicle.

Bear in mind that at a speed of just 30 mph (approximately 50 km/h), your vehicle is covering a distance of 44 feet (approximately 14 m) every second.

Never operate radio transmitters equipped with a built-in or attached antenna (i.e. without being connected to an external antenna) from inside the vehicle while the engine is running. Doing so could lead to a malfunction of the vehicle's electronic system, possibly resulting in an accident and/or personal injury.

You can use the functions in the TEL menu to operate your telephone, provided it is connected to a hands-free system and switched on.

- ▶ Switch on the telephone and COMAND.
- ▶ Press button  or  on the steering wheel repeatedly until you see the TEL menu in the multifunction display.

Which messages will appear in the multifunction display field depends on whether your telephone is switched on or off:

- If the telephone is off, the message in the multifunction display is: TEL OFF.
- If the telephone is on:

The telephone will then search for a network. During this time the multifunction display reads NO SERVICE.

As soon as the telephone has found a network, READY is indicated in the multifunction display.

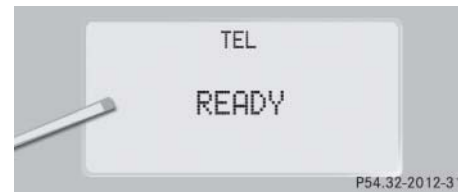

The standby message indicates that your telephone is ready for use and you can operate it using the control system.

Control system

The following functions are available:

Function	Page
Answering a call	148
Ending a call	148
Dialing a number from the phone book	148
Redialing	149

Answering a call

When your telephone is ready to receive calls, you can answer a call at any time. In the multifunction display you will then see the message:



- ▶ Press button .

You have answered the call. In the multifunction display you see the length of the call positioned above the number.



If you do not wish to accept a call, press button .





Ending a call

- ▶ Press button .

You have ended the call. In the multifunction display you will again see the standby message.

Dialing a number from the phone book



If your telephone is ready to receive calls, you may select and dial a number from the phone book at any time.

- ▶ Press button  or  repeatedly until you see the TEL menu in the multifunction display.
- ▶ Press button  or .

The control system reads the phone book which is stored in the telephone. The transmission depends on the number of entries in the phone book and



can take up to 60 seconds. In the multifunction display you will see the message PLEASE WAIT!.

When the message PLEASE WAIT! disappears, the phone book has been loaded.

- ▶ Press button  or  repeatedly until the desired name appears in the multifunction display.

The stored names are displayed in ascending or descending alphabetical order.



If you press and hold  or  for longer than 1 second, the system scrolls rapidly through the list of names until you release the button again.

Cancel the quick search mode by pressing .

- ▶ Press button .

The system dials the selected phone number.

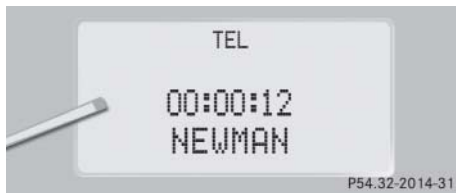

- If the connection is successful, the name of the party you called and the duration of the call will appear in the multifunction display.



- If no connection is made, the control system stores the dialed number in the redial memory.



Redialing

The control system stores the most recently dialed phone numbers. This eliminates the need to search through your entire phone book.

- ▶ Press button  or  repeatedly until you see the TEL menu in the multifunction display.

- ▶ Press button .

In the multifunction display you see the first number in the redial memory.

- ▶ Press button  or  repeatedly until the desired name appears in the multifunction display.





If you do not want to use the telephone, press button .

- ▶ Press button .

The control system dials the selected phone number.

NAVI menu

In the NAVI menu, you will see the navigation system's status.

- ▶ Press button  or  repeatedly until you see the message NAVI in the multifunction display.

- If COMAND is switched off, the message NAVI OFF is shown in the multifunction display.

- With COMAND switched on but route guidance not activated, the direction of travel and, if available, the name of the street currently traveled on appear in the multifunction display.

- With COMAND switched on and route guidance activated, the direction of travel and maneuver instructions appear in the multifunction display.



Please refer to separate COMAND operating instructions on how to activate the route guidance system.

Control system

Distronic* menu

Use the **DISTRONIC** menu to display the current settings for your DISTRONIC system. What information is shown in the multifunction display depends on whether the DISTRONIC system is active or inactive.

Please refer to the “Driving systems” section of this manual (▷ page 208) for instructions on how to activate DISTRONIC.

- ▶ Press button  or  repeatedly until you see one of the following two pictures in the multifunction display.

Distronic deactivated

When DISTRONIC is deactivated you will see the standard display.

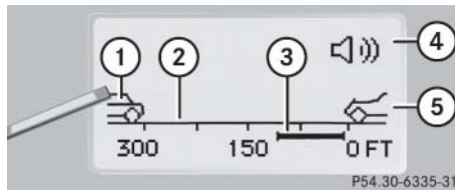

- ① Vehicle ahead, if detected
- ② Actual distance to vehicle ahead
- ③ Preset distance threshold to vehicle ahead
- ④ Symbol for activated distance warning function
- ⑤ Your vehicle

Distronic activated

When you activate DISTRONIC, you will see the set speed for about 5 seconds in the DISTRONIC display. The following display then appears:

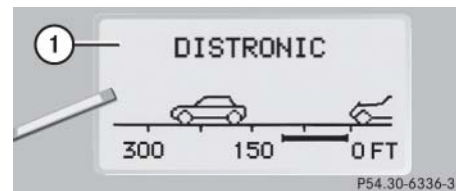





- ① DISTRONIC activated

Trip computer menu

Use the trip computer menu to call up statistical data on your vehicle. The following information is available:

Function	Page
Fuel consumption statistics after start	151
Fuel consumption statistics since last reset	152
Resetting fuel consumption statistics	152
Calling up range (distance to empty)	152

Fuel consumption statistics after start

- ▶ Press button  or  repeatedly until you see the first function of the trip computer menu.
- ▶ Press button  or  repeatedly until you see this message in the multi-function display: AFTER START.



Each time you call up the trip computer, the last function used appears as the first display.

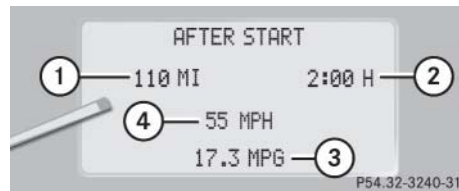

- ① Distance driven since start
- ② Time elapsed since start
- ③ Average fuel consumption since start
- ④ Average speed since start

Incorporating statistics from the previous journey in the consumption statistics

When you restart the engine, the AFTER START display flashes for:

- a distance of approximately 1.25 miles (2 kilometers)
- or
- a duration of 2 minutes

During this period, the data from the previous journey can be incorporated as follows:

- ▶ Press the reset button **R** in the instrument cluster (▷ page 134).





The statistics will be incorporated.



If you do not press the reset button **R**, the consumption statistics will be reset to 0.

Control system



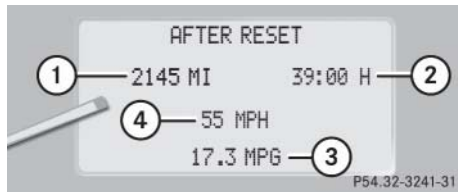

Fuel consumption since last reset

- ▶ Press button  or  repeatedly until you see the first function of the trip computer menu.
- ▶ Press button  or  repeatedly until you see this message in the multifunction display: AFTER RESET.







- ① Distance driven since last reset
- ② Time elapsed since last reset
- ③ Average fuel consumption since last reset
- ④ Average speed since last reset

Resetting fuel consumption statistics

- ▶ Press button  or  repeatedly until you see the first function of the trip computer menu.
- ▶ Press button  or  repeatedly until you see the reading that you want to reset in the multifunction display.
- ▶ Press and hold the reset button  (▶ page 134) until the value is reset to 0.

Calling up range (distance to empty)

- ▶ Press button  or  repeatedly until you see the first function of the trip computer menu.
- ▶ Press button  or  repeatedly until you see this message in the multifunction display: RANGE.

In the multifunction display you will see the calculated range based on the current fuel tank level.

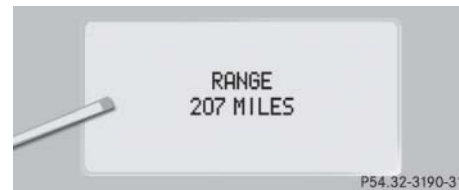



Vehicle status message memory menu

Use the vehicle status message memory menu to scan malfunction and warning messages that may be stored in the system. Such messages appear in the multifunction display and are based on conditions or system status the vehicle's system has recorded.

Warning!



Malfunction and warning messages are only indicated for certain systems and are intentionally not very detailed. The malfunction and warning messages are simply a reminder with respect to the operation of certain systems and do not replace the owner's and/or driver's responsibility to maintain the vehicle's operating safety by having all required maintenance and safety checks performed on the vehicle and by bringing the vehicle to an authorized Mercedes-Benz Center to address the malfunction and warning messages (▷ page 337).

- ▶ Press button  or  repeatedly until the vehicle status message memory appears in the multifunction display.

No vehicle status messages

If no conditions are recorded in the memory, the message in the multifunction display is:

NO MESSAGES

Vehicle status messages have been recorded

If conditions have occurred causing status messages to be recorded, the number of messages appears in the multifunction display:



① Number of messages

- ▶ Press button  or .

The stored messages will now be displayed in the order in which the malfunctions have occurred. See the “Practical hints” section for malfunction and warning messages (▷ page 337).

Should the vehicle's system record any conditions while driving, the number of messages will reappear in the multifunction display when the SmartKey in the starter switch is turned to position **0** or removed from the starter switch. If you press the reset button  in the instrument cluster (▷ page 134), the next message will be displayed immediately.





The vehicle status message memory will be cleared when you switch off the ignition. You will then only see high-priority messages in the multifunction display. These are highlighted in red color (▷ page 337).

Control system

Settings menu

In the **SETTINGS** menu there are two functions:

- The function **TO RESET PRESS R BUTTON FOR 3 SEC.**, with which you can reset all settings to the original factory settings.
 - A collection of submenus with which you can make individual settings for your vehicle.
- ▶ Press button  or  repeatedly until the **SETTINGS** menu appears in the multifunction display.





The following settings and submenus are available:

Function	Page
Resetting all settings	154
Submenus in the settings menu	155
Instrument cluster submenu	157
Lighting submenu	158
Vehicle submenu	162
Convenience submenu	163

Resetting all settings

You can reset all the functions of all submenus to the factory settings.

- ▶ Press the reset button  (▷ page 134) for approximately 3 seconds.

In the multifunction display you will see the request to press the reset button  again to confirm.

- ▶ Press the reset button  again.

The functions of all the submenus will reset to factory settings.



The settings you have changed will not be reset unless you confirm the action by pressing the reset button  a second time.



Due to safety reasons, resetting all of the settings while driving will not reset all of the values in the **LIGHTING** or the **VEHICLE** menu.

Submenus in the Settings menu



- ▶ Press button .



In the multifunction display you will see the collection of the submenus.





- ▶ Press button  or .

The selection marker moves to the next submenu.

The submenus are arranged by hierarchy. Scroll down with the  button, scroll up with the  button.

With the selection marker on the desired submenu, use the  button to access the individual functions within that submenu. Once within the submenu, you can use the button  to move to the next function or the button  to move to the previous function within that submenu.

The settings themselves are made with button  or .

Control system

The table below shows what settings can be changed within the various menus. Detailed instructions on making individual settings can be found on the following pages.

INSTRUMENT CLUSTER	LIGHTING	VEHICLE	CONVENIENCE
Select temperature display mode	Set daytime running lamp mode (USA only)	Set automatic locking	Activating easy-entry/exit feature
Select multifunction display mode	Set locator lighting	Limiting opening height of trunk lid*	Set fold-in function for exterior rear view mirrors
Select language	Exterior lamps delayed shut-off		
Select tire inflation pressure unit	Interior lighting delayed shut-off		

Instrument cluster submenu

Access the INST. CLUS. submenu via the SETTINGS menu. Use the INST. CLUS. submenu to change the instrument cluster display settings. The following functions are available:

Function	Page
Select temperature display mode	157
Select speedometer display mode	157
Select language	158
Select tire inflation pressure unit	158

Selecting temperature display mode

- ▶ Move the selection marker with the **+** or **-** button to the INST. CLUS. submenu.
- ▶ Press button **↶** or **↷** repeatedly until you see this message in the multi-function display: TEMP. INDICATOR.

The selection marker is on the current setting.

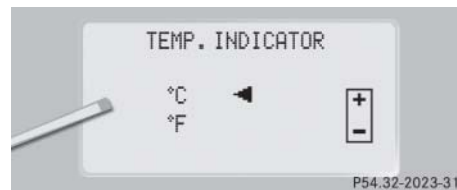

- ▶ Press **+** or **-** to set the temperature unit to degrees Celsius (°C) or degrees Fahrenheit (°F).

Selecting speedometer display mode

- ▶ Move the selection marker with the **+** or **-** button to the INST. CLUS. submenu.
- ▶ Press button **↶** or **↷** repeatedly until you see this message in the multi-function display: DISPLAY VALUES IN.

The selection marker is on the current setting.

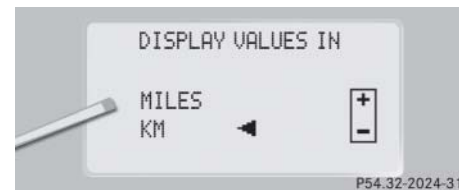

- ▶ Press **+** or **-** to set speedometer unit to MILES or KM.

Control system

Selecting language

- ▶ Move the selection marker with the **+** or **-** button to the INST. CLUS. submenu.
- ▶ Press button **↶** or **↷** repeatedly until you see this message in the multifunction display: LANGUAGE

The selection marker is on the current setting.



- ▶ Press **+** or **-** to select the language to be used for the multifunction display messages.

Available languages:

- German
- English
- French
- Italian
- Spanish

Selecting tire inflation pressure unit

Use this function to set the unit for the tire inflation pressure display.

- ▶ Move the selection marker with the **+** or **-** button to the INST. CLUS. submenu.
- ▶ Press button **↶** or **↷** repeatedly until you see this message in the multifunction display: DISPLAY UNIT TIRE PRESSURE.

The selection marker is on the current setting.



- ▶ Press **+** or **-** to select the desired tire inflation pressure unit.

Lighting submenu

Access the LIGHTING submenu via the SETTINGS menu. Use the LIGHTING submenu to change the lamp and lighting settings on your vehicle. The following functions are available:

Function	Page
Set daytime running lamp mode (USA only)	159
Set locator lighting	160
Exterior lights delayed shut-off	160
Interior lighting delayed shut-off	161

Setting daytime running lamp mode (USA only)



This function is not available in countries where the daytime running lamp mode is mandatory and therefore in a constant mode.

- ▶ Move the selection marker with the **+** or **-** button to the LIGHTING submenu.
- ▶ Press button **↶** or **↷** repeatedly until you see this message in the multifunction display: LIGHTING CIRCUIT HEADLAMP MODE.

The selection marker is on the current setting.

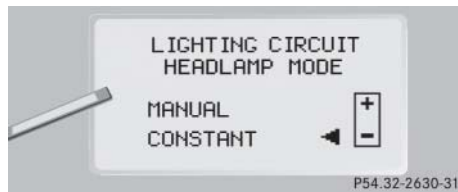

- ▶ Press **+** or **-** to select manual or daytime running lamp (constant) mode. This function is not available in countries where daytime running lamps are mandatory.

With daytime running lamp mode selected and the exterior lamp switch at position **0**, the following lamps will come on automatically when the engine is turned on:

- Parking lamps and low beam headlamps
- License plate lamps (in low ambient light conditions)



If you turn the exterior lamp switch to another position, the corresponding lamp(s) will switch on.

For safety reasons, resetting the LIGHTING submenu to factory settings (> page 155) while driving will not reset the daytime running lamp mode.

In the multifunction display you will then see the message: LIGHTING - CANNOT BE COMPLETELY RESET TO FACTORY SETTINGS WHILE DRIVING.

Control system

Setting locator lighting

With the locator lighting feature activated and the exterior lamp switch in position **AUTO**, the following lamps will switch on during darkness when the vehicle is unlocked with the SmartKey:

- Parking lamps
- Tail lamps
- License plate lamps
- Front fog lamps

To activate locator lighting:

- ▶ Make sure the function LOCATOR LIGHTING is set.
- ▶ Turn the exterior lamp switch to position **AUTO** when exiting the vehicle.

If you do not open a door after unlocking the vehicle with the SmartKey, the lamps will switch off automatically after approximately 40 seconds.

- ▶ Move the selection marker with the **+** or **-** button to the LIGHTING submenu.
- ▶ Press button **▲** or **▼** repeatedly until you see this message in the multi-function display: LOCATOR LIGHTING.

The selection marker is on the current setting.



- ▶ Press **+** or **-** to select the desired setting.

The locator lighting will be switched ON or OFF.

Setting night security illumination

(Exterior lights delayed switch-off)

Use the HEADLAMPS DELAYED SWITCH-OFF function to set whether and for how long you would like the exterior lamps to illuminate during darkness after all doors are closed. When the delayed switch-off feature is activated and the exterior lamp switch is in position **AUTO** before the engine is turned off, the following lamps will remain lit when the engine is turned off:

- Parking lamps
- Tail lamps
- License plate lamps
- Front fog lamps



You can reactivate this function within 10 minutes by opening a door.

If after turning off the engine you do not open a door or do not close an opened door, the lamps will automatically switch off after 60 seconds.

To activate night security illumination:

- ▶ Select delayed switch-off period (see below).
- ▶ Turn the exterior lamp switch to position **AUTO** before turning off the engine.

To select delayed switch-off period:

- ▶ Move the selection marker with the **+** or **-** button to the LIGHTING submenu.
- ▶ Press button **↕** or **↴** repeatedly until you see this message in the multi-function display: HEADLAMPS DELAYED SWITCH-OFF.

The selection marker is on the current setting.



- ▶ Press **+** or **-** to select the desired lamp-on period.

You can select:

- 0 SEC., the delayed switch-off feature is deactivated
- 15 SEC., 30 SEC., 45 SEC., or 60 SEC., the delayed switch-off feature is activated

You can temporarily deactivate the delayed switch-off feature:

- ▶ Before leaving the vehicle, turn the SmartKey in the starter switch to position **0**.

- ▶ Turn the SmartKey in the starter switch to position **2** and back to **0**.

The delayed switch-off feature is deactivated. It will reactivate as soon as you reinsert the SmartKey in the starter switch.

Vehicles with KEYLESS-GO*:

- ▶ Press the KEYLESS-GO start/stop button (▷ page 35) on the gear selector lever.

Interior illumination delayed switch-off

Use this function to set whether and for how long you would like the interior lighting to remain lit during darkness after the SmartKey is removed from the starter switch.

- ▶ Move the selection marker with the **+** or **-** button to the LIGHTING submenu.





Control system

- ▷▷ Press button  or  repeatedly until you see this message in the multi-function display: INTERIOR LIGHTING DELAYED SWITCH-OFF.

The selection marker is on the current setting.



- ▶ Press  or  to select the desired lamp-on time period. You can select:
- 0 SEC., the delayed switch-off feature is deactivated.
 - 5 SEC., 10 SEC., 15 SEC., or 20 SEC., the delayed switch-off feature is activated.





Vehicle submenu

Access the VEHICLE submenu via the SETTINGS menu. Use the VEHICLE submenu to make general vehicle settings. The following functions are available:

Function	Page
Set automatic locking	162
Limiting opening height of trunk lid*	163

Setting automatic locking

Use this function to activate or deactivate the automatic central locking. With the automatic central locking system activated, the vehicle is centrally locked at vehicle speeds of approximately 9 mph (15 km/h).

- ▶ Press button  or  to move the selection marker to the VEHICLE submenu.
- ▶ Press button  or  repeatedly until you see this message in the multi-function display: AUTOMATIC DOOR LOCK.

The selection marker is on the current setting.



- ▶ Press  or  to switch AUTOMATIC DOOR LOCK ON or OFF.

Limiting opening height of trunk lid*

This function is available on vehicles with the trunk opening/closing system*. Use this function to activate or deactivate the limiting opening height of trunk lid.

- ▶ Move the selection marker with the **+** or **-** button to VEHICLE submenu.
- ▶ Press button **↶** or **↷** repeatedly until you see this message in the multi-function display:

OPENING LIMITER
TRUNK LID

The selection marker is on the current setting.



P54.30-7427-31

- ▶ Press button **+** or **-** to switch the opening limiter for trunk lid ON or OFF.

Convenience submenu

Access the CONVENIENCE submenu via the SETTINGS menu. Use the CONVENIENCE submenu to change the settings for a number of convenience features. The following functions are available:

Function	Page
Activating easy-entry/exit feature	163
Setting fold-in function for exterior rear view mirrors	164

Activating easy-entry/exit feature

Use this function to activate and deactivate the easy-entry/exit feature (▷ page 112).

Warning!



You must make sure no one can become trapped or injured by the moving steering wheel and driver's seat when the easy-entry/exit feature is activated.

To cancel seat/steering wheel movement, do one of the following:

- Press seat adjustment switch (▷ page 38).
- Move steering column stalk (▷ page 42).
- Press one of the memory position buttons or the memory button **M** (▷ page 123).



Control system

▷▷ Do not leave children unattended in the vehicle, or with access to an unlocked vehicle. Children could open the driver's door and unintentionally activate the easy-entry/exit feature, which could result in an accident and/or serious personal injury.

- ▶ Move the selection marker with the **+** or **-** button to the CONVENIENCE submenu.
- ▶ Press button **↶** or **↷** repeatedly until you see this message in the multifunction display: EASY-ENTRY FEATURE ACTIVATE.

The selection marker is on the current setting.



- ▶ Press **+** or **-** to change the easy-entry/exit setting.

The following settings are available for the easy-entry/exit feature:

OFF	The easy-entry/exit feature is deactivated.
STEER. COL	Only the steering column is moved.
ST.COL+SEAT	Both the steering column and the driver's seat are moved.

Setting fold-in function for exterior rear view mirrors

Using this function, you can set the exterior or rear view mirrors to be automatically folded in when you lock your vehicle (▷ page 180).

- ▶ Move the selection marker to the CONVENIENCE submenu with the **+** or **-** button.
- ▶ Press button **↶** or **↷** repeatedly until the message FOLD IN MIRRORS WHEN LOCKING appears in the multifunction display.

The selection marker is on the current setting.



- ▶ Press button **+** or **-** to switch the automatic fold-in setting for the mirrors ON or OFF.

▼ Automatic transmission

For more information on driving with an automatic transmission see “Automatic transmission” (▷ page 48).

Your vehicle’s transmission adapts its gear shifting process to your individual driving style by continually adjusting the shift points up or down. These shift point adjustments are performed based on current operating and driving conditions.

If the operating conditions change, the automatic transmission reacts by adjusting its shift program.



During the brief warm-up, transmission upshifting is delayed. This allows the catalytic converter to heat up more quickly to operating temperature.

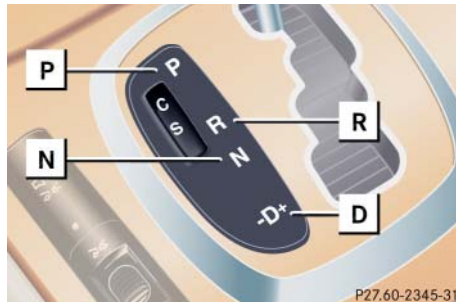

Gearshift pattern for automatic transmission

The automatic transmission selects individual gears automatically, depending on:

- the gear selector lever position **D** (▷ page 167) with gear ranges (▷ page 170)
- the selected program mode:
(**C/S**) (▷ page 171)
or
(**M/C/S**) (CL 55 AMG and CL 65 AMG only) (▷ page 175)
- the position of the accelerator pedal (▷ page 169)
- the vehicle speed

Automatic transmission



P54.30-8014-31

- ① Current gear range/gear selector lever position
- ② Current program mode

The current gear range/gear selector lever position and program mode (C/S) or (M/C/S) appear in the tachometer display.

Warning!



It is dangerous to shift the gear selector lever out of **P** or **N** if the engine speed is higher than idle speed. If your foot is not firmly on the brake pedal, the vehicle could accelerate quickly forward or reverse. You could lose control of the vehicle and hit someone or something. Only shift into gear when the engine is idling normally and when your right foot is firmly on the brake pedal.



Allow engine to warm up under low load use. Do not place full load on the engine until the operating temperature has been reached.

Shift into reverse gear **R** or parking position **P** only when the vehicle is stopped.

Avoid spinning of a drive wheel for an extended period when driving off on slippery road surfaces. This may cause serious damage to the drivetrain which is not covered by the Mercedes-Benz Limited Warranty.

When the gear selector lever is in position **D**, you can influence transmission shifting by:

- limiting the gear range
- changing gears manually

Gear selector lever position

	Effect
P	<p>Park position</p> <p>Gear selector lever position when the vehicle is parked. Place gear selector lever in position P only when vehicle is stopped. The park position is not intended to serve as a brake when the vehicle is parked. Rather, the driver should always set the parking brake in addition to placing the gear selector lever in position P to secure the vehicle.</p>

	Effect
	<p>The SmartKey can only be removed from the starter switch with the gear selector lever in position P. With the SmartKey removed, the gear selector lever is locked in position P.</p>
R	<p>Reverse gear</p> <p>Place gear selector lever in position R only when vehicle is stopped.</p>

	Effect
N	<p>Neutral</p> <p>No power is transmitted from the engine to the drive axle. When the brakes are released, the vehicle can be moved freely (pushed or towed).</p> <p>To avoid damage to the transmission, never engage N while driving.</p> <p>If the ESP® is deactivated or malfunctioning: Move the gear selector lever to N only if the vehicle is in danger of skidding, e.g. on icy roads.</p>
D	<p>Drive</p> <p>The transmission shifts automatically. All forward gears are available.</p>

Automatic transmission



Coasting the vehicle, or driving for any other reason with gear selector lever in **N** can result in transmission damage that is not covered by the Mercedes-Benz Limited Warranty.

Warning!



Getting out of your vehicle with the gear selector lever not fully engaged in position **P** is dangerous. Also, position **P** alone is not intended to or capable of preventing your vehicle from moving, possibly hitting people or objects.

Always set the parking brake in addition to shifting to position **P** (▷ page 50).

When parked on an incline, turn the front wheels towards the road curb.

Do not park this vehicle in areas where combustible materials such as grass, hay or leaves can come into contact with the hot exhaust system, as these materials could be ignited and cause a vehicle fire.

Warning!



When leaving the vehicle, always remove the SmartKey or SmartKey with KEYLESS-GO* from the starter switch, take it with you, and lock the vehicle. Do not leave children unattended in the vehicle, or with access to an unlocked vehicle. Children could move the gear selector lever from position **P**, which could result in an accident and/or serious personal injury.

Driving tips

Accelerator position

Your driving style influences the transmission's shifting behavior:

Less throttle	Earlier upshifting
More throttle	Later upshifting

Kickdown

Use kickdown when you want maximum acceleration.

- ▶ Press the accelerator past the point of resistance.

The transmission shifts into a lower gear.

- ▶ Ease on the accelerator when you have reached the desired speed.

The transmission shifts up again.

Stopping

When you stop briefly, e.g. at traffic lights:

- ▶ Leave the transmission in gear.
- ▶ Hold the vehicle with the brake.

When you stop longer with the engine idling and/or on a hill:

- ▶ Set the parking brake.
- ▶ Move the gear selector lever to position **P**.

Maneuvering

When you maneuver in tight areas, e.g. when pulling into a parking space:

- ▶ Control the vehicle speed by gradually releasing the brakes.
- ▶ Accelerate gently.
- ▶ Never abruptly step on the accelerator.

Working on the vehicle

Warning!



When working on the vehicle, set the parking brake and move the gear selector lever to position **P**. Otherwise the vehicle could roll away.

Automatic transmission

Gear ranges

With the gear selector lever in position **D** and driving in the automatic shift program **C** or **S** (▷ page 171), you can select a gear range for the automatic transmission to operate within:

Gear selector lever (▷ page 172):

You can limit the gear range by pressing the gear selector lever to the left (**D-**), and reverse the gear range limit by pressing the gear selector lever to the right (**D+**).

Steering wheel gearshift control (CL 55 AMG and CL 65 AMG only) (▷ page 173):

You can limit the gear range by pressing the downshift button on the steering wheel gearshift control, and reverse the gear range limit by pressing the upshift button on the steering wheel gearshift control.

The selected gear range appears in the tachometer display (▷ page 166). If you press on the accelerator when the engine has reached its rpm limit, the transmission will upshift beyond any gear range limit selected.

Effect	
6	The transmission shifts through sixth gear only (applies to vehicles with 7-speed automatic transmission only).
5	The transmission shifts through fifth gear only (applies to vehicles with 7-speed automatic transmission only).
4	The transmission shifts through fourth gear only.

Effect	
3	The transmission shifts through third gear only. With this selection you can use the braking effect of the engine.
2	The transmission shifts through second gear only. Allows the use of engine's braking power when driving: <ul style="list-style-type: none">• on steep downgrades• in mountainous regions• under extreme operating conditions
1	The transmission operates in first gear only. For maximum use of engine's braking effect on very steep or lengthy downgrades.

Automatic shift program

The program mode selector switch is located on the lower part of the center console.

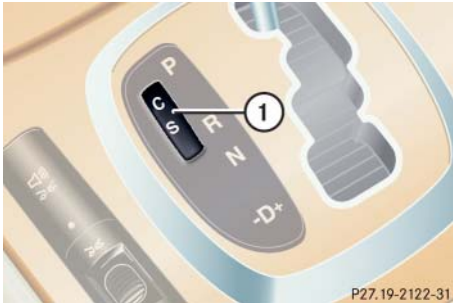

① Program mode selector switch

C Comfort For comfort driving

S Sport For standard driving

The current gear selector lever position and the selected program mode (C/S) are indicated in the tachometer display (▷ page 166).



Never change the program mode when the gear selector lever is out of position **P**. This could result in a change of driving characteristics for which you may not be prepared.



The last selected program mode (**C** or **S**) is switched on when the engine is restarted.

- ▶ Press program mode selector switch ① repeatedly until the letter of the desired program mode appears in the tachometer display.

Select **C** for comfort driving:

- The vehicle starts out in second gear (both forward and reverse) for gentler starts. This does not apply if full throttle is applied or gear range **1** is selected.
- Traction and driving stability are improved on icy roads.
- Upshifts occur earlier even when you give more gas. The engine then operates at lower rpms and the wheels are less likely to spin.

Automatic transmission

Gear selector lever one-touch gearshifting

Even with an automatic transmission, you can change the gears manually and limit or extend the gear range for automatic shifting with the gear selector lever in position **D** and driving in the automatic program mode **C** or **S**.



Allow engine to warm up under low load use. Do not place full load on the engine until the operating temperature has been reached.

Shift into reverse gear **R** or parking position **P** only when the vehicle is stopped.

Avoid spinning of a drive wheel for an extended period when driving off on slippery road surfaces. This may cause serious damage to the drivetrain which is not covered by the Mercedes-Benz Limited Warranty.

Downshifting

Warning!



On slippery road surfaces, never downshift in order to obtain braking action. This could result in drive wheel slip and reduced vehicle control. Your vehicle's ABS will not prevent this type of loss of control.

- ▶ Briefly press the gear selector lever to the left in the **D-** direction.

The transmission will shift from the current gear to the next lower gear as permitted by the shift program. This action simultaneously limits the gear range of the transmission (▷ page 170).



To avoid overrevving the engine when the gear selector lever is moved to the **D-** direction, the transmission will not shift to a lower gear if the engine's max. speed would be exceeded.

Upshifting

- ▶ Briefly press the gear selector lever to the right in the **D+** direction.

The transmission will shift from the current gear to the next higher gear as permitted by the shift program. This action simultaneously extends the gear range of the transmission.

Canceling gear range limit

- ▶ Press and hold the gear selector lever in the **D+** direction until **D** reappears in the tachometer display.

The transmission will shift from the current gear range directly to gear range **D**.

Shifting into optimal gear range

- ▶ Press and hold the gear selector lever in the **D-** direction.

The transmission will automatically select the gear range suited for optimal acceleration and deceleration. This may involve shifting down one or more gears.

Steering wheel gearshift control one-touch gear shifting CL 55 AMG and CL 65 AMG

The steering wheel gearshift control provides an alternative method for changing the gears manually and limiting or extending the gear range for automatic shifting with the gear selector lever in position **D** and driving in the automatic program mode **C** or **S**.



For information on using the steering wheel gearshift control in manual program mode **M** (CL 55 AMG and CL 65 AMG only), see “Manual shift program CL 55 AMG and CL 65 AMG” (> page 175).



To avoid overrevving the engine when downshifting with steering wheel gearshift buttons, the transmission will not shift to a lower gear if the engine's max. speed would be exceeded.



Allow engine to warm up under low load use. Do not place full load on the engine until the operating temperature has been reached.

Shift into reverse gear **R** or parking position **P** only when the vehicle is stopped.

Avoid spinning of a drive wheel for an extended period when driving off on slippery road surfaces. This may cause serious damage to the drivetrain which is not covered by the Mercedes-Benz Limited Warranty.

The steering wheel gearshift buttons are located to the left and right of the steering wheel.

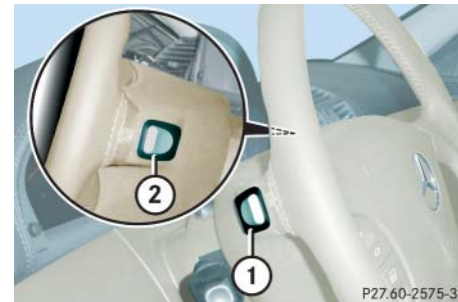

- ① Left button: downshift
- ② Right button: upshift

Automatic transmission



You cannot shift with the steering wheel gearshift buttons when the gear selector lever is in position **P**, **N** or **R**.

The last selected program mode (**C** or **S**) is switched on when the engine is restarted in the automatic program mode.

The following instructions describe operation of the steering wheel gearshift control when driving in the automatic program mode **C** or **S**.

For instructions on operating the steering wheel gearshift control and gear selector lever in the manual program mode **M**, see “Manual shift program CL 55 AMG and CL 65 AMG” (▷ page 175).

Downshifting

Warning!



On slippery road surfaces, never downshift in order to obtain braking action. This could result in drive wheel slip and reduced vehicle control. Your vehicle's ABS will not prevent this type of loss of control.

- ▶ Briefly press button ① on the left side of the steering wheel.

The transmission will shift to the next lower gear as permitted by the shift program. This action simultaneously limits the gear range of the transmission (▷ page 170) when you are driving in the automatic program mode (**C** or **S**).

Upshifting

- ▶ Briefly press button ② on the right side of the steering wheel.

The transmission will shift to the next higher gear as permitted by the shift program. This action simultaneously extends the gear range of the transmission when you are driving in the automatic program mode (**C** or **S**).

Canceling gear range limit

- ▶ Press and hold button ② on the right side of the steering wheel until **D** reappears in the tachometer display.

The transmission will shift from the current gear range directly to gear range **D**.

Shifting into optimal gear range

- ▶ Press and hold button ① on the left side of the steering wheel.

The transmission will automatically select the gear range suited for optimal acceleration and deceleration. This may involve shifting down one or more gears.

Manual shift program CL 55 AMG and CL 65 AMG

In addition to the automatic shift program **C** or **S**, your vehicle is equipped with the manual shift program **M**.

In the manual program mode **M**, system-controlled automatic gearshifting is switched off and you need to change the gears by manually upshifting or downshifting using the steering wheel gearshift buttons to the left and right of the steering wheel (▷ page 173) or the gear selector lever.



Allow engine to warm up under low load use. Do not place full load on the engine until the operating temperature has been reached.

Shift into reverse gear **R** or parking position **P** only when the vehicle is stopped.

Avoid spinning of a drive wheel for an extended period when driving off on slippery road surfaces. This may cause serious damage to the drivetrain which is not covered by the Mercedes-Benz Limited Warranty.

The program mode selector switch is located on the lower part of the center console.

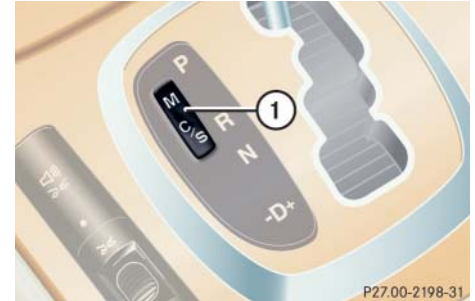

① Program mode selector switch

- | | |
|------------------|--------------------------|
| M Manual | For manual gear shifting |
| C Comfort | For comfort driving |
| S Sport | For standard driving |

The current gear selector lever position and the selected program mode (M/C/S) are indicated in the tachometer display (▷ page 166).

Automatic transmission



For information on automatic program modes **C** or **S**, see “Automatic shift program” (▷ page 171), “Gear selector lever one-touch gearshifting” (▷ page 172), and “Steering wheel gearshift control one-touch gear shifting CL 55 AMG and CL 65 AMG” (▷ page 173).

Activating manual shift program

- ▶ Press program mode selector switch ① repeatedly until the **M** for the manual program mode **M** appears in the tachometer display.

The transmission switches to the manual program mode **M**. Automatic shifting is switched off. The gear range is not limited.

You can change the gears manually when the gear selector lever is in position **D**. You can upshift or downshift through the gears in succession.



The manual program mode **M** will not be stored. When the engine is turned off with the manual program mode **M** selected, the transmission will go to the automatic program mode (**C** or **S**) when the engine is restarted.

Upshifting

- ▶ Briefly press the gear selector lever to the right in the **D+** direction.

or

- ▶ Briefly press button ② on the right side of the steering wheel (▷ page 173).

The transmission shifts to the next higher gear.

Downshifting

Warning!



On slippery road surfaces, never downshift in order to obtain braking action. This could result in drive wheel slip and reduced vehicle control. Your vehicle's ABS will not prevent this type of loss of control.

- ▶ Briefly press the gear selector lever to the left in the **D-** direction.

or

- ▶ Briefly press button ① on the left side of the steering wheel (▷ page 173).

The transmission shifts to the next lower gear.



When you brake or stop, the transmission shifts down to a gear from which you can easily accelerate or take off.

Kickdown

The kickdown can also be used for maximum acceleration when driving in the manual program mode **M**.

- ▶ Press the accelerator past the point of resistance.

The transmission shifts to a lower gear.

- ▶ Shift up once the desired speed has been reached.



When driving at full throttle, the transmission shifts to the next higher gear when maximum engine speed has been reached.

Deactivating manual shift program

- ▶ Press the program mode selector switch (▷ page 175) repeatedly until **C** or **S** appears in the tachometer display.

or

- ▶ Restart the engine (▷ page 48).

The transmission will go to the automatic program mode (**C** or **S**).

The manual program mode **M** is not stored.

Emergency operation (Limp Home Mode)

If vehicle acceleration worsens or the transmission no longer shifts, the transmission is most likely operating in limp home (emergency operation) mode. In this mode only second gear and reverse gear can be activated.

- ▶ Stop the vehicle in a safe location.
- ▶ Move the gear selector lever to **P**.
- ▶ Turn off the engine.
- ▶ Wait at least 10 seconds before restarting.
- ▶ Restart the engine (▷ page 48).
- ▶ Move the gear selector lever to position **D** (for second gear) or **R**.
- ▶ Have the transmission checked at an authorized Mercedes-Benz Center as soon as possible.

Good visibility

For information on the windshield wipers, see “Windshield wipers” (▷ page 54).

Headlamp cleaning system

The button is located on the left side of the dashboard.



① Headlamp washer button

- ▶ Switch on the ignition (▷ page 34).
- ▶ Press button ①.

The headlamps are cleaned with a high-pressure water jet.



The headlamps will automatically be cleaned when you have

- switched on the headlamps and
- operated the windshield wipers with windshield washer fluid fifteen times

When you switch off the ignition, the counter resets.

For information on filling up the washer reservoir, see “Windshield washer system and headlamp cleaning system” (▷ page 282).

Rear view mirrors

For information on setting the rear view mirrors, see “Mirrors” (▷ page 43).

Auto-dimming rear view mirrors

The reflection brightness of the exterior rear view mirror on the driver’s side and the interior rear view mirror will respond automatically to glare when

- the ignition is switched on and
- incoming light from headlamps falls on the sensor in the interior rear view mirror.

The interior rear view mirror will not react if

- reverse gear is engaged
- the interior lighting is turned on

Warning!



The auto-dimming function does not react if incoming light is not aimed directly at sensors in the interior rear view mirror.

The interior rear view mirror and the exterior rear view mirror on the driver's side do not react, for example, if the rear window sunshade is in raised position.

Glare can endanger you and others.

Warning!



In case of an accident, liquid electrolyte may escape from the mirror housing if the mirror glass breaks.

Electrolyte has an irritating effect. Do not allow the liquid to come into contact with eyes, skin, clothing, or respiratory system. In case it does, immediately flush affected area with water, and seek medical help if necessary.



Electrolyte drops coming into contact with the vehicle paint finish can be completely removed only while in the liquid state by applying plenty of water.

Warning!



Exercise care when using the passenger-side exterior rear view mirror. The mirror surface is convex (outwardly curved surface for a wider field of view). Objects in mirror are closer than they appear. Check your inside rear view mirror or glance over your shoulder before changing lanes.

Good visibility

Activating exterior rear view mirror parking position

Follow these steps to activate the mirror parking position so that the passenger-side exterior rear view mirror will be turned downward to the stored position.

- ▶ Make sure you have stored a parking position for the passenger-side exterior rear view mirror (▷ page 124).
- ▶ Switch on the ignition (▷ page 34).

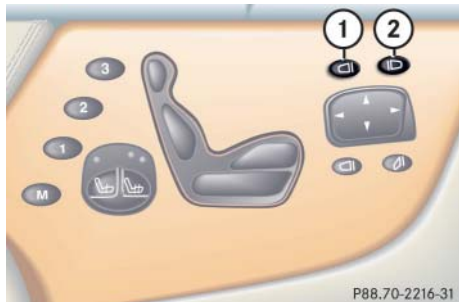

- ① Driver's side exterior rear view mirror button
- ② Passenger-side exterior rear view mirror button

- ▶ Press button ② for passenger-side exterior rear view mirror.
- ▶ Place the gear selector lever in reverse gear **R**.

The passenger-side exterior rear view mirror will be turned downward in the stored position.

The exterior rear view mirror returns to its previously stored driving position:

- 10 seconds after you put the gear selector lever out of position **R**
- immediately once your vehicle exceeds a speed of approximately 6 mph (10 km/h)
- immediately when you press button ① for driver's side mirror

Power folding exterior rear view mirrors



Before driving the vehicle through an automatic car wash, fold the exterior mirrors in. Otherwise they may get damaged.

Folding exterior rear view mirrors in and out automatically

When the corresponding function in the control system is activated (▷ page 164):

- The exterior rear view mirrors automatically fold in as soon as the vehicle is locked from the outside.
- The exterior rear view mirrors automatically fold out as soon as the vehicle is unlocked and the driver's or passenger door are subsequently opened.



If you are driving at more than approximately 9 mph (15 km/h), you will not be able to fold the exterior mirrors in.

Folding exterior rear view mirrors in and out manually

The exterior rear view mirrors can vibrate if they are not folded out completely.

The buttons are located on the driver's door.

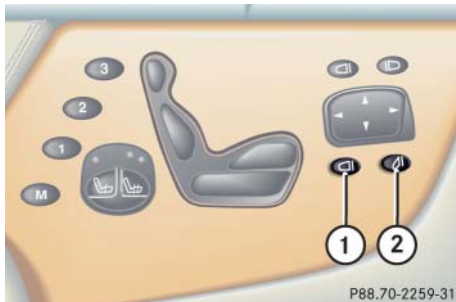

- ① Folds the exterior mirrors out
- ② Folds the exterior mirrors in

- ▶ Switch on the ignition (▷ page 34).

Folding in

- ▶ Press button ② briefly.
Both mirrors fold in.

Folding out

- ▶ Press button ① briefly.
Both mirrors fold out.



If an exterior rear view mirror housing is forcibly pushed forward (hit from the rear), reposition it manually by applying firm pressure until it snaps back into place.

If an exterior rear view mirror housing is forcibly pushed rearward (hit from the front), press button ② to fold mirrors in, then press button ① to fold mirrors out. Do not force mirrors by hand as it may damage the adjustment mechanism.

Sun visors

The sun visors protect you from sun glare while driving.

Warning!



Do not use the vanity mirror while driving.
Keep the mirrors in the sun visors closed while vehicle is in motion. Reflected glare can endanger you and others.



For information on vanity mirrors (▷ page 230)

Good visibility

Glare from the front

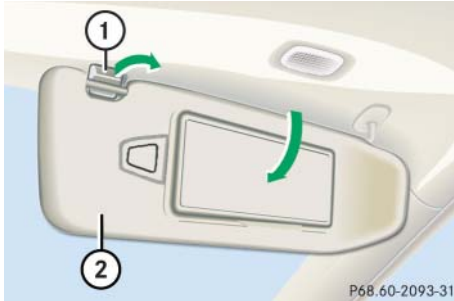

- ① Mounting
- ② Sun visor

- ▶ Swing sun visor ② down.

Glare from the front and sides



Close the vanity mirror cover (if open) before you disengage sun visor ② from mounting ① and pivot it to the side.

- ▶ Swing sun visor ② down.
- ▶ Disengage sun visor ② from mounting ①.
- ▶ Pivot sun visor to the side.

Rear window sunshade*

The button is located in the upper part of the front center console.



- ① Rear window sunshade button

- ▶ Switch on the ignition (▷ page 34).
- ▶ Press button ① briefly to raise the sunshade.
- ▶ Press button ① briefly to lower the sunshade.

Always raise the sunshade fully for its support against the window frame.

Warning!



When operating the rear window sunshade, make sure that there is no danger of anyone being harmed by the raising or lowering procedure.

The raising or lowering procedure can be immediately reversed by pressing button ①.

Warning!



When leaving the vehicle, always remove the SmartKey or SmartKey with KEYLESS-GO* from the starter switch, take it you, and lock the vehicle. Do not leave children unattended in the vehicle, or with access to an unlocked vehicle. Unsupervised use of vehicle equipment may cause an accident and/or serious personal injury.

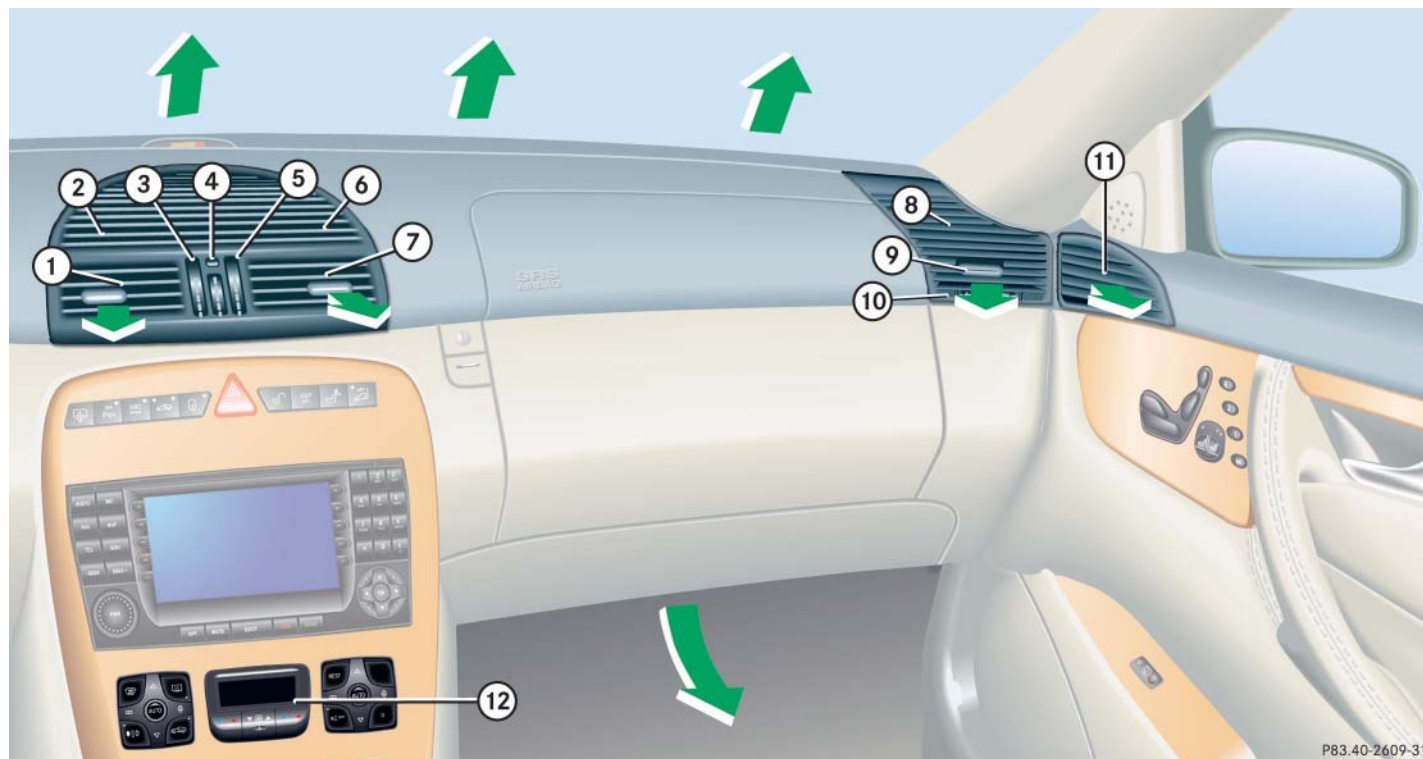

P83.40-2609-31

Automatic climate control

Item
① Left center air vent, adjustable
② Left air vent, fixed
③ Thumbwheel for air volume control for left center air vent
④ Thumbwheel for air temperature control for center air vents
⑤ Thumbwheel for air volume control for right center air vent
⑥ Right air vent, fixed
⑦ Right center air vent, adjustable
⑧ Side defroster vent, fixed
⑨ Side air vent, adjustable
⑩ Thumbwheel for air volume control for side air vent
⑪ Door air vent
⑫ Automatic climate control panel



For draft-free ventilation, move the sliders for the center air vents ①, ⑦, ⑨ to the middle position.



P83.40-2469-31

Automatic climate control panel

Item
① Front defroster
② Rear window defroster
③ Display
④ Residual engine heat utilization
⑤ Automatic climate control on/off
⑥ Air distribution, right (automatic, manual)
⑦ AC cooling on/off
⑧ Right side temperature control
⑨ Air volume (automatic, manual)
⑩ Left side temperature control
⑪ Air recirculation
⑫ Air distribution, left (automatic, manual)
⑬ Activated charcoal filter

Automatic climate control

The automatic climate control is operational whenever the engine is running. You can operate the climate control system in either the automatic or manual mode. The system cools or heats the interior depending on the selected interior temperature and the current outside temperature.

Warning!



When operating the automatic climate control, the air that enters the passenger compartment through the air vents can be very hot or very cold (depending on the set temperature). This may cause burns or frostbite to unprotected skin in the immediate area of the air vents. Always keep sufficient distance between unprotected parts of the body and the air vents. If necessary, use the air distribution control (▷ page 185) to direct the air to air vents in the vehicle interior that are not in the immediate area of unprotected skin.

Nearly all dust particles, pollutants and odors are filtered out before outside air enters the passenger compartment through the air distribution system.

The air conditioning will not engage (no cooling) if the **AC^{OFF}** mode is selected (▷ page 193).

Warning!



Follow the recommended settings for heating and cooling given on the following pages. Otherwise the windows could fog up, impairing visibility and endangering you and others.



The current climate control settings (ON/OFF, temperature, air volume, activated charcoal filter, etc.) are stored for each SmartKey before it is removed from the starter switch or when the vehicle is locked using the SmartKey with KEYLESS-GO* (▷ page 122).

If the vehicle interior is hot, ventilate the interior before driving off.

Keep the air intake grille in front of the windshield free of snow, leaves, sticks, and any other debris.

Do not obstruct air volume by placing objects on the air volume-through exhaust slots below the rear window.



When operating the climate control system in automatic mode, you will only rarely need to adjust the temperature, air volume and air distribution.

Deactivating the climate control system

Deactivating

It is possible to completely deactivate the automatic climate control system.

- ▶ Press button **0** (▷ page 185).

The display shows 0.



When the air conditioning is switched off, the outside air supply and circulation are also switched off. Only choose this setting for a short time. Otherwise the windows could fog up.

Reactivating

- ▶ Press button **0** (▷ page 185).

Setting the temperature

Use temperature controls **10** and **8** (▷ page 185) to separately adjust the air temperature on each side of the passenger compartment. You should raise or lower the temperature setting in small increments, preferably starting at 72°F (22°C).

Increasing/decreasing

- ▶ Press button **10** or **8** repeatedly up or down until the display shows the desired temperature.

The automatic climate control system will accordingly adjust the interior air temperature.

Adjusting the temperature for center air vents

When outside temperatures are low, you can manually raise the air temperature for the center and side air vents. The thumbwheel **4** is located between the center air vents (▷ page 184).

Automatic temperature control

- ▶ Turn thumbwheel **4** to **A**.

The indicator lamp above the thumbwheel comes on. The temperature is automatically adjusted to the set value.

Turning on warm air

- ▶ Turn thumbwheel **4** in the direction of the white marking.

Warm air will enter from the center air vent.

Turning on cooler air





- ▶ Turn thumbwheel **4** in the direction of the blue marking.

Cooler air will enter from the center air vent.

Automatic climate control

Adjusting air distribution





Use the air distribution controls ⑫ and ⑥ (▷ page 185) to separately adjust the air distribution on each side of the passenger compartment. The following symbols are found on the controls:

Symbol	Function
	Directs air through the center air vents
	Directs air to the windows
	Directs air into the entire vehicle interior
	Directs air to the footwells

Adjusting manually

- ▶ Press left or right button **AUTO**.

The button **AUTO** will pop out.





The button emerges and the , ,  and  symbols become visible.

- ▶ Turn the marking on the regulator to the desired symbol.

The air will be directed to the vents corresponding to this symbol.

Adjusting automatically

- ▶ Press left or right button **AUTO** until it clicks in.

The , ,  and  symbols are no longer visible.

The air distribution is adjusted automatically.

Windows fogged on the inside





- ▶ Press button **AC OFF** to switch on the air conditioning (▷ page 185).

The indicator lamp in the button goes out.

- ▶ Press button  to switch off the air recirculation (▷ page 185).

The indicator lamp on the button goes out.

- ▶ Make sure left and right button **AUTO** emerges.

The , ,  and  symbols become visible.

- ▶ Press left and right button .
- ▶ Set blower to the maximum speed.
- ▶ Adjust left and right air vents ① and ⑦ upwards (▷ page 184).
- ▶ Increase temperature setting.
- ▶ Open the side air vents ⑨ and direct them onto the side windows (▷ page 184).

Windshield fogged on the outside

- ▶ Switch the windshield wipers on (▷ page 54).
- ▶ Press on both buttons **AUTO** until they click in.

The , ,  and  symbols are no longer visible.

Adjusting air volume

Use air volume control ⑨ (▷ page 185) for both automatic and manual air volume adjustment.

Adjusting automatically

- ▶ Press **A** on air volume switch ⑨ (▷ page 185).

The display shows **AUTO**. The air volume is adjusted automatically.

Adjusting manually

Reducing air volume

- ▶ Press switch ⑨ down until the desired air volume is reached.

The display shows the current level.

Increasing air volume

- ▶ Press switch ⑨ up until the desired air volume is reached.

The display shows the current level.

Maximum cooling MAXCOOL

If the left and right air distribution controls as well as the air volume control are set to **AUTO** and there is a high need for cooling, the display **AUTO MAXCOOL** appears.

This provides the fastest possible cooling of the vehicle interior (when windows and tilt/sliding sunroof roof are closed).

Defrosting



These settings should only be selected for a short time.

Activating

- ▶ Press button  (▷ page 185).

The indicator lamp on the button comes on.

Switch off air recirculation, if selected.

- ▶ Press button  (▷ page 185).

The indicator lamp on the button goes out.

- ▶ Close center air vents.
- ▶ Adjust side air vents upwards.

Deactivating

- ▶ Press button  (▷ page 185).

The indicator lamp on the button goes out. Defrosting is turned off.

Automatic climate control

Air recirculation mode

Switch to air recirculation mode to prevent unpleasant odors from entering the vehicle from the outside. This setting cuts off the intake of outside air and recirculates the air in the passenger compartment.

Warning!



When the outside temperature is below 41°F (5°C), only switch to air recirculation mode for short periods to prevent window fogging.

Activating

- ▶ Press button  (▷ page 185).

The indicator lamp on the button comes on.





If you press and hold button  the windows and tilt/sliding sunroof will close.

Warning!



Never operate the windows and the tilt/sliding sunroof if there is the possibility of anyone being harmed by the closing procedure.

In the event that the procedure causes potential danger, the closing of the windows can be immediately halted by releasing button  or by pressing the respective window switch. The closing of the tilt/sliding sunroof can be immediately halted by releasing button  or by moving the tilt/sliding sunroof switch in the overhead control panel in any direction.



The air recirculation mode is activated automatically:

- at high outside temperatures
- if the concentration of carbon monoxide and nitrogen oxide in the outside air increases beyond a predetermined level, for example in a tunnel

Please note that the charcoal filter must be activated (▷ page 191) for the air recirculation mode to be activated automatically.

If you have turned off the air conditioning (▷ page 193) or the outside temperature is below 41°F (5°C), the air recirculation mode will not switch on automatically.

Deactivating

- ▶ Press button  (> page 185).

The indicator lamp on the button goes out.



If you press and hold button  the windows and or tilt/sliding sunroof will return to their previous position.

A window or tilt/sliding sunroof will only return to its previous position if it has not been moved to another position using the respective window switch or tilt/sliding sunroof switch after it was closed with button .

A window or tilt/sliding sunroof that was moved will remain in its current position if button  is used to re-open the remaining windows or tilt/sliding sunroof.

The air recirculation mode is deactivated automatically:

- after 5 minutes if the outside temperature is below approximately 41°F (5°C)
- after 5 minutes if the air conditioning is turned off
- after 30 minutes if the outside temperature is above approximately 41°F (5°C)

At outside temperatures above 79°F (26°C) the system will not automatically switch back to outside air. A quantity of outside air is added after approximately 30 minutes.

Charcoal filter

An activated charcoal filter markedly reduces bad odors and removes pollutants from air entering the passenger compartment.

Activating

- ▶ Press button  (> page 185).

The indicator lamp on the button comes on.



If you press and hold button  the windows and tilt/sliding sunroof will close.







Warning!



Never operate the windows and the tilt/sliding sunroof if there is the possibility of anyone being harmed by the closing procedure.

In the event that the procedure causes potential danger, the closing of the windows can be immediately halted by releasing button  or by pressing the respective window switch. The closing of the tilt/sliding sunroof can be immediately halted by releasing button  or by moving the tilt/sliding sunroof switch in the overhead control panel in any direction.

Deactivating

- ▶ Press button  (▷ page 185).

The indicator lamp on the button goes out.



If you press and hold button  the windows and or tilt/sliding sunroof will return to their previous position.

A window or tilt/sliding sunroof will only return to its previous position if it has not been moved to another position using the respective window switch or tilt/sliding sunroof switch after it was closed with button .

A window or tilt/sliding sunroof that was moved will remain in its current position if button  is used to re-open the remaining windows or tilt/sliding sunroof.

The system switches automatically to the air recirculation mode if the carbon monoxide (CO) or nitrogen oxide (NO_x) concentration of the outside air increases beyond a predetermined level, for example in a tunnel.

The automatic air recirculation mode does not function if **AC^{OFF}** mode is selected or if the outside temperature has fallen below 41°F (5°C).

The activated charcoal filter should be switched off when windows fog up on the inside, or if the passenger compartment needs to be quickly heated or cooled down.

Rear window defroster

The rear window defroster uses a large amount of power. To keep battery drain to a minimum, switch off the defroster as soon as the rear window is clear. The defroster is automatically deactivated after approximately 6 to 17 minutes of operation depending on the outside temperature.

Activating

- ▶ Press button  (> page 185).
The indicator lamp on the button comes on.

Deactivating

- ▶ Press button  (> page 185) again.
The indicator lamp on the button goes out.

Warning!



Any accumulation of snow and ice should be removed from the rear window before driving. Visibility could otherwise be impaired, endangering you and others.



If the rear window defroster switches off too soon and the indicator lamp starts flashing, this means that too many electrical consumers are operating simultaneously and there is insufficient voltage in the battery. The system responds automatically by deactivating the rear window defroster.

As soon as the battery has sufficient voltage, the rear window defroster automatically turns itself back on.

Air conditioning

The air conditioning is operational while the engine is running and cools the interior air to the temperature set by the operator.



Condensation may drip out from underneath the vehicle. This is normal and not an indication of a malfunction.

Deactivating

It is possible to deactivate the air conditioning (cooling) function of the automatic climate control system. The air in the vehicle will then no longer be cooled or dehumidified.

- ▶ Press button  (> page 185).

The indicator lamp on the button  comes on.

Automatic climate control

Activating

Moist air can fog up the windows. You can dehumidify the air with the air conditioning.

- ▶ Press **AC^{OFF}** again (▷ page 185).

The indicator lamp on the button **AC^{OFF}** goes out.

The air conditioning uses the refrigerant R134a. This refrigerant is free of CFCs which are harmful to the ozone layer.



If button **AC^{OFF}** on the automatic climate control panel starts to flash, this indicates that the air conditioning is losing refrigerant. The compressor has turned itself off. The air conditioning cannot be turned on again.

Have the air conditioning checked at the nearest authorized Mercedes-Benz Center.

Residual heat and ventilation

With the engine switched off, it is possible to continue to heat or ventilate the interior for up to 30 minutes. This feature makes use of the residual heat produced by the engine.

Activating

- ▶ Turn the SmartKey in the starter switch to position **1** or **0**, or remove it from the starter switch.
- ▶ Press button **REST** (▷ page 185).

The indicator lamp on button **REST** comes on.

Deactivating

- ▶ Press button **REST** (▷ page 185).

The indicator lamp on button **REST** goes out.

The residual heat is automatically turned off:

- when the ignition is switched on
- after about 30 minutes
- if the battery voltage drops



How long the system will provide heating depends on the coolant temperature and the temperature set by the operator. The blower will run at speed setting 1 regardless of the air distribution control setting.

Ventilated storage compartment

Depending on vehicle model and configuration, your vehicle is equipped with a storage compartment under the front armrest (▷ page 232) which can be ventilated when the automatic air conditioning is switched on. If so equipped, the switch is located inside the storage compartment in the front. The air temperature is about the same as that of the center air vents.

The air volume is dependent on the setting of:

- Air distribution control
- Air volume control
- Air vents in the dashboard

The air temperature is about the same as that of the dashboard air vents. It cannot be regulated separately.

Switching ventilation on

- ▶ Open the storage compartment in front of the armrest, see “Storage compartment below the front armrest” (▷ page 232)
- ▶ Push upper portion of switch.

Switching ventilation off

- ▶ Open the storage compartment in front of the armrest, see “Storage compartment below the front armrest” (▷ page 232).
- ▶ Push lower portion of switch.



Do not obstruct the air vent in the storage compartment.



The compartment can get very warm due to its confined space. When storing heat sensitive objects in the compartment, close the air vent while heating the passenger compartment.

Automatic climate control

Rear passenger compartment adjustable air vents

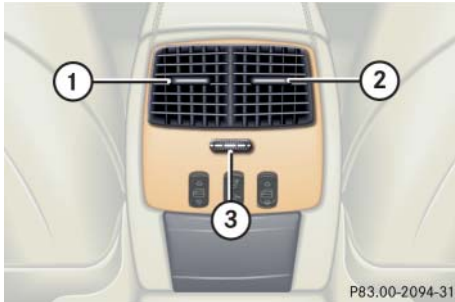

- ① Left center air vent, adjustable
- ② Right center air vent adjustable
- ③ Thumbwheel for center air vents with adjustable booster blower

To open center air vents and to adjust the booster blower:

- ▶ Turn thumbwheel ③.



The booster blower allows air volume speed to the rear passenger compartment to be increased at four different levels.

The temperature at the air vents for rear passenger compartment ① and ② is the same as at the dashboard center air vents.

▼ Power windows

Opening and closing the power windows

The side windows are opened and closed electrically. The switches for all side windows are on the driver's door. The switch for the front passenger door window is on the front passenger door.

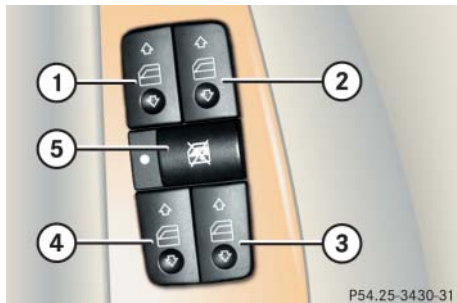

- ① Left door window
- ② Right door window
- ③ Right rear side window
- ④ Left rear side window
- ⑤ Rear side windows override switch
(▷ page 78)

The additional switches for the rear side windows are on the rear center console.



- ⑥ Left rear side window
- ⑦ Right rear side window

Warning!





When closing the windows, make sure that there is no danger of anyone being harmed by the closing procedure.

The closing of the door windows can be immediately halted by releasing the switch or, if the switch was pressed past the resistance point and released, by pressing the respective switch.

The closing of the rear side windows can be immediately halted by releasing the switch.

The door windows are equipped with the express-close and automatic reversal function. If a door window encounters an obstruction that blocks its path in a circumstance where you pressed the switch past the resistance point and released it to close the door window, the automatic reversal function will stop the door window and open it slightly.

If the door window encounters an obstruction that blocks its path in a circumstance where you are closing the door window by pressing and holding the switch, by pressing and holding button  on the SmartKey, by pressing and holding the lock button (vehicles with KEYLESS-GO*) on an outside door handle, or by pressing and holding button  or button  on the climate control panel, the automatic reversal function will not operate.





Power windows

▷▷ When leaving the vehicle, always remove the SmartKey or SmartKey with KEYLESS-GO* from the starter switch, take it with you, and lock the vehicle.

Do not leave children unattended in the vehicle, or with access to an unlocked vehicle. Unsupervised use of vehicle equipment may cause an accident and/or serious personal injury.



You can also open or close the side windows and power tilt/sliding sunroof using the SmartKey or SmartKey with KEYLESS-GO*, see “Summer opening feature” (▷ page 200) and “Convenience closing feature” (▷ page 200).

Depending on current position, the windows may also open or close when the air recirculation button  or the charcoal filter button  in the climate control panel (▷ page 185) is pressed and held.



Operating the rear side windows from the rear is not possible if you activate the override switch (▷ page 78).



With the SmartKey in starter switch position **0** or removed from the starter switch, the door windows can be operated:

- until you open the driver's or passenger door
- for at least 5 minutes

▶ Switch on the ignition (▷ page 34).

Opening the power windows

▶ Press switch ① to ④ at the symbol  to the resistance point.

The corresponding window will move downwards until you release the switch.

Closing the power windows

▶ Press switch ① to ④ at the symbol  to the resistance point.

The corresponding window will move upwards until you release the switch.

Warning!



If you press and hold the switch up when closing a door window, and upward movement of the window is blocked by some obstruction including but not limited to arms, hands, fingers, etc., the automatic reversal will not operate.

Fully opening the power windows (Express-open)

▶ Press switch ① to ④ at the symbol  past the resistance point and release.

The corresponding window opens completely.

Fully closing the power windows (Express-close)

- ▶ Press switch ① to ② at the symbol  past the resistance point and release.

The corresponding window closes completely.



Warning!



Driver's door only:

If within 5 seconds you again press the switch past the resistance point and release, the automatic reversal will not function.



If the upward movement of the door window is blocked during the closing procedure, the door window will stop and open slightly. Remove the obstruction, press the respective door window switch at the symbol  again past the resistance point and release. If the door window still does not close when there is no obstruction, press and hold the respective door window switch at the symbol . The door window will then close without the obstruction sensor function.

Stopping power windows during Express-operation

- ▶ Briefly press the respective window switch again.

Synchronizing the power windows

The windows must be synchronized each time

- after the battery has been disconnected
- if the windows cannot be fully opened (Express-open) or closed (Express-close)

Each window must be synchronized.

- ▶ Close all doors.
- ▶ Switch on the ignition (▷ page 34).
- ▶ Press and hold switches ① to ④ at the symbol  until the windows are completely closed.
- ▶ Hold on to switches ① to ④ for approximately 1 second.

The windows are synchronized.

Power windows

Summer opening feature

If the weather is warm, you can ventilate the vehicle before driving off by simultaneously:

- opening the windows
- opening the tilt/sliding sunroof
- turning on the seat ventilation* for the driver's seat





The seat ventilation* for the driver's seat is automatically set to the highest level if activated via summer opening feature.



- ▶ Aim transmitter eye of the SmartKey or SmartKey with KEYLESS-GO* at the driver's outside door handle.

The SmartKey or SmartKey with KEYLESS-GO* must be in close proximity to the driver's door handle.



- ▶ Press and hold button  until the windows and tilt/sliding sunroof have reached the desired position.
- ▶ Release button  to interrupt procedure.

Convenience closing feature

When you lock the vehicle, you can close the windows and tilt/sliding sunroof simultaneously.

- ▶ Aim transmitter eye of the SmartKey or SmartKey with KEYLESS-GO* at the driver's outside door handle.

The SmartKey or SmartKey with KEYLESS-GO* must be in close proximity to the driver's door handle.

- ▶ Press and hold button  until the windows and tilt/sliding sunroof are completely closed.
- ▶ Release button  to interrupt procedure.

Vehicles with KEYLESS-GO*:



- ▶ Press and hold the lock button on an outside door handle (▷ page 60) until the windows and the tilt/sliding sunroof are completely closed.
- ▶ Release the lock button at the outside door handle to interrupt procedure.

Warning!



When closing the windows and the tilt/sliding sunroof, make sure that there is no danger of anyone being harmed by the closing procedure.

If potential danger exists, proceed as follows:

- Release button  to stop the closing procedure. To open, press and hold button . To continue the closing after making sure that there is no danger of anyone being harmed by the closing procedure, press and hold button .

Vehicles with KEYLESS-GO*:

- Release the lock button on the outside door handle (▷ page 60) to stop the closing procedure.
- Pull on the door handle and hold firmly. The windows and the tilt/sliding sunroof will open for as long as the door handle is held but the door is not opened.

Power tilt/sliding sunroof

Opening and closing the power tilt/sliding sunroof

The tilt/sliding sunroof is opened and closed electrically. The switch for the tilt/sliding sunroof is on the overhead control panel.



- ① Push up to raise sunroof at rear
- ② Pull down to lower sunroof at rear
- ③ Push forward to slide sunroof closed
- ④ Push back to slide sunroof open

With the sunroof closed or tilted open, a screen can be slid into the roof opening to help provide shade. When sliding the sunroof open, the screen will also retract.



Warning!



When closing the tilt/sliding sunroof, make sure that there is no danger of anyone being harmed by the closing procedure.

The closing procedure of the tilt/sliding sunroof can be immediately halted by releasing the switch or, if the switch was moved past the resistance point and released, by moving the switch in any direction.

The tilt/sliding sunroof is made out of glass. In the event of an accident, the glass may shatter. This may result in an opening in the roof.

In a vehicle rollover, occupants not wearing their seat belts or not wearing them properly may be thrown out of the opening. Such an opening also presents a potential for injury for occupants wearing their seat belts properly as entire body parts or portions of them may protrude from the passenger compartment.

When leaving the vehicle, always remove the SmartKey or SmartKey with KEYLESS-GO* from the starter switch, take it with you, and lock the vehicle. Do not leave children unattended in the vehicle, or with access to an unlocked vehicle. Unsupervised use of vehicle equipment can cause an accident and/or serious personal injury.





To avoid damaging the seals, do not transport any objects with sharp edges which can stick out of the tilt/sliding sunroof.

Do not open the tilt/sliding sunroof if there is snow or ice on the roof, as this could result in malfunctions.

The tilt/sliding sunroof can be opened or closed manually should an electrical malfunction occur (▷ page 375).



You can also open or close the side windows and power tilt/sliding sunroof using the SmartKey or SmartKey with KEYLESS-GO*, see “Summer opening feature” (▷ page 200) and “Convenience closing feature” (▷ page 200).

Depending on current position, the tilt/sliding sunroof may also open or close when the air recirculation button  or the charcoal filter button  in the climate control panel (▷ page 185) is pressed and held.



With the SmartKey in starter switch position **0** or removed from the starter switch, the tilt/sliding sunroof can be operated

- until you open the driver’s or passenger door
- for up to approximately 5 minutes.

- ▶ Switch on the ignition (▷ page 34).

Opening and closing the power tilt/sliding sunroof

- ▶ To open, close, raise or lower the tilt/sliding sunroof, move the switch to resistance point in the required direction ① to ④.
- ▶ Release the sunroof switch when the tilt/sliding sunroof has reached the desired position.

Fully opening (Express-open) and closing (Express-close) the power the tilt/sliding sunroof

- ▶ To open, close, raise or lower the tilt/sliding sunroof, move the switch past the resistance point in the required direction ① to ④ and release.

The tilt/sliding sunroof opens or closes completely. >>>

Power tilt/sliding sunroof



The selecting a tilt/sliding sunroof opening position feature is activated for Canada vehicles, but deactivated for U.S. vehicles at the factory. If you wish to have it activated, contact an authorized Mercedes-Benz Center.

To select a tilt/sliding sunroof opening position, press the sunroof switch to the resistance point and release it when the tilt/sliding sunroof has reached the desired position. The tilt/sliding sunroof now opens to the position set when the sunroof switch is pressed past the resistance point in the “open” direction.

Stopping the power tilt/sliding sunroof during Express-operation

- ▶ Move the switch in any direction.



If the movement of the tilt/sliding sunroof is blocked during the closing procedure, the sunroof will stop and reopen slightly.

Synchronizing the power tilt/sliding sunroof

The tilt/sliding sunroof must be synchronized

- after the vehicle battery has been disconnected or discharged
- after the tilt/sliding sunroof has been closed manually (▷ page 375)
- the tilt/sliding sunroof does not open smoothly
- after a malfunction

- ▶ Switch on the ignition (▷ page 34).
- ▶ Press and hold the sunroof switch in the direction of arrow ① until the tilt/sliding sunroof is fully raised at the rear.

Keep holding the sunroof switch in the direction of arrow ① for approximately 1 second.
- ▶ Check the Express-open feature (▷ page 203).

If the tilt/sliding sunroof opens completely, the sunroof is synchronized. Otherwise repeat the above steps.

▼ Driving systems

The driving systems of your vehicle are described on the following pages:

- Cruise control and Distronic*, with which the vehicle can maintain a preset speed.
- ABC with vehicle level control system, with which you can change vehicle suspension characteristics.
- Parktronic*, which serves as a parking assistant.

For information on the BAS, ABS, and ESP® driving systems, see “Driving safety systems” (▷ page 80).

Cruise control

Cruise control automatically maintains the speed you set for your vehicle.

Use of cruise control is recommended for driving at a constant speed for extended periods of time. You can set or resume cruise control at any speed over 20 mph (30 km/h).

The cruise control function is operated by means of the cruise control lever.

The cruise control lever is the uppermost lever on the left-hand side of the steering column (▷ page 22).

Warning!



Cruise control is a convenience system designed to assist the driver during vehicle operation. The driver is and must remain at all times responsible for the vehicle speed and for safe brake operation.

Only use cruise control if the road, traffic and weather conditions make it advisable to travel at a steady speed.

- The use of cruise control can be dangerous on winding roads or in heavy traffic because conditions do not allow safe driving at a steady speed.
- The use of cruise control can be dangerous on slippery roads. Rapid changes in tire traction can result in wheel spin and loss of control.
- Deactivate cruise control when driving in fog.

The “Resume” function should only be operated if the driver is fully aware of the previously set speed and wishes to resume this particular preset speed.

Driving systems

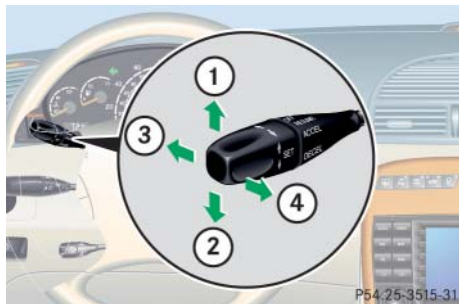

- ① Sets current or higher speed
- ② Sets current or lower speed
- ③ Cancels cruise control
- ④ Resumes at last set speed

Setting current speed

- ▶ Accelerate or decelerate to the desired speed.
- ▶ Briefly lift the cruise control lever in the direction of arrow ① or depress in the direction of arrow ②.

The current speed is set.

- ▶ Remove your foot from the accelerator pedal.

Cruise control is activated.

The selected speed appears in the multi-function display for approximately 5 seconds, and the corresponding speedometer segments from the selected speed to the vehicle maximum speed are illuminated.



On uphill or downhill grades, cruise control may not be able to maintain the set speed. Once the grade eases, the set speed will be resumed.

Canceling cruise control

There are several ways to cancel cruise control:

- ▶ Step on the brake pedal.

Cruise control is canceled. The last speed set is stored for later use.

or

- ▶ Briefly push the cruise control lever in the direction of arrow ③.

Cruise control is canceled. The last speed set is stored for later use.



Moving the gear selector lever to position **N** while driving also cancels cruise control. However, the gear selector lever should not be moved to position **N** while driving, except to coast when the vehicle is in danger of skidding (e.g. on icy roads).



The last stored speed is canceled when you turn off the engine.

Setting a higher speed

- ▶ Lift cruise control lever in the direction of arrow ① and hold it up until the desired speed is reached.
- ▶ Release cruise control lever.
The new speed is set.



Depressing the accelerator pedal does not deactivate cruise control. After brief acceleration (e.g. for passing), cruise control will resume the last speed set.

Setting a lower speed

- ▶ Depress cruise control lever in the direction of arrow ② and hold it down until the desired speed is reached.
- ▶ Release cruise control lever.
The new speed is set.



When you use the cruise control lever to decelerate, the transmission will automatically downshift if the engine's braking power does not brake the vehicle sufficiently.

Fine adjustment in 1 mph (Canada: 1 km/h) increments

Faster

- ▶ Briefly tip cruise control lever in the direction of arrow ①.

Slower

- ▶ Briefly tip cruise control lever in the direction of arrow ②.

Setting to last stored speed ("Resume" function)

Warning!



The speed stored in memory should only be set again if prevailing road conditions permit. Possible acceleration or deceleration differences arising from returning to the pre-set speed could cause an accident and/or serious injury to you and others.

- ▶ Briefly push cruise control lever in the direction of arrow ④.

The cruise control resumes the last set speed.

- ▶ Remove your foot from the accelerator pedal.

The selected speed appears in the multi-function display for approximately 5 seconds, and the corresponding speedometer segments from the selected speed to the vehicle maximum speed are illuminated.

Driving systems

Distronic*

When activated, the DISTRONIC adaptive cruise control system increases driving convenience afforded by the cruise control during travel on expressways and other major roads.

- If the DISTRONIC distance sensor detects a slower moving vehicle directly ahead, your vehicle speed will be reduced so that you follow that vehicle at a preset distance.
- If there is no vehicle directly ahead of you, DISTRONIC will function in the same way as cruise control (▷ page 205).

Warning!



DISTRONIC adaptive cruise control is no substitute for active driving involvement. It does not react to stationary objects, nor does it recognize or predict the curvature and lane layout or the movement of vehicles ahead. DISTRONIC can only apply a maximum of 20% of the vehicle's braking power.

It is the driver's responsibility at all times to be attentive to traffic and road conditions and to provide the steering, braking and other driving inputs necessary to retain control of the vehicle.

Warning!



DISTRONIC is a convenience system. Its speed adjustment reduction capability is intended to make cruise control more effective and usable when traffic speeds vary. However, it is not intended to, nor does it, replace the need for extreme care. The responsibility for the vehicle speed and the distance to the vehicle ahead, including most importantly brake operation to assure safe stopping distance, always rests with the driver.

DISTRONIC cannot take street and traffic conditions into account.

Warning!



DISTRONIC requires familiarity with its operational characteristics. We strongly recommend that you review the following information carefully before operating the system.



USA only:

This device complies with Part 15 of the FCC Rules. Operation is subject to the following two conditions:

- (1) This device may not cause harmful interference, and
- (2) this device must accept any interference received, including interference that may cause undesired operation.

Any unauthorized modification to this device could void the user's authority to operate the equipment.



Canada only:

This device complies with RSS-210 of Industry Canada. Operation is subject to the following two conditions:

- (1) This device may not cause interference, and
- (2) this device must accept any interference received, including interference that may cause undesired operation of the device.

Any unauthorized modification to this device could void the user's authority to operate the equipment.

Warning!



Distronic cannot take street and traffic conditions into account. Only use Disticronic if the road, weather and traffic conditions make it advisable to travel at a steady speed.

Warning!



Use of Disticronic can be dangerous on slippery roads. Rapid changes in tire traction can result in wheel spin and loss of control.

Disticronic does not act upon adverse sight distance conditions. Do not use Disticronic during conditions of fog and heavy rain, snow or sleet.

Warning!



Close attention to road and traffic conditions is imperative at all times, regardless of whether or not Disticronic is activated.

Use of Disticronic can be dangerous on winding roads or in heavy traffic because conditions do not allow safe driving at a steady speed.

Disticronic will not react to stationary objects in the roadway (e.g. a stopped vehicle in a traffic jam or a disabled vehicle). Disticronic will also not respond to oncoming vehicles.

Switch off Disticronic:

- when changing from the left to the right lane if vehicles are moving more slowly in the left lane
- when entering a turn lane or highway off ramp
- in complex driving situations, such as in highway construction zones

In these situations, Disticronic will continue to maintain the set speed unless deactivated.

Disticronic is designed and intended only to maintain a set speed and keep a set distance from moving objects in front of it.

Warning!



The "Resume" function should only be operated if the driver is fully aware of the previously set speed and wishes to resume this particular preset speed.

Driving systems

Distronic displays in the speedometer dial



Set speed

If DISTRONIC is activated, one or two segments come on in the mph scale around the set speed.



The vehicle speed displayed on the speedometer can briefly vary from the speed setting on the DISTRONIC system.



Segments

If DISTRONIC detects a vehicle directly ahead, the segments (representing the difference) between the speed of the vehicle ahead and the set speed comes on.

If DISTRONIC calculates that there is a danger of collision (▷ page 216):

- The distance warning lamp  in the instrument cluster comes on.
- An intermittent warning sounds.



- ▶ Immediately brake the vehicle to avoid a collision.

Under no circumstances should the driver await the intermittent warning sound before braking.

The intermittent warning sound ceases and the red distance warning lamp  goes out when the necessary distance to the vehicle ahead is again established.

Distronic menu in the control system

In the DISTRONIC menu you see the current settings for DISTRONIC. What appears in the multifunction display depends on whether DISTRONIC and the distance warning function are turned on or off.

- ▶ Press button  or  repeatedly until you see one of the following displays.

Warning!



An intermittent warning sounds and the distance warning lamp  in the instrument cluster is illuminated if the DISTRONIC system calculates that the distance to the vehicle ahead and your vehicle's current speed indicate that DISTRONIC will not be capable of slowing the vehicle sufficiently to maintain the preset following distance, which creates a danger of a collision.

Immediately brake the vehicle to increase the distance between your vehicle and the vehicle in front of you. The warning sound is intended as a final caution that you have not interceded with your own braking inputs to avoid a potentially dangerous situation. Do not wait for the operation of the warning signal to intercede with your own braking, as that will result in potentially dangerous emergency braking which will not always result in an impact being avoided.

Tailgating increases the risk of an accident.

Warning!



DISTRONIC brakes your vehicle with a maximum of 6.5 ft/s^2 (2 m/s^2). This corresponds to about 20% of the maximum deceleration ability of your vehicle.

DISTRONIC brakes the vehicle in an effort to restore the preset distance or to maintain the speed. The brake pedal is automatically applied as this happens which results in the brake pedal moving.

Keep driver's foot area clear at all times, including the area under the brake pedal. Objects stored in this area may impair pedal movement which could interfere with the braking ability of the DISTRONIC system.

Do not place your foot under the brake pedal – your foot could become caught.

Driving systems

Distronic deactivated

If Distronic is deactivated, you can see the standard display of Distronic in the multifunction display.

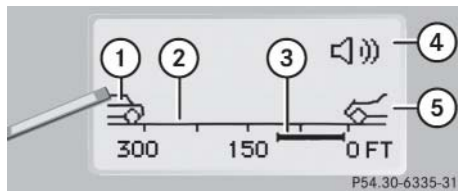

- ① Vehicle ahead, if detected
- ② Actual distance to vehicle ahead
- ③ Preset distance threshold to vehicle ahead
- ④ Symbol for activated distance warning function
- ⑤ Your vehicle

Distronic activated

If you turn Distronic on, you will see the set speed in the multifunction display for about 5 seconds. You then see the following display in the multifunction display.

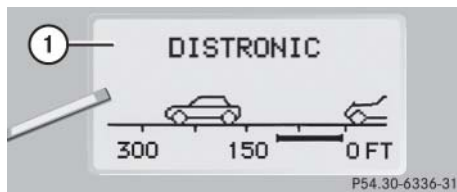

- ① Distronic activated

Cruise control lever

The Distronic system is operated by means of the cruise control lever.

The cruise control lever is the uppermost lever on the left-hand side of the steering column.

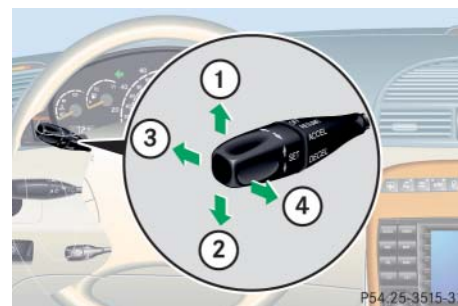

- ① Sets current or higher speed
- ② Sets current or lower speed
- ③ Deactivates Distronic
- ④ Resumes at last set speed

Activating Distronic

You can activate Distronic when

- you are driving above 25 mph (40 km/h)
- the ESP® switched on (▷ page 82)



The maximum speed you can set is 110 mph (180 km/h).

If Distronic has not been activated after pressing the cruise control lever, you will see the message --- in the multifunction display.

In the following cases you cannot activate Distronic:

- up to 2 minutes after starting the engine
- when you brake
- if you have set the parking brake
- if the gear selector lever is in position **P**, **R** or **N**
- if the ESP® is switched off

Setting the current speed

- ▶ Accelerate or decelerate to the desired speed.
- ▶ Briefly lift the cruise control lever in the direction of arrow ① or depress in the direction of arrow ②.
Distronic is activated and the current speed is set.
- ▶ Remove your foot from the accelerator pedal.



If you do not take your foot off of the accelerator completely, the following message will appear in the multifunction display:

DISTRONIC OVERRIDE

Distronic will not work to maintain the distance to a slower moving vehicles in front of you. Your vehicle speed will then be determined only by the accelerator pedal position.

Driving systems

Setting a higher speed

- ▶ Briefly tip the cruise control lever in the direction of arrow ① (▷ page 212) to decrease vehicle speed in increments of 5 mph (Canada: 10 km/h).

The new speed is set.

The stored speed is displayed in the multifunction display for approximately 5 seconds (▷ page 212), and one or two segments around the stored speed come on the speedometer (▷ page 210).



Depressing the accelerator pedal does not deactivate DISTRONIC. After brief acceleration (e.g. for passing), the cruise control resumes the last speed set.

Setting a lower speed

- ▶ Briefly tip the cruise control lever in the direction of arrow ② (▷ page 212) to decrease vehicle speed in increments of 5 mph (Canada: 10 km/h).

The new speed is set.

The stored speed is displayed in the multifunction display for approximately 5 seconds (▷ page 212), and one or two segments around the stored speed come on the speedometer (▷ page 210).



When you use the cruise control lever to decelerate, the brakes will be applied to support deceleration.

In addition, the transmission will automatically downshift on long downhill grades.

Fine adjustment in 1 mph (Canada: 1 km/h) increments

Faster

- ▶ Briefly tip the cruise control lever in the direction of arrow ④ (▷ page 212).

Setting to last stored speed ("Resume" function)

Warning!



The speed stored in memory should only be set again if prevailing road conditions permit. Possible acceleration or deceleration differences arising from returning to preset speed could cause an accident and/or serious injury to you and others.

- ▶ Briefly tip the cruise control lever in the direction of arrow ④ (▷ page 212).
DISTRONIC is set to the last stored speed.
- ▶ Remove your foot from the accelerator pedal.

Deactivating Distronic

There are several ways to deactivate the Distronic system:

- ▶ Briefly tip the cruise control lever in the direction of arrow ③ (▷ page 212).

or

- ▶ Step on the brake pedal.

Distronic will be deactivated. The last speed set will be stored into memory.



The following message will appear in the multifunction display for approximately 5 seconds:

DISTRONIC OFF

The last stored speed is deleted when you turn off the engine.

Distronic deactivates automatically when:

- You set the parking brake.
- You drive slower than 22 mph (35 km/h).
- The ESP® engages (▷ page 82) or you switch off the ESP®.
- You move the gear selector lever into position **N**.

A signal will sound. The DISTRONIC OFF message appears in the multifunction display for approximately 5 seconds.

Warning!



Distronic switches off and releases the brakes when the vehicle decelerates below the minimum speed of approximately 22 mph (35 km/h) by operation of the system. At that time the driver must apply the brakes in order to reduce vehicle speed further or bring it to a stop.

Setting the following distance in Distronic

You can set the specified following distance for Distronic by varying the time setting between 1.0 and 2.0 seconds. Using this time setting and the current speed of your vehicle, Distronic calculates and sets the required following distance to the vehicle ahead. The set distance will be shown in the multifunction display field.

Warning!



It is up to the driver to exercise discretion to select the appropriate setting given road conditions, traffic, driver's preferred driving style and applicable laws and driving recommendations for safe following distance.

Driving systems

The distance warning function on/off button and thumbwheel for setting distance are located on the lower part of the front center console.



- ① Distance warning function on/off button
- ② Thumbwheel for setting distance

Increasing distance

Increasing the distance setting tells DISTRONIC to maintain a greater following distance to the vehicle ahead.

- ▶ Turn thumbwheel ② towards .

Decreasing distance

Decreasing the distance setting tells DISTRONIC to maintain a shorter following distance to the vehicle ahead.

- ▶ Turn thumbwheel ② towards .

Distance warning function

When DISTRONIC is deactivated, this function will continue to warn you when recognizing a slower vehicle moving in the vehicle's path and the danger of a collision exists:

- The distance warning lamp  in the instrument cluster comes on.
- An intermittent warning sounds.

If these warnings are issued, you must brake manually to maintain a safe distance and avoid a collision with the vehicle ahead.

When pressing the brake pedal, the warning sound stops. The warning sound also stops when the distance to the vehicle ahead is sufficient again without applying the brake pedal. In this case the distance warning lamp  also extinguishes.

Warning!

If the distance warning lamp  in the instrument cluster comes on while driving and/or an intermittent warning sounds, immediate attention on the part of the driver is required. As required by the traffic situation, apply the brakes and navigate around a possible obstacle. However, do not drive by relying on the distance warning function, as this will result in an emergency braking application. Especially depending on road surface conditions and driver reaction, this will not always enable you to avoid a collision.



Complex driving situations are not always fully recognized by Distronic. This could result in wrong or missing distance warnings.

Activating

- ▶ Press button .

Indicator lamp on the button comes on. A loudspeaker symbol appears in the multifunction display (▷ page 212).

Deactivating

- ▶ Press button .

Indicator lamp on the switch goes out. No loudspeaker symbol appears in the multifunction display.

Driving with Distronic

This section describes a number of driving situations where special precaution is required on the part of the driver. Be prepared to brake in such situations. This will deactivate the Distronic system.

Warning!

Distronic works to maintain the speed selected by the driver unless a moving obstacle proceeding directly ahead of it in the same travel direction is detected (e.g. following another vehicle ahead of you at a distance set by Distronic). This means that:

- Your vehicle can pass another vehicle after you change lanes.
- While in a sharp turn or if the vehicle in front is in a sharp turn, Distronic could lose sight of a vehicle traveling in front of it, then your vehicle could accelerate to the previously selected speed.



Driving systems

▷▷ DISTRONIC regulates only the distance between your vehicle and those directly ahead of it, but does not register stationary objects in the road, e.g.:

- a stopped vehicle in a traffic jam
- a disabled vehicle
- an oncoming vehicle

The driver must always be on the alert, observe all traffic and intercede as required by steering or braking the vehicle.

Warning!



DISTRONIC should not be used in snowy or icy road conditions.

The most likely cause for a malfunctioning system is a dirty sensor (located behind the hood grille), especially at times of snow and ice or heavy rain. In such a case, DISTRONIC will switch off, and the message `DISTRONIC CURRENTLY UNAVAILABLE SEE OPERATORS MANUAL` appears in the multi-function display.

For cleaning and care of the DISTRONIC sensor, see “Cleaning the DISTRONIC* system sensor cover” (▷ page 322).



If the message `DISTRONIC CURRENTLY UNAVAILABLE SEE OPERATORS MANUAL` disappears during driving and the last speed stored flashes for approximately 5 seconds, the dirt (e.g. slush) has dissolved; DISTRONIC is again operational.

Turns and bends

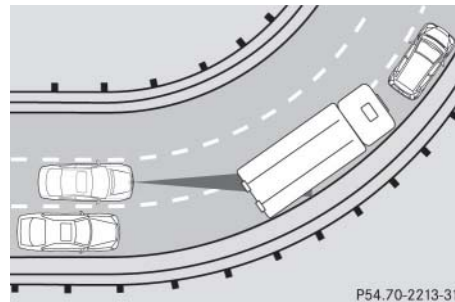

In turns or bends, DISTRONIC may not detect a moving vehicle in front, or it may detect one too soon. This may cause your vehicle to brake late or unexpectedly.

Offset driving

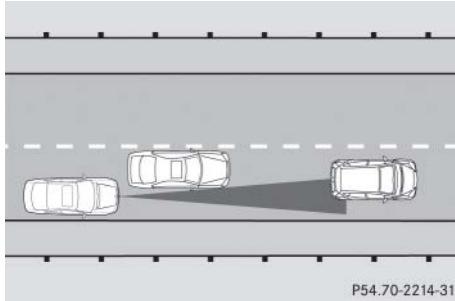

A vehicle traveling in your lane but offset from your direct line of travel may not be detected by DISTRONIC. There will be insufficient distance to the vehicle ahead.

Lane changing

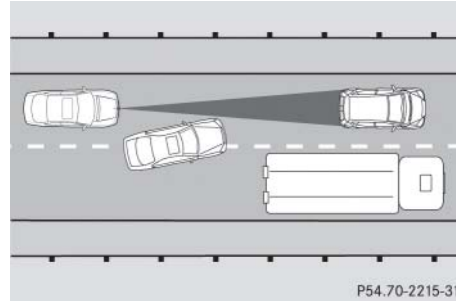

DISTRONIC has not yet detected the vehicle changing lanes. There will be insufficient distance to the lane changing vehicle.

Narrow vehicles

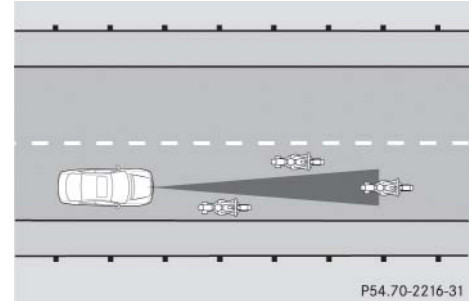

Because of their narrow profiles, the vehicles traveling near the outer edges of the lane have not yet been detected by DISTRONIC. There will be insufficient distance to the vehicles ahead.

Driving systems

Active Body Control (ABC)

The ABC system automatically selects the optimum suspension tuning and ride height for your vehicle.

Suspension tuning

The suspension tuning is set according to:

- your driving style
- road surface conditions
- the vehicle loading
- your choice of suspension style

You can set following suspension style:

- Regular (convenience)
- Sporty



The selected setting is stored, even if the engine is turned off.

The ABC button with the indicator lamps is located on the upper part of the front center console.



- ① ABC button
- ② Indicator lamp

▶ Start the engine (▷ page 48).

Suspension for sporty driving style

The setting for sporty driving is selected when indicator lamp ② is illuminated.

▶ Press button ①.

Indicator lamp ② comes on.

The message:

ACTIVE BODY CONTROL
ABC
SPORTS

appears in the multifunction display for a short time.

Suspension for regular driving style

The setting for regular driving is selected when indicator lamp ② is off.

▶ Press button ①.

Indicator lamp ② goes out.

The message:

ACTIVE BODY CONTROL
ABC
CONVENIENCE

appears in the multifunction display for a short time.

Vehicle level control

Warning!



To help avoid personal injury, keep hands and feet away from wheel housing area, and stay away from under the vehicle when lowering the vehicle chassis.

Your vehicle automatically adjusts its ride height to

- increase vehicle safety
- reduce fuel consumption

The vehicle chassis ride height is raised or lowered according to the selected level setting and to the vehicle speed:

- With increasing speed, ride height is reduced by up to approximately 0.95 in (24 mm).
- With decreasing speed, the ride height is again raised to the selected vehicle level.



These height adjustments are so small that you may not notice any change.

Select the level 1 and 2 settings only when required by current driving conditions. Otherwise

- Fuel consumption may increase.
- Handling may be impaired.

The following vehicle level settings can be selected when the vehicle is stationary:

Vehicle level when stationary	Use for	Ride height increase over normal	Automatic lowering	Indicator lamps
Normal level	Normal operation	None	Max. approx. 0.4 in (11 mm)	Both lamps off
Level 1	Driving with snow chains (▷ page 314)	Max. 0.55 in (14 mm) ¹	Max. approx. 0.55 in (14 mm)	One lamp on
Level 2	Very rough road surface conditions	Max. 0.95 in (24 mm) ¹	Max. approx. 0.95 in (24 mm)	Both lamps on

¹ Dependent on load

Driving systems

The button with the indicator lamps is located in the upper part of the front center console.



- ① Indicator lamps
- ② Vehicle level control button

- ▶ Start the engine (▷ page 48).
- ▶ Briefly press button ② to change from one level setting to the next.
 - The normal level is selected if both indicator lamps are off.
 - At level 1, one of the indicator lamps ① is on.
 - At level 2, both indicator lamps ① are on.

The message:

ACTIVE BODY CONTROL
ABC
VEHICLE RISING

appears in the multifunction display for a short time.

When the vehicle is at level 2, pressing the button will return the vehicle to normal level.



Pressing the button twice in quick succession will cause the vehicle to immediately raise or lower to the new vehicle level as selected.

The selected setting is stored, even if the engine is turned off.

Parktronic system* (Parking assist)**Warning!**

Parktronic is a supplemental system. It is not intended to, nor does it replace, the need for extreme care. The responsibility during parking and other critical maneuvers always rests with the driver.

Special attention must be paid to objects with smooth surfaces or low silhouettes (e.g. trailer couplings, painted posts, or road curbs). Such objects may not be detected by the system and can damage the vehicle.

The operational function of the Parktronic system can be affected by dirty sensors, especially at times of snow and ice, see “Cleaning the Parktronic* system sensors” (▷ page 322).

Interference caused by other ultrasonic signals (e.g. working jackhammers, car wash, or the air brakes of trucks) can cause the system to send erratic indications, and should be taken into consideration.

Warning!

Make sure no persons or animals are in the area in which you are maneuvering. You could otherwise injure them.

The Parktronic system is an electronic aid designed to assist the driver during parking maneuvers. It visually and audibly indicates the relative distance between the vehicle and an obstacle.

The Parktronic system is automatically activated when you switch on the ignition and placed the gear selector lever in position **D**, **R**, or **N**.

The Parktronic system deactivates at speeds over approximately 11 mph (18 km/h). At lower speeds the Parktronic system turns on again.

The Parktronic system also deactivates when you place the gear selector lever in position **P**.

The Parktronic system monitors the surroundings of your vehicle with six sensors in the front bumper and four sensors in the rear bumper.

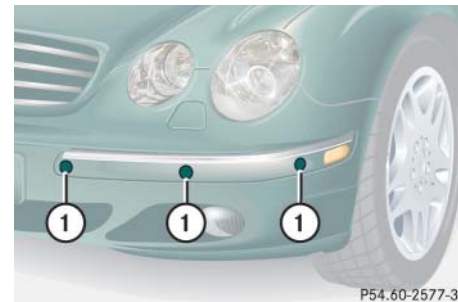

P54.60-2577-31

① Sensors in the front bumper

Driving systems

Range of the sensors

To function properly, the sensors must be free of dirt, ice, snow and slush. Clean the sensors regularly, being careful not to scratch or damage the sensors, see “Cleaning the Parktronic* system sensors” (▷ page 322).

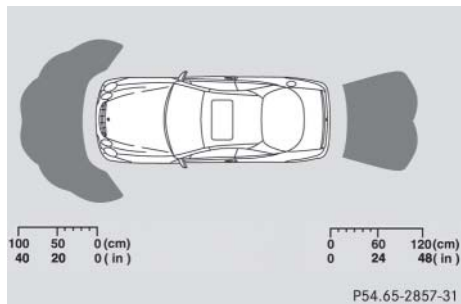
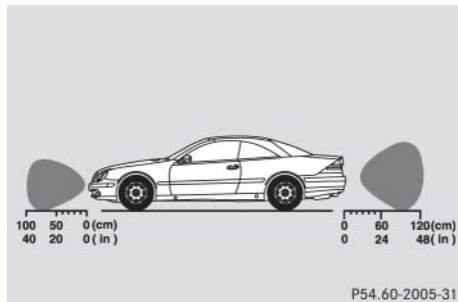

Front sensors

Center	approx. 40 in (100 cm)
Corners	approx. 24 in (60 cm)

Rear sensors

Center	approx. 48 in (120 cm)
Corners	approx. 32 in (80 cm)



During parking maneuvers, pay special attention to objects located above or below the height of the sensors (e.g. street curbs, painted posts, or trailer hitches etc.). The Parktronic system will not detect such objects at close range and damage to your vehicle or the object may result.

Ultrasonic signals from outside sources (e.g. truck air brakes, car wash, or jackhammers) may impair the operation of the Parktronic system.

Minimum distance

Center	approx. 8 in (20 cm)
Corners	approx. 6 in (15 cm)

If the system detects an obstacle in this range, all the distance warning segments illuminate and you hear a warning signal. If the obstacle is closer than the minimum distance, the actual distance may no longer be indicated by the system.

Warning indicators

Visual signals indicate to the driver the relative distance between the sensors and an obstacle. The warning indicators for the front area are located above the left air vents and center air vents in the dashboard. The warning indicator for the rear area is integrated in the rear trim.

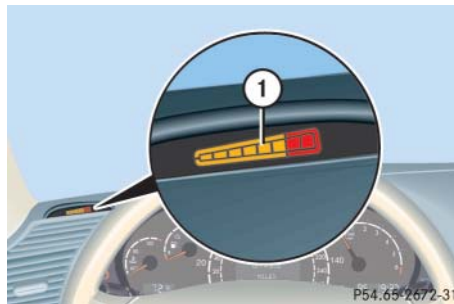

① Left side of the vehicle

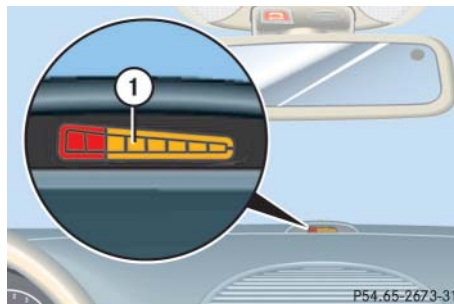

① Right side of the vehicle

Each warning indicator is divided into six yellow and two red distance segments for either side of the vehicle. The Parktronic system is ready when the border around the indicator is illuminated.

The position of the gear selector lever determines which warning indicators will be activated.

Gear selector lever position	Warning indicator
D	Front area activated
R or N	Front and rear area activated
P	Neither activated

Driving systems

As your vehicle approaches an object, one or more distance segments will illuminate, depending on the distance. When the eighth distance segment illuminates, you have reached the minimum distance.

- **Front area:** An intermittent acoustic warning will sound as the first red distance segment illuminates and a constant acoustic warning lasting a maximum of 2 seconds will sound for the second red distance segment. The signal is canceled when the gear selector lever is placed in position **P**.
- **Rear area:** An intermittent acoustic warning will sound as the first red distance segment illuminates and a constant acoustic warning lasting a maximum of 2 seconds will sound for the second red distance segment. The signal is canceled when the gear selector lever is placed in position **D** or **P**.

Switching the Parktronic system on/off

The Parktronic system can be switched off manually.

The Parktronic button is located in the upper part of the front center console.

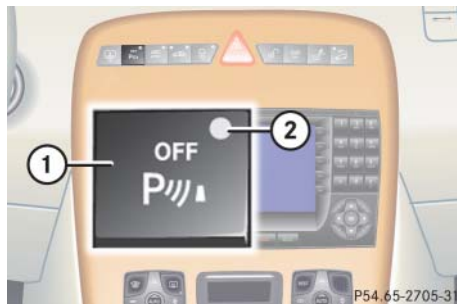

- ① Parktronic button
- ② Indicator lamp

Switching off the Parktronic system

- ▶ Press button ①.
- Indicator lamp ② comes on.

Switching on the Parktronic system

- ▶ Press button ① again.
- Indicator lamp ② goes out.



The Parktronic system is automatically switched on when the ignition is switched on (▷ page 34).

Parktronic system malfunction

If only the red distance segments illuminate and an acoustic warning sounds, there is a malfunction in the Parktronic system. The Parktronic system will automatically switch off after 20 seconds and the indicator lamp in the Parktronic switch comes on.

- ▶ Have the Parktronic system checked by an authorized Mercedes-Benz Center as soon as possible.

If only the red distance segments illuminate and no acoustic warning sounds, the Parktronic system sensors are dirty or there is an interference from other radio or ultrasonic signals. The Parktronic system will automatically switch off after 20 seconds and the indicator lamp in the Parktronic switch comes on.

- ▶ Switch off the ignition (▷ page 34).
- ▶ Clean Parktronic system sensors (▷ page 322).
- ▶ Switch on the ignition.

or

- ▶ Check Parktronic system operation at another location to rule out interference from outside radio or ultrasonic signals.

Loading

Roof rack*

Warning!



Use only roof racks approved by Mercedes-Benz for your vehicle model to avoid damage to the vehicle. Follow manufacturer's installation instructions.

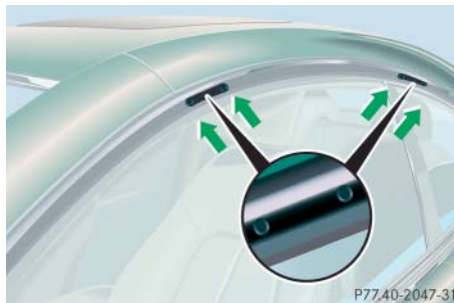

Preparing roof rack installation

- ▶ Open trim at the trim strips in the roof.
- ▶ Secure the roof rack according to manufacturer's instructions for installation.



Load the roof rack in such a way that the vehicle cannot be damaged while driving.

Make sure

- you can fully raise the tilt/sliding sunroof
- you can fully open the trunk

Loading instructions

The total load weight including vehicle occupants and luggage/cargo should not exceed the load limit or vehicle capacity weight as indicated on the corresponding placard located on the driver's door B-pillar.

Warning!



Always fasten items being carried as securely as possible.

In an accident, during hard braking or sudden maneuvers, loose items will be thrown around inside the vehicle and can cause injury to vehicle occupants unless the items are securely fastened in the vehicle.

To help avoid personal injury during a collision or sudden maneuver, exercise care when transporting cargo. Put luggage or cargo in the trunk if possible. Do not pile luggage or cargo higher than the seat backs. Do not place anything on the rear-window shelf.

Never drive vehicle with trunk open. Deadly carbon monoxide (CO) gases may enter vehicle interior resulting in unconsciousness and death.

Cargo tie-down hooks

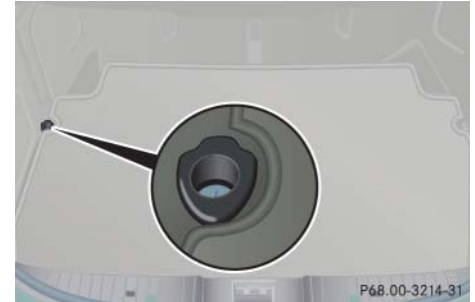

Six hooks are located in the trunk.

- ▶ Carefully secure cargo by applying even load on all hooks with rope of sufficient strength to hold down the cargo.

Useful features

Vanity mirrors

Vanity mirror in the sun visor

Warning!



Do not use the vanity mirror while driving.

Keep the mirrors in the sun visors closed while vehicle is in motion. Reflected glare can endanger you and others.



Close the vanity mirror cover (if open) before you disengage the sun visor from the mounting and pivot it to the side (▷ page 181).

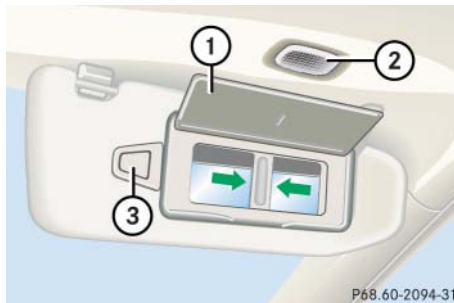

- ① Mirror cover
- ② Mirror lamp
- ③ Document holder

- ▶ To use mirror, lift up cover ①.

Mirror lamp ② comes on.



If you disengage the sun visor from the mounting, mirror lamp ② will switch off.

Adjusting the vanity mirror

- ▶ Slide the mirror to the left or to the right.

Images in the mirror appear in normal size or larger, depending on the position of the mirror.

Document holder

You can use the plastic tab of the document holder ③ to hold admission tickets, parking passes, or similar items in place.

Storage compartments

Warning!



To help avoid personal injury during a collision or sudden maneuver, exercise care when storing objects in the vehicle. Put luggage or cargo in the trunk if possible. Do not pile luggage or cargo higher than the seat backs.

Luggage nets cannot secure hard or heavy objects.

Keep compartment lids closed. This will help to prevent stored objects from being thrown about and injuring vehicle occupants during an accident.

Glove box

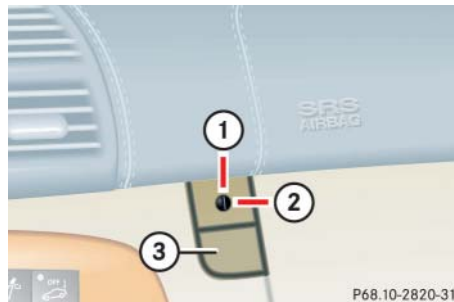

- ① Unlocked
- ② Locked
- ③ Glove box lid release

Opening glove box

- ▶ Press glove box lid release ③.
The glove box lid opens downward.

Closing glove box

- ▶ Push glove box lid up to close.

Locking glove box

- ▶ Insert the mechanical key (▷ page 372) into the glove box lock.
- ▶ Turn the mechanical key to position ②.

Unlocking glove box

- ▶ Insert the mechanical key (▷ page 372) into the glove box lock.
- ▶ Turn the mechanical key to position ①.

Useful features

Storage compartment in the glove box

A storage compartment is located in the cover of the glove box. It can be used to store cards, pens, a flashlight, etc.



① Storage compartment in glove box

- ▶ Lightly press the marking on the lid of storage compartment ①.

The lid opens upward.

Storage compartment in front of armrest

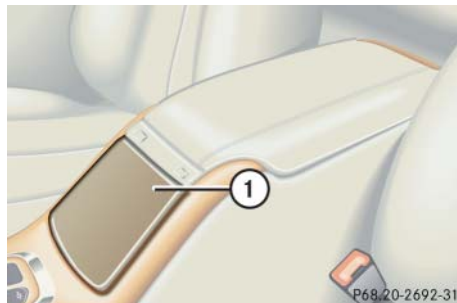

① Storage compartment

Opening

The compartment contains a cup holder (▶ page 235).

- ▶ Lightly touch cover plate ①.

The cover opens automatically.

Closing

- ▶ Lightly push the cover plate ① up until it engages in lock.

Storage compartment below the front armrest

Depending on vehicle model and configuration, your vehicle is equipped with a storage compartment below the front armrest.

The storage compartment below the front armrest is illuminated with the exterior lamps switched on.

The buttons are located under the cushion of the armrest.

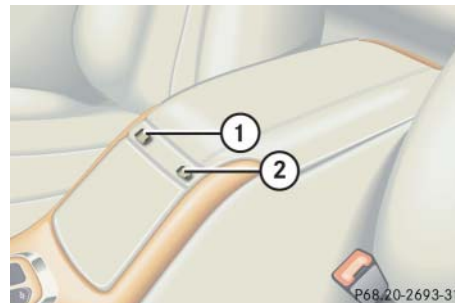

① Button to open storage compartment

② Button to open storage tray and telephone holder*

Opening storage compartment

- ▶ Press button ① and lift the armrest lid.



The storage compartment can be heated or cooled.

The compartment can get very warm due to its confined space. When storing heat-sensitive objects in the compartment, close the air vent (▷ page 195) while heating the passenger compartment.



Do not obstruct the air vent in the storage compartment.

Opening storage tray and telephone holder*

The tray contains a coin holder and a telephone* holder.

- ▶ Press button ② and lift the armrest.

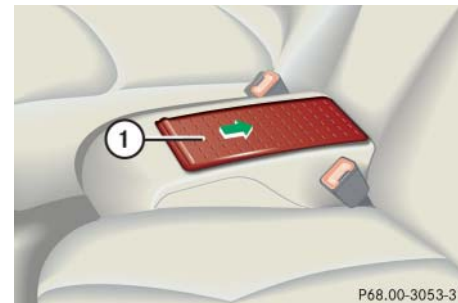

Do not let bank cards, credit cards or other cards with a magnetic strip come near the storage tray as a magnet built into the tray could erase or change the information on the card.

Storage compartment between rear seats

- ① Cover

Opening

- ▶ Slide cover ① rearward.

Closing

- ▶ Slide cover ① forward.

Useful features

Storage compartments under the front seats

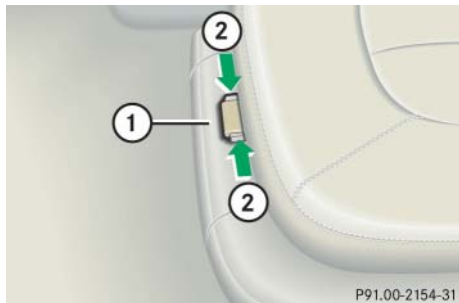

- ① Lid
- ② Buttons

Opening

- ▶ Press buttons ② together and fold lid ① down.

Closing

- ▶ Close lid ① until both buttons ② of lock engage.

Parcel net in front passenger footwell

A small convenience parcel net is located in the front passenger footwell. It is for small and light items, such as road maps, mail, etc.

Warning!



The parcel net is intended for storing light-weight items only.

Heavy objects, objects with sharp edges or fragile objects may not be transported in the parcel net. In an accident, during hard braking, or sudden maneuvers, they could be thrown around inside the vehicle and cause injury to vehicle occupants

The parcel net cannot protect transported goods in the event of an accident.

Parcel net in trunk

You can hang a parcel net in the trunk. The hooks and the parcel net in the trunk can hold a load of up to 29.8 lbs (13.5 kg).



- ① Hook

- ▶ Hang the parcel net on hooks ① on the left and right sides of the trunk.



The parcel net cannot protect or sufficiently secure goods in the event of an accident.

Cup holders

Warning!



In order to help prevent spilling liquids on vehicle occupants and/or vehicle equipment, only use containers that fit into the cup holder. Use lids on open containers and do not fill containers to a height where the contents, especially hot liquids, could spill during braking, vehicle maneuvers, or in an accident. Liquids spilled on vehicle occupants may cause serious personal injury. Liquids spilled on vehicle equipment may cause damage not covered by the Mercedes-Benz Limited Warranty.

When not in use, keep the cup holder closed. An open cup holder may cause injury to you or others when contacted during braking, vehicle maneuvers, or in an accident.

Keep in mind that objects placed in the cup holder may come loose during braking, vehicle maneuvers, or in an accident and be thrown around in the vehicle interior. Objects thrown around in the vehicle interior may cause an accident and/or serious personal injury.

Cup holder in front of seat armrest

Folding out cup holder



Only place containers with a maximum diameter of $2\frac{3}{4}$ in (72 mm) in the cup holder. Larger containers could damage the holder arm.

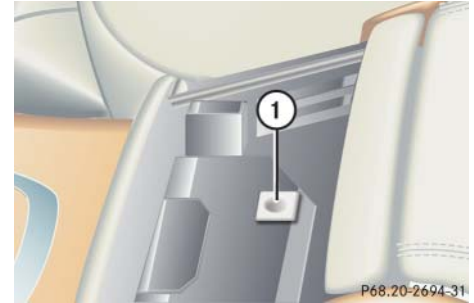

① Button for folding out the cup holder

- ▶ Open the storage compartment in front of the armrest (▷ page 232).
- ▶ Push button ①.

The cup holder opens automatically. ▷▷

Useful features



② Button for folding out the second cup holder

- ▶ Push button ②.

The second cup holder folds out in the direction indicated by the arrow.

Folding in cup holder

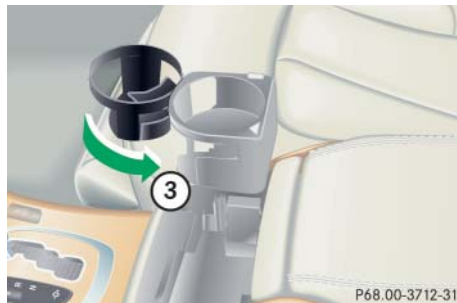

③ Fold in the second cup holder

- ▶ Press the second cup holder in the direction of arrow ③ until it engages.

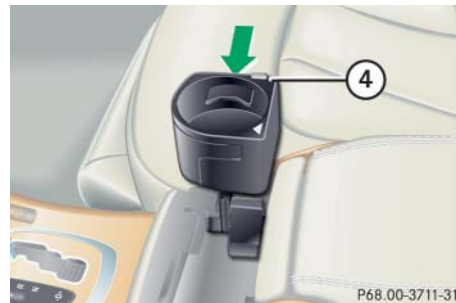

④ Release button

- ▶ Press release button ④ and fold the cup holder into the storage compartment until it engages.
- ▶ Close the storage compartment.

Cup holder in rear seat armrest

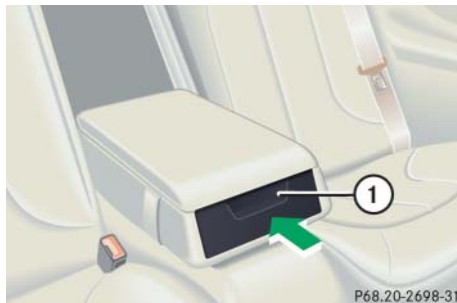

- ① Compartment for cup holder

Opening cup holder

- ▶ Push front of sliding compartment ①. The cup holder slides out.

Closing cup holder

- ▶ Push sliding compartment ① back until it engages.

Ashtrays

Center console ashtray



- ① Button for disengaging ashtray

Opening ashtray

- ▶ Briefly touch cover plate. The ashtray opens automatically.

Removing ashtray insert

Warning!



Remove front ashtray only with vehicle standing still. Set the parking brake to secure vehicle from movement. Move the gear selector lever to position **N**. With gear selector lever in position **N**, turn off the engine.

- ▶ Secure vehicle from movement by setting the parking brake. Move the gear selector lever to position **N**.

Now you have more room to remove the insert.

- ▶ Push sliding button ① to the right. The ashtray is disengaged and slides out a short way.
- ▶ Remove insert from ashtray frame.

Reinstalling the ashtray insert

- ▶ Install insert by pushing back into the frame until it engages.

Useful features

Rear seat ashtray



① Latch

Opening ashtray

- ▶ Pull at top of cover to open ashtray.

Removing ashtray insert

- ▶ Pull latch ① to disengage ashtray insert and remove it.

Reinstalling the ashtray insert

- ▶ Install ashtray insert.
- ▶ Close the ashtray.

Cigarette lighter



① Cigarette lighter

- ▶ Switch on the ignition (▷ page 34).
- ▶ Push in cigarette lighter ①.

The lighter will pop out automatically when hot.

Warning!



Never touch the heating element or sides of the lighter; they are extremely hot. Hold the knob only.

When leaving the vehicle, always remove the SmartKey or SmartKey with KEYLESS-GO* from the starter switch, take it with you, and lock the vehicle. Do not leave children unattended in the vehicle, or with access to an unlocked vehicle. Unsupervised use of vehicle equipment may cause an accident and/or serious personal injury.



The lighter socket can accommodate 12V DC electrical accessories (up to a maximum of 85 W) designed for use with the standard “cigarette lighter plug”. Keep in mind, however, that connecting accessories to the lighter socket (for example extensive connecting and disconnecting, or using plugs that do not fit properly) can damage the lighter socket. With the socket damaged, the lighter may no longer be able to be placed in the heating (pushed-in) position, or the lighter may pop out too early with the lighter not hot enough.

Heated steering wheel* (CL 500 and CL 600)

The steering wheel heating warms up the leather area of the steering wheel.

The stalk is on the lower left-hand side of the steering wheel.

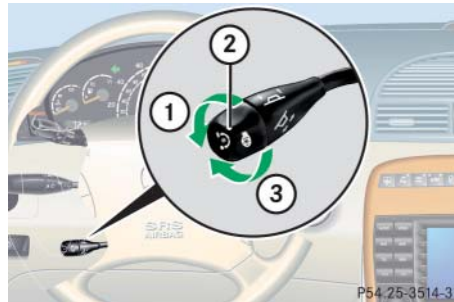

- ① Switching on
- ② Indicator lamp
- ③ Switching off

Switching on

- ▶ Switch on the ignition (▷ page 34).
- ▶ Turn switch at the tip of stalk in the direction of arrow ①.

The steering wheel is heated. Indicator lamp ② comes on.



The steering wheel heating is temporarily suspended while indicator lamp ② remains on when

- the temperature of the vehicle interior is above 86°F (30°C)
- the temperature of the steering wheel is above 95°F (35°C)

When these conditions do not apply anymore, steering wheel heating continues.

Useful features

Switching off

- ▶ Turn switch at the tip of stalk in the direction of arrow ③.

The steering wheel heating is turned off. Indicator lamp ② goes out.



Indicator lamp ② flashes or goes out

- in case of power surge or undervoltage
- in case of a steering wheel heating malfunction



The steering wheel heating switches off automatically when you remove the SmartKey from the starter switch or, on vehicles with KEYLESS-GO*, when you switch off the ignition (▷ page 34) and open the driver's door.

For information on the steering wheel, see "Steering wheel" (▷ page 42).

Telephone*

Warning!



Never operate radio transmitters equipped with a built-in or attached antenna (i.e. without being connected to an external antenna) from inside the vehicle while the engine is running. Doing so could lead to a malfunction of the vehicle's electronic system, possibly resulting in an accident and/or serious personal injury.

Radio transmitters, such as a portable telephone or a citizens band unit, should only be used inside the vehicle if they are connected to an antenna that is installed on the outside of the vehicle.

The external antenna must be approved by Mercedes-Benz. Please contact an authorized Mercedes-Benz Center for information on the installation of an approved external antenna. Refer to the radio transmitter operation instructions regarding use of an external antenna.

Warning!





Please do not forget that your primary responsibility is to drive the vehicle. A driver's attention to the road must always be his/her primary focus when driving. For your safety and the safety of others, we recommend that you pull over to a safe location and stop before placing or taking a telephone call.

If you choose to use the telephone¹ while driving, please use the hands-free device and only use the telephone when road, weather and traffic conditions permit. Some jurisdictions prohibit the driver from using a cellular telephone while driving a vehicle.

Only operate the COMAND (Cockpit Management and Data System)¹ if road, weather and traffic conditions permit.

¹ Observe all legal requirements.

Bear in mind that at a speed of just 30 mph (approximately 50 km/h), your vehicle is covering a distance of 44 feet (approximately 14 m) every second.

You can take and make telephone calls using the  and  buttons on the steering wheel. To carry out other telephone functions, use the control system (▷ page 147).

See separate operating manual for instructions on how to use the telephone.

Tele Aid



The initial activation of the Tele Aid system may only be performed by completing the subscriber agreement and placing an acquaintance call using the Information button . Failure to complete either of these steps will result in a system that is not activated.

If you have any questions regarding activation, please call the Response Center at 1-800-756-9018 (in the USA) or 1-888-923-8367 (in Canada).



The Tele Aid system



(Telematic Alarm Identification on Demand)

The Tele Aid system consists of three types of response:

- automatic and manual emergency
- roadside assistance and
- information



The Tele Aid system is operational providing that the vehicle's battery is charged, properly connected, not damaged and cellular and GPS coverage is available.

The speaker volume of a Tele Aid call can be adjusted when using the volume control on the multifunction steering wheel. To raise, press button  and to lower, press button  or use the volume knob on your COMAND head unit.

- ▶ To activate, press the SOS button, the Roadside Assistance button  or the Information button , depending on the type of response required.



The SOS button is located above the interior rear view mirror.

The Roadside Assistance button  and the Information button  are located below the center armrest cover.



Useful features

Shortly after the completion of your Tele Aid acquaintance call, you will receive a user ID and password. By visiting www.mbusa.com and selecting “Tele Aid” (USA only), you will have access to account information, remote door unlock, and more.



The Tele Aid system utilizes the cellular network for communication and the GPS (Global Positioning System) satellites for vehicle location. If either of these signals are unavailable, the Tele Aid system may not function and if this occurs, assistance must be summoned by other means.

System self-check

Initially, after switching on the ignition, malfunctions are detected and indicated (the indicator lamps in the SOS button, the Roadside Assistance button  and the Information button  stay on longer than 10 seconds or do not come on). The message:

TELE AID MALFUNCTION
DRIVE TO WORKSHOP



appears for approximately 10 seconds in the multifunction display.



The Tele Aid system utilizes the cellular network for communication and the GPS (Global Positioning System) satellites for vehicle location. If either of these signals are unavailable, the Tele Aid system may not function and if this occurs, assistance must be summoned by other means.

Warning!



If the indicator lamps in the SOS button, in the Roadside Assistance button  and/or in the Information button  do not come on during the system self-check, or if any of these indicators remain illuminated continuously in red and/or the message:

TELE AID MALFUNCTION
DRIVE TO WORKSHOP

is displayed in the multifunction display after the system self-check, a malfunction in the system has been detected.

If a malfunction is indicated as outlined above, the system may not operate as expected. Have the system checked at the nearest Mercedes-Benz Center as soon as possible.

Emergency calls

An emergency call is initiated automatically following an accident in which the emergency tensioning devices (ETDs) or air bags deploy.

An emergency call can also be initiated manually by opening the cover next to the interior rear view mirror labeled SOS, then briefly pressing the button located under the cover. See (> page 244) for instructions on initiating an emergency call manually.

Once the emergency call is in progress, the indicator lamp in the SOS button will begin to flash. The message `CONNECTING CALL` appears in the multifunction display and the audio system is muted. When the connection is established, the message `CALL CONNECTED` appears in the multifunction display. All information relevant to the emergency, such as the location of the vehicle (determined by the GPS satellite location system), vehicle model, identification number and color are generated.

A voice connection between the Response Center and the occupants of the vehicle will be established automatically soon after the emergency call has been initiated. The Response Center will attempt to determine more precisely the nature of the accident provided they can speak to an occupant of the vehicle.

The Tele Aid system is available if

- it has been activated and is operational. Activation requires a subscription for monitoring services, connection, and cellular air time
- the relevant cellular phone network and GPS signals are available and pass the information on to the Response Center



Location of the vehicle on a map is only possible if the vehicle is able to receive signals from the GPS satellite network and pass the information on to the Response Center.

Warning!



If the indicator lamp in the SOS button is flashing continuously and there was no voice connection to the Response Center established, then the Tele Aid system could not initiate an emergency call (e.g. the relevant cellular phone network is not available). The message `CALL FAILED` appears in the multifunction display for approximately 10 seconds.

Should this occur, assistance must be summoned by other means.

Useful features

Initiating an emergency call manually

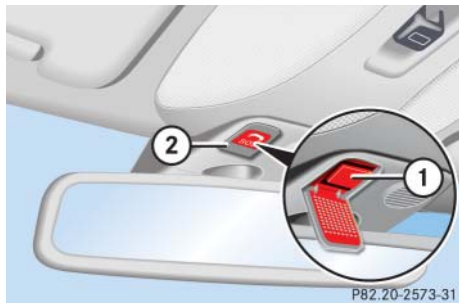

① SOS button

② Cover

- ▶ Briefly press on cover ②.

The cover will open.

- ▶ Press SOS button ① briefly.

The indicator lamp in SOS button ① will flash until the emergency call is concluded.



- ▶ Wait for a voice connection to the Response Center.
- ▶ Close cover ② after the emergency call is concluded.

Warning!





If you feel at any way in jeopardy when in the vehicle (e.g. smoke or fire in the vehicle, vehicle in a dangerous road location), please do not wait for voice contact after you have pressed the emergency button. Carefully leave the vehicle and move to a safe location. The Response Center will automatically contact local emergency officials with the vehicle's approximate location if they receive an automatic SOS signal and cannot make voice contact with the vehicle occupants.

Roadside Assistance button and Information button

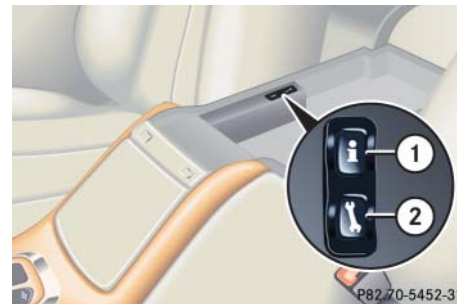
The Roadside Assistance button  and the Information button  are located in the storage compartment below the front armrest (▷ page 232).



① Information button 

② Roadside Assistance button 

Roadside Assistance button 

- ▶ Press and hold the button  (for longer than 2 seconds).

A call to a Mercedes-Benz Roadside Assistance dispatcher will be initiated. The button will flash while the call is in progress. The message **CONNECTING CALL** will appear in the multifunction display and the audio system is muted.

When the connection is established, the message **CALL CONNECTED** appears in the multifunction display. The Tele Aid system will transmit data generating the vehicle identification number, model, color and location (subject to availability of cellular and GPS signals).



A voice connection between the Roadside Assistance dispatcher and the occupants of the vehicle will be established.

- ▶ Describe the nature of the need for assistance.

The Mercedes-Benz Roadside Assistance dispatcher will either dispatch a qualified Mercedes-Benz technician or arrange to tow your vehicle to the nearest authorized Mercedes-Benz Center. For services such as labor and/or towing, charges may apply. Refer to the Roadside Assistance Manual for more information.

Sign and Drive services (only available in the USA): Services such as jump start, a few gallons of fuel or the replacement of a flat tire with the vehicle spare tire are obtainable.



The indicator lamp in the Roadside Assistance button  remains illuminated in red for approximately 10 seconds during the system self-check after switching on the ignition (together with the SOS button and the Information button ).

See system self-check (▷ page 242) when the indicator lamp does not come on in red or stays on longer than approximately 10 seconds.

If the indicator lamp in the Roadside Assistance button  is flashing continuously and no voice connection to the Response Center was established, the Tele Aid system could not initiate a Roadside Assistance call (e.g. the relevant cellular phone network is not available). The message **CALL FAILED** appears in the multifunction display.

Roadside Assistance calls can be terminated using the  button on the multifunction steering wheel or the respective button for ending a telephone call on the COMAND head unit.

Useful features

Information button

The Information button  is located below the center armrest cover.

- ▶ Press and hold the button  (for longer than 2 seconds).



A call to the Customer Assistance Center will be initiated. The button will flash while the call is in progress. The message **CONNECTING CALL** will appear in the multifunction display.

When the connection is established, the message **CALL CONNECTED** appears in the multifunction display. The Tele Aid system will transmit data generating the vehicle identification number, model, color and location (subject to availability of cellular and GPS signals).

A voice connection between the Customer Assistance Center representative and the occupants of the vehicle will be established. Information regarding the operation of your vehicle, the nearest authorized Mercedes-Benz Center or Mercedes-Benz USA products and services is available to you.

For more details concerning the Tele Aid system, please visit www.mbusa.com and use your ID and password (sent to you separately) to learn more (USA only).



The indicator lamp on the Information button  remains illuminated in red for approximately 10 seconds during the system self-check after switching on the ignition (together with the SOS button and the Roadside Assistance button ).

See system self-check (▷ page 242) when the indicator lamp does not come on in red or stays on longer than approximately 10 seconds.

If the indicator lamp in the Information button  is illuminated continuously and no voice connection to the Response Center was established, then the Tele Aid system could not initiate an Information call (e.g. the relevant cellular phone network is not available). The message **CALL FAILED** appears in the multifunction display.

Information calls can be terminated using the  button on the multifunction steering wheel or the respective button for ending a telephone call on the COMAND head unit.



If the indicator lamps do not start flashing after pressing one of the buttons or remain illuminated (in red) at any time, the Tele Aid system has detected a fault or the service is not currently active, and may not initiate a call. Visit an Mercedes-Benz Center and have the system checked or contact the Response Center at 1-800-756-9018 (in the USA) or 1-888-923-8367 (in Canada) as soon as possible.

Call priority

If other service calls such as a Roadside Assistance call or Information call are active, an emergency call is still possible. In this case, the emergency call will take priority and override all other active calls.



The indicator lamp in the respective button flashes until the call is concluded. Calls can only be terminated by a Response Center or Customer Assistance Center representative except Roadside Assistance and Information calls, which can also be terminated by pressing button  on the multifunction steering wheel or the respective button for ending a telephone call on the COMAND head unit.



If the indicator lamp continues to flash or the system does not reset, contact the Response Center at 1-800-756-9018 (in the USA) or 1-888-923-8367 (in Canada), or Mercedes-Benz Customer Assistance at 1-800-FOR-MERCEdes (1-800-367-6372) in the USA or Customer Service at 1-800-387-0100 in Canada.

Useful features



When a Tele Aid call has been initiated, the audio system or the COMAND* system audio is muted and the selected mode (radio or CD) pauses. The optional cellular phone (if installed) switches off. If you must use this phone, the vehicle must be parked. Disconnect the coiled cord and place the call. The COMAND* navigation system (if engaged) will continue to run. The display in the instrument cluster is available for use, and spoken commands are only available by pressing the RPT button on the COMAND* unit. A pop-up window will appear in the COMAND* display to indicate that a Tele Aid call is in progress.

Remote door unlock

In case you have locked your vehicle unintentionally (e.g. SmartKey inside vehicle), and the reserve SmartKey is not handy:

- ▶ Contact the Mercedes-Benz Response Center at 1-800-756-9018 (in the USA) or 1-888-923-8367 (in Canada).

You will be asked to provide your password which you provided when you completed the subscriber agreement.

- ▶ Then return to your vehicle and press the trunk lid button for a minimum of 20 seconds until the SOS button is flashing.

The message `CALL CONNECTED` appears in the multifunction display.

As an alternative, you may unlock the vehicle via Internet using the ID and password sent to you shortly after the completion of your acquaintance call.

The Response Center will then unlock your vehicle with the remote door unlocking feature.



The remote door unlock feature is available if the relevant cellular phone network is available.

The SOS button will flash and the message `CALL CONNECTED` will appear in the multifunction display to indicate receipt of the door unlock command.

Once the vehicle is unlocked, a Response Center specialist will attempt to establish voice contact with the vehicle occupants.

If the trunk lid button was pressed for more than 20 seconds before door unlock authorization was received by the Response Center, you must wait 15 minutes before pressing the trunk lid button again.

Stolen Vehicle Recovery services

In the event your vehicle was stolen:

- ▶ Report the incident to the police.
The police will issue a numbered incident report.
- ▶ Pass this number on to the Mercedes-Benz Response Center along with your password issued to you when you subscribed to the service.

The Response Center will then attempt to covertly contact the vehicle's Tele Aid system. Once the vehicle is located, the Response Center will contact the local law enforcement and you. The vehicle's location will only be provided to law enforcement.



When the anti-theft alarm or the tow-away alarm stays on for more than 30 seconds, a call is initiated automatically to the Response Center. See anti-theft alarm system (▷ page 85) and tow-away alarm (▷ page 87).

Garage door opener

The integrated remote control is capable of operating up to three separately controlled devices. It provides a convenient way to replace up to three hand-held remote controls used to operate devices such as garage door openers, gate openers, or other devices compatible with HomeLink® or some other systems.

Before the integrated remote control can be used, it must be programmed to the garage door opener, gate operator or other device you wish to operate. See the following instructions for programming information.

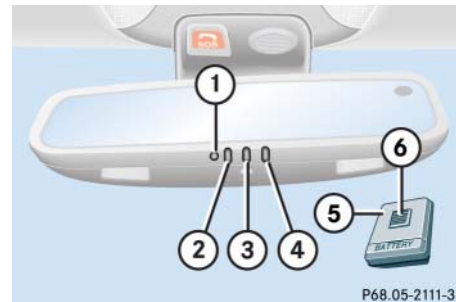

Interior rear view mirror with integrated remote control

- ① Indicator lamp
- ② ③ ④ Signal transmitter button

Needed for programming (not part of vehicle equipment):

- ⑤ Hand-held remote control of garage door opener, gate operator or other device
- ⑥ Hand-held remote control button

Warning!



Before programming the integrated remote control to a garage door opener or gate operator, make sure people and objects are out of the way of the device to prevent potential harm or damage. When programming a garage door opener, the door moves up or down. When programming a gate operator, the gate opens or closes.

Do not use the integrated remote control with any garage door opener that lacks safety stop and reverse features as required by U.S. federal safety standards (this includes any garage door opener model manufactured before April 1, 1982).

A garage door that cannot detect an object - signaling the door to stop and reverse - does not meet current U.S. federal safety standards.

When programming a garage door opener, it is advised to park outside the garage.

Do not run the engine while programming the integrated remote control. Inhalation of exhaust gas is hazardous to your health. All exhaust gas contains carbon monoxide, and inhaling it can cause unconsciousness and possible death.

Programming the integrated remote control

Step 1:

- ▶ Switch on the ignition (▷ page 34).

Step 2:

- ▶ If you have previously programmed a signal transmitter button and wish to retain its programming, proceed to step 3.

If you are programming the integrated remote control for the first time, press and hold the two outer signal transmitter buttons ② and ④ and release them only when the indicator lamp ① begins to flash after approximately 20 seconds (do not hold the button for longer than 30 seconds). This procedure erases any previous settings for all three channels and initializes the memory.

If you later wish to program a second and/or third hand-held transmitter to the remaining two signal transmitter buttons, do not repeat this step and begin directly with step 3.

Step 3:

- ▶ Hold the end of the hand-held remote control ⑤ of the device you wish to train approximately 2 to 5 in (5 to 12 cm) away from the signal transmitter button (②, ③ or ④) to be programmed, while keeping the indicator lamp ① in view.

Step 4:

- ▶ Using both hands, simultaneously press the hand-held remote control button ⑥ and the desired signal transmitter button (②, ③ or ④). Do not release the buttons until step 5 is completed.

The indicator lamp ① will flash, first slowly and then rapidly.



The indicator lamp ① flashes immediately the first time the signal transmitter button is programmed. If this button has already been programmed, the indicator lamp will only start flashing after 20 seconds.

Step 5:

- ▶ After the indicator lamp ① changes from a slow to a rapidly flashing light, release the hand-held remote control button and the signal transmitter button.

Step 6:

- ▶ Press and hold the just-trained signal transmitter button (②, ③ or ④) and observe the indicator lamp ①.

If the indicator lamp ① stays on constantly, programming is complete and your device should activate when the respective signal transmitter button (②, ③ or ④) is pressed and released.



If the indicator lamp ① flashes rapidly for about 2 seconds and then turns to a constant light, continue with programming steps 8 through 12 as your garage door opener may be equipped with the “rolling code” feature.

Step 7:

- ▶ To program the remaining two signal transmitter buttons, repeat the steps above starting with step 3.

Useful features

Rolling code programming

To train a garage door opener (or other rolling code devices) with the rolling code feature, follow these instructions after completing the “Programming” portion (steps 1 through 6) of this text. (A second person may make the following training procedures quicker and easier.)

Step 8:

- ▶ Locate “training” button on the garage door opener motor head unit.

Exact location and color of the button may vary by garage door opener brand. Depending on manufacturer, the “training” button may also be referred to as “learn” or “smart” button. If there is difficulty locating the transmitting button, refer to the garage door opener operator’s manual.

Step 9:

- ▶ Press the “training” button on the garage door opener motor head unit.

The “training light” is activated.

You have 30 seconds to initiate the following two steps.

Step 10:

- ▶ Return to the vehicle and firmly press, hold for 2 seconds and release the programmed signal transmitter button (②, ③ or ④).

Step 11:

- ▶ Press, hold for 2 seconds and release same signal transmitter button a second time to complete the training process.



Some garage door openers (or other rolling code equipped devices) may require you to press, hold for 2 seconds and release the same signal transmitter button a third time to complete the training process.

Step 12:

- ▶ Confirm the garage door operation by pressing the programmed signal transmitter button (②, ③ or ④).

Step 13:

- ▶ To program the remaining two signal transmitter buttons, repeat the steps above starting with step 3.

Gate operator/Canadian programming

Canadian radio-frequency laws require transmitter signals to “time-out” (or quit) after several seconds of transmission which may not be long enough for the integrated signal transmitter to pick up the signal during programming. Similar to this Canadian law, some U.S. gate operators are designed to “time-out” in the same manner.

If you live in Canada or if you are having difficulties programming a gate operator (regardless of where you live) by using the programming procedures, replace step 4 with the following:

Step 4:

- ▶ Press and hold the signal transmitter button (②, ③ or ④). Do not release this button until it has been successfully trained.
- ▶ While still holding down the signal transmitter button (②, ③ or ④), “cycle” your hand-held remote control button ⑥ as follows: Press and hold button ⑥ for 2 seconds, then release it for 2 seconds, and again press and hold it for 2 seconds. Repeat this sequence on the hand-held remote control until the frequency signal has been learned. Upon successful training, the indicator lamp ① will flash slowly and then rapidly after several seconds.
- ▶ Proceed with programming step 5 and step 6 to complete.



Upon completion of programming the integrated remote control, make sure you retain the hand-held remote control that came with the garage door opener, gate operator or other device. You may need it for use in other vehicles, for future programming of an integrated remote control, or simply for continued use as a hand-held remote control to operate the respective device in other situations.

Useful features

Reprogramming a single signal transmitter button

To program a device using a signal transmitter button previously trained, follow these steps:

- ▶ Switch on the ignition (▷ page 34).
- ▶ Press and hold the desired signal transmitter button (②, ③ or ④). Do not release the button.
- ▶ The indicator lamp ① will begin to flash after 20 seconds. Without releasing the signal transmitter button, proceed with programming starting with step 3.

Operation of integrated remote control

- ▶ Switch on the ignition (▷ page 34).
- ▶ Select and press the appropriate integrated signal transmitter button (②, ③ or ④) to activate the remote controlled device.

The integrated remote control transmitter continues to send the signal as long as the button is pressed – up to 20 seconds.

Erasing the integrated remote control memory

- ▶ Switch on the ignition (▷ page 34).
- ▶ Simultaneously press and hold down the outer signal transmitter buttons ② and ④, for approximately 20 seconds, until the indicator lamp ① flashes rapidly. Do not hold for longer than 30 seconds.

The codes of all three channels are erased.



If you sell your vehicle, erase the codes of all three channels.

Programming tips

If you are having difficulty programming the integrated remote control, here are some helpful tips:

- Check the frequency of the hand-held remote control ⑤ (typically located on the reverse side of the remote). The integrated remote control is compatible with radio-frequency devices operating between 288-399 MHz.
- Put a new battery in the hand-held remote control ⑤. This will increase the likelihood of the hand-held remote control sending a faster and more accurate signal to the integrated remote control.
- While performing step 3, hold the hand-held remote control ⑥ at different lengths and angles from the signal transmitter button (②, ③ or ④) you are programming. Attempt varying angles at the distance of 2 to 5 inches (5 to 12 cm) away or the same angle at varying distances.
- If another hand-held remote control is available for the same device, try the programming steps again using that other hand-held remote control. Make sure new batteries are in the hand-held remote control before beginning the procedure.
- Straighten the antenna wire from the garage door opener assembly. This may help improve transmitting and/or receiving signals.



Certain types of garage door openers are incompatible with the integrated remote control. If you should experience further difficulties with programming the integrated remote control, contact an authorized Mercedes-Benz Center, or call Mercedes-Benz Customer Assistance Center (in the USA only) at 1-800-FOR-MERCEdes, or Customer Service (in Canada) at 1-800-387-0100.



USA only:

This device complies with Part 15 of the FCC Rules. Operation is subject to the following two conditions:

- (1) This device may not cause harmful interference, and
- (2) this device must accept any interference received, including interference that may cause undesired operation.

Any unauthorized modification to this device could void the user's authority to operate the equipment.

Useful features



Canada only:

This device complies with RSS-210 of Industry Canada. Operation is subject to the following two conditions:

- (1) This device may not cause interference, and
- (2) this device must accept any interference received, including interference that may cause undesired operation of the device.

Any unauthorized modification to this device could void the user's authority to operate the equipment.

Infrared reflecting windshield



- ① Mounting location for electronic toll collection devices (infrared transparent)
- ② Infrared transparent area (pass-through for electronic signals)
- ③ 31.5 in (80 cm)
- ④ 19.0 in (48 cm)
- ⑤ 1.75 in (4.5 cm)

Your vehicle is equipped with infrared reflecting glass which reduces the amount of radiated heat entering the interior through the windows.

The infrared reflecting glass also prevents the transmission of signals through the glass by in-vehicle electronic devices (e.g. electronic toll collection devices).

To allow the use of these devices in the vehicle, two infrared transparent areas (① and ②) are placed in the windshield.

The first 1000 miles (1500 km)

Driving instructions

At the gas station

Engine compartment

Tires and wheels

Winter driving

Maintenance

Vehicle care



The first 1000 miles (1500 km)

In the “Operation” section you will find detailed information on operating, maintaining and caring for your vehicle.

The more cautiously you treat your vehicle during the break-in period, the more satisfied you will be with its performance later on.

- Drive your vehicle during the first 1000 miles (1500 km) at varying but moderate vehicle and engine speeds.
- During this period, avoid heavy loads (full throttle driving) and excessive engine speeds (no more than $\frac{2}{3}$ of maximum rpm in each gear).
- Avoid accelerating by kick-down.
- Do not attempt to slow the vehicle down by shifting to a lower gear using the gear selector lever.
- Select positions **3**, **2** or **1** only when driving at moderate speeds (for hill driving).
- Select **C** as the preferred shift program (▷ page 171) for the first 1000 miles (1500 km).

After 1000 miles (1500 km), you may gradually increase vehicle and engine speeds to the permissible maximum.



Additional instructions for AMG vehicles:

- During the first 1000 miles (1500 km), do not exceed a speed of 85 mph (140 km/h).
- During this period, avoid engine speeds above 4500 rpm (CL 55 AMG) or 4000 rpm (CL 65 AMG) in each gear.

All of the above instructions, as may apply to your vehicle type, also apply when driving the first 1000 miles (1500 km) after the engine or the rear differential has been replaced.



Always obey applicable speed limits.

▼ Driving instructions

Drive sensibly – save fuel

Fuel consumption, to a great extent, depends on driving habits and operating conditions.

To save fuel you should:

- Keep tires at the recommended tire inflation pressures.
- Remove unnecessary loads.
- Remove roof rack when not in use.
- Allow engine to warm up under low load use.
- Avoid frequent acceleration and deceleration.
- Have all maintenance work performed at the intervals specified in the Maintenance Booklet and as required by the Maintenance System (U.S. vehicles) or FSS (Canada vehicles). Contact an authorized Mercedes-Benz Center.

Fuel consumption is also increased by driving in cold weather, in stop-and-go traffic, on short trips, and in hilly area.

Drinking and driving

Warning!



Drinking and driving and/or taking drugs and driving are very dangerous combinations. Even a small amount of alcohol or drugs can affect your reflexes, perceptions and judgment.

The possibility of a serious or even fatal accident are greatly increased when you drink or take drugs and drive.

Do not drink or take drugs and drive or allow anyone to drive who has been drinking or taking drugs.

Pedals

Warning!



Keep driver's foot area clear at all times. Objects stored in this area may impair pedal movement.

Power assistance

Warning!



With the engine not running, there is no power assistance for the brake and steering systems. In this case, it is important to keep in mind that a considerably higher degree of effort is necessary to brake and steer the vehicle.

Driving instructions

Brakes

Warning!



After driving in heavy rain for some time without applying the brakes or through water deep enough to wet brake components, the first braking action may be somewhat reduced and increased pedal pressure may be necessary to obtain expected braking effect. Maintain a safe distance from vehicles in front.

Resting your foot on the brake pedal will cause excessive and premature wear of the brake pads.

It can also result in the brakes overheating, thereby significantly reducing their effectiveness. It may not be possible to stop the vehicle in sufficient time to avoid an accident.

To help prevent brake disk corrosion after driving on wet road surfaces (particularly salted roads), it is advisable to brake the vehicle with considerable force prior to parking. The heat generated serves to dry the brakes.

If your brake system is normally only subjected to moderate loads, you should occasionally test the effectiveness of the brakes by applying above-normal braking pressure at higher speeds. This will also enhance the grip of the brake pads.

Warning!



Make sure not to endanger any other road users when carrying out these braking maneuvers.

Refer to the description of the Brake Assist System (BAS) (▷ page 81).

If the parking brake is released and the brake warning lamp in the instrument cluster stays on, the brake fluid level in the reservoir is too low.

Brake pad wear or a leak in the system may be the reason for low brake fluid in the reservoir.

Have the brake system inspected immediately. Contact an authorized Mercedes-Benz Center.

All checks and service work on the brake system should be carried out by qualified technicians only. Contact an authorized Mercedes-Benz Center.

Only install brake pads and brake fluid recommended by Mercedes-Benz.

Warning!

If other than recommended brake pads are installed, or other than recommended brake fluid is used, the braking properties of the vehicle can be degraded to an extent that safe braking is substantially impaired. This could result in an accident.



When driving down long and steep grades, relieve the load on the brakes by shifting into a lower gear to use the engine's braking power. This helps prevent overheating of the brakes and reduces brake pad wear.

After hard braking, it is advisable to drive on for some time, rather than immediately park, so that the air stream can cool down the brakes faster.

**High-performance brake system
(CL 65 AMG only)**

The high-performance brake system is designed to operate under the extremely high operating demands required to accommodate the performance capabilities of the vehicle. The brakes may produce a squeaking-type noise depending on the

- vehicle speed
- brake force applied
- ambient conditions, e.g. temperature and humidity

As with any brake system, the wear of individual brake system components such as brake pads or disks strongly depends on your driving style and the conditions under which you operate the vehicle. Thus, a driving style calling for high demand braking will cause your vehicle's brakes to wear more quickly.

Warning!

New vehicle brake pads and discs, and replacement brake pads and discs may take several hundred miles of driving until they provide optimum braking efficiency. Until that time, you may need to use increased brake pedal pressure while braking. Please be aware of this and adjust your driving and braking accordingly during this break-in period.

Excessive high demand braking will cause correspondingly high brake wear. Please be attentive to the brake warning lamp in the instrument cluster and brake condition messages in the multifunction display. Especially for high performance driving, it is important to maintain and have the brake system checked regularly.

Driving instructions

Driving off

Apply the brakes to test them briefly after driving off. Perform this procedure only when the road is clear of other traffic.

Warm up the engine smoothly. Do not place full load on the engine until the operating temperature has been reached.

When starting off on a slippery surface, do not allow a drive wheel to spin for an extended period with the ESP® switched off. Doing so may cause serious damage to the drivetrain which is not covered by the Mercedes-Benz Limited Warranty.



Simultaneously depressing the accelerator pedal and applying the brake reduces engine performance and causes premature brake and drivetrain wear.

Parking

Warning!



Do not park this vehicle in areas where combustible materials such as grass, hay or leaves can come into contact with the hot exhaust system, as these materials could be ignited and cause a vehicle fire.

To reduce the risk of personal injury as a result of inadvertent vehicle movement, before turning off the engine and leaving the vehicle always:

- Keep right foot on brake pedal.
- Firmly depress parking brake pedal.
- Move the gear selector lever to position **P**.
- Slowly release brake pedal.
- When parked on an incline, turn front wheel towards the road curb.

- Turn the SmartKey to starter switch position **0** and remove, or press KEYLESS-GO* start/stop button (> page 35).
- Take the SmartKey or the SmartKey with KEYLESS-GO* with you and lock vehicle when leaving.



Set the parking brake whenever parking or leaving the vehicle. In addition, move the gear selector lever to position **P**.

When parking on hills, always turn front wheels towards the road curb.

Tires

Warning!



If you feel a sudden significant vibration or ride disturbance, or you suspect that possible damage to your vehicle has occurred, you should turn on the hazard warning flashers, carefully slow down, and drive with caution to an area which is a safe distance from the road.

Inspect the tires and the vehicle underbody for possible damage. If the vehicle or tires appear unsafe, have the vehicle towed to the nearest Mercedes-Benz Center or tire dealer for repairs.

Treadwear indicators (TWI) are required by law. These indicators are located in six places on the tread circumference and become visible at a tread depth of approximately $\frac{1}{16}$ in (1.6 mm), at which point the tire is considered worn and should be replaced.

The treadwear indicator appears as a solid band across the tread.

Warning!



Although the applicable federal motor vehicle safety laws consider a tire to be worn when the treadwear indicators (TWI) become visible at approximately $\frac{1}{16}$ in (1.6 mm), we recommend that you do not allow your tires to wear down to that level. As tread depth approaches $\frac{1}{8}$ in (3 mm), the adhesion properties on a wet road are sharply reduced.

Depending upon the weather and/or road surface (conditions), the tire traction varies widely.

Specified tire inflation pressures must be maintained. This applies particularly if the tires are subject to extreme operating conditions (e.g. high speeds, heavy loads, high ambient temperatures).

Warning!



Do not drive with a flat tire. A flat tire affects the ability to steer or brake the vehicle. You may lose control of the vehicle. Continued driving with a flat tire or driving at high speed with a flat tire will cause excessive heat build-up and possibly a fire.

Hydroplaning

Depending on the depth of the water layer on the road, hydroplaning may occur, even at low speeds and with new tires. Reduce vehicle speed, avoid track grooves in the road and apply brakes cautiously in the rain.

Driving instructions

Tire traction

The safe speed on a wet, snow covered or icy road is always lower than on a dry road.

You should pay particular attention to the condition of the road whenever the outside temperatures are close to the freezing point.

Warning!



If ice has formed on the road, tire traction will be substantially reduced. Under such weather conditions, drive, steer and brake with extreme caution.

Mercedes-Benz recommends winter tires (▷ page 313) with a minimum tread depth of approximately $\frac{1}{6}$ in (4 mm) on all four wheels for the winter season to ensure normal balanced handling characteristics. On packed snow, they can reduce your stopping distance compared to summer tires. Stopping distance, however, is still considerably greater than when the road is not covered with snow or ice. Exercise appropriate caution.



Avoid spinning of a drive wheel. This may cause serious damage to the drivetrain which is not covered by the Mercedes-Benz Limited Warranty.

Tire speed rating

Regardless of the tire rating, local speed limits should be obeyed. Use prudent driving speeds appropriate to prevailing conditions.

Warning!



Even when permitted by law, never operate a vehicle at speeds greater than the maximum speed rating of the tires.

Exceeding the maximum speed for which tires are rated can lead to sudden tire failure, causing loss of vehicle control and possibly resulting in an accident and/or serious personal injury and possible death, for you and for others.

CL 500

Your vehicle is factory equipped with “H”-rated tires, which have a speed rating of 130 mph (210 km/h).

An electronic speed limiter prevents your vehicle from exceeding a speed of 130 mph (210 km/h).

CL 600

Your vehicle is factory equipped with “Y”-rated tires, which have a speed rating of 186 mph (300 km/h).

An electronic speed limiter prevents your vehicle from exceeding a speed of 130 mph (210 km/h).

CL 500 and CL 600 with Sport Package* (standard on U.S. vehicles) and Appearance Package*

Your vehicle is factory equipped with “Y”-rated tires, which have a speed rating of 186 mph (300 km/h).

An electronic speed limiter prevents your vehicle from exceeding a speed of 130 mph (210 km/h).

CL 55 AMG and CL 65 AMG

Your vehicle is factory equipped with min. “Y”-rated tires, which have a speed rating of 186 mph (300 km/h).

An electronic speed limiter prevents your vehicle from exceeding a speed of 155 mph (250 km/h).



For information on speed rating for winter tires, see “Winter driving” (▷ page 313).

For additional general information on tire speed markings on tire sidewall, see “Tire speed rating” (▷ page 311).

Winter driving instructions

The most important rule for slippery or icy roads is to drive sensibly and to avoid abrupt acceleration, braking and steering maneuvers. Do not use the cruise control system under such conditions.

When the vehicle is in danger of skidding, move the gear selector lever to position **N**. Try to keep the vehicle under control by corrective steering action.



For information on driving with snow chains, see “Snow chains” (▷ page 314).

Warning!

On slippery road surfaces, never downshift in order to obtain braking action. This could result in drive wheel slip and reduced vehicle control. Your vehicle’s ABS will not prevent this type of control loss.

Driving instructions

Road salts and chemicals can adversely affect braking efficiency. Increased pedal force may become necessary to produce the normal braking effect.

Depressing the brake pedal periodically when traveling at length on salt-strewn roads can bring road-salt impaired braking efficiency back to normal.

If the vehicle is parked after being driven on salt-treated roads, the braking efficiency should be tested as soon as possible after driving is resumed.

Warning!



Make sure not to encoder any other road users when carrying out these braking maneuvers.

Warning!



If the vehicle becomes stuck in snow, make sure that snow is kept clear of the exhaust pipe and from around the vehicle with the engine running. Otherwise, deadly carbon monoxide (CO) gases may enter vehicle interior resulting in unconsciousness and death.

To assure sufficient fresh air ventilation, open a window slightly on the side of the vehicle not facing the wind.

Warning!



The outside temperature indicator is not designed to serve as an ice-warning device and is therefore unsuitable for that purpose. Indicated temperatures just above the freezing point do not guarantee that the road surface is free of ice.

For more information on winter driving, see “Winter driving” (▷ page 313).

Standing water



Do not drive through flooded areas or water of unknown depth. Before driving through water, determine its depth. Never accelerate before driving into water. The bow wave could force water into the engine and auxiliary equipment, thus damaging them.

If you must drive through standing water, drive slowly to prevent water from entering the passenger compartment or the engine compartment. Water in these areas could cause damage to electrical components or wiring of the engine or transmission, or could result in water being ingested by the engine through the air intake causing severe internal engine damage. Any such damage is not covered by the Mercedes-Benz Limited Warranty.

Passenger compartment

Warning!



Always fasten items being carried as securely as possible.

In an accident, during hard braking or sudden maneuvers, loose items will be thrown around inside the vehicle, and cause injury to vehicle occupants unless the items are securely fastened in the vehicle.

The trunk is the preferred place to carry objects.

Driving abroad

Abroad, there is an extensive Mercedes-Benz service network at your disposal. If you plan to drive into areas which are not listed in the index of your Mercedes-Benz Center directory, you should request pertinent information from an authorized Mercedes-Benz Center.

Control and operation of radio transmitters

COMAND, radio and telephone*

Warning!



Please do not forget that your primary responsibility is to drive the vehicle safely. Only operate the COMAND (Cockpit Management and Data System), radio or telephone¹ if road, weather and traffic conditions permit.

Bear in mind that at a speed of just 30 mph (approximately 50 km/h), your vehicle is covering a distance of 44 feet (approximately 14 m) every second.

¹ Observe all legal requirements.

Telephones and two-way radios

Warning!



Never operate radio transmitters equipped with a built-in or attached antenna (i.e. without being connected to an external antenna) from inside the vehicle while the engine is running. Doing so could lead to a malfunction of the vehicle's electronic system, possibly resulting in an accident and/or personal injury.

Radio transmitters, such as a portable telephone or a citizens band unit should only be used inside the vehicle if they are connected to an antenna that is installed on the outside of the vehicle.

Refer to the radio transmitter operation instructions regarding use of an external antenna.

Driving instructions

Catalytic converter

Your Mercedes-Benz is equipped with monolithic-type catalytic converters, an important element in conjunction with the oxygen sensors to achieve substantial control of the pollutants in the exhaust emissions. Keep your vehicle in proper operating condition by following our recommended maintenance instructions as outlined in your Maintenance Booklet.



To prevent damage to the catalytic converters, use only premium unleaded gasoline in this vehicle.

Any noticeable irregularities in engine operation should be dealt with promptly. Otherwise, excessive unburned fuel may reach the catalytic converter, causing it to overheat and potentially start a fire.

Warning!



As with any vehicle, do not idle, park or operate this vehicle in areas where combustible materials such as grass, hay or leaves can come into contact with the hot exhaust system, as these materials could be ignited and cause a vehicle fire.

Emission control

Certain systems of the engine serve to keep the toxic components of the exhaust gases within permissible limits required by law.

These systems, of course, will function properly only when maintained strictly according to factory specifications. Any adjustments to the engine should therefore be carried out only by qualified Mercedes-Benz Center authorized technicians.

Engine adjustments should not be altered in any way. Moreover, the specified service jobs must be carried out regularly according to Mercedes-Benz servicing requirements. For details refer to the Maintenance Booklet.

Warning!

Inhalation of exhaust gas is hazardous to your health. All exhaust gas contains carbon monoxide, and inhaling it can cause unconsciousness and possible death.

Do not run the engine in confined areas (such as a garage) which are not properly ventilated. If you think that exhaust gas fumes are entering the vehicle while driving, have the cause determined and corrected immediately. If you must drive under these conditions, drive with at least one window fully open at all times.

Coolant temperature

During severe operating conditions, e.g. stop-and-go traffic, the coolant temperature may rise close to approx. 248°F (120°C).

The engine should not be operated with the coolant temperature over 248°F (120°C). Doing so may cause serious engine damage which is not covered by the Mercedes-Benz Limited Warranty.

Warning!

- Driving when your engine is badly overheated can cause some fluids, which may have leaked into the engine compartment, to catch fire. You could be seriously burned.
- Steam from an overheated engine can cause serious burns and can occur just by opening the hood. Stay away from the engine if you see or hear steam coming from it.

Turn off the engine, get out of the vehicle and do not stand near the vehicle until the engine has cooled down.

At the gas station

Refueling

Warning!



Gasoline is highly flammable and poisonous. It burns violently and can cause serious injury. Whenever you are around gasoline, avoid inhaling fumes and skin contact, extinguish all smoking materials. Never allow sparks, flame or smoking materials near gasoline!

The fuel filler flap is located on the right-hand side of the vehicle towards the rear. Locking/unlocking the vehicle with the SmartKey or the SmartKey with KEYLESS-GO* automatically locks/unlocks the fuel filler flap.



- ▶ Turn the engine off
 - by turning the SmartKey to position **0**. Remove the SmartKey from the starter switch.
 - by pressing the KEYLESS-GO* start/stop button (▷ page 35). Open the driver's door (with the driver's door open, starter switch is

now in position **0**, same as SmartKey removed from starter switch).

- ▶ Open the fuel filler flap by pushing at the point indicated by the arrow.
The fuel filler flap springs open.
- ▶ Turn the fuel cap to the left and hold on to it until possible pressure is released.
- ▶ Take off the cap and set it in the recess on the fuel filler flap.
To prevent fuel vapors from escaping into open air, fully insert filler nozzle unit.
- ▶ Only fill your tank until the filler nozzle unit cuts out – **do not top up or over-fill**.

Warning!



Overfilling of the fuel tank may create pressure in the system which could cause a gas discharge. This could cause the gas to spray back out when removing the fuel pump nozzle, which could cause personal injury.

- ▶ Replace fuel cap by turning it clockwise until it audibly engages.
- ▶ Close the fuel filler flap.





Only use premium unleaded gasoline with a minimum Posted Octane Rating of 91 (average of 96 RON/86 MON).

Information on gasoline quality can normally be found on the fuel pump.

More information on gasoline can be found in the Factory Approved Service Products pamphlet.



Leaving the engine running and the fuel cap open can cause the yellow engine malfunction indicator lamp

 (USA only),  (Canada only) to illuminate.

For more information, see “Practical hints” (▷ page 331).

Check regularly and before a long trip

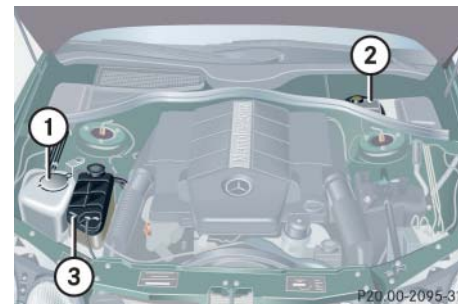

- ① Windshield washer and headlamp cleaning system
- ② Brake fluid
- ③ Coolant level



Opening the hood, see (▷ page 273).

At the gas station

Windshield washer system and headlamp cleaning system

For more information on refilling the washer reservoir, see “Windshield washer system and headlamp cleaning system” (▷ page 282).

Coolant

For more information, see “Coolant level” (▷ page 280) and “Coolants” (▷ page 422).

Brake fluid



If you find that the brake fluid in the brake fluid reservoir has fallen to the minimum mark or below, have the brake system checked for brake pad thickness and leaks immediately. Notify an authorized Mercedes-Benz Center immediately. Do not add brake fluid as this will not solve the problem. For more information, see “Practical hints” (▷ page 329).

For more information on brake fluid, see “Brake fluid” (▷ page 420).

Engine oil level

For more information on engine oil, see “Engine oil” (▷ page 274).

Vehicle lighting

Check function and cleanliness. For more information on replacing light bulbs, see “Replacing bulbs” (▷ page 378).

For more information, see “Exterior lamp switch” (▷ page 125).

Tire inflation pressure

For information on tire inflation pressure, see “Checking tire inflation pressure” (▷ page 294).

▼ Engine compartment

Hood

Warning!



Do not pull the release lever while the vehicle is in motion. Otherwise the hood could be forced open by passing air flow.

Opening

The hood lock release lever is located in the driver's footwell to the left of the parking brake pedal.

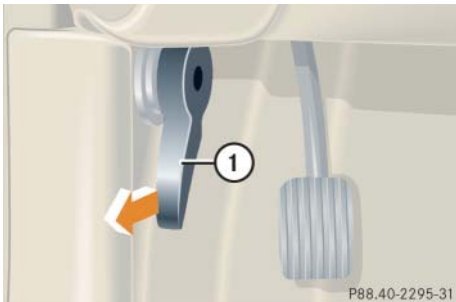

① Release lever

- ▶ Pull release lever ① in the direction of arrow.

The hood is unlocked and handle ② will extend out of the radiator grille.



To avoid damage to the windshield wipers or hood, never open the hood if the wiper arms are folded forward away from the windshield.



② Handle for opening the hood

- ▶ Pull handle ② to its stop out of radiator grille.
- ▶ Pull up on the hood (do not pull up on the handle) and then release it.

The hood will be automatically held open at shoulder height.

Warning!



To help prevent personal injury, stay clear of moving parts when the hood is open and the engine is running. Make sure the hood is properly closed before driving. When closing the hood, use extreme caution not to catch hands or fingers.

The radiator fan may continue to run for approximately 30 seconds or even restart after the engine has been turned off. Stay clear of fan blades.



Engine compartment



Warning!



If you see flames or smoke coming from the engine compartment, or if the coolant temperature gauge indicates that the engine is overheated, do not open the hood. Move away from vehicle and do not open the hood until the engine has cooled down. If necessary, call the fire department.

Warning!



The engine is equipped with a transistorized ignition system. Because of the high voltage it is dangerous to touch any components (ignition coils, spark plug sockets, diagnostic socket) of the ignition system

- with the engine running
- while starting the engine
- if ignition is “on” and the engine is turned manually

Closing

Warning!



Be careful that you do not close the hood on anyone.

- ▶ Let the hood drop from a height of approximately 1 ft (30 cm).

The hood will lock audibly.

- ▶ Check to make sure the hood is fully closed.

If you can raise the hood at a point above the headlamps, then it is not properly closed. Open it again and let it drop with somewhat greater force.

Engine oil

The amount of oil your engine needs will depend on a number of factors, including driving style. Higher oil consumption can occur when

- the vehicle is new
- the vehicle is driven frequently at higher engine speeds

Engine oil consumption checks should only be made after the vehicle break-in period.



Do not use any special lubricant additives, as these may damage the drive assemblies. Using special additives not approved by Mercedes-Benz may cause damage not covered by the Mercedes-Benz Limited Warranty.

More information on this subject is available at any Mercedes-Benz Center.

Checking the engine oil level with the control system



When checking the oil level

- the vehicle must be parked on level ground
- with the engine at operating temperature, the vehicle must have been stationary for at least 5 minutes with the engine turned off
- with the engine not at operating temperature yet, the vehicle must have been stationary for at least 30 minutes with the engine turned off

To check the engine oil level via the multifunction display, do the following:

- ▶ Switch on the ignition (▷ page 34).

The standard display (▷ page 142) should appear in the multifunction display.

- ▶ Press button  or  on the multifunction steering wheel until the following message is seen in the multifunction display:

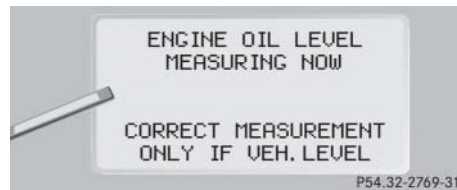



One of the following messages will subsequently appear in the multifunction display:

- ENGINE OIL LEVEL OK
- ADD 1.0 QT. TO REACH MAX. OIL LEVEL
(Canada: 1.0 LITER)
- ADD 1.5 QTS. TO REACH MAX. OIL LEVEL
(Canada: 1.5 LITERS)

- ADD 2.0 QTS. TO REACH MAX. OIL LEVEL
(Canada: 2.0 LITERS)



If you want to interrupt the checking procedure, press the  or  button on the multifunction steering wheel.

- ▶ If necessary, add engine oil.

For adding engine oil (▷ page 278).

For more information on engine oil, see the “Technical data” section (▷ page 418) and (▷ page 420).

Engine compartment

Other display messages

If the SmartKey or KEYLESS-GO* start/stop button (▷ page 35) is not in position **2**, the following message will appear:

FOR ENGINE OIL LEVEL
SWITCH IGNITION ON

- ▶ Switch on the ignition (▷ page 34).

If you see the message:

PERF. SERV. ON TIME

- ▶ If engine is at operating temperature, wait 5 minutes before repeating check procedure.
- ▶ If engine is not at operating temperature yet, wait 30 minutes before repeating check procedure.

If you see the message:

ENGINE OIL LEVEL
NOT WHEN ENGINE ON

- ▶ Turn off the engine.
- ▶ If the engine is at operating temperature, wait 5 minutes before checking oil.
- ▶ If the engine is not at operating temperature yet, you must wait 30 minutes before checking oil.

If there is excess engine oil with the engine at normal operating temperature, the following message will appear:

ENGINE OIL LEVEL
REDUCE OIL LEVEL

- ▶ Have excess oil siphoned or drained off. Contact an authorized Mercedes-Benz Center.



Excess oil must be siphoned or drained off. It could cause damage to the engine and catalytic converter not covered by the Mercedes-Benz Limited Warranty.



Perform the engine oil level check with the dipstick (CL 500 and CL 55 AMG only) if it cannot be completed with the control system.

In this case we recommend that you have the system checked at a Mercedes-Benz Center.

For more information on messages in the multifunction display concerning engine oil, see the “Practical hints” section (▷ page 351).

Checking the engine oil level with the oil dipstick (CL 500, CL 55 AMG only)

When checking the oil level

- the vehicle must be parked on level ground
- with the engine at operating temperature, the vehicle must have been stationary for at least 5 minutes with the engine turned off
- with the engine not at operating temperature yet, the vehicle must have been stationary for at least 30 minutes with the engine turned off



The engine oil level can be checked by either the oil dipstick or via the multifunction display in the instrument cluster (▷ page 275). The amount of engine oil needed is shown more precisely in the multifunction display.

To check the engine oil level with the oil dipstick, do the following:

- ▶ Open the hood (▷ page 273).
- ▶ Pull out oil dipstick ① (▷ page 278).
- ▶ Wipe oil dipstick ① clean.
- ▶ Fully insert oil dipstick ① into the dipstick guide tube.
- ▶ Pull out oil dipstick ① again after approximately 3 seconds to obtain accurate reading.

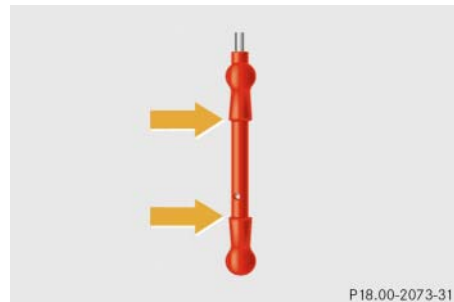

P18.00-2073-31

Oil dipstick

The oil level is correct when it is between the lower (min) and upper (max) mark of the oil dipstick.



The filling quantity between upper and lower oil dipstick marking level is approximately 2.1 US qt (2.0 l).

- ▶ If necessary, add engine oil.

For adding engine oil see (▷ page 278).

For more information on engine oil, see the “Technical data” section (▷ page 418) and (▷ page 420).

For more information on messages in the multifunction display concerning engine oil, see the “Practical hints” section (▷ page 351)

Engine compartment

Adding engine oil



Only use approved engine oils and oil filters required for vehicles with Maintenance System (U.S. vehicles) or FSS (Canada vehicles). For a listing of approved engine oils and oil filters, refer to the Factory Approved Service Products pamphlet in your vehicle literature portfolio, or contact an authorized Mercedes-Benz Center.

Using engine oils and oil filters of specification other than those expressly required for the Maintenance System (U.S. vehicles) or FSS (Canada vehicles), or changing of oil and oil filter at change intervals longer than those called for by the Maintenance System (U.S. vehicles) or FSS (Canada vehicles) will result in engine damage not covered by the Mercedes-Benz Limited Warranty.

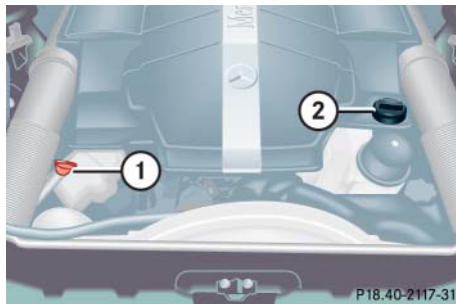

CL 500, CL 55 AMG

- ① Oil dipstick
- ② Filler cap

- ▶ Unscrew filler cap ② from filler neck.
- ▶ Add engine oil as required. Be careful not to overfill with oil.

Be careful not to spill any oil when adding. Avoid environmental damage caused by oil entering the ground or water.



Excess oil must be siphoned or drained off. It could cause damage to the engine and catalytic converter not covered by the Mercedes-Benz Limited Warranty.

- ▶ Screw filler cap ② back on filler neck.

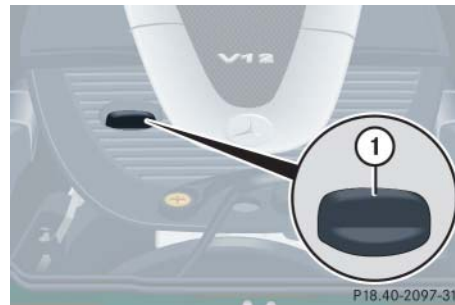

CL 600

- ① Filler cap



CL 65 AMG

① Filler cap

- ▶ Unscrew filler cap ① from filler neck.
- ▶ Add engine oil as required. Be careful not to overfill with oil.

Be careful not to spill any oil when adding. Avoid environmental damage caused by oil entering the ground or water.



Excess oil must be siphoned or drained off. It could cause damage to the engine and catalytic converter not covered by the Mercedes-Benz Limited Warranty.

- ▶ Screw filler cap ① back on filler neck.

For more information on engine oil, see the “Technical data” section (▷ page 418) and (▷ page 420).

Transmission fluid level

The transmission fluid level does not need to be checked. If you notice transmission fluid loss or gear shifting malfunctions, have an authorized Mercedes-Benz Center check the automatic transmission.

Active Body Control (ABC) fluid level

Regular fluid level check is not required. If you notice fluid leaks or malfunction messages in the multifunction display, have an authorized Mercedes-Benz Center check the ABC system.

Engine compartment

Coolant level

The engine coolant is a mixture of water and anticorrosion/antifreeze.

When checking the coolant level,

- the vehicle must be parked on level ground, and
- the engine must be cool.

Warning!



In order to avoid any possibly serious burns:

- Use extreme caution when opening the hood if there are any signs of steam or coolant leaking from the cooling system, or if the coolant temperature gauge indicates that the coolant is overheated.
- Do not remove pressure cap on coolant reservoir if coolant temperature is above 158°F (70°C). Allow engine to cool down before removing cap. The coolant reservoir contains hot fluid and is under pressure.

- Using a rag, slowly open the cap approximately $\frac{1}{2}$ turn to relieve excess pressure. If opened immediately, scalding hot fluid and steam will be blown out under pressure.
- Do not spill antifreeze on hot engine parts. Antifreeze contains ethylene glycol which may burn if it comes into contact with hot engine parts.

The coolant expansion tank is located on the passenger side of the engine compartment.

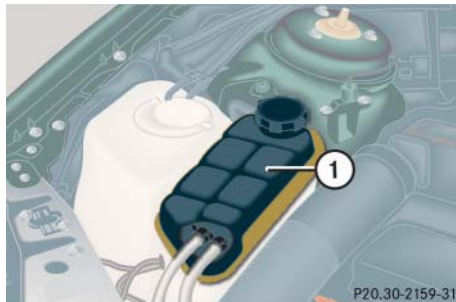

① Coolant expansion tank

- ▶ Using a rag, turn the cap slowly approximately one half turn to the left to release any excess pressure.
- ▶ Continue turning the cap to the left and remove it.



CL 600 and CL 65 AMG:

Only open the cap on coolant expansion tank ①. Never open the cap between the charge-air coolers.

Otherwise, the engine could be damaged.

The coolant level is correct if the level

- for cold coolant: reaches the white marking (plastic bridge) inside the coolant expansion tank.
- for warm coolant: is approximately 0.6 in (1.5 cm) higher
- ▶ Add coolant as required.
- ▶ Replace and tighten cap.

For more information on coolant, see “Coolants” (▷ page 422).

Battery

Your vehicle's battery is located in the trunk under the right hand wheel well cover panel (▷ page 391).

The battery should always be sufficiently charged in order to achieve its rated service life. Refer to Maintenance Booklet for battery maintenance intervals.

If you use your vehicle mostly for short-distance trips, you will need to have the battery charge checked more frequently.

When replacing the battery, always use batteries approved by Mercedes-Benz.

If you do not intend to operate your vehicle for an extended period of time, consult an authorized Mercedes-Benz Center about steps you need to observe.

	Observe all safety instructions and precautions when handling automotive batteries.
	Risk of explosion.
	Keep flames or sparks away from battery. Do not smoke.
	Battery acid is caustic. Do not allow it to come into contact with skin, eyes or clothing. In case it does, immediately flush affected area with clean water and seek medical help if necessary.

	Wear eye protection.
	Keep children away.
	Follow the instructions in this Operator's Manual.

Batteries contain materials that can harm the environment if disposed of improperly. Recycling of batteries is the preferred method of disposal. Many states require sellers of batteries to accept old batteries for recycling.

Engine compartment

Windshield washer system and headlamp cleaning system

The windshield washer reservoir is located in the engine compartment.

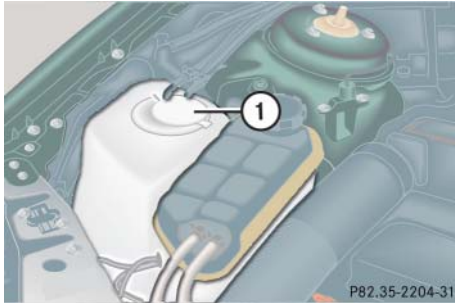

① Washer fluid reservoir

Fluid for the windshield washer system and the headlamp cleaning system is supplied from the windshield washer reservoir. It has a capacity of approx. 7.1 US qt. (6.7 l).

During all seasons, add MB Windshield Washer Concentrate “S” to water. Premix the windshield washer fluid in a suitable container.

Warning!



Washer solvent/antifreeze is highly flammable. Do not spill washer solvent/antifreeze on hot engine parts, because it may ignite and burn. You could be seriously burned.

- ▶ Refill the reservoir with MB Windshield Washer Concentrate and water (or commercially available premixed windshield washer solvent/antifreeze, depending on ambient temperatures).

Always use washer solvent/antifreeze where temperatures may fall below freezing point. Failure to do so could result in damage to the washer system/reservoir.



Only use washer fluid which is suitable for plastic lenses. Improper washer fluid can damage the plastic lenses of the headlamps.

For more information, see “Windshield washer system and headlamp cleaning system” (▷ page 425).

▼ Tires and wheels

See an authorized Mercedes-Benz Center for information on tested and recommended rims and tires for summer and winter operation. They can also offer advice concerning tire service and purchase.

Warning!



Replace rims or tires with the same designation, manufacturer and type as shown on the original part. See an authorized Mercedes-Benz Center for further information. If incorrectly sized rims and tires are mounted:

- The wheel brakes or suspension components can be damaged.
- The operating clearance of the wheels and the tires may no longer be correct.

Warning!



Worn, old tires can cause accidents. If the tire tread is badly worn, or if the tires have sustained damage, replace them.

When replacing rims, only use Genuine Mercedes-Benz wheel bolts specified for the particular rim type. Failure to do so can result in the bolts loosening and possibly an accident.

Retreaded tires are not tested or recommended by Mercedes-Benz, since previous damage cannot always be recognized on retreads. The operating safety of the vehicle cannot be assured when such tires are used.

Important guidelines

- Only use sets of tires and rims of the same type and make.
- Tires must be of the correct size for the rim.
- Break in new tires for approximately 60 miles (100 km) at moderate speeds.
- Regularly check the tires and rims for damage. Dented or bent rims can cause tire inflation pressure loss and damage to the tire beads.
- If vehicle is heavily loaded, check tire inflation pressure and correct as required.
- Do not allow your tires to wear down too far. Adhesion properties on wet roads are sharply reduced at tread depths under $\frac{1}{8}$ in (3 mm).
- When replacing individual tires, you should mount new tires on the front wheels first (on vehicles with same-sized wheels all around).

Tires and wheels

Tire care and maintenance

Warning!



Regularly check the tires for damage. Damaged tires can cause tire inflation pressure loss. As a result, you could lose control of your vehicle.

Worn, old tires can cause accidents. If the tire tread is badly worn, or if the tires have sustained damage, replace them.

Regularly check your tire inflation pressure at least once a month. For more information on checking tire inflation pressure, see “Recommended tire inflation pressure” (▷ page 292).

Tire inspection

Every time you check your tire inflation pressure, you should also inspect your tires for the following:

- excessive treadwear (▷ page 285)
- cord or fabric showing through the tire’s rubber
- bumps, bulges, cuts, cracks or splits in the tread or side of the tire

Replace the tire if you find any of the above conditions.

Make sure you also inspect the spare tire periodically for condition and inflation. Spare tires will age and become worn over time even if never used, and thus should be inspected and replaced when necessary.

Life of tire

The service life of a tire is dependent upon varying factors including but not limited to:

- Driving style
- Tire inflation pressure
- Distance driven

Warning!



Tires and spare tire should be replaced after 6 years, regardless of the remaining tread.

Tread depth

Do not allow your tires to wear down too far. Adhesion properties on wet roads are sharply reduced at tread depths under $\frac{1}{8}$ in (3 mm).

Treadwear indicators (TWI) are required by law. These indicators are located in six places on the tread circumference and become visible at a tread depth of approximately $\frac{1}{16}$ in (1.6 mm), at which point the tire is considered worn and should be replaced.

Recommended minimum tire tread depth:

- Summer tires $\frac{1}{8}$ in (3 mm)
- Winter tires $\frac{1}{6}$ in (4 mm)

Warning!



Although the applicable federal motor safety laws consider a tire to be worn when the tread wear indicators (TWI) become visible at approximately $\frac{1}{16}$ in (1.6 mm), we recommend that you do not allow your tires

to wear down to that level. As tread depth approaches $\frac{1}{8}$ in (3 mm), the adhesion properties on a wet road are sharply reduced.

Depending upon the weather and/or road surface (conditions), the tire traction varies widely.

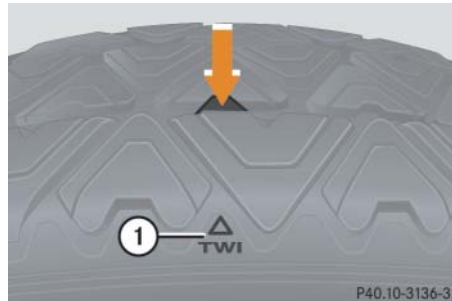

① TWI (TreadWear Indicator)

The treadwear indicator appears as a solid band across the tread.

Storing tires



Keep unmounted tires in a cool, dry place with as little exposure to light as possible. Protect tires from contact with oil, grease and gasoline.

Cleaning tires



Never use a round nozzle to power wash tires. The intense jet of water can result in damage to the tire.

Always replace a damaged tire.

Tires and wheels

Direction of rotation

Unidirectional tires offer added advantages, such as better hydroplaning performance. To benefit, however, you must make sure the tires rotate in the direction specified.

An arrow on the sidewall indicates the intended direction of rotation (spinning) of the tire.



Spare wheels may be mounted against the direction of rotation (spinning) even with a unidirectional tire for temporary use only until the regular drive wheel has been repaired or replaced. Always observe and follow applicable temporary use restrictions and speed limitations indicated on the spare wheel.

Loading the vehicle

Two labels on your vehicle show how much weight it may properly carry.

- The Tire and Loading Information placard (Example A) or the Vehicle Tire Information placard (Example B) can be found on the driver's door B-pillar. This placard tells you important information about the number of people that can be in the vehicle and the total weight that can be carried in the vehicle. It also contains information on the proper size and recommended tire inflation pressures for the original equipment tires on your vehicle.
- The Certification label, also found on the driver's door B-pillar tells you about the gross weight capacity of your vehicle, called the Gross Vehicle Weight Rating (GVWR). The GVWR includes the weight of the vehicle, all occupants, fuel and cargo. The Certification label also tells you about the front and rear axle weight capacity, called the Gross

Axle Weight Rating (GAWR). The GAWR is the total allowable weight that can be carried by a single axle (front or rear). Never exceed the GVWR or GAWR for either the front axle or rear axle.

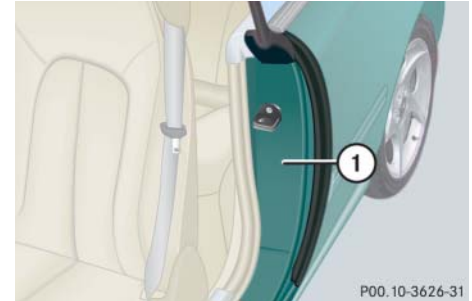

① Driver's door B-pillar

Following is a discussion on how to work with the information contained on the two placards with regards to loading your vehicle.

Tire and Loading Information

Warning!

Do not overload the tires by exceeding the specified load limit or vehicle capacity weight as indicated on the placard on the driver's door B-pillar. Overloading the tires can overheat them, possibly causing a blowout. Overloading the tires can also result in handling or steering problems, or brake failure.

Your vehicle is equipped with either the Tire and Loading Information placard (Example A) or the Vehicle Tire Information placard (Example B).

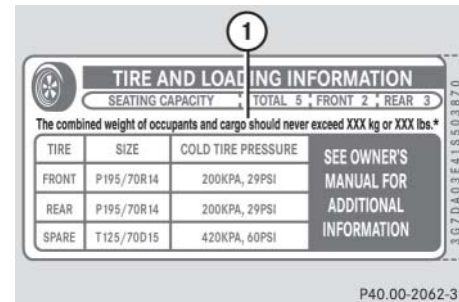

Data shown on placard examples are for illustration purposes only. Load limit data are specific to each vehicle and may vary from data shown in the illustrations below. Refer to placard on vehicle for actual data specific to your vehicle.

Placard (Example A)

- ① Load limit information on the Tire and Loading Information placard

The placard showing the load limit information is located on the driver's door B-pillar. If your vehicle is equipped with the Tire and Loading Information placard (Example A), locate the statement "The combined weight of occupants and cargo should never exceed XXX kilograms or XXX lbs." on this placard. The combined weight of all occupants, cargo / luggage and trailer tongue load (if applicable) should never exceed the weight referenced in that statement.

Tires and wheels

Placard (Example B)

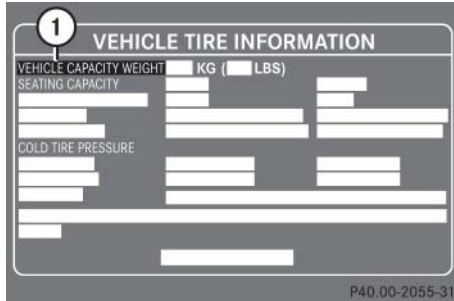

- ① Load limit information on the Vehicle Tire Information placard

The placard showing the load limit information is located on the driver's door B-pillar. If your vehicle is equipped with the Vehicle Tire Information placard (Example B), locate the heading "Vehicle Capacity Weight" on this placard. The combined weight of all occupants, cargo/luggage and trailer tongue (if applicable) should never exceed the weight listed next to vehicle capacity weight.

Seating capacity

The seating capacity gives you important information on the number of occupants that can be in the vehicle. Observe front and rear seating capacity. Your vehicle is equipped with either placard Example A or placard Example B located on the driver's door B-pillar (▷ page 286).



Data shown on placard examples are for illustration purposes only. Seating data are specific to each vehicle and may vary from data shown in the illustrations below. Refer to placard on vehicle for actual data specific to your vehicle.

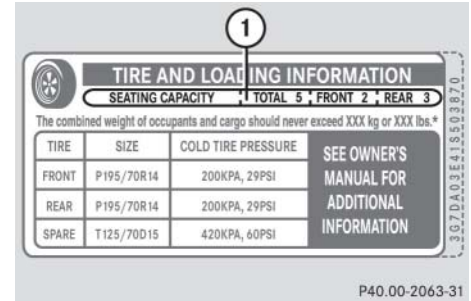

Placard (Example A)

- ① Seating capacity

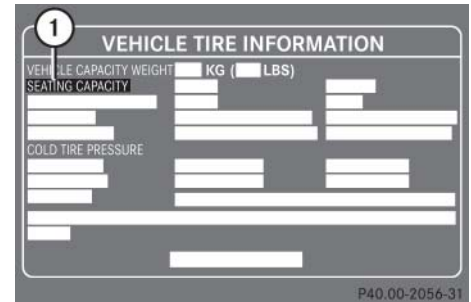

Placard (Example B)

- ① Seating capacity

Steps for determining correct load limit

The following steps have been developed as required of all manufacturers under Title 49, Code of U.S. Federal Regulations, Part 575 pursuant to the “National Traffic and Motor Vehicle Safety Act of 1966”.

Step 1 (Vehicles equipped with placard Example A)

- ▶ Locate the statement “The combined weight of occupants and cargo should never exceed XXX kg or XXX lbs.” on your vehicle’s placard.

Step 1 (Vehicles equipped with placard Example B)

- ▶ Locate the heading “Vehicle Capacity Weight” on your vehicle’s placard.

Step 2

- ▶ Determine the combined weight of the driver and passengers that will be riding in your vehicle.

Step 3

- ▶ Subtract the combined weight of the driver and passengers from XXX kilograms or XXX lbs.

Step 4

- ▶ The resulting figure equals the available amount of cargo and luggage load capacity. For example, if the “XXX” amount equals 1400 lbs. and there will be five 150 lbs. passengers in your vehicle, the amount of available cargo and luggage load capacity is 650 lbs. (1400 - 750 (5 x 150) = 650 lbs.)

Step 5

- ▶ Determine the combined weight of luggage and cargo being loaded on the vehicle. That weight may not safely exceed the available cargo and luggage load capacity calculated in step 4.

Step 6 (if applicable)

- ▶ If your vehicle will be towing a trailer, load from your trailer will be transferred to your vehicle. Consult this manual to determine how this reduces the available cargo and luggage load capacity of your vehicle (▷ page 291).

The following table shows examples on how to calculate total and cargo load capacities with varying seating configurations and number and size of occupants. The following examples use a load limit of 1500 lbs. **This is for illustration purposes only.** Make sure you are using the actual load limit for your vehicle stated on the vehicle’s placard (▷ page 287).

Tires and wheels

Example	Combined weight limit of occupants and cargo from placard	Number of occupants (driver and passengers)	Seating configuration	Occupants weight	Combined weight of all occupants	Available cargo/luggage and trailer tongue weight (total load limit or vehicle capacity weight from placard minus combined weight of all occupants)
1	1500 lbs	4	front: 2 rear: 2	Occupant 1: 150 lbs Occupant 2: 180 lbs Occupant 3: 160 lbs Occupant 4: 140 lbs	630 lbs	1500 lbs - 630 lbs = 870 lbs
2	1500 lbs	3	front: 1 rear: 2	Occupant 1: 200 lbs Occupant 2: 190 lbs Occupant 3: 150 lbs	540 lbs	1500 lbs - 540 lbs = 960 lbs
3	1500 lbs	1	front: 1	Occupant 1: 150 lbs	150 lbs	1500 lbs - 150 lbs = 1350 lbs

The higher the weight of all occupants, the less cargo and luggage load capacity is available.

For more information, see “Trailer tongue load” (> page 291).

Certification label

Even after careful determination of the combined weight of all occupants, cargo and the trailer tongue load (if applicable) (▷ page 291) as to not exceed the permissible load limit, you must make sure that your vehicle never exceeds the Gross Vehicle Weight Rating (GVWR) and the Gross Axle Weight Rating (GAWR) for either the front or rear axle. You can obtain the GVWR and GAWR from the Certification label. The Certification Label can be found on the driver's door B-pillar, see "Technical data" (▷ page 406).

Gross Vehicle Weight Rating (GVWR): The total weight of the vehicle, all occupants, all cargo, and the trailer tongue load (▷ page 291) must never exceed the GVWR.

Gross Axle Weight Rating (GAWR): The total allowable weight that can be carried by a single axle (front or rear).

To assure that your vehicle does not exceed the maximum permissible weight limits (GVWR and GAWR for front and rear axle), have the loaded vehicle (including driver, passengers and all cargo and, if applicable, trailer fully loaded) weighed on a suitable commercial scale.

Trailer tongue load

The tongue load of any trailer is an important weight to measure because it affects the load you can carry in your vehicle. If a trailer is towed, the tongue load must be added to the weight of all occupants riding and any cargo you are carrying in the vehicle. The tongue load typically is 10 percent of the trailer weight and everything loaded in it.

Your Mercedes-Benz has been designed primarily to carry passengers and their cargo. Mercedes-Benz does not recommend trailer towing with your vehicle.

Tires and wheels

Recommended tire inflation pressure

Warning!



Follow recommended tire inflation pressures.

Do not underinflate tires. Underinflated tires wear excessively and /or unevenly, adversely affect handling and fuel economy, and are more likely to fail from being overheated.

Do not overinflate tires. Overinflated tires can adversely affect handling and ride comfort, wear unevenly, increase stopping distance, and result in sudden deflation (blowout) because they are more likely to become punctured or damaged by road debris, potholes etc.

Your vehicle is equipped with either the Tire and Loading Information placard (Example A) or the Vehicle Tire Information placard (Example B) located on the driver's door B-pillar (▷ page 286).

The tire inflation pressure should be checked regularly and should only be adjusted on cold tires. The tires can be considered cold if the vehicle has been parked for at least 3 hours or driven less than 1 mile (1.6 km).

Follow recommended cold tire inflation pressures listed on placard.

Keeping the tires properly inflated provides the best handling, tread life and riding comfort.

In addition to the tire placard on the driver's door B-pillar, also consult the fuel filler flap for any additional information pertaining to special driving situations. For more information, see "Important notes on tire inflation pressure" (▷ page 293).



Data shown on placard examples are for illustration purposes only. Tire data are specific to each vehicle and may vary from data shown in the illustrations below. Refer to placard on vehicle for actual data specific to your vehicle.

Placard (Example A)

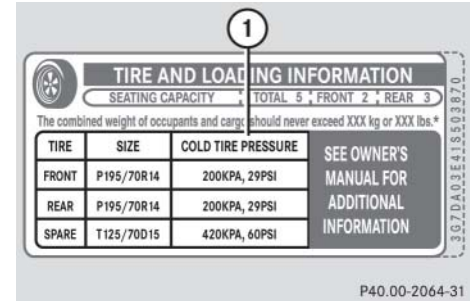

- ① Tire and Loading Information placard with recommended cold tire inflation pressures

Placard (Example A) lists the recommended cold tire inflation pressures for maximum loaded vehicle weight. The tire inflation pressures listed apply to the tires installed as original equipment.

Placard (Example B)

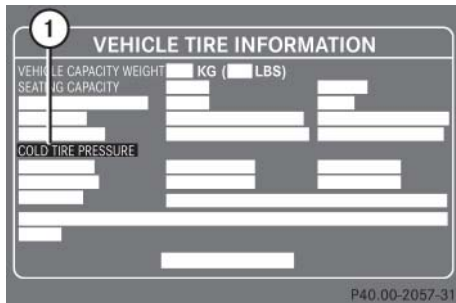

- ① Vehicle Tire Information placard with recommended cold tire inflation pressures

Placard (Example B) lists the recommended cold tire inflation pressures for maximum loaded vehicle weight. The tire inflation pressures listed apply to the tires installed as original equipment.



Placard (Example B) may list recommended cold tire inflation pressures for different vehicle loads.

Important notes on tire inflation pressure

Warning!

If the tire inflation pressure repeatedly drops:

- Check the tires for punctures from foreign objects.
- Check to see whether air is leaking from the valves or from around the rim.

Tire temperature and tire inflation pressure are also increased while driving, depending on the driving speed and the tire load.

If you will be driving your vehicle at high speeds of 100 mph (160 km/h) or higher, where it is legal and conditions allow, consult the placard on the inside of the fuel filler flap on how to adjust the cold tire inflation pressure. If you do not adjust the tire inflation pressure, excessive heat can build up and result in sudden tire failure.

Be sure to readjust the tire inflation pressure for normal driving speeds. You should wait until the tires are cold before adjusting the tire inflation pressure.

Some vehicles may have supplemental tire pressure information for vehicle loads less than the maximum loaded vehicle condition. If such information is provided, it can be found on the placard located on the inside of the fuel filler flap.

Tire inflation pressure changes by approximately 1.5 psi (0.1 bar) per 18°F (10°C) of air temperature change. Keep this in mind when checking tire inflation pressure where the temperature is different from the outside temperature.

Tires and wheels

Checking tire inflation pressure

Regularly check your tire inflation pressure at least once a month.

Check and adjust the tire inflation pressure when the tires are cold. The tires can be considered cold if the vehicle has been parked for at least 3 hours or driven less than 1 mile (1.6 km).

If you check the tire inflation pressure when the tires are warm (the vehicle has been driven for several miles or sitting less than 3 hours), the reading will be approximately 4 psi (0.3 bar) higher than the cold reading. This is normal. Do not let air out to match the specified cold tire inflation pressure. Otherwise, the tire will be underinflated.

Checking tire inflation pressure manually

Follow the steps below to achieve correct tire inflation pressure:

- ▶ Remove the cap from the valve on one tire.
- ▶ Firmly press a tire gauge onto the valve.
- ▶ Read tire inflation pressure on tire gauge and check against the recommended tire inflation pressure on the placard on the driver's door B-pillar (▷ page 292). If necessary, add air to achieve the recommended tire inflation pressure.



If you have overfilled the tire, release tire inflation pressure by pushing the metal stem of the valve with e.g. a tip of a pen. Then recheck the tire inflation pressure with the tire gauge.

- ▶ Install the valve cap.
- ▶ Repeat this procedure for each tire.

Checking tire inflation pressure electronically*

The tire inflation pressure monitor only functions on wheels that are equipped with the proper electronic sensors. It monitors the tire inflation pressure, as selected by the driver, in all four tires. A warning is issued to alert you to a decrease in tire inflation pressure in one or more of the tires.

You can call up the tire inflation pressure monitoring display using the control system (▷ page 137).



After you have reactivated the tire inflation pressure monitor, the current tire inflation pressures will only be shown after a few minutes' driving time.

During this time, you will see the following message in the multifunction display:

TIRE PRES. DISPLAY
APPEARS AFTER
DRIVING A FEW
MINUTES



Possible differences between the readings of a tire inflation pressure gauge of an air hose, e.g. gas station equipment, and the vehicle's control system can occur. The readings issued by the control system are more precise.

- ▶ Switch on the ignition (▷ page 34).

- ▶ Press button or on the multifunction steering wheel repeatedly until the standard display menu appears in the multifunction display (▷ page 137).
- ▶ Press button or repeatedly until the current tire inflation pressures for each tire appear in the multifunction display.

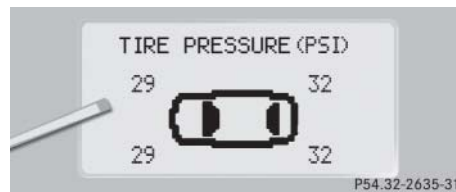

You can select the unit of measure (Bar/Psi) used for the tire inflation pressure by changing the setting in the control system (▷ page 158).

Warning!



When the tire inflation pressure monitoring system warning light is lit, one or more of your tires is significantly under-inflated. You should stop and check your tires as soon as possible, and inflate them to the proper tire inflation pressure as indicated on the vehicle's tire information placard. Driving on a significantly under-inflated tire causes the tire to overheat and can lead to tire failure. Under-inflation also reduces fuel efficiency and tire tread life, and may affect the vehicle's handling and stopping ability. Each tire, including the spare, should be checked monthly when cold and set to the recommended tire inflation pressure as specified in the vehicle placard and owner's manual.

Tires and wheels



The recommended tire inflation pressures for your vehicle can be found on the tire placard located on the driver's door B-pillar. The tire inflation pressures are not listed in the owner's manual.



Operating radio transmission equipment (e.g. wireless headsets, two-way radios) in or near the vehicle could cause the tire inflation pressure monitor to malfunction.

Warning!



The tire inflation pressure monitor does not indicate a warning for wrongly selected tire inflation pressures. Always adjust tire inflation pressure according to the placard on the driver's door B-pillar or, if available, the inside of the fuel filler flap.

The tire inflation pressure monitor is not able to issue a warning due to a sudden dramatic loss of tire inflation pressure (e.g. tire blowout caused by a foreign object). In this case bring the vehicle to a halt by carefully applying the brakes and avoiding abrupt steering maneuvers.

Warning!



Follow recommend tire inflation pressures.



Do not underinflate tires. Underinflated tires wear excessively and/or unevenly, adversely affect handling and fuel economy, and are more likely to fail from being overheated.



Do not overinflate tires. Overinflated tires can adversely affect handling and ride comfort, wear unevenly, increase stopping distance, and result in sudden deflation (blowout) because they are more likely to become punctured or damaged by road debris, potholes etc.

Do not overload the tires by exceeding the specified load limit or vehicle capacity weight as indicated on the placard on the driver's door B-pillar (▷ page 286). Overloading the tires can overheat them, possibly causing a blowout.

Reactivating the tire inflation pressure monitor

The tire inflation pressure monitor must be reactivated in the following situations:

- if you have changed the tire inflation pressure
 - if you have replaced the wheels or tires
 - if you have installed new wheels or tires
- ▶ Using the tire placard on the driver's door B-pillar or, if available, the inside of the fuel filler flap, make sure the tire inflation pressure of all four tires is correct.
- ▶ Press button  or  on the multifunction steering wheel repeatedly until the standard display menu appears in the multifunction display (▷ page 137).

- ▶ Press button  or  repeatedly until you see the current tire inflation pressures for each tire appear in the multifunction display or the following message appears in the multifunction display:

TIRE PRES. DISPLAY
APPEARS AFTER
DRIVING A FEW
MINUTES



If you are transporting a deflated tire in the vehicle, do not activate the tire inflation pressure monitor until

- the deflated tire is no longer in the vehicle
 - you have inflated the tire to the correct tire inflation pressure
- ▶ Press the reset button  on the instrument cluster (▷ page 134).

The following message will appear in the multifunction display:
MONITOR CURRENT
TIRE
PRESSURES?

- ▶ Press the  button.

The following message will appear in the multifunction display:
TIRE PRES. MONITOR
REACTIVATED

The tire inflation pressure monitor will now monitor the tire inflation pressure values of all four tires.

The following message will appear in the multifunction display:
TIRE PRES. DISPLAY
APPEARS AFTER
DRIVING A FEW
MINUTES

This display appears until the individual tire inflation pressure values are matched with the tires. The individual values are then displayed (▷ page 295).



Tires and wheels

▷▷ If you wish to cancel activation:

- ▶ Press the  button.

If one of the following messages appears in the multifunction display:

- TIRE PRES. MONITOR
REACTIVATE AFTER
CORRECTING PRESSURE
- TIRE PRESSURE
PLEASE CORRECT
- ▶ Check the tire inflation pressures and correct them if necessary.
- ▶ Reactivate the tire inflation pressure monitor.

Potential problems associated with underinflated and overinflated tires

Underinflated tire inflation pressure

Underinflated tires can:

- cause excessive and uneven tire wear
- adversely affect fuel economy
- lead to tire failure from being overheated
- adversely affect handling characteristics

Warning!



Follow recommended tire inflation pressures.

Do not underinflate tires. Underinflated tires wear excessively and / or unevenly, adversely affect handling and fuel economy, and are more likely to fail from being overheated.

Overinflated tire inflation pressure

Overinflated tires can:

- adversely affect handling characteristics
- cause uneven tire wear
- be more prone to damage from road hazards
- adversely affect ride comfort
- increase stopping distance

Warning!



Follow recommended tire inflation pressures.

Do not overinflate tires. Overinflated tires can adversely affect handling and ride comfort, wear unevenly, increase stopping distance, and result in sudden deflation (blowout) because they are more likely to become punctured or damaged by road debris, potholes etc.

Tire labeling

Besides tire name (sales designation) and manufacturer name, a number of markings can be found on a tire.

Following are some explanations for the markings on your vehicle's tires:

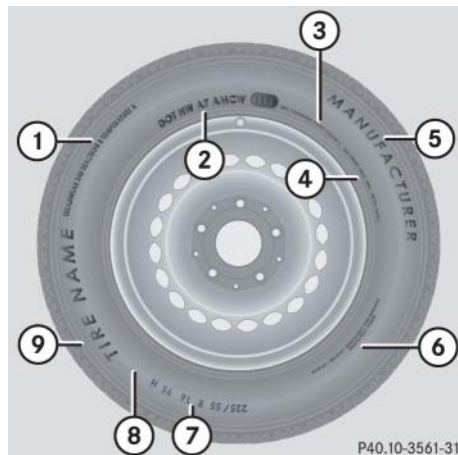

- ① Uniform Quality Grading Standards (▷ page 306)
- ② DOT, Tire Identification Number (TIN) (▷ page 304)
- ③ Maximum tire load (▷ page 305)
- ④ Maximum tire inflation pressure (▷ page 306)
- ⑤ Manufacturer
- ⑥ Tire ply material (▷ page 308)
- ⑦ Tire size designation, load and speed rating (▷ page 299)
- ⑧ Load identification (▷ page 303)
- ⑨ Tire name



For illustration purposes only. Actual data on tires are specific to each vehicle and may vary from data shown in above illustration.

For more information, see “Rims and Tires” (▷ page 4 10).

Tire size designation, load and speed rating

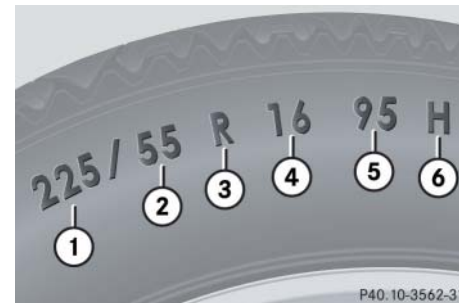

- ① Tire width
- ② Aspect ratio in %
- ③ Radial tire code
- ④ Rim diameter
- ⑤ Tire load rating
- ⑥ Tire speed rating



For illustration purposes only. Actual data on tires are specific to each vehicle and may vary from data shown in above illustration.

Tires and wheels

General:

Depending on the design standards used, the tire size molded into the sidewall may have no letter or a letter preceding the tire size designation.

No letter preceding the size designation (as illustrated above): Passenger car tire based on European design standards.

Letter “P” preceding the size designation: Passenger car tire based on U.S. design standards.

Letter “LT” preceding the size designation: Light Truck tire based on U.S. design standards.

Letter “T” preceding the size designation: Temporary spare tires which are high pressure compact spares designed for temporary emergency use only.

Tire width

The tire width ① (▷ page 299) indicates the nominal tire width in mm.

Aspect ratio

The aspect ratio ② (▷ page 299) is the dimensional relationship between tire section height and section width and is expressed in percentage. The aspect ratio is arrived at by dividing section height by section width.

Tire code

The tire code ③ (▷ page 299) indicates the tire construction type. The “R” stands for radial tire type. Letter “D” means diagonal or bias ply construction; letter “B” means belted-bias ply construction.

At the tire manufacturer’s option, any tire with a speed capability above 149 mph (240 km/h) can include a “ZR” in the size designation (for example: 245/40 ZR 18). For additional information, see “Tire speed rating” (▷ page 301).

Rim diameter

The rim diameter ④ (▷ page 299) is the diameter of the bead seat, not the diameter of the rim edge. Rim diameter is indicated in inches (in).

Tire load rating

The tire load rating ⑤ (▷ page 299) is a numerical code associated with the maximum load a tire can support.

For example, a load rating of 91 corresponds to a maximum load of 1356 lbs (615 kg) the tire is designed to support. See also “Maximum tire load” (▷ page 305) where the maximum load associated with the load index is indicated in kilograms and lbs.

Warning!

The tire load rating must always be at least half of the GAWR (▷ page 309) of your vehicle. Otherwise, tire failure may be the result which may cause an accident and/or serious personal injury to you or others.

Always replace rims and tires with the same designation, manufacturer and type as shown on the original part.

Warning!

Do not overload the tires by exceeding the specified load limit or vehicle capacity weight as indicated on the placard located on the driver's door B-pillar. Overloading the tires can overheat them, possibly causing a blowout. Overloading the tires can also result in handling or steering problems, or brake failure.

For additional information on tire load rating, see “Load identification” (▷ page 303).



Tire load rating ⑤ (▷ page 299) and tire speed rating ⑥ (▷ page 299) are also referred to as “service description”.

Tire speed rating

The tire speed rating ⑥ (▷ page 299) indicates the approved maximum speed for the tire.

Warning!

Even when permitted by law, never operate a vehicle at speeds greater than the maximum speed rating of the tires.

Exceeding the maximum speed for which tires are rated can lead to sudden tire failure, causing loss of vehicle control and possibly resulting in an accident and/or personal injury and possible death, for you and for others.



Tire load rating ⑤ (▷ page 299) and tire speed rating ⑥ (▷ page 299) are also referred to as “service description”.

Tires and wheels

Summer tires

Index	Speed rating
Q	up to 100 mph (160 km/h)
R	up to 106 mph (170 km/h)
S	up to 112 mph (180 km/h)
T	up to 118 mph (190 km/h)
H	up to 130 mph (210 km/h)
V	up to 149 mph (240 km/h)
W	up to 168 mph (270 km/h)
Y	up to 186 mph (300 km/h)
(Y)	above 186 mph (300 km/h)
ZR	above 149 mph (240 km/h)

- At the tire manufacturer's option, any tire with a speed capability above 149 mph (240 km/h) can include a "ZR" in the size designation (for example: 245/40 ZR18). To determine the maximum speed capability of the tire, the service description for the tire must be referred to. The service description

is comprised of the tire load rating ⑤ (▷ page 299) and the tire speed rating ⑥ (▷ page 299).

If your tire includes "ZR" in the size designation and no service description ⑤ and ⑥ (▷ page 299) is given, the tire manufacturer must be consulted for the maximum speed capability.

If a service description ⑤ and ⑥ (▷ page 299) is given, the speed capability is limited by the speed symbol in the service description.

Example: 245/40 ZR18 97Y.

In this example, "97Y" is the service description. The letter "Y" designates the speed rating and the speed capability of the tire is limited to 186 mph (300 km/h).

- Any tire with a speed capability above 186 mph (300 km/h) must include a "ZR" in the size designation AND the service description must be placed in parenthesis. Example: 275/40 ZR 18 (99Y). The "(Y)" speed rating in parenthesis designates the maximum speed capability of the tire as being above 186 mph (300 km/h). Consult the tire manufacturer for the actual maximum permissible speed of the tire.

All-season and winter tires

Index	Speed rating
Q M+S ¹	up to 100 mph (160 km/h)
T M+S ¹	up to 118 mph (190 km/h)
H M+S ¹	up to 130 mph (210 km/h)
V M+S ¹	up to 149 mph (240 km/h)

¹ or M+S  for winter tires



Not all M+S rated tires provide special winter performance. Make sure the tires you use show M+S and the mountain/snowflake  marking on the tire sidewall. These tires meet specific snow traction performance requirements of the Rubber Manufacturers Association (RMA) and the Rubber Association of Canada (RAC) and have been designed specifically for use in snow conditions.

Load identification



① Load identification



For illustration purposes only. Actual data on tires are specific to each vehicle and may vary from data shown in above illustration.

In addition to tire load rating, special load information may be molded into the tire sidewall following the letter designating the tire speed rating ⑥ (▷ page 299).

No specification given: absence of any text (like in above example) indicates a standard load (SL) tire.

XL (Extra Load): designates an extra load (or reinforced) tire.

Light Load: designates a light load tire.

C, D, E: designates load range associated with the maximum load a tire can carry at a specified pressure.

Tires and wheels

DOT, Tire Identification Number (TIN)

U.S. tire regulations require each new tire manufacturer or tire retreader to mold a TIN into or onto a sidewall of each tire produced.

The TIN is a unique identifier which facilitates efforts by tire manufacturers to notify purchasers in recall situations or other safety matters concerning tires and gives purchasers the means to easily identify such tires.

The TIN is comprised of “Manufacturer’s identification mark”, “Tire size”, “Tire type code” and “Date of manufacture”.

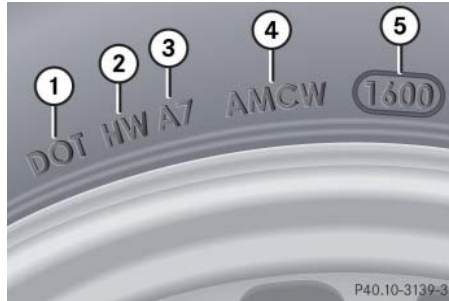

- ① DOT
- ② Manufacturer’s identification mark
- ③ Tire size
- ④ Tire type code (at the option of the tire manufacturer)
- ⑤ Date of manufacture



For illustration purposes only. Actual data on tires are specific to each vehicle and may vary from data shown in above illustration.

DOT (Department of Transportation)

A tire branding symbol ① (▷ page 304) which denotes the tire meets requirements of the U.S. Department of Transportation.

Manufacturer’s identification mark

The manufacturer’s identification mark ② (▷ page 304) denotes the tire manufacturer.

New tires have a mark with two symbols.

Retreaded tires have a mark with four symbols. For more information on retreaded tires (▷ page 283).

Tire size

The code ③ (▷ page 304) indicates the tire size.

Tire type code

The code ④ (▷ page 304) may, at the option of the manufacturer, be used as a descriptive code for identifying significant characteristics of the tire.

Date of manufacture

The date of manufacture ⑤ (▷ page 304) identifies the week and year of manufacture.

The first two figures identify the week, starting with “01” to represent the first full week of the calendar year. The second two figures represent the year.

For example, “3202” represents the 32nd week of 2002.

Maximum tire load



① Maximum tire load rating



For illustration purposes only. Actual data on tires are specific to each vehicle and may vary from data shown in above illustration.

The maximum tire load is the maximum weight the tires are designed to support.

Warning!



Do not overload the tires by exceeding the specified load limit or vehicle capacity weight as indicated on the placard located on the driver's door B-pillar. Overloading the tires can overheat them, possibly causing a blowout. Overloading the tires can also result in handling or steering problems, or brake failure.

For more information on tire load rating (▷ page 300).

For information on calculating total and cargo load capacities (▷ page 289).

Tires and wheels

Maximum tire inflation pressure



- ① Maximum permissible tire inflation pressure



For illustration purposes only. Actual data on tires are specific to each vehicle and may vary from data shown in above illustration.

This is the maximum permissible tire inflation pressure for the tire.

Always follow the recommended tire inflation pressure (▷ page 292) for proper tire inflation.

Warning!



Never exceed the max. tire inflation pressure. Follow recommended tire inflation pressures.

Do not underinflate tires. Underinflated tires wear excessively and / or unevenly, adversely affect handling and fuel economy, and are more likely to fail from being overheated.

Do not overinflate tires. Overinflated tires can adversely affect handling and ride comfort, wear unevenly, increase stopping distance, and result in sudden deflation (blowout) because they are more likely to become punctured or damaged by road debris, potholes etc.

Uniform Tire Quality Grading Standards (U.S. vehicles)

Tire manufacturers are required to grade tires based on three performance factors: treadwear, traction and temperature resistance.



- ① Treadwear
- ② Traction
- ③ Temperature resistance



For illustration purposes only. Actual data on tires are specific to each vehicle and may vary from data shown in above illustration.

Quality grades can be found, where applicable, on the tire sidewall between tread shoulder and maximum section width. For example:

Treadwear	Traction	Temperature
200	AA	A

All passenger car tires must conform to federal safety requirements in addition to these grades.

Treadwear

The treadwear grade is a comparative rating based on the wear rate of the tire when tested under controlled conditions on a specified government test course. For example, a tire graded 150 would wear one and one-half ($1\frac{1}{2}$) times as well on the government course as a tire graded 100. The relative performance of tires depends upon the actual conditions of their use, however, and may depart significantly from the norm due to variations in driving habits, service practices and differences in road characteristics and climate.

Traction

The traction grades, from highest to lowest, are AA, A, B, and C. Those grades represent the tire's ability to stop on wet pavement as measured under controlled conditions on specified government test surfaces of asphalt and concrete. A tire marked C may have poor traction performance.

Warning!



The traction grade assigned to this tire is based on straight-ahead braking traction tests, and does not include acceleration, cornering, hydroplaning, or peak traction characteristics.

Tires and wheels

Temperature

The temperature grades are A (the highest), B, and C, representing the tire's resistance to the generation of heat and its ability to dissipate heat when tested under controlled conditions on a specified indoor laboratory test wheel. Sustained high temperature can cause the material of the tire to degenerate and reduce tire life, and excessive temperature can lead to sudden tire failure. The grade C corresponds to a level of performance which all passenger car tires must meet under the Federal Motor Vehicle Safety Standard No. 109. Grades B and A represent higher levels of performance on the laboratory test wheel than the minimum required by law.

Warning!



The temperature grade for this tire is established for a tire that is properly inflated and not overloaded. Excessive speed, underinflation, or excessive loading, either separately or in combination, can cause excessive heat build-up and possible tire failure.

Tire ply material

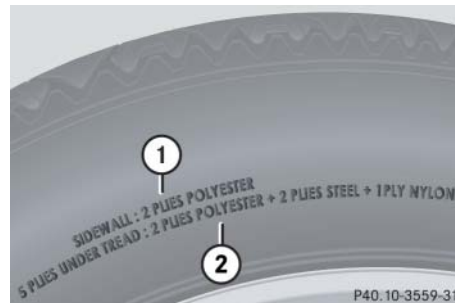

- ① Plies in sidewall
- ② Plies under tread



For illustration purposes only. Actual data on tires are specific to each vehicle and may vary from data shown in above illustration.

This marking tells you about the type of cord and number of plies in the sidewall and under the tread.

Tire and loading terminology

Accessory weight

The combined weight (in excess of those standard items which may be replaced) of automatic transmission, power steering, power brakes, power windows, power seats, radio, and heater, to the extent that these items are available as factory-installed equipment (whether installed or not).

Air pressure

The amount of air inside the tire pressing outward on each square inch of the tire. Air pressure is expressed in pounds per square inch (psi), or kilopascal (kPa) or bars.

Aspect ratio

Dimensional relationship between tire section height and section width expressed in percentage.

Bar

Another metric unit for air pressure. There are 14.5038 pounds per square inch (psi) to 1 bar; there are 100 kilopascals (kPa) to 1 bar.

Bead

The tire bead contains steel wires wrapped by steel cords that hold the tire onto the rim.

Cold tire inflation pressure

Tire inflation pressure when your vehicle has been sitting for at least 3 hours or driven no more than 1 mile (1.6 km).

Curb weight

The weight of a motor vehicle with standard equipment including the maximum capacity of fuel, oil, and coolant, and, if so equipped, air conditioning and additional optional equipment, but without passengers and cargo.

DOT (Department of Transportation)

A tire branding symbol which denotes the tire meets requirements of the U.S. Department of Transportation.

GAWR (Gross Axle Weight Rating)

The GAWR is the maximum permissible axle weight. The gross vehicle weight on each axle must never exceed the GAWR for the front and rear axle indicated on the Certification label located on the driver's door B-pillar.

GVW (Gross Vehicle Weight)

The GVW comprises the weight of the vehicle including fuel, tools, spare wheel, installed accessories, passengers and cargo and, if applicable, trailer tongue load. The GVW must never exceed the GVWR indicated on the Certification label located on the driver's door B-pillar.

Tires and wheels

GVWR (Gross Vehicle Weight Rating)

This is the maximum permissible vehicle weight of the fully loaded vehicle (weight of the vehicle including all options, passengers, fuel, and cargo and, if applicable, trailer tongue load). It is indicated on Certification label located on the driver's door B-pillar.

Kilopascal (kPa)

The metric unit for air pressure. There are 6.9 kilopascals (kPa) to 1 psi; another metric unit for air pressure is bars. There are 100 kilopascals (kPa) to 1 bar.

Maximum load rating

The maximum load in kilograms and pounds that can be carried by the tire.

Maximum loaded vehicle weight

The sum of curb weight, accessory weight, vehicle capacity weight and production options weight.

Maximum tire inflation pressure

This number is the greatest amount of air pressure that should ever be put in the tire under normal driving conditions.

Normal occupant weight

The number of occupants the vehicle is designed to seat, multiplied by 68 kilograms (150 lbs).

Occupant distribution

The distribution of occupants in a vehicle at their designated seating positions.

Production options weight

The combined weight of those installed regular production options weighing over 5 lbs (2.3 kilograms) in excess of those standard items which they replace, not previously considered in curb weight or accessory weight, including heavy duty brakes, ride levelers, roof rack, heavy duty battery, and special trim.

PSI (Pounds per square inch)

A standard unit of measure for air pressure -> bar, kilopascal (kPa).

Recommended tire inflation pressure

Recommended tire inflation pressure listed on placard located on driver's door B-pillar for normal driving conditions. Provides best handling, tread life and riding comfort.

Rim

A metal support for a tire or a tire and tube assembly upon which the tire beads are seated.

Sidewall

The portion of a tire between the tread and the bead.

TIN (Tire Identification Number)

Unique identifier which facilitates efforts by tire manufacturers to notify purchasers in recall situations or other safety matters concerning tires and gives purchases the means to easily identify such tires. The TIN is comprised of “Manufacturer’s identification mark”, “Tire size”, “Tire type code” and “Date of manufacture”.

Tire load rating

Numerical code associated with the maximum load a tire can support.

Tire ply composition and material used

This indicates the number of plies or the number of layers of rubber-coated fabric in the tire tread and sidewall. Tire manufacturers also must indicate the ply materials in the tire and sidewall, which include steel, nylon, polyester, and others.

Tire speed rating

Part of tire designation; indicates the speed range for which a tire is approved.

Traction

Force exerted by the vehicle on the road via the tires. The amount of grip provided.

Tread

The portion of a tire that comes into contact with the road.

Treadwear indicators

Narrow bands, sometimes called “wear bars” that show across the tread of a tire when only $\frac{1}{16}$ in (1.6 mm) of tread remains.

Uniform Tire Quality Grading Standards

A tire information system that provides consumers with ratings for a tire’s traction, temperature and treadwear. Ratings are determined by tire manufacturers using government testing procedures. The ratings are molded into the sidewall of the tire.

Vehicle capacity weight

Rated cargo and luggage load plus 68 kilograms (150 lbs) times the vehicle’s designated seating capacity.

Vehicle maximum load on the tire

Load on an individual tire that is determined by distributing to each axle its share of the maximum loaded vehicle weight and dividing it by two.

Tires and wheels

Rotating tires

Warning!



Rotate front and rear wheels only if the tires are of the same dimension.

If your vehicle is equipped with mixed-size tires (different tire dimensions front vs. rear), tire rotation is not possible.

Tire rotation can be performed on vehicles with tires of the same dimension all around. If your vehicle is equipped with tires of the same dimension all around, tires can be rotated, observing a front-to-rear rotation pattern that will maintain the intended rotation (spinning) direction of the tire (▷ page 286).

In some cases, such as when your vehicle is equipped with mixed-size tires (different tire dimension front vs. rear), tire rotation is not possible.

If applicable to your vehicle's tire configuration, tires can be rotated according to the tire manufacturer's recommended intervals in the tire manufacturer's warranty pamphlet located in your vehicle literature portfolio. If none is available, tires should be rotated every 3000 to 6000 miles (5000 to 10000 km), or sooner if necessary, according to the degree of tire wear. The same rotation (spinning) direction must be maintained (▷ page 286).

Rotate tires before the characteristic tire wear pattern becomes visible (shoulder wear on front tires and tread center wear on rear tires).

Thoroughly clean the mounting face of wheels and brake disks, i.e. the inner side of the wheels/tires, during each rotation. Check for and ensure proper tire inflation pressure.

Warning!



Have the tightening torque checked after changing a wheel. Wheels could become loose if not tightened with a torque of 110 lb-ft (150 Nm).

Only use Genuine Mercedes-Benz wheel bolts specified for your vehicle's rims.

For information on wheel change, see the "Practical hints" section (▷ page 386).

▼ Winter driving

Before the onset of winter, have your vehicle winterized at an authorized Mercedes-Benz Center. This service includes:

- Check of anticorrosion and antifreeze concentration.
- Addition of cleaning concentrate to the water of the windshield and headlamp cleaning system. Add MB Concentrate “S” to a premixed windshield washer solvent/antifreeze which is formulated for below freezing temperatures (▷ page 423).
- Battery test. Battery capacity drops with decreasing ambient temperature. A well charged battery helps to make sure that the engine can be started, even at low ambient temperatures.
- Tire change.

Winter tires

Always use winter tires at temperatures below 45°F (7°C) and whenever wintry road conditions prevail. Not all M+S rated

tires provide special winter performance. Make sure the tires you use show the mountain/snowflake  marking on the tire sidewall. These tires meet specific snow traction performance requirements of the Rubber Manufacturers Association (RMA) and the Rubber Association of Canada (RAC) and have been designed specifically for use in snow conditions. Use of winter tires is the only way to achieve the maximum effectiveness of the ABS and ESP® in winter operation.

For safe handling, make sure that all mounted winter tires are of the same make and have the same tread design.

Warning!



Winter tires with a tread depth under $\frac{1}{6}$ in (4 mm) must be replaced. They are no longer suitable for winter operation.

Always observe the speed rating of the winter tires installed on your vehicle. If the maximum speed for which your tires are rated is below the speed rating of your vehicle, you must place a notice to this effect where it will be seen by the driver. Such notices are available from your tire dealer or from any authorized Mercedes-Benz Center.

Warning!



If you use your spare tire when winter tires are fitted on the other wheels, be aware that the difference in tire characteristics may very well impair turning stability and that overall driving stability may be reduced. Adapt your driving style accordingly.

Have the spare tire replaced with a winter tire at the nearest authorized Mercedes-Benz Center.

Winter driving

Block heater (Canada only)

The engine is equipped with a block heater.

The electrical cable may be installed at an authorized Mercedes-Benz Center.

Snow chains

Snow chains should only be driven on snow-covered roads at speeds not to exceed 30 mph (50 km/h). Remove chains as soon as possible when driving on roads without snow.



When driving with snow chains, you may wish to deactivate the ESP® (▷ page 83) before setting the vehicle in motion. This will improve the vehicle's traction.



Please observe the following guidelines when using snow chains:

- Use of snow chains is not permissible with all wheel/tire combinations.
- Snow chains should only be used on the rear wheels. Follow the manufacturer's mounting instructions.
- Only use snow chains that are approved by Mercedes-Benz. Your authorized Mercedes-Benz Center will be glad to advise you on this subject.
- Use of snow chains may be prohibited depending on location. Always check local and state laws before installing snow chains.



Even on vehicles with all-wheel-drive use snow chains on rear tires only.

Some tire sizes do not leave adequate clearance for snow chains. To help avoid serious damage to your vehicle or tires, use of snow chains is not permissible with the following tire sizes:

- 245/45 R18 100V XL (Extra Load) M+S  on 8.5 x 18 rims
- 245/45 R18 96H M+S  on 8.5 x 18 rims
- 245/45 R18 100Y XL (Extra Load) on 8.5 x 18 rims
- 245/45 R18 96Y on 8.5 x 18 rims
- 265/40 R18 101Y XL (Extra Load)
- 265/40 R18 97Y
- 245/40 ZR19 98Y XL (Extra Load)
- 245/40 ZR19
- 275/35 ZR19 100Y XL (Extra Load)
- 275/35 ZR19

▼ Maintenance

We strongly recommend that you have your vehicle serviced by an authorized Mercedes-Benz Center, in accordance with the Maintenance Booklet at the times called for by the maintenance service indicator.

Failure to have the vehicle maintained in accordance with the Maintenance Booklet and maintenance service indicator at the designated times/mileage will result in vehicle damage not covered by the Mercedes-Benz Limited Warranty.

Maintenance service indicator message

The maintenance service indicator will notify you when your next maintenance service is due.

Starting approximately 1 month before your next maintenance service is due, one of the following messages will appear in the multifunction display while you are driving or when you switch on the ignition (example service A):

'A' SERVICE
IN XXXXX MI

(Canada: IN XXXXX KM)

'A' SERVICE
IN XXX DAYS

'A' SERVICE
IN X DAY

'A' SERVICE DUE NOW



The type of maintenance service due is indicated in the multifunction display:



Basic service (A)



Extended service (B)



Vehicles equipped with FSS (Flexible Service System) only (Canada vehicles):

The interval between services depends on your driving habits. A gentle driving style, moderate engine speeds and the avoidance of short-distance trips will lengthen the interval between services.

Clearing the maintenance service indicator

The maintenance service indicator message is automatically cleared after approximately 30 seconds when you switch on the ignition or when reaching the service threshold while driving. You can also clear it yourself.



① Reset button **R**

- ▶ Press reset button **R** ① on the instrument cluster.

The maintenance service indicator message is cleared and the standard display appears in the multifunction display (▷ page 142).

Maintenance service term exceeded

If you have exceeded the suggested maintenance service term, you will see the following message in the multifunction display:

'A' SERVICE
EXCEEDED BY
XXXX MI

(Canada: XXXX KM)

'A' SERVICE
EXCEEDED BY
XXX DAYS

'A' SERVICE
EXCEEDED BY
X DAY

In addition, a signal sounds when the message appears.

Any authorized Mercedes-Benz Center will reset the maintenance service indicator following a completed maintenance service.

Calling up the maintenance service indicator

- ▶ Switch on the ignition (▷ page 34).
- ▶ Press button or on the multifunction steering wheel repeatedly until the standard display appears in the multifunction display (▷ page 142).
- ▶ Press button or until the maintenance service indicator display with the service symbol or and the service deadline appears in the multifunction display.



If the battery is disconnected, the days of disconnection will not be included in the count shown by the maintenance service indicator. To arrive at the true maintenance service deadline, you will need to subtract these days from the days shown in the maintenance service indicator.

Do not confuse the maintenance service indicator with the engine oil level indicator .

Resetting the maintenance service indicator

In the event that the maintenance service on your vehicle is not carried out by an authorized Mercedes-Benz Center, you can have the maintenance service indicator reset. The automotive maintenance facility carrying out the maintenance service will find the information for resetting the maintenance service indicator in the maintenance-relevant information for your vehicle. Such information is available from either your authorized Mercedes-Benz Center or directly from Mercedes-Benz USA, LLC.



If the maintenance service indicator was inadvertently reset, have an authorized Mercedes-Benz Center correct it.

Only reset if the proper maintenance service has been performed. Resetting the system without performing the proper service as called for by the maintenance service indicator will result in engine damage and/or other vehicle damage not covered by the Mercedes-Benz Limited Warranty.

Cleaning and care of vehicle

Warning!



Many cleaning products can be hazardous. Some are poisonous, others are flammable. Always follow the instructions on the particular container. Always open your vehicle's doors or windows when cleaning the inside.

Never use fluids or solvents that are not designed for cleaning your vehicle.

Always lock away cleaning products and keep them out of reach of children.

While in operation, even while parked, your vehicle is subjected to varying external influences which, if gone unchecked, can attack the paintwork as well as the vehicle underbody and cause lasting damage.

Such damage is caused not only by extreme and varying climatic conditions, but also by:

- Air pollution
- Road salt
- Tar
- Gravel and stone chipping

To avoid paint damage, you should immediately remove:

- Grease and oil
- Fuel
- Coolant
- Brake fluid
- Bird droppings
- Insects
- Tree resins, etc.

Frequent washing reduces and/or eliminates the aggressiveness and potency of the above adverse influences.

More frequent washings are necessary to deal with unfavorable conditions:

- near the ocean
- in industrial areas (smoke, exhaust emissions)
- during winter operation

You should check your vehicle from time to time for stone chipping or other damage. Any damage should be repaired as soon as possible to prevent corrosion.

In doing so, do not neglect the underbody of the vehicle. A prerequisite for a thorough check is a washing of the underbody followed by a thorough inspection. Damaged areas need to be re-undercoated.

Your vehicle has been treated at the factory with a wax-base rustproofing in the body cavities which will last for the lifetime of the vehicle. Post-production treatment is neither necessary nor recommended by Mercedes-Benz because of the possibility of incompatibility between materials used in the production process and others applied later.

We have selected car-care products and compiled recommendations which are specially matched to our vehicles and which always reflect the latest technology. You can obtain Mercedes-Benz approved car-care products at an authorized Mercedes-Benz Center.

Scratches, corrosive deposits, corrosion or damage due to negligent or incorrect care cannot always be removed or repaired with the car-care products recommended here. In such cases it is best to seek aid at an authorized Mercedes-Benz Center.

The following topics deal with the cleaning and care of your vehicle and give important “how-to” information as well as references to Mercedes-Benz approved car-care products.

Power washer



Follow the instructions provided by the power washer manufacturer on maintaining a distance between the vehicle and the nozzle of the power washer.

Never use a round nozzle to power-wash tires. The intense jet of water can result in damage to the tire.

Always replace a damaged tire.

Always keep the jet of water moving across the surface. Do not aim directly at electrical parts, electrical connectors, seals, or other rubber parts.



Vehicles with KEYLESS-GO*:
If a door handle is hit by a strong jet of water, and a SmartKey with KEYLESS-GO* is in close proximity, i.e. within approximately 3 ft. (approximately 1 m), the vehicle could be inadvertently locked or unlocked.

Tar stains

Quickly remove tar stains before they dry and become more difficult to remove. A tar remover is recommended.

Paintwork, painted body components



Affixing stickers, adhesive tape or similar materials to painted body components may damage the paintwork.

Mercedes-Benz approved Paint Care should be applied when water drops on the paint surface do not “bead up”. This should normally be done every 3 to 5 months, depending on the climate and washing detergent used.

Mercedes-Benz approved Paint Cleaner should be applied if the paint surface shows signs of embedded dirt (i.e. loss of gloss).

Do not apply any of these products or wax if your vehicle is parked in the sun or if the hood is still hot.

Vehicle care

- ▶ Use the appropriate MB-Touch-Up Stick for quick and provisional repairs of minor paint damage (i.e. chips from stones, vehicle doors, etc.).

Engine cleaning

Prior to cleaning the engine compartment, make sure to protect electrical components and connectors from contact with water and cleaning agents.

Corrosion protection, such as MB Anticorrosion Wax, should be applied to the engine compartment after every engine cleaning. Before applying, all control linkage bushings and joints should be lubricated. The poly-V-belt and all pulleys should be protected from any wax.

Vehicle washing

In the winter, thoroughly remove all traces of road salt as soon as possible.

When washing the vehicle underbody, do not forget to clean the inner sides of the wheels.



Vehicles with KEYLESS-GO*:

If a door handle is hit by a strong jet of water, and a SmartKey with KEYLESS-GO* is in close proximity, i.e. within approximately 3 ft (approximately 1 m), the vehicle could be inadvertently locked or unlocked.

Hand-wash

Do not use hot water or wash your vehicle in direct sunlight.

- ▶ Only use a mild car wash detergent, such as Mercedes-Benz approved Car Shampoo.
- ▶ Thoroughly spray the vehicle with a diffused jet of water.

Direct only a very weak spray towards the ventilation intake.

- ▶ Use plenty of water and rinse the sponge and chamois frequently.
- ▶ Rinse with clean water and thoroughly dry with a chamois.

Do not allow cleaning agents to dry on the finish.

Automatic car wash

You can have your car washed in an automatic car wash from the start. Automatic car washes without brushes are preferable.

If the vehicle is very dirty, prewash it before running it through the automatic car wash.



Due to the width of the vehicle, fold in exterior rear view mirrors prior to running the vehicle through an automatic car wash to prevent damage to the mirrors.

Make sure that the windshield wiper switch is set to **0** (> page 54). Otherwise, the rain sensor could activate and cause the wipers to move unintentionally. This may lead to vehicle damage.



After running the vehicle through an automatic car wash, wipe any wax off of the windshield (> page 323). This will prevent smears and reduce wiping noise which can be caused by residual wax on the windshield.

When leaving the car wash, make sure that the mirrors are folded out. Otherwise they may vibrate.

Ornamental moldings

For regular cleaning and care of ornamental moldings, use a damp cloth.



Do not use chrome cleaner on ornamental moldings. Although ornamental moldings may have chrome appearance, they could be made of anodized aluminum that will be damaged when cleaned with chrome cleaner. Instead, use a damp cloth to clean those ornamental moldings.

For very dirty ornamental moldings of which you are sure are chrome-plated, use a chrome cleaner. If in doubt whether an ornamental molding is chrome-plated, contact an authorized Mercedes-Benz Center.

Headlamps, tail lamps, side markers, turn signal lenses

- ▶ Use a mild car wash detergent, such as Mercedes-Benz approved Car Shampoo, with plenty of water.



Only use window cleaning solutions that are suitable for plastic lamp lenses. Window cleaning solutions which are not suitable may damage the plastic lamp lenses of the headlamps. Therefore, do not use abrasives, solvents or cleaners that contain solvents.

Never apply strong force and only use a soft, non-scratching cloth when cleaning the lenses. Do not attempt to wipe dirty lenses with a dry cloth or sponge.

Otherwise you may scratch or damage the lens surface.

Vehicle care

Cleaning the DISTRONIC* system sensor cover



① DISTRONIC system sensor cover

- ▶ Switch off the ignition (▷ page 34).
- ▶ Use a mild car wash detergent, such as Mercedes-Benz approved Car Shampoo, with plenty of water and a non-scratching cloth to clean sensor cover ①.



To prevent scratches or damage, never apply strong force and only use a soft, non-scratching cloth when cleaning the sensor cover ①. Do not attempt to wipe dirty sensors with a dry cloth or sponge.

Cleaning the Parktronic* system sensors

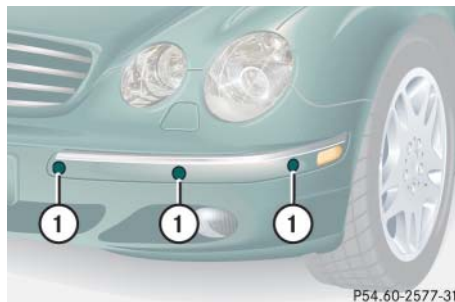

① Parktronic system sensors in front bumper

- ▶ Use a mild car wash detergent, such as Mercedes-Benz approved Car Shampoo, with plenty of water and a soft, non-scratching cloth to clean sensors ① on the bumpers.



Do not apply strong pressure to the sensor covers. Applying strong pressure may damage the sensor covers.

Follow the instructions provided by the power washer manufacturer on maintaining a distance between the vehicle and the nozzle of the power washer.



To prevent scratches, never apply strong force and only use a soft, non-scratching cloth when cleaning the sensors. Do not attempt to wipe dirty sensors with a dry cloth or sponge.

Cleaning the windows and the wiper blades



The windshield wipers must be in a vertical position before folding them away from the windshield. They could otherwise damage the hood.

Never open the hood when the wiper arms are folded forward.

- ▶ Switch on the ignition (▷ page 34).
- ▶ Turn combination switch to wiper setting **II** (▷ page 54).
- ▶ With wiper arms in vertical position, switch off the ignition (▷ page 384).

Warning!



For safety reasons, switch off wipers and remove SmartKey from starter switch (vehicles with KEYLESS-GO*): Make sure the vehicle's on-board electronics have status **0** before cleaning the windshield the windshield and/or the wiper blades. Otherwise, the wiper motor could suddenly turn on and cause injury.

- ▶ Fold the wiper arms forward until they snap into place.
- ▶ Clean the wiper blade inserts with a clean cloth and detergent solution.
- ▶ Use a soft, clean cloth and a mild window cleaning solution on all outside and inside glass surfaces.

An automotive glass cleaner is recommended.



Fold the windshield wiper arms back onto the windshield before turning the SmartKey in the starter switch or pressing the KEYLESS-GO* start/stop button (vehicles with KEYLESS-GO*).

Hold on to the wiper when folding the wiper arm back. If released, the force of the impact from the tensioning spring could crack the windshield.



To clean the window interior, do not use a dry cloth, abrasives, solvents or cleaners containing solvents. Do not touch the inside of the front, rear or side windows with hard objects such as an ice scraper or ring. Doing so may damage the windows.

Vehicle care

Light alloy wheels

If possible, clean wheels once a week.

- ▶ Use Mercedes-Benz approved Wheel Care, a soft bristle brush and a strong spray of water for cleaning the light alloy wheels.



Only use acid-free cleaning materials. Acid may cause corrosion or damage the clear coat.



The vehicle should not be parked for an extended period of time immediately after it has been cleaned, especially not after the wheel rims have been cleaned with wheel rim cleaner. Wheel rim cleaners can lead to increased corrosion of the brake disks and brake pads. Therefore, the vehicle's brake system should always be warmed-up before it is parked after cleaning. To do so, please drive your vehicle for several minutes to allow the brakes to dry.

When applying Mercedes-Benz approved Tire Care and Mercedes-Benz approved Wheel Care products, take care not to spray them on the brake disks.

Plastic and rubber parts

- ▶ Use a gentle dishwashing detergent or mild detergent for delicate fabrics as a washing solution.



Do not use oil or wax on these parts.

Instrument cluster and cup holders

- ▶ Use a gentle dishwashing detergent or mild detergent for delicate fabrics as a washing solution.
- ▶ Wipe with a cloth moistened in a lukewarm solution.



To prevent scratches, do not use scouring agents.

Hard plastic trim items

- ▶ Use Mercedes-Benz approved Interior Care, a soft, lint-free cloth and apply with light pressure.



To prevent scratches, do not use scouring agents.

Steering wheel and gear selector lever

- ▶ Wipe with a damp cloth and dry thoroughly or clean with Mercedes-Benz approved Leather Care.

Carpets

- ▶ Use Mercedes-Benz approved Carpet and Fabric Care for cleaning the carpets.

Headliner and shelf below rear window

- ▶ Use a soft bristle brush or a dry-shampoo cleaner in case of excessive dirt.

Seat belts

- ▶ Only use clear, lukewarm water and soap.



The webbing must not be treated with chemical cleaning agents. Do not dry the webbing at temperatures above 176°F (80°C) or in direct sunlight.

Warning!



Do not bleach or dye seat belts as this may severely weaken them. In a crash they may not be able to provide adequate protection.

Upholstery

Using aftermarket seat covers or wearing clothing that have the tendency to give off coloring (e.g. when wet, etc.) may cause the upholstery to become permanently discolored. By lining the seats with a proper intermediate cover, contact-discoloration will be prevented.

Leather upholstery

- ▶ Wipe leather upholstery with a damp cloth and dry thoroughly or clean with Mercedes-Benz approved Leather Care.

Exercise particular care when cleaning perforated leather as its underside should not become wet.

Wood trims

- ▶ Dampen cloth using water and use damp cloth to clean wood trims in your vehicle.



Do not use solvents like tar remover or wheel cleaner nor polishes or waxes as these may be abrasive.

Practical hints

What to do if ...?

Where will I find ...?

Unlocking/locking in an emergency

Opening/closing in an emergency

Replacing SmartKey batteries

Replacing bulbs

Replacing wiper blades

Flat tire

Battery

Jump starting

Towing the vehicle

Fuses



What to do if ...?

Lamps in instrument cluster

General information:

If any of the following lamps in the instrument cluster fails to come on during the lamp self-check when switching on the

ignition, have the respective bulb checked and replaced if necessary.

Problem	Possible cause/consequence	Suggested solution
 <p>The yellow Antilock Brake System (ABS) indicator lamp comes on while driving.</p>	<p>The ABS has detected a malfunction and has switched off. The BAS and the ESP® are also switched off (see messages in multifunction display).</p> <p>The brake system is still functioning normally but without the ABS available.</p> <p>If the ABS control unit is malfunctioning, other systems such as Parktronic*, Distronic*, and the automatic transmission may also be malfunctioning.</p> <p>The charging voltage has fallen below 10 volts and the ABS has switched off.</p> <p>The battery may not be charged sufficiently.</p>	<ul style="list-style-type: none"> ▶ Continue driving with added caution. Wheels may lock during hard braking, reducing steering capability. ▶ Read and observe messages in the multifunction display (> page 337). ▶ Have the system checked at an authorized Mercedes-Benz Center as soon as possible. <p>Failure to follow these instructions increases the risk of an accident.</p> <ul style="list-style-type: none"> ▶ Switch off electrical consumers that are currently not needed, e.g. seat heating*. ▶ If necessary, have the generator (alternator) and battery checked. <p>When the voltage is above this value again, the ABS is operational again.</p>

Problem	Possible cause/consequence	Suggested solution
BRAKE (USA only)  (Canada only)	The red brake warning lamp comes on while driving and you hear a warning sound. The red brake warning lamp comes on while driving.	You are driving with the parking brake set. There is insufficient brake fluid in the reservoir. Risk of accident!
		<ul style="list-style-type: none"> ▶ Release the parking brake (▷ page 50). ▶ Carefully stop the vehicle in a safe location and notify an authorized Mercedes-Benz Center. Do not add brake fluid! This will not solve the problem.

Warning!





Driving with the brake warning lamp illuminated can result in an accident. Have your brake system checked immediately if the brake warning lamp stays on. Do not add brake fluid before checking the brake system. Overfilling the brake fluid reservoir can result in spilling brake fluid on hot engine parts and the brake fluid catching fire. You can be seriously burned.





If you find that the brake fluid in the brake fluid reservoir has fallen to the minimum mark or below, have the brake system checked for brake pad thickness and leaks.



What to do if ...?

Problem	Possible cause/consequence	Suggested solution
<p>CHECK ENGINE (USA only)</p>  <p>(Canada only)</p> <p>The yellow engine malfunction indicator lamp comes on while driving.</p>	<p>There is a malfunction in:</p> <ul style="list-style-type: none"> • The fuel management system • The ignition system • The emission control system • Systems which affect emissions <p>Such malfunctions may result in excessive emissions values and may switch the engine to its limp-home (emergency operation) mode.</p> <p>Your fuel tank is empty.</p>	<p>► Have the vehicle checked as soon as possible by an authorized Mercedes-Benz Center. An on-board diagnostic connector is used by the service station to link the vehicle to the shop diagnostics system. It allows the accurate identification of system malfunctions through the read-out of diagnostic trouble codes. It is located in the front left area of the footwell next to the parking brake pedal.</p> <p>► After refuelling, start, turn off, and restart the engine three or four times in succession.</p> <p>The limp-home mode is canceled. You do not need to have your vehicle checked.</p>

Problem	Possible cause/consequence	Suggested solution
<p>CHECK ENGINE (USA only)</p>  <p>(Canada only)</p> <p>The yellow engine malfunction indicator lamp comes on while driving.</p>	<p>A loss of pressure has been detected in the fuel system. The fuel cap may not be closed properly or the fuel system may be leaky.</p>	<ul style="list-style-type: none"> ▶ Check the fuel cap (▷ page 270). <p>If it is not closed properly:</p> <ul style="list-style-type: none"> ▶ Close the fuel cap. <p>If it is closed properly:</p> <ul style="list-style-type: none"> ▶ Have the fuel system checked by an authorized Mercedes-Benz Center.
<p>The yellow fuel tank reserve warning lamp comes on while driving.</p>	<p>The fuel level has gone below the reserve mark.</p>	<ul style="list-style-type: none"> ▶ Refuel at the next gas station (▷ page 270).

What to do if ...?

Problem	Possible cause/consequence	Suggested solution
 Only vehicles with DISTRONIC*: The red distance warning lamp comes on while driving.	You are too close to the vehicle in front of you to maintain selected speed.	<ul style="list-style-type: none"> ▶ Apply the brakes immediately to increase the following distance.
 Only vehicles with DISTRONIC*: The red distance warning lamp comes on while driving and you hear a warning sound.	<ul style="list-style-type: none"> • You are gaining too rapidly on the vehicle ahead of you. • The distance warning system has recognized a stationary obstacle on your probable line of travel. 	<ul style="list-style-type: none"> ▶ Apply the brakes immediately. ▶ Carefully observe the traffic situation. You may need to brake or maneuver to avoid hitting an obstacle.
 The yellow ESP® warning lamp flashes while driving.	The ESP® or traction control has come into operation because of detected traction loss in at least one tire. DISTRONIC* is deactivated.	<ul style="list-style-type: none"> ▶ When driving off, apply as little throttle as possible. ▶ While driving, ease up on the accelerator. ▶ Adapt your speed and driving to the prevailing road and weather conditions. ▶ Do not deactivate the ESP®. Exceptions: (▷ page 83). <p>Failure to follow these instructions increases the risk of an accident.</p>

Problem	Possible cause/consequence	Suggested solution
 <p>The yellow ESP® warning lamp comes on while driving.</p>	<p>The ESP® switched off.</p>	<p>Risk of accident!</p> <ul style="list-style-type: none"> ▶ Switch the ESP® back on (▷ page 84). ▶ Adapt your speed and driving to the prevailing road and weather conditions. <p>If the ESP® cannot be switched back on, have the system checked at an authorized Mercedes-Benz Center as soon as possible.</p>
 <p>The red seat belt telltale illuminates briefly after starting the engine.</p>	<p>The driver has not fastened his or her seat belt.</p>	<ul style="list-style-type: none"> ▶ Fasten your seat belt. <p>The warning lamp goes out.</p>

What to do if ...?

Problem	Possible cause/consequence	Suggested solution
 The yellow warning lamp for the tire inflation pressure monitor comes on.	The tire inflation pressure monitor detects a loss of pressure in at least one tire.	<ul style="list-style-type: none">▶ Bring the vehicle to a halt, avoiding abrupt steering and braking maneuvers. Observe the traffic situation around you.▶ Read and observe messages in the multifunction display. <p>The warning lamp goes out once the tire inflation pressure monitor has been reactivated after the tire inflation pressures have been corrected.</p>

Warning!



When the tire inflation pressure monitoring system warning light is lit, one or more of your tires is significantly under-inflated. You should stop and check your tires as soon as possible, and inflate them to the proper pressure as indicated on the vehicle's tire information placard. Driving on a significantly under-inflated tire causes the tire to overheat and can lead to tire failure.

Under-inflation also reduces fuel efficiency and tire tread life, and may affect the vehicle's handling and stopping ability. Each tire, including the spare, should be checked monthly when cold and set to the recommended inflation pressure as specified in the vehicle placard and owner's manual.



The recommended tire inflation pressures for your vehicle can be found on the tire placard on the driver's door B-pillar or, if available, the inside of the fuel filler flap, not in the owner's manual.

Problem	Possible cause/consequence	Suggested solution
<p>SRS The red Supplemental Restraint System (SRS) indicator lamp comes on while driving.</p>	<p>There is a malfunction in the restraint systems. The air bags or emergency tensioning devices (ETDs) could deploy unexpectedly or fail to activate in an accident.</p>	<p>► Drive with added caution to the nearest authorized Mercedes-Benz Center.</p>

Warning!



In the event a malfunction of the SRS is indicated as outlined above, the SRS may not be operational. For your safety, we strongly recommend that you visit an authorized Mercedes-Benz Center immediately to have the system checked; otherwise the SRS may not be activated when needed in an accident, which could result in serious or fatal injury, or it might deploy unexpectedly and unnecessarily which could result in an accident and/or injury to you or to others.

What to do if ...?

Lamp in center console

Lamp	Problem	Possible cause/consequence	Suggested solution
	The indicator lamp comes on and remains illuminated.	A BabySmart™ child seat is installed on the front passenger seat. Therefore the passenger front air bag is switched off.	
	The indicator lamp comes on and remains illuminated if there is no BabySmart™ child seat installed on the front passenger seat.	The system is malfunctioning.	<ul style="list-style-type: none"> ▶ Have the system checked as soon as possible by an authorized Mercedes-Benz Center.
	The indicator lamp does not come on or does not remain illuminated with a BabySmart™ child seat properly installed on the front passenger seat.	The system is malfunctioning.	<ul style="list-style-type: none"> ▶ Make sure there is nothing between seat cushion and child seat and check installation of the child seat. ▶ If the front passenger front air bag off indicator lamp remains out, have the system checked as soon as possible by an authorized Mercedes-Benz Center. ▶ Do not use the BabySmart™ restraint to transport children on the front passenger seat until the system has been repaired.

Vehicle status messages in the multifunction display





Warning and malfunction messages appear in the multifunction display located in the instrument cluster.





Certain warning and malfunction messages are accompanied by an audible signal.

Address these messages accordingly and follow the additional instructions given in this Operator's Manual.

Selecting the vehicle status message memory menu in the control system (▷ page 153) displays both cleared and uncleared messages.

High-priority messages appear in the multifunction display in red color.

Certain messages of high priority cannot be cleared from the multifunction display using the reset button  (▷ page 134) or button , , , or  on the multifunction steering wheel (▷ page 138).

Other messages of high priority and messages of less immediate priority can be cleared from the multifunction display using the reset button  or button , , , or  on the multifunction steering wheel. They are then stored in the vehicle status message memory (▷ page 153). Remember that clearing a message will only make the message disappear. Clearing a message will not correct the condition that caused the message to appear.

Warning!



All categories of messages contain important information which should be taken note of and, where a malfunction is indicated, addressed as soon as possible at an authorized Mercedes-Benz Center.

Failure to repair condition noted may cause damage not covered by the Mercedes-Benz Limited Warranty, or result in property damage or personal injury.

Warning!



No messages will be displayed if either the instrument cluster or the multifunction display is inoperative. Contact your nearest authorized Mercedes-Benz Center.

What to do if ...?



Switching on the ignition causes all instrument cluster lamps (except high beam headlamp indicator lamp and turn signal indicator lamps unless activated) as well as the multifunction display to come on. Make sure the lamps and multifunction display are in working order before starting your journey.

On the pages that follow, you will find a compilation of the most important warning and malfunction messages that may appear in the malfunction display.

For your convenience the messages are divided into two sections:

- Text messages (▷ page 339)
- Symbol messages (▷ page 345)

Text messages

Display	Possible cause/consequence	Possible solution
<p>ABC</p> <p>ACTIVE BODY CONTROL DRIVE CAREFULLY</p>	<p>The capability of the ABC system is restricted. This can impair the handling.</p>	<ul style="list-style-type: none"> ▶ Do not exceed a speed of 50 mph (80 km/h). ▶ Visit an authorized Mercedes-Benz Center as soon as possible.
<p>ACTIVE BODY CONTROL STOP, CAR TOO LOW</p>	<p>The vehicle is losing oil.</p>	<ul style="list-style-type: none"> ▶ Stop your vehicle as soon as it is safe to do so.
	<p>The vehicle is parked on an extremely uneven surface and/or is heavily laden.</p>	<ul style="list-style-type: none"> ▶ Press the vehicle level control button to select level 2 (▷ page 222). <li style="padding-left: 20px;">You can continue to drive, if the vehicle raised and the message disappears. ▶ Set the desired vehicle level using the vehicle level control button.

What to do if ...?

Display	Possible cause/consequence	Possible solution
<p>ABC</p> <p>ACTIVE BODY CONTROL STOP, CAR TOO LOW</p>	<p>ABC is malfunctioning.</p>	<ul style="list-style-type: none"> ▶ Stop and press the vehicle level control button to select a higher vehicle level (▷ page 222). If the vehicle is not raised, observe the following when you continue to drive: <ul style="list-style-type: none"> ▶ Do not turn steering wheel too far to avoid damaging the front fenders. ▶ Listen for scraping noises. ▶ Do not exceed a speed of 50 mph (80 km/h). ▶ Visit an authorized Mercedes-Benz Center as soon as possible.
<p>ABC</p> <p>DISPLAY DEFECTIVE VISIT WORKSHOP</p>	<p>The display for ABC or the ABC system itself is malfunctioning.</p>	<ul style="list-style-type: none"> ▶ Visit an authorized Mercedes-Benz Center as soon as possible.
<p>ACTIVE BODY CONTROL VISIT WORKSHOP</p>	<p>The capability of the ABC system is restricted.</p>	<ul style="list-style-type: none"> ▶ Do not exceed a speed of 50 mph (80 km/h). ▶ Visit an authorized Mercedes-Benz Center as soon as possible.

Display		Possible cause/consequence	Possible solution
ABS	MALFUNCTION VISIT WORKSHOP	<p>The ABS has detected a malfunction and has switched off. The ESP® and the BAS are also deactivated.</p> <p>The brake system is still functioning normally but without the ABS available.</p>	<ul style="list-style-type: none"> ▶ Continue driving with added caution. Wheels may lock during hard braking, reducing steering capability. ▶ Have the system checked at an authorized Mercedes-Benz Center as soon as possible. <p>Failure to follow these instructions increases the risk of an accident.</p>
	DISPLAY DEFECTIVE VISIT WORKSHOP	The ABS or the ABS display is malfunctioning.	<ul style="list-style-type: none"> ▶ Continue driving with added caution. Wheels may lock during hard braking, reducing steering capability. ▶ Have the system checked at an authorized Mercedes-Benz Center as soon as possible. <p>Failure to follow these instructions increases the risk of an accident.</p>
AIR CLEANER CHANGE CARTRIDGE VISIT WORKSHOP		The air filter is clogged.	<ul style="list-style-type: none"> ▶ Have the air filter checked by an authorized Mercedes-Benz Center.

What to do if ...?

Display	Possible cause/consequence	Possible solution
DISTRONIC EXTERNAL MALFUNCTION REACTIVATE	DISTRONIC* is switched off and is temporarily unavailable.	▶ Try activating DISTRONIC* again later.
DISTRONIC CURRENTLY UNAVAILABLE SEE OPERATORS MANUAL	DISTRONIC* is switched off because the DISTRONIC* cover in the radiator grille is dirty.	▶ Clean the DISTRONIC* cover in the radiator grille (▷ page 322). ▶ Restart the vehicle.
DISTRONIC DRIVE TO WORKSHOP	DISTRONIC* is malfunctioning or the display is malfunctioning.	▶ Visit an authorized Mercedes-Benz Center as soon as possible.
ESP MALFUNCTION VISIT WORKSHOP	The ESP® has detected a malfunction and switched off. The ABS may still be operational.	▶ Continue driving with added caution. ▶ Have the system checked at an authorized Mercedes-Benz Center as soon as possible. Failure to follow these instructions increases the risk of an accident.
DISPLAY DEFECTIVE VISIT WORKSHOP	The ESP® or the ESP® display is malfunctioning.	▶ Continue driving with added caution. ▶ Have the system checked at an authorized Mercedes-Benz Center as soon as possible. Failure to follow these instructions increases the risk of an accident.

Display	Possible cause/consequence	Possible solution
ESP UNAVAILABLE SEE OPERATORS MANUAL	The ESP® was deactivated because the power supply has been interrupted. The ABS is still operational.	<ul style="list-style-type: none"> ▶ Synchronize the ESP®. With the vehicle stationary and the engine running, turn the steering wheel completely to the left and then to the right to synchronize the ESP®. If the ESP® message does not go out: <ul style="list-style-type: none"> ▶ Continue driving with added caution. ▶ Have the system checked at an authorized Mercedes-Benz Center as soon as possible. Failure to follow these instructions increases the risk of an accident.





When synchronizing the ESP®, make sure you can turn the steering wheel in both directions as far as it will go without the wheel hitting any objects, e.g. a road curb.



What to do if ...?

Display	Possible cause/consequence	Possible solution
MOVE SELECTOR LEVER TO PARK	You have tried to turn off the engine with the KEYLESS-GO* start/stop button (▷ page 35) with the gear selector lever not in P .	▶ Place the gear selector lever in position P .

Symbol messages

Display	Possible cause/consequence	Possible solution
 <p>BATTERY CHARGE VISIT WORKSHOP</p>	<p>The battery is no longer charging. Possible causes:</p> <ul style="list-style-type: none"> • alternator malfunctioning • broken poly-V-belt <p>Do not forget that the brake system requires electrical energy and may be operating with restricted capability. Considerably greater brake pedal force is required and the stopping distance is longer.</p>	<p>► Stop immediately in a safe location or as soon as it is safe to do so and check the poly-V-belt.</p> <p>If it is broken:</p> <p>► Do not continue to drive. Otherwise the engine will overheat due to an inoperative water pump which may result in damage to the engine. Notify an authorized Mercedes-Benz Center.</p> <p>If it is intact:</p> <p>► Drive immediately to the nearest authorized Mercedes-Benz Center. Adjust driving to be consistent with reduced braking responsiveness.</p>
<p>BRAKE (USA only)</p>  <p>(Canada only)</p> <p>RELEASE PARKING BRAKE</p>	<p>You are driving with the parking brake engaged.</p>	<p>► Release the parking brake (> page 50).</p>

What to do if ...?

Display	Possible cause/consequence	Possible solution
 BRAKE PAD WEAR VISIT WORKSHOP	The brake pads have reached their wear limit.	▶ Have the brake pads replaced as soon as possible.
 BRAKE FLUID VISIT WORKSHOP (USA only)	There is insufficient brake fluid in the reservoir.	▶ Risk of accident! Stop the vehicle in a safe location and notify an authorized Mercedes-Benz Center. Do not add brake fluid! This will not solve the problem.
 (Canada only)		

Failure to follow these instructions increases the risk of accident.

Warning!





Driving with the message BRAKE FLUID VISIT WORKSHOP displayed can result in an accident. Have your brake system checked immediately. Do not add brake fluid before checking the brake system. Overfilling the brake fluid reservoir can result in spilling brake fluid on hot engine parts and the brake fluid catching fire. You can be seriously burned.



If you find that the brake fluid in the brake fluid reservoir has fallen to the minimum mark or below, have the brake system checked for brake pad thickness and leaks.



Brake pad thickness must be visually checked by a qualified technician at the intervals specified in the Maintenance Booklet.

Display	Possible cause/consequence	Possible solution
 VISIT WORKSHOP	There may be a malfunction in the: <ul style="list-style-type: none"> • Fuel injection system • Ignition system • Exhaust system • Fuel system 	<ul style="list-style-type: none"> ▶ Visit an authorized Mercedes-Benz Center as soon as possible.
 COOLANT CHECK LEVEL	The coolant level is too low.	<ul style="list-style-type: none"> ▶ Add coolant (▷ page 280). ▶ If you have to add coolant frequently, have the cooling system checked by an authorized Mercedes-Benz Center.

Warning!



Do not spill antifreeze on hot engine parts. Antifreeze contains ethylene glycol which may burn if it comes into contact with hot engine parts. You can be seriously burned.



Do not ignore the low engine coolant level warning. Extended driving with the message and symbol displayed may cause serious engine damage not covered by the Mercedes-Benz Limited Warranty.

Do not drive without a sufficient amount of coolant in the cooling system. The engine will overheat, causing major engine damage.

What to do if ...?

Display	Possible cause/consequence	Possible solution
 <p>COOLANT STOP, ENGINE OFF</p>	The coolant is too hot.	<ul style="list-style-type: none"> ▶ Stop the vehicle in a safe location and turn off the engine. ▶ Only start the engine again after the message disappears. You could otherwise damage the engine.

Warning!



Driving when your engine is badly overheated can cause some fluids which may have leaked into the engine compartment to catch fire. You could be seriously burned.

Steam from an overheated engine can cause serious burns and can occur just by opening the engine hood. Stay away from the engine if you see or hear steam coming from it.

Turn off the engine, get out of the vehicle and do not stand near the vehicle until the engine has cooled down.





During severe operating conditions, e.g. stop-and-go traffic, the coolant temperature may rise close to 248°F (120°C).



The engine should not be operated with the coolant temperature above 248°F (120°C). Doing so may cause serious engine damage which is not covered by the Mercedes-Benz Limited Warranty.

Display	Possible cause/consequence	Possible solution
 <p>COOLANT STOP, ENGINE OFF</p>	<p>The poly-V-belt could be broken.</p>	<ul style="list-style-type: none"> ▶ Stop the vehicle in a safe location and immediately turn off the engine. ▶ Check the poly-V-belt. <p>If it is broken:</p> <ul style="list-style-type: none"> ▶ Do not continue to drive. Otherwise the engine will overheat due to an inoperative water pump which may result in damage to the engine. Notify an authorized Mercedes-Benz Center. <p>If it is intact:</p> <ul style="list-style-type: none"> ▶ Restart the engine only after the message disappears from the multifunction display. Doing so could result in serious engine damage that is not covered by the Mercedes-Benz Limited Warranty. ▶ Observe the coolant temperature gauge in the instrument cluster (> page 24). ▶ Drive immediately to the nearest authorized Mercedes-Benz Center. Adjust driving to be consistent with reduced braking responsiveness.

What to do if ...?

Display	Possible cause/consequence	Possible solution
 <p>COOLANT VISIT WORKSHOP</p>	The cooling fan for the coolant is malfunctioning.	<ul style="list-style-type: none"> ▶ Observe the coolant temperature display. ▶ Have the fan replaced as soon as possible.
 <p>CRUISE CONTROL DRIVE TO WORKSHOP</p>	Cruise control or Distronic* is malfunctioning.	<ul style="list-style-type: none"> ▶ Have cruise control or Distronic* checked by an authorized Mercedes-Benz Center.
 <p>DISPLAY DEFECTIVE VISIT WORKSHOP</p>	The instrument cluster display is malfunctioning.	<ul style="list-style-type: none"> ▶ Continue driving with added caution. ▶ Visit an authorized Mercedes-Benz Center as soon as possible.
 <p>DISPLAY DEFECTIVE VISIT WORKSHOP</p>	<p>Certain electronic systems are unable to relay information to the control system. The following systems may have failed:</p> <ul style="list-style-type: none"> • Coolant temperature display • Tachometer • Cruise control display 	<ul style="list-style-type: none"> ▶ Have the electronic systems checked by an authorized Mercedes-Benz Center.
 <p>DOOR OPEN</p>	You are attempting to drive with one or more doors open.	<ul style="list-style-type: none"> ▶ Close the doors.

Display	Possible cause/consequence	Possible solution
 <p>ADD 1.0 QT. OIL AT FILLING STATION (Canada: 1.0 LITER)</p>	The engine oil level is too low.	<ul style="list-style-type: none"> ▶ Add engine oil (▷ page 278) and check the engine oil level (▷ page 275).
<p>ENGINE OIL LEVEL STOP, ENGINE OFF</p>	There is no oil in the engine.	<p>There is a danger of engine damage.</p> <ul style="list-style-type: none"> ▶ Carefully bring the vehicle to a halt as soon as possible. ▶ Turn off the engine. ▶ Add engine oil (▷ page 278) and check the engine oil level (▷ page 275).
<p>ENGINE OIL LEVEL REDUCE OIL LEVEL</p>	You have added too much engine oil. There is a risk of damaging the engine or the catalytic converter.	<ul style="list-style-type: none"> ▶ Have excess oil siphoned or drained off. Observe all legal requirements with respect to its disposal.

What to do if ...?

Display	Possible cause/consequence	Possible solution
 ENGINE OIL LEVEL VISIT WORKSHOP	The engine oil has dropped to a critical level.	<ul style="list-style-type: none"> ▶ Check the engine oil level (▷ page 275) and add engine oil as required (▷ page 278). ▶ If you must add engine oil frequently, have the engine checked for possible leaks.
	There is water in the engine oil.	<ul style="list-style-type: none"> ▶ Have the engine oil checked.
OIL SENSOR MALFUNCT. VISIT WORKSHOP	The measuring system is malfunctioning.	<ul style="list-style-type: none"> ▶ Have the measuring system checked by an authorized Mercedes-Benz Center.

When the message:

ADD 1.0 QT. OIL
AT FILLING STATION

(Canada: 1.0 LITER)



appears while the engine is running and at operating temperature, the engine oil level has dropped to approximately the minimum level.

When this occurs, the warning will first come on intermittently and then stay on if the oil level drops further.



Visually check for oil leaks. If no obvious oil leaks are noted, drive to the nearest service station where the engine oil should be topped to the required level with an approved oil specified in the Factory Approved Service Products pamphlet.



The engine oil level warnings should not be ignored. Extended driving with the symbol displayed could result in serious engine damage that is not covered by the Mercedes-Benz Limited Warranty.

Display	Possible cause/consequence	Possible solution
 <p>ENTRY POSITION DO NOT DRIVE</p>	Seat, exterior mirrors and steering wheel have not yet moved to their preset driving positions.	<ul style="list-style-type: none"> ▶ Wait until the seat, exterior mirrors and steering wheel have moved to their driving positions. The message will disappear.
 <p>HOOD OPEN</p>	You are driving with the hood open.	<ul style="list-style-type: none"> ▶ Close the hood (▷ page 274).
 <p>REMOVE KEY</p>	You have forgotten to remove the SmartKey.	<ul style="list-style-type: none"> ▶ Remove the SmartKey from the starter switch.
<p>REPLACE KEY DRIVE TO WORKSHOP</p>	The SmartKey is malfunctioning.	<ul style="list-style-type: none"> ▶ Visit an authorized Mercedes-Benz Center as soon as possible.
<p>AUTOMATIC LIGHT ON REMOVE KEY</p>	SmartKey in starter switch position 1 or 2 .	<ul style="list-style-type: none"> ▶ Remove the SmartKey from the starter switch.
<p>KEY CHECK BATTERY</p>	The battery in the SmartKey with KEYLESS-GO* is discharged.	<ul style="list-style-type: none"> ▶ Replace the battery (▷ page 377).
<p>KEY NOT RECOGNIZED</p>	<p>SmartKey with KEYLESS-GO* is not recognized while the engine is running because</p> <ul style="list-style-type: none"> • the SmartKey is not in the vehicle • there is strong radio-frequency interference 	<ul style="list-style-type: none"> ▶ Stop the vehicle in a safe location as soon as it is safe to do so. ▶ Search for the SmartKey. <p>Otherwise the vehicle cannot be centrally locked nor can the engine be started again after it has been stopped.</p>

What to do if ...?

Display	Possible cause/consequence	Possible solution
 <p>KEY NOT RECOGNIZED</p>	The SmartKey with KEYLESS-GO* is momentarily not recognized.	<ul style="list-style-type: none"> ▶ Change the position of the SmartKey with KEYLESS-GO* in the vehicle. ▶ Operate the vehicle with the SmartKey in the starter switch if necessary.
<p>KEY STILL IN VEHICLE</p>	A SmartKey with KEYLESS-GO* left in the vehicle was recognized while locking the vehicle from the outside.	▶ Take the SmartKey with KEYLESS-GO* out of the vehicle.
<p>KEYLESS-GO DRIVE TO WORKSHOP</p>	The KEYLESS-GO* system is malfunctioning.	▶ Visit an authorized Mercedes-Benz Center as soon as possible.
 <p>3RD BRAKE LIGHT CHECK LIGHT</p>	The high mounted brake lamp is malfunctioning.	▶ Visit an authorized Mercedes-Benz Center as soon as possible.
<p>STOP LAMP VISIT WORKSHOP</p>	Brake lamp illumination is delayed or lamp is permanently on.	▶ Visit an authorized Mercedes-Benz Center as soon as possible.

Display	Possible cause/consequence	Possible solution
 BRAKE LIGHT LEFT SUBSTITUTE LAMP ON	The left brake lamp is malfunctioning. A substitute bulb is being used.	► Visit an authorized Mercedes-Benz Center as soon as possible.
BRAKE LIGHT RIGHT SUBSTITUTE LAMP ON	The right brake lamp is malfunctioning. A substitute bulb is being used.	► Visit an authorized Mercedes-Benz Center as soon as possible.
DISPLAY DEFECTIVE VISIT WORKSHOP	The display for the lamps or the system is malfunctioning.	► Visit an authorized Mercedes-Benz Center as soon as possible.
FRONT FOG LAMP, LEFT CHECK LIGHT	The left front fog lamp is malfunctioning.	► Visit an authorized Mercedes-Benz Center as soon as possible.
FRONT FOG LAMP, RIGHT CHECK LIGHT	The right front fog lamp is malfunctioning.	► Visit an authorized Mercedes-Benz Center as soon as possible.
HIGH BEAM, LEFT CHECK LIGHT	The left high beam lamp is malfunctioning.	► Replace the bulb as soon as possible.
HIGH BEAM, RIGHT CHECK LIGHT	The right high beam lamp is malfunctioning.	► Replace the bulb as soon as possible.
LICENSE PLATE L, L CHECK LIGHT	The left license plate lamp is malfunctioning.	► Replace the bulb as soon as possible.
LICENSE PLATE L, R CHECK LIGHT	The right license plate lamp is malfunctioning.	► Replace the bulb as soon as possible.





What to do if ...?

Display	Possible cause/consequence	Possible solution
 LIGHT SENSOR DRIVE TO WORKSHOP	The lamp sensor is malfunctioning. The headlamps switch on automatically.	<ul style="list-style-type: none"> ▶ In the control system, set lamp operation to manual (▷ page 159). ▶ Switch on headlamps using the exterior lamp switch. ▶ Visit an authorized Mercedes-Benz Center as soon as possible.
LOW BEAM, LEFT CHECK LIGHT	The left low beam lamp is malfunctioning.	▶ Visit an authorized Mercedes-Benz Center as soon as possible.
LOW BEAM, RIGHT CHECK LIGHT	The right low beam lamp is malfunctioning.	▶ Visit an authorized Mercedes-Benz Center as soon as possible.
MARKER LIGHT, FL CHECK LIGHT	The front left side marker lamp is malfunctioning.	▶ Visit an authorized Mercedes-Benz Center as soon as possible.
MARKER LIGHT, FR CHECK LIGHT	The front right side marker lamp is malfunctioning.	▶ Visit an authorized Mercedes-Benz Center as soon as possible.







Display	Possible cause/consequence	Possible solution
 REAR FOGLIGHT CHECK LIGHT	The rear fog lamp is malfunctioning.	► Replace the bulb as soon as possible.
REVERSE LIGHT, LEFT CHECK LIGHT	The left reverse lamp is malfunctioning.	► Replace the bulb as soon as possible.
REVERSE LIGHT, RIGHT CHECK LIGHT	The right reverse lamp is malfunctioning.	► Replace the bulb as soon as possible.
STANDING LIGHT, L CHECK LIGHT	The left front standing lamp is malfunctioning.	► Replace the bulb as soon as possible.
STANDING LIGHT, R CHECK LIGHT	The right front standing lamp is malfunctioning.	► Replace the bulb as soon as possible.
STANDING LIGHT, L SUBSTITUTE LAMP ON	The left rear standing lamp is malfunctioning. A substitute bulb is being used.	► Replace the bulb as soon as possible.
STANDING LIGHT, R SUBSTITUTE LAMP ON	The right rear standing lamp is malfunctioning. A substitute bulb is being used.	► Replace the bulb as soon as possible.
TAIL LIGHT, LEFT SUBSTITUTE LAMP ON	The left tail lamp is malfunctioning. A substitute bulb is being used.	► Replace the bulb as soon as possible.
TAIL LIGHT, RIGHT SUBSTITUTE LAMP ON	The right tail lamp is malfunctioning. A substitute bulb is being used.	► Replace the bulb as soon as possible.

What to do if ...?

Display	Possible cause/consequence	Possible solution
 TURN OFF LIGHTS	You have removed the SmartKey from the starter switch and opened the driver's door or removed the SmartKey with KEYLESS-GO* from the vehicle and left the headlamps on.	▶ Turn the exterior lamp switch to 0 (▷ page 52).
FRONT TURN SIGNAL, L CHECK LIGHT	The left front turn signal lamp is malfunctioning.	▶ Replace the bulb as soon as possible.
FRONT TURN SIGNAL, R CHECK LIGHT	The right front turn signal lamp is malfunctioning.	▶ Replace the bulb as soon as possible.
REAR TURN SIGNAL, L SUBSTITUTE LAMP ON	The left rear turn signal lamp is malfunctioning. A substitute bulb is being used.	▶ Replace the bulb as soon as possible.
REAR TURN SIGNAL, R SUBSTITUTE LAMP ON	The right rear turn signal lamp is malfunctioning. A substitute bulb is being used.	▶ Replace the bulb as soon as possible.
MIRROR TURN SIG., L CHECK LIGHT	The left turn signal in the side mirror is malfunctioning. This message will only appear if all light emitting diodes have stopped working.	▶ Visit an authorized Mercedes-Benz Center as soon as possible.
MIRROR TURN SIG., R CHECK LIGHT	The right turn signal in the side mirror is malfunctioning. This message will only appear if all light emitting diodes have stopped working.	▶ Visit an authorized Mercedes-Benz Center as soon as possible.

Display	Possible cause/consequence	Possible solution
 SEAT BACKREST, LEFT LOCK SEAT BACKREST, RIGHT LOCK	The driver seat backrest is not engaged.	▶ Fold back and push the seat backrest until the seat cushion and seat backrest audibly engage into the driving position.
	The passenger seat backrest is not engaged.	▶ Fold back and push the seat backrest until the seat cushion and seat backrest audibly engage into the driving position.
 SEAT BELT SYSTEM DRIVE TO WORKSHOP	The seat belt system is malfunctioning.	▶ Visit an authorized Mercedes-Benz Center as soon as possible.
 CLOSE SUNROOF	You have opened the driver's door with the SmartKey removed from the starter switch and the sliding portion of the tilt/sliding sunroof open.	▶ Close the tilt/sliding sunroof (▷ page 202).
 CLOSE SUNROOF	You have opened the driver's door with the SmartKey removed from the starter switch and the tilting portion of the tilt/sliding sunroof open.	▶ Close the tilt/sliding sunroof (▷ page 202).
 TELE AID DRIVE TO WORKSHOP TELE AID BATTERY DRIVE TO WORKSHOP	One or more main functions of the Tele Aid system are malfunctioning.	▶ Have the Tele Aid system checked by an authorized Mercedes-Benz Center.
	The emergency power battery for the Tele Aid system is malfunctioning. If the vehicle battery is also discharged, Tele Aid will not be operational.	▶ Have the Tele Aid system checked by an authorized Mercedes-Benz Center.

What to do if ...?

Display	Possible cause/consequence	Possible solution
 <p>FUNCTION UNAVAILABLE</p>	<p>This display appears if button  or  on the multifunction steering wheel is pressed and the vehicle is not equipped with a telephone.</p>	
 <p>TANK OPEN CHECK FILLER CAP</p>	<p>A loss of pressure has been detected in the fuel system. The fuel cap may not be closed properly or the fuel system may be leaky.</p>	<ul style="list-style-type: none"> ▶ Check the fuel cap (▷ page 270). <p>If it is not closed properly:</p> <ul style="list-style-type: none"> ▶ Close the fuel cap. <p>If it is closed properly:</p> <ul style="list-style-type: none"> ▶ Have the fuel system checked by an authorized Mercedes-Benz Center.
 <p>TRUNK OPEN</p>	<p>This message will appear whenever the trunk is open.</p>	<ul style="list-style-type: none"> ▶ Close the trunk.
 <p>WASHER FLUID CHECK LEVEL</p>	<p>The fluid level has dropped to about $\frac{1}{3}$ of total reservoir capacity.</p>	<ul style="list-style-type: none"> ▶ Add washer fluid (▷ page 282).

Tire inflation pressure monitor messages

Display	Possible cause/consequence	Possible solution
TIRE PRES. MONITOR REACTIVE AFTER CORRECTING PRESSURE	There was a tire inflation pressure warning message. The yellow warning lamp for the tire inflation pressure monitor comes on and you have not reactivated the system since the last tire inflation pressure check.	▶ Activate the tire inflation pressure monitor after correcting the tire inflation pressure values (▷ page 294).
TIRE PRESSURE DISPLAY ONLY AVAILABLE WHEN IGNITION IS ON		▶ Switch on the ignition (▷ page 34).
TIRE PRES. MONITOR REACTIVATED	The tire inflation pressure monitor is using the current pressure values as the basis for monitoring.	

Warning!



Do not drive with a flat tire. A flat tire affects the ability to steer or brake the vehicle.

You may lose control of the vehicle. Continued driving with a flat tire will cause excessive heat build-up and possibly a fire.

What to do if ...?

Display	Possible cause/consequence	Possible solution
TIRE PRES. MONITOR CURRENTLY UNAVAILABLE	<p>The tire inflation pressure monitor* is unable to monitor the tire inflation pressure due to:</p> <ul style="list-style-type: none"> • the presence of several wheel sensors in the vehicle • excessive wheel sensor temperatures • a nearby radio interference source • unrecognized wheel sensors installed 	<p>► Remove any extra wheel sensors from the vehicle.</p> <p>As soon as the causes of the malfunction have been removed, the tire inflation pressure monitor automatically becomes active again.</p>
TIRE PRES. MONITOR NOT OPERATIONAL DRIVE TO WORKSHOP	<p>The tire inflation pressure monitor or a wheel sensor is malfunctioning.</p> <p>A wheel without proper sensor was installed.</p>	<p>► Have the tire inflation pressure monitor checked by an authorized Mercedes-Benz Center.</p> <p>► Have the wheels checked.</p>

Warning!



Do not drive with a flat tire. A flat tire affects the ability to steer or brake the vehicle. You may lose control of the vehicle. Continued driving with a flat tire will cause excessive heat build-up and possibly a fire.

Display	Possible cause/consequence	Possible solution
 <p>TIRE PRESSURE PLEASE CORRECT</p> <p>TIRE PRESSURE CAUTION, TIRE PRES.</p>	<p>The pressure is too low in one or more tires.</p> <p>One or more tires are deflating.</p>	<ul style="list-style-type: none"> ▶ Check and correct tire inflation pressure as required (▷ page 294). ▶ Carefully bring the vehicle to a halt, avoiding abrupt steering and braking maneuvers. Observe the traffic situation around you. ▶ Change the damaged wheel (▷ page 386). ▶ Have the damaged wheel repaired or replaced at an authorized Mercedes-Benz Center.

Warning!



Do not drive with a flat tire. A flat tire affects the ability to steer or brake the vehicle. You may lose control of the vehicle. Continued driving with a flat tire will cause excessive heat build-up and possibly a fire.

What to do if ...?

Display	Possible cause/consequence	Possible solution
 <p>TIRE PRESSURE CHECK TIRES</p>	<p>The pressure has fallen significantly in one or more tires.</p>	<ul style="list-style-type: none"> ▶ Carefully bring the vehicle to a halt, avoiding abrupt steering and braking maneuvers. Observe the traffic situation around you. ▶ Check the tires. If no damage visible, check and correct tire inflation pressure as required. ▶ Change the damaged wheel (▷ page 386). ▶ Have the damaged wheel repaired or replaced at an authorized Mercedes-Benz Center.

Warning!



Do not drive with a flat tire. A flat tire affects the ability to steer or brake the vehicle. You may lose control of the vehicle. Continued driving with a flat tire will cause excessive heat build-up and possibly a fire.

Display	Possible cause/consequence	Possible solution
 <p>TIRE PRESSURE, LF CAUTION, TIRE PRES.</p>	The left front tire is deflating.	<ul style="list-style-type: none"> ▶ Bring the vehicle to a halt, avoiding abrupt braking maneuvers. Observe the traffic situation around you. ▶ Change the wheel (▷ page 386). ▶ Have the damaged wheel repaired or replaced at an authorized Mercedes-Benz Center.
<p>TIRE PRESSURE, LF CHECK TIRES</p>	The left front tire inflation pressure is low.	<ul style="list-style-type: none"> ▶ Carefully bring the vehicle to a halt. ▶ Check the tires. If no damage visible, check and correct tire inflation pressure as required (▷ page 294). ▶ If necessary, change the wheel (▷ page 386). ▶ Have the damaged wheel repaired or replaced at an authorized Mercedes-Benz Center.

Warning!



Do not drive with a flat tire. A flat tire affects the ability to steer or brake the vehicle.

You may lose control of the vehicle. Continued driving with a flat tire will cause excessive heat build-up and possibly a fire.

What to do if ...?

Display	Possible cause/consequence	Possible solution
 <p>TIRE PRESSURE, RF CAUTION, TIRE PRES.</p>	The right front tire is deflating.	<ul style="list-style-type: none"> ▶ Bring the vehicle to a halt, avoiding abrupt braking maneuvers. Observe the traffic situation around you. ▶ Change the wheel (▷ page 386). ▶ Have the damaged wheel repaired or replaced at an authorized Mercedes-Benz Center.
<p>TIRE PRESSURE, RF CHECK TIRES</p>	The right front tire inflation pressure is low.	<ul style="list-style-type: none"> ▶ Carefully bring the vehicle to a halt. ▶ Check the tires. If no damage visible, check and correct tire inflation pressure as required (▷ page 294). ▶ If necessary, change the wheel (▷ page 386). ▶ Have the damaged wheel repaired or replaced at an authorized Mercedes-Benz Center.

Warning!



Do not drive with a flat tire. A flat tire affects the ability to steer or brake the vehicle.

You may lose control of the vehicle. Continued driving with a flat tire will cause excessive heat build-up and possibly a fire.

Display	Possible cause/consequence	Possible solution
 <p>TIRE PRESSURE, LR CAUTION, TIRE PRES.</p>	The left rear tire is deflating.	<ul style="list-style-type: none"> ▶ Bring the vehicle to a halt, avoiding abrupt braking maneuvers. Observe the traffic situation around you. ▶ Change the wheel (▷ page 386). ▶ Have the damaged wheel repaired or replaced at an authorized Mercedes-Benz Center.
<p>TIRE PRESSURE, LR CHECK TIRES</p>	The left rear tire inflation pressure is low.	<ul style="list-style-type: none"> ▶ Carefully bring the vehicle to a halt. ▶ Check the tires. If no damage visible, check and correct tire inflation pressure as required (▷ page 294). ▶ If necessary, change the wheel (▷ page 386). ▶ Have the damaged wheel repaired or replaced at an authorized Mercedes-Benz Center.

Warning!



Do not drive with a flat tire. A flat tire affects the ability to steer or brake the vehicle.

You may lose control of the vehicle. Continued driving with a flat tire will cause excessive heat build-up and possibly a fire.

What to do if ...?

Display	Possible cause/consequence	Possible solution
 <p>TIRE PRESSURE, RR CAUTION, TIRE PRES.</p>	The right rear tire is deflating.	<ul style="list-style-type: none"> ▶ Bring the vehicle to a halt, avoiding abrupt braking maneuvers. Observe the traffic situation around you. ▶ Change the wheel (▷ page 386). ▶ Have the damaged wheel repaired or replaced at an authorized Mercedes-Benz Center.
<p>TIRE PRESSURE, RR CHECK TIRES</p>	The right rear tire inflation pressure is low.	<ul style="list-style-type: none"> ▶ Carefully bring the vehicle to a halt. ▶ Check the tires. If no damage visible, check and correct tire inflation pressure as required (▷ page 294). ▶ If necessary, change the wheel (▷ page 386). ▶ Have the damaged wheel repaired or replaced at an authorized Mercedes-Benz Center.

Warning!



Do not drive with a flat tire. A flat tire affects the ability to steer or brake the vehicle.

You may lose control of the vehicle. Continued driving with a flat tire will cause excessive heat build-up and possibly a fire.

▼ Where will I find ...?

First aid kit

The first aid kit is located in the storage compartment under the front passenger seat.

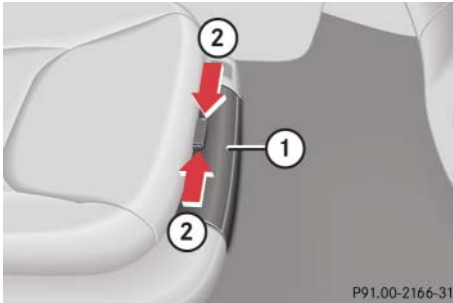

- ① Lid
- ② Buttons

Removing the first aid kit

- ▶ Press buttons ② together and fold lid ① down.
- ▶ Remove first aid kit.

Storing the first aid kit

- ▶ Place first aid kit in the storage compartments.
- ▶ Close lid ① until both buttons ② of lock engage.



Check expiration dates and contents for completeness at least once a year and replace missing/expired items.

Where will I find ...?

Vehicle jack, vehicle tool kit, luggage bowl, spare wheel

The spare wheel, the vehicle tool kit and the luggage bowl are stored in the compartment underneath the trunk floor.

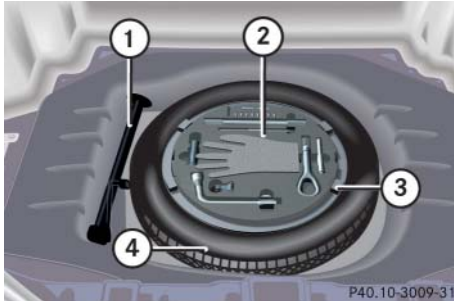

- ① Vehicle jack
- ② Vehicle tool kit
- ③ Luggage bowl
- ④ Spare wheel

- ▶ Lift up trunk floor cover and engage trunk floor handle in upper edge of trunk.
You can now remove the tools and accessories.



To prevent damage, always disengage trunk floor handle from trunk edge and lower trunk floor before closing the trunk.

The vehicle tool kit includes:

- One interchangeable slot/Phillips screwdriver
- One towing eye bolt
- One wheel bolt wrench with socket wrench
- One alignment bolt
- One pair of gloves
- One fuse extractor
- One fuse chart for the main fuse box
- Spare fuses

Vehicle jack

To prepare the vehicle jack for use

- ▶ Remove the vehicle jack from the spare wheel well under the trunk floor.
- ▶ Push the crank handle up.
- ▶ Turn the crank handle clockwise until it engages (operational position).



Storing the vehicle jack in the trunk

- ▶ Retract the vehicle jack arm to the base of the vehicle jack.
- ▶ Push the crank handle up.
- ▶ Turn the crank handle counterclockwise to the end of the stop (storage position).

Warning!

The jack is designed exclusively for jacking up the vehicle at the jack take-up brackets built into both sides of the vehicle. To help avoid personal injury, use the jack only to lift the vehicle during a wheel change. Never get beneath the vehicle while it is supported by the jack. Keep hands and feet away from the area under the lifted vehicle. Always firmly set parking brake and block wheels before raising vehicle with jack.

Do not disengage parking brake while the vehicle is raised. Be certain that the jack is always vertical (plumb line) when in use, especially on hills. Always try to use the jack on level surface. Make sure the jack arm is fully seated in the jack take-up bracket. Always lower the vehicle onto sufficient capacity jackstands before working under the vehicle.

Spare wheel**Removing the spare wheel**

- ▶ Take out vehicle tool kit tray ②.
- ▶ Turn the luggage bowl ③ counterclockwise.
- ▶ Remove the spare wheel ④.

Storing the spare wheel

- ▶ Place spare wheel ④ in wheel well and secure it with luggage bowl ③.
- ▶ Turn the luggage bowl ③ clockwise to its stop.
- ▶ Place vehicle tool kit tray ② in luggage bowl ③.

Unlocking/locking in an emergency

Unlocking the vehicle

If you are unable to unlock the vehicle with the SmartKey or KEYLESS-GO*, open the driver's door and the trunk using the mechanical key.



Unlocking and opening the driver's door and/or the trunk with the mechanical key will trigger the anti-theft alarm system.

To cancel the alarm, insert the SmartKey or SmartKey with KEYLESS-GO* in the starter switch.

Removing the mechanical key



- ① Mechanical key locking tab
 - ② Mechanical key
- ▶ Move locking tab ① in the direction of arrow.
 - ▶ Slide the mechanical key ② out of the housing.

Unlocking the driver's door



- ① Unlocking
- ▶ Insert the mechanical key into the driver's door lock until it stops.
 - ▶ Turn the mechanical key counterclockwise to position ①.
- The driver's door is unlocked.

Unlocking/locking in an emergency

Unlocking the trunk

A minimum height clearance of 6.3 ft (1.90 m) is required to open the trunk lid.

The trunk lid lock is located next to the handle above the rear license plate recess.

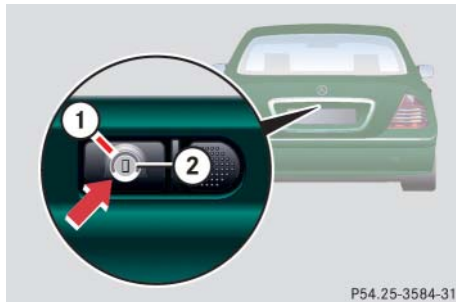

P54.25-3584-31

- ① Unlocking and opening
- ② Trunk lid lock

- ▶ Insert the mechanical key into the trunk lid lock until it stops.

- ▶ Turn the mechanical key counterclockwise to position ①.

The trunk opens.



The trunk lid swings open upwards automatically. Always make sure that there is sufficient overhead clearance.

- ▶ Turn the mechanical key back and remove it from the trunk lid lock.

Locking the vehicle

If you cannot lock the vehicle with the SmartKey or the SmartKey with KEYLESS-GO*, do the following:

- ▶ Close the passenger door and the trunk.
- ▶ Press the central locking switch in the center console (▷ page 111).
- ▶ Check to see whether the locking knob on the passenger door has moved down.

- ▶ If necessary, push it down manually.

Except for the driver's door, the vehicle should now be locked.

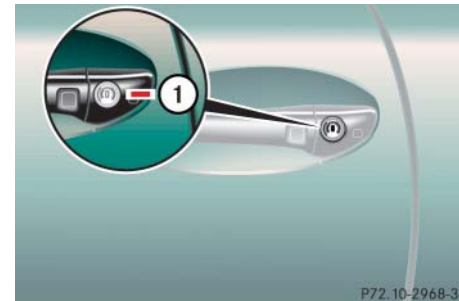

P72.10-2968-31

① Locking

- ▶ Remove the mechanical key out of the SmartKey (▷ page 372).
- ▶ Insert the mechanical key into the driver's door lock until it stops.
- ▶ Turn the mechanical key clockwise to position ①.

The driver's door is locked.

Unlocking/locking in an emergency

Fuel filler flap

In case the central locking system does not release the fuel filler flap, you can open it manually.

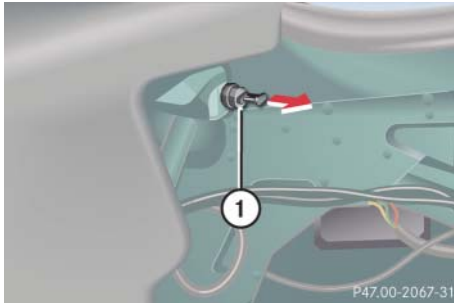

- ① Release knob
- ▶ Open the trunk.
- ▶ Remove the battery cover and the trim inside the trunk on the right-hand side.
- ▶ Pull release knob ① in the direction of arrow.

The fuel filler flap can be opened.

Opening/closing in an emergency

▼ Opening/closing in an emergency

Tilt/sliding sunroof

You can open or close the tilt/sliding sunroof manually should an electrical malfunction occur.

The tilt/sliding sunroof drive is located behind the lens of the interior overhead light.



① Lens

- ▶ Pry off lens ① using a flat blade screw-driver (▷ page 370).
- ▶ Switch on the ignition (▷ page 34).
- ▶ Take the crank from the operator's manual pouch.



② Crank

- ▶ Insert crank ② through hole.
- ▶ Turn crank ② clockwise to:
 - slide sunroof closed
 - raise roof at the rear
- ▶ Turn crank ② counterclockwise to:
 - slide sunroof open
 - lower roof at the rear



Turn crank ② slowly and smoothly.

The tilt/sliding sunroof must be synchronized after being operated manually (▷ page 204).

Replacing SmartKey batteries

If the batteries in the SmartKey or the SmartKey with KEYLESS-GO* are discharged, the vehicle can no longer be locked or unlocked. It is recommended to have the batteries replaced at an authorized Mercedes-Benz Center.

Warning!



Batteries contain poisonous and corrosive substances. Therefore keep the batteries out of reach of children.

If a battery is swallowed, seek medical help immediately.

Batteries contain materials that can harm the environment if disposed of improperly. Recycling of batteries is the preferred method of disposal. Many states require sellers of batteries to accept old batteries for recycling.



When inserting the batteries, make sure they are clean and free of lint.



The required replacement batteries are available at any authorized Mercedes-Benz Center.

SmartKey

Replacement batteries: Lithium, type CR 2025 or equivalent.



When changing batteries, always replace both batteries.

- ▶ Remove the mechanical key out of the SmartKey (▷ page 372).

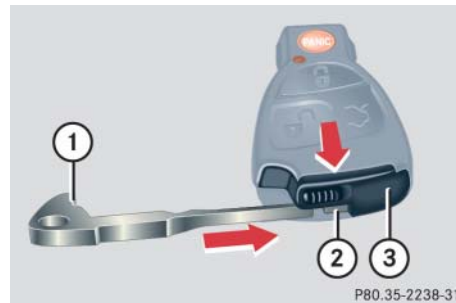

- ① Mechanical key
- ② Slide
- ③ Battery compartment

- ▶ Insert mechanical key ① in the direction of arrow in side opening.
- ▶ Using mechanical key ①, push gray slide ② to unlatch battery compartment ③.
- ▶ Pull battery compartment ③ out of the housing in the direction of arrow.

Replacing SmartKey batteries

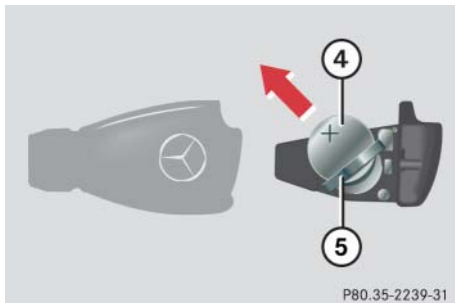

④ Battery

⑤ Contact spring

- ▶ Remove the batteries ④ in the direction of arrow.
- ▶ Using a lint-free cloth, insert new batteries ④ under the contact spring ⑤ with the positive terminal (+) side facing up.
- ▶ Return battery compartment ③ (▷ page 376) into housing until it locks into place.
- ▶ Slide mechanical key ① (▷ page 372) back into the SmartKey.
- ▶ Check the operation of the SmartKey.

SmartKey with KEYLESS-GO*

Replacement battery: Lithium, type CR 2025 or equivalent.

- ▶ Remove the mechanical key out of the SmartKey with KEYLESS-GO (▷ page 372).
- ▶ Remove battery compartment ③ out of the housing (▷ page 376).

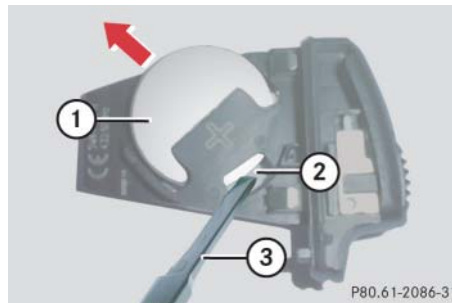

① Battery

② Tilt battery up

③ Mechanical key

- ▶ Using mechanical key ③, apply pressure to position ②.
- ▶ Battery ① tilts up slightly.
- ▶ Pull out battery ① in the direction of arrow.
- ▶ Using a lint-free cloth, insert new battery ① with the plus (+) side facing up.
- ▶ Return battery compartment ③ (▷ page 376) into housing until it locks into place.
- ▶ Slide mechanical key ① (▷ page 376) back into the SmartKey with KEYLESS-GO.
- ▶ Check the operation of KEYLESS-GO.

Replacing bulbs

Safe vehicle operation depends on proper exterior lighting and signaling. It is therefore essential that all bulbs and lamp assemblies are in good working order at all times.

Correct headlamp adjustment is extremely important. Have headlamps checked and readjusted at regular intervals and when a bulb has been replaced. See your authorized Mercedes-Benz Center for headlamp adjustment.



If the headlamps or front fog lamps are fogged up on the inside as a result of high humidity, driving the vehicle a distance with the lights on should clear up the fogging.



Substitute bulbs will be brought into use when the following lamps malfunction:

- Brake lamps
- Rear parking lamps
- Rear turn signal lamps
- Tail lamps

Observe the messages in the multi-function display (▷ page 354).

Bulbs

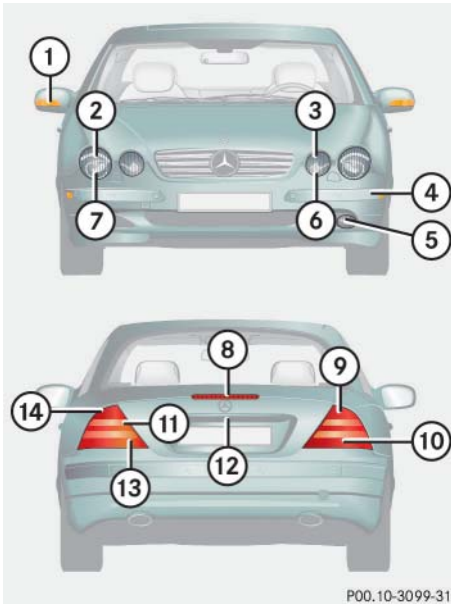

P00.10-3099-31

Front lamps

	Lamp	Type
①	Additional turn signal lamp	LED
②	Turn signal lamp	1156 NA
③	High beam flasher	H7-55 W
④	Side marker lamp	W 5 W
⑤	Fog lamp	HB4-55 W
⑥	Parking and standing lamp	W 5 W
⑦	Low beam and high beam lamp	Xenon ¹ D2S-35 W

¹ Bi-Xenon headlamps: For safety reasons (high voltage), do not replace the Xenon bulb yourself. Contact your authorized Mercedes-Benz Center.

Rear lamps

	Lamp	Type
⑧	High mounted brake lamp	LED
⑨	Brake lamp	LED
⑩	Tail, parking and standing lamp	P 21/4 W
	Side marker lamp	LED
⑪	Backup lamp	P 21 W
⑫	License plate lamp	C 5 W
⑬	Rear fog lamp, driver's side	P 21/4 W
⑭	Turn signal lamp	PY 21 W

Replacing bulbs

Notes on bulb replacement

Warning!



Keep bulbs out of reach of children.

Bulbs and bulb sockets can get very hot. Allow the lamp to cool down before changing a bulb.

Halogen lamps contain pressurized gas. A bulb can explode if you

- touch or move it when hot
- drop the bulb
- scratch the bulb

Wear eye and hand protection.

Because of high voltage in Xenon lamps, it is dangerous to replace the bulb or repair the lamp and its components. We recommend that you have such work done by a qualified technician.

- Only use 12-volt-bulbs of the same type and with the specified watt rating.
- Switch lights off before changing a bulb to prevent short circuits.
- Always use a clean lint-free cloth when handling bulbs.
- Your hands should be dry and free of oil and grease.
- If the newly installed bulb does not come on, visit an authorized Mercedes-Benz Center.

Have the LEDs and bulbs for the following lamps replaced by an authorized Mercedes-Benz Center.

- Additional turn signal lamps in the exterior rear view mirrors
- Bi-Xenon lamps
- High mounted brake lamp
- Brake lamps
- Front side marker lamps
- Rear side marker lamps
- Rear parking lamps



Have the headlamp adjustment checked regularly.

Replacing bulbs for front lamps

Before you start to replace a bulb for a front lamp, do the following first:

- ▶ Turn the exterior lamp switch to **0** (▷ page 52).
- ▶ Open the hood (▷ page 273) (except for side marker lamps).

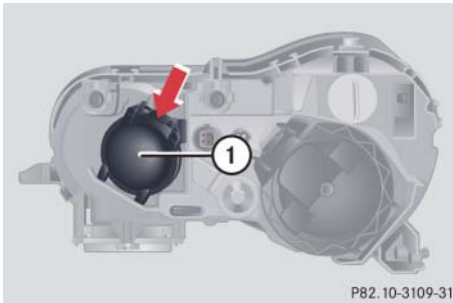

- ① Housing cover for high beam flasher bulb, parking and standing lamp

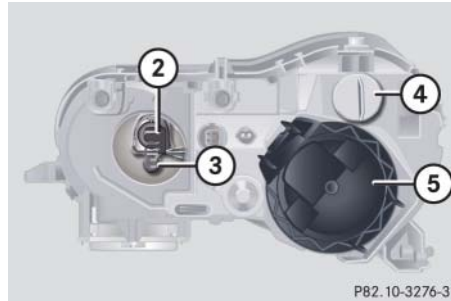

- ② Electrical connector for high beam flasher housing bulb
- ③ Bulb socket for parking and standing lamp
- ④ Bulb socket for turn signal lamp
- ⑤ Housing cover for Bi-Xenon headlamp

Bi-Xenon headlamp

Warning!



Do not remove the cover for the Bi-Xenon headlamp. Because of high voltage in Xenon lamps, it is dangerous to replace the bulb or repair the lamp and its components. We recommend that you have such work done by a qualified technician.

Replacing bulbs

High beam flasher bulb

- ▶ Press ends of housing cover ① tab together and remove cover.
- ▶ Press connector ② downward.
- ▶ Remove connector ② with the bulb.
- ▶ Insert the new bulb so that the base locates in the recess on the holder.
- ▶ From below, press connector ② with bulb upward onto the reflector.
- ▶ Align housing cover ① and click into place.

Front turn signal bulb

- ▶ Turn bulb socket ④ counterclockwise and pull out.
- ▶ Gently push bulb into bulb socket ④, turn counterclockwise and remove.
- ▶ Insert new bulb in bulb socket ④, push in and twist clockwise.
- ▶ Reinsert bulb socket ④ in lamp and twist clockwise.

Parking and standing lamp bulb

- ▶ Press ends of housing cover ① tab together and remove cover.
- ▶ Pull out the bulb socket ③ with the bulb.
- ▶ Pull the bulb out of the bulb socket ③.
- ▶ Insert a new bulb in the socket ③.
- ▶ Reinstall the bulb socket ③.
- ▶ Align housing cover ① and click into place.

Front side marker lamp bulbs

Since replacing the side marker lamp bulbs is a technically highly demanding process, we recommend you have the side marker lamp bulbs replaced by an authorized Mercedes-Benz Center.

Replacing bulbs for rear lamps

Before you start to replace a bulb for a front lamp, do the following first:

- ▶ Turn the exterior lamp switch to **0** (▷ page 52).
- ▶ Open the trunk (▷ page 101).

Tail lamp assemblies

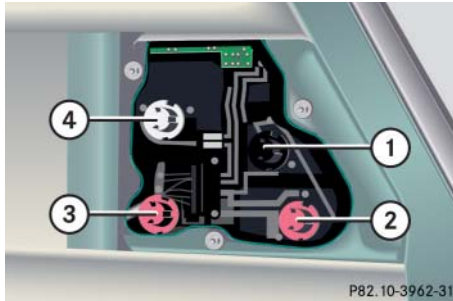

Passenger side

- ① Black socket:
Backup lamp
- ② Red socket:
Driver's side: Tail, parking and rear fog lamp
Passenger's side: Tail and parking lamp
- ③ Red socket:
Tail, standing and parking lamp
- ④ White socket:
Turn signal lamp

- ▶ Turn the locking knob and move the trim to the side.
- ▶ Turn bulb socket counterclockwise and pull out.
- ▶ Gently twist bulb counterclockwise and pull out of bulb holder.
- ▶ Insert new bulb into the holder and turn it clockwise.
- ▶ Reinstall bulb socket.
The bulb socket should audibly click.
- ▶ Replace trim and secure with lock.

License plate lamp

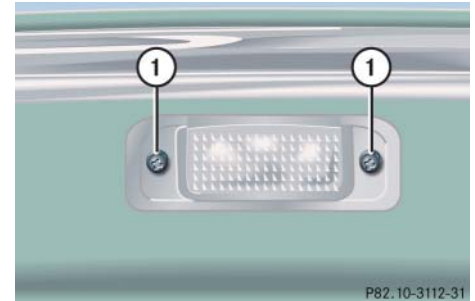

① Screws

- ▶ Loosen both screws ①.
- ▶ Remove the license plate lamp.
- ▶ Replace the bulb.
- ▶ Reinstall the license plate lamp.
- ▶ Retighten screws ①.

Replacing wiper blades



To avoid damage to the hood, the wiper arms should only be folded forward when in the vertical position.



Wiper blades in vertical position

Removing wiper blades

- ▶ Turn SmartKey in starter switch to position **1**.
- ▶ Turn combination switch to wiper setting **II** (> page 54).
- ▶ With wiper arm in vertical position, turn SmartKey in starter switch to position **0**.

Warning!



For safety reasons, switch off wipers and remove SmartKey from starter switch (vehicles with KEYLESS-GO*: Make sure the vehicle's on-board electronics have status **0**) before replacing a wiper blade. Otherwise, the wiper motor could suddenly turn on and cause injury.

- ▶ Fold the wiper arm forward until it snaps into place.

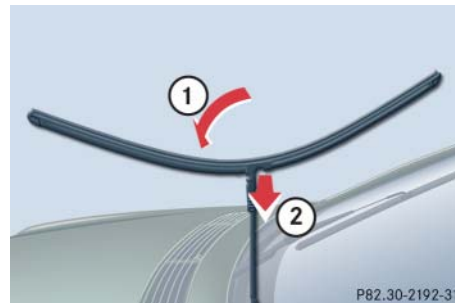

- ▶ Turn the wiper blade at a right angle to wiper arm (arrow ①).
- ▶ Slide the wiper blade sideways out of the retainer in the direction of arrow ②.

Installing wiper blades

- ▶ Slide the wiper blade onto wiper arm until it locks in place.
- ▶ Rotate the wiper blade into position parallel to wiper arm.
- ▶ Fold the wiper arm backward to rest on the windshield. Make sure you hold onto the wiper when folding the wiper arm back.



Never open the hood when the wiper arm is folded forward.

Hold on to the wiper when folding the wiper arm back. If released, the force of the impact from the tensioning spring could crack the windshield.

Do not allow the wiper arms to contact the windshield glass without a wiper blade inserted.

Make certain that the wiper blades are properly installed. Improperly installed wiper blades may cause windshield damage.

For your convenience, we recommend that you have this work carried out by an authorized Mercedes-Benz Center.

Flat tire

Preparing the vehicle

- ▶ Park the vehicle as far as possible from moving traffic on a hard, flat surface when possible.
- ▶ Turn on the hazard warning flashers.
- ▶ Turn the steering wheel so that the front wheels are in a straight ahead position.
- ▶ Set the parking brake.
- ▶ Move the gear selector lever to position **P**.

Vehicles with SmartKey:

- ▶ Turn off the engine (▷ page 59).
- ▶ Remove the SmartKey from the starter switch.

Vehicles with SmartKey with KEYLESS-GO*:

- ▶ Turn off the engine by pressing the KEYLESS-GO* button on the gear selector lever once (▷ page 59).

- ▶ Open the driver's door (this puts the starter switch in position **0**, same as with the SmartKey removed from the starter switch). The driver's door then can be closed again.



Open door only when conditions are safe to do so.

Vehicles with SmartKey:

- ▶ Have any passenger exit the vehicle at a safe distance from the roadway.

Mounting the spare wheel

Warning!



Never operate the vehicle with more than one spare wheel mounted.

When driving with spare wheel mounted, ensure proper tire inflation pressure.

The spare wheel rim is for temporary use only. Use for over a total of 12 000 miles (20 000 km) (aggregate of all uses) may cause wheel rim failure leading to an accident and possible injuries.

The spare wheel should only be used temporarily and replaced with a regular road wheel as quickly as possible.

Additional information for CL 55 AMG, CL 65 AMG and vehicles with Sport Package:

The dimensions of the spare wheel are different from those of the road wheels. As a result, the vehicle handling characteristics change when driving with a mounted spare wheel. Adapt your driving style accordingly.

The spare wheel is for temporary use only. When driving with spare wheel mounted, do not exceed vehicle speed of 50 mph (80 km/h).

Preparing the vehicle

- ▶ Take vehicle tool kit tray and vehicle jack out of trunk.
- ▶ Take the spare wheel out of wheel well (▷ page 371).

Lifting the vehicle

- ▶ Prevent the vehicle from rolling away by blocking wheels with wheel chocks (not included) or other sizeable objects.

When changing wheel on a level surface:

- ▶ Place wheel chocks or other sizeable suitable objects in front of and one behind the wheel that is diagonally opposite to the wheel being changed.

Always try lifting the vehicle using the jack on a level surface. However, should circumstances require you to do so on a hill, place the wheel chocks or other sizeable suitable objects as follows:

- ▶ Place wheel chocks or other sizeable suitable objects on the downhill side blocking both wheels of the axle not being worked on.

Warning!



The jack is designed exclusively for jacking up the vehicle at the jack take-up brackets built into both sides of the vehicle. To help avoid personal injury, use the jack only to lift the vehicle during a wheel change. Never get beneath the vehicle while it is supported by the jack. Keep hands and feet away from the area under the lifted vehicle. Always firmly set parking brake and block wheels before raising vehicle with jack.

Do not disengage parking brake while the vehicle is raised. Be certain that the jack is always vertical (plumb line) when in use, especially on hills. Always try to use the jack on level surface. Make sure the jack arm is fully seated in the jack take-up bracket. Always lower the vehicle onto sufficient capacity jackstands before working under the vehicle.



Flat tire



- ▶ Take the two-piece wheel wrench out of the vehicle tool kit tray. Assemble wheel wrench.
- ▶ On wheel to be changed, loosen but do not yet remove the wheel bolts (approximately one full turn with wrench).

The tube openings are located directly behind the front wheel housings and in front of the rear wheel housings.



- ① Jack support tube cover
- ▶ Move cover ① toward rear by pressing at point indicated by arrow.
- ▶ Remove cover ① carefully to avoid damage to the locking tabs.

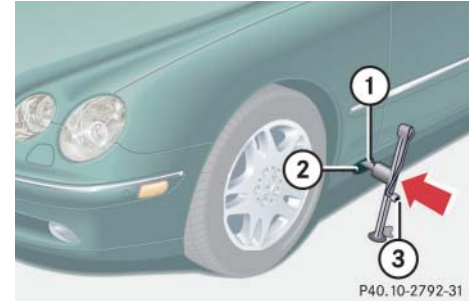

- ① Jack arm
- ② Jack support tube hole
- ③ Crank
- ▶ Insert jack arm ① fully into tube hole ② up to the stop.

Warning!



Insert the jack arm fully into the jack support tube hole up to the stop. Otherwise the vehicle may fall off the jack and cause personal injury or damage to the vehicle.

- ▶ Keeping jack in this position, turn crank ③ clockwise until the jack base meets the ground. Make sure the jack is vertical (plumb line).
- ▶ Continue to turn the crank until the tire is a maximum of 1.2 in (3 cm) from the ground.

Warning!



The jack is intended only for lifting the vehicle briefly for wheel changes. It is not suited for performing maintenance work under the vehicle.

- Never start the engine when the vehicle is raised.
- Never lie down under the raised vehicle.

Removing the wheel

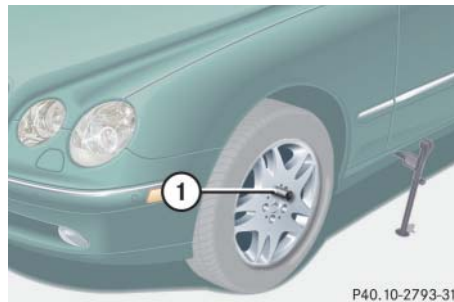

① Alignment bolt

- ▶ Unscrew upper-most wheel bolt and remove.
- ▶ Replace this wheel bolt with alignment bolt ① supplied in the tool kit.
- ▶ Remove the remaining bolts.



Do not place wheel bolts in sand or dirt. This could result in damage to the bolt and wheel hub threads.

- ▶ Remove the wheel.

Mounting the new wheel

- ▶ Clean contact surfaces of wheel and wheel hub.



To avoid paint damage, place wheel flat against hub and hold it there while installing first wheel bolt.

Warning!



Always replace wheel bolts that are damaged or rusted.

Never apply oil or grease to wheel bolts.

Damaged wheel hub threads should be repaired immediately. Do not continue to drive under these circumstances! Contact an authorized Mercedes-Benz Center or call Roadside Assistance.

Incorrect wheel bolts or improperly tightened wheel bolts can cause the wheel to come off. This could cause an accident. Make sure you are using the correct wheel bolts.



Flat tire

- ▷▷ Guide the spare wheel onto the alignment bolt and push it on.
- ▶ Insert wheel bolts and tighten them slightly.
- ▶ Unscrew the alignment bolt, install last wheel bolt and tighten slightly.

Warning!



Use only Genuine equipment Mercedes-Benz wheel bolts. Other wheel bolts may come loose.

Do not tighten the wheel bolts when the vehicle is raised. Otherwise the vehicle could fall off the jack.

Lowering the vehicle

- ▶ Lower vehicle by turning crank counterclockwise until vehicle is resting fully on its own weight.
- ▶ Remove the jack.

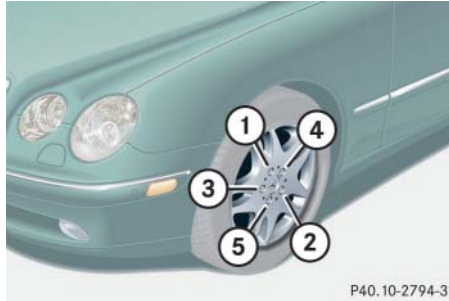

P40.10-2794-31

① - ⑤ Wheel bolts

- ▶ Tighten the five wheel bolts evenly, following the diagonal sequence illustrated (① to ⑤), until all bolts are tight. Observe a tightening torque of 110 lb-ft (150 Nm).

Warning!



Have the tightening torque checked after changing a wheel. The wheels could come loose if they are not tightened to a torque of 110 lb-ft (150 Nm).

- ▶ Before storing the jack in the trunk, it should be fully collapsed, with handle folded in.
- ▶ Place the wheel bolt wrench, alignment bolt and jack back in the vehicle tool kit in the trunk and close the covering lid.

Replacing jack support tube cover

- ▶ Slide tongue of cover under the upper edge of the tube opening.
- ▶ Applying even pressure, press cover until it snaps into place. Be careful not to damage the locking tabs or clamp the plastic retaining strap.



You can also store and secure the damaged wheel in the spare wheel well in the trunk.

Do not activate the tire inflation pressure monitor until the depressurized tire is no longer in the vehicle.

▼ Battery

Warning!

Failure to follow these instructions can result in severe injury or death.

Never lean over batteries while connecting, you might get injured.

Battery fluid contains sulfuric acid. Do not allow this fluid to come in contact with eyes, skin or clothing. In case it does, immediately flush affected area with water and seek medical help if necessary.

A battery will also produce hydrogen gas, which is flammable and explosive. Keep flames or sparks away from battery, avoid improper connection of jumper cables, smoking, etc.

Warning!

Do not place metal objects on the battery as this could result in a short circuit.

Use leak-proof battery only to avoid the risk of acid burns in the event of an accident.



Never loosen or detach battery terminal clamps while the engine is running or the SmartKey is in the starter switch. Otherwise the alternator and other electronic components could be severely damaged.

Have the battery checked regularly by an authorized Mercedes-Benz Center. Refer to Maintenance Booklet for maintenance intervals or contact your authorized Mercedes-Benz Center for further information.

Warning!

With a disconnected battery

- you will no longer be able to turn the SmartKey in the starter switch and pressing the KEYLESS-GO* start/stop button (▷ page 35) on the gear selector lever will have no effect
- the gear selector lever will remain locked in position **P**

The battery is located in the trunk under the right hand wheel well cover panel.

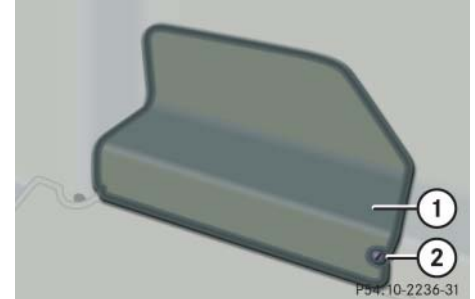

① Battery cover

② Locking knob

- ▶ Rotate and loosen locking knob ② approx. one-half turn.
- ▶ Remove battery cover ①.

Battery

Disconnecting the battery

- ▶ Turn off all electrical consumers.
- ▶ Open the trunk (▷ page 101).
- ▶ Read and observe safety instructions and precautions (▷ page 391).
- ▶ Remove the battery cover ①.

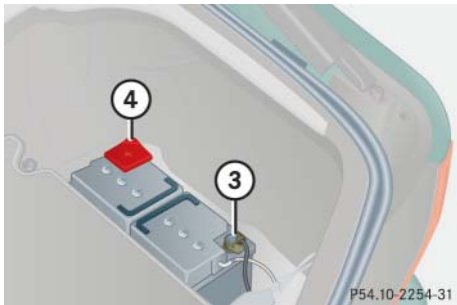

- ③ Negative terminal
- ④ Cover over positive terminal
- ▶ Use a 10-mm open-end wrench to disconnect the battery negative lead ③.
- ▶ Remove cover ④ from the positive terminal.
- ▶ Disconnect the battery positive lead.

Removing the battery

- ▶ Remove the screw securing the battery.
- ▶ Remove the battery support and bracket.
- ▶ Pull out the battery ventilation tube from the battery (depending on battery arrangement in your vehicle model, the ventilation tube is located either on the left or right side of the battery).
- ▶ Take out the battery.

Charging and reinstalling the battery

- ▶ Charge battery in accordance with the instructions of the battery charger manufacturer.
- ▶ Reinstall the charged battery. Follow the previously described steps in reverse order.

Warning!



Never charge a battery while still installed in the vehicle unless the accessory battery charge unit approved by Mercedes-Benz is being used. Gases may escape during charging and cause explosions that may result in paint damage, corrosion or personal injury.

An accessory battery charge unit specially adapted for Mercedes-Benz vehicles and tested and approved by Mercedes-Benz is available, permitting the charging of the battery in its installed position. Contact an authorized Mercedes-Benz Center for information and availability. Charge battery in accordance with the separate instructions for the accessory battery charger.



The battery, its filler caps and the battery ventilation tube must always be securely installed when the vehicle is in operation.

Reconnecting the battery

- ▶ Turn off all electrical consumers.
- ▶ Connect the positive lead and fasten its cover ④.
- ▶ Connect negative lead ③.



Never invert the terminal connections.



The following procedures must be carried out following any interruption of battery power (e.g. due to reconnecting):

- Set the clock (see COMAND operator's manual).
- Synchronize the ESP® (▷ page 343).
- Synchronize the power windows (▷ page 199).
- Synchronize the power tilt/sliding sunroof (▷ page 204).

Batteries contain materials that can harm the environment if disposed of improperly. Large 12-volt storage batteries contain lead. Recycling of batteries is the preferred method of disposal. Many states require sellers of batteries to accept old batteries for recycling.

Jump starting

Warning!



Failure to follow these directions will cause damage to the electronic components, and can lead to a battery explosion and severe injury or death.

Never lean over batteries while connecting or jump starting, you might get injured.

Battery fluid contains sulfuric acid. Do not allow this fluid to come in contact with eyes, skin or clothing. In case it does, immediately flush affected area with water, and seek medical help if necessary.

A battery will also produce hydrogen gas, which is flammable and very explosive. Keep flames or sparks away from battery, avoid improper connection of jumper cables, smoking, etc.

Attempting to jump start a frozen battery can result in it exploding, causing personal injury.

Read all instructions before proceeding.

If the battery is discharged, the engine can be started with jumper cables and the battery of another vehicle. Observe the following:

- Jump starting should only be performed when the engine and catalytic converter are cold.
- Do not start the engine if the battery is frozen. Let the battery thaw out first.
- Only use 12-volt battery to jump start your vehicle. Jump starting with a more powerful battery could damage the vehicle's electrical system, which will not be covered by the Mercedes-Benz Limited Warranty.
- Only use jumper cables with sufficient cross-section and insulated terminal clamps.
- Always make sure that the jumper cables are not on or near pulleys, fans or other parts that move when an engine is started or running.



Avoid repeated and lengthy starting attempts.

Do not attempt to start the engine using a battery quick charge unit.

If engine does not run after several unsuccessful starting attempts, have it checked at the nearest authorized Mercedes-Benz Center.

Excessive unburned fuel generated by repeated failed starting attempts may damage the catalytic converter and may present a fire risk.

Make sure the jumper cables do not have loose or missing insulation.

Make sure the cable clamps do not touch any other metal part while the other end is still attached to a battery.



Do not tow-start the vehicle.

Warning!



Keep flames or sparks away from battery. Do not smoke.

Observe all safety instructions and precautions when handling automotive batteries (▷ page 281).

The battery is located on the right side of the trunk under the battery cover (▷ page 391).

- ▶ Make sure the two vehicles do not touch.
- ▶ Turn off all electrical consumers.
- ▶ Apply parking brake.
- ▶ Shift gear selector lever to position **P**.
- ▶ Open the trunk.
- ▶ Remove battery cover.
- ▶ Remove red cover from positive terminal ①.

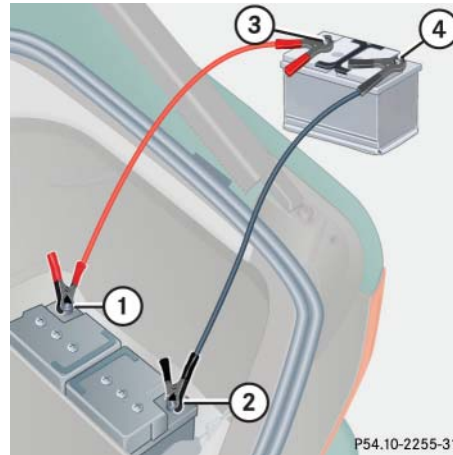

- ① Positive terminal of discharged battery
 - ② Negative terminal of discharged battery
 - ③ Positive terminal of charged battery
 - ④ Negative terminal of charged battery
- ▶ Connect positive terminals ① and ③ of the batteries with the jumper cable. Clamp cable to charged battery ③ first.



Never invert the terminal connections.

- ▶ Start engine of the vehicle with the charged battery and run at idle speed.
- ▶ Connect negative terminals ② and ④ of the batteries with the jumper cable. Clamp cable to charged battery ④ first.
- ▶ Start the engine of the disabled vehicle.

Now you can again turn on the electrical consumers. Do not turn on the lights under any circumstances.

- ▶ Remove the jumper cables first from negative terminals ② and ④ and then from positive terminals ① and ③.

You can now turn on the lights.

- ▶ Have the battery checked at the nearest authorized Mercedes-Benz Center.

Towing the vehicle

Mercedes-Benz recommends that the vehicle be transported with all wheels off the ground using flatbed or appropriate wheel lift/dolly equipment. This method is preferable to other types of towing.



Use flatbed or wheel lift/dolly equipment with SmartKey in starter switch turned to position **0**.

Do not tow with sling-type equipment. Towing with sling-type equipment over bumpy roads will damage radiator and supports.

To prevent damage during transport, do not tie down vehicle by its chassis or suspension parts.

Switch off the tow-away alarm (▷ page 87) and the automatic central locking (▷ page 162).

Do not tow-start the vehicle.

When circumstances do not permit the recommended towing methods, the vehicle may be towed with all wheels on the ground or front wheels raised only so far as necessary to have the vehicle moved to a safe location where the recommended towing methods can be employed.



If the vehicle is towed with the front axle raised, the engine must be shut off (SmartKey in starter switch position **0** or **1**). Otherwise, the ESP® will immediately be engaged and will apply the rear wheel brakes.

When towing the vehicle with all wheels on the ground, the selector lever must be in position **N** and the SmartKey must be in starter switch position **2**.

When towing the vehicle with all wheels on the ground or the front axle raised, the vehicle may be towed only for distances up to 30 miles (50 km) and at a speed not to exceed 30 mph (50 km/h).



To be certain to avoid a possibility of damage to the drivetrain, however, we recommend the drive shaft be disconnected at the rear axle drive flange for any towing beyond a short tow to a nearby garage.

Warning!

If circumstances require towing the vehicle with all wheels on the ground, always tow with a tow bar if:

- the engine will not run
- there is a malfunction in the power supply or in the vehicle's electrical system

as that will be necessary to adequately control the towed vehicle.

Prior to towing the vehicle with all wheels on the ground, make certain that the SmartKey is in starter switch position **2**.

If the SmartKey is left in starter switch position **0** for an extended period of time, it can no longer be turned in the switch. In this case, the steering is locked. To unlock, remove SmartKey from starter switch and re-insert.

Warning!

With the engine not running, there is no power assistance for the brake and steering systems. In this case, it is important to keep in mind that a considerably higher degree of effort is necessary to brake and steer the vehicle. Adapt your driving accordingly.



The gear selector lever will remain locked in position **P** and the SmartKey will not turn in the starter switch if the battery is disconnected or discharged. See information on the battery (▷ page 391) or on jump starting (▷ page 394).



To signal turns while being towed with the hazard warning flasher in use, turn SmartKey in starter switch to position **2** and activate the combination switch for the left or right turn signal in the usual manner – only the selected turn signal will operate.

Upon canceling the turn signal, the hazard warning flasher will operate again.

Towing the vehicle



When towing the vehicle with all wheels on the ground, please note the following:

With the automatic central locking activated and the SmartKey in starter switch position **2**, or KEYLESS-GO* start/stop button (▷ page 35) in position **2**, the vehicle doors lock if the left front wheel as well as the right rear wheel are turning at vehicle speeds of approx. 9 mph (15 km/h) or more.

Switch off the tow-away alarm (▷ page 87).

To prevent the vehicle door locks from locking, deactivate the automatic central locking (▷ page 162).

Towing of the vehicle should only be done using the properly installed towing eye bolt. Never attach tow cable, tow rope or tow rod to the vehicle chassis, frame or suspension parts.

Installing towing eye bolt

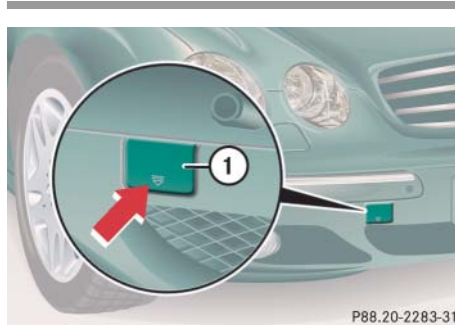

① Cover on right side of front bumper

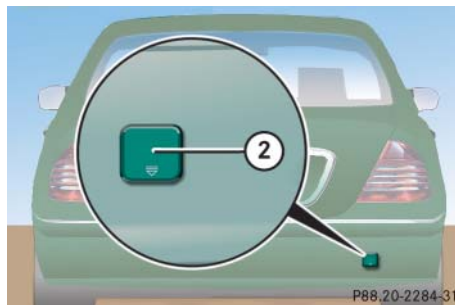

② Cover on right side of rear bumper

Removing cover

- ▶ Press mark on cover in the direction of arrow.
- ▶ Lift cover off to reveal the threaded hole for the towing eye bolt.

Installing towing eye bolt

- ▶ Take towing eye bolt and wheel wrench out of trunk (▷ page 370).
- ▶ Screw towing eye bolt clockwise into its stop and tighten with wheel wrench.

Removing towing eye bolt

- ▶ Loosen towing eye bolt counterclockwise with wheel wrench.
- ▶ Unscrew towing eye bolt.
- ▶ Store towing eye bolt and wheel wrench in trunk.

Installing cover

- ▶ Fit cover and snap into place.

▼ Fuses

Fuses are designed to protect the electrical circuits in your vehicle from a short circuit. If a fuse is blown, the component(s) and systems controlled by that fuse will stop working.

The following aids are available to help you replace fuses (▷ page 399):

- Fuse chart
- Spare fuses
- Special fuse extractor

Warning!



Only use fuses approved by Mercedes-Benz and which have the specified amperage. Using other fuses may cause an overload and lead to a fire, or cause damage to electrical components and/or systems.



Never attempt to repair or bridge a blown fuse. Have the cause determined and remedied by an authorized Mercedes-Benz Center.

Your vehicle's electrical fuses are located in various fuse boxes:

- In the dashboard on the passenger side (▷ page 400)
- In the rear passenger compartment under the right rear seat (▷ page 400)
- In the engine compartment on the driver's side (▷ page 401)
- In the engine compartment on the passenger side (▷ page 401)

Aids for replacing fuses

Fuse chart

A chart explaining fuse allocation and fuse amperages can be found in the vehicle tool kit in the trunk (▷ page 370).

Spare fuses

Spare fuses are found in the vehicle tool kit in the trunk (▷ page 370).

Fuse extractor

The fuse extractor is found in the vehicle tool kit in the trunk (▷ page 370).

Fuses

Fuse boxes in passenger compartment

There are two fuse boxes in the in passenger compartment. One fuse box is located in the dashboard. An additional fuse box is located in the rear passenger compartment.

Fuse box in dashboard



① Cover



Do not use sharp objects such as a screw driver to open the fuse box cover ① in the dashboard, as this could damage it.

Opening

- ▶ Open the front passenger door.
 - ▶ Using the flat of your hand, press on the middle of the cover ①.
- The edge of cover ① lifts up slightly from the dashboard.
- ▶ Insert flat, blunt object into the edge of the cover as a lever.
 - ▶ Loosen cover ① from the dashboard using lever.
 - ▶ Using your hands, pull cover ① in the direction of the arrow and remove.

Closing

- ▶ Hook cover ① into the opening at the front.
- ▶ Press cover ① back on until it engages.

Fuse box in the rear passenger compartment

The fuse box is located in the footwell below the right rear seat.

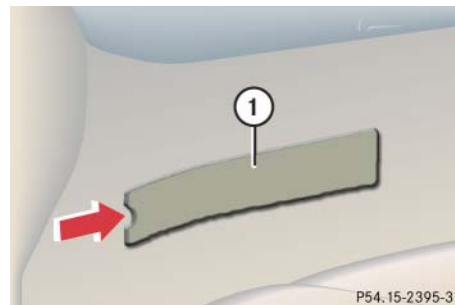

① Cover

Opening

- ▶ Pull cover ① away from fuse box in the direction of arrow.
- ▶ Remove cover rearward.

Closing

- ▶ Press cover back on until it engages.

Fuse boxes in engine compartment

There are three fuse boxes located in the engine compartment in front of the firewall (dividing wall between engine compartment and passenger compartment):

- one box on the driver's side
- two boxes on the front passenger side

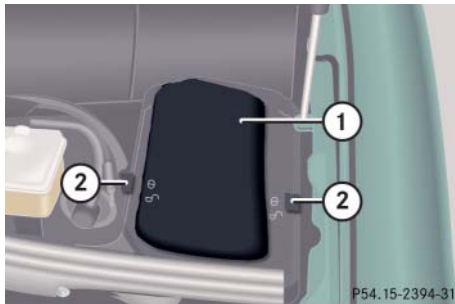

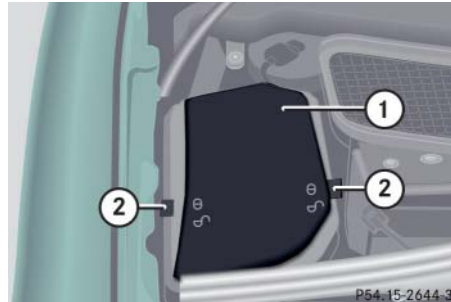

Fuse box, driver's side

- ① Cover
- ② Slide



Fuse box, front passenger side

- ① Cover
- ② Slide

- ▶ To open, push slides ② to symbol  and remove cover ①.
- ▶ To close, replace cover ① and press it down and push both slides ② to symbol .



The cover ① must fit properly and the slides ② must be positioned at symbol , as otherwise moisture or dirt may impair the functionality of the fuses.

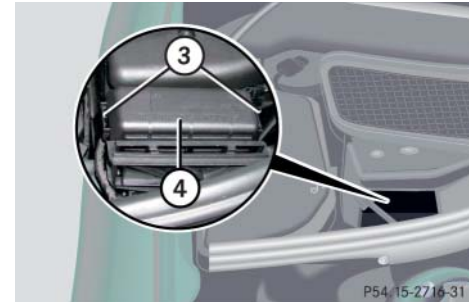

Additional fuse box, front passenger side

- ③ Tabs
- ④ Cover

- ▶ To open, press tabs ③ together and remove cover ④.
- ▶ To close, place cover ④ and push it down until it engages.



The cover ④ must fit properly, as otherwise moisture or dirt may impair the functionality of the fuses.

Parts service

Warranty coverage

Identification labels

Layout of poly-V-belt drive

Engine

Rims and Tires

Electrical system

Main dimensions and weights

Fuels, coolants, lubricants, etc.



The “Technical data” section provides the necessary technical data for your vehicle.

All authorized Mercedes-Benz Centers maintain a stock of Genuine Mercedes-Benz parts required for maintenance and repair work. In addition, strategically located parts distribution centers provide quick and reliable parts service.

More than 300 000 different parts for Mercedes-Benz models are available.

Genuine Mercedes-Benz parts are subjected to stringent quality inspections. Each part has been specifically developed, manufactured or selected for and adapted to Mercedes-Benz vehicles.

Therefore, Genuine Mercedes-Benz parts should be installed.



The use of non-genuine Mercedes-Benz parts and accessories not authorized by Mercedes-Benz could damage the vehicle, which is not covered by the Mercedes-Benz Limited Warranty, or could compromise the vehicle’s durability or safety.

▼ Warranty coverage

Your vehicle is covered under the terms of the warranties printed in the Service and Warranty Information booklet. Your authorized Mercedes-Benz Center will exchange or repair any defective parts originally installed in the vehicle in accordance with the terms of the following warranties:

- New Vehicle Limited Warranty
- Emission System Warranty
- Emission Performance Warranty
- California, Maine, Massachusetts, and Vermont Emission Control Systems Warranty

Replacement parts and accessories are covered by the Mercedes-Benz Parts and Accessories warranties, copies of which are available at any Mercedes-Benz Center.

Loss of Service and Warranty Information Booklet

Should you lose your Service and Warranty Information booklet, have an authorized Mercedes-Benz Center arrange for a replacement. It will be mailed to you.

Identification labels

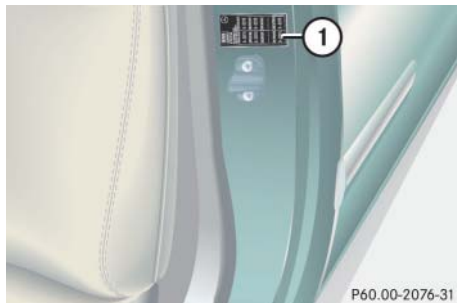

- ① Certification label
(on driver's B pillar)

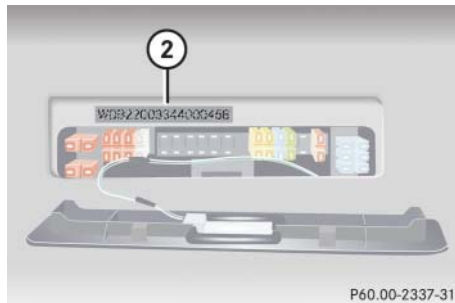

- ② Vehicle Identification Number (VIN)
(below right rear passenger seat)

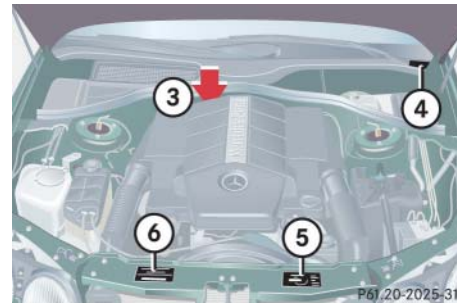

- ③ Engine number (engraved on engine)
④ VIN, visible (lower edge of windshield)
⑤ Vacuum line routing diagram label
⑥ Emission control information label,
includes both federal and California
certification exhaust emission
standards



When ordering parts, please specify vehicle identification and engine numbers.

▼ Layout of poly-V-belt drive

CL 500

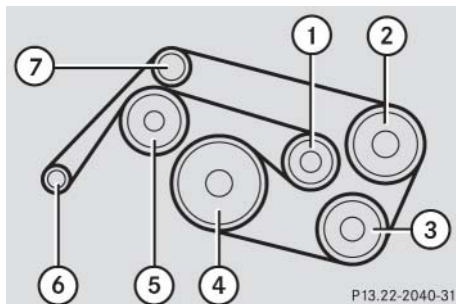

- ① Automatic belt tensioner
- ② ABC tandem pump (pump for power-steering assistance and ABC chassis)
- ③ Air conditioning compressor
- ④ Crankshaft
- ⑤ Coolant pump
- ⑥ Generator (alternator)
- ⑦ Idler pulley

CL 55 AMG

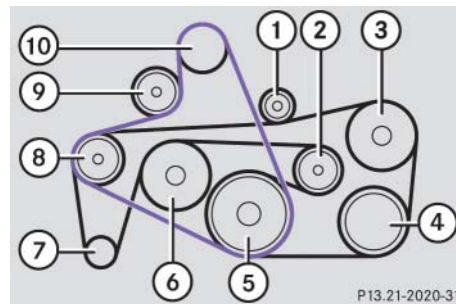

The CL 55 AMG has two poly-V-belts (belt one shown in purple/belt two shown in black).

- ① Idler pulley
- ② Automatic belt tensioner
- ③ ABC tandem pump (pump for power-steering assistance and ABC chassis)
- ④ Air conditioning compressor
- ⑤ Crankshaft
- ⑥ Coolant pump
- ⑦ Generator (alternator)
- ⑧ Idler pulley
- ⑨ Automatic belt tensioner
- ⑩ Supercharger

CL 600 and CL 65 AMG

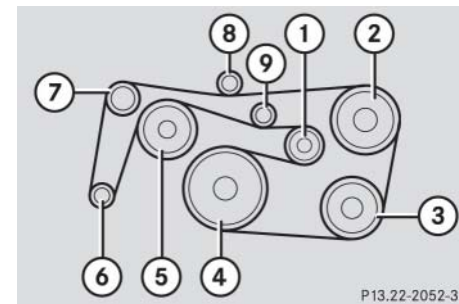

- ① Automatic belt tensioner
- ② ABC tandem pump (pump for power-steering assistance and ABC chassis)
- ③ Air conditioning compressor
- ④ Crankshaft
- ⑤ Coolant pump
- ⑥ Generator (alternator)
- ⑦ Idler pulley
- ⑧ Idler pulley
- ⑨ Idler pulley

Engine

Model	CL 500 (215.375)¹	CL 55 AMG (215.374)¹
Engine	113	113
Mode of operation	4-stroke engine, gasoline injection	4-stroke engine, gasoline injection
No. of cylinders	8	8
Bore	3.82 in (97.00 mm)	3.82 in (97.00 mm)
Stroke	3.31 in (84.00 mm)	3.60 in (92.00 mm)
Total piston displacement	303.0 cu in (4966 cm ³)	331.8 cu in (5439 cm ³)
Compression ratio	10:1	9:1
Output acc. to SAE J 1349	302 hp/5600 rpm ² (225 kW/5600 rpm)	493 hp/6100 rpm ² (368 kW/6100 rpm)
Maximum torque acc. to SAE J 1349	339 lb-ft/2700 - 4250 rpm (460 Nm/2700 - 4250 rpm)	516 lb-ft/2750-4000 rpm (700 Nm/2750-4000 rpm)
Maximum engine speed	6000 rpm	6500 rpm
Firing order	1-5-4-2-6-3-7-8	1-5-4-2-6-3-7-8
Poly-V-belt	2380 mm	Belt one: 1289 mm Belt two: 2462 mm

¹ The quoted data apply only to the standard vehicle. See an authorized Mercedes-Benz Center for the corresponding data of all special bodies and special equipment.

² Premium fuel required. Performance may vary with fuel octane rating.

Model	CL 600 (215.376) ¹	CL 65 AMG (215.379) ¹
Engine	275	275
Mode of operation	4-stroke engine, gasoline injection	4-stroke engine, gasoline injection
No. of cylinders	12	12
Bore	3.23 in (82.00 mm)	3.25 in (82.60 mm)
Stroke	3.43 in (87.00 mm)	3.66 in (93.00 mm)
Total piston displacement	336.4 cu in (5513 cm ³)	364.9 cu in (5980 cm ³)
Compression ratio	9:1	9:1
Output acc. to SAE J 1349	493 hp/5000 rpm ² (368 kW/5000 rpm)	603 hp/4750 rpm ² (450 kW/4750 rpm)
Maximum torque acc. to SAE J 1349	590 lb-ft/1800–3500 rpm (800 Nm/1800–3500 rpm)	738 lb-ft/2000 - 3000 rpm (1000 Nm/2000 - 3000 rpm)
Maximum engine speed	5950 rpm	5950 rpm
Firing order	1-12-5-8-3-10-6-7-2-11-4-9	1-12-5-8-3-10-6-7-2-11-4-9
Poly-V-belt	2335 mm	2335 mm

¹ The quoted data apply only to the standard vehicle. See an authorized Mercedes-Benz Center for the corresponding data of all special bodies and special equipment.

² Premium fuel required. Performance may vary with fuel octane rating.

Rims and Tires



Only use tires which have been tested and approved for your vehicle by Mercedes-Benz. Tires approved by Mercedes-Benz are developed to provide best possible performance in conjunction with the driving safety systems on your vehicle such as ABS or ESP®. Tires specially developed for your vehicle and tested and approved by Mercedes-Benz can be identified by finding the following on the tire's sidewall:

- MO = Mercedes-Benz Original equipment tires

AMG vehicles:

Does not apply to all approved tires on AMG vehicles. For information on tested and approved tires for AMG vehicles, contact an authorized Mercedes-Benz Center.

Using tires other than those approved by Mercedes-Benz may result in damage that is not covered by the Mercedes-Benz Limited Warranty.



Using tires other than those approved by Mercedes-Benz can have detrimental effects, such as

- poor handling characteristics
- increased noise
- increased fuel consumption

Moreover, tires and rims not approved by Mercedes-Benz may, under load, exhibit dimensional variations and different tire deformation characteristics that could cause them to come into contact with the vehicle body or axle parts. Damage to the tires or the vehicle may be the result.



Further information on tires and rims is available at any authorized Mercedes-Benz Center. A placard with the recommended tire inflation pressures is located on the driver's door B-pillar (▷ page 286). Some vehicles may have supplemental tire inflation pressure information for driving at high speeds (▷ page 293) or for vehicle loads less than the maximum loaded vehicle condition (▷ page 299). If such information is provided, it can be found on the placard located on the inside of the fuel filler flap. The tire inflation pressure should be checked regularly and should only be adjusted on cold tires. Follow tire manufacturer's maintenance recommendation included with vehicle.



The following pages also list the approved wheel rim and tire sizes for equipping your vehicles with winter tires. Winter tires are not available as standard or optional factory equipment, but can be purchased from an authorized Mercedes-Benz Center.

Depending on vehicle model and the standard or optional factory-equipped wheel rim/tire configuration on your vehicle (Appearance Package, Sport Package etc.), equipping your vehicle with winter tires approved for your vehicle model may also require the purchase of two or four wheel rims of the recommended size for use with these winter tires. See an authorized Mercedes-Benz Center for more information.

Rims and Tires



Same size tires

	CL 500 (without Sport Package* [standard on U.S. vehicles] and without Appearance Package*)	CL 600 (without Sport Package* [standard on U.S. vehicles] and without Appearance Package*)	CL 500, CL 600 (with Appearance Package*)
Rims (light alloy)	7.5 J x17 H2	8 J x18 H2 ¹	8 J x18 H2 ¹
Wheel offset	1.81 in (46 mm)	1.73 in (44 mm)	1.73 in (44 mm)
Summer tires²	-	245/45 R18 96Y ¹	245/45 R18 96Y ¹
All-season tires²	225/55 R17 97H M+S	-	-
Winter tires^{2, 3}	225/55 R17 97H M+S 	245/45 R18 100V XL (Extra Load) M+S  ¹ or 245/45 R18 96H M+S  ¹	245/45 R18 100V XL (Extra Load) M+S  ¹ or 245/45 R18 96H M+S  ¹

¹ For use with snow chains contact an authorized Mercedes-Benz Center.

² Radial-ply tires.

³ For more information, see "Winter tires" (> page 313).

	CL 500, CL 600 (with Appearance Package*)	CL 65 AMG
Rims (light alloy)	8 J x18 H2 ^{1, 2} or 8.5J x18 EH2 ³	8.5 J x19 H2 ^{1, 2}
Wheel offset	1.73 in (44 mm)	1.73 in (44 mm)
Summer tires ⁴	245/45 R18 100Y XL (Extra Load)	-
All-season tires ⁴	-	-
Winter tires ^{4, 5}	245/45 R18 100V XL (Extra Load) M+S  ² or 245/45 R18 96H M+S  ²	245/40 R19 98V XL (Extra Load) M+S  ²

¹ For use with winter tires only.

² For use with snow chains contact an authorized Mercedes-Benz Center.

³ Must not be used with snow chains.

⁴ Radial-ply tires.

⁵ For more information, see “Winter tires” (> page 313).

Rims and Tires

Mixed size tires

	CL 500, CL 600 (with Sport Package*)	CL 55 AMG	CL 65 AMG
Front axle:			
AMG light alloy rims	8.5 J x 18 EH2 ²	8.5 J x 19 H2 ²	8.5 J x 19 H2 ²
Wheel offset	1.73 in (44 mm)	1.73 in (44 mm)	1.73 in (44 mm)
Summer tires ¹	245/45 R18 100Y XL (Extra Load) or 245/45 R18 96Y	245/40 ZR19 98Y XL (Extra Load) ² or 245/40 ZR19 ²	245/40 ZR19 98Y XL (Extra Load) ² or 245/40 ZR19 ²
Rear axle:			
AMG light alloy rims	9 J x 18 EH2 ²	9.5 J x 19 H2 ²	9.5 J x 19 H2 ²
Wheel offset	1.73 in (44 mm)	1.81 in (46 mm)	2.36 in (60 mm)
Summer tires ¹	265/40 R18 101Y XL (Extra Load) ² or 265/40 R18 97Y ²	275/35 ZR19 100Y XL (Extra Load) ² or 275/35 ZR19 ²	275/35 ZR19 100Y XL (Extra Load) ² or 275/35 ZR19 ²

¹ Radial-ply tires.

² Must not be used with snow chains.

Spare wheel

	CL 500 (without Sport Package* [standard on U.S. vehicles] and without Appearance Package*)	CL 600, CL 500 (with Sport Package* [standard on U.S. vehicles] and with Appearance Package*) CL 55 AMG	CL 65 AMG
Rims (light alloy)	7.5 J x 17 H2	8 J x 18 H2	8 J x 19 H2
Wheel offset	2.0 in (51 mm)	1.73 in (44 mm)	1.97 in (50 mm)
Summer tires¹	-	245/45 ZR18 96Y	245/40 ZR19 98Y XL (Extra Load)
All-season tires¹	225/55 R17 97H M+S	-	-

¹ Radial-ply tires.

Electrical system

Model	CL 500	CL 55 AMG	CL 600	CL 65 AMG
Generator (alternator)	14 V/150 A	14 V/180 A	14 V/180 A	14 V/180 A
Starter motor	12 V/1.7 kW	12 V/1.7 kW	12 V/1.7 kW	12 V/1.7 kW
Battery	12 V/95 Ah	12 V/95 Ah	12 V/95 Ah	12 V/95 Ah
Spark plugs	Bosch F 8 DPP332 NGK PFR 5 R-11	NGK ILFR 6 A	NGK NFR 6Q G	NGK NFR 6Q G
Electrode gap	0.039 in (1.0 mm)	0.031 in (0.8 mm)	0.028 in (0.7 mm)	0.028 in (0.7 mm)
Tightening torque	18 – 22 lb-ft (25 – 30 Nm)	18 – 22 lb-ft (25 – 30 Nm)	15 – 22 lb-ft (20 – 30 Nm)	15 – 22 lb-ft (20 – 30 Nm)

▼ Main dimensions and weights

Main dimensions

Model	CL 500	CL 55 AMG	CL 600	CL 65 AMG
Overall vehicle length	196.4 in (4989 mm)	196.4 in (4989 mm)	196.4 in (4989 mm)	196.4 in (4989 mm)
Overall vehicle width (exterior rear view mirrors folded out)	82.8 in (2104 mm)	82.8 in (2104 mm)	82.8 in (2104 mm)	82.8 in (2104 mm)
Overall vehicle height	55.4 in (1408 mm)	55.4 in (1408 mm)	55.4 in (1408 mm)	55.4 in (1408 mm)
Wheelbase	113.6 in (2885 mm)	113.6 in (2885 mm)	113.6 in (2885 mm)	113.6 in (2885 mm)
Track, front	62.1 in (1577 mm)	62.2 in (1581 mm)	62.1 in (1577 mm)	62.2 in (1581 mm)
Track, rear	62.1 in (1578 mm)	62.2 in (1582 mm)	62.1 in (1578 mm)	62.2 in (1582 mm)

Weights

Roof load max.	220 lb (100 kg)
Trunk load max.	220 lb (100 kg)

Fuels, coolants, lubricants, etc.

Capacities

Vehicle components and their respective lubricants must match. Therefore use only products tested and approved by Mercedes-Benz.

Please refer to the Factory Approved Service Products pamphlet, or inquire at your Mercedes-Benz Center.

	Model	Capacity	Fuels, coolants, lubricants, etc.
Engine with oil filter	CL 500	8.5 US qt (8.0 l)	Approved engine oils
	CL 55 AMG	8.0 US qt (7.5 l)	
	CL 600	9.5 US qt (9.0 l)	
	CL 65 AMG	11.0 US qt (10.5 l)	
Automatic transmission	CL 500	9.1 US qt (8.6 l)	MB Automatic Transmission Fluid
	CL 55 AMG	9.1 US qt (8.6 l)	
	CL 600	8.2 US qt (7.7 l)	
	CL 65 AMG	8.2 US qt (7.7 l)	
Rear axle	CL 500	1.7 US qt (1.6 l)	Hypoid gear oil SAE 85 W 90
	CL 55 AMG	2.1 US qt (2.0 l)	
	CL 600	2.1 US qt (2.0 l)	
	CL 65 AMG	2.1 US qt (2.0 l)	
Hydraulic system for ABC		approx. 4.2 US qt (4.0 l)	MB Hydraulic Fluid
Power steering		approx. 1.1 US qt (1.0 l)	MB Power Steering Fluid (Pentosin CHF 11S)
Front wheel hubs		approx. 3.5 oz (100 g) each	High temperature roller bearing grease
Brake system		0.7 US qt (0.7 l)	MB Brake Fluid (DOT 4+)

Fuels, coolants, lubricants, etc.

	Model	Capacity	Fuels, coolants, lubricants, etc.	
Cooling system	CL 500	approx. 12.15 US qt (11.5 l)	MB 325.0 Anticorrosion/Antifreeze	
	CL 55 AMG	approx. 12.68 US qt (12.0 l)		
	CL 600	approx. 15.85 US qt (15.0 l)		
	CL 65 AMG	approx. 16.18 US qt (15.3 l)		
Low temperature cooling system	CL 600	2.3 US qt (2.2 l)	MB 325.0 Anticorrosion/Antifreeze	
	CL 65 AMG	3.06 US qt (2.9 l)		
Fuel tank		23.2 US gal (88.0 l)	Premium unleaded gasoline: Minimum Posted Octane 91 (Avg. of 96 RON/86 MON)	
	including a reserve of	CL 500 and CL 600		2.9 US gal (11.0 l)
	including a reserve of	CL 55 AMG and CL 65 AMG		3.7 US gal (14.0 l)
Air conditioning system			R-134a refrigerant and special PAG lubricant oil (never R-12)	
Windshield washer and headlamp cleaning system		7.1 US qt (6.7 l)	MB Windshield Washer Concentrate ¹	

¹ Use MB Windshield Washer Concentrate “S” and water for temperatures above freezing or MB Windshield Washer Concentrate “S” and commercially available pre-mixed windshield washer solvent/antifreeze for temperatures below freezing point. Follow suggested mixing ratios (▷ page 425).

Fuels, coolants, lubricants, etc.

Engine oils

Engine oils are specifically tested for their suitability in our engines and durability for our service intervals. Therefore, only use approved engine oils and oil filters required for vehicles with Maintenance System (U.S. vehicles) or FSS (Canada vehicles). For a listing of approved engine oils and oil filters, refer to the Factory Approved Service Products pamphlet, or contact an authorized Mercedes-Benz Center.



Using engine oils and oil filters of specification other than those expressly required for the Maintenance System (U.S. vehicles) or FSS (Canada vehicles), or changing of oil and oil filter at change intervals longer than those called for by the Maintenance System (U.S. vehicles) or FSS (Canada vehicles) will result in engine damage not covered by the Mercedes-Benz Limited Warranty.

Please follow Maintenance System (U.S. vehicles) or FSS (Canada vehicles) recommendations for scheduled oil changes. Failure to do so will result in engine damage not covered by the Mercedes-Benz Limited Warranty.

Engine oil additives

Do not blend oil additives with engine oil. They may damage the engine.

Damage or malfunctions resulting from blending oil additives are not covered by the Mercedes-Benz Limited Warranty.

Air conditioning refrigerant

R-134a (HFC) refrigerant and special PAG lubricating oil is used in the air conditioning system.

Never use R-12 (CFC) or mineral-based lubricating oil. Otherwise damage to the system will occur.

Brake fluid

During vehicle operation, the boiling point of the brake fluid is continuously reduced through the absorption of moisture from the atmosphere.

Warning!



Under extremely strenuous operating conditions, this moisture content can lead to the formation of bubbles in the system, thus reducing the system's efficiency.

Therefore, the brake fluid must be replaced regularly. Refer to your vehicle's Maintenance Booklet for replacement.

Only brake fluid approved by Mercedes-Benz is recommended. Your authorized Mercedes-Benz Center will provide you with additional information.

Premium unleaded gasoline

Warning!



Gasoline is highly flammable and poisonous. It burns violently and can cause serious injury. Whenever you are around gasoline, avoid inhaling fumes and skin contact, extinguish all smoking materials. Never allow sparks, flame or smoking materials near gasoline!



To maintain the engine's durability and performance, premium unleaded gasoline must be used. If premium unleaded is not available and low octane fuel is used, follow these precautions:

- Have the fuel tank only partially filled with unleaded regular and fill up with premium unleaded as soon as possible.
- Avoid full throttle driving and abrupt acceleration.
- Do not exceed an engine speed of 3000 rpm if the vehicle is loaded with a light load such as two persons and no luggage.
- Do not exceed $\frac{2}{3}$ of maximum accelerator pedal position if the vehicle is fully loaded or operating in mountainous terrain.

Fuel requirements

Use only premium unleaded fuel:

- The octane number (posted at the pump) must be 91 min. It is an average of both the Research (R) octane number and the Motor (M) octane number: $(R+M)/2$. This is also known as the ANTI-KNOCK INDEX.

Unleaded gasoline containing oxygenates such as ethanol, IPA, IBA and TBA can be used provided the ratio of any one of these oxygenates to gasoline does not exceed 10%; MTBE must not exceed 15%.

The ratio of methanol to gasoline must not exceed 3% plus additional cosolvents.

Using mixtures of ethanol and methanol is not allowed. Gasohol, which contains 10% ethanol and 90% unleaded gasoline, can be used.

These blends must also meet all other fuel requirements, such as resistance to spark knock, boiling range, vapor pressure, etc.

Fuels, coolants, lubricants, etc.

Gasoline additives

A major concern among engine manufacturers is carbon build-up caused by gasoline. Mercedes-Benz recommends only the use of quality gasoline containing additives that prevent the build-up of carbon deposits.

After an extended period of using fuels without such additives, carbon deposits can build up especially on the intake valves and in the combustion area, leading to engine performance problems such as:

- Warm-up hesitation
- Unstable idle
- Knocking/pinging
- Misfire
- Power loss

In areas where carbon deposits may be encountered due to lack of availability of gasolines which contain these additives, Mercedes-Benz recommends the use of additives approved by us for use on Mercedes-Benz vehicles. Refer to Factory Approved Service Products Pamphlet for a listing of approved product(s). Follow directions on product label.

Do not blend other fuel additives with fuel. This only results in unnecessary cost and may be harmful to the engine operation.

Damage or malfunction resulting from poor fuel quality or from blending additional fuel additives other than those tested and approved by us for use on Mercedes-Benz vehicles listed in the Factory Approved Service Products Pamphlet are not covered by the Mercedes-Benz Limited Warranty.

Coolants

The engine coolant is a mixture of water and anticorrosion/antifreeze, which provides:

- Corrosion protection
- Freeze protection
- Boiling protection (by increasing the boiling point)

The cooling system was filled at the factory with a coolant providing freeze protection to approximately -22°F (-30°C) and corrosion protection.

If the antifreeze mixture is effective to -22°F (-30°C), the boiling point of the coolant in the pressurized cooling system is reached at approximately 266°F (130°C).

The coolant solution must be used year-round to provide the necessary corrosion protection and increase boil-over protection. Refer to Maintenance Booklet for replacement interval.

Coolant system design and coolant used determine the replacement interval. The replacement interval published in the Maintenance Booklet is only applicable if MB 325.0 anticorrosion/antifreeze solution or other Mercedes-Benz approved products of equal specification (see Factory Approved Service Products Pamphlet) are used to renew the coolant concentration or bring it back up to the proper level.

To provide important corrosion protection, the solution must be at least 45% anticorrosion/antifreeze [equivalent to freeze protection to approx. -22°F (-30°C)]. If you use a solution that is more than 55% anticorrosion/antifreeze [freeze protection to approx. -49°F (-45°C)], the engine temperature will increase due to the lower heat transfer capability of the solution. Therefore, do not use more than this amount of anticorrosion/antifreeze.

If the coolant level is low, water and MB 325.0 anticorrosion/antifreeze should be used to bring it up to the proper level (have cooling system checked for signs of leakage). Please make sure the mixture is in accordance with label instructions.

The water in the cooling system must meet minimum requirements, which are usually satisfied by normal drinking water. If you are not sure about the water quality, consult an authorized Mercedes-Benz Center.

Anticorrosion/antifreeze

Your vehicle contains a number of aluminum parts. The use of aluminum components in motor vehicle engines necessitates that anticorrosion/antifreeze coolant used in such engines be specifically formulated to protect the aluminum parts. (Failure to use such anticorrosion/antifreeze coolant will result in a significantly shortened service life.)

Therefore, the following product is strongly recommended for use in your vehicle: Mercedes-Benz 325.0 anticorrosion/antifreeze agent.

Before the start of the winter season (or once a year in hot southern regions), you should have the anticorrosion/antifreeze concentration checked. The coolant is also regularly checked each time you bring your vehicle to an authorized Mercedes-Benz Center for service.

Fuels, coolants, lubricants, etc.

Anticorrosion/antifreeze quantity

Model	Approx. freeze protection	
	- 35°F (- 37°C)	- 49°F (- 45°C)
CL 500	6.1 US qt (5.75 l)	6.7 US qt (6.3 l)
CL 600 (main cooling system)	7.9 US qt (7.5 l)	8.7 US qt (8.25 l)
CL 600 (low temperature cooling system)	1.2 US qt (1.1 l)	1.3 US qt (1.2 l)
CL 55 AMG	6.34 US qt (6.0 l)	6.97 US qt (6.6 l)
CL 65 AMG (main cooling system)	8.08 US qt (7.65 l)	8.9 US qt (8.42 l)
CL 65 AMG (low temperature cooling system)	1.53 US qt (1.45 l)	1.7 US qt (1.6 l)

Windshield washer system and headlamp cleaning system

Both the windshield and headlamp washer systems are supplied from the windshield washer fluid reservoir.

The windshield and headlamp washer fluid reservoir has a capacity of approx. 7.1 US qt (6.7 l).

- ▶ Refill the reservoir with MB Windshield Washer Concentrate and water (or concentrate and commercially available premixed windshield washer solvent/antifreeze, depending on ambient temperatures).

Warning!



Washer solvent/antifreeze is highly flammable. Do not spill washer solvent/antifreeze on hot engine parts, because it may ignite and burn. You could be seriously burned.

Windshield and headlamp washer fluid mixing ratio

For temperatures above freezing point, use MB Windshield Washer Concentrate “S” and water:

- 1 part “S” to 100 parts water [40 ml “S” to 1 gallon (4 liters) water].

For temperatures below freezing point, use MB Windshield Washer Concentrate “S” and commercially available premixed windshield washer solvent/antifreeze:

- 1 part “S” to 100 parts solvent [40 ml “S” to 1 gallon (4 liters) solvent].

ABC

(Active Body Control)

Active, computer-controlled system that hydraulically adjusts the suspension at all four wheels in response to various driving situations.

ABS

(Antilock Brake System)

Prevents the wheels from locking up during braking so that the vehicle can continue to be steered.

Accessory weight

(▷ page 309)

Air pressure

(▷ page 309)

Alignment bolt



Metal pin with thread. The centering pin is an aid used when changing a tire to align the wheel with the wheel hub.

Aspect ratio

(▷ page 309)

BabySmart™ air bag deactivation system

This system detects if a special system compatible child restraint seat is installed on the front passenger seat. The system will automatically deactivate the passenger front air bag when such a seat is properly installed

(the   indicator lamp in the center console comes on and remains illuminated).

BabySmart™ compatible child seats

Special restraint system for children. The sensor system for the front passenger seat prevents deployment of the passenger front air bag if a BabySmart™ compatible child seat is installed. See an authorized Mercedes-Benz Center for availability.

Bar

(▷ page 309)

BAS

(Brake Assist System)

System for potentially reducing braking distances in emergency braking situations. The system is activated when it senses an emergency based on how fast the brake is applied.

Bead

(▷ page 309)

Bi-Xenon headlamps

Headlamps which use an electric arc as the light source and produce a more intense light than filament headlamps. Bi-Xenon headlamps produce low beam and high beam.

CAC

(Customer Assistance Center)

Mercedes-Benz customer service center, which can help you with any questions about your vehicle and provide assistance in the event of a breakdown.

CAN system

(Controller Area Network)

Data bus network serving to control vehicle functions such as door locking or windshield wiping.

Cockpit

All instruments, switches, buttons and indicator/warning lamps in the passenger compartment needed for vehicle operation and monitoring.

Cold tire inflation pressure

(▷ page 309)

COMAND

(Cockpit Management and Data System)

Information and operating center for vehicle sound and communications systems, including the radio and navigation system, as well as other optional equipment (CD changer, telephone, etc.).

Control system

The control system is used to call up vehicle information and to change component settings. Information and messages appear in the multifunction display. The driver uses the buttons on the multifunction steering wheel to navigate through the system and to adjust settings.

Cruise control

Driving convenience system that automatically maintains the vehicle speed set by the driver.

Curb weight

(▷ page 309)

Distronic*

A driving convenience cruise control system which helps the driver maintain a pre-selected speed:

- If there is no vehicle directly ahead, the system operates in the same way as conventional ->cruise control.

- If a slower moving vehicle is ahead, Distronic will reduce your vehicle speed to the extent permitted by reduced throttle and up to 20% braking power to maintain the preset minimum following distance.

DOT

(Department of Transportation)
(▷ page 309)

Engine number

The number set by the manufacturer and placed on the cylinder block to uniquely identify each engine produced.

Engine oil viscosity

Measurement for the inner friction (viscosity) of the oil at different temperatures. The higher the temperature an oil can tolerate without becoming thin, or the lower the temperature it can tolerate without becoming viscous, the better the viscosity.

ESP®

(Electronic Stability Program)
Improves vehicle handling and directional stability.

ETD

(Emergency Tensioning Device)
Device which deploys in certain frontal and rear collisions exceeding the system's threshold to tighten the seat belts.
->SRS

FSS (Canada vehicles)

(Flexible Service System)
Maintenance service indicator in the multifunction display that informs the driver when the next vehicle maintenance service is due. FSS evaluates engine temperature, oil level, vehicle speed, engine speed, distance driven and the time elapsed since your last maintenance service, and calls for the next maintenance service accordingly.

GAWR

(Gross Axle Weight Rating)
(▷ page 309)

Gear range

Number of gears which are available to the automatic transmission for shifting. The automatic gear shifting process can be adapted to specific operating conditions using the selector lever.

GPS

(Global Positioning System)
Satellite-based system for relaying geographic location information to and from vehicles equipped with special receivers. Employs DVD digital maps for navigation.

GVW

(Gross Vehicle Weight)
(▷ page 309)

GVWR

(Gross Vehicle Weight Rating)
(▷ page 310)

Instrument cluster

The displays and indicator/warning lamps in the driver's field of vision, including the tachometer, speedometer, engine temperature and fuel gauge.

KEYLESS-GO*

System for entering and operating the vehicle without the use of a SmartKey.

Kickdown

Depressing the accelerator past the point of resistance shifts the transmission down to the lowest possible gear. This very quickly accelerates the vehicle and should not be used for normal acceleration needs.

Kilopascal (kPa)

(▷ page 310)

Line of fall

The direct line that an object moves downhill when influenced by the force of gravity alone.

Locking knob

Knob on the door which indicates whether the door is locked or unlocked. Pushing the locking knob down on an individual door from inside will lock that door.

Maintenance System (U.S. vehicles)

Maintenance service indicator in the multifunction display that informs the driver when the next vehicle maintenance service is due. The Maintenance System in your vehicle tracks distance driven and the time elapsed since your last maintenance service, and calls for the next maintenance service accordingly.

Maximum load rating

(▷ page 310)

Maximum loaded vehicle weight

(▷ page 310)

Maximum tire inflation pressure

(▷ page 310)

Memory function

Used to store three individual seat, steering wheel and exterior mirror positions.

MON

(Motor Octane Number)

The Motor Octane Number for gasoline as determined by a standardized method. It is an indication of a gasoline's ability to resist undesired detonation (knocking). The average of both the MON (Motor Octane Number) and →RON (Research Octane Number) is posted at the pump, also known as ANTI-KNOCK INDEX.

Multifunction display

Display field in the speedometer used to present information provided by the control system.

Multifunction steering wheel

Steering wheel with buttons for operating the control system.

Normal occupant weight

(▷ page 310)

Overspeed range

Engine speeds within the red marking of the tachometer dial. Avoid this engine speed range, as it may result in serious engine damage that is not covered by the Mercedes-Benz Limited Warranty.

Parktronic system (Parking assist)*

System which uses visual and acoustic signals to assist the driver during parking maneuvers.

Poly-V-belt drive

Drives engine-components (alternator, AC compressor, etc.) from the engine.

Power train

Collective term designating all components used to generate and transmit motive power to the drive axles, including:

- Engine
- Clutch/torque converter
- Transmission
- Transfer case
- Drive shaft
- Differential
- Axle shafts/axles

Production options weight

(▷ page 310)

Program mode selector switch

Used to switch the automatic transmission between standard operation **S** and comfort operation **C**.

CL 55 AMG and CL 65 AMG with steering wheel gearshift control and manual shift program: in addition to **S** and **C** (see above), you can use **M** for manual operation

PSI

(Pounds per square inch)
(▷ page 310)

Recommended tire inflation pressure

(▷ page 310)

REST

(Residual engine heat utilization)
Feature that uses the engine heat stored in the coolant to heat the vehicle interior for a short time after the engine has been turned off.

Restraint systems

Seat belts, belt tensioners, air bags and child restraint systems. As independent systems, their protective functions complement one another.

Rim

(▷ page 310)

RON

(Research Octane Number)

The Research Octane Number for gasoline as determined by a standardized method. It is an indication of a gasoline's ability to resist undesired detonation (knocking). The average of both the →MON (Motor Octane Number) and RON (Research Octane Number) is posted at the pump, also known as ANTI-KNOCK INDEX.

Shift lock

When the vehicle is parked, this lock prevents the transmission selector lever from being inadvertently moved out of position **P** without the SmartKey turned and the brake pedal depressed.

Sidewall

(▷ page 310)

SRS

(Supplemental Restraint System)

Seat belts, emergency tensioning device and air bags. Though independent systems, they are closely interfaced to provide effective occupant protection.

Tele Aid System

(Telematic Alarm Identification on Demand)

The Tele Aid system consists of three types of response: automatic and manual emergency, roadside assistance and information. Tele Aid is initially activated by completing a subscriber agreement and placing an acquaintance call.

The Tele Aid system is operational provided that the vehicle's battery is charged, properly connected, not damaged and cellular and GPS coverage is available.

Telematics

A combination of the terms “telecommunications” and “informatics”.

Tightening torque

Force times lever arm (e.g. a lug wrench) with which threaded fasteners such as wheel bolts are tightened.

TIN

(Tire Identification Number)

(▷ page 311)

Tire load rating

(▷ page 311)

Tire ply composition and material used

(▷ page 311)

Tire speed rating

(▷ page 311)

Traction

(▷ page 311)

Tread

(▷ page 311)

Treadwear indicators

(▷ page 311)

Uniform Tire Quality Grading Standards

(▷ page 311)

Vehicle capacity weight

(▷ page 311)

Vehicle level control

The ground clearance of the vehicle is automatically controlled according to a selected setting and speed. The driver can choose manually within a range of ground clearance, for example on very rough roads.

Vehicle maximum load on the tire

(▷ page 311)

VIN

(Vehicle Identification Number)

The number set by the manufacturer and placed on the body to uniquely identify each vehicle produced.

Voice control system*

Voice control system for car phones, portable cell phones and audio systems (radio, CD, etc.).

- A**
- ABC 220, 427
 - Messages in display 339
 - Setting vehicle level 221
 - Suspension tuning 220
 - ABS 80, 427
 - Indicator lamp 328
 - Messages in display 341
 - Accelerator position, Automatic transmission 169
 - Accessory weight 309
 - Accident 56
 - Active Body Control see ABC
 - Additional turn signals
 - Replacing bulbs 379
 - Air bags 63
 - BabySmart™ air bag deactivation system 74, 427
 - Children 64
 - Front 67
 - Safety guidelines 66
 - Side impact 67
 - Window curtain 68
 - Air cleaner see Air filter
 - Air conditioning refrigerant 419, 420
 - Air conditioning system see Automatic climate control
 - Air conditioning, Cooling 193
 - Air distribution 188
 - Air filter
 - Message in display 341
 - Air recirculation mode 190
 - Air vents 185, 196
 - Air volume 189
 - Alarm system see Anti-theft alarm system
 - Alignment bolt (vehicle tool kit) 370, 389, 427
 - Anticorrosion/antifreeze 423, 424
 - Antiglare, Rear view mirror 178
 - Antilock Brake System see ABS
 - Anti-theft alarm systems
 - Indicator lamp 86
 - Anti-theft systems 85
 - Anti-theft alarm system 85
 - Immobilizer 85
 - Tow-away alarm 87
 - Aquaplaning see Hydroplaning
 - Armrest 232, 233
 - Ashtrays 237
 - Aspect ratio 309
 - AUDIO menu 142
 - Audio system
 - CD changer operating mode 145
 - Auto-dimming, Rear view mirror 178
 - Automatic central locking, Control system 110, 162
 - Automatic climate control 184
 - Air conditioning refrigerant 420
 - Air conditioning, Cooling 193
 - Air distribution 188
 - Air recirculation mode 190
 - Air vents 185, 196
 - Air volume 189
 - Charcoal filter 191
 - Control panel 185
 - Deactivating system 187
 - Defogging 188
 - Defrosting 189
 - MAXCOOL maximum cooling 189
 - Rear window defroster 193
 - Residual engine heat and ventilation (REST) 194
 - Setting the temperature 187
 - Automatic headlamp mode 126
 - Automatic lighting control, Interior lighting 131

- Automatic locking when driving 110
- Automatic transmission 48, 165
 - Accelerator position 169
 - Driving tips 169
 - Emergency operation (Limp Home Mode) 177
 - Gear ranges 170
 - Gear selector lever position 48, 165, 167
 - Gear shifting malfunctions 177
 - Kickdown 169
 - Kickdown, manual shift program
 - CL 55 AMG and CL 65 AMG 177
 - Manual (One-touch) gearshifting 172
 - Manual shift program CL 55 AMG and CL 65 AMG 175
 - Shift program mode selector
 - switch 171
 - Starting the engine 48
 - Steering wheel gearshift control
 - CL 55 AMG and CL 65 AMG 173
 - Transmission fluid level 279
 - Warning sounds (vehicles with KEYLESS-GO*) 59

B

BabySmart™

- Air bag deactivation system 74
- Compatible child seats 427
- Self-test 74

Backrest

- Power seats 37
- Power seats, Multicontour* 117

Backrest supports

- Shoulder region (Multicontour seats*) 117

Backup lamps

- Replacing bulbs 379, 383

Bar 309

BAS 81, 427

Batteries, SmartKey

- Checking battery condition 93
- Replacing 376

Battery, SmartKey with KEYLESS-GO*

- Checking battery condition 99
- Replacing 377

Battery, Vehicle 281, 391

- Charging 392
- Disconnecting 392
- Jump starting 394
- Message in display 345

- Reconnecting 393

- Reinstalling 392

- Removing 392

Bead 309

- Beverage holder see Cup holder

- Bi-Xenon headlamps see Headlamps

- Block heater (Canada only) 314

- Brake Assist System see BAS

- Brake fluid 420

- Brake warning lamp 329

- Checking 271

- Message in display 346

Brake lamp

- High mounted 379

- Messages in display 354

- Replacing bulbs 379

Brake pads

- Message in display 346

Brakes 260

- High-performance brake system (CL 65 AMG only) 261

- Warning lamp 329

- Break-in the vehicle 258

Bulbs, replacing

- Side marker lamps, front 382

- Bulbs, replacing see Replacing bulbs

- C**
- CAC 427
 - California retail buyers and lessees, important notice for 11
 - Can holder see Cup holder
 - CAN system 428
 - Capacities and recommended
 - fuel/lubricants 418
 - Cargo area see Trunk
 - Cargo tie-down hooks 229
 - Carpets, cleaning 325
 - Catalytic converter 268
 - CD changer 145
 - Central locking
 - Automatic 110, 162
 - Locking/unlocking from inside 111
 - Central locking/unlocking switches 111
 - Certification label 406
 - Charcoal filter 191
 - Children in the vehicle 72
 - Air bags 64
 - BabySmart™ compatible child seat 72
 - Blocking of rear window operation 78
 - Indicator lamp, front passenger front air bag 74
 - Infant and child restraint systems 72
 - LATCH-type child seat mounts 77
 - Tether attachment points 76
 - Cigarette lighter 238
 - Clock 25
 - See separate COMAND operating instructions
 - Cockpit 22, 428
 - COMAND see separate operating instructions
 - Combination switch 52, 53, 54, 129
 - Control system 137, 428
 - Multifunction display 137
 - Multifunction steering wheel 138
 - Resetting to factory default 154
 - Control system menus
 - AUDIO 142
 - Distronic* 150
 - NAVI 149
 - Settings 154
 - Standard display 142
 - TEL* 147
 - Trip computer 151
 - Vehicle status message memory 153
 - Control system submenus
 - Convenience 163
 - Instrument cluster 157
 - Lighting 158
 - Vehicle 162
 - Controller Area Network see CAN system
 - Coolant 271, 280, 422
 - Anticorrosion/antifreeze mixing ratio and quantity 424
 - Capacities 419, 424
 - Checking level 271, 280
 - Messages in display 347
 - Temperature 269
 - Temperature gauge 25, 135
 - Courtesy lighting 133
 - Cruise control 205, 428
 - Message in display 350
 - Cruise control lever 205
 - Cup holder 235
 - Cup holders
 - Cleaning 324
 - Curb weight 309, 428
 - Customer Assistance Center see CAC

D

- Daytime running lamp mode 127
 - Setting 159
- Deep water see Standing water
- Defogging windshield 188
- Defrosting, Front 189
- Defrosting, Rear 193
- Delayed switch-off
 - Exterior lights 160
 - Interior illumination 161
- Department of Transportation see DOT
- Difficulties
 - While driving 56
 - With starting 50
- Digital clock see Clock
- Digital speedometer 142
- Dimensions, Vehicle 417
- Direction of rotation, Tires 286
- Displays
 - Digital speedometer 142
 - Maintenance service indicator 315
 - Messages in display 337
 - Multifunction display 137
 - Outside temperature 25, 136, 157
 - Showing malfunctions 153
 - Symbol messages 345
 - Text messages 339
 - Vehicle status messages 153, 337
 - Vehicle system settings, Control system 137
- Distance to empty (Range) 152
- Distronic* 150, 208, 428
 - Activating/deactivating 213
 - Cleaning system sensor 322
 - Control system 150
 - Distance warning function 216
 - Driving hints 217
 - Menu 211
 - Messages in display 342
 - Sensor cover 322
 - Warning and indicator lamps 210
 - Warning sounds 216, 332
- Document holder 230
- Door
 - Entry lamps 133
 - Inside door handle 30, 100
 - Locking/unlocking, SmartKey 60, 90
 - Locking/unlocking, SmartKey with KEYLESS-GO* 60, 94
 - Message in display 350
 - Opening from inside/outside 32, 33, 90, 94, 100
 - Power closing assist for doors 110
 - Remote door unlock (Tele Aid) 248
 - Unlocking the driver's door, Mechanical key 372
- DOT 309
- Drink holder see Cup holder
- Drinking and driving 259
- Drive gear position, Automatic transmission 48, 165, 167
- Driving
 - Abroad 267
 - Hydroplaning 263
 - In winter 265
 - Instructions 45, 259
 - Problems 56
 - Safety systems 80
 - Systems 205
 - Through standing water 266
 - Tips, Automatic transmission 169

Driving safety systems

ABS 80

BAS 81

ESP® 82, 429

Driving systems 205

ABC 220

Cruise control 205

Distronic* 208

Parktronic* 223

Vehicle level control 221

E

Easy-entry/exit feature 112, 163

Electrical fuses see Fuses

Electrical system, Technical data 416

Electronic Stability Program see ESP®

Emergency call system

Hands-free microphone 29

Emergency calls

Tele Aid 243, 244

Emergency operations

Fuel filler flap 374

Limp Home Mode, Automatic
transmission 177

Locking/unlocking the vehicle 372

Power tilt/sliding sunroof, Manual
operation 375

Remote door unlock (Tele Aid) 248

Trunk, Releasing from inside 109

Trunk, Unlocking 373

Emergency Tensioning Device see ETD

Emergency, In case of

Battery, Jump starting 394

First aid kit 369

Flat tire, Changing 386

Fuses 399

Hazard warning flasher 130

Instrument cluster, Indicator
lamps 328

Roadside Assistance 12

Roadside Assistance (Tele Aid) 244

Towing the vehicle 396

Emission control 268

Information label 406

System warranties 10

Vacuum line routing diagram
label 406

Engine

Block heater (Canada only) 314

Break-in recommendations 258

Cleaning 320

Compartment 273

Malfunction indicator lamp 25, 330

Number 406, 428

Poly-V-belt layout 407, 408

Starting 48

Tachometer 25, 136

Technical data 408

Turning off 58

Engine coolant see Coolant

- Engine oil 274, 420
 - Adding 278
 - Additives 420
 - Changing 278, 420
 - Checking level 274
 - Consumption 274
 - Filler neck 278, 279
 - Messages in display 275, 276, 351
 - Recommended engine oils and oil filter 420
 - Viscosity 428
- ESP® 82, 429
 - Messages in display 342
 - Warning lamp 332, 333
- ETD 71, 429
 - Safety guidelines 66
- Exterior rear view mirrors 43
 - Auto-dimming on the driver's side 178
 - Parking position 124, 180
 - Parking position for 164
 - Power folding 180
 - Storing parking position 124
- F**
 - Filler neck, Engine oil 278, 279
 - First aid kit 369
 - Flat tire 386
 - Jacking up the vehicle 387
 - Lowering the vehicle 390
 - Mounting the spare wheel 386
 - Preparing the vehicle 386
 - Flexible Service System see FSS
 - Fluids
 - ABC fluid 279
 - Automatic transmission 279, 418
 - Brake fluid 272, 418, 420
 - Capacities 418
 - Engine coolant 280, 419, 422
 - Engine oil 418, 420
 - Hydraulic system for ABC 418
 - Power steering fluid 418
 - Windshield washer system and headlamp cleaning system 282, 419, 425
 - Fog lamps 128, 379
 - Messages in display 355, 357
 - Replacing bulbs 379, 383
 - Front air bags 67
 - Front lamps see Headlamps
 - Front passenger front air bag 63, 67
 - Front passenger front air bag off indicator lamp 74, 336
 - Front seat head restraints see Head restraints
 - FSS (Canada vehicles) 315, 429
 - Fuel 271, 419, 421
 - Additives 422
 - Capacities, Fuel tank 419
 - Consumption statistics after start 151
 - Consumption statistics since last reset 152
 - Filling the tank 270
 - Fuel filler flap and cap 270, 374
 - Fuel gauge 25, 331
 - Fuel reserve warning lamp 25, 331
 - Requirements, Octane rating 271, 419, 421
 - Technical data 419, 421
 - Fuel cap
 - Engine malfunction indicator lamp 331
 - Message in display 360

Fuel filler flap 270
 Locking/unlocking 270
 Opening in an emergency 374
 Opening/closing 270

Fuel reserve warning lamp 331

Fuel tank
 Capacity 419
 Filler flap 270

Fuel tank reserve warning lamp 25

Fuel, Premium unleaded gasoline 271, 419

Fuels, coolants, lubricants etc.
 Capacities 418

Fuses 399
 Aids for replacing fuses 399
 Fuse boxes in engine compartment 401
 Fuse boxes in passenger compartment 400
 Fuse chart 370
 Fuse extractor 370
 Replacing 399
 Spare fuses 370

G

Garage door opener 249

Gasoline see Fuel

GAWR 309

Gear range 429
 Automatic transmission 170
 Limiting 170
 Shifting into optimal 172

Gear selector lever 48, 165
 Cleaning 324
 Lock 51
 Message in display 344
 Position indicator 166
 Position, Automatic transmission 48, 165, 167

Global locking/unlocking see Key

Global Positioning System see GPS

Glove box 231

Good visibility 178

GPS 429

Gross Axle Weight Rating see GAWR

Gross Vehicle Weight Rating see GVWR

Gross Vehicle Weight see GVW

GVW 309

GVWR 310

H

Hands-free microphone 29

Hard plastic trim items, cleaning 324

Hazard warning flasher 130

Head restraints
 Folding rear head restraints back 115
 Front seat 38, 39
 Front seat, Removing and installing 114
 Rear seat 115

Head unit see COMAND

Headlamp switch-off delay see Delayed switch-off, Exterior lights

Headlamps
 Automatic headlamp mode 126
 Bi-Xenon 379, 427
 Cleaning lenses 321
 Cleaning system 178, 282, 425
 Cleaning system washer reservoir 271, 282
 Manual headlamp mode 126
 Messages in display 355
 Replacing bulbs 379
 Switch 52, 125

- Headliner, cleaning 325
- Heated seats 119
- Heated steering wheel* 239
- High beam flasher 52, 129
 - Replacing bulbs 379, 382
- High beam headlamps
 - Indicator lamp 25
 - Messages in display 355
 - Replacing bulbs 379
 - Switching on 52, 129
- High mounted brake lamp 379
- High-performance brake system (CL 65 AMG only) 261
- Hood 273
 - Message in display 353
- Horn 23
- HVAC see Automatic climate control
- Hydroplaning 263

I

- Identification labels 406
 - Certification 406
 - Emission control information 406
 - Vacuum line routing 406
- Identification number, Vehicle (VIN) 406
- Ignition 34, 36
- Immobilizer 85
- Indicator lamps see Lamps, indicator and warning
- Infant and child restraint systems see Children in the vehicle
- Inflation pressure see Tires, Inflation pressure
- Inside door handle 100
- Instrument cluster 24, 134, 429
 - Cleaning 324
 - Illumination brightness 134
 - Lamps 328
 - Message in display 350
 - Multifunction display 137
- Instrument lighting see Instrument cluster, Illumination brightness
- Instrument panel see Instrument cluster
- Instruments and controls see Cockpit
- Interior lighting 131
 - Delayed switch-off 161
- Interior rear view mirror 43, 178
 - Antiglare 178
 - Auto-dimming 178
- Interior storage spaces see Storage compartments

J

Jack 370, 388
 Jacking up the vehicle 387
 Jump starting 394

K

Key, Mechanical 372
 Key, SmartKey 90
 Battery check lamp 90, 92
 Checking the batteries 93
 Factory setting 92
 Locking/unlocking 32, 60, 90
 Locking/unlocking, Global setting 92
 Locking/unlocking, Selective setting 92
 Loss of 94
 Messages in display 353
 Opening the trunk 93
 Operating the power tilt/sliding sunroof 200
 Operating the power windows 200
 Position in starter switch 34
 Remote control 90
 Replacing the batteries 376
 Starting the engine 48
 Turning off the engine 59

Key, SmartKey with KEYLESS-GO* 94, 429
 Battery check lamp 94, 98
 Checking the battery 99
 Factory setting 97
 Locking the vehicle 99
 Locking/unlocking 33, 60, 94
 Locking/unlocking, Global setting 97
 Locking/unlocking, Selective setting 98
 Loss of 100
 Messages in display 353
 Opening the trunk 100
 Operating the power tilt/sliding sunroof 200
 Operating the power windows 200
 Remote control 94
 Replacing the battery 377
 Starting the engine 49
 Turning off the engine 59
 KEYLESS-GO* see Key, SmartKey with KEYLESS-GO*
 Kickdown 169, 429
 Kilopascal 310

L

- Labels 406
- Lamp sensor
 - Message in display 356
- Lamps, exterior 125, 379
 - Messages in display 354
 - Replacing bulbs 379, 381, 382
 - Warning sounds 59, 126
- Lamps, indicator and warning
 - ABS 25, 328
 - Anti-theft alarm systems 86
 - Battery (SmartKey with KEYLESS-GO*) 98
 - Battery (SmartKey) 92
 - Brakes 25, 329
 - Distronic* 25, 210, 216
 - Engine diagnostics 330, 331
 - Engine malfunction 25, 330, 331
 - ESP® 25, 332, 333
 - Fog lamps 125
 - Front passenger front air bag off 28, 67, 74, 336
 - Fuel reserve 25, 331
 - High beam headlamp 25
 - Instrument cluster 328
 - Parking lamps 125
 - Parktronic*, Warning indicators 225
 - Seat belt telltale 25, 333
 - SRS 25, 63
 - Tire inflation pressure 25
 - Tow-away alarm 88
 - Turn signals 25
- Lamps, interior 131
- Language, Setting 158
- LATCH-type child seat anchors see Children in the vehicle
- Lever for voice control system* 23
- License plate lamp
 - Messages in display 355
 - Replacing bulbs 379, 383
- Light alloy wheels, cleaning 324
- Lighter see Cigarette lighter
- Lighting, Exterior and interior 125
- Limp Home Mode, Emergency operation of automatic transmission 177
- Line of fall 429
- Loading see Vehicle loading
- Locator lighting 160
- Locking knob 100, 429
- Loss of
 - Mechanical key 94, 100
 - Service and Warranty Information Booklet 405
 - SmartKey 94
 - SmartKey with KEYLESS-GO* 100
- Low beam headlamps
 - Messages in display 356
 - Replacing bulbs 379
 - Switching on 52
- Lubricants 418

M

- Maintenance 12, 315
 - Calling up service indicator 316
 - Clearing service indicator 316
 - FSS (Canada vehicles) 315, 429
 - Maintenance System (U.S. vehicles) 430
 - Maintenance System (U.S. vehicles) 315
 - Resetting service indicator 317
 - Service indicator 315
 - Service term exceeded 316
- Maintenance System (U.S. vehicles) 430
- Manual headlamp mode see Headlamps
- Manual shift program CL 55 AMG and CL 65 AMG
 - Automatic transmission 175
- Massage function (PULSE, Multicontour seats*) 118
- Maximum load rating, Tires 310
- Maximum loaded vehicle weight 310
- Maximum tire inflation pressure 310
- Mechanical key 372
 - Loss of 94, 100
- Memory function 430
- Menus see Control system menus
- Messages in display see Multifunction display messages
- Microphone, Hands-free 29
- Mirrors
 - Adjusting 43
 - Antiglare positions 178
 - Auto-dimming mirrors 178
 - Exterior rear view mirror, Storing parking position 124
 - Exterior rear view mirrors 43, 178
 - Interior rear view mirror 43, 178
 - Power folding exterior rear view mirrors 180
 - Vanity mirror in sun visor 181, 230
- MON 271, 419, 430
- Motor Octane Number see MON
- MP3-CD operation
 - Selecting tracks 144
- Multicontour seats* 117
- Multifunction display 137, 430
 - Changing settings see Control system menus and Control system sub-menus
 - Selecting language 158
 - Standard display 141
- Multifunction display messages
 - ABC 339
 - ABS 341
 - Air filter 341
 - Battery 345
 - Brake fluid 346
 - Brake lamps 354
 - Brake pads 346
 - Coolant 347
 - Cruise control 350
 - Distronic* 342
 - Door 350
 - Engine oil 275, 351
 - ESP® 342
 - Fog lamps 355, 357
 - Fuel cap 360
 - Headlamps 355

- Hood 353
- Instrument cluster 350
- Lamp sensor 356
- Lamps 354
- License plate lamp 355
- Low beam headlamps 356
- Maintenance service indicator 315
- Parking brake 345
- Parking lamps 357
- Power tilt/sliding sunroof 359
- Reverse lamps 357
- Seat belts 359
- Selector lever 344
- Side marker lamps 356
- SmartKey 353
- SmartKey with KEYLESS-GO* 353
- Tail lamps 357
- Tele Aid 359
- Telephone* 360
- Tires 361
- Trunk 360
- Turn signal lamps 358
- Washer fluid 360
- Multifunction steering wheel 138, 430
 - Button operation 138

N

- Navigation system
 - See separate COMAND operating instructions
- Net, parcel 234
- Neutral gear position, Automatic transmission 48, 165, 167
- New vehicle break-in 258
- Night security illumination 160
- Normal occupant weight 310
- Number, vehicle identification (VIN) 406

O

- Occupant distribution 310
- Occupant safety 62
 - Air bags 63
 - Children and air bags 64
 - Children in the vehicle 72
 - Fastening the seat belt 45
 - Front passenger front air bag off indicator lamp 74
 - Infant and child restraint systems 72
 - LATCH-type child seat anchors 77
 - Seat belts 45, 66
- Odometer 135
- Oil see Engine oil
- One-touch gearshifting 172
- Operating safety 16
- Ornamental moldings, cleaning 321
- Outside temperature indicator 25, 136
- Overdue maintenance service 316
- Overhead control panel 29
- Overspeed range, Engine 430

- P**
- Paintwork, Cleaning 319
 - Panic alarm 79
 - Parcel net
 - Front passenger footwell 234
 - Trunk 234
 - Parking 57, 262
 - Parking assist see Parktronic*
 - Parking brake 50, 58
 - Message in display 345
 - Warning sounds 51, 329
 - Parking lamps 125
 - Messages in display 357
 - Replacing bulbs 379, 382, 383
 - Parking position
 - Exterior rear view mirrors 124, 164, 180
 - Gear position, Automatic transmission 48, 165, 167
 - Parktronic* 223, 430
 - Activating/deactivating 226
 - Cleaning system sensors 322
 - Malfunctioning 227
 - Minimum distance 225
 - Range of the sensors 224
 - System sensors 322
 - Warning indicators 225
 - Warning sounds 225
 - Parts service 404
 - PASS AIR BAG OFF indicator lamp see Front passenger front air bag off indicator lamp 74
 - Passenger compartment 267
 - Fuse boxes 400
 - Interior lighting 131
 - Interior rear view mirror 43
 - Parcel net in front passenger footwell 234
 - Passenger safety see Occupant safety
 - Pedals 259
 - Phone see Telephone*
 - Plastic parts, cleaning 324
 - Poly-V-belt drive 408, 430
 - Layout 407
 - Positions (Memory function) see Power seats
 - Power assistance 259
 - Power closing assist for doors and trunk lid 110
 - Power seats 37, 112
 - Easy entry/exit feature 112
 - Folding back front seat backrests 40
 - Folding forward front seat backrests 40
 - Heating 119
 - Lumbar support 117
 - Memory function 122
 - Multicontour* 117
 - Multicontour*, Lumbar support 118
 - Multicontour*, Massage function (PULSE) 118
 - Multicontour*, Shoulder support 117
 - Multicontour*, Side bolsters 118
 - Ventilation* 121
 - Power tilt/sliding sunroof 202
 - Messages in display 359
 - Opening/closing in an emergency 375
 - Operating 202
 - Operating, SmartKey 200
 - Operating, SmartKey with KEYLESS-GO* 200
 - Stopping 204
 - Synchronizing 204
 - Power train 431

- Power washer 319
 - Power windows 197
 - Cleaning 323
 - Operating 197
 - Operating, SmartKey 200
 - Operating, SmartKey with KEYLESS-GO* 200
 - Rear door window, Blocking operation 78
 - Stopping 199
 - Synchronizing 199
 - Practical hints 327
 - Premium unleaded gasoline 271, 419, 421
 - Problems
 - While driving 56
 - With vehicle 17
 - Product information 9
 - Production options weight 310
 - Program mode selector switch 431
 - Automatic shift program 171
 - PSI 310
 - Push starting 394
- R**
- Radio
 - Selecting stations 143
 - Selecting stations, Satellite radio* 143
 - Radio transmitters 267
 - Range (distance to empty) 152
 - Reading lamps 132
 - Rear door windows
 - Blocking operation 78
 - Rear fog lamp 379, 383
 - Switching on 128
 - Rear fog lamp see Fog lamps
 - Rear lamps see Tail lamps
 - Rear seat ashtray see Ashtrays
 - Rear seat head restraints see Head restraints
 - Rear view mirrors see Mirrors
 - Rear window defroster 193
 - Rear window sunshade* 182
 - Recommended tire inflation pressure 292, 310
 - Recovery services, Stolen vehicle (Tele Aid) 249
 - Refrigerant, Air conditioning 419, 420
 - Refueling 270
 - Regular checks 271
 - Reminder, Seat belt see Seat belts, Telltale
 - Remote control
 - SmartKey 90
 - SmartKey with KEYLESS-GO* 94
 - Remote door unlock (Tele Aid) 248
 - Replacing bulbs 378
 - Additional turn signals 379
 - Backup lamps 379, 383
 - Brake lamp 379
 - Fog lamps 379
 - Front turn signal bulb 382
 - High beam flasher bulb 382
 - High beam headlamps 379
 - High mounted brake lamp 379
 - License plate lamp 379, 383
 - Low beam 379
 - Parking lamps 379, 382, 383
 - Rear fog lamp 383
 - Side marker lamps 379
 - Standing lamps 379, 382, 383
 - Tail lamp assemblies 379, 383
 - Turn signal lamps 379, 383
 - Reporting safety defects 18

- Research Octane Number see RON
 - Reset button in the instrument
 - cluster 134, 154
 - Residual engine heat and ventilation 194, 431
 - REST see Residual engine heat and ventilation
 - Restraint system
 - See Children in the vehicle
 - See SRS
 - Reverse gear position, Automatic transmission 48, 165, 167
 - Reverse lamps
 - Messages in display 357
 - Rims 310, 410
 - Roadside Assistance 12
 - Tele Aid 244
 - RON 271, 419, 431
 - Roof rack* 228
 - Rubber parts, cleaning 324
- S**
- Safety
 - Driving safety systems 80
 - Occupant 62
 - Reporting defects 18
 - Safety belts see Seat belts
 - Satellite radio* 143
 - Seat belts 68
 - Children in the vehicle 72
 - Cleaning 325
 - Fastening 45
 - Force limiter 71
 - Message in display 359
 - Proper use of 47, 70
 - Safety guidelines 66
 - Telltale 333
 - Warning sounds 68
 - Seating capacity 288
 - Seats see Power seats
 - Securing cargo 229
 - Selector lever see Gear selector lever
 - Self-test
 - BabySmart™ air bag deactivation system 74
 - Lamps in instrument cluster 328
 - Tele Aid 242
 - Service and warranty information 10
 - Service intervals see Maintenance, Service indicator
 - Service life, Tires 284
 - Service see Maintenance
 - Service system see FSS (Canada vehicles) or Maintenance System (US vehicles)
 - Service, Parts 404
 - Settings
 - Control system menus 139, 154
 - Control system submenus 155, 156
 - Factory, SmartKey 92
 - Factory, SmartKey with KEYLESS-GO* 97
 - Individual, Vehicle 162
 - Memory function 122
 - Menus, submenus and functions 141
 - Resetting all, Control system 154
 - Selective, SmartKey 92
 - Selective, SmartKey with KEYLESS-GO* 98
 - Shelf below rear window, cleaning 325
 - Shift lever position indicator 166
 - Shift lock 431
 - Shift program mode, Automatic transmission 171

- Shifting
 - Automatic transmission 48, 165
 - Gear selector lever positions 167
 - Into optimal gear range (automatic transmission) 172
- Shoulder support (Multicontour seats*) 117
- Side impact air bags 67
- Side marker lamps
 - Cleaning lenses 321
 - Messages in display 356
 - Replacing bulbs 379
- Side windows see Power windows
- Sidewall 310, 432
- SmartKey see Key, SmartKey
- SmartKey with KEYLESS-GO* see Key, SmartKey with KEYLESS-GO*
- Snow chains 314
- Snow tires 313
- Spare fuses 370
- Spare wheel 386
 - Mounting 386
- Speed settings
 - Cruise control 207
- Speedometer 25, 142
- SRS 70, 432
 - Indicator lamp 25, 62, 335
- Standing lamps 125
 - Replacing bulbs 379, 382, 383
- Standing water, Driving through 266
- Starter switch 23
 - Positions 34
- Starting difficulties, Engine 50
- Starting, Engine 48
- Steering column 42
- Steering wheel 42, 138
 - Cleaning 324
 - Electrical adjustment 42
 - Heated steering wheel* 239
- Steering wheel gearshift control
 - CL 55 AMG and CL 65 AMG
 - Automatic transmission 173
- Stolen vehicle, Recovery services (Tele Aid) 249
- Storage compartments 231
 - Armrest 232, 233
 - Below the front armrest 232
 - Between rear seats 233
 - Cup holders 235
 - Glove box 231
 - In front of armrest 232
 - Parcel nets 234
 - Storage tray and telephone holder* 233
 - Under the front seats 234
- Storing, Tires 285
- Submenus see Control system submenus
- Sun visors 181
- Sunroof see Power tilt/sliding sunroof
- Sunshade* 182
- Supplemental Restraint System see SRS
- Symbols used in this operator's manual 15

- T**
- Tachometer 25, 136
 - Overspeed range 136
 - Tachometer display
 - Clock 25
 - Current program mode 166
 - Displaying gear range 166
 - Tail lamps
 - Cleaning lenses 321
 - Messages in display 357
 - Replacing bulbs 379, 383
 - Tar stains 319
 - Technical data
 - Air conditioning refrigerant 419, 420
 - Brake fluid 418, 420
 - Capacities fuels, coolants, lubricants, etc. 418
 - Coolant 419, 422
 - Electrical system 416
 - Engine 408
 - Engine oil additives 420
 - Engine oils 418, 420
 - Fuel requirements 419, 421
 - Gasoline additives 422
 - Main dimensions and weights 417
 - Premium unleaded gasoline 419, 421
 - Rims and Tires 410
 - Windshield washer system and head-lamp cleaning system 419, 425
 - Tele Aid 241, 432
 - Call priority 247
 - Emergency call system button 29, 244
 - Emergency calls 243
 - Hands-free microphone 29
 - Information 246
 - Initiating an emergency call manually 244
 - Messages in display 359
 - Remote door unlock 248
 - Roadside Assistance 244
 - SOS button 244
 - Stolen Vehicle Recovery services 249
 - System self-check 242
 - Telematics* 432
 - Telephone* 240
 - Answering/ending a call 148
 - Hands-free microphone 29
 - Message in display 360
 - Operation 148, 240
 - Phone book 148
 - Redialing 149
 - Temperature
 - Display mode 157
 - Interior temperature 187
 - Setting display unit 157
 - Tether attachment points, see Children in the vehicle
 - Tie-down hooks, Trunk 229
 - Tightening torque, Wheel bolts 390, 432
 - Tilt/sliding sunroof see Power tilt/sliding sunroof
 - TIN 311
 - Tire and Loading Information Placard 287
 - Tire and Loading Information Terminology 309
 - Tires 283, 410
 - Air pressure 309
 - Care and maintenance 284
 - Chains 314

- Cleaning 285
- Direction of rotation, Spinning 286
- Driving instructions 263
- Important notes, Tire inflation pressure 293
- Inflation pressure 292, 293, 294, 298, 306, 309, 310
- Information placard 288
- Inspection 284
- Load rating 300, 305, 311
- Messages in display 361
- Ply composition and material used 311
- Problems under-/overinflation 298
- Retreads 283
- Rims and Tires 410
- Rotating 312
- Service life 284
- Sizes 410
- Snow 313
- Spare wheel 370, 371, 386, 415
- Speed rating 264, 301, 311
- Storing 285
- Temperature 293, 308
- Terminology 309
- Tire Identification Number see TIN
- Tire inflation pressure monitor warning lamp 334
- Tire inflation pressure, Setting units 158
- Traction 264
- Tread 285, 313
- Treadwear indicators 311
- Wear pattern 312
- Winter 313
- Tools 370
- Top tether, see Children in the vehicle
- Tow-away alarm 87
- Towing eye bolt 370
- Towing the vehicle 396
- Traction 171, 264, 311
- Transmission gear selector lever see Gear selector lever
- Transmission see Automatic transmission
- Traveling abroad 267
- Tread 311
- Tread depth 285, 313
- Treadwear indicators 311
- Trip computer 151
- Trip odometer 135
- Trunk
 - Closing 103
 - Emergency release 109
 - Lighting 132, 133
 - Limiting opening height of trunk lid* 102
 - Message in display 360
 - Opening 101
 - Opening with SmartKey 93
 - Opening with SmartKey with KEYLESS-GO 100
 - Parcel net 234
 - Power closing assist for trunk lid 110
 - Tie-down hooks 229
 - Unlocking in an emergency 373
 - Vehicle loading 417
- Trunk lid see Trunk
- Turn signal lamps
 - Cleaning lenses 321
 - Messages in display 358
 - Replacing bulbs 379, 382, 383
- Turn signals 53
 - Additional in mirrors 379
 - Indicator lamps 25
- Turning off engine 58

U

- Uniform Tire Quality Grading Standards 311
- Units, Settings
 - Speedometer 157
 - Temperature 157
- Unleaded gasoline, Premium 271, 419, 421
- Upholstery
 - Cleaning 325
- Useful features 230

V

- Vacuum line routing diagram label 406
- Vanity mirror in the sun visor 230
- Vehicle
 - Battery 281, 391
 - Breaking-in the vehicle 258
 - Care 318
 - Control system, Settings
 - submenu 162
 - Dimensions 417
 - Level control 221, 432
 - Locking/unlocking 32, 33, 60, 90, 94, 99, 110, 111, 162
 - Locking/unlocking in an emergency 373
 - Lowering 390
 - Modifications and alterations, Operating safety 16
 - Towing 396
 - Unlocking in an emergency 372
 - Washing 318, 320
 - Weights 417

- Vehicle capacity weight 311
- Vehicle Identification Number see VIN
- Vehicle jack 370, 388
- Vehicle lighting 125, 272, 378
- Vehicle loading 228
 - Cargo tie-down hooks 229
 - Instructions 229, 287
 - Load limit 287
 - Roof rack* 228, 417
 - Terminology 309
 - Trunk 417
- Vehicle maximum load on the tire 311
- Vehicle outside the USA and Canada 13
- Vehicle recovery services, Stolen (Tele Aid) 249
- Vehicle status message memory 153
- Vehicle tool kit 370
- VIN 406, 432
- Voice control system* 432
 - Hands-free microphone 29

W

Warning lamps see Lamps, indicator and warning

Warning sounds

Automatic transmission (vehicles with KEYLESS-GO*) 59

DISTRONIC* 210, 216, 332

Exterior lamps 59, 126

Parking brake 51, 329

Parktronic* 225, 227

Seat belt telltale 68

Warranty coverage 10, 405

Washer fluid see Windshield washer fluid

Washer reservoir level 271, 282

Washing the vehicle 318

Wear pattern, Tires 312

Weights 417

Wheel

Bolts 370

Change 386

Removing 389

Sizes 283

Spare 370, 371, 386

Tightening torque 390, 432

Tires and wheels 283

Window curtain air bags 68

Windows, cleaning 323

Windshield

Cleaning wiper blades 323

Defogging 188

Windshield washer fluid 282, 419, 425

Message in display 360

Mixing ratio 425

Refilling 282, 425

Reservoir level 271, 282

Wiping 55

Windshield washer system 425

Windshield wipers

Replacing wiper blades 384

Winter driving 313

Block heater (Canada only) 314

Snow chains 314

Tires 313

Winter driving instructions 265

Winter tires 313

Wood trims, cleaning 325

X

Xenon headlamps see Headlamps

Service and Literature

Your authorized Mercedes-Benz Center has trained technicians and original Mercedes-Benz parts to service your vehicle properly.
For expert advice and quality service, see your authorized Mercedes-Benz Center.

If you are interested in obtaining service literature for your vehicle, please contact an authorized Mercedes-Benz Center.
We consider this the best way for you to obtain accurate information for your vehicle.

For further information you can find us on the Mercedes-Benz web-site www.mbusa.com or www.mercedes-benz.ca.

Warning!



To help avoid personal injury, be extremely careful when performing any service work or repairs. Improper or incomplete service or the use of incorrect or inappropriate parts or materials may damage the vehicle or its equipment, which may in turn result in personal injury.

If you have any questions about carrying out any type of service, turn to the advice of an authorized Mercedes-Benz Center.

We reserve the right to modify the technical details of the vehicle as given in the data and illustrations of this Operator's Manual.
Reprinting, translation and copying, even of excerpts, is not permitted without our prior authorization in writing.

Title illustration no. P00.01-2397-31

Press time May 25, 2005

GSP/TIP

Printed in Germany