



2215841381

Order No. 6515 2186 13 Part No. 221 584 13 81 USA Edition A 2007

Operator's Manual S-Class



Operator's Manual
S-Class



Mercedes-Benz

S 550

S 600

Our company and staff congratulate you on the purchase of your new Mercedes-Benz.

Your selection of our product is a demonstration of your trust in our company name. Furthermore, it exemplifies your desire to own an automobile that will be as easy as possible to operate and provide years of service.

Your Mercedes-Benz represents the efforts of many skilled engineers and craftsmen. To help assure your driving pleasure, and also the safety of you and your passengers, we ask you to make a small investment of time:

- Please read this manual carefully, then return it to your vehicle where it will be handy for your reference.
- Please follow the recommendations contained in this manual. They are designed to acquaint you with the operation of your Mercedes-Benz.
- Please pay attention to the warnings and cautions contained in this manual. They are designed to help improve the safety of the vehicle operator and occupants.

We extend our best wishes for many miles of safe, pleasurable driving.

Mercedes-Benz USA, LLC
A DaimlerChrysler Company

Introduction	13
Product information	13
Operator's Manual	14
Service and warranty information ..	14
Important notice for California retail buyers and lessees of Mercedes-Benz automobiles	15
Maintenance	15
Roadside Assistance	16
Change of address or ownership....	16
Operating your vehicle outside the USA or Canada.....	16
Where to find it.....	17
Symbols.....	18
Operating safety	19
Proper use of the vehicle	19
Problems with your vehicle.....	20
Reporting safety defects.....	21
Reporting safety defects	21
Vehicle data recording.....	22
Information regarding electronic recording devices.....	22

At a glance	23
Exterior view.....	24
Cockpit.....	26
Instrument cluster	28
Control systems	30
Center console	32
Upper part	32
Lower part	33
Automatic climate control	34
Overview	34
Automatic climate control panel, front.....	36
Overhead control panel	37
Driver's door control panel	38
Rear door control panel.....	39
Storage compartments.....	40
Rear passenger compartment	42

Safety and Security	43
Occupant safety	44
Air bags	45
Occupant Classification System	50
Seat belts	55
Luxury active head restraints (S 600 only)	59
Preventive occupant safety (PRE-SAFE®)	60
Children in the vehicle	61
Override switch for rear passenger compartment.....	67
Panic alarm	68
Activating.....	68
Deactivating.....	68
Driving safety systems	69
ABS.....	69
Adaptive Brake	70
Adaptive Brake Lights (S 600 and USA only)	70
BAS.....	71
BAS Plus*	71
EBP	71
ESP®	72

Contents

Anti-theft systems.....	75	COMAND satellite radio* (USA only) ...	98	Ejecting a PCMCIA card	109
Immobilizer.....	75	Submenu overview.....	98	Submenu overview.....	110
Anti-theft alarm system.....	75	Introduction to Satellite radio	98	Switching to audio CD,	
Tow-away alarm	76	Switching to satellite radio.....	99	audio DVD or MP3 mode	111
Canceling the alarm	76	Main satellite radio menu.....	100	Stop function	112
		Selecting program category	100	Pause function	112
		Tuning in channels	100	Selecting CD / DVD / MP3 media .	112
		Saving channels	102	Selecting a track.....	113
		Show program info.....	103	Fast forward/rewind.....	113
		Channel update.....	103	Selecting a folder.....	113
		Calling Sirius Service Center.....	103	Setting the audio format.....	114
		COMAND audio CD/		Playback options.....	114
		audio DVD/MP3.....	104	COMAND telephone*	115
		Safety precautions	104	Safety precautions.....	115
		Notes about MP3 mode	104	General notes	115
		Notes about audio DVD		Switching telephone on or off	116
		operation.....	106	Activating telephone mode	117
		Notes about CDs / DVDs	106	Telephone keypad.....	117
		Notes about handling CDs /		“911” emergency call	117
		DVDs.....	107	Entering the PIN.....	119
		Inserting CDs and DVDs.....	107	Entering the PIN2.....	119
		Inserting a PCMCIA card	108	Entering the PUK / PUK2	119
		Ejecting CDs and DVDs.....	109	Entering the unlock code	119
Control systems	77				
COMAND operating safety.....	78				
COMAND introduction	79				
Availability of functions while					
the vehicle is in motion	79				
Switching COMAND on or off.....	79				
COMAND components	79				
Operating COMAND	84				
Main menus of COMAND	89				
COMAND FM/AM radio.....	93				
Submenu overview.....	93				
Switching to radio mode	94				
Switching wavebands.....	94				
Selecting stations/channels	94				
Saving stations.....	96				
Station name display.....	97				

Telephone submenu overview	120	COMAND navigation system	Example of a display without
Main telephone menu	121	(entering a destination)	driving maneuvers
Mailbox	121	Entering a destination by address.	Destination or destination area
Call lists	122	Entering a destination from	reached
Incoming call.....	124	the destination memory.....	Partially digitized areas.....
Making an outgoing call	125	Entering a destination from	Off-road and off-map
Functions during a single-call		the list of last destinations.....	Navigation announcements
connection	127	Entering a destination from	COMAND navigation system
Transferring a call	128	the map	(during route guidance).....
COMAND phone book.....	129	Entering a stopover.....	Cancel route guidance.....
SMS messages (Short Message		COMAND navigation system	Continuing cancelled route
Service).....	137	(Point of interest entry)	guidance
COMAND navigation (introduction)...	140	Entering a POI in the surrounding	Route browser
Safety precautions	140	area	Displaying route information.....
Map software	140	Entering a POI in the surroundings	Detour function.....
Updating the map software.....	141	of a given town	COMAND navigation system
Updating process.....	141	Entering a POI in a different	(destination memory)
Loading a DVD into the		region.....	Saving a destination in the
DVD changer.....	142	Designating a POI category.....	destination memory.....
Updating	142	Entering a POI from the map.....	Deleting a destination from the
General notes.....	144	COMAND navigation system	destination memory.....
Input restrictions.....	146	(route guidance)	Own address.....
Navigation system menu overview	147	Route guidance	
Calling up the map display and		Examples of displays and announce-	
switching to navigation mode	148	ments for a driving maneuver	
Basic settings.....	150		

Contents

COMAND navigation system (last destinations)	201	Calling a number saved in an entry	209	Activating easy-entry/exit feature	224
Saving a destination permanently in the destination memory	201	Starting route guidance to an entry	209	Setting interior ambient lighting ..	225
Saving the vehicle position in the list of last destinations	201	Voice entries	210	Setting interior lighting delayed switch-off	226
Saving the crosshair position in the list of last destinations	201	Saving a phone book entry from mobile phone in the COMAND address book	211	Extending or retracting rear window sunshade	227
Deleting one of the last destinations	201	Importing data from external Bluetooth devices	212	Trunk opening-height restriction on/off	227
COMAND address book	202	COMAND system settings	213	Switching on/of the tow-away alarm	228
General notes	202	Systems settings menu overview .	213	COMAND automatic climate control .	229
Address book menu overview	202	Display settings	213	Setting temperature	230
Calling up the address book	202	Time settings	213	Adjusting air distribution	230
Selecting an entry in the main address book display	202	Voice Control* settings	215	Adjusting air volume	230
Creating a new address book entry	203	Setting the system language	216	Central climate control menu via COMAND	231
Deleting an entry	204	Assigning the favorite button	216	Operating rear climate control* from the front	234
Searching for an address book entry	204	Bluetooth settings	217	COMAND seats	236
Displaying a complete address book entry	206	Reset	219	Operating seats via COMAND	236
Displaying of a complete phone book entry in the mobile phone	207	COMAND vehicle menu	220	Lumbar support	237
Changing an entry	207	Setting night security illumination	220	Multicontour seats*, front	237
		Locator lighting on/off	221	Drive-dynamic multicontour seats, front*	240
		Exterior mirror convenience settings	222		
		Automatic locking on/off	223		

Instrument cluster control system.....	241	Dialog for entering a complete address	271	Voice Control* troubleshooting.....	299
Multifunction display	241	Commands for entering parts of an address	276	Help function	299
Multifunction steering wheel.....	242	Voice Control* address book	279	Help commands.....	299
Menus	243	COMAND address book overview .	279	Help window	299
Trip menu.....	245	Operation with address book not open (global).....	279	Entering digits and spelling.....	299
Navi menu	246	Operation with address book open (local).....	279	What to do if	300
Audio menu	248	Operating and using address book.....	280	Voice Control* individualization	302
Telephone menu*.....	249	Available commands with the address book not open	280		
Assistance menu*	252	Available commands with the address book open	281	Controls in detail	303
Service menu	253	Voice Control* radio.....	282	Locking and unlocking	304
Settings menu.....	254	Radio operation	282	SmartKey.....	304
Voice Control* operating safety	257	Radio commands	282	SmartKey with KEYLESS-GO*	306
Voice Control* introduction.....	258	Voice Control* CD/ DVD changer/MP3.....	286	Checking batteries in the SmartKey or SmartKey with KEYLESS-GO.....	311
Spelling.....	259	Operation.....	286	Loss of the SmartKey or SmartKey with KEYLESS-GO	311
Command types.....	259	Commands.....	286	Opening doors from the inside	312
Active System	259	Voice Control* command list	288	Power closing assist for doors and trunk lid	313
Controls	260	Command list.....	288	Automatic central locking.....	313
Symbols	261			Locking and unlocking from the inside	314
Voice Control* telephone	262				
Telephone operation	262				
Telephone commands.....	263				
Voice Control* navigation.....	269				
Important notes	269				
Navigation operation.....	270				
Navigation commands.....	270				

Contents

Starter switch positions	315	Fastening the seat belts	339	Driving and parking	359
SmartKey	315	Proper use of seat belts	341	Starting the engine	359
SmartKey with KEYLESS-GO*	316	Seat belt height adjustment.....	341	Driving off	361
Seats.....	318	Lighting.....	342	Turn signals.....	362
Seat adjustment.....	318	Exterior lamp switch.....	342	Problems while driving.....	362
Seat heating*	322	Combination switch	346	Parking.....	363
Seat ventilation*	323	Corner-illuminating lamps	347	Turning off the engine	365
Head restraints.....	324	Hazard warning flasher	348	Releasing seat belts	366
Multicontour seats*, rear	327	Interior lighting.....	348	Automatic transmission.....	367
Easy-entry/exit feature	328	Courtesy lighting	350	Gear selector lever.....	367
Steering wheel	330	Door entry lamps	350	Shifting procedure	369
Steering wheel adjustment.....	330	Trunk lamp	350	Automatic transmission positions	370
Heated steering wheel*	331	Windshield wipers.....	351	Gear ranges	372
Mirrors	332	Switching on/off windshield		Driving tips.....	373
Interior rear view mirror	332	wipers	351	Automatic shift program	374
Exterior rear view mirrors.....	332	Intermittent wiping.....	352	Steering wheel gearshift control ..	375
Power folding exterior rear view		Single wipe.....	352	Emergency operation	
mirrors	333	Wiping with windshield washer		(Limp-Home Mode)	377
Auto-dimming rear view mirrors ...	334	fluid.....	352	Instrument cluster	378
Activating exterior rear view		Power windows.....	353	Adjusting instrument cluster and	
mirror parking position.....	335	Opening and closing power		COMAND display illumination	378
Memory function.....	336	windows.....	353	Coolant temperature gauge	378
Storing positions into memory	337	Rear side window sunshades*	355	Tachometer.....	379
Recalling positions from memory .	337	Summer opening feature.....	355	Outside temperature indicator.....	379
Storing exterior rear view mirror		Convenience closing feature	356	Fuel gauge	379
parking position	338				

Driving systems	380	Front passenger compartment		Loading and storing.....	447
Cruise control	380	adjustable air vents.....	433	Roof rack*	447
DISTRONIC Plus*	385	Rear passenger compartment		Loading instructions	447
Airmatic (S 550 only)	401	adjustable air vents.....	434	Storage compartments	448
Active Body Control (ABC)*	403	Rear passenger compartment		Cup holders	452
Parktronic system*	405	climate control*	434	Trunk	453
Park Assist*	409	Trunk	436	Useful features	455
Dynamic Rear View Monitor*	413	Opening trunk	436	Sun visors	455
Night View Assist*	420	Closing trunk	437	Vanity mirror in rear.....	455
Automatic climate control	424	Trunk emergency release.....	440	Rear window sunshade	456
Deactivating climate control		Power tilt/sliding sunroof.....	441	Ashtrays.....	456
system	428	Opening and closing power		Cigarette lighters	457
Operating climate control system		tilt/sliding sunroof.....	441	Power outlet	458
in automatic mode	428	Synchronizing	442	Telephone*	459
Setting temperature	429	Panorama roof with power		Tele Aid.....	462
Adjusting air volume	429	tilt/sliding panel*	443	Garage door opener.....	470
Front defroster	429	Roller sunblinds	443	Infrared reflecting windshield	475
Rear window defroster	430	Opening and closing panorama			
Maximum cooling MAXCOOL		roof with power tilt/sliding panel..	444		
(USA only)	430	Synchronizing	446		
Air recirculation mode.....	431				
Residual engine heat and					
ventilation	433				

Contents

Operation	477	At the gas station	489	DOT, Tire Identification Number (TIN)	522
The first 1000 miles (1500 km)	478	Refueling	489	Maximum tire load	523
Driving instructions	479	Check regularly and before a long trip	490	Maximum tire inflation pressure ..	523
Drive sensibly – save fuel	479	Engine compartment	492	Uniform Tire Quality Grading Standards (U.S. vehicles)	524
Drinking and driving	479	Hood	492	Tire ply material	525
Pedals	479	Engine oil	494	Tire and loading terminology	526
Power assistance	479	Transmission fluid level	497	Rotating tires	529
Brakes	480	Active Body Control* (ABC*) fluid level	497	Winter driving	530
Driving off	481	Coolant level	497	Winter tires	530
Parking	481	Windshield washer system and headlamp cleaning system	498	Snow chains	531
Tires	482	Tires and wheels	500	Maintenance	532
Hydroplaning	483	Important guidelines	500	Maintenance service indicator message	532
Tire traction	483	Tire care and maintenance	501	Calling up the maintenance service indicator display	533
Tire speed rating	484	Direction of rotation	503	Resetting the maintenance service indicator	533
Winter driving instructions	484	Loading the vehicle	503	Recommended tire inflation pressure	509
Standing water	485	Recommended tire inflation pressure	509	Checking tire inflation pressure ...	511
Passenger compartment	486	Checking tire inflation pressure ...	511	Tire labeling	518
Driving abroad	486	Tire labeling	518	Load identification	521
Control and operation of radio transmitters	486	Load identification	521		
Catalytic converter	487				
Emission control	488				
Coolant temperature	488				
				Vehicle care	534
				Cleaning and care of vehicle	534

Practical hints	543	Resetting activated head restraints (S 600 only).....	618	Batteries.....	634
What to do if ...?.....	544	Replacing SmartKey batteries	619	Disconnecting starter battery	636
Lamps in instrument cluster	544	SmartKey/SmartKey with KEYLESS-GO*	619	Removing starter battery	637
Air bag off indicator lamp.....	555	Replacing bulbs	621	Charging battery	637
Vehicle status messages in the multifunction display.....	557	Bulbs.....	622	Reinstalling starter battery	638
Where will I find ...?	611	Replacing bulbs for front lamps	623	Reconnecting starter battery	638
First aid kit	611	Replacing wiper blades.....	627	Jump starting.....	639
Vehicle jack, vehicle tool kit, luggage bowl, Minispare wheel	611	Placing wiper arms in vertical position.....	627	Towing the vehicle.....	642
Unlocking/locking in an emergency..	614	Removing wiper blades	628	Installing towing eye bolt.....	644
Unlocking the vehicle.....	614	Installing wiper blades	628	Fuses.....	645
Locking the vehicle	615	Flat tire.....	629	Aids for replacing fuses	646
Mechanically releasing the electric parking brake	616	Preparing the vehicle	629	Fuse boxes in engine compartment.....	646
Opening/closing in an emergency.....	617	Mounting the Minispare wheel.....	629	Fuse boxes in passenger compartment.....	647
Power tilt/sliding sunroof or panorama roof with power tilt/sliding panel*	617			Emergency engine shut-down.....	648

Contents

Technical data	649	Fuels, coolants, lubricants, etc.	661	Technical terms	669
Parts service	650	Capacities	661		
Warranty coverage.....	651	Engine oils.....	663		
Loss of Service and Warranty		Engine oil additives	663	Index	679
Information Booklet.....	651	Air conditioning refrigerant	663		
Identification labels.....	652	Brake fluid.....	663		
Layout of poly-V-belt drive	653	Premium unleaded gasoline	664		
S 550	653	Fuel requirements	664		
S 600	653	Gasoline additives	665		
Engine.....	654	Coolants.....	665		
Rims and tires.....	655	Windshield and headlamp			
Same size tires	656	washer system	668		
Mixed size tires	657				
Minispare wheel	658				
Electrical system.....	659				
Main dimensions and weights.....	660				
Main dimensions	660				
Weights	660				

▼ Product information

Please observe the following in your own best interest:

We recommend using Genuine Mercedes-Benz parts as well as conversion parts and accessories explicitly approved by us for your vehicle model.

We have tested these parts to determine their reliability, safety and special suitability for Mercedes-Benz vehicles.

We are unable to make an assessment for other products and therefore cannot be held responsible for them, even if in individual cases an official approval or authorization by governmental or other agencies should exist. Use of such parts and accessories could adversely affect the safety, performance or reliability of your vehicle. Please do not use them.

Genuine Mercedes-Benz parts as well as conversion parts and accessories approved by us are available at your authorized Mercedes-Benz Center where you will receive comprehensive information, also on permissible technical modifications, and where proper installation will be performed.

This Operator's Manual contains a great deal of useful information. We urge you to read it carefully and familiarize yourself with the vehicle before driving.

For your own safety and longer service life of the vehicle, we urge you to follow the instructions and warnings contained in this manual. Ignoring them could result in damage to the vehicle or personal injury to you or others. Vehicle damage caused by failure to follow instructions is not covered by the Mercedes-Benz Limited Warranty.

Your vehicle may have some or all of the equipment described in this manual. Therefore, you may find explanations for optional equipment not installed in your vehicle. If you have any questions about the operation of any equipment, your authorized Mercedes-Benz Center will be glad to demonstrate the proper procedures.

We continuously strive to improve our product, and ask for your understanding that we reserve the right to make changes in design and equipment. Therefore, information, illustrations and descriptions in this Operator's Manual might differ from your vehicle.

Optional equipment is also described in this manual, including operating instructions wherever necessary. Since they are special-order items, the descriptions and illustrations herein may vary slightly from the actual equipment of your vehicle.

If there are any equipment details that are not shown or described in this Operator's Manual, your authorized Mercedes-Benz Center will be glad to inform you of correct care and operating procedures. The Operator's Manual and Maintenance Booklet are important documents and should be kept with the vehicle.

Service and warranty information

The Service and Warranty Information Booklet contains detailed information about the warranties covering your Mercedes-Benz, including:

- New Vehicle Limited Warranty
- Emission System Warranty
- Emission Performance Warranty
- California, Maine, Massachusetts, and Vermont Emission Control System Warranty (California, Maine, Massachusetts, and Vermont only)
- State Warranty Enforcement Laws (Lemon Laws)

Important notice for California retail buyers and lessees of Mercedes-Benz automobiles

Under California law you may be entitled to a replacement of your vehicle or a refund of the purchase price or lease price, if Mercedes-Benz USA, LLC and/or its authorized repair or service facilities fail to fix one or more substantial defects or malfunctions in the vehicle that are covered by its express warranty after a reasonable number of repair attempts. During the period of 18 months from original delivery of the vehicle or the accumulation of 18 000 miles (approx. 29 000 km) on the odometer of the vehicle, whichever occurs first, a reasonable number of repair attempts is presumed for a retail buyer or lessee if one or more of the following occurs:

(1) the same substantial defect or malfunction results in a condition that is likely to cause death or serious bodily injury if the vehicle is driven, that defect or malfunction has been subject to

repair two or more times, and you have directly notified Mercedes-Benz USA, LLC in writing of the need for its repair,

- (2) the same substantial defect or malfunction of a less serious nature than category (1) has been subject to repair four or more times and you have directly notified us in writing of the need for its repair, or
- (3) the vehicle is out of service by reason of repair of the same or different substantial defects or malfunctions for a cumulative total of more than 30 calendar days.

Written notification should be sent to us, not a dealer, at Mercedes-Benz USA, LLC, Customer Assistance Center, One Mercedes Drive, Montvale, NJ 07645-0350.

Maintenance

The Maintenance Booklet describes all the necessary maintenance work which should be performed at regular intervals.

Always have the Maintenance Booklet with you when you take the vehicle to your authorized Mercedes-Benz Center for service. The service advisor will record each service in the booklet for you.

Roadside Assistance

The Mercedes-Benz Roadside Assistance Program provides factory trained technical help in the event of a breakdown. Calls to the toll-free Roadside Assistance number

1-800-FOR-MERCEdes (in the USA)
1-800-387-0100 (in Canada)

will be answered by Mercedes-Benz Customer Assistance Representatives 24 hours a day, 365 days a year.

For additional information refer to the Mercedes-Benz Roadside Assistance Program brochure in your vehicle literature portfolio.

Change of address or ownership

If you change your address, be sure to send in the “Change of Address Notice” found in the Service and Warranty Information Booklet, or simply call the Mercedes-Benz Customer Assistance Center (in the USA) at 1-800-FOR-MERCEdes, or Customer

Service (in Canada) at 1-800-387-0100. It is in your own interest that we can contact you should the need arise.

If you sell your Mercedes, please leave all literature with the vehicle to make it available to the next operator.

If you bought this vehicle used, be sure to send in the “Notice of Purchase of Used Car” found in the Service and Warranty Information Booklet, or call the Mercedes-Benz Customer Assistance Center (in the USA) at 1-800-FOR-MERCEdes, or Customer Service (in Canada) at 1-800-387-0100.

Operating your vehicle outside the USA or Canada

If you plan to operate your vehicle in foreign countries, please be aware that:

- service facilities or replacement parts may not be readily available,

- unleaded gasoline for vehicles with catalytic converters may not be available; the use of leaded fuels will damage the catalysts,
- gasoline may have a considerably lower octane rating, and improper fuel can cause engine damage.

Certain Mercedes-Benz models are available for delivery in Europe under our European Delivery Program. For details, consult your authorized Mercedes-Benz Center or write to:

In the USA:

Mercedes-Benz USA, LLC
European Delivery Department
One Mercedes Drive
Montvale, NJ 07645-0350

In Canada:

Mercedes-Benz Canada, Inc.
European Delivery Department
98 Vanderhoof Avenue
Toronto, Ontario M4G 4C9

▼ Where to find it

This Operator's Manual is designed to provide comprehensive support information for you, the vehicle operator. Each section has its own reference color.

At a glance

Here you will find an overview of all the controls that can be operated in the vehicle's interior.

Safety and Security

Here you will find descriptions of the safety and security features of your vehicle.

Control systems

Here you will find detailed information about the operation of the COMAND system, instrument cluster control system and Voice Control*.

Controls in detail

Here you will find detailed information about the equipment installed in your vehicle. This section also describes technical innovations.

Operation

Here you will find all the information you need for the proper operation of your vehicle.

Practical hints

This section provides fast assistance for dealing with problems you may encounter.

Technical data

All important technical data for your vehicle can be found in this section.

Indexes

The glossary provides explanations of the most important technical terms.

The table of contents and the index are designed to help you find information quickly and easily.

The following publications are part of your vehicle documentation:

- this Operator's Manual
- the Maintenance Booklet

Separate operating instructions will be provided as required depending on the equipment options installed in your vehicle.

Symbols

Trademarks:

- ESP® and PRE-SAFE® are registered trademarks of DaimlerChrysler.
- HomeLink® is a registered trademark of Prince, a Johnson Controls Company.
- SIRIUS and related marks are trademarks of Sirius Satellite Radio Inc.
- LOGIC7® is a registered trademark of Harman International Industries, Incorporated.

The following symbols are found in this Operator's Manual:

- * Optional equipment is identified with an asterisk. Since standard equipment varies between models, the descriptions and illustrations in this manual may differ slightly from the actual equipment of your vehicle.

Warning!



Warning notices draw your attention to hazards that may endanger your health or life, or the health or life of others.

 *Highlights hazards that may result in damage to your vehicle.*

 *Helpful hints or further information you may find useful.*

- ▶ This symbol points to instructions for you to follow.
- ▶ A number of these symbols appearing in succession indicates a multiple-step procedure.

▷ Page This symbol tells you where to look for further information on a topic.

▷▷ This continuation symbol marks an interrupted warning which will be continued on the next page.

▷▷ This continuation symbol marks an interrupted procedure which will be continued on the next page.

-> In the glossary of technical terms, this symbol is used to indicate cross-references to term definitions.

Display Words appearing in the multi-function display and COMAND display are printed in the type shown here.

▼ Operating safety

Warning!



Work improperly carried out on electronic components and associated software could cause them to cease functioning. Because the vehicle's electronic components are interconnected, any modifications made may produce an undesired effect on other systems. Electronic malfunctions could seriously impair the operating safety of your vehicle.

See an authorized Mercedes-Benz Center for repairs or modifications to electronic components.

Other improper work or modifications on the vehicle could also have a negative impact on the operating safety of the vehicle.

Some safety systems only function while the engine is running. You should therefore never turn off the engine while driving.

Warning!



Heavy blows against the vehicle underbody or tires/wheels, for example when running over an obstacle, road debris or a pothole, may cause serious damage and impair the operating safety of your vehicle. If you feel a sudden significant vibration or ride disturbance, or you suspect that damage to your vehicle has occurred, you should turn on your hazard warning flashers, carefully slow down, and drive with caution to an area which is a safe distance from the road.

Inspect the vehicle underbody and tires/wheels for possible damage. If the vehicle appears unsafe, have it towed to the nearest authorized Mercedes-Benz Center or other qualified maintenance or repair facility for further inspection or repairs.

Proper use of the vehicle

Proper use of the vehicle requires that you are familiar with the following information and rules:

- the safety precautions in this manual
- the “Technical data” section in this manual
- traffic rules and regulations
- motor vehicle laws and safety standards

Warning!



Various warning labels are attached to your vehicle. These warning labels are intended to make you and others aware of various risks. You should not remove any of these warning labels unless explicitly instructed to do so by information on the label itself. Removal of any of these labels may cause you and others to be unaware of certain risks which may result in an accident and/or personal injury.

Problems with your vehicle

If you should experience a problem with your vehicle, particularly one that you believe may affect its safe operation, we urge you to immediately contact an authorized Mercedes-Benz Center to have the problem diagnosed and corrected if required. If the matter is not handled to your satisfaction, please discuss the problem with the Mercedes-Benz Center management, or if necessary contact us at one of the following addresses:

In the USA:

Customer Assistance Center
Mercedes-Benz USA, LLC
One Mercedes Drive
Montvale, NJ 07645-0350

In Canada:

Customer Relations Department
Mercedes-Benz Canada, Inc.
98 Vanderhoof Avenue
Toronto, Ontario, M4G 4C9

▼ Reporting safety defects

For the USA only:

The following text is published as required of manufacturers under Title 49, Code of U.S. Federal Regulations, Part 575 pursuant to the “National Traffic and Motor Vehicle Safety Act of 1966.”

Reporting safety defects

If you believe that your vehicle has a defect which could cause a crash or could cause injury or death, you should immediately inform the National Highway Traffic Safety Administration (NHTSA) in addition to notifying Mercedes-Benz USA, LLC.

If NHTSA receives similar complaints, it may open an investigation, and if it finds that a safety defect exists in a group of vehicles, it may order a recall and remedy campaign. However, NHTSA cannot become involved in individual problems between you, your dealer, or Mercedes-Benz USA, LLC.

To contact NHTSA, you may call the Vehicle Safety Hotline toll-free at 1-888-327-4236 (TTY: 1-800-424-9153); go to <http://www.safercar.gov>; or write to: Administrator, NHTSA, 400 Seventh Street, SW., Washington, DC 20590. You can also obtain other information about motor vehicle safety from <http://www.safercar.gov>.

Vehicle data recording

Information regarding electronic recording devices

(Including notice pursuant to California Code § 9951)

Please note that your vehicle is equipped with devices that can record vehicle systems data and, if equipped with the Tele Aid system, may transmit some data in certain accidents.

This information helps, for example, to diagnose vehicle systems after a collision and to continuously improve vehicle safety. DaimlerChrysler may access the information and share it with others

- for safety research or vehicle diagnosis purposes
- with the consent of the vehicle owner or lessee
- in response to an official request by law enforcement or other government agency
- for use in dispute resolution involving DaimlerChrysler, its affiliates or sales/service organization and/or
- as otherwise required or permitted by law.

Please check the Tele Aid subscription service agreement for details regarding the information that may be recorded or transmitted via that system.

Exterior view

Cockpit

Instrument cluster

Control systems

Center console

Automatic climate control

Overhead control panel

Driver's door control panel

Rear door control panel

Storage compartments

Rear passenger compartment



Exterior view

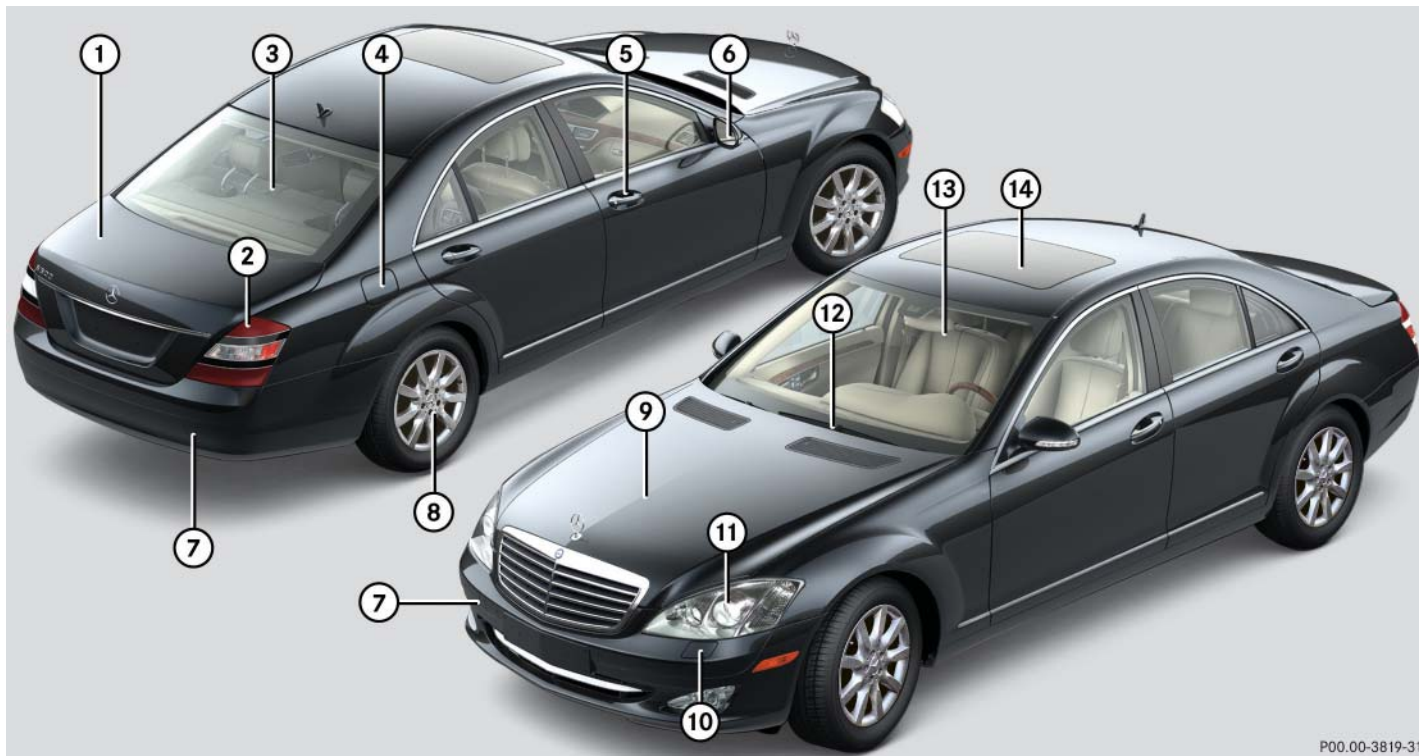

P00.00-3819-31

Item	Page
① Trunk	
• Unlocking	436
• Opening and closing	436
• Minispare wheel	629
• Vehicle tool kit	611
② Rear lamps	622
③ Rear window, defrosting	430
④ Fuel filler flap	489
Gasoline	664
⑤ Doors	
• Locking and unlocking	304
• Opening and closing	312

Item	Page
⑥ Exterior rear view mirror	334
Parking position	335
⑦ Towing eye bolt	644
General information	642
⑧ Rims and tires	655
• Checking tire inflation pressure	511
• Minispare wheel	613
• Flat tire	629
⑨ Hood, opening	492
Engine oil	494
Coolant	497

Item	Page
⑩ Headlamp cleaning system	346
⑪ Front lamps	622
⑫ Windshield wipers	351
Wiper blades, replacing	627
Wiper blades, cleaning	540
⑬ Window, cleaning	540
⑭ Roofs	
• Power tilt/sliding sunroof	441
• Panorama roof with power tilt/sliding panel*	443

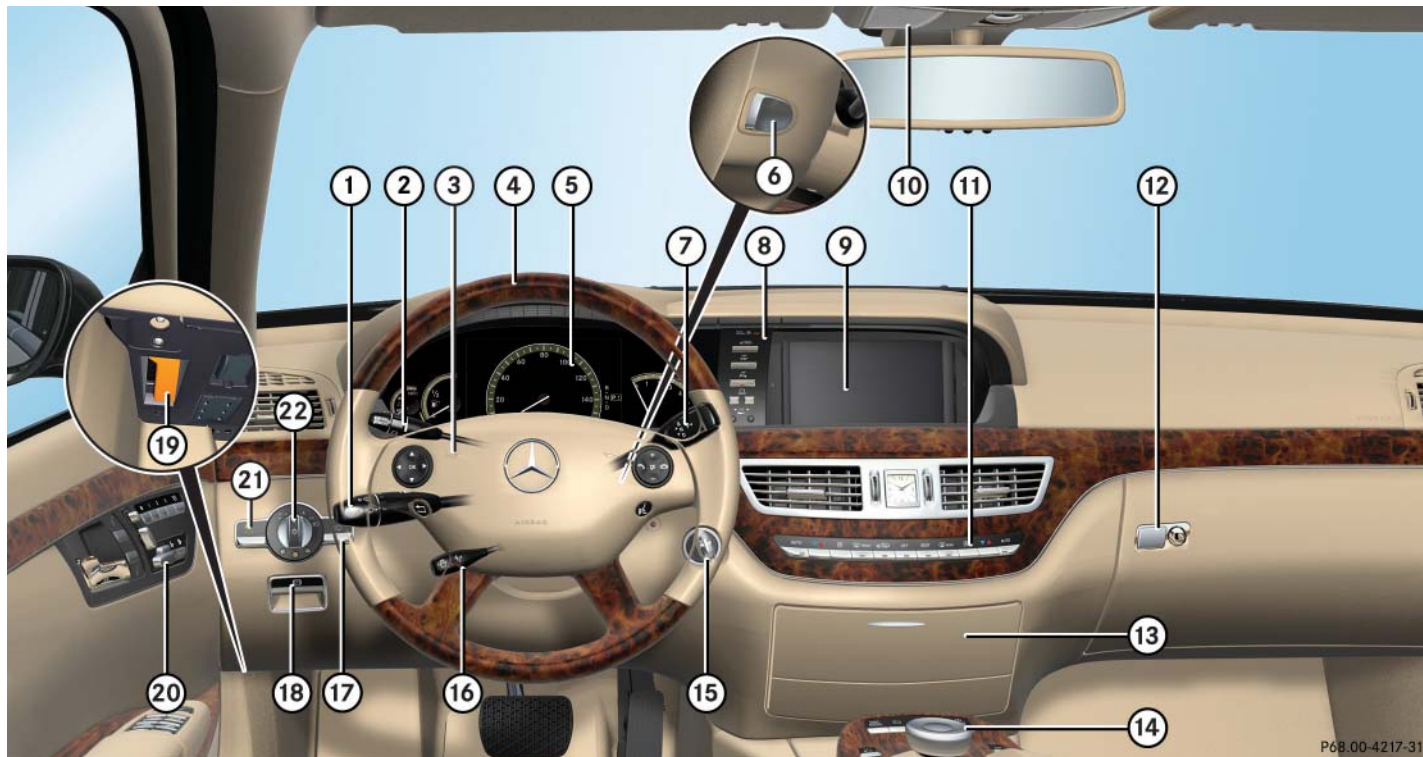

P68.00-4217-31

Item	Page
① Combination switch	
• Turn signals	362
• Windshield wipers	351
• High beam	346
• Cornering lamps	347
② Lever for	
• Cruise control	380
• DISTRONIC Plus*	385
③ Horn	
④ Multifunction steering wheel	242
⑤ Instrument cluster	28
⑥ Steering wheel gearshift control	375
⑦ Gear selector lever for automatic transmission	359





Item	Page
⑧ Control panel with	
• Front passenger front air bag indicator lamp	53
• Vehicle level control switch	401, 403
• Electronic Stability Program (ESP®) switch	73
• Parktronic* /Park Assist* deactivation switch	408, 408
• Swivel COMAND display	81
• COMAND/instrument cluster illumination	378
⑨ COMAND display	79
⑩ Overhead control panel	37
⑪ Automatic climate control	424
Center console, upper part	32

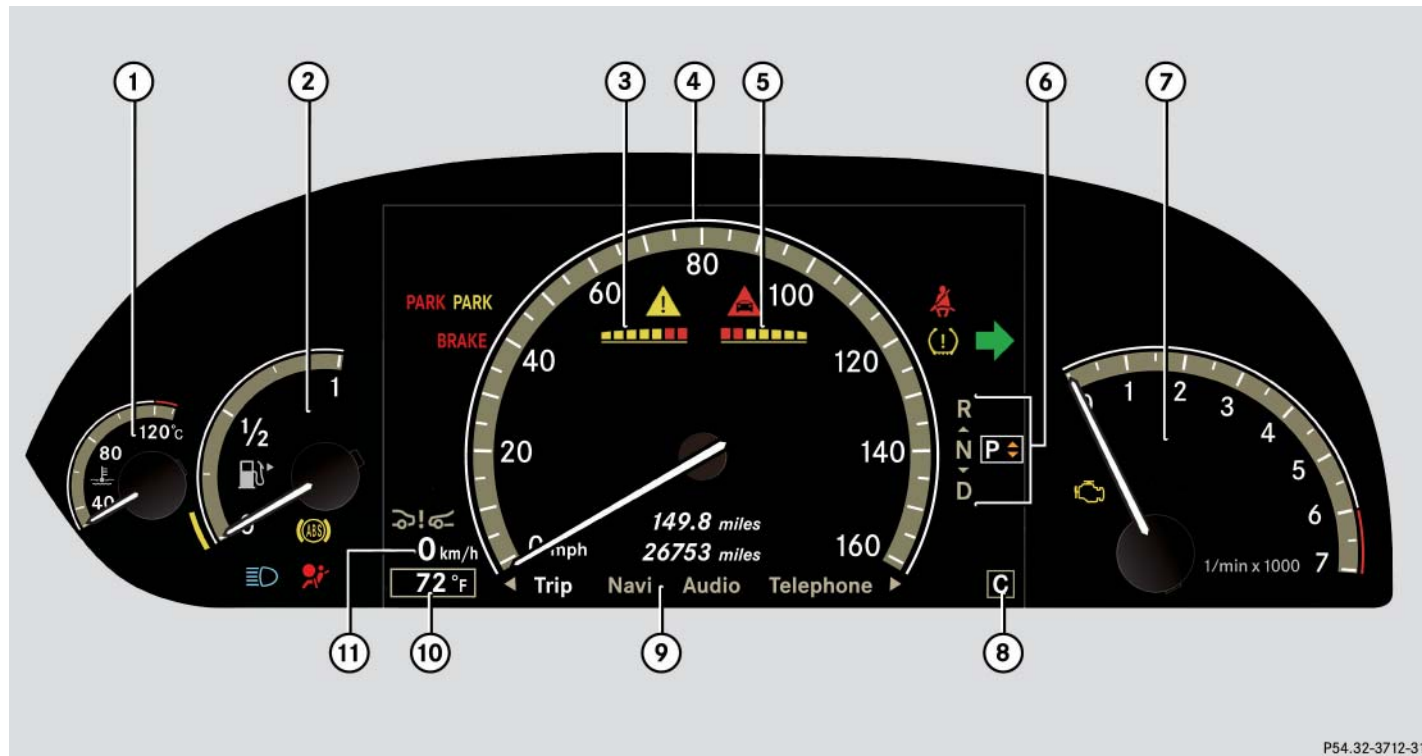





Item	Page
⑫ Glove box lock	448
⑬ Cover of compartment with	
• CD changer	107
• PCMCIA card slot	108
⑭ Center console, lower part	33
⑮ Starter switch	315
KEYLESS-GO* start/stop button	316
⑯ Steering wheel adjustment	330
Heated steering wheel*	331
⑰ Headlamp washer button	346
⑱ Parking brake	364
⑲ Hood lock release	492
⑳ Door control panel	39
㉑ Night View Assist*	420
㉒ Exterior lamp switch	342



Instrument cluster



P54.32-3712-31





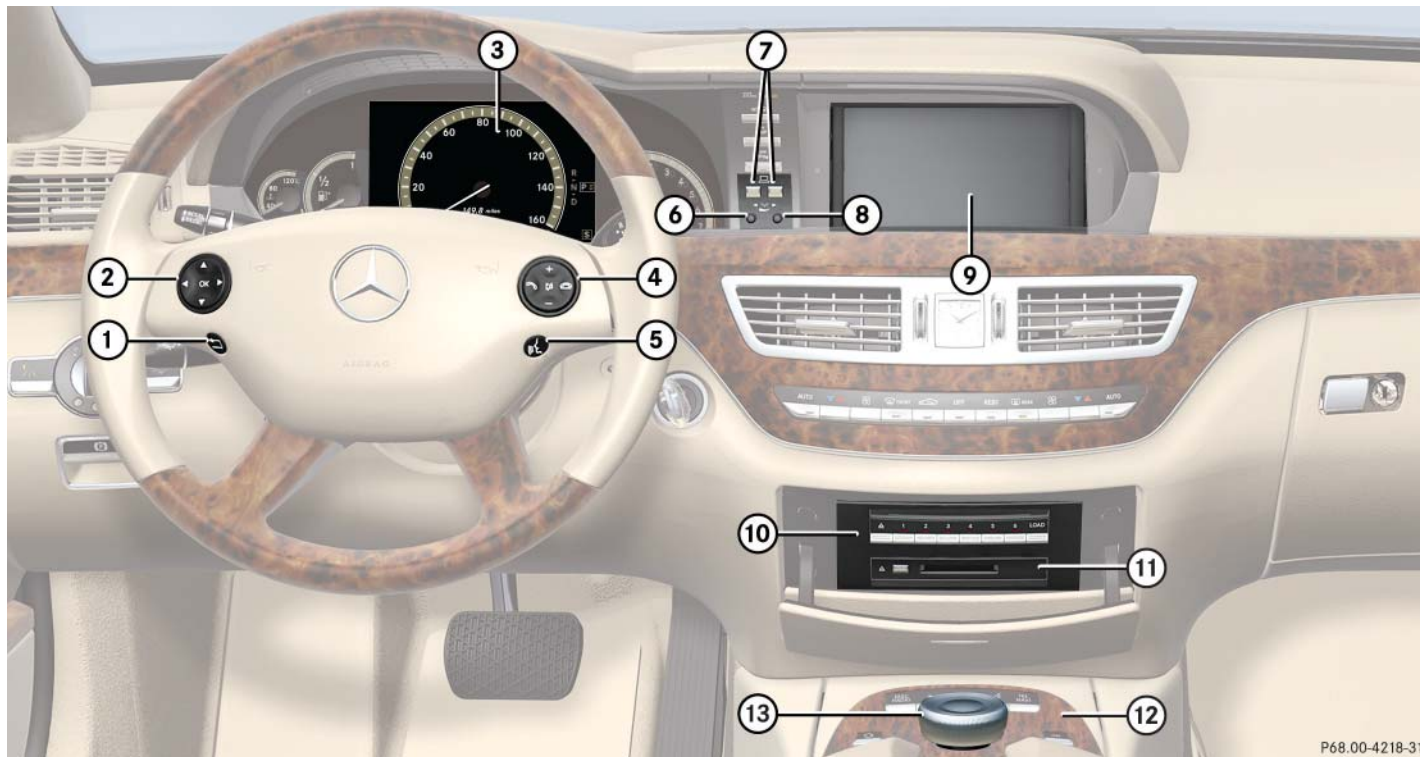

	Item	Page
①	Coolant temperature gauge	378
②	Fuel gauge with:	
	Fuel tank reserve warning lamp	550
	 High beam headlamp indicator lamp	346
	 ABS indicator lamp	544
	 SRS indicator lamp	552
③	Parktronic*/Park Assist* warning indicator for left front area	407, 411
④	Speedometer with:	
	 Parking brake warning or indicator lamps	546
	USA only	
	 Canada only	







	Item	Page
	 Brake warning lamp	545
	USA only	
	 Canada only	
	 Seat belt telltale	550
	 Combination low tire pressure*/TPMS malfunction telltale*	553
	 Left/right turn signal indicator lamps	362
	 ESP® warning lamp	549
	 Distance warning lamp*	397, 549
⑤	Parktronic*/Park Assist* warning indicator for right front area	407, 411

	Item	Page
⑥	Gear position/range indicator	370
⑦	Tachometer with:	
	 Engine malfunction indicator lamp	547
⑧	Selected program mode indicator	370
⑨	Main menu for control system, multifunction display	241
⑩	Outside temperature	379
⑪	Display with:	
	Additional speedometer	255
	 Distance warner*	397, 252



P68.00-4218-31

	Item	Page
①	 back/to deactivate Voice Control*	242 260
②	 scroll up	
	 scroll down	
	 scroll to the right	
	 scroll to the left	
	 confirm selection	
③	Multifunction display	241

	Item	Page
④	 to take a call to dial a number	249
	 to end a call to reject an incoming call	249
	 volume up	
	 volume down	
	 mute function	
⑤	 to accept a call/ to activate Voice Control*	124 260

	Item	Page
⑥	Instrument cluster illumination	378
⑦	Swivel COMAND display	81
⑧	COMAND display illumination	378
⑨	COMAND display	80
⑩	CD changer	107
⑪	PCMCIA card slot	108
⑫	COMAND shortcut buttons	80
⑬	COMAND controller	82

Center console

Upper part

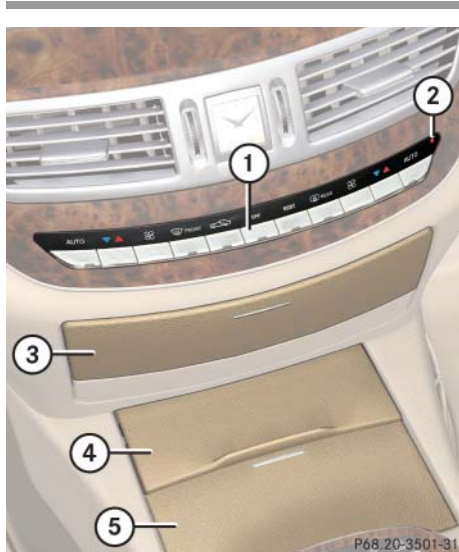

Item	Page
① Automatic climate control panel, front	36
② Alarm system indicator lamp	75
③ Cover of compartment with <ul style="list-style-type: none">• CD changer• PCMCIA card slot	107 108
④ Cover of compartment with: <ul style="list-style-type: none">• Ashtray• Lighter	456 457
⑤ Cup holder	452

Lower part



P68.20-3513-31

Item	Page
① Favorite button	216
② Rear head restraints retract button	325
③ Program mode selector switch for:	374
<ul style="list-style-type: none"> • automatic transmission shift program • suspension tuning of Airmatic (only S 550) or ABC* • engine control 	
④ Shortcut button for:	
<ul style="list-style-type: none"> • radio • CD/DVD 	94 111
⑤ Back button	87

Item	Page
⑥ Hazard warning flasher	348
⑦ Seat operation via COMAND:	236
<ul style="list-style-type: none"> • Lumbar support • Multicontour seat* • Drive-dynamic multicontour seat* 	237 237 240
⑧ Shortcut button for:	
<ul style="list-style-type: none"> • telephone* • navigation 	115 148
⑨ COMAND controller	82
⑩ COMAND on/off switch	79
⑪ Volume adjustment	89
⑫ Mute function	89
⑬ Telephone keypad	117

Overview

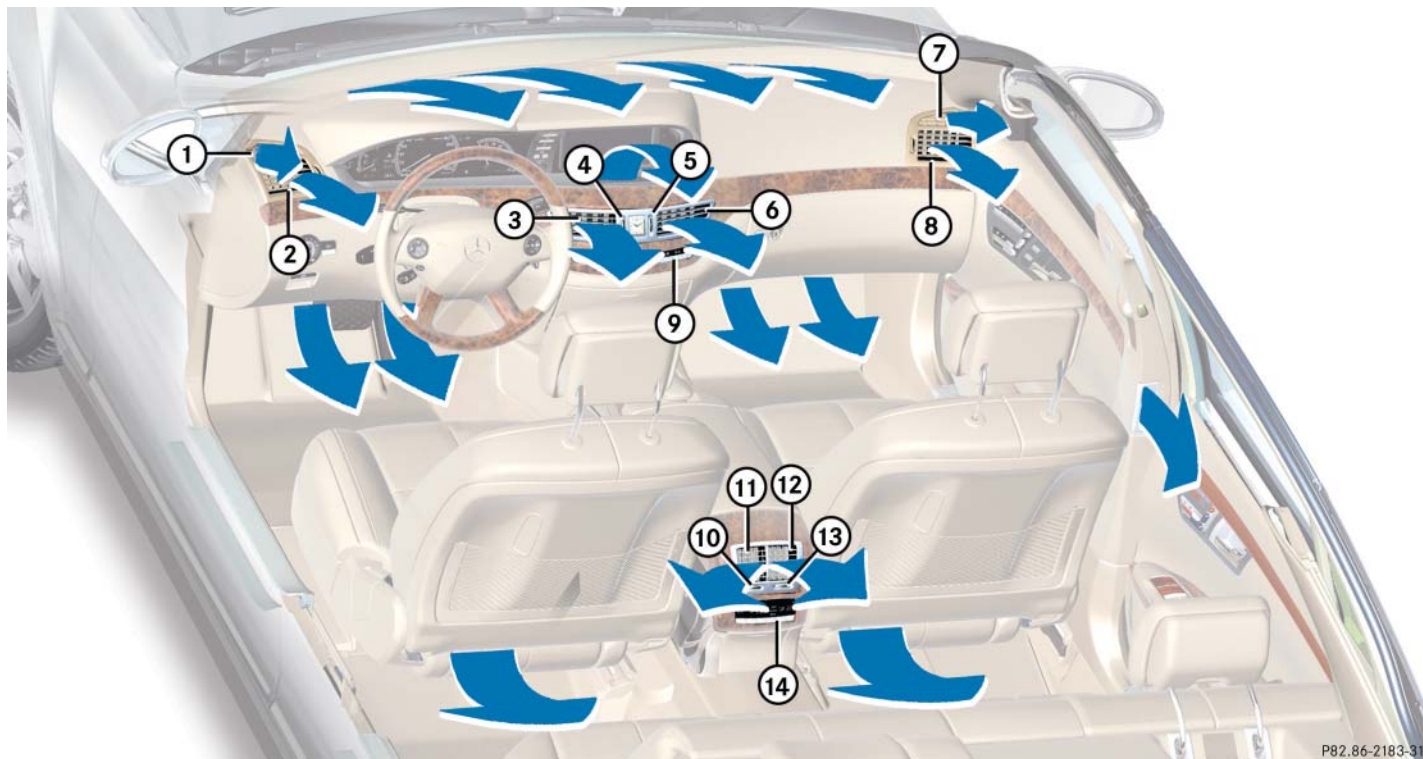

P82.86-2183-31

Automatic climate control

Item	Page
① Left side defroster vent, fixed	
② Left side air vent, adjustable	
③ Left center air vent, adjustable	
④ Thumbwheel for air volume control for left center air vent	433
⑤ Thumbwheel for air volume control for right center air vent	433

Item	Page
⑥ Right center air vent, adjustable	
⑦ Right side defroster vent, fixed	
⑧ Right side air vent, adjustable	
⑨ Front climate control panel	36
⑩ Thumbwheel for left rear center air vents	434

Item	Page
⑪ Left rear center air vent, adjustable	
⑫ Right rear center air vent, adjustable	
⑬ Thumbwheel for right rear center air vents	434
⑭ Rear climate control panel*	434

Automatic climate control

Automatic climate control panel, front



P83.40-3117-31

Item	Page
① AUTO mode for air distribution and volume, left	428
② Temperature control, left	429
③ Manual fan speed adjustment, left	429
④ Front defroster	429

Item	Page
⑤ Air recirculation	431
⑥ Climate control on/off	428
⑦ Residual engine heat and ventilation (REST)	433
⑧ Rear window defroster	430

Item	Page
⑨ Manual fan speed adjustment, right	429
⑩ Temperature control, right	429
⑪ AUTO mode for air distribution and volume, right	428

▼ Overhead control panel



Item	Page
① Eyeglasses compartment	449
② Left reading lamp on/off	348
③ Rear interior lighting on/off	348
④ Front interior lighting on/off	348
⑤ Power tilt/sliding sunroof or tilt/sliding panel*	441
⑥ Tele Aid (emergency call system) button	462
⑦ Interior lighting control	348

Item	Page
⑧ Opening/closing rear roller sunblinds	443
⑨ Right reading lamp on/off	348
⑩ Rear view mirror	332
⑪ Garage door opener	470
⑫ Hands-free microphone for	
• Tele Aid (emergency call system)	462
• Telephone*	459
• Voice Control*	255

Driver's door control panel

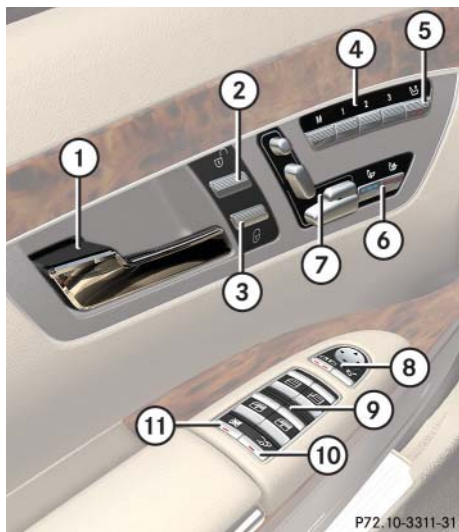

P72.10-3311-31

Item	Page
① Inside door handle	312
② Central unlocking switch	312
③ Central locking switch	312
④ Memory function (for storing seat, exterior mirror, and steering wheel settings)	336
⑤ Selector button for front passenger seat	321
⑥ Seat heating	322
⑦ Seat adjustment	318
Seat ventilation*	323

Item	Page
⑧ Exterior rear view mirrors adjustment	332
Mirror folding function	333
⑨ Switches for opening/ closing side windows	353
Switches for opening/ closing rear door window sunshades*	355
⑩ Remote trunk opening/ closing* switch	436
⑪ Override switch for rear passenger compartment	67

▼ Rear door control panel

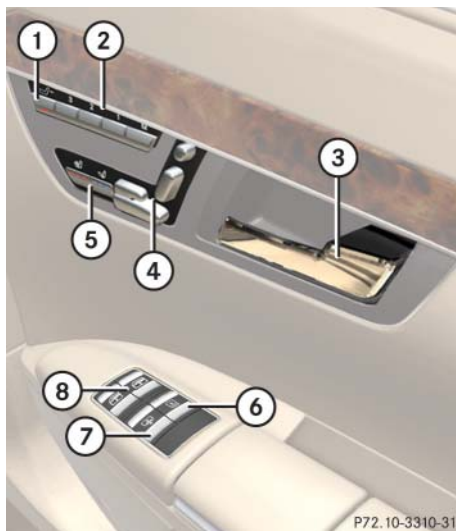

Item	Page
① Selection switch for right front passenger seat adjustment* ¹	320
② Memory function* (for storing seat settings) (Canada only)	336
③ Inside door handle	312
④ Seat adjustment	318
⑤ Seat heating*	322
Seat ventilation*	323

¹ This switch is located on the right rear passenger side only.

Item	Page
⑥ Button for extending/retracting panorama roof sunblind*	443
⑦ Switch for extending/retracting rear window sunshade*	456
⑧ Switches for opening/closing side windows	353
Switches for opening/closing rear side window sunshades*	355

Storage compartments

Item	Page
① Glove box	448
② Document holder in sun visor	455
③ Door pocket	
④ Ruffled storage pocket	451
⑤ Door pocket	
Ashtray	456
⑥ Side storage pocket in trunk	
Holder for Operator's Manual pouch	
⑦ Additional storage spaces under the trunk floor	453
⑧ Side storage pocket in trunk	
⑨ Door pocket	
Ashtray	456

Item	Page
⑩ Ruffled storage pocket	451
⑪ Door pocket	
⑫ Document holder in sun visor	455
⑬ Ashtray	456
Cigarette lighter	457
⑭ Eyeglasses compartment in overhead control panel	449
⑮ Parcel net in front passenger footwell	449
⑯ Front passenger seat storage compartment with first aid kit	611

Item	Page
⑰ Front center armrest with storage compartments	448
⑱ Cup holder in the rear center armrest	452
Cup holder under the rear center storage compartment*	452
⑲ Rear center armrest with storage compartment	450
⑳ Rear storage box	451
㉑ Cup holder in the front center console	452
㉒ Driver's seat storage compartment	449

Rear passenger compartment



	Item	Page
①	Cup holder under the rear center storage compartment*	452
②	Cup holder in the rear center armrest	452
③	Control panel for rear multi-ontour seats*	327
④	Rear center armrest with storage compartment	450
⑤	Rear storage box	451

Occupant safety

Panic alarm

Driving safety systems

Anti-theft systems



Occupant safety

In this section you will learn the most important facts about the restraint systems of the vehicle.

The restraint systems are

- Seat belts (▷ page 55)
- Child restraints (▷ page 61)
- Lower anchors and tethers for children (LATCH) (▷ page 64)

Additional protection potential provide

- Supplemental Restraint System (SRS) with
 - Air bags (▷ page 45)
 - Air bag control unit (with crash sensors)
 - Emergency tensioning device (ETD) for seat belts (▷ page 58)
 - Seat belt force limiter (▷ page 58)
- Preventive occupant safety (PRE-SAFE®) (▷ page 60)

Air bag system components with

- The front passenger front air bag off indicator lamp (▷ page 53)
- Front passenger seat with Occupant Classification System (OCS) (▷ page 50)

As independent systems, their protective functions work in conjunction with each other.

 For information on infants and children traveling with you in the vehicle and restraint systems for infants and children, see “Children in the vehicle” (▷ page 61).

The SRS system conducts a self-test when the ignition is switched on and in regular intervals while the engine is running. This facilitates early detection of malfunctions. The  indicator lamp in the instrument cluster (▷ page 28) comes on when the ignition is switched on and goes out no later than a few seconds after the engine has been started.

The SRS components are in operational readiness when the  indicator lamp is not lit when the engine is running.

A malfunction in the system has been detected if the  indicator lamp:

- fails to go out not later than approximately 4 seconds after the engine was started
- does not come on at all
- comes on after the engine was started or while driving

Warning!



Modifications to or work improperly conducted on restraint systems (such as seat belts and anchors, emergency tensioning devices, seat belt force limiters or air bags) or their wiring, as well as tampering with interconnected electronic systems, can lead to the restraint systems no longer functioning as intended.

Air bags or emergency tensioning devices, for example, could deploy inadvertently or fail to deploy in accidents although the deceleration threshold for air bag deployment is exceeded. Therefore, never modify the restraint systems. Do not tamper with electronic components or their software.

Warning!



In the event that the  indicator lamp comes on during driving or does not come on at all, the SRS self-check has detected a malfunction. For your safety, we strongly recommend that you visit an authorized Mercedes-Benz Center immediately to have the system checked; otherwise the SRS may not deploy when needed in an accident, which could result in serious or fatal injury, or it might deploy unexpectedly and unnecessarily which could also result in injury.

In addition, improper work on the SRS creates a risk of rendering the SRS inoperative or causing unintended air bag deployment. Work on the SRS must therefore only be performed by qualified technicians. Contact an authorized Mercedes-Benz Center.

If it is necessary to modify an air bag system to accommodate a person with disabilities, contact your local authorized Mercedes-Benz Center or call our Customer Assistance Center at 1-800-FOR-MERCEdes (1-800-367-6372) for details.

Air bags

Warning!



Air bags are designed to reduce the potential of injury and fatality in certain frontal impacts (front air bags), side impacts (side impact air bags and head protection window curtain air bags) or rollovers (head protection window curtain air bags). However, no system available today can totally eliminate injuries and fatalities.

The deployment of the air bags temporarily releases a small amount of dust from the air bags. This dust, however, is neither injurious to your health, nor does it indicate a fire in the vehicle. The dust might cause some temporary breathing difficulty for people with asthma or other breathing trouble. To avoid this, you may wish to get out of the vehicle as soon as it is safe to do so. If you have any breathing difficulty but cannot get out of the vehicle after the air bag inflates, then get fresh air by opening a window or door.

Occupant safety

Warning!



To reduce the risk of injury when the front air bags inflate, it is very important for the driver and front passenger to always be in a properly seated position and to wear their respective seat belt.

For maximum protection in the event of a collision always be in normal seated position with your back against the backrest. Fasten your seat belt and make sure that it is properly positioned on your body (▷ page 339).

Since the air bag inflates with considerable speed and force, a proper seating and hands on steering wheel position will help to keep you at a safe distance from the air bag. Occupants who are unbelted, out of position or too close to the air bag can be seriously injured or killed by an air bag as it inflates with great force in the blink of an eye:

- Sit properly belted in a nearly upright position with your back against the seat backrest.

- Adjust the driver's seat as far as possible rearward, still permitting proper operation of vehicle controls. The distance from the center of the driver's breastbone to the center of the air bag cover on the steering wheel must be at least 10 inches (25 cm) or more. You should be able to accomplish this by a combination of adjustments to the seat and steering wheel. If you have any problems, please see an authorized Mercedes-Benz Center.
- Do not lean your head or chest close to the steering wheel or dashboard.
- Keep hands on the outside of steering wheel rim. Placing hands and arms inside the rim can increase the risk and potential severity of hand/arm injury when driver's front air bag inflates.
- Adjust the front passenger seat as far as possible rearward from the dashboard when the seat is occupied.

- Always sit nearly upright, properly use the seat belts and use an appropriately sized infant or toddler restraint or booster seat recommended for the size and weight of the child.

Failure to follow these instructions can result in severe injuries to you or other occupants.

If you sell your vehicle, it is important that you make the buyer aware of this safety information. Be sure to give the buyer this Operator's Manual.

Warning!

Accident research shows that the safest place for children in an automobile is in the rear seat.

It should be noted that with respect to both front and rear side impact air bags there is a possibility for a side impact air bag related injury if occupants, especially children, are not properly seated or restrained when next to a side impact air bag which needs to deploy rapidly in a side impact in order to do its job.

To help avoid the possibility of injury, please follow these guidelines:

- (1) Always sit nearly upright, properly use the seat belts and for children 12 years old and under, use an appropriately sized infant or toddler restraint or booster seat recommended for the size and weight of the child.
- (2) Always wear seat belts properly.

i *Air bags are designed to deploy only in certain frontal impacts (front air bags), and in side impacts (side impact and head protection window curtain air bags) which exceed preset thresholds, and in certain rollovers (head protection window curtain air bags). Only during these events will they provide their supplemental protection.*

The driver and passengers should always wear their seat belts. Otherwise it is not possible for air bags to provide their supplemental protection.

In case of other types of impacts and impacts below air bag deployment thresholds, air bags will not deploy. The driver and passenger will then be protected to the extent possible by a properly fastened seat belt. A properly fastened seat belt is also needed to provide the best possible protection in a rollover.

We caution you not to rely on the presence of the air bags in order to avoid wearing your seat belt.

It is important to your safety and that of your passengers that you replace deployed air bags and repair any malfunctioning air bags to make sure the vehicle will continue to provide supplemental crash protection for occupants.

Safety guidelines for the seat belt, emergency tensioning device and air bag**Warning!**

- Damaged seat belts or belts that were highly stressed in an accident must be replaced and their anchoring points must also be checked. Only use belts installed or supplied by an authorized Mercedes-Benz Center.
- Air bags and pyrotechnic emergency tensioning devices (ETDs) are designed to function on a one-time-only basis. An air bag or ETD that is deployed must be replaced. PRE-SAFE® has electrically operated reversible pre-tensioners in addition to the pyrotechnic ETDs.
- Do not pass belts over sharp edges. They could tear.
- Do not make any modification that could change the effectiveness of the belts.



Occupant safety



- Do not bleach or dye seat belts as this may severely weaken them. In a crash they may not be able to provide adequate protection.
- No modifications of any kind may be made to any components or wiring of the SRS. This includes changing or removing any component or part of the SRS, the installation of additional trim material, badges, etc. over the steering wheel hub, front passenger front air bag cover, outboard sides of the seat backrests, door trim panels, or door frame trims, and installation of additional electrical/electronic equipment on or near SRS components and wiring. Keep area between air bags and occupants free from objects (e.g. packages, purses, umbrellas, etc.).
- Do not hang items such as coat hangers from the coat hooks or handles over the door. These items may turn into projectiles and cause head and other injuries when window curtain air bag is deployed.

- Air bag system components will be hot after an air bag has inflated. Do not touch.
- Never place your feet on the instrument panel, dashboard, or on the seat. Always keep both feet on the floor in front of the seat.
- In addition, improper repair work on the SRS creates a risk of rendering the SRS inoperative or causing unintended air bag deployment. Work on the SRS must therefore only be performed by qualified technicians. Contact an authorized Mercedes-Benz Center.
- For your protection and the protection of others, when scrapping the air bag unit or emergency tensioning device, our safety instructions must be followed. These instructions are available from your authorized Mercedes-Benz Center.

- Given the considerable deployment speed, required inflation volume, and the textile structure of the air bags, there is the possibility of abrasions or other, potentially more serious injuries resulting from air bag deployment.

Warning!



Only use seat covers which have been tested and approved by Mercedes-Benz for your vehicle model. Using other seat covers may interfere with or prevent the deployment of the front side impact air bags or the rear side impact air bags*. Contact an authorized Mercedes-Benz Center for availability.

When you sell your vehicle we strongly urge you to give notice to the subsequent owner that it is equipped with an SRS by alerting them to the applicable section in the Operator's Manual.

Front air bags



- ① Driver air bag
- ② Front passenger front air bag

Driver and front passenger front air bags are deployed:

- in the event of certain frontal impacts
- if impact exceeds a preset deployment threshold
- independently of the side impact air bags

i *The front air bags in this vehicle have been designed to inflate in two stages. This allows the air bag to have different rates of inflation that are*

based on the rate of relevant vehicle deceleration as assessed by the air bag control unit

On the front passenger-side, the front air bag deployment is additionally influenced by the passenger's weight category as identified by the Occupant Classification System (OCS) (▷ page 50).

The lighter the front passenger-side occupant, the higher the vehicle deceleration rate required for the second stage inflation of the air bag.

The air bags will not deploy in impacts which do not exceed the system's deployment thresholds. You will then be protected by the fastened seat belts.

The passenger front air bag will only be deployed if:

- the system, based on OCS weight sensor readings, senses that the front passenger seat is occupied
- the  **PASS AIR BAG OFF** indicator lamp in the center console is not lit (▷ page 53)
- the impact exceeds a preset deployment threshold

Side impact air bags



- ① Front side impact air bag
- ② Rear side impact air bag

The side impact air bags are deployed:

- in impacts exceeding a preset deployment threshold
- on the impacted side of the vehicle
- independently of the front air bags

The front passenger side impact air bag ① will not deploy if the OCS senses that the front passenger seat is empty and the front passenger seat belt is not fastened (latch plate is not inserted into the buckle). With an empty front passenger seat and the

Occupant safety

seat belt fastened (latch plate properly inserted into buckle) the front passenger side impact air bag will deploy regardless of the empty seat.

The side impact air bags are not deployed in impacts which do not exceed the system's deployment threshold.

Window curtain air bags



① Window curtain air bag

The side window curtain air bags are deployed:

- in impacts exceeding a preset deployment threshold

- on the impacted side of the vehicle
- independently of the front air bags
- in certain vehicle rollovers

The side window curtain air bags are not deployed in impacts which do not exceed the system's deployment threshold.

The window curtain air bags fill up the area indicated by the arrows.

Occupant Classification System

The Occupant Classification System (OCS) automatically turns the front passenger front air bag on or off based on the classified occupant weight category determined by weight sensor readings from the front passenger seat.

i The system does not deactivate the front passenger side impact air bag, the window curtain air bag and the emergency tensioning device.

Occupants must sit properly belted in a nearly upright position with their back against the seat backrest and feet on the

floor to be correctly classified. If the occupant's weight is transferred to another object in the vehicle (e.g. by leaning on armrests), the OCS may not be able to properly approximate the occupant's weight category.

Furthermore, the occupant weight may appear to increase or decrease due to objects hanging on the seat, other passengers pushing on the seat, objects lodged underneath the seat or stuffed between seat and middle console or between seat and door or due to objects applying pressure on the back of the seat. Always make sure that the seat has clearance in all directions at all times.



i If your seat, including your trim cover and cushion needs to be serviced in any way, take the vehicle to your authorized Mercedes-Benz Center.

Only seat accessories approved by Mercedes-Benz may be used.

Both driver and the front passenger should always use the  PASS AIR BAG OFF indicator lamp as an indication of whether or not the front passenger is properly positioned.

Warning!





If the  PASS AIR BAG OFF indicator lamp illuminates when an adult or someone larger than a small individual is in the front passenger seat, have the front passenger re-position himself or herself in the seat until the  PASS AIR BAG OFF indicator lamp goes out, or check whether objects are caught under or around the seat.



More information about air bag display messages (▷ page 562).

In the event of a collision, the air bag control unit will not allow front passenger front air bag deployment when the OCS classified the front passenger seat occupant as being up to or less than the weight of a typical 12-month-old child in a standard child restraint or if the front passenger seat is sensed as being empty.

When the OCS senses that the front passenger seat occupant is classified as being up to or less than the weight of a typical 12-month-old child in a standard child restraint, the  PASS AIR BAG OFF indicator lamp will illuminate when the engine is started and remain illuminated, indicating that the front passenger front air bag is deactivated.

When the OCS senses that the front passenger seat is classified as being empty, the  PASS AIR BAG OFF indicator lamp will illuminate when the engine is started and remain illuminated, indicating that the front passenger front air bag is deactivated.

When the OCS senses that the front passenger seat occupant is classified as being heavier than the weight of a typical 12-month-old child seated in a standard child restraint or as being a small individual (such as a young teenager or a small adult), the  PASS AIR BAG OFF indicator lamp will illuminate for approximately 6 seconds when the engine is started and then, depending on occupant weight sensor readings from

the seat, remain illuminated or go out. With the  PASS AIR BAG OFF indicator lamp illuminated, the front passenger front air bag is deactivated. With the  PASS AIR BAG OFF indicator lamp out, the front passenger front air bag is activated.

When the OCS senses that the front passenger seat occupant is classified as an adult or someone larger than a small individual, the  PASS AIR BAG OFF indicator lamp will illuminate for approximately 6 seconds when the engine is started and then go out, indicating that the front passenger front air bag is activated.

If the  PASS AIR BAG OFF indicator lamp is illuminated, the front passenger front air bag is deactivated and will not be deployed.

If the  PASS AIR BAG OFF indicator lamp is not illuminated, the front passenger front air bag is activated and will be deployed:

- in the event of certain frontal impacts
- if impact exceeds a preset deployment threshold



Occupant safety



- independently of the side impact air bags.

If the front passenger air bag is deployed, the rate of inflation will be influenced by:

- the rate of relevant vehicle deceleration as assessed by the air bag control unit
- front passenger's weight category as identified by the Occupant Classification System (OCS).

Warning!



According to accident statistics, children are safer when properly restrained in the rear seating positions than in the front seating position. Thus, we strongly recommend that children be placed in the rear seats whenever possible. Regardless of seating position, children 12 years old and under must be seated and properly secured in an appropriate infant or child restraint recommended for the size and weight of the child.





The infant or child restraint must be properly secured with the vehicle's seat belt, the seat belt and top tether strap, or lower anchors and top tether strap, fully in accordance with the child seat manufacturer's instructions.

Children can be killed or seriously injured by an inflating air bag. Note the following important information when circumstances require you to place a child in the front passenger seat:

- Your vehicle is equipped with air bag technology designed to turn off the front passenger front air bag in your vehicle when the system senses the weight of a typical 12-month-old child or less along with the weight of a standard appropriate child restraint on the front passenger seat.

- A child in a rear-facing child restraint on the front passenger seat will be seriously injured or even killed if the front passenger front air bag inflates in a collision which could occur under some circumstances, even with the air bag technology installed in your vehicle.

The only means to completely eliminate this risk is to never place a child in a rear-facing child restraint in the front seat. We therefore strongly recommend that you always place a child in a rear-facing child restraint in the back seat.

- If you must install a rear-facing child restraint on the front passenger seat because circumstances require you to do so, make sure that the  **PASS AIR BAG OFF** indicator lamp is illuminated, indicating that the front passenger front air bag is deactivated. Should the  **PASS AIR BAG OFF** not illuminate or go out while the restraint is installed, please check installation. Periodically check the  **PASS AIR BAG OFF** indicator lamp while driving to make sure the  **PASS AIR BAG OFF** indicator lamp is illuminated.

If the  **PASS AIR BAG OFF** indicator lamp goes out or remains out, do not transport a child on the front passenger seat until the system has been repaired. A child in a rear-facing child restraint on the front passenger seat will be seriously injured or even killed if the front passenger front air bag inflates.

- If you have to place a child in a forward-facing child restraint on the front passenger seat, move the seat as far back as possible, use the proper child restraint recommended for the age, size and weight of the child, and secure child restraint with the vehicle's seat belt according to the child seat manufacturer's instructions. For children larger than the typical 12-month-old child, the front passenger front air bag may or may not be activated (> page 51).

i *Deployment of the driver front air bag does not mean that the front passenger front air bag also should have deployed.*

The Occupant Classification System (> page 50) may have determined:

- *that the seat was empty or occupied by the weight up to or less than that of a typical 12-month-old child seated in a standard child restraint – both instances where the system suppresses deployment of the front passenger front air bag even though the impact met the criteria and was of sufficient severity to deploy the driver front air bag.*
- *that the seat was occupied by a small individual (such as a young teenager or a small adult) or a child weighing more than the weight of a typical 12-month-old child in a standard child restraint – instances where the system may suppress deployment of the front passenger front air bag even though the impact met the criteria and was of sufficient severity to deploy the driver front air bag.*

The  **PASS AIR BAG OFF** indicator lamp is located on the dashboard to the right of the instrument cluster.





① Indicator lamp

The  **PASS AIR BAG OFF** indicator lamp ① will be illuminated, except with the SmartKey removed from the starter switch or with the starter switch in position **0** (> page 317).

Occupant safety

Warning!





If the  indicator lamp and the  PASS AIR BAG OFF indicator lamp are lit at the same time, there is a malfunction in the Occupant Classification System. The front passenger front air bag will be deactivated in this case.

In order to ensure proper operation of the air bag system and OCS:

- Have the system checked as soon as possible by qualified technicians. Contact an authorized Mercedes-Benz Center.
- Do not place more than 4.4 lbs (2 kg) into the ruffled storage bag on the back of the front passenger seat. Otherwise, the OCS may not be able to properly approximate the occupant weight category.
- Do not place objects under and/or around the front passenger seat.
- Do not hang anything from or attach any items to the seats.

- Do not stuff objects such as books between the middle console and the front passenger seat.
- Do not move the front passenger seat backwards against stiff objects.
- Sit properly belted in a nearly upright position with your back against the seat backrest.
- Do not lean on the armrests or lift yourself from the seat by using the handle over the door as this may cause the OCS to be unable to correctly approximate the occupant weight category.
- Only have the seat repaired or replaced by an authorized Mercedes-Benz Center.
- Read and observe all warnings in this chapter.

Self-test Occupant Classification System

After turning the SmartKey in the starter switch to position **1** or **2** or pressing the KEYLESS-GO* start/stop button once or twice (▷ page 317), the  PASS AIR BAG OFF indicator lamp ① located in the center console illuminates. If an adult occupant is properly sitting on the front passenger seat and the system senses the occupant as being an adult, the  PASS AIR BAG OFF indicator lamp will illuminate and go out after approximately 6 seconds.

If the seat is not occupied and the system senses the front passenger seat as being empty, the  PASS AIR BAG OFF indicator lamp will illuminate and not go out.

Warning!



If the  PASS AIR BAG OFF indicator lamp should not illuminate, the system is not functioning. You must see an authorized Mercedes-Benz Center before seating any child on the front passenger seat.

For more information, see the “Practical hints” section (▷ page 555).

Warning!





Never place anything between seat cushion (e.g. pillow), since it reduces the effectiveness of the Occupant Classification System. The bottom of the child seat must make full contact with the passenger seat cushion. An incorrectly mounted child seat could cause injuries to the child in case of an accident, instead of increasing protection for the child.

Follow the manufacturer's instructions for installation of child seats.



Seat belts

When the engine is started, the seat belt telltale  illuminates for a maximum of 6 seconds and a warning chime sounds to remind you and your passengers to fasten your seat belts.

If after these 6 seconds, the driver's or the front passenger's seat belt (with the front passenger seat occupied) are not fastened with all doors closed,

- and the vehicle speed does not exceed 15 mph (25 km/h), the seat belt telltale  remains illuminated for as long as either the driver's or front passenger's seat belt is not fastened.
- and the vehicle speed exceeds 15 mph (25 km/h), the seat belt telltale  starts flashing and a warning chime sounds with increasing intensity until both the driver's and front passenger's seat belt are fastened, or for a maximum of 60 seconds from the time the vehicle speed

exceeded 15 mph (25 km/h) if either the driver's or front passenger's seat belt remains unfastened.

If the driver's or front passenger's seat belt remains unfastened after 60 seconds, the seat belt telltale  stops flashing and the warning chime stops sounding. The seat belt telltale  then continues to be illuminated for as long as either the driver's or front passenger's seat belt are not fastened.

The seat belt telltale  will only go out if both the driver's and the front passenger's seat belt (with the front passenger seat occupied) are fastened, or the vehicle is standing still and a front door is opened.

For more information, see “Practical hints” (▷ page 550).

Always wear your seat belt. All vehicle occupants always need to have their seat belts fastened and wear them properly.

Occupant safety

In addition, applicable motor vehicle safety laws require you to wear seat belts. Even where this is not the case, we strongly recommend that all vehicle occupants have their seat belts fastened and wear them properly.

For more information, see “Fastening the seat belts” (▷ page 339).

 For information on infants and children traveling with you in the vehicle and restraint systems for infants and children, see “Children in the vehicle” (▷ page 61).

Warning!



Always fasten your seat belt before driving off. Always make sure all of your passengers are properly restrained, even those sitting in the rear and pregnant women.

Failure to wear and properly fasten and position your seat belt greatly increases your risk of injuries and their likely severity in an accident. You and your passengers should always wear seat belts.

If you are ever in an accident, your injuries can be considerably more severe without your seat belt properly buckled. Without your seat belt buckled, you are much more likely to hit the interior of the vehicle or be ejected from it. You can be seriously injured or killed.

In the same crash, the possibility of injury or death is lessened if you are properly wearing your seat belt. Air bags can only protect as they are designed if the occupants are properly wearing their seat belts.

Warning!



Never ride in a moving vehicle with the seat backrest in an excessively reclined position as this can be dangerous. You could slide under the seat belt in a collision. If you slide under it, the belt would apply force at the abdomen or neck. That could cause serious or even fatal injuries. The seat backrest and seat belt provide the best restraint when the

wearer is in a nearly upright position and the belt is properly positioned on the body.

Warning!



Never let more people ride in the vehicle than there are seat belts available. Make sure everyone riding in the vehicle is correctly restrained with a separate seat belt. Never use a seat belt for more than one person at a time.

Warning!



Damaged seat belts or belts that were highly stressed in an accident must be replaced and their anchoring points must also be checked.

Only use seat belts which have been approved by Mercedes-Benz.

Do not make any modifications to the seat belts. This can lead to unintended activation of the ETDs or to failure.

Do not bleach or dye seat belts as this may severely weaken them. In a crash they may not be able to provide adequate protection.

Have all work carried out only by qualified technicians. Contact an authorized Mercedes-Benz Center.

Warning!



USE SEAT BELTS PROPERLY

- Seat belts can only work when used properly. Never wear seat belts in any other way than as described in this section, as that could result in serious injuries in case of an accident.
- Each occupant should wear their seat belt at all times, because seat belts help reduce the likelihood of and potential severity of injuries in accidents, including rollovers. The integrated restraint system includes SRS (driver air bag, passenger front air bag, side impact air bags, head protection window curtain air bags for side windows), ETD (seat belt emergency tensioning device with

belt force limiters), and front seat knee bolsters. The system is designed to enhance the protection offered to properly belted occupants in certain frontal (front air bags and ETD with belt force limiters) and side (side impact and window curtain air bags) impacts which exceed preset deployment thresholds and in certain rollovers (window curtain air bags and ETD).

- Never wear the shoulder belt under your arm, against your neck or off your shoulder. In a frontal crash, your body would move too far forward. That would increase the chance of head and neck injuries. The belt would also apply too much force to the ribs or abdomen, which could severely injure internal organs such as your liver or spleen.
- Never wear belts over rigid or breakable objects in or on your clothing, such as eyeglasses, pens, SmartKeys, etc., as these might cause injuries.

- Position the lap belt as low as possible on your hips and not across the abdomen. If the belt is positioned across your abdomen, it could cause serious injuries in a crash.
- Never use a seat belt for more than one person at a time. Do not fasten a seat belt around a person and another person or other objects.
- Belts should not be worn twisted. In a crash, you wouldn't have the full width of the belt to distribute impact forces. The twisted belt against your body could cause injuries.
- Pregnant women should also use a lap-shoulder belt. The lap belt portion should be positioned as low as possible on the hips to avoid any possible pressure on the abdomen.
- Never place your feet on the instrument panel, dashboard or on the seat. Always keep both feet on the floor in front of the seat.



Occupant safety





- When using a seat belt to secure infant or toddler restraints or children in booster seats, always follow the child seat manufacturer's instructions.

Emergency tensioning device (ETD), seat belt force limiter

The seat belts for the front and rear outer seats are equipped with emergency tensioning devices and belt force limiters.

The ETD is designed to activate in the following cases:

- in frontal or rear-end impacts exceeding the system deployment threshold
- in certain vehicle rollovers
- if the restraint systems are operational and functioning correctly, see  indicator lamp (▷ page 552)

 *The ETDs for the front seats will only activate if the front seat belt is fastened (latch plate properly inserted into buckle).*

The ETDs for the rear outer seats will activate with or without the respective seat belt fastened.

In an impact, emergency tensioning devices remove slack from the belts in such a way that the seat belts fit more snugly against the body. Belt force limiters, when activated, are employed to help reduce the peak force exerted by the seat belts on occupants during a crash.

Warning!



A pyrotechnic emergency tensioning device (ETD) that was activated must be replaced.

When disposing of the pyrotechnic emergency tensioning device, our safety instructions must be followed. These are available at your authorized Mercedes-Benz Center.

PRE-SAFE® has electrically operated reversible pre-tensioners that do not require replacement after activation.

Luxury active head restraints (S 600 only)

The active head restraints are intended to offer the driver and front passenger increased protection from head and neck injury. In the event of a rear-end collision, the active head restraints on the driver's and front passenger's seats are designed to move forward in the direction of travel, providing the head with increased support earlier on in the collision sequence. The active head restraints move forward whether the seat is occupied or not.

Warning!



Only use seat or head restraint covers which have been tested and approved by Mercedes-Benz for your vehicle model. Using other seat or head restraint covers may interfere with or prevent the activation of the active head restraints. Contact an authorized Mercedes-Benz Center for availability.

Do not attach any objects (e.g. hangers) to the head restraint posts. Otherwise, the active head restraints may not be able to function properly or offer the intended degree of protection in the event of an accident.

Warning!



For your protection, drive only with properly positioned head restraints.

Adjust head restraint so that it is as close to the head as possible and the center of the head restraint supports the back of the head at eye level. This will reduce the potential for injury to the head and neck in the event of an accident or similar situation.

Do not drive the vehicle without the seat head restraints. Head restraints are intended to help reduce injuries during an accident.

If the luxury active head restraints have been triggered in an accident, the luxury active head restraints must be reset. Oth-

erwise, the luxury active head restraints cannot offer any additional protection in the event of another rear-end collision.

For information on resetting the activated active head restraints, see "Resetting activated head restraints (S 600 only)" (▷ page 618).

You cannot remove the active head restraint on the driver's and passenger's seats.

For removal contact an authorized Mercedes-Benz Center.

For information on head restraint adjustment, see "Head restraints" (▷ page 324).

Occupant safety

Preventive occupant safety (PRE-SAFE®)

Warning!



The PRE-SAFE® system is intended to reduce the effects of an accident on properly seat-belted vehicle occupants. Despite having the PRE-SAFE® system in your vehicle, the possibility of injuries occurring as a result of an accident cannot be eliminated. Therefore, you should always drive carefully and adjust your driving to the prevailing road, weather, and traffic conditions.

Your vehicle automatically takes preventive measures to better protect the occupants in the following hazardous situations.

PRE-SAFE® takes action in the following instances:

- Emergency braking situations, e.g. when BAS (▷ page 71) is activated or when BAS Plus* (▷ page 71) is strongly intervening.
- Critical dynamic driving situations, e.g. when the vehicle is understeering or oversteering because it has exceeded its physical limitations.
- Evasive steering maneuvers at speeds above 19 mph (30 km/h).

When you are driving faster than 19 mph (30 km/h), PRE-SAFE® takes the following measures in such situations:

- The front seat belts are pre-tensioned electrically.
- If the OCS senses that the front passenger seat is occupied and the seat is in an unfavorable position, it will be adjusted to a better position.

- If the vehicle is equipped with power adjustable rear seats* and the passenger outer seats are in an unfavorable position, they will be adjusted to a better position.
- It increases the air pressure in the air pockets (on the sides of the seat cushion and backrest) of the multicontour* and/or drive-dynamic front seats*.
- If the vehicle is understeering or oversteering, the tilt/sliding sunroof and the side windows also close until only a small gap remains.

Once the hazardous situation is over without an accident occurring, PRE-SAFE® loosens the belt pre-tension and decreases the air pressure in the air pockets of the multicontour and drive-dynamic seats*. You can readjust all of the settings made by PRE-SAFE®.

i *If the closing procedure of the tilt/sliding sunroof or door windows is blocked, the tilt/sliding sunroof or door windows will stop and open slightly.*

If the seat belts do not release:

- ▶ Adjust the backrest or seat slightly to the rear until the seat belt tension is diminished.

The locking mechanism releases.

! *When moving the seat, make sure there are no items in the footwell or behind the seats. Otherwise you could damage the seats.*

Children in the vehicle

If an infant or child is traveling with you in the vehicle:

- Secure the child using an infant or child restraint appropriate to the age and size of the child.
- Make sure the infant or child is properly secured at all times while the vehicle is in motion.

Warning!



Do not leave children unattended in the vehicle, even if they are secured in a child restraint system. The children could

- injure themselves on parts of the vehicle
- be seriously or fatally injured through excessive exposure to extreme heat or cold

Do not expose the child restraint system to direct sunlight. The child restraint system's metal parts, for example, could become very hot, and the child could be burned on these parts.

If children open a door, they could

- injure other persons
- get out of the car and injure themselves or be injured by following traffic

Do not carry heavy or hard objects in the passenger compartment or trunk unless they are firmly secured in place. For more information, see “Loading and storing” (> page 447) section of the “Controls in detail” chapter.

Unsecured or improperly positioned cargo increases a child's risk of injury in the event of

- strong braking maneuvers
- sudden changes of direction
- an accident

Occupant safety

Infant and child restraint systems

We recommend all infants and children be properly restrained at all times while the vehicle is in motion.

All lap-shoulder belts except the driver's seat belt have special seat belt retractors for secure fastening of child restraints.

To fasten a child restraint, follow child restraint instructions for mounting. Then pull the shoulder belt out completely and let it retract. During seat belt retraction, a ratcheting sound can be heard to indicate that the special seat belt retractor is activated. The belt is now locked. Push down on child restraint to take up any slack.

To deactivate, release seat belt buckle and let seat belt retract completely. To deactivate the special seat belt retractor for the front passenger seat, the front passenger seat must be in the most backward position. The seat belt can again be used in the usual manner.

Warning!



Never release the seat belt buckle while the vehicle is in motion, since the special seat belt retractor will be deactivated.

i Information on child seats with mounting fittings for tether anchorages (▷ page 64).

For information on LATCH-type child seat mounts (▷ page 65).

! The use of infant or child restraints is required by law in all 50 states, the District of Columbia, the U.S. territories and all Canadian provinces.

Infants and small children should be seated in an appropriate infant or child restraint system properly secured by a lap/shoulder belt or, if so equipped, a top tether anchorage point and a child restraint lower anchorage system that complies with U.S. Federal Motor Vehicle Safety Standards 213 and 225 and Canadian Motor Vehicle Safety Standard 213 and 210.2.

A statement by the child restraint manufacturer of compliance with this standard can be found on the instruction label on the restraint and in the instruction manual provided with the restraint.

When using any infant or child restraint system, make sure to carefully read and follow all manufacturer's instructions for installation and use.

Please read and observe warning labels affixed to the inside of the vehicle and to infant or child restraints.

Warning!



According to accident statistics, children are safer when properly restrained in the rear seating positions than in the front seating position. Thus, we strongly recommend that children be placed in the rear seats whenever possible. Regardless of seating position, children 12 years old and under must be seated and properly secured in an appropriate infant, or toddler restraint, or booster seat recommended for the size and weight of the child.

The infant or child restraint must be properly secured with the vehicle's seat belt, the seat belt and top tether strap, or lower anchors and top tether strap, fully in accordance with the child seat manufacturer's instructions.



Always sit nearly upright, properly use the seat belts and use an appropriately sized infant or toddler restraint or booster seat recommended for the size and weight of the child.

Children can be killed or seriously injured by an inflating air bag. Note the following important information when circumstances require you to place a child in the front passenger seat:

- Your vehicle is equipped with air bag technology designed to turn off the front passenger front air bag in your vehicle when the OCS senses the weight of a typical 12-month-old child or less along with the weight of a standard appropriate child restraint on the front passenger seat.

- A child in a rear-facing child restraint on the front passenger seat will be seriously injured or even killed if the front passenger front air bag inflates in a collision which could occur under some circumstances, even with the air bag technology installed in your vehicle.

The only means to completely eliminate this risk is to never place a child in a rear-facing child restraint in the front seat. We therefore strongly recommend that you always place a child in a rear-facing child restraint in the back seat.

- If you must install a rear-facing child restraint on the front passenger seat because circumstances require you to do so, make sure that the  **PASS AIR BAG OFF** indicator lamp is illuminated, indicating that the front passenger front air bag is deactivated. Should the  **PASS AIR BAG OFF** indicator lamp not illuminate or go out while the restraint is installed, please check installation. Periodically check the  **PASS AIR BAG OFF** indicator lamp while driving to make sure the lamp is illuminated.

If the  **PASS AIR BAG OFF** indicator lamp goes out or remains out, do not transport a child on the front passenger seat until the system has been repaired.

A child in a rear-facing child restraint on the front passenger seat will be seriously injured or even killed if the front passenger front air bag inflates.

- If you have to place a child in a forward-facing child restraint on the front passenger seat, move the seat as far back as possible, use the proper child restraint recommended for the age, size and weight of the child, and secure child restraint with the vehicle's seat belt according to the child seat manufacturer's instructions. For children larger than the typical 12-month-old child, the front passenger front air bag may or may not be activated (> page 51).

Occupant safety

Warning!



Infants and small children should never share a seat belt with another occupant. During an accident, they could be crushed between the occupant and seat belt.

A child's risk of serious or fatal injuries is significantly increased if the child restraints are not properly secured in the vehicle and/or the child is not properly secured in the child restraint.

Children too big for a toddler restraint must ride in seats using regular seat belts. Position shoulder belt across chest and shoulder, not face or neck. A booster seat may be necessary to achieve proper belt positioning for children over 41 lbs until they reach a height where a lap/shoulder belt fits properly without a booster.

When the child restraint is not in use, remove it from the vehicle or secure it with the seat belt to prevent the child restraint from becoming a projectile in the event of an accident.

Do not leave children unattended in the vehicle, even if the children are secured in a child restraint system. Unsupervised children in a child restraint system may use vehicle equipment and may cause an accident and/or serious personal injury.

Installation of infant and child restraint systems

This vehicle is equipped with tether anchorages for a top tether strap at each of the rear seating positions.



- ① Cover of top anchorage ring
- ▶ Bring the rear power seat backrest* to a fully upright position (▷ page 320).
- ▶ Remove cover ① from anchorage ring.
- ▶ Store cover ① in a convenient place (e.g. glove box).
- ▶ Guide tether strap between head restraint and top of seat back.

Head restraints must be positioned such that the top tether strap can pass freely between the head restraint and top of seat back.

- ▶ Make sure the tether strap is not twisted.

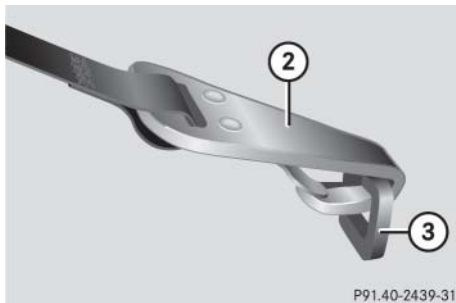

- ② Hook
- ③ Anchorage ring

- ▶ Securely fasten hook ②, which is part of the tether strap, to anchorage ring ③.

i For safety reasons, make sure hook ② has attached to ring ③ beyond the safety catch, as illustrated.

Once the top tether anchorage hook is attached, the child restraint itself can be secured. Tighten the top tether strap according to the child restraint manufacturer's instructions.

- ▶ Reinstall cover after removing the tether strap.

Warning!



Vehicles with adjustable rear seats/bench*: Never adjust the rear seat position after installing the child restraint. Adjusting the rear seat position after installing the child restraint could damage the child restraint and/or introduce undesirable slack or tension into the seat belt and loosen or misposition the child restraint, lessening the effectiveness of the child restraint and thus increasing the chance or severity of injury in an accident.

Child seat anchors – LATCH type

This vehicle is equipped with two LATCH (Lower Anchors and Tethers for Children) type anchors (at each of the rear seats) for the installation of a LATCH child seat with the matching anchor fittings.

If you have not installed a child seat, the LATCH anchor are covered with an upholstery blend.

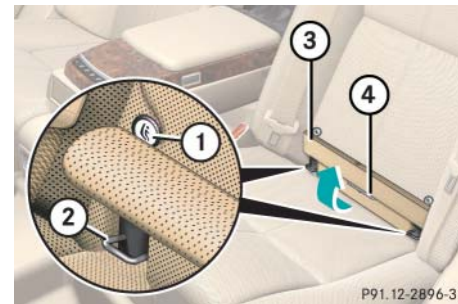

- ① Indicates the position of the anchors
- ② Anchors
- ③ Upholstery blend
- ④ Installation device



Occupant safety

- ▷▷ Bring the rear power seat backrest* to its fully upright position (▷ page 320).
- ▶ Fold upholstery blend ③ upward.
- ▶ Turn installation device ④ to a vertical position so that upholstery blend ③ does not fold down.
- ▶ Install child seat according to the manufacturer's instructions.

A rigid connection is established between the child seat and the body of the vehicle.

Do not adjust rear power seat* /bench* position after installing child restraint.

Warning!



Vehicles with adjustable rear seats/bench*: Never adjust the rear seat position after installing the child restraint. Adjusting the rear seat position after installing the child restraint could damage the child restraint and/or introduce undesirable slack or tension into the seat belt and loosen or misposition the child restraint, lessening the effectiveness of the child restraint and thus increasing the chance or severity of injury in an accident.

i *The child seat must be firmly attached in the right and left side anchor fittings.*

Make sure the seat belt for the center seat can operate freely with a child seat installed.

Non-LATCH type child seats may also be used and can be installed using the vehicle's seat belt system. Install child seat according to the manufacturer's instructions.

Warning!



Children too big for a toddler restraint must ride in seats using regular seat belts. Position. Position shoulder belt across chest and shoulder, not face or neck. A booster seat may be necessary to achieve proper belt positioning for children over 41 lbs until they reach a height where a lap/shoulder belt fits properly without a booster.

Install child seat according to manufacturer's instructions.

The child seat must be firmly attached in right and left side anchors ②.

An incorrectly mounted child seat may come loose during an accident which could result in serious injury or death to the child.

Damaged or impact damaged child seats or child seat mounting fittings must be replaced.

Do not leave children unattended in the vehicle, even if the children are secured in a child restraint system.

Override switch for rear passenger compartment

You can disable select functions in the rear passenger compartment for added safety (for instance when you have children riding in the rear passenger compartment).

You can disable the following functions in the rear passenger compartment:

- rear door window operation (▷ page 353)
- adjustment of front passenger seat from the rear* (▷ page 320)
- rear center console lighter (▷ page 458)
- sunblinds for panorama roof* (▷ page 443)
- rear window sunshade (▷ page 456) and rear side window sunshades (▷ page 355)

The override switch is located on the driver's door.

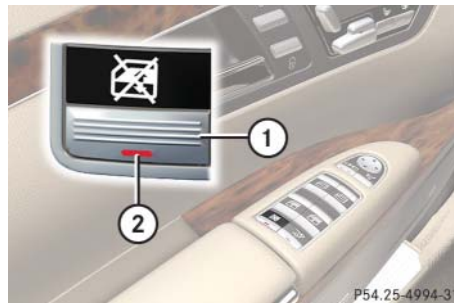

- ① Override switch
- ② Indicator lamp

► **Activating:** Press switch ①.

Indicator lamp ② comes on. The functions in the rear are disabled.

Warning!



Activate the override switch when children are riding in the back seats of the vehicle.

The children may otherwise injure themselves, e.g. by becoming trapped in the window opening.

When leaving the vehicle, always remove the SmartKey or SmartKey with KEYLESS-GO* from the starter switch, take it with you, and lock your vehicle. Do not leave children unattended in the vehicle, or with access to an unlocked vehicle. Unsupervised use of vehicle equipment may cause an accident and/or serious personal injury.

i Operation of the rear door windows with the switches located in the driver's door is still possible.

► **Deactivating:** Press switch ① again.

Indicator lamp ② goes out. The functions in the rear are enabled again.

Panic alarm



① **PANIC** button

i USA only:

This device complies with Part 15 of the FCC Rules. Operation is subject to the following two conditions:

- (1) This device may not cause harmful interference, and*
- (2) this device must accept any interference received, including interference that may cause undesired operation.*

Any unauthorized modification to this device could void the user's authority to operate the equipment.

i Canada only:

This device complies with RSS-210 of Industry Canada. Operation is subject to the following two conditions:

- (1) This device may not cause interference, and*
- (2) this device must accept any interference received, including interference that may cause undesired operation of the device.*

Any unauthorized modification to this device could void the user's authority to operate the equipment.

Activating

- ▶ Press and hold **PANIC** button for at least 1 second.

An audible alarm and flashing exterior lamps will operate briefly.

Deactivating

- ▶ Press **PANIC** button again.

or

- ▶ Insert the SmartKey or the SmartKey with KEYLESS-GO* in starter switch.

or

- ▶ Press the KEYLESS-GO* start/stop button (▷ page 317).

The SmartKey with KEYLESS-GO must be inside the vehicle.

▼ Driving safety systems

This section contains information about Adaptive Brake Lights as well as the following driving safety systems:

- ABS (Antilock Brake System)
- Adaptive Brake
- BAS (Brake Assist System)
- BAS Plus* (Brake Assist System Plus*)
- EBP (Electronic Brake Proportioning)
- ESP® (Electronic Stability Program)
- ETS (Electronic Traction System)

Warning!



The following factors increase the risk of accidents:

- Excessive speed, especially in turns
- Wet and slippery road surfaces
- Following another vehicle too closely

The ABS, BAS, BAS Plus*, EBP, ESP® and ETS cannot reduce this risk.

Always adjust your driving style to the prevailing road and weather conditions.

i In winter operation, the maximum effectiveness of the ABS, Adaptive Brake, BAS, BAS Plus*, EBP, ESP® and ETS is only achieved with winter tires (▷ page 530), or snow chains as required.

ABS

Warning!



Do not pump the brake pedal. Use firm, steady brake pedal pressure instead. Pumping the brake pedal defeats the purpose of the ABS and significantly reduces braking effectiveness.

The Antilock Brake System (ABS) regulates the brake pressure so that the wheels do not lock during braking. This allows you to maintain the ability to steer your vehicle.

The ABS is functional above a speed of approximately 5 mph (8 km/h) independent of road surface conditions.

On slippery road surfaces, the ABS will respond even to light brake pressure.

The  indicator lamp in the instrument cluster (▷ page 28) comes on when you switch on the ignition (▷ page 315). It goes out when the engine is running.

Braking

At the instant one of the wheels is about to lock up, a slight pulsation can be felt in the brake pedal, indicating that the ABS is in the regulating mode.

- ▶ Keep firm and steady pressure on the brake pedal while experiencing the pulsation.

Continuous, steady brake pedal pressure yields the advantages provided by the ABS, namely braking power and the ability to steer the vehicle.

Driving safety systems

The pulsating brake pedal can be an indication of hazardous road conditions and functions as a reminder to take extra care while driving.

Emergency brake maneuver

- ▶ Keep continuous full pressure on the brake pedal.

Warning!



When the ABS is malfunctioning, the BAS, BAS Plus*, ESP® and ETS are also switched off.

When the ABS is malfunctioning, the wheels may lock during hard braking, reducing steering capability and extending the braking distance.

Warning!



The ABS cannot prevent the natural laws of physics from acting on the vehicle, nor can it increase braking or steering efficiency

beyond that afforded by the condition of the vehicle brakes and tires or the traction afforded. The ABS cannot prevent accidents, including those resulting from excessive speed in turns, following another vehicle too closely, or hydroplaning. Only a safe, attentive, and skillful driver can prevent accidents.

The capabilities of an ABS equipped vehicle must never be exploited in a reckless or dangerous manner which could jeopardize the user's safety or the safety of others.

For more information, see “Practical hints” (▷ page 544).

Adaptive Brake

Adaptive Brake provides a high level of braking safety as well as increased braking comfort.

Adaptive Brake Lights (S 600 and USA only)

Depending on vehicle production date the brake lamps flash in quick intervals while you are braking in order to signal to cars behind you that

- you are braking strongly at a speed of more than 30 mph (50 km/h)
- you are braking with the aid of BAS or BAS Plus*

If you bring the car to a complete stop by hard braking at a speed of more than 40 mph (70 km/h), the hazard warning flasher automatically comes on as soon as the vehicle is at a standstill. While the vehicle is stationary, the brake lamps are continuously lit up. Once you drive faster than 6 mph (10 km/h) afterward, the hazard warning flasher goes out.

BAS

The Brake Assist System (BAS) operates in emergency situations. If you apply the brakes very quickly, the BAS automatically provides full brake boost, thereby potentially reducing the braking distance.

- ▶ Apply continuous full braking pressure until the emergency braking situation is over.

The ABS will prevent the wheels from locking.

When you release the brake pedal, the brakes function again as normal. The BAS is then deactivated.

Warning!



When the BAS is malfunctioning, the brake system is still functioning normally, but without the additional brake boost available that BAS would normally provide in an emergency braking maneuver. Therefore, the braking distance may increase.

Warning!



The BAS cannot prevent the natural laws of physics from acting on the vehicle, nor can it increase braking efficiency beyond that afforded by the condition of the vehicle brakes and tires or the traction afforded. The BAS cannot prevent accidents, including those resulting from excessive speed in turns, following another vehicle too closely, or hydroplaning. Only a safe, attentive, and skillful driver can prevent accidents.

The capabilities of a BAS equipped vehicle must never be exploited in a reckless or dangerous manner which could jeopardize the user's safety or the safety of others.

For more information, see "Practical hints" section (▷ page 544).

BAS Plus*

BAS Plus operates in emergency braking situations and uses radar sensors to assess the traffic situation.

When you step quickly on the brake pedal in an emergency braking situation, BAS Plus automatically regulates the brake pressure to a level that is suitable for the traffic situation.

If BAS Plus requires a particularly high brake pressure, PRE-SAFE® is activated at the same time.

- ▶ Step on the brake pedal until the emergency braking situation is over.

During this process, ABS prevents the wheels from locking up.

Once you take your foot off the brake pedal or when there is no longer a risk of collision, the brake pedal functions again as usual. BAS Plus is deactivated.

EBP

The Electronic Brake Proportioning (EBP) enhances braking effectiveness by allowing the rear brakes to supply a greater proportion of the braking effort in straight line braking without a loss of vehicle stability.

Driving safety systems

Warning!



When the EBP is malfunctioning, the ABS, BAS, BAS Plus*, ESP® and ETS are also switched off.

If the EBP is malfunctioning, the brake system will still function with full brake boost. However, the rear wheels could lock up during emergency braking situations, for example. You could lose control of the vehicle and cause an accident. Adapt your driving style to the changed driving characteristics.

ESP®

The Electronic Stability Program (ESP®) is operational as soon as the engine is running and monitors the vehicle's traction (force of adhesive friction between the tires and the road surface) and handling.

The ESP® recognizes when a wheel is spinning or if the vehicle starts to skid. By applying brakes to the appropriate wheel and by limiting the engine output, the ESP®

works to stabilize the vehicle. The ESP® is especially useful while driving off and on wet or slippery road surfaces. The ESP® also stabilizes the vehicle during braking maneuvers.

The ESP® warning lamp  in the instrument cluster flashes when the ESP® is engaged.

The ESP® warning lamp  in the instrument cluster comes on when you switch on the ignition (> page 315). It goes out when the engine is running.

Warning!



Never switch off the ESP® when you see the ESP® warning lamp  flashing in the instrument cluster. In this case proceed as follows:

- While driving off, apply as little throttle as possible.
- While driving ease up on the accelerator.

- Adapt your speed and driving style to the prevailing road conditions.

Failure to observe these guidelines could cause the vehicle to skid.

The ESP® cannot prevent accidents resulting from excessive speed.

Warning!



The ESP® cannot prevent the natural laws of physics from acting on the vehicle, nor can it increase the traction afforded. The ESP® cannot prevent accidents, including those resulting from excessive speed in turns, or hydroplaning. Only a safe, attentive, and skillful driver can prevent accidents. The capabilities of an ESP® equipped vehicle must never be exploited in a reckless or dangerous manner which could jeopardize the user's safety or the safety of others.

 *DISTRONIC Plus* is switched off when the ESP® engages.*

i The ESP® will only function properly if you use wheels of the recommended tire size (▷ page 655).

! Because of the ESP's® automatic operation, the engine and ignition must be shut off (SmartKey in starter switch position **0** or **1** or KEYLESS-GO start/stop button* in position **0** or **1**) when

- the parking brake is being tested on a brake test dynamometer
- the vehicle is being towed with the front/rear axle raised

Active braking action through the ESP® may otherwise seriously damage the brake system.

For more information, see “Practical hints” section (▷ page 549) and (▷ page 582).

ETS

The Electronic Traction System is a component of ESP®.

The Electronic Traction System (ETS) improves the vehicle's ability to utilize available traction, especially under slippery

road conditions. The brakes are applied to the spinning wheel and power is transferred to the wheel(s) with traction.

The ESP® warning lamp  in the instrument cluster starts to flash at any vehicle speed, as soon as a tire loses traction and the wheel begins to spin.

When you switch off the ESP®, the ETS is still enabled.

Warning!



If you are driving too fast, the Electronic Traction System cannot reduce the risk of an accident.

The ETS cannot prevent the natural laws of physics from acting on the vehicle.

i If the yellow ESP® warning lamp  comes on while driving, the ETS is being switched off temporarily to prevent overheating of the drive wheel brakes. In addition, the message “ESP Currently unavailable See Oper. Manual” appears in the multifunction display.

Switching off the ESP®

Warning!



The ESP® should not be switched off during normal driving other than in the circumstances described below. Disabling of the system will reduce vehicle stability in standard driving maneuvers.

To improve the vehicle's traction, turn off the ESP® in driving situations where it would be advantageous to have the drive wheels spin and thus cut into surfaces for better grip such as:

- when driving with snow chains
- in deep snow
- in sand or gravel

! Turn the ESP® on immediately if the aforementioned circumstances do not apply anymore.

i DISTRONIC Plus* cannot be activated when the ESP® has been switched off.

Driving safety systems

When you switch off the ESP®

- the ESP® does not stabilize the vehicle
- the engine output is not limited, which allows the drive wheels to spin and thus cut into surfaces for better grip
- the traction control will still brake a spinning wheel
- the ESP® continues to operate when you are braking

i When the ESP® is switched off and one or more drive wheels are spinning, the ESP® warning lamp  in the instrument cluster flashes. However, the ESP® will then not stabilize the vehicle.



① ESP® off/on

- ▶ Press ESP® switch ① until the ESP® warning lamp  in the speedometer comes on.

The ESP® is switched off.

! Avoid spinning of a drive wheel for an extended period with the ESP® switched off. This may cause serious damage to the drivetrain which is not covered by the Mercedes-Benz Limited Warranty.

Switching on the ESP®

- ▶ Press ESP® switch ①.

The ESP® warning lamp  in the instrument cluster goes out.

You are now again in normal driving mode with the ESP® switched on.

Warning!



When the ESP® warning lamp  is illuminated continuously, the ESP® is switched off.

Adapt your speed and driving to the prevailing road conditions and to the non-operating status of the ESP®.

▼ Anti-theft systems

Immobilizer

The immobilizer prevents unauthorized persons from starting your vehicle.

Activating

- ▶ **With the SmartKey:** Remove the SmartKey from the starter switch.
- ▶ **With the KEYLESS-GO*:** Turn off the engine (▷ page 317) and open the driver's door.

Deactivating

- ▶ Switch on the ignition (▷ page 315).

i Starting the engine will also deactivate the immobilizer.

In case the engine cannot be started (yet the vehicle's battery is charged), the system is not operational. Contact an authorized Mercedes-Benz Center or call 1-800-FOR-MERCEdes (in the USA), or 1-800-387-0100 (in Canada).

Anti-theft alarm system

Once the alarm system has been armed, a visual and audible alarm is triggered when someone opens:

- a door
- the trunk
- the hood

The alarm will stay on even if the activating element (a door, for example) is immediately closed.

The alarm system will also be triggered when

- the vehicle is raised
- the vehicle is opened with the mechanical key
- a door is opened from the inside

To cancel the alarm after it has been triggered, see "Canceling the alarm" (▷ page 76).

i If the alarm stays on for more than 30 seconds, a call to the Response Center is initiated automatically by the Tele Aid system (▷ page 462) provided Tele Aid service was subscribed to and properly activated, and that necessary mobile phone, power supply and GPS coverage are available.

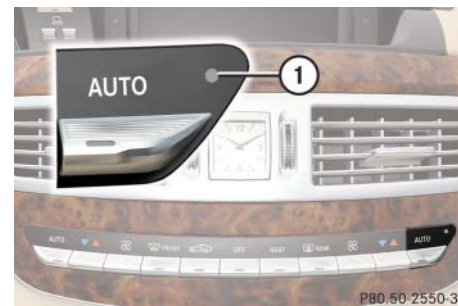

① Indicator lamp

- ▶ **Arming:** Lock your vehicle with the SmartKey or KEYLESS-GO*.

The turn signal lamps flash three times to indicate that the alarm system is activated. The indicator lamp ① flashes to indicate that the alarm system is armed.



Anti-theft systems

▷ **i** If the turn signal lamps does not flash three times one of the following elements may not be properly closed:

- a door
- the trunk

Close the respective element and lock the vehicle again.

▶ **Disarming:** Unlock your vehicle with the SmartKey or KEYLESS-GO*.

The turn signal lamps flash once to indicate that the alarm system is disarmed.

i The alarm system will rearm automatically again after approximately 40 seconds if no door was opened.

Tow-away alarm

Once the tow-away alarm is armed, a visual and audible alarm will be triggered when someone attempts to raise the vehicle.

To cancel the alarm after it has been triggered, see “Canceling the alarm” (▷ page 76).

i If the alarm stays on for more than 30 seconds, a call to the Response Center is initiated automatically by the Tele Aid system (▷ page 462) provided Tele Aid service was subscribed to and properly activated and that necessary mobile phone, power supply and GPS coverage are available.

▶ **Arming:** Lock your vehicle with the SmartKey or KEYLESS-GO*.

The tow-away alarm is automatically armed after about 30 seconds.

▶ **Disarming:** Unlock your vehicle with the SmartKey or KEYLESS-GO*.

i When you unlock your vehicle, the tow-away protection disarms automatically.

The tow-away alarm remains disarmed until you lock your vehicle again.



To prevent triggering the tow-away alarm feature, switch off the tow-away alarm before towing the vehicle, or when parking on a surface subject to movement, such as a ferry or auto train.

To switch off the tow-away alarm, see “Switching on/of the tow-away alarm” (▷ page 228).

Canceling the alarm

To cancel the alarm, do one of the following:

▶ Insert the SmartKey in the starter switch.

▶ Press the  or  button on the SmartKey.

In vehicles with KEYLESS-GO*:

▶ Grasp an outside door handle.

The SmartKey with KEYLESS-GO must be within 3 ft. (1 m) of the vehicle.

▶ Press the KEYLESS-GO start/stop button (▷ page 317).

The SmartKey with KEYLESS-GO must be inside the vehicle.

COMAND operating safety	COMAND address book
COMAND introduction	COMAND system settings
COMAND FM/AM radio	COMAND vehicle menu
COMAND satellite radio* (USA only)	COMAND automatic climate control
COMAND audio CD/audio DVD/MP3	COMAND seats
COMAND telephone*	Instrument cluster control system
COMAND navigation (introduction)	Voice Control* operating safety
COMAND navigation system (entering a destination)	Voice Control* introduction
COMAND navigation system (Point of interest entry)	Voice Control* telephone
COMAND navigation system (route guidance)	Voice Control* navigation
COMAND navigation system (during route guidance)	Voice Control* address book
COMAND navigation system (destination memory)	Voice Control* radio
COMAND navigation system (last destinations)	Voice Control* CD/DVD changer/MP3
	Voice Control* command list
	Voice Control* troubleshooting
	Voice Control* individualization



COMAND operating safety

Warning!



Any alteration of electronic components or software can cause malfunctions.

Radio, satellite radio* (USA only), amplifier, CD changer, navigation module, telephone and voice control systems* are interconnected. Therefore, if one of the components is not operational, or has not been removed/ replaced properly, the function of other components could be impaired.

Such conditions might seriously impair the operating safety of your vehicle.

We recommend to have any service work on electronic components carried out by an authorized Mercedes-Benz Center.

Warning!



In order to avoid distraction which could lead to an accident, the driver should enter system settings while the vehicle is at a standstill, and operate the system only when permitted by road, weather and traffic conditions.

Bear in mind that at a speed of just 30 mph (approximately 50 km/h), your car covers a distance of 44 feet (approximately 14 m) every second.

COMAND supplies you with information to help you select your route more easily and guide you conveniently and safely to your destination. For safety reasons, we encourage the driver to stop the vehicle in a safe place before answering or placing a call, or consulting the COMAND screen to read navigational maps, instructions, or downloaded information.

Warning!



While the navigation system provides directional assistance, the driver must remain focused on safe driving behavior, especially attention to traffic and street signs, and should utilize the system's audio cues while driving.

The navigation system does not supply any information on stop signs, yield signs, traffic regulations or traffic safety rules. Their observance always remains in the driver's personal responsibility. DVD maps do not cover all areas nor all routes within an area.

▼ COMAND introduction

Availability of functions while the vehicle is in motion

For safety reasons, certain COMAND functions are not available while the vehicle is in motion or they are only available to a limited extent. You will notice this, for example, by the fact that certain menu items cannot be selected or that the COMAND display shows a corresponding message.

Switching COMAND on or off

- ▶ Press the **ON** shortcut button in the center console (▷ page 80).

COMAND calls up the menu last selected.

i *When you switch off COMAND, you also switch off the currently playing audio source. During a telephone call, you cannot switch off COMAND.*

COMAND components

In your vehicle, COMAND can be used to operate:

- audio functions
- the navigation system
- the telephone* and communication functions (SMS*)
- various vehicle settings

COMAND consists of the following:

- COMAND shortcut buttons
- COMAND display
- telephone* keypad
- COMAND controller

COMAND introduction

COMAND shortcut buttons

i During Dynamic Rear View Monitor* operation (▷ page 413) it is not possible to operate the COMAND shortcut buttons.

Use the COMAND shortcut buttons to select main menus directly.



	Function	Page
①	Favorite button	216
②	Shortcut button for: <ul style="list-style-type: none"> radio CD/DVD 	94 111
③	Back button	87
④	Seat menu	236
⑤	Shortcut button for: <ul style="list-style-type: none"> telephone* Navi 	115 148
⑥	COMAND on/off button	79
⑦	Volume control	89
⑧	Mute button	89

Example:

- ▶ **Switching directly to Radio or CD menu:** Press once or twice.

COMAND display

In the COMAND display, you will find the function currently selected and the corresponding menus. The COMAND display is divided into several areas.

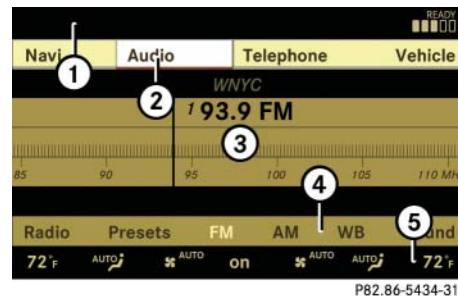

- ① Status line
- ② Main menus
- ③ Main area
- ④ Submenus
- ⑤ Climate control settings

A white bar under the main menu ② indicates the active area.

Once you have selected a main menu ②, the main area ③ is active.

i The layout of the menus may vary depending on your vehicle's equipment. This manual shows the menus for a fully equipped vehicle.

Instrument cluster multifunction display

This section describes features and controls via the COMAND controller, display and shortcut buttons only.

Please refer to the "Instrument cluster control system" section of this manual (▷ page 241) for function descriptions and operation of the instrument cluster multifunction display and multifunction steering wheel buttons as they relate to COMAND features described in this section.

Adjusting COMAND display and instrument cluster illumination



- ① To adjust instrument cluster illumination and multifunction display
- ② To adjust COMAND display
- ▶ **Brightening illumination:** Turn knob ① or ② clockwise.
- ▶ **Dimming illumination:** Turn knob ① or ② counterclockwise.

Swiveling COMAND display

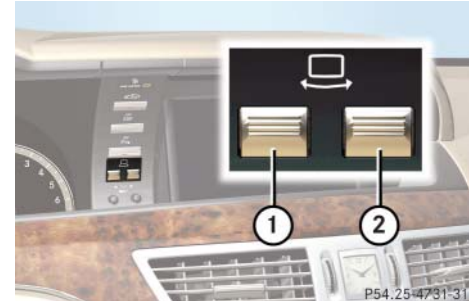

- ① Button for swiveling display to the left
- ② Button for swiveling display to the right

You can swivel the COMAND display to the left or right. The buttons are on the right-hand side of the instrument cluster.

COMAND introduction

Telephone keypad*

With the help of the telephone keypad, you can use your mobile phone if it is inserted in the cradle (▷ page 460).



- ① Telephone keypad
- ② Folding cover

COMAND controller

Use the COMAND controller to select menu functions shown on the COMAND display.



- ① COMAND controller

You can operate the COMAND controller as follows:



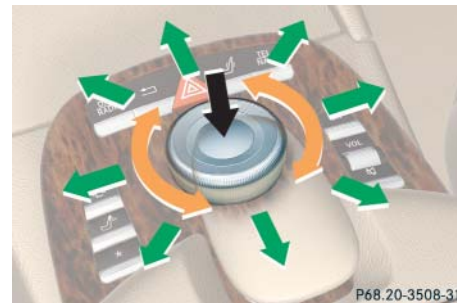

- press briefly or press and hold
- rotate to the left or right
- slide to the left, right, up, down or diagonally

In this way, you can move through the menus, select menu items or exit menus.

You can move through the menus either by rotating or sliding the controller.



Operating COMAND controller

Symbol	How to use the COMAND controller	Function
	▶ Press briefly.	<ul style="list-style-type: none"> • Select menu item. • Exit full-screen image with Navi.
	▶ Press and hold until the selected action has been carried out.	<ul style="list-style-type: none"> • Save a station. • Accept a destination for navigation.
	▶ Rotate.	<ul style="list-style-type: none"> • Move through vertical or horizontal menus. • Move through text. • Program settings.
	▶ Slide.	<ul style="list-style-type: none"> • Move through vertical menus. • Exit horizontal menus.
	▶ Slide and hold.	<ul style="list-style-type: none"> • Move through a navigation map.
	▶ Slide.	<ul style="list-style-type: none"> • Move through horizontal menus. • Exit vertical menus.
	▶ Slide and hold.	<ul style="list-style-type: none"> • Fast forward or reverse for audio CD or audio DVD playback. • Move through a navigation map.
	▶ Slide and hold.	<ul style="list-style-type: none"> • Move through a navigation map.

COMAND introduction

Operating COMAND

Menu overview

The illustration below shows the structure of the main menus and their main menus.

Each main menu has a main menu. Each menu item in the main menu in turn has several submenu items.

	Navi	Page	Audio	Page	Telephone*	Page	Vehicle	Page
Commands/ menus	Map Display	150	FM/AM Radio	93	Telephone*	115	Exterior Lighting Delayed Switch-off	220
	Mode	152	Sat Radio* (USA only)	98	Address Book*	202	Locator Lighting	221
			CD	104	Telephone OFF*	116	Exterior Mirror Convenience Settings	222
			DVD-Audio	104			Automatic Locking	223
			MP3	104			Easy Entry/Exit Feature	224
			Audio OFF	92			Interior Lighting Delayed Switch-off	226
							Interior Ambient Light	225
							Rear Window Sunshade*	227
							Trunk Opening-height Restriction	227
							Tow-away Alarm	228

Calling up the main menu

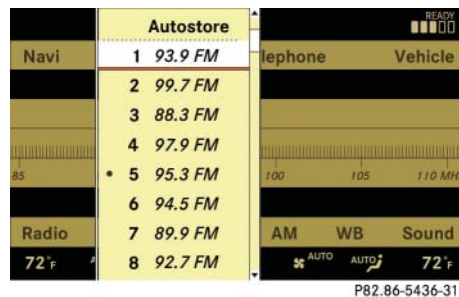

Illustration: audio main menu

You can call up the main menu of a main menu in the following manner:

- ▶ **Moving to the main menu line:** Slide \uparrow or rotate \uparrow .
- ▶ **Selecting a main menu:** Slide \leftarrow or rotate \leftarrow .
- ▶ **Confirming selection:** Press \odot .

Vertical menus



- ▶ **Moving through the menu:** Slide \downarrow or rotate \downarrow .
- ▶ **Selecting a menu item:** Press \odot .
- ▶ **Exiting a menu without making a selection:** Slide \leftarrow in the opposite direction of the list orientation or press back button \leftarrow .

Horizontal menus

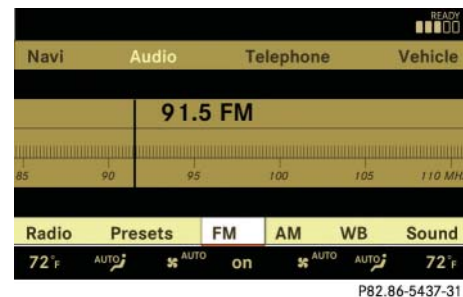

- ▶ **Moving through the menu:** Slide \leftarrow or rotate \leftarrow .
- ▶ **Selecting a menu item:** Press \odot .
- ▶ **Exiting a menu without making a selection:** Slide \downarrow in the opposite direction of the list orientation or press back button \leftarrow .

COMAND introduction

Entering characters

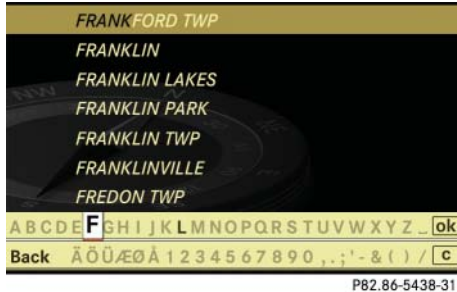

Illustration: entering a navigation destination

Selecting characters

- ▶ Slide or rotate .
- ▶ **Confirming selection:** Press .

COMAND completes your entry as soon as it can be clearly identified. In this case, you do not need to switch to the list.

Deleting individual characters

- ▶ Select and press repeatedly in the bottom line.

Deleting entire words or numbers

- ▶ Press and hold in the bottom line until the word or number is deleted.

Exiting character entry

- ▶ Select and press “Back” in the bottom line.

or

- ▶ Press back button in the center console (▶ page 80).

Switching to the list

- ▶ Slide .

or

- ▶ Select and press **ok** in the second line from the bottom.
- ▶ To exit list, slide to select “Back”.

Accepting first entry

- ▶ Press until you exit the character entry window.

Selecting list item

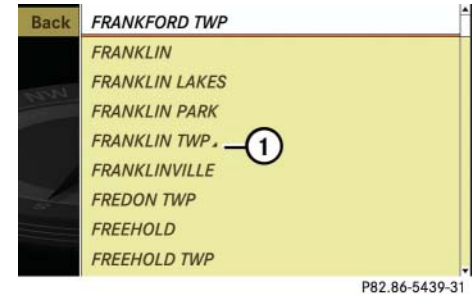



Illustration: list of towns and cities for navigation

- ① Symbol for other selection options (e.g. county)
- ▶ **Selecting a line:** Slide or rotate .

- **Confirming selection:** Press .

Additional selection options are available for list entries featuring symbol . For example, cities marked with symbol  indicate that the selected country has more than one city featuring that name. Confirming such a list entry opens up another submenu.

Back button



-  Back button

- **Switching to the next highest menu:**

Press  briefly.

COMAND switches to the next highest menu level within the currently active operating mode.

- **Switching to the main menu:** Press and hold .

You will hear a signal, and COMAND switches to the main menu of the currently active operating mode.

Example of how to use COMAND

In the descriptions below, the main menus always serve as the starting point for locating the individual menu items.

Example:

“Audio” → “Audio” → “FM/AM Radio” → “Radio” → “Save Station”

 In the COMAND display, you will see the submenu previously called up for each main menu.



If you already see one of the submenus on the screen (e.g. the “Audio” → “Audio” → “Radio” submenu), it is not necessary to perform the first steps.

The individual steps for the above-mentioned example are described below.

- **Switching to the main menu line:**

Slide .

- **Selecting “Audio” main menu:**

Slide  or rotate .

- **Confirming selection:** Press .

The audio operating mode last selected appears.



P82.86-5440-31 

COMAND introduction

- ▶▶ **Selecting “Audio” in the main menu:**
Slide ↑⊙.

- ▶ **Confirming selection:** Press ⊙.

A selection list with the functions of the “Audio” main menu appears.



- ▶ **Selecting “FM/AM Radio”:**
Slide ↑⊙ or rotate ⊙↻.
 - ▶ **Confirming selection:** Press ⊙.
- The Radio main menu appears.



- ▶ **Selecting “Radio”:** Slide ⊙↓ or rotate ⊙↻.
- ▶ **Confirming selection:** Press ⊙.

The Radio menu appears.

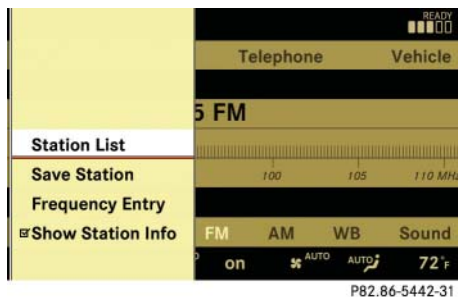

- ▶ Select “Save Station” from selection list by rotating ⊙↻ or sliding ↓⊙↑.
- ▶ Select desired position.



- ▶ **Confirming selection:** Press ⊙.

The selected station is saved at the designated position. The display switches back to the Radio display.

Main menus of COMAND

i The components and operating principles of COMAND can be found on (▷ page 79).

Sound

► **Muting:** Press the  shortcut button in the center console (▷ page 80).

The sound of the current audio source is switched on or is muted.

i When the sound is muted, you will see the symbol  in the status line. When you change the audio source, the sound is automatically switched on. You will be able to hear announcements from the navigation system even when the sound is muted.

Switching off navigation announcements entirely

► **Canceling navigation message:**

Briefly press  shortcut button during an announcement.

► **Switching off navigation messages:**

Press and hold  during an announcement until the announcement is switched off.

You will see the message “*The driving instructions have been muted.*” for a short while.

i The announcements remain switched off even if you start a new route guidance or if COMAND is switched off/on with the  button.

If you switch COMAND off by removing the SmartKey from the starter switch and then switch the ignition back on after more than 3 minutes, the announcements are automatically switched back on.

Adjusting volume



① Thumbwheel

► **Adjusting:** Turn  thumbwheel.

The volume of the currently selected audio source changes.

COMAND introduction

Volume of navigation announcements

You can adjust the volume of the navigation announcements independently from the volume of the respective audio source.

During a navigation announcement:

- ▶ turn thumbwheel **VOL**
- or
- ▶ press **+** or **-** on the multifunction steering wheel.

Adjusting volume for telephone calls

In hands-free mode, you can adjust the volume of a telephone call while the call is currently active.

During a telephone call:

- ▶ turn thumbwheel **VOL**
- or
- ▶ press **+** or **-** on the multifunction steering wheel.

Selecting sound settings

You can select different sound settings for each individual audio source. The respective sound menu can be found via the submenu for which you wish to make settings.

Example:

“Audio” → “Audio” → “FM/AM Radio” → “Sound”

Adjusting treble or bass

- ▶ Select “Sound” → “Treble” or “Bass”.

The setting last selected is indicated by an outlined bar.



P82.86-5444-31

Adjusting treble and bass

- ① Setting last selected
- ② Current setting
- ▶ **Changing setting:** Slide **↓** **⊙** **↑** or rotate **⊙** until desired treble or bass setting is reached.
- ▶ **Exiting menu:** Press **⊙**, **←** or Slide **←** **⊙** **→**.

The setting is saved.

Adjusting balance or fader

Balance is used to determine whether the sound focus should be shifted toward the driver's side or the passenger's side.

Fader is used to determine whether the sound focus should be shifted toward the front or rear of the vehicle

- ▶ Select "Sound" → "Balance/Fader".

The setting last selected is indicated by an outlined bar.

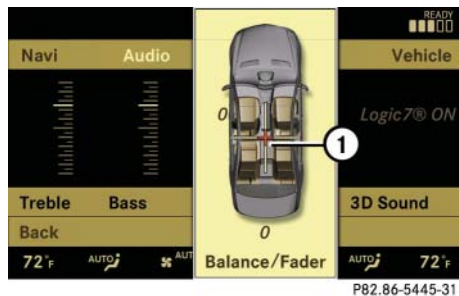

Adjusting balance and fader

- ① Current setting indicated by orange cross-hair symbol

- ▶ **Changing setting:** Slide $\downarrow \odot \uparrow$ or $\leftarrow \odot \rightarrow$ until desired balance/fader setting is reached.

- ▶ **Exiting menu:** Press \odot or \leftarrow .

The setting is saved.

Surround sound

With surround sound, you can choose between "LOGIC7® ON" and "LOGIC7® OFF".

Harman/kardon LOGIC7® surround sound is available for the following operating modes:

- Audio DVD (MLP, DTS, PCM, and Dolby Digital audio formats)
- Audio CD
- MP3
- Radio (FM, AM, WB, Satellite* (USA only))
- PCMCIA

i Since some DVDs contain both stereo as well as multi-channel audio formats, it may be necessary to adapt the audio format (▷ page 114).

i The "LOGIC7® ON" function of the harman/kardon LOGIC7® surround sound system makes it possible to play discrete 5.1 and stereo recordings with optimal surround sound for every passenger. Music on CDs or audio DVDs with high-resolution surround formats such as MLP, DTS or Dolby Digital is played back optimally.

For an ideal sound experience on all seats, LOGIC7® distributes 5.1 surround information via the 13-channel system architecture. The result is a sound as intended by the sound engineers during the original recording.

harman/kardon LOGIC7® converts all two-channel stereo sound material into multi-channel surround sound. With the help of LOGIC7®, surround information stored during the original recording are read out and distributed through the 13 channels. No effects are created during this process; only that which was already there becomes audible.

In addition, harman/kardon LOGIC7® moves the perceived sound source away from the individual loudspeakers, thus generating a natural 360° sound experience for every passenger.

COMAND introduction

i By selecting “LOGIC7® OFF”, all compatible formats as they are present on the medium are played back. Due to the vehicle’s spatial characteristics, an optimal sound experience is not ensured on all seats.

Adjusting surround sound

With surround sound, you can choose between “LOGIC7® ON” and “LOGIC7® OFF”.

▶ Select “Sound” → “3D Sound”.

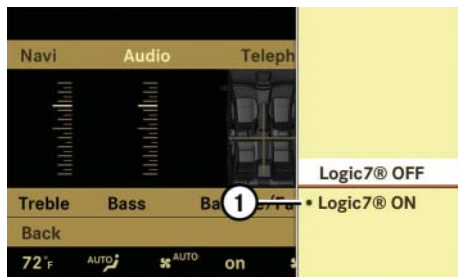

P82.86-5446-31

Adjusting surround sound

① Current setting

▶ **Selecting a setting:** Slide ↓Ⓞ↑ or rotate Ⓞ.

▶ **Saving setting:** Press Ⓞ.

The setting is saved and the menu is closed.

▶ **Exiting menu without saving changes:** Press ⏪ or slide ←Ⓞ→.

i Please note the following:

- For an ideal sound experience at all seats, the balance and fader should be adjusted to the center of the passenger compartment with LOGIC7® switched on.
- The best sound results are achieved by playing high-quality audio CDs and audio DVDs.
- For MP3 tracks, the bit rate should be at least 128kBit/s.
- Surround sound does not function for mono-signal sources.
- In the event of poor radio reception quality, e.g. inside a tunnel, you should switch off LOGIC7®, as a dynamic switch from Stereo to Mono could occur, resulting in temporary sound distortion.

- With some stereo recordings, the resulting sound may deviate from conventional stereo playback.

Switching off/on the audio source

i When you insert an audio CD or audio DVD, it automatically becomes the active audio source.

▶ **Switching off:** Select “Audio” → “Audio” → “Audio OFF”.

The audio source is switched off; “Audio OFF” appears in the display.

▶ **Switching on:** Select “Audio”, then the desired audio source.

OR

▶ Load CD/DVD (▷ page 107) or a PCMCIA card (▷ page 108).

▼ **COMAND FM/AM radio****Submenu overview**

 *The components and operating principles of COMAND can be found on [page 79](#).*

Radio (except Weather Band)	Presets (except Weather Band)	Channel (only Weather Band)	FM or AM or WB	Sound
Station List (in FM waveband only)	Autostore	Channel list	Switch to FM waveband	Treble
Save Station	Preset station list		Switch to AM waveband	Bass
Frequency Entry			Switch to Weather Band	Balance/Fader
Show Station Info (in FM waveband only)				3D Sound

COMAND FM/AM radio

Switching to radio mode

- ▶ Select “Audio”→ “Audio”→ “FM/AM Radio”.

or

- ▶ Press the **DISC RADIO** shortcut button once or twice.

The radio display appears once you have switched to radio mode. You will hear the station/channel last tuned in in the previously selected waveband, provided that the station/channel can be received.

i The number of times you have to press the **DISC RADIO** shortcut button depends on the operating mode currently selected.

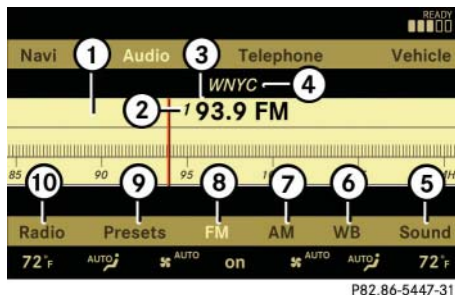

Illustration: radio mode in FM waveband

- ① Main area with frequency display
- ② Preset position of selected station
- ③ Frequency of selected station
- ④ Name of selected station
- ⑤ Sound settings
- ⑥ To switch to Weather Band
- ⑦ To switch to AM waveband
- ⑧ Selected waveband
- ⑨ Preset options
- ⑩ Radio options

i Station name display ④ is available for the FM waveband and can only be seen when it is switched on (▷ page 97) and if the station transmits a name.

Switching wavebands

You can switch between the FM, AM and WB (Weather Band) wavebands.

- ▶ Select “Audio”→ “Audio”→ “FM/AM Radio”→ “FM” or “AM” or “WB”.

You will hear the station last tuned in on the selected waveband.

Selecting stations/channels

You have the following selection options:

- The station list
- The search function
- The station presets
- The manual frequency entry
- The channel list

Selecting stations using the station list

i The station list is only available for the FM waveband. It contains all the stations that can be currently received and is sorted by station frequencies.

- ▶ Select “Audio”→ “Audio”→ “FM/AM Radio”→ “FM”.

- ▶ Select “Radio”→ “Station List”.

The station list appears. The dot ● in front of a list entry indicates the currently selected station. A number in front of the list entry indicates the preset position in the station preset memory.

- ▶ Select a station by rotating or sliding and press .

Selecting stations/channels using the search function

- ▶ Slide or rotate when the main area is selected.

Depending on the direction in which the controller is being slid or rotated, the system searches upward or downward and stops at the next receivable station/channel.

Selecting stations using station presets

This function is not available for Weather Band.

- ▶ Select “Audio” → “Audio” → “FM/AM Radio” → “FM” or “AM”.

- ▶ Select “Presets”.

or

- ▶ Press when the main area is selected.

The preset menu appears. The dot ● in front of a preset position indicates that the currently selected station is saved there.

- ▶ Select station preset by rotating or sliding and press .

Selecting stations by entering the frequency manually

This function is not available for Weather Band.

- ▶ Select “Audio”→ “Audio”→ “FM/AM Radio”→ “FM” or “AM”.

- ▶ Select “Radio”→ “Frequency Entry”.

The menu for manual frequency entry appears.

- ▶ **Exiting menu without making an entry:** Press back button in the center console (▷ page 80).

- ▶ **Increasing or decreasing number:** Slide or rotate .

You can only select currently permitted numbers.

- ▶ **Selecting the next number:** Slide .

- ▶ **Confirming frequency entry:** Press .

COMAND tunes in to the frequency entered.



COMAND FM/AM radio

- ▷▷ **i** *If you enter a frequency in the AM waveband which is outside the frequency range, COMAND tunes in to the next lowest frequency.*

Selecting channels using the channel list



i *This function is only available for Weather Band.*

- ▶ Select “Audio” → “Audio” → “FM/AM Radio” → “WB” → “Channel”.

or

- ▶ Press  when the main area is selected.

The channel list appears. The dot ● in front of a list entry indicates the currently selected channel.

- ▶ Select channel by rotating  or sliding  and press .

Saving stations

i *Twenty stations can be saved in each waveband except for Weather Band.*

You have the following options:

- Saving stations manually
- Saving stations using Autostore

Saving stations manually

Option 1

- ▶ Select “Audio” → “Audio” → “FM/AM Radio” → “FM” or “AM”.
- ▶ Select “Radio” → “Save Station”.

Option 2



- ▶ Press  when the main area is selected.

Option 3

- ▶ Select “Audio” → “Audio” → “FM/AM Radio” → “FM” or “AM”.
- ▶ Select “Presets”.

All three of these will call up a station preset screen. The dot ● in front of a preset position indicates that the currently selected station is saved there.



- ▶ **Selecting a preset position:**
Slide  or rotate .

Saving a station to a selected preset position

If you have called up the station preset screen using option 1:

- ▶ Press  briefly.

In options 2 and 3:

- ▶ Press and hold  until you hear a signal.

The station is saved.

Saving using autostore

i This function is not available for Weather Band. The Autostore function saves receivable stations as presets in order of their reception quality. All stations saved manually in the preset memory will be lost if COMAND finds 20 stations. If COMAND finds less than 20 stations, for example 9, then the stations saved in preset positions 1 – 9 will be over written.

Option 1

- ▶ Press  when the main area is selected.
- ▶ Select “Autostore”.

Option 2

- ▶ Select “Audio” → “Audio” → “FM/AM Radio” → “FM” or “AM”.
- ▶ Select “Presets” → “Autostore”.

Option 3

- ▶ Select “Audio” → “Audio” → “FM/AM Radio” → “Radio” → “Save Station” → “Autostore”.

Station name display

i In the FM waveband, COMAND can show the name of the station currently tuned in. Station name display ① can only be seen when it is switched on and if the station transmits a name.



① Station name display

- ▶ **Switching the station name display on/off:** Select “Audio” → “Audio” → “FM/AM Radio” → “FM” → “Radio” → “Show Station Info”.

The display is switched on or off, depending on the previous setting. When the display is switched on, a check-mark appears in front of the “Show Station Info” menu item.

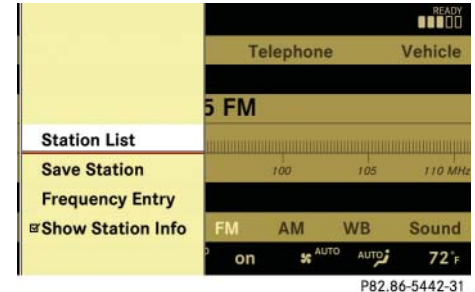

COMAND satellite radio* (USA only)

Submenu overview

i The components and operating principles of COMAND can be found on (▷ page 79).

Sat Radio	Presets	Info	Category	Sound
Channel List	Station presets	Show program info	Select category	Treble
Save Channel				Bass
Channel Entry				Balance/Fader
Service				3D Sound

Introduction to Satellite radio

i A subscription to Sirius satellite radio service provider is required for the satellite radio operation described in this chapter. Contact an authorized Mercedes-Benz Center for details and availability for your vehicle.

Sirius Satellite Radio provides 100 channels, so called streams, of digital-quality radio, among others music, sports, news, and entertainment free of commercials. Sirius Satellite Radio uses a fleet of

high-power satellites to broadcast 24 hours per day, coast-to-coast, in the contiguous US.

This diverse, satellite-delivered programming is available for a monthly subscription fee.

For more information and service availability call the Sirius Service Center (▷ page 103), or go to www.siriusradio.com.

i Satellite radio service may be unavailable or interrupted from time to time for a variety of reasons, such as environmental or topographic conditions and other things we can't control. Service might also not be available in certain places (e.g., in tunnels, parking garages, or within or next to buildings) or near other technologies. In such situations, the satellite radio's main menu shows the "Acquiring signal..." screen. At this point, the radio's functions are restricted to manual channel number entry (▷ page 101) and service info display (▷ page 103).

COMAND satellite radio* (USA only)

Switching to satellite radio

- ▶ Select “Audio” → “Audio” → “Sat Radio”.

or

- ▶ Press the **DISC RADIO** shortcut button once or twice. The Satellite radio menu appears if it was the last active radio mode.

The screen which then appears depends on the activation status of the satellite radio service.

The following options are possible:

- Satellite radio service is not activated
- Only the preview channel is activated
- Satellite radio service is fully activated

Satellite radio service is not activated

The telephone number of the Sirius Service Center and the twelve-digit electronic serial number (SIRIUS-ID) of the particular receiver are displayed.

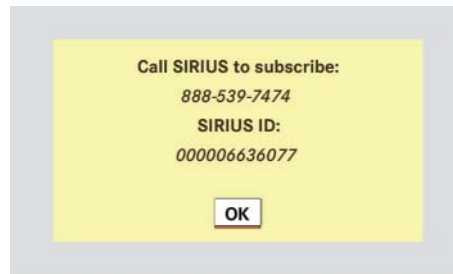

This information is required when calling the Sirius Service Center for an activation request.

i Credit card information is also required for your application. The activation process takes approximately 5 to 10 minutes after calling the Sirius Service Center.

- ▶ **Closing screen:** Press **⏏**.

Only the preview channel is activated

The satellite radio preview channel appears.



i If only the preview channel is activated, you cannot tune in another channel. If you try to do this, you will see the screen described in the section “Satellite radio service is not activated” (▷ page 99).

Satellite radio service is fully activated

The main satellite radio menu appears. You will hear the channel last tuned in, provided that it can be received.

COMAND satellite radio* (USA only)

Main satellite radio menu

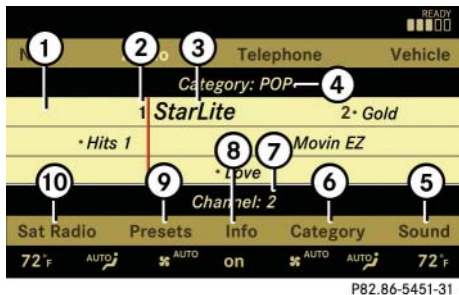

- ① Main area with channel display
- ② Preset position of selected channel
- ③ Selected channel
- ④ Selected program category
- ⑤ Sound settings
- ⑥ To select program category
- ⑦ Channel number of selected channel
- ⑧ Other channel information
- ⑨ Preset options
- ⑩ Satellite radio options

i Main area ① can show all channels included in your subscription. Which channels are shown depends on the selected program category ④.

Note that categories and channels shown in illustrations are dependent on programming content delivered by the service provider. Programming content is subject to change.

Therefore, channel and categories shown in illustrations and descriptions contained in this manual may differ from the channels and categories delivered by the service provider.

Selecting program category

i The channels are categorized. Categories allow you to tune to stations broadcasting a certain type of program.

- ▶ Select “Audio” → “Audio” → “Sat Radio” → “Category”.

The category list appears.

i If only the preview channel is activated, only certain categories are available on the list. Which categories these are depend on the service provider.

- ▶ Select category by rotating or sliding and press .

When selecting a channel using the channel search function or the channel list, you have access to the channels you subscribe to and which are included in the selected category.

i When you select the category “All Channels”, you have access to all the channels you subscribe to, regardless of category, when you are tuning in a channel using the channel search function or the channel list.

Tuning in channels

You have the following selection options:

- The channel search function
- The channel presets
- The manual channel number entry
- The channel list

COMAND satellite radio* (USA only)

Tuning in channels using channel search function

i This function is not possible when only the preview channel is activated. If you try to tune in a channel in this instance, you will see the screen described in the section “Satellite radio service is not activated” (▷ page 99).

- ▶ Slide ←↻→ or rotate ↻ when the main area is selected.

Depending on the direction in which the controller is being pressed or rotated, the system searches upward or downward and stops at the next receivable channel.

i Which channels are found by the channel search function depends on which channels you have subscribed to and the program category you have selected (▷ page 100).

Tuning in channels using channel presets

- ▶ Select “Audio” → “Audio” → “Sat Radio” → “Presets”.

or

- ▶ Press ↻ when the main area is selected.

The preset menu appears. The dot • in front of a preset position indicates that this is the channel currently selected and being listened to.



- ▶ Select station preset and briefly press ↻.

COMAND tunes in the corresponding channel as long as it is included in your subscription and is still available.

If the channel is not included in your subscription, you will see the message described in the section “Satellite radio service is not activated” (▷ page 99).

If the channel is no longer available or only the preview channel is activated, you will see the message “Invalid Channel”.

- ▶ **Closing message:** Press ↻.

Tuning in channels using manual channel number entry

i This function is not possible when only the preview channel is activated. If you try to tune in a channel in this instance, you will see the screen described in the section “Satellite radio service is not activated” (▷ page 99).

- ▶ Select “Audio” → “Audio” → “Sat Radio” → “Sat Radio” → “Channel Entry”.

The menu for manual channel number entry appears.

- ▶ **Exiting menu without making an entry:** Press  back button in the center console (▷ page 80).

- ▶ **Increase or decreasing number:** Slide ↑↻↓ or rotate ↻.

- ▶ **Selecting next number:** Slide ←↻→. ▷▷

COMAND satellite radio* (USA only)

- ▷▷ **Confirming channel entry:** Press .

Further operation depends on whether the selected channel number is valid or if the channel is included in your subscription.

Channel number is valid and channel is included in subscription

COMAND tunes in the channel entered.

Channel number is invalid

You will see the message “Invalid Channel”.

- ▶ **Closing message:** Press .

Channel number is valid but channel is not included in subscription



You will see the screen described in the section “Satellite radio service is not activated” (▷ page 99).

- ▶ **Closing display:** Press .

Tuning in channels using the channel list

- ▶ Select “Audio” → “Audio” → “Sat Radio” → “Sat Radio” → “Channel List”.

The channel list appears. The dot • in front of a list entry indicates the currently selected channel.

- ▶ Select channel by rotating  or sliding  and press .

 *The contents of the channel list depends on which channels are included in your subscription and which program category you have selected (▷ page 100). If only the preview channel is activated, the channel list contains only the preview channel.*

Saving channels

 *There are twenty preset positions available.*

Option 1

- ▶ Select “Audio” → “Audio” → “Sat Radio” → “Sat Radio” → “Save Channel”.

Option 2

- ▶ Press  when the main area is selected.



Option 3

- ▶ Select “Audio” → “Audio” → “Sat Radio” → “Presets”.

All three of these will call up a preset menu. The dot • in front of a preset position indicates that this is the channel currently selected and being listened to.



P82.86-5452-31

- ▶ **Selecting a preset position:** Slide  or rotate .

Saving a channel to a selected preset position

If you have called up the channel preset screen using option 1:

- ▶ Press  briefly.

In options 2 and 3:

- ▶ Press and hold  until you hear a signal.

The channel is saved.

Show program info

- ▶ Select “Audio” → “Audio” → “Sat Radio” → “Info”.





 *If the program provider does not offer any information, the “Info” menu item cannot be selected.*

You will see a screen that may contain the following information:

- Selected program category
- Selected channel

- Artist of the track currently being played
- Name of current track

 *The program provider determines what information is displayed on the screen. COMAND shows no more than two lines per item of information. If an item of information is too long, COMAND shortens it.*

- ▶ **Closing screen:** Slide    or press .

Channel update

The service provider may conduct a channel update.

During the update, the message “Updating channels...” will appear on the display.





No functions can be operated in satellite radio mode during the update.

Calling Sirius Service Center

 *It may be necessary to call the Sirius Service Center if, for example:*

- You want to cancel the subscription or re-subscribe at a later date
- You forget to pay the bill
- You sell the car to another person
- ▶ Select “Audio” → “Audio” → “Sat Radio” → “Sat Radio” → “Service”.

The telephone number of the Sirius Service Center and the twelve-digit electronic serial number (SIRIUS-ID) of the particular receiver are displayed.

- ▶ **Closing screen:** Slide    or press .

COMAND audio CD/audio DVD/MP3

Safety precautions

Warning!



COMAND is classified as a Class 1 laser product. You must not open the casing. There is a risk of exposure to invisible laser radiation if you open the casing, or if the casing is faulty or damaged. COMAND does not contain any parts that you are able to maintain yourself. For safety reasons, all maintenance work must be carried out by qualified technicians.

Bear in mind that at a speed of just 30 mph (approximately 50 km/h), your vehicle is covering a distance of 44 feet (approximately 14 m) every second.

Warning!



Only carry out the following when the vehicle is stationary:

- Inserting a disc
- Ejecting a disc

There is a risk of accident by being distracted from road and traffic conditions if you load a CD/DVD while the vehicle is in motion.

Notes about MP3 mode

Permissible media for MP3 files

- CD-R and CD-RW
- DVD+R and DVD+RW
- DVD-R and DVD-RW
- PCMCIA card (▷ page 108)

Permissible file systems

- ISO9660 / Joliet for CDs
- UDF for DVDs
- FAT16 or FAT32 for PCMCIA cards with storage medium

Multisession CDs

For multisession CDs, the first session type of the CD determines how COMAND will process the CD.

For example, if the first session type is according to the audio CD standard and the second session type is according to the data CD standard containing MP3 tracks, COMAND will treat the CD as a conventional audio CD. This means that it is only possible to access the audio CD tracks. Access to the MP3 tracks is not possible.

Similarly, if the first session type is according to the data CD standard containing MP3 tracks and the second session type is according to the audio CD standard, COMAND will treat the CD as a data CD. This

means that it is only possible to access the MP3 tracks. Access to the audio CD tracks is not possible.

File structure on a disc

When you create an MP3 disc, the MP3 tracks can be organized in folders. A folder can also contain other folders. A disc can contain a maximum of 255 folders. Each folder can contain a maximum of 255 tracks and 255 folders. A disc can contain a maximum of 4,000 tracks. Usually this number will not be reached because each minute of an MP3 track requires approximately 1 MB of storage space.

Track and folder names

When you create an MP3 disc, you can assign names to the MP3 tracks and folders.

COMAND uses these names for the corresponding display in MP3 mode. Empty folders or folders which contain data other than MP3 tracks are not displayed by COMAND.

If MP3 files are saved in the root directory itself, the root directory will also be treated as a folder. COMAND will then show the name of the root directory as the folder name.

You must observe the following when assigning track names:

- Track names must have at least one character.
- Track names must have the extension “mp3”.
- There must be a period between the track name and the extension.

Example of a correct track name:
Track 1.mp3

i *COMAND does not support ID3 tags.*

Permissible MP3 formats

COMAND supports the MPEG1 Audio Layer 3 format.

i *This format is generally known as “MP3”.*

Permissible bit and sampling rates

- Fixed and variable bit rates up to 320 kbit / s
- Sampling rates of 24 kHz – 48 kHz

i *Only use MP3 tracks with a bit rate of at least 128 kbit/s and a sampling rate of at least 44.1 kHz. Smaller rates can cause a noticeable deterioration in sound quality. This is especially the case if you have activated a surround sound function.*

Notes on copyright

The music tracks that you create for MP3 mode and can play back in MP3 mode are generally subject to copyright protection in accordance with the applicable international and national regulations.

In many countries, reproductions are not permitted without the prior consent of the copyright holder, not even for private use.

Make sure that you know the applicable copyright regulations and that you comply with these.

COMAND audio CD/audio DVD/MP3

If you own these rights yourself, e.g. for your own compositions and recordings, or the copyright holder has granted you permission, these restrictions do not apply.

Notes about audio DVD operation

COMAND can playback commercially available, prerecorded audio DVDs that bear the following label. You will usually find the label on the DVD booklet, the inlay, or the DVD itself.



i Audio DVDs differ from recordable DVD-R, DVD+R, DVD-RW and DVD+RW discs.

i COMAND cannot playback video DVDs.

Data on audio DVDs are stored either in uncompressed format or in lossless compressed format. The sound quality on audio DVDs is therefore better than on recordable DVDs that contain MP3 data because the MP3 format uses a lossy type of compression.

You cannot delete data from or record additional data to commercially available, prerecorded audio DVDs.

Please note the following information about CDs/DVDs and pay special attention to the notes on copied and/or self-written CDs/DVDs.

Notes about CDs/DVDs

i Audio CDs with copy protection are not compatible with the CD audio standard and therefore may not be able to be played by COMAND.

There may be playback problems when playing copied discs.

There is a large variety of discs, disc-writing software and writers available. This variety means that there is no guarantee that the system will be able to play discs that you have written/copied yourself.

There may be playback problems if you use CD-R or CD-RW type discs you have copied yourself with a storage capacity of more than 700 MB. These CDs are not compatible with currently applicable standards.

! *Do not affix stickers or labels to the discs. These could peel away and damage COMAND. COMAND is designed to hold discs which comply with the IEC 60908 standard. You can therefore only use discs with a maximum thickness of 1.3 mm.*

If you insert thicker discs, e.g. those that contain data on both sides (DVD on one side and audio data on the other), they cannot be ejected and can damage COMAND.

Do not use discs with an 8-cm diameter, even if they have an adapter.

Only use round discs with a 12-cm diameter.

Notes about handling CDs/DVDs

- Only hold discs by the edge.
- Handle discs carefully to prevent playback problems.
- Avoid getting scratches, fingerprints and dust on discs.
- Clean discs from time to time with a commercially-available cleaning cloth. Do not wipe them with a circular motion, but only in straight lines from the center outwards.
- Only use a pen designed for such a purpose to label discs.
- Place discs back in their boxes after use.
- Protect discs from heat and direct sunlight.

Inserting CDs and DVDs

Warning!



Only insert a CD or DVD when the vehicle is stationary. There is a risk of accident by being distracted from road and traffic conditions if you load a CD/DVD while the vehicle is in motion.

Bear in mind that at a speed of just 30 mph (approximately 50 km/h), your vehicle is covering a distance of 44 feet (approximately 14 m) every second.

i If the CD/DVD has a printed side, this must face upwards when the CD/DVD is inserted. If neither side is printed, the side to be played should face downwards.

Loading the CD/DVD changer

The CD/DVD changer can hold up to a total of 6 audio CDs or DVDs.

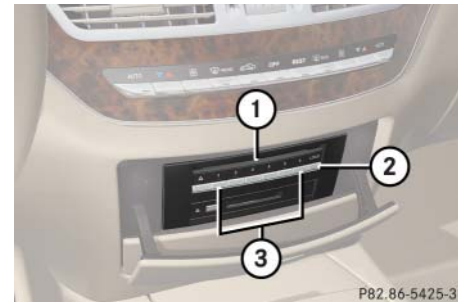

- ① Disc slot
- ② Load button (all magazine trays)
- ③ Magazine tray buttons 1 – 6

i Each magazine tray button ③ indicates the status of the corresponding magazine tray by means of an LED.

- LED off = magazine tray is empty
- LED constantly lit = magazine tray is loaded
- LED flashes = CD/DVD changer requesting disc to be loaded

COMAND audio CD/audio DVD/MP3

Loading an individual magazine tray

- ▶ Press desired magazine tray button ③.
If a disc is loaded, it will be ejected.
- ▶ Take disc out of slot ①.
- ▶ Wait until LED for magazine tray button ③ which you pressed flashes quickly.
- ▶ Insert disc into slot ①.
The DVD changer draws the disc in and begins playback if:
 - it has been loaded correctly
 - it is a permissible type of disc

Loading all six magazine trays

- ▶ Press load button ②.
The DVD changer checks the load status of all magazine trays and switches to the first empty tray.
- ▶ Wait until LED for corresponding magazine tray button ③ flashes quickly.

- ▶ Insert disc into slot ①.
The DVD changer switches to the next empty magazine tray.
- i** If a disc is not inserted within approx. 15 seconds COMAND resumes playback of the last disc.
- ▶ Repeat last two steps until all trays are loaded.

The DVD changer will play the last disc you loaded if:

- it has been loaded correctly
- it is a permissible type of disc

Inserting a PCMCIA card

i COMAND supports commercially available PCMCIA cards or PCMCIA card adapters with storage media that may not be designed for the temperatures which occur in the vehicle. You should therefore remove the PCMCIA card from the vehicle when not in use since extreme temperatures could damage these devices.



① Slot for PCMCIA card

- ▶ Insert PCMCIA card into slot ①.

The side with the contact must point towards the slot.

If the PCMCIA card contains a storage medium with MP3 tracks, COMAND switches to MP3 mode.

Ejecting CDs and DVDs

Warning!



Only eject a disc when the vehicle is stationary. You may otherwise be distracted from the traffic conditions and could cause an accident.

Ejecting from the DVD changer

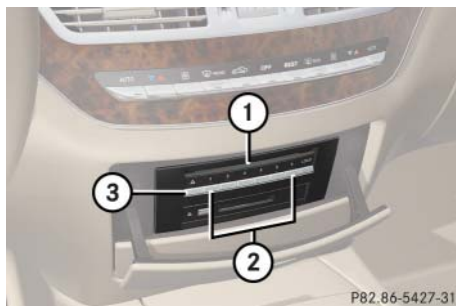

- ① Disc slot
- ② Magazine tray buttons 1 – 6
- ③ Eject button (all discs)

i If you eject one disc while playing another disc, the DVD changer interrupts playback. Playback continues once the disc has been ejected.

▶ **Ejecting one disc:** Press desired magazine tray button ②.

▶ Take disc out of slot ①.

If you do not take the disc out of slot ①, the DVD changer will draw it back in automatically approx. 15 seconds.

▶ **Ejecting all discs:** Press eject button ③.

The DVD changer switches to the first loaded tray and ejects the disc.

▶ Take disc out of slot ①.

The DVD changer switches to the next loaded magazine tray and ejects the disc.

▶ Repeat last step until magazine is empty.

Ejecting a PCMCIA card

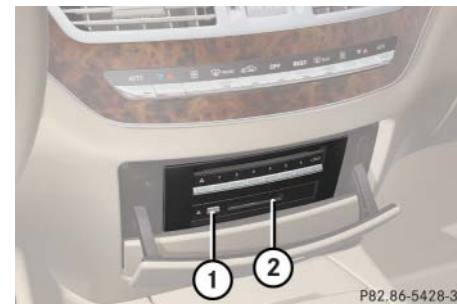

① Eject button

② Slot for PCMCIA card

▶ Press eject button ① twice.

The PCMCIA card is ejected.

▶ Take PCMCIA card out of slot ②.

COMAND audio CD/audio DVD/MP3

Submenu overview

i *The components and operating principles of COMAND can be found on (▷ page 79).*

CD or DVD-A or MP3	Pause/Stop/Play (audio DVD mode only)	Tracks/Track List/Tracks A-Z	Folders (MP3 mode only)	Changer	Sound
Normal Track Sequence	Pause playback	Show track list (audio CD mode and audio DVD mode)	Select folder	Select medium	Treble
Random Tracks	Stop playback	Display alphabetical track listing (MP3 mode only)			Bass
Random folder (MP3 mode only)	Restart playback				Balance/Fader
Repeat folder (MP3 mode only)					3D Sound

COMAND audio CD/audio DVD/MP3

Switching to audio CD, audio DVD or MP3 mode

- ▶ Load CD / DVD (▷ page 107) or PCMCIA card (▷ page 108).

or

- ▶ Select “Audio” → “Audio”, then “CD” or “DVD-Audio” or “MP3”.

or

- ▶ Press the **DISC RADIO** shortcut button once or twice.

i The **DISC RADIO** shortcut button takes you directly to the previously set disc mode (audio CD, audio DVD or MP3-CD/DVD). The number of times you have to press the shortcut button depends on the previously set mode.

Example display in audio CD mode



P82.86-5453-31

- ① Current playback option
- ② Track number
- ③ Disc number
- ④ Disc name (only if saved on the disc)
- ⑤ Track name (only if saved on the disc)
- ⑥ Track time
- ⑦ Graphic time and track display
- ⑧ Sound settings
- ⑨ Medium selection
- ⑩ To call up track listing
- ⑪ Disc type
- ⑫ Playback options

Example display in audio DVD mode



P82.86-5454-31

- ① Current playback option
- ② Track number
- ③ Disc number
- ④ Disc name (only if saved on the disc)
- ⑤ Track name (only if saved on the disc)
- ⑥ Track time
- ⑦ Graphic time and track display
- ⑧ Sound settings
- ⑨ Medium selection
- ⑩ To call up track listing
- ⑪ Stop function
- ⑫ Pause (“Play” appears if paused)
- ⑬ Disc type
- ⑭ Playback options

COMAND audio CD/audio DVD/MP3

Example display in MP3 mode

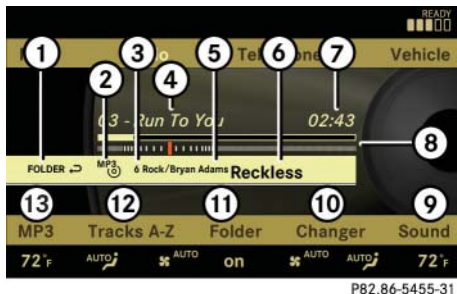

- ① Current playback option
- ② Medium type
- ③ Disc number (not on PCMCIA card)
- ④ Track name
- ⑤ Current folder path
- ⑥ Current folder
- ⑦ Track time
- ⑧ Graphic time and track display
- ⑨ Sound settings
- ⑩ Medium selection
- ⑪ Folder listing
- ⑫ Track listing
- ⑬ Playback options

Stop function

i This function is only available in audio DVD mode.

- ▶ **Stopping playback:** Select “Audio” → “Audio” → “DVD-Audio” → “Stop”.
- ▶ **Restarting playback:** Select “Audio” → “Audio” → “DVD-Audio” → “Play”.

Playback starts at the beginning of the DVD.

Pause function

In audio CD, audio DVD and MP3 mode

- ▶ **Pausing playback:**
Press  briefly.
- ▶ **Continuing playback:** Press  again briefly.

Only in audio DVD mode

- ▶ **Pausing playback:**
Select “Audio” → “Audio” → “DVD-Audio” → “Pause”.

The “Pause” screen changes to “Play”.

- ▶ **Continuing playback:** Select “Audio” → “Audio” → “DVD-Audio” → “Play”.

The “Play” screen changes to “Pause”.

Selecting CD / DVD / MP3 media

- ▶ Select “Audio” → “Audio”.
 - ▶ Select “CD”, “DVD-Audio” or “MP3”.
- COMAND begins playback.
- ▶ **In audio CD, audio DVD and MP3 mode:** Select “Changer”.

or

- ▶ **In audio CD and audio DVD mode only:** Press  when the main area is selected.

The media list appears. The dot • indicates the current medium.

- ▶ Select a medium or folder.
- COMAND changes the medium.

COMAND audio CD/audio DVD/MP3

Selecting a track

Selecting by skipping to tracks

- ▶ **Skipping forwards or backwards to a track (in CD or DVD mode only):** rotate .

 *Skipping forwards through the tracks skips to the next track. Skipping backwards through the tracks skips to the beginning of the current track if the track has been playing for more than 8 seconds. If the track has been playing for less than 8 seconds, it skips to the start of the previous track.*

If you have switched on the “Random Tracks” playback option, the order of the tracks is random.



Selecting from the track list

- ▶ Select “Audio” → “Audio”.
- ▶ Select “CD” or “DVD-Audio” or “MP3”.
- ▶ Select “Tracks”, “Tracks A-Z” or “Track list”.

or

- ▶ **Only in MP3 mode:** Press  when the main area is selected.

The track list of the current folder appears. The dot • indicates the current track.

- ▶ Select a track by rotating  or sliding .

 *In MP3 mode, the list shows all the tracks in alphabetical order.*

Fast forward/rewind

- ▶ Select main area.
- ▶ Slide and hold  until desired place is reached.

Selecting a folder

 *This function is only available in audio MP3 mode.*

- ▶ Select “Audio” → “Audio” → “MP3” → “Folder”.

or

- ▶ Press  when main area is selected.

The track list of the current folder appears.

This is what the illustration in the right column is showing as well.



P82.86-5456-31

- ① Back folder symbol
- ② Current track symbol
- ③ Track symbol

- ▶ **Selecting one folder higher:** Select the  symbol.

The display changes to the next folder up in the folder structure on the disc.

COMAND audio CD/audio DVD/MP3



P82.86-5457-31

- ① Back folder symbol
- ② Current folder symbol
- ③ Folder symbol containing tracks

► **Selecting a folder:** Select desired folder.

You will see the tracks in the folder.

► Select a track.

The track is played and the corresponding folder is now the active folder.

Setting the audio format

This function lets you choose the audio format that you would like COMAND to play and is only available in DVD-AUDIO mode.

i The tracks on an audio DVD can be stored in various audio formats. The number of audio formats depends on the audio DVD.

► Select “Audio” → “Audio” → “DVD-Audio” → “Group”.

i The “Group” menu item cannot be selected if only one audio format is saved on the DVD.

The list of available audio formats appears. A dot ● indicates the format currently selected.

► **Changing setting:** Slide ↑⊙↓ or rotate (⊙↻).

Exiting menu: Slide ←⊙→.

Playback options

The following options are available:

- “Normal Track Sequence”
Tracks playback in the order on the disc (e.g. track 1, 2, 3, etc.).
- “Random Tracks”
Tracks playback in a random order (e.g. track 3, 8, 5, etc.).

- “Random Folder” (in MP3 mode only)
Tracks in the active folder and any sub-folders playback in random order.

- “Repeat Folder” (in MP3 mode only)
Tracks in the active folder will be repeated until you switch the function off.

► **Selecting an option:** Select “Audio” → “Audio”.

► Select “CD”, “DVD-Audio” or “MP3”.

The option list appears. A dot ● indicates which option is switched on.

► Select an option and press (⊙).

The option is switched on. For all options except “Normal Track Sequence”, you will see a corresponding indicator in the main area.

i The “Normal Track Sequence” option is automatically activated when you select a different medium. If an option is activated, it remains activated after COMAND is switched on/off.

▼ COMAND telephone*

Safety precautions

Warning!



Some jurisdictions prohibit the driver from using a cellular telephone while driving. Whether or not prohibited by law, for safety reasons, the driver should not use the cellular telephone while the vehicle is in motion. Stop the vehicle in a safe location before placing or answering a call.

If you nonetheless choose to use the cellular phone while driving, please use the hands-free feature and be sure to pay attention to the traffic situation at all times. Use the cellular phone only when road, weather and traffic conditions permit.

Bear in mind that at a speed of just 30 mph (approximately 50 km/h), your vehicle is covering a distance of 44 feet (approximately 14 m) every second.

Warning!



Never operate radio transmitters equipped with a built-in or attached antenna (i.e. without being connected to an external antenna) from inside the vehicle while the engine is running. Doing so could lead to a malfunction of the vehicle's electronic system, possibly resulting in an accident and/or personal injury.

General notes

Calls disconnected while the vehicle is in motion

A call may be disconnected if:

- there is insufficient network coverage
- you move from one transmitter/receiver area (cell) into another and no channels are free or the cell is full

Operating options

i *The components and operating principles of COMAND can be found on (▷ page 79) and (▷ page 87).*

If the mobile phone is inserted in the cradle, you can use the mobile phone functions with the following devices:

- COMAND / telephone keypad
- Multifunction steering wheel
- Voice Control*
- Bluetooth headset

i *In order for the functions described in this section to work correctly, the Bluetooth headset must be linked to COMAND (▷ page 217). Please make sure any Bluetooth headset linked with the mobile phone is switched off or that the headset is linked with COMAND before you use the functions described in this section.*

The descriptions in this section assume that the mobile phone is inserted in the cradle. Exceptions to this are clearly stated.

COMAND telephone*

Unless otherwise indicated, the descriptions and illustrations in this section refer to COMAND and the telephone keypad. Operation using the mobile phone and Bluetooth headset is described in the respective separate Operating Instructions.

Caller ID

COMAND can display the telephone number and the name of the caller, e.g. for an incoming call and also in other menus or displays.

For the telephone number to be displayed, the caller must transmit their telephone number.

This is also the case for name displays. For this, the telephone number and the name of the caller must also be saved in the mobile phone book.

Functional restrictions

You will not be able to use the telephone, or you may have to wait a while, in the following situations:

- If the telephone has not yet logged into the network.

The telephone automatically tries to log into a network. If no network is available, you will also not be able to make a “911” emergency call.

If you attempt to make an outgoing call, the “*No Service*” message will appear for a short while.

- If the mobile phone is not inserted in the cradle.
- SIM card is not inserted in GSM type phone

Switching telephone on or off

- ▶ **Switching on:** insert mobile phone into cradle when COMAND is switched on.

or

- ▶ Switch on the mobile phone (see mobile phone operating instructions).

- ▶ **Switching off:** Select “*Telephone*” → “*Telephone*” → “*Telephone OFF*”.

or

- ▶ Switch off mobile phone (see mobile phone operating instructions).

Activating telephone mode

- ▶ Select “Telephone” → “Telephone” → “Telephone”.

or



- ▶ Press  on telephone keypad.

Telephone keypad





- ① Telephone keypad
- ② Folding cover

With the telephone keypad you can:

- Enter and clear numbers and special characters
- Reject, accept, connect and end calls
- ▶ **Entering characters:** Select “Telephone” → “Telephone” → “Telephone”.
- ▶ Fold up cover ②.
- ▶ Enter characters using  - .

i You can enter the * character by pressing  once. Pressing this button again within 1.5 seconds enters the + character.

- ▶ **Deleting individual characters:**
Press .
- ▶ **Deleting an entire word or number:**
Press and hold  until the word or number is deleted.

“911” emergency call

Warning!



The “911” emergency call system is a public service. Using it without due cause is a criminal offense.

i This function places a call to the local 911 provider. It does not initiate a Tele Aid call.

The following conditions must be fulfilled in order to make a “911” emergency call:

- The phone is switched on
- A mobile network is available
- There is a valid SIM card in the phone (not necessary in all mobile networks)

i If no SIM card is inserted in the mobile phone, you can only initiate a “911” emergency call by using COMAND and the mobile phone.

If you cannot make an emergency call, you must initiate rescue measures yourself. The “911” emergency call is a public service. Any misuse is punishable by law.

COMAND telephone*

Placing a “911” emergency call before entering PIN / PIN2, PUK / PUK2 or unlock code

Entering the number using the COMAND controller

- ▶ Select “Telephone” → “Telephone” → “Telephone” → “Dial 911”.

Entering the number using the telephone keypad

- ▶ Enter digits 9-1-1 (▷ page 117).
- ▶ Press .

Placing a “911” emergency call after entering PIN / PIN2, PUK / PUK2 or unlock code

Entering the number using the COMAND controller

- ▶ Select “Telephone” → “Telephone” → “Telephone”.
- ▶ Select all the digits in sequence.
- ▶ Select “.

Entering the number using the telephone keypad

- ▶ Enter digits 9-1-1 (▷ page 117).
- ▶ Press .

Confirming the emergency call

After the digits have been entered, you will see the question “*Do you want to dial the 911 emergency number?*”.

- ▶ Use COMAND controller to select “Yes”.





The telephone makes the connection.

- ▶ Wait until the emergency call center answers and describe the emergency situation.



Entering the PIN

 *The PIN entry applies only to GSM mobile phones.*

Entering using the COMAND controller

- ▶ Select “Telephone” → “Telephone” → “Telephone”.
- ▶ **Entering:** Select all the digits in sequence.
- ▶ **Deleting a digit:** Select  and briefly press .
- ▶ **Deleting an entire number:** Select  and press and hold n until the number is deleted.
- ▶ **Confirming an entry:** Press .

Entering using the telephone keypad

- ▶ **Entering:** Enter digits (▷ page 117).
- ▶ **Confirming an entry:** Press  or press .

Entering the PIN2

 *The PIN2 entry applies only to GSM mobile phones.*

The phone may request the PIN2 in order to use certain functions. A corresponding message appears in the display.

- ▶ Enter PIN2 digits into mobile phone.

Entering the PUK/PUK2

 *The PUK/PUK2 entry applies only to GSM mobile phones.*

If you enter the PIN or PIN2 incorrectly three times, the SIM card will be locked. A corresponding message appears in the display. It is necessary to enter the PUK/PUK2 to unlock it. The PUK and/or PUK2 are provided by your telephone service provider.

- ▶ Enter PUK/PUK2 digits into mobile phone.

Entering the unlock code

Many mobile phones can be protected from unauthorized use with an unlock code (see mobile phone operating instructions). If you wish to use the phone functions when the unlock code is active, a screen appears requesting that you enter the unlock code. You cannot use the phone functions (except “911” emergency call) until you have entered the unlock code.

- ▶ Proceed in the same way as entering the PIN (▷ page 119).

COMAND telephone*

Telephone submenu overview

 *The components and operating principles of COMAND can be found on [page 79](#).*

Name (only when the mobile phone is inserted in the cradle)	Call lists (not during a call)	DTMF (only during a call)	Mic OFF/ON (only during a call)	Text message (not during a call)
Display COMAND phone book	Display call list selection: <ul style="list-style-type: none">• Calls received• Calls dialed	Send numerical sequence	Switch hands-free microphone on/off	Call up SMS inbox

Main telephone menu



► **Calling up main menu:** Select “Telephone” → “Telephone” → “Telephone”.

or

► Press  on the telephone keypad (▷ page 117).

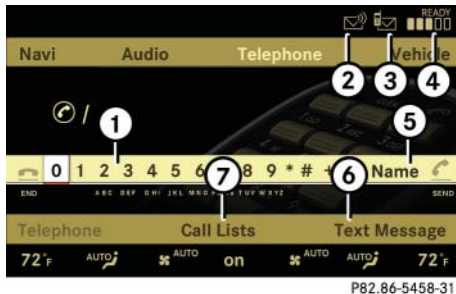
i If you press  when the main telephone menu has already been called up, the “Calls Dialed” list will appear (▷ page 122).



- ① Numbers / characters to enter telephone number
- ② Symbol  for new voice message in mailbox
- ③ Symbol  for unread SMS messages in SMS inbox (▷ page 137)
- ④ Signal strength and network status display
 - Network status “READY” = mobile phone is logged in with its own provider’s network
 - Network status “READY ROAM” = mobile phone is logged in with another provider’s network
 - Network status “No Service” = No network available
- ⑤ To show COMAND phone book (“Name”) (▷ page 129)
- ⑥ To call up text message (SMS) (▷ page 137)
- ⑦ To display call list selection (▷ page 122)

Mailbox

The  symbol in the example illustration above indicates that your mailbox contains new voice messages. You will have to call the mailbox in order to retrieve the messages.

You can call your mailbox by:

- Speed dialing (▷ page 126)
- Entering a telephone number using the telephone keypad (▷ page 125)
- Entering the telephone number using the COMAND controller (▷ page 125)

i Once connection with your mailbox has been established, the mailbox system will guide you through the next steps.

COMAND telephone*

Call lists

COMAND can display the following calls in separate lists:

- Calls received
- Calls dialed

i The list of incoming calls contains received calls as well as missed calls.

Calling up a list

- ▶ Select “Call List” from main telephone menu.
- ▶ Select “Calls Received” or “Calls Dialed”.

The corresponding list appears.

i The “Calls Received” and “Calls Dialed” menu items do not function if the respective list has no entries. The “Call List” menu item does not function if neither list has any entries.

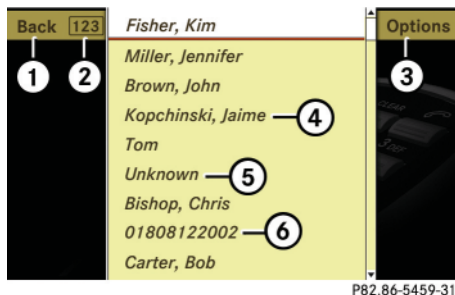

Illustration: list of incoming calls

- ① To close list
- ② To switch list display (“123” or “ABC”)
- ③ To call up options
- ④ Name or telephone number of a caller
- ⑤ Unknown caller
- ⑥ Telephone number of a caller

i In the list of calls received, you will see the name of caller ④ if

- the caller transmitted the telephone number
- the name and telephone number are saved in the COMAND address book or in the phone book on the mobile phone
- the telephone number is saved in the same way in which the caller transmits it

You will see the telephone number of caller ⑥ if

- the caller transmitted the telephone number
- no caller data is saved in either the COMAND address book or the phone book on the mobile phone

An unknown caller ⑤ has not transmitted his or her telephone number.

i In the list of dialed calls, you will see the name of the person called if you have saved his or her telephone number and name in the COMAND address book or in the phone book on the mobile phone. If no data has been saved, you will see the telephone number.

- ▶ **Switching to list display:** Select “123” or “ABC”.

The display changes to telephone number or name display.

- ▶ **Closing list:** Slide ←⊙→ and select “Back”.
- ▶ **Selecting a list entry:** Slide ↑⊙↓ or rotate ⌚ and select entry.

Displaying details of a list entry

COMAND can also show a shortened list entry in its entirety.

- ▶ Select list entry (▷ page 122).
- ▶ Slide ←⊙→ and select “Options” → “Details”.

The detailed view appears.

- ▶ **Closing detailed view:** Slide ↑⊙↓ or ←⊙→ or press ⏻.

Saving a list entry in the address book

i List entries that show a telephone number are neither saved in the COMAND address book, nor in the phone book on the mobile phone. You can save such entries in the COMAND address book. You can also save list entries in the COMAND address book which have already been saved in the phone book on the mobile phone.

Saving as a new entry in the COMAND address book

- ▶ Slide ←⊙→ or rotate ⌘⊙ and select list entry (▷ page 122).
- ▶ Select “Options” → “Save” → “New Entry”.

i “Save” does not function if the selected list entry is already saved in the COMAND address book.

- ▶ Select a number category, e.g. “Home”.
- ▶ Select a telephone category, e.g. “Land Line”.
- ▶ Select “Save”.

The input menu appears with the data fields. The data field for the telephone number is filled in automatically. The data field for the last name is also filled in automatically if the entry to be saved contains a name.

- ▶ **If you would like to save the entry now:** Select ok .



- ① Data field
- ② Input mark (cursor)
- ③ Input characters

- ▶ **If you want to change the available characters:** Proceed as described in the “Changing data field” paragraph in the “Assigning a New Entry in the Address Book” section (▷ page 133).

Adding to an existing entry in the COMAND address book

- ▶ Slide ←⊙→ or rotate ⌘⊙ and select list entry (▷ page 122).
- ▶ Select “Options” → “Save” → “Add”.

COMAND telephone*

i “Save” does not function if the selected list entry is already saved in the COMAND address book.

- ▶ Select a number category to add, e.g. “Home”.
- ▶ Select a telephone category to add, e.g. “Land Line”.
- ▶ Select “Save”.

The search menu for COMAND address book entries appears.

- ▶ Search for desired entry.

i There is a detailed description of searching for an COMAND address book entry in the “Searching for an address book entry” section (▷ page 204).

- ▶ Press  when you have finished searching.

COMAND saves the data if there are fewer than four numbers assigned to the entry you are searching for in the selected number category.

If four numbers are saved for the entry you are searching for, a prompt will appear asking whether you want to overwrite one of the existing numbers.

- ▶ Select “Yes” or “No”.

If you select “Yes”, a selection list will appear containing the four existing numbers.

- ▶ Select the number to be overwritten.

COMAND overwrites the selected number with the new data.

Incoming call

Rejecting or accepting the call

- ▶ **Rejecting:** Select “Reject”.

or

- ▶ Press  on the telephone keypad or on the multifunction steering wheel.

i If you have a CDMA/TDMA mobile phone and reject a call, only the ring tone will stop. The call itself can only be ended by the caller.

- ▶ **Accepting:** Select “Accept”.

or

- ▶ Press  on the telephone keypad or on the multifunction steering wheel.

or

- ▶ Press  on the multifunction steering wheel.

- ▶ Use the mobile phone (see mobile phone operating instructions).

or

- ▶ Use the Bluetooth headset (see headset operating instructions).

i The use of a Bluetooth headset requires Bluetooth to be activated and the Bluetooth headset to be authorized (▷ page 217).

If you have accepted the call using COMAND, the telephone keypad, the multifunction steering wheel or the mobile phone, the call will be conducted via the hands-free system. The volume of the call can be adjusted (▷ page 89).

If you have accepted the call using the Bluetooth headset, the call will be conducted via the headset.

Further operating functions can be found in the “Functions during a single-call connection” section (▷ page 127).

You can also accept a call if the COMAND display is showing a screen other than the telephone mode screen. After accepting the call, you will see the caller's data in a window.

- ▶ **Closing window:** Slide or or press .

Making an outgoing call

If you place an outgoing call and receive a busy signal, the telephone automatically starts to redial as long as the provider and the mobile phone support this function (see mobile phone operating instructions).

While the call is connecting, you can also send character strings (▷ page 127).

Entering the telephone number using the COMAND controller

- ▶ **Switching screen to telephone mode:** Call up main telephone menu (▷ page 121).
- ▶ **Entering digits:** Select desired digits by rotating or sliding and press .
- ▶ **Deleting individual digits:** Select and briefly press .
- ▶ **Deleting an entire telephone number:** Select and press and hold until the telephone number is deleted.
- ▶ **Connecting a call:** Select “”.

Entering a telephone number using the telephone keypad

- ▶ **Switching screen to telephone mode:** Call up main telephone menu (▷ page 121).
- ▶ Use telephone keypad to enter digits.

A detailed description of how to enter digits using the telephone keypad can be found on (▷ page 82).

- ▶ **Connecting a call:** Press .

Redial

- ▶ **Switching screen to telephone mode:** Call up main telephone menu (▷ page 121).
- ▶ Use COMAND controller to select “”.

or

- ▶ Press on the telephone keypad (▷ page 82).

The list of dialed numbers appears. The most recently dialed number is at the top.

- ▶ Select desired entry.
- ▶ **Connecting a call:** Press .

If the list of dialed calls contains no entries, the “” menu item cannot be selected and the button on the telephone keypad does not function.

COMAND telephone*

Placing a call to a call list entry or COMAND phone book entry

- ▶ Call up a call list and select an entry (▷ page 122).

or

- ▶ Call up COMAND phone book and select an entry (▷ page 129).
- ▶ **Connecting a call:** Press .

Speed dialing





You can save telephone numbers in the speed-dial preset locations on the mobile phone and call up the speed-dial presets (see mobile phone operating instructions).

 *By default, the mailbox number is preset in the speed dial memory unless you have modified it. For more information on the mailbox (▷ page 121).*

You can also call up speed-dial numbers using COMAND.

 *Operation during call connection depends on the speed-dial preset position called up.*

Calling up speed-dial presets using the COMAND controller

- ▶ **Switching screen to telephone mode:** Call up main telephone menu (▷ page 121).
- ▶ **Entering number of a speed-dial preset:** Select all the digits in sequence.
 - ▶ **Deleting individual digits:** Select  and briefly press .
 - ▶ **Deleting entire number:** Select  and press  until the number is deleted.
- ▶ **Connecting a call (speed-dial presets 1 -99):** Select ".



or

- ▶ **Connecting a call (speed-dial presets 100 - 999):** Select "#" after the digits → ".



In both cases, the telephone connects the call to the saved telephone number. If the speed-dial memory contains no telephone numbers, you will see a corresponding message.

- ▶ **Deleting message:** Press .





Calling up speed-dial numbers using the telephone keypad

- ▶ **Switching screen to telephone mode:** Call up main telephone menu (▷ page 121).
- ▶ **Single-digit numbers:** Press and hold  -  buttons.

or

- ▶ **Single- and two-digit numbers:** Enter number using the  -  buttons.
- ▶ Press .

or

- ▶ **Three-digit numbers:** Enter number using the  -  buttons.
- ▶ Press , and then .

In all three cases, COMAND connects the call to the saved telephone number. If the speed-dial memory contains no telephone numbers, you will see a corresponding message.

- ▶ **Deleting message:** Press .

Functions during a single-call connection



P82.86-5461-31

Illustration: telephone mode during a call

- ① Symbol  for active telephone connection (also visible in other operating modes)
- ② Signal strength display
- ③ To switch hands-free microphone on or off
- ④ Length of call display
- ⑤ To send character strings
- ⑥ To end a call
- ⑦ Person you are calling

i The name of the person you are speaking with can only be seen in display ⑦ if his or her telephone number and name have been saved in the COMAND address book or phone book on the mobile phone. The telephone number must also be saved in the same way in which the person you are talking to transmits it.

Switching the hands-free microphone on or off

- ▶ **Switching screen to telephone mode:** Call up main telephone menu (▷ page 121).

- ▶ **Switching off microphone:** Select “Mic OFF” and press .

or

- ▶ Press  shortcut button.

If the microphone is switched off, the  symbol appears in the main area.

- ▶ **Switching on microphone:** Select “Mic ON”.

or

- ▶ Press  shortcut button.

The  symbol disappears.

Sending a character string via DTMF

i This function is not possible with every mobile phone. If the mobile phone supports the function, you can use it during the call connection and also during a call.

Answering machines or other devices can be controlled by character strings (e.g. for remote query functions).

Sending character strings via the DTMF menu

- ▶ During a call, select “DTMF”.

The DTMF dialing display appears.

COMAND telephone*



P82.86-5462-31

- ① Back to the call display
- ② Character entry
- ③ To call up the phone book

▶ Sending individual characters:

Rotate or slide and select desired character.

Each character you select can be seen in the main area and is sent immediately.

▶ Sending a phone book entry as a character string: Select "Name".

- ▶ Select desired phone book entry.

The entry is immediately sent as a character string.

i Telephone numbers containing the + character may impair the function.

- ▶ **Switching back to the call display:** Select "".

Sending character strings via the telephone keypad

- ▶ Press corresponding button on telephone keypad.

Each character you select is immediately sent.

i The + character may impair the function.

Ending an active call

- ▶ **Ending a call:** Select " END" in the call display.

or

- ▶ Press on the telephone keypad or on the multifunction steering wheel.

Transferring a call

From the hands-free system to the Bluetooth headset

i The use of a Bluetooth headset requires Bluetooth to be activated and the Bluetooth headset to be authorized (▷ page 217).

The call transfer is controlled by pressing the PTT button on the Bluetooth headset (see headset operating instructions). Normally, it is sufficient to press the PTT button once, but under certain circumstances you may have to press it a second time.

Once the call has been transferred to the Bluetooth headset, all the functions will be available to you which are described in the "Functions during a single-call connection" section (▷ page 127).

Exception: "Switching the hands-free microphone on or off" function (▷ page 127).

From the Bluetooth headset to the hands-free system

On most Bluetooth headsets, you press the PTT button on the headset twice quickly to transfer the call (see headset operating instructions).

From the hands-free system to the mobile phone

- ▶ **If the mobile phone has a folding upper section:** flip upper section open.
- ▶ Take mobile phone out of cradle.
The “*No telephone inserted*” message appears on the COMAND display. Subsequent operation is only possible using the mobile phone.

From the mobile phone to the hands-free system

- ▶ Insert mobile phone into cradle.
Once the call has been transferred to the hands-free feature, all the functions will be available to you which are described in the “Functions during a single-call connection” section (▷ page 127).

COMAND phone book

The COMAND phone book contains both the COMAND address book entries and mobile phone entries that have at least one telephone number.

The COMAND address book entries are permanently available even when a mobile phone is not inserted in the cradle.

When the mobile phone is inserted in the cradle, COMAND will read the phone book entries in the mobile phone and compares them with the COMAND address book entries.

If any of the telephone numbers of a phone book entry in the mobile phone are the same as an address book entry, COMAND will only display the address book entry.

If the entries are not the same, the COMAND phone book will show the phone book entry in the mobile phone.

Calling up the COMAND phone book

- ▶ Select “*Telephone*” → “*Telephone*” → “*Telephone*” → “*Name*”.

The COMAND phone book appears. ▷▷

COMAND telephone*



Illustration: a phone book with name display and smart speller activated

- ① Category symbol
- ② Upper entry from address book (without category symbol)
- ③ Symbol for several telephone numbers (subentries) under the main entry
- ④ Symbol for summarized entries from the mobile phone with the same name but different telephone numbers
- ⑤ Smart speller
- ⑥ Voice entry symbol
- ⑦ To close the phone book

Entries with category symbol ① come from the mobile phone. The following category symbols are possible:

- = symbol for “Mobile” category
- = symbol for “Home” category
- = symbol for “Work” category
- = symbol for “Fax” category
- = symbol for “Pager” category
- = symbol for “Main” category or for unknown category or for phone entries that are saved on the SIM card of a GSM mobile phone

Entries without a category symbol or with the symbol come from the COMAND address book.

Entries with the symbol contain a voice entry. Voice entries can be added to the address book (▷ page 210). This function is available in vehicles with Voice Control*.

Switching between the smart speller and the list

- ▶ **Switching from the smart speller to the list:** Slide repeatedly or press until the smart speller is hidden.

or

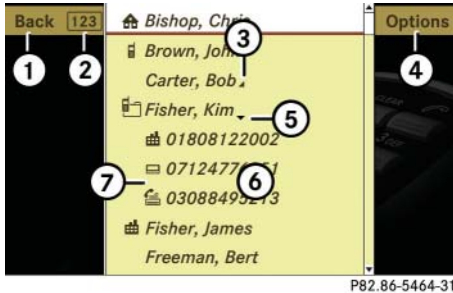

- ▶ Rotate or slide and select **ok**.

The smart speller is hidden.



P82.86-5464-31

Illustration: list of phone book entries with name display and hidden smart speller

- ① Back to smart speller
- ② To switch phone book display (“123” or “ABC”)
- ③ Symbol  for several telephone numbers (subentries) under the main entry, subentry list is closed
- ④ To call up options
- ⑤ Symbol  for open subentry list
- ⑥ List of phone book entries
- ⑦ Subentry list with category symbols and telephone numbers

i The following options are available under “Options” menu item ④:

- *Displaying details about an entry* (▷ page 132)
- *Creating a new entry in the address book* (▷ page 133)
- *Deleting an entry* (▷ page 134)
- *Saving a phone book entry from mobile phone in the address book* (▷ page 134)
- *Adding a telephone number to an address book entry* (▷ page 136)

▶ **Switching from the list to the smart speller:** Select “Back” from the list.

or

▶ Press back button  in the center console (▷ page 80).

▶ **Changing phone book display in the list:** Select “123” or “ABC”.

The screen changes to telephone number or name display.

Closing the COMAND phone book

- ▶ In the smart speller, select “Back”.
- or
- ▶ Press back button  in the center console (▷ page 80).

Selecting an entry in the COMAND phone book

Selecting entries using the smart speller

- ▶ Switch from the list to the smart speller if necessary.
- ▶ **Changing smart speller language:** Select .
- ▶ Select desired language. ▷▷



COMAND telephone*

▷▷ **Changing smart speller character set:**



Select .

Depending on the previous setting, you will change to letters with special characters or to numbers with special characters.

- ▶ **Entering characters:** Select the characters of the entry you are searching for one by one.



- ▶ **Deleting individual characters:** Select  and briefly press .

Each time you enter or delete a character, the closest match will be displayed at the top of the list.



- ▶ **Deleting an entire entry:** Select  and press and hold  until the entry is deleted.
- ▶ **Canceling search:** Switch from the smart speller to the list.



The entry at the top of the list is automatically highlighted.



Selecting using the list

- ▶ If necessary, switch from the smart speller to the list.
- ▶ Rotate  or slide   until the desired entry is highlighted.

Selecting subentries

- ▶ Select an entry with the  symbol and press .

The  symbol changes to  and the subentries are displayed.







- ▶ Rotate  or slide   until the desired subentry is highlighted.

Displaying details of an entry

COMAND can also show a shortened entry in its entirety. For entries featuring subentries, the detailed view is only available for the subentries and not for the main entry.

- ▶ Select entry (▷ page 131).
- ▶ Select “Options” → “Details”.

The detailed view appears.

- ▶ **Closing detailed view:** Slide   or   or press  or back button  in the center console (▷ page 80).

Starting to dial the number of an entry

- ▶ Select entry (▷ page 131).
- ▶ Press .

or

- ▶ Press  on the telephone keypad.

A list appears if the entry contains subentries.

- ▶ Select desired subentry.
- ▶ Press  again.

or

- ▶ Press  on the telephone keypad.

COMAND telephone*

▷▷▶ **Deleting individual characters:**

Select **[c]** and briefly press **⏏**.

The character to the left of the cursor is deleted.

▶ **Deleting an entire entry:** Select **[c]** and press and hold **⏏** until the entry is deleted.

▶ **Saving an entry:** Select **ok**.

▶ **Canceling an entry:** Select **“Back”**.

If one of the data fields contains data, a prompt will appear asking whether you want to save the entry.

- ▶ Select **“Yes”** or **“No”**.
- ▶ The entry will either be saved or not, depending on your selection.

Deleting an entry

i *It is not possible to delete a phone book entry from the mobile phone using the COMAND phone book.*

The deletion rules may vary, depending on the entry selected:

- Upper entry selected from the address book:
the entry is deleted from the COMAND phone book and also from the address book, if the address book entry only contains telephone numbers.
- Subentry of an address book entry selected:
the subentry is deleted from the COMAND phone book and from the address book.
- ▶ **Deleting:** Select entry (▷ page 131).
- ▶ Select **“Options”** → **“Delete”**.
A prompt appears asking whether the entry should be deleted.
- ▶ Select **“Yes”** or **“No”**.

Once **“Yes”** has been selected, the entry will be deleted according to the rules mentioned above.

Saving a phone book entry from the mobile phone in the address book







i *This function is used to save an existing phone book entry from the mobile phone in the address book. The following options are available:*

- *Saving as a new address book entry*
- *Adding a telephone number to an existing address book entry*

Saving as a new address book entry

- ▶ Select phone book entry from mobile phone (▷ page 131).

i *All entries with the following category symbols are phone book entries in the mobile phone.*

-  = symbol for **“Mobile”** category
-  = symbol for **“Home”** category
-  = symbol for **“Work”** category
-  = symbol for **“Fax”** category
-  = symbol for **“Pager”** category
-  = symbol for **“Main”** category

- ▶ Select **“Options”** → **“Save”** → **“New Entry”**.

- ▶ **Selecting a number category:**
Select a category, e.g. “Home”.
- ▶ **Selecting a telephone category:**
Select a category, e.g. “Land Line”.
- ▶ **Confirming selection:** Select “Save”.

The input menu appears with the data fields. The data field for the telephone number is filled in automatically. The data field for the last name is also filled when the entry to be saved contains a name.



P82.86-5466-31

- ① Data field
- ② Input mark (cursor)
- ③ Input characters

- ▶ Proceed as described in the “Changing data field” paragraph in the “Assigning a New Entry in the Address Book” section (▷ page 133).

Adding a telephone number to an existing address book entry

- ▶ Select phone book entry from mobile phone (▷ page 131).

i All entries with the following category symbols are phone book entries in the mobile phone.

- = symbol for “Mobile” category
 - = symbol for “Home” category
 - = symbol for “Work” category
 - = symbol for “Fax” category
 - = symbol for “Pager” category
 - = symbol for “Main” category
- ▶ Select “Options” → “Save” → “Add”.
 - ▶ **Selecting a number category:**
Select a category, e.g. “Home”.
 - ▶ **Selecting a telephone category:**
Select a category, e.g. “Land Line”.

- ▶ **Confirming selection:** Select “Save”.

The search menu for address book entries appears.

- ▶ Search for desired entry using smart speller function.

i There is a detailed description of how to search for an address book entry in the “Searching for an address book entry” section (▷ page 204).

- ▶ After selecting an entry, press .

If there are fewer than four numbers assigned to the selected entry in the selected number category, COMAND will save the data.

If four numbers are saved for the selected entry, a prompt will appear asking whether you want to overwrite one of the existing numbers.

- ▶ Select “Yes” or “No”.

If you select “Yes”, a selection list will appear containing the four existing numbers.



COMAND telephone*

- ▷▷ Select number to be overwritten.

COMAND overwrites the selected number with the new data.

Adding a telephone number to an address book entry

i *This function is used to add a telephone number to an existing address book entry. The telephone number can be entered manually.*

- ▶ Select address book entry
(▷ page 131).

i *All entries with the  symbol or without a symbol are address book entries.*

- ▶ Select “Options” → “Add Number”.

i *“Add Number” does not function if you have selected the main entry for an address book entry with subentries.*

- ▶ **Selecting a number category:**
Select a category, e.g. “Home”.
- ▶ **Selecting a telephone category:**
Select a category, e.g. “Land Line”.
- ▶ **Confirming selection:** Select “Save”.





If four numbers are saved for the entry in the selected number category, a prompt will appear asking whether one of the existing numbers should be overwritten.

- ▶ Select “Yes” or “No”.



If you select “Yes”, a selection list will appear containing the four existing numbers.

- ▶ Select number to be overwritten.

The input menu appears with the data field for entering the new telephone number.

- ▶ **Entering digits:** Select all digits one by one from the input characters.
- ▶ **Moving cursor in the data field:**
Select  or .
- ▶ **Deleting individual digits:** Select  and briefly press .

The digit to the left of the cursor is deleted.

- ▶ **Deleting an entire number:**
Select  and press and hold  until the number is deleted.
- ▶ **Saving entry:** Select **ok** .
- ▶ **Canceling an entry:** Select “Back”.

If you have already entered data, a prompt will appear asking whether the entry should be saved.

- ▶ Select “Yes” or “No”.

The entry will either be saved or not, depending on your selection.

SMS messages (Short Message Service)

SMS functions

The following functions are available:

- Receive
- Read

The following conditions must be fulfilled in order to use the functions:

- The mobile phone is inserted in the cradle and switched on
- The PIN has been entered (only GSM mobile phones)
- The mobile phone is logged into a mobile network
- Mobile phone phone book must be downloaded and available in COMAND

Inbox

Calling up the SMS inbox

- ▶ Select “Telephone” → “Telephone”.

The main telephone menu appears.



- ① Symbol  for unread messages in the SMS inbox

i The  symbol only appears for those messages which are received while the mobile phone is inserted in the cradle.

- ▶ Select “Text Message”.

The SMS inbox appears.

i “Text Message” does not function if the SMS inbox contains no SMS messages. The SMS inbox only shows the messages which are received while the mobile phone is inserted in the cradle.



- ① Date and time the highlighted SMS message was received
- ② To call up options
- ③ Highlighted SMS message
- ④ Symbol  for unread SMS message
- ⑤ Back to main telephone menu

COMAND telephone*

i The SMS messages are sorted by the date and time they were received. The most recent message is at the top of the list. If the name and telephone number of the sender is saved in the address book or phone book of the mobile phone, you will see the name of the sender in the SMS inbox. Otherwise, you will see the telephone number of the sender.

Selecting an SMS message

- ▶ Rotate or slide and then press .

Showing abbreviated sender display in full

- ▶ Select SMS message → “Options” → “Details”.

The detailed view appears.

- ▶ **Closing detailed view:** Slide or press .

Calling an SMS sender

- ▶ Select SMS message → “Options” → “Call”.

The telephone connects the call.

Saving SMS sender as new COMAND address book entry

- ▶ **Selecting an SMS message:** in the SMS inbox, select a message → “Options” → “Save Number” → “New Entry”.
- ▶ **Selecting a number category:** Select a category, e.g. “Home”.
- ▶ **Selecting a telephone category:** Select a category, e.g. “Land Line”.
- ▶ **Saving:** Select “Save”.

The input menu appears with the data fields. The data field for the telephone number is filled in automatically.



P82.86-5469-31

- ① Data field
 - ② Input mark (cursor)
 - ③ Input characters
- ▶ Proceed as described in the “Changing data field” paragraph in the “Assigning a New Entry in the Address Book” section (▶ page 133).

Adding an SMS sender's telephone number to an existing address book entry

- ▶ **Selecting an SMS message:** in the SMS inbox, select a message → “Options” → “Save Number” → “Add”.

- ▶ Proceed as described in the “Selecting a number category” paragraph in the “Adding a telephone number to an existing address book entry” section (▷ page 135).

Exiting the SMS inbox

- ▶ Select “Back”.

The main telephone menu appears.

Reading an SMS message

- ▶ In the SMS inbox, select an SMS message and press .

The SMS message appears.

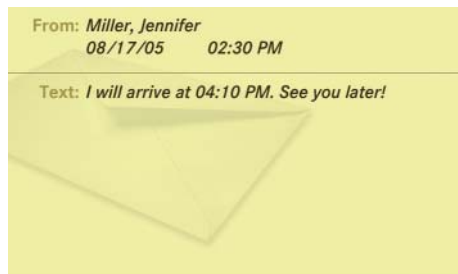

P82.86-5470-31

Using data in a text message

 If the SMS message contains telephone numbers or navigable address data, you can select this data and place a telephone call or transfer the address data to the navigation system.

▶ Selecting data from the text:

Rotate  or slide .

▶ Using data: Press → “Use”.

If you have selected a telephone number, the telephone connects the call.
If you have selected a navigable address, it is transferred to the navigation system.

Calling an SMS sender

- ▶ Press  → “Call”.

The telephone connects the call.

 This function is not possible with all SMS senders.

Saving SMS sender as new address book entry

 This function is not possible with all SMS senders.

- ▶ Press  → “Save Number” → “New Entry”.

- ▶ Proceed as described in the “Selecting a number category” paragraph in the “Saving SMS sender as new address book entry” section (▷ page 138).

Adding an SMS sender’s telephone number to an existing address book entry

- ▶ Press  → “Save Number” → “Add”.

- ▶ Proceed as described in the “Selecting a number category” paragraph in the “Adding a telephone number to an existing address book entry” section (▷ page 135).

Closing an SMS message and returning to SMS inbox

- ▶ Press  → “Back”.

COMAND navigation (introduction)

Safety precautions

Warning!



For safety reasons, only enter a destination when the vehicle is stationary. When the vehicle is in motion, a passenger should enter the destination. Study manual and select route before driving.

Bear in mind that at a speed of just 30 mph (approximately 50 km/h), your vehicle is covering a distance of 44 feet (approximately 14 m) every second.

COMAND calculates the route to the destination without taking account of the following, for example:

- Traffic lights
- Stop and right-of-way signs
- Parking or stopping prohibited areas
- Lane merging
- Other road and traffic rules and regulations
- Narrow bridges

COMAND may give incorrect navigation commands if the data in the digital map does not correspond with the actual road/traffic situation. DVD maps do not cover all areas nor all routes within an area. For example, if the traffic routing has been changed or the direction of a one-way road has been reversed.

For this reason, you must always observe applicable road and traffic rules and regulations during your journey. Road and traffic rules and regulations always have priority over the navigation commands generated by the system.

Warning!



Navigation announcements are intended to direct you while driving without diverting your attention from the road and driving.

Please always use this feature instead of consulting the map display for directions. Consulting the symbols or map display for directions may cause you to divert your attention from driving and increase your risk of an accident.

Map software

The digital maps generated by the map software become outdated in the same way as conventional road maps. Optimum route guidance can only be provided by the navigation system in conjunction with the most up-to-date map software. Information about new map software versions can be obtained from an authorized Mercedes-Benz Center.

Updating the map software

You can update the map software yourself using a DVD.

Notes about handling DVDs

- Only hold discs by the edge.
- Handle discs carefully to prevent read problems.
- Avoid getting scratches, fingerprints and dust on discs.
- Use a commercially-available cleaning cloth to clean discs. Do not wipe them with a circular motion, but only in straight lines from the center outwards.
- Place discs back in their boxes after use.
- Protect discs from heat and direct sunlight.

Updating process

The updating process has the following phases:

- Loading a DVD into the DVD changer (▷ page 142)
- Updating process (▷ page 142)

i *The updating process can take between 10 and 60 minutes, depending on the size of the map software. If the radio was switched on before you started the updating process, you can still adjust the volume. You can also use COMAND to operate the automatic air conditioning and to cancel the process. Other functions are not operational. If possible, carry out the update when the vehicle is stationary.*

i *If you carry out the update with the engine switched off and the vehicle battery has insufficient power, COMAND may automatically switch off during the process in order to protect the battery. If this occurs, restart the update with the engine running period. Similarly, if the SmartKey position is unintentionally switched to 0, restart the update.*

Warning!



Never leave the engine running in an enclosed space. The exhaust gases contain carbon monoxide. Inhaling exhaust gases constitutes a health hazard and could lead to loss of consciousness or even death.

COMAND navigation (introduction)

Loading a DVD into the DVD changer



- ① Disc slot
- ② Magazine tray buttons 1 – 6

i Each magazine tray button ② indicates the status of the corresponding magazine tray by means of an LED.

- LED off = magazine tray is empty
 - LED constantly lit = magazine tray is loaded
 - LED flashes = CD/DVD changer requesting disc to be loaded
- ▶ Switch on COMAND (▷ page 79).

- ▶ Press one of the magazine tray buttons ②.
If a disc is loaded, it will be ejected.
- ▶ Take disc out of slot ①.
- ▶ Wait until LED for magazine button ② which you pressed flashes quickly.
- ▶ Slide DVD into slot ① with printed side facing upwards.
COMAND loads the DVD.

Updating

After you have loaded the DVD, you will see a message to the effect that the disc does not contain a recognizable audio format.

- ▶ **Confirming message:** Press .
- COMAND checks whether the map software on the DVD is compatible with the vehicle's navigation system and whether it is compatible with the current system software.

Map software is compatible with the navigation system and the current system software

COMAND now checks whether the map data on the DVD is already installed.

Map data is not yet installed

You will see a comparison of the version statuses in the display and a prompt will appear asking whether you want to continue with the update.

- ▶ Select “Yes” or “No”.

If you select “No”, COMAND automatically ejects the DVD and the map data is not updated.

- ▶ Take DVD out of the slot.

If you select “Yes”, the map data is updated.

COMAND navigation (introduction)

Map data is already installed

You will see a message that the map data is already installed and a prompt will appear asking you whether you want to continue with the update.

- ▶ Select “Yes” or “No”.

If you select “No”, COMAND automatically ejects the DVD and the map data is not updated.

- ▶ Take DVD out of slot.

If you select “Yes”, the existing map data is saved again.

Updating the map data

While the update is running, you will see a message to this effect and a progress bar. The progress bars fills up from left to right during the update.



- ① Progress bar

You can either cancel the update or allow it to run to the end without canceling.

- ▶ **Canceling an update on the single DVD drive:** Press eject button ②.
- ▶ **Canceling an update on the DVD changer:** Press corresponding magazine tray button ②.

The DVD will be ejected in both cases.

- ▶ Take DVD out of slot.

i If the update is canceled, the navigation system remains fully operational with the previous map data. You can restart the update at a later date. It will then continue from the point where it was canceled.

- ▶ **To allow the update to run to the end without canceling:** take no further action.

If the update is successfully completed, you will see a message to this effect.

- ▶ **Confirming message:** Press .

COMAND ejects the DVD.

- ▶ Take DVD out of slot.

The update is complete.

If the update is not successfully completed, you will see a message that the map update is not possible.

- ▶ **Confirming message:** Press .

COMAND ejects the DVD.

- ▶ Take DVD out of slot.

COMAND navigation (introduction)

i *The navigation system remains fully operational with the previous map data.*

The update may not be successfully completed for the following reasons:

- ▶ DVD dirty or scratched
 - ▶ Clean DVD.
See the “Notes about handling DVDs” section (▷ page 141).
 - ▶ Restart update.
- Overheating due to excessive temperatures in the vehicle interior
 - ▶ Wait until vehicle interior has cooled down.
 - ▶ Restart update.
- The storage medium (hard disk) integrated in COMAND is defective.
 - ▶ Consult an authorized Mercedes-Benz Center.

Map software is not compatible with the navigation system

You will see a message that the update is not possible.

- ▶ **Confirming message:** Press .
COMAND ejects the DVD.
- ▶ Take DVD out of slot.
- ▶ Load a DVD which is compatible with the vehicle’s navigation system.

Map software is not compatible with the current system software

You will see a message that the system software and the map software are not compatible.

- ▶ **Confirming message:** Press .
COMAND ejects the DVD.
- ▶ Take DVD out of slot.
- ▶ Have the system software updated at an authorized Mercedes-Benz Center.

i *The map software cannot be updated until the system software has been updated.*

General notes

Operational readiness of the navigation system following a system software update by an authorized Mercedes-Benz Center

After a system software update by an authorized Mercedes-Benz Center, the installed map software may no longer be compatible. If this is the case, the navigation system will not be operational.

You will know if this is the case, when the following message will appear when you switch to navigation mode: *“The system software has been updated. The map software must be updated now. Please insert the DVD with the map software.”*

- ▶ **Updating map software:** Proceed as described in the “Updating the map software” section (▷ page 141). Use map software which is compatible with the system software.

i Please note that the update must be allowed to run to the end in this case. If you interrupt it, the navigation system will continue to be non-operational.

Initial use or use following a system software update

In both these cases, the navigation system must determine the position of the vehicle. You may have to drive for a while before precise route guidance is possible.

GPS reception

Correct functioning of the navigation system depends on GPS reception, among other things. In certain situations, GPS reception may be impaired, there may be interference or there may be no reception at all, e.g. in tunnels, in multistory parking garage or due to snow on the GPS antenna. If there is snow on the GPS antenna, you should remove it. The GPS antenna is at the back of the vehicle roof.

Route guidance after vehicle transportation

COMAND has to redetermine the position of the vehicle if the vehicle has been transported (e.g. by ferry, by train or after towing).

Positioning takes place automatically even when COMAND is switched off. The duration varies from one case to another.

Route guidance may be restricted as follows during vehicle positioning:

- Navigation announcements, route guidance displays and displayed street names are not consistent with the actual location of the vehicle.
- COMAND does not generate navigation announcements.
- Instead of the route guidance displays, you see the “Off Road” display and a direction arrow. The direction arrow shows the compass heading to the destination.

When positioning is complete, route guidance is once again possible using navigation announcements and route guidance displays.

Interrupting the journey during route guidance

The following applies if you interrupt the journey during route guidance and continue the journey later:

- COMAND resumes route guidance automatically if you continue the journey within 2 hours.
- Route guidance is canceled if you continue the journey after more than 2 hours. It will be necessary to resume the canceled route guidance manually (> page 192).

i The journey is interrupted if you park the vehicle and switch off COMAND. The journey is continued when you switch COMAND back on and start driving on.

COMAND navigation (introduction)

Hard disk errors

COMAND has an integrated hard disk on which the map software is saved.

If an area of the hard disk has an error, COMAND can no longer access the map data in this area, for example, when calculating a route.

The message *“Navigation Unavailable. Please refer to the operating instructions.”* appears.

- ▶ **Deleting message:** Switch COMAND off and back on.

i *If you switch the navigation system off/on, it will be operational again until it has to access the faulty area of the hard disk again. The message will then appear again. Consult an authorized Mercedes-Benz Center.*

Units of measurement

The units of measurement in navigation mode are identical to those set in the instrument cluster.

Input restrictions

The input restrictions are imposed starting at a particular vehicle speed. The restrictions are canceled as soon as the speed drops below a certain value.

When the restriction is active, certain operations or entries are not possible.

You will notice this by the fact that some menu items cannot be selected or certain operations will not be possible.

Navigation system menu overview

 The components and operating principles of COMAND can be found on [page 79](#).

Guide	Route (only with route guidance active)	Position	 (only with route guidance active)	Destination
Select a special destination from the current map view	<ul style="list-style-type: none"> • Call up route info • Call up route browser • Call up the detour function 	<ul style="list-style-type: none"> • Call up the save position memory function • Center the map on the vehicle's position • Center the map on the destination position 	Repeat the current navigation announcement	Select: <ul style="list-style-type: none"> • a destination • stopover • save destination • cancel route guidance

COMAND navigation (introduction)

Calling up the map display and switching to navigation mode

- ▶ Press the **TEL NAVI** shortcut button once or twice.

i The number of times you have to press the **TEL NAVI** shortcut button depends on the operating mode currently selected.

or

- ▶ In the main menu line, select “Navi”.

Both of these will call up the map display. You will see the map with the menu system either shown or hidden.

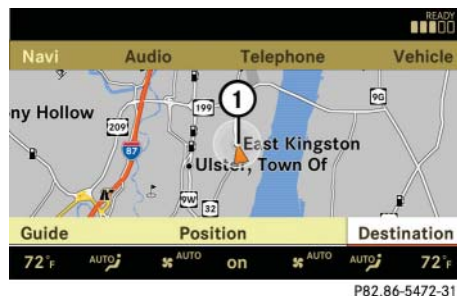

Illustration: map with route guidance inactive and with the menu system shown

- ① Current vehicle position



Illustration: map with route guidance inactive and with the menu system hidden (full screen mode)

- ① Current vehicle position
- ② Set map orientation (▷ page 150)
- ③ Map scale selected (▷ page 149)

Hiding or showing the menu system

- ▶ **Hiding:** Slide **↑**

The “Full Screen” menu item appears in the main area of the display; it is automatically selected.

- ▶ Press

The menu system is hidden. The map can be seen in the full screen.

COMAND navigation (introduction)

- ▶ **Showing:** Press  in the full-screen map display.



Adjusting the map scale

 It is only possible to adjust the map scale with the menu system hidden (full-screen map display).

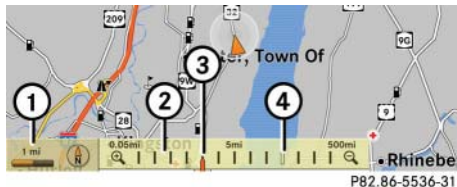
- ▶ Rotate  until the desired map scale is set.



- 1 Currently set map scale as number
- 2 Scale
- 3 Currently set map scale as a needle on the scale
- 4 Previously set value before calling up the scale

As soon as you rotate , scale  appears. Rotating clockwise zooms in, rotating counterclockwise zooms out.

Saving current vehicle position as destination in last destinations list

- ▶ **Showing menu system, if necessary:** Press .
- ▶ **Saving:** Select “Position” → “Save Position”.

COMAND saves the current vehicle position as a destination in the last destinations (▷ page 201).

Moving the map



 It is only possible to move the map with the menu system hidden.

- ▶ Slide , , ,  or .

A crosshair appears on the map.



- 1 Crosshair
- 2 Details of the crosshair position
- 3 Map scale

 Display  may be the name of a road, for example, provided the digital map contains the necessary data.

If no data is available, display  shows:

- the coordinates of the crosshair if the geo-coordinate display is switched on (▷ page 151) and the GPS signal is strong enough
- no display if the geo-coordinate display is switched off (▷ page 151)

COMAND navigation (introduction)

Adjusting the map scale

- ▶ Rotate .

Rotating clockwise zooms in, rotating counterclockwise zooms out.

Saving crosshair position as destination in last destinations list

- ▶ **Showing menu system, if necessary:** Press .
- ▶ **Saving:** Select “Position” → “Save Position”.

COMAND saves the crosshair position as a destination in the last destinations list (▷ page 201).

Hiding the crosshair

- ▶ Press back button  in the center console (▷ page 80).

The crosshair disappears and the map is centered on the vehicle position.

or

- ▶ Set the map to the vehicle or destination position, see the explanation below.

Centering the map on the vehicle or destination position

 *If you have moved the map, you can use this function to rapidly return the map to the position of the vehicle or destination. It is only possible to center the map on the destination position when route guidance is active.*

- ▶ **Centering on the vehicle’s position:** Select “Navi” → “Position” → “Vehicle Position Map”.

or

- ▶ Press  when the crosshair is displayed.
- ▶ **Centering on the destination:** Select “Navi” → “Position” → “Destination Position Map”.

Basic settings



 *You can make the following settings regardless of whether route guidance is active or inactive.*

Map orientation



- ① Current map orientation

The following may be displayed:

-  = “Heading Up” (the map is displayed so that the direction of travel is always up; the orange point of the icon points north)
-  = “North Up” (the map view is displayed so that north is always up)

COMAND navigation (introduction)

▶ **Setting map orientation:**

Select “Navi” → “Navi” → “Map Display”.

The map display list appears. A dot • indicates the current setting.

▶ Select “North Up” or “Heading Up”.

▶ **Exiting menu:** Slide ←⊙→.

The map orientation changes accordingly.

Setting POI symbols

You can set which points of interest (POIs) should be displayed as symbols in the map. POIs are garages, hotels, movie theaters or restaurants, for example.

i Depending on the map scale on the map, POI symbols may not be visible on the map although their display is activated. In addition, POI symbols may be covered by the map's labels.

The following settings are possible:

- “Standard symbols” (symbol determined by the factory settings)

- “Personal symbols” (you can determine the symbols yourself)

- “No symbols”

▶ **Adjusting:** Select “Navi” → “Navi” → “Map Display”.

The map display list appears. A dot • indicates the current setting.

▶ Select “Standard symbols”, “Personal symbols” or “No symbols”.

If you select “Personal symbols”, the list of POIs appears.

▶ **Switching POI symbol display on or off:** Select the desired POI.

The corresponding symbol displays are switched on or off, depending on the previous status. A checkmark indicates which status is active. You can switch on the symbol displays for more than one POI.

i The list shows all symbols that are contained in the digital map across all states (USA) and/or provinces (CDN). Not all POIs in all states (USA) or in all provinces (CDN) are available, however. Certain POI symbols may not be displayed on the map, even if the symbol display is switched on.

▶ **Exiting menu:** Slide ←⊙→ or press back button  in the center console (▷ page 80).**Geo-coordinate display****Illustration: map with geo-coordinate display switched on**

- ① Current height above sea level
- ② Number of GPS satellites from which signals for positioning can be received
- ③ Coordinate display

COMAND navigation (introduction)

i There must be sufficient GPS reception for displays ①, ② and ③ to be shown. Height display ① is an approximation because the navigation system uses the GPS signals for the calculation.

Display options with geo-coordinate display switched on

If the crosshair is displayed on the map view (map was moved manually), only display ③ is visible.

It shows either the coordinates of the crosshair or other data on the crosshair position, e.g. a street name. The digital map must contain relevant data in order for this other data to be displayed.

i If there is no crosshair on the map view, displays ①, ② and ③ are visible. Display ③ shows the coordinates of the current vehicle position.

Switching the geo-coordinate display on or off

▶ Select “Navi” → “Navi” → “Map Display”.

The map display list appears.

▶ Select “Coordinates”.

The geo-coordinate display is switched on or off, depending on the previous status. A checkmark indicates which status is active.

▶ **Exiting menu:** Slide ←⊙→ or press back button  in the center console (▷ page 80).

Setting route mode

i This function allows you to set the following options for route guidance:

- “Minimize Highways”
 - “Minimize Toll Roads”
 - “Minimize Tunnels”
 - “Minimize Ferries/Motorail”
- ▶ Select “Navi” → “Navi” → “Mode”.

The mode list appears.

▶ **Switching mode on or off:**

Select desired modes.

Depending on the previous status, the mode is switched on or off. A checkmark indicates that the mode is switched on. It is possible to switch on more than one mode.

▶ **Exiting menu:** Slide ←⊙→ or press back button  in the center console (▷ page 80).

COMAND will verify whether it can incorporate the modes if you select them with route guidance active.

If it can, COMAND calculates a new route while incorporating the modes selected.

If it cannot, you will see and hear a corresponding message.

▶ Select “OK”.

COMAND calculates a new route. Only those modes which can be incorporated are used.

COMAND navigation system (entering a destination)

▼ COMAND navigation system (entering a destination)

Warning!

For safety reasons, only enter a new destination when the vehicle is stationary.

i It is possible to enter a destination regardless of whether route guidance is active or inactive.

The following destination entry options are available:

- Entering a destination by address
- Entering a destination from the destination memory
- Entering a destination from the list of last destinations
- Entering a destination from the map
- Entering a stopover
- Entering a POI

Entering a destination by address

i It is not possible to enter an address when the vehicle has exceeded a certain speed. As soon as the vehicle speed drops below a certain value, the function is available again.

i If Russian or Chinese is set as the system language, the address must be entered using Latin letters. Setting the system language (> page 216).

To enter an address you may proceed as follows:

- Enter state (USA) or province (CDN), street and town/city
- Enter state (USA) or province (CDN), town/city and street
- Enter state (USA) or province (CDN), town/city and center
- Enter state (USA) or province (CDN), zip code and center
- Enter state (USA) or province (CDN), zip code and street

i As additional information to the street entry, you can enter either a house number or an intersection.

A zip code entry replaces the town/city entry.

Calling up the address input menu

- ▶ Select “Navi” → “Destination” → “Address Entry”.

The address input menu appears. It shows a state (USA) or a province (CDN). Which state or province is shown depends on the vehicle’s location.

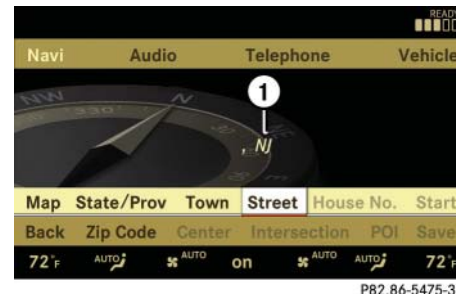

- ① State (USA) or province (CDN)

COMAND navigation system (entering a destination)

Menu items in the address input menu

Some menu items will not or not yet be available, depending on the sequence in which you enter the address and the data version.

Example: If you have not made any entries, menu items “House No.,” “Center,” “Intersection,” “POI,” “Start” and “Save” will not yet be available. And the “Zip Code” menu item will not be available if the digital map does not contain any zip codes.

Entering a state (USA)

i You can only enter those states which are saved on the digital map.

- ▶ In the address input menu, select “State/Prov” → “States (U.S.)”.

A list of states appears with input characters; the input characters are automatically activated.

List of states with input characters



- ① Top list entry based on the input data up to that point
- ② Characters entered by the user
- ③ Characters automatically added by the system
- ④ Clear last character entry
- ⑤ Currently selectable characters
- ⑥ Currently non-selectable characters
- ⑦ Input characters
- ⑧ List of states
- ⑨ Currently selected characters

i In the list of input characters (7), you can only select currently selectable characters. Which characters are included depends on the sequence in which you have entered your destination and the data version of the digital map.

While the numbers are being selected as described below, the top list entry (1) always shows the state which best corresponds to the input data as it has been entered up to that point.

At the same time, COMAND automatically supplements characters (2) entered by the user with other likely input characters (3).

- ▶ **Selecting characters:** Slide ←⊙→ or rotate ⏪⏩.
- ▶ **Confirming character selection:** Press ⊙.
- ▶ **Deleting individual characters:** Select [c] in the bottom line and press ⊙.
- ▶ **Deleting an entire entry:** Select [c] in the bottom line and press ⊙ until the entire entry is deleted.

COMAND navigation system (entering a destination)



- ▶ **Canceling an entry:** Select “Back” in the bottom line and press .

or

- ▶ Press back button  in the center console (▷ page 80).

As soon as COMAND can clearly attribute the characters entered to a state, the input characters  disappear automatically. You see the list of states without the input characters. Here you can confirm the current entry or make another selection.









During character entry, you can also manually switch to the list of states without input characters at any time.

- ▶ **Switching manually to list of states without input characters:** Slide  .

or

- ▶ Select **ok** in the second line from the bottom and press .

List of states without input characters

- ▶ **Selecting a state:** Slide   or rotate .
- ▶ **Canceling selection:** Select “Back” by sliding   and press .
- ▶ Press back button  in the center console (▷ page 80).
- ▶ **Confirming selection:** Press .

The address input menu appears again. It shows the abbreviation for the selected state.

The following menu items are now available:

- “Map”: Entering a destination from the map (▷ page 174)
- “State/Prov”: re-enter state (USA) or province (CDN)
- “Town”: Entering a town or city (▷ page 159)
- “Street”: Entering a street (▷ page 161)
- “Zip Code”: Entering the zip code (▷ page 157)

 *It is not possible to enter zip codes if the digital map does not contain any zip codes for the selected state.*

- ▶ **Continuing destination entry:** Select one of the menu items mentioned above.

COMAND navigation system (entering a destination)

Entering a province (Canada)

- ▶ In the address input menu, select “State/Prov” → “Provinces (Canada)”.

A list of provinces appears.

- ▶ Select desired province.

The address input menu appears again. It shows the abbreviation for the selected province.

The following menu items are now available:

- “Map”: Entering a destination from the map (▷ page 174)
- “State/Prov”: re-enter state (USA) or province (CDN)
- “Town”: Entering a town or city (▷ page 159)
- “Street”: Entering a street (▷ page 161)
- “Zip Code”: Entering the zip code (▷ page 157)

i *It is not possible to enter a zip code if the digital map does not contain any zip codes for the selected province (CDN).*

- ▶ **Continuing destination entry:**
Select one of the menu items mentioned above.

Quick access to most recently entered states (USA) or provinces (CDN)

- ▶ In the address input menu “State/Prov” → “Last States/Provinces”.

The list of most recently entered states (USA) or provinces (CDN) appears. The last entry is at the top of the list.

- ▶ Select desired state (USA) or desired province (CDN).

The address input menu appears again. It shows the abbreviation for the selected state (USA) or province (CDN).

The following menu items are now available:

- “Map”: Entering a destination from the map (▷ page 174)
- “State/Prov”: re-enter state (USA) or province (CDN)
- “Town”: Entering a town or city (▷ page 159)
- “Street”: Entering a street (▷ page 161)
- “Zip Code”: Entering the zip code (▷ page 157)

i *It is not possible to enter a zip code if the digital map does not contain any zip codes for the selected state (USA) or province (CDN).*

- ▶ **Continuing destination entry:**
Select one of the menu items mentioned above.

COMAND navigation system (entering a destination)

Entering the zip code

i It is not possible to enter a zip code if you have already entered other address data aside from the state (USA) or province (CDN).

You can only enter those zip codes which are saved on the digital map.

The available zip codes depend on the state (USA) or province (CDN) most recently entered.

- ▶ In the address input menu, select “Zip Code”. A list of zip codes appears with input characters; the input characters ④ are automatically activated.

List of zip codes with input characters

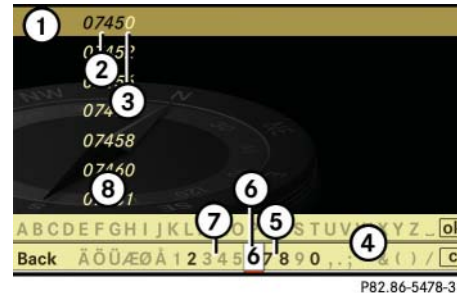

- ① Top list entry based on the input data up to that point
- ② Numbers entered by the user
- ③ Numbers automatically added by the system
- ④ Input characters
- ⑤ Currently selectable numbers
- ⑥ Currently selected numbers
- ⑦ Currently non-selectable numbers
- ⑧ List of zip codes

i In the list of input characters ④, you can only select numbers which can be currently entered. Which characters are included depends on the sequence in which you have entered your destination and the data version of the digital map.

While the numbers are being selected as described below, the top list entry ① always shows the zip code which best corresponds to the input data as it has been entered up to that point.

At the same time, COMAND automatically supplements numbers ② entered by the user with other likely numbers ③.

▶ **Selecting numbers:** Slide $\leftarrow \odot \rightarrow$ or rotate $\{\odot\}$.

▶ **Confirming number selection:** Press \odot .

▶ **Deleting individual numbers:** Select \square in the bottom line and press \odot .

▶ **Deleting an entire entry:** Select \square in the bottom line and press \odot until the entire entry is deleted.



COMAND navigation system (entering a destination)

▷▷▶ **Canceling an entry:** Select “Back” in the bottom line and press .

or

▶ Press back button  in the center console (▷ page 80).

As soon as COMAND can clearly attribute the numbers entered to a zip code, input characters ④ disappear. You see the list of zip codes without the input characters. Here you can confirm the current entry or make another selection.

During character entry, you can also manually switch to the list of zip codes without input characters at any time.

▶ **Switching manually to list of zip codes without input characters:**

Slide  .

or

▶ Select **ok** in the second line from the bottom and press .

List of zip codes without input characters

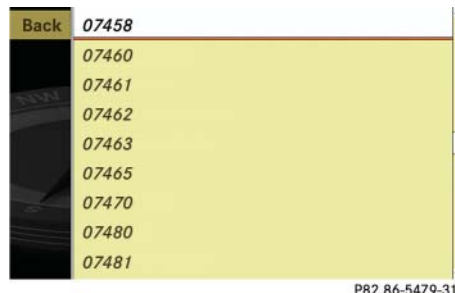

▶ **Selecting a zip code:** Slide   or rotate .

▶ **Canceling selection:** Select “Back” and press .

or

▶ Press back button  in the center console (▷ page 80).

▶ **Confirming selection:** Press .

You will see the address input menu again.

It shows one of the following items of information:

- Street and if necessary, house number, town/city, state (USA) or province (CDN)
- Town/city, state (USA) or province (CDN) and zip code
- State (USA) or province (CDN) and zip code

 *The street and, if necessary, the house number, will then appear as soon as COMAND can attribute the zip code to an appropriate address.*

Which of the following menu items are now available depends on the situation, or may depend on the data version of the digital map. The menu items which are not available cannot be selected.

- “Map”: using the map to enter a destination (▷ page 174)

 *In this case, using the map for destination entry is based on the town or city seen in the address input menu.*

COMAND navigation system (entering a destination)

- “Street”: entering a street (▷ page 161)
- “Center”: entering a center (▷ page 164)
- “POI”: entering a point of interest (▷ page 177)

i In this case, entering a POI is based on the town or city seen in the address input menu.

- “Save”: saving a destination in the destination memory (▷ page 195)
- “Start”: starting the route calculation (▷ page 171)

► **Continuing or completing destination entry:** Select one of the menu items mentioned above.

Entering a town or city

i You can only enter those towns or cities which are saved on the digital map. It is not possible to enter a town or city when you have already entered a street which COMAND can clearly attribute to a town or city. If COMAND cannot clearly attribute a previously entered street to a town/city, only those towns or cities are available which have a street of that name. If you have not yet entered a street before entering the town or city, towns or cities within the state (USA) or province (CDN) previously entered are available.

► In the address input menu, select “Town”.

The list of towns/cities appears either with or without the input characters (▷ page 160). Whether or not the input characters appear depends on how many towns or cities are available for the desired state (USA) or province (CDN).

List of towns or cities with input characters

When this list appears, the input characters ④ are automatically activated.

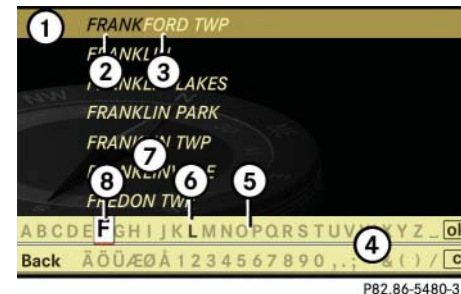

- ① Top list entry based on the input data up to that point
- ② Characters entered by the user
- ③ Characters automatically added by the system
- ④ Input characters
- ⑤ Currently non-selectable characters
- ⑥ Currently selectable character
- ⑦ List of towns/cities
- ⑧ Currently selected character

COMAND navigation system (entering a destination)

i In the list of input characters ④, you can only select currently selectable characters. Which characters are included depends on the sequence in which you have entered your destination and the data version of the digital map.

The top list entry ① at first shows either the town or city in which the vehicle is currently located or the town or city which best corresponds to the input data as it has been entered up to that point.

i The current town or city is shown if:

- you have accepted the current state (USA) or province (CDN) when entering the state (USA) or province (CDN)
- and if you select town/city entry immediately afterward

As soon as you enter a character from input characters ④, the top list entry ① shows the town or city that best corresponds to the input data as it has been entered up to that point.

At the same time, COMAND automatically supplements characters ② entered by the user with appropriate characters ③.

▶ **Selecting characters:** Slide ←⊙→ or rotate ⏪⏩.

▶ **Confirming character selection:** Press ⊙.

▶ **Deleting individual characters:** Select **[c]** in the bottom line and press ⊙.

▶ **Deleting an entire entry:** Select **[c]** in the bottom line and press ⊙ until the entire entry is deleted.

▶ **Canceling an entry:** Select “Back” in the bottom line and press ⊙.

or

▶ Press back button **⏪** in the center console (▷ page 80).

As soon as COMAND can clearly attribute the characters entered to a town or city, the input characters ④ disappear automatically. You see the list of towns or cities without the input characters. Here you can confirm the current entry or make another selection.

During character entry, you can also manually switch to the list of towns/cities without input characters at any time.

▶ **Switching manually to the list of towns/cities without input characters:** Slide ↑⊙.

or

▶ Select **ok** in the second line from the bottom and press ⊙.

List of towns/cities without input characters



P82.86-5439-31

① Symbol for more selection options

▶ **Selecting a town or city:** Slide ↑⊙↓ or rotate ⏪⏩.

COMAND navigation system (entering a destination)

- ▶ **Canceling selection:** Select “Back” and press .

or

- ▶ Press back button  in the center console (▷ page 80).

- ▶ **Confirming selection:** Press .

Towns/cities with symbol ① mean that there is more than one in the selected state (USA) or province (CDN). Confirming one of these towns/cities will take you to a further sub-selection.

If there are no other selection options, the address input menu appears again.

It shows one of the following items of information:

- Town/city and state (USA) or province (CDN)
- Street, town/city and state (USA) or province (CDN)

 *The street is visible if you have entered it before entering the town or city.*

Which of the following menu items are now available depends on the situation, or may depend on the data version of the digital map. The menu items which are not available cannot be selected.

- “Map”: using the map to enter a destination (▷ page 174)

 *In this case, using the map for destination entry is based on the town or city seen in the address input menu.*

- “Street”: entering the street (▷ page 161)
- “House No.”: entering the house number (▷ page 166)
- “Center”: entering the center (▷ page 164)
- “Intersection”: entering the intersection (▷ page 169)
- “POI”: entering a point of interest (▷ page 177)

 *In this case, entering a POI is based on the town or city seen in the address input menu.*

- “Save”: saving a destination in the destination memory (▷ page 195)
- “Start”: starting the route calculation (▷ page 171)
- ▶ **Continuing or completing destination entry:** Select one of the menu items mentioned above.

Entering a street

 *It is not possible to enter a street if:*

- you have already entered a center
- you have already entered a zip code that COMAND can clearly attribute to a street

 *You can only enter those streets which are saved on the digital map.*

If you have not entered a town or city before entering the street, only those streets within the state (USA) or province (CDN) previously entered are available. If you have already entered a town or city, streets within that town or city are available.

If you have entered a zip code before entering the street, only those streets within the zip code area are available.

COMAND navigation system (entering a destination)

- ▶ In the address input menu, select “Street”.

The list of streets appears either with or without the input characters (▷ page 163). Whether or not the input characters appear depends on how many streets are available for the selected town or city.

Street list with input characters

When this list appears, the input characters ⑥ are automatically activated.

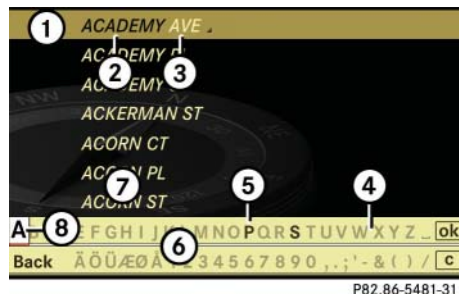

- ① Top list entry based on the input data up to that point
- ② Characters entered by the user
- ③ Characters automatically added by the system
- ④ Currently non-selectable characters
- ⑤ Currently selectable character
- ⑥ Input characters
- ⑦ Street list
- ⑧ Currently selected character

i In the list of input characters ⑥, you can only select currently selectable characters. Which characters are included depends on the sequence in which you have entered your destination and the data version of the digital map.

The top list entry ① first shows the street first alphabetically and best corresponds to the input data as it has been entered up to that point.

As soon as you enter a character from input characters ⑥, the top list entry ① shows the street which best corresponds to the input data as it has been entered up to that point.



At the same time, COMAND automatically supplements characters ② entered by the user with appropriate characters ③.

▶ **Selecting characters:** Slide ←○→ or rotate ⏪⏩.

▶ **Confirming character selection:** Press ⏹.

▶ **Deleting individual characters:** Select [c] in the bottom line and press ⏹.

COMAND navigation system (entering a destination)



- ▶ **Deleting an entire entry:** Select **c** in the bottom line and press  until the entire entry is deleted.
- ▶ **Canceling an entry:** Select “Back” in the bottom line and press .

or

- ▶ Press back button  in the center console (▷ page 80).

As soon as COMAND can clearly attribute the characters entered to a street, the input characters  disappear. You see the street list without the input characters. Here you can confirm the current entry or make another selection.

During character entry, you can also manually switch to the street list without input characters at any time.





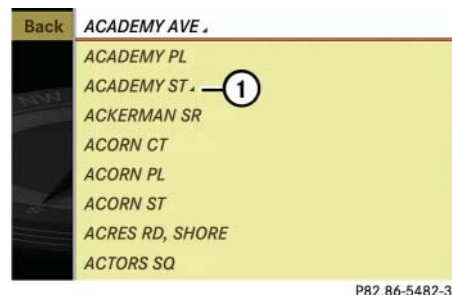

- ▶ **Switching manually to the street list without input characters:** Slide  .

or

- ▶ Select **ok** in the second line from the bottom and press .

Street list without input characters

-  Symbol for more selection options

- ▶ **Selecting a street:** Slide    or rotate .
 - ▶ **Canceling selection:** Select “Back” and press .
- or
- ▶ Press back button  in the center console (▷ page 80).
 - ▶ **Confirming selection:** Press .

Streets with symbol  run through several suburbs. Confirming one of these streets takes you to a further sub-selection.

If there are no other selection options, the address input menu appears again after the confirmation.

It shows one of the following items of information:

- Street and state (USA) or province (CDN)
- Street, town/city and state (USA) or province (CDN)

 *The town or city is visible if you have entered it before entering the street, or if COMAND can clearly attribute the street entered to a town or city.*

Which of the following menu items are now available depends on the situation, or may depend on the data version of the digital map. The menu items which are not available cannot be selected.

- “Map”: using the map to enter a destination (▷ page 174)

 *In this case, using the map for destination entry is based on the town or city seen in the address input menu.*

COMAND navigation system (entering a destination)

- “House No.”: entering the house number (▷ page 166)
- “Intersection”: entering the intersection (▷ page 169)

i Entering an intersection is restricted to streets within the vicinity of the street entered.

- “POI”: entering a point of interest (▷ page 177)

i In this case, entering a POI is based on the town or city seen in the address input menu.

- “Save”: saving a destination in the destination memory (▷ page 195)
- “Start”: starting the route calculation (▷ page 171)
- ▶ **Continuing or completing destination entry:** Select one of the menu items mentioned above.

Entering a center

i It is not possible to enter a center if:

- you have not yet entered a town or city
- you have already entered a street
- you have already entered a zip code that COMAND can clearly attribute to an address

You can only enter those centers which are saved on the digital map.

Depending on the previous entry, centers are available either for the town/city entered or the zip code area entered.

- ▶ In the address input menu, select “Center”.

The list of centers appears either with or without the input characters (▷ page 165). Whether or not the input characters appear depends on how many centers are available in the selected town or city.

List of centers with input characters

When this list appears, the input characters (7) are automatically activated.



P82.86-5483-31

- ① Top list entry based on the input data up to that point
- ② Characters entered by the user
- ③ Characters automatically added by the system
- ④ Currently non-selectable characters
- ⑤ Currently selectable character
- ⑥ Currently selected character
- ⑦ Input characters
- ⑧ List of centers

COMAND navigation system (entering a destination)

i In the list of input characters ⑦, you can only select currently selectable characters. Which characters are included depends on the sequence in which you have entered your destination and the data version of the digital map.

While the characters are being selected as described below, the top list entry ① always shows the center which best corresponds to the input data as it has been entered up to that point.

At the same time, COMAND automatically supplements characters ② entered by the user with appropriate characters ③.

- ▶ **Selecting characters:** Slide ←②→ or rotate ⏪⏩.
- ▶ **Confirming character selection:** Press ⏹.
- ▶ **Deleting individual characters:** Select [c] in the bottom line and press ⏹.
- ▶ **Deleting an entire entry:** Select [c] in the bottom line and press ⏹ until the entire entry is deleted.

▶ **Canceling an entry:** Select “Back” in the bottom line and press ⏹.

or

▶ Press back button ⏪ in the center console (▷ page 80).

As soon as COMAND can clearly attribute the characters entered to a center, the input characters ⑦ disappear. You see the list of centers without the input characters. Here you can confirm the current entry or make another selection.

During character entry, you can also manually switch to the list of centers without input characters at any time.

▶ **Switching manually to the list of centers without input characters:**

Slide ↑②.

or

▶ Select **ok** in the second line from the bottom and press ⏹.

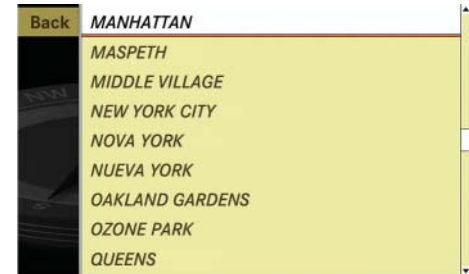
List of centers without input characters

▶ **Selecting a center:** Slide ↑②↓ or rotate ⏪⏩.

▶ **Canceling selection:** Select “Back” and press ⏹.

or

▶ Press back button ⏪ in the center console (▷ page 80).

▶ **Confirming selection:** Press ⏹.

After the confirmation, the address input menu appears again. It shows the center, town/city and state (USA) or province (CDN).

COMAND navigation system (entering a destination)

Which of the following menu items are now available may depend on the data version of the digital map. The menu items which are not available cannot be selected.

- “Map”: using the map to enter a destination (▷ page 174)

i In this case, using the map for destination entry is based on the center seen in the address input menu.

- “POI”: entering a point of interest (▷ page 177)

i In this case, entering a point of interest is based on the center seen in the address input menu.

- “Save”: saving a destination in the destination memory (▷ page 195)
- “Start”: starting the route calculation (▷ page 171)
- ▶ **Continuing or completing destination entry:** Select one of the menu items mentioned above.

Entering a house number

i The house number can only be entered after the street has been entered. You can only enter those house numbers which are saved on the digital map. The digital map does not contain all house numbers for all streets.

How the house number is entered depends on whether you have already entered just the street or both the street and the town or city (▷ page 167).

With only the street entered previously

When COMAND can clearly allocate the street to a town or city, the house number appears without input characters. Select a house number from the list (▷ page 169).

When COMAND cannot clearly allocate the street to a town or city, a house number screen appears. You can now enter a house number.

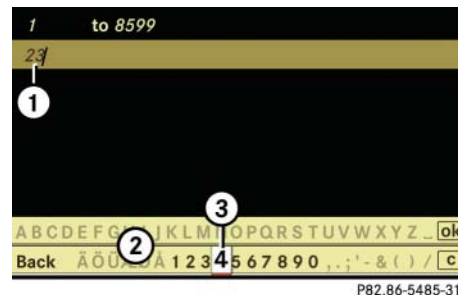

- ① Numbers entered by the user
- ② Input characters
- ③ Currently selected number

- ▶ **Selecting numbers:** Slide ←→ or rotate (⊙).
- ▶ **Confirming number selection:** Press ↵.
- ▶ **Deleting individual numbers:** Select [c] in the bottom line and press ↵.
- ▶ **Deleting an entire entry:** Select [c] in the bottom line and press ↵ until the entire entry is deleted.

COMAND navigation system (entering a destination)

- ▶ **Canceling an entry:** Select “Back” in the bottom line and press .

or

- ▶ Press back button  in the center console (▷ page 80).

- ▶ **Confirming entry:** Select **ok** in the second line from the bottom and press .

If COMAND cannot clearly attribute the house number to a town or city, the town/city input menu appears.



- ▶ **Entering town:** Proceed as described in the “Entering a town or city” section (▷ page 159).

After the town or city has been entered, the address input menu appears again.

If COMAND can clearly attribute the house number to a town or city, the address input menu also appears.

In both cases, the address input menu shows the house number, street, town/city and state (USA) or province (CDN).

Which of the following menu items are now available may depend on the data version of the digital map. The menu items which are not available cannot be selected.

- “Map”: using the map to enter a destination (▷ page 174)
-  *In this case, using the map for destination entry is based on the town or city seen in the address input menu.*
- “POI”: entering a point of interest (▷ page 177)
-  *In this case, entering a POI is based on the town or city seen in the address input menu.*
- “Save”: saving a destination in the destination memory (▷ page 195)
- “Start”: starting the route calculation (▷ page 171)

- ▶ **Continuing or completing destination entry:** Select one of the menu items mentioned above.

With the street and town/city previously entered

- ▶ In the address input menu, select “House No.”.

The list of house numbers appears either with or without the input characters (▷ page 169). Whether or not the input characters appear depends on how many house numbers are available in the selected street.

COMAND navigation system (entering a destination)

List of house numbers with input characters

When this list appears, the input characters ④ are automatically activated.

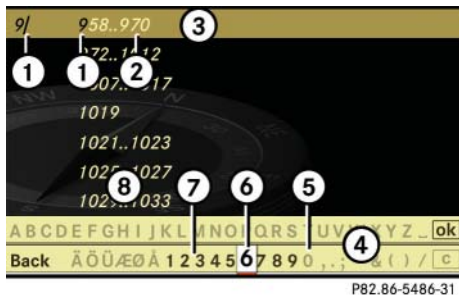

- ① Numbers entered by the user
- ② Numbers automatically added by the system
- ③ Top list entry based on the input data up to that point
- ④ Input characters
- ⑤ Currently non-selectable numbers
- ⑥ Currently selected number
- ⑦ Currently selectable numbers
- ⑧ List of house numbers

i In the list of input characters ④, you can only select currently selectable characters. Which characters are included depends on the sequence in which you have entered your destination and the data version of the digital map.

While the numbers are being selected as described below, the top list entry ③ always shows the house number which best corresponds to the input data as it has been entered up to that point.

At the same time, COMAND automatically supplements numbers ① entered by the user with appropriate numbers ②.

- ▶ **Selecting numbers:** Slide $\leftarrow \odot \rightarrow$ or rotate $\left\{ \odot \right\}$.
- ▶ **Confirming number selection:** Press \odot .
- ▶ **Deleting individual numbers:** Select \square in the bottom line and press \odot .
- ▶ **Deleting an entire entry:** Select \square in the bottom line and press \odot until the entire entry is deleted.

▶ **Canceling an entry:** Select “Back” in the bottom line and press \odot .

or

▶ Press back button \leftarrow in the center console (\triangleright page 80).

As soon as COMAND can clearly attribute the numbers entered to a house number, the input characters ④ disappear. You see the list of house numbers without the input characters. Here you can confirm the current entry or make another selection.

During number entry, you can also manually switch to the list of house numbers without input characters at any time.

▶ **Switching manually to the list of house numbers without input characters:** Slide $\uparrow \odot$.

or

▶ Select **ok** in the second line from the bottom and press \odot .

COMAND navigation system (entering a destination)

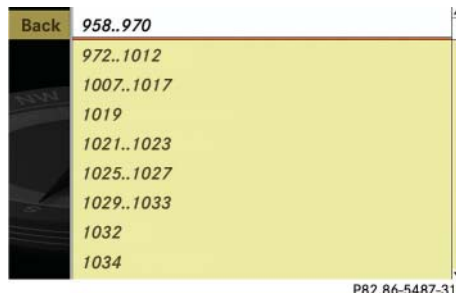
List of house numbers without input characters▶ **Selecting house numbers:**

Slide or rotate .

▶ **Canceling selection:** Select “Back” and press .

or

▶ Press back button in the center console (▷ page 80).

▶ **Confirming selection:** Press .

After the confirmation, the address input menu appears again. It shows the house number, street, town/city and state (USA) or province (CDN).

Which of the following menu items are now available may depend on the data version of the digital map. The menu items which are not available cannot be selected.

- “Map”: using the map to enter a destination (▷ page 174)

In this case, using the map for destination entry is based on the town or city seen in the address input menu.

- “POI”: entering a point of interest (▷ page 177)

In this case, entering a POI is based on the town or city seen in the address input menu.

- “Save”: saving a destination in the destination memory (▷ page 195)
 - “Start”: starting the route calculation (▷ page 171)
- ▶ **Continuing or completing destination entry:** Select one of the menu items mentioned above.

Entering an intersection

The intersection can only be entered after the street has been entered. You can only enter those intersections which are saved on the digital map.

- ▶ In the address input menu, select “Intersection”.

The list of intersections appears either with or without the input characters (▷ page 171). Whether or not the input characters appear depends on how many intersections are available for the selected street.

COMAND navigation system (entering a destination)

List of intersections with input characters

When this list appears, the input characters ④ are automatically activated.



- ① Top list entry based on the input data up to that point
- ② Characters entered by the user
- ③ Characters automatically added by the system
- ④ Input characters
- ⑤ Currently non-selectable characters
- ⑥ Currently selectable character
- ⑦ List of intersections
- ⑧ Currently selected character

i In the list of input characters ④, you can only select currently selectable characters. Which characters are included depends on the sequence in which you have entered your destination and the data version of the digital map.

While the characters are being selected as described below, the top list entry ① always shows the intersection which best corresponds to the input data as it has been entered up to that point. At the same time, COMAND automatically supplements characters ② entered by the user with appropriate characters ③.

- ▶ **Selecting characters:** Slide $\leftarrow \odot \rightarrow$ or rotate $\leftarrow \odot \rightarrow$.
- ▶ **Confirming character selection:** Press \odot .
- ▶ **Deleting individual characters:** Select \boxed{c} in the bottom line and press \odot .
- ▶ **Deleting an entire entry:** Select \boxed{c} in the bottom line and press \odot until the entire entry is deleted.

▶ **Canceling character entry:** Select "Back" in the bottom line and press \odot .

or

▶ Press back button \leftarrow in the center console (\triangleright page 80).

As soon as COMAND can clearly attribute the characters entered to an intersection, the input characters ④ disappear. You see the list of intersections without the input characters. Here you can confirm the current entry or make another selection.

During character entry, you can also manually switch to the list of intersections without input characters at any time.

▶ **Switching manually to the list of intersections without input characters:** Slide $\uparrow \odot$.

or

▶ Select **ok** in the second line from the bottom and press \odot .

COMAND navigation system (entering a destination)

List of intersections without input characters

- ▶ **Selecting an intersection:** Slide or rotate .

- ▶ **Confirming selection:** press .

Either the address input menu appears again, or the town/city input menu.

- The town/city input menu appears if the intersection entered cannot be clearly attributed to a town or city.*

- ▶ **Canceling selection:** Select “Back” and press .

or

- ▶ Press back button in the center console (▷ page 80).

- ▶ **If the town/city input menu appears:** Enter a town or city.

- A detailed description of how to enter a town or city can be found in the “Entering a town or city” section (▷ page 159).*

After the town or city has been entered, the address input menu appears again.

Which of the following menu items are now available may depend on the data version of the digital map. The menu items which are not available cannot be selected.

- “Map”: using the map to enter a destination (▷ page 174)
- In this case, using the map for destination entry is based on the town or city seen in the address input menu.*
- “POI”: entering a point of interest (▷ page 177)
- In this case, entering a POI is based on the town or city seen in the address input menu.*

- “Save”: saving a destination in the destination memory (▷ page 195)
- “Start”: starting the route calculation
- ▶ **Continuing or completing destination entry:** Select one of the menu items mentioned above.

Starting the route calculation

- You cannot start the route calculation until all the necessary address data has been entered.*

- ▶ After entering the destination, select “Start”.

The route calculation will start if route guidance has not already been activated.

If route guidance has already been activated, a prompt will appear asking whether you want to end the current route guidance.



COMAND navigation system (entering a destination)

- ▷▷ Select “Yes” or “No”.

If you select “Yes”, COMAND will stop the route guidance and start the route calculation for the new destination.

If you select “No”, COMAND will continue with the active route guidance.

The new destination is discarded.

During the route calculation, an arrow will indicate the linear direction to the destination. Below this, you will see the message “Calculating Route”.

Once the route has been calculated, route guidance begins (▷ page 185).

i *Route calculation requires a certain amount of time. The time depends on the distance from the destination, for example.*

COMAND calculates the route using the digital map data. The calculated route may differ from the actual road situation, e.g. due to road construction or incomplete map data. Please make sure that you observe the notes about the digital map (▷ page 140).

Entering a destination from the destination memory

- ▷ Select “Navi” → “Destination” → “From Memory”.

The destination memory list appears either with or without the input characters (▷ page 173). Whether the input characters appear depends on the number of entries in the destination memory.

i *The destination memory always contains an entry called “My Address”. You can save your home address, for example, under this entry (▷ page 195).*

Destination memory list with input characters

When this list appears, the input characters **④** are automatically activated.



P82.86-5490-31

- ① Top list entry based on the input data up to that point
- ② Characters entered by the user
- ③ Characters automatically added by the system
- ④ Input characters
- ⑤ Currently non-selectable characters
- ⑥ Destination memory list
- ⑦ Currently selected character
- ⑧ Currently selectable characters

i *In the list of input characters **④**, you can only select currently selectable characters. Which characters are included depends on the sequence in which you have entered your destination and the content of the destination memory.*

COMAND navigation system (entering a destination)

While the characters are being selected as described below, the top list entry ① always shows the destination which best corresponds to the input data as it has been entered up to that point.



At the same time, COMAND automatically supplements characters ② entered by the user with appropriate characters ③.

▶ **Changing language for the input characters:** Select .

▶ Select desired language.



▶ **Changing character set for the input characters:** Select .



Depending on the previous setting, you will change to letters with special characters or to numbers with special characters.

▶ **Selecting characters:** Slide   or rotate .

▶ **Confirming character selection:** Press .

▶ **Deleting individual characters:**

Select  in the bottom line and press .

▶ **Deleting an entire entry:** Select  in the bottom line and press  until the entire entry is deleted.

▶ **Canceling an entry:** Select “Back” in the bottom line and press .

or

▶ Press back button  in the center console (▷ page 80).

As soon as COMAND can clearly attribute the characters entered to a destination, the input characters ④ disappear. You see the destination memory list without input characters. Here you can confirm the current entry or make another selection.

You can also manually switch to the destination memory list without input characters at any time.

▶ **Switching manually to the destination memory list without input characters:** Slide  .

or

▶ Select **ok** in the second line from the bottom and press .

Destination memory list without input characters

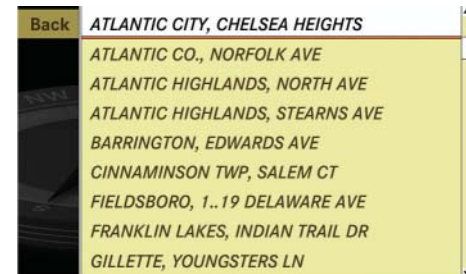

P82.86-5491-31

▶ **Selecting a destination:** Slide   or rotate .

▶ **Canceling selection:** Press back button  in the center console (▷ page 80).

or

▷▷

COMAND navigation system (entering a destination)

▷▷ Select “Back” and press .

i The “Back” menu item is only present if this list was called up from the list with input characters.

▶ **Confirming selection:** Press .

▶ **Starting route calculation:**

Select “Start”, see also (▷ page 171).

Entering a destination from the list of last destinations

▶ Select “Navi” → “Destination” → “From Last Destinations”.

The list of last destinations appears. The most recent destination is at the top of the list.

▶ Select desired destination.

▶ **Starting route calculation:**

Select “Start”, see also (▷ page 171).

Entering a destination from the map

i Depending on the factory settings of the vehicle, it may not be possible to enter a destination while the vehicle exceeds a preset speed. As soon as the vehicle's speed drops to below the preset speed, the function is available again. You can enter a destination via the map if the digital map does not contain the address of the destination, but the destination must be within the area of the digital map.

Calling up the map

▶ In the address input menu, select “Map” (▷ page 153).

You will see the map with a crosshair. The map is set to the address set in the address input menu.

or

▶ Select “Navi” → “Destination” → “Via Map”.

You will see the map with a crosshair.

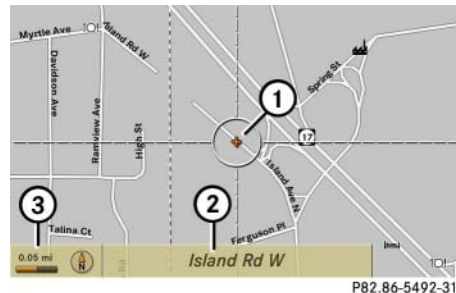

① Crosshair

② Details of the crosshair position

③ Map scale





i Display ② may be the name of a road, for example, provided the digital map contains the necessary data.



If no data is available, display ② shows:

- the coordinates if the geo-coordinate display is switched on (▷ page 151)
- no display if the geo-coordinate display is switched off (▷ page 151)

COMAND navigation system (entering a destination)

Moving the map and selecting the destination

- ▶ **Moving map:** Slide  ,   or .

- ▶ **Adjusting map scale:** rotate  .

Rotating clockwise enlarges the map, rotating counterclockwise reduces it.

- ▶ **Selecting a destination:** Press .

If the crosshair is located off the edge of the digital map, a route cannot be calculated to this destination and you will see the message “*The destination is located off the map.*”.

- ▶ Select “OK”.
- ▶ Move the map and select a destination again.

If the destination is within the limits of the digital map, COMAND attempts to attribute the destination to the map, which can take approximately 2 seconds.

If the destination can be attributed, you will see the address of the destination. If not, you will see the display “*Destination from map*”.

- ▶ **Starting route calculation:** Select “Start”, see also (▷ page 171).

Entering a stopover

 *When route guidance is active, you can enter a stopover. Stopovers can be predefined destinations from the following predefined categories:*

- “Mercedes-Benz Center”
- “Hospital”
- “Gas station”
- “Parking lot”
- “Restaurant”

However, you can also enter destinations other than the predefined ones.

 *You can use the stopover function to influence the route guidance calculation to the main destination. When you have reached your stopover, COMAND automatically calculates the route to the main destination.*

Entering predefined destinations

- ▶ Select “Nav” → “Destination” → “Stopover”.

If a stopover has already been entered, you can change it.

- ▶ **Changing:** Select “Change Stopover”.

You can now select a category.

- ▶ **Selecting a category:** Select category, e.g. “Gas station”.

COMAND first looks for destinations within the immediate vicinity of the vehicle and near the vehicle’s route. If there are no destinations available there, COMAND searches for destinations in an area around the vehicle position.

If COMAND does not find any destinations, you will see a message to this effect.

- ▶ Select “OK”.

You can now select a different category. ▷▷

COMAND navigation system (entering a destination)

- ▷▷ If COMAND finds destinations, you will see a list of the destinations and details of how far away they are in the right-hand side of the display. The information about how far away the destinations are can take a few seconds to be displayed.

The left-hand part of the display shows the destinations on the map. The destination marked in the list is highlighted in the map.

- ▶ **Selecting a destination:** Select the desired destination from list.

The address of the destination appears.

- ▶ **Starting route calculation:** Select “Start”, see also (▷ page 171).

Entering another destination as a stopover

- ▶ Select “Navi” → “Destination” → “Stopover”.
- ▶ **Entering:** Select “Other”.

You can select between the following menu items:

- “Address Entry”
- “From Memory”
- “From Last Destinations”
- “From POIs”

- ▶ Select a menu item.

Subsequent destination entries may differ, depending on your selection:

- “Address Entry” selection:
 - ▶ Enter a destination by address (▷ page 153).
- “From Memory” selection:
 - ▶ Enter a destination from the destination memory (▷ page 172).
- “From Last Destinations” selection:
 - ▶ Enter a destination from the list of last destinations (▷ page 174).
- “From POIs” selection:

- ▶ Enter a special destination (▷ page 177).

- ▶ **Starting route calculation:** after entering a destination, select “Start” (▷ page 171).

Changing a stopover

If a stopover has already been entered, you can change it.

- ▶ Select “Navi” → “Destination” → “Stopover” → “Change Stopover”.
- ▶ Enter another destination as a stopover.

Deleting the stopover

If a stopover has already been entered, you can delete it.

- ▶ Select “Navi” → “Destination” → “Stopover” → “Delete Stopover”.

COMAND deletes the stopover and calculates the route to the main destination.

COMAND navigation system (Point of interest entry)

▼ COMAND navigation system (Point of interest entry)

Entering a POI in the surrounding area

- ▶ In the map view while the menu system is displayed, select (▷ page 148) “*Destination*” → “*From POIs*” → “*Current Position*”.
- ▶ Continue with designating the POI category (▷ page 178).

Entering a POI in the surroundings of a given town**Option 1**

- ▶ In the map view while the menu system is displayed, select (▷ page 148) “*Destination*” → “*From POIs*” → “*Other Town*”.
- ▶ If necessary, enter state (USA) (▷ page 154) or province (CDN) (▷ page 154).

- ▶ **Entering town:** Select “*Town*”.

The town/city input menu appears.

- ▶ Then proceed as described in the “Entering a town or city” section (▷ page 159).
- ▶ After entering the town or city, continue with designating the POI category (▷ page 178).

Option 2

- ▶ Enter an address in the address input menu (▷ page 153).
- ▶ Select “*POI*”.
- ▶ Continue with designating the POI category (▷ page 178).

Entering a POI in a different region

i *This function gives you quick access to POIs which are of national interest in the state (USA) or province (CDN) you have selected. The following categories may be available:*

- “*AIRPORT*”
- “*BORDER CROSSING*”
- “*HIGHWAY ACCESS*”

Not all categories are available in all states (USA) or provinces (CDN).

- ▶ In the map view while the menu system is displayed, select “*Destination*” → “*From POIs*” → “*Global POI*” (▷ page 148).

The category list appears. The state (USA) or province (CDN) currently selected is shown in the first list entry. ▷▷

COMAND navigation system (Point of interest entry)

- ▷▷ **Selecting another state (USA) or province (CDN):** Select the first list entry.

A list of states/provinces appears.

- ▶ Select desired state (USA) or province (CDN).

If there are no POIs for the selected state (USA) or province (CDN), you will see a corresponding message.

- ▶ **Closing message:** Select “OK”.

You can again select a state (province).

If there are POIs, you will see the category list again.

- ▶ Proceed as described in the “Selecting a category” paragraph in the “Main category list without input characters” section (▷ page 180).

Designating a POI category

The categories and POIs available depend on the distance from the vehicle position you have set for the POI.

- POI in the surrounding area: categories sorted alphabetically and POIs sorted by distance within a radius of about 12 mi around the vehicle position are available. You can extend the search radius using the list options (▷ page 183).
- POI within a given town: If you have only entered the state (USA) or province (CDN) and the town or city, alphabetically sorted categories and alphabetically sorted POIs within the town/city are available.

If you have entered more than the state (USA) or province (CDN) and the town or city, alphabetically sorted categories and POIs sorted by distance within a radius of about 12 mi around the address entered are available.

You can extend the search radius and the category selection using the list options (▷ page 183).

- POIs in a different region: Alphabetically sorted categories and alphabetically sorted POIs are available.

Entering a category

Depending on the number of available categories, the main category list appears for category entry either with or without input characters (▷ page 180).

COMAND navigation system (Point of interest entry)

Main category list with input characters

When this list appears, the input characters ⑤ are automatically activated.



P82.86-5493-31

- ① Top list entry based on the input data up to that point
- ② Characters entered by the user
- ③ Characters automatically added by the system
- ④ Symbol for available POIs or other available subcategories
- ⑤ Input characters
- ⑥ Currently non-selectable characters
- ⑦ Currently selectable character
- ⑧ Currently selected character
- ⑨ Main category list

i In the list of input characters ⑤, you can only select currently selectable characters. Which characters are included depends on the sequence in which you have entered your destination and the data version of the digital map.

While the characters are being selected as described below, the top list entry ① always shows the category which best corresponds to the input data as it has been entered up to that point.

At the same time, COMAND automatically supplements characters ② entered by the user with appropriate characters ③.

- ▶ **Selecting characters:** Slide ←→ or rotate ↻.
- ▶ **Confirming character selection:** Press ↵.
- ▶ **Deleting individual characters:** Select [c] in the bottom line and press ↵.
- ▶ **Deleting an entire entry:** Select [c] in the bottom line and press ↵ until the entire entry is deleted.

▶ **Canceling an entry:** Select “Back” in the bottom line and press ↵.

or

▶ Press back button [↵] in the center console (▷ page 80).

As soon as COMAND can clearly attribute the characters entered to a category, the input characters ⑤ disappear.

You see the list of main categories without the input characters. Here you can confirm the current entry or make another selection.

You can also manually switch to the main category list without input characters at any time.

▶ **Switching manually to the main category list without input characters:** Slide ↑↻.

or

▶ Select **ok** in the second line from the bottom and press ↵.

COMAND navigation system (Point of interest entry)

Main category list without input characters

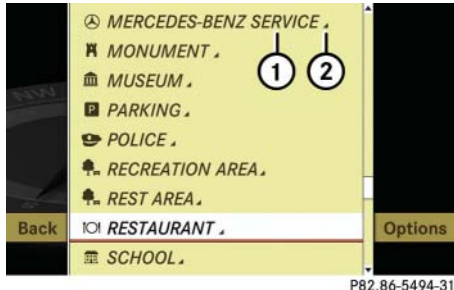

Example illustration: main category list for POIs in the surrounding area

- ① Category
- ② Symbol for available POIs or other available subcategories

► **Selecting a main category:** Slide $\uparrow \odot \downarrow$ or rotate $\left\{ \odot \right\}$.

► **Canceling selection:** Select “Back” and press \odot .

or

► Press back button \leftarrow in the center console (\triangleright page 80).

► **Confirming selection:** Press \odot .

Main categories with symbol ② contain either POIs or subcategories. Further operation depends on whether the selected main category contains subcategories or only POIs.

Selected main category contains subcategories:

Selecting such a main category opens a list of subcategories. The illustration below shows by way of example the “RESTAURANT” main category with available subcategories ④.



- ① Main category
- ② To show all POIs for all subcategories under category ①
- ③ Symbol for available POIs
- ④ Subcategory

► **Selecting a subcategory:** Slide $\uparrow \odot \downarrow$ or rotate $\left\{ \odot \right\}$.

► **Canceling selection:** Select “Back” and press \odot .



or

► Press back button \leftarrow in the center console (\triangleright page 80).

COMAND navigation system (Point of interest entry)

- **Confirming selection:** Press .

After selecting a subcategory, a list of POIs appears. It contains the POIs available within the search radius of the subcategory.

 If you have selected list item , the POI list contains all POIs for all subcategories within the search radius of main category .

Selected main category contains no subcategories, but only POIs:

Selecting such a main category immediately opens a list of POIs. The POI list contains the available POIs within the search radius of the main category.





POI list

Depending on the situation, COMAND first shows the following list or the POI list with input characters.

The illustration below shows by way of example the POI list for the “RESTAURANT” main category, “FRENCH CUISINE” subcategory within the surrounding area.



- ① Compass heading to the destination
- ② Linear distance to the destination
- ③ Special destination

 Displays  and  are not visible if you have already entered a POI within a particular town or city. Displays  and  are static; they do not change while you are driving.

In the POI list, you can either select a POI or enter the name of the POI.

Selecting a POI

- Select desired POI.

The POI list disappears and the address of the POI appears.

- **Back to POI list:** Select “Back” and press .

or

- Press back button  in the center console (> page 80).

- **Starting route calculation:** Select “Start”, see also (> page 171).

COMAND navigation system (Point of interest entry)

Entering name of POI

- ▶ Select “Options” → “Spell”.

The POI list appears with input characters; the input characters are automatically activated.

POI list with input characters

i For POIs in other regions, this list also shows the compass heading to the destination as well as the linear distance to the destination, as in the previous illustration.



- ① Top list entry based on the input data up to that point
- ② Characters entered by the user
- ③ Characters automatically added by the system
- ④ Input characters
- ⑤ Currently selectable character
- ⑥ Currently non-selectable characters
- ⑦ POI list
- ⑧ Currently selected character

i In the list of input characters ④, you can only select currently selectable characters. Which characters are included depends on the sequence in which you have entered your destination and the data version of the digital map.

While the characters are being selected as described below, the top list entry ① always shows the POI that best corresponds to the input data as it has been entered up to that point.

At the same time, COMAND automatically supplements characters ② entered by the user with appropriate characters ③.

- ▶ **Selecting characters:** Slide ←⊙→ or rotate .
- ▶ **Confirming character selection:** Press .
- ▶ **Deleting individual characters:** Select in the bottom line and press .
- ▶ **Deleting an entire entry:** Select in the bottom line and press until the entire entry is deleted.
- ▶ **Canceling an entry:** Select “Back” in the bottom line and press .

or

- ▶ Press back button in the center console (▷ page 80).

COMAND navigation system (Point of interest entry)

As soon as COMAND can clearly attribute the characters entered to a POI, the input characters ④ disappear.

You see the POI list without input characters. Here you can confirm the current entry or make another selection.

You can also manually switch to the POI list without input characters at any time.

- ▶ **Switching manually to the POI list without input characters:** Slide ↑⊙.

or

- ▶ Select **ok** in the second line from the bottom and press Ⓜ.

POI list without input characters

- ▶ **Selecting a destination:** Slide ↑⊙↓ or rotate Ⓜ.

- ▶ **Canceling selection:** Select “Back” and press Ⓜ.

or

- ▶ Press back button ⏪ in the center console (▷ page 80).
- ▶ **Confirming selection:** Press Ⓜ.
- ▶ **Starting route calculation:** Select “Start”, see also (▷ page 171).

List options**Options in category and POI lists**

If you enter a POI in the surrounding area, initially, only categories and POIs within a radius of approx. 12 mi around the vehicle position are available.

The same applies if you enter a POI within a given town or city and have previously entered more than the state (USA) or province (CDN) and the city or town.

If you expand the list, the search radius increases to around 90 mi. This gives you access to all categories and POIs within a radius of about 90 mi.

- ▶ **Expanding list:** In one of the lists select “Options” → “Expand Search” lists, select.

The list is expanded.

COMAND navigation system (Point of interest entry)

Options only in POI lists

- ▶ **Displaying details of the selected entry:** Select “Options” → “Details”.
The detailed view appears.
- ▶ **Closing detailed view:** Select “OK”.

Entering a POI from the map

i If the crosshair is shown on the map, you can enter POIs in the vicinity of the crosshair. If the crosshair is not shown on the map, you can enter POIs in the vicinity of the vehicle's current position.

- ▶ Select “Guide” in the map view with the menu system displayed (▷ page 148).
You will see POI symbols on the map, depending on whether POIs are available and which map scale is set.

The scale at which the symbols are displayed on the map varies according to the symbol.

You can set which symbols COMAND should display (▷ page 151).

The POI closest to the center of the screen is automatically marked.

If there are no POIs available, the “Back” menu item is automatically highlighted and you cannot select other menu items.



- ① Highlighted POI
- ② Information about the highlighted POI

- ▶ **Selecting a POI:** Select “Next” or “Previous”.

The next or the previous POI is marked.

- ▶ **Displaying details of the selection:** Select “Details”.

- ▶ **Starting route calculation:** Select “Start”, see also (▷ page 171).

A prompt appears asking whether the POI should be used as the destination.

- ▶ Select “Yes” or “No”.

If you select “Yes”, the route calculation begins. If you select “No”, you can select a new POI.

COMAND navigation system (route guidance)

▼ COMAND navigation system (route guidance)

Route guidance

Warning!

COMAND calculates the route to the destination without taking account of the following, for example:

- Traffic lights
- Stop and right-of-way signs
- Parking or stopping prohibited areas
- Lane merges
- Other road and traffic rules and regulations
- Narrow bridges

COMAND may give incorrect navigation commands if the data in the digital map does not correspond with the actual road/traffic situation. For example, if the traffic routing has been changed or the direction of a one-way road has been reversed.

For this reason, you must always observe applicable road and traffic rules and regulations during your journey. Road and traffic rules and regulations always have priority over the navigation commands generated by the system.

COMAND guides you to the destination using navigation commands in the form of audible navigation announcements and route guidance displays.

i *The route guidance displays can only be seen if the display is switched to navigation mode.*

If, for any reason, you do not follow the navigation commands or if you leave the calculated route, COMAND automatically calculates a new route to the destination.

If the map data contains the relevant information, COMAND tries to avoid roads that only have limited access, e.g. roads closed to through-traffic and non-residents.

Roads that have time restrictions (e.g. closed on Sundays and public holidays) are not considered for route guidance, if the digital map contains the relevant information.

Examples of displays and announcements for a driving maneuver

Driving maneuvers have three phases:

- Preparation phase
- Announcement phase
- Maneuver phase

COMAND navigation system (route guidance)

Preparation phase

COMAND prepares you for the upcoming driving maneuver. Based on the example display below, the driving maneuver is announced with the “*Prepare to turn left*” message. The display is not split and shows the map over the full screen.



- ① Point at which the driving maneuver takes place (light blue dot)
- ② Route (highlighted blue)
- ③ Current vehicle position; the triangle points in the vehicle’s direction of travel

Announcement phase

COMAND announces the next driving maneuver. Based on the example display below, the driving maneuver is announced 700 feet in advance with the “*Turn left in 700 feet to your destination*” message.

The display is divided in two. In the left half, you see the normal map view. In the right half, there is either an enlarged view of the area surrounding the intersection (intersection zoom) or simply a symbol for the next driving maneuver.

The following example illustration shows the intersection zoom in the right half.

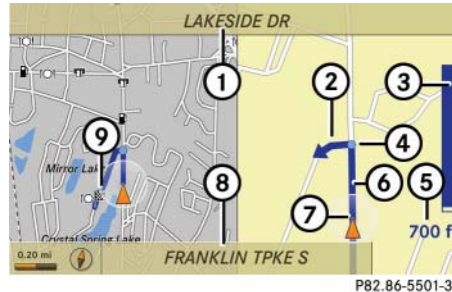

- ① Next road
- ② Driving maneuver (turn left)
- ③ Graphical representation of the distance to the driving maneuver
- ④ Point at which the driving maneuver takes place (light blue dot, shown in both the left and right displays)
- ⑤ Information about distance to the next driving maneuver
- ⑥ Route (highlighted in blue; shown in both the left and right displays)
- ⑦ Current vehicle position; the triangle indicates the vehicle’s direction of travel (shown in both the left and right displays)
- ⑧ Street on which you are currently driving, if included on the digital map
- ⑨ Destination

i The filled-in section of distance graphic ⑤ gets shorter the nearer you get to the announced driving maneuver.

COMAND navigation system (route guidance)

Maneuver phase

COMAND announces the next driving maneuver. Based on the example display below, the driving maneuver is announced 150 feet in advance with the “Now turn left” message. The display is also split into two halves, as for the announcement phase.

i Once the maneuver is completed, COMAND automatically switches back to the non-split screen.

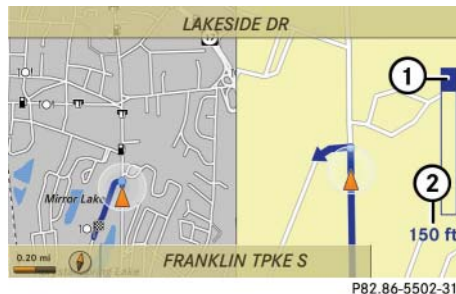

- ① Graphical representation of the distance to the next driving maneuver
- ② Information about distance to the next driving maneuver

Example of a display without driving maneuvers

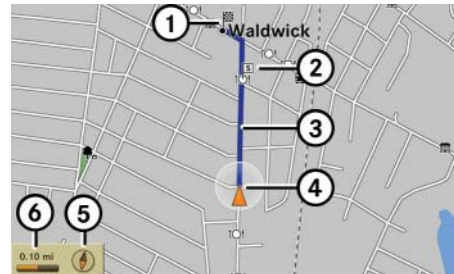

- ① Main destination
- ② Stopover (only visible if a stopover has been entered)
- ③ Route (highlighted blue)
- ④ Current vehicle position; the triangle indicates the vehicle's direction of travel
- ⑤ Set map orientation – for an explanation and settings, see (▷ Seite 150)
- ⑥ Set scale – for an explanation and settings, see (▷ Seite 149)

Destination or destination area reached

Once you have reached your destination, you will hear the announcement “You have reached the destination”. For certain POIs (airports or highway junctions), you will hear the announcement “You have reached the destination area”. In addition, you will see a corresponding display and route guidance is automatically ended.



- ① Destination on the map
- ② Destination flag

COMAND navigation system (route guidance)

Partially digitized areas

i The digital map may contain areas that are only partially digitized although they are within a digitized region.

Warning!



Due to incomplete digitization, the route shown on the map may differ from the actual road/traffic situation.

If you follow the route shown on the map, for example, it is possible that you could drive the wrong way down a one-way street or that a street cannot be driven on.

When using route guidance in a partially digitized area, you must therefore be sure to observe all relevant traffic regulations and the course of the road.

All relevant traffic regulations and the course of the road always take priority over the route shown on the map.

If the destination is within a partially digitized area

COMAND guides you through fully digitized areas for as long as possible. Route guidance is conducted in the usual manner, i.e. with navigation announcements and route guidance displays.

Before the vehicle reaches a partially digitized area, COMAND notifies you of this with the following announcements:

- *“Be prepared to enter an area where turn by turn guidance cannot be provided.”*
- *“In 700 feet you will enter an area where turn by turn guidance cannot be provided.”*
- **i** *The indicated distance can be seen here by way of example. In reality, it may be different.*
- *“You are about to enter an area where turn by turn guidance cannot be provided.”*

i When you call up the route info to this type of destination, (▷ page 193) the following data shown there may differ from the actual situation:

- *Distance to the destination*
- *Estimated driving time to the destination*
- *Estimated arrival time*

Route guidance within a partially digitized area

If you start route guidance in this type of area, you will hear the following announcement: *“You are currently in an area where turn by turn guidance cannot be provided.”*

Route guidance is provided by means of a direction arrow showing the compass heading to the destination. COMAND will not generate automatic navigation announcements.

If you try to call up an announcement manually, (▷ page 191) you will hear the announcement *“You are currently in an area where turn by turn guidance cannot be provided.”*

COMAND navigation system (route guidance)

During route guidance, the display is divided. On the right-hand side you will see the direction arrow showing the compass heading to the destination.

On the left-hand side of the display you will see the map with the suggested route. The suggested route is highlighted blue. However, it may not be possible to follow the suggested route because, for example, the road is closed or not open for car traffic.

If, during route guidance, COMAND leads you back into a fully digitalized area, route guidance will simply continue in the usual manner.

Off-road and off-map

Route guidance to an off-road destination

Warning!



The COMAND navigation system may direct you to off-road routes that your vehicle may not be capable of traversing through without damaging your tires, wheels or vehicle. It is the driver's sole responsibility to determine the suitability of the route. Off-road routes may be of varying conditions and their appropriateness for use may be affected by various factors such as time of day, time of year and immediate weather conditions that cannot be judged or taken into consideration by the COMAND system.

COMAND can guide you to destinations within the area covered by the digital map, even if a destination is not located at a road known to the system.

These destinations are shown as off-road destinations, which you can enter using the map, for example.

In these cases, COMAND guides you for as long as possible with navigation announcements and displays on roads known to the system.

Shortly before you reach the last known point to leave the digitized road network, you will hear the announcement *"The destination is nearby. Follow the arrow on the display"*.

You will then see an arrow that indicates the direction to the off-road destination. When the off-road destination is close to the road, *"Area of dest. reached"* appears in addition below the arrow.

The section of the route from the last known point on the map to the off-road destination is indicated with a dashed line after a certain length. It simply shows the direction to the off-road destination without taking account of any type of obstacles in the way.

COMAND navigation system (route guidance)

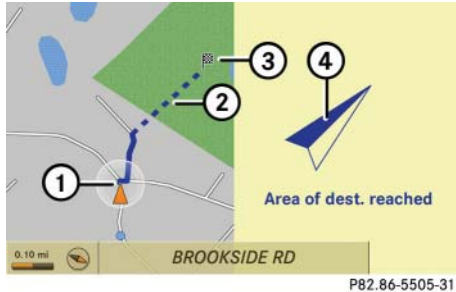

- ① Current vehicle position; the triangle indicates the vehicle's direction of travel
- ② Off-road section of the route
- ③ Off-road destination
- ④ Direction arrow, shows compass heading to destination

On the off-road section of the route, direction arrows showing the compass heading to the destination guide you. You will also see the “*Direction to destination*” display.

Route guidance from an off-road location to a destination

If there is no road available on map at current position of the car, vehicle is off road. COMAND is also able to guide you to a destination from such a location.

At the start of the route guidance, you will see the “*Off Road*” message and a direction arrow. The direction arrow shows the compass heading to the actual destination.

The route is highlighted blue from the nearest road known to the system.

As soon as the vehicle is back on a road known to the system, route guidance continues in the usual way.

Route guidance from an off-map location to a destination

If the vehicle position is outside the area covered by the digital map, then the vehicle is in an off-map location. COMAND is also able to guide you to a destination from such a location.

At the start of the route guidance, you will see the “*Off Map*” message and a direction arrow. The direction arrow shows the compass heading to the actual destination.

The route is highlighted blue from the nearest road known to the system.

As soon as the vehicle is back on a road known to the system, route guidance continues in the usual way.

Off-road during route guidance

The road layout may differ from the data on the digital map, due to road construction measures, for example.

In such cases, the system cannot allocate the vehicle's position to the digital map and the vehicle is therefore in an off-road position.

The “*Off Road*” message and an arrow showing the compass heading to the destination appear on the display.

As soon as the system can allocate the vehicle position's to the map again, route guidance continues in the usual way.

COMAND navigation system (route guidance)

Navigation announcements

Warning!

Navigation announcements are intended to direct you while driving without diverting your attention from the road and driving.

Please always use this feature instead of consulting the map display for directions. Consulting the symbols or map display for directions may cause you to divert your attention from driving and increase your risk of an accident.

i If Russian or Chinese is set as the system language, the navigation announcements are in English. You will find how to set the system language on (▷ page 216).

Navigation announcements are muted during telephone calls. You can, however, call up a current announcement at any time. You can also call up a current announcement at any time if you have missed an announcement.

Route guidance is already active.

▶ **Calling up a current announcement:**

Select “Nav” →

or

▶ Press favorite button if the button has been programmed with this function.

i You will find the button programming on (▷ page 216).

▶ **Canceling navigation message:**

Briefly press shortcut button during an announcement.

▶ **Switching off navigation messages:**

Press and hold during an announcement until the announcement is switched off.

You will see the message “The driving instructions have been muted.” for a short while.

i The announcements remain switched off even if you start a new route guidance or if COMAND is switched off/on with the **ON** button.

If you switch COMAND off by removing the SmartKey from the starter switch and then switch the ignition back on after more than 3 minutes, the announcements are automatically switched back on.

▶ **Switching navigation announcements back on manually:**

Select “Nav” →

▶ **Adjusting volume of the messages:**

adjust the volume during an automatic announcement (▷ page 89).

or

▶ Call up an announcement manually using “Nav” →

COMAND navigation system (during route guidance)

Cancel route guidance

- ▶ Select “Destination” → “Cancel Route Guidance” in map view with the menu system displayed (▷ page 148).

Continuing cancelled route guidance

- ▶ Select “Destination” → “Continue Route Guidance” in map view with the menu system displayed (▷ page 148).

COMAND calculates the route.

Route browser

i The route browser shows an overview of the route. You can use the route browser to move along the route section by section and view information about and details of each section of the route.

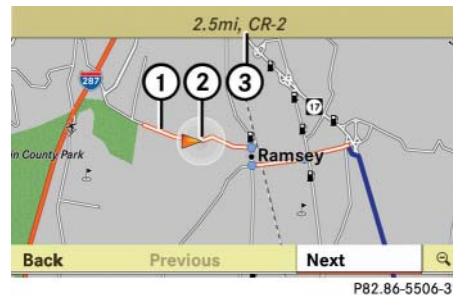

- ▶ Select “Route” → “Route Browser” in map view with the menu system displayed (▷ page 148).

The route browser appears.



- ① Highlighted route section
- ② Current vehicle position; the triangle indicates the vehicle's direction of travel
- ③ Information about the highlighted route section

i The information ③ about the marked route section shows the street name and the length of the route section. Marked route section ① is always highlighted in white and outlined in red.

- ▶ **Displaying next or previous route section:** Select “Next” or “Previous”.
- ▶ **Increasing or reducing size of the map:** Select  or .
- ▶ **Closing route browser:** Select “Back”.

COMAND navigation system (during route guidance)



Displaying route information

- ▶ Select “Route” → “Route Info” in map view with the menu system displayed (▷ page 148).

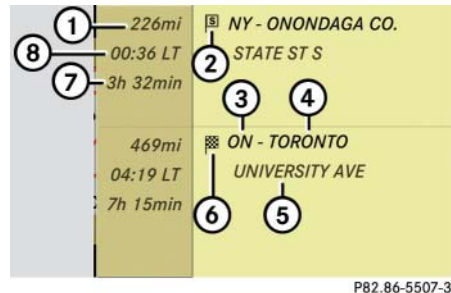
The route information appears.



Example display with main destination and stopover

- ① Distance to the destination
- ② Symbol  for stopover
- ③ Abbreviation for province (CDN) or state (USA)
- ④ Town/city
- ⑤ Street
- ⑥ Symbol  for main destination
- ⑦ Estimated driving time to the destination
- ⑧ Estimated arrival time



i COMAND uses the time set in COMAND as the basis for calculating the estimated arrival time. The clock must be set correctly in COMAND (▷ page 213). The calculation of the estimated arrival time does not additionally take into account whether Daylight Saving Time or standard time is applicable at the destination. If the destination is in a different time zone, arrival time display ⑧ is in local time. This is indicated by “LT” in the display.

The following data cannot be seen until the route calculation has been completed:

- Distance to destination ①
- Estimated arrival time ⑧
- Estimated remaining travel time ⑦

If the destination is located within a partially digitized area, the following data may differ from the facts:

- Distance to destination ①
- Estimated arrival time ⑧
- Estimated remaining travel time ⑦

- ▶ **Closing route info:** Slide   or press back button  in the center console (▷ page 80).

COMAND navigation system (during route guidance)

Detour function

i The detour function blocks a section of the route ahead of you. You can set the length of the blockage. If possible, COMAND calculates a detour route.

i The Detour function may direct you to off-road routes. See *Off-road and Off-map for additional routes and cautions* (▷ page 189).

- ▶ Select “Route” → “Detour” in map view with the menu system displayed (▷ page 148).

The detour function display appears.

▶ Setting length of the blockage:

Select “More” or “Less” until the desired length is set.

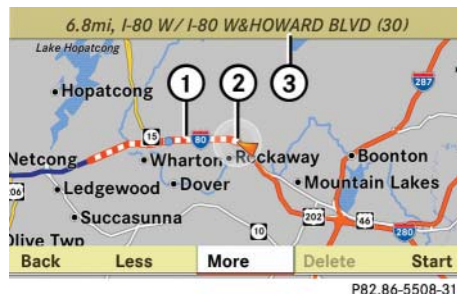

- ① Blocked route section
- ② Current vehicle position; the triangle indicates the vehicle’s direction of travel
- ③ Information about the blocked route section

i Blocked route section ① is always highlighted in red/white. The information about blocked route section ③ shows which section of the route is blocked and the length of the blocked section.

▶ Starting route calculation:

Select “Start”, see also (▷ page 171).

- ▶ **Deleting blockage:** Select “Navi” → “Route” → “Detour” → “Delete”.

- ▶ Select “Back”.

COMAND navigation system (destination memory)

▼ COMAND navigation system (destination memory)

Saving a destination in the destination memory

i This function also saves the destination in the address book. There COMAND creates an address book entry containing complete, navigable address data. You can then select this entry in the address book and start navigation to the address.

Saving after the address has been entered

- ▶ Select “Save” after entering the address (▷ page 153).

You can now select save options.

Saving during route guidance

- ▶ Select “Destination” → “Save Destination” during route guidance.

You can now select save options.

Saving a destination from the list of last destinations

- ▶ Select “Navi” → “Destination” → “From Last Destinations”.

The list of last destinations appears.

- ▶ Select desired destination.

The address of the destination is displayed.

- ▶ Select “Save”.

You can now select save options.

Selecting save options**Saving a destination without a name**

- ▶ Select “Save Without Name”.

COMAND saves the destination in the destination memory and uses the address as the destination name.

or

- ▶ Select “Save as ‘My Address’.”

- ▶ Select desired category, e.g. “Home”.

COMAND saves the destination in the destination memory as your own address.

Saving a destination with a name

- ▶ Select “Save new entry”.

- ▶ Select desired category, e.g. “Home”.

The input menu appears with the data fields and the input characters.

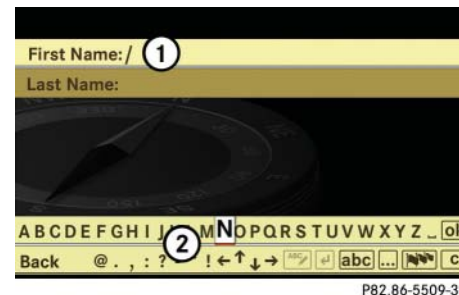

① Selected data field with input mark (cursor)

② Input characters



COMAND navigation system (destination memory)

- ▷▷ **Entering data:** Proceed as described in the “Changing the data field” operating step in the “Creating a new address book entry” section (▷ page 203).

Assigning a destination to an address book entry

i This function assigns the complete, navigable address data to an already existing address book entry. You can then select this entry in the address book and start navigation to the address from there.

- ▶ Select “Assign Address Book Entry”.
- ▶ Select desired category, e.g. “Home”.

The menu appears for searching for an address book entry.

- ▶ Select desired address book entry. Proceed as described in the “Searching for an address book entry” section (▷ page 204).

If the selected address book entry does not yet contain any navigable address data, COMAND saves the data.

If the selected address book entry already contains navigable address data, you will see a question asking you if the previous data should be overwritten.

- ▶ Select “Yes” or “No”.

If you select “Yes”, COMAND saves the data.

Deleting a destination from the destination memory

- ▶ Select “Nav” → “Destination” → “From Memory”.

Depending on the number of entries in the destination memory, you will see the destination memory list with or without input characters.

My Address	
APOLLO BEACH, LAKEWAY LN, home	idance
ASHFORD, SOUTHWORTH, DR, home	
EDWARDSVILLE, COLLEGE ST, home	
JACINTO CITY, MARKET ST, home	ions
LITTLE CREEK, MAIN ST, home	
MABLETOWN, NAPIER RD SE, home	
MANSFIELD, AIRPORT RD, home	
NEW BROCKTON, BYRD MILL RD, home	

P82.86-5516-31

Example illustration: destination memory list without input characters

COMAND navigation system (destination memory)



Example illustration: destination memory list with input characters

① Input characters

In the destination memory list with input characters ①, the input characters are automatically activated.

- ▶ **Destination memory list without input characters:** Press immediately.

or

- ▶ **Destination memory list with input characters:** Slide repeatedly until the input characters disappear.

The list entry “My Address” is automatically highlighted as long as you have not entered any characters using the input characters.

- ▶ **If you have entered characters from the list of input characters:** Rotate or slide repeatedly until the list entry “My Address” is highlighted.

- ▶ Press .

Further operation depends on whether you want to enter the address manually or use an address book entry as your own address.

Entering an address manually

- ▶ **If you want to assign your own address for the first time:** Select “Save new entry”.

or

- ▶ **If you want to change your own address:** Select “Change” → “Save new entry”.

In both cases, the address input menu appears.

- ▶ Enter the address. Proceed as described for destination entry in the “Entering a destination by address” section (▷ page 153).
- ▶ Select “Save” after entering the address.

Your address is saved.

COMAND navigation system (destination memory)

Using the address book entry as your own address**▶ If you want to assign your own address for the first time:**

Select “Assign Address Book Entry”.

or

▶ If you want to change your own address: Select “Change” → “Assign Address Book Entry”.

In both cases, the menu appears for searching for an address book entry.

▶ Select desired address book entry. Proceed as described in the “Searching for an address book entry” section (▷ page 204).

Once the address data is complete and if it matches the digital map data, COMAND saves the entry as your own address in the destination memory.

If address data is still missing or if it cannot be found on the digital map, a message appears indicating that the address is incomplete.

▶ Closing message: Select “OK”.

i *In the address book entry, the town/city and street must be spelled in the same way as the destination entry so that the data matches the digital map data. In order for the state (USA) or province (CDN) to match the map data, you may either enter the entire name or the abbreviation in the address book.*

Examples:

- *Florida or FL*
- *Colorado or CO*
- *Alberta or AB*
- *Ontario or ON*

Depending on which data is missing or cannot be found on the digital map, you must now either:

- Select a state (USA) or province (CDN)
- or enter a town/city
- or enter a street
- or enter a house number

▶ Selecting a state (USA) or province (CDN): Select desired state (USA) or province (CDN) from the list.**▶ Entering a town:** Proceed as described for destination entry in the “Entering a town or city” section (▷ page 159).**▶ Entering a street:** Proceed as described for destination entry in the “Entering a street” section (▷ page 161).**▶ Entering a house number:** Proceed as described for destination entry in the “Entering a house number” section (▷ page 166).

If all data is available and matches the digital map data, you can save the address.

▶ Saving: Select “Save”.

COMAND navigation system (destination memory)

Displaying your own address

- ▶ Select “Navi” → “Destination” → “From Memory”.

The destination memory list appears either with or without the input characters. Whether the input characters appear depends on the number of entries in the destination memory.

- ▶ Press .

Destination memory list without input characters



In the destination memory list without input characters, the “My Address” entry is automatically highlighted.

- ▶ Press .

If your own address has already been assigned, you will see the menu for starting route guidance with your own address data.



- ▶ **Exiting menu:** Select “Back”.

Destination memory list with input characters





- ① Input characters

In the destination memory list with input characters ①, the input characters are automatically activated.

- ▶ Slide   repeatedly until the input characters disappear.

The list entry “My Address” is automatically highlighted as long as you have not entered any characters using the input characters.

- ▶ **If you have entered characters from the list of input characters:** Rotate  or slide   repeatedly until the list entry “My Address” is highlighted.

- ▶ Press .

If your own address has already been assigned, you will see the menu for starting route guidance with your own address data.

- ▶ **Exiting menu:** Select “Back”.

COMAND navigation system (last destinations)

▼ COMAND navigation system (last destinations)

i COMAND automatically saves the last destinations for which the route calculation was launched. It is stored in the “last destinations” memory. If this memory is full, COMAND deletes the oldest destination. You can also save one destination from the list of last destinations in the destination memory. It will be saved there permanently.

Saving a destination permanently in the destination memory

- ▶ Proceed as described in the “Saving a destination from the list of last destinations” section (▷ page 195).

Saving the vehicle position in the list of last destinations

- ▶ **Centering map on the vehicle’s position:** Select “Nav” → “Position” → “Vehicle Position Map”.
- ▶ **Saving:** Select “Nav” → “Position” → “Save Position”.

COMAND saves the current vehicle position as a destination in the list of last destinations.

Saving the crosshair position in the list of last destinations

i If you have manually moved the map, you will see a crosshair on the map (▷ Seite 149). You can save the crosshair position as a destination in the list of last destinations.

- ▶ **Showing menu system, if necessary:** Press .

- ▶ Select “Position” → “Save Position”.

COMAND saves the crosshair position as a destination in the list of last destinations.

Deleting one of the last destinations

- ▶ Select “Nav” → “Destination” → “From Last Destinations”.

The list of last destinations appears.

- ▶ Select desired destination.

The address of the destination appears.

- ▶ Select “Delete”.
- ▶ Select “Yes” or “No”.

General notes

The address book contains the entries that are saved in the COMAND address book memory. The entries are permanently available even if the phone is not inserted in the cradle*. When you insert the mobile phone into the cradle*, COMAND reads-in the phone book entries saved in the mobile phone and stores the entries as a separate list from the COMAND address book. This list is a copy of the phone's phone book. This can take several minutes, depending on how many entries the phone book and the address book contain. After the read-in process, the COMAND compares the phone book entries with the address book entries. If all of the telephone numbers of a phone book entry in the mobile phone are present in an address book entry, the address book shows only the address book entry. If not, the address book also shows the phone book entry in the mobile phone.

Address book menu overview

i *The components and operating principles of COMAND can be found on (▷ page 79).*

Search	New Entry
Search for an address book entry	Create new address book entry

Calling up the address book

- ▶ Select “Telephone” → “Telephone” → “Address Book”.

The main address book display appears. If the address book already contains entries, you will see the data of an entry.



P82.86-5510-31

Illustration: address book entry

i *For phone book entries in the mobile phone that contain a name and a telephone number, you will see the name and the number. If a phone book entry in the mobile phone contains several telephone numbers, you will see the message “Multiple Numbers” instead of a telephone number.*

Selecting an entry in the main address book display

- ▶ Slide ←→ or rotate ↻ until the main area is selected.

Creating a new address book entry

i Please observe the following when creating a new address book entry:

You can define your own address in the destination memory in navigation mode. When defining the address, you can transfer data already entered as an address book entry.

In the address book entry, the town/city and street must be spelled in the same way as the destination entry so that the data matches the digital map data.

In order for the state (province) to match the map data, its complete name or abbreviation may be entered.

Examples:

- Florida or FL
- Colorado or CO
- Alberta or AB
- Ontario or ON

► Select “Telephone” → “Telephone” → “Address Book” → “New Entry”.

The input menu appears with the data fields and the input characters.

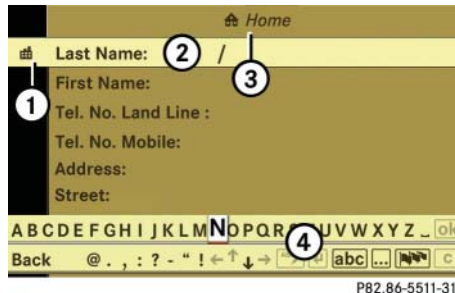

Illustration: input menu for private data

- ① To switch between work and home data (or symbol)
- ② Selected data field with input mark (cursor)
- ③ Display of set data type – in example display, home data is set (symbol and “Home” display)
- ④ Input characters

► **Switching between private and business data:** Select symbol ①.

The display switches to private or business data, depending on the previous status.

► **Changing data field:** Slide repeatedly until desired entry is highlighted.

or

► Select or repeatedly until desired entry is highlighted.

► **Entering data into a field:**

Select desired characters one by one from the input characters.

► **Toggling upper and lower case for the input characters:** Select or .

► **Changing language for the input characters:** Select .

► Select desired language.

► **Changing character set for the input characters:** Select .

Depending on the previous setting, you will change to letters with special characters or to numbers with special characters.



▷▷ Moving cursor in the data field:

Select or .

▶ Deleting individual characters:

Select and briefly press .

The character to the left of the cursor is deleted.

▶ Deleting an entire entry: Select and press and hold until the entry is deleted.

▶ Saving an entry: Select **ok**.

▶ Canceling an entry: Select **Back**.

If one of the data fields contains new data, a prompt will appear asking whether you want to save the entry.

▶ Select **Yes** or **No**.

The entry will either be saved or not, depending on your selection.

Deleting an entry

You cannot delete phone book entries from the mobile phone.

▶ Search for desired entry (▷ page 204).

▶ Select **Options** → **Delete**.

A deletion prompt appears.

▶ Select **Yes** or **No**.

The entry will either be deleted or not, depending on your selection.

Searching for an address book entry

▶ Select **Telephone** → **Telephone** → **Address Book** → **Search**.







The search menu appears with the smart speller.





P82.86-5512-31

- ① Symbol for complete address data from the navigation system
- ② Symbol for summarized entries from the mobile phone with the same name but different telephone numbers
- ③ Category symbol
- ④ Smart speller
- ⑤ Symbol for voice entry
- ⑥ Back to the main address book display

Entries with category symbol ③ come from the mobile phone. The following category symbols are possible:



-  = symbol for “*Mobile*” category
-  = symbol for “*Home*” category
-  = symbol for “*Work*” category
-  = symbol for “*Fax*” category
-  = symbol for “*Pager*” category
-  = symbol for “*Main*” category or for unknown category or for phone entries that are saved on the SIM card of a GSM mobile phone

Entries without a category symbol or with the  or  symbols come from the COMAND address book. All other entries come from the mobile phone and are only visible when the mobile phone is in the cradle*.

Entries with the  symbol contain a voice entry (▷ page 210). It is possible to add voice entries in vehicles with Voice Control*.

Entries with the  symbol contain complete, navigable address data from the navigation system that correspond to digital map data. It is possible to quickly start route guidance to these types of entry (▷ page 209).

Switching from the smart speller to the list

- ▶ Slide   repeatedly or press  until the smart speller is hidden.

or

- ▶ Select **ok** .

Switching from the list to the smart speller

- ▶ Select “*Back*” from the list.

Searching

Searching via the smart speller

- ▶ Switch from the list to the smart speller if necessary.

▶ Changing smart speller language:

Select .



- ▶ Select desired language.

▶ Changing smart speller character set: Select .



Depending on the previous setting, you will change to letters with special characters or to numbers with special characters.

- ▶ **Entering characters:** Select the characters one by one of the entry you are searching for.

▶ Deleting individual characters:

Select  and briefly press .

Each time you enter or delete a character, the closest match will be displayed at the top of the list.

- ▶ **Deleting an entire entry:** Select  and press and hold  until the entry is deleted.



COMAND address book

- ▷▷ **Canceling search:** Switch from the smart speller to the list (▷ page 205).

The entry at the top of the list is automatically highlighted.

- ▶ **Going back to main address book display:** If necessary, switch from the list to the smart speller (▷ page 205) and select “Back” in the smart speller.

Searching via the list

- ▶ If necessary, switch from the smart speller to the list (▷ page 205).
- ▶ Rotate (↻) or slide (↑↓) until desired entry is highlighted on the list.

Displaying a complete address book entry**Searching for the desired entry**

- ▶ Search for an address book entry (▷ page 204).

or

- ▶ Select an address book entry in the main address book menu (▷ page 202).

- ▶ Press (⌂).

The detailed view appears.

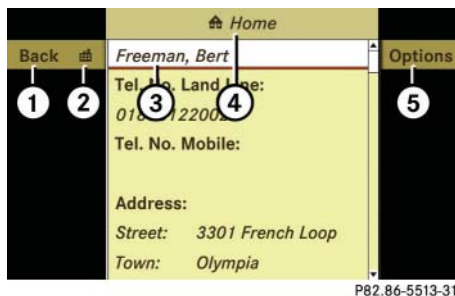
**Illustration: detailed view for private data**

- ① To go back to the previous menu
- ② To switch between work and home data (☰ symbol or 🏠)
- ③ Selected data field
- ④ Display of set data type – in example display, home data is set (🏠 symbol and “Home” display)
- ⑤ To call up options

① The options available under “Options” menu item ④ depend on which data field ③ is selected. The following options may be available:

- Displaying abbreviated content in full (▷ page 207)
- Changing an address book entry (▷ page 207)
- Changing the description of a telephone number data field (▷ page 208)
- Adding a telephone number data field (▷ page 208)
- Calling a number saved in an entry (▷ page 209)
- Starting route guidance to an entry (▷ page 209)
- Options for voice entries (▷ page 210)

Switching between private or business data

- ▶ Select symbol ②.

The display switches to private or business data, depending on the previous status.

Selecting a different data field

- ▶ Rotate or slide .

Displaying abbreviated content in full

- ▶ Select “Options” → “Details”.

The display is shown in full.

- ▶ **Closing entire display:** Slide or or press .

Closing the detailed view

- ▶ Select “Back”.

Displaying of a complete phone book entry in the mobile phone

- The mobile phone must be inserted in the cradle*.*

Searching for the desired entry

- ▶ Search for phone book entry in mobile phone (▷ page 204).

or

- ▶ Select a phone book entry from the mobile phone using the COMAND address book menu (▷ page 202).

- ▶ Press .

The detailed view appears.

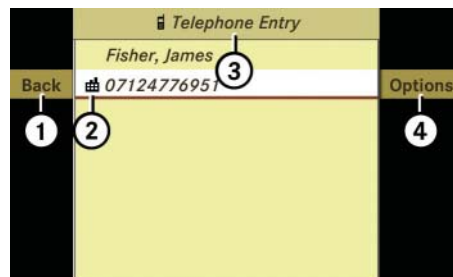

P82.86-5514-31

- ① To go back to the previous menu
- ② Category symbol
- ③ Display for phone book entry in mobile phone
- ④ To call up options

- If a phone book entry in the mobile phone has more than one telephone number, you will see all telephone numbers with the respective category symbol ② in the detailed view.*

- The options available under “Options” menu item ④ depend on which data field ③ is selected. The following options may be available:*

- Changing a phone book entry in the mobile phone (▷ page 207)
- Calling a number saved in an entry (▷ page 209)
- Saving a phone book entry from mobile phone in the address book (▷ page 212)

Closing the detailed view

- ▶ Select “Back”.

Changing an entry

- You cannot change address book entries that come from the phone book in the mobile phone.*

Changing an address book entry

- ▶ Search for an address book entry (▷ page 204) then, select “Options” → “Change”.

or

▷▷

COMAND address book

- ▷▷ Display the details of an address book entry (▷ page 206) then, select “Options” → “Change Content”.

The input menu appears with the data fields.

- ▶ Proceed as described in the “Switching between private and business data” paragraph in the Creating a new address book entry section (▷ Seite 203).

Changing the description of a telephone number data field

i *This function is not possible for phone book entries in the mobile phone.*

- ▶ Display the details of an entry and highlight the telephone number data field (▷ page 206).
- ▶ Select “Options” → “Change Entry Name”.
- ▶ Select a number category, e.g. “Home”.
- ▶ Select a telephone category, e.g. “Land Line”.
- ▶ Select “Save”.

COMAND saves the data if there are fewer than four numbers assigned to the entry you are searching for in the selected number category.

Otherwise, you will see a prompt asking whether one of the existing numbers should be overwritten.

- ▶ Select “Yes” or “No”.

If you select “Yes”, a selection list will appear containing the four existing numbers.

- ▶ Select number to be overwritten.

COMAND overwrites the selected number with the new data.

Adding to a telephone number data field

i *One address book entry may contain up to four data fields for private telephone numbers and four data fields for business telephone numbers.*

This function is not possible for phone book entries in the mobile phone.

- ▶ Display the details of an entry and highlight the telephone number data field (▷ page 206).

- ▶ Select “Options” → “Add Number”.

- ▶ Select a number category, e.g. “Home”.

- ▶ Select a telephone category, e.g. “Land Line”.

- ▶ Select “Save”.

COMAND adds the data field to the entry if there are fewer than four numbers assigned to the entry in the selected number category. You can now enter a number into the data field.

- ▶ Proceed as described from the “Entering data into a field” operating step in the Creating a new address book entry section (▷ Seite 203).

If four numbers are already saved for the entry in the selected number category, a prompt will appear asking whether one of the data fields should be overwritten.

- ▶ Select “Yes” or “No”.

If you select “Yes”, a selection list will appear containing the four data fields.

- ▶ Select field to be overwritten.

COMAND deletes the number of the selected field. You can now enter a new number into the data field.

- ▶ Proceed as described from the “Entering data into a field” operating step in the Creating a new address book entry section (▷ Seite 203).

Calling a number saved in an entry

i To do this, COMAND must be equipped with a telephone*. The mobile phone must be inserted in the cradle*.

- ▶ Display the details of an entry and highlight the telephone number data field (▷ page 206).
 - ▶ Press .
- or

- ▶ Select “Options” → “Call”.

In both cases, the telephone* connects the call.

Starting route guidance to an entry

- ▶ Search for an address book entry (▷ page 204).
- ▶ Display the details of an entry and highlight the address data field (▷ page 206).
- ▶ Select “Options” → “Navigate”.

or

- ▶ Press .

i Pressing  only functions if one of the address data fields contains data.

Further operation depends on whether the address data is complete and matches the digital map data of the navigation system. It does not match, for example, if it is not spelled in the same way as the destination entry.

Address data is complete and matches digital map

If “Navigate” is selected, the navigation system starts the route calculation.

Address data is incomplete or does not match digital map

i For the route calculation, the navigation system requires the correct spellings of the state (province), the town/city or zip code, the street and under some circumstances, the house number. The town/city and street must be spelled in the same manner as the destination entry. The state (province) can be spelled as an entire name or as an abbreviation.

Examples:

- Florida or FL
- Colorado or CO
- Alberta or AB
- Ontario or ON

If “Navigate” is selected, a message appears indicating that the address is incomplete.

- ▶ **Closing message:** Select “OK”.

Depending on which data is missing or cannot be found on the digital map, you must now either:

- select a state (province)
- select a county
- or enter a town/city
- or enter a street
- or enter a house number

▶ **Selecting a state (province):**

Select desired state (province) from the list.

▶ **Selecting a county:** Select desired county from the list.

▶ **Entering a town:** Proceed as described for destination entry in the “Entering a town or city” section (▷ page 159).

▶ **Entering a street:** Proceed as described for destination entry in the “Entering a street” section (▷ page 161).

▶ **Entering a house number:** Proceed as described for destination entry in the “Entering a house number” section (▷ page 166).

i *If you have added data, COMAND saves your additions. This means that you do not need to re-enter this additional data later on. The COMAND memory saves the additional data in a special field, which cannot be displayed. The data, which you have entered in the address book initially in the display, remains unchanged.*

If all data is available and matches the digital map data, the navigation system starts the route calculation.

Voice entries

i *For voice entries, your vehicle must be equipped with Voice Control*. You can not add voice entries for address book entry that come from the phone book in the mobile phone.*

Adding or changing a voice entry

i *You can add one voice entry per address book entry.*

- ▶ Search for the address book entry with or without a voice entry (▷ page 204).
- ▶ Select “Options” → “Voice Name” → “Add” or “Change”.

Subsequent operation is controlled by voice. Voice Control* guides you through the dialogs.

Deleting a voice entry

- ▶ Search for the address book entry with a voice entry (▷ page 204).

- ▶ Select “Options” → “Voice Name” → “Delete”.

A deletion prompt appears.

- ▶ Select “Yes” or “No”.

COMAND deletes the voice entry depending on your selection.

Listening to a voice entry

- ▶ Search for the address book entry with a voice entry (▷ page 204).

- ▶ Select “Options” → “Voice Name” → “Read Aloud”.

You will hear the voice entry.

Saving a phone book entry from mobile phone in the COMAND address book

Saving a phone book entry from mobile phone as new address book entry

i *The mobile phone must be inserted in the cradle* and the COMAND have read out the mobile phone book data. This can take several minutes, depending on how many entries each phone book contains.*

- ▶ Search for phone book entry in mobile phone (▷ page 204).

or

- ▶ Display details of a phone book entry in the mobile phone (▷ page 206).
- ▶ Select “Options” → “Save” → “New Entry”.
- ▶ Select a number category, e.g. “Work”.
- ▶ Select a telephone category, e.g. “Mobile”.

- ▶ Select “Save”.

The input menu appears with the data fields. The name and the telephone number are entered automatically.

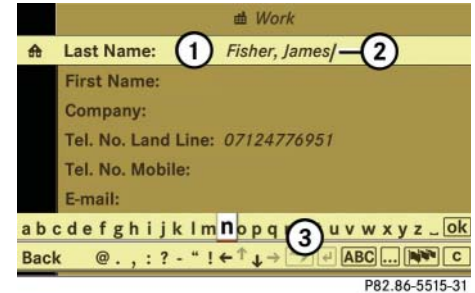

- ① Data field
- ② Input mark (cursor)
- ③ Input characters

- ▶ Proceed as described in the “Changing a data field” paragraph in the “Creating a new address book entry” section (▷ Seite 203).

COMAND address book

Saving a phone book entry from the mobile phone in an existing address book entry

i *The mobile phone must be inserted in the cradle*.*

- ▶ Search for a phone book entry in the mobile phone (▷ page 204).

or

- ▶ Display details of a phone book entry in the mobile phone (▷ page 206).
- ▶ Select “Options” → “Save” → “Add”.
- ▶ Select a number category, e.g. “Home”.
- ▶ Select a telephone category, e.g. “Land Line”.
- ▶ Select “Save”.

The search menu for address book entries appears.

- ▶ Search for desired entry.

i *There is a detailed description of how to search for an address book entry in the “Searching for an address book entry” section (▷ page 204).*

- ▶ After selecting an entry, press .

COMAND saves the data if there are fewer than four numbers assigned to the selected entry in the selected number category. Otherwise, you will see a prompt asking whether one of the existing numbers should be overwritten.

- ▶ Select “Yes” or “No”.

If you select “Yes”, a selection list will appear containing the four existing numbers.

- ▶ Select the number to be overwritten.

COMAND overwrites the selected number with the new data.

Importing data from external Bluetooth devices

You can import vCards from external Bluetooth devices into the address book.

Please keep the following in mind:

- Bluetooth is activated in COMAND (▷ page 217) and in the device concerned.

- The external device must be able to send vCards by Bluetooth.
- The external device is inside the vehicle, switched on and authorized (▷ page 217).

- ▶ **Importing:** Start data transfer on the external device (see operating instructions of the device concerned).

If there is no address book entry with the same first name and last name, COMAND imports the data.

If there is already an address book entry with the same first name and last name, a prompt will appear asking whether the existing data should be overwritten.

- ▶ Select “Yes” or “No”.

The existing address book entry will be overwritten or not, depending on your selection.

▼ COMAND system settings



Systems settings menu overview

i The components and operating principles of COMAND can be found on (▷ page 79).

Display	Time	Voice Control*	Language	Favorite	Services	Reset
(▷ page 213)	(▷ page 213)	(▷ page 215)	(▷ page 216)	(▷ page 216)	(▷ page 217)	(▷ page 213)
Display settings	Time settings	Voice Control* settings	Language settings	Assign favorite button	Bluetooth settings	Reset COMAND to factory settings

Display settings

Switching the display on or off

- ▶ **Switching off:** Select “Vehicle” → “Display OFF”.
- ▶ **Switching back on:** Rotate  or slide  .

Setting the display design

- ▶ Select “Vehicle” → “System Settings” → “Display”.
- ▶ Select “Day Mode” or “Night Mode” or “Automatic”.







i In the “Automatic” setting, COMAND analyzes the automatic vehicle light sensor and switches between the display design automatically.

Time settings

Setting the time

i The correct time must be set for the following navigation system functions to operate correctly:

- Route guidance on routes with time-dependent traffic guidance
- Calculation of estimated arrival time

- ▶ Select “Vehicle” → “System Settings” → “Time” → “Time”.
- ▶ **Selecting hour or minute(s):** Slide  .
- ▶ **Setting value:** Rotate  or slide  .
- ▶ **Saving setting:** Press .

i The increment value for setting the minutes depends on the situation. If GPS reception is available, it is 30 minutes. If GPS reception is not available, it is one minute.

COMAND system settings

Setting the time zone and switching between Daylight Saving Time and standard time

i *The correct time zone and Daylight Saving Time/standard time must be set for the following navigation system functions to operate correctly:*

- *Route guidance on routes with time-dependent traffic guidance*
- *Calculation of estimated arrival time*

▶ **Setting time zone:** Select “*Vehicle*” → “*System Settings*” → “*Time*” → “*Time Zone*”.

The country list appears. The dot • in front of a list entry indicates the current setting.

▶ Select the country in which you are currently driving.

A time zone list may also be displayed, depending on the country selected.

▶ Select desired time zone.

Subsequent operation depends on:

- whether your navigation system has GPS reception
- which country you have previously set.

You may either:

- manually switch between “*Daylight Savings Time (Summer)*” and “*Standard time (Winter)*” in a list

or

- switch automatic Daylight Saving Time to standard time changeover (and vice versa) on or off.

▶ **Switching manually:** Select “*Daylight Savings Time (Summer)*” or “*Standard time (Winter)*”.

The dot • in front of a list entry indicates the current setting.

▶ **Switching automatic changeover on or off:** Select “*Automatic Daylight Savings Time*”.

You have switched the function on or off. A checkmark appears when the function is switched on.

▶ **Saving setting and exit the menu:** Slide ←⊙→.

i *If you have switched off the automatic changeover function, you must change Daylight Saving Time to standard time and vice versa yourself.*

Setting the date

▶ Select “*Vehicle*” → “*System Settings*” → “*Time*” → “*Date*”.

▶ **Selecting month, day or year:** Slide ←⊙→.

▶ **Setting value:** Rotate 🕒 or slide ↑⊙↓.

▶ **Saving setting:** Press 🏠.

Setting the time/date format

- ▶ Select “Vehicle” → “System Settings” → “Time” → “Format”.

The format list appears. The dots • in front of the list entries indicate the current setting.

- ▶ **Changing format setting:**
Select desired format.
- ▶ **Saving setting and exit the menu:**
Slide ←⊙→.

Voice Control* settings

Switching help window on or off

- ▶ Select “Vehicle” → “System Settings” → “Voice Control”.
- ▶ Select “Help Window”.

You can switch the help window on or off. A checkmark appears when the help window is switched on.

Individualization

Using individualization, you can fine-tune Voice Control* to your own voice and thus improve voice recognition. The ability of the system to recognize the commands of other users does not deteriorate as a result.

Individualization consists of two parts. You train the system to recognize digits in the first part and specific commands in the second part.

Starting new individualization

i *It is only possible to start individualization with the vehicle stationary. After starting the session, the system will guide you through the individualization by means of acoustic instructions.*

- ▶ Select “Vehicle” → “System Settings” → “Voice Control” → “Start new individualization”.

A prompt appears asking whether you would like further information.

- ▶ Select “Yes” or “No”.

If you select “No”, the first part of individualization begins.

If you select “Yes”, an information display will be shown with audio instruction.

- ▶ **Closing display:** Select “OK”.

The first part of individualization begins.

At the end of the first part, you will see a prompt asking whether you want to begin the second part.

- ▶ Select “Yes” or “No”.

If you select “No”, individualization will be canceled. The data from the first part is saved automatically.

If you select “Yes”, the second part begins.

Individualization is completed at the end of the second part. You will see a message to this effect. The data from the second part is saved automatically.

COMAND system settings

Canceling during the first or second part of individualization

- ▶ Select “Cancel”.

A prompt appears asking whether you really do want to cancel.

- ▶ Select “Yes” or “No”.

If you select “Yes”, individualization will be canceled. The data from the part at which you exited is not saved.

If you select “No”, the part at which you stopped begins again.

Deleting existing individualization data

- ▶ Select “Vehicle” → “System Settings” → “Voice Control” → “Delete individualization”.

A prompt appears asking whether you really do want to delete.

- ▶ Select “Yes” or “No”.

The individualization data will either be deleted or not, depending on your selection.

Setting the system language

- ▶ Select “Vehicle” → “System Settings” → “Language”.

The language list appears. A dot • indicates the current setting.

- ▶ **Changing setting:** Select desired language.

The language is set.

Assigning the favorite button





- ① Favorite button

You can assign the following predefined functions to the favorite button :

- “Rear Window Sunshade”
You can use the favorite button to extend or retract the rear window sunshade. This is the default setting.
 - “Display OFF”
You can use the favorite button to switch the COMAND display on or off.
 - “Tow-away Alarm”
You can use the favorite button to activate or deactivate the tow-away alarm*.
 - “Repeat Navigation Command”
You can use the favorite button to recall the last command issued by the navigation system.
- ▶ Select “Vehicle” → “System Settings” → “Favorite”.

The list of predefined functions appears. The dot • in front of the list entry indicates the current setting.

- ▶ **Changing setting:** Rotate  and select desired function.
- ▶ **Saving setting and exit the menu:**
Press .

Bluetooth settings

General information about Bluetooth

Bluetooth technology is the standard for short-range wireless data transmission of up to approximately 10 meters. Bluetooth can be used to exchange vCards or make calls using a headset.

Activate or deactivate Bluetooth

- ▶ Select “Vehicle” → “System Settings” → “Services” → “Deactivate Bluetooth”.

You have activated or deactivated Bluetooth. A checkmark appears when Bluetooth is deactivated.

Connecting Bluetooth devices

 *To connect a Bluetooth device, the Bluetooth function must be activated in COMAND and in the device concerned. The Bluetooth device must also be set to “visible” or “findable” in order for COMAND to find and display it. For the setting procedures, please see the operating instructions for the Bluetooth device.*

It is possible to establish a Bluetooth connection between COMAND and the following types of device:

- Mobile phone (only for transferring business cards)
- Headset
- Laptop / PDA

You can connect up to twelve devices to COMAND but only one device can be active at a time.

The connection process includes searching for the device and its subsequent authorization.

Calling up the Bluetooth device list and searching for devices

- ▶ **Calling up the list:** Select “Vehicle” → “System Settings” → “Services” → “Search for Bluetooth devices”.

When you call up the list for the first time after switching on COMAND, the search for devices in the reception range starts automatically. You will see a display to this effect.

The device list appears after a short while.

- ▶ **Canceling search:**
Select “Cancel”.

The second time you call up the list, and each time thereafter, the device list appears immediately if COMAND has not been switched off and on again in the meantime.

- ▶ **Starting search manually:**
select “Update”.

COMAND system settings

The device list can contain the following devices:

- All detected devices, whether authorized or not.
- All authorized devices, whether detected or not.

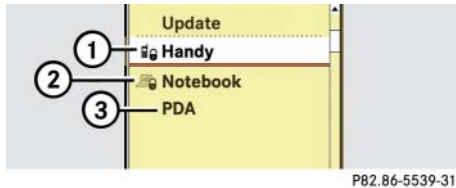

- ① Authorized and detected device – device and padlock symbol are the same color
- ② Device which was not detected, but which has been authorized in the past – device and padlock symbol are different colors (the device may be switched off or not in the vehicle, for example)
- ③ Newly detected device – not yet authorized (no symbol)

i If the device list already contains twelve authorized devices, you must revoke authorization for one of the authorized devices. Then you must switch this device off and then restart the search. Any new devices for which you would like to search will otherwise not appear in the list.

Displaying details of a Bluetooth device

- ▶ Call up Bluetooth device list (▷ page 217).
- ▶ Select desired device.
- ▶ Select “Details”.

The detailed display for this device appears.

- ▶ **Closing detailed display:** Slide or press .

Authorizing a Bluetooth device

- ▶ Call up Bluetooth device list (▷ page 217).
- ▶ Select unauthorized device.
- ▶ Select “Authorize”.

The input menu for the passkey appears.

i The passkey is any one to sixteen-digit number which you can set yourself. You must enter the same number in COMAND and also in the device to be authorized.

i On devices which do not have an input keypad (e.g. headsets), the passkey is predetermined. In this case, it is not necessary to enter the number on the device itself. You will usually find the passkey in the operating instructions for the device.

► **Entering passkey into COMAND:**

Select the digits one by one.

- **Deleting digits:** Select **[c]** and briefly press .

► **Canceling entry into COMAND:**

select “Back”.

► **Confirming entry into COMAND:**

Select **ok**.

- If necessary, enter the same passkey into the Bluetooth device (see the operating instructions for the device).

The device is authorized.

De-authorizing a Bluetooth device

- Call up Bluetooth device list (▷ page 217).

- Select authorized device.

- Select “De-authorize”.

A prompt appears asking whether you really want to de-authorize this device.

- Select “Yes” or “No”.

If you select “Yes”, the device will be de-authorized.

i *If you de-authorize a device which has been authorized in the past and which is not detected in the search, this device will no longer be displayed in the device list.*

Devices which have been authorized in the past but which are not detected in the search are either not switched on or not in the vehicle.

Reset

i *You can reset COMAND back to its factory settings.*

In this case, all personal data (e.g. address book entries, entries in the destination memory and the list of last destinations of the navigation system), among other things, is deleted.

- Select “Vehicle” → “System Settings” → “Reset”.

A prompt appears asking whether you really want to reset.

- Select “Yes” or “No”.

If you select “Yes” another prompt will appear asking whether you really want to reset.

- Select “Yes” or “No”.

If you select “Yes”, COMAND will be reset and restarted.

COMAND vehicle menu

In this menu, you can program the following vehicle functions:

Function	Page
Exterior Lighting Delayed Switch-off	220
Locator Lighting	221
Exterior Mirror Convenience Settings	222
Automatic Locking	223
Easy Entry/Exit Feature	224
Interior Ambient Light	225
Interior Lighting Delayed Switch-off	226
Rear Window Sunshade	227
Trunk Opening-height Restriction	227
Tow-away Alarm	228

Setting night security illumination

(Exterior Lighting Delayed Switch-off)

i The components and operating principles of COMAND can be found on (▷ page 79).

Use this function to set whether and how long you would like the exterior lighting to illuminate during darkness after exiting the vehicle and all doors closed.

The exterior lighting automatically goes out after the delayed switch-off time has expired.

You can select:

- “0 sec.”, the delayed switch-off feature is deactivated
- “15 sec.”, “30 sec.”, “45 sec.”, or “60 sec.”, the delayed switch-off feature is activated

i You can reactivate this function within 10 minutes by opening a door.

- ▶ Select “Vehicle”.

The main area is active.

- ▶ **Selecting “Exterior Lighting Delayed Switch-off” menu:** Slide ←⊙→ or rotate ⏪⏩.

- ▶ **Confirming selection:** Press ⊙.



P82.86-4849-31

- ▶ **Selecting length of time:** Slide ↑⊙↓ or rotate ⏪⏩.

- ▶ **Confirming selection:** Press ⊙.

or

- ▶ Select “Vehicle” → “Vehicle” → “Exterior Lighting Delayed Switch-off”.

A selection list appears.

The current setting is indicated by a dot •.

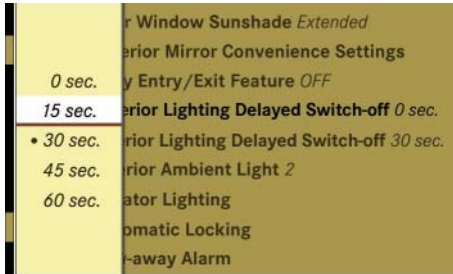

P82.86-4850-31

- ▶ **Selecting length of time:** Slide ↑⊙↓ or rotate ⏪⊙⏩.
- ▶ **Confirming selection:** Press ⏹.

To activate night security illumination:

- ▶ Select delayed switch-off period (see above).
- ▶ Turn the exterior lamp switch to position **A** before turning off the engine.

Locator lighting on/off

i *The components and operating principles of COMAND can be found on (▷ page 79).*

With the locator lighting feature activated and the exterior lamp switch in position **A** (▷ page 346), the following lamps will switch on during darkness when the vehicle is unlocked from the outside:

- Parking lamps
- Tail lamps
- License plate lamps
- Front fog lamps
- Door entry lamps in the mirror
- Side marker lamps

The locator lighting switches off when the driver's door is opened.

If you do not open a door after unlocking the vehicle with the SmartKey, the lamps will switch off automatically after approximately 40 seconds.

- ▶ Select "Vehicle".
The main area is active.
- ▶ **Selecting "Locator Lighting" function:** Slide ←⊙→ or rotate ⏪⊙⏩.
- ▶ **Confirming selection:** Press ⏹.



P82.86-4846-31

- ▶ **Switching locator lighting on or off:** Press ⏹.

or



COMAND vehicle menu

- ▷▷ Select “Vehicle” → “Vehicle” → “Locator Lighting”.

A checkmark appears when the locator lighting is switched on.



P82.86-4998-31

- ▶ **Confirming selection:** Press .

To activate locator lighting:

- ▶ Make sure the function “Locator Lighting” is set.
- ▶ Turn the exterior lamp switch to position **A** when exiting the vehicle.

Exterior mirror convenience settings



 The components and operating principles of COMAND can be found on (▷ page 79).

In the “Exterior Mirror Convenience Settings” menu, you can switch the following exterior mirror functions on or off:

- Exterior mirrors automatically fold in when the vehicle is locked
- Exterior mirror on front passenger’s side automatically tilts downward when the vehicle is reversing

- ▶ Select “Vehicle”.

The main area is active.

- ▶ **Selecting “Exterior Mirror Convenience Settings” menu:** Slide    or rotate .

- ▶ **Confirming selection:** Press .



P82.86-4845-31

- ▶ **Selecting “Fold in automatically when locking” or “Lower mirror when reversing”:** Rotate .

- ▶ **Confirming selection:** Press .

- ▶ Slide    to exit.

or

- ▶ Select “Vehicle” → “Vehicle” → “Exterior mirror Convenience Settings”.

A selection list appears.

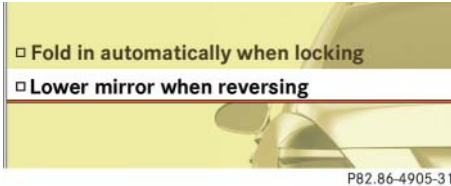

P82.86-4905-31

- ▶ **Selecting a function:** Slide $\uparrow \odot \downarrow$ or rotate $\left\{ \odot \right\}$.

A checkmark appears in the corresponding box when the option has been selected.

- ▶ **Confirming selection:** Press \odot .
- ▶ Slide $\leftarrow \odot \rightarrow$ to exit.

Automatic locking on/off

i The components and operating principles of COMAND can be found on (▷ page 79).

Use this function to activate or deactivate the automatic central locking (▷ page 313). With the automatic central locking system activated, the vehicle is centrally locked at vehicle speeds of approximately 9 mph (15 km/h).

- ▶ Select “Vehicle”.
The main area is active.
- ▶ **Selecting “Automatic Locking” function:** Slide $\leftarrow \odot \rightarrow$ or rotate $\left\{ \odot \right\}$.

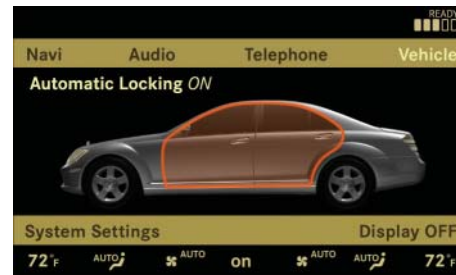

P82.86-4901-31

- ▶ **Switching automatic locking on or off:** Press \odot .
- or
- ▶ Select “Vehicle” → “Vehicle” → “Automatic Locking”.

A checkmark appears when automatic locking is switched on.

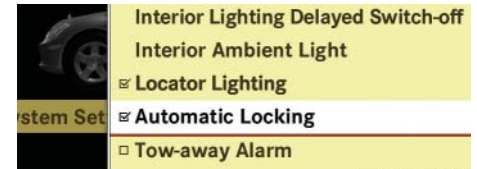

P82.86-4902-31

- ▶ **Confirming selection:** Press \odot .
- ▶ Slide $\leftarrow \odot \rightarrow$ to exit.

COMAND vehicle menu

Activating easy-entry/exit feature

i The components and operating principles of COMAND can be found on (▷ page 79).

Use this function to activate and deactivate the easy-entry/exit feature (▷ page 328).

The following settings are available for the easy-entry/exit feature:

OFF	The easy-entry/exit feature is deactivated.
Steering Column & Seat	Both the steering column and the driver's seat are moved.

Warning!



You must make sure no one can become trapped or injured by the moving steering wheel and driver's seat when the easy-entry/exit feature is activated.

To cancel seat/steering wheel movement, do one of the following:

- Press seat adjustment switch (▷ page 319).
- Move steering column stalk (▷ page 330).
- Press one of the memory position buttons or the memory button **M** (▷ page 337).

Do not leave children unattended in the vehicle, or with access to an unlocked vehicle. Children could open the driver's door and unintentionally activate the easy-entry/exit feature, which could result in an accident and/or serious personal injury.

- ▶ Select "Vehicle".
The main area is active.
- ▶ **Selecting "Easy Entry/Exit Feature" menu:** Slide ←○→ or rotate ⏪⏩.

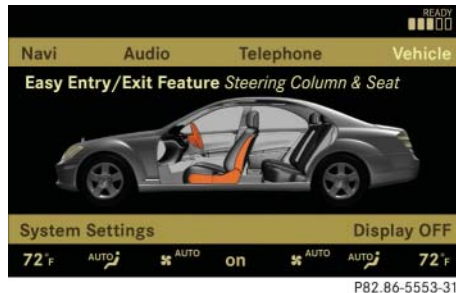

- ▶ **Confirming selection:** Press .

or

- ▶ Select "Vehicle" → "Vehicle" → "Easy Entry/Exit Feature".

- ▶ **Confirming selection:** Press .

A selection list appears.

The current setting is indicated by a dot •.

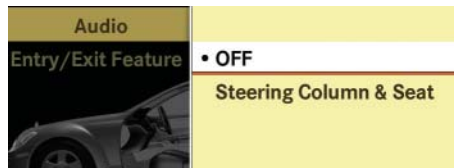

- ▶ **Selecting a setting:** Slide $\uparrow \odot \downarrow$ or rotate $\left\{ \odot \right\}$.
- ▶ **Confirming selection:** Press \odot .

Setting interior ambient lighting

 The components and operating principles of COMAND can be found on [page 79](#).

You can adjust the brightness of the interior lighting on a scale of “0” (off) to “5” (bright).

- ▶ Select “Vehicle”.
The main area is active.
- ▶ **Selecting “Interior Ambient Light” menu:** Slide $\leftarrow \odot \rightarrow$ or rotate $\left\{ \odot \right\}$.
- ▶ **Confirming selection:** Press \odot .

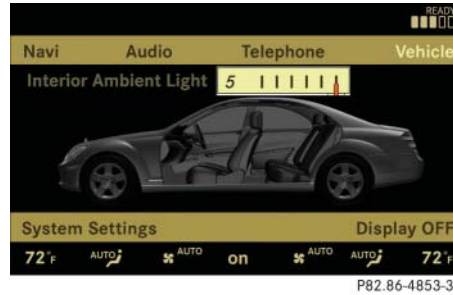

P82.86-4853-31

- ▶ **Adjusting brightness:** Slide $\leftarrow \odot \rightarrow$ or rotate $\left\{ \odot \right\}$.
 - ▶ **Confirming selection:** Press \odot .
- or
- ▶ Select “Vehicle” → “Vehicle” → “Interior Ambient Light”.



P82.86-4900-31

- ▶ **Adjusting brightness:** Slide $\uparrow \odot \downarrow$ or rotate $\left\{ \odot \right\}$.
- ▶ **Confirming selection:** Press \odot .

COMAND vehicle menu

Setting interior lighting delayed switch-off

i The components and operating principles of COMAND can be found on (▷ page 79).

Use this function to set whether and how long you would like the interior lighting to remain lit during darkness after you have removed the SmartKey from the starter switch.

You can select:

- “0 sec.”, the delayed switch-off feature is deactivated
 - “15 sec.”, “30 sec.”, “45 sec.”, or “60 sec.”, the delayed switch-off feature is activated
- ▶ Select “Vehicle”.
- The main area is active.
- ▶ **Selecting “Interior Lighting Delayed Switch-off” menu:** Slide ←⊙→ or rotate Ⓞ.

- ▶ **Confirming selection:** Press ⊙.

A selection list appears.

The current setting is indicated by a dot • .

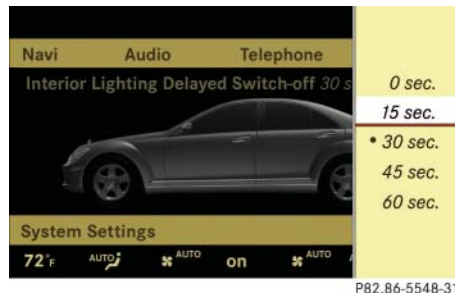

- ▶ **Selecting length of time:** Slide ↑⊙↓ or rotate Ⓞ.

- ▶ **Confirming selection:** Press ⊙.

or

- ▶ Select “Vehicle” → “Vehicle” → “Interior Lighting Delayed Switch-off”.

A selection list appears.

The current setting is indicated by a dot • .



- ▶ **Selecting length of time:** Slide ↑⊙↓ or rotate Ⓞ.

- ▶ **Confirming selection:** Press ⊙.

Extending or retracting rear window sunshade

i The components and operating principles of COMAND can be found on (▷ page 79).

This function is used to extend or retract the rear sunshade.

i If you operate the rear-window sunshade via COMAND or by using the favorite button (▷ page 216), this takes precedence over the buttons for the rear window sunshade in the rear doors (▷ page 456).

i You can program this function using the favorite button (▷ page 216).

i At temperatures below -4°F (-20°C), the rear window sunshade is switched off.

- ▶ Select “Vehicle”.

The main area is active.

- ▶ **Selecting “Rear-window Sunshade” function:** Slide $\leftarrow \odot \rightarrow$ or rotate $\left\{ \odot \right\}$.

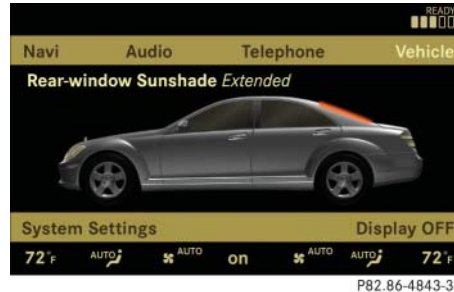

- ▶ **Extending or retracting rear window sunshade:** Press \odot .

or

- ▶ Select “Vehicle” → “Vehicle” → “Rear-window Sunshade”.

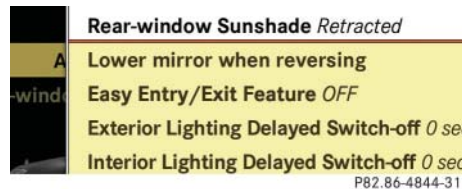

- ▶ **Confirming selection:** Press \odot .

Trunk opening-height restriction on/off

i The components and operating principles of COMAND can be found on (▷ page 79).

You can select whether the trunk lid should open fully or only to the height of the roof.

- ▶ Select “Vehicle”.

The main area is active.

- ▶ **Selecting “Trunk Opening-height Restriction” function:** Slide $\leftarrow \odot \rightarrow$ or rotate $\left\{ \odot \right\}$.

- ▶ **Confirming selection:** Press \odot .

or



P82.86-5001-31 ▷▷

COMAND vehicle menu

- ▷▷ Select “Vehicle” → “Vehicle” → “Trunk Opening-height Restriction”.

A checkmark appears when the trunk opening-height restriction is switched on.

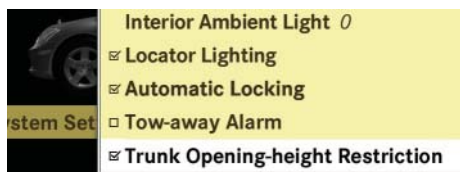

P82.86-5002-31

- ▶ **Confirming selection:** Press .





Switching on/of the tow-away alarm

i The components and operating principles of COMAND can be found on (▷ page 79).

i You can program the tow-away alarm function (▷ page 216) using the favorite button in the center console.

When you press the favorite button, you can switch the functions on or off.

To prevent triggering the tow-away alarm feature (▷ page 76), switch off the tow-away alarm before towing the vehicle, or when parking on a surface subject to movement, such as a ferry or auto train.

- ▶ Select “Vehicle”.
- The main area is active.
- ▶ **Selecting “Tow-away Alarm” function:** Slide   or rotate .
- ▶ **Confirming selection:** Press .



P82.86-4999-31

or

- ▶ Select “Vehicle” → “Vehicle” → “Tow-away Alarm”.

A checkmark appears when the tow-away alarm is switched on.

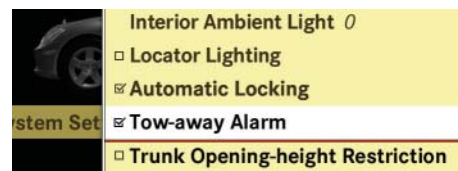

P82.86-5549-31

- ▶ **Confirming selection:** Press .

▼ COMAND automatic climate control

i The components and operating principles of COMAND can be found on (▷ page 79).

Warning!



When operating the automatic climate control, the air that enters the passenger compartment through the air vents can be very hot or very cold (depending on the set temperature). This may cause burns or frostbite to unprotected skin in the immediate area of the air vents.

Always keep sufficient distance between unprotected parts of the body and the air vents. If necessary, use the air distribution adjustment (▷ page 230) to direct the air to air vents in the vehicle interior that are not in the immediate area of unprotected skin.

Warning!



Follow the recommended settings for heating and cooling given on the following pages

and pages in the “Controls in detail” part (▷ page 424) Otherwise the windows could fog up, impairing visibility and endangering you and others.

You can operate the automatic climate control via COMAND or via the buttons on the front and rear* automatic climate control panel (▷ page 424).

The following automatic climate control functions can be operated via COMAND:

Function	Page
Temperature	230
Air distribution	230
Air volume	230
Switching off cooling (“AC ^{OFF} ”)	231
Central climate control (“Mono”)	232
Footwell temperature	232
Air flow from air vents	233
Rear climate control*	234

The automatic climate control menu is called up via the climate control settings.





Climate control settings with functions (submenus)

- ① Temperature, left
- ② Air distribution, left
- ③ Air volume, left
- ④ Central menu, climate control
- ⑤ Air volume, right
- ⑥ Air distribution, right
- ⑦ Temperature, right



COMAND automatic climate control





Setting temperature

Use the temperature controls   (▷ page 426) in the center console or COMAND climate control settings to separately adjust the air temperature on each side of the passenger compartment.

- ▶ Select climate control settings → Temperature, left or right and then press .



- ▶ **Changing temperature:** Slide   or rotate .

- ▶ **Exiting menu:** Press , back button  in the center console (▷ page 80) or slide  .

The setting is saved.

Adjusting air distribution

You can adjust the air distribution separately for the driver's and front passenger's side.





 *When you change the air distribution, the automatic function of the climate control system is switched off.*

- ▶ Select climate control settings → Air distribution, left or right.



- ▶ **Changing air distribution:** Rotate .

The symbol for air distribution changes. The direction and size of the arrows represent the air distribution.

- ▶ **Exiting menu:** Press , back button  in the center console (▷ page 80) or slide  .

The setting is saved.

Adjusting air volume

Use buttons  (▷ page 426) in the center console or COMAND climate control settings to separately adjust the air volume on each side of the passenger compartment.

 *When you change the air volume, the automatic function of the climate control system is switched off.*

- ▶ Select climate control settings → Air volume, left or right.

COMAND automatic climate control



P82.86-5006-31

- ▶ **Changing air volume:** Slide or rotate .
- ▶ **Exiting menu:** Press , back button in the center console (> page 80) or slide .

The setting is saved.

Central climate control menu via COMAND

The central climate control menu is in the center of the climate control settings. When the automatic climate control is switched on, you will see “on” in the cen-

tral menu. The following functions can only be operated in the central climate control menu via COMAND:

Function	Page
Switching off cooling (“AC ^{OFF} ”)	231
Central climate control (“Mono”)	232
Footwell temperature	232
Air flow from air vents	233
Rear climate control	234

- ▶ Select climate control settings → Central menu.

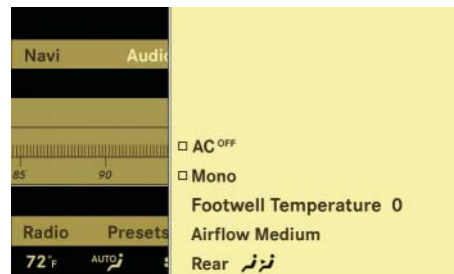

P82.86-5007-31

Switching cooling on or off

The cooling function, only operational when the engine is running, cools the vehicle interior down to the selected temperature. The cooling function also dehumidifies the air in the vehicle interior, thus preventing the windows from fogging up.

Condensation may drip out from underneath the vehicle. This is normal and not an indication of a malfunction.

The “AC^{OFF}” function is used to permanently switch off the cooling function of the automatic climate control system.

Warning!



If you turn off the cooling function, the vehicle will not be cooled when weather conditions are warm. The windows can fog up more quickly. Window fogging may impair visibility and endanger you and others.

COMAND automatic climate control

- ▶ Select climate control settings → Central climate control menu.
- ▶ **Selecting “AC^{OFF}”:** Slide or rotate .
- ▶ **Confirming selection:** Press .

A checkmark appears when the cooling is switched off.

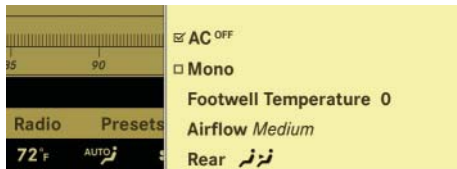

P82.86-5008-31

“AC^{OFF}” appears in the central menu of the climate control settings.

! *If the air conditioning cannot be turned on again, this indicates that the air conditioning is losing refrigerant. The compressor has turned itself off.*

Have the air conditioning checked at the nearest authorized Mercedes-Benz Center.

Selecting “Mono” mode

“Mono” is used to adjust the climate zones for the entire vehicle at the same time. When the “Mono” function is switched on and you change the climate on the driver’s side, these changes will be carried out in the same manner for all climate zones.

- ▶ Select climate control settings → Central climate control menu.
- ▶ **Selecting “Mono”:** Slide or rotate .
- ▶ **Confirming selection:** Press .

A checkmark appears when the function has been selected.



P82.86-5009-31

- ▶ **Exiting menu:** Press back button in the center console (▷ page 80) or slide .

The “Mono” function is automatically switched off when you:

- change an automatic climate control setting for the front passenger’s side using COMAND
- operate a button from the automatic climate control for the front passenger’s side
- operate one of the buttons for the rear climate control system.

Adjusting footwell temperature

i *In automatic mode, this setting optimizes the footwell temperature when outside temperatures are low.*

The “Footwell Temperature” function is used to adjust the temperature difference between the footwell and the rest of the passenger compartment.

The higher the selected value, the higher the temperature in the footwell will be.

- ▶ Select climate control settings → Central climate control menu.

► **Selecting “Footwell Temperature”:**

Slide or rotate and then press .

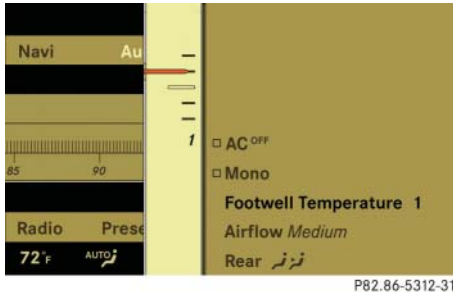

► **Changing temperature difference:**

Slide or rotate .

► **Exiting menu:** Press , back button in the center console (> page 80) or slide .

The setting is saved.

Adjusting air flow from air vents

In automatic mode, this setting optimizes the air flow when outside temperatures are high.

The “Airflow” setting defines air distribution and air volume in automatic mode:

- “Focused” (default setting, increased air flow)
- “Medium” (reduced air flow)
- “Diffuse” (minimal air flow)

When the interior ambient temperature of the vehicle is very hot and the automatic climate control is cooling the interior, the setting for air flow is temporarily overridden.

► Select climate control settings → Central climate control menu → “Airflow”.

A selection list appears.

The current setting is indicated by a dot •.



P82.86-5550-31

► **Changing air flow:** Slide or rotate .

► **Confirming selection:** Press .

COMAND automatic climate control

Operating rear climate control* from the front

The “Rear *نفر*” function is used to operate the rear climate control via COMAND and the buttons on the center console control unit (▷ page 434).

Switching on rear climate control operation from the front

- ▶ Select climate control settings → Central climate control menu.
- ▶ **Selecting “Rear *نفر*”**: Slide ↑⊙↓ or rotate ⏪⊙⏩.



- ▶ **Confirming selection**: Press ⊙.

In the climate control settings, “*نفر*” appears in the central menu. The rear climate control can be operated from the front.

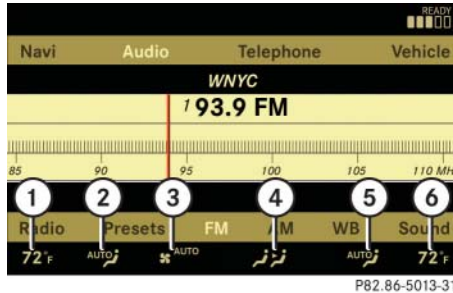

Climate control settings, rear climate control

- ① Rear temperature, left
- ② Rear air distribution, left
- ③ Rear air volume
- ④ Central menu for rear climate control
- ⑤ Rear air distribution, right
- ⑥ Rear temperature, right

The rear climate control is operated in the same manner as the climate control system for the driver’s and front passenger’s side (▷ page 229).

Central menu for rear climate control

In the central menu for the rear climate control, you can:

- switch back to operating the front climate control system
 - switch off the rear climate control
 - switch the automatic function of the rear climate control from automatic to manual
- ▶ Select climate control settings → Central climate control menu.

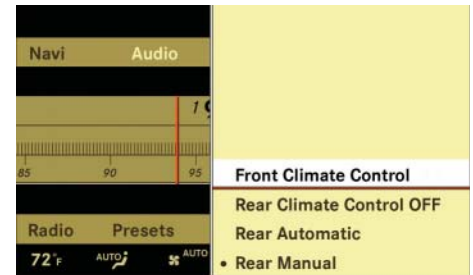

P82.86-5014-31

COMAND automatic climate control

Switching off rear climate control operation from the front

- ▶ Select climate control settings → Central climate control menu.

The current setting is indicated by a dot • .

- ▶ **Selecting “Front Climate Control”:** Slide or rotate .

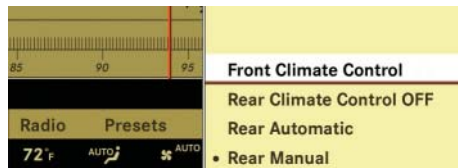

P82.86-5015-31

- ▶ **Confirming selection:** Press .

The climate control settings shows the climate control settings for the driver and front passenger.

Switching off rear climate control

- ▶ Select climate control settings → Central climate control menu.

The current setting is indicated by a dot • .

- ▶ **Selecting “Rear Climate Control OFF”:** Slide or rotate .

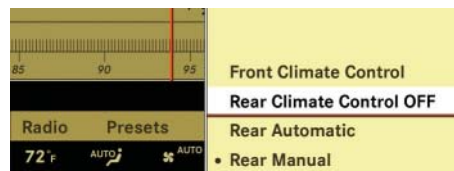

P82.86-5016-31

- ▶ **Confirming selection:** Press .

The rear climate control is switched off.

Switching on the automatic function of the rear climate control

- ▶ Select climate control settings → Central climate control menu.

The current setting is indicated by a dot • .

- ▶ **Selecting “Rear Automatic”:** Slide or rotate .

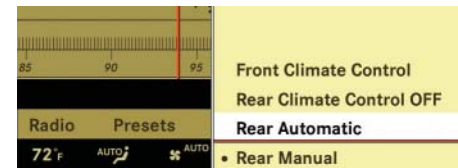

P82.86-5017-31

- ▶ **Confirming selection:** Press .

The automatic function of the rear climate control is switched on.

COMAND seats

When adjusting the seats, observe the safety notes in the section “Seats” (▷ page 318).

Operating seats via COMAND

i The components and operating principles of COMAND can be found on (▷ page 79).

The following seat adjustments can be made via COMAND:

Settings	Page
Lumbar support	237
Multicontour seat*, front	237
Drive-dynamic multicontour seat*	240

Selecting a seat

You must first select the seat for which you would like to make adjustments.



① Seat menu button

▶ Press .

The main area is active.

▶ **Switching to the bottom menu line:**

Slide .

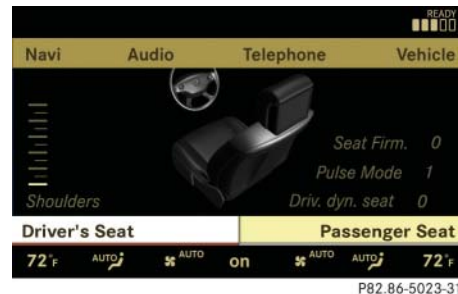

Example illustration (vehicles with Drive-dynamic multicontour seat*)

▶ **Selecting seat:** Slide or rotate .

▶ **Confirming selection:** Press .

Exiting menu

There are several ways to exit the multicontour seat menu.

▶ Press again.

or

▶ Press any shortcut button.

or

- ▶ Select another main menu from the main menu line.

Lumbar support

To support the spine, you can adjust the curvature of the front seat backrests.





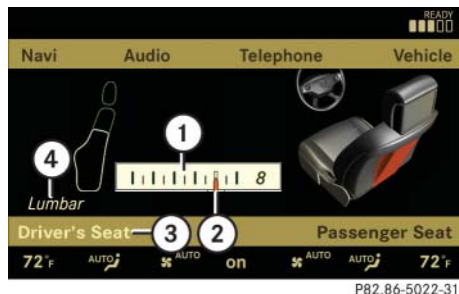

- ▶ Press .

The main area of the COMAND display is active. A scale appears.



P82.86-5022-31

- ① Scale
- ② Cursor
- ③ Current seat
- ④ Current setting

- ▶ Select seat (▷ page 236).
- ▶ **Adjusting lumbar support:**
Slide   or rotate  until desired setting is reached.
- ▶ **Confirming selection:** Press .
- ▶ **Switching to the bottom menu line:**
Slide  .
- ▶ **Confirming selection:** Press .

i After you have pressed , the seat last adjusted is active.

Multicontour seats*, front

i If PRE-SAFE® has been activated, the air pressure in the air chambers (on the sides of the seat cushion and backrest) of the front multicontour seats is increased.

To support the spine, you can individually adjust the backrest contour of the front seats by regulating the air pressure in the air chambers of the multicontour seat.

The settings are made on the COMAND display.





i When you adjust the multicontour seat, noises may result from pumping air into or releasing air out of the air chambers.

You can adjust the following air chambers:

- sides of seat cushion
- thigh support
- sides of backrest
- backrest curvature in lumbar area
- backrest curvature in shoulder area
- seat firmness

Adjusting sides of seat cushion

This function is used to adjust the air chambers in the sides of the seat cushion.

- ▶ Select seat (▷ page 236).
- ▶ **Selecting "Seat sides":** Slide   or rotate .
- ▶ **Confirming selection:** Press .

A scale appears.

COMAND seats

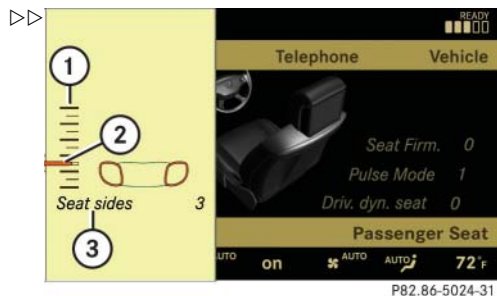

- ① Scale
- ② Cursor
- ③ Current setting

- ▶ Slide $\uparrow\odot\downarrow$ or rotate $\{\odot\}$ until desired setting is reached.
- ▶ **Saving setting:** Press \odot .

Adjusting thigh support

This function is used to adjust the air chambers for the thighs.

- ▶ Select seat (▷ page 236).
- ▶ **Selecting “Thighs”:** Slide $\uparrow\odot\downarrow$ or rotate $\{\odot\}$.

- ▶ **Confirming selection:** Press \odot .
- A scale appears.

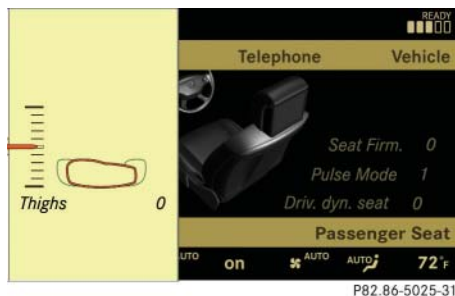

- ▶ Slide $\uparrow\odot\downarrow$ or rotate $\{\odot\}$ until desired setting is reached.
- ▶ **Saving setting:** Press \odot .

Adjusting backrest sides

This function is used to adjust the air chambers in the backrest sides.

- ▶ Select seat (▷ page 236).
- ▶ **Selecting “Seatback Sides”:** Slide $\uparrow\odot\downarrow$ or rotate $\{\odot\}$.

- ▶ **Confirming selection:** Press \odot .
- A scale appears.

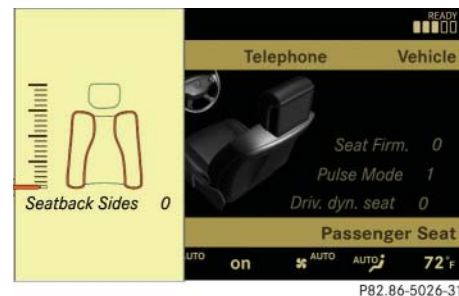

- ▶ Slide $\uparrow\odot\downarrow$ or rotate $\{\odot\}$ until desired setting is reached.
- ▶ **Saving setting:** Press \odot .

Adjusting backrest curvature in lumbar area

This function is used to adjust the air chambers in the lumbar area of the backrest.



- ▶ Select seat (▷ page 236).
- ▶ **Selecting “Lumbar”:** Slide $\leftarrow\odot\rightarrow$ or rotate $\{\odot\}$.

- ▶ **Confirming selection:** Press .

Cross-hairs appear. You can use them to make two settings:

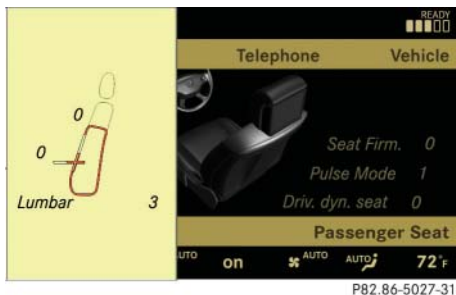

- **vertical:** shift the point of greatest curvature upward or downward
- **horizontal:** adjust the degree of curvature



- ▶ Slide  or  until desired setting is reached.
- ▶ **Saving setting:** Press .



Adjusting backrest curvature in shoulder area

This function is used to adjust the air chambers in the shoulder area of the backrest.

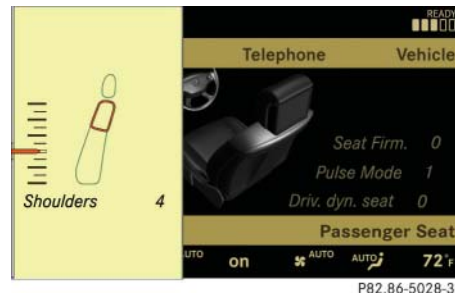

- ▶ Select seat (▷ page 236).
- ▶ **Selecting “Shoulders”:** Slide  or rotate .
- ▶ **Confirming selection:** Press .

A scale appears.



- ▶ Slide  or rotate  until desired setting is reached.
- ▶ **Saving setting:** Press .



Adjusting seat firmness

- ▶ Select seat (▷ page 236).
- ▶ **Selecting “Seat Firm.”:** Slide  or rotate .
- ▶ **Confirming selection:** Press .

A scale appears. You can choose between:

- “0”: off
- “1”: level 1
- “2”: level 2



- ▶ Slide  or rotate  until desired setting is reached.
- ▶ **Saving setting:** Press .

COMAND seats

Drive-dynamic multicontour seats, front*

For information on manual multicontour seat settings, see “Multicontour seats*, front” (▷ page 237).

i If PRE-SAFE® has been activated, the air pressure in the air chambers (sides of seat cushion and backrest) of the drive-dynamic multicontour seats is increased.

The Drive-dynamic multicontour seat automatically adjusts the lateral support provided by the backrest to your driving style.

The Drive-dynamic multicontour seat electronically controls the air pressure in the air chambers of the backrest side bolsters. This function improves driving comfort and pleasure.

- ▶ Select seat (▷ page 236).
- ▶ **Selecting “*Driv. dyn. seat*”:** Slide ←→ or rotate ⏸.

- ▶ **Confirming selection:** Press ⏸.

A scale appears. You can choose between:

- “0”: off
- “1”: level 1
- “2”: level 2

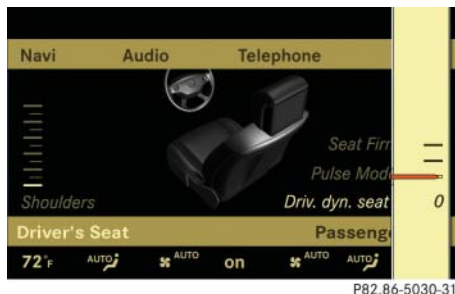

- ▶ Slide ↑⏸↓ or rotate ⏸ until desired setting is reached.
- ▶ **Saving setting:** Press ⏸.

Pulse mode

- ▶ Select seat (▷ page 236).

- ▶ **Selecting “*Pulse Mode*”:** Slide ←⏸→ or rotate ⏸.

- ▶ **Confirming selection:** Press ⏸.

A list appears. You can choose between different types of massage:



PB2.86-5031-31

The current setting is indicated by a solid circle.

- ▶ Slide ↑⏸↓ or rotate ⏸ until desired setting is reached.
- ▶ **Saving setting:** Press ⏸.

i Depending on the setting, the massage function runs for about 7 to 10 minutes.

▼ Instrument cluster control system

The control system is activated as soon as the SmartKey in the starter switch is turned to position **2** or as soon as the KEYLESS-GO* start/stop button (▷ page 317) is in position **2**. The control system enables you to:

- call up information about your vehicle
- change vehicle settings

For example, you can use the control system to find out when your vehicle is next due for service, to call up statistical data on your vehicle, and much more.

Warning!



A driver's attention to the road and traffic conditions must always be his/her primary focus when driving.

For your safety and the safety of others, selecting features through the multifunction steering wheel should only be done by the driver when traffic and road conditions permit it to be done safely.

Bear in mind that at a speed of just 30 mph (approximately 50 km/h), your vehicle is covering a distance of 44 feet (approximately 14 m) every second.

The control system relays information to the multifunction display.

Multifunction display

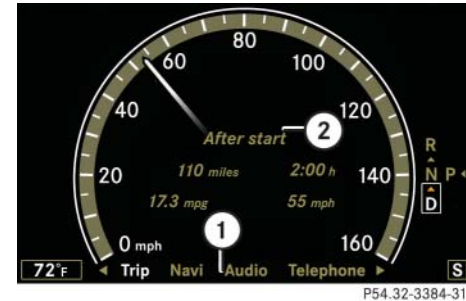

- ① Line for main menus
- ② Text field in multifunction display









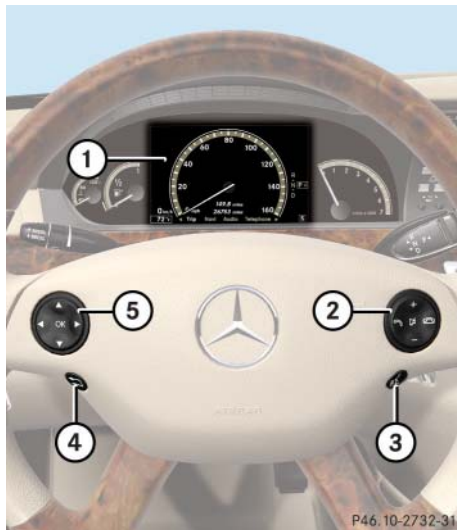



Settings, functions, submenus as well as any malfunctions are shown to you in the text field.

Instrument cluster control system

Multifunction steering wheel

The displays in the multifunction display and the settings in the control system are controlled using the buttons on the multifunction steering wheel.





①	Multifunction display
②	 to take a call to dial a number  to end a call to reject an incoming call  volume up  volume down  mute
③	 to accept a call activate Voice Control*
④	 back/cancel Voice Control*
⑤	 scroll up  scroll down  scroll to the right  scroll to the left  confirm selection

The information available in the multifunction display is arranged in menus, each containing a number of functions or sub-menus. For example, in the “Settings” menu, you will find functions for making

settings to your vehicle. There are functions for calling up information and for making settings to your vehicle.

It is helpful to think of the menus as being arranged in a circular pattern:

▶ Press  or  repeatedly to switch menus.

The number of menus available in the system depends on which optional equipment is installed in your vehicle.

Press button  to return to the next highest menu level.

From a menu’s highest level, you will always see the screen from the “Trip” menu that was last active. When you press  again, you switch to the standard display (▷ page 245).

For information about warning and malfunction messages appearing in the multifunction display (▷ page 557).

Menus

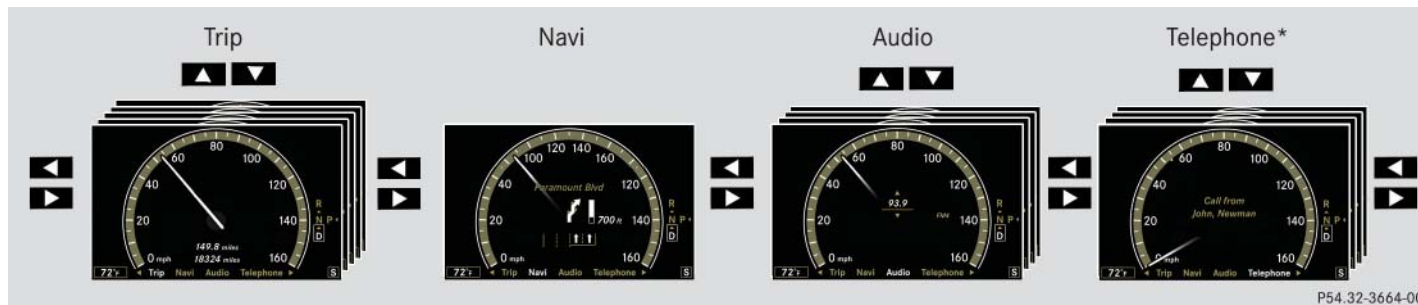

	Trip (▷ page 245)	Navi (▷ page 246)	Audio (▷ page 248)	Telephone* (▷ page 249)
Commands/submenus	Standard display	Show route guidance instructions, current direction traveled	Select radio station	Answer a call
	Fuel consumption statistics after start		Select satellite radio channel* (USA only)	Dial a number from the phone book
	Fuel consumption statistics since the last reset		Operate CD changer/DVD-Audio/MP3	Redialing
	Call up range			End a call or reject an incoming call
	Digital speedometer			

Instrument cluster control system

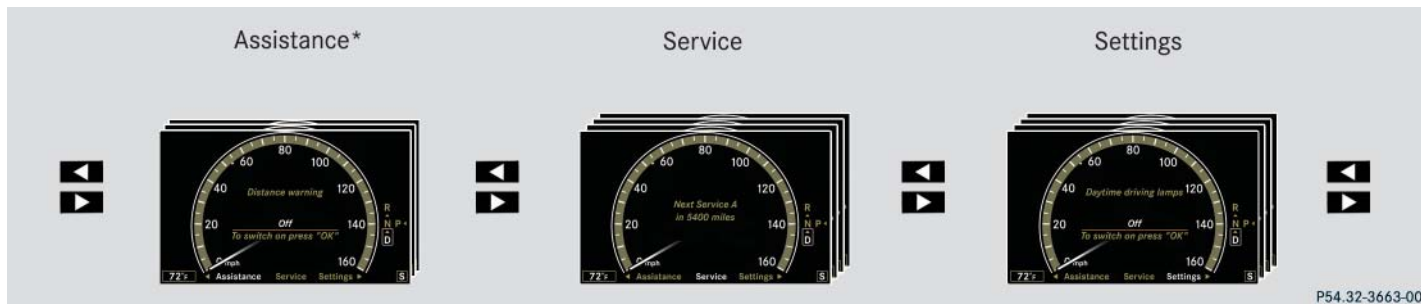

P54.32-3663-00

	Assistance* (▷ page 252)	Service (▷ page 253)	Settings (▷ page 254)
Commands/submenus	Displaying the distance graphic* (DISTRONIC Plus*)	Call up vehicle malfunction, warning and system status messages stored in memory	Set daytime running lamp mode (USA only)
	Distance warning function* activating/deactivating	Check tire inflation pressure	Switch additional speedometer on or off
	Switch on the Dynamic Rear View Monitor* automatically	Call up maintenance service display	Switch radar sensors* on or off
		Check engine oil level*	

i The headings used in the menus table are designed to facilitate navigation within the system and are not necessarily identical to those shown in the control system displays.

The first function displayed in each menu will automatically show you which part of the system you are in.

Instrument cluster control system

Trip menu

i The menu overview can be found on (▷ page 243).

In the “Trip” menu, you can show an additional display for the speedometer and call up or reset your vehicle’s statistical data.

Standard display

In the standard display, the trip odometer and main odometer are shown in the multifunction display.

▶ Press ◀ or ▶ to select the “Trip” menu.

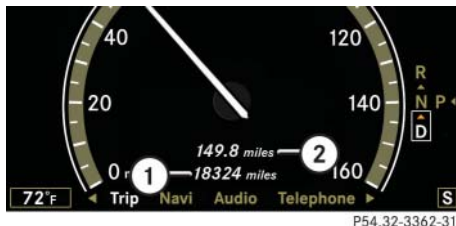

- ① Main odometer
- ② Trip odometer

Fuel consumption statistics after start

- ▶ Press ◀ or ▶ to select the “Trip” menu.
- ▶ Press ▼ to select “After start”.

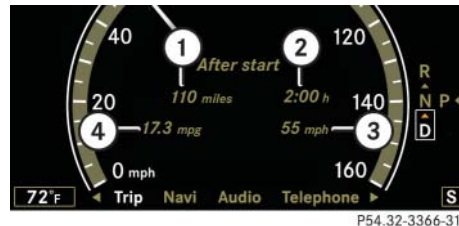

- ① Distance driven since start
- ② Time elapsed since start
- ③ Average fuel consumption since start
- ④ Average speed since start

i All values that are based on the last start are reset when you turn off the vehicle’s engine for more than four hours (▷ page 365).

i If you turn the SmartKey to position 1 or 2 again during this time, the values will not be reset. After 999 hours or 9999 miles (kilometers), the fuel consumption statistics after start are automatically reset.

Fuel consumption statistics since last reset

- ▶ Press ◀ or ▶ to select the “Trip” menu.
- ▶ Press ▼ or ▲ to select “After reset”.

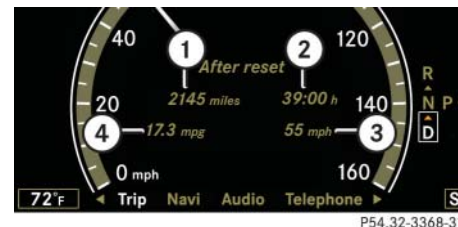

- ① Distance driven since last reset
- ② Time elapsed since last reset
- ③ Average fuel consumption since last reset
- ④ Average speed since last reset

i After 9999 hours or 99,999 miles (kilometers), the fuel consumption statistics since last reset are automatically reset.

Instrument cluster control system

Resetting fuel consumption statistics

- ▶ Press **◀** or **▶** to select the “Trip” menu.
- ▶ Press **▼** or **▲** to select the function you wish to reset.
- ▶ Press **OK**.

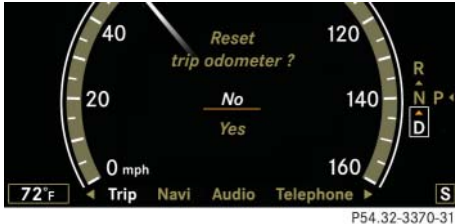

P54.32-3370-31

Illustration: Reset trip odometer

- ▶ Press **▼** to select “Yes” and confirm with **OK**.

i You can reset the trip odometer by pressing and holding the **↵** button. The trip odometer is then reset without confirmation.

Distance to empty

- ▶ Press **◀** or **▶** to select the “Trip” menu.
- ▶ Press **▼** or **▲** to select “Range”. In the display you will see the calculated range based on the current fuel tank level.

Digital speedometer

- ▶ Press **◀** or **▶** to select the “Trip” menu.
- ▶ Press **▼** or **▲** to select the digital speedometer.



P54.32-3369-31

① Digital speedometer

Navi menu

i The menu overview can be found on (▷ page 243).

The display in the “Navi” menu depends on whether route guidance is active or not.

- ▶ Press **◀** or **▶** to select the “Navi” menu.

Route guidance not active

The multifunction display shows the direction of travel and the name of the street you are currently driving on, if known by the navigation system.

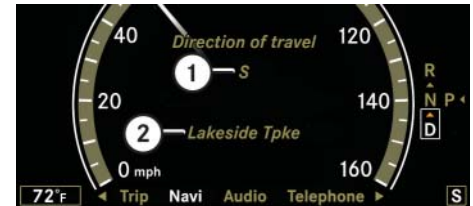

P54.32-3371-31

- ① Direction of travel
- ② Street you are currently driving on

Instrument cluster control system

Route guidance active

The image on the multifunction display depends on whether you are being notified of a driving maneuver.

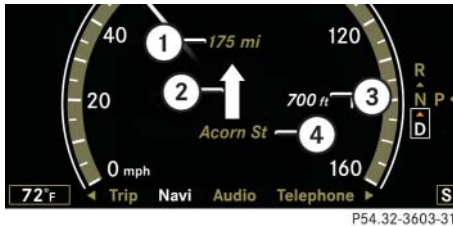
No notification of driving maneuver**Example illustration**

- ① Distance to destination
- ② Symbol for “follow the course of the road”
- ③ Distance to next driving maneuver
- ④ Street you are currently driving on

Notification of driving maneuver without lane recommendation**Example illustration**

- ① Street into which the driving maneuver leads
- ② Symbol for “driving maneuver”
- ③ Distance to driving maneuver and visual distance display

When you are being notified of a driving maneuver, you will see a visual distance display ③ next to the driving maneuver symbol. The visual distance display is reduced from bottom to top the closer you come to the announced driving maneuver.

Navigation status displays in the instrument cluster

While route guidance is active, the following messages may be shown on the multifunction display:

- You have reached your destination.
- “Area of dest. reached”
You have arrived in the area of your destination. The message appears, for example, for relatively large POIs.
- “New Route...”
COMAND calculates a new route, e.g. because you have deviated from the calculated route or due to a detour report. Afterward, COMAND continues route guidance.

Instrument cluster control system

- “Calculating Route”

COMAND is calculating a route. Afterward, COMAND starts route guidance.

- “Off Map”

The vehicle’s location is outside of the digital map’s range. The vehicle is in an off-map position (▷ page 190).

- “Off Road”

The vehicle is either on a road that has not been digitized (▷ page 190) or on the side of a road, e.g. in a parking space.

- “No Route”

COMAND cannot calculate a route to the selected destination.

- “Direction of Dest.”

The vehicle has gone off the map during route guidance (▷ page 190).

Audio menu

i The menu overview can be found on (▷ page 243).

The functions in the “Audio” menu operate the audio equipment which you currently have turned on.

If no audio equipment is currently turned on, the message: “Audio off” is shown in the multifunction display.

Select radio station

- ▶ Turn on COMAND and select “Radio” (▷ page 93).
- ▶ Press **◀** or **▶** to select the “Audio” menu.
- ▶ Press **▼** or **▲** to select a station.



P54.32-3373-31

① Station frequency

② Waveband

▶ Press **+** or **-** to adjust the volume.

i You can only change the frequency band and save new stations using COMAND (▷ page 93).

Select satellite radio* channel (USA only)

The satellite radio is treated as a radio application.

▶ Turn on COMAND and select “Sat Radio” (▷ page 98).

Instrument cluster control system

- ▶ Press **◀** or **▶** to select the “Audio” menu.
- ▶ Press **▼** or **▲** to select a station.

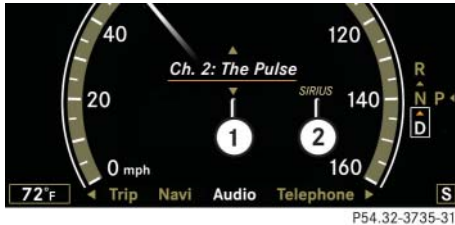

- ① Channel number and/or name
- ② SAT mode

- ▶ Press **+** or **-** to adjust the volume.

i A subscription to Sirius satellite radio service provider is required for the satellite radio operation. Contact an authorized Mercedes-Benz Center for details and availability for your vehicle.

For more information, see *Sat Radio* (▷ page 98).

Operating DVD changer/audio CD/audio DVD/MP3

- ▶ Turn on COMAND and select “CD”, “DVD-Audio” or “MP3” (▷ page 104).
- ▶ Press **◀** or **▶** to select the “Audio” menu.
- ▶ Press **▼** or **▲** to select a track.



Example: audio CD

- ① Current track
- ▶ Press **+** or **-** to adjust the volume.
- i** When you play a CD or DVD with text, the multifunction display shows the name and number of the track. For MP3s, only the track is shown.

Telephone menu*

i The menu overview can be found on (▷ page 243).

Warning!



Some jurisdictions prohibit the driver from using a cellular telephone while driving. Whether or not prohibited by law, for safety reasons, the driver should not use the cellular telephone while the vehicle is in motion. Stop the vehicle in a safe location before placing or answering a call.

If you nonetheless choose to use the cellular phone while driving, please use the hands-free feature and be sure to pay attention to the traffic situation at all times. Use the cellular phone only when road, weather and traffic conditions permit.

Bear in mind that at a speed of just 30 mph (approximately 50 km/h), your vehicle is covering a distance of 44 feet (approximately 14 m) every second.

Instrument cluster control system



Warning!



Never operate radio transmitters equipped with a built-in or attached antenna (i.e. without being connected to an external antenna) from inside the vehicle while the engine is running. Doing so could lead to a malfunction of the vehicle's electronic system, possibly resulting in an accident and/or personal injury.

You can use the functions in the “*Telephone*” menu to operate your telephone, provided it is inserted in the cradle and switched on.

Logging-on to a network

- ▶ Switch on the telephone and COMAND (▷ page 79).
- ▶ Press  or  to select the “*Telephone*” menu.

Which messages appear in the multifunction display field depends on whether your telephone is switched on or off.

- If the telephone is off, the message in the multifunction display is: “*Telephone OFF*”.
- If the telephone is not inserted in the cradle, the message in the multifunction display is: “*No telephone inserted*”.
- If the PIN or unlock code is not yet entered, the message in the multifunction display is “*Please enter PIN*” or “*Enter unlock code*”.
- If the telephone is switched on, the telephone will then search for a network. During this time, the multifunction display is blank. If no network available, the multifunction display reads “*No Service*”.
- If the telephone is on, as soon as the telephone has found a network, “*Ready*” or “*Ready (Roaming)*” appears in the multifunction display.

Entering the PIN or unlock code

- ▶ Enter the PIN or unlock code using the telephone keypad*, Voice Control* or telephone*.

The telephone will then search for a network.





You may carry out the following functions:





Function	Page
Dialing a number from the phone book	250
Redialing	251
Answering a call	252
Ending a call or rejecting an incoming call	252

Dialing a number from the mobile phone book



If your telephone is ready to receive calls, you may select and dial a number from the phone book at any time.





- ▶ Log on to the network (▷ page 250).



i When you insert a Mercedes-Benz approved mobile phone into the cradle*, the control system reads in the phone book that is saved on the SIM card or in the phone book of the mobile phone. This can take several minutes, depending on how many entries each phone book contains. When you press , , ,  or **OK** during the download of the phone book the message “Reading telephone data, please wait...” appears in the multifunction display. When the message: “Reading telephone data, please wait...” disappears, the phone book has been loaded.

- ▶ Press ,  or **OK** to switch to the phone book.
- ▶ Press ,  to select the desired name.

The stored names are displayed in ascending alphabetical order.

i If you do not want to dial from the phone book, press  or . In the multifunction display appears again “Ready” or “Ready (Roaming)”.

i If you press and hold  or  for more than 1 second, the system scrolls rapidly through the list of names. If you press and hold  or  for more than 4 seconds, the control system shows the first four entries of the letter next used. Release the button to stop the quick search. The search stops automatically at the end of the list.

- ▶ Press  or **OK** to start dialing.
- If several entries are present for the same name, they are all shown.
- ▶ Select the desired entry.
 - ▶ Press  or **OK** to start dialing.

The message “Connecting call...” appears on the multifunction display, as well as the dialed telephone number or name as long as it is stored in the phone book.





The dialed number is saved in the “Dialed numbers” list.

Once a connection has been established, the name appears on the multifunction display, provided that it has

been stored in the phone book, otherwise the dialed telephone number appears.

Redialing

The control system stores the most recently dialed phone numbers. This eliminates the need to search through your entire phone book.

- ▶ Log on to the network (▷ page 250).
- ▶ Press  to switch to the number and/or name last dialed in the redial memory.
- ▶ Press ,  to select the desired number and/or name.
- ▶ Press  or **OK** to start dialing.

Once a connection has been established, the name appears in the multifunction display, provided that it has been stored in the phone book, otherwise the dialed telephone number appears.

Instrument cluster control system

Answering a call

When your telephone is ready to receive calls, you can answer a call at any time with the ignition on. When you are in the “Telephone” menu, you will see the following message on the multifunction display:

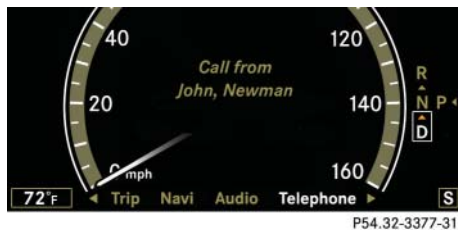

P54.32-3377-31

- ▶ Press .

i The caller's number appears only if it is transmitted.

The caller's name appears only if the number and the name are stored in the phone book.

Ending a call or rejecting an incoming call

- ▶ Press .

Assistance menu*

i The menu overview can be found on (▷ page 243).

In the “Assistance” menu, you can change the settings of your driving systems.

Displaying distance graphic*

Please refer to the “Driving systems” section of this manual (▷ page 385) for instructions on how to activate DISTRONIC Plus*.

- ▶ Press or to select the “Assistance” menu.
- ▶ Press or to select the “Distance display” function.
- ▶ Press **OK**.

The DISTRONIC Plus distance graphic appears on the multifunction display.

Distance warning function* activating/deactivating

- ▶ Press or to select the “Assistance” menu.
- ▶ Press or to select the “Distance warning” function.
- ▶ Press **OK**.



P54.32-3378-31

- ▶ Press **OK** again if you would like to change the current status.

Distance warning appears on the left-hand side of the multifunction display.

For more information (▷ page 397).

Switching on the Dynamic Rear View Monitor* automatically

i The image from the Dynamic Rear View Monitor is shown on the COMAND display.

- ▶ Press **◀** or **▶** to select the “Assistance” menu.
- ▶ Press **▼** or **▲** to select the “Rearview camera” function.
- ▶ Press **OK**.



- ▶ Press **OK** again if you would like to change the current status.

The following settings are available:

“On when in Reverse”	The Dynamic Rear View Monitor automatically switches on when reverse gear is engaged.
“OFF”	The Dynamic Rear View Monitor is not switched on.

Service menu

i The menu overview can be found on (▷ page 243).

The “Service” menu is used for

- calling up messages
- checking tire inflation pressure electronically with the Advanced TPMS* (standard on U.S. vehicles)
- activating Run Flat Indicator (Canada only)
- calling up the maintenance service indicator display
- check engine oil level*

Calling up vehicle malfunction, warning and system status messages stored in memory

Use the vehicle status message memory menu to scan malfunction and warning messages that may be stored in the system. Such messages appear in the multi-function display and are based on conditions or system status the vehicle’s system has recorded.

The vehicle status message memory menu only appears if there are any messages stored.

Warning!



Malfunction and warning messages are only indicated for certain systems and are intentionally not very detailed. The malfunction and warning messages are simply a reminder with respect to the operation of certain systems and do not replace the owner’s and/or driver’s responsibility to maintain the vehicle’s operating safety by having all required maintenance and safety checks



Instrument cluster control system



performed on the vehicle and by bringing the vehicle to an authorized Mercedes-Benz Center to address the malfunction and warning messages (▷ page 557).

- ▶ Press or to select the “Service” menu.

If conditions have occurred causing status messages to be recorded, the number of messages appears in the multifunction display: “2 Messages”.

- ▶ Press or to select the message.
- ▶ Press to confirm.

See the “Practical hints” section for malfunction and warning messages (▷ page 557).

If you turn the SmartKey in the starter switch to position **0** and then back to position **2**, all messages will be deleted from the message memory.

Checking tire inflation pressure

For information about checking tire inflation pressure (▷ page 511).

Activating Run Flat Indicator*

For information about activating Run Flat Indicator (▷ page 515).

Calling up the maintenance service indicator display

For information about maintenance (▷ page 532).

Checking engine oil level (S 600)*

For information about checking engine oil level (▷ page 494).

Settings menu

The menu overview can be found on (▷ page 243).

In the “Settings” menu, you can:

- switch the daytime driving lamps on or off
- switch the additional speedometer on or off
- switch the radar sensors* on or off.

Daytime driving lamps mode on/off (USA only)

i This function is not available in countries where the “Daytime driving lamps” mode is mandatory and therefore in a constant mode.

- ▶ Press **◀** or **▶** to select the “Settings” menu.
- ▶ Press **▼** or **▲** to select the “Daytime driving lamps” function.
- ▶ Press **OK**.
- ▶ Press **OK** again if you would like to change the current status.

Depending on the previous status, the daytime driving lamps will be switched on or off.

With “Daytime driving lamps” mode selected and the exterior lamp switch at position **0** or **A**, the low beam headlamps are switched on when the engine is running.

In low ambient light conditions the following lamps will switch on additionally:

- Parking lamps
- Tail lamps
- License plate lamps
- Side marker lamps

For more information on the daytime running lamp mode (▷ page 344).

i If you turn the exterior lamp switch to another position, the corresponding lamp(s) will switch on.

i Make sure that the light switch is set to **☞** or **A** when you switch off the daytime driving lamps while driving at night.

Showing or hiding additional speedometer

You can have an additional digital speedometer shown on the multifunction display. The speed is shown in the unit of kilometers/hour (USA) or miles/hour (CAN).

- ▶ Press **◀** or **▶** to select the “Settings” menu.
- ▶ Press **▼** or **▲** to select the “Add. speedometer” function.
- ▶ Press **OK**.
- ▶ Press **OK** again if you would like to change the current status.

Depending on the previous status, the additional speedometer will be switched on or off.

Instrument cluster control system

Switching radar sensors* on or off

If your vehicle is equipped with a 24 GHz radar sensor system, you can switch it on or off.

! You must switch off the 24 GHz radar sensor system in certain countries and near radio-astronomical facilities.

i Please ask an authorized Mercedes-Benz Center where you must switch off the radar sensor system.

i USA only:
This device complies with Part 15 of the FCC Rules. Operation is subject to the following two conditions:

- (1) This device may not cause harmful interference, and
- (2) this device must accept any interference received, including interference that may cause undesired operation.

Any unauthorized modification to this device could void the user's authority to operate the equipment.

i Canada only:
This device complies with RSS-210 of Industry Canada. Operation is subject to the following two conditions:

- (1) This device may not cause interference, and
- (2) this device must accept any interference received, including interference that may cause undesired operation of the device.

Any unauthorized modification to this device could void the user's authority to operate the equipment.

- ▶ Press **◀** or **▶** to select the "Settings" menu.
- ▶ Press **▼** or **▲** to select the "Radar sensor" function.
- ▶ Press **OK**.
- ▶ Press **OK** again if you would like to change the current status.

Depending on the previous status, the radar sensors will be switched on or off.

i The selected status of the radar sensors remains stored in memory even if the engine is turned off and restarted.

When you switch off the radar sensors, the following systems are deactivated:

- DISTRONIC Plus*
- BAS Plus*
- Park Assist*
- Distance warner*

i Depending on production date, the following messages may appear in the multifunction display, when you have switched off the radar sensors and

- you attempt to activate DISTRONIC Plus*:
DISTRONIC PLUS
currently unavailable
See Oper. Manual
- you attempt to activate Park Assist*:
Park Assist
currently unavailable
See Oper. Manual
- you attempt to activate DISTRONIC Plus* or Park Assist*:
Radar sensor
deactivated
See Oper. Manual

For more information (▷ page 557).

▼ Voice Control* operating safety

Warning!



Please devote your attention first and foremost to the traffic situation you are in. While the system permits hands-free phone operation, attention to traffic may be diverted not only by physical operation of a phone, but also by the distraction of a phone conversation while driving. As such, for safety reasons, we encourage the driver to stop the vehicle in a safe place before answering or placing a phone call.

For safety reasons, you should only select a destination when the vehicle is stationary.

While the navigation system provides directional assistance, the driver must remain focused on safe driving behavior, especially attention to traffic and street signs, and should utilize the system's audio cues while driving.

The navigation system does not supply any information on stop signs, yield signs, traffic regulations or traffic safety rules. Their observance always remains in the driver's personal responsibility. DVD maps do not cover all areas nor all routes within an area.

Traffic regulations always have priority over any route recommendations given.

Bear in mind that at a speed of just 30 mph (approximately 50 km/h), your vehicle is covering a distance of 44 feet (approximately 13.5 m) every second.

Warning!



Navigation announcements are intended to direct you while driving without diverting your attention from the road and driving.

Please always use this feature instead of consulting the map display for directions. Consulting the symbols or map display for directions may cause you to divert your attention from driving and increase your risk of an accident.

Warning!



Please do not use the Voice Control System in an emergency, as the tone of your voice may change in a stressful situation. This could cause a delay in completing your phone call in a timely manner. This could distract you in an emergency situation and cause you to be involved in an accident.

Voice Control* introduction

The Voice Control System gives you the capability to control the following systems on your vehicle using spoken commands:

- Telephone*
- Navigation
- Address book
- Audio (AM/FM radio, CD/DVD changer, MP3 player)

You control these systems using spoken commands. Moreover, controls such as the buttons on the multifunction steering wheel (▷ page 260) allow you to keep your hands on the steering wheel.

The command vocabulary consists of approximately 300 ready to use phrases.

The Voice Control System recognizes commands and number sequences, irrespective of the speaker. To optimize speech recognition for your voice follow the individualization process (▷ page 302).

You can use the Voice Control System to call up all of COMAND's main menu items, with the exception of the main menus for "Vehicle" and "Navi".

The commands and digit sequences can be spoken without pausing between the individual words. If an unavailable or incorrect command is used, the Voice Control System will prompt you for a new command by asking "Please repeat" or "Please repeat your entry".

In order to provide for a safe and comfortable dialog, the Voice Control System acknowledges important commands.

Spelling

You may not need to spell the entire name (street, intersection, city or point of interest) especially if the name is lengthy. Spelling the first three to five characters of the name should be sufficient for the system to recognize the name provided it is available on the navigation DVD.

The selection appearing on the COMAND display is sorted based on your recognized voice input and a matching algorithm.

You can use the commands “Next page” or “Previous page” to scroll up or down in the list.

Use the command “Correction” to start over by again spelling the name.

Speak each character as clearly as you can, especially when they sound very similar (d or e).

Command types

The Voice Control System commands can be categorized as:

- **General Commands**
These are commands always available to you as soon as the Voice Control System is activated (for example “Help” commands).
- **Local Commands**
These are commands specific to the currently active system shown in the COMAND display (for example commands to control the CD changer).

For a complete list of commands (▷ page 288).

i *During Voice Control System operation visual help windows also appear in the COMAND display (▷ page 261).*

Active System

The active system is the system currently shown in the COMAND display.







If, for example, you listen to the radio while the telephone system is active on the COMAND display, you have to switch to the radio using the command “Radio” before you can operate the radio.

Voice Control* introduction

Controls

Operation via the multifunction steering wheel



Item	Page
① Press button:  to activate Voice Control to accept a call	260
② Press button:  to cancel Voice Control	260
③ Setting the volume Press button:  volume up  volume down	261 261
Telephone Press button:  to accept an incoming call to dial a number  to end a call to reject an incoming call	262 264 260

i Voice Control can be cancelled at any time, even during a dialog. Please note that if the Voice Control System is cancelled during a dialog, then the complete procedure is stopped and Voice Control is cancelled.

Activating Voice Control

- ▶ Switch on COMAND (▷ page 79).
- ▶ Press .

An audible tone (beep) confirms the activation of the system.

- ▶ Speak a command.

Cancelling Voice Control

- ▶ Press , or
- ▶ speak the command “Cancel”

(except for speaking voice entries, entering a town or city or carrying out individualization), or

- ▶ press any COMAND button.

Setting volume level

- ▶ Activate Voice Control.
- ▶ Speak a command, for example “Help”.
- ▶ Press **+** or **-**. The volume is increased or decreased during voice output, or
- ▶ set volume for voice output using the COMAND volume thumbwheel on the lower part of the front central console (▷ page 89).

Displays

COMAND Display

In addition to the acoustic help function, a visual help function (▷ page 215) is available on the COMAND display.

Upon activating the Voice Control, the most important available commands for the currently active system appear on the COMAND display.

When the Voice Control System requires additional information from the user, a selection list is shown on the COMAND display in the address book and navigation system.

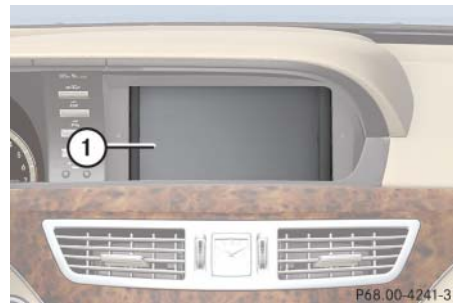

① COMAND display

Multifunction display



For example: telephone numbers are shown on the multifunction display while dialing when the main “Telephone” menu is selected in the instrument cluster control system.



① Multifunction display

Symbols

The following symbols are found in following Voice Control System pages:

-  This symbol stands for commands and voice entries you are speaking.
-  This symbol stands for voice output by the system.
-  This symbol indicates that information is available on the COMAND display.

Voice Control* telephone

Warning!



Some jurisdictions prohibit the driver from using a cellular telephone while driving. Whether or not prohibited by law, for safety reasons, the driver should not use the cellular telephone while the vehicle is in motion. Stop the vehicle in a safe location before placing or answering a call.

If you nonetheless choose to use the cellular phone while driving, please use the hands-free feature and be sure to pay attention to the traffic situation at all times. Use the cellular phone only when road, weather and traffic conditions permit.

Bear in mind that at a speed of just 30 mph (approximately 50 km/h), your vehicle is covering a distance of 44 feet (approximately 14 m) every second.

Warning!



Never operate radio transmitters equipped with a built-in or attached antenna (i.e. without being connected to an external antenna) from inside the vehicle while the engine is running. Doing so could lead to a malfunction of the vehicle's electronic system, possibly resulting in an accident and/or personal injury.

Telephone operation

The Voice Control System gives you the following capabilities:

- Enter a telephone unlock code
- Dial a phone number by speaking the telephone number
- Store names and numbers in the COMAND address book
- Dial a phone number by speaking the name of an COMAND address book entry

- Delete an address book entry from the address book
- Have the system read out the phone book of the address book entry by entry
- Manage and access the automated answering system/voice mail box

- Redial names and numbers

The Voice Control System detects whether

- your telephone is switched on
- the corresponding mobile network is logged in
- it is possible to dial

If dialing is not possible, the Voice Control System will advise you accordingly.

 You can continue operating your mobile phone using the telephone keypad or keypad on your phone.

Before you can operate the telephone using the Voice Control System, you have to activate the Voice Control (> page 260).

Telephone commands

For a complete list of commands (▷ page 288).

“Telephone”

Use the command “Telephone” to activate the telephone main menu. Use this command if you want the digits you are entering to appear on the COMAND display.

“Help telephone”

The Voice Control System features a comprehensive help function.

Use the command “Help telephone” and the Voice Control System will read out an option list of available functions and commands that can be used in conjunction with the telephone (▷ page 215).

“Enter PIN”

 *The PIN (only GSM mobile phones) prompt starts automatically whenever the phone is locked and you wish to use it.*

Use the command “Enter PIN” to input the code to unlock your telephone. After speaking the command, you are prompted to enter the code.

Speak the code

- as a continuously spoken string of digits, or
- in digit blocks of three to five digits.

Digits from “Zero” to “Nine” may be used. After each digit block (separate the digit blocks by using an approximately 0.5 second pause), the Voice Control System repeats the recognized digits and waits until you continue speaking.

Sample dialog:



Enter PIN



Please say the PIN



Zero zero one one



Zero zero one one



OK

Voice Control* telephone

“Dial number”

You can dial a phone number using the command “Dial number”.

Digits from “Zero” to “Nine” may be used.









The phone number must be spoken



- as a continuously spoken string of digits, or
- in digit blocks (three to five digits in each block).

After each digit block (separate the digit blocks by using an approx. 0.5 second pause), the Voice Control System repeats the recognized digits and waits until you continue speaking.

When dialing 1800 numbers, you may pronounce the first four digits as “One eight hundred” and the system will recognize the spoken entries as “One eight zero zero”. All other numeric entries must be spoken as individual numbers.

Sample dialog:

-  Dial number
-  Please say the number
-  One two three
-  One two three
-  Four five six seven
-  Four five six seven
-  OK
-  Dialing











 You can also dial the telephone number spoken by pressing button  on the multifunction steering wheel (instead of using the command “OK”):

You can dial the telephone number before all numbers are recited in full.

“Confirm”

Using the command “Confirm” will repeat all digits spoken up to that point. Upon repeating the digits, the system will prompt you to continue your input.













Sample dialog:

-  Dial number
-  Please say the number
-  One two three
-  One two three
-  Confirm
-  One two three, please continue
-  Four five six seven
-  Four five six seven
-  OK
-  Dialing

“Correction”

Using the command “Correct” will correct the last entered digit block. After speaking the command, the last digit block is deleted and all previously entered digits are repeated. The system then prompts you to continue your input.













Sample dialog:

-  Dial number
-  Please say the number
-  One two three
-  One two three
-  Four five six seven
-  Five five six seven
-  Correction
-  One two three, please continue
-  Four five six seven
-  Four five six seven
-  OK
-  Dialing

“Delete”

Using the command “Delete” will erase all digits entered. The system then prompts you to start your input again.

Sample dialog:

-  Dial number
-  Please say the number
-  One two three
-  One two three
-  Four five six seven
-  Four five six seven
-  Delete
-  Number deleted. Please enter the number again
-  Four two seven three
-  Four two seven three
-  Three nine one
-  Three nine one
-  OK

 Dialing**“Redial”**

Use the command “Redial” to dial the last dialed number.

“Save name” (COMAND address book)

Use the command “Save name” to create a new entry in your COMAND address book. After using the command, the system will prompt you to enter a phone number.

Digits from “Zero” to “Nine” can be entered (> page 264).

Speak the telephone number

- as a continuous string
- or, with longer phone numbers,
- in form of digit blocks (three to five digits). After each digit block (separate the digit blocks by using an approximately 0.5 second pause), the Voice Control System repeats the recognized digits and waits until you continue speaking.















Voice Control* telephone

After the command “OK”, you will be prompted up to two times to input the name. When repeating the name, make sure that you pronounce it in the same manner as during the first input. Otherwise the name cannot be saved and the Voice Control System cancels the save procedure.

i *The Voice Control System may recognize names even if not saved in your voice. For optimum call-up performance, however, you should speak and save the names you intend to use yourself.*

i *You can also add a name to an entry by calling up the corresponding menu on COMAND and saying the name twice (▷ page 202).*



Sample dialog:

-  Save name
-  Please say the number first
-  One two three
-  One two three
-  Four five six seven
-  Four five six seven
-  OK
-  Please say the name
-  John Smith
-  Please repeat the name
-  John Smith
-  Do you want to save the number in a category?
-  No
-  Name and number saved



“Dial name” (COMAND address book)

Use the command “Dial name” to place a phone call by selecting a name previously saved in your personal address book.

Sample dialog:

-  Dial name
-  Please say the name
-  John Smith

If several telephone numbers exist for the same entry, the Voice Control System will ask for clarification.

-  Do you want to place a work call or a home call?
-  Work
-  John Smith work
- Dialing

“Call <voice entry>” (Address book)

Use the command “Call <voice entry>” to place a phone call by directly selecting a name previously stored in your address book.

One address book entry can have up to three different telephone numbers (mobile phone/car/land line) for both the home and work fields.

If only one telephone number is stored for a given name, you can recall the entry using the command “Call John Smith”.

If several telephone numbers are associated with one entry, you can recall the desired telephone number by using the following commands:

- “Call John Smith home”
- “Call John Smith work”
- “Call John Smith home cell phone”
- “Call John Smith home car”
- “Call John Smith home land line”
- “Call John Smith work cell phone”

- “Call John Smith work car”
- “Call John Smith work land line”

The system confirms your input and the number is dialed.

Sample dialog:

 Call John Smith

If several telephone numbers exist for the same entry, the Voice Control System will ask for clarification.

 Do you want to place a work call or a home call?

 Work

 John Smith work

Dialing

“Delete name” (COMAND Address book)

Use the command “Delete name” to delete a name from the COMAND address book.

Sample dialog:

 Delete name

 The name, please

 Smith office

 Smith office: Would you like to delete the voice name?

 Yes

 The voice name is deleted

Voice Control* telephone

“List phone book” and dialing a phone number

Use the command “List phone book” to listen to all voice entries in the phone book with a phone number stored, and select an entry and dial that number.

Sample dialog:



List phone book

The system reads out the complete phone book entry by entry.

Selecting an entry and dialing that number

- ▶ For the desired entry, press during or immediately after voice output.

If more than one phone number exists for a given entry, the Voice Control System prompts:



Do you want to place a work call or a home call?



Home

The system reads out the name of the selected entry and dials the corresponding number.

Canceling the dialog:

- ▶ Press .

The system confirms “Cancel”.

The dialog is concluded.

Managing automated answering system/voice mail box

Activate the Voice Control System to access and manage your answering machine/voice mail box.

- ▶ Activate the Voice Control System during a phone call (▷ page 260).

An audible tone (beep) confirms the activation of the system.

- ▶ Speak the required digits (“Zero” to “Nine”).
or
- ▶ Speak the required words “Star” and “Pound”.
- ▶ Speak the final command “OK”.
The system dials the number entered.

▼ Voice Control* navigation

Important notes

Warning!



For safety reasons, you should only select a destination when the vehicle is stationary. While the navigation system provides directional assistance, the driver must remain focused on safe driving behavior, especially attention to traffic and street signs, and should utilize the system's audio cues while driving.

The navigation system does not supply any information on stop signs, yield signs, traffic regulations or traffic safety rules. Their observance always remains in the driver's personal responsibility. DVD maps do not cover all areas nor all routes within an area.

Traffic regulations always have priority over any route recommendations given.

Bear in mind that at a speed of just 30 mph (approximately 50 km/h), your vehicle is covering a distance of 44 feet (approximately 13.5 m) every second.

During route guidance, you will not receive information on:

- traffic lights
- stop and yield signs
- parking or stopping zones
- one-way streets
- narrow bridges, or
- other traffic regulation data.

You should therefore always strictly observe traffic regulations while driving. Drive carefully and always obey traffic laws and road signs, even if they contradict navigation system instructions.

Warning!



Please do not use the Voice Control System in an emergency, as the tone of your voice may change in a stressful situation. This could cause a delay in completing your phone call in a timely manner. This could distract you in an emergency situation and cause you to be involved in an accident.

Warning!



Navigation announcements are intended to direct you while driving without diverting your attention from the road and driving.

Please always use this feature instead of consulting the map display for directions. Consulting the symbols or map display for directions may cause you to divert your attention from driving and increase your risk of an accident.

Voice Control* navigation

Navigation operation



The Voice Control System allows you to

- enter a state or province
- enter a city
- spell the name of a city
- spell the name of district or center
- spell the name of a street
- spell the name of an intersection
- enter a house number
- enter a complete address
- select one of your last destinations
- enter a POI (point of interest)
- select one of your last destinations
- save a destination
- navigate to a destination stored in the destination memory of the address book

- start route guidance
- display the map
- zoom in or zoom out of the map
- listen to the destination memory
- cancel route guidance
- turn guide instructions on or off

Before you can operate navigation using the Voice Control System, you have to activate the Voice Control System (▷ page 260).

Selecting navigation mode

- ▶ Press .
- ▶ Speak the command “Navigation”.
- ▶ Press .
- ▶ Speak one of the navigation commands.

Navigation commands

 You cannot start the route guidance until all necessary address data has been entered.

For a complete list of commands (▷ page 288).

“Help navigation”/“Help”

Use the command “Help navigation” to read out an option list of available functions and commands that can be used in conjunction with the navigation system.

“Enter state”, “Enter province”

Use the command “Enter state” or “Enter province” to select a different state or province on the navigation DVD.

Sample dialog:

 Enter state

 Please say the name of the state

 New York

 The system shows a numbered list of states recognized by the system

 Please select a line number

 Number two
or accept, say

 Yes

 State accepted

The selected entry is adopted from the list.

“Last states”

Use the command “Last states” to select a state or province from among a number of last selected states or provinces.

Dialog for entering a complete address**“Enter destination”**

Use the command “Enter destination” to enter a complete destination address.

The system guides you through the dialog. As soon as a valid address has been entered, you can start route guidance or save the destination. For information on spelling (▷ page 276).

Sample dialog:

 Enter destination

 Please spell a New York street name

 B-R-O-A-D-W

 The system displays a numbered list of matching street names on the COMAND display

 Please select a line number

 Number two

 Number two accepted

 Do you want to enter a house number?

 No

 Do you want to enter an intersection?

 No

 Do you want to spell the town's name?

 Yes

 Please spell the town name

 N-E-W-Y-O-R-K

 The system displays a numbered list of matching city names on the COMAND display

 Please select a line number

Voice Control* navigation

 Number one

 Number one accepted

 Do you want to start route guidance?

 Yes

 Starting route guidance

The system calculates the route and, upon completing route calculation, starts route guidance.

i *You may not need to spell the entire name (street, intersection, city or point of interest) especially if the name is lengthy. Spelling the first three to five characters of the name should be sufficient for the system to recognize the name provided it is available on the navigation DVD.*

i *The selection appearing on the COMAND display is sorted based on your recognized voice input and a matching algorithm.*

You can use the commands “Continue” or “Back” to scroll up or down in the list.

Use the command “Correction” to start over by again spelling the name.

Speak each character as clearly as you can, especially when they sound very similar (d or e).

“Points of interest”

Use the command “Points of interest” to select a point of interest (POI) such as airports, railroad stations, gas stations etc.

Sample dialog:

 Points of interest

 The system shows the following list on the COMAND display:

- current position
- other town/city
- Global POI

 Please select a line number

 Number one

 The system displays a numbered list of available POI categories:
Select POI category menu

 Please select a line number

 Number one

 The system displays a numbered list search categories: Find menu

 Please select a line number

 Number one

 The system displays a numbered list of airports sorted by distance

 Please select a line number

 Number one

 Point of interest accepted

 Do you want to start route guidance?

 Yes

 Starting route guidance

i *Depending on the number of categories and POI's available for a given area, the system may display several lists on each of which you may have to make a selection by speaking the desired line number or you have to spell the name of a POI.*

“Next POI”

With the commands

- “Next gas station”
- “Next parking lot”
- “Next Mercedes-Benz service”
- “Next restaurant”
- “Next hospital”

you can select POIs in your vicinity.

Sample dialog:

 Next gas station

 The system shows a numbered list of gas stations on the COMAND display.

 Please select a line number

 Number one

 Number one accepted

 Do you want to start route guidance?

 Yes

The system calculates the route and, upon completing route calculation, starts route guidance.

“Last destinations”

Use the command “Last destinations” to select a destination from among a number of destinations last navigated to.

“Save destination”

Use the command “Save destination” to save the current destination in the address book.

 *The Voice Control System may recognize names even if not saved in your voice. For best possible call-up performance, however, you should speak and save the names you intend to use yourself.*

If an entry is already available in the address book, the system will ask you if you would like to add the address to the available entry.

Sample dialog:

 Save destination

 Please say the name

 John Smith

 Please repeat the name

 John Smith

 Where do you want to save: home or work?

 Work

 The destination has been saved

Voice Control* navigation

“Navigate to <voice entry>” (Address book)

Use the command “Navigate to <voice entry>” to start route guidance by selecting voice entry with a saved destination address from the COMAND address book.

A voice entry may have two different destination addresses associated with it (home or work).

The system confirms your command, calculates the route, and begins route guidance.

If only one address is stored, you can use the command “Navigate <voice name>” to select the stored destination address for that name.

If two addresses are stored, you can use the commands

- “Navigate <voice name> home”

or

- “Navigate <voice name> work”

to directly select between home or work address for that name. The system confirms your selection, calculates the route, and begins route guidance.

Sample dialog:



Navigate to John Smith

If more than one address exists for this voice entry, the Voice Control System will prompt you:



Navigate to home or work?



Work



John Smith work

Starting route guidance

“Start route guidance”

Use the command “Start route guidance” to start route guidance after entering a valid destination.

Sample dialog:



Start route guidance



Starting route guidance

Route guidance begins.

“Guidance instructions on”

Use the command “Guidance instruction on” to have the Voice Control System repeat the last guidance instruction. If guidance voice output was previously muted, using this command will deactivate the muting of the voice output.

“Guidance instruction off”

Use the command “Guidance instruction off” to mute the systems’ guidance voice output.

“Cancel route guidance”

Use the command “Cancel route guidance” to cancel route guidance.

Sample dialog:

 Cancel route guidance

 Are you sure you want to cancel route guidance?

 Yes

Route guidance is canceled.

or

 No

 Cancel

The dialog with the Voice Control System is canceled. Route guidance remains active.

“Map”

Use the command “Map” to activate or switch to map display.

“Zoom in”, “Zoom out”

Use these commands to zoom in on map or to zoom out of map to the desired level of map detail.

“Zoom in completely”, “Zoom out completely”

These commands are used to adapt the map display directly to the smallest or largest map scale.

“List destination memory”

Use the command “List destination memory” to have the system read out all destination memory entries and select an entry for route guidance.

Sample dialog:

 List destination memory

The system reads out the address book destination memory.

To select a voice entry and adopt address for route guidance:

- ▶ When the system reads the desired entry, press .

If more than one address is available, the system will prompt you:

 Navigate to home or work?

 Home

The system reads the selected voice entry and starts route guidance.

To cancel the dialog:

- ▶ Press .

You have canceled the dialog. The system confirms cancellation by saying “Cancel”.

Voice Control* navigation

Commands for entering parts of an address





“Enter town”

The “Enter town” command is used to enter any larger town or city in the USA or Canada.

i If the desired town/city does not appear on the list of towns/cities, the town or city can be entered by using the “Spell town” command.

i You can scroll through the list by using the “Continue” or “Back” command. Say “Correction” to enter the town or city again.

Sample dialog:

-  Enter town
-  Please spell the name of the town
-  E-A-S-T-O-N
-  The system displays a numbered list of available city names

 Please select a line number

 Number one

 Number one, town accepted



The city selected is adopted for route guidance.

“Spell town”

Use the command “Spell town” to enter a city name by spelling mode and see if it matches an entry available on the navigation DVD.

Speak the characters as a continuous string (five to seven characters). The system then displays a list of cities on the COMAND display from which you can select the desired city.

Sample dialog:

-  Spell town
-  Please spell the town name

 N-E-W-Y-O-R

 The system displays a numbered list of available city names

 Please select a line number

 Number one

 Number one, town accepted

The city selected is adopted for route guidance.

i You can use the commands “Continue” or “Back” to scroll up or down in the list. Use the command “Correction” to start over again by spelling the name of the town.

i You must also spell foreign towns or cities in English. Please note that the list on the COMAND display is sorted according to the probability of the voice recognition.

Speak each character as clearly as you can, especially when they sound very similar (d or e).

“District” or “Center”

Use the command “District” or “Center” to spell a city location in the city previously selected.

Speak the characters as a continuous string (five to seven characters). The system then displays a list of available city districts or centers on the COMAND display. Select the desired city center from that list.

Sample dialog:

 District

 Please spell the center

 S-T-A-T-E-N-I-S

 The system displays a list of available districts if more than one name matches the name of a district for the given city.

 Please select a line number

 Number one

 Number one, center accepted

The district selected is adopted for route guidance.

“Street”

Use the command “Street” to spell and select a street for the adopted city. Only street names available on the navigation DVD can be selected.

Speak the characters as a continuous string (five to seven characters). The system then displays a list of available street names on the COMAND display. Select the desired street name from that list.

Sample dialog:

 Street

 Please spell the name of the street

 F-O-R-E-S-T

 The system displays a numbered list of available street names.

 Please select a line number

 Number one

 Number one, street accepted

The street name selected is adopted for route guidance.

Voice Control* navigation

“Intersection”, “cross street”

Use the command “Intersection” to spell and select an intersection.

Speak the characters as a continuous string (five to seven characters). The system then displays a list of available intersections on the COMAND display. Select the desired intersection from that list.

Sample dialog:

 Intersection

 Please spell the first street name

 F-O-R-E-S-T

 Please spell the name of the crossing street

 D-U-D-L-E-Y

 The system displays a numbered list of available intersections on the COMAND display.

 Please select a line number

 Number one

 Intersection accepted

The intersection is adopted for route guidance. If an address at the intersection is recognized, the system asks if it is correct. Say “Yes” or “No”.

“House number”

Use the command “House number” to select a house number for the street previously selected. Speak the house number in single digits.

Sample dialog:

 House number

 Please say the house number in single digits

 Three two

 Is three two correct?

 OK

 House number accepted

The house number is adopted for route guidance.

▼ Voice Control* address book

Warning!



Please devote your attention first and foremost to the traffic situation you are in.

Before your journey, please familiarize yourself with the address book functions.

Only use the Voice Control System when road and traffic conditions permit you to do so. Otherwise you could be involved in an accident in which you or others could be injured.

COMAND address book overview

The Voice Control System Address book function gives you the capability to store names and associated phone numbers and address information.

You can store up to 80 speaker-dependent voice entries in the Voice Control System Address book.

Using these voice entries, you can dial a phone number stored in address book or start route guidance to an address stored

in the address book. Available commands are dependent on the status of the address book. The address book can be in one of the following status:

- Address book not open
- Address book open.

Operation with address book not open (global)

The Voice Control System gives you the following capabilities:

- Store a name (▷ page 265)
- Dial a name (▷ page 266)
- Delete a name (▷ page 267)
- Navigate to an entry (▷ page 274)
- List address book (▷ page 280)
- List phone book of the address (▷ page 268)
- List address book destination memory (▷ page 275)
- Delete the address book (▷ page 281)

- Open the address book

Opening address book

- ▶ Press .
- ▶ Speak the command “Address book”.
- ▶ Press .
- ▶ Speak one of the address book commands described below.

Operation with address book open (local)

In addition to the capabilities listed when the address book is not open, the address book opened allows you to:

- open an entry using the corresponding voice entry
- open any entry by spelling the name
- ▶ **Opening entry:** Speak the command “Open entry”.

Voice Control* address book

Operating and using address book

- ▶ Press .
- ▶ Speak one of the following commands depending on the address book status (open or not open).

Available commands with the address book not open

For a complete list of commands
(▷ page 288).

“Help address book”

Use the command “Help address book” to have the Voice Control System read out an option list of all available commands for the address book.

“Save name” (▷ page 265)

“Dial name” (▷ page 266)

“Call <voice name>” (▷ page 267)

“Delete name” (Address book)

Use the command “Delete name” to delete a voice name from your address book.

Sample dialog:



Delete name



Please say the name



John Smith



Do you want to delete John Smith?



Yes



The voice name is deleted

“Navigate <voice entry>” (Address book)

(▷ page 274)

“List address book”

Use the command “List address book” to have the system read out all available address book entries and, if desired, select an entry when it is being read.

Sample dialog:



List address book

The system reads out all available address book entries.

- ▶ **Selecting address book entry:** When the system reads the desired entry, press .

The entry is selected and shown on the COMAND display.

- ▶ **Canceling the dialog:** Press .

You have canceled the dialog. The system reads out “Cancel”.

“List phone book” and dialing a phone number (▷ page 268)

“List destination memory” (▷ page 275)

“Delete address book”

Use the command “Delete address book” to delete all or individual voice names of the address book entries. Only the voice name is deleted; the remaining data in the entry are retained.

“Address book”

Use this command to open the address book.

Available commands with the address book open**“Help address book”**

Use the command “Help address book” to have the Voice Control System read out an option list of all available commands for the address book.

“Open <voice name>”

Use the command “Open <voice name>” to open an entry in your address book that has a voice name already assigned to it.

Sample dialog:

 Open John Smith

 The entry “John Smith” appears on the COMAND display.

“Select entry”

Use the command “Select entry” to open an entry in your address book.

Sample dialog:

 Select entry

 Please say the name

 John Smith

 The entry “John Smith” appears on the COMAND display.

“Spell entry”

Use the command “Spell entry” to open an address book entry by spelling the name.

Speak the name as continuous string (five to seven characters).

The system will display a list of possible matches on the COMAND display from which you can select the desired entry.

Sample dialog:

 Spell entry

 Please spell the name

 S-M-I-T-H

 The system displays a numbered list of matching entries on the COMAND display.

 Please select a line number

 Number two

 The system opens the entry associated with line number two on the list.

 You can use the commands “Continue” or “Back” to scroll up or down the next page. Use the command “Correction” to exit the current selection list and spell the name again.

Warning!



Please devote your attention first and foremost to the traffic situation you are in.

Before your journey, please familiarize yourself with the radio functions.

Only use the Voice Control System when road and traffic conditions permit you to do so. Otherwise you could be involved in an accident in which you or others could be injured.



Radio operation

The Voice Control System gives you the capability to:

- Select a station
- Seek a station
- Select a specific frequency
- Save up to 20 stations in your station list
- Select frequency band (FM or AM)
- Select weatherband
- Switch to satellite radio* (USA only)
- Delete station (from station list)
- List the station list
- Delete the station list

To operate the radio using the Voice Control System, the Voice Control System must be activated (▷ page 260).

Selecting radio mode:

- ▶ Press .
- ▶ Speak the command “Radio”.
- ▶ Press .
- ▶ Speak one of the radio commands.

The system switches to the last tuned station in the selected band.

Radio commands

For a complete list of commands (▷ page 288).

“Help Radio”

Use the commands

- “FM”
- “AM”
- “Weatherband”

to select the desired frequency band or switch the radio to the weatherband.

“Sat Radio*” (USA only)

Use this command for switching on the satellite radio*.

“Next station” or “Previous station”

The following commands are used to start the station search and to tune in the next station:

- “Next station”
- “Previous station”

Selecting frequency (FM, AM only)

You may, for example, select a frequency in the FM band (87.9 to 107.9 Megahertz) directly using a verbal command such as “Ninety-five five”. The Voice Control System also recognizes the words “frequency”, “point” and “megahertz”. You may for example use the command “Frequency ninety-five point five”.

Sample dialog:

 Ninety-five point five

The Voice Control System tunes the radio to frequency FM 95.5.

“Save station” (List saved stations)

Use this command to save the set station (AM and FM only) by name in your personal station list. After using this command, the Voice Control System will prompt you to repeat the name two to four times before it is saved in the station list. When repeating the station name, make sure that you pronounce it in the same manner as during the first input. Otherwise the name cannot be saved and the Voice Control System cancels the save procedure.

 *The Voice Control System may recognize names even if not saved in your voice. For optimum performance, however, call up only names you have saved yourself.*

 *You can freely select the station name, for example “Favorite station”.*

Sample dialog:

 Save station

 Please say the station name

 Smooth Jazz

 Please say the station name again

 Smooth Jazz

 The station Smooth Jazz has been saved

“Select station” (List saved stations)

Use the command “Select station” (AM and FM only) to select a saved station name from your station list.

Sample dialog:

 Select station

 Please say the station name

 Smooth Jazz

The Voice Control System tunes to the corresponding frequency.

Voice Control* radio

“Station Smooth Jazz” (List saved stations)

Use this command (AM and FM only) to directly select a saved station name from your station list.

Sample dialog:

 Station Smooth Jazz

The Voice Control System tunes to the corresponding station.

 *If the Voice Control System does not recognize the station name you requested, please refer to the section “List station list” (▷ page 284). By following the dialog, you can check and determine if the name is saved in the station list.*

“List station list” and select station from list

Use this command to list the entire station list, or to select an entry from the station list.

Sample dialog:

 List station list

The Voice Control System reads out the entire list.

To select a station:

When the system reads the desired station:

▶ Press .

▶ **Canceling the dialog:** Press .

The dialog is concluded. The system confirms “Cancel”.

“Delete station” (List saved stations)

Use the command “Delete station” (AM and FM only) to delete a station from your personal station list.

Sample dialog:

 Delete station

 Which station do you want to delete?

 Smooth Jazz

 Do you want to delete Smooth Jazz?

 Yes

 Station deleted

“Delete station list”

Use this command to delete the complete station list or one or more stations from the station list.

Sample dialog:

 Delete station list

 Do you want to delete all voice names from the station list?

 Yes

 Are you sure?

 Yes

 All voice names have been deleted from the station list.

The system deletes the complete station list. The deletion of the station list cannot be undone.

or

 No

The system starts reading the station list.

When the system reads the station to be deleted:

▶ Press .

The station to be deleted is selected.

The name of the selected station is read out once more.

 Do you want to delete Smooth Jazz?

 Yes

 Station deleted

The station is erased and the remaining station entries are read out.

or

 No

The system continues reading the station list entry by entry.

Voice Control* CD/DVD changer/MP3

Operation



The Voice Control System gives you the ability to:

- Select a CD/DVD/medium
- Select a track
- Select a folder in MP3 mode
- Select a group in audio-DVD mode

i *The following commands “Next/Previous CD/DVD” and “CD/DVD 1” to “CD/DVD 6”, cause the DVD changer to switch from one slot to another, regardless of the type of medium found in the selected slot. In your command, you can therefore replace the term “CD/DVD” with “Medium”.*

To operate the DVD changer using the Voice Control System, the Voice Control System must be activated (▷ page 260).

Selecting CD mode:

- ▶ Press .
- ▶ Speak one of the following commands:
 - “CD”
 - “DVD”
 - “MP3”
- ▶ Press .
- ▶ Speak one of the following commands.

Commands

For a complete list of commands (▷ page 288).

“Help CD” or “Help DVD” “Help MP3”

Use the commands

- “Help CD”
- “Help DVD”
- “Help MP3”

and the Voice Control System will read out a complete list of available commands for the CD, DVD or MP3.

“CD/DVD/Medium 1” to “CD/DVD/Medium 6”

Use commands “CD/DVD/Medium 1” to “CD/DVD/Medium 6” to select one of up to 6 mediums in your DVD changer.

“Next CD/DVD/Medium”

Use the command “Next CD/DVD/Medium” to select the next available medium in the DVD changer.

“Track 1” to “Track 39”

Use the commands “Track 1” to “Track 39” to select one of up to 39 title numbers of a loaded medium.

“Next track”

Use the command “Next track” to select the next track.

“Previous track” or “Repeat track”

Use the command “Previous track” or “Repeat track” to play again the track you are listening to.

“Group 1” to “Group 9”

The “Group 1” to “Group 9” commands are used to select a group on the inserted audio-DVD.

“Next group”/“Previous group”

The “Next group”/“Previous group” commands are used to select a group on the inserted audio-DVD.

“Memory card”

The “Memory card” command is used to switch from the DVD drive to the PCMCIA card.

“Drive”

The “Drive” command is used to switch from the PCMCIA card to the DVD drive.

Voice Control* command list

Command list

Chapter “Command list” gives you an overview of all commands available for use to control the Voice Control System.

Which commands are available for use is dependent on the equipment level in your vehicle.

i Some functions can be operated using several different commands. In the following list, these commands are grouped in one cell. Choose your preferred command from those available.

General commands

- yes
- right
- ok
- cancel
- stop
- quit
- abort
- terminate
- no
- no thank you
- address book
- MP3
- CD

- navigation
- route guidance
- audio DVD
- radio
- sat radio
- satellite radio*
- telephone
- messages
- SMS
- vehicle
- correction
- wrong
- incorrect

- help
- help please
- please help
- help functions
- help devices
- help voice control
- linguatronic help
- general help
- help permanent commands
- help global commands
- letters of the English alphabet
- digits 0 - 9
- continue

Voice Control* command list

- go forward
- next page
- back
- go back
- previous page
- help radio
- help tuner
- help radio
- radio help
- tuner help
- help telephone
- help phone
- help address book
- help CD
- help disc
- help CD player
- help CD changer
- help audio DVD
- help DVDA

- help DVD audio
- help DVD audio player
- help DVD audio changer
- help navigation
- help nav
- help navi
- help route guidance
- help routing
- help destination guidance

Telephone* commands

- telephone (on)
- phone (on)
- telephone off
- save
- save PIN
- save PIN code
- save number
- save PIN number

- save telephone number
- save name
- save password
- store PIN
- store PIN code
- store number
- store PIN number
- store telephone number
- store name
- store password
- dial
- dial PIN
- dial number
- dial PIN number
- dial PIN code
- dial phone number
- dial telephone number
- dial password
- dial unlock code

Voice Control* command list

- confirm
- confirm PIN
- confirm number
- confirm PIN number
- confirm PIN code
- confirm phone number
- confirm telephone number
- confirm password
- confirm unlock code
- repeat PIN
- repeat number
- repeat PIN number
- repeat PIN code
- repeat phone number
- repeat telephone number
- repeat password
- repeat unlock code
- enter PIN
- enter PIN code

- enter PIN number
- enter code
- enter unlock code
- list phone book
- read out phone book
- play phone book
- get phone book
- recall phone book
- redial
- redial last number
- redial last phone number
- correction
- wrong PIN
- wrong number
- wrong PIN number
- wrong PIN code
- wrong phone number
- wrong telephone number
- wrong unlock code

- incorrect PIN
- incorrect number
- incorrect PIN number
- incorrect PIN code
- incorrect phone number
- incorrect telephone number
- incorrect unlock code
- delete
- delete PIN
- delete number
- delete PIN number
- delete PIN code
- delete phone number
- delete telephone number
- delete unlock code

Navigation commands

- navigation
- nav

Voice Control* command list

- navi
- route guidance
- routing
- destination guidance
- guidance instructions on
- switch guidance instruction on
- switch guidance instructions on
- switch route guidance instruction on
- switch route guidance instructions on
- switch on guidance instruction
- switch on guidance instructions
- switch on route guidance instruction
- switch on route guidance instructions
- guidance instructions off
- switch guidance instructions off
- switch route guidance instructions off
- switch off guidance instructions
- switch off route guidance instructions
- mute guidance instructions

- mute route guidance instructions
- house number
- enter house number
- map (on)
- show map
- switch on map
- zoom in
- zoom in on map
- zoom out
- zoom out on map
- zoom in completely
- zoom out completely
- enter country
- enter another country
- spell country
- spell another country
- change country
- change another country
- intersection

- spell intersection
- spell cross street
- enter intersection
- enter cross street
- last destinations
- last states
- last provinces
- spell town
- spell city
- spell name of town
- spell name of city
- enter town
- enter city
- enter name of town
- enter name of city
- district
- center
- spell district
- spell center

Voice Control* command list

- enter district
- enter center
- points of interest
- enter points of interest
- enter point of interest
- enter POI
- enter POIs
- street
- spell street
- spell name of street
- enter street
- enter name of street
- enter destination
- destination entry
- destination input
- address entry
- address input
- save destination
- save address

- store destination
- store address
- start route guidance
- start navigation
- start route guidance
- start routing
- begin route guidance
- begin navigation
- begin route guidance
- begin routing
- continue route guidance
- continue navigation
- continue route guidance
- continue routing
- destination guidance on
- cancel route guidance
- cancel navigation
- cancel nav
- cancel routing

- cancel destination guidance
- exit route guidance
- exit navigation
- exit nav
- exit routing
- exit destination guidance
- terminate route guidance
- terminate navigation
- terminate nav
- terminate routing
- terminate destination guidance
- next gas station
- next Mercedes-Benz service
- next workshop
- next MB service
- next MB service point
- next MB service center
- next Mercedes service
- next Mercedes service point

- next Mercedes service center
- next Mercedes-Benz service point
- next Mercedes-Benz service center
- next service point
- next service center
- next hospital
- next parking lot
- next restaurant

Address book commands

- address book (on)
- address list (on)
- addresses (on)
- list address book
- read out address book
- play address book
- get address book
- recall address book
- delete address book

- spell entry
- spell name
- spell heading
- search entry
- search name
- search heading
- open entry
- show entry
- list entry
- select entry
- get entry
- open entry
- open page
- open item
- open name
- open <voice name>
- delete name
- delete <voice name>
- list destination memory

- read out destination memory
- play destination memory
- get destination memory
- recall destination memory
- <voice name>
- <voice name> car
- <voice name> car phone
- <voice name> land line
- <voice name> phone
- <voice name> telephone
- <voice name> cell phone
- <voice name> mobile phone
- <voice name> cellular phone
- call <voice name>
- call <voice name> work
- call <voice name> office
- call <voice name> business
- call <voice name> company
- <voice name> home

Voice Control* command list

- call <voice name> home

- work

- office

- business

- company

- car

- car phone

- land line

- land line phone

- land line telephone

- cell phone

- mobile phone

- cellular phone

- work car (phone)

- office car (phone)

- business car (phone)

- company car (phone)

- car (phone) work

- car (phone) office

- car (phone) business

- car (phone) company

- work land line

- office phone

- land line phone business

- land line telephone company

- work cell phone

- office mobile phone

- business cellular phone

- cell phone company

- home

- home car

- home car phone

- car home

- car phone home

- home land line

- home land line phone

- land line home

- land line phone home

- home cell phone

- home mobile

- cell home

- cell phone home

- mobile home

- mobile phone home

- cellular home

- cellular phone home

- call <voice name> work car

- call <voice name> work land line

- call <voice name> work cell phone

- call <voice name> home car

- call <voice name> land line phone

- call <voice name> cell phone home

- navigate to <voice name>

- drive to <voice name>

- navigate to <voice name> work

- navigate to <voice name> home

- dial name

Voice Control* command list

- dial voice name
- save name
- save voice name
- save number
- save telephone number
- store voice name
- store number
- store telephone number

- accept
- accept PIN
- accept PIN code
- accept lock code
- accept PIN number
- accept number
- accept telephone number
- accept name
- accept password
- OK
- finished

- <1> - <8>
- use <1> - <8>
- number <1> - <8>
- line <1> - <8>

Audio commands

- audio
- audio off

Radio

- radio (on)
- AM
- MW
- FM
- weatherband
- next station
- station search
- going up
- other station

- radio seek
- station <voice entry>
- go to <voice entry>
- <voice entry>
- delete station
- save station
- store station
- select station
- select channel
- list station list
- read out station list
- play station list
- get station list
- recall station list
- delete station list
- previous station
- last station
- coming down
- station search coming down

Voice Control* command list

Example: 95.5 FM

- ninety-five five
- ninety-five five megahertz
- ninety-five point five
- ninety-five point five megahertz
- frequency ninety-five five
- frequency ninety-five point five
- frequency ninety-five five megahertz
- frequency ninety-five point five megahertz

Example: 540 AM

- five-hundred-forty
- five-hundred-forty kilohertz
- frequency five-hundred-forty
- frequency five-hundred-forty kilohertz

Satellite radio* (USA only)

- sat radio*

- satellite radio*

CD

- CD (on)
- CD player (on)
- CD changer (on)

- next CD
- other CD
- next medium
- other medium

- previous CD
- last CD
- preceding CD
- replay CD
- replay medium
- repeat medium
- last medium
- previous medium
- next track

- other track

- previous track
- last track
- repeat track
- replay track

- track 1-39
- load track 1-39
- load track number 1-39
- select track 1-39
- select track number 1-39

- CD 1-6
- CD number 1-6
- medium 1-6
- medium number 1-6

MP3

- MP3 (on)
- MP3 player (on)
- MP3 changer (on)

Voice Control* command list

- next MP3
- other MP3
- next medium
- other medium

- previous MP3
- last MP3
- preceding MP3
- replay MP3
- replay medium
- repeat medium
- last medium
- previous medium

- next directory
- other directory
- next folder
- other folder

- previous directory
- previous folder
- last directory

- last folder
- repeat directory
- repeat folder

- next track
- other track

- previous track
- last track
- repeat track
- replay track

- track 1-39
- load track 1-39
- load track number 1-39
- select track 1-39
- select track number 1-39

- MP3 1-6
- MP3 number 1-6
- medium 1-6
- medium number 1-6
- drive

- memory card

DVD

- audio DVD
- DVDA player (on)
- audio DVD player (on)
- DVD audio player (on)
- DVDA changer (on)
- audio DVD changer (on)
- DVD audio changer (on)

- next DVDA
- other DVDA
- next DVD audio
- other DVD audio
- next audio DVD
- other audio DVD
- next medium
- other medium
- previous DVDA

Voice Control* command list

- last DVDA
- preceding DVDA
- replay DVDA
- previous DVD audio
- last DVD audio
- preceding DVD audio
- replay DVD audio
- previous audio DVD
- last audio DVD
- preceding audio DVD
- replay audio DVD
- replay medium
- repeat medium
- last medium
- previous medium
- next directory
- other directory
- next folder
- other folder

- previous directory
- previous folder
- last directory
- last folder
- repeat directory
- repeat folder
- next group
- other group
- previous group
- previous repeat group
- previous replay group
- last group
- last repeat group
- last replay group
- group 1-9
- select group 1-9
- group number 1-9
- select group number 1-9
- next track

- other track
- previous track
- last track
- repeat track
- replay track
- track 1-39
- load track 1-39
- load track number 1-39
- select track 1-39
- select track number 1-39
- DVDA 1-6
- DVDA number 1-6
- DVD audio 1-6
- DVD audio number 1-6
- audio DVD 1-6
- audio DVD number 1-6
- medium 1-6
- medium number 1-6

▼ Voice Control* troubleshooting

Help function

To support the user, the Voice Control System contains an extensive help function.

The help function gives you:

- General hints on how to best use the Voice Control System
- A listing of all available commands

Help commands

“Help voice control”

Using the command “Help voice control” will give you information on how to best use the Voice Control System.

“Help”

In a main menu, help can be accessed at any time by saying the command “Help”. The Voice Control System will then read out the available functions and commands of all systems.

In a submenu, help can also be accessed at any time by saying the command “Help”. The Voice Control System will then read out an option list of all available functions and commands available in the particular submenu.

You can also use the help function to access help for a specific system. To access help for the phone operation, you would speak the command “Help Telephone”.

If you wish to hear the last command read out:

▶ Press .

Help window

You can use the help window to view a selection of valid commands on the COMAND display.

The help functions can be switched on or off via COMAND in the “System settings” menu (▷ page 215).

Entering digits and spelling

Entering digits

- Digits from “Zero” to “Nine” may be used.
- Speaking phone numbers in digit blocks of 3 to 5 digits has proven a very reliable method for the input of phone numbers.

Spelling

- The letters of the English alphabet and the digits 0 - 9 may be used.
- Speak the letters in blocks of 5 - 7 letters at a time.
- Speak each individual letter clearly.

Voice Control* troubleshooting

What to do if ...

Problem	Possible cause/consequence	Suggested solution
Voice Control System does not recognize a station list entry.	The voice entries for the station names sound too similar.	<ul style="list-style-type: none"> ▶ When you create your address book entries, select names with the greatest possible acoustic differences. ▶ Speak the command “List station list”. The system reads out the station list entry by entry. ▶ Press  when the desired station name is being read out. The station is selected (▷ page 284).
Should interference occur during the process of storing a name, the Voice Control System prompts you to repeat your voice entry a third and fourth time. If the interference continues, the dialog is stopped.	Both voice entries differ.	<ul style="list-style-type: none"> ▶ Pronounce the voice entries both times in the same manner.

Voice Control* troubleshooting

Problem	Possible cause/consequence	Suggested solution
Voice Control System does not recognize commands.	You have not operated the system from the driver's seat.	▶ Operate the Voice Control System only by the driver as the microphone is geared to the driver side.
	You have spoken unclearly, too loudly or too quietly.	▶ Speak the commands in a continuous manner using a normal tone.
	A blower is set to the highest setting or wind noise is being created through open windows.	▶ Avoid loud disturbances.
Voice Control System does not recognize a address book entry.	The voice entries in the address book sound too similar.	▶ When you create your address book entries, select names with the greatest possible acoustic differences: If for example you have the names Smith and Schmidt, choose for example "Smith work" or "Schmidt John".
		▶ Speak the command "List phone book". The system reads out the address book entry by entry. ▶ Press  when the desired entry is being read out. The entry is selected and the corresponding number is dialed (▷ page 268).

Voice Control* individualization

i *The individualization can only be performed when the vehicle is stationary.*

If you drive off, the individualization will be canceled.

After starting the session, the system will guide you through the individualization by means of acoustic instructions.

The individualization is used to adapt the Voice Control System to your own voice and to therefore improve speech recognition. This does not affect the speech recognition of other users.

Individualization consists of two stages:

- Digits
- Commands

You can activate individualization in the COMAND system settings (> page 215). A dialog and screen displays will guide you through the individualization process.

The system can be reset to the factory settings at any time.

i *You may wish to complete only a portion of the individualization process.*

Completing the digits portion alone may result in an improved recognition rate.

Individualization can be exited at any time. The data trained, however, will only be retained if a given individualization portion is completed and the data is stored when prompted to do so by the system.

Locking and unlocking
Starter switch positions
Seats
Steering wheel
Mirrors
Memory function
Fastening the seat belts
Lighting
Windshield wipers
Power windows

Driving and parking
Automatic transmission
Instrument cluster
Driving systems
Automatic climate control
Trunk
Power tilt/sliding sunroof
Panorama roof with power tilt/sliding panel*
Loading and storing
Useful features



Locking and unlocking

SmartKey

Your vehicle comes supplied with two SmartKeys, each with remote control and a removable mechanical key.

The locking tabs for the mechanical key portion of the two SmartKeys are of different color to help distinguish each SmartKey unit.

The SmartKey provides an extended operating range. To prevent theft, however, it is advisable to only unlock the vehicle when you are in close proximity to it.

The SmartKey centrally locks and unlocks:

- the doors
- the trunk
- the fuel filler flap

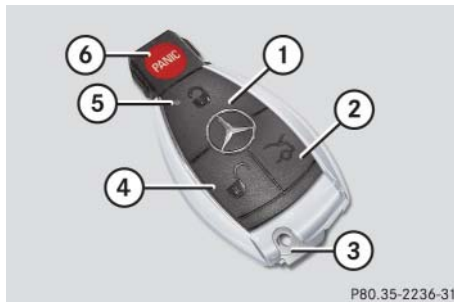

SmartKey with remote control

- ① Lock button
- ② Opening button for trunk (▷ page 436)
- ③ Mechanical key locking tab
- ④ Unlock button
- ⑤ Battery check lamp
- ⑥ PANIC button (▷ page 68)

! *To prevent possible malfunction, avoid exposing the SmartKey to high levels of electromagnetic radiation.*

Warning!



When leaving the vehicle, always remove the SmartKey from the starter switch, take it with you, and lock the vehicle. Do not leave children unattended in the vehicle, or with access to an unlocked vehicle. It is possible for children to open a locked door from the inside, which could result in an accident and/or serious personal injury.

Warning!



To prevent possible personal injury, always keep hands and fingers away from the door or trunk lid opening when closing a door or the trunk. Be especially careful when small children are around.

Before closing doors, make sure there is no possibility of someone getting caught in a door during closing.

i USA only:

This device complies with Part 15 of the FCC Rules. Operation is subject to the following two conditions:

- (1) This device may not cause harmful interference, and
- (2) this device must accept any interference received, including interference that may cause undesired operation.

Any unauthorized modification to this device could void the user's authority to operate the equipment.

i Canada only:

This device complies with RSS-210 of Industry Canada. Operation is subject to the following two conditions:

- (1) This device may not cause interference, and
- (2) this device must accept any interference received, including interference that may cause undesired operation of the device.

Any unauthorized modification to this device could void the user's authority to operate the equipment.

i You can also open and close the door windows and tilt/sliding sunroof, or the tilt/ sliding panel* using the SmartKey (▷ page 355).

Factory setting

- ▶ **Global unlocking:** Press button .

All turn signal lamps flash once. The locking knobs in the doors move up. The anti-theft alarm system is disarmed.



The vehicle will lock again automatically and reactivate the anti-theft alarm system within approximately 40 seconds of unlocking if:

- neither a door nor the trunk is opened
 - the SmartKey is not inserted in the starter switch
 - the central locking switch is not activated
- ▶ **Global locking:** Press button .

With the trunk and all doors closed, all turn signal lamps flash three times. The locking knobs in the doors move down. The anti-theft alarm system is armed.

Selective setting

If you frequently travel alone, you may wish to reprogram the SmartKey so that pressing  only unlocks the driver's door and the fuel filler flap.

- ▶ Press and hold buttons  and  simultaneously for about 5 seconds until battery check lamp  (▷ page 304) flashes twice.

The SmartKey will then function as follows:

- ▶ **Unlocking driver's door and fuel filler flap:** Press button  once.

All turn signal lamps flash once. The locking knob in the driver's door moves up. The anti-theft alarm system is disarmed.

- ▶ **Global unlocking:** Press button  twice.



All turn signal lamps flash once. The locking knobs in the doors move up. The anti-theft alarm system is disarmed.



Locking and unlocking

▷▷ **Global locking:** Press button .

With the trunk and all doors closed, all turn signal lamps flash three times. The locking knobs in the doors move down. The anti-theft alarm system is armed.

▶ **Restoring to factory setting:** Press and hold buttons  and  simultaneously for about 5 seconds until battery check lamp  (▷ page 304) flashes twice.

SmartKey with KEYLESS-GO*

Vehicles equipped with KEYLESS-GO come with two SmartKeys with KEYLESS-GO, each with remote control and a removable mechanical key.

The locking tabs for the mechanical key portion of the two SmartKeys with KEYLESS-GO are of different color to help distinguish each SmartKey with KEYLESS-GO unit.





The KEYLESS-GO function is integrated into the SmartKey. On these vehicles, the validity of the SmartKey with KEYLESS-GO is checked every time you grasp an outside door handle.

If the SmartKey with KEYLESS-GO is valid, your vehicle unlocks:

- the doors
- the trunk
- the fuel filler flap



SmartKey with KEYLESS-GO

- ①  Lock button
- ②  Opening button for trunk (▷ page 436)
- ③ Locking tab for mechanical key
- ④  Unlock button
- ⑤ Battery check lamp
- ⑥  PANIC Panic button (▷ page 68)

i When any outside door handle other than the driver's outside door handle is grasped, the vehicle is centrally unlocked.

! To prevent possible malfunction, avoid exposing the SmartKey with KEYLESS-GO to high levels of electromagnetic radiation.

Warning!

When leaving the vehicle, always take the SmartKey with KEYLESS-GO* with you and lock the vehicle. Do not leave children unattended in the vehicle, or with access to an unlocked vehicle. It is possible for children to open a locked door from the inside, which could result in an accident and/or serious personal injury.

They could start the vehicle with a valid SmartKey with KEYLESS-GO left in the vehicle or with the KEYLESS-GO button on the starter switch, or they could release the electric parking brake, thereby putting themselves and others in danger. Switch off the engine and take the SmartKey with KEYLESS-GO with you even if you are only leaving the vehicle for a short while.

Warning!

To prevent possible personal injury, always keep hands and fingers away from the door or trunk lid opening when closing a door or the trunk. Be especially careful when small children are around.

Before closing doors, make sure there is no possibility of someone getting caught in a door during closing.

i USA only:

This device complies with Part 15 of the FCC Rules. Operation is subject to the following two conditions:

- (1) This device may not cause harmful interference, and*
- (2) this device must accept any interference received, including interference that may cause undesired operation.*

Any unauthorized modification to this device could void the user's authority to operate the equipment.

i Canada only:

This device complies with RSS-210 of Industry Canada. Operation is subject to the following two conditions:

- (1) This device may not cause interference, and*
- (2) this device must accept any interference received, including interference that may cause undesired operation of the device.*

Any unauthorized modification to this device could void the user's authority to operate the equipment.

i *You can also open and close the door windows and tilt/sliding sunroof, or the tilt/ sliding panel* using the SmartKey with KEYLESS-GO (▷ page 355).*

Locking and unlocking

Important notes on using KEYLESS-GO

- You can also use the SmartKey with KEYLESS-GO like a normal SmartKey (▷ page 304).

The starter switch is under the KEYLESS-GO button. Pull the KEYLESS-GO button out in order to access the starter switch.

- You can combine KEYLESS-GO functions with normal SmartKey functions (e.g. unlocking with KEYLESS-GO and locking with button ).
- Always carry the SmartKey with KEYLESS-GO with you.
- Never store the SmartKey with KEYLESS-GO together with:
 - Electronic items such as a mobile phone or another SmartKey with KEYLESS-GO
 - Metallic objects such as coins or metal foil

Doing so could impair the function of the KEYLESS-GO system.

- To lock or unlock the vehicle, the SmartKey with KEYLESS-GO must be located outside the vehicle within approximately 3 ft. (1 m) of a door or the trunk lid.
- In order to start the engine with the SmartKey with KEYLESS-GO:
 - The SmartKey with KEYLESS-GO must be located in the vehicle.
 - The brake pedal must be firmly depressed. Do not depress the accelerator.
- If the SmartKey with KEYLESS-GO is positioned farther away from the vehicle, the system may no longer recognize the SmartKey with KEYLESS-GO. The vehicle then cannot be locked or the engine started via the KEYLESS-GO system.
- If the SmartKey with KEYLESS-GO is removed from the vehicle (e.g. if passenger exits the vehicle with the SmartKey with KEYLESS-GO)
 - when pressing the KEYLESS-GO start/stop button or trying to lock the vehicle with the outside door handle the message “*Key not recognized*” appears in the multifunction display
 - with the engine running, the message “*Key not recognized*” appears in the multifunction display while driving off.

Find the SmartKey or change its present location immediately (e.g. place it on the front passenger seat or insert it in shirt pocket).

- If you have started the engine with the KEYLESS-GO start/stop button (▷ page 317), you can turn it off again with:
 - the KEYLESS-GO start/stop button
 - the SmartKey inserted in the starter switch, when the automatic transmission is in position **P**

- Remember that the engine can be started by anyone with a SmartKey with KEYLESS-GO that is left inside the vehicle.

Possibility 1: (One SmartKey with KEYLESS-GO in the vehicle, one SmartKey with KEYLESS-GO outside the vehicle):

If you leave the SmartKey with KEYLESS-GO behind when exiting and locking the vehicle, no message appears in the multifunction display.

Possibility 2: (One SmartKey with KEYLESS-GO in the vehicle, no SmartKey with KEYLESS-GO outside the vehicle):

When exiting and trying to lock the vehicle, the message “*Key still in vehicle*” appears in the multifunction display. The vehicle will not be locked.

Factory setting

- **Global unlocking:** Grasp an outside door handle.

All turn signal lamps flash once. The locking knobs in the doors move up. The anti-theft alarm system is disarmed.

i *If the vehicle has been parked for more than 72 hours, you must pull an outside door handle in order to activate the KEYLESS-GO function.*

The vehicle will lock again automatically and reactivate the anti-theft alarm system within approximately 40 seconds of unlocking if:

- neither a door nor the trunk is opened
- the central locking switch is not activated

i *The vehicle could inadvertently be unlocked if the SmartKey with KEYLESS-GO is within 3 ft. (1 m) of the vehicle and:*

- *an outside door handle is splashed with water, or*
- *you attempt to clean an outside door handle.*

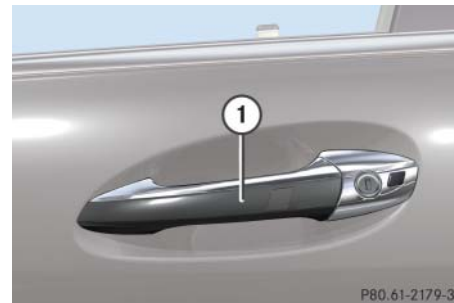

① Outside door handle



- **Global locking:** close all doors and touch outside of door handle ①. Do not keep your hand in the door handle recess.

With the trunk and all doors closed, all turn signal lamps flash three times. The locking knobs in the doors move down. The anti-theft alarm system is armed.

Locking and unlocking

Selective setting

If you frequently travel alone, you may wish to reprogram the SmartKey with KEYLESS-GO so when you, grasp the driver's outside door handle only the driver's door and the fuel filler flap unlocks.

- ▶ Press and hold buttons  and  simultaneously for about 6 seconds until battery check lamp  (▷ page 306) flashes twice.

The SmartKey with KEYLESS-GO will then function as follows:

- ▶ **Unlocking driver's door and fuel filler flap:** Grasp the driver's outside door handle.

All turn signal lamps flash once. The locking knob in the driver's door moves up. The anti-theft alarm system is disarmed.



- ▶ **Global unlocking:** Grasp any outside door handle other than the driver's outside door handle.

All turn signal lamps flash once. The locking knobs in the doors move up. The anti-theft alarm system is disarmed.

- ▶ **Global locking:** close all doors and touch outside of door handle . Do not keep your hand in the door handle recess.

With the trunk and all doors closed, all turn signal lamps flash three times. The locking knobs in the doors move down. The anti-theft alarm system is armed.

 You can also lock the vehicle using the lock button on trunk lid (▷ page 310) or, vehicles with trunk opening/closing system*, KEYLESS-GO locking/closing switch (▷ page 440).

- ▶ **Restoring to factory setting:** Press and hold buttons  and  simultaneously for about 5 seconds until battery check lamp  (▷ page 306) flashes twice.

Global locking using lock button on trunk lid

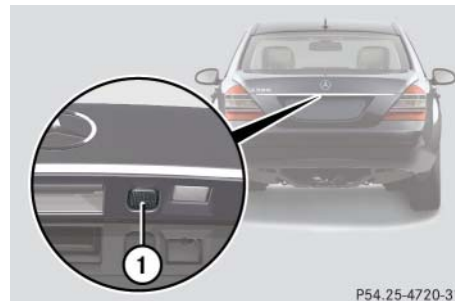

Lock button on trunk lid

- ▶ Close all doors and press lock button .

With the trunk and all doors closed, all turn signal lamps flash three times. The locking knobs in the doors move down. The anti-theft alarm system is armed.

 To prevent a possible inadvertent lockout, the trunk will open automatically if a SmartKey with KEYLESS-GO is recognized inside the vehicle or in the trunk.

i You can also lock the vehicle using the outside door handle (▷ page 309) or, vehicles with trunk opening/closing system*, KEYLESS-GO locking/closing switch (▷ page 440).

Checking batteries in the SmartKey or SmartKey with KEYLESS-GO

! If you cannot lock or unlock the vehicle with the SmartKey or SmartKey with KEYLESS-GO, then either the batteries in the SmartKey or SmartKey with KEYLESS-GO are discharged, the SmartKey or SmartKey with KEYLESS-GO is malfunctioning or the vehicle batteries are drained.

- Check the batteries in the SmartKey or SmartKey with KEYLESS-GO and replace them necessary (▷ page 619).
- Use the mechanical key to unlock the driver's door (▷ page 614) and trunk (▷ page 615).
- Have the vehicle batteries and their connections checked (▷ page 634).

If the SmartKey or SmartKey with KEYLESS-GO is malfunctioning, contact an authorized Mercedes-Benz Center.



- ▶ Press button  or .

The battery check lamp (▷ page 304) (▷ page 306) comes on briefly to indicate that the SmartKey or SmartKey with KEYLESS-GO batteries are in order.

! If the battery check lamp does not come on briefly during check, the SmartKey or SmartKey with KEYLESS-GO batteries are discharged.

Replace the batteries (▷ page 619).

You can obtain the required batteries at any authorized Mercedes-Benz Center.

i If the batteries are checked within signal range of the vehicle, pressing button  or  will lock or unlock the vehicle accordingly.

Loss of the SmartKey or SmartKey with KEYLESS-GO

If you lose your SmartKey, SmartKey with KEYLESS-GO or mechanical key, you should do the following:

- ▶ Have the SmartKey or SmartKey with KEYLESS-GO deactivated by an authorized Mercedes-Benz Center.
- ▶ Report the loss of the SmartKey, SmartKey with KEYLESS-GO or the mechanical key immediately to your car insurance company.
- ▶ Have the mechanical lock replaced if necessary.

Your authorized Mercedes-Benz Center will be glad to supply you with a replacement.

Locking and unlocking

Opening doors from the inside

You can open a locked door from the inside. Open door only when conditions are safe to do so.

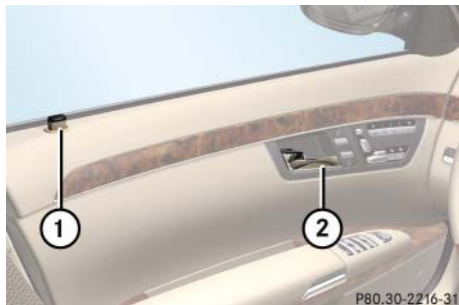



① Locking knob

② Inside door handle

i If the vehicle has previously been locked with the SmartKey or KEYLESS-GO*, opening a door from the inside will trigger the anti-theft alarm system.

To cancel the alarm, do one of the following:

- Insert the SmartKey in the starter switch.
- Press button  or  on the SmartKey.

In vehicles with KEYLESS-GO*:

- Grasp an outside door handle.
The SmartKey with KEYLESS-GO must be within 3 ft. (1 m) of the vehicle.
- Press the KEYLESS-GO* start/stop button (▷ page 317).
The SmartKey with KEYLESS-GO must be inside the vehicle.

Front doors

- ▶ Pull on door handle ② on the respective front door to open door.

If door was locked, locking knob ① will move up.

Rear doors

- ▶ Pull up locking knob ① on the respective rear door to unlock door.
- ▶ Pull on door handle ② on the respective rear door to open door.

Power closing assist for doors and trunk lid

It is not necessary to slam the door or trunk lid closed. An electrical power-assisted mechanism draws doors and trunk lid closed quietly and automatically once door and trunk lid has been latched. When the electrical power-assisted mechanism has stopped, doors and/or trunk can be re-opened.

Warning!



To prevent possible personal injury, always keep hands and fingers away from the door or trunk lid opening when closing a door or the trunk. Be especially careful when small children are around.

In case of danger, pull the inside or outside door handle, or pull the trunk lid handle.

To prevent personal injury, never actuate the closing assist mechanism by tampering with the door or trunk lid latch.

- ▶ **Power closing assist for doors:** Press the doors gently past the initial engage position into the lock.

The doors close automatically.

Warning!



Only drive with the doors closed. Otherwise, one or more of the doors could open while the vehicle is in motion, putting you and/or others at risk.

- ▶ **Power closing assist for trunk lid:** Press the trunk lid gently into its lock.

The trunk closes automatically.

Warning!



Only drive with the trunk closed as, among other dangers such as blocked visibility, exhaust fumes may enter the vehicle interior.

Automatic central locking

The doors and the trunk automatically lock when the ignition is switched on and the wheels are turning at vehicle speeds of approximately 9 mph (15 km/h) or more. The locking knobs in the doors move down.

You can open a locked door from the inside. Open door only when conditions are safe to do so.

i *The doors are designed to unlock automatically after an accident if the force of the impact exceeds a preset threshold. The vehicle locks automatically when the ignition is switched on and the wheels are turning at vehicle speeds of approximately 9 mph (15 km/h) or more. You could therefore lock yourself out when the vehicle*

- *is pushed or towed*
- *is on a test stand*

You can deactivate the automatic locking using the COMAND system (▷ page 223).

Locking and unlocking

Locking and unlocking from the inside

Warning!



When leaving the vehicle, always remove the SmartKey or SmartKey with KEYLESS-GO* from the starter switch, take it with you, and lock the vehicle. Do not leave children unattended in the vehicle, or with access to an unlocked vehicle. Unsupervised use of vehicle equipment may cause an accident and/or serious personal injury.

You can lock or unlock the doors and the trunk from the inside using the central locking or unlocking switch. This can be useful, for example, if you want to lock the vehicle before starting to drive.

The fuel filler flap will not be locked or unlocked with the central locking or unlocking switch, respectively.

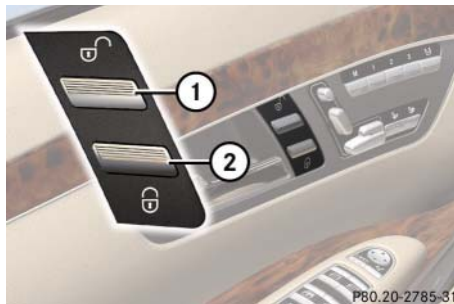

① Central unlocking switch

② Central locking switch

► **Locking:** Press switch .

If the front passenger door is closed, the vehicle locks.

► **Unlocking:** Press switch .

The vehicle unlocks.

i You can open a locked door from the inside. Open door only when conditions are safe to do so.

If the vehicle was previously centrally locked with the SmartKey or the with KEYLESS-GO*, it will not unlock using the central unlocking switch ①.

If the vehicle was previously locked with the central locking switch ②:

- While in the global remote control mode, the vehicle is unlocked completely when a door is opened from the inside.
- While in the selective remote control mode, only the door opened from inside is unlocked.

▼ Starter switch positions

Warning!



When leaving the vehicle, always remove the SmartKey or SmartKey with KEYLESS-GO* from the starter switch, take it with you, and lock the vehicle. Do not leave children unattended in the vehicle, or with access to an unlocked vehicle. Unsupervised use of vehicle equipment may cause an accident and/or serious personal injury.

SmartKey



Starter switch

0 For removing SmartKey

1 Power supply for some electrical consumers, such as seat adjustment

2 Ignition (power supply for all electrical consumers) and driving position.

All lamps (except high beam headlamp indicator lamp and turn signal indicator lamps unless activated) in the instrument cluster come on. If a lamp in the instrument cluster fails to come on when the ignition is switched on, have it checked and replaced if necessary.

If a lamp in the instrument cluster remains on after starting the engine or comes on while driving, refer to “Lamps in instrument cluster” (▷ page 544).

3 Starting position

i When you switch on the ignition, the indicator and warning lamps (except high beam headlamp indicator lamp and turn signal indicator lamps unless activated) in the instrument cluster come on. The indicator and warning lamps (except high beam headlamp indicator lamp and turn signal indicator lamps if activated) should go out when the engine is running. This indicates that the respective systems are operational.

i When the SmartKey is removed from the starter switch and the automatic transmission is in a position other than **P**, the automatic transmission automatically shifts to **P**.

! If the SmartKey cannot be turned in the starter switch, the battery may not be sufficiently charged.

- Check the battery and charge it if necessary (▷ page 634).
- Get a jump start (▷ page 639).

To prevent accelerated battery discharge or a completely discharged battery, always remove the SmartKey from the starter switch when the engine is not in operation.

For information on starting the engine using the SmartKey, see “Starting with the SmartKey” (▷ page 359).

Starter switch positions

SmartKey with KEYLESS-GO*

Vehicles equipped with the KEYLESS-GO feature are supplied with a SmartKey with integrated KEYLESS-GO function and a removable KEYLESS-GO start / stop button.

With the KEYLESS-GO start/stop button inserted and the SmartKey with KEYLESS-GO present in the vehicle, pressing the KEYLESS-GO start/stop button

- without the brake pedal depressed corresponds to the various starter switch positions (▷ page 315)
- with the brake pedal firmly depressed will start the engine (▷ page 360)

If you wish or should there be a need to insert the SmartKey with KEYLESS-GO in the starter switch, the KEYLESS-GO start/stop button can be easily removed by pulling it out of the starter switch.

i The function of the SmartKey overrides the KEYLESS-GO function.

i The KEYLESS-GO start/stop button does not need to be removed from the starter switch when you leave the vehicle. However, always take the SmartKey with KEYLESS-GO with you when you leave the vehicle. As long as the SmartKey with KEYLESS-GO is in the vehicle, the vehicle's electrical systems can be switched on or the engine can be started using the KEYLESS-GO start/stop button.

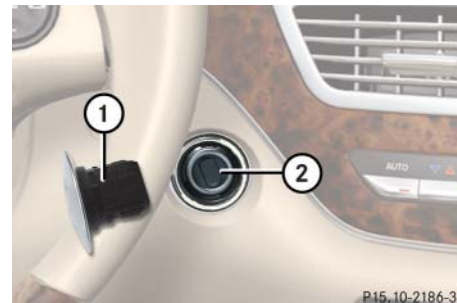

① KEYLESS-GO start/stop button

② Starter switch

- Insert KEYLESS-GO start/stop button ① into starter switch ② (if not inserted already).

i When you switch from SmartKey mode back to KEYLESS-GO mode, the system requires 2 seconds of detection time before you can use the KEYLESS-GO button as usual.

The SmartKey with KEYLESS-GO must be located in the vehicle.

- ▶ Make sure the automatic transmission is set to **P**.
- ▶ Do not depress the brake pedal.



KEYLESS-GO start/stop button

- ① USA only
- ② Canada only

Position 0

Before you press the KEYLESS-GO start/stop button, the vehicle's on-board electronics have status **0** (as with SmartKey removed).

Position 1

- ▶ Press the KEYLESS-GO start/stop button once.

This supplies power for some electrical consumers, such as seat adjustment.

i If you now press the KEYLESS-GO start/stop button

- once again, the ignition (position 2) is switched on
- twice, the power supply is again switched off

Ignition (or position 2)

- ▶ Press the KEYLESS-GO start/stop button twice.

This supplies power for all electrical consumers.

All lamps (except high beam headlamp indicator lamp and turn signal indicator lamps unless activated) in the instrument cluster come on. If a lamp in the instrument cluster fails to come on when the ignition is switched on, have it checked and replaced if necessary.

If a lamp in the instrument cluster remains on after starting the engine or comes on while driving, refer to "Lamps in instrument cluster" (▷ page 544).

i If you now press the KEYLESS-GO start/stop button once, the power supply is again switched off.

i When you switch on the ignition, the indicator and warning lamps (except high beam headlamp indicator lamp and turn signal indicator lamps unless activated) in the instrument cluster come on. The indicator and warning lamps (except high beam headlamp indicator lamp and turn signal indicator lamps if activated) should go out when the engine is running. This indicates that the respective systems are operational.

For information on starting the engine using the KEYLESS-GO start/stop button, see "Starting with KEYLESS-GO*" (▷ page 360).

Warning!



All seat, head restraint adjustments, as well as fastening of seat belts, must be done before the vehicle is put into motion.

Seat adjustment

Warning!



Do not adjust the driver's seat while driving. Adjusting the seat while driving could cause the driver to lose control of the vehicle.

Never ride in a moving vehicle with the seat back in an excessively reclined position as this can be dangerous. You could slide under the seat belt in a collision. If you slide under it, the belt would apply force at the abdomen or neck. That could cause serious or fatal injuries. The seat backrest and seat belts provide the best restraint when the wearer is in a nearly upright position and belts are properly positioned on the body.

Your seat must be adjusted so that you can correctly fasten your seat belt (▷ page 339).

Never place hands under the seat or near any moving parts while a seat is being adjusted.

Warning!



When leaving the vehicle, always remove the SmartKey or SmartKey with KEYLESS-GO* from the starter switch, take it with you, and lock the vehicle.

Even with the SmartKey or SmartKey with KEYLESS-GO* removed from the starter switch or the SmartKey with KEYLESS-GO* removed from the vehicle, the power seats can be operated when the respective door is open. Therefore, do not leave children unattended in the vehicle, or with access to an unlocked vehicle. Unsupervised use of vehicle equipment may cause an accident and/or serious personal injury.

Warning!



According to accident statistics, children are safer when properly restrained in the rear seating positions than in the front seating position. Thus, we strongly recommend that children be placed in the rear seats whenever possible. Regardless of seating position, children 12 years old and under must be seated and properly secured in an appropriate infant, or toddler restraint, or booster seat recommended for the size and weight of the child. For additional information, see "Children in the vehicle" (▷ page 61).

A child's risk of serious or fatal injuries is significantly increased if the child restraints are not properly secured in the vehicle and the child is not properly secured in the child restraint.

You can adjust the lumbar support, multi-contour seats for driver and front passenger, as well as drive-dynamic multicontour seats using COMAND (▷ page 236).

Front power seat adjustment



Example driver's door

- ① Head restraint height (▷ page 324)
 - ② Seat height
 - ③ Seat cushion tilt
 - ④ Seat cushion depth
 - ⑤ Seat fore and aft adjustment
 - ⑥ Seat backrest tilt
- ▶ Switch on the ignition (▷ page 315).
 - or
 - ▶ Open the respective door.

i If PRE-SAFE® has been activated, the front passenger's seat and/or electrically adjustable rear seats* will be moved to a more favorable seat position.

i The memory function (▷ page 336) lets you store the settings for the seat positions together with the settings for the steering wheel and the exterior rear view mirrors.

! When moving the seat, make sure there are no items in the footwell or behind the seats. Otherwise you could damage the seats.

- ▶ **Seat height:** Press the switch up or down in the direction of arrow ②.
- ▶ **Seat cushion tilt:** Press the switch up or down in the direction of arrow ③ until your upper legs are lightly supported.
- ▶ **Seat cushion depth:** Press the switch forward or backward in the direction of arrow ④ until your legs are supported comfortably.

- ▶ **Seat fore and aft adjustment:** Press the switch forward or backward in the direction of arrow ⑤.

Adjust the seat to a comfortable seating position that still allows you to reach the accelerator/brake pedal safely. The position should be as far to the rear as possible, consistent with ability to properly operate controls.

i Depending on the set height of the head restraint, the seat fore and aft position is automatically pre-set.

- ▶ **Seat backrest tilt:** Press the switch forward or backward in the direction of arrow ⑥ until your arms are slightly angled when holding the steering wheel.

i To ensure a maximum range of movement for seat adjustment, various adjustment functions also involve other indirect adjustments being made.

Seats

Rear power seat* adjustment (rear outer seats)

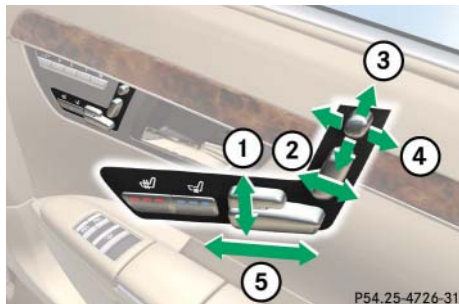

Example rear right door

- ① Seat cushion tilt
- ② Seat backrest tilt
- ③ Folding down and placing upright head restraint (▷ page 326)
- ④ Head restraint tilt (▷ page 326)
- ⑤ Seat fore and aft adjustment

▶ Switch on the ignition (▷ page 315).

or

- ▶ Open the respective door.
- ▶ Adjust desired seat using seat switches ①, ② and ⑤.

Warning!



The seat belt only offers its intended protection when the seat backrest is in a nearly vertical position and the occupant is sitting upright. Avoid sitting in positions that prevent the seat belt from being properly positioned against the body (▷ page 339). You should therefore adjust the backrest to a position as upright as possible.

Adjusting front passenger seat from driver's seat/rear*

Warning!



When adjusting the front passenger seat, make sure the seat, if occupied, is as far from the passenger front air bag as possible.

Otherwise, the passenger could be seriously or even fatally injured in the event of an accident or braking maneuver.

Make sure no one is caught or injured while the seat is being adjusted.

Even with the SmartKey or SmartKey with KEYLESS-GO* removed from the starter switch or the SmartKey with KEYLESS-GO* removed from the vehicle, the power seats can be operated when the respective door is open. Therefore, do not leave children unattended in the vehicle, or with access to an unlocked vehicle. Unsupervised use of vehicle equipment may cause an accident and/or serious personal injury.

! Do not move the front passenger seat completely forward if objects are stored in the parcel net in the front passenger-side footwell. Items in the net may be damaged.

Adjusting front passenger seat from driver's seat*

You can adjust the front passenger seat using the seat switches on the driver's side.



① Adjusting front passenger seat

- ▶ Switch on the ignition (▷ page 315).
- ▶ Press button ①.

When the indicator lamp on button ① is on, you can operate the following features of the front passenger seat:

- seat adjustment
- seat heating/ventilation*

- memory function

Setting front passenger seat position from rear*

The switch is located on the right rear passenger door.



- ① To select front or rear passenger seat
- ② Seat height
- ③ Head restraint height (▷ page 324)
- ④ Backrest tilt
- ⑤ Seat fore and aft adjustment

- ▶ Switch on the ignition (▷ page 315).
- or
- ▶ Open the right rear passenger door.

- ▶ Press button ① to adjust the front passenger seat.

The Indicator lamp in the button ① comes on.

- ▶ Adjust front passenger seat using seat switches ②, ③, ④ and ⑤.
 - ▶ To adjust right rear passenger seat (▷ page 320), press button ① again.
- The Indicator lamp in the button ① goes out.

i Adjusting the passenger seat position from the rear is not possible if you deactivate the override switch (▷ page 67).

Seats

Seat heating*

The buttons for seat heating are located on the respective door. The red indicator lamps on the button come on to show the heating level selected.

Level	
3	Three indicator lamps on (highest level) The seat heating automatically switches to level 2 after approximately 5 minutes.
2	Two indicator lamps on The seat heating automatically switches to level 1 after approximately 10 minutes.
1	One indicator lamp on (lowest level) The seat heating automatically switches off after approximately 20 minutes.
off	No indicator lamp on



① Seat heating button

- ▶ Switch on the ignition (▷ page 315).
- ▶ **Switching on:** Press button ① repeatedly until the desired heating level is set.
One or more red indicator lamps on the button show the selected heating level.
- ▶ **Switching off:** Press button ① repeatedly until all indicator lamps go out.

i If one or more of the lamps on the seat heating button are flashing, there is insufficient voltage available since too many electrical consumers are turned on. The seat heating switches off automatically.

The seat heating will switch back on again automatically as soon as sufficient voltage is available.

Seat ventilation*

The buttons for seat ventilation are located on the respective door. The blue indicator lamps on the button come on show the ventilation level selected.

Level	
3	Three indicator lamps on (highest level)
2	Two indicator lamps on
1	One indicator lamp on (lowest level)
off	No indicator lamp on

i The seat ventilation for the driver's seat can be activated using summer opening feature (▷ page 355).



① Seat ventilation button

- ▶ Switch on the ignition (▷ page 315).
- ▶ **Switching on:** Press button ① repeatedly until the desired ventilation level is set.

One or more blue indicator lamps on the button show the selected ventilation level.

- ▶ **Switching off:** Press button ① repeatedly until all indicator lamps go out.

i If one or more of the lamps on the seat ventilation button are flashing, there is insufficient voltage available since too many electrical consumers are turned on. The seat ventilation switches off automatically.

The seat ventilation will switch back on again automatically as soon as sufficient voltage is available.

Seats

Head restraints

Warning!



For your protection, drive only with properly positioned head restraints.

Adjust head restraint so that it is as close to the head as possible and the center of the head restraint supports the back of the head at eye level. This will reduce the potential for injury to the head and neck in the event of an accident or similar situation.

Do not drive the vehicle without the seat head restraints. Head restraints are intended to help reduce injuries during an accident.

i Adjust the head restraint in such a way that it is as close to the head as possible.

Front power head restraints

Head restraint height



① Head restraint height

- ▶ Press the switch up or down in the direction of arrow ①.

i Depending on the seat's set fore and aft position, the head restraint height is automatically pre-set.

i The head restraint on the front passenger's side is automatically lowered all the way down while the vehicle is in motion if no one is sitting on the seat. This helps you to acquire a better all-round view.

Head restraint tilt



Manually adjust the angle of the head restraint.

- ▶ Push or pull on the upper edge of the head restraint cushion.

Luxury active head restraints (S 600 only) (front seats)

Warning!



When folding back the side cushions, never reach between the side cushion and the mounting post. You could otherwise be trapped.

Adjustment

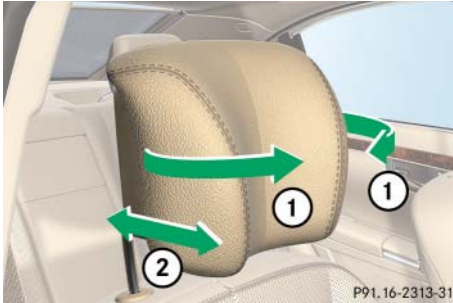

- ① Head restraint side cushions
- ② Adjusting head restraint forward and backward

You can individually adjust side cushions ① of the luxury head restraints.

- ▶ **Adjusting side cushions:** Pull or push side cushions ① into desired position.
- ▶ **Adjusting forward or backward:** Pull or push head restraint in direction of arrow ②.

Resetting

If the luxury active head restraints have been triggered in an accident, the luxury active head restraints must be reset. Otherwise, the luxury active head restraints cannot offer any additional protection in the event of another rear-end collision.

Have this work carried out by an authorized Mercedes-Benz Center.

For information on luxury active head restraints, see “Luxury active head restraints (S 600 only)” (▷ page 59).

Rear head restraints

Warning!



For safety reasons, always drive with the rear head restraints in the upright position when the rear seats are occupied.

Otherwise, the back of the head will not be supported in the event of a collision. As a result, rear seat occupants could be injured.

Warning!



Keep the area around head restraints clear of articles (e.g. clothing) to not obstruct the folding operation of the head restraints.

- ⓘ You can only fold back the rear seat head restraints when no rear seat passenger is wearing a seat belt.

Folding head restraints back

The rear seat head restraints and the rear seat power head restraints* can be folded backward for increased visibility.



- ① Switch in the front center console

Seats

- ▶ Switch on the ignition (▷ page 315).
- ▶ Press switch ① in the front center console briefly.

The rear head restraints will fold backward.

Placing head restraints upright



- ▶ Pull the rear head restraint upright until it locks into position.

! Make sure the head restraints engage when placing them upright manually. Otherwise their protective function cannot be ensured.

Placing power head restraints* upright (rear outer seats)

- ▶ Switch on the ignition (▷ page 315).
- ▶ Press and hold switch ① in the front center console and hold.

The rear outer seats head restraints will place upright.

- ▶ Pull the rear center seat head restraint upright manually until it locks into position.

i When you fasten your seat belt in the rear, the respective rear outer seat head restraint places upright.

Rear power head restraints* (rear outer seats)

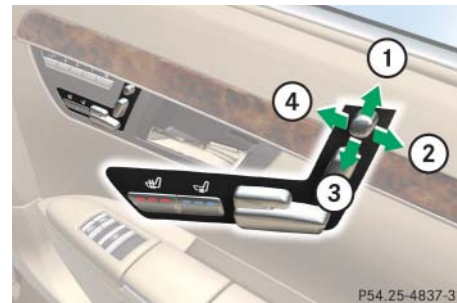

- ① Placing upright head restraint
- ② Folding down head restraint
- ③ Head restraint tilt
- ④ Head restraint tilt

- ▶ Switch on the ignition (▷ page 315) or open the respective door.
- ▶ Press switch up in the direction of arrow ①.

The rear outer seats power head restraint will place upright.

- ▶ Press switch down in the direction of arrow ③.
The rear power head restraint will fold backward.
- ▶ Press the switch forward or backward in the direction of arrow ② or ④.
The power head restraint will be tilted.

Luxury head restraints* (rear outer seats)

Warning!



When folding back the side cushions, never reach between the side cushion and the mounting post. You could otherwise be trapped.

Adjustment

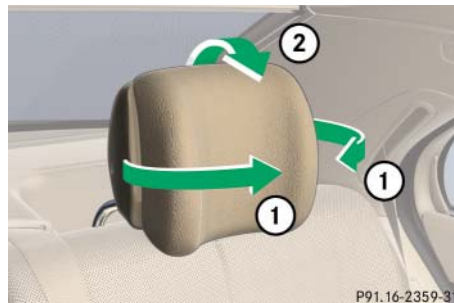

- ① Head restraint side cushions
- ② Head restraint height

You can individually adjust side cushions ① of the luxury head restraints

- ▶ **Adjusting side cushions:** Pull or push side cushions ① into desired position.
- ▶ **Adjusting head restraint angle:** Grip head restraint at upper edge of cushion and pull it forward or backward in direction of arrow ②.

Multicontour seats*, rear

You can adjust the rear outer multicontour seats using the buttons on the center console.

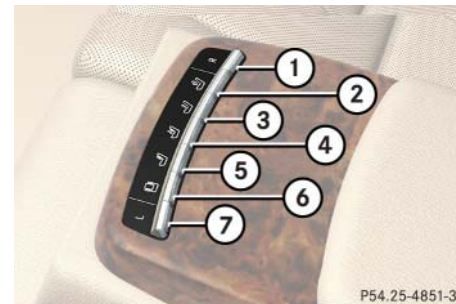

- ① To select right rear passenger seat
 - ② Massage setting, gentle
 - ③ Massage setting, vigorous
 - ④ To adjust position of backrest curvature (lordosis)
 - ⑤ Lumbar region support
 - ⑥ Side bolster adjustment
 - ⑦ To select left rear passenger seat
- ▶ Switch on the ignition (▷ page 315). ▷▷

Seats

- ▷▷ **Selecting a seat:** Press rocker switch ① or ⑦ forward or backward.

The indicator lamp on the selected button lights up for a short while.

Gentle massage

- ▶ **Switching on:** Press rocker switch ② forward.
- ▶ **Switching off:** Pull rocker switch ② backward.

Vigorous massage

- ▶ **Switching on:** Press rocker switch ③ forward.
- ▶ **Switching off:** Pull rocker switch ③ backward.

Position of backrest curvature

- ▶ **Moving upward:** Press rocker switch ④ forward.
- ▶ **Moving downward:** Pull rocker switch ④ backward.

Lumbar region support

- ▶ **Selecting greater curvature:** Press rocker switch ⑤ forward.
- ▶ **Selecting less curvature:** Pull rocker switch ⑤ backward.

Side bolster adjustment

- ▶ **Reducing width:** Press rocker switch ⑥ forward.
- ▶ **Increasing width:** Pull rocker switch ⑥ backward.

Easy-entry/exit feature

This feature allows for easier entry into and exit from the vehicle. When entering and exiting the vehicle, the driver's seat is in its maximum rearward position and the steering wheel is in its uppermost position.

The easy-entry/exit feature can be activated or deactivated in the "Vehicle" menu of the COMAND system (▷ page 224).

Warning!



You must make sure no one can become trapped or injured by the moving steering wheel and driver's seat when the easy-entry/exit feature is activated.

To cancel seat/steering wheel movement, do one of the following:

- Press seat adjustment switch (▷ page 319).
- Move steering column stalk (▷ page 330).
- Press one of the memory position buttons or the memory button **M** (▷ page 337).

Do not leave children unattended in the vehicle, or with access to an unlocked vehicle. Children could open the driver's door and unintentionally activate the easy-entry/exit feature, which could result in an accident and/or serious personal injury.

! Do not activate the easy-entry/exit feature if the seat backrest is in an excessively reclined position. Doing so could cause damage to front or rear seats.

First move the seat backrest to an upright position.

With the easy-entry/exit feature activated, the steering wheel and driver's seat will return to their last set memory position or a factory-set maximum forward position when you:

- close the driver's door with the ignition switched on
- insert the SmartKey into the starter switch or press the KEYLESS-GO* start/stop button (▷ page 317) once with the driver's door closed.

i For safety reasons, the driver's seat will not return to its last set position with the easy-entry/exit feature activated if the system recognizes the last set position as an extreme forward position. Instead, the driver's seat will remain at or move to a factory-set maximum forward position. To again fully return the driver's seat to

your last set position or to memory position, adjust the seat to the desired position or press and hold the respective memory position button (▷ page 337).

i The last set driver's seat and steering wheel positions are stored when

- the ignition is switched off
- the position is stored in memory (▷ page 336)

With the easy-entry/exit feature activated the steering wheel tilts upwards and the driver's seat moves a few inches to the rear when you:

- remove the SmartKey from the starter switch,
- or
- open the driver's door with the SmartKey in starter switch position **0** or **1** or the KEYLESS-GO* start/stop button (▷ page 317) in position **1**.

i If the current position for the steering wheel is in the uppermost tilt position, the steering wheel will no longer be able to move upward when the easy-entry/exit feature is activated.

If the current seat position falls into a factory-set position range and the system recognizes the current seat position to be rearward enough for easy entry and exit, the driver's seat will not move to the rear when the easy-entry/exit feature is activated.

The adjustment procedure is briefly interrupted when the engine is started.

Warning!



Let the system complete the adjustment procedure before setting the vehicle in motion. All driver's seat and steering wheel adjustments must be completed before setting the vehicle in motion. Driving off with the driver's seat/steering wheel still adjusting could cause the driver to lose control of the vehicle.

Steering wheel

Warning!



Do not adjust the steering wheel while driving. Adjusting the steering wheel while driving could cause the driver to lose control of the vehicle.

When leaving the vehicle, always remove the SmartKey or SmartKey with KEYLESS-GO* from the starter switch, take it with you, and lock the vehicle.

Even with the SmartKey or SmartKey with KEYLESS-GO* removed from the starter switch or the SmartKey with KEYLESS-GO* removed from the vehicle, the steering wheel adjustment feature can be operated when the driver's door is open. Therefore, do not leave children unattended in the vehicle, or with access to an unlocked vehicle. Unsupervised use of vehicle equipment may cause an accident and/or serious personal injury.

Steering wheel adjustment

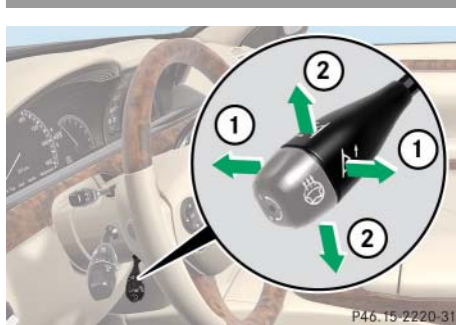

- ① Adjusting steering column, in or out
 - ② Adjusting steering column, up or down
- ▶ Switch on the ignition (▷ page 315) or open the driver's door.

- ▶ **Adjusting steering column in or out:** Move stalk forward or back in the direction of arrow ① until a comfortable steering wheel position is reached with your arms slightly bent at the elbow.
- ▶ **Adjusting steering column up or down:** Move the stalk up or down in the direction of arrow ②.

Make sure your legs can move freely and all the displays (incl. malfunction and indicator lamps) on the instrument cluster are clearly visible.

i The memory function (▷ page 336) lets you store settings for the steering wheel together with the settings for the exterior rear view mirrors and the seat positions.

Heated steering wheel*

The steering wheel heating warms up the leather area of the steering wheel.

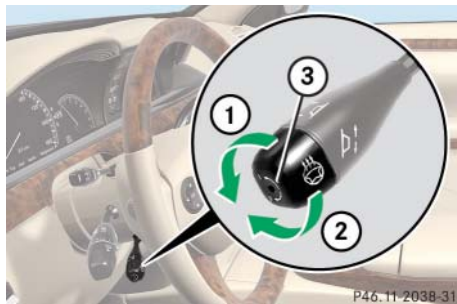

- ① Switching on
- ② Switching off
- ③ Indicator lamp

► Switch on the ignition (▷ page 315).

► **Switching on:** Turn switch at the tip of stalk in the direction of arrow ①.

The steering wheel is heated. Indicator lamp ③ comes on.

i The steering wheel heating will not switch on, when the temperature of the vehicle interior is above 86°F (30°C).

► **Switching off:** Turn switch at the tip of stalk in the direction of arrow ②.

The steering wheel heating is turned off. Indicator lamp ③ goes out.

i Indicator lamp ③ flashes or goes out

- in case of power surge or undervoltage
- in case of a steering wheel heating malfunction

i The steering wheel heating switches off automatically:

- when you remove the SmartKey from the starter switch
- on vehicles with KEYLESS-GO*, when you switch off the ignition (▷ page 315) and open the driver's door
- when the temperature of the vehicle interior is above 86°F (30°C)
- after approximately 30 minutes

Mirrors

Adjust the interior and exterior rear view mirrors before driving so that you have a good view of the road and traffic conditions.

Warning!



In case of an accident, liquid electrolyte may escape the mirror housing if the mirror glass breaks.

Electrolyte has an irritating effect. Do not allow the liquid to come into contact with eyes, skin, clothing, or respiratory system. In case it does, immediately flush affected area with water, and seek medical help if necessary.

! *Electrolyte drops coming into contact with the vehicle paint finish can only be completely removed while in their liquid state and by applying plenty of water.*

Interior rear view mirror

- ▶ Manually adjust the interior rear view mirror.

For more information, see “Auto-dimming rear view mirrors” (▷ page 334).

Exterior rear view mirrors

Warning!



Exercise care when using the passenger side exterior rear view mirror. The mirror surface is convex (outwardly curved surface for a wider field of view). Objects in mirror are closer than they appear. Check your interior rear view mirror or glance over your shoulder before changing lanes.



- ① Selector switch for right or left exterior mirror
 - ② Adjustment button
- ▶ Switch on the ignition (▷ page 315).
 - ▶ Press button ① repeatedly until desired exterior mirror is selected.
The left or right indicator lamp in button ① comes on.
 - ▶ Push adjustment button ② up, down, left, or right according to the desired setting.

i When you press button ① for the first time, the exterior mirror on the driver's side is always selected.

If you do not make adjustments to the selected exterior rear view mirror within 15 seconds, the indicator lamp goes out. You will then have to select the desired exterior rear view mirror again before any adjustments can be made. Adjustments can only be made with the indicator lamp for the respective exterior rear view mirror button illuminated.

i At low ambient temperatures, the exterior rear view mirrors will be heated automatically.

i The memory function (▷ page 336) lets you store the setting for the exterior rear view mirrors together with the setting for the steering wheel and the seat positions.

Power folding exterior rear view mirrors

! Before driving the vehicle through an automatic car wash, fold the exterior mirrors in. Otherwise they may get damaged.

Folding exterior rear view mirrors in and out automatically

When the corresponding function in the COMAND system is activated (▷ page 222):

- The exterior rear view mirrors automatically fold in as soon as the vehicle is locked from the outside.
- The exterior rear view mirrors automatically fold out as soon as the vehicle is unlocked and the driver's or front passenger door are subsequently opened.

i The mirrors do not fold out if they were previously folded in manually.

i If you are driving at more than approximately 9 mph (15 km/h), you will not be able to fold the exterior mirrors in.

Folding exterior rear view mirrors in and out manually

The exterior rear view mirrors can vibrate if they are not folded out completely.



- ① Folds the exterior mirrors in and out
- ▶ Switch on the ignition (▷ page 315).
 - ▶ **Folding in:** Press button ①.
 - ▶ **Folding out:** Press button ① again. ▷▷

Mirrors

- ▷▷ **!** *If an exterior rear view mirror housing is forcibly pushed forward (hit from the rear), reposition it manually by applying firm pressure until it snaps back into place.*

If an exterior rear view mirror housing is forcibly pushed rearward (hit from the front), press button ① to fold mirrors in, then press button ① again to fold mirrors out. Do not force mirrors by hand as this may damage the adjustment mechanism.

The mirror housing is then properly positioned and you can adjust the mirror in the usual manner.

Auto-dimming rear view mirrors

The reflection brightness of the exterior rear view mirror on the driver's side and the interior rear view mirror will respond automatically to glare when

- the ignition is switched on (▷ page 315)
- and
- incoming light from headlamps falls on the sensor in the interior rear view mirror

The interior rear view mirror will not react if

- reverse gear **R** is engaged
- the interior lighting is turned on

Warning!



The auto-dimming function does not react if incoming light is not aimed directly at sensors in the interior rear view mirror.

The interior rear view mirror and the exterior rear view mirror on the driver's side do not react, for example, if the rear window sunshade is in raised position.

Light hitting the mirror(s) at certain angles (incident light) could blind you. As a result, you may not be able to observe traffic conditions and could cause an accident.

Warning!



In case of an accident, liquid electrolyte may leak from the mirror housing if the mirror glass breaks.

Electrolyte has an irritating effect. Do not allow the liquid to come into contact with eyes, skin, clothing, or respiratory system. In case it does, immediately flush affected area with water, and seek medical help if necessary.

! *Electrolyte drops coming into contact with the vehicle paint finish can be completely removed only while in the liquid state by applying plenty of water.*

Warning!



Exercise care when using the passenger-side exterior rear view mirror. The mirror surface is convex (outwardly curved surface for a wider field of view). Objects in mirror are closer than they appear. Check your inside rear view mirror or glance over your shoulder before changing lanes.

Activating exterior rear view mirror parking position

Follow these steps to activate the mirror parking position so that the passenger-side exterior rear view mirror will be turned downward to the stored position.

- ▶ Make sure you have stored a parking position for the passenger-side exterior rear view mirror (▷ page 338).
- ▶ Make sure the “*Lower mirror when reversing*” function in the “*Exterior Mirror Convenience Settings*” submenu of the COMAND system is selected (▷ page 222).
- ▶ Switch on the ignition (▷ page 315).



- ① Selector switch for right or left exterior mirror
- ▶ Press switch ① repeatedly until the exterior mirror on the front passenger side is selected.
- i** *With the automatic transmission in reverse gear R, the previously selected exterior rear view mirror is activated.*

- ▶ Shift the automatic transmission in reverse gear **R**.

The passenger-side exterior rear view mirror will be turned downward to the stored position.

The exterior rear view mirror returns to its previously stored driving position:

- when you switch off the ignition
- 10 seconds after you have put the automatic transmission out of reverse gear **R**
- immediately once your vehicle exceeds a speed of approximately 6 mph (10 km/h)
- immediately when you press button ① for driver’s side exterior rear view mirror.

i *If you adjust the exterior mirrors while they are in the parking position, the new mirror position is stored as a new parking position.*

Memory function

Prior to operating the vehicle, the driver should check and adjust the seat height, seat position fore and aft, and seat back-rest angle if necessary, to ensure adequate control, reach, and comfort. The head restraint should also be adjusted for proper height. See also the section on air bags (▷ page 45) for proper seat positioning.

In addition, adjust the steering wheel to ensure adequate control, reach, operation and comfort. Both the inside and outside rear view mirrors should be adjusted for adequate rear vision.

Fasten seat belts. Infants and small children should be seated in a properly secured restraint system that complies with U.S. Federal Motor Vehicle Safety Standards 213 and 225 and Canadian Motor Vehicle Safety Standards 213 and 210.2.

With the memory function you can store up to 3 different settings.

The following settings are saved for each stored position the driver's door:

- Seat position and lumbar support
- Multicontour seat*: previously selected setting
- Drive-dynamic multicontour seat*: activation/deactivation
- Steering wheel position
- Exterior rear view mirrors position

The following settings are stored when using the buttons on the front passenger door:

- Seat position and lumbar support
- Multicontour seat*: previously selected setting
- Drive-dynamic multicontour seat*: activation/deactivation

The following settings are stored when using the buttons* on the rear passenger doors (Canada only):

- Seat position
- Multicontour seat*: previously selected setting

Warning!



Do not activate the memory function while driving. Activating the memory function while driving could cause the driver to lose control of the vehicle.

The memory button and stored position buttons are located on the door control panel.



M Memory button

1 2 3 Memory position buttons

- ▶ Switch on the ignition (▷ page 315).
- or
- ▶ Open the respective door.

Storing positions into memory

- ▶ Adjust the seat (▷ page 318) to the desired position.
- ▶ On the driver's side: adjust the steering wheel (▷ page 330) and the exterior rear view mirrors (▷ page 332) to the desired position.
- ▶ Press memory button **M**.
- ▶ Release memory button **M** and push one of the position buttons within 3 seconds.

All the settings are stored with the selected position.

Recalling positions from memory

! Do not operate the power seats using the memory button if the seat backrest is in an excessively reclined position. Doing so could cause damage to front or rear seats.

First move seat backrest to an upright position.

- ▶ Press and hold one of the position buttons until the seat, steering wheel and exterior rear view mirrors have fully moved to the stored positions.

i Releasing the button immediately stops movement to the stored positions.

The multicontour seat and/or lumbar support will continue to be adjusted.*

Memory function

Storing exterior rear view mirror parking position

For easier parking, you can adjust the passenger-side exterior rear view mirror so that you can see the right rear wheel as soon as you engage reverse gear **R**.

For information on activating the parking position, see “Activating exterior rear view mirror parking position” (▷ page 335).



- ① Memory button **M**
- ② Adjustment button
- ③ Selector switch for right or left exterior mirror

- ▶ Stop the vehicle.
- ▶ Make sure the ignition is switched on (▷ page 315).
- ▶ Press switch ③ until the exterior mirror on the front passenger side is selected.
- ▶ Adjust the passenger-side exterior rear view mirror with button ② so that you see the rear wheel and the road curb.
- ▶ Press memory button **M**.
- ▶ Within 3 seconds, press one of adjustment buttons ②.

The parking position is stored if the mirror does not move.

i If the mirror does move, repeat the above steps. After the setting is stored, you can move the mirror again.

▼ Fastening the seat belts

Warning!



Always fasten your seat belt before driving off. Always make sure all of your passengers are properly restrained, even those sitting in the rear and pregnant women.

Failure to wear and properly fasten and position your seat belt greatly increases your risk of injuries and their likely severity in an accident. You and your passengers should always wear seat belts.

If you are ever in an accident, your injuries can be considerably more severe without your seat belt properly buckled. Without your seat belt buckled, you are much more likely to hit the interior of the vehicle or be ejected from it. You can be seriously injured or killed.

In the same crash, the possibility of injury or death is lessened if you are wearing your seat belt. The air bags can only provide the protection they were designed to afford if the occupants are using their seat belts (▷ page 45).

Warning!



According to accident statistics, children are safer when properly restrained in the rear seating positions than in the front seating position. Thus, we strongly recommend that children be placed in the rear seats whenever possible. Regardless of seating position, children 12 years old and under must be seated and properly secured in an appropriate infant, or toddler restraint, or booster seat recommended for the size and weight of the child. For additional information, see “Children in the vehicle” (▷ page 61).

Warning!



Never let more people ride in the vehicle than there are seat belts available. Be sure everyone riding in the vehicle is correctly restrained with a separate seat belt. Never use a seat belt for more than one person at a time.

Fastening the seat belts

Warning!



Never ride in a moving vehicle with the seat backrest in an excessively reclined position as this can be dangerous. You could slide under the seat belt in a collision. If you slide under it, the belt would apply force at the abdomen or neck. That could cause serious or even fatal injuries. The seat backrest and seat belt provide the best restraint when the wearer is in a nearly upright position and the belt is properly positioned on the body.

Warning!



Read and observe the additional warning notices printed in the “Safety and Security” section (▷ page 44).

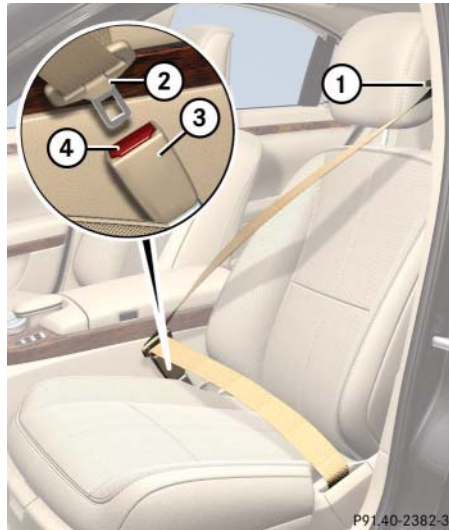

- ① Belt outlet
- ② Latch plate
- ③ Buckle
- ④ Release button

- ▶ Pull the seat belt smoothly from the seat belt outlet ①.

- ▶ Place the shoulder portion of the belt across the top of your shoulder and the lap portion across your hips.
- ▶ Push latch plate ② into buckle ③ until it clicks.
- ▶ If necessary, tighten the lap portion to a snug fit by pulling shoulder portion up.
- ▶ To release the seat belt, press release button ④ and guide latch plate back to belt outlet.

Proper use of seat belts

- Do not twist the belt when fastening.
- Adjust seat belt so that the shoulder portion is located as close as possible to the middle of the shoulder (it should not touch the neck). Never pass the shoulder portion of the belt under your arm.
- Position the lap belt as low as possible on your hips (over hip joint) and not across the abdomen.
- Place the seat backrest in a nearly upright position.
- Never use a seat belt for more than one person at a time.
- Do not fasten a seat belt around a person and another object at the same time. When using a seat belt to secure infant or toddler restraints or children in booster seats, always follow the child seat manufacturer's instructions.

- Check your seat belt during travel to make sure that it is properly positioned.
- Make sure the seat belt is always fitted snugly. Take special care of this when wearing loose clothing.

Warning!



Do not pass belts over sharp edges. They could tear.

Do not allow the belt to get caught in the door or in the seat adjustment mechanism. This could damage the belt.

Never attempt to make modifications to seat belts. This could impair the effectiveness of the belts.

Do not bleach or dye seat belts as this may severely weaken them. In a crash, they may not be able to provide adequate protection.

Damaged seat belts or belts that were highly stressed in an accident must be replaced. Contact an authorized Mercedes-Benz Center.

For more information, see "Seat belts" (▷ page 55).

Seat belt height adjustment

The vehicle automatically adjusts the seat belt height for the driver's and front passenger's seats as well as for the rear outer seats. Comply with the instructions on how to properly fasten a seat belt (▷ page 339).

Lighting







i If you drive in countries where vehicles drive on the other side of the road than the country in which the vehicle is registered, you must have the headlamps modified for symmetrical low beams. Relevant information can be obtained at your authorized Mercedes-Benz Center.

i The active Bi-Xenon headlamps monitor the vehicles steering angle, then automatically shift their beams to either side to better follow the curvature of the road ahead, increasing usable illumination over conventional headlamps.

Exterior lamp switch

The exterior lamp switch is located on the dashboard to the left of the steering wheel.



- 0** Off
Daytime running lamp mode
(▷ page 344)
- A** Automatic headlamp mode
Daytime running lamp mode
(▷ page 344)
-  Parking lamps (also side marker lamps, tail lamps, license plate lamps, instrument panel lamps)
-  Low beam headlamps (or high beam headlamps when the combination switch is pushed forward) and parking lamps
- P**  Standing lamps, right (turn left one stop)
- ←P**  Standing lamps, left (turn left two stops)
-  Indicator lamp for parking lamps
-  Indicator lamp for front fog lamps
-  Indicator lamp for rear fog lamp

i With the SmartKey removed from the starter switch or the engine turned off with KEYLESS-GO* and the driver's door open, a warning sounds if the parking lamps or low beam headlamps are switched on.

The message: "Please switch off lights" appears in the multifunction display.

i With the daytime running lamp mode activated and the engine running, the low beam headlamps cannot be switched off manually.

For information on how to activate the daytime running lamp mode, see "Daytime running lamp mode" (▷ page 344).

Low beam headlamps

The exterior lamp switch is located on the dashboard to the left of the steering wheel.

► Turn the switch to .

The green indicator lamp  in the exterior lamp switch comes on.

Manual headlamp mode

The low beam headlamps and parking lamps can be switched on and off with the exterior lamp switch. For exterior lamp switch (▷ page 342).

Automatic headlamp mode

The following lamps switch on and off automatically depending on the brightness of the ambient light:

- Low beam headlamps
- Tail and parking lamps
- License plate lamps
- Side marker lamps

Warning!





If the exterior lamp switch is set to **A**,

- the headlamps may switch off unexpectedly when the system senses bright ambient light, for example light from oncoming traffic.

If the exterior lamp switch is set to **A**,

- the headlamps may switch off unexpectedly when the system senses bright ambient light, for example light from oncoming traffic.
- the headlamps will not be automatically switched on under foggy conditions.

To minimize risk to you and to others, activate headlamps by turning exterior lamp switch to  when driving or when traffic and/or ambient lighting conditions require you to do so.

In low ambient lighting conditions, only switch from position **A** to  with the vehicle at a standstill in a safe location. Switching from **A** to  will briefly switch off the headlamps. Doing so while driving in low ambient lighting conditions may result in an accident.

The automatic headlamp feature is only an aid to the driver. The driver is responsible for the operation of the vehicle's lights at all times.

Lighting

i *The front fog lamps and rear fog lamp cannot be switched on manually with exterior lamp switch in position **A**. To activate the fog lamps, turn exterior lamp switch to position  and pull the exterior lamp switch to first or second stop (▷ page 345).*

- ▶ Turn the exterior lamp switch to **A**.

With the SmartKey in starter switch position **1** or the KEYLESS-GO* start/stop button pressed once, only the parking lamps will switch on and off automatically.

When the engine is running, the low beam headlamps, the tail and parking lamps, the license plate lamps, and the side marker lamps will switch on and off automatically.

Daytime running lamp mode

- ▶ Turn exterior lamp switch to position **0** or **A**.

When the engine is running, the low beam headlamps are switched on. In low ambient light conditions, the following lamps will switch on additionally:



- tail and parking lamps
- license plate lamps
- side marker lamps

For nighttime driving you should turn the exterior lamp switch to position  to permit activation of the high beam headlamps.

Canada only

The daytime running lamp mode is mandatory and therefore in a constant mode. When the engine is running, and you shift from a driving position to position **N** or **P**, the low beam headlamps will switch off with a 3-minute delay.



When the engine is running, and you

- turn the exterior lamp switch to position , the parking lamps switch on additionally.
- turn the exterior lamp switch to position , the manual headlamp mode has priority over the daytime running lamp mode.

The corresponding exterior lamps switch on (▷ page 622).

USA only

By default, the daytime running lamp mode is deactivated. Activate the daytime running lamp mode using the control system, see “Daytime driving lamps mode on/off (USA only)” (▷ page 255).



When the engine is running, and you turn the exterior lamp switch to position  or , the manual headlamp mode has priority over the daytime running lamp mode.

The corresponding exterior lamps switch on (▷ page 622).



Fog lamps

Warning!



In low ambient lighting or foggy conditions, only switch from position **A** to  with the vehicle at a standstill in a safe location. Switching from **A** to  will briefly switch off the headlamps. Doing so while driving in low ambient lighting conditions may result in an accident.

 *Fog lamps will operate with the parking lamps and/or the low beam headlamps on. Fog lamps should only be used in conjunction with low beam headlamps. Consult your State or Province Motor Vehicle Regulations regarding permissible lamp operation.*

 *Fog lamps cannot be switched on with exterior lamp switch in position **A**. For switching on the fog lamps, turn exterior lamp switch to position .*

Front fog lamps

▶ Switch on the low beam headlamps (▷ page 343).

▶ Pull out exterior lamp switch to first stop.

The front fog lamps are switched on.

The green indicator lamp  in the lamp switch comes on (▷ page 342).

▶ Push in the exterior lamp switch.

The front fog lamps are switched off.

The green indicator lamp  in the lamp switch goes out (▷ page 342).

Rear fog lamp (driver's side only)

▶ Switch on the front fog lamps (▷ page 345).

▶ Pull out exterior lamp switch to second stop.

The rear fog lamp is switched on.

The yellow indicator lamp  in the lamp switch comes on (▷ page 342).

 *If so equipped, the front fog lamps will also switch on.*

▶ Push in the exterior lamp switch to first stop.

The rear fog lamp is switched off.

The green indicator lamp  in the lamp switch goes out (▷ page 342).

The front fog lamps remain lit.

Lighting

Locator lighting and night security illumination

Locator lighting and night security illumination are described in the COMAND vehicle section under “Setting locator lighting” (▷ page 221) and “Setting night security illumination” (▷ page 220).

Headlamp cleaning system



① Headlamp washer button

- ▶ Switch on the ignition (▷ page 315).
- ▶ Press button ①.

The headlamps are cleaned with a high-pressure water jet.

i The headlamps are automatically cleaned if, at the same time,

- the engine is running
- the lights are switched on
- the windshield wipers have wiped the windshield with washer fluid 15 times

When you switch off the ignition or press button ①, the automatic function is reset and will start counting the next time from the beginning.

For information on filling up the washer reservoir, see “Windshield washer system and headlamp cleaning system” (▷ page 498).

Combination switch



- ① High beam
- ② High beam flasher

Switching on high beams

- ▶ Turn exterior lamp switch to position  or to **A** (▷ page 342).
- ▶ Push the combination switch in the direction ①.

The high beam indicator  on the instrument cluster comes on.

High beam flasher

- ▶ Pull the combination switch briefly in the direction ②.

Corner-illuminating lamps

The corner-illuminating lamps improve illumination of the area in the direction into which you are turning.

Corner-illuminating lamps will operate with:

- the engine running
- during darkness
- the headlamps switched on

i The corner-illuminating lamps function is not available at a vehicle speed above 25 mph (40 km/h).

Switching on corner-illuminating lamps

- ▶ Depending on whether you are turning left or right, switch on the left or right turn signal (▷ page 342).

The respective corner-illuminating lamp comes on and illuminates the area in the direction into which you are turning.

i The corner-illuminating lamps will come on automatically up to a speed of approximately 25 mph (40 km/h) depending on the steering angle, even if you did not switch on either turn signal. If the corner-illuminating lamps came on automatically, they will also go out automatically depending on the steering angle.

i If you have switched on the turn signal for one side but turn the steering wheel in the other direction, the corner-illuminating lamp lights up on the side of the turn signal.

i The corner-illuminating lamps temporarily light up on both sides of the vehicle if you turn the steering wheel in one direction and then in the other direction shortly thereafter.

i When you shift the automatic transmission in reverse gear **R**, the inverse corner-illuminating lamp comes on automatically depending on the steering direction and steering angle.

The turn signal has no influence on the corner-illuminating lamp on the outside of the curve.

Switching off the corner-illuminating lamps

The combination switch for the turn signal resets automatically after major steering wheel movements. This will switch off the corner-illuminating lamps if they were activated by switching on the left or right turn signal.

If the turn signal should stay on after making the turn, the turn signal and corner-illuminating lamp can be switched off by returning the combination switch to its original position.

i If you are driving faster than 25 mph (40 km/h) when activating the turn signal indicator, the corner-illuminating lamp function is switched off.

i The corner-illuminating lamp may remain lit for a short time. The corner-illuminating lamp lights up for no more than 20 seconds with the vehicle standing still. It is then switched off even if the turn signal is still switched on or you have turned the steering wheel to full lock.

Lighting

Hazard warning flasher

The hazard warning flasher can be switched on at all times, even with the SmartKey removed from the starter switch or with the SmartKey with KEYLESS-GO* removed from the vehicle.

The hazard warning flasher is automatically switched on if

- an air bag has been triggered
- S 600 and USA only: you brake the vehicle strongly at a speed of more than 50 mph (70 km/h) and bring it to a complete stop.



① Hazard warning flasher switch

- ▶ **Switching on:** Press hazard warning flasher switch.

All turn signals will flash.

i With the hazard warning flasher activated and the combination switch set for either left or right turn, only the respective left or right turn signals will operate when the SmartKey in the starter switch is in position **1** or **2** or the KEYLESS-GO* start/stop button (▷ page 317) is pressed once or twice.

- ▶ **Switching off:** Press hazard warning flasher switch again.

i If the hazard warning flasher was activated automatically, also press hazard warning flasher switch ① to switch off the hazard warning flasher.

Interior lighting

i When you lock the vehicle from the outside, the interior lighting is switched off. As soon as one of the interior lighting buttons inside the vehicle is pressed, however, the selected lamp comes on and all of the lamps inside the vehicle that are not switched on via a button are activated.

If you do not lock the vehicle, all lamps will be switched off after 30 minutes. When you open the door, you can still use the lighting for the storage compartment, glove box and vanity mirror without in the starter switch in position **1** or **2** or the KEYLESS-GO* start/stop button (▷ page 317) pressed once or twice.

Interior lighting in the front

The controls are located in the overhead control panel.

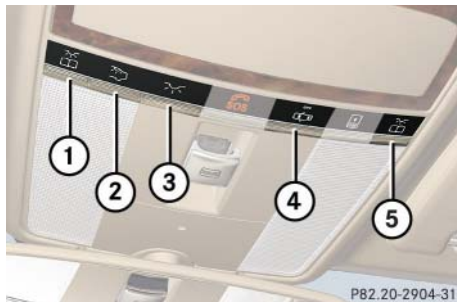

- ① Left reading lamp on/off
- ② Rear interior lamps on/off
- ③ Front interior lighting on/off
- ④ Interior lighting control
- ⑤ Right reading lamp on/off

! Leaving an interior light switch in the ON position for extended periods of time with the engine turned off could result in a discharged battery.

Automatic control

- ▶ **Deactivating:** Press button ④.

The OFF indicator lamp next to the button comes on.

The interior lighting remains switched off in darkness, even when you:

- unlock the vehicle
- remove the SmartKey from the starter switch
- open a door
- open the trunk

- ▶ **Activating:** Press button ④.

The interior lighting switches on in darkness when you:

- unlock the vehicle
- remove the SmartKey from the starter switch
- open a door
- open the trunk

The interior lighting switches off automatically following an adjustable time delay (▷ page 226).

i If the door remains open, the interior lighting switches off automatically after approximately 5 minutes.

An interior lamp switched on manually does not go out automatically.

Manual control

- ▶ **Switching on/off front interior lighting:** Press button ③.
- ▶ **Switching on/off rear interior lighting:** Press button ②.
- ▶ **Switching on/off front reading lamps:** Press button ① or ⑤.

The reading lamps are integrated into the interior rear view mirror.

- ▶ **Ambient lighting:** the brightness of the ambient lighting is adjusted via COMAND (▷ page 79).

Lighting

Interior lighting in the rear

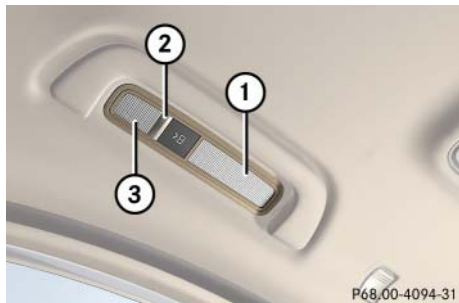

- ① Rear interior lamp
- ② Button
- ③ Reading lamp

► Press button ②.

You can switch the lamps on/off in succession as follows:

- reading lamp ③ and rear interior lamp ① on
- only reading lamp ③ on
- reading lamp ③ off

Courtesy lighting

For better orientation in the dark, courtesy lamps will illuminate the interior of your vehicle as follows:

With parking lamps switched on:

- the door handles
- the driver and passenger footwells

With the SmartKey in the starter switch position 1:

- the door handles
- the center console

i If you turn the SmartKey in the starter switch to position 0 and switch off the exterior headlamps, the door handle lamps will remain lit for approximately 5 minutes.

Door entry lamps

For better orientation in the dark, the corresponding door entry lamps will switch on in darkness when you open a door and the automatic control is activated.

The door entry lamps switch off when the corresponding door is closed.

i If you turn the SmartKey in the starter switch to position 0 and switch off the exterior headlamps, the door entry lamps will remain lit for approximately 5 minutes.

Trunk lamp

The trunk lamp switches on if the trunk is opened.

If the trunk remains open, the trunk lighting switches off automatically after approximately 10 minutes.

i The interior lighting is factory-set to automatic mode (▷ page 349).

The setting selected for the interior lighting is used for the trunk lighting as well.

▼ Windshield wipers

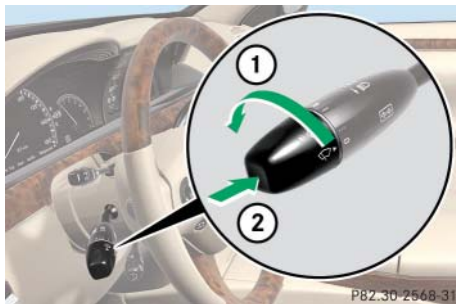

Combination switch

- ① Switching on windshield wipers
- ② Single wipe
Wiping with windshield washer fluid

! If the windshield wipers leave smears on the windshield after the car has been driven through an automatic car wash, then wax or other residue is on the windshield. Shortly after washing the car in an automatic car wash, clean the windshield with windshield washer fluid (▷ page 352).

! Do not operate the wipers when the windshield is dry. Dust that accumulates on a windshield might scratch the glass and/or damage the wiper blades when wiping occurs on a dry windshield. If it is necessary to operate the wipers in dry weather conditions, always operate the wipers with windshield washer fluid (▷ page 352).

! If anything blocks the windshield wipers (leaves, snow, etc.), switch them off immediately.

- For safety reasons, stop the vehicle in a safe location,
 - turn off the engine by turning the SmartKey to position 0 and withdraw SmartKey from starter switch
 or
 - turn off the engine by pressing the KEYLESS-GO* start/stop button (▷ page 317) and open the driver's door (with the driver's door open, starter switch is in position 0, same as with SmartKey removed from starter switch) before attempting to remove any blockage.
- Remove blockage.
- Turn the windshield wipers on again.

If the windshield wipers fail to function at all in combination switch position **—**,

- set the combination switch to the next higher wiper speed
 - have the windshield wipers checked at the nearest authorized Mercedes-Benz Center
- ▶ Switch on the ignition (▷ page 315).

Switching on/off windshield wipers

- ▶ Turn the combination switch to the desired position depending on the intensity of the rain.

- 0** Windshield wipers off
- ...** Slow intermittent wiping (rain sensor operation low sensitivity)
-** Fast intermittent wiping (rain sensor operation low sensitivity)
- Slow continuous wiping
- ==** Fast continuous wiping

Windshield wipers



i When the windshield wipers are switched on and you brake the vehicle to a stop, the wipers operate more slowly.

Intermittent wiping

Only switch on intermittent wiping under wet weather conditions or in the presence of precipitation.

! Do not leave windshield wipers in intermittent setting when the vehicle is taken to an automatic car wash or during windshield cleaning. Wipers will operate in the presence of water sprayed on the windshield, and windshield wipers may be damaged as a result.

! If you have set intermittent wiping, dirt on the surface of the rain sensor or optical effects may cause the windshield wipers to wipe in an undesired fashion. This could then damage the windshield wiper blades or scratch the windows. You should therefore switch off the windshield wipers when weather conditions are dry.

- ▶ Set the wiper switch to position  or .

The wipers move across the windshield. Afterward, the wiping intervals are determined by the wetness of the windshield.

After the initial wipe, pauses between wipes are automatically controlled by the rain sensor.

i Intermittent wiping is interrupted when the vehicle is at a standstill and a front door is opened. This protects persons getting into or out of the vehicle from being sprayed.

Intermittent wiping will be continued when

- all doors are closed and the automatic transmission is set to position **D** or **R**

or

- the wiper setting is changed using the combination switch

Single wipe

- ▶ Press the combination switch briefly in the direction of arrow .

The windshield wipers wipe one time without washer fluid.

Wiping with windshield washer fluid

- ▶ Press the combination switch in the direction of arrow  past the resistance point.

The windshield wiper operates with washer fluid.

i To prevent smears on the windshield, wipe with windshield washer fluid every now and then even when it is raining.

For information on filling up the washer reservoir, see “Windshield washer system and headlamp cleaning system” ( page 498).

▼ Power windows

Opening and closing power windows

The door windows are opened and closed electrically. The switches

- for all side windows are on the driver's door
- for the front passenger side window are on the front passenger door
- for each rear side window are on the rear doors



- ① Left front door window
- ② Right front door window
- ③ Left rear door window
- ④ Right rear door window

Warning!





When closing the windows, make sure that there is no danger of anyone being harmed by the closing procedure.

Activate the override switch (▷ page 67) when children are riding in the back seats of the vehicle. The children may otherwise injure themselves, e.g. by becoming trapped in the window opening.

The closing of the door windows can be immediately halted by releasing the switch or, if the switch was pressed past the resistance point and released, by pressing the lower part of the respective switch again.

The door windows are equipped with the express-close and automatic reversal function. If the window encounters an obstruction that blocks its path in a circumstance where you pressed the switch past the resistance point and released it to close the window, the automatic reversal function will stop the window and open it slightly.

If the window encounters an obstruction that blocks its path in a circumstance where you are closing the window by pressing and holding the switch, by pressing and holding button  on the SmartKey or SmartKey with KEYLESS-GO*, by pressing and holding the sensor surface (vehicles with KEYLESS-GO*) on an outside door handle, or by pressing and holding button  on the climate control panel, the automatic reversal function will not operate.

When leaving the vehicle, always remove the SmartKey or SmartKey with KEYLESS-GO* from the starter switch, take it with you, and lock the vehicle. Do not leave children unattended in the vehicle, or with access to an unlocked vehicle. Unsupervised use of vehicle equipment may cause an accident and/or serious personal injury.

Power windows

i You can also open or close the windows using the SmartKey, see “Summer opening feature” (▷ page 355) and “Convenience closing feature” (▷ page 356).

Depending on current position, the windows may also open or close when the air recirculation button  (▷ page 426) is pressed and held for 2 seconds

i Operating the windows from the rear is not possible if you activate the override switch (▷ page 67).

i If PRE-SAFE® has been activated, the side windows close automatically until only a small gap remains.

i With the SmartKey in starter switch position 0 or removed from the starter switch, the power windows can be operated:

- until you open the driver's or front passenger door
 - for at least 5 minutes
- ▶ Switch on the ignition (▷ page 315).

▶ **Opening:** Press the lower part of switch ① to ④ (▷ page 353) to the resistance point.

The corresponding window will move downwards until you release the switch.

▶ **Closing:** Press the upper part of switch ① to ④ (▷ page 353) to the resistance point.

The corresponding window will move upwards until you release the switch.

Warning!



If you press and hold the switch up when closing the window, and upward movement of the window is blocked by some obstruction including but not limited to arms, hands, fingers, etc., the automatic reversal will not operate.

▶ **Express-opening:** Press the upper part of switch ① to ④ (▷ page 353) past the resistance point and release.

The corresponding window opens completely.

▶ **Express-closing:** Press the upper part of switch ① to ④ (▷ page 353) past the resistance point and release.

The corresponding window closes completely.

Warning!



Driver's door only:

If within 5 seconds you again press the switch past the resistance point and release, the automatic reversal will not operate.

! If the upward movement of the window is blocked during the closing procedure, the window will stop and open slightly. Remove the obstruction, press the respective power window switch at the upper part again past the resistance point and release. If the window still does not close when there is no obstruction, press and hold the respective power window switch at the upper part. The side window will then close without the obstruction sensor function.

- **Stopping during Express-operation:**
Briefly press the respective power window switch again.

Rear side window sunshades*

- **Closing:** With the side window fully closed, press top part of respective rocker switch ③ or ④ (▷ page 353).

The rear side window sunshade will be fully closed.

i The rear side window sunshade cannot be partially closed.

- **Opening:** Press bottom part of respective rocker switch ③ or ④ (▷ page 353).

The rear side window sunshade will be fully opened.

i The rocker switches on the rear doors can also be used to close the rear side window sunshades on the other side of the vehicle.

i The rocker switches on the driver's door take precedence over the rocker switches on the other doors.

Summer opening feature

If the weather is warm, you can ventilate the vehicle before driving off by simultaneously:

- opening the side windows and rear side window sunshades*
- opening the tilt/sliding sunroof or tilt/sliding panel* and extending the roller sunblinds*
- turning on the seat ventilation* for the driver's seat

i The "Summer opening" function can only be activated via the remote control.



i The seat ventilation* for the driver's seat is automatically set to the highest level if activated via summer opening feature.



- Aim transmitter eye of the SmartKey or SmartKey with KEYLESS-GO* at the driver's outside door handle. The SmartKey or SmartKey with KEYLESS-GO* must be in close proximity to the driver's door handle.



Power windows

Vehicles with tilt/sliding sunroof



- ▶ Press and hold button  until the side windows and tilt/sliding sunroof have reached the desired position.
- ▶ Release button  to interrupt procedure.

Vehicles with panorama roof* and/or rear side window sunshades*

If roller sunblinds are retracted and/or rear side window sunshades* are closed:

- ▶ Press and hold button . The windows and sunblinds and/or rear side window sunshades* begin to open/extend after approximately 1 second.
- ▶ With the windows and roller blinds and/or rear side window sunshades* fully opened/extended, press and hold button  again. The tilt/sliding panel tilts and opens.

If roller sunblinds and/or rear side window sunshades* are open/extended:

- ▶ Press and hold button . The windows move down and the tilt/sliding panel tilts and opens after approximately 1 second.
- ▶ Release button  to interrupt procedure.

Convenience closing feature

When you lock the vehicle, you can close the side windows and tilt/sliding sunroof or tilt/sliding panel* simultaneously.

Afterward, you can close the roller sunblinds* of the panorama tilt/sliding sunroof* and the rear side window sunshades*.



 *The function of the SmartKey overrides the KEYLESS-GO function.*

Warning!



When closing the windows and the tilt/sliding sunroof or tilt/sliding panel*, make sure that there is no danger of anyone being harmed by the closing procedure.

If potential danger exists, proceed as follows:

- Release button  to stop the closing procedure. To open, press and hold button . To continue the closing after making sure that there is no danger of anyone being harmed by the closing procedure, press and hold button .

Vehicles with KEYLESS-GO*:



- Release the sensor surface on the outside door handle (▷ page 358) to stop the closing procedure.
- Immediately pull on the same outside door handle and hold firmly. The side windows and the tilt/sliding sunroof or tilt/sliding panel* will open for as long as the outside door handle is held but the door is not opened.

Vehicles with SmartKey









- ▶ Aim transmitter eye of the SmartKey towards the sensor in the driver's door handle. The SmartKey must be in close proximity to the driver's door handle.

Vehicles with tilt/sliding sunroof

- ▶ Press and hold button  until the side windows and the tilt/sliding sunroof are completely closed.
- ▶ Release button  to interrupt procedure.

Vehicles with panorama roof* and/or rear side window sunshades*

- ▶ Press and hold button  until the side windows and the tilt/sliding panel are completely closed.
- ▶ Press and hold button  again.
The roller sunblinds and/or rear side window sunshades* close.
- ▶ Release button  to interrupt procedure.

 If you press  while one of the front side windows is open and one of the rear side windows is closed, for example, then the front side window and the rear side window sunshade will be closed. To prevent this from happening, first open all side windows slightly by briefly pressing  and then close all side windows by pressing .

Power windows

Vehicles with KEYLESS-GO*



① Sensor surface on door handle

The SmartKey with KEYLESS-GO must be located outside the vehicle within approximately 3 ft. (1 m) of a door.

- ▶ Close all doors.

Vehicles with tilt/sliding sunroof

- ▶ Touch and hold sensor surface ① until the windows and the tilt/sliding sunroof are completely closed.

i Make sure that you are only touching the sensor surface.

- ▶ Release sensor surface ① to interrupt procedure.

Vehicles with panorama roof* and/or rear side window sunshades*

- ▶ Touch and hold sensor surface ① until the windows and the tilt/sliding panel are completely closed.

i Make sure that you are only touching the sensor surface.

- ▶ Touch and hold sensor surface ① again.

The roller sunblinds and/or rear side window sunshades* close.

- ▶ Release sensor surface ① to interrupt procedure.

i If you touch the sensor surface while one of the front side windows is open and one of the rear side windows is closed, for example, the front side window will be closed as well as the rear side window sunshade*.

▼ **Driving and parking**

Warning!



Make sure that absolutely no objects are obstructing the pedals' range of movement. Keep the driver's footwell clear of all obstacles. If there are any floor mats or carpets in the footwell, make sure that the pedals still have sufficient clearance.

During sudden driving or braking maneuvers the objects could get caught between the pedals. You could then no longer brake or accelerate. This could lead to accidents and injury.

Starting the engine

Warning!



Inhalation of exhaust gas is hazardous to your health. All exhaust gas contains carbon monoxide (CO), and inhaling it can cause unconsciousness and possible death.

Do not run the engine in confined areas

(such as a garage) which are not properly ventilated. If you think that exhaust gas fumes are entering the vehicle while driving, have the cause determined and corrected immediately. If you must drive under these conditions, drive with at least one window fully open.

Automatic transmission



Gearshift pattern for automatic transmission

- P** Park position
- R** Reverse gear
- N** Neutral
- D** Drive position

For more information on how to operate the gear selector lever, see “Automatic transmission” (▷ page 367).

Starting with the SmartKey

- ▶ Make sure the automatic transmission is set to **P**.

The gear position indicator in the tachometer display should be on **P**.

- ▶ Do not depress accelerator.
- ▶ Turn the SmartKey in the starter switch to position **3** and hold until the engine starts (▷ page 315).

i You can also use the “touch-start” function. Turn the SmartKey to position **3** and release it again immediately. The engine then starts automatically.

i You can also start the engine with the automatic transmission set to **N**.

For information on turning off the engine with the SmartKey, see “Turning off the engine” (▷ page 365).

Starting with KEYLESS-GO*

Warning!



As long as the SmartKey with KEYLESS-GO is in your vehicle, the vehicle can be started. Therefore, never leave children unattended in the vehicle, as they could otherwise accidentally start the engine.

When leaving the vehicle, always take the SmartKey with KEYLESS-GO with you and lock the vehicle. Do not leave children unattended in the vehicle, or with access to an unlocked vehicle.

You can start your vehicle without the SmartKey in the starter switch using the KEYLESS-GO start/stop button on the starter switch.

The SmartKey with KEYLESS-GO must be located in the vehicle.



KEYLESS-GO* start/stop button

- ① USA only
- ② Canada only

- ▶ Make sure KEYLESS-GO start/stop button is inserted in the starter switch (▷ page 316).
- ▶ Make sure the automatic transmission is set to **P**.
The gear position indicator in the tachometer display should be on **P**.
- ▶ Depress the brake pedal during the starting procedure.
- ▶ Do not depress accelerator.

- ▶ Press KEYLESS-GO start/stop button once.

The engine starts if the SmartKey with KEYLESS-GO is in the vehicle.

i You can also start the engine with the automatic transmission set to **N**.

i If you wish to start the vehicle with the SmartKey instead of the KEYLESS-GO feature, remove the KEYLESS-GO start/stop button from the starter switch and proceed as described in “Starting with the SmartKey” (▷ page 359).

For information on turning off the engine with KEYLESS-GO, see “Turning off the engine” (▷ page 365).

Starting difficulties

If the engine does not start as described, carry out the following steps:

- ▶ If you are starting the engine with the SmartKey: Turn SmartKey in starter switch to position **0** and repeat starting procedure.

- ▶ If you are starting the engine with KEYLESS-GO: Close any doors that may be open to allow for better detection of the SmartKey with KEYLESS-GO.

or

- ▶ Remove the KEYLESS-GO* start/stop button from starter switch.
- ▶ Start the engine with the SmartKey as radio signals from another source may be interfering with the SmartKey with KEYLESS-GO.
- ▶ Repeat the starting procedure (▷ page 359). Remember that extended starting attempts can drain the battery.
- ▶ Get a jump start (▷ page 639).

If the engine does not start after several starting attempts, there could be a malfunction in the engine electronics or in the fuel supply system.

- ▶ Call Roadside Assistance.

- ▶ Notify an authorized Mercedes-Benz Center.

Driving off

- ▶ Depress the brake pedal.
The gear selector lever can now be used.
- ▶ Shift automatic transmission to **D** or **R**.

i Wait for the gear selection process to complete before setting the vehicle in motion.

i Shifting from gear position **P** to position **R**, **N**, or **D** is only possible with the brake pedal depressed. Without the brake pedal depressed, the gear selector lever can be moved, but the parking pawl remains engaged, not allowing shifting to occur.

- ▶ Release the brake pedal.

- ▶ Carefully depress the accelerator pedal.

The electric parking brake is automatically released (▷ page 364).

The red brake warning **PARK** (USA only) or **(P)** (Canada only) in the instrument cluster goes out.

Once the vehicle is in motion, the automatic central locking system engages and the locking knobs in the doors move down.

i After driving off the doors and the trunk lock automatically.

You can open a locked door from the inside. Open door only when conditions are safe to do so.

You can deactivate the automatic locking using the COMAND system (▷ page 223).

After a cold start, the automatic transmission shifts at a higher engine revolution. This allows the catalytic converter to reach its operating temperature earlier.

▷▷



Warning!



On slippery road surfaces, never downshift in order to obtain braking action. This could result in drive wheel slip and reduced vehicle control. Your vehicle's ABS will not prevent this type of loss of control.

Warning!



It is dangerous to shift the gear selector lever out of **P** or **N** if the engine speed is higher than idle speed. If your foot is not firmly on the brake pedal, the vehicle could accelerate quickly forward or in reverse. You could lose control of the vehicle and hit someone or something. Only shift into gear when the engine is idling normally and when your right foot is firmly on the brake pedal.

! Shift the automatic transmission to **P** or **R** only when the vehicle is stopped in order to avoid damaging the transmission.

! Do not run cold engine at high engine speeds. Running a cold engine at high engine speeds may shorten the service life of the engine.

! Simultaneously depressing the accelerator pedal and applying the brake reduces engine performance and causes premature brake and drivetrain wear.

For more information, see “Driving instructions” (▷ page 479).



Turn signals



Combination switch

- ① Turn signals, right
- ② Turn signals, left

- ▶ Press the combination switch up ① or down ②.

The corresponding turn signal indicator lamp  or  flashes in the instrument cluster (▷ page 28).

The combination switch resets automatically after major steering wheel movements.

i To signal minor directional changes, e.g. passing or changing lanes, move combination switch to point of resistance only and release. The corresponding turn signal flashes three times.

Problems while driving

The engine runs erratically and misfires

- An ignition cable may be damaged.
- The engine electronics may not be operating properly.
- Unburned gasoline may have entered the catalytic converter and damaged it.
- ▶ Give very little gas.

- ▶ Have the problem repaired by an authorized Mercedes-Benz Center as soon as possible.

The coolant temperature is above 248°F (120°C)

The coolant is too hot and is no longer cooling the engine.

- ▶ Stop the vehicle in a safe location as soon as possible and turn off the engine. Allow engine and coolant to cool.
- ▶ Check the coolant level and add coolant if necessary (▷ page 497).

 Excessive coolant temperatures trigger a warning message in the multifunction display (▷ page 588).

In case of accident

If the vehicle is leaking gasoline:

- ▶ Do not start the engine under any circumstances.
- ▶ Move away from vehicle.

- ▶ Notify local fire and/or police authorities.

If the extent of the damage cannot be determined:

- ▶ Notify an authorized Mercedes-Benz Center.

If no damage can be determined on the

- major assemblies
- fuel system
- engine mount:
- ▶ Start the engine in the usual manner.

Parking

Warning!



With the engine not running, there is no power assistance for the brake and the steering systems. In this case, it is important to keep in mind that a considerably higher degree of effort is necessary to brake and steer the vehicle.

Warning!



Do not park this vehicle in areas where combustible materials such as grass, hay, or leaves can come into contact with the hot exhaust system, as these materials could be ignited and cause a vehicle fire.

To reduce the risk of personal injury as a result of vehicle movement, before turning off the engine and leaving the vehicle always:

- Press the parking brake handle.
- Shift the automatic transmission to **P**.
- When parked on an incline, turn front wheels towards the road curb.
- Turn the SmartKey to starter switch position **0** and remove, or press KEYLESS-GO* start/stop button (▷ page 317).
- Take the SmartKey or the SmartKey with KEYLESS-GO* with you and lock vehicle when leaving.

Electric parking brake

Warning!



Do not leave children unattended in the vehicle, or with access to an unlocked vehicle. Children could release the parking brake and/or shift the automatic transmission out of position **P**, either of which could result in an accident and/or serious personal injury.

Warning!



Getting out of your vehicle with the automatic transmission not fully engaged in position **P** is dangerous. Also, when parked on an incline, position **P** alone may not prevent your vehicle from moving, possibly hitting people or objects.

Always set the parking brake in addition to shifting to position **P** (▷ page 359).



① Handle for electric parking brake

Manually releasing electric parking brake

- ▶ Pull handle ①.

The red indicator lamp **PARK** (USA only) or **(P)** (Canada only) in the instrument cluster goes out.

You cannot release the electric parking brake until the ignition is switched on.

Automatically releasing electric parking brake

Your vehicle's electric parking brake is automatically released when:

- The engine is running.
- Transmission is in position **D** or **R**.
- The hood is closed.
- You have fastened your seat belt.
- You step on the accelerator pedal.

If gear **R** is engaged, the trunk must be closed.

i If you have not fastened your seat belt, the following conditions must be met in order for the parking brake to be automatically released:

- The driver's door is closed
- You must move the gear selector out of **P** position or drive faster than 2 mph (3 km/h).

Manually engaging electric parking brake

- ▶ Press handle ①.

The red indicator lamp **PARK** (USA only) or  (Canada only) in the instrument cluster comes on.

 When parked on an incline, turn front wheels towards the road curb.

 You can also engage the electric parking brake when the SmartKey is removed from the starter switch.

Automatically engaging electric parking brake

Your vehicle's electric parking brake is automatically engaged when DISTRONIC Plus* (▷ page 385) brings your vehicle to a standstill and at least one of the following conditions is met:

- The engine is switched off
- The driver's door is opened and the seat belt is not inserted in the belt buckle

- The hood is released
- The trunk lid is open while gear **R** is engaged
- The vehicle is parked for an extended period

The red indicator lamp **PARK** (USA only) or  (Canada only) in the instrument cluster comes on.

 In addition to the electric parking brake, park position **P** can be automatically engaged.

Emergency braking with electric parking brake

In an emergency situation, you can also brake your vehicle while driving by using the electric parking brake.

- ▶ While driving, press handle for electric parking brake (▷ page 364).

 Your vehicle will be braked for as long as you press and hold the switch for the electric parking brake. The longer you keep the electric parking brake pressed, the more strongly your vehicle will be braked. This method occurs on all 4 wheels, not just the rear wheels.

During the braking procedure, the red indicator lamp **PARK** (USA only) or  (Canada only) flashes in the instrument cluster, the message "Please release parking brake" appears on the multifunction display and you will hear a warning tone.

Once the vehicle comes to a complete stop the electronic parking brake will engage.

Turning off the engine

Warning!



Do not turn off the engine before the vehicle has come to a complete stop. With the engine not running, there is no power assistance for the brake and steering systems. In this case, it is important to keep in mind that a considerably higher degree of effort is necessary to brake and steer the vehicle.

 With the SmartKey removed from the starter switch or the engine turned off with KEYLESS-GO* and the driver's door open, a warning sounds if the parking lamps or low beam ▷▷

Driving and parking

▷▷ headlamps are switched on.

The message: “Please switch off lights” appears in the multifunction display.

▶ Shift the automatic transmission to **P**.

i When parked on an incline, also turn front wheels towards the road curb.

i If the engine can no longer be stopped using the SmartKey or KEYLESS-GO*, the engine can be turned off by withdrawing two fuses. For more information, see “Emergency engine shut-down” (▷ page 648).

Turning off with SmartKey

▶ Turn the SmartKey in the starter switch to position **0** (▷ page 315) and remove it.

The immobilizer is activated.

i If you turn off the engine using the SmartKey and remove the SmartKey from the starter switch with the automatic transmission in a position other than **P**, the transmission will automatically shift to **P**.

Keep in mind that turning off the engine with the SmartKey alone will not automatically shift the transmission to **P**.

Only when the SmartKey is removed from the starter switch will the transmission automatically shift to **P**.

Turning off with KEYLESS-GO*

▶ Press the KEYLESS-GO start/stop button (▷ page 317) to turn off the engine.

With the driver’s door closed, the starter switch is now in position **1**. With the driver’s door opened, the starter switch is set to position **0**, same as SmartKey removed from starter switch (▷ page 315).

i In an emergency you can turn off the engine while driving by pressing and holding the KEYLESS-GO start/ stop button for approximately 3 seconds.

i If you turn off the engine using the KEYLESS-GO start/stop button and open the driver’s door with the automatic transmission in a position other than **P**, the transmission will automatically shift to **P**.

Keep in mind that turning off the engine with the KEYLESS-GO start/stop button alone will not automatically shift the transmission to **P**. Only when the driver’s door is opened will the transmission automatically shift to **P**.

i If you drive through an automatic conveyor type car wash, you can switch on the ignition with the KEYLESS-GO button and engage gear **N** or insert the SmartKey into the starter switch.

Releasing seat belts

▶ Press the seat belt release button (▷ page 340).

Allow the retractor to completely rewind the seat belt by guiding the latch plate.

! Make sure the seat belt retracts fully so that the seat belt and/or latch plate cannot get caught or pinched in the door or in the seat mechanism. This can damage the seat belt and impair the effectiveness of the seat belt, and/or cause damage to the door and/or door trim panel. Such damage is not covered by the Mercedes-Benz Limited Warranty.

Damaged seat belts must be replaced. Contact an authorized Mercedes-Benz Center.

▼ Automatic transmission

For more information on driving with an automatic transmission, see “Automatic transmission” (▷ page 359).

Your vehicle’s automatic transmission adapts its gear shifting process to your individual driving style by continually adjusting the shift points up or down. These shift point adjustments are performed based on current operating and driving conditions.

If the operating conditions change, the automatic transmission reacts by adjusting its shift program.

i During the brief warm-up, automatic transmission upshifting is delayed. This allows the catalytic converter to heat up more quickly to operating temperature.

Warning!



Make sure that absolutely no objects are obstructing the pedals’ range of movement. Keep the driver’s footwell clear of all obstacles. If there are any floor mats or carpets in the footwell, make sure that the pedals still

have sufficient clearance. During sudden driving or braking maneuvers the objects could get caught between the pedals. You could then no longer brake or accelerate.

Gear selector lever

The gear selector lever is located on the right of the steering column.



Gearshift pattern for automatic transmission

- P** Park position
- R** Reverse gear
- N** Neutral
- D** Drive position

i The current automatic transmission position **P**, **R**, **N** or **D** appears in the tachometer display (▷ page 370).

Warning!



It is dangerous to shift the automatic transmission out of park position **P** or neutral position **N** if the engine speed is higher than idle speed. If your foot is not firmly on the brake pedal, the vehicle could accelerate quickly forward or reverse. You could lose control of the vehicle and hit someone or something. Only shift into gear when the engine is idling normally and when your right foot is firmly on the brake pedal.

Automatic transmission

Shifting from P to N

Moving the gear selector lever up or down shifts the automatic transmission out of park position **P**:

- ▶ With the vehicle at a standstill, depress the brake pedal and keep it pressed.
- ▶ Move gear selector lever up or down to resistance point to select neutral position **N**.

i *The gear selector lever returns to its original position.*

Shifting from N to R or from N to D

- ▶ With the vehicle at a standstill, depress the brake pedal and keep it pressed.
- ▶ Move gear selector lever up past the resistance point to select reverse gear **R**.

or

- ▶ Move gear selector down past the resistance point to select drive position **D**.

i *The gear selector lever returns to its original position.*

- ▶ Release the brake pedal.
- ▶ Carefully depress the accelerator pedal to drive off when it is safe to do so.

The electric parking brake is automatically released (▷ page 364).

The red brake warning **PARK** (USA only) or **(P)** (Canada only) in the instrument cluster goes out.

Shifting from P to R

- ▶ With the vehicle at a standstill, depress the brake pedal and keep it pressed.
- ▶ Move gear selector lever up past the resistance point to select reverse gear **R**.

i *The gear selector lever returns to its original position.*

- ▶ Release the brake pedal.
- ▶ Carefully depress the accelerator pedal to drive off when it is safe to do so.

i *When driving off, the electric parking brake is released automatically (▷ page 364).*

Shifting from P to D

- ▶ With the vehicle at a standstill, depress the brake pedal and keep it pressed.
- ▶ Move gear selector lever down past the resistance point to select drive position **D**.

i *The gear selector lever returns to its original position.*

- ▶ Release the brake pedal.
- ▶ Carefully depress the accelerator pedal to drive off when it is safe to do so.

i *When driving off, the electric parking brake is released automatically (▷ page 364).*

Shifting from D, R, or N to P

If you want to select park position **P** with the automatic transmission being in drive position **D**, reverse gear **R** or neutral position **N**:

- ▶ With the vehicle at a standstill, depress the brake pedal and keep it pressed.
- ▶ Press the handle for electric parking brake (▷ page 364).
- ▶ Press button at the end of the gear selector lever in direction of arrow (▷ page 367) to select park position **P**.
- ▶ Release the brake pedal.

! *Shift the automatic transmission directly from drive position **D** to reverse gear **R**, from reverse gear **R** to drive position **D** or directly to park position **P** only when the vehicle is stopped. Otherwise the automatic transmission could be damaged.*

When trying to free a vehicle stuck in mud or snow, see “Rocking the vehicle” (▷ page 373).

Shifting from **D** or **R** to **N**

If you want to select neutral position **N** with the automatic transmission being in drive position **D** or reverse gear **R**:

- ▶ With the vehicle at a standstill, depress the brake pedal and keep it pressed.

- ▶ Press the handle for electric parking brake (▷ page 364).

i *When the vehicle needs to be moved with the engine switched off and the automatic transmission set to neutral position **N** (▷ page 371), e.g. in an automatic car wash, do not press the handle for electric parking brake.*

- ▶ Move gear selector lever up to resistance point when in drive position **D** or down to resistance point when in reverse gear **R** to select neutral position **N**.
- ▶ Release the brake pedal.

Shifting procedure

The automatic transmission selects individual gears automatically, depending on:

- drive position **D** (▷ page 370) with gear ranges (▷ page 372)
- the selected program mode (**C/S**) (▷ page 374)
- the position of the accelerator pedal (▷ page 373)

- the vehicle speed

! *Allow engine to warm up under low load use. Do not place full load on the engine until the operating temperature has been reached.*

*Shift into reverse gear **R** or parking position **P** only when the vehicle is stopped.*

Avoid spinning of a drive wheel for an extended period when driving off on slippery road surfaces. This may cause serious damage to the drivetrain which is not covered by the Mercedes-Benz Limited Warranty.

With drive position **D** selected, you can use the steering wheel gearshift control buttons (▷ page 375) to influence automatic transmission shifting by:

- limiting the gear range
- changing gears manually

Automatic transmission

Automatic transmission positions

The current automatic transmission position appears in the tachometer display.

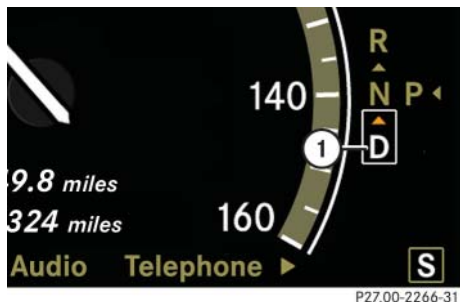

① Current automatic transmission position

! *If the automatic transmission position fails in the tachometer display, you should check whether the gear selector lever is placed in the desired position while driving off with added caution. We recommend you to shift the gear selector lever to position **D**. Do not limit the gear range.*

Effect

P Park position

Shift into park position **P** only when vehicle is stopped. The park position is not intended to serve as a brake when the vehicle is parked. Rather, the driver should always set the electric parking brake in addition to shifting into park position **P** to secure the vehicle.

If the vehicle's electrical system is malfunctioning, the automatic transmission could remain locked in park position **P**.

- ▶ Have the vehicle checked as soon as possible by an authorized Mercedes-Benz Center.

! SmartKey:

*If you turn off the engine using the SmartKey and remove the SmartKey from the starter switch, the automatic transmission will shift to park position **P** automatically. Keep in mind that turning off the engine with the SmartKey alone will*

*not automatically shift the automatic transmission to park position **P**. Only when the SmartKey is removed from the starter switch, will the automatic transmission automatically shift to park position **P**.*

KEYLESS-GO*:

*If you turn off the engine using the KEYLESS-GO start/stop button and open the driver's door, the automatic transmission will shift to park position **P** automatically. Keep in mind that turning off the engine using the KEYLESS-GO start/stop button alone will not automatically shift the automatic transmission to park position **P**. Only when the driver's door is opened, will the automatic transmission automatically shift to park position **P**.*

DISTRONIC Plus*:

*the transmission will shift to park position **P** automatically, only when DISTRONIC Plus brings your vehicle to a standstill, and when it meets at least one of the following conditions at the same time:*

- *the engine is turned off*
- *the driver's or passenger door opens and the seat belt is not engaged in the buckle*

*In addition to shifting to park position **P**, the electric parking brake will be engaged automatically.*

Even though this is possible, make it a practice to always shift into park position **P** before turning off the engine and remove the SmartKey from the starter switch, or when using KEYLESS-GO*, before turning off the engine with the start/stop button and opening the driver's door.

! If you want the gear position to remain in neutral position **N** (for example when the vehicle is pulled through a car wash)

- do not remove the SmartKey from the starter switch

or, when using KEYLESS-GO*

- do not turn off the engine using the KEYLESS-GO start/stop button* and open the driver's door

Otherwise, the automatic transmission will shift to park position **P** and lock the wheels, preventing the vehicle from being pulled through a car wash.

	Effect
R	<p>Reverse gear</p> <p>Shift into reverse gear R only when the vehicle is stopped.</p>
N	<p>Neutral</p> <p>No power is transmitted from the engine to the drive axle. When the brakes are released, the vehicle can be moved freely (pushed or towed).</p> <p>To avoid damage to the automatic transmission, avoid shifting into neutral position N while driving.</p> <p>If the ESP® is deactivated or malfunctioning: Shift into neutral position N only if the vehicle is in danger of skidding, e.g. on icy roads.</p>
D	<p>Drive</p> <p>The automatic transmission shifts automatically. All forward gears are available.</p>

! Coasting the vehicle, or driving for any other reason in neutral position **N** can result in automatic transmission damage that is not covered by the Mercedes-Benz Limited Warranty.

Warning!



Getting out of your vehicle without shifting into park position **P** is dangerous. Also, park position **P** alone is not intended to or capable of preventing your vehicle from moving, possibly hitting people or objects.

Always set the electric parking brake in addition to shifting to park position **P** (▷ page 364).

When parked on an incline, turn the front wheels towards the road curb.

Do not park this vehicle in areas where combustible materials such as grass, hay or leaves can come into contact with the hot exhaust system, as these materials could be ignited and cause a vehicle fire.

Automatic transmission

Warning!



When leaving the vehicle, always remove the SmartKey or SmartKey with KEYLESS-GO* from the starter switch, take it with you, and lock the vehicle. Do not leave children unattended in the vehicle, or with access to an unlocked vehicle. Children could shift the automatic transmission out of park position **P**, which could result in an accident and/or serious personal injury.

Gear ranges

With the automatic transmission in drive position **D**, you can select a gear range for the automatic transmission to operate within.

You can limit the gear range by pressing the respective downshift button on the steering wheel gearshift control, and reverse the gear range limit by pressing the respective upshift button on the steering wheel gearshift control (▷ page 375).

The selected gear range appears in the tachometer display.



P27.00-2269-31

① Current gear range

Effect	
6	The automatic transmission shifts through sixth gear only (applies to vehicles with 7-speed automatic transmission only).
5	The automatic transmission shifts through fifth gear only (applies to vehicles with 7-speed automatic transmission only).
4	The automatic transmission shifts through fourth gear only.

Effect	
3	The automatic transmission shifts through third gear only. With this selection you can use the braking effect of the engine.
2	The automatic transmission shifts through second gear only. Allows the use of engine's braking power when driving: <ul style="list-style-type: none"> • on steep downgrades • in mountainous regions • under extreme operating conditions
1	The automatic transmission operates in first gear only. For maximum use of engine's braking effect on very steep or lengthy downgrades.

Driving tips

Accelerator position

Your driving style influences the automatic transmission's shifting behavior:

Less throttle	Earlier upshifting
More throttle	Later upshifting

Kickdown

Use kickdown when you want maximum acceleration.

- ▶ Press the accelerator past the point of resistance.

Depending on the engine speed the automatic transmission shifts into a lower gear.

- ▶ Ease on the accelerator when you have reached the desired speed.

The automatic transmission shifts up again.

Stopping

When you stop briefly, e.g. at traffic lights:

- ▶ Leave the automatic transmission in gear.
- ▶ Hold the vehicle with the brake.

When you stop for a longer period of time with the engine idling and/or on a hill:

- ▶ Set the electric parking brake.
- ▶ Shift into park position **P**.

Maneuvering

When you maneuver in tight areas, e.g. when pulling into a parking space:

- ▶ Control the vehicle speed by gradually releasing the brakes.
- ▶ Accelerate gently.
- ▶ Never abruptly step on the accelerator.

Rocking the vehicle

Rocking the vehicle by shifting between drive position **D** and reverse gear **R** can help free a vehicle stuck in mud or snow. The engine control system of this vehicle electronically limits shifting between drive position **D** and reverse gear **R** to very low speeds (i.e. approx. 5 mph (9 km/h)). To shift between drive position **D** and reverse gear **R**, move the gear selector lever past the resistance point up or down.

Working on the vehicle

Warning!



When working on the vehicle, set the electric parking brake and shift to park position **P**. Otherwise the vehicle could roll away.

Automatic transmission

Hill start assist system

Warning!



The hill start assist system is not designed to function as a parking brake and does not prevent the vehicle from moving when parked on an incline.

Always set the electric parking brake in addition to shifting to park position **P**.

On uphill grades with a gradient angle of more than 5°, the hill start assist system maintains the pressure in the brake system for approximately 1 second after you have released the brake pedal. Therefore, you can start off smoothly without the vehicle moving immediately after releasing the brake pedal.

The hill start assist system is inactive

- when starting off on a level road or downhill grades
- with the automatic transmission in neutral position **N**
- with the electric parking brake set
- if the ESP® has switched off due to a malfunction

Automatic shift program

The program mode selector switch is used to adjust

- shift program
- suspension tuning of Airmatic* (▷ page 402) or ABC* (▷ page 404)
- engine control



Program mode selector switch

- | | |
|------------------|----------------------|
| C Comfort | For comfort driving |
| S Sport | For standard driving |

The selected program mode **C** or **S** appears in the tachometer display.

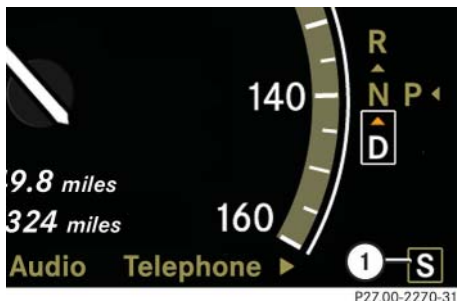

① Current program mode

! Never change the program mode when the automatic transmission is out of park position **P**. This could result in a change of driving characteristics for which you may not be prepared.

i The last selected program mode (**C** or **S**) is switched on when the engine is restarted.

- ▶ Press program mode selector switch repeatedly until the letter of the desired program mode appears in the tachometer display.

Program mode **C**:

- Engine, automatic transmission and suspension tuning are comfortable.
- The vehicle starts out in second gear (both forward and reverse) for gentler starts. This does not apply if full throttle is applied or gear range **1** is selected.
- Traction and driving stability are improved on icy roads.
- Upshifts occur earlier even when you give more gas. The engine then operates at lower rpms and the wheels are less likely to spin.

Program mode **S**:

- Engine, automatic transmission and suspension tuning are more performance oriented.
- The vehicle starts out in first gear.
- Upshifts occur later.

Steering wheel gearshift control

With drive position **D** selected, you can limit or extend the gear range.

! Allow engine to warm up under low load use. Do not place full load on the engine until the operating temperature has been reached.

Shift into reverse gear **R** or park position **P** only when the vehicle is stopped.

Avoid spinning of a drive wheel for an extended period when driving off on slippery road surfaces. This may cause serious damage to the drivetrain which is not covered by the Mercedes-Benz Limited Warranty.

The steering wheel gearshift buttons are located on the back of the steering wheel to the left and right.

Automatic transmission



- ① Right button: upshift
- ② Left button: downshift

i You cannot shift with the steering wheel gearshift buttons when the automatic transmission is in position **P**, **N** or **R**.

Downshifting

Warning!



On slippery road surfaces, never downshift in order to obtain braking action. This could result in drive wheel slip and reduced vehicle control. Your vehicle's ABS will not prevent this type of loss of control.

- ▶ Briefly press button ② on the back of the steering wheel.

The automatic transmission will shift to the next lower gear as permitted by the shift program. This action simultaneously limits the gear range of the automatic transmission (▷ page 372).

i To avoid overrevving the engine when downshifting, the automatic transmission will not shift to a lower gear if the engine's max. speed would be exceeded.

Upshifting

- ▶ Briefly press button ① on the back of the steering wheel.

The automatic transmission will shift to the next higher gear as permitted by the shift program. This action simultaneously extends the gear range of the automatic transmission.

i If you press on the accelerator when the engine has reached its rpm limit, the automatic transmission will upshift beyond any gear range limit selected.

Canceling gear range limit

- ▶ Press and hold button ① on the back of the steering wheel until the cipher for the current gear range disappears from the tachometer display (▷ page 372).

The automatic transmission will shift from the current gear range directly to gear range **D**.

Shifting into optimal gear range

- ▶ Press and hold button ② on the back of the steering wheel.

The automatic transmission will automatically select the gear range suited for optimal acceleration and deceleration. This will involve shifting down one or more gears.

Emergency operation (Limp-Home Mode)

If vehicle acceleration becomes less responsive or sluggish or the automatic transmission no longer shifts, the automatic transmission is most likely operating in limp-home (emergency operation) mode. In this mode only second gear and reverse gear can be selected.

- ▶ Stop the vehicle in a safe location.
- ▶ Shift to park position **P**.
- ▶ Turn off the engine.
- ▶ Wait at least 10 seconds before restarting.
- ▶ Restart the engine.
- ▶ Shift to drive position **D** (for second gear) or reverse gear **R**.
- ▶ Have the automatic transmission checked at an authorized Mercedes-Benz Center as soon as possible.

Instrument cluster

A full view illustration of the instrument cluster can be found in the “At a glance” section of this manual (▷ page 28).

The instrument cluster is activated when you:

- open a door
- switch on the ignition (▷ page 315)
- switch on the exterior lamps

The language setting for the multifunction display can be changed via COMAND (▷ page 79).

Warning!



No messages will be displayed if either the instrument cluster or the multifunction display is inoperative.

As a result, you will not be able to see information about your driving conditions, such as speed or outside temperature, warning/indicator lamps, malfunction/warning messages or the failure of any systems. Driving characteristics may be impaired.

If you must continue to drive, please do so with added caution. Visit an authorized Mercedes-Benz Center as soon as possible.

Adjusting instrument cluster and COMAND display illumination

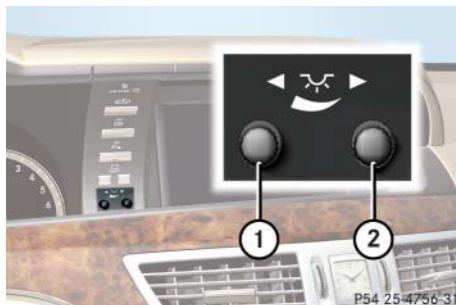

- ① To adjust instrument cluster illumination and multifunction display
- ② To adjust COMAND display

i *The instrument cluster illumination is dimmed or brightened automatically to suit ambient light conditions.*

The instrument cluster illumination will also be adjusted automatically when you switch on the vehicle's exterior lamps.

- ▶ **Brightening illumination:** Turn knob ① or ② clockwise.
- ▶ **Dimming illumination:** Turn knob ① or ② counterclockwise.

Coolant temperature gauge

Warning!



- Driving when your engine is overheated can cause some fluids which may have leaked into the engine compartment to catch fire. You could be seriously burned.
- Steam from an overheated engine can cause serious burns and can occur just by opening the hood. Stay away from the engine if you see or hear steam coming from it.

Stop the vehicle in a safe location away from other traffic. Turn off the engine, get out of the vehicle and do not stand near the vehicle until the engine has cooled down.

! Excessive coolant temperature triggers a warning in the multifunction display (▷ page 588).

The engine should not be operated with the coolant temperature above 248°F (120°C), i.e. in the red zone of the coolant temperature gauge. Doing so may cause serious engine damage which is not covered by the Mercedes-Benz Limited Warranty.

i During severe operating conditions, e.g. stop-and-go traffic, the coolant temperature may rise close to 248°F (120°C), i.e. close to the red zone of the temperature gauge.

Tachometer

The red marking on the tachometer denotes excessive engine speed.

! Avoid driving at excessive engine speeds, as it may result in serious engine damage that is not covered by the Mercedes-Benz Limited Warranty.

To help protect the engine, the fuel supply is interrupted if the engine is operated within the red marking.

Outside temperature indicator

Warning!



The outside temperature indicator is not designed to serve as an ice-warning device and is therefore unsuitable for that purpose.

Indicated temperatures just above the freezing point do not guarantee that the road surface is free of ice. The road may still be icy, especially in wooded areas or on bridges.

The outside temperature indicator is on the bottom left-hand side of the instrument cluster.

The temperature sensor is located in the front bumper area. Due to its location, the sensor can be affected by road or engine heat during idling or slow driving. Therefore, the accuracy of the displayed temperature can only be verified by comparison to a thermometer placed next to the sensor, not by comparison to external displays (e.g. bank signs, etc.).

When moving the vehicle into colder ambient temperatures (e.g. when leaving your garage), you will notice a delay before the lower temperature is displayed.

A delay also occurs when ambient temperatures rise. This prevents inaccurate temperature indications caused by heat radiated from the engine during idling or slow driving.

Fuel gauge

The fuel gauge is on the left-hand side of the instrument cluster (▷ page 28). Once the fuel level has fallen below the reserve mark, the yellow segment indicator for the fuel reserve comes on (▷ page 550).

Driving systems

The driving systems of your vehicle are described on the following pages:

- Cruise control and DISTRONIC Plus*, with which the vehicle can maintain a preset speed.
- Distance warning function* (only available with DISTRONIC Plus*), which warns of a stationary obstacle or slower moving vehicle that you are closing on to quickly.
- Airmatic (S 550 only) and ABC* adjust the vehicle suspension characteristics automatically and control the vehicle level.
- Parktronic* and Park Assist*, which serve as a parking assistant.
- Dynamic Rear View Monitor* is an electronic and visual parking aid.
- Night View Assist* illuminates the road with infrared light in addition to the normal headlamps.

For information on the ABS, Adaptive Brake, BAS, BAS Plus*, EBP, and ESP® driving systems, see “Driving safety systems” (▷ page 69).

Cruise control

Cruise control automatically maintains the speed you set for your vehicle.

The use of cruise control is recommended for driving at a constant speed for extended periods of time. You can set or resume cruise control at any speed over 20 mph (30 km/h).

The cruise control function is operated by means of the cruise control lever.

Warning!



Cruise control is a convenience system designed to assist the driver during vehicle operation. The driver is and must always remain responsible for the vehicle's speed and for safe brake operation.

Only use the cruise control if the road, traffic and weather conditions make it advisable to travel at a steady speed.

- The use of cruise control can be dangerous on winding roads or in heavy traffic because conditions do not allow safe driving at a steady speed.
- The use of cruise control can be dangerous on slippery roads. Rapid changes in tire traction can result in wheel spin and loss of control.
- Deactivate cruise control when driving in fog.

The “Resume” function should only be operated if the driver is fully aware of the previously set speed and wishes to resume this particular preset speed.

Warning!

Cruise control brakes automatically so that the set speed is not exceeded. The brake pedal depresses when cruise control engages the brakes.

Keep driver's foot area clear at all times, including the area under the brake pedal. Objects stored in this area may impair pedal movement which could interfere with the braking ability of the cruise control system.

Do not place your foot under the brake pedal – your foot could become caught.

Keep in mind that cruise control is a convenience system designed to assist the driver during vehicle operation. The driver is and must always remain responsible for the vehicle's speed and for safe brake operation.

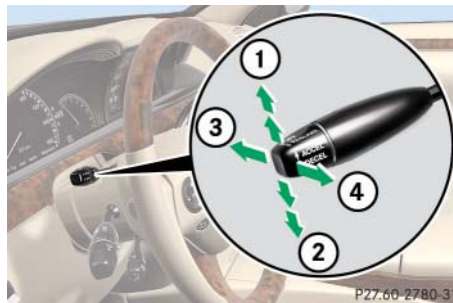

- ① Setting current or higher speed
Adjustment in 1 mph increments (to resistance point) or 5 mph increments (past resistance point)
(Canada: 1 km/h or 10 km/h)
- ② Setting current or lower speed
Adjustment in 1 mph increments (to resistance point) or 5 mph increments (past resistance point)
(Canada: 1 km/h or 10 km/h)
- ③ Cancel cruise control
- ④ Resume to last set speed

Activating cruise control

You can activate cruise control if the vehicle speed is above 20 mph (30 km/h).

In the following cases you cannot activate cruise control:

- when you brake
- the vehicle is secured with the electric parking brake
- if the automatic transmission is set to position **P**, **R**, or **N**
- if ESP® is switched off

Setting current speed

- ▶ Accelerate or decelerate to the desired speed.
- ▶ Briefly lift the cruise control lever in direction of arrow ① or depress in direction of arrow ②.

The current speed is set.



Driving systems

- ▷▷ Remove your foot from the accelerator pedal.

Cruise control is activated.

- The last set speed appears in the multifunction display for approximately 5 seconds.
- The corresponding speedometer segments from the selected speed to the vehicle maximum speed in the multifunction display are illuminated.
- The set speed is shown by a triangle in the speedometer.

i *On uphill grades, cruise control may not be able to maintain the set speed. Once the grade eases, the set speed will be resumed.*

On downhill grades, cruise control maintains the set speed with braking from the vehicle's braking system. In addition, on longer downhill grades the automatic transmission will automatically downshift.

Canceling cruise control

There are several ways to cancel cruise control:

- ▶ Step on the brake pedal.

Cruise control is canceled. The last speed set is stored for later use.

or

- ▶ Briefly push the cruise control lever in direction of arrow ③.

Cruise control is canceled. The last speed set is stored for later use.

i *Upon switching off the engine, the last stored speed is deleted.*

i *Cruise control switches off automatically when*

- *you step on the brake pedal*
- *the vehicle is secured with the parking brake*
In this case the segments in the multifunction display go out and no warning sounds.
- *the vehicle speed is below 20 mph (30 km/h)*
- *the ESP® is in operation or switched off with the ESP® switch (▷ page 73)*
- *you set the automatic transmission to **N** while driving*

The segments in the multifunction display go out, and an acoustic warning sounds.

! *Setting the automatic transmission to **N** while driving cancels cruise control. However, the automatic transmission should not be set to **N** while driving except to coast when the vehicle is in danger of skidding (e.g. on icy roads).*

i *Depressing the accelerator pedal does not deactivate cruise control. After brief acceleration (e.g. for passing), cruise control will resume the last speed set.*

Setting a higher speed

You can increase the set speed in two ways.

Adjustment in 1 mph (Canada: 1 km/h) increments

i *The set speed value is increased in 1 mph (Canada: 1 km/h) increments each time you lift the cruise control lever up to the resistance point.*

- ▶ Briefly lift the cruise control lever to the resistance point in direction of arrow ① (▷ page 381).
- ▶ Release the cruise control lever.

The vehicle set speed increases in increments 1 mph (Canada: 1 km/h).

Adjustment in 5 mph (Canada: 10 km/h) increments

Warning!



You can increase the vehicle set speed in 5 mph (Canada 10 km/h) increments. When using this feature, keep in mind that it may take a brief moment until the vehicle has reached the set speed.

Increase the vehicle set speed to a value that the prevailing road conditions permit. Otherwise, sudden and unexpected acceleration of the vehicle could cause an accident and/or serious injury to you and others.

i *The set speed value is increased in 5 mph (Canada: 10 km/h) increments each time you lift the cruise control lever up past the resistance point.*

- ▶ Briefly lift the cruise control lever past the resistance point in direction of arrow ① (▷ page 381).

- ▶ Release the cruise control lever.

The vehicle set speed increases in increments 5 mph (Canada: 10 km/h).

i *The new speed is set and the vehicle will accelerate. Keep in mind that it may take a brief moment until the vehicle has reached the set speed.*

Setting a lower speed

You can reduce the set speed in two ways.

i *When you use the cruise control lever to decelerate, the brake system will automatically brake the vehicle if the engine's braking power does not brake the vehicle sufficiently.*

Adjustment in 1 mph (Canada: 1 km/h) increments

i *The set speed value is decreased in 1 mph (Canada: 1 km/h) increments each time you press the cruise control lever down to the resistance point.*

- ▶ Briefly press the cruise control lever down to the resistance point in direction of arrow ② (▷ page 381).



Driving systems

- ▷▷ Release the cruise control lever.

The vehicle set speed decreases in increments 1 mph (Canada: 1 km/h).

Adjustment in 5 mph (Canada: 10 km/h) increments

Warning!



You can decrease the vehicle set speed in 5 mph (Canada 10 km/h) increments. When using this feature, keep in mind that it may take a brief moment until the vehicle has reached the set speed.

Decelerate the vehicle set speed to a value that the prevailing road conditions permit. Otherwise, sudden and unexpected deceleration of the vehicle could cause an accident and/or serious injury to you and others.

i *The set speed value is decreased in 5 mph (Canada: 10 km/h) increments each time you press the cruise control lever down past the resistance point.*

- ▶ Briefly press the cruise control lever down past the resistance point in direction of arrow ② (▷ page 381).

- ▶ Release the cruise control lever.

The vehicle set speed decreases in increments 5 mph (Canada: 10 km/h).

i *The new speed is set and the vehicle will decelerate. Keep in mind that it may take a brief moment until the vehicle has reached the set speed.*

Setting to last stored speed ("Resume" function)

Warning!



The set speed stored in memory should only be set again if prevailing road conditions permit. Possible acceleration or deceleration differences arising from returning to the preset speed could cause an accident and/or serious injury to you and others.

- ▶ Briefly pull the cruise control lever in the direction of arrow ④ (▷ page 381).

The cruise control resumes to the last set speed or if no speed is stored, it will set and store the current speed.

- ▶ Remove your foot from the accelerator pedal.

The last set speed appears in the multi-function display for approximately 5 seconds, and the corresponding speedometer segments from the selected speed to the vehicle maximum speed are illuminated.

i *The last stored set speed is deleted when the engine is turned off.*

DISTRONIC Plus*

When activated, the DISTRONIC Plus adaptive cruise control system increases driving convenience afforded by the cruise control during travel on expressways and other major roads.

- If the DISTRONIC Plus distance sensor detects a slower moving vehicle directly ahead, your vehicle speed will be reduced so that you follow that vehicle at a preset distance.
- If there is no vehicle directly ahead of you, DISTRONIC Plus will function in the same way as cruise control (> page 380).

DISTRONIC Plus functions within a speed range of 0 to 124 mph (0 to 200 km/h).

Warning!



DISTRONIC Plus is a convenience system. Its speed adjustment reduction capability is intended to make cruise control more effective and usable when traffic speeds vary. It is not however, intended to, nor does it, replace the need for extreme care. The responsibility for the vehicle speed and the distance to the vehicle ahead, including most importantly brake operation to assure safe stopping distance, always rests with the driver.

DISTRONIC Plus cannot take street and traffic conditions into account.

Complex driving situations are not always fully recognized by DISTRONIC Plus. This could result in wrong or missing distance warnings.

Warning!



The DISTRONIC Plus adaptive cruise control is no substitute for active driving involvement. It does not react to pedestrians or stationary objects, nor does it recognize or predict the curvature and lane layout or the movement of vehicles ahead.

DISTRONIC Plus can only apply a maximum of 40% of the vehicle's braking power.

DISTRONIC Plus may not detect narrow vehicles possibly driving in front of you, such as motorcycles and vehicles driving in an offset formation.

It is the driver's responsibility at all times to be attentive to road, weather and traffic conditions and to provide the steering, braking and other driving inputs necessary to retain control of the vehicle.

High-frequency sources such as toll stations, speed measuring systems etc. can cause the DISTRONIC Plus system to temporarily cease functioning properly.

Driving systems

Warning!



DISTRONIC Plus requires familiarity with its operational characteristics. We strongly recommend that you review the following information carefully before operating the system.

Warning!



DISTRONIC Plus cannot take street and traffic conditions into account. Only use DISTRONIC Plus if the road, weather and traffic conditions make it advisable to travel at a steady speed.

Warning!



Use of DISTRONIC Plus can be dangerous on slippery roads. Rapid changes in tire traction can result in wheel spin and loss of control.

DISTRONIC Plus does not act upon adverse sight distance conditions. Do not use DISTRONIC Plus during conditions of fog and heavy rain, snow or sleet.

Warning!



DISTRONIC Plus cannot take weather conditions into account. Switch off DISTRONIC Plus or do not turn it on if:

- roads are slippery or covered with snow or ice. The wheels could lose traction while braking or accelerating, and the vehicle could skid.
- the sensor is dirty or visibility is diminished due to snow, rain or fog. The distance control could be impaired.

Always pay attention to traffic conditions even while DISTRONIC Plus is switched on. Otherwise, you may not be able to recognize dangerous situations until it is too late and could cause an accident resulting in personal or fatal injury to you or others.

Warning!



The “Resume” function should only be operated if the driver is fully aware of the previously set speed and wishes to resume this particular preset speed.

Warning!



Close attention to road and traffic conditions is imperative at all times, regardless of whether or not DISTRONIC Plus is activated.

Use of DISTRONIC Plus can be dangerous on winding roads as conditions do not allow safe driving at a steady speed.

DISTRONIC Plus may not react to stationary objects in the roadway (e.g. a stopped vehicle in a traffic jam or a disabled vehicle). DISTRONIC Plus will also not respond to oncoming vehicles.

Switch off DISTRONIC Plus:

- when changing from the left to the right lane if vehicles are moving more slowly in the left lane
- when entering a turn lane or highway off ramp
- in complex driving situations, such as in highway construction zones

In these situations, DISTRONIC Plus will continue to maintain the set speed unless deactivated.

DISTRONIC Plus is designed and intended only to maintain a set speed and keep a set distance from moving objects in front of it.

i Do not use DISTRONIC Plus if you are driving on a road with steep uphill or downhill slopes.

i In certain countries and near radio-astronomical facilities, you must switch off the radar systems (▷ page 256).

i Due to its radar-emitting nature DISTRONIC Plus may have an appearance similar to a radar detector to law enforcement officials. You may want to refer to this section of your Operator's Manual when asked.

i USA only:
This device complies with Part 15 of the FCC Rules. Operation is subject to the following two conditions:

- (1) This device may not cause harmful interference, and
- (2) this device must accept any interference received, including interference that may cause undesired operation.

Any unauthorized modification to this device could void the user's authority to operate the equipment.

i Canada only:
This device complies with RSS-210 of Industry Canada. Operation is subject to the following two conditions:

- (1) This device may not cause interference, and
- (2) this device must accept any interference received, including interference that may cause undesired operation of the device.

Any unauthorized modification to this device could void the user's authority to operate the equipment.

DISTRONIC Plus displays in the speedometer dial



- ① Speed of the vehicle ahead
- ② Set speed

If DISTRONIC Plus is activated, the marker ② indicates the set speed.

i The vehicle speed displayed on the speedometer can briefly vary from the speed setting on the DISTRONIC Plus system.

Driving systems

When DISTRONIC Plus detects a vehicle driving ahead of you, the ring on the speedometer dial lights up between the speed of the vehicle ahead of you and set speed (2).

If DISTRONIC Plus calculates that there is a danger of collision (▷ page 397):

- The distance warning lamp  in the instrument cluster comes on.
- An intermittent warning sounds.
- ▶ Immediately brake the vehicle to avoid a collision.

Under no circumstances should the driver await the intermittent warning sound before braking. See the following warning note.

The intermittent warning sound ceases and the distance warning lamp  goes out when the necessary distance to the vehicle ahead is again established.

Warning!



An intermittent warning sounds and the distance warning lamp  in the instrument cluster is illuminated if the DISTRONIC Plus system calculates that the distance to the vehicle ahead and your vehicle's current speed indicate that DISTRONIC Plus will not be capable of slowing the vehicle sufficiently to maintain the preset following distance, which creates a danger of a collision.

Immediately brake your vehicle to increase the distance between your vehicle and the vehicle in front of you. The warning sound is intended as a final caution that you have not interceded with your own braking inputs to avoid a potentially dangerous situation. Do not wait for the operation of the warning signal to intercede with your own braking, as that will result in potentially dangerous emergency braking which will not always result in an impact being avoided.

Tailgating increases the risk of an accident.

Warning!



DISTRONIC Plus brakes your vehicle with a maximum of 13 ft/s^2 (4 m/s^2). This corresponds to about 40% of the maximum deceleration ability of your vehicle.

DISTRONIC Plus brakes the vehicle in an effort to restore the preset distance or to maintain the speed. The brake pedal is automatically applied as this happens which results in the brake pedal moving.

Keep driver's foot area clear at all times, including the area under the brake pedal. Objects stored in this area may impair pedal movement which could interfere with the braking ability of the DISTRONIC Plus system.

Do not place your foot under the brake pedal – your foot could become caught.

Displaying the distance graphic

In the “Assistance” menu under “Distance display” you see the current settings for DISTRONIC Plus. The information shown in the multifunction display depends on whether DISTRONIC Plus is activated or deactivated.

i For activating or deactivating the DISTRONIC Plus system, see “Activating DISTRONIC Plus” (▷ page 390) or “Activating DISTRONIC Plus” (▷ page 395).

For activating or deactivating the distance warning function, see “Distance warning function* activating/deactivating” (▷ page 252).

- ▶ Press **◀** or **▶** to select the “Assistance” menu.
- ▶ Press **▼** or **▲** to select the “Distance display” function.
- ▶ Press **OK**.

The DISTRONIC Plus distance graphic appears and you will see one of the following displays on the multifunction display.

DISTRONIC Plus activated

When you turn DISTRONIC Plus on, you will see the set speed in the multifunction display for about 5 seconds. You then see the following display in the multifunction display.

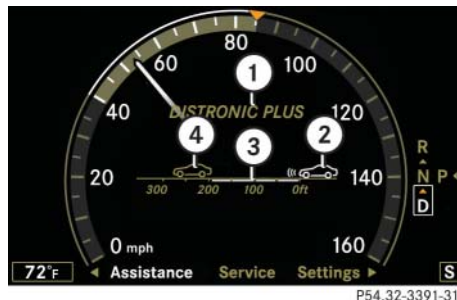

- ① DISTRONIC Plus activated
- ② Your vehicle
- ③ Preset distance threshold to vehicle ahead
- ④ Vehicle ahead, if detected

DISTRONIC Plus deactivated

If DISTRONIC Plus is deactivated, the standard display of DISTRONIC Plus appears in the multifunction display.

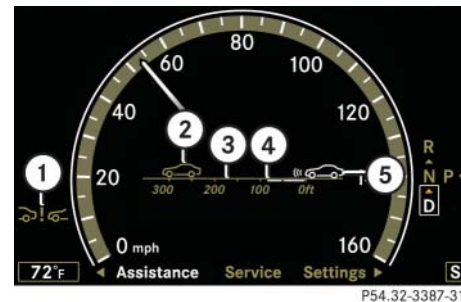

- ① Symbol for activated distance warning function
- ② Vehicle ahead, if detected
- ③ Actual distance to vehicle ahead
- ④ Preset distance threshold to vehicle ahead
- ⑤ Your vehicle

Driving systems

DISTRONIC Plus lever

The DISTRONIC Plus system is operated by means of the DISTRONIC Plus lever.

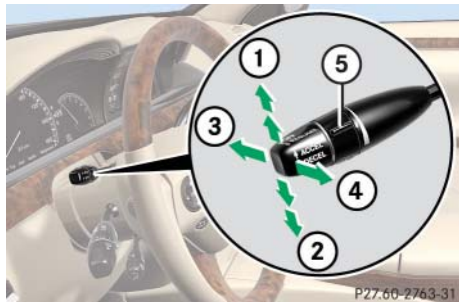

- ① Setting current or higher speed Adjustment in 1 mph or 5 mph increments (Canada: 1 km/h or 10 km/h)
- ② Setting current or lower speed Adjustment in 1 mph or 5 mph increments (Canada: 1 km/h or 10 km/h)
- ③ Canceling DISTRONIC Plus
- ④ Activating DISTRONIC Plus or resuming to last set speed
- ⑤ Setting target distance

Activating DISTRONIC Plus

Warning!



When DISTRONIC Plus is braking, the brake pedal is retracted (i.e. depressed automatically). The pedals' range of motion must not be impeded by any obstacles:

- Do not place any objects in the footwell.
- Make sure that the floor mats and carpets are securely in place.
- Do not rest your foot underneath the brake pedal, as it could otherwise be trapped.

You could otherwise cause an accident and injure yourself and others.

Warning!



When DISTRONIC Plus is switched on, the vehicle can be braked. You should therefore switch off DISTRONIC Plus if the vehicle must be towed.

You can activate DISTRONIC Plus when:

- you are driving slower than 20 mph (30 km/h) and DISTRONIC Plus has detected a vehicle ahead of you
- you are driving above 20 mph (30 km/h)

i *The maximum speed you can set is 124 mph (200 km/h).*

If DISTRONIC Plus has not been activated after pressing the DISTRONIC Plus lever, you will see the message: “*DISTRONIC PLUS Off*” in the multifunction display.

In the following cases you cannot activate DISTRONIC Plus:

- up to 2 minutes after starting the engine
- if the engine is switched off
- if you step on the brake pedal while driving
- the vehicle is secured with the electric parking brake

- if the gear selector lever is in position **P**, **R**, or **N**
- if ESP® is switched off
- if the hood is open
- if the driver's door is open and the driver has not fastened his or her seat belt
- if the radar sensors are switched off (▷ page 256).

Switching on while driving

- ▶ Tap DISTRONIC Plus lever up ① or down ② until desired speed is set. DISTRONIC Plus is switched on.

or

- ▶ Pull DISTRONIC Plus lever briefly in direction of arrow ④ to call up speed last set (▷ page 395). DISTRONIC Plus is switched on.

- ▶ Take your foot off the accelerator pedal.

Your vehicle adapts its speed to the vehicle ahead, observing the set speed as a maximum value.

i Under 20 mph (30 km/h), you can only switch on DISTRONIC Plus if the vehicle ahead of you has been detected and is shown on the multifunction display. If you no longer see the vehicle in front of you on the multifunction display and if it is no longer detected because it has changed lanes, for example, DISTRONIC Plus switches off and you will hear a signal.

i If you do not completely lift your foot off the accelerator pedal, the message "DISTRONIC PLUS passive" appears on the multifunction display. The distance to a slower-driving vehicle will not be set. You will drive at the speed you dictate by pressing the accelerator pedal.

Switching on when approaching a stationary vehicle

If the vehicle in front of you is stationary, you can only switch on DISTRONIC Plus if your vehicle is also at a standstill.

- ▶ Tap DISTRONIC Plus lever up ① or down ② until desired speed is set.

DISTRONIC Plus is switched on.

or

- ▶ Pull DISTRONIC Plus lever briefly in direction of arrow ④ to call up speed last set (▷ page 395).

DISTRONIC Plus is switched on.

i It is helpful to switch on the DISTRONIC Plus display in the instrument cluster since you can only switch on DISTRONIC Plus under a speed of 20 mph (30 km/h) when a vehicle has been detected in front of you.

i You can adjust the set speed using the DISTRONIC Plus lever and the target distance using the distance setting switch on the DISTRONIC Plus lever (▷ page 396).

i The distance warning function will still issue warnings even when DISTRONIC Plus is switched off if you have activated it on using the instrument cluster control system (▷ page 252).

Driving systems

Starting off

When the vehicle in front of you starts off:

- ▶ Remove your foot from the brake pedal.
- ▶ Pull DISTRONIC Plus lever briefly in direction of arrow ④.

or

- ▶ Briefly step on the accelerator pedal.

Your vehicle starts off and adapts its speed to the vehicle in front of you.

Driving

If no vehicle is driving ahead of you, DISTRONIC Plus functions like cruise control (▷ page 380).

When DISTRONIC Plus detects that the vehicle in front of you is driving more slowly, it brakes the vehicle in order to keep the distance specified by you.

When DISTRONIC Plus detects that the vehicle in front of you is driving faster, the vehicle accelerates up to the set speed.

Warning!



When you step on the brake pedal, you switch off DISTRONIC Plus except when the vehicle is at a standstill. DISTRONIC Plus will no longer brake your vehicle. You are always responsible for maintaining a distance from other vehicles, observing road speeds and braking well in advance.

Stopping

Warning!



DISTRONIC Plus's braking effect is canceled and the vehicle can start to roll if

- DISTRONIC Plus is switched off using the DISTRONIC Plus lever
- you accelerate
- the system or the power supply is malfunctioning, e.g. due to battery failure
- the electrical components in the engine compartment or the fuses have been manipulated

- the battery is disconnected

Warning!



Never get out of the vehicle while DISTRONIC Plus is switched on!

DISTRONIC Plus must never be operated or switched off by passengers or from outside the vehicle.

DISTRONIC Plus is not a substitute for the electric parking brake and may not be used for parking.

When you get out of the vehicle or switch off the engine, deactivate DISTRONIC Plus and secure the vehicle from rolling away by engaging the electric parking brake.

When DISTRONIC Plus detects that the vehicle in front of you is stopping, the vehicle brakes until it also stops.

Once DISTRONIC Plus has stopped your vehicle and it is at a standstill, it remains stationary; the brake pedal does not need to be depressed.

i After a short while, your vehicle is secured in place by the electric parking brake so that the operating brake can be relieved of load.

i Depending on the following distance set using the distance setting switch on the DISTRONIC Plus lever, your vehicle will stop approx. 13.1 ft. (4 m) away from the vehicle in front of you.

Setting the current speed

- ▶ Accelerate or decelerate to the desired speed.
 - ▶ Briefly lift the DISTRONIC Plus lever in the direction of arrow ① or depress in the direction of arrow ②.
- DISTRONIC Plus is activated and the current speed is set.
- ▶ Remove your foot from the accelerator pedal.

i If you do not take your foot off of the accelerator completely, the following message will appear in the multifunction display:

DISTRONIC PLUS passive

The distance to a slower moving vehicle in front of you will not be set. Your vehicle speed will then be determined only by the accelerator pedal position.

Setting a higher speed

You can increase the set speed in two stages.

Adjustment in 1 mph (Canada: 1 km/h) increments

i The set speed value is increased in 1 mph (Canada: 1 km/h) increments each time you lift the DISTRONIC Plus lever to the resistance point.

- ▶ Briefly lift the DISTRONIC Plus lever to the resistance point in direction of arrow ① (▷ page 381).

- ▶ Release the DISTRONIC Plus lever.

The vehicle speed increases in increments of 1 mph (Canada: 1 km/h).

Adjustment in 5 mph (Canada: 10 km/h) increments

Warning!



You can increase the vehicle speed in 5 mph (Canada 10 km/h) increments. When using this feature, keep in mind that it may take a brief moment until the vehicle has reached the set speed.

Increase the vehicle speed to a value that the prevailing road conditions permit. Otherwise, sudden and unexpected acceleration of the vehicle could cause an accident and/or serious injury to you and others.

i The set value is increased in 5 mph (Canada: 10 km/h) increments each time you lift the DISTRONIC Plus lever past the resistance point.



Driving systems

▷▷ Briefly lift the DISTRONIC Plus lever past the resistance point in direction of arrow ① (▷ page 381).

▶ Release the DISTRONIC Plus lever.

The vehicle speed increases in increments of 5 mph (Canada: 10 km/h).

i *The new speed is set and the vehicle will accelerate. Keep in mind that it may take a brief moment until the vehicle has reached the set speed.*

Setting a lower speed

You can reduce the speed in two stages.

i *When you use the DISTRONIC Plus lever to decelerate, the brake system will automatically brake the vehicle if the engine's braking power does not brake the vehicle sufficiently.*

Adjustment in 1 mph (Canada: 1 km/h) increments

i *The set value is decreased in 1 mph (Canada: 1 km/h) increments each time you press the DISTRONIC Plus lever down to the resistance point.*

▶ Briefly press the DISTRONIC Plus lever down to the resistance point in direction of arrow ② (▷ page 381).

▶ Release the DISTRONIC Plus lever.

The vehicle speed decreases in increments of 1 mph (Canada: 1 km/h).

Adjustment in 5 mph (Canada: 10 km/h) increments

Warning!



You can decrease the vehicle speed in 5 mph (Canada 10 km/h) increments. When using this feature, keep in mind that it may take a brief moment until the vehicle has reached the set speed.

Decelerate the vehicle speed to a value that the prevailing road conditions permit. Otherwise, sudden and unexpected deceleration of the vehicle could cause an accident and/or serious injury to you and others.

i *The set value is decreased in 5 mph (Canada: 10 km/h) increments each time you press the DISTRONIC Plus lever down past the resistance point.*

▶ Briefly press the DISTRONIC Plus lever down past the resistance point in direction of arrow ② (▷ page 381).

▶ Release the DISTRONIC Plus lever.

The vehicle speed decreases in increments of 5 mph (Canada: 10 km/h).

i *The new speed is set and the vehicle will decelerate. Keep in mind that it may take a brief moment until the vehicle has reached the set speed.*

Setting to last stored speed (“Resume” function)

Warning!



The speed stored in memory should only be set again if prevailing road conditions permit. Possible acceleration or deceleration differences arising from returning to preset speed could cause an accident and/or serious injury you and others.

- ▶ Briefly pull the DISTRONIC Plus lever in the direction of arrow ④ (▷ page 390).

DISTRONIC Plus is set to the last stored speed.

DISTRONIC Plus resumes the last set speed or if no speed is stored, it will set and store the current speed.

- ▶ Remove your foot from the accelerator pedal.

i Upon switching off the engine, the last stored speed is deleted.

Deactivating DISTRONIC Plus

There are several ways to deactivate the DISTRONIC Plus system:

- ▶ Briefly tip the DISTRONIC Plus lever in the direction of arrow ③ (▷ page 390).

or

- ▶ Step on the brake pedal.

DISTRONIC Plus will be deactivated. The last speed set will be stored into memory.

i The following message will appear in the multifunction display for approximately 5 seconds:

DISTRONIC PLUS Off

The last stored speed is deleted when you turn off the engine.

i DISTRONIC Plus deactivates automatically when:

- the vehicle is secured with the electric parking brake
- the vehicle speed is below 20 mph (30 km/h) and no preceding vehicle is detected
- the ESP® is in operation or switched off with the ESP® switch (▷ page 73)
- you set the automatic transmission to **P**, **R**, or **N** while driving
- the radar sensors are switched off (▷ page 256).

The segments in the multifunction display go out, an acoustic warning sounds, and the message “DISTRONIC PLUS Off” appears in the multifunction display for approximately 5 seconds.

If the vehicle has been stopped by DISTRONIC Plus and a malfunction occurs in the system, the message “Brake immediately” will appear on the multifunction display. Step on the brake immediately to prevent the vehicle from rolling. DISTRONIC Plus is then switched off and the message disappears.

Warning!



DISTRONIC Plus switches off and releases the brakes when the vehicle decelerates below the minimum speed of 20 mph (30 km/h) by operation of the system unless DISTRONIC Plus detects a vehicle directly ahead of you. At that time the driver must apply the brakes in order to reduce vehicle speed further or bring it to a stop.

! *Setting the automatic transmission to **N** while driving cancels the DISTRONIC Plus. However, the automatic transmission should not be set to **N** while driving except to coast when the vehicle is in danger of skidding (e.g. on icy roads).*

i *Depressing the accelerator pedal does not deactivate DISTRONIC Plus. After brief acceleration (e.g. for passing), DISTRONIC Plus will resume the last speed set.*

Setting the following distance in DISTRONIC Plus

You can set the specified following distance for DISTRONIC Plus by varying the time setting between 1.0 and 2.0 seconds. Using this time setting and the current set speed of your vehicle, DISTRONIC Plus calculates and sets the required following distance to the vehicle ahead. The set distance will be shown in the multifunction display.

Warning!



It is up to the driver to exercise discretion to select the appropriate setting given road conditions, traffic, driver's preferred driving style and applicable laws and driving recommendations for safe following distance.

The distance setting switch for the target distance is located on the DISTRONIC Plus lever.

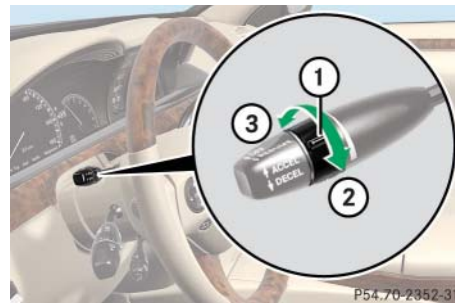

- ① Distance setting switch for target distance
- ② To increase target distance
- ③ To decrease target distance

Increasing distance

Increasing the distance setting causes DISTRONIC Plus to maintain a greater following distance to the vehicle ahead.

- ▶ Move distance setting switch ① in direction ②.

Decreasing distance

Decreasing the distance setting causes DISTRONIC Plus to maintain a shorter following distance to the vehicle ahead.

- Move distance setting switch ① in direction ③.

Distance warning function

When DISTRONIC Plus is deactivated, this function will continue to warn you when recognizing a slower vehicle moving in your vehicle's path or a stationary object in your vehicle's path and the danger of a collision exists:

- The distance warning lamp  in the instrument cluster comes on.
- An intermittent warning sounds.

If these warnings are issued, you must brake manually to maintain a safe distance and avoid a collision with the vehicle or stationary object ahead.

When pressing the brake pedal, the warning sound stops. The warning sound also stops when the distance to the vehicle ahead is sufficient again without applying the brake pedal. In this case the distance warning lamp  also goes out.

Warning!



If the DISTRONIC Plus warning lamp  in the instrument cluster comes on while driving and/or an intermittent warning sounds, immediate attention on the part of the driver is required. As required by the traffic situation, apply the brakes and navigate around a possible obstacle. However, do not drive by relying on the distance warning function, as this will result in an emergency braking application. Especially depending on road surface conditions and driver reaction, this will not always enable you to avoid a collision.

Activating and deactivating

The distance warning function can be activated or deactivated using the instrument cluster control system (▷ page 252).

After the function has been activated,  appears on the left-hand side of the multifunction display.

Driving with DISTRONIC Plus

This section describes a number of driving situations where special precaution is required on the part of the driver. Be prepared to brake in such situations which will deactivate the DISTRONIC Plus system.

Warning!



DISTRONIC Plus works to maintain the speed selected by the driver unless a moving obstacle proceeding directly ahead of it in the same travel direction is detected (e.g. following another vehicle ahead of you at a distance set by DISTRONIC Plus).



Driving systems



This means that:

- Your vehicle can pass another vehicle after you change lanes.
- While in a sharp turn or if the vehicle in front is in a sharp turn, DISTRONIC Plus could lose sight of a vehicle traveling in front of it, then your vehicle could accelerate to the previously selected speed.

DISTRONIC Plus regulates only the distance between your vehicle and those directly ahead of it. It may not register stationary objects in the road, e.g.:

- a stopped vehicle in a traffic jam
- a disabled vehicle
- an oncoming vehicle

The driver must always be on the alert, observe all traffic and intercede as required by steering or braking the vehicle.

Warning!



DISTRONIC Plus should not be used in snowy or icy road conditions.

The most likely cause for a malfunctioning system is a dirty sensor (located behind the hood grille), especially at times of snow and ice or heavy rain. In such a case, DISTRONIC Plus will switch off, and the message:

*DISTRONIC PLUS
currently unavailable
See Oper. Manual*

appears in the multifunction display.

For cleaning and care of the DISTRONIC Plus sensor, see “Cleaning the DISTRONIC Plus* system sensor cover” (▷ page 537).



If the message:

*DISTRONIC PLUS
currently unavailable
See Oper. Manual*

disappears during driving and the last speed stored flashes for approximately 5 seconds, the dirt (e.g. slush) has dissolved; DISTRONIC Plus is again operational.

Another cause might be that the radar sensors have been manually switched off in the instrument cluster control system. Please verify that the radar sensors are switched on (▷ page 256).

Turns and bends

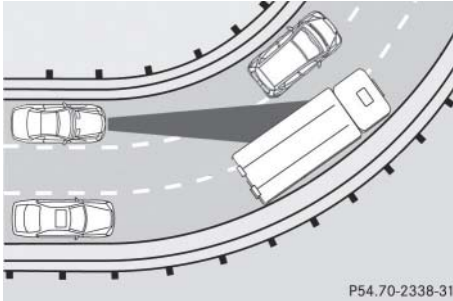

In turns or bends, DISTRONIC Plus may not detect a moving vehicle in front, or it may detect one too soon. This may cause your vehicle to brake late or unexpectedly.

Offset driving

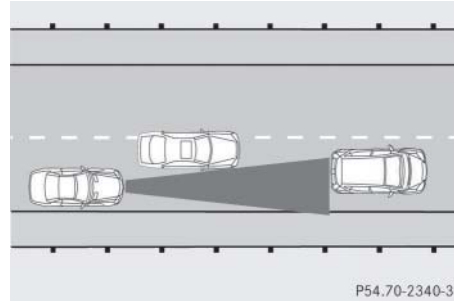

A vehicle traveling in your lane but offset from your direct line of travel may not be detected by DISTRONIC Plus. There will be insufficient distance to the vehicle ahead.

Lane changing

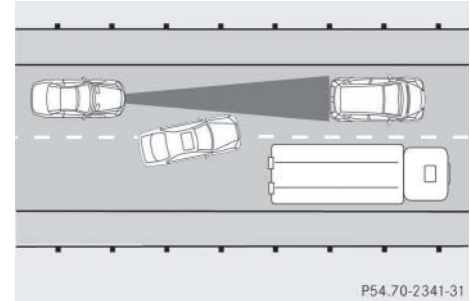

DISTRONIC Plus has not yet detected the vehicle changing lanes. There will be insufficient distance to the lane-changing vehicle.

Driving systems

Narrow vehicles

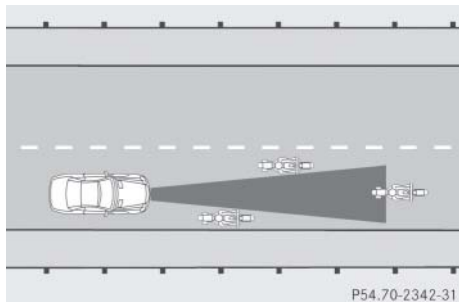

Because of their narrow profile, the vehicles traveling near the outer edge of the lane have not yet been detected by DISTRONIC Plus. There will be insufficient distance to the vehicles ahead.

Obstacles and stationary vehicles

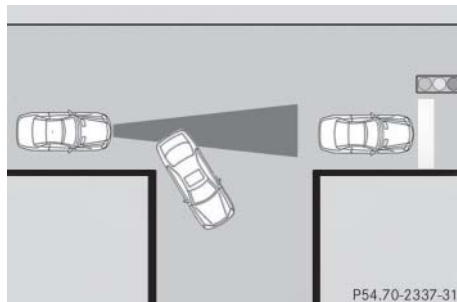

DISTRONIC Plus does not brake for obstacles or stationary vehicles. If, for example, the vehicle detected in front of you changes lanes to bypass an obstacle or stationary vehicle in front of it, DISTRONIC Plus will not brake for the obstacle or stationary vehicle.

Cross-traffic

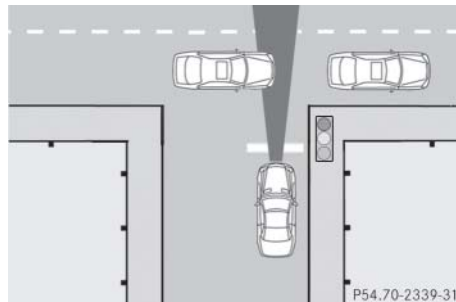

DISTRONIC Plus may inadvertently detect crossing vehicles. If you switch on DISTRONIC Plus, for example, at a traffic light with cross-traffic, the vehicle may suddenly start to drive off.

Airmatic (S 550 only)

Airmatic automatically selects the optimum suspension tuning and ride height for your vehicle.

Airmatic consists of two components:

- Level control system
- Adaptive Damping System (ADS)

The ADS automatically selects the optimum damping for the respective driving conditions. At the same time the suspension is set to either sporty or regular.

Vehicle level control with Airmatic

Your vehicle automatically adjusts its ride height to:

- reduce fuel consumption
- increase vehicle stability

The vehicle chassis ride height is raised or lowered according to the selected level setting and to the vehicle speed:

- With increasing speed, ride height is reduced by up to approximately 0.8 in (20 mm).
- With decreasing speed, the ride height is again raised to the selected vehicle level.

 *These height adjustments are so small that you may not notice any change.*

The following vehicle level settings can be selected when the vehicle is stationary:

Level	
Normal	For driving on normal roads. The indicator lamp is off.
Raised	For driving on rough roads or with snow chains. The indicator lamp is on.

Select the “Raised” level setting only when required by current driving conditions. Otherwise:

- Fuel consumption may increase.
- Handling may be impaired.

Driving systems

Warning!



To help avoid personal injury, keep hands and feet away from wheel housing area, and stay away from under the vehicle when lowering the vehicle chassis.

The Airmatic button with the indicator lamp is located on the control panel on the right-hand side of the instrument cluster.



① Vehicle level control switch

② Indicator lamp

- ▶ Start the engine.
- ▶ Briefly press switch ① to change from one level setting to the other.

The message:

Vehicle rising

appears in the multifunction display when changing from normal level to raised level.

The indicator lamp ② is then lit. The display switches off when the vehicle is raised.

- ▶ Press switch ① again to lower the vehicle. The indicator lamp ② is off.

i *The selected vehicle level setting remains stored in memory even if the engine is turned off and restarted except when you*

- *exceed a speed of 75 mph (120 km/h)*
or
- *maintain a speed of between 50 mph (80 km/h) and 75 mph (120 km/h) for more than 3 minutes*

The vehicle then lowers to regular level.

Suspension tuning

The Adaptive Damping System (ADS) automatically tunes shock absorbers and springs.

The program mode selector switch (S/C) (▷ page 374) is used to adjust the suspension tuning:

Driving program	Suspension tuning
C Comfort	Comfortable (default setting)
S Standard	Standard for dynamic driving

In addition, suspension characteristics in both driving programs (S/C) depend on:

- your driving style
- road surface conditions
- the vehicle loading

Active Body Control (ABC)*

The ABC system automatically selects the optimum suspension tuning and ride height for your vehicle.

The ABC system consists of an active, hydraulically controlled suspension and damping system.

Vehicle level control with ABC*

Your vehicle automatically adjusts its ride height to:

- reduce fuel consumption
- increase vehicle stability

The vehicle chassis ride height is raised or lowered according to the selected level setting and to the vehicle speed:

- With increasing speed, ride height is reduced by up to approximately 0.6 in (15 mm).
- With decreasing speed, the ride height is again raised to the selected vehicle level.

i *These height adjustments are so small that you may not notice any change.*

The following vehicle level settings can be selected when the vehicle is stationary:

Level	
Normal	For driving on normal roads. The indicator lamp is off.
Raised	For driving on rough roads or with snow chains. The indicator lamp is on.

Select the “Raised” level setting only when required by current driving conditions. Otherwise:

- Fuel consumption may increase.
- Handling may be impaired.

i *The selected vehicle level setting remains stored in memory even if the engine is turned off and restarted.*

Warning!



To help avoid personal injury, keep hands and feet away from wheel housing area, and stay away from under the vehicle when lowering the vehicle chassis.

Driving systems

The ABC level control switch with the indicator lamp is located on the control panel on the right-hand side of the instrument cluster.



- ① Vehicle level control switch
- ② Indicator lamp

Selecting a higher level

- ▶ Start the engine.

If indicator lamp ② is off:

- ▶ Press switch ①.

Indicator lamp ② comes on. The vehicle is raised to a higher level.

Selecting a normal level

- ▶ Start the engine.

If indicator lamp ② is on:

- ▶ Press switch ①.

Indicator lamp ② goes out. The vehicle is adjusted to a normal level.

Suspension tuning

The program mode selector switch (C/S) (▷ page 374) is used to adjust the suspension tuning:

Driving program	Suspension tuning
C Comfort	Comfortable (default setting)
S Standard	Standard for dynamic driving

In addition, suspension characteristics in both driving programs (S/C) depend on:

- your driving style
- road surface conditions
- the vehicle loading

Parktronic system*

Warning!



Parktronic is a supplemental system. It is not intended to, nor does it replace, the need for extreme care. The responsibility during parking and other critical maneuvers always rests with the driver.

Special attention must be paid to objects with smooth surfaces or low silhouettes (e.g. trailer couplings, painted posts, or road curbs). Such objects may not be detected by the system and can damage the vehicle.

The operational function of the Parktronic system can be affected by dirty sensors, especially at times of snow and ice, see “Cleaning the Parktronic* system sensors” (▷ page 538).

Warning!



Make sure no persons or animals are in the area in which you are maneuvering. You could otherwise injure them.

i *Interference caused by other ultrasonic signals (e.g. working jackhammers, car wash, or the air brakes of trucks) can cause the system to send erratic indications, and should be taken into consideration.*

Parktronic is an electronic parking aid with ultrasonic sensors that helps you while parking.

It visually and audibly indicates the relative distance between the vehicle and an obstacle.

Parktronic is automatically activated when you switch on the ignition, release the electric parking brake or start the engine and engage gear **D**, **R** or **N**.

The Parktronic system deactivates at speeds over approximately 11 mph (18 km/h). At lower speeds the Parktronic system turns on again.

Parktronic is also switched off when you engage gear **P** or secure the vehicle in place with the electric parking brake and switch off the engine.

The Parktronic system monitors the surroundings of your vehicle with six sensors in the front bumper and four sensors in the rear bumper.

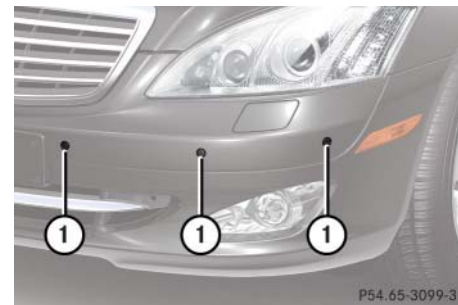

① Sensors in the front bumper (Only visible without DISTRONIC Plus*)

Driving systems

i To function properly, the sensors must be free of dirt, ice, snow and slush. Clean the sensors regularly, being careful not to scratch or damage the sensors, see “Cleaning the Parktronic* system sensors” (▷ page 538).

Range of the sensors

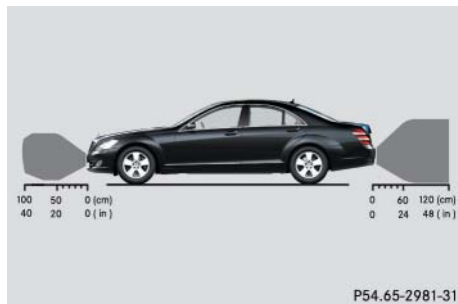

Front sensors

Center	approx. 40 in (100 cm)
Corners	approx. 24 in (60 cm)

Rear sensors

Center	approx. 48 in (120 cm)
Corners	approx. 32 in (80 cm)

! During parking maneuvers, pay special attention to objects located above or below the height of the sensors (e.g. street curbs, painted posts, or trailer hitches etc.). The Parktronic system will not detect such objects at close range and damage to your vehicle or the object may result.

Ultrasonic signals from outside sources (e.g. truck air brakes, car wash, or jackhammers) may impair the operation of the Parktronic system.

Minimum distance

Center	approx. 8 in (20 cm)
Corners	approx. 6 in (15 cm)

If the system detects an obstacle in this range, all the distance warning segments illuminate and you hear a warning signal. If the obstacle is closer than the minimum distance, the actual distance may no longer be indicated by the system.

Warning indicators

Visual signals indicate to the driver the relative distance between the sensors and an obstacle.

The warning indicator for the front area is in the instrument cluster. The warning indicator for the rear area is on the roof liner in the rear.

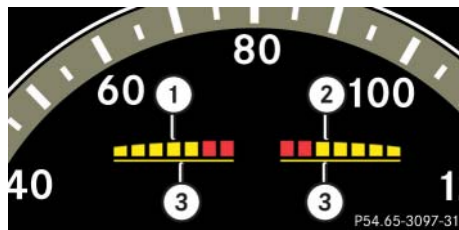

- ① Left side of the vehicle
- ② Right side of the vehicle
- ③ Indicator

Each warning indicator is divided into five yellow and two red distance segments for either side of the vehicle.

If yellow indicators ③ under the segments are lit, Parktronic is ready to measure.

The position of the gear selector lever determines which warning indicators will be activated.

Gear selector lever position	Warning indicator
D	Front area activated
R or N	Front and rear area activated
P	Neither activated

As your vehicle approaches an object, one or more distance segments will illuminate, depending on the distance. When the seventh distance segment illuminates, you have reached the minimum distance.

- Front area: An intermittent acoustic warning will sound as the first red distance segment illuminates and a constant acoustic warning lasting a maximum of 2 seconds will sound for the second red distance segment. The signal is canceled when the gear selector lever is placed in position **P**.
- Rear area: An intermittent acoustic warning will sound as the first red distance segment illuminates and a constant acoustic warning lasting a maximum of 2 seconds will sound for the second red distance segment. The signal is canceled when the gear selector lever is placed in position **D** or **P**.

Driving systems

Switching Parktronic system on/off

The Parktronic system can be switched off manually.

The Parktronic button with the indicator lamp is on the control panel on the right-hand side of the instrument cluster.

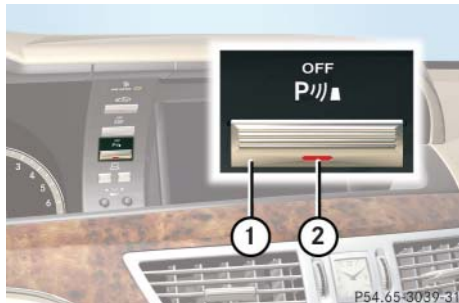

- ① Parktronic button
- ② Indicator lamp

▶ Switching off the Parktronic system:

Press button ①.

Indicator lamp ② comes on.

▶ Switching on the Parktronic system:

Press button ① again.

Indicator lamp ② goes out.

i The Parktronic system is automatically switched on when the ignition is switched on (▷ page 315).

Parktronic system malfunction

If only the red distance segments illuminate and an acoustic warning sounds, there is a malfunction in the Parktronic system. The Parktronic system will automatically switch off after 20 seconds and the indicator lamp in the Parktronic switch comes on.

- ▶ Have the Parktronic system checked by an authorized Mercedes-Benz Center as soon as possible.

If only the red distance segments illuminate and no acoustic warning sounds, the Parktronic system sensors are dirty or there is an interference from other radio or ultrasonic signals. The Parktronic system will automatically switch off after 20 seconds and the indicator lamp in the Parktronic switch comes on.

- ▶ Switch off the ignition (▷ page 315).
 - ▶ Clean the Parktronic system sensors (▷ page 538).
 - ▶ Switch on the ignition.
- or
- ▶ Check the Parktronic system operation at another location to rule out interference from outside radio or ultrasonic signals.

Park Assist*

Warning!



Park Assist is a supplemental system. It is not intended to, nor does it replace, the need for extreme care. The responsibility during parking and other critical maneuvers always rests with the driver.

Warning!



Make sure no persons or animals are in the area in which you are maneuvering. You could otherwise injure them.

! *Special attention must be paid to objects with smooth surfaces or low silhouettes (e.g. trailer couplings, painted posts, elevated cross-bars or road curbs). Such objects may not be detected by the system and can damage the vehicle.*

! *The operational function of the Park Assist system can be affected by dirty sensors, especially at times of snow and ice.*

Make sure that the area on the bumpers around the sensors is free of dirt, ice and/or slush, otherwise Park Assist may not function properly, see "Cleaning the Park Assist system sensors" (▷ page 538).*

! *High-frequency sources such as toll stations, speed measuring systems, etc. can cause the Park Assist system to malfunction. You can switch off the Park Assist using the Park Assist button (▷ page 412) or switch off the radar sensors (▷ page 256) to prevent possible malfunction.*

i *In certain countries and near radio-astronomical facilities, you must switch off the radar sensors (▷ page 256).*

Park Assist is an electronic parking aid with radar sensors that helps you while parking. It visually and audibly indicates the relative distance between the vehicle and an obstacle.

Park Assist is automatically activated when the engine is running and the transmission is in position **D**, **R** or **N**.

The Park Assist system deactivates at speeds over approximately 11 mph (18 km/h). At lower speeds the Parktronic system turns on again.

Park Assist is also switched off when the transmission is in position **P** or switch off the engine.

While the transmission is in position **N**, Park Assist is switched off if you secure the vehicle in place with the electric parking brake.

The Park Assist system monitors the surroundings of your vehicle with four sensors in the front bumper and two sensors in the rear bumper.

Driving systems

Range of the sensors

The sensors of the Park Assist system are integrated in the front and rear bumpers. Make sure that the bumpers are clear of dirt, ice and slush in the area of the sensors, as otherwise, Park Assist may not function properly, see “Cleaning the Park Assist* system sensors” (▷ page 538).

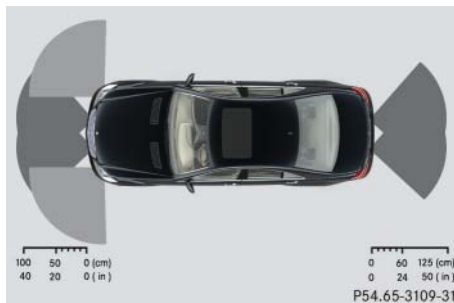
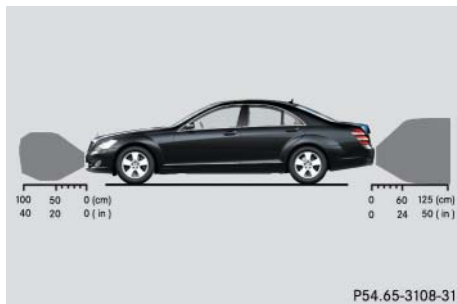

i Due to the sensors' broad detection range, it is possible that Park Assist also detects the following obstacles and issues a warning:

- obstacles in the ground, e.g. sewer canal covers, rails, bumps in the road or gutters
- obstacles moving upward quickly, e.g. rolling garage doors

Front sensors

Center	approx. 40 in (100 cm)
Corners	approx. 24 in (60 cm)

Rear sensors

Center	approx. 50 in (125 cm)
Corners	approx. 24 in (60 cm)

! While parking, pay particular attention to objects over or underneath the sensors, e.g. flower boxes, an elevated crossbar or a trailer tow hitch. Park Assist does not detect such nearby objects. You could otherwise damage the vehicle or the objects.

Warning indicators

Visual signals indicate to the driver the relative distance between the sensors and an obstacle.

The warning indicator for the front area is in the instrument cluster. The warning indicator for the rear area is on the roof liner in the rear.

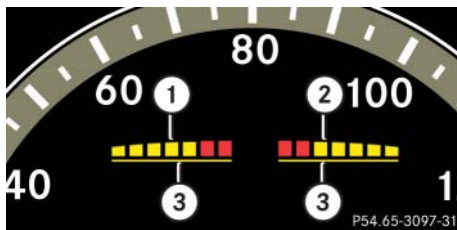

- ① Left side of the vehicle
- ② Right side of the vehicle
- ③ Indicator

Each warning indicator is divided into five yellow and two red distance segments for either side of the vehicle.

If yellow indicators ③ under the segments are lit, Park Assist is ready to measure.

The position of the gear selector lever determines which warning indicators will be activated.

Gear selector lever position	Warning indicator
D	Front area activated
R	Front and rear area activated
N	With the electric parking brake engaged: neither activated. With the electric parking brake released: front and rear area activated.
P	Neither activated

As your vehicle approaches an object, one or more distance segments will illuminate, depending on the distance. When the seventh distance segment illuminates, you have reached the minimum distance.

- Front area:
As soon as the first red segment lights up, you will hear an intermittent warning tone for approx. two seconds. Once the second red segment lights up, you will hear a continuous warning tone. You have reached the minimum distance.
- Rear area:
As soon as the first red segment lights up, you will hear an intermittent warning tone for approx. two seconds. Once the second red segment lights up, you will hear a continuous warning tone. You have reached the minimum distance.

i During strong rainfall, the warning indicators and warning tones may be triggered, for example, by water splashing into the area of the sensors.

Driving systems

Collision warning

Park Assist can detect obstacles from a considerable distance. If you drive in reverse towards an obstacle, you will hear a warning tone. You must then brake in order to avoid a collision. The warning tone for a collision will not sound when the vehicle is at a standstill very close to the obstacle. In this case, you will hear a corresponding tone for the warning indicator in the rear area.

i During strong rainfall, the collision warning may be triggered, for example, by water splashing into the area of the sensors.

Switching Park Assist system on/off

The Park Assist system can be switched off manually.

The Park Assist button with the indicator lamp is located on the control panel on the right-hand side of the instrument cluster.

i When the indicator lamp is on, the Park Assist system is switched off.

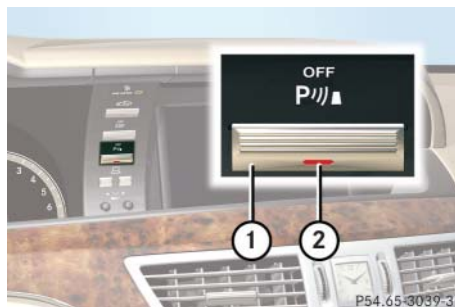

- ① Park Assist button
- ② Indicator lamp

► Switching off Park Assist system:

Press button ①.

Indicator lamp ② comes on.

► Switching on Park Assist system:

Press button ① again.

Indicator lamp ② goes out.

i The Park Assist system is automatically switched on when the ignition (▷ page 315) and radar sensors are switched on (▷ page 256).

Dynamic Rear View Monitor*

The Dynamic Rear View Monitor is an electronic and visual parking aid. It shows you the area behind the vehicle on the COMAND display.

In addition, the Dynamic Rear View Monitor contains guide lines to help you with reverse parking (back-in parking) and parallel parking.

The area behind the vehicle is displayed as a reverse-mirror image similar to the view in a rear-view mirror.

The Dynamic Rear View Monitor is in the handle strip of the trunk lid.

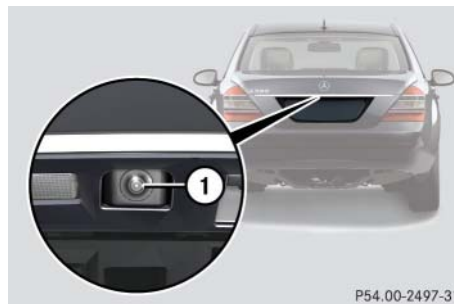

① Dynamic Rear View Monitor

View through the camera

i The image from the Dynamic Rear View Monitor is shown on the COMAND display (▷ page 31).



Warning!



Please note that objects which do not touch the ground, such as the bumper of a vehicle parked behind you, a trailer hitch, or the back of a truck, may appear to be further away than they actually are. In this case, you should not use the guide lines to judge distance. The use of the guide lines to judge distance increases the risk of impacting the objects.

Warning!



The Dynamic Rear View Monitor is a supplement system. It is not intended to, nor does it replace, the need for extreme care. The responsibility during parking and other driving maneuvers always rests with the driver.

The Dynamic Rear View Monitor may show obstacles with a distorted perspective, incorrectly or not at all.

Special attention must be paid to objects outside of the camera's field of view such as those located very close to or below the rear bumper, or above the recessed grip of the luggage compartment lid. Such objects may not be detected by the system and can damage the vehicle.

The Dynamic Rear View Monitor does not warn you about impending collisions with objects. The driver is always responsible for safety and must continue to pay attention to the immediate surroundings while parking or maneuvering the vehicle. This applies not only to the area behind the vehicle, but also

to the area in front of and to the sides of the vehicle. Failure to do so could result in injury to persons and/or damage to the vehicle or other property. We also recommend that the driver use the Parktronic system* or Park Assist* when parking or maneuvering the vehicle.

Warning!



Make sure that no persons or animals are standing in the area where you are maneuvering. You could otherwise injure them.

Warning!



The Dynamic Rear View Monitor may not function if:

- the trunk lid is not completely closed
- it is raining or snowing heavily, or if there is thick fog
- in a very dark area

- the camera is exposed to very strong white light (white stripes may appear on the COMAND display)
- the surrounding area is lit with fluorescent light (the COMAND display can flicker)
- there is a sudden change in temperature, for example when you drive out of the cold into a heated garage in winter (lens condensation)
- outside temperatures are very high (lens condensation)
- the camera lens is dirty or covered, see "Cleaning of the Dynamic Rear View Monitor lens*" (▷ page 538)
- the rear of your vehicle is damaged. In this case, have the position and setting of the camera checked by a qualified technician. Contact an authorized Mercedes-Benz Center.

Do not use the Dynamic Rear View Monitor if the roads are icy, slippery or covered with snow. The vehicle could slip causing the actual vehicle position to deviate from the one shown on the COMAND display.

This may cause injury to you or others, or damage the vehicle or objects.

Mounting tires/rims of other specification than the original equipment tires/rims may impair the function of the Dynamic Rear View Monitor. Contact an authorized Mercedes-Benz Center.

Warning!



Use of Dynamic Rear View Monitor can be dangerous if you are color-blind or have impaired color vision.

Only use Dynamic Rear View Monitor if you can see and distinguish all colored guide lines shown by Dynamic Rear View Monitor on the COMAND display.

Switching on Dynamic Rear View Monitor

i The Dynamic Rear View Monitor must be activated in the instrument cluster control system in order for it to be switched on (▷ page 253).

- ▶ Switch on the ignition (▷ page 315).
- ▶ Switch on COMAND (▷ page 79).
- ▶ Move gear selector lever to position **R** (reverse gear).

The COMAND display will show the area behind the vehicle with guide lines to help you reverse into a parking place.

i If you activate a different function on the driver's COMAND controls while reverse parking or parallel parking, the image from the back-up camera is interrupted.

To reactivate the camera, take the vehicle out of reverse gear and then re-engage reverse gear again.

Reverse parking (back-in parking)

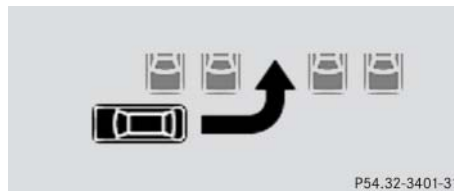

P54.32-3401-31

This function helps you when you are reversing in a straight line or backing in at any angle.

The space required by the vehicle for reversing is shown by guide lines.

When you turn the steering wheel to a straight-ahead position, you will see the guide lines on the COMAND display in the following order:

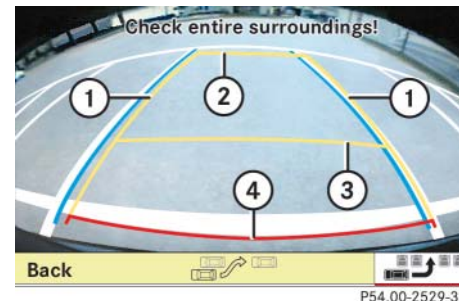

P54.00-2529-31

- ① Yellow and blue guide lines for vehicle width
- ② Yellow 13 ft (4 m) guide line
- ③ Yellow 39 in (1 m) guide line
- ④ Red 10 in (0.25 m) guide line

Driving systems

The red 10 in (0.25 m) guide line ④, the yellow 39 in (1 m) guide line ③ and the yellow 13 ft (4 m) guide line ② correspond to the relevant distance from the rear of the vehicle. The yellow and blue guide lines for vehicle width ① show the required width for the vehicle.

Warning!



Please note that objects which do not touch the ground, such as the bumper of a vehicle parked behind you, a trailer hitch, or the back of a truck, may appear to be further away than they actually are. In this case, you should not use the guide lines to judge distance as the use of the guide lines to judge distance increases the risk of impacting the objects.

Even when the object you approach is directly on the ground (and nothing on the object extends above the ground beyond the object's contours directly touching the ground) and no objects that do not touch the ground, such as the bumper of a vehicle

parked behind you, a trailer hitch, or the back of a truck are in the path, do not approach the object on the ground any closer than red guide line ④.

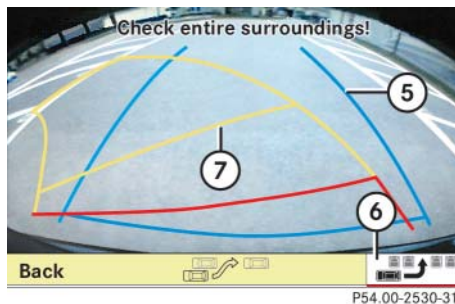

- ⑤ Blue guide lines for straight driving
- ⑥ Symbol for “reverse parking”
- ⑦ Yellow and red guide lines for cornering

When you turn the steering wheel out of the straight-ahead position, the positions of the yellow and red guide lines ⑦ change depending on the steering wheel's position. The space required by the vehicle for reverse cornering is indicated by yellow and red guide lines ⑦.

Backing in straight

i The Dynamic Rear View Monitor must be activated in the instrument cluster control system in order for it to be switched on (▷ page 253).

- ▶ Switch on the ignition (▷ page 315).
- ▶ Switch on COMAND (▷ page 79).
- ▶ Move gear selector lever to position **R** (reverse gear).
- ▶ Use the COMAND controller (▷ page 82) to select “reverse parking” function ⑥.

You will see the guide lines for reverse parking on the COMAND display.

The desired parking space is wide enough if nothing is inside the yellow and blue guide lines ① of your intended driving path or protrudes into this area.

! While parking, do not approach any obstacles closer than indicated by red guide line ④.

- ▶ Back in straight carefully.

Backing in at any angle

i The Dynamic Rear View Monitor must be activated in the instrument cluster control system in order for it to be switched on (▷ page 253).

- ▶ Switch on the ignition (▷ page 315).
- ▶ Switch on COMAND (▷ page 79).
- ▶ Move gear selector lever to position **R** (reverse gear).
- ▶ Use the COMAND controller (▷ page 82) to select “reverse parking” function ⑥.

You will see the guide lines for reverse parking on the COMAND display.

- ▶ Turn steering wheel so that the yellow and red guide lines for cornering ⑦ are pointing towards the desired parking space.

The desired parking space is wide enough if nothing is inside yellow and red guide lines ⑦ of your intended driving path or protrudes into this area.

! While parking, do not approach any obstacles closer than indicated by red guide line ④.

- ▶ Back in carefully.
- ▶ When the blue guide lines ⑤ for straight driving lie parallel inside the desired parking space, straighten the steering wheel for straight driving.
- ▶ Back in enough to leave sufficient free space around the vehicle.

Parallel parking

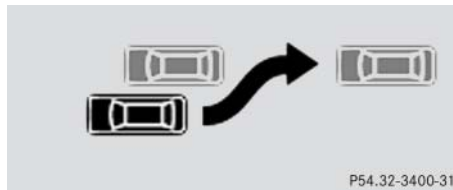

This function assists you when you wish to park in a row, e.g. in a parking place parallel to the road.

i The Dynamic Rear View Monitor must be activated in the instrument cluster control system in order for it to be switched on (▷ page 253).

- ▶ Stop the vehicle
 - at a distance of approximately three feet (one meter) parallel to the vehicle that is in front of the desired parking space.
 - in such a way that the front of the parked vehicle is parallel to your rear wheel.
- ▶ Switch on COMAND (▷ page 79).
- ▶ Move gear selector lever to position **R** (reverse gear).

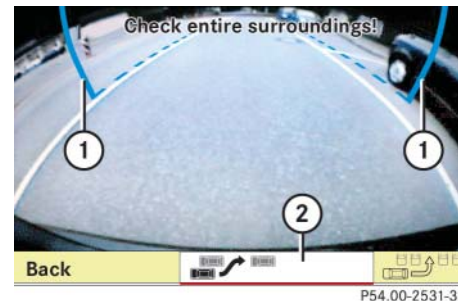

- ① Vertical blue guide line
- ② Symbol for “parallel parking”



Driving systems

- ▷▷ Use the COMAND controller (▷ page 82) to select “parallel parking” function ②.

You will see the guide lines for parallel parking on the COMAND display.

- ▶ Back up carefully parallel to parked car until the respective vertical blue guide line ① is at the end of the parked vehicle next to you.
- ▶ Stop the vehicle.

Warning!



If the respective vertical guide line ① is not yet located at the end of the parked vehicle and you are already turning into the parking space, you could collide with the parked vehicle. Stop the parking procedure immediately. Pull out of the parking space and start the parking procedure over again.

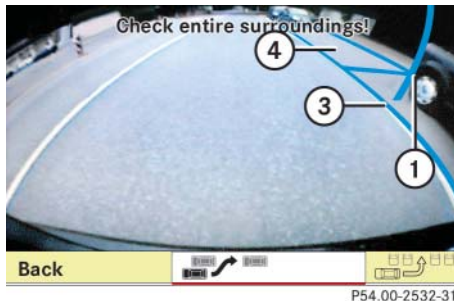

- ① Vertical blue guide line
- ③ Extended blue guide line
- ④ Blue guide lines for vehicle contour

- ▶ With the vehicle at a standstill, turn steering wheel in parking direction until blue guide lines ③ and ④ appear and the rectangle formed by guide lines ④ shows the desired parking position. If another vehicle is located next to you, the extended blue guide line ④ must just touch the corresponding vertical blue guide line ①.

i If an obstacle is inside of or protrudes into the area marked by blue guide lines ④ for the vehicle, the parking space is too small for the vehicle.

i If you turn the steering wheel too far, the message “Steering wheel turned too far. Please adjust steering wheel” appears on the COMAND display. Turn the steering wheel back until the message disappears and the extended blue guide line ④ intersects with vertical blue guide line ①.

If you back up using the wrong wheel angle, the following appears in the COMAND display: “Steering wheel turned too far. Park Assist disabled.”. Pull out of the parking space and start the parking procedure over again.



⑤ Bent blue guide line

- ▶ Back up with the set wheel angle.

The guide lines in the COMAND display disappear. After a short distance, the bent blue guide line ⑤ appears.

i If you turn the steering wheel while backing up, the following appears in the COMAND display: “The steering wheel position has been changed. Park Assist disabled.”. Pull out of the parking space and start the parking procedure over again.

- ▶ Back up until bent guide line ⑤ intersects the edge of the parking space, e.g. the curb.
- ▶ Stop the vehicle.

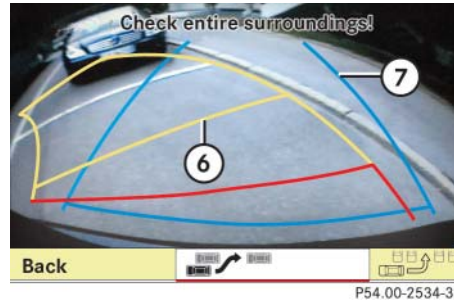

- ⑥ Yellow and red guide lines for cornering
- ⑦ Blue guide line for straight driving

- ▶ With the vehicle at a standstill, turn steering wheel as far as it will go in the opposite direction.

The guide lines for straight driving ⑦ and cornering ⑥ appear in the COMAND display.

- ▶ Back up using the set wheel angle until blue guide line ⑦ for straight driving is parallel to the edge of the parking space, e.g. the curb.
- ▶ Now straighten out steering wheel and back up until you still have just enough room behind the vehicle.

While doing so, observe Parktronic* (▶ page 405) or Park Assist* (▶ page 409) warning indicators.

Driving systems

Night View Assist*

Warning!



Night View Assist is only an aid to support you while driving and cannot substitute your careful attention. Do not rely on the display of the Night View Assist; instead, continue to look through the windshield. You are always responsible for safety and must drive in accordance with traffic conditions. Otherwise, you could endanger yourself and others.

If it is foggy, raining or snowing, the clarity of the Night View Assist image on the multifunction display may be diminished.

Night View Assist illuminates the road with infrared light in addition to the normal headlamps.

A camera at the top of the windshield measures the infrared light and shows a black-and-white image on the multifunction display.

The image on the multifunction display corresponds to a road lit up by high-beam headlamps.

Warning!



Night View Assist cannot record objects immediately in front of or next to the vehicle. When maneuvering, continue to look through the windshield. Make sure that no persons or animals are in or near the area in which you are maneuvering.

The Night View Assist image on the multifunction display is not impaired

- by the headlamps of approaching vehicles
- if you cannot switch on the high beams due to oncoming traffic

As a result, you can better follow the course of the road and detect obstacles earlier on.

i *Infrared light is invisible to the human eye and can therefore remain permanently switched on without blinding oncoming traffic.*

The camera is at the top of the windshield.

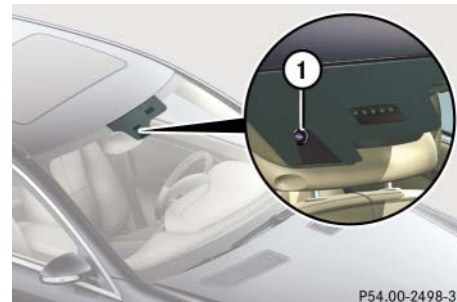

① Night View Assist camera

Switching on or off

You can only switch on the Night View Assist if

- the SmartKey in the starter switch is set to position **2**
- it is dark
- the light switch is set to **A** or  or if the daytime driving lamps are switched on
- the automatic transmission is not in position **R**



① Night View Assist on or off

► Press button ①.

The Night View Assist image appears on the multifunction display.

i *The infrared headlamps only come on above a speed of approx. 9 mph (15 km/h). Therefore, when you are at a standstill, you do not have a complete view and cannot check the function of the Night View Assist.*

Image on multifunction display

When you switch on Night View Assist, the image for the speed gauge changes on the multifunction display. The speed gauge is shown as a bar on the lower edge of the multifunction display. The line for main menus is no longer available. If you would like to change a setting using the steering wheel buttons, you must first switch off Night View Assist.

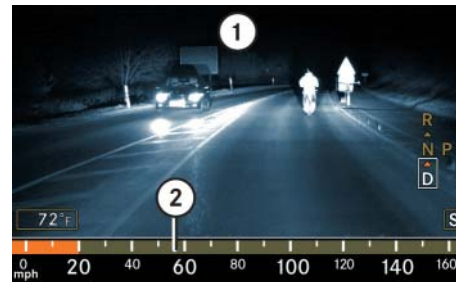

- ① Night View Assist image
- ② Speedometer display

i *If you change the brightness of the instrument cluster while Night View Assist is switched on, only the brightness of the multifunction display is changed.*

Driving systems

Dirty or fogged-up windshield

If the windshield in front of the camera is fogged up on the inside or outside or if it is dirty, the Night View Assist image is diminished.

Warning!



Please do not forget that your primary responsibility is to drive the vehicle. A driver's attention to the road must always be his/her primary focus when driving. For your safety and the safety of others, stop before trying to remove window fogging or cleaning the window in front of the Night View Assist camera.

Bear in mind that at a speed of just 30 mph (approximately 50 km/h), your vehicle is covering a distance of 44 feet (approximately 14 m) every second.

Removing condensation



- ① Recessed handles on camera cover
- ▶ Fold camera cover downward using recessed handles ①.
- ▶ Check settings of automatic climate control and change them, if necessary (▷ page 424).

Once the image is no longer impaired:

- ▶ Fold camera cover back up using recessed handles ①.

Cleaning inside of windshield

- ▶ Clean inside of windshield in front of camera (▷ page 539).

Night View Assist* malfunction

Problem	Possible cause	Suggested solution
The quality of the Night View Assist image has diminished.	The windshield wipers are leaving streaks on the windshield.	▶ Replace windshield wiper blades (▷ page 627).
	The area of the windshield within the camera's field of view is dirty.	▶ Clean windshield (▷ page 539).
	The area of the windshield within the camera's field of view has been damaged.	▶ Replace windshield.
	The area of the windshield within the camera's field of view is fogged over.	▶ Remove condensation (▷ page 539).
	The area of the windshield within the camera's field of view is iced over.	▶ Defrost windshield (▷ page 429).

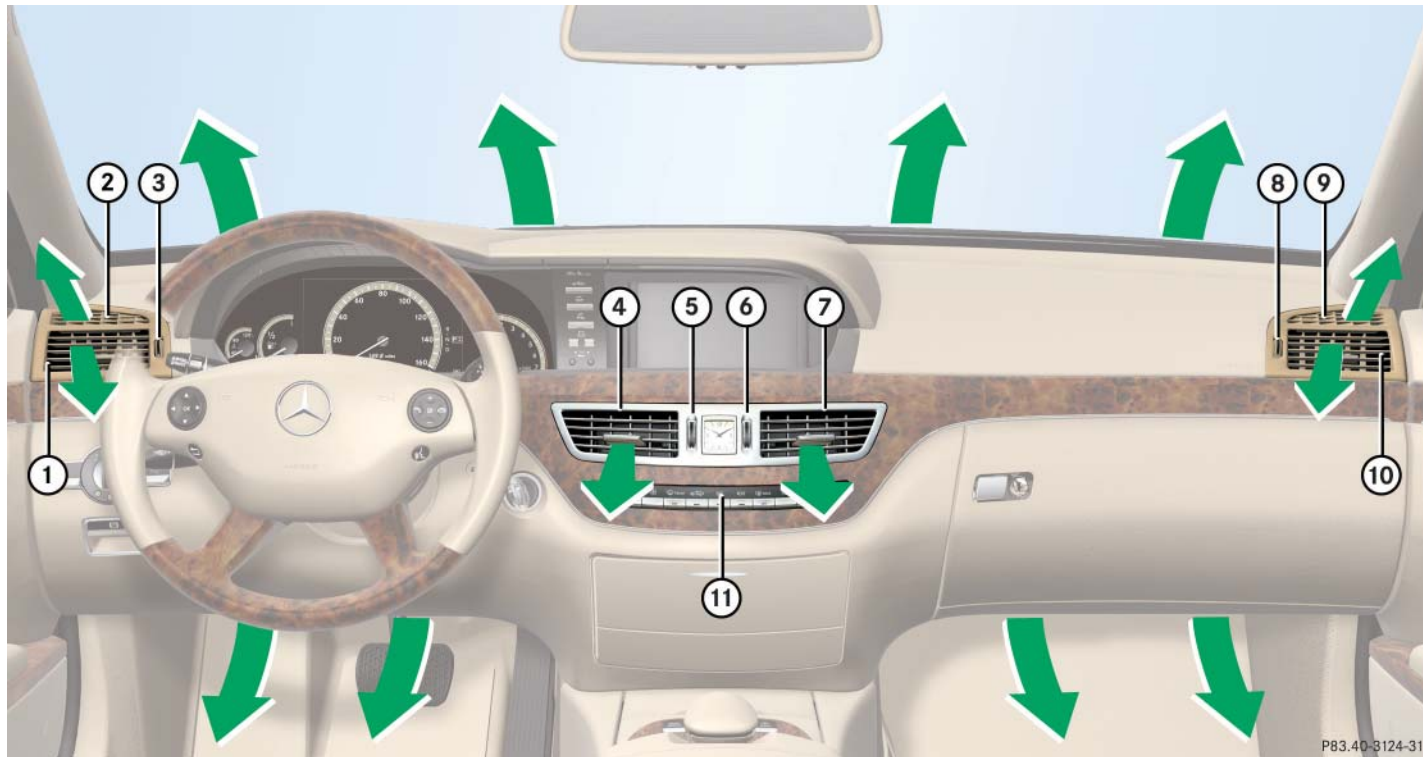

Item
① Left side air vent, adjustable
② Left side defroster vent, fixed
③ Thumbwheel for air volume control for left air vent
④ Left center air vent, adjustable
⑤ Thumbwheel for air volume control for left center air vent
⑥ Thumbwheel for air volume control for right center air vent
⑦ Right center air vent, adjustable
⑧ Thumbwheel for air volume control for right air vent
⑨ Right side defroster vent, fixed
⑩ Right side air vent, adjustable
⑪ Climate control panel

i For draft-free ventilation, move the sliders for the center air vents ④ and ⑦ to the middle position.

Warning!



When operating the automatic climate control, the air that enters the passenger compartment through the air vents can be very hot or very cold (depending on the set temperature). This may cause burns or frostbite to unprotected skin in the immediate area of the air vents.

Always keep sufficient distance between unprotected parts of the body and the air vents. If necessary, use the air distribution adjustment (▷ page 230) to direct the air to air vents in the vehicle interior that are not in the immediate area of unprotected skin.

Automatic climate control



P83.40-3117-31

Automatic climate control panel, front

Item
① AUTO mode for air distribution and volume, left
② Temperature control, left
③ Manual fan speed adjustment, left
④ Front defroster

Item
⑤ Air recirculation
⑥ Automatic climate control on/off
⑦ Residual engine heat and ventilation (REST)
⑧ Rear window defroster

Item
⑨ Manual fan speed adjustment, right
⑩ Temperature control, right
⑪ AUTO mode for air distribution and volume, right

i If you have the air distribution and air volume automatically controlled, you can adjust the temperature, footwell temperature and air flow. The following basic settings are recommended:

- Automatic air distribution control (▷ page 428)
- Temperature: 72°F (22°C) (▷ page 429)
- Footwell temperature: 0 (▷ page 232)
- Air flow: focused (▷ page 233)

The automatic climate control is operational whenever the engine is running. You can operate the climate control system in either the automatic or manual mode. The system cools or heats the interior depending on the selected interior temperature and the current outside temperature.

It can only function optimally when you are driving with the windows and the tilt/sliding sunroof/panorama sunroof* closed.

It is possible to completely deactivate the climate control system (▷ page 428).

Nearly all dust particles, pollutants and odors are filtered out before outside air enters the passenger compartment through the air distribution system.

Warning!



Follow the recommended settings for heating and cooling given on the following pages and in the “COMAND automatic climate control” section (▷ page 229). Otherwise the windows could fog up, impairing visibility and endangering you and others.

i Severe conditions (e.g. strong air pollution) may require replacement of the filter before its scheduled interval. A clogged filter will reduce the air volume to the interior.

If the vehicle interior is hot, ventilate the interior before driving off, see “Summer opening feature” (▷ page 355). The automatic climate control will then adjust the interior temperature to the set value much faster.

Keep the air intake grille in front of the windshield free of snow, leaves, sticks, and any other debris.

Do not obstruct air volume by placing objects on the air volume-through exhaust slots below the rear window.

The following automatic climate control functions can be operated via COMAND:

Function	Page
Temperature	230
Air distribution	230
Air volume	230
Switching off cooling (“AC ^{OFF} ”)	231
Central climate control (“Mono”)	232
Footwell temperature	232
Air flow from air vents	233
Rear climate control*	234

Automatic climate control

Deactivating climate control system

- ▶ **Deactivating:** Press button **OFF** (▷ page 426) up or down.

The indicator lamp on the button comes on.

Warning!



When the automatic climate control is switched off, the outside air supply and circulation are also switched off. Only choose this setting for a short time. Otherwise the windows could fog up, impairing visibility and endangering you and others.

- ▶ **Reactivating:** Press button **OFF** (▷ page 426) up or down.

The indicator lamp on the button goes out.

Operating climate control system in automatic mode

i *When operating the climate control system in automatic mode, you will only rarely need to adjust the temperature, air volume and air distribution.*

Activating

- ▶ Press button **AUTO** (▷ page 426) up or down.

The indicator lamp on the button comes on.

Deactivating

- ▶ Press button **AUTO** (▷ page 426) up or down.

or

- ▶ Adjust air distribution (▷ page 230).



or



- ▶ Adjust air volume (▷ page 429).

The indicator lamp on button **AUTO** goes out. The automatic function is switched off.

You can adjust the air distribution (▷ page 230) or air volume (▷ page 429) manually.

Setting temperature

Use temperature controls   ② and ⑩ (▷ page 426) in the center console or COMAND (▷ page 230) to separately adjust the air temperature on each side of the passenger compartment. You should raise or lower the temperature setting in small increments, preferably starting at 72°F (22°C). The automatic climate control will adjust to the set temperature as fast as possible.

- ▶ Press temperature control   ② and/or ⑩ (▷ page 426) upward or downward.

The climate control system will correspondingly adjust the interior air temperature.

Adjusting air volume

Use buttons  (▷ page 426) in the center console or COMAND to separately adjust the air volume on each side of the passenger compartment.

i *When you change the air volume, the automatic function of the climate control system is switched off.*

- ▶ Press button  up to increase or down to decrease air volume.

The indicator lamps on buttons  (▷ page 426) goes out.

Front defroster

You can use this setting to defrost the windshield, for example if it is iced up. You can also defog the windshield and the side windows.

i *Keep this setting selected only until the windshield is clear again.*

Activating

- ▶ Press button  (▷ page 426) up or down.

The indicator lamp on the button comes on.

The air conditioning switches to the following functions automatically:

- increased blowing and heating power
- air flows onto the windshield and the front side windows
- the air conditioning compressor switches on at outside temperatures above approximately 41°F (5°C) for dehumidifying the air
- the air recirculation mode is switched off

Automatic climate control

Deactivating

- ▶ Press button  (▷ page 426) up or down.

The indicator lamp on the button goes out.

The previous settings are once again in effect, except air recirculation mode stays off.

Windshield fogged on the outside

- ▶ Switch the windshield wipers on (▷ page 351).
- ▶ Press button  (▷ page 426) up or down.

The indicator lamp on the button comes on.

Rear window defroster

Activating

- ▶ Switch on the ignition (▷ page 315).

- ▶ Press button  (▷ page 426) up or down.

The indicator lamp on the button comes on.

 *The rear window defroster uses a large amount of power. To keep battery drain to a minimum, switch off the defroster as soon as the rear window is clear.*

Deactivating

- ▶ Press button  (▷ page 426) up or down.

The indicator lamp on the button goes out.

 *The defroster is automatically deactivated after some time of operation depending on the outside temperature.*

 *If the rear window defroster switches off too soon and the indicator lamp goes out, this indicates that too many electrical consumers are operating simultaneously and the load on the battery is reducing available voltage. The system responds automatically by deactivating the rear window defroster.*

Maximum cooling MAXCOOL (USA only)

If  is selected on both the left and right side and there is a high demand for cooling, the display “MAXCOOL” appears in the COMAND display.

This provides the fastest possible cooling of the vehicle interior (when windows and tilt/sliding sunroof or tilt/sliding panel* are closed).

 *Maximum cooling MAXCOOL is only available when the engine is running.*

Warning!



Any accumulation of snow and ice should be removed from the rear window before driving. Visibility could otherwise be impaired, endangering you and others.

Air recirculation mode

Switch to air recirculation mode to prevent unpleasant odors from entering the vehicle from the outside (e.g. before driving in a tunnel). This setting cuts off the intake of outside air and recirculates the air in the passenger compartment.

Warning!



Fogged windows impair visibility, endangering you and others. If the windows begin to fog on the inside, switching off the air recirculation mode immediately should clear interior window fogging. If interior window fogging persists, make sure the air conditioning (▷ page 231) is activated, or press button .

- ▶ **Activating:** Press button  (▷ page 426) up or down.

The indicator lamp on the button comes on.

i The air recirculation mode is activated automatically at high outside temperatures.

The indicator lamp on button  is not lit when the air recirculation mode is automatically activated.

A quantity of outside air is added when the cooling demand is not at maximum.

If the air conditioning has been turned off (▷ page 231) or the outside temperature is below 41 °F (5 °C), the air recirculation mode will not switch on automatically.

- ▶ **Deactivating:** Press button  (▷ page 426) up or down.

The indicator lamp on the button goes out.

i The manually selected air recirculation mode is deactivated automatically:

- after 5 minutes if the outside temperature is below approximately 41 °F (5 °C)
- after 5 minutes if the air conditioning is turned off
- after 30 minutes if the outside temperature is above approximately 41 °F (5 °C)

Air recirculation mode with convenience closing or opening feature

Warning!



Never operate the side windows and the tilt/sliding sunroof or tilt/sliding panel* if there is the possibility of anyone being harmed by the closing procedure.

Vehicles with tilt/sliding sunroof: In the event that the procedure causes potential danger, the closing of the side windows can be immediately halted by pressing the respective window switch. The closing of the tilt/sliding sunroof can be immediately halted by moving the tilt/sliding sunroof switch in the overhead control panel in any direction.

Vehicles with panorama roof*: In the event that the procedure causes potential danger, the closing of the side windows or the tilt/sliding panel can be immediately halted by releasing button .





Automatic climate control





The closing of the side windows and the tilt/sliding sunroof or tilt/sliding panel* can be reversed by again pressing and holding button .

Vehicles with tilt/sliding sunroof



- ▶ **Convenience closing:** Press button  for approximately 2 seconds.

The side windows and/or tilt/sliding sunroof will close. You can release button  once the closing procedure has begun. The windows and tilt/sliding sunroof continue closing until they are fully closed. The indicator lamp on the button comes on. The air recirculation mode is activated.

- ▶ **Convenience opening:** Press button  for approximately 2 seconds.

The side windows and/or tilt/sliding sunroof will return to their previous position. You can release button  once the opening procedure has begun. The windows and tilt/sliding sunroof continue opening until they have reached their previous positions. The indicator lamp on the button goes out. The air recirculation mode is deactivated.

Vehicles with panorama roof*

- ▶ **Convenience closing:** Press and hold button  until the side windows and the tilt/sliding panel are closed or have reached the desired position. The indicator lamp on the button comes on. The air recirculation mode is activated.
- ▶ **Convenience opening:** Press and hold button  until the side windows and the tilt/sliding panel are opened or have reached the desired position.

The indicator lamp on the button goes out. The air recirculation mode is deactivated.

i A window or tilt/sliding sunroof (or tilt/sliding panel*) will only return to its previous position if it has not been moved to another position using the respective window switch or tilt/sliding sunroof (or tilt/sliding panel*) switch after it was closed with button .

A window or tilt/sliding sunroof (or tilt/sliding panel*) that has been moved will remain in its current position if button  is used to reopen the remaining windows or tilt/sliding sunroof (or tilt/sliding panel*).

Residual engine heat and ventilation

With the engine switched off, it is possible to continue to heat or ventilate the interior. This feature makes use of the residual heat produced by the engine.

i *If you switch on the residual heat function when outside temperatures are high, only the ventilation will be switched on.*

i *Regardless of the selected air volume, the blower operates at low speed when heating. In case of ventilation the blower operates at higher speed.*

i *How long the system will provide heating depends on*

- *the coolant temperature*
- *the temperature set by the operator*

Activating

- ▶ Switch off the ignition (▷ page 315).
- ▶ Press button **REST** (▷ page 426) up or down.

The indicator lamp on the button comes on.

Deactivating

- ▶ Press button **REST** (▷ page 426) up or down.

The indicator lamp on the button goes out.

i *The residual heat is automatically turned off:*

- *when the ignition is switched on*
- *after approximately 30 minutes*
- *if the battery voltage drops*
- *if the coolant temperature is too low*

Front passenger compartment adjustable air vents

- ▶ **Opening/closing the air vents:**
Turn thumbwheels ③, ⑤, ⑥ and ⑧ (▷ page 425).

Automatic climate control

Rear passenger compartment adjustable air vents

Rear center console air vents

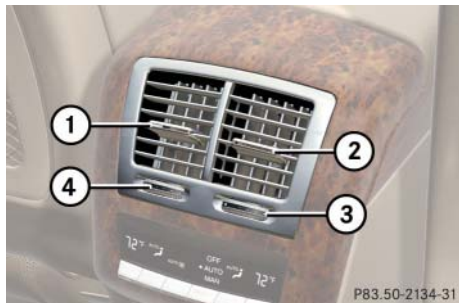

- ① Left center air vent, adjustable
- ② Right center air vent, adjustable
- ③ Thumbwheel for right center air vents
- ④ Thumbwheel for left center air vents

► Opening/closing air vents:

Turn thumbwheel ③ or ④.

i Vehicles without rear passenger compartment climate control*:
The temperature at the air vents for rear passenger compartment ① and ② will be approximately the same as at the dashboard center air vents.

Rear passenger compartment climate control*

Warning!



Follow the recommended settings for heating and cooling as given in the instructions for the front climate control (▷ page 424). Otherwise the windows could fog up, impairing visibility for the driver and endangering you and others.

i At low outside temperatures or if you have switched off the cooling function, you cannot cool the rear passenger compartment.



Automatic climate control panel, rear

Item
① Temperature control, left
② Air distribution, left (automatic, manual)
③ Air volume (automatic, manual)
④ Mode selector
⑤ Air distribution, right (automatic, manual)
⑥ Temperature control, right

i If the climate control system in the rear passenger compartment is adjusted using COMAND (▷ page 234), the **فزر** symbol appears in the display of the rear control unit. The rear climate control system can no longer be adjusted using the rear control unit.

- ▶ **Switching on automatic mode:** Press button ④ (▷ page 434) up or down repeatedly until “*AUTO*” mode is selected in display.
- ▶ **Switching off rear climate control:** Press button ④ (▷ page 434) up or down repeatedly until “*OFF*” mode is selected in display.

▶ **Switching off automatic mode:** Press button ④ (▷ page 434) up or down repeatedly until “*MAN*” mode is selected in display.

▶ **Setting temperature:** Use temperature controls ① and ⑥ (▷ page 434) to separately adjust the air temperature on each side of the rear passenger compartment.

▶ **Increasing/decreasing:** Press temperature control ① or ⑥ up or down.

The climate control system will correspondingly adjust the interior air temperature.

▶ **Adjusting air distribution:** Press button ② or ⑤ (▷ page 434) up or down repeatedly until desired air distribution is set.

The direction of the arrows represent the air distribution. “*MAN*” appears in the display over the button for the function mode.

▶ **Adjusting air volume** Press air volume control ③ (▷ page 434) up or down.

The air volume is increased or decreased. “*MAN*” appears in the display over the button for the function mode.

Trunk

Warning!



Only drive with the trunk closed as, among other dangers such as blocked visibility, exhaust fumes may enter the vehicle interior.

Opening trunk

A minimum height clearance of 5.9 ft. (1.80 m) is required to open the trunk lid.

! *The trunk lid swings open upwards automatically. Always make sure that there is sufficient overhead clearance.*

Opening trunk from outside

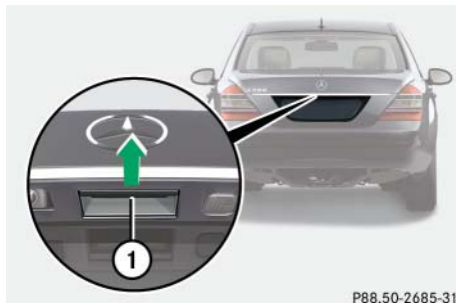



① Trunk lid handle

In vehicles without KEYLESS-GO*: The vehicle must be unlocked.

▶ Pull on handle ①.

or

▶ Press and hold button  on the SmartKey or SmartKey with KEYLESS-GO* until trunk unlocks and begins to open.

! *Vehicles with trunk opening/closing system*: To stop the opening procedure, press button  on the SmartKey or SmartKey with KEYLESS-GO*.*

Opening trunk from inside

You can open the trunk from the inside if the vehicle is stationary.

Vehicles without trunk opening/closing system*

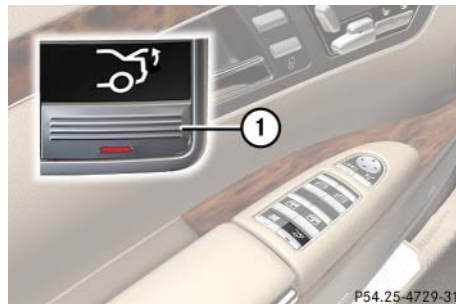

① Remote trunk opening switch

▶ Press switch ① until the trunk begins to open.

The trunk opens. The indicator lamp in switch ① comes on and remains lit until the trunk closed.

Vehicles with trunk opening/closing system*

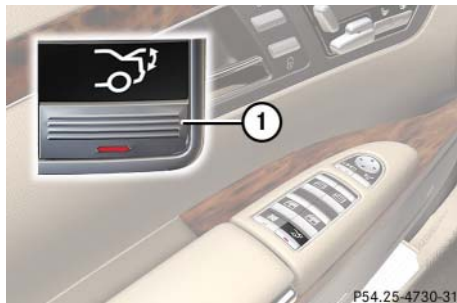

- ① Remote trunk opening/closing* switch
- ▶ Press and hold switch ① until the trunk is opened.

The indicator lamp in switch ① comes on and remains lit until the trunk is closed.

To interrupt the closing procedure:

- ▶ Release switch ①.

Trunk opening-height restriction*

Vehicles with trunk opening/closing system*:

The trunk lid opening height can be limited when transporting goods on a roof rack (e.g. presence of an optional MB sport luggage container). When activated, the trunk opens to approximately the height of the roof edge.

- ▶ Activate the limiting opening height of trunk lid using the COMAND system (▶ page 227).

Closing trunk

i Do not place the SmartKey in the open trunk. You may lock yourself out.

i If the vehicle was previously centrally locked, the trunk will lock automatically after closing it. All turn signal lamps flash three times to confirm locking.

Vehicles with KEYLESS-GO: To prevent a possible inadvertent lockout, the trunk will open automatically if a SmartKey with KEYLESS-GO is recognized inside the vehicle or in the trunk.*

The vehicle is only locked when the turn signals flash three times. If you are carrying a second SmartKey with KEYLESS-GO with you, you can still lock the vehicle.

Closing trunk from outside manually

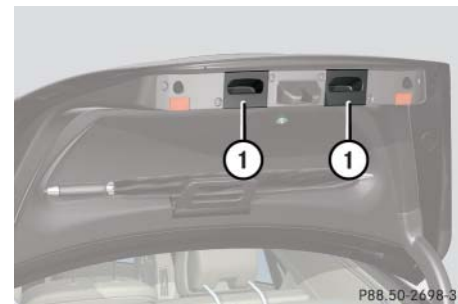

- ① Handles
- ▶ Lower trunk lid by pulling firmly on handles ①.
- ▶ Close trunk lid with hands placed flat on trunk lid.

The power closing assist automatically ensures that the lid is pulled closed completely (▶ page 313).

Trunk

Warning!



To prevent possible personal injury, always keep hands and fingers away from the trunk lid opening when closing the trunk. Be especially careful when small children are around.

When leaving the vehicle, always remove the SmartKey or SmartKey with KEYLESS-GO* from the starter switch, take it with you, and lock the vehicle. Do not leave children unattended in the vehicle, or with access to an unlocked vehicle. Unsupervised use of vehicle equipment may cause an accident and/or serious personal injury.

Closing trunk from inside automatically*

Warning!



Maintain sight of trunk area while operating door mounted switch. Monitor the closing

procedure carefully to make sure no one is in danger of being injured.

To interrupt the closing procedure, release the door mounted remote trunk opening/closing* switch again.

Even with the SmartKey or SmartKey with KEYLESS-GO* removed from the starter switch or the SmartKey with KEYLESS-GO* removed from the vehicle, the remote trunk opening/closing* switch can be operated. Therefore, do not leave children unattended in the vehicle, or with access to an unlocked vehicle. Unsupervised use of vehicle equipment may cause an accident and/or serious personal injury.

In vehicles with trunk opening/closing system* you can close the trunk from the inside using the remote trunk opening/closing* switch.

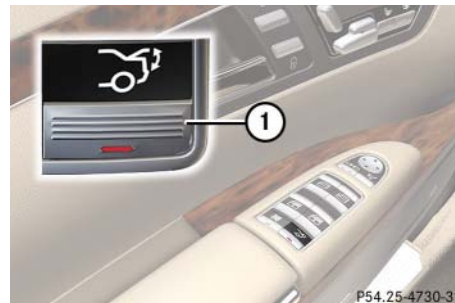

① Remote trunk opening/closing* switch (vehicles with trunk opening/closing system*)

► Press and hold switch ① until the trunk is closed.

The indicator lamp in the switch goes out when the trunk is closed.

To interrupt the closing procedure:

► Release switch ①.

i If the trunk lid comes into contact with an object while closing (e.g. luggage that has been piled too high) in the upper motion sequence, the closing procedure is stopped and the trunk re-opens slightly.

Closing trunk from outside automatically*

Warning!



Monitor the closing procedure carefully to make sure no one is in danger of being injured. To prevent possible personal injury, always keep hands and fingers away from the trunk lid opening when closing the trunk. Be especially careful when small children are around. To stop the closing procedure, do one of the following:

- press button  on the SmartKey
- press the trunk opening/closing* switch (on the driver's door)
- press trunk closing switch
- press the KEYLESS-GO locking/closing switch*

Even with the SmartKey removed from the starter switch, the trunk opening/closing* switch can be operated. Therefore, do not leave children unattended in the vehicle, or with access to an unlocked vehicle. Unsupervised use of vehicle equipment may cause an accident and/or serious personal injury.

In vehicles with trunk opening/closing system* you can close the trunk separately from the outside using the trunk closing switch.

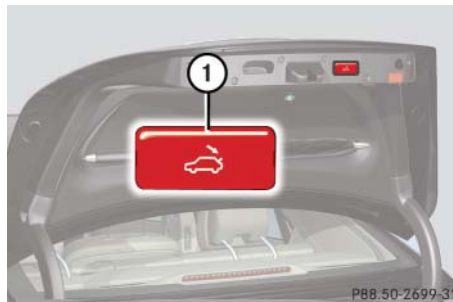

Vehicles without KEYLESS-GO*

- ① Trunk closing switch

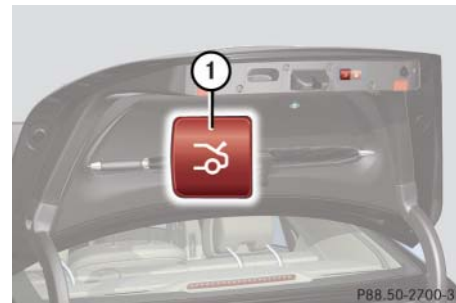

Vehicles with KEYLESS-GO*

- ① Trunk closing switch
- ▶ Press trunk closing switch ① briefly.

The trunk closes.

i If the trunk lid comes into contact with an object while closing (e.g. luggage that has been piled too high) in the upper motion sequence, the closing procedure is stopped and the trunk re-opens slightly.

Trunk

Closing trunk and locking vehicle from outside (vehicles with KEYLESS-GO*)

In vehicles with trunk opening/closing system* and KEYLESS-GO*, you can close the trunk and lock the vehicle simultaneously from the outside using the KEYLESS-GO locking/closing switch.

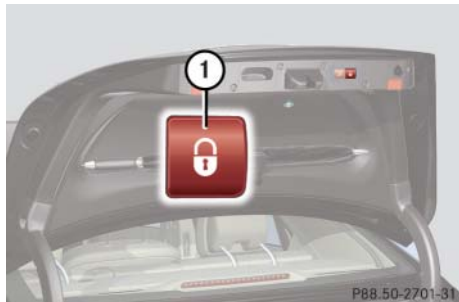

- ① KEYLESS-GO locking/closing switch
 - ▶ Make sure you have the SmartKey with KEYLESS-GO with you.
 - ▶ Press switch ① briefly.
- The vehicle is locked and the trunk closes automatically.

With the hood and all doors closed, all turn signal lamps flash three times to confirm locking. The locking knobs in the doors move down. The anti-theft alarm system is activated.

i If the trunk lid comes into contact with an object while closing (e.g. luggage that has been piled too high) in the upper motion sequence, the closing procedure is stopped and the trunk re-opens slightly.

Trunk emergency release

With the emergency release button, the trunk can be opened from inside the trunk.



- ① Emergency release button

- ▶ Briefly press emergency release button ①.

The trunk opens.

i The emergency release button unlocks and opens the trunk while the vehicle is standing still or in motion.

Illumination of the emergency release button:

- The button will flash for 30 minutes after opening the trunk.
- The button will flash for 60 minutes after closing the trunk.

i The emergency release button does not open the trunk if the vehicle battery is discharged or disconnected.

▼ Power tilt/sliding sunroof

Opening and closing power tilt/sliding sunroof

Warning!



When closing the tilt/sliding sunroof, make sure that there is no danger of anyone being harmed by the closing procedure.

If the tilt/sliding sunroof encounters an obstruction that blocks its path in a circumstance where you are closing the tilt/sliding sunroof by moving the tilt/sliding sunroof switch past the resistance point, or by pressing and holding button  on the SmartKey, by pressing and holding the sensor surface (vehicles with KEYLESS-GO*) on the outside door handle, the automatic reversal function will not operate.

The opening/closing procedure of the tilt/sliding sunroof can be immediately halted by releasing the switch or, if the switch was moved past the resistance point and released, by moving the switch in any direction.

The tilt/sliding sunroof is made out of glass. In the event of an accident, the glass may shatter. This may result in an opening in the roof.

In a vehicle rollover, occupants not wearing their seat belts or not wearing them properly may be thrown out of the opening. Such an opening also presents a potential for injury for occupants wearing their seat belts properly as entire body parts or portions of them may protrude from the passenger compartment.

When leaving the vehicle, always remove the SmartKey or SmartKey with KEYLESS-GO* from the starter switch, take it with you, and lock the vehicle. Do not leave children unattended in the vehicle, or with access to an unlocked vehicle. Unsupervised use of vehicle equipment can cause an accident and/or serious personal injury.

! To avoid damaging the seals, do not transport any objects with sharp edges which can stick out of the tilt/sliding sunroof.

Do not open the tilt/sliding sunroof if there is snow or ice on the roof, as this could result in malfunctions.

The tilt/sliding sunroof can be opened or closed manually should an electrical malfunction occur (▷ page 617).

i When the tilt/sliding sunroof is open, resonance noises may result in addition to the usual wind noises. They are caused by minimal pressure changes in the passenger compartment. To reduce or eliminate these noises, change the position of the tilt/sliding sunroof or open a side window slightly.

i You can also open or close the tilt/sliding sunroof using the SmartKey, see “Summer opening feature” (▷ page 355) and “Convenience closing feature” (▷ page 356). Depending on current position, the tilt/sliding sunroof may also open or close when the air recirculation button  (▷ page 426) is pressed and held for 2 seconds.

i If PRE-SAFE® has been activated, the tilt/sliding sunroof closes automatically until only a small gap remains.

Power tilt/sliding sunroof

i With the SmartKey in starter switch position **0** or removed from the starter switch, the tilt/sliding sunroof can be operated

- until you open the driver's or passenger door
- for up to approximately 5 minutes

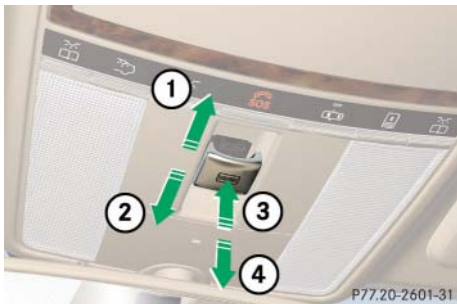

- ① Push back to slide sunroof open
- ② Push forward to slide sunroof closed
- ③ Push up to raise sunroof at rear
- ④ Pull down to lower sunroof at rear

With the sunroof closed or tilted open, a screen can be slid into the roof opening to help provide shade. When sliding the sunroof open, the screen will also retract.

- ▶ Switch on the ignition (▷ page 315).

- ▶ To open, close, raise or lower, move the switch to resistance point in the required direction ① to ④ until the tilt/sliding sunroof has reached the desired position.

- ▶ **Express-operation:** To open, close, raise or lower, move the switch past the resistance point in the required direction ① to ④ and release.

The tilt/sliding sunroof opens or closes completely.

- ▶ **Stopping during Express-opening/closing:** Move the switch in any direction.

i If the movement of the tilt/sliding sunroof is blocked during the closing procedure, the sunroof will stop and reopen slightly.

Synchronizing

The tilt/sliding sunroof must be synchronized

- after the tilt/sliding sunroof has been closed manually (▷ page 617)

- if the tilt/sliding sunroof can only be opened with a jerking motion
- after a malfunction

! Do not open the tilt/sliding sunroof completely if it is not aligned. Otherwise you could damage the tilt/sliding sunroof.

- ▶ Switch on the ignition (▷ page 315).
- ▶ Press and hold the sunroof switch in the direction of arrow ③ until the tilt/sliding sunroof is fully raised at the rear.

Keep holding the sunroof switch in the direction of arrow ③ for approximately 1 second.

- ▶ Check the Express-operation feature (▷ page 442).

If the tilt/sliding sunroof opens completely, the sunroof is synchronized. Otherwise repeat the above steps.

Panorama roof with power tilt/sliding panel*

▼ Panorama roof with power tilt/sliding panel*

Roller sunblinds

The roller sunblinds are designed to protect you from excessive sunlight streaming in through the panorama roof with power tilt/sliding panel.

The front roller sunblind only operates with the tilt/sliding panel closed. The front and rear roller sunblind cannot be operated individually.

Warning!



When extending/retracting the roller sunblinds, make sure that no one is in danger of being injured by the closing procedure. The extending/retracting of the roller sunblinds can be immediately halted by releasing the switch or, if the switch was pressed past the resistance point and released, by pressing the switch in any direction.

- ▶ Switch on the ignition (▷ page 315).

Operating front roller sunblind

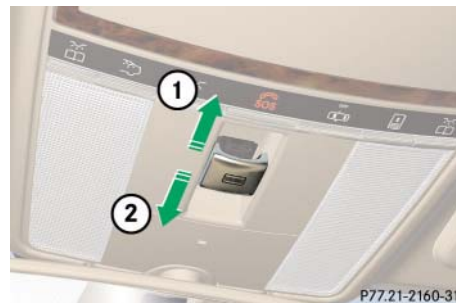

Roof panel switch

- ① Extend front roller sunblind
- ② Retract front roller sunblind

- ▶ **Extending or retracting:** Move the roof panel switch to the resistance point in the required direction of arrow ① or ② until the front roller sunblind has reached the desired position.
- ▶ **Express-extending:** Move the roof panel switch past the resistance point in direction of arrow ① and release.
The front roller sunblind extends completely.

- ▶ **Stopping during Express-extending:** Move the roof panel switch in any direction.

Operating rear roller sunblind from front

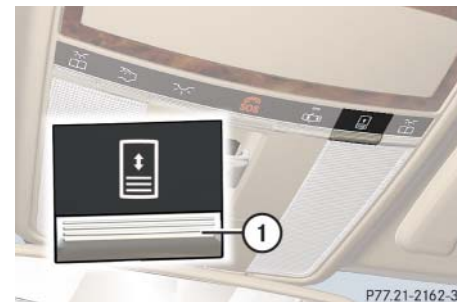

- ① Extending and retracting
- ▶ **Extending or retracting:** Press button ① until the rear roller sunblind has reached the desired position.
- i** To change directions, you must first extend or retract the rear roller sunblind completely.

Panorama roof with power tilt/sliding panel*

Operating rear roller sunblind from rear



Rear door control panel

- ① Retracting
- ② Extending
- ▶ **Extending:** Press button ② on the rocker switch until the rear roller sunblind has reached the desired position.
- ▶ **Retracting:** Press button ① on the rocker switch until the rear roller sunblind has reached the desired position.

Opening and closing panorama roof with power tilt/sliding panel

Warning!



When opening or closing the tilt/sliding panel, make sure that there is no danger of anyone being harmed by the opening or closing procedure.

The opening procedure of the tilt/sliding panel can be immediately halted by releasing the switch or, if the switch was moved past the resistance point and released, by moving the switch in any direction.

The closing procedure of the tilt/sliding panel can be immediately halted by releasing the switch.

The panorama roof with power tilt/sliding panel is made out of glass. In the event of an accident, the glass may shatter. This may result in an opening in the roof.

In a vehicle rollover, occupants not wearing their seat belts or not wearing them properly may be thrown out of the opening.

Such an opening also presents a potential for injury for occupants wearing their seat belts properly as entire body parts or portions of them may protrude from the passenger compartment.

When leaving the vehicle, always remove the SmartKey or SmartKey with KEYLESS-GO* from the starter switch, take it with you, and lock the vehicle. Do not leave children unattended in the vehicle, or with access to an unlocked vehicle. Unsupervised use of vehicle equipment can cause an accident and/or serious personal injury.

! *To avoid damaging the seals, do not transport any objects with sharp edges which can stick out of the tilt/sliding panel.*

Do not open the tilt/sliding panel if there is snow or ice on the roof, as this could result in malfunctions.

The tilt/sliding panel can be opened or closed manually should an electrical malfunction occur (▷ page 617).

Panorama roof with power tilt/sliding panel*

i When the panorama roof with power tilt/sliding panel is open, resonance noises may result in addition to the usual wind noises. They are caused by minimal pressure changes in the passenger compartment. To reduce or eliminate these noises, change the position of the panorama roof with power tilt/sliding panel or open a side window slightly.

i You can also open or close the tilt/sliding panel using the SmartKey, see “Summer opening feature” (▷ page 355) and “Convenience closing feature” (▷ page 356).

Depending on current position, the tilt/sliding panel may also open or close when the air recirculation button  in the control panel of the climate control (▷ page 424), is pressed and held for 2 seconds.

The tilt/sliding panel only operates with the roller sunblinds extended.

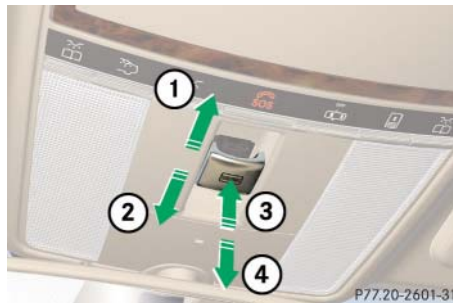

Roof panel switch

- ① Push back to slide roof panel open
 - ② Push forward to slide roof panel closed
 - ③ Push up to raise roof panel
 - ④ Pull down to lower roof panel
- ▶ Switch on the ignition (▷ page 315).
 - ▶ To open, close, raise, or lower the tilt/sliding panel, move the roof panel switch to resistance point in the required direction of arrows ① to ④.

Release the roof panel switch when the tilt/sliding panel has reached the desired position.

i If the front roller sunblind is retracted while being raised, it will extend first.

- ▶ **Express-opening:** Move the roof panel switch past the resistance point in direction of arrow ① and release.

The tilt/sliding panel opens completely.

- ▶ **Express-raising:** Move the roof panel switch past the resistance point in direction of arrow ③ and release.

The tilt/sliding panel raises completely.

- ▶ **Stopping during Express-operation:** Move the roof panel switch in any direction.

i You cannot automatically close and lower the panorama roof with power tilt/sliding panel.

Panorama roof with power tilt/sliding panel*

Synchronizing

The tilt/sliding panel and front roller sunblinds must be synchronized

- ▶ after the tilt/sliding panel has been closed manually (▷ page 617)
- ▶ after a malfunction
- ▶ if the panorama roof with power tilt/sliding panel can only be opened with a jerking motion

Tilt/sliding panel and front roller sunblind

- ▶ Switch on the ignition (▷ page 315).

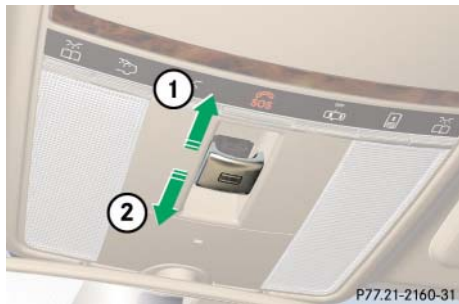

- ▶ Move and hold the roof panel switch in direction of arrow ② until the front roller sunblind is fully retracted.
- ▶ Keep holding the roof panel switch in direction of arrow ② for approximately 1 second.
- ▶ Move and hold the roof panel switch in direction of arrow ① until the front roller sunblind is fully extended.
- ▶ Move and hold the roof panel switch in direction of arrow ① until the tilt/sliding panel is slightly opened.
- ▶ Move and hold the roof panel switch in direction of arrow ② until the tilt/sliding panel is fully closed.
- ▶ Keep holding the roof panel switch in direction of arrow ② for approximately 1 second.
- ▶ Check the Express-open feature of the tilt/sliding panel (▷ page 445).

If the tilt/sliding panel opens completely, the roof is synchronized. Otherwise repeat the above steps.

Rear roller sunblind

- ▶ Switch on the ignition (▷ page 315).

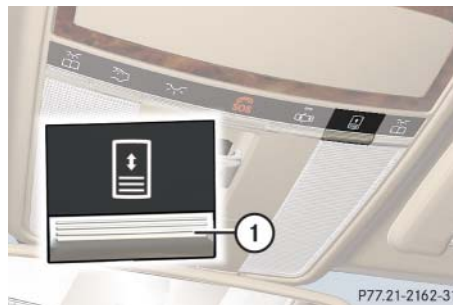

- ▶ Press button ① until the rear roller sunblind is fully retracted.
- ▶ Keep holding button ① for approximately 1 second.

▼ Loading and storing

Roof rack*

Warning!



Only use roof racks approved by Mercedes-Benz for your vehicle model to avoid damage to the vehicle.

Follow the manufacturer's installation instructions. Otherwise, an improperly attached roof rack system or its load could become detached from the vehicle.

Do not exceed the maximum roof load of 220 lb (100 kg).

Take into consideration that when the roof rack is loaded, the handling characteristics are different from those when operating the vehicles without the roof rack loaded.

! Load the roof rack in such a way that the vehicle cannot be damaged while driving.

Make sure

- you can fully raise tilt/sliding sunroof or the panorama roof with tilt/sliding panel*
- you can fully open the trunk

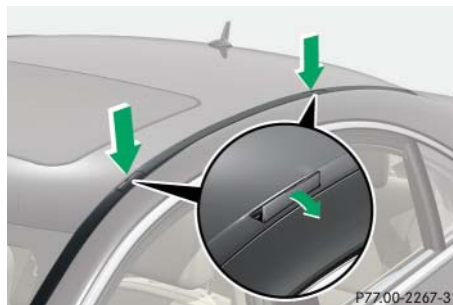

- ▶ Flip the covers upward.
- ▶ Only attach the roof-rack system to the anchorage points under the covers.

Observe manufacturer's instructions for installation.

Loading instructions

The total load weight including vehicle occupants and luggage/cargo should not exceed the load limit or vehicle capacity weight as indicated on the corresponding placard located on the driver's door B-pillar (▷ page 503).

Warning!



Always fasten items being carried as securely as possible using cargo tie-down hooks and fastening materials appropriate for the weight and size of the load.

In an accident, during hard braking or sudden maneuvers, loose items will be thrown around inside the vehicle and can cause injury to vehicle occupants unless the items are securely fastened in the vehicle.

To help avoid personal injury during a collision or sudden maneuver, exercise care when transporting cargo. Put luggage or cargo in the trunk if possible.



Loading and storing

▷▷ Do not pile luggage or cargo higher than the seat backs. Do not place anything on the rear-window shelf.

Never drive vehicle with trunk open. Deadly carbon monoxide (CO) gases may enter vehicle interior resulting in unconsciousness and death.

Storage compartments

Warning!



To help avoid personal injury during a collision or sudden maneuver, exercise care when storing objects in the vehicle. Put luggage or cargo in the trunk if possible. Do not pile luggage or cargo higher than the seat backs.

Parcel nets cannot secure hard or heavy objects.

Keep compartment lids closed. This will help to prevent stored objects from being thrown

about and injuring vehicle occupants during

- braking
- vehicle maneuvers or
- an accident.

Storage compartments in the front passenger compartment

Glove box

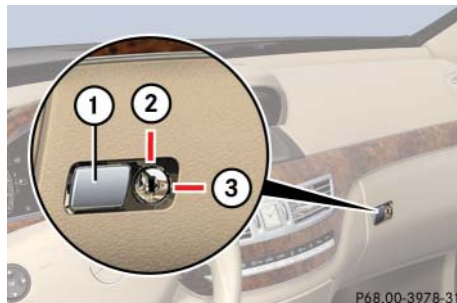

- ① Glove box lid release
- ② Unlocking glove box
- ③ Locking glove box

The glove box can be unlocked and locked with the mechanical key (▷ page 6 14).

▶ **Opening:** Press glove box lid release ①.

▶ **Closing:** Push the lid up.

▶ **Locking:** Insert the mechanical key into the glove box lock and turn it clockwise to position ③.

▶ **Unlocking:** Insert the mechanical key into the glove box lock and turn it counterclockwise to position ②.

Storage compartments in the front armrest



- ① Storage tray/telephone compartment
- ② Storage compartment (not with rear climate control system*)

- ▶ **Opening storage tray/telephone compartment:** Press button ① and swing armrest to left or right side.
- ▶ **Opening storage compartment:** Press button ② and swing center armrest upward.

Storage compartments below the front seats

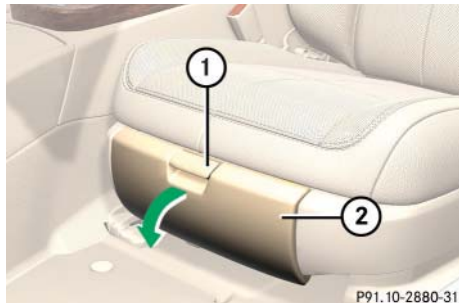

- ▶ **Opening:** Pull tab ① upward and fold cover ② forward.

Eyeglasses compartment

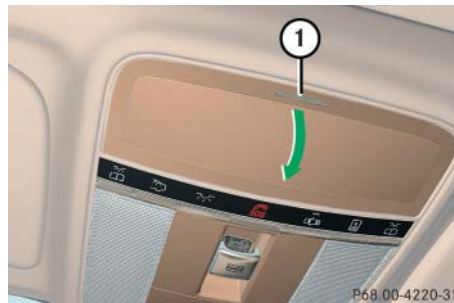

- ▶ **Opening:** Press mark ①.
- ▶ **Closing:** Swing eyeglasses compartment upward until it engages.

Parcel net in front passenger footwell

Warning!



The parcel net is intended for storing light-weight items only. Heavy objects, objects with sharp edges or fragile objects may not be transported in the parcel net. In an accident, during hard

braking, or sudden maneuvers, they could be injury to vehicle occupants.

The parcel net cannot protect transported goods in the event of an accident.

A small convenience parcel net is located in the front passenger footwell. It is for small and light items, such as road maps, mail, etc.

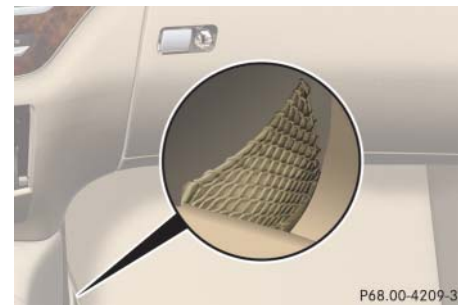

Loading and storing

Storage compartments in rear passenger compartment

Armrest with integrated storage compartment

! Before storing the armrest in the backrest, close the storage compartment cover.

! Do not sit on or lean your body weight against the armrest when it is folded down, as you could otherwise damage it.



Vehicles without control panel* in rear armrest

► **Opening:** Pull release catch ① and swing the cover upward.



Vehicles with control panel* in rear armrest

► **Opening:** Press button ① and swing the cover upward.

Storage compartment between rear seats

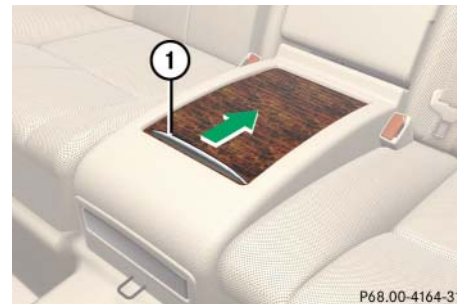

Vehicles without rear center seat*

► **Opening:** Pull handle ① backward in direction of arrow.

Rear storage box

! Do not sit on or lean your body weight against the armrest when it is folded down, as you could otherwise damage it.

i When the rear seats are in their basic position, you can open the cover more easily.



► **Opening:** Fold down rear center armrest and swing down cover ①.

Ruffled storage pockets



Ruffled storage pockets ① are located on the back of the front seats.

Warning!



Do not place objects with a combined weight of more than 4.4 lbs (2 kg) into the ruffled storage pocket. Otherwise, the Occupant Classification System OCS (> page 50) may not be able to properly approximate the occupant weight category.

The ruffled storage pocket is intended for storing light-weight items only.

Heavy objects, objects with sharp edges or fragile objects may not be transported in the ruffled storage pocket. In an accident, during hard braking, or sudden maneuvers, they could be thrown around inside the vehicle and cause injury to vehicle occupants.

The ruffled storage pocket cannot protect transported goods in the event of an accident.

Loading and storing

Cup holders

Warning!



In order to help prevent spilling liquids on vehicle occupants and/or vehicle equipment, only use containers that fit into the cup holder. Use lids on open containers and do not fill containers to a height where the contents, especially hot liquids, could spill during braking, vehicle maneuvers, or in an accident. Liquids spilled on vehicle occupants may cause serious personal injury. Liquids spilled on vehicle equipment may cause damage not covered by the Mercedes-Benz Limited Warranty.

When not in use, keep the cup holders closed. An open cup holder may cause injury to you or others when contacted during braking, vehicle maneuvers, or in an accident.

Keep in mind that objects placed in the cup holder may come loose during braking, vehicle maneuvers, or in an accident and be thrown around in the vehicle interior. Objects thrown around in the vehicle interior may cause an accident and/or serious personal injury.

Cup holder in front center console



- ① Mark
- ② Handle

- ▶ **Opening:** Press mark ① on the front.
- ▶ **Closing:** Fold cover in until it engages.

❗ You can remove the cup holder to clean it. Only clean it using clear, lukewarm water.

- ▶ **Removing:** Pull cup holder out by pulling silver handle ② upward in direction of arrow.
- ▶ **Inserting:** Press downward until it engages. While doing so, make sure that the word “Front” is in the proper installation position.

Cup holder in rear



Vehicles without control panel* in rear armrest

- ① Compartment for cup holder
- ▶ **Opening:** Press mark ① on the front.

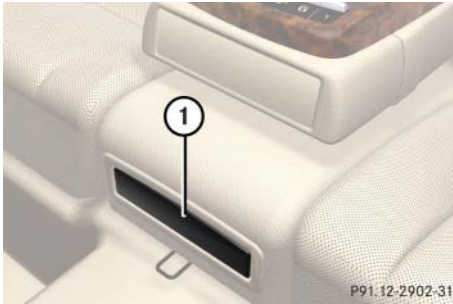

Vehicles with control panel* in rear armrest

① Compartment for cup holder

► **Opening:** Press front of cup holder ①.

Trunk

Storage spaces under trunk floor

You can fold back the front and rear parts of the trunk floor.

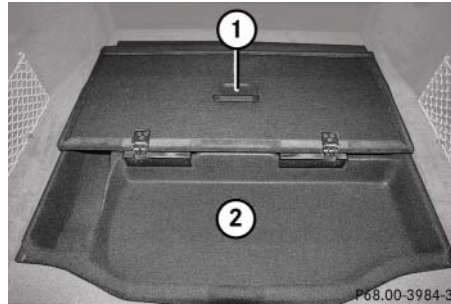

① Trunk floor

② Storage spaces

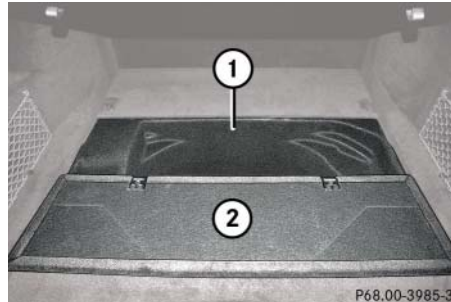

① Storage space

② Trunk floor

Cargo tie-down hooks

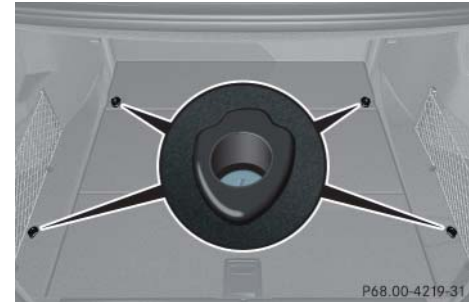

4 hooks are located in the trunk.

► Carefully secure cargo by applying even load on all hooks with rope of sufficient strength to hold down the cargo.

Loading and storing

Retaining hooks

Two hooks are located on the upper edge of the trunk and can be used to attach cargo items such as bags.



- ▶ Pull tab ① of retaining hook ② down.

! Do not use the retaining hooks to tie down cargo.

Parcel net in trunk

There is a pocket net on each side of the right and left trunk side walls to secure loads.

Retainer for Operator's Manual pouch

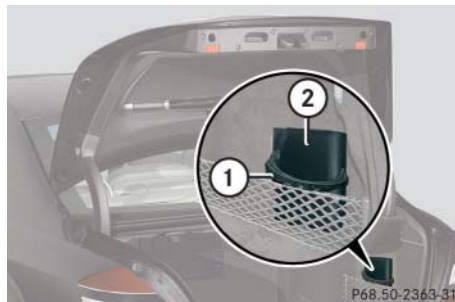

Use Velcro strap ① to fasten Operator's Manual pouch ② in place.

Umbrella holder

You can attach an umbrella to the trunk lid.

Warning!



Do not pull on the umbrella holder when you are closing the trunk lid. You could otherwise injure yourself on the trunk lid.

i You can purchase a suitable umbrella at any authorized Mercedes-Benz Center.



① Umbrella holder

② Umbrella

- ▶ Swing down holder ① in direction of arrow.
- ▶ Take umbrella ② out of holder ①.

▼ Useful features

Sun visors

Warning!



Do not use the vanity mirror while driving.

Keep the vanity mirrors in the sun visors closed while vehicle is in motion. Reflected glare can endanger you and others.



- ① Sun visor
- ② Vanity mirror cover
- ③ Vanity mirror lamp
- ④ Document holder

Glare from front

- ▶ Swing sun visor ① down.

Glare from front and sides

! Close vanity mirror cover ② (if open) before you disengage sun visor ① from the mounting and pivot it to the side.

- ▶ Disengage sun visor ① from the mounting.
- ▶ Pivot sun visor ① to the side.

Vanity mirror in sun visor

- ▶ To use vanity mirror, lift up cover ②.

Vanity mirror lamp ③ comes on.

i If you disengage sun visor ① from the mounting, vanity mirror lamp ② will switch off.

Document holder

You can use the plastic tab of document holder ④ to hold admission tickets, parking passes, or similar items in place.

Vanity mirror in rear



- ▶ **Opening:** Press mark ①.

The vanity mirror swings down in the direction of the arrow.

- ▶ **Closing:** Swing vanity mirror up until it engages.

Useful features

Rear window sunshade

The switches are on the rear doors.



- ① Opening
- ② Closing

You can also operate the rear window sunshade via COMAND (▷ page 227) or via the favorite button (▷ page 216).

- ▶ Switch on the ignition (▷ page 315).
- ▶ Press upper part ① of the rocker switch briefly to extend the sunshade.
- ▶ Press lower part ② of the rocker switch briefly to retract the sunshade.

i Operating the rear window sunshade from the rear is not possible if you activate the override switch (▷ page 67).

i If you operate the rear window sunshade via COMAND or via the favorite button, this takes precedence over the rear window sunshade buttons on the rear doors.

i The rear window sunshade is switched off at temperatures below -4°F (-20°C).

Ashtrays

Center console ashtray

Warning!



Remove ashtray only with vehicle standing still. Set the parking brake to secure vehicle from movement. Set automatic transmission to **P**. With the automatic transmission set to **P**, turn off the engine.

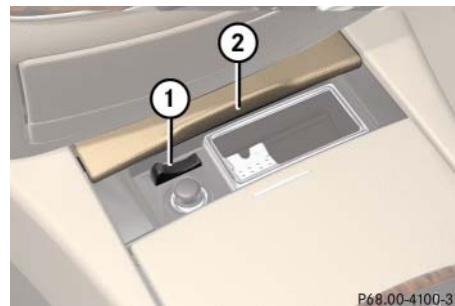

- ① Button for disengaging ashtray
- ② Cover plate

Opening ashtray

- ▶ Press mark on cover plate ② forward.

Removing ashtray insert

- ▶ Push sliding button ① to the left.
The ashtray is disengaged and slides out a short way.
- ▶ Remove the insert from the ashtray frame.

Reinstalling ashtray insert

- ▶ Install the insert by pushing it back into the frame until it engages.

Closing ashtray

- ▶ Briefly press mark on cover plate ② forward.

Rear door ashtray**Opening ashtray**

- ▶ Lift up the cover.

Removing ashtray insert

- ① Insert
- ▶ Press the open cover outwards beyond the stop.
Ashtray insert ① pops out of the holder.
- ▶ Remove insert by pulling it upward.

Reinstalling ashtray insert

- ▶ Install the insert by pushing it back into the frame until it engages.

Cigarette lighters**Warning!**

Never touch the heating element or sides of the lighter; they are extremely hot. Hold the knob only.

Make sure that any children traveling with you do not injure themselves or start a fire with the hot cigarette lighter.

When leaving the vehicle, always remove the SmartKey or SmartKey with KEYLESS-GO* from the starter switch, take it with you, and lock the vehicle. Do not leave children unattended in the vehicle, or with access to an unlocked vehicle. Unsupervised use of vehicle equipment may cause an accident and/or serious personal injury.

To avoid possible injury to children sitting in the rear seat, activate the override switch (▷ page 67). Activation of the override switch deactivates the rear center console lighter.

Useful features



① Center console cigarette lighter



① Rear center console lighter

- ▶ Switch on the ignition (▷ page 315).
- ▶ Push in cigarette lighter ①.

The lighter will pop out automatically when hot.

! *The lighter socket can be used to accommodate 12V DC electrical accessories (up to a maximum of 85 W) designed for use with the standard “cigarette lighter” plug type. Keep in mind, however, that connecting accessories to the lighter socket (for example extensive connecting and disconnecting, or using plugs that do not fit properly) can damage the lighter socket. With the socket damaged, the lighter may no longer be able to be placed in the heating (pushed-in) position, or the lighter may pop out too early with the lighter not hot enough.*

To help avoid damaging the cigarette lighter socket, we recommend connecting 12V DC electrical accessories designed for use with a standard “cigarette lighter” plug type to the 12V power outlets (▷ page 458) in your vehicle whenever possible.

i *Operation of the rear door lighters is only possible, if the override switch (▷ page 67) is deactivated.*

i *If the engine is off and the cigarette lighter is being used extensively, the vehicle battery may become discharged.*

Power outlet

The power outlet is located in the rear center console.

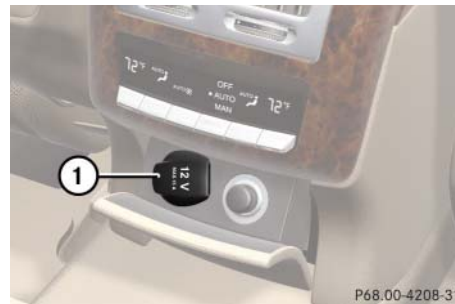

- ▶ Switch on the ignition (▷ page 315).
- ▶ Flip up cover ① and insert electrical plug (cigarette lighter type).

i *The power outlet can be used to accommodate 12V DC electrical accessories (e.g. air pump, auxiliary lamps) up to a maximum of 180 W.*

If the engine is off and the outlet is being used extensively, the vehicle battery may become discharged.

Telephone*

Warning!



Never operate radio transmitters equipped with a built-in or attached antenna (i.e. without being connected to an external antenna) from inside the vehicle while the engine is running. Doing so could lead to a malfunction of the vehicle's electronic system, possibly resulting in an accident and/or serious personal injury.

Radio transmitters, such as a portable telephone or a citizens band unit, should only be used inside the vehicle if they are connected to an antenna that is installed on the outside of the vehicle.

The external antenna must be approved by Mercedes-Benz. Please contact an authorized Mercedes-Benz Center for information on the installation of an approved external antenna. Refer to the radio transmitter operation instructions regarding use of an external antenna.

Warning!



Please do not forget that your primary responsibility is to drive the vehicle. A driver's attention to the road must always be his/her primary focus when driving. For your safety and the safety of others, we recommend that you pull over to a safe location and stop before placing or taking a telephone call.



If you choose to use the telephone¹ while driving, please use the hands-free device and only use the telephone when road, weather and traffic conditions permit. Some jurisdictions prohibit the driver from using a mobile telephone while driving a vehicle.

Only operate the COMAND (Cockpit Management and Data System)¹ if road, weather and traffic conditions permit.

Bear in mind that at a speed of just 30 mph (approximately 50 km/h), your vehicle is covering a distance of 44 feet (approximately 14 m) every second.

¹ Observe all legal requirements.

When the mobile phone is inserted in the cradle, you can operate the telephone using the following devices:

- mobile phone keypad
- COMAND telephone keypad (▷ page 115)
- buttons  and  on the steering wheel (▷ page 249)
- Voice Control* (▷ page 262)
- Bluetooth headset (▷ page 217)

See also separate operating manual for instructions on how to use the mobile phone.

 *Various mobile phone cradles can be installed in the cockpit. These mobile phone cradles can be obtained from an authorized Mercedes-Benz Center.*

The functions and services available to you while using the mobile phone depend on your service provider and the type of mobile phone you are using.

Useful features

The cradle is located in the center armrest.

- ▶ Open telephone compartment (▷ page 448).

Inserting mobile phone in mobile phone cradle

Once the mobile phone has been inserted in the mobile phone cradle, calls can only be made via the hands-free system* or Bluetooth headset*.

! Do not try to remove the mobile phone along with the cradle. You could otherwise damage the mobile phone cradle.

- ▶ If applicable, remove the cover for the external antenna connection from the back of the mobile phone and store it in a safe place. Be sure to comply with the mobile phone's operating instructions, as well.

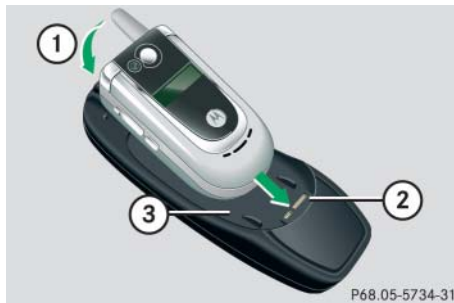

Example illustration

- ① Insert the mobile phone
 - ② Connector contact
 - ③ Mobile phone cradle
- ▶ Slide the lower end of the mobile phone into connector contact ② on cradle ③.
 - ▶ Push the top of the mobile phone in direction of arrow ①, until the lug on the mobile phone release button engages.

The mobile phone is connected to the network via the external antenna.

The mobile phone is linked to the hands-free device and the multifunction steering wheel.

The battery is charged depending on its charge status and the position of the SmartKey in the starter switch. The charge procedure will be indicated in the mobile phone's display.

You can place or receive phone calls. You can control other functions of the mobile phone via the control system (▷ page 249) or COMAND (▷ page 115).

i When you take the SmartKey or SmartKey with KEYLESS-GO* out of the starter switch, the mobile phone remains switched on for approx. 10 minutes. If you place or receive a call during this time, the mobile phone switches off 10 minutes after the call has been completed.

Removing mobile phone from mobile phone cradle



Example illustration

- ① Release catch for mobile phone
- ② Mobile phone cradle

i When using a flip-style mobile phone, open flip top before removing from the cradle while a call is connected. Otherwise, the call will be disconnected.

- ▶ Press release catch in direction of arrow ① and take mobile phone out of mobile phone cradle ②.

Changing mobile phone cradle

If you require a different cradle for your mobile phone, remove the present cradle before installing a new one.

Removing an existing mobile phone cradle

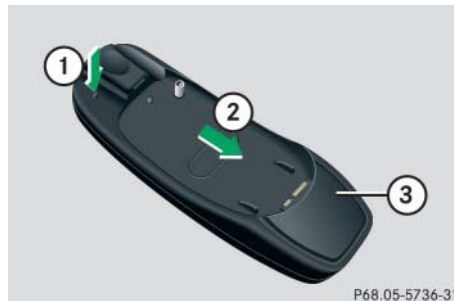

Example illustration

- ① To release the mobile phone cradle
- ② To remove the mobile phone cradle
- ③ Mobile phone cradle

- ▶ Press release button in direction of arrow ① and take mobile phone cradle ③ out in direction of arrow ②.

Installing a different mobile phone cradle

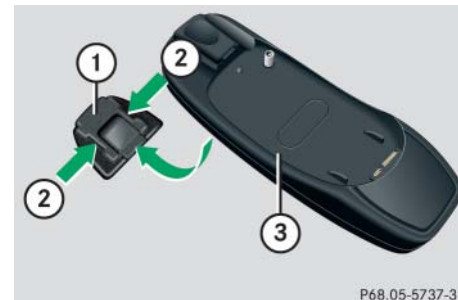

Example illustration

- ① Contact plate
 - ② Recesses
 - ③ Mobile phone cradle
- ▶ Insert mobile phone cradle ③ into recesses ② of contact plate ①.
 - ▶ Push mobile phone cradle ③ forward until it engages.

Useful features

Tele Aid

! *The initial activation of the Tele Aid system may only be performed by completing the subscriber agreement and placing an acquaintance call using the Information button . Failure to complete either of these steps will result in a system that is not activated.*

If you have any questions regarding activation, please call the Response Center at 1-800-756-9018 (in the USA) or 1-888-923-8367 (in Canada).

The Tele Aid system



(Telematic Alarm Identification on Demand)



The Tele Aid system consists of three types of response:

- automatic and manual emergency
- roadside assistance, and
- information



The Tele Aid system is operational providing that the vehicle's battery is charged, properly connected, not damaged and mobile phone and GPS coverage are available.

i *The Tele Aid system utilizes the mobile phone network for communication and the GPS (Global Positioning System) satellites for vehicle location. If either of these signals are unavailable, the Tele Aid system may not function and if this occurs, assistance must be summoned by other means.*

The speaker volume of a Tele Aid call can be adjusted when using the volume control on the multifunction steering wheel. To raise, press button  and to lower, press button  or use the COMAND volume thumbwheel  on the lower part of the front central console (▷ page 89).



- ▶ To activate, press the SOS button, the Roadside Assistance button  or the Information button , depending on the type of response required.

i *The SOS button is located above the interior rear view mirror (▷ page 464).*



The Roadside Assistance button  and the Information button  are located below the center armrest cover (▷ page 465).

Shortly after the completion of your Tele Aid acquaintance call, you will receive a user ID and password. By visiting www.mbusa.com and selecting "Tele Aid" (USA only), you will have access to account information, remote door unlock and more.

System self-check

Initially, after switching on the ignition, malfunctions are detected and indicated. If a malfunction is detected, the indicator lamps in the SOS button, the Roadside Assistance button  and the Information button  stay on longer than 10 seconds or do not come on. The message "Tele Aid not activated" or "Tele Aid inoperative" appears in the multifunction display.

Warning!

If the indicator lamps in the SOS button, in the Roadside Assistance button  and/or in the Information button  do not come on during the system self-check, or if any of these indicators remain illuminated continuously in red and/or the message “Tele Aid not activated” or “Tele Aid inoperative” is displayed in the multifunction display after the system self-check, a malfunction in the system has been detected.

If a malfunction is indicated as outlined above, the system may not operate as expected. Have the system checked at the nearest Mercedes-Benz Center as soon as possible.

Emergency calls

An emergency call is initiated automatically following an accident in which the emergency tensioning devices (ETDs) or air bags deploy.

An emergency call can also be initiated manually by opening the cover next to the interior rear view mirror labeled SOS, then briefly pressing the button located under the cover. For instructions on initiating an emergency call manually (▷ page 464).

Once the emergency call is in progress, the indicator lamp in the SOS button will begin to flash. The message:

- “**Connecting call**” appears in the multifunction display
- “**Emergency Call Activated**” appears in the COMAND display

and the audio system is muted. When the connection is established, the message:

- “**Call connected**” appears in the multifunction display
- “**Emergency Call Activated**” appears in the COMAND display

All information relevant to the emergency, such as the location of the vehicle (determined by the GPS satellite location system), vehicle model, identification number and color are generated.

 *During the emergency call message “Emergency Call Activated” is displayed, operation from COMAND is not possible. The automatic climate control can be still adjusted using the switches on the climate control panel.*

A voice connection between the Response Center and the occupants of the vehicle will be established automatically soon after the emergency call has been initiated. The Response Center will attempt to determine more precisely the nature of the accident provided they can speak to an occupant of the vehicle.

 *If no vehicle occupant responds, an ambulance will be sent to the vehicle immediately.*

Useful features

The Tele Aid system is available if

- it has been activated and is operational. Activation requires a subscription for monitoring services, connection, and cellular air time
- the relevant mobile phone and GPS coverage are available and pass the information on to the Response Center
- there is sufficient voltage in the vehicle batteries

i Location of the vehicle on a map is only possible if the vehicle is able to receive signals from the GPS satellite network and pass the information on to the Response Center.

Warning!



If the indicator lamp in the SOS button is flashing continuously and there was no voice connection to the Response Center established, then the Tele Aid system could not initiate an emergency call (e.g. the relevant mobile phone network is not available).

The message:

- **“Call failed”** appears in the multifunction display for approximately 10 seconds
- A pop-up window with the message: **“Call could not be connected! Please dial 911 directly using the mobile telephone keypad.”** appears in the COMAND display. Confirm the message pressing  (> page 82).

Should this occur, assistance must be summoned by other means.

Initiating an emergency call manually

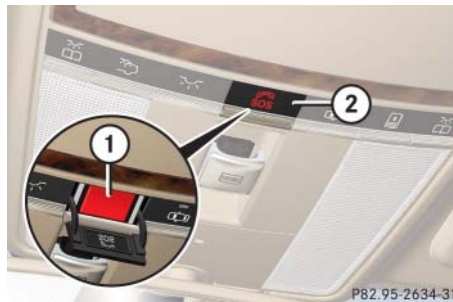

- ① SOS button
- ② Cover

- ▶ Briefly press button on cover ② to open.

Cover ② will open.

- ▶ Press SOS button ① (for longer than 2 seconds).

The indicator lamp in SOS button ① will flash until the emergency call is concluded.

- ▶ Wait for a voice connection to the Response Center.
- ▶ Close cover ② after the emergency call is concluded.



Warning!



If you feel at any way in jeopardy when in the vehicle (e.g. smoke or fire in the vehicle, vehicle in a dangerous road location), please do not wait for voice contact after you have pressed the emergency button. Carefully leave the vehicle and move to a safe location. The Response Center will automatically contact local emergency officials with the

vehicle's approximate location if they receive an automatic SOS signal and cannot make voice contact with the vehicle occupants.

Roadside Assistance button and Information button

The Roadside Assistance button  and the Information button  are located in the storage compartment below the front armrest (▷ page 448).



① Information button 

② Roadside Assistance button 

Roadside Assistance button

- ▶ Press and hold Roadside Assistance button  (for longer than 2 seconds).

A call to a Mercedes-Benz Roadside Assistance dispatcher will be initiated. The button will flash while the call is in progress. The message:

- “*Connecting call*” appears in the multifunction display
- “*Roadside Assistance Activated*” appears in the COMAND display and the audio system is muted.

When the connection is established, the message:

- “*Call connected*” appears in the multifunction display
- “*Roadside Assistance Activated*” appears in the COMAND display

The Tele Aid system will transmit data generating the vehicle identification number, model, color and location (subject to availability of cellular and GPS signals).

A voice connection between the Roadside Assistance dispatcher and the occupants of the vehicle will be established.



- ▶ Describe the nature of the need for assistance.

The Mercedes-Benz Roadside Assistance dispatcher will either dispatch a qualified Mercedes-Benz technician or arrange to tow your vehicle to the nearest authorized Mercedes-Benz Center. For services such as labor and/or towing, charges may apply. Refer to the Roadside Assistance Manual for more information.

These programs are only available in the USA:

- Sign and Drive services: Services such as jump start, a few gallons of fuel or the replacement of a flat tire with the vehicle spare tire are obtainable.

Useful features

i The indicator lamp in the Roadside Assistance button  remains illuminated in red for approximately 10 seconds during the system self-check after switching on the ignition (together with the SOS button and the Information button ).

See system self-check (▷ page 462) if the indicator lamp does not come on in red or stays on longer than approximately 10 seconds.

If the indicator lamp in the Roadside Assistance button  is flashing continuously and no voice connection to the Response Center was established, the Tele Aid system could not initiate a Roadside Assistance call (e.g. the relevant mobile phone network is not available). The message:

- “Call failed” appears in the multifunction display for approximately 10 seconds
- “Call could not be connected!” appears in the COMAND display. Confirm the message pressing  (▷ page 82).

Roadside Assistance calls can be terminated using button  on the multifunction steering wheel or COMAND (▷ page 115).

Information button

- ▶ Press and hold Information button  (for longer than 2 seconds).

A call to the Customer Assistance Center will be initiated. The button will flash while the call is in progress. The message:

- “Connecting call” appears in the multifunction display
 - “Information Call Activated” appears in the COMAND display
- and the audio system is muted.



When the connection is established, the message:

- “Call connected” appears in the multifunction display
- “Information Call Activated” appears in the COMAND display

The Tele Aid system will transmit data generating the vehicle identification number, model, color and location (subject to availability of cellular and GPS signals).

A voice connection between the Customer Assistance Center representative and the occupants of the vehicle will be established. Information regarding the operation of your vehicle, the nearest authorized Mercedes-Benz Center or Mercedes-Benz USA products and services is available to you.

For more details concerning the Tele Aid system, please visit www.mbusa.com and use your ID and password (sent to you separately) to learn more (USA only).

i The indicator lamp on the Information button  remains illuminated in red for approximately 10 seconds during the system self-check after switching on the ignition (together with the SOS button and the Roadside Assistance button .

See system self-check (▷ page 462) if the indicator lamp does not come on in red or stays on longer than approximately 10 seconds.

If the indicator lamp in the Information button  is flashing continuously and no voice connection to the Response Center was established, then the Tele Aid system could not initiate an Information call (e.g. the relevant

mobile phone network is not available). The message:

- “Call failed” appears in the multifunction display for approximately 10 seconds
- “Call could not be connected!” appears in the COMAND display. Confirm the message pressing  (▷ page 82).

Information calls can be terminated using button  on the multifunction steering wheel or COMAND (▷ page 115).

! If the indicator lamps do not start flashing after pressing one of the buttons or remain illuminated (in red) at any time, the Tele Aid system has detected a fault or the service is not currently activated, and may not initiate a call. Visit an Mercedes-Benz Center and have the system checked or contact the Response Center at 1-800-756-9018 (in the USA) or 1-888-923-8367 (in Canada) as soon as possible.

Destination Download to the COMAND System

i The components and operating principles of COMAND can be found on (▷ page 79).







Destination Download allows you access to a database of over 10,000,000 Points Of Interest (POIs) that can be downloaded to your vehicle's navigation system. If you know the destination the address can be downloaded. Or if you are unsure of your destination you can be provided with Points Of Interests near your location.

The Response Center can transmit destination data to the COMAND during the connection with the Roadside Assistance or Customer Assistance Center.

The transmitted data can contain address details for a Mercedes-Benz Center or POIs (Points of Interest).

Route guidance

A prompt appears for confirmation if route guidance to the address is to be started.

- ▶ Slide    or rotate    to select “Yes” menu item and confirm by pressing .

The system starts the route calculation and subsequently the route guidance to the defined address (▷ page 140).

i If you select “No”, you can save the address in your address book (▷ page 202).

i The destination download feature is available if the relevant mobile phone network is available and data connection is possible.

Call priority

If other service calls such as a Roadside Assistance call or Information call are active, an emergency call is still possible. In this case, the emergency call will take priority and override all other active calls.

Useful features

i The indicator lamp in the respective button flashes until the call is concluded. Calls can only be terminated by a Response Center or Customer Assistance Center representative except Roadside Assistance and Information calls, which can also be terminated by pressing button  on the multifunction steering wheel or COMAND (▷ page 115).

! If the indicator lamp continues to flash or the system does not terminate the call at all, contact the Response Center at 1-800-756-9018 (in the USA) or 1-888-923-8367 (in Canada), or Mercedes-Benz Customer Assistance at 1-800-FOR-MERCEdes (1-800-367-6372) in the USA or Customer Service at 1-800-387-0100 in Canada.

i When a Tele Aid call has been initiated, the audio system is muted. The optional mobile phone (if installed) switches off. If you must use this phone, the vehicle must be parked. Unplug the telephone, switch it on and place the call. The COMAND navigation system (if engaged) will continue to run. The multifunction display in the instrument cluster is available for use, but spoken commands are not available.

i You can exit Roadside Assistance and/ or the information display during an active connection and call up the COMAND application last selected. To do so, select “Back”. Meanwhile, mute remains active (▷ page 79).

Remote door unlock

In case you have locked your vehicle unintentionally (e.g. SmartKey inside vehicle), and the reserve SmartKey is not handy:

- ▶ Contact the Mercedes-Benz Response Center at 1-800-756-9018 (in the USA) or 1-888-923-8367 (in Canada).

You will be asked to provide your password which you provided when you completed the subscriber agreement.

or

- ▶ Contact the Tele Aid web page via Internet using the ID and password sent to you shortly after the completion of your acquaintance call.

- ▶ Then return to your vehicle and pull the trunk lid handle for a minimum of 20 seconds until the SOS button begins to flash.

The message: “Call connecting” appears in the multifunction display and the SOS button is flashing.

The Response Center will then unlock your vehicle with the remote door unlocking feature.

i The remote door unlock feature is available if the relevant mobile phone network is available and data connection is possible.

The SOS button will flash and the message: “Call connecting” appears in the multifunction display to indicate receipt of the door unlock command.

Once the vehicle is unlocked, a Response Center specialist might attempt to establish voice contact with the vehicle occupants.

If the trunk lid handle was pulled for more than 20 seconds before door unlock authorization was received by the Response Center, you must wait 15 minutes before pulling the trunk lid handle again.

Remote door lock

If you have forgotten to lock your vehicle and are no longer near it, you can have it locked remotely through the Response Center.

The vehicle can be remotely locked within 4 days after the ignition has been switched off.

- ▶ Contact the Mercedes-Benz Response Center at 1-800-756-9018 (in the USA) or 1-888-923-8367 (in Canada).

You will be asked to provide your password which you provided when you completed the subscriber agreement.

When you are inside your vehicle the next time and switch on the ignition, the message “Tele Aid Doors locked by remote control” will appear on the multifunction display.

i *The remote door lock feature is available if the relevant mobile phone network is available and data connection is possible.*

Automatic Maintenance Call

The 2007 S-Class is equipped with a feature which considerably enhances the care of your vehicle. Just prior to your vehicle reaching a maintenance milestone Tele Aid will initiate a message informing the service center, important vehicle maintenance information and the vehicle is due for a service appointment. The message is transmitted in the background with no driver interaction necessary. This feature allows your preferred Mercedes-Benz Center to significantly improve the process of arranging your service appointment and ensures that your vehicle receives the best possible care.

i *The Automatic Maintenance Call feature is available if the relevant mobile phone network is available and data connection is possible.*

Stolen Vehicle Recovery services

In the event your vehicle was stolen:

- ▶ Report the incident to the police.
The police will issue a numbered incident report.
- ▶ Pass this number on to the Mercedes-Benz Response Center along with your password issued to you when you subscribed to the service.

The Response Center will then attempt to covertly contact the vehicle’s Tele Aid system. Once the vehicle is located, the Response Center will contact the local law enforcement and you. The vehicle’s location will only be provided to law enforcement.

i *When the anti-theft alarm or the tow-away alarm stays on for more than 30 seconds, a call is initiated automatically to the Response Center. See anti-theft alarm system (▷ page 75) and tow-away alarm (▷ page 76).*

Useful features

Garage door opener

The integrated remote control is capable of operating up to three separately controlled devices. It provides a convenient way to replace up to three hand-held remote controls used to operate devices such as garage door openers, gate openers, or other devices compatible with HomeLink® or some other systems.

Before the integrated remote control can be used, it must be programmed to the garage door opener, gate operator or other device you wish to operate. See the following instructions for programming information.

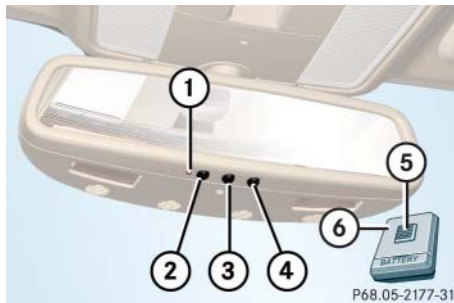

Interior rear view mirror with integrated remote control

- ① Indicator lamp
- ② ③ ④ Signal transmitter button
Needed for programming (not part of vehicle equipment):
- ⑤ Hand-held remote control of garage door opener, gate operator or other device
- ⑥ Hand-held remote control button

Warning!



Before programming the integrated remote control to a garage door opener or gate operator, make sure people and objects are out of the way of the device to prevent potential harm or damage. When programming a garage door opener, the door moves up or down. When programming a gate operator, the gate opens or closes.

Do not use the integrated remote control with any garage door opener that lacks safety stop and reverse features as required by U.S. federal safety standards (this includes any garage door opener model manufactured before April 1, 1982). A garage door that cannot detect an object – signaling the door to stop and reverse – does not meet current U.S. federal safety standards.

When programming a garage door opener, park the vehicle outside the garage.

Do not run the engine while programming the integrated remote control. Inhalation of exhaust gas is hazardous to your health. All exhaust gas contains carbon monoxide (CO), and inhaling it can cause unconsciousness and possible death.

Programming integrated remote control

Step 1:

- ▶ Switch on the ignition (▷ page 315).

Step 2:

- ▶ If you have previously programmed a signal transmitter button and wish to retain its programming, proceed to step 3.

If you are programming the integrated remote control for the first time, press and hold the two outer signal transmitter buttons ② and ④ and release them only when the indicator lamp ① begins to flash after approximately 20 seconds (do not hold the button for

longer than 30 seconds). This procedure erases any previous settings for all three channels and initializes the memory.

If you later wish to program a second and/or third hand-held transmitter to the remaining two signal transmitter buttons, do not repeat this step and begin directly with step 3.

Step 3:

- ▶ Hold the end of the hand-held remote control ⑤ of the device you wish to train approximately 2 to 5 in (5 to 12 cm) away from the signal transmitter button (②, ③ or ④) to be programmed, while keeping the indicator lamp ① in view.

Step 4:

- ▶ Using both hands, simultaneously press the hand-held remote control button ⑥ and the desired signal transmitter button (②, ③ or ④). Do not release the buttons until step 5 is completed.

The indicator lamp ① will flash, first slowly and then rapidly.

i *The indicator lamp ① flashes immediately the first time the signal transmitter button is programmed. If this button has already been programmed, the indicator lamp will only start flashing after 20 seconds.*

Step 5:

- ▶ After the indicator lamp ① changes from a slow to a rapidly flashing light, release the hand-held remote control button and the signal transmitter button.

Step 6:

- ▶ Press and hold the just-trained signal transmitter button (②, ③ or ④) and observe the indicator lamp ①.

If the indicator lamp ① stays on constantly, programming is complete and your device should activate when the respective signal transmitter button (②, ③ or ④) is pressed and released.

Useful features

i If the indicator lamp ① flashes rapidly for about 2 seconds and then turns to a constant light, continue with programming steps 8 through 12 as your garage door opener may be equipped with the “rolling code” feature.

Step 7:

- ▶ To program the remaining two signal transmitter buttons, repeat the steps above starting with step 3.

Rolling code programming

To train a garage door opener (or other rolling code devices) with the rolling code feature, follow these instructions after completing the “Programming” portion (steps 1 through 6) of this text. (A second person may make the following training procedures quicker and easier.)

Step 8:

- ▶ Locate “training” button on the garage door opener motor head unit.

Exact location and color of the button may vary by garage door opener brand. Depending on manufacturer, the

“training” button may also be referred to as “learn” or “smart” button. If there is difficulty locating the transmitting button, refer to the garage door opener operator’s manual.

Step 9:

- ▶ Press the “training” button on the garage door opener motor head unit.

The “training light” is activated.

You have 30 seconds to initiate the following two steps.

Step 10:

- ▶ Return to the vehicle and firmly press, hold for 2 seconds and release the programmed signal transmitter button (②, ③ or ④).

Step 11:

- ▶ Press, hold for 2 seconds and release same signal transmitter button a second time to complete the training process.

i Some garage door openers (or other rolling code equipped devices) may require you to press, hold for 2 seconds and release the same signal transmitter button a third time to complete the training process.

Step 12:

- ▶ Confirm the garage door operation by pressing the programmed signal transmitter button (②, ③ or ④).

Step 13:

- ▶ To program the remaining two signal transmitter buttons, repeat the steps above starting with step 3.

Gate operator/Canadian programming

Canadian radio-frequency laws require transmitter signals to “time-out” (or quit) after several seconds of transmission which may not be long enough for the integrated signal transmitter to pick up the signal during programming. Similar to this Canadian law, some U.S. gate operators are designed to “time-out” in the same manner.

If you live in Canada or if you are having difficulties programming a gate operator (regardless of where you live) by using the programming procedures, replace step 4 with the following:

Step 4:

- ▶ Press and hold the signal transmitter button (②, ③ or ④). Do not release this button until it has been successfully trained.
- ▶ While still holding down the signal transmitter button (②, ③ or ④), “cycle” your hand-held remote control button ⑥ as follows: Press and hold button ⑥ for 2 seconds, then release it for 2 seconds, and again press and hold it for 2 seconds. Repeat this sequence on the hand-held remote control until the frequency signal has been learned. Upon successful training, the indicator lamp ① will flash slowly and then rapidly after several seconds.
- ▶ Proceed with programming step 5 and step 6 to complete.

i Upon completion of programming the integrated remote control, make sure you retain the hand-held remote control that came with the garage door opener, gate operator or other device. You may need it for use in other vehicles, for future programming of an integrated remote control, or simply for continued use as a hand-held remote control to operate the respective device in other situations.

Reprogramming a single signal transmitter button

To program a device using a signal transmitter button previously trained, follow these steps:

- ▶ Switch on the ignition (▷ page 315).
- ▶ Press and hold the desired signal transmitter button (②, ③ or ④). Do not release the button.
- ▶ The indicator lamp ① will begin to flash after 20 seconds. Without releasing the signal transmitter button, proceed with programming starting with step 3.

Operation of integrated remote control

- ▶ Switch on the ignition (▷ page 315).
- ▶ Select and press the appropriate integrated signal transmitter button (②, ③ or ④) to activate the remote controlled device.

The integrated remote control transmitter continues to send the signal as long as the button is pressed – up to 20 seconds.

Erasing integrated remote control memory

- ▶ Switch on the ignition (▷ page 315).
- ▶ Simultaneously press and hold down the outer signal transmitter buttons ② and ④, for approximately 20 seconds, until the indicator lamp ① flashes rapidly. Do not hold for longer than 30 seconds.

The codes of all three channels are erased.

Useful features

i If you sell your vehicle, erase the codes of all three channels.

Programming tips

If you are having difficulty programming the integrated remote control, here are some helpful tips:

- Check the frequency of the hand-held remote control ⑤ (typically located on the reverse side of the remote). The integrated remote control is compatible with radio-frequency devices operating between 288-399 MHz.
- Put a new battery in the hand-held remote control ⑤. This will increase the likelihood of the hand-held remote control sending a faster and more accurate signal to the integrated remote control.
- While performing step 3, hold the hand-held remote control ⑤ at different lengths and angles from the signal transmitter button (②, ③ or ④) you are programming. Attempt varying an-

gles at the distance of 2 to 5 inches (5 to 12 cm) away or the same angle at varying distances.

- If another hand-held remote control is available for the same device, try the programming steps again using that other hand-held remote control. Make sure new batteries are in the hand-held remote control before beginning the procedure.
- Straighten the antenna wire from the garage door opener assembly. This may help improve transmitting and/or receiving signals.

i Certain types of garage door openers are incompatible with the integrated remote control. If you should experience further difficulties with programming the integrated remote control, contact an authorized Mercedes-Benz Center, or call Mercedes-Benz Customer Assistance Center (in the USA only) at 1-800-FOR-MERCEdes, or Customer Service (in Canada) at 1-800-387-0100.

i USA only:

This device complies with Part 15 of the FCC Rules. Operation is subject to the following two conditions:

- (1) *This device may not cause harmful interference, and*
- (2) *this device must accept any interference received, including interference that may cause undesired operation.*

Any unauthorized modification to this device could void the user's authority to operate the equipment.

i Canada only:

This device complies with RSS-210 of Industry Canada. Operation is subject to the following two conditions:

- (1) *This device may not cause interference, and*
- (2) *this device must accept any interference received, including interference that may cause undesired operation of the device.*

Any unauthorized modification to this device could void the user's authority to operate the equipment.

Infrared reflecting windshield

Your vehicle is equipped with infrared reflecting glass, which reduces the amount of radiated heat entering the vehicle interior through the windows.

The infrared reflecting glass also prevents the transmission of signals through the glass by in-vehicle electronic devices (e.g. electronic toll collection devices).

To allow the use of these devices in the vehicle, transparent areas ① and ③ are placed in the windshield.

You can see them from certain angles when ambient light condition permit.



Vehicles without Night View Assist*

- ① Transparent area (located left and right to the cover of the rain light sensor)
- ② Cover of the rain light sensor
- ③ Transparent area



Vehicles with Night View Assist*

- ① Transparent area (located left to the cover of the rain light sensor)
- ② Cover of the rain light sensor
- ③ Transparent area

The first 1000 miles (1500 km)

Driving instructions

At the gas station

Engine compartment

Tires and wheels

Winter driving

Maintenance

Vehicle care



The first 1000 miles (1500 km)

In the “Operation” section you will find detailed information on operating, maintaining and caring for your vehicle.

The more cautiously you treat your vehicle during the break-in period, the more satisfied you will be with its performance later on.

- Drive your vehicle during the first 1000 miles (1500 km) at varying but moderate vehicle and engine speeds.
- During this period, avoid heavy loads (full throttle driving) and excessive engine speeds (no more than $\frac{2}{3}$ of maximum rpm in each gear).
- Avoid accelerating by kick-down.
- Do not attempt to slow the vehicle down by shifting to a lower gear using the gear selector lever.
- Select positions **3**, **2** or **1** only when driving at moderate speeds (for hill driving).
- Select **C** as the preferred shift program (▷ page 374) for the first 1000 miles (1500 km).

After 1000 miles (1500 km) you may gradually increase vehicle and engine speeds to the permissible maximum.

All of the above instructions, as may apply to your vehicle type, also apply when driving the first 1000 miles (1500 km) after the engine or the rear differential has been replaced.

 *Always obey applicable speed limits.*

▼ Driving instructions

Drive sensibly – save fuel

Fuel consumption, to a great extent, depends on driving habits and operating conditions.

To save fuel you should:

- Keep tires at the recommended tire inflation pressures.
- Remove unnecessary loads.
- Remove roof rack when not in use.
- Allow engine to warm up under low load use.
- Avoid frequent acceleration and deceleration.
- Have all maintenance work performed at the intervals specified in the Maintenance Booklet and as required by the Maintenance System (U.S. vehicles) or FSS PLUS (Canada vehicles). Contact an authorized Mercedes-Benz Center.

Fuel consumption is also increased by driving in cold weather, in stop-and-go traffic, on short trips, and in hilly area.

Drinking and driving

Warning!



Drinking and driving and/or taking drugs and driving are very dangerous combinations. Even a small amount of alcohol or drugs can affect your reflexes, perceptions and judgment.

The possibility of a serious or even fatal accident are greatly increased when you drink or take drugs and drive.

Do not drink or take drugs and drive or allow anyone to drive who has been drinking or taking drugs.

Pedals

Warning!



Make sure that absolutely no objects are obstructing the pedals' range of movement.

Keep the driver's footwell clear of all obstacles. If there are any floor mats or carpets in the footwell, make sure that the pedals still have sufficient clearance.

Power assistance

Warning!



With the engine not running, there is no power assistance for the brake and steering systems. In this case, it is important to keep in mind that a considerably higher degree of effort is necessary to brake and steer the vehicle.

Driving instructions

Brakes

Warning!



After driving in heavy rain for some time without applying the brakes or through water deep enough to wet brake components, the first braking action may be somewhat reduced and increased pedal pressure may be necessary to obtain expected braking effect. Maintain a safe distance from vehicles in front.

Resting your foot on the brake pedal will cause excessive and premature wear of the brake pads.

It can also result in the brakes overheating, thereby significantly reducing their effectiveness. It may not be possible to stop the vehicle in sufficient time to avoid an accident.

To help prevent brake disk corrosion after driving on wet road surfaces (particularly salted roads), it is advisable to brake the vehicle with considerable force prior to parking. The heat generated serves to dry the brakes.

If your brake system is normally only subjected to moderate loads, you should occasionally test the effectiveness of the brakes by applying above-normal braking pressure at higher speeds. This will also enhance the grip of the brake pads.

Warning!



Make sure not to endanger any other road users when carrying out these braking maneuvers.

Refer to the description of the Brake Assist System (BAS) (▷ page 71).

If the parking brake is released and the brake warning lamp in the instrument cluster stays on and there is no audible warning (EBP), the brake fluid level in the reservoir is too low.

Brake pad wear or a leak in the system may be the reason for low brake fluid in the reservoir.

Have the brake system inspected immediately. Contact an authorized Mercedes-Benz Center.

All checks and service work on the brake system should be carried out by qualified technicians only. Contact an authorized Mercedes-Benz Center.

Only install brake pads and brake fluid recommended by Mercedes-Benz.

Warning!

If other than recommended brake pads are installed, or other than recommended brake fluid is used, the braking properties of the vehicle can be degraded to an extent that safe braking is substantially impaired. This could result in an accident.

! *When driving down long and steep grades, relieve the load on the brakes by shifting into a lower gear to use the engine's braking power. This helps prevent overheating of the brakes and reduces brake pad wear.*

When using the engine's braking power, a drive wheel may not spin for an extended period of time, e.g. on slippery road surfaces. This may cause serious damage to the drivetrain which is not covered by the Mercedes-Benz Limited Warranty.

After hard braking, it is advisable to drive on for some time, rather than immediately park, so that the air stream can cool down the brakes faster.

Driving off

Apply the brakes to test them briefly after driving off. Perform this procedure only when the road is clear of other traffic.

Warm up the engine smoothly. Do not place full load on the engine until the operating temperature has been reached.

When starting off on a slippery surface, do not allow a drive wheel to spin for an extended period with the ESP[®] switched off. Doing so may cause serious damage to the drivetrain which is not covered by the Mercedes-Benz Limited Warranty.

! *Simultaneously depressing the accelerator pedal and applying the brake reduces engine performance and causes premature brake and drivetrain wear.*

Parking**Warning!**

Do not park this vehicle in areas where combustible materials such as grass, hay or leaves can come into contact with the hot exhaust system, as these materials could be ignited and cause a vehicle fire.

To reduce the risk of personal injury as a result of inadvertent vehicle movement, before turning off the engine and leaving the vehicle always:

- Keep right foot on brake pedal.
- Firmly depress parking brake pedal.
- Shift the automatic transmission to **P**.
- Slowly release brake pedal.
- When parked on an incline, turn front wheels towards the road curb.



Driving instructions



- Turn the SmartKey to starter switch position **0** and remove the SmartKey from the starter switch, or press the KEYLESS-GO* start/stop button (▷ page 317).
- Take the SmartKey or the SmartKey with KEYLESS-GO* with you and lock the vehicle when leaving.

! *Set the parking brake whenever parking or leaving the vehicle. In addition, shift the automatic transmission to **P**.*

When parking on hills, always turn front wheels towards the road curb.

Tires

Warning!



If you feel a sudden significant vibration or ride disturbance, or you suspect that possible damage to your vehicle has occurred, you should turn on the hazard warning flashers, carefully slow down, and drive with caution to an area which is a safe distance from the road.

Inspect the tires and the vehicle underbody for possible damage. If the vehicle or tires appear unsafe, have the vehicle towed to the nearest Mercedes-Benz Center or tire dealer for repairs.

Treadwear indicators (TWI) are required by law. These indicators are located in six places on the tread circumference and become visible at a tread depth of approximately $\frac{1}{16}$ in (1.6 mm), at which point the tire is considered worn and should be replaced.

The treadwear indicator appears as a solid band across the tread.

Warning!



Although the applicable federal motor vehicle safety laws consider a tire to be worn when the treadwear indicators (TWI) become visible at approximately $\frac{1}{16}$ in (1.6 mm), we recommend that you do not allow your tires to wear down to that level. As tread depth approaches $\frac{1}{8}$ in (3 mm), the adhesion properties on a wet road are sharply reduced.

Depending upon the weather and/or road surface (conditions), the tire traction varies widely.

Specified tire inflation pressures must be maintained. This applies particularly if the tires are subject to extreme operating conditions (e.g. high speeds, heavy loads, high ambient temperatures).

Warning!

Do not drive with a flat tire. A flat tire affects the ability to steer or brake the vehicle. You may lose control of the vehicle. Continued driving with a flat tire or driving at high speed with a flat tire will cause excessive heat build-up and possibly a fire.

Hydroplaning

Depending on the depth of the water layer on the road, hydroplaning may occur, even at low speeds and with new tires. Reduce vehicle speed, avoid track grooves in the road and apply brakes cautiously in the rain.

Tire traction

The safe speed on a wet, snow covered or icy road is always lower than on a dry road.

You should pay particular attention to the condition of the road whenever the outside temperatures are close to the freezing point.

Warning!

If ice has formed on the road, tire traction will be substantially reduced. Under such weather conditions, drive, steer and brake with extreme caution.

Mercedes-Benz recommends winter tires (▷ page 530) with a minimum tread depth of approximately $\frac{1}{6}$ in (4 mm) on all four wheels for the winter season to ensure normal balanced handling characteristics. On packed snow, they can reduce your stopping distance compared to summer tires.

Stopping distance, however, is still considerably greater than when the road is not covered with snow or ice. Exercise appropriate caution.

! *Avoid spinning of a drive wheel. This may cause serious damage to the drivetrain which is not covered by the Mercedes-Benz Limited Warranty.*

Driving instructions

Tire speed rating

Regardless of the tire speed rating, local speed limits should be obeyed. Use prudent driving speeds appropriate to prevailing conditions.

Warning!



Even when permitted by law, never operate a vehicle at speeds greater than the maximum speed rating of the tires.

Exceeding the maximum speed for which tires are rated can lead to sudden tire failure, causing loss of vehicle control and possibly resulting in an accident and/or serious personal injury and possible death, for you and for others.

An electronic speed limiter prevents your vehicle from exceeding a speed of 130 mph (210 km/h). The factory equipped tires on your vehicle may have a tire speed rating above the maximum speed permitted by the electronic speed limiter.

Make sure your tires have the required tire speed rating as specified for your vehicle in the “Technical data” section (▷ page 655), for example when purchasing new tires.

For information on how to identify the tire speed rating on a tire’s sidewall, see “Tire size designation, load and speed rating” (▷ page 518).

If you are uncertain about the correct reading of the information given on a tire’s sidewall, any authorized Mercedes-Benz Center will be glad to assist you.

Winter driving instructions

The most important rule for slippery or icy roads is to drive sensibly and to avoid abrupt acceleration, braking and steering maneuvers. Do not use the cruise control or DISTRONIC Plus* system under such conditions.

When the vehicle is in danger of skidding, move gear selector lever to position **N**. Try to keep the vehicle under control by corrective steering action.

 For information on driving with snow chains, see “Snow chains” (▷ page 531).

Warning!



On slippery road surfaces, never downshift in order to obtain braking action. This could result in drive wheel slip and reduced vehicle control. Your vehicle’s ABS will not prevent this type of control loss.

Road salts and chemicals can adversely affect braking efficiency. Increased pedal force may become necessary to produce the normal braking effect.

Depressing the brake pedal periodically when traveling at length on salt-strewn roads can bring road-salt impaired braking efficiency back to normal.

If the vehicle is parked after being driven on salt-treated roads, the braking efficiency should be tested as soon as possible after driving is resumed.

Warning!

Make sure not to endanger any other road users when carrying out these braking maneuvers.

Warning!

If the vehicle becomes stuck in snow, make sure that snow is kept clear of the exhaust pipe and from around the vehicle with the engine running. Otherwise, deadly carbon monoxide (CO) gases may enter vehicle interior resulting in unconsciousness and death.

To assure sufficient fresh air ventilation, open a window slightly on the side of the vehicle not facing the wind.

Warning!

The outside temperature indicator is not designed to serve as an ice-warning device and is therefore unsuitable for that purpose. Indicated temperatures just above the freezing point do not guarantee that the road surface is free of ice.

For more information on winter driving, see “Winter driving” (▷ page 530).

Standing water

! Do not drive through flooded areas or water of unknown depth. Before driving through water, determine its depth. Never accelerate before driving into water. The bow wave could force water into the engine and auxiliary equipment, thus damaging them.

If you must drive through standing water, drive slowly to prevent water from entering the passenger compartment or the engine compartment. Water in these areas could cause damage to electrical components or wiring of the engine or transmission, or could result in water being ingested by the engine through the air intake causing severe internal engine damage. Any such damage is not covered by the Mercedes-Benz Limited Warranty.

Driving instructions

Passenger compartment

Warning!



Always fasten items being carried as securely as possible.

In an accident, during hard braking or sudden maneuvers, loose items will be thrown around inside the vehicle, and cause injury to vehicle occupants unless the items are securely fastened in the vehicle.

The trunk is the preferred place to carry objects.

Driving abroad

Abroad, there is an extensive Mercedes-Benz service network at your disposal. If you plan to drive into areas which are not listed in the index of your Mercedes-Benz Center directory, you should request pertinent information from an authorized Mercedes-Benz Center.

Control and operation of radio transmitters

COMAND, radio, and telephone*

Warning!



Please do not forget that your primary responsibility is to drive the vehicle safely. Only operate the COMAND (Cockpit Management and Data System), radio, or telephone¹ if road, weather and traffic conditions permit.

Bear in mind that at a speed of just 30 mph (approximately 50 km/h), your vehicle is covering a distance of 44 feet (approximately 14 m) every second.

¹ Observe all legal requirements.

Telephones and two-way radios

Warning!



Never operate radio transmitters equipped with a built-in or attached antenna (i.e. without being connected to an external antenna) from inside the vehicle while the engine is running. Doing so could lead to a malfunction of the vehicle's electronic system, possibly resulting in an accident and/or personal injury.

Radio transmitters, such as a portable telephone or a citizens band unit should only be used inside the vehicle if they are connected to an antenna that is installed on the outside of the vehicle.

Refer to the radio transmitter operation instructions regarding use of an external antenna.

Catalytic converter

Your Mercedes-Benz is equipped with monolithic-type catalytic converters, an important element in conjunction with the oxygen sensors to achieve substantial control of the pollutants in the exhaust emissions. Keep your vehicle in proper operating condition by following our recommended maintenance instructions as outlined in your Maintenance Booklet.

! *To prevent damage to the catalytic converters, only use premium unleaded gasoline in this vehicle.*

Any noticeable irregularities in engine operation should be repaired promptly. Otherwise, excessive unburned fuel may reach the catalytic converter, causing it to overheat and potentially start a fire.

Warning!



As with any vehicle, do not idle, park or operate this vehicle in areas where combustible materials such as grass, hay or leaves can come into contact with the hot exhaust system, as these materials could be ignited and cause a vehicle fire.

Driving instructions

Emission control

Certain systems of the engine serve to keep the toxic components of the exhaust gases within permissible limits required by law.

These systems, of course, will function properly only when maintained strictly according to factory specifications. Any adjustments on the engine should, therefore, be carried out only by qualified Mercedes-Benz Center authorized technicians.

Engine adjustments should not be altered in any way. The specified service jobs must be carried out regularly according to Mercedes-Benz servicing requirements. For details please refer to the Maintenance Booklet.

Warning!



Inhalation of exhaust gas is hazardous to your health. All exhaust gas contains carbon monoxide (CO), and inhaling it can cause unconsciousness and possible death.

Do not run the engine in confined areas (such as a garage) which are not properly ventilated. If you think that exhaust gas fumes are entering the vehicle while driving, have the cause determined and corrected immediately. If you must drive under these conditions, drive only with at least one window fully open at all times.

Coolant temperature

During severe operating conditions, e.g. stop-and-go traffic, the coolant temperature may rise close to approximately 248°F (120°C).

The engine should not be operated with the coolant temperature over 248°F (120°C). Doing so may cause serious engine damage which is not covered by the Mercedes-Benz Limited Warranty.

Warning!



- Driving when your engine is badly overheated can cause some fluids, which may have leaked into the engine compartment, to catch fire. You could be seriously burned.
- Steam from an overheated engine can cause serious burns and can occur just by opening the hood. Stay away from the engine if you see or hear steam coming from it.

Stop the vehicle in a safe location away from other traffic. Turn off the engine, get out of the vehicle and do not stand near the vehicle until the engine has cooled down.

▼ At the gas station

Refueling

Warning!

Gasoline is highly flammable and poisonous. It burns violently and can cause serious injury. Never allow sparks, flame or smoking materials near gasoline!

Do not allow fuel to come into contact with skin or clothing. Direct skin contact with fuels and the inhalation of fuel vapors are damaging to your health.

Switch off the engine before refueling.

The fuel filler flap is located on the right-hand side of the vehicle towards the rear. Locking and unlocking the vehicle automatically locks and unlocks the fuel filler flap.

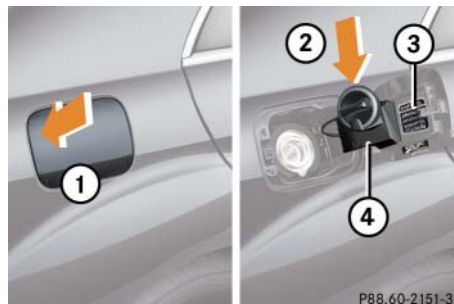

- ① To open fuel filler flap
- ② To insert fuel filler cap
- ③ Supplemental tire inflation pressure information (▷ page 510)
- ④ To insert fuel filler cap

- ▶ Turn off the engine (▷ page 366).
- ▶ Shift the automatic transmission to **P** (▷ page 367).
- ▶ Remove the SmartKey from the starter switch.

Vehicles with SmartKey with KEYLESS-GO*:

- ▶ Turn off the engine by pressing the KEYLESS-GO* button once (▷ page 366).
- ▶ Open the driver's door (this puts the starter switch in position **0**, same as with the SmartKey removed from the starter switch). The driver's door then can be closed again.
- ▶ Open the fuel filler flap by pushing at the point indicated by the arrow ①. The fuel filler flap springs open.
- ▶ Turn the fuel cap counterclockwise and hold on to it until possible pressure is released.



At the gas station

- ▷▷ Take off fuel filler cap and set it in direction of arrow ② in the recess on the inside of fuel filler flap ④.

To prevent fuel vapors from escaping into open air, fully insert filler nozzle unit.

- ▶ Only fill your tank until the filler nozzle unit cuts out – **do not top up or overfill**.

Warning!



Overfilling of the fuel tank may create pressure in the system which could cause a gas discharge. This could cause the gas to spray back out when removing the fuel pump nozzle, which could cause personal injury.

- ▶ Replace fuel cap by turning it clockwise until it audibly engages.
- ▶ Close the fuel filler flap.

i Only use premium unleaded gasoline with a minimum Posted Octane Rating of 91 (average of 96 RON/86 MON).

Information on gasoline quality can normally be found on the fuel pump.

More information on gasoline can be found in the Factory Approved Service Products pamphlet.

i Leaving the engine running and the fuel cap open can cause the yellow engine malfunction indicator lamp  to illuminate.

For more information, see the “Practical hints” section (▷ page 547).

Check regularly and before a long trip

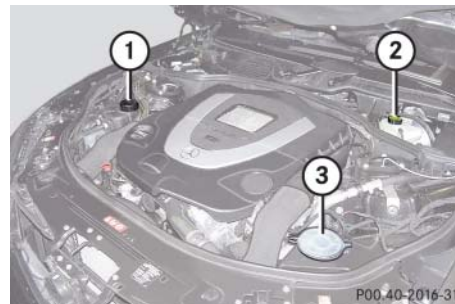

Example illustration from S 550

- ① Coolant level
- ② Brake fluid
- ③ Windshield washer and headlamp cleaning system

i Opening the hood (▷ page 492).

Windshield washer system and headlamp cleaning system

For more information on refilling the washer reservoir, see “Windshield washer system and headlamp cleaning system” (▷ page 498).

Coolant

For more information on coolant, see “Coolant level” (▷ page 497) and see “Fuels, coolants, lubricants, etc.” (▷ page 661).

Brake fluid

! *If you find that the brake fluid in the brake fluid reservoir has fallen to the minimum mark or below, have the brake system checked for brake pad thickness and leaks immediately. Notify an authorized Mercedes-Benz Center immediately. Do not add brake fluid as this will not solve the problem. For more information, see “Practical hints” (▷ page 545).*

For information on brake fluid, see “Brake fluid” (▷ page 663)

Engine oil level

For more information on engine oil, see “Engine oil” (▷ page 494).

Vehicle lighting

Check function and cleanliness. For more information on replacing light bulbs, see “Replacing bulbs” (▷ page 621).

For more information, see “Lighting” (▷ page 342).

Tire inflation pressure

For information on tire inflation pressure, see “Checking tire inflation pressure” (▷ page 511).

Engine compartment

Hood

Warning!



Do not pull the release lever while the vehicle is in motion. Otherwise the hood could be forced open by passing air flow.

This could cause the hood to come loose and injure you and others.

Opening

Warning!



You could be injured when the hood is open – even when the engine is switched off.

Parts of the engine can become very hot. To prevent burns, only touch the components described in the Operator's Manual and comply with all relevant safety precautions.



① Release lever

▶ Pull release lever ①.

The hood is unlocked.



② Handle for opening the hood

▶ Lift the hood slightly.

Handle ② will extend out of the radiator grille.

❗ To avoid damage to the windshield wipers or hood, never open the hood if the wiper arms are folded forward away from the windshield.

❗ To avoid damage to handle ② never pull up the hood on handle ②.

▶ Pull handle ② to its stop out of radiator grille.

▶ Lift bottom of hood at edge of radiator grille.

The hood will be automatically held open at shoulder height by gas-filled struts.

Warning!

To help prevent personal injury, stay clear of moving parts when the hood is open and the engine is running. Make sure the hood is properly closed before driving. When closing the hood, use extreme caution not to catch hands or fingers.

The radiator fan may continue to run for approximately 30 seconds or even restart after the engine has been turned off. Stay clear of fan blades.

Warning!

If you see flames or smoke coming from the engine compartment, or if the coolant temperature gauge indicates that the engine is overheated, do not open the hood. Move away from vehicle and do not open the hood until the engine has cooled down. If necessary, call the fire department.

Warning!

The engine is equipped with a transistorized ignition system. Because of the high voltage it is dangerous to touch any components (ignition coils, spark plug sockets, diagnostic socket) of the ignition system

- with the engine running
- while starting the engine
- if ignition is “on” and the engine is cranked manually

Closing**Warning!**

Be careful that you do not close the hood on anyone.

Make sure that the hood is securely engaged before driving off. Do not continue driving if the hood can no longer engage after an accident, for example. The hood could otherwise come loose while the vehicle is in motion and endanger you and others.

- ▶ Let the hood drop from a height of approximately 1 ft. (30 cm).
The hood will lock audibly.
- ▶ Check to make sure the hood is fully closed.

If you can raise the hood at a point above the headlamps, then it is not properly closed. Open it again and let it drop with somewhat greater force.

Engine compartment

Engine oil

The amount of oil your engine needs will depend on a number of factors, including driving style. Higher oil consumption can occur when

- the vehicle is new
- the vehicle is driven frequently at higher engine speeds

Engine oil consumption checks should only be made after the vehicle break-in period.

! Do not use any special lubricant additives, as these may damage the drive assemblies. Using special additives not approved by Mercedes-Benz may cause damage not covered by the Mercedes-Benz Limited Warranty.

More information on this subject is available at any Mercedes-Benz Center.

Checking engine oil level with the control system (S 600)





When checking the oil level

- the vehicle must be parked on level ground

- with the engine at operating temperature, the vehicle must have been stationary for at least 5 minutes with the engine turned off
- with the engine not at operating temperature yet, the vehicle must have been stationary for at least 30 minutes with the engine turned off

To check the engine oil level via the multifunction display, do the following:

i The menu overview can be found on (▷ page 243).

- ▶ Switch on the ignition (▷ page 315).
- ▶ Press  or  to select the menu "Service".
- ▶ Press  or  to select "Engine oil level".
- ▶ Press .



The following message is seen in the multifunction display:

*Engine oil level
Measuring now*

*Correct measurement
only if vehicle is level*

One of the following messages will subsequently appear in the multifunction display:

- *Engine oil level
OK*
- *Add 1.0 qts. engine oil
at next refueling
(Canada: 1.0 l)*
- *Add 1.5 qts. engine oil
at next refueling
(Canada: 1.5 l)*
- *Add 2.0 qts. engine oil
at next refueling
(Canada: 2.0 l)*

i If you want to interrupt the checking procedure, press button  or  on the multifunction steering wheel.

- ▶ If necessary, add engine oil.

For adding engine oil (▷ page 496).

For more information on engine oil, see the “Technical data” section (▷ page 661) and (▷ page 663).

Other display messages

If the SmartKey or KEYLESS-GO* start/stop button is not in position **2**, the following message will appear:

*For engine oil level,
turn on ignition*

- ▶ Switch on the ignition (▷ page 315).

If you see the message

*Waiting period for,
engine oil level
not complete*

- ▶ If engine is at operating temperature, wait 5 minutes before repeating check procedure.

- ▶ If engine is not at operating temperature yet, wait 30 minutes before repeating check procedure.

If you see the message

*Engine oil level
Not when engine on*

- ▶ Turn off the engine.
- ▶ If the engine is at operating temperature, wait 5 minutes before checking oil.
- ▶ If the engine is not at operating temperature yet, you must wait 30 minutes before checking oil.

If there is excess engine oil with the engine at operating temperature, the following message will appear:

*Engine oil level
Reduce oil level*

- ▶ Have excess oil siphoned or drained off. Contact an authorized Mercedes-Benz Center.

! *Excess oil must be siphoned or drained off. It could cause damage to the engine and catalytic converter (gasoline engine) not covered by the Mercedes-Benz Limited Warranty.*

For more information on messages in the multifunction display concerning engine oil, see the “Practical hints” section (▷ page 602).

Checking engine oil level with the oil dipstick (S 550)

When checking the oil level

- the vehicle must be parked on level ground
- with the engine at operating temperature, the vehicle must have been stationary for at least 5 minutes with the engine turned off
- with the engine not at operating temperature yet, the vehicle must have been stationary for at least 30 minutes with the engine turned off

Engine compartment

To check the engine oil level with the oil dipstick, do the following:

- ▶ Open the hood (▷ page 492).

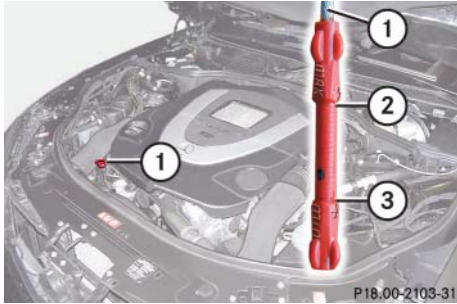

S 550

- ① Oil dipstick
- ② Upper mark
- ③ Lower mark

- ▶ Pull out oil dipstick ①.
- ▶ Wipe oil dipstick ① clean.
- ▶ Fully insert oil dipstick ① into the dipstick guide tube.
- ▶ Pull out oil dipstick ① again after approximately 3 seconds to obtain accurate reading.

The oil level is correct when it is between lower mark ③ (min.) and upper mark ② (max.) mark of the oil dipstick.

i The filling quantity between the upper and lower marks on the oil dipstick is approximately 2.1 US qt. (2.0 l).

- ▶ If necessary, add engine oil.

For adding engine oil (▷ page 496).

For more information on engine oil, see the “Technical data” section (▷ page 661) and (▷ page 663).

For more information on messages in the multifunction display concerning engine oil, see the “Practical hints” section (▷ page 602).

Adding engine oil

! Only use approved engine oils and oil filters required for vehicles with Maintenance System (U.S. vehicles) or FSS PLUS (Canada vehicles). For a listing of approved engine oils and oil filters, refer to the Factory Approved Service Products pamphlet in your vehicle literature portfolio, or contact an authorized Mercedes-Benz Center.

Using engine oils and oil filters of specification other than those expressly required for the Maintenance System (U.S. vehicles) or FSS PLUS (Canada vehicles), or changing of oil and oil filter at change intervals longer than those called for by the Maintenance System (U.S. vehicles) or FSS PLUS (Canada vehicles) will result in engine damage not covered by the Mercedes-Benz Limited Warranty.

Warning!



Parts of the engine can become very hot. To prevent burns, only touch the components described in the Operator’s Manual and comply with all relevant safety precautions.

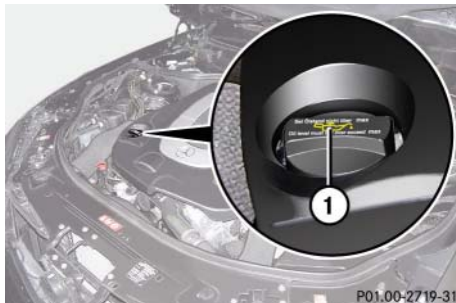

Example illustration from S 550

① Filler cap

- ▶ Unscrew filler cap ① from filler neck.
- ▶ Add engine oil as required. Be careful not to overfill with oil.

Be careful not to spill any oil when adding. Avoid environmental damage caused by oil entering the ground or water.

! *Excess oil must be siphoned or drained off. It will cause damage to the engine and catalytic converter not covered by the Mercedes-Benz Limited Warranty.*

- ▶ Screw filler cap ① back on filler neck.

For more information on engine, see the “Technical data” section (▷ page 661) and (▷ page 663).

Transmission fluid level

The transmission fluid level does not need to be checked. If you notice transmission fluid loss or gear shifting malfunctions, have an authorized Mercedes-Benz Center check the automatic transmission.

Active Body Control* (ABC*) fluid level

Regular fluid level check is not required. If you notice fluid leaks or malfunction messages in the multifunction display, have an authorized Mercedes-Benz Center check the ABC-system.

Coolant level

The engine coolant is a mixture of water and anticorrosion/antifreeze. To check the coolant level, the vehicle must be parked on level ground and the engine must be cool.

Warning!



In order to avoid any possibly serious burns:

- Use extreme caution when opening the hood if there are any signs of steam or coolant leaking from the cooling system, or if the coolant temperature gauge indicates that the coolant is overheated.
- Do not remove pressure cap on coolant reservoir if coolant temperature is above 158°F (70°C). Allow engine to cool down before removing cap. The coolant reservoir contains hot fluid and is under pressure.



Engine compartment



- Using a rag, slowly open the cap approximately $\frac{1}{2}$ turn to relieve excess pressure. If opened immediately, scalding hot fluid and steam will be blown out under pressure.
- Do not spill antifreeze on hot engine parts. Antifreeze contains ethylene glycol which may burn if it comes into contact with hot engine parts.

The coolant expansion tank is located on the passenger side of the engine compartment.

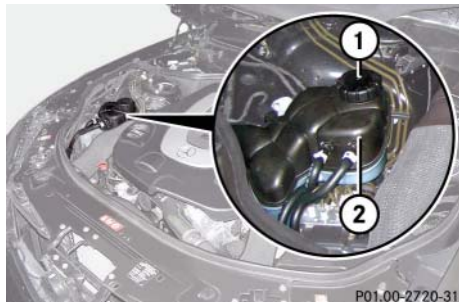

Example illustration from S 550

- ① Cap
- ② Coolant expansion tank

- ▶ Using a rag, turn cap ① slowly approximately one half turn counterclockwise to release any excess pressure.
- ▶ Continue turning the cap counterclockwise and remove it.

The coolant level is correct if the level

- for cold coolant: reaches the white marking (plastic bridge) inside the coolant expansion tank
 - for warm coolant: is approximately 0.6 in (1.5 cm) higher
- ▶ Add coolant as required.
 - ▶ Replace and tighten cap ①.

For more information on coolant, see the “Technical data” section (▷ page 665).

Windshield washer system and headlamp cleaning system

The washer fluid reservoir is located on the left-hand side of the engine compartment when looking in the direction of travel. It supplies the windshield washer system and headlamp cleaning system* with washer fluid.



S 550 with Airmatic

- ① Cap

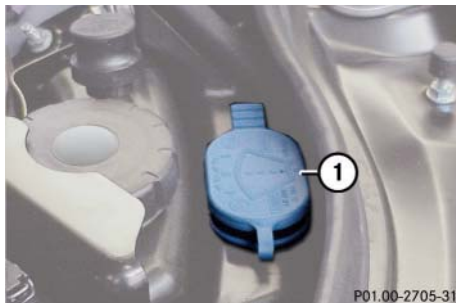

Vehicles with ABC*

① Cap

Fluid for the windshield washer system and the headlamp cleaning system is supplied from the windshield washer reservoir. It has a capacity of approximately:

- 6.93 US qt (6.56 l) in vehicles with Airmatic*
- 6.76 US qt (6.4 l) in vehicles with ABC*

During all seasons, add MB Windshield Washer Concentrate “MB SummerFit” to water. Premix the windshield washer fluid in a suitable container.

Warning!



Washer solvent/antifreeze is highly flammable. Do not spill washer solvent/antifreeze on hot engine parts, because it may ignite and burn. You could be seriously burned.

- ▶ **To open washer fluid reservoir:** pull tab of cap ① upward.
- ▶ Refill the reservoir with MB Windshield Washer Concentrate and water (or commercially available premixed windshield washer solvent/antifreeze, depending on ambient temperatures).

Always use washer solvent/antifreeze where temperatures may fall below freezing point. Failure to do so could result in damage to the washer system/reservoir.
- ▶ **To close washer fluid reservoir:** press cap ① onto filler hole until it engages.

❗ Only use washer fluid which is suitable for plastic lenses. Improper washer fluid can damage the plastic lenses of the headlamps.

For more information, see “Windshield and headlamp washer system” (> page 668).

Tires and wheels

See an authorized Mercedes-Benz Center for information on tested and recommended rims and tires for summer and winter operation. They can also offer advice concerning tire service and purchase.

Warning!



Replace rims or tires with the same designation, manufacturer and type as shown on the original part. See an authorized Mercedes-Benz Center for further information. If incorrectly sized rims and tires are mounted:

- The wheel brakes or suspension components can be damaged.
- The operating clearance of the wheels and the tires may no longer be correct.

Warning!



Worn, old tires can cause accidents. If the tire tread is badly worn, or if the tires have sustained damage, replace them.

When replacing rims, only use Genuine Mercedes-Benz wheel bolts specified for the particular rim type. Failure to do so can result in the bolts loosening and possibly an accident.

Retreaded tires are not tested or recommended by Mercedes-Benz, since previous damage cannot always be recognized on re-treads. The operating safety of the vehicle cannot be assured when such tires are used.

Important guidelines

- Only use sets of tires and rims of the same type and make.
- Tires must be of the correct size for the rim.
- Break in new tires for approximately 60 miles (100 km) at moderate speeds.
- Regularly check the tires and rims for damage. Dented or bent rims can cause tire inflation pressure loss and damage to the tire beads.
- If vehicle is heavily loaded, check tire inflation pressure and correct as required.
- Do not allow your tires to wear down too far. Adhesion properties on wet roads are sharply reduced at tread depths under $\frac{1}{8}$ in (3 mm).
- When replacing individual tires, you should mount new tires on the front wheels first (on vehicles with same-sized wheels all around).

Tire care and maintenance

Warning!



Regularly check the tires for damage. Damaged tires can cause tire inflation pressure loss. As a result, you could lose control of your vehicle.

Worn, old tires can cause accidents. If the tire tread is badly worn, or if the tires have sustained damage, replace them.

Regularly check your tire inflation pressure at least once a month. For more information on checking tire inflation pressure, see “Recommended tire inflation pressure” (▷ page 509).

Tire inspection

Every time you check your tire inflation pressure, you should also inspect your tires for the following:

- excessive treadwear (▷ page 502)
- cord or fabric showing through the tire’s rubber
- bumps, bulges, cuts, cracks or splits in the tread or side of the tire

Replace the tire if you find any of the above conditions.

Make sure you also inspect the spare tire periodically for condition and inflation. Spare tires will age and degrade over time even if never used, and thus should be inspected and replaced when necessary.

Life of tire

The service life of a tire is dependent upon varying factors including but not limited to:

- Driving style
- Tire inflation pressure
- Distance driven

Warning!



Tires and spare tire should be replaced after 6 years, regardless of the remaining tread.

Tires and wheels

Tread depth

Do not allow your tires to wear down too far. Adhesion properties on wet roads are sharply reduced at tread depths under $\frac{1}{8}$ in (3 mm).

Treadwear indicators (TWI) are required by law. These indicators are located in six places on the tread circumference and become visible at a tread depth of approximately $\frac{1}{16}$ in (1.6 mm), at which point the tire is considered worn and should be replaced.

Recommended minimum tire tread depth:

- Summer tires $\frac{1}{8}$ in (3 mm)
- Winter tires $\frac{1}{6}$ in (4 mm)

Warning!



Although the applicable federal motor safety laws consider a tire to be worn when the treadwear indicators (TWI) become visible at approximately $\frac{1}{16}$ in (1.6 mm), we recommend that you do not allow your tires

to wear down to that level. As tread depth approaches $\frac{1}{8}$ in (3 mm), the adhesion properties on a wet road are sharply reduced.

Depending upon the weather and/or road surface (conditions), the tire traction varies widely.

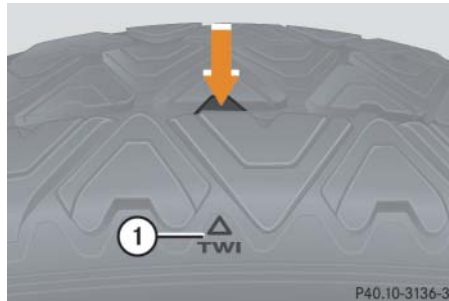

① TWI (TreadWear Indicator)

The treadwear indicator appears as a solid band across the tread.

Storing tires

! Keep unmounted tires in a cool, dry place with as little exposure to light as possible. Protect tires from contact with oil, grease and gasoline.

Cleaning tires

! Never use a round nozzle to power wash tires. The intense jet of water can result in damage to the tire.

Always replace a damaged tire.

Direction of rotation

Unidirectional tires offer added advantages, such as better hydroplaning performance. To benefit, however, you must make sure the tires rotate in the direction specified.

An arrow on the sidewall indicates the intended direction of rotation (spinning) of the tire.

i *Spare wheels may be mounted against the direction of rotation (spinning) even with a unidirectional tire for temporary use only until the regular drive wheel has been repaired or replaced. Always observe and follow applicable temporary use restrictions and speed limitations indicated on the spare wheel.*

Loading the vehicle

Two labels on your vehicle show how much weight it may properly carry.

- The Tire and Loading Information placard (Example A) or the Vehicle Tire Information placard (Example B) can be found on the driver's door B-pillar. This placard tells you important information about the number of people that can be in the vehicle and the total weight that can be carried in the vehicle. It also contains information on the proper size and recommended tire inflation pressures for the original equipment tires on your vehicle.
- The Certification label, also found on the driver's door B-pillar, tells you about the gross weight capacity of your vehicle, called the Gross Vehicle Weight Rating (GVWR). The GVWR includes the weight of the vehicle, all occupants, fuel and cargo. The Certification label also tells you about the front and rear axle weight capacity, called the Gross

Axle Weight Rating (GAWR). The GAWR is the total allowable weight that can be carried by a single axle (front or rear). Never exceed the GVWR or GAWR for either the front axle or rear axle.



① Driver's door B-pillar

Following is a discussion on how to work with the information contained on the two placards with regards to loading your vehicle.

Tires and wheels

Tire and Loading Information

Warning!



Do not overload the tires by exceeding the specified load limit or vehicle capacity weight as indicated on the placard on the driver's door B-pillar. Overloading the tires can overheat them, possibly causing a blowout. Overloading the tires can also result in handling or steering problems, or brake failure.

Your vehicle is equipped with either the Tire and Loading Information placard (Example A) or the Vehicle Tire Information placard (Example B).

i Data shown on placard examples are for illustration purposes only. Load limit data are specific to each vehicle and may vary from data shown in the illustrations below. Refer to placard on vehicle for actual data specific to your vehicle.

Placard (Example A)

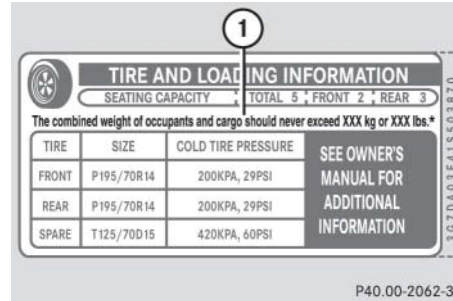

① Load limit information on the Tire and Loading Information placard

The placard showing the load limit information is located on the driver's door B-pillar. If your vehicle is equipped with the Tire and Loading Information placard (Example A), locate the statement "The combined weight of occupants and cargo should never exceed XXX kilograms or XXX lbs." on this placard. The combined weight of all occupants, cargo / luggage and trailer tongue load (if applicable) should never exceed the weight referenced in that statement.

Placard (Example B)

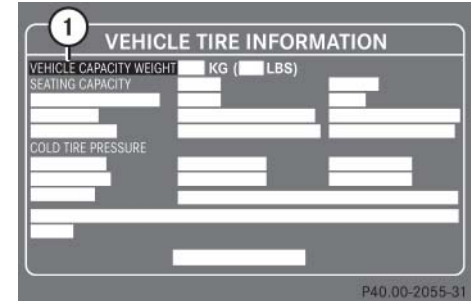

① Load limit information on the Vehicle Tire Information placard

The placard showing the load limit information is located on the driver's door B-pillar. If your vehicle is equipped with the Vehicle Tire Information placard (Example B), locate the heading "Vehicle Capacity Weight" on this placard. The combined weight of all occupants, cargo / luggage and trailer tongue (if applicable) should never exceed the weight listed next to vehicle capacity weight.

Seating capacity

The seating capacity gives you important information on the number of occupants that can be in the vehicle. Observe front and rear seating capacity. Your vehicle is equipped with either placard Example A or placard Example B located on the driver's door B-pillar (▷ page 503).

i Data shown on placard examples are for illustration purposes only. Seating data are specific to each vehicle and may vary from data shown in the illustrations below. Refer to placard on vehicle for actual data specific to your vehicle.

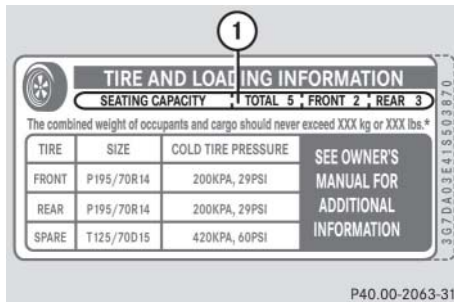

Placard (Example A)

① Seating capacity

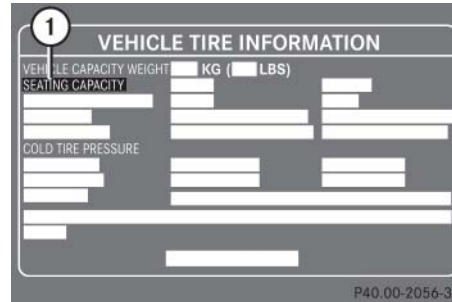

Placard (Example B)

① Seating capacity

Steps for determining correct load limit

The following steps have been developed as required of all manufacturers under Title 49, Code of U.S. Federal Regulations, Part 575 pursuant to the “National Traffic and Motor Vehicle Safety Act of 1966”.

Step 1 (Vehicles equipped with placard Example A)

- ▶ Locate the statement “The combined weight of occupants and cargo should never exceed XXX kg or XXX lbs.” on your vehicle’s placard.

Step 1 (Vehicles equipped with placard Example B)

- ▶ Locate the heading “Vehicle Capacity Weight” on your vehicle’s placard.

Step 2

- ▶ Determine the combined weight of the driver and passengers that will be riding in your vehicle.



Tires and wheels

▷▷ Step 3

- ▶ Subtract the combined weight of the driver and passengers from XXX kilograms or XXX lbs.

Step 4

- ▶ The resulting figure equals the available amount of cargo and luggage load capacity. For example, if the “XXX” amount equals 1400 lbs. and there will be five 150 lbs. passengers in your vehicle, the amount of available cargo and luggage load capacity is 650 lbs. (1400 – 750 (5 x 150) = 650 lbs.)

Step 5

- ▶ Determine the combined weight of luggage and cargo being loaded on the vehicle. That weight may not safely exceed the available cargo and luggage load capacity calculated in step 4.

Step 6 (if applicable)

- ▶ If your vehicle will be towing a trailer, load from your trailer will be transferred to your vehicle. Consult this manual to determine how this reduces the available cargo and luggage load capacity of your vehicle (▷ page 508).

The following table shows examples on how to calculate total and cargo load capacities with varying seating configurations and number and size of occupants. The following examples use a load limit of 1500 lbs. **This is for illustration purposes only.** Make sure you are using the actual load limit for your vehicle stated on the vehicle’s placard (▷ page 504).

Example	Combined weight limit of occupants and cargo from placard	Number of occupants (driver and passengers)	Seating configuration	Occupants weight	Combined weight of all occupants	Available cargo/luggage and trailer tongue weight (total load limit or vehicle capacity weight from placard minus combined weight of all occupants)
1	1500 lbs	5	front: 2 rear: 3	Occupant 1: 150 lbs Occupant 2: 180 lbs Occupant 3: 160 lbs Occupant 4: 140 lbs Occupant 5: 120 lbs	750 lbs	1500 lbs - 750 lbs = 750 lbs
2	1500 lbs	3	front: 1 rear: 2	Occupant 1: 200 lbs Occupant 2: 190 lbs Occupant 3: 150 lbs	540 lbs	1500 lbs - 540 lbs = 960 lbs
3	1500 lbs	1	front: 1	Occupant 1: 150 lbs	150 lbs	1500 lbs - 150 lbs = 1350 lbs

The higher the weight of all occupants, the less cargo and luggage load capacity is available.

For more information, see “Trailer tongue load” (> page 508).

Tires and wheels

Certification label

Even after careful determination of the combined weight of all occupants, cargo and the trailer tongue load (if applicable) (▷ page 508) as to not exceed the permissible load limit, you must make sure that your vehicle never exceeds the Gross Vehicle Weight Rating (GVWR) and the Gross Axle Weight Rating (GAWR) for either the front or rear axle. You can obtain the GVWR and GAWR from the Certification label. The Certification Label can be found on the driver's door B-pillar, see "Technical data" (▷ page 652).

Gross Vehicle Weight Rating (GVWR): The total weight of the vehicle, all occupants, all cargo, and the trailer tongue load (▷ page 508) must never exceed the GVWR.

Gross Axle Weight Rating (GAWR): The total allowable weight that can be carried by a single axle (front or rear).

To assure that your vehicle does not exceed the maximum permissible weight limits (GVWR and GAWR for front and rear axle), have the loaded vehicle (including driver, passengers and all cargo and, if applicable, trailer fully loaded) weighed on a suitable commercial scale.

Trailer tongue load

The tongue load of any trailer is an important weight to measure because it affects the load you can carry in your vehicle. If a trailer is towed, the tongue load must be added to the weight of all occupants riding and any cargo you are carrying in the vehicle. The tongue load typically is 10 percent of the trailer weight and everything loaded in it.

Your Mercedes-Benz has been designed primarily to carry passengers and their cargo. Mercedes-Benz does not recommend trailer towing with your vehicle.

Recommended tire inflation pressure

Warning!



Follow recommended tire inflation pressures.

Do not underinflate tires. Underinflated tires wear excessively and/or unevenly, adversely affect handling and fuel economy, and are more likely to fail from being overheated.

Do not overinflate tires. Overinflated tires can adversely affect handling and ride comfort, wear unevenly, increase stopping distance, and result in sudden deflation (blowout) because they are more likely to become punctured or damaged by road debris, potholes etc.

Your vehicle is equipped with either the Tire and Loading Information placard (Example A) or the Vehicle Tire Information placard (Example B) located on the driver's door B-pillar (▷ page 503).

The tire inflation pressure should be checked regularly and should only be adjusted on cold tires. The tires can be considered cold if the vehicle has been parked for at least 3 hours or driven less than 1 mile (1.6 km).

Follow recommended cold tire inflation pressures listed on placard.

Keeping the tires properly inflated provides the best handling, tread life and riding comfort.

In addition to the tire placard on the driver's door B-pillar, also consult the fuel filler flap for any additional information pertaining to special driving situations. For more information, see "Important notes on tire inflation pressure" (▷ page 510).

i Data shown on placard examples are for illustration purposes only. Tire data are specific to each vehicle and may vary from data shown in the illustrations below. Refer to placard on vehicle for actual data specific to your vehicle.

Placard (Example A)

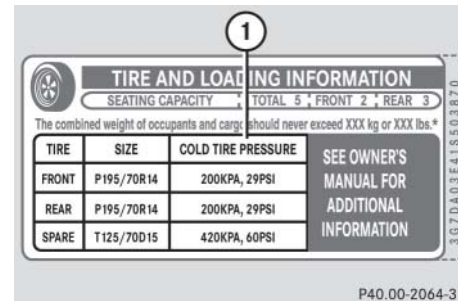

① Tire and Loading Information placard with recommended cold tire inflation pressures

Placard (Example A) lists the recommended cold tire inflation pressures for maximum loaded vehicle weight. The tire inflation pressures listed apply to the tires installed as original equipment.

Tires and wheels

Placard (Example B)

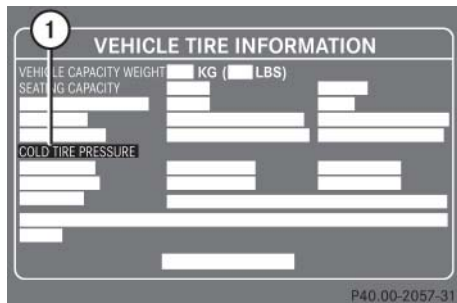

- ① Vehicle Tire Information placard with recommended cold tire inflation pressures

Placard (Example B) lists the recommended cold tire inflation pressures for maximum loaded vehicle weight. The tire inflation pressures listed apply to the tires installed as original equipment.

i *Placard (Example B) may list recommended cold tire inflation pressures for different vehicle loads.*

Important notes on tire inflation pressure

Warning!



If the tire inflation pressure repeatedly drops:

- Check the tires for punctures from foreign objects.
- Check to see whether air is leaking from the valves or from around the rim.

Tire temperature and tire inflation pressure are also increased while driving, depending on the driving speed and the tire load.

If you will be driving your vehicle at high speeds of 100 mph (160 km/h) or higher, where it is legal and conditions allow, consult the placard on the inside of the fuel filler flap on how to adjust the cold tire inflation pressure. If you do not adjust the tire inflation pressure, excessive heat can build up and result in sudden tire failure.

Be sure to readjust the tire inflation pressure for normal driving speeds. You should wait until the tires are cold before adjusting the tire inflation pressure.

Some vehicles may have supplemental tire inflation pressure information for vehicle loads less than the maximum loaded vehicle condition (▷ page 518). If such information is provided, it can be found on the placard located on the inside of the fuel filler flap (▷ page 489).

Tire inflation pressure changes by approximately 1.5 psi (0.1 bar) per 18°F (10°C) of air temperature change. Keep this in mind when checking tire inflation pressure where the temperature is different from the outside temperature.

Checking tire inflation pressure

Regularly check your tire inflation pressure at least once a month.

Check and adjust the tire inflation pressure when the tires are cold. The tires can be considered cold if the vehicle has been parked for at least 3 hours or driven less than 1 mile (1.6 km).

If you check the tire inflation pressure when the tires are warm (the vehicle has been driven for several miles or sitting less than 3 hours), the reading will be approximately 4 psi (0.3 bar) higher than the cold reading. This is normal. Do not let air out to match the specified cold tire inflation pressure. Otherwise, the tire will be underinflated.

Checking tire inflation pressure manually

Follow the steps below to achieve correct tire inflation pressure:

- ▶ Remove the cap from the valve on one tire.
- ▶ Firmly press a tire gauge onto the valve.
- ▶ Read tire inflation pressure on tire gauge and check against the recommended tire inflation pressure on the placard on the driver's door B-pillar (▷ page 503). If necessary, add air to achieve the recommended tire inflation pressure.

i *If you have overfilled the tire, release tire inflation pressure by pushing the metal stem of the valve with e.g. a tip of a pen. Then recheck the tire inflation pressure with the tire gauge.*

- ▶ Install the valve cap.
- ▶ Repeat this procedure for each tire.

Checking tire inflation pressure electronically with the Advanced Tire Pressure Monitoring System (Advanced TPMS)*, (standard on U.S. vehicles)

i *The Advanced Tire Pressure Monitoring System (Advanced TPMS) is equipped with a combination low tire pressure/TPMS malfunction telltale in the instrument cluster (▷ page 28). Depending on how the telltale illuminates, it indicates a low tire inflation pressure condition or a malfunction in the TPMS system itself:*

- *If the telltale illuminates continuously, one or more of your tires is significantly under-inflated. There is no malfunction in the TPMS.*
- *If the telltale flashes for 60 seconds and then stays illuminated, the TPMS system itself is not operating properly.*

Tires and wheels

The TPMS only functions on wheels that are equipped with the proper electronic sensors. It monitors the tire inflation pressure, as selected by the driver, in all four tires. A warning is issued to alert you to a decrease in pressure in one or more of the tires.

Tire inflation pressure inquiries are made using the multifunction display. The present inflation pressures are displayed only after a few minutes of travel time.

i Possible differences between the readings of a tire inflation pressure gauge of an air hose, e.g. gas station equipment, and the vehicle's control system can occur. Usually the readings issued by the control system are more precise.

i The menu overview can be found on (▷ page 243).

- ▶ Switch on the ignition (▷ page 315).
- ▶ Press **◀** or **▶** to select the menu "Service".
- ▶ Press **▲** or **▼** to select "Tire pressure".
- ▶ Press **OK**.

i When the message "Tire pressures displayed after driving a few minutes" appears in the display, the individual inflation pressure values are matched with the tires. The individual values are displayed after a few minutes driving.

Warning!



It is the driver's responsibility to calibrate the TPMS on the recommended cold inflation pressure. Underinflated tires affect the ability to steer or brake the vehicle. You might lose control over the vehicle.



i With a spare wheel without wheel sensor mounted, the system may still indicate the tire inflation pressure of the removed wheel for some minutes. If this happens, keep in mind that the indicated value where the spare wheel is mounted does not reflect the actual spare tire inflation pressure.

Warning!



The TPMS does not indicate a warning for wrongly selected inflation pressures. Always adjust tire inflation pressure according to the placard on the driver's door B-pillar or, if available, the supplemental tire pressure information on the inside of the fuel filler flap.

The TPMS is not able to issue a warning due to a sudden dramatic loss of pressure (e.g. tire blowout caused by a foreign object). In this case bring the vehicle to a halt by carefully applying the brakes and avoiding abrupt steering maneuvers.

Warning!

Each tire, including the spare (if provided), should be checked monthly when cold and inflated to the inflation pressure recommended by the vehicle manufacturer on the vehicle placard or the tire inflation pressure label. (If your vehicle has tires of a different size than the size indicated on the vehicle placard or the tire inflation pressure label, you should determine the proper tire inflation pressure for those tires).

As an added safety feature, your vehicle has been equipped with a tire pressure monitoring system (TPMS) that illuminates a low tire pressure telltale when one or more of your tires is significantly under-inflated. Accordingly, when the low tire pressure telltale illuminates, you should stop and check your tires as soon as possible, and inflate them to the proper pressure. Driving on a significantly under-inflated tire causes the tire to overheat and can lead to tire failure.

Under-inflation also reduces fuel efficiency and tire tread life, and may affect the vehicle's handling and stopping ability. Please note that the TPMS is not a substitute for proper tire maintenance, and it is the driver's responsibility to maintain correct tire pressure, even if under-inflation has not reached the level to trigger illumination of the TPMS low tire pressure telltale.

Your vehicle has also been equipped with a TPMS malfunction indicator to indicate when the system is not operating properly. The TPMS malfunction indicator is combined with the low tire pressure telltale. When the system detects a malfunction, the telltale will flash for approximately one minute and then remain continuously illuminated. This sequence will continue upon subsequent vehicle start-ups as long as the malfunction exists. When the malfunction indicator is illuminated, the system may not be able to detect or signal low tire pressure as intended.

TPMS malfunctions may occur for a variety of reasons, including the installation of replacement or alternate tires or wheels on the vehicle that prevent the TPMS from functioning properly. Always check the TPMS malfunction telltale after replacing one or more tires or wheels on your vehicle to ensure that the replacement or alternate tires and wheels allow the TPMS to continue to function properly.

i *If a condition causing the TPMS to malfunction develops, it may take up to 10 minutes for the system to signal a malfunction using the TPMS telltale flashing and illumination sequence.*

The telltale extinguishes after a few minutes driving if the malfunction has been corrected.

i *Operating radio transmission equipment (e.g. wireless headsets, two-way radios) in or near the vehicle could cause the TPMS to malfunction.*

Tires and wheels

Reactivating Advanced TPMS

The TPMS must be reactivated when you have adjusted the tire inflation pressure to a new level (e.g. because of different load or driving conditions). The TPMS is then recalibrated to the current tire inflation pressures.

Warning!







It is the driver's responsibility to calibrate the TPMS on the recommended cold inflation pressure. Underinflated tires affect the ability to steer or brake the vehicle. You might lose control over the vehicle.

- ▶ Using the tire placard on the driver's door B-pillar (▷ page 503) or, if available, the supplemental tire inflation pressure information on the inside of the fuel filler flap (▷ page 489), make sure the tire inflation pressure of all four tires is correct.

i Reactivate the TPMS after adjusting the tire inflation pressure to the inflation pressure recommended for the vehicle operating condition. Tire inflation pressure should only be adjusted on cold tires. Observe the recommended tire inflation pressure on the placard on the driver's door B-pillar (▷ page 503). Some vehicles may have supplemental tire inflation pressure information for driving at high speeds (▷ page 510) or for vehicle loads less than the maximum loaded vehicle condition. If such information is provided, it can be found on the inside of the fuel filler flap (▷ page 489).

i After wheel rotation or sensor replacement, the vehicle must be parked for 20 minutes before attempting to reactivate the TPMS.

i The menu overview can be found on (▷ page 243).

- ▶ Switch on the ignition (▷ page 315).
- ▶ Press  or  to select the menu "Service".
- ▶ Press  or  to select "Tire pressure".

- ▶ Press .

You will see

- the current inflation pressures for each tire
- or
- the message
Tire pressures displayed after driving a few minutes

appear in the multifunction display.

- ▶ Press .

The message

*Use current pressure values as new reference values
To confirm press "OK"*

appears in the multifunction display.

- ▶ Press **OK**.

The message

*Tire pressure monitor
reactivated*

appears in the multifunction display.

After a few minutes driving, the current tire inflation pressure values are accepted as reference values and then monitored.

If you wish to cancel activation:

- ▶ Press **←**.

or

- ▶ Press **▲** to exit menu screen.

i *When the wheel positions are changed on the vehicle, it is possible that the air pressure is temporarily displayed for the wrong position. This will be corrected after driving for several minutes, and the air pressure will be shown for the correct position.*

Run Flat Indicator (Canada only)

While the vehicle is being driven, the Run Flat Indicator monitors the set tire inflation pressures by evaluating each wheel's rotational speed. This allows the system to detect a significant loss of pressure in a tire. If a wheel's rotational speed changes due to falling tire inflation pressure, you will see a corresponding warning message in the multifunction display.

The Run Flat Indicator may function in a restricted manner or with a delay if:

- snow chains are mounted to the vehicle
- in presence of ice and snow
- you are driving on a loose surface (e.g. sand or gravel)
- you are driving in a very sporty manner (involving rapid acceleration or high speeds in curves)

Warning!



When the multifunction display shows the message “*Tire pressure Check tires*”, one or more of your tires is significantly underinflated. You should stop and check your tires as soon as possible, and inflate them to the proper tire inflation pressure as indicated on the vehicle's tire information placard. Driving on a significantly underinflated tire causes the tire to overheat and can lead to tire failure. Under-inflation also reduces fuel efficiency and tire tread life, and may affect the vehicle's handling and stopping ability. Each tire, including the spare, should be checked monthly when cold and set to the tire inflation pressure recommended by the vehicle manufacturer on the vehicle placard or the tire inflation pressure label.

Tires and wheels

Warning!



The Run Flat Indicator does not provide a warning for wrongly selected tire inflation pressures. Always adjust tire inflation pressure according to the placard on the driver's door B-pillar or fuel filler flap.

The Run Flat Indicator does not replace regular checks of the tire inflation pressures since a gradual pressure loss in all four tires cannot be detected by the Run Flat Indicator.

The Run Flat Indicator is not able to issue a warning due to a sudden dramatic loss of tire inflation pressure (e.g. tire blowout caused by a foreign object). In this case bring the vehicle to a halt by carefully applying the brakes and avoiding abrupt steering maneuvers.

Reactivating the Run Flat Indicator

The tire inflation pressure monitor must be reactivated in the following situations:

- If you have changed the tire inflation pressure
- If you have replaced the wheels or tires
- If you have installed new wheels or tires
- ▶ Using the tire placard on the driver's door B-pillar (▷ page 503) or, if available, the inside of the fuel filler flap (▷ page 489), make sure the tire inflation pressure of all four tires is correct.





Warning!



The Run Flat Indicator can only warn you in a reliable manner if you have set the correct tire inflation pressures for each tire.

If an incorrect tire inflation pressure was set, the system will monitor the pressure according to the incorrect value.

 The menu overview can be found on (▷ page 243).

- ▶ Switch on the ignition (▷ page 315).
- ▶ Press  or  to select the menu "Service".
- ▶ Press  or  to select "Tire pressure".
- ▶ Press .

The message

Run Flat Indicator active

Reactivation possible: OK

appears in the multifunction display.



- ▶ Press .

The message

Tire pressure now OK?

appears in the multifunction display.

If you wish to confirm activation:

- ▶ Press  or  to select “Yes”.
- ▶ Press .

The message

*Run Flat Indicator
reactivated*

appears in the multifunction display.

After a certain “learning phase”, the Run Flat Indicator checks the set pressure values for all four tires.

If you wish to cancel activation:



- ▶ Press .

or

When the message

*Tire pressure
now OK?*

appears in the multifunction display:

- ▶ Press  or  to select “No”.
- ▶ Press .

Potential problems associated with underinflated and overinflated tires

Underinflated tires

Underinflated tires can:

- cause excessive and uneven tire wear
- adversely affect fuel economy
- lead to tire failure from being overheated
- adversely affect handling characteristics

Warning!



Follow recommended tire inflation pressures.

Do not underinflate tires. Underinflated tires wear excessively and / or unevenly, adversely affect handling and fuel economy, and are more likely to fail from being overheated.

Overinflated tires

Overinflated tires can:

- adversely affect handling characteristics
- cause uneven tire wear
- be more prone to damage from road hazards
- adversely affect ride comfort
- increase stopping distance

Warning!



Follow recommended tire inflation pressures.

Do not overinflate tires. Overinflated tires can adversely affect handling and ride comfort, wear unevenly, increase stopping distance, and result in sudden deflation (blowout) because they are more likely to become punctured or damaged by road debris, potholes etc.

Tires and wheels

Tire labeling

Besides tire name (sales designation) and manufacturer name, a number of markings can be found on a tire.

Following are some explanations for the markings on your vehicle's tires:

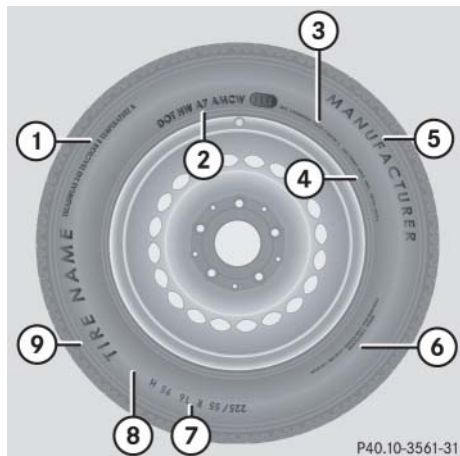

- ① Uniform Quality Grading Standards (▷ page 524)
- ② DOT, Tire Identification Number (TIN) (▷ page 522)
- ③ Maximum tire load (▷ page 523)
- ④ Maximum tire inflation pressure (▷ page 523)
- ⑤ Manufacturer
- ⑥ Tire ply material (▷ page 525)
- ⑦ Tire size designation, load and speed rating (▷ page 518)
- ⑧ Load identification (▷ page 521)
- ⑨ Tire name

i For illustration purposes only. Actual data on tires are specific to each vehicle and may vary from data shown in above illustration.

For more information, see “Rims and tires” (▷ page 655).

Tire size designation, load and speed rating

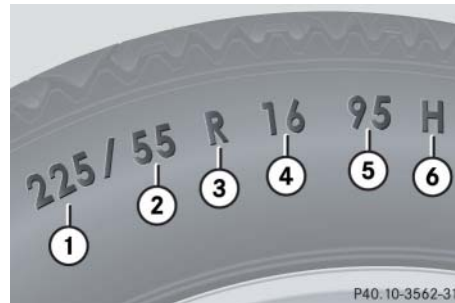

- ① Tire width
- ② Aspect ratio in %
- ③ Radial tire code
- ④ Rim diameter
- ⑤ Tire load rating
- ⑥ Tire speed rating

i For illustration purposes only. Actual data on tires are specific to each vehicle and may vary from data shown in above illustration.

General:

Depending on the design standards used, the tire size molded into the sidewall may have no letter or a letter preceding the tire size designation.

No letter preceding the size designation (as illustrated above): Passenger car tire based on European design standards.

Letter “P” preceding the size designation: Passenger car tire based on U.S. design standards.

Letter “LT” preceding the size designation: Light Truck tire based on U.S. design standards.

Letter “T” preceding the size designation: Temporary spare tires which are high pressure compact spares designed for temporary emergency use only.

Tire width

The tire width ① (▷ page 518) indicates the nominal tire width in mm.

Aspect ratio

The aspect ratio ② (▷ page 518) is the dimensional relationship between tire section height and section width and is expressed in percentage. The aspect ratio is arrived at by dividing section height by section width.

Tire code

The tire code ③ (▷ page 518) indicates the tire construction type. The “R” stands for radial tire type. Letter “D” means diagonal or bias ply construction; letter “B” means belted-bias ply construction.

At the tire manufacturer’s option, any tire with a speed capability above 149 mph (240 km/h) can include a “ZR” in the size designation (for example: 245/40 ZR 18). For additional information, see “Tire speed rating” (▷ page 520).

Rim diameter

The rim diameter ④ (▷ page 518) is the diameter of the bead seat, not the diameter of the rim edge. Rim diameter is indicated in inches (in).

Tire load rating

The tire load rating ⑤ (▷ page 518) is a numerical code associated with the maximum load a tire can support.

For example, a load rating of 91 corresponds to a maximum load of 1356 lbs (615 kg) the tire is designed to support. See also “Maximum tire load” (▷ page 523) where the maximum load associated with the load index is indicated in kilograms and lbs.

Tires and wheels

Warning!



The tire load rating must always be at least half of the GAWR (▷ page 526) of your vehicle. Otherwise, tire failure may be the result which may cause an accident and/or serious personal injury to you or others.

Always replace rims and tires with the same designation, manufacturer and type as shown on the original part.

Warning!



Do not overload the tires by exceeding the specified load limit or vehicle capacity weight as indicated on the placard located on the driver's door B-pillar (▷ page 503). Overloading the tires can overheat them, possibly causing a blowout. Overloading the tires can also result in handling or steering problems, or brake failure.

For additional information on tire load rating, see “Load identification” (▷ page 521).

i *Tire load rating ⑤ (▷ page 518) and tire speed rating ⑥ (▷ page 518) are also referred to as “service description”.*

Tire speed rating

The tire speed rating ⑥ (▷ page 518) indicates the approved maximum speed for the tire.

Warning!



Even when permitted by law, never operate a vehicle at speeds greater than the maximum speed rating of the tires.

Exceeding the maximum speed for which tires are rated can lead to sudden tire failure, causing loss of vehicle control and possibly resulting in an accident and/or personal injury and possible death, for you and for others.

i *Tire load rating ⑤ (▷ page 518) and tire speed rating ⑥ (▷ page 518) are also referred to as “service description”.*

Summer tires

Index	Speed rating
Q	up to 100 mph (160 km/h)
R	up to 106 mph (170 km/h)
S	up to 112 mph (180 km/h)
T	up to 118 mph (190 km/h)
H	up to 130 mph (210 km/h)
V	up to 149 mph (240 km/h)
W	up to 168 mph (270 km/h)
Y	up to 186 mph (300 km/h)
(Y)	above 186 mph (300 km/h)
ZR	above 149 mph (240 km/h)

- At the tire manufacturer's option, any tire with a speed capability above 149 mph (240 km/h) can include a “ZR” in the size designation (for example: 245/40 ZR18). To determine the maximum speed capability of the tire,

the service description for the tire must be referred to. The service description is comprised of the tire load rating ⑤ (▷ page 518) and the tire speed rating ⑥ (▷ page 518).

If your tire includes “ZR” in the size designation and no service description ⑤ and ⑥ (▷ page 518) is given, the tire manufacturer must be consulted for the maximum speed capability.

If a service description ⑤ and ⑥ (▷ page 518) is given, the speed capability is limited by the speed symbol in the service description.

Example: 245/40 ZR18 97Y.

In this example, “97Y” is the service description. The letter “Y” designates the speed rating and the speed capability of the tire is limited to 186 mph (300 km/h).

- Any tire with a speed capability above 186 mph (300 km/h) must include a “ZR” in the size designation AND the service description must be placed in parenthesis.

Example: 275/40 ZR 18 (99Y).

The “(Y)” speed rating in parenthesis designates the maximum speed capability of the tire as being above 186 mph (300 km/h). Consult the tire manufacturer for the actual maximum permissible speed of the tire.

All-season and winter tires

Index	Speed rating
Q M+S ¹	up to 100 mph (160 km/h)
T M+S ¹	up to 118 mph (190 km/h)
H M+S ¹	up to 130 mph (210 km/h)
V M+S ¹	up to 149 mph (240 km/h)

¹ or M+S  for winter tires

i Not all M+S rated tires provide special winter performance. Make sure the tires you use show M+S and the mountain/snowflake  marking on the tire sidewall. These tires meet specific snow traction performance requirements of the Rubber Manufacturers Association (RMA) and the Rubber Association of Canada (RAC) and have been designed specifically for use in snow conditions.

Load identification



① Load identification

i For illustration purposes only. Actual data on tires are specific to each vehicle and may vary from data shown in above illustration.

Tires and wheels

In addition to tire load rating, special load information may be molded into the tire sidewall following the letter designating the tire speed rating ⑥ (▷ page 518).

No specification given: absence of any text (like in above example) indicates a standard load (SL) tire.

XL (Extra Load): designates an extra load (or reinforced) tire.

Light Load: designates a light load tire.

C, D, E: designates load range associated with the maximum load a tire can carry at a specified pressure.

DOT, Tire Identification Number (TIN)

U.S. tire regulations require each new tire manufacturer or tire retreader to mold a TIN into or onto a sidewall of each tire produced.

The TIN is a unique identifier which facilitates efforts by tire manufacturers to notify purchasers in recall situations or other

safety matters concerning tires and gives purchasers the means to easily identify such tires.

The TIN is comprised of “Manufacturer’s identification mark”, “Tire size”, “Tire type code” and “Date of manufacture”.

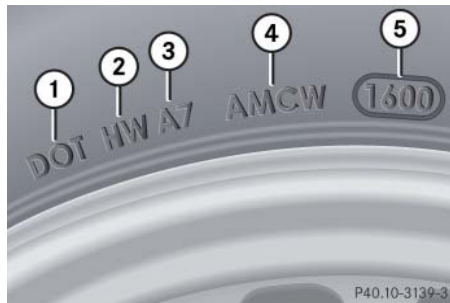

- ① DOT
- ② Manufacturer’s identification mark
- ③ Tire size
- ④ Tire type code (at the option of the tire manufacturer)
- ⑤ Date of manufacture

i *For illustration purposes only. Actual data on tires are specific to each vehicle and may vary from data shown in above illustration.*

DOT (Department of Transportation)

A tire branding symbol ① (▷ page 522) which denotes the tire meets requirements of the U.S. Department of Transportation.

Manufacturer’s identification mark

The manufacturer’s identification mark ② (▷ page 522) denotes the tire manufacturer.

New tires have a mark with two symbols.

Retreaded tires have a mark with four symbols. For more information on retreaded tires (▷ page 500).

Tire size

The code ③ (▷ page 522) indicates the tire size.

Tire type code

The code ④ (▷ page 522) may, at the option of the manufacturer, be used as a descriptive code for identifying significant characteristics of the tire.

Date of manufacture

The date of manufacture ⑤ (▷ page 522) identifies the week and year of manufacture.

The first two figures identify the week, starting with “01” to represent the first full week of the calendar year. The second two figures represent the year.

For example, “3202” represents the 32nd week of 2002.

Maximum tire load

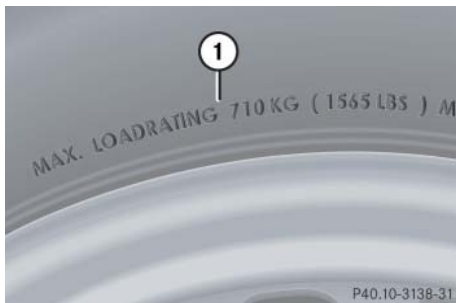

① Maximum tire load rating

i For illustration purposes only. Actual data on tires are specific to each vehicle and may vary from data shown in above illustration.

The maximum tire load is the maximum weight the tires are designed to support.

Warning!



Do not overload the tires by exceeding the specified load limit or vehicle capacity weight as indicated on the placard located on the driver's door B-pillar (▷ page 503). Overloading the tires can overheat them, possibly causing a blowout. Overloading the tires can also result in handling or steering problems, or brake failure.

For more information on tire load rating (▷ page 519).

For information on calculating total and cargo load capacities (▷ page 505).

Maximum tire inflation pressure



① Maximum permissible tire inflation pressure

i For illustration purposes only. Actual data on tires are specific to each vehicle and may vary from data shown in above illustration.

This is the maximum permissible tire inflation pressure for the tire.

Always follow the recommended tire inflation pressure (▷ page 509) for proper tire inflation.

Tires and wheels

Warning!



Never exceed the max. tire inflation pressure. Follow recommended tire inflation pressures.

Do not underinflate tires. Underinflated tires wear excessively and / or unevenly, adversely affect handling and fuel economy, and are more likely to fail from being overheated.

Do not overinflate tires. Overinflated tires can adversely affect handling and ride comfort, wear unevenly, increase stopping distance, and result in sudden deflation (blowout) because they are more likely to become punctured or damaged by road debris, potholes etc.

Uniform Tire Quality Grading Standards (U.S. vehicles)

Tire manufacturers are required to grade tires based on three performance factors: treadwear, traction and temperature resistance.

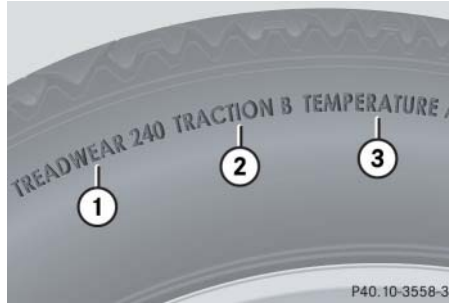

- ① Treadwear
- ② Traction
- ③ Temperature resistance

i For illustration purposes only. Actual data on tires are specific to each vehicle and may vary from data shown in above illustration.

Quality grades can be found, where applicable, on the tire sidewall between tread shoulder and maximum section width. For example:

Treadwear	Traction	Temperature
200	AA	A

All passenger car tires must conform to federal safety requirements in addition to these grades.

Treadwear

The treadwear grade is a comparative rating based on the wear rate of the tire when tested under controlled conditions on a specified government test course. For example, a tire graded 150 would wear one and one-half ($1\frac{1}{2}$) times as well on the government course as a tire graded 100. The relative performance of tires depends upon the actual conditions of their use, however, and may depart significantly from the norm due to variations in driving habits, service practices and differences in road characteristics and climate.

Traction

The traction grades, from highest to lowest, are AA, A, B, and C. Those grades represent the tire's ability to stop on wet pavement as measured under controlled conditions on specified government test surfaces of asphalt and concrete. A tire marked C may have poor traction performance.

Warning!



The traction grade assigned to this tire is based on straight-ahead braking traction tests, and does not include acceleration, cornering, hydroplaning, or peak traction characteristics.

Temperature

The temperature grades are A (the highest), B, and C, representing the tire's resistance to the generation of heat and its ability to dissipate heat when tested under controlled conditions on a specified indoor laboratory test wheel. Sustained high tem-

perature can cause the material of the tire to degenerate and reduce tire life, and excessive temperature can lead to sudden tire failure. The grade C corresponds to the minimum level of performance which all passenger car tires must meet under the Federal Motor Vehicle Safety Standard No. 109. Grades B and A represent higher levels of performance on the laboratory test wheel than the minimum required by law.

Warning!



The temperature grade for this tire is established for a tire that is properly inflated and not overloaded. Excessive speed, underinflation, or excessive loading, either separately or in combination, can cause excessive heat build-up and possible tire failure.

Tire ply material

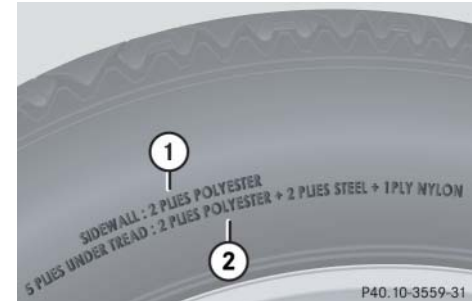

- ① Plies in sidewall
- ② Plies under tread

i For illustration purposes only. Actual data on tires are specific to each vehicle and may vary from data shown in above illustration.

This marking tells you about the type of cord and number of plies in the sidewall and under the tread.

Tires and wheels

Tire and loading terminology

Accessory weight

The combined weight (in excess of those standard items which may be replaced) of automatic transmission, power steering, power brakes, power windows, power seats, radio, and heater, to the extent that these items are available as factory-installed equipment (whether installed or not).

Air pressure

The amount of air inside the tire pressing outward on each square inch of the tire. Air pressure is expressed in pounds per square inch (psi), or kilopascal (kPa) or bars.

Aspect ratio

Dimensional relationship between tire section height and section width expressed in percentage.

Bar

Another metric unit for air pressure. There are 14.5038 pounds per square inch (psi) to 1 bar; there are 100 kilopascals (kPa) to 1 bar.

Bead

The tire bead contains steel wires wrapped by steel cords that hold the tire onto the rim.

Cold tire inflation pressure

Tire inflation pressure when your vehicle has been sitting for at least 3 hours or driven no more than 1 mile (1.6 km).

Curb weight

The weight of a motor vehicle with standard equipment including the maximum capacity of fuel, oil, and coolant, and, if so equipped, air conditioning and additional optional equipment, but without passengers and cargo.

DOT (Department of Transportation)

A tire branding symbol which denotes the tire meets requirements of the U.S. Department of Transportation.

GAWR (Gross Axle Weight Rating)

The GAWR is the maximum permissible axle weight. The gross vehicle weight on each axle must never exceed the GAWR for the front and rear axle indicated on the Certification label located on the driver's door B-pillar.

GVW (Gross Vehicle Weight)

The GVW comprises the weight of the vehicle including fuel, tools, spare wheel, installed accessories, passengers and cargo and, if applicable, trailer tongue load. The GVW must never exceed the GVWR indicated on the Certification label located on the driver's door B-pillar.

GVWR (Gross Vehicle Weight Rating)

This is the maximum permissible vehicle weight of the fully loaded vehicle (weight of the vehicle including all options, passengers, fuel, and cargo and, if applicable, trailer tongue load). It is indicated on Certification label located on the driver's door B-pillar.

Kilopascal (kPa)

The metric unit for air pressure. There are 6.9 kilopascals (kPa) to 1 psi; another metric unit for air pressure is bars. There are 100 kilopascals (kPa) to 1 bar.

Maximum load rating

The maximum load in kilograms and pounds that can be carried by the tire.

Maximum loaded vehicle weight

The sum of curb weight, accessory weight, vehicle capacity weight and production options weight.

Maximum tire inflation pressure

This number is the greatest amount of air pressure that should ever be put in the tire under normal driving conditions.

Normal occupant weight

The number of occupants the vehicle is designed to seat, multiplied by 68 kilograms (150 lbs).

Occupant distribution

The distribution of occupants in a vehicle at their designated seating positions.

Production options weight

The combined weight of those installed regular production options weighing over 5 lbs (2.3 kilograms) in excess of those standard items which they replace, not previously considered in curb weight or accessory weight, including heavy duty brakes, ride levelers, roof rack, heavy duty battery, and special trim.

PSI (Pounds per square inch)

A standard unit of measure for air pressure -> bar, kilopascal (kPa).

Recommended tire inflation pressure

Recommended tire inflation pressure listed on placard located on driver's door B-pillar for normal driving conditions. Provides best handling, tread life and riding comfort.

Rim

A metal support for a tire or a tire and tube assembly upon which the tire beads are seated.

Sidewall

The portion of a tire between the tread and the bead.

TIN (Tire Identification Number)

Unique identifier which facilitates efforts by tire manufacturers to notify purchasers in recall situations or other safety matters

Tires and wheels

concerning tires and gives purchases the means to easily identify such tires. The TIN is comprised of “Manufacturer’s identification mark”, “Tire size”, “Tire type code” and “Date of manufacture”.

Tire load rating

Numerical code associated with the maximum load a tire can support.

Tire ply composition and material used

This indicates the number of plies or the number of layers of rubber-coated fabric in the tire tread and sidewall. Tire manufacturers also must indicate the ply materials in the tire and sidewall, which include steel, nylon, polyester, and others.

Tire speed rating

Part of tire designation; indicates the speed range for which a tire is approved.

Traction

Force exerted by the vehicle on the road via the tires. The amount of grip provided.

Tread

The portion of a tire that comes into contact with the road.

Treadwear indicators

Narrow bands, sometimes called “wear bars” that show across the tread of a tire when only $\frac{1}{16}$ in (1.6 mm) of tread remains.

Uniform Tire Quality Grading Standards

A tire information system that provides consumers with ratings for a tire’s traction, temperature and treadwear. Ratings are determined by tire manufacturers using government testing procedures. The ratings are molded into the sidewall of the tire.

Vehicle capacity weight

Rated cargo and luggage load plus 68 kilograms (150 lbs) times the vehicle’s designated seating capacity.

Vehicle maximum load on the tire

Load on an individual tire that is determined by distributing to each axle its share of the maximum loaded vehicle weight and dividing it by two.

Rotating tires

Warning!



Rotate front and rear wheels only if the tires are of the same dimension.

If your vehicle is equipped with mixed-size tires (different tire dimensions front vs. rear), tire rotation is not possible.

Tire rotation can be performed on vehicles with tires of the same dimension all around. If your vehicle is equipped with tires of the same dimension all around, tires can be rotated, observing a front-to-rear rotation pattern that will maintain the intended rotation (spinning) direction of the tire (▷ page 503).

In some cases, such as when your vehicle is equipped with mixed-size tires (different tire dimension front vs. rear), tire rotation is not possible.

If applicable to your vehicle's tire configuration, tires can be rotated according to the tire manufacturer's recommended intervals in the tire manufacturer's warranty pamphlet located in your vehicle literature portfolio. If none is available, tires should be rotated every 3000 to 6000 miles (5000 to 10000 km), or sooner if necessary, according to the degree of tire wear. The same rotation (spinning) direction must be maintained (▷ page 503).

Rotate tires before the characteristic tire wear pattern becomes visible (shoulder wear on front tires and tread center wear on rear tires).

Thoroughly clean the mounting face of wheels and brake disks, i.e. the inner side of the wheels/tires, during each rotation. Check for and ensure proper tire inflation pressure.

Warning!



Have the tightening torque checked after changing a wheel. Wheels could become loose if not tightened with a torque of 110 lb-ft (150 Nm).

Only use Genuine Mercedes-Benz wheel bolts specified for your vehicle's rims.

For information on wheel change, see the "Practical hints" section (▷ page 629).

Winter driving

Before the onset of winter, have your vehicle winterized at an authorized Mercedes-Benz Center. This service includes:

- Check of anticorrosion and antifreeze concentration.
- Addition of cleaning concentrate to the water of the windshield and headlamp cleaning system. Add MB Concentrate “S” to a premixed windshield washer solvent/antifreeze which is formulated for below freezing temperatures (▷ page 666).
- Battery test. Battery capacity drops with decreasing ambient temperature. A well charged battery helps to make sure that the engine can be started, even at low ambient temperatures.
- Tire change.

Winter tires

Always use winter tires at temperatures below 45°F (7°C) and whenever wintry road conditions prevail. Not all M+S rated

tires provide special winter performance. Make sure the tires you use show the mountain/snowflake  marking on the tire sidewall. These tires meet specific snow traction performance requirements of the Rubber Manufacturers Association (RMA) and the Rubber Association of Canada (RAC) and have been designed specifically for use in snow conditions. Use of winter tires is the only way to achieve the maximum effectiveness of the ABS, EBP and ESP® in winter operation.

For safe handling, make sure that all mounted winter tires are of the same make and have the same tread design.

Warning!



Winter tires with a tread depth under $\frac{1}{6}$ in (4 mm) must be replaced. They are no longer suitable for winter operation.

Always observe the speed rating of the winter tires installed on your vehicle. If the maximum speed for which your tires are rated is below the speed rating of your vehicle, you must place a notice to this effect where it will be seen by the driver. Such notices are available from your tire dealer or from any authorized Mercedes-Benz Center.

Warning!



If you use your spare tire when winter tires are fitted on the other wheels, be aware that the difference in tire characteristics may very well impair turning stability and that overall driving stability may be reduced. Adapt your driving style accordingly.

Have the spare tire replaced with a winter tire at the nearest authorized Mercedes-Benz Center.

Snow chains

! When driving with snow chains, always select the raised level of the level control system Airmatic* (▷ page 401). Other settings may result in damage to your vehicle.

Snow chains should only be driven on snow-covered roads at speeds not to exceed 30 mph (50 km/h). Remove chains as soon as possible when driving on roads without snow.

i When driving with snow chains, you may wish to deactivate the ESP® (▷ page 73) before setting the vehicle in motion. This will improve the vehicle's traction.

Please observe the following guidelines when using snow chains:

- Use of snow chains is not permissible with all wheel/tire combinations.
- Snow chains should only be used on the rear wheels. Follow the manufacturer's mounting instructions.
- Only use snow chains that are approved by Mercedes-Benz. Your authorized Mercedes-Benz Center will be glad to advise you on this subject.
- Use of snow chains may be prohibited depending on location. Always check local and state laws before installing snow chains.

! Some tire sizes do not leave adequate clearance for snow chains. To help avoid serious damage to your vehicle or tires, use of snow chains is not permissible with the spare wheel.

For use of snow chains on tire size 255/45 R18 99H M+S , contact an authorized Mercedes-Benz Center.

We strongly recommend that you have your vehicle serviced by an authorized Mercedes-Benz Center, in accordance with the Maintenance Booklet at the times called for by the maintenance service indicator.

Failure to have the vehicle maintained in accordance with the Maintenance Booklet and maintenance service indicator at the designated times /mileage will result in vehicle damage not covered by the Mercedes-Benz Limited Warranty.

Maintenance service indicator message

The maintenance service indicator message will notify you when your next maintenance service is due.

Starting approximately 1 month before your next maintenance service is due, one of the following messages will appear in the multifunction display while you are driving or when you switch on the ignition (example service A):

Next Service A due in XXX miles (km)

Next Service A due in XX days

Service A due

The maintenance services will be indicated by showing a service type A through type H in the multifunction display. Types A through H are classified based on estimated time needed to perform the maintenance service, ranging

from “Service A”

(approx. 1 hour)

to “Service H”

(approx. 8 hours)



Refer to Maintenance Booklet for a listing of maintenance services and intervals they need to be performed at.

- ▶ **To clear the maintenance service indicator message:** Press  (▷ page 242).

i *Vehicles equipped with FSS PLUS (Flexible Service System PLUS) only (Canada vehicles): The interval between maintenance services depends on your driving habits. A gentle driving style, moderate engine speeds and the avoidance of short-distance trips will lengthen the interval between services.*

Maintenance service term exceeded

If you have exceeded the suggested maintenance service term, you will see the following message in the multifunction display:

*Service A exceeded by XXX miles (km)
Service A exceeded by XX days*

Any authorized Mercedes-Benz Center will reset the maintenance service indicator following a completed maintenance service.

Calling up the maintenance service indicator display

i *The menu overview can be found on (▷ page 243).*

You can call up the maintenance service indicator display at any time to check when the next maintenance service is due.

- ▶ Switch on the ignition (▷ page 315).
- ▶ Press **◀** or **▶** on multifunction steering wheel to select “Service” menu.

▶ Press **▼** or **▲** to select “ASSYST PLUS”.

▶ Press **OK**.

The service deadline appears in the multifunction display.

i *If the battery is disconnected, the days of disconnection will not be included in the count shown by the maintenance service indicator. To arrive at the true maintenance service deadline, you will need to subtract these days from the days shown in the maintenance service indicator message or maintenance service indicator display.*

Resetting the maintenance service indicator

In the event that the maintenance service on your vehicle is not carried out by an authorized Mercedes-Benz Center, you can have the maintenance service indicator reset. The automotive maintenance facility carrying out the maintenance service will find the information for resetting the maintenance service indicator in the maintenance-relevant information for your vehicle. Such information is available from either your authorized Mercedes-Benz Center or directly from Mercedes-Benz.

i *If the maintenance service indicator was inadvertently reset, have an authorized Mercedes-Benz Center correct it.*

Only reset if the proper maintenance service has been performed. Resetting the system without performing the proper service as called for by the maintenance service indicator will result in engine damage and/or other vehicle damage not covered by the Mercedes-Benz Limited Warranty.

Cleaning and care of vehicle

Warning!



Many cleaning products can be hazardous. Some are poisonous, others are flammable. Always follow the instructions on the particular container. Always open your vehicle's doors or windows when cleaning the inside.

Never use fluids or solvents that are not designed for cleaning your vehicle.

Always lock away cleaning products and keep them out of reach of children.

While in operation, even while parked, your vehicle is subjected to varying external influences which, if gone unchecked, can attack the paintwork as well as the vehicle underbody and cause lasting damage.

Such damage is caused not only by extreme and varying climatic conditions, but also by:

- Air pollution
- Road salt
- Tar
- Gravel and stone chipping

To avoid paint damage, you should immediately remove:

- Grease and oil
- Fuel
- Coolant
- Brake fluid
- Bird droppings
- Insects
- Tree resins, etc.

Frequent washing reduces and/or eliminates the aggressiveness and potency of the above adverse influences.

More frequent washings are necessary to deal with unfavorable conditions:

- near the ocean
- in industrial areas (smoke, exhaust emissions)
- during winter operation

You should check your vehicle from time to time for stone chipping or other damage. Any damage should be repaired as soon as possible to prevent corrosion.

In doing so, do not neglect the underbody of the vehicle. A prerequisite for a thorough check is a washing of the underbody followed by a thorough inspection. Damaged areas need to be re-undercoated.

Your vehicle has been treated at the factory with a wax-base rustproofing in the body cavities which will last for the lifetime of the vehicle. Post-production treatment is neither necessary nor recommended by Mercedes-Benz because of the possibility of incompatibility between materials used in the production process and others applied later.

We have selected car-care products and compiled recommendations which are specially matched to our vehicles and which always reflect the latest technology. You can obtain Mercedes-Benz approved car-care products at an authorized Mercedes-Benz Center.

Scratches, corrosive deposits, corrosion or damage due to negligent or incorrect care cannot always be removed or repaired with the car-care products recommended here. In such cases it is best to seek aid at an authorized Mercedes-Benz Center.

The following topics deal with the cleaning and care of your vehicle and give important “how-to” information as well as references to Mercedes-Benz approved car-care products.

Power washer

! Follow the instructions provided by the power washer manufacturer on maintaining a distance between the vehicle and the nozzle of the power washer.

Never use a round nozzle to power-wash tires. The intense jet of water can result in damage to the tire.

Always replace a damaged tire.

Always keep the jet of water moving across the surface. Do not aim directly at electrical parts, electrical connectors, seals, or other rubber parts.

i *Vehicles with KEYLESS-GO*: If a door handle is hit by a strong jet of water, and a SmartKey with KEYLESS-GO* is in close proximity, i.e. within approximately 3 ft. (approximately 1 m), the vehicle could be inadvertently locked or unlocked.*

Tar stains

Quickly remove tar stains before they dry and become more difficult to remove. A tar remover is recommended.

Paintwork, painted body components

! Affixing stickers, adhesive tape or similar materials to painted body components may damage the paintwork.

Mercedes-Benz approved Paint Care should be applied when water drops on the paint surface do not “bead up”. This should normally be done every 3 to 5 months, depending on the climate and washing detergent used.

Mercedes-Benz approved Paint Cleaner should be applied if the paint surface shows signs of embedded dirt (i.e. loss of gloss).

Do not apply any of these products or wax if your vehicle is parked in the sun or if the hood is still hot.

- ▶ Use the appropriate MB-Touch-Up Stick for quick and provisional repairs of minor paint damage (i.e. chips from stones, vehicle doors, etc.).

Vehicle care

Engine cleaning

Prior to cleaning the engine compartment, make sure to protect electrical components and connectors from contact with water and cleaning agents.

Corrosion protection, such as MB Anticorrosion Wax, should be applied to the engine compartment after every engine cleaning. Before applying, all control linkage bushings and joints should be lubricated. The poly-V-belt and all pulleys should be protected from any wax.

Vehicle washing

In the winter, thoroughly remove all traces of road salt as soon as possible.

When washing the vehicle underbody, do not forget to clean the inner sides of the wheels.

i *Vehicles with KEYLESS-GO*: If a door handle is hit by a strong jet of water, and a SmartKey with KEYLESS-GO* is in close proximity, i.e. within approximately 3 ft (approximately 1 m), the vehicle could be inadvertently locked or unlocked.*

Hand-wash

Do not use hot water or wash your vehicle in direct sunlight.

- ▶ Only use a mild car wash detergent, such as Mercedes-Benz approved Car Shampoo.
- ▶ Thoroughly spray the vehicle with a diffused jet of water.

Direct only a very weak spray towards the ventilation intake.

- ▶ Use plenty of water and rinse the sponge and chamois frequently.
- ▶ Rinse with clean water and thoroughly dry with a chamois.

Do not allow cleaning agents to dry on the finish.

Automatic car wash

You can have your vehicle washed in an automatic car wash from the start. Automatic car washes without brushes are preferable.

! *Do not clean your vehicle in an automatic touchless car wash which uses caustic spray. Otherwise the caustic spray will damage the paint or ornamental moldings.*

If the vehicle is very dirty, prewash it before running it through the automatic car wash.

! *Due to the width of the vehicle, fold in exterior rear view mirrors prior to running the vehicle through an automatic car wash to prevent damage to the mirrors.*

Make sure that the windshield wiper switch is set to 0 (▷ page 351). Otherwise, the rain sensor could activate and cause the wipers to move unintentionally. This may lead to vehicle damage.

i *After running the vehicle through an automatic car wash, wipe any wax off of the windshield (▷ page 540). This will prevent smears and reduce wiping noise which can be caused by residual wax on the windshield.*

When leaving the car wash, make sure that the mirrors are folded out. Otherwise they may vibrate.

Ornamental moldings

For regular cleaning and care of ornamental moldings, use a damp cloth.

! Do not use chrome cleaner on ornamental moldings. Although ornamental moldings may have chrome appearance, they could be made of anodized aluminum that will be damaged when cleaned with chrome cleaner. Instead, use a damp cloth to clean those ornamental moldings.

For very dirty ornamental moldings of which you are sure are chrome-plated, use a chrome cleaner. If in doubt whether an ornamental molding is chrome-plated, contact an authorized Mercedes-Benz Center.

Headlamps, tail lamps, side markers, turn signal lenses

► Use a mild car wash detergent, such as Mercedes-Benz approved Car Shampoo, with plenty of water.

! Only use window cleaning solutions that are suitable for plastic lamp lenses. Window cleaning solutions which are not suitable may damage the plastic lamp lenses of the headlamps. Therefore, do not use abrasives, solvents or cleaners that contain solvents.

Never apply strong force and only use a soft, non-scratching cloth when cleaning the lenses. Do not attempt to wipe dirty lenses with a dry cloth or sponge.

Otherwise you may scratch or damage the lens surface.

Cleaning the DISTRONIC Plus* system sensor cover



① DISTRONIC Plus system sensor cover

- Switch off the ignition (▷ page 315).
- Use a mild car wash detergent, such as Mercedes-Benz approved Car Shampoo, with plenty of water and a non-scratching cloth to clean sensor cover ①.

! To prevent scratches or damage, never apply strong force and only use a soft, non-scratching cloth when cleaning the sensor cover ①. Do not attempt to wipe dirty sensors with a dry cloth or sponge.

Vehicle care

Cleaning the Parktronic* system sensors

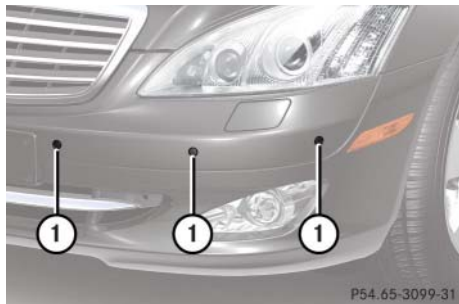

① Parktronic system sensors

- ▶ Use a mild car wash detergent, such as Mercedes-Benz approved Car Shampoo, with plenty of water and a soft, non-scratching cloth to clean sensors ① on the bumpers.

! Do not apply strong pressure to the sensor covers. Applying strong pressure may damage the sensor covers.

Follow the instructions provided by the power washer manufacturer on maintaining a distance between the vehicle and the nozzle of the power washer.

! To prevent scratches, never apply strong force and only use a soft, non-scratching cloth when cleaning the sensors. Do not attempt to wipe dirty sensors with a dry cloth or sponge.

Cleaning the Park Assist* system sensors

The sensors are integrated in the front and rear bumpers and cannot be seen from the outside.



Position of sensors

- ▶ Clean bumper area near sensors with water, shampoo and a soft cloth.

! Do not use any dry, rough or hard cloths and do not scrub. You could otherwise scratch or damage the surface.

Cleaning of the Dynamic Rear View Monitor lens*

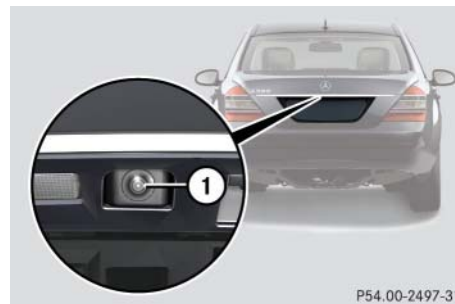

① Camera lens

- ▶ Only clean the camera lens ① with clean water and a soft cloth.
- ▶ Be careful not to apply wax to the camera lens ① when waxing the vehicle. If necessary, remove the wax using a mixture of commercially available car shampoo and water.

! Do not clean the camera and the area around the camera:

- with a high-pressure cleaner
- with a dry cloth and high pressure
- with aggressive cleaning agents

You could otherwise damage the camera.

Cleaning the windshield in front of the Night View Assist camera*

! Do not clean the lens of the Night View Assist camera. If the camera lens is dirty, please contact a qualified specialist workshop such as a Mercedes-Benz Center.

! If you use a windshield cleaning product, make sure that none of the cleaning product comes into contact with the lens of the Night View Assist camera.



- ① Recessed handles of camera cover
- ▶ Use recessed handles ① to swing camera cover downward.

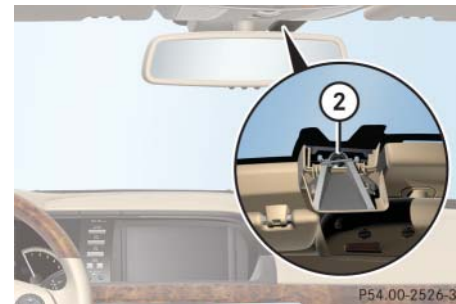

- ② Camera
- ▶ Clean inside of windshield in front of camera ② with a soft cloth.
 - ▶ Use recessed handles ① to swing camera cover up.

Vehicle care

Cleaning the windows and the wiper blades

! *If the windshield wipers leave smears on the windshield after the vehicle has been driven through an automatic car wash, wax or other residue is on the windshield. Clean the windshield with washer fluid shortly after cleaning the car in an automatic car wash (▷ page 352).*

! *The windshield wipers must be in a vertical position before folding them away from the windshield. They could otherwise damage the hood.*

Never open the hood when the wiper arms are folded forward.

- ▶ Make sure the hood is fully closed.
- ▶ Place wiper arms in vertical position (▷ page 627).
- ▶ Make sure the vehicle's on-board electronics have status **0** (▷ page 315).

Warning!



For safety reasons, switch off wipers and remove SmartKey from starter switch (vehicles with KEYLESS-GO*): Make sure the vehicle's on-board electronics have status **0** before cleaning the windshield and/or the wiper blades. Otherwise, the wiper motor could suddenly turn on and cause injury.

- ▶ Fold the wiper arms forward until they snap into place.
- !** *While doing so, only touch the wiper arm so as not to damage the wiper blade inserts.*
- ▶ Clean the wiper blade inserts with a clean cloth and detergent solution.

- ▶ Use a soft, clean cloth and a mild window cleaning solution on all outside and inside glass surfaces.

An automotive glass cleaner is recommended.

! *Fold the windshield wiper arms back onto the windshield before turning the SmartKey in the starter switch or pressing the KEYLESS-GO* start/stop button (vehicles with KEYLESS-GO*).*

Hold on to the wiper when folding the wiper arm back. If released, the force of the impact from the tensioning spring could crack the windshield.

! *To clean the window interior, do not use a dry cloth, abrasives, solvents or cleaners containing solvents. Do not touch the inside of the front, rear or side windows with hard objects such as an ice scraper or ring. Doing so may damage the windows.*

Cleaning the panorama roof with tilt/sliding panel*

The rear part of the tilt/sliding panel has a protective layer on the inside.

- ▶ Use a soft, clean cloth and a mild window cleaning solution.

An automotive glass cleaner is recommended.

! Do not use a dry cloth, abrasives, solvents or cleaners containing solvents. Do not touch the protective layer with hard objects such as an ice scraper or ring. Never apply strong force and only use a soft, non-scratching cloth when cleaning the rear part of the tilt/sliding panel.

Otherwise you may scratch or damage the protective layer.

Light alloy wheels

If possible, clean wheels once a week.

- ▶ Use Mercedes-Benz approved Wheel Care, a soft bristle brush and a strong spray of water for cleaning the light alloy wheels.

! Only use acid-free cleaning materials. Acid may cause corrosion or damage the clear coat.

! The vehicle should not be parked for an extended period of time immediately after it has been cleaned, especially not after the wheel rims have been cleaned with wheel rim cleaner. Wheel rim cleaners can lead to increased corrosion of the brake disks and brake pads. Therefore, the vehicle's brake system should always be warmed-up before it is parked after cleaning. To do so, please drive your vehicle for several minutes to allow the brakes to dry.

When applying Mercedes-Benz approved Tire Care and Mercedes-Benz approved Wheel Care products, take care not to spray them on the brake disks.

Plastic and rubber parts

- ▶ Use a gentle dishwashing detergent or mild detergent for delicate fabrics as a washing solution.

! Do not use oil or wax on these parts.

Instrument cluster and cup holders

- ▶ Use a gentle dishwashing detergent or mild detergent for delicate fabrics as a washing solution.
- ▶ Wipe with a cloth moistened in a luke-warm solution.

! To prevent scratches, do not use scouring agents.

Vehicle care

Hard plastic trim items

- ▶ Use Mercedes-Benz approved Interior Care, a soft, lint-free cloth and apply with light pressure.

! *To prevent scratches, do not use scouring agents.*

Steering wheel

- ▶ Wipe with a damp cloth and dry thoroughly or clean with Mercedes-Benz approved Leather Care.

Carpets

- ▶ Use Mercedes-Benz approved Carpet and Fabric Care for cleaning the carpets.

Headliner and shelf below rear window

- ▶ Use a soft bristle brush or a dry-shampoo cleaner in case of excessive dirt.

Seat belts

- ▶ Only use clear, lukewarm water and soap.

! *The webbing must not be treated with chemical cleaning agents. Do not dry the webbing at temperatures above 176°F (80°C) or in direct sunlight.*

Warning!



Do not bleach or dye seat belts as this may severely weaken them. In a crash they may not be able to provide adequate protection.

Upholstery

Using aftermarket seat covers or wearing clothing that have the tendency to give off coloring (e.g. when wet, etc.) may cause the upholstery to become permanently discolored. By lining the seats with a proper intermediate cover, contact-discoloration will be prevented.

Leather upholstery

- ▶ Wipe leather upholstery with a damp cloth and dry thoroughly or clean with Mercedes-Benz approved Leather Care.

Exercise particular care when cleaning perforated leather as its underside should not become wet.

Wood trims

- ▶ Dampen cloth using water and use damp cloth to clean wood trims in your vehicle.

! *Do not use solvents like tar remover or wheel cleaner nor polishes or waxes as these may be abrasive.*

! *S 600 only: Do not cover the luxury active head restraints*.*

What to do if ...?

Where will I find ...?

Unlocking/locking in an emergency

Opening/closing in an emergency

**Resetting activated head restraints
(S 600 only)**

Replacing SmartKey batteries

Replacing bulbs

Replacing wiper blades

Flat tire

Batteries

Jump starting

Towing the vehicle

Fuses



What to do if ...?





Lamps in instrument cluster

General information:



If any of the following lamps in the instrument cluster fails to come on during the

bulb self-check when switching on the ignition, have the respective bulb checked and replaced if necessary.

Problem	Possible cause/consequence	Suggested solution
 <p>The yellow Antilock Brake System (ABS) indicator lamp comes on while the engine is running.</p>	<p>The ABS has detected a malfunction and has switched off. The BAS, ESP® and PRE-SAFE® are also switched off (see messages in multifunction display).</p> <p>The brake system is still functioning normally but without the ABS available.</p> <p>If the ABS control unit is malfunctioning, other systems such as Parktronic*, DISTRONIC Plus*, navigation system, Park Assist* and the automatic transmission may also be malfunctioning.</p> <p>The charging voltage has fallen below 10 volts. The ABS has switched off.</p> <p>The battery may not be charged sufficiently.</p>	<ul style="list-style-type: none"> ▶ Continue driving with added caution. Wheels may lock during hard braking, reducing steering capability. ▶ Read and observe messages in the multifunction display (▷ page 557). ▶ Have the system checked at an authorized Mercedes-Benz Center as soon as possible. <p>Failure to follow these instructions increases the risk of an accident.</p> <p>When the voltage is above this value again, the ABS is operational again and the ABS indicator lamp should go out.</p> <p>If the ABS indicator lamp does not go out:</p> <ul style="list-style-type: none"> ▶ Have the generator (alternator) and the battery checked.

Problem	Possible cause/consequence	Suggested solution
<p>BRAKE (USA only)</p> <p> (Canada only)</p> <p> </p> <p>The red brake warning lamp comes on while the engine is running. In addition, the yellow ABS malfunction indicator lamp, and the yellow ESP[®] warning lamp come on and a warning will sound.</p>	<p>A malfunction in the Electronic Brake Proportioning (EBP) was detected. The ABS, BAS, ESP[®] and PRE-SAFE[®] are also switched off (see messages in multifunction display).</p> <p>The brake system continues to function normally, but without electronic support.</p>	<ul style="list-style-type: none"> ▶ Continue driving with added caution. Wheels may lock during hard braking, reducing steering capability. ▶ Read and observe messages in the multifunction display (▷ page 557). ▶ Have the system checked at an authorized Mercedes-Benz Center as soon as possible. <p>Failure to follow these instructions increases the risk of an accident.</p>
<p> </p> <p>The yellow ABS malfunction indicator lamp, and the yellow ESP[®] warning lamp come on while the engine is running and a warning will sound.</p>	<p>ABS and ESP[®] are switched off due to a malfunction.</p> <p>The BAS, EBP and PRE-SAFE[®] are also switched off (see messages in multifunction display).</p>	<ul style="list-style-type: none"> ▶ Continue driving with added caution. Wheels may lock during hard braking, reducing steering capability. ▶ Read and observe messages in the multifunction display (▷ page 557). ▶ Have the system checked at an authorized Mercedes-Benz Center as soon as possible. <p>Failure to follow these instructions increases the risk of an accident.</p>

What to do if ...?

Problem	Possible cause/consequence	Suggested solution
<p>PARK (USA only)</p> <p> (Canada only)</p> <p>The red indicator lamp for the electric parking brake flashes and/or the yellow warning lamp for the electric parking brake is on.</p>	<p>The electric parking brake is malfunctioning or defective.</p>	<ul style="list-style-type: none"> ▶ Read and observe messages in the multifunction display (▷ page 557). ▶ Have the system checked at an authorized Mercedes-Benz Center as soon as possible.
<p>BRAKE (USA only)</p> <p> (Canada only)</p> <p>The red brake warning lamp comes on while driving and you hear a warning sound.</p>	<p>There is insufficient brake fluid in the reservoir.</p>	<ul style="list-style-type: none"> ▶ Risk of accident! Do not drive any further. Consult a Mercedes-Benz Center. Under no circumstances should you top up the brake fluid. This will not solve the problem.

Warning!



Driving with the brake warning lamp illuminated can result in an accident. Have your brake system checked immediately if the brake warning lamp stays on. Do not add

brake fluid before checking the brake system. Overfilling the brake fluid reservoir can result in spilling brake fluid on hot engine parts and the brake fluid catching fire. You can be seriously burned.



! *If you find that the brake fluid in the brake fluid reservoir has fallen to the minimum mark or below, have the brake system checked for brake pad thickness and leaks.*

Problem	Possible cause/consequence	Suggested solution
 <p>The yellow engine malfunction indicator lamp comes on while driving.</p>	<p>There is a malfunction in:</p> <ul style="list-style-type: none"> • The fuel management system • The ignition system • The emission control system • Systems which affect emissions <p>Such malfunctions may result in excessive emissions values and may switch the engine to its limp-home (emergency operation) mode.</p>	<p>► Have the vehicle checked as soon as possible by an authorized Mercedes-Benz Center. An on-board diagnostic connector is used by the service station to link the vehicle to the shop diagnostics system. It allows the accurate identification of system malfunctions through the read-out of diagnostic trouble codes. It is located in the front left area of the footwell.</p>



 *Some states may by law require you to visit a workshop immediately as soon as the engine malfunction indicator lamp comes on. Check local requirements.*



What to do if ...?

Problem	Possible cause/consequence	Suggested solution
 The yellow engine malfunction indicator lamp comes on while driving.	A loss of pressure has been detected in the fuel system. The fuel cap may not be closed properly or the fuel system may be leaky.	<ul style="list-style-type: none">▶ Check the fuel cap. If it is not closed properly: <ul style="list-style-type: none">▶ Close the fuel cap. If it is closed properly: <ul style="list-style-type: none">▶ Have the fuel system checked by an authorized Mercedes-Benz Center.
	Your fuel tank is empty.	<ul style="list-style-type: none">▶ After refueling, start, turn off, and restart the engine three or four times in succession. The limp-home mode is canceled. You do not need to have your vehicle checked.

Problem	Possible cause/consequence	Suggested solution
 <p>Only vehicles with DISTRONIC Plus*: The red distance warning lamp comes on while driving.</p>	<p>You are too close to the vehicle in front of you to maintain selected speed.</p>	<ul style="list-style-type: none"> ▶ Apply the brakes immediately to increase the following distance.
 <p>Only vehicles with DISTRONIC Plus*: The red distance warning lamp comes on while driving and you hear a warning sound.</p>	<ul style="list-style-type: none"> • You are gaining too rapidly on the vehicle ahead of you. • The distance warning system has recognized a stationary obstacle on your probable line of travel. 	<ul style="list-style-type: none"> ▶ Apply the brakes immediately. ▶ Carefully observe the traffic situation. You may need to brake or maneuver to avoid hitting an obstacle.
 <p>The yellow ESP® warning lamp flashes while driving.</p>	<p>The ESP® or ETS has come into operation because of detected traction loss in at least one tire.</p> <p>Cruise control and DISTRONIC Plus* are deactivated.</p>	<ul style="list-style-type: none"> ▶ When driving off, apply as little throttle as possible. ▶ While driving, ease up on the accelerator. ▶ Adapt your speed and driving to the prevailing road and weather conditions. ▶ Do not deactivate the ESP®. Exceptions: (▷ page 73). <p>Failure to follow these instructions increases the risk of an accident.</p>

What to do if ...?

Problem	Possible cause/consequence	Suggested solution
 <p>The yellow ESP® warning lamp comes on while the engine is running.</p>	<p>The ESP® is deactivated. Risk of accident! Adapt your speed and driving to the prevailing road, weather, and traffic conditions.</p> <p>ESP® is switched off due to a malfunction. Risk of accident! Adapt your speed and driving to the prevailing road, weather, and traffic conditions.</p>	<ul style="list-style-type: none"> ▶ Switch the ESP® back on (▷ page 72). Exceptions: (▷ page 73). <p>If the ESP® cannot be switched back on:</p> <ul style="list-style-type: none"> ▶ Have the system checked at an authorized Mercedes-Benz Center as soon as possible. <ul style="list-style-type: none"> ▶ Continue driving with added caution. ▶ Read and observe messages in the multifunction display (▷ page 557). ▶ Have the system checked at an authorized Mercedes-Benz Center as soon as possible.
<p>The yellow fuel tank reserve warning lamp in the fuel gauge comes on while driving.</p>	<p>The fuel level has gone below the reserve mark.</p>	<ul style="list-style-type: none"> ▶ Refuel at the next gas station (▷ page 489).
 <p>The red seat belt telltale comes on and a warning chime sounds for approximately 6 seconds after starting the engine with all doors closed.</p>	<p>The seat belt telltale reminds you and your passengers to fasten your seat belts before driving off.</p>	<ul style="list-style-type: none"> ▶ Fasten your seat belts. <p>The seat belt telltale goes out and the warning chime stops sounding.</p>

Problem	Possible cause/consequence	Suggested solution
 <p>The red seat belt telltale remains illuminated after driving off. The vehicle's speed does not exceed 15 mph (25 km/h).</p>	<p>You and/or your front passenger have forgotten to fasten your seat belts.</p> <p>There are items placed on the front passenger seat and therefore the system senses the front passenger seat as being occupied.</p>	<ul style="list-style-type: none"> ▶ Fasten your seat belts. or ▶ Remove the items from the front passenger seat and put them in a safe place. <p>The seat belt telltale goes out.</p>
 <p>The red seat belt telltale flashes and you additionally hear an intermittent warning chime with increasing intensity for a maximum of 60 seconds from the time the vehicle's speed exceeds 15 mph (25 km/h).</p>	<p>You and/or your front passenger have forgotten to fasten your seat belts.</p> <p>There are items placed on the front passenger seat and therefore the system senses the front passenger seat as being occupied.</p>	<ul style="list-style-type: none"> ▶ Fasten your seat belts. or ▶ Remove the items from the front passenger seat and put them in a safe place. <p>The seat belt telltale goes out and the warning chime stops sounding.</p>

i After 60 seconds with an unfastened seat belt the warning chime stops sounding and the seat belt telltale illuminates continuously. The seat belt telltale will only go out if both, the driver and front passenger's, seat belt are fastened, or the vehicle is standing still and a front door is opened.



What to do if ...?

Problem	Possible cause/consequence	Suggested solution
 The red SRS indicator lamp comes on while the engine is running.	There is a malfunction in the supplemental restraint systems. The air bags or emergency tensioning devices (ETDs) could deploy unexpectedly or fail to activate in an accident.	► Drive with added caution to the nearest authorized Mercedes-Benz Center.

Warning!



In the event a malfunction of the SRS is indicated as outlined above, the SRS may not be operational. For your safety, we strongly recommend that you visit an authorized Mercedes-Benz Center immediately to have the system checked; otherwise the SRS may not be activated when needed in an accident, which could result in serious or fatal injury, or it might deploy unexpectedly and unnecessarily which could result in an accident and/or injury to you or to others.

Problem	Possible cause/consequence	Suggested solution
 <p>Combination low tire pressure/TPMS malfunction telltale for the Advanced TPMS* illuminates continuously.</p>	<p>The Advanced TPMS* detects a loss of pressure in at least one tire.</p>	<ul style="list-style-type: none"> ▶ Carefully bring the vehicle to a halt, avoiding abrupt steering and braking maneuvers. Observe the traffic situation around you. ▶ Read and observe messages in the multifunction display (▷ page 557). <p>If the tire inflation pressure in the respective tire(s) has (have) been corrected, the combination low tire pressure/TPMS malfunction telltale goes out after few minutes driving.</p>
 <p>Combination low tire pressure/TPMS malfunction telltale for the Advanced TPMS* flashes for 60 seconds and then stays illuminated.</p>	<p>There is a malfunction in the Advanced TPMS*.</p>	<ul style="list-style-type: none"> ▶ Read and observe messages in the multifunction display (▷ page 557). ▶ Have the Advanced TPMS* checked by an authorized Mercedes-Benz Center. <p>After the malfunction has been remedied the combination low tire pressure/TPMS malfunction telltale goes out after few minutes driving.</p>

What to do if ...?

Warning!



Each tire, including the spare (if provided), should be checked monthly when cold and inflated to the inflation pressure recommended by the vehicle manufacturer on the vehicle placard or the tire inflation pressure label. (If your vehicle has tires of a different size than the size indicated on the vehicle placard or the tire inflation pressure label, you should determine the proper tire inflation pressure for those tires).



As an added safety feature, your vehicle has been equipped with a tire pressure monitoring system (TPMS) that illuminates a low tire pressure telltale when one or more of your tires is significantly under-inflated. Accordingly, when the low tire pressure telltale illuminates, you should stop and check your tires as soon as possible, and inflate them to the proper pressure. Driving on a significantly under-inflated tire causes the tire to overheat and can lead to tire failure.

Under-inflation also reduces fuel efficiency and tire tread life, and may affect the vehicle's handling and stopping ability. Please note that the TPMS is not a substitute for proper tire maintenance, and it is the driver's responsibility to maintain correct tire pressure, even if under-inflation has not reached the level to trigger illumination of the TPMS low tire pressure telltale.

Your vehicle has also been equipped with a TPMS malfunction indicator to indicate when the system is not operating properly. The TPMS malfunction indicator is combined with the low tire pressure telltale. When the system detects a malfunction, the telltale will flash for approximately one minute and then remain continuously illuminated. This sequence will continue upon subsequent vehicle start-ups as long as the malfunction exists. When the malfunction indicator is illuminated, the system may not be able to detect or signal low tire pressure as intended.



TPMS malfunctions may occur for a variety of reasons, including the installation of replacement or alternate tires or wheels on the vehicle that prevent the TPMS from functioning properly. Always check the TPMS malfunction telltale after replacing one or more tires or wheels on your vehicle to ensure that the replacement or alternate tires and wheels allow the TPMS to continue to function properly.

Air bag off indicator lamp

Problem	Possible cause/consequence	Suggested solution
  The front passenger front air bag off indicator lamp illuminates and remains illuminated with the weight of a typical adult or someone larger than a small individual on the front passenger seat.	The system is malfunctioning.	<ul style="list-style-type: none"> ▶ Have the system checked as soon as possible by an authorized Mercedes-Benz Center. ▶ Also read and observe any messages in the multifunction display and follow corrective steps (▷ page 564).

Warning!



If the   indicator lamp illuminates and remains illuminated with the weight of a typical adult or someone larger than a small individual on the front passenger seat, do not have any passenger use the front passenger seat until the system has been repaired.

What to do if ...?

Problem	Possible cause/consequence	Suggested solution
<p> PASS AIR BAG OFF</p> <p>The front passenger front air bag off indicator lamp does not illuminate and/or does not remain illuminated with the weight of a typical 12-month-old child in a standard child restraint or less on the front passenger seat.</p>	<p>The system is malfunctioning.</p>	<ul style="list-style-type: none"> ▶ Make sure there is nothing between seat cushion and child seat and check installation of the child seat. ▶ Make sure no objects applying supplemental weight onto the seat are present. ▶ Make sure no objects which apply forces to the seat are present (e.g. objects such as books, briefcases etc. lodged behind or around the seat, head restraints pushing against roof etc.). The system may recognize such forces as supplemental weight. ▶ If the front passenger front air bag off indicator lamp remains out, have the system checked as soon as possible by an authorized Mercedes-Benz Center. Do not transport a child on the front passenger seat until the system has been repaired. ▶ Also read and observe any messages in the multifunction display and follow corrective steps (▷ page 564).

Warning!



If the  **PASS AIR BAG OFF** indicator lamp does not illuminate or remains out with the weight of a typical 12-month-old child in a standard child restraint or less on the front

passenger seat, do not transport a child on the front passenger seat until the system has been repaired.

Vehicle status messages in the multifunction display

Warning and malfunction messages appear in the multifunction display located in the instrument cluster.

Certain warning and malfunction messages are accompanied by an audible signal.

High-priority messages are shown in red on the multifunction display. Messages of lower priority are also shown in yellow or white.

Address these messages accordingly and follow the additional instructions given in this Operator's Manual.

Certain messages of high priority cannot be cleared from the multifunction display using **OK** or **↩** on the multifunction steering wheel (▷ page 242).

Other messages of high priority and messages of less immediate priority can be cleared from the multifunction display using **OK** or **↩**. They are then stored in the vehicle status message memory (▷ page 253). Remember that clearing a message will only make the message disappear. Clearing a message will not correct the condition that caused the message to appear.

Warning!



No messages will be displayed if either the instrument cluster or the multifunction display is inoperative.

As a result, you will not be able to see information about your driving conditions, such as speed or outside temperature, warning/indicator lamps, malfunction/warning messages or the failure of any systems. Driving characteristics may be impaired.

If you must continue to drive, please do so with added caution. Visit an authorized Mercedes-Benz Center as soon as possible.

What to do if ...?

Warning!



All categories of messages contain important information which should be taken note of and, where a malfunction is indicated, addressed as soon as possible at an authorized Mercedes-Benz Center.

Failure to repair condition noted may cause damage not covered by the Mercedes-Benz Limited Warranty, or result in property damage or personal injury.

i *Switching on the ignition causes all instrument cluster lamps (except high beam headlamp indicator lamp and turn signal indicator lamps unless activated) as well as the multifunction display to come on. Make sure the lamps and multifunction display are in working order before starting your journey.*

On the pages that follow, you will find a compilation of the most important warning and malfunction messages that may appear in the malfunction display.

For your convenience the messages are divided into two sections:

- Text messages (▷ page 559)
- Symbol messages (▷ page 570)

Text messages

Display	Possible cause/consequence	Possible solution
<i>Apply brake to shift from 'P'</i>	You have tried to Shift the automatic transmission to D , R or N without stepping on the brake.	▶ Step on brake.
USA only: <i>Cruise control --- mph</i> Canada only: <i>Cruise control --- km/h</i>	You have tried to switch on cruise control below a speed of 20 mph (30 km/h).	▶ Drive faster than 20 mph (30 km/h) and save the speed.
	ESP® is deactivated.	▶ Activate ESP® (▷ page 72).
	The automatic transmission is in position P , R or N .	▶ Shift the automatic transmission to D (▷ page 367).
	The system is overheated.	▶ Wait until the system cools down.
	The vehicle is secured in place by the electric parking brake.	▶ Release electric parking brake (▷ page 364).
<i>Cruise control inoperative</i>	Cruise control is malfunctioning.	▶ Have cruise control checked by an authorized Mercedes-Benz Center.



What to do if ...?

Display	Possible cause/consequence	Possible solution
DISTRONIC PLUS <i>currently unavailable</i> <i>See Oper. Manual</i>	You attempt to activate DISTRONIC Plus* even though you have switched off the radar sensors* on the vehicle.	<ul style="list-style-type: none"> ▶ Check if the radar sensors* may be switched on (▷ page 256). ▶ Switch on the radar sensors* using the instrument cluster control system.
	DISTRONIC Plus* is switched off and is temporarily unavailable. DISTRONIC Plus* is deactivated if: <ul style="list-style-type: none"> • the DISTRONIC Plus* cover in the radiator grille is dirty • the radar sensors* does not sense any other vehicles or objects, i.e. road sign or similar to this, for a long time • the system is overheated • its function is impaired as a result of heavy precipitation or fog • the battery voltage is insufficient 	<ul style="list-style-type: none"> ▶ Clean the DISTRONIC Plus* cover in the radiator grille (▷ page 537). ▶ Restart the vehicle. ▶ Try activating DISTRONIC Plus* again later. ▶ Wait until the system cools down or the battery recovers. DISTRONIC Plus* will be operational again without you needing to restart the engine if: <ul style="list-style-type: none"> • the dirt (e.g. slush) loosens while you are driving • the system detects that the sensors* are fully available again • the message in the multifunction display disappears
	DISTRONIC Plus* is switched off because the radar sensor system* is temporarily inoperative due to electromagnetic interference near television and radio transmitter stations, toll stations, speed measuring systems, etc.	<ul style="list-style-type: none"> ▶ Wait until the message in the multifunction display disappears.

Display	Possible cause/consequence	Possible solution
<i>DISTRONIC PLUS inoperative</i>	DISTRONIC Plus* is malfunctioning.	▶ Visit an authorized Mercedes-Benz Center as soon as possible.
<i>DISTRONIC PLUS passive</i>	You have depressed the accelerator pedal, DISTRONIC Plus* is no longer controlling the speed of the vehicle.	▶ Release the accelerator pedal.
USA only: <i>DISTRONIC PLUS --- mph</i>	You have attempted to activate DISTRONIC Plus* at a speed below 20 mph (30 km / h) without the vehicle in front being displayed in the multifunction display (▷ page 385).	▶ Drive faster than 20 mph (30 km / h) and activate DISTRONIC Plus* again.
Canada only: <i>DISTRONIC PLUS --- km/h</i>		
	ESP® is deactivated.	▶ Activate ESP® (▷ page 72).
	The automatic transmission is in position P , R or N .	▶ Shift the automatic transmission to D (▷ page 367).
	The system is overheated.	▶ Wait until the system cools down.
	The vehicle is secured in place by the electric parking brake.	▶ Release electric parking brake (▷ page 364).
	The driver's door is open and the driver's seat belt is unbuckled.	▶ Close the driver's door and fasten your seat belt.
	The hood is open.	▶ Close the hood (▷ page 493).

What to do if ...?

Display	Possible cause/consequence	Possible solution
<i>Door Open</i> <i>Vehicle not in Park</i>	You have opened the driver's door and the automatic transmission is still in position D , R or N .	<ul style="list-style-type: none"> ▶ Before you leave the vehicle, make sure that the automatic transmission is shift to position P and that the parking brake is engaged.
<i>Front passenger airbag disabled</i> <i>See Oper. Manual</i>	Front passenger front air bag is deactivated while driving even though an adult or someone larger than a small individual is occupying the front passenger seat. Forces acting on the seat may make the system sense a decrease in weight.	<p>Stop the vehicle in a safe location as soon as possible and check the front passenger seat for the following:</p> <ul style="list-style-type: none"> ▶ Switch off the ignition (▷ page 315). ▶ Have the front passenger vacate the seat and exit the vehicle. ▶ Adjust the seat in a height position (▷ page 318). ▶ Make sure that no objects which apply forces to the seat are present (e.g. objects such as books, briefcases etc. lodged underneath, behind or around the seat). Such forces may cause the system to sense that an occupant of a lesser weight than actually present is on the front passenger seat. ▶ Keep the seat unoccupied, close the front passenger door and switch on the ignition (▷ page 315). <p>Monitor the  PASS AIR BAG OFF indicator lamp right of the instrument cluster (▷ page 53) and the multifunction display in the instrument cluster (▷ page 241) for the following:</p> <p>(Continued on next page)</p>

Display	Possible cause/consequence	Possible solution
<p>Front passenger airbag disabled See Oper. Manual</p>		<p>With the seat unoccupied and the ignition switched on (▷ page 315),</p> <ul style="list-style-type: none"> the  PASS AIR BAG OFF indicator lamp right of the instrument cluster should illuminate and remain illuminated, indicating that the OCS (▷ page 50) has deactivated the air bag. the message “Front passenger airbag enabled See Oper. Manual” or the message “Front passenger airbag disabled See Oper. Manual” should not appear in the multifunction display at any time the seat is unoccupied. Wait at least 60 seconds for the system to complete the necessary check cycles and to make sure neither message appears in the multifunction display. <p>If above conditions are met, you can occupy the front passenger seat again. Depending on the front passenger classification sensed by the OCS (▷ page 50), the  PASS AIR BAG OFF indicator lamp will remain illuminated or go out.</p> <p>If above conditions are not met, the system is not working properly. Have the system checked as soon as possible by an authorized Mercedes-Benz Center.</p>

Warning!





If the  **PASS AIR BAG OFF** indicator lamp remains illuminated with an adult occupant on the front passenger seat even after

performing the above corrective steps, do not have any passenger use the front passenger seat until the system has been repaired.

What to do if ...?

Display	Possible cause/consequence	Possible solution
<p><i>Front passenger airbag enabled</i> See Oper. Manual</p>	<p>Front passenger front air bag is activated while driving even though a child, small individual, or object below the system's weight threshold is on the front passenger seat, or the front passenger seat is empty. Objects on the seat or forces acting on the seat may make the system sense supplemental weight.</p>	<p>Stop the vehicle in a safe location as soon as possible and check the front passenger seat for the following:</p> <ul style="list-style-type: none"> ▶ Switch off the ignition (▷ page 315). ▶ Remove child and child restraint from front passenger seat and properly secure the child in rear seat employing the child restraint if necessary. ▶ Remove any other items from on and around the front passenger seat and make sure the storage bag on the back of the front passenger seat is empty. ▶ Make sure that no objects which apply forces to the seat are present (e.g. objects such as books, briefcases etc. lodged behind or around the seat, head restraints pushing against roof etc.). The system may recognize such forces as supplemental weight and sense that an occupant on the front passenger seat is of a greater weight than actually present. ▶ Keep the seat unoccupied, close the front passenger door and switch on the ignition (▷ page 315). <p>Monitor the  PASS AIR BAG OFF indicator lamp right of the instrument cluster (▷ page 53) and the multifunction display in the instrument cluster (▷ page 241) for the following:</p> <p>(Continued on next page)</p>

Display	Possible cause/consequence	Possible solution
<p>Front passenger airbag enabled See Oper. Manual</p>		<p>With the seat unoccupied and the ignition switched on (▷ page 315),</p> <ul style="list-style-type: none"> the  PASS AIR BAG OFF indicator lamp right of the instrument cluster should illuminate and remain illuminated, indicating that the OCS (▷ page 50) has deactivated the air bag. the message “Front passenger airbag enabled See Oper. Manual” or the message “Front passenger airbag disabled See Oper. Manual” should not appear in the multifunction display at any time the seat is unoccupied. Wait at least 60 seconds for the system to complete the necessary check cycles and to make sure neither message appears in the multifunction display. <p>If above conditions are met, you can occupy the front passenger seat again. Depending on the front passenger classification sensed by the OCS (▷ page 50), the  PASS AIR BAG OFF indicator lamp will remain illuminated or go out.</p> <p>If above conditions are not met, the system is not working properly. Have the system checked as soon as possible by an authorized Mercedes-Benz Center.</p>

Warning!



If the  **PASS AIR BAG OFF** indicator lamp remains illuminated with an adult occupant on the front passenger seat even after

performing the above corrective steps, do not have any passenger use the front passenger seat until the system has been repaired.

What to do if ...?

Display	Possible cause/consequence	Possible solution
<i>Next Service X due in ... days due in ... mls (km)</i>	Service X must be carried out in ... days or after ... miles (kilometers) (▷ page 532).	▶ Have the maintenance service carried out by an authorized Mercedes-Benz Center.
<i>Only shift to position 'P' when vehicle is stationary</i>	You have tried to Shift the automatic transmission to P using the gear selector lever although the vehicle is still in motion.	▶ Stop the vehicle.
<i>Park Assist currently unavailable See Oper. Manual</i>	You attempt to activate Park Assist* even though you have switched off the radar sensors* on the vehicle.	▶ Check if the radar sensors* may be switched on (▷ page 256). ▶ Switch on the radar sensors* using the instrument cluster control system.
	Park Assist* is deactivated because the area around the sensors* in the front or the rear bumper (▷ page 538) is dirty.	▶ Clean the front and rear bumper (▷ page 538).
	Park Assist* is deactivated because the battery voltage is insufficient.	▶ Have the battery checked by an authorized Mercedes-Benz Center.
	Park Assist* is switched off because the radar sensor system* is temporarily inoperative due to electromagnetic interference near television and radio transmitter stations, toll stations, speed measuring systems, etc.	▶ Wait until the message in the multifunction display disappears.

Display	Possible cause/consequence	Possible solution
<i>Park Assist inoperative</i>	Park Assist* is unavailable due to a malfunction.	▶ Visit an authorized Mercedes-Benz Center as soon as possible.
<i>PRE-SAFE inoperative</i> <i>See Owner's Manual</i>	PRE-SAFE® itself has failed. All other occupant safety systems, such as the air bags, are still available.	▶ Visit an authorized Mercedes-Benz Center as soon as possible.
<i>Check tires then restart Run Flat Indicator</i>	There was a warning message about a loss in tire inflation pressure and the Run Flat Indicator* has not been restarted yet.	▶ Check and adjust tire inflation pressure as required (▷ page 514). ▶ Then restart the Run Flat Indicator* (▷ page 515).
<i>Radar sensor deactivated</i> <i>See Oper. Manual</i>	You attempt to activate DISTRONIC Plus* or Park Assist* even though you have switched off the radar sensors* on the vehicle.	▶ Check if the radar sensors* may be switched on (▷ page 256). ▶ Switch on the radar sensors* using the instrument cluster control system.
<i>Run Flat Indicator inoperative</i>	The Run Flat Indicator* is malfunctioning.	▶ Visit an authorized Mercedes-Benz Center as soon as possible.
<i>Service X due</i>	Service X must be carried out (▷ page 532).	▶ Have the maintenance service carried out by an authorized Mercedes-Benz Center.
<i>Service X exceeded by X days by XXX mls (km)</i>	Service X must be carried within the next ... or before you have driven ... miles (kilometers) (▷ page 532).	▶ Have the maintenance service carried out by an authorized Mercedes-Benz Center as soon as possible.
<i>Shift to P or N to start engine</i>	You have attempted to start the engine while the automatic transmission was set to position R or D .	▶ Shift the automatic transmission to P or N (▷ page 367).

What to do if ...?

Display	Possible cause/consequence	Possible solution
<i>Tire pressure</i> <i>Check tires</i>	The pressure has fallen significantly in one or more tires.	<ul style="list-style-type: none"> ▶ Carefully bring the vehicle to a halt, avoiding abrupt steering and braking maneuvers. Observe the traffic situation around you. ▶ Check and adjust tire inflation pressure as required (▷ page 511). ▶ If necessary, change the wheel (▷ page 629). ▶ Restart the Run Flat Indicator* after adjusting the tire inflation pressure values (▷ page 516).
<i>Tire pressure monitor</i> <i>inoperative</i>	The Advanced TPMS* or a wheel sensor is malfunctioning.	▶ Have the Advanced TPMS* checked by an authorized Mercedes-Benz Center.
<i>Tire pressure monitor</i> <i>inoperative</i> <i>No wheel sensors</i>	The Advanced TPMS* is deactivated because wheels without proper sensors were installed.	<ul style="list-style-type: none"> ▶ Have the wheel sensors installed by an authorized Mercedes-Benz Center. <p>As soon as all wheels with sensors have been mounted, the Advanced TPMS* is switched back on after driving for several minutes.</p>

Warning!



Do not drive with a flat tire. A flat tire affects the ability to steer or brake the vehicle. You

may lose control of the vehicle. Continued driving with a flat tire will cause excessive heat build-up and possibly a fire.

Display	Possible cause/consequence	Possible solution
<i>Tire pressure monitor currently unavailable</i>	<p>The Advanced TPMS* is unable to monitor the tire inflation pressure due to:</p> <ul style="list-style-type: none"> • a nearby radio interference source • the on-board voltage is too low • excessive wheel sensor temperatures 	<p>As soon as the causes for the malfunction are no longer present, the Advanced TPMS* automatically becomes active again after a few minutes driving.</p>
<i>Tire pressures displayed after driving a few minutes</i>	<p>Vehicles with Advanced TPMS*: The tire inflation pressure is being checked.</p>	<ul style="list-style-type: none"> ▶ Drive the vehicle for a few minutes.
<i>Visit workshop without shifting gears</i>	<p>The automatic transmission cannot be shifted out of the set position because of a malfunction.</p>	<p>If the automatic transmission is shift to position D:</p> <ul style="list-style-type: none"> ▶ Without changing the automatic transmission from position D, drive to an authorized Mercedes-Benz Center. <p>If the automatic transmission is shift to position N, R or P:</p> <ul style="list-style-type: none"> ▶ Do not drive. ▶ Consult an authorized Mercedes-Benz Center.

What to do if ...?



Symbol messages

Display	Possible cause/consequence	Possible solution
 <p><i>Malfunction Stop Vehicle!</i></p>	<p>You have started driving although the vehicle level is still too low.</p> <p>The vehicle is raised. The ABC* message goes out after a few seconds.</p>	<ul style="list-style-type: none"> ▶ Stop your vehicle as soon as it is safe to do so. ▶ Wait until the message disappears from the multifunction display. You may then drive off.
	<p>The vehicle is losing oil.</p> <p>The ABC* message is continuously shown.</p>	<ul style="list-style-type: none"> ▶ Stop your vehicle as soon as it is safe to do so. ▶ Call Roadside Assistance. ▶ Notify an authorized Mercedes-Benz Center.
	<p>ABC* is malfunctioning.</p> <p>The ABC* message is continuously shown.</p>	<ul style="list-style-type: none"> ▶ Do not turn steering wheel too far to avoid damaging the front fenders. ▶ Listen for scraping noises. ▶ Do not exceed a speed of 50 mph (80 km/h). ▶ Visit an authorized Mercedes-Benz Center as soon as possible.

Display	Possible cause/consequence	Possible solution
<p>ABC</p> <p><i>Malfunction</i></p>	<p>The capability of the ABC* system is restricted. This can impair the handling.</p>	<ul style="list-style-type: none"> ▶ Do not exceed a speed of 50 mph (80 km/h). ▶ Visit an authorized Mercedes-Benz Center as soon as possible.
<p><i>Vehicle rising</i></p> <p><i>Please wait a moment</i></p>	<p>The vehicle's level is too low while at a standstill. The vehicle will be raised.</p>	<ul style="list-style-type: none"> ▶ Do not drive off. ▶ Wait until the message disappears from the multifunction display. <p>You may then drive off.</p>

What to do if ...?

Display	Possible cause/consequence	Possible solution
 <p><i>ABS and ESP inoperative See Oper. Manual</i></p>	<p>ABS, ESP® as well as PRE-SAFE® are switched off due to a malfunction. BAS is also switched off.</p> <p>The brake system is still functioning normally but without the ABS available.</p>	<ul style="list-style-type: none"> ▶ Continue driving with added caution. Wheels may lock during hard braking, reducing steering capability. ▶ Have the system checked at an authorized Mercedes-Benz Center as soon as possible. <p>Failure to follow these instructions increases the risk of an accident.</p>
<p><i>ABS and ESP currently unavailable See Oper. Manual</i></p>	<p>ABS, ESP® as well as PRE-SAFE® are not available due to a malfunction. BAS is also switched off. It is possible that the self-diagnostics have not yet been completed.</p> <p>The brake system still functions normally.</p>	<ul style="list-style-type: none"> ▶ Drive a short distance with gentle turns above a speed of 12 mph (20 km/h). The message disappears when ABS and ESP® are again available.
	<p>The ABS, ESP® as well as PRE-SAFE® were deactivated because of insufficient power supply. The charging voltage has fallen below 10 volts.</p> <p>The brake system still functions normally but without the ABS, ESP® and PRE-SAFE® available.</p>	<p>When the voltage is above this value again, the ABS, ESP® and PRE-SAFE® are operational again and the message in the multifunction display should disappear.</p> <p>If the message in the multifunction display does not disappear:</p> <ul style="list-style-type: none"> ▶ Have the generator (alternator) and the battery checked.

Display	Possible cause/consequence	Possible solution
<div data-bbox="97 232 248 348">  </div> <p data-bbox="260 232 399 288"><i>Check brake fluid level</i></p> <p data-bbox="97 359 209 387">(USA only)</p> <div data-bbox="97 404 248 519">  </div> <p data-bbox="97 527 244 555">(Canada only)</p>	<p data-bbox="512 232 981 288">There is insufficient brake fluid in the reservoir.</p>	<p data-bbox="991 232 1517 387">► Risk of accident! Stop the vehicle in a safe location as soon as it is safe to do so and notify an authorized Mercedes-Benz Center. Do not add brake fluid! This will not solve the problem.</p>



Warning!





Driving with the message “*Check brake fluid level!*” displayed can result in an accident. Have your brake system checked immediately. Do not add brake fluid before checking the brake system. Overfilling the brake fluid reservoir can result in spilling brake fluid on hot engine parts and the brake fluid catching fire. You can be seriously burned.

! *If you find that the brake fluid in the brake fluid reservoir has fallen to the minimum mark or below, have the brake system checked for brake pad thickness and leaks.*



What to do if ...?



Display	Possible cause/consequence	Possible solution
<p>BRAKE</p> <p><i>Brake immediately</i></p> <p>(USA only)</p>  <p>(Canada only)</p>	<p>A malfunction has occurred while DISTRONIC Plus* was switched on.</p>	<ul style="list-style-type: none"> ▶ While observing surrounding traffic conditions and when it is safe, immediately depress the brake pedal firmly until the warning message disappears. ▶ Secure vehicle from rolling away before getting out of it (▷ page 363).
<p>BRAKE</p> <p><i>EBV, ABS, ESP inoperative</i> <i>See Oper. Manual</i></p> <p>(USA only)</p>  <p>(Canada only)</p>	<p>ESP®, EBP and ABS are switched off due to a malfunction. BAS is also switched off. As a result, PRE-SAFE® is also inoperative.</p>	<ul style="list-style-type: none"> ▶ Continue driving with added caution. ▶ Have the system checked at an authorized Mercedes-Benz Center as soon as possible. <p>Failure to follow these instructions increases the risk of an accident.</p>

Display	Possible cause/consequence	Possible solution
 <p><i>Service See Oper. Manual</i></p> <p>(USA only)</p>  <p>(Canada only)</p>	<p>S 600 only:</p> <p>The brake system sensors are malfunctioning. The brake system continues to function normally with full brake force boost.</p>	<ul style="list-style-type: none"> ▶ Continue driving with added caution. ▶ Have the system checked at an authorized Mercedes-Benz Center as soon as possible.
 <p><i>Brake wear</i></p>	<p>The brake pads have reached their wear limit.</p>	<ul style="list-style-type: none"> ▶ Have the brake pads replaced as soon as possible.



! Brake pad thickness must be visually checked by a qualified technician at the intervals specified in the Maintenance Booklet.



What to do if ...?

Display	Possible cause/consequence	Possible solution
<div data-bbox="82 232 233 348">  </div> <p data-bbox="245 232 443 292"><i>Parking brake See Oper. Manual</i></p> <p data-bbox="82 359 196 387">(USA only)</p> <div data-bbox="82 404 233 519">  </div> <p data-bbox="82 530 229 558">(Canada only)</p>	<p data-bbox="496 232 965 356">The red indicator lamp for the electric parking brake is either on or off and the yellow warning lamp for the electric parking brake comes on.</p> <p data-bbox="496 372 965 434">The electric parking brake is malfunctioning.</p>	<p data-bbox="976 232 1098 260">To release:</p> <ul data-bbox="976 277 1406 339" style="list-style-type: none"> ▶ Pull handle of electric parking brake (▷ page 364). <p data-bbox="976 356 1002 384">or</p> <ul data-bbox="976 400 1492 507" style="list-style-type: none"> ▶ Drive off carefully (▷ page 364). ▶ Visit an authorized Mercedes-Benz Center as soon as possible. <p data-bbox="976 524 1002 552">or</p> <ul data-bbox="976 568 1492 708" style="list-style-type: none"> ▶ Release electric parking brake mechanically (▷ page 616). ▶ Visit an authorized Mercedes-Benz Center as soon as possible. <p data-bbox="976 725 1098 753">To engage:</p> <ul data-bbox="976 770 1492 860" style="list-style-type: none"> ▶ Switch off ignition and press handle for electric parking brake until the warning message on the multifunction display disappears.



Display	Possible cause/consequence	Possible solution
<div data-bbox="97 232 248 348">  </div> <p data-bbox="97 359 212 389">(USA only)</p> <div data-bbox="97 406 248 521">  </div> <p data-bbox="97 529 244 560">(Canada only)</p>	<p data-bbox="512 232 981 292">The red indicator lamp for the electric parking brake flashes.</p> <p data-bbox="512 311 981 426">The power supply for the electric parking brake was malfunctioning or the electric parking brake was previously mechanically released.</p>	<ul style="list-style-type: none"> <li data-bbox="991 232 1430 292">▶ Pull handle for electric parking brake (▷ page 364). <li data-bbox="991 311 1018 333">or <li data-bbox="991 352 1377 381">▶ Carefully drive off (▷ page 364). <li data-bbox="991 400 1018 423">or <li data-bbox="991 442 1505 535">▶ Press handle for electric parking brake until the warning message disappears from the multifunction display.



What to do if ...?

Display	Possible cause/consequence	Possible solution
<div data-bbox="82 232 233 348">  </div> <p data-bbox="245 232 443 292"><i>Parking brake See Oper. Manual</i></p> <p data-bbox="82 359 193 387">(USA only)</p> <div data-bbox="82 404 233 519">  </div> <p data-bbox="82 530 229 558">(Canada only)</p>	<p data-bbox="497 232 970 359">The red indicator lamp for the electric parking brake flashes and the yellow warning lamp for the electric parking brake lights up.</p> <p data-bbox="497 374 970 433">The electric parking brake is malfunctioning.</p>	<ul style="list-style-type: none"> <li data-bbox="976 232 1492 325">▶ Switch ignition off and back on again, and engage or release electric parking brake (▷ page 364). <li data-bbox="976 344 1002 367">or <li data-bbox="976 389 1362 412">▶ Carefully drive off (▷ page 364). <li data-bbox="976 434 1492 493">▶ Visit an authorized Mercedes-Benz Center as soon as possible. <li data-bbox="976 512 1002 535">or <li data-bbox="976 557 1492 617">▶ Release electric parking brake mechanically (▷ page 616). <li data-bbox="976 636 1492 695">▶ Visit an authorized Mercedes-Benz Center as soon as possible.



Display	Possible cause/consequence	Possible solution
<div data-bbox="97 232 248 348">  </div> <p data-bbox="261 232 456 292"><i>Parking brake</i> <i>See Oper. Manual</i></p> <p data-bbox="97 359 212 389">(USA only)</p> <div data-bbox="97 406 248 516">  </div> <p data-bbox="97 529 244 560">(Canada only)</p>	<p data-bbox="512 232 978 451">When you engage or release the electric parking brake, the red indicator lamp for the electric parking brake flashes for approx. 10 seconds. Afterward, it goes out or lights up continuously. The yellow warning lamp for the electric parking brake lights up.</p> <p data-bbox="512 471 978 561">The electric parking brake is malfunctioning or overheated for example due to over- or undervoltage.</p>	<ul style="list-style-type: none"> <li data-bbox="991 232 1377 263">▶ Carefully drive off (▷ page 364). <li data-bbox="991 277 1509 337">▶ Visit an authorized Mercedes-Benz Center as soon as possible. <p data-bbox="991 356 1465 386">In the event of overvoltage or undervoltage:</p> <ul style="list-style-type: none"> <li data-bbox="991 400 1513 493">▶ Remove the cause of the overvoltage or undervoltage, e.g. charge the battery or restart the engine. <li data-bbox="991 512 1513 605">▶ Switch ignition off and back on again, and engage or release electric parking brake (▷ page 364). <p data-bbox="991 619 1485 678">If the electric parking brake still cannot be released:</p> <ul style="list-style-type: none"> <li data-bbox="991 697 1506 757">▶ Release electric parking brake mechanically (▷ page 616). <li data-bbox="991 776 1506 835">▶ Visit an authorized Mercedes-Benz Center as soon as possible. <p data-bbox="991 848 1265 879">(Continued on next page)</p>



What to do if ...?

Display	Possible cause/consequence	Possible solution
 <p><i>Parking brake</i> <i>See Oper. Manual</i></p> <p>(USA only)</p>		<p>If overheated:</p> <ul style="list-style-type: none"> ▶ Let vehicle cool down, and do not engage electric parking brake during this time. <p>or</p> <ul style="list-style-type: none"> ▶ Switch ignition off and back on again, and engage or release electric parking brake.
 <p>(Canada only) <i>Parking brake inoperative</i></p>	<p>When you engage or release the electric parking brake, the red indicator lamp for the electric parking brake flashes and goes out after approx. 10 seconds. The yellow warning lamp for the electric parking brake lights up.</p> <p>The electric parking brake is malfunctioning.</p>	<ul style="list-style-type: none"> ▶ Switch ignition off and back on again, and engage electric parking brake (▷ page 364). <p>If the electric parking brake cannot be engaged:</p> <ul style="list-style-type: none"> ▶ Shift the automatic transmission to P (▷ page 367). ▶ Protect vehicle from rolling away while parked by using a chock from the vehicle tool kit (▷ page 613). ▶ Visit an authorized Mercedes-Benz Center as soon as possible.



Display	Possible cause/consequence	Possible solution
<div data-bbox="97 232 248 348">  </div> <p data-bbox="261 232 416 292"><i>Please release parking brake</i></p> <p data-bbox="97 359 209 387">(USA only)</p> <div data-bbox="97 406 248 516">  </div>	<p data-bbox="512 232 979 325">The red indicator lamp for the electric parking brake flashes and you also hear a warning tone.</p> <p data-bbox="512 342 979 465">You are driving with the electric parking brake activated, or you are carrying out an emergency brake application with the electric parking brake (▷ page 364).</p>	<ul style="list-style-type: none"> <li data-bbox="991 232 1366 260">▶ Release electric parking brake. <li data-bbox="991 281 1018 303">or <li data-bbox="991 322 1377 350">▶ Carefully drive off (▷ page 364). <li data-bbox="991 370 1018 393">or <li data-bbox="991 412 1513 440">▶ Release the handle for electric parking brake.
<p data-bbox="97 529 240 557">(Canada only)</p> <div data-bbox="261 529 416 589"> <p><i>Please release parking brake</i></p> </div>	<p data-bbox="512 529 979 652">The red indicator lamp for the electric parking brake flashes and the yellow warning lamp for the electric parking brake comes on. You also hear a warning tone.</p> <p data-bbox="512 669 963 729">The electric parking brake is malfunctioning; braking action is restricted.</p>	<p data-bbox="991 529 1139 557">While driving:</p> <ul style="list-style-type: none"> <li data-bbox="991 574 1513 602">▶ Release the handle for electric parking brake. <p data-bbox="991 619 1214 647">While at a standstill:</p> <ul style="list-style-type: none"> <li data-bbox="991 664 1513 757">▶ Switch off ignition and press handle for electric parking brake until the warning message disappears from the multifunction display.



What to do if ...?

Display	Possible cause/consequence	Possible solution
<p>PARK</p> <p><i>Turn on the ignition to release the parking brake</i></p> <p>(USA only)</p>	<p>The yellow indicator lamp for the electric parking brake comes on.</p> <p>You have tried to release the electric parking brake, but the ignition was not switched on.</p>	<ul style="list-style-type: none"> ▶ Switch on the ignition (▷ page 315).
<p></p> <p>(Canada only)</p>		
<p>ESP</p> <p><i>Inoperative</i> <i>See Oper. Manual</i></p>	<p>ESP® as well as PRE-SAFE® are switched off due to a malfunction. In addition, the  warning lamp in the instrument cluster comes on.</p> <p>The ABS is still operational.</p>	<ul style="list-style-type: none"> ▶ Continue driving with added caution. ▶ Have the system checked at an authorized Mercedes-Benz Center as soon as possible. <p>Failure to follow these instructions increases the risk of an accident.</p>



Display	Possible cause/consequence	Possible solution
<div style="background-color: black; color: yellow; padding: 5px; display: inline-block; font-weight: bold; font-size: 1.2em;">ESP</div> <p style="color: yellow; margin-left: 10px;"><i>Inoperative</i> <i>See Oper. Manual</i></p>	<p>S 600 only:</p> <p>ESP® as well as PRE-SAFE® are switched off due to a malfunction. In addition, the  and  (USA only) or  (Canada only) warning lamps come on in the instrument cluster.</p> <p>Brake force assistance is impaired and is sustained through an electric substitute function as long as the engine is running.</p> <p>The brake system continues to function normally. You will feel a pulsating effect at the brake pedal while braking.</p>	<ul style="list-style-type: none"> ▶ Continue driving with added caution. ▶ Have the system checked at an authorized Mercedes-Benz Center as soon as possible. <p>Failure to follow these instructions increases the risk of an accident.</p>

What to do if ...?

Display	Possible cause/consequence	Possible solution
ESP <i>Currently unavailable</i> <i>See Oper. Manual</i>	<p>ESP® and PRE-SAFE® are temporarily unavailable. It is possible that the self-diagnostics have not yet completed.</p> <p>In addition, the yellow ESP® warning lamp  comes on.</p> <p>The brake system functions normally.</p>	<p>▶ Synchronize the ESP®:</p> <p>Drive a short distance with gentle turns at a speed above 12 mph (20 km/h).</p> <p>The message disappears when ESP® is again available.</p>
	<p>ESP® and PRE-SAFE® are switched off due to undervoltage. It is possible that the battery is not charged.</p> <p>The brake system functions normally.</p>	<p>▶ Continue driving with added caution.</p> <p>▶ Have the system checked at an authorized Mercedes-Benz Center as soon as possible.</p> <p>Failure to follow these instructions increases the risk of an accident.</p>
	<p>If the yellow ESP® warning lamp  flashes while driving and this message appears, the ETS has switched off to prevent overheating of the drive wheel brakes.</p>	<p>As soon as the brakes have cooled off, the ETS switches on again.</p> <p>The message in the multifunction display disappears and the ESP® warning lamp  goes out.</p>

Display	Possible cause/consequence	Possible solution
 <p><i>STOP, car too low</i></p>	<p>You have started driving although the vehicle level was too low.</p> <p>The vehicle will be raised. The Airmatic* warning lamp goes out after several seconds.</p>	<ul style="list-style-type: none"> ▶ Stop your vehicle as soon as it is safe to do so. ▶ Wait until the message disappears from the multifunction display. <p>You may then drive off.</p>
<p><i>STOP, car too low</i></p>	<p>The Airmatic* is malfunctioning.</p> <p>The Airmatic* warning lamp lights up continuously.</p>	<ul style="list-style-type: none"> ▶ Stop and press the vehicle level control button to select a higher vehicle level (▷ page 401). ▶ Do not turn steering wheel too far to avoid damaging the front fenders. ▶ Listen for scraping noises. ▶ Do not exceed a speed of 50 mph (80 km/h). ▶ Visit an authorized Mercedes-Benz Center as soon as possible. <p>There is otherwise danger of an accident.</p>
 <p><i>Malfunction</i></p>	<p>The capability of the Airmatic* system is restricted. This can impair the handling.</p>	<ul style="list-style-type: none"> ▶ Do not exceed a speed of 50 mph (80 km/h). ▶ Visit an authorized Mercedes-Benz Center as soon as possible.

What to do if ...?

Display	Possible cause/consequence	Possible solution
 <p><i>Vehicle rising</i> <i>Please wait a moment</i></p>	<p>The vehicle level is too low while at a standstill. The vehicle will be raised.</p>	<ul style="list-style-type: none"> ▶ Do not drive off. ▶ Wait until the message disappears from the multifunction display. <p>You may then drive off.</p>
	<p>The battery is no longer charging. Possible causes:</p> <ul style="list-style-type: none"> • alternator malfunctioning • broken poly-V-belt 	<ul style="list-style-type: none"> ▶ Stop immediately and check the poly-V-belt. <p>If it is broken:</p> <ul style="list-style-type: none"> ▶ Do not continue to drive. Otherwise the engine will overheat due to an inoperative water pump which may result in damage to the engine. Notify an authorized Mercedes-Benz Center. <p>If it is intact:</p> <ul style="list-style-type: none"> ▶ Drive immediately to the nearest authorized Mercedes-Benz Center.

Display	Possible cause/consequence	Possible solution
 <p><i>Coolant, please refill See Oper. Manual</i></p>	<p>The coolant level is too low.</p>	<ul style="list-style-type: none"> ▶ Add coolant (▷ page 497). ▶ If you have to add coolant frequently, have the cooling system checked by an authorized Mercedes-Benz Center.

Warning!



Do not spill antifreeze on hot engine parts. Antifreeze contains ethylene glycol which may burn if it comes into contact with hot engine parts. You can be seriously burned.

! *Do not ignore the low engine coolant level warning. Extended driving with the message and symbol displayed may cause serious engine damage not covered by the Mercedes-Benz Limited Warranty.*

Do not drive without a sufficient amount of coolant in the cooling system. The engine will overheat, causing major engine damage.

What to do if ...?

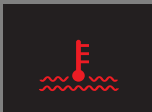
Display	Possible cause/consequence	Possible solution
 <p><i>Coolant level Stop vehicle! Switch engine off</i></p>	The coolant is too hot.	<ul style="list-style-type: none"> ▶ Stop the vehicle in a safe location or as soon as it is safe to do so and immediately turn off the engine. ▶ Only start the engine again after the message disappears. You could otherwise damage the engine. ▶ Observe the coolant temperature gauge in the instrument cluster (▷ page 28).

Warning!



- Driving when your engine is overheated can cause some fluids which may have leaked into the engine compartment to catch fire. You could be seriously burned.
- Steam from an overheated engine can cause serious burns which can occur just by opening the engine hood. Stay away from the engine if you see or hear steam coming from it.



Stop the vehicle in a safe location away from other traffic. Turn off the engine, get out of the vehicle and do not stand near the vehicle until the engine has cooled down.



During severe operating conditions, e.g. stop-and-go traffic, the coolant temperature may rise close to 248°F (120°C).

! *The engine should not be operated with the coolant temperature above 248°F (120°C). Doing so may cause serious engine damage which is not covered by the Mercedes-Benz Limited Warranty.*

Display	Possible cause/consequence	Possible solution
 <p><i>Coolant level Stop vehicle! Switch engine off</i></p>	<p>The poly-V-belt could be broken.</p>	<ul style="list-style-type: none"> ▶ Stop the vehicle in a safe location or as soon as it is safe to do so and immediately turn off the engine. ▶ Check the poly-V-belt. <p>If it is broken:</p> <ul style="list-style-type: none"> ▶ Do not continue to drive. Otherwise the engine will overheat due to an inoperative water pump which may result in damage to the engine. Notify an authorized Mercedes-Benz Center. <p>If it is intact:</p> <ul style="list-style-type: none"> ▶ Do not continue to drive the vehicle with this message displayed. Doing so could result in serious engine damage that is not covered by the Mercedes-Benz Limited Warranty. ▶ Observe the coolant temperature gauge in the instrument cluster (> page 28). <p>(Continued on next page)</p>



What to do if ...?

Display	Possible cause/consequence	Possible solution
 <p><i>Coolant level Stop vehicle! Switch engine off</i></p>		<ul style="list-style-type: none"> ▶ Restart the engine. <p>If this message disappears from the multi-function display:</p> <ul style="list-style-type: none"> ▶ Drive immediately to the nearest authorized Mercedes-Benz Center. <p>If this message does not disappear from the multifunction display:</p> <ul style="list-style-type: none"> ▶ Call Roadside Assistance.
	The cooling fan for the coolant is malfunctioning.	<ul style="list-style-type: none"> ▶ Observe the coolant temperature gauge in the instrument cluster (▷ page 28). ▶ Have the fan replaced as soon as possible.
	<p>You are driving with one or more doors open.</p> <p>The display symbol shows you which doors are open.</p>	<ul style="list-style-type: none"> ▶ Close the doors.

Display	Possible cause/consequence	Possible solution
 <p><i>Gas cap open</i></p>	<p>A loss of pressure has been detected in the fuel system. The fuel cap may not be closed properly or the fuel system may be leaky.</p>	<ul style="list-style-type: none"> ▶ Check the fuel cap (▷ page 489). <p>If it is not closed properly:</p> <ul style="list-style-type: none"> ▶ Close the fuel cap. <p>If it is closed properly:</p> <ul style="list-style-type: none"> ▶ Have the fuel system checked by an authorized Mercedes-Benz Center.
	<p>You are driving with the hood open.</p>	<ul style="list-style-type: none"> ▶ Stop your vehicle as soon as it is safe to do so. ▶ Close the hood (▷ page 493). <p>There is otherwise danger of an accident.</p>

What to do if ...?

Display	Possible cause/consequence	Possible solution
 <p data-bbox="245 232 408 291"><i>Key not recognized</i></p>	<p>The SmartKey with KEYLESS-GO* is not recognized while the engine is running because the SmartKey with KEYLESS-GO* is not in the vehicle.</p>	<ul style="list-style-type: none"> ▶ Stop the vehicle in a safe location as soon as it is safe to do so. ▶ Search for the SmartKey. <p>Otherwise the vehicle cannot be centrally locked nor can the engine be started again after the engine is stopped.</p>
	<p>The SmartKey with KEYLESS-GO* is not recognized while the engine is running because there is strong radio-frequency interference.</p>	<ul style="list-style-type: none"> ▶ Stop the vehicle in a safe location as soon as it is safe to do so. ▶ Remove KEYLESS-GO* button from over starter switch (▷ page 316). ▶ Operate the vehicle with the SmartKey in the starter switch.
	<p>The SmartKey with KEYLESS-GO* is momentarily not recognized.</p>	<ul style="list-style-type: none"> ▶ Change the position of the SmartKey in the vehicle. ▶ If necessary, operate vehicle using SmartKey with KEYLESS-GO* in starter switch under KEYLESS-GO* button (▷ page 316).

Display	Possible cause/consequence	Possible solution
 <p><i>Close doors to lock them</i></p>	<p>You wanted to lock the vehicle but not all doors were closed.</p>	<p>▶ Close doors and lock vehicle again.</p>
<p><i>Do not forget key</i></p>	<p>This display appears (for a maximum of 60 seconds) if the driver's door is opened with the engine shut off and no SmartKey in the starter switch. This message is only a reminder.</p>	<p>▶ Insert SmartKey in the starter switch. or ▶ Take the SmartKey with KEYLESS-GO* with you when leaving the vehicle.</p>
<p><i>Please remove key</i></p>	<p>You have forgotten to remove the SmartKey.</p>	<p>▶ Remove the SmartKey from the starter switch.</p>
 <p><i>Change key batteries</i></p>	<p>The batteries in the SmartKey with KEYLESS-GO* are discharged.</p>	<p>▶ Replace the batteries (▷ page 619).</p>
<p><i>Key still in vehicle</i></p>	<p>A SmartKey with KEYLESS-GO* left in the vehicle was recognized while locking the vehicle from the outside.</p>	<p>▶ Take the SmartKey with KEYLESS-GO* out of the vehicle.</p>

What to do if ...?

Display	Possible cause/consequence	Possible solution
 <p><i>Key not recognized</i></p>	The SmartKey with KEYLESS-GO* is momentarily not recognized.	<ul style="list-style-type: none"> ▶ Change the position of the SmartKey in the vehicle. ▶ If necessary, operate vehicle using SmartKey with KEYLESS-GO* in starter switch under KEYLESS-GO* button (▷ page 316).
<p><i>Key being initialized... Please wait</i></p>	The SmartKey with KEYLESS-GO* is being initialized in the vehicle.	<ul style="list-style-type: none"> ▶ Wait until the message disappears from the multifunction display.
<p><i>Remove starting button, then insert key</i></p>	The KEYLESS-GO* system is malfunctioning.	<ul style="list-style-type: none"> ▶ Remove KEYLESS-GO* button from over starter switch (▷ page 316). ▶ Operate the vehicle with the SmartKey in the starter switch.
<p><i>Replace key</i></p>	The SmartKey with KEYLESS-GO* must be replaced.	<ul style="list-style-type: none"> ▶ Visit an authorized Mercedes-Benz Center as soon as possible.

Display	Possible cause/consequence	Possible solution
	<p><i>Third brake lamp</i></p> <p>The high mounted brake lamp is malfunctioning. This message will only appear if all light emitting diodes have stopped working.</p>	<p>► Visit an authorized Mercedes-Benz Center as soon as possible.</p>
	<p><i>Corner. lamp, Left</i></p> <p>The left-hand corner-illuminating lamp is malfunctioning.</p>	<p>► Replace the bulb as soon as possible (▷ page 621).</p>
	<p><i>Corner. lamp, Right</i></p> <p>The right-hand corner-illuminating lamp is malfunctioning.</p>	<p>► Replace the bulb as soon as possible (▷ page 621).</p>
	<p><i>Low beam, Left</i></p> <p>The left low beam lamp is malfunctioning.</p>	<p>Bi-Xenon headlamp:</p> <p>► Visit an authorized Mercedes-Benz Center as soon as possible.</p>

What to do if ...?

Display	Possible cause/consequence	Possible solution
 <i>Low beam, Right</i>	The right low beam lamp is malfunctioning.	▶ Visit an authorized Mercedes-Benz Center as soon as possible.
<i>Active headlamps inoperative</i>	The active headlamps are malfunctioning.	▶ Visit an authorized Mercedes-Benz Center as soon as possible.
<i>AUTO lamps inoperative</i>	The light sensor is malfunctioning. Daytime driving lamps are switched on.	▶ Visit an authorized Mercedes-Benz Center as soon as possible.
<i>Turn signal, Rear Left</i>	The left rear turn signal lamp is malfunctioning.	▶ Visit an authorized Mercedes-Benz Center as soon as possible.
<i>Turn signal, Rear Left Substitute bulb on</i>	The left rear turn signal lamp is malfunctioning. A substitute bulb is being used.	▶ Visit an authorized Mercedes-Benz Center as soon as possible.
<i>Turn signal, Rear Right</i>	The right rear turn signal lamp is malfunctioning.	▶ Visit an authorized Mercedes-Benz Center as soon as possible.
<i>Turn signal, Rear Right Substitute bulb on</i>	The right rear turn signal lamp is malfunctioning. A substitute bulb is being used.	▶ Visit an authorized Mercedes-Benz Center as soon as possible.

Display	Possible cause/consequence	Possible solution
 <i>Turn signal, Left mirror</i>	The turn signal in the left exterior rear view mirror is malfunctioning. This message will only appear if all light emitting diodes have stopped working.	► Have the LEDs replaced as soon as possible.
 <i>Turn signal, Right mirror</i>	The turn signal in the right exterior rear view mirror is malfunctioning. This message will only appear if all light emitting diodes have stopped working.	► Have the LEDs replaced as soon as possible.
 <i>Turn signal, Front Left</i>	The left front turn signal lamp is malfunctioning.	► Visit an authorized Mercedes-Benz Center as soon as possible.
 <i>Turn signal, Front Right</i>	The right front turn signal lamp is malfunctioning.	► Visit an authorized Mercedes-Benz Center as soon as possible.
 <i>High beam, Left</i>	The left high beam lamp is malfunctioning.	► Replace the bulb as soon as possible (▷ page 621).
 <i>High beam, Right</i>	The right high beam lamp is malfunctioning.	► Replace the bulb as soon as possible (▷ page 621).
 <i>License plate lamp, Left</i>	The left license plate lamp is malfunctioning.	► Visit an authorized Mercedes-Benz Center as soon as possible.
 <i>License plate lamp, Right</i>	The right license plate lamp is malfunctioning.	► Visit an authorized Mercedes-Benz Center as soon as possible.





What to do if ...?

Display	Possible cause/consequence	Possible solution
 <p><i>Please switch off lights</i></p>	You are getting out of the vehicle and the lights are still switched on.	<ul style="list-style-type: none"> ▶ Turn the exterior lamp switch to 0 (▷ page 342).
<p><i>Switch off lights or remove key</i></p>	The light switch is set to A and you have forgotten to take out the SmartKey. The parking lamps remain switched on.	<ul style="list-style-type: none"> ▶ Turn the exterior lamp switch to 0 (▷ page 342). ▶ Remove the SmartKey from the starter switch.
<p><i>Front foglamp, Left</i></p>	The left front fog lamp is malfunctioning.	<ul style="list-style-type: none"> ▶ Visit an authorized Mercedes-Benz Center as soon as possible.
<p><i>Front foglamp, Right</i></p>	The right front fog lamp is malfunctioning.	<ul style="list-style-type: none"> ▶ Visit an authorized Mercedes-Benz Center as soon as possible.
<p><i>Rear foglamp, Left</i></p>	The left rear fog lamp is malfunctioning.	<ul style="list-style-type: none"> ▶ Visit an authorized Mercedes-Benz Center as soon as possible.
<p><i>Rear foglamp, Left</i> <i>Substitute bulb on</i></p>	The left rear fog lamp is malfunctioning. A substitute bulb is being used.	<ul style="list-style-type: none"> ▶ Visit an authorized Mercedes-Benz Center as soon as possible.
<p><i>Rear foglamp, Right</i></p>	The right rear fog lamp is malfunctioning.	<ul style="list-style-type: none"> ▶ Visit an authorized Mercedes-Benz Center as soon as possible.
<p><i>Rear foglamp, Right</i> <i>Substitute bulb on</i></p>	The right rear fog lamp is malfunctioning. A substitute bulb is being used.	<ul style="list-style-type: none"> ▶ Visit an authorized Mercedes-Benz Center as soon as possible.





Display	Possible cause/consequence	Possible solution
 <p><i>Parking lamp, Front Left</i></p>	<p>The left front parking lamp is malfunctioning.</p>	<p>► Visit an authorized Mercedes-Benz Center as soon as possible.</p>
<p><i>Fr. parking lamp, left Substitute bulb on</i></p>	<p>The left front parking lamp is malfunctioning. A substitute bulb is being used.</p>	<p>► Visit an authorized Mercedes-Benz Center as soon as possible.</p>
<p><i>Parking lamp, Right front</i></p>	<p>The right front parking lamp is malfunctioning.</p>	<p>► Visit an authorized Mercedes-Benz Center as soon as possible.</p>
<p><i>Fr. parking lamp, Right Substitute bulb on</i></p>	<p>The right front parking lamp is malfunctioning. A substitute bulb is being used.</p>	<p>► Visit an authorized Mercedes-Benz Center as soon as possible.</p>
<p><i>Side marker lamp, Left Front</i></p>	<p>The front left side marker lamp is malfunctioning.</p>	<p>► Visit an authorized Mercedes-Benz Center as soon as possible.</p>
<p><i>Side marker lamp, Right Front</i></p>	<p>The front right side marker lamp is malfunctioning.</p>	<p>► Visit an authorized Mercedes-Benz Center as soon as possible.</p>
<p><i>Side marker lamp, Rear Left</i></p>	<p>The rear left side marker lamp is malfunctioning.</p>	<p>► Visit an authorized Mercedes-Benz Center as soon as possible.</p>
<p><i>Side marker lamp, Rear Right</i></p>	<p>The rear right side marker lamp is malfunctioning.</p>	<p>► Visit an authorized Mercedes-Benz Center as soon as possible.</p>
<p><i>Reverse lamp, Left</i></p>	<p>The left reverse lamp is malfunctioning.</p>	<p>► Visit an authorized Mercedes-Benz Center as soon as possible.</p>

What to do if ...?

Display	Possible cause/consequence	Possible solution
	<p><i>Reverse lamp, Right</i></p>	<p>The right reverse lamp is malfunctioning.</p> <p>▶ Visit an authorized Mercedes-Benz Center as soon as possible.</p>
	<p><i>Tail lamp/brake lamp, Left</i> <i>Substitute bulb on</i></p>	<p>The left tail lamp/brake lamp is malfunctioning.</p> <p>This message will only appear if all light emitting diodes have stopped working. A substitute bulb is being used.</p> <p>▶ Visit an authorized Mercedes-Benz Center as soon as possible.</p>
	<p><i>Tail lamp/brake lamp, Left</i></p>	<p>The left tail lamp/brake lamp is malfunctioning.</p> <p>This message will only appear if all light emitting diodes have stopped working.</p> <p>▶ Visit an authorized Mercedes-Benz Center as soon as possible.</p>
	<p><i>Tail lamp/brake lamp, Right</i> <i>Substitute bulb on</i></p>	<p>The right tail lamp/brake lamp is malfunctioning.</p> <p>This message will only appear if all light emitting diodes have stopped working. A substitute bulb is being used.</p> <p>▶ Visit an authorized Mercedes-Benz Center as soon as possible.</p>
	<p><i>Tail lamp/brake lamp, Right</i></p>	<p>The right tail lamp/brake lamp is malfunctioning.</p> <p>This message will only appear if all light emitting diodes have stopped working.</p> <p>▶ Visit an authorized Mercedes-Benz Center as soon as possible.</p>



Display	Possible cause/consequence	Possible solution
 <p><i>Night View Assist inoperative</i></p>	<p>Night View Assist* is malfunctioning.</p>	<p>▶ Visit an authorized Mercedes-Benz Center as soon as possible.</p>
<p><i>Night View Assist currently unavailable</i></p>	<p>The temperature of the camera* is too high (▷ page 420).</p>	<p>▶ Wait until the message “<i>Night View Assist available again</i>” appears.</p> <p>In addition you can:</p> <ul style="list-style-type: none"> ▶ Swing the camera* cover down (▷ page 539). ▶ Adjust the air distribution of the automatic climate control so that air flows upward (▷ page 230).
 <p><i>Night View Assist Lights must be on or set to AUTO</i></p>	<p>You have tried to switch on Night View Assist*, but the light switch is not set to A or .</p>	<p>▶ Turn the exterior lamp switch to A or  (▷ page 342).</p>
<p><i>Night View Assist Not in Reverse gear</i></p>	<p>You have tried to switch on Night View Assist* while the automatic transmission was in position R.</p>	<p>▶ Shift the automatic transmission to P, N or D (▷ page 367).</p>

What to do if ...?

Display	Possible cause/consequence	Possible solution
 <p><i>Night View Assist Lights ON or AUTO, not in R gear</i></p>	<p>You have tried to switch on Night View Assist* but the light switch is not set to A or .</p> <p>In addition, the automatic transmission is in position R.</p>	<ul style="list-style-type: none"> ▶ Turn the exterior lamp switch to A or  (▷ page 342). ▶ Shift the automatic transmission to P, N or D (▷ page 367).
<p><i>Night View Assist only when it is dark</i></p>	<p>You have tried to switch on Night View Assist* by daylight.</p>	<p>You can only switch on Night View Assist* when it is dark.</p>
 <p><i>Engine oil level Stop vehicle! Switch engine off</i></p>	<p>S 600 only:</p> <p>There is no oil in the engine. There is a danger of engine damage.</p>	<ul style="list-style-type: none"> ▶ Carefully bring the vehicle to a halt as soon as it is safe to do so in a safe location. ▶ Turn off the engine. ▶ Add engine oil (▷ page 494) and check the engine oil level (▷ page 494).

Display	Possible cause/consequence	Possible solution
<div data-bbox="97 232 248 348" style="background-color: black; color: yellow; padding: 5px; text-align: center;">  </div> <p data-bbox="261 232 501 325">USA only: <i>Add 1.0 qts. engine oil at next refueling</i></p> <p data-bbox="261 329 501 422">Canada only: <i>Add 1.0 l engine oil at next refueling</i></p> <hr/> <p data-bbox="261 430 501 493"><i>Check engine oil level at next refueling</i></p>	<p data-bbox="512 232 979 306">S 600 only: The engine oil level is too low.</p> <p data-bbox="512 430 979 538">S 550 only: The engine oil level has dropped to approximately the minimum level.</p>	<ul style="list-style-type: none"> <li data-bbox="991 232 1511 295">▶ Check the engine oil level (▷ page 494) and add engine oil as required (▷ page 494). <li data-bbox="991 306 1511 369">▶ If you must add engine oil frequently, have the engine checked for possible leaks. <ul style="list-style-type: none"> <li data-bbox="991 430 1511 492">▶ Check the engine oil level (▷ page 495) and add engine oil as required (▷ page 494). <li data-bbox="991 504 1511 566">▶ If you must add engine oil frequently, have the engine checked for possible leaks.

What to do if ...?

Display	Possible cause/consequence	Possible solution
 <p><i>Engine oil level cannot be measured</i></p>	<p>S 600 only:</p> <p>The measuring system is malfunctioning.</p>	<p>▶ Have the measuring system checked by an authorized Mercedes-Benz Center.</p>
 <p><i>Engine oil level Reduce oil level</i></p>	<p>S 600 only:</p> <p>You have added too much engine oil.</p> <p>There is a risk of damaging:</p> <ul style="list-style-type: none"> • the engine • the catalytic converter 	<p>▶ Have excess oil siphoned or drained off. Contact an authorized Mercedes-Benz Center.</p>

When the message “*Check engine oil level at next refueling*” (S 550) or “*Add 1.0 qts. (Canada: 1.0 l) engine oil at next refueling*” (S 600) appears while the engine is running and at operating temperature, the engine oil level has dropped to approximately the minimum level.

When this occurs, the warning will first come on intermittently and then stay on if the oil level drops further.

Visually check for oil leaks. If no obvious oil leaks are noted, drive to the nearest service station where the engine oil should be topped to the required level with an approved oil specified in the Factory Approved Service Products pamphlet.

! *The engine oil level warnings should not be ignored. Extended driving with the symbol displayed could result in serious engine damage that is not covered by the Mercedes-Benz Limited Warranty.*

Display	Possible cause/consequence	Possible solution
 <p><i>Restraint system malfunction</i> <i>Visit workshop</i></p>	<p>There is a malfunction in the supplemental restraint systems. The air bags or emergency tensioning devices (ETDs) could deploy unexpectedly or fail to activate in an accident.</p>	<p>► Drive with added caution to the nearest authorized Mercedes-Benz Center.</p>
<p><i>Malfunction on front left side</i> <i>Visit workshop</i></p>	<p>Components of the driver's supplemental restraint system may not work properly.</p>	<p>► Drive with added caution to the nearest authorized Mercedes-Benz Center.</p>
<p><i>Malfunction on Front Right side</i> <i>Visit workshop</i></p>	<p>Components of the front passenger's supplemental restraint system may not work properly.</p>	<p>► Drive with added caution to the nearest authorized Mercedes-Benz Center.</p>
<p><i>Malfunction on Rear Left side</i> <i>Visit workshop</i></p>	<p>Components of the left rear passenger's supplemental restraint system may not work properly.</p>	<p>► Drive with added caution to the nearest authorized Mercedes-Benz Center.</p>

Warning!



In the event a malfunction of the SRS is indicated as outlined above, the SRS may not be operational. For your safety, we strongly

recommend that you visit an authorized Mercedes-Benz Center immediately to have the system checked; otherwise the SRS may not be activated when needed in an

accident, which could result in serious or fatal injury, or it might deploy unexpectedly and unnecessarily which could result in an accident and/or injury to you or to others.

What to do if ...?

Display	Possible cause/consequence	Possible solution
 <p><i>Malfunction in Rear Center Visit workshop</i></p>	Components of the center rear passenger's supplemental restraint system may not work properly.	▶ Drive with added caution to the nearest authorized Mercedes-Benz Center.
<p><i>Malfunction on Rear Right side Visit workshop</i></p>	Components of the right rear passenger's supplemental restraint system may not work properly.	▶ Drive with added caution to the nearest authorized Mercedes-Benz Center.
<p><i>Left window curtain airbag malfunction Visit workshop</i></p>	The left side window curtain air bag may not work properly.	▶ Drive with added caution to the nearest authorized Mercedes-Benz Center.
<p><i>Right window curtain airbag malfunction Visit workshop</i></p>	The right side window curtain air bag may not work properly.	▶ Drive with added caution to the nearest authorized Mercedes-Benz Center.



Warning!



In the event a malfunction of the SRS is indicated as outlined above, the SRS may not be operational. For your safety, we strongly

recommend that you visit an authorized Mercedes-Benz Center immediately to have the system checked; otherwise the SRS may not be activated when needed in an

accident, which could result in serious or fatal injury, or it might deploy unexpectedly and unnecessarily which could result in an accident and/or injury to you or to others.

Display	Possible cause/consequence	Possible solution
 <p><i>Tele Aid inoperative</i></p>	One or more main functions of the Tele Aid system are malfunctioning.	<ul style="list-style-type: none"> ▶ Have the Tele Aid system checked by an authorized Mercedes-Benz Center.
 <p><i>Tire pressure Caution, tire defect</i></p>	<p>Vehicles with Advanced TPMS*: One or more tires are deflating.</p>	<ul style="list-style-type: none"> ▶ Carefully bring the vehicle to a halt, avoiding abrupt steering and braking maneuvers. ▶ If necessary, change the wheel (▷ page 629).
 <p><i>Caution Tire defect</i></p>	<p>Vehicles with Advanced TPMS*: One or more tires are deflating. The respective tire is shown in the multifunction display.</p>	<ul style="list-style-type: none"> ▶ Carefully bring the vehicle to a halt, avoiding abrupt steering and braking maneuvers. ▶ If necessary, change the wheel (▷ page 629).

Warning!



Do not drive with a flat tire. A flat tire affects the ability to steer or brake the vehicle. You may lose control of the vehicle. Continued driving with a flat tire will cause excessive heat build-up and possibly a fire.

What to do if ...?

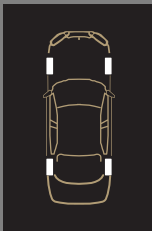
Display	Possible cause/consequence	Possible solution
 <p><i>Tire pressure Check tires</i></p>	<p>Vehicles with Advanced TPMS*: The pressure is too low in one or more tires.</p>	<ul style="list-style-type: none"> ▶ Carefully bring the vehicle to a halt, avoiding abrupt steering and braking maneuvers. ▶ Check and adjust tire inflation pressure as required (▷ page 5 14). ▶ If necessary, change the wheel (▷ page 5 14).
 <p><i>Check tires</i></p>	<p>Vehicles with Advanced TPMS*: The pressure is too low in one or more tires. The respective tire is shown in the multi-function display.</p>	<ul style="list-style-type: none"> ▶ Carefully bring the vehicle to a halt, avoiding abrupt steering and braking maneuvers. ▶ Check and adjust tire inflation pressure as required (▷ page 5 14). ▶ If necessary, change the wheel (▷ page 5 14).

Warning!



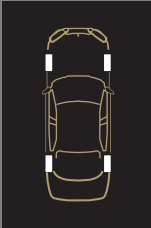

Do not drive with a flat tire. A flat tire affects the ability to steer or brake the vehicle. You

may lose control of the vehicle. Continued driving with a flat tire will cause excessive heat build-up and possibly a fire.

Display	Possible cause/consequence	Possible solution
 <p><i>Wheel sensor(s) missing</i></p>	<p>One or more sensors malfunction (e.g. battery in one or more wheel sensor is empty).</p> <p>One or more wheels without wheel sensors mounted (e.g. spare tire).</p> <p>No pressure value is shown on the multifunction display for the tire in question.</p>	<ul style="list-style-type: none"> ▶ Have the Advanced TPMS* checked by an authorized Mercedes-Benz Center. ▶ Have the wheel sensors installed by an authorized Mercedes-Benz Center. <p>The tire pressure for the respective tire is shown in the multifunction display after a few minutes driving.</p>
<p><i>Tire pressure Please rectify</i></p>	<p>Vehicles with Advanced TPMS*:</p> <p>The pressure is too low in one or more tires. Or the tire pressures of the individual wheels differ too radically from one another.</p>	<ul style="list-style-type: none"> ▶ Check and adjust tire inflation pressure as required (▷ page 514).

What to do if ...?

Display	Possible cause/consequence	Possible solution
 <p><i>Shift to 'P'</i></p>	<p>You have attempted to turn off the engine with the KEYLESS-GO* start/stop button and opened the driver's door with the automatic transmission not shift to position P.</p>	<ul style="list-style-type: none"> ▶ Shift the automatic transmission to P (▷ page 367). or ▶ Close the driver's door.
	<p>You are driving with the trunk open.</p>	<ul style="list-style-type: none"> ▶ Close the trunk (▷ page 437).
 <p><i>Washer fluid, please refill</i></p>	<p>The water level has dropped to approx. 1.1 US qts (1.0 l).</p>	<ul style="list-style-type: none"> ▶ Add washer fluid (▷ page 498).

▼ Where will I find ...?

First aid kit

! Always keep the storage compartment under the front passenger seat closed while the vehicle is in motion.

i Check expiration dates and contents for completeness at least once a year and replace missing/expired items.

The first aid kit is located in the storage compartment under the front passenger seat.

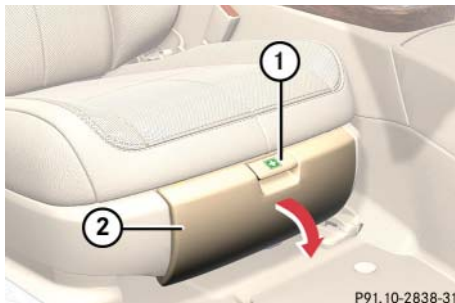

- ① Tab
- ② Cover

► Pull tab ① upward.

- Fold the covering forward in the direction of arrow.
- Remove the first aid kit.

Vehicle jack, vehicle tool kit, luggage bowl, Minispare wheel

The vehicle jack, Minispare wheel, the vehicle tools, and the luggage bowl are stored in the compartment underneath the trunk floor.

- Lift up trunk floor cover and engage trunk floor handle in upper edge of trunk.

You can now remove the tools and accessories.

! To prevent damage, always disengage trunk floor handle from trunk lid and lower trunk floor before closing the trunk.

The vehicle tool kit includes:

- One towing eye bolt
- One wheel bolt wrench with socket wrench
- One alignment bolt
- One pair of gloves
- One fuse extractor
- One fuse chart for the main fuse box
- Spare fuses
- Collapsible wheel chock
- Wheel bolts for Minispare wheel

Where will I find ...?

Vehicle jack

Warning!



The jack is designed exclusively for jacking up the vehicle at the jack take-up brackets built into both sides of the vehicle. To help avoid personal injury, use the jack only to lift the vehicle during a wheel change. Never get beneath the vehicle while it is supported by the jack. Keep hands and feet away from the area under the lifted vehicle. Always firmly set parking brake and block wheels before raising vehicle with jack.

Do not disengage parking brake while the vehicle is raised. Be certain that the jack is always vertical (plumb line) when in use, especially on hills. Always try to use the jack on level surface. Make sure the jack arm is fully seated in the jack take-up bracket. Always lower the vehicle onto sufficient capacity jackstands before working under the vehicle.

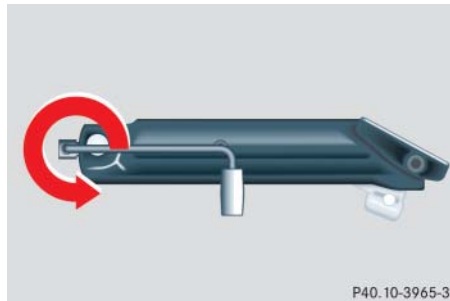

Storage position

- ▶ Remove vehicle jack from its compartment.
- ▶ Turn crank handle in direction of arrow as far as it will go.

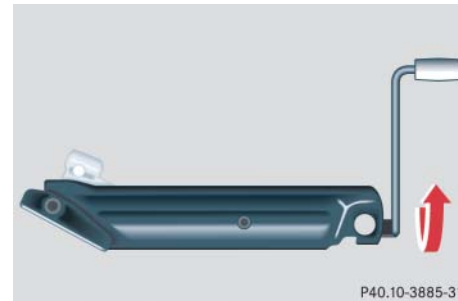

Operational position

- ▶ Turn crank handle clockwise.
- Before storing the vehicle jack in its compartment:
- It should be fully collapsed.
 - The handle must be folded in (storage position).

Minispare wheel

The Minispare wheel is stored in the compartment underneath the trunk floor.

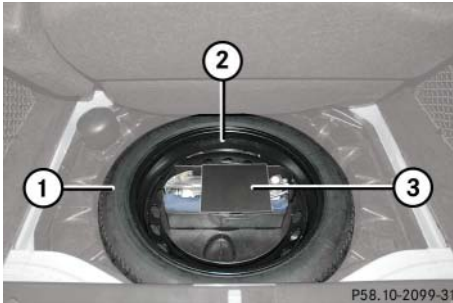

- ① Minispare wheel with spare wheel bolts in container on wheel rim
- ② Luggage bowl
- ③ Vehicle tool kit, jack and collapsible wheel chock

Removing the Minispare wheel

- ▶ Turn luggage bowl ② counterclockwise.
- ▶ Remove Minispare wheel ①.

Setting up the collapsible wheel chock

The collapsible wheel chock serves to additionally secure the vehicle, e.g. while changing the wheel.

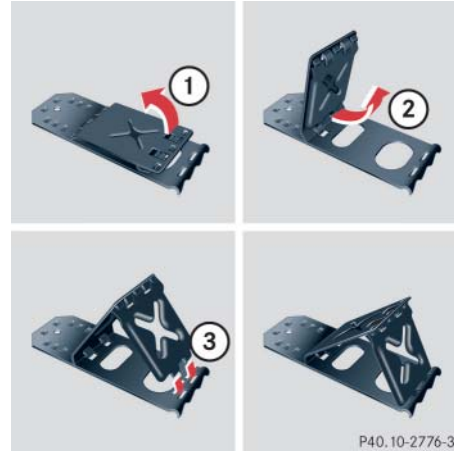

- ① Tilt the plates upward
- ② Fold the lower plate outward
- ③ Insert the plate

- ▶ Tilt both plates upward ①.
- ▶ Fold the lower plate outward ②.
- ▶ Guide the tabs of the lower plate all the way into the openings of the base plate ③.

Unlocking/locking in an emergency

Unlocking the vehicle

If you are unable to unlock the vehicle with the SmartKey or KEYLESS-GO*, open the driver's door and the trunk using the mechanical key.

i *Unlocking the driver's door and/or the trunk with the mechanical key will trigger the anti-theft alarm system (> page 75).*

To cancel the alarm, insert the SmartKey or SmartKey with KEYLESS-GO in the starter switch.*

Removing the mechanical key

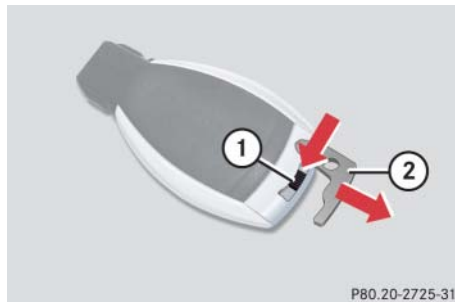

① Mechanical key locking tab

② Mechanical key

- ▶ Move locking tab ① in the direction of arrow.
- ▶ Slide mechanical key ② out of the housing.

Unlocking the driver's door

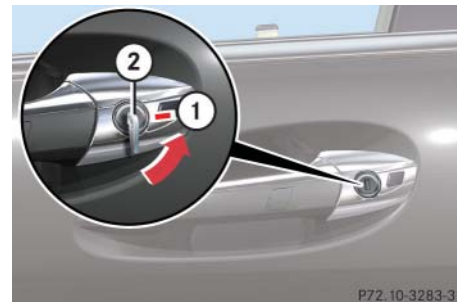

① Unlocking

② Mechanical key

- ▶ Insert mechanical key ② into the driver's door lock until it stops.
- ▶ Turn mechanical key ② counterclockwise to position ①.
The driver's door is unlocked.
- ▶ Pull door handle quickly.
The locking knob moves up.
- ▶ Turn back mechanical key ② and remove.
- ▶ Pull door handle again.

Unlocking/locking in an emergency

Unlocking the trunk

A minimum height clearance of 5.9 ft. (1.80 m) is required to open the trunk lid.



① Trunk lid lock

- ▶ Insert the mechanical key into the trunk lid lock ① until it stops.
- ▶ Turn mechanical key all the way to the left.

The trunk opens.

! *The trunk lid swings open upwards automatically. Always make sure that there is sufficient overhead clearance.*

- ▶ Turn the mechanical key back and remove it from the trunk lid lock.

Locking the vehicle

If you cannot lock the vehicle with the SmartKey or KEYLESS-GO*, do the following:

- ▶ Close the front passenger door, the rear right door and the trunk.
- ▶ Open the driver's door and the rear left door.
- ▶ Press the central locking switch on the driver's door (▷ page 314).

The locking knobs of the front passenger door and the rear doors move down.

If the vehicle battery is disconnected or drained:

- ▶ Press down the locking knobs of the front passenger door and the rear doors manually.

- ▶ Exit the vehicle.
- ▶ Close the driver's door.
- ▶ Enter the vehicle through the rear left door.
- ▶ Press down the locking knob of the driver's door.

! *To prevent inadvertent lockout, make sure to have the SmartKey or SmartKey with KEYLESS-GO* with you before proceeding with the next step. The next step will lock the vehicle.*

- ▶ Exit the vehicle.
 - ▶ Close the rear left door.
- The vehicle is locked.

Unlocking/locking in an emergency

Mechanically releasing the electric parking brake

The mechanical release device for the electric parking brake is underneath the fuel filler flap next to the fuel cap.

Warning!



If you mechanically release the electric parking brake, the vehicle may start to move on its own. Make sure that no one is in front of or behind the vehicle. Otherwise, an accident could occur resulting in injury or fatality. Shift the automatic transmission to **P** and secure your vehicle in place using the chock from the vehicle tool kit.

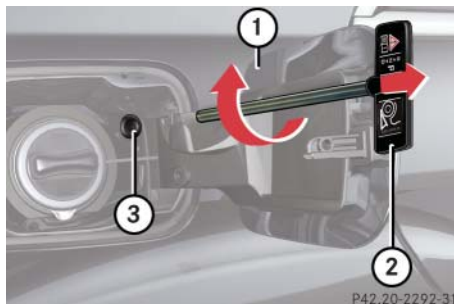

- ① Fuel filler flap
- ② Release tool
- ③ Protective cap

- ▶ Shift the automatic transmission to **P** (▷ page 367).
- ▶ Place chock from vehicle tool kit (▷ page 611) under a rear wheel.
- ▶ Open fuel filler flap ①.
- ▶ Remove protective cap ③.
- ▶ Screw release tool ② from vehicle tool kit clockwise 2 to 3 rotations onto release lever.

- ▶ Pull release tool ② in direction of arrow.

The electric parking brake is released. The red indicator lamp **PARK** (USA only) or **(P)** (Canada only) in the instrument cluster for the electric parking brake flashes. The message “*Parking brake See Oper. Manual*” appears on the driver’s display.

After it has been unlocked, you can engage the electric parking brake again from the driver’s seat.

- ▶ Press the electric parking brake handle (▷ page 364).

i You must pull the release tool with more force if the electric parking brake cannot be released.

! Reattach protective cap ③ after you have mechanically released the electric parking brake.

Opening/closing in an emergency

▼ Opening/closing in an emergency

Power tilt/sliding sunroof or panorama roof with power tilt/sliding panel*

You can open or close the tilt/sliding sunroof or tilt/sliding panel manually should an electrical malfunction occur.

The drive mechanism is behind the left sun visor.



① Cover

▶ Remove cover ①.



② Crank

▶ Take crank ② from the Operator's Manual pouch.

▶ Switch on the ignition (▷ page 315).

▶ Insert crank ② through the hole.

▶ Turn crank ② clockwise to:

- slide roof panel/sunroof closed

- raise roof panel/sunroof at the rear

▶ Turn crank ③ counterclockwise to:

- slide roof panel/sunroof open
- lower roof panel/sunroof at the rear

i Turn crank ② slowly and smoothly.

The tilt/sliding sunroof (▷ page 442) or tilt/sliding panel (▷ page 446) must be synchronized after being operated manually.

Resetting activated head restraints (S 600 only)

If the luxury active head restraints (front seats) have been triggered in an accident, the active head restraints must be reset. Otherwise, the active head restraints cannot offer any additional protection in the event of another rear-end collision.

i For your convenience, we recommend that you have this work carried out by an authorized Mercedes-Benz Center.

You will find the reset tool for manually operating the head restraints in the Mercedes-Benz vehicle literature pouch.



- ▶ Take reset tool ① out of the Mercedes-Benz vehicle literature pouch.
- ▶ Guide reset tool ① into center of head restraint between head restraint cushion and rear head restraint cover.
- ▶ **!** Be careful not to damage upholstery.
- ▶ Press reset tool ① forward in direction of arrow.
- ▶ Press reset tool downward until you hear the head restraint release mechanism audibly engage.
- ▶ Pull out reset tool ①.
- ▶ Firmly press head restraint cushion backward towards the rear of the vehicle until it engages.

Warning!



When pushing back the head restraint cushion, take care that your fingers do not become caught between the head restraint cushion and the cover. Failing to do so may lead to injury.

- ▶ Repeat this procedure on the active head restraints for second head restraint.

For information on active head restraints, see “Luxury active head restraints (S 600 only)” (▷ page 59).

For information on head restraint adjustment, see “Head restraints” (▷ page 324).

Replacing SmartKey batteries

▼ Replacing SmartKey batteries

If the batteries in the SmartKey or the SmartKey with KEYLESS-GO* are discharged, the vehicle can no longer be locked or unlocked. It is recommended to have the batteries replaced at an authorized Mercedes-Benz Center.

Warning!



Batteries contain poisonous and corrosive substances. Therefore keep the batteries out of reach of children.

If a battery is swallowed, seek medical help immediately.

Batteries contain materials that can harm the environment if disposed of improperly. Recycling of batteries is the preferred method of disposal. Many states require sellers of batteries to accept old batteries for recycling.

i When inserting the batteries, make sure they are clean and free of lint.

i When changing batteries, always replace both batteries.

The required replacement batteries are available at any authorized Mercedes-Benz Center.

SmartKey/SmartKey with KEYLESS-GO*

Replacement batteries: Lithium, type CR 2025 or equivalent.

- ▶ Remove the mechanical key out of the SmartKey or the SmartKey with KEYLESS-GO* (> page 614).

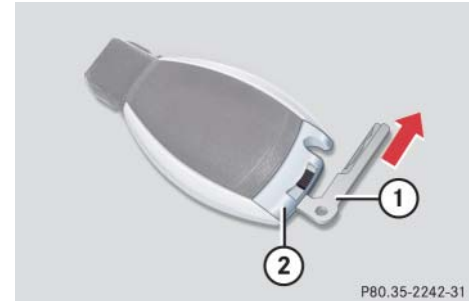

- ① Mechanical key
- ② Battery compartment

- ▶ Insert mechanical key ① into opening.
- ▶ Press mechanical key ① in direction of arrow.

The battery compartment is unlatched.>>

Replacing SmartKey batteries

- ▷▷ Pull battery compartment ② out of the housing.

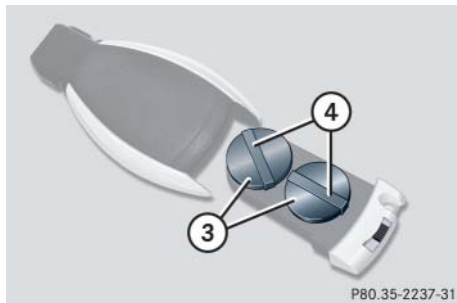

③ Batteries

④ Contact springs

- ▶ Pull out batteries ③.

- ▶ Using a line-free cloth, insert new batteries ③ under contact springs ④ with the positive terminal (+) side facing up.
- ▶ Return battery compartment ② (▷ page 6 19) into housing until it locks into place.
- ▶ Slide the mechanical key back into the SmartKey/SmartKey with KEYLESS-GO*.
- ▶ Check the operation of the SmartKey/KEYLESS-GO*.

▼ Replacing bulbs

Safe vehicle operation depends on proper exterior lighting and signaling. It is therefore essential that all bulbs and lamp assemblies are in good working order at all times.

Correct headlamp adjustment is extremely important. Have headlamps checked and readjusted at regular intervals and when a bulb has been replaced. See an authorized Mercedes-Benz Center for headlamp adjustment.

i *If the headlamps or front fog lamps are fogged up on the inside as a result of high humidity, driving the vehicle a distance with the lights on should clear up the fogging.*

i *Substitute bulbs will be brought into use when the following lamps malfunction:*

- *Brake lamps*
- *Rear fog lamps*
- *Front parking lamps*
- *Tail lamps*
- *Turn signal lamps*

Observe the messages in the multifunction display (▷ page 557).

Replacing bulbs

Bulbs

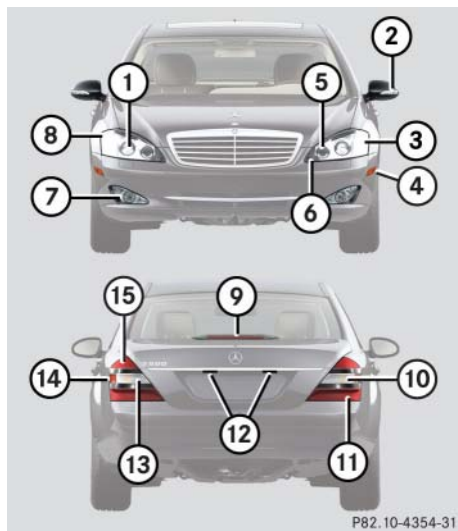

P82.10-4354-31

Front lamps

Lamp	Type
① Bi-Xenon headlamp: Low and high beam ¹	D1S-35 W
② Additional turn signal lamp	LED
③ Parking and standing lamp	W 5 W
④ Side marker lamp	W 5 W
⑤ Bi-Xenon headlamp: High beam flasher lamp	H7-55 W
IR emitter* (for Night View Assist*)	H11-55 W
⑥ Corner-illuminating lamp	H7-55 W
⑦ Fog lamp	H11-55 W
⑧ Turn signal lamp	PY 24 W

¹ Bi-Xenon headlamps: Low beam and high beam use the same D1S-35W lamp. Do not replace the Bi-Xenon bulbs yourself. Contact an authorized Mercedes-Benz Center.

Rear lamps

Lamp	Type
⑨ High mounted brake lamp	LED
⑩ Turn signal lamp	HiP 16 W
⑪ Brake lamp/tail lamp and standing lamp	LED
⑫ License plate lamp	W 5 W
⑬ Backup lamp	HiP 16 W
⑭ Side marker lamp	LED
⑮ Rear fog lamp (driver's side only)	HiP 16 W

Notes on bulb replacement

Warning!

Keep bulbs out of reach of children.

Bulbs and bulb sockets can be very hot. Allow the lamp to cool down before changing a bulb.

Halogen lamps contain pressurized gas. A bulb can explode if you:

- touch or move it when hot
- drop the bulb
- scratch the bulb

Wear eye and hand protection.

Because of high voltage in Xenon lamps, it is dangerous to replace the bulb or repair the lamp and its components. We recommend that you have such work done by a qualified technician.

- Only use 12-volt-bulbs of the same type and with the specified watt rating.
- Switch lights off before changing a bulb to prevent short circuits.
- Always use a clean lint-free cloth when handling bulbs.
- Your hands should be dry and free of oil and grease.
- If the newly installed bulb does not come on, visit an authorized Mercedes-Benz Center.

Have the LEDs and bulbs for the following lamps replaced by an authorized Mercedes-Benz Center.

- the Bi-Xenon lamps
- the front turn signal lamps
- the front fog lamps
- the additional turn signal lamps in the exterior rear view mirrors
- the parking and standing lamps
- the front side marker lamps

- the high mounted brake lamps
- the brake, tail and rear standing lamps
- the rear side marker lamps
- the rear fog lamp
- the rear turn signal lamps
- the rear side marker lamps
- the license plate lamps

 *Have the headlamp adjustment checked regularly.*

Replacing bulbs for front lamps

Before you start to replace a bulb for a front lamp, do the following first:

- ▶ Turn the exterior lamp switch to **0** (▷ page 342).
- ▶ Open the hood (▷ page 492) (except for side marker lamps).

Replacing bulbs

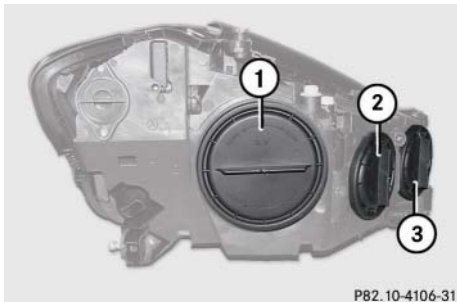

- ① Cover 1
- ② Cover 2
- ③ Cover 3

Removing and installing washer fluid reservoir on left-hand side

*Vehicles with Airmatic**

You must remove the washer fluid reservoir in order to change the bulbs of the front headlamp on the left-hand side. The washer fluid reservoir is on the front left-hand side of the engine compartment.

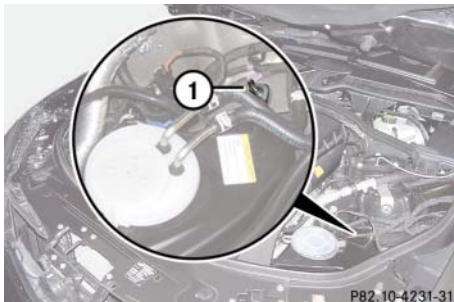

Washer fluid reservoir (example illustration from S 550)

- ① Retaining screw

Removing

- ▶ Turn retaining screw ① counterclockwise.
- ▶ Take washer fluid reservoir out of mounting.
- ▶ Place washer fluid reservoir to the side and do not disconnect any wires or cables.

Installing

- ▶ Guide washer fluid reservoir into mounting so that the bottom retaining lug slides into the rubber sleeve on the longitudinal member.
- ▶ Turn retaining screw ① clockwise.

Bi-Xenon headlamps

Warning!



Do not remove the cover for the Bi-Xenon headlamp. Because of high voltage in Xenon lamps, it is dangerous to replace the bulb or repair the lamp and its components. We recommend that you have such work done by a qualified technician.

High beam flasher lamp

In vehicles with Bi-Xenon headlamps, you can only change the halogen bulb for the high-beam flasher lamp.

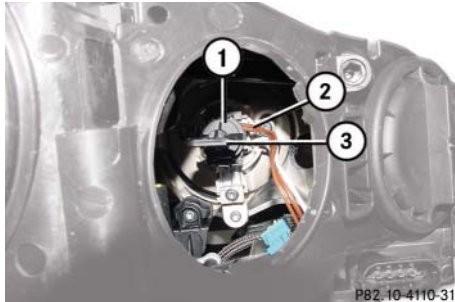

- ① Bulb holder
- ② Wire position
- ③ Grip

- ▶ Turn cover **2** (▷ page 624) counter-clockwise and remove it.
- ▶ Turn bulb holder ① counterclockwise until it disengages.
- ▶ Take out bulb holder ①.
- ▶ Take bulb out of holder.
- ▶ Insert new bulb into holder and press it all the way down.

The tab of the bulb holder must be positioned on the upper left-hand side and wire ② must point upward and to the right for the left headlamp, downward and to the left for the right headlamp.

- ▶ Turn bulb holder clockwise until it engages and grip ③ is in a vertical position.

IR emitter*



- ① Bulb
- ② Wire position

- ▶ Turn cover **2** (▷ page 624) counter-clockwise and remove it.
- ▶ Turn bulb holder ① counterclockwise until it disengages.
- ▶ Take out bulb holder ①.
- ▶ Press both catches on left and right sides of bulb holder ① and take bulb out of holder.
- ▶ Insert new bulb into holder until it engages.

▷▷

Replacing bulbs

- ▶▶ Insert bulb holder ① into guide in headlamp. Wire ② must point downward and to the right.
- ▶ Turn bulb holder ① clockwise until it engages and wire ② points downward and to the left.

Corner-illuminating lamp

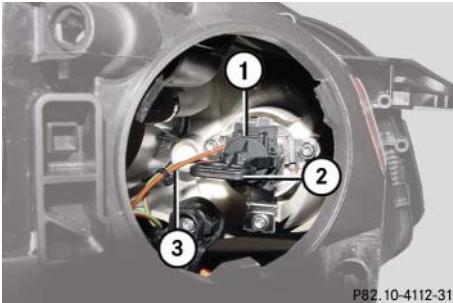

- ① Bulb holder
- ② Grip
- ③ Wire position

- ▶ Turn cover 3 (▶ page 624) counterclockwise and remove it.
- ▶ Turn bulb holder ① counterclockwise until it disengages.
- ▶ Take out bulb holder ①.
- ▶ Take bulb out of holder.
- ▶ Insert new bulb into holder and press it all the way down.
- ▶ Insert bulb holder ① into guide in headlamp.

The tab of the bulb holder must be positioned on the upper left-hand side and wire ③ must point downward and to the left for the left headlamp, upward and to the right for the right headlamp.

- ▶ Turn bulb holder ① clockwise until it engages and grip ② is in a horizontal position.

Additional turn signal lamp bulbs

The additional turn signal lamps in the exterior rear view mirrors have LEDs.

If a malfunction occurs or LEDs fail to function, the entire turn signal unit must be replaced. Have the turn signal unit replaced by an authorized Mercedes-Benz Center.

Front side marker lamp bulbs

Since replacing the side marker lamp bulbs is a technically highly demanding process, we recommend you have the side marker lamp bulbs replaced by an authorized Mercedes-Benz Center.

▼ Replacing wiper blades

Warning!



For safety reasons, switch off wipers and remove SmartKey from starter switch (vehicles with KEYLESS-GO*): Make sure the vehicle's on-board electronics have status **0** before replacing a wiper blade. Otherwise, the wiper motor could suddenly turn on and cause injury.

Warning!



Wiper blades are components that are subject to wear and tear. Change the wiper blades twice a year, preferably in the spring and fall. Otherwise the windows will not be properly wiped. As a result, you may not be able to observe surrounding traffic conditions and could cause an accident.

! To avoid damage to the hood:

- The wiper arms should only be folded forward when in the vertical position.
- Never open the hood when the wiper arm is folded forward.

! Hold on to the wiper when folding the wiper arm back. If released, the force of the impact from the tensioning spring could crack the windshield.

Do not allow the wiper arms to contact the windshield glass without a wiper blade inserted.

Make certain that the wiper blades are properly installed. Improperly installed wiper blades may cause windshield damage.

For your convenience, we recommend that you have this work carried out by an authorized Mercedes-Benz Center.

Placing wiper arms in vertical position



Wiper blades in vertical position

Vehicles with SmartKey

- ▶ Turn SmartKey in starter switch position **1**.
- ▶ Turn combination switch to wiper setting  (> page 351).
- ▶ With wiper arm in vertical position, turn the SmartKey in starter switch to position **0**.

Replacing wiper blades

Vehicles with KEYLESS-GO*

- ▶ Turn off the engine (▷ page 366).
- ▶ Take foot off brake pedal.
- ▶ Turn combination switch to wiper setting  (▷ page 351).
- ▶ Press KEYLESS-GO start/stop button (▷ page 317) repeatedly until windshield wipers start.
- ▶ Press KEYLESS-GO start/stop button (▷ page 317) when the wiper arms are in a vertical position.

Removing wiper blades

- ▶ Fold the wiper arm forward until it snaps into place.

! *To do so, only touch the wiper arm so as not to damage the wiper blade inserts.*

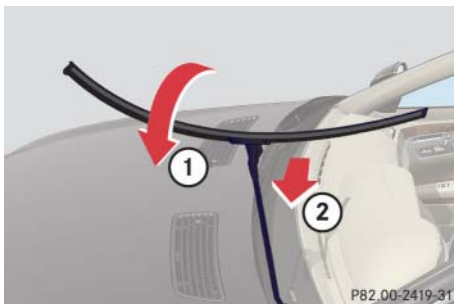

- ▶ Turn the wiper blade at a right angle to wiper arm (arrow ①).
- ▶ Slide the wiper blade sideways out of the retainer in the direction of arrow ②.

Installing wiper blades

- ▶ Slide the wiper blade onto wiper arm until it locks in place.
- ▶ Rotate the wiper blade into position parallel to wiper arm.
- ▶ Fold the wiper arm backward to rest on the windshield. Make sure you hold onto the wiper when folding the wiper arm back.

▼ Flat tire

Preparing the vehicle

- ▶ Park the vehicle in a safe distance from moving traffic on a hard, flat surface when possible.
- ▶ Turn on the hazard warning flashers.
- ▶ Turn the steering wheel so that the front wheels are in a straight ahead position.
- ▶ Shift the automatic transmission to **P**.
- ▶ Turn off the engine (▷ page 365).

- ▶ Remove the SmartKey from the starter switch.

Vehicles with SmartKey with KEYLESS-GO*:

- ▶ Turn off the engine by pressing the KEYLESS-GO* button once (▷ page 366).
- ▶ Open the driver's door (this puts the starter switch in position **0**, same as with the SmartKey removed from the starter switch). The driver's door then can be closed again.

 *Open the door only when conditions are safe to do so.*

- ▶ Have any passenger exit the vehicle at a safe distance from the roadway.

Mounting the Minispare wheel

Warning!



The dimensions of the Minispare wheel are different from those of the road wheels. As a result, the vehicle handling characteristics change when driving with a Minispare wheel mounted. Adapt your driving style accordingly.

The Minispare wheel is for temporary use only. When driving with Minispare wheel mounted, ensure proper tire inflation pressure and do not exceed a vehicle speed of 50 mph (80 km/h).

Drive to the nearest Mercedes-Benz Center as soon as possible to have the Minispare wheel replaced with a regular road wheel.

Never operate the vehicle with more than one Minispare wheel mounted.

Do not switch off the ESP® when a Minispare wheel is mounted.

Flat tire

Preparing the vehicle

- ▶ Prepare the vehicle as described (▷ page 629).
- ▶ Take vehicle tool kit tray and vehicle jack out of trunk (▷ page 611).
- ▶ Take the Minispare wheel from the wheel well under the trunk floor (▷ page 613).

Lifting the vehicle

- ▶ Prevent the vehicle from rolling away by blocking wheels with wheel chocks or other sizeable objects.

One wheel chock is included with the vehicle tool kit (▷ page 613).

When changing wheel on a level surface:

- ▶ Place the wheel chock in front of and another sizeable suitable object behind the wheel that is diagonally opposite to the wheel being changed.

Always try lifting the vehicle using the jack on a level surface. However, should circumstances require you to do so on a hill, place the wheel chock and another sizeable suitable object as follows:

- ▶ Place the wheel chock and another sizeable suitable object on the downhill side blocking both wheels of the axle not being worked on.

Warning!



The jack is designed exclusively for jacking up the vehicle at the jack take-up brackets built into both sides of the vehicle. To help avoid personal injury, use the jack only to lift the vehicle during a wheel change. Never get beneath the vehicle while it is supported by the jack. Keep hands and feet away from the area under the lifted vehicle. Always firmly set parking brake and block wheels before raising vehicle with jack.

Do not disengage parking brake while the vehicle is raised. Be certain that the jack is always vertical (plumb line) when in use, especially on hills. Always try to use the jack on level surface. Make sure the jack arm is fully seated in the jack take-up bracket. Always lower the vehicle onto sufficient capacity jackstands before working under the vehicle.

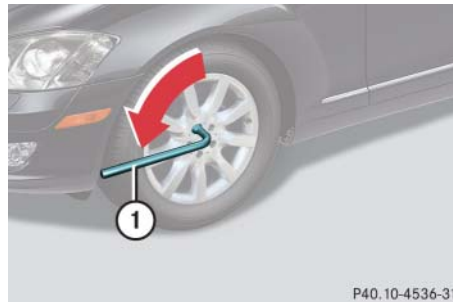

- ▶ Take two-piece wheel wrench ① out of the vehicle tool kit tray.

The jack take-up brackets are located directly behind the front wheel housings and in front of the rear wheel housings.



P40.10-4537-31

- ① Jack take-up bracket
- ② Jack
- ③ Crank

- ▶ Place jack ② on firm ground.
- ▶ Position jack ② under take-up bracket ① so that it is always vertical (plumb-line) as seen from the side, even if the vehicle is parked on an incline.

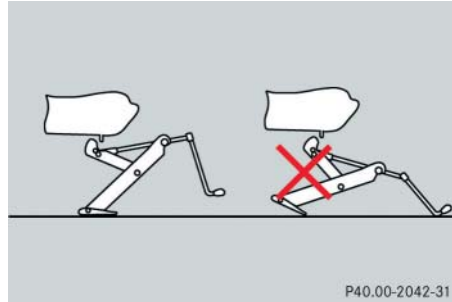

P40.00-2042-31

- ▶ Jack up the vehicle until the wheel is a maximum of 1.2 in (3 cm) from the ground. Never start engine while vehicle is raised.

Warning!



Position the jack only on the jack take-up brackets designed for this purpose. If the jack is not properly positioned, the vehicle may slip off of the jack.

Warning!



The jack is intended only for lifting the vehicle briefly for wheel changes. It is not suited for performing maintenance work under the vehicle.

- Never start the engine when the vehicle is raised.
- Never lie down under the raised vehicle.

Removing the wheel



P40.10-4538-31

- ① Alignment bolt

- ▶ Unscrew upper-most wheel bolt and remove.



Flat tire

▷▷ Replace this wheel bolt with alignment bolt ① supplied in the tool kit.

▶ Remove the remaining bolts.

❗ *Do not place wheel bolts in sand or dirt. This could result in damage to the bolt and wheel hub threads.*

▶ Remove the wheel.

Mounting the Minispare wheel

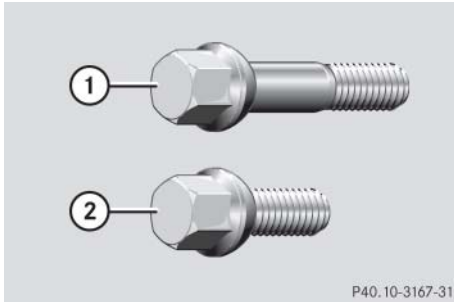

① Wheel bolt for light alloy rims

② Wheel bolt for Minispare wheel
(located in trunk with spare wheel)

❗ *Wheel bolts ② must be used when mounting the Minispare wheel. The use of any wheel bolts other than wheel bolts ② for the Minispare wheel will physically damage the vehicle's brakes.*

Warning!



Make sure to use the original length wheel bolts when remounting the original wheel after it has been repaired.

▶ Clean contact surfaces of wheel and wheel hub.

❗ *To avoid paint damage, place wheel flat against hub and hold it there while installing first wheel bolt.*

Warning!



Always replace wheel bolts that are damaged or rusted.

Never apply oil or grease to wheel bolts.

Damaged wheel hub threads should be repaired immediately. Do not continue to drive under these circumstances! Contact an authorized Mercedes-Benz Center or call Roadside Assistance.

Incorrect wheel bolts or improperly tightened wheel bolts can cause the wheel to come off. This could cause an accident. Make sure you are using the correct wheel bolts.

- ▶ Guide the Minispare wheel onto the alignment bolt and push it on.
- ▶ Insert wheel bolts ② and tighten them slightly.



P40.10-4539-31

- ▶ Unscrew the alignment bolt, install the last wheel bolt and tighten slightly.

Warning!

Only use Genuine equipment Mercedes-Benz wheel bolts. Other wheel bolts may come loose.

Do not tighten the wheel bolts when the vehicle is raised. Otherwise the vehicle could fall off the jack.

Lowering the vehicle

- ▶ Lower vehicle by turning crank counterclockwise until vehicle is resting fully on its own weight.
- ▶ Remove the jack.

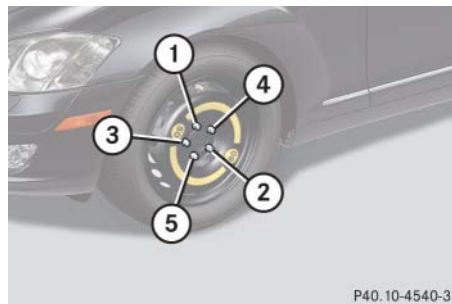

P40.10-4540-31

① - ⑤ Wheel bolts

- ▶ Tighten the five wheel bolts evenly, following the diagonal sequence illustrated (① to ⑤), until all bolts are tight. Observe a tightening torque of 110 lb-ft (150 Nm).

Warning!

Have the tightening torque checked after changing a wheel. The wheels could come loose if they are not tightened to a torque of 110 lb-ft (150 Nm).

Before storing the jack, it should be fully collapsed, with handle folded in (storage position).

- ▶ Store the jack and the other vehicle tools in the designated storage space underneath the trunk floor (▷ page 611).

i Do not activate the tire inflation pressure monitor (▷ page 511) until the depressurized tire has been removed from the trunk.

Batteries

Your vehicle is equipped with two batteries:

- The starter battery (located in the engine compartment)
- The battery for electrical consumers (located in the trunk)

! *Do not tow-start the vehicle.*

The batteries should always be sufficiently charged in order to achieve its rated service life. Refer to Maintenance Booklet for battery maintenance intervals.

If you use your vehicle mostly for short-distance trips, you will need to have the battery charge checked more frequently.

When replacing the batteries, always use batteries approved by Mercedes-Benz.

If you do not intend to operate your vehicle for an extended period of time, consult an authorized Mercedes-Benz Center about steps you need to observe.

Warning!



Observe all safety instructions and precautions when handling automotive batteries.



Risk of explosion.



Fire, open flames and smoking are prohibited when handling batteries. Avoid creating sparks.



Battery acid is caustic. Do not allow it to come into contact with skin, eyes or clothing.

Wear suitable protective clothing, especially gloves, apron and faceguard.



Wear eye protection.

Rinse any acid spills immediately with clear water. Contact a physician if necessary.



Keep children away.



Follow the instructions in this Operator's Manual.

Batteries contain materials that can harm the environment if disposed of improperly. Large 12-volt storage batteries contain lead. Recycling of batteries is the preferred method of disposal. Many states require sellers of batteries to accept old batteries for recycling.

! *The consumer battery located in the trunk is a valve-regulated lead acid (VRLA) battery, also referred to as “fleece” battery. Such batteries do not require topping-up of the electrolyte level. VRLA batteries therefore do not have cell caps and the battery cover is non-removable. Do not attempt to open the consumer battery as otherwise the battery will be damaged.*

Even though VRLA batteries do not require topping-up of the electrolyte level and cannot be opened to check the electrolyte level, the battery condition must be checked periodically by performing a battery conductance test. Refer to Maintenance Booklet for battery condition testing intervals.

As with any other battery, disconnect the consumer battery if you do not intend to operate your vehicle for an extended period of time to prevent battery discharge or connect an accessory battery charge unit expressly approved by Mercedes-Benz for your vehicle model to maintain the battery charge. Contact an authorized Mercedes-Benz Center for further information.

! *The factory-equipped VRLA battery is leak-proofed. Only use a battery as replacement that has the same security features and is of identical size, voltage, and capacity as the factory-equipped battery.*

The battery, the battery ventilation and the lateral plug must always be securely installed when the vehicle is in operation.

Warning!



Failure to follow these instructions can result in severe injury or death.

Never lean over batteries while connecting, you might get injured.

Battery fluid contains sulfuric acid. Do not allow this fluid to come in contact with eyes, skin or clothing. In case it does, immediately flush affected area with water and seek medical help if necessary.

A battery will also produce hydrogen gas, which is flammable and explosive. Keep flames or sparks away from battery, avoid improper connection of jumper cables, smoking, etc.

Warning!



Do not place metal objects on the battery as this could result in a short circuit.

Use leak-proof battery only to avoid the risk of acid burns in the event of an accident.

Take care that you do not become statically charged, e.g. by wearing synthetic clothing or rubbing against textiles. For this reason, you also should not pull or push the battery over carpets or other synthetic materials.

Never touch the battery first. First touch the outside body of the vehicle in order to release any possible electrostatic charges.



Batteries



Do not rub the battery with rags or cloths. The battery could explode if touched due to electrostatic charge or due to spark formation.

! Switch off the engine and switch off the vehicle's internal electrical functions (▷ page 637) before you disconnect or remove the battery's terminal clamps. You could otherwise destroy electronic assemblies such as the generator.

Have the battery checked regularly by an authorized Mercedes-Benz Center. Refer to Maintenance Booklet for maintenance intervals or contact an authorized Mercedes-Benz Center for further information.

! Do not connect any consumers directly to the starter battery. The starter battery will otherwise be discharged.

i Only replace a discharged battery with a battery recommended by Mercedes-Benz. The consumer battery is installed in the trunk in such a way that it is safeguarded as much as possible against mechanical destruction in the event of an accident.

i Remove SmartKey from starter switch (vehicles with KEYLESS-GO*: Make sure the vehicle's on-board electronics have status 0) (▷ page 315) when you turn off the engine and no longer require any electrical consumers. The vehicle then uses very little power and the consumer battery is spared.

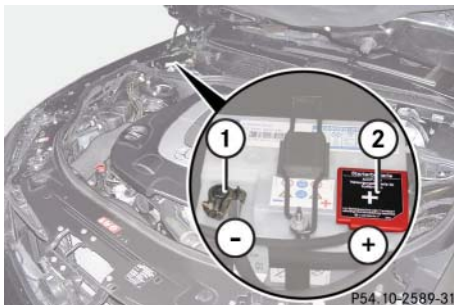

Starter battery (example illustration from S 550)

① Negative terminal

② Positive terminal

i If the consumer battery is discharged, you must use the mechanical key to unlock the vehicle (▷ page 614). Since the vehicle has a separate starter battery, however, you can still start the vehicle.

Disconnecting starter battery

! Always disconnect the starter battery in the order described below. You could otherwise damage the vehicle's electronics.

! Switch off the vehicle's internal electrical functions before disconnecting the starter battery. If the vehicle is stationary for more than one hour with the SmartKey removed, you do not need to switch off the vehicle's internal electrical functions.

Switching off vehicle's internal electrical functions

i Vehicles with KEYLESS-GO: remove the KEYLESS-GO button (▷ page 316) and use the SmartKey with KEYLESS-GO like a normal SmartKey.

- ▶ Shift the automatic transmission to **P**.
- ▶ Turn off all electrical consumers.
- ▶ Turn SmartKey in starter switch to position **0**.
- ▶ Turn SmartKey in starter switch to position **1**.
- ▶ Wait for 30 seconds.
The vehicle's internal electrical functions are switched off.
- ▶ Turn SmartKey in starter switch to position **0**.

! Do not remove the SmartKey!

Disconnecting starter battery

- ▶ Open the hood (▷ page 492).
- ▶ Use a 10-mm open-end wrench to disconnect the battery negative lead.
- ▶ Remove cover ② (▷ page 636) from the positive terminal.
- ▶ Disconnect the battery positive lead.

Removing starter battery

i For your convenience, have the starter battery removed by a Mercedes-Benz Center.

- ▶ Pull out the battery ventilation hose from the battery (depending on battery arrangement in your vehicle model, the ventilation hose is located either on the left or right side of the battery).
- ▶ Fold bar on starter battery up.
- ▶ Take out the starter battery.

Charging battery

Warning!



Never charge a battery while still installed in the vehicle unless the accessory battery charge unit approved by Mercedes-Benz is being used. Gases may escape during charging and cause explosions that may result in paint damage, corrosion or personal injury.

An accessory battery charge unit specially adapted for Mercedes-Benz vehicles and tested and approved by Mercedes-Benz is available, permitting the charging of the battery in its installed position. Contact an authorized Mercedes-Benz Center for information and availability. Charge battery in accordance with the separate instructions for the accessory battery charger.

i Have the batteries charged by a Mercedes-Benz Center. If you charge the batteries yourself, follow the operating instructions for your charging device.

Batteries

! Only use charging devices with a maximum charging voltage of 14.8 V.

Starter battery

Warning!



During the charge procedure, there is a risk of acid burns due to gases escaping from the battery. Do not bend over the battery during the charge procedure.

- ▶ Connect the switched-off charging device to the terminals of the starter battery. Observe the operating instructions in the manual for the charging device while doing so.

Reinstalling starter battery

- ▶ Install starter battery in engine compartment.
- ▶ Swing retaining bar down.

! The battery and the battery ventilation hose must always be securely installed when the vehicle is in operation.

Reconnecting starter battery

! Always connect the starter battery in the order described below. Otherwise, the vehicle's electronics could be damaged.

Warning!



Do not drive without a properly installed and connected consumer battery.

Have any work on the consumer battery carried out by an authorized Mercedes-Benz Center.

- ▶ Make sure that the consumer battery in the trunk is correctly installed and connected.
- ▶ Turn SmartKey in starter switch to position **0** and remove.
- ▶ Connect the positive lead and fasten its cover ② (▷ page 636).
- ▶ Connect negative lead ① (▷ page 636).
- ▶ Attach ventilation tube.
- !** Never invert the terminal connections.
- !** Make sure that the battery has a plug where the ventilation tube is attached to it.
- ▶ Switch on the ignition (▷ page 315).
- ▶ Start the engine (▷ page 359).
- ▶ Check vehicle functions.

▼ Jump starting

Warning!



Failure to follow these directions will cause damage to the electronic components, and can lead to a battery explosion and severe injury or death.

Never lean over batteries while connecting or jump starting, you might get injured.

Battery fluid contains sulfuric acid. Do not allow this fluid to come in contact with eyes, skin or clothing. In case it does, immediately flush affected area with water, and seek medical help if necessary.

A battery will also produce hydrogen gas, which is flammable and very explosive. Keep flames or sparks away from battery, avoid improper connection of jumper cables, smoking, etc.

Attempting to jump start a frozen battery can result in it exploding, causing personal injury.

Read all instructions before proceeding.

! Do not tow-start the vehicle.

If the starter battery is discharged, the engine can be started with jumper cables and the battery of another vehicle. Observe the following:

- Jump starting should only be performed when the engine and catalytic converter are cold.
- Do not start the engine if the battery is frozen. Let the battery thaw out first.
- Only use 12-volt battery to jump start your vehicle. Jump starting with a more powerful battery could damage the vehicle's electrical system, which will not be covered by the Mercedes-Benz Limited Warranty.
- Only use jumper cables with sufficient cross-section and insulated terminal clamps.
- Always make sure that the jumper cables are not on or near pulleys, fans or other parts that move when an engine is started or running.

! Jump starting should only be performed on the starter battery installed in the engine compartment.

Avoid repeated and lengthy starting attempts.

Do not attempt to start the engine using a battery quick charge unit.

If engine does not run after several unsuccessful starting attempts, have it checked at the nearest authorized Mercedes-Benz Center.

Excessive unburned fuel generated by repeated failed starting attempts may damage the catalytic converter and may present a fire risk.

Make sure the jumper cables do not have loose or missing insulation.

Make sure the cable clamps do not touch any other metal part while the other end is still attached to a battery.

Jump starting

Warning!



Keep flames or sparks away from battery. Do not smoke.

Observe all safety instructions and precautions when handling automotive batteries (▷ page 634).

Jump starting should only be performed on the starter battery. The starter battery is located in the engine compartment on the passenger side (▷ page 634).

i Vehicles with KEYLESS-GO: remove the KEYLESS-GO button (▷ page 316) and use the SmartKey with KEYLESS-GO like a normal SmartKey.

- ▶ Make sure the two vehicles do not touch.
- ▶ Secure vehicle in place with electric parking brake.
- ▶ Shift the automatic transmission to **P**.
- ▶ Turn off all electrical consumers, except hazard warning flashers or work lights.
- ▶ Open the hood (▷ page 492).
- ▶ Start the engine of the vehicle with the charged battery and run at idle speed.

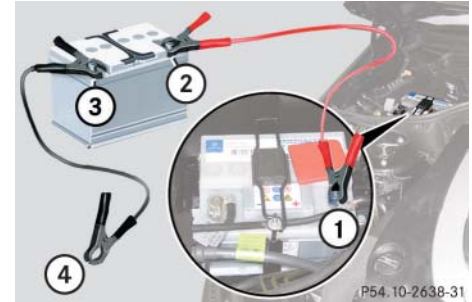

- ① Positive terminal of your vehicle's battery
- ② Positive terminal of other vehicle's battery
- ③ Negative terminal of other vehicle's battery
- ④ Negative clamp

- ▶ Remove red cover from positive terminal ①.
- ▶ Connect positive terminal ② of the charged battery with positive terminal ① of the discharged battery with the jumper cable. Clamp cable to charged battery ② first.
- ▶ **!** *Never invert the terminal connections.*
- ▶ Connect negative terminal ③ of charged battery to jumper cables and attach other end ④ to a suitable ground point on the vehicle.
- ▶ Get into vehicle and start engine within 30 seconds.
If the starting attempt does not succeed:
 - ▶ Turn the SmartKey in starter switch to position 0.
 - ▶ Take out the SmartKey.
 - ▶ Turn off engine of donor vehicle, restart it and let it run at idle speed for several minutes.
 - ▶ Disconnect the jumper cable during this time.
 - ▶ Reconnect jumper cable as described before.
 - ▶ Restart engine.
- ▶ While the engine is running, switch off several electrical consumers such as the blower.
- ▶ Disconnect jumper cables first from ground point ④ and negative terminal ③, then from positive terminals ① and ②.
- ▶ Have the battery checked at the nearest authorized Mercedes-Benz Center.

Towing the vehicle

Mercedes-Benz recommends that the vehicle be transported with all wheels off the ground using flatbed or appropriate wheel lift/dolly equipment. This method is preferable to other types of towing.

! Do not tow-start the vehicle.

! Use flatbed or wheel lift/dolly equipment with SmartKey in starter switch turned to position **0**.

Do not tow with sling-type equipment. Towing with sling-type equipment over bumpy roads will damage radiator and supports.

To prevent damage during transport, do not tie down vehicle by its chassis or suspension parts.

Switch off the ESP® (▷ page 73), the tow-away alarm (▷ page 76) and the automatic central locking (▷ page 313).

If the vehicle's transmission is damaged, only have it towed with the drive shaft disconnected.

When circumstances do not permit the recommended towing methods, the vehicle may be towed with all wheels on the ground or front wheels raised only so far as

necessary to have the vehicle moved to a safe location where the recommended towing methods can be employed.

! Make sure that the electric parking brake is released. If the electric parking brake is malfunctioning, release it mechanically (▷ page 616).

! In vehicles with KEYLESS-GO, insert the SmartKey into the starter switch under the KEYLESS-GO button and turn the SmartKey in the starter switch to **0**.

! If the vehicle is towed with the front axle raised, the engine must be shut off (SmartKey in starter switch starter switch position **0** or **1**). Otherwise the ESP®/ETS will immediately be engaged and will apply the rear wheel brakes.

While towing, the battery must be connected and charged. Otherwise:

- you will not be able to switch on the ignition
- you will not be able to engage the automatic transmission in position **N**

When towing the vehicle with all wheels on the ground, the automatic transmission must be shifted to **N** and the SmartKey must be in starter switch position **2**.

In vehicles with KEYLESS-GO*, you must use the starter switch under the KEYLESS-GO* button (▷ page 315).

When towing the vehicle with all wheels on the ground or the front axle raised, the vehicle may be towed only for distances up to 30 miles (50 km) and at a speed not to exceed 30 mph (50 km/h).

! To be certain to avoid a possibility of damage to the drivetrain, however, we recommend the drive shaft be disconnected at the rear axle drive flange for any towing beyond a short tow to a nearby garage.

Warning!

If circumstances require towing the vehicle with all wheels on the ground, always tow with a tow bar if:

- the engine will not run
- there is a malfunction in the brake system
- there is a malfunction in the power supply or in the vehicle's electrical system as that will be necessary to adequately control the towed vehicle.

Prior to towing the vehicle with all wheels on the ground, make sure the SmartKey is in starter switch position **2** and automatic locking is deactivated (▷ page 223).

Warning!

With the engine not running, there is no power assistance for the brake and steering systems. In this case, it is important to keep in mind that a considerably higher degree of effort is necessary to brake and steer the vehicle. Adapt your driving accordingly.

i *The automatic transmission will remain locked in position **P** and the SmartKey will not turn in the starter switch if the consumer battery is disconnected or discharged. See information on the battery (▷ page 634) or on jump starting (▷ page 639).*

i *To signal turns while being towed with the hazard warning flasher in use, turn SmartKey in starter switch to position **2** and activate the combination switch for the left or right turn signal in the usual manner – only the selected turn signal will operate.*

Upon canceling the turn signal, the hazard warning flasher will operate again.

! *When towing the vehicle with all wheels on the ground, please note the following:*

*With the automatic central locking activated and the SmartKey in starter switch position **2**, or KEYLESS-GO* start/stop button (▷ page 317) in position **2**, the vehicle doors lock if the left front wheel as well as the right rear wheel are turning at vehicle speeds of approximately 9 mph (15 km/h) or more.*

Switch off the tow-away alarm (▷ page 76).

To prevent the vehicle doors from locking, deactivate the automatic central locking (▷ page 313).

Towing of the vehicle should only be done using the properly installed towing eye bolt. Never attach tow cable, tow rope or tow rod to vehicle chassis, frame or suspension parts.

Towing the vehicle

Installing towing eye bolt



① Cover on right side of front bumper



① Cover on right side of rear bumper

Removing cover

- ▶ Press mark on cover ① in the direction of arrow.
- ▶ Lift cover off to reveal the threaded hole for towing eye bolt.

Installing towing eye bolt

- ▶ Take towing eye bolt and wheel wrench out of the vehicle tool kit in the trunk (▷ page 611).
- ▶ Screw towing eye bolt clockwise into its stop and tighten with wheel wrench.

Removing towing eye bolt

- ▶ Loosen towing eye bolt counterclockwise with wheel wrench.
- ▶ Unscrew towing eye bolt.
- ▶ Store towing eye bolt and wheel wrench in the vehicle tool kit in the trunk.

Installing cover

- ▶ Fit cover ① and snap into place.

▼ Fuses

The electrical fuses in your vehicle serve to switch off malfunctioning power circuits.

If a fuse is blown, the component(s) and systems secured by that fuse will stop operating.

The following aids are available to help you replace fuses (▷ page 646):

- Fuse chart
- Spare fuses
- Special fuse extractor

i *Blown fuses must be replaced by like fuses (recognizable by the color and amperage) with the amperage recommended in the fuse allocation chart. A Mercedes-Benz Center will be happy to advise you.*

Only change fuses while the vehicle is parked. First switch off all electrical consumers and turn off the ignition.

Warning!



Only use fuses approved by Mercedes-Benz with the specified amperage for the system in question. Using other fuses may cause an overload leading to a fire, and/or cause damage to electrical components and/or systems.

! *Keep the fuse boxes free by contamination and wetness. Otherwise, electrical parts or systems could be damaged.*

! *Never attempt to repair or bridge a blown fuse. Have the cause determined and remedied by an authorized Mercedes-Benz Center.*

! *Switch off the vehicle's internal electrical functions (▷ page 637) when you are working on the fuses.*

The electrical fuses are located in different fuse boxes:

- In the dashboard on the passenger side (▷ page 647)
- In the dashboard on the driver's side (▷ page 647)
- Behind the rear center armrest (▷ page 647)
- In the engine compartment on the driver's side (▷ page 646)
- In the engine compartment on the passenger side (▷ page 647)

Fuses

Aids for replacing fuses

Fuse chart

The fuse chart is located in the fuse box in the vehicle tool kit in the trunk (▷ page 611). The amperages of the fuses are also given there.

Spare fuses

The spare fuses are located in the vehicle tool kit in the trunk (▷ page 611).

Fuse extractor

The fuse extractor is located in the vehicle tool kit in the trunk (▷ page 611).

Fuse boxes in engine compartment

! *The cover must fit properly, as otherwise moisture or dirt may impair the functionality of the fuses.*

Box on the driver's side

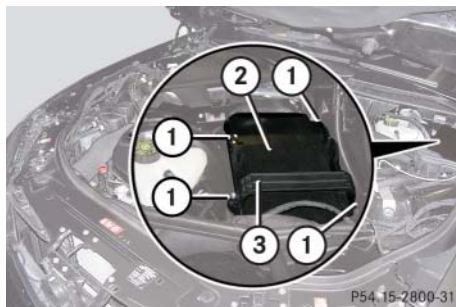

Fuse box, driver's side (example illustration from S 550)

- ① 4 screws
- ② Cover
- ③ Jumper

Opening

- ▶ Take the crank from the Operator's Manual pouch.
- ▶ Loosen screws ① with crank.
- ▶ Remove jumper ③.
- ▶ Remove cover ②.

Closing

- ▶ Attach cover ②.
- ▶ Attach jumper ③.
- ▶ Tighten screws ① with crank.

Box on the front passenger side

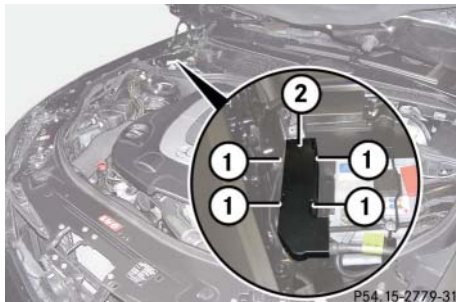

Fuse box, front passenger side (example illustration from S 550)

- ① Retaining lugs
- ② Cover

Opening

- ▶ Press retaining lugs ①.
- ▶ Remove cover ②.

Closing

- ▶ Attach cover ②.
- ▶ Press cover ② down manually.

Fuse boxes in passenger compartment

! Do not use sharp objects such as a screw driver to open the fuse box cover in the dashboard, as this could damage it.

Fuse boxes in dashboard



Fuse box dashboard on the driver's side

- ① Cover

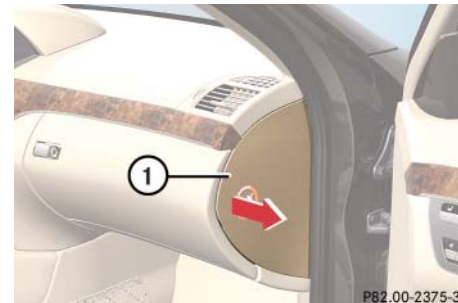

Fuse box dashboard on the passenger side

- ① Cover

Opening

- ▶ Open the respective door.
- ▶ Using your hands, pull cover ① in the direction of the arrow and remove.

Closing

- ▶ Hook cover ① into the opening at the front.
- ▶ Press cover ① back on until it engages.

Fuses

Fuse box in the rear passenger compartment

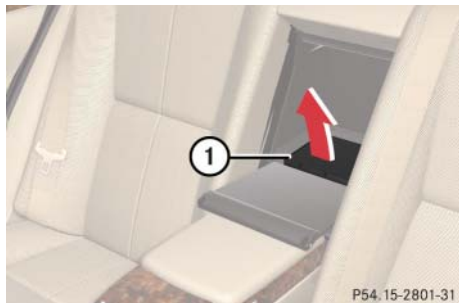

① Cover

Opening

- ▶ Swing down center armrest.
- ▶ Open cover behind center armrest.
- ▶ Pull cover ① forward in direction of arrow.

Closing

- ▶ Press cover ① backward and engage.

! Make sure that the seal in the cover is not damaged during opening or closing.

Emergency engine shut-down

If the engine can no longer be stopped using the SmartKey or the KEYLESS-GO* start/stop button, the engine can be turned off by withdrawing 3 fuses.

For easy removal of fuses, use the fuse extractor (supplied with vehicle tool kit) to pull out the fuses marked on the fuse chart as “Emergency engine shut-down”.

The fuse chart is also located in the vehicle tool kit (▷ page 611).

Parts service

Warranty coverage

Identification labels

Layout of poly-V-belt drive

Engine

Rims and tires

Electrical system

Main dimensions and weights

Fuels, coolants, lubricants, etc.



Parts service

The “Technical data” section provides the necessary technical data for your vehicle.

All authorized Mercedes-Benz Centers maintain a stock of Genuine Mercedes-Benz parts required for maintenance and repair work. In addition, strategically located parts distribution centers provide quick and reliable parts service.

More than 300 000 different parts for Mercedes-Benz models are available.

Genuine Mercedes-Benz parts are subjected to stringent quality inspections. Each part has been specifically developed, manufactured or selected for and adapted to Mercedes-Benz vehicles.

Therefore, Genuine Mercedes-Benz parts should be installed.

! *The use of non-genuine Mercedes-Benz parts and accessories not authorized by Mercedes-Benz could damage the vehicle, which is not covered by the Mercedes-Benz Limited Warranty, or could compromise the vehicle’s durability or safety.*

▼ Warranty coverage

Your vehicle is covered under the terms of the warranties printed in the Service and Warranty Information booklet. Your authorized Mercedes-Benz Center will exchange or repair any defective parts originally installed on the vehicle in accordance with the terms of the following warranties:

- New Vehicle Limited Warranty
- Emission System Warranty
- Emission Performance Warranty
- California, Maine, Massachusetts, and Vermont Emission Control Systems Warranty

Replacement parts and accessories are covered by the Mercedes-Benz Parts and Accessories warranties, copies of which are available at any authorized Mercedes-Benz Center.

Loss of Service and Warranty Information Booklet

Should you lose your Service and Warranty Information booklet, have an authorized Mercedes-Benz Center arrange for a replacement. It will be mailed to you.

Identification labels



- ① Certification label, includes Paintwork code (on driver's B-pillar)

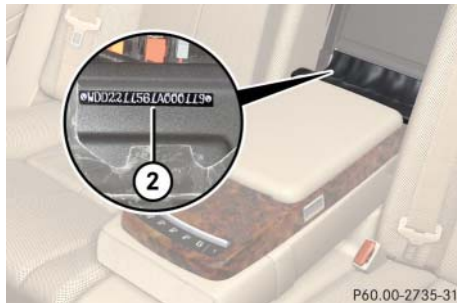

- ② Vehicle Identification Number (VIN)
- ▶ Fold down rear center armrest.
- Vehicle Identification Number ② is underneath a cover in the center armrest.

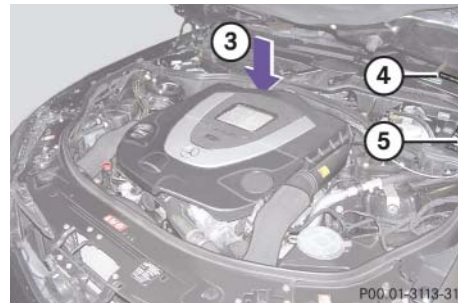

Example illustration from S 550

- ③ Engine number (engraved on engine)
- ④ VIN, visible (lower edge of windshield)
- ⑤ Emission control information label, includes both federal and California certification exhaust emission standards
Vacuum line routing diagram label

i When ordering parts, please specify vehicle identification and engine numbers.

▼ Layout of poly-V-belt drive

S 550

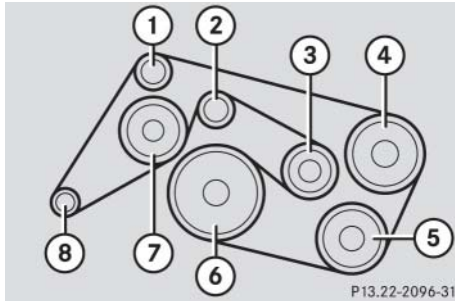

- ① Idler pulley
- ② Idler pulley
- ③ Automatic belt tensioner
- ④ ABC* tandem pump (pump for power-steering assistance and ABC* chassis)
- ⑤ Air conditioning compressor
- ⑥ Crankshaft
- ⑦ Coolant pump
- ⑧ Generator (alternator)

S 600

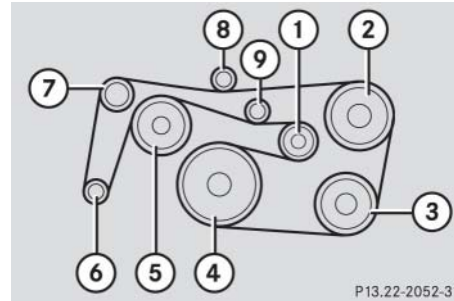

- ① Automatic belt tensioner
- ② ABC tandem pump (pump for power-steering assistance and ABC chassis)
- ③ Air conditioning compressor
- ④ Crankshaft
- ⑤ Coolant pump
- ⑥ Generator (alternator)
- ⑦ Idler pulley
- ⑧ Idler pulley
- ⑨ Idler pulley

Engine

Model	S 550 (221.171) ¹	S 600 (221.176) ¹
Engine	273	275
Mode of operation	4-stroke engine, gasoline injection	4-stroke engine, gasoline injection
No. of cylinders	8	12
Bore	3.86 in (98.00 mm)	3.23 in (82.00 mm)
Stroke	3.56 in (90.50 mm)	3.43 in (87.00 mm)
Total piston displacement	333.3 cu in (5461 cm ³)	336.4 cu in (5513 cm ³)
Compression ratio	10.7:1	9:1
Output acc. to SAE J 1349 ²	382 hp/6000 rpm (285 kW/6000 rpm)	510 hp/5000 rpm (380 kW/5000 rpm)
Maximum torque acc. to SAE J 1349	384 lb-ft/3000 rpm (520 Nm/3000 rpm)	612 lb-ft/1800 - 3500 rpm (830 Nm/1800 - 3500 rpm)
Maximum engine speed	6500 rpm	5950 rpm
Firing order	1-5-4-2-6-3-7-8	1-12-5-8-3-10-6-7-2-11-4-9
Poly-V-belt	2404 mm	2370 mm

¹ The quoted data apply only to the standard vehicle. See an authorized Mercedes-Benz Center for the corresponding data of all special bodies and special equipment.

² Premium fuel required. Performance may vary with fuel octane rating.

▼ Rims and tires

! Only use tires which have been tested and approved for your vehicle by Mercedes-Benz. Tires approved by Mercedes-Benz are developed to provide best possible performance in conjunction with the driving safety systems on your vehicle such as ABS or ESP®. Tires specially developed for your vehicle and tested and approved by Mercedes-Benz can be identified by finding the following on the tire's sidewall:

- MO = Mercedes-Benz Original equipment tires

Using tires other than those approved by Mercedes-Benz may result in damage that is not covered by the Mercedes-Benz Limited Warranty.

! Using tires other than those approved by Mercedes-Benz can have detrimental effects, such as

- poor handling characteristics
- increased noise
- increased fuel consumption

Moreover, tires and rims not approved by Mercedes-Benz may, under load, exhibit dimensional variations and different tire deformation characteristics that could cause them to come into contact with the vehicle body or axle parts.

Damage to the tires or the vehicle may be the result.

i Further information on tires and rims is available at any authorized Mercedes-Benz Center. A placard with the recommended tire inflation pressures is located on the driver's door B-pillar (▷ page 503). Some vehicles may have supplemental tire inflation pressure information for driving at high speeds (▷ page 510) or for vehicle loads less than the maximum loaded vehicle condition (▷ page 518). If such information is provided, it can be found on the placard located on the inside of the fuel filler flap.



The tire inflation pressure should be checked regularly and should only be adjusted on cold tires. Follow tire manufacturer's maintenance recommendation included with vehicle.

i The following pages also list the approved wheel rim and tire sizes for equipping your vehicles with winter tires. Winter tires are not available as standard or optional factory equipment, but can be purchased from an authorized Mercedes-Benz Center.

Depending on vehicle model and the standard or optional factory-equipped wheel rim/tire configuration on your vehicle (Appearance Package, Sport Package etc.), equipping your vehicle with winter tires approved for your vehicle model may also require the purchase of two or four wheel rims of the recommended size for use with these winter tires. See an authorized Mercedes-Benz Center for more information.

Rims and tires

Same size tires

	S 550	S 600 S 550 (Sport Package*) S 600 (Sport Package*)
Rims (light alloy)	8.5 J x18 H2	8.5 J x18 H2
Wheel offset	1.69 in (43 mm)	1.69 in (43 mm)
Summer tires¹	–	–
All-season tires¹	255/45 R18 99H M+S	–
Winter tires^{1, 2, 3}	255/45 R18 99H M+S 	255/45 R18 99H M+S 

¹ Radial-ply tires

² For use with snow chains contact an authorized Mercedes-Benz Center.

³ Not available as factory equipment.

Mixed size tires

	S 600	S 550* S 600*	S 550 (Sport Package*) S 600 (Sport Package*)
Front axle:			
Rims (light alloy)	8.5 J x 18 H2	8.5 J x 19 H2	-
AMG rims (light alloy)	-	-	8.5 J x 19 H2
Wheel offset	1.69 in (43 mm)	1.69 in (43 mm)	1.69 in (43 mm)
Summer tires ¹	255/45 R18 99V	255/40 R19 96Y	255/40 R19 96Y
Rear axle:			
Rims (light alloy)	9.5 J x 18 H2	9.5 J x 19 H2	-
AMG rims (light alloy)	-	-	9.5 J x 19 H2
Wheel offset	1.69 in (43 mm)	1.69 in (43 mm)	1.69 in (43 mm)
Summer tires ¹	275/45 R18 103V	275/40 R19 101Y	275/40 R19 101Y

¹ Radial-ply tires

Rims and tires

Minispare wheel

Rim	4.5 B x 19
Wheel offset	1.38 in (35 mm)
Tire	T 155/70 R19 113M ¹

¹ Must not be used with snow chains.

! Please compare the recommended tire inflation pressure for your vehicle with the tire inflation pressure on the yellow label located on the Minispare wheel rim.

If the tire inflation pressure on the yellow label on the Minispare wheel rim differs from the values given in this Operator's Manual, inflate the spare wheel tire to the recommended tire inflation pressure given on the yellow label on the Minispare wheel rim.

i Please note that the tire inflation pressure of the Minispare differs from the tire inflation pressure of the road tires.

Make sure the Minispare tire is inflated to approximately 61 psi (4.2 bar).

▼ **Electrical system**

Model	S 550	S 600
Generator (alternator)	14 V/180 A	14 V/220 A
Starter motor	12 V/1.7 kW	12 V/1.7 kW
Starter battery	12 V/35 Ah	12 V/35 Ah
Electrical consumer battery	12 V/95 Ah	12 V/95 Ah
Spark plugs	NGK PLKR 6A Bosch Y 7 MPP 33	NGK IFR 6Q-G
Electrode gap	0.031 in (0.8 mm)	0.028 in (0.7 mm)
Tightening torque	15 – 18 lb-ft (20 – 25 Nm)	18 – 22 lb-ft (25 – 30 Nm)

Main dimensions and weights

Main dimensions

Model	S 550 (221.171) S 600 (221.176)
Overall vehicle length	204.7 in (5206 mm)
Overall vehicle width (exterior rear view mirrors folded out)	83.2 in (2113 mm)
Overall vehicle height	58.0 in (1473 mm)
Wheelbase	124.6 in (3165 mm)
Track, front	63.2 in (1604 mm)
Track, rear	63.3 in (1606 mm)

Weights

Max. roof load	220 lb (100 kg)
Max. trunk load	220 lb (100 kg)

Fuels, coolants, lubricants, etc.

▼ Fuels, coolants, lubricants, etc.

Capacities

Vehicle components and their respective lubricants must match. Therefore use only products tested and approved by Mercedes-Benz.

Please refer to the Factory Approved Service Products pamphlet, or inquire at your Mercedes-Benz Center.

Warning!



Comply with all valid regulations with respect to handling, storing and disposing of service fluids. Otherwise you could endanger persons or the environment.

Keep service fluids out of the reach of children.

If a service fluid is swallowed, contact a physician immediately.

Warning!



Gasoline is highly flammable and poisonous. It burns violently and can cause serious injury. Never allow sparks, flame or smoking materials near gasoline!

Do not allow fuel to come into contact with skin or clothing. Direct skin contact with fuels and the inhalation of fuel vapors are damaging to health.

Switch off the engine before refueling.

	Model	Capacity	Fuels, coolants, lubricants, etc.
Engine with oil filter	S 550	8.98 US qt. (8.5 l)	Approved engine oils
	S 600	9.51 US qt. (9.0 l)	
Automatic transmission	S 550	10.36 US qt. (9.8 l)	MB Automatic Transmission Fluid
	S 600	8.14 US qt. (7.7 l)	
Rear axle	S 550	1.27 US qt. (1.2 l)	Hypoid gear oil SAE 85 W 90
	S 600	2.11 US qt. (2.0 l)	
Hydraulic system for ADS or ABC	All models	4.2 US qt. (4.0 l)	MB Hydraulic Fluid
Power steering	S 550	approx. 1.06 US qt. (1.0 l)	MB Power Steering Fluid (Pentosin CHF 11S)
	S 600	approx. 1.27 US qt. (1.2 l)	

Fuels, coolants, lubricants, etc.

		Model	Capacity	Fuels, coolants, lubricants, etc.
Front wheel hubs		All models	approx. 2.1 oz. (60 g) each	High-temperature roller bearing grease
Brake system		All models	approx. 0.53 US qt. (0.5 l)	MB Brake Fluid (DOT 4+)
Cooling system	Vehicles without rear passenger compartment climate control*	S 550	12.15 US qt. (11.5 l)	MB 325.0 Anticorrosion/Antifreeze
	Vehicles with rear passenger compartment climate control*	S 550	13.9 US qt. (13.15 l)	
		S 600	14.69 US qt. (13.9 l)	
Low temperature cooling system		S 600	2.75 US qt. (2.6 l)	
Fuel tank		All models	23.78 US gal (90.0 l)	Premium unleaded gasoline: Minimum Posted Octane 91 (Avg. of 96 RON/86 MON)
	including a reserve of	All models	2.9 US gal (11.0 l)	
Air conditioning system		All models		R-134a refrigerant and special PAG lubricant oil (never R-12)
Windshield washer	Vehicles with ABC*	All models	6.93 US qt (6.56 l)	MB Windshield Washer Concentrate ¹
	Vehicles with Airmatic*	All models	6.76 US qt (6.4 l)	

¹ Use MB Windshield Washer Concentrate “MB SummerFit” and water for temperatures above freezing or MB Windshield Washer Concentrate “MB SummerFit” and commercially available premixed windshield washer solvent/antifreeze for temperatures below freezing point. Follow suggested mixing ratios (▷ page 668).

Engine oils

Engine oils are specifically tested for their suitability in our engines and durability for our service intervals. Therefore, only use approved engine oils and oil filters required for vehicles with Maintenance System (U.S. vehicles) or FSS PLUS (Canada vehicles). For a listing of approved engine oils and oil filters, refer to the Factory Approved Service Products pamphlet, or contact an authorized Mercedes-Benz Center.

! *Using engine oils and oil filters of specification other than those expressly required for the Maintenance System (U.S. vehicles) or FSS PLUS (Canada vehicles), or changing of oil and oil filter at change intervals longer than those called for by the Maintenance System (U.S. vehicles) or FSS PLUS (Canada vehicles) will result in engine damage not covered by the Mercedes-Benz Limited Warranty.*

Please follow Maintenance System (U.S. vehicles) or FSS (Canada vehicles) recommendations for scheduled oil changes. Failure to do so will result in engine damage not covered by the Mercedes-Benz Limited Warranty.

Engine oil additives

Do not blend oil additives with engine oil. They may damage the engine. Damage or malfunctions resulting from blending oil additives are not covered by the Mercedes-Benz Limited Warranty.

Air conditioning refrigerant

R-134a (HFC) refrigerant and special PAG lubricating oil are used in the air conditioning system.

Never use R-12 (CFC) or mineral-based lubricating oil. Otherwise damage to the system will occur.

Brake fluid

During vehicle operation, the boiling point of the brake fluid is continuously reduced through the absorption of moisture from the atmosphere.

Warning!



Under extremely strenuous operating conditions, this moisture content can lead to the formation of bubbles in the system, thus reducing the system's efficiency.

Therefore, the brake fluid must be replaced regularly. Refer to your vehicle's Maintenance Booklet for replacement interval.

Only brake fluid approved by Mercedes-Benz is recommended. Your authorized Mercedes-Benz Center will provide you with additional information.

Fuels, coolants, lubricants, etc.

Premium unleaded gasoline

Warning!



Gasoline is highly flammable and poisonous. It burns violently and can cause serious injury. Whenever you are around gasoline, avoid inhaling fumes and skin contact, extinguish all smoking materials. Never allow sparks, flame or smoking materials near gasoline!

Switch off the engine before refueling.

Warning!



Do not allow fuel to come into contact with skin or clothing.

Direct skin contact with fuels and the inhalation of fuel vapors are damaging to health.

! *To maintain the engine's durability and performance, premium unleaded gasoline must be used. If premium unleaded gasoline is not available and low octane fuel is used, follow these precautions:*

- *Have the fuel tank only partially filled with unleaded regular and fill up with premium unleaded as soon as possible.*
- *Avoid full throttle driving and abrupt acceleration.*
- *Do not exceed an engine speed of 3000 rpm if the vehicle is loaded with a light load such as two persons and no luggage.*
- *Do not exceed $\frac{2}{3}$ of maximum accelerator pedal position if the vehicle is fully loaded or operating in mountainous terrain.*

Fuel requirements

Use only premium unleaded fuel:

- The octane number (posted at the pump) must be 91 min. It is an average of both the Research (R) octane number and the Motor (M) octane number: $(R+M)/2$. This is also known as the ANTI-KNOCK INDEX.

Unleaded gasoline containing oxygenates such as ethanol, IPA, IBA and TBA can be used provided the ratio of any one of these oxygenates to gasoline does not exceed 10%; MTBE must not exceed 15%.

The ratio of methanol to gasoline must not exceed 3% plus additional co-solvents.

Using mixtures of ethanol and methanol is not allowed. Gasohol, which contains 10% ethanol and 90% unleaded gasoline, can be used.

These blends must also meet all other fuel requirements, such as resistance to spark knock, boiling range, vapor pressure, etc.

Gasoline additives

A major concern among engine manufacturers is carbon build-up caused by gasoline. Mercedes-Benz recommends only the use of quality gasoline containing additives that prevent the build-up of carbon deposits.

After an extended period of using fuels without such additives, carbon deposits can build up especially on the intake valves and in the combustion area, leading to engine performance problems such as:

- Warm-up hesitation
- Unstable idle
- Knocking/pinging
- Misfire
- Power loss

In areas where carbon deposits may be encountered due to lack of availability of gasolines which contains these additives, Mercedes-Benz recommends the use of additives approved by us for use on Mercedes-Benz vehicles. Refer to Factory Approved Service Products Pamphlet for a listing of approved product(s). Follow directions on product label.

Do not blend other fuel additives with fuel. This only results in unnecessary cost and may be harmful to the engine operation.

Damage or malfunction resulting from poor fuel quality or from blending additional fuel additives other than those tested and approved by us for use on Mercedes-Benz vehicles listed in the Factory Approved Service Products Pamphlet are not covered by the Mercedes-Benz Limited Warranty.

Coolants

The engine coolant is a mixture of water and anticorrosion/antifreeze, which provides:

- Corrosion protection
- Freeze protection
- Boiling protection (by increasing the boiling point)

The cooling system was filled at the factory with a coolant providing freeze protection to approximately -22°F (-30°C) and corrosion protection.

If the antifreeze mixture is effective to -22°F (-30°C), the boiling point of the coolant in the pressurized cooling system is reached at approximately 266°F (130°C).

Fuels, coolants, lubricants, etc.

The coolant solution must be used year-round to provide the necessary corrosion protection and increase boil-over protection. Refer to Maintenance Booklet for replacement interval.

Coolant system design and coolant used determine the replacement interval. The replacement interval published in the Maintenance Booklet is only applicable if MB 325.0 anticorrosion/antifreeze solution or other Mercedes-Benz approved products of equal specification (see Factory Approved Service Products pamphlet) are used to renew the coolant concentration or bring it back up to the proper level.

To provide important corrosion protection, the solution must be at least 45% anticorrosion/antifreeze [equivalent to freeze protection to approximately -22°F (-30°C)]. If you use a solution that is more than 55% anticorrosion/antifreeze [freeze protection to approximately -49°F (-45°C)], the engine temperature will increase due to the lower heat transfer capa-

bility of the solution. Therefore, do not use more than this amount of anticorrosion/antifreeze.

If the coolant level is low, water and MB 325.0 Anticorrosion/Antifreeze should be used to bring it up to the proper level (have cooling system checked for signs of leakage).

The water in the cooling system must meet minimum requirements, which are usually satisfied by normal drinking water. If you are not sure about the water quality, consult an authorized Mercedes-Benz Center.

Anticorrosion/antifreeze

Your vehicle contains a number of aluminum parts. The use of aluminum components in motor vehicle engines necessitates that anticorrosion/antifreeze coolant used in such engines be specifically formulated to protect the aluminum parts. (Failure to use such anticorrosion/antifreeze coolant will result in a significantly shortened service life.)

Therefore, the following product is strongly recommended for use in your vehicle: Mercedes-Benz 325.0 anticorrosion/antifreeze agent.

Before the start of the winter season (or once a year in hot southern regions), you should have the anticorrosion/antifreeze concentration checked. The coolant is also regularly checked each time you bring your vehicle to an authorized Mercedes-Benz Center for service.

Anticorrosion/antifreeze quantity

Model		Approx. freeze protection	
		- 35°F (- 37°C)	- 49°F (- 45°C)
S 550	Vehicles without rear passenger compartment climate control*	6.08 US qt. (5.75 l)	6.71 US qt. (6.35 l)
	Vehicles with rear passenger compartment climate control*	6.97 US qt. (6.60 l)	7.66 US qt. (7.25 l)
S 600 (main cooling system)		7.34 US qt. (6.95 l)	8.08 US qt. (7.65 l)
S 600 (low temperature cooling system)		1.37 US qt. (1.3 l)	1.51 US qt. (1.43 l)

Fuels, coolants, lubricants, etc.

Windshield and headlamp washer system

Both the windshield and headlamp washer systems are supplied from the windshield washer fluid reservoir.

The washer fluid reservoir has a capacity of approximately:

- 6.93 US qt (6.56 l) in vehicles with Airmatic*
- 6.76 US qt (6.4 l) in vehicles with ABC*

- ▶ Refill the reservoir with MB Windshield Washer Concentrate and water (or concentrate and commercially available premixed windshield washer solvent/antifreeze, depending on ambient temperatures).

Warning!



Washer solvent/antifreeze is highly flammable. Do not spill washer solvent/antifreeze on hot engine parts, because it may ignite and burn. You could be seriously burned.

Windshield and headlamp washer fluid mixing ratio

For temperatures above freezing point, use MB Windshield Washer Concentrate “MB SummerFit” and water:

- 1 part “MB SummerFit” to 100 parts water
[1.34 fl oz (40 ml) “MB SummerFit” to 1 gal (4.0 l) water].

For temperatures below freezing point, use MB Windshield Washer Concentrate “MB SummerFit” and commercially available premixed windshield washer solvent/antifreeze:

- 1 part “MB SummerFit” to 100 parts solvent
[1.34 fl oz (40 ml) “MB SummerFit” to 1 gal (4.0 l) solvent].

ABC

(Active Body Control)

Active, computer-controlled system that hydraulically adjusts the suspension at all four wheels in response to various driving situations.

ABS

(Antilock Brake System)

Prevents the wheels from locking up during braking so that the vehicle can continue to be steered.

Accessory weight

(▷ page 526)

Adaptive Brake

Brake system that is coupled with ->ABS, ->ESP and ->BAS. Adaptive Brake takes driver and vehicle characteristics into consideration, thus achieving an optimal braking effect.

ADS

(Adaptive Damping System)

Automatically adapts the optimum suspension damping to prevailing driving conditions.

Advanced TPMS*

(Tire Pressure Monitoring System)

The Advanced TPMS monitors the tire inflation pressure in all four tires. A warning is issued to alert you to a decrease in pressure in one or more of the tires. Tire inflation pressure inquiries are made using the ->Instrument cluster control system.

Airmatic

Automatically selects the optimum suspension tuning and ride height for your vehicle. Airmatic consists of two components:

- Adaptive Damping System
- Vehicle level control

Air pressure

(▷ page 526)

Alignment bolt

Metal pin with thread. The centering pin is an aid used when changing a tire to align the wheel with the wheel hub.

A-pillar

Front connecting pillar between the roof and the vehicle body (->B-pillar, ->C-pillar).

Aspect ratio

(▷ page 526)

Bar

(▷ page 526)

BAS

(Brake Assist System)

System for potentially reducing braking distances in emergency braking situations. The system is activated when it senses an emergency based on how fast the brake is applied.

BAS Plus*

(Brake Assist System Plus)

A system based on radar sensors for providing brake support in situations where there is a risk of collision.

BAS Plus is activated in hazardous situations by stepping quickly on the brake pedal. During the process, the brake force is adapted depending on the proximity to the vehicle in front.

Bead

(▷ page 526)

Bit

(Binary digit)

The smallest unit of digital information.

Bit rate (MP3)

Measurement of transmission speed. Indicates the number of ->bits transmitted per time unit.

Bi-xenon headlamps

Headlamps which use an electric arc as the light source and produce a more intense light than filament headlamps.

Bi-xenon headlamps produce low beam and high beam.

B-pillar

Center connecting pillar between roof and vehicle body (->A-pillar, ->C-pillar).

Bluetooth

Standard for short-range wireless technologies, suitable for transmitting voice and data. It is possible to connect Bluetooth devices wirelessly.

Bluetooth technology uses the freely available ISM (Industrial Scientific Medical) wireless network that works at 2.45 GHz. Ranges of up to ten meters are possible with Bluetooth.

CAC

(Customer Assistance Center)

Mercedes-Benz customer service center, which can help you with any questions about your vehicle and provide assistance in the event of a breakdown.

CAN system

(Controller Area Network)

Data bus network serving to control vehicle functions such as door locking or windshield wiping.

CD

(Compact Disc)

Digital storage medium in disc form.

CD-R

(Compact Disc Recordable)

->CD which can be written to once and read many times.

CD-RW

(Compact Disc Rewritable)

->CD which be read and written to many times.

Cockpit

All instruments, switches, buttons and indicator/warning lamps in the passenger compartment needed for vehicle operation and monitoring.

Cold tire inflation pressure

(▷ page 526)

COMAND

(Cockpit Management and Data System)

Information and operating center for vehicle sound and communications systems, including the radio and navigation system, as well as other optional equipment (CD changer, telephone*, etc.).

C-pillar

The C-pillar is the rear connecting pillar between the roof and the vehicle body (->B-pillar, ->C-pillar).

Cruise control

Driving convenience system that automatically maintains the vehicle speed set by the driver.

Curb weight

(▷ page 526)

DISTRONIC Plus*

A driving convenience cruise control system which helps the driver maintain a pre-selected speed:

- If there is no vehicle directly ahead, the system operates in the same way as conventional ->cruise control.
- If a slower moving vehicle is ahead, DISTRONIC Plus will reduce your vehicle speed to the extent permitted by reduced throttle and up to 20% braking power to maintain the preset minimum following distance.

DOT

(Department of Transportation)
(▷ page 526)

DVD

(Digital Versatile Disc)
Digital storage medium for storing large amounts of data, e.g. movies.

DVD-R

(Digital Versatile Disc Recordable)
->DVD which can be written to once and read many times.

DVD+R

(Digital Versatile Disc Recordable)
->DVD which can be written to once and read many times.

DVD-RW

(Digital Versatile Disc Rewritable)
->DVD which can be read and written to many times.

DVD+RW

(Digital Versatile Disc Rewritable)
->DVD which can be read and written to many times.

Dynamic Rear View Monitor*

The Dynamic Rear View Monitor is an optical parking aid. It shows you the area behind the vehicle on the ->COMAND display. In addition, the Dynamic Rear View Monitor contains guide lines to help you with reverse parking and parallel parking. The Dynamic Rear View Monitor is also called "Park Assist" in ->COMAND display.

EBP

(Electronic Brake Proportioning)
The EBP enhances braking effectiveness by allowing the rear brakes to supply a greater proportion of the braking effort without a loss of vehicle stability.

ELCODE

(Electronic Code System)
System that electronically checks whether a person entering or driving the vehicle is authorized to do so. It is part of the Mercedes-Benz anti-theft protection program.

Electric parking brake

Protects the vehicle from rolling away when parked. The electric parking brake is also called "Parking brake" in ->multifunction display messages.

Emergency call

This function places a call to a local 911 provider. It does not initiate a ->Tele Aid call. Please note that the 911 emergency call system is a public service. Using it without due cause is a criminal offense.

Engine number

The number set by the manufacturer and stamped on the cylinder block to uniquely identify each engine produced.

Engine oil viscosity

Measurement for the inner friction (viscosity) of the oil at different temperatures. The higher the temperature an oil can tolerate without becoming thin, or the lower the temperature it can tolerate without becoming viscous, the better the viscosity.

ESP®

(Electronic Stability Program)
Improves vehicle handling and directional stability.

ETD

(Emergency Tensioning Device)
Device which deploys in certain frontal and rear collisions exceeding the system's threshold to tighten the seat belts.
->SRS

ETS

(Electronic Traction System)
Automatically brakes spinning wheels, thus ensuring optimal ->traction at all times.

FAT

(File Allocation Table)
A table used to locate files on a disk or memory device.

FSS PLUS (Canada vehicles)

(Flexible Service System PLUS)
Maintenance service indicator in the ->multifunction display that informs the driver when the next vehicle maintenance service is due. FSS evaluates engine temperature, oil level, vehicle speed, engine speed, distance driven and the time elapsed since your last service, and calls for the next maintenance service accordingly.

GAWR

(Gross Axle Weight Rating)
(▷ page 526)

Gear range

Number of gears which are available to the automatic transmission for shifting. The automatic gear shifting process can be adapted to specific operating conditions using the selector lever.

GPS

(Global Positioning System)
Satellite-based system for relaying geographic location information to and from vehicles equipped with special receivers. Employs DVD digital maps for navigation.

GSM

(Global System for Mobile Communication)
A standard network protocol used throughout the world for digital cellular communication.

GVW

(Gross Vehicle Weight)
(▷ page 526)

GVWR

(Gross Vehicle Weight Rating)
(▷ page 527)

HiP

(High Performance light bulbs)
Light bulbs filled with xenon which are used in rear lamps.

ID3 tag

Additional information which may be included in MP3 files (e.g. title, artist, album).

Instrument cluster control system

The Instrument cluster control system is used to call up vehicle information and to change component settings. Information and messages appear in the ->multifunction display. The driver uses the buttons on the ->multifunction steering wheel to navigate through the system and to adjust settings.

Instrument cluster

The displays and indicator/warning lamps in the driver's field of vision, including the tachometer, speedometer, engine temperature and fuel gauge.

ISO9660

A standard file system for recording data on CDs.

Joliet

Standard for recording data on CDs; an extension of ISO 9660.

KEYLESS-GO*

System for entering and operating the vehicle without the use of a SmartKey.

Kickdown

Depressing the accelerator past the point of resistance shifts the transmission down to the lowest possible gear. This very quickly accelerates the vehicle and should not be used for normal acceleration needs.

Kilopascal (kPa)

(▷ page 527)

LED

(Light Emitting Diode)

Semiconductor element that converts electricity directly into light.

Line of fall

The direct line that an object moves downhill when influenced by the force of gravity alone.

LOGIC7® surround

Multichannel surround technology from the professional audio industry that plays back 5.1 and stereo recordings in surround sound. LOGIC7® creates a natural 360° sound experience on all seats.

Locking knob

Knob on the door which indicates whether the door is locked or unlocked. Pushing the locking knob down on an individual door from inside will lock that door.

Maintenance System (U.S. vehicles)

Maintenance service indicator in the ->multifunction display that informs the driver when the next vehicle maintenance service is due. The Maintenance System in your vehicle tracks distance driven and the time elapsed since your last maintenance service, and calls for the next maintenance service accordingly.

Maximum load rating

(▷ page 527)

Maximum loaded vehicle weight

(▷ page 527)

Maximum tire inflation pressure

(▷ page 527)

Memory function

Used to store three individual seat, steering wheel and exterior mirror positions.

MON

(Motor Octane Number)
 The Motor Octane Number for gasoline as determined by a standardized method. It is an indication of a gasoline's ability to resist undesired detonation (knocking). The average of both the MON (Motor Octane Number) and ->RON (Research Octane Number) is posted at the pump, also known as ANTI-KNOCK INDEX.

MP3

The term used in everyday speech for ->MPEG 1 Audio Layer 3.

MPEG1 Audio Layer 3

A means of compressing digital audio data.

Multifunction display

Display field in the speedometer used to present information provided by the control system.

Multifunction steering wheel

Steering wheel with buttons for operating the control system.

Night View Assist*

Driving system that illuminates roads with infrared light in addition to the normal headlamps and shows a black-and-white image of the road in the multifunction display.

Normal occupant weight

(▷ page 527)

Occupant distribution

(▷ page 527)

OCS

(Occupant Classification System)
 The Occupant Classification System automatically turns the front passenger front air bag on or off based on the classified occupant weight category determined by weight sensor readings from the front passenger seat.

Overspeed range

Engine speeds within the red marking of the tachometer dial. Avoid this engine speed range, as it may result in serious engine damage that is not covered by the Mercedes-Benz Limited Warranty.

Parktronic system*

System which uses visual and acoustic signals to assist the driver during parking maneuvers.

Park Assist*

System which uses visual and acoustic signals to assist the driver during parking maneuvers.

PCMCIA

(Personal Computer Memory Card
International Association)

Portable memory cards designed to be inserted into laptop computers to enable additional functions.

PIN code

(Personal Identification Number code)

Your PIN code prevents unauthorized persons from using your ->GSM mobile phone. The PIN code is a number string, which you have to enter when switching on the telephone.

Poly-V-belt drive

Drives engine components (alternator, AC compressor, etc.) from the engine.

Power train

Collective term designating all components used to generate and transmit motive power to the drive axles, including:

- Engine
- Clutch/torque converter
- Transmission
- Transfer case
- Drive shaft
- Differential
- Axle shafts/axles

PRE-SAFE®

(Preventive Occupant Safety System)

Vehicles equipped with PRE-SAFE® take preventive measures when the system senses certain driving dynamics suggesting a possible accident.

Production options weight

(▷ page 527)

Program mode selector switch

Used to switch the automatic transmission between standard operation **S** and comfort operation **C**.

PSI

(Pounds per square inch)
(▷ page 527)

PUK

(Personal Unblocking Key)

Must be entered if the wrong ->PIN was entered three consecutive times.

Recommended tire inflation pressure

(▷ page 527)

REST

(Residual engine heat utilization)
Feature that uses the engine heat stored in the coolant to heat the vehicle interior for a short time after the engine has been turned off.

Restraint systems

Seat belts, belt tensioners, air bags and child restraint systems. As independent systems, their protective functions complement one another.

Rim

(▷ page 527)

Root directory

The uppermost directory on a storage medium.

Run Flat Indicator

The Run Flat Indicator monitors the set tire inflation pressures by evaluating each wheel's rotational speed. If a wheel's rotational speed changes due to falling tire inflation pressure, a corresponding warning message appears in the ->Instrument cluster control system.

RON

(Research Octane Number)
The Research Octane Number for gasoline as determined by a standardized method. It is an indication of a gasoline's ability to resist undesired detonation (knocking). The average of both the ->MON (Motor Octane Number) and RON (Research Octane Number) is posted at the pump, also known as ANTI-KNOCK INDEX.

Sidewall

(▷ page 527)

SIM

(Subscriber Identify Module)
Card provided by the ->GSM telephone service provider. Necessary for accessing a mobile communication network.

SMS

(Short Message Service)
With this function you can receive, read and delete short text messages (if SMS service is provided by your carrier).

SRS

(Supplemental Restraint System)
Seat belts, emergency tensioning device and air bags. Though independent systems, they are closely interfaced to provide effective occupant protection.

Tele Aid

(Telematic Alarm Identification on Demand)
The Tele Aid system consists of three types of response: automatic and manual emergency, Roadside Assistance and information. Tele Aid is initially activated by completing a subscriber agreement and placing an acquaintance call. The Tele Aid system is operational provided that the vehicle's battery is charged, properly connected, not damaged and mobile phone and ->GPS coverage is available.

Telematics

A combination of the terms "telecommunications" and "informatics."

Tightening torque

Force times lever arm (e.g. a lug wrench) with which threaded fasteners such as wheel bolts are tightened.

TIN

(Tire Identification Number)
(▷ page 527)

Tire load rating

(▷ page 528)

Tire ply composition and material used

(▷ page 528)

Tire speed rating

(▷ page 528)

Traction

(▷ page 528)

Tread

(▷ page 528)

Treadwear indicators

(▷ page 528)

UDF

(Universal Disc Format)

A universal file system for optical media allowing an operating system to read, write and modify data stored on optical media that was created by another operating system.

Uniform Tire Quality Grading Standards

(▷ page 528)

Uphill driving assistant

While you are driving up a hill, this system holds the vehicle in place for approx. one second after you have taken your foot off the brake pedal.

Vehicle capacity weight

(▷ page 528)

Vehicle level control

The ground clearance of the vehicle is automatically controlled according to a selected setting and speed. The driver can choose manually within a range of ground clearance, for example on very rough roads.

Vehicle maximum load on the tire

(▷ page 528)

VIN

(Vehicle Identification Number)

The number set by the manufacturer and stamped on the body to uniquely identify each vehicle produced.

Voice Control*

Voice control system for car phones, portable cell phones and audio systems (radio, CD, etc.).

- A**
- ABC* 403
 - Messages in display 570
 - Setting vehicle level 403
 - ABS 69
 - Indicator lamp 29, 69, 544
 - Messages in display 572
 - Accelerator position, automatic transmission 373
 - Accessory weight 526
 - Accident 363
 - Active headlamps 342
 - Adaptive Brake Lights (S 600 and USA only) 70
 - Adaptive Damping System (Airmatic) 401
 - Additional turn signals 622
 - Address book (COMAND) 202
 - Calling up 202
 - Changing an entry 207
 - Creating an entry 203
 - Deleting an entry 204
 - Details about an entry 206
 - Displaying details about an entry in the phone book on the mobile phone 207
 - Importing data 212
 - Making a call 209
 - Menu overview 202
 - Searching for an entry 204
 - Starting route guidance 209
 - Voice entry 210
 - Address book (Voice Control*) 279
 - Adjustable air vents, rear passenger compartment 434
 - ADS (Airmatic) 401
 - Air bags 45
 - Children 61
 - Front 49
 - Front passenger front air bag indicator lamp 53
 - OCS 50
 - Safety guidelines 47
 - Side impact 49
 - Window curtain 49, 50
 - Air conditioning, Refrigerant 662, 663
 - Air distribution
 - Adjusting 435
 - Adjusting (COMAND) 230
 - Air pressure 526
 - Air pressure see Tire inflation pressure
 - Air recirculation mode 431
 - Air vents 433
 - Air vents, rear passenger compartment
 - Adjustable 434
 - Air volume
 - Adjusting 429, 435
 - Adjusting (COMAND) 230
 - Airmatic 401
 - Messages in display 585
 - Setting vehicle level 401
 - Alarm
 - Audible alarm and flashing exterior lamps (Panic alarm) 68
 - Alarm system see Anti-theft alarm system
 - Alignment bolt (vehicle tool kit) 611, 631, 669
 - Ambient lighting
 - COMAND menu 225
 - Antiglare
 - Rear view mirrors 334
 - Anti-theft systems 75
 - Alarm, visual and audible 75
 - Anti-theft alarm system 75
 - Immobilizer 75
 - Tow-away alarm 76
 - Tow-away alarm (COMAND) 228

- Aquaplaning see Hydroplaning
 - Armrest 448, 450
 - Ashtrays 456
 - Aspect ratio 526
 - Audio (COMAND) 104
 - CD mode 111
 - DVD mode 111
 - MP3 mode 111
 - Audio (Control system instrument cluster) 248
 - CD changer 249
 - DVD changer 249
 - Audio DVD
 - Fast forward/rewind (COMAND) 113
 - Menu overview (COMAND) 110
 - Pause function (COMAND) 112
 - Stop function (COMAND) 112
 - Auto-dimming, Rear view mirrors 334
 - Automatic climate control 424
 - Adjusting air distribution (COMAND) 230
 - Adjusting air flow from air vents (COMAND) 233
 - Adjusting air volume (COMAND) 230
 - Adjusting the footwell temperature (COMAND) 232
 - Air recirculation mode 431
 - Central climate control menu (COMAND) 231
 - Central menu for rear climate control* (COMAND) 234
 - Defrosting 429
 - Operating the rear climate control* from the front 234
 - Operating via COMAND 229
 - Rear window defroster 430
 - Selecting Mono mode (COMAND) 232
 - Setting temperature (COMAND) 230
 - Setting the temperature 429
 - Setting the temperature in the rear passenger compartment 435
 - Switching cooling on or off (COMAND) 231
 - Automatic headlamp mode 255, 343
 - Automatic lighting control, Interior lighting 349
 - Automatic locking when driving 313
 - Automatic shift program 374
 - Automatic transmission
 - Accelerator position 373
 - Automatic shift program 374
 - Emergency operation (limp-home mode) 377
 - Fluid 661
 - Fluid level 497
 - Gear ranges 372
 - Gear selector lever 367
 - Gear shifting malfunctions 377
 - Hill start assist system 374
 - Kickdown 373
 - Program mode selector switch 374
 - Shifting procedure 369
 - Starting the engine 359
 - Steering wheel gearshift control 375
 - Transmission fluid 497
 - Transmission positions 370
- B**
- Backup lamps
 - Replacing bulbs 622
 - Bar 526
 - BAS 71
 - Batteries, SmartKey
 - Checking battery condition 311
 - Replacing 619
 - Batteries, SmartKey with KEYLESS-GO*
 - Checking battery condition 311
 - Replacing 619

- Batteries, vehicle 634
 - Charging 637
 - Discharged, Jump starting 639
 - Disconnecting 636
 - For electrical consumers 634
 - For starter 634
 - Message in display 586
 - Reconnecting 638
 - Removing 637
- Bead 526
- Beverage holder see Cup holder
- Bi-Xenon headlamps see Headlamps
- Bluetooth
 - Settings (COMAND) 217
- Brake assist system (BAS Plus) 71
- Brake assist system (BAS) 71
- Brake fluid 490, 662, 663
- Brake lamp bulbs 622
- Brake lamp, high mounted 622
- Brake pads
 - Message in display 575
- Brake warning lamp 29
- Brakes 480
 - Warning lamp 545
- Break-in period 478
- Bulbs, replacing 621
 - Additional turn signals 622
 - Brake lamps 622
 - Fog lamps 622
 - Front lamps 622
 - High beam 622
 - High mounted brake lamp 622
 - License plate lamps 622
 - Low beam 622
 - Parking and standing lamps 622
 - Rear fog lamp 622
 - Turn signal lamps 622
- C**
- CAC (Customer Assistance Center) 670
- California retail buyers and lessees, important notice for 15
- Can holder see Cup holder
- CAN system 670
- Canceling
 - Cruise control 382
- Capacities and recommended fuel/lubricants 661
- Cargo area see Trunk
- Cargo tie-down hooks 453
- Carpets, Cleaning and care of 542
- Catalytic converter 487
- CD
 - Ejecting (COMAND) 109
 - Loading (COMAND) 107
 - Menu overview (COMAND) 110
 - Playback options (COMAND) 114
 - Selecting a medium (COMAND) 112
 - Selecting a track (COMAND) 113
- CD (COMAND) 104
- Central locking
 - Automatic 313
 - Locking/unlocking from inside 314
- Central locking/unlocking switches 314
- Certification label 652
- Change of address or ownership 16
- Changing
 - Vehicle level (ABC*) 404
 - Vehicle level (Airmatic) 402

- Children in the vehicle 61
 - Air bags 61
 - Indicator lamp front passenger front air bag off 53, 555
 - Indicator lamp, front passenger front air bag off 53
 - Infant and child restraint systems 62
 - LATCH-type child seat anchors 65
 - Override switch for rear passenger compartment 67
 - Tether attachment points 64
- Cigarette lighter 457
- Cloth upholstery, Cleaning and care of 542
- Cockpit 26, 671
- Cockpit management and data system see COMAND
- COMAND 671
 - Adjusting volume 89
 - Components 79
 - Controller 82
 - Display 80
 - Function buttons 80
 - Main menus 89
 - Menu overview 84
 - Navigation system 140
 - Operating 84
 - Operating safety 78
 - Operating seats 236
 - Phone book* 129
 - Radio, FM/AM 93
 - Selecting sound settings 90
 - SMS messages 137
 - Surround sound 91
 - Switching off/on the audio source 92
 - Switching on or off 79
 - Swiveling display 81
 - system settings 213
 - Telephone keypad* 82
 - Telephone menu* 115
 - Vehicle menu 220
 - Voice Control* settings 215
- Combination switch 346
- Corner-illuminating lamps 347
 - High beam 346
 - High beam flasher 347
 - Turn signals 362
 - Windshield wipers 351
- Command list (Voice Control*) 288
 - Address book commands 293
 - Audio commands 295
 - General commands 288
 - Navigation commands 290
 - Telephone* commands 289
- Control system instrument cluster 241
 - Multifunction display 241
 - Multifunction steering wheel 242
- Control system instrument cluster menus
 - Assistance* 252
 - Audio 248
 - Navi 246
 - Service 253
 - Settings 254
 - Telephone* 249
 - Trip 245
 - Vehicle status message memory 253
- Controller Area Network see CAN system
- Coolant 497
 - Adding 498
 - Anticorrosion/antifreeze mixing ratio and quantity 665
 - Checking level 497
 - Messages in display 587
 - Temperature 488
 - Temperature gauge 29, 378
- Coolant level
 - Checking 497

- Corner-illuminating lamps 347
- Courtesy lighting 350
- Cruise control 380, 671
 - Activating 381
 - Canceling 382
 - Driving downhill 382
 - Driving uphill 382
 - Message in display 559
 - Setting current speed 381
 - Setting to last stored speed (“Resume” function) 384
- Cup holder
 - Cleaning 541
 - In front seat armrest 452
 - In rear seat armrest 452
- Curb weight 526, 671
- Customer Assistance Center see CAC
- D**
- Date
 - Setting (COMAND) 214
- Daytime running lamp mode 344
- Deceleration
 - With DISTRONIC Plus* 388
- Deep water see Standing water
- Defrosting 429
- Delayed switch-off
 - Exterior lighting (COMAND) 220
 - Interior lighting (COMAND) 226
- Department of Transportation see DOT
- Destination entry (COMAND) 153
- Destination memory (COMAND) 195
- Difficulties
 - While driving 362
 - While starting 360
- Digital speedometer 246
 - Additional speedometer 255
- Dimensions, Vehicle 660
- Direction of rotation, Tires 503
- Displays
 - Additional speedometer 255
 - Digital speedometer 246
 - DISTRONIC Plus* 387
 - Maintenance service indicator 532
 - Multifunction display 241
 - Vehicle status message see Multifunction display messages
- Distance
 - Decreasing in DISTRONIC Plus* 397
 - Increasing in DISTRONIC Plus* 396
 - Setting in DISTRONIC Plus* 396
- Distance to Empty (Range) 246
- Distance warning function*
 - Activating 397
 - Deactivating 397
 - Distance warning lamp 397
 - Intermittent warning sound 397
- DISTRONIC Plus* 385
 - Activated 389
 - Activating 390
 - Calling up settings 389
 - Cleaning system sensor 537
 - Deactivated 389
 - Deactivating 395
 - Deceleration 388
 - Decreasing distance 397
 - Decreasing time interval 396
 - Displays in the speedometer dial 387
 - Distance warning function 397
 - Driving hints 397
 - Increasing distance 396
 - Increasing time interval 396
 - Intermittent signal tone 388
 - Lever 390
 - Menu 389
 - Messages in display 560
 - Sensor cover 537
 - Setting a higher speed 393

- Setting a slower speed 394
- Setting following distance 396
- Setting the current speed 393
- Setting to last stored speed (“Resume” function) 395
- Warning and indicator lamps 388
- Warning lamp 549
- Document holder 455
- Door
 - Control panel 38, 39, 42
 - Entry lamps 350
 - Inside door handle 312
 - Locking 305, 309
 - Locking with Tele Aid 469
 - Messages in display 562, 590
 - Opening from inside vehicle 312
 - Opening from outside 305, 309
 - Power closing assist 313
 - Unlocking 305, 309
 - Unlocking with Tele Aid 468
- DOT 526
- Downhill driving
 - Cruise control 382
- Drink holder see Cup holder
- Drinking and driving 479
- Drive-dynamic multicontour seats*, front
 - Adjusting (COMAND) 240
- Driving 359
 - Abroad 486
 - Hydroplaning 483
 - In winter 484
 - Instructions 359, 479
 - Problems 362
 - Safety systems 69
 - Through standing water 485
 - With DISTRONIC Plus* 397
- Driving maneuver (COMAND) 185
- Driving off 481
- Driving safety systems
 - ABS 69
 - Adaptive Brake Lights (S 600 and USA only) 70
 - BAS 71
 - BAS Plus 71
 - EBP 71
 - ESP® 72
 - ETS 73
- Driving systems 380
 - ABC* 403
 - Airmatic 401
 - Cruise control 380
 - DISTRONIC Plus* 385
 - Driving safety systems 69
 - Dynamic Rear View Monitor* 413
 - Park Assist* 409
 - Parktronic system* 405
 - Vehicle level control (ABC*) 403
 - Vehicle level control (Airmatic) 401
- Driving tips 373
 - Kickdown 373
- DVD 104
 - Audio (COMAND) 104
 - Changer (COMAND) 107
 - Changer (Voice Control*) 286
 - Ejecting (COMAND) 109
 - Loading (COMAND) 107
 - Playback options (COMAND) 114
 - Selecting a medium (COMAND) 112
 - Selecting a track (COMAND) 113
 - Setting the audio format (COMAND) 114

- Dynamic Rear View Monitor* 413
 - Parallel parking 417
 - Reverse parking (back-in parking) 415
 - Switching on 415
 - View through the camera 413
- E**
- Easy-entry/exit feature 328
 - COMAND menu 224
- EBP 71
- ELCODE 672
- Electric parking brake 364
- Electrical fuses see Fuses
- Electrical outlet see Power outlet
- Electrical system, Technical Data 659
- Electronic Brake Proportioning see EBP
- Electronic Stability Program see ESP®
- Emergency call system 462
- Emergency calls, Tele Aid 463
- Emergency engine shut-down 648
- Emergency operation (Limp-Home Mode) 377
- Emergency operations
 - Locking the vehicle 614
 - mechanically releasing the parking brake 616
 - Releasing from inside 440
 - Remote door lock 469
 - Remote door unlock 468
 - Tilt/sliding sunroof or tilt/sliding panel* 617
 - Unlocking the trunk 615
 - Unlocking the vehicle 614
- Emergency tensioning device see ETD
- Emergency, In case of
 - Battery, Jump starting 639
 - First aid kit 611
 - Flat tire 629
 - Fuses 645
 - Instrument cluster, Indicator lamps 544
 - Roadside Assistance 16
 - Roadside Assistance (Tele Aid) 465
 - Towing the vehicle 642
- Emission control 488
- Emission control information label 652
- Emission control system warranties 14
- Engine
 - Belt layout 653
 - Cleaning 536
 - Compartment 492
 - Coolant 497, 662, 665
 - Malfunction indicator lamp 547
 - Number 652, 672
 - Oil 496, 661, 663
 - Oils 494
 - Residual heat and ventilation 433
 - Starting 359
 - Technical data 654
 - Turning off 365
- Engine coolant see Coolant
- Engine oil 494
 - Adding 496
 - Additives 663
 - Checking level 494
 - Checking level (Dipstick) 495
 - Checking level (Instrument cluster control system) 494
 - Consumption 494
 - Dipstick 495
 - Filler neck 496, 497
 - Messages in display 495, 602
 - Recommended engine oils and oil filters 661
 - Viscosity 672
- ESP® 72
 - Messages in display 572, 582
 - Warning lamp 549

- ETD 58, 672
 - Safety guidelines 47
- Exterior lighting
 - Delayed switch-off (COMAND) 220
 - Locator lighting (COMAND) 221
- Exterior rear view mirrors
 - Adjusting 332
 - Auto-dimming on the driver's side 334
 - Fold in automatically when locking (COMAND) 222
 - Lower mirror when reversing (COMAND) 222
 - Power folding 333
- F**
- Favorite button 216
- First aid kit 611
- Flat tire 629
 - Jacking up the vehicle 630
 - Lowering the vehicle 633
 - Mounting the Minispare wheel 629
 - Preparing the vehicle 629
- Flexible Service System see FSS
- Fluids
 - Automatic transmission fluid 661
 - Brake fluid 662, 663
 - Capacities 661
 - Engine coolant 497, 662, 665
 - Engine oil 496, 661, 663
 - Power steering fluid 661
 - Windshield washer and headlamp cleaning system 662, 668
- Fog lamps
 - Messages in display 598
 - Replacing bulbs 622
- Front air bags 49
- Front lamps
 - Replacing bulbs 622, 623
- Front lamps see headlamps
- Front passenger front air bag 49
- Front passenger front air bag off indicator lamp 53, 555
- FSS (Canada vehicles) 532
- Fuel 490, 662, 664
 - Additives 665
 - Capacity, Fuel tank 662
 - Filling the tank 489
 - Fuel filler flap and cap 489
 - Fuel reserve warning lamp 29, 550
 - Premium unleaded gasoline 490, 662, 664
 - Requirements, Octane rating 664
- Fuel cap
 - Message in display 591
- Fuel consumption statistics
 - After start 245
 - Since last reset 245
- Fuel filler flap 489
 - Locking/Unlocking 489
- Fuel tank
 - Capacity 662
 - Filler flap 489
- Fuels, coolants, lubricants etc.
 - Capacities 661
- Fuses 645
 - Aids for replacing fuses 646
 - Fuse box in engine compartment 646
 - Fuse box in passenger compartment 647
 - Fuse boxes in dashboard 647
 - Fuse chart (vehicle tool kit) 611
 - Fuse extractor (vehicle tool kit) 611
 - Replacing 645
 - Spare fuses (vehicle tool kit) 611

G

- Garage door opener 470
- Gasoline see Fuel
- GAWR 526
- Gear range 673
 - Automatic transmission 372
 - Limiting 372
 - Shifting into optimal 376
- Gear selector lever 367
 - Gearshift pattern 367
 - Messages in display 562, 566, 567, 569, 610
 - Position 369
 - Shifting procedure 369
 - Transmission position 370
- Global Positioning System see GPS
- Glove box 448
- Gloves, Vehicle tool kit 611
- GPS 673
 - Reception (COMAND) 145
 - Tele Aid 462
- Gross Axle Weight Rating see GAWR
- Gross Vehicle Weight Rating see GVWR
- Gross Vehicle Weight see GVW
- GVW 526
- GVWR 527

H

- Hands-free microphone 37
- Hard plastic trim items, Cleaning 542
- Hazard warning flasher 348
- Head restraints 324
 - Adjustment 324
 - Folding back and placing upright rear head restraints 325
 - Front seat 324
 - Luxury active head restraints (\$600 only) 59
 - Rear seat 325
 - Resetting activated luxury active head restraints (\$600 only) 618
- Headlamp cleaning system 346, 498
 - Washer fluid 662, 668
- Headlamps
 - Automatic control 343
 - Automatic headlamp mode 255
 - Cleaning lenses 537
 - Cleaning system 498
 - Manual headlamp mode 255
 - Messages in display 595
 - Refilling washer fluid 499
- Headliner and shelf below rear window, Cleaning and care of 542
- Heated seats* 322
- Heated steering wheel* 331
- Height adjustments
 - Vehicle level (ABC*) 403
- High beam
 - Replacing bulbs 622
- High beam flasher 347
- High beam headlamps
 - Switching on 346
- High mounted brake lamp 622
- Hood 492
 - Message in display 591
 - Opening 492
- Horn 27
- Hydroplaning 483

I

- Identification labels 652
- Identification Number, Vehicle (VIN) 652
- Ignition 315, 317
 - Switching on 315
 - Switching on, KEYLESS-GO* 317
- Immobilizer 75
- Indicator lamps see Lamps, indicator and warning
- Individualization
 - Voice Control* 302

- Infant and child restraint systems see Children in the vehicle
- Inflation pressure see Tires
- Infrared reflecting windshield 475
- Inside door handle 312
- Instrument cluster 28, 378, 674
 - Cleaning 541
 - Coolant temperature gauge 378
 - Illumination 81, 378
 - Lamps 544
 - Multifunction display 241
 - Outside temperature indicator 379
 - Selecting the language (COMAND) 216
- Interior lighting 348
 - Activating automatic control 349
 - Ambient lighting (COMAND) 225
 - Deactivating automatic control 349
 - Delayed switch-off (COMAND) 226
 - In the rear 350
 - Reading lamps in the front 349
 - Reading lamps in the rear 350
- Interior rear view mirror
 - Adjusting 332
 - Auto-dimming 334
- Interior storage spaces see Storage compartments
- J**
- Jack 612, 630
- Jacking up the vehicle 630
- Jump starting 639
- K**
- Key, Mechanical 614
 - Loss of 311
- Key, SmartKey 304
 - Battery check lamp 304, 305
 - Factory setting 305
 - Global locking and unlocking 305
 - Lock button 304
 - Locking and unlocking 304
 - Loss of 311
 - Messages in display 593
 - Opening button for trunk 304
 - Panic button 68
 - Remote control 304
 - Restoring to factory setting 306
 - Selective setting 305
 - Starting the engine 359
 - Switching on ignition with 315
- Turning off engine 366
- Unlock button 304
- Key, SmartKey with KEYLESS-GO* 306
 - Battery check lamp 306, 310
 - Closing, Trunk 440
 - Factory setting 309
 - Global locking and unlocking 309
 - Important notes on using KEYLESS-GO* 308
 - Lock button 306
 - Locking and unlocking 306
 - Locking using the lock button on door or on trunk lid 310
 - Loss of 311
 - Messages in display 592
 - Opening button for trunk 306
 - Panic button 68
 - Remote control 306
 - Restoring to factory setting 310
 - Selective setting 310
 - Starting the engine 360
 - Switching on ignition with 317
 - Turning off engine 366
 - Unlock button 306
- Kickdown 373, 674
- Kilopascal 527

- L**
- Labels 652
 - Certification 652
 - Emission control information 652
 - Supplemental tire inflation pressure information 489
 - Tire and Loading Information 504
 - Vacuum line routing diagram 652
 - Lamp bulbs, exterior 621
 - Lamps, exterior
 - Front 622
 - Light sensor 596
 - Rear 622
 - Lamps, indicator and warning
 - ABS 29, 69, 544
 - Air bag Off 49
 - Battery (SmartKey with KEYLESS-GO*) 310
 - Battery check lamp (SmartKey) 305
 - Brakes 545
 - DISTRONIC Plus* 29, 388, 397, 549
 - Engine diagnostics 547
 - Engine malfunction 547
 - ESP® 549
 - Front passenger front air bag off 53, 555
 - Fuel reserve 550
 - Instrument cluster 544
 - Maintenance service indicator 532
 - Seat belts telltale 550
 - SRS 552
 - Language (COMAND) 216
 - LATCH-type child seat anchors see Children in the vehicle
 - Leather upholstery, Cleaning and care of 542
 - Lever
 - For automatic transmission (gear selector lever) 367
 - For cruise control 381
 - For DISTRONIC Plus* 390
 - License plate lamps
 - Messages in display 597
 - Replacing bulbs 622
 - Light alloy wheels, Cleaning 541
 - Light sensor
 - Message in display 596
 - Lighter see Cigarette lighter
 - Lighting 342
 - Automatic headlamp mode 343
 - Combination switch 346
 - Corner-illuminating lamps 347
 - Courtesy lighting 350
 - Daytime running lamp mode 344
 - Door entry lamps 350
 - High beam flasher 347
 - High beams 346
 - Instrument cluster illumination 81, 378
 - Interior 348
 - Manual headlamp mode 343
 - Trunk 350
 - Limp-home mode 377
 - Line of fall 674
 - Loading see Vehicle loading
 - Locator lighting (COMAND) 221
 - Lock button
 - Door handle (KEYLESS-GO*) 309, 358
 - Key, SmartKey 304
 - Key, SmartKey with KEYLESS-GO* 306
 - Trunk lid (KEYLESS-GO*) 310
 - Locking 363
 - Automatic central locking (COMAND) 223
 - Vehicle in an emergency 615
 - Locking knob 312, 674

- Loss of
 - Key, Mechanical 311
 - Key, SmartKey 311
 - Key, SmartKey with KEYLESS-GO* 311
 - Service and Warranty Information Booklet 651
- Low beam headlamps
 - Replacing bulbs 622
- Lowering
 - Vehicle 633
- Lubricants 661
- Lumbar support (COMAND) 237
- M**
- Maintenance 15, 532
 - Automatic Call (Tele Aid) 469
 - Calling up service indicator display 533
 - Clearing service indicator message 532
 - FSS (Canada vehicles) 532
 - Maintenance System (U.S. vehicles) 532
 - Resetting service indicator 533
 - Service indicator message 532
 - Service term exceeded 533
- Maintenance System (U.S. vehicles) 674
- Maintenance System (U.S. vehicles) 532
- Manual headlamp mode 343
- MAXCOOL
 - Maximum cooling 430
- Maximum load rating, Tires 527
- Maximum loaded vehicle weight 509, 510, 527
- Maximum tire inflation pressure 523, 527
- Maximum tire load rating 523
- Memory function 336
- Messages in display see Multifunction display messages
- Microphone, Hands-free 37
- Minispare wheel 613, 658
 - Mounting 629
- Mirrors
 - Activating exterior rear view mirror parking position 335
 - Adjusting 332
 - Auto-dimming for rear view mirrors 334
 - Exterior rear view mirrors 332
 - Interior rear view mirror 332
- Mobile phone see Telephone*
- Modifications and alterations, Operating safety 19
- MON 490, 662
- Motor Octane Number see MON
- MP3
 - Menu overview (COMAND) 110
 - Operation (COMAND) 111
 - Playback options (COMAND) 114
 - Selecting a folder (COMAND) 113
 - Selecting a medium (COMAND) 112
 - Selecting a track (COMAND) 113
- MP3 (COMAND) 104
- Multicontour rear seats* 327
- Multicontour seats*, front
 - Adjusting (COMAND) 237
- Multifunction display 241, 675
- Multifunction display messages
 - ABC* 570
 - ABS 572
 - Airmatic 585
 - Batteries, vehicle 586
 - Brake fluid 573
 - Brake pads 575
 - Check engine 547
 - Coolant 588
 - Coolant level 587

Cruise control 559
 DISTRONIC Plus* 560
 Doors 590
 EBP (Electronic Brake Proportioning) 574
 Engine 547
 Engine oil 494, 602
 ESP® 572, 582
 Fog lamps 598
 Front passenger front air bag 562
 Fuel cap 591
 Gear selector lever 562, 566, 567, 569, 610
 Headlamps 595
 Hood 591
 Key, SmartKey with KEYLESS-GO* 592
 Lamps, exterior 595
 License plate lamps 597
 Light sensor 596
 Night View Assist* 601
 Park Assist* 566
 Parking brake 576
 Parking lamps 599
 PRE-SAFE® 567, 572
 Restraint systems 605

Side marker lamps 599
 SRS 605
 Tail lamps 600
 Tele Aid 607
 Trunk 610
 Turn signals 596
 Windshield washer fluid 610
 Multifunction steering wheel 242, 675

N

Navigation system
 Menu overview (COMAND) 147
 Navigation system (COMAND) 140
 Basic settings 150
 Destination entry 153
 Destination memory 195
 Detour function (COMAND) 194
 Driving maneuver 185
 Hiding/showing the menu system 148
 Last destinations 201
 Map display 148
 Operation 148
 POI entry 177
 Route guidance 185

Navigation system (Instrument cluster control system) 246
 Driving maneuver 247
 Navigation system (Voice Control*) 269
 Neutral gear position, Automatic transmission 367, 370
 New vehicle break-in 478
 Night View Assist* 420
 Cleaning the windshield in front of the camera 539
 Dirty or fogged-up windshield 422
 Image on multifunction display 421
 Malfunction 423
 Messages in display 601
 Removing condensation 422
 Switching on or off 421
 Normal occupant weight 527
 Number, Vehicle Identification (VIN) 652

O

Occupant Classification System see OCS
 Occupant distribution 527

- Occupant safety 44
 - Air bags 45
 - Children and air bags 61
 - Children in the vehicle 61
 - Fastening the seat belt 339
 - Front passenger front air bag off indicator lamp 53
 - Infant and child restraint systems 62
 - LATCH-type child seat anchors 65
 - Seat belts 47, 339
 - OCS 50
 - Self-test 54
 - Odometer 245
 - Oil
 - Filler neck 497
 - Oil level see Engine oil
 - One-touch gearshifting 375
 - Operating safety 19
 - Voice Control* 257
 - Ornamental moldings, Cleaning 537
 - Outside temperature indicator 29, 379
 - Overdue maintenance service 533
 - Overhead control panel 37
 - Override switch 67
 - Overspeed range, Engine 675
- P**
- Paintwork, Cleaning 535
 - Panic alarm
 - Audible alarm and flashing exterior lamps 68
 - Panic button 68
 - Panorama roof with power tilt/sliding panel* 443
 - Opening/closing 444
 - Opening/closing in an emergency 617
 - Synchronizing 446
 - Panorama roof with tilt/sliding panel*
 - Cleaning 541
 - Parcel net in front passenger footwell 449
 - Park Assist* 409
 - Messages in display 566
 - Warning indicators 411
 - Parking 363, 481
 - Parking and standing lamps
 - Replacing bulbs 622
 - Parking brake
 - mechanically releasing 616
 - Messages in display 576
 - Parking lamps
 - Messages in display 599
 - Parking position
 - Exterior rear view mirrors 335
 - Parktronic system* 405
 - Parktronic*
 - Cleaning system sensors 538
 - Malfunctioning 408
 - System sensors 538
 - Warning indicators 407
 - Parts service 650
 - Passenger compartment 486
 - Passenger safety see Occupant safety
 - PCMCIA card
 - Ejecting (COMAND) 109
 - Loading (COMAND) 108
 - Pedals 479
 - Plastic and rubber parts, Cleaning 541
 - POIs 177
 - Poly-V-belt drive 653, 676
 - Layout 653
 - Potential problems associated with under-inflated and overinflated tires 517
 - Power assistance 479
 - Power closing assist for doors and trunk lid 313

- Power folding exterior rear view
 - mirrors 333
 - Power outlet 458
 - Power tilt/sliding sunroof 441
 - Emergency operations 617
 - Opening/closing 441
 - Opening/closing in an emergency 617
 - Synchronizing 442
 - Power train 676
 - Power washer 535
 - Power windows 353
 - Blocking of rear window operation 67
 - Cleaning 540
 - Opening/closing 353
 - Practical hints 557, 611
 - Premium unleaded gasoline 490, 662, 664
 - PRE-SAFE® 60
 - Message in display 567
 - Messages in display 572
 - Preventive occupant safety see PRE-SAFE®
 - Problems
 - While driving 362
 - With vehicle 20
 - Product information 13
 - Production options weight 527
 - Program mode see Automatic transmission, Automatic shift program
 - Program mode selector switch 676
 - Automatic shift program 374
 - Proper use of the vehicle 19
 - PSI 527
 - Push-start see Tow-start
- R**
- Radio
 - FM/AM operation (COMAND) 93
 - Saving stations, FM/AM (COMAND) 96
 - Selecting satellite radio* channel (Instrument cluster control system) 248
 - Selecting stations 248
 - Submenu overview, FM/AM (COMAND) 93
 - Switching wavebands, FM/AM (COMAND) 94
 - Tuning in stations/channels 94
 - Voice Control* 282
 - Radio transmitters, control and operation 486
 - Range (distance to empty) 246
 - Reading lamps in the front 349
 - Reading lamps in the rear 350
 - Rear door window
 - Blocking operation 67
 - Rear fog lamp
 - Replacing bulbs 622
 - Rear lamps see Tail lamps
 - Rear passenger compartment
 - Adjustable air vents 434
 - Rear seats
 - Adjustment 318
 - Folding back and placing upright rear head restraints 325
 - Head restraints 324
 - Heating* 322
 - Multicontour* 327
 - Setting front passenger seat position from rear 321
 - Ventilation* 323
 - Rear view mirrors see Mirrors
 - Rear window defroster 430
 - Activating 430
 - Deactivating 430
 - Recommended inflation pressure 527, 676

- Recovery services, Stolen vehicle (Tele Aid) 469
 - Refrigerant, Air conditioning 662, 663
 - Refueling 489
 - Regular checks 490
 - Remote
 - Control, SmartKey 304
 - Control, SmartKey with KEYLESS-GO* 306
 - Door lock with Tele Aid 469
 - Door unlock with Tele Aid 468
 - Trunk opening switch 436
 - Trunk opening/closing* switch 437, 438
 - Replacing
 - Bulbs 621
 - Front lamp bulbs 623
 - Rear lamp bulbs 622
 - Reporting safety defects 21
 - Research Octane Number see RON
 - Reset (COMAND) 219
 - Residual engine heat and ventilation 433
 - Residual heat utilization 677
 - REST 676
 - REST (Residual engine heat utilization) 677
 - REST see Residual engine heat and ventilation
 - Rest tool
 - Depository 618
 - Restraint systems
 - Messages in display 605
 - See Children in the vehicle
 - See SRS
 - Reverse gear position, Automatic transmission 367, 370
 - Rims 527
 - And Tires 655
 - Tires and wheels 500
 - Roadside Assistance 16
 - Tele Aid 465
 - RON 490, 662, 677
 - Roof rack* 447
 - Route guidance (COMAND) 185
 - Route guidance (Instrument cluster control system) 246
 - Rubber and plastic parts, Cleaning 541
 - Run Flat Indicator (Canada only) 515
- S**
- Safety
 - Driving safety systems 69
 - Occupant 44
 - Reporting defects 21
 - Safety belts see Seat belts
 - Satellite radio*
 - Calling Sirius Service Center (COMAND) 103
 - Channel update (COMAND) 103
 - Operation (COMAND) 98
 - Selecting channel (Instrument cluster control system) 248
 - Selecting program category (COMAND) 100
 - Showing program info (COMAND) 103
 - Submenu overview (COMAND) 98
 - Tuning in channels (COMAND) 100, 102
 - Voice Control* 283

- Seat belts 55
 - Children in the vehicle 61
 - Cleaning 542
 - Fastening 55, 339
 - Force limiter 58
 - Messages in display 605
 - Proper use of 57, 341
 - Safety guidelines 47
 - Telltale 29, 55, 550
- Seating capacity 505
- Seats 318
 - adjusting front passenger seat from driver's seat 321
 - Adjustment 318
 - Drive-dynamic multicontour* in the front, Adjusting (COMAND) 240
 - Easy entry/exit feature 328
 - Folding back and placing upright rear head restraints 325
 - Head restraints 324
 - Lumbar support (COMAND) 237
 - Memory function 336
 - Multicontour* in the front, Adjusting (COMAND) 237
 - Operating via COMAND 236
 - Setting front passenger seat position
 - from rear 321
 - Ventilation* 323
- Seats*
 - Heating 322
- Securing cargo
 - Cargo tie-down hooks 453
- Selector lever
 - Lock 359
- Selector lever see Gear selector lever
- Self-test
 - OCS 54
 - Tele Aid 462
- Service and warranty information 14
- Service intervals see Maintenance service indicator
- Service life, Tires 501
- Service see Maintenance
- Service system see FSS (Canada vehicles) or Maintenance System (U.S. vehicles)
- Service, Parts 650
- Setting
 - Cruise control 381
 - DISTRONIC Plus* time interval 396
 - Following distance in DISTRONIC Plus* 396
 - Higher speed in cruise control 383
 - Higher speed in DISTRONIC Plus* 393
 - Lower speed in cruise control 383
 - Lower speed in DISTRONIC Plus* 394
 - Slower speed in cruise control 383
 - Slower speed in DISTRONIC Plus* 394
 - Speed in DISTRONIC Plus* 393
 - Suspension tuning (ABC*) 403
 - Temperature (interior) 429
 - Temperature (rear passenger compartment) 435
 - To last stored speed ("Resume" function) in cruise control 384
 - To last stored speed in DISTRONIC Plus* ("Resume" function) 395
 - Vehicle level control (ABC*) 403
- Setting current speed 381
- Settings
 - Calling up DISTRONIC Plus* 389
 - Control system instrument cluster menus 254
 - Resetting trip odometer 246

- Shelf below rear window, Cleaning and care of 542
- Shift program mode, Automatic transmission 374
- Shifting, Automatic transmission 367
- Side impact air bags 49
- Side marker lamps
 - Cleaning lenses 537
 - Messages in display 599
- Side windows see Power windows
- Sidewall 527, 677
- Sirius satellite radio* (COMAND) 98
- SmartKey see Key, SmartKey
- SmartKey with KEYLESS-GO* see Key, SmartKey with KEYLESS-GO*
- SMS messages 137
- Snow chains 531
- Spare fuses 646
- Spare wheel see Minispare wheel
- Speed
 - Setting current 381
 - Setting to last stored speed in DISTRONIC Plus* (“Resume” function) 395
- Speed settings
 - Cruise control 383
 - DISTRONIC Plus* 393, 394
 - To last stored speed (“Resume” function) in Cruise control 384
- Speedometer
 - Displays 387
- SRS 57, 677
 - Indicator lamp 552
 - Messages in display 605
- Standing water, Driving through 485
- Starter battery 636
- Starter switch 315
 - Positions 315
- Starting difficulties, Engine 360
- Starting, Engine 359
- Steering column 330
- Steering wheel
 - Adjustment 330
 - Cleaning 542
 - Easy entry/exit feature 328
 - Heated steering wheel* 331
 - Power steering fluid 661
- Steering wheel gearshift control
 - Automatic transmission 375
- Stolen Vehicle Recovery services 469
- Storage compartments 448
 - Cup holder 452
 - Front armrest 448
 - Parcel net 449
 - Rear armrest 450
 - Ruffled storage pockets 451
 - Storage compartment in front of armrest 448
 - Under the front seats 449
- Storing tires 502
- Summer opening feature 355
- Sun visors 455
- Sunroof see Power tilt/sliding sunroof
- Sunshades
 - Extending or retracting rear window sunshade (COMAND) 227
 - Extending/retracting rear window sunshade 456
 - Opening or closing rear side window sunshades 355
- Supplemental Restraint System see SRS
- Suspension tuning
 - Setting (ABC*) 403

- Symbols used in this operator's manual 18
- System settings (COMAND)
 - Bluetooth settings 217
 - Display 213
 - Favorite button 216
 - Menu overview 213
 - Reset 219
 - Setting the system language 216
 - Time settings 213
 - Voice Control* settings (COMAND) 215
- T**
- Tachometer 379
 - Overspeed range 379
- Tail lamps
 - Cleaning lenses 537
 - Messages in display 600
- Tar stains 535
- Tele Aid 462, 677
 - Automatic Maintenance Call 469
 - Call priority 467
 - Emergency calls 463
 - Hands-free microphone 37
 - Information 466
 - Information button 465
 - Initiating an emergency call manually 464
 - Messages in display 607
 - Remote door lock 469
 - Remote door unlock 468
 - Roadside Assistance 465
 - Roadside Assistance button 465
 - SOS button 464
 - Stolen Vehicle Recovery services 469
 - System self-check 462
- Telematics 677
- Telephone cradle
 - Changing 461
- Telephone* 459
 - "911" emergency call (COMAND) 117
 - Accepting/ending a call (COMAND) 124
 - Answering/ending a call (Instrument cluster control system) 252
 - Call lists (COMAND) 122
 - Changing mobile phone cradle 461
 - Dialing (Instrument cluster control system) 250
 - Entering the telephone number (COMAND) 125
 - Hands-free microphone 37
 - Inserting in cradle 460
 - Installing a different mobile phone cradle 461
 - Operation 249
 - Operation (COMAND) 115
 - Phone book (COMAND) 129
 - Phone book (Instrument cluster control system) 250
 - PIN (COMAND) 119
 - PIN2 (COMAND) 119
 - PUK / PUK2 (COMAND) 119
 - Redialing (COMAND) 125
 - Redialing (Instrument cluster control system) 251
 - Removing from cradle 461
 - Single call connection (COMAND) 127
 - Speed dialing (COMAND) 126
 - Submenu overview (COMAND) 120
 - Switching on/off (COMAND) 116
 - Transferring a call (COMAND) 128
 - Unlock code (COMAND) 119
 - Voice Control* 262

- Temperature
 - Outside temperature indicator 29
 - Setting interior temperature (COMAND) 230
 - Tires 510
- Tie-down hooks, Trunk 453
- Tightening torque, Wheel bolts 633, 678
- Tilt/sliding sunroof see Power tilt/sliding sunroof
- Time
 - Setting (COMAND) 213
- TIN 527
- Tire and Loading Information
 - Placard 504
- Tire Identification Number see TIN
- Tires 500
 - Advanced Tire Pressure Monitoring System (Advanced TPMS)* 511
 - And Rims 655
 - And Wheels 500
 - Care and maintenance 501
 - Chains 531
 - Checking inflation pressure electronically with Advanced Tire Pressure Monitoring System (Advanced TPMS)* 511
 - Checking inflation pressure electronically with Run Flat Indicator (Canada only) 515
 - Cleaning 502
 - Cold tire inflation pressure 526
 - Direction of rotation 503
 - Driving instructions 482
 - Important notes on tire inflation pressure 510
 - Inflation pressure 509
 - Information placard 504
 - Inspection 501
 - Load rating 519, 528
 - Load rating, Maximum 523, 527
 - Minispare wheel 613, 658
 - Ply composition and material used 528
 - Problems under-/overinflation 509
 - Retreads 500
 - Rotating 529
 - Run Flat Indicator (Canada only) 515
 - Service life 501
 - Sizes 655
 - Snow 530
 - Speed rating 484, 520, 528
 - Storing 502
 - Supplemental tire inflation pressure information 489
 - Temperature 510, 525
 - Terminology 526
 - TPMS malfunction telltale 553
 - Traction 483, 528
 - Tread depth 502
 - Tread depth, Winter 530
 - Treadwear indicators 528
 - Vehicle maximum load on 528
 - Wear pattern 529
 - Winter 530
- Tools 611
- Top tether
 - Children in the vehicle 64
- Tow-away alarm 76
- Tow-away alarm (COMAND) 228
- Towing eye bolt (vehicle tool kit) 611, 644
- Towing the vehicle 642
- Tow-start 639, 642
- Traction 73, 483, 525, 528
- Transmission see Automatic transmission
- Traveling abroad 486
- Tread 528
- Tread depth, Tires 502

- Tread depth, Winter tires 530
- Treadwear indicators 528
- Trip odometer 245
 - Resetting 246
- Troubleshooting
 - Voice Control* 299
- Trunk
 - Closing 437, 614
 - Emergency release 440
 - Lighting 350
 - Message in display 610
 - Opening 436
 - Opening/closing system* 437, 438
 - Opening-height restriction (COMAND) 227
 - Power closing assist for trunk lid 313
 - Tie-down hooks 453
 - Unlocking in an emergency 614
- Trunk, Trunk lid, Lock button (KEYLESS-GO*) 310
- Tumbler holder see Cup holder
- Turn signal lamps
 - Cleaning lenses 537
 - Replacing bulbs 622
- Turn signals 362
 - Additional in mirrors 622
 - Front bulbs 622
 - Messages in display 596
 - Rear bulbs 622
- U**
- Uniform Tire Quality Grading Standards 528
- Uphill driving
 - Cruise control 382
- Upholstery, Cleaning and care of 542
- Useful features 455
- V**
- Vanity mirrors
 - In the sun visor 455
- Vehicle
 - Batteries 634
 - Breaking-in period 478
 - Care 534
 - Dimensions 660
 - Individual settings, control system instrument cluster 254
 - Locking/unlocking 304, 306
 - Locking/unlocking in an emergency 614
 - Lowering 633
 - Menu (COMAND) 220
 - Service battery 634
 - Towing 642
 - Washing 534, 536
 - Weights 660
- Vehicle capacity weight 528
- Vehicle data recording 22
- Vehicle Identification Number see VIN
- Vehicle jack 612, 630
- Vehicle level
 - Changing (ABC*) 404
 - Changing (Airmatic) 402
 - Setting
 - Manual (ABC*) 404
 - Manual (Airmatic) 402
 - Setting (ABC*) 404
 - Setting (Airmatic) 402
 - Setting, Automatic 402
 - Setting, Automatic (ABC*) 404
- Vehicle level control 678
- Vehicle level control (Airmatic) 401

- Vehicle loading 447, 503
 - Cargo tie-down hooks 453
 - Instructions 447
 - Load limit 504
 - Roof rack* 447
 - Terminology 526
 - Vehicle maximum load on the tire 528
 - Vehicle Recovery services, Stolen (Tele Aid) 469
 - Vehicle tool kit 611
 - VIN 652, 678
 - Voice control system* 678
 - Voice Control*
 - Address book 279
 - Command list 288
 - DVD changer 286
 - Individualization 302
 - Individualization (COMAND) 215
 - Introduction 258
 - Navigation 269
 - Operating safety 257
 - Operation via the multifunction steering wheel 260
 - Radio 282
 - Switching help window on or off (COMAND) 215
 - Telephone 262
 - Troubleshooting 299
- W**
- Warning indicators
 - Park Assist* 411
 - Parktronic* 407
 - Warning lamps see Lamps, indicator and warning
 - Warning sounds
 - Distance warning function* 397
 - DISTRONIC Plus* 388
 - Drivers seat belts 55
 - Parking brake 365
 - Warranty coverage 651
 - Washing the vehicle 534
 - Wear pattern, Tires 529
 - Weights, Vehicle 660
 - Wheels
 - Change 629
 - Collapsible wheel chock 613
 - Minispare wheel 613, 658
 - Removing 631
 - Rims and Tires 655
 - Sizes 655
 - Tightening torque 633, 678
 - Tires and wheels 500
 - Window curtain air bags 49, 50
 - Windows see Power windows
 - Windshield
 - Cleaning 540
 - Cleaning wiper blades 540
 - Infrared reflecting 475
 - Windshield washer fluid 662, 668
 - Mixing ratio 668
 - Refilling 498
 - Wiping with 352
 - Windshield wipers 351
 - Cleaning wiper blades 540
 - Replacing wiper blades 627
 - Single wipe 352
 - Winter driving 530
 - Snow chains 531
 - Tires 530
 - Winter driving instructions 484
 - Winter tires 530
 - Wood trims, Cleaning 542
 - Wrench, wheel (vehicle tool kit) 611
- X**
- Xenon headlamp see Headlamps

Service and Literature

Your authorized Mercedes-Benz Center has trained technicians and original Mercedes-Benz parts to service your vehicle properly.
For expert advice and quality service, contact your authorized Mercedes-Benz Center.

If you are interested in obtaining service literature for your vehicle, please contact an authorized Mercedes-Benz Center.
We consider this the best way for you to obtain accurate information for your vehicle.

For further information you can find us on the Mercedes-Benz web-site www.mbusa.com or www.mercedes-benz.ca.

Warning!



To help avoid personal injury, be extremely careful when performing any service work or repairs. Improper or incomplete service or the use of incorrect or inappropriate parts or materials may damage the vehicle or its equipment, which may in turn result in personal injury.

If you have any questions about carrying out any type of service, turn to the advice of an authorized Mercedes-Benz Center.

We reserve the right to modify the technical details of the vehicle as given in the data and illustrations of this Operator's Manual.
Reprinting, translation and copying, even of excerpts, is not permitted without our prior authorization in writing.

Press time December 05, 2005

GSP/TIP

Printed in Germany

