

TABLE OF CONTENTS

1	Before driving	Adjusting and operating features such as door locks, mirrors, and steering column.
2	When driving	Driving, stopping and safe-driving information.
3	Interior features	Air conditioning and audio systems, as well as other interior features for a comfortable driving experience.
4	Maintenance and care	Cleaning and protecting your vehicle, performing do-it-yourself maintenance, and maintenance information.
5	When trouble arises	What to do if the vehicle needs to be towed, gets a flat tire, or is involved in an accident.
6	Vehicle specifications	Detailed vehicle information.
7	For owners	Reporting safety defects for U.S. owners and seat belt instructions for Canadian owners
	Index	Alphabetical listing of information contained in this manual.

1 Before driving

1-1. Key information 20
 Keys 20

1-2. Opening, closing and locking the doors and trunk 22
 Smart access system with push-button start 22
 Wireless remote control 34
 Doors..... 37
 Trunk..... 41

1-3. Adjustable components (seats, mirrors, steering wheel)..... 44
 Front seats 44
 Driving position memory 46
 Seat position memory 49
 Head restraints..... 51
 Seat belts 52
 Steering wheel (manually adjustable type) 58
 Steering wheel (power-adjustable type)..... 59
 Anti-glare inside rear view mirror 60
 Outside rear view mirrors..... 61

1-4. Opening and closing the windows and moon roof 64
 Power windows..... 64
 Moon roof 66

1-5. Refueling..... 69
 Opening the fuel tank cap..... 69

1-6. Theft deterrent system..... 72
 Engine immobilizer system..... 72
 Alarm..... 74
 Theft prevention labels (U.S.A.)..... 76

1-7. Safety information..... 77
 Correct driving posture 77
 SRS airbags 79
 Front passenger occupant classification system..... 90
 Child restraint systems 95
 Installing child restraints 98

2 When driving

2-1. Driving procedures..... 108
 Driving the vehicle..... 108
 Engine (ignition) switch 117
 Automatic Transmission 122
 Manual Transmission..... 126
 Turn signal lever..... 128
 Parking brake 129

2-2. Instrument cluster.....	130
Gauges and meters	130
Indicators and warning lights ...	136
Multi-information display.....	139
2-3. Operating the lights and windshield wipers.....	143
Headlight switch.....	143
Fog light switch	146
Windshield wipers and washer.....	147
Headlight cleaner switch.....	151
2-4. Using other driving systems....	152
Cruise control	152
Dynamic radar cruise control.....	155
Intuitive parking assist	164
Driving assist systems.....	170
PCS (Pre-Collision System)....	176
2-5. Driving information	179
Cargo and luggage.....	179
Vehicle load limits.....	182
Winter driving tips	183
Trailer towing.....	187
Dinghy towing (vehicles with an automatic transmission)	188
Dinghy towing (vehicles with a manual transmission).....	189

3 Interior features

3-1. Using the air conditioning system and defogger	192
Automatic air conditioning system	192
Rear window and outside rear view mirror defoggers	200
3-2. Using the audio system.....	201
Audio system type	201
Using the radio.....	204
Using the CD player.....	211
Playing back MP3 and WMA discs.....	217
Optimal use of the audio system	225
Using the AUX adapter.....	228
Using the steering wheel audio switches	229
3-3. Using the interior lights.....	231
Interior lights list.....	231
• Interior lights	234
• Personal lights	234

3-4. Using the storage features 236

- List of storage features..... 236
- Glove box..... 236
- Console boxes 237
- Overhead console..... 238
- Cup holders..... 239
- Bottle holders/
door pockets..... 241

3-5. Other interior features..... 242

- Sun visors..... 242
- Vanity mirror..... 243
- Clock..... 244
- Satellite switches 245
- Ashtrays 248
- Cigarette lighter 249
- Power outlet 250
- Seat heaters..... 251
- Seat heaters and ventilators 253
- Armrest 255
- Rear sunshade..... 256
- Trunk storage extension..... 258
- Coat hooks 259
- Floor mat..... 260
- Trunk features..... 261
- Garage door opener..... 264
- Compass..... 269

4 Maintenance and care

4-1. Maintenance and care..... 274

- Cleaning and protecting
the vehicle exterior..... 274
- Cleaning and protecting
the vehicle interior 277

4-2. Maintenance..... 280

- Maintenance requirements 280
- General maintenance 282
- Emission inspection and
maintenance (I/M)
programs 285

**4-3. Do-it-yourself
maintenance..... 286**

- Do-it-yourself service
precautions..... 286
- Hood..... 289
- Positioning a floor jack..... 290
- Engine compartment..... 292
- Tires 306
- Tire inflation pressure..... 316
- Wheels..... 320
- Air conditioning filter 322
- Electronic key battery 325
- Checking and replacing
fuses..... 327
- Headlight aim..... 341
- Light bulbs..... 342

5 When trouble arises

5-1. Essential information	350
If your vehicle needs to be towed	350
If you think something is wrong	356
Fuel pump shut off system	357
Event data recorder	358
5-2. Steps to take in an emergency	360
If a warning light turns on or a warning buzzer sounds... ..	360
If a warning message is displayed	369
If you have a flat tire.....	382
If the engine will not start	391
If the shift lever cannot be shifted from P	392
If you lose your keys	393
If the electronic key does not operate properly	394
If the vehicle battery is discharged	397
If your vehicle overheats	400
If the vehicle becomes stuck ...	402

6 Vehicle specifications

6-1. Specifications	406
Maintenance data (fuel, oil level, etc.).....	406
Fuel information.....	421
Tire information	424
6-2. Customization	436
Customizable features	436
6-3. Initialization	441
Items to initialize	441

7 For owners

Reporting safety defects for U.S. owners.....	444
Seat belt instructions for Canadian owners (in French).....	445

Index

Abbreviation list	448
Alphabetical index	450
What to do if...	462



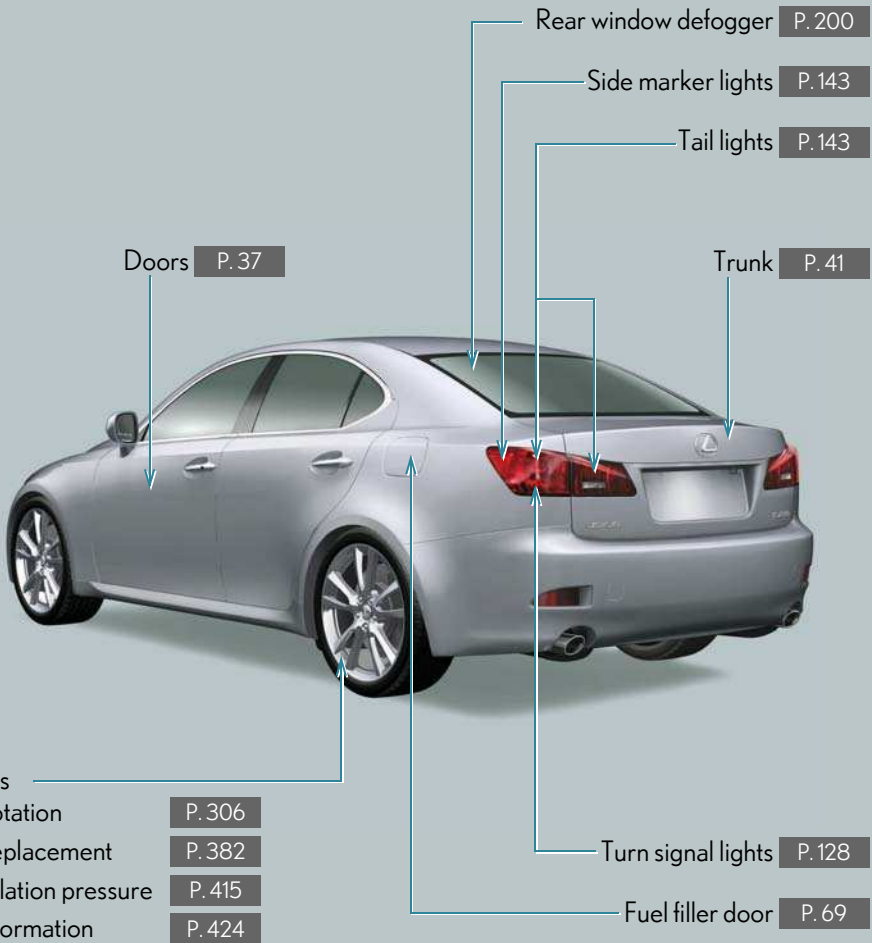

*: If equipped

Pictorial index

Interior

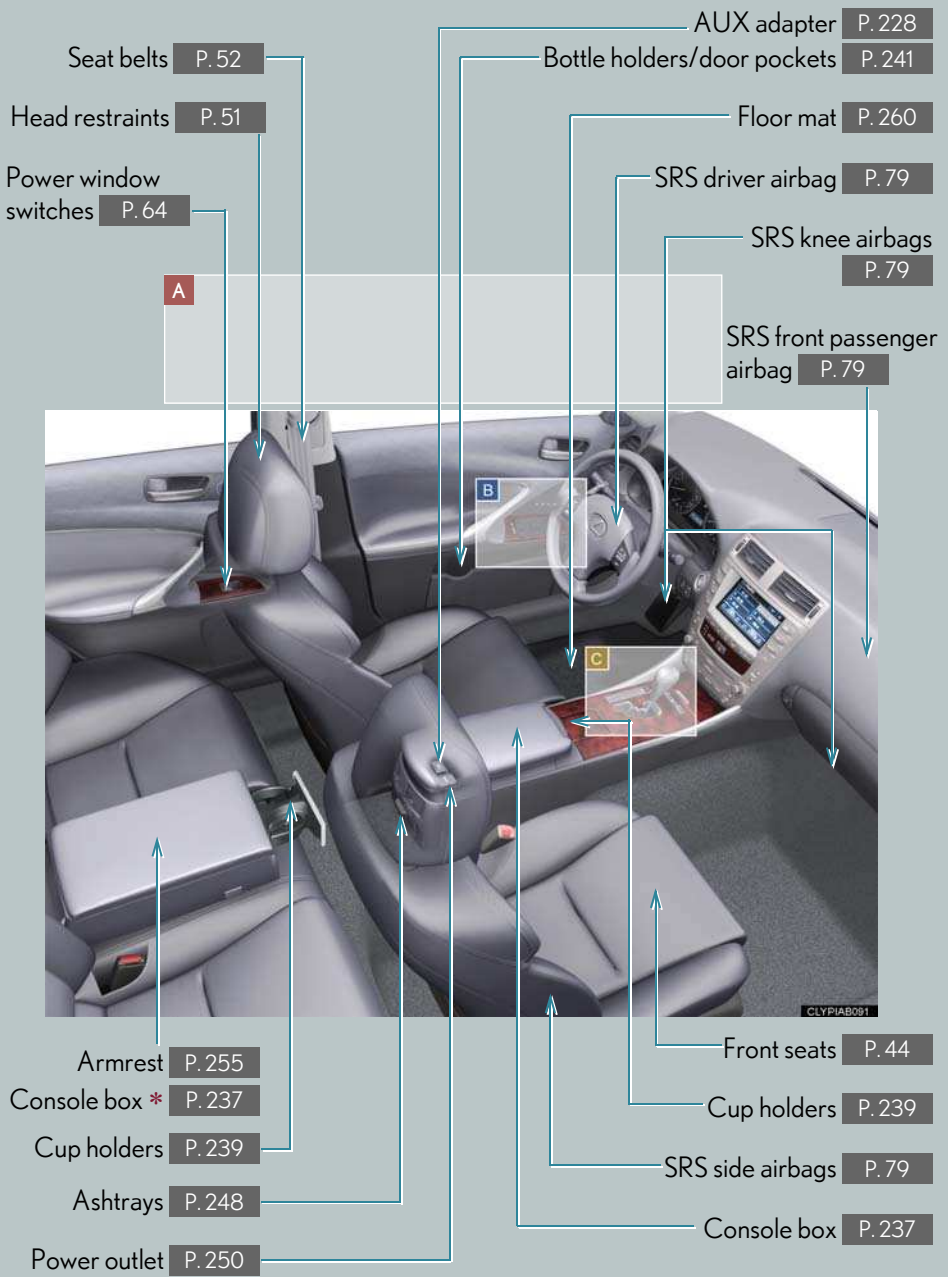

A

Anti-glare inside rear view mirror P. 60

Personal lights P. 234

Moon roof switch * P. 66

Interior lights P. 234

Personal lights P. 234

Interior lights P. 234



Coat hooks P. 259

SRS curtain shield airbags P. 79

Vanity mirrors P. 243

Sun visors P. 242

Garage door opener switches P. 264

Compass P. 269

*: If equipped

B

Driving position memory switches * P. 46

Seat position memory switches * P. 49

Door lock switch P. 37



Outside rear view mirror switches P. 61

Window lock switch P. 64

Power window switches P. 64

C

► **Automatic transmission**

Automatic transmission shift lever P. 122



Seat heater switches * P. 251

Seat heater/ventilator switches * P. 253

Shift lock override button P. 392

Cigarette lighter P. 249

Ashtrays P. 248

► **Manual transmission**

Manual transmission shift lever P. 126



Parking brake lever P. 129

Seat heater switches * P. 251

Seat heater/ventilator switches * P. 253

Cigarette lighter P. 249

Ashtrays P. 248

*: If equipped

Pictorial index

Instrument panel

Headlight switch P. 143
Turn signal lever P. 128
Fog light switch P. 146

Shift paddle switches * P. 124

Gauges and meters P. 130

Multi-information display P. 139

Windshield wipers and washer switch P. 147

Engine (ignition) switch P. 117



Trunk opener main switch P. 41

Glove box P. 236

Tilt and telescopic steering lock release lever * P. 58

Tilt and telescopic steering control switch * P. 59

Parking brake pedal (automatic transmission) P. 129

Audio remote control switches P. 229

A

► Without navigation system

Air conditioning system

P. 192

Audio system

P. 201

Clock

P. 244

Rear window and outside rear view mirror defoggers P. 200

Security indicator P. 72, 74

Emergency flashers



► With navigation system

Navigation system*

Clock P. 244

Audio system*

Rear window and outside rear view mirror defoggers*

Security indicator P. 72, 74

Air conditioning system*

Emergency flashers



*: If equipped

*: Refer to "Navigation System Owner's Manual".

B

▶ Without navigation system

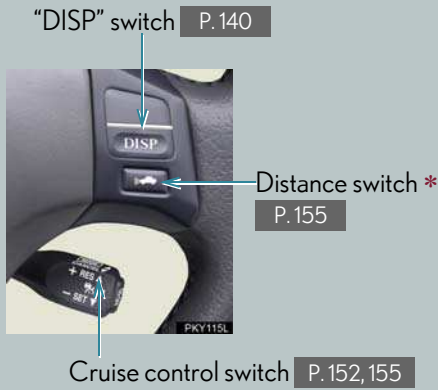

▶ With navigation system

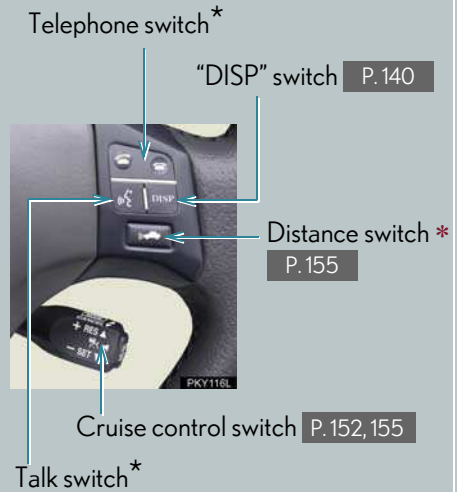

C

▶ Automatic transmission



▶ Manual transmission

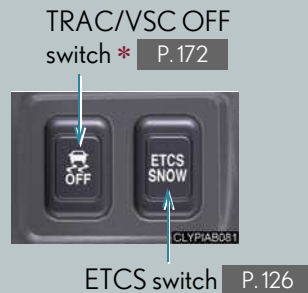

D

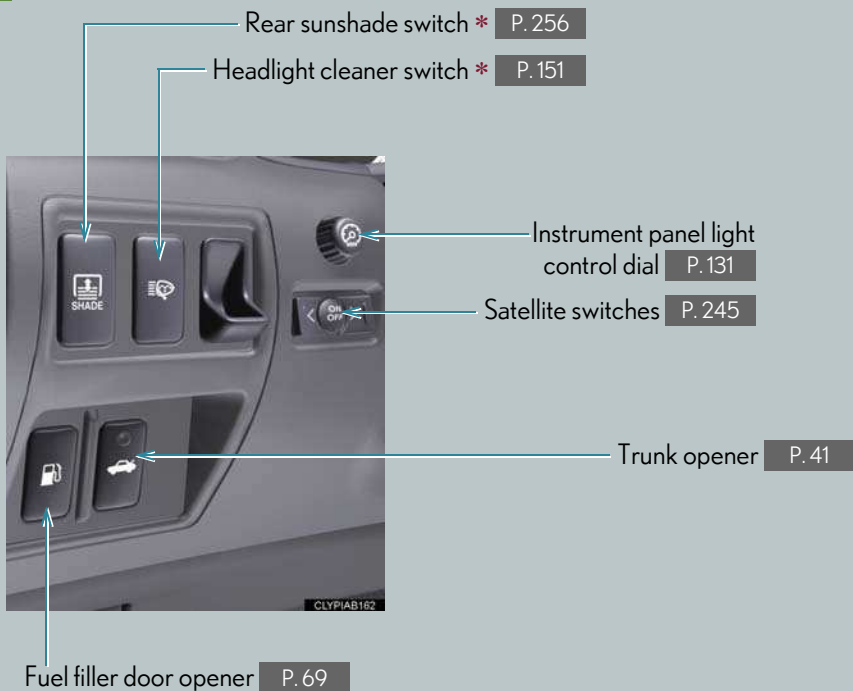

*: If equipped

*: Refer to "Navigation System Owner's Manual".

For your information

Main Owners Manual

Please note that this manual applies to all models and explains all equipment, including options. Therefore, you may find some explanations for equipment not installed on your vehicle.

All specifications provided in this manual are current at the time of printing. However, because of the Lexus policy of continual product improvement, we reserve the right to make changes at any time without notice.

Depending on specifications, the vehicle shown in the illustration may differ from your vehicle in terms of color and equipment.

Accessories, spare parts and modification of your Lexus

A wide variety of non-genuine spare parts and accessories for Lexus vehicles are currently available in the market. You should know that Toyota does not warrant these products and is not responsible for their performance, repair, or replacement, or for any damage they may cause to, or adverse effect they may have on, your Lexus vehicle.

This vehicle should not be modified with non-genuine Lexus products. Modification with non-genuine Lexus products could affect its performance, safety or durability, and may even violate governmental regulations. In addition, damage or performance problems resulting from the modification may not be covered under warranty.

Installation of a mobile two-way radio system

As the installation of a mobile two-way radio system in your vehicle could affect electronic systems such as the multiport fuel injection system/sequential multiport fuel injection system, cruise control system, anti-lock brake system, SRS airbag system and seat belt pretensioner system, be sure to check with your Lexus dealer for precautionary measures or special instructions regarding installation.

Scrapping of your Lexus

The SRS airbag and seat belt pretensioner devices in your Lexus contain explosive chemicals. If the vehicle is scrapped with the airbags and seat belt pretensioners left as they are, this may cause an accident such as fire. Be sure to have the systems of the SRS airbag and seat belt pretensioner removed and disposed of by a qualified service shop or by your Lexus dealer before you scrap your vehicle.

Perchlorate Material

Special handling may apply, See www.dtsc.ca.gov/hazardouswaste/perchlorate.

Your vehicle has components that may contain perchlorate. These components may include airbag, seat belt pretensioners, and wireless remote control batteries.

CAUTION

n General precautions while driving

Driving under the influence: Never drive your vehicle when under the influence of alcohol or drugs that have impaired your ability to operate your vehicle. Alcohol and certain drugs delay reaction time, impair judgment and reduce coordination, which could lead to an accident that will hurt or kill you, your occupants or others.

Defensive driving: Always drive defensively. Anticipate mistakes that other drivers or pedestrians might make and be ready to avoid accidents.

Driver distraction: Always give your full attention to driving. Anything that distracts the driver, such as adjusting controls, talking on a cellular phone or reading can result in a collision with resulting death or serious injury to you, your occupants or others.

n General precaution regarding children's safety

Never leave children unattended in the vehicle, and never allow children to have or use the key.

Children may be able to start the vehicle or shift the vehicle into neutral. There is also a danger that children may injure themselves by playing with the cigarette lighter, the windows, the moon roof, or other features of the vehicle. In addition, heat build-up or extremely cold temperatures inside the vehicle can be fatal to children.

Symbols used throughout this manual

Cautions & Notices

CAUTION

This is a warning against anything which may cause injury to people if the warning is ignored. You are informed about what you must or must not do in order to reduce the risk of injury to yourself and others.

NOTICE

This is a warning against anything which may cause damage to the vehicle or its equipment if the warning is ignored. You are informed about what you must or must not do in order to avoid or reduce the risk of damage to your Lexus and its equipment.

Symbols used in illustrations



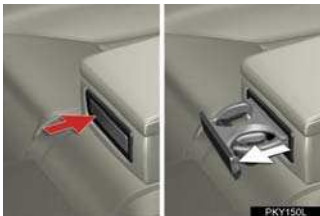

Safety symbol

The symbol of a circle with a slash through it means “Do not”, “Do not do this”, or “Do not let this happen.”



Arrows indicating operations

 Indicates the action (pushing, turning, etc.) used to operate switches and other devices.

 Indicates the outcome of an operation (e.g. a lid opens).

1-1. Key information

Keys

The following keys are provided with the vehicle.



1 Electronic keys

- Operating the smart access system with push-button start (→P. 22)
- Operating the wireless remote control function (→P. 34)

2 Mechanical keys

3 Key number plate

Using the mechanical key



Take out the mechanical key.

The mechanical key can only be inserted in one direction, as the key only has grooves on one side. If the key cannot be inserted in a lock cylinder, turn it over and re-attempt to insert it.

After using the mechanical key, store it in the electronic key. Carry the mechanical key together with the electronic key. If the electronic key battery is depleted or the entry function does not operate properly, you will need the mechanical key.

n When required to leave a key to the vehicle with a parking attendant

Turn the trunk opener main switch off and lock the glove box as circumstances demand. (→P. 41, 236)

Remove the mechanical key for your own use and provide the attendant with the electronic key only.

n Key number plate

Keep the plate in a safe place such as your wallet, not in the vehicle. In the event that a mechanical key is lost, a new key can be made at your Lexus dealer using the key number plate. (→P. 393)

NOTICE

n To prevent key damage

- 1 Do not subject the keys to strong shocks, expose them to high temperatures by placing them in direct sunlight, or get them wet.
- 1 Do not expose the keys to electromagnetic materials or attach any material that blocks electromagnetic waves to the key surface.
- 1 Do not disassemble the electronic key.

1-2. Opening, closing and locking the doors and trunk Smart access system with push-button start

The following operations can be performed simply by carrying the electronic key on your person, for example in your pocket.
(The driver should always carry the electronic key.)

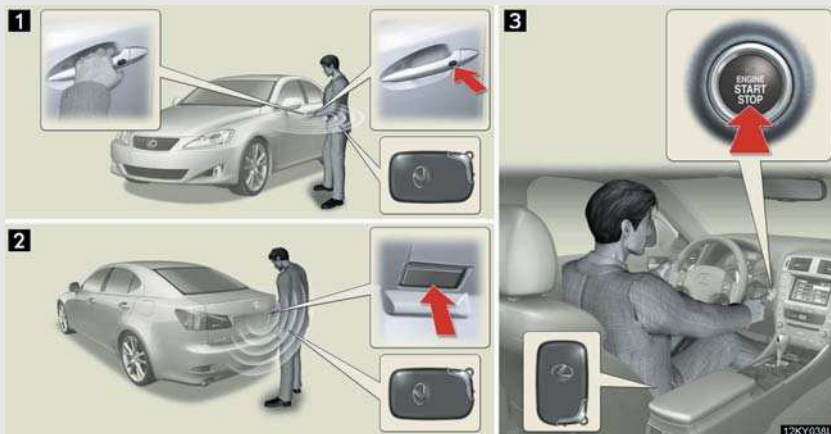

- 1** Locks and unlocks the doors (→P. 23)
- 2** Unlocks the trunk (→P. 23)
- 3** Starts the engine (→P. 117)

Locking and unlocking the doors (front door handles only)



Press the lock button to lock the door.



Grip the handle to unlock the door.

Make sure to touch the sensor on the back of the handle.

The door cannot be unlocked for 3 seconds after the door is locked.

Unlocking the trunk



Press the button to unlock the trunk.

Antenna location and effective range

n Antenna location

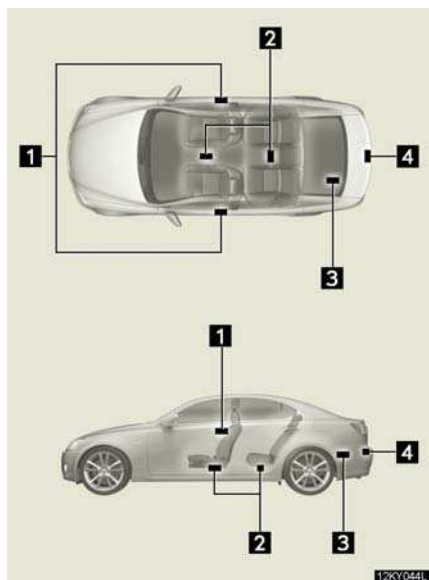

- 1 Antennas outside cabin
- 2 Antennas inside cabin
- 3 Antenna inside trunk
- 4 Antenna outside trunk

n Effective range (areas within which the electronic key is detected)

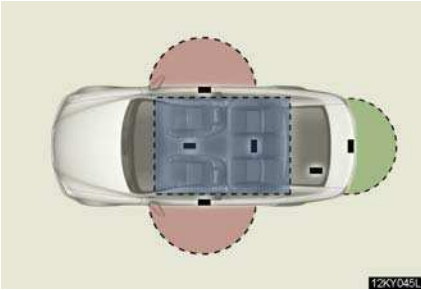

- When locking or unlocking the doors

The system can be operated when the electronic key is within about 2.3 ft. (70 cm) of either of the outside front door handles. (Only the doors detecting the key can be operated.)

- When unlocking the trunk

The system can be operated when the electronic key is within about 2.3 ft. (70 cm) of the trunk release button.

- When starting the engine or changing “ENGINE START STOP” switch modes

The system can be operated when the electronic key is inside the vehicle.

n Operation signals

A buzzer sounds and the emergency flashers flash to indicate that the doors have been locked/unlocked. (Locked: Once; Unlocked: Twice)

n Conditions affecting operation

The smart access system with push-button start uses weak radio waves. In the following situations, the communication between the electronic key and the vehicle may be affected, preventing the smart access system with push-button start from operating properly:





(Ways of coping: →P. 394)

- 1 When the electronic key battery is depleted
- 1 Near a TV tower, electric power plant, gas station, radio station, large display, airport or other facility that generates strong radio waves or electrical noise
- 1 When carrying a portable radio, cellular phone, cordless phone or other wireless communication devices
- 1 When the electronic key is in contact with, or is covered by the following metallic objects
 - Cards to which aluminum foil is attached
 - Cigarette boxes that have aluminum foil inside
 - Metallic wallets or bags
 - Coins
 - Hand warmers made of metal
 - Media such as CDs and DVDs
- 1 When multiple electronic keys are in the vicinity
- 1 When another wireless key (that emits radio waves) is being used nearby
- 1 When carrying or using the electronic key together with the following devices that emit radio waves
 - Another vehicle's electronic key or a wireless key that emits radio waves
 - Personal computer or personal digital assistant (PDA)
 - Digital audio player
 - Portable game system
- 1 If window tint with a metallic content or metallic objects are attached to the rear window



n **Switching the door unlock function**

It is possible to set which doors the entry function unlocks.

STEP 1 Turn the “ENGINE START STOP” switch OFF.

STEP 2 When the indicator on the key surface is turned off, push and hold  ,  , or  for approximately 5 seconds while pushing  on the key.

The setting changes each time an operation is performed, as shown below. (When changing the setting continuously, release the buttons, wait for at least 5 seconds, and repeat step 2.)

Multi-information display	Unlocking doors	Beep
	Hold the driver's door handle to unlock only the driver's door.	Exterior: Beeps three times Interior: Pings once
	Hold the front passenger's door handle to unlock all doors	
	Hold either front door handle to unlock all doors	Exterior: Beeps twice Interior: Pings once

STEP 3 Unlock the doors using the electronic key and open one of the doors.

If a door is not opened within 60 seconds after  is pressed, the doors will be locked again and the alarm will automatically be set. In case that the alarm is triggered, immediately stop the alarm. (→P. 74)

n **Battery-saving function**

In the following circumstances, the entry function is disabled in order to prevent the vehicle and electronic key batteries from discharging.

- 1 When the entry function has not been used for a month or more
- 1 When the electronic key has been left within approximately 3 ft. (1 m) of the vehicle for 10 minutes or more

The system will resume operation when...

- 1 The vehicle is locked using the door handle lock switch.
- 1 The vehicle is locked/unlocked using the wireless remote control function. (→P. 34)
- 1 The vehicle is locked/unlocked using the mechanical key. (→P. 394)

n **Electronic key battery depletion**

1 The standard battery life is 1 to 2 years. (The battery becomes depleted even if the electronic key is not used.) If the smart access system with push-button start or the wireless remote control function does not operate, or the detection area becomes smaller, the battery may be depleted. Replace the battery when necessary. (→ P. 325)

1 To avoid serious deterioration, do not leave the electronic key within 3 ft. (1 m) of the following electrical appliances that produce a magnetic field.

- TVs
- Personal computers
- Cellular phones, cordless phones and battery chargers
- Recharging cellular phones or cordless phones
- Glass top ranges
- Table lamps

n **To operate the system properly**

Make sure to carry the electronic key when operating the system. Do not get the electronic key too close to the vehicle when operating the system from the outside of the vehicle.

Depending on the position and holding condition of the electronic key, the key may not be detected correctly and the system may not operate properly. (The alarm may go off accidentally, or the door lock prevention may not function.)

n Note for the entry function

- l Even when the electronic key is within the effective range (detection areas), the system may not operate properly in the following cases.
 - The electronic key is too close to the window or outside door handle, near the ground, or in a high place when the doors are locked or unlocked.
 - The electronic key is near the ground or in a high place, or too close to the rear bumper center when the trunk is unlocked.
 - The electronic key is on the instrument panel, rear package tray or floor, or in the glove box when the engine is started or “ENGINE START STOP” switch modes are changed.
- l As long as the electronic key is within the effective range, the doors may be locked or unlocked by anyone.
- l Even if the electronic key is not inside the vehicle, it may be possible to start the engine if the electronic key is near the window.
- l The doors may unlock if a large amount of water splashes on the door handle, such as in the rain or in a car wash. (The doors will automatically be locked after approximately 60 seconds if the doors are not opened and closed.)
- l Gripping the door handle when wearing a glove may not unlock the door.
- l If the wireless remote control is used to lock the doors when the electronic key is near the vehicle, there is a possibility that the door may not be unlocked by the entry function. (Use the wireless remote control to unlock the doors.)
- l A sudden approach to the effective range or door handle operation may prevent the doors from being unlocked. In this case, return the door handle to the original position and check that the doors unlock before pulling the door handle again.

n When the vehicle is not driven for extended periods

To prevent theft of the vehicle, do not leave the electronic key within 6 ft. (2 m) of the vehicle.

n Security feature

If a door is not opened within approximately 60 seconds after the vehicle is unlocked, the anti-theft system automatically locks the vehicle again.

▯ Alarms and warning indicators

A combination of exterior and interior alarms as well as warnings displayed on the multi-information display are used to prevent theft of the vehicle and unforeseeable accidents resulting from erroneous operation. Take appropriate measures in response to any warning indications on the multi-information display. (→P. 369)

The following table describes circumstances and correction procedures when only alarms are sounded.

Alarm	Situation	Correction procedure
Exterior alarm sounds once for 2 seconds	Tried to lock the doors using the entry function while the electronic key is still inside the passenger compartment	Retrieve the electronic key from the passenger compartment and lock the doors again.
	Closed the trunk while the electronic key is still inside and all doors are locked	Retrieve the electronic key from the trunk and close the trunk lid.
Exterior alarm sounds once for 60 seconds	Tried to exit the vehicle with the electronic key and lock the doors without first turning the "ENGINE START STOP" switch OFF	Turn the "ENGINE START STOP" switch OFF and lock the doors again.
Exterior alarm sounds once for 10 seconds	Tried to lock the vehicle using the entry function while a door is open	Close all of the doors and lock the doors again.
Interior alarm sounds continuously*	Tried to open the door and exit the vehicle without shifting the shift lever to P	Shift the shift lever to P.

Alarm	Situation	Correction procedure
Interior alarm pings continuously	Switched to ACCESSORY mode while the driver's door is open (Opened the driver's door when the "ENGINE START STOP" switch is in ACCESSORY mode.)	Turn the "ENGINE START STOP" switch OFF and close the driver's door.
	Turned the "ENGINE START STOP" switch OFF while the driver's door is open	Close the driver's door.

*: Vehicles with an automatic transmission only

n If the smart access system with push-button start does not operate properly

1 Locking and unlocking the doors and trunk: Use the mechanical key. (→P. 394)

1 Starting the engine: →P. 117

n When the electronic key battery is fully depleted

→P. 325

n Customization that can be configured at Lexus dealer

It is possible to deactivate systems such as the smart access system with push-button start. (Customizable features →P. 436)

n Certification for the smart access system with push-button start

► For vehicles sold in the U.S.A.

FCC ID: NI4TMLF-1

NOTE:

This device complies with Part 15 of the FCC Rules. Operation is subject to the following two conditions: (1) This device may not cause harmful interference, and (2) this device must accept any interference received, including interference that may cause undesired operation.

NOTICE:

This equipment has been tested and found to comply with the limits for a Class B digital device, pursuant to Part 15 of the FCC Rules. These limits are designed to provide reasonable protection against harmful interference in a residential installation. This equipment generates, uses and can radiate radio frequency energy and, if not installed and used in accordance with the instructions, may cause harmful interference to radio communications. However, there is no guarantee that interference will not occur in a particular installation. If this equipment does cause harmful interference to radio or television reception, which can be determined by turning the equipment off and on, the user is encouraged to try to correct the interference by one or more of the following measures:

- 1 Reorient or relocate the receiving antenna.
- 1 Increase the separation between the equipment and receiver.
- 1 Connect the equipment into an outlet on a circuit different from that to which the receiver is connected.
- 1 Consult the dealer or an experienced radio/TV technician for help.

FCC WARNING:

Changes or modifications not expressly approved by the party responsible for compliance could void the user's authority to operate the equipment.

► For vehicles sold in Canada

NOTE:

Operation is subject to the following two conditions: (1) this device may not cause interference, and (2) this device must accept any interference, including interference that may cause undesired operation of the device.

 CAUTION

n Caution regarding interference with electronic devices

I People with implanted pacemakers or cardiac defibrillators should keep away from the smart access system antennas. (→P. 24)

The radio waves may affect the operation of such devices. If necessary, the entry function can be disabled. Ask your Lexus dealer for details, such as the frequency of radio waves and timing of emitting the radio waves. Then, consult your doctor to see if you should disable the entry function.

I User of any electrical medical device other than implanted pacemakers and implanted cardiac defibrillators should consult the manufacturer of the device for information about its operation under the influence of radio waves.

Radio waves could have unexpected effects on the operation of such medical devices.

Ask your Lexus dealer for details for disabling the entry function.

1-2. Opening, closing and locking the doors and trunk

Wireless remote control

The wireless remote control can be used to lock and unlock the vehicle and the trunk from outside the vehicle.



- 1 Locks all doors
- 2 Unlocks all doors
- 3 Opens the windows and moon roof (push and hold)
- 4 Unlocks the trunk (push and hold)
- 5 Sounds alarm (push and hold) (→P. 74)

n 2-step unlocking function

When you push  , the driver's door is unlocked. Pushing the button again within 3 seconds unlocks the other doors.

n Operation signals

Doors: A buzzer sounds and the emergency flashers flash to indicate that the doors have been locked/unlocked. (Locked: Once; Unlocked: Twice)

Trunk: A buzzer sounds to indicate that the trunk has been unlocked.

Windows and moon roof: A buzzer sounds to indicate that the windows and moon roof are operating.

n Door lock buzzer

If a door is not fully closed, a buzzer sounds if an attempt to lock the door is made. Fully close the door to stop the buzzer, and lock the vehicle once more.

n Alarm

Using the wireless remote control to lock the door will set the alarm system.

n Electronic key battery depletion

→P. 28

n Security feature

→P. 29

n **When the electronic key battery is fully depleted**

→P. 325

n **Conditions affecting operation**

→P. 26

n **Customization that can be configured at Lexus dealer**

Settings (e.g. trunk unlocking function) can be changed. (Customizable features →P. 436)

n **Certification for wireless remote control**

► For vehicles sold in the U.S.A.

FCC ID: NI4TMLF-1

NOTE:

This device complies with Part 15 of the FCC Rules. Operation is subject to the following two conditions: (1) This device may not cause harmful interference, and (2) this device must accept any interference received, including interference that may cause undesired operation.

NOTICE:

This equipment has been tested and found to comply with the limits for a Class B digital device, pursuant to Part 15 of the FCC Rules. These limits are designed to provide reasonable protection against harmful interference in a residential installation. This equipment generates, uses and can radiate radio frequency energy and, if not installed and used in accordance with the instructions, may cause harmful interference to radio communications. However, there is no guarantee that interference will not occur in a particular installation. If this equipment does cause harmful interference to radio or television reception, which can be determined by turning the equipment off and on, the user is encouraged to try to correct the interference by one or more of the following measures:

- 1 Reorient or relocate the receiving antenna.
- 1 Increase the separation between the equipment and receiver.
- 1 Connect the equipment into an outlet on a circuit different from that to which the receiver is connected.
- 1 Consult the dealer or an experienced radio/TV technician for help.

FCC WARNING:

Changes or modifications not expressly approved by the party responsible for compliance could void the user's authority to operate the equipment.

► For vehicles sold in Canada

NOTE:

Operation is subject to the following two conditions: (1) this device may not cause interference, and (2) this device must accept any interference, including interference that may cause undesired operation of the device.

1-2. Opening, closing and locking the doors and trunk

Doors

1

Before driving

The vehicle can be locked and unlocked using the entry function, wireless remote control or door lock switch.

n Entry function

→P. 23

n Wireless remote control

→P. 34

n Door lock switch

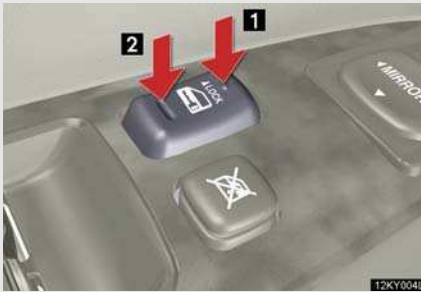

- 1 Locks all doors
- 2 Unlocks all doors

n Inside lock button

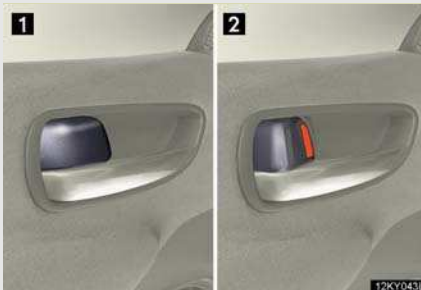

- 1 Locks the door
- 2 Unlocks the door

The front doors can be opened by pulling the inside handle even if the lock buttons are in the lock position.

Locking the front doors from the outside without a key

The door cannot be locked if the “ENGINE START STOP” switch is in ACCESSORY or IGNITION ON mode, or the electronic key is left inside the vehicle.

Depending on the position of the electronic key, the key may not be detected correctly and the door may be locked.

Rear door child-protector lock

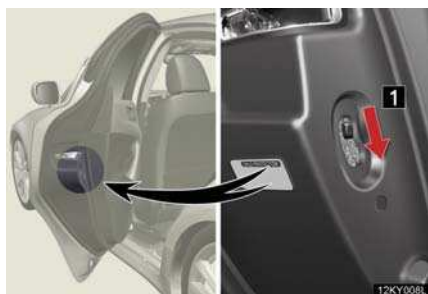

1 The door cannot be opened from inside the vehicle when the locks are set.

These locks can be set to prevent children from opening the rear doors. Push down on each rear door switch to lock both rear doors.

Automatic door locking and unlocking systems

The following functions can be set or cancelled:

Function	Operation
Shift position linked door locking function*	Shifting the shift lever out of P locks all doors.
Shift position linked door unlocking function*	Shifting the shift lever to P unlocks all doors.
Speed linked door locking function	All doors are locked when the vehicle speed is approximately 12 mph (20 km/h) or higher.
Driver's door linked door unlocking function	All doors are unlocked when the driver's door is opened within 10 seconds after turning the “ENGINE START STOP” switch OFF.

*: Vehicles with an automatic transmission only

n Setting and canceling the functions

To switch between setting and canceling, follow the procedure below:

STEP 1 Close all the doors and switch the “ENGINE START STOP” switch to IGNITION ON mode. (Perform the step 2 within 10 seconds.)

STEP 2 Shift the shift lever to P or N, and press and hold the driver's door lock switch (**1** or **2**) for approximately 5 seconds and then release.

The shift lever and switch positions corresponding to the desired function to be set or canceled are shown as follows.

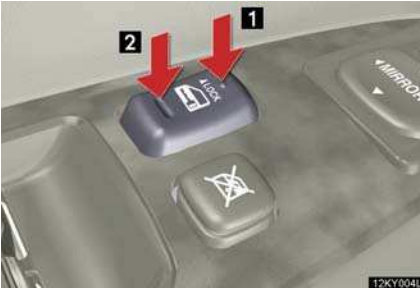

Function	Shift lever position	Switch position
Shift position linked door locking function	P	1
Shift position linked door unlocking function		2
Speed linked door locking function	N	1
Driver's door linked door unlocking function		2

When the setting or canceling operation is complete, all doors are locked and then unlocked.

n Impact detection door lock release system

In the event that the vehicle is subject to a strong impact, all the doors are unlocked. Depending on the force of the impact or the type of accident, however, the system may not operate.

n Using the mechanical key

The doors can also be locked and unlocked with the mechanical key. (→P. 394)

n Customization that can be configured at Lexus dealer

Settings (e.g. unlocking function using a key) can be changed. (Customizable features →P. 436)

CAUTION

n To prevent an accident

Observe the following precautions while driving the vehicle.

Failing to do so may result in a door opening and an occupant falling out, resulting in death or serious injury.

1 Always use a seat belt.

1 Always lock all doors.

1 Ensure that all doors are properly closed.

1 Do not pull the inside handle of the front door while driving.

1 Set the rear door child protector locks when children are seated in the rear seat.

1-2. Opening, closing and locking the doors and trunk

Trunk

The trunk can be opened using the trunk opener, entry function or wireless remote control.

n Trunk opener



Release the trunk lid.

n Entry function

→P. 23

n Wireless remote control

→P. 34

1

Before driving

Locking the trunk opener feature

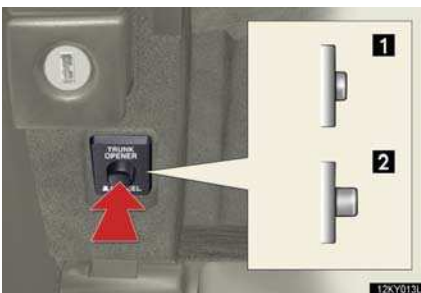

Turn the main switch in the glove box off to disable the trunk opener.

1 On

2 Off

The trunk lid cannot be opened even with the wireless remote control or the entry function.

n Trunk light

When the trunk light switch is set to on, the trunk light turns on when the trunk is opened.

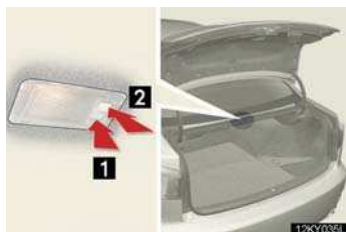

- 1 On
- 2 Off

n Trunk handle



Use the trunk handle when closing the trunk.

n Internal trunk release lever



The trunk lid can be opened by pulling down on the glow-in-the-dark lever located on the inside of trunk lid.

The lever will continue to glow for some time after the trunk lid is closed.

n Using the mechanical key

The trunk can be also opened using the mechanical key. (→P. 394)

 CAUTION

n Caution while driving

Keep the trunk lid closed.

This not only keeps personal belongings from being thrown out, but also prevents exhaust gases from entering the vehicle.

n When children are in the vehicle

Never leave children unattended in the vehicle as they may lock themselves in the vehicle or trunk, which could cause the child to overheat or suffocate, resulting in death or serious injury.

1-3. Adjustable components (seats, mirrors, steering wheel)

Front seats

► Manual seat



- 1 Seat position lever
- 2 Seatback angle lever
- 3 Vertical height adjustment lever
- 4 Seat cushion (front) angle knob

► Power seat



- 1 Seat position switch
- 2 Seatback angle switch
- 3 Seat cushion (front) angle switch
- 4 Vertical height adjustment switch
- 5 Lumbar support switch

! CAUTION

n Seat adjustment

- 1 Do not recline the seat more than necessary when the vehicle is in motion to reduce the risk of sliding under the lap belt.
If the seat is too reclined, the lap belt may slide past the hips and apply restraint forces directly to the abdomen or your neck may contact the shoulder belt, increasing the risk of death or serious injury in the event of an accident.
- 1 Manual seat only: After adjusting the seat, make sure that the seat is locked in position.

1-3. Adjustable components (seats, mirrors, steering wheel)

Driving position memory (if equipped)

Your preferred driving position (the position of the driver's seat, steering wheel and outside rear view mirrors) can be memorized and recalled with the touch of a button. It is also possible to set this function to activate automatically when the doors are unlocked.

Three different driving positions can be entered into memory.

n Entering a position to memory

Vehicles with an automatic transmission: Check that the shift lever is set in P.

Vehicles with a manual transmission: Check that the parking brake is set.

STEP 1 Switch to IGNITION ON mode.

STEP 2 Adjust the driver's seat, steering wheel, and outside rear view mirrors to the desired positions.

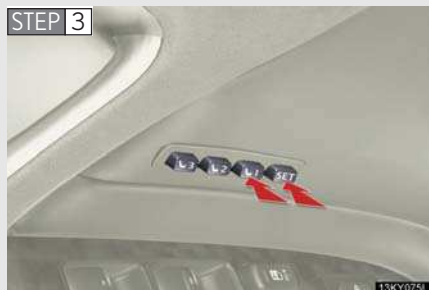

While pushing the "SET" button, push button "1", "2" or "3" until the signal beeps.

If the selected button has already been preset, the previously recorded position will be overwritten.

n Recalling the memorized position

Vehicles with an automatic transmission: Check that the shift lever is set in P.

Vehicles with a manual transmission: Check that the parking brake is set.

STEP 1 Switch to IGNITION ON mode.

STEP 2



Push button "1", "2" or "3" to recall the memorized position.

Linking driving position memory with door unlock operation

Record your driving position to button "1", "2" or "3" before performing the following.

STEP 1 Turn the "ENGINE START STOP" switch OFF and close the driver's door.

STEP 2

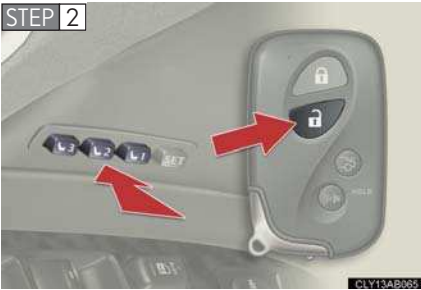

While the desired button ("1", "2" or "3") press  on the wireless remote control until the signal beeps.

The driving position is recalled when the driver's door is unlocked using the entry function or wireless remote control and the driver's door is opened.

STEP 3 Open one of the doors

If a door is not opened within 60 seconds after  is pressed, the doors will be locked again and the alarm will automatically be set. In case that the alarm is triggered, immediately stop the alarm. (→P. 74)

n Canceling the linked door unlock operation

STEP 1 Turn the “ENGINE START STOP” switch OFF and close the driver's door.

STEP 2 While pushing the “SET” button, push  on the wireless remote control until the signal beeps.

n Operating the driving position memory after turning the “ENGINE START STOP” switch OFF

Memorized positions (except for the steering wheel positions) can be activated up to 30 seconds after the driver's door is opened, even after turning the “ENGINE START STOP” switch OFF.

n To cancel seat position recall

Perform any of the following operations.

1 Push the “SET” button.

1 Push button “1”, “2” or “3”.

1 Adjust the seat using the switches (only cancels seat position recall).

n If the battery is disconnected

The memorized positions are erased when the battery is disconnected.

CAUTION

n Seat adjustment caution

Take care during seat adjustment that the seat does not strike the rear passenger or squeeze your body against the steering wheel.

1-3. Adjustable components (seats, mirrors, steering wheel)

Seat position memory (if equipped)

Your preferred front passenger seat position can be memorized and recalled with the touch of a button.

Three different seat positions can be entered into memory.

n Entering a position to memory

Vehicles with an automatic transmission: Check that the shift lever is set in P.

Vehicles with a manual transmission: Check that the parking brake is set.

STEP 1 Switch to IGNITION ON mode.

STEP 2 Adjust the front passenger seat to the desired position.

STEP 3



While pushing the “SET” button, push button “1”, “2” or “3” until the signal beeps.

If the selected button has already been preset, the previously recorded position will be overwritten.

n Recalling the memorized position

Vehicles with an automatic transmission: Check that the shift lever is set in P.

Vehicles with a manual transmission: Check that the parking brake is set.



Push button “1”, “2” or “3” to recall the memorized position.

n **Operating the seat position memory after turning the “ENGINE START STOP” switch OFF**

Memorized position can be activated up to 30 seconds after the front passenger door is opened, even after turning the “ENGINE START STOP” switch OFF.

n **To cancel seat position recall**

Perform any of the following operations.

- l Push the “SET” button.
- l Push button “1”, “2” or “3”.
- l Adjust the seat position using the switches.

n **If the battery is disconnected**

The memorized positions are erased when the battery is disconnected.

CAUTION

n **Seat adjustment caution**

Take care during seat adjustment that the seat does not strike the rear passenger.

1-3. Adjustable components (seats, mirrors, steering wheel)

Head restraints



1 Vertical adjustment

Push and hold the lock release button when lowering the head restraint.

2 Removal

Pull the head restraint up while pushing the lock release button.

1

Before driving

n Adjusting the height of the head restraints

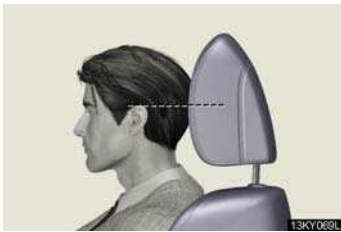

Make sure that the head restraints are adjusted so that the center of the head restraint is closest to the top of your ears.

n Adjusting the rear seat head restraints

Always raise the head restraint one level from the stowed position when using.

! CAUTION

n Head restraint precautions

Observe the following precautions regarding the head restraints. Failure to do so may result in death or serious injury.

- 1 Use the head restraints designed for each respective seat.
- 1 Adjust the head restraints to the correct position at all times.
- 1 Do not drive with the head restraints removed.

1-3. Adjustable components (seats, mirrors, steering wheel)

Seat belts

Make sure that all occupants are wearing their seat belts before driving the vehicle.

n Correct use of the seat belts



- 1 Extend the shoulder belt so that it comes fully over the shoulder, but does not come into contact with the neck or slide off the shoulder.
- 1 Position the lap belt as low as possible over the hips.
- 1 Adjust the position of the seatback. Sit up straight and well back in the seat.
- 1 Do not twist the seat belt.

n Fastening and releasing the seat belt

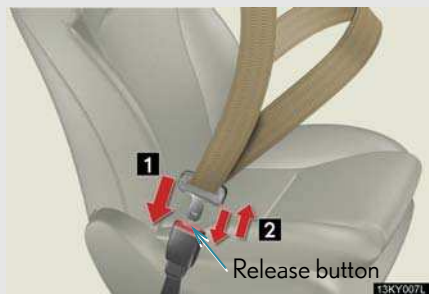

- 1** Fastening the belt
Push the tab into the buckle until a clicking sound is heard.
- 2** Releasing the belt
Press the release button.

n Adjusting the height of the belt (front seats)

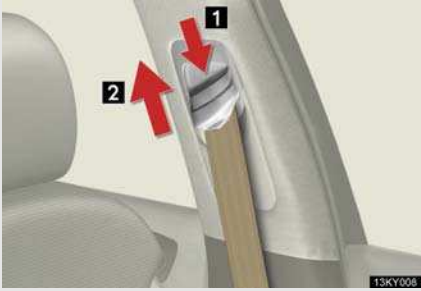

1 Down

2 Up

Move the height adjuster up and down as needed until you hear a click.

Seat belt comfort guide (outside rear seats)

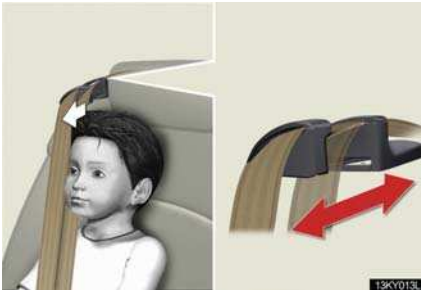

If the shoulder belt sits close to a person's neck, slide the seat belt comfort guide forward.

Seat belt pretensioners (front and outside rear seats)



The pretensioner helps the seat belt to quickly restrain the occupant by retracting the seat belt when the vehicle is subjected to certain types of severe frontal collision.

The pretensioner may not activate in the event of a minor frontal impact, a side impact or a rear impact.

Pre-collision seat belts (front seats of vehicles with pre-collision system)

When the pre-collision sensor detects an obstacle and determines that a collision is unavoidable, the seat belts lessen collision injury by retracting the slack in the front seat belts before the collision, thus restraining the driver and passenger at an earlier stage.

The seat belts will also operate in the event of sudden braking. (→P. 176)

n Emergency locking retractor (ELR)

The retractor will lock the belt during a sudden stop or on impact. It may also lock if you lean forward too quickly. A slow, easy motion will allow the belt to extend so that you can move around fully.

n Automatic locking retractor (ALR)

When a passenger's shoulder belt is completely extended and then retracted even slightly, the belt is locked in that position and cannot be extended. This feature is used to hold the child restraint system (CRS) firmly. To free the belt again, fully retract the belt and then pull the belt out once more. (→P. 98)

n Pregnant women

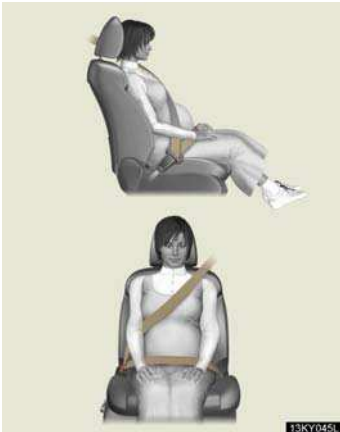

Obtain medical advice and wear the seat belt in the proper way. (→P. 52)

Women who are pregnant should position the lap belt as low as possible over the hips in the same manner as other occupants. Extend the shoulder belt completely over the shoulder and position the belt across the chest. Avoid belt contact over the rounding of the abdominal area.

If the seat belt is not worn properly, not only a pregnant woman, but also the fetus could suffer death or serious injury as a result of sudden braking or a collision.

n **People suffering illness**

Obtain medical advice and wear the seat belt in the proper way.

n **Child seat belt usage**

The seat belts of your vehicle were principally designed for persons of adult size.

1 Use a child restraint system appropriate for the child, until the child become large enough to properly wear the vehicle's seat belt. (→P. 95)

1 When the child becomes large enough to properly wear the vehicle's seat belt, follow the instructions on P. 52 regarding seat belt usage.

n **Replacing the belt after the pretensioner has been activated**

If the vehicle is involved in multiple collisions, the pretensioner will activate for the first collision, but will not activate for the second or subsequent collisions.

n **Seat belt extender**



If your seat belts cannot be fastened securely because they are not long enough, a personalized seat belt extender is available from your Lexus dealer free of charge.

CAUTION

Observe the following precautions to reduce the risk of injury in the event of sudden braking or an accident.

Failing to do so may cause death or severe injury.

n Wearing a seat belt

- 1 Ensure that all passengers wear a seat belt.
- 1 Always wear a seat belt properly.
- 1 Each seat belt should be used by one person only. Do not use a seat belt for more than one person at once, including children.
- 1 Lexus recommends that children be seated in the rear seat and always use a seat belt and/or an appropriate child restraint system.
- 1 Do not recline the seat any more than necessary to achieve a proper seating position. The seat belt is most effective when the occupants are sitting up straight and well back in the seats.
- 1 Do not wear the shoulder belt under your arm.
- 1 Always wear your seat belt low and snug across your hips.

n Seat belt pretensioners

- 1 Do not place anything, such as a cushion, on the front passenger's seat. Doing so will disperse the passenger's weight, which prevents the sensor from detecting the passenger's weight properly. As a result, the seat belt pretensioner for the front passenger's seat may not activate in the event of a collision.
- 1 If the pretensioner has activated, the seat belt becomes locked: it cannot be further extended, nor will it return to the stowed position. The seat belt cannot be used again and must be replaced at your Lexus dealer.

⚠ CAUTION**n Seat belt damage and wear**

- I** Do not damage the seat belts by allowing the belt, plate, or buckle to be jammed in the door.
- I** Inspect the seat belt system periodically. Check for cuts, fraying, and loose parts. Do not use a damaged seat belt until it is replaced. Damaged seat belts cannot protect an occupant from death or serious injury.
- I** Ensure that the belt and tab are locked and the belt is not twisted. If the seat belt does not function correctly, immediately contact your Lexus dealer.
- I** Replace the seat assembly, including the belts, if your vehicle has been involved in a serious accident, even if there's no obvious damage.
- I** Do not attempt to install, remove, modify, disassemble or dispose of the seat belts. Have any necessary repairs carried out by your Lexus dealer. Inappropriate handling of the pretensioner may prevent it from operating properly resulting in death or serious injury.

n Using a seat belt extender

- I** Do not wear the seat belt extender if you can fasten the seat belt without the extender.
- I** Do not use the seat belt extender when installing a child restraint system because the belt will not securely hold the child restraint system, increasing the risk of death or injury in the event of a collision.
- I** The personalized extender may not be safe on another vehicle, when used by another person, or at a different seating position other than the one originally intended.

⚠ NOTICE**n When using a seat belt extender**

When releasing the seat belt, press on the buckle release button on the extender, not on the seat belt.

This helps prevent damage to the vehicle interior and the extender itself.

1-3. Adjustable components (seats, mirrors, steering wheel)

Steering wheel (manually adjustable type)

The steering wheel can be adjusted to a comfortable position.



STEP 1 Hold the steering wheel and press the lever down.

STEP 2 Adjust to the ideal position by moving the steering wheel horizontally and vertically.

STEP 3 Pull the lever up.

CAUTION

n Caution while driving

Do not adjust the steering wheel while driving.

Doing so may cause the driver to mishandle the vehicle and an accident, resulting in death or serious injury.

n After adjusting the steering wheel

Make sure that the steering wheel is securely locked.

Otherwise, the steering wheel may move suddenly, possibly causing an accident.

1-3. Adjustable components (seats, mirrors, steering wheel)

Steering wheel (power-adjustable type)

The steering wheel can be adjusted to a comfortable position while the “ENGINE START STOP” switch is in ACCESSORY or IGNITION ON mode.

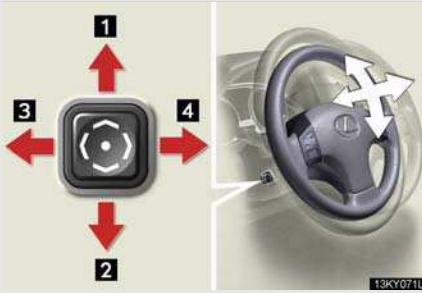

- 1 Up
- 2 Down
- 3 Away from the driver
- 4 Toward the driver

1

Before driving

Auto tilt away



When the “ENGINE START STOP” switch is turned OFF, the steering wheel returns to its stowed position by moving up and away to enable easier driver entry and exit.

Switching to ACCESSORY or IGNITION ON mode will return the steering wheel to the original position.

⚠ CAUTION

n Caution while driving

Do not adjust the steering wheel while driving.

Doing so may cause the driver to mishandle the vehicle and an accident, resulting in death or serious injury.

1-3. Adjustable components (seats, mirrors, steering wheel)

Anti-glare inside rear view mirror

In “AUTO” mode, sensors are used to detect the headlights of vehicles behind and automatically reduce the reflected light.

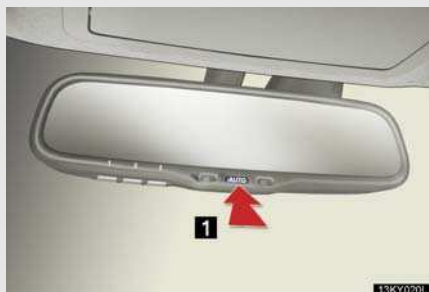

1 Turns “AUTO” mode on/off

The indicator comes on when “AUTO” mode is turned on.

The anti-glare mirror default mode is “AUTO”. The anti-glare mirror is automatically set to “AUTO” whenever the “ENGINE START STOP” switch is turned on.

n To prevent sensor error

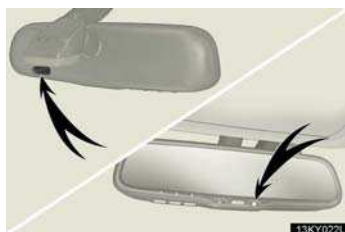

To ensure that the sensors operate properly, do not touch or cover them.

! CAUTION

n Caution while driving

Do not adjust the position of the mirror while driving.

Doing so may lead to mishandling of the vehicle and an accident, resulting in death or serious injury.

Outside rear view mirrors

Mirror angle can be adjusted using the switch when the “ENGINE START STOP” switch is in ACCESSORY or IGNITION ON mode.



- 1 Select a mirror to adjust (“L”: left or “R”: right)
- 2 Adjust the mirror up, down, in, or out using the switch

1

Before driving

n When the mirrors are fogged up

Turn on the mirror defoggers to defog the mirrors. (→P. 200)

n Folding back the mirrors



Push back in the direction of the vehicle's rear.

n One-touch adjustment of the mirror angle (vehicles with driving position memory)

A desired mirror face angle can be entered to memory and adjusted with the touch of a button. (→P. 46)

▣ **Linked mirror function when reversing (vehicles with driving position memory)**

The outside rear view mirrors will automatically angle downwards when the vehicle is reversing in order to give a better view of the ground. However, this function will not operate when the mirror select switch is in the neutral position (between "L" and "R").

▣ **Auto anti-glare function (vehicles with sports or luxury package)**

When the anti-glare inside rear view mirror is set to "AUTO" mode, the outside rear view mirrors will activate in conjunction with the anti-glare inside rear view mirror to reduce reflected light. (→P. 60)

▣ **Rain clearing mirrors**

When water droplets collect on the mirror surface, for example when it rains, the rain clearing (hydrophilic) effect of the mirrors causes the droplets to be spread out into a film making the rear view clearer. In the following cases, the rain clearing effect will be reduced temporarily, but will return after 1 or 2 days' exposure to direct sunlight.

1 After wiping dirt off the mirrors

1 When the mirrors fog up

1 After waxing your vehicle in an automatic car wash

1 After your vehicle has been parked for a long period in underground parking lots, etc. where there is no direct sunlight.

 **CAUTION****n When driving the vehicle**

Observe the following precautions while driving.

Failing to do so may result in loss of control of the vehicle and cause an accident, resulting in death or serious injury.

I Do not adjust the mirrors while driving.

I Do not drive with the mirrors folded back.

I Both the driver and passenger side mirrors must be extended and properly adjusted before driving.

n When the mirror defoggers are operating

Do not touch the surface of the mirror, as it may be hot.

 **NOTICE****n If the mirrors become iced up**

In order to retain the rain-clearing properties of the mirror, do not attempt to scrape the ice off. Instead, remove it by turning on the mirror defoggers or by applying warm water.

1-4. Opening and closing the windows and moon roof

Power windows

The power windows can be opened and closed using the following switches.

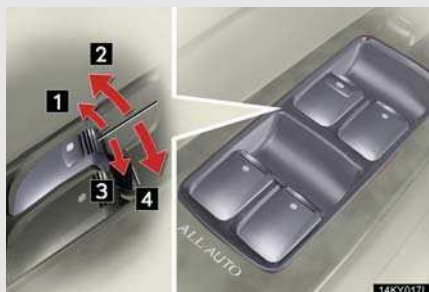

- 1 Closing
- 2 One-touch closing*
- 3 Opening
- 4 One-touch opening*

*: Pushing the switch in the opposite direction will stop window travel partway.

Lock switch



Press the switch down to lock passenger window switches.

Use this switch to prevent children from accidentally opening or closing a passenger window.

n The power windows can be operated when

The "ENGINE START STOP" switch is in IGNITION ON mode.

n Door lock linked window operation

- 1 The power windows can be opened and closed using the mechanical key. (→P. 394)
- 1 The power windows can be opened using the wireless remote control. (→P. 34)

n Operating the power windows after turning the “ENGINE START STOP” switch OFF

The power windows can be operated for approximately 45 seconds even after the “ENGINE START STOP” switch is switched to ACCESSORY mode or turned OFF. They cannot, however, be operated once either front door is opened.

n Jam protection function

If an object becomes caught between the window and the window frame, window travel is stopped and the window is opened slightly.

n When the battery is disconnected

The power windows must be initialized in order to ensure proper operation. (Perform for each window with the switch for each seat.)

STEP 1 Open the window halfway.

STEP 2 Fully close the window by pulling the switch up and continue holding the switch for one second.

The indicator on the switch changes from a flashing pattern to being on when initial settings are complete.

n Customization that can be configured at Lexus dealer

Settings (e.g. linked door lock operation) can be changed. (Customizable features →P. 436)

CAUTION

n Closing the windows

Observe the following precautions.

Failing to do so may result in death or serious injury.

I Check to make sure that all passengers do not have any part of their body in a position where it could be caught when a window is being operated.

I Do not allow children to operate the power windows.

Closing a power window on someone can cause serious injury, and in some instances, even death.

n Jam protection function

I Never try jamming any part of your body to activate the jam protection function intentionally.

I The jam protection function may not work if something gets caught just before the window fully closes.

1-4. Opening and closing the windows and moon roof

Moon roof (if equipped)

Use the overhead switches to open, close, and tilt the moon roof up and down.

n Manually opening and closing

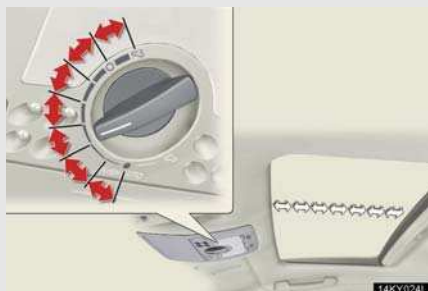

 Fully open

 Fully close

The moon roof can be opened in 7 steps by changing the position of the switch.

n One-touch open and close

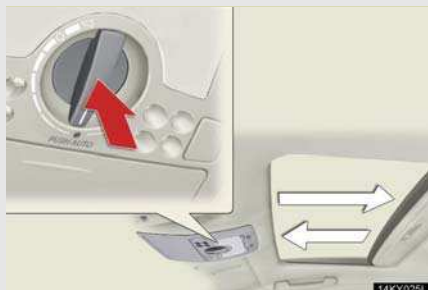

Open to step 6

While the moon roof is opening, pushing the switch will stop the moon roof operation partway. Any further opening must be performed manually, using the switch.

After the operation stops, press the switch again to fully close the moon roof.

n Tilt up and down



 Tilt up

 Tilt down

Fully up/fully down.

n **The moon roof can be operated when**

The "ENGINE START STOP" switch is in IGNITION ON mode.

n **Door lock linked moon roof operation**

l The moon roof can be opened and closed using the mechanical key. (→P. 394)

l The moon roof can be opened using the wireless remote control. (→P. 34)

n **Operating the moon roof after turning the "ENGINE START STOP" switch OFF**

The moon roof can be operated for approximately 45 seconds even after the "ENGINE START STOP" switch is switched to ACCESSORY mode or turned OFF. It cannot, however, be operated once either front door is opened.

n **Jam protection function**

If an object is detected between the moon roof and the frame while closing or tilting down, travel is stopped and the moon roof opens slightly.

n **If the moon roof can not be closed**

Pressing the switch of at ● for more than 10 seconds closes the moon roof.

n **To reduce moon roof wind noise**

l Drive with the moon roof switch in ○ when you open and close the moon roof manually.

l Drive with the moon roof where it has stopped when opening automatically.

n **Sunshade**

The sunshade can be opened and closed manually. However, the sunshade will open automatically when the moon roof is opened.

n **Customization that can be configured at Lexus dealer**

Settings (e.g. linked door lock operation) can be changed. (Customizable features →P. 436)

CAUTION

n Opening the moon roof

Observe the following precautions.

Failing to do so may cause death or serious injury.

- 1** Do not allow any passengers to put their hands or heads outside the vehicle while it is moving.
- 1** Do not sit on top of the moon roof.

n Closing the moon roof

Observe the following precautions.

Failing to do so may result in death or serious injury.

- 1** Check to make sure that all passengers do not have any part of their bodies in a position where they could be caught when the moon roof is being operated.
- 1** Do not allow children to operate the moon roof.
Closing the moon roof on someone can cause death or serious injury.

n Jam protection function

- 1** Never try jamming any part of your body to activate the jam protection function intentionally.
- 1** The jam protection function may not work if something gets caught just before the moon roof fully closes.

1-5. Refueling

Opening the fuel tank cap

Perform the following steps to open the fuel tank cap.

n Before refueling the vehicle

Turn the “ENGINE START STOP” switch OFF and ensure that all the doors and windows are closed.

n Opening the fuel tank cap

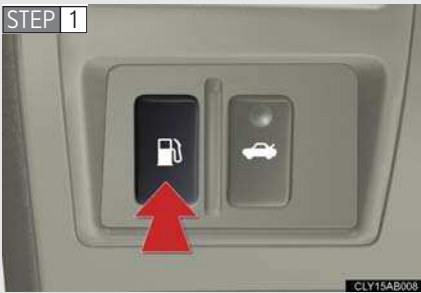

Open the fuel filler door.



Turn the fuel tank cap slowly to open.



Hang the fuel tank cap on the back of the fuel filler door.

Closing the fuel tank cap



When replacing the fuel tank cap, turn it until a clicking sound is heard.

After releasing your hand, the cap will turn slightly to the opposite direction.

n Fuel types

Use unleaded gasoline. (91 Octane rating [Research Octane Number 96] or higher)

n Fuel tank capacity (reference)

17.2 gal. (65 L, 14.3 Imp.gal.)

n When the fuel filler door opener is inoperable

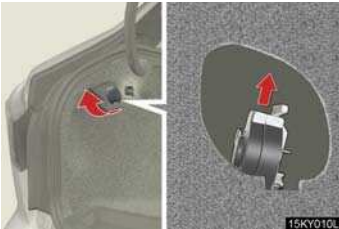

The lever can be used to open the fuel filler door if the fuel filler door cannot be opened using the inside switch because the battery is discharged or for any other reason.

⚠ CAUTION**n Refueling the vehicle**

Observe the following precautions while refueling the vehicle. Failure to do so, may result in death or serious injury.

- I** Touch the vehicle or some other metal surface to discharge any static electricity. Sparks resulting from discharging static electricity may cause the fuel vapors to ignite.
- I** Always hold the grips on the fuel tank cap and turn it slowly to remove it. A whooshing sound may be heard when the fuel tank cap is loosened. Wait until the sound cannot be heard before fully removing the cap. In hot weather, pressurized fuel may spray out the filler neck and cause injury.
- I** Do not allow anyone that has not discharged static electricity from their bodies to come close to an open fuel tank.
- I** Do not inhale vaporized fuel. Fuel contains substances that are harmful if inhaled.
- I** Do not smoke while refueling the vehicle. Doing so may cause the fuel to ignite and cause a fire.
- I** Do not return to the vehicle or touch any person or object that is statically charged. This may cause static electricity to build up, resulting in a possible ignition hazard.

n When replacing the fuel cap

Do not use anything but a genuine Lexus fuel tank cap designed for your vehicle. Failure to do so may cause a fire or other incident which may result in death or serious injury.

⚠ NOTICE**n Refueling**

Do not spill fuel during refueling.

Failing to do so may damage the vehicle, such as causing the exhaust systems to operate abnormally or damaging fuel system components or the vehicle's painted surface.

1-6. Theft deterrent system

Engine immobilizer system

The vehicle's keys have built-in transponder chips that prevent the engine from starting if the key has not been previously registered in the vehicle's on-board computer.

Never leave the keys inside the vehicle when you leave the vehicle.



The indicator light flashes after the “ENGINE START STOP” switch has been turned OFF to indicate that the system is operating.

n System maintenance

The vehicle has a maintenance-free type of engine immobilizer system.

n Conditions that may cause the system to malfunction

- 1 If the grip portion of the key is in contact with a metallic object
- 1 If the key is in close proximity to or touching a key to the security system (key with a built-in transponder chip) of another vehicle

n Certifications for the engine immobilizer system

► For vehicles sold in the U.S.A.

FCC ID: NI4TMIMB-1

This device complies with Part 15 of the FCC Rules. Operation is subject to the following two conditions: (1) this device may not cause harmful interference, and (2) this device must accept any interference received, including interference that may cause undesired operation.

► For vehicles sold in Canada

Operation is subject to the following two conditions: (1) this device may not cause interference, and (2) this device must accept any interference, including interference that may cause undesired operation of the device.

 **CAUTION**

Changes or modifications not expressly approved by the party responsible for compliance could void the user's authority to operate the equipment.

 **NOTICE****n To prevent damage to the key**

Do not modify, remove or disable the engine immobilizer system. If any unauthorized changes or modifications are made, the proper operation of the system cannot be guaranteed.

1

Before driving

1-6. Theft deterrent system

Alarm

The system sounds the alarm and flashes lights when forcible entry is detected.

n Triggering of the alarm

The alarm is triggered in the following situations.

- 1 A locked door or trunk is unlocked or opened in any way other than using the entry function, wireless remote door lock function or mechanical key with the alarm being set.
- 1 The hood is opened with the alarm being set.

n Setting the alarm system



Close the doors, trunk and hood, and lock all doors using the entry function, wireless remote door lock function or mechanical key.

The system will be set automatically after 30 seconds.

The indicator light changes from being on to flashing when the system is set.

n Deactivating or stopping the alarm

Do one of the following to deactivate or stop the alarm.

- 1 Unlock the doors or trunk using the entry function, wireless remote door lock function or mechanical key.
- 1 Turn the "ENGINE START STOP" switch to ACCESSORY or IGNITION ON mode. (The alarm will be deactivated or stopped after a few seconds.)

n Items to check before locking the vehicle

To prevent unexpected triggering of the alarm and vehicle theft, make sure of the following.

- 1 Nobody is in the vehicle.
- 1 The windows and moon roof are closed before the alarm is set.
- 1 No valuables or other personal items are left in the vehicle.

n Panic mode



When  is pushed for longer than about one second, an alarm will sound for about 60 seconds and the vehicle lights will flash to deter any person from trying to break into or damage your vehicle.

To stop the alarm, push any button on the wireless remote control.

n Triggering of the alarm

The alarm may be triggered in the following situations.
Stopping the alarm deactivates the system.

- 1 A person inside the vehicle opens a door, the trunk or hood.
- 1 The battery is recharged or replaced when the vehicle is locked.

n When the battery is disconnected

Be sure to deactivate the alarm system.

If the battery is disconnected before deactivating the alarm system, the alarm may be triggered when the battery is reconnected.

1-6. Theft deterrent system

Theft prevention labels (U.S.A.)



These labels are attached to the vehicle to reduce vehicle theft by facilitating the tracing and recovery of parts from stolen vehicles. Do not remove under penalty of law.

Correct driving posture

Drive in a good posture as follows:



- 1 Sit upright and well back in the seat. (→P. 44)
- 2 Adjust the position of the seat forward or backward to ensure the pedals can be reached and easily depressed to the extent required. (→P. 44)
- 3 Adjust the seatback so that the controls are easily operable.
- 4 Adjust the tilt and telescopic positions of the steering wheel downward so the air-bag is facing your chest. (→P. 58, 59)
- 5 Lock the head restraint in place with the center of the head restraint closest to the top of your ears. (→P. 51)
- 6 Wear the seat belt correctly. (→P. 52)

! CAUTION

n While driving

- 1 Do not adjust the position of the driver's seat while driving. Doing so could cause the driver to lose control of the vehicle.

 **CAUTION**

n While driving

- I** Do not place a cushion between the driver or passenger and the seatback. A cushion may prevent correct posture from being achieved, and reduce the effectiveness of the seat belt and head restraint, increasing the risk of death or serious injury to the driver or passenger.
- I** Do not place anything under the front seats. Objects placed under the front seats may become jammed in the seat tracks and stop the seat from locking in place. This may lead to an accident. The adjustment mechanism may also be damaged.

n Adjusting the seat position:

- I** Take care when adjusting the seat position to ensure that other passengers are not injured by the moving seat.
- I** Do not put your hands under the seat or near the moving parts to avoid injury. Fingers or hands may become jammed in the seat mechanism.

1-7. Safety information

SRS airbags

The SRS airbags inflate when the vehicle is subjected to certain types of severe impacts that may cause significant injury to the occupants. They work together with the seat belts to help reduce the risk of death or serious injury.



► SRS front airbags

1 SRS driver airbag/front passenger airbag

Can help protect the head and chest of the driver and front passenger from impact with interior components.

2 Knee airbags

Can help provide driver and front passenger protection.

► SRS side and curtain shield airbags

3 SRS side airbags

Can help protect the torso of the front seat occupants.

4 SRS curtain shield airbags

Can help protect primarily the head of outside occupants.

1

Before driving

Airbag system components

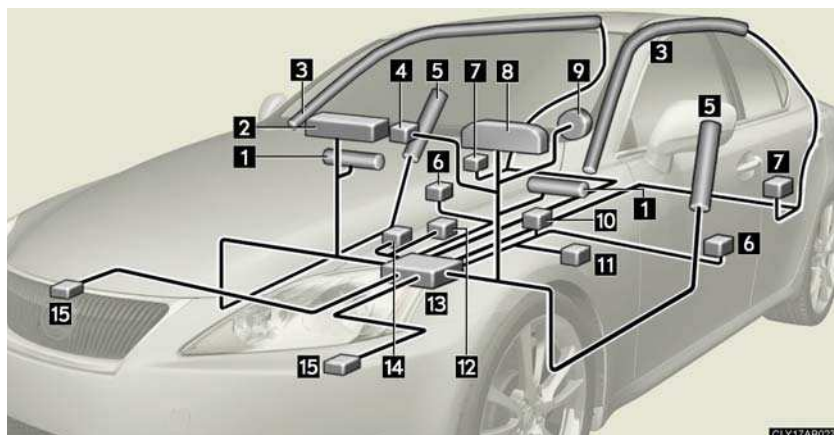

CLY17AB027

- | | |
|--|---|
| 1 Knee airbags | 8 SRS warning light |
| 2 Front passenger airbag | 9 Driver airbag |
| 3 Curtain shield airbags | 10 Driver's seat belt buckle switch |
| 4 "AIR BAG ON" and "AIR BAG OFF" indicator lights | 11 Driver's seat position sensor |
| 5 Side airbags | 12 Front passenger's seat belt buckle switch |
| 6 Side and curtain shield airbag sensors | 13 Airbag sensor assembly |
| 7 Curtain shield airbag sensors | 14 Occupant detection system (ECU and sensors) |
| | 15 Front airbag sensors |

Your vehicle is equipped with ADVANCED AIRBAGS designed based on US motor vehicle safety standards (FMVSS208). The airbag system controls airbag deployment power for the driver and front passenger. The driver airbag system consists of the driver seat's position sensor etc. The front passenger's airbag system consists of the front passenger occupant classification sensor etc.

The main SRS airbag system components are shown above. The SRS airbag system is controlled by the airbag sensor assembly. The airbag sensor assembly consists of a safing sensor and an airbag sensor.

In certain types of severe frontal or side impacts, the SRS airbag system triggers the airbag inflators. A chemical reaction in the inflators quickly fills the airbags with non-toxic gas to help restrain the motion of the occupants.

n SRS warning light

This warning light system monitors the airbag sensor assembly, front airbag sensors, side and curtain shield airbag sensor assemblies, curtain shield airbag sensor assemblies, driver's seat position sensor, driver's seat belt buckle switch, seat belt pretensioner assemblies, inflators, interconnecting wiring and power sources. (→P. 361)

n If the SRS airbags deploy (inflate)

- 1 Bruising and slight abrasions may result from contact with a deploying (inflating) SRS airbag.
- 1 A loud noise and white powder will be emitted.
- 1 Parts of the airbag module (steering wheel hub, airbag cover and inflator) as well as the front seats, and parts of the front pillar, rear pillar and roof side rail, may be hot for several minutes. The airbag itself may also be hot.
- 1 The front windshield may crack.

n Operating conditions (front airbags)

- 1 The SRS front airbags will deploy if the severity of the frontal impact is above the designed threshold level, comparable to an approximate 15 mph (25 km/h) collision when the vehicle impacts straight into a fixed barrier that does not move or deform.

However, this threshold velocity will be considerably higher if the vehicle strikes an object, such as a parked vehicle or sign pole, which can move or deform on impact, or if the vehicle is involved in an underride collision (e.g. a collision in which the front of the vehicle "underrides", or goes under, the bed of a truck, etc.).

- 1 It is possible that in some collisions where the forward deceleration of the vehicle is very close to the designed threshold level, the SRS front airbags and the seat belt pretensioners may not activate together.
- 1 The SRS front passenger airbag will not activate if there is no passenger sitting in the front passenger seat. However, the front passenger airbag may deploy if luggage is put in the seat, or the seat belt is fastened, even if the seat is unoccupied. (→P. 90)

n Operating conditions (side and curtain shield airbags)

- 1 The SRS side airbags and curtain shield airbags are designed to inflate when the passenger compartment is subjected to a severe impact from the side.
- 1 The SRS side airbag on the passenger seat will not activate if there is no passenger sitting in the front passenger seat. However, the side airbag on the passenger seat may deploy if luggage is put in the seat, even if the seat is unoccupied. (→P. 90)

n Conditions under which the SRS airbags may deploy (inflate), other than a collision

The SRS front airbags may also deploy if a serious impact occurs to the underside of your vehicle. Some examples are shown in the illustration.

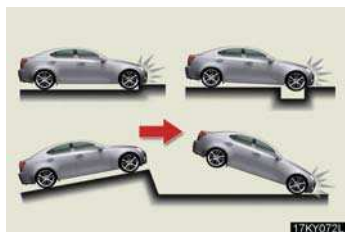

- 1 Hitting a curb, edge of pavement or hard surface
- 1 Falling into or jumping over a deep hole
- 1 Landing hard or vehicle falling

n Types of collisions that may not deploy the SRS airbag (front airbags)

The SRS front airbags are generally not designed to inflate if the vehicle is involved in a side or rear collision, if it rolls over, or if it is involved in a low-speed frontal collision. But, whenever a collision of any type causes sufficient forward deceleration of the vehicle, deployment of the SRS front airbags may occur.

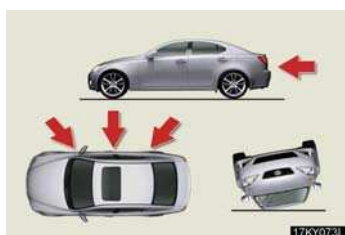

- 1 Collision from the side
- 1 Collision from the rear
- 1 Vehicle rollover

n Types of collisions that may not deploy the SRS airbag (side and curtain shield airbags)

The SRS side airbag and curtain shield airbag system may not activate if the vehicle is subjected to a collision from the side at certain angles, or a collision to the side of the vehicle body other than the passenger compartment.

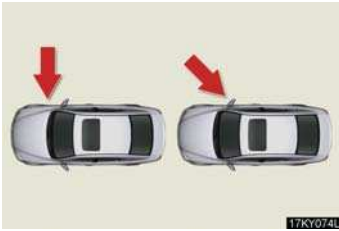

- 1 Collision from the side to the vehicle body other than the passenger compartment
- 1 Collision from the side at an angle

The SRS side airbags and curtain shield airbags are not generally designed to inflate if the vehicle is involved in a frontal or rear collision, if it rolls over, or if it is involved in a low-speed side collision.

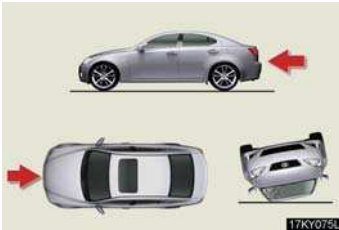

- 1 Collision from the front
- 1 Collision from the rear
- 1 Vehicle rollover

■ When to contact your Lexus dealer

In the following cases, contact your Lexus dealer as soon as possible. Do not disconnect the battery cables before contacting your Lexus dealer.

1 Any of the SRS airbags have been inflated.

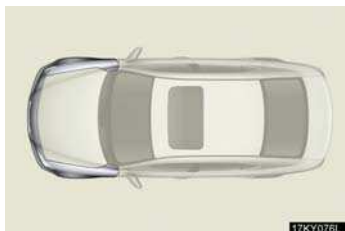

- 1 The front of the vehicle is damaged or deformed, or was involved in an accident that was not severe enough to cause the SRS airbags to inflate.



- 1 A portion of the doors is damaged or deformed, or the vehicle was involved in an accident that was not severe enough to cause the SRS side airbags and curtain shield airbags to inflate.



- 1 The pad section of the steering wheel, front passenger airbag cover or lower portion of the instrument panel is scratched, cracked, or otherwise damaged.



- 1 The surface of the seats with the side airbag is scratched, cracked, or otherwise damaged.
- 1 The portion of the front pillars, rear pillars or roof side rail garnishes (padding) containing the curtain shield airbags inside is scratched, cracked, or otherwise damaged.

! CAUTION**n SRS airbag precautions**

Observe the following precautions regarding the airbags.
Failure to do so may cause death or serious injury.

- 1** The driver and all passengers in the vehicle must wear their seat belts properly. The SRS airbags are supplemental devices to be used with the seat belts.
- 1** The SRS driver airbag deploys with considerable force, and can cause death or serious injury especially if the driver is very close to the airbag. The National Highway Traffic Safety Administration ("NHTSA") advises:

Since the risk zone for driver airbag is the first 2 - 3 in. (50 - 75 mm) of inflation, placing yourself 10 in. (250 mm) from your driver airbag provides you with a clear margin of safety. This distance is measured from the center of the steering wheel to your breastbone. If you sit less than 10 in. (250 mm) away now, you can change your driving position in several ways:

- Move your seat to the rear as far as you can while still reaching the pedals comfortably.
- Slightly recline the back of the seat.
Although vehicle designs vary, many drivers can achieve the 10 in. (250 mm) distance, even with the driver seat all the way forward, simply by reclining the back of the seat somewhat. If reclining the back of your seat makes it hard to see the road, raise yourself by using a firm, non-slippery cushion, or raise the seat if your vehicle has that feature.
- If your steering wheel is adjustable, tilt it downward. This points the airbag toward your chest instead of your head and neck.

The seat should be adjusted as recommended by NHTSA above, while still maintaining control of the foot pedals, steering wheel, and your view of the instrument panel controls.

! CAUTION

n SRS airbag precautions



- I** If the seat belt extender has been connected to the driver's seat belt buckle but the seat belt extender has not also been fastened to the latch plate of the driver's seat belt, the SRS driver's airbag system will judge that the driver is wearing the seat belt even though the seat belt has not been connected. In this case, the driver's airbag may not activate correctly in a collision, resulting in death or serious injury in the event of collision. Be sure to wear the seat belt with the seat belt extender.

- I** The SRS front passenger airbag also deploys with considerable force, and can cause death or serious injury especially if the front passenger is very close to the airbag. The front passenger seat should be as far from the airbag as possible with the seatback adjusted, so the front passenger sits upright.

- I** Improperly seated and/or restrained infants and children can be killed or seriously injured by a deploying airbag. An infant or child who is too small to use a seat belt should be properly secured using a child restraint system. Lexus strongly recommends that all infants and children be placed in the rear seats of the vehicle and properly restrained. The rear seats are the safest for infants and children. (→P. 95)

 CAUTION

n SRS airbag precautions

- 1 Do not sit on the edge of the seat or lean against the dashboard.



- 1 Do not allow a child to stand in front of the SRS front passenger airbag unit or sit on the knees of a front passenger.
- 1 Do not drive the vehicle while the driver or passenger have items resting on their knees.



- 1 Do not lean against the door, the roof side rail or the front, side and rear pillars.



- 1 Do not allow anyone to kneel on the passenger seat toward the door or put their head or hands outside the vehicle.

1

Before driving

! CAUTION

n SRS airbag precautions



I Do not attach anything to or lean anything against areas such as the dashboard, steering wheel pad or lower portion of the instrument panel.

These items can become projectiles when SRS driver, front passenger and knee airbags deploy.



I Do not attach anything to areas such as the door, windshield glass, side door glass, front and rear pillars, roof side rail or assist grip.

I Do not hang coat hangers or other hard objects on the coat hooks. All of these items could become projectiles and seriously injure or kill you, should the SRS curtain shield airbag deploy.

- I** If the vinyl cover is put on the area where the SRS knee airbag will deploy, be sure to remove it.
- I** Do not use seat accessories which cover the parts where the SRS side airbags inflate as they may interfere with inflation of the airbags.
- I** Do not strike or apply significant levels of force to the area of the SRS airbag components shown on P. 80.
Doing so can cause the SRS airbags to malfunction.
- I** Do not touch any of the component parts immediately after the SRS airbags have deployed (inflated) as they may be hot.
- I** If breathing becomes difficult after the SRS airbag has deployed, open a door or window to allow fresh air in, or leave the vehicle if it is safe to do so. Wash off any residue as soon as possible to prevent skin irritation.
- I** If the areas where the SRS airbags are stored, such as the steering wheel pad and front pillar garnish, are damaged or cracked, have them replaced by your Lexus dealer.

 **CAUTION****n Modification and disposal of SRS airbag system components**

Do not dispose of your vehicle or perform any of the following modifications without consulting your Lexus dealer.

The SRS airbag may malfunction or deploy (inflate) accidentally, causing death or serious injury.

- 1 Installation, removal, disassembly and repair of the SRS airbags
- 1 Repairs, modifications, removal or replacement of the steering wheel, instrument panel, dashboard, seats or seat upholstery, front, side and rear pillars or roof side rails
- 1 Repairs or modifications of the front fender, front bumper, or side of the occupant compartment
- 1 Installation of snow plows, winches, etc. to the front grille (bull bars, kangaroo bar etc.)
- 1 Modifications to the vehicle's suspension system
- 1 Installation of electronic devices such as mobile two-way radios or CD players
- 1 Modifications to your vehicle for a person with a physical disability

1-7. Safety information

Front passenger occupant classification system

Your vehicle is equipped with a front passenger occupant classification system. This system detects the conditions of the front passenger seat and activates or deactivates the devices for front passenger.



- 1 SRS warning light
- 2 "AIR BAG OFF" indicator light
- 3 "AIR BAG ON" indicator light
- 4 Front passenger's seat belt reminder light

Condition and operation in the front passenger occupant classification system

n Adult^{*1}

Indicator/ warning light	"AIR BAG ON" and "AIR BAG OFF" indicator lights	"AIR BAG ON"
	SRS warning light	Off
	Front passenger's seat belt reminder light	Flashing ^{*2}
Devices	Front passenger airbag	Activated
	Side airbag on the front passenger seat	
	Curtain shield airbag in the front passenger side	
	Front passenger knee airbag	
	Front passenger's seat belt pretensioner	

1

Before driving

n Child^{*3} or child restraint system^{*4}

Indicator/ warning light	"AIR BAG ON" and "AIR BAG OFF" indicator lights	"AIR BAG OFF" ^{*5}
	SRS warning light	Off
	Front passenger's seat belt reminder light	Flashing ^{*2}
Devices	Front passenger airbag	Deactivated
	Side airbag on the front passenger seat	
	Curtain shield airbag in the front passenger side	Activated
	Front passenger knee airbag	Deactivated
	Front passenger's seat belt pretensioner	Activated

n Unoccupied

Indicator/ warning light	“AIR BAG ON” and “AIR BAG OFF” indicator lights	Not illuminated
	SRS warning light	Off
	Front passenger’s seat belt reminder light	
Devices	Front passenger airbag	Deactivated
	Side airbag on the front passenger seat	
	Curtain shield airbag in the front passenger side	Activated
	Front passenger knee airbag	Deactivated
	Front passenger’s seat belt pretensioner	

n There is a malfunction in the system

Indicator/ warning light	“AIR BAG ON” and “AIR BAG OFF” indicator lights	“AIR BAG OFF”
	SRS warning light	On
	Front passenger’s seat belt reminder light	Off
Devices	Front passenger airbag	Deactivated
	Side airbag on the front passenger seat	
	Curtain shield airbag in the front passenger side	Activated
	Front passenger knee airbag	Deactivated
	Front passenger’s seat belt pretensioner	Activated

- *1: The system judges a person of adult size as an adult. When a smaller adult sits in the front passenger seat, the system may recognize him/her as a child depending on his/her physique and posture.
- *2: In the event the front passenger does not wear a seat belt.
- *3: When a larger child who has outgrown a child restraint system sits in the front passenger seat, the system may recognize him/her as an adult depending on his/her physique or posture.

- *4: Never install a rear-facing child restraint system on the front passenger seat. A forward-facing child restraint system should only be installed on the front passenger seat when it is unavoidable. (→P. 95)
- *5: In case the indicator is not illuminated, consult this manual as for installing the child restraint system properly. (→P. 98)

CAUTION

n Front passenger occupant classification system precautions

Observe the following precautions regarding front passenger occupant classification system.

Failure to do so may cause death or serious injury.

- 1** Wear the seat belt properly.
- 1** Make sure the front passenger's seat belt tab has not been left inserted into the buckle before someone sits in the front passenger seat.
- 1** Make sure the "AIR BAG OFF" indicator light is not illuminated when using the seat belt extender for the front passenger seat. If the "AIR BAG OFF" indicator light is illuminated, disconnect the extender tongue from the seat belt buckle, then reconnect the seat belt. Reconnect the seat belt extender after making sure the "AIR BAG ON" indicator light is illuminated. If you use the seat belt extender while the "AIR BAG OFF" indicator light is illuminated, the front passenger airbag, side airbag on the front passenger side and front passenger knee airbag may not activate correctly, which could cause death or serious injury in the event of collision.
- 1** Do not put weight on the front passenger seat by putting your hands or feet on the front passenger seat seatback from the rear passenger seat.
- 1** Do not let a rear passenger lift the front passenger seat with their feet or press on the seatback with their legs.
- 1** Do not put objects under the front passenger seat.
- 1** Do not recline the front passenger seatback so far that it touches a rear seat. This may cause the "AIR BAG OFF" indicator light to be illuminated, which indicates that the passenger's airbags will not deploy in the event of a severe accident. If the seatback touches the rear seat, return the seatback to a position where it does not touch the rear seat. Keep the front passenger seatback as upright as possible when the vehicle is moving. Reclining the seatback excessively may lessen the effectiveness of the seat belt system.

 CAUTION

n Front passenger occupant classification system precautions

- I** If an adult sits in the front passenger seat, the “AIR BAG ON” indicator light is illuminated. If the “AIR BAG OFF” indicator is illuminated, ask the passenger to sit up straight, well back in the seat, feet on the floor, and with the seat belt worn correctly. If the “AIR BAG OFF” indicator still remain illuminated, either ask the passenger to move to the rear seat, or if that is not possible, move the front passenger seat fully rearward.
- I** When it is unavoidable to install the forward-facing child restraint system on the front passenger seat, install the child restraint system on the front passenger seat in the proper order. (→P. 98)
- I** Do not modify or remove the front seats.
- I** Do not kick the front passenger seat or subject it to severe impact. Otherwise, the SRS warning light may come on to indicate a malfunction of the detection system. In this case, contact your Lexus dealer immediately.
- I** Child restraint systems installed on the rear seat should not contact the front seat-backs.
- I** Do not use a seat accessory, such as a cushion or seat cover, that covers the seat cushion surface.
- I** Do not modify or replace the upholstery of the front seat.

Child restraint systems

A child restraint system for a small child or baby must itself be properly restrained on the seat with the lap portion of the lap/shoulder belt.

The laws of all 50 states of the U.S.A. and Canada now require the use of child restraint systems.

1

Before driving

Points to remember

Studies have shown that installing a child restraint on a rear seat is much safer than installing one to the front passenger seat.

- 1 Choose a child restraint system appropriate to the age and size of the child.
- 1 For installation details, follow the instructions provided with the child restraint system.
General installation instructions are provided in this manual. (→P. 98)

Types of child restraints

Child restraint systems are classified into the following 3 types according to the age and size of the child.

► Infant seat



► Convertible seat



► Booster seat



n **Selecting an appropriate child restraint system**

Get an appropriate child restraint system for the child. If a child is too large for a child restraint system, sit the child on a rear seat and use the vehicle's seat belt. (→P. 52)

! CAUTION

n **Child restraint precautions**

- 1 For effective protection in automobile accidents and sudden stops, a child must be properly restrained, using a seat belt or child restraint system depending on the age and size of the child. Holding a child in your arms is not a substitute for a child restraint system. In an accident, the child can be crushed against the windshield, or between you and the vehicle's interior.

! CAUTION**n Child restraint precautions**

- 1** Lexus strongly urges the use of a proper child restraint system that conforms to the size of the child, installed on the rear seat. According to accident statistics, the child is safer when properly restrained in the rear seat than in the front seat.
- 1** Never install a rear-facing child restraint system on the front passenger seat. In the event of an accident, the force of the rapid inflation of the front passenger airbag can cause death or serious injury to the child if the rear-facing child restraint system is installed on the front passenger seat.
- 1** A forward-facing child restraint system should allowed to be installed on the front passenger seat only when it is unavoidable. Always move the seat as far back as possible, because the front passenger airbag could inflate with considerable speed and force. Otherwise, the child may be killed or seriously injured.
- 1** Do not use the seat belt extender when installing a child restraint system on the front or rear passenger seat. If installing a child restraint system with the seat belt extender connected to the seat belt, the seat belt will not securely hold the child restraint system, which could cause death or serious injury to the child or other passengers in the event of collision.
- 1** Do not allow the child to lean his/her head or any part of his/her body against the door or the area of the seat, front pillar, rear pillar or roof side rail from which the side airbags or curtain shield airbags deploy even if the child is seated in the child restraint system. It is dangerous if the side airbags and curtain shield airbags inflate, and the impact could cause death or serious injury to the child.
- 1** Make sure you have complied with all installation instructions provided by the child restraint manufacturer and that the system is properly secured. If it is not secured properly, it may cause death or serious injury to the child in the event of a sudden stop or accident.

n When the child restraint system is not in use

- 1** Keep the child restraint system properly secured on the seat even if it is not in use. Do not store the restraint unsecured in the passenger compartment.
- 1** If it is necessary to detach the child restraint system, remove it from the vehicle or store it securely in the trunk. This will prevent it from injuring passengers in the event of a sudden stop or accident.

Installing child restraints

Follow the child restraint system manufacturer's instructions. Firmly secure child restraints to the rear seats using a seat belt or a child restraint lower anchorage. Attach the top strap when installing a child restraint.



1 Seat belts equipped with a child restraint locking mechanism (ALR/ELR belts except driver's seat belt) (→P. 52)



2 Child restraint lower anchorages

Lower anchorages are provided for the outside rear seats. (Buttons displaying the location of the anchorages are attached to the seats.)



3 Anchor bracket (for top strap)

Anchor brackets are provided for all rear seats.

Installing child restraints using a seat belt (child restraint lock function belt)

n Rear facing — Infant seat/convertible seat

STEP 1

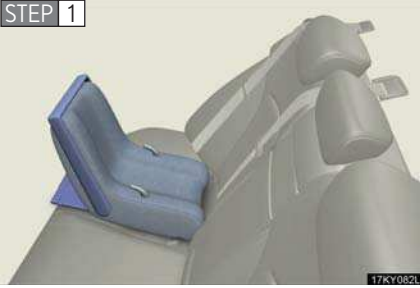

Place the child seat on the rear seat facing the rear of the vehicle.

STEP 2



Run the seat belt through the child seat and insert the plate into the buckle. Make sure that the belt is not twisted.

STEP 3

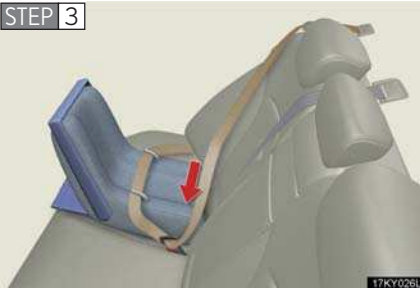

Fully extend the shoulder belt and then allow it to retract slightly in order to activate the ALR lock mode.

Lock mode allows the seat belt to retract only.

1

Before driving

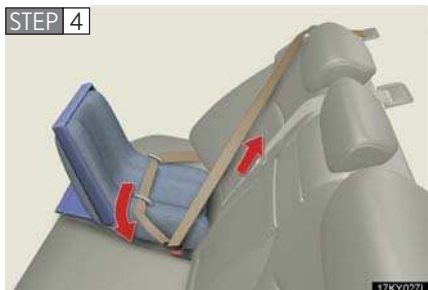

While pushing the child seat down into the rear seat, allow the shoulder belt to retract until the child seat is securely in place.

After the shoulder belt has retracted to a point where there is no slack in the belt, pull the belt to check that it cannot be extended.

n Forward facing — Convertible seat



Place the child seat on the seat facing the front of the vehicle.



Run the seat belt through the child seat and insert the plate into the buckle. Make sure that the belt is not twisted.



Fully extend the shoulder strap and then allow it to retract slightly into the ALR lock mode.

Lock mode allows the seat belt to retract only.



n Booster seat



While pushing the child seat into the rear seat, allow the shoulder belt to retract until the child seat is securely in place.

After the shoulder belt has retracted to a point where there is no slack in the belt, pull the belt to check that it cannot be extended.

Place the booster seat on the seat facing the front of the vehicle.

Sit the child in the booster seat. Fit the seat belt to the booster seat according to the manufacturer's instructions and insert the plate into the buckle. Make sure that the belt is not twisted.

Check that the shoulder belt is correctly positioned over the child's shoulder, and that the lap belt is as low as possible. (→P. 52)

Removing a child restraint installed with a seat belt



Push the buckle release button and fully retract the seat belt.

Installation with child restraint lower anchorages

► Type A

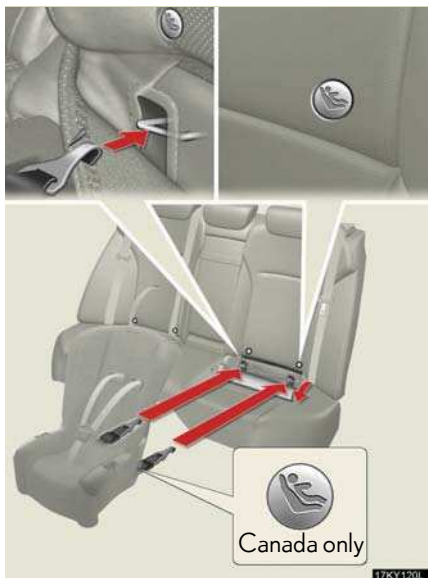

STEP 1 Flip the cover.

STEP 2 Latch the hooks of the lower straps onto the anchorages.

If the child restraint has a top strap, the top strap should be latched onto the anchorages.

For owners in Canada:
The symbol on a child restraint system indicates the presence of a lower connector system.

► Type B

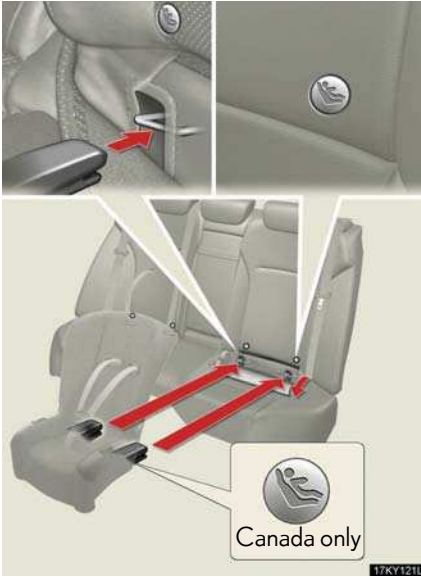

STEP 1 Flip the cover.

STEP 2 Latch the buckles onto the anchorages.

If the child restraint has a top strap, the top strap should be latched onto the anchorages.

For owners in Canada:
The symbol on a child restraint system indicates the presence of a lower connector system.

1
Before driving

Child restraint systems with a top strap



Secure the child restraint using a seat belt or a lower anchors, and lock the head restraint in place at the lowest position.



Open the anchor bracket cover, latch the hook onto the anchor bracket and tighten the top strap.

Make sure the top strap is securely latched.

n Laws and regulations pertaining to anchorages

Anchorage conform to FMVSS225 or CMVSS210.2.

Child restraint systems conforming to FMVSS213 or CMVSS213 specifications can be used.

This vehicle is designed to conform to the SAE J1819.

! CAUTION

n When installing a booster seat

Do not fully extend the shoulder belt to prevent the belt from going to ALR lock mode: (→P. 54)

- 1 ALR mode causes the belt to tighten only which could cause injury or discomfort to the child.
- 1 Do not allow the child to play with the seat belt or the child could be killed or seriously injured.

! CAUTION**n When installing a child restraint system**

Follow the directions given in the child restraint system installation manual and fix the child restraint system securely in place.

If the child restraint system is not correctly fixed in place, the child or other passengers may be injured or even killed in the event of sudden braking or an accident.



- 1 If the driver's seat interferes with the child restraint system and prevents it from being attached correctly, attach the child restraint system to the right-hand rear seat.



- 1 Only put a forward facing or booster child seat on the front seat when unavoidable. When installing a forward facing or booster child seat on the front passenger seat, move the seat as far back as possible. Failing to do so may result in death or serious injury if the airbags deploy (inflate).

- 1 When a booster seat is installed, always ensure that the shoulder belt is positioned across the center of the child's shoulder. The belt should be kept away from the child's neck, but not so that it could fall off the child's shoulder. Failing to do so may result in death or serious injury in the event of an accident or sudden braking.
- 1 Ensure that the belt and tab are securely locked and the seat belt is not twisted.
- 1 Push and pull the child seat in different directions to be sure it is secure.
- 1 Follow all installation instructions provided by the child restraint system manufacturer.

 **CAUTION**

n Do not use a seat belt extender

If a seat belt extender is used when installing a child restraint system, the seat belt will not securely hold the child restraint system, which could cause death or serious injury to the child or other passengers in the event of a collision.

n To correctly attach a child restraint system to the anchor

When using the lower anchor, be sure that there are no foreign objects around the anchorages and that the seat belt is not caught behind the child restraint. Make sure the child restraint system is securely attached, or it may cause death or serious injury to the child or other passengers in the event of a sudden stop or accident.

2-1. Driving procedures

Driving the vehicle

The following procedures should be observed to ensure safe driving.

n Starting the engine (→P. 117)

n Driving

▶ Automatic transmission

STEP 1 With the brake pedal depressed, shift the shift lever to D. (→P. 122)

STEP 2 Release the parking brake. (→P. 129)

STEP 3 Gradually release the brake pedal and gently push the accelerator pedal to accelerate the vehicle.

▶ Manual transmission

STEP 1 With the clutch pedal fully depressed, shift the shift lever into 1. (→P.126)

STEP 2 Release the parking brake. (→P.129)

STEP 3 Gradually release the clutch pedal. At the same time, gently depress the accelerator pedal to accelerate the vehicle.

n Stopping

▶ Automatic transmission

STEP 1 With the shift lever in D, push the brake pedal.

STEP 2 If necessary, set the parking brake.

When the vehicle is stopped for an extended period of time, shift the shift lever to P or N. (→P.122)

▶ Manual transmission

STEP 1 With the clutch pedal fully depressed, push the brake pedal.

STEP 2 If necessary, set the parking brake.

When the vehicle is stopped for an extended period of time, shift the shift lever into N. (→P.126)

n Parking the vehicle

► Automatic transmission

- STEP 1** With the shift lever in D, push the brake pedal.
- STEP 2** Set the parking brake. (→P.129)
- STEP 3** Shift the shift lever to P. (→P.122)
- STEP 4** Press the “ENGINE START STOP” switch and stop the engine.
- STEP 5** Lock the door, making sure that you have the electronic key on your person.

► Manual transmission

- STEP 1** With the clutch pedal fully depressed, push the brake pedal.
- STEP 2** Set the parking brake. (→P.129)
- STEP 3** Shift the shift lever into N. (→P.126)
- STEP 4** Press the “ENGINE START STOP” switch to stop the engine.
- STEP 5** Lock the door, making sure that you have the electronic key on your person.

Starting on a steep uphill

► Automatic transmission

- STEP 1** Firmly set the parking brake and shift the shift lever to D.
- STEP 2** Gently depress the accelerator pedal.
- STEP 3** Release the parking brake.

► Manual transmission

- STEP 1** With the parking brake firmly set and the clutch pedal fully depressed, shift the shift lever into 1.
- STEP 2** Lightly depress the accelerator pedal at the same time as gradually releasing the clutch pedal.
- STEP 3** Release the parking brake.

n **Driving in the rain**

- 1 Drive carefully when it is raining, because visibility will be reduced, the windows may become fogged-up, and the road will be slippery.
- 1 Drive carefully when it starts to rain, because the road surface will be especially slippery.
- 1 Refrain from high speeds when driving on an expressway in the rain, because there may be a layer of water between the tires and the road surface, preventing the steering and brakes from operating properly.

n **Breaking in your new Lexus**

To extend the life of the vehicle, the following precautions are recommended to observe:

- 1 For the first 186 miles (300 km):
Avoid sudden stops.
- 1 For the first 621 miles (1000 km):
 - Do not drive at extremely high speeds.
 - Avoid sudden acceleration.
 - Do not drive continuously in the low gears.
 - Do not drive at a constant speed for extended periods.

n **Drum-in-disc type parking brake system**

Your vehicle has a drum-in-disc type parking brake system. This type of brake system needs bedding-down of the brake shoes periodically or whenever the parking brake shoes and/or drum are replaced. Have your Lexus dealer perform the bedding down.

n **Operating your vehicle in a foreign country**

Comply with the relevant vehicle registration laws and confirm the availability of the correct fuel. (→P. 409)

n **Normal characteristics after turning off the engine**

Approximately five hours after the engine is turned off, you may hear sound coming from under the vehicle for several minutes. This is because fuel evaporation leakage check is performed. It does not indicate a malfunction.

! CAUTION**n When starting the vehicle**

With automatic transmission vehicles, always keep your foot on the brake pedal while stopped with the engine running. This prevents the vehicle from creeping.

n When driving the vehicle

- I** Do not drive if you are unfamiliar with the location of the brake and accelerator pedals to avoid depressing the wrong pedal.
 - Accidentally depressing the accelerator pedal instead of the brake pedal will result in sudden acceleration that may lead to an accident that could result in death or serious injury.
 - When backing up, you may twist your body around, leading to a difficulty in operating the pedals. Make sure to operate the pedals properly.
 - Make sure to keep a correct driving posture even when moving the vehicle only slightly, allowing you to depress the brake and accelerator pedals properly.
 - Depress the brake pedal using your right foot. Depressing the brake pedal using your left foot may delay response in an emergency, resulting in an accident.
- I** Do not drive the vehicle over or stop the vehicle near flammable materials.
- I** With automatic transmission vehicles, do not let the vehicle roll backwards while the shift lever is in a driving position, or roll forward while the shift lever is in R. Doing so may cause the engine to stall or lead to poor brake and steering performance, resulting in an accident or damage to the vehicle.
- I** If the smell of exhaust is noticed inside the vehicle, open the windows and check that the trunk is closed. Large amounts of exhaust in the vehicle can cause driver drowsiness and an accident, resulting in death or a serious health hazard. Have the vehicle inspected by your Lexus dealer immediately.
- I** Do not under any circumstances shift the shift lever to P, R or N (automatic transmission vehicles) or R (manual transmission vehicles) while the vehicle is moving. Doing so can cause significant damage to the transmission system and may result in a loss of vehicle control.
- I** Do not shift the shift lever to N while the vehicle is moving. Doing so may cause the engine brake to not operate properly and lead to an accident.

CAUTION

- I** Do not turn the engine off while driving.
The power steering and brake booster system will not operate properly if the engine is not running.
- I** Use engine braking (downshift) to maintain a safe speed when driving down a steep hill.
Using the brakes continuously may cause the brakes to overheat and lose effectiveness. (→P. 123)
- I** When stopped on an inclined surface, use the brake pedal and parking brake to prevent the vehicle from rolling backward or forward and causing an accident.
- I** Do not adjust the position of the steering wheel, the seat, or the inside or outside rear view mirrors while driving.
Doing so may result in a loss of vehicle control that can cause accidents that may result in death or serious injury.
- I** Always check that all passengers' arms, heads or other parts of their bodies are not outside the vehicle, as this may result in death or serious injury.
- I** Do not drive the vehicle off-road.
This is not a AWD vehicle designed for real off-road driving. Proceed with all due caution if it becomes unavoidable to drive off-road.
- I** Do not drive across river crossings or through other bodies of water.
This may cause electric/electronic components to short circuit, damage the engine or cause other serious damage to the vehicle.
- I** Do not drive in excess of the speed limit. Even if the legal speed limit permits it, do not drive over 85 mph (140 km/h) unless your vehicle has high-speed capability tires. Driving over 85 mph (140 km/h) may result in tire failure, loss of control and possible injury. Be sure to consult a tire dealer to determine whether the tires on your vehicle are high-speed capability tires or not before driving at such speeds.
- n** **When driving on slippery road surfaces**
 - I** Sudden braking, acceleration and steering may cause tire slippage and reduce your ability to control the vehicle, resulting in an accident.
 - I** Sudden changes in engine speed, such as engine braking caused by up-shifting or down-shifting, may cause the vehicle to skid, resulting in an accident.
 - I** After driving through a puddle, lightly depress the brake pedal to make sure that the brakes are functioning properly. Wet brake pads may prevent the brakes from functioning properly. If the brakes on only one side are wet and not functioning properly, steering control may be affected, resulting in an accident.

! CAUTION**n When shifting the shift lever**

With automatic transmission vehicles, be careful not to shift the shift lever with the accelerator pedal depressed.

This may lead to unexpected rapid acceleration of the vehicle that may cause an accident and result in death or serious injury.

n When the vehicle is stopped

I Do not race the engine.

If the vehicle is in any gear other than P (vehicles with an automatic transmission only) or N the vehicle may accelerate suddenly and unexpectedly, and may cause an accident.

I Do not leave the vehicle with the engine running for a long time.

If such a situation cannot be avoided, park the vehicle in an open space and check that exhaust fumes do not enter the vehicle interior.

I With automatic transmission vehicles, always keep a foot on the brake pedal while the engine is running to prevent an accident caused by the vehicle moving.

n When the vehicle is parked

I Do not leave glasses, cigarette lighters, spray cans, or soft drink cans in the vehicle when it is in the sun.

Doing so may result in the following.

- Gas may leak from a cigarette lighter or spray can, and may lead to a fire.
- The temperature inside the vehicle may cause the plastic lenses and plastic material of eye glasses to deform or crack.
- Soft drink cans may fracture, causing the contents to spray over the interior of the vehicle, and may also cause a short circuit in the vehicle's electrical components.

I Always apply the parking brake, shift the shift lever to P (vehicles with an automatic transmission only), stop the engine and lock the vehicle.

Do not leave the vehicle unattended while the engine is running.

I Do not touch the exhaust pipe while the engine is running or immediately after turning the engine off.

Doing so may cause burns.

CAUTION

I Do not leave the engine running in an area with snow build-up, or where it is snowing. If snowbanks build up around the vehicle while the engine is running, exhaust gases may collect and enter the vehicle. This may lead to death or a serious health hazard.

n Exhaust gases

Exhaust gases include harmful carbon monoxide (CO) that is colorless and odorless. Inhaling exhaust gases may lead to death or a serious health hazard.

I If the vehicle is in a poorly ventilated area, stop the engine. In a closed area, such as a garage, exhaust gases may collect and enter the vehicle. This may lead to death or a serious health hazard.

I The exhaust should be checked occasionally. If there is a hole or crack caused by corrosion, damage to a joint or abnormal exhaust noise, be sure to have the vehicle inspected and repaired by your Lexus dealer. Failure to do so may allow exhaust gases to enter the vehicle, resulting in death or a serious health hazard.

n When taking a nap in the vehicle

Always turn the engine off. Otherwise, you may accidentally move the shift lever or depress the accelerator pedal, which could cause an accident or fire due to engine overheating. Additionally, if the vehicle is parked in a poorly ventilated area, exhaust gases may collect and enter the vehicle, leading to death or a serious health hazard.

n When braking the vehicle

I When the brakes are wet, drive more cautiously.

Braking distance increases when the brakes are wet, and may cause one side of the vehicle to brake differently than the other side. Also the parking brake may not securely hold the vehicle.

I If the power brake assist function does not operate, do not follow other vehicles closely and avoid downhills or sharp turns that require braking.

In this case, braking is still possible, but it will require more force on the pedal than usual. Braking distance may also increase.

I Do not pump the brake pedal if the engine stalls.

Each push on the brake pedal uses up the reserve for the power-assisted brakes.

⚠ CAUTION

I The brake system consists of 2 individual hydraulic systems: if one of the systems fails, the other will still operate. In this case, the brake pedal should be depressed more firmly than usual and braking distance becomes longer.
Do not drive your vehicle with only a single brake system. Have your brakes fixed immediately.

n If the vehicle becomes stuck or bogged (AWD models)

Do not spin the wheels recklessly when any of the tires is up in the air, or stuck in sand or mud, etc. This may damage the drive system components or propel the vehicle forward (or in another direction) and cause an accident.

⚠ NOTICE**n When driving the vehicle**

I With manual transmission vehicles, do not rest your foot on the clutch pedal while driving.
Doing so may cause clutch trouble.

I With manual transmission vehicles, do not use any gears other than the first gear when starting off and moving forward.
Doing so may damage the clutch.

I With automatic transmission vehicles, do not use the accelerator pedal or depress accelerator and brake pedals together to hold the vehicle on a hill.

I With manual transmission vehicles, do not use the clutch to hold the vehicle when stopping on an uphill grade.

n When parking the vehicle

With automatic transmission vehicles, always put the shift lever in P. Failure to do so may cause the vehicle to move or the vehicle may accelerate suddenly if the accelerator pedal is accidentally depressed.

n Avoiding damage to vehicle parts

I Do not turn the steering wheel fully in either direction and hold it there for a long time.
Doing so may damage the power steering motor.

I When driving over bumps in the road, drive as slowly as possible to avoid damaging the wheels, underside of the vehicle, etc.

NOTICE

n If you hear a squealing or scraping noise (brake pad wear limit indicators)

Have your Lexus dealer check and replace the brake pads as soon as possible. The rotor damage can result if the pads are not replaced when needed.

Front brake only: Moderate levels of the brake pad and disc wear allow enhanced front braking power. As a result, the discs may wear more quickly than conventional brake discs. Therefore, when replacing the brake pads, Lexus recommends that you also have the thickness of the discs measured.

It is dangerous to drive the vehicle when the wear limits of the brake pads and/or that of the brake discs are exceeded.

n If you get a flat tire while driving

A flat or damaged tire may cause the following situations. Hold the steering wheel firmly and gradually press the brake pedal to slow down the vehicle.

1 It may be difficult to control your vehicle.

1 The vehicle will make abnormal sounds.

1 The vehicle will behave abnormally.

Replace a flat tire with a new one. (→P. 384)

n When encountering flooded roads

Do not drive on a road that has flooded after heavy rain etc. Doing so may cause the following serious damage to the vehicle.

1 Engine stalling

1 Short in electrical components

1 Engine damage caused by water immersion

In the event that you drive on a flooded road and the vehicle is flooded, be sure to have your Lexus dealer check the following.

1 Brake function

1 Changes in quantity and quality of oil and fluid used for the engine, transmission, differential, etc.

1 Lubricant condition for the propeller shaft, bearings and suspension joints (where possible) and the function of all joints, bearings, etc.

2-1. Driving procedures

Engine (ignition) switch

Modes can be switched by pressing the “ENGINE START STOP” switch when carrying the electronic key on your person. (The engine can be started in any mode by operating the switch at the same time as depressing the brake pedal or clutch pedal.)

n Starting the engine

► Automatic transmission

STEP 1 Check that the parking brake is set.

STEP 2 Check that the shift lever is set in P.

STEP 3 Sit in the driver’s seat and firmly depress the brake pedal.

The “ENGINE START STOP” switch indicator turns green.

STEP 4



Press the “ENGINE START STOP” switch.



► Manual transmission

STEP 1 Check that the parking brake is set.

STEP 2 Check that the shift lever is set in N.

STEP 3 Firmly depress the clutch pedal.

The “ENGINE START STOP” switch indicator turns green.

STEP 4

Press the “ENGINE START STOP” switch.



n Changing “ENGINE START STOP” switch mode

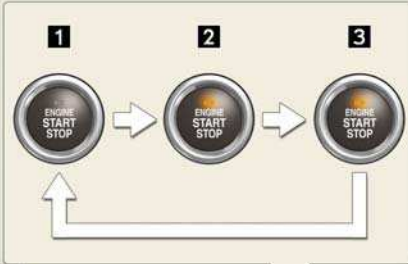

1 OFF*

Emergency flashers can be used.

2 ACCESSORY mode

Some electrical components such as the audio system can be used.

The “ENGINE START STOP” switch indicator turns amber.

3 IGNITION ON mode

All electrical components can be used.

The “ENGINE START STOP” switch indicator turns amber.

*: The engine cannot be switched to OFF unless the shift lever is in P.

n **If the engine does not start**

The engine immobilizer system may not have been deactivated. (→P. 72)

n **When the “ENGINE START STOP” switch indicator flashes in amber**

The system may be malfunctioning. Have the vehicle inspected by your Lexus dealer immediately.

n **Auto power OFF function**

If the vehicle is left in ACCESSORY mode for more than an hour with the shift lever in P, the “ENGINE START STOP” switch will automatically turn OFF.

n **Electronic key battery depletion**

→P. 28

n **When the electronic key battery is fully discharged**

→P. 325

n **Conditions affecting operation**

→P. 26

n **Note for the entry function**

→P. 29

CAUTION

n **When starting the engine**

Always start the engine while sitting in the driver's seat. Do not press the accelerator while starting the engine under any circumstances.

Doing so may cause an accident resulting in death or serious injury.

n **Stopping the engine in an emergency**

If you want to stop the engine in an emergency while driving the vehicle, push and hold the “ENGINE START STOP” switch for more than 3 seconds.

However, do not touch the “ENGINE START STOP” switch while driving except in an emergency. If the engine stops while the vehicle is being driven, this could lead to an unexpected accident.

 NOTICE**n To prevent battery discharge**

Do not leave the "ENGINE START STOP" switch in ACCESSORY or IGNITION ON mode for long periods without the engine running.

n When starting the engine

I Do not race a cold engine.

I If the engine becomes difficult to start or stalls frequently, have the engine checked immediately.

2-1. Driving procedures

Automatic Transmission (if equipped)

Select a shift position appropriate for the driving conditions.

n Shifting the shift lever

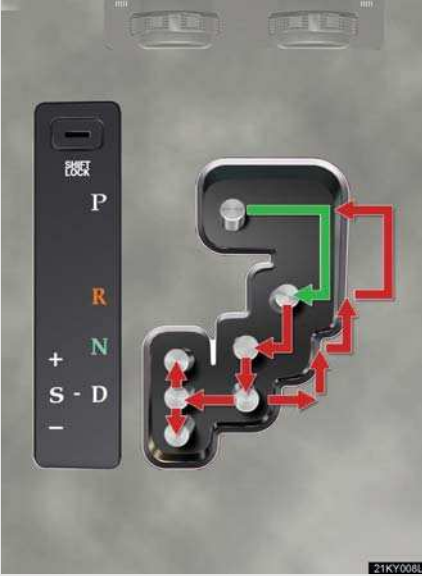

While the “ENGINE START STOP” switch is in IGNITION ON mode, depress the brake pedal and move the shift lever.

n Shift position uses

Shift position	Function
P	Parking the vehicle or starting the engine
R	Reversing
N	Neutral
D	Normal driving ^{*1}
S	S mode driving ^{*2} (→P. 124)

- *1: To improve fuel consumption and reduce noises, set the shift lever in the D position for normal driving.
- *2: Selecting shift ranges using S mode restricts the upper limit of the possible gear ranges, controls engine braking forces, and prevents unnecessary upshifting.

n Selecting a driving mode

The following patterns can be selected to suit current driving and operating conditions.



- 1** Power mode
For powerful acceleration and driving in mountainous regions.
- 2** Normal mode
- 3** Snow mode
For accelerating and driving on slippery road surfaces, such as on snow.
Press "SNOW" to return to normal mode.

Changing shift ranges in S mode

Shift the shift lever to the S position and operate the shift lever or shift paddle switch.

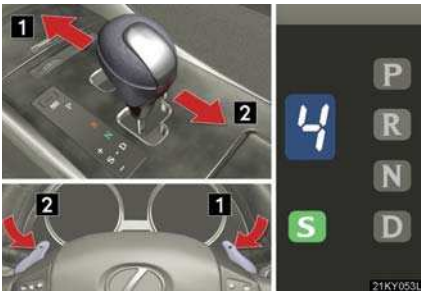

- 1 Upshifting
- 2 Downshifting

The initial shift range in S mode is automatically set to 5 or 4 according to vehicle speed. However, the initial shift range may be set to 3 or 2 if the AI-SHIFT has operated while the shift lever was in the D position. (→P.125)

n Shift ranges and their functions

Shift range	Function
6	Automatically selecting gears between 1 and 6 according to vehicle speed and driving conditions.
5	Automatically selecting gears between 1 and 5 according to vehicle speed and driving conditions.
4	Automatically selecting gears between 1 and 4 according to vehicle speed and driving conditions.
3	Automatically selecting gears between 1 and 3 according to vehicle speed and driving conditions.
2	Automatically selecting gears between 1 and 2 according to vehicle speed and driving conditions.
1	Setting the gear at 1.

A lower shift range will provide greater engine braking forces than a higher shift range.

n Gear position display when driving in S mode

The current gear is displayed on the multi-information display. (→P. 142)

n Downshifting restrictions warning buzzer (in the S mode)

To help ensure safety and driving performance, downshifting operation may sometimes be restricted. In some circumstances, downshifting may not be possible even when the shift lever or shift paddle switch is operated. (The warning buzzer will sound twice.)

n When driving with the cruise control system or dynamic radar cruise control system

The engine brake will not operate in the S mode, even when downshifting to 5 or 4. (→P. 152, 155)

n Snow mode automatic deactivation

Snow mode is automatically deactivated if the "ENGINE START STOP" switch is turned off after driving in snow mode.

n If the shift lever cannot be shifted from P

→P. 392

n If **S** does not come on even after shifting the shift lever to S

This may indicate a malfunction in the automatic transmission system. Have the vehicle inspected by your Lexus dealer immediately.

(In this situation, the vehicle will operate as if the shift lever is in D.)

n AI-SHIFT

The AI-SHIFT automatically shifts the gear to the optimal position according to the driver performance and driving conditions.

The AI-SHIFT automatically operates when the shift lever is in the D position. (Shifting the shift lever to the S position cancels the function.)

2-1. Driving procedures

Manual Transmission (if equipped)

n Shifting the shift lever

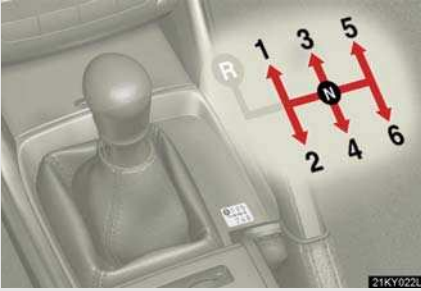

Fully depress the clutch pedal before operating the shift lever, and then release it slowly.

n Shifting the shift lever into R

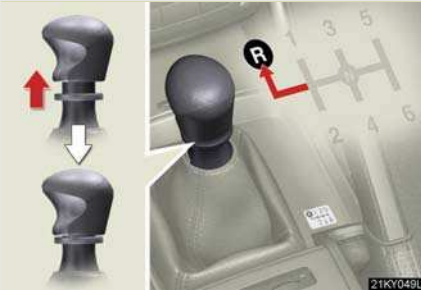

Shift the shift lever into the R position while lifting up the ring section.

Snow mode



The snow mode is used for accelerating and driving on slippery road surfaces, such as on snow.

Push the switch once more to return to normal mode.

n Maximum downshifting speed

Adhere to the downshifting speeds in the following table in order to prevent over-revving the engine.

Shift position	mph (km/h)	
	Maximum speed	
1	33 (54)	
2	56 (90)	
3	83 (134)	
4	108 (172)	

2

When driving

2-1. Driving procedures

Turn signal lever

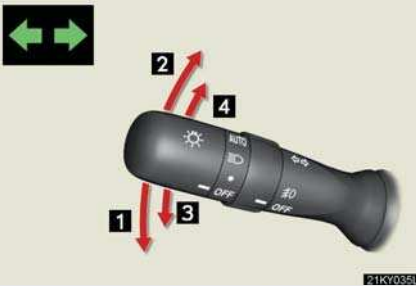

- 1 Left turn
- 2 Right turn
- 3 Move and hold the lever part-way to signal a lane change
The left hand signal will flash until you release the lever.
- 4 Move and hold the lever part-way to signal a lane change
The right hand signal will flash until you release the lever.

n Turn signals can be operated when

The "ENGINE START STOP" switch is in IGNITION ON mode.

n If the indicators flash faster than usual

Check that a light bulb in the front or rear turn signal lights has not burned out.

2-1. Driving procedures

Parking brake

▶ Automatic transmission

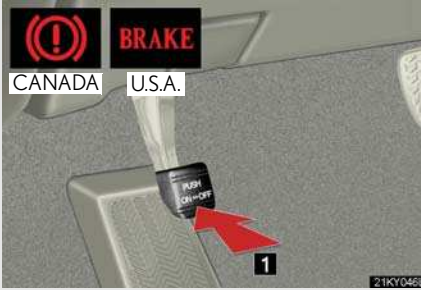

- 1 Sets the parking brake* (Depressing the pedal again releases the parking brake.)

*: Fully depress the parking brake pedal with your left foot while depressing the brake pedal with your right foot.

▶ Manual transmission

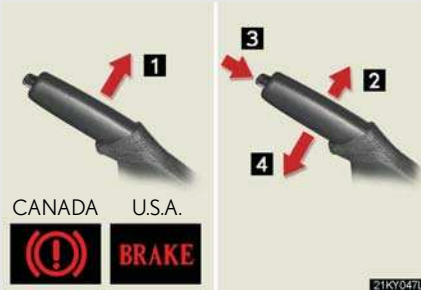

- 1 Sets the parking brake
Fully set the parking brake while depressing the brake pedal.
- 2 3 4 Releases the parking brake

⚠ NOTICE

n Before driving

Fully release the parking brake.

Driving the vehicle with the parking brake set will lead to brake components overheating, which may affect braking performance and increase brake wear.

2-2. Instrument cluster

Gauges and meters



The units used on the speedometer and the tachometer gauge display may differ depending on the model/type.

The following gauges, meters and display illuminate when the “ENGINE START STOP” switch is in IGNITION ON mode.

1 Speedometer

Displays the vehicle speed.

2 Multi-information display

→P.139

3 Tachometer

Displays the engine speed in revolutions per minute.

4 Tacho indicator

When the set engine speed is reached, this ring-shaped indicators comes on in yellow. The indicator comes on in red when the engine speed reaches a dangerous range.

5 Engine coolant temperature gauge

Displays the engine coolant temperature.

6 Odometer and trip meter

Odometer: Displays the total distance the vehicle has been driven.

Trip meter: Displays the distance the vehicle has been driven since the meter was last reset. Trip meters "A" and "B" can be used to record and display different distances independently.

7 Speed indicator

When the set speed is reached while driving, this ring-shaped indicator comes on in yellow. The indicator comes on in red when the vehicle speed reaches the dangerous range.

8 Fuel gauge

Displays the quantity of fuel remaining in the tank.

9 Odometer/trip meter and trip meter reset button

Switches between odometer and trip meter displays. Pushing and holding the button will reset the trip meter when the trip meter is being displayed.

Instrument panel light control

The brightness of the instrument panel lights can be adjusted.



1 Darker

2 Brighter

Speed and tacho indicators

n Turning the indicator on/off



Bring up the satellite switch mode on the multi-information display.

Press <, > or the “ON/OFF” button.

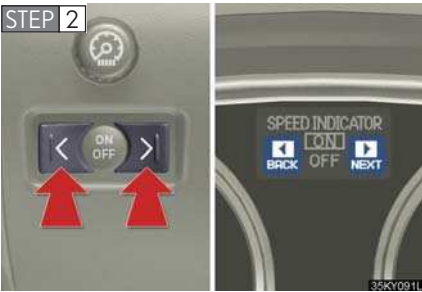

Select the item whose setting is to be changed.

Press < or > to display the item whose setting is to be changed.

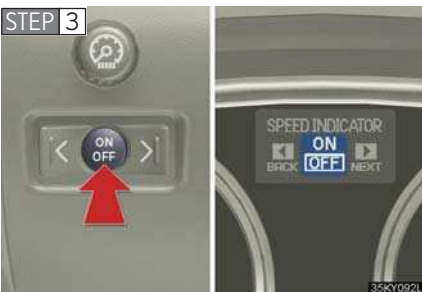

Change the settings.

Press “ON/OFF” button to change the settings (e.g. on/off).

n Changing the indicator setting

The satellite switch can be used to change the set speed at which the yellow speed or tacho indicator ring comes on.

The setting can be made only when the “ENGINE START STOP” switch is in IGNITION ON mode and the vehicle is stopped.

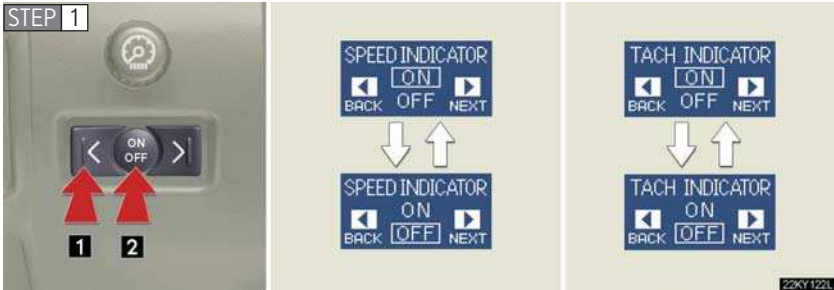

Push < or > to select the speed or tacho indicator set mode. (1) Turn the speed or tacho indicator to “OFF” and then “ON” by pushing the “ON/OFF” button. (2)

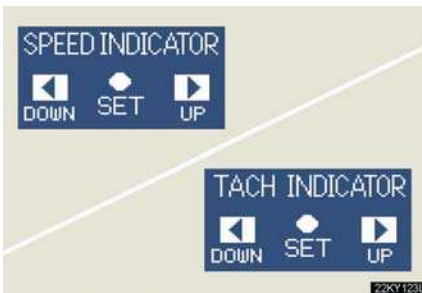

After one second, the mode enters the indicator setting mode.

The speedometer or tachometer needle moves to the previously set speed.



Push < or > within 6 seconds of the speedometer or tachometer needle moving to change the setting of the desired speed, then turn the indicator mode to “ON” by pushing the “ON/OFF” button.

Pushing and holding the switch changes values at a faster rate.

If the satellite switch is not operated for some time, the multi-information display returns to its previously displayed content.



The yellow indicator is displayed to indicate that the desired speed has been set.

■ Speed indicator display conditions and vehicle speed setting range

Vehicle speed setting range: Approximately 30 to 100 mph
(approximately 50 to 160 km/h)

When the maximum speed is selected, the speed indicator comes on only in red.

■ Tacho indicator display conditions and engine speed setting range

Engine rpm setting range: Approximately 2000 to 6500 rpm (r/min)

When the maximum rpm is selected, the tacho indicator comes on only in red.

 NOTICE**n To prevent damage to the engine and its components**

- l** Do not let the indicator needle of the tachometer enter the red zone, which indicates the maximum engine speed.
- l** The engine may be overheating if the temperature gauge is in the red zone (H). In this case, immediately stop the vehicle in a safe place, and check the engine after it has cooled completely. (→P. 400)

2-2. Instrument cluster

Indicators and warning lights

The indicator and warning lights on the instrument cluster and center panel inform the driver of the status of the vehicle's various systems.

► Instrument cluster



The units used on the speedometer and the tachometer gauge display may differ depending on the model/type.

► Center panel



n Indicators

The indicators inform the driver of the operating state of the vehicle's various systems.



Turn signal indicator
(→P. 128)



Headlight high beam indicator (→P. 143)



Headlight indicator
(U.S.A.) (→P. 143)



(CANADA)

Tail light indicator
(→P. 143)



Front fog light indicator
(→P. 146)



(vehicles with an automatic transmission)

Shift position and shift range indicators (→P. 122)



(vehicles with an automatic transmission)

"ECT SNOW" indicator
(→P. 123)



(vehicles with a manual transmission)

"ETCS SNOW" indicator
(→P. 126)



(vehicles with an automatic transmission)

"ECT PWR" indicator
(→P. 123)



Cruise control indicator
(→P. 152)



(if equipped)

"AFS OFF" indicator light
(→P. 144)



(if equipped)

Intuitive parking assist indicator (→P. 164)



Slip indicator (→P. 171)



"VSC OFF" indicator
(→P. 172)



SRS airbag on-off indicator (→P. 90)

n Warning lights

Warning lights inform the driver of malfunctions in any of the vehicle's systems. (→P. 360)

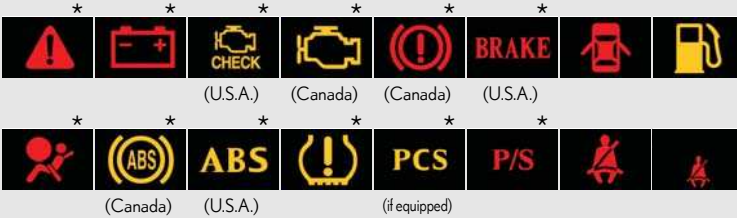

*: These lights turn on when the “ENGINE START STOP” switch is turned to IGNITION ON mode to indicate that a system check is being performed. They will turn off after the engine is started, or after a few seconds. There may be a malfunction in a system if a light does not come on, or if the lights do not turn off. Have the vehicle inspected by your Lexus dealer.

! CAUTION

n If a safety system warning light does not come on

Should a safety system light such as the ABS and SRS warning light not come on when you start the engine, this could mean that these systems are not available to help protect you in an accident, which could result in death or serious injury. Have the vehicle inspected by your Lexus dealer immediately if this occurs.

Multi-information display

The multi-information display presents the driver with a variety of driving-related data, including the current outside air temperature.



1 Trip information (→P.140)

Displays driving range, fuel consumption and other cruising related information.

1 Satellite switch mode display (→P.245)

This switch is used to configure various function settings.

1 Intuitive parking assist display (if equipped)

Automatically displayed when using intuitive parking assist.

1 Dynamic radar cruise control display (if equipped) (→P.155)

Automatically displayed when using dynamic radar cruise control.

1 Warning messages (→P.369)

Automatically displayed when a malfunction occurs in one of the vehicle's systems.

Trip information

- ▶ Without navigation system



Display items can be switched by pushing the "DISP" switch.

- ▶ With navigation system



n Outside temperature



Displays the outside air temperature.

The temperature range that can be displayed is from -40°F (40°C) to 122°F (50°C).

When the temperature drops to 37°F (3°C), the digits of the display will flash for 10 seconds.

n Driving range



Displays the estimated maximum distance that can be driven with the quantity of fuel remaining.

- This distance is computed based on your average fuel consumption. As a result, the actual distance that can be driven may differ from that displayed.
- When only a small amount of fuel is added to the tank, the display may not be updated.

n Average fuel consumption



Displays the average fuel consumption since the function was reset.

The function can be reset by pushing the "DISP" switch for longer than one second when the average fuel consumption is displayed.

n Average fuel consumption after refueling



Displays the average fuel consumption since the vehicle was last refueled.

n Current fuel consumption



Displays the current rate of fuel consumption.

n Average vehicle speed



Displays the average vehicle speed since the engine was started or the function was reset.

The function can be reset by pushing the "DISP" switch for longer than one second when the average vehicle speed is displayed.

**n Gear position display
(vehicles with an automatic transmission only)**



Indicates the current gear, and the range of gears that is available when the shift lever is in the S or D position. the gear range is shown by the number of dots (•) and the current gear is shown as a number. The transmission automatically selects the gears within the driver selected gear range.

In the illustration to the left, a range of 6 available gears (1 through 6) has been selected by the driver. (The shift lever is in the D or S position with 6 ranges enabled) It is possible for the transmission to automatically select between all 6 of the gears. In this case, the transmission has selected third gear.

n System check display

After switching the “ENGINE START STOP” switch to IGNITION ON mode, “CHECK” is displayed while system operation is checked. When the system check is complete, “COMPLETED” is displayed before returning to the normal screen.

! CAUTION

n The information display at low temperatures

Allow the interior of the vehicle to warm up before using the liquid crystal information display. At extremely low temperatures, the information display monitor may respond slowly, and display changes may be delayed.

For example, there is a lag between the driver’s shifting and the new gear number appearing on the display. This lag could cause the driver to downshift again, causing rapid and excessive engine braking and possibly an accident resulting in personal death or injury.

2-3. Operating the lights and windshield wipers

Headlight switch

The headlights can be operated manually or automatically.

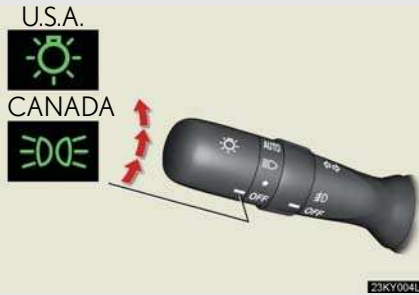

● The side marker, parking, tail, license plate and instrument panel lights turn on.

☰☉ The headlights and all lights listed above turn on.

AUTO The headlights and parking lights turn on and off automatically. (When the “ENGINE START STOP” switch is in IGNITION ON mode)

2

When driving

Turning on the high beam headlights

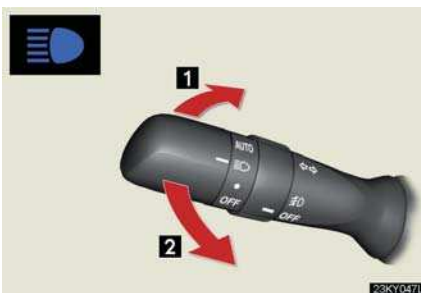

1 With the headlights on, push the lever forward to turn on the high beams.

Pull the lever back to the center position to turn the high beams off.

2 Pull the lever toward you to turn on the high beams.

Release to turn them off. You can flash the high beams with the headlights on or off.

AFS (vehicles with discharge headlights)

AFS (Adaptive Front-lighting System) improves visibility at intersections and on curves by automatically adjusting the level of the headlights according to vehicle speed and the degree of the tire angle that are controlled by steering input.

Operates at speeds of 6 mph (10 km/h) or higher.

n Deactivating AFS

How to switch: →P. 245

**AFS
OFF** turns on when the AFS is deactivated.

n Daytime running light system

To make your vehicle more visible to other drivers, the headlights turn on automatically (at a reduced intensity) whenever the engine is started and the parking brake is released. Daytime running lights are not designed for use at night.

n Headlight control sensor



The sensor may not function properly if an object is placed on the sensor, or anything that blocks the sensor is affixed to the windshield.

Doing so interferes with the sensor detecting the level of ambient light and may cause the automatic headlight system to malfunction.

n Automatic light off system

- l When the headlights come on: The headlights and tail lights turn off 30 seconds after a door is opened and closed if the “ENGINE START STOP” switch has been switched to ACCESSORY mode or turned OFF. (The light turns off immediately if  on the key is pressed after all doors are locked.)
- l When only the tail lights come on: The tail lights turn off automatically if the “ENGINE START STOP” switch is switched to ACCESSORY mode or turned OFF and driver’s door is opened.

To turn the lights on again, switch to IGNITION ON mode, or turn the light switch off once and then back to ● or .

n Automatic headlight leveling system (vehicles with discharge headlights)

The level of the headlights is automatically adjusted according to the number of passengers and the loading condition of the vehicle to ensure that the headlights do not interfere with other road users.

n If flashes... (vehicles with discharge headlights)

It may indicate a malfunction in the system. Contact your Lexus dealer.

n Customization that can be configured at Lexus dealer

Settings (e.g. light sensor sensitivity) can be changed. (Customizable features →P. 436)

NOTICE

n To prevent battery discharge

Do not leave the lights on longer than necessary when the engine is not running.

2-3. Operating the lights and windshield wipers

Fog light switch

The fog lights improve visibility in difficult driving conditions, such as in rain or fog. They can be turned on only when the headlights are on low beam.

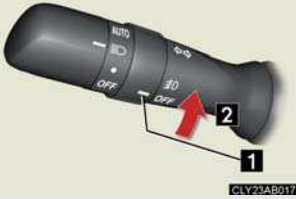

- 1 To turn the front fog lights off
- 2 To turn the front fog lights on

2-3. Operating the lights and windshield wipers

Windshield wipers and washer

n Intermittent wiper with interval adjuster (if equipped)

Wiper intervals can be adjusted for intermittent operation (when "INT" is selected).



- 1 Intermittent windshield wiper interval adjustment (increase)
- 2 Intermittent windshield wiper interval adjustment (decrease)
- 3 Intermittent windshield wiper operation
- 4 Low speed windshield wiper operation
- 5 High speed windshield wiper operation
- 6 Temporary operation
- 7 Wash/wipe operation

Wipers operate automatically. (After operating several times, the wipers operate one more time after a short delay to prevent dripping.)

n Rain-sensing windshield wipers (if equipped)

With “AUTO” selected, the wipers will operate automatically when the sensor detects falling rain. The system automatically adjusts wiper timing in accordance with rain volume and vehicle speed.



- 1 Sensor sensitivity (low)
- 2 Sensor sensitivity (high)
- 3 Rain-sensing wiper operation
- 4 Low speed wiper operation
- 5 High speed wiper operation
- 6 Temporary operation
- 7 Wash/wipe operation

Wipers operate automatically. (After operating several times, the wipers operate one more time after a short delay to prevent dripping.)

n The windshield wiper and washer can be operated when

The “ENGINE START STOP” switch is in IGNITION ON mode.

n Effects of vehicle speed on wiper operation

Vehicle speed affects the following even when the wipers are not in “AUTO” mode.

- 1 Intermittent wiper interval (“INT” mode)
- 1 Wiper operation when the washer is being used (delay until drip prevention wiper sweep occurs)

With “LO” selected, wiper operation will be switched from low speed to intermittent wiper operation only when the vehicle is stationary. (However, the mode cannot be switched when the adjustment dial for the intermittent wiper interval is set to the lowest setting.)

- n **Rain drop sensor (vehicles equipped with the rain-sensing windshield wipers)**



The sensor judges the amount of raindrops.

- n **Outside rear view mirror defogger activation linked to windshield wiper operation**

The outside rear view mirror defogger automatically turns on when you operate the windshield wipers.

- n **If no windshield washer fluid sprays**

Check that the washer nozzles are not blocked if there is washer fluid in the windshield washer fluid reservoir.

- n **Customization that can be configured at Lexus dealer**

Settings (e.g. drip prevention function) can be changed. (Customizable features →P. 436)

CAUTION

- n **Caution regarding the use of windshield wipers in "AUTO" mode**

The windshield wipers may operate unexpectedly if the sensor is touched or the windshield is subject to vibration in "AUTO" mode. Take care that your fingers or anything else do not become caught in the windshield wipers.

NOTICE

n When the windshield is dry

Do not use the wipers, as they may damage the windshield.

n When there is no washer fluid spray from the nozzle

Damage to the washer fluid pump may be caused if the lever is pulled toward you and held continually.

n When using an automatic car wash

Set the wiper switch to "OFF".

If the wiper switch is in "AUTO", the wipers may operate and the wiper blades may be damaged.

2-3. Operating the lights and windshield wipers Headlight cleaner switch (if equipped)

Washer fluid can be sprayed on the headlights.



Press the switch to clean the headlights.

2

When driving

n The headlight cleaner can be operated when

When the "ENGINE START STOP" switch is in IGNITION ON mode and the headlight switch is turned on.

⚠ NOTICE

n When the washer fluid tank is empty

Do not use this function when the washer fluid tank is empty. This may cause the washer fluid pump to overheat.

2-4. Using other driving systems

Cruise control (if equipped)

Use the cruise control to maintain a set speed without using the accelerator.

n Set the vehicle speed



Turn the "ON-OFF" button on.

Push the button once more to deactivate the cruise control.

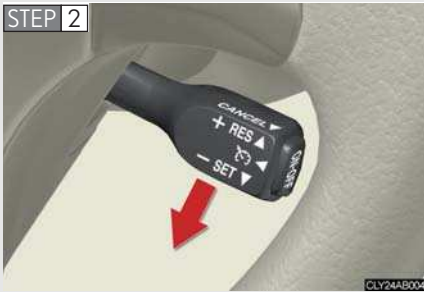

Accelerate or decelerate to the desired speed and press the lever down to set the cruise control speed.

n Adjusting the speed setting



1 Increase speed

2 Decrease speed

Hold the lever until the desired speed setting is obtained.

Fine adjustment of the set speed (approximately 1.0 mph [1.6 km/h]) can be made by lightly pressing the lever up or down and releasing it.

n Canceling and resuming regular acceleration

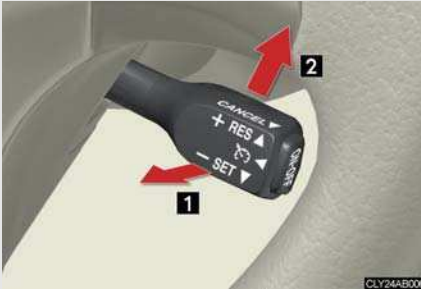

1 Cancel

Push the lever towards you to cancel cruise control.

The speed setting is also canceled when the brakes are applied or the clutch (manual transmission) is depressed.

2 Resume

To resume cruise control and return to the set speed, push the lever up.

2

When driving

n Cruise control can be set when

- 1 The shift lever is in the D or 4, 5 or 6 range of S. (vehicles with an automatic transmission)
- 1 Vehicle speed is between approximately 25 mph (40 km/h) and 125 mph (200 km/h).

n Accelerating

The vehicle can be accelerated normally.

n Automatic cruise control cancellation

The set speed is automatically cancelled in any of the following situations.

- 1 Actual vehicle speed falls more than 10 mph (16 km/h) below the preset vehicle speed
At this time, the memorized set speed is not retained.
- 1 Actual vehicle speed is below 25 mph (40km/h)
- 1 VSC is activated

n If the cruise control indicator light flashes

Turn the "ON-OFF" button off once, and then reactivate the system.

If the cruise control speed cannot be set or if the cruise control cancels immediately after being activated, there may be a malfunction in the cruise control system. Have the vehicle inspected by your Lexus dealer.

CAUTION

n To avoid operating the cruise control by mistake

Keep the "ON-OFF" button off when not in use.

n Situations unsuitable for cruise control

Do not use cruise control in any of the following situations.

Doing so may result in control of the vehicle being lost and could cause serious or fatal accident.

1 In heavy traffic

1 On roads with sharp bends

1 On slippery roads, such as those covered with rain, ice or snow

1 On steep hills

1 On winding roads

2-4. Using other driving systems

Dynamic radar cruise control (if equipped)

Dynamic radar cruise control supplements conventional cruise control with a vehicle-to-vehicle distance control. In the vehicle-to-vehicle distance control mode, the vehicle automatically accelerates or decelerates in order to maintain a set following distance from vehicles ahead.

1 Select cruise mode



Selecting vehicle-to-vehicle distance control mode

- 1 Turn the “ON-OFF” button on.

Push the button once more to deactivate.



Selecting conventional constant speed control mode

- 1 Turn the “ON-OFF” button on.

Push the button once more to deactivate.

Vehicle-to-vehicle distance control mode is always reset when the “ENGINE START STOP” switch is switched to IGNITION ON mode.

- 2 Switch to constant speed control mode.
(push and hold for approximately one second)

n Driving in the selected cruise control mode



Accelerate or decelerate the vehicle to the desired speed and press the lever down to set.

n Adjusting the speed setting



1 Increase speed

2 Decrease speed

To change the set speed, operate the lever until the desired set speed is displayed.

Fine Adjustment (1mph increments)

Momentarily move lever in desired direction and release

Coarse adjustment (5mph increments)

Hold the lever in the desired direction **Coarse adjustment** will continue to change the set speed approximately 5mph per second until the lever is released.

n Canceling and resuming the speed setting



1 Cancel

Push the lever towards you to cancel cruise control.

The setting is also canceled when the brakes are applied.

2 Resume

To resume cruise control and return to the set speed, push the lever up.

n Changing the vehicle-to-vehicle distance



Each push of the switch changes the vehicle-to-vehicle distance

1 Long

2 Medium

3 Short

The vehicle-to-vehicle distance is automatically set to the long mode when the "ENGINE START STOP" switch is switched to IGNITION ON mode.

A mark will be displayed to indicate the presence of the vehicle if a vehicle is running ahead of you.

Driving in vehicle-to-vehicle distance control mode

This mode employs a radar sensor to detect the presence of vehicles within 328 ft. (100 m) ahead and to judge the distance between your vehicle and those vehicles.

Note that vehicle-to-vehicle distance will close when traveling on long downhill slopes.

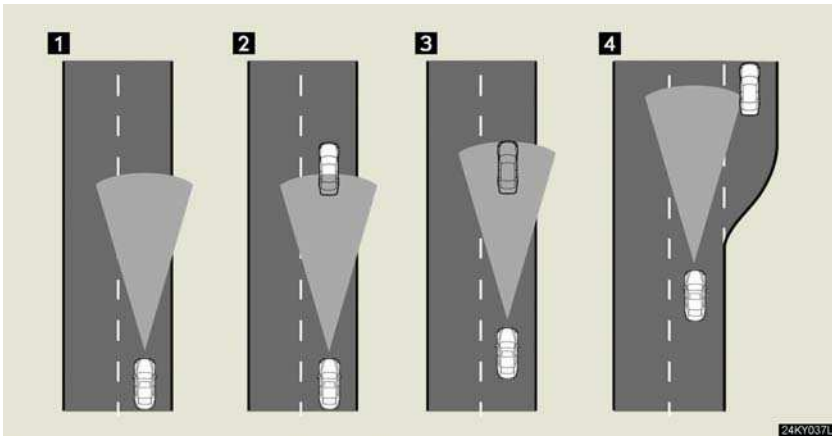

- 1 Example of constant speed cruising (when there are no vehicles ahead): When set to 62 mph (100 km/h)

The vehicle travels at the speed set by the driver. The desired vehicle-to-vehicle distance can also be set by operating the vehicle-to-vehicle distance switch.

- 2 Example of deceleration cruising (when the vehicle ahead is driving slower than the set speed): When fixed speed cruising is set at 62 mph (100 km/h) and the vehicle ahead is driving at 50 mph (80 km/h)

When a vehicle is detected running ahead of you, in the same lane, the system automatically decelerates your vehicle. When a greater reduction in vehicle speed is necessary, the system applies the brakes. A warning tone warns you when the system cannot decelerate sufficiently to prevent your vehicle from closing on the vehicle ahead.

- 3 Example of follow-up cruising (when following a vehicle driving slower than the set speed): When the speed is set to 62 mph (100 km/h) and the vehicle ahead is driving at 50 mph (80 km/h)

The system continues follow-up cruising while adjusting for changes in the speed of the vehicle ahead in order to maintain the vehicle-to-vehicle distance set by the driver.

- 4** Example of acceleration (when there are no longer vehicles driving slower than the set speed in the lane ahead): When the speed is set to 62 mph (100 km/h) and the vehicle ahead driving at 50 mph (80 km/h) is out of the lane

When the vehicle ahead of you executes a lane change, the system slowly accelerates until the set vehicle speed is reached. The system then returns to fixed speed cruising.

2

When driving

n **Dynamic radar cruise control warning lights, messages and buzzers**

Warning lights, messages and buzzers are used to indicate a system malfunction or to alert you to the need for caution while driving. (→P. 369)

n **The dynamic radar cruise can be set when**

- 1 The shift lever is in D or the 4, 5 or 6 range of S.
- 1 Vehicle speed is between approximately 30 mph (45 km/h) and 85 mph (135 km/h).

n **Accelerating**

The vehicle can be accelerated normally.

n **Automatically canceling vehicle-to-vehicle distance control**

Vehicle-to-vehicle distance control driving is automatically canceled in the following situations.

- 1 Vehicle speed falls below 25 mph (40 km/h)
- 1 VSC is activated
- 1 The sensor cannot operate correctly because it is covered in some way.
- 1 The windshield wipers are operating at high speed.
- 1 The "ECT SNOW" switch is set to snow mode.

If vehicle-to-vehicle distance control driving is automatically canceled for any other reason, there may be a malfunction in the system. Contact your Lexus dealer.

■ Automatically cancelling constant speed control

The set speed is automatically canceled in the following situations.

- 1 Actual vehicle speed is more than 10 mph (16 km/h) below the preset vehicle speed
At this time, the memorized set speed is not retained.
- 1 Vehicle speed falls below 25 mph (40 km/h)
- 1 VSC is activated

■ Vehicle-to-vehicle distance settings

Select a distance from the table below. Note that the distances shown correspond to a vehicle speed of 50 mph (80 km/h). Vehicle-to-vehicle distance increases/decreases in accordance with vehicle speed.

Distance options	Vehicle-to-vehicle distance
Long	Approximately 164 ft. (50 m)
Medium	Approximately 132 ft. (40 m)
Short	Approximately 100 ft. (30 m)

■ Radar sensor and grille cover

Always keep the sensor and grille cover clean to ensure that the vehicle-to-vehicle distance control operates properly. (Some obstructions, such as snow, ice or plastic objects, cannot be detected by the obstruction sensor.)

Dynamic radar cruise control is canceled if an obstruction is detected.



1 Grille cover

2 Radar sensor

n Certification

- ▶ For vehicles sold in U.S.A.

FCC WARNING

Changes or modifications not expressly approved by the party responsible for compliance could void the user's authority to operate the equipment.

FCC RF exposure information

This device complies with the FCC RF exposure requirements.

- ▶ For vehicles sold in Canada

Operation is subject to the following two conditions;

- (1) This device may not cause interference, and
- (2) This device must accept any interference received, including interference that may cause undesired operation of the device.

CAUTION

n Before using dynamic radar cruise control

Do not overly rely on vehicle-to-vehicle distance control.

Be aware of the set vehicle speed. If automatic deceleration/acceleration is not appropriate, adjust the vehicle speed, as well as the distance between your vehicle and vehicles ahead by applying the brakes, etc.

n To avoid inadvertent cruise control activation

Keep the "ON-OFF" button off when not in use.

CAUTION

n Situations unsuitable for dynamic radar cruise control

Do not use dynamic radar cruise control in any of the following situations. Doing so may result in inappropriate control of speed and could cause serious or fatal accident.

- I In heavy traffic
- I On roads with sharp bends
- I On winding roads
- I On slippery roads, such as those covered with rain, ice or snow
- I Where there are sudden changes between sharp up and down gradients
- I At entrances to expressways
- I When weather conditions are bad enough that they may prevent the sensors from functioning correctly (fog, snow, sandstorm, etc.)
- I Where buzzer can be heard often

n When the radar sensor may not be correctly detecting the vehicle ahead

Apply the brakes as necessary when any of the following types of vehicles are in front of you.

As the sensor may not be able to correctly detect these types of vehicles, the proximity alarm (→P. 369) will not be activated, and an accident may result.

- I Vehicles that cut in suddenly
- I Vehicles traveling at low speeds
- I Vehicles that are not moving
- I Vehicles with small rear ends (trailers with no load on board etc.)
- I Motorcycles traveling in the same lane

 **CAUTION**
n Conditions under which the vehicle-to-vehicle distance control may not function correctly

Apply the brakes as necessary in the following conditions as the radar sensor may not be able to correctly detect vehicles ahead, and an accident may result.

- l When water or snow thrown up by the surrounding vehicles hinders the functioning of the sensor
- l When your vehicle is pointing upwards (caused by a heavy load in the trunk, etc.)
- l When the road curves or when the lanes are narrow
- l When steering wheel operation or your position in the lane is unstable

n To ensure the radar sensor functions correctly

Do not do the following to the sensor or grille cover as doing so may cause the sensor not to function correctly and could result in an accident.

- l Stick or attach anything to them
- l Leave them dirty
- l Disassemble, subject them to strong shocks
- l Modify or paint them
- l Replace them with non-genuine parts

2-4. Using other driving systems

Intuitive parking assist (if equipped)

The distance to obstacles measured by the sensors is communicated via the multi-information display and a buzzer when parallel parking or maneuvering into a garage. Always check the surrounding area when using this system.

For vehicles equipped with a navigation system, refer to the separate “Navigation System Owner’s Manual” for further details.

n Types of sensors



- 1 Front corner sensors
- 2 Rear corner sensors
- 3 Back sensors

n Multi-information display (→P. 139)

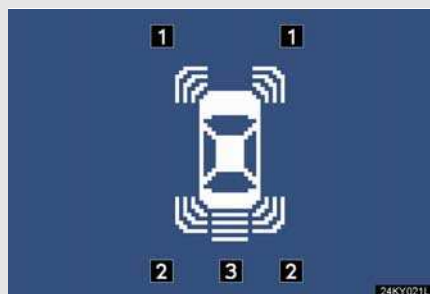

- 1 Front corner sensor operation
- 2 Rear corner sensor operation
- 3 Back sensor operation

n Intuitive parking assist switch (→P. 245)

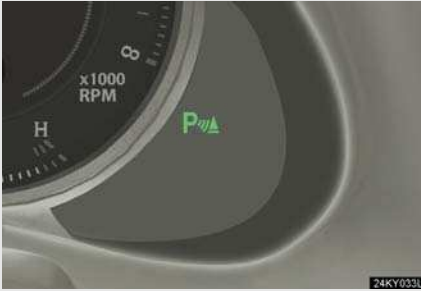

When on, an indicator is displayed to inform the driver that the function is operational.

The display and buzzer system

n Corner sensor operation display and distance to an obstacle

The system operates when the vehicle approaches within approximately 1.6 ft. (50 cm) of an obstacle.

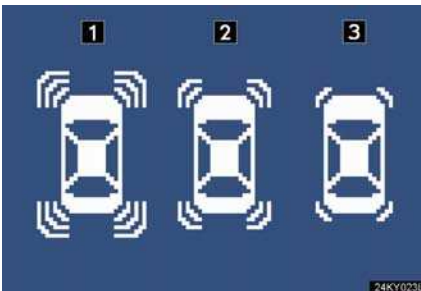

- 1 Approximately 1.2 ft. (37.5 cm) to 1.6 ft. (50 cm) from the obstacle
- 2 Approximately 0.8 ft. (25 cm) to 1.2 ft. (37.5 cm) from the obstacle
- 3 Flashing: Within 0.8 ft. (25 cm) of the obstacle

n Back sensor operation display and distance to an obstacle

The system operates when the vehicle approaches within approximately 4.9 ft. (150 cm) of an obstacle.

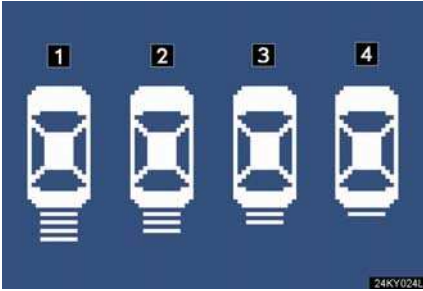

- 1** Approximately 2.0 ft. (60 cm) to 4.9 ft. (150 cm) from the obstacle
- 2** Approximately 1.5 ft. (45 cm) to 2.0 ft. (60 cm) from the obstacle
- 3** Approximately 1.1 ft. (35 cm) to 1.5 ft. (45 cm) from the obstacle
- 4** Flashing: Within 1.1 ft. (35 cm) of the obstacle

n Buzzer operation and distance to the obstacle

A buzzer sounds when the corner sensors and back sensor are operating.

- 1** The buzzer beeps faster as the vehicle approaches an obstacle. When the vehicle comes within the following distance of the obstacle, the buzzer sounds continuously.
 - Corner sensors: Approximately 0.8 ft. (25 cm)
 - Back sensors: Approximately 1.1 ft. (35 cm)
- 1** When two or more obstacles are detected simultaneously, the buzzer system responds to the nearest obstacle.

Detection range of the sensors

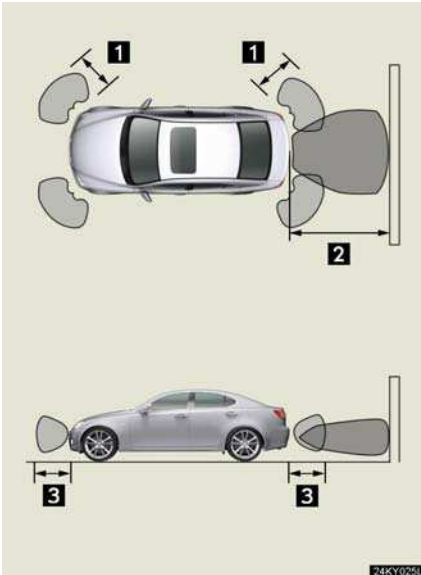

- ❶ Approximately 1.6 ft. (50 cm)
- ❷ Approximately 4.9 ft. (150 cm)
- ❸ Approximately 1.6 ft. (50 cm)

The diagram shows the detection range of the sensors. Note that the sensors cannot detect obstacles that are extremely close to the vehicle.

The range of the sensors may change depending on the shape of the object etc.

2

When driving

n **Sensor detection information**

l Certain vehicle conditions and the surrounding environment may affect the ability of the sensor to correctly detect obstacles. Particular instances where this may occur are listed below.

- There is dirt, snow or ice on the sensor.
- The sensor is frozen.
- The sensor is covered in any way.
- The vehicle is leaning considerably to one side.
- On an extremely bumpy road, on an incline, on gravel, or on grass.
- The vicinity of the vehicle is noisy due to vehicle horns, motorcycle engines, air brakes of large vehicles, or other loud noises producing ultrasonic waves.
- There is another vehicle equipped with parking assist sensors in the vicinity.
- The sensor is coated with a sheet of spray or heavy rain.
- The vehicle is equipped with a fender pole or wireless antenna.
- Towing eyelets are installed.
- The bumper or sensor receives a strong impact.
- The vehicle is approaching a tall or curved curb.
- In harsh sunlight or intense cold weather

In addition to the examples above, there are instances in which, because of their shapes, signs and other objects may be judged by the sensor to be closer than they are.

l The shape of the obstacle may prevent the sensor from detecting it. Pay particular attention to the following obstacles.

- Wires, fences, ropes etc.
- Cotton, snow and other materials that absorb radio waves
- Sharply-angled objects
- Low obstacles
- Tall obstacles with upper sections projecting outwards in the direction of your vehicle

n **When the display flashes and a message is displayed**

→P. 369

n **Certification (Canada only)**

This ISM device complies with Canadian ICES-001.

n Customization that can be configured at Lexus dealer

Settings (e.g. buzzer volume) can be changed. (Customizable features →P. 436)

⚠ CAUTION**n Caution when using the intuitive parking sensor**

Observe the following precautions.

Failing to do so may result in the vehicle being unable to be driven safely and possibly cause an accident.

I Do not use the sensor at speeds in excess of 6 mph (10 km/h).

I Do not attach any accessories within the sensor range.

⚠ NOTICE**n Notes when washing the vehicle**

Do not apply intensive bursts of water or steam to the sensor area.

Doing so may result in the sensor malfunctioning.

2-4. Using other driving systems

Driving assist systems

To help enhance driving safety and performance, the following systems operate automatically in response to various driving situations. Be aware, however, that these systems are supplementary and should not be relied upon too heavily when operating the vehicle.

n ABS (Anti-lock Brake System)

Helps to prevent wheel lock when the brakes are applied suddenly, or if the brakes are applied while driving on a slippery road surface.

n Brake assist

Generates an increased level of braking force after the brake pedal is depressed, when the system detects a panic stop situation.

n VSC (Vehicle Stability Control)

Helps the driver to control skidding when swerving suddenly or turning on slippery road surfaces.

n TRAC (Traction Control)

Maintains drive power and prevents the rear wheels (2WD models) or all wheels (AWD models) from spinning when starting the vehicle or accelerating on slippery roads.

n Hill-start assist control (vehicles with an automatic transmission)

Prevents the vehicle from rolling backwards when starting on an incline or slippery slope.

n EPS (Electric Power Steering)

Employs an electric motor to reduce the amount of effort needed to turn the steering wheel.

n VDIM (Vehicle Dynamics Integrated Management) (IS350)

Provides integrated control of the ABS, brake assist, TRAC, VSC, hill-start assist control, and EPS systems.

Maintains vehicle stability when swerving on slippery road surfaces by controlling the brakes and engine output.

n PCS (Pre-Collision System) (if equipped)

→P.176

When the VSC/TRAC/hill-start assist control systems are operating



If the vehicle is in danger of slipping, rolling backwards when starting on an incline, or if the rear wheels (2WD) or 4 wheels (AWD) spin, the slip indicator light flashes to indicate that the VSC/TRAC/hill-start assist control systems have been engaged.

A buzzer (intermittent) sounds to indicate that VSC is operating.

The stop lights and high mounted stoplight turn on when the hill-start assist control system is operating.

To disable TRAC and/or VSC

If the vehicle gets stuck in fresh snow or mud, TRAC and VSC may reduce power from the engine to the wheels. You may need to turn the system off to enable you to rock the vehicle in order to free it.

n Turning off TRAC



Quickly push and release the button to turn off TRAC.

The slip indicator light should come on.

Push the button again to turn the system back on.

n Turning off TRAC and VSC



Push and hold the button for more than 3 seconds while the vehicle is stopped to turn off TRAC and VSC.

The slip indicator light and "VSC OFF" indicator light should come on.

Push the button again to turn the system back on.

n **Automatic reactivation of TRAC and VSC**

Turning the “ENGINE START STOP” switch OFF after turning off the TRAC and VSC systems will automatically re-enable them.

n **Automatic TRAC reactivation**

If only the TRAC system is turned off, the TRAC system will turn on when vehicle speed increases.

n **Automatic TRAC and VSC reactivation**

If the TRAC and VSC systems are turned off, the systems will not turn on even when vehicle speed increases.

n **Sounds and vibrations caused by the ABS, brake assist, VSC, TRAC and hill-start assist control systems**

- 1 A sound may be heard from the engine compartment when the engine is started or just after the vehicle begins to move. This sound does not indicate that a malfunction has occurred in any of these systems.
- 1 Any of the following conditions may occur when the above systems are operating. None of these indicates that a malfunction has occurred.
 - Vibrations may be felt through the vehicle body and steering.
 - A motor sound may be heard after the vehicle comes to a stop.
 - The brake pedal may pulsate slightly after the ABS is activated.
 - The brake pedal may move down slightly after the ABS is activated.

n Hill-start assist control is operational when

- l The shift lever is in the D or S position.
- l The brake pedal is not depressed.

n Reduced effectiveness of EPS

The effectiveness of EPS is reduced to prevent the system from overheating when there is frequent steering input over an extended period of time. The steering wheel may feel heavy as a result. Should this occur, refrain from excessive steering input or stop the vehicle and turn the engine OFF. The system should return to normal within 10 minutes.

CAUTION

n The ABS does not operate effectively when

- l The limits of tire gripping performance have been exceeded.
- l The vehicle hydroplanes while driving at high speed on the wet or slick road.

n Stopping distance when the ABS is operating will exceed that of normal conditions

The ABS is not designed to shorten the vehicle's stopping distance. Always maintain a safe distance from the vehicle in front of you in the following situations.

- l When driving on dirt, gravel or snow-covered roads
- l When driving with tire chains
- l When driving over bumps in the road
- l When driving over roads with potholes or roads with uneven roads

! CAUTION**n TRAC may not operate effectively when**

Directional control and power may not be achievable while driving on slippery road surfaces, even if the TRAC system is operating.

Do not drive the vehicle in conditions where stability and power may be lost.

n If hill-start assist control does not operate effectively (vehicles with an automatic transmission)

The hill-start assist control may not operate effectively on steep inclines and roads covered in ice.

n When the VSC is activated

The slip indicator light flashes and a warning buzzer sounds. Always drive carefully. Reckless driving may cause an accident. Exercise particular care when the indicator light flashes and a buzzer sounds.

n When TRAC and VSC are off

Be especially careful and drive at a speed appropriate to the road conditions. As there are systems to ensure vehicle stability and driving force, do not turn off TRAC and VSC unless necessary.

n Replacing tires

Make sure that all tires are of the same size, brand, tread pattern and total load capacity. In addition, make sure that the tires are inflated to the recommended tire pressure level.

The ABS and VSC systems will not function correctly if different tires are fitted on the vehicle.

Contact your Lexus dealer for further information when replacing tires or wheels.

n Handling of tires and suspension

Using tires with any kind of problem or modifying the suspension will affect the driving assist systems, and may cause the system to malfunction.

2-4. Using other driving systems

PCS (Pre-Collision System) (if equipped)

Safety systems such as the brakes and seat belts are automatically engaged to lessen impact and injuries to occupants as well as vehicle damage when the radar sensor detects an unavoidable frontal collision.

n Pre-collision seat belts

The seat belts are immediately retracted as the effect of the pretensioner is increased (→P. 53), to provide even greater constraining force to protect the driver and passengers. In the event of sudden braking or skidding, the system will operate even if no obstacle has been detected.

n Pre-collision brake assist

Applies greater braking force in relation to how strongly the brake pedal is depressed.

Radar sensor



Detects vehicles or other obstacles on or near the road ahead and determines whether a collision is imminent based on the position, speed, and heading of the obstacles.

- 1 Grille cover
- 2 Radar sensor

n Obstacles not detected

The sensor cannot detect plastic obstacles such as pylons. There may also be occasions when the sensor cannot detect pedestrians, animals, bicycles, motorcycles, trees, or snowdrifts.

n The pre-collision system is operational when

- l Seat belt (linked to the radar sensor)
 - Vehicle speed is above 3 mph (5 km/h).
 - The speed at which your vehicle is approaching the obstacle or oncoming vehicle exceeds 18 to 24 mph (30 to 40 km/h).
 - The front occupants are wearing a seat belt.
- l Seat belts (linked to brake operation)
 - Vehicle speed exceeds 9 mph (15 km/h).
 - The system detects sudden braking or skidding.
 - The front occupants are wearing a seat belt.
- l Brake Assist
 - Vehicle speed is above 18 mph (30 km/h).
 - The speed at which your vehicle is approaching the obstacle or the vehicle is greater than 18 to 24 mph (30 to 40 km/h).
 - The brake pedal is depressed.

n Conditions that may trigger the system even if there is no danger of collision

- l When there is an object by the roadside at the entrance to a curve
- l When passing an oncoming vehicle on a curve
- l When driving over a narrow iron bridge
- l When there is a metal object on the road surface
- l When driving on an uneven road surface
- l When passing an oncoming vehicle on a left-turn
- l When your vehicle rapidly closes on the vehicle in front

When the system is activated in the situations described above there is also a possibility that the seat belts will retract quickly and the brakes will be applied with a force greater than normal. When the seat belt is locked in the retracted position, stop the vehicle in a safe place, release the seat belt and refasten.

n When there is a malfunction in the system

Warning lights and/or warning messages will turn on or flash. (→P. 360, 369)

 CAUTION

n Handling the radar sensor

Observe the following to ensure the pre-collision system can function effectively.

- I** Keep the sensor and front grille clean at all times.
Clean the sensor and front grille with a soft cloth so you do not mark or damage them.
- I** Do not subject the sensor or surrounding area to a strong impact.
If the sensor moves even slightly off position, the system may malfunction. If the sensor or surrounding area are subject to a strong impact, always have the area inspected and adjusted by a Lexus dealer.
- I** Do not disassemble the sensor.
- I** Do not attach accessories or stickers to the sensor, grille guard or surrounding area.

n Limitations of the pre-collision system

Do not rely on the pre-collision system. Always drive safely, taking care to observe your surroundings and checking for any obstacles or other road hazards.

Take notice of the following information about storage precautions, cargo capacity and load.

- 1 Stow cargo and luggage in the trunk whenever possible. Be sure all items are secured in place.
- 1 Be careful to keep the vehicle level. Placing the weight as far forward as possible helps maintain vehicle balance.
- 1 For better fuel economy, do not carry unnecessary weight.

Capacity and distribution

Cargo capacity depends on the total weight of the occupants.

(Cargo capacity) = (Total load capacity) – (Total weight of occupants)

Steps for Determining Correct Load Limit—

- (1) Locate the statement “The combined weight of occupants and cargo should never exceed XXX kg or XXX lbs.” on your vehicle’s placard.
- (2) Determine the combined weight of the driver and passengers that will be riding in your vehicle.
- (3) Subtract the combined weight of the driver and passengers from XXX kg or XXX lbs.
- (4) The resulting figure equals the available amount of cargo and luggage load capacity.

For example, if the “XXX” amount equals 1400 lbs. and there will be five 150 lb. passengers in your vehicle, the amount of available cargo and luggage load capacity is 650 lbs. (1400 – 750 (5 × 150) = 650 lbs.)

- (5) Determine the combined weight of luggage and cargo being loaded on the vehicle. That weight may not safely exceed the available cargo and luggage load capacity calculated in Step 4.

(6) If your vehicle will be towing a trailer, load from your trailer will be transferred to your vehicle. Consult this manual to determine how this reduces the available cargo and luggage load capacity of your vehicle.

Lexus does not recommend towing a trailer with your vehicle. Your vehicle is not designed for trailer towing.

Example on your vehicle

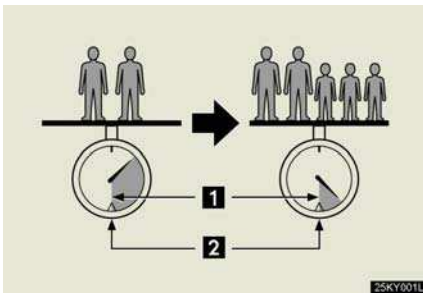

When 2 people with the combined weight of 366 lb. (166 kg) are riding in your vehicle, which has a total load capacity of 825 lb. (375 kg), the available amount of cargo and luggage load capacity will be as follows:

$$825 \text{ lb.} - 366 \text{ lb.} = 459 \text{ lb.} \quad (375 \text{ kg} - 166 \text{ kg} = 209 \text{ kg})$$

In this condition, if 3 more passengers with the combined weight of 388 lb. (176 kg) get on, the available cargo and luggage load will be reduced as follows:

$$459 \text{ lb.} - 388 \text{ lb.} = 71 \text{ lb.} \quad (209 \text{ kg} - 176 \text{ kg} = 33 \text{ kg})$$

As shown in the above example, if the number of occupants increases, the cargo and luggage load equaling the combined weight of the occupants who got on later, by an amount. In other words, if an increase in the number of occupants causes an excess of the total load capacity (combined weight of occupants plus cargo and luggage load), you must reduce the cargo and luggage on your vehicle.

 **CAUTION****n Storage precautions**

- I** Do not place anything on the package tray behind the rear seatback. Such items may be thrown about and possibly injure people in the vehicle during sudden braking or in an accident.
- I** Do not drive with objects on top of the instrument panel. They may interfere with the driver's field of view or move during sharp acceleration or turning, thus impairing the driver's control of the vehicle. In an accident they may injure the vehicle occupants.
- I** Secure all items in the occupant compartment, as they may shift and injure someone during an accident or sudden braking.

n Capacity and distribution

- I** Do not exceed the maximum axle weight rating or the total vehicle weight rating.
- I** Even if the total load of occupant's weight and the cargo load is less than the total load capacity, do not apply the load unevenly. Improper loading may cause deterioration of steering or braking control which may cause death or serious injury.

2-5. Driving information

Vehicle load limits

Vehicle load limits include total load capacity, seating capacity, towing capacity and cargo capacity.

n Total load capacity: 825 lb. (375 kg)

Total load capacity means the combined weight of occupants, cargo and luggage.

n Seating capacity: 5 occupants (Front 2, Rear 3)

Seating capacity means the maximum number of occupants whose estimated average weight is 150 lb. (68 kg) per person.

n Towing capacity

Lexus does not recommend towing a trailer with your vehicle.

n Cargo capacity

Cargo capacity may increase or decrease depending on the weight and the number of occupants.

n Total load capacity and seating capacity

These details are also described on the tire and loading information label.
(→P. 316)

CAUTION

n Overloading the vehicle

Do not overload the vehicle.

It may not only cause damage to the tires, but also degrade steering and braking ability, resulting in an accident.

Carry out the necessary preparations and inspections before driving the vehicle in winter. Always drive the vehicle in a manner appropriate to the prevailing weather conditions.

n Pre-winter preparations

- 1 Use fluids that are appropriate to the prevailing outside temperatures.
 - Engine oil
 - Engine coolant
 - Washer fluid
 - Have a service technician inspect the level and specific gravity of battery electrolyte.
- 1 Have the vehicle fitted with four snow tires or purchase a set of tire chains for the rear tires.

Ensure that all tires are the specified size and the same brand, and that chains match the size of the tires.

n Before driving the vehicle

Perform the following according to the driving conditions.

- 1 Do not try to forcibly open a window or move a wiper that is frozen. Pour warm water over the frozen area to melt the ice. Wipe away the water immediately to prevent it from freezing.
- 1 To ensure proper operation of the climate control system fan, remove any snow that has accumulated on the air inlet vents in front of the windshield.
- 1 Remove any ice that has accumulated on the vehicle chassis.
- 1 Periodically check for and remove any excess ice or snow that may have accumulated in the wheel well or on the brakes.

n When driving the vehicle

Accelerate the vehicle slowly and drive at a reduced speed suitable to road conditions.

n When parking the vehicle

Park the vehicle and move the shift lever to P (automatic transmission) or R (manual transmission) without setting the parking brake. The parking brake may freeze up, preventing it from being released.

Selecting snow chains

Snow chains can be mounted on 16- and 17-inch tires. They cannot be mounted on 18-inch tires. Use the correct snow chain size when mounting the snow chains. Chain size is regulated for each tire sizes.

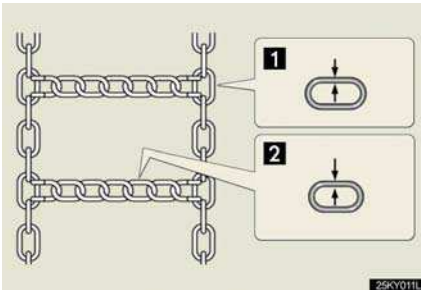

- 1** Side chain
(0.12 in. [3 mm] in diameter)
- 2** Cross chain
(0.16 in. [4 mm] in diameter)

Regulations on the use of snow chains

- 1 Regulations regarding the use of tire chains vary according to location and type of road. Always check local regulations before installing chains.
- 1 Install the chains on the rear tires.
- 1 Retighten the chains after driving 1/4 - 1/2 mile (0.5 - 1.0 km).

n Snow chain installation

Observe the following precautions when installing and removing chains.

- I Install and remove tire chains in a safe location.
- I Install tire chains on the rear tires only. Do not install tire chains on front tires.
- I Install the tire chains on rear tires as tightly as possible. Retighten chains after driving 1/4 - 1/2 mile (0.5 - 1.0 km).
- I Install tire chains following the instructions provided in the accompanying instructions.

! CAUTION**n Driving with snow tires**

Observe the following precautions to reduce the risk of accidents.

Failing to do so may result in a loss of vehicle control and cause death or serious injury.

- I Use tires of the size specified for your vehicle.
- I Maintain the recommended level of air pressure.
- I Do not drive in excess of 75 mph (120 km/h), regardless of the type of snow tires being used.
- I Use snow tires on all, not just some wheels.

n Driving with snow chains

Observe the following precautions to reduce the risk of accidents.

Failing to do so may result in the vehicle being unable to be driven safely, and may cause death or serious injury.

- I Do not drive in excess of the speed limit specified for the tire chains being used, or 30 mph (50 km/h), whichever is lower.
- I Avoid driving on bumpy road surfaces or over potholes.
- I Avoid sudden turns and braking, as use of chains may adversely affect vehicle handling.
- I Slow down sufficiently before entering a curve to ensure that vehicle control is maintained.

NOTICE

n Repairing or replacing snow tires

Request repairs of and obtain replacement snow tires from Lexus dealers or legitimate tire retailers.

This is because the removal and attachment of snow tires affects the operation of the tire air pressure sensor.

n Fitting tire chains

The tire air pressure sensor may not function correctly when tire chains are fitted.

2-5. Driving information

Trailer towing

Lexus does not recommend towing a trailer with your vehicle. Lexus also does not recommend the installation of a tow hitch or the use of a tow hitch carrier for a wheelchair, scooter, bicycle, etc. Your Lexus is not designed for trailer towing or for the use of tow hitch mounted carriers.



2-5. Driving information

Dinghy towing (vehicles with an automatic transmission)

Your vehicle is not designed to be dinghy towed (with 4 wheels on the ground) behind a motor home.

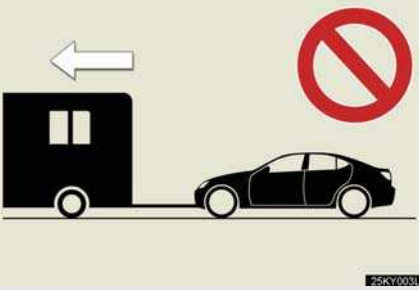

NOTICE

n To avoid serious damage to your vehicle

Do not tow your vehicle with four wheels on the ground.

2-5. Driving information

Dinghy towing (vehicles with a manual transmission)

Your vehicle can be dinghy towed in a forward direction (with 4 wheels on the ground) behind a motor home.

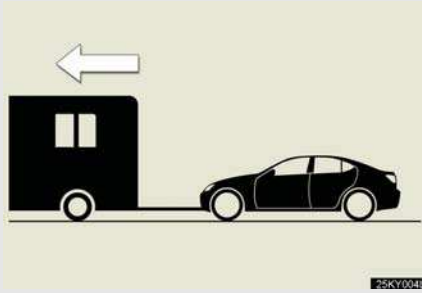

2

When driving

Towing your vehicle with 4 wheels on the ground

To prevent damage to your vehicle, perform the following procedures before towing.

STEP 1 Shift the shift lever to neutral.

STEP 2 Switch to ACCESSORY mode. (→P. 119)

Ensure that the audio system and other powered devices have been turned OFF.

STEP 3 Release the parking brake.

After towing, leave the engine in idle for at least 3 minutes before driving the vehicle.

n Necessary equipment and accessories

Specialized equipment and accessories are required for dinghy towing. Contact the service branch of the motor home manufacturer regarding recommended equipment.

 NOTICE

n Dinghy towing direction



Do not tow the vehicle backwards.
Doing so may cause serious damage.

n To prevent the steering from locking

Ensure the “ENGINE START STOP” switch is in ACCESSORY mode.

3-1. Using the air conditioning system and defogger

Automatic air conditioning system

Airflow and outlets are automatically adjusted according to the temperature setting.

► With navigation system

Owners of models equipped with a navigation system should refer to the "Navigation System Owner's Manual".

► Without navigation system

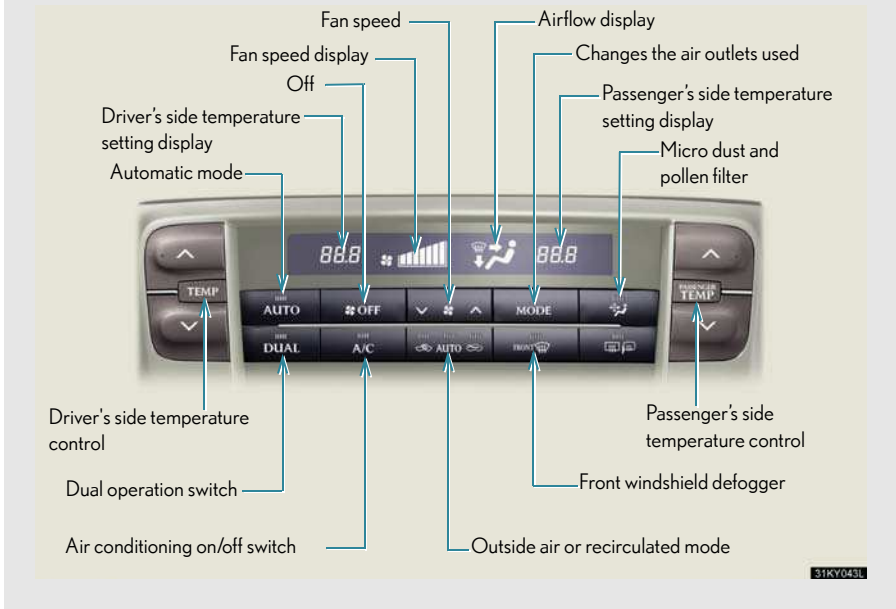

Using the automatic mode

STEP 1 Press .

➔ The air conditioning system will begin to operate. Air outlets and fan speed are automatically adjusted according to the temperature setting.

STEP 2 Press  to switch to automatic mode. (IS350 only)

➔ Automatically switches between outside air and recirculated air modes.

STEP 3] Press \wedge to increase the temperature and \vee to decrease the tem-

perature on .



The temperature for the driver and passenger seats can be set separately.

Adjusting the settings

n Adjusting the temperature setting

Press \wedge to increase the temperature and \vee to decrease the tempera-

ture on .

Press \wedge (increase) or \vee (decrease) on  to separately adjust the temperature for the passenger and driver sides (dual mode). Press  to return the driver and passenger side temperatures to the same setting (simultaneous mode).

The air conditioning system switches between individual and simultaneous modes each time  is pressed.

n Adjusting the fan speed

Press \wedge (increase) or \vee (decrease) on .

Press  to turn the fan off.

n Changing the air outlets



Press  .

The air outlets switch each time the button is pressed.

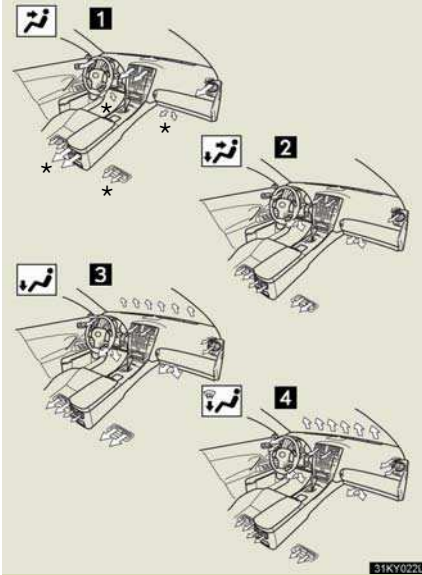

1 Air flows to the upper body.

2 Air flows to the upper body and feet.

3 Air flows to the feet.



4 Air flows to the feet and the front windshield defogger operates.

*: Only in the automatic mode

n Switching between outside air and recirculated air modes



▶ IS250

Press  .

The mode switches between  (recycles air inside the vehicle) and  (introduces air from outside the vehicle) modes each time the button is pressed.

▶ IS350

Press  .

The mode switches among  (recycles air inside the vehicle), "AUTO" and  (introduces air from outside the vehicle) modes each time the button is pressed.

When the system is switched to automatic mode, the air conditioning system operates automatically.

Defogging the front windshield



1 Defogging

The air conditioning system control operates automatically.

Recirculated air mode may automatically switch to  (outside air) mode.

Micro dust and pollen filter



Press  .

Outside air mode switches to  (recirculated air) mode. Pollen is removed from the air and the air flows to the upper part of the body.

To stop the operation, press  again.

Adjusting the sensitivity of the air intake control in automatic mode (IS350 only)



Press  for 2 or more seconds.

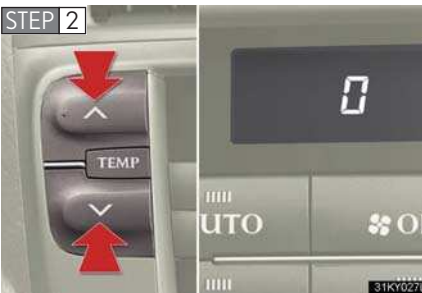

Press \wedge (increase) or \vee (decrease)

on  .

From -3 (low) to 3 (high) can be set.

Adjusting the position of and opening and closing the air outlets

► Center outlets

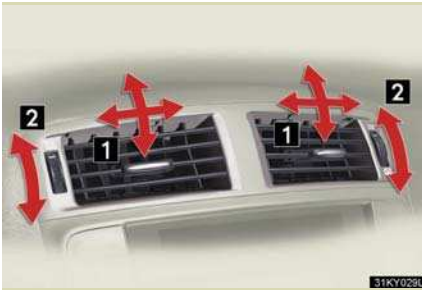

- 1 Direct air flow to the left or right, up or down
- 2 Turn the knob up to open the vent and down to close the vent

► Front outlets (right and left side)

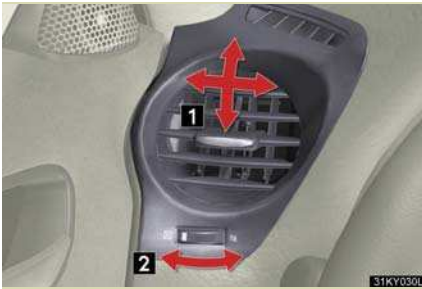

- 1 Direct air flow to the left or right, up or down
- 2 Turn the knob right to open the vent and left to close the vent

► Rear outlets

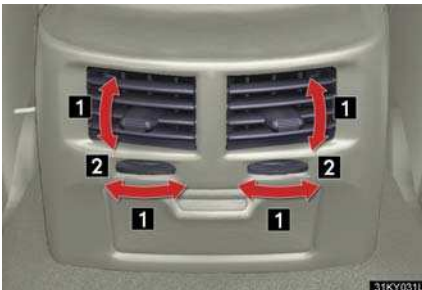

- 1 Direct air flow to the left or right, up or down
- 2 Turn the knob fully to the outside of the vehicle to close the vent

n Using the automatic mode

Fan speed is adjusted automatically in accordance with the temperature setting and ambient conditions. As a result, the following may occur.

- 1 The system may switch automatically to recirculated mode when the coolest temperature setting is selected in summer.
- 1 Immediately after the switch is pressed, the fan may stop for a while until warm or cool air is ready to flow.
- 1 Cool air may flow to the area around the upper body when the heater is on.

n Using the system in recirculated air mode

The windows will fog up more easily if the recirculated air mode is used for an extended period.

n Window defogger feature

Recirculated air mode may automatically switch to  (outside air) mode in situations where the windows need to be defogged.

n When outside air temperature approaches 32°F (0°C)

The air conditioning system may not operate even when  is pressed.



n When the indicator light on flashes

Press  and turn off the air conditioning system before turning it on once more. There may be a problem in the air conditioning system if the indicator light continues to flash. Turn the air conditioning system off and have it inspected by your Lexus dealer.

n Automatic mode for air intake control (IS350 only)

In automatic mode, the system detects exhaust gas and other pollutants and automatically switches between outside air and recirculated air modes.

n Micro dust and pollen filter

- 1 In order to prevent the window from fogging up when the outside air is cold, the following may occur.
 - Outside air mode does not switch to .
 - The air conditioning system operates automatically.
 - The operation cancels after 1 minute.
- 1 In rainy weather, the windows may fog up. Press .

 CAUTION

n To prevent the windshield from fogging up

Do not use  during cool air operation in extremely humid weather. The difference between the temperature of the outside air and that of the windshield can cause the outer surface of the windshield to fog up, blocking your vision.

 NOTICE

n To prevent battery discharge

Do not leave the automatic air conditioning system on longer than necessary when the engine is stopped.

3-1. Using the air conditioning system and defogger

Rear window and outside rear view mirror defoggers

These features are used to defog the rear window, and to remove rain-drops, dew and frost from the outside rear view mirrors.



1 On/off

The defoggers will automatically turn off after approximately 15 minutes.

CAUTION

n When the outside rear view mirror defoggers are on

Do not touch the outside surface of the rear view mirror, as it can become very hot and burn you.

3-2. Using the audio system

Audio system type

▶ With navigation system

Owners of models equipped with a navigation system should refer to the "Navigation System Owner's Manual".

▶ Without navigation system (type A)

CD player with changer and AM/FM radio



▶ Without navigation system (type B)

CD player with changer and AM/FM radio



Title	Page
Using the radio	P. 204
Using the CD player	P. 211
Playing back MP3 and WMA discs	P. 217
Optimal use of the audio system	P. 225
Using the AUX adapter	P. 228
Using the steering wheel audio switches	P. 229

n Using cellular phones

Interference may be heard through the audio system's speakers if a cellular phone is being used inside or close to the vehicle while the audio system is operating.

CAUTION

n For vehicles sold in U.S.A. and Canada

I Part 15 of the FCC Rules

FCC Warning:

Any unauthorized changes or modifications to this equipment will void the user's authority to operate this device.

I Laser products

- Do not take this unit apart or attempt to make any changes yourself.

This is an intricate unit that uses a laser pickup to retrieve information from the surface of compact discs. The laser is carefully shielded so that its rays remain inside the cabinet. Therefore, never try to disassemble the player or alter any of its parts since you may be exposed to laser rays and dangerous voltages.

- This product utilizes a laser.

Use of controls or adjustments or performance of procedures other than those specified herein may result in hazardous radiation exposure.

 NOTICE

n To prevent battery discharge

Do not leave the audio system on longer than necessary with the engine off.

n To avoid damaging the audio system

Take care not to spill drinks or other fluids over the audio system.

3-2. Using the audio system

Using the radio

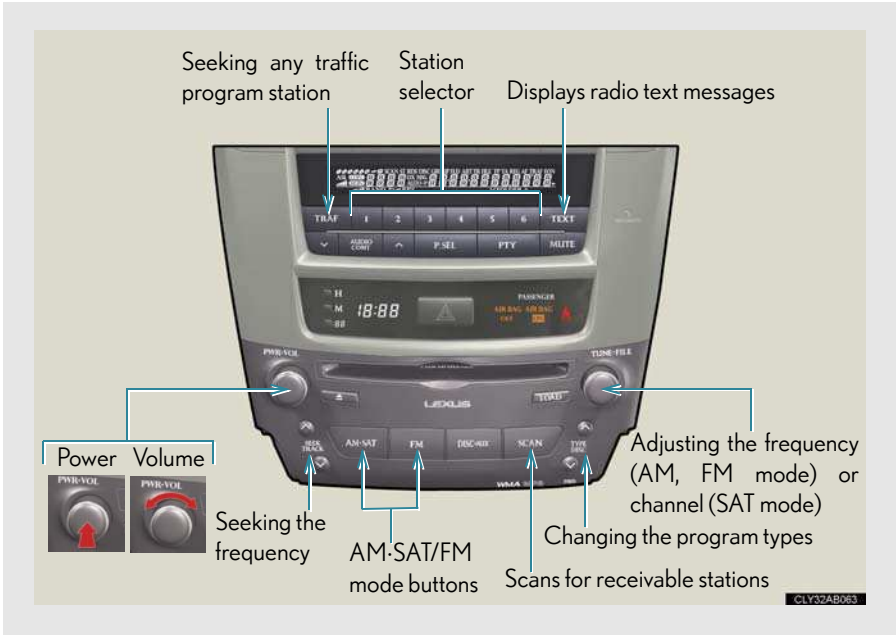

Setting station presets (excluding XM[®] Satellite Radio)

STEP 1 Search for desired stations by turning  or pressing \wedge or \vee



STEP 2 Press and hold the button (from **1** to **6**) the station is to be set to, and you hear a beep.

Scanning radio stations (excluding XM[®] Satellite Radio)

n Scanning the preset radio stations

STEP 1 Press and hold  until you hear a beep.

Preset stations will be played for 5 seconds each.

STEP 2 When the desired station is reached, press the button once again.

n Scanning all radio stations within range

STEP 1 Press .

All stations with reception will be played for 5 seconds each.

STEP 2 When the desired station is reached, press the button once again.

RDS (Radio Data System)

This feature allows your radio to receive station identification information and program information (classical, jazz, etc.) from radio stations which broadcast this information.

n Receiving RDS broadcasts

STEP 1 Press \wedge or \vee on  during FM reception.

The type of program changes each time the button is pressed.

- 1 ROCK
- 1 EASYLIS (Easy listening)
- 1 CLS/JAZZ (Classical music and Jazz)
- 1 R & B (Rhythm and Blues)
- 1 INFORM (Information)
- 1 RELIGION
- 1 MISC (Miscellaneous)
- 1 ALERT (Emergency messages)

If the system receives no RDS stations, "NO PTY" appears on the display.

STEP 1 Press , or \wedge or \vee on .

The radio seeks or scans the station by the relevant program type.



n **Displaying radio station names**

Press .

n **Displaying radio text messages**

Press  twice.

If MSG shows in the display, a text message will be displayed.

If the text continues past the end of the display,  is displayed. Press and hold  until you hear a beep.

XM[®] Satellite Radio (if equipped)



n **Receiving XM[®] Satellite Radio**

STEP 1 Press and hold  until SAT shows in the display.



The display changes as follows each time the switch is pressed.

AM → SAT1 → SAT2 → SAT3



STEP 2 Turn  to select the desired channel in the all categories or

press  or  on  to select the desired channel in the current category.

n **Setting XM[®] Satellite Radio channel presets**

Select the desired channel. Press the button the channel is to be set to (from  to ), and you hear a beep.

n **Changing the channel category**

Press  or  on .

n Scanning XM[®] Satellite Radio channels

1 Scanning channels in the current category

STEP 1 Press  .

STEP 2 When the desired channel is reached, press the switch again.

1 Scanning preset channels

STEP 1 Press and hold  until you hear a beep.

STEP 2 When the desired channel is reached, press the switch again.

n Displaying text information

Press  .

The display will show up to 10 characters.

The display changes as follows each time the button is pressed.

- 1 CH NAME
- 1 TITLE (SONG/PROGRAM TITLE)
- 1 NAME (ARTIST NAME/FEATURE)
- 1 CH NUMBER

n **When the battery is disconnected**

Stations presets are erased.

n **Reception sensitivity**

- 1 Maintaining perfect radio reception at all times is difficult due to the continually changing position of the antenna, differences in signal strength and surrounding objects, such as trains, transmitters, etc.
- 1 The radio antenna is mounted inside the rear window. To maintain clear radio reception, do not attach metallic window tinting or other metallic objects to the antenna wire mounted inside the rear window.

n **XM[®] Satellite Radio**

An XM[®] Satellite Radio is a tuner designed exclusively to receive broadcasts provided under a separate subscription. Availability is limited to the 48 contiguous states and 10 Canadian provinces.

1 XM[®] subscriptions

For detailed information about XM[®] Satellite Radio or to subscribe:
U.S.A. —

Visit on the web at www.xmradio.com or call 1-877-515-3987.

Canada —

Visit on the web at www.xmradio.ca or call 1-877-438-9677.

1 Radio ID

You will need the radio ID when activating XM[®] service or reporting a problem. Select "CH000" using , and the receiver's 8-character ID number

will appear.

1 Satellite tuner

The tuner supports only Audio Services (Music and Talk) and the accompanying Text Information of XM[®] Satellite Radio.

n If the satellite radio does not operate normally

If a problem occurs with the XM[®] tuner, a message will appear on the display. Refer to the table below to identify the problem, and take the suggested corrective action.

"ANTENNA"	The XM [®] antenna is not connected. Check whether the XM [®] antenna cable is attached securely.
	There is a short-circuit in the antenna or the surrounding antenna cable. See a Lexus certified dealer.
"UPDATING"	You have not subscribed to the XM [®] Satellite Radio. The radio is being updated with the latest encryption code. Contact the XM [®] Satellite Radio for subscription information. When a contract is canceled, you can choose the "CH000" and all free-to-air channels.
	The premium channel you selected is not authorized. Wait for about 2 seconds until the radio returns to the previous channel or "CH001". If it does not change automatically, select another channel. If you want to listen to the premium channel, contact the XM [®] Satellite Radio.
"NO SIGNAL"	The XM [®] signal is too weak at the current location. Wait until your vehicle reaches a location with a stronger signal.
"LOADING"	The unit is acquiring audio or program information. Wait until the unit has received the information.
"OFF AIR"	The channel you selected is not broadcasting any programming. Select another channel.
"-----"	There is no song/program title or artist name/feature associated with the channel at that time. No action needed.

“ --- ”

The channel you selected is no longer available. Wait for about 2 seconds until the radio returns to the previous channel or “CH001”. If it does not change automatically, select another channel.

Contact the XM[®] Listener Care Center at 1-877-515-3987 (U.S.A.) or 1-877-438-9677 (Canada).

■ **Certifications for the radio tuner**

This equipment has been tested and found to comply with the limits for a class B digital device, pursuant to Part 15 of the FCC Rules. These limits are designed to provide reasonable protection against harmful interference in a residential installation. This equipment generates, uses and can radiate radio frequency energy and, if not installed and used in accordance with the instructions, may cause harmful interference to radio communications. However, there is no guarantee that interference will not occur in a particular installation.

If this equipment does cause harmful interference to radio or television reception, which can be determined by turning the equipment off and on, the user is encouraged to try to correct the interference by trying one or more of the following:

- 1 Reorienting or relocate the receiving antenna.
- 1 Increasing the separation between the equipment and receiver.
- 1 Connecting the equipment into an outlet on a circuit different from that to which the receiver is connected.
- 1 Consulting the dealer or an experienced radio/TV technician for help.

3-2. Using the audio system

Using the CD player

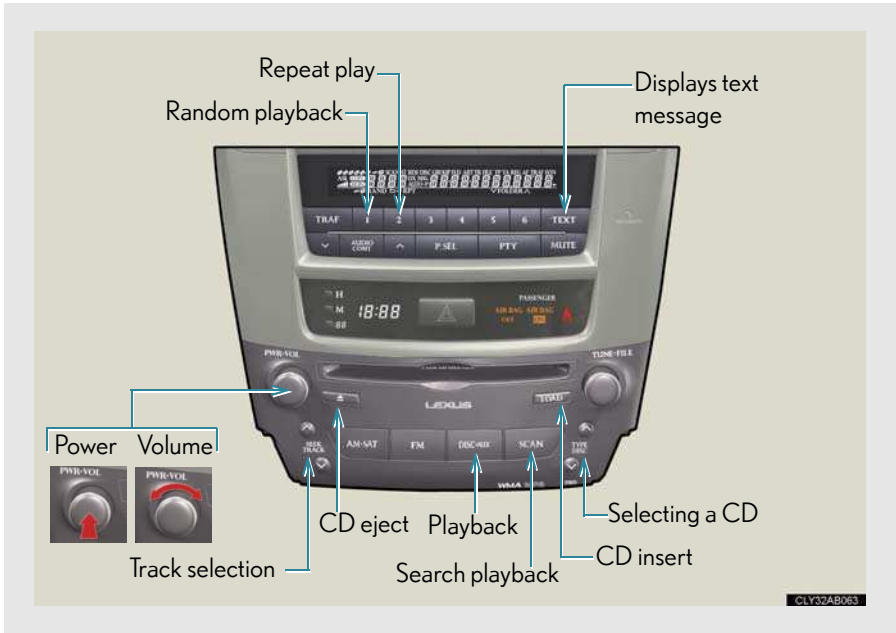

Loading CDs

1 Loading a CD

STEP 1 Push **LOAD**.

“WAIT” is shown on the display.

STEP 2 Insert a CD when the indicator on the slot turns from amber to green.

The display changes from “WAIT” to “LOAD”.

1 Loading multiple CDs

STEP 1 Press and hold **LOAD** until you hear a beep.

“WAIT” is shown on the display.

STEP 2 Insert a CD when the indicator on the slot turns from amber to green.

The display changes from “WAIT” to “LOAD”.

The indicator on the slot turns to amber when the CD is inserted.

STEP 3 Insert the next CD when the indicator on the slot turns from amber to green again.

Repeat the procedure for the remaining CDs.

To stop the operation, press .

Ejecting CDs

n Ejecting a CD



To select the CD to be ejected, press \wedge or \vee on .

The number of the CD selected is shown on the display.

STEP 2 Press  and remove the CD.

n Ejecting all the CDs

Press and hold  until you hear a beep, and then remove the CDs.

Selecting, fast-forwarding, reversing and scanning tracks

n Selecting a track

Press \wedge to move up and \vee to move down using  until the desired track number is displayed.

To fast forward or reverse, press and hold \wedge or \vee on .

n Scanning a CD

STEP 1 Press .

The first ten seconds of each track will be played.

STEP 2 Press the switch again when the desired track is reached.

Selecting a CD

n To select a CD to play

To select the desired CD, press \wedge or \vee on .

n To scan loaded CDs

STEP 1 Press and hold  until you hear a beep.

The first ten seconds of the first track on each CD will be played.

STEP 2 Press the switch again when the desired CD is reached.

Random playback

n Current CD

Press  (RAND).

Songs are played in random order until random playback is canceled.

n All CDs

Press and hold  (RAND) until you hear a beep.

Tracks on all loaded CDs are played in a random order until the button is pressed once more.

Switching the display

Press .

Each time the switch is pressed, the display changes in the order of Track no./ Elapsed time → CD title → Track name.

■ Canceling random, repeat and scan playback

Press  (RAND),  (RPT), or  again.

■ When “LOAD”, “ERROR” or “WAIT” is shown on the display

“LOAD”: This indicates that the CD player has completed loading the CD.

“ERROR”: Make sure the label of the displayed disc is facing up, and then reinsert it in the player.

“WAIT”: Operation is stopped due to a high temperature inside the player. Wait for a while and then press . Contact your Lexus dealer if the CD still cannot be played back.

■ Discs that can be used

Discs with the marks shown below can be used.

Playback may not be possible depending on recording format or disc features, or due to scratches, dirt or deterioration.



■ CD player protection feature

To protect the internal components, playback is automatically stopped when a problem is detected.

■ If CDs are left inside the CD player or in the ejected position for extended periods

CDs may be damaged and may not play properly.

■ Lens cleaners

Do not use lens cleaners. Doing so may damage the CD player.

 NOTICE

n CDs and adapters that cannot be used

Do not use the following types of CDs, 3 in. (8 cm) CD adapters or Dual Discs. Doing so may damage the CD player and/or the CD insert/eject function.



- 1 CDs that have a diameter that is not 4.7 in. (12 cm).

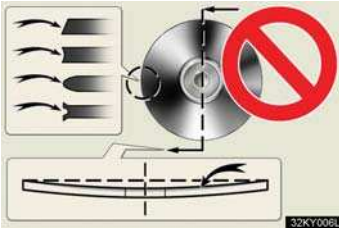

- 1 Low-quality and deformed CDs.



- 1 CDs with a transparent or translucent recording area.



- 1 CDs that have had tape, stickers or CD-R labels attached to them, or that have had the label peeled off.

NOTICE

n CD player precautions

Failure to follow the precautions below may result in serious damage to the CDs or the player itself.

- I Do not insert anything other than CDs into the CD slot.
- I Do not apply oil to the CD player.
- I Store CDs away from direct sunlight.
- I Never try to disassemble any part of the CD player.



- I Do not insert more than one CD at a time.

3-2. Using the audio system

Playing back MP3 and WMA discs

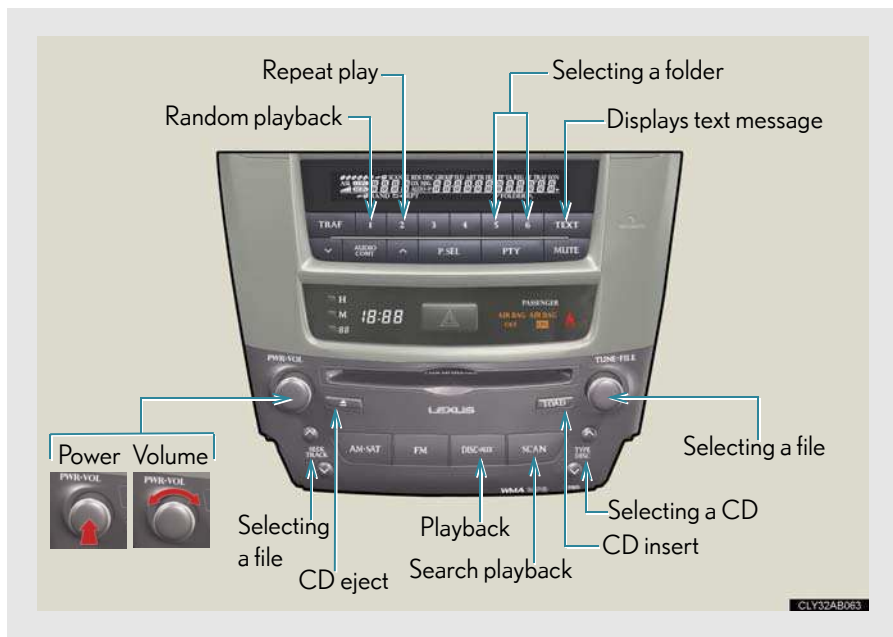

Loading and ejecting MP3 and WMA discs

Refer to the section entitled “Using the CD player” for details. (→P. 211)

Selecting a folder

n Selecting folders one at a time

Press **6** (^) or **5** (v) to select the desired folder.

n Selecting the desired folder by cueing the first file of each folder

Press and hold **SCAN** until you hear a beep. When the desired folder is reached, press the switch once again.

n Returning to the first folder

Press and hold **5** (v) until you hear a beep.

Selecting files

n Selecting one file at a time

Turn  or press \wedge or \vee on  to select the desired file.

n Selecting the desired file by cueing the files in the folder

Press .

When the desired file is reached, press the switch once again.

File repeat

Press  (RPT).

Folder repeat

Press and hold  (RPT) until you hear a beep.

Random playback

n To play files from a particular folder in random order

Press  (RAND).

n To play all of the files on a disc in random order

Press and hold  (RAND) until you hear a beep.

Switching the display

Press .

Each time the switch is pressed, the display changes in the order of Folder no./File no./Elapsed time → Folder name → File name → Album title (MP3 only) → Track title → Artist name.

n **Canceling random, repeat and scan playback**

Press  (RAND),  (RPT), or  again.

n **When “LOAD”, “ERROR”, “WAIT” or “NO MUSIC” is shown on the display.**

“LOAD”: This indicates that the CD player has completed loading the CD.

“ERROR”: Make sure the label of the displayed disc is facing up, and then reinsert it in the player.

“WAIT”: Operation is stopped due to a high temperature inside the player. Wait for a while and then press . Contact your Lexus dealer if the CD still cannot be played back.

“NO MUSIC”: This indicates that the MP3/WMA file is not included in the CD.

n **CD player protection feature**

To protect the internal components, playback is automatically stopped when a problem is detected while the CD player is being used.

n **If CDs are left inside the CD player or in the ejected position for extended periods**

CDs may be damaged and may not play properly.

n **Lens cleaners**

Do not use lens cleaners. Doing so may damage the CD player.

■ MP3 and WMA files

MP3 (MPEG Audio LAYER 3) is a standard audio compression format.

Files can be compressed to approximately 1/10 of their original size by using MP3 compression.

WMA (Windows Media™ Audio) is a Microsoft audio compression format.

This format compresses audio data to a size smaller than that of the MP3 format.

There is a limit to the MP3 and WMA file standards and to the media/formats recorded by them that can be used.

I MP3 file compatibility

- Compatible standards
MP3 (MPEG1 LAYER3, MPEG2 LSF LAYER3)
- Compatible sampling frequencies
MPEG1 LAYER3: 32, 44.1, 48 (kHz)
MPEG2 LSF LAYER3: 16, 22.05, 24 (kHz)
- Compatible bit rates
MPEG1 LAYER3: 64, 80, 96, 112, 128, 160, 192, 224, 256, 320 (kbps)
MPEG2 LSF LAYER3: 64, 80, 96, 112, 128, 144, 160 (kbps)
* Compatible with VBR
- Compatible channel modes: stereo, joint stereo, dual channel and monaural

I WMA file compatibility

- Compatible standards
WMA Ver. 7, 8, 9
- Compatible sampling frequencies
32, 44.1, 48 (kHz)
- Compatible bit rates
Ver. 7, 8: CBR 48, 64, 80, 96, 128, 160, 192 (kbps)
Ver. 9: CBR 48, 64, 80, 96, 128, 160, 192, 256, 320 (kbps)
* Only compatible with 2-channel playback

I Compatible media

Media that can be used for MP3 and WMA playback are CD-Rs and CD-RWs.

Playback in some instances may not be possible, depending on the status of the CD-R or CD-RW. Playback may not be possible or the audio may jump if the disc is scratched or marked with fingerprints.

1 Compatible disc formats

The following disc formats can be used.

- Disc formats: CD-ROM Mode 1 and Mode 2
CD-ROM XA Mode 2, Form 1 and Form 2
- File formats: ISO9660 Level 1, Level 2, (Romeo, Joliet)
MP3 and WMA files written in any format other than those listed above may not play correctly, and their file names and folder names may not be displayed correctly.

Items related to standards and limitations are as follows.

- Maximum directory hierarchy: 8 levels
- Maximum length of folder names/file names: 32 characters
- Maximum number of folders: 192 (including the root)
- Maximum number of files per disc: 255

1 File names

The only files that can be recognized as MP3/WMA and played are those with the extension .mp3 or .wma.

1 Multi-sessions

As the audio system is compatible with multi-sessions, it is possible to play discs that contain MP3 and WMA files. However, only the first session can be played.

1 ID3 and WMA tags

ID3 tags can be added to MP3 files, making it possible to record the track title and artist name, etc.

The system is compatible with ID3 Ver. 1.0, 1.1, and Ver. 2.2, 2.3 ID3 tags. (The number of characters is based on ID3 Ver. 1.0 and 1.1.)

WMA tags can be added to WMA files, making it possible to record the track title and artist name in the same way as with ID3 tags.

1 MP3 and WMA playback

When a disc containing MP3 or WMA files is inserted, all files on the disc are first checked. Once the file check is finished, the first MP3 or WMA file is played. To make the file check finish more quickly, we recommend you do not write in any files other than MP3 or WMA files or create any unnecessary folders.

Discs that contain a mixture of music data and MP3 or WMA format data cannot be played.

1 Extensions

If the file extensions .mp3 and .wma are used for files other than MP3 and WMA files, they will be mistakenly recognized and played as MP3 and WMA files. This may result in large amounts of interference and damage to the speakers.

1 Playback

- To play MP3 file with steady sound quality, we recommend a fixed bit rate of 128 kbps and a sampling frequency of 44.1 kHz.
- CD-R or CD-RW playback may not be possible in some instances, depending on the characteristics of the disc.
- There is a wide variety of freeware and other encoding software for MP3 and WMA files on the market, and depending on the status of the encoding and the file format, poor sound quality or noise at the start of playback may result. In some cases, playback may not be possible at all.
- When files other than MP3 or WMA files are recorded on a disc, it may take more time to recognize the disc and in some cases, playback may not be possible at all.
- Microsoft, Windows, and Windows Media are the registered trademarks of Microsoft Corporation in the U.S.A. and other countries.

 NOTICE

n CDs and adapters that cannot be used

Do not use the following types of CDs, 3 in. (8 cm) CD adapters or Dual Discs. Doing so may damage the CD player and render the CD insert/eject function unusable.



- 1 CDs that have a diameter that is not 4.7 in. (12 cm)

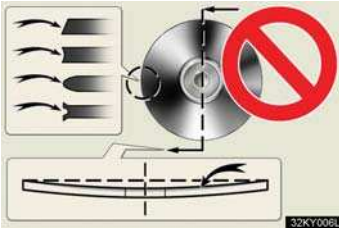

- 1 Low-quality and deformed CDs



- 1 CDs with a transparent or translucent recording area



- 1 CDs that have had tape, stickers or CD-R labels attached to them, or that have had the label peeled off

NOTICE

n CD player precautions

Failure to follow the precautions below may result in damage to the CDs or the player itself.

- I Do not insert anything other than CDs into the CD slot.
- I Do not apply oil to the CD player.
- I Store CDs away from direct sunlight.
- I Never try to disassemble any part of the CD player.



- I Do not insert more than one CD at a time.

3-2. Using the audio system

Optimal use of the audio system

► Type A

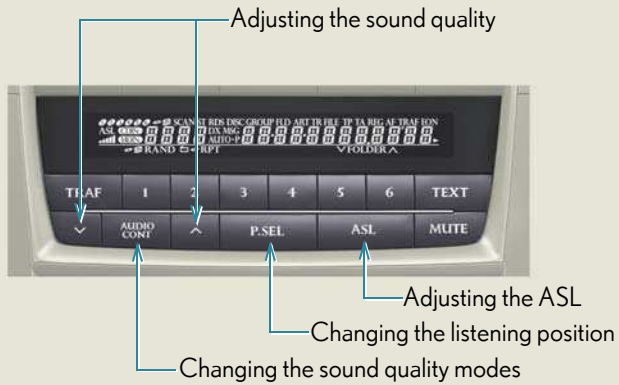

► Type B

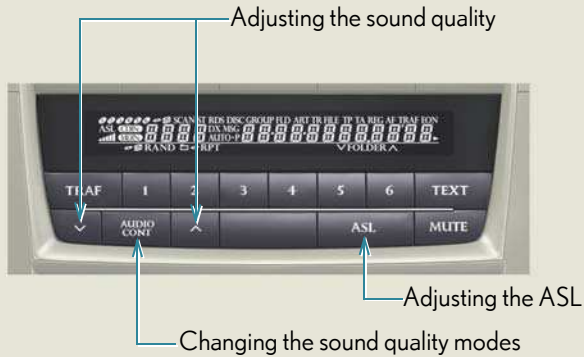

Adjusting the Automatic Sound Levelizer (ASL)

Press .

The ASL switches between on and off modes each time the switch is pressed.

ASL automatically adjusts the volume and tone quality according to the noise level as you drive your vehicle.

Changing the listening position (type A only)

The sound feel setting can be changed to produce the best sound for each listening position.

Press  (position selector) to change the setting.

The display changes as follows each time the button is pressed.

Display	Listening position
"DRIVER"	Position best suited to the driver's seat
"FRONT"	Position best suited to the driver's and front passenger seats
"REAR"	Position best suited to the rear seats
"ALL"	Position best suited to all seats

Adjusting sound quality and volume balance

n Changing sound quality modes

Press .

Pressing the button changes the sound mode in the following order.

"BAS" → "MID" → "TRE" → "FAd" → "BAL" → "SURROUND" (type B only)

n Adjusting sound quality

Press  or  to adjust the level.

Sound quality mode	Mode displayed	Level	Press ∨	Press ∧
Bass*	"BAS"	-5 to 5	Low	High
Mid-range*	"MID"	-5 to 5		
Treble*	"TRE"	-5 to 5		
Front/rear volume balance	"FAd"	F7 to R7	Shifts to rear	Shifts to front
Left/right volume balance	"BAL"	L7 to R7	Shifts to left	Shifts to right
Surround (type B only)	"SUR-ROUND"	On/off	Off	On

*: The sound quality level is adjusted individually in each AM·FM or CD mode.

n Surround (type B only)

When the surround mode is on, the matrix 7.1 surround sound system provides a realistic sound field.

3-2. Using the audio system

Using the AUX adapter

This adapter can be used to connect a portable audio device and listen to it through the vehicle's speakers.

STEP 1



Connect the portable audio device.

STEP 2

Press  .

Operating portable audio devices connected to the audio system

The volume can be adjusted using the vehicle's audio controls. All other adjustments must be made on the portable audio device itself.

When using a portable audio device connected to the power outlet

Noise may occur during playback. Use the power source of the portable audio device.

3-2. Using the audio system

Using the steering wheel audio switches

Some audio features can be controlled using the switches on the steering wheel.



- 1 Power on, select audio source
- 2 Volume
- 3 Radio: Select radio stations
CD: Select tracks, files (MP3 and WMA) and discs

Turning on the power

Press **MODE** when the audio system is turned off.

The audio system can be turned off by holding the switch down for 1 second or more.

Changing the audio source

Press **MODE** when the audio system is turned on. The audio source changes as follows each time the switch is pressed.

FM1→FM2→CD changer→AUX→AM→SAT1→SAT2→SAT3

Adjusting the volume

Press + on **+** to increase the volume and - to decrease the volume.

Hold down the switch to continue increasing or decreasing the volume.

Selecting a radio station

STEP 1 Press **MODE** to select the radio mode.

STEP 2 Press \wedge or \vee on  to select a radio station.

To scan for receivable stations, press and hold the switch until you hear a beep.

Selecting a track/file

STEP 1 Press **MODE** to select the CD mode.

STEP 2 Press \wedge or \vee on  to select the desired track/file.

Selecting a disc in the CD player

STEP 1 Press **MODE** to select the CD mode.

STEP 2 Press and hold \wedge or \vee on  until a beep is heard.

CAUTION

n To reduce the risk of an accident

Exercise care when operating the audio switches on the steering wheel.

3-3. Using the interior lights

Interior lights list

Your Lexus is equipped with the illuminated entry system to assist in entering the vehicle. Owing to the function of the system, the lights shown in the following illustration automatically turn on/off according to the presence of the electronic key, whether the doors are locked/unlocked, whether the doors are opened/closed, and the “ENGINE START STOP” switch mode.

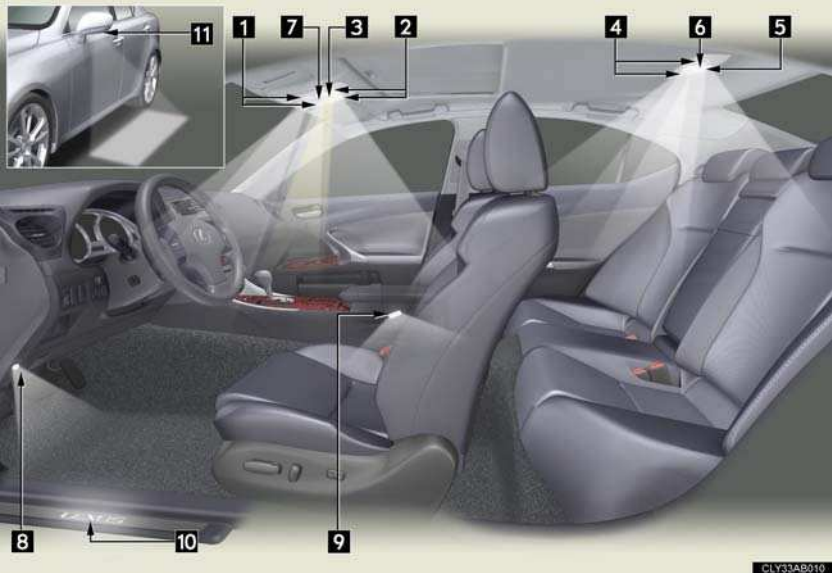

- 1 Front personal lights (→P. 234)
- 2 Front interior light (→P. 234)
- 3 Front overhead courtesy light
- 4 Rear personal lights (→P. 234)
- 5 Rear interior light
- 6 Rear overhead courtesy light
- 7 Shift lever lighting (when “ENGINE START STOP” switch is in ACCESSORY or IGNITION ON mode)
- 8 Front foot well lighting

- 9 Front door courtesy lighting
- 10 Front scuff lighting (if equipped)
- 11 Outer foot lights

Turning the instrument panel light control knob fully to the left disables the shift lever lighting and front foot well lighting.

n **Illuminated entry system**

The following interior lights come on automatically when you approach the vehicle with the electronic key on your person. Note that the illuminated entry system operates only when the interior light switch (door position on/off) is on.

- l Front overhead courtesy light
- l Rear overhead courtesy light
- l Outer foot light

The following lights turn on when any of the doors is unlocked or opened.

- l Front interior light
- l Rear interior lights
- l Front foot well lighting
- l Front door courtesy lighting
- l Front scuff lighting

The following lights turn on for approximately 15 seconds when the “ENGINE START STOP” switch is turned to OFF from the IGNITION ON or ACCESSORY mode. (The lights turn off immediately if the doors are locked or the “ENGINE START STOP” switch is set to ACCESSORY or IGNITION ON mode.)

- l Front overhead courtesy light
- l Rear overhead courtesy light

n **To prevent the battery from being discharged**

If the overhead courtesy lights and interior lights remain on when the door is not fully closed and the interior light switch (door position on/off) is on, the lights will go off automatically after 20 minutes.

n **Customization that can be configured at Lexus dealer**

Setting (e.g. The time elapsed before lights turn off) can be changed. (Customizable features →P. 436)

Interior lights

- ▶ Models without an electric moon roof

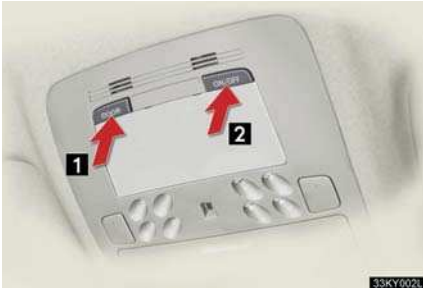

- 1 Door position on/off
- 2 On/off

- ▶ Models with an electric moon roof



- 1 Door position on/off
- 2 On/off

Personal lights

- ▶ Front (models without an electric moon roof)



- 1 On/off

► Front (models with an electric moon roof)

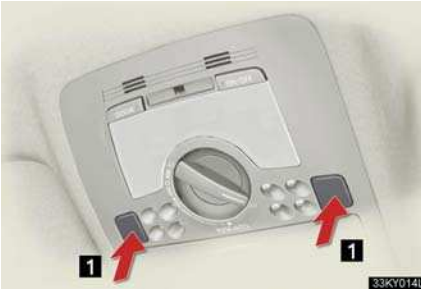

1 On/off

► Rear

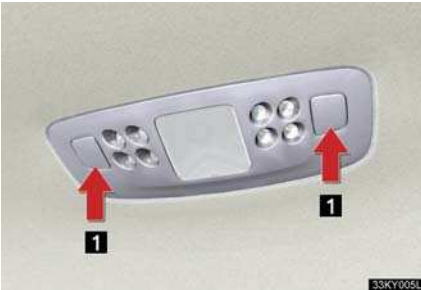

1 On/off

3-4. Using the storage features

List of storage features

Glove box

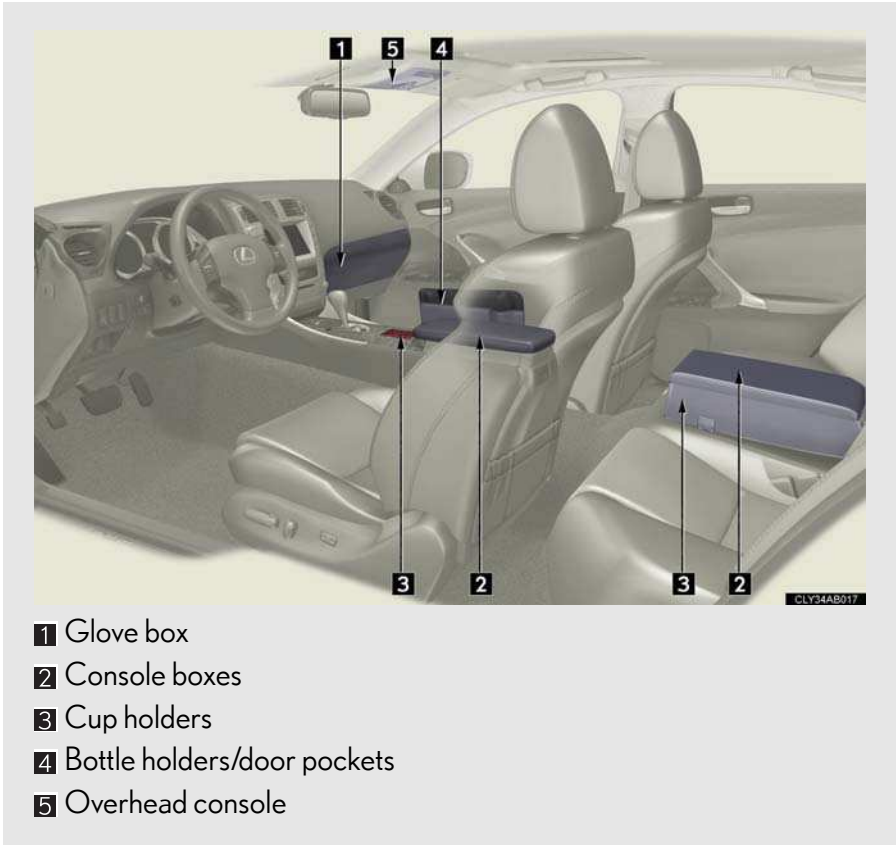

- 1 Glove box
- 2 Console boxes
- 3 Cup holders
- 4 Bottle holders/door pockets
- 5 Overhead console

Glove box

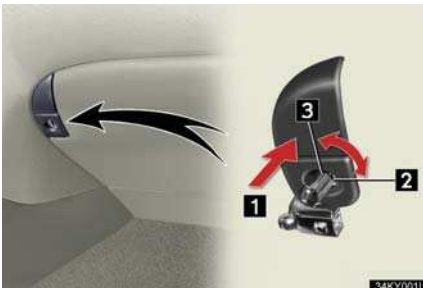

- 1 Open (push button)
- 2 Lock with the mechanical key
- 3 Unlock with the mechanical key

n Glove box light

The glove box light turns on when the “ENGINE START STOP” switch is in IGNITION ON mode.

n Trunk opener main switch

The trunk opener main switch located in the glove box. (→ P. 41)

! CAUTION

n Caution while driving

Keep the glove box closed.

Injuries may result in the event of an accident or sudden braking.

Console boxes

► Front

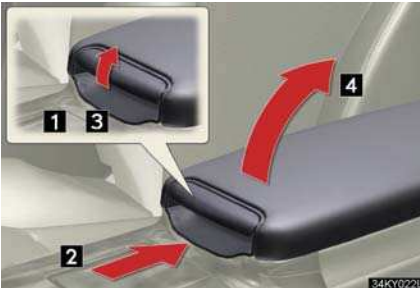

- 1 Pull up the knob to release the lock.
- 2 Slide armrest.
- 3 Pull up the knob to release the lock.
- 4 Lift the armrest to open.

► Rear (if equipped)

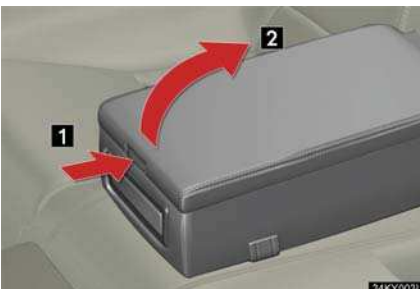

- 1 Press the button to release the lock.
- 2 Lift the armrest to open.

n **Console box light (front)**

The console box light turn on when the “ENGINE START STOP” switch is in IGNITION ON mode.

n **Using the front console box to store CD cases**



Store a CD case with the hinged portion facing either the front or back of the console box.

! CAUTION

n **Caution while driving**

Keep the console box closed.
Injuries may result in the event of an accident or sudden braking.

Overhead console

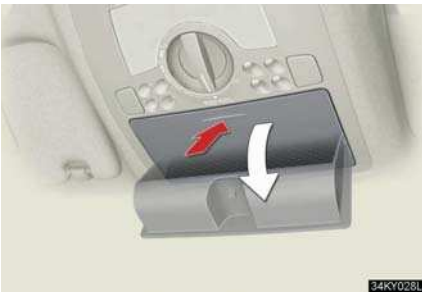

The overhead console is useful for temporarily storing sunglasses and similar small items.

! CAUTION

n Items that should not be left in the overhead console

Do not leave glasses or lighters in the console.

If the interior of the vehicle becomes hot, lighters may explode and glasses may warp or become cracked.

n Caution while driving

Do not leave the overhead console open while driving.

Items may fall out and cause injury.

Cup holders

► Front (type A)



To open, press down and release the front of the cup holder lid.

► Front (type B)

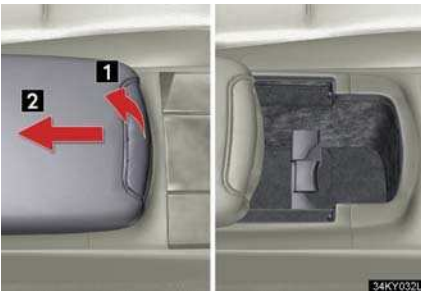

1 Press the knob to release the lock.

2 Slide armrest.

► Rear

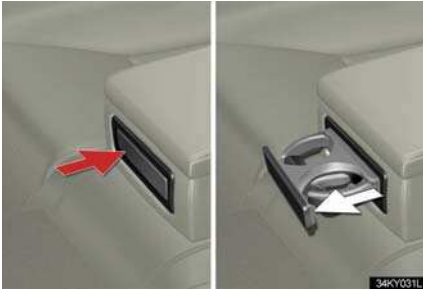

To open, press in and release the rear cup holder on the rear center armrest.

■ Using the front cup holder (type B) to store small items



Remove the cup holder insert holding the base part.

⚠ CAUTION

■ Items unsuitable for the cup holder

Do not place anything other than cups or aluminum cans in the cup holders. Other items may be thrown out of the holders in the event of an accident or sudden braking and cause injury. If possible, cover hot drinks to prevent burns.

■ When not in use

Keep the cup holders closed. Injuries may result in the event of an accident or sudden braking.

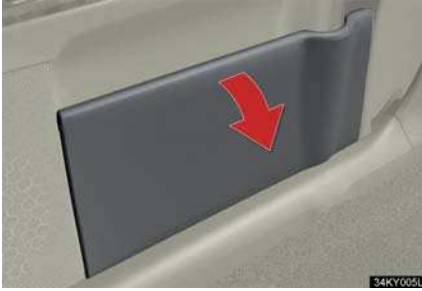
Bottle holders/door pockets

The door pocket can be opened and closed.

When installing the bottle, close the cap of the bottle.

! CAUTION**n Caution while driving**

Keep the door pockets closed.

Injuries may result in the event of an accident or sudden braking.

3-5. Other interior features

Sun visors



- 1 Forward position:
Flip down.
- 2 Side position:
Flip down, unhook, and swing
to the side.

3-5. Other interior features

Vanity mirror

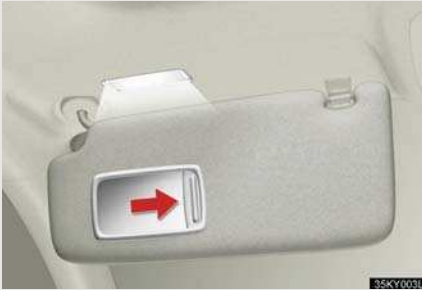

Slide the cover.

The light turns on when the cover is opened.

3-5. Other interior features

Clock



- 1 Adjusts the hour.
- 2 Adjusts the minutes.
- 3 Rounds to the nearest hour.*

*: e.g. 1:00 to 1:29 → 1:00

1:30 to 1:59 → 2:00

n The clock is displayed when

The "ENGINE START STOP" switch is in ACCESSORY or IGNITION ON mode.

3-5. Other interior features

Satellite switches

The satellite switches can be used to change the settings of various features. Settings are shown on the multi-information display.

n Operating the satellite switches



Bring up the satellite switch mode on the multi-information display.

Press <, > or the "ON/OFF" button.

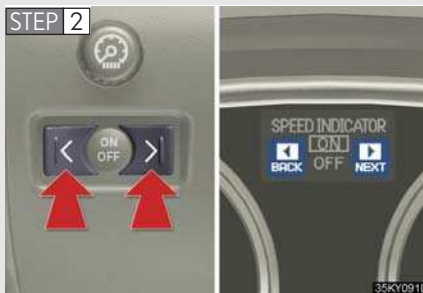

Select the item whose setting is to be changed.

Press < or > to display the item whose setting is to be changed.

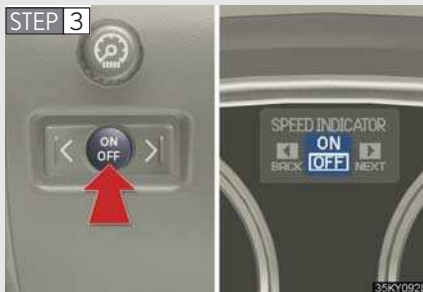

Change the settings.

Press the "ON/OFF" button to change the settings (e.g. on/off).

n Items that can be set using the satellite switches



Intuitive parking assist (→P. 164) on/off (if equipped)



Tire pressure warning system initialization (→P. 308)



ID code selection for tire air pressure system (→P. 310)



AFS (Adaptive Front-lighting System) (→P. 144) on/off (if equipped)



Vehicle speed indicator on/off and speed setting (→P. 132)



Tacho indicator on/off and engine speed (rpm) setting (→P. 132)

n Changing the settings

Each item is displayed and its setting can be changed only in the following conditions:

- l Intuitive parking assist: When the “ENGINE START STOP” switch is in IGNITION ON mode.
- l Items other than the above: When the “ENGINE START STOP” switch is in IGNITION ON mode and the vehicle is stopped.

n Display

The display will return to the original display if the satellite switches are not operated for an extended period.

Even if the display is in satellite switch mode, it will switch in the event of a warning or when the radar cruise control is used. If this occurs, press any of the satellite switches or “DISP” switch on the steering wheel to return the display to satellite switch mode.

3-5. Other interior features

Ashtrays

► Front



Push the back part of the lid to open. Push the lid again to close.

Push the lever to remove the ashtray.

► Rear

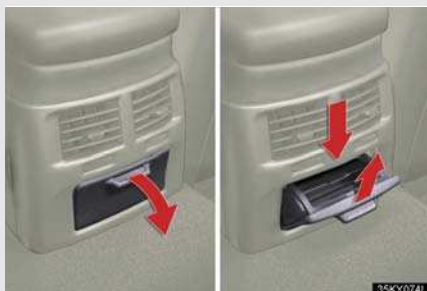

Pull the ashtray lid to open.

Hold the plate down and pull the ashtray upwards to remove.

! CAUTION

n When not in use

Keep the ashtray closed.

Injuries may result in the event of an accident or sudden braking.

n To prevent fire

1 Fully extinguish matches and cigarettes before putting them in the ashtray, then make sure the ashtray is fully closed.

1 Do not place paper or any other type of flammable object in the ashtray.

3-5. Other interior features

Cigarette lighter



Push the back part of the lid to open, and push the cigarette lighter down.

The cigarette lighter will pop up when it is ready for use.

n The cigarette lighter can be used when

The "ENGINE START STOP" switch is in ACCESSORY or IGNITION ON mode.

CAUTION

n To avoid burns or fires

- ! Do not touch the metal parts of the cigarette lighter.
- ! Do not hold the cigarette lighter down. It could overheat and cause a fire.
- ! Do not insert anything other than the cigarette lighter into the outlet.

3-5. Other interior features

Power outlet

The power outlet can be used for 12 V accessories that run on less than 10 A.

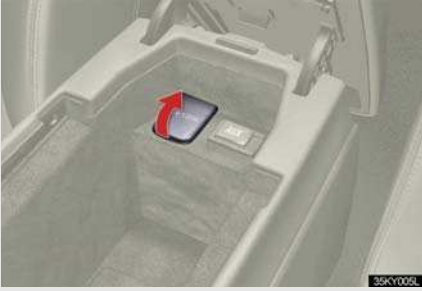

n The power outlet can be used when

The "ENGINE START STOP" switch is in ACCESSORY or IGNITION ON mode.

⚠ NOTICE

n To avoid damaging the power outlet

Close the power outlet lid when the power outlet is not in use.
Foreign objects or liquids that enter the power outlet may cause a short circuit.

n To prevent the fuse from being blown

Do not use an accessory that uses more than 12 V 10 A.

n To prevent the battery from being discharged

Do not use the power outlet longer than necessary when the engine is not running.

3-5. Other interior features

Seat heaters (if equipped)

▶ Vehicles with an automatic transmission

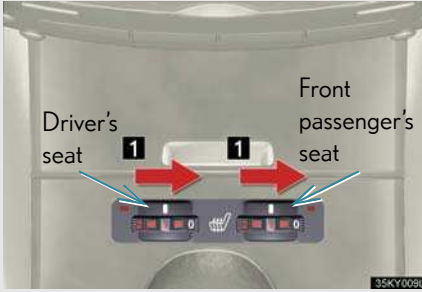

1 Heats the seats

The indicator light comes on. The higher the number, the warmer the seats become.

▶ Vehicles with a manual transmission

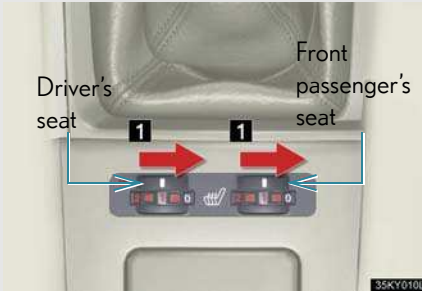

1 Heats the seats

The indicator light comes on. The higher the number, the warmer the seats become.

n The seat heaters can be used when

The "ENGINE START STOP" switch is in IGNITION ON mode.

n When not in use

Set the dial to "0". The indicator light turns off.

 **CAUTION**

n Burns

- I** Use caution when seating the following persons in a seat with the seat heater on to avoid the possibility of burns:
- Babies, small children, the elderly, the sick and the disabled
 - Persons with sensitive skin
 - Persons who are fatigued
 - Persons who have taken alcohol or drugs that induce sleep (sleeping drugs, cold remedies, etc.)
- I** Do not cover the seat with anything when using the seat heater. Using the seat heater with a blanket or cushion increases the temperature of the seat and may lead to overheating.

 **NOTICE**

n To prevent seat heater damage

Do not put unevenly weighted objects on the seat and do not stick sharp objects (needles, nails, etc.) into the seat.

n To prevent battery discharge

Turn the switches off when the engine is not running.

3-5. Other interior features

Seat heaters and ventilators (if equipped)

The seat heaters and ventilators heat the seats and maintain good airflow by blowing air from the seats.

► Vehicles with an automatic transmission

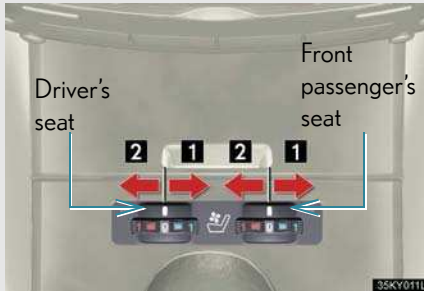

1 Heats the seats

The indicator light (red) comes on.

The higher the number, the warmer the seats become.

2 Blows air from the seats

The indicator light (green) comes on.

The higher the number, the stronger the airflow becomes.

► Vehicles with a manual transmission

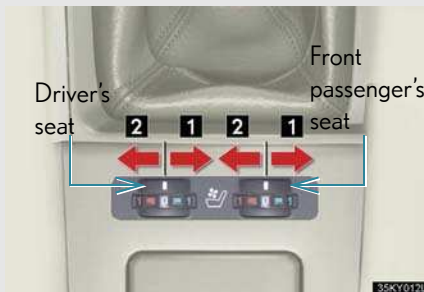

1 Heats the seats

The indicator light (red) comes on.

The higher the number, the warmer the seats become.

2 Blows air from the seats

The indicator light (green) comes on.

The higher the number, the stronger the airflow becomes.

n The seat heaters and ventilators can be used when

The "ENGINE START STOP" switch is in IGNITION ON mode.

n When not in use

Set the dial to "0". The indicator light turns off.

CAUTION

n Burns

- I** Use caution when seating the following persons in a seat with the seat heater on to avoid the possibility of burns:
- Babies, small children, the elderly, the sick and the disabled
 - Persons with sensitive skin
 - Persons who are fatigued
 - Persons who have taken alcohol or drugs that induce sleep (sleeping drugs, cold remedies, etc.)
- I** Do not cover the seat with anything when using the seat heater. Using the seat heater with a blanket or cushion increases the temperature of the seat and may lead to overheating.

NOTICE

n To prevent seat heater damage

Do not put unevenly weighted objects on the seat and do not stick sharp objects (needles, nails, etc.) into the seat.

n To prevent battery discharge

Turn the switches off when the engine is not running.

3-5. Other interior features

Armrest

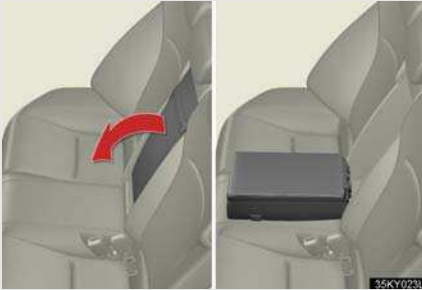

Pull the armrest down for use.

NOTICE

n To prevent damage to the armrest

Do not place too much strain on the armrest.

3-5. Other interior features

Rear sunshade (if equipped)

The rear sunshade can be raised and lowered by operating the switch shown below.



1 Raise/lower

n Reverse operation feature

To ensure adequate rear visibility, the sunshade automatically lowers when the gear is shifted to R.

However, the rear sunshade is raised again if either of the following occurs:

- 1 The switch is pressed again.
- 1 The shift lever is shifted out of R, and the vehicle reaches a speed of 9 mph (15 km/h).

If the engine is turned off when the rear sunshade has been lowered due to the reverse operation feature, it will not be raised even when the engine is turned on again and the vehicle reaches a speed of 9 mph (15 km/h). To raise the sunshade again, press the switch.

n The rear sunshade can be used when

The "ENGINE START STOP" switch is in IGNITION ON mode.

 **CAUTION****n When the rear sunshade is being raised or lowered**

Do not place fingers or other objects in the fastener section or in the opening. They may get caught, causing injury.

 **NOTICE****n To prevent the battery from being discharged**

Do not operate the rear sunshade when the engine is not running.

n To ensure normal operation of the sunshade

Observe the following precautions.

- l** Do not place excessive load on the motor or other components.
- l** Do not place objects where they may hinder opening and closing operations.
- l** Do not attach items to the rear sunshade.
- l** Keep the opening clean and clear of obstructions.
- l** Do not operate the rear sunshade continuously over long periods of time.

3-5. Other interior features

Trunk storage extension

Long objects can be loaded in the vehicle by utilizing the trunk space and rear seat area.

STEP 1



Pull down the rear seat armrest.

STEP 2



Open the inside trunk door from the trunk and load baggage or other items.

CAUTION

When not in use

Ensure that the inside trunk door is closed.

In the event of sudden braking, items stored in the trunk may be thrown forward into the cabin, resulting in injury.

3-5. Other interior features

Coat hooks

Pull out the hooks to hang coats or other soft items.

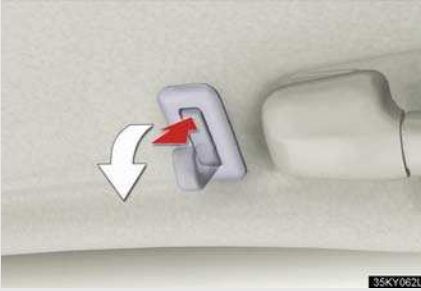

CAUTION

n Items that must not be hung on the hook

Do not hang a coat hanger or other hard or sharp object on the hook. If the SRS curtain shield airbags deploy, these items may become projectiles that cause death or serious injury.

3-5. Other interior features

Floor mat

Securely place a mat that matches the size of the space on the carpet.

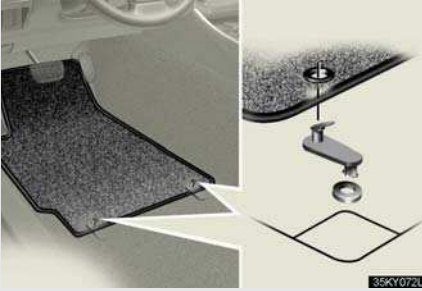

Secure the driver's floor mat using the hooks provided.

! CAUTION

n When inserting the floor mat

Observe the following precautions.

Failure to do so may result in the floor mat slipping and interfering with the movement of the pedals during driving, resulting in an accident.

- I** Make sure the floor mat is properly placed on the vehicle carpet and the correct side faces upward.
- I** Do not place floor mats on top of existing mats.

3-5. Other interior features

Trunk features

n Cargo hooks



Cargo hooks are provided for securing loose items.

n Shopping bag hooks

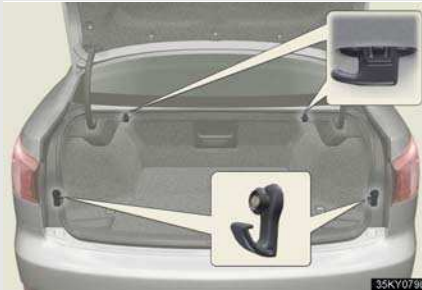

n First-aid kit storage belt

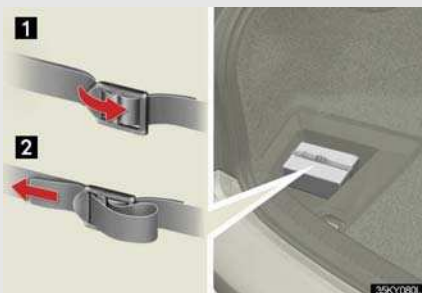

- 1 Loosen
- 2 Tighten

n Warning triangle storage belt

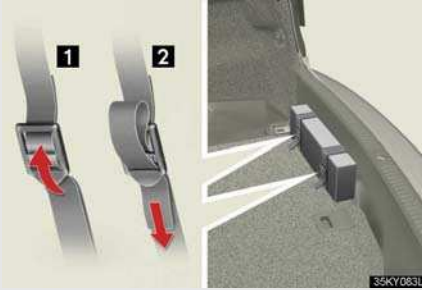

n Luggage mat

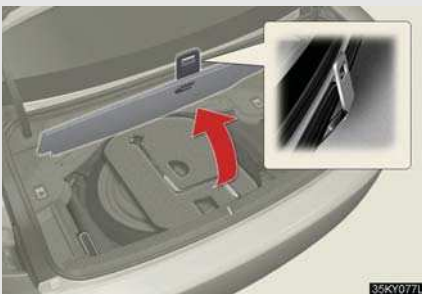

! CAUTION

n When the cargo hooks are not in use

To avoid injury, always return the cargo hooks to their positions when they are not in use.

 NOTICE**n When closing the trunk**

Do not leave the luggage mat lever hooked on the edge of the trunk.
The luggage mat may get damaged.

3-5. Other interior features

Garage door opener

The garage door opener can be programmed to operate garage doors, gates, entry doors, door locks, home lighting systems, and security systems, and other devices.

The garage door opener (HomeLink[®] Universal Transceiver) is manufactured under license from HomeLink[®].

Programming the HomeLink[®] (for U.S.A. owners)

The HomeLink[®] compatible transceiver in your vehicle has 3 buttons which can be programmed to operate 3 different devices. Refer to the programming method below appropriate for the device.

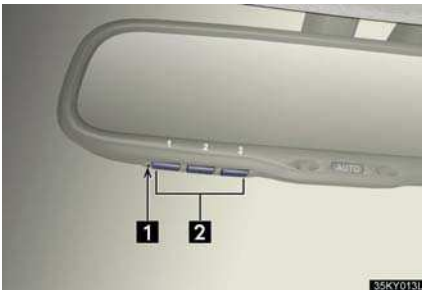

- 1 Indicator
- 2 Buttons

n Programming the HomeLink[®]

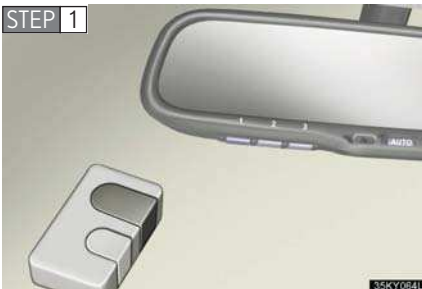

Point the remote control for the device 1 to 3 in. (25 to 75 mm) from the HomeLink[®] control buttons.

Keep the indicator light on the HomeLink[®] in view while programming.

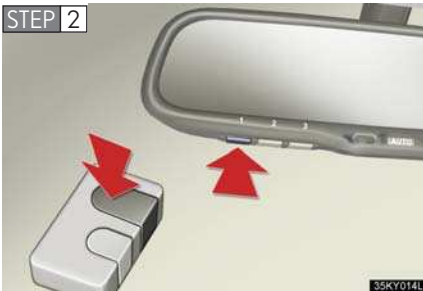

Press and hold down one of the buttons on the HomeLink[®] and the button on the transmitter. When the indicator light on the HomeLink[®] changes from a slow to a rapid flash after 20 seconds, you can release both buttons.

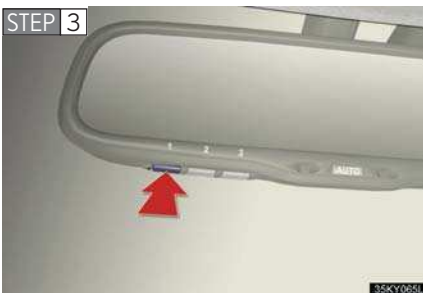

Test the operation of the HomeLink[®] by pressing the newly programmed button.

If programming a garage door opener, check to see if the garage door opens and closes. If the garage door does not operate, see if your garage transmitter is of the Rolling Code type. Press and hold the programmed HomeLink[®] button. The garage door has the rolling code feature if the indicator light (on the HomeLink[®]) flashes rapidly for 2 seconds and then remains lit. If your transmitter is the Rolling Code type, proceed to the heading "Programming a rolling code system".

STEP 4 Repeat the steps above to program another device for each of the remaining HomeLink[®] buttons.

n Programming a Rolling Code system (for U.S.A. owners)

If your device is Rolling Code equipped, follow the steps under the heading “Programming the HomeLink[®]” before proceeding with the steps listed below.

STEP 1 Locate the training button on the ceiling mounted garage door opener motor. The exact location and color of the button may vary by brand of garage door opener.

Refer to the operation manual supplied with the garage door opener for the location of the training button.

STEP 2 Press the training button.

STEP 3 Press and release the vehicle’s programmed HomeLink[®] button twice. The garage door may open.

If the garage door opens, the programming process is complete. If the door does not open, press and release the button a third time. This third press and release will complete the programming process by opening the garage door.

The ceiling mounted garage door opener motor should now recognize the HomeLink[®] transceiver and operate the garage door.

STEP 4 Repeat the steps above to program another rolling code system for any of the remaining HomeLink[®] buttons.

n Programming an entry gate (for U.S.A. owners)/Programming all devices in the Canadian market

STEP 1 Place your transmitter 1 to 3 in. (25 to 75 mm) away from the surface of the HomeLink[®].

Keep the indicator light on the HomeLink[®] in view while programming.

STEP 2 Press and hold the selected HomeLink[®] button.

STEP 3 Repeatedly press and release (cycle) the device’s remote control button for two seconds each until step 4 is complete.

STEP 4 When the indicator light on the HomeLink[®] compatible transceiver start to flashing rapidly, release the buttons.

STEP 5 Test the operation of the HomeLink[®] by pressing the newly programmed button. Check to see if the gate/device operates correctly.

STEP 6 Repeat the steps above to program another device for each of the remaining HomeLink[®] buttons.

n Programming other devices

To program other devices such as home security systems, home door locks or lighting, contact your authorized Lexus dealer for assistance.

n Reprogramming a button

The individual HomeLink[®] buttons cannot be erased but can be reprogrammed. To reprogram a button, follow the programming instructions.

Operating the HomeLink[®]

Press the appropriate HomeLink[®] button. The HomeLink[®] indicator light on the HomeLink[®] transceiver should turn on.

The HomeLink[®] continues to send a signal for up to 20 seconds as long as the button is pressed.

Erasing the entire HomeLink[®] memory (all three programs)

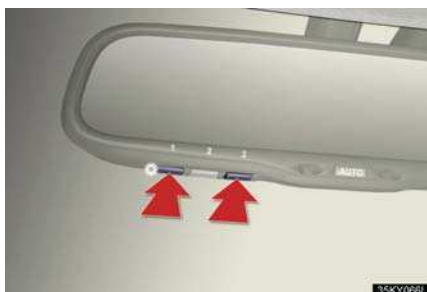

Press and hold down the 2 outside buttons for 20 seconds until the indicator light flashes.

If you sell your vehicle, be sure to erase the programs stored in the HomeLink[®] memory.

n Before programming

- 1 Install a new battery in the transmitter.
- 1 The battery side of the transmitter must be pointed away from the HomeLink®.

n Certification for the garage door opener

This device complies with Part 15 of the FCC Rules and with RSS-210 of the IC Rules.

Operation is subject to the following two conditions: (1) This device may not cause harmful interference, and (2) this device must accept any interference received, including interference that may cause undesired operation.

WARNING: This transmitter has been tested and complies with FCC and IC rules. Changes or modifications not expressly approved by the party responsible for compliance could void the user's authority to operate the device.

CAUTION

n When programming a garage door or other remote control device

The garage door may operate, so ensure people and objects are out of danger to prevent potential harm.

n Conforming to federal safety standards

Do not use the HomeLink® Compatible Transceiver with any garage door opener or device that lacks safety stop and reverse features as required by federal safety standards.

This includes any garage door that cannot detect an obstruction object. A door or device without these features increases the risk of death or serious injury.

Compass

The compass on the inside rear view mirror indicates the direction in which the vehicle is heading.

n Operation

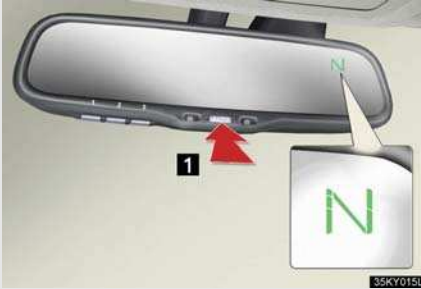

1 To turn the compass on or off, push “AUTO” for longer than 3 seconds.

Push and hold the button for 3 seconds or more.

n Displays and directions

Display	Direction
“N”	North
“NE”	Northeast
“E”	East
“SE”	Southeast
“S”	South
“SW”	Southwest
“W”	West
“NW”	Northwest

Calibrating the compass

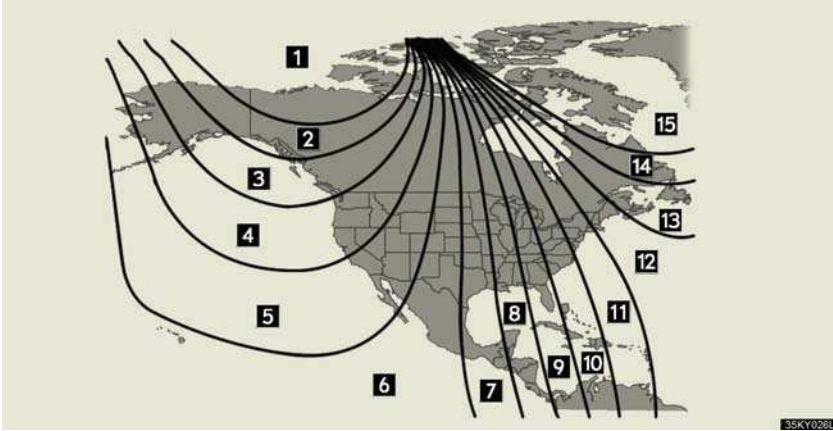

The direction display deviates from the true direction determined by the earth's magnetic field. The amount of deviation varies according to the geographic position of the vehicle.

If you cross over a map boundary shown in illustration, the compass will deviate.

To obtain higher precision or perfect calibration, refer to the following.

n Deviation calibration

STEP 1 Stop the vehicle where it is safe to drive in a circle.

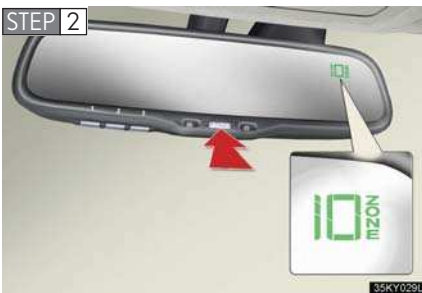

STEP 3 Press "AUTO", and referring to the map above, select the number of the zone where you are.

STEP 4 Press “AUTO” again.

If the direction is displayed several seconds after adjustment, the calibration is complete.

n Circling calibration

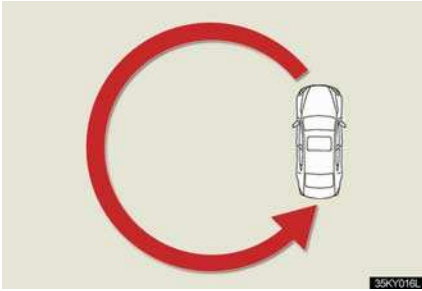

If “CAL” appears on the display, drive the vehicle at 5 mph (8 km/h) or less in a circle until a direction is displayed.

If there is not enough space to drive in a circle, drive around the block until the direction is displayed.

n Conditions unfavorable to correct operation

The compass may not show the correct direction in the following conditions:

- 1 The vehicle is stopped immediately after turning.
- 1 The vehicle is on an inclined surface.
- 1 The vehicle is in a place where the earth's magnetic field is subject to interference by artificial magnetic fields (underground car park/parking lot, under a steel tower, between buildings, roof car park/parking lot, near an intersection, near a large vehicle, etc.).
- 1 The vehicle has become magnetized.
(There is a magnet or metal object near the inside rear view mirror.)
- 1 The battery has been disconnected.
- 1 A door is open.

 CAUTION

n While driving the vehicle

Do not adjust the display. Be sure to adjust the display only when the vehicle is stopped.

n When doing the circling calibration

Be sure to secure a wide space, and watch out for people and vehicles in the neighborhood. Do not violate any local traffic rules while performing circling calibration.

 NOTICE

n To avoid the compass malfunctions

Do not place magnets or any metal objects near the inside rear view mirror. Doing this may cause a malfunction of the compass sensor.

n To ensure normal operation of the compass

- l** Do not perform circling calibration of the compass in a place where the earth's magnetic field is subject to interference by artificial magnetic fields.
- l** During calibration, do not operate electric systems (moon roof, power windows, etc.) as they may interfere with the calibration.

4-1. Maintenance and care

Cleaning and protecting the vehicle exterior

Perform the following to protect the vehicle and maintain it in prime condition.

1 Working from top to bottom, liberally apply water to the vehicle body, wheel wells and underside of the vehicle to remove any dirt and dust.

Wash the vehicle body using a sponge or soft cloth, such as a chamois.

1 For hard-to-remove marks, use car wash soap and rinse thoroughly with water.

1 Wipe away any water.

1 Wax the vehicle when the waterproof coating deteriorates.

If water does not bead on a clean surface, apply wax when the vehicle body is cool.

n Automatic car washes

1 Fold the mirrors back before washing the vehicle.

1 Brushes used in automatic car washes may scratch the vehicle surface and harm your vehicle's paint.

n High pressure car washes

1 Do not allow the nozzles of the car wash to come within close proximity of the windows.

1 Before car wash, check that the fuel filler door on your vehicle is closed properly.

n Aluminum wheels

Remove any dirt immediately by using a neutral detergent. Do not use hard brushes or abrasive cleaners. Do not use strong or harsh chemical cleaners. Use the same mild detergent and wax as used on the paint.

n Bumpers and side moldings

Do not scrub with abrasive cleaners.

n Outside rear view mirror rain-clearing coating

Observe the following precautions in order to retain the rain-clearing properties of the mirror.

- 1 Clean the mirrors using car shampoo or glass cleaner that does not contain silicone or an abrasive compound, and rinse thoroughly with water.
- 1 Allow the mirrors to be exposed to direct sunlight for 1 to 2 days.

n To prevent deterioration and do by corrosion

- 1 Wash the vehicle immediately in the following cases:
 - After driving near the sea coast
 - After driving on salted roads
 - If you see coal tar or tree sap on the paint surface
 - If you see dead insects or insect droppings on the paint
 - After driving in an area contaminated with soot, oily smoke, mine dust, iron powder or chemical substances
 - If the vehicle becomes heavily soiled in dust or mud
 - If liquids such as benzene and gasoline are spilled on the paint surface
- 1 If the paint is chipped or scratched, have it repaired immediately.

CAUTION

n Caution about the exhaust pipe

Exhaust gasses cause the exhaust pipe to become quite hot.

When washing the vehicle, be careful not to touch the pipe until it has cooled sufficiently, as touching a hot exhaust pipe can cause burns.

NOTICE

n To protect your vehicle's painted surfaces

Do not use organic cleaners such as benzene or gasoline.

n Cleaning the exterior lights

I Wash carefully. Do not use organic substances or scrub with a hard brush. This may damage the surfaces of the lights.

I Do not apply wax on the surfaces of the lights. Wax may cause damage to the lenses.

n To prevent damage to the windshield wiper arms

When lifting the wiper arms away from the windshield, pull the driver side wiper arm upward first, and repeat for the passenger side. When returning the wipers to their original position, do so from the passenger side first.

n When using an automatic car wash



Set the wiper switch to "OFF".

If the wiper switch is in "AUTO", the wipers may operate and the wiper blades may be damaged.

Cleaning and protecting the vehicle interior

The following procedures will help protect your vehicle's interior and keep it in top condition:

n Protecting the vehicle interior

Remove dirt and dust using a vacuum cleaner. Wipe dirty surfaces with a cloth dampened with lukewarm water.

n Cleaning the leather areas

1 Remove dirt and dust using a vacuum cleaner.

1 Wipe any excess dirt and dust with a soft cloth dampened with diluted detergent.

Use a diluted water solution of approximately 5% neutral wool detergent.

1 Wring out any excess water from the cloth and thoroughly wipe off all remaining traces of detergent.

1 Wipe the surface with a dry, soft cloth to remove any remaining moisture. Allow the leather to dry in shaded and ventilated area.

n Synthetic leather areas

1 Remove loose dirt using a vacuum cleaner.

1 Apply a mild soap solution to the synthetic leather using a sponge or soft cloth.

1 Allow the solution to soak in for a few minutes. Remove the dirt and wipe off the solution with a clean, damp cloth.

n **Cleaning the inside of the rear window**

Do not use glass cleaner to clean the rear window, as this may cause damage to the rear window defogger heater wires. Use a cloth dampened with lukewarm water to gently wipe the window clean. Wipe the window in strokes running parallel to the heater wires.

n **Caring for leather areas**

Lexus recommends cleaning the interior of the vehicle at least twice a year to maintain the quality of the vehicle's interior.

n **Shampooing the carpets**

There are several commercial foaming-type cleaners available. Use a sponge or brush to apply the foam. Rub in overlapping circles. Do not apply water. The excellent results are obtained when keeping the carpet as dry as possible.

n **Seat belts**

Clean with mild soap and lukewarm water using a cloth or sponge. Also check the belts periodically for excessive wear, fraying or cuts.

CAUTION

n **Water in the vehicle**

1 Be careful not to splash or spill liquid on the floor.

1 Do not get any of the SRS components or wiring in the vehicle interior wet.
(→P.79)

Electrical malfunction may cause the airbags to deploy or not function properly, resulting in death or severe injury.

 NOTICE**n Cleaning detergents**

Do not use organic substances such as benzene or gasoline, acidic or alkaline solutions, dye, bleach or other detergent. Doing so may discolor the vehicle interior or cause streaks or damage to painted surfaces.

n Preventing damage to leather surfaces

Observe the following precautions to avoid damage to and deterioration of leather surfaces.

I Remove any dust or dirt on leather surfaces immediately.

I Do not expose the vehicle to direct sunlight for extended periods of time. Park the vehicle in the shade, especially during summer.

I Do not place items made of vinyl, plastic, or that contain wax on the upholstery, as they may stick to the leather surface if the vehicle interior heats up significantly.

n Water on the floor

Do not wash the vehicle floor with water.

Vehicle systems such as the audio system may be damaged if water comes into contact with electrical components under the floor of the vehicle, and may also cause the body to rust.

n Cleaning the inside of the rear window

Be careful not to scratch or damage the heater wires or antenna.

Maintenance requirements

To ensure safe and economical driving, day-to-day care and regular maintenance is essential. It is the owner's responsibility to perform regular checks. Lexus recommends the following maintenance.

n General maintenance

Should be performed on a daily basis. This can be done by yourself or by a Lexus dealer.

n Scheduled maintenance

Should be performed at specified intervals according to the maintenance schedule.

For details about maintenance items and schedules, refer to the "Warranty and Services Guide/Owner's Manual Supplement/Scheduled Maintenance".

n Do-it-yourself maintenance

You can perform some maintenance procedures yourself.

Please be aware that do-it-yourself maintenance may affect warranty coverage.

The use of Lexus Repair Manuals is recommended.

For details about warranty coverage, see the separate "Owner's Guide", "Warranty and Services Guide", "Owner's Manual Supplement" or "Warranty Booklet".

n Repair and replacement

It is recommended that genuine Lexus parts be used for repair to ensure performance of each system. If non-Lexus parts are used in replacement or if a repair shop other than a Lexus dealer performs repairs, confirm the warranty coverage.

n Allow inspection and repairs to be performed by a Lexus dealer

- I Lexus technicians are well-trained specialists and are kept up to date with the latest service information. They are well informed about the operations of all systems on your vehicle.
- I Keep a copy of the repair order. It proves that the maintenance that has been performed is under warranty coverage. If any problem should arise while your vehicle is under warranty, your Lexus dealer will promptly take care of it.

! CAUTION

n If your vehicle is not properly maintained

It could result in serious damage to the vehicle and possible serious injury or death.

n Warning in handling of battery

- I Engine exhaust, some of its constituents, and a wide variety of automobile components contain or emit chemicals known to the State of California to cause cancer and birth defects and other reproductive harm. Work in a well ventilated area.
- I Oils, fuels and fluids contained in vehicles as well as waste produced by component wear contain or emit chemicals known to the State of California to cause cancer and birth defects or other reproductive harm. Avoid exposure and wash any affected area immediately.
- I Battery posts, terminals and related accessories contain lead and lead compounds which are known to cause brain damage. Wash your hands after handling. (→P. 302)

4-2. Maintenance

General maintenance

Listed below are the general maintenance items that should be performed at the intervals specified in the “Warranty and Services Guide” or “Owners Manual Supplement”. It is recommended that any problem you notice should be brought to the attention of your Lexus dealer or qualified service shop for advice.

Engine compartment

Items	Check points
Battery	Maintenance-free. (→P. 302)
Brake fluid	At the correct level? (→P. 301)
Engine coolant	At the correct level? (→P. 299)
Engine oil	At the correct level? (→P. 295)
Exhaust system	No fumes or strange sounds?
Radiator/condenser/hoses	Not blocked with foreign matter? (→P. 301)
Washer fluid	At the correct level? (→P. 305)

Vehicle interior

Items	Check points
Accelerator pedal	<ul style="list-style-type: none"> • Moves smoothly (without uneven pedal effort or catching)?
Automatic transmission "Park" mechanism	<ul style="list-style-type: none"> • Can the vehicle be hold securely on an incline with the shift lever in P?
Brake pedal	<ul style="list-style-type: none"> • Moves smoothly? • Does it have appropriate clearance and correct amount of free play?
Brakes	<ul style="list-style-type: none"> • Not pull to one side when applied? • Loss of brake effectiveness? • Spongy feeling brake pedal? • Pedal almost touches floor?
Head restraints	<ul style="list-style-type: none"> • Move smoothly and lock securely?
Indicators/buzzers	<ul style="list-style-type: none"> • Function properly?
Lights	<ul style="list-style-type: none"> • Do all the lights come on? • Headlights aimed correctly? (→P. 341)
Parking brake	<ul style="list-style-type: none"> • Moves smoothly? • Can hold the vehicle securely on an incline?
Seat belts	<ul style="list-style-type: none"> • Does the seat belt system operate smoothly? • Are the belts undamaged?
Seats	<ul style="list-style-type: none"> • Do the seat controls operate properly?

Items	Check points
Steering wheel	<ul style="list-style-type: none"> • Moves smoothly? • Has correct free play? • No strange noises?

Vehicle exterior

Items	Check points
Door/trunk	<ul style="list-style-type: none"> • Operate smoothly?
Engine hood	<ul style="list-style-type: none"> • The lock system works properly?
Fluid leaks	<ul style="list-style-type: none"> • Is there any leakage after parking?
Tire	<ul style="list-style-type: none"> • Inflation pressure is correct? • Tire surfaces not worn or damaged? • Tires rotated according to the maintenance schedule? • Wheel nuts are not loose?

CAUTION

n If the engine is running

Turn the engine off and ensure that there is adequate ventilation before performing maintenance checks.

Some states have vehicle emission inspection programs which include OBD (On Board Diagnostics) checks. The OBD system monitors the operation of the emission control system.

n If the malfunction indicator lamp comes on

The OBD system determines that a problem exists somewhere in the emission control system. Your vehicle may not pass the I/M test and may need to be repaired. Contact your Lexus dealer to service the vehicle.

n Your vehicle may not pass the I/M test:

1 When the battery is disconnected or discharged

Readiness codes that are set during ordinary driving are erased. Also, depending on your driving habits, the readiness codes may not be completely set.

1 When the fuel tank cap is loose

The malfunction indicator lamp comes on as a temporary malfunction and your vehicle may not pass the I/M test.

n When the malfunction indicator lamp goes off after several driving trips

The error code in the OBD system will not be cleared unless the vehicle is driven 40 or more times.

n If your vehicle does not pass the I/M test

Contact your Lexus dealer to prepare the vehicle for re-testing.

4-3. Do-it-yourself maintenance

Do-it-yourself service precautions

If you perform maintenance yourself, be sure to follow the correct procedure given in these sections.

Items	Parts and tools
Battery condition (→P. 302)	<ul style="list-style-type: none">• Warm water• Baking soda• Grease• Conventional wrench (for terminal clamp bolts)
Brake fluid level (→P. 301)	<ul style="list-style-type: none">• FMVSS No.116 DOT 3 or SAE J1703 brake fluid• Rag or paper towel• Funnel (used only for adding brake fluid)
Engine coolant level (→P. 299)	<ul style="list-style-type: none">• “Toyota Super Long Life Coolant” or similar high-quality ethylene glycol-based non-silicate, non-amine, non-nitrite and non-borate coolant with long-life hybrid organic acid technology. For the U.S.A.: “Toyota Super Long Life Coolant” is pre-mixed with 50% coolant and 50% deionized water. For Canada: “Toyota Super Long Life Coolant” is pre-mixed with 55% coolant and 45% deionized water.• Funnel (used only for adding engine coolant)

Items		Parts and tools
Engine oil level	(→P. 295)	<ul style="list-style-type: none"> • “Toyota Genuine Motor Oil” or equivalent • Rag or paper towel, funnel (used only for adding engine oil)
Fuses	(→P. 327)	<ul style="list-style-type: none"> • Fuse with same amperage rating as original
Tire inflation pressure	(→P. 316)	<ul style="list-style-type: none"> • Tire pressure gauge • Compressed air source
Headlight aim	(→P. 341)	<ul style="list-style-type: none"> • Phillips-head screwdriver
Radiator and condenser	(→P. 301)	—
Washer fluid	(→P. 305)	<ul style="list-style-type: none"> • Water washer fluid containing anti-freeze (for winter use) • Funnel

CAUTION

The engine compartment contains many mechanisms and fluids that may move suddenly, become hot, or become electrically energized. To avoid death or serious injury, observe the following precautions.

n When working on the engine compartment:

- 1 Keep hands, clothing, and tools away from the moving fan and engine drive belt.
- 1 Be careful not to touch the engine, radiator, exhaust manifold, etc. right after driving as they may be hot. Oil and other fluids may also be hot.
- 1 Do not leave anything that may burn easily, such as paper or rags, in the engine compartment.
- 1 Do not smoke, cause sparks or expose an open flame to fuel or the battery. Fuel and battery fumes are flammable.
- 1 Be extremely cautious when working on the battery. It contains poisonous and corrosive sulfuric acid.

 CAUTION

n When working near the electric cooling fan or radiator grille:

Be sure the “ENGINE START STOP” switch is OFF.
With the “ENGINE START STOP” switch in IGNITION ON mode, the electric cooling fan may automatically start to run if the air conditioning is on and/or the coolant temperature is high.
(→P. 301)

n Safety glasses

Wear safety glasses to prevent flying or falling material, fluid spray, etc. from getting in the eyes.

 NOTICE

n If you remove the air cleaner:

Driving with the air filter removed may cause excessive engine wear due to dirt in the air. Also a backfire could cause a fire in the engine compartment.

4-3. Do-it-yourself maintenance

Hood

Release the lock from the inside of the vehicle to open the hood.



Pull the hood release lever.

The hood will pop up slightly.

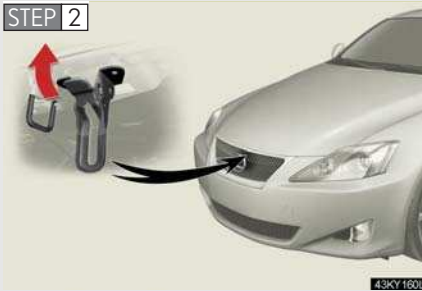

Lift the auxiliary catch lever and lift the hood.

CAUTION

n Pre-driving check

Check that the hood is fully closed and locked.

If the hood is not locked properly it may open while the vehicle is in motion and cause an accident, which may result in death or serious injury.

4-3. Do-it-yourself maintenance

Positioning a floor jack

When raising your vehicle with a floor jack, position the jack correctly. Improper placement may damage your vehicle or cause injury.

n Front

► 2WD

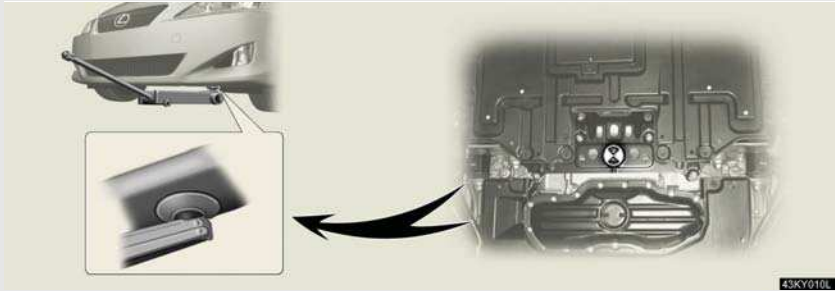

► AWD

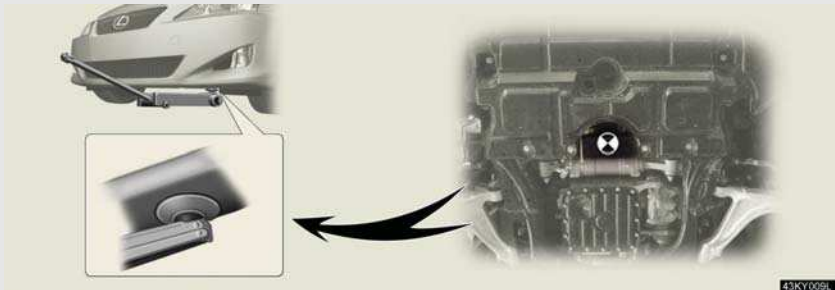

n Rear

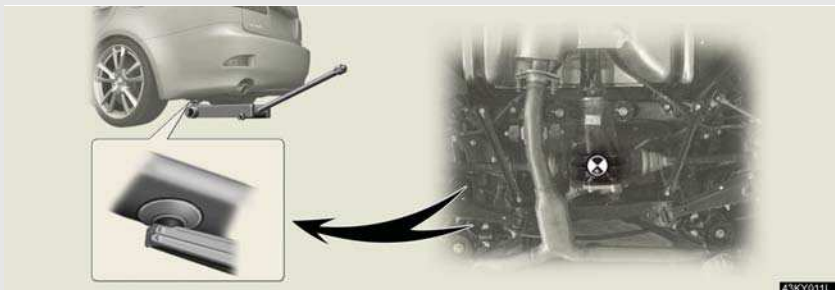

! CAUTION**n When raising your vehicle:**

Make sure to observe the following to reduce the possibility of death or serious injury.



I Lift up the vehicle using a floor jack such as the one shown in the illustration.

- I** Do not use the jack that was supplied with your vehicle.
- I** Do not put any part of your body or get underneath the vehicle supported only by the floor jack.
Always use automotive jack stands on a solid, level, surface.
- I** Do not start the engine while the vehicle is supported by the floor jack.
- I** Stop the vehicle on level firm ground, firmly set the parking brake and put the shift lever in P (automatic) or R (manual).
- I** Make sure to set the floor jack properly at the jack point.
Raising the vehicle with an improperly positioned floor jack will damage the vehicle and may cause the vehicle to fall off the floor jack.
- I** Do not raise the vehicle while someone is in the vehicle.
- I** When raising the vehicle, do not place any objects on top of or underneath the floor jack.

4-3. Do-it-yourself maintenance

Engine compartment

► IS350



- | | | | |
|------------------------------------|-----------|------------------------------------|-----------|
| 1 Battery | (→P. 302) | 6 Washer fluid tank | (→P. 305) |
| 2 Engine oil level dipstick | (→P. 295) | 7 Electric cooling fans | |
| 3 Engine oil filler cap | (→P. 295) | 8 Condenser | (→P. 301) |
| 4 Brake fluid reservoir | (→P. 301) | 9 Radiator | (→P. 301) |
| 5 Fuse boxes | (→P. 327) | 10 Engine coolant reservoir | (→P. 299) |

▶ IS250

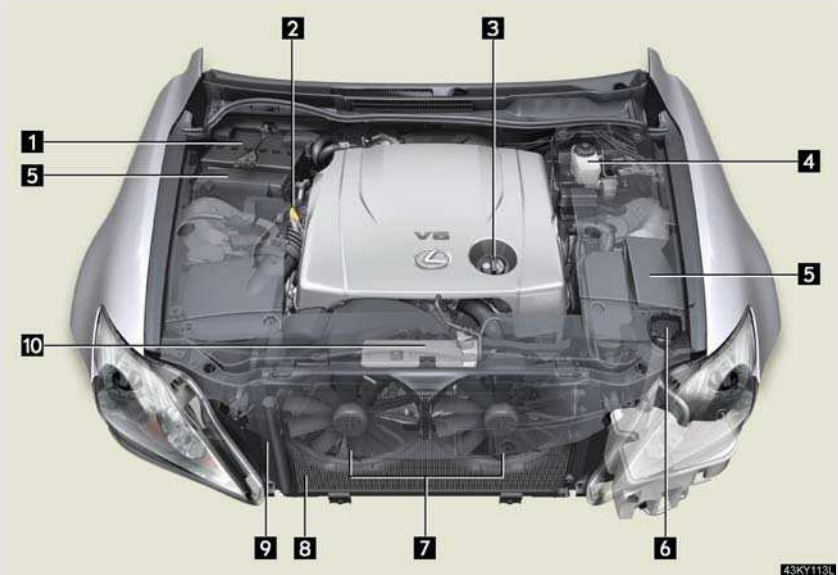

- | | | | |
|------------------------------------|-----------|------------------------------------|-----------|
| 1 Battery | (→P. 302) | 6 Washer fluid tank | (→P. 305) |
| 2 Engine oil level dipstick | (→P. 295) | 7 Electric cooling fans | |
| 3 Engine oil filler cap | (→P. 295) | 8 Condenser | (→P. 301) |
| 4 Brake fluid reservoir | (→P. 301) | 9 Radiator | (→P. 301) |
| 5 Fuse boxes | (→P. 327) | 10 Engine coolant reservoir | (→P. 299) |

Engine compartment cover

n Removing the engine compartment cover

► Front



► Outside

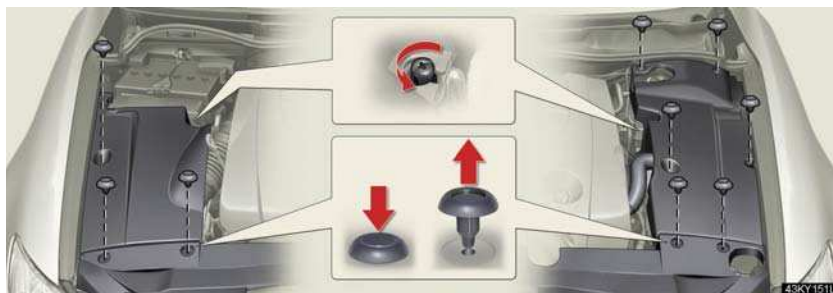

n Installing the clips

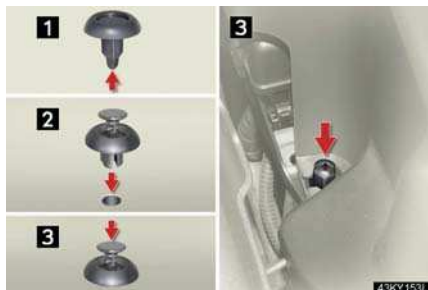

1 Press the tip of the clip against a hard surface, such as a desk, to allow the center part of the clip to be pushed up.

2 Insert

3 Press

Engine oil

With the engine at operating temperature and turned off, check the oil level on the dipstick.

n Checking the engine oil

STEP 1 Park the vehicle on level ground. After turning off the engine, wait a few minutes for the oil to drain back into the bottom of the engine.

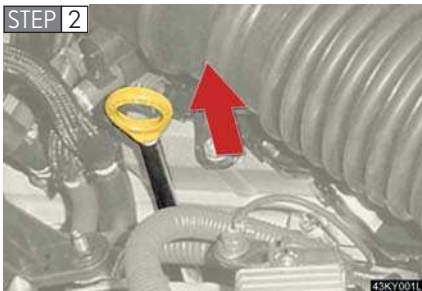

Hold a rag under the end and pull the dipstick out.

STEP 3 Wipe the dipstick clean.

STEP 4 Reinsert the dipstick fully.

STEP 5 Holding a rag under the end, pull the dipstick out and check the oil level.

STEP 6 Wipe the dipstick and reinsert it fully.

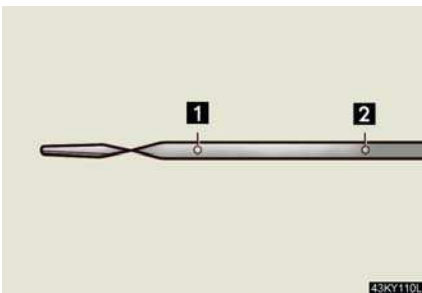

1 Low

2 Full

n Adding engine oil



If the oil level is below or near the low level mark, add engine oil of the same type as already in the engine.

Make sure to check the oil type and prepare the items needed before adding oil.

Oil grade	ILSAC multi-grade engine oil
Items	Clean funnel

STEP 1 Remove the oil filler cap.

STEP 2 Add engine oil slowly, checking the dipstick.

STEP 3 Install the filler cap, turning it clockwise.

It takes about 1.6 qt. (1.5 L, 1.3 Imp.qt.) to raise the oil level from low to full on the dipstick.

n Recommended viscosity

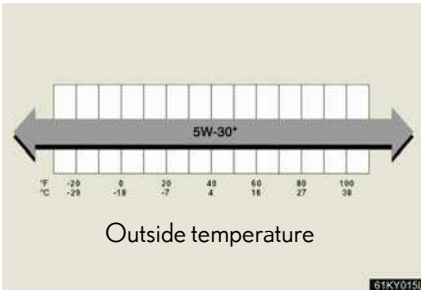

SAE 5W-30 is the best choice for good fuel economy, and good starting in cold weather.

*: If SAE 5W-30 oil is not available, SAE 10W-30 oil may be used. However, it should be replaced with SAE 5W-30 at the next oil change.

n How to read oil container labels

Some oil containers are labeled with ILSAC certification marks that help you to select the proper oil.



n Engine oil consumption

- 1 The amount of engine oil consumed depends on the oil viscosity, the quality of the oil and the way the vehicle is driven.
- 1 More oil is consumed under driving conditions such as high speeds and frequent acceleration and deceleration.
- 1 A new engine consumes more oil.
- 1 When judging the amount of oil consumption, keep in mind that the oil may have become diluted, making it difficult to judge the true level accurately.
- 1 Oil consumption: Max. 1.1 qt./600 miles, 0.9 Imp.qt./600 miles (1.0 L per 1000 km)
- 1 If you consume more than 1.1 qt. (1.0 L, 0.9 Imp.qt.) every 600 miles (1000 km), contact your Lexus dealer.

n After changing the engine oil (U.S.A. only)

The oil change system should be reset. Perform the following procedures:

STEP 1 Switch the display to the odometer (→P. 130) when the engine is running.

STEP 2 Turn the “ENGINE START STOP” switch OFF.

STEP 3 While pressing the trip meter reset button, set the “ENGINE START STOP” switch to the IGNITION ON mode (but do not start the engine because otherwise the reset mode will be cancelled). Continue to press and hold the button until the trip meter displays 000000.

CAUTION

n Used engine oil

- 1 Used engine oil contains potentially harmful contaminants which may cause skin disorders such as inflammation or skin cancer, so care should be taken to avoid prolonged and repeated contact. To remove used engine oil from your skin, wash thoroughly with soap and water.
- 1 Dispose of used oil and filters only in a safe and acceptable manner. Do not dispose of used oil and filters in household trash, in sewers or onto the ground. Call your Lexus dealer, service station or auto parts store for information concerning recycling or disposal.
- 1 Do not leave used engine oil within the reach of children.

 NOTICE

n To prevent serious engine damage:

Check the oil level on regular basis.

n When replacing the engine oil

- I** Be careful not to spill engine oil on the vehicle components.
- I** Avoid overfilling, or the engine could be damaged.
- I** Check the oil level on the dipstick every time you refill the vehicle.
- I** Be sure the engine oil filler cap is properly tightened.

Engine coolant

The coolant level is satisfactory if it is between the “FULL” and “LOW” lines on the reservoir when the engine is cold.

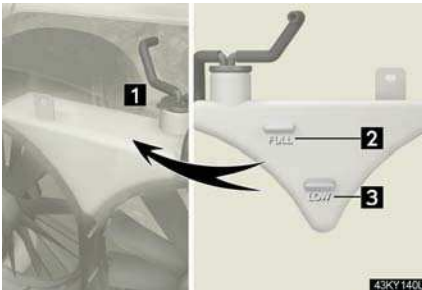

- 1** Reservoir cap
- 2** “FULL”
- 3** “LOW”

If the level is on or below the “LOW” line, add coolant up to the “FULL” line.

n If the coolant level drops within a short time after replenishing

Visually check the radiator, hoses, engine coolant filler cap, radiator cap, drain cock and water pump.

If you cannot find a leak, have your Lexus dealer pressure test the cap and check for leaks in the cooling system.

n Coolant selection

Only use “Toyota Super Long Life Coolant” or similar high-quality ethylene glycol-based non-silicate, non-amine, non-nitrite, and non-borate coolant with long-life hybrid organic acid technology.

U.S.A.: “Toyota Super Long Life Coolant” is a mixture of 50% coolant and 50% deionized water. (Enabled: -31°F [-35°C])

Canada: “Toyota Super Long Life Coolant” is a mixture of 55% coolant and 45% deionized water. (Enabled: -44°F [-42°C])

For more details about engine coolant, contact your Lexus dealer.

! CAUTION

n When the engine is hot

Do not remove the radiator cap.

The cooling system may be under pressure and may spray hot coolant if the cap is removed, causing burns or other injuries.

! NOTICE

n When adding engine coolant

Coolant is neither plain water nor straight antifreeze. The correct mixture of water and antifreeze must be used to provide proper lubrication, corrosion protection and cooling. Be sure to read the antifreeze or coolant label.

n If you spill coolant

Be sure to wash it off with water to prevent it damaging parts or paint.

Radiator and condenser

Check the radiator and condenser and clear any foreign objects. If either of the above parts are extremely dirty or you are not sure of their condition, have your vehicle checked by your Lexus dealer.

⚠ CAUTION

n When the engine is hot

Do not touch the radiator or condenser, as they may be hot and you may be burned.

Brake fluid

n Checking fluid level



The brake fluid level should be between the "MAX" and "MIN" lines on the tank.

Make sure to check the fluid type and prepare the necessary items.

n Adding fluid

Fluid type	FMVSS No.116 DOT 3 or SAE J1703 brake fluid
Items	Clean funnel

n Brake fluid can absorb moisture from the air

Excess moisture in the fluid can cause a dangerous loss of braking efficiency. Use only newly opened brake fluid.

! CAUTION

n When filling the reservoir

Take care because brake fluid can harm your hands or eyes and damage painted surfaces.

If fluid gets in your eyes, flush your eyes with clean water immediately.

If you still experience discomfort, see a doctor.

! NOTICE

n If the fluid level is low or high

It is normal for the brake fluid level to go down slightly as the brake pads wear or when the fluid level in the accumulator is high.

If the reservoir needs frequent refilling, it may indicate a serious problem.

Battery

Check the battery as follows.

n Battery exterior

Make sure that the battery terminals are not corroded and that there are no loose connections, cracks, or loose clamps.

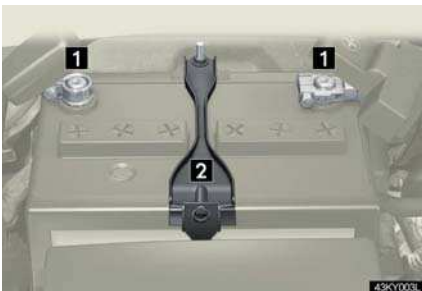

1 Terminals

2 Hold-down clamp

n Checking battery condition

Check the battery condition using the indicator color.

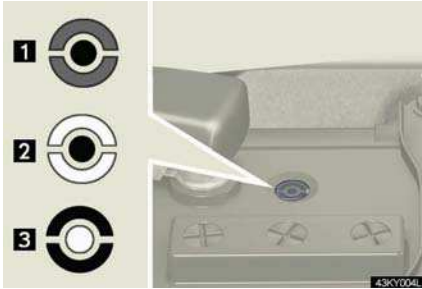

- 1** Blue: Good condition
- 2** White: Charging is necessary. Have the vehicle inspected by your Lexus dealer.
- 3** Red: Not working properly, have the battery checked by your Lexus dealer.

n Before recharging

When recharging, the battery produces hydrogen gas which is flammable and explosive. Therefore, before recharging:

- 1 If recharging with the battery installed on the vehicle, be sure to disconnect the ground cable.
- 1 Make sure the power switch on the charger is off when connecting and disconnecting the charger cables to the battery.

n After recharging the battery

The engine may not start. Follow the procedure below to initialize the system.

- STEP 1** Shift the shift lever to P (automatic) or depress the brake pedal with the shift lever in N (manual).
- STEP 2** Open and close any of the doors.
- STEP 3** Restart the engine.

! CAUTION

n Chemicals in the battery:

A battery contains poisonous and corrosive sulfuric acid and may produce hydrogen gas which is flammable and explosive. To reduce the risk of death or serious injury, take the following precautions while working on or near battery:

- I** Do not cause sparks by touching the battery terminals with tools.
- I** Do not smoke or light a match near the battery.
- I** Avoid contact with eyes, skin and clothes.
- I** Never inhale or swallow electrolyte.
- I** Wear protective safety glasses when working near the battery.
- I** Keep children away from the battery.

n Where to safely charge the battery

Always charge the battery in an open area. Do not charge the battery in a garage or closed room where there is not sufficient ventilation.

n How to recharge the battery

Only perform a slow charge (5 A or less). The battery may explode if charged at a quicker rate.

n Emergency measures regarding electrolyte

- I** If electrolyte gets in your eyes
Flush your eyes with clean water for at least 15 minutes and get immediate medical attention. If possible, continue to apply water with a sponge or cloth while traveling to the nearest medical facility.
- I** If electrolyte gets on your skin
Wash the affected area thoroughly. If you feel pain or burning, get medical attention immediately.
- I** If electrolyte gets on your clothes
It can soak through clothing on to your skin. Immediately take off the clothing and follow the procedure above if necessary.
- I** If you accidentally swallow electrolyte
Drink a large quantity of water or milk. Follow with milk of magnesia, beaten raw egg or vegetable oil. Get emergency medical attention immediately.

⚠ NOTICE

n When recharging the battery

Never recharge the battery while the engine is running. Also, be sure all accessories are turned off.

Washer fluid



If any washer does not work or the warning message appears on the multi-information display, the washer tank may be empty. Add washer fluid.

⚠ CAUTION

n When refilling the washer fluid

Do not refill the washer fluid when the engine is hot or running, as the washer fluid contains alcohol and may catch fire if spilled on the engine etc.

⚠ NOTICE

n Do not use any fluid other than washer fluid

Do not use soapy water or engine antifreeze instead of washer fluid. Doing so may cause streaking on the vehicle's painted surfaces.

n Diluting washer fluid

Dilute washer fluid with water as necessary. Refer to the freezing temperatures listed on the washer fluid tank.

4-3. Do-it-yourself maintenance

Tires

Replace or rotate tires in accordance with maintenance schedules and treadwear.

n Checking tires



- 1 New tread
- 2 Treadwear indicator
- 3 Worn tread

The location of treadwear indicators is shown by the “TWI” or “Δ” marks, etc., molded on the sidewall of each tire.

Check spare tire condition and pressure if not rotated.

n Tire rotation

- ▶ 2WD models with 16-inch tires and AWD models

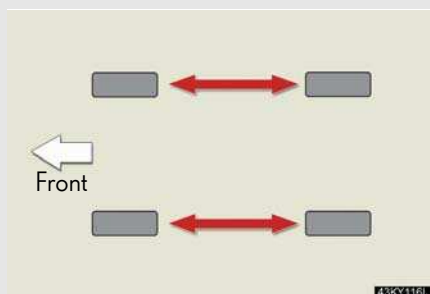

Rotate the tires in the order shown.

To equalize tire wear and extend tire life, Lexus recommends that tire rotation is carried out at the same interval as tire inspection.

Do not fail to initialize the tire pressure warning system after tire rotation.

- ▶ 2WD models with 18-inch tires

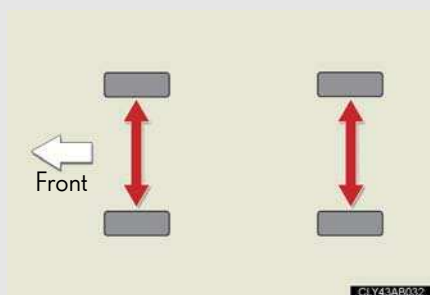

Rotate the tires in the order shown.

To equalize tire wear and extend tire life, Lexus recommends that tire rotation is carried out at the same interval as tire inspection.

- ▶ 2WD models with 17-inch tires
Tires cannot be rotated.

n The tire pressure warning system

Your Lexus is equipped with a tire pressure warning system that uses tire pressure warning valves and transmitters to detect low tire inflation pressure before serious problems arise. (→P. 362, 370)

Directional tires



1 Tire direction marks

The tires listed below are directional. The tire sidewalls are marked with arrows indicating the rolling direction of the tire. If mounted on the wrong side of the vehicle, directional tires will perform poorly.

Tire size of turning directional tires

Front	225/45R17 90W
Rear	245/45R17 95W

Installing tire pressure warning valves and transmitters

When replacing tires or wheels, tire pressure warning valves and transmitters must also be installed.

When new tire pressure warning valves and transmitters are installed, new tire pressure warning valve and transmitter ID codes must be registered in the tire pressure warning computer and tire pressure warning system must be initialized. Have tire pressure warning valve and transmitter ID codes registered by your Lexus dealer. (→P. 310)

Initializing the tire pressure warning system

n The tire pressure warning system must be initialized in the following circumstances:

- I When rotating the tires on vehicles differing with front and rear tire inflation pressures.
- I When changing the tire inflation pressure by changing traveling speed.
- I When changing the tire size.

When the tire pressure warning system is initialized, the current tire inflation pressure is set as the pressure benchmark.

n How to initialize the tire pressure warning system

To initialize the system, use the satellite switch. (→P. 245)

STEP 1 Park the vehicle in safe place and turn the “ENGINE START STOP” switch OFF.

While the vehicle is moving, initialization is not performed.

STEP 2 Adjust the tire inflation pressure to the specified cold tire inflation pressure level. (→P. 415)

Make sure to adjust the tire pressure to the specified cold tire inflation pressure level. The tire pressure warning system will operate based on this pressure level.

STEP 3 Turn the “ENGINE START STOP” switch to IGNITION ON mode.



1 The tire inflation pressure initialization setting display

Continue to press < or > until the initialization setting display appears.

It may take several minutes to complete the setting. Wait for several minutes before turning the “ENGINE START STOP” switch to OFF if necessary.



2 Recording tire inflation pressure settings

Press and hold the “ON/OFF” button until the tire pressure warning light blinks slowly 3 times and the message “PRESSURE INITIAL” showing that the initial setting is complete is displayed on the multi-information display.

STEP 5 Wait for a few minutes with the IGNITION ON mode, and then turn the “ENGINE START STOP” switch OFF.

Registering and selecting ID codes

To select tire pressure warning valve and transmitter ID codes, use the satellite switch. (→P. 245)

n Registering ID codes

2 sets of tire pressure warning valve and transmitter ID codes can be registered. Once a second set of tires is registered at “2ND”, you can switch between tire set settings simply by pressing the tire pressure warning select switch.

There are 2 settings:

“MAIN” position: The ID code of the tire pressure warning valve and transmitter on the tires originally installed on the vehicle is registered.

“2ND” position: The ID code is not registered. When you replace a new set of tires, purchase tire pressure warning valves and transmitters from your Lexus dealer and have the new ID code registered by your Lexus dealer.

n Selecting ID codes

When replacing tires, make sure to select the ID code set that matches the new tire set. If the tire pressure select switch is set to the wrong tire setting, the tire pressure warning system will not operate properly. After driving for about 20 minutes, the tire pressure warning light comes on after blinking for 1 minute to indicate a system malfunction.



1 Tire pressure warning valve and transmitter ID code settings display

Press < or > repeatedly until the setting display appears.

2 Switching ID codes

Press the “ON/OFF” button to switch between “MAIN” and “2ND” ID codes.

n **When to replace your vehicle's tires**

Tires should be replaced if:

- 1 You have tire damage such as cuts, splits, cracks deep enough to expose the fabric or bulges indicating internal damage
- 1 A tire goes flat repeatedly or cannot be properly repaired due to the size or location of a cut or other damage

If you are not sure, consult with your Lexus dealer.

n **Replacing tires and wheels**

If the ID code of the tire pressure warning valve and transmitter is not registered, the tire pressure warning system will not work properly. After driving for about 20 minutes, the tire pressure warning light comes on after blinking for 1 minute to indicate a system malfunction.

n **Tire life**

Any tire over 6 years old must be checked by a qualified technician even if they have seldom or never been used or damage is not obvious.

n **If the tread wears down below 0.16 in. (4 mm) on snow tires**

The effectiveness of snow tires is lost.

n **Low profile tires (models not equipped with 16-inch tires)**

Generally, low profile tires will wear more rapidly and tire grip performance will be reduced on snowy and/or icy roads when compared to standard tires. Be sure to use snow tires or tire chains* on snowy and/or icy roads and drive carefully at a speed appropriate for road and weather conditions.

*: Tire chains cannot be mounted on 18-inch tires.

n **Maximum load of tire**

Check that the maximum load of the replaced tire is greater than 1/2 of the Gross Axle Weight Ratings (GAWR) of either the front axle or the rear axle, whichever is greater.

As for the maximum load of the tire, see the load limit at maximum cold tire inflation pressure mentioned on the sidewall of the tire, and as for the Gross Axle Weight Ratings (GAWR), see the Certification Label. (→P. 316, 424).

n Tire types

1 Summer tires

Summer tires are high-speed performance tires best suited to highway driving under dry conditions. Since summer tires do not have the same traction performance as snow tires, summer tires are inadequate for driving on snow-covered or icy roads. For driving on snow-covered roads or icy roads, the use of snow tires is recommended. When installing snow tires, be sure to replace all four tires.

2 All season tires

All season tires are designed to provide better traction in snow and to be adequate for driving in most winter conditions, as well as for use year round. All season tires, however, do not have adequate traction performance compared with snow tires in heavy or loose snow. Also, all season tires fall short in acceleration and handling performance compared with summer tires in highway driving.

3 Snow tires

For driving on snow-covered roads or icy roads, we recommend using snow tires. If you need snow tires, select tires of the same size, construction and load capacity as the originally installed tires. Since your vehicle has radial tires as original equipment, make sure your snow tires also have radial construction. Do not install studded tires without first checking local regulations for possible restriction. Snow tires should be installed on all wheels. (→P. 183)

n Initializing the tire pressure warning system

Initialize the tires with the tire inflation pressure adjusted to the specified level.

n When the initialization of the tire pressure warning system has failed

Initialization can be completed in a few minutes. However, in the following cases, the settings have not been recorded and the system will not operate properly. If repeated attempts to record tire inflation pressure settings are unsuccessful, have the vehicle inspected by your Lexus dealer.

- 1 When operating the tire pressure warning reset switch, the tire pressure warning light does not flash 3 times and the setting message does not appear on the multi-information display.
- 1 After carrying out the initialization procedure, the tire pressure warning light blinks for 1 minute then stays on after driving for about 20 minutes.

n Routine tire inflation pressure checks

The tire pressure warning system does not replace routine tire inflation pressure checks. Make sure to check tire inflation pressure as part of your routine of daily vehicle checks.

n Tire pressure warning system certification

► For vehicles sold in the U.S.A.

This device complies with Part 15 of the FCC Rules. Operation is subject to the following two conditions: (1) this device may not cause harmful interference, and (2) this device must accept any interference received, including interference that may cause undesired operation.

NOTICE:

This equipment has been tested and found to comply with the limits for a Class B digital device, pursuant to Part 15 of the FCC Rules. These limits are designed to provide reasonable protection against harmful interference in a residential installation. This equipment generates, uses and can radiate radio frequency energy and, if not installed and used in accordance with the instructions, may cause harmful interference to radio communications. However, there is no guarantee that interference will not occur in a particular installation. If this equipment does cause harmful interference to radio or television reception, which can be determined by turning the equipment off and on, the user is encouraged to try to correct the interference by one or more of the following measures:

- 1 Reorient or relocate the receiving antenna.
- 1 Increase the separation between the equipment and receiver.
- 1 Connect the equipment into an outlet on a circuit different from that to which the receiver is connected.
- 1 Consult the dealer or an experienced radio/TV technician for help.

FCC WARNING:

Changes or modifications not expressly approved by the party responsible for compliance could void the user's authority to operate the equipment.

► For vehicles sold in Canada

Operation is subject to the following two conditions: (1) this device may not cause interference, and (2) this device must accept any interference, including interference that may cause undesired operation of the device.

CAUTION

n When inspecting or replacing tires

Observe the following precautions to prevent accidents. Failure to do so may cause damage to parts of the drive train, as well as dangerous handling characteristics, which may lead to fatal or injury accidents.

- I** Do not mix tires of different makes, models, tread patterns or treadwear.
- I** Do not use tire sizes other than those recommended by Lexus.
- I** Do not mix radial, bias-belted, or bias-ply tires.
- I** Do not mix summer, all season and winter tires.

n When initializing the tire pressure warning system

Do not press the satellite switch without first adjusting the tire inflation pressure to the specified level. Otherwise, the tire pressure warning light may not come on even if the tire inflation pressure is low, or it may come on when the tire inflation pressure is actually normal.

NOTICE

n Repairing or replacing tires, wheels and tire pressure warning valves and transmitters

When removing or fitting the wheels, tires or the tire pressure warning valve and transmitter, contact your Lexus dealer as the tire pressure warning valve and transmitter may be damaged if not handled correctly.

n To avoid damaging the tire pressure warning valves and transmitters

Do not use liquid sealants on flat tires.

 NOTICE**n Driving on rough roads**

Take particular care when driving on roads with loose surfaces or pot holes. These conditions may cause losses in tire inflation pressure, reducing the cushioning ability of the tires. In addition driving on rough roads may cause damage to the tires themselves, as well as the vehicle's wheels and body.

n Low profile tires and wheels

Wheels with profile tires like 17- and 18-inch tires may cause greater damage than usual to the tire wheel when receiving impact from the road surface. Therefore pay attention to the following:

- I** Be sure to use proper tire inflation pressure. If tires are under-inflated, they may be damaged more severely.
- I** Avoid pot holes, uneven pavement, curbs and other road hazards. Failure to do so can lead to severe tire and wheel damage.

n If tire inflation pressures become low while driving

Do not continue driving, or your tires and/or wheels may be ruined.

4-3. Do-it-yourself maintenance

Tire inflation pressure

n Tire inflation pressure

The recommended cold tire inflation pressure and tire size is displayed on the tire and loading information label. (→P. 415)



TIRE AND LOADING INFORMATION			INFORMATION SUR LES PNEUS ET LE CHARGEMENT		
SEATING CAPACITY: TOTAL X FRONT X-REAR X The combined weight of occupants and cargo should never exceed 1000 kg or 2000 lbs.			NOMBRE DE PLACES ASSISES: TOTAL X AVANT X-ARRIÈRE X Le poids total des occupants et du chargement ne doit jamais être supérieur à 1000 kg ou 2000 lbs.		
TIRE	SIZE	COLD TIRE PRESSURE	PNEUS	DIMENSION	PRESSION DE GONFLAGE À FROID
FRONT	XXXXXXRXX	XXXXPa,XXKPSI	AVANT	XXXXXXRXX	XXXXPa,XXKPSI
REAR	XXXXXXRXX	XXXXPa,XXKPSI	ARRIÈRE	XXXXXXRXX	XXXXPa,XXKPSI
SPARE	TXXXXXXDX	XXXXPa,XXKPSI	SECOURS	TXXXXXXDX	XXXXPa,XXKPSI
SEE OWNER'S MANUAL FOR ADDITIONAL INFORMATION			POUR DE PLUS AMPLES INFORMATIONS, VOIR LE MANUEL DU PROPRIÉTAIRE		

43KY129L

n Inspection and adjustment procedure



- 1 Tire valve
- 2 Tire pressure gauge

STEP 1 Remove the tire valve cap.

STEP 2 Press the tip of the tire pressure gauge onto the tire valve.

STEP 3 Read the pressure using the graduations of the gauge.

STEP 4 If the tire inflation pressure is not within the recommended levels, adjust the pressure.

If you add too much air, press the center of the valve to lower.

STEP 5 After completing the tire inflation pressure measurement and adjustment, apply soapy water to the valve and check for leakage.

STEP 6 Reinstall the tire valve cap.

n Tire inflation pressure check interval

You should check tire inflation pressure every two weeks, or at least once a month. Do not forget to check the spare.

n **Effects of incorrect tire inflation pressure**

Driving with incorrect tire inflation pressure may result in the following:

- l Reduced fuel efficiency
- l Reduced driving comfort and tire life
- l Reduced safety
- l Damage to the drive train

If a tire needs frequent refilling, have it checked by your Lexus dealer.

n **Instructions for checking tire inflation pressure**

When checking tire inflation pressure, observe the following:

- l Check only when the tires are cold.

If your vehicle has been parked for at least 3 hours and has not been driven for more than 1 mile or 1.5 km, you will get an accurate cold tire inflation pressure reading.

- l Always use a tire pressure gauge.

The appearance of the tire can be misleading. In addition, tire inflation pressures that are even just a few pounds off can degrade ride and handling.

- l Do not bleed or reduce tire inflation pressure after driving. It is normal for the tire inflation pressure to be higher after driving.

- l Never exceed the vehicle capacity weight.

Passengers and luggage weight should be placed so that the vehicle is balanced.

 **CAUTION****n Proper inflation is critical to save tire performance**

Keep your tires properly inflated. Otherwise, the following conditions may occur and result in an accident causing death or serious injury.

- I Excessive wear
- I Uneven wear
- I Poor handling
- I Possibility of blowouts resulting from overheated tires
- I Poor sealing of the tire bead
- I Wheel deformation and/or tire separation
- I A greater possibility of tire damage from road hazards

 **NOTICE****n When inspecting and adjusting tire inflation pressure**

Be sure to reinstall the tire valve caps.

Without the valve caps, dirt or moisture could get into the valve and cause air leakage, which could result in an accident. If the caps have been lost, replace them as soon as possible.

Wheels

If a wheel is bent, cracked or heavily corroded, it should be replaced. Otherwise, the tire may separate from the wheel or cause loss of handling control.

n Wheel selection

When replacing wheels, care should be taken to ensure that they are equivalent to those removed in load capacity, diameter, rim width, and offset.

Replacement wheels are available at your Lexus dealer.

Lexus does not recommend using:

- Wheels of different sizes or types
- Used wheels
- Bent wheels that have been straightened

n Aluminum wheel precautions

1 Use only Lexus wheel nuts and wrenches designed for use with your aluminum wheels.

1 When rotating, repairing or changing your tires, check that the wheel nuts are still tight after driving 1000 miles (1600 km).

1 Be careful not to damage the aluminum wheels when using tire chains.

1 Use only Lexus genuine balance weights or equivalent and a plastic or rubber hammer when balancing your wheels.

n When replacing wheels

The wheels of your Lexus are equipped with tire pressure warning valves and transmitters that allow the tire pressure warning system to provide advanced warning in the event of a loss in tire inflation pressure. Whenever wheels are replaced, the tire pressure warning valves and transmitters must be installed. (→P. 308)

 CAUTION**n When replacing wheels**

- I** Do not use wheels that are a different size from those recommended in the Owner's Manual, as this may result in loss of handling control.
- I** Never use an inner tube in a leaking wheel which is designed for a tubeless tire. Doing so may result in an accident, causing death or serious injury.

 NOTICE**n Replacing tire inflation pressure warning valves and transmitters**

- I** Because tire repair or replacement may affect the tire pressure warning valves and transmitters, make sure to have tires serviced by your Lexus dealer or other qualified service shop. In addition, make sure to purchase your tire pressure warning valves and transmitters at your Lexus dealer.
- I** Ensure that only Genuine Lexus wheels are used on your vehicle. Tire pressure warning valves and transmitters may not work properly with non-genuine wheels.

4-3. Do-it-yourself maintenance

Air conditioning filter

The air conditioning filter must be cleaned or changed regularly to maintain air conditioning efficiency.

n Removal method

STEP 1 Set the air conditioning system to recirculated mode.

The air conditioning filter case cannot be removed with the system in the outside air mode.

STEP 2 Turn the “ENGINE START STOP” switch OFF.

STEP 3

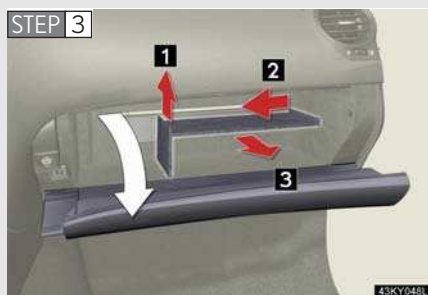

Open the glove box. Lift and remove the partition.

STEP 4

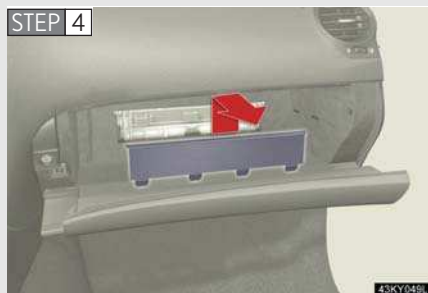

Remove the filter cover.

STEP 5

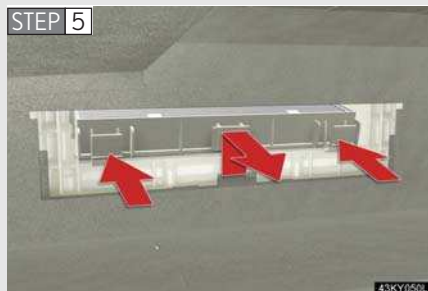

Remove the filter case.

n Cleaning method



If the filter is dirty, clean by blowing compressed air through the filter from the downward side.

Hold the air gun 2 in. (5 cm) from the filter and blow for approximately 2 minutes at 72 psi (500 kPa, 5.0 kgf/cm² or bar).

If it is not available, have the filter cleaned by your Lexus dealer.

n Replacement method

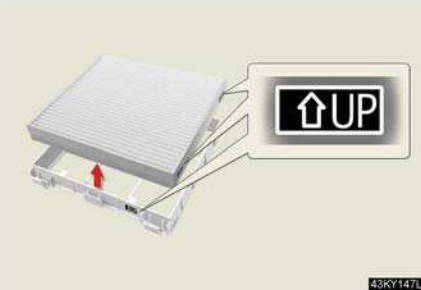

Remove the air conditioning filter from the filter case and replace it with a new one.

The “↑UP” marks shown on the filter and the filter case should be pointing up.

n Checking interval

Inspect and replace the air conditioning filter according to the maintenance schedule. In dusty areas or areas with heavy traffic flow, early replacement may be required. (For scheduled maintenance information, please refer to the “Owner’s Manual Supplement/Scheduled Maintenance”.)

n If air flow from the vents decreases dramatically

The filter may be clogged. Check the filter and replace if necessary.

NOTICE

n To prevent damage to the system

- l** When using the air conditioning system, make sure that a filter is always installed.
- l** When cleaning the filter, do not clean the filter with water.

4-3. Do-it-yourself maintenance

Electronic key battery

Replace the battery with a new one if it is discharged.

n You will need the following items:

- 1 Flathead screwdriver
- 1 Small Phillips-head screwdriver
- 1 Lithium battery (CR1632)

n Replacing the battery

STEP 1



Take out the mechanical key.

STEP 2



Remove the cover.

STEP 3

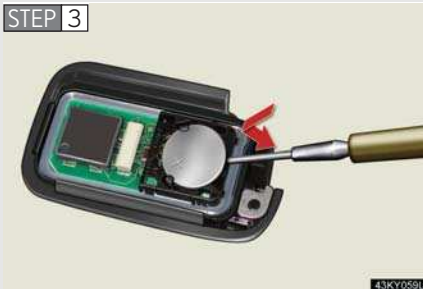

Remove the depleted battery.

Insert a new battery with the “+” terminal facing up.

n **If the electronic key battery is discharged**

The following symptoms may occur.

- l The smart access system with push-button start and wireless remote control will not function properly.
- l The operational range is reduced.

n **Use a CR1632 lithium battery**

- l Batteries can be purchased at your Lexus dealer, jewelers, or camera stores.
- l Replace only with the same or equivalent type recommended by a Lexus dealer.
- l Dispose of used batteries according to the local laws.

CAUTION

n **Removed battery and other parts**

Keep away from children.

These parts are small and if swallowed by a child they can cause choking.

NOTICE

n **For normal operation after replacing the battery**

Observe the following precautions to prevent accidents.

- l Always work with dry hands.
Moisture may cause the battery to rust.
- l Do not touch or move any other components inside the remote control.
- l Do not bend either of the battery terminals.

4-3. Do-it-yourself maintenance

Checking and replacing fuses

If any of the electrical components do not operate, a fuse may have blown. If this happens, check and replace the fuses as necessary.

STEP 1 Turn the “ENGINE START STOP” switch OFF.

STEP 2 Remove the engine compartment cover. (→P. 294)

STEP 3 Open the fuse box cover.

▶ Engine compartment (type A)



Push the tabs in and lift the lid off.

▶ Engine compartment (type B)



Push the tabs in and lift the lid off.

▶ Driver's side instrument panel



Remove the lid.

▶ Passenger's side instrument panel



Remove the lid.

STEP 4 After a system failure, see "Fuse layout and amperage ratings" (→P. 331) for details about which fuse to check.

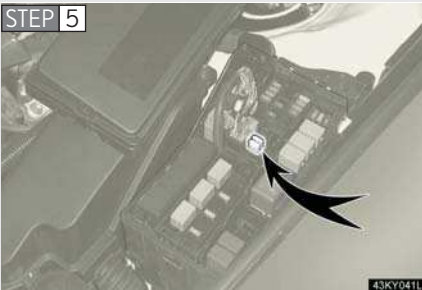

Remove the fuse with the pull-out tool.

STEP 6 Check if the fuse has blown.

▶ Type A

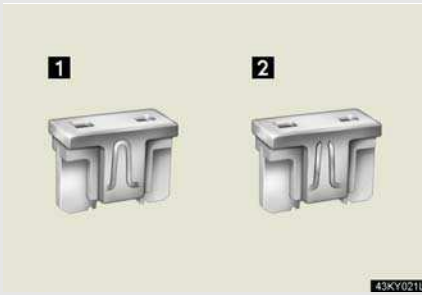
**1** Normal fuse**2** Blown fuse

Replace it with one of an appropriate amperage rating. The amperage rating can be found on the fuse box lid.

▶ Type B

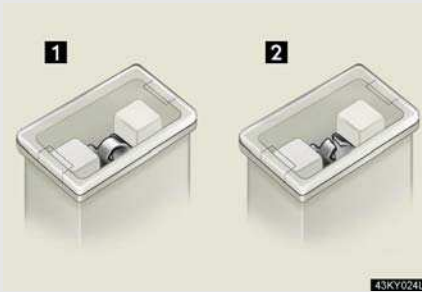
**1** Normal fuse**2** Blown fuse

Replace it with one of an appropriate amperage rating. The amperage rating can be found on the fuse box lid.

▶ Type C

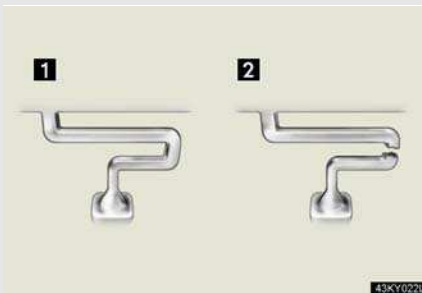
**1** Normal fuse**2** Blown fuse

Contact your Lexus dealer.

► Type D

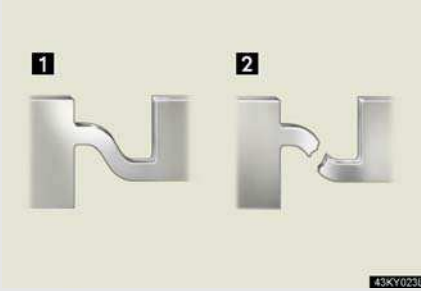

1 Normal fuse

2 Blown fuse

Contact your Lexus dealer.

Removing the front controller (engine compartment: type B)

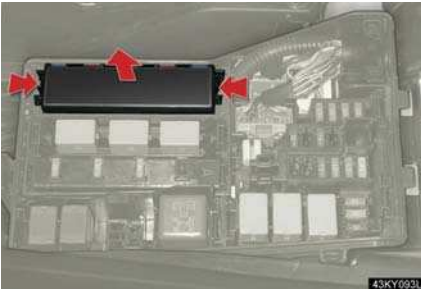

Lift the lid off while pushing the tabs on either side.

Fuse layout and amperage ratings

n Engine compartment (type A)

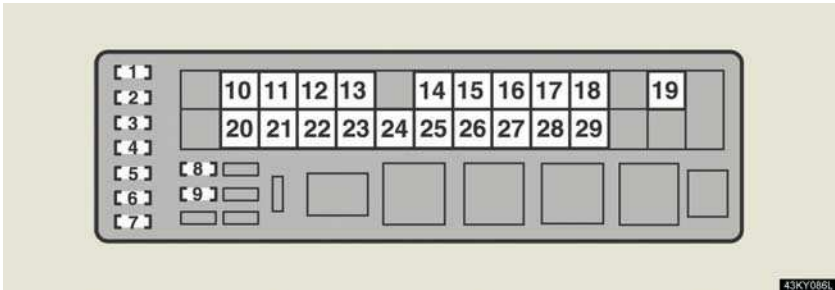

	Fuse	Ampere	Circuit
1	ABS NO.3	25 A	VDIM
2	PWR HTR	25 A	—
3	TURN-HAZ	15 A	Emergency flashers, turn signals
4	IG2 MAIN	20 A	IG2, IGN, GAUGE
5	RAD NO.2	30 A	Audio
6	D/C CUT	20 A	DOME, MPX-B
7	RAD NO.1	30 A	Audio
8	MPX-B	10 A	Headlights, front fog lights, parking lights, license plate lights, windshield washer, horn, power door lock system, power windows, power seats, electric tilt and telescopic steering column, meter, smart access system with push-button start, outside rear view mirrors, air conditioning system, security system
9	DOME	10 A	Interior lights, meter

4-3. Do-it-yourself maintenance

Fuse		Ampere	Circuit
10	E/G-B	60 A	FR CTRL-B, ETCS, ALT-S, steering lock system, exhaust system
11	DIESEL GLW	80 A	—
12	ABS1	50 A	VSC, VDIM
13	RH J/B-B	30 A	Power door lock system, smart access system with push-button start
14	MAIN	30 A	Headlight low beams
15	STARTER	30 A	Smart access system with push-button start
16	LH J/B-B	30 A	Power door lock system, SECURITY
17	P/I-B	60 A	Multipoint fuel injection system/ sequential multipoint fuel injection system
18	EPS	80 A	Power steering
19	ALT	150 A	LH J/B-AM, E/G-AM, GLW PLG2, HEATER, FAN1, FAN2, DEFOG, ABS2, RH J/B-AM, GLW PLG1, LH J/B-B, RH J/B-B
20	GLW PLG1	50 A	PTC heater
21	RH J/B-AM	80 A	OBD, STOP SW, TI&TE, FR P/SEAT RH, RAD NO.3, ECU-IG RH, RH-IG, FR S/HTR RH, ACC, CIG, PWR OUTLET
22	ABS2	30 A	VSC
23	DEFOG	50 A	Rear window defogger
24	FAN2	40 A	Electric cooling fans
25	FAN1	40 A	Electric cooling fans
26	HEATER	50 A	Air conditioning system

	Fuse	Ampere	Circuit
27	GLW PLG2	50 A	PTC heater
28	E/G-AM	60 A	Headlight cleaners, front fog lights, parking lights, air conditioning system
29	LH J/B-AM	80 A	S/ROOF, FR P/SEAT LH, TV NO.1, A/C, FUEL/OPEN, PSB, FR WIP, H-LP LVL, LH-IG, ECU-IG LH, PANEL, TAIL, MIR HTR, FR S/HTR LH

n Engine compartment (type B)

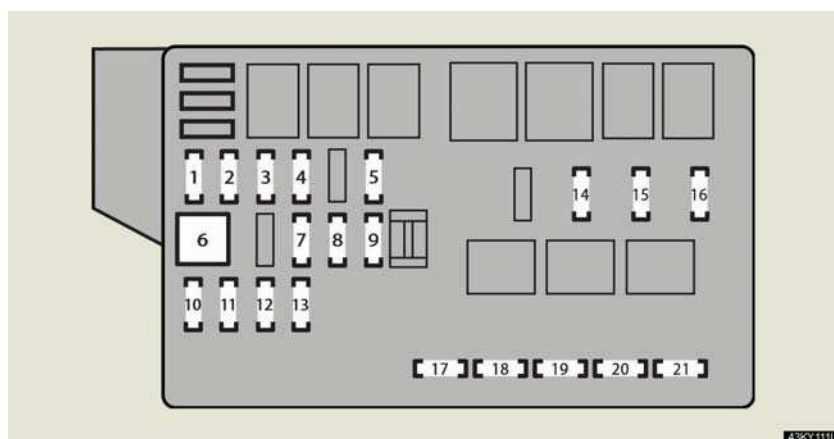

Fuse		Ampere	Circuit
1	FR CTRL-B	25 A	Headlight high beam, horn
2	A/F	15 A	Exhaust system
3	ETCS	10 A	Multiport fuel injection system/ sequential multiport fuel injection system
4	ALT-S	7.5 A	Charging system
5	STR LOCK	25 A	Steering lock
6	H-LP CLN	30 A	Headlight cleaner
7	A/C COMP	7.5 A	Air conditioning system
8	DEICER	25 A	—
9	FR CTRL-AM	30 A	Front fog lights, parking lights, windshield washer
10	IG2	10 A	Ignition system
11	EFI NO.2	10 A	Fuel system, exhaust system
12	H-LP R LWR	15 A	Headlight low beam (right)
13	H-LP L LWR	15 A	Headlight low beam (left)

	Fuse	Ampere	Circuit
14	F/PMP	25 A	Fuel system
15	EFI	25 A	Multiport fuel injection system/ sequential multiport fuel injection system
16	INJ	20 A	Multiport fuel injection system/ sequential multiport fuel injection system
17	H-LP UPR	15 A	Headlight high beams
18	HORN	10 A	Horns
19	WASHER	20 A	Windshield washer
20	FR TAIL	10 A	Parking lights
21	FR FOG	15 A	Front fog lights

n Driver's side instrument panel

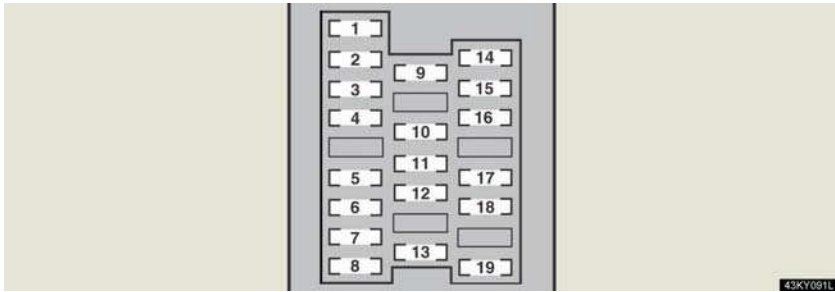

Fuse		Ampere	Circuit
1	FR P/SEAT LH	30 A	Power seat
2	A/C	7.5 A	Air conditioning system
3	MIR HTR	15 A	Outside rear view mirror defoggers
4	TV NO.1	10 A	Display
5	FUEL OPEN	10 A	Fuel filler door opener
6	TV NO.2	7.5 A	————
7	PSB	30 A	Pre-collision seat belt
8	S/ROOF	25 A	Electric moon roof
9	TAIL	10 A	Tail lights, license plate lights, parking lights
10	PANEL	7.5 A	Switch illumination, air conditioning system, display
11	RR FOG	7.5 A	————
12	ECU-IG LH	10 A	Cruise control, air conditioning system, power steering, rain sensor, anti-glare inside rear view mirror, shift lock system, moon roof, tire inflation pressure warning system
13	FR S/HTR LH	15 A	Seat heaters and ventilators

	Fuse	Ampere	Circuit
14	RR DOOR LH	20 A	Power windows
15	FR DOOR LH	20 A	Power windows
16	SECURITY	7.5 A	Smart access system with push-button start
17	H-LP LVL	7.5 A	AFS
18	LH-IG	10 A	Charging system, headlight cleaner, rear window defogger, electric cooling fans, emergency flashers, turn signal lights, back-up lights, stop lights, mirror heaters, sun shade, seat belts, Intuitive parking assist, cruise control, air conditioning system, PTC heater
19	FR WIP	30 A	Windshield wipers

n Passenger's side instrument panel

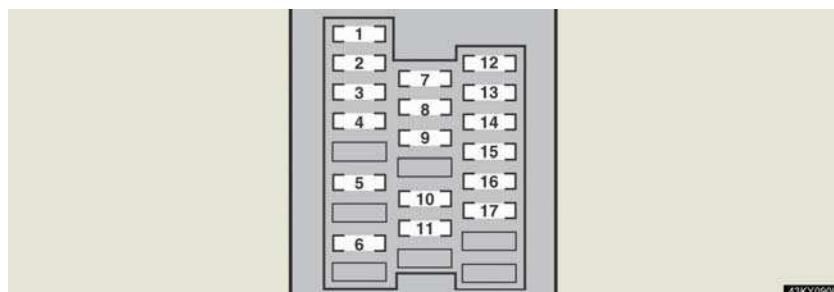

Fuse		Ampere	Circuit
1	FR P/SEAT RH	30 A	Power seat
2	DOOR DL	15 A	—
3	OBD	7.5 A	On-board diagnosis system
4	STOP SW	7.5 A	Stop lights
5	TI & TE	20 A	Electric tilt and telescopic steering column
6	RAD NO.3	10 A	Audio
7	GAUGE	7.5 A	Meter
8	IGN	10 A	SRS airbag system, cruise control, steering lock system, fuel system
9	ACC	7.5 A	Lexus link system, clock, air conditioning system, audio, display, outside rear view mirrors, smart access system with push-button start
10	CIG	15 A	Cigarette lighter
11	PWR OUTLET	15 A	Power outlet
12	RR DOOR RH	20 A	Power windows

Fuse		Ampere	Circuit
13	FR DOOR RH	20 A	Power windows, outside rear view mirrors
14	AM2	15 A	Smart access system with push-button start
15	RH-IG	7.5 A	Seat belts, intuitive parking assist, automatic transmission, seat heater and ventilator
16	FR S/HTR RH	15 A	Seat heaters and ventilators
17	ECU-IG RH	10 A	Power seats, smart access system with push-button start, AWD system, outside rear view mirrors, VDIM, VSC, air conditioning system, pre-collision seat belt, electric tilt and telescopic steering, power windows, navigation system

n After a fuse is replaced

- l If the lights do not turn on even after the fuse has been replaced, a bulb may need replacement. (→P. 342)
- l If the replaced fuse blows again, have the vehicle inspected by your Lexus dealer.

n If there is an overload in the circuits

The fuses are designed to blow before the entire wiring harness is damaged.

 **CAUTION**

n To prevent system breakdowns and vehicle fire

- I** Observe the following precautions.
Failing to do so may cause damage, and possibly a fire or injury.
- I** Never use a fuse of a higher amperage rating than indicated, or use any other object in place of a fuse.
- I** Always use a genuine Lexus fuse or equivalent.
Never replace a fuse with a wire, even as a temporary fix.
This can cause extensive damage or even fire.
- I** Do not modify fuses or the fuse box.

 **NOTICE**

n Before replacing fuses

Have the cause of electrical overload determined and repaired by your Lexus dealer.

4-3. Do-it-yourself maintenance

Headlight aim

n Vertical movement adjusting bolts

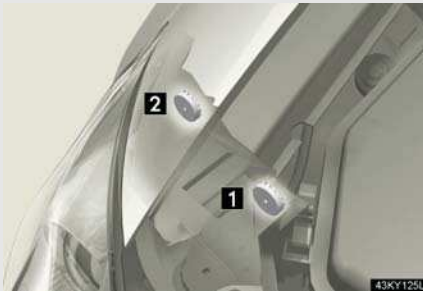

1 Adjustment bolt A

2 Adjustment bolt B

n Before checking the headlight aim

STEP 1 Make sure the vehicle has a full tank of gas and the area around the headlight is not deformed.

STEP 2 Park the vehicle on level ground.

STEP 3 Sit in the driver's seat.

STEP 4 Bounce the vehicle several times.

n Adjusting the headlight aim



Turn bolt A in either direction using a Phillips-head screwdriver.

Remember the turning direction and the number of turns in mind.



Turn bolt B the same number of turns and in the same direction as step 1 using a Phillips-head screwdriver.

If the error is over the value specified above, take the vehicle to your Lexus dealer to adjust the headlight aim.

4-3. Do-it-yourself maintenance

Light bulbs

You may replace the following bulbs yourself. For more information about replacing other light bulbs, contact your Lexus dealer.

n Preparing a replacement light bulb

Check the wattage of the light bulb being replaced. (→P. 420)

n Removing the engine compartment cover

→P. 294

n Front bulb locations

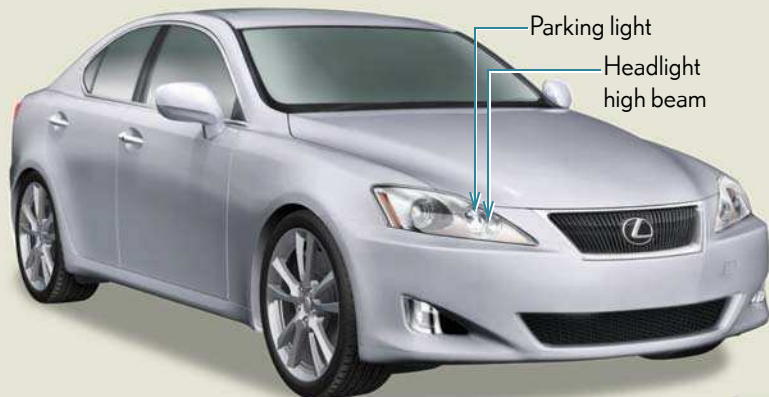

n Rear bulb locations

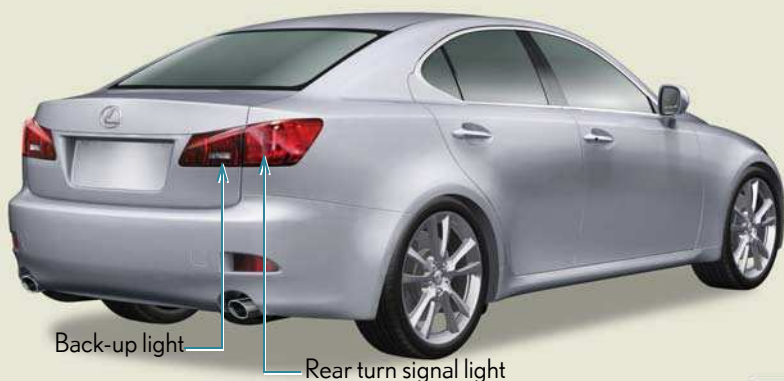

Replacing light bulbs

n Headlight high beams

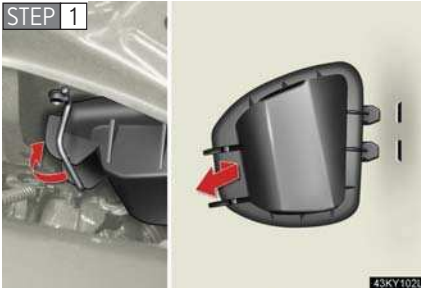

Release the lock and remove the cover.



Turn the bulb base counterclockwise.

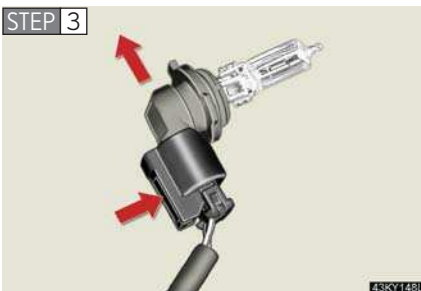

Unplug the connector while depressing the lock release.

n Parking lights

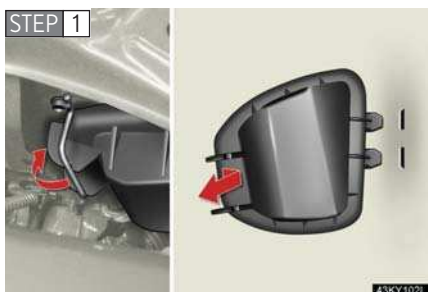

Release the lock and remove the cover.



Turn the bulb base counterclockwise.



Remove the light bulb.

n Back-up light



Open the trunk door and remove the trunk panel cover clips.

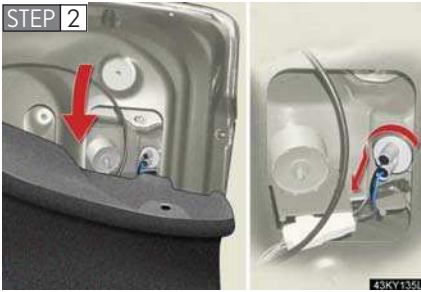

Partly remove the trunk panel cover and turn bulb bases counterclockwise.

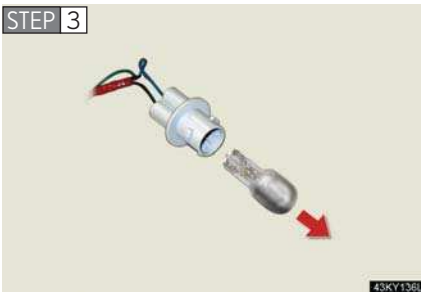

Remove the light bulb.

n Rear turn signal lights

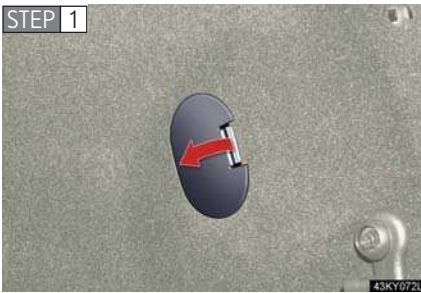

Open the trunk door and remove the cover.



Turn the bulb base counterclockwise.

STEP 3



Remove the light bulb.

n Bulbs other than the above

If any of the bulbs listed below has burnt out, have your Lexus dealer replace it.

- 1 Headlight low beams (halogen bulbs)
- 1 Headlight high and low beams (discharge bulbs)
- 1 Front fog lights
- 1 Front turn signal lights
- 1 Front side marker lights
- 1 Stop/tail lights
- 1 Tail lights
- 1 Rear side marker lights
- 1 High mounted stoplight
- 1 License plate lights

n When replacing the front left headlight and parking light bulbs



Remove the securing bolt and move the washer fluid filler opening to allow easy access to the light bulbs.

After replacing the bulbs, make sure to secure the washer fluid filler opening with the bolt.

n Condensation build-up on the inside of the lens

Contact your Lexus dealer for more information in the following situations. Temporary condensation build-up on the inside of the headlight lens does not indicate a malfunction.

- l Large drops of water are built up on the inside of the lens.
- l Water has built up inside the headlight.

n Discharge headlights (if equipped)

If voltage to the discharge bulbs is insufficient, the bulbs may not come on, or may go out temporarily. The discharge bulbs will come on when normal power is restored.

 **CAUTION**

n Replacing light bulbs

- 1** Turn off the headlights. Do not attempt to replace the bulb immediately after turning off the headlights.
The bulbs become very hot and may cause burns.
- 1** Do not touch the glass portion of the light bulb with bare hands. Hold the bulb by the plastic or metal portion.
If the bulb is scratched or dropped it may blow out or crack.
- 1** Fully install light bulbs and any parts used to secure them. Failing to do so may result in heat damage, fire, or water entering the headlight unit. This may damage the headlights or cause condensation to build up on the lens.
- 1** Do not attempt to take apart or repair the low beam headlight bulbs, connectors, power supply circuits, or related components.
Doing so could result in electric shock and serious injury or death.

n Discharge headlights (if equipped)

- 1** Contact your Lexus dealer before replacing discharge headlights (including light bulbs).
- 1** Do not touch the high-intensity discharge headlight's high voltage socket when the headlights are turned on.
An extremely high voltage of 20000 V will be discharged and could result in serious injury or death by electric shock.

n To prevent damage or fire

- Make sure bulbs are fully seated and locked.

5-1. Essential information

If your vehicle needs to be towed

If towing is necessary, we recommend having your vehicle towed by your Lexus dealer or a commercial towing service, using a lift-type truck or a flat bed truck.

Use a safety chain system for all towing, and abide by all state/provincial and local laws.

If towing from the rear, the vehicle's front wheels and axles must be in good condition. (→P. 354)

If they are damaged, use a towing dolly or flat bed truck.

Before towing

The following may indicate a problem with your transmission. Contact your Lexus dealer before towing.

- 1 The engine is running, but the vehicle will not move.
- 1 The vehicle makes an abnormal sound.

Emergency towing

If a tow truck is not available, in an emergency your vehicle may be temporarily towed using a cable or chain secured to the emergency towing eyelet(s). This should only be attempted on hard, surfaced roads for short distances at low speeds.

A driver must be in the vehicle to steer and operate the brakes. The vehicle's wheels, drive train, axles, steering and brakes must be in good condition.

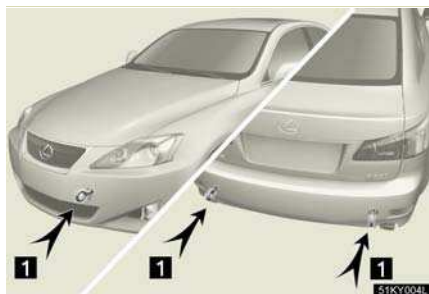

1 Towing eyelets

n Emergency towing procedure

- STEP 1** Release the parking brake.
- STEP 2** Shift the shift lever to N.
- STEP 3** Put the “ENGINE START STOP” switch in ACCESSORY mode (engine off) or IGNITION ON mode (engine running).

CAUTION

n Caution while towing

- I Use extreme caution when towing the vehicle.
Avoid sudden starts or erratic driving maneuvers which place excessive stress on the emergency towing eyelets and the cables or chains.
- I If the engine is not running, the power assist for the brakes and steering will not function, making steering and braking more difficult.

NOTICE

n To prevent causing serious damage to the transmission (vehicles with an automatic transmission)

Never tow this vehicle from the front with the rear wheels on the ground. This may cause serious damage to the transmission.

n When towing a vehicle without using a towing dolly (vehicles with a manual transmission)

The “ENGINE START STOP” switch must not be OFF.

Installing towing eyelets

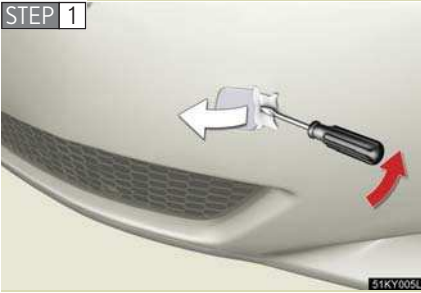

Remove the eyelet cover using a flat head screwdriver.

To protect the bodywork, place a rag between the screwdriver and the vehicle body, as shown in the illustration.

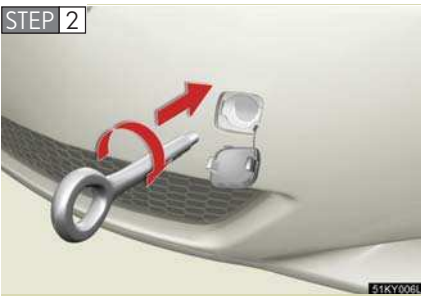

Insert the towing eyelet into the hole and tighten partially by hand.

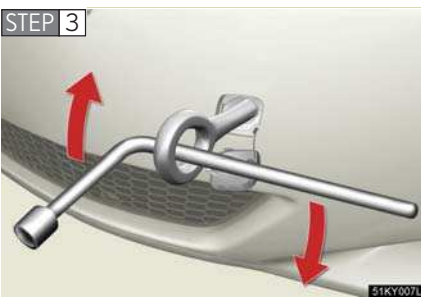

Tighten down the towing eyelet securely using a wheel nut wrench.

- n Location of the emergency towing eyelet
→P. 382

! CAUTION**n Installing towing eyelets to the vehicle**

Make sure that towing eyelets are installed securely.

If not securely installed, towing eyelets may come loose during towing. This may lead to accidents that cause serious injury or even death.

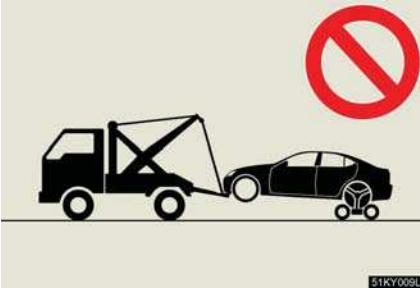
Towing with a sling-type truck**! NOTICE****n To prevent body damage**

Do not tow with a sling type truck, either from the front or rear.

Towing with a wheel lift-type truck

► From the front

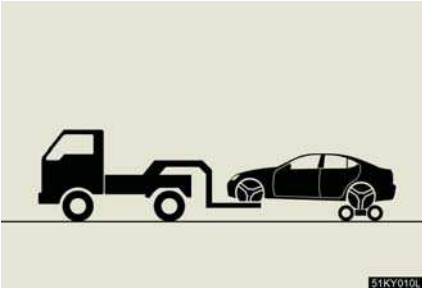

Vehicles with an automatic transmission: Use a towing dolly under the rear wheels.

Vehicles with a manual transmission: We recommend to use a towing dolly under the rear wheels.

When not using a towing dolly, release the parking brake and shift the shift lever to N.

► From the rear (2WD models)

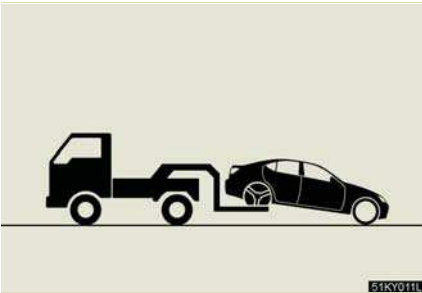

Switch to ACCESSORY mode so that the steering wheel is unlocked.

► From the rear (AWD models)

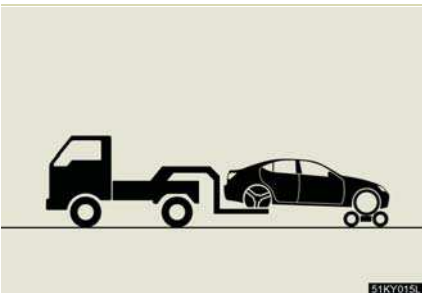

Use a towing dolly under the front wheel.

 NOTICE

n To prevent causing serious damage to the transmission (vehicles with an automatic transmission)

Never tow this vehicle from the front with the rear wheels on the ground.

n To prevent damaging the vehicle

I Do not tow the vehicle from the rear with the “ENGINE START STOP” switch OFF.

The steering lock mechanism is not strong enough to hold the front wheel straight.

I When raising the vehicle from the rear, ensure adequate ground clearance for towing at the opposite end of the raised vehicle. Without adequate clearance, the vehicle could be damaged while being towed from the rear.

Using a flat bed truck

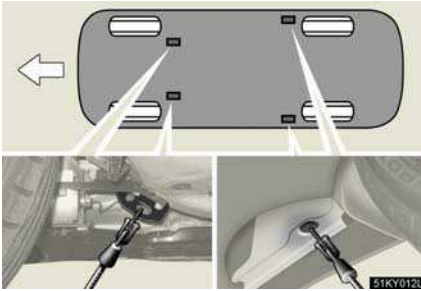

If your Lexus is transported by a flat bed truck, it should be tied down at the locations shown in the illustration.

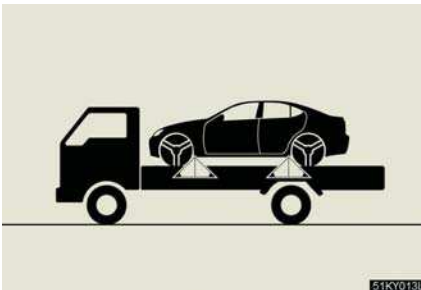

If you use chains or cables to tie down your vehicle, the angles shaded in black must be 45°.

Do not overly tighten the tie downs or the vehicle may be damaged.

5-1. Essential information

If you think something is wrong

If you notice any of the following symptoms, your vehicle probably needs adjustment or repair. Contact your Lexus dealer as soon as possible.

n Visible symptoms

- 1 Fluid leaks under the vehicle
(Water dripping from the air conditioning after use is normal.)
- 1 Flat-looking tires or uneven tire wear
- 1 Engine coolant temperature gauge needle continually points higher than normal

n Audible symptoms

- 1 Changes in exhaust sound
- 1 Excessive tire squeal when cornering
- 1 Strange noises related to the suspension system
- 1 Pinging or other noises related to the engine

n Operational symptoms

- 1 Engine missing, stumbling or running rough
- 1 Appreciable loss of power
- 1 Vehicle pulls heavily to one side when braking
- 1 Vehicle pulls heavily to one side when driving on a level road
- 1 Loss of brake effectiveness, spongy feeling, pedal almost touches the floor

5-1. Essential information

Fuel pump shut off system

To minimize the risk of fuel leakage when the engine stalls or an airbag inflates upon collision, the fuel pump shut off system stops supplying fuel to the engine.

Follow the procedure below to restart the engine after the system is activated.

STEP 1 Switch to ACCESSORY mode or OFF.

STEP 2 Restart the engine.

NOTICE

n Before starting the engine

Inspect the ground under the vehicle.

If you find that fuel has leaked on to the ground, the fuel system has been damaged and is in need of repair. Do not restart the engine.

5-1. Essential information

Event data recorder

Your vehicle has computers that monitor and control certain aspects of your vehicle. These computers assist in driving and maintaining optimal vehicle performance.

Besides storing data useful for troubleshooting, there is an event data recorder (EDR) that records data in a crash or a near car crash event.

In a crash or a near car crash event

The SRS airbag sensor assembly contains the EDR. In a crash or a near car crash event, this device may record some or all of the following information:

- 1 Engine speed
- 1 Whether the brake pedal was applied or not
- 1 Vehicle speed
- 1 To what extent the accelerator pedal was depressed
- 1 Position of the transmission shift lever
- 1 Whether the driver and front passenger wore seat belts or not
- 1 Driver's seat position
- 1 SRS airbag deployment data
- 1 SRS airbag system diagnostic data
- 1 Front passenger's occupant classification

The information above is intended to be used for the purpose of improving vehicle safety performance. Unlike general data recorders, the EDR does not record sound data such as conversation between passengers.

Disclosure of the data

Lexus will not disclose the data recorded in an EDR to a third party except when:

- 1 An agreement from the vehicle's owner (or the leasing company for a leased vehicle) is obtained
- 1 Officially requested by the police or other authorities
- 1 Used as a defense for Lexus in a law suit
- 1 Ordered by a court law

However, if necessary Lexus will:

- 1 Use the data for research on Lexus vehicle safety performance
- 1 Disclose the data to a third party for research purposes without disclosing details of the vehicle owner, and only when it is deemed necessary
- 1 Disclose summarized data cleared of vehicle identification information to a non-Lexus organization for research purposes



5-2. Steps to take in an emergency

If a warning light turns on or a warning buzzer sounds...

Calmly perform the following actions if any of the warning lights turn on or flash. If a light turns on or flashes, but then turns off, this does not necessarily indicate a malfunction in the system.

Stop the vehicle immediately. Continuing to drive the vehicle may be dangerous.

The following warning indicates a possible problem in the brake system. Immediately stop the vehicle in a safe place and contact your Lexus dealer.

Warning light	Warning light/Details
 (U.S.A.)	Brake system warning light (warning buzzer)* <ul style="list-style-type: none">• Low brake fluid• Malfunction in the brake booster system This light also comes on when the parking brake is not released. If the light turns off after the parking brake is fully released the system is operating normally.
 (Canada)	

*: Parking brake engaged warning buzzer:

→P. 373



Stop the vehicle immediately.

The following warnings indicate the possibility of damage to the vehicle that may lead to an accident. Immediately stop the vehicle in a safe place and contact your Lexus dealer.





Warning light	Warning light/Details
	Charging system warning light Indicates a malfunction in the vehicle's charging system.

Have the vehicle inspected by your Lexus dealer immediately.

Failing to investigate the cause of the following warnings may lead to the system operating abnormally and possibly cause an accident. Have the vehicle inspected by your Lexus dealer immediately.



Warning light	Warning light/Details
 (U.S.A.)  (Canada)	Malfunction indicator lamp Indicates a malfunction in: <ul style="list-style-type: none"> • The electronic engine control system; • The electronic throttle control system; or • The electronic automatic transmission control system.
	SRS warning light Indicates a malfunction in: <ul style="list-style-type: none"> • The SRS airbag system; or • The seat belt pretensioner system.



5-2. Steps to take in an emergency

Warning light	Warning light/Details
 (U.S.A.)  (Canada)	“ABS” warning light Indicates a malfunction in: <ul style="list-style-type: none"> • The ABS; • The brake assist system.
	Electric power steering system warning light Indicates a malfunction in the EPS (Electric Power Steering) system.
	Pre-collision system warning light (if equipped) Indicates a malfunction in the pre-collision system.

Follow the correction procedures.

After taking the specified steps to correct the suspected problem, check that the warning light turns off.

Warning light	Warning light/Details	Correction procedure
	Open door warning light (warning buzzer)*¹ Indicates that a door or a trunk is not fully closed.	Check that all doors and the trunk are closed.
	Low fuel level warning light Remaining fuel (Approximately 2.9 gal. [11 L, 2.4 Imp.gal.] or less)	Refuel the vehicle.
 (On the instrument cluster)	Driver's seat belt reminder light (warning buzzer)*² Warns the driver to fasten his/her seat belt.	Fasten the seat belt.

Warning light	Warning light/Details	Correction procedure
 (On the center panel)	Front passenger's seat belt reminder light (warning buzzer)*2 Warns the front passenger to fasten his/her seat belt.	Fasten the seat belt.
	Tire pressure warning light	
	When the light comes on: Low tire inflation pressure	Adjust the tire inflation pressure.
	When the light comes on after blinking for 1 minute: Malfunction in the tire pressure warning system	Have the system checked by your Lexus dealer.
	Master warning light A buzzer sounds and the warning light comes on and flashes to indicate that the master warning system has detected a malfunction.	→P. 369

*1:Open door warning buzzer:

→P. 373

*2:Driver's and front passenger's seat belt reminders buzzer:

The driver's and front passenger's seat belts reminder sounds to alert the driver and front passenger that his or her seat belt is not fastened. The buzzer sounds intermittently for 10 seconds after the vehicle has reached a speed of at least 12 mph (20 km/h). Then, if the seat belt is still unfastened, the buzzer will sound in a different tone for 20 more seconds.

n **If the malfunction indicator lamp comes on while driving**

First check the following:

- 1 Is the fuel empty?
If it is, fill the fuel tank immediately.
- 1 Is the fuel tank cap loose?
If it is, tighten it securely.

The lamp will go off after taking several driving trips.

If the lamp does not go off even after several trips, contact your Lexus dealer as soon as possible.

n **Front passenger detection sensor and passenger seat belt reminder and warning buzzer**

- 1 If luggage is placed on the front passenger seat, the front passenger detection sensor may cause the warning light to flash and the warning buzzer to sound, even if a passenger is not sitting in the seat.
- 1 If a cushion is placed on the seat, the sensor may not detect a passenger, and the warning light may not operate properly.

n **When the tire pressure warning light comes on**

Check the tire inflation pressure and adjust to the appropriate level. Pressing the satellite switch does not turn off the tire pressure warning light.

n **The tire pressure warning light may turn on due to natural causes**

The tire pressure warning light may turn on due to natural causes such as natural air leaks or tire inflation pressure changes caused by temperature. In this case, adjusting the tire inflation pressure will turn off the warning light (after a few minutes).

n **When a tire is replaced with a spare tire**

The compact spare tire is not equipped with the tire pressure warning valve and transmitter. If a tire goes flat, the tire pressure warning light will not turn off even though the flat tire is replaced with the spare tire. Replace the spare tire with the repaired tire and adjust the proper tire inflation pressure. The tire pressure warning light will turn off after a few minutes.

n If the tire pressure warning system is inoperative

The tire pressure warning system will be disabled in the following conditions:
(When the condition becomes normal, the system will work properly.)

- 1 If tires not equipped with tire pressure warning valves and transmitters are used
- 1 If the ID code on the tire pressure warning valves and transmitters is not registered in the tire pressure warning computer
- 1 If a different set of tires has been selected using the satellite switch.
- 1 If the tire inflation pressure is 73 psi (500 kPa, 5.1 kgf/cm² or bar) or higher

The tire pressure warning system may be disabled in the following conditions:
(When the condition becomes normal, the system will work properly.)

- 1 If electronic devices or facilities using similar radio wave frequencies are nearby
- 1 If a radio set at similar frequencies is in use in the vehicle
- 1 If there is a lot of snow or ice on the vehicle, in particular around the wheels or wheel housings
- 1 If non-genuine Lexus wheels are used (Even if you use Lexus wheels, the tire pressure warning system may not work properly with some types of tires.)
- 1 If tire chains are used

n If the tire pressure warning light comes on after blinking for 1 minute frequently

If the tire pressure warning light comes on after blinking for 1 minute frequently when the “ENGINE START STOP” switch is turned to IGNITION ON mode, have it checked by your Lexus dealer.

 **CAUTION**

n If the tire pressure warning light comes on

Be sure to observe the following precautions. Failure to do so could cause loss of vehicle control and result in death or serious injury.

- I** Stop your vehicle in a safe place as soon as possible. Adjust the tire inflation pressure immediately.
- I** If the tire pressure warning light comes on even after tire inflation pressure adjustment, it is probable that you have a flat tire. Check the tires. If the tire is flat, change to the spare tire and have the flat tire repaired by the nearest Lexus dealer.
- I** Avoid abrupt maneuvering and braking. If the vehicle tires deteriorate, you could lose control of the steering wheel or the brakes.

n If a blowout or sudden air leakage should occur

The tire pressure warning system may not activate immediately.

 **CAUTION**
n Maintenance of the tires

Each tire, including the spare (if provided), should be checked monthly when cold and inflated to the inflation pressure recommended by the vehicle manufacturer on the vehicle placard or tire inflation pressure label (tire and loading information label). (If your vehicle has tires of a different size than the size indicated on the vehicle placard or tire inflation pressure label [tire and loading information label], you should determine the proper tire inflation pressure for those tires.)

As an added safety feature, your vehicle has been equipped with a tire pressure monitoring system (TPMS-tire pressure warning system) that illuminates a low tire pressure telltale (tire pressure warning light) when one or more of your tires is significantly under-inflated. Accordingly, when the low tire pressure telltale (tire pressure warning light) illuminates, you should stop and check your tires as soon as possible, and inflate them to the proper pressure. Driving on a significantly under-inflated tire causes the tire to overheat and can lead to tire failure. Under-inflation also reduces fuel efficiency and tire tread life, and may affect the vehicle's handling and stopping ability.

Please note that the TPMS (tire pressure warning system) is not a substitute for proper tire maintenance, and it is the driver's responsibility to maintain correct tire pressure, even if under-inflation has not reached the level to trigger illumination of the TPMS low tire pressure telltale (tire pressure warning light).

Your vehicle has also been equipped with a TPMS (tire pressure warning system) malfunction indicator to indicate when the system is not operating properly. The TPMS (tire pressure warning system) malfunction indicator is combined with the low tire pressure telltale (tire pressure warning light). When the system detects a malfunction, the telltale will flash for approximately one minute and then remain continuously illuminated. This sequence will continue upon subsequent vehicle start-ups as long as the malfunction exists. When the malfunction indicator is illuminated, the system may not be able to detect or signal low tire pressure as intended.

TPMS (tire pressure warning system) malfunctions may occur for a variety of reasons, including the installation of replacement or alternate tires or wheels on the vehicle that prevent the TPMS (tire pressure warning system) from functioning properly. Always check the TPMS (tire pressure warning system) malfunction telltale after replacing one or more tires or wheels on your vehicle to ensure that the replacement or alternate tires and wheels allow the TPMS (tire pressure warning system) to continue to function properly.

 NOTICE

n Precaution when installing a different tire

When a tire of a different specification or maker is installed, the tire pressure warning system may not operate properly.

5-2. Steps to take in an emergency If a warning message is displayed

If a warning is shown on the multi-information display, stay calm and perform the following actions:



1 Master warning light



The master warning light also comes on or flashes in order to indicate that a message is currently being displayed on the multi-information display.

2 Multi-information display

If any of the warning light turns on again after performing the following actions, contact your Lexus dealer.







Stop the vehicle immediately.

A buzzer sounds and a warning message is shown on the multi-information display. The following warnings indicate the possibility of damage to the vehicle that may lead to an accident. Immediately stop the vehicle in a safe place and contact your Lexus dealer.

Warning message	Details
  (Flashing)	<p>Indicates an abnormal engine oil pressure.</p> <p>The warning light may turn on if the engine oil pressure is too low.</p>

Have the vehicle inspected by your Lexus dealer immediately.



A buzzer sounds and a warning message is shown on the multi-information display. Failing to investigate the cause of the following warnings may lead to the system operating abnormally and possibly cause an accident. Have the vehicle inspected by your Lexus dealer immediately.

Warning message	Details
  (If equipped)	Indicates a malfunction in the AWD system.
  (Flashing and then continuously on) 	Indicates a malfunction in the tire pressure warning system. (→P. 307) The tire pressure warning light comes on after blinking for 1 minute.
  (Flashing)	Indicates a malfunction in the steering lock system.

Warning message	Details
 <p>PCS</p>  <p>(If equipped)</p>	<p>Indicates a malfunction in the pre-collision system.</p>
  <p>(If equipped)</p>	<p>Indicates intuitive parking assist malfunction. The malfunctioning assist-sensor is shown flashing on the display.</p>
 <p>CRUISE (Flashing)</p>  <p>(If equipped)</p>	<p>Indicates a malfunction in the radar cruise control system.</p>







Have the vehicle inspected by your Lexus dealer immediately.







Failing to investigate the cause of the following warning may lead to the system operating abnormally and possibly cause an accident. Have the vehicle inspected by your Lexus dealer immediately.







Warning message	Details
 	<p>Indicates a malfunction in the TRAC, VSC or hill-start assist control systems.</p>

Follow the correction procedures.







A buzzer sounds and a warning message is shown on the multi-information display. After taking the specified steps to correct the suspected problem, check that the warning message turns off.





Warning message	Details	Correction procedure
 RIGHT FRONT DOOR  LEFT FRONT DOOR  RIGHT REAR DOOR  LEFT REAR DOOR	<p>Indicates that one or more of the doors is not fully closed.</p> <p>The system also indicates which doors are not fully closed.</p>  flashes and a buzzer sounds to indicate that one or more of the doors is not fully closed (with the vehicle having reached a speed of 3 mph [5 km/h]).	<p>Make sure that all of the doors are closed.</p>
 HOOD OPEN	<p>Indicates that the hood is not fully closed.</p>  flashes and a buzzer sounds to indicate that hood is not fully closed (with the vehicle having reached a speed of 3 mph [5 km/h]).	<p>Close the hood.</p>

Warning message	Details	Correction procedure
	<p>Indicates that the trunk is not fully closed.</p>  flashes and a buzzer sounds to indicate that trunk is not fully closed (with the vehicle having reached a speed of 3 mph [5 km/h]).	<p>Close the trunk.</p>
  (Flashing)	<p>Indicates that the moon roof is not fully closed (with the “ENGINE START STOP” switch OFF and the driver’s door opened).</p>	<p>Close the moon roof.</p>
	<p>Indicates that the parking brake is still engaged.</p>  flashes and a buzzer sounds to indicate that the parking brake is still engaged (with the vehicle having reached a speed of 3 mph [5 km/h]).	<p>Release the parking brake.</p>
 	<p>Indicates that the washer fluid level is low.</p>	<p>Add washer fluid.</p>

Warning message	Details	Correction procedure
 	<p>Indicates that engine oil level is low.</p>	<p>Check the level of engine oil, and add if necessary.</p>
  (U.S.A. only)	<p>Indicates that the engine oil is scheduled to be changed.</p> <p>Comes on approximately 4500 miles (7200 km) after the engine oil is changed. (The indicator will not work properly unless the oil maintenance data has been reset.)</p>	<p>Check the engine oil, and change if necessary.</p>
  (U.S.A. only)	<p>Indicates that the engine oil should be changed.</p> <p>Comes on approximately 5000 miles (8000 km) after the engine oil is changed (and the oil maintenance data has been reset).</p>	<p>Check and change the engine oil.</p>

5-2. Steps to take in an emergency

Warning message	Details	Correction procedure
 <p>LOW TIRE</p>  	<p>Indicates low tire inflation pressure.</p>	<p>Check the tire inflation pressure, and adjust to the appropriate level.</p>
 <p>PCS NOT AVAILABLE NOW</p> <p>PCS (Flashing)</p>  <p>(If equipped)</p>	<p>Indicates that the pre-collision system is not currently functional.</p>	<p>Clean the grille and the sensor. This message appears when the pre-collision system is hot. In this case, wait until the system cools down.</p>
 <p>CLEAN SONAR</p>  <p>(If equipped)</p>	<p>Indicates that intuitive parking assist is dirty or covered with ice.</p>	<p>Clean the sensor.</p>
 <p>CLEAN RADAR SENSOR</p> <p>CRUISE (Flashing)</p>  <p>(If equipped)</p>	<p>Indicates that the radar cruise control sensor is dirty or covered with ice.</p>	<p>Clean the sensor.</p>

Warning message	Details	Correction procedure
 <p>(Flashing and then continuously on)</p>  (Flashing)  (If equipped)	<p>Indicates that the radar cruise control system is unable to judge vehicle-to-vehicle distance.</p>	<ul style="list-style-type: none"> • Switch the driving mode to either the normal or power mode. • If the windshield wipers are on, turn them off or set them to either the intermittent or the slow mode.
 <p>(Flashing) (If equipped)</p>	<p>Indicates that your vehicle is nearing the vehicle ahead (in radar cruise mode).</p>	<p>Slow the vehicle by applying the brakes.</p>

n Changing the engine oil (U.S.A. only)

Make sure to reset the oil change system. (→P. 295)





n Warning light display in radar cruise mode







In the following cases, the warning light may not be displayed even if vehicle-to-vehicle distance closes.

- 1 When your vehicle and the vehicle ahead are traveling at the same speed or the vehicle ahead is traveling more quickly than your vehicle
- 1 When the vehicle ahead is traveling at a very low speed
- 1 Immediately after cruise control speed is set
- 1 At the instant the accelerator pedal is depressed





Follow the correction procedures.

After taking the specified steps to correct the suspected problem, check that the warning light turns off.

Interior buzzer	Exterior buzzer	Warning message	Details	Correction procedure
Once	—	 <p>(Comes on for 10 seconds.)</p>  (Flashing)	Indicates that an attempt was made to start the engine without the electronic key being present, or the electronic key was not functioning normally.	Start the engine with the electronic key [*] present.
Once	3 times	 <p>(Flashing)</p> 	Indicates that a door other than the driver's door has been opened or closed with the "ENGINE START STOP" switch in any mode other than OFF and the electronic key outside of the detection area.	Confirm the location of the electronic key.

Interior buzzer	Exterior buzzer	Warning message	Details	Correction procedure
Once	3 times	 <p>(Vehicles with an automatic transmission)</p>  (Flashing)	Indicates that the driver's door has been opened or closed with the shift lever in P, the "ENGINE START STOP" switch in any mode other than OFF and the electronic key outside of the detection area.	Turn the "ENGINE START STOP" switch OFF or confirm the location of the electronic key.
Once	Continuous	  <p>(Displayed alternately) (Vehicles with an automatic transmission)</p>  (Flashing)	Indicates that the driver's door has been opened or closed (with the shift lever out of in P, the "ENGINE START STOP" switch in any mode other than OFF and the electronic key outside of the detection area).	<ul style="list-style-type: none"> • Shift the shift lever to P. • Confirm the location of the electronic key.
Once	—	  (Flashing)	Indicates that the key battery is low.	Replace the battery. (→P. 325)

5-2. Steps to take in an emergency

Interior buzzer	Exterior buzzer	Warning message	Details	Correction procedure
Once	—	 <p>(Vehicles with an automatic transmission)</p>	Indicates that a door has been opened or closed and the “ENGINE START STOP” switch has been switched twice to ACCESSORY mode from OFF.	Press the “ENGINE START STOP” switch while applying the brakes.
Once	—	 <p>(Vehicles with a manual transmission)</p>	Indicates that a door has been opened or closed and the “ENGINE START STOP” switch has been switched twice to ACCESSORY mode from OFF.	Press the “ENGINE START STOP” switch while depressing the clutch pedal.
Once	—	  (Flashing)	Indicates that the steering lock has not released within 3 seconds of pressing the “ENGINE START STOP” switch.	Press the “ENGINE START STOP” switch again while turning the steering wheel with the brake pedal depressed.

Interior buzzer	Exterior buzzer	Warning message	Details	Correction procedure
Once	—	<p>DEPRESS THE BRAKE PEDAL, AND TOUCH THE ENGINE SWITCH WITH THE KEY</p> <p>(Vehicles with an automatic transmission)</p>	Indicates that the electronic key does not operate properly.	→P. 395
—	—	<p>TO START, DEPRESS THE BRAKE PEDAL, AND PUSH THE ENGINE SWITCH</p> <p>(Vehicles with an automatic transmission)</p>		
Once	—	<p>DEPRESS THE CLUTCH PEDAL, AND TOUCH THE ENGINE SWITCH WITH THE KEY</p> <p>(Vehicles with a manual transmission)</p>	Indicates that the electronic key does not operate properly.	→P. 395
—	—	<p>TO START, DEPRESS THE CLUTCH PEDAL, AND PUSH THE ENGINE SWITCH</p> <p>(Vehicles with a manual transmission)</p>		

*: If the engine does not start when the electronic key is inside the vehicle, the electronic key battery may be depleted or there may be difficulties receiving the signal from the key. (→P. 26)

5-2. Steps to take in an emergency If you have a flat tire

Remove the flat tire and replace it with the spare provided.

n Before jacking up the vehicle

- 1 Stop the vehicle on a hard, flat surface.
- 1 Set the parking brake.
- 1 Shift the shift lever to P (automatic) or R (manual).
- 1 Stop the engine.
- 1 Turn on the emergency flashers.

n Location of the spare tire, jack and tools

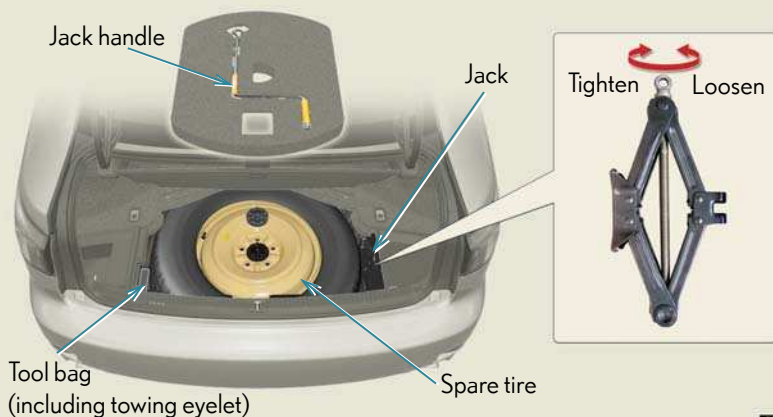

Taking out the spare tire

STEP 1



Lift up the hook of the panel on the trunk floor.

STEP 2

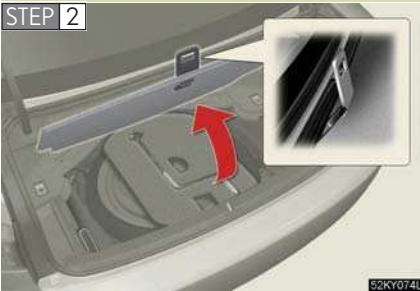

Secure the panel using the hook provided.

STEP 3

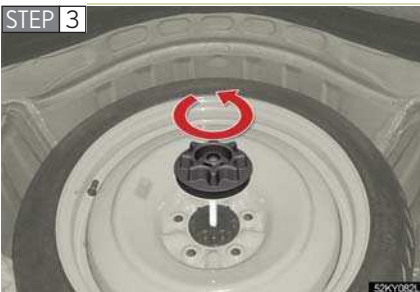

Loosen the center fastener that secures the spare tire.

Replacing a flat tire

STEP 1



Check the tires.

Flat tire		Wheel chock positions
Front	Left-hand side	Behind the rear right-hand side tire
	Right-hand side	Behind the rear left-hand side tire
Rear	Left-hand side	In front of the front right-hand side tire
	Right-hand side	In front of the front left-hand side tire

STEP 2



Slightly loosen the wheel nuts (one turn).

STEP 3

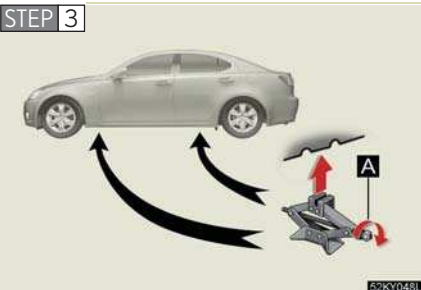

Turn the tire jack portion "A" by hand until the notch of the jack is in contact with the jack point.



Raise the vehicle until the tire is slightly raised off the ground.



Remove all the wheel nuts and the tire.

When resting the tire on the ground, place the tire so that the wheel design faces up to avoid scratching the wheel surface.

Installing the spare tire

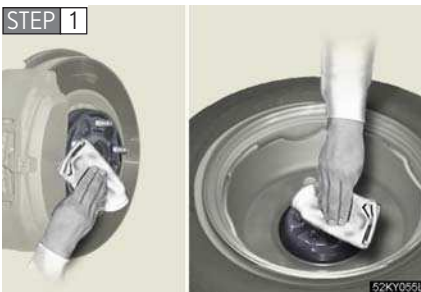

Remove any dirt or foreign matter from the wheel contact surface.

If foreign matter is on the wheel contact surface, the wheel nuts may loosen while the vehicle is in motion, and the tire may come off the vehicle.

5-2. Steps to take in an emergency

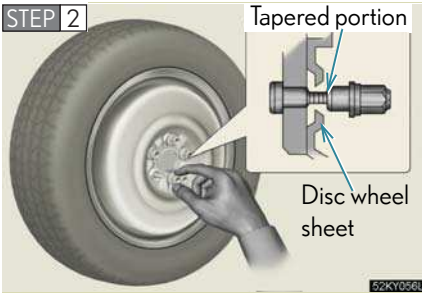

Install the spare tire and loosely tighten each nut by hand to approximately the same amount.

Tighten the wheel nuts until the tapered portion comes into loose contact with the disc wheel sheet.



Lower the vehicle.

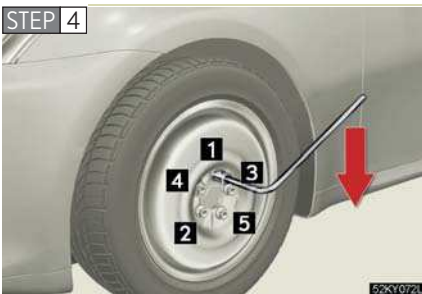

Firmly tighten each nut two or three times in the order shown in the illustration.

Tightening torque:
76 ft•lbf (103 N•m, 10.5 kgf•m)

STEP 5 Stow the flat tire, tire jack and all tools.

n **The compact spare tire**

- 1 The compact spare tire is identified by the label "TEMPORARY USE ONLY" on the tire sidewall.
Use the compact spare tire temporarily only in an emergency.
- 1 Make sure to check the tire pressure of the compact spare tire. (→P. 415)

n **When using the compact spare tire**

As the compact spare tire is not equipped with the tire pressure warning valve and transmitter, low inflation pressure of the spare tire will not be warned. Also, if you replace the compact spare tire after the tire pressure warning light comes on, the light remains on.

n **If you have a flat rear tire on a road covered with snow or ice**

Install the compact spare tire on the front of the vehicle. Perform the following steps and fit tire chains to the rear tires.

STEP 1 Replace a front tire with the compact spare tire.

STEP 2 Replace the flat rear tire with the tire removed from the front of the vehicle.

STEP 3 Fit tire chains to the rear tires.

n **After completing the tire change**

The tire pressure warning system must be reset. (→P. 308)

CAUTION

n Using the tire jack

Improper use of the tire jack may lead to death or injuries due to the vehicle suddenly falling off the jack.

- I** Do not use the tire jack for any purpose other than replacing tires or installing and removing tire chains.
- I** Only use the tire jack that comes with this vehicle for replacing a flat tire. Do not use it on other vehicles, and do not use other tire jacks for replacing tires on this vehicle.
- I** Always check that the tire jack is securely set to the jack point.
- I** Do not put any part of your body under the vehicle supported by a jack.
- I** Do not start or run the engine while your vehicle is supported by the jack.
- I** Do not raise the vehicle while someone is in it.
- I** When raising the vehicle, do not put an object on or under the jack.
- I** Do not raise the vehicle to a height greater than that required to replace the tire.
- I** Use a jack stand if it is necessary to get under the vehicle.

Take particular care when lowering the vehicle to ensure that no one working on or near the vehicle may be injured.

n Replacing a flat tire

Observe the following precautions to reduce the risk of death or serious injury.

- I** Never use oil or grease on the wheel bolts or wheel nuts. The oil or grease can cause the wheel nuts to loosen, causing a serious accident. Remove any oil or grease on the wheel bolts or wheel nuts.
- I** Have the wheel nuts tightened with a torque wrench to 76 ft•lbf (103 N•m, 10.5 kgf•m) as soon as possible after changing wheels. Failure to follow these precautions could cause the nuts to loosen and the wheels may fall off, which could lead to an accident causing death or serious injury.

 **CAUTION**
n When using the compact spare tire

- I Remember that your compact spare tire is specifically designed for use with your vehicle. Do not use your compact spare tire on another vehicle.
- I Do not use two compact spare tires simultaneously.
- I Replace the compact spare tire with a standard tire as soon as possible.
- I Avoid sudden acceleration, deceleration and braking, as well as sharp cornering.

n Speed limit when using the compact spare tire

Do not drive at speeds in excess of 50 mph (80 km/h) when a compact spare tire is installed on the vehicle.

The compact spare tire is not designed for driving at high speeds. Failing to observe this precaution may lead to an accident causing death or serious injury.

n When the compact spare tire attached

The vehicle speed may not be correctly detected, and the following systems may not operate correctly:

- I ABS & brake assist
- I VSC
- I TRAC
- I Navigation system (if equipped)

Also, not only can the following system not be utilized fully, it may actually negatively effect the drive-train components:

- I AWD system

 NOTICE

n Do not drive the vehicle with a flat tire.

Do not continue driving with a flat tire.

Driving even a short distance with a flat tire can damage the tire and the wheel beyond repair.

n Be careful when driving over bumps with the compact spare tire installed on the vehicle.

The vehicle becomes lower when driving with the compact spare tire compared to when driving with standard tires. Be careful when driving over uneven road surfaces.

n Driving with tire chains and the compact spare tire

Do not fit tire chains to the compact spare tire.

Tire chains may damage the vehicle body and adversely affect driving performance.

n When replacing the tires

When removing or fitting the wheels, tires or the tire pressure warning valve and transmitter, contact your Lexus dealer as the tire pressure warning valve and transmitter may be damaged if not handled correctly.

n To avoid damaging the tire pressure warning valves and transmitters

Do not use liquid sealants on flat tires.

5-2. Steps to take in an emergency If the engine will not start

If the engine will not start, even though correct starting procedures are being followed (→P. 117), consider each of the following points.

n The engine will not start even when the starter motor operates normally.

One of the following may be the cause of the problem.

1 There may not be sufficient fuel in the vehicle's tank.

Refuel the vehicle.

1 The engine may be flooded.

Try to restart the engine once more following correct starting procedures. (→P. 117)

1 There may be a malfunction in the engine immobilizer system.

(→P. 72)

n The starter motor turns over slowly, the interior lights and headlights are dim, or the horn does not sound or sounds at a low volume.

One of the following may be the cause of the problem.

1 The battery may be discharged. (→P. 397)

1 The battery terminal connections may be loose or corroded.

n The starter motor does not turn over, the interior lights and headlights do not turn on, or the horn does not sound.

One of the following may be the cause of the problem.

1 One or both of the battery terminals may be disconnected.

1 The battery may be discharged. (→P. 397)

1 There may be a malfunction in the steering lock system.

Contact your Lexus dealer if the problem cannot be repaired, or if repair procedures are unknown.

5-2. Steps to take in an emergency

If the shift lever cannot be shifted from P

If the shift lever cannot be shifted with your foot on the brake, there may be a problem with the shift lock system (a system to prevent accidental operation of the shift lever). Have the vehicle inspected by your Lexus dealer immediately.

The following steps may be used as an emergency measure to ensure that the shift lever can be shifted.

STEP 1 Set the parking brake.

STEP 2 Turn the “ENGINE START STOP” switch to ACCESSORY mode.

STEP 3 Depress the brake pedal.

STEP 4



Pry the cover up with a flathead screwdriver or equivalent.

STEP 5

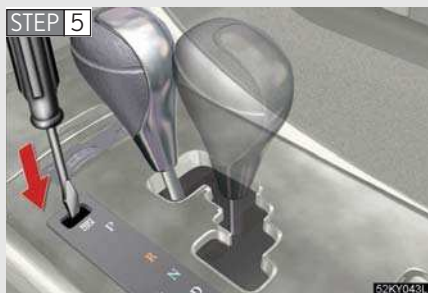

Press the shift lock override button.

The shift lever can be shifted while the button is pressed.

5-2. Steps to take in an emergency

If you lose your keys

New genuine Lexus keys can be made by your Lexus dealer using the other key and the key number stamped on your key number plate.

5-2. Steps to take in an emergency

If the electronic key does not operate properly

If communication between the electronic key and vehicle is interrupted (→P. 26) or the electronic key cannot be used because the battery is depleted, the smart access system with push-button start and wireless remote control cannot be used. In such cases, the doors and trunk can be opened or the engine can be started by following the procedure below.

Locking and unlocking the doors, unlocking the trunk and key linked functions

► Doors



Remove the cover on the driver's door handle using the mechanical key in order to perform the following operations.

- 1** Locks all doors
- 2** Closes the windows/moon roof (turn and hold)
- 3** Unlocks the door

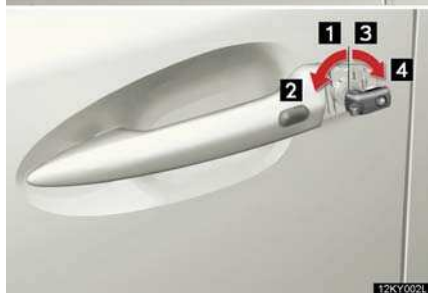

Turning the key rearward unlocks the driver's door. Turning the key once again unlocks the other doors.

- 4** Opens the windows/moon roof (turn and hold)

Return the cover to the original position after use.

▶ Trunk



Turn the mechanical key clockwise to open.

Changing “ENGINE START STOP” switch modes and starting the engine

▶ Automatic transmission

STEP 1 Shift the shift lever to P and apply the brakes.



STEP 2

Touch the Lexus emblem side of the electronic key to the “ENGINE START STOP” switch.

An alarm will sound to indicate that the start function cannot detect the electronic key that is touched to the “ENGINE START STOP” switch if any of the doors is opened and closed while the key is touched to the switch.

STEP 3 To change “ENGINE START STOP” switch modes: Within 10 seconds of the buzzer sounding, release the brake pedal and press the “ENGINE START STOP” switch. Modes can be changed each time the switch is pressed.
(→P. 117)

To start the engine: Press the “ENGINE START STOP” switch within 10 seconds after the buzzer sounds, keeping the brake pedal depressed.

► Manual transmission

STEP 1 Shift the shift lever to N and depress the clutch pedal.



Touch the Lexus emblem side of the electronic key to the “ENGINE START STOP” switch.

An alarm will sound to indicate that the start function cannot detect the electronic key that is touched to the “ENGINE START STOP” switch if any of the doors is opened and closed while the key is touched to the switch.

STEP 3 To change “ENGINE START STOP” switch modes: Within 10 seconds of the buzzer sounding, release the clutch pedal and press the “ENGINE START STOP” switch. Modes can be changed each time the switch is pressed.
(→P. 117)

To start the engine: Press the “ENGINE START STOP” switch within 10 seconds after the buzzer sounds, keeping the clutch pedal depressed.

In the event that the engine still cannot be started, contact your Lexus dealer.

▮ **Stopping the engine**

For vehicles with an automatic transmission: Shift the shift lever to P and press the “ENGINE START STOP” switch as you normally do when stopping the engine.

For vehicles with a manual transmission: Shift the shift lever to N position and press the “ENGINE START STOP” switch as you normally do when stopping the engine.

▮ **Replacing the key battery**

As the above procedure is the temporary measure, it is recommended that the electronic key battery be replaced immediately when the battery depletes.
(→P. 325)

5-2. Steps to take in an emergency If the vehicle battery is discharged

The following procedures may be used to start the engine if the vehicle's battery is discharged.

You can call your Lexus dealer, or qualified repair shop.

If you have a set of jumper (or booster) cables and a second vehicle with a 12-volt battery, you can jump start your Lexus following the steps below.

STEP 1 Remove the engine compartment covers. (→P. 294)

STEP 2

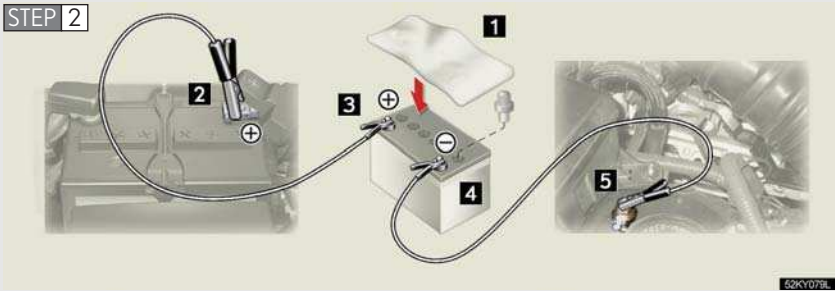

Connecting the jumper cables.

- 1** If required, remove all vent plugs from the booster battery. Lay a cloth over the open vents on the booster battery. (This helps reduce the explosion hazard, personal injuries and burns.)
- 2** Positive (+) battery terminal on your vehicle
- 3** Positive (+) battery terminal on the second vehicle
- 4** Negative (-) battery terminal on the second vehicle
- 5** Connect the jumper cable to ground on your vehicle as shown in the illustration.

STEP 3 Start the engine of the second vehicle. Increase the engine speed slightly and maintain at that level for approximately 5 minutes to recharge the battery of your vehicle.

STEP 4 Open and close any of the doors with the "ENGINE START STOP" switch OFF.

STEP 5 Maintain the engine speed on the second vehicle and turn the “ENGINE START STOP” switch to IGNITION ON mode, then start the vehicle’s engine.

STEP 6 Once the vehicle’s engine has started, remove the jumper cables in the exact reverse order in which they were connected.

Once the engine starts, have the vehicle checked at your Lexus dealer as soon as possible.

n **Avoiding a discharged battery**

- 1 Turn off the headlights and the audio system while the engine is off.
- 1 Turn off any unnecessary electrical components when the vehicle is running at a low speed for an extended period, such as in heavy traffic, etc.

n **When the battery is removed or discharged**

The power windows must be initialized. (→P. 64)

CAUTION

n **Avoiding battery fires or explosions**

Observe the following precautions to prevent accidentally igniting the flammable gas that may be emitted from the battery.

- 1 Make sure the jumper cable is connected to the correct terminal and that it is not unintentionally in contact with any part other than the intended terminal.
- 1 Do not allow the jumper cables to come into contact with the “+” and “-” terminals.
- 1 Do not allow open flame or use matches, cigarette lighters or smoke near the battery.

 **CAUTION**
n Battery precautions

The battery contains poisonous and corrosive acidic electrolyte, while related parts contain lead and lead compounds. Observe the following precautions when handling the battery.

- I** When working with the battery, always wear safety glasses and take care not to allow any battery fluids (acid) to come into contact with skin, clothing or the vehicle body.
- I** Do not lean over the battery
- I** In the event that battery fluid comes into contact with the skin or eyes, immediately wash the affected area with water and seek medical attention.
Place a wet sponge or cloth over the affected area until medical attention can be received.
- I** Always wash your hands after handling the battery support, terminals, and other battery-related parts.
- I** Do not allow children near the battery.

 **NOTICE**
n To prevent damaging the vehicle

Do not pull- or push-start the vehicle, because the three-way catalytic converter may overheat and become a fire hazard.

n When handling jumper cables

Be careful that the jumper cables do not become tangled in the cooling fan or any of the belts when connecting or disconnecting them.

5-2. Steps to take in an emergency If your vehicle overheats

If your engine overheats:

STEP 1 Stop the vehicle in a safe place and turn off the automatic air conditioning system.

STEP 2 Check to see if steam is coming out from under the hood.

If you see steam:

Stop the engine and carefully lift the hood.

If you do not see steam:

Leave the engine running and carefully lift the hood.

STEP 3 Remove the engine compartment cover. (→P. 294)

STEP 4 Check to see if the cooling fan is operating.

If the fan is operating:

Wait until the temperature of the engine (shown on the instrument cluster) begins to fall and then stop the engine.

If the fan is not operating:

Stop the engine immediately and call your local Lexus dealer.

STEP 5



After the engine has cooled down sufficiently, check the engine coolant level and inspect the radiator core (radiator) for any leaks.

STEP 6

Add engine coolant if required.

Water can be used in an emergency measure if engine coolant is unavailable. (→P. 411)

Have the vehicle checked at your nearest Lexus dealer as soon as possible.

n Overheating

If you observe the following, your vehicle may be overheating.

- 1 The engine coolant temperature gauge enters the red zone or a loss of power is experienced.
- 1 Steam is coming from under the hood.

! CAUTION

n To prevent an accident or injury when inspecting under the hood of your vehicle

- 1 Keep hands and clothing away from the fan and other belts while the engine is running.
- 1 Do not loosen the radiator cap while the engine and radiator are hot. Serious injury, such as burns, may result from hot coolant and steam released under pressure.

! NOTICE

n When adding engine coolant

Wait until the engine has cooled down before adding engine coolant. When adding coolant, do so slowly. Adding cool coolant to a hot engine too quickly can cause damage to the engine.

5-2. Steps to take in an emergency If the vehicle becomes stuck

Carry out the following procedures if the tires spin or the vehicle becomes stuck in mud, dirt, or snow.

STEP 1 Stop the engine. Set the parking brake and put the selector lever in P (vehicles with an automatic transmission) or N (vehicles with a manual transmission).

STEP 2 Remove the mud, snow, or sand from around the stuck tire.

STEP 3 Place wood, stones or some other material to help provide traction under the tires.

STEP 4 Restart the engine.

STEP 5 Shift the shift lever to the D or R position (automatic) or 1 or R position (manual) and carefully apply the accelerator to free the vehicle.

Turn off TRAC and VSC if these functions are hampering your attempts to free the vehicle. (→ P.172)

CAUTION

n When attempting to free a stuck vehicle

If you choose to rock the vehicle back and forth to free it, make sure the surrounding area is clear, to avoid striking other vehicles, objects or persons. The vehicle may also lunge forward or lunge back suddenly as it becomes free. Use extreme caution.

n When shifting the shift lever

With automatic transmission vehicles, be careful not to shift the shift lever with the accelerator pedal depressed.

This may lead to unexpected rapid acceleration of the vehicle that may cause an accident and result in death or serious injury.

 NOTICE

n To avoid damaging the transmission and other components

- l** Avoid spinning the wheels and do not rev the engine.
- l** If the vehicle remains stuck after trying these procedures, the vehicle may require towing to be freed.

6-1. Specifications

Maintenance data (fuel, oil level, etc.)

Dimensions and weight

Overall length		180.1 in. (4575 mm)
Overall width		70.9 in. (1800 mm)
Overall height *1	2WD models	56.1 in. (1425 mm)
	AWD models	56.7 in. (1440 mm)
Wheelbase		107.4 in. (2730 mm)
Tread	Front	60.4 in. (1535 mm)
	Rear	60.0 in. (1525 mm)*2 60.4 in. (1535 mm)*3
Vehicle capacity weight (Occupants + luggage)		825 lb. (375 kg)

*1: Unladen vehicle

*2: Vehicle with 255/40R18 tires

*3: Vehicle with tires other than the above

Vehicle identification

n Vehicle identification number

The vehicle identification number (VIN) is the legal identifier for your vehicle. This is the primary identification number for your Lexus. It is used in registering the ownership of your vehicle.

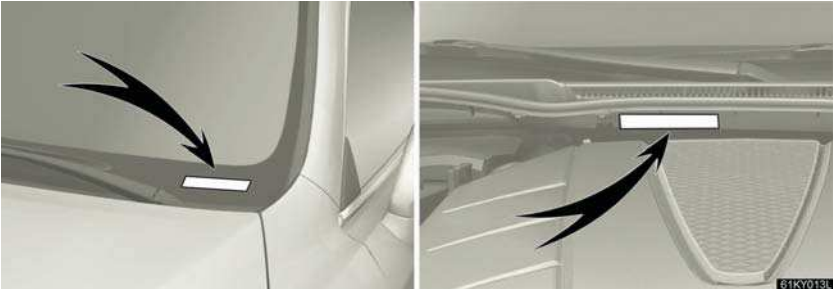

This number is stamped on the top left of the instrument panel and in the engine compartment.



This number is also on the Certification Label.

n Engine number

The engine number is stamped on the engine block as shown.

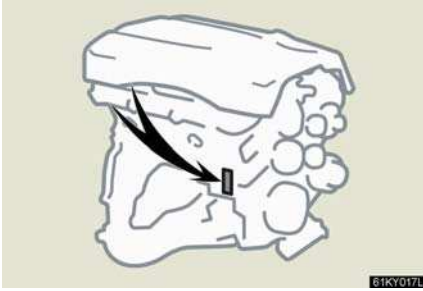

Engine

	IS250	IS350
Model	4GR-FSE	2GR-FSE
Type	6-cylinder V type, 4-cycle, gasoline	6-cylinder V type, 4-cycle, gasoline
Bore and stroke	3.27 × 3.03 in. (83.0 × 77.0 mm)	3.70 × 3.27 in. (94.0 × 83.0 mm)
Displacement	152.5 cu.in. (2500 cm ³)	210.9 cu.in. (3456 cm ³)
Drive belt tension	Automatic adjustment	

Fuel

Fuel type	Unleaded gasoline only
Octane rating	91 (Research octane number 96) or higher
Fuel tank capacity	17.2 gal. (65 L, 14.3 Imp.gal.)

Lubrication system

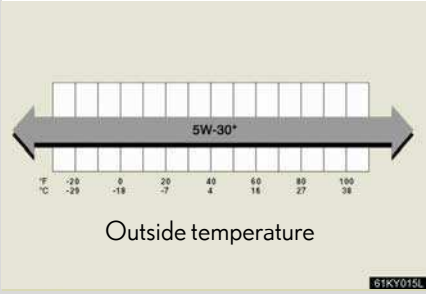
	IS250	IS350
Oil capacity (drain and refill)		
with filter		
2WD models	6.6 qt. (6.3 L, 5.5 Imp.qt.)	6.6 qt. (6.3 L, 5.5 Imp.qt.)
AWD models	6.8 qt. (6.4 L, 5.7 Imp.qt.)	—
without filter		
2WD models	6.2 qt. (5.9 L, 5.2 Imp.qt.)	6.2 qt. (5.9 L, 5.2 Imp.qt.)
AWD models	6.3 qt. (6.0 L, 5.3 Imp.qt.)	—
Oil grade	ILSAC multi-grade engine oil	
Recommended oil viscosity	<p>Use Lexus approved “Toyota Genuine Motor Oil” or equivalent to satisfy the grade and viscosity shown below.</p> 	

*:5W-30 is an oil that provides optimal levels of fuel efficiency.

Oil viscosity

- 1 The 5W portion of the oil viscosity rating indicates the characteristic of the oil which allows cold startability. Oils with a lower value before the W allow for easier starting of the engine in cold weather.
- 1 The 30 in 5W-30 indicates the oil viscosity when the oil is at its operating temperature. An oil with a higher viscosity may be better suited if the vehicle is operated at high speeds, or under extreme load condition.

Cooling system

Capacity	9.6 qt. (9.1 L, 8.0 Imp.qt.)
Coolant type	Use either of the following. <ul style="list-style-type: none"> • “Toyota Super Long Life Coolant” • Similar high-quality ethylene glycol-based non-silicate, non-amine, non-nitrite, and non-borate coolant with long-life hybrid organic acid technology Do not use plain water alone.

Ignition system

Spark plug	
Make	DENSO FK20HBR11
Gap	0.043 in. (1.1 mm)

NOTICE

n Iridium-tipped spark plugs

Use only iridium-tipped spark plugs. Do not adjust gap when tuning engine.

Electrical system

Battery	
Open voltage* at 68°F (20°C):	12.6 — 12.8 V Fully charged 12.2 — 12.4 V Half charged 11.8 — 12.0 V Discharged (*: Voltage checked 20 minutes after the engine and all the lights are turned off)
Charging rates	5 A max.

Differential

Oil capacity	Front	0.74 qt. (0.70 L, 0.61 Imp.qt.)
	Rear	IS350: 1.42 qt. (1.35 L, 1.19 Imp.qt.) IS250 (2WD models): 1.20 qt. (1.15 L, 1.01 Imp.qt.) IS250 (AWD models): 1.10 qt. (1.05 L, 0.92 Imp.qt.)
Oil type and viscosity*	IS250 (AWD)	Hypoid gear oil API GL-5 Above 0°F (-18°C): SAE90 Below 0°F (-18°C): SAE80W or SAE80W-90
	Others	"Toyota Genuine Differential Gear Oil LT 75W-85 GL-5" or equivalent

*: "Toyota Genuine Differential gear oil LT" is filled in your Lexus vehicle at factory fill. Use Lexus approved "Toyota Genuine Differential gear oil LT" or an equivalent of matching quality to satisfy the above specification. Please contact your Lexus dealer for further details.

Automatic Transmission

	IS350	IS250 (2WD)	IS250 (AWD)
Fluid capacity*	7.5 qt. (7.1 L, 6.2 Imp.qt.)	7.5 qt. (7.1 L, 6.2 Imp.qt.)	9.4 qt. (8.9 L, 7.8 Imp.qt.)
Fluid type	Toyota Genuine ATF WS		

*: The fluid capacity is provided as a reference. If replacement is necessary, contact your Lexus dealer.

NOTICE

Using automatic transmission fluid other than “Toyota Genuine ATF WS” may cause deterioration in shift quality, locking up of your transmission accompanied by vibration, and ultimately damage the automatic transmission of your vehicle.

Manual Transmission

Gear oil capacity	1.9 qt. (1.8 L, 1.6 Imp.qt.)
Gear oil type	API GL-5
Recommended gear oil viscosity	SAE75W-90

NOTICE

Using manual transmission gear oil other than “TOYOTA Genuine Manual Transmission Gear Oil API GL-5” may cause occurrence of gear noise or other deterioration.

Clutch

Clutch free play	0.2—0.6 in. (5—15 mm)
Fluid type	SAE J1703 or FMVSS No.116 DOT 3

Brakes

Pedal clearance ^{*1} IS 350 IS 250 Manual transmission Automatic transmission	4.13 in. (105 mm) Min. 4.09 in. (104 mm) Min. 4.3 in. (108 mm) Min.
Pedal free play	0.04 — 0.08 in. (1.0 — 2.0 mm)
Brake pad wear limit	0.04 in. (1.0 mm)
Parking brake lining wear limit	0.04 in. (1.0 mm)
Parking brake pedal travel ^{*2} / lever travel ^{*3} Pedal type Lever type	7 — 9 clicks 4 — 6 clicks
Fluid type	SAE J1703 or FMVSS No. 116 DOT 3

*1: Minimum pedal clearance when depressed with a force of 110 lbf (490 N, 50 kgf) while the engine is running.

*2: Parking brake pedal travel when depressed with a force of 67.4 lbf (300 N, 30.6 kgf).

*3: Parking brake lever travel when pulled up with a force of 45.0 lbf (200 N, 20.4 kgf).

Steering

Free play	Less than 1.2 in. (30 mm)
-----------	---------------------------

Tires and wheels

► Type A

Tire size	205/55R16 89W, T125/70D17 98M (spare)
Front and rear tire inflation pressure (Recommended cold tire inflation pressure)	<p>Driving under normal conditions</p> <p>Front: 35 psi (240 kPa, 2.4 kgf/cm² or bar)*</p> <p>Rear: 38 psi (260 kPa, 2.6 kgf/cm² or bar)*</p> <p>Spare: 60 psi (420 kPa, 4.2 kgf/cm² or bar)</p> <p>*: When driving at high speeds above 100 mph (160 km/h), in countries where such speeds are permitted by law, add 5.8 psi (40 kPa, 0.4 kgf/cm² or bar) to the front tires and rear tires. Never exceed the maximum cold tire inflation pressure indicated on the tire sidewall.</p>
Wheel size	16 × 7JJ, 17 × 4T (spare)
Wheel nut torque	76 ft•lbf (103 N•m, 10.5 kgf•m)

► Type B

Tire size	225/45R17 90W, 245/45R17 95W, T125/70D17 98M (spare)
Front and rear tire inflation pressure (Recommended cold tire inflation pressure)	<p>Driving under normal conditions</p> <p>Front: 35 psi (240 kPa, 2.4 kgf/cm² or bar)*</p> <p>Rear: 38 psi (260 kPa, 2.6 kgf/cm² or bar)*</p> <p>Spare: 60 psi (420 kPa, 4.2 kgf/cm² or bar)</p> <p>*: When driving at high speeds above 100 mph (160 km/h), in countries where such speeds are permitted by law, add 4.5 psi (30 kPa, 0.3 kgf/cm² or bar) to the front tires and rear tires. Never exceed the maximum cold tire inflation pressure indicated on the tire sidewall.</p>
Wheel size	17 × 8JJ, 17 × 4T (spare)
Wheel nut torque	76 ft•lbf (103 N•m, 10.5 kgf•m)

► Type C

Tire size	225/45R17 91V, 225/45R17 91V, T125/70D17 98M
Front and rear tire inflation pressure (Recommended cold tire inflation pressure)	<p>Driving under normal conditions</p> <p>Front: 35 psi (240 kPa, 2.4 kgf/cm² or bar)*</p> <p>Rear: 38 psi (260 kPa, 2.6 kgf/cm² or bar)*</p> <p>Spare: 60 psi (420 kPa, 4.2 kgf/cm² or bar)</p> <p>*: When driving at high speeds above 100 mph (160 km/h), in countries where such speeds are permitted by law, add 7.2 psi (50 kPa, 0.5 kgf/cm² or bar) to the front tires and rear tires. Never exceed the maximum cold tire inflation pressure indicated on the tire sidewall.</p>
Wheel size	17 × 8JJ, 17 × 4T (spare)
Wheel nut torque	76 ft•lbf (103 N•m, 10.5 kgf•m)

► Type D

Tire size	Front tires: 225/45R17 91V Rear tires: 245/45R17 95V Spare tire: T125/70R17 98M
Front and rear tire inflation pressure (Recommended cold tire inflation pressure)	Driving under normal conditions Front: 35 psi (240 kPa, 2.4 kgf/cm ² or bar)* Rear: 38 psi (260 kPa, 2.6 kgf/cm ² or bar)* Spare: 60 psi (420 kPa, 4.2 kgf/cm ² or bar) *: When driving at high speeds above 100 mph (160 km/h), in countries where such speeds are permitted by law, add 10 psi (70 kPa, 0.7 kgf/cm ² or bar) to the front tires and rear tires. Never exceed the maximum cold tire inflation pressure indicated on the tire sidewall.
Wheel size	17 × 8JJ, 17 × 4T (spare)
Wheel nut torque	76 ft•lbf (103 N•m, 10.5 kgf•m)

► Type E

Tire size	Front tires: 225/40R18 88Y Rear tires: 255/40R18 95Y Spare tire: T145/70R17 106M
Front and rear tire inflation pressure (Recommended cold tire inflation pressure)	Driving under normal conditions Front: 35 psi (240 kPa, 2.4 kgf/cm ² or bar)* Rear: 38 psi (260 kPa, 2.6 kgf/cm ² or bar)* Spare: 60 psi (420 kPa, 4.2 kgf/cm ² or bar) *: When driving at high speeds above 100 mph (160 km/h), in countries where such speeds are permitted by law, add 7.2 psi (50 kPa, 0.5 kgf/cm ² or bar) to the front tires and rear tires. Never exceed the maximum cold tire inflation pressure indicated on the tire sidewall.
Wheel size	Front wheels: 18 × 8J Rear wheels: 18 × 8 1/2J Spare wheel: 17 × 4T
Wheel nut torque	76 ft•lbf (103 N•m, 10.5 kgf•m)

Light bulbs

	Light Bulbs	Bulb No.	W	Type
Exterior	Headlights			
	High beam	9005	60	D
	Low/high* beam (discharge bulbs)	D4S	35	A
	Low beam* (halogen bulbs)	H11	55	B
	Front turn signal lights	—	21	C
	Parking lights	168	5	E
	Front fog lights	9006	55	F
	Trunk light	—	5	G
	Rear turn signal lights	7440	21	E
Interior	Back-up lights	921	16	E
	Outer foot lights	—	5	E
	Vanity lights	—	8	E
	Interior lights			
	Front	—	10	E
	Rear		3.0	G
	Overhead courtesy lights			
Front	—	3.8	E	
Rear		3.0	G	
Door courtesy lights	—	3.8	E	

*: If equipped

A: D4S discharge bulbs

B: H11 halogen bulbs

C: Wedge base bulbs (amber)

D: HB3 halogen bulbs

E: Wedge base bulbs (clear)

F: HB4 halogen bulbs

G: Double end bulbs

Fuel information

Your vehicle must use only unleaded gasoline.

Premium unleaded gasoline with an octane rating of 91 (Research Octane Number 96) or higher required for optimum engine performance.

At minimum, the gasoline you use should meet the specifications of ASTM D4814 in the U.S.A. and CGSB3.5-M93 in Canada.

n Fuel tank opening for unleaded gasoline

To help prevent incorrect fueling, your Lexus has a fuel tank opening that only accommodates the special nozzle on unleaded fuel pumps.

n If premium gasoline is not available

If 91 rating gasoline cannot be obtained, you may use unleaded gasoline with an octane rating as low as 87 (Research Octane Rating 91).

n If your engine knocks

1 Consult your Lexus dealer.

1 You may occasionally notice light knocking for a short time while accelerating or driving uphill. This is normal and there is no need for concern.

n Gasoline quality

In very few cases, driveability problems may be caused by the brand of gasoline you are using. If driveability problems persist, try changing the brand of gasoline. If this does not correct the problem, consult your Lexus dealer.

n **Gasoline quality standards**

- 1 Automotive manufacturers in the US, Europe and Japan have developed a specification for fuel quality called World-Wide Fuel Charter (WWFC) that is expected to be applied worldwide.
- 1 The WWFC consists of four categories that are based on required emission levels. In the US, category 4 has been adopted.
- 1 The WWFC improves air quality by lowering emissions in vehicle fleets, and customer satisfaction through better performance.

n **Lexus recommends the use of gasoline containing detergent additives**

- 1 Lexus recommends the use of gasoline that contains detergent additives to avoid build-up of engine deposits.
- 1 All gasoline sold in the US contains detergent additives to clean and/or keep clean intake systems.

n **Lexus recommends the use of cleaner burning gasoline**

Cleaner burning gasoline, including reformulated gasoline that contains oxygenates such as ethanol or MTBE (Methyl Tertiary Butyl Ether) is available in many areas.

Lexus recommends the use of cleaner burning gasoline and appropriately blended reformulated gasoline. These types of gasoline provide excellent vehicle performance, reduce vehicle emissions and improve air quality.

n **Lexus does not recommend blended gasoline**

- 1 Lexus allows the use of oxygenate blended gasoline where the oxygenate content is up to 10% ethanol or 15% MTBE.
- 1 If you use gasohol in your Lexus, be sure that it has an octane rating no lower than 87.
- 1 Lexus DOES NOT recommend the use of gasoline containing methanol.

n **Lexus does not recommend gasoline containing MMT**

Some gasoline contains octane enhancing additive called MMT (Methylcyclopentadienyl Manganese Tricarbonyl).

Lexus DOES NOT recommend the use of gasoline that contains MMT. If fuel containing MMT is used, your emission control system may be adversely affected.

The malfunction indicator lamp on the instrument cluster may come on. If this happens, contact your Lexus dealer for service.

 NOTICE**n Notice on gasoline quality**

- i** Do not use leaded gasoline.
Leaded gasoline can cause damage to your vehicle's three-way catalytic converters causing the emission control system to malfunction.
- i** Do not use gasohol other than that stated here.
Other gasohol may cause fuel system damage or vehicle performance problems.
- i** IS250: Use of unleaded gasoline with an octane rating lower than 91 may result in engine knocking. Persistent knocking can lead to engine damage and should be corrected by refueling with higher octane unleaded gasoline.
- i** IS350: Use of unleaded gasoline with an octane rating lower than 91 may result in engine knocking and significantly reduced performance. Persistent knocking can lead to engine damage and should be corrected by refueling with higher octane unleaded gasoline.

n Fuel-related poor driveability

If after using a different type of fuel, poor driveability is encountered (poor hot starting, vaporization, engine knocking, etc.), discontinue the use of that type of fuel.

n When refueling with gasohol

Take care not to spill gasohol. It can damage your vehicle's paint.

6-1. Specifications

Tire information

Typical tire symbols

► Standard tire



61KY014L

► Compact spare tire



CLY61AB014

- 1 Tire size (→P. 426)
- 2 DOT and Tire Identification Number (TIN) (→P. 426)
- 3 Location of treadwear indicators (→P. 306)
- 4 Tire ply composition and materials

Plies are layers of rubber-coated parallel cords. Cords are the strands which form the plies in a tire.

5 Radial tires or bias-ply tires

A radial tire has “RADIAL” on the sidewall. A tire not marked “RADIAL” is a bias-ply tire.

6 TUBELESS or TUBE TYPE

A tubeless tire does not have a tube and air is directly filled in the tire. A tube type tire has a tube inside the tire and the tube maintains the air pressure.

7 Load limit at maximum cold tire inflation pressure (→P. 311)**8** Maximum cold tire inflation pressure (→P. 415)

This means the pressure to which a tire may be inflated.

9 Uniform tire quality grading

For details, see “Uniform tire quality grading” that follows.

10 Summer tire or all season tire (→P. 312)

An all season tire has “M+S” on the sidewall. A tire not marked “M+S” is a summer tire.

11 “TEMPORARY USE ONLY” (→P. 387)

A compact spare tire is identified by the phrase “TEMPORARY USE ONLY” molded into its sidewall. This tire is designed for temporary emergency use only.

Typical DOT and tire identification number (TIN)

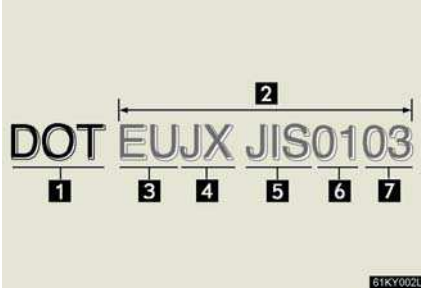

- 1 DOT symbol*
- 2 Tire Identification Number (TIN)
- 3 Tire manufacturer's identification mark
- 4 Tire size code
- 5 Manufacturer's optional tire type code (3 or 4 letters)
- 6 Manufacturing week
- 7 Manufacturing year

*:The DOT symbol certifies that the tire conforms to applicable Federal Motor Vehicle Safety Standards.

Tire size

n Typical tire size information



The illustration indicates typical tire size.

- 1 Tire use
(P = Passenger car,
T = Temporary use)
- 2 Section width (millimeters)
- 3 Aspect ratio
(tire height to section width)
- 4 Tire construction code
(R = Radial, D = Diagonal)
- 5 Wheel diameter (inches)
- 6 Load index (2 or 3 digits)
- 7 Speed symbol
(alphabet with one letter)

n Tire dimensions



- 1 Section width
- 2 Tire height
- 3 Wheel diameter

Tire section names

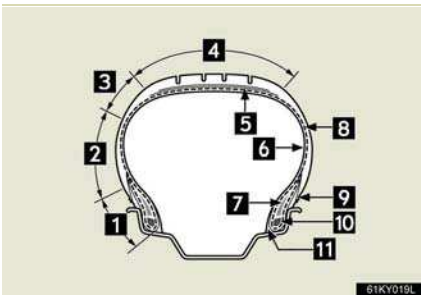

- 1 Bead
- 2 Sidewall
- 3 Shoulder
- 4 Tread
- 5 Belt
- 6 Inner liner
- 7 Reinforcing rubber
- 8 Carcass
- 9 Rim lines
- 10 Bead wires
- 11 Chafer

Uniform Tire Quality Grading

This information has been prepared in accordance with regulations issued by the National Highway Traffic Safety Administration of the U.S.A. Department of Transportation.

It provides the purchasers and/or prospective purchasers of Lexus vehicles with information on uniform tire quality grading.

Your Lexus dealer will help answer any questions you may have as you read this information.

n DOT quality grades

All passenger vehicle tires must conform to Federal Safety Requirements in addition to these grades. Quality grades can be found where applicable on the tire sidewall between tread shoulder and maximum section width.

For example: Treadwear 200 Traction AA Temperature A

n Treadwear

The treadwear grade is a comparative rating based on the wear rate of the tire when tested under controlled conditions on a specified government test course.

For example, a tire graded 150 would wear one and a half (1 - 1/2) times as well on the government course as a tire graded 100.

The relative performance of tires depends upon the actual conditions of their use, however, and may depart significantly from the norm due to variations in driving habits, service practices and differences in road characteristics and climate.

n Traction AA, A, B, C

The traction grades, from highest to lowest, are AA, A, B and C, and they represent the tire's ability to stop on wet pavement as measured under controlled conditions on specified government test surfaces of asphalt and concrete.

A tire marked C may have poor traction performance.

Warning: The traction grade assigned to this tire is based on braking (straight ahead) traction tests and does not include cornering (turning) traction.

n Temperature A, B, C

The temperature grades are A (the highest), B, and C, representing the tire's resistance to the generation of heat and its ability to dissipate heat when tested under controlled conditions on a specified indoor laboratory test wheel.

Sustained high temperature can cause the material of the tire to degenerate and reduce tire life, and excessive temperature can lead to sudden tire failure.

The grade C corresponds to a level of performance which all passenger car tires must meet under the Federal Motor Vehicle Safety Standard No. 109.

Grades B and A represent higher levels of performance on the laboratory test wheel than the minimum required by law.

Warning: The temperature grades for this tire are established for a tire that is properly inflated and not overloaded.

Excessive speed, underinflation, or excessive loading, either separately or in combination, can cause heat buildup and possible tire failure.

Glossary of tire terminology

Tire related term	Meaning
Accessory weight	The combined weight (in excess of those standard items which may be replaced) of automatic transmission, power steering, power brakes, power windows, power seats, radio and heater, to the extent that these items are available as factory-installed equipment (whether installed or not)
Cold tire inflation pressure	Tire pressure when the vehicle has been parked for three hours or more, or has not been driven more than 1 mile or 1.5 km under that condition
Curb weight	The weight of a motor vehicle with standard equipment, including the maximum capacity of fuel, oil and coolant, and if so equipped, air conditioning and additional weight optional engine

Tire related term	Meaning
Maximum inflation pressure	The maximum cold inflated pressure to which a tire may be inflated, shown on the sidewall of the tire
Maximum loaded vehicle weight	The sum of: (a) Curb weight (b) Accessory weight (c) Vehicle capacity weight (d) Production options weight
Normal occupant weight	150 lb. (68 kg) times the number of occupants specified in the second column of Table 1* that follows
Production options weight	The combined weight of installed regular production options weighing over 5 lb. (2.3 kg) in excess of the standard items which they replace, not previously considered in curb weight or accessory weight, including heavy duty brakes, ride levelers, roof rack, heavy duty battery, and special trim
Vehicle capacity weight (Total load capacity)	The rated cargo and luggage load plus 150 lb. (68 kg) times the vehicle's designated seating capacity
Occupant distribution	Distribution of occupants in a vehicle as specified in the third column of Table 1* below
Recommended inflation pressure	Cold tire inflation pressure recommended by a manufacturer.
Rim	A metal support for a tire or a tire and tube assembly upon which the tire beads are seated
Rim diameter (Wheel diameter)	Nominal diameter of the bead seat
Rim size designation	Rim diameter and width
Rim type designation	The industry manufacturer's designation for a rim by style or code

Tire related term	Meaning
Rim width	Nominal distance between rim flanges
Vehicle maximum load on the tire	The load on an individual tire that is determined by distributing to each axle its share of the maximum loaded vehicle weight, and dividing by two
Vehicle normal load on the tire	The load on an individual tire that is determined by distributing to each axle its share of curb weight, accessory weight, and normal occupant weight (distributed in accordance with Table 1* below), and dividing it by two
Weather side	The surface area of the rim not covered by the inflated tire

Tire related term	Meaning
Bead	The part of the tire that is made of steel wires, wrapped or reinforced by ply cords and that is shaped to fit the rim
Bead separation	A breakdown of the bond between components in the bead
Bias ply tire	A pneumatic tire in which the ply cords that extend to the beads are laid at alternate angles substantially less than 90 degrees to the centerline of the tread
Carcass	The tire structure, except tread and sidewall rubber which, when inflated, bears the load
Chunking	The breaking away of pieces of the tread or sidewall
Cord	The strands forming the plies in the tire
Cord separation	The parting of cords from adjacent rubber compounds
Cracking	Any parting within the tread, sidewall, or innerliner of the tire extending to cord material
CT	A pneumatic tire with an inverted flange tire and rim system in which the rim is designed with rim flanges pointed radially inward and the tire is designed to fit on the underside of the rim in a manner that encloses the rim flanges inside the air cavity of the tire
Extra load tire	A tire designed to operate at higher loads and at higher inflation pressures than the corresponding standard tire
Groove	The space between two adjacent tread ribs
Innerliner	The layer(s) forming the inside surface of a tubeless tire that contains the inflating medium within the tire
Innerliner separation	The parting of the innerliner from cord material in the carcass

Tire related term	Meaning
Intended outboard sidewall	(a) The sidewall that contains a whitewall, bears white lettering, or bears manufacturer, brand, and/or model name molding that is higher or deeper than the same molding on the other sidewall of the tire, or (b) The outward facing sidewall of an asymmetrical tire that has a particular side that must always face outward when mounted on a vehicle
Light truck (LT) tire	A tire designated by its manufacturer as primarily intended for use on lightweight trucks or multipurpose passenger vehicles
Load rating	The maximum load that a tire is rated to carry for a given inflation pressure
Maximum load rating	The load rating for a tire at the maximum permissible inflation pressure for that tire
Maximum permissible inflation pressure	The maximum cold inflation pressure to which a tire may be inflated
Measuring rim	The rim on which a tire is fitted for physical dimension requirements
Open splice	Any parting at any junction of tread, sidewall, or innerliner that extends to cord material
Outer diameter	The overall diameter of an inflated new tire
Overall width	The linear distance between the exteriors of the sidewalls of an inflated tire, including elevations due to labeling, decorations, or protective bands or ribs
Passenger car tire	A tire intended for use on passenger cars, multipurpose passenger vehicles, and trucks, that have a gross vehicle weight rating (GVWR) of 10000 lb. or less.
Ply	A layer of rubber-coated parallel cords

Tire related term	Meaning
Ply separation	A parting of rubber compound between adjacent plies
Pneumatic tire	A mechanical device made of rubber, chemicals, fabric and steel or other materials, that, when mounted on an automotive wheel, provides the traction and contains the gas or fluid that sustains the load
Radial ply tire	A pneumatic tire in which the ply cords that extend to the beads are laid at substantially 90 degrees to the centerline of the tread
Reinforced tire	A tire designed to operate at higher loads and at higher inflation pressures than the corresponding standard tire
Section width	The linear distance between the exteriors of the sidewalls of an inflated tire, excluding elevations due to labeling, decoration, or protective bands
Sidewall	That portion of a tire between the tread and bead
Sidewall separation	The parting of the rubber compound from the cord material in the sidewall
Snow tire	A tire that attains a traction index equal to or greater than 110, compared to the ASTM E-1136 Standard Reference Test Tire, when using the snow traction test as described in ASTM F-1805-00, Standard Test Method for Single Wheel Driving Traction in a Straight Line on Snow-and Ice-Covered Surfaces, and which is marked with an Alpine Symbol () on at least one sidewall
Test rim	The rim on which a tire is fitted for testing, and may be any rim listed as appropriate for use with that tire

Tire related term	Meaning
Tread	That portion of a tire that comes into contact with the road
Tread rib	A tread section running circumferentially around a tire
Tread separation	Pulling away of the tread from the tire carcass
Treadwear indicators (TWI)	The projections within the principal grooves designed to give a visual indication of the degrees of wear of the tread
Wheel-holding fixture	The fixture used to hold the wheel and tire assembly securely during testing

*: Table 1 — Occupant loading and distribution for vehicle normal load for various designated seating capacities

Designated seating capacity, Number of occupants	Vehicle normal load, Number of occupants	Occupant distribution in a normally loaded vehicle
2 through 4	2	2 in front
5 through 10	3	2 in front, 1 in second seat
11 through 15	5	2 in front, 1 in second seat, 1 in third seat, 1 in fourth seat
16 through 20	7	2 in front, 2 in second seat, 2 in third seat, 1 in fourth seat

6-2. Customization

Customizable features

Your vehicle includes a variety of electronic features that can be personalized to your preferences. Programming these preferences requires specialized equipment and may be performed by an authorized Lexus dealership.

Some function settings are changed simultaneously with other functions being customized. Contact your Lexus dealer for further details.

Item	Function	Default setting	Customized setting
Smart access system with push-button start (→P. 22)	Smart access system with push-button start	On	Off
	Operation signal (Emergency flashers)	On	Off
	Operation signal (Buzzer)	On	Off
Wireless remote control (→P. 34)	Wireless remote control	On	Off
	Unlocking operation	Driver's door unlocked in one step, all doors unlocked in two steps	All doors unlocked in one step
	Automatic door lock function to be activated if door is not opened after being unlocked	On	Off

Item	Function	Default setting	Customized setting
Wireless remote control (→P. 34)	Time elapsed before automatic door lock function is activated if door is not opened after being unlocked	60 seconds	30 seconds
			120 seconds
	Operation signal (Emergency flashers)	On	Off
	Operation signal (Buzzer)	On	Off
	Trunk unlocking function	On	Off
	Trunk unlocking operation	Push and hold	Push twice
			One short push
Panic function	On	Off	

Item	Function	Default setting	Customized setting
Door lock (→P. 37)	Unlocking using a key	Driver's door unlocked in one step, all doors unlocked in two steps	All doors unlocked in one step
	Speed-detecting automatic door lock function (Manual transmissions)	On	Off
	Speed-detecting automatic door lock function (Automatic transmissions)	Off	On
	Opening driver's door unlocks all doors (Manual transmissions)	On	Off
	Opening driver's door unlocks all doors (Automatic transmissions)	Off	On
	Shifting gears to P unlocks all doors.	On	Off
	Shifting gears to position other than P locks all doors.	On	Off

Item	Function	Default setting	Customized setting
Power windows (→P. 64)	Linked door lock operation	On	Off
	Linked door key operation	Open and close	Open only
			Close only
Wireless remote control linked operation	On	Off	
Moon roof (→P. 66)	Linked door lock operation	On	Off
	Linked door key operation	Open and close	Open only
			Close only
	Linked operation of components when door key is used	Slide only	Tilt only
	Wireless remote control linked operation	On	Off
Linked operation of components when wireless remote control used	Slide only	Tilt only	
Automatic light control system (→P. 143)	Light sensor sensitivity	Level 3	Level 1 to 5
	Time elapsed before headlights automatically turn off after doors are closed	30 seconds	0 seconds
			60 seconds
		90 seconds	

Item	Function	Default setting	Customized setting
Windshield wipers and washer (→P. 147)	Switching operation when the vehicle is stationary	On	Off
	Drip prevention function	On	Off
	Time elapsed before the drip prevention function operates	Variable depending on the vehicle speed	3 seconds
Intuitive parking assist (→P. 164)	Back sensor operation display and buzzer	On	Off
	Buzzer volume	Level 3	Level 1 to 5
	Distance which a sensor detects	150 cm (4.9 ft.)	60 cm (2.0 ft.)
Illumination (→P. 231)	Time elapsed before lights turn off	15 seconds	7.5 seconds
			30 seconds
	Operation when the doors are unlocked	On	Off
	Operation after the "ENGINE START STOP" switch turned OFF	On	Off
	Front foot well lighting	On	Off
	Shift lever lighting	On	Off
Outer foot light	On	Off	

Multi-information display (→P. 139)

Country	Available language
Canada	English and French

6-3. Initialization Items to initialize

The following item must be initialized for normal system operation in cases such as after the battery is reconnected, or maintenance is performed on the vehicle.

Item	When to initialize	Reference
Power window	After reconnecting or changing the battery	P. 64
Engine oil maintenance data	After changing engine oil	P. 295
Tire pressure warning system	<ul style="list-style-type: none">• When rotating the tires differing with front and rear tire inflation pressures.• When changing the tire inflation pressure by changing traveling speed.• When changing the tire size.	P. 307

Reporting safety defects for U.S. owners

If you believe that your vehicle has a defect which could cause a crash or could cause injury or death, you should immediately inform the National Highway Traffic Safety Administration (NHTSA) in addition to notifying the Lexus Division of Toyota Motor Sales, U.S.A., Inc. (Toll-free: 1-800-25-LEXUS).

If NHTSA receives similar complaints, it may open an investigation, and if it finds that a safety defect exists in a group of vehicles, it may order a recall and remedy campaign. However, NHTSA cannot become involved in individual problems between you, your dealer, or Lexus Division of Toyota Motor Sales, U.S.A., Inc.

To contact NHTSA, you may call the Vehicle Safety Hotline toll-free at 1-888-327-4236 (TTY: 1-800-424-9153); go to <http://www.safercar.gov>; or write to: Administrator, NHTSA, 1200 New Jersey Ave, S.E., Washington, DC 20590. You can also obtain other information about motor vehicle safety from <http://www.safercar.gov>.

Seat belt instructions for Canadian owners (in French)

The following is a French explanation of seat belt instructions extracted from the seat belt section in this manual.

See the seat belt section for more detailed seat belt instructions in English.

Utilisation correcte des ceintures de sécurité



- Déroulez la sangle diagonale de telle sorte qu'elle passe bien sur l'épaule, sans pour autant être en contact avec votre cou ou glisser de votre épaule.
- Placez la sangle abdominale le plus bas possible sur les hanches.
- Réglez la position du dossier de siège. Asseyez-vous le dos le plus droit possible et caliez-vous bien dans le siège.
- Ne vrillez pas la ceinture de sécurité.

Guide de confort de ceinture de sécurité (sièges arrière extérieurs)

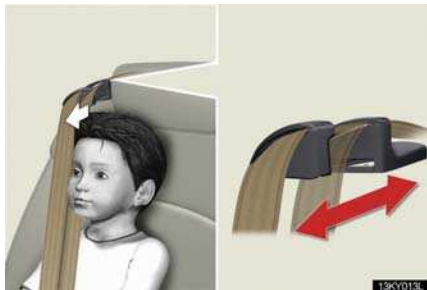

Si la sangle diagonale est proche du cou de la personne, faites coulisser le guide de confort de ceinture de sécurité vers l'avant.

Entretien et soin

■ Ceintures de sécurité

Nettoyez avec un chiffon ou une éponge humectée d'eau savonneuse tiède. Profitez de l'occasion pour vérifier régulièrement que les ceintures ne sont pas effilochées, entaillées, ou ne paraissent pas exagérément usées.

ATTENTION

■ Détérioration et usure des ceintures de sécurité

Inspectez les ceintures de sécurité périodiquement. Contrôlez qu'elles ne sont pas entaillées, effilochées, et que leurs ancrages ne sont pas desserrés. N'utilisez pas une ceinture de sécurité défectueuse avant qu'elle ne soit remplacée. Une ceinture de sécurité défectueuse n'apporte aucune garantie de protection de l'occupant en cas d'accident.

Abbreviation/Acronym list

ABBREVIATIONS	MEANING
ABS	Anti-Lock Brake System
AFS	Adaptive Front-lighting System
AI-SHIFT	Artificial Intelligence Shift
ALR	Automatic Locking Retractor
CAL	Calibration
CRS	Child Restraint System
DISP	Display
ECT	Electronic Controlled Transmission
ECU	Electronic Control Unit
EDR	Event data recorder
ELR	Emergency Locking Retractor
EPS	Electric Power Steering
ETCS	Electronic Throttle Control System
GAWR	Gross Axle Weight Rating
I/M	Emission inspection and maintenance
INT	Intermittent
MMT	Methylcyclopentadienyl Manganese Tricarbonyl
M + S	Mud and Snow
MTBE	Methyl Tertiary Butyl Ether
OBD	On Board Diagnostics
PCS	Pre-Collision System
SRS	Supplemental Restraint System
TIN	Tire Identification Number
TPMS	Tire Pressure Warning System
TRAC	Traction Control

ABBREVIATIONS	MEANING
VDIM	Vehicle Dynamics Integrated Management
VIN	Vehicle Identification Number
VSC	Vehicle Stability Control

A	A/C	192	Alarm.....	74
	ABS.....	170	Antenna.....	208
	AFS.....	144	Anti-lock brake system.....	170
	Adaptive front lighting system	144	Armrest	255
	Air conditioning filter	322	Ashtrays.....	248
	Air conditioning system		Audio input.....	228
	Air conditioning filter	322	Audio system	
	Automatic air conditioning		Antenna.....	208
	system.....	192	Audio input.....	228
	Airbags		AUX adapter	228
	Airbag operating conditions.....	81	CD player/changer	211
	Airbag precautions for your		MP3/WMA disc.....	217
	child.....	85	Optimal use	225
	Airbag warning light	361	Portable music player	228
	Curtain shield airbag operating		Radio	204
	conditions.....	82	Steering wheel audio switch.....	229
	Curtain shield airbag		Automatic air conditioning	
	precautions	85	system	192
	Front passenger occupant		Automatic headlight leveling	
	classification system.....	90	system	145
	General airbag precautions	85	Automatic light control system.....	143
	Locations of airbags.....	79	Automatic transmission	
	Modification and disposal of		Automatic transmission	122
	airbags.....	89	If the shift lever cannot be	
	Proper driving posture	77, 85	shifted from P.....	392
	Side airbag operating		S mode	124
	conditions.....	82	AUX adapter	228
	Side airbag precautions	85		
	SRS airbags	79		

B

- Back-up lights
 - Wattage 420
- Battery
 - Checking 302
 - If the vehicle has discharged battery 397
 - Preparing and checking before winter 183
- Bottle holders 241
- Brake
 - Fluid 301
 - Parking brake 129
- Brake assist 170

C

- Care
 - Exterior 274
 - Interior 277
 - Seat belts 278
- Cargo capacity 179
- Cargo hooks 261
- CD changer 211
- CD player 211
- Chains 183
- Child restraint system
 - Booster seats, definition 95
 - Booster seats, installation 99
 - Convertible seats, definition 95
 - Convertible seats, installation 99

- Front passenger occupant classification system 90
- Infant seats, definition 95
- Infant seats, installation 99
- Installing CRS with lower anchorages 102
- Installing CRS with seat belts 99
- Installing CRS with top straps 103
- Child safety**
 - Airbag precautions 85
 - Battery precautions 304, 399
 - Child restraint system 95
 - Child-protectors 38
 - How your child should wear the seat belt 55
 - Installing child restraints 98
 - Moon roof precautions 68
 - Power window lock switch 64
 - Power window precautions 65
 - Removed electronic key battery precautions 326
 - Seat belt comfort guide 53
 - Seat belt extender precautions 57
 - Seat belt precautions 56
 - Seat heater precautions 252, 254
 - Trunk precautions 43
- Child-protectors 38
- Cigarette lighter 249

Cleaning
 Exterior274
 Interior277
 Seat belts.....278
 Clock244
 Coat hooks.....259
 Compass269
 Condenser301
 Console box237
 Cooling system
 Engine overheating400
 Cornering assist sensors164
 Cruise control
 Cruise control152
 Dynamic radar cruise control155
 Cup holder239
 Curtain shield airbags.....79
 Customizable features436

D Daytime running light system144
 Defogger
 Rear window200
 Side mirror200
 Dimension406
 Dinghy towing.....188, 189
 Display
 Dynamic radar cruise control.....155
 Satellite switch mode.....245
 Trip information.....140
 Warning message369
 Do-it-yourself maintenance286
 Door courtesy lights
 Door courtesy lights231
 Wattage420
 Door pockets241
 Doors
 Door glasses.....64
 Door lock.....22, 34, 37
 Side mirrors.....61
 Driver's seat belt reminder light.....362
 Driving
 Correct posture.....77
 Procedures.....108
 Driving position memory.....46

E	Electric power steering	170
	Electronic key	
	If the electronic key does not operate properly	394
	Emergency, in case of	
	If the engine will not start	391
	If the shift lever cannot be shifted from P	392
	If the vehicle has discharged battery	397
	If the warning buzzer sounds	360
	If the warning light turns on	360
	If the warning message is displayed	369
	If you have a flat tire	382
	If you lose your keys	393
	If you think something is wrong	356
	If the electronic key does not operate properly	394
	If your vehicle becomes stuck	402
	If your vehicle needs to be towed	350
	If your vehicle overheats	400

Engine	
Compartment	292
Engine switch	117
Hood	289
How to start the engine	117
Identification number	407
If the engine will not start	391
Ignition switch	117
Overheating	400
Engine compartment cover	294
Engine coolant	
Capacity	411
Checking	299
Preparing and checking before winter	183
Engine coolant temperature gauge	130
Engine immobilizer system	72
Engine oil	
Capacity	410
Checking	295
Preparing and checking before winter	183
Engine oil maintenance data	298
EPS	170
Event data recorder	358

F First-aid kit storage belt 261
 Floor mat260
 Fluid
 Brake..... 301
 Washer305
 Fog lights
 Switch146
 Wattage.....420
 Foot well lighting 231
 Front fog lights
 Switch146
 Wattage.....420
 Front passenger occupant
 classification system90
 Front passenger's seat belt
 reminder light.....362
 Front seats
 Adjustment..... 44
 Driving position memory..... 46
 Seat position memory 49

Front turn signal lights
 Switch.....128
 Wattage 420
Fuel
 Capacity 409
 Fuel gauge.....130
 Fuel pump shut off system.....357
 Gas station information 464
 Information 421
 Refueling.....69
 Fuel door 69
 Fuel filler door 69
 Fuel pump shut off system..... 357
 Fuses 327

G Garage door opener 264
 Gas station information 464
 Gauges 130
 Glove box 236
 Glove box light 237

H	Head restraints	
	Adjusting	51
	Headlight aim	341
	Headlight cleaner	151
	Headlights	
	Discharge headlights	
	precautions	348
	Replacing light bulbs	342
	Switch	143
	Wattage	420
	Heaters	
	Seat heaters	251, 253
	Side mirror	200
	Hill-start assist control	170
	Hood	289
	Hooks	
	Cargo	261
	Coat	259
	Shopping bag	261

I	I/M test	285
	Identification	
	Engine	407
	Vehicle	407
	Ignition switch	117
	Illuminated entry system	233
	Indicator lights	136
	Initialization	
	Items to initialize	441
	Inside rear view mirror	60
	Interior lights	
	Interior lights	231
	Switch	234
	Wattage	420
J	Jack	
	Positioning a floor jack	290
	Replacing the wheel	382
	Jack handle	382

K	Keyless entry.....	34
	Keys	
	Electronic key.....	20
	Engine switch.....	117
	If you lose your keys.....	393
	If the electronic key does not operate properly.....	394
	Key number.....	20
	Keyless entry.....	34
	Keys.....	20
	Mechanical key.....	20
	Wireless remote control key.....	34
L	Light bulbs	
	Replacing.....	342
	Wattage.....	420
	Lights	
	Door courtesy lights.....	231
	Fog light switch.....	146
	Headlights switch.....	143
	Interior light switch.....	234
	Outer foot lights.....	231
	Overhead courtesy light.....	231
	Personal light switch.....	234
	Replacing light bulbs.....	342
	Scuff lighting.....	231
	Shift lever lighting.....	231
	Turn signal lever.....	128
	Vanity lights.....	243
	Wattage.....	420
	Load capacity.....	182

M	Maintenance	
	Do-it-yourself maintenance.....	286
	General maintenance.....	282
	Maintenance data.....	406
	Maintenance requirements.....	280
	Manual transmission.....	126
	Meter	
	Instrument panel light control.....	131
	Meters.....	130
	Micro dust and pollen filter.....	196
	Mirrors	
	Inside rear view mirror.....	60
	Side mirror heater.....	200
	Side mirrors.....	61
	Vanity mirrors.....	243
	Moon roof.....	66
	MP3 disc.....	217
	Multi-information display.....	139
O	Odometer.....	130
	Oil	
	Engine oil.....	295
	Opener	
	Fuel filler door.....	69
	Hood.....	289
	Trunk.....	41
	Outer foot lights	
	Outer foot lights.....	231
	Wattage.....	420
	Outside rear view mirrors	
	Adjusting and folding.....	61
	Mirror position memory.....	46
	Outside temperature display.....	140
	Overhead console.....	238

	Overhead courtesy lights	
	Overhead courtesy lights.....	231
	Wattage.....	420
	Overheating, Engine.....	400
P	Parking assist sensors.....	164
	Parking brake.....	129
	Parking lights	
	Replacing light bulbs.....	342
	Switch.....	143
	Wattage.....	420
	PCS.....	176
	Personal lights	
	Switch.....	234
	Power outlet.....	250
	Power windows.....	64
	Pre-collision system.....	176
R	Radar cruise control.....	155
	Radiator.....	301
	Radio.....	204
	RDS.....	205
	Rear sunshade.....	256
	Rear turn signal lights	
	Replacing light bulbs.....	342
	Wattage.....	420
	Rear view mirror	
	Compass.....	269
	Rear window defogger.....	200
	Replacing	
	Electronic key battery.....	325
	Fuses.....	327
	Light bulbs.....	342
	Reporting safety defects for	
	U.S. owners.....	444
S	Scuff lighting.....	231
	Seat belts	
	Adjusting the seat belt.....	53
	Automatic locking retractor.....	54
	Child restraint system	
	installation.....	98
	Cleaning and maintaining	
	the seat belts.....	278
	Emergency locking retractor.....	54
	How to wear your seat belt.....	52
	How your child should wear	
	the seat belt.....	55
	Pregnant women,	
	proper seat belt use.....	54
	Reminder light.....	362
	Seat belt extenders.....	55
	Seat belt pretensioners.....	53
	Seat heaters.....	251, 253
	Seat position memory.....	49
	Seat ventilators.....	253
	Seating capacity.....	182
	Seats	
	Adjustment.....	44
	Adjustment precautions.....	45
	Child seats/child restraint	
	system installation.....	98
	Cleaning.....	277
	Driver's seat position memory.....	46
	Front passenger seat position	
	memory.....	49
	Head restraint.....	51
	Properly sitting in the seat.....	77
	Seat heaters.....	251, 253
	Ventilated seats.....	253
	Service reminder indicators.....	136

Shift lever	
Automatic transmission.....	122
If the shift lever cannot be shifted from P.....	392
Manual transmission.....	126
Shift lever lighting	231
Shift lock system	392
Shopping bag hooks	261
Side airbags	79
Side marker lights	
Switch.....	143
Side mirror	
Adjusting and folding	61
Mirror position memory	46
Smart access system with push-button start	
Entry function.....	22
Starting the engine.....	117
Spare tire	
Inflation pressure.....	316
Spare tire.....	382
Spark plug	411
Specifications	406
Speech command switch*	
Speedometer	
Speed indicator	130
Speedometer.....	130

Steering wheel	
Audio switches.....	229
Manual adjustment.....	58
Power adjustment.....	59
Steering wheel position memory	46
Storage feature	236
Stuck	
If your vehicle becomes stuck....	402
Sun visors	242
Sunshade	
Rear.....	256
Roof.....	67
Switch	
ECT switch.....	123
Engine switch.....	117
ETCS switch.....	126
Fog light switch	146
Ignition switch	117
Light switches.....	143
Power door lock switch.....	37
Power window switch	64
Satellite switches.....	245
Transmission shift switches	124
Window lock switch.....	64
Wipers and washer switch.....	147

T

Tachometer
 Tacho indicator130
 Tachometer130

Tail lights
 Switch143

Talk switch*

Telephone switch*

Theft deterrent system
 Alarm74
 Engine immobilizer system72

Theft prevention labels76

Tire inflation pressure316

Tire information
 Glossary429
 Size426
 Tire identification number426
 Uniform tire quality grading427

Tires
 Chains183
 Checking306
 If you have a flat tire382
 Inflation pressure316
 Inflation pressure sensor308
 Information424
 Replacing382
 Rotating tires306
 Size415
 Snow tires183

Tools382

Total load capacity182

Towing
 Dinghy towing188, 189
 Emergency towing350
 Trailer towing187

TRAC170

Traction control170

Transmission shift switches124

Trip meter130

Trunk
 Extending a space258
 Opener41

Trunk light
 Trunk light42
 Wattage420

Turn signal lights
 Replacing light bulbs342
 Switch128
 Wattage420

*: Refer to the "Navigation System Owner's Manual"

V

Vanity lights
 Vanity lights 243
 Wattage..... 420
 Vanity mirrors 243
 VDIM..... 170
 Vehicle dynamics integrated
 management 170
 Vehicle identification number 407
 Vehicle stability control..... 170
 Ventilators 253
 VSC..... 170

W

Warning buzzers
 Brake system 360
 Open door 362
 Seat belt reminder..... 362
 Warning lights
 Anti-lock brake system..... 361
 Brake assist system..... 361
 Brake system 360
 Charging system 361
 Electric power steering
 warning light..... 361
 Low fuel level..... 362
 Malfunction indicator lamp..... 361
 Master warning light 362
 Open door 362
 Pre-collision system 361
 Pretensioners..... 361
 Seat belt reminder light 362
 SRS airbags 361
 Tire pressure warning
 light..... 362

Warning messages

AWD system..... 370
 Dynamic radar
 cruise control..... 370, 373
 Engine oil level..... 373
 Engine oil maintenance..... 373
 Engine oil pressure..... 369
 Hill-start assist control 372
 Hood..... 373
 Intuitive parking assist 370, 373
 Moon roof..... 373
 Open door..... 373
 Parking brake..... 373
 Pre-collision system..... 370, 373
 Smart access system with
 push-button start 378
 Steering lock..... 370
 Tire pressure
 warning system..... 370, 373
 Traction control..... 372
 Trunk..... 373
 Vehicle stability control..... 372
 Washer fluid 373

Washer

Checking..... 305
 Preparing and checking
 before winter..... 183
 Switch..... 147

Washing and waxing..... 274

Weight

Cargo capacity 179
 Load limits..... 182
 Weight..... 406

Wheels	320
Window glasses	64
Window lock switch.....	64
Windows	
Power windows	64
Rear window defogger	200
Washer.....	147
Windshield wipers	147
Wireless remote control key	
Replacing the battery	325
WMA disc.....	217

What to do if...

What to do if...



A tire punctures

P. 382 If you have a flat tire



The engine does not start

P. 391 If the engine will not start

P. 72 Engine immobilizer system

P. 394 If the vehicle battery is discharged



The shift lever cannot be moved out

P. 392 If the shift lever cannot be shifted from P



The engine coolant temperature gauge enters the red zone

P. 400 If your vehicle overheats



Steam can be seen coming from under the hood



The key is lost

P. 393 If you lose your keys



The battery runs out

P. 397 If the vehicle battery is discharged



The doors cannot be locked

P. 37 Doors



The horn begins to sound

P. 74 Alarm



The vehicle is stuck in mud or sand



P. 402 If the vehicle becomes stuck

 The warning light or indicator light comes on

P. 360 If a warning light turns on or a warning buzzer sounds...





n Warning lights

 Brake system warning light
or



P. 360

 Malfunction indicator lamp
or

P. 361

 "ABS" warning light
or



P. 361

 Driver's seat belt reminder light
P. 362

 Front passenger's seat belt reminder light
P. 362

 Low fuel level warning light
P. 362

 Master warning light
P. 362

 SRS warning light
P. 361

 Electric power steering warning light
P. 361

 Open door warning light
P. 362

 Pre-collision system warning light
P. 361

 Charging system warning light
P. 361

 Low tire pressure warning light
P. 362

 The warning message is displayed

P. 369 If the warning message is displayed

GAS STATION INFORMATION

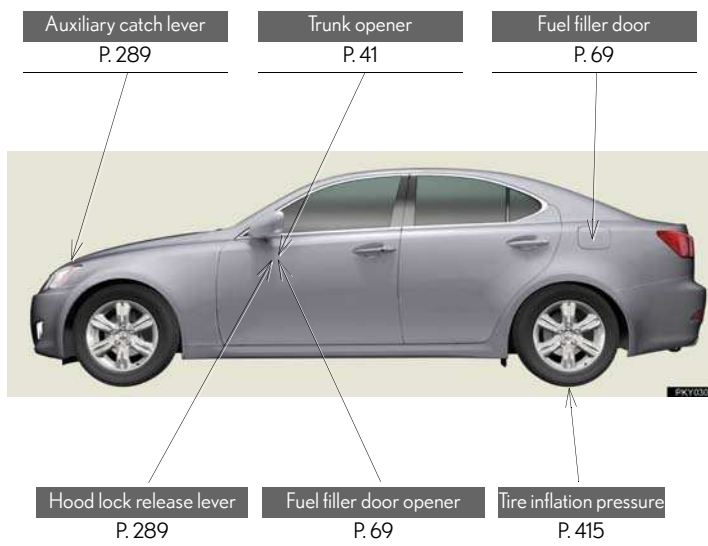

Fuel tank capacity	17.2 gal. (65 L, 14.3 Imp.gal.)			
Fuel type	Unleaded gasoline only		P. 70, 409	
Cold tire inflation pressure	P. 415			
Engine oil capacity (Drain and refill)	qt. (L, Imp.qt.)			
		IS250 (2WD models)	IS250 (AWD models)	IS350
	With filter	6.6 (6.3, 5.5)	6.8 (6.4, 5.7)	6.6 (6.3, 5.5)
Without filter	6.2 (5.9, 5.2)	6.3 (6.0, 5.3)	6.2 (5.9, 5.2)	
Engine oil type	Toyota Genuine Motor Oil or equivalent Oil grade: ILSAC multigrade engine oil Recommended oil viscosity: SAE 5W-30		P. 410	



2008

ES, GS, IS, LS, SC

WARRANTY AND SERVICES GUIDE

Owner Amenities | Warranty Information | Maintenance Requirements

AUTHORIZED DEALERSHIP MAINTENANCE AND REPAIRS

Lexus recommends having maintenance and repairs for your vehicle performed by an authorized Lexus dealership. To locate your nearest authorized Lexus dealership, contact Lexus Customer Satisfaction at (800) 255-3987 or log on to www.lexus.com.

IMPORTANT BRAKE INFORMATION: GS, IS, LS 460 L

The GS and IS feature high-friction front brake pads. The LS 460 L equipped with Touring Package features high-friction front and rear brake pads. These brake pads provide a higher coefficient of friction on the rotors for superior stopping performance and pedal feel. The brakes on these models are designed for high-performance driving. Depending on your driving habits, you may experience more aggressive wear of the brake pads and rotors.

For information on proper maintenance of your brakes, refer to the "Maintenance" section of this booklet. For additional information on your brakes and their operation, refer to your *Owner's Manual*.



From everyone at Lexus, thank you for purchasing one of our vehicles. Your Lexus is designed to deliver uncompromising luxury and performance. We are committed to providing you with an ownership experience that is second to none, and we look forward to serving you in the years ahead. Welcome to the Lexus family!

Taking Delivery of Your New Lexus

As you take delivery of your new vehicle, there are some important services you should know about. These include:

Lexus Personalized Settings: Your vehicle includes a variety of electronic features that can be personalized to your preferences. For example, doors can be programmed to remain locked when you shift into "Park." See your dealer for details.

Pre-Delivery Service: Your dealership has performed a thorough service to prepare your vehicle for delivery. This includes initializing certain electronic features, such as the one-touch power windows.

Scheduled Maintenance: Your vehicle requires maintenance every six months or 5,000 miles, whichever comes first. See page 44 for details.

Dealership Service Department: Your service department is committed to helping you keep your Lexus performing at its best. Your dealer will provide you with the department's hours of operation, appointment procedures and information on any special services.

Warranty Coverage: Your Lexus is covered by one of the finest warranties in the industry. See page 15 for a summary of coverages.

Roadside Assistance: Roadside assistance is provided for 48 months from your vehicle's in-service date, regardless of mileage. See page 5 for details.

Again, thank you for choosing Lexus. We wish you many years of safe and pleasurable driving.

OWNER AMENITIES

Complimentary Services

First Scheduled Maintenance Service 4
Second Scheduled Maintenance Service 4
Loaner Vehicle 5
Travel Protection 5
Roadside Assistance 5

Other Benefits and Assistance

Quality Control 7
Vehicle Service History 7
Vehicle Service Agreements 7
Additional Keys 8
Collision Repairs 8

WARRANTY INFORMATION

Introduction

If You Need Assistance 9
The Lexus Commitment 14
Warranty Coverages at a Glance 15

Your Warranties in Detail

General Warranty Provisions 16
New Vehicle Limited Warranty 18
Federal Emission Control Warranty 22

California Emission Control Warranty 28

Tire Limited Warranty 34

Your Responsibilities

Operation and Maintenance 35

Obtaining Warranty Service 37

MAINTENANCE INFORMATION

Introduction

The Importance of Scheduled Maintenance 39

Maintenance and Lexus Warranty Coverage 40

Lexus Dealership Service 41

General Maintenance and Regular Use 42

Scheduled Maintenance Log

Determining Your Maintenance Interval: Months vs. Mileage 44

Complimentary First Scheduled Maintenance Service 44

Complimentary Second Scheduled Maintenance Service 44

Scheduled Maintenance Log 46

Explanation of Maintenance Items 66

Vehicle Identification 70

INDEX 71

To help ensure that your ownership experience is pleasant, convenient and trouble-free, Lexus provides you with a variety of complimentary services. These services are described on the following pages. Other valuable owner benefits are described in the section entitled “Other Benefits and Assistance” beginning on page 7.

First Scheduled Maintenance Service: 30 Days or 1,000 Miles

Lexus provides your first scheduled maintenance service at no charge. The service is performed at 30 days or 1,000 miles, whichever occurs first, and includes these items:

- Inspect body/chassis
- Check for fluid leaks
- Road-test vehicle
- Program Lexus Personalized Settings, if requested

What are Lexus Personalized Settings?

Your vehicle includes a variety of electronic features that can be programmed to your preferences. For example, doors can be programmed to remain locked when you shift into “Park.” (For more information, see the “Customizable Features” section of

the Specifications chapter in your *Owner’s Manual*.) Programming of these features is performed once at no charge, provided you obtain the service at the 30-day/1,000-mile scheduled maintenance service. Programming of your Lexus Personalized Settings requires special equipment and may be performed only by an authorized Lexus dealership.

Second Scheduled Maintenance Service: Six Months or 5,000 Miles

Lexus also provides your second scheduled maintenance service at no charge. The service is performed at six months or 5,000 miles, whichever occurs first, and includes these items:

- Replace engine oil and oil filter; reset reminder light
- Rotate tires
- Visually inspect brake pads and rotors
- Road-test vehicle

If you drive primarily on dirt roads or dusty roads or if you drive primarily while towing, additional items are included in this service. See page 46 for details.

Loaner Vehicle

If your vehicle must be kept overnight at a Lexus dealership for a warranty-covered condition that requires more than eight hours to repair, Lexus will provide you with a complimentary loaner vehicle for up to five days.

Travel Protection

Lexus will reimburse for a rental car for up to five days and for overnight lodging for up to three nights (not to exceed \$200 per night) if all of the following occur:

- Your vehicle becomes inoperable or unsafe to drive when you are more than 100 miles from home.
- Your vehicle's malfunction is caused by a warranty-covered condition.
- Repairs will take longer than eight hours to complete.

To obtain reimbursement for rental car and lodging expenses, contact a Lexus dealership service consultant.

Roadside Assistance

Lexus roadside assistance coverage is for 48 months from your vehicle's in-service date, regardless of mileage. Coverage is provided 24 hours a day, 365 days a year, for vehicles operated in the United States, U.S. territories and Canada. Assistance is administered through the American Automobile Association.

Services Provided

- Roadside services such as battery jump-start, tire change and fuel delivery.
- Towing to the nearest Lexus dealership (or an alternate repair facility, if necessary).
- Assistance in locating alternate transportation and lodging.

How to Get Help

To obtain roadside assistance, take the following steps:

- 1) Call (800) 25-LEXUS (800/255-3987).

2) Have as much of the following information as possible:

- Vehicle identification number (located on the driver's-side corner of the dashboard, under the window)
- Owner's name and home address
- Vehicle license plate number
- Location of vehicle, including the nearest major intersection

3) To determine your location, the dispatch operator will ask you for the area code and first three digits of the phone number from which you are calling. If you are calling from your cellular phone:

- Obtain a phone number from a telephone near your location; or
- Call directory assistance and obtain the phone number of a nearby business; or
- Call the local cellular operator and ask for the area code and prefix of the cell you are in.

If you are unable to obtain the area code and prefix for the area you are calling from, give the name of the city you are calling from.

4) Wait at your vehicle or in a nearby secure location for the roadside assistance provider to arrive.

Additional Coverage

After your roadside assistance coverage expires, you may join a motor club created exclusively for Lexus owners. Benefits include roadside assistance coverage, a trip-planning service and discounts on travel and dining. For further information, call (800) 25-LEXUS.

Quality Control

You may have noticed a few miles on the odometer when you took delivery of your Lexus. This mileage is a result of the comprehensive process used to ensure the quality of your vehicle. This process includes extensive inspections during and after production. The final inspection takes place at the selling dealership and includes a road-test conducted by a trained Lexus technician.

If you'd like to know more about Lexus quality-control procedures, ask a Lexus dealership service consultant.

Vehicle Service History

When you have your vehicle serviced at a Lexus dealership, your service information is recorded in the Lexus National Service History database. This is the first database of its kind in the automotive industry. It can be

accessed by any Lexus dealership in the United States – a great convenience if you relocate or need to have your vehicle serviced while traveling.

Vehicle Service Agreements

If you plan to keep your vehicle for several years or if you accumulate mileage quickly, you may want to purchase a Lexus vehicle service agreement. These agreements cover the cost of specific repairs beyond the factory warranty period. They also cover services such as towing, substitute transportation and lodging to minimize your inconvenience should your vehicle require repair. Lexus vehicle service agreements are available with a variety of coverage options. A Lexus dealership sales consultant can help you select the plan that's best for you.

Additional Keys

If you require additional keys, call or visit an authorized Lexus dealership. You will need to provide the dealership with your vehicle's key code (found on the key number plate provided with your original set of keys). In most cases, new keys can be ready within five business days.

Collision Repairs

If you're involved in a collision, you want your vehicle to be returned to its pre-accident condition when repaired. That's why it is important to make sure repairs are made only with Genuine Lexus Parts. Some repair shops and insurance companies may suggest using imitation or salvaged parts to save money. However, these parts do not meet Lexus' high standards for quality, fit and corrosion resistance. In addition, imitation and salvaged parts (and any damage or failures they may cause) are not covered by any Lexus warranty.

The best way to ensure that your vehicle is repaired with Genuine Lexus Parts is to take it to a Lexus dealership. Each dealership works with selected collision repair centers that meet Lexus' strict requirements for training, equipment, quality and customer satisfaction. These repair centers use Genuine Lexus Parts exclusively in the repair of Lexus vehicles.

Both Lexus and your Lexus dealer are dedicated to serving your automotive needs. Your complete satisfaction is our first priority. Should you have a problem or concern, please take the following steps to ensure the quickest possible response:

Step 1

Discuss the situation with a dealership manager, such as the service manager or customer satisfaction manager. If necessary, ask the dealership owner or general manager for assistance. In most cases, a satisfactory solution can be reached at this step.

Step 2

If the dealership does not address your concern to your satisfaction, call the Lexus Customer Satisfaction Department at (800) 25-LEXUS (800/255-3987). In Canada, call (800) 26-LEXUS (800/265-3987). In Mexico, call 95-1-310-328-2075.

If you are hearing- or speech-impaired, call (800) 443-4999 (TDD).

You may also write to us at:

Lexus Customer Satisfaction
Department
P.O. Box 2991
Torrance, CA 90509-2991

Whether calling or writing, please provide the following information:

- Vehicle identification number (located on the driver's side corner of the dashboard, under the window)
- Current vehicle mileage
- Name of your selling and servicing Lexus dealerships
- Your day and evening telephone numbers

Step 3

If your concern has still not been resolved to your satisfaction, Lexus offers additional assistance through:

National Center for Dispute Settlement (NCDS)

P.O. Box 457

Mt. Clemens, MI 48046

(866) 272-4872

Important: You must use NCDS prior to exercising rights or seeking remedies available to you through a court action pursuant to the Magnuson-Moss Warranty Act. In addition, you must use NCDS if you are required to do so prior to exercising certain rights or seeking certain remedies available under the Lemon Laws of your state. See the *Lemon Law Guide* for specific requirements applicable in your state.

However, if your state law permits and if you choose to exercise rights and seek remedies that are not created by the Act, you need not use NCDS.

NCDS Arbitration

What is the Dispute Settlement Program?

This program consists of local professionals who are trained and experienced in arbitration. The arbitrator(s) appointed by NCDS will arbitrate your case by reviewing the facts you present; having the vehicle inspected, if necessary; and promptly rendering a fair and equitable decision.

How much will it cost?

The service is provided at no cost to you. It is part of Lexus' effort to promptly and equitably resolve your concerns. The decision-maker is an impartial third party. The decision of the arbitrator(s) is binding on Lexus but not on you.

What types of disputes are eligible?

NCDS resolves disputes involving Lexus product reliability and warranty performance that arise during the greater of 1) four years or 50,000 miles from the vehicle's in-service date, whichever is earlier; or 2) the applicable provision of the Lexus New Vehicle Limited Warranty. However, NCDS will not arbitrate 1) claims involving a vehicle used primarily for commercial purposes unless the Lemon Laws of your state cover vehicles used for commercial purposes; or 2) claims that an air bag failed to deploy or deployed when it should not have; or 3) disputes regarding fires and/or accidents and/or theft. Since there are other additional exclusions, please contact NCDS for further information on eligibility guidelines. You must file a request for arbitration with NCDS within six months of the expiration of the eligibility period, provided the concern or alleged defect was brought to the attention of Lexus or one of its dealers during the eligibility period.

How long is the arbitration process?

The entire process – from the time NCDS receives your request for arbitration to the arbitrator's decision – is designed to take no more than 40 days. A decision may be delayed if:

- You fail to provide certain information required by NCDS.
- You fail to make your vehicle available for inspection by NCDS in a timely manner (if an inspection is required).

How do I request arbitration?

To initiate arbitration, you must complete an NCDS customer claim form and mail it to NCDS. A claim form is included in the *Lemon Law Guide* located in your vehicle, or you may request a form by calling NCDS at (866) 272-4872. When you call, please have ready your vehicle identification number (VIN), the names of your selling and servicing dealerships, and the current mileage on your Lexus.

In addition to completing the customer claim form, please provide NCDS with the following information:

- Vehicle year, make, model, VIN, mileage and date of purchase.
- A brief description of your complaint and the actions you have taken to resolve it.
- What action or remedy you believe would resolve your problem.

If you are seeking reimbursement for repairs or incidental expenses, please provide copies of applicable receipts.

Send your request to:

National Center for Dispute Settlement
P.O. Box 457
Mt. Clemens, MI 48046

Upon receipt of your request, NCDS will contact you regarding the status of your case and supply you with additional details about the program.

How does the arbitration process work?

When NCDS receives your request, it will be forwarded to the Lexus area office for response.

At the request of either party or the arbitrators, NCDS may schedule a technical inspection. This may include an inspection of the vehicle by an independent technical expert with a Lexus representative present. The technical expert will forward his or her evaluation to NCDS.

An oral hearing will be held prior to a decision being rendered. At this hearing, all relevant evidence is admissible. You and a Lexus representative will present both sides of the case to the NCDS arbitrator(s). You will each be given an equal opportunity to give testimony and provide documents. Then you will each be given an opportunity for rebuttal. After considering all testimony and documents, the arbitrator(s) will review the applicable legal standards and render a decision within 10 days.

A settlement satisfactory to all parties may be negotiated at any time during the process.

What types of decisions are rendered, and how do I know if Lexus will abide by the decision of the arbitrator(s)?

Arbitrated decisions are based on what the arbitrator(s) believe to be fair and equitable after applying the appropriate legal standards. Remedies include but are not limited to repairs; reimbursement for repairs and incidental expenses, such as towing costs; and repurchase or replacement of your vehicle.

The decision of the arbitrator(s) is binding on Lexus but not on you. Lexus must comply with the decision shortly after it is rendered, usually within 30 days of your acceptance of the decision. NCDS will contact you within 10 days of scheduled compliance to ensure that Lexus has complied in a timely manner.

Are there limits to the scope of arbitrated decisions?

Arbitrated decisions do not include:

- Attorney fees
- Punitive damages
- Multiple damages
- Consequential damages, other than incidental damages that you may be entitled to under law

What other recourse do I have?

If you are dissatisfied with the arbitrator's decision or Lexus' compliance, you may pursue any other legal remedies available to you, including small claims court. You should be aware that the decision of the arbitrator(s) is admissible as evidence in any legal proceedings concerning your vehicle.

Is the Dispute Settlement Program subject to change?

The information in this booklet about the program is correct as of the date of printing. However, the program may be changed without notice. Contact the Lexus Customer Satisfaction Department at (800) 255-3987 for the most current information concerning the Dispute Settlement Program.

You have purchased one of the finest vehicles built in the world today, and it is backed by one of the finest warranties in the industry. This excellent warranty coverage demonstrates not only our confidence in Lexus vehicles, but also our commitment to every Lexus customer. We're dedicated to ensuring that you enjoy exceptional quality, dependability and peace of mind throughout your ownership experience.

To further demonstrate our commitment to our customers' satisfaction, occasionally we may establish a special policy adjustment to pay for specific repairs that are no longer covered by warranty. When we establish such a policy adjustment, we mail details to all applicable owners on record. That's why it is important to send in the card at the back of this booklet if you change your address or if you have purchased your Lexus from a previous owner.

You've made a wise decision to purchase a Lexus. Your vehicle delivers world-class luxury and performance,

along with an unparalleled commitment from Lexus to ensuring your satisfaction. You can be confident – as we are – that you'll enjoy owning your Lexus as much as you enjoy driving it.

This section of the *Warranty and Services Guide* describes the terms of Lexus warranty coverage as well as general owner responsibilities. The section beginning on page 39 describes your vehicle's maintenance requirements. Be sure to review this information carefully, since proper maintenance is required to ensure that warranty coverage remains intact.

All warranty information is the latest available at the time of publication and, with the exception of the emission control warranties, is subject to change without notice.

WARRANTY COVERAGES AT A GLANCE

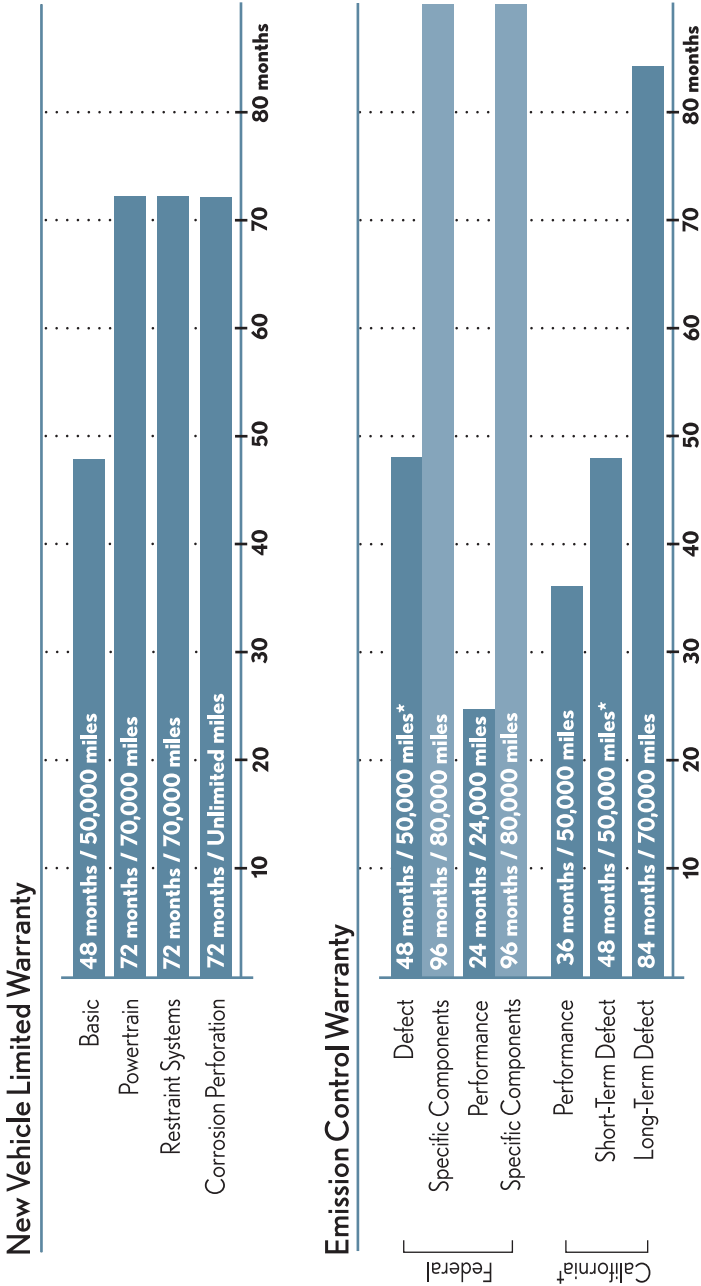

*Specific components may have longer coverage under terms of the Powertrain Warranty.

†Also applies to Connecticut, Maine, Massachusetts, Pennsylvania, Rhode Island and Vermont vehicles equipped with a California Certified Emission Control System. Vehicles covered by this warranty are also covered by the Federal Emission Control Warranty.

WARRANTY

Who Is the Warrantor

The warrantor for these limited warranties is Lexus, a division of Toyota Motor Sales, U.S.A., Inc., 19001 South Western Avenue, Torrance, California 90509-2991, a California corporation.

Which Vehicles Are Covered

These warranties apply to 2008 model-year Lexus passenger vehicles, excluding hybrid models, registered and normally operated in the United States, U.S. territories and Canada. Warranty coverage is automatically transferred at no cost to subsequent vehicle owners.

Multiple Warranty Conditions

This booklet contains warranty terms and conditions that may vary depending on the part covered. A warranty for specific parts or systems, such as the Powertrain Warranty or Emission Performance Warranty, is governed by the coverage set forth in that warranty as well as the General Warranty Provisions.

When Warranty Begins

The warranty period begins on the vehicle's in-service date, which is the first date the vehicle is either delivered to an ultimate purchaser, leased, or used as a company car or demonstrator.

Repairs Made at No Charge

Repairs and adjustments covered by these warranties are made at no charge for parts and labor.

Parts Replacement

Any needed parts replacement will be made using new or remanufactured parts. The decision whether a part should be repaired or replaced will be made by the servicing Lexus dealership and/or Lexus. Parts scheduled to be replaced as required maintenance are warranted until their first replacement only.

Note: Lexus remanufactured parts meet or exceed all factory standards for safety, quality and reliability.

Limitations

The performance of necessary repairs and adjustments is the exclusive remedy under these warranties or any implied warranties. Lexus does not authorize any person to create for it any other obligation or liability in connection with this vehicle.

Any implied warranty of merchantability or fitness for a particular purpose is limited to the duration of these written warranties. Some states do not allow restrictions on how long an implied warranty lasts, so this limitation may not apply to you.

Your Rights Under State Law

These warranties give you specific legal rights. You may also have other rights that vary from state to state.

WHAT IS COVERED AND HOW LONG

Basic Warranty

This warranty covers repairs and adjustments needed to correct defects in materials or workmanship of any part supplied by Lexus, subject to the exceptions indicated under “What Is Not Covered” on pages 19–20.

Coverage is for 48 months or 50,000 miles, whichever occurs first, with the exception of wheel alignment and wheel balancing, which are covered for 12 months or 20,000 miles, whichever occurs first.

Powertrain Warranty

This warranty covers repairs needed to correct defects in materials or workmanship of any component listed here and supplied by Lexus, subject to the exceptions indicated under “What Is Not Covered” on pages 19–20.

Coverage is for 72 months or 70,000 miles, whichever occurs first.

Engine

Cylinder block and head and all internal parts, timing belt and cover, flywheel, oil pan, water pump, fuel pump, engine mounts, engine control computer, seals and gaskets.

Transmission and Transaxle

Case and all internal parts, torque converter, clutch cover, mounts, engine control computer, seals and gaskets.

Front-Wheel-Drive System

Drive shaft, axle, hub, bearings, seals and gaskets.

Rear-Wheel-Drive System

Differential carrier assembly, drive shaft, axle carrier, axle case, axle bearing, axle shaft, seals and gaskets.

Restraint Systems Warranty

This warranty covers repairs needed to correct defects in materials or workmanship of any seatbelt or air bag system supplied by Lexus, subject to the exceptions indicated under “What Is Not Covered” on pages 19–20.

Coverage is for 72 months or 70,000 miles, whichever occurs first.

For vehicles sold and registered in Kansas, the warranty for seatbelts and related components is 10 years, regardless of mileage.

Corrosion Perforation Warranty

This warranty covers repair or replacement of any original body panel that develops perforation from corrosion (rust-through), subject to the exceptions indicated under “What Is Not Covered” on pages 19-20.

Coverage is for 72 months, regardless of mileage.

For information on how to protect your vehicle from corrosion, see the section entitled “Service Procedures and Specifications – Body” in the *Owner’s Manual*.

Towing

When your vehicle is inoperable due to failure of a warranted part, towing service to the nearest authorized Lexus dealership is covered.

WHAT IS NOT COVERED

This warranty does not cover damage or failures resulting directly or indirectly from any of the following:

- Fire, accidents or theft
- Abuse or negligence
- Misuse – for example, racing or overloading
- Improper repairs
- Alteration or tampering, including installation of non-Genuine Lexus Accessories
- Lack of or improper maintenance, including use of fluids other than those specified in the *Owner’s Manual*
- Installation of non-Genuine Lexus Parts
- Airborne chemicals, tree sap, road debris (including stone chips), rail dust, salt, hail, floods, wind storms, lightning and other environmental conditions
- Water contamination

This warranty also does not cover the following:

Tires

Tires are covered by a separate warranty provided by the tire manufacturer. See page 34.

Normal Wear and Tear

Noise, vibration, cosmetic conditions and other deterioration caused by normal wear and tear.

Maintenance Expense*

Normal maintenance services such as engine tune-ups; replacement of fluids and filters; lubrication; cleaning and polishing; replacement of spark plugs and fuses; and replacement of worn wiper blades, brake pads/linings and clutch linings.

Vehicles With Altered Odometer

Failure of a vehicle on which the odometer has been altered so that actual vehicle mileage cannot be readily determined.

Vehicles With Unknown Vehicle Identification Number

Any vehicle for which the original factory-assigned vehicle identification number cannot be determined.

Salvage or Total-Loss Vehicles

Any vehicle that has ever been issued a “salvage” title or similar title under any state’s law; or has ever been declared a “total loss” or equivalent by a financial institution or insurer, such as by payment for a claim in lieu of repairs because the cost of repairs exceeded the cash value of the vehicle. This exclusion does not apply to the emission control warranties.

Incidental Damages

Incidental or consequential damages associated with a vehicle failure. Such damages include but are not limited to inconvenience; the cost of transportation, telephone calls and lodging; the loss of personal or commercial property; and the loss of pay or revenue.

**Lexus provides the first two scheduled maintenance services at no charge. See page 4 for details.*

Disclaimer of Extra Expenses and Damages

The performance of necessary repairs and adjustments is the exclusive remedy under this warranty or any implied warranty. Lexus does not authorize any person to create for it any other obligation or liability in connection with this vehicle. Lexus shall not be liable for incidental or consequential damages resulting from breach of this written warranty or any implied warranty.

Any implied warranty of merchantability or fitness for a particular purpose is limited to the duration of this written warranty, except in states where this limitation is not allowed.

DISPUTE RESOLUTION

If a dispute arises regarding your warranty coverage, please follow the steps described on pages 9-10. Please note that you must use the National Center for Dispute Settlement before seeking remedies through a court action pursuant to the Magnuson-Moss Warranty Act. You may also be required to use the National Center for Dispute Settlement before seeking remedies under the Lemon Laws of your state. For the requirements applicable to your state, see the appropriate page of the *Lemon Law Guide* located in your vehicle.

WHAT IS COVERED AND HOW LONG

Emission Defect Warranty

Lexus warrants that your vehicle:

- Was designed, built and equipped to conform at the time of sale with applicable federal emissions standards.
- Is free from defects in materials and workmanship that may cause the vehicle to fail to meet these standards.

Federal regulations require that this warranty be in effect for two years or 24,000 miles from the vehicle's in-service date, whichever occurs first. However, under the terms of the Basic Warranty, Lexus provides coverage of four years or 50,000 miles, whichever occurs first. Specific components may have longer coverage under the terms of the Powertrain Warranty. Additionally, components marked "8/80" in the parts list on pages 23-24 have coverage of eight years or 80,000 miles, whichever occurs first.

Emission Performance Warranty

Some states and localities have established vehicle inspection and maintenance (I/M) programs to encourage proper vehicle maintenance. If an EPA-approved I/M program is in force in your area, you are eligible for Emission Performance Warranty coverage.

Under the terms of the Emission Performance Warranty and federal regulations, Lexus will make all necessary repairs if both of the following occur:

- Your vehicle fails to meet applicable emissions standards as determined by an EPA-approved emissions test.
- This failure results or will result in some penalty to you – such as a fine or denial of the right to use your vehicle – under local, state or federal law.

This warranty is in effect for two years or 24,000 miles from the vehicle's in-service date, whichever occurs first. Additionally, components marked "8/80" in the parts list on pages 23-24 have coverage of eight years or 80,000 miles, whichever occurs first.

WHAT IS NOT COVERED

These warranty obligations do not apply to failures or noncompliance caused by:

- The use of replacement parts not certified in accordance with aftermarket parts certification regulations.
- The use of replacement parts not equivalent in quality or design to original equipment parts.

Provisions under the “What Is Not Covered” section of the New Vehicle Limited Warranty also apply to this warranty.

WARRANTY PARTS LIST

Air/Fuel Metering System

- Air/fuel ratio feedback control system
- Cold-start enrichment system
- Deceleration control system
- Electronic fuel injection system components
 - Airflow sensor
 - Engine control module (8/80)
 - Throttle body
 - Other components

Air Induction System

- Intake manifold and intake air surge tank

Air Injection System

- Air injection manifold
- Air injection pump
- Airflow control valves

Catalyst System

- Catalytic converter and protector (8/80)
- Constricted fuel filler neck
- Exhaust manifold
- Exhaust pipe (manifold to catalyst and/or catalyst to catalyst)

8/80 = Covered for eight years or 80,000 miles, whichever occurs first.

Evaporative Control System

- Charcoal canister
- Diaphragm valve
- Fuel filler cap
- Fuel tank
- Vapor liquid separator

Exhaust Gas Recirculation (EGR) System

- EGR gas temperature sensor
- EGR valve
- Associated parts

Ignition System

- Distributor and internal parts
- Ignition coil and ignitor
- Ignition wires
- Spark plugs*

Positive Crankcase Ventilation (PCV) System

- Oil filler cap
- PCV valve or orifice

Other Parts Used in Systems Listed

- Data link connector (8/80)
- Hoses, clamps, fittings, tubing and mounting hardware
- Malfunction indicator light and bulb (8/80)
- Pulleys, belts and idlers
- Sealing gaskets and devices
- Sensors, solenoids, switches and valves

8/80 = Covered for eight years or 80,000 miles, whichever occurs first.

*Warranted until first required maintenance under terms of the California Emission Control Warranty.

MAINTENANCE

You are responsible for performance of the required maintenance indicated in the *Owner's Manual* and this guide. Lexus will not deny a warranty claim solely because you do not have records to show that you maintained your vehicle. However, any failure or noncompliance caused by lack of maintenance is not covered by this warranty.

When maintenance and repairs are paid for by you, these services may be performed by you or by any automotive service provider you choose. Lexus will not deny a warranty claim solely because you used a service provider other than a Lexus dealership for maintenance and repairs. However, any failure or noncompliance caused by improper maintenance or repairs is not covered by this warranty.

REPLACEMENT PARTS

To ensure optimum performance and maintain the quality built into your vehicle's emission control systems, Lexus recommends the use of Genuine Lexus Parts when servicing or repairing the systems.

Warranty coverage is not dependent upon the use of any particular brand of replacement parts and you may elect to use non-Genuine Lexus Parts for maintenance and repairs. However, use of replacement parts that are not equivalent in quality to Genuine Lexus Parts may impair the effectiveness of the emission control systems.

If you use replacement parts that have maintenance or replacement schedules different from those of Genuine Lexus Parts, you must follow the maintenance and replacement schedules for the parts you are using. In addition, you should ensure that such parts are warranted by their manufacturers to be equivalent to Genuine Lexus Parts.

IF YOUR VEHICLE FAILS AN EMISSIONS TEST

If your vehicle fails an EPA-approved emissions test, you may make a claim under the Emission Performance Warranty. To do so, take your vehicle to an authorized Lexus dealership and present a copy of the emissions test report. Also, take your maintenance records in case they are needed.

If your claim qualifies for coverage, the dealership will repair your vehicle within 30 days (unless a shorter period is required by law). If your claim is denied, Lexus will notify you in writing of the reason within the same period. If we fail to do so, we will repair your vehicle free of charge. The only exceptions allowed are when you request or agree to a delay, or when a delay is caused by factors beyond the control of Lexus or the dealership.

For information on how to obtain service under the Emission Defect Warranty, see page 37, "Obtaining Warranty Service."

IF YOU HAVE QUESTIONS

If you have questions or concerns about your vehicle's federal emission warranty coverage, please follow the steps described on pages 9-10. In the case of the Emission Performance Warranty, you may also request information from or report complaints to:

U.S. Environmental Protection Agency
Vehicle Programs & Compliance Division (6405J)
Attn: Warranty Complaints
401 M Street SW
Washington, D.C. 20460

Vehicles equipped with a California Certified Emission Control System that are registered and operated in California or any state that adopts California emission warranty provisions are also covered by the California Emission Control Warranty (see page 28). Connecticut, Maine, Massachusetts, Pennsylvania, Rhode Island and Vermont are the other states to which the California Emission Control Warranty currently applies.

DEALER CERTIFICATE

We (the dealership) want you to know that at the time your new Lexus vehicle is being delivered:

- 1) On the basis of written notification furnished by Lexus, we have knowledge that the vehicle is covered by an EPA Certificate of Conformity.
- 2) We have visually inspected those emission control devices or portions thereof that are visible without removing or adjusting any components or systems, emissions-related or otherwise. On the basis of this inspection, there are no apparent deficiencies in the installation of emission control devices by Lexus. (For purposes of this certificate, "emission control devices" is limited to devices installed on a vehicle for the sole or primary purpose of controlling emissions and which were not in general use before 1968.)
- 3) We have performed all emission control system preparations required by Lexus prior to the sale of the vehicle as set forth in Lexus' current pre-delivery service manual.
- 4) Except as may be provided in Paragraph 5, if this vehicle fails an EPA-approved emissions test within three months or 4,000 miles (whichever comes first) of delivery to the ultimate purchaser, and the vehicle has been maintained and

used in accordance with the written instructions for proper maintenance and use, Lexus will remedy the nonconformity free of charge under the terms of the Emission Performance Warranty.

- 5) If vehicle was used as a company car or demonstrator, check box and complete the following:

The vehicle with which this statement is delivered was placed into service as a company car or demonstrator prior to delivery. The Emission Performance Warranty period commenced on the date the vehicle was first placed into service, which was

 Month Day Year

Note: The dealership makes no representation or warranty that the emission control system or any part thereof is without defect or that the system will perform properly. The Emission Performance Warranty referred to in Paragraph 4 and furnished with the vehicle is solely that of the manufacturer.

This statement is required by section 207 of the Clean Air Act (42 U.S.C. 7541) and the EPA regulations issued thereunder.

 Dealership name

WARRANTY

Vehicles equipped with a California Certified Emission Control System that are registered and operated in California or any state that adopts California emission warranty provisions are covered by this warranty. Connecticut, Maine, Massachusetts, Pennsylvania, Rhode Island and Vermont are the other states to which this warranty currently applies. Vehicles covered by this warranty are also covered by the Federal Emission Control Warranty (see page 22).

YOUR WARRANTY RIGHTS AND OBLIGATIONS

The California Air Resources Board (CARB) and Lexus are pleased to explain the emission control system warranty for your 2008 vehicle. In California, new motor vehicles must be designed, built and equipped to meet the state's stringent anti-smog standards. CARB regulations require that Lexus must warrant the emission control system on your vehicle for the time periods indicated on the next page, provided there has been no abuse, neglect or improper maintenance of your vehicle.

Your emission control system may include parts such as the fuel injection system, ignition system, catalytic converter and engine computer. Also included may be hoses, belts, connectors and other emissions-related assemblies.

Where a warrantable condition exists, Lexus will repair your vehicle at no cost to you, including diagnosis, parts and labor.

MANUFACTURER'S WARRANTY COVERAGE

- 1) For three years or 50,000 miles, whichever occurs first:
- If your vehicle fails a smog-check test, all necessary repairs and adjustments will be made by Lexus to ensure that your vehicle passes the test. This is your Emission Control System PERFORMANCE WARRANTY.
 - If an emissions-related part listed on pages 23–24 is defective, the part will be repaired or replaced by Lexus. This is your SHORT-TERM Emission Control System DEFECT WARRANTY.
Note: Under the terms of the Basic Warranty, Lexus provides coverage of four years or 50,000 miles, whichever occurs first. Specific components may have longer coverage under the terms of the Powertrain Warranty.
- 2) For seven years or 70,000 miles, whichever occurs first:
- If an emissions-related part listed on pages 30–31 is defective, the part will be repaired or replaced by Lexus. This is your LONG-TERM Emission Control System DEFECT WARRANTY.

OWNER'S WARRANTY RESPONSIBILITIES

You are responsible for performance of the required maintenance indicated in the *Owner's Manual* and this guide. Lexus recommends that you retain all receipts covering maintenance on your vehicle, but Lexus cannot deny warranty coverage solely for the lack of receipts or your failure to ensure the performance of all scheduled maintenance.

You are responsible for presenting your vehicle to a Lexus dealership as soon as a problem exists. The warranty repairs should be completed in a reasonable amount of time, not to exceed 30 days.

You should also be aware that Lexus may deny you warranty coverage if your vehicle or a part has failed due to abuse, neglect, improper maintenance or unapproved modifications.

If you have any questions regarding your warranty rights and responsibilities, you should contact the Lexus Customer Satisfaction Department at (800) 255-3987 or the California Air Resources Board, Mobile Source Control Division, at 9528 Telstar Avenue, P.O. Box 8001, El Monte, CA 91734-8001.

WHAT IS NOT COVERED

These warranty obligations do not apply to failures or noncompliance caused by:

- The use of replacement parts not certified in accordance with aftermarket parts certification regulations.
- The use of replacement parts not equivalent in quality or design to original equipment parts.

Provisions under the “What Is Not Covered” section of the New Vehicle Limited Warranty also apply to this warranty.

PARTS LIST: LONG-TERM EMISSION DEFECT WARRANTY

The parts listed here are covered for seven years or 70,000 miles from the vehicle’s in-service date, whichever occurs first.

Air/Fuel Metering System

- Air/fuel ratio sensor on GS 460, LS 460
- Engine control computer (engine control module)
- Fuel pump on IS 250, IS 350, GS 350, SC 430
- Throttle body

Air Induction System

- Intake manifold and intake air surge tank

Catalyst System

- Catalytic converter (warm-up three-way catalyst)
- Exhaust front pipe
- Exhaust manifold
- Exhaust manifold gasket on GS 460, LS 460, SC 430

Evaporative Control System

- Charcoal canister
- Fuel tank

Ignition System

- Knock sensor on ES 350, GS 460, IS 250, IS 350, LS 460, SC 430

Other Parts Used in Above Systems

- Transmission solenoid on GS 350, GS 460, IS 250, IS 350, LS 460, SC 430

MAINTENANCE

You are responsible for performance of the required maintenance indicated in the *Owner's Manual* and this guide. Lexus will not deny a warranty claim solely because you do not have records to show that you maintained your vehicle. However, any failure or noncompliance caused by lack of maintenance is not covered by this warranty.

When maintenance and repairs are paid for by you, these services may be performed by you or by any automotive service provider you choose. Lexus will not deny a warranty claim solely because you used a service provider other than a Lexus dealership for maintenance and repairs. However, any failure or noncompliance caused by improper maintenance or repairs is not covered by this warranty.

REPLACEMENT PARTS

To ensure optimum performance and maintain the quality built into your vehicle's emission control systems, Lexus recommends the use of Genuine Lexus Parts when servicing or repairing the systems.

Warranty coverage is not dependent upon the use of any particular brand of replacement parts and you may elect to use non-Genuine Lexus Parts for maintenance and repairs. However, use of replacement parts that are not equivalent in quality to Genuine Lexus Parts may impair the effectiveness of the emission control systems.

If you use replacement parts that have maintenance or replacement schedules different from those of Genuine Lexus Parts, you must follow the maintenance and replacement schedules for the parts you are using. In addition, you should ensure that such parts are warranted by their manufacturers to be equivalent to Genuine Lexus Parts.

IF YOUR VEHICLE FAILS A SMOG-CHECK TEST

If your vehicle fails a smog-check test, you may make a claim under the Emission Performance Warranty. To do so, take your vehicle to an authorized Lexus dealership and present a copy of the smog-check test report. Also, take your maintenance records in case they are needed.

If your claim qualifies for coverage, the dealership will repair your vehicle within 30 days (unless a shorter period is required by law). If your claim is denied, Lexus will notify you in writing of the reason within the same period. If we fail to do so, we will repair your vehicle free of charge. The only exceptions allowed are when you request or agree to a delay, or when a delay is caused by factors beyond the control of Lexus or the dealership.

For information on how to obtain service under the Emission Defect Warranty, see page 37, "Obtaining Warranty Service."

REPAIR DELAYS

If a Lexus dealership is unable to complete repairs on your vehicle within 30 days, you may have the repairs made under Lexus' provisions for emergency warranty repairs. See page 37 for details.

IF YOU HAVE QUESTIONS

If you have questions or concerns about your vehicle's California emission warranty coverage, please follow the steps described on pages 9-10. You may also request information from or report complaints to:

California Air Resources Board
Mobile Source Control Division
P.O. Box 8001
El Monte, CA 91734-8001
(800) 242-4450

OBTAINING WARRANTY SERVICE

The tires that come as original equipment on your vehicle are warranted by their manufacturer and not Lexus. Please refer to the tire warranty statement included with the owner information in your vehicle.

To obtain warranty service for a tire, take the tire to an authorized dealer of the tire manufacturer. (Refer to your local phone directory for dealer locations.) Your Lexus dealer may also be able to assist you in obtaining warranty service from the manufacturer.

For additional warranty information or service assistance, contact the tire manufacturer directly.

ORIGINAL EQUIPMENT TIRE MANUFACTURERS

Bridgestone/Firestone

535 Marriott Drive
Nashville, TN 37214
Bridgestone: (800) 847-3272
Firestone: (800) 356-4644

Dunlop Tires

1144 East Market Street
Akron, OH 44316
(800) 321-2136

Michelin North America

One Park Way South
P.O. Box 19001
Greenville, SC 29602
(800) 847-3435

Yokohama Tire Corporation

601 South Acacia Avenue
Fullerton, CA 92831
(800) 722-9888

GENERAL INFORMATION

You are responsible for ensuring that your Lexus is operated and maintained according to the instructions in the *Owner's Manual* and the "Maintenance Information" section of this guide.

You should keep detailed records of vehicle maintenance, since under some circumstances they may be required for warranty coverage. These records should include date of service, mileage at time of service and a description of service performed and/or parts installed. For your convenience, maintenance logs are included in the "Maintenance Information" section of this guide. If you sell your vehicle, you should give your maintenance records to the new owner.

Lexus will not deny a warranty claim solely because you do not have records to show that you maintained your vehicle. However, damage or failures caused by lack of proper maintenance are not covered under warranty.

WHERE TO GO FOR MAINTENANCE

You may have maintenance performed on your vehicle by any qualified person or facility. However, Lexus recommends having maintenance performed by an authorized Lexus dealership.

Lexus dealership technicians are specially trained to maintain and repair Lexus vehicles. They stay current on the latest service information through Lexus technical bulletins, service publications and training courses. Many are also certified through the Lexus Commitment to Perfection Certification Program, which requires specialized, state-of-the-art training as well as rigorous exams through both Lexus and the National Institute for Automotive Service Excellence.

You can be confident you're getting the best possible service for your vehicle when you take it to a Lexus dealership. Plus, a Lexus dealership will always use Genuine Lexus Parts designed specifically for your vehicle.

REPLACEMENT PARTS

Warranty coverage is not dependent upon the use of any particular brand of replacement parts. However, Lexus recommends using only Genuine Lexus Parts when you need to replace a part on your vehicle. Like all Lexus products, Genuine Lexus Parts are built to the highest standards of quality, durability and performance. They are also designed to fit your vehicle's exact specifications.

Your Lexus dealership maintains an extensive inventory of Genuine Lexus Parts to meet your vehicle service needs. And because it is linked electronically to Lexus Parts Distribution Centers, the dealership has quick access to any parts it may not have in stock.

Genuine Lexus Parts are covered by their own warranty (see your dealer for details) or the remainder of any applicable New Vehicle Limited Warranty, whichever is longer. **Non-Genuine Lexus Parts, or any damage or failures resulting from their use, are not covered by any Lexus warranty.**

BY GEOGRAPHIC REGION

In the United States, U.S. Territories and Canada

To obtain warranty service in the United States, U.S. territories or Canada, take your vehicle to an authorized Lexus dealership. If your vehicle cannot be driven, contact your nearest Lexus dealership for towing assistance. You do not have to pay for towing to the nearest Lexus dealership if your vehicle is inoperable due to failure of a warranted part.

Outside the United States, U.S. Territories and Canada

If you are using your vehicle outside the United States, U.S. territories and Canada and need warranty service, contact a local Lexus dealership. Please note, however, that your vehicle may not be repaired free of charge because the local Lexus distributor may have no obligation to provide warranty service for your vehicle, and/or your vehicle may not comply with local regulatory or environmental requirements.

EMERGENCY REPAIRS

Lexus recommends having maintenance and repairs for your vehicle performed by an authorized Lexus dealership. To locate your nearest authorized Lexus dealership, contact Lexus Customer Satisfaction at (800) 255-3987 or log on to www.lexus.com.

Maintenance and repairs not performed by an authorized Lexus dealership should be performed by a qualified technician following procedures in Lexus service and repair publications.

If your vehicle is inoperable or unsafe to drive and there is no Lexus dealership reasonably available to make repairs, you may perform the repairs yourself or have them performed by another automotive service provider. Lexus will reimburse you for any of the repairs that are covered by warranty. To receive reimbursement, present to an authorized Lexus dealership your paid repair invoices and any parts that were removed from the vehicle. You will be reimbursed for

warranted parts at the manufacturer's suggested retail price and warranted labor at a geographically appropriate hourly rate multiplied by Lexus' recommended time allowance for the repair.

If your vehicle requires emergency repair, Lexus assumes no liability for subsequent failures caused by improper repairs or the use of non-Genuine Lexus Parts unless you have the vehicle properly repaired in a timely manner. To ensure that warranty coverage remains intact, have your vehicle inspected by an authorized Lexus dealership as soon as possible after an emergency repair.

Regular maintenance is essential to obtaining the highest level of performance, safety and reliability from your Lexus. It can also enhance your vehicle's resale value. This section of the *Warranty and Services Guide* is designed to help you make sure your vehicle receives proper and timely maintenance. It includes factory-recommended maintenance guidelines as well as logs in which to document your vehicle's maintenance history.

In addition to scheduled maintenance, your Lexus requires ongoing general

maintenance such as fluid checks and visual inspections. These procedures are listed on pages 42-43 of this booklet and described in detail in the "Maintenance" section of the *Owner's Manual*.

With proper maintenance and care, your vehicle will last longer and deliver more dependable, economical performance. Follow this booklet's recommendations and you'll enjoy maximum reliability and peace of mind from your Lexus for many years to come.



Maintaining your vehicle according to the recommendations in this booklet is required to ensure that your warranty coverage remains intact. You should keep detailed records of vehicle maintenance, including date of service, mileage at time of service and a description of service and/or parts installation performed. The maintenance logs in this booklet are a good place to record this information. If you sell your vehicle, be sure to give your maintenance records to the new owner.

Lexus will not deny a warranty claim solely because you do not have records to show that you maintained your vehicle. However, damage or failures caused by lack of proper maintenance are not covered under warranty.

Maintenance and repair services may be performed by you or by any automotive service provider you choose. Lexus will not deny a warranty claim solely because you used a service

provider other than a Lexus dealership for maintenance and repairs. However, damage or failures caused by improper maintenance or repairs are not covered under warranty.

Your dealer may recommend more frequent maintenance intervals or more maintenance services than those listed in the scheduled maintenance log. These additional services are not required to maintain your warranty coverage. Ask your dealer for an explanation of any recommended maintenance not included in the scheduled maintenance log.

For a complete description of Lexus warranty coverages, see pages 16–33 of this booklet.

To ensure that your vehicle receives first-quality service and factory-authorized parts, Lexus recommends having maintenance performed by an authorized Lexus dealership. To locate your nearest authorized Lexus dealership, contact Lexus Customer Satisfaction at (800) 255-3987 or log on to www.lexus.com.

Lexus dealership technicians are experts in the maintenance and repair of Lexus vehicles. They stay current on the latest service information through Lexus technical bulletins, service publications and training courses. Many are also certified through the Lexus Commitment to Perfection Certification Program, which requires specialized, state-of-the-art training as well as rigorous exams through both Lexus and the National Institute for Automotive Service Excellence.

Additionally, when you have your vehicle serviced at a Lexus dealership, your service information is recorded in the Lexus National Service History database. This is the first database of its kind in the automotive industry. It can be accessed by

any Lexus dealership in the U.S. – a great convenience if you relocate or need to have your vehicle serviced while traveling.

You can be confident you're getting the best possible service for your vehicle when you take it to a Lexus dealership. Don't trust your investment to anything less than a team of Lexus specialists.

Maintenance and repairs not performed by an authorized Lexus dealership should be performed by a qualified technician following procedures in Lexus service and repair publications.

In addition to scheduled maintenance, your Lexus requires ongoing general maintenance such as fluid checks and visual inspections. The recommended guidelines for inspections are listed below. Please refer to the “Maintenance” section of the *Owner’s Manual* for a detailed description of inspection procedures.

When Refueling

When refueling, perform these inspections:

- Check engine oil level using the dipstick
- Visually check engine coolant level on the see-through reservoir (under cover)
- Visually check brake fluid level on the see-through reservoir
- Visually check power steering fluid level on the see-through reservoir (under cover)
- Visually check condition of battery (under cover)
- Check level of windshield washer fluid

Every 30 Days

At least once every 30 days, perform these inspections:

- Check tire pressure
- Check tires for damage and wear

When Cleaning the Interior

- Remove dirt and dust with a vacuum cleaner. Wipe dirty surfaces with a soft cloth dampened with warm water.
- When cleaning carpet or cloth interior, remove dirt and dust with a vacuum cleaner. Apply a foaming-type carpet cleaner with a sponge or brush, allowing cleaner to work for a few minutes to loosen dirt. Continue by rubbing carpet or cloth interior in a circular motion. Wipe off any excess cleaner with a clean cloth. If any dirt remains, repeat process. Best results are obtained by keeping carpet and cloth interior as dry as possible.
- When cleaning leather interior, remove dirt and dust with a vacuum cleaner. Using a sponge, apply a small amount of neutral

wool detergent mixed in water, rubbing in a circular motion. Wipe off any excess detergent and let leather dry in an open-air location.

When Cleaning the Exterior

- Working from top to bottom, apply lots of low-pressure water to the body, wheel wells and underside of vehicle to remove dirt and dust. Wash the vehicle body using a soft sponge or cotton cloth with mild car-wash soap. Rinse off with water.
- If water does not bead on a clean vehicle surface, apply car wax using a soft cotton cloth when the body of the vehicle is cool.

When Cleaning the Wheels

- Wait for hot wheels to cool before getting wheels wet.
- Using a soft sponge or cotton cloth, apply same mild car-wash soap as used for the vehicle body. Quickly rinse off with water. Using a soft cotton cloth, apply same car wax as used for the vehicle body.

Determining Your Maintenance Interval: Months vs. Mileage

Lexus recommends obtaining scheduled maintenance for your vehicle every six months or 5,000 miles, whichever occurs first.

For example:

- If at six months you have driven less than 5,000 miles, you should obtain maintenance at **six months**; don't wait until 5,000 miles.
- If you drive 5,000 miles in less than six months, you should obtain maintenance at **5,000 miles**; don't wait until six months.

Be sure to keep an eye on your mileage so that you obtain maintenance when recommended. If you are a low-mileage driver, mark your calendar to remind yourself to obtain maintenance every six months.

Complimentary First Scheduled Maintenance Service: 30 Days or 1,000 Miles

Lexus provides your first scheduled maintenance service at no charge. The service is performed at 30 days or 1,000 miles, whichever occurs first, and includes the items listed in the chart on the next page. To obtain this complimentary service, contact your Lexus dealership.

Complimentary Second Scheduled Maintenance Service: Six Months or 5,000 Miles

Lexus also provides your second scheduled maintenance service at no charge. The service is performed at six months or 5,000 miles, whichever occurs first, and includes the items listed in the chart on page 46. To obtain this complimentary service, contact your Lexus dealership.

30 Days or 1,000 Miles

Complimentary First
Scheduled Maintenance Service

- Inspect body/chassis
- Check for fluid leaks
- Road-test vehicle
- Program Lexus Personalized Settings, if requested

Date: _____ Mileage: _____

Notes:

What are Lexus Personalized Settings?

Your vehicle includes a variety of electronic features that can be programmed to your preferences. For example, doors can be programmed to remain locked when you shift into "Park." (For more information, see the "Customizable Features" section of the Specifications chapter in your *Owner's Manual*.) Programming of these features is performed once at no charge, provided you obtain the service at the 30-day/1,000-mile scheduled maintenance service. Programming of your Lexus Personalized Settings requires special equipment and may be performed only by an authorized Lexus dealership.

SCHEDULED MAINTENANCE LOG

6 Months or 5,000 Miles¹

- Replace engine oil and oil filter; reset reminder light
- Rotate tires²
- Visually inspect brake pads and rotors
- Road-test vehicle

Additional Maintenance Required If You Drive Primarily Under the Following Conditions

Driving on dirt roads or dusty roads:

- Inspect axle shaft boots
- Inspect ball joints and dust covers
- Inspect engine air filter
- Inspect steering linkage and boots
- Tighten nuts and bolts on chassis

Driving while towing:

- Tighten nuts and bolts on chassis (ES)

Date: _____ Mileage: _____

Notes:

12 Months or 10,000 Miles

- Replace engine oil and oil filter; reset reminder light
- Rotate tires²
- Measure thickness of brake pads and rotors (GS, IS, LS³)
- Replace air conditioner filter (LS, SC)
- Visually inspect brake pads and rotors
- Road-test vehicle

Additional Maintenance Required If You Drive Primarily Under the Following Conditions

Driving on dirt roads or dusty roads:

- Inspect axle shaft boots
- Inspect ball joints and dust covers
- Inspect engine air filter
- Inspect steering linkage and boots
- Tighten nuts and bolts on chassis

Driving while towing:

- Tighten nuts and bolts on chassis (ES)

Date: _____ Mileage: _____

Notes:

¹This service is complimentary when performed by an authorized Lexus dealership.

²Applies to models with same size front and rear tires and wheels.

³Applies to LS 460 L with Touring Package.

18 Months or 15,000 Miles

- Replace engine oil and oil filter; reset reminder light
- Rotate tires²
- Clean air conditioner filter (ES, GS, IS)
- Visually inspect brake pads and rotors
- Road-test vehicle
- Inspect the following:

<input type="checkbox"/> Axle shaft boots	<input type="checkbox"/> Front differential oil (GS 350 AWD, IS 250 AWD)
<input type="checkbox"/> Ball joints and dust covers	<input type="checkbox"/> Rack and pinion assembly
<input type="checkbox"/> Body	<input type="checkbox"/> Rear differential oil (GS, IS, LS, SC)
<input type="checkbox"/> Brake lines and hoses	<input type="checkbox"/> Steering linkage and boots
<input type="checkbox"/> Engine coolant (see page 67)	
<input type="checkbox"/> Exhaust pipes and mountings	

Additional Maintenance Required If You Drive Primarily Under the Following Conditions

Driving on dirt roads or dusty roads:

- Inspect engine air filter
- Tighten nuts and bolts on chassis

Driving while towing:

- Tighten nuts and bolts on chassis (ES)

Date: _____ Mileage: _____

Notes:

24 Months or 20,000 Miles

- Replace engine oil and oil filter; reset reminder light
- Rotate tires¹
- Measure thickness of brake pads and rotors (GS, IS, LS²)
- Replace air conditioner filter (LS, SC)
- Visually inspect brake pads and rotors
- Road-test vehicle

Additional Maintenance Required If You Drive Primarily Under the Following Conditions

Driving on dirt roads or dusty roads:

- Inspect axle shaft boots
- Inspect ball joints and dust covers
- Inspect engine air filter
- Inspect steering linkage and boots
- Tighten nuts and bolts on chassis

Driving while towing:

- Tighten nuts and bolts on chassis (ES)

Date: _____ Mileage: _____

Notes:

30 Months or 25,000 Miles

- Replace engine oil and oil filter; reset reminder light
- Rotate tires¹
- Visually inspect brake pads and rotors
- Road-test vehicle

Additional Maintenance Required If You Drive Primarily Under the Following Conditions

Driving on dirt roads or dusty roads:

- Inspect axle shaft boots
- Inspect ball joints and dust covers
- Inspect engine air filter
- Inspect steering linkage and boots
- Tighten nuts and bolts on chassis

Driving while towing:

- Tighten nuts and bolts on chassis (ES)

Date: _____ Mileage: _____

Notes:

¹Applies to models with same size front and rear tires and wheels.

²Applies to LS 460 L with Touring Package.

36 Months or 30,000 Miles

- Replace engine oil and oil filter; reset reminder light
- Rotate tires¹
- Measure thickness of brake pads and rotors; measure rotor runout (GS, IS, LS²)
- Replace air conditioner filter
- Replace brake fluid
- Replace engine air filter
- Visually inspect brake pads and rotors
- Road-test vehicle
- Inspect the following:

<ul style="list-style-type: none"> <input type="checkbox"/> Axle shaft boots <input type="checkbox"/> Ball joints and dust covers <input type="checkbox"/> Body <input type="checkbox"/> Brake lines and hoses <input type="checkbox"/> Engine coolant (see page 67) <input type="checkbox"/> Exhaust pipes and mountings <input type="checkbox"/> Front differential oil (GS 350 AWD, IS 250 AWD) <input type="checkbox"/> Fuel lines and connections, fuel tank band and fuel tank vapor vent system hoses 	<ul style="list-style-type: none"> <input type="checkbox"/> Fuel tank cap gasket <input type="checkbox"/> Manual transmission oil (IS 250) <input type="checkbox"/> Rack and pinion assembly <input type="checkbox"/> Rear differential oil (GS, IS, LS, SC) <input type="checkbox"/> Steering linkage and boots <input type="checkbox"/> Transfer case for signs of leakage (GS 350 AWD, IS 250 AWD) <input type="checkbox"/> Transmission for signs of leakage
--	---

Additional Maintenance Required If You Drive Primarily Under the Following Conditions

Driving on dirt roads or dusty roads:

- Tighten nuts and bolts on chassis

Driving while towing:

- Tighten nuts and bolts on chassis (ES)

Date: _____ Mileage: _____

Notes:

SCHEDULED MAINTENANCE LOG

42 Months or 35,000 Miles

- Replace engine oil and oil filter; reset reminder light
- Rotate tires¹
- Visually inspect brake pads and rotors
- Road-test vehicle

Additional Maintenance Required If You Drive Primarily Under the Following Conditions

Driving on dirt roads or dusty roads:

- Inspect axle shaft boots
- Inspect ball joints and dust covers
- Inspect engine air filter
- Inspect steering linkage and boots
- Tighten nuts and bolts on chassis

Driving while towing:

- Tighten nuts and bolts on chassis (ES)

Date: _____ Mileage: _____

Notes:

48 Months or 40,000 Miles

- Replace engine oil and oil filter; reset reminder light
- Rotate tires¹
- Measure thickness of brake pads and rotors (GS, IS, LS²)
- Replace air conditioner filter (LS, SC)
- Visually inspect brake pads and rotors
- Road-test vehicle

Additional Maintenance Required If You Drive Primarily Under the Following Conditions

Driving on dirt roads or dusty roads:

- Inspect axle shaft boots
- Inspect ball joints and dust covers
- Inspect engine air filter
- Inspect steering linkage and boots
- Tighten nuts and bolts on chassis

Driving while towing:

- Tighten nuts and bolts on chassis (ES)

Date: _____ Mileage: _____

Notes:

¹Applies to models with same size front and rear tires and wheels.

²Applies to LS 460 L with Touring Package.

54 Months or 45,000 Miles

- Replace engine oil and oil filter; reset reminder light
- Rotate tires¹
- Clean air conditioner filter (ES, GS, IS)
- Visually inspect brake pads and rotors
- Road-test vehicle
- Inspect the following:

<input type="checkbox"/> Axle shaft boots	<input type="checkbox"/> Front differential oil (GS 350 AWD, IS 250 AWD)
<input type="checkbox"/> Ball joints and dust covers	<input type="checkbox"/> Rack and pinion assembly
<input type="checkbox"/> Body	<input type="checkbox"/> Rear differential oil (GS, IS, LS, SC)
<input type="checkbox"/> Brake lines and hoses	<input type="checkbox"/> Steering linkage and boots
<input type="checkbox"/> Engine coolant (see page 67)	
<input type="checkbox"/> Exhaust pipes and mountings	

Additional Maintenance Required If You Drive Primarily Under the Following Conditions

Driving on dirt roads or dusty roads:

- Inspect engine air filter
- Tighten nuts and bolts on chassis

Driving while towing:

- Tighten nuts and bolts on chassis (ES)

Date: _____ Mileage: _____

Notes:

60 Months or 50,000 Miles

- Replace engine oil and oil filter; reset reminder light
- Rotate tires¹
- Measure thickness of brake pads and rotors (GS, IS, LS²)
- Replace air conditioner filter (LS, SC)
- Visually inspect brake pads and rotors
- Road-test vehicle

Additional Maintenance Required If You Drive Primarily Under the Following Conditions

Driving on dirt roads or dusty roads:

- Inspect axle shaft boots
- Inspect ball joints and dust covers
- Inspect engine air filter
- Inspect steering linkage and boots
- Tighten nuts and bolts on chassis

Driving while towing:

- Tighten nuts and bolts on chassis (ES)

Date: _____ Mileage: _____

Notes:

66 Months or 55,000 Miles

- Replace engine oil and oil filter; reset reminder light
- Rotate tires¹
- Visually inspect brake pads and rotors
- Road-test vehicle

Additional Maintenance Required If You Drive Primarily Under the Following Conditions

Driving on dirt roads or dusty roads:

- Inspect axle shaft boots
- Inspect ball joints and dust covers
- Inspect engine air filter
- Inspect steering linkage and boots
- Tighten nuts and bolts on chassis

Driving while towing:

- Tighten nuts and bolts on chassis (ES)

Date: _____ Mileage: _____

Notes:

¹Applies to models with same size front and rear tires and wheels.

²Applies to LS 460 L with Touring Package.

72 Months or 60,000 Miles

- Replace engine oil and oil filter; reset reminder light
- Rotate tires¹
- Measure thickness of brake pads and rotors; measure rotor runout (GS, IS, LS²)
- Replace air conditioner filter
- Replace brake fluid
- Replace engine air filter
- Replace spark plugs (GS, IS, LS)³
- Visually inspect brake pads and rotors
- Road-test vehicle
- Inspect the following:

<ul style="list-style-type: none"> ___ Axle shaft boots ___ Ball joints and dust covers ___ Body ___ Brake lines and hoses ___ Drive belt ___ Engine coolant (see page 67) ___ Engine valve clearance (SC) ___ Exhaust pipes and mountings ___ Front differential oil (GS 350 AWD, IS 250 AWD) ___ Fuel lines and connections, fuel tank band and fuel tank vapor vent system hoses 	<ul style="list-style-type: none"> ___ Fuel tank cap gasket ___ Manual transmission oil (IS 250) ___ Rack and pinion assembly ___ Rear differential oil (GS, IS, LS, SC) ___ Steering linkage and boots ___ Transfer case for signs of leakage (GS 350 AWD, IS 250 AWD) ___ Transmission for signs of leakage
---	--

Additional Maintenance Required If You Drive Primarily Under the Following Conditions

Driving on dirt roads or dusty roads:

- Tighten nuts and bolts on chassis

Driving while towing:

- Replace transmission fluid (ES only; use type ATFWS or equivalent)
- Tighten nuts and bolts on chassis (ES)

Date: _____ Mileage: _____

Notes:

³Required under the terms of the Emission Control Warranty.

SCHEDULED MAINTENANCE LOG

78 Months or 65,000 Miles

- Replace engine oil and oil filter; reset reminder light
- Rotate tires¹
- Visually inspect brake pads and rotors
- Road-test vehicle

Additional Maintenance Required If You Drive Primarily Under the Following Conditions

Driving on dirt roads or dusty roads:

- Inspect axle shaft boots
- Inspect ball joints and dust covers
- Inspect engine air filter
- Inspect steering linkage and boots
- Tighten nuts and bolts on chassis

Driving while towing:

- Tighten nuts and bolts on chassis (ES)

Date: _____ Mileage: _____

Notes:

84 Months or 70,000 Miles

- Replace engine oil and oil filter; reset reminder light
- Rotate tires¹
- Measure thickness of brake pads and rotors (GS, IS, LS²)
- Replace air conditioner filter (LS, SC)
- Visually inspect brake pads and rotors
- Road-test vehicle

Additional Maintenance Required If You Drive Primarily Under the Following Conditions

Driving on dirt roads or dusty roads:

- Inspect axle shaft boots
- Inspect ball joints and dust covers
- Inspect engine air filter
- Inspect steering linkage and boots
- Tighten nuts and bolts on chassis

Driving while towing:

- Tighten nuts and bolts on chassis (ES)

Date: _____ Mileage: _____

Notes:

¹Applies to models with same size front and rear tires and wheels.

²Applies to LS 460 L with Touring Package.

90 Months or 75,000 Miles

- Replace engine oil and oil filter; reset reminder light
- Rotate tires¹
- Clean air conditioner filter (ES, GS, IS)
- Visually inspect brake pads and rotors
- Road-test vehicle
- Inspect the following:

<ul style="list-style-type: none"> ___ Axle shaft boots ___ Ball joints and dust covers ___ Body ___ Brake lines and hoses ___ Drive belt ___ Engine coolant (see page 67) 	<ul style="list-style-type: none"> ___ Exhaust pipes and mountings ___ Front differential oil (GS 350 AWD, IS 250 AWD) ___ Rack and pinion assembly ___ Rear differential oil (GS, IS, LS, SC) ___ Steering linkage and boots
--	--

Additional Maintenance Required If You Drive Primarily Under the Following Conditions

Driving on dirt roads or dusty roads:

- Inspect engine air filter
- Tighten nuts and bolts on chassis

Driving while towing:

- Tighten nuts and bolts on chassis (ES)

Date: _____ Mileage: _____

Notes:

96 Months or 80,000 Miles

- Replace engine oil and oil filter; reset reminder light
- Rotate tires¹
- Measure thickness of brake pads and rotors (GS, IS, LS²)
- Replace air conditioner filter (LS, SC)
- Visually inspect brake pads and rotors
- Road-test vehicle

Additional Maintenance Required If You Drive Primarily Under the Following Conditions

Driving on dirt roads or dusty roads:

- Inspect axle shaft boots
- Inspect ball joints and dust covers
- Inspect engine air filter
- Inspect steering linkage and boots
- Tighten nuts and bolts on chassis

Driving while towing:

- Tighten nuts and bolts on chassis (ES)

Date: _____ Mileage: _____

Notes:

102 Months or 85,000 Miles

- Replace engine oil and oil filter; reset reminder light
- Rotate tires¹
- Visually inspect brake pads and rotors
- Road-test vehicle

Additional Maintenance Required If You Drive Primarily Under the Following Conditions

Driving on dirt roads or dusty roads:

- Inspect axle shaft boots
- Inspect ball joints and dust covers
- Inspect engine air filter
- Inspect steering linkage and boots
- Tighten nuts and bolts on chassis

Driving while towing:

- Tighten nuts and bolts on chassis (ES)

Date: _____ Mileage: _____

Notes:

¹Applies to models with same size front and rear tires and wheels.

²Applies to LS 460 L with Touring Package.

108 Months or 90,000 Miles

- Replace engine oil and oil filter; reset reminder light
- Rotate tires¹
- Measure thickness of brake pads and rotors; measure rotor runout (GS, IS, LS²)
- Replace air conditioner filter
- Replace brake fluid
- Replace engine air filter
- Replace timing belt (SC)
- Visually inspect brake pads and rotors
- Road-test vehicle
- Inspect the following:

<ul style="list-style-type: none"> ___ Axle shaft boots ___ Ball joints and dust covers ___ Body ___ Brake lines and hoses ___ Drive belt ___ Engine coolant (see page 67) ___ Exhaust pipes and mountings ___ Front differential oil (GS 350 AWD, IS 250 AWD) ___ Fuel lines and connections, fuel tank band and fuel tank vapor vent system hoses 	<ul style="list-style-type: none"> ___ Fuel tank cap gasket ___ Manual transmission oil (IS 250) ___ Rack and pinion assembly ___ Rear differential oil (GS, IS, LS, SC) ___ Steering linkage and boots ___ Transfer case for signs of leakage (GS 350 AWD, IS 250 AWD) ___ Transmission for signs of leakage
--	--

Additional Maintenance Required If You Drive Primarily Under the Following Conditions

Driving on dirt roads or dusty roads:

- Tighten nuts and bolts on chassis

Driving while towing:

- Tighten nuts and bolts on chassis (ES)

Date: _____ Mileage: _____

Notes:

114 Months or 95,000 Miles

- Replace engine oil and oil filter; reset reminder light
- Rotate tires¹
- Visually inspect brake pads and rotors
- Road-test vehicle

Additional Maintenance Required If You Drive Primarily Under the Following Conditions

Driving on dirt roads or dusty roads:

- Inspect axle shaft boots
- Inspect ball joints and dust covers
- Inspect engine air filter
- Inspect steering linkage and boots
- Tighten nuts and bolts on chassis

Driving while towing:

- Tighten nuts and bolts on chassis (ES)

Date: _____ Mileage: _____

Notes:

120 Months or 100,000 Miles

- Replace engine oil and oil filter; reset reminder light
- Rotate tires¹
- Measure thickness of brake pads and rotors (GS, IS, LS²)
- Replace air conditioner filter (LS, SC)
- Replace engine coolant (see page 67)
- Visually inspect brake pads and rotors
- Road-test vehicle

Additional Maintenance Required If You Drive Primarily Under the Following Conditions

Driving on dirt roads or dusty roads:

- Inspect axle shaft boots
- Inspect ball joints and dust covers
- Inspect engine air filter
- Inspect steering linkage and boots
- Tighten nuts and bolts on chassis

Driving while towing:

- Tighten nuts and bolts on chassis (ES)

Date: _____ Mileage: _____

Notes:

¹Applies to models with same size front and rear tires and wheels.

²Applies to LS 460 L with Touring Package.

126 Months or 105,000 Miles

- Replace engine oil and oil filter; reset reminder light
- Rotate tires¹
- Clean air conditioner filter (ES, GS, IS)
- Visually inspect brake pads and rotors
- Road-test vehicle
- Inspect the following:

___ Axle shaft boots	___ Front differential oil (GS 350 AWD, IS 250 AWD)
___ Ball joints and dust covers	___ Rack and pinion assembly
___ Body	___ Rear differential oil (GS, IS, LS, SC)
___ Brake lines and hoses	___ Steering linkage and boots
___ Drive belt	
___ Exhaust pipes and mountings	

Additional Maintenance Required If You Drive Primarily Under the Following Conditions

Driving on dirt roads or dusty roads:

- Inspect engine air filter
- Tighten nuts and bolts on chassis

Driving while towing:

- Tighten nuts and bolts on chassis (ES)

Date: _____ Mileage: _____

Notes:

132 Months or 110,000 Miles

- Replace engine oil and oil filter; reset reminder light
- Rotate tires¹
- Measure thickness of brake pads and rotors (GS, IS, LS²)
- Replace air conditioner filter (LS, SC)
- Visually inspect brake pads and rotors
- Road-test vehicle

Additional Maintenance Required If You Drive Primarily Under the Following Conditions

Driving on dirt roads or dusty roads:

- Inspect axle shaft boots
- Inspect ball joints and dust covers
- Inspect engine air filter
- Inspect steering linkage and boots
- Tighten nuts and bolts on chassis

Driving while towing:

- Tighten nuts and bolts on chassis (ES)

Date: _____ Mileage: _____

Notes:

138 Months or 115,000 Miles

- Replace engine oil and oil filter; reset reminder light
- Rotate tires¹
- Inspect engine coolant (see page 67)
- Visually inspect brake pads and rotors
- Road-test vehicle

Additional Maintenance Required If You Drive Primarily Under the Following Conditions

Driving on dirt roads or dusty roads:

- Inspect axle shaft boots
- Inspect ball joints and dust covers
- Inspect engine air filter
- Inspect steering linkage and boots
- Tighten nuts and bolts on chassis

Driving while towing:

- Tighten nuts and bolts on chassis (ES)

Date: _____ Mileage: _____

Notes:

¹Applies to models with same size front and rear tires and wheels.

²Applies to LS 460 L with Touring Package.

144 Months or 120,000 Miles

- Replace engine oil and oil filter; reset reminder light
- Rotate tires¹
- Measure thickness of brake pads and rotors; measure rotor runout (GS, IS, LS²)
- Replace air conditioner filter
- Replace brake fluid
- Replace engine air filter
- Replace spark plugs³ (for ES 350, use Denso FK20HR11 plugs or equivalent)
- Visually inspect brake pads and rotors
- Road-test vehicle
- Inspect the following:

<ul style="list-style-type: none"> ___ Axle shaft boots ___ Ball joints and dust covers ___ Body ___ Brake lines and hoses ___ Drive belt ___ Engine valve clearance (SC) ___ Exhaust pipes and mountings ___ Front differential oil (GS 350 AWD, IS 250 AWD) ___ Fuel lines and connections, fuel tank band and fuel tank vapor vent system hoses 	<ul style="list-style-type: none"> ___ Fuel tank cap gasket ___ Manual transmission oil (IS 250) ___ Rack and pinion assembly ___ Rear differential oil (GS, IS, LS, SC) ___ Steering linkage and boots ___ Transfer case for signs of leakage (GS 350 AWD, IS 250 AWD) ___ Transmission for signs of leakage
---	--

Additional Maintenance Required If You Drive Primarily Under the Following Conditions

Driving on dirt roads or dusty roads:

- Tighten nuts and bolts on chassis

Driving while towing:

- Replace transmission fluid (ES only; use type ATFWS or equivalent)
- Tighten nuts and bolts on chassis (ES)

Date: _____ Mileage: _____

Notes:

³Required under the terms of the Emission Control Warranty.

SCHEDULED MAINTENANCE LOG

150 Months or 125,000 Miles

- Replace engine oil and oil filter; reset reminder light
- Rotate tires¹
- Visually inspect brake pads and rotors
- Road-test vehicle

Additional Maintenance Required If You Drive Primarily Under the Following Conditions

Driving on dirt roads or dusty roads:

- Inspect axle shaft boots
- Inspect ball joints and dust covers
- Inspect engine air filter
- Inspect steering linkage and boots
- Tighten nuts and bolts on chassis

Driving while towing:

- Tighten nuts and bolts on chassis (ES)

Date: _____ Mileage: _____

Notes:

156 Months or 130,000 Miles

- Replace engine oil and oil filter; reset reminder light
- Rotate tires¹
- Inspect engine coolant (see page 67)
- Measure thickness of brake pads and rotors (GS, IS, LS²)
- Replace air conditioner filter (LS, SC)
- Visually inspect brake pads and rotors
- Road-test vehicle

Additional Maintenance Required If You Drive Primarily Under the Following Conditions

Driving on dirt roads or dusty roads:

- Inspect axle shaft boots
- Inspect ball joints and dust covers
- Inspect engine air filter
- Inspect steering linkage and boots
- Tighten nuts and bolts on chassis

Driving while towing:

- Tighten nuts and bolts on chassis (ES)

Date: _____ Mileage: _____

Notes:

¹Applies to models with same size front and rear tires and wheels.

²Applies to LS 460 L with Touring Package.

162 Months or 135,000 Miles

- Replace engine oil and oil filter; reset reminder light
- Rotate tires¹
- Clean air conditioner filter (ES, GS, IS)
- Visually inspect brake pads and rotors
- Road-test vehicle
- Inspect the following:

<ul style="list-style-type: none"> ___ Axle shaft boots ___ Ball joints and dust covers ___ Body ___ Brake lines and hoses ___ Drive belt ___ Exhaust pipes and mountings 	<ul style="list-style-type: none"> ___ Front differential oil (GS 350 AWD, IS 250 AWD) ___ Rack and pinion assembly ___ Rear differential oil (GS, IS, LS, SC) ___ Steering linkage and boots
---	---

Additional Maintenance Required If You Drive Primarily Under the Following Conditions

Driving on dirt roads or dusty roads:

- Inspect engine air filter
- Tighten nuts and bolts on chassis

Driving while towing:

- Tighten nuts and bolts on chassis (ES)

Date: _____ Mileage: _____

Notes:

168 Months or 140,000 Miles

- Replace engine oil and oil filter; reset reminder light
- Rotate tires¹
- Measure thickness of brake pads and rotors (GS, IS, LS²)
- Replace air conditioner filter (LS, SC)
- Visually inspect brake pads and rotors
- Road-test vehicle

Additional Maintenance Required If You Drive Primarily Under the Following Conditions

Driving on dirt roads or dusty roads:

- Inspect axle shaft boots
- Inspect ball joints and dust covers
- Inspect engine air filter
- Inspect steering linkage and boots
- Tighten nuts and bolts on chassis

Driving while towing:

- Tighten nuts and bolts on chassis (ES)

Date: _____ Mileage: _____

Notes:

174 Months or 145,000 Miles

- Replace engine oil and oil filter; reset reminder light
- Rotate tires¹
- Inspect engine coolant (see page 67)
- Visually inspect brake pads and rotors
- Road-test vehicle

Additional Maintenance Required If You Drive Primarily Under the Following Conditions

Driving on dirt roads or dusty roads:

- Inspect axle shaft boots
- Inspect ball joints and dust covers
- Inspect engine air filter
- Inspect steering linkage and boots
- Tighten nuts and bolts on chassis

Driving while towing:

- Tighten nuts and bolts on chassis (ES)

Date: _____ Mileage: _____

Notes:

¹Applies to models with same size front and rear tires and wheels.

²Applies to LS 460 L with Touring Package.

180 Months or 150,000 Miles

- Replace engine oil and oil filter; reset reminder light
- Rotate tires¹
- Measure thickness of brake pads and rotors; measure rotor runout (GS, IS, LS²)
- Replace air conditioner filter
- Replace brake fluid
- Replace engine air filter
- Replace engine coolant (see page 67)
- Visually inspect brake pads and rotors
- Road-test vehicle
- Inspect the following:

<ul style="list-style-type: none"> ___ Axle shaft boots ___ Ball joints and dust covers ___ Body ___ Brake lines and hoses ___ Drive belt ___ Exhaust pipes and mountings ___ Front differential oil (GS 350 AWD, IS 250 AWD) ___ Fuel lines and connections, fuel tank band and fuel tank vapor vent system hoses 	<ul style="list-style-type: none"> ___ Fuel tank cap gasket ___ Manual transmission oil (IS 250) ___ Rack and pinion assembly ___ Rear differential oil (GS, IS, LS, SC) ___ Steering linkage and boots ___ Transfer case for signs of leakage (GS 350 AWD, IS 250 AWD) ___ Transmission for signs of leakage
--	--

Additional Maintenance Required If You Drive Primarily Under the Following Conditions

Driving on dirt roads or dusty roads:

- Tighten nuts and bolts on chassis

Driving while towing:

- Tighten nuts and bolts on chassis (ES)

Date: _____ Mileage: _____

Notes:

The following descriptions are provided to give you a better understanding of the maintenance services that should be performed on your vehicle. The scheduled maintenance log indicates at which time/mileage intervals each service should be performed. Please note that many maintenance services should be performed only by a qualified technician.

For further information on maintenance services that you can perform yourself, see the maintenance sections of your *Owner's Manual*.

Air Conditioner Filter

Clean or replace at specified intervals. More frequent cleaning or replacement may be required when driving in dusty conditions.

Axle Shaft Boots

Check the axle shaft boots and clamps for cracks, deterioration and damage. Replace any damaged parts and, if necessary, repack the grease. A qualified technician should perform these operations.

Ball Joints and Dust Covers

Check the suspension and steering linkage ball joints for looseness and damage. Check all dust covers for deterioration and damage. A qualified technician should perform these inspections.

Body Inspection

Visually check for corrosion, scratches and other damage. Check outer body panels, inner panels of the hood and doors, and underneath the vehicle. Apply touch-up paint to any chips and scratches or have them repaired by a qualified technician.

Brake Fluid

Replace using fluid type specified in your *Owner's Manual*. A qualified technician should perform this operation.

Brake Lines and Hoses

Visually inspect for proper installation. Check for chafing, cracks, deterioration and signs of leakage. Replace any deteriorated or damaged parts. A qualified technician should perform these operations.

Brake Pads/Rotors and Parking Brake Linings/Drums

Check brake pads and rotors for excessive wear; check brake rotors for runout. Check brake calipers for fluid leakage. Check the parking brake linings (shoes) and drums for scoring, burning, fluid leakage, broken parts and excessive wear. Some models are equipped with directional rotors. When servicing these rotors, reinstall at same location. A qualified technician should perform these operations. See inside front cover for additional brake information.

Drive Belt

Inspect for cracks, excessive wear and oiliness. Check the belt tension and adjust if necessary. Replace the belt if it is damaged.

Engine Air Filter

Check for damage, excessive wear and oiliness. Replace if necessary.

Engine Coolant

When inspecting, visually check the engine coolant level on the see-through reservoir. Add coolant as

necessary. When replacing, drain and flush the cooling system and refill with coolant. Always use Genuine Toyota Super Long-Life Coolant or similar high-quality non-silicate, non-amine, non-borate ethylene-glycol coolant with long-life hybrid organic acid technology (i.e., a combination of low phosphates and organic acids). A qualified technician should perform these operations.

Note: Initial replacement is at 120 months/100,000 miles. Replace every 60 months/50,000 miles thereafter.

Engine Oil and Oil Filter

Replace the oil filter and drain and refill the engine oil at specified intervals. For recommended oil grade and viscosity, refer to your *Owner's Manual*. Some models are equipped with a replaceable oil-filter element and oil-filter cap O-ring; replace both at each oil change. For instructions on how to reset the reminder light, refer to your *Owner's Manual*.

Engine Valve Clearance (SC)

Inspect for excessive lifter noise and engine vibration and adjust if necessary. (All other models are equipped with hydraulic valve lash adjusters that require no periodic clearance inspection or adjustment.)

Exhaust Pipes and Mountings

Visually inspect the exhaust pipes, muffler and hangers for cracks, deterioration and damage. Start the engine and listen carefully for any exhaust leakage. Tighten connections and replace parts as necessary.

Fuel Lines and Connections, Fuel Tank Band and Fuel Tank Vapor Vent System Hoses

Visually inspect for corrosion, damage, cracks, and loose or leaking connections. Tighten connections and replace parts as necessary.

Fuel Tank Cap Gasket

Visually inspect for cracks, deterioration and damage and replace if necessary.

Nuts and Bolts on Chassis

Check that tightness of the seat-mounting bolts and front/rear suspen-

sion-member retaining bolts matches torque measurements specified in the *Repair Manual*.

Power Steering Fluid

When inspecting, visually check the power steering fluid level on the see-through reservoir. Add fluid as necessary. For fluid specifications, refer to your *Owner's Manual*.

Rack and Pinion Assembly

Inspect the rack and pinion assembly for signs of leakage, damage and loose electrical connections. Tighten connections and if you discover any leakage or damage, have it repaired immediately by a qualified technician.

Road Test

While driving the vehicle, check for proper operation of engine, transmission, brakes and steering. Also check for abnormal noise or vibration from any part of the vehicle.

Spark Plugs

Replace at specified interval. A qualified technician should perform this operation. To ensure optimum engine performance on ES 350, replace only with Denso FK20HR11 plugs or equivalent.

Steering Linkage and Boots

With the vehicle stopped, check for excessive freeplay in the steering wheel. Inspect the linkage for bending and damage and the dust boots for deterioration, cracks and damage. Replace any damaged parts. A qualified technician should perform these operations.

Timing Belt (SC)

Replace every 90,000 miles or 108 months. A qualified technician should perform this operation.

Timing Chain (ES, GS, IS, LS)

The ES, GS, IS and LS are equipped with a timing chain that requires no periodic inspection.

Tire Rotation

Tires should be rotated according to the instructions in your *Owner's Manual*. When rotating tires, check pressure and check for damage and uneven wear. If the spare is not rotated, check the condition and pressure of the spare.

Tire-Pressure Warning Sensors

A tire-pressure sensor is mounted on each full-size wheel. These sensors do not require periodic maintenance.

When a sensor's long-life lithium battery becomes discharged, the battery should be replaced by a qualified technician following procedures in Lexus service and repair publications.

Transfer Case/Transmission

Inspect each transfer case/transmission component for signs of leakage. If you discover any leakage, have it repaired immediately by a qualified technician.

Note: The transfer case/transmission and transmission fluid are a completely sealed unit. Therefore, periodic checks and replacement of the transmission fluid are not required, and there is no dipstick on the transmission. Any repairs that require adding or replacing fluid should be performed by a qualified technician following procedures in Lexus service and repair publications.

VEHICLE IDENTIFICATION

Model _____

Body style _____

In-service date _____

Mileage at delivery _____

Selling dealership _____

Selling dealership phone number _____

Key number _____

Vehicle Identification Number _____

Air conditioner filter46-65*, 66

Axle shaft boots46-65*, 66

Ball joints and dust covers46-65*, 66

Body inspection46-65*, 66

Brakes

 General informationinside front cover

 Fluid42, 66

 Lines and hoses46-65*, 66

 Pads/rotors and linings/drums46-65*, 67

Collision repairs8

Complimentary services

 Maintenance services4, 44-45

 Other services4-6

Dispute resolution9-13, 21

Drive belt46-65*, 67

Emergency repairs37-38

Engine air filter46-65*, 67

Engine coolant43, 46-65*, 67

Engine oil and filter43, 46-65*, 67

Engine valve clearance46-65*, 68

Exhaust pipes and mountings46-65*, 68

Fuel lines and connections, fuel tank band and
fuel tank vapor vent system hoses46-65*, 68

Fuel tank cap gasket46-65*, 68

Inspections, general maintenance42-43

Keys8

*See scheduled maintenance log for maintenance interval.

Lexus Personalized Settings	1, 4, 45
Loaner vehicle	5
Maintenance	
As related to warranty coverage	25, 30, 35, 40
Complimentary first and second services	4, 44-46
Explanation of maintenance items	66-69
General maintenance and inspections	42-43
Importance of maintenance	39
Maintenance intervals	44
Scheduled maintenance log	45-65
Where to obtain maintenance	inside front cover, 35, 41
Nuts and bolts on chassis	46-65*, 68
Oil change	46-65*, 67
Owner responsibilities	25, 29, 30, 35-38
Parts replacement	8, 16, 25, 31, 36
Power steering fluid	42, 68
Pre-delivery service	1
Quality control	7
Rack and pinion assembly	46-65*, 68
Road test	46-65*, 68
Roadside assistance	1, 5-6
Service agreements	7
Service history	7
Smog-check tests	26, 31
Spark plugs	53, 61, 68
Steering linkage and boots	46-65*, 69

Timing belt57, 69

Timing chain 69

Tire inspections42

Tire rotation46-65*, 69

Tire-pressure warning sensors 69

Tires, warranty coverage 34

Transfer case46-65*, 69

Transmission46-65*, 69

Travel protection5

Warranty coverages

- Basic18
- California Emission Control28-32
- Corrosion perforation19
- Coverages at a glance15
- Federal Emission Control22-27
- General provisions16-17
- Powertrain18
- Restraint systems18
- Tires34
- Towing19
- What is not covered17, 19-21, 23, 29

*See scheduled maintenance log for maintenance interval.

Owner Information Change Form

FBC

If your name or address has changed or if you purchased your Lexus as a used vehicle, please complete and mail one of the attached cards, even if your warranty coverage has expired. This will enable Lexus to contact you with important product or safety updates concerning your vehicle. If there is no longer a card attached, please call the Lexus Customer Satisfaction Department at (800) 255-3987.

Check one:

- Same owner, name and/or address changed
- Same owner, additional driver who should receive product/safety updates
- New owner, purchased vehicle used from a Lexus dealership on this date: _____
- New owner, purchased vehicle used from other than a Lexus dealership on this date: _____

Vehicle Identification Number (required to process change)

Today's date: _____
Mo. Day Year

Mr. Mrs. Ms. Miss Dr.

First name

M.I.

Last name

Company name

Check here if address below is for company:

Street address or P.O. Box

Apt. or suite number

City

State

_____ - _____

Zip code

_____ - _____ - _____

Primary phone number

_____ - _____ - _____

Secondary phone number

E-mail address: _____

This information is obtained solely for the use of Lexus. Lexus occasionally sends special promotional offers to registered owners. Check here if you prefer not to receive these offers.



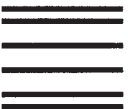

NO POSTAGE
NECESSARY
IF MAILED
IN THE
UNITED STATES



BUSINESS REPLY MAIL

FIRST-CLASS MAIL PERMIT NO. 449 TORRANCE, CA

POSTAGE WILL BE PAID BY THE ADDRESSEE

LEXUS
L202
ATTN: CUSTOMER SATISFACTION
PO BOX 2991
TORRANCE CA 90509-9975



Owner Information Change Form

FBC

If your name or address has changed or if you purchased your Lexus as a used vehicle, please complete and mail one of the attached cards, even if your warranty coverage has expired. This will enable Lexus to contact you with important product or safety updates concerning your vehicle. If there is no longer a card attached, please call the Lexus Customer Satisfaction Department at (800) 255-3987.

Check one:

- Same owner, name and/or address changed
- Same owner, additional driver who should receive product/safety updates
- New owner, purchased vehicle used from a Lexus dealership on this date: _____
- New owner, purchased vehicle used from other than a Lexus dealership on this date: _____

Vehicle Identification Number (required to process change)

Today's date: _____

Mo.

Day

Year

Mr. Mrs. Ms. Miss Dr.

First name

M.I.

Last name

Company name

Check here if address below is for company:

Street address or P.O. Box

Apt. or suite number

City

State

_____ - _____

Zip code

_____ - _____ - _____

Primary phone number

_____ - _____ - _____

Secondary phone number

E-mail address: _____

This information is obtained solely for the use of Lexus. Lexus occasionally sends special promotional offers to registered owners. Check here if you prefer not to receive these offers.



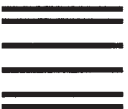

NO POSTAGE
NECESSARY
IF MAILED
IN THE
UNITED STATES

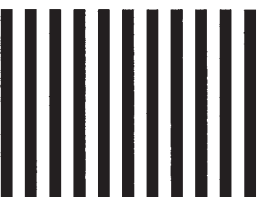

BUSINESS REPLY MAIL

FIRST-CLASS MAIL PERMIT NO. 449 TORRANCE, CA

POSTAGE WILL BE PAID BY THE ADDRESSEE

LEXUS
L202
ATTN: CUSTOMER SATISFACTION
PO BOX 2991
TORRANCE CA 90509-9975

