

Jeep



2016 **CHEROKEE** USER GUIDE



If you are the first registered retail owner of your vehicle, you may obtain a complimentary printed copy of the Owner's Manual, Navigation/Uconnect Manuals or Warranty Booklet by calling **1-877-426-5337 (U.S.)** or **1-800-387-1143 (Canada)** or by contacting your dealer.

The driver's primary responsibility is the safe operation of the vehicle. Driving while distracted can result in loss of vehicle control, resulting in a collision and personal injury. FCA US LLC strongly recommends that the driver use extreme caution when using any device or feature that may take their attention off the road.

Use of any electrical devices, such as cellular telephones, computers, portable radios, vehicle navigation or other devices, by the driver while the vehicle is moving is dangerous and could lead to a serious collision. Texting while driving is also dangerous and should never be done while the vehicle is moving.

If you find yourself unable to devote your full attention to vehicle operation, pull off the road to a safe location and stop your vehicle. Some states or provinces prohibit the use of cellular telephones or texting while driving. It is always the driver's responsibility to comply with all local laws.

## Important:

---

This User Guide is intended to familiarize you with the important features of your vehicle. The DVD enclosed contains your Owner's Manual, Navigation/Uconnect Manuals, Warranty Booklets, Tire Warranty and Roadside Assistance (new vehicles purchased in the U.S.) or Roadside Assistance (new vehicles purchased in Canada) in electronic format. We hope you find it useful. U.S. residents can purchase replacement DVD kits by visiting **[www.techauthority.com](http://www.techauthority.com)** and Canadian residents can purchase replacement DVD kits by calling **1-800-387-1143**.

# TABLE OF CONTENTS

## **INTRODUCTION/WELCOME**

WELCOME FROM FCA US LLC . . . . . 3

## **CONTROLS AT A GLANCE**

DRIVER COCKPIT . . . . . 6  
INSTRUMENT CLUSTER . . . . . 8

## **GETTING STARTED**

KEY FOB . . . . . 10  
REMOTE START . . . . . 12  
VEHICLE SECURITY ALARM . . . . . 13  
KEYLESS ENTER-N-GO — PASSIVE  
ENTRY . . . . . 13  
KEYLESS ENTER-N-GO — IGNITION . . 16  
SEAT BELT SYSTEMS . . . . . 18  
SUPPLEMENTAL RESTRAINT SYSTEM  
(SRS) — AIR BAGS . . . . . 19  
CHILD RESTRAINTS . . . . . 28  
HEAD RESTRAINTS . . . . . 33  
FRONT SEATS . . . . . 35  
REAR SEATS . . . . . 39  
HEATED/VENTILATED SEATS . . . . . 41  
HEATED STEERING WHEEL . . . . . 42  
TILT/TELESCOPING STEERING  
COLUMN . . . . . 43

## **OPERATING YOUR VEHICLE**

ENGINE BREAK-IN  
RECOMMENDATIONS . . . . . 44  
TURN SIGNAL/HIGH BEAM LEVER . . . 45  
HEADLIGHT SWITCH . . . . . 46  
WIPER/WASHER LEVER . . . . . 48  
ELECTRONIC SPEED CONTROL . . . . . 49  
ADAPTIVE CRUISE CONTROL (ACC) . . 51  
FORWARD COLLISION WARNING (FCW)  
WITH MITIGATION . . . . . 56  
MANUAL CLIMATE CONTROLS WITHOUT  
TOUCHSCREEN . . . . . 58  
MANUAL CLIMATE CONTROLS WITH  
TOUCHSCREEN . . . . . 59  
AUTOMATIC TEMPERATURE CONTROLS  
(ATC) . . . . . 62  
STOP/START SYSTEM — IF  
EQUIPPED . . . . . 66  
ELECTRIC PARK BRAKE (EPB) . . . . . 67  
PARKSENSE . . . . . 69  
LANESENSE . . . . . 71  
PARKVIEW REAR BACK UP CAMERA . . 72  
POWER SUNROOF . . . . . 73  
WIND BUFFETING . . . . . 75

## **ELECTRONICS**

YOUR VEHICLE'S SOUND SYSTEM . . . 76  
CYBERSECURITY . . . . . 78  
IDENTIFYING YOUR RADIO . . . . . 79  
UCONNECT ACCESS . . . . . 80

UCONNECT 5.0 . . . . . 92  
UCONNECT 8.4A/8.4AN . . . . . 97  
UCONNECT 8.4A/8.4AN VOICE  
RECOGNITION QUICK TIPS . . . . . 111  
UCONNECT PHONE . . . . . 130  
STEERING WHEEL AUDIO  
CONTROLS . . . . . 141  
ELECTRONIC VEHICLE INFORMATION  
CENTER (EVIC) AND DRIVER  
INFORMATION DISPLAY (DID) . . . . . 142  
PROGRAMMABLE FEATURES . . . . . 143  
UNIVERSAL GARAGE DOOR  
OPENER (HomeLink) . . . . . 143  
POWER INVERTER . . . . . 146  
POWER OUTLET . . . . . 147  
WIRELESS CHARGING PAD . . . . . 149

## **OFF-ROAD CAPABILITIES**

FOUR-WHEEL DRIVE OPERATION . . . 152  
SELEC-TERRAIN . . . . . 155

## **UTILITY**

CARGO AREA FEATURES . . . . . 156  
TRAILER TOWING . . . . . 157  
RECREATIONAL TOWING  
(BEHIND MOTORHOME, ETC.) . . . . . 158

## **WHAT TO DO IN EMERGENCIES**

ROADSIDE ASSISTANCE . . . . . 164  
WARNING AND INDICATOR LIGHTS . . 164  
IF YOUR ENGINE OVERHEATS . . . . . 174  
TIRE SERVICE KIT . . . . . 175  
JACKING AND TIRE CHANGING . . . . . 182  
JUMP-STARTING PROCEDURES . . . . . 188  
FREEING A STUCK VEHICLE . . . . . 191  
RECOVERY STRAP — IF EQUIPPED . . 192  
GEAR SELECTOR OVERRIDE . . . . . 193  
TOWING A DISABLED VEHICLE . . . . . 193  
ENHANCED ACCIDENT RESPONSE  
SYSTEM (EARS) . . . . . 194  
EVENT DATA RECORDER (EDR) . . . . 194

## **MAINTAINING YOUR VEHICLE**

TO OPEN AND CLOSE THE HOOD . . . 195  
ENGINE COMPARTMENT — 2.4L . . . . 196  
ENGINE COMPARTMENT — 3.2L . . . . 198  
FLUID CAPACITIES . . . . . 200  
FLUIDS, LUBRICANTS, AND GENUINE  
PARTS . . . . . 200  
FLEXIBLE FUEL (2.4L ENGINE  
ONLY) — IF EQUIPPED . . . . . 201  
MAINTENANCE PROCEDURES . . . . . 202  
MAINTENANCE SCHEDULE . . . . . 202  
FUSES . . . . . 206  
ADDING FUEL . . . . . 211  
TIRES — GENERAL INFORMATION . . 213  
REPLACEMENT BULBS . . . . . 216

# TABLE OF CONTENTS

## **CUSTOMER ASSISTANCE**

FCA US LLC CUSTOMER CENTER . . .	217
FCA CANADA INC. CUSTOMER CENTER . . . . .	217
ASSISTANCE FOR THE HEARING IMPAIRED . . . . .	217
PUBLICATIONS ORDERING . . . . .	217
REPORTING SAFETY DEFECTS IN THE UNITED STATES . . . . .	218

## **MOPAR® ACCESSORIES**

AUTHENTIC ACCESSORIES BY MOPAR . . . . .	219
--	-----

## **FAQ's**

FREQUENTLY ASKED QUESTIONS . . .	220
----------------------------------	-----

<b>INDEX . . . . .</b>	<b>221</b>
------------------------	------------



# INTRODUCTION/WELCOME

## WELCOME FROM FCA US LLC

Congratulations on selecting your new FCA US LLC ("FCA US") vehicle. Be assured that it represents precision workmanship, distinctive styling, and high quality - all essentials that are traditional to our vehicles.

Your new FCA US vehicle has characteristics to enhance the driver's control under some driving conditions. These are to assist the driver and are never a substitute for attentive driving. They can never take the driver's place. Always drive carefully.

Your new vehicle has many features for the comfort and convenience of you and your passengers. Some of these should not be used when driving because they take your eyes from the road or your attention from driving. Never text while driving or take your eyes more than momentarily off the road.

This guide illustrates and describes the operation of features and equipment that are either standard or optional on this vehicle. This guide may also include a description of features and equipment that are no longer available or were not ordered on this vehicle. Please disregard any features and equipment described in this guide that are not available on this vehicle. FCA US reserves the right to make changes in design and specifications and/or make additions to or improvements to its products without imposing any obligation upon itself to install them on products previously manufactured.

This User Guide has been prepared to help you quickly become acquainted with the important features of your vehicle. It contains most things you will need to operate and maintain the vehicle, including emergency information.

The DVD includes a computer application containing detailed owner's information which can be viewed on a personal computer or MAC computer. The multimedia DVD also includes videos which can be played on any standard DVD player (including the Uconnect Touchscreen Radios if equipped with DVD player capabilities). Additional DVD operational information is located on the back of the DVD sleeve.

**For complete owner information, refer to your Owner's Manual on the DVD in the owner's kit provided at the time of new vehicle purchase.** For your convenience, the information contained on the DVD may also be printed and saved for future reference.

FCA US is committed to protecting our environment and natural resources. By converting from paper to electronic delivery for the majority of the user information for your vehicle, together we greatly reduce the demand for tree-based products and lessen the stress on our environment.

# INTRODUCTION/WELCOME

## VEHICLES SOLD IN CANADA

With respect to any vehicles sold in Canada, the name FCA US LLC shall be deemed to be deleted and the name FCA Canada Inc. used in substitution (excluding legal lines).

### **WARNING!**

- Pedals that cannot move freely can cause loss of vehicle control and increase the risk of serious personal injury.
- Always make sure that objects cannot fall into the driver foot well while the vehicle is moving. Objects can become trapped under the brake pedal and accelerator pedal causing a loss of vehicle control.
- Failure to properly follow floor mat installation or mounting can cause interference with the brake pedal and accelerator pedal operation causing loss of control of the vehicle.
- Never leave children alone in a vehicle, or with access to an unlocked vehicle. Allowing children to be in a vehicle unattended is dangerous for a number of reasons. A child or others could be seriously or fatally injured. Children should be warned not to touch the parking brake, brake pedal or the transmission gear selector.
- Do not leave the key fob in or near the vehicle, or in a location accessible to children. A child could operate power windows, other controls, or move the vehicle.
- Never use the 'PARK' position as a substitute for the parking brake. Always apply the parking brake fully when parked to guard against vehicle movement and possible injury or damage.
- Refer to your Owner's Manual on the DVD for further details.

# INTRODUCTION/WELCOME

## Rollover Warning



### WARNING!

- Pedals that cannot move freely can cause loss of vehicle control and increase the risk of serious personal injury.
- Always make sure that objects cannot fall into the driver foot well while the vehicle is moving. Objects can become trapped under the brake pedal and accelerator pedal causing a loss of vehicle control.
- Failure to properly follow floor mat installation or mounting can cause interference with the brake pedal and accelerator pedal operation causing loss of control of the vehicle.
- Refer to your Owner's Manual on the DVD for further details.
- Never use the 'PARK' position as a substitute for the parking brake. Always apply the parking brake fully when parked to guard against vehicle movement and possible injury or damage.

## USE OF AFTERMARKET PRODUCTS (ELECTRONICS)

The use of aftermarket devices including cell phones, MP3 players, GPS systems, or chargers may affect the performance of on-board wireless features including Keyless Enter-N-Go and Remote Start range. If you are experiencing difficulties with any of your wireless features, try disconnecting your aftermarket devices to see if the situation improves. If your symptoms persist, please see an authorized dealer.

When it comes to service, remember that your authorized dealer knows your Jeep® vehicle best, has factory-trained technicians and genuine MOPAR® parts, and cares about your satisfaction.



# CONTROLS AT A GLANCE

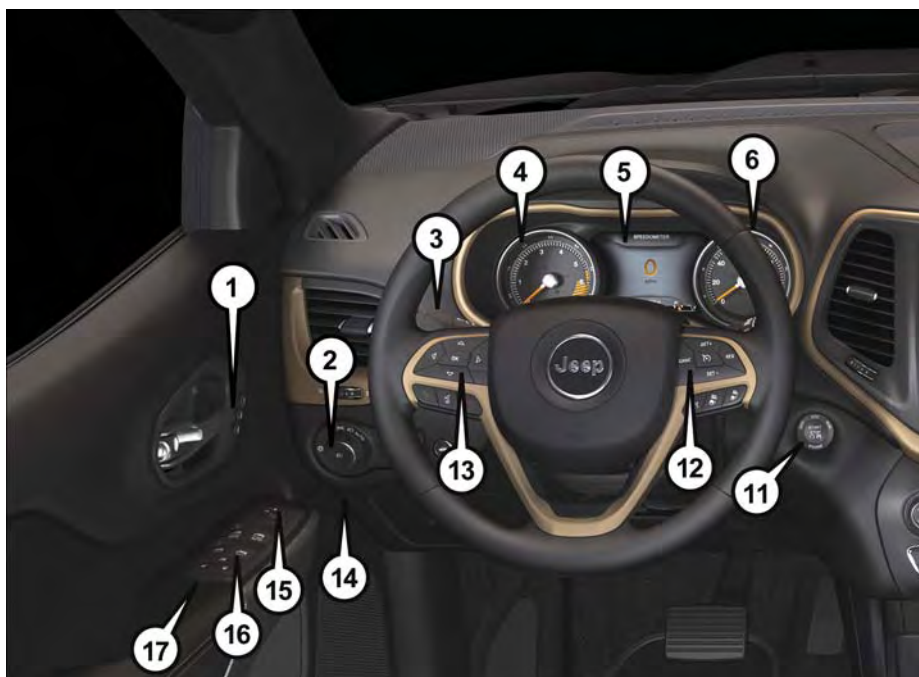

## DRIVER COCKPIT

1. Driver Memory Seat pg. 36
2. Headlight Switch pg. 46
3. Turn Signal/Light Lever pg. 45
4. Tachometer pg. 8
5. Electronic Vehicle Information Center (EVIC) Or Driver Information Display (DID) pg. 142
6. Speedometer pg. 8
7. Your Vehicle's Sound System pg. 76
8. Switch Panel
  - ParkSense pg. 69
9. Climate Controls pg. 62

# CONTROLS AT A GLANCE



10. Gear Selector
11. Engine Start/Stop
12. Electronic Speed Control pg. 49
13. Electronic Vehicle Information Center (EVIC) Or Driver Information Display (DID) Controls pg. 142
14. Opening The Hood pg. 195
15. Power Mirror Switch
16. Power Windows
17. Power Door Locks

# CONTROLS AT A GLANCE



## INSTRUMENT CLUSTER

1. Tachometer
2. Temperature Gauge
3. Electronic Vehicle Information Center (EVIC) Or Driver Information Display (DID)

(See page 164 for Instrument Cluster Warning Lights information.)

# CONTROLS AT A GLANCE



4. Fuel Filler Door Location

5. Fuel Gauge

6. Speedometer

(See page 171 for Instrument Cluster Indicator Lights information.)

# GETTING STARTED

## KEY FOB

- This feature allows the driver to operate the ignition switch with the push of a button as long as the Remote Keyless Entry (RKE) Key Fob is in the passenger compartment.
- The Keyless Push Button Ignition has four operating positions, three of which are labeled and will illuminate when in position. The three positions are OFF, ACC, and ON/RUN. The fourth position is START, during start, RUN will illuminate.



Key Fob

- 1 — Liftgate
  - 2 — Unlock
  - 3 — Lock
  - 4 — Remote Start
  - 5 — Panic
-



# GETTING STARTED

## NOTE:

In case the ignition switch does not change with the push of a button, the RKE Key Fob may have a low or dead battery. In this situation, a back up method can be used to operate the ignition switch. Put the nose side (side opposite of the emergency key) of the Key Fob against the ENGINE START/STOP button and push to operate the ignition switch.

- The Ignition Node Module (IGNM) operates similar to an ignition switch. It has four operating positions, three with detents and one that is spring-loaded. The detent positions are OFF, ACC, and ON/RUN. The START position is a spring-loaded momentary contact position. When released from the START position, the switch automatically returns to the ON/RUN position.



**Key Fob**

- 1 — Liftgate
  - 2 — Lock
  - 3 — Unlock
  - 4 — Panic
  - 5 — Remote Start
  - 6 — Emergency Key Release
  - 7 — Emergency Key
- 

## Locking And Unlocking The Doors/Liftgate

- Push LOCK button once to lock all the doors and the liftgate. Push UNLOCK button once to unlock the driver's door only and twice within five seconds to unlock all the doors and the liftgate.
- All doors can be programmed to unlock on the first push the UNLOCK button. Refer to "Programmable Features" in this guide.

# GETTING STARTED

## Panic Alarm

- Push PANIC button once to turn the panic alarm on.
- Wait approximately three seconds and push button a second time to turn the panic alarm off.

### WARNING!

- When leaving the vehicle, always remove the RKE Key Fob from the ignition and lock your vehicle.
- Never leave children alone in a vehicle, or with access to an unlocked vehicle. Allowing children to be in a vehicle unattended is dangerous for a number of reasons. A child or others could be seriously or fatally injured. Children should be warned not to touch the parking brake, brake pedal or the transmission gear selector.
- Do not leave the RKE Key Fob in or near the vehicle (or in a location accessible to children), and do not leave the ignition of a vehicle equipped with Keyless Enter-N-Go in the ACC or ON/RUN mode. A child could operate power windows, other controls, or move the vehicle.

## REMOTE START

- Push REMOTE START button  on the Key Fob twice within five seconds. Pushing the REMOTE START button a third time shuts the engine off.
- To drive the vehicle, push UNLOCK button, insert the key in the ignition and turn to the ON/RUN position.
- With remote start, the engine will only run for 15 minutes (timeout) unless the ignition key is placed in the ON/RUN position.
- The vehicle must be started with the key after two consecutive timeouts.

### WARNING!

- Do not start or run an engine in a closed garage or confined area. Exhaust gas contains Carbon Monoxide (CO) which is odorless and colorless. Carbon Monoxide is poisonous and can cause serious injury or death when inhaled.
- Keep RKE Key Fobs away from children. Operation of the Remote Start System, windows, door locks or other controls could cause serious injury or death.

## Remote Start Windshield Wiper De-icer Activation – If Equipped

When Remote Start is active and the outside ambient temperature is less than 40° F (4.4° C), the wiper De-Icer will be enabled. On exiting remote start resume previous operation except, if the De-Icer is active, the De-Icer timer and operation will continue.

# GETTING STARTED

## VEHICLE SECURITY ALARM

The Vehicle Security Alarm monitors the vehicle doors for unauthorized entry and the ignition for unauthorized operation. While the Vehicle Security Alarm is armed, interior switches for door locks and liftgate are disabled. If something triggers the alarm, the Vehicle Security Alarm will provide the following audible and visible signals: the horn will pulse, the park lamps and/or turn signals will flash, and the Vehicle Security Light in the instrument cluster will flash.

### To Arm The System:

Lock the door using either the power door lock switch (one door must be open) or the LOCK button on the RKE Key Fob (doors can be open or closed), and close all doors.

The Vehicle Security Light in the instrument cluster will flash for 16 seconds. This shows that the Vehicle Security Alarm is arming. During this period, if a door is opened, the ignition is cycled to ON/RUN, or the power door locks are unlocked in any manner, the Vehicle Security Alarm will automatically disarm.

### NOTE:

- The Vehicle Security Alarm will not arm if you lock the doors with the manual door lock plungers.
- Once armed, the Vehicle Security Alarm disables the unlock switch on the driver door trim panel and passenger door trim panel.

### To Disarm The System:

Push the RKE Key Fob UNLOCK button or cycle the ignition to the ON/RUN position.

The Vehicle Security Alarm is designed to protect your vehicle. However, you can create conditions where the Vehicle Security Alarm will give you a false alarm. If one of the previously described arming sequences has occurred, the Vehicle Security Alarm will arm regardless of whether you are in the vehicle or not. If you remain in the vehicle and open a door, the alarm will sound. If this occurs, disarm the Vehicle Security Alarm.

If the Vehicle Security Alarm is armed and the battery becomes disconnected, the Vehicle Security Alarm will remain armed when the battery is reconnected. The exterior lights will flash, and the horn will sound. If this occurs, disarm the Vehicle Security Alarm.

## KEYLESS ENTER-N-GO – PASSIVE ENTRY

The Keyless Enter-N-Go Passive Entry system is an enhancement to the vehicle's Remote Keyless Entry (RKE) feature. This feature allows you to lock and unlock the vehicle's door(s) and liftgate without having to push the RKE Key Fob LOCK or UNLOCK buttons, as well as starting and stopping the vehicle with the push of a button.

# GETTING STARTED

## To Unlock From The Driver Or Passenger Side:

With a valid Keyless Enter-N-Go Key Fob located outside the vehicle and within 5 ft (1.5 m) of the driver or passenger side door handle, grab either front door handle to unlock the door automatically.



**Grab The Door Handle To Unlock**

## To Lock The Vehicle:

Both front door handles have buttons located on the outside of the handle. With one of the vehicle's Keyless Enter-N-Go Key Fobs located outside the vehicle and within 5 ft (1.5m) of the driver's or passenger front door handle, push the door handle button to lock all four doors and liftgate.

Do NOT grab the door handle when pushing the door handle lock button. This could unlock the door(s).



**Push The Door Handle Button To Lock**



**Do NOT Grab The Handle When Locking**

# GETTING STARTED

## NOTE:

- If “Unlock All Doors 1st Press” is programmed, all doors will unlock when you grab hold of the front driver's door handle. To select between “Unlock Driver Door 1st Press” and “Unlock All Doors 1st Press,” refer to the “Uconnect Settings” in your vehicle's Owner's Manual on the DVD or “Programmable Features” in this guide for further information.
- If “Unlock All Doors 1st Press” is programmed, all doors and liftgate will unlock when you push the liftgate button. If “Unlock Driver Door 1st Press” is programmed, only the liftgate will unlock when you push the liftgate button. To select between “Unlock Driver Door 1st Press” and “Unlock All Doors 1st Press,” refer to the “Uconnect Settings” in your vehicle's Owner's Manual on the DVD or “Programmable Features” in this guide for further information.
- If a Key Fob is detected in the vehicle when locking the vehicle using the power door lock switch, the doors and liftgate will unlock and the horn will chirp three times. On the third attempt, your Key Fob can be locked inside the vehicle.
- After pushing the Keyless Enter-N-Go LOCK button, you must wait two seconds before you can lock or unlock the vehicle using the door handle. This is done to allow you to check if the vehicle is locked by pulling the door handle without the vehicle reacting and unlocking.

## Lock Or Unlock The Liftgate

- To Lock The Liftgate — With a valid Passive Entry RKE Key Fob within 5 ft (1.5 m) of the liftgate, push passive entry lock button located to the right of electronic liftgate handle.
- To Unlock/Enter The Liftgate — The liftgate passive entry unlock feature is built into the electronic liftgate handle. With a valid passive entry RKE Key Fob within 5 ft (1.5 m) of the liftgate, push electronic release switch to open the liftgate.

## NOTE:

Refer to your Owner's Manual on the DVD for further information.

# GETTING STARTED

## KEYLESS ENTER-N-GO – IGNITION

### Engine Starting/Stopping

#### Starting

With a valid Keyless Enter-N-Go Key Fob inside the vehicle.

Place the shift lever in PARK or NEUTRAL.

While pushing the brake pedal, push the ENGINE START/STOP button once. If the engine fails to start, the starter will disengage automatically after 10 seconds.

To stop the cranking of the engine prior to the engine starting, push the button again.



Engine Start/Stop Button

#### NOTE:

In case the ignition switch does not change with the push of a button, the RKE transmitter (Key Fob) may have a low or dead battery. In this situation, a back up method can be used to operate the ignition switch. Put the nose side of the Key Fob against the ENGINE START/STOP button and push to operate the ignition switch.

#### Stopping

Place the shift lever in PARK.

Push the ENGINE START/STOP button once. The ignition switch will return to the OFF position.

**If the shift lever is not in PARK, the ENGINE START/STOP button must be held for two seconds and vehicle speed must be above 5 MPH (8 km/h) before the engine will shut off.**

# GETTING STARTED

## Accessory Positions With Engine Off

### NOTE:

The following functions are with the driver's foot OFF the Brake Pedal (Transmission in PARK or NEUTRAL Position).

### Starting With The Ignition Switch In The OFF Position:

1. Push the ENGINE START/STOP button once to change the ignition switch to the ACC position.
2. Push the ENGINE START/STOP button a second time to change the ignition switch to the ON/RUN position.
3. Push the ENGINE START/STOP button a third time to return the ignition switch to the OFF position.

### NOTE:

If the ignition switch is left in the ACC or ON/RUN (engine not running) position and the transmission is in PARK, the system will automatically time out after 30 minutes of inactivity and the ignition will switch to the OFF position.

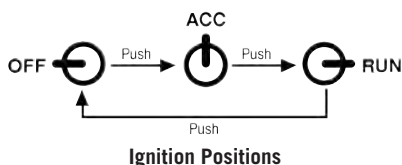

In case the ignition switch does not change with the push of a button, the RKE transmitter (Key Fob) may have a low or dead battery. In this situation, a back up method can be used to operate the ignition switch. Put the nose side (side opposite of the emergency key) of the Key Fob against the ENGINE START/STOP button and push to operate the ignition switch.

# GETTING STARTED

## SEAT BELT SYSTEMS

### Lap/Shoulder Belts

All seating positions in your vehicle are equipped with lap/shoulder belts.

Be sure everyone in your vehicle is in a seat and using a seat belt properly.

Position the lap belt so that it is snug and lies low across your hips, below your abdomen. To remove slack in the lap belt portion, pull up on the shoulder belt. To loosen the lap belt if it is too tight, tilt the latch plate and pull on the lap belt. A snug seat belt reduces the risk of sliding under the seat belt in a collision.

Position the shoulder belt across the shoulder and chest with minimal, if any slack so that it is comfortable and not resting on your neck. The retractor will withdraw any slack in the shoulder belt.

### Seat Belt Pretensioner

The front seat belt system is equipped with pretensioning devices that are designed to remove slack from the seat belt in the event of a collision.

A deployed pretensioner or a deployed air bag must be replaced immediately.

### WARNING!

- In a collision, you and your passengers can suffer much greater injuries if you are not properly buckled up. You can strike the interior of your vehicle or other passengers, or you can be thrown out of the vehicle. Always be sure you and others in your vehicle are buckled up properly.
- A shoulder belt placed behind you will not protect you from injury during a collision. You are more likely to hit your head in a collision if you do not wear your shoulder belt. The lap and shoulder belt are meant to be used together.
- A seat belt that is too loose will not protect you properly. In a sudden stop, you could move too far forward, increasing the possibility of injury. Wear your seat belt snugly.
- A frayed or torn seat belt could rip apart in a collision and leave you with no protection. Inspect the seat belt system periodically, checking for cuts, frays, or loose parts. Damaged parts must be replaced immediately. Do not disassemble or modify the system. Seat belt assemblies must be replaced after a collision.



# GETTING STARTED

## SUPPLEMENTAL RESTRAINT SYSTEM (SRS) – AIR BAGS

### Air Bag System Components

Your vehicle may be equipped with the following air bag system components:

- Occupant Restraint Controller (ORC)
- Air Bag Warning Light 
- Steering Wheel and Column
- Instrument Panel
- Knee Impact Bolsters
- Advanced Front Air Bags
- Supplemental Side Air Bags
- Supplemental Knee Air Bags
- Front and Side Impact Sensors
- Seat Belt Pretensioners
- Seat Belt Buckle Switch
- Seat Track Position Sensors
- Occupant Classification System

### Advanced Front Air Bags

This vehicle has Advanced Front Air Bags for both the driver and front passenger as a supplement to the seat belt restraint systems. The Advanced Front Air Bags will not deploy in every type of collision.

Advanced Front Air Bags are designed to provide additional protection by supplementing the seat belts. Advanced Front Air Bags are not expected to reduce the risk of injury in rear, side, or rollover collisions.

The Advanced Front Air Bags will not deploy in all frontal collisions, including some that may produce substantial vehicle damage — for example, some pole collisions, truck underrides, and angle offset collisions.

On the other hand, depending on the type and location of impact, Advanced Front Air Bags may deploy in crashes with little vehicle front-end damage but that produce a severe initial deceleration.

Because air bag sensors measure vehicle deceleration over time, vehicle speed and damage by themselves are not good indicators of whether or not an air bag should have deployed.

Seat belts are necessary for your protection in all collisions, and also are needed to help keep you in position, away from an inflating air bag.

After any collision, the vehicle should be taken to an authorized dealer immediately.

# GETTING STARTED

Do not drive your vehicle after the air bags have deployed. If you are involved in another collision, the air bags will not be in place to protect you.

If it is necessary to modify the air bag system for persons with disabilities, contact your authorized dealer.

Refer to the Owner's Manual on the DVD for further details regarding the Supplemental Restraint System (SRS).

## Occupant Classification System

This vehicle is equipped with a right front passenger Occupant Classification System ("OCS") that is designed to provide Passenger Advanced Front Air Bag output appropriate to the occupant's seated weight input, as determined by the OCS.

The Occupant Classification System (OCS) consists of the following:

- Occupant Restraint Controller (ORC)
- Occupant Classification Module (OCM) and Sensor located in the front passenger seat
- Air Bag Warning Light

The OCS will NOT prevent deployment of the Passenger Advanced Front Air Bag. The OCS may reduce the inflation rate of the Passenger Advanced Front Air Bag if the OCS estimates that:

- The front passenger seat is unoccupied or has very light objects on it; or
- The front passenger seat is occupied by a small passenger, including a child; or
- The front passenger seat is occupied by a rear-facing child restraint; or
- The front passenger is not properly seated or his or her weight is taken off of the seat for a period of time.

Front Passenger Seat Occupant Status	Front Passenger Air Bag Output
Rear-facing child restraint	Reduced-power deployment
Child, including a child in a forward-facing child restraint or booster seat*	Full-power deployment OR reduced-power deployment
Properly seated adult	Full-power deployment OR reduced-power deployment
Unoccupied seat	Reduced-power deployment

\* It is possible for a child to be classified as an adult, allowing a full-power Passenger Advanced Front Air Bag deployment. Never allow children to ride in the front passenger seat and never install a child restraint system, including a rear-facing child restraint, in the front passenger seat.

# GETTING STARTED

The OCS determines the front passenger's most probable classification.

The OCS estimates the seated weight on the front passenger seat and where that weight is located. The OCS communicates the classification status to the ORC. The ORC uses the classification to determine whether the Passenger Advanced Front Air Bag inflation rate should be adjusted. In order for the OCS to operate as designed, it is important for the front passenger to be seated properly and properly wearing the seat belt. Properly seated passengers are:

- Sitting upright
- Facing forward
- Sitting in the center of the seat with their feet comfortably on or near the floor
- Sitting with their back against the seatback and the seatback in an upright position

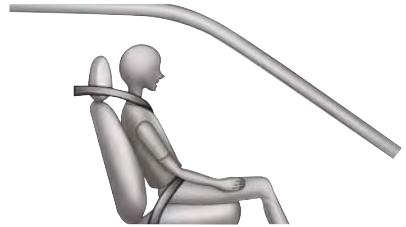

**Seated Properly**

## **Lighter Weight Passengers (Including Small Adults)**

When a lighter weight passenger, including a small adult, occupies the front passenger seat, the OCS may reduce the inflation rate of the Passenger Advanced Front Air Bag. This does not mean that the OCS is working improperly.

### **Do not decrease OR increase the front passenger's seated weight on the front passenger seat**

The front passenger's seated weight must be properly positioned on the front passenger seat. Failure to do so may result in serious injury or death. The OCS determines the most probable classification of the occupant that it detects. The OCS will detect the front passenger's decreased or increased seated weight, which may result in an adjusted inflation rate of the Passenger Advanced Front Air Bag in a collision. This does not mean that the OCS is working improperly. Decreasing the front passenger's seated weight on the front passenger seat may result in a reduced-power deployment of the Passenger Advanced Front Air Bag. Increasing the front passenger's seated weight on the front passenger seat may result in a full-power deployment of the Passenger Advanced Front Air Bag. Examples of improper front passenger seating include:

- The front passenger's weight is transferred to another part of the vehicle (like the door, arm rest or instrument panel).

# GETTING STARTED

- The front passenger leans forward, sideways, or turns to face the rear of the vehicle.
- The front passenger's seatback is not in the full upright position.
- The front passenger carries or holds an object while seated (e.g., backpack, box, etc.).
- Objects are lodged under the front passenger seat.
- Objects are lodged between the front passenger seat and center console.
- Accessories that may change the seated weight on the front passenger seat are attached to the front passenger seat.
- Anything that may decrease or increase the front passenger's seated weight.

The OCS determines the front passenger's most probable classification. If an occupant in the front passenger seat is seated improperly, the occupant may provide an output signal to the OCS that is different from the occupant's properly seated weight input, for example:

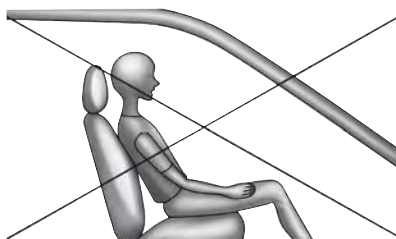

**Not Seated Properly**

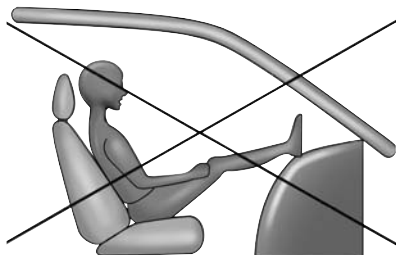

**Not Seated Properly**

# GETTING STARTED

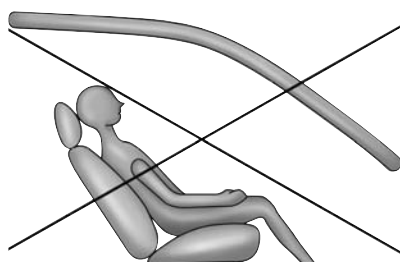

**Not Seated Properly**

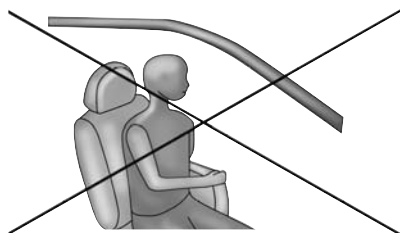

**Not Seated Properly**

The Air Bag Warning Light in the instrument panel  will turn on whenever the OCS is unable to classify the front passenger seat status. A malfunction in the OCS may affect the operation of the air bag system.

If the Air Bag Warning Light  does not come on, or stays on after you start the vehicle, or it comes on as you drive, take the vehicle to an authorized dealer for service immediately.

The passenger seat assembly contains critical OCS components that may affect the Passenger Advanced Front Air Bag inflation. In order for the OCS to properly classify the seated weight of a front seat passenger, the OCS components must function as designed.

Do not make any modifications to the front passenger seat components, assembly, or to the seat cover. If the seat, trim cover, or cushion needs service for any reason, take the vehicle to your authorized dealer. Only FCA US LLC approved seat accessories may be used.

The following requirements must be strictly followed:

- Do not modify the front passenger seat assembly or components in any way.
- Do not use prior or future model year seat covers or cushions not designated by FCA US LLC for the specific model being repaired. Always use the correct seat cover and cushion specified for the vehicle.

# GETTING STARTED

- Do not replace the seat cover or cushion with an aftermarket seat cover or cushion.
- Do not add a secondary seat cover or mat.
- At no time should any Supplemental Restraint System (SRS) component or SRS related component or fastener be modified or replaced with any part except those which are approved by FCA US LLC.

## Supplemental Knee Air Bags

This vehicle is equipped with a Supplemental Driver Knee Air Bag mounted in the instrument panel below the steering column and a Supplemental Passenger Knee Air Bag mounted in the instrument panel below the glove compartment. The Supplemental Knee Air Bags provide enhanced protection during a frontal impact by working together with the seat belts, pretensioners, and Advanced Front Air Bags.

### WARNING!

- Relying on the air bags alone could lead to more severe injuries in a collision. The air bags work with your seat belt to restrain you properly. In some collisions, the air bags won't deploy at all. Always wear your seat belts even though you have air bags.
- Being too close to the steering wheel or instrument panel during Advanced Front Air Bag deployment could cause serious injury, including death. Air bags need room to inflate. Sit back, comfortably extending your arms to reach the steering wheel or instrument panel.
- No objects should be placed over or near the air bag on the instrument panel or steering wheel because any such objects could cause harm if the vehicle is in a collision severe enough to cause the air bag to inflate.

### WARNING!

- Relying on the air bags alone could lead to more severe injuries in a collision. The air bags work with your seat belt to restrain you properly. In some collisions, the air bags won't deploy at all. Always wear your seat belts even though you have air bags.
- Being too close to the steering wheel or instrument panel during Advanced Front Air Bag deployment could cause serious injury, including death. Air bags need room to inflate. Sit back, comfortably extending your arms to reach the steering wheel or instrument panel.
- No objects should be placed over or near the air bag on the instrument panel or steering wheel because any such objects could cause harm if the vehicle is in a collision severe enough to cause the air bag to inflate.

# GETTING STARTED

## Supplemental Side Air Bags

- This vehicle is equipped with Supplemental Seat-Mounted Side Air Bags (SABs) located in the outboard side of the front and rear (in vehicles equipped with outboard rear seat SABs) seats. The SABs are marked with a SRS AIRBAG or AIRBAG label sewn into the outboard side of the seats.
- This vehicle is equipped with Supplemental Side Air Bag Inflatable Curtains (SABICs) located above the side windows. The trim covering the SABICs is labeled SRS AIRBAG or AIRBAG. The SABICs may help reduce the risk of partial or complete ejection of vehicle occupants through side windows in certain side impact events.
- The SABICs and SABs (“Side Air Bags”) are designed to activate in certain side impacts and certain rollover events. The Occupant Restraint Controller (“ORC”) determines whether the deployment of the Side Air Bags in a particular side impact or rollover event is appropriate, based on the severity and type of collision. Vehicle damage by itself is not a good indicator of whether or not Side Air Bags should have deployed.

### **WARNING!**

- Side Air Bags need room to inflate. Do not lean against the door or window. Sit upright in the center of the seat.
- Being too close to the Side Air Bags during deployment could cause you to be severely injured or killed.
- Relying on the Side Air Bags alone could lead to more severe injuries in a collision. The Side Air Bags work with your seat belt to restrain you properly. In some collisions, Side Air Bags won't deploy at all. Always wear your seat belt even though you have Side Air Bags.
- This vehicle is equipped with left and right Supplemental Side Air Bag Inflatable Curtains (SABICs). Do not stack luggage or other cargo up high enough to block the deployment of the SABICs. The trim covering above the side windows where the SABIC and its deployment path are located should remain free from any obstructions.
- This vehicle is equipped with SABICs. In order for the SABICs to work as intended, do not install any accessory items in your vehicle which could alter the roof. Do not add an aftermarket sunroof to your vehicle. Do not add roof racks that require permanent attachments (bolts or screws) for installation on the vehicle roof. Do not drill into the roof of the vehicle for any reason.
- Do not use accessory seat covers or place objects between you and the Side Air Bags; the performance could be adversely affected and/or objects could be pushed into you, causing serious injury.

# GETTING STARTED

## Enhanced Accident Response System

In the event of an impact, if the communication network remains intact, and the power remains intact, depending on the nature of the event, the ORC will determine whether to have the Enhanced Accident Response System perform the following functions:

- Cut off fuel to the engine.
- Flash hazard lights as long as the battery has power or until the hazard light button is pushed. The hazard lights can be deactivated by pushing the hazard light button.
- Turn on the interior lights, which remain on as long as the battery has power.
- Unlock the power door locks.

## Enhanced Accident Response System Reset Procedure

In order to reset the Enhanced Accident Response System functions after an event, the ignition switch must be changed from ignition START or ON/RUN to ignition OFF. Carefully check the vehicle for fuel leaks in the engine compartment and on the ground near the engine compartment and fuel tank before resetting the system and starting the engine.

## Air Bag Warning Light

The air bags must be ready to inflate for your protection in a collision. The Occupant Restraint Controller (ORC) monitors the internal circuits and interconnecting wiring associated with air bag system electrical components.

The ORC monitors the readiness of the electronic parts of the air bag system whenever the ignition switch is in the START or ON/RUN position. If the ignition switch is in the OFF position or in the ACC position, the air bag system is not on and the air bags will not inflate.

The ORC turns on the Air Bag Warning Light in the instrument panel for approximately four to eight seconds for a self-check when the ignition switch is first turned to the ON/RUN position. After the self-check, the Air Bag Warning Light will turn off. If the ORC detects a malfunction in any part of the system, it turns on the Air Bag Warning Light, either momentarily or continuously. A single chime will sound to alert you if the light comes on again after initial startup.



# GETTING STARTED

If the Air Bag Warning Light in the instrument panel is not on during the four to eight seconds when the ignition switch is first turned to the ON/RUN position, stays on, or turns on while driving, have the vehicle serviced by an authorized service center immediately.

**NOTE:**

If the speedometer, tachometer, or any engine related gauges are not working, the Occupant Restraint Controller (ORC) may also be disabled. In this condition the air bags may not be ready to inflate for your protection. Have an authorized dealer service the air bag system immediately.

## Event Data Recorder (EDR)

This vehicle is equipped with an event data recorder (EDR). The main purpose of an EDR is to record, in certain crash or near crash-like situations, such as an air bag deployment or hitting a road obstacle, data that will assist in understanding how a vehicle's systems performed. The EDR is designed to record data related to vehicle dynamics and safety systems for a short period of time, typically 30 seconds or less. The EDR in this vehicle is designed to record such data as:

- How various systems in your vehicle were operating;
- Whether or not the driver and passenger safety belts were buckled/fastened;
- How far (if at all) the driver was depressing the accelerator and/or brake pedal; and,
- How fast the vehicle was traveling.

These data can help provide a better understanding of the circumstances in which crashes and injuries occur.

**NOTE:**

EDR data are recorded by your vehicle only if a non-trivial crash situation occurs; no data are recorded by the EDR under normal driving conditions and no personal data (e.g., name, gender, age, and crash location) are recorded. However, other parties, such as law enforcement, could combine the EDR data with the type of personally identifying data routinely acquired during a crash investigation.

To read data recorded by an EDR, special equipment is required, and access to the vehicle or the EDR is needed. In addition to the vehicle manufacturer, other parties, such as law enforcement, that have the special equipment, can read the information if they have access to the vehicle or the EDR.

# GETTING STARTED

## CHILD RESTRAINTS

Children 12 years or younger should ride properly buckled up in a rear seat, if available. According to crash statistics, children are safer when properly restrained in the rear seats rather than in the front.

Every state in the United States and all Canadian provinces require that small children ride in proper restraint systems. This is the law, and you can be prosecuted for ignoring it.

### NOTE:

- For additional information, refer to [www.Seatcheck.org](http://www.Seatcheck.org) or call: 1-866-732-8243
- Canadian residents should refer to Transport Canada's website for additional information: <http://www.tc.gc.ca/eng/motorvehiclesafety/safedrivers-childsafety-index-53.htm>

### LATCH – Lower Anchors And Tethers For Children

Your vehicle is equipped with the child restraint anchorage system called LATCH, which stands for Lower Anchors and Tethers for Children.

All rear seating positions have lower anchors and top tether anchors.

### LATCH System Weight Limit

You may use the LATCH anchorage system until the combined weight of the child and the child restraint is 65 lbs (29.5 kg). Use the seat belt and tether anchor instead of the LATCH system once the combined weight is more than 65 lbs (29.5 kg).

# GETTING STARTED

## Locating LATCH Anchorages

The lower anchorages are round bars that are found at the rear of the seat cushion where it meets the seatback. They are just visible when you lean into the rear seat to install the child restraint. You will easily feel them if you run your finger along the gap between the seatback and seat cushion.



Lower Anchors

## Locating Tether Anchorages

In addition, there are tether strap anchorages  behind each rear seating position located on the back of the seat.

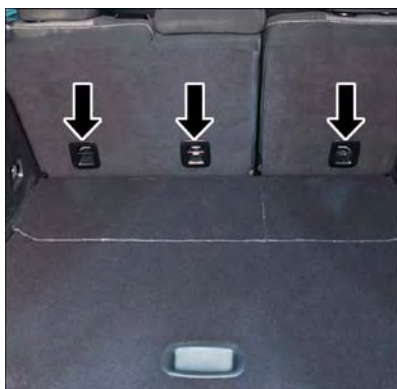

Tether Anchors

# GETTING STARTED

## Center Seat LATCH

The center seating position in this vehicle has a single dedicated anchorage. Use anchorages 3 and 4 to install a child seat in the center position. Do not use anchorages 2 and 3 to install a child seat. If you are installing three child restraints, you must use the seatbelt to install the center child restraint and you must use the LATCH anchors for the outboard position on the left side. You can use either the LATCH anchors or the vehicle's seat belt for installing the child seat in the outboard position on the right side. See the vehicle owner's manual for more information about center LATCH.



Lower Child Seat Anchors

## Installing The Child Restraint Using The LATCH Lower Anchors

### NOTE:

Never “share” a LATCH anchorage with two or more child restraints.

1. Loosen the adjusters on the lower straps and on the tether strap of the child seat so that you can more easily attach the hooks or connectors to the vehicle anchorages.
2. Attach the lower hooks or connectors of the child restraint to the lower anchorages in the selected seating position.
3. If the child restraint has a tether strap, connect it to the top tether anchorage. See below for directions to attach a tether anchor.
4. Tighten all of the straps as you push the child restraint rearward and downward into the seat. Remove slack in the straps according to the child restraint manufacturer's instructions.
5. Test that the child restraint is installed tightly by pulling back and forth on the child seat at the belt path. It should not move more than 1 inch (25.4 mm) in any direction.

# GETTING STARTED

## **Installing The Child Restraint Using The Vehicle Seat Belts**

The seat belts in the passenger seating positions are equipped with a Switchable Automatic Locking Retractor (ALR) that is designed to keep the lap portion of the seat belt tight around the child restraint. Any seat belt system will loosen with time, so check the belt occasionally, and pull it tight if necessary.

### **Tether Anchorage Weight Limit**

Always use the tether anchor when using the seat belt to install a forward facing child restraint, up to the recommended weight limit of the child restraint.

### **To Install A Child Seat Using An ALR**

1. Pull enough of the seat belt webbing from the retractor to pass it through the belt path of the child restraint. Do not twist the belt webbing in the belt path.
2. Slide the latch plate into the buckle until you hear a “click.”
3. Pull on the webbing to make the lap portion tight against the child seat.
4. To lock the seat belt, pull down on the shoulder part of the belt until you have pulled all the seat belt webbing out of the retractor. Then, allow the webbing to retract back into the retractor. As the webbing retracts, you will hear a clicking sound. This means the seat belt is now in the Automatic Locking mode.
5. Try to pull the webbing out of the retractor. If it is locked, you should not be able to pull out any webbing. If the retractor is not locked, repeat the last step.
6. Finally, pull up on any extra webbing to tighten the lap portion around the child restraint while you push the child restraint rearward and downward into the vehicle seat.
7. If the child restraint has a top tether strap and the seating position has a top tether anchorage, connect the tether strap to the anchorage and tighten the tether strap. See below for directions to attach a tether anchor.
8. Test that the child restraint is installed tightly by pulling back and forth on the child seat at the belt path. It should not move more than 1 inch (25.4 mm) in any direction.

## **Installing The Top Tether Strap (With Either Lower Anchors Or Vehicle Seat Belt)**

When installing a forward-facing child restraint, always secure the top tether strap, up to the tether anchor weight limit, whether the child restraint is installed with the lower anchors or the vehicle seat belt.

### **Tether Strap Installation**

1. Route the tether strap to provide the most direct path for the strap between the anchor and the child seat.

# GETTING STARTED

2. If your vehicle is equipped with adjustable rear head restraints, raise the head restraint, and where possible, route the tether strap under the head restraint and between the two posts. If not possible, lower the head restraint and pass the tether strap around the outboard side of the head restraint.
3. Attach the tether strap hook of the child restraint to the top tether anchorage and remove slack in the tether strap according to the child restraint manufacturer's instructions.



**Tether Anchorage Locations**

## **WARNING!**

- In a collision, an unrestrained child, even a tiny baby, can become a projectile inside the vehicle. The force required to hold even an infant on your lap could become so great that you could not hold the child, no matter how strong you are. The child and others could be severely injured or killed. Any child riding in your vehicle should be in a proper restraint for the child's size.
- Never place a rear-facing child restraint in front of an air bag. A deploying Passenger Advanced Front Air Bag can cause death or serious injury to a child 12 years or younger, including a child in a rear-facing child restraint.
- Only use a rear-facing child restraint in a vehicle with a rear seat.
- Improper installation of a child restraint to the LATCH anchorages can lead to failure of an infant or child restraint. The child could be severely injured or killed. Follow the manufacturer's directions exactly when installing an infant or child restraint.
- An incorrectly anchored tether strap could lead to increased head motion and possible injury to the child. Use only the anchor positions directly behind the child seat to secure a child restraint top tether strap.
- If your vehicle is equipped with a split rear seat, make sure the tether strap does not slip into the opening between the seatbacks as you remove slack in the strap.

# GETTING STARTED

## HEAD RESTRAINTS

Head restraints are designed to reduce the risk of injury by restricting head movement in the event of a rear impact. Head restraints should be adjusted so that the top of the head restraint is located above the top of your ear.

### WARNING!

The head restraints for all occupants must be properly adjusted prior to operating the vehicle or occupying a seat. Head restraints should never be adjusted while the vehicle is in motion. Driving a vehicle with the head restraints improperly adjusted or removed could cause serious injury or death in the event of a collision.

### NOTE:

Do not reverse the head restraints (making the rear of the head restraint face forward) in an attempt to gain additional clearance to the back of your head.

### Reactive Head Restraints – Front Seats

The front driver and passenger seats are equipped with Reactive Head Restraints (RHR). In the event of a rear impact the RHRs will automatically extend forward minimizing the gap between the back of the occupant's head and the RHR.

The RHRs will automatically return to their normal position following a rear impact. If the RHRs do not return to their normal position see your authorized dealer immediately.

To raise the head restraint, pull upward on the head restraint. To lower the head restraint, push the adjustment button, located at the base of the head restraint, and push downward on the head restraint.

### NOTE:

To remove the head restraint, raise it as far as it can go then push the release button and the adjustment button at the base of each post while pulling the head restraint up. Seatback angle may need to be adjusted to fully remove the head restraint. To reinstall the head restraint, put the head restraint posts into the holes and push downward. Then adjust the head restraint to the appropriate height.

# GETTING STARTED

## WARNING!

- A loose head restraint thrown forward in a collision or hard stop could cause serious injury or death to occupants of the vehicle. Always securely stow removed head restraints in a location outside the occupant compartment.
- ALL the head restraints MUST be reinstalled in the vehicle to properly protect the occupants. Follow the re-installation instructions above prior to operating the vehicle or occupying a seat.
- Do not place items over the top of the Reactive Head Restraint, such as coats, seat covers or portable DVD players. These items may interfere with the operation of the Reactive Head Restraint in the event of a collision and could result in serious injury or death.

## Rear Head Restraints

The rear outboard head restraints have three positions Up, Mid and Down. The center head restraint has only two positions, Up and Down. When the center seat is being occupied the head restraint should be in the raised position. When there is no occupant in the center seat the head restraint can be lowered for maximum visibility for the driver.

To raise the head restraint, pull upward on the head restraint. To lower the head restraint, push the adjustment button, located at the base of the head restraint, and push downward on the head restraint.

### NOTE:

To remove the head restraint, raise it as far as it can go then push the release button and the adjustment button at the base of each post while pulling the head restraint up. To reinstall the head restraint, put the head restraint posts into the holes and push downward. Then adjust the head restraint to the appropriate height.

## WARNING!

ALL the head restraints MUST be reinstalled in the vehicle to properly protect the occupants. Follow the re-installation instructions above prior to operating the vehicle or occupying a seat.



# GETTING STARTED

## FRONT SEATS

### Power Seats — If Equipped

Some models may be equipped with a power driver's seat. The power seat switch is located on the outboard side of the seat near the floor. Use the switch to move the seat up, down, forward or rearward.



**Power Seat Switches**

- 1 — Power Seat Switch
- 2 — Recline Switch
- 3 — Power Lumbar Switch

### Reclining The Seatback Forward Or Rearward

The seatback can be reclined both forward and rearward. Push the seat recliner switch forward or rearward. The seatback will move in the direction of the switch. Release the switch when the desired position has been reached.

#### **WARNING!**

Do not ride with the seatback reclined so that the shoulder belt is no longer resting against your chest. In a collision you could slide under the seat belt, which could result in serious injury or death.

### Power Lumbar — If Equipped

Vehicles equipped with power driver or passenger seats may be equipped with power lumbar. The power lumbar switch is located on the outboard side of the power seat. Push the switch forward or rearward to increase or decrease the lumbar support. Push the switch upward or downward to raise or lower the lumbar support.

# GETTING STARTED

## Memory Seat

The memory seat feature allows you to save two different driver seating positions, driver's outside mirror, and radio station preset settings. The memory seat buttons are located on the driver's door panel.



Memory Seat Buttons

### To set a memory position:

1. Cycle the vehicles ignition to the ON position.
2. Adjust all memory profile settings.
3. Push and release the S (SET) button.
4. Push and release the 1 or 2 button within five seconds.

### NOTE:

Before programming your RKE transmitters you must select the “Memory Linked To Fob” feature through the Uconnect system. Refer to “Uconnect Settings” in “Understanding Your Instrument Panel” in the Owner’s Manual on the DVD for further details.

### To program a Key Fob to the memory position:

1. Cycle the vehicles ignition to the OFF position.
2. Select the desired memory profile 1 or 2.
3. Push and release the S (SET) button on the memory switch, then within five seconds push and release the 1 or 2 button accordingly.
4. Push and release the LOCK button on the RKE transmitter within 10 seconds.

To recall the saved positions, push 1 or 2 on the memory switch or push UNLOCK on the programmed RKE transmitter.

# GETTING STARTED

## Easy Entry/Exit Feature

The memory seat has an Easy Entry/Exit feature. This feature provides automatic driver seat positioning to enhance driver mobility when entering and exiting the vehicle.

### NOTE:

The Easy Entry/Exit feature is not enabled when the vehicle is delivered from the factory. To enable (or later disable) this feature you must select “Easy Exit Seats” in “Engine Off Options” through the programmable features in the Uconnect system. Refer to “Uconnect Customer Programmable Features” in “Electronics” of this User Guide.

For further details refer to “Uconnect Settings” in “Understanding Your Instrument Panel” in the Owner’s Manual on the DVD.

## Manual Seat Adjustments

### Manual Front Seat Forward/Rearward Adjustment

On models equipped with manual seats, the adjusting bar is located at the front of the seats, near the floor.

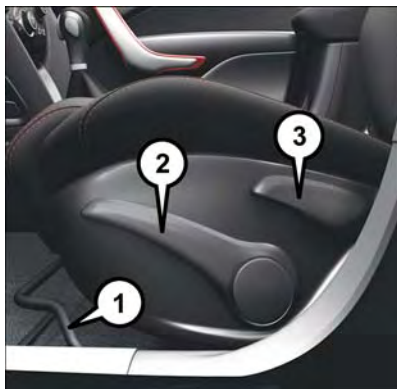

**Manual Seat Adjustment**

- 1 — Forward/Rearward Adjusting Bar
- 2 — Height Adjustment
- 3 — Recliner Lever

While sitting in the seat, lift up on the bar and move the seat forward or rearward. Release the bar once you have reached the desired position. Then, using body pressure, move forward and rearward on the seat to be sure that the seat adjusters have latched.

# GETTING STARTED

## **WARNING!**

- Adjusting a seat while driving may be dangerous. Moving a seat while driving could result in loss of control which could cause a collision and serious injury or death.
- Seats should be adjusted before fastening the seat belts and while the vehicle is parked. Serious injury or death could result from a poorly adjusted seat belt.

### **Manual Front Seat Recline Adjustment**

To adjust the seatback, lift the lever located on the outboard side of the seat, lean back to the desired position and release the lever. To return the seatback, lift the lever, lean forward and release the lever.

## **WARNING!**

Do not ride with the seatback reclined so that the shoulder belt is no longer resting against your chest. In a collision you could slide under the seat belt, which could result in serious injury or death.

### **Manual Seat Height Adjustment — If Equipped**

The driver's seat height can be raised or lowered by using a lever, located on the outboard side of the seat. Pull upward on the lever to raise the seat height or push downward on the lever to lower the seat height.

# GETTING STARTED

## REAR SEATS

### 60/40 Split Folding Rear Seat With Fold-Flat Feature

To provide additional storage area, each rear seat can be folded flat. This allows for extended cargo space and still maintains some rear seating room.



60/40 Rear Seat

- 1 — Lift Lever To Fold
- 2 — Pull Strap To Recline
- 3 — Lift Bar To Adjust Forward/  
Rearward

#### NOTE:

Prior to folding the rear seat, it may be necessary to position the front seat to its mid-track position. Also, be sure that the front seats are fully upright and positioned forward. This will allow the rear seat to fold down easily.

#### WARNING!

- It is extremely dangerous to ride in a cargo area, inside or outside of a vehicle. In a collision, people riding in these areas are more likely to be seriously injured or killed.
- Do not allow people to ride in any area of your vehicle that is not equipped with seats and seat belts.
- Be sure everyone in your vehicle is in a seat and using a seat belt properly.

# GETTING STARTED

## Rear Seat Forward/Rearward Adjustment — If Equipped

Lift up on the adjusting bar located at the front of the seat near the floor and release it when the seat is at the desired position. Then, using body pressure, move forward and rearward on the seat to be sure that the seat adjusters have latched.

## To Lower The Rear Seat

1. Lift the seatback release lever located on the upper outer edge of the seat or pull the pull strap located on the middle outer edge of the seat.
2. Fold the rear seatback completely forward.

### NOTE:

You may experience deformation in the seat cushion from the seat belt buckles if the seats are left folded for an extended period of time. This is normal and by simply opening the seats to the open position, over time the seat cushion will return to its normal shape.

## To Raise The Rear Seat

### NOTE:

If interference from the cargo area prevents the seatback from fully locking, you will have difficulty returning the seat to its proper position.

Raise the seatback and lock it into place.

### WARNING!

Be certain that the seatback is securely locked into position. If the seatback is not securely locked into position the seat will not provide the proper stability for child seats and/or passengers. An improperly latched seat could cause serious injury.

## Recliner Adjustment

The rear seatback also reclines for additional passenger comfort. Pull on the pull strap while sitting in the rear seat to recline the seatback.

### WARNING!



Do not ride with the seatback reclined so that the shoulder belt is no longer resting against your chest. In a collision you could slide under the seat belt, which could result in serious injury or death.

# GETTING STARTED

## HEATED/VENTILATED SEATS

### Front Heated Seats

If your vehicle is equipped with front heated seats, the control buttons are located within the Uconnect system. You can gain access to the control buttons through the climate screen or the controls screen.

- Press the heated seat button  once to turn the HI setting ON.
- Press the heated seat button  a second time to turn the LO setting ON.
- Press the heated seat button  a third time to turn the heating elements OFF.

If the HI-level setting is selected, the system will automatically switch to LO-level after approximately 60 minutes of continuous operation. At that time, the display will change from HI to LO, indicating the change. The LO-level setting will turn OFF automatically after approximately 45 minutes.

#### NOTE:

The engine must be running for the heated seats to operate.

### Vehicles Equipped With Remote Start

On models that are equipped with remote start, the heated seats can be programmed to come on during a remote start.

This feature can be programmed through the Uconnect system. Refer to “Uconnect Settings” in “Understanding Your Instrument Panel” in the Owner’s Manual on the DVD for further information.

### WARNING!



- Persons who are unable to feel pain to the skin because of advanced age, chronic illness, diabetes, spinal cord injury, medication, alcohol use, exhaustion or other physical condition must exercise care when using the seat heater. It may cause burns even at low temperatures, especially if used for long periods of time.
- Do not place anything on the seat or seatback that insulates against heat, such as a blanket or cushion. This may cause the seat heater to overheat. Sitting in a seat that has been overheated could cause serious burns due to the increased surface temperature of the seat.

# GETTING STARTED

## Front Ventilated Seats

If your vehicle is equipped with ventilated seats, the seat cushion and seat back will have fans that draw the air from the passenger compartment and move air through fine perforations in the seat cover to help keep the driver and front passenger cooler in higher ambient temperatures. The fans operate at two speeds, HI and LO.

The front ventilated seats control buttons are located within the Uconnect system. You can gain access to the control buttons through the climate screen or the controls screen.

- Press the ventilated seat button  once to choose HI.
- Press the ventilated seat button  a second time to choose LO.
- Press the ventilated seat button  a third time to turn the ventilated seat OFF.

### NOTE:

The engine must be running for the ventilated seats to operate.

## Vehicles Equipped With Remote Start

On models that are equipped with remote start, the ventilated seats can be programmed to come on during a remote start.

This feature can be programmed through the Uconnect system. Refer to “Uconnect Settings” in “Understanding Your Instrument Panel” in the Owner’s Manual on the DVD.

## HEATED STEERING WHEEL

If your vehicle is equipped with a heated steering wheel, it contains a heating element that will keep your hands warm in cold weather. The heated steering wheel has only one temperature setting. Once the heated steering wheel has been turned on it can operate for up to 120 minutes before automatically shutting off. The heated steering wheel can shut off early or may not turn on when the steering wheel is already warm.

The heated steering wheel control button is located within the Uconnect system. You can gain access to the control button through the climate screen or the controls screen.

- Press the heated steering wheel button  once to turn the heating element ON.
- Press the heated steering wheel button  a second time to turn the heating element OFF.

### NOTE:

The engine must be running for the heated steering wheel to operate.



# GETTING STARTED

## Vehicles Equipped With Remote Start

On models that are equipped with remote start, the heated steering wheel can be programmed to come on during a remote start through the Uconnect system. Refer to “Uconnect Settings” in “Understanding Your Instrument Panel” in the Owner’s Manual on the DVD for further information.

### WARNING!

- Persons who are unable to feel pain to the skin because of advanced age, chronic illness, diabetes, spinal cord injury, medication, alcohol use, exhaustion, or other physical conditions must exercise care when using the steering wheel heater. It may cause burns even at low temperatures, especially if used for long periods.
- Do not place anything on the steering wheel that insulates against heat, such as a blanket or steering wheel covers of any type and material. This may cause the steering wheel heater to overheat.

## TILT/TELESCOPING STEERING COLUMN

This feature allows you to tilt the steering column upward or downward. It also allows you to lengthen or shorten the steering column. The tilt/telescoping lever is located below the steering wheel at the end of the steering column.

To unlock the steering column, push the control handle downward (toward the floor). To tilt the steering column, move the steering wheel upward or downward as desired. To lengthen or shorten the steering column, pull the steering wheel outward or push it inward as desired. To lock the steering column in position, push the control handle upward until fully engaged.



Tilt/Telescoping Lever

### WARNING!

Do not adjust the steering column while driving. Adjusting the steering column while driving or driving with the steering column unlocked, could cause the driver to lose control of the vehicle. Failure to follow this warning may result in serious injury or death.

# OPERATING YOUR VEHICLE

## ENGINE BREAK-IN RECOMMENDATIONS

A long break-in period is not required for the engine and drivetrain (transmission and axle) in your vehicle.

Drive moderately during the first 300 miles (500 km). After the initial 60 miles (100 km), speeds up to 50 or 55 mph (80 or 90 km/h) are desirable.

While cruising, brief full-throttle acceleration within the limits of local traffic laws contributes to a good break-in. Wide-open throttle acceleration in low gear can be detrimental and should be avoided.

The engine oil installed in the engine at the factory is a high-quality energy conserving type lubricant. Oil changes should be consistent with anticipated climate conditions under which vehicle operations will occur. Refer to "Maintenance Procedures" in "Maintaining Your Vehicle" in your Owner's Manual on the DVD for further details.

### **NOTE:**

A new engine may consume some oil during its first few thousand miles (kilometers) of operation. This should be considered a normal part of the break-in and not interpreted as an indication of an engine problem or malfunction.

<b>CAUTION!</b>
Never use Non-Detergent Oil or Straight Mineral Oil in the engine or damage may result.

# OPERATING YOUR VEHICLE

## TURN SIGNAL/HIGH BEAM LEVER

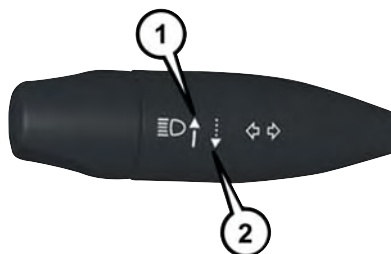

**Turn Signal/High Beam Lever**

- 1 — High Beam (Push Forward)
  - 2 — Flash To Pass (Pull Toward Driver)
- 

### **Turn Signals/Lane Change Assist**

Tap the lever up or down once and the turn signal (right or left) will flash three times and automatically turn off.

### **Flash To Pass**

Pull the lever toward you to activate the high beams. The high beams will remain on until the lever is released.

### **High Beam Operation**

Push the lever forward to activate the high beams.

### **NOTE:**

For safe driving, turn off the high beams when oncoming traffic is present to prevent headlight glare and as a courtesy to other motorists.

# OPERATING YOUR VEHICLE

## HEADLIGHT SWITCH

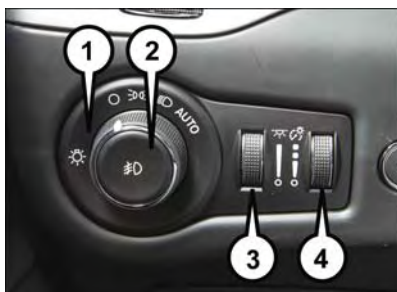



**Headlight Switch**

- 1 — Rotate Headlight
  - 2 — Push Fog
  - 3 — Ambient Light Dimmer
  - 4 — Instrument Panel Dimmer
- 

### **Automatic Headlights/Parking Lights/Headlights**

The headlight switch is located on the instrument panel to the left of the steering wheel.

- Rotate the headlight switch to the first detent  for parking lights and to the second detent  for headlights.
- With the parking lights or low beam headlights on, push in the center of the headlight switch once for fog lights.
- Rotate the headlight switch to the third detent AUTO for automatic headlights.

When set to AUTO, the system automatically turns the headlights on or off based on ambient light levels.

# OPERATING YOUR VEHICLE

## **Automatic High Beams**

The Automatic High Beams system provides increased forward lighting at night by automating high beam control through the use of a digital camera mounted above the inside rearview mirror. This camera detects vehicle specific light and automatically switches from high beams to low beams until the approaching vehicle is out of view. This feature is programmable through the Uconnect system. Refer to “Uconnect Settings” in “Understanding Your Instrument Panel” in the Owner’s Manual on the DVD for further details.

## **Instrument Panel Dimmer**

- Rotate the right dimmer control to the extreme bottom position to fully dim the instrument panel lights and prevent the interior lights from illuminating when a door is opened.
- Rotate the right dimmer control up to increase the brightness of the instrument panel when the parking lights or headlights are on.
- Rotate the right dimmer control up to the next detent position to fully brighten the odometer and radio when the parking lights or headlights are on.
- Rotate the right dimmer control up to the last detent position to turn on the interior lighting.
- If your vehicle is equipped with a touchscreen, the dimming is programmable through the Uconnect system. Refer to “Uconnect Settings” in “Understanding Your Instrument Panel” in the Owner’s Manual on the DVD for further details.

## **Ambient Light Dimmer**

- Rotate the left dimmer control upward or downward to increase or decrease the brightness of the ambient light located in the overhead console, door handle lights, under I/P lights, door map pocket lights, and cubby bin lights.
- Rotate the left dimmer control to the extreme bottom position to turn off the ambient lights.

# OPERATING YOUR VEHICLE

## WIPER/WASHER LEVER

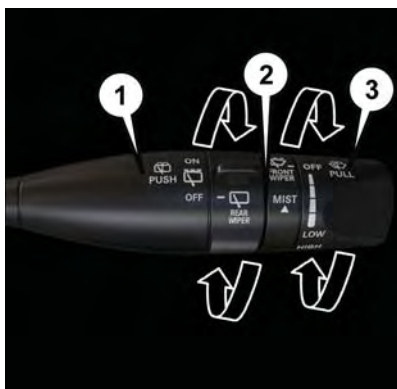

**Multifunction Lever**

- 1 — Rear Washer (Push Forward)
- 2 — Lift Up For Mist
- 3 — Front Washer (Pull Toward Driver)

### Front Wipers

#### Intermittent, Low And High Operation

- Rotate the end of the lever to one of the first four detent positions for intermittent settings, the fifth detent for low wiper operation and the sixth detent for high wiper operation.

#### Washer Operation

- Pull the lever rearward toward you and hold for as long as spray is desired.

#### Mist

- Push the lever upward to the Mist position and release for a single wiping cycle.

#### NOTE:

The mist feature does not activate the washer pump; therefore, no washer fluid will be sprayed on the windshield. The wash function must be activated in order to spray the windshield with washer fluid.

### Rain Sensing Wipers

This feature senses moisture on the vehicle's windshield and automatically activates the wipers for the driver when the switch is in the intermittent position.

# OPERATING YOUR VEHICLE

## Rear Wiper

### Rear Wiper Operation

- Rotate the center portion of the lever upward to the first detent for intermittent operation and to the second detent for continuous rear wiper operation.

### Rear Washer Operation

- Push the lever forward and hold while spray is desired.

## ELECTRONIC SPEED CONTROL

The Electronic Speed Control switches are located on the right side of the steering wheel.



**Electronic Speed Control Switches**

- 1 — Push Cancel
- 2 — Push Set+/Accel
- 3 — Push Resume
- 4 — Push On/Off
- 5 — Push Set-/Decel

## Cruise ON/OFF

- Push the ON/OFF button  to activate the Electronic Speed Control.

CRUISE CONTROL READY will appear in the Electronic Vehicle Information Center (EVIC) or Driver Information Display (DID) to indicate the Electronic Speed Control is on.

- Push the ON/OFF button  a second time to turn the system off.

CRUISE CONTROL OFF will appear in the Electronic Vehicle Information Center (EVIC) or Driver Information Display (DID) to indicate the Electronic Speed Control is off.

# OPERATING YOUR VEHICLE

## SET

- With the Electronic Speed Control on, push and release the SET+ or SET- button to set a desired speed.

Once a speed has been set, a message CRUISE CONTROL SET TO MPH/KM will appear indicating what speed was set. An indicator message, CRUISE will also appear and stay on in the Electronic Vehicle Information Center (EVIC) or Driver Information Display (DID) when the speed is set.

## Accel/Decel

### To Increase Speed

- When the Electronic Speed Control is set, you can increase speed by pushing the SET + button.

The drivers preferred units can be selected through the instrument panel settings if equipped. Refer to “Understanding Your Instrument Panel” in the Owner’s Manual on the DVD for more information. The speed increment shown is dependant on the speed of U.S. (mph) or Metric (km/h) units:

#### U.S. Speed (mph)

- Pushing the SET + button once will result in a 1 mph increase in set speed. Each subsequent tap of the button results in an increase of 1 mph.
- If the button is continually pushed, the set speed will continue to increase until the button is released, then the new set speed will be established.

#### Metric Speed (km/h)

- Pushing the SET + button once will result in a 1 km/h increase in set speed. Each subsequent tap of the button results in an increase of 1 km/h.
- If the button is continually pushed, the set speed will continue to increase until the button is released, then the new set speed will be established.

### To Decrease Speed

- When the Electronic Speed Control is set, you can decrease speed by pushing the SET - button.

The drivers preferred units can be selected through the instrument panel settings if equipped. Refer to “Understanding Your Instrument Panel” in the Owner’s Manual on the DVD for more information. The speed decrement shown is dependant on the speed of U.S. (mph) or Metric (km/h) units:

#### U.S. Speed (mph)

- Pushing the SET - button once will result in a 1 mph decrease in set speed. Each subsequent tap of the button results in a decrease of 1 mph.
- If the button is continually pushed, the set speed will continue to decrease until the button is released, then the new set speed will be established.



# OPERATING YOUR VEHICLE

## Metric Speed (km/h)

- Pushing the SET - button once will result in a 1 km/h decrease in set speed. Each subsequent tap of the button results in a decrease of 1 km/h.
- If the button is continually pushed, the set speed will continue to decrease until the button is released, then the new set speed will be established.

## Resume

To resume a previously selected set speed in memory, push the RES button and release.

## Cancel

- Push the CANCEL button, or apply the brakes to cancel the set speed and maintain the set speed memory.
- Push the ON/OFF button to turn the system off and erase the set speed memory.

### WARNING!

Leaving the Electronic Speed Control system on when not in use is dangerous. You could accidentally set the system or cause it to go faster than you want. You could lose control and have an accident. Always leave the system OFF when you are not using it.

## ADAPTIVE CRUISE CONTROL (ACC)

If your vehicle is equipped with Adaptive Cruise Control the controls operate exactly the same as the electronic speed control with only a couple of differences. With this option you can set a specified distance you would like to maintain between you and the vehicle in front of you.

If the ACC sensor detects a vehicle ahead, ACC will apply limited braking or acceleration automatically to maintain a preset following distance, while matching the speed of the vehicle ahead.

If the sensor does not detect a vehicle ahead of you, ACC will maintain a fixed set speed.



**Adaptive Cruise Switches**

- 1 — Adaptive Cruise Control (ACC) On/Off
- 2 — Distance Setting – Decrease
- 3 — Distance Setting – Increase

# OPERATING YOUR VEHICLE

## ACC ON/OFF

- Push and release the Adaptive Cruise Control (ACC) ON/OFF button.

ACC READY will appear in the Electronic Vehicle Information Center (EVIC) or Driver Information Display (DID) to indicate the ACC is on.

- Push and release the Adaptive Cruise Control (ACC) ON/OFF button a second time to turn the system off.

Adaptive Cruise Control (ACC) Off will appear in the Electronic Vehicle Information Center (EVIC) or Driver Information Display (DID) to indicate the ACC is off.

## To Vary The Speed Setting

### To Increase Speed

While ACC is set, you can increase the set speed by pushing the SET + button.

The drivers preferred units can be selected through the instrument panel settings if equipped. Refer to “Understanding Your Instrument Panel” in the Owner’s Manual on the DVD for more information. The speed increment shown is dependant on the speed of U.S. (mph) or Metric (km/h) units:

#### U.S. Speed (mph)

- Pushing the SET + button once will result in a 1 mph increase in set speed. Each subsequent tap of the button results in an increase of 1 mph.
- If the button is continually pushed, the set speed will continue to increase in 5 mph increments until the button is released. The increase in set speed is reflected in the EVIC/DID.

#### Metric Speed (km/h)

- Pushing the SET + button once will result in a 1 km/h increase in set speed. Each subsequent tap of the button results in an increase of 1 km/h.
- If the button is continually pushed, the set speed will continue to increase in 10 km/h increments until the button is released. The increase in set speed is reflected in the EVIC/DID.

### To Decrease Speed

While ACC is set, the set speed can be decreased by pushing the SET - button.

The drivers preferred units can be selected through the instrument panel settings if equipped. Refer to “Understanding Your Instrument Panel” in the Owner’s Manual on the DVD for more information. The speed increment shown is dependant on the speed of U.S. (mph) or Metric (km/h) units:

#### U.S. Speed (mph)

- Pushing the SET - button once will result in a 1 mph decrease in set speed. Each subsequent tap of the button results in a decrease of 1 mph.

# OPERATING YOUR VEHICLE

- If the button is continually pushed, the set speed will continue to decrease in 5 mph decrements until the button is released. The decrease in set speed is reflected in the EVIC/DID.

## Metric Speed (km/h)

- Pushing the SET - button once will result in a 1 km/h decrease in set speed. Each subsequent tap of the button results in a decrease of 1 km/h.
- If the button is continually pushed, the set speed will continue to decrease in 10 km/h decrements until the button is released. The decrease in set speed is reflected in the EVIC/DID.

## NOTE:

- When you override and push the SET + button or SET - buttons, the new Set Speed will be the current speed of the vehicle.
- When you use the SET - button to decelerate, if the engine's braking power does not slow the vehicle sufficiently to reach the set speed, the brake system will automatically slow the vehicle.
- The ACC system applies the brake down to a full stop when following a target vehicle. If an ACC host vehicle follows a target vehicle to a standstill, the host vehicle will release the vehicle brakes two seconds after coming to a full stop.
- The ACC system maintains set speed when driving up hill and down hill. However, a slight speed change on moderate hills is normal. In addition, downshifting may occur while climbing uphill or descending downhill. This is normal operation and necessary to maintain set speed. When driving up hill and down hill, the ACC system will cancel if the braking temperature exceeds normal range (overheated).

## Distance Setting (ACC Only)

The specified following distance for ACC can be set by varying the distance setting between four bars (longest), three bars (long), two bars (medium) and one bar (short). Using this distance setting and the vehicle speed, ACC calculates and sets the distance to the vehicle ahead. This distance setting displays in the EVIC/DID.

- To increase the distance setting, push the Distance Setting—Increase button and release. Each time the button is pushed, the distance setting increases by one bar (longer).
- To decrease the distance setting, push the Distance Setting—Decrease button and release. Each time the button is pushed, the distance setting decreases by one bar (shorter).

# OPERATING YOUR VEHICLE

## ACC Operation At Stop

If the ACC system brings your vehicle to a standstill while following a target vehicle, if the target vehicle starts moving within two seconds of your vehicle coming to a standstill, your vehicle will resume motion without the need for any driver action.

If the target vehicle does not start moving within two seconds of your vehicle coming to a standstill, the driver will either have to push the RES (resume) button, or apply the accelerator pedal to reengage the ACC to the existing Set Speed.

### **NOTE:**

After the ACC system holds your vehicle at a standstill for approximately three consecutive minutes, the parking brake will be activated, and the ACC system will be cancelled.

While the ACC system is holding your vehicle at a standstill, if the driver seatbelt is unbuckled or the driver door is opened, the parking brake will be activated, and the ACC system will be cancelled.

## Changing Modes (ACC Only)

If desired, the Adaptive Cruise Control mode can be turned off and the system can be operated as a normal (Fixed Speed) Speed Control mode. When in the normal (Fixed Speed) Speed Control mode the distance setting feature will be disabled and the system will maintain the speed you set.

- To change between the different cruise control modes, push the ADAPTIVE CRUISE CONTROL (ACC) ON/OFF button which turns the ACC and the normal (Fixed Speed) Speed Control OFF.
- Pushing the normal (Fixed Speed) SPEED CONTROL ON/OFF button will result in turning ON (changing to) the normal (Fixed Speed) Speed Control mode.

Refer to your Owner's Manual on the DVD for further information.

# OPERATING YOUR VEHICLE

## WARNING!

Adaptive Cruise Control (ACC) is a convenience system. It is not a substitute for active driving involvement. It is always the driver's responsibility to be attentive of road, traffic, and weather conditions, vehicle speed, distance to the vehicle ahead; and, most importantly, brake operation to ensure safe operation of the vehicle under all road conditions. Your complete attention is always required while driving to maintain safe control of your vehicle. Failure to follow these warnings can result in a collision and death or serious personal injury.

The ACC system:

- Does not react to pedestrians, oncoming vehicles, and stationary objects (e.g., a stopped vehicle in a traffic jam or a disabled vehicle).
- Cannot take street, traffic, and weather conditions into account, and may be limited upon adverse sight distance conditions.
- Does not always fully recognize complex driving conditions, which can result in wrong or missing distance warnings.
- Will bring the vehicle to a complete stop while following a target vehicle and hold the vehicle for approximately 3 minutes in the stop position. If the target vehicle does not start moving within 3 minutes the parking brake will be activated, and the ACC system will be cancelled.

You should switch off the ACC system:

- When driving in fog, heavy rain, heavy snow, sleet, heavy traffic, and complex driving situations (i.e., in highway construction zones).
- When entering a turn lane or highway off ramp; when driving on roads that are winding, icy, snow-covered, slippery, or have steep uphill or downhill slopes.
- When towing a trailer up or down steep slopes.
- When circumstances do not allow safe driving at a constant speed.

The Cruise Control system has two control modes:

- Adaptive Cruise Control mode for maintaining an appropriate distance between vehicles.
- Normal (fixed speed) electronic speed control mode for cruising at a constant preset speed. For additional information, refer to "Normal (Fixed Speed) Cruise Control Mode" section in the Owner's Manual on your DVD.

Normal (fixed speed) electronic speed control will not react to preceding vehicles. Always be aware of the mode selected.

You can change the mode by using the Cruise Control buttons. The two control modes function differently. Always confirm which mode is selected.

# OPERATING YOUR VEHICLE

## FORWARD COLLISION WARNING (FCW) WITH MITIGATION

The Forward Collision Warning (FCW) system with mitigation provides the driver with audible warnings, visual warnings (within the EVIC/DID), and may apply a brake jerk to warn the driver when it detects a potential frontal collision. The warnings and limited braking are intended to provide the driver with enough time to react, avoid or mitigate the potential collision.

- FCW monitors the information from the forward looking sensors as well as the Electronic Brake Controller (EBC), to calculate the probability of a forward collision. When the system determines that a forward collision is probable, the driver will be provided with audible and visual warnings and may provide a brake jerk warning.
- If the driver does not take action based upon these progressive warnings, then the system will provide a limited level of active braking to help slow the vehicle and mitigate the potential forward collision. If the driver reacts to the warnings by braking and the system determines that the driver intends to avoid the collision by braking but has not applied sufficient brake force, the system will compensate and provide additional brake force as required.

### Turning FCW ON Or OFF

#### NOTE:

The default status of FCW is “On,” this allows the system to warn you of a possible collision with the vehicle in front of you when you are farther away and it applies limited braking. This gives you the most reaction time to avoid a possible collision.

The forward collision button is on the switch panel that is located in the center of the instrument panel.

- To turn the FCW system OFF, push the forward collision button once (LED turns on).
- To turn the FCW system back ON, push the forward collision button again (LED turns off).

### Changing FCW Status

The FCW feature has two settings and can be changed within the Uconnect System Screen:

- Far
- Near

#### NOTE:

The FCW and active braking settings can only be changed when the vehicle is in PARK.

# OPERATING YOUR VEHICLE

## Far

The default status of FCW is the “Far” setting.

The far setting provides warnings for potential collisions more distant in front of the vehicle, allowing the driver to have the most reaction time to avoid a collision.

This setting is designed to provide early warnings per NHTSA (National Highway Traffic Safety Administration) recommendations.

More cautious drivers that do not mind frequent warnings may prefer this setting.

### **NOTE:**

This setting gives you the most reaction time.

## Near

Changing the FCW status to the “Near” setting, allows the system to warn you of a potential frontal collision when you are much closer.

This setting provides less reaction time than the “Far” setting, which allows for a more dynamic driving experience.

More dynamic or aggressive drivers that want to avoid frequent warnings may prefer this setting.

## Off

Changing the FCW status to “Off” prevents the system from warning you of a possible collision with the vehicle in front of you.

### **Turning Active Braking ON Or OFF**

The Active Braking feature has two settings and can be changed within the Uconnect System Screen:

- On
- Off

Changing the Active Braking status to “Off” prevents the system from providing limited autonomous braking, or additional brake support if the driver is not braking adequately in the event of a potential frontal collision.

### **NOTE:**

If FCW is set to “Off,” “FCW OFF” will be displayed in the EVIC/DID.

Refer to the Owner's Manual on the DVD for further details.

## **WARNING!**

Forward Collision Warning (FCW) is not intended to avoid a collision on its own, nor can FCW detect every type of potential collision. The driver has the responsibility to avoid a collision by controlling the vehicle via braking and steering. Failure to follow this warning could lead to serious injury or death.

# OPERATING YOUR VEHICLE

## MANUAL CLIMATE CONTROLS WITHOUT TOUCHSCREEN



**Manual Climate Controls Without Touchscreen**

- 1 — Blower Control Knob
- 2 — Air Recirculation Button
- 3 — Temperature Control Knob
- 4 — Rotate To MAX A/C

- 5 — A/C Button
- 6 — Mode Control Knob
- 7 — Rear Defroster Button

### Air Recirculation

- Use Recirculation for maximum A/C operation.
- For window defogging, turn the Recirculation button off.
- Recirculation is allowed in floor mode and defrost/floor (mix mode) for approximately five minutes.

### Heated Mirrors

The mirrors are heated to melt frost or ice. This feature is activated whenever you turn on the rear window defroster.



# OPERATING YOUR VEHICLE

## MANUAL CLIMATE CONTROLS WITH TOUCHSCREEN

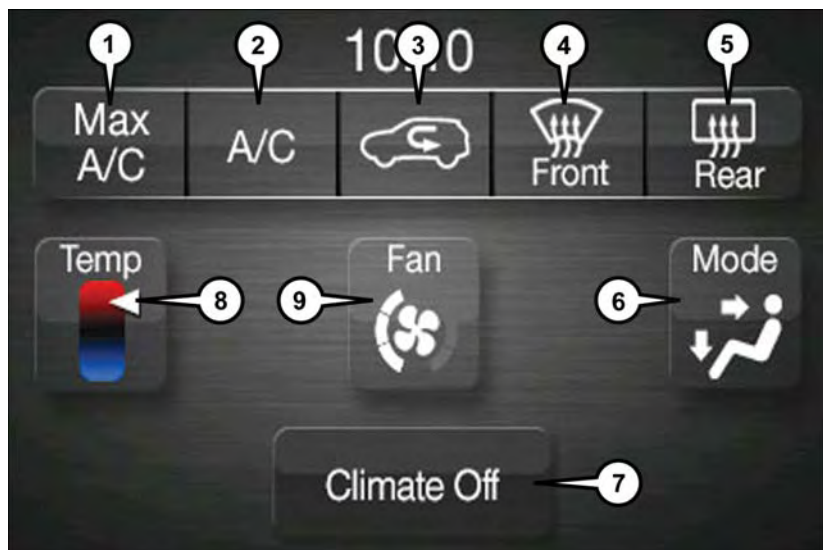

Uconnect 5.0 Touchscreen Manual Climate Controls

- |                              |                                |
|------------------------------|--------------------------------|
| 1 — MAX A/C Button           | 6 — Mode Control Button        |
| 2 — A/C Button               | 7 — OFF Button                 |
| 3 — Air Recirculation Button | 8 — Temperature Control Button |
| 4 — Front Defroster Button   | 9 — Blower Speed Button        |
| 5 — Rear Defroster Button    |                                |

# OPERATING YOUR VEHICLE



## Uconnect 8.4 Touchscreen Manual Climate Controls

1 — MAX A/C Button

2 — A/C Button

3 — Air Recirculation Button

4 — Front Defroster Button

5 — Rear Defroster Button

6 — Blower Speed Up

7 — Mode Control Buttons

8 — Blower Speed Down

9 — OFF Button

10 — Temperature Control Buttons

# OPERATING YOUR VEHICLE



## Manual Climate Controls

- |                              |                              |
|------------------------------|------------------------------|
| 1 — Temperature Down Control | 5 — Front Defrost Button     |
| 2 — Blower Control Knob      | 6 — Off Button               |
| 3 — Temperature Up Control   | 7 — Air Recirculation Button |
| 4 — Rear Defrost Button      | 8 — A/C Button               |

## Air Recirculation

- Use Recirculation for maximum A/C operation.
- For window defogging, turn the Recirculation button off.
- Recirculation is allowed in floor mode and defrost/floor (mix mode) for approximately five minutes.

## Heated Mirrors

The mirrors are heated to melt frost or ice. This feature is activated whenever you turn on the rear window defroster.

# OPERATING YOUR VEHICLE

## AUTOMATIC TEMPERATURE CONTROLS (ATC)

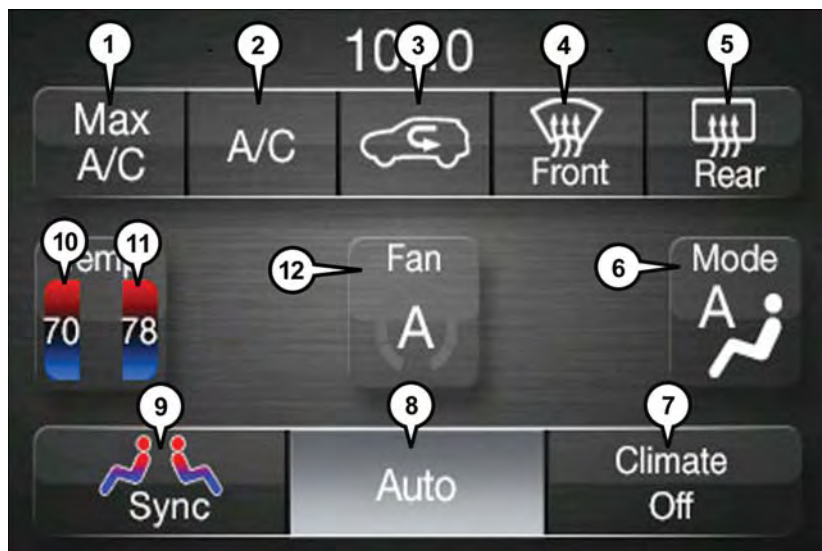

Uconnect 5.0 Automatic Climate Controls

- |                                  |                                    |
|----------------------------------|------------------------------------|
| 1 — MAX A/C Button               | 7 — OFF Button                     |
| 2 — A/C Button                   | 8 — Auto Button                    |
| 3 — Recirculation Button         | 9 — SYNC Button                    |
| 4 — Front Defroster Button       | 10 — Driver Temperature Control    |
| 5 — Rear Window Defroster Button | 11 — Passenger Temperature Control |
| 6 — Mode Control Button          | 12 — Blower control                |

# OPERATING YOUR VEHICLE



## Uconnect 8.4 Automatic Climate Controls

- |                                |                              |
|--------------------------------|------------------------------|
| 1 — MAX A/C Button             | 9 — SYNC Button              |
| 2 — A/C Button                 | 10 — Blower Speed Up         |
| 3 — Air Recirculation Button   | 11 — Mode Control Buttons    |
| 4 — AUTO Button                | 12 — Blower Speed Down       |
| 5 — FRONT Defroster Button     | 13 — OFF Button              |
| 6 — REAR Defroster Button      | 14 — Driver Temperature Down |
| 7 — Passenger Temperature Up   | 15 — Driver Temperature Up   |
| 8 — Passenger Temperature Down |                              |
-

# OPERATING YOUR VEHICLE



## Automatic Climate Controls

- |                                   |                              |
|-----------------------------------|------------------------------|
| 1 — Driver Temperature Control    | 6 — Front Defroster Button   |
| 2 — OFF Button                    | 7 — AUTO Button              |
| 3 — Blower Control Knob           | 8 — Air Recirculation Button |
| 4 — Passenger Temperature Control | 9 — A/C Button               |
| 5 — Rear Defroster Button         |                              |

## Automatic Operation

- Turn the Mode and Blower Controls to the AUTO position.
- Select the desired temperature by rotating the Temperature Control.
- The system will maintain the set temperature automatically.

## Air Conditioning (A/C)

If the air conditioning button is pressed while in AUTO mode, the system will exit AUTO mode and stay in A/C. The mode and blower will be set at the closest mode and blower position that the system was operating in AUTO.

## MAX A/C

- MAX A/C sets the control for maximum cooling performance.
- Press and release to toggle between MAX A/C and the prior settings. The button on the touchscreen illuminates when MAX A/C is ON.

# OPERATING YOUR VEHICLE

- In MAX A/C, the blower level and mode position can be adjusted to desired user settings. Pressing other settings will cause the MAX A/C operation to switch to the prior settings and the MAX A/C indicator will turn off.

## Air Recirculation

- Push the Recirculation button for maximum A/C operation.
- To turn off Recirculation for window defogging, push the Recirculation button a second time.
- If the Recirculation button is pushed while in the AUTO mode, the indicator light shall illuminate. In cold weather, use of Recirculation mode may lead to excessive window fogging. The recirculation feature may be unavailable (button greyed out) if conditions exist that could create fogging on the inside of the windshield.

## Heated Mirrors

The mirrors are heated to melt frost or ice. This feature is activated whenever you turn on the rear window defroster.

## Windshield Wiper De-icer – If Equipped

The windshield wiper de-icer is a heating element located at the base of the windshield.

The windshield wiper de-icer operates automatically once the following conditions are met:

- **Activation By Front Defrost**

The wiper de-icer activates automatically during a cold weather manual start with **full defrost**, the **blower speed is greater than five**, and when the **ambient temperature is below 40° F (4.4° C)**.

- **Activation By Rear Defrost**

The wiper de-icer activates automatically when the Rear Defrost is operating and the **ambient temperature is below 40° F (4.4° C)**.

- **Activation By Remote Start Operation**

When the Remote Start is activated and the **outside ambient temperature is less than 40° F (4.4° C)** the windshield wiper de-icer is activated. Upon exiting Remote Start, the climate control functions will resume their previous operation except, if the de-icer is active, the de-icer timer and operation will continue.

# OPERATING YOUR VEHICLE

## STOP/START SYSTEM – IF EQUIPPED

The Stop/Start function was developed to reduce fuel consumption. The system will stop the engine automatically during a vehicle stop if the required conditions are met. Releasing the brake pedal or pressing the accelerator pedal will automatically restart the engine.

### Automatic Mode

The Stop/Start feature is enabled after every normal customer engine start. At that time, the system will go into STOP/START READY and if all other conditions are met, can go into a STOP/START AUTOSTOP ACTIVE “Autostop” mode.

### To Activate The Autostop Mode, The Following Must Occur:

- The system must be in STOP/START READY state. A STOP/START READY message will be displayed in the Electronic Vehicle Information Center (EVIC) or Driver Information Display (DID) within the Stop/Start section. Refer to “Electronic Vehicle Information Center (EVIC)” or “Driver Information Display (DID)” in “Understanding Your Instrument Panel” in your Owner’s Manual on the DVD for further information.
- The vehicle must be completely stopped.
- The shifter must be in a forward gear and the brake pedal depressed.

The engine will shut down, the tachometer will move to the zero position and the Stop/Start telltale will illuminate indicating you are in Autostop. Customer settings will be maintained upon return to an engine running condition.

Refer to the “Stop/Start System” in the “Starting And Operating” section located in your Owner’s Manual on the DVD for further information.

### To Manually Turn Off The Stop/Start System

1. Push the STOP/START Off switch (located on the switch bank). The light on the switch will illuminate.
2. The “STOP/START OFF” message will appear in Electronic Vehicle Information Center (EVIC) or Driver Information Display (DID). Refer to “Electronic Vehicle Information Center (EVIC)” or “Driver Information Display (DID)” in “Understanding Your Instrument Panel” in your owner’s manual on the DVD for further information.
3. At the next vehicle stop (after turning off the STOP/START system), the engine will not be stopped.



**STOP/START OFF Switch**



# OPERATING YOUR VEHICLE

4. The STOP/START system will reset itself back to an ON condition every time the ignition is turned off and back on.

## To Manually Turn On The Stop/Start System

Push the STOP/START Off switch (located on the switch bank). The light on the switch will turn off.

For complete details on the Stop/Start System, refer to the “Stop/Start System” in the “Starting And Operating” section located in your owners manual on the DVD for further information.

## ELECTRIC PARK BRAKE (EPB)

Your vehicle is equipped with a new Electric Park Brake System (EPB) that offers greater convenience. The park brake switch is located in the center console.

To apply the park brake manually, pull up on the switch momentarily. The BRAKE telltale light in the instrument cluster and an indicator on the switch will illuminate.

To release the park brake manually, the ignition switch must be in RUN. Then put your foot on the brake pedal and push the park brake switch down momentarily. Once the park brake is fully disengaged, the BRAKE telltale light and the switch indicator will extinguish.

The park brake can also be automatically released. With the engine running and the transmission in gear, release the brake pedal and depress the throttle pedal. For safety reasons, your seat belt must also be fastened.

### NOTE:

- You may hear a slight whirring sound from the back of the vehicle while the parking brake engages or disengages.
- If your foot is on the brake pedal while you are engaging or disengaging the parking brake, you may notice a small amount of brake pedal movement.
- The new Auto Park Brake feature can be used to apply the park brake automatically every time you park the vehicle. Auto Park Brake can be enabled and disabled in the Settings menu in Uconnect.
- The parking brake can be engaged even when the ignition switch is OFF, however, it can only be disengaged when the ignition switch is in the ON/RUN position.



**Parking Brake Switch**

# OPERATING YOUR VEHICLE

- SafeHold a new feature that will automatically apply the park brake under certain conditions. The EPB monitors the status of the driver's seat belt, driver's door and pedal positions to determine if the driver may have exited while the vehicle is still capable of moving and will then automatically apply the park brake to prevent the vehicle from rolling.
- The EPB fault light will illuminate if the EPB switch is held for longer than 20 seconds in either the released or applied position. The light will extinguish upon releasing the switch.
- Refer to the Starting And Operating section of your vehicle's Owner's Manual on the DVD for further details.

## **CAUTION!**

If the Brake System Warning Light remains on with the parking brake released, a brake system malfunction is indicated. Have the brake system serviced by an authorized dealer immediately.

## **WARNING!**

- Never use the PARK position as a substitute for the parking brake. Always apply the parking brake fully when parked to guard against vehicle movement and possible injury or damage.
- When leaving the vehicle, always make sure the ignition is in the OFF mode, remove the Key Fob from the vehicle, and lock your vehicle.
- Never leave children alone in a vehicle, or with access to an unlocked vehicle. Allowing children to be in a vehicle unattended is dangerous for a number of reasons. A child or others could be seriously or fatally injured. Children should be warned not to touch the parking brake, brake pedal or the transmission gear selector.
- Do not leave the Key Fob in or near the vehicle, (or in a location accessible to children), and do not leave the ignition in the ACC or ON/RUN mode. A child could operate power windows, other controls, or move the vehicle.
- Be sure the parking brake is fully disengaged before driving; failure to do so can lead to brake failure and a collision.
- Always fully apply the parking brake when leaving your vehicle, or it may roll and cause damage or injury. Also be certain to leave the transmission in PARK. Failure to do so may allow the vehicle to roll and cause damage or injury.
- Driving the vehicle with the parking brake engaged, or repeated use of the parking brake to slow the vehicle may cause serious damage to the brake system.

# OPERATING YOUR VEHICLE

## PARKSENSE

### ParkSense Front And Rear Park Assist

ParkSense can be enabled and disabled by pushing the ParkSense switch located on the switch panel below the Uconnect display.

The six ParkSense sensors, located in the rear fascia/bumper, monitor the area behind the vehicle that is within the sensors' field of view. The sensors can detect obstacles from approximately 12 in (30 cm) up to 79 in (200 cm) from the rear fascia/bumper in the horizontal direction, depending on the location, type and orientation of the obstacle.

The six ParkSense sensors, located in the front fascia/bumper, monitor the area in front of the vehicle that is within the sensors' field of view. The sensors can detect obstacles from approximately 12 in (30 cm) up to 47 in (120 cm) from the front fascia/bumper in the horizontal direction, depending on the location, type and orientation of the obstacle.



**ParkSense Switch**

When an object is detected within 2 meters behind the rear bumper while the vehicle is in REVERSE, a warning will display in the Electronic Vehicle Information Center (EVIC) or Driver Information Display (DID). In addition a chime will sound (when Sound and Display is selected from the Customer Programmable Features screen of the Uconnect System). As the vehicle moves closer to the object, the chime rate will change from single 1/2 second tone (for rear only), to slow (for rear only), to fast, to continuous.

Refer to your Owner's Manual on the DVD for further details.

# OPERATING YOUR VEHICLE

## ParkSense Active Park Assist

The ParkSense Active Park Assist system can be enabled and disabled with the ParkSense Active Park Assist switch, located on the switch panel below the Uconnect display.

The ParkSense Active Park Assist system is intended to assist the driver during parallel and perpendicular parking maneuvers by identifying a proper parking space, providing audible/visual instructions, and controlling the steering wheel. The ParkSense Active Park Assist system is defined as “semi-automatic” since the driver maintains control of the accelerator, gear selector and brakes. Depending on the driver’s parking maneuver selection, the ParkSense Active Park Assist system is capable of maneuvering a vehicle into a parallel or a perpendicular parking space on either side (i.e., driver side or passenger side).



**ParkSense Active Park Assist Switch**

Refer to your Owner's Manual on the DVD for further details.

### **CAUTION!**

- ParkSense is only a parking aid and it is unable to recognize every obstacle, including small obstacles. Parking curbs might be temporarily detected or not detected at all. Obstacles located above or below the sensors will not be detected when they are in close proximity.
- The vehicle must be driven slowly when using ParkSense in order to be able to stop in time when an obstacle is detected. It is recommended that the driver looks over his/her shoulder when using ParkSense.

# OPERATING YOUR VEHICLE

## WARNING!

- Drivers must be careful when backing up even when using ParkSense. Always check carefully behind your vehicle, look behind you, and be sure to check for pedestrians, animals, other vehicles, obstructions, and blind spots before backing up. You are responsible for safety and must continue to pay attention to your surroundings. Failure to do so can result in serious injury or death.
- Before using ParkSense, it is strongly recommended that the ball mount and hitch ball assembly is disconnected from the vehicle when the vehicle is not used for towing. Failure to do so can result in injury or damage to vehicles or obstacles because the hitch ball will be much closer to the obstacle than the rear fascia when the loudspeaker sounds the continuous tone. Also, the sensors could detect the ball mount and hitch ball assembly, depending on its size and shape, giving a false indication that an obstacle is behind the vehicle.

## LANESENSE

The LaneSense system can be enabled and disabled with the LaneSense button  located on the switch panel below the Uconnect display.

- Push the LaneSense button to turn the system ON (LED turns off).

The LaneSense system is operational at speeds above 37 mph (60 km/h) and below 112 mph (180 km/h). The LaneSense system uses a forward looking camera to detect lane markings and measure vehicle position within the lane boundaries.

When both lane markings are detected and the driver unintentionally drifts out of the lane (no turn signal applied), the LaneSense system provides a haptic warning in the form of torque applied to the steering wheel to prompt the driver to remain within the lane boundaries. If the driver continues to unintentionally drift out of the lane, the LaneSense system provides a visual warning through the Electronic Vehicle Information Center (EVIC) or Driver Information Display (DID) to prompt the driver to remain within the lane boundaries.

The driver may manually override the haptic warning by applying torque into the steering wheel at any time.

When only a single lane marking is detected and the driver unintentionally drifts across the lane marking (no turn signal applied), the LaneSense system provides a visual warning through the Electronic Vehicle Information Center (EVIC) or Driver Information Display (DID) to prompt the driver to remain within the lane. When only a single lane marking is detected, a haptic (torque) warning will not be provided.

# OPERATING YOUR VEHICLE

Refer to your Owner's Manual on the DVD for further details.

## **NOTE:**

When operating conditions have been met, the LaneSense system will monitor if the driver's hands are on the steering wheel and provides an audible warning to the driver when the driver's hands are not detected on the steering wheel. The system will cancel if the driver does not return their hands to the wheel.

## **PARKVIEW REAR BACK UP CAMERA**

Your vehicle may be equipped with the ParkView Rear Back Up Camera that allows you to see an on-screen image of the rear surroundings of your vehicle whenever the gear selector is put into REVERSE. The image will be displayed in the touchscreen display along with a caution note to "check entire surroundings" across the top of the screen. After five seconds this note will disappear. The ParkView camera is located on the rear of the vehicle above the rear License plate.

## **NOTE:**

The ParkView Rear Back Up Camera has programmable modes of operation that may be selected through the Uconnect System. Refer to "Uconnect Settings" in "Understanding Your Instrument Panel" for further information.

When the vehicle is shifted out of REVERSE (with camera delay turned OFF), the rear camera mode is exited and the previous screen appears again. When the vehicle is shifted out of REVERSE (with camera delay turned ON), the camera image will continue to be displayed for up to 10 seconds after shifting out of REVERSE unless the vehicle speed exceeds 8 mph (13 km/h), the vehicle is shifted into PARK or the vehicles ignition is cycled to the OFF position.

When enabled, active guide lines are overlaid on the image to illustrate the width of the vehicle and its projected backup path based on the steering wheel position. A dashed center line overlay indicates the center of the vehicle to assist with parking or aligning to a hitch/receiver.

When enabled, fixed guide lines are overlaid on the image to illustrate the width of the vehicle.

Different colored zones indicate the distance to the rear of the vehicle.

### **WARNING!**

Drivers must be careful when backing up even when using the ParkView Rear Back Up Camera. Always check carefully behind your vehicle, and be sure to check for pedestrians, animals, other vehicles, obstructions, or blind spots before backing up. You are responsible for the safety of your surroundings and must continue to pay attention while backing up. Failure to do so can result in serious injury or death.

# OPERATING YOUR VEHICLE

## CAUTION!

- To avoid vehicle damage, ParkView should only be used as a parking aid. The ParkView camera is unable to view every obstacle or object in your drive path.
- To avoid vehicle damage, the vehicle must be driven slowly when using ParkView to be able to stop in time when an obstacle is seen. It is recommended that the driver look frequently over his/her shoulder when using ParkView.

### NOTE:

If snow, ice, mud, or any foreign substance builds up on the camera lens, clean the lens, rinse with water, and dry with a soft cloth. Do not cover the lens.

## POWER SUNROOF

The power sunroof switches are located on the overhead console.

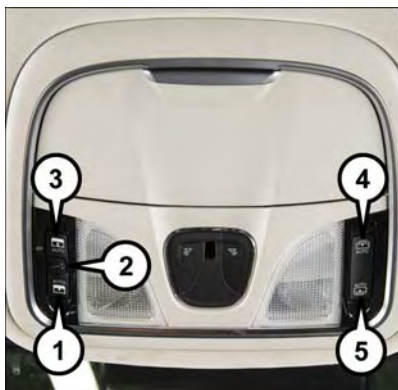

Power Sunroof Switches

- 1 — Closing Sunroof
- 2 — Venting Sunroof
- 3 — Opening Sunroof
- 4 — Opening Power Shade
- 5 — Closing Power Shade

### Opening Sunroof

#### Express

- Push the sunroof switch rearward and release it within one-half second and the sunroof will automatically open to the halfway position and stop automatically.
- Push the sunroof switch a second time from the halfway position and the sunroof will automatically open to the full open position and stop automatically.

# OPERATING YOUR VEHICLE

## Manual

- Push and hold the sunroof switch rearward. The sunroof will open and stop automatically at the half-open position.
- Push and hold the sunroof switch rearward again and the sunroof will open automatically to the full-open position.

## NOTE:

Any release of the sunroof switch will stop the movement and the sunroof will remain in a partially opened condition until the sunroof switch is pushed and held rearward again.

## Closing Sunroof

### Express

- Push the sunroof switch forward and release it within one-half second and the sunroof will close automatically from any position.

### Manual

- To close the sunroof, push and hold the sunroof switch in the forward position.

## NOTE:

Any release of the sunroof switch will stop the movement and the sunroof will remain in a partially closed condition until the switch is pushed and held forward again.

## Venting Sunroof

Push and release the button and the sunroof will open to the vent position.

This is called “Express Vent” and will occur regardless of sunroof position. During Express Vent operation, any movement of the switch will stop the sunroof.

## Opening Power Shade

### Express

Push the shade switch rearward and release it within one-half second and the shade will automatically open to the halfway position and stop automatically.

Push the switch a second time from the halfway position and the shade will automatically open to the full open position and stop automatically.

### Manual

To open the shade, push and hold the switch rearward. The shade will open and stop automatically at the half-open position.

Push and hold the shade switch rearward again and the shade will open automatically to the full-open position.

## NOTE:

Any release of the switch will stop the movement and the shade will remain in a partially opened condition until the switch is pushed and held rearward again.



# OPERATING YOUR VEHICLE

## Closing Power Shade

### Express

Push the switch forward and release it within one-half second and the shade will close automatically from any position.

### Manual

To close the shade, push and hold the switch in the forward position.

### NOTE:

Any release of the switch will stop the movement and the shade will remain in a partially closed condition until the switch is pushed and held forward again.

## Pinch Protection Feature

This feature will detect an obstruction in the opening of the sunroof during Express Close operation. If an obstruction in the path of the sunroof is detected, the sunroof will automatically retract. Remove the obstruction if this occurs. Next, push the switch forward and release to Express Close.

### NOTE:

If three consecutive sunroof close attempts result in Pinch Protect reversals, the fourth close attempt will be a Manual Close movement with Pinch Protect disabled.

## WARNING!

- Do not let children play with the sunroof. Never leave children unattended in a vehicle, or with access to an unlocked vehicle. Do not leave the Key Fob in or near the vehicle, and do not leave the ignition of a vehicle equipped with Keyless Enter-N-Go in the ACC or ON/RUN mode. Occupants, particularly unattended children, can become entrapped by the power sunroof while operating the power sunroof switch. Such entrapment may result in serious injury or death.
- In a collision, there is a greater risk of being thrown from a vehicle with an open sunroof. You could also be severely injured or killed. Always fasten your seat belt properly and make sure all passengers are properly secured.
- Do not allow small children to operate the sunroof. Never allow your fingers, other body parts, or any object to project through the sunroof opening. Injury may result.

## WIND BUFFETING

Wind buffeting can be described as a helicopter-type percussion sound. If buffeting occurs with the rear windows open, adjust the front and rear windows together.

If buffeting occurs with the sunroof open, adjust the sunroof opening, or adjust any window. This will minimize buffeting.

# ELECTRONICS



## YOUR VEHICLE'S SOUND SYSTEM

1. Uconnect Phone Button pg. 130
2. Uconnect Voice Command Button pg. 111
3. Phone Hang Up Button
4. Steering Wheel Audio Controls (Left – Behind Steering Wheel) pg. 141
5. Steering Wheel Audio Controls (Right – Behind Steering Wheel) pg. 141
6. Volume Knob — Mute Button
7. SCREEN OFF Button

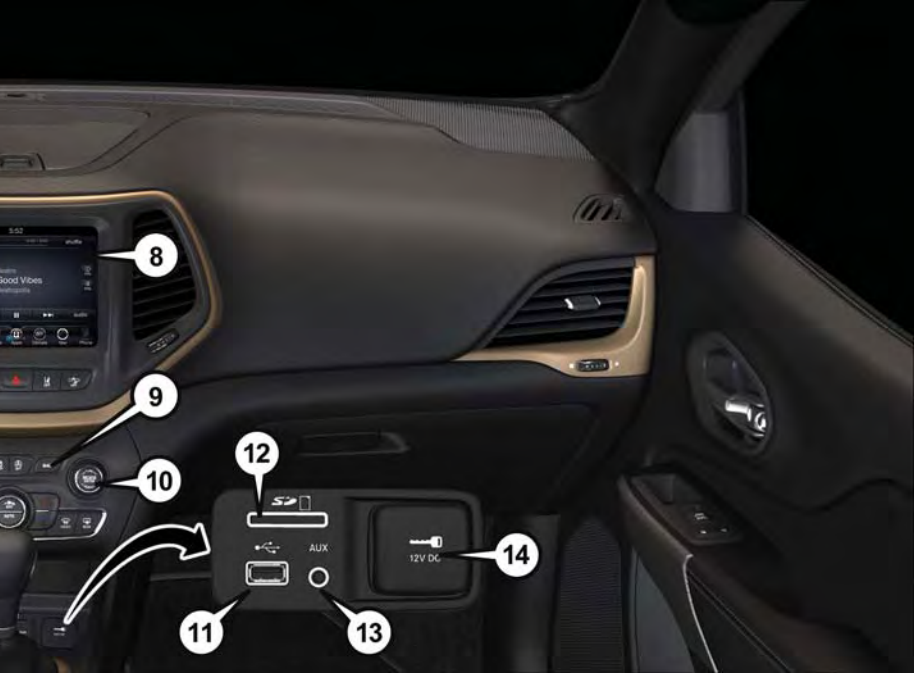

- 8. Uconnect 8.4 Radio pg. 97
- 9. BACK Button
- 10. BROWSE/ENTER Button — TUNE/SCROLL Knob
- 11. USB Port pg. 104
- 12. SD Card Slot pg. 104
- 13. Audio Jack pg. 104
- 14. Power Outlet pg. 147

# ELECTRONICS

## CYBERSECURITY

Your vehicle may be a connected vehicle and may be equipped with both wired and wireless networks. These networks allow your vehicle to send and receive information. This information allows systems and features in your vehicle to function properly.

Your vehicle may be equipped with certain security features to reduce the risk of unauthorized and unlawful access to vehicle systems and wireless communications. Vehicle software technology continues to evolve over time and FCA US LLC, working with its suppliers, evaluates and takes appropriate steps as needed. Similar to a computer or other devices, your vehicle may require software updates to improve the usability and performance of your systems or to reduce the potential risk of unauthorized and unlawful access to your vehicle systems.

The risk of unauthorized and unlawful access to your vehicle systems may still exist, even if the most recent version of vehicle software (such as Uconnect software) is installed.

### WARNING!

- It is not possible to know or to predict all of the possible outcomes if your vehicle's systems are breached. It may be possible that vehicle systems, including safety related systems, could be impaired or a loss of vehicle control could occur that may result in an accident involving serious injury or death.
- ONLY insert media (e.g., USB, SD card, or CD) into your vehicle if it came from a trusted source. Media of unknown origin could possibly contain malicious software, and if installed in your vehicle, it may increase the possibility for vehicle systems to be breached.
- As always, if you experience unusual vehicle behavior, take your vehicle to your nearest authorized dealer immediately.

### NOTE:

- FCA or your dealer may contact you directly regarding software updates.
- To help further improve vehicle security and minimize the potential risk of a security breach, vehicle owners should:
  - Routinely check [www.driveuconnect.com/software-update](http://www.driveuconnect.com/software-update) to learn about available Uconnect software updates.
  - Only connect and use trusted media devices (e.g. personal mobile phones, USBs, CDs).

Privacy of any wireless and wired communications cannot be assured. Third parties may unlawfully intercept information and private communications without your consent. For further information, refer to "Privacy Practices – If Equipped with Uconnect 8.4 radio" in "All About Uconnect Access" in your Uconnect Owner's Manual Supplement and "Onboard Diagnostic System (OBD II) Cybersecurity" in "Maintaining Your Vehicle" in your Owner's Manual on the DVD.

# ELECTRONICS

## IDENTIFYING YOUR RADIO

### Uconnect 5.0

- 5" Touchscreen
- Three buttons on each side of the display



Uconnect 5.0



Uconnect 5.0

### Uconnect 8.4A

- 8.4" Touchscreen
- SiriusXM Travel Link feature NOT listed within Apps



Uconnect 8.4A

### Uconnect 8.4AN

- 8.4" Touchscreen
- HD Button will be visible on right side of screen when viewing AM or FM
- SiriusXM Travel Link feature listed within Apps (US Market Only)



Uconnect 8.4AN

# ELECTRONICS

## UCONNECT ACCESS

**Uconnect Access – If Equipped (Available On Uconnect 8.4A/8.4AN – U.S. Residents Only)**

### WARNING!

- ALWAYS obey traffic laws and pay attention to the road. Some Uconnect Access services, including 9-1-1 and Assist, will NOT work without an operable 1X (voice/data) or 3G (data) network connection.
- ALWAYS drive safely with your hands on the steering wheel. You have full responsibility and assume all risks related to the use of the Uconnect features and applications in this vehicle. Only use Uconnect when it is safe to do so. Failure to do so may result in an accident involving serious injury or death.

### NOTE:

Your vehicle may be transmitting data as authorized by the subscriber.

Uconnect Access enhances your ownership and driving experience by connecting your vehicle to an operable 1X (voice/data) or 3G (data) network. When connected to an operable 1X (voice/data) or 3G (data) network, you can:

- Place a call to a local 9-1-1 Operator for emergency assistance.
- Remotely lock/unlock your doors and start your vehicle from virtually anywhere, using the Uconnect Access App from your device. You can also do so by logging into Mopar Owner Connect, or by calling Uconnect Care when your vehicle has an operable 1X (voice/data) or 3G (data) network connection. Services can only be used where coverage is available; see coverage map for details.
- Turn your vehicle into a 3G Wi-Fi Hotspot and connect your devices to the internet.
- Receive text or email notifications if your vehicle's security alarm goes off.
- Receive stolen vehicle assistance, using GPS technology to help authorities locate your vehicle if it is stolen.
- Listen to your text messages or send free-form text messages with your voice while keeping your hands on the wheel, using the Voice Texting feature. Requires a device that supports Bluetooth Message Access Profile (MAP).
- Search for places to eat, shop, relax and play with Yelp, using your voice or on-screen menu. Then navigate to them (navigation standard on Uconnect 8.4AN, optional on Uconnect 8.4A).
- Get operator assistance using the ASSIST button on your interior rearview mirror.

**Before you drive, familiarize yourself with the easy-to-use Uconnect Access.**

1. The ASSIST and 9-1-1 buttons are located on your rearview mirror. The ASSIST button is used for contacting Roadside Assistance, Vehicle Care and Uconnect Care. The 9-1-1 button connects you to emergency services.

# ELECTRONICS

## NOTE:

Vehicles sold in Canada and Mexico DO NOT have 9-1-1 call system capabilities. 9-1-1 or other emergency line operators in Canada and Mexico may not answer or respond to 9-1-1 system calls.

2. The Uconnect “Apps ” button in the center of the menu bar of the radio touchscreen. This is where you can begin your registration process, manage your Apps and purchase WiFi on demand.
3. The Uconnect Voice Command and Uconnect Phone buttons are located on the left side of your steering wheel. These buttons let you use your voice to give commands, make phone calls, send and receive text messages hands-free, enter navigation destinations, and control your radio and media devices.

## Included Trial Period For New Vehicles

Your new vehicle may come with an included trial period for use of the Uconnect Access Services starting at the date of vehicle purchase (date based on vehicle sales notification from your dealer). **To activate the trial, you must first register with Uconnect Access.** After the trial period, if you wish to continue your Uconnect Access Services you can choose to purchase a subscription.

## Features And Packages

- After the trial period, you can subscribe to continue your service by visiting the Uconnect Store located within the Mopar Owner Connect website [moparownerconnect.com](http://moparownerconnect.com). If you need assistance, U.S. residents can call Uconnect Care at 1-855-792-4241 .
- For the latest information on packages and pricing information: U.S. residents visit [DriveUconnect.com](http://DriveUconnect.com).

## Uconnect Access Registration (Uconnect 8.4A/8.4AN, U.S. 48 Contiguous States, Alaska And Hawaii)

To unlock the full potential of Uconnect Access in your vehicle, you first need to register with Uconnect Access.

1. Push the ASSIST button on your rearview mirror.
2. Press the “Uconnect Care” button on the touchscreen.
3. A helpful Uconnect Care Agent will register your vehicle and handle all of the details.



ASSIST Button

# ELECTRONICS

**Signing up is easy!** Simply follow the steps above. Or, press the “Apps ” button on the touchscreen, then select the Uconnect registration app to “Register By Web” and complete the process using your device or computer.

**Why sign up for Uconnect Access?** Here are just a few examples of things you’ll be able to do:

- Know that help, if you need it, is only a button press away.
- Lock and unlock your vehicle doors from hundreds of miles away.
- Discover great, new places around you using Yelp.
- Dictate and send text messages by speaking out loud (all while keeping both hands on the wheel!)
- Enjoy the best in music and entertainment from around the world with apps like Pandora.

For further information please visit [DriveUconnect.com](http://DriveUconnect.com).

## Download The Uconnect Access App

You’re only a few steps away from using remote commands and playing your favorite music in your vehicle.

To link your internet radio accounts:

1. Download the **Uconnect Access App** on your device.
2. Press the Via Mobile icon on the navigation bar at the bottom of the app.
3. Press the app you’d like to connect to your vehicle.
4. Enter your login information for the selected app and press Link.
5. Next time you’re in your vehicle, enable Bluetooth, pair your device and select the Via Mobile app you want to play from the Uconnect touchscreen to stream your personalized music.



Mobile App

### NOTE:

- You can also complete this process on the web. Simply visit [moparownerconnect.com](http://moparownerconnect.com) login and click **Link My Internet Radio Accounts (Pandora, iHeartRadio, Slacker Radio, Aha)** (under Quick Links).
- Once you download the app to your compatible device, you will also be able to start your vehicle and lock/unlock its doors from virtually anywhere.



# ELECTRONICS

## Via Mobile Apps — If Equipped

- **Aha by HARMAN** — Aha by HARMAN makes it easy to instantly access your favorite Web content on the go. Choose from over 40,000+ stations spanning internet radio, personalized music, news, entertainment, hotels, weather, audiobooks, Facebook, Twitter, and more.
- **iHeartRadio** — iHeartRadio provides instant access to more than 1,500 live radio stations from across the country and allows listeners to create custom music stations inspired by their favorite artists or songs.
- **Pandora** — Pandora gives people the music and comedy they love anytime, anywhere. Personalized stations launch instantly, with the input of a favorite artist, track, comedian, or genre.
- **Slacker Radio** — Enjoy millions of songs and hundreds of handcrafted stations.



Via Mobile

### NOTE:

For detailed information on how to use Via Mobile apps visit the Mopar Owner Connect website [moparownerconnect.com](http://moparownerconnect.com) and login using the username and password you set up when registering for Uconnect Access.

# ELECTRONICS

## **Renewing Subscriptions And Purchasing 3G Wi-Fi Hotspot (Uconnect 8.4A/8.4AN, U.S. 48 Contiguous States, Alaska And Hawaii)**

Subscriptions, and 3G Wi-Fi Hotspot, can be purchased from the Uconnect Store within your vehicle, and online at Mopar Owner Connect. If you need help push the ASSIST button on the rearview mirror, then select Uconnect Care (or dial 1-855-792-4241 ).

### **NOTE:**

You must set up a Uconnect Access Payment Account online (log in to moparownerconnect.com, go to Edit Profile, then Uconnect Payment Account, to set up and manage your Payment Account).

## **Getting Started With Apps**

Applications (Apps for short) in your Uconnect Access system are designed to deliver the features and services that you want. There are two basic categories:

1. **Built-In Features** — use the 1X (voice/data) or 3G (data) network on your Uconnect 8.4A or 8.4AN radio.
2. **Uconnect Access Via Mobile** — use the Uconnect Access App and your device's data plan to access your personal Pandora, iHeartRadio, Aha and Slacker accounts from the vehicle and control them using the touchscreen. Customer's data plan charges will apply. Available on Uconnect 8.4A and 8.4AN Radios (if equipped).

# ELECTRONICS

## Apps Main Menu

Press the “Apps 

### Uconnect Apps

1 — Apps Button

2 — Page Forward Button

## App Manager

Press the “App Manager” button to access the following categories:

**Favorite Apps** — This is the default screen when you first press the “App Manager” button on the touchscreen, and is a good place to put the apps you use most frequently. To make an App a “favorite”, press the “Settings” button on the touchscreen to the right of the App.

**All Apps** — All of your available Apps will reside in the “All Apps” folder.

**Running Apps** — Press this tab to see which apps are currently running.

# ELECTRONICS

## Maintaining Your Uconnect Access Account

### Selling Your Vehicle

When you sell your vehicle, we recommend that you remove your Uconnect Access Account information from the vehicle. You can do this on the Mopar Owner Connect website [moparownerconnect.com](http://moparownerconnect.com). Removing your account information cancels your subscription and makes your vehicle factory-ready for a new owner/subscriber.

For additional information on Uconnect, visit [DriveUconnect.com](http://DriveUconnect.com) or call 1-877-855-8400 .

### Built-In Features

#### WARNING!

- ALWAYS obey traffic laws and pay attention to the road. Some Uconnect Access services, including 9-1-1 and Assist, will NOT work without an operable 1X (voice/data) or 3G (data) network connection.
- ALWAYS drive safely with your hands on the steering wheel. You have full responsibility and assume all risks related to the use of the Uconnect features and applications in this vehicle. Only use Uconnect when it is safe to do so. Failure to do so may result in an accident involving serious injury or death.
- Ignoring the rearview mirror light could mean you may not have 9-1-1 Call service if needed. If the rearview mirror light is illuminated, have an authorized dealer service the 9-1-1 Call system immediately.
- The Occupant Restraint Controller (ORC) turns on the Air Bag Warning Light on the instrument panel if a malfunction is detected in any part of the airbag system. If the Air Bag Warning Light is illuminated, the air bag system may not be working properly and the 9-1-1 system may not send a signal to a 9-1-1 operator if an air bag is deployed. If the Air Bag Warning Light is illuminated, have an authorized dealer service your vehicle immediately.
- If anyone in the vehicle could be in danger (e.g., fire or smoke is visible, dangerous road conditions or location), do not wait for voice contact from a 9-1-1 operator. All occupants should exit the vehicle immediately and move to a safe location.
- The 9-1-1 Call system is embedded into the vehicle's electrical system. Do not add aftermarket electrical equipment to the vehicle's electrical system. This may prevent your vehicle from sending a signal to initiate an emergency call. To avoid interference that can cause the 9-1-1 Call system to fail, never add aftermarket equipment (e.g., two-way mobile radio, CB radio, data recorder, etc.) to your vehicle's electrical system or modify the antennas on your vehicle.
- IF YOUR VEHICLE LOSES BATTERY POWER FOR ANY REASON (INCLUDING DURING OR AFTER AN ACCIDENT), the Uconnect features, apps and services, among others, will not operate.

#### NOTE:

Your vehicle may be transmitting data as authorized by the subscriber.

# ELECTRONICS

1. **Assist Call (8.4AN)** — The rearview mirror contains an ASSIST push button which automatically connects the vehicle occupants to one of these predefined destinations for immediate support:

- **Roadside Assistance Call** — If you get a flat tire, or need a tow, you'll be connected to someone who can help anytime. Additional fees may apply. Additional information in this section.
- **Uconnect Access Care** — In vehicle support for Uconnect Access System, Apps and Features.
- **Vehicle Care** — Total support for your FCA US LLC vehicle.



**ASSIST And 9-1-1 Buttons**

- 1 — ASSIST Button  
2 — 9-1-1 Button

2. **Emergency 9-1-1 Call (If Equipped)** — The rearview mirror contains a 9-1-1 button that, when pressed, may place a call from your vehicle to a local 9-1-1 operator to request help from local police, fire or ambulance personnel. If this button is accidentally pressed, you will have 7 seconds to stop the call. To cancel, press the 9-1-1 Call button again or press the “Cancel” button shown on the touchscreen. After 7 seconds has passed, the 9-1-1 call will be placed and only the 9-1-1 operator can cancel it. The LED light on the rearview mirror will turn green once a connection to a 9-1-1 operator has been made. The green LED light will turn off once the 9-1-1 call is terminated. Have an authorized dealer service the vehicle if the rearview mirror light is continuously red. On equipped vehicles, this feature requires a functioning electrical system and an operable 1X (voice/data) or 3G (data) network connection to function properly. **If a connection is made between a 9-1-1 operator and your vehicle, you understand and agree that 9-1-1 operators may, like any other 9-1-1 call, record conversations and sounds in and near your vehicle upon connection.**
3. **Roadside Assistance (If Equipped)** — If your vehicle is equipped with this feature and has an operable 1X (voice/data) or 3G (data) network connection, you may be able to connect with Roadside Assistance by pushing the "ASSIST" button on the rearview mirror. You will be presented with Assist Care options. Make a selection by pressing the prompts displayed on the radio. If Roadside Assistance is provided to your vehicle, you agree to be responsible for any additional roadside assistance service costs that you may incur. In order to provide Uconnect Services to you, we may record and monitor your conversations with Roadside Assistance, Uconnect Care or Vehicle Care, whether such conversations are initiated through the Uconnect Services in your vehicle, your device or via a landline device, and

# ELECTRONICS

may share information obtained through such recording and monitoring in accordance with regulatory requirements. You acknowledge, agree and consent to any recording, monitoring or sharing of information obtained through any such call recordings.

- 4. Yelp** — Customers have the ability to search for nearby destinations or a Point of Interest (POI) either by category or custom search by using keywords (for example, “Italian restaurant”). Searching can be done by either voice or by using the touchscreen keypad. Using the touchscreen, launch Yelp by selecting the “Apps  ” icon, then press “Yelp.” To use voice recognition, push the VR button on the steering wheel and say “launch Yelp,” then follow the instructions on the Teleprompter.
- 5. Security Alarm Notification** — The Security Alarm Notification feature notifies you via email or text (SMS) message when the vehicle’s factory-installed security alarm system has been set-off. There are a number of reasons why your alarm may have been triggered, one of which could be that your vehicle was stolen. If so, please see the details of the Stolen Vehicle Assistance service below. When you register, Security Alarm Notification is automatically set to send you an email at the mail address you provide should the alarm go off. You may also opt to have a text message sent to your device.
- 6. Stolen Vehicle Assistance** — If your vehicle is stolen, contact local law enforcement immediately to file a stolen vehicle report. Once this report has been filed, Uconnect care can help locate your vehicle. The Uconnect Care agent will ask for the stolen vehicle report number issued by local law enforcement. As long as your vehicle has an operable 1X (voice/data) or 3G (data) network connection, the Uconnect Care Agent may be able to locate the stolen vehicle and work with law enforcement to help recover it. Your vehicle must have an operable 1X (voice/data) or 3G (data) network connection and must be registered with Uconnect Access with an active subscription that includes the applicable feature.
- 7. 3G Wi-Fi Hotspot** — The 3G Wi-Fi Hotspot is an in-vehicle feature that connects your device to an operable 1X (voice/data) or 3G (data) network using Uconnect Access and is ready to go where ever you are. Once your vehicle is registered for Uconnect Access, you can purchase a 3G Wi-Fi Hotspot subscription at the Uconnect Store. After you’ve made your purchase, turn on your signal and connect your passengers devices. It’s never been easier to bring your home or office with you.

## WARNING!

NEVER use the WiFi Hotspot when you are driving the vehicle. As the driver, you should only use the WiFi Hotspot when the vehicle is parked in a safe location. Failure to do so may result in an accident involving serious injury or death.

**NOTE:**

Your vehicle must have a working electrical system for any of the in vehicle Uconnect features to operate.

**Uconnect Access Remote Features**

If you own a compatible iPhone or Android powered device, the Uconnect Access App allows you to remotely lock or unlock your doors, start your engine or activate your horn and lights from virtually anywhere. Your vehicle must be equipped with remote start and your vehicle must have an operable 1X (voice/data) or 3G (data) network connection). Services can only be used where coverage is available; see coverage map for details. You can download the App from Mopar Owner Connect or from the App Store (iPhone) or Google Play Store (Android). Visit [UconnectPhone.com](http://UconnectPhone.com) to determine if your device is compatible. For Uconnect Phone customer support and to determine if your device is compatible.

U.S. residents - visit [UconnectPhone.com](http://UconnectPhone.com) or call 1-877-855-8400.

**Remote Start (If Equipped)** — This feature provides the ability to start the engine on your vehicle, without the keys and from virtually any distance. You can send a request to your vehicle in one of two ways:

1. Using the Uconnect Access App from a compatible device.
2. From the Mopar Owner Connect website.
  - After 15 minutes if you have not entered your vehicle with the key, the engine will shut off automatically.
  - You can also send a command to turn-off an engine that has been remote started.
  - This remote function requires your vehicle to be equipped with a factory-installed Remote Start system. To utilize this feature after the Uconnect Access App is downloaded, login with your user name and password.

To use this feature after the Uconnect Access App is downloaded, login using your user name and password. You will need your four digit Uconnect Security PIN to confirm the request. Press the “remote start” icon on your Uconnect Access App to remotely start the vehicle.

You can set-up notifications for your account to receive an email or text (SMS) message every time a command is sent. Login to Mopar Owner Connect [moparownerconnect.com](http://moparownerconnect.com) and click on Edit Profile to manage Uconnect Notifications.

**Remote Door Lock/Unlock** — This feature provides the ability to lock or unlock the door on your vehicle, without the keys and from virtually any distance. You can send a request to your vehicle in one of three ways:

1. Using the Uconnect Access App from a compatible device.
2. From the Mopar Owner Connect website.

# ELECTRONICS

3. By contacting the Uconnect Care on the phone.

To use this feature after the Uconnect Access App is downloaded, login using your user name and password. You will need your four digit Uconnect Security PIN to confirm the request. Press the “closed lock” icon on your Uconnect Access App to lock the doors, and press the “open lock” icon to unlock the driver’s door.

You can set-up notifications for your account to receive an email or text (SMS) message every time a command is sent. Login to Mopar Owner Connect [moparownerconnect.com](http://moparownerconnect.com) and click on Edit Profile to manage Uconnect Notifications.

**Remote Horn And Lights** — It’s easy to locate a vehicle in a dark, crowded or noisy parking area by activating the horn and lights. It may also help if you need to draw attention to your vehicle for any reason. You can send a request to your vehicle in one of three ways:

1. Using the Uconnect Access App from a compatible device.
2. From the Mopar Owner Connect website.
3. By contacting the Uconnect Care on the phone.

To use this feature after the Uconnect Access App is downloaded, login using your user name and password. You will need your four digit Uconnect Security PIN to confirm the request. You can set-up notifications for your account to receive an email or text (SMS) message every time a command is sent. Login to Mopar Owner Connect [moparownerconnect.com](http://moparownerconnect.com) and click on Edit Profile to manage Uconnect Notifications.

**Voice Texting** — Want to dictate a personal message? Register with Uconnect Access to take advantage of a new, cloudbased Voice Texting service, an enhancement to Voice Text Reply.

Voice Texting allows you to compose a new text or reply to an incoming text message. Before you attempt to use the Voice Texting feature, check to ensure you have the following:

1. A paired, Bluetooth enabled device with the Message Access Profile (MAP). Not all Bluetooth enabled devices support MAP, including all iPhones (Apple iOS). Visit [UconnectPhone.com](http://UconnectPhone.com) for system and device compatibility information.
2. An active Uconnect Access trial or paid subscription.
3. Accept the “Allow MAP” profile request on your device. (Please refer to device manufacturer instructions for details).

## To Send A Text Message:

1. Push the Uconnect Phone Button  on the steering wheel.
2. Wait for the beep.
3. Say “Text.”



# ELECTRONICS

4. Uconnect will prompt you "Say the phone number, or full name and phone type of the contact you want to send a message to."
5. Wait for the beep and say a contact that is in your phonebook, or a mobile phone number that you would like to send the message to.
6. Uconnect will prompt you "Please say the message that you would like to send." (If you do not hear this prompt, you may not have an active subscription with Uconnect Access).
7. Wait for the beep, and then dictate any message up to 140 characters. If you exceed 140 characters, you will hear the following prompt: "Message was too long; your message will be truncated."
8. Uconnect will then repeat the message back to you.
9. Uconnect will prompt you: "To add to your message, say "Continue"; To delete the current message and start over, say "Start Over"; to send the current message, say "Send"; to hear the message again, say "Repeat".
10. If you are happy with your message and would like to send it, wait for the beep and say "Send".
11. Uconnect will then say "Sending your message."

## Sample Commands For Voice Text Reply And Voice Texting

Example Command	Action
"Text John Smith"	Send a message to specific contact in address book
"Text 123 456 7890"	Send 123 456 7890 a message from your phonebook
"Show messages"	See recent text messages listed by number on Uconnect screen
"Listen to/view (message number four, for example)"	Hear messages or read it on Uconnect screen
"Reply"	Send a voice text reply to a current message
"Forward text/message to "John Smith"	Forward current text to specific contact in address book
"Forward text/message to "123 456 7890"	Forward current text to specific phone number

# ELECTRONICS

## UCONNECT 5.0



**Uconnect 5.0 Radio**

- |                                |                           |
|--------------------------------|---------------------------|
| 1 — Radio Mode Button          | 4 — MORE Functions Button |
| 2 — Compass Information Button | 5 — Uconnect Phone Button |
| 3 — Climate Functions Button   | 6 — Media Mode Button     |

### **WARNING!**

ALWAYS drive safely with your hands on the wheel. You have full responsibility and assume all risks related to the use of the Uconnect features and applications in this vehicle. Only use Uconnect when it is safe to do so. Failure to do so may result in an accident involving serious injury or death.

### **CAUTION!**

Do NOT attach any object to the touchscreen, doing so can result in damage to the screen.

## **Clock Setting**

To start the clock setting procedure, perform the following:

1. Push the MORE button on the faceplate. Next press the “Settings” button on the touchscreen and then press the “Clock and Date” button on the touchscreen.
2. Press the “Set Time” button on the touchscreen.
3. Press the “Up” or “Down” arrows to adjust the hours or minutes, then select the “AM” or “PM” button on the touchscreen. You can also select 12hr or 24hr format by pressing the desired button on the touchscreen.
4. Once the time is set, press the “Done” button on the touchscreen to exit the time screen.

### **NOTE:**

In the Clock Setting Menu, you can also select “Display Clock”, which turns the clock display in the status bar on or off.

## **Equalizer, Balance And Fade**

1. Push the MORE button on the faceplate.
2. Press the “Settings” button on the touchscreen.
3. Scroll down and press the “Audio” button on the touchscreen to get to the Audio menu.
4. The Audio Menu shows the following options for you to customize your audio settings.

### **Equalizer**

- Press the “Equalizer” button on the touchscreen to adjust the Bass, Mid and Treble. Use the “+” or “-” button on the touchscreen to adjust the equalizer to your desired settings. Press the “Done” button on the touchscreen when finished.

### **Balance/Fade**

- Press the “Balance/Fade” button on the touchscreen to adjust the sound from the speakers. Use the “arrow” button on the touchscreen to adjust the sound level from the front and rear or right and left side speakers. Press the Center “C” button on the touchscreen to reset the balance and fade to the factory setting. Press the “Done” button on the touchscreen when finished.

### **Speed Adjustable**

- Press the “Speed Adjusted Volume” button on the touchscreen to select between OFF, 1, 2 or 3. This will decrease the radio volume relative to a decrease in vehicle speed. Press the “Done” button on the touchscreen when finished.

### **Loudness**

- Press the “Loudness” button on the touchscreen to select the Loudness feature. When this feature is activated it improves sound quality at lower volumes.

# ELECTRONICS

## Radio Operation

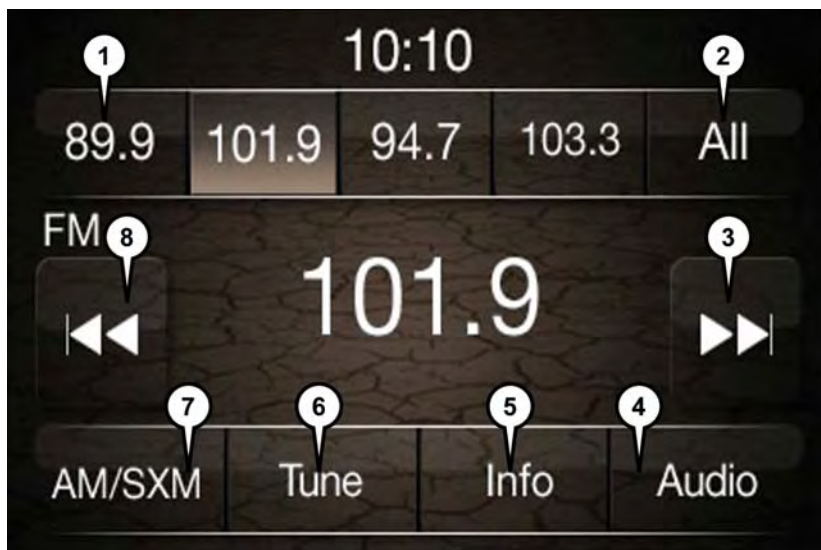

Uconnect 5.0 Radio Screen

- 1 — Radio Station Presets
- 2 — Show All Presets
- 3 — Seek Up
- 4 — Audio Settings

- 5 — Station Info
- 6 — Direct Tune
- 7 — Radio Band
- 8 — Seek Down

### Seek Up/Down Buttons

- Press the up or down button to seek through radio stations in AM, FM or SXM bands.
- Hold either button to bypass stations without stopping.

### Store Radio Presets Manually

The Radio stores up to 12 presets in each of the Radio modes. There are four visible presets at the top of the radio screen. Pressing the “All” button on the touchscreen on the radio home screen will display all of the preset stations for that mode.

To store a radio preset manually, follow the steps below:

1. Tune to the desired station.
2. Press and hold the desired preset button on the touchscreen for more that two seconds or until you hear a confirmation beep.

## SiriusXM Premier Over 160 channels

Get every channel available on your satellite radio, and enjoy all you want, all in one place. Hear commercial-free music plus sports, news, talk and entertainment. Get all the premium programming, including Howard Stern, every NFL game, Oprah Radio, every MLB and NHL game, every NASCAR race, Martha Stewart and more. And get 20+ extra channels, including SiriusXM Latino, offering 20 channels of commercial free music, news, talk, comedy, sports and more dedicated to Spanish language programming.

To access SiriusXM Satellite Radio, push the RADIO button on the faceplate and then the SXM button on the touchscreen.

SiriusXM services require subscriptions, sold separately after the 12-month trial included with the new vehicle purchase. **If you decide to continue your service at the end of your trial subscription, the plan you choose will automatically renew and bill at then-current rates until you call SiriusXM at 1-866-635-2349 for U.S. residents and 1-888-539-7474 for Canadian residents to cancel. See SiriusXM Customer Agreement for complete terms at [www.siriusxm.com](http://www.siriusxm.com) for U.S. residents and [www.siriusxm.ca](http://www.siriusxm.ca) for Canadian residents.** All fees and programming subject to change. Our satellite service is available only to those at least 18 and older in the 48 contiguous USA and D.C. Our Sirius satellite service is also available in PR (with coverage limitations). Our Internet radio service is available throughout our satellite service area and in AK and HI. © 2016 Sirius XM Radio Inc. Sirius, XM and all related marks and logos are trademarks of Sirius XM Radio Inc.

## Disc Operation (If Equipped)

Your vehicle may have a remote CD player located in the lower center console storage bin, or in the lower center bench seat bin.

- CD/Disc Mode is entered by either inserting a CD/Disc or by pushing the MEDIA button located on the side of the display. Once in Media Mode, select “Disc.”
- Gently insert one CD into the CD player with the CD label facing as indicated on the illustration located on the Disc player.

## Seek Up/Down Buttons

- Press to seek through Disc tracks.
- Hold either button to bypass tracks without stopping.

## Browse

- Press the “Browse” button on the touchscreen to scroll through and select a desired track on the Disc. Press the “Exit” button on the touchscreen if you want to cancel the browse function.

# ELECTRONICS

## USB/Audio Jack (AUX)/SD CARD – If Equipped

To select a specific audio source, push the MEDIA button on the faceplate. To allow music to play from your device through the vehicle's speakers, press the "Source" button then select one of the following modes:



**Uconnect Media Hub**

- 1 — SD Card Slot
- 2 — Audio/AUX Jack
- 3 — USB Port

### USB/iPod

- USB/iPod Mode is entered by either inserting a USB Jump Drive or iPod cable into the USB port or by pushing the MEDIA button on the faceplate located left of the display.

### Audio Jack (AUX)

- The AUX allows a device, such as an MP3 player or an iPod, to be plugged into the radio and utilize the vehicle's audio system, using a 3.5 mm audio cable, to amplify the source and play through the vehicle speakers.
- The functions of the device are controlled using the device buttons, not the buttons on the radio. The volume may be controlled using the radio or device.

### SD Card

- Play songs stored on an SD card inserted into the SD card slot.
- Song playback can be controlled using the radio or Steering Wheel Audio Controls to play, skip to the next or previous track, browse, and list the contents.

### Bluetooth

- If using a Bluetooth-equipped device, you may also be able to stream music to your vehicle's sound system.

# ELECTRONICS

## UCONNECT 8.4A/8.4AN

### Uconnect 8.4A/8.4AN At A Glance



Uconnect 8.4AN Radio Screen

### WARNING!

ALWAYS drive safely with your hands on the wheel. You have full responsibility and assume all risks related to the use of the Uconnect features and applications in this vehicle. Only use Uconnect when it is safe to do so. Failure to do so may result in an accident involving serious injury or death.

### CAUTION!

Do NOT attach any object to the touchscreen, doing so can result in damage to the screen.

# ELECTRONICS

## Setting The Time

- Model 8.4AN synchronizes time automatically via GPS, so it should not require any time adjustment. If you do need to set the time manually, follow the instructions below for Model 8.4A.
- For Model 8.4A, turn the unit on, then press the time display at the top of the screen. Press “Yes.”
- If the time is not displayed at the top of the screen, press the “Settings” button on the touchscreen. In the Settings screen, press the “Clock” button on the touchscreen, then check or uncheck this option.
- Press “+” or “-” next to Set Time Hours and Set Time Minutes to adjust the time.
- If these features are not available, uncheck the Sync Time box.
- Press “X” to save your settings and exit out of the Clock Setting screen.

## Background Themes

- Screen background themes are selectable from a pre-loaded list of themes. If you'd like to set a theme, follow the instructions below.
- Press the “Settings” button on the touchscreen.
- Press the “Display” button on the touchscreen.
- Then press “Set Theme” button on the touchscreen and select a theme.

## Audio Settings

- Press of the “Audio” button on the touchscreen to activate the Audio settings screen to adjust Balance\Fade, Equalizer, and Speed Adjusted Volume.
- You can return to the Radio screen by pressing the “X” located at the top right.

## Balance/Fade

- Press the “Balance/Fade” button on the touchscreen to Balance audio between the front speakers or fade the audio between the rear and front speakers.
- Pressing the “Front,” “Rear,” “Left,” or “Right” buttons on the touchscreen or press and drag the Speaker Icon to adjust the Balance/Fade.

## Equalizer

- Press the “Equalizer” button on the touchscreen to activate the Equalizer screen.
- Press the “+” or “-” buttons on the touchscreen, or press and drag over the level bar for each of the equalizer bands. The level value, which spans between plus or minus 9, is displayed at the bottom of each of the Bands.

## Speed Adjusted Volume

- Press the “Speed Adjusted Volume” button on the touchscreen to activate the Speed Adjusted Volume screen. The Speed Adjusted Volume is adjusted by pressing the volume level indicator. This alters the automatic adjustment of the audio volume with variation to vehicle speed.



# ELECTRONICS

## Personalized Menu Bar

The Uconnect features and services in the main menu bar are easily changed for your convenience. Simply follow these steps:

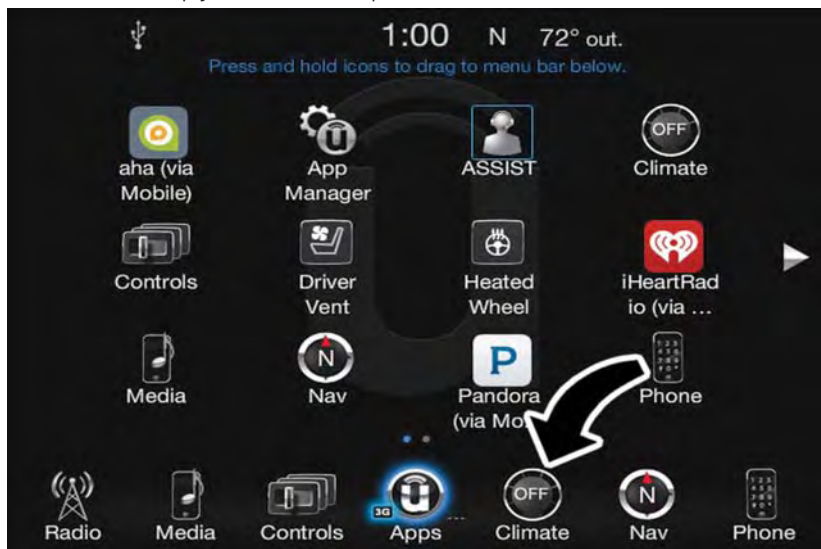

Uconnect 8.4A/8.4AN Main Menu

1. Press the “Apps 

The replaced shortcut will now be an active App/shortcut on the main menu bar.

# ELECTRONICS

## Radio



### Uconnect 8.4AN Radio

- |                               |                                    |
|-------------------------------|------------------------------------|
| 1 — Radio Station Presets     | 7 — Audio Settings                 |
| 2 — Toggle Between Presets    | 8 — Seek Up                        |
| 3 — Status Bar                | 9 — Direct Tune To A Radio Station |
| 4 — View Small Navigation Map | 10 — Seek Down                     |
| 5 — HD Radio                  | 11 — Browse And Manage Presets     |
| 6 — Main Category Bar         | 12 — Radio Bands                   |

### WARNING!

ALWAYS drive safely with your hands on the wheel. You have full responsibility and assume all risks related to the use of the Uconnect features and applications in this vehicle. Only use Uconnect when it is safe to do so. Failure to do so may result in an accident involving serious injury or death.

- To access the Radio mode, press the “Radio” button on the touchscreen.

### Selecting Radio Stations

- Press the desired radio band (AM, FM or SXM) button on the touchscreen.

## **Seek Up/Seek Down**

- Press the Seek up or down arrow buttons on the touchscreen for less than two seconds to seek through radio stations.
- Press and hold either arrow button on the touchscreen for more than two seconds to bypass stations without stopping. The radio will stop at the next listenable station once the arrow button on the touchscreen is released.

## **Direct Tune**

- Tune directly to a radio station by pressing the “Tune” button on the screen, and entering the desired station number.

## **Store Radio Presets Manually**

Your radio can store 36 total preset stations, 12 presets per band (AM, FM and SXM). They are shown at the top of your radio screen. To see the 12 preset stations per band, press the arrow button on the touchscreen at the top right of the screen to toggle between the two sets of six presets.

To store a radio preset manually, follow the steps below:

1. Tune to the desired station.
2. Press and hold the desired numbered button on the touchscreen for more than two seconds or until you hear a confirmation beep.

## **HD Radio — If Equipped**

- HD Radio (available on Uconnect 8.4AN) operates similar to conventional radio except it allows broadcasters to transmit a high-quality digital signal.
- With an HD radio receiver, the listener is provided with a clear sound that enhances the listening experience. HD radio can also transmit data such as song title or artist.

## **SiriusXM Premier Over 160 Channels**

Get every channel available on your satellite radio, and enjoy all you want, all in one place. Hear commercial-free music plus sports, news, talk and entertainment. Get all the premium programming, including Howard Stern, every NFL game, Oprah Radio, every MLB and NHL game, every NASCAR race, Martha Stewart and more. And get 20+ extra channels, including SiriusXM Latino, offering 20 channels of commercial free music, news, talk, comedy, sports and more dedicated to Spanish language programming.

- To access SiriusXM Satellite Radio, press the “SXM” button on the touchscreen on the main Radio screen.

# ELECTRONICS

The following describes features that are available when in SiriusXM Satellite Radio mode:

## **Seek Up/Seek Down**

- Press the Seek arrow buttons on the touchscreen for less than two seconds to seek through channels in SXM mode.
- Press and hold either arrow button on the touchscreen for more than two seconds to bypass channels without stopping. The radio will stop at the next listenable channel once the arrow button on the touchscreen is released.

## **Direct Tune**

- Tune directly to a SXM channel by pressing the “Tune” button on the touchscreen on the screen, and entering the desired station number.

## **Tune Start**

- The Tune Start feature begins playing a song from the beginning when you tune to your favorite preset SXM channel. Tune Start can be enabled or disabled through the SiriusXM setup page.

## **Jump**

- Automatically tells you when Traffic & Weather for a favorite city is available, and gives you the option to switch to that channel. Press “Jump” to activate the feature. After listening to Traffic and Weather, press “Jump” again to return to the previous channel.

## **Fav**

- Activates the favorites menu. You can add up to 50 favorite artists or songs. Just press “Add Fav Artist” or “Add Fav Song” while the song is playing. You will then be alerted any time one of these songs, or works by these artists, is playing on other SiriusXM channels.

## **Album Art**

- When arriving at a station, the Channel Art will be displayed to the left of the station information. After 5 seconds the Channel Art will be replaced with the Album Art (if available).

## **SiriusXM Parental Controls**

- You can skip or hide certain channels from view if you do not want access to them. Press the “Apps” button on the touchscreen, then the “Settings” button on the touchscreen, next press the “Sirius Setup” button on the touchscreen, then select Channel Skip. Press the box check-mark next to the channel you want skipped. They will not show up in normal usage.
- SiriusXM also offers the option to permanently block selected channels. Call (1-888-601-6297 for U.S. customers, 1-877-438-9677 for Canadian customers) and request the Family-Friendly Package.

# ELECTRONICS

## Browse

Lets you browse the SiriusXM channel listing or Genre listing. Favorites, Game Zone, Weather and Jump settings also provide a way to browse the SiriusXM channel list.

Browse Sub-Menu	Sub-Menu Description
All	Shows the channel listing.
Genre	Provides a list of all genres, and lets you jump to a channel within the selected genre.
Presets	Lets you scroll the list of Preset satellite channels. Press the channel, or press Enter on the Tune knob, to go to that channel. Press the trash can icon to delete a preset. Your presets are also shown at the top of the main Satellite Radio screen.
Favorites	Lets you manage artists and songs in the Favorites list and configure Alert Settings to let you know when favorite songs or artists are playing on other channels. Also, view a list of channels airing any of your Favorites.
Game Zone	Provides alerts when your favorite sports teams are starting a game which is being aired on other SiriusXM channels, or when their game score is announced. You can select and manage your Teams list here, and configure alerts.
Jump	Lets you select your favorite cities for Traffic & Weather information, which is used by the Jump feature on the main satellite radio screen.

## Replay

Lets you replay up to 44 minutes of the content of the current SiriusXM channel.

Replay Option	Option Description
Play/Pause	Press to Pause content playback. Press Pause/Play again to resume playback.
Rewind/RW	Rewinds the channel content in steps of five seconds. Press and hold to rewind continuously, then release to begin playing content at that point.
Fast Forward/FW	Forwards the content, and works similarly to Rewind/RW. However, Fast Forward/FW can only be used when content has been previously rewind.
Replay Time	Displays the amount of time in the upper center of the screen by which your content lags the Live channel.
Live	Resumes playback of Live content at any time while replaying rewind content.

- SiriusXM services require subscriptions, sold separately after the 12-month trial included with the new vehicle purchase. **If you decide to continue your service at the end of your trial subscription, the plan you choose will automatically renew and bill at then-current rates until you call SiriusXM at 1-866-635-2349 for U.S. residents and 1-888-539-7474 for Canadian residents to cancel. See SiriusXM Customer Agreement for complete terms at [www.siriusxm.com](http://www.siriusxm.com) (U.S. residents) or [siriusxm.ca](http://siriusxm.ca) (Canadian residents).** All fees and programming subject to change. Our satellite service is available only to those at least 18 and older in the 48 contiguous USA and D.C. Our Sirius satellite service is also available in PR (with coverage limitations). Our

# ELECTRONICS

Internet radio service is available throughout our satellite service area and in AK and HI. ©2015 Sirius XM Radio Inc. Sirius, XM and all related marks and logos are trademarks of Sirius XM Radio Inc.

## Disc Operation (If Equipped)

- Your vehicle may have a remote CD player located in the lower center console storage bin, or in the lower center bench seat bin.
- CD/Disc Mode is entered by either inserting a CD/Disc or by pressing the MEDIA button. Once in Media Mode, select “Disc.”
- Gently insert one CD into the CD player with the CD label facing as indicated on the illustration located on the Disc player.

## Seek Up/Down Buttons

- Press to seek through Disc tracks.
- Hold either button to bypass tracks without stopping.

## Browse

- Press the “Browse” button on the touchscreen to scroll through and select a desired track on the Disc. Press the “Exit” button on the touchscreen if you wish to cancel the browse function.

## Media Hub – USB/Audio Jack (AUX)/SD Card – If Equipped

There are many ways to play music from MP3 players, USB devices, or SD Cards through your vehicle's sound system. Press your Media button on the touchscreen to begin.



**Uconnect Media Hub**

- 1 — SD Card Slot
- 2 — Audio/AUX Jack
- 3 — USB Port

## Audio Jack (AUX)

- The AUX allows a device to be plugged into the radio and utilize the vehicle's sound system, using a 3.5 mm audio cable, to amplify the source and play through the vehicle speakers.
- Pressing the “AUX” button on the touchscreen will change the mode to auxiliary device if the audio jack is connected, allowing the music from your device to be heard through the vehicle's speakers. To activate the AUX, plug in the audio jack.

# ELECTRONICS

- The functions of the device are controlled using the device buttons. The volume may be controlled using the radio or device.
- To route the audio cable out of the center console, use the access cut out in the front of the console.

## USB Port

- Connect your compatible device using a USB cable into the USB Port. USB Memory sticks with audio files can also be used. Audio from the device can be played on the vehicles sound system while providing metadata (artist, track title, album, etc.) information on the radio display.
- When connected, the compatible USB device can be controlled using the radio or Steering Wheel Audio Controls to play, skip to the next or previous track, browse, and list the contents.
- The battery charges when plugged into the USB port (if supported by the specific device).
- To route the USB cable out of the center console, use the access cut out.

## NOTE:

When connecting your device for the first time, the system may take several minutes to read your music, depending on the number of files. For example, the system will take approximately five minutes for every 1,000 songs loaded on the device. Also during the reading process, the Shuffle and Browse functions will be disabled. This process is needed to ensure the full use of your features and only happens the first time it is connected. After the first time, the reading process of your device will take considerably less time unless changes are made or new songs are added to the playlist.

## SD Card

- Play songs stored on an SD card inserted into the SD card slot.
- Song playback can be controlled using the radio or Steering Wheel Audio Controls to play, skip to the next or previous track, browse, and list the contents.

## Bluetooth Streaming Audio

- If equipped with Uconnect Voice Command, your Bluetooth-equipped device may also be able to stream music to your vehicle's sound system. Your connected device must be Bluetooth-compatible and paired with your system (see Uconnect Phone for pairing instructions). You can access the music from your connected Bluetooth device by pressing the Bluetooth  button on the touchscreen while in Media mode.

# ELECTRONICS

## Media Controls



### Media Controls

- |                             |  |
|-----------------------------|--|
| 1 — Repeat Music Track      | 5 — Show Songs Currently In Cue To Be Played |
| 2 — Music Track And Time    | 6 — Browse Music By                          |
| 3 — Shuffle Music Tracks    | 7 — Music Source                             |
| 4 — Music Track Information |  |

The controls are accessed by pressing the desired button on the touchscreen and choosing between Disc, AUX, USB, Bluetooth or SD Card.

#### NOTE:

Uconnect will automatically switch to the appropriate mode when something is first connected or inserted into the system.

### Navigation

- The information in the section below is only applicable if you have the 8.4AN system or the Navigation has been activated on your 8.4A system.
- If you have a Uconnect 8.4A system your radio is "Navigation-Ready," and can be equipped with Navigation at an extra cost. Please see your dealer for details.

Press the "Nav" button on the touchscreen in the menu bar to access the Navigation system.



## Changing The Navigation Voice Prompt Volume

1. Press the “View Map” button on the touchscreen from the Nav Main Menu.
2. With the map displayed, press the “Settings” button on the touchscreen in the lower right area of the screen.
3. In the Settings menu, press the “Guidance” button on the touchscreen.
4. In the Guidance menu, adjust the Nav Volume by pressing the “+” or “-” buttons on the touchscreen.



### Uconnect 8.4AN Navigation

- |                        |                                  |
|------------------------|----------------------------------|
| 1 — Find A Destination | 5 — Navigation Settings          |
| 2 — View Map           | 6 — Stop A Route                 |
| 3 — Information        | 7 — Detour A Route               |
| 4 — Emergency          | 8 — Repeat Route Guidance Prompt |

## Finding Points Of Interest

- From the main Navigation menu, press the “Where To?” button on the touchscreen, then press the “Points of Interest” button on the touchscreen.
- Select a Category and then a subcategory, if necessary.
- Select your destination and press the “Yes” button on the touchscreen.

# ELECTRONICS

## Finding A Place By Spelling The Name

- From the Main Navigation Menu press the “Where to?” button on the touchscreen, press the “Points of Interest” button on the touchscreen, then press the “Spell Name” button on the touchscreen.
- Enter the name of your destination.
- Press the “List” button on the touchscreen.
- Select your destination and press the “Yes” button on the touchscreen.

## One-Step Voice Destination Entry

- Enter a navigation destination without taking your hands off the wheel.
- Just push the Uconnect Voice Command  button on the steering wheel, wait for the beep and say something like, "**Find Address** 800 Chrysler Drive Auburn Hills MI."

### NOTE:

Destination entry is not available while your vehicle is in motion. However, you can also use Voice Commands to enter an address while moving. Refer to Common Navigation Voice Commands in the Uconnect Voice Command section.

## Setting Your Home Location

- Press the “Nav” button on the touchscreen in the menu bar to access the Navigation system and the Main Navigation menu.
- Press the “Where To?” button on the touchscreen, then press the “Go Home” button on the touchscreen.
- You may enter your address directly, use your current location as your home address, or choose from recently found locations.
- To delete your Home location (or other saved locations) so you can save a new Home location, press the “Where To?” button on the touchscreen from the Main Navigation menu, then press the “Go Home” button on the touchscreen, and in the Yes screen press the “Options” button on the touchscreen. In the Options menu press the “Clear Home” button on the touchscreen. Set a new Home location by following the previous instructions.

## Go Home

- A Home location must be saved in the system. From the Main Navigation menu, press the “Where To?” button on the touchscreen, then press the “Go Home” button on the touchscreen.

# ELECTRONICS



Uconnect 8.4AN Map

- |                               |                                |
|-------------------------------|--------------------------------|
| 1 — Distance To Next Turn     | 5 — Your Location On The Map   |
| 2 — Next Turn Street          | 6 — Navigation Main Menu       |
| 3 — Estimated Time Of Arrival | 7 — Current Street Location    |
| 4 — Zoom In And Out           | 8 — Navigation Routing Options |

Your route is marked with a blue line on the map. If you depart from the original route, your route is recalculated. A speed limit icon could appear as you travel on major roadways.

## Adding A Stop

- To add a stop you must be navigating a route.
- Press the “Menu” button on the touchscreen to return to the Main Navigation menu.
- Press the “Where To?” button on the touchscreen, then search for the extra stop. When another location has been selected, you can choose to cancel your previous route, add as the first destination or add as the last destination.
- Press the desired selection and press the “Yes” button on the touchscreen.

## Taking A Detour

- To take a detour you must be navigating a route.
- Press the “Detour” button on the touchscreen.

## NOTE:

If the route you are currently taking is the only reasonable option, the device may not calculate a detour. For more information, see your Uconnect Owner's Manual Supplement.

# ELECTRONICS

## **SiriusXM Traffic (8.4AN & US Market Only)**

### **Don't Drive Through Traffic. Drive Around It.**

Avoid congestion before you reach it. By enhancing your vehicle's navigation system with the ability to see detailed traffic information, you can pinpoint traffic incidents, determine average traffic speed and estimate travel time along your route. Since the service is integrated with a vehicle's navigation system, SiriusXM Traffic can help drivers pick the fastest route based on traffic conditions.

- Detailed information on traffic speed, accidents, construction, and road closings.
- Traffic information from multiple sources, including police and emergency services, cameras and road sensors.
- Coast-to-coast delivery of traffic information.
- View conditions for points along your route and beyond. Available in over 130 markets.

## **SiriusXM Travel Link (8.4AN & US Market Only)**

In addition to delivering over 130 channels of the best sports, entertainment, talk, and commercial-free music, SiriusXM offers premium data services that work in conjunction with compatible navigation systems. SiriusXM Travel Link brings a wealth of useful information into your vehicle and right to your fingertips.

- **Fuel Prices** — Check local gas and diesel prices in your area and route to the station of your choice.
- **Movie Listings** — Check local movie theatres and listings in your area and route to the theater of your choice.
- **Sports Scores** — In-game and final scores as well as weekly schedules.
- **Weather** — Check variety of local and national weather information from radar maps to current and 5-day forecast.

SiriusXM Travel Link feature is completely integrated into your vehicle. A few minutes after you start your vehicle, Travel Link information arrives and updates in the background. You can access the information whenever you like, with no waiting.

To access SiriusXM Travel Link, press “Apps” button on the touchscreen, then press the “SiriusXM Travel Link” button on the touchscreen.

### **NOTE:**

SiriusXM Travel Link requires a subscription, sold separately after the five (5) year trial subscription included with your vehicle purchase.

SiriusXM Travel Link is only available in the United States.

## UCONNECT 8.4A/8.4AN VOICE RECOGNITION QUICK TIPS

### Introducing Uconnect

Start using Uconnect Voice Recognition with these helpful quick tips. It provides the key Voice Commands and tips you need to know to control your Uconnect 8.4AN system.

If you see the  icon on your touchscreen, you have the Uconnect 8.4AN system. If not, you have a Uconnect 8.4A system.



Uconnect 8.4AN

### WARNING!

ALWAYS drive safely with your hands on the wheel. You have full responsibility and assume all risks related to the use of the Uconnect features and applications in this vehicle. Only use Uconnect when it is safe to do so. Failure to do so may result in an accident involving serious injury or death.

# ELECTRONICS



## Get Started

1. Visit **UconnectPhone.com** to check device and feature compatibility and to find device pairing instructions.
2. Reduce background noise. Wind and passenger conversations are examples of noise that may impact recognition.
3. Speak clearly at a normal pace and volume while facing straight ahead. The microphone is positioned on the rearview mirror and aimed at the driver.
4. Each time you give a Voice Command, you must first push either the VR or Phone button, wait until **after** the beep, then say your Voice Command.
5. You can interrupt the help message or system prompts by pushing the VR or Phone button and saying a Voice Command from current category.

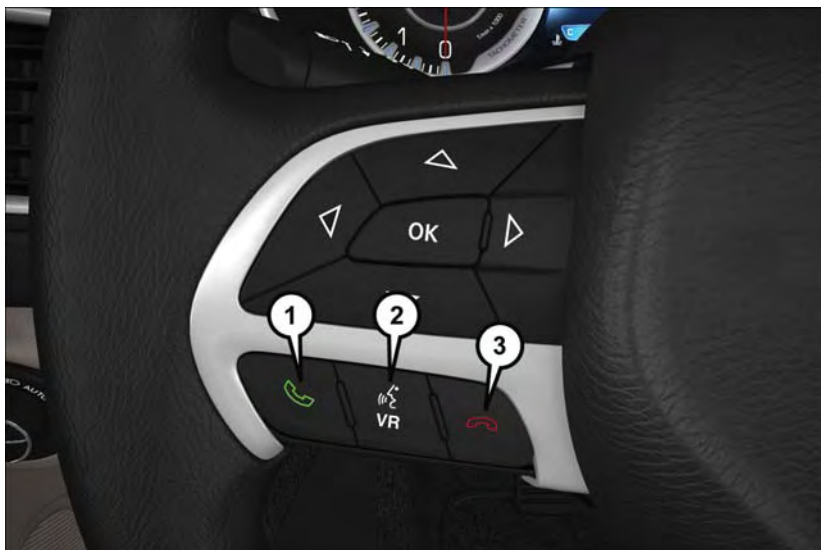
All you need to control your Uconnect system with your voice are the buttons on your steering wheel.



### Uconnect VR And Phone Buttons

1. Uconnect Phone Button  , Push to initiate, answer, or end a phone call, send or receive a text.
2. Uconnect Voice Recognition Button  .
  - a. Short Press: **Push and release** the VR button to begin Radio, Climate, Navigation, and other embedded functions. After you hear the single beep, say a command.

- b. Long Press: **Push and hold continuously for a few milliseconds, then release** the VR button for Siri functions. After you hear the familiar Siri "double beep," say a command.

### 3. Phone Hang Up Button.

#### Basic Voice Commands

The basic Voice Commands below can be given at any point while using your Uconnect system.

Push the VR button . After the beep, say:

- **Cancel** to stop a current voice session
- **Help** to hear a list of suggested Voice Commands
- **Repeat** to listen to the system prompts again

Notice the visual cues that inform you of your voice recognition system's status. Cues appear on the touchscreen.



Uconnect 8.4A/8.4AN

# ELECTRONICS

## Radio

Use your voice to quickly get to the AM, FM or SiriusXM Satellite Radio stations you would like to hear. (Subscription or included SiriusXM Satellite Radio trial required.)

Push the VR button . After the beep, say:

- **Tune to** ninety-five-point-five FM
- **Tune to** Satellite Channel Hits 1

**TIP:** At any time, if you are not sure of what to say or want to learn a Voice Command, push the VR button  and say **"Help."** The system will provide you with a list of commands.



Uconnect 8.4A/8.4AN Radio



# ELECTRONICS

## Siri Eyes Free — If Equipped

Siri lets you use your voice to send text messages, select media, place phone calls and much more. Siri uses your natural language to understand what you mean and will respond back to confirm your requests. The system is designed to keep your eyes on the road and your hands on the wheel by letting Siri help you perform useful tasks.

To enable Siri push and hold, then release the Uconnect Voice Recognition (VR) button on the steering wheel. After you hear a double beep you can ask Siri to play podcasts and music, get directions, read text messages and many other useful requests.



Siri Eyes Free Available

# ELECTRONICS

## Getting Started

Ensure Siri is enabled on your iPhone.

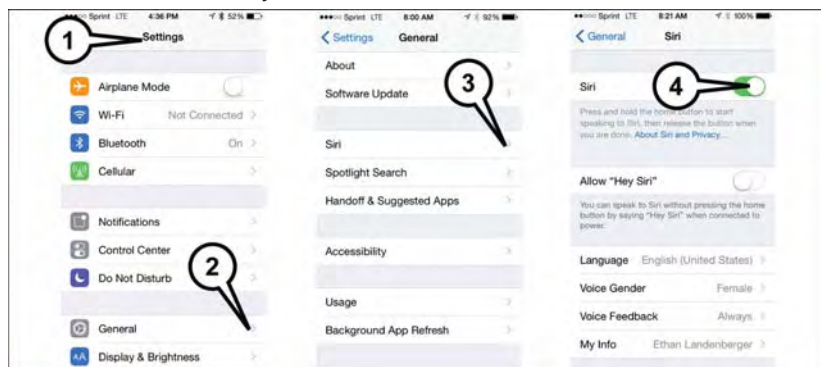

### Enable Siri

- 1 — Select Settings on your iPhone
- 2 — Select General

- 3 — Select Siri
- 4 — Enable Siri

# ELECTRONICS

1. Pair your Siri enabled device to the vehicles sound system. Refer to “Uconnect Phone” in “Electronics” for a detailed pairing procedure.



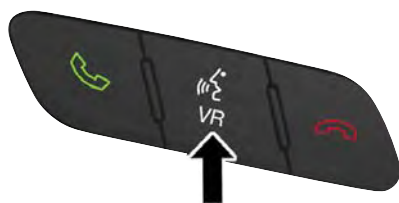

Pair Your iPhone



VR/Siri Button

2. Push and Hold, then release the Uconnect Voice Recognition (VR) button  on the steering wheel. After you hear the familiar Siri "double beep," say a command.

## NOTE:

A **push and release** of the  button will start normal embedded VR functions. The **push and hold, then release** of the  button will start Siri functions.

# ELECTRONICS

3. After the double beep, begin speaking to Siri.

Examples of Siri commands and questions:

- "Play Rolling Stones"
- "Send text message to John"
- "Read text message from Sarah"
- "Take me to the nearest coffee shop"

## NOTE:

- Speak clearly at a normal pace and volume while facing straight ahead to ensure your command is understood.
- Siri is available on iPhone 4S and later.



Siri Eyes Free

# ELECTRONICS

## Media

Uconnect offers connections via USB, SD, Bluetooth and auxiliary ports (If Equipped). Voice operation is only available for connected USB and iPod devices. (Remote CD player optional and not available on all vehicles.)

Push the VR button . After the beep, say one of the following commands and follow the prompts to switch your media source or choose an artist.

- **Change source** to Bluetooth
- **Change source** to iPod
- **Change source** to USB
- **Play artist** Beethoven; **Play album** Greatest Hits; **Play song** Moonlight Sonata; **Play genre** Classical

**TIP:** Press the Browse button on the touchscreen to see all of the music on your iPod or USB device. Your Voice Command must match **exactly** how the artist, album, song and genre information is displayed.



Uconnect 8.4A/8.4AN Media

# ELECTRONICS

## Phone

Making and answering hands-free phone calls is easy with Uconnect. When the Phonebook button is illuminated on your touchscreen, your system is ready.

U.S. residents can visit:

- UconnectPhone.com for device compatibility and pairing instructions.

Canadian residents can visit:

- UconnectPhone.com for device compatibility and pairing instructions.

Push the Phone button . After the beep, say one of the following commands...

- **Call** John Smith
- **Dial** 123-456-7890 and follow the system prompts
- **Redial** (call previous outgoing phone number)
- **Call back** (call previous incoming phone number)

**TIP:** When providing a Voice Command, push the Phone button  and say "Call," then pronounce the name **exactly** as it appears in your phone book. When a contact has multiple phone numbers, you can say "Call John Smith **work**."



Uconnect 8.4A/8.4AN Phone

## Voice Text Reply

Uconnect will announce **incoming** text messages. Push the Phone button  and say **Listen**. (Must have compatible device paired to Uconnect system.)

1. Once an incoming text message is read to you, push the Phone button . After the beep, say: **Reply**.
2. Listen to the Uconnect prompts. After the beep, repeat one of the pre-defined messages and follow the system prompts.

PRE-DEFINED VOICE TEXT REPLY RESPONSES		
Yes.	Stuck in Traffic.	See you later.
No.	Start without me.	I'll be Late.
Okay.	Where are you?	I will be <number> minutes late.
Call me.	Are you there yet?	
I'll call you later.	I need directions.	See you in <number> minutes.
I'm on my way.	Can't talk right now.	Thanks.
I'm lost.		

**TIP:** Your device must have the full implementation of the **Message Access Profile (MAP)** to take advantage of this feature. For details about MAP, visit [UconnectPhone.com](http://UconnectPhone.com) for U.S. residents. Apple iPhone iOS6 or later supports reading **incoming** text messages only. To enable this feature on your Apple iPhone, follow these 4 simple steps:

1. Select "Settings."
2. Select "Bluetooth."
3. Select the (i) for the paired vehicle.
4. Turn on "Show Notifications."



**iPhone Notification Setting**

**TIP:** Voice Text Reply is not compatible with iPhone, but if your vehicle is equipped with Siri Eyes Free, you can use your voice to send a text message.

# ELECTRONICS

## Climate (8.4A/8.4AN)

Too hot? Too cold? Adjust vehicle temperatures hands-free and keep everyone comfortable while you keep moving ahead. (If vehicle is equipped with climate control.)

Push the VR button . After the beep, say one of the following commands:

- **Set driver temperature to 70 degrees**
- **Set passenger temperature to 70 degrees**

**TIP:** Voice Command for Climate may only be used to adjust the interior temperature of your vehicle. Voice Command will not work to adjust the heated seats or steering wheel (if equipped).



Uconnect 8.4A/8.4AN Climate



# ELECTRONICS

## Navigation (8.4A/8.4AN)

The Uconnect navigation feature helps you save time and become more productive when you know exactly how to get to where you want to go. (Navigation is optional on the Uconnect 8.4A system. See your dealer to activate navigation at any time.)

1. To enter a destination, push the VR button . After the beep, say:

- For the 8.4A Uconnect System, say: **Enter state**.
- For the 8.4AN Uconnect System, say: **Find Address** 800 Chrysler Drive Auburn Hills, Michigan.

2. Then follow the system prompts.

**TIP:** To start a Point Of Interest (POI) search, push the VR button . After the beep, say “**Find nearest** coffee shop.”



Uconnect 8.4A/8.4AN Navigation

# ELECTRONICS

## Uconnect Access — If Equipped (8.4A/8.4AN)

### WARNING!

ALWAYS obey traffic laws and pay attention to the road. Some Uconnect Access services, including 9-1-1 and Assist, will NOT work without an operable 1X (voice/data) or 3G (data) network connection.

### NOTE:

Your vehicle may be transmitting data as authorized by the subscriber.

An included trial and/or subscription is required to take advantage of the Uconnect Access services in the next section of this guide. To register with Uconnect Access, press the “Apps” button on the 8.4-inch touchscreen to get started. Detailed registration instructions can be found on the next page.

### NOTE:



- If your vehicle is not connected to an operable 1X (voice/data) or 3G (data) network, the signal strength bars on the “Apps” button on the touchscreen will show a single bar and a prohibition symbol to indicate your vehicle is not connected to an operable 1X (voice/data) or 3G (data) network.

- Uconnect Access is available only on properly equipped vehicles purchased within the continental United States, Alaska and Hawaii when connected to an operable 1X (voice/data) or 3G (data) network. Services can only be used where coverage is available; see coverage map for details.

- CALL 9-1-1 Call
- Remote Door Lock/Unlock
- Remote Vehicle Start\*\*
- Remote Horn and Lights
- Roadside Assistance Call
- Theft Alarm Notification

- Stolen Vehicle Assistance
- Yelp Search
- Voice Texting
- Vehicle Health Reports\*\*
- Vehicle Health Alert\*\*
- 3G Wi-Fi Hotspot\*\*\*

\*\*If vehicle is properly equipped.

\*\*\*Extra charges apply.

## Register (8.4A/8.4AN)

To unlock the full potential of Uconnect Access in your vehicle, you first need to register with Uconnect Access.

1. Push the ASSIST button on your rearview mirror.



**Uconnect 8.4 Registration**

2. Press the “Uconnect Care” button on the touchscreen.
3. A helpful Uconnect Care Agent will register your vehicle and handle all of the details.

**Signing up is easy!** Simply follow the steps above. Or, press the “Apps 

For further information please visit [www.driveuconnect.com](http://www.driveuconnect.com)

# ELECTRONICS

## Mobile App (8.4A/8.4AN)

You're only a few steps away from using remote commands and playing your favorite music in your vehicle.

To link your internet radio accounts:

1. Download the **Uconnect Access App** on your device.
2. Press the Via Mobile icon on the navigation bar at the bottom of the app.
3. Press the app you'd like to connect to your vehicle.
4. Enter your login information for the selected app and press Link.
5. Next time you're in your vehicle, enable Bluetooth, pair your device and select the Via Mobile app you want to play from the Uconnect touchscreen to stream your personalized music.



Mobile App

### NOTE:

- You can also complete this process on the web. Simply visit [moparownerconnect.com](http://moparownerconnect.com) log in and click **Set Up Via Mobile Profile** (under Quick Links).
- Once you download the app to your compatible device, you will also be able to start your vehicle and lock/unlock its doors from virtually anywhere.

## Voice Texting (8.4A/8.4AN)

You must be registered with Uconnect Access and have a compatible MAP – enabled device to use your voice to send a personalized text message. (Not compatible with iPhone.)

1. To send a message, push the Phone button . After the beep, say: **“Send message to John Smith.”**
2. Listen to the prompt. After the beep, dictate the message you would like to send. Wait for Uconnect to process your message.
3. The Uconnect system will repeat your message and provide a variety of options to add to, delete, send or hear the message again. After the beep, tell Uconnect what you'd like to do. For instance, if you're happy with your message, after the beep, say **“Send.”**

# ELECTRONICS

You must be registered with Uconnect Access and have a compatible MAP – enabled device to use your voice to send a personalized text message. For details about MAP, visit [UconnectPhone.com](http://UconnectPhone.com). Apple iPhone iOS6 or later supports reading incoming text messages only. To enable this feature on your Apple iPhone, follow these 4 simple steps:

1. Select “Settings.”
2. Select “Bluetooth.”
3. Select the (i) for the paired vehicle.
4. Turn on “Show Notifications.”



**iPhone Notification Setting**



**TIP:**

- Voice Texting is not compatible with iPhone, but if your vehicle is equipped with Siri Eyes Free, you can use your voice to send a text message.
- Messages are limited to 140 characters.
- The Messaging button on the touchscreen must be illuminated to use the feature.

# ELECTRONICS

## Yelp (8.4A/8.4AN)

Once registered with Uconnect Access, you can use your voice to search for the most popular places or things around you.

1. Push the VR button . After the beep, say: **Launch YELP.**
2. Once the YELP home screen appears on the touchscreen, push the VR button , then say: **YELP search.**
3. Listen to the system prompts and after the beep, tell Uconnect the place or business that you'd like Uconnect to find.

**TIP:** Once you perform a search, you can reorganize the results by selecting either the Best Match, Rating or Distance tab on the top of the touchscreen display.



Yelp

# ELECTRONICS

## SiriusXM Travel Link (8.4A/8.4AN – US Market Only)

Need to find a gas station, view local movie listings, check a sports score or the 5-day weather forecast? SiriusXM Travel Link is a suite of services that brings a wealth of information right to your Uconnect 8.4AN system. (Not available for 8.4A system.)

Push the VR button . After the beep, say one of the following commands:

- **Show fuel prices**
- **Show 5 - day weather forecast**
- **Show extended weather**

**TIP:** Traffic alerts are not accessible with Voice Command.

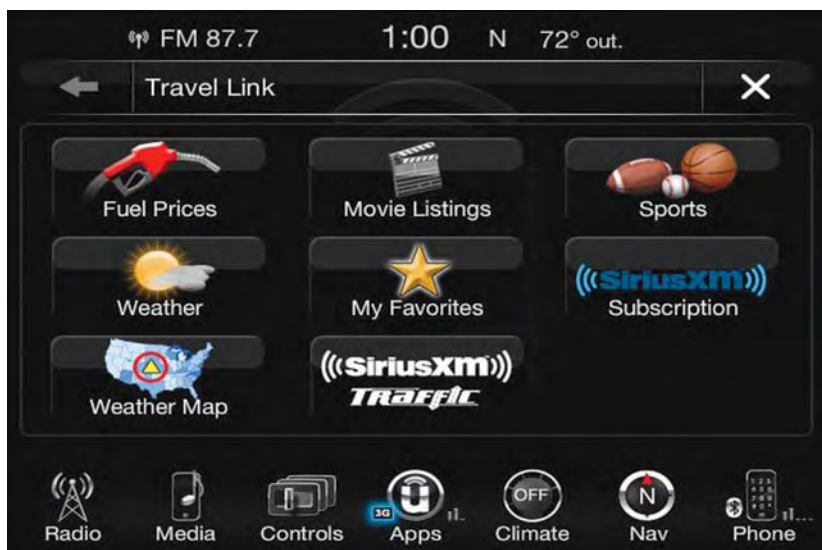

SiriusXM Travel Link

# ELECTRONICS

## Additional Information

© 2016 FCA US LLC. All rights reserved. Mopar, Mopar Owner Connect and Uconnect are registered trademarks of FCA US LLC. Android is a trademark of Google Inc. SiriusXM and all related marks and logos are trademarks of SiriusXM Radio Inc. Yelp, Yelp logo, Yelp burst and related marks are registered trademarks of Yelp.

For Uconnect system support, visit [DriveUconnect.com](http://DriveUconnect.com) or call: 1-877-855-8400 (24 hours a day 7 days a week)

Uconnect Access Services Support: 1-855-792-4241. Please have your Uconnect Security PIN ready when you call.

## UCONNECT PHONE

### Uconnect Phone (Bluetooth Hands Free Calling)



Uconnect 5.0 Phone Menu

- |                                      |   |
|--------------------------------------|---|
| 1 — Call/Redial/Hold                 | 7 — Uconnect Phone Settings Menu        |
| 2 — Mobile Phone Signal Strength     | 8 — Text Messaging                      |
| 3 — Currently Paired Mobile Phone    | 9 — Direct Dial Pad                     |
| 4 — Mobile Phone Battery Life        | 10 — Recent Call Log                    |
| 5 — Mute Microphone                  | 11 — Browse Phone Book (Contains 9-1-1) |
| 6 — Transfer To/From Uconnect System | 12 — End Call                           |





**Uconnect 8.4A/8.4AN Phone Menu**

- |                                      |   |
|--------------------------------------|---|
| 1 — Favorite Contacts                | 12 — Browse Phone Book Entries<br>(Contains 9-1-1)  |
| 2 — Mobile Phone Battery Life        | 13 — End Call   |
| 3 — Currently Paired Mobile Phone    | 14 — Call/Redial/Hold   |
| 4 — Mobile Phone Signal Strength     | 15 — Do Not Disturb   |
| 5 — Mute Microphone                  | 16 — Reply with Text Message  |
| 6 — Transfer To/From Uconnect System | * — Conference call feature only<br>available on GSM mobile devices                                     |
| 7 — Conference Call*                 | ** — Text messaging feature not<br>available on all mobile phones (re-<br>quires Bluetooth MAP profile) |
| 8 — Manage Paired Mobile Phones      |   |
| 9 — Text Messaging**                 |   |
| 10 — Direct Dial Pad                 |   |
| 11 — Recent Call Log                 |   |

The Uconnect Phone feature enables you to place and receive hands-free mobile phone calls. Drivers can also place mobile phone calls using their voice or by using the buttons on the touchscreen (see Voice Command section).

The hands-free calling feature is made possible through Bluetooth technology — the global standard that enables different electronic devices to connect to each other wirelessly.

# ELECTRONICS

If the Uconnect Phone Button  exists on your steering wheel, you then have the Uconnect Phone features.

## NOTE:

- The Uconnect Phone requires a mobile phone equipped with the Bluetooth Hands-Free Profile, Version 1.0 or higher.
- Most mobile phones/devices are compatible with the Uconnect system, however some mobile phones/devices may not be equipped with all of the required features to utilize all of the Uconnect system features.
- For Uconnect Customer Care:
  - U.S. residents visit [UconnectPhone.com](http://UconnectPhone.com) or call 1-877-855-8400.

## Pairing (Wirelessly Connecting) Your Mobile Phone To The Uconnect System

Mobile phone pairing is the process of establishing a wireless connection between a cellular phone and the Uconnect system.

## NOTE:

- To use the Uconnect Phone feature, you first must determine if your mobile phone and software are compatible with the Uconnect system. Please visit [UconnectPhone.com](http://UconnectPhone.com) for complete mobile phone compatibility information.
- Mobile phone pairing is not available while the vehicle is in motion.
- A maximum of 10 mobile phones can be paired to the Uconnect system.

## Start Pairing Procedure On The Radio

### Uconnect 5.0:

1. Place the ignition in the ACC or ON position.
2. Press the "Phone" button.
3. Select "Settings."
4. Select "Paired Phones."
5. Select "Add device."
  - Uconnect Phone will display an "In progress" screen while the system is connecting.



Uconnect 5.0

# ELECTRONICS

## Uconnect 8.4A, 8.4AN:

1. Place the ignition in the ACC or ON position.
2. Press the "Phone" button in the Menu Bar on the touchscreen.
3. Select "Settings."
4. Select "Paired Phones."
5. Select "Add device."
  - Uconnect Phone will display an "In progress" screen while the system is connecting.



Uconnect 8.4A & 8.4AN

## Pair Your iPhone:

To search for available devices on your Bluetooth enabled iPhone:

1. Press the Settings button.
2. Select Bluetooth.
  - Ensure the Bluetooth feature is enabled. Once enabled, the mobile phone will begin to search for Bluetooth connections.
3. When your mobile phone finds the Uconnect system, select "Uconnect".



Bluetooth On/Uconnect Device

## Complete The iPhone Pairing Procedure:

1. When prompted on the mobile phone, accept the connection request from Uconnect Phone.

### NOTE:

Some mobile phones will require you to enter the PIN number.



Pairing Request

# ELECTRONICS

## Select The iPhone's Priority Level

When the pairing process has successfully completed, the system will prompt you to choose whether or not this is your favorite mobile phone. Selecting “Yes” will make this mobile phone the highest priority. This mobile phone will take precedence over other paired mobile phones within range and will connect to the Uconnect system automatically when entering the vehicle. Only one mobile phone and/or one Bluetooth audio device can be connected to the Uconnect system at a time. If “No” is selected, simply select “Uconnect” from the mobile phone/audio device Bluetooth screen, and the Uconnect system will reconnect to the Bluetooth device.

## Pair Your Android Device:

To search for available devices on your Bluetooth enabled Android Device:

1. Push the Menu button.
2. Select Settings.
3. Select Connections.
4. Turn Bluetooth setting to “On.”
  - Ensure the Bluetooth feature is enabled. Once enabled, the mobile phone will begin to search for Bluetooth connections.
5. Once your mobile phone finds the Uconnect system, select “Uconnect”.
  - You may be prompted by your mobile phone to download the phonebook, check “Do Not Ask Again” to automatically download the phonebook. This is so you can make calls by saying the name of your contact.



Uconnect Device

## Complete The Android Pairing Procedure:

1. Confirm the passkey shown on the mobile phone matches the passkey shown on the Uconnect system then accept the Bluetooth pairing request.

### NOTE:

Some mobile phones require the PIN to be entered manually, enter the PIN number shown on the Uconnect screen.

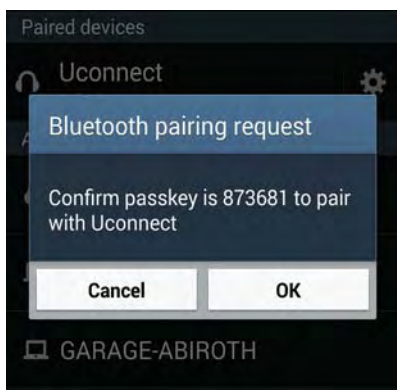

Pairing Request

## Select The Android Mobile Phone's Priority Level

When the pairing process has successfully completed, the system will prompt you to choose whether or not this is your favorite mobile phone. Selecting “Yes” will make this mobile phone the highest priority. This mobile phone will take precedence over other paired mobile phones within range and will connect to the Uconnect system automatically when entering the vehicle. Only one mobile phone and/or one Bluetooth audio device can be connected to the Uconnect system at a time. If “No” is selected, simply select “Uconnect” from the mobile phone/audio device Bluetooth screen, and the Uconnect system will reconnect to the Bluetooth device.

You are now ready to make hands-free calls. Press the Uconnect “Phone” button  on your steering wheel to begin.

### NOTE:

Refer to [UconnectPhone.com](http://UconnectPhone.com) website for additional information on mobile phone pairing and for a list of compatible phones.

## Common Phone Commands (Examples)

- “Call John Smith”
- “Call John Smith mobile”
- “Dial 1 248 555 1212”
- “Redial”

## Mute (Or Unmute) Microphone During Call

- During a call, press the “Mute” button on the Phone main screen to mute and unmute the call.

## Transfer Ongoing Call Between Handset And Vehicle

- During an on-going call, press the “Transfer” button on the Phone main screen to transfer an on-going call between handset and vehicle.

## Phonebook

The Uconnect system will automatically sync your phonebook from your paired phone, if this feature is supported by your phone. Phonebook contacts are updated each time that the phone is connected. If your phone book entries do not appear, check the settings on your phone. Some phones require you to enable this feature manually.

- Your phonebook can be browsed on the Uconnect system touchscreen, but editing can only be done on your phone. To browse, press the “Phone” button on the touchscreen, then the “Phonebook” button on the touchscreen.

Favorite phonebook entries can be saved as Favorites for quicker access. Favorites are shown at the top of the main phone screen.

# ELECTRONICS

## Voice Command Tips

- Speaking complete names (i.e; Call John Doe vs. Call John) will result in greater system accuracy.
- You can “link” commands together for faster results. Say “Call John Doe, mobile,” for example.
- If you are listening to available voice command options, you do not have to listen to the entire list. When you hear the command that you need, push the  VR button on the steering wheel, wait for the beep and say your command.



## Changing The Volume

- Start a dialogue by pushing the Phone button  , then say a command for example - "Help".
- Use the radio VOLUME/MUTE rotary knob to adjust the volume to a comfortable level while the Uconnect system is speaking.

### NOTE:

The volume setting for Uconnect is different than the audio system.

### NOTE:

To access help, push the Uconnect Phone button  on the steering wheel and say "help." Push the Uconnect Phone Pickup button  or the VR button  and say "cancel" to cancel the help session.

## Using Do Not Disturb

With Do Not Disturb, you can disable notifications from incoming calls and texts, allowing you to keep your eyes on the road and hands on the wheel. For your convenience there is a counter display to keep track of your missed calls and text messages while you were using Do Not Disturb.

Do Not Disturb can automatically reply with a text message, a call or both, when declining an incoming call and send it to voicemail.

Automatic reply messages can be:

- “I am driving right now, I will get back to you shortly.”
- Create a custom auto reply message up to 160 characters.

While in Do Not Disturb, Conference Call can be selected so you can still place a second call without being interrupted by incoming calls.

### NOTE:

- Only the beginning of your custom message will be seen on the touchscreen.
- Reply with text message is not compatible with iPhones.
- Auto reply with text message is only available on phones that supporting Bluetooth MAP.

# ELECTRONICS

## Incoming Text Messages

After pairing your Uconnect system with a Bluetooth enabled mobile device with the Message Access Profile (MAP), the Uconnect system can announce a new incoming text message and read it to you over the vehicle's audio system.

### NOTE:

Only incoming text messages received during the current ignition cycle can be viewed/read.

### To enable incoming text messaging:

#### iPhone

1. Press the settings button on the mobile phone.
2. Select Bluetooth.
  - Ensure Bluetooth is enabled, and the mobile phone is paired to the Uconnect system.
3. Select ⓘ located under DEVICES next to Uconnect.
4. Turn "Show Notifications" to On.



Enable iPhone Incoming Text Messages

# ELECTRONICS

## Android Devices

1. Push the Menu button on the mobile phone.
2. Select Settings.
3. Select Connections.
4. Turn "Show Notifications" to On.
  - A pop up will appear asking you to accept a request for permission to connect to your messages. Select "Don't ask again" and press OK.

### NOTE:

All incoming text messages received during the current ignition cycle will be deleted from the Uconnect system when the ignition is turned to the Off position.

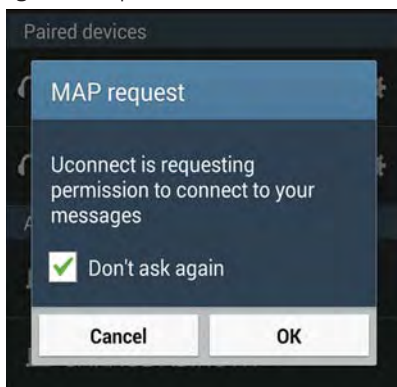

Enable Android Device Incoming Text Messages

## Voice Text Reply (Not Compatible With iPhone)

### NOTE:

Voice texting reply and voice texting features require a compatible mobile device enabled with Bluetooth Message Access Profile (MAP). iPhone, and some other smartphones, may not entirely support Bluetooth MAP. Visit [UconnectPhone.com](http://UconnectPhone.com) for the latest system and device compatibility.

- Due to the extremely large number of mobile phone manufacturers, your mobile device may not be listed. For further assistance, contact Uconnect Customer Care @ 1-877-855-8400 for U.S. residents or, 1-800-465-2001 (English) / 1-800-387-9983 (French) for Canadian residents.

Once your Uconnect system is paired with a compatible mobile device, the system can announce a new incoming text message, and read it to you over the vehicle audio system. You can reply to the message using Voice Recognition by selecting, or saying, one of the 18 pre-defined messages.



## Here's How:

1. Push the Uconnect Phone button  and wait for the beep, then say “reply.” Uconnect will give the following prompt: “Please say the message you would like to send.”
2. Wait for the beep and say one of the pre-defined messages. (If you are not sure, you can say “help”). Uconnect will then read the pre-defined messages allowed.
3. As soon as you hear the message you would like to send, you can interrupt the list of prompts by pushing the Uconnect phone button and saying the phrase. Uconnect will confirm the message by reading it back to you.
4. Push the Phone button and say “Send.”

PRE-DEFINED VOICE TEXT REPLY RESPONSES		
Yes.	Stuck in Traffic.	See you later.
No.	Start without me.	I'll be Late.
Okay.	Where are you?	I will be <5, 10, 15,...etc.> minutes late.
Call me.	Are you there yet?	
I'll call you later.	I need directions.	See you in <5, 10, 15,...etc.> of minutes.
I'm on my way.	Can't talk right now.	
I'm lost.		Thanks.

## NOTE:

To make the SMS voice reading function available, the SMS notification option on phone must be enabled; this option is usually available on the phone, in the Bluetooth connections menu for a device registered as Uconnect. After enabling this function on the mobile phone, it must be disconnected and reconnected with the Uconnect system in order to make it effective.

## Helpful Tips And Common Questions To Improve Bluetooth Performance With Your Uconnect System

### Mobile Phone won't reconnect to system after pairing:

- Set mobile phone to auto-connect or trusted device in mobile phone Bluetooth settings (Blackberry devices).
- Perform a factory reset on your mobile phone. Refer to your mobile phone manufacturer or cellular provider for instructions.
- Many mobile phones do not automatically reconnect after being restarted (hard reboot). Your mobile phone can still be connected manually. Close all applications that may be operating (refer to mobile phone manufacturer's instructions), and follow “Pairing (Wirelessly Connecting) Your Mobile Phone To The Uconnect System”.

# ELECTRONICS

## **Mobile Phone won't pair to system:**

- Perform a hard reset in the mobile phone by removing the battery (if removable — see your mobile phone's owner manual).
- Delete pairing history in mobile phone and Uconnect system; usually found in phone's Bluetooth connection settings.
- Verify you are selecting "Uconnect" in the discovered Bluetooth devices on your mobile phone.
- If your vehicle system generates a pin code the default is 0000.

## **Mobile Phonebook didn't download:**

- Check "Do not ask again," then accept the "phonebook download" request on your mobile phone.
- Up to 5,000 contact names with four numbers per contact will transfer to the Uconnect 8.4A/8.4AN system phonebook.
- Up to 2,000 contact names with six numbers per contact will transfer to the Uconnect 5.0 system phonebook.

## **Text messaging won't work:**

- Check "Do not ask again," then accept the "connect to your messages" request on your mobile phone.
- Verify that your mobile phone has the Bluetooth feature (Message Access Profile).

## **Can't make a conference call:**

- CDMA (Code-Division Multiple Access) carriers do not support conference calling. Refer to your mobile phone user's manual for further information.

## **Making calls while connected to AUX:**

- Plugging in your mobile phone to AUX while connected to Bluetooth will disable Hands-Free Calling. Do not make calls while your mobile phone is plugged into the AUX jack.

## STEERING WHEEL AUDIO CONTROLS

The steering wheel audio controls are located on the rear surface of the steering wheel.



Steering Wheel Audio Controls

### Right Switch

- Push the switch up or down to increase or decrease the volume.
- Push the button in the center to change modes AM/FM/CD/SXM.

### Left Switch

- Push the switch up or down to search for the next listenable station or select the next or previous CD track.
- Push the button in the center to select the next preset station (radio) or to change CDs if equipped with a CD Player.

# ELECTRONICS

## ELECTRONIC VEHICLE INFORMATION CENTER (EVIC) AND DRIVER INFORMATION DISPLAY (DID)

Your vehicle may be equipped with one of the following vehicle information systems:

- Electronic Vehicle Information Center (EVIC).
- Driver Information Display (DID).

The EVIC/DID features a driver interactive display that is located in the instrument cluster. Pushing the controls on the left side of the steering wheel allows the driver to select vehicle information and Personal Settings. For additional information, refer to “Programmable Features” in this guide.



EVIC/DID Controls

- Push the **UP**  $\triangle$  button to scroll upward through the main menus (Speedometer, Vehicle Info, Driver Assist, Fuel Economy, Trip, Audio, Messages, Screen Set Up).
- Push the **DOWN**  $\nabla$  arrow button to scroll downward through the main menu and submenus (Speedometer, Vehicle Info, Driver Assist, Fuel Economy, Trip, Audio, Messages, Screen Set Up).
- Push the **RIGHT**  $\triangleright$  arrow button to access the information screens or submenu screens of a main menu item.
- Push the **LEFT**  $\triangleleft$  arrow button to access the information screens or submenu screens of a main menu item.
- Push the **OK** button to access/select the information screens or submenu screens of a main menu item. Push and hold the **OK** arrow button for two seconds to reset displayed/selected features that can be reset.

### Compass Calibration

This compass is self-calibrating, which eliminates the need to set the compass manually. When the vehicle is new, the compass may appear erratic, and the EVIC/DID will display “CAL” until the compass is calibrated.

You may also calibrate the compass by completing one or more 360 degree turns (in an area free from large metal or metallic objects) until the “CAL” message displayed in the EVIC/DID turns off. The compass will now function normally.

## PROGRAMMABLE FEATURES

### Uconnect Customer Programmable Features



The Uconnect system allows you to access Customer Programmable feature settings through buttons on the touchscreen.

- Push the MORE or SETTINGS button (Uconnect 5.0), or press the “Apps” button (Uconnect 8.4) located near the bottom of the touchscreen, then press the “Settings” button on the touchscreen to access the Settings screen. When making a selection, scroll up or down until the preferred setting is highlighted, then press and release the preferred setting until a check-mark appears next to the setting, showing that setting has been selected. The following feature settings are available:
  - Display
  - Voice
  - Clock
  - Safety & Driving Assistance
  - Lights
  - Compass (Uconnect 5.0)
  - Doors & Locks
  - Auto-On Comfort
  - Engine Off Options
  - Audio
  - Phone/Bluetooth
  - SiriusXM Setup
  - Restore Settings
  - Clear Personal Data
  - System Information

#### NOTE:

Depending on the vehicles options, feature settings may vary.

## UNIVERSAL GARAGE DOOR OPENER (HomeLink)

- HomeLink  replaces up to three hand-held transmitters that operate devices such as garage door openers, motorized gates, lighting or home security systems. The HomeLink unit is powered by your vehicles 12 Volt battery.
- The HomeLink buttons that are located in the overhead console or sunvisor designate the three different HomeLink channels.
- The HomeLink indicator  is located above the center button.



Universal Garage Door Opener (HomeLink)

# ELECTRONICS

## Before You Begin Programming HomeLink

Ensure that your vehicle is parked outside of the garage before you begin programming.

For efficient programming and accurate transmission of the radio-frequency signal, it is recommended that a new battery be placed in the hand-held transmitter of the device that is being programmed to the HomeLink system.

To erase the channels, place the ignition switch into the ON/RUN position, then push and hold the two outside HomeLink buttons (I and III) for up to 20 seconds or until the red indicator flashes.

### NOTE:

Erasing all channels should only be performed when programming HomeLink for the first time. Do not erase channels when programming additional buttons.

If you have any problems, or require assistance, please call toll-free 1-800-355-3515 or, on the Internet at HomeLink.com for information or assistance.

## Programming A Rolling Code

### NOTE:

For programming Garage Door Openers that were manufactured after 1995. These Garage Door Openers can be identified by the "LEARN" or "TRAIN" button located where the hanging antenna is attached to the Garage Door Opener. It is NOT the button that is normally used to open and close the door. The name and color of the button may vary by manufacturer.

1. Place the ignition switch into the ON/RUN position.
2. Place the hand-held transmitter 1 to 3 inches (3 to 8 cm) away from the HomeLink button you wish to program while keeping the HomeLink indicator light in view.
3. Push and hold the HomeLink button you want to program while you push and hold the hand-held transmitter button.
4. Continue to hold both buttons and observe the indicator light. The HomeLink indicator will flash slowly and then rapidly after HomeLink has received the frequency signal from the hand-held transmitter. Release both buttons after the indicator light changes from slow to rapid.
5. At the garage door opener motor (in the garage), locate the "LEARN" or "TRAINING" button. This can usually be found where the hanging antenna wire is attached to the garage door opener motor. Firmly push and release the "LEARN" or "TRAINING" button.

### NOTE:

You have 30 seconds in which to initiate the next step after the LEARN button has been pushed.

6. Return to the vehicle and push the programmed HomeLink button twice (holding the button for two seconds each time). If the device is plugged in and activates, programming is complete.

**NOTE:**

If the device does not activate, push the button a third time (for two seconds) to complete the training.

7. To program the remaining two HomeLink buttons, repeat each step for each remaining button. DO NOT erase the channels.

## Programming A Non-Rolling Code

**NOTE:**

For programming Garage Door Openers manufactured before 1995.

1. Place the ignition switch to the ON/RUN position.
2. Place the hand-held transmitter 1 to 3 inches (3 to 8 cm) away from the HomeLink button you wish to program while keeping the HomeLink indicator light in view.
3. Push and hold the HomeLink button you want to program while you push and hold the hand-held transmitter button.
4. Continue to hold both buttons and observe the indicator light. The HomeLink indicator will flash slowly and then rapidly after HomeLink has received the frequency signal from the hand-held transmitter. Release both buttons after the indicator light changes from slow to rapid.
5. Push and hold the programmed HomeLink button and observe the indicator light. If the indicator light stays on constantly, programming is complete and the garage door (or device) should activate when the HomeLink button is pushed.
6. To program the two remaining HomeLink buttons, repeat each step for each remaining button. DO NOT erase the channels.

## Using HomeLink

To operate, push and release the programmed HomeLink button. Activation will now occur for the programmed device (i.e., garage door opener, gate operator, security system, entry door lock, home/office lighting, etc.,). The hand-held transmitter of the device may also be used at any time.

**WARNING!**

- Your motorized door or gate will open and close while you are programming the universal transceiver. Do not program the transceiver if people or pets are in the path of the door or gate.
- Do not run your vehicle in a closed garage or confined area while programming the transceiver. Exhaust gas from your vehicle contains Carbon Monoxide (CO) which is odorless and colorless. Carbon Monoxide is poisonous when inhaled and can cause you and others to be severely injured or killed.

# ELECTRONICS

## POWER INVERTER

A 115 Volt, 150 Watt power inverter outlet is located on the rear of the center console. This outlet can power cellular phones, electronics and other low power devices requiring power up to 150 Watts.

The power inverter is designed with built-in overload protection. If the power rating of 150 Watts is exceeded, the power inverter will automatically shut down. Once the electrical device has been removed from the outlet, the inverter should automatically reset.

If the power rating exceeds approximately 170 Watts, the power inverter may have to be reset manually. To reset the inverter manually, unplug the device and plug it in again. To avoid overloading the circuit, check the power ratings on electrical devices prior to using the inverter.



**Power Inverter**

### **WARNING!**

To Avoid Serious Injury or Death DO NOT:

- insert any objects into the receptacles
- touch with wet hands

Close the lid when not in use. If this outlet is mishandled, it may cause an electric shock and failure.



# ELECTRONICS

## POWER OUTLET

There are three 12 Volt electrical power outlets on this vehicle.

The front 12 Volt power outlet is located below the climate controls in the Center Console Media Center, and is powered when the ignition switch is in the ON/RUN position. The outlet can operate a conventional cigar lighter unit or power accessories designed for use with a standard power outlet adapter.



**Front Power Outlet**

The center console 12 Volt power outlet is powered directly from the battery (power available at all times). Items plugged into this outlet may discharge the battery and/or prevent the engine from starting.



**Center Console Power Outlet**

# ELECTRONICS

There is also a 12 Volt power outlet located in the rear cargo area of the vehicle. This power outlet has power available directly from the battery (power available at all times). Items plugged into this outlet also may discharge the battery and/or prevent the engine from starting.

## NOTE:

- Do not exceed the maximum power of 160 Watts (13 Amps) at 12 Volts. If the 160 Watt (13 Amp) power rating is exceeded, the fuse protecting the system will need to be replaced.
- Power outlets are designed for accessory plugs only. Do not insert any other object in the power outlet as this will damage the outlet and blow the fuse. Improper use of the power outlet can cause damage not covered by your new vehicle Limited warranty.
- The rear cargo power outlet can be switched to “battery” powered all the time by switching the power outlet right rear quarter panel fuse in the fuse panel.



**Rear Cargo Power Outlet**

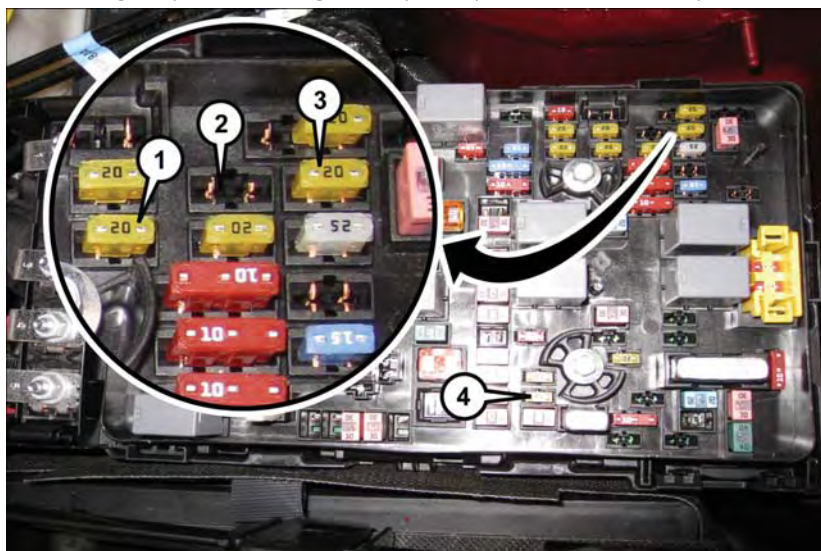

**Power Outlets Fuse Locations**

- 1 — F75 Fuse 20A Yellow Front Power Outlet/Cigar Lighter Console Bin
- 2 — F81 Fuse 20A Yellow Rear Power Outlet (battery powered at all times)
- 3 — F91 Fuse 20A Yellow Rear Power Outlet (powered when the ignition switch is in the ON or ACC position)
- 4 — F60 Fuse 20A Yellow Power Outlet Center Console

## WIRELESS CHARGING PAD

### Wireless Charging Pad – If Equipped

Your vehicle may be equipped with a wireless charging pad located inside the upper portion of the center console. This charging pad is designed to wirelessly charge your Qi enabled mobile phone. Qi is a standard that uses magnetic induction to transfer power to your mobile device.

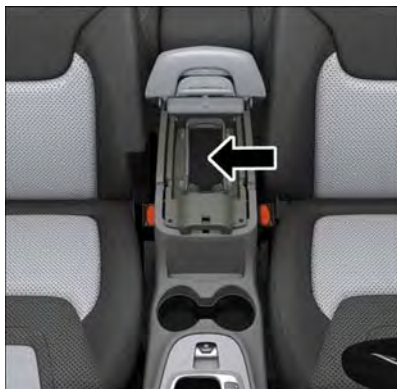

Wireless Charging Pad

Your mobile phone must be designed for Qi wireless charging, be equipped with an aftermarket sleeve or equipped with a back plate from your mobile phone provider, or an online or local electronics retailer. The wireless charging pad is equipped with an anti-slip mat, an adjustable cradle to hold your mobile phone in place and an LED indicator light.

**NOTE:**

Visit [UconnectPhone.com](http://UconnectPhone.com) for supported mobile phones and compatible aftermarket sleeves.

# ELECTRONICS

## Wireless Charging Pad Operation

To use the wireless charging pad, the coil in your mobile phone needs to align with the coil in the charging pad, which is located directly under the Qi logo. Since each mobile phone's coil location is different, you may need a few attempts to locate the correct spot for your mobile phone:

1. Place your mobile phone on the wireless charging pad, towards the Qi logo, so that the LED turns red. If the LED does not turn red, pick up the mobile phone and change its location.



Mobile Phone Alignment

### NOTE:

The mobile phone **must** be aligned around the Qi logo for the LED to transition from red to flashing green.

2. Once the LED transitions from red to flashing green, your mobile phone is correctly placed and charging.
3. If the LED does not transition from red to flashing green, and just turns off, pick up your mobile phone and reposition it on the charging pad.

# ELECTRONICS

4. Use the adjustable cradle to hold the mobile phone in position. The cradle moves by pushing down on the finger tabs and moving the cradle in or out.

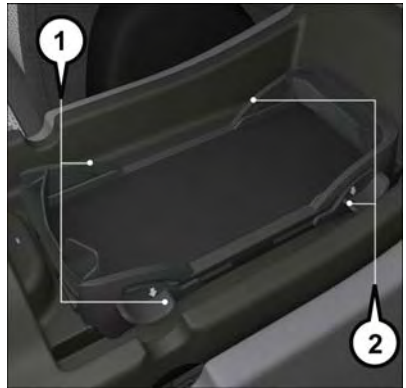

**Adjustable Cradle**

- 1 — Front Cradle Adjustment  
2 — Rear Cradle Adjustment

**NOTE:**

The initial adjustment will only need to be done once as long as only one mobile phone is used. If a different mobile phone is used, the cradle will need to be readjusted.

The LED indicator will flash green while the mobile phone is charging. The Qi enabled phone is able to function normally as it is charging.

**CAUTION!**

Do not place your vehicle Key Fob on the wireless charging pad, the Keyless Enter-N-Go feature may not work properly while a mobile phone is being charged.

**WARNING!**

Do not place metal object(s) between the mobile phone and wireless charging pad. Metal object(s) such as coins, rings or keys will become very **HOT**. If metal object(s) become lodged between the mobile phone and wireless charging pad, carefully remove the mobile phone and allow the metal object(s) to cool before removing. Failure to wait until the object(s) cool could result in personal injury, including burns.

# OFF-ROAD CAPABILITIES

## FOUR-WHEEL DRIVE OPERATION

### 1-Speed Four-Wheel Drive (4X4)

This feature provides on-demand Four-Wheel Drive (4X4) with no driver inputs or additional driving skills required.

Under normal driving conditions, the front wheels provide most of the traction.



**1-Speed 4X4 Switch**

If the front wheels begin to lose traction, power is shifted automatically to the rear wheels.

#### **NOTE:**

On dry pavement under heavy throttle input (where one may have wheel spin), torque will be sent to the rear wheels to improve vehicle launch and performance characteristics.

# OFF-ROAD CAPABILITIES

## 2-Speed Four-Wheel Drive (4X4)

This electronically shifted Power Transfer Unit provides three mode positions:

- Four Wheel Drive High (4WD)
- Neutral (N)
- Four Wheel Drive Low (4WDLOW)

The 4X4 LOW range can be used when additional traction is required to force the front and rear wheels to rotate at the same speed.

4X4 LOW is intended for loose, slippery road surfaces only.

The NEUTRAL position allows vehicles with 2-speed Four-Wheel Drive to be flat towed (with all wheels on the ground) without damaging the drivetrain. Refer to “Recreational Towing” for instructions on shifting into and out of NEUTRAL.



2-Speed 4X4 Switch

### NOTE:

In 4X4 LOW the engine speed is approximately three times that of the normal driving mode at a given road speed. Take care not to overspeed the engine and do not exceed 25 mph (40 km/h).

## Shifting Procedures

### 4X4 HI To 4X4 LOW

With the vehicle at speeds of 0 to 3 mph (0 to 5 km/h), the ignition switch in the ON position or the engine running, shift the transmission into NEUTRAL, and push the “4WD LOW” button once. The “4WD LOW” indicator light in the instrument cluster will begin to flash and remain on solid when the shift is complete.

### NOTE:

If shift conditions/interlocks are not met a message will flash from the Electronic Vehicle Information Center (EVIC)/Driver Information Display (DID) with instructions on how to complete the requested shift. Refer to “Electronic Vehicle Information Center (EVIC)” or “Driver Information Display (DID)” in “Understanding Your Instrument Panel” on the DVD for further information.

# OFF-ROAD CAPABILITIES

## 4X4 LOW To 4X4 HI

With the vehicle at speeds of 0 to 3 mph (0 to 5 km/h), the ignition switch in the ON position or the engine running, shift the transmission into NEUTRAL, and push the “4WD LOW” button once. The “4WD LOW” indicator light in the instrument cluster will flash and go out when the shift is complete.

### NOTE:

If shift conditions/interlocks are not met a message will flash from the Electronic Vehicle Information Center (EVIC)/Driver Information Display (DID) with instructions on how to complete the requested shift. Refer to “Electronic Vehicle Information Center (EVIC)” or “Driver Information Display (DID)” in “Understanding Your Instrument Panel” on the DVD for further information.

## Rear Electronic Locker (E-Locker) System

The Rear E-Locker System features a mechanical locking rear differential to provide better traction in the 4WD LOW position. The “REAR LOCK” button is on the Selec-Terrain Knob.

### Activating The Rear E-Locker

To activate the Rear E-Locker System, the following conditions must be met:

- The 4WD system must be in 4WD LOW.
- The ignition switch in the ON position or the engine running.
- Vehicle speed must be below 15 MPH (24 km/h).
- To engage Rear E-Locker, push the REAR LOCK button once.

### Deactivating The Rear E-Locker System

To deactivate the Rear E-Locker System, the following conditions must be met:

- Rear E-Locker must be engaged, and the REAR LOCK indicator light on.
- The ignition switch in the ON position or the engine running.
- To disengage Rear E-Locker , push the REAR LOCK button once.

### NOTE:

- It may also be necessary to drive slowly steering back and forth to complete engagement and disengagement of the E- Locker.
- When engaging Rear E-Locker, the indicator lights in the instrument cluster and on the REAR LOCK button will begin to flash. When the shift is complete the REAR LOCK indicator lights will remain on.
- When disengaging Rear E-Locker, the indicator lights in the instrument cluster and on the REAR LOCK button will begin to flash. When the shift is complete the REAR LOCK indicator lights will remain off.



# OFF-ROAD CAPABILITIES

- Shifting into or out of Rear E-Locker is possible with the vehicle completely stopped; however, difficulty may occur due to the mating clutch teeth not being properly aligned. Several attempts may be required for clutch teeth alignment and shift completion to occur. The preferred method is for the vehicle to be rolling, below 15 MPH (24 km/h), while including right and left steering maneuvers to allow for the clutch teeth to align.
- The Rear E-Locker System must be disengaged prior to taking the vehicle out of 4X4 LOW range. If 4X4 LOW shift conditions/interlocks are not met, a message will flash from the Electronic Vehicle Information Center (EVIC)/Driver Information Display with instructions on how to complete the requested shift.

## SELEC-TERRAIN

Selec-Terrain combines the capabilities of the vehicle control systems, along with driver input, to provide the best performance for all terrains.

Rotate the mode control knob to select the following Selec-Terrain positions:

- **Auto** — Fully automatic full time four-wheel drive operation can be used on and off road. Balances traction with seamless steering feel to provide improved handling and acceleration over two-wheel drive vehicles.
- **Snow** — Tuning set for additional stability in inclement weather. Use on and off road on loose traction surfaces such as snow. When in SNOW mode (depending on certain operating conditions), the transmission may use second gear (rather than first gear) during launches, to minimize wheel slippage.
- **Sport** — This mode alters the transmission's automatic shift schedule for sportier driving. Upshift speeds are increased to make full use of available engine power.
- **Sand/Mud** — Off road calibration for use on low traction surfaces such as mud, sand, or wet grass. Driveline is maximized for traction. Some binding may be felt on less forgiving surfaces. The electronic brake controls are set to limit traction control management of throttle and wheel spin.
- **Rock** — Off-road calibration only available in 4WD LOW range. Traction based tuning with improved steer-ability for use on high traction off-road surfaces. Activate the Hill Descent Control for steep downhill control. Use for low speed obstacles such as large rocks, deep ruts, etc.



**Selec-Terrain Switch**

### NOTE:

SPORT mode is not available when 4X4 LOW is selected.

# UTILITY

## CARGO AREA FEATURES

### Cargo Load Floor

The cargo load floor system has a load capacity of 400 lbs (181 kg).

To provide additional storage area, each rear seat can be folded flat. This allows for extended cargo space and still maintains some rear seating room. Refer to “Rear Seats” in “Getting Started” for further information.

### Cargo Extension Panels

Cargo extension panels can be folded and unfolded. When the rear seats are moved to the more forward positions and the rear seat backs are folded down, the extension panels can be unfolded manually by hand (2 of them). The extension panels can be used to extend the load floor to the rear seats and/or hide the gap between the load floor and rear seats, or to assist in loading large items into the cargo area.

### Cargo Tie-Down Hooks And Loops

The tie-downs located on the cargo area floor should be used to secure loads safely when the vehicle is moving.

Cargo tie-down loops are located on the trim panels.

### **WARNING!**

- Cargo tie-downs are not safe anchors for a child seat tether strap. In a sudden stop or accident, a tie-down could pull loose and allow the child seat to come loose. A child could be badly injured. Use only the anchors provided for child seat tethers.
- To help protect against personal injury, passengers should not be seated in the rear cargo area. The rear cargo space is intended for load carrying purposes only, not for passengers, who should sit in seats and use seat belts.

## WARNING!

The weight and position of cargo and passengers can change the vehicle center of gravity and vehicle handling. To avoid loss of control resulting in personal injury, follow these guidelines for loading your vehicle:

- Do not carry loads that exceed the load limits described on the label attached to the left door or left door center pillar.
- Always place cargo evenly on the cargo floor. Put heavier objects as low and as far forward as possible.
- Place as much cargo as possible in front of the rear axle. Too much weight or improperly placed weight over or behind the rear axle can cause the vehicle to sway.
- Do not pile luggage or cargo higher than the top of the seatback. This could impair visibility or become a dangerous projectile in a sudden stop or accident.

## TRAILER TOWING

### Trailer Towing Weights (Maximum Trailer Weight Ratings)

Engine/ Transmission	Model	Frontal Area	Maximum GTW (Gross Trailer Wt.)	Maximum Tongue Wt. (See Note)
2.4L/Automatic with or without Trailer Tow Package	FWD or 4WD	32 sq ft (2.97 sq m)	2,000 lbs (907 kg)	200 lbs (90 kg)
3.2L/Automatic	FWD or 4WD	32 sq ft (2.97 sq m)	2,000 lbs (907 kg)	200 lbs (90 kg)
3.2L/Automatic with Trailer Tow Package	FWD or 4WD	39.44 sq ft (3.66 sq m)	4,500 lbs (2 041 kg)	450 lbs (204 kg)

Refer to local laws for maximum trailer towing speeds.

**NOTE: The trailer tongue weight must be considered as part of the combined weight of occupants and cargo, and should never exceed the weight referenced on the Tire and Loading Information placard.**

# UTILITY

## RECREATIONAL TOWING (BEHIND MOTORHOME, ETC.)

### Towing This Vehicle Behind Another Vehicle

Towing Condition	Wheels OFF the Ground	Front-Wheel Drive (FWD) Models	1-Speed Power Transfer Unit	4X4 Models
				2-Speed Power Transfer Unit
Flat Tow	NONE	<b>NOT ALLOWED</b>	<b>NOT ALLOWED</b>	<b>See Instructions:</b> <ul style="list-style-type: none"> <li>• Before towing, See your authorized dealer for the Mopar flat tow wiring kit</li> <li>• It is recommended to charge the battery of the towed vehicle during recreational towing</li> <li>• Transmission in <b>PARK</b></li> <li>• Power transfer unit in <b>NEUTRAL (N)</b></li> <li>• Tow in <i>forward</i> direction</li> </ul>
Dolly Tow	Front	OK	<b>NOT ALLOWED</b>	<b>NOT ALLOWED</b>
	Rear	<b>NOT ALLOWED</b>	<b>NOT ALLOWED</b>	<b>NOT ALLOWED</b>
On Trailer	ALL	OK	OK	OK

NOTE:

- You must ensure that the Auto Park Brake feature is disabled before towing this vehicle, to avoid inadvertent Electric Park Brake engagement. The Auto Park Brake feature is enabled or disabled via the customer programmable features in the Uconnect Settings.
- When recreational towing your vehicle, always follow applicable state and provincial laws. Contact state and provincial Highway Safety offices for additional details.

### Recreational Towing – Front-Wheel Drive (FWD) Models

**DO NOT** flat tow this vehicle. Damage to the drivetrain will result.

Recreational towing (for front-wheel drive models) is allowed **ONLY** if the front wheels are **OFF** the ground. This may be accomplished using a tow dolly or vehicle trailer. If using a tow dolly, follow this procedure:

1. Properly secure the dolly to the tow vehicle, following the dolly manufacturer's instructions.
2. Drive the front wheels onto the tow dolly.
3. Apply the parking brake. Place the transmission in PARK. Turn the engine OFF.

4. Properly secure the front wheels to the dolly, following the dolly manufacturer's instructions.
5. Turn the ignition to the ON/RUN position, but do not start the engine.
6. Press and hold the brake pedal.
7. Release the parking brake.
8. Turn the ignition OFF, remove the Key Fob, and release the brake pedal.

## CAUTION!

- Towing with the front wheels on the ground will cause severe transmission damage. Damage from improper towing is not covered under the New Vehicle Limited Warranty.
- Ensure that the Electric Park Brake is released, and remains released, while being towed.

### Recreational Towing – 4X4 Models With 1-Speed Power Transfer Unit

**Recreational towing is not allowed.** These models do not have a NEUTRAL (N) position in the power transfer unit.

#### NOTE:

This vehicle may be towed on a flatbed or vehicle trailer provided all four wheels are OFF the ground.

## CAUTION!

Towing this vehicle with **ANY** of its wheels on the ground can cause severe transmission and/or power transfer unit damage. Damage from improper towing is not covered under the New Vehicle Limited Warranty.

# UTILITY

## Recreational Towing — 4X4 Models With 2-Speed Power Transfer Unit

The power transfer unit must be shifted into NEUTRAL (N) and the transmission must be in PARK for recreational towing. The NEUTRAL (N) selection button is adjacent to the 4WD selector switch. Shifts into and out of NEUTRAL (N) can take place with the selector switch in any mode position.

### CAUTION!

- Failure to use the proper Mopar wiring kit to power the steering system during recreational towing may damage the vehicle's steering system and/or other vehicle components.
- DO NOT dolly tow any 4x4 vehicle. Towing with only one set of wheels on the ground (front or rear) will cause severe transmission and/or power transfer unit damage. Tow with all four wheels either ON the ground, or OFF the ground (using a vehicle trailer).
- Tow only in a forward direction. Towing this vehicle backwards can cause severe damage to the power transfer unit.
- The transmission must be in PARK for recreational towing.
- Before recreational towing, perform the procedure outlined under "Shifting into NEUTRAL (N)" to be certain that the power transfer unit is fully in NEUTRAL (N). Otherwise, internal damage will result.
- Towing this vehicle in violation of the above requirements can cause severe transmission and/or power transfer unit damage. Damage from improper towing is not covered under the New Vehicle Limited Warranty.
- Ensure that the Electric Park Brake is released, and remains released, while being towed.
- Do not use a bumper-mounted clamp-on tow bar on your vehicle. The bumper face bar will be damaged.

## Shifting Into NEUTRAL (N)

### WARNING!

You or others could be injured or killed if you leave the vehicle unattended with the power transfer unit in the NEUTRAL (N) position without first fully engaging the parking brake. The NEUTRAL (N) position disengages both the front and rear driveshafts from the powertrain and will allow the vehicle to roll, even if the transmission is in PARK. The parking brake should always be applied when the driver is not in the vehicle.

Use the following procedure to shift the 4WD system into NEUTRAL (N).

## CAUTION!

It is necessary to follow these steps to be certain that the power transfer unit is fully in NEUTRAL (N) before recreational towing to prevent damage to internal parts.

1. Bring the vehicle to a complete stop and shift the transmission to PARK.
2. Turn the engine OFF.
3. Turn the ignition switch to the ON/RUN position, but do not start the engine.
4. Press and hold the brake pedal.
5. Shift the transmission into NEUTRAL.
6. Using a ballpoint pen or similar object, push and hold the recessed NEUTRAL (N) button (located by the selector switch) for four seconds. The light behind the NEUTRAL (N) symbol will blink, indicating shift in progress. The light will stop blinking (stay on solid) when the shift to NEUTRAL (N) is complete.
7. After the shift is completed and the NEUTRAL (N) light stays on, release the NEUTRAL (N) button.
8. Start the engine.
9. Shift the transmission into REVERSE.
10. Release the brake pedal for five seconds and ensure that there is no vehicle movement.
11. Shift the transmission to NEUTRAL.
12. Apply the parking brake.
13. Shift the transmission into PARK, turn the engine OFF, and remove the key fob.
14. Attach the vehicle to the tow vehicle using a suitable tow bar.
15. Turn the ignition to the ON/RUN position, but do not start the engine.
16. Press and hold the brake pedal.
17. Release the parking brake.
18. Turn the ignition OFF, remove the Key Fob, and release the brake pedal.

### NOTE:

- Steps 1 through 5 are requirements that must be met before pushing the NEUTRAL (N) button, and must continue to be met until the shift has been completed. If any of these requirements are not met before pushing the NEUTRAL (N) button or are no longer met during the shift, then the NEUTRAL (N) indicator light will flash continuously until all requirements are met or until the NEUTRAL (N) button is released.

# UTILITY

- The ignition switch must be in the ON/RUN position for a shift to take place and for the position indicator lights to be operable. If the ignition switch is not in the ON/RUN position, the shift will not take place and no position indicator lights will be on or flashing.
- A flashing NEUTRAL (N) position indicator light indicates that shift requirements have not been met.

## Shifting Out Of NEUTRAL (N)

Use the following procedure to prepare your vehicle for normal usage.

1. Bring the vehicle to a complete stop, leaving it connected to the tow vehicle.
2. Apply the parking brake.
3. Turn the ignition switch to the ON/RUN position, but do not start the engine.
4. Press and hold the brake pedal.
5. Shift the transmission into NEUTRAL.
6. Using a ballpoint pen or similar object, push and hold the recessed power transfer unit NEUTRAL (N) button (located by the selector switch) for one second.
7. When the NEUTRAL (N) indicator light turns off, release the NEUTRAL (N) button.
8. After the NEUTRAL (N) button has been released, the power transfer unit will shift to the position indicated by the selector switch.

### NOTE:

When shifting the power transfer unit out of NEUTRAL (N), the engine should remain OFF to avoid gear clash.

9. Shift the transmission into PARK.
10. Release the brake pedal.
11. Disconnect vehicle from the tow vehicle.
12. Start the engine.
13. Press and hold the brake pedal.
14. Release the parking brake.
15. Shift the transmission into DRIVE, release the brake pedal, and check that the vehicle operates normally.
16. Re-enable the Auto Park Brake feature, if desired.



**NOTE:**

- Steps 1 through 5 are requirements that must be met before pushing the NEUTRAL (N) button, and must continue to be met until the shift has been completed. If any of these requirements are not met before pushing the NEUTRAL (N) button or are no longer met during the shift, the NEUTRAL (N) indicator light will flash continuously until all requirements are met or until the NEUTRAL (N) button is released.
- The ignition switch must be in the ON/RUN position for a shift to take place and for the position indicator lights to be operable. If the ignition switch is not in the ON/RUN position, the shift will not take place and no position indicator lights will be on or flashing.
- A flashing NEUTRAL (N) position indicator light indicates that shift requirements have not been met.

# WHAT TO DO IN EMERGENCIES

## ROADSIDE ASSISTANCE

Dial toll-free 1-800-521-2779 for U.S. Residents or 1-800-363-4869 for Canadian Residents.

- Provide your name, vehicle identification number, license plate number, and your location, including the telephone number from which you are calling.
- Briefly describe the nature of the problem and answer a few simple questions.
- You will be given the name of the service provider and an estimated time of arrival. If you feel you are in an “unsafe situation”, please let us know. With your consent, we will contact local police or safety authorities.

## WARNING AND INDICATOR LIGHTS

**IMPORTANT:** The warning/indicator lights switch on in the instrument panel together with a dedicated message and/or acoustic signal when applicable. These indications are indicative and precautionary and as such must not be considered as exhaustive and/or alternative to the information contained in the Owner's Manual, which you are advised to read carefully in all cases. Always refer to the information in this chapter in the event of a failure indication.

All active telltales will display first, if applicable. The system check menu may appear different based upon equipment options and current vehicle status.

This guide illustrates and describes the operation of warning and indicator telltales that are either standard or optional based on the vehicle build. FCA reserves the right to make changes in design and specifications and/or make additions to or improvements to its products without imposing any obligation upon itself to install them on products previously manufactured.

### Instrument Cluster Warning Lights

#### – Low Fuel Warning Light

This warning light indicates when the fuel level reaches approximately 1.5 gal (5.8 L). This light will turn on and a single chime will sound.

#### – Battery Charge Warning Light

This light illuminates when the battery is not charging properly. If the battery charge warning light remains on, it means that the vehicle is experiencing a problem with the charging system.

We recommend you do not continue driving if it is on. Have the vehicle serviced immediately.

# WHAT TO DO IN EMERGENCIES

## **(!) – Tire Pressure Monitoring System (TPMS) Light**

Each tire, including the spare (if provided), should be checked monthly, when cold and inflated to the inflation pressure recommended by the vehicle manufacturer on the vehicle placard or tire inflation pressure label. (If your vehicle has tires of a different size than the size indicated on the vehicle placard or tire inflation pressure label, you should determine the proper tire inflation pressure for those tires.)

As an added safety feature, your vehicle has been equipped with a Tire Pressure Monitoring System (TPMS) which display in the Electronic Vehicle Information Center (EVIC) or Driver Information Display (DID) when one or more of your tires is significantly under-inflated. Accordingly, when the low tire pressure EVIC or DID display illuminates, you should stop and check your tires as soon as possible, and inflate them to the proper pressure. Driving on a significantly under-inflated tire causes the tire to overheat and can lead to tire failure. Under-inflation also reduces fuel efficiency and tire tread life, and may affect the vehicle's handling and stopping ability.

**IF THE LIGHT STARTS FLASHING INDICATING A LOW TIRE PRESSURE, ADJUST THE AIR PRESSURE IN THE LOW TIRE TO THE AIR PRESSURE SHOWN ON THE VEHICLE PLACARD OR TIRE INFLATION PRESSURE LABEL LOCATED ON THE DRIVER'S DOOR.**

### **NOTE:**

**After inflation, the vehicle may need to be driven for 20 minutes before the flashing light will turn off.**

Please note that the TPMS is not a substitute for proper tire maintenance, and it is the driver's responsibility to maintain correct tire pressure, even if under-inflation has not reached the level to trigger illumination of the TPMS low EVIC or DID display.

Your vehicle has also been equipped with a TPMS malfunction indicator to indicate when the system is not operating properly. The TPMS malfunction indicator is combined with the low tire pressure telltale. When the system detects a malfunction, the telltale will flash for approximately one minute and then remain continuously illuminated. This sequence will continue each time the vehicle is restarted as long as the malfunction exists.

# WHAT TO DO IN EMERGENCIES

When the malfunction indicator is illuminated, the system may not be able to detect or signal low tire pressure as intended. TPMS malfunctions may occur for a variety of reasons, including the installation of replacement or alternate tires or wheels on the vehicle that prevent the TPMS from functioning properly. Always check the TPMS malfunction telltale after replacing one or more tires or wheels on your vehicle, to ensure that the replacement or alternate tires and wheels allow the TPMS to continue to function properly.

## **NOTE:**

Tire pressures change by approximately 1 psi (7 kPa) per 12° F (7° C) of air temperature change. Keep this in mind when checking tire pressure inside a garage, especially in the Winter. Example: If garage temperature is 68°F (20°C) and the outside temperature is 32°F (0°C), then the cold tire inflation pressure should be increased by 3 psi (21 kPa), which equals 1 psi (7 kPa) for every 12°F (7°C) for this outside temperature condition.

## **CAUTION!**

The TPMS has been optimized for the original equipment tires and wheels. TPMS pressures and warning have been established for the tire size equipped on your vehicle. Undesirable system operation or sensor damage may result when using replacement equipment that is not of the same size, type, and/or style. Aftermarket wheels can cause sensor damage. Do not use tire sealant from a can, or balance beads if your vehicle is equipped with a TPMS, as damage to the sensors may result.

## – **Electronic Throttle Control (ETC) Light**

This light informs you of a problem with the Electronic Throttle Control (ETC) system.

If a problem is detected, the light will come on while the engine is running. Cycle the ignition key when the vehicle has completely stopped and the gear selector is placed in the PARK position; the light should turn off.

If the light remains lit with the engine running, your vehicle will usually be drivable. However, see an authorized service center immediately. If the light is flashing when the engine is running, immediate service is required and you may experience reduced performance, an elevated/rough idle or engine stall and your vehicle may require towing.

# WHAT TO DO IN EMERGENCIES

## – Air Bag Warning Light

This light will turn on for four to eight seconds as a bulb check when the ignition switch is first turned to the ON/RUN position. If the light is either not on during starting, stays on, or turns on while driving, have the system inspected at an authorized dealer as soon as possible. Refer to “Occupant Restraints” in “Things To Know Before Starting Your Vehicle” in your Owner’s Manual on the DVD for further information.

### **NOTE:**

The Air Bag System is designed to be maintenance free.

## – Anti-Lock Brake (ABS) Light

This light monitors the Anti-Lock Brake System (ABS). The light will turn on when the ignition switch is turned to the ON/RUN position and may stay on for as long as four seconds.

If the ABS light remains on or turns on while driving, it indicates that the Anti-Lock portion of the brake system is not functioning and that service is required. However, the conventional brake system will continue to operate normally if the BRAKE warning light is not on.

If the ABS light is on, the brake system should be serviced as soon as possible to restore the benefits of Anti-Lock brakes. If the ABS light does not turn on when the ignition switch is turned to the ON/RUN position, have the light inspected by an authorized dealer.

## – Oil Pressure Warning Light

This light indicates low engine oil pressure. If the light turns on while driving, stop the vehicle and shut off the engine as soon as possible. A chime will sound for four minutes when this light turns on.

We recommend you do not operate the vehicle or engine damage will occur. Have the vehicle serviced immediately.

## - Engine Temperature Warning Light

- This light warns of an overheated engine condition.
- If the light turns on and a warning chime sounds while driving, safely pull over and stop the vehicle. If the A/C system is on, turn it off. Also, shift the transmission into NEUTRAL and idle the vehicle. If the temperature reading does not return to normal, turn the engine off immediately.
- We recommend that you do not operate the vehicle or engine damage will occur. Have the vehicle serviced immediately.

### **WARNING!**

A hot engine cooling system is dangerous. You or others could be badly burned by steam or boiling coolant.

# WHAT TO DO IN EMERGENCIES

## - Transmission Temperature Warning Light

This light indicates that there is excessive transmission fluid temperature that might occur with severe usage such as trailer towing. If this light turns on, stop the vehicle and run the engine at idle, with the transmission in NEUTRAL, until the light turns off. Once the light turns off, you may continue to drive normally.

### CAUTION!

Continuous driving with the Transmission Temperature Warning Light illuminated will eventually cause severe transmission damage or transmission failure.

### WARNING!

If you continue operating the vehicle when the Transmission Temperature Warning Light is illuminated you could cause the fluid to boil over, come in contact with hot engine or exhaust components and cause a fire.

## - Seat Belt Reminder Light

When the ignition switch is first turned to ON/RUN, this light will turn on if the driver's seat belt is unbuckled, and a chime will sound. When driving, if the driver's seat belt remains unbuckled, the Seat Belt Reminder Light will illuminate, and the chime will sound.

### WARNING!

Driving a vehicle with the red brake light on is dangerous. Part of the brake system may have failed. It will take longer to stop the vehicle. You could have a collision. Have the vehicle checked immediately.

## **BRAKE** – Brake Warning Light

This light monitors various brake functions, including brake fluid level and parking brake application. If the brake light turns on, it may indicate that the parking brake is applied, that the brake fluid level is low, or that there is a problem with the brake system master cylinder reservoir.

If the light remains on when the parking brake has been disengaged, and the fluid level is at the full mark on the master cylinder reservoir, it indicates a possible brake hydraulic system malfunction or that a problem with the Brake Booster has been detected by the Anti-Lock Brake System (ABS)/Electronic Stability Control (ESC) system. In this case, the light will remain on until the condition has been corrected. If the problem is related to the brake booster, the ABS pump will run when applying the brake, and a brake pedal pulsation may be felt during each stop.

# WHAT TO DO IN EMERGENCIES

The dual brake system provides a reserve braking capacity in the event of a failure to a portion of the hydraulic system. A leak in either half of the dual brake system is indicated by the Brake Warning Light, which will turn on when the brake fluid level in the master cylinder has dropped below a specified level. The light will remain on until the cause is corrected.

Vehicles equipped with the Anti-Lock Brake System (ABS) are also equipped with Electronic Brake Force Distribution (EBD). In the event of an EBD failure, the Brake Warning Light will turn on along with the ABS Light. Immediate repair to the ABS system is required.

Operation of the Brake Warning Light can be checked by turning the ignition switch from the OFF position to the ON/RUN position. The light should illuminate for approximately two seconds. The light should then turn off unless the parking brake is applied or a brake fault is detected. If the light does not illuminate, have the light inspected by an authorized dealer.

The light also will turn on when the parking brake is applied with the ignition switch in the ON/RUN position.

## **NOTE:**

This light shows only that the parking brake is applied. It does not show the degree of brake application.

## **WARNING!**

Driving a vehicle with the red brake light on is dangerous. Part of the brake system may have failed. It will take longer to stop the vehicle. You could have a collision. Have the vehicle checked immediately.

## – Malfunction Indicator Light (MIL)

The Malfunction Indicator Light (MIL) is part of an onboard diagnostic system called OBD II that monitors engine and automatic transmission control systems. The light will illuminate when the key is in the ON/RUN position before engine start. If the bulb does not come on when turning the key from OFF to ON/RUN, have the condition checked promptly.

Certain conditions, poor fuel quality, etc., may illuminate the light after engine start. The vehicle should be serviced if the light stays on through several of your typical driving cycles. In most situations, the vehicle will drive normally and will not require towing.

## **WARNING!**

A malfunctioning catalytic converter, as referenced above, can reach higher temperatures than in normal operating conditions. This can cause a fire if you drive slowly or park over flammable substances such as dry plants, wood, cardboard, etc. This could result in death or serious injury to the driver, occupants or others.

# WHAT TO DO IN EMERGENCIES

## CAUTION!

Prolonged driving with the Malfunction Indicator Light (MIL) on could cause damage to the engine control system. It also could affect fuel economy and driveability. If the MIL is flashing, severe catalytic converter damage and power loss will soon occur. Immediate service is required.

### – **SERV (Service) 4WD Indicator Light**

If the light stays on or comes on during driving, it means that the 4WD system is not functioning properly and that service is required. We recommend you drive to the nearest service center and have the vehicle serviced immediately.

### – **Electronic Stability Control (ESC) Activation/Malfunction Indicator Light**





If this indicator light flashes during acceleration, apply as little throttle as possible. While driving, ease up on the accelerator. Adapt your speed and driving to the prevailing road conditions. To improve the vehicle's traction when starting off in deep snow, sand or gravel, it may be desirable to switch the ESC system off.

## Oil Life Reset

- Your vehicle is equipped with an engine oil change indicator system. The “Oil Change Due” message will flash in the EVIC display for approximately 10 seconds after a single chime has sounded to indicate the next scheduled oil change interval. The engine oil change indicator system is duty cycle based, which means the engine oil change interval may fluctuate, dependent upon your personal driving style.
- Unless reset, this message will continue to display each time you turn the ignition switch to the ON/RUN position or cycle the ignition to the ON/RUN position if equipped with Keyless Enter-N-Go. To turn off the message temporarily, push and release the MENU button. To reset the oil change indicator system (after performing the scheduled maintenance), refer to the following procedure:

## Vehicles Equipped With Passive Entry

Without pushing the brake pedal, push the ENGINE START/STOP button and cycle the ignition to the ON/RUN position (Do not start the engine).





1. Push the **OK** button to enter the EVIC menu screen.
2. Push and release the **DOWN**  arrow button to access the “Oil Life” menu screen.
3. Push the **LEFT**  arrow button or **RIGHT**  arrow button to access the “VEHICLE INFO” submenu.
4. Hold the **OK** button to reset the “OIL LIFE” to 100%.
5. Push the **UP**  arrow button to exit the EVIC menu screen.



# WHAT TO DO IN EMERGENCIES

## Vehicles Not Equipped With Passive Entry

Without pushing the brake pedal, cycle the ignition to the ON/RUN position (Do not start the engine).

1. Push the **OK** button to enter the EVIC menu screen.
2. Push and release the **DOWN**  arrow button to access the "Oil Life" menu screen.
3. Push the **LEFT**  arrow button or **RIGHT**  arrow button to access the "VEHICLE INFO" submenu.
4. Hold the **OK** button to reset the "OIL LIFE" to 100%.
5. Push the **UP**  arrow button to exit the EVIC menu screen.

### NOTE:

If the indicator message illuminates when you start the vehicle, the oil change indicator system did not reset. If necessary, repeat this procedure.

## Instrument Cluster Indicator Lights

### – Stop/Start Indicator — If Equipped

This telltale will illuminate when the Stop/Start function is in "Autostop" mode.

### – Turn Signal Indicator

The arrows will flash with the exterior turn signals when the turn signal lever is operated. A tone will chime, and a EVIC/DID message will appear if either turn signal is left on for more than 1 mile (1.6 km).

### NOTE:

If either indicator flashes at a rapid rate, check for a defective outside light bulb.

### – High Beam Indicator

Indicates that headlights are on high beam.

### – Front Fog Light Indicator

This indicator will illuminate when the front fog lights are on.

### – Vehicle Security Light

This light will flash rapidly for approximately 15 seconds when the vehicle security alarm is arming. The light will flash at a slower speed continuously after the alarm is set. The security light will also come on for about three seconds when the ignition is first turned on.

# WHAT TO DO IN EMERGENCIES

## - Fuel Cap/Loose Gas Cap EVIC Message

- If a “gas cap” message (shown as gASCAP) appears, tighten the gas cap until a “clicking” sound is heard.
- If the message continues to appear for more than three days after tightening the gas cap, see your authorized service center.

## – Electronic Speed Control ON Indicator

This indicator will illuminate when the electronic speed control has been activated to the “ON” position.

## – Electronic Speed Control SET Indicator

This indicator will illuminate when the cruising speed has been set.

## – Adaptive Cruise Control (ACC) ON Indicator

If your vehicle is equipped with adaptive cruise control, the controls operate exactly the same as the normal (fixed speed) cruise control with one difference. You can set a specified distance you would like to maintain between you and the vehicle in front of you.

If the ACC sensor detects a vehicle ahead, ACC will apply limited braking or acceleration automatically to maintain a preset following distance, while matching the speed of the vehicle ahead.

If the sensor does not detect a vehicle ahead of you, ACC will maintain a fixed set speed.

Refer to “Speed Control” in “Operating Your Vehicle” for further information on Adaptive Cruise Control (ACC) ON operation and proper use.

### **NOTE:**

Adaptive Cruise Control (ACC) increases the driving convenience provided by cruise control while traveling on highways and major roadways. However, it is not a safety system and not designed to prevent collisions.

# WHAT TO DO IN EMERGENCIES



## **–Adaptive Cruise Control (ACC) SET Indicator**

- When ACC is set, the set speed will continue to display in the lower right hand corner of the cluster.
- The ACC screen will display once again if any ACC activity occurs, which may include any of the following:
  - Distance Setting Change
  - System Cancel
  - Driver Override
  - System Off
  - ACC Proximity Warning
  - ACC Unavailable Warning
  - The EVIC will return to the last display selected after five seconds of no ACC display activity.
- For further information on Adaptive Cruise Control (ACC) SET operation and proper use, refer to “Speed Control ” in “Operating Your Vehicle.”

### **NOTE:**

Adaptive Cruise Control (ACC) increases the driving convenience provided by cruise control while traveling on highways and major roadways. However, it is not a safety system and not designed to prevent collisions.



## **– Hill Descent Control Indicator — If Equipped**

This indicator will illuminate when Hill Descent Control (HDC) has been selected using the Hill Descent Control Switch.



## **– Park/Headlight ON Indicator**

This indicator will illuminate when the park lights or headlights are turned on.



## **– Electronic Stability Control (ESC) OFF Indicator Light**

This light indicates the Electronic Stability Control (ESC) is off.



## **– Windshield Washer Fluid Low Indicator**

This indicator will illuminate when the windshield washer fluid is low.



## **– Door Open Indicator**

This indicator will illuminate when a door(s) is left open and not fully closed.



## **– Forward Collision Warning (FCW) OFF Indicator**

### **NOTE:**

- The default status of FCW is “On,” this allows the system to warn you of a possible collision with the vehicle in front of you.
- The forward collision button is located on the switch panel below the Uconnect display.

# WHAT TO DO IN EMERGENCIES

- To turn the FCW system OFF, push the forward collision button once to turn the system OFF (led turns on).
- Refer to “Speed Control ” in “Operating Your Vehicle” for further information on Forward Collision Warning (FCW) operation and proper use.

## – Liftgate Ajar Indicator — If Equipped

This indicator will illuminate when the liftgate is left ajar and not fully closed.

## IF YOUR ENGINE OVERHEATS

In any of the following situations, you can reduce the potential for overheating your engine by taking the appropriate action.

- On the highways — slow down.
- In city traffic — while stopped, put transmission in NEUTRAL, but do not increase engine idle speed.

### CAUTION!

Driving with a hot cooling system could damage your vehicle. If the temperature gauge reads “H,” pull over and stop the vehicle. Idle the vehicle with the air conditioner turned off until the pointer drops back into the normal range. If the pointer remains on the “H” and you hear continuous chimes, turn the engine off immediately and call for service.

#### NOTE:

There are steps that you can take to slow down an impending overheat condition:

- If your air conditioner (A/C) is on, turn it off. The A/C system adds heat to the engine cooling system and turning the A/C off can help remove this heat.
- You can also turn the temperature control to maximum heat, the mode control to floor and the blower control to high. This allows the heater core to act as a supplement to the radiator and aids in removing heat from the engine cooling system.

### WARNING!

You or others can be badly burned by hot engine coolant (antifreeze) or steam from your radiator. If you see or hear steam coming from under the hood, do not open the hood until the radiator has had time to cool. Never try to open a cooling system pressure cap when the radiator or coolant bottle is hot.

# WHAT TO DO IN EMERGENCIES

## TIRE SERVICE KIT

Your vehicle may be equipped with a Tire Service Kit.

Small punctures up to 1/4" (6 mm) in the tire tread can be sealed with the Tire Service Kit. Foreign objects (e.g., screws or nails) should not be removed from the tire. The Tire Service Kit can be used in outside temperatures down to approximately -4°F (-20°C).

This kit will provide a temporary tire seal, allowing you to drive your vehicle up to 100 miles (160 km) with a maximum speed of 55 mph (90 km/h).

### TIRE SERVICE KIT STORAGE

- The Tire Service Kit is located in the cargo compartment behind the rear seat underneath the load floor.

### Tire Service Kit Components And Operation

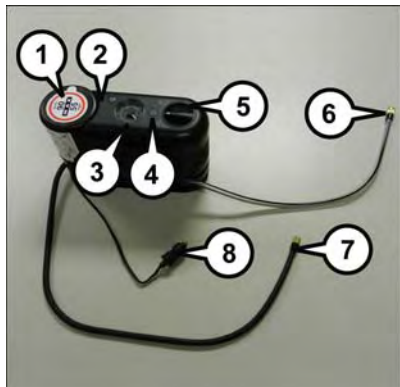

**Tire Service Kit Components**

- 1 — Sealant Bottle
- 2 — Deflation Button
- 3 — Pressure Gauge
- 4 — Power Button
- 5 — Mode Select Knob
- 6 — Sealant Hose (Clear)
- 7 — Air Pump Hose (Black)
- 8 — Power Plug (located on bottom side of Tire Service Kit)

### Using The Mode Select Knob And Hoses

Your Tire Service Kit is equipped with the following symbols to indicate the air or sealant mode.

# WHAT TO DO IN EMERGENCIES

## **Selecting Air Mode**

Turn the Mode Select Knob (5) to this position for air pump operation only. Use the Black Air Pump Hose (7) when selecting this mode.

## **Selecting Sealant Mode**

Turn the Mode Select Knob (5) to this position to inject the Tire Service Kit Sealant and to inflate the tire. Use the Sealant Hose (clear hose) (6) when selecting this mode.

## **Using The Power Button**

Push and release the Power Button (4) once to turn On the Tire Service Kit. Push and release the Power Button (4) again to turn Off the Tire Service Kit.

## **Using The Deflation Button**

Push the Deflation Button (2) to reduce the air pressure in the tire if it becomes over-inflated.

## **Tire Service Kit Usage Precautions**

- Replace the Tire Service Kit Sealant Bottle (1) and Sealant Hose (6) prior to the expiration date (printed on the bottle label) to assure optimum operation of the system. Refer to “Sealing A Tire With Tire Service Kit” section (F) “Sealant Bottle and Hose Replacement.”
- The Sealant Bottle (1) and Sealant Hose (6) are a one tire application use. After each use, always replace these components immediately at an authorized dealer.
- When the Tire Service Kit sealant is in a liquid form, clean water, and a damp cloth will remove the material from the vehicle or tire and wheel components. Once the sealant dries, it can easily be peeled off and properly discarded.
- For optimum performance, make sure the valve stem on the wheel is free of debris before connecting the Tire Service Kit.
- You can use the Tire Service Kit air pump to inflate bicycle tires. The kit also comes with two needles, located in the Accessory Storage Compartment (on the bottom of the air pump) for inflating sport balls, rafts, or similar inflatable items. However, use only the Air Pump Hose (7) and make sure the Mode Select Knob (5) is in the Air Mode when inflating such items to avoid injecting sealant into them. The Tire Service Kit Sealant is only intended to seal punctures less than 1/4 inch (6 mm) diameter in the tread of your vehicle.
- Do not lift or carry the Tire Service Kit by the hoses.

# WHAT TO DO IN EMERGENCIES

## Sealing A Tire With Tire Service Kit

### (A) Whenever You Stop To Use Tire Service Kit:

1. Pull over to a safe location and turn on the vehicle's Hazard Warning flashers.
2. Verify that the valve stem (on the wheel with the deflated tire) is in a position that is near to the ground. This will allow the Tire Service Kit Hoses (6) and (7) to reach the valve stem and keep the Tire Service Kit flat on the ground. This will provide the best positioning of the kit when injecting the sealant into the deflated tire and running the air pump. Move the vehicle as necessary to place the valve stem in this position before proceeding.
3. Place the transmission in PARK (auto transmission) or in Gear (manual transmission) and cycle the ignition to the OFF position.
4. Set the parking brake.

### (B) Setting Up To Use Tire Service Kit:

1. Turn the Mode Select Knob (5) to the Sealant Mode position.
2. Uncoil the Sealant Hose (6) and then remove the cap from the fitting at the end of the hose.
3. Place the Tire Service Kit flat on the ground next to the deflated tire.
4. Remove the cap from the valve stem and then screw the fitting at the end of the Sealant Hose (6) onto the valve stem.
5. Uncoil the Power Plug (8) and insert the plug into the vehicle's 12 Volt power outlet.
6. Do not remove foreign objects (e.g., screws or nails) from the tire.

### (C) Injecting Tire Service Kit Sealant Into The Deflated Tire:

Always start the engine before turning ON the Tire Service Kit.

#### **NOTE:**

Manual transmission vehicles must have the parking brake engaged and the gear selector in NEUTRAL.

After pushing the Power Button (4), the sealant (white fluid) will flow from the Sealant Bottle (1) through the Sealant Hose (6) and into the tire.

#### **NOTE:**

Sealant may leak out through the puncture in the tire.

# WHAT TO DO IN EMERGENCIES

**If the sealant (white fluid) does not flow within 0 – 10 seconds through the Sealant Hose (6):**

1. Push the Power Button (4) to turn Off the Tire Service Kit. Disconnect the Sealant Hose (6) from the valve stem. Make sure the valve stem is free of debris. Reconnect the Sealant Hose (6) to the valve stem. Check that the Mode Select Knob (5) is in the Sealant Mode position and not Air Mode. Push the Power Button (4) to turn On the Tire Service Kit.
2. Connect the Power Plug (8) to a different 12 Volt power outlet in your vehicle or another vehicle, if available. Make sure the engine is running before turning ON the Tire Service Kit.
3. The Sealant Bottle (1) may be empty due to previous use. Call for assistance.

**NOTE:**

If the Mode Select Knob (5) is on Air Mode and the pump is operating, air will dispense from the Air Pump Hose (7) only, not the Sealant Hose (6).

**If the sealant (white fluid) does flow through the Sealant Hose (6):**

1. Continue to operate the pump until sealant is no longer flowing through the hose (typically takes 30 - 70 seconds). As the sealant flows through the Sealant Hose (6), the Pressure Gauge (3) can read as high as 70 psi (4.8 Bar). The Pressure Gauge (3) will decrease quickly from approximately 70 psi (4.8 Bar) to the actual tire pressure when the Sealant Bottle (1) is empty.
2. The pump will start to inject air into the tire immediately after the Sealant Bottle (1) is empty. Continue to operate the pump and inflate the tire to the pressure indicated on the tire pressure label on the driver-side latch pillar (recommended pressure). Check the tire pressure by looking at the Pressure Gauge (3).

**If the tire does not inflate to at least 26 psi (1.8 Bar) pressure within 15 minutes:**

The tire is too badly damaged. Do not attempt to drive the vehicle further. Call for assistance.

**NOTE:**

If the tire becomes over-inflated, push the Deflation Button to reduce the tire pressure to the recommended inflation pressure before continuing.

**If the tire inflates to the recommended pressure or is at least 26 psi (1.8 Bar) pressure within 15 minutes:**

1. Push the Power Button (4) to turn off the Tire Service Kit.
2. Remove the Speed Limit sticker from the top of the Sealant Bottle (1) and place the sticker on the instrument panel.
3. Immediately disconnect the Sealant Hose (6) from the valve stem, reinstall the cap on the fitting at the end of the hose, and place the Tire Service Kit in the vehicle storage location. Quickly proceed to (D) "Drive Vehicle."



# WHAT TO DO IN EMERGENCIES

## **(D) Drive Vehicle:**

Immediately after injecting sealant and inflating the tire, drive the vehicle 5 miles (8 km) or 10 minutes to ensure distribution of the Tire Service Kit Sealant within the tire. Do not exceed 55 mph (88 km/h).

## **(E) After Driving:**

Pull over to a safe location. Refer to “Whenever You Stop to Use Tire Service Kit” before continuing.

1. Turn the Mode Select Knob (5) to the Air Mode position.
2. Uncoil the Air Pump Hose (7) (black in color) and screw the fitting at the end of hose (7) onto the valve stem.
3. Uncoil the power plug and insert the plug into the vehicles 12 Volt power outlet.
4. Check the pressure in the tire by reading the Pressure Gauge (3).

**If tire pressure is less than 19 psi (1.3 Bar), the tire is too badly damaged. Do not attempt to drive the vehicle further. Call for assistance.**

### **If the tire pressure is 19 psi (1.3 Bar) or higher:**

1. Push the Power Button (4) to turn on Tire Service Kit and inflate the tire to the pressure indicated on the tire and loading information label on the driver-side door opening.
2. Disconnect the Tire Service Kit from the valve stem, reinstall the cap on the valve stem and unplug from 12 Volt outlet.
3. Place the Tire Service Kit in its proper storage area in the vehicle.
4. Have the tire inspected and repaired or replaced at the earliest opportunity at an authorized dealer or tire service center.
5. Remove the Speed Limit sticker from the instrument panel after the tire has been repaired.
6. Replace the Sealant Bottle (1) and Sealant Hose (6) assembly at your authorized dealer as soon as possible. Refer to “(F) Sealant Bottle and Hose Replacement.”

### **NOTE:**

- If the tire becomes over-inflated, push the Deflation Button to reduce the tire pressure to the recommended inflation pressure before continuing.
- When having the tire serviced, advise the authorized dealer or service center that the tire has been sealed using the Tire Service Kit.

# WHAT TO DO IN EMERGENCIES

## **(F) Sealant Bottle And Hose Replacement:**

1. Uncoil the Sealant Hose (6) (clear in color).
2. Locate the round Sealant Bottle release button in the recessed area under the sealant bottle.
3. Push the Sealant Bottle release button. The Sealant Bottle (1) will pop up. Remove the bottle and dispose of it accordingly.
4. Clean any remaining sealant from the Tire Service Kit housing.
5. Position the new Sealant Bottle (1) in the housing so that the Sealant Hose (6) aligns with the hose slot in the front of the housing. Push the bottle into the housing. An audible click will be heard indicating the bottle is locked into place.
6. Verify that the cap is installed on the fitting at the end of the Sealant Hose (6) and return the hose to its storage area (located on the bottom of the air pump).
7. Return the Tire Service Kit to its storage location in the vehicle.

## **NOTE:**

- The metal end fitting from Power Plug (8) may get hot after use, so it should be handled carefully.
- Failure to reinstall the cap on the fitting at the end of the Sealant Hose (6) can result in sealant contacting your skin, clothing, and the vehicle's interior. It can also result in sealant contacting internal Tire Service Kit components which may cause permanent damage to the kit.

# WHAT TO DO IN EMERGENCIES

## WARNING!

- Do not attempt to seal a tire on the side of the vehicle closest to traffic. Pull far enough off the road to avoid the danger of being hit when using the Tire Service Kit.
- Do not use the Tire Service Kit or drive the vehicle under the following circumstances:
  - If the puncture in the tire tread is approximately 1/4". (6 mm) or larger.
  - If the tire has any sidewall damage.
  - If the tire has any damage from driving with extremely low tire pressure.
  - If the tire has any damage from driving on a flat tire.
  - If the wheel has any damage.
  - If you are unsure of the condition of the tire or the wheel.
- Keep the Tire Service Kit away from open flames or heat source.
- A loose Tire Service Kit thrown forward in a collision or hard stop could endanger the occupants of the vehicle. Always stow the Tire Service Kit in the place provided. Failure to follow these warnings can result in injuries that are serious or fatal to you, your passengers, and others around you.
- Take care not to allow the contents of the Tire Service Kit to come in contact with hair, eyes, or clothing. The Tire Service Kit is harmful if inhaled, swallowed, or absorbed through the skin. It causes skin, eye, and respiratory irritation. Flush immediately with plenty of water if there is any contact with eyes or skin. Change clothing as soon as possible, if there is any contact with clothing.
- The Tire Service Kit Sealant solution contains latex. In case of an allergic reaction or rash, consult a physician immediately. Keep the Tire Service Kit out of reach of children. If swallowed, rinse mouth immediately with plenty of water and drink plenty of water. Do not induce vomiting! Consult a physician immediately.
- The Tire Service Kit is not a permanent flat tire repair. Have the tire inspected and repaired or replaced after using the Tire Service Kit. Do not exceed 55 mph (88 km/h) until the tire is repaired or replaced. Failure to follow this warning can result in injuries that are serious or fatal to you, your passengers, and others around you.

# WHAT TO DO IN EMERGENCIES

## JACKING AND TIRE CHANGING

### WARNING!

- Do not attempt to change a tire on the side of the vehicle close to moving traffic. Pull far enough off the road to avoid the danger of being hit when operating the jack or changing the wheel.
- Being under a jacked-up vehicle is dangerous. The vehicle could slip off the jack and fall on you. You could be crushed. Never put any part of your body under a vehicle that is on a jack. If you need to get under a raised vehicle, take it to a service center where it can be raised on a lift.
- Never start or run the engine while the vehicle is on a jack.
- The jack is designed to be used as a tool for changing tires only. The jack should not be used to lift the vehicle for service purposes. The vehicle should be jacked on a firm level surface only. Avoid ice or slippery areas.

### Jack Location/Spare Tire Stowage

The jack, wheel chocks and spare tire are stowed under the load floor behind the rear seat.

1. Open the liftgate.
2. Lift the access cover using the load floor handle.
3. Remove the hook from the stowed position on the back side of the load floor and place the hook over the top body flange and weather seal. This will hold the load floor up while obtaining the jack and spare tire.
4. Remove the fastener securing the jack and spare tire.
5. Remove the chocks.
6. Remove the scissors jack and wheel bolt wrench from the spare wheel as an assembly. Turn the jack screw to the left to loosen the wheel bolt wrench, and remove the wrench from the jack assembly.

### NOTE:

The jack handle attaches to the side of the jack with two attachment points. When the jack is partially expanded, the tension between the two attachment points holds the jack handle in place.

7. Remove the spare tire.

### WARNING!

A loose tire or jack thrown forward in a collision or hard stop could endanger the occupants of the vehicle. Always stow the jack parts and the spare tire in the places provided. Have the deflated (flat) tire repaired or replaced immediately.

# WHAT TO DO IN EMERGENCIES

## Preparations For Jacking

1. Park the vehicle on a firm level surface as far from the edge of the roadway as possible. Avoid icy or slippery areas.

### **WARNING!**

Do not attempt to change a tire on the side of the vehicle close to moving traffic, pull far enough off the road to avoid being hit when operating the jack or changing the wheel.

2. Turn on the Hazard Warning flasher.
3. Set the parking brake.
4. Place the gear selector into PARK.
5. Turn the ignition off to the LOCK position.
6. Chock both the front and rear of the wheel diagonally opposite of the jacking position. For example, if changing the right front tire, chock the left rear wheel.

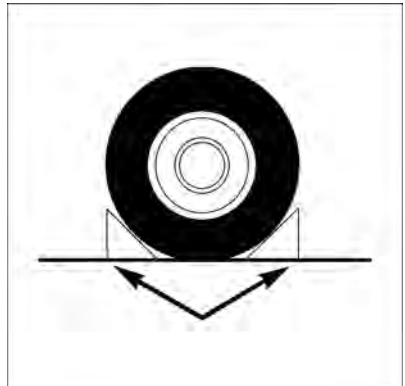

**Wheel Chocks**

### **NOTE:**

Passengers should not remain in the vehicle when the vehicle is being jacked.

# WHAT TO DO IN EMERGENCIES

## Jacking Instructions

### WARNING!

Carefully follow these tire changing warnings to help prevent personal injury or damage to your vehicle:

- Always park on a firm, level surface as far from the edge of the roadway as possible before raising the vehicle.
- Turn on the Hazard Warning flasher.
- Chock the wheel diagonally opposite the wheel to be raised.
- Set the parking brake firmly and set the transmission in PARK.
- Never start or run the engine with the vehicle on a jack.
- Do not let anyone sit in the vehicle when it is on a jack.
- Do not get under the vehicle when it is on a jack. If you need to get under a raised vehicle, take it to a service center where it can be raised on a lift.
- Only use the jack in the positions indicated and for lifting this vehicle during a tire change.
- If working on or near a roadway, be extremely careful of motor traffic.
- To assure that spare tires, flat or inflated, are securely stowed, spares must be stowed with the valve stem facing the ground.



Warning Label

### CAUTION!

Do not attempt to raise the vehicle by jacking on locations other than those indicated in the Jacking Instructions for this vehicle.

1. Remove the spare tire, jack, and wheel bolt wrench.
2. If equipped with aluminum wheels where the center cap covers the wheel bolts, use the wheel bolt wrench to pry the center cap off carefully before raising the vehicle.
3. Before raising the vehicle, use the wheel bolt wrench to loosen, but not remove, the wheel bolts on the wheel with the flat tire. Turn the wheel bolts counterclockwise one turn while the wheel is still on the ground.

# WHAT TO DO IN EMERGENCIES

4. Place the jack underneath the lift area that is closest to the flat tire. Turn the jack screw clockwise to firmly engage the jack saddle with the lift area of the sill flange, centering the jack saddle inside the cutout in the sill cladding.



**Jacking Locations**

# WHAT TO DO IN EMERGENCIES

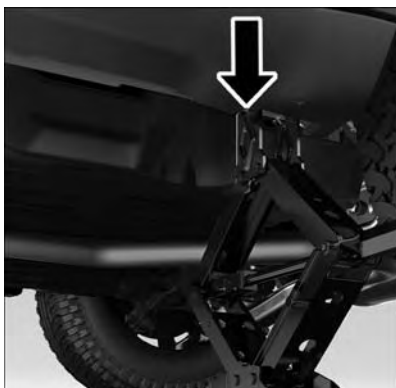

**Rear Jack Location Engaged**



**Front Jack Location Engaged**

5. Raise the vehicle just enough to remove the flat tire.

## **WARNING!**

Raising the vehicle higher than necessary can make the vehicle less stable. It could slip off the jack and hurt someone near it. Raise the vehicle only enough to remove the tire.

6. Remove the wheel bolts and tire.
7. Remove the alignment pin from the jack assembly and thread the pin into the wheel hub to assist in mounting the spare tire.



# WHAT TO DO IN EMERGENCIES

8. Mount the spare tire.

## CAUTION!

Be sure to mount the spare tire with the valve stem facing outward. The vehicle could be damaged if the spare tire is mounted incorrectly.

### NOTE:

- For vehicles so equipped, do not attempt to install a center cap or wheel cover on the compact spare.
  - Refer to “Compact Spare Tire” and to “Limited-Use Spare” under “Tires—General Information” in “Starting and Operating” in the Owner’s Manual on the DVD for additional warnings, cautions, and information about the spare tire, its use, and operation.
9. Install the wheel bolts with the threaded end of the wheel bolt toward the wheel. Lightly tighten the wheel bolts.

## WARNING!

To avoid the risk of forcing the vehicle off the jack, do not fully tighten the wheel bolts until the vehicle has been lowered. Failure to follow this warning may result in serious injury.

10. Lower the vehicle to the ground by turning the jack handle counterclockwise.
11. Finish tightening the lug bolts. Push down on the wrench while at the end of the handle for increased leverage. Tighten the lug bolts in a star pattern until each nut has been tightened twice. The correct wheel bolt tightness is 100 ft lb (135 N·m). If in doubt about the correct tightness, have them checked with a torque wrench by your authorized dealer or at a service station.
12. Securely stow the jack, tools, chocks and flat tire.

## WARNING!

A loose tire or jack thrown forward in a collision or hard stop could endanger the occupants of the vehicle. Always stow the jack parts and the spare tire in the places provided. Have the deflated (flat) tire repaired or replaced immediately.

# WHAT TO DO IN EMERGENCIES

## Road Tire Installation

1. Mount the road tire on the axle.
2. Install the remaining wheel bolts with the threaded end of the wheel bolt toward the wheel. Lightly tighten the wheel bolts.

### WARNING!

To avoid the risk of forcing the vehicle off the jack, do not tighten the lug nuts fully until the vehicle has been lowered. Failure to follow this warning may result in serious injury.

3. Lower the vehicle to the ground by turning the jack handle counterclockwise.
4. Finish tightening the lug bolts. Push down on the wrench while at the end of the handle for increased leverage. Tighten the lug bolts in a star pattern until each nut has been tightened twice. The correct wheel bolt tightness is 100 ft lb (135 N·m). If in doubt about the correct tightness, have them checked with a torque wrench by your authorized dealer or at a service station.
5. Lower the jack until it is free. Remove the wheel chocks. Reassemble the lug wrench to the jack assembly and stow it in the spare tire area. Secure the assembly using the means provided. Release the parking brake before driving the vehicle.
6. After 25 miles (40 km) check the wheel bolt torque with a torque wrench to ensure that all wheel bolts are properly seated against the wheel.

## JUMP-STARTING PROCEDURES

If your vehicle has a discharged battery it can be jump-started using a set of jumper cables and a battery in another vehicle or by using a portable battery booster pack. Jump-starting can be dangerous if done improperly so please follow the procedures in this section carefully.

### NOTE:

When using a portable battery booster pack follow the manufacturer's operating instructions and precautions.

### WARNING!

Do not attempt jump-starting if the battery is frozen. It could rupture or explode and cause personal injury.

# WHAT TO DO IN EMERGENCIES

## CAUTION!

Do not use a portable battery booster pack or any other booster source with a system voltage greater than 12 Volts or damage to the battery, starter motor, alternator or electrical system may occur.

### Preparations For Jump-Start

The battery in your vehicle is located in the front of the engine compartment, behind the left headlight assembly.

#### NOTE:

The positive battery post is covered with a protective cap. Lift up on the cap to gain access to the positive battery post.

## WARNING!

- Take care to avoid the radiator cooling fan whenever the hood is raised. It can start anytime the ignition switch is ON. You can be injured by moving fan blades.
- Remove any metal jewelry such as rings, watch bands and bracelets that could make an inadvertent electrical contact. You could be seriously injured.
- Batteries contain sulfuric acid that can burn your skin or eyes and generate hydrogen gas which is flammable and explosive. Keep open flames or sparks away from the battery.

1. Set the parking brake, shift the automatic transmission into PARK and turn the ignition to LOCK.
2. Turn off the heater, radio, and all unnecessary electrical accessories.
3. If using another vehicle to jump-start the battery, park the vehicle within the jumper cables reach, set the parking brake and make sure the ignition is OFF.

## WARNING!

Do not allow vehicles to touch each other as this could establish a ground connection and personal injury could result.

# WHAT TO DO IN EMERGENCIES

## Jump Starting Procedure

### WARNING!

Failure to follow this jump-starting procedure could result in personal injury or property damage due to battery explosion.

### CAUTION!

Failure to follow these procedures could result in damage to the charging system of the booster vehicle or the discharged vehicle.

### Connecting The Jumper Cables

1. Connect the positive (+) end of the jumper cable to the positive (+) post of the discharged vehicle.
2. Connect the opposite end of the positive (+) jumper cable to the positive (+) post of the booster battery.
3. Connect the negative (-) end of the jumper cable to the negative (-) post of the booster battery.
4. Connect the opposite end of the negative (-) jumper cable to a good engine ground (exposed metal part of the discharged vehicle's engine) away from the battery and the fuel injection system.

### WARNING!

Do not connect the jumper cable to the negative (-) post of the discharged battery. The resulting electrical spark could cause the battery to explode and could result in serious injury. Only use the specific ground point, do not use any other exposed metal parts.

5. Start the engine in the vehicle that has the booster battery, let the engine idle a few minutes, and then start the engine in the vehicle with the discharged battery.
6. Once the engine is started, remove the jumper cables in the reverse sequence:

### Disconnecting The Jumper Cables

1. Disconnect the negative (-) end of the jumper cable from the engine ground of the vehicle with the discharged battery.
2. Disconnect the opposite end of the negative (-) jumper cable from the negative (-) post of the booster battery.
3. Disconnect the positive (+) end of the jumper cable from the positive (+) post of the booster battery.
4. Disconnect the opposite end of the positive (+) jumper cable from the positive (+) post of the vehicle with the discharged battery.

# WHAT TO DO IN EMERGENCIES

If frequent jump starting is required to start your vehicle you should have the battery and charging system inspected at your authorized dealer.

## CAUTION!

Accessories plugged into the vehicle power outlets draw power from the vehicle's battery, even when not in use (i.e., cellular devices, etc.). Eventually, if plugged in long enough without engine operation, the vehicle's battery will discharge sufficiently to degrade battery life and/or prevent the engine from starting.

## FREING A STUCK VEHICLE

If your vehicle becomes stuck in mud, sand or snow, it can often be moved using a rocking motion. Turn the steering wheel right and left to clear the area around the front wheels. Push and hold the lock button on the gear selector. Then shift back and forth between DRIVE and REVERSE, while gently pressing the accelerator.

### NOTE:

Shifts between DRIVE and REVERSE can only be achieved at wheel speeds of 5 mph (8 km/h) or less. Whenever the transmission remains in NEUTRAL for more than two seconds, you must press the brake pedal to engage DRIVE or REVERSE.

Use the least amount of accelerator pedal pressure that will maintain the rocking motion without spinning the wheels or racing the engine.

## CAUTION!

- Racing the engine or spinning the wheels may lead to transmission overheating and failure. Allow the engine to idle with the transmission in NEUTRAL for at least one minute after every five rocking-motion cycles. This will minimize overheating and reduce the risk of transmission failure during prolonged efforts to free a stuck vehicle.
- When "rocking" a stuck vehicle by shifting between DRIVE and REVERSE, do not spin the wheels faster than 15 mph (24 km/h), or drivetrain damage may result.
- Revving the engine or spinning the wheels too fast may lead to transmission overheating and failure. It can also damage the tires. Do not spin the wheels above 30 mph (48 km/h) while in gear (no transmission shifting occurring).

### NOTE:

Push the "ESC Off" switch (if necessary), to place the Electronic Stability Control (ESC) system in "Partial Off" mode, before rocking the vehicle. Refer to "Electronic Brake Control" in "Starting And Operating" in the Owner's Manual on the DVD for further information. Once the vehicle has been freed, push the "ESC Off" switch again to restore "ESC On" mode.

# WHAT TO DO IN EMERGENCIES

## **WARNING!**

Fast spinning tires can be dangerous. Forces generated by excessive wheel speeds may cause damage, or even failure, of the axle and tires. A tire could explode and injure someone. Do not spin your vehicle's wheels faster than 30 mph (48 km/h) or for longer than 30 seconds continuously without stopping when you are stuck and do not let anyone near a spinning wheel, no matter what the speed.

## **RECOVERY STRAP – IF EQUIPPED**

Your vehicle may be included with a recovery strap. Recovery straps do not act like traditional tow straps, chains, or winch cables.

## **WARNING!**

Recovery straps should only be used in emergencies to rescue stranded vehicles. Only use Recovery straps on vehicles that fit within the recommended GVW of your recovery strap. Only attach recovery straps to OE recommended anchor points or emergency towing anchor points. Never attach to tow ball or vehicle tie down point, these are not designed for this purpose. Never attach to vehicle steering, drive train, or any other suspension components. NEVER pull a strap over sharp edges or abrasive surfaces that can damage the recovery strap. NEVER use a damaged strap, it has reduced strength. DO NOT attempt to repair straps. ONLY persons involved in the recovery should be in either vehicle. No passengers. Anyone inside the vehicles can be struck by strap recoil, causing serious injury. MOVE bystanders at least 40 ft (12.2 m) from the recovery area when using the recovery strap.

### **Using Recovery Strap**

1. Review all warnings and instructions first.
2. Position the recovery vehicle.
3. Connect the recovery strap.
4. Add a recovery damper or blanket.
5. Clear the danger zone.
6. Safely and slowly start pulling.
7. Disconnect the recovery strap after both vehicle are secure and parked.

# WHAT TO DO IN EMERGENCIES

## GEAR SELECTOR OVERRIDE

If a malfunction occurs and the gear selector cannot be moved out of the PARK position, you can use the following procedure to temporarily move the gear selector:

1. Turn the engine OFF.
2. Apply the parking brake.
3. Using a screwdriver or similar tool, carefully separate the shifter bezel and boot assembly from the center console.
4. Press and maintain firm pressure on the brake pedal.
5. Insert a small screwdriver or similar tool down into the gear selector override access hole (at the right front corner of the gear selector assembly), and push and hold the override release lever down.
6. Move the gear selector to the NEUTRAL position.
7. The vehicle may then be started in NEUTRAL.
8. Reinstall the gear selector boot.

## TOWING A DISABLED VEHICLE

Towing Condition	Wheels OFF the Ground	FWD MODELS	4X4 MODELS	
			1-SPEED POWER TRANSFER UNIT	2-SPEED POWER TRANSFER UNIT
Flat Tow	NONE	<b>NOT ALLOWED</b>	<b>NOT ALLOWED</b>	See instructions under "Recreational Towing" in "Utility" <ul style="list-style-type: none"><li>• Transmission in <b>PARK</b></li><li>• Power Transfer Unit in <b>NEUTRAL</b></li><li>• Tow in <b>forward</b> direction</li></ul>
Wheel Lift or Dolly Tow	Rear	<b>NOT ALLOWED</b>	<b>NOT ALLOWED</b>	<b>NOT ALLOWED</b>
	Front	OK	<b>NOT ALLOWED</b>	<b>NOT ALLOWED</b>
Flatbed	<b>ALL</b>	<b>BEST METHOD</b>	OK	<b>BEST METHOD</b>

### NOTE:

You must ensure that the Auto Park Brake feature is disabled before towing this vehicle, to avoid inadvertent Electric Park Brake engagement. The Auto Park Brake feature is enabled or disabled via the customer programmable features in the Uconnect Settings.

# WHAT TO DO IN EMERGENCIES

## **ENHANCED ACCIDENT RESPONSE SYSTEM (EARS)**

This vehicle is equipped with an Enhanced Accident Response System.

Please refer to “Supplemental Restraint System (SRS) — Air Bags” for further information on the Enhanced Accident Response System (EARS) function.

## **EVENT DATA RECORDER (EDR)**

This vehicle is equipped with an Event Data Recorder (EDR). The main purpose of an EDR is to record, in certain crash or near crash-like situations, such as an air bag deployment or hitting a road obstacle, data that will assist in understanding how a vehicle’s systems performed.

Please refer to “Supplemental Restraint System (SRS) — Air Bags” for further information on the Event Data Recorder (EDR).



# MAINTAINING YOUR VEHICLE

## TO OPEN AND CLOSE THE HOOD

Two latches must be released to open the hood.

1. Pull the hood release lever located under the drivers side of the instrument panel.
2. Move to the outside of the vehicle and pull the safety latch release lever forward (toward you). The safety latch release lever is located behind the front edge of the hood, slightly off-center to the right.

### **WARNING!**

Be sure the hood is fully latched before driving your vehicle. If the hood is not fully latched, it could open when the vehicle is in motion and block your vision. Failure to follow this warning could result in serious injury or death.

### **CAUTION!**

To prevent possible damage, do not slam the hood to close it. Lower hood to approximately 12 in (30 cm) and drop the hood to close. Make sure hood is fully closed for both latches. Never drive vehicle unless hood is fully closed, with both latches engaged.

# MAINTAINING YOUR VEHICLE

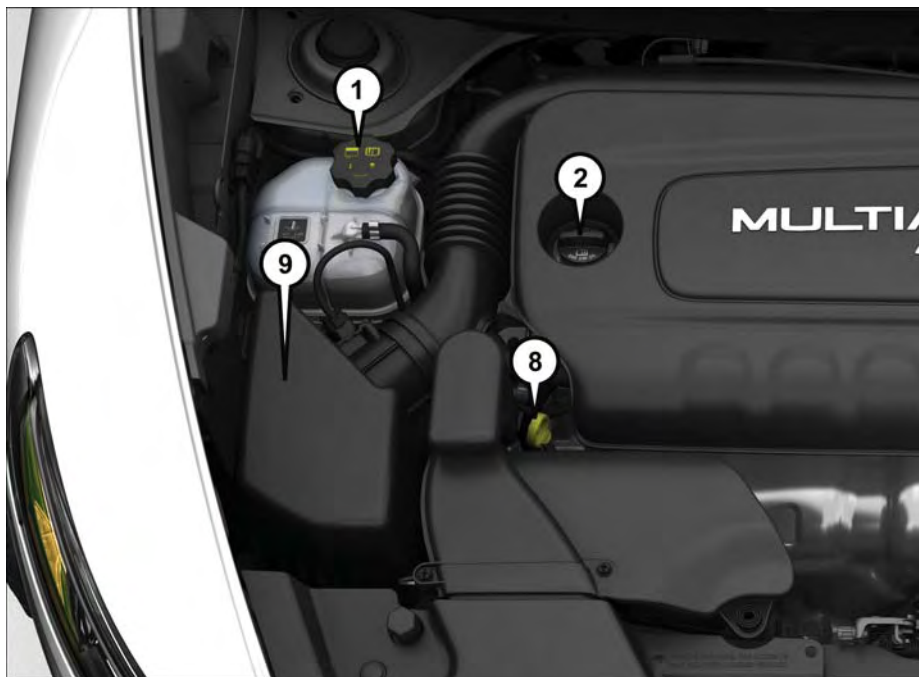

## ENGINE COMPARTMENT – 2.4L

1. Engine Coolant Reservoir
2. Engine Oil Fill
3. Brake Fluid Reservoir
4. Battery Terminals (Jump Starting)
5. Battery

# MAINTAINING YOUR VEHICLE

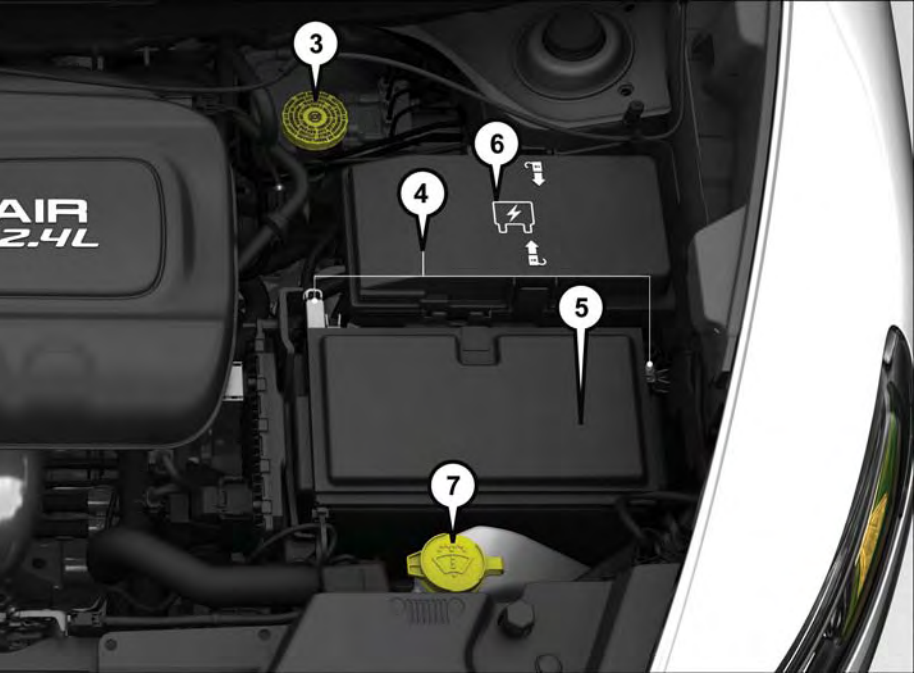

- 6. Power Distribution Center (Fuses)
- 7. Washer Fluid Reservoir
- 8. Engine Oil Dipstick
- 9. Air Cleaner Filter

# MAINTAINING YOUR VEHICLE

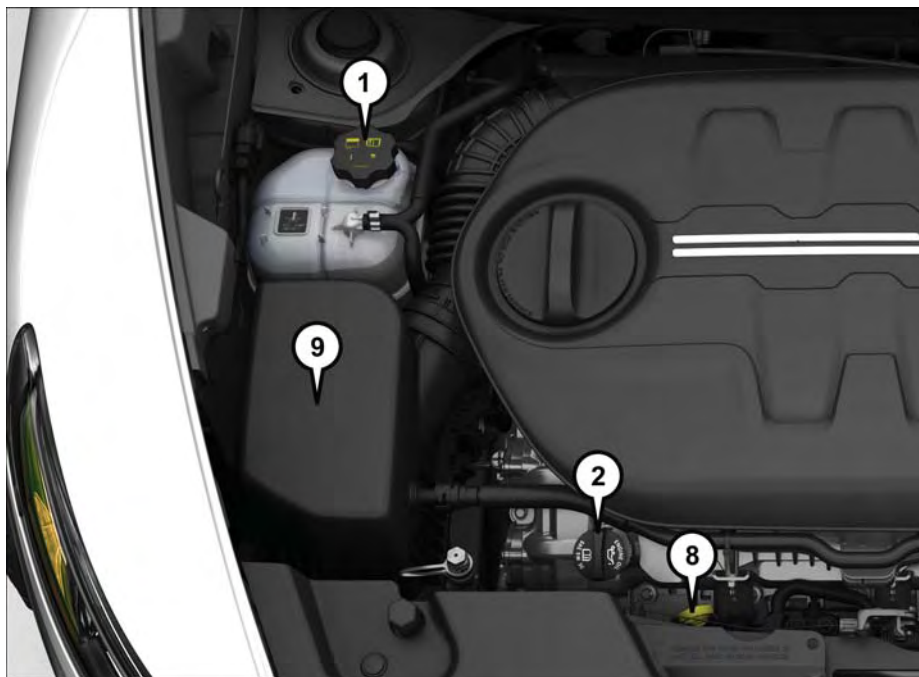

## ENGINE COMPARTMENT – 3.2L

1. Engine Coolant Reservoir
2. Engine Oil Fill
3. Brake Fluid Reservoir
4. Battery Terminals (Jump Starting)
5. Battery
6. Windshield Washer Fluid Reservoir
7. Power Steering Fluid Reservoir
8. Engine Oil Dipstick
9. Battery Cover

# MAINTAINING YOUR VEHICLE

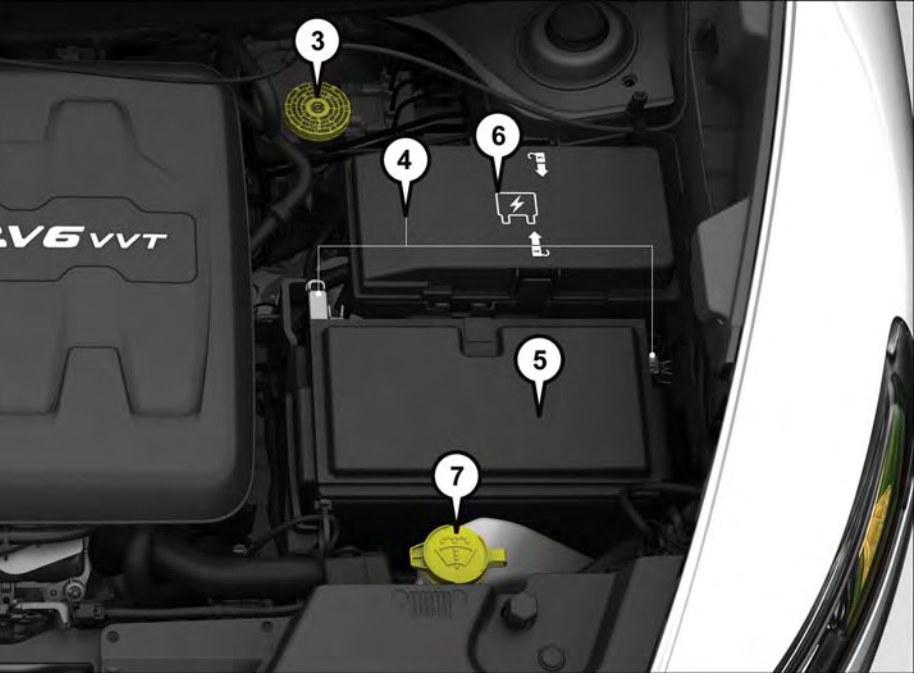

- 6. Power Distribution Center (Fuses)
- 7. Washer Fluid Reservoir
- 8. Engine Oil Dipstick
- 9. Air Cleaner Filter

# MAINTAINING YOUR VEHICLE

## FLUID CAPACITIES

	U.S.	Metric
<b>Fuel (Approximate)</b>		
2.4L and 3.2L Engines	15.8 Gallons	60 Liters
<b>Engine Oil With Filter</b>		
2.4 Liter Engine (SAE 0W-20, API Certified)	5.5 Quarts	5.2 Liters
3.2 Liter Engine (SAE 5W-20, API Certified)	6 Quarts	5.6 Liters
<b>Cooling System*</b>		
2.4 Liter Engine (MOPAR Antifreeze/Engine Coolant 10 Year/150,000 Mile Formula)	7.2 Quarts	6.8 Liters
3.2 Liter Engine (MOPAR Antifreeze/Engine Coolant 10 Year/150,000 Mile Formula)	10 Quarts	9.5 Liters
* Includes heater and coolant recovery bottle filled to MAX level.		

## FLUIDS, LUBRICANTS, AND GENUINE PARTS

### Engine

Component	Fluid, Lubricant, or Genuine Part
Engine Coolant	We recommend you use MOPAR Antifreeze/Coolant 10 Year/150,000 Mile Formula OAT (Organic Additive Technology) or equivalent meeting the requirements of FCA Standard MS.90032.
Engine Oil – 2.4L Engine	We recommend you use SAE 0W-20 API Certified Engine Oil, meeting the requirements of FCA Material Standard MS-6395 such as MOPAR, Pennzoil, and Shell Helix. Refer to your engine oil filler cap for correct SAE grade.
Engine Oil – 3.2L Engine	We recommend you use API Certified SAE 5W-20 Engine Oil, meeting the requirements of FCA Material Standard MS-6395 such as MOPAR, Pennzoil, and Shell Helix. Refer to your engine oil filler cap for correct SAE grade.
Engine Oil Filter	We recommend you use a MOPAR Engine Oil Filter.
Spark Plugs	We recommend you use MOPAR Spark Plugs.
Fuel Selection – 2.4L Flex Fuel (E-85) Engines	87 Octane, Up To 85% Ethanol.
Fuel Selection – 2.4L and 3.2L Engines	87 Octane, 0-15% Ethanol.

# MAINTAINING YOUR VEHICLE

## CAUTION!

- Mixing of engine coolant (antifreeze) other than specified Organic Additive Technology (OAT) engine coolant (antifreeze), may result in engine damage and may decrease corrosion protection. Organic Additive Technology (OAT) engine coolant is different and should not be mixed with Hybrid Organic Additive Technology (HOAT) engine coolant (antifreeze) or any “globally compatible” coolant (antifreeze). If a non-OAT engine coolant (antifreeze) is introduced into the cooling system in an emergency, the cooling system will need to be drained, flushed, and refilled with fresh OAT coolant (conforming to MS.90032), by an authorized dealer as soon as possible.
- Do not use water alone or alcohol-based engine coolant (antifreeze) products. Do not use additional rust inhibitors or antirust products, as they may not be compatible with the radiator engine coolant and may plug the radiator.
- This vehicle has not been designed for use with propylene glycol-based engine coolant (antifreeze). Use of propylene glycol-based engine coolant (antifreeze) is not recommended.

## Chassis

Component	Fluid, Lubricant, or Genuine Part
Automatic Transmission	Use only MOPAR ZF 8&9 Speed ATF Automatic Transmission Fluid, or equivalent. Failure to use the correct fluid may affect the function or performance of your transmission.
Brake Master Cylinder	We recommend you use MOPAR DOT 3 Brake Fluid, SAE J1703 should be used. If DOT 3, SAE J1703 brake fluid is not available, then DOT 4 is acceptable. Use only recommended brake fluids.

## FLEXIBLE FUEL (2.4L ENGINE ONLY) – IF EQUIPPED

### E-85 General Information

The information in this section is unique for Flexible Fuel vehicles only. These vehicles can be identified by a unique fuel filler door label that states **Ethanol (E-85) or Unleaded Gasoline Only** and a yellow fuel cap. Refer to the Owner's Manual on the DVD for further information.

## CAUTION!

Only vehicles with the E-85 fuel filler door label or a yellow gas cap can operate on E-85.

# MAINTAINING YOUR VEHICLE

## MAINTENANCE PROCEDURES

For information on the maintenance procedures for your vehicle, please refer to “Maintenance Procedures” in “Maintaining Your Vehicle” in your Owner’s Manual or applicable supplement on the DVD for further details.

## MAINTENANCE SCHEDULE

Your vehicle is equipped with an automatic oil change indicator system. The oil change indicator system will remind you that it is time to take your vehicle in for scheduled maintenance.

Based on engine operation conditions, the oil change indicator message will illuminate. This means that service is required for your vehicle. Operating conditions such as frequent short-trips, trailer tow, extremely hot or cold ambient temperatures will influence when the “Oil Change Required” message is displayed. Severe Operating Conditions can cause the change oil message to illuminate as early as 3,500 miles (5,600 km) since last reset. Have your vehicle serviced as soon as possible, within the next 500 miles (805 km).

Your authorized dealer will reset the oil change indicator message after completing the scheduled oil change. If a scheduled oil change is performed by someone other than your authorized dealer, the message can be reset by referring to the steps described under “Instrument Cluster Warning Lights” in “What To Do In Emergencies” in this guide or “Electronic Vehicle Information Center (EVIC)” or “Driver Information Display (DID)” in “Understanding Your Instrument Panel” in your Owners Manual on the DVD for further information.

### **NOTE:**

Under no circumstances should oil change intervals exceed 10,000 miles (16,000 km), twelve months or 350 hours of engine run time, whichever comes first. The 350 hours of engine run or idle time is generally only a concern for fleet customers.

### **Severe Duty All Models**

Change Engine Oil at 4,000 miles (6,500 km) if the vehicle is operated in a dusty and off road environment or is operated predominately at idle or only very low engine RPM’s. This type of vehicle use is considered Severe Duty.



# MAINTAINING YOUR VEHICLE

## Once A Month Or Before A Long Trip:

- Check engine oil level.
- Check windshield washer fluid level.
- Check tire pressure and look for unusual wear or damage. Rotate tires at the first sign of irregular wear, even if it occurs before the oil indicator system turns on.
- Check the fluid levels of the coolant reservoir and brake master cylinder, fill as needed.
- Check function of all interior and exterior lights.

## Required Maintenance Intervals.

Refer to the maintenance schedules on the following page for the required maintenance intervals.

<b>At Every Oil Change Interval As Indicated By Oil Change Indicator System:</b>
• Change oil and filter
• Rotate the tires. <b>Rotate at the first sign of irregular wear, even if it occurs before the oil indicator system turns on.</b>
• Inspect battery and clean and tighten terminals as required
• Inspect brake pads, shoes, rotors, drums, hoses and park brake
• Inspect engine cooling system protection and hoses
• Inspect exhaust system
• Inspect engine air cleaner if using in dusty or off-road conditions

# MAINTAINING YOUR VEHICLE

## Maintenance Chart

Mileage or time passed (whichever comes first)	20,000	30,000	40,000	50,000	60,000	70,000	80,000	90,000	100,000	110,000	120,000	130,000	140,000	150,000
<b>Or Years:</b>	2	3	4	5	6	7	8	9	10	11	12	13	14	15
<b>Or Kilometers:</b>	32,000	48,000	64,000	80,000	96,000	112,000	128,000	144,000	160,000	176,000	192,000	208,000	224,000	240,000
<b>Additional Inspections</b>														
Inspect the CV joints.	X		X		X		X		X		X		X	
Inspect front suspension, boot seals, tie rod ends, and replace if necessary.	X		X		X		X		X		X		X	
Inspect the brake linings, parking brake function.	X		X		X		X		X		X		X	
Inspect front accessory drive belt, tensioner, idler pulley, and replace if necessary.														X
<b>Additional Maintenance</b>														
Replace engine air cleaner filter.		X			X			X			X			X
Replace air conditioning/cabin air filter.	X		X		X		X		X		X		X	
Replace spark plugs **									X					
Flush and replace the engine coolant at 10 years or 150,000 miles (240,000 km) whichever comes first.									X					X
Inspect and replace PCV valve if necessary.									X					

\*\* The spark plug change interval is mileage based only, yearly intervals do not apply.

### WARNING!

- You can be badly injured working on or around a motor vehicle. Do only service work for which you have the knowledge and the right equipment. If you have any doubt about your ability to perform a service job, take your vehicle to a competent mechanic.
- Failure to properly inspect and maintain your vehicle could result in a component malfunction and effect vehicle handling and performance. This could cause an accident.

# MAINTAINING YOUR VEHICLE

## MAINTENANCE RECORD

	Odometer	Date	Signature, Authorized Service Center
20,000 Miles (32,000 km) or 2 Years			
30,000 Miles (48,000 km) or 3 Years			
40,000 Miles (64,000 km) or 4 Years			
50,000 Miles (80,000 km) or 5 Years			
60,000 Miles (96,000 km) or 6 Years			
70,000 Miles (112,000 km) or 7 Years			
80,000 Miles (128,000 km) or 8 Years			

	Odometer	Date	Signature, Authorized Service Center
90,000 Miles (144,000 km) or 9 Years			
100,000 Miles (160,000 km) or 10 Years			
110,000 Miles (176,000 km) or 11 Years			
120,000 Miles (192,000 km) or 12 Years			
130,000 Miles (208,000 km) or 13 Years			
140,000 Miles (224,000 km) or 14 Years			
150,000 Miles (240,000 km) or 15 Years			

# MAINTAINING YOUR VEHICLE

## FUSES

### WARNING!

- When replacing a blown fuse, always use an appropriate replacement fuse with the same amp rating as the original fuse. Never replace a fuse with another fuse of higher amp rating. Never replace a blown fuse with metal wires or any other material. Failure to use proper fuses may result in serious personal injury, fire and/or property damage.
- Before replacing a fuse, make sure that the ignition is off and that all the other services are switched off and/or disengaged.
- If the replaced fuse blows again, contact an authorized dealer.
- If a general protection fuse for safety systems (air bag system, braking system), power unit systems (engine system, gearbox system) or steering system blows, contact an authorized dealer.

### Power Distribution Center

The Power Distribution Center is located in the engine compartment near the battery. This center contains cartridge fuses, mini-fuses and relays. A label that identifies each component is printed on the inside of the cover.

Cavity	Blade Fuse	Cartridge Fuse	Description
F06	–	–	Not Used
F07	15 Amp Blue	–	Powertrain Control Module - PCM (Diesel Only)
F08	25 Amp Clear	–	Engine Control Module (ECM)/ Fuel Injection
F09	–	–	Not Used
F10	20 Amp Yellow	–	Power Transfer Unit (PTU) - If Equipped
F11	–	–	Not Used
F12	20 Amp Yellow	–	Brake Vacuum Pump - If Equipped
F13	10 Amp Red	–	Engine Control Module (ECM)
F14	10 Amp Red	–	Drivetrain Control Module (DTCM) / Power Take-Off Unit (PTU) / Brake System Module (BSM) - If Equipped/Brake Pedal Switch/Back Up Switch (Diesel Only)
F15	–	–	Not Used
F16	20 Amp Yellow	–	Ign Coil (Gas) / Engine Sensor (Diesel)
F17	–	–	Not Used
F18	–	–	Not Used

# MAINTAINING YOUR VEHICLE

<b>Cavity</b>	<b>Blade Fuse</b>	<b>Cartridge Fuse</b>	<b>Description</b>
F19	–	40 Amp Green	Starter Solenoid BCM
F20	10 Amp Red	–	A/C Compressor Clutch
F21	–	–	Not Used
F22	5 Amp Tan	–	Radiator Fan
F23	70 Amp Tan	–	Body Controller Module (BCM) - Feed 2
F23	50 Amp Red	–	Voltage Stability Module (VSM) Feed #2 - If Equipped With Stop/Start Engine Option
F24	20 Amp Yellow	–	Rear Wiper - If Equipped With Stop/Start Engine Option
F25B	20 Amp Yellow	–	Front Washer - If Equipped With Stop/Start Engine Option
F26	–	30 Amp Pink	Fuel Heater - Diesel Only
F27	–	–	Not Used
F28	15 Amp Blue	–	Transmission Control Module (TCM)
F29	–	–	Not Used
F30	10 Amp Red	–	Engine Control Module (ECM)/ (EPS)/(PCM)
F31	–	–	Not Used
F32	–	–	Not Used
F33	–	–	Not Used
F34	–	–	Not Used
F35	–	–	Not Used
F36	–	–	Not Used
F37	–	–	Not Used
F38	–	60 Amp Yellow	Glow Plugs (Diesel Only) - If Equipped
F39	–	40 Amp Green	HVAC Blower Motor
F40	–	20 Amp Blue	Trailer Tow Park Light - If Equipped
F40	–	30 Amp Pink	Headlamp Washer Pump - If Equipped
F41	–	60 Amp Yellow	Body Controller Module (BCM) - Feed 1
F41	–	50 Amp Red	Voltage Stability Module - Feed 1 - If Equipped With Stop/Start Engine Option
F42	–	30 Amp Pink	Trailer Tow Electric Brake Module - If Equipped
F43	20 Amp Yellow	–	Fuel Pump Motor

# MAINTAINING YOUR VEHICLE

<b>Cavity</b>	<b>Blade Fuse</b>	<b>Cartridge Fuse</b>	<b>Description</b>
F44	–	30 Amp Pink	Trailer Tow / 7-Way Connector - If Equipped
F45	–	30 Amp Pink	Passenger Door Module (PDM) - If Equipped
F46	–	25 Amp Clear	Sunroof - If Equipped
F48	–	30 Amp Pink	Driver Door Module - If Equipped
F49	–	30 Amp Pink	Power Inverter (115V A/C) - If Equipped
F50	–	30 Amp Pink	Power Liftgate - If Equipped
F51	–	–	Not Used
F52	–	30 Amp Pink	Front Wipers - If Equipped With Stop/Start Engine Option
F53	–	30 Amp Pink	Brake System Module & Valves
F54	–	30 Amp Pink	Body Control Module (BCM) Feed 3
F55	10 Amp Red	–	Blind Spot Sensors / Compass / Rearview Camera / Trunk Lamp With Flashlamp Charger - If Equipped
F56	15 Amp Blue	–	Ignition Node Module (IGNM)/ KIN/RF Hub/Electric Steering Column Lock (ESL)
F57	20 Amp Yellow	–	Trailer Tow Lights Left - If Equipped
F58	10 Amp Red	–	Occupant Classification Module/VSM/ESC
F59	–	30 Amp Pink	Drivetrain Control Module (DTCM) If Equipped
F60	20 Amp Yellow	–	Power Outlet - Center Console
F61	20 Amp Yellow	–	Trailer Tow Lights Right - If Equipped
F62	20 Amp Yellow	–	Windshield de-icer - If Equipped
F63	20 Amp Yellow	–	Front Heated/Vented Seats - If Equipped
F64	20 Amp Yellow	–	Heated Steering Wheel - If Equipped
F65	10 Amp Red	–	In Vehicle Temperature Sensor / Humidity Sensor / Driver Assist System Module (DASM) / Park Assist (PAM) - If Equipped With Stop/Start option

# MAINTAINING YOUR VEHICLE

<b>Cavity</b>	<b>Blade Fuse</b>	<b>Cartridge Fuse</b>	<b>Description</b>
F66	15 Amp Blue	–	HVAC (ECC) / Instrument Panel Cluster (IPC)
F67	10 Amp Red	–	In Vehicle Temperature Sensor / Humidity Sensor / Driver Assist System Module (DASM) / Park Assist (PAM) - If Not Equipped With Stop/Start Option
F68	–	–	Not Used
F69	10 Amp Red	–	Power Transfer Unit Switch (TSBM) / Active Grill Shutter (AGS) - If Equipped With Gas Engine
69A	10 Amp Red	–	Power Transfer Unit Switch (TSBM) - If Equipped With Diesel Engine
F70	5 Amp Tan	–	Intelligent Battery Sensor If Equipped With Stop/Start Engine Option
F71	20 Amp Yellow	–	HID Headlamp Right if Equipped With Stop/Start Engine Option
F72	10 Amp Red	–	Heated Mirrors - If Equipped
F73	–	20 Amp Blue	Trailer Tow Back Up - If Equipped
F74	–	30 Amp Pink	Rear Defroster
F75	20 Amp Yellow	–	Cigar Lighter - If Equipped
F76	20 Amp Yellow	–	Rear Differential Module (RDM) - If Equipped
F77	10 Amp Red	–	Fuel Door Release/Brake Pedal Switch
F78	10 Amp Red	–	Diagnostic Port / Digital TV (Japan Only)
F79	10 Amp Red	–	Integrated Center Stack (ICS) / HVAC / Aux Switch Bank Module (ASBM) / Instrument Panel Cluster (IPC)
F80	20 Amp Yellow	–	Radio / CD - If Equipped
F81	–	–	Not Used
F82	–	–	Not Used
F83	–	20 Amp Blue	Engine Controller Module (Gas)
F84	–	30 Amp Pink	Electric Park Brake (EPB) - Left
F85	–	–	Not Used

# MAINTAINING YOUR VEHICLE

Cavity	Blade Fuse	Cartridge Fuse	Description
F86	20 Amp Yellow	–	Horns - If Equipped With Stop/Start Engine Option
F87	20 Amp Yellow	–	HID Headlamp Left if Equipped With Stop/Start Engine Option
F88	15 Amp Blue	–	Smart Camera
F89	10 Amp Red	–	Auto Headlamp
F90	–	–	Not Used
F91	20 Amp Yellow	–	Power Outlet (D-Piler)
F92	–	–	Not Used
F93	–	40 Amp Green	BCM
F94	–	30 Amp Pink	EPB
F95	10 Amp Red	–	Sunroof/Rain Sensor/ECM
F96	10 Amp Red	–	ORC
F97	10 Amp Red	–	ORC
F98	25 Amp Clear	–	Radio Amp

## Interior Fuses

The interior fuse panel is located on the Body Control Module (BCM) in the passenger compartment on the left side dash panel under the instrument panel.

Cavity	Blade Fuse	Description
F13	15 Amp Blue	Low Beam Left
F32	10 Amp Red	Interior Lighting
F36	10 Amp Red	Intrusion Module/Siren – If Equipped
F38	20 Amp Yellow	Deadbolt All Unlock
F43	20 Amp Yellow	Washer Pump Front
F48	25 Amp Clear	Fog Lamp Rear Left/Right – If Equipped
F49	7.5 Amp Brown	Lumbar Support
F50	7.5 Amp Brown	Wireless Charging Pad – If Equipped
F51	10 Amp Red	Driver Window Switch/Power Mirrors – If Equipped
F53	7.5 Amp Brown	UCI Port (USB & AUX)
F89	10 Amp Red	Door Locks – Driver Unlock
F91	7.5 Amp Brown	Fog Lamp Front Left
F92	7.5 Amp Brown	Fog Lamp Front Right
F93	10 Amp Red	Low Beam Right



# MAINTAINING YOUR VEHICLE

## ADDING FUEL

The gas cap is located behind the fuel filler door, on the passenger side of the vehicle. If the gas cap is lost or damaged, be sure the replacement cap has been designed for use with this vehicle.

### NOTE:

When removing the fuel filler cap, lay the cap tether in the hook, located on the fuel filler door reinforcement.

1. Push the fuel filler door release switch (located on the driver's side door trim).



**Fuel Filler Door Release Switch**

2. Open the fuel filler door, and remove the fuel filler cap.

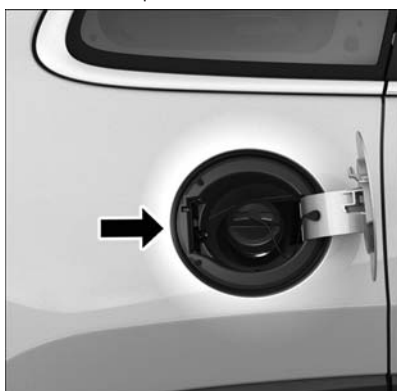

**Fuel Filler Cap (Gas Cap)**

# MAINTAINING YOUR VEHICLE

## NOTE:

- In certain cold conditions, ice may prevent the fuel door from opening. If this occurs, lightly push on the fuel door to break the ice buildup and re-release the fuel door using the inside release button. Do not pry on the door.
- When the fuel nozzle “clicks” or shuts off, the fuel tank is full.
- Tighten the gas cap about one quarter turn until you hear one click. This is an indication that the cap is properly tightened.
- If the gas cap is not tightened properly, the MIL will come on. Be sure the gas cap is tightened every time the vehicle is refueled.

## CAUTION!

- Damage to the fuel system or emission control system could result from using an improper fuel filler cap. A poorly fitting cap could let impurities into the fuel system. Also, a poorly fitting aftermarket cap can cause the “Malfunction Indicator Light (MIL)” to illuminate, due to fuel vapors escaping from the system.
- A poorly fitting fuel filler cap may cause the MIL to turn on.
- To avoid fuel spillage and overfilling, do not “top off” the fuel tank after filling.

## WARNING!

- Never have any smoking materials lit in or near the vehicle when the gas cap is removed or the tank is being filled.
- Never add fuel when the engine is running. This is in violation of most state and federal fire regulations and may cause the MIL to turn on.
- A fire may result if gasoline is pumped into a portable container that is inside of a vehicle. You could be burned. Always place gas containers on the ground while filling.

## Emergency Fuel Filler Door Release

If you are unable to open the fuel filler door, use the fuel filler door emergency release.

1. Open the liftgate.
2. Remove access door located on right interior trim panel for release cable with the tip of your key.
3. Grab the release cable tether and pull up to release the fuel filler door.

# MAINTAINING YOUR VEHICLE

## Loose Fuel Filler Cap Message

If the vehicle diagnostic system determines that the fuel filler cap is loose, improperly installed, or damaged, a “CHECK GASCAP” message will be displayed in the Electronic Vehicle Information Center (EVIC) or Driver Information Display (DID). Refer to “Electronic Vehicle Information (EVIC) or “Driver Information Display (DID)” in “Understanding Your Instrument Panel” for further information. Tighten the fuel filler cap until a “clicking” sound is heard. This is an indication that the fuel filler cap is properly tightened. Refer to “Onboard Diagnostic System” in “Maintaining Your Vehicle” for further information.

## TIRES – GENERAL INFORMATION

### Tire Pressures

Check the inflation pressure of each tire, including the spare tire (if equipped), at least monthly and inflate to the recommended pressure for your vehicle.

The tire pressures recommended for your vehicle are found on the “Tire and Loading Information” label located on the driver’s side door opening or B-Pillar.



**Tire And Loading Information Location  
(Example)**

### NOTE:

Refer to the Owner's Manual on the DVD or the Tire Information Supplement located in your Owner's Information kit for more information regarding tire warnings and instructions.

# MAINTAINING YOUR VEHICLE

## WARNING!

- Overloading of your tires is dangerous. Overloading can cause tire failure, affect vehicle handling, and increase your stopping distance. Use tires of the recommended load capacity for your vehicle. Never overload them.
- Improperly inflated tires are dangerous and can cause collisions. Under-inflation increases tire flexing and can result in over-heating and tire failure. Over-inflation reduces a tire's ability to cushion shock. Objects on the road and chuck holes can cause damage that results in tire failure. Unequal tire pressures can cause steering problems. You could lose control of your vehicle. Over-inflated or under-inflated tires can affect vehicle handling and can fail suddenly, resulting in loss of vehicle control. Always drive with each tire inflated to the recommended cold tire inflation pressure.

## Spare Tires – If Equipped

### NOTE:

For vehicles equipped with Tire Service Kit instead of a spare tire, please refer to the “Tire Service Kit” section located in your Owner’s Information kit for further information.

## CAUTION!

Because of the reduced ground clearance, do not take your vehicle through an automatic car wash with a compact or limited-use temporary spare installed. Damage to the vehicle may result.

## Spare Tire Matching Original Equipped Tire And Wheel — If Equipped

Your vehicle may be equipped with a spare tire and wheel equivalent in look and function to the original equipment tire and wheel found on the front or rear axle of your vehicle. This spare tire may be used in the tire rotation for your vehicle. If your vehicle has this option, refer to an authorized tire dealer for the recommended tire rotation pattern.

## Compact Spare Tire — If Equipped

The compact spare is for temporary emergency use only. You can identify if your vehicle is equipped with a compact spare by looking at the spare tire description on the Tire and Loading Information Placard located on the driver’s side door opening or on the sidewall of the tire. Compact spare tire descriptions begin with the letter “T” or “S” preceding the size designation. Example: T145/80D18 103M.

T, S = Temporary Spare Tire

Since this tire has limited tread life, the original equipment tire should be repaired (or replaced) and reinstalled on your vehicle at the first opportunity.

# MAINTAINING YOUR VEHICLE

Do not install a wheel cover or attempt to mount a conventional tire on the compact spare wheel, since the wheel is designed specifically for the compact spare tire. Do not install more than one compact spare tire and wheel on the vehicle at any given time.

## **WARNING!**

Compact spares are for temporary emergency use only. With these spares, do not drive more than 50 mph (80 km/h). Temporary use spares have limited tread life. When the tread is worn to the tread wear indicators, the temporary use spare tire needs to be replaced. Be sure to follow the warnings, which apply to your spare. Failure to do so could result in spare tire failure and loss of vehicle control.

### **Full Size Spare — If Equipped**

The full size spare is for temporary emergency use only. This tire may look like the originally equipped tire on the front or rear axle of your vehicle, but it is not. This spare tire may have limited tread life. When the tread is worn to the tread wear indicators, the temporary use full size spare tire needs to be replaced. Since it is not the same as your original equipment tire, replace (or repair) the original equipment tire and reinstall on the vehicle at the first opportunity.

### **Limited Use Spare — If Equipped**

The limited use spare tire is for temporary emergency use only. This tire is identified by a label located on the limited use spare wheel. This label contains the driving limitations for this spare. This tire may look like the original equipped tire on the front or rear axle of your vehicle, but it is not. Installation of this limited use spare tire affects vehicle handling. Since it is not the same as your original equipment tire, replace (or repair) the original equipment tire and reinstall on the vehicle at the first opportunity.

## **WARNING!**

Limited use spares are for emergency use only. Installation of this limited use spare tire affects vehicle handling. With this tire, do not drive more than the speed listed on the limit use spare wheel. Keep inflated to the cold tire inflation pressures listed on your Tire and Loading Information Placard located on the driver's side B-Pillar or the rear edge of the driver's side door. Replace (or repair) the original equipment tire at the first opportunity and reinstall it on your vehicle. Failure to do so could result in loss of vehicle control.

# MAINTAINING YOUR VEHICLE

## Wheel And Wheel Trim Care

All wheels and wheel trim, especially aluminum and chrome plated wheels, should be cleaned regularly with a mild soap and water to prevent corrosion.

To remove heavy soil and/or excessive brake dust, use MOPAR Wheel Cleaner or equivalent or select a non-abrasive, non-acidic cleaner.

### CAUTION!

Do not use scouring pads, steel wool, a bristle brush, or metal polishes. Do not use oven cleaner. These products may damage the wheel's protective finish. Avoid automatic car washes that use acidic solutions or harsh brushes that may damage the wheel's protective finish. Only MOPAR Wheel Cleaner or equivalent is recommended.

## REPLACEMENT BULBS

### Interior Bulbs

	Bulb Number
Cargo Lamp	TL212-2
Overhead Console Lamp	PLW214-2A
Reading Lamp	WL212-2

### Exterior Bulbs

	Bulb Number
Low Beam/High Beam (Bi-Halogen) Headlamps	HIR2
Low Beam/High Beam (Bi-Xenon) Headlamps	D3S (Serviced at an Authorized Dealer)
Front Park/Daytime Running Lamps	LED (Serviced at an Authorized Dealer)
Front Turn Signal Lamps	WY21W
Front Fog Lamps	H11LL
Rear Tail/Turn/Stop Lamps	LED ( Serviced at an Authorized Dealer)
Center High Mounted Stop Lamp (CHMSL)	LED (Serviced at an Authorized Dealer)
Back-Up Lamps	W16W or 921
License Plate Lamp	W5W

# CUSTOMER ASSISTANCE

## FCA US LLC CUSTOMER CENTER

P.O. Box 21-8004 Auburn Hills, MI 48321-8004 Phone: 1-877-426-5337

## FCA CANADA INC. CUSTOMER CENTER

P.O. Box 1621 Windsor, Ontario N9A 4H6 Phone: 1-800-465-2001 (English)  
Phone: 1-800-387-9983 (French)

## ASSISTANCE FOR THE HEARING IMPAIRED

To assist customers who have hearing difficulties, the manufacturer has installed special TDD (Telecommunication Devices for the Deaf) equipment at its customer center. Any hearing or speech impaired customer, who has access to a TDD or a conventional teletypewriter (TTY) in the United States, can communicate with the manufacturer by dialing 1-800-380-CHRY. Canadian residents with hearing difficulties that require assistance can use the special needs relay service offered by Bell Canada. For TTY teletypewriter users, dial 711 and for Voice callers, dial 1-800-855-0511 to connect with a Bell Relay Service operator.

### WARNING!

Engine exhaust, some of its constituents, and certain vehicle components contain, or emit, chemicals known to the State of California to cause cancer and birth defects, or other reproductive harm. In addition, certain fluids contained in vehicles and certain products of component wear contain, or emit, chemicals known to the State of California to cause cancer and birth defects, or other reproductive harm.

## PUBLICATIONS ORDERING

- If you are the first registered retail owner of your vehicle, you may obtain a complimentary printed copy of the Owner's Manual, Navigation/Uconnect Manuals or Warranty Booklet. United States customers may visit the Jeep Contact Us page at [www.jeep.com](http://www.jeep.com) scroll to the bottom of the page and select the "Contact Us" link, then select the "Owner's Manual and Glove Compartment Material" from the left menu. You may also obtain a complimentary copy by calling 1-877-426-5337 (U.S.) or 1-800-387-1143 (Canada).
- Replacement User Guide kits or DVDs or, if you prefer, additional printed copies of the Owner's Manual, Warranty Booklet or Radio Manuals may be purchased by visiting [www.techauthority.com](http://www.techauthority.com) or by calling 1-877-890-4038 (U.S.) or 1-800-387-1143 (Canada). Visa, Master Card, American Express and Discover orders are accepted. If you prefer mailing your order, please call the above numbers for an order form.

### NOTE:

- A street address is required when ordering manuals (no P.O. Boxes).

# CUSTOMER ASSISTANCE

- The Owner's Manual and User Guide electronic files are also available on the Chrysler, Jeep, Ram Truck, Dodge and SRT websites.
- Click on the "For Owners" tab, select "Owner/Service Manuals", then select your desired model year and vehicle from the drop down lists.

## REPORTING SAFETY DEFECTS IN THE UNITED STATES

If you believe that your vehicle has a defect that could cause a collision or cause injury or death, you should immediately inform the National Highway Traffic Safety Administration (NHTSA) in addition to notifying the manufacturer.

If NHTSA receives similar complaints, it may open an investigation, and if it finds that a safety defect exists in a group of vehicles, it may order a recall and remedy campaign. However, NHTSA cannot become involved in individual problems between you, your authorized dealer and the manufacturer.

To contact NHTSA, you may either call the Auto Safety Hotline toll free at 1-888-327-4236 (TTY: 1-800-424-9153), or go to <http://www.safercar.gov>; or write to: Administrator, NHTSA, 1200 New Jersey Avenue, SE., West Building, Washington, D.C. 20590. You can also obtain other information about motor vehicle safety from <http://www.safercar.gov>.

### In Canada

If you believe that your vehicle has a safety defect, you should contact the Customer Service Department immediately. Canadian customers who wish to report a safety defect to the Canadian government should contact Transport Canada, Motor Vehicle Defect Investigations and Recalls at 1-800-333-0510 or go to <http://www.tc.gc.ca/roadsafety/>.

French Canadian customers who wish to report a safety defect to the Canadian government should contact Transport Canada, Motor Vehicle Defect Investigations and Recalls at 1-800-333-0510 or go to <http://www.tc.gc.ca/securiteroutiere/>.



# MOPAR® ACCESSORIES

## AUTHENTIC ACCESSORIES BY MOPAR

- The following highlights just some of the many Authentic Jeep Accessories by MOPAR featuring a fit, finish, and functionality specifically for your Jeep Cherokee.
- In choosing Authentic Accessories you gain far more than expressive style, premium protection, or extreme entertainment, you also benefit from enhancing your vehicle with accessories that have been thoroughly tested and factory-approved.
- For the full line of Authentic Jeep Accessories by Mopar, visit your local dealership or online at [mopar.com](http://mopar.com) for U.S. residents and [mopar.ca](http://mopar.ca) for Canadian residents.

### NOTE:

All parts are subject to availability.

### JEEP CARGO MANAGEMENT SYSTEM:

- Off Road Kit
- First Aid Kit
- Roadside Safety Kit
- Collapsible Tote
- Cooler

### EXTERIOR:

- Rock Rails
- Wheels
- Wheel Locks
- Front End Cover
- Splash Guards
- Locking Gas Cap
- Hood Decal
- Skid Plates

### INTERIOR:

- Premium Floor Mats
- Security Cover
- Slush Mats
- Cargo Area Cover
- Emergency Roadside Kit
- Bright Pedal Kit
- Door Sill Guards
- Molded Cargo Tray
- Ambient Light Kit
- Katzkin Leather Interiors

### ELECTRONICS:

- MOPAR Web (WiFi)
- Remote Start
- Park Distance Sensors
- Speaker Upgrades
- Rear View Camera
- Electronic Vehicle Tracking System

### CARRIERS:

- Hitch-mount Bike Carrier
- Roof Top Cargo Basket
- Sport Utility Bars
- Roof-mount Ski and Snowboard Carrier
- Roof-mount Bike Carrier
- Roof Cargo Box Carrier

# FAQ's

## FREQUENTLY ASKED QUESTIONS

### GETTING STARTED

How do I install my LATCH Equipped Child Seat? pg. 30

How do I program my Front Seat Memory? pg. 36

### ELECTRONICS

Which radio is in my vehicle?

- Uconnect 5.0 pg. 92
- Uconnect 8.4A/8.4AN pg. 97

How do I activate the Audio Jack?

- Uconnect 5.0 pg. 96
- Uconnect 8.4A/8.4AN pg. 104

How do I set the clock on my radio?

- Uconnect 5.0 pg. 93
- Uconnect 8.4A/8.4AN pg. 97

How do I use the Navigation feature?

- Uconnect 8.4A/8.4AN pg. 106

How do I configure my Universal Garage Door Opener (HomeLink)? pg. 143

How do I pair my cell phone via Bluetooth with the Uconnect Hands-Free Voice Activation System? pg. 130

How do I improve the Bluetooth performance of my Uconnect System? pg. 139

### OFF-ROAD CAPABILITIES

How do I shift into different four-wheel drive selections? pg. 152

### UTILITY

How do I know how much I can tow with my Jeep Cherokee? pg. 157

### WHAT TO DO IN EMERGENCIES

What do I do if my TPMS warning light is blinking? pg. 165

How do I change a flat tire? pg. 182

How do I Jump-Start my vehicle? pg. 188

### MAINTAINING YOUR VEHICLE

Where is my Fuse Block located? pg. 206

What type of oil do I use? pg. 200

How often should I change my engine's oil? pg. 202

What should my tire pressure be set at? pg. 213

# INDEX

- Access
  - Uconnect . . . . . 80, 81, 86
- Adaptive Cruise Control (ACC)
  - Off . . . . . 52
  - On . . . . . 52
- Adaptive Cruise Control (ACC)  
(Cruise Control) . . . . . 51
- Adding Engine Coolant  
(Antifreeze). . . . . 202
- Adding Washer Fluid . . . . . 202
- Air Bag
  - Advanced Front Air Bag . . . . . 19
  - Advance Front Air Bag . . . . . 19
  - Air Bags . . . . . 19
  - Air Bag Warning
    - Light . . . . . 19, 26, 167
  - Driver Knee Air Bag . . . . . 24
  - Enhanced Accident Response . . . . . 26, 194
  - Event Data Recorder (EDR) . . . . . 27, 194
  - Front Air Bag . . . . . 19
  - Passenger Knee Air Bag . . . . . 24
  - Rollover . . . . . 19
  - Side Impacts . . . . . 19
- Air Bag Light . . . . . 26
- Air Cleaner, Engine (Engine Air Cleaner Filter) . . . . . 202
- Air Conditioner Maintenance . . . 202
- Air Conditioning . . . . . 58, 59, 62, 64
- Air Conditioning Refrigerant . . . . 202
- Air Conditioning System . . . . . 202
- Alarm
  - Arm The System . . . . . 13
  - Disarm The System . . . . . 13
  - Vehicle Security Alarm . . . . . 13
- Alarm, Panic . . . . . 12
- Alarm (Security Alarm) . . . . . 13, 171
- Antifreeze (Engine Coolant) . 200, 202
  - Disposal . . . . . 202
- Anti-Lock Brake System (ABS) . . . 167
- APP
  - Uconnect Access . . . . . 82
- Appearance Care . . . . . 202
- Assistance Towing . . . . . 164
- Audio Jack . . . . . 96, 104
- Automatic Headlights . . . . . 46, 172
- Automatic High Beams . . . . . 47
- Automatic Temperature Control (ATC) . . . . . 62
- Automatic Transmission
  - Adding Fluid . . . . . 201
  - Fluid Type . . . . . 201
- Axle Fluid . . . . . 201
- Axle Lubrication. . . . . 201
- Background Themes
  - Uconnect 8.4A . . . . . 97
  - Uconnect 8.4N . . . . . 97, 113
- Battery . . . . . 202
  - Charging System Light . . . . . 164
- Body Mechanism Lubrication . . . 202
- Brake Fluid . . . . . 201
- Brakes . . . . . 202
- Brake System . . . . . 202
  - Fluid Check . . . . . 201
  - Master Cylinder . . . . . 202
  - Warning Light . . . . . 168
- Break-In Recommendations, New Vehicle . . . . . 44
- Bulb Replacement . . . . . 216
- Bulbs, Light . . . . . 216
- Calibration, Compass . . . . . 142
- Camera, Rear . . . . . 72
- Canada . . . . . 4, 218
- Capacities, Fluid . . . . . 200
- Caps, Filler
  - Fuel . . . . . 211
  - Oil (Engine) . . . . . 202
- Cargo Area Features . . . . . 156
- Cargo Compartment . . . . . 156
- Cargo Load Floor . . . . . 156
- Cargo Tie-Downs . . . . . 156
- Car Washes . . . . . 202
- CD (Compact Disc) Player. . . . . 95, 104
- Change Oil Indicator . . . . . 170
- Changing A Flat Tire . . . . . 182
- Charging Pad, Wireless. . . . . 149
- Charging System Light . . . . . 164
- Check Engine Light (Malfunction Indicator Light) . . . . . 169
- Child Restraint . . . . . 28
- Child Restraints . . . . . 28
  - Lower Anchors And Tethers For Children . . . . . 28

# INDEX

- Lower Anchors And Tethers For Children . . . . .28
- Child Seat Installation . . . . .28
- Cleaning
  - Wheels . . . . .202
  - Windshield Wiper Blades . . . .202
- Climate Control . . . . .58, 59, 62, 122
- Clock . . . . .93
- Cluster Warning/Indicator Lights
  - Air Bag Warning Light . . . . .167
  - Brake Warning Light . . . . .168
  - Electronic Speed Control ON Indicator . . . . .172
  - Electronic Speed Control SET Indicator . . . . .172
  - Front Fog Light Indicator . . . .171
  - High Beam Indicator . . . . .171
  - Instrument Cluster Warning Lights . . . . .164
  - Park/Headlight ON Indicator . . .173
  - Seat Belt Reminder Light . . . .168
  - Turn Signal Indicator . . . . .171
  - Vehicle Security Light . . . . .171
- Clutch . . . . .202
- Clutch Fluid . . . . .202
- Compact Spare Tire . . . . .214
- Compass Calibration . . . . .142
- Cooling System . . . . .202
  - Adding Coolant (Antifreeze) . .202
  - Coolant Capacity . . . . .200
  - Coolant Level . . . . .202
  - Disposal Of Used Coolant . . . .202
  - Drain, Flush, And Refill . . . . .202
  - Inspection . . . . .202
  - Points To Remember . . . . .202
  - Pressure Cap . . . . .202
  - Selection Of Coolant (Antifreeze) . . . . .200, 202
- Corrosion Protection . . . . .202
- Cruise Control (Speed Control) . . .49
- Cruise Light . . . . .49
- Customer Assistance . . . . .217, 218
- Customer Programmable Features . . . . .143
- Defects, Reporting . . . . .218
- Defroster, Rear Window . . . . .58, 59
- Defroster, Windshield . . . . .58, 59
- Dimmer Control . . . . .47
- Dimmer Switch, Headlight . . . . .47
- Disabled Vehicle Towing . . . . .164
- Disarming, Security System . . . . .13
- Disposal
  - Antifreeze (Engine Coolant) . . .202
- Disturb . . . . .136
- Driver Cockpit . . . . .6
- Driver's Seat Back Tilt . . . . .38
- E-85 Fuel . . . . .201
- Electric Parking Brake . . . . .67
- Electronics
  - Your Vehicle's Sound System . . .76
- Electronic Speed Control (Cruise Control) . . . . .49
- Electronic Throttle Control Warning Light . . . . .166
- Electronic Vehicle Information Center (EVIC) . . . . .72, 142
- Emergency, In Case Of
  - Brake Warning Light . . . . .168
  - Jacking . . . . .182
  - Jump Starting . . . . .188
  - Overheating . . . . .174
  - Towing . . . . .164
- Engine
  - Air Cleaner . . . . .202
  - Break-In Recommendations . . .44
  - Checking Oil Level . . . . .202
  - Coolant (Antifreeze) . . . . .200
  - Cooling . . . . .202
  - Jump Starting . . . . .188
  - Malfunction Indicator (Check Engine) . . . . .169
  - Oil . . . . .200, 202
  - Oil Filler Cap . . . . .202
  - Oil Selection . . . . .200, 202
  - Overheating . . . . .174
- Enhanced Accident Response
  - Feature . . . . .194
- Ethanol . . . . .201
- Exhaust System . . . . .202
- FAQ . . . . .220
- Filters
  - Air Cleaner . . . . .202
  - Engine Oil . . . . .200, 202

# INDEX

- Engine Oil Disposal . . . . .202
- Flashers
  - Turn Signal . . . . .171
- Flash-To-Pass . . . . .45
- Flexible Fuel Vehicles
  - Fuel Requirements . . . . .201
- Fluid, Brake . . . . .201
- Fluid Capacities . . . . .200
- Fluids, Lubricants And Genuine
  - Parts . . . . .200
- Fog Lights . . . . .46, 171
- Folding Rear Seat . . . . .39
- Forward Collision Warning . . . . .56
- Four Wheel Drive . . . . .155
- Four Wheel Drive Operation . . . . .152
- Freeing A Stuck Vehicle . . . . .191
- Frequently Asked Questions . . . . .220
- Front And Rear ParkSense System . .69
- Front ParkSense System . . . . .69
- Fuel
  - Ethanol . . . . .201
  - Filler Cap (Gas Cap) . . . .172, 211
  - Octane Rating . . . . .200
  - Specifications . . . . .200
  - Tank Capacity . . . . .200
- Fuel, Flexible . . . . .201
- Fuses . . . . .206
- Garage Door Opener (HomeLink) . .143
- Gas Cap (Fuel Filler Cap) . . . . .211
- Gear Select Lever Override . . . . .193
- General Maintenance . . . . .202
- Glass Cleaning . . . . .202
- Hands-Free Phone (Uconnect) . . .130
- Headlights . . . . .46
  - Automatic . . . . .46
  - Cleaning . . . . .202
  - Dimmer Switch . . . . .47
  - High Beam . . . . .45
- Head Restraints . . . . .33
- Head Rests . . . . .33
- Heated Mirrors . . . . .58, 61, 65
- High Beam Indicator . . . . .171
- High Beam/Low Beam Select
  - (Dimmer) Switch . . . . .45
- HomeLink (Garage Door Opener) . .143
- Hood Release . . . . .195
- Identifying Your Radio . . . . .79
- Installing A Child Restraint With
  - ALR . . . . .31
- Installing Child Restraints Using The
  - LATCH Lower Anchorages . . . .30
- Installing Child Restraints Using The
  - Vehicle Seat Belt . . . . .31
- Instrument Cluster . . . . .8
- Instrument Cluster Warning
  - Lights . . . . .171
- Instrument Panel Cover . . . . .202
- Instrument Panel Lens Cleaning . .202
- Interior And Instrument Lights . . . .7
- Interior Appearance Care . . . . .202
- Interior Fuses . . . . .210
- Intermittent Wipers (Delay Wipers) .48
- Introduction . . . . .3
  - Canada . . . . .4
- In Vehicle Features
  - Uconnect Access . . . . .86
- Inverter Outlet (115V) . . . . .146
- Inverter, Power . . . . .146
- iPod/USB/MP3 Control
  - Bluetooth Streaming Audio . . .130
- Jacking Instructions . . . . .184
- Jack Location . . . . .182
- Jack Operation . . . . .182, 184
- Jump Starting . . . . .188
- Key Fob . . . . .10
  - Arm The Alarm . . . . .13
  - Disarm The Alarm . . . . .13
- Keyless Enter-N-Go . . . . .13
  - Key Fob . . . . .13
  - Lock/Unlock . . . . .14, 15
  - Passive Entry . . . . .13
  - Remote Control . . . . .13
- Lane Change And Turn Signals . . .45
- Lane Change Assist . . . . .45
- LaneSense . . . . .71
- Lap/Shoulder Belts . . . . .18
- Latches
  - Hood . . . . .195
- Light Bulbs . . . . .216

# INDEX

- Lights
  - Air Bag . . . . .26
  - Bulb Replacement . . . . .216
  - Engine Temperature Warning . .167
  - Fog . . . . .171
  - Headlights . . . . .46
  - High Beam Indicator . . . . .171
  - Hill Descent Control Indicator . . . . .173
  - Low Fuel . . . . .164
  - Security Alarm . . . . .171
  - Service . . . . .216
  - Turn Signal . . . . .45
- Load Floor, Cargo . . . . .156
- Lower Anchors And Tether For CHildren (LATCH) . . . . .29
- Lubrication, Body . . . . .202
- Maintenance Free Battery . . . . .202
- Maintenance, General . . . . .202
- Maintenance Procedures . . . . .202
- Maintenance Record . . . . .205
- Maintenance Schedule . . . . .202
- Malfunction Indicator Light (Check Engine) . . . . .169
- Master Cylinder (Brakes) . . . . .202
- Media Hub . . . . .119
- Mirrors
  - Heated . . . . .58, 61, 65
- MOPAR Accessories . . . . .219
- Navigation . . . . .106, 110, 123
- New Vehicle Break-In Period . . . .44
- Octane Rating, Gasoline (Fuel) . . .200
- Oil Change Indicator . . . . .170
- Oil Change Indicator, Reset . . . .170
- Oil, Engine . . . . .200, 202
  - Capacity . . . . .200
  - Change Interval . . . . .202
  - Checking . . . . .202
  - Disposal . . . . .202
  - Filter . . . . .200, 202
  - Filter Disposal . . . . .202
  - Materials Added To . . . . .202
  - Recommendation . . . . .200, 202
  - Viscosity . . . . .200, 202
- Oil Filter, Selection . . . . .202
- Outlet
  - Power . . . . .147
- Overheating, Engine . . . . .174
- Paint Care . . . . .202
- Panic Alarm . . . . .12
- Parking Brake . . . . .67
- ParkSense . . . . .69
  - ParkSense Active Park Assist . . . .70
  - ParkSense System, Front And Rear . . . . .69
  - ParkSense System, Rear . . . . .69
- Personalized Menu Bar . . . . .99
- Phone, Hands-Free (Uconnect) . . .130
- Phone (Pairing) . . . . .112, 132
- Phone (Uconnect) . . . . .120, 130
- Placard, Tire And Loading Information . . . . .213
- Power
  - Glass Sunroof . . . . .73
  - Inverter . . . . .146
  - Outlet (Auxiliary Electrical Outlet) . . . . .147
- Power Shade
  - Close . . . . .75
  - Open . . . . .74
- Preparation For Jacking . . . . .183
- Programmable Electronic Features . . . . .143
- Purchase Apps
  - Uconnect Access . . . . .84, 126
- Radio . . . . .92, 114
  - Balance and Fade . . . . .93
  - Equalizer . . . . .93
  - Operation . . . . .94
  - Presets . . . . .100
  - Setting the Clock . . . . .93
- Radio Screens . . . . .97
- Radio (Sound Systems) . . . . .92
- Rain Sensitive Wiper System . . . .48
- Rear Camera . . . . .72
- Rear Park Assist System . . . . .69
- Rear ParkSense System . . . . .69
- Rear Seat, Folding . . . . .39
- Recreational Towing . . . . .158
  - Shifting Into Power Transfer Unit Neutral (N) . . . . .160

- Shifting Into Transfer Case
  - Neutral (N) . . . . .160
- Shifting Out Of Power Transfer Unit Neutral (N) . . . . .162
- Shifting Out Of Transfer Case
  - Neutral (N) . . . . .162
- Refrigerant. . . . .202
- Release, Hood. . . . .195
- Remote Keyless Entry (RKE)
  - Arm The Alarm . . . . .13
  - Disarm The Alarm . . . . .13
- Remote Starting System. . . . .12
- Replacement Bulbs. . . . .216
- Reporting Safety Defects. . . . .218
- Restraint, Head. . . . .33
- Roll Over Warning . . . . .5
  
- Schedule, Maintenance . . . . .202
- SD Card Port . . . . .96, 104
- Seat Belt
  - Seat Belt Pretensioner . . . . .18
- Seat Belt Maintenance. . . . .202
- Seat Belts . . . . .18
  - Adjustable Shoulder Belt . . . . .18
  - Pretensioners . . . . .18
- Seats . . . . .35, 41
  - Adjustment . . . . .37
  - Head Restraints . . . . .33
  - Heated . . . . .41
  - Rear Folding . . . . .39
  - Seatback Release . . . . .38, 39
  - Tilting . . . . .38
  - Vented . . . . .42
  - Ventilated . . . . .42
- Security Alarm . . . . .171
  - Arm The System . . . . .13
  - Disarm The System . . . . .13
  - Security Alarm . . . . .13
- Selec-Terrain . . . . .155
- Selection Of Coolant (Antifreeze) . .200
- Shifting
  - Power Transfer Unit, Shifting Into Power Transfer Unit
    - Neutral (N) . . . . .160, 162
  - Transfer Case, Shifting Into Transfer Case Neutral (N) . . . . .160
  - Transfer Case, Shifting Out Of Transfer Case Neutral (N) . . . .162
- Shift Lever Override . . . . .193
- Signals, Turn . . . . .45, 171
- Siri. . . . .115, 116
- Sirius Satellite Radio . . . . .95, 101
  - Traffic & Weather . . . . .110
- SIRIUS Travel Link . . . . .110
- Sound Systems (Radio) . .92, 104, 106
- Spare Tire . . . . .214, 215
- Spark Plugs . . . . .200
- Specifications
  - Fuel (Gasoline) . . . . .200
  - Oil . . . . .200
- Speed Control
  - Accel/Decel . . . . .50
  - Accel/Decel (ACC Only) . . . . .52
  - Distance Setting (ACC Only) . . . . .51, 53
  - Mode Setting (ACC Only) . . . . .54
- Speed Control (Cruise Control) . . .49
- Starting
  - Remote . . . . .12
- Steering
  - Tilt Column . . . . .43
  - Wheel, Heated . . . . .42
  - Wheel, Tilt . . . . .43
- Steering Wheel Audio Controls . .141
- Stuck, Freeing. . . . .191
- Sunroof
  - Venting . . . . .74
- Sun Roof . . . . .73
- Supplemental Restraint System - Air Bag . . . . .19
  
- Telescoping Steering Column . . . .43
- Temperature Control, Automatic (ATC) . . . . .62
- Tether Anchor, Child Restraint . . .31
- Text Messaging . .121, 126, 137, 138
- Tie Down Hooks, Cargo. . . . .156
- Tilt Steering Column . . . . .43
- Tires . . . . .213, 214
  - Air Pressure . . . . .213
  - Changing . . . . .182
  - Compact Spare . . . . .214
  - General Information . . . .213, 214
  - Jacking . . . . .182
  - Pressure Warning Light . . . .165
  - Spare Tire . . . . .214, 215

# INDEX

- Tire Service Kit . . . . .175
- To Open Hood . . . . .195
- Towing . . . . .157
  - Disabled Vehicle . . . . .193
  - Recreational . . . . .158
- Towing Vehicle Behind A
  - Motorhome . . . . .158
- Trailer Towing . . . . .157
  - Trailer And Tongue Weight . . .157
- Trailer Towing Guide . . . . .157
- Trailer Weight . . . . .157
- Transfer Case
  - Fluid . . . . .201
- Transmission
  - Fluid . . . . .201, 202
  - Maintenance . . . . .202
- Turn Signals . . . . .45, 171
- Uconnect
  - Access . . . . .80, 81, 86
  - Account . . . . .81, 86, 89
  - Maintaining Your Account . . . .86
  - Registration . . . . .81, 125
  - Remote Features . . . . .89
  - Using Access . . . . .84
  - Via Mobile Apps . . . . .83
- Uconnect 5.0 . . . . .92
- Uconnect 8.4A . . . . .97, 124
  - Helpful Tips For Bluetooth . . .139
  - Mute . . . . .135
  - Phonebook . . . . .135
  - Transfer Ongoing Call Between Handset And Vehicle . . . . .135
  - Voice Recognition Tips . . . . .136
- Uconnect 8.4A/8.4AN Voice Recognition
  - SiriusXM Travel Link . . . . .129
  - Voice Texting . . . . .136
- Uconnect 8.4AN . . . . .97, 124
- Uconnect Access . . . . .80, 124
  - APP . . . . .82
  - In Vehicle Features . . . . .86
  - Purchase Apps . . . . .84, 126
  - Yelp . . . . .128
- Uconnect (Hands-Free Phone)
  - Making A Phone Call . . .130, 136
  - Receiving A Call . . . . .130
- Uconnect Phone. .112, 130, 135, 137
- Uconnect Voice Command . .111, 135
- USB Port . . . . .96, 104
- Using Access
  - Uconnect . . . . .84
- Using The Top Tether Anchorage . . .31
- Vehicle Security Alarm Disarming . .13
- Ventilated . . . . .41
- Via Mobile Apps
  - Uconnect . . . . .83
- Voice Command . . . .111, 113, 135
- Voice Recognition System (VR) . . . . .111, 135, 136
- Warning, Roll Over . . . . .5
- Washer
  - Adding Fluid . . . . .202
  - Rear . . . . .49
- Washers, Windshield . . . . .48
- Washing Vehicle. . . . .202
- Wheel And Wheel Trim . . . . .202
- Wheel And Wheel Trim
  - Care . . . . .202, 216
- Wind Buffeting . . . . .75
- Windshield Washers . . . . .48
  - Fluid . . . . .173
- Windshield Wiper Blades . . . . .202
- Windshield Wipers . . . . .48
- Wiper Blade Replacement . . . . .202
- Wiper, Rear . . . . .49
- Wireless Charging Pad . . . . .149



---

---

---

---

---

---

---

---

---

---

---

---

---

---

---

---

---

---

---

---

---

---

---

# NOTES

---

---

---

---

---

---

---

---

---

---

---

---

---

---

---

---

---

---

---

---

---

---



# NOTES

---

---

---

---

---

---

---

---

---

---

---

---

---

---

---

---

---

---

---

---

---

---

---

---

---

---

---

---

---

---

---

---

---

---

---

---

---

---

---

---

---

---

---

---

---

---

---

---

---

# NOTES

---

---

---

---

---

---

---

---

---

---

---

---

---

---

---

---

---

---

---

---

---

---

---

---

---

---

---

---



This guide has been prepared to help you get quickly acquainted with your new Jeep® Brand Vehicle and to provide a convenient reference source for common questions. However, it is not a substitute for your Owner's Manual.



For complete operational instructions, maintenance procedures and important safety messages, please consult your Owner's Manual, Navigation/Uconnect Manuals and other Warning Labels in your vehicle.



Not all features shown in this guide may apply to your vehicle. For additional information on accessories to help personalize your vehicle, visit [www.mopar.com](http://www.mopar.com) (U.S.), [www.mopar.ca](http://www.mopar.ca) (Canada) or your local Jeep brand dealer.

## Driving and Alcohol:

---

Drunken driving is one of the most frequent causes of collisions. Your driving ability can be seriously impaired with blood alcohol levels far below the legal minimum. If you are drinking, don't drive. Ride with a designated non-drinking driver, call a cab, a friend, or use public transportation.

## WARNING:

---

Driving after drinking can lead to a collision. Your perceptions are less sharp, your reflexes are slower, and your judgment is impaired when you have been drinking. Never drink and then drive.



## Jeep.com (U.S.) Jeep.ca (Canada)

**DOWNLOAD A FREE ELECTRONIC COPY** of the Owner's Manual and Warranty Booklet by visiting:

[www.jeep.com/en/owners/manuals](http://www.jeep.com/en/owners/manuals) or

[www.jeep.com/en/warranty](http://www.jeep.com/en/warranty) (U.S.);

[www.owners.mopar.ca/en](http://www.owners.mopar.ca/en) (Canada).

© 2016 FCA US LLC. All Rights Reserved.  
Jeep is a registered trademark of FCA US LLC.



16KL74-926-AA  
**Cherokee**  
Fourth Edition  
User Guide