

2016
GRAND CARAVAN
USER
GUIDE





IMPORTANT

This User Guide is intended to familiarize you with the important features of your vehicle. The DVD enclosed contains your Owner's Manual, Navigation/Uconnect Manuals, Warranty Booklets, Tire Warranty and Roadside Assistance (new vehicles purchased in the U.S.) or Roadside Assistance (new vehicles purchased in Canada) in electronic format. We hope you find it useful. U.S. residents can purchase replacement DVD kits by visiting www.techauthority.com and Canadian residents can purchase replacement DVD kits by calling 1-800-387-1143.

If you are the first registered retail owner of your vehicle, you may obtain a complimentary printed copy of the Owner's Manual, Navigation/Uconnect Manuals or Warranty Booklet by calling 1-800-423-6343 (U.S.) or 1-800-387-1143 (Canada) or by contacting your dealer.



The driver's primary responsibility is the safe operation of the vehicle. Driving while distracted can result in loss of vehicle control, resulting in a collision and personal injury. FCA US LLC strongly recommends that the driver use extreme caution when using any device or feature that may take their attention off the road. Use of any electrical devices, such as cellular telephones, computers, portable radios, vehicle navigation or other devices, by the driver while the

vehicle is moving is dangerous and could lead to a serious collision. Texting while driving is also dangerous and should never be done while the vehicle is moving. If you find yourself unable to devote your full attention to vehicle operation, pull off the road to a safe location and stop your vehicle. Some states or provinces prohibit the use of cellular telephones or texting while driving. It is always the driver's responsibility to comply with all local laws.

TABLE OF CONTENTS

INTRODUCTION/WELCOME

WELCOME FROM FCA US LLC	2
-------------------------	---

CONTROLS AT A GLANCE

DRIVER COCKPIT	4
INSTRUMENT CLUSTER	6

GETTING STARTED

KEY FOB	8
REMOTE START — IF EQUIPPED	9
KEYLESS ENTER-N-GO	10
VEHICLE SECURITY ALARM	13
SEAT BELT SYSTEMS	14
SUPPLEMENTAL RESTRAINT SYSTEM (SRS) — AIR BAGS	15
CHILD RESTRAINTS	20
HEAD RESTRAINTS	25
POWER SEATS	27
HEATED SEATS	32
HEATED STEERING WHEEL	33
TILT/TELESCOPING STEERING COLUMN	34

OPERATING YOUR VEHICLE

ENGINE BREAK-IN RECOMMENDATIONS	35
MULTIFUNCTION LEVER	36
HEADLIGHT SWITCH	39
ELECTRONIC RANGE SELECT (ERS)	41
FUEL ECONOMY (ECON) MODE	42
THREE ZONE AUTOMATIC TEMPERATURE CONTROLS (ATC)	43
PARKSENSE REAR PARK ASSIST	45
PARKVIEW REAR BACK-UP CAMERA	45
BLIND SPOT MONITORING WITH REAR CROSS PATH	45

ELECTRONICS

YOUR VEHICLE'S SOUND SYSTEM	46
CYBERSECURITY	48
UCONNECT 130	49
UCONNECT 130 WITH SiriusXM SATELLITE RADIO	51
UCONNECT 430/430N	54
SiriusXM SATELLITE RADIO/TRAVEL LINK	65
STEERING WHEEL AUDIO CONTROLS	69
iPod/USB/MP3 CONTROL	69
UCONNECT PHONE	70
UCONNECT VOICE COMMAND	73
BLUETOOTH STREAMING AUDIO	76
VIDEO ENTERTAINMENT SYSTEM (VES)	76
ELECTRONIC VEHICLE INFORMATION CENTER (EVIC)	78
PROGRAMMABLE FEATURES	79
UNIVERSAL GARAGE DOOR OPENER (HomeLink)	81

UTILITY

TRAILER TOWING WEIGHTS (MAXIMUM TRAILER WEIGHT RATINGS)	84
RECREATIONAL TOWING (BEHIND MOTORHOME, ETC.)	84

WHAT TO DO IN EMERGENCIES

ROADSIDE ASSISTANCE	86
INSTRUMENT CLUSTER WARNING LIGHTS	86
INSTRUMENT CLUSTER INDICATOR LIGHTS	90
IF YOUR ENGINE OVERHEATS	92
TIRE SERVICE KIT	93
JACKING AND TIRE CHANGING — IF EQUIPPED	99
JUMP-STARTING	113
GEAR SELECTOR OVERRIDE	116
TOWING A DISABLED VEHICLE	117
FREEDING A STUCK VEHICLE	119
ENHANCED ACCIDENT RESPONSE SYSTEM (EARS)	120
EVENT DATA RECORDER (EDR)	120

MAINTAINING YOUR VEHICLE

OPENING THE HOOD	121
ENGINE COMPARTMENT — 3.6L	122
FLUID CAPACITIES	124
FLUIDS, LUBRICANTS, AND GENUINE PARTS	124
MAINTENANCE PROCEDURES	125
MAINTENANCE SCHEDULE	125
FUSES	130
TIRES — GENERAL INFORMATION	133
ADDING FUEL	136
FLEXIBLE FUEL — IF EQUIPPED	137
REPLACEMENT BULBS	137

CONSUMER ASSISTANCE

FCA US LLC CUSTOMER CENTER	138
FCA CANADA INC. CUSTOMER CENTER	138
PUBLICATIONS ORDERING	138
ASSISTANCE FOR THE HEARING IMPAIRED	139
REPORTING SAFETY DEFECTS IN THE UNITED STATES	139

MOPAR® ACCESSORIES

AUTHENTIC ACCESSORIES BY MOPAR	140
--------------------------------	-----

FREQUENTLY ASKED QUESTIONS

FREQUENTLY ASKED QUESTIONS	141
----------------------------	-----

INDEX	143
-------	-----



INTRODUCTION/WELCOME

WELCOME FROM FCA US LLC

Congratulations on selecting your new FCA US LLC (“FCA US”) vehicle. Be assured that it represents precision workmanship, distinctive styling, and high quality - all essentials that are traditional to our vehicles.

Your new FCA US vehicle has characteristics to enhance the driver's control under some driving conditions. These are to assist the driver and are never a substitute for attentive driving. They can never take the driver's place. Always drive carefully.

Your new vehicle has many features for the comfort and convenience of you and your passengers. Some of these should not be used when driving because they take your eyes from the road or your attention from driving. Never text while driving or take your eyes more than momentarily off the road.

This guide illustrates and describes the operation of features and equipment that are either standard or optional on this vehicle. This guide may also include a description of features and equipment that are no longer available or were not ordered on this vehicle. Please disregard any features and equipment described in this guide that are not available on this vehicle. FCA US reserves the right to make changes in design and specifications and/or make additions to or improvements to its products without imposing any obligation upon itself to install them on products previously manufactured.

This User Guide has been prepared to help you quickly become acquainted with the important features of your vehicle. It contains most things you will need to operate and maintain the vehicle, including emergency information.

The DVD includes a computer application containing detailed Owner's information which can be viewed on a personal computer or MAC computer. The multimedia DVD also includes videos which can be played on any standard DVD player (including the Uconnect Touchscreen Radios if equipped with DVD player capabilities). Additional DVD operational information is located on the back of the DVD sleeve.

For complete owner information, refer to your Owner's Manual on the DVD in the owner's kit provided at the time of new vehicle purchase. For your convenience, the information contained on the DVD may also be printed and saved for future reference.

FCA US is committed to protecting our environment and natural resources. By converting from paper to electronic delivery for the majority of the user information for your vehicle, together we greatly reduce the demand for tree-based products and lessen the stress on our environment.

INTRODUCTION/WELCOME

VEHICLES SOLD IN CANADA

With respect to any vehicles sold in Canada, the name FCA US LLC shall be deemed to be deleted and the name FCA Canada Inc. used in substitution (excluding legal lines).

WARNING!

- Pedals that cannot move freely can cause loss of vehicle control and increase the risk of serious personal injury.
- Always make sure that objects cannot fall into the driver foot well while the vehicle is moving. Objects can become trapped under the brake pedal and accelerator pedal causing a loss of vehicle control.
- Failure to properly follow floor mat installation or mounting can cause interference with the brake pedal and accelerator pedal operation causing loss of control of the vehicle.
- Never leave children alone in a vehicle, or with access to an unlocked vehicle. Allowing children to be in a vehicle unattended is dangerous for a number of reasons. A child or others could be seriously or fatally injured. Children should be warned not to touch the parking brake, brake pedal or the transmission gear selector.
- Do not leave the key fob in or near the vehicle, or in a location accessible to children. A child could operate power windows, other controls, or move the vehicle.
- Never use the 'PARK' position as a substitute for the parking brake. Always apply the parking brake fully when parked to guard against vehicle movement and possible injury or damage.
- Refer to your Owner's Manual on the DVD for further details.

USE OF AFTERMARKET PRODUCTS (ELECTRONICS)

The use of aftermarket devices including cell phones, MP3 players, GPS systems, or chargers may affect the performance of on-board wireless features including Keyless Enter-N-Go and Remote Start range. If you are experiencing difficulties with any of your wireless features, try disconnecting your aftermarket devices to see if the situation improves. If your symptoms persist, please see an authorized dealer.

When it comes to service, remember that your authorized dealer knows your vehicle best, has factory-trained technicians and genuine MOPAR® parts, and cares about your satisfaction.



CONTROLS AT A GLANCE

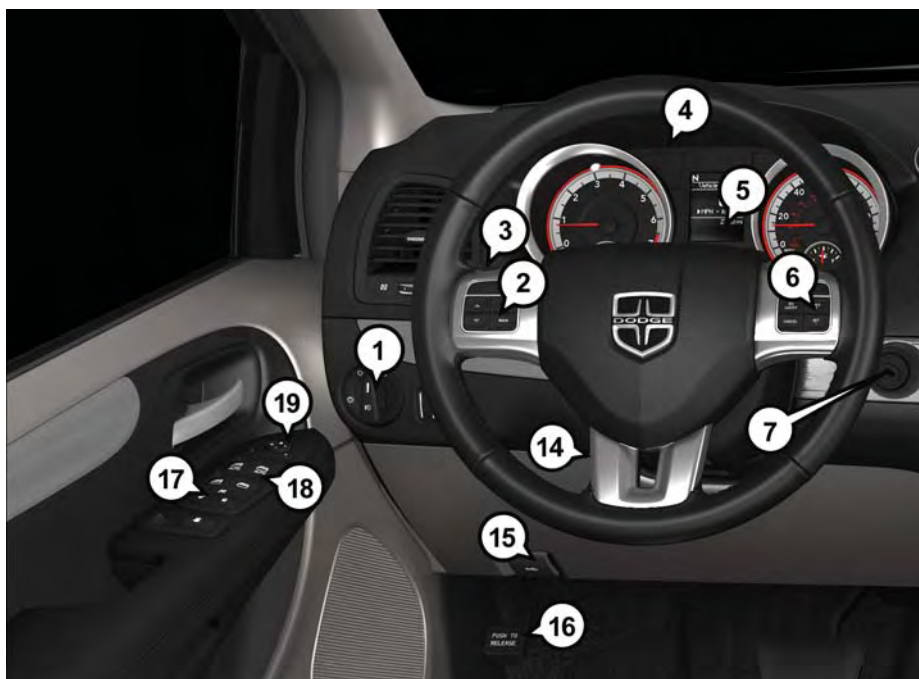

DRIVER COCKPIT

1. Headlight Switch pg. 39
2. Electronic Vehicle Information Center (EVIC) Controls pg. 78
3. Turn Signal/Wiper/Washer/High Beams Lever (behind steering wheel) pg. 36
4. Instrument Cluster pg. 6
5. Electronic Vehicle Information Center (EVIC) Display
6. Speed Control
7. Ignition
8. Shift Lever
9. Audio System (Touchscreen Radio Shown) pg. 46
10. Manual Climate Controls

CONTROLS AT A GLANCE



11. Glove Compartment
12. Switch Panel
 - ParkSense pg. 45
 - ECO On pg. 42
 - Electronic Stability Control (ESC) OFF pg. 90
13. DVD Player
14. Tilt/Telescoping Steering Column pg. 34
15. Hood Release pg. 121
16. Emergency Brake Pedal
17. Power Door Locks
18. Power Windows
19. Power Mirrors

CONTROLS AT A GLANCE



INSTRUMENT CLUSTER

1. Tachometer
2. Temperature Gauge
3. Electronic Vehicle Information Center (EVIC)

(See page 86 for more Instrument Cluster Warning Light information.)

CONTROLS AT A GLANCE



- 4. Speedometer
- 5. Fuel Gauge
- 6. Fuel Filler Door Location

(See page 90 for more Instrument Cluster Indicator Light information.)

GETTING STARTED

KEY FOB

Locking And Unlocking The Doors And Liftgate

Lock The Doors And Liftgate

Push and release the LOCK button on the RKE transmitter to lock all doors and liftgate. The turn signal lights will flash, and the horn will chirp to acknowledge the signal.

Unlock The Doors And Liftgate

Push and release the UNLOCK button on the RKE transmitter once to unlock the driver's door or twice within five seconds to unlock all doors and liftgate. The turn signal lights will flash to acknowledge the unlock signal. The illuminated entry system will also turn on.

All doors can be programmed to unlock on the first push of the UNLOCK button. Refer to "Electronic Vehicle Information Center (EVIC) Customer Programmable Features" in "Electronics" for further information.



Key Fob

- 1 — Left Power Sliding Door
- 2 — Liftgate
- 3 — Lock
- 4 — Unlock
- 5 — Remote Start
- 6 — Right Power Sliding Door
- 7 — Emergency Key

Panic Alarm

1. Push the PANIC button once to turn the Panic Alarm on.
2. Wait approximately three seconds and push the button a second time to turn the Panic Alarm off.

Power Liftgate

Push the LIFTGATE button twice within five seconds to power open/close the Power Liftgate. If the button is pushed twice while the liftgate is being power closed, the liftgate will reverse to the full open position.

Power Sliding Doors

Push the LEFT or RIGHT Power Sliding Door button twice within five seconds to power open/close the Power Sliding Door. If the button is pushed again while the door is being power closed, the door will reverse to the full open position.

Emergency Key

Should the battery in the vehicle or the Key Fob transmitter go dead, there is an emergency key located in the Key Fob that can be used for locking and unlocking the doors.

To remove the emergency key, slide the button at the top of the Key Fob sideways with your thumb and then pull the key out with your other hand.

WARNING!

- Never leave children alone in a vehicle, or with access to an unlocked vehicle. Allowing children to be in a vehicle unattended is dangerous for a number of reasons. A child or others could be severely injured or killed. Children should be warned not to touch the parking brake, brake pedal, or the transmission gear selector. Do not leave the Key Fob in or near the vehicle, or in a location accessible to children, and do not leave the ignition of a vehicle equipped with Keyless Enter-N-Go in the ACC or ON/RUN mode. A child could start the vehicle, operate power windows, other controls, or move the vehicle.
- Do not leave children or animals inside parked vehicles in hot weather. Interior heat build-up may cause them to be severely injured or killed.
- Keep Key Fob transmitters away from children. Operation of the Remote Start System, windows, door locks or other controls could cause serious injury or death.

REMOTE START — IF EQUIPPED

Push the REMOTE START button  on the Key Fob twice within five seconds. Pushing the REMOTE START button a third time shuts the engine off.

To drive the vehicle, push the UNLOCK button, insert the Key Fob in the ignition, and turn to the ON/RUN position.

With Remote Start, the engine will only run for 15 minutes (timeout) unless the ignition Key Fob is placed in the ON/RUN position.

The vehicle must be started with the Key Fob after two consecutive timeouts.

WARNING!

- Do not start or run an engine in a closed garage or confined area. Exhaust gas contains Carbon Monoxide (CO) which is odorless and colorless. Carbon Monoxide is poisonous and can cause you or others to be severely injured or killed when inhaled.
- Keep Key Fob transmitters away from children. Operation of the Remote Start System, windows, door locks or other controls could cause you and others to be severely injured or killed.

GETTING STARTED

KEYLESS ENTER-N-GO

The Keyless Enter-N-Go system is an enhancement to the vehicle's Remote Keyless Entry (RKE) feature. This feature allows you to lock and unlock the vehicle's door(s) and liftgate without having to push the Key Fob LOCK or UNLOCK buttons, as well as starting and stopping the vehicle with the push of a button.

To Unlock From The Driver or Passenger Side:

With a valid Keyless Enter-N-Go Key Fob located outside the vehicle and within 5 ft (1.5 m) of the driver or passenger side door handle, grab either front door handle to unlock the door automatically.



Grab The Door Handle To Unlock

To Lock The Vehicle

Both front door handles have buttons located on the outside of the handle. With one of the vehicles Keyless Enter-N-Go Key Fobs located outside the vehicle and within 5 ft (1.5m) of the driver's or passenger front door handle, push the door handle button to lock all four doors and liftgate.

DO NOT grab the door handle, when pushing the door handle button. This could unlock the door(s).



Push The Door Handle Button To Lock



Do Not Grab The Door Handle

NOTE:

- If “Unlock All Doors 1st Press” is programmed, all doors will unlock when you grab hold of the front driver's door handle. To select between “Unlock Driver Door 1st Press” and “Unlock All Doors 1st Press,” refer to the “Electronic Vehicle Information Center (EVIC)” in your vehicles Owner's Manual on the DVD or “Programmable Features” in this guide for further information.
- If “Unlock All Doors 1st Press” is programmed, all doors and liftgate will unlock when you push the liftgate button. If “Unlock Driver Door 1st Press” is programmed, only the liftgate will unlock when you push the liftgate button. To select between “Unlock Driver Door 1st Press” and “Unlock All Doors 1st Press,” refer to the “Electronic Vehicle Information Center (EVIC)” in your vehicles Owner's Manual on the DVD or “Programmable Features” in this guide for further information.
- If a Key Fob is detected in the vehicle when locking the vehicle using the power door lock switch, the doors and liftgate will unlock, and the horn will chirp three times. On the third attempt, your Key Fob can be locked inside the vehicle.
- After pushing the Keyless Enter-N-Go LOCK button, you must wait two seconds before you can lock or unlock the vehicle using the door handle. This is done to allow you to check if the vehicle is locked by pulling the door handle without the vehicle reacting and unlocking.
- If a Keyless Enter-N-Go door handle has not been used for 72 hours, the Keyless Enter-N-Go feature for that handle may time out. Pulling the deactivated front door handle will reactivate the door handle's Keyless Enter-N-Go feature.

Lock Or Unlock The Liftgate:

With a valid Passive Entry RKE transmitter within 5 ft (1.5 m) of the liftgate, cycle the handle to open the liftgate and pull the liftgate open with one fluid motion.

NOTE:

- All doors will remain locked when the liftgate release handle is pushed regardless of the driver's door unlock preference setting (“Unlock Driver Door 1st Press” or “Unlock All Doors 1st Press”).
- Refer to “Keyless Enter-N-Go” in “Things To Know Before Starting” located in your Owner's Manual on the DVD for further information.

GETTING STARTED

Installing And Removing The ENGINE START/STOP Button

Installing The Button

1. Remove the Key Fob from the ignition switch.
2. Insert the ENGINE START/STOP button into the ignition switch with the lettering facing up and readable.
3. Push firmly on the center of the button to secure it into position.

Removing The Button

The ENGINE START/STOP button can be removed from the ignition switch for Key Fob use.

- Insert the metal part of the emergency key under the chrome bezel at the 6 o'clock position and gently pry the button loose.

NOTE:

The ENGINE START/STOP button should only be removed or inserted with the ignition in the LOCK position (OFF position for Keyless Enter-N-Go).



ENGINE START/STOP Button Removal

Engine Starting/Stopping

Starting

Perform the following starting procedure with a Remote Keyless Entry (RKE) transmitter inside the vehicle:

1. Place the shift lever in PARK or NEUTRAL.
2. While depressing the brake pedal, push the ENGINE START/STOP button once. If the engine fails to start, the starter will disengage automatically after 10 seconds.
3. To stop the cranking of the engine prior to the engine starting, push the button again.

Stopping

1. Bring the vehicle to a complete stop.
2. Shift the transmission to PARK (P).
3. Push the ENGINE START/STOP button once. The ignition switch will return to the OFF position.

NOTE:

If the transmission is not in PARK and the vehicle is in motion, the ENGINE START/STOP button must be held for two seconds with the vehicle speed above 5 mph (8 km/h) before the engine will shut off.

Accessory Positions With Engine Off

NOTE:

The following functions are with the driver's foot off of the Brake Pedal (transmission in PARK or NEUTRAL).

Beginning With The Ignition Switch In The OFF Position:

1. Push the ENGINE START/STOP button once to cycle the ignition to the ACC position.
2. Push the ENGINE START/STOP button a second time to cycle the ignition to the ON/RUN position.
3. Push the ENGINE START/STOP button a third time to return the ignition to the OFF position.

NOTE:

If the ignition is left in the ACC or ON/RUN (engine not running) position and the transmission is in PARK, the system will automatically time out after 30 minutes of inactivity, and the ignition is returned to the OFF position.

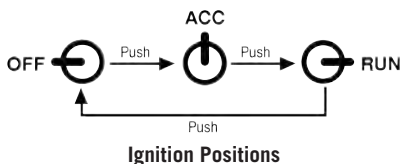

VEHICLE SECURITY ALARM

The Vehicle Security Alarm monitors the vehicle doors for unauthorized entry and the ignition for unauthorized operation. While the Vehicle Security Alarm is armed, interior switches for door locks and decklid release are disabled. If something triggers the alarm, the Vehicle Security Alarm will provide the following audible and visible signals: the horn will pulse, the park lamps and/or turn signals will flash, and the Vehicle Security Light in the instrument cluster will flash.

To Arm The System:

Lock the door using either the power door lock switch (one door must be open) or the LOCK button on the Remote Keyless Entry (RKE) transmitter (doors can be open or closed), and close all doors.

The Vehicle Security Light in the instrument cluster will flash for 16 seconds. This shows that the Vehicle Security Alarm is arming. During this period, if a door is opened, the ignition is cycled to ON/RUN, or the power door locks are unlocked in any manner, the Vehicle Security Alarm will automatically disarm.

GETTING STARTED

NOTE:

- The Vehicle Security Alarm will not arm if you lock the doors with the manual door lock plungers.
- Once armed, the Vehicle Security Alarm disables the unlock switch on the driver door trim panel and passenger door trim panel.

To Disarm The System:

Push the Key Fob UNLOCK button or cycle the ignition to the ON/RUN position.

The Vehicle Security Alarm is designed to protect your vehicle. However, you can create conditions where the Vehicle Security Alarm will give you a false alarm. If one of the previously described arming sequences has occurred, the Vehicle Security Alarm will arm regardless of whether you are in the vehicle or not. If you remain in the vehicle and open a door, the alarm will sound. If this occurs, disarm the Vehicle Security Alarm.

If the Vehicle Security Alarm is armed and the battery becomes disconnected, the Vehicle Security Alarm will remain armed when the battery is reconnected. The exterior lights will flash, and the horn will sound. If this occurs, disarm the Vehicle Security Alarm.

SEAT BELT SYSTEMS

Lap/Shoulder Belts

All seating positions in your vehicle are equipped with lap/shoulder belts.

Be sure everyone in your vehicle is in a seat and using a seat belt properly.

Position the lap belt so that it is snug and lies low across your hips, below your abdomen. To remove slack in the lap belt portion, pull up on the shoulder belt. To loosen the lap belt if it is too tight, tilt the latch plate and pull on the lap belt. A snug seat belt reduces the risk of sliding under the seat belt in a collision.

Position the shoulder belt across the shoulder and chest with minimal, if any slack so that it is comfortable and not resting on your neck. The retractor will withdraw any slack in the shoulder belt.

Seat Belt Pretensioner

The front seat belt system is equipped with pretensioning devices that are designed to remove slack from the seat belt in the event of a collision.

A deployed pretensioner or a deployed air bag must be replaced immediately.

WARNING!

- In a collision, you and your passengers can suffer much greater injuries if you are not properly buckled up. You can strike the interior of your vehicle or other passengers, or you can be thrown out of the vehicle. Always be sure you and others in your vehicle are buckled up properly.
- A shoulder belt placed behind you will not protect you from injury during a collision. You are more likely to hit your head in a collision if you do not wear your shoulder belt. The lap and shoulder belt are meant to be used together.
- A seat belt that is too loose will not protect you properly. In a sudden stop, you could move too far forward, increasing the possibility of injury. Wear your seat belt snugly.
- A frayed or torn seat belt could rip apart in a collision and leave you with no protection. Inspect the seat belt system periodically, checking for cuts, frays, or loose parts. Damaged parts must be replaced immediately. Do not disassemble or modify the system. Seat belt assemblies must be replaced after a collision.

SUPPLEMENTAL RESTRAINT SYSTEM (SRS) — AIR BAGS

Air Bag System Components

Your vehicle may be equipped with the following air bag system components:

- Occupant Restraint Controller (ORC)
- Air Bag Warning Light 
- Steering Wheel and Column
- Instrument Panel
- Knee Impact Bolsters
- Advanced Front Air Bags
- Supplemental Side Air Bags
- Supplemental Knee Air Bags
- Front and Side Impact Sensors
- Seat Belt Pretensioners
- Seat Belt Buckle Switch
- Seat Track Position Sensors

GETTING STARTED

Advanced Front Air Bags

This vehicle has Advanced Front Air Bags for both the driver and front passenger as a supplement to the seat belt restraint systems. The Advanced Front Air Bags will not deploy in every type of collision.

Advanced Front Air Bags are designed to provide additional protection by supplementing the seat belts. Advanced Front Air Bags are not expected to reduce the risk of injury in rear, side, or rollover collisions.

The Advanced Front Air Bags will not deploy in all frontal collisions, including some that may produce substantial vehicle damage — for example, some pole collisions, truck underrides, and angle offset collisions.

On the other hand, depending on the type and location of impact, Advanced Front Air Bags may deploy in crashes with little vehicle front-end damage but that produce a severe initial deceleration.

Because air bag sensors measure vehicle deceleration over time, vehicle speed and damage by themselves are not good indicators of whether or not an air bag should have deployed.

Seat belts are necessary for your protection in all collisions, and also are needed to help keep you in position, away from an inflating air bag.

After any collision, the vehicle should be taken to an authorized dealer immediately.

Do not drive your vehicle after the air bags have deployed. If you are involved in another collision, the air bags will not be in place to protect you.

Refer to the Owner's Manual on the DVD for further details regarding the Supplemental Restraint System (SRS).

If it is necessary to modify the air bag system for persons with disabilities, contact your authorized dealer.

Supplemental Knee Air Bags

This vehicle is equipped with a Supplemental Driver Knee Air Bag mounted in the instrument panel below the steering column. The Supplemental Driver Knee Air Bag provides enhanced protection during a frontal impact by working together with the seat belts, pretensioners, and Advanced Front Air Bags.

WARNING!

- Relying on the air bags alone could lead to more severe injuries in a collision. The air bags work with your seat belt to restrain you properly. In some collisions, the air bags won't deploy at all. Always wear your seat belts even though you have air bags.
- Being too close to the steering wheel or instrument panel during Advanced Front Air Bag deployment could cause serious injury, including death. Air bags need room to inflate. Sit back, comfortably extending your arms to reach the steering wheel or instrument panel.
- No objects should be placed over or near the air bag on the instrument panel or steering wheel because any such objects could cause harm if the vehicle is in a collision severe enough to cause the air bag to inflate.

Supplemental Side Air Bags

This vehicle is equipped with Supplemental Seat-Mounted Side Air Bags (SABs) located in the outboard side of the front seats. The SABs are marked with a SRS AIRBAG or AIRBAG label sewn into the outboard side of the seats.

This vehicle is equipped with Supplemental Side Air Bag Inflatable Curtains (SABICs) located above the side windows. The trim covering the SABICs is labeled SRS AIRBAG or AIRBAG. The SABICs may help reduce the risk of partial or complete ejection of vehicle occupants through side windows in certain rollover or side impact events.

The SABICs and SABs (“Side Air Bags”) are designed to activate in certain side impacts and certain rollover events. The Occupant Restraint Controller (“ORC”) determines whether the deployment of the Side Air Bags in a particular side impact or rollover event is appropriate, based on the severity and type of collision. Vehicle damage by itself is not a good indicator of whether or not Side Air Bags should have deployed.

GETTING STARTED

WARNING!

- Side Air Bags need room to inflate. Do not lean against the door or window. Sit upright in the center of the seat.
- Being too close to the Side Air Bags during deployment could cause you to be severely injured or killed.
- Relying on the Side Air Bags alone could lead to more severe injuries in a collision. The Side Air Bags work with your seat belt to restrain you properly. In some collisions, Side Air Bags won't deploy at all. Always wear your seat belt even though you have Side Air Bags.
- This vehicle is equipped with left and right Supplemental Side Air Bag Inflatable Curtains (SABICs). Do not stack luggage or other cargo up high enough to block the deployment of the SABICs. The trim covering above the side windows where the SABIC and its deployment path are located should remain free from any obstructions.
- This vehicle is equipped with SABICs. In order for the SABICs to work as intended, do not install any accessory items in your vehicle which could alter the roof. Do not add an aftermarket sunroof to your vehicle. Do not add roof racks that require permanent attachments (bolts or screws) for installation on the vehicle roof. Do not drill into the roof of the vehicle for any reason.
- Do not use accessory seat covers or place objects between you and the Side Air Bags; the performance could be adversely affected and/or objects could be pushed into you, causing serious injury.

Enhanced Accident Response System

In the event of an impact, if the communication network remains intact, and the power remains intact, depending on the nature of the event, the ORC will determine whether to have the Enhanced Accident Response System perform the following functions:

- Cut off fuel to the engine.
- Flash hazard lights as long as the battery has power or until the hazard light button is pushed. The hazard lights can be deactivated by pushing the hazard light button.
- Turn on the interior lights, which remain on as long as the battery has power.
- Unlock the power door locks.

Enhanced Accident Response System Reset Procedure

In order to reset the Enhanced Accident Response System functions after an event, the ignition switch must be changed from ignition START or ON/RUN to ignition OFF. Carefully check the vehicle for fuel leaks in the engine compartment and on the ground near the engine compartment and fuel tank before resetting the system and starting the engine.

Air Bag Warning Light

The air bags must be ready to inflate for your protection in a collision. The Occupant Restraint Controller (ORC) monitors the internal circuits and interconnecting wiring associated with air bag system electrical components.

The ORC monitors the readiness of the electronic parts of the air bag system whenever the ignition switch is in the START or ON/RUN position. If the ignition switch is in the OFF position or in the ACC position, the air bag system is not on and the air bags will not inflate.

The ORC turns on the Air Bag Warning Light in the instrument panel for approximately four to eight seconds for a self-check when the ignition switch is first turned to the ON/RUN position. After the self-check, the Air Bag Warning Light will turn off. If the ORC detects a malfunction in any part of the system, it turns on the Air Bag Warning Light, either momentarily or continuously. A single chime will sound to alert you if the light comes on again after initial startup.

If the Air Bag Warning Light in the instrument panel is not on during the four to eight seconds when the ignition switch is first turned to the ON/RUN position, stays on, or turns on while driving, have the vehicle serviced by an authorized service center immediately.

NOTE:

If the speedometer, tachometer, or any engine related gauges are not working, the Occupant Restraint Controller (ORC) may also be disabled. In this condition the air bags may not be ready to inflate for your protection. Have an authorized dealer service the air bag system immediately.

Event Data Recorder (EDR)

This vehicle is equipped with an event data recorder (EDR). The main purpose of an EDR is to record, in certain crash or near crash-like situations, such as an air bag deployment or hitting a road obstacle, data that will assist in understanding how a vehicle's systems performed. The EDR is designed to record data related to vehicle dynamics and safety systems for a short period of time, typically 30 seconds or less. The EDR in this vehicle is designed to record such data as:

- How various systems in your vehicle were operating;
- Whether or not the driver and passenger safety belts were buckled/fastened;
- How far (if at all) the driver was depressing the accelerator and/or brake pedal; and,
- How fast the vehicle was traveling.

These data can help provide a better understanding of the circumstances in which crashes and injuries occur.

GETTING STARTED

NOTE:

EDR data are recorded by your vehicle only if a non-trivial crash situation occurs; no data are recorded by the EDR under normal driving conditions and no personal data (e.g., name, gender, age, and crash location) are recorded. However, other parties, such as law enforcement, could combine the EDR data with the type of personally identifying data routinely acquired during a crash investigation.

To read data recorded by an EDR, special equipment is required, and access to the vehicle or the EDR is needed. In addition to the vehicle manufacturer, other parties, such as law enforcement, that have the special equipment, can read the information if they have access to the vehicle or the EDR.

CHILD RESTRAINTS

Children 12 years or younger should ride properly buckled up in a rear seat, if available. According to crash statistics, children are safer when properly restrained in the rear seats rather than in the front.

Every state in the United States and all Canadian provinces require that small children ride in proper restraint systems. This is the law, and you can be prosecuted for ignoring it.

NOTE:

- For additional information, refer to www.Seatcheck.org or call:

1-866-732-8243

- Canadian residents should refer to Transport Canada's website for additional information: <http://www.tc.gc.ca/eng/motorvehiclesafety/safedrivers-childsafety-index-53.htm>

LATCH – Lower Anchors And Tethers For Children

The second row seating positions and the third row center position have lower anchors and top tether anchors.

Your vehicle is equipped with the child restraint anchorage system called LATCH, which stands for Lower Anchors and Tethers for Children.

LATCH System Weight Limit

You may use the LATCH anchorage system until the combined weight of the child and the child restraint is 65 lbs (29.5 kg). Use the seat belt and tether anchor instead of the LATCH system once the combined weight is more than 65 lbs (29.5 kg).

Locating LATCH Anchorages

The lower anchorages are round bars that are found at the rear of the seat cushion where it meets the seatback. They are just visible when you lean into the rear seat to install the child restraint. You will easily feel them if you run your finger along the gap between the seatback and seat cushion.



Lower Anchorages

Locating Tether Anchorages

In addition, there are tether strap anchors  located behind each rear seatback, near the floor.



Tether Anchorages

GETTING STARTED

Center Seat LATCH

If a child restraint installed in the center position blocks the seat belt webbing or buckle for the outboard position, do not use that outboard position. If a child seat in the center position blocks the outboard LATCH anchors or seat belt, do not install a child seat in that outboard position.

Installing The Child Restraint Using The LATCH Lower Anchors

NOTE:

Never “share” a LATCH anchorage with two or more child restraints.

1. Loosen the adjusters on the lower straps and on the tether strap of the child seat so that you can more easily attach the hooks or connectors to the vehicle anchorages.
2. Attach the lower hooks or connectors of the child restraint to the lower anchorages in the selected seating position.
3. If the child restraint has a tether strap, connect it to the top tether anchorage. See below for directions to attach a tether anchor.
4. Tighten all of the straps as you push the child restraint rearward and downward into the seat. Remove slack in the straps according to the child restraint manufacturer's instructions.
5. Test that the child restraint is installed tightly by pulling back and forth on the child seat at the belt path. It should not move more than 1 inch (25.4 mm) in any direction.

Installing The Child Restraint Using The Vehicle Seat Belts

Except for the center position in the third row, all of the seat belts in the passenger seating positions are equipped with a Switchable Automatic Locking Retractor (ALR). The third row center position is equipped with a cinching latch plate. Both types of seat belts are designed to keep the lap portion of the seat belt tight around the child restraint. Any seat belt system will loosen with time, so check the belt occasionally, and pull it tight if necessary.

Tether Anchorage Weight Limit

Always use the tether anchor when using the seat belt to install a forward facing child restraint, up to the recommended weight limit of the child restraint.

To Install A Child Seat Using An ALR

1. Pull enough of the seat belt webbing from the retractor to pass it through the belt path of the child restraint. Do not twist the belt webbing in the belt path.
2. Slide the latch plate into the buckle until you hear a “click.”
3. Pull on the webbing to make the lap portion tight against the child seat.

4. To lock the seat belt, pull down on the shoulder part of the belt until you have pulled all the seat belt webbing out of the retractor. Then, allow the webbing to retract back into the retractor. As the webbing retracts, you will hear a clicking sound. This means the seat belt is now in the Automatic Locking mode.
5. Try to pull the webbing out of the retractor. If it is locked, you should not be able to pull out any webbing. If the retractor is not locked, repeat the last step.
6. Finally, pull up on any extra webbing to tighten the lap portion around the child restraint while you push the child restraint rearward and downward into the vehicle seat.
7. If the child restraint has a top tether strap and the seating position has a top tether anchorage, connect the tether strap to the anchorage and tighten the tether strap. See below for directions to attach a tether anchor.
8. Test that the child restraint is installed tightly by pulling back and forth on the child seat at the belt path. It should not move more than 1 inch (25.4 mm) in any direction.

To Install A Child Seat Using A Cinching Latch Plate:

1. Place the child seat in the center of the seating position.
2. Next, pull enough of the seat belt webbing from the retractor to pass it through the belt path of the child restraint. Do not twist the belt webbing in the belt path.
3. Slide the latch plate into the buckle until you hear a “click.”
4. Finally, pull up on any excess webbing to tighten the lap portion around the child restraint while you push the child restraint rearward and downward into the vehicle seat.
5. If the child restraint has a top tether strap and the seating position has a top tether anchorage, connect the tether strap to the anchorage and tighten the tether strap. See below for directions to attach a tether anchor.
6. Test that the child restraint is installed tightly by pulling back and forth on the child seat at the belt path. It should not move more than 1 inch (25.4 mm) in any direction.

Installing The Top Tether Strap (With Either Lower Anchors Or Vehicle Seat Belt)

When installing a forward-facing child restraint, always secure the top tether strap, up to the tether anchor weight limit, whether the child restraint is installed with the lower anchors or the vehicle seat belt.

GETTING STARTED

Tether Strap Installation

1. Route the tether strap to provide the most direct path for the strap between the anchor and the child seat.
2. If your vehicle is equipped with adjustable rear head restraints, raise the head restraint, and where possible, route the tether strap under the head restraint and between the two posts. If not possible, lower the head restraint and pass the tether strap around the outboard side of the head restraint.
3. Attach the tether strap hook of the child restraint to the top tether anchorage and remove slack in the tether strap according to the child restraint manufacturer's instructions.



Rear Seat Tether Strap Mounting (Second Row Anchorage Shown)

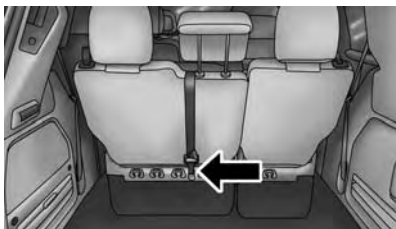

Top Tether Strap Mounting (Third Row 60/40 Anchorage Shown)

WARNING!

- In a collision, an unrestrained child, even a tiny baby, can become a projectile inside the vehicle. The force required to hold even an infant on your lap could become so great that you could not hold the child, no matter how strong you are. The child and others could be severely injured or killed. Any child riding in your vehicle should be in a proper restraint for the child's size.
- Never place a rear-facing child restraint in front of an air bag. A deploying Passenger Advanced Front Air Bag can cause death or serious injury to a child 12 years or younger, including a child in a rear-facing child restraint.
- Only use a rear-facing child restraint in a vehicle with a rear seat.
- Improper installation of a child restraint to the LATCH anchorages can lead to failure of an infant or child restraint. The child could be severely injured or killed. Follow the manufacturer's directions exactly when installing an infant or child restraint.
- An incorrectly anchored tether strap could lead to increased head motion and possible injury to the child. Use only the anchor positions directly behind the child seat to secure a child restraint top tether strap.
- If your vehicle is equipped with a split rear seat, make sure the tether strap does not slip into the opening between the seatbacks as you remove slack in the strap.

HEAD RESTRAINTS

Head restraints are designed to reduce the risk of injury by restricting head movement in the event of a rear impact. Head restraints should be adjusted so that the top of the head restraint is located above the top of your ear.

WARNING!

The head restraints for all occupants must be properly installed and adjusted prior to operating the vehicle or occupying a seat. Head restraints should never be adjusted while the vehicle is in motion. Driving a vehicle with the head restraints improperly adjusted or removed could cause serious injury or death in the event of a collision.

Supplemental Active Head Restraints — Front Seats

Active Head Restraints are passive, deployable components, and vehicles with this equipment cannot be readily identified by any markings, only through visual inspection of the head restraint. The Active Head Restraints (AHR) will be split in two halves, with the front half being soft foam and trim, the back half being decorative plastic.

When AHRs deploy during a rear impact, the front half of the head restraint extends forward to minimize the gap between the back of the occupant's head and the AHR. This system is designed to help prevent or reduce the extent of injuries to the driver and front passenger in certain types of rear impacts. Refer to "Occupant Restraints" in "Things To Know Before Starting" in your Owner's Manual on the DVD for further information.

GETTING STARTED

To raise the head restraint, pull upward on the head restraint. To lower the head restraint, push the adjustment button, located at the base of the head restraint, and push downward on the head restraint.

For comfort the Active Head Restraints can be tilted forward and rearward. To tilt the head restraint closer to the back of your head, pull forward on the bottom of the head restraint. Push rearward on the bottom of the head restraint to move the head restraint away from your head.

NOTE:

- The head restraints should only be removed by qualified technicians, for service purposes only. If either of the head restraints require removal, see your authorized dealer.
- In the event of deployment of an Active Head Restraint, refer to “Occupant Restraints” in “Things To Know Before Starting” in your Owner’s Manual on the DVD for further information.

WARNING!

- All occupants, including the driver, should not operate a vehicle or sit in a vehicle’s seat until the head restraints are placed in their proper positions in order to minimize the risk of neck injury in the event of a collision.
- Do not place items over the top of the Active Head Restraint, such as coats, seat covers or portable DVD players. These items may interfere with the operation of the Active Head Restraint in the event of a collision and could result in serious injury or death.
- Active Head Restraints may be deployed if they are struck by an object such as a hand, foot or loose cargo. To avoid accidental deployment of the Active Head Restraint ensure that all cargo is secured, as loose cargo could contact the Active Head Restraint during sudden stops. Failure to follow this warning could cause personal injury if the Active Head Restraint is deployed.

Head Restraints — Second Row Quad Seats

To raise the head restraint, pull upward on the head restraint. To lower the head restraint, push the adjustment button, located at the base of the head restraint, and push downward on the head restraint.

Head Restraints — Second Row Bench

If your vehicle is equipped with a second row bench seat, the head restraints are not adjustable.

Head Restraints — Third Row

The head restraint in the center position can be raised and lowered for tether routing. Refer to “Occupant Restraints” in your Owner’s Manual on the DVD for further information.

POWER SEATS

Some models may be equipped with eight-way power seats for the driver and front passenger. The power seat switches are located on the outboard side of the seat. The switches control the movement of the seat cushion and the seatback.



Driver Power Seat Switch

- 1 — Lower Seat Switch
- 2 — Recline Switch
- 3 — Power Lumbar Switch

WARNING!

- Adjusting a seat while driving may be dangerous. Moving a seat while driving could result in loss of control which could cause a collision and serious injury or death.
- Seats should be adjusted before fastening the seat belts and while the vehicle is parked. Serious injury or death could result from a poorly adjusted seat belt.
- Do not ride with the seatback reclined so that the shoulder belt is no longer resting against your chest. In a collision you could slide under the seat belt, which could result in serious injury or death.

CAUTION!

Do not place any article under a power seat or impede its ability to move as it may cause damage to the seat controls. Seat travel may become limited if movement is stopped by an obstruction in the seat's path.

GETTING STARTED

Adjusting The Seat Forward Or Rearward

The seat can be adjusted both forward and rearward. Push the seat switch forward or rearward. The seat will move in the direction of the switch. Release the switch when the desired position has been reached.

Adjusting The Seat Up Or Down

The height of the seats can be adjusted up or down. Pull upward or push downward on the seat switch, the seat will move in the direction of the switch. Release the switch when the desired position has been reached.

Tilting The Seat Up Or Down

The angle of the seat cushion can be adjusted in four directions. Pull upward or push downward on the front or rear of the seat switch, the front or rear of the seat cushion will move in the direction of the switch. Release the switch when the desired position has been reached.

Reclining The Seatback

The angle of the seatback can be adjusted forward or rearward. Push the seatback switch forward or rearward, the seat will move in the direction of the switch. Release the switch when the desired position is reached.

CAUTION!

Do not place any article under a power seat or impede its ability to move as it may cause damage to the seat controls. Seat travel may become limited if movement is stopped by an obstruction in the seat's path.

WARNING!

- Adjusting a seat while driving may be dangerous. Moving a seat while driving could result in loss of control which could cause a collision and serious injury or death.
- Seats should be adjusted before fastening the seat belts and while the vehicle is parked. Serious injury or death could result from a poorly adjusted seat belt.
- Do not ride with the seatback reclined so that the shoulder belt is no longer resting against your chest. In a collision you could slide under the seat belt, which could result in serious injury or death.

Power Lumbar

Vehicles equipped with power driver or passenger seats may also be equipped with power lumbar. The power lumbar switch is located on the outboard side of the power seat. Push the switch forward to increase the lumbar support. Push the switch rearward to decrease the lumbar support.

Driver Memory Seat

The Memory Buttons 1 and 2 on the driver's door panel can be programmed to recall the driver's seat, outside mirrors, and radio station preset settings. Your Remote Keyless Entry (RKE) transmitters can also be programmed to recall the same positions when the UNLOCK button is pushed.

Your vehicle may have been delivered with two RKE transmitters, one RKE transmitter can be linked to each of the memory positions.



Driver Memory Switch

Programming The Memory Feature

To create a new memory profile, perform the following:

1. Cycle the vehicles ignition to the ON/RUN position (do not start the engine).
2. Adjust all memory profile settings to desired preferences (i.e., driver's seat, outside mirrors, adjustable pedals [if equipped] and radio station presets).
3. Push and release the S (Set) button on the memory switch.
4. Within five seconds, push and release either of the memory buttons (1) or (2). The Electronic Vehicle Information Center (EVIC) will display which memory position has been set.

NOTE:

- Memory profiles can be set without the vehicle in PARK, but the vehicle must be in PARK to recall a memory profile.
- To set a memory profile to your RKE transmitter, refer to “Linking And Unlinking The Remote Keyless Entry Transmitter To Memory” in this section.

GETTING STARTED

Linking And Unlinking The Remote Keyless Entry Transmitter To Memory

Your RKE transmitters can be programmed to recall one of two pre-programmed memory profiles by pushing the UNLOCK button on the RKE transmitter.

NOTE:

Before programming your RKE transmitters you must select the "RKE Linked To Memory" feature through the Electronic Vehicle Information Center (EVIC). Refer to "Electronic Vehicle Information Center (EVIC) " in "Understanding Your Instrument Panel" on the DVD for further information.

To program your RKE transmitters, perform the following:

1. Cycle the vehicles ignition to the OFF position.
2. Select a desired memory profile (1) or (2).

NOTE:

If a memory profile has not already been set, refer to "Programming The Memory Feature" in this section for instructions on how to set a memory profile.

3. Once the profile has been recalled, push and release the SET (S) button on the memory switch.
4. Push and release button (1) or (2) accordingly. "Memory Profile Set" (1 or 2) will display in the instrument cluster.
5. Push and release the LOCK button on the RKE transmitter within 10 seconds.

NOTE:

Your RKE transmitters can be unlinked to your memory settings by pushing the SET (S) button, and within 10 seconds, followed by pushing the UNLOCK button on the RKE transmitter.

Memory Position Recall

NOTE:

The vehicle must be in PARK to recall memory positions. If a recall is attempted when the vehicle is not in PARK, a message will be displayed in the EVIC.

To recall the memory settings for driver one, push MEMORY button 1 on the driver's door or the UNLOCK button on the RKE transmitter linked to memory position 1.

To recall the memory setting for driver two, push MEMORY button 2 on the driver's door or the UNLOCK button on the RKE transmitter linked to Memory Position 2.

A recall can be cancelled by pushing any of the MEMORY buttons on the driver's door during a recall (S, 1, or 2). When a recall is cancelled, the driver's seat, and the pedals (if equipped) stop moving. A delay of one second will occur before another recall can be selected.

NOTE:

Pushing the mirror adjust switch will cancel the memory mirror recall.

Easy Entry/Exit Seat (Available With Memory Seat Only)

This feature provides automatic driver seat positioning to enhance driver mobility when entering and exiting the vehicle.

The distance the driver seat moves depends on where you have the driver seat positioned when you remove the key from the ignition switch.

- When you remove the key from the ignition switch, the driver seat will move about 2.4 inches (60 mm) rearward if the driver seat position is greater than or equal to 2.7 inches (67.7 mm) forward of the rear stop. The seat will return to its previously set position when you insert the key into the ignition switch and turn it out of the LOCK position.
- When you remove the key from the ignition switch the driver seat will move to a position 0.3 inches (7.7 mm) forward of the rear stop if the driver seat position is between 0.9 – 2.7 inches (22.7 – 67.7 mm) forward of the rear stop. The seat will return to its previously set position when you insert the key into the ignition switch and turn it out of the LOCK position.
- The Easy Entry/Easy Exit feature is disabled when the driver seat position is less than 0.9 inches (22.7 mm) forward of the rear stop. At this position, there is no benefit to the driver by moving the seat for Easy Exit or Easy Entry.

Each stored memory setting will have an associated Easy Entry and Easy Exit Position.

NOTE:

The Easy Entry/Easy Exit feature can be enabled or disabled through the programmable features in the Electronic Vehicle Information Center (EVIC). If your vehicle is not equipped with an EVIC, your dealership can activate/deactivate this feature for you. For further information refer to “Electronic Vehicle Information Center (EVIC)” in “Understanding Your Instrument Panel” on the DVD.

GETTING STARTED

HEATED SEATS

On some models, the front and rear seats may be equipped with heaters located in the seat cushions and seat backs.

WARNING!

- Persons who are unable to feel pain to the skin because of advanced age, chronic illness, diabetes, spinal cord injury, medication, alcohol use, exhaustion or other physical condition must exercise care when using the seat heater. It may cause burns even at low temperatures, especially if used for long periods of time.
- Do not place anything on the seat or seatback that insulates against heat, such as a blanket or cushion. This may cause the seat heater to overheat. Sitting in a seat that has been overheated could cause serious burns due to the increased surface temperature of the seat.

Vehicles Equipped With Remote Start

On models that are equipped with remote start, the driver's heated seat can be programmed through the Electronic Vehicle Information Center (EVIC) to come on during a remote start. Refer to "Electronic Vehicle Information Center (EVIC)" in "Understanding Your Instrument Panel" on the DVD for further information.

Front Heated Seats

There are two heated seat switches that allow the driver and passenger to operate the seats independently. The controls for each heater are located on the switch bank below the climate controls.

You can choose from HI, LO or OFF heat settings. Amber indicator lights in each switch indicate the level of heat in use. Two indicator lights will illuminate for HI, one for LO and none for OFF.

Push the switch once to select HI-level heating. Push the switch a second time to select LO-level heating. Push the switch a third time to shut the heating elements OFF.

NOTE:

Once a heat setting is selected, heat will be felt within two to five minutes.

If the HI-level setting is selected, the system will automatically switch to LO-level after approximately 60 minutes of continuous operation. At that time, the display will change from HI to LO, indicating the change. The LO-level setting will turn OFF automatically after approximately 45 minutes.



Heated Seat Switch Location

Rear Heated Seats

On some models, the second row seats are equipped with heaters. There are two heated seat switches that allow the second row passengers to operate the seats independently. The heated seat switches are located on the sliding side door handle trim panels.

You can choose from HI, LO or OFF heat settings. Amber indicator lights in each switch indicate the level of heat in use. Two indicator lights will illuminate for HI, one for LO and none for OFF.

Push the switch once to select HI-level heating. Push the switch a second time to select LO-level heating. Push the switch a third time to shut the heating elements OFF.

NOTE:

Once a heat setting is selected, heat will be felt within two to five minutes.

When the HI-level setting is selected, the heater will provide a boosted heat level during the initial stages of operation. Then, the heat output will drop to the normal HI-level. If the HI-level setting is selected, the system will automatically switch to LO-level after approximately 60 minutes of continuous operation. At that time, the display will change from HI to LO, indicating the change. The LO-level setting will turn OFF automatically after approximately 45 minutes.





Second Row Heated Seat Switch

HEATED STEERING WHEEL

The steering wheel contains a heating element that helps warm your hands in cold weather. The heated steering wheel has only one temperature setting. Once the heated steering wheel has been turned on it can operate for up to approximately 95 minutes before automatically shutting off. The heated steering wheel can shut off early or may not turn on when the steering wheel is already warm.

The heated steering wheel control button is located on the center of the instrument panel below the climate controls.

- Push the heated steering wheel button  once to turn the heating element ON.
- Push the heated steering wheel button  a second time to turn the heating element OFF.

NOTE:

The engine must be running for the heated steering wheel to operate.

GETTING STARTED

Vehicles Equipped With Remote Start

On models that are equipped with remote start, the heated steering wheel can be programmed to come on during a remote start. Refer to “Electronic Vehicle Information Center (EVIC)” in “Understanding Your Instrument Panel” on the DVD for further information.

WARNING!

- Persons who are unable to feel pain to the skin because of advanced age, chronic illness, diabetes, spinal cord injury, medication, alcohol use, exhaustion, or other physical conditions must exercise care when using the steering wheel heater. It may cause burns even at low temperatures, especially if used for long periods.
- Do not place anything on the steering wheel that insulates against heat, such as a blanket or steering wheel covers of any type and material. This may cause the steering wheel heater to overheat.

TILT/TELESCOPING STEERING COLUMN

This feature allows you to tilt the steering column upward or downward. It also allows you to lengthen or shorten the steering column. The tilt/telescoping lever is located below the steering wheel at the end of the steering column.

To unlock the steering column, push the lever downward (toward the floor). To tilt the steering column, move the steering wheel upward or downward as desired. To lengthen or shorten the steering column, pull the steering wheel outward or push it inward as desired. To lock the steering column in position, push the lever upward until fully engaged.



Tilt/Telescoping Lever

WARNING!

Do not adjust the steering column while driving. Adjusting the steering column while driving or driving with the steering column unlocked, could cause the driver to lose control of the vehicle. Failure to follow this warning may result in serious injury or death.

ENGINE BREAK-IN RECOMMENDATIONS

A long break-in period is not required for the engine and drivetrain (transmission and axle) in your vehicle.

Drive moderately during the first 300 miles (500 km). After the initial 60 miles (100 km), speeds up to 50 or 55 mph (80 or 90 km/h) are desirable.

While cruising, brief full-throttle acceleration within the limits of local traffic laws contributes to a good break-in. Wide-open throttle acceleration in low gear can be detrimental and should be avoided.

The engine oil installed in the engine at the factory is a high-quality energy conserving type lubricant. Oil changes should be consistent with anticipated climate conditions under which vehicle operations will occur. Refer to “Maintaining Your Vehicle,” for the recommended viscosity and quality grades.

NOTE:

A new engine may consume some oil during its first few thousand miles (kilometers) of operation. This should be considered a normal part of the break-in and not interpreted as an indication of an engine problem or malfunction.

CAUTION!
Never use Non-Detergent Oil or Straight Mineral Oil in the engine or damage may result.

OPERATING YOUR VEHICLE

MULTIFUNCTION LEVER

The multifunction lever is located on the left side of the steering column.

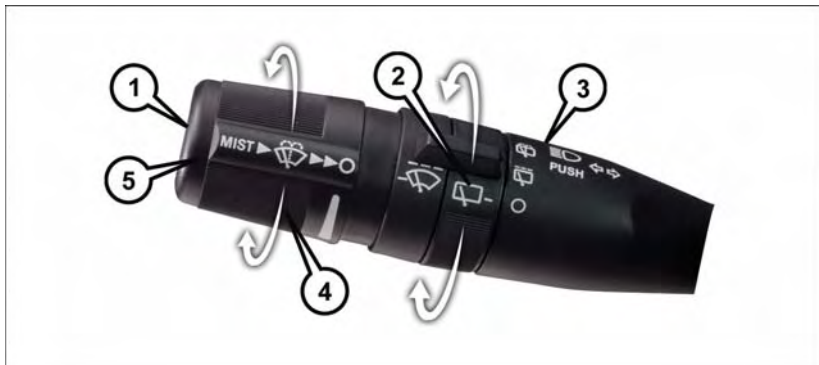

Multifunction Lever

- 1 — Mist (Push To First Detent)
- 2 — Rear Wiper/Washer
- 3 — Push Lever For High Beams
- 4 — Front Wipers
- 5 — Front Washer (Push To Second Detent)

Turn Signals

Move the multifunction lever up or down and the arrows on each side of the instrument cluster flash to show proper operation of the front and rear turn signal lights.

NOTE:

If either light remains on and does not flash, or there is a very fast flash rate, check for a defective outside light bulb. If an indicator fails to light when the lever is moved, it would suggest that the indicator bulb is defective.

Turn Signal Warning

If the vehicle electronics sense that the vehicle has traveled at over 18 mph (29 km/h) for about 1 mile (1.6 km) with the turn signals on, a chime will sound to alert the driver.

Lane Change Assist

Tap the lever up or down once, without moving beyond the detent, and the turn signal (right or left) will flash three times then automatically turn off.

Windshield Wiper And Washers

The wipers and washers are operated by a switch within the multifunction lever. Rotate the end of the multifunction lever to select the desired wiper speed.

NOTE:

Always remove any buildup of snow that prevents the windshield wiper blades from returning to the off position. If the windshield wiper switch is turned off and the blades cannot return to the off position, damage to the wiper motor may occur.

WARNING!

Sudden loss of visibility through the windshield could lead to a collision. You might not see other vehicles or other obstacles. To avoid sudden icing of the windshield during freezing weather, warm the windshield with the defroster before and during windshield washer use.

Intermittent Wiper System

Use the intermittent wiper when weather conditions make a single wiping cycle with a variable pause between cycles desirable. Rotate the end of the multifunction lever to the first detent position, and then turn the end of the lever to select the desired delay interval. There are five delay settings, which allow you to regulate the wipe interval from a minimum of one cycle every second to a maximum of approximately 36 seconds between cycles. The delay intervals will double in duration when the vehicle speed is 10 mph (16 km/h) or less.

Windshield Wiper Operation

Rotate the end of the lever upward, to the first detent past the intermittent settings for low-speed wiper operation. Rotate the end of the lever upward to the second detent past the intermittent settings for high-speed wiper operation.

Windshield Washers

To use the Washer, push on the end of the lever to the second detent and hold while spray is desired. If the lever is pushed while on the intermittent setting, the wipers will turn on and operate for several wipe cycles after the lever is released, and then resume the intermittent interval previously selected. If the lever is pushed while the wipers are in the off position, the wipers will operate several wipe cycles, then turn off.

Mist Feature

Push the end of the multifunction lever inward (toward the steering column) to the first detent and release for a single wiping cycle.

NOTE:

The mist feature does not activate the washer pump; therefore, no washer fluid will be sprayed on the windshield. The wash function must be used in order to spray the windshield with washer fluid.

OPERATING YOUR VEHICLE

Rear Wiper And Washer

Rotating the rotary ring to the first detent activates the rear intermittent wipers. To activate the washers, rotate the rotary ring fully forward and the washers will spray until the ring is released, and then resume the intermittent interval.

NOTE:

Rear window wipers function in the intermittent wiper speed only.

Rain Sensing Wipers — If Equipped

This feature senses moisture on the windshield and automatically activates the wipers for the driver. This feature is especially useful for road splash or overspray from the windshield washers of the vehicle ahead. Rotate the end of the multifunction lever to one of the five intermittent wiper sensitivity settings to activate this feature.

The sensitivity of the system is adjustable from the multifunction lever. Wiper sensitivity position 3 has been calibrated for best overall wiping sensitivity. If the operator desires more wiping sensitivity, they may select sensitivity positions 4 or 5. If the operator desires less wiping sensitivity, they may select sensitivity positions 2 or 1. Place the multifunction lever in the OFF position when not using the system.

NOTE:

- The Rain Sensing feature will not operate when the wiper speed is in the low or high position.
- The Rain Sensing feature may not function properly when ice or dried saltwater is present on the windshield.
- Use of Rain-X or products containing wax or silicone may reduce rain sensor performance.
- The Rain Sensing feature can be turned on and off through the EVIC (if equipped). Refer to “Electronic Vehicle Information Center (EVIC)/Personal Settings (Customer-Programmable Features)” in “Understanding Your Instrument Panel” for further information.

The Rain Sensing system has protective features for the wiper blades and arms. It will not operate under the following conditions:

- **Low Temperature Wipe Inhibit** — The Rain Sensing feature will not operate when the ignition is first switched ON, and the vehicle is stationary, and the outside temperature is below 32°F (0°C), unless the wiper control on the multifunction lever is moved, or the vehicle speed becomes greater than 0 mph (0 km/h), or the outside temperature rises above freezing.
- **Neutral Wipe Inhibit** — The Rain Sensing feature will not operate when the ignition is ON, and the transmission gear selector is in the NEUTRAL position, and the vehicle speed is less than 5 mph (8 km/h), unless the wiper control on the multifunction lever is moved or the gear selector is moved out of the NEUTRAL position.

OPERATING YOUR VEHICLE

- **Remote Start Mode Inhibit** — On vehicles equipped with Remote Starting system, Rain Sensing wipers are not operational when the vehicle is in the remote start mode. Once the operator is in the vehicle and has placed the ignition switch in the RUN position, rain sensing wiper operation can resume, if it has been selected, and no other inhibit conditions (mentioned previously) exist.

High/Low Beam Switch

When the headlights are turned on, pushing the multifunction lever toward the instrument panel will switch from low beams to high beams. Pulling back to the neutral position returns the headlights to the low beam operation.

Flash-To-Pass

You can signal another vehicle with your headlights by lightly pulling the multifunction lever toward you. This will cause the headlights to turn on at high beam and remain on until the lever is released.

HEADLIGHT SWITCH

The headlight switch is located on the left side of the instrument panel. The switch controls the operation of the headlights, parking lights, instrument panel lights, interior lights and the fog lights.

Rotate the headlight switch clockwise to the first detent for parking light and instrument panel light operation. Rotate the headlight switch to the second detent for headlight, parking light and instrument panel operation.

Automatic Headlights

This system automatically turns your headlights on or off based on ambient light levels. To turn the system on, turn the headlight switch to the extreme counterclockwise position aligning the indicator with the AUTO on the headlight switch. When the system is on, the Headlight Time Delay feature is also on. This means your headlights will stay on for up to 90 seconds after you turn the ignition switch OFF. To turn the Automatic System off, turn the headlight switch clockwise to the O (OFF) position.

NOTE:

The engine must be running before the headlights will come on in the Automatic mode.



Headlight Switch/Halo Light Switch

- 1 — Auto
- 2 — Push Fog Light
- 3 — Rotate Halo Light Dimmer Control
- 4 — Rotate Dimmer Control
- 5 — Rotate Headlight Switch

OPERATING YOUR VEHICLE

Dimmer Controls

The dimmer switch is located next to the headlight switch.

With the parking lights or headlights on, rotating the dimmer control upward will increase the brightness of the instrument panel lights.

Interior Lighting On

Rotate the left dimmer control completely upward to the second detent (extreme top position) to turn on the interior lights. The interior lights will remain on when the dimmer control is in this position.

Interior lights are also turned on when a door or liftgate is opened, the Remote Keyless Entry (RKE) transmitter is activated, or when the dimmer control is moved to the extreme top.

The interior lights will automatically turn off in approximately 10 minutes for the first activation and 90 seconds every activation thereafter until the engine is started, if one of the following occur:

- A door, sliding door or the liftgate is left open.
- Any overhead reading light is left on.

NOTE:

The ignition must be cycled to the OFF position for this feature to operate.

Interior Lighting Off

Rotate the left dimmer control to the off position (extreme bottom). The interior lights will remain off when the doors or liftgate are open.

Parade Mode (Daytime Brightness Feature)

Rotate the left dimmer control to the first detent. This feature brightens the odometer, radio and overhead displays when the parking lights or headlights are on.

Halo Lights

Halo lights are strategically placed soft lighting that help to illuminate specific areas to aid the occupants in locating specific features while driving at night.

The Halo control switch is located to the right of the dimmer switch.

To activate the Halo lights, rotate the Halo switch control upward or downward to increase or decrease the lighting.

ELECTRONIC RANGE SELECT (ERS)

Electronic Range Select (ERS) allows you to limit the highest available transmission gear, and can be activated during any driving condition. When towing a trailer or operating the vehicle in off-road conditions, using ERS shift control will help you maximize both performance and engine braking.

- To shift from DRIVE mode to ERS mode, tap the shift lever to the left (-) once. The current gear will be displayed in the instrument cluster, and will be maintained as the top available gear. Once in ERS mode, tapping the shift lever to the left (-) or right (+) will change the top available gear. To disable ERS, simply press and hold the shift lever to the right (+) until "D" is displayed in the instrument cluster odometer.

Switching between ERS and DRIVE mode can be done at any vehicle speed.

Refer to your Owner's Manual on the DVD for further details.



Electronic Range Select

OPERATING YOUR VEHICLE

FUEL ECONOMY (ECON) MODE

The Fuel Economy (ECON) mode can improve the vehicle's overall fuel economy during normal driving conditions.

- Push the ECON switch in the center stack of the instrument panel and a green light will indicate the ECON mode is engaged.

When the ECON Mode is engaged, the vehicle control systems will be able to change the following:

- The transmission will upshift sooner and downshift later.
- The transmission will skip select gears during shifts to allow the engine to operate at lower speeds.
- The torque converter clutch may engage sooner (lower engine rpm's) and remain on longer.
- The engine idle speed will be lower.
- The overall driving performance will be more conservative.



ECON Switch Location

OPERATING YOUR VEHICLE

THREE ZONE AUTOMATIC TEMPERATURE CONTROLS (ATC)



Three Zone Automatic Temperature Controls (ATC)

- | | |
|--------------------------------------|---------------------------------------|
| 1 — Push Driver Temp. Control Up | 9 — Push Passenger Temp. Control Down |
| 2 — Push Air Recirc. Button | 10 — Push Rear Control Button |
| 3 — Push A/C Button | 11 — Push Rear Lock Button |
| 4 — Push Mode Control Button | 12 — Push OFF Button |
| 5 — Push AUTO Button | 13 — Rotate Blower Control |
| 6 — Push Front Window Defrost Button | 14 — Push SYNC Button |
| 7 — Push Rear Window Defrost Button | 15 — Push Driver Temp. Control Down |
| 8 — Push Passenger Temp. Control Up | |

Automatic Operation

- Push the AUTO mode button to activate the ATC system.
- Select the desired temperature by pressing the temperature control buttons for the driver or passenger.
- The system will maintain the set temperature automatically.

Air Conditioning (A/C)

- If the air conditioning button is pushed while in AUTO mode, the indicator light will flash three times to indicate the cabin air is being controlled automatically.

SYNC Temperature Button

- Push the SYNC button once to control driver and passenger temperatures simultaneously. Push the SYNC button a second time to control the temperatures individually.

OPERATING YOUR VEHICLE

Air Recirculation

- Use Recirculation for maximum A/C operation.
- For window defogging, turn the Recirculation button off.
- If the Recirculation button is pressed when the system is in Defrost mode the Recirculation LED indicator will flash three times to indicate Recirculation mode is not allowed.

Heated Mirrors

The mirrors are heated to melt frost or ice. This feature is activated whenever you turn on the rear window defroster.

Rear Window Defroster

- Pushing the rear window defroster button will turn on the defroster for approximately 10 minutes. An indicator in the button will illuminate when the rear window defroster is on. For an additional 10 minutes of operation, push the button a second time.

Activating Rear Automatic Temperature Control

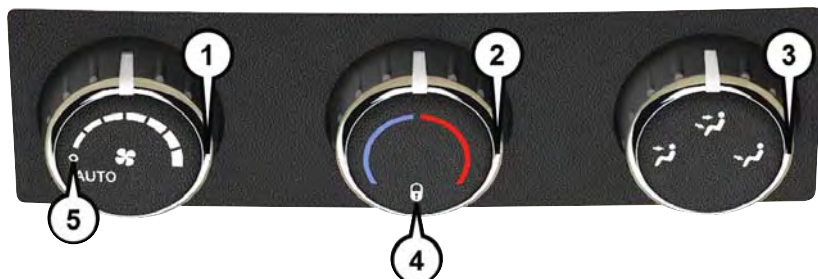

Rear Automatic Temperature Control

- 1 — Rotate Blower Control
- 2 — Rotate Temperature Control
- 3 — Rotate Mode Control

- 4 — Rear Temperature Lock
- 5 — Rear Blower Control AUTO Mode

- Pushing the REAR LOCK button for the Rear Automatic Temperature Control (ATC) System from the front lower ATC panel, illuminates a LOCK symbol in the rear display. The rear temperature and air source are controlled from the front lower ATC panel.
- Rear second row occupants can only adjust the rear ATC control when the REAR LOCK button is turned off.
- The Rear ATC system is located in the headliner, near the center of the vehicle.

PARKSENSE REAR PARK ASSIST

If an object is detected behind the rear bumper while the vehicle is in REVERSE, a warning will display in the instrument cluster and a tone will sound, (closer the object the faster the tone) that changes speed depending on the distance of the object from the bumper, will sound.

When the Instrument Cluster reads either “Clean Sensor” or “Blinded”, clean off the bumper sensors to see if the condition is corrected.

Refer to “ParkSense Rear Park Assist” in “Understanding The Features” on the DVD for further information.

PARKVIEW REAR BACK-UP CAMERA

You can see an on-screen image of the rear of your vehicle whenever the gear selector is put into REVERSE. The ParkView Rear Back-Up Camera image will be displayed on the radio display screen, located on the center stack of the instrument panel.

If the radio display screen appears foggy, clean the camera lens located on the liftgate.

Refer to your Owner's Manual on the DVD for further details.

WARNING!

Drivers must be careful when backing up even when using the ParkView Rear Back Up Camera. Always check carefully behind your vehicle, and be sure to check for pedestrians, animals, other vehicles, obstructions, or blind spots before backing up. You are responsible for the safety of your surroundings and must continue to pay attention while backing up. Failure to do so can result in serious injury or death.

BLIND SPOT MONITORING WITH REAR CROSS PATH

The Blind Spot Monitoring (BSM) system uses two radar-based sensors, located inside the rear bumper fascia, to detect Highway licensable vehicles (automobiles, trucks, motorcycles etc.) that enter the blind spot zones from the rear/front/side of the vehicle.

The Blind Spot Monitoring (BSM) system warning light, located in the outside mirrors, will illuminate if a vehicle moves into a blind spot zone.

The BSM system can also be configured to sound an audible (chime) alert and mute the radio to notify you of objects that have entered the detection zones.

Refer to your Owner's Manual on the DVD for further details.



YOUR VEHICLE'S SOUND SYSTEM

1. Uconnect Voice Command Button pg. 73
2. Uconnect Phone Button pg. 70
3. Steering Wheel Audio Controls (Left) pg. 69
4. Steering Wheel Audio Controls (Right) pg. 69



- 5. USB port pg. 58
- 6. Audio Jack pg. 58
- 7. USB Port (inside upper glove box) pg. 69

CYBERSECURITY

Your vehicle may be a connected vehicle and may be equipped with both wired and wireless networks. These networks allow your vehicle to send and receive information. This information allows systems and features in your vehicle to function properly.

Your vehicle may be equipped with certain security features to reduce the risk of unauthorized and unlawful access to vehicle systems and wireless communications. Vehicle software technology continues to evolve over time and FCA US LLC, working with its suppliers, evaluates and takes appropriate steps as needed. Similar to a computer or other devices, your vehicle may require software updates to improve the usability and performance of your systems or to reduce the potential risk of unauthorized and unlawful access to your vehicle systems.

The risk of unauthorized and unlawful access to your vehicle systems may still exist, even if the most recent version of vehicle software (such as Uconnect software) is installed.

WARNING!

- It is not possible to know or to predict all of the possible outcomes if your vehicle's systems are breached. It may be possible that vehicle systems, including safety related systems, could be impaired or a loss of vehicle control could occur that may result in an accident involving serious injury or death.
- ONLY insert media (e.g., USB, SD card, or CD) into your vehicle if it came from a trusted source. Media of unknown origin could possibly contain malicious software, and if installed in your vehicle, it may increase the possibility for vehicle systems to be breached.
- As always, if you experience unusual vehicle behavior, take your vehicle to your nearest authorized dealer immediately.

NOTE:

- FCA or your dealer may contact you directly regarding software updates.
- To help further improve vehicle security and minimize the potential risk of a security breach, vehicle owners should:
 - Routinely check www.driveuconnect.com/software-update to learn about available Uconnect software updates.
 - Only connect and use trusted media devices (e.g. personal mobile phones, USBs, CDs).

Privacy of any wireless and wired communications cannot be assured. Third parties may unlawfully intercept information and private communications without your consent. For further information, refer to "Onboard Diagnostic System (OBD II) Cybersecurity" in "Maintaining Your Vehicle" in your Owner's Manual on the DVD.

UNCONNECT 130

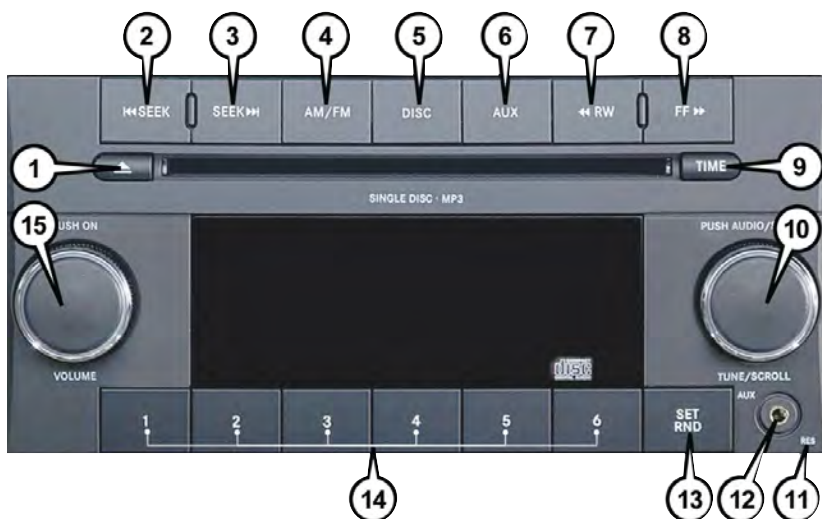

Uconnect 130

- | | |
|-------------------------|------------------------------------|
| 1 — CD Eject Button | 9 — Set Clock Button |
| 2 — Seek Down Button | 10 — Audio Settings/Rotate To Tune |
| 3 — Seek Up Button | 11 — Radio Sales Code |
| 4 — AM/FM Button | 12 — Audio Jack |
| 5 — Disc Mode Button | 13 — Set Preset/CD Random Play |
| 6 — AUX Mode Button | 14 — Station Presets Buttons |
| 7 — Rewind Button | 15 — ON/OFF/Rotate For Volume |
| 8 — Fast Forward Button | |

NOTE:

- Your radio has many features that add to the comfort and convenience for you and your passengers.
- Some of these radio features should not be used when driving because they take your eyes from the road or your attention from driving.

Clock Setting

- Push and hold the TIME button until the hours blink.
- Turn the TUNE/SCROLL control knob to set the hours.
- Push the TUNE/SCROLL control knob until the minutes begin to blink.
- Turn the TUNE/SCROLL control knob to set the minutes.

5. Push the TUNE/SCROLL control knob to save the changes.
6. Push any button/knob or wait five seconds to exit.

Equalizer, Balance And Fade

1. Push the TUNE/SCROLL control knob and “BASS” will display.
2. Rotate the TUNE/SCROLL control knob to select the desired setting.
3. Continue pushing the TUNE/SCROLL control knob to display and set “MID RANGE,” “TREBLE,” “BALANCE” and “FADE.”

Radio Operation

Seek Up/Down Buttons

- Push the seek up or down button to seek through radio stations in AM or FM bands.
- Hold either button to bypass stations without stopping.

Store Radio Presets Manually

- Tune to the desired station.
- Push the SET/RND or SET (depending on the radio) button once and SET 1 will show in the display. Then select a preset button (1–6).
- A second station may be added to each push button. Push the SET/RND or SET (depending on the radio) button twice and SET 2 will show in the display. Then select a preset button (1–6).

CD/DISC Operation

Seek Up/Down Buttons

- Push to seek through CD tracks.
- Hold either button to bypass tracks without stopping.

SET/RND Or RND (Depending On Radio) Button (Random Play)

- Push this button while the CD is playing to activate Random Play.
- This feature plays the selections on the CD in random order to provide an interesting change of pace.

Audio Jack Operation

The AUX/Audio Jack provides a means to connect a portable audio device, such as an MP3 player or an iPod, to the vehicle's sound system. This requires the use of a 3.5 mm stereo audio patch cable.

- Pushing the AUX button will change the mode to auxiliary device if the Audio Jack is connected, allowing the music from your portable device to play through the vehicle's speakers.

The functions of the portable device are controlled using the device buttons, not the buttons on the radio. However, the volume may be controlled using the radio or portable device.

UCONNECT 130 WITH SiriusXM SATELLITE RADIO

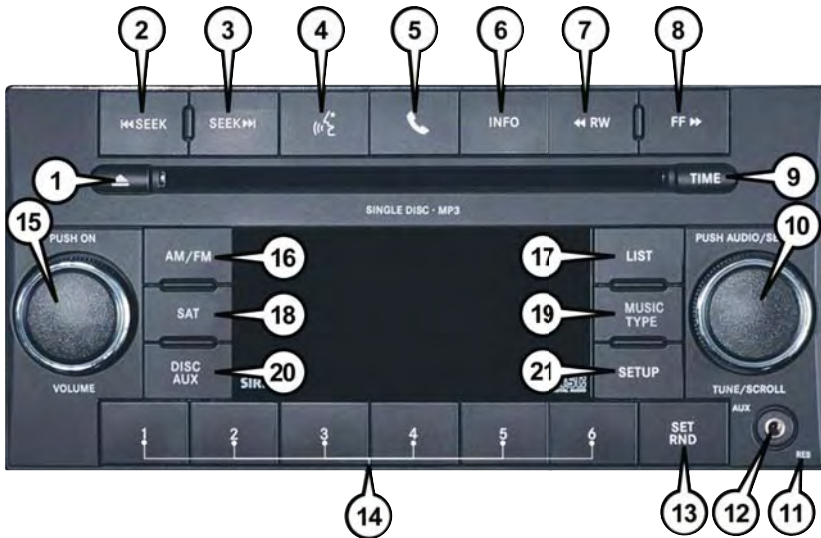

Uconnect 130 With SiriusXM Satellite Radio

- | | |
|------------------------------------|--------------------------------|
| 1 — CD Eject Button | 12 — Audio Jack |
| 2 — Seek Down Button | 13 — Set Preset/CD Random Play |
| 3 — Seek Up Button | 14 — Station Preset Buttons |
| 4 — Voice Command Button | 15 — ON/OFF/Rotate For Volume |
| 5 — Uconnect Phone Button | 16 — AM/FM Mode Button |
| 6 — Station Info Button | 17 — List Folders On A CD |
| 7 — Rewind Button | 18 — Satellite Radio Button |
| 8 — Fast Forward Button | 19 — Music Type Button |
| 9 — Set Clock Button | 20 — Disc Mode Button |
| 10 — Audio Settings/Rotate To Tune | 21 — Set Up Function Button |
| 11 — Radio Sales Code | |

NOTE:

- Your radio may not be equipped with the Uconnect Voice Command and Uconnect Phone features. To determine if your radio has these features, push the Voice Command button on the radio. You will hear a voice prompt if you have the feature, or see a message on the radio stating "Uconnect Phone not available" if you do not.
- Your radio has many features that add to the comfort and convenience of you and your passengers. Some of these radio features should not be used when driving because they take your eyes from the road or your attention from driving.

Clock Setting

1. Push and hold the TIME button until the hours blink.
2. Turn the TUNE/SCROLL control knob to set the hours.
3. Push the TUNE/SCROLL control knob until the minutes begin to blink.
4. Turn the TUNE/SCROLL control knob to set the minutes.
5. Push the TUNE/SCROLL control knob to save the changes.
6. Push any button/knob or wait five seconds to exit.

Equalizer, Balance And Fade

1. Push the TUNE/SCROLL control knob and “BASS” will display.
2. Rotate the TUNE/SCROLL control knob to select the desired setting.
3. Continue pushing the TUNE/SCROLL control knob to display and set “MID RANGE,” “TREBLE,” “BALANCE” and “FADE.”

Radio Operation

Seek Up/Down Buttons

- Push the seek up or down button to seek through radio stations in AM, FM, or SAT bands.
- Hold either button to bypass stations without stopping.

Store Radio Presets Manually

- Tune to the desired station.
- Push the SET/RND or SET (depending on the radio) button once and SET 1 will show in the display. Then select a preset button (1–6).
- A second station may be added to each push button. Push the SET/RND or SET (depending on the radio) button twice and SET 2 will show in the display. Then select a preset button (1–6).

Music Type

NOTE:

The Music Type function only operates when in FM mode.

- Push the MUSIC TYPE button to activate this mode. Push the MUSIC TYPE button again or turn the TUNE/SCROLL control knob to select the desired music type (Adult Hits, Country, Jazz, Oldies, Rock, etc.).
- When a music type is chosen and the Music type is displayed, Push either SEEK button and the radio will only search for stations with the selected music type.

SETUP Button

- Pushing the SETUP button allows you to select between items that are available in that particular mode.
- Turn the TUNE/SCROLL control knob to scroll through the entries. Push the AUDIO/SELECT button to select an entry and make changes.

SiriusXM Satellite Radio

SiriusXM services require subscriptions, sold separately after the 12-month trial included with the new vehicle purchase. **If you decide to continue your service at the end of your trial subscription, the plan you choose will automatically renew and bill at then-current rates until you call SiriusXM at 1-866-635-2349 to cancel.** See SiriusXM Customer Agreement for complete terms at www.siriusxm.com. All fees and programming subject to change. Our satellite service is available only to those at least 18 and older in the 48 contiguous USA and D.C. Our Sirius satellite service is also available in PR (with coverage limitations). Our Internet radio service is available throughout our satellite service area and in AK and HI. ©2015 Sirius XM Radio Inc. Sirius, XM and all related marks and logos are trademarks of Sirius XM Radio Inc.

SiriusXM Satellite Radio gives you over 130 channels, including 100% commercial-free music from nearly every genre, plus all your favorite sports, news, talk and entertainment channels – all with crystal clear, coast-to-coast coverage, all in one place and all at your fingertips.

- To access SiriusXM Satellite Radio, push the SAT button on the faceplate.

CD/DISC Operation

Seek Up/Down Buttons

- Push to seek through CD tracks.
- Hold either button to bypass tracks without stopping.

SET/RND or RND (Depending On Radio) Button (Random Play)

- Push this button while the CD is playing to activate Random Play.
- This feature plays the selections on the CD in random order to provide an interesting change of pace.

LIST Button

- Push the LIST button to bring up a list of all folders on the CD. Scroll up or down the list by turning the TUNE/SCROLL control knob.
- To select a folder from the list, push the TUNE/SCROLL control knob and the radio will begin playing the files contained in that folder.

Audio Jack Operation

The AUX/Audio Jack provides a means to connect a portable audio device, such as an MP3 player or an iPod, to the vehicle's sound system. This requires the use of a 3.5 mm stereo audio patch cable.

- Pushing the AUX button will change the mode to auxiliary device if the Audio Jack is connected, allowing the music from your portable device to play through the vehicle's speakers.

The functions of the portable device are controlled using the device buttons, not the buttons on the radio. However, the volume may be controlled using the radio or portable device.

UCONNECT 430/430N



Uconnect 430/430N

- | | |
|--------------------------------|-------------------------------|
| 1 — Voice Command Button | 7 — Audio Jack |
| 2 — Open/Close Display | 8 — Radio Sales Code |
| 3 — Menu Button | 9 — ON/OFF/Rotate For Volume |
| 4 — Audio Settings Button | 10 — Select Media Mode Button |
| 5 — Internal Hard Drive Button | 11 — Radio Mode Button |
| 6 — USB Port | 12 — Uconnect Phone Button |

NOTE:

- Your radio may not be equipped with the Uconnect Voice Command and Uconnect Phone features. To determine if your radio has these features, push the Voice Command button on the radio. You will hear a voice prompt if you have the feature, or see a message on the radio stating “Uconnect Phone not available” if you do not.
- Your radio has many features that add to the comfort and convenience of you and your passengers. Some of these radio features should not be used when driving because they take your eyes from the road or your attention from driving.

Clock Setting

1. Turn the radio on, then press the screen where the time is displayed.
2. Press the “User Clock” button on the touchscreen or the time display (Navigation radio only).
3. To adjust the hours, press either the “Hour Forward” or “Hour Backward” button on the touchscreen.
4. To adjust the minutes, press either the “Minute Forward” or “Minute Backward” button on the touchscreen.
5. To save the new time setting, press the screen where the word “Save” is displayed.

Menu

- Push the MENU button on the faceplate to access the System Setup menu and the My Files menu.
- Push the MENU button on the faceplate in an active mode (SAT, CD, AUX, etc.) to change mode specific settings.

Equalizer, Balance And Fade

Audio Control Menu

- Push the AUDIO button on the faceplate on the right side of the radio.
- Use either the “arrow” buttons on the touchscreen or the sliders to adjust BASS, MID, and/or TREBLE.
- Press the “BAL/FADE” button on the touchscreen and use either the “arrow” buttons on the touchscreen or the cross-hair to change Balance and Fade. The “Center” button on the touchscreen resets the settings.



Audio Control Menu

Display Settings

- Push the MENU button on the faceplate and press the “Display Settings” button on the touchscreen to access the Display Settings menu.
- Select the “Daytime Colors” button on the touchscreen to switch to manual daytime mode and to adjust the brightness of the display using daytime colors.
- Select the “Nighttime Colors” button on the touchscreen to switch to manual nighttime mode and to adjust the brightness of the display using nighttime colors.



Display Settings

- Select the “Auto Color Mode” button on the touchscreen to switch to automatic daytime/nighttime mode and to control the brightness of the display using the dimmer switch of the vehicle.
- Press the “Exit” button on the touchscreen to save your settings.

Radio Operation

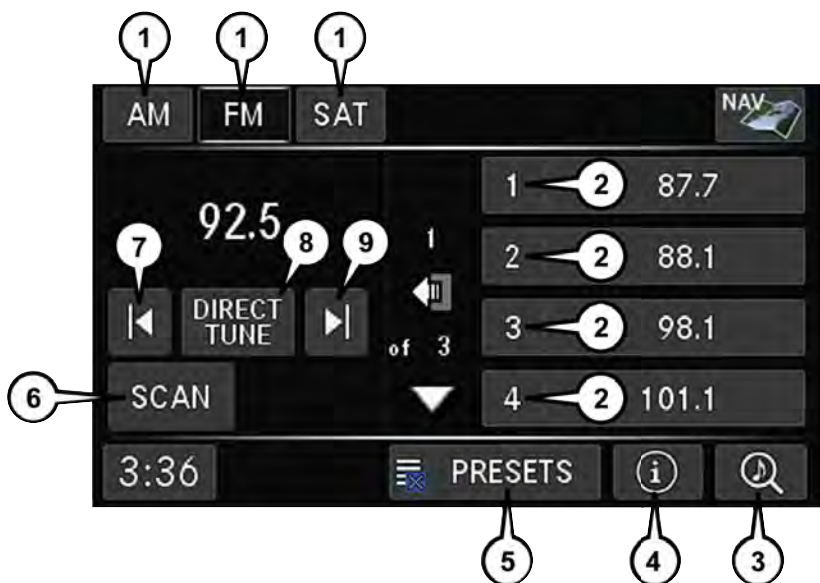

Radio Operation

- | | |
|------------------------------|------------------|
| 1 — Radio Tuner Tabs | 6 — Station Scan |
| 2 — Individual Presets | 7 — Seek Down |
| 3 — Search/Browse | 8 — Direct Tune |
| 4 — Radio Station/Track Info | 9 — Seek Up |
| 5 — Sort Presets | |

- To access Radio Mode, push the RADIO button on the left side of the faceplate, then press the “AM,” “FM” or “SAT” button on the touchscreen to select the band.

Seek Up/Seek Down

- Press the “SEEK UP” or “SEEK DOWN” buttons on the touchscreen to seek through radio stations in AM, FM, or SAT bands. Hold either seek button to bypass stations without stopping.

Store Radio Presets Manually

- Select the radio band by pressing either the “AM,” “FM,” or “SAT” button on the touchscreen.
- Find the station to store by either pressing the “SEEK UP” or “SEEK DOWN” buttons on the touchscreen, pressing the “Scan” button on the touchscreen, or by using the “Direct Tune” button on the touchscreen.
- Once the desired station is found, press and hold one of the “PRESETS” buttons on the touchscreen in the list to the right, until the preset key flashes and the station text on the button on the touchscreen changes.

NOTE:

If the Presets are not visible on the right side of the screen, press the “PRESETS” button on the touchscreen.

CD/DVD Disc Operation



CD/DVD Disc Operation

- 1 — Media Source Tabs
- 2 — Folder/Track
- 3 — Open Folder
- 4 — Track Information
- 5 — Sort Tracks

- 6 — Track Scan
- 7 — Seek Down
- 8 — Play/Pause
- 9 — Seek Up

- Push the MEDIA button on the faceplate to display the media source tabs at the top of the screen. Select the source by pressing the “HDD,” “DISC” or “AUX” media source button on the touchscreen.

NOTE:

Your Touchscreen Radio will usually automatically switch to the appropriate mode when something is first connected or inserted into the system.

Insert A CD/DVD Disc

- To insert a disc, push the LOAD button on the faceplate.
- With the printed side upwards, insert the disc into the disc slot of the radio. The radio pulls the disc in automatically and closes the flip screen. The radio selects the appropriate mode after the disc is recognized, and starts playing the first track. The display shows “Reading...” during this process.

Seek Up/Seek Down

- Push the SEEK UP or SEEK DOWN buttons on the faceplate to seek through tracks in Disc Mode. Holding the SEEK UP button on the touchscreen will fast forward through the track until the beginning of the track is reached; if still held it will fast-forward through the next sequential track(s) (if random play mode is not active) until released. Holding the SEEK DOWN button on the touchscreen will fast-reverse through the track until the beginning of the track is reached; if still held it will fast-reverse through the next sequential track(s) (if random play mode is not active) until released.

Audio Jack Operation

The AUX/Audio Jack provides a means to connect a portable audio device, such as an MP3 player or an iPod, to the vehicle's sound system. This requires the use of a 3.5 mm stereo audio patch cable.

- Push the MEDIA button on the faceplate then the “AUX” button on the touchscreen to change the mode to auxiliary device if the Audio Jack is connected, allowing the music from your portable device to play through the vehicle's speakers.

NOTE:

The functions of the portable device are controlled using the device itself, not the buttons on the radio. However, the volume may be controlled using the radio or portable device.

Hard Disk Drive (HDD) Operation

- The Hard Disk Drive (HDD) mode gives you access to the audio files on the internal hard disk drive. It functions similar to a CD player, with the exception that the internal HDD can hold more tracks.
- It is also possible to import display pictures to the internal hard disk drive. The pictures can be displayed on the right half of the radio screen.
- Before using the HDD mode, you will need to copy songs and pictures to the internal hard drive. Songs and pictures can be added to the hard drive by using a CD or USB device (e.g. thumb drive or memory stick).

NOTE:

- HDD supports only .jpg/JPEG formats for photos.
- WMA/MP3 Files and Selective Songs from a CD can also be added to the HDD. See the Uconnect 430/430N User's Manual for more information.

Copying Music From CD

- Push the LOAD button on the faceplate.
- Insert a disc, then push the MY FILES button on the faceplate. Select the "MY MUSIC" button on the touchscreen.
- Press the "Add Music Files to HDD" button on the touchscreen, then press the "Disc" button on the touchscreen in the next screen to start the process.

NOTE:

- You might need to select the folder or title depending on the CD, then push "DONE" to start the copy process.
- The copy progress is shown in the lower left corner of the screen.

**Copying Music From CD****Copying Music From USB**

- The USB port on the radio face plate allows you to copy files to your hard drive. To access, lift up on the cover.
- Insert a USB device (e.g. thumb drive or memory stick), then select the "MY MUSIC" button on the touchscreen.
- Press the "Add Music Files to HDD" button on the touchscreen, then press the "Front USB" button on the touchscreen in the next screen.
- Select the folders or titles you would like to copy, then press the "SAVE" button on the touchscreen to start the copy process.
- To copy all of the titles, press the "ALL" button on the touchscreen then press the "SAVE" button on the touchscreen.

**Copying Music From USB****NOTE:**

The copy progress is shown in the lower left corner of the screen.

Copying Pictures To The HDD

- Insert either a CD or a USB device containing your pictures in JPEG format.
- Push the MY FILES button on the faceplate.
- Press the “My Pictures” button on the touchscreen to get an overview of the currently stored images, then press the “Add” button on the touchscreen.
- Press the “Disc” or “USB” button on the touchscreen, then select the folders and pictures you wish to copy to the HDD. Use the “PAGE” buttons on the touchscreen to page through the list of pictures.
- Press the desired pictures or press the “All” button on the touchscreen for all pictures. Confirm your selections by pressing the “SAVE” button on the touchscreen.

NOTE:

The copy progress is shown in the lower left corner of the screen.

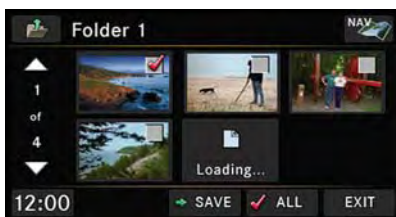

Copying Pictures To The HDD

Display A Picture On The Radio Screen

- Once the import is complete, the pictures will then be available in the “MY PICTURES” screen.
- Push the MY FILES button on the faceplate, then press the “My Pictures” button on the touchscreen. Press the desired picture, press the “Set as Picture View” button on the touchscreen and then press the “Exit” button on the touchscreen. Lastly push the MENU button on the faceplate and press the “Picture View” button on the touchscreen to display the chosen picture on the radio screen.

NOTE:

- A check mark in the My Pictures screen indicates the currently used picture.
- You can also delete pictures by pressing the “Delete” button on the touchscreen.

Playing Music From The HDD

- Push the MEDIA button on the faceplate to display the media source tabs at the top of the screen. Press the “HDD” button on the touchscreen. Press the desired track button on the touchscreen to play or press the “SEARCH/BROWSE” button on the touchscreen to search by artist, by album, by song, by genre, from a folder, or from Favorites.



Playing Music From The HDD

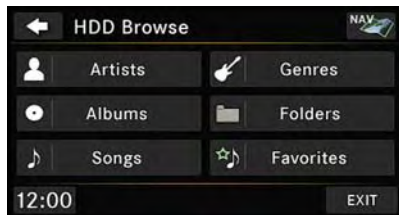

Browsing Music From The HDD

Cleaning Your Touchscreen Radio

- If necessary, use a dry micro fiber lens cleaning cloth dampened with a cleaning solution such as isopropyl alcohol or an isopropyl alcohol and water solution ratio of 50:50. Always follow the solvent manufacturer's precautions and directions.

CAUTION!

Do not spray any liquid or caustic chemicals directly on the screen. Use a clean and dry micro fiber lens cleaning cloth to clean the touchscreen.

Garmin Navigation

- Uconnect 430N integrates Garmin's consumer-friendly navigation into your vehicle. Garmin Navigation includes a database with over six million points of interest.
- Press the "NAV" button in the upper right corner of the touchscreen to access the Navigation system.



Garmin Navigation

Changing The Navigation Voice Prompt Volume

1. Program a destination.
2. While traveling on your route, press the upper left area of the map screen where your next turn is displayed.
3. The Navigation system will then repeat the distance to your next turn.
4. While the Navigation system is speaking, use the ON/OFF VOLUME rotary knob to adjust the volume to a comfortable level. Please note the volume setting for Navigation Voice Prompt is different than the audio system.

NOTE:

For your own safety and the safety of others, it is not possible to use certain features while the vehicle is in motion.

Main Navigation Menu

Finding Points Of Interest

- From the main Navigation menu, press the "Where To?" button on the touchscreen, then press the "Points of Interest" button on the touchscreen.
- Select a Category, then a subcategory, if necessary.
- Select your destination and press the "Go" button on the touchscreen.



Main Navigation Menu

Finding A Place By Spelling The Name

- From the Main Navigation Menu press the “Where To?” button on the touchscreen. Next, press the “Points of Interest” button on the touchscreen then press the “Spell Name” button on the touchscreen.
- Enter the name of your destination.
- Press the “Done” button on the touchscreen.
- Select your destination and press the “Go” button on the touchscreen.

Entering A Destination Address

- From the main Navigation menu press the “Where To?” button on the touchscreen, then press the “Address” button on the touchscreen.
- Follow the on-screen prompts to enter the address then press the “Go” button on the touchscreen.

Setting Your Home Location

- From the main Navigation menu press the "Tools" icon. Next select the "My Data" folder icon. Then select "Set Home Location."
- You may enter your address directly, use your current location as your home address, or choose from recently found locations.

Edit Home Location

- From the main Navigation menu press the “Where To?” button on the touchscreen, then press the "Tools" icon. Next, press the "My Data" folder.
- You may enter a new address directly, use your current location or choose from recently found locations.

Go Home

- A Home location must be saved in the system. From the Main Navigation menu, press the “Where To?” button on the touchscreen, then press the “Go Home” button on the touchscreen.

Following Your Route

Your route is marked with a magenta line on the map. If you depart from the original route, your route is recalculated. A speed limit icon could appear as you travel on major roadways.

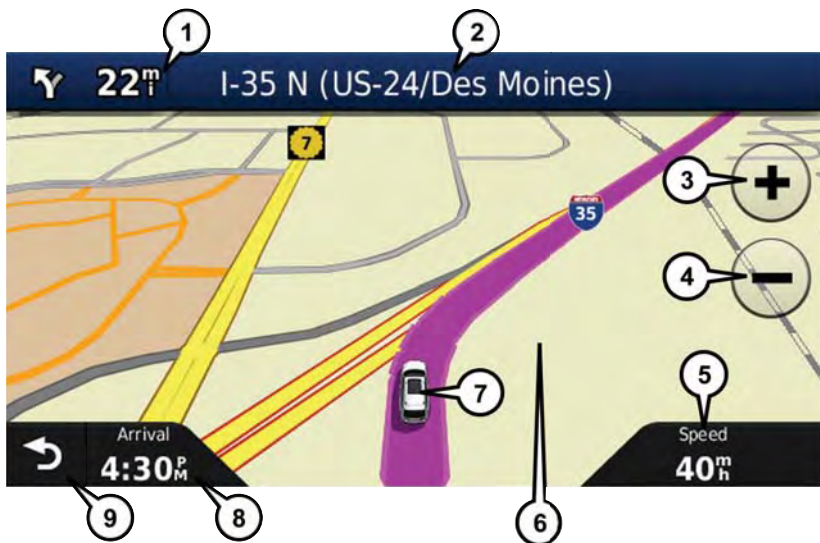

Following Your Route

- 1 — Distance To Next Turn
- 2 — Current Location
- 3 — Zoom In
- 4 — Zoom Out
- 5 — Current Speed

- 6 — Drag Map For Different View
- 7 — Your Location On The Map
- 8 — Estimated Time Of Arrival
- 9 — Navigation Main Menu

Adding A Via Point

To add a stop between the current location and the end destination (Via Point) you must be navigating a route.

- Press the “back arrow” icon multiple times to return to the Main Navigation menu.
- Press the “Where To?” button on the touchscreen, then search for the additional stop. Select the destination you wish to add from the given search results.
- Press the “Go” button on the touchscreen, then press “Add as a Via Point” button on the touchscreen and press the “Done” button on the touchscreen.

Taking A Detour

To take a detour you must be navigating a route.

- Press the “back arrow” icon button on the touchscreen multiple times to return to the Main Navigation menu.
- Press the “Detour” button on the touchscreen.

NOTE:

If the route you are currently taking is the only reasonable option, the device might not calculate a detour.

Acquiring Satellites

The GPS Satellite strength bars indicate the strength of your satellite reception.

- Acquiring satellite signals can take a few minutes. When at least one of the bars is green, your device has acquired satellite signals.
- You may experience delays receiving satellite signals when in areas with an obstructed view to the sky, such as garages, tunnels, or large cities with tall buildings.

SiriusXM SATELLITE RADIO/TRAVEL LINK

- SiriusXM Travel Link requires a subscription, sold separately after the five (5) year trial subscription included with your vehicle purchase.
- SiriusXM Travel Link is only available in the United States.
- The following describes features that are available when in SiriusXM Satellite Radio mode.
- To access SiriusXM Satellite Radio, push the RADIO/MEDIA or RADIO button on the faceplate, then press the “SAT” button on the touchscreen.

Info

- Press the “i” button on the touchscreen to view detailed information about the current Sirius XM Satellite channel.

SiriusXM Parental Controls

- SiriusXM offers the option to permanently block selected channels. Call 1-888-539-7474 and request the Family Package.
- Push the “MENU” button on the faceplate while in SiriusXM Satellite Radio Mode, then press the “Channel Lock” to enable and/or disable desired channels. The SEEK and SCAN function will then only display channels without Channel lock.

Search/Browse

- Press the “magnifying glass” button on the touchscreen to search/browse the SiriusXM channel listing by Favorites and Categories such as Song, Artist and Channel Name. The Search/Browse also allows you to manage your Favorites.

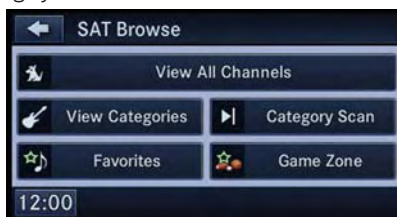

SAT Browse

SiriusXM Satellite Radio Favorites (SAT Favorites)

- You can save 50 favorite songs and 50 favorite artists.
- Press the “Add Favorite” button on the touchscreen to add either the song or the artist of the currently playing program to the SAT Favorites list. The favorite star will appear in the upper right corner, below the “SAT” button on the touchscreen.
- You will see a favorite star indicator in the upper right side of the screen below the “SAT” button on the touchscreen and a pop up will alert you that a favorite song or artist is currently playing on one of the SiriusXM satellite radio channels.



Manage SAT Favorites

NOTE:

Refer to your Uconnect Supplement Manual for more information.



Favorites Alert

Display SAT Favorites List

- Press the “Search/Browse” button on the touchscreen and select “Favorites” from the SAT Browse screen.
- Press the desired favorites button on the touchscreen to switch the SAT tuner to the corresponding channel.

You may use the “LIST” button on the touchscreen to toggle between:

- Favorite Songs
- Favorite Artists
- Currently playing favorites

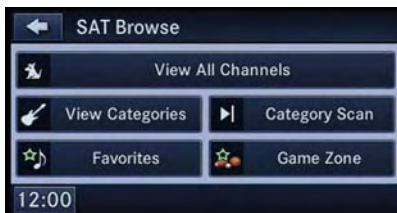

SAT Browse

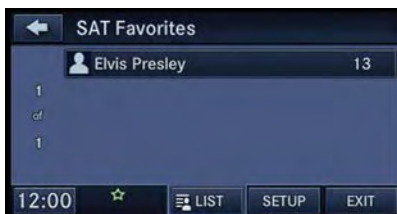

SAT Favorites

Replay

- While you are in SAT mode, you can replay 44 minutes of the current SiriusXM channel (when the channel is changed, this audio buffer is erased). Push the REPLAY button to listen to the stored audio.
- You can press the on-screen controls to pause and rewind audio playback, press the SCAN button to preview each of the tracks stored in the buffer, or select a track from the list.

The time displayed below the bar indicates how much time is present between the current buffer play position and the live broadcast.



SAT Mode Replay

Replay Option	Option Description
Play/Pause	Press to pause content playback. Press Pause/Play again to resume playback.
Rewind/RW	Rewinds the channel content in steps of five seconds. Press and hold to rewind continuously, then release to begin playing content at that point.

Replay Option	Option Description
Fast Forward/FW	Forwards the content, and works similarly to Rewind/RW. However, Fast Forward/FW can only be used when content has been previously rewound.
Replay Time	Displays the amount of time in the upper center of the screen by which your content lags the live channel.
Live	Resumes playback of live content at any time while replaying rewind content.

SiriusXM Travel Link (Uconnect 430N Only)

- SiriusXM Travel Link brings a wealth of useful information into your vehicle and right to your fingertips.
- To access Travel Link, push the MENU button on the faceplate, then the “Travel Link” button on the touchscreen.



SiriusXM Travel Link

1 – Favorites	View and store your favorite location, theater and sport teams for quick access.
2 – Forecast	View detailed weather conditions, forecasts and ski/snowboarding conditions at resorts.
3 – Ski Info	View ski and snowboarding conditions at ski resorts.
4 – Fuel Prices	View detailed price information for fuel stations.
5 – Movies	View information on movies that are playing at theaters.
6 – Sports	View sports scores and upcoming events for all major sports.

NOTE:

- SiriusXM Travel Link requires a subscription, sold separately after the five (5) year trial subscription included with your vehicle purchase.
- SiriusXM Travel Link is only available in the United States.

STEERING WHEEL AUDIO CONTROLS

The steering wheel audio controls are located on the rear surface of the steering wheel.

Right Switch

- Push the switch up or down to increase or decrease the volume.
- Push the button in the center to change modes AM/FM/CD/SAT.

Left Switch

- Push the switch up or down to search for the next listenable station.
- Push the button in the center to select the next preset station.



Steering Wheel Audio Controls

iPod/USB/MP3 CONTROL

There are many ways to play music from iPod/MP3 players or USB devices through your vehicle's sound system.

- The remote USB port, located within the upper glove compartment, allows you to plug an iPod into the vehicle's sound system.

Non-Touchscreen Radios: To hear audio from devices connected to the USB port, push the "AUX" button faceplate.

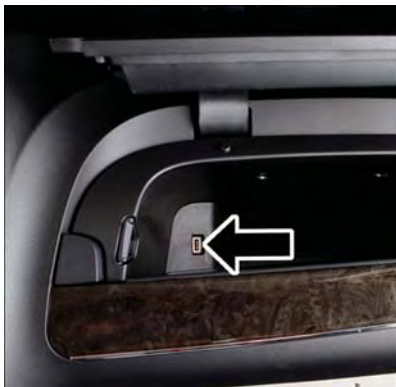

Remote USB Port

Touchscreen Radios: To hear audio from devices connected to the USB port, Push the “MEDIA” button on the faceplate, then press the “AUX” or “iPod” button on the touchscreen.

When connected to this feature:

- The iPod can be controlled using the radio buttons to Play, Browse, and List the iPod or external devices contents.
- The iPod battery charges when plugged into the USB port (if supported by the specific audio device).
- Compatible iPod devices may also be controllable using voice commands. Refer to the Owner's Manual on the DVD for details.



iPod/USB/MP3 Control

NOTE:

The USB port supports certain Mini, Classic, Nano, Touch, and iPhone devices. The USB port also supports playing music from compatible external USB Mass Storage Class memory devices. For supported audio file formats, refer to the USB Port section in the Owner's Manual on the DVD. Refer to UconnectPhone.com for a list of tested iPods. Some iPod software versions may not fully support the USB port features. Please visit Apple's website for iPod software updates.

WARNING!

Do not plug in or remove the iPod or external device while driving. Failure to follow this warning could result in a collision.

UCONNECT PHONE

The Uconnect Phone is a voice-activated, hands-free, in-vehicle communications system with Voice Command Capability that allows you to dial a phone number with your mobile phone using simple voice commands (see Voice Command section).

- To determine if your vehicle is equipped with Uconnect Phone, push the “Uconnect Phone” button  located on the radio faceplate. If your vehicle has this feature, you will hear a voice prompt. If not, you will see a message on the radio “Uconnect Phone not available.”

NOTE:

To access the tutorial, push the “Uconnect Phone” button . After the BEEP, say “tutorial.” Push any button on the faceplate, or press any button on the touchscreen, to cancel the tutorial.

- Refer to your vehicle Owner's Manual on the DVD for further details.

NOTE:

The Uconnect Phone requires a mobile phone equipped with the Bluetooth Hands-Free Profile, Version 1.0 or higher. For Uconnect Customer Support: U.S. residents - visit UconnectPhone.com or call 1-877-855-8400. Canadian residents - visit UconnectPhone.com or call, 1-800-465-2001 (English) or 1-800-387-9983 (French). This site will provide specific instructions based on the type of mobile phone being paired.

Phone Pairing

NOTE:

Pairing is a one - time initial setup before using the phone. Prior to starting the pairing procedure ensure all additional phones within the vehicle have their Bluetooth disabled.

1. Activate Bluetooth on the mobile phone you are pairing.
2. Push the “Phone”  button.
3. Wait for the “ready” prompt and BEEP.
4. After the BEEP, say ”setup” or “Uconnect device setup.”
5. After the BEEP, say “device pairing.”
6. After the BEEP, say “pair a device.”
7. Follow the audible prompts.

- You will be asked to say a four-digit Personal Identification Number (PIN), which you will later need to enter into your mobile phone. You can say any four-digit PIN. You will not need to remember this PIN after the initial pairing process.



Mobile Phone Pairing

- You will then be prompted to give the phone pairing a name (each phone paired should have a unique name).
- Next you will be asked to give this new pairing a priority of 1 through 7 (up to seven phones may be paired); 1 is the highest and 7 is the lowest priority. The system will only connect to the highest priority phone that exists within the proximity of the vehicle.
- You will then need to start the pairing procedure on your cell phone. Follow the Bluetooth instructions in your cell phone Owner's Manual to complete the phone pairing setup.

Phonebook

Phonebook Download — Automatic Phonebook Transfer From Mobile Phone

If equipped and specifically supported by your phone, Uconnect Phone automatically downloads names (text names) and number entries from your mobile phone's phonebook. Specific Bluetooth Phones with Phone Book Access Profile may support this feature. Automatic Transfer is indicated by a green arrow at the bottom of the screen. See UconnectPhone.com for supported phones.

- Automatic download and update, if supported, begins as soon as the Bluetooth wireless phone connection is made to the Uconnect Phone. For example, after you start the vehicle.



Uconnect myPHONE

NOTE:



The mobile phone may require authorization prior to download.

- A maximum of 1,000 entries per phone will be downloaded and updated every time a phone is connected to the Uconnect Phone.
- Depending on the maximum number of entries downloaded, there may be a short delay before the latest downloaded names can be used. Until then, if available, the previously downloaded phonebook is available for use.
- Only the phonebook of the currently connected mobile phone is accessible.
- Only the mobile phone's phonebook is downloaded. The SIM card phonebook is not part of the Mobile phonebook.
- This downloaded phonebook cannot be edited or deleted on the Uconnect Phone. These can only be edited on the mobile phone. The changes are transferred and updated to Uconnect Phone on the next phone connection.

Making A Phone Call

- Push the "Phone" button .
- After the BEEP, say "dial" (or "call" a name).
- After the BEEP, say number (or name).

Receiving A Call — Accept (And End)

- When an incoming call rings/is announced on Uconnect, push the "Phone" button .
- To end a call, push the "Phone" button .

Mute (Or Unmute) Microphone During Call

- During a call, push the "Voice Command" button .
- After the BEEP, say "mute" (or "mute off").

Transfer Ongoing Call Between Handset And Vehicle

- During a call, push the “Voice Command” button .
- After the BEEP, say “transfer call.”

Changing The Volume

- Start a dialogue by pushing the “Phone” button , then adjust the volume during a normal call.
- Use the radio ON/OFF VOLUME rotary knob to adjust the volume to a comfortable level while the Uconnect system is speaking. Please note the volume setting for Uconnect is different than the audio system.



WARNING!

- Any voice commanded system should be used only in safe driving conditions following applicable laws regarding phone use. Your attention should be focused on safely operating the vehicle. Failure to do so may result in a collision causing you and others to be severely injured or killed.
- In an emergency, to use Uconnect Phone, your mobile phone must be:
 - turned on
 - paired to Uconnect Phone
 - have network coverage

UCONNECT VOICE COMMAND

Voice Command Operation

The Uconnect Voice Command system allows you to control your AM, FM radio, satellite radio, disc player, HDD, Uconnect Phone, a memo recorder, and supported portable media devices.



- When you push the “Voice Command” button  located on the radio faceplate or steering wheel, you will hear a beep. The beep is your signal to give a command. If you do not say a command within a few seconds, the system will present you with a list of options. If you ever want to interrupt the system while it lists options, push the “Voice Command” button , listen for the BEEP, and say your command.

NOTE:

U.S. residents visit driveuconnect.com for more info on which voice command features apply to your vehicle. Canadian residents visit driveuconnect.ca for more info on which voice command features apply to your vehicle.

- Start a dialogue by pushing the “Voice Command” button  , you will hear a beep. The beep is your signal to give a command. Below are a list of voice commands for each of the different modes:

While In:	Voice Command Example:
Main Menu	“Radio AM” (to switch to the AM radio mode)
	“Radio FM” (to switch to the FM radio mode)
	“Satellite Radio” (to switch to the Satellite radio mode)
	“Disc” (to switch to the disc mode)
	“USB” (to switch to the USB mode)
	“Bluetooth Streaming” (to switch to the Bluetooth Streaming mode)
	“Memo” (to switch to the memo recorder)
Radio Mode	“System Setup” (to switch to system setup)
	“Frequency” (to change the frequency)
	“Next Station” (to select the next station)
	“Previous Station” (to select the previous station)
	“Main Menu” (to switch to the main menu)
SiriusXM Satellite Radio Mode	“Radio Menu” (to switch to the radio menu)
	“Channel Number” (to change the channel by its spoken number)
	“Next Channel” (to select the next channel)
	“Previous Channel” (to select the previous channel)
	“List Channel” (to hear a list of available channels)
	“Channel Name” (to change the channel by its spoken name)
	“Select Name” (to say the name of a channel)
Disc Mode	“Radio Menu” (to switch to the radio menu)
	“Main Menu” (to switch to the main menu)
	“Track” (#) (to change the track)
	“Next Track” (to play the next track)
	“Previous Track” (to play the previous track)
	“Main Menu” (to switch to the main menu)

While In:	Voice Command Example:
Memo Mode	To switch to the voice recorder mode, say "Memo." The following are common voice commands for this mode: "New Memo" (to record a new memo) — During the recording, you may push the Voice Command button  to stop recording. You proceed by saying one of the following commands:
	— "Save" (to save the memo)
	— "Continue" (to continue recording)
	— "Delete" (to delete the recording)
	— "Play Memos" (to play previously recorded memos) — During the playback you may push the Voice Command button  to stop playing memos. You proceed by saying one of the following commands:
	— "Repeat" (to repeat a memo)
	— "Next" (to play the next memo)
	— "Previous" (to play the previous memo)
	— "Delete" (to delete a memo)
— "Delete All" (to delete all memos)	

Voice Text Reply

If equipped with Uconnect Voice Command, your Uconnect 430N radio may be able to play incoming Short Message Service (SMS) messages (text messages) through the vehicle's sound system. It also allows you to respond by selecting from various predefined phrases.

NOTE:

Not all phones are compatible with this feature. Refer to the phone compatibility list at UconnectPhone.com. Connected mobile phones must be bluetooth-compatible and paired with your radio.

- Push the "Voice Command" button  and after the BEEP, say "SMS" to get started.

NOTE:

To access the tutorial, push the "Voice Command" button . After the BEEP, say "tutorial." Push any button on the faceplate or press any button on the touchscreen to cancel the tutorial.

WARNING!

Any voice commanded system should be used only in safe driving conditions following applicable laws regarding phone use. Your attention should be focused on safely operating the vehicle. Failure to do so may result in a collision causing you and others to be severely injured or killed.

BLUETOOTH STREAMING AUDIO

If equipped with Uconnect Voice Command, your Bluetooth-equipped iPod devices, cell phones or other media players, may also be able to stream music to your vehicle's speakers. Your connected device must be Bluetooth-compatible, and paired with your radio (see UconnectPhone.com for pairing instructions).

Non-Touchscreen Radios: Push the AUX button on the faceplate until "BT" or "Audio Streaming" is displayed on the radio screen.

Touchscreen-Radios: Push the RADIO/MEDIA or MEDIA button on the faceplate and then press the "AUX" button on the touchscreen.



Bluetooth Streaming Audio

VIDEO ENTERTAINMENT SYSTEM (VES)

System Operation

The screen(s) are located in the overhead compartment console. To lower a screen, push the release button located in the center of the console rear of the screen.

The system may be controlled by the front seat occupants using either the radio or DVD player controls, or by the rear seat occupants using the remote control.

The video screen displays information in a split screen format. The left side of the screen is referred to as Channel 1 and the right side of the screen is referred to as Channel 2. All modes except video modes are displayed in a split screen format.

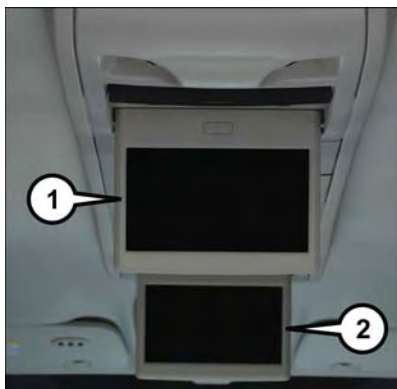

Video Entertainment System (VES)

1 – 3rd Row Screen

2 – 2nd Row Screen

- To use the headphones, push the power button located on the right ear cup. Select the channel on the headphones (1 or 2) which corresponds to the channel selected on the desired video screen.
- To receive VES audio through the vehicle's sound system, press the VES button on the touchscreen.

Operation Of The Touchscreen Radio/DVD Player/Blu-Ray Player

To view a DVD/Blu-ray, push the OPEN/CLOSE or LOAD button on the faceplate and insert the disc or insert the disc into the optional DVD/Blu-ray player. Playback will begin automatically after the DVD/Blu-ray is recognized by the disc drive. If playback does not begin automatically when the disc is inserted into the DVD/Blu-ray player push the PLAY button. If playback does not begin automatically after the disc is inserted into the touchscreen radio follow these steps:

- Push the MENU button on the faceplate, then press the Rear VES button on the touchscreen. If a chapter list appears on the right side of the screen, press the HIDE LIST button on the touchscreen to display the Rear VES control screen.
- Press the “1” button on the touchscreen to select an audio channel, then press the “DISC” button on the touchscreen in the MEDIA column.

Operation Of The Remote Control

The remote control operates similarly to any DVD remote you may have used before and allows the rear seat passengers to change stations, tracks, discs and audio/video modes.

The remote control is designed to control either channel by using the selector switch located on the right side of the remote.

Connect the video game or other external media devices to the AUX jacks following the color coding for the VES jacks.

- Pushing the power button will turn the VES system ON/OFF.
- Pushing the mode button causes the MODE SELECTION menu to appear on the VES screen. Use the remote control arrow buttons to scroll through the available modes, and then push ENTER to select the desired mode.

Auxiliary Audio/Video Input Jacks

The AUX jacks are located on the drivers side rear trim panel behind the sliding door.



Connect the video game or other external media devices to the AUX jacks following the color coding for the VES jacks.

Using either the touchscreen radio or remote control, select AUX from the REAR VES CONTROL or the MODE SELECTION screen.

Refer to the Uconnect Multimedia – Video Entertainment System (VES) section in the vehicle Owner's Manual on the DVD for further details.

ELECTRONIC VEHICLE INFORMATION CENTER (EVIC)

The EVIC features a driver interactive display that is located in the instrument cluster. Pushing the controls on the left side of the steering wheel allows the driver to select vehicle information and Personal Settings. Refer to “Programmable Features” located in this guide for further information.

- Push the **UP**  arrow button to scroll upward through the main menus (Fuel Economy, Vehicle Speed, Trip Info, Vehicle Info, Messages, Units, System Set-Up, Turn Menu Off) and sub menus.
- Push the **DOWN**  arrow button to scroll downward through the main menus and sub menus.
- Push the **RIGHT**  arrow button for access to main menus, sub menus or to select a personal setting in the setup menu.
- Push the **BACK** button to scroll back to a previous menu or sub menu.



EVIC Controls

Compass Calibration



This compass is self-calibrating, which eliminates the need to set the compass manually. When the vehicle is new, the compass may appear erratic, and the EVIC will display “CAL” until the compass is calibrated.

You may also calibrate the compass by completing one or more 360 degree turns (in an area free from large metal or metallic objects) until the “CAL” message displayed in the EVIC turns off. The compass will now function normally.

PROGRAMMABLE FEATURES

Electronic Vehicle Information Center (EVIC) — If Equipped

Personal Settings allows you to set and recall features when the transmission is in PARK. If the transmission is out of PARK or the vehicle begins moving, a warning message SYSTEM SETUP NOT AVAILABLE VEHICLE NOT IN PARK displays when you try to select “System Setup” from the main menu.

The EVIC can be used to program the following Personal Settings. Push the **RIGHT**  arrow button until Personal Settings displays, then push the **DOWN**  arrow button to scroll through the settings. Push the **RIGHT**  arrow button to change the setting.

- Select Language
- Nav-Turn By Turn
- Auto Lock Doors
- Auto Unlock Doors
- Remote Unlock Sequence
- Remote Start Comfort Sys.
- Horn with Remote Lock
- Flash Lamps With Lock
- Headlamp Off Delay
- Headlamps With Wipers
- Key-Off Power Delay
- Illuminated Approach
- Hill Start Assist
- Flashers with Sliding Door
- Calibrate Compass
- Compass Variance
- Park Assist - If Equipped
- Automatic High Beams - If Equipped
- Keyless Enter-N-Go - If Equipped
- RKE Linked To Memory - If Equipped

Key Fob Programmable Features

The following features may also be programmed by using the Key Fob transmitter or the ignition and driver's door lock switch. Refer to “Uconnect Settings” in “Understanding Your Instrument Panel” in the Owner's Manual on the DVD for further information.

NOTE:

Pushing the LOCK button while you are inside the vehicle will activate the Vehicle Security Alarm. Opening a door with the Vehicle Security Alarm activated will cause the alarm to sound. Push the UNLOCK button to deactivate the Vehicle Security Alarm.

Unlock On First Press

To unlock either the driver's side, or all doors, on the first press of the UNLOCK button:

- Push and hold the LOCK button for at least four seconds, but no longer than 10 seconds. Then, push and hold the UNLOCK button while still holding the LOCK button.
- Release both buttons at the same time.

Auto Unlock Doors On Exit

To have all of the vehicle doors unlock when any door is opened:

- Enter your vehicle and close all the doors, and fasten your seat belt.
- Cycle the ignition switch between the LOCK and ON position four times, ending in the LOCK position (do not start the engine).
- Push the power door UNLOCK switch to unlock the doors. A single chime will indicate that programming is complete.

Sound Horn With Lock

To turn the horn chirp on or off when the doors are locked:

- Push the LOCK button for at least four seconds, but no longer than 10 seconds. Then, push the PANIC button while still holding the LOCK button.
- Release both buttons at the same time.

Flashing Lights With Lock

The turn signal lights flash when the doors are locked, which can be turned on or off. To turn this feature on or off:

- Push and hold the UNLOCK button and the LOCK button at the same time for at least four seconds, but no longer than 10 seconds.
- Release both buttons at the same time.

UNIVERSAL GARAGE DOOR OPENER (HomeLink)

HomeLink replaces up to three hand-held transmitters that operate devices such as garage door openers, motorized gates, lighting or home security systems. The HomeLink unit is powered by your vehicles 12 Volt battery.

The HomeLink buttons that are located in the overhead console or sunvisor designate the three different HomeLink channels.

The HomeLink indicator is located above the center button.

Before You Begin Programming HomeLink

Ensure that your vehicle is parked outside of the garage before you begin programming.

For efficient programming and accurate transmission of the radio-frequency signal, it is recommended that a new battery be placed in the hand-held transmitter of the device that is being programmed to the HomeLink system.

To erase the channels, place the ignition switch into the ON/RUN position, then push and hold the two outside HomeLink buttons (I and III) for up to 20 seconds or until the red indicator flashes.

NOTE:

Erasing all channels should only be performed when programming HomeLink for the first time. Do not erase channels when programming additional buttons.

If you have any problems, or require assistance, please call toll-free 1-800-355-3515 or, on the Internet at HomeLink.com for information or assistance.



HomeLink Buttons

Programming A Rolling Code

NOTE:

For programming Garage Door Openers that were manufactured after 1995. These Garage Door Openers can be identified by the “LEARN” or “TRAIN” button located where the hanging antenna is attached to the Garage Door Opener. It is NOT the button that is normally used to open and close the door. The name and color of the button may vary by manufacturer.

1. Place the ignition switch into the ON/RUN position.
2. Place the hand-held transmitter 1 to 3 inches (3 to 8 cm) away from the HomeLink button you wish to program while keeping the HomeLink indicator light in view.
3. Push and hold the HomeLink button you want to program while you push and hold the hand-held transmitter button.
4. Continue to hold both buttons and observe the indicator light. The HomeLink indicator will flash slowly and then rapidly after HomeLink has received the frequency signal from the hand-held transmitter. Release both buttons after the indicator light changes from slow to rapid.
5. At the garage door opener motor (in the garage), locate the “LEARN” or “TRAINING” button. This can usually be found where the hanging antenna wire is attached to the garage door opener motor. Firmly push and release the “LEARN” or “TRAINING” button.

NOTE:

You have 30 seconds in which to initiate the next step after the LEARN button has been pushed.

6. Return to the vehicle and push the programmed HomeLink button twice (holding the button for two seconds each time). If the device is plugged in and activates, programming is complete.

NOTE:

If the device does not activate, push the button a third time (for two seconds) to complete the training.

7. To program the remaining two HomeLink buttons, repeat each step for each remaining button. DO NOT erase the channels.

Programming A Non-Rolling Code

NOTE:

For programming Garage Door Openers manufactured before 1995.

1. Place the ignition switch to the ON/RUN position.
2. Place the hand-held transmitter 1 to 3 inches (3 to 8 cm) away from the HomeLink button you wish to program while keeping the HomeLink indicator light in view.
3. Push and hold the HomeLink button you want to program while you push and hold the hand-held transmitter button.
4. Continue to hold both buttons and observe the indicator light. The HomeLink indicator will flash slowly and then rapidly after HomeLink has received the frequency signal from the hand-held transmitter. Release both buttons after the indicator light changes from slow to rapid.
5. Push and hold the programmed HomeLink button and observe the indicator light. If the indicator light stays on constantly, programming is complete and the garage door (or device) should activate when the HomeLink button is pushed.
6. To program the two remaining HomeLink buttons, repeat each step for each remaining button. DO NOT erase the channels.

Using HomeLink

To operate, push and release the programmed HomeLink button. Activation will now occur for the programmed device (e.g., garage door opener, gate operator, security system, entry door lock, home/office lighting, etc.). The hand-held transmitter of the device may also be used at any time.

WARNING!

- Your motorized door or gate will open and close while you are programming the universal transceiver. Do not program the transceiver if people or pets are in the path of the door or gate.
- Do not run your vehicle in a closed garage or confined area while programming the transceiver. Exhaust gas from your vehicle contains Carbon Monoxide (CO) which is odorless and colorless. Carbon Monoxide is poisonous when inhaled and can cause you and others to be severely injured or killed.

TRAILER TOWING WEIGHTS (MAXIMUM TRAILER WEIGHT RATINGS)

Engine/ Transmission	GCWR (Gross Combined Wt. Rating)	Frontal Area	Max. GTW (Gross Trailer Wt.)	Max. Tongue Wt.
3.6L/Automatic	8,750 lbs (3,969 kg)	40 sq ft (3.72 sq m)	Up to 2 persons & Luggage 3,600 lbs (1,633 kg) *	360 lbs (163 kg)
	8,750 lbs (3,969 kg)	40 sq ft (3.72 sq m)	3 to 5 persons & Luggage 3,350 lbs (1,519 kg) *	335 lbs (152 kg)
	8,750 lbs (3,969 kg)	40 sq ft (3.72 sq m)	6 to 7 persons & Luggage 3,000 lbs (1,360 kg) *	300 lbs (136 kg)
* For vehicles equipped with Fold-in-Floor seating, the Gross Trailer Weight must be reduced by 100 lbs (45 kg). Refer to local laws for maximum trailer towing speeds.				
NOTE: The trailer tongue weight must be considered as part of the combined weight of occupants and cargo, and should never exceed the weight referenced on the Tire and Loading Information placard.				

RECREATIONAL TOWING (BEHIND MOTORHOME, ETC.)

Towing Condition	Wheels OFF the Ground	All Models
Flat Tow	NONE	NOT ALLOWED
Dolly Tow	Front	OK
	Rear	NOT ALLOWED
On Trailer	ALL	OK

Recreational Towing — All Models

Recreational towing is allowed **ONLY** if the front wheels are **OFF** the ground. This may be accomplished using a tow dolly or vehicle trailer. If using a tow dolly, follow this procedure:

1. Properly secure the dolly to the tow vehicle, following the dolly manufacturer's instructions.
2. Drive the front wheels onto the tow dolly.
3. Firmly apply the parking brake. Place the transmission in PARK.
4. Properly secure the front wheels to the dolly, following the dolly manufacturer's instructions.
5. Release the parking brake.

CAUTION!
<ul style="list-style-type: none">• DO NOT flat tow this vehicle. Damage to the drivetrain will result.• Towing this vehicle in violation of the above requirements can cause severe transmission damage. Damage from improper towing is not covered under the New Vehicle Limited Warranty.

WHAT TO DO IN EMERGENCIES

ROADSIDE ASSISTANCE

Dial toll-free 1-800-521-2779 for U.S. Residents or 1-800-363-4869 for Canadian Residents.

- Provide your name, vehicle identification number, license plate number, and your location, including the telephone number from which you are calling.
- Briefly describe the nature of the problem and answer a few simple questions.
- You will be given the name of the service provider and an estimated time of arrival. If you feel you are in an “unsafe situation”, please let us know. With your consent, we will contact local police or safety authorities.

INSTRUMENT CLUSTER WARNING LIGHTS

– Low Fuel Warning Light

This warning light indicates when the fuel level reaches approximately 1.5 gal (5.8 L). This light will turn on and a single chime will sound.

– Charging System Light

This light shows the status of the electrical charging system. If the charging system light remains on, it means that the vehicle is experiencing a problem with the charging system.

We recommend you do not continue driving if the charging system light is on. Have the vehicle serviced immediately.

– Oil Pressure Warning Light

This light indicates low engine oil pressure. If the light turns on while driving, stop the vehicle and shut off the engine as soon as possible. A chime will sound when this light turns on.

We recommend you do not operate the vehicle or engine damage will occur. Have the vehicle serviced immediately.

– Anti-Lock Brake (ABS) Light

This light monitors the Anti-Lock Brake System (ABS).

If the light is not on during startup, stays on, or turns on while driving we recommend you contact the nearest authorized dealer and have the vehicle serviced immediately.

– Air Bag Warning Light

If the light is not on during startup, stays on, or turns on while driving have the vehicle serviced by an authorized dealer immediately.

WHAT TO DO IN EMERGENCIES

– Electronic Throttle Control (ETC) Indicator Light

This light informs you of a problem with the system.

If a problem is detected, the light will come on while the engine is running. Cycle the ignition when the vehicle has completely stopped and the shift lever is placed in the PARK position; the light should turn off.

If the light remains lit with the engine running, your vehicle will usually be drivable. However, see an authorized dealer immediately. If the light is flashing when the engine is running, immediate service is required, and you may experience reduced performance, an elevated/rough idle or engine stall, and your vehicle may require towing.

– Tire Pressure Monitoring System (TPMS) Light

Each tire, including the spare (if provided), should be checked monthly when cold and inflated to the inflation pressure recommended by the vehicle manufacturer on the vehicle placard or tire inflation pressure label. (If your vehicle has tires of a different size than the size indicated on the vehicle placard or tire inflation pressure label, you should determine the proper tire inflation pressure for those tires).

As an added safety feature, your vehicle has been equipped with a tire pressure monitoring system (TPMS) that illuminates a low tire pressure telltale when one or more of your tires is significantly under-inflated. Accordingly, when the low tire pressure telltale illuminates, you should stop and check your tires as soon as possible and inflate them to the proper pressure. Driving on a significantly under-inflated tire causes the tire to overheat and can lead to tire failure. Under-inflation also reduces fuel efficiency and tire tread life and may affect the vehicle's handling and stopping ability.

IF THE LIGHT STARTS FLASHING INDICATING A LOW TIRE PRESSURE, ADJUST THE AIR PRESSURE IN THE LOW TIRE TO THE AIR PRESSURE SHOWN ON THE VEHICLE PLACARD OR TIRE INFLATION PRESSURE LABEL LOCATED ON THE DRIVER'S DOOR.

NOTE:

AFTER INFLATION, THE VEHICLE MAY NEED TO BE DRIVEN FOR 20 MINUTES BEFORE THE FLASHING LIGHT WILL TURN OFF.

Please note that the TPMS is not a substitute for proper tire maintenance, and it is the driver's responsibility to maintain correct tire pressure, even if under-inflation has not reached the level to trigger illumination of the TPMS low tire pressure telltale.

Your vehicle has also been equipped with a TPMS malfunction indicator to indicate when the system is not operating properly. The TPMS malfunction indicator is combined with the low tire pressure telltale.

WHAT TO DO IN EMERGENCIES

When the system detects a malfunction, the telltale will flash for approximately one minute and then remain continuously illuminated. This sequence will continue upon subsequent vehicle start-ups as long as the malfunction exists. When the malfunction indicator is illuminated, the system may not be able to detect or signal low tire pressure as intended. TPMS malfunctions may occur for a variety of reasons, including the installation of replacement or alternate tires or wheels on the vehicle that prevent the TPMS from functioning properly. Always check the TPMS malfunction telltale after replacing one or more tires or wheels on your vehicle to ensure that the replacement or alternate tires and wheels allow the TPMS to continue to function properly.

NOTE:

Tire pressures change by approximately 1 psi (7 kPa) per 12° F (7° C) of air temperature change. Keep this in mind when checking tire pressure inside a garage, especially in the Winter. Example: If garage temperature is 68°F (20°C), and the outside temperature is 32°F (0°C), then the cold tire inflation pressure should be increased by 3 psi (21 kPa), which equals 1 psi (7 kPa) for every 12°F (7°C) for this outside temperature condition.

CAUTION!

The TPMS has been optimized for the original equipment tires and wheels. TPMS pressures and warning have been established for the tire size equipped on your vehicle. Undesirable system operation or sensor damage may result when using replacement equipment that is not of the same size, type, and/or style. Aftermarket wheels can cause sensor damage. Do not use tire sealant from a can, or balance beads if your vehicle is equipped with a TPMS, as damage to the sensors may result.

– Engine Temperature Warning Light

This light warns of an overheated engine condition.

If the light turns on or flashes continuously while driving, safely pull over and stop the vehicle. If the A/C system is on, turn it off. Also, shift the transmission into NEUTRAL and idle the vehicle. If the temperature reading does not return to normal, turn the engine off immediately and call for service.

We recommend that you do not operate the vehicle or engine damage will occur. Have the vehicle serviced immediately.

WARNING!

A hot engine cooling system is dangerous. You or others could be badly burned by steam or boiling coolant.

WHAT TO DO IN EMERGENCIES

– Seat Belt Reminder Light

When the ignition switch is first turned to the ON/RUN position, this light will turn on for four to eight seconds as a bulb check. During the bulb check, if the driver's seat belt is unbuckled, a chime will sound. After the bulb check or when driving, if the driver or front passenger seat belt remains unbuckled, the Seat Belt Indicator Light will flash or remain on continuously. Refer to "Seat Belt Systems" in "Things To Know Before Starting" in your Owner's Manual on the DVD for further information.

BRAKE – Brake Warning Light

This light monitors various brake functions, including brake fluid level and parking brake application. If the brake light turns on, it may indicate that the parking brake is applied, that the brake fluid level is low, or that there is a problem with the brake system master cylinder reservoir.

If the light remains on when the parking brake has been disengaged, and the fluid level is at the full mark on the master cylinder reservoir, it indicates a possible brake hydraulic system malfunction or that a problem with the Brake Booster has been detected by the Anti-Lock Brake System (ABS)/Electronic Stability Control (ESC) system. In this case, the light will remain on until the condition has been corrected. If the problem is related to the brake booster, the ABS pump will run when applying the brake, and a brake pedal pulsation may be felt during each stop.

The dual brake system provides a reserve braking capacity in the event of a failure to a portion of the hydraulic system. A leak in either half of the dual brake system is indicated by the Brake Warning Light, which will turn on when the brake fluid level in the master cylinder has dropped below a specified level. The light will remain on until the cause is corrected.

Vehicles equipped with the Anti-Lock Brake System (ABS) are also equipped with Electronic Brake Force Distribution (EBD). In the event of an EBD failure, the Brake Warning Light will turn on along with the ABS Light. Immediate repair to the ABS system is required.

Operation of the Brake Warning Light can be checked by turning the ignition switch from the OFF position to the ON/RUN position. The light should illuminate for approximately two seconds. The light should then turn off unless the parking brake is applied or a brake fault is detected. If the light does not illuminate, have the light inspected by an authorized dealer.

The light also will turn on when the parking brake is applied with the ignition switch in the ON/RUN position.

NOTE:

This light shows only that the parking brake is applied. It does not show the degree of brake application.

WARNING!

Driving a vehicle with the red brake light on is dangerous. Part of the brake system may have failed. It will take longer to stop the vehicle. You could have a collision. Have the vehicle checked immediately.

WHAT TO DO IN EMERGENCIES

– Malfunction Indicator Light (MIL)

Certain conditions, such as a loose or missing gas cap, poor fuel quality, etc., may illuminate the MIL after engine start. The vehicle should be serviced if the light stays on through several typical driving cycles. In most situations, the vehicle will drive normally and not require towing.

If the MIL flashes when the engine is running, serious conditions may exist that could lead to immediate loss of power or severe catalytic converter damage. We recommend you do not operate the vehicle. Have the vehicle serviced immediately.

– Electronic Stability Control (ESC) Indicator Light

If this indicator light flashes during acceleration, apply as little throttle as possible. While driving, ease up on the accelerator. Adapt your speed and driving to the prevailing road conditions. To improve the vehicle's traction when starting off in deep snow, sand or gravel, it may be desirable to switch the ESC system off.

INSTRUMENT CLUSTER INDICATOR LIGHTS

– Turn Signal Indicator

The arrows will flash with the exterior turn signals when the turn signal lever is operated. A tone will chime, and a EVIC message will appear if either turn signal is left on for more than 1 mile (1.6 km).

NOTE:

If either indicator flashes at a rapid rate, check for a defective outside light bulb.

– High Beam Indicator

Indicates that headlights are on high beam.

– Front Fog Light Indicator

This indicator will illuminate when the front fog lights are on.

– Vehicle Security Light

This light will flash rapidly for approximately 15 seconds when the vehicle security alarm is arming. The light will flash at a slower speed continuously after the alarm is set. The security light will also come on for about three seconds when the ignition is first turned on.

– Electronic Stability Control (ESC) OFF Indicator Light

The ESC Off mode is intended for off-highway or off-road use only and should not be used on any public roadways. In this mode, all TCS and ESC stability features are turned OFF. To enter the "Full Off" mode, push and hold the "ESC" switch for five seconds while the vehicle is stopped with the engine running. After five seconds, a chime will sound, the "ESC OFF" Indicator Light will illuminate, and the "ESC OFF" message will display in the vehicle cluster (left of the odometer). The "ESC OFF" message may appear in the Driver Information Display (DID). To turn ESC ON again, momentarily press the "ESC" switch.

WHAT TO DO IN EMERGENCIES

– Electronic Speed Control ON Indicator

This indicator will illuminate when the electronic speed control has been activated to the “ON” position.

– Electronic Speed Control SET Indicator

This indicator will illuminate when the cruising speed has been set.

OIL CHANGE REQUIRED

Your vehicle is equipped with an engine oil change indicator system. The Oil Change Required message will display in the EVIC display for approximately 10 seconds, after a single chime has sounded, to indicate the next scheduled oil change interval. The engine oil change indicator system is duty-cycle based, which means the engine oil change interval may fluctuate dependent upon your personal driving style.

Unless reset, this message will continue to display each time you turn the ignition switch to the ON/RUN position or cycle the ignition to the ON/RUN position if equipped with Keyless Enter-N-Go. To turn off the message temporarily, push and release the MENU button. To reset the oil change indicator system (after performing the scheduled maintenance), refer to the following procedure.

Vehicles Equipped With Keyless Enter-N-Go

1. Without pushing the brake pedal, push the ENGINE START/STOP button and cycle the ignition to the ON/RUN position (do not start the engine).
2. Fully depress the accelerator pedal, slowly, three times within 10 seconds.
3. Without pushing the brake pedal, push the ENGINE START/STOP button once to return the ignition to the OFF/LOCK position.

Vehicles Not Equipped With Keyless Enter-N-Go

1. Turn the ignition switch to the ON/RUN position (do not start the engine).
2. Fully depress the accelerator pedal, slowly, three times within 10 seconds.
3. Turn the ignition switch to the OFF/LOCK position.

NOTE:

If the indicator message illuminates when you start the engine, the oil change indicator system did not reset. If necessary, repeat these steps.

Resetting The Light After Servicing

Vehicles Equipped With Keyless Enter-N-Go

1. Without pushing the brake pedal, push the ENGINE START/STOP button and cycle the ignition to the ON/RUN position (do not start the engine).
2. Fully depress the accelerator pedal, slowly, three times within 10 seconds.
3. Without pushing the brake pedal, push the ENGINE START/STOP button once to return the ignition to the OFF/LOCK position.

WHAT TO DO IN EMERGENCIES

Vehicles Not Equipped With Keyless Enter-N-Go

1. Turn the ignition switch to the ON/RUN position (do not start the engine).
2. Fully depress the accelerator pedal, slowly, three times within 10 seconds.
3. Turn the ignition switch to the OFF/LOCK position.

NOTE:

- If the indicator message illuminates when you start the vehicle, the oil change indicator system did not reset. If necessary, repeat this procedure.
- Resetting the oil life can also be done within the "Oil Life" menu under "Vehicle Info."

IF YOUR ENGINE OVERHEATS

In any of the following situations, you can reduce the potential for overheating by taking the appropriate action:

- On the highways — slow down.
- In city traffic — while stopped, shift the transmission to NEUTRAL, but do not increase engine idle speed.

NOTE:

There are steps that you can take to slow down an impending overheat condition:

- If your air conditioner (A/C) is on, turn it off. The A/C system adds heat to the engine cooling system and turning the A/C off can help remove this heat.
- You can also turn the temperature control to maximum heat, the mode control to floor and the blower control to high. This allows the heater core to act as a supplement to the radiator and aids in removing heat from the engine cooling system.

CAUTION!

Driving with a hot cooling system could damage your vehicle. If the temperature gauge reads HOT (H), pull over and stop the vehicle. Idle the vehicle with the air conditioner turned off until the pointer drops back into the normal range. If the pointer remains on HOT (H), and you hear continuous chimes, turn the engine off immediately, and call for service.

WARNING!

You or others can be badly burned by hot engine coolant (antifreeze) or steam from your radiator. If you see or hear steam coming from under the hood, do not open the hood until the radiator has had time to cool. Never try to open a cooling system pressure cap when the radiator or coolant bottle is hot.

WHAT TO DO IN EMERGENCIES

TIRE SERVICE KIT

Small punctures up to 1/4 inch (6 mm) in the tire tread can be sealed with Tire Service Kit. Foreign objects (e.g., screws or nails) should not be removed from the tire. Tire Service Kit can be used in outside temperatures down to approximately -4°F (-20°C).

This kit will provide a temporary tire seal, allowing you to drive your vehicle up to 100 miles (160 km) with a maximum speed of 55 mph (90 km/h).

Tire Service Kit Storage

The Tire Service Kit is stowed behind the rear left side trim panel in the rear cargo area.

1. Open the liftgate.
2. Turn the two rear left side trim panel latches to release the trim panel.

Tire Service Kit Components And Operation

Using The Mode Select Knob And Hoses

Your Tire Service Kit is equipped with the following symbols to indicate the air or sealant mode.

-  **Selecting Air Mode**

Push in the Mode Select Knob (5) and turn to this position for air pump operation only. Use the Black Air Pump Hose (7) when selecting this mode.

-  **Selecting Sealant Mode**

Push in the Mode Select Knob (5) and turn to this position to inject the Tire Service Kit Sealant and to inflate the tire. Use the Sealant Hose (clear hose) (6) when selecting this mode.

-  **Using The Power Button**

Push and release the Power Button (4) once to turn On the Tire Service Kit. Push and release the Power Button (4) again to turn Off the Tire Service Kit.

-  **Using The Deflation Button**

Push the Deflation Button (2) to reduce the air pressure in the tire if it becomes over-inflated.

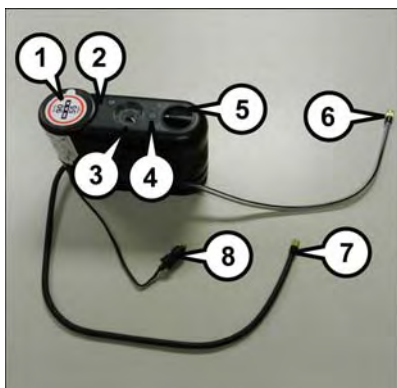

Tire Service Kit Components

- 1 — Sealant Bottle
- 2 — Deflation Button
- 3 — Pressure Gauge
- 4 — Power Button
- 5 — Mode Select Knob
- 6 — Sealant Hose (Clear)
- 7 — Air Pump Hose (Black)
- 8 — Power Plug (located on the bottom side of the Tire Service Kit)

WHAT TO DO IN EMERGENCIES

Tire Service Kit Usage Precautions

- Replace the Tire Service Kit Sealant Bottle (1) and Sealant Hose (6) prior to the expiration date (printed at the lower right hand corner on the bottle label) to assure optimum operation of the system. Refer to “Sealing a Tire with Tire Service Kit” section (F) “Sealant Bottle and Hose Replacement”.
- The Sealant Bottle (1) and Sealant Hose (6) are a one tire application use and need to be replaced after each use. Always replace these components immediately at your original equipment vehicle dealer.
- When the Tire Service Kit sealant is in a liquid form, clean water, and a damp cloth will remove the material from the vehicle or tire and wheel components. Once the sealant dries, it can easily be peeled off and properly discarded.
- For optimum performance, make sure the valve stem on the wheel is free of debris before connecting the Tire Service Kit.
- You can use the Tire Service Kit air pump to inflate bicycle tires. The kit also comes with two needles, located in the Accessory Storage Compartment (on the bottom of the air pump) for inflating sport balls, rafts, or similar inflatable items. However, use only the Air Pump Hose (7) and make sure the Mode Select Knob (5) is in the Air Mode when inflating such items to avoid injecting sealant into them. The Tire Service Kit Sealant is only intended to seal punctures less than 1/4 inch (6 mm) diameter in the tread of your vehicle.
- Do not lift or carry the Tire Service Kit by the hoses.

WARNING!

- Do not attempt to seal a tire on the side of the vehicle closest to traffic. Pull far enough off the road to avoid the danger of being hit when using the Tire Service Kit.
- Do not use Tire Service Kit or drive the vehicle under the following circumstances:
 - If the puncture in the tire tread is approximately 1/4 inch (6 mm) or larger.
 - If the tire has any sidewall damage.
 - If the tire has any damage from driving with extremely low tire pressure.
 - If the tire has any damage from driving on a flat tire.
 - If the wheel has any damage.
 - If you are unsure of the condition of the tire or the wheel.
- Keep Tire Service Kit away from open flames or heat source.
- A loose Tire Service Kit thrown forward in a collision or hard stop could endanger the occupants of the vehicle. Always stow the Tire Service Kit in the place provided. Failure to follow these warnings can result in injuries that are serious or fatal to you, your passengers, and others around you.
- Take care not to allow the contents of Tire Service Kit to come in contact with hair, eyes, or clothing. Tire Service Kit sealant is harmful if inhaled, swallowed, or absorbed through the skin. It causes skin, eye, and respiratory irritation. Flush immediately with plenty of water if there is any contact with eyes or skin. Change clothing as soon as possible, if there is any contact with clothing.
- Tire Service Kit Sealant solution contains latex. In case of an allergic reaction or rash, consult a physician immediately. Keep Tire Service Kit out of reach of children. If swallowed, rinse mouth immediately with plenty of water and drink plenty of water. Do not induce vomiting! Consult a physician immediately.

WHAT TO DO IN EMERGENCIES

Sealing A Tire With Tire Service Kit

(A) Whenever You Stop To Use Tire Service Kit:

1. Pull over to a safe location and turn on the vehicle's Hazard Warning flashers.
2. Verify that the valve stem (on the wheel with the deflated tire) is in a position that is near to the ground. This will allow the Tire Service Kit Hoses (6) and (7) to reach the valve stem and keep the Tire Service Kit flat on the ground. This will provide the best positioning of the kit when injecting the sealant into the deflated tire and running the air pump. Move the vehicle as necessary to place the valve stem in this position before proceeding.
3. Place the transmission in PARK (auto transmission) or in Gear (manual transmission) and place the ignition in the OFF position.
4. Set the parking brake.

(B) Setting Up To Use Tire Service Kit:

1. Push in the Mode Select Knob (5) and turn to the Sealant Mode position.
2. Uncoil the Sealant Hose (6) and then remove the cap from the fitting at the end of the hose.
3. Place the Tire Service Kit flat on the ground next to the deflated tire.
4. Remove the cap from the valve stem and then screw the fitting at the end of the Sealant Hose (6) onto the valve stem.
5. Uncoil the Power Plug (8) and insert the plug into the vehicle's 12 Volt power outlet.

NOTE:

Do not remove foreign objects (e.g., screws or nails) from the tire.

(C) Injecting Tire Service Kit Sealant Into The Deflated Tire:

- Always start the engine before turning ON the Tire Service Kit.

NOTE:

Manual transmission vehicles must have the parking brake engaged and the gear selector in NEUTRAL.

- After pushing the Power Button (4), the sealant (white fluid) will flow from the Sealant Bottle (1) through the Sealant Hose (6) and into the tire.

NOTE:

Sealant may leak out through the puncture in the tire.

WHAT TO DO IN EMERGENCIES

If the sealant (white fluid) does not flow within 0 – 10 seconds through the Sealant Hose (6):

1. Push the Power Button (4) to turn Off the Tire Service Kit. Disconnect the Sealant Hose (6) from the valve stem. Make sure the valve stem is free of debris. Reconnect the Sealant Hose (6) to the valve stem. Check that the Mode Select Knob (5) is in the Sealant Mode position and not Air Mode. Push the Power Button (4) to turn On the Tire Service Kit.
2. Connect the Power Plug (8) to a different 12 Volt power outlet in your vehicle or another vehicle, if available. Make sure the engine is running before turning ON the Tire Service Kit.
3. The Sealant Bottle (1) may be empty due to previous use. Call for assistance.

NOTE:

If the Mode Select Knob (5) is on Air Mode and the pump is operating, air will dispense from the Air Pump Hose (7) only, not the Sealant Hose (6).

If the sealant (white fluid) does flow through the Sealant Hose (6):

1. Continue to operate the pump until sealant is no longer flowing through hose (typically takes 30 - 70 seconds). As the sealant flows through the Sealant Hose (6), the Pressure Gauge (3) can read as high as 70 psi (4.8 Bar). The Pressure Gauge (3) will decrease quickly from approximately 70 psi (4.8 Bar) to the actual tire pressure when the Sealant Bottle (1) is empty.
2. The pump will start to inject air into the tire immediately after the Sealant Bottle (1) is empty. Continue to operate the pump and inflate the tire to the pressure indicated on the tire pressure label on the driver-side latch pillar (recommended pressure). Check the tire pressure by looking at the Pressure Gauge (3).

If the tire does not inflate to at least 26 psi (1.8 Bar) pressure within 15 minutes:

- The tire is too badly damaged. Do not attempt to drive the vehicle further. Call for assistance.

NOTE:

If the tire becomes over-inflated, push the Deflation Button to reduce the tire pressure to the recommended inflation pressure before continuing.

If the tire inflates to the recommended pressure or is at least 26 psi (1.8 Bar) pressure within 15 minutes:

1. Push the Power Button (4) to turn off the Tire Service Kit.
2. Remove the Speed Limit sticker from the top of the Sealant Bottle (1) and place the sticker on the instrument panel.
3. Immediately disconnect the Sealant Hose (6) from the valve stem, reinstall the cap on the fitting at the end of the hose, and place the Tire Service Kit in the vehicle storage location. Quickly proceed to (D) "Drive Vehicle."

WHAT TO DO IN EMERGENCIES

CAUTION!

- The metal end fitting from Power Plug (8) may get hot after use, so it should be handled carefully.
- Failure to reinstall the cap on the fitting at the end of the Sealant Hose (6) can result in sealant contacting your skin, clothing, and the vehicle's interior. It can also result in sealant contacting internal Tire Service Kit components which may cause permanent damage to the kit.

(D) Drive Vehicle:

Immediately after injecting sealant and inflating the tire, drive the vehicle 5 miles (8 km) or 10 minutes to ensure distribution of the Tire Service Kit Sealant within the tire. Do not exceed 55 mph (90 km/h).

WARNING!

Tire Service Kit is not a permanent flat tire repair. Have the tire inspected and repaired or replaced after using Tire Service Kit. Do not exceed 55 mph (90 km/h) until the tire is repaired or replaced. Failure to follow this warning can result in injuries that are serious or fatal to you, your passengers, and others around you.

(E) After Driving:

Pull over to a safe location. Refer to “Whenever You Stop to Use Tire Service Kit” before continuing.

1. Push in the Mode Select Knob (5) and turn to the Air Mode position.
2. Uncoil the power plug and insert the plug into the vehicle's 12 Volt power outlet.
3. Uncoil the Air Pump Hose (7) (black in color) and screw the fitting at the end of hose (7) onto the valve stem.
4. Check the pressure in the tire by reading the Pressure Gauge (3).

If tire pressure is less than 19 psi (1.3 Bar):

The tire is too badly damaged. Do not attempt to drive the vehicle further. Call for assistance.

WHAT TO DO IN EMERGENCIES

If the tire pressure is 19 psi (1.3 Bar) or higher:

1. Push the Power Button (4) to turn on Tire Service Kit and inflate the tire to the pressure indicated on the tire and loading information label on the driver-side door opening.

NOTE:

If the tire becomes over-inflated, push the Deflation Button to reduce the tire pressure to the recommended inflation pressure before continuing.

2. Disconnect the Tire Service Kit from the valve stem, reinstall the cap on the valve stem and unplug from 12 Volt outlet.
3. Place the Tire Service Kit in its proper storage area in the vehicle.
4. Have the tire inspected and repaired or replaced at the earliest opportunity at an authorized dealer or tire service center.
5. Remove the Speed Limit sticker from the instrument panel after the tire has been repaired.
6. Replace the Sealant Bottle (1) and Sealant Hose (6) assembly at your authorized dealer as soon as possible. Refer to (F) "Sealant Bottle and Hose Replacement".

NOTE:

When having the tire serviced, advise the authorized dealer or service center that the tire has been sealed using the Tire Service Kit.

(F) Sealant Bottle And Hose Replacement:

1. Uncoil the Sealant Hose (6) (clear in color).
2. Locate the round Sealant Bottle release button in the recessed area under the sealant bottle.
3. Push the Sealant Bottle release button. The Sealant Bottle (1) will pop up. Remove the bottle and dispose of it accordingly.
4. Clean any remaining sealant from the Tire Service Kit housing.
5. Position the new Sealant Bottle (1) in the housing so that the Sealant Hose (6) aligns with the hose slot in the front of the housing. Push the bottle into the housing. An audible click will be heard indicating the bottle is locked into place.
6. Verify that the cap is installed on the fitting at the end of the Sealant Hose (6) and return the hose to its storage area (located on the bottom of the air pump).
7. Return the Tire Service Kit to its storage location in the vehicle.

WHAT TO DO IN EMERGENCIES

JACKING AND TIRE CHANGING — IF EQUIPPED

WARNING!

- Do not attempt to change a tire on the side of the vehicle close to moving traffic. Pull far enough off the road to avoid the danger of being hit when operating the jack or changing the wheel.
- Being under a jacked-up vehicle is dangerous. The vehicle could slip off the jack and fall on you. You could be crushed. Never put any part of your body under a vehicle that is on a jack. If you need to get under a raised vehicle, take it to a service center where it can be raised on a lift.
- Never start or run the engine while the vehicle is on a jack.
- The jack is designed to be used as a tool for changing tires only. The jack should not be used to lift the vehicle for service purposes. The vehicle should be jacked on a firm level surface only. Avoid ice or slippery areas.

Jack Location

The jack, jack handle and winch handle tools are stowed behind the rear left side trim panel in the rear cargo area. Turn the two cover latches to release the cover.



Jack And Tool Location

WHAT TO DO IN EMERGENCIES

Spare Tire Removal

The spare tire is stowed inside a protective cover located under the center of the vehicle between the front doors by means of a cable winch mechanism. The “spare tire drive” nut is located on the floor, under a plastic cap at the front of the floor console or under front super console forward bin liner.

To Access Spare Tire Winch Drive Nut

To access the spare tire winch drive nut and lower the spare tire, you will need to refer to one of the following center console configurations.

Super Console

For vehicles equipped with the Super Console, the spare tire winch assembly drive nut is located beneath the console.

1. Pull the lower drawer out from the rear of the floor console to gain clear access of the tire winch drive nut.



Super Console

- 1 — Lower Drawer
- 2 — Front Drawer Liner
- 3 — Front Drawer

WHAT TO DO IN EMERGENCIES

2. Open the front drawer to expose the storage compartment.



Storage Compartment Location

3. Remove the liner from the console's storage compartment to access the spare tire winch drive nut.



Winch Drive Nut Location

WHAT TO DO IN EMERGENCIES

Premium/Base/Cargo Center Console

Pull the Winch Cover assembly plug (if equipped) to access the winch drive nut.



Winch Cover Location

Spare Tire Tools

The tool pouch contains three pieces and can be assembled into a spare tire hook; to remove the compact spare tire/cover assembly from under the vehicle, or a Winch T-handle; to raise/lower the compact spare tire/cover assembly.

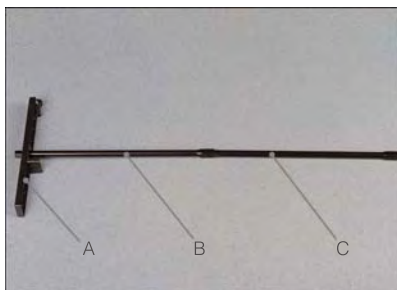

Assembled T-handle

- A — Spare Tire Hook/T-handle
 - B — Extension 1
 - C — Extension 2
-

WHAT TO DO IN EMERGENCIES

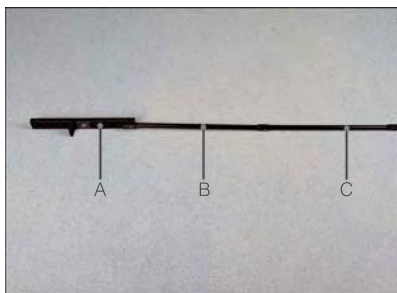

Assembling The Spare Tire Hook

- A — Spare Tire Hook/T-handle
- B — Extension 1
- C — Extension 2

Spare Tire Removal Instructions

The spare tire is located under the vehicle beneath the center console area.

1. Assemble the spare tire tools into a T-handle and place the square end over the spare tire winch drive nut.
2. Rotate the nut to the left until the winch mechanism stops turning freely. This will allow enough slack in the cable to allow you to pull the spare tire out from underneath the vehicle.



Spare Tire Carrier

CAUTION!

The winch mechanism is designed for use with the winch T-handle only. Use of an air wrench or other power tools is not recommended and can damage the winch.

WHAT TO DO IN EMERGENCIES

3. To remove the compact spare tire/cover assembly, assemble the winch T-handle extensions to form a spare tire hook, and pull the spare tire out from under the vehicle.

NOTE:

If either front tire is flat it may be necessary to jack up the vehicle to remove the compact spare tire/cover assembly from under the vehicle.



Spare Tire And Hook

- 1 — Spare Tire
 - 2 — Spare Tire Hook
-

4. Stand the tire/cover assembly upright and remove the wheel spacer by squeezing the winch retaining tabs together. Push the retainer through the spare tire to release it from the wheel.



Wheel Spacer

WHAT TO DO IN EMERGENCIES

Preparations For Jacking

1. Park the vehicle on a firm, level surface. Avoid ice or slippery areas.

WARNING!

Do not attempt to change a tire on the side of the vehicle close to moving traffic, pull far enough off the road to avoid being hit when operating the jack or changing the wheel.

2. Turn on the Hazard Warning flasher.
3. Set the parking brake.
4. Place the gear selector into PARK.
5. Turn OFF the ignition.
6. Block both the front and rear of the wheel diagonally opposite of the jacking position.
For example, if changing the right front tire, block the left rear wheel.

NOTE:

Passengers should not remain in the vehicle when the vehicle is being jacked.

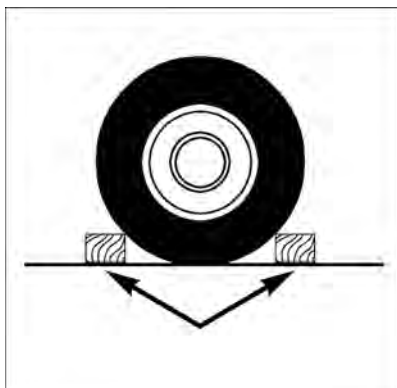

Wheels Blocked

WHAT TO DO IN EMERGENCIES

Jacking Instructions

WARNING!

Carefully follow these tire changing warnings to help prevent personal injury or damage to your vehicle:

- Always park on a firm, level surface as far from the edge of the roadway as possible before raising the vehicle.
- Turn on the Hazard Warning flasher.
- Block the wheel diagonally opposite the wheel to be raised.
- Set the parking brake firmly and set an automatic transmission in PARK; a manual transmission in REVERSE.
- Never start or run the engine with the vehicle on a jack.
- Do not let anyone sit in the vehicle when it is on a jack.
- Do not get under the vehicle when it is on a jack. If you need to get under a raised vehicle, take it to a service center where it can be raised on a lift.
- Only use the jack in the positions indicated and for lifting this vehicle during a tire change.
- If working on or near a roadway, be extremely careful of motor traffic.
- To assure that compact spare tires, flat or inflated, are securely stowed, compact spares must be stowed with the valve stem facing the ground.



Warning Label

CAUTION!

Do not attempt to raise the vehicle by jacking on locations other than those indicated in the Jacking Instructions for this vehicle.

NOTE:

Refer to the "Compact Spare Tire" section of "Tires – General Information" for information about the compact spare tire, its use, and operation.

1. Loosen (but do not remove) the wheel lug nuts by turning them to the left one turn while the wheel is still on the ground.

WHAT TO DO IN EMERGENCIES

2. There are two jack engagement locations on each side of the vehicle body. These locations are on the sill flange of the vehicle body.

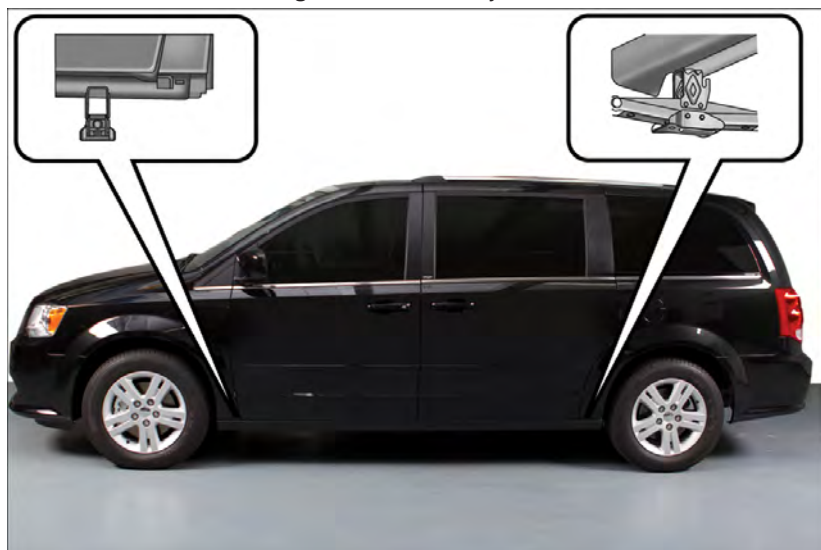

Jack Engagement Locations

CAUTION!

Do not attempt to raise the vehicle by jacking on locations other than those indicated.

Rear jack locations are between a pair of down-facing tabs on the sill flange of the vehicle side body.



Rear Jacking Location Engaged

WHAT TO DO IN EMERGENCIES

Front jack location is on the sill flange of the vehicle body and is located 6 inches (150 mm) from door edge.

NOTE:

In some situations the jack may need to be placed on its side in order to be pushed under the vehicle. Return the jack to its correct orientation once it is under the vehicle.

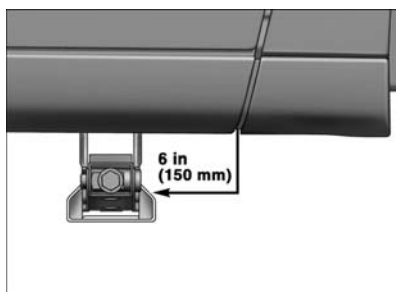

Front Jacking Location Engaged

WARNING!

Being under a jacked-up vehicle is dangerous. The vehicle could slip off the jack and fall on you. You could be crushed. Never get any part of your body under a vehicle that is on a jack. If you need to get under a raised vehicle, take it to a service center where it can be raised on a lift.

3. Place the wrench on the jack screw and turn to the right until the jack head is properly engaged in the described location. **Do not raise the vehicle until you are sure the jack is securely engaged.**
4. Raise the vehicle by turning the jack screw to the right, using the swivel wrench. Raise the vehicle only until the tire just clears the surface and enough clearance is obtained to install the compact spare tire. Minimum tire lift provides maximum stability.

WARNING!

Raising the vehicle higher than necessary can make the vehicle less stable. It could slip off the jack and hurt someone near it. Raise the vehicle only enough to remove the tire.

5. Remove the wheel lug nuts, for vehicles with wheel covers, remove the cover from the wheel by hand. Do not pry the wheel cover off. Then pull the wheel off the hub.
6. Install the compact spare tire. Lightly tighten the lug nuts.

WHAT TO DO IN EMERGENCIES

CAUTION!

Be sure to mount the compact spare tire with the valve stem facing outward. The vehicle could be damaged if the compact spare tire is mounted incorrectly.



Installing Compact Spare

WARNING!

To avoid the risk of forcing the vehicle off the jack, do not tighten the wheel nuts fully until the vehicle has been lowered. Failure to follow this warning may result in serious injury.

NOTE:

Do not install the wheel cover on the compact spare.

7. Lower the vehicle by turning the jack screw to the left.
8. Finish tightening the lug nuts. Push down on the wrench while at the end of the handle for increased leverage. Tighten the lug nuts in a star pattern until each nut has been tightened twice. The correct tightness of each lug nut is 100 ft-lbs (135 N-m). If in doubt about the correct tightness, have them checked with a torque wrench by your authorized dealer or service station.
9. Lower the jack to its fully-closed position.

WARNING!

A loose tire or jack thrown forward in a collision or hard stop could endanger the occupants of the vehicle. Always stow the jack parts and the spare tire in the places provided. Have the deflated (flat) tire repaired or replaced immediately.

10. Place the deflated (flat) tire and compact spare tire cover assembly in the rear cargo area. **Do not stow the deflated tire in the compact spare tire location.** Have the full-sized tire repaired or replaced, as soon as possible.
11. Stow the cable and wheel spacer before driving the vehicle. Reassemble the winch handle extensions to form a "T" and fit the winch T-handle over the drive nut. Rotate the nut to the right until the winch mechanism clicks at least three times.

WHAT TO DO IN EMERGENCIES

NOTE:

Refer to the “Spare Tire Tools” section for instructions on assembling the T-handle.

12. Stow the jack, jack handle and winch handle tools back in the stowage compartment.
13. Check the compact spare tire pressure as soon as possible. Correct the tire pressure, as required.

Securing The Compact Spare Tire

1. Assemble the winch handle extensions to form a T-handle and fit the winch T-handle over the drive nut. Rotate the nut to the left until the winch mechanism stops turning freely. This will allow enough slack in the cable to allow you to pull the wheel spacer out from under the vehicle.

WARNING!

A loose compact spare tire/cover assembly, thrown forward in a collision or hard stop could endanger the occupants of the vehicle. Always stow the compact spare tire with the cover assembly in the place provided.

CAUTION!

The winch mechanism is designed for use with the winch T-handle only. Use of an air wrench or other power tools is not recommended and can damage the winch.

2. Assemble the winch handle extensions to form the spare tire hook, and pull the wheel spacer from under the vehicle.
3. Turn the compact spare tire so that the valve stem is down, and place the tire into the compact spare tire/cover assembly. Slide the wheel spacer through the center of the wheel and compact spare tire/cover assembly, so that the two retainer tabs snap out and engage the compact spare tire cover on the opposite side.

CAUTION!

The compact spare tire/cover assembly must be used when the compact spare tire is stored. Failure to use this cover could drastically reduce the life of the compact spare tire.

WARNING!

Verify that both retainer tabs of the wheel spacer have been properly extended through the center of the wheel and compact spare tire/cover assembly. Failure to properly engage both retainer tabs could result in loss of the compact spare tire and cover assembly, which will cause vehicle damage and may cause loss of vehicle control and serious personal injury.

WHAT TO DO IN EMERGENCIES

- Using the winch T-handle, rotate the drive nut to the right until the compact spare tire/cover assembly is drawn into place against the underside of the vehicle.
- Continue to rotate the nut to the right until you hear the winch mechanism click three times. It cannot be overtightened. Check under the vehicle to ensure the compact spare tire/cover assembly is positioned correctly against the underside of the vehicle.

CAUTION!

The winch mechanism is designed specifically to stow a compact spare tire only. Do not attempt to use the winch to stow the full size deflated tire, or any other full-size tire, as the tire may not be held securely. Vehicle damage may result.

Road Tire Installation

Vehicles Equipped With Wheel Covers

- Mount the road tire on the axle.
- To ease the installation process for steel wheels with wheel covers, install two lug nuts on the mounting studs which are on each side of the valve stem. Install the lug nuts with the cone shaped end of the nut toward the wheel. Lightly tighten the lug nuts.
- Align the valve notch in the wheel cover with the valve stem on the wheel. Install the cover by hand, snapping the cover over the two lug nuts. Do not use a hammer or excessive force to install the cover.
- Install the remaining lug nuts with the cone shaped end of the nut toward the wheel. Lightly tighten the lug nuts.

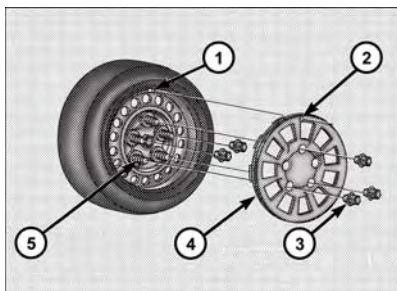

Wheel Cover Installation

- 1 — Valve Stem
- 2 — Valve Notch
- 3 — Wheel Lug Nut
- 4 — Wheel Cover
- 5 — Mounting Stud

WARNING!

To avoid the risk of forcing the vehicle off the jack, do not tighten the wheel nuts fully until the vehicle has been lowered. Failure to follow this warning may result in serious injury.

WHAT TO DO IN EMERGENCIES

5. Lower the vehicle to the ground by turning the jack handle counterclockwise.
6. Finish tightening the lug nuts. Push down on the wrench while at the end of the handle for increased leverage. Tighten the lug nuts in a star pattern until each nut has been tightened twice. The correct tightness of each lug nut is 100 ft-lbs (135 N·m). If in doubt about the correct tightness, have them checked with a torque wrench by your authorized dealer or service station.
7. After 25 miles (40 km) check the lug nut torque with a torque wrench to ensure that all lug nuts are properly seated against the wheel.

Vehicles Without Wheel Covers

1. Mount the road tire on the axle.
2. Install the remaining lug nuts with the cone shaped end of the nut toward the wheel. Lightly tighten the lug nuts.

WARNING!

To avoid the risk of forcing the vehicle off the jack, do not tighten the wheel nuts fully until the vehicle has been lowered. Failure to follow this warning may result in serious injury.

3. Lower the vehicle to the ground by turning the jack handle counterclockwise.
4. Finish tightening the lug nuts. Push down on the wrench while at the end of the handle for increased leverage. Tighten the lug nuts in a star pattern until each nut has been tightened twice. The correct tightness of each lug nut is 100 ft-lbs (135 N·m). If in doubt about the correct tightness, have them checked with a torque wrench by your authorized dealer or service station.
5. After 25 miles (40 km) check the lug nut torque with a torque wrench to ensure that all lug nuts are properly seated against the wheel.

WHAT TO DO IN EMERGENCIES

JUMP-STARTING

If your vehicle has a discharged battery it can be jump-started using a set of jumper cables and a battery in another vehicle or by using a portable battery booster pack. Jump-starting can be dangerous if done improperly so please follow the procedures in this section carefully.

NOTE:

When using a portable battery booster pack follow the manufacturer's operating instructions and precautions.

CAUTION!

Do not use a portable battery booster pack or any other booster source with a system voltage greater than 12 Volts or damage to the battery, starter motor, alternator or electrical system may occur.

WARNING!

Do not attempt jump-starting if the battery is frozen. It could rupture or explode and cause personal injury.

Preparations For Jump-Start

The battery in your vehicle is located on the left side of the engine compartment.



Positive Battery Post

WHAT TO DO IN EMERGENCIES

WARNING!

- Take care to avoid the radiator cooling fan whenever the hood is raised. It can start anytime the ignition switch is ON. You can be injured by moving fan blades.
- Remove any metal jewelry such as rings, watch bands and bracelets that could make an inadvertent electrical contact. You could be seriously injured.
- Batteries contain sulfuric acid that can burn your skin or eyes and generate hydrogen gas which is flammable and explosive. Keep open flames or sparks away from the battery.

1. Set the parking brake, shift the automatic transmission into PARK and turn the ignition to LOCK.
2. Turn off the heater, radio, and all unnecessary electrical accessories.
3. If using another vehicle to jump-start the battery, park the vehicle within the jumper cables reach, set the parking brake and make sure the ignition is OFF.

WARNING!

Do not allow vehicles to touch each other as this could establish a ground connection and personal injury could result.

Jump-Starting Procedure

WARNING!

Failure to follow this jump-starting procedure could result in personal injury or property damage due to battery explosion.

CAUTION!

Failure to follow these procedures could result in damage to the charging system of the booster vehicle or the discharged vehicle.

WHAT TO DO IN EMERGENCIES

Connecting The Jumper Cables

1. Connect the positive (+) end of the jumper cable to the positive (+) post of the vehicle with the discharged battery.
2. Connect the opposite end of the positive (+) jumper cable to the positive (+) post of the booster battery.
3. Connect the negative (-) end of the jumper cable to the negative (-) post of the booster battery.
4. Connect the opposite end of the negative (-) jumper cable to a good engine ground (exposed metal part of the discharged vehicle's engine) away from the battery and the fuel injection system.

WARNING!

Do not connect the jumper cable to the negative (-) post of the discharged battery. The resulting electrical spark could cause the battery to explode and could result in personal injury. Only use the specific ground point, do not use any other exposed metal parts.

5. Start the engine in the vehicle that has the booster battery, let the engine idle a few minutes, and then start the engine in the vehicle with the discharged battery.
6. Once the engine is started, remove the jumper cables in the reverse sequence:

Disconnecting The Jumper Cables

1. Disconnect the negative (-) end of the jumper cable from the engine ground of the vehicle with the discharged battery.
2. Disconnect the opposite end of the negative (-) jumper cable from the negative (-) post of the booster battery.
3. Disconnect the positive (+) end of the jumper cable from the positive (+) post of the booster battery.
4. Disconnect the opposite end of the positive (+) jumper cable from the positive (+) post of the vehicle with the discharged battery.

If frequent jump-starting is required to start your vehicle you should have the battery and charging system inspected at your authorized dealer.

CAUTION!

Accessories plugged into the vehicle power outlets draw power from the vehicle's battery, even when not in use (i.e., cellular devices, etc.). Eventually, if plugged in long enough without engine operation, the vehicle's battery will discharge sufficiently to degrade battery life and/or prevent the engine from starting.

WHAT TO DO IN EMERGENCIES

GEAR SELECTOR OVERRIDE

If a malfunction occurs and the gear selector cannot be moved out of the PARK position, you can use the following procedure to temporarily move the gear selector:

1. Turn the engine OFF.
2. Firmly apply the parking brake.
3. Using a small screwdriver or similar tool, remove the gear selector override access cover (located near the top right of the gear selector in the instrument panel).
4. Press and maintain firm pressure on the brake pedal.
5. Insert the screwdriver or similar tool into the access hole, and push and hold the override release lever forward.
6. Move the gear selector to the NEUTRAL position.
7. The vehicle may then be started in NEUTRAL.
8. Reinstall the gear selector override access cover.



Gear Selector Override

WHAT TO DO IN EMERGENCIES

TOWING A DISABLED VEHICLE

This section describes procedures for towing a disabled vehicle using a commercial towing service.

Towing Condition	Wheels OFF the Ground	ALL MODELS
Flat Tow	NONE	If transmission is operable: <ul style="list-style-type: none">• Transmission in NEUTRAL• 25 mph (40 km/h) max speed• 15 miles (24 km) max distance
Wheel lift	Rear	OK
	Front	
Flatbed	ALL	BEST METHOD

Proper towing or lifting equipment is required to prevent damage to your vehicle. Use only tow bars and other equipment designed for this purpose, following equipment manufacturer's instructions. Use of safety chains is mandatory. Attach a tow bar or other towing device to main structural members of the vehicle, not to bumpers or associated brackets. State and local laws regarding vehicles under tow must be observed.

If you must use the accessories (wipers, defrosters, etc.) while being towed, the ignition must be in the ON/RUN position, not the ACC position.

If the key fob is unavailable or the vehicle's battery is discharged, refer to "Gear Selector Override" in this section for instructions on shifting the transmission out of PARK for towing.

CAUTION!

- Do not use sling type equipment when towing. Vehicle damage may occur.
- When securing the vehicle to a flatbed truck, do not attach to front or rear suspension components. Damage to your vehicle may result from improper towing.
- Do not push or tow this vehicle with another vehicle as damage to the bumper fascia and transmission may result.



WHAT TO DO IN EMERGENCIES

The manufacturer recommends towing your vehicle with all four wheels OFF the ground using a flatbed. If flatbed equipment is not available, and the transmission is operable, the vehicle may be flat towed (with all four wheels on the ground) under the following conditions:

- The transmission must be in NEUTRAL.
- The towing distance must not exceed 15 miles (24 km).
- The towing speed must not exceed 25 mph (40 km/h).

If the transmission is not operable, or the vehicle must be towed faster than 25 mph (40 km/h) or farther than 15 miles (24 km), it must be towed with the front wheels OFF the ground (using a flatbed truck, or wheel lift equipment with the front wheels raised).

CAUTION!

- Towing faster than 25 mph (40 km/h) or farther than 15 mi (24 km) with front wheels on the ground can cause severe transmission damage. Damage from improper towing is not covered under the New Vehicle Limited Warranty.
- Towing this vehicle in violation of the above requirements can cause severe transmission damage. Damage from improper towing is not covered under the New Vehicle Limited Warranty.

WHAT TO DO IN EMERGENCIES

FREEING A STUCK VEHICLE

If your vehicle becomes stuck in mud, sand or snow, it can often be moved using a rocking motion. Turn the steering wheel right and left to clear the area around the front wheels. Then shift back and forth between DRIVE and REVERSE while gently pressing the accelerator. Use the least amount of accelerator pedal pressure that will maintain the rocking motion, without spinning the wheels or racing the engine.

CAUTION!

Racing the engine or spinning the wheels may lead to transmission overheating and failure. Allow the engine to idle with the transmission in NEUTRAL for at least one minute after every five rocking-motion cycles. This will minimize overheating and reduce the risk of transmission failure during prolonged efforts to free a stuck vehicle.

NOTE:

Push the "ESC Off" switch, to place the Electronic Stability Control (ESC) system in "Partial Off" mode before rocking the vehicle. Refer to "Electronic Brake Control System" in "Starting and Operating" for further information. Once the vehicle has been freed, push the "ESC Off" switch again to restore "ESC On" mode.

CAUTION!

- When "rocking" a stuck vehicle by shifting between DRIVE and REVERSE, do not spin the wheels faster than 15 mph (24 km/h), or drivetrain damage may result.
- Revving the engine or spinning the wheels too fast may lead to transmission overheating and failure. It can also damage the tires. Do not spin the wheels above 30 mph (48 km/h) while in gear (no transmission shifting occurring).

WARNING!

Fast spinning tires can be dangerous. Forces generated by excessive wheel speeds may cause damage, or even failure, of the axle and tires. A tire could explode and injure someone. Do not spin your vehicle's wheels faster than 30 mph (48 km/h) or for longer than 30 seconds continuously without stopping when you are stuck and do not let anyone near a spinning wheel, no matter what the speed.



WHAT TO DO IN EMERGENCIES

ENHANCED ACCIDENT RESPONSE SYSTEM (EARS)

This vehicle is equipped with an Enhanced Accident Response System.

Please refer to “Supplemental Restraint System (SRS) — Air Bags” in “Getting Started” in this guide for further information on the Enhanced Accident Response System (EARS) function.

EVENT DATA RECORDER (EDR)

This vehicle is equipped with an event data recorder (EDR). The main purpose of an EDR is to record, in certain crash or near crash-like situations, such as an air bag deployment or hitting a road obstacle, data that will assist in understanding how a vehicle’s systems performed.

Please refer to “Supplemental Restraint System (SRS) — Air Bags” in “Getting Started” in this guide for further information on the Event Data Recorder (EDR).

MAINTAINING YOUR VEHICLE

OPENING THE HOOD

1. Pull the hood release lever located on the instrument panel, below the steering column.
2. Raise the hood and locate the safety catch lever, in the middle of the hood opening.
3. Move the safety latch while lifting the hood at the same time.
4. Insert the support rod into the slot on the hood.
5. To close the hood, remove the support rod and place it in the retaining clip, then lower the hood slowly.



Hood Release Lever

WARNING!

Be sure the hood is fully latched before driving your vehicle. If the hood is not fully latched, it could open when the vehicle is in motion and block your vision. Failure to follow this warning could result in serious injury or death.

MAINTAINING YOUR VEHICLE

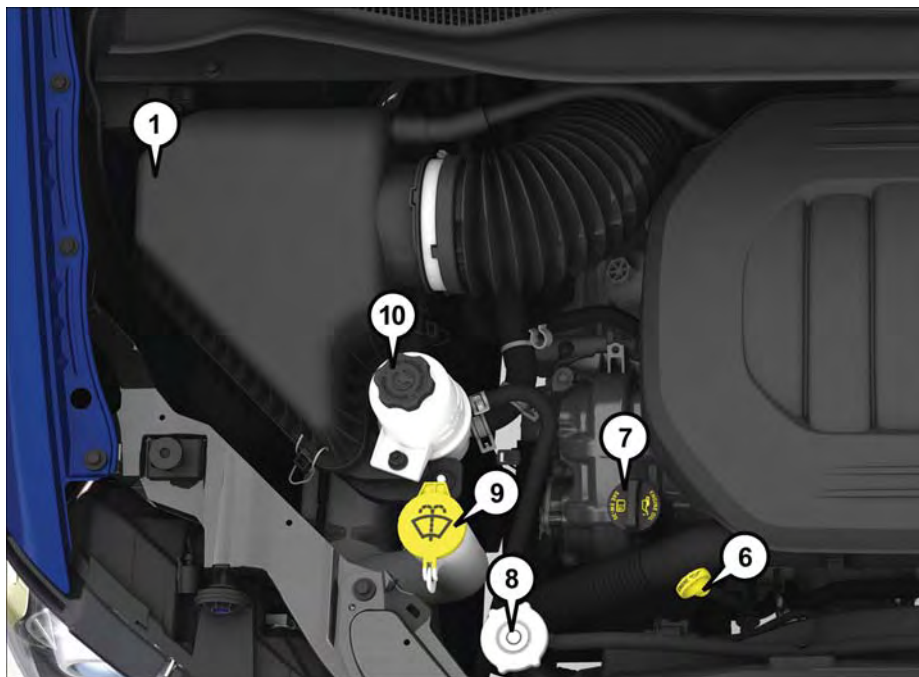

ENGINE COMPARTMENT — 3.6L

1. Air Cleaner Filter
2. Brake Fluid Reservoir
3. Integrated Power Module (Fuses)
4. Battery
5. Engine Coolant Reservoir

MAINTAINING YOUR VEHICLE

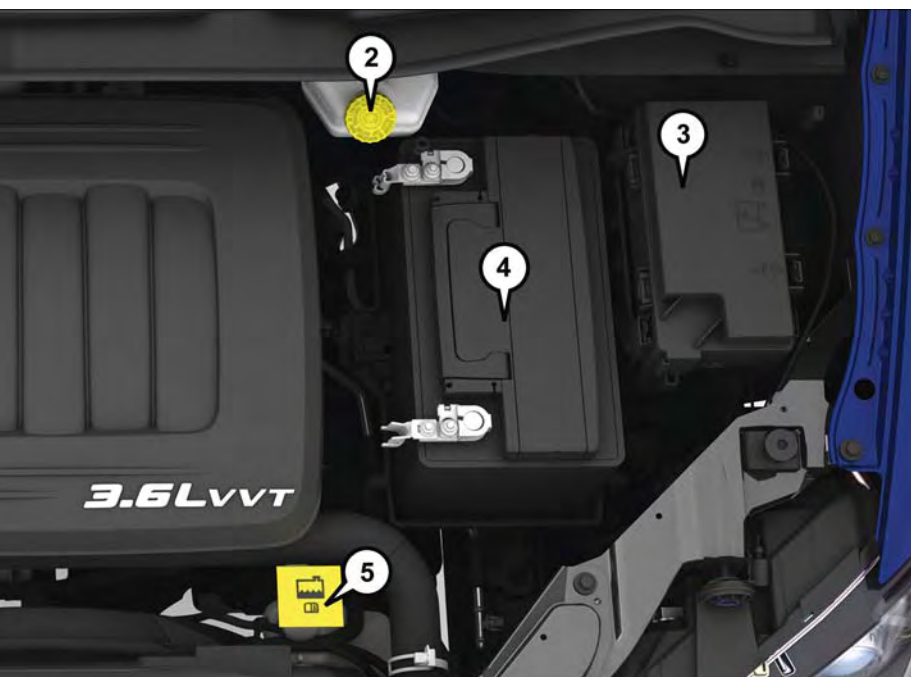

- 6. Engine Oil Dipstick
- 7. Engine Oil Fill
- 8. Engine Coolant Pressure Cap
- 9. Washer Fluid Reservoir
- 10. Power Steering Fluid Reservoir

MAINTAINING YOUR VEHICLE

FLUID CAPACITIES

	U.S.	Metric
Fuel (Approximate)	20 Gallons	76 Liters
Engine Oil with Filter		
3.6L Engine (SAE 5W-20, API Certified).	6 Quarts	5.6 Liters
Cooling System *		
3.6L Engine (MOPAR Antifreeze/Engine Coolant 10 Year/150,000 Mile Formula or equivalent) meeting the requirements of FCA Material Standard MS.90032.	13.4 Quarts	12.6 Liters
* Includes heater and coolant recovery bottle filled to MAX level. Add 2.9 Quarts (2.8 Liters) if equipped with a rear heater.		

FLUIDS, LUBRICANTS, AND GENUINE PARTS

Engine

Component	Fluid, Lubricant, or Genuine Part
Engine Coolant	We recommend you use MOPAR Antifreeze/Coolant 10 Year/150,000 Mile Formula OAT (Organic Additive Technology) meeting the requirements of FCA Material Standard MS.90032.
Engine Oil	We recommend you use API Certified SAE 5W-20 Engine Oil, meeting the requirements of FCA Material Standard MS-6395 such as MOPAR, Pennzoil, and Shell Helix. Refer to your engine oil filler cap for correct SAE grade.
Engine Oil Filter	We recommend you use MOPAR Engine Oil Filters.
Spark Plugs	We recommend you use MOPAR Spark Plugs.
Fuel Selection – 3.6L Engine	87 Octane, 0-15% Ethanol.
Fuel Selection – 3.6L Flex Fuel (E-85) Engine	87 Octane, Up to 85% Ethanol.

MAINTAINING YOUR VEHICLE

CAUTION!

- Mixing of engine coolant (antifreeze) other than specified Organic Additive Technology (OAT) engine coolant (antifreeze), may result in engine damage and may decrease corrosion protection. Organic Additive Technology (OAT) engine coolant is different and should not be mixed with Hybrid Organic Additive Technology (HOAT) engine coolant (antifreeze) or any “globally compatible” coolant (antifreeze). If a non-OAT engine coolant (antifreeze) is introduced into the cooling system in an emergency, the cooling system will need to be drained, flushed, and refilled with fresh OAT coolant (conforming to MS.90032), by an authorized dealer as soon as possible.
- Do not use water alone or alcohol-based engine coolant (antifreeze) products. Do not use additional rust inhibitors or antirust products, as they may not be compatible with the radiator engine coolant and may plug the radiator.
- This vehicle has not been designed for use with propylene glycol-based engine coolant (antifreeze). Use of propylene glycol-based engine coolant (antifreeze) is not recommended.

Chassis

Component	Fluid, Lubricant, or Genuine Part
Automatic Transmission	Use Only ATF+4 Automatic Transmission Fluid. Failure to use ATF+4 fluid may affect the function or performance of your transmission. We recommend MOPAR ATF+4 Fluid.
Brake Master Cylinder	We recommend you use MOPAR DOT 3. If DOT 3 brake fluid is not available, then DOT 4 is acceptable.
Power Steering Reservoir	We recommend you use MOPAR Power Steering Fluid +4, MOPAR ATF+4 Automatic Transmission Fluid.

MAINTENANCE PROCEDURES

For information on the maintenance procedures for your vehicle, please refer to “Maintenance Procedures” in “Maintaining Your Vehicle” in your Owner’s Manual or applicable supplement on the DVD for further details.

MAINTENANCE SCHEDULE

Your vehicle is equipped with an automatic oil change indicator system. The oil change indicator system will remind you that it is time to take your vehicle in for scheduled maintenance.

Based on engine operation conditions, the oil change indicator message will illuminate. This means that service is required for your vehicle. Operating conditions such as frequent short-trips, trailer tow, extremely hot or cold ambient temperatures, and E85 fuel usage

MAINTAINING YOUR VEHICLE

will influence when the “Oil Change Required” message is displayed. Severe Operating Conditions can cause the change oil message to illuminate as early as 3,500 miles (5,600 km) since last reset. Have your vehicle serviced as soon as possible, within the next 500 miles (805 km).

Your authorized dealer will reset the oil change indicator message after completing the scheduled oil change. If a scheduled oil change is performed by someone other than your authorized dealer, the message can be reset by referring to the steps described under “Instrument Cluster Warning Lights” in “What To Do In Emergencies” in this guide or “Electronic Vehicle Information Center (EVIC)” in “Understanding Your Instrument Panel” in your Owner’s Manual on the DVD for further information.

NOTE:

Under no circumstances should oil change intervals exceed 10,000 miles (16,000 km), twelve months or 350 hours of engine run time, whichever comes first. The 350 hours of engine run or idle time is generally only a concern for fleet customers.

Severe Duty All Models

Change Engine Oil at 4,000 miles (6,500 km) if the vehicle is operated in a dusty and off road environment or is operated predominately at idle or only very low engine RPM's. This type of vehicle use is considered Severe Duty.

Once A Month Or Before A Long Trip:

- Check engine oil level.
- Check windshield washer fluid level.
- Check tire pressure and look for unusual wear or damage. Rotate tires at the first sign of irregular wear, even if it occurs before the oil indicator system turns on.
- Check the fluid levels of the coolant reservoir, brake master cylinder, and power steering and fill as needed.
- Check function of all interior and exterior lights.

Required Maintenance Intervals.

Refer to the maintenance schedules on the following page for the required maintenance intervals.

At Every Oil Change Interval As Indicated By Oil Change Indicator System:
• Change oil and filter.
• Rotate the tires. Rotate at the first sign of irregular wear, even if it occurs before the oil indicator system turns on.
• Inspect battery and clean and tighten terminals as required.
• Inspect brake pads, shoes, rotors, drums, hoses and park brake.
• Inspect engine cooling system protection and hoses.
• Inspect exhaust system.
• Inspect engine air cleaner if using in dusty or off-road conditions.

Maintenance Chart

Refer to the Maintenance Schedules on the following pages for the required maintenance intervals.

Mileage or time passed (whichever comes first)	20,000	30,000	40,000	50,000	60,000	70,000	80,000	90,000	100,000	110,000	120,000	130,000	140,000	150,000
0r Years:	2	3	4	5	6	7	8	9	10	11	12	13	14	15
Or Kilometers:	32,000	48,000	64,000	80,000	96,000	112,000	128,000	144,000	160,000	176,000	192,000	208,000	224,000	240,000
Additional Inspections														
Inspect the CV joints.		X			X			X			X			X
Inspect front suspension, tie rod ends, boot seals, and replace if necessary.	X		X		X		X		X		X		X	
Inspect the brake linings, replace as necessary.	X		X		X		X		X		X		X	
Additional Maintenance														
Replace engine air filter.		X			X			X			X			X
Replace cabin/air conditioning filter.	X		X		X		X		X		X		X	
Replace spark plugs (3.6L engine). **									X					
Flush and replace the engine coolant at 10 years or 150,000 miles (240,000 km) whichever comes first.									X					X
Change automatic transmission fluid and filter if using your vehicle for any of the following: police, taxi, fleet, or frequent trailer towing.					X						X			

MAINTAINING YOUR VEHICLE

Mileage or time passed (whichever comes first)	20,000	30,000	40,000	50,000	60,000	70,000	80,000	90,000	100,000	110,000	120,000	130,000	140,000	150,000
Or Years:	2	3	4	5	6	7	8	9	10	11	12	13	14	15
Or Kilometers:	32,000	48,000	64,000	80,000	96,000	112,000	128,000	144,000	160,000	176,000	192,000	208,000	224,000	240,000
Change automatic transmission fluid and filter.											X			
Inspect and replace PCV valve if necessary.									X					

** The spark plug change interval is mileage based only, yearly intervals do not apply.

WARNING!

- You can be badly injured working on or around a motor vehicle. Do only service work for which you have the knowledge and the right equipment. If you have any doubt about your ability to perform a service job, take your vehicle to a competent mechanic.
- Failure to properly inspect and maintain your vehicle could result in a component malfunction and effect vehicle handling and performance. This could cause an accident.

MAINTENANCE RECORD

	Odometer	Date	Signature, Authorized Service Center
20,000 Miles (32,000 km) or 2 Years			
30,000 Miles (48,000 km) or 3 Years			
40,000 Miles (64,000 km) or 4 Years			
50,000 Miles (80,000 km) or 5 Years			
60,000 Miles (96,000 km) or 6 Years			
70,000 Miles (112,000 km) or 7 Years			
80,000 Miles (128,000 km) or 8 Years			

	Odometer	Date	Signature, Authorized Service Center
90,000 Miles (144,000 km) or 9 Years			
100,000 Miles (160,000 km) or 10 Years			
110,000 Miles (176,000 km) or 11 Years			
120,000 Miles (192,000 km) or 12 Years			
130,000 Miles (208,000 km) or 13 Years			
140,000 Miles (224,000 km) or 14 Years			
150,000 Miles (240,000 km) or 15 Years			

MAINTAINING YOUR VEHICLE

FUSES

WARNING!

- When replacing a blown fuse, always use an appropriate replacement fuse with the same amp rating as the original fuse. Never replace a fuse with another fuse of higher amp rating. Never replace a blown fuse with metal wires or any other material. Failure to use proper fuses may result in serious personal injury, fire and/or property damage.
- Before replacing a fuse, make sure that the ignition is off and that all the other services are switched off and/or disengaged.
- If the replaced fuse blows again, contact an authorized dealer.
- If a general protection fuse for safety systems (air bag system, braking system), power unit systems (engine system, gearbox system) or steering system blows, contact an authorized dealer.

Totally Integrated Power Module (Fuses)

The Totally Integrated Power Module is located in the engine compartment near the battery. Refer to the applicable “Engine Compartment” illustration in this section. This center contains cartridge fuses and mini-fuses. A label that identifies each component may be printed or embossed on the inside of the cover.

CAUTION!

- When installing the Totally Integrated Power Module cover, it is important to ensure the cover is properly positioned and fully latched. Failure to do so may allow water to get into the Integrated Power Module, and possibly result in a electrical system failure.
- When replacing a blown fuse, it is important to use only a fuse having the correct amperage rating. The use of a fuse with a rating other than indicated may result in a dangerous electrical system overload. If a properly rated fuse continues to blow, it indicates a problem in the circuit that must be corrected.

The numbers inside the TIPM cover correspond to the following table.

Cavity	Cartridge Fuse	Mini-Fuse	Description
J1	40 Amp Green	–	Power Folding Seat
J2	30 Amp Pink	–	Power Liftgate Module
J3	30 Amp Pink	–	Rear Door Module
J4	25 Amp Clear	–	Driver Door Node
J5	25 Amp Clear	–	Passenger Door Node
J6	40 Amp Green	–	Antilock Brakes Pump/Stability Control System
J7	30 Amp Pink	–	Antilock Brakes Valve/Stability Control System

MAINTAINING YOUR VEHICLE

Cavity	Cartridge Fuse	Mini-Fuse	Description
J8	40 Amp Green	–	Power Memory Seat – If Equipped
J9	40 Amp Green	–	Partial Zero Emissions Vehicle Motor/Flex Fuel – If Equipped
J10	30 Amp Pink	–	Headlamp Wash/Manifold Tuning Valve – If Equipped
J11	30 Amp Pink	–	Power Sliding Door Module/Anti-Theft Module – If Equipped
J12	30 Amp Pink	–	HVAC Rear Blower, Radiator Fan Motor
J13	60 Amp Yellow	–	Ignition Off Draw (IOD) – Main
J14	40 Amp Green	–	Rear Window Defogger
J15	40 Amp Green	–	Front Blower
J17	40 Amp Green	–	Starter Solenoid
J18	20 Amp Blue	–	Powertrain Control Module Trans Range
J19	60 Amp Yellow	–	Radiator Fan
J20	30 Amp Pink	–	Front Wiper LO/HI
J21	20 Amp Blue	–	Front/Rear Washer
J22	25 Amp Clear	–	Sunroof Module
M1	–	15 Amp Blue	Rear Center Brake Lamp/Brake Switch
M2	–	20 Amp Yellow	Front Fog Lamps
M3	–	20 Amp Yellow	Front/Rear Axle Locker, Vacuum Pump Motor
M5	–	25 Amp Clear	Inverter
M6	–	20 Amp Yellow	Power Outlet #1 (ACC), Rain Sensor, Cigar Lighter (Instrument Panel or with Console Rear)
M7	–	20 Amp Yellow	Power Outlet #2 (BATT/ACC SELECT) – Center Seat or with Console Rear
M8	–	20 Amp Yellow	Front Heated Seat – If Equipped
M9	–	20 Amp Yellow	Rear Heated Seat – If Equipped
M10	–	15 Amp Blue	Ignition Off Draw — Video System, Satellite Radio, DVD, Hands-Free Module, Universal Garage Door Opener, Vanity Lamp, Streaming Video Module – If Equipped
M11	–	10 Amp Red	Climate Control System
M12	–	30 Amp Green	Amplifier/Radio
M13	–	20 Amp Yellow	Instrument Cluster, SIREN, Clock Module, Multifunction Control Switch – If Equipped
M14	–	20 Amp Yellow	Trailer Tow – If Equipped
M15	–	20 Amp Yellow	Rear View Mirror, Instrument Cluster, Multifunction Control Switch, Tire Pressure Monitor

MAINTAINING YOUR VEHICLE

Cavity	Cartridge Fuse	Mini-Fuse	Description
M16	–	10 Amp Red	Airbag Module/Occupant Classification Module
M17	–	15 Amp Blue	Left Tail/License/Park Lamp, Running Lamps
M18	–	15 Amp Blue	Right Tail/Park/Run Lamp
M19	–	25 Amp Clear	Powertrain
M20	–	15 Amp Blue	Instrument Cluster Interior Light, Switch Bank, Steering Column Module, Switch Steering Wheel
M21	–	20 Amp Yellow	Powertrain
M22	–	10 Amp Red	Horn
M23	–	10 Amp Red	Horn
M24	–	25 Amp Clear	Rear Wiper
M25	–	20 Amp Yellow	Fuel Pump
M26	–	10 Amp Red	Power Mirror Switch, Driver Window Switch
M27	–	10 Amp Red	Wireless Control Module, Keyless Entry Module
M28	–	10 Amp Red	Powertrain, Transmission Control Module
M29	–	10 Amp Red	Occupant Classification Module
M30	–	15 Amp Blue	Rear Wiper Module, Power Folding Mirror
M31	–	20 Amp Yellow	Back-Up Lamps
M32	–	10 Amp Red	Airbag Module, THATCHUM – If Equipped
M33	–	10 Amp Red	Powertrain
M34	–	10 Amp Red	Park Assist, Heater Climate Control Module, Headlamp Wash, Compass, Rear Camera, Door Lamps, Flashlight, Relay Diesel Cabin Heater
M35	–	10 Amp Red	Heated Mirrors
M36	–	20 Amp Yellow	Power Outlet #3 (Instrument Panel or with Console Center)
M37	–	10 Amp Red	Antilock Brakes, Stability Control, Stop Lamp, Fuel Pump
M38	–	25 Amp Clear	Door Lock/Unlock Motors, Liftgate Lock/Unlock Motors

The power windows are fused by a 25 Amp circuit breaker located in the Totally Integrated Power Module.

MAINTAINING YOUR VEHICLE

TIRES — GENERAL INFORMATION

TIRE PRESSURES

Check the inflation pressure of each tire, including the spare tire (if equipped), at least monthly and inflate to the recommended pressure for your vehicle.

The tire pressures recommended for your vehicle are found on the “Tire and Loading Information” label located on the driver’s side door opening or B pillar.

NOTE:

Refer to the Owner’s Manual on the DVD or the Tire Information Supplement located in your Owner’s Information kit for more information regarding tire warnings and instructions.



**Tire And Loading Information Location
(Example)**

WARNING!

- Overloading of your tires is dangerous. Overloading can cause tire failure, affect vehicle handling, and increase your stopping distance. Use tires of the recommended load capacity for your vehicle. Never overload them.
- Improperly inflated tires are dangerous and can cause collisions. Under-inflation increases tire flexing and can result in over-heating and tire failure. Over-inflation reduces a tire's ability to cushion shock. Objects on the road and chuck holes can cause damage that results in tire failure. Unequal tire pressures can cause steering problems. You could lose control of your vehicle. Over-inflated or under-inflated tires can affect vehicle handling and can fail suddenly, resulting in loss of vehicle control. Always drive with each tire inflated to the recommended cold tire inflation pressure.

MAINTAINING YOUR VEHICLE

SPARE TIRES — IF EQUIPPED

NOTE:

For vehicles equipped with Tire Service Kit instead of a spare tire, please refer to “Tire Service Kit” in “What To Do In Emergencies” on your DVD for further information.

CAUTION!

Because of the reduced ground clearance, do not take your vehicle through an automatic car wash with a compact or limited-use temporary spare installed. Damage to the vehicle may result.

Spare Tire Matching Original Equipped Tire And Wheel — If Equipped

Your vehicle may be equipped with a spare tire and wheel equivalent in look and function to the original equipment tire and wheel found on the front or rear axle of your vehicle. This spare tire may be used in the tire rotation for your vehicle. If your vehicle has this option, refer to an authorized tire dealer for the recommended tire rotation pattern.

Compact Spare Tire — If Equipped

The compact spare is for temporary emergency use only. You can identify if your vehicle is equipped with a compact spare by looking at the spare tire description on the Tire and Loading Information Placard located on the driver's side door opening or on the sidewall of the tire. Compact spare tire descriptions begin with the letter “T” or “S” preceding the size designation. Example: T145/80D18 103M.

T, S = Temporary Spare Tire

Since this tire has limited tread life, the original equipment tire should be repaired (or replaced) and reinstalled on your vehicle at the first opportunity.

Do not install a wheel cover or attempt to mount a conventional tire on the compact spare wheel, since the wheel is designed specifically for the compact spare tire. Do not install more than one compact spare tire and wheel on the vehicle at any given time.

WARNING!

Compact spares are for temporary emergency use only. With these spares, do not drive more than 50 mph (80 km/h). Temporary use spares have limited tread life. When the tread is worn to the tread wear indicators, the temporary use spare tire needs to be replaced. Be sure to follow the warnings, which apply to your spare. Failure to do so could result in spare tire failure and loss of vehicle control.

Full Size Spare — If Equipped

The full size spare is for temporary emergency use only. This tire may look like the originally equipped tire on the front or rear axle of your vehicle, but it is not. This spare tire may have limited tread life. When the tread is worn to the tread wear indicators, the temporary use full size spare tire needs to be replaced. Since it is not the same as your original equipment tire, replace (or repair) the original equipment tire and reinstall on the vehicle at the first opportunity.

Limited Use Spare — If Equipped

The limited-use spare tire is for temporary emergency use only. This tire is identified by a label located on the limited-use spare wheel. This label contains the driving limitations for this spare. This tire may look like the original equipped tire on the front or rear axle of your vehicle, but it is not. Installation of this limited-use spare tire affects vehicle handling. Since it is not the same as your original equipment tire, replace (or repair) the original equipment tire and reinstall on the vehicle at the first opportunity.

WARNING!

Limited-use spares are for emergency use only. Installation of this limited-use spare tire affects vehicle handling. With this tire, do not drive more than the speed listed on the limit-use spare wheel. Keep inflated to the cold tire inflation pressures listed on your Tire and Loading Information Placard located on the driver's side B-Pillar or the rear edge of the driver's side door. Replace (or repair) the original equipment tire at the first opportunity and reinstall it on your vehicle. Failure to do so could result in loss of vehicle control.

WHEEL AND WHEEL TRIM CARE

All wheels and wheel trim, especially aluminum and chrome plated wheels, should be cleaned regularly with a mild soap and water to prevent corrosion.

To remove heavy soil and/or excessive brake dust, use MOPAR Wheel Cleaner or equivalent or select a non-abrasive, non-acidic cleaner.

CAUTION!

Do not use scouring pads, steel wool, a bristle brush, or metal polishes. Do not use oven cleaner. These products may damage the wheel's protective finish. Avoid automatic car washes that use acidic solutions or harsh brushes that may damage the wheel's protective finish. Only MOPAR Wheel Cleaner or equivalent is recommended.

MAINTAINING YOUR VEHICLE

ADDING FUEL

Fuel Filler Cap (Gas Cap)

The gas cap is located behind the fuel filler door on the left side of the vehicle. If the gas cap is lost or damaged, be sure the replacement cap is for use with this vehicle.

When the fuel nozzle “clicks” or shuts off, the fuel tank is full.

Tighten the gas cap until you hear a “clicking” sound. This is an indication that the gas cap is properly tightened. If not properly tightened, the MIL (Malfunction Indicator Light) may come on.

NOTE:

The driver’s side sliding door cannot be opened while the fuel door is open.



Fuel Filler

CAUTION!

- Damage to the fuel system or emissions control system could result from using an improper gas cap. A poorly fitting cap could let impurities into the fuel system and may cause the MIL to turn on, due to fuel vapors escaping from the system.
- To avoid fuel spillage and overfilling, do not “top off” the fuel tank after filling.

WARNING!

- Never have any smoking materials lit in or near the vehicle when the gas cap is removed or the tank filled.
- Never add fuel when the engine is running. This is in violation of most state and federal fire regulations and/or local bylaws, and will cause the MIL to turn on.
- A fire may result if gasoline is pumped into a portable container that is inside of a vehicle. You could be burned. Always place gas containers on the ground while filling.

MAINTAINING YOUR VEHICLE

FLEXIBLE FUEL — IF EQUIPPED

E-85 General Information

The information in this section is unique for Flexible Fuel vehicles only. These vehicles can be identified by a unique fuel filler door label that states **Ethanol (E-85) or Unleaded Gasoline Only** and a yellow fuel cap. Refer to the Owner's Manual on the DVD for further information.

CAUTION!

Only vehicles with the E-85 fuel filler door label or a yellow gas cap can operate on E-85.

REPLACEMENT BULBS

Interior Bulbs

	Bulb Number
Center & Rear Dome Lamp	578
Center & Rear Reading Lamps	578
Front Door Courtesy Lamp	578
Front Header Reading Lamps – If Equipped	578
Instrument Cluster Lamps	PC74
Liftgate Lamp(s)	578
Overhead Console Reading Lamps	PC579
Removable Console Lamp – If Equipped	194
Visor Vanity Lamps	6501966

NOTE:

For lighted switches, see your authorized dealer for replacement instructions.

Exterior Bulbs

	Bulb Number
Headlamp	H11LL
Fog Lamp – If Equipped	PSX24W
Front Side Marker, Park/Turn Signal	3757A or PY27/7W
Rear Tail, Stop, Turn Signal Lamp	LED (Serviced at Authorized Dealer)
Center High-Mounted Stop Lamp	LED (Serviced at Authorized Dealer)
Backup Lamp	3157
License	168

NOTE:

All of the interior bulbs are glass wedge base or glass cartridge types. Aluminum base bulbs are not approved and should not be used for replacement.

CONSUMER ASSISTANCE

FCA US LLC CUSTOMER CENTER

P.O. Box 21-8004 Auburn Hills, MI 48321-8004 Phone: 1-800-423-6343

FCA CANADA INC. CUSTOMER CENTER

P.O. Box 1621 Windsor, Ontario N9A 4H6 Phone: 1-800-465-2001 (English) Phone: 1-800-387-9983 (French)

PUBLICATIONS ORDERING

- If you are the first registered retail owner of your vehicle, you may obtain a complimentary printed copy of the Owner's Manual, Navigation/Uconnect Manuals or Warranty Booklet. United States customers may visit the Dodge Contact Us page at www.dodge.com scroll to the bottom of the page and select the "Contact Us" link, then select the "Owner's Manual and Glove Compartment Material" from the left menu. You may also obtain a complimentary copy by calling 1-800-423-6343 (U.S.) or 1-800-387-1143 (Canada).
- Replacement User Guide kits or DVDs or, if you prefer, additional printed copies of the Owner's Manual, Warranty Booklet or Radio Manuals may be purchased by visiting www.techauthority.com or by calling 1-800-890-4038 (U.S.) or 1-800-387-1143 (Canada). Visa, Master Card, American Express and Discover orders are accepted. If you prefer mailing your order, please call the above numbers for an order form.

NOTE:

- A street address is required when ordering manuals (no P.O. Boxes).
- The Owner's Manual and User Guide electronic files are also available on the Chrysler, Jeep®, Ram Truck, Dodge and SRT websites.
- Click on the "For Owners" tab, select "Owner/Service Manuals", then select your desired model year and vehicle from the drop down lists.

ASSISTANCE FOR THE HEARING IMPAIRED

To assist customers who have hearing difficulties, the manufacturer has installed special TDD (Telecommunication Devices for the Deaf) equipment at its customer center. Any hearing or speech impaired customer, who has access to a TDD or a conventional teletypewriter (TTY) in the United States, can communicate with the manufacturer by dialing 1-800-380-CHRY. Canadian residents with hearing difficulties that require assistance can use the special needs relay service offered by Bell Canada. For TTY teletypewriter users, dial 711 and for Voice callers, dial 1-800-855-0511 to connect with a Bell Relay Service operator.

WARNING!

Engine exhaust, some of its constituents, and certain vehicle components contain, or emit, chemicals known to the State of California to cause cancer and birth defects, or other reproductive harm. In addition, certain fluids contained in vehicles and certain products of component wear contain, or emit, chemicals known to the State of California to cause cancer and birth defects, or other reproductive harm.

REPORTING SAFETY DEFECTS IN THE UNITED STATES

If you believe that your vehicle has a defect that could cause a collision or cause injury or death, you should immediately inform the National Highway Traffic Safety Administration (NHTSA) in addition to notifying the manufacturer.

If NHTSA receives similar complaints, it may open an investigation, and if it finds that a safety defect exists in a group of vehicles, it may order a recall and remedy campaign. However, NHTSA cannot become involved in individual problems between you, your authorized dealer and the manufacturer.

To contact NHTSA, you may either call the Auto Safety Hotline toll free at 1-888-327-4236 (TTY: 1-800-424-9153), or go to <http://www.safercar.gov>; or write to: Administrator, NHTSA, 1200 New Jersey Avenue, SE., West Building, Washington, D.C. 20590. You can also obtain other information about motor vehicle safety from <http://www.safercar.gov>.

In Canada

If you believe that your vehicle has a safety defect, you should contact the Customer Service Department immediately. Canadian customers who wish to report a safety defect to the Canadian government should contact Transport Canada, Motor Vehicle Defect Investigations and Recalls at 1-800-333-0510 or go to <http://www.tc.gc.ca/roadsafety/>.

French Canadian customers who wish to report a safety defect to the Canadian government should contact Transport Canada, Motor Vehicle Defect Investigations and Recalls at 1-800-333-0510 or go to <http://www.tc.gc.ca/securiteroutiere/>.

MOPAR® ACCESSORIES

AUTHENTIC ACCESSORIES BY MOPAR

The following highlights just some of the many Authentic Dodge Accessories by Mopar featuring a fit, finish, and functionality specifically for your Dodge Grand Caravan.

In choosing Authentic Accessories you gain far more than expressive style, premium protection, or extreme entertainment, you also benefit from enhancing your vehicle with accessories that have been thoroughly tested and factory-approved.

For the full line of Authentic Dodge Accessories by Mopar, visit your local dealership or online at mopar.com for U.S. residents and mopar.ca for Canadian residents.

EXTERIOR:

- Front Air Deflector
- Hitch Receiver
- Molded Running Boards
- Front End Cover
- Fog Lights
- Removable Roof Rack
- Molded Splash Guards
- Side Window Air Deflectors

INTERIOR:

- Storage Bags
- Slush Mats
- Premium Carpet Floor Mats
- Door Sill Guards
- Ambient Light Kit
- Cargo Tray
- Cargo Liner

ELECTRONICS:

- Park Distance Sensors
- Electronic Vehicle Tracking System
- Mopar Connect (WiFi)
- Remote Start
- Rearview Camera
- DVD Rear Seat Video

CARRIERS:

- Hitch-mount Bike Carrier
- Roof Mount Ski and Snowboard Carrier
- Roof Mount Bike Carrier
- Tent Kit
- Roof Box Cargo Carrier
- Roof Mount Canoe Carrier

NOTE:

All parts are subject to availability.

FREQUENTLY ASKED QUESTIONS

FREQUENTLY ASKED QUESTIONS

GETTING STARTED

- How do I install my LATCH Equipped Child Seat? pg. 22
- How do I program my Front Seat Memory? pg. 30

OPERATING YOUR VEHICLE

- How does the Electronic Range Select (ERS) operate? pg. 41

ELECTRONICS

Which radio is in my vehicle?

- Uconnect 130 pg. 49
- Uconnect 130 WITH SiriusXM pg. 51
- Uconnect 430/430N pg. 54

How do I activate the Audio Jack?

- Uconnect 130 pg. 54
- Uconnect 130 WITH SiriusXM pg. 54
- Uconnect 430/430N pg. 58

How do I set the clock on my radio?

- Uconnect 130 pg. 52
- Uconnect 130 WITH SiriusXM pg. 52
- Uconnect 430/430N pg. 55

How do I use the Navigation feature?

- Uconnect 430/430N pg. 62
- How do I pair my cell phone via Bluetooth with the Uconnect Hands-Free Voice Activation System? pg. 71
- How do I use my USB port to listen to audio through my touch-screen radio? pg. 69
- How do I configure my Universal Garage Door Opener (HomeLink)? pg. 81

UTILITY

- How do I know how much I can tow with my Dodge Grand Caravan? pg. 84

WHAT TO DO IN EMERGENCIES

- What do I do if my TPMS warning light is blinking? pg. 87
- How do I change a flat tire? pg. 99
- How do I Jump-Start my vehicle? pg. 113



FREQUENTLY ASKED QUESTIONS

MAINTAINING YOUR VEHICLE

- Where is my Fuse Block located? pg. 130
- What type of oil do I use? pg. 124
- How often should I change my engine's oil? pg. 125
- What should my tire pressure be set at? pg. 133

Accessories	140
Mopar	140
Adding Engine Coolant (Antifreeze)	125
Adding Washer Fluid	125
Adjust	
Forward	28
Rearward	28
Aftermarket	3
Air Bag	
Advanced Front Air Bag	16
Advance Front Air Bag	15
Air Bags	15
Air Bag Warning Light	15, 19
Driver Knee Air Bag	17
Enhanced Accident Response	18, 120
Event Data Recorder (EDR)	19, 120
Front Air Bag	15
Passenger Knee Air Bag	17
Rollover	15
Side Air Bags	17
Side Impacts	15
Air Bag Light	19, 86
Air Cleaner, Engine (Engine Air Cleaner Filter)	125
Air Conditioner Maintenance	125
Air Conditioning Refrigerant	125
Air Conditioning System	125
Alarm	
Arm The System	13
Disarm The System	14
Vehicle Security Alarm	13
Alarm (Security Alarm)	13, 90
Antifreeze (Engine Coolant)	124, 125
Disposal	125
Anti-Lock Warning Light	86
Appearance Care	125
Assistance Towing	86
Audio Jack	50, 54, 58
Audio Settings	50, 52
Audio Systems (Radio)	49
Automatic Headlights	39
Automatic Temperature Control (ATC)	43
Automatic Transmission	
Fluid Type	125
Auxiliary Audio/Video Input Jacks	77
Back-Up Camera	45
Battery	125
Jump Starting	113
Blind Spot Monitoring	45
Body Mechanism Lubrication	125
Brake Fluid	125
Brakes	125
Brake System	125
Master Cylinder	125
Warning Light	89
Break-In Recommendations, New Vehicle	35
Bulbs, Light	137
Calibration, Compass	78
Canada	3, 139
Capacities, Fluid	124
Caps, Filler	
Oil (Engine)	125
Car Washes	125
CD (Compact Disc) Player	50, 53
Center Seat LATCH	22
Change Oil Indicator	91
Changing A Flat Tire	99
Charging System Light	86
Child Restraint	20
Child Restraints	20
Lower Anchors And Tethers For Children	20
Child Seat Installation	20
Cleaning	
Wheels	125
Windshield Wiper Blades	125
Clock Setting	49, 52, 55
Cluster Warning/Indicator Lights	
Anti-Lock Brake (ABS) Light	86
Brake Warning Light	89
Charging System Light	86
Electronic Speed Control ON Indicator	91
Electronic Speed Control SET Indicator	91
Electronic Throttle Control (ETC) Indicator Light	87
Front Fog Light Indicator	90
High Beam Indicator	90
Malfunction Indicator Light (MIL)	90
Oil Pressure Warning Light	86
Tire Pressure Monitoring System (TPMS) Light	87

- Turn Signal Indicator 90
- Vehicle Security Light 90
- Clutch 125
- Clutch Fluid 125
- Compact Spare Tire 134
- Compass Calibration. 78
- Cooling System. 125
 - Adding Coolant (Antifreeze) . . . 125
 - Coolant Capacity 124
 - Coolant Level 125
 - Disposal Of Used Coolant 125
 - Drain, Flush, And Refill 125
 - Inspection 125
 - Points To Remember 125
 - Pressure Cap 125
 - Selection Of Coolant (Antifreeze) 124, 125
- Corrosion Protection 125
- Customer Assistance. 138, 139
- Defects, Reporting 139
- Delay (Intermittent) Wipers 37
- Dimmer Control 40
- Disabled Vehicle Towing. 86, 117
- Disarming, Security System. 14
- Disposal
 - Antifreeze (Engine Coolant) . . . 125
- Driver Cockpit 4
- E-85 Fuel. 137
- Economy (Fuel) Mode 42
- Electronics. 3
 - Your Vehicle's Sound System . . . 46
- Electronic Stability Control (ESC). . . 90
- Electronic Stability Control (ESC) OFF Indicator 90
- Electronic Throttle Control Warning Light 87
- Electronic Vehicle Information Center (EVIC) 78, 79
- Emergencies, What To Do In 86
- Emergency. 86
- Emergency, In Case Of
 - Jacking 99, 106
 - Jump Starting 113
 - Overheating 92
 - Towing 86
- Engine 122
- Air Cleaner 125
- Break-In Recommendations 35
- Checking Oil Level 125
- Coolant (Antifreeze) 124
- Cooling 125
- Fuel Requirements 124
- Oil 124, 125
- Oil Filler Cap 125
- Oil Selection 124, 125
- Overheating 92
- Enhanced Accident Response
 - Feature 120
- Ethanol 137
- Exhaust System 125
- Exterior Lights 137
- FAQ 141
- Filters
 - Air Cleaner 125
 - Engine Oil 124, 125
 - Engine Oil Disposal 125
- Flashers
 - Turn Signal 90
- Flash-To-Pass 39
- Flexible Fuel Vehicles
 - Fuel Requirements 137
- Fluid Capacities 124
- Fluids, Lubricants And Genuine Parts. 124
- Fog Lights 90
- Freeing A Stuck Vehicle 119
- Frequently Asked Questions. 141
- Fuel
 - Economy Mode 42
 - Ethanol 137
 - Octane Rating 124
 - Requirements 124
 - Tank Capacity 124
- Fuel, Flexible. 137
- Fuses 130
- Garage Door Opener (HomeLink). .81, 83
- Gear Select Lever Override 116
- General Maintenance 125
- Glass Cleaning 125
- GPS Navigation (Uconnect GPS) . . . 64
- Headlights
 - Cleaning 125

- Passing39
- Head Restraints25
- Heated Mirrors44
- High Beam Indicator90
- High Beam/Low Beam Select (Dimmer)
 - Switch39
- HomeLink
 - Operation83
- HomeLink (Garage Door Opener) .81, 83
- Hood Release121

- Installing A Child Restraint With ALR .22
- Installing Child Restraints Using The
 - LATCH Lower Anchorages22
- Instrument Panel Cover125
- Instrument Panel Lens Cleaning . . .125
- Integrated Power Module (Fuses) . . .130
- Interior And Instrument Lights5
- Interior Appearance Care125
- Interior Lights40
- Intermittent Wipers (Delay Wipers) . .37
- Introduction2
 - Aftermarket Electronics3
 - Canada3
- iPod/USB/MP3 Control69
 - Bluetooth Streaming Audio76

- Jack Location99
- Jack Operation99
- Jump Starting113

- Key Fob8
 - Arm The Alarm13
 - Disarm The Alarm14
 - Lock The Doors8
 - Unlock The Doors8
- Key Fob Programmable Features . . .79
- Keyless Enter-N-Go10
 - Accessory Postition13
 - Automatic Trans12
 - Engine Stopping12
 - Key Fob10
 - Lock/Unlock10
 - Passive Entry10
 - Remote Control10
- Lane Change Assist36
- Lap/Shoulder Belts14

- Left Switch
 - Steering Wheel Audio Controls . . .69
- Liftgate, Power8
- Lights
 - Air Bag19
 - Automatic Headlights39
 - Bulb Replacement137
 - Dimmer Switch, Headlight40
 - Fog90
 - High Beam Indicator90
 - High Beam/Low Beam Select . . .39
 - Interior40
 - Low Fuel86
 - Passing39
 - Seat Belt Reminder89
 - Security Alarm90
 - Service137
 - Tire Pressure Monitoring (TPMS) . .87
- Locks
 - Liftgate, Tailgate8
- Lubrication, Body125

- Maintaining Your Vehicle121
- Maintenance121
- Maintenance Free Battery125
- Maintenance, General121, 125
- Maintenance Procedures125
- Maintenance Record129
- Maintenance Schedule125
- Malfunction Indicator Light (Check
 - Engine)90
- Master Cylinder (Brakes)125
- Media Center Radio54
- Memory Feature (Memory Seat)29
- Memory Seat29
- Mirrors
 - Heated44
 - Memory29
- Mopar140
- MOPAR Accessories140
- Multi-Function Control Lever36

- Navigation62
- Navigation System (Uconnect GPS) . .62
- Navigation Voice Prompt Volume . . .62
- New Vehicle Break-In Period35

- Oil Change Indicator91

- Oil Change Indicator, Reset 91
- Oil, Engine 124, 125
 - Capacity 124
 - Change Interval 125
 - Checking 125
 - Disposal 125
 - Filter 124, 125
 - Filter Disposal 125
 - Materials Added To 125
 - Recommendation 124, 125
 - Viscosity 124, 125
- Oil Filter, Selection. 125
- Oil Pressure Light 86
- Overheating, Engine. 92

- Paint Care 125
- Panic Alarm 8
- ParkSense System, Rear 45
- Phone (Uconnect) 70
- Placard, Tire And Loading Information . 133
- Power
 - Lift Gate 8
 - Seats 27
- Power Seats
 - Forward 28
 - Rearward 28
 - Recline 28
- Power Steering Fluid. 125
- Preparation For Jacking 105
- Programmable Electronic Features . . 79

- Radio
 - Presets 50, 52, 56
- Radio Operation. 50, 52
- Rear Camera 45
- Rear Cross Path 45
- Rear ParkSense System 45
- Recreational Towing. 84
- Refrigerant 125
- Remote Keyless Entry (RKE)
 - Arm The Alarm 13
 - Disarm The Alarm 14
 - Lock The Doors 8
 - Remote Keyless Entry (RKE) 8
 - Unlock The Doors 8
- Remote Starting System 9
- Replacement Bulbs 137
- Reporting Safety Defects 139

- Restraint, Head 25
- Rocking Vehicle When Stuck 119

- Satellite Radio
 - (Uconnect Studios) 51, 53
- Schedule, Maintenance 125
- Seat Belt
 - Seat Belt Pretensioner 15
- Seat Belt Maintenance 125
- Seat Belts 14
 - Adjustable Shoulder Belt 14
 - Pretensioners 14
 - Reminder 89
- Seats 28
 - Adjustment 28
 - Memory 29
 - Power 27
- Security Alarm 90
 - Arm The System 13
 - Disarm The System 14
 - Security Alarm 13
- Selection Of Coolant (Antifreeze) . . 124
- Shift Lever Override 116
- Signals, Turn 36, 90
- Sirius Satellite Radio 65
- SIRIUS Travel Link 65
- Spare Tire 100, 134, 135
- Spark Plugs 124
- Starting
 - Remote 9
- Steering
 - Tilt Column 34
 - Wheel, Heated 33
 - Wheel, Tilt 34
- Steering Wheel Audio Controls 69
- Supplemental Restraint System - Air
 - Bag 15

- Telescoping Steering Column 34
- Tether Anchor, Child Restraint 22
- Tilt Steering Column. 34
- Tires 133, 134
 - Air Pressure 133
 - Changing 99
 - Compact Spare 134
 - General Information 133, 134
 - Jacking 99, 106
 - Spare Tire 100, 134, 135

Tire Service Kit93, 94, 95, 97, 98	Video Entertainment System (Rear Seat Video System)76
Touchscreen Radio		Voice Command73
Cleaning Your Touchscreen Radio .61		Voice Prompt Volume	
Towing84	Navigation62
Disabled Vehicle117	Volume	
Recreational84	Navigation Voice Prompt62
Trailer Towing		Washer	
Trailer And Tongue Weight84	Adding Fluid125
Trailer Weight84	Washing Vehicle125
Transmission		Wheel And Wheel Trim.125
Fluid125	Wheel And Wheel Trim Care.125, 135
Maintenance125	Windshield Washers37
Turn Signals90	Windshield Wiper Blades125
Uconnect Voice Command73	Wiper Blade Replacement.125
Using The Top Tether Anchorage23	Wipers, Intermittent37
Vehicle Security Alarm Disarming14		



NOTES





NOTES

DODGE.COM (U.S.) DODGE.CA (CANADA)

This guide has been prepared to help you get quickly acquainted with your new Dodge brand vehicle and to provide a convenient reference source for common questions. However, it is not a substitute for your Owner's Manual.

For complete operational instructions, maintenance procedures and important safety messages, please consult your Owner's Manual, Navigation/Uconnect Manuals and other Warning Labels in your vehicle.

Not all features shown in this guide may apply to your vehicle. For additional information on accessories to help personalize your vehicle, visit www.mopar.com (U.S.), www.mopar.ca (Canada) or your local Dodge brand dealer.



DRIVING AND ALCOHOL

Drunken driving is one of the most frequent causes of accidents. Your driving ability can be seriously impaired with blood alcohol levels far below the legal minimum. If you are drinking, don't drive. Ride with a designated non-drinking driver, call a cab, a friend, or use public transportation.

WARNING!

Driving after drinking can lead to an accident. Your perceptions are less sharp, your reflexes are slower, and your judgment is impaired when you have been drinking. Never drink and then drive.

DOWNLOAD A FREE
ELECTRONIC COPY OF THE OWNER'S
MANUAL AND WARRANTY BOOKLET

BY VISITING:

WWW.DODGE.COM/EN/OWNERS/MANUALS
OR WWW.DODGE.COM/EN/WARRANTY (U.S.);
WWW.OWNERS.MOPAR.CA/EN (CANADA).

© 2015 FCA US LLC. ALL RIGHTS RESERVED.

DODGE IS A REGISTERED TRADEMARK OF FCA US LLC.

DODGE 



16Y532-926-AA
GRAND CARAVAN

SECOND EDITION REV. 1
USER GUIDE