

Pictorial index	Search by illustration
1 For safety and security	Make sure to read through them
2 Instrument cluster	How to read the gauges and meters, the variety of warning lights and indicators, etc.
3 Operation of each component	Opening and closing the doors and windows, adjustment before driving, etc.
4 Driving	Operations and advice which are necessary for driving
5 Interior features	Usage of the interior features, etc.
6 Maintenance and care	Caring for your vehicle and maintenance procedures
7 When trouble arises	What to do in case of malfunction or emergency
8 Vehicle specifications	Vehicle specifications, customizable features, etc.
9 For owners	Reporting safety defects for U.S. owners, and seat belt, SRS airbag and headlight aim instructions for Canadian owners
Index	Search by symptom
	Search alphabetically

2 TABLE OF CONTENTS

For your information.....	8
Reading this manual.....	12
How to search.....	13
Pictorial index.....	14

1 For safety and security

1-1. For safe use	
Before driving.....	32
For safety drive.....	34
Seat belts.....	36
SRS airbags.....	41
Front passenger occupant classification system.....	52
Safety information for children.....	58
Child restraint systems.....	59
Installing child restraints.....	63
Exhaust gas precautions.....	71
1-2. Theft deterrent system	
Engine immobilizer system.....	72
Alarm.....	74

2 Instrument cluster

2. Instrument cluster	
Warning lights and indicators.....	78
Gauges and meters (GS350/GS200t).....	86
Gauges and meters (GS F).....	92
Multi-information display (GS350/GS200t).....	100
Multi-information display (GS F).....	108
Head-up display.....	120
Fuel consumption information.....	127

3 Operation of each component

3-1. Key information	
Keys.....	132
3-2. Opening, closing and locking the doors and trunk	
Doors.....	137
Trunk.....	143
Smart access system with push-button start.....	150
3-3. Adjusting the seats	
Front seats.....	158
Driving position memory.....	160
Head restraints.....	165

3-4. Adjusting the steering wheel and mirrors

Steering wheel	168
Inside rear view mirror.....	169
Outside rear view mirrors.....	171

3-5. Opening, closing the windows and moon roof

Power windows.....	175
Moon roof.....	178

4 Driving

4-1. Before driving

Driving the vehicle	182
Cargo and luggage.....	191
Vehicle load limits.....	194
Trailer towing	195
Dinghy towing.....	196

4-2. Driving procedures

Engine (ignition) switch.....	197
Automatic transmission	202
Turn signal lever.....	209
Parking brake	210
Brake Hold (GS350/GS200t).....	212
ASC (Active Sound Control) (GS F).....	214

4-3. Operating the lights and wipers

Headlight switch	215
Automatic High Beam.....	218
Windshield wipers and washer	222

4-4. Refueling

Opening the fuel tank cap	227
---------------------------------	-----

4-5. Using the driving support systems

Lexus Safety System+	231
PCS (Pre-Collision System)	237
LKA (Lane-Keeping Assist)	249
LDA (Lane Departure Alert with steering control).....	258
Dynamic radar cruise control with full-speed range.....	266
Dynamic radar cruise control	278
Cruise control	290
Driving mode select switch.....	293
BSM (Blind Spot Monitor)	298
• The Blind Spot Monitor function	301
• The Rear Cross Traffic Alert function	303
TVD (Torque Vectoring Differential) (GS F)	306
Driving assist systems	308

4-6. Driving tips

Winter driving tips.....	316
--------------------------	-----

5 Interior features

5-1. Remote Touch screen
 Remote Touch/12.3-inch display..... 322

5-2. Using the air conditioning system and defogger
 Front automatic air conditioning system..... 328
 Rear air conditioning system..... 339
 Heated steering wheel/ seat heaters/seat ventilators..... 342

5-3. Using the interior lights
 Interior lights list 347
 • Interior lights.....348
 • Personal lights348

5-4. Using the storage features
 List of storage features 350
 • Glove box351
 • Console box351
 • Cup holders 352
 • Auxiliary boxes 353
 Trunk features..... 354

5-5. Using the other interior features

Other interior features.....358
 • Sun visors358
 • Vanity mirrors.....358
 • Clock 359
 • Ashtrays..... 359
 • Power outlets.....360
 • Armrest.....360
 • Rear sunshade/ rear door sunshades.....361
 • Trunk storage extension 363
 • Coat hooks.....364
 • Assist grips 364
 Garage door opener 365
 LEXUS Enform Safety Connect.....372

6 Maintenance and care

6-1. Maintenance and care
 Cleaning and protecting the vehicle exterior378
 Cleaning and protecting the vehicle interior..... 382

6-2. Maintenance
 Maintenance requirements...385
 General maintenance..... 387
 Emission inspection and maintenance (I/M) programs.....390

6-3. Do-it-yourself maintenance

Do-it-yourself service precautions..... 391
 Hood..... 393
 Positioning a floor jack..... 394
 Engine compartment 396
 Tires..... 413
 Tire inflation pressure 422
 Wheels 425
 Air conditioning filter 427
 Electronic key battery..... 429
 Checking and replacing fuses..... 431
 Headlight aim (vehicles with single-beam headlights) 435
 Light bulbs 437

7 When trouble arises

7-1. Essential information

Emergency flashers 442
 If your vehicle has to be stopped in an emergency 443

7-2. Steps to take in an emergency

If your vehicle needs to be towed..... 444
 If you think something is wrong..... 450
 Fuel pump shut off system..... 451
 If a warning light turns on or a warning buzzer sounds 452
 If a warning message is displayed 459
 If you have a flat tire (vehicles with spare tire) 491
 If you have a flat tire (vehicles without spare tire)..... 502
 If the engine will not start..... 515
 If the shift lever cannot be shifted from P 517
 If the parking brake cannot be released..... 518
 If the electronic key does not operate properly..... 520
 If the vehicle battery is discharged..... 523
 If your vehicle overheats..... 528
 If the vehicle becomes stuck 534



8 Vehicle specifications

8-1. Specifications
 Maintenance data
 (fuel, oil level, etc.)538
 Fuel information.....555
 Tire information.....558

8-2. Customization
 Customizable features568

8-3. Initialization
 Items to initialize.....583

9 For owners

Reporting safety defects
 for U.S. owners.....586

Seat belt instructions
 for Canadian owners
 (in French).....587

SRS airbag instructions
 for Canadian owners
 (in French).....589

Headlight aim instructions
 for Canadian owners
 (in French) (vehicles with
 single-beam headlights).....597

Index

What to do if...
 (Troubleshooting)600
 Alphabetical index604

For information regarding the equipment listed below, refer to the “NAVIGATION AND MULTIMEDIA SYSTEM OWNER’S MANUAL”.

- Audio system
- Intuitive parking assist
- Navigation system
- Lexus parking assist monitor



For your information

Main Owner's Manual

Please note that this manual applies to all models and explains all equipment, including options. Therefore, you may find some explanations for equipment not installed on your vehicle.

All specifications provided in this manual are current at the time of printing. However, because of the Lexus policy of continual product improvement, we reserve the right to make changes at any time without notice.

Depending on specifications, the vehicle shown in the illustrations may differ from your vehicle in terms of color and equipment.

Noise from under vehicle after turning off the engine

Approximately five hours after the engine is turned off, you may hear sound coming from under the vehicle for several minutes. This is the sound of a fuel evaporation leakage check and, it does not indicate a malfunction.

Accessories, spare parts and modification of your Lexus

A wide variety of non-genuine spare parts and accessories for Lexus vehicles are currently available in the market. You should know that Toyota does not warrant these products and is not responsible for their performance, repair, or replacement, or for any damage they may cause to, or adverse effect they may have on, your Lexus vehicle.

This vehicle should not be modified with non-genuine Lexus products. Modification with non-genuine Lexus products could affect its performance, safety or durability, and may even violate governmental regulations. In addition, damage or performance problems resulting from the modification may not be covered under warranty.

Installation of a mobile two-way radio system

The installation of a mobile two-way radio system in your vehicle could affect electronic systems such as:

- Multiport fuel injection system/sequential multiport fuel injection system
- Dynamic radar cruise control with full-speed range system
- Dynamic radar cruise control system
- Cruise control system
- Anti-lock brake system
- Vehicle dynamics integrated management
- SRS airbag system
- Seat belt pretensioner system

Be sure to check with your Lexus dealer for precautionary measures or special instructions regarding installation of a mobile two-way radio system.

Vehicle data recordings

Your Lexus is equipped with several sophisticated computers that will record certain data, such as:

- Engine speed
- Accelerator status
- Brake status
- Vehicle speed
- Shift position

The recorded data varies according to the vehicle grade level and options with which it is equipped. Furthermore, these computers do not record conversations, sounds or pictures.

● Data usage

Lexus may use the data recorded in these computers to diagnose malfunctions, conduct research and development, and improve quality.

Lexus will not disclose the recorded data to a third party except:

- With the consent of the vehicle owner or with the consent of the lessee if the vehicle is leased
- In response to an official request by the police, a court of law or a government agency
- For use by Lexus in a lawsuit
- For research purposes where the data is not tied to a specific vehicle or vehicle owner

● Usage of data collected through Safety Connect / Lexus Enform (U.S. mainland only)

If your Lexus has Safety Connect or Lexus Enform and if you have subscribed to those services, please refer to the Safety Connect / Lexus Enform Telematics Subscription Service Agreement for information on data collected and its usage.

Event data recorder

This vehicle is equipped with an event data recorder (EDR). The main purpose of an EDR is to record, in certain crash or near crash-like situations, such as an air bag deployment or hitting a road obstacle, data that will assist in understanding how a vehicle's systems performed. The EDR is designed to record data related to vehicle dynamics and safety systems for a short period of time, typically 30 seconds or less.

The EDR in this vehicle is designed to record such data as:

- How various systems in your vehicle were operating;
- Whether or not the driver and passenger safety belts were buckled/fastened;
- How far (if at all) the driver was depressing the accelerator and/or brake pedal; and,
- How fast the vehicle was traveling.

These data can help provide a better understanding of the circumstances in which crashes and injuries occur.

NOTE: EDR data are recorded by your vehicle only if a nontrivial crash situation occurs; no data are recorded by the EDR under normal driving conditions and no personal data (e.g., name, gender, age, and crash location) are recorded. However, other parties, such as law enforcement, could combine the EDR data with the type of personally identifying data routinely acquired during a crash investigation.

To read data recorded by an EDR, special equipment is required, and access to the vehicle or the EDR is needed. In addition to the vehicle manufacturer, other parties, such as law enforcement, that have the special equipment, can read the information if they have access to the vehicle or the EDR.

● Disclosure of the EDR data

Lexus will not disclose the data recorded in an EDR to a third party except when:

- An agreement from the vehicle's owner (or the lessee for a leased vehicle) is obtained
- In response to an official request by the police, a court of law or a government agency
- For use by Lexus in a lawsuit

However, if necessary, Lexus may:

- Use the data for research on vehicle safety performance
- Disclose the data to a third party for research purposes without disclosing information about the specific vehicle or vehicle owner

Scrapping of your Lexus

The SRS airbag and seat belt pretensioner devices in your Lexus contain explosive chemicals. If the vehicle is scrapped with the airbags and seat belt pretensioners left as they are, this may cause an accident such as fire. Be sure to have the systems of the SRS airbag and seat belt pretensioner removed and disposed of by a qualified service shop or by your Lexus dealer before you scrap your vehicle.

Perchlorate Material

Special handling may apply, See www.dtsc.ca.gov/hazardouswaste/perchlorate.

Your vehicle has components that may contain perchlorate. These components may include airbag, seat belt pretensioners, and wireless remote control batteries.

WARNING

■ General precautions while driving

Driving under the influence: Never drive your vehicle when under the influence of alcohol or drugs that have impaired your ability to operate your vehicle. Alcohol and certain drugs delay reaction time, impair judgment and reduce coordination, which could lead to an accident that could result in death or serious injury.

Defensive driving: Always drive defensively. Anticipate mistakes that other drivers or pedestrians might make and be ready to avoid accidents.

Driver distraction: Always give your full attention to driving. Anything that distracts the driver, such as adjusting controls, talking on a cellular phone or reading can result in a collision with resulting death or serious injury to you, your occupants or others.

■ General precaution regarding children's safety

Never leave children unattended in the vehicle, and never allow children to have or use the key.

Children may be able to start the vehicle or shift the vehicle into neutral. There is also a danger that children may injure themselves by playing with the windows, the moon roof, or other features of the vehicle. In addition, heat build-up or extremely cold temperatures inside the vehicle can be fatal to children.

Reading this manual

 **WARNING:**
Explains something that, if not obeyed, could cause death or serious injury to people.

 **NOTICE:**
Explains something that, if not obeyed, could cause damage to or a malfunction in the vehicle or its equipment.

1 2 3... Indicates operating or working procedures. Follow the steps in numerical order.

 Indicates the action (pushing, turning, etc.) used to operate switches and other devices.

 Indicates the outcome of an operation (e.g. a lid opens).

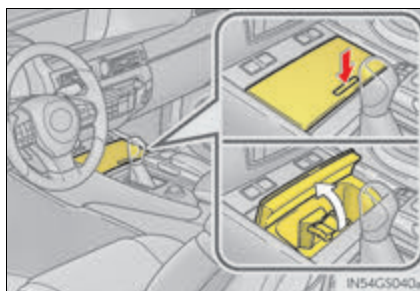

 Indicates the component or position being explained.

 Means "Do not", "Do not do this", or "Do not let this happen".

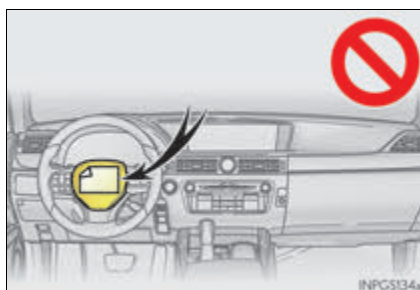

How to search

■ Searching by name

- Alphabetical index.....P. 604

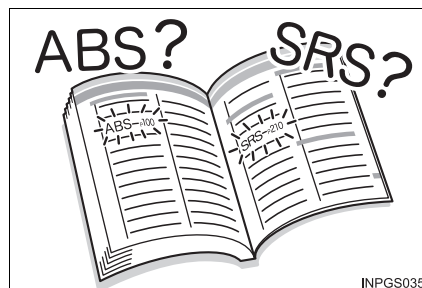

■ Searching by installation position

- Pictorial index.....P. 14

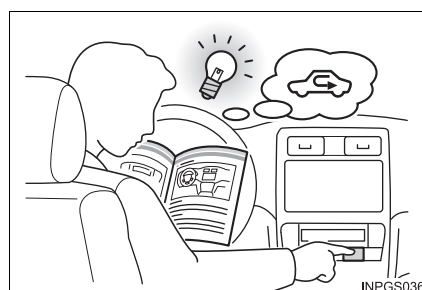

■ Searching by symptom or sound

- What to do if...
(Troubleshooting).....P. 600



■ Searching by title

- Table of contents..... P. 2

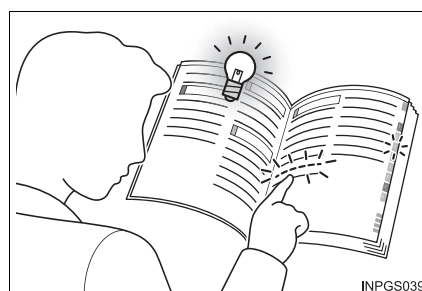

Pictorial index

■ Exterior (front)

► GS350/GS200t

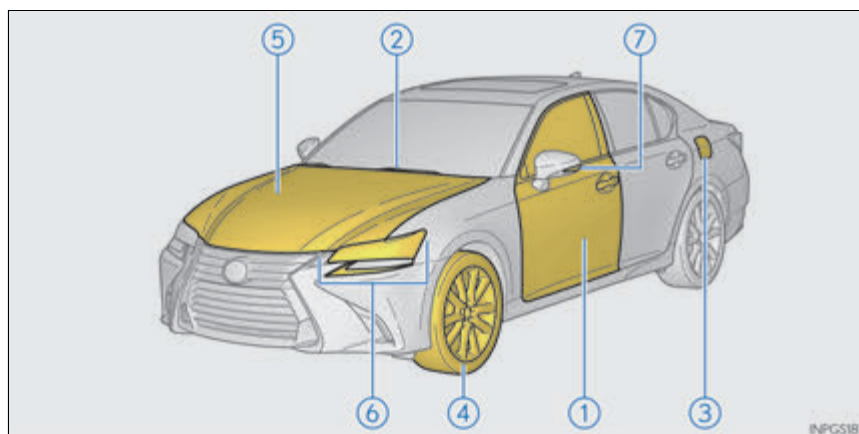

► GSF

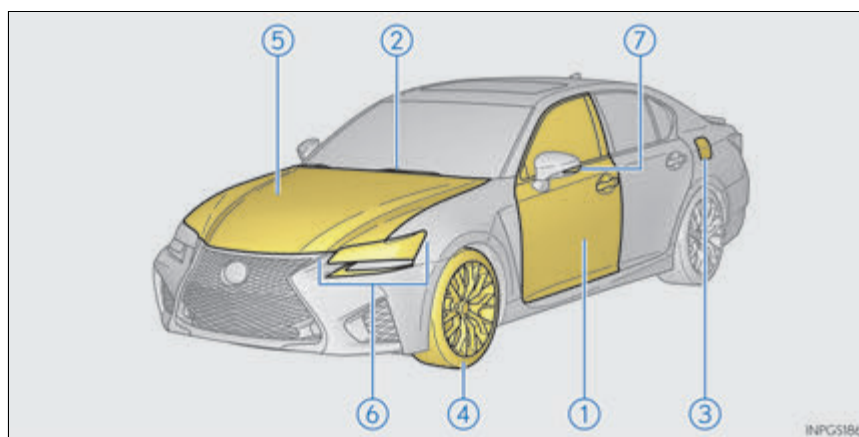

①	Doors	P. 137
	Locking/unlocking	P. 137
	Opening/closing the door glasses	P. 175
	Locking/unlocking by using the mechanical key	P. 520
	Warning lights/warning messages	P. 454, 461
②	Windshield wipers	P. 222
	Precautions against winter season	P. 316
	To prevent freezing (windshield wiper de-icer)*	P. 334
	Precautions against car wash	P. 380
③	Fuel filler door	P. 227
	Refueling method	P. 227
	Fuel type/fuel tank capacity	P. 541
④	Tires	P. 413
	Tire size/inflation pressure	P. 550
	Winter tires/tire chain	P. 316
	Checking/rotation/tire pressure warning system	P. 413
	Coping with flat tires	P. 491, 502
⑤	Hood	P. 393
	Opening	P. 393
	Engine compartment cover	P. 399
	Engine oil	P. 542
	Coping with overheat	P. 528
	Warning messages	P. 461

Light bulbs of the exterior lights for driving
(Replacing method: P. 437, Watts: P. 554)

⑥	Headlights/parking lights/daytime running lights/ front side marker lights	P. 215
	Front turn signal lights	P. 209
⑦	Side turn signal lights	P. 209

*: If equipped

■ Exterior (rear)

▶ GS350/GS200t

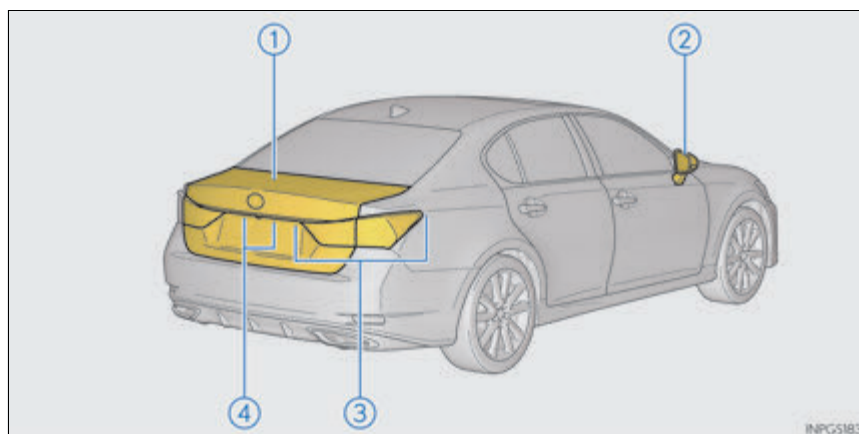

▶ GSF

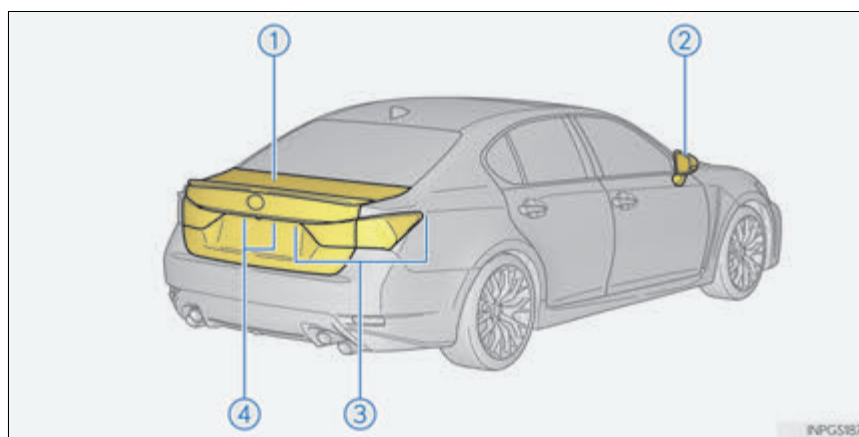

- ① **Trunk** P.143
 - Opening from inside the cabin P.143
 - Opening from outside P.143
 - Opening by using the mechanical key P.520
 - Warning lights/warning messages P.454, 461
- ② **Outside rear view mirrors** P.171
 - Adjusting the mirror angle P.171
 - Folding the mirrors P.171
 - Driving position memory P.160
 - Defogging the mirrors P.334

Light bulbs of the exterior lights for driving
(Replacing method: P.437)

- ③ **Tail lights/rear side marker lights** P.215
 - Stop lights** P.182
 - Rear turn signal lights** P.209
 - Back-up light**
 - Shifting the shift lever to R P.202
- ④ **License plate lights** P.215

■ Instrument panel

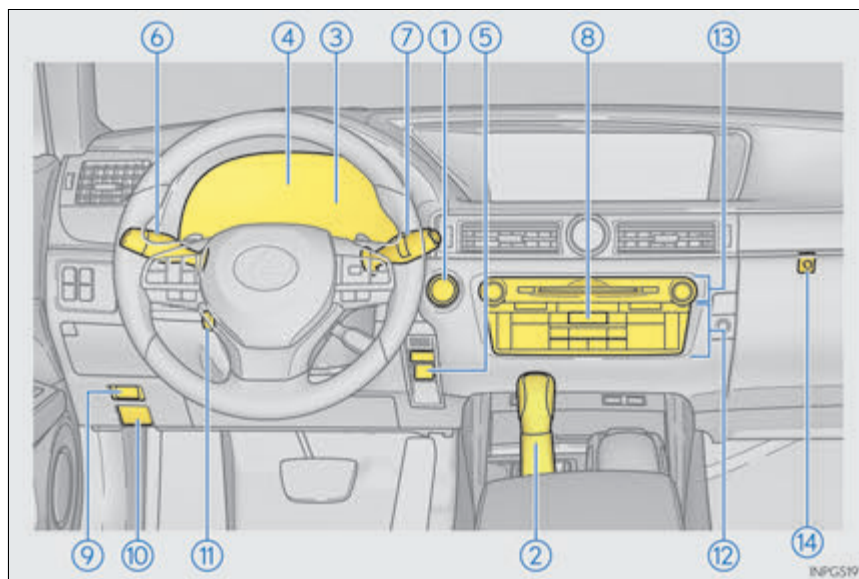

①	Engine switch	P. 197
	Starting the engine/changing the modes	P. 197
	Emergency stop of the engine	P. 443
	When the engine will not start	P. 515
	Warning messages	P. 468, 486
②	Shift lever	P. 202
	Changing the shift position	P. 202
	Precautions against towing	P. 444
	When the shift lever does not move	P. 517
③	Meters	P. 86, 92
	Reading the meters/adjusting the instrument panel light	P. 86, 92
	Warning lights/indicator lights	P. 78
	When the warning lights come on	P. 452

④	Multi-information display	P. 100, 108
	Display	P. 100, 108
	When the warning messages are displayed	P. 459
⑤	Parking brake switches	P. 210
	Applying/releasing	P. 210
	Precautions against winter season	P. 317
	Warning buzzer/message	P. 454, 473
⑥	Turn signal lever	P. 209
	Headlight switch	P. 215
	Headlights/parking lights/tail lights/daytime running lights	P. 215
⑦	Windshield wiper and washer switch	P. 222
	Usage	P. 222
	Adding washer fluid	P. 412
	Headlight cleaners* ¹	P. 223
	Warning messages	P. 481
⑧	Emergency flasher switch	P. 442
⑨	Trunk opener	P. 143
⑩	Hood lock release lever	P. 393
⑪	Tilt and telescopic steering control switch	P. 168
	Adjustment	P. 168
	Driving position memory	P. 160
⑫	Air conditioning system	P. 328
	Usage	P. 328
	Rear window defogger	P. 334
⑬	Audio system * ²	
⑭	Trunk opener main switch	P. 145

*¹: If equipped

*²: Refer to "NAVIGATION AND MULTIMEDIA SYSTEM OWNER'S MANUAL".

■ Switches

▶ GS350/GS200t

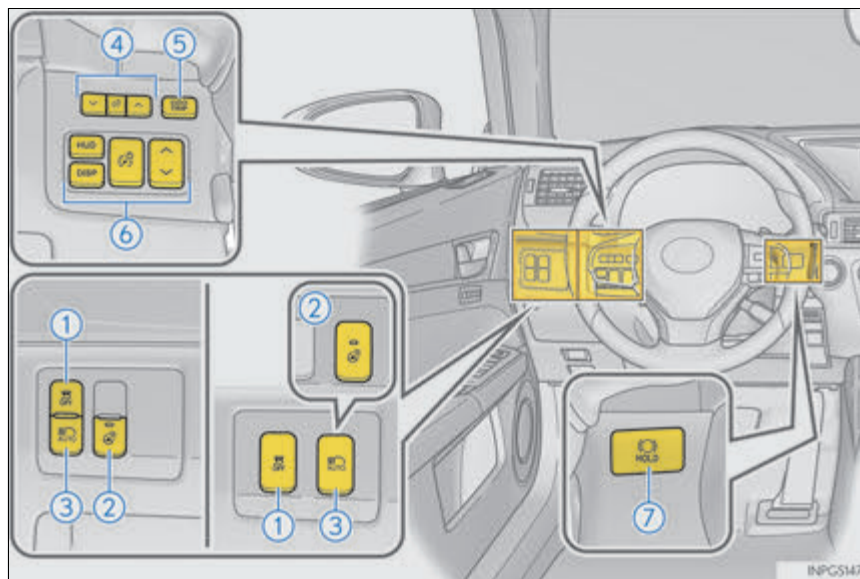

▶ GSF

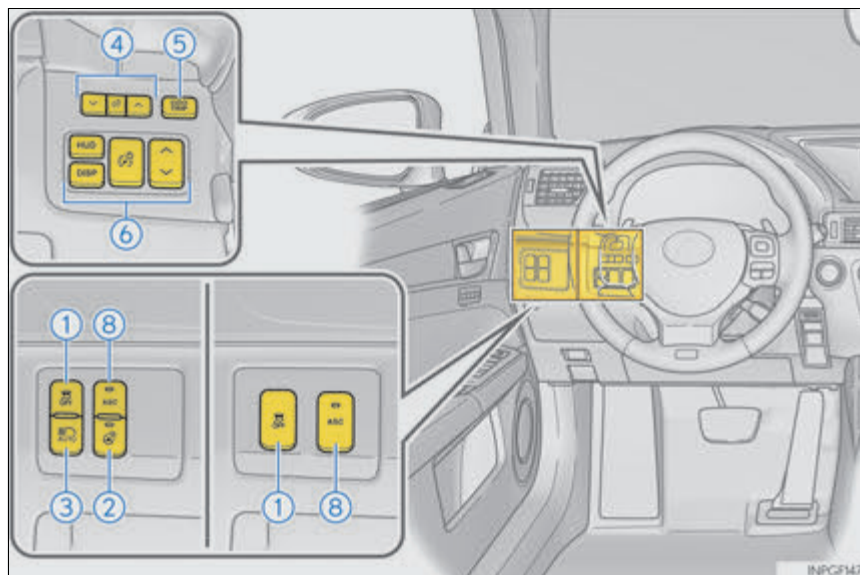

① VSC OFF switch.....	P. 310
② Heated steering wheel switch*	P. 342
③ Automatic High Beam switch*	P. 218
④ Instrument panel light control switches.....	P. 89, 97
⑤ Odometer/trip meter and trip meter reset button	P. 89, 96
⑥ HUD (Head-up display) switches*	P. 120
⑦ Brake hold switch.....	P. 212
⑧ ASC switch	P. 214

*: If equipped

► GS350/GS200t

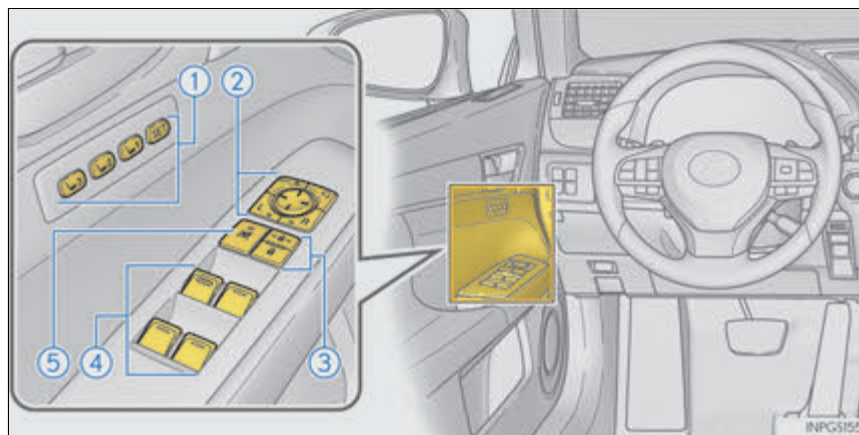

► GSF

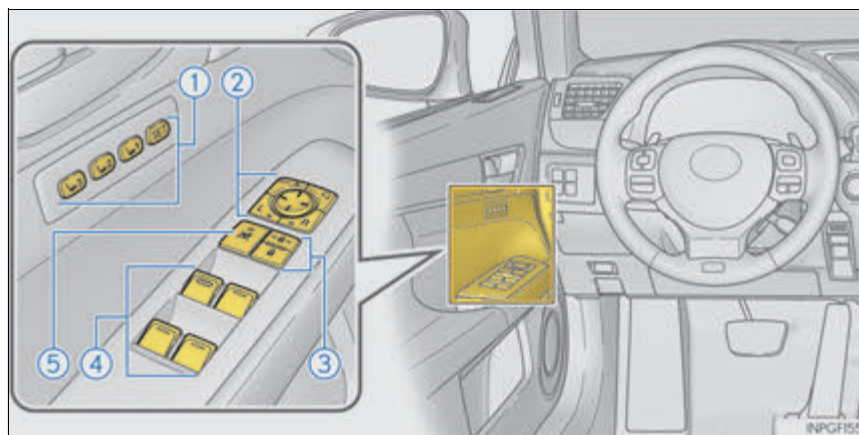

- ① Driving position memory switches P.160
- ② Outside rear view mirror switches P.171
- ③ Door lock switches P.139
- ④ Power window switches P.175
- ⑤ Window lock switch P.175

► GS350/GS200t

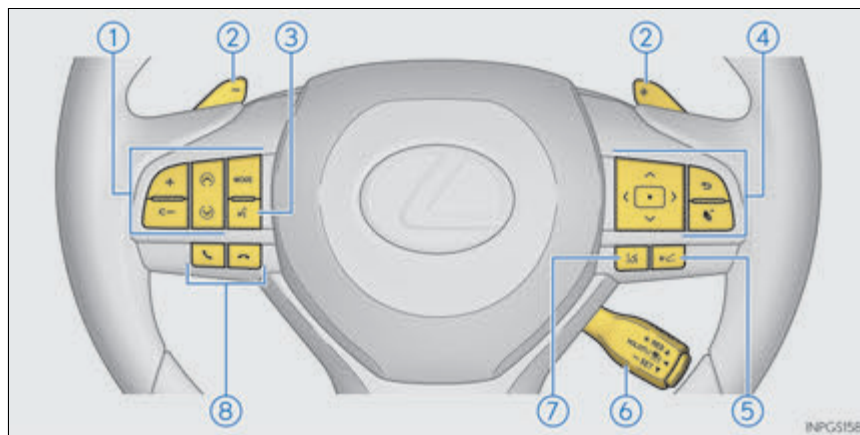

► GSF

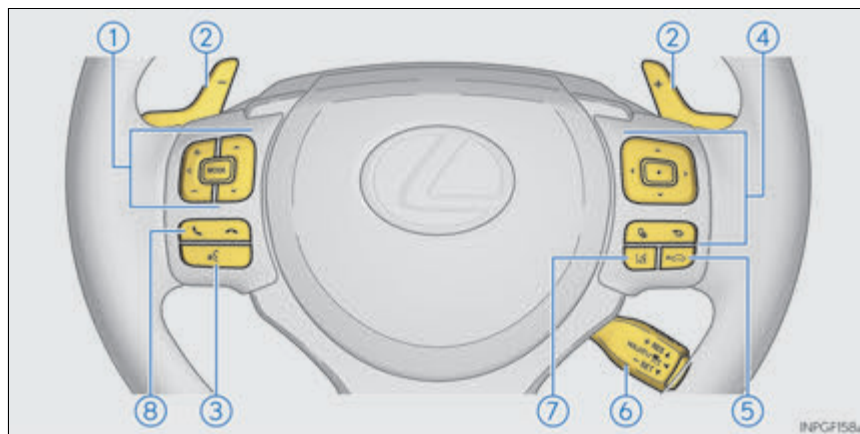

- ① Audio remote control switches^{*1}
- ② Paddle shift switches.....P. 204
- ③ Talk switch^{*1}
- ④ Meter control switches.....P. 101, 109
- ⑤ Vehicle-to-vehicle distance button^{*2}.....P. 272, 284
- ⑥ Cruise control switch
 - Cruise control^{*2}.....P. 290
 - Dynamic radar cruise control^{*2}.....P. 278
 - Dynamic radar cruise control with full-speed range^{*2}.....P. 266
- ⑦ LKA (Lane-Keeping Assist) switch^{*2}.....P. 249
- LDA (Lane Departure Alert with steering control) switch^{*2}.....P. 258
- ⑧ Telephone switches^{*1}

^{*1}: Refer to "NAVIGATION AND MULTIMEDIA SYSTEM OWNER'S MANUAL"

^{*2}: If equipped

► GS350/GS200t

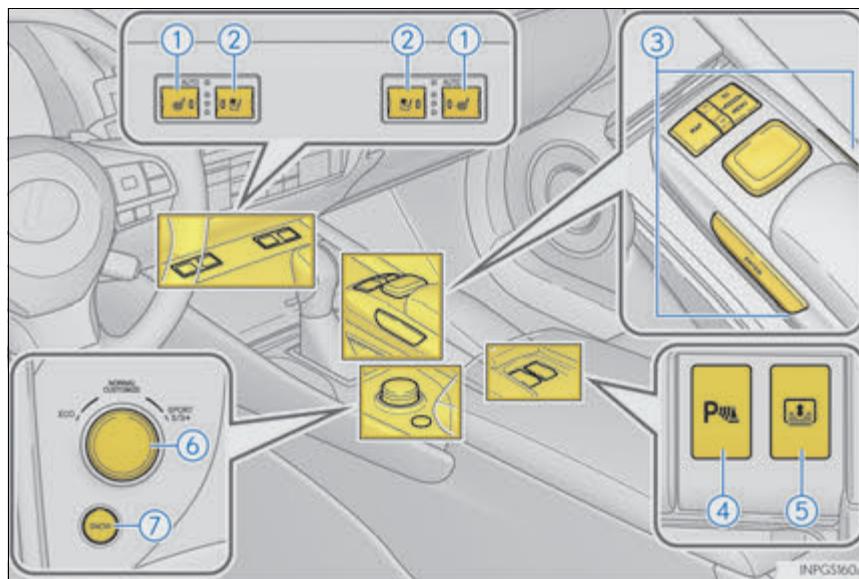

► GSF

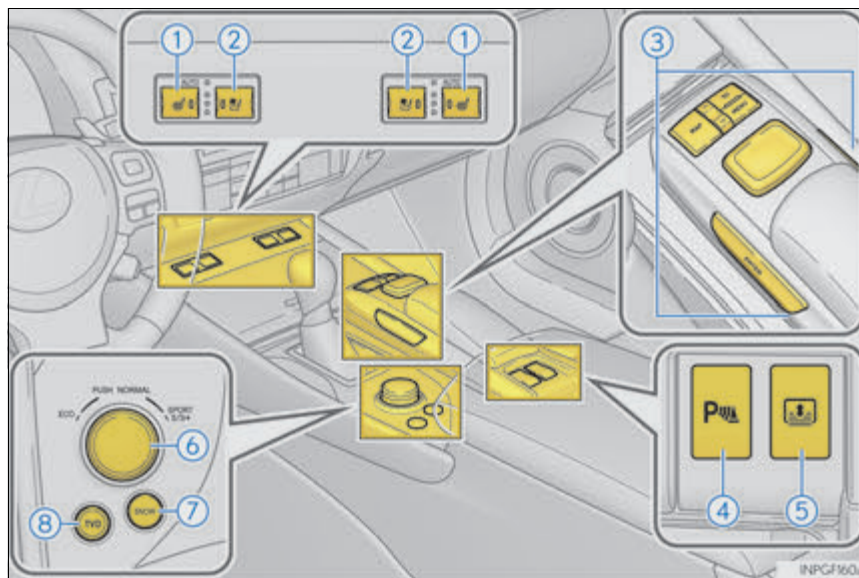

GS350_200t_GSF_OM_OM30E86U_(U)

①	Seat heater switches ^{*1}	P. 343
②	Seat ventilator switches ^{*1}	P. 343
③	Remote Touch	P. 322
④	Intuitive parking assist switch ^{*1, 2}	
⑤	Rear sunshade switch ^{*1}	P. 361
⑥	Driving mode select switch	P. 293
⑦	Snow mode switch	P. 203
⑧	TVD switch	P. 306

^{*1}: If equipped

^{*2}: Refer to "NAVIGATION AND MULTIMEDIA SYSTEM OWNER'S MANUAL"

■ Interior

► GS350/GS200t

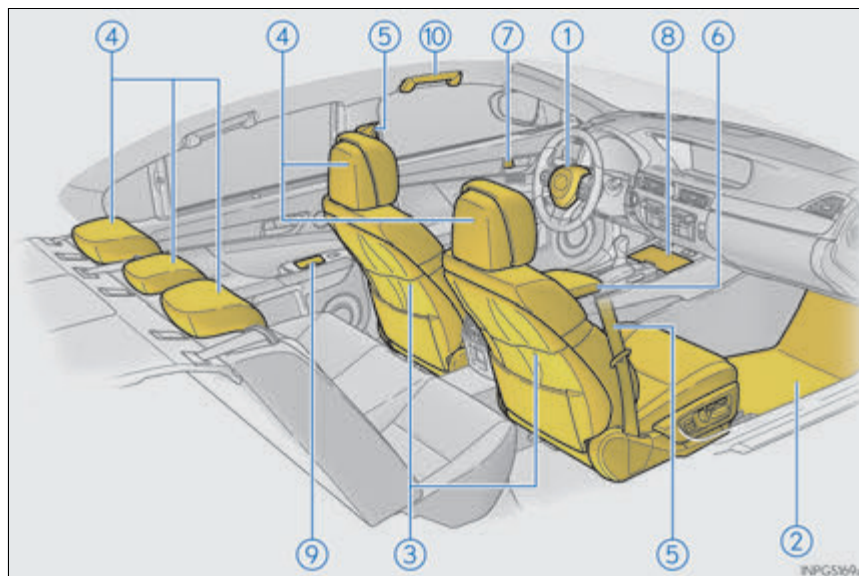

► GSF

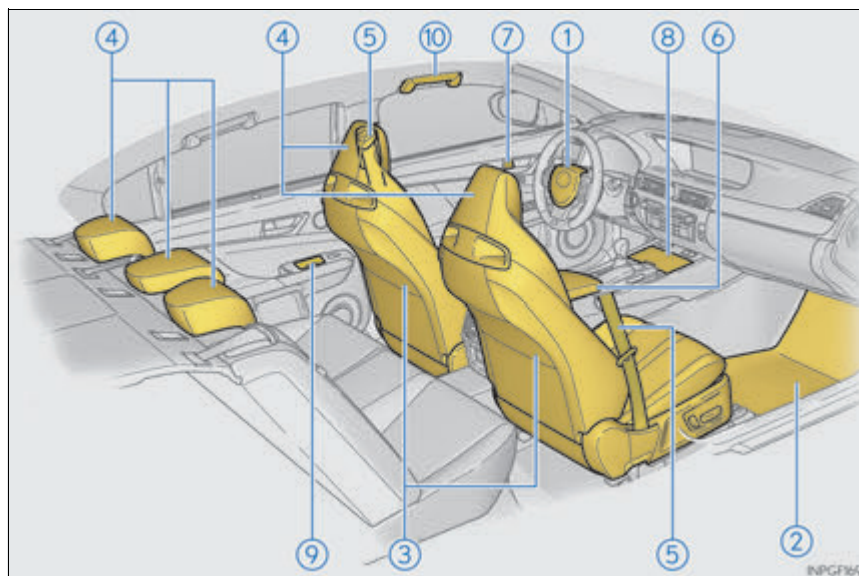

① SRS airbags.....	P. 41
② Floor mats.....	P. 32
③ Front seats.....	P. 158
④ Head restraints.....	P. 165
⑤ Seat belts.....	P. 36
⑥ Console box.....	P. 351
⑦ Inside lock buttons.....	P. 139
⑧ Cup holders.....	P. 352
⑨ Auxiliary boxes*.....	P. 353
Ashtrays*.....	P. 359
⑩ Assist grips.....	P. 364

*: If equipped

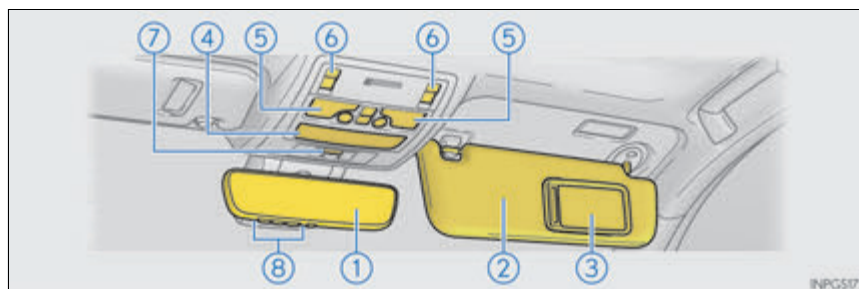

① Inside rear view mirror	P.169
② Sun visors	P.358
③ Vanity mirrors.....	P.358
④ Interior light*1	P.348
⑤ Personal lights*1	P.348
⑥ Moon roof switches	P.178
⑦ "SOS" button*2	P.372
⑧ Garage door opener switches	P.365

*1: The illustration shows the front, but they are also equipped in the rear.
 *2: If equipped

For safety and security

1

31

1-1. For safe use

Before driving..... 32
For safety drive.....34
Seat belts 36
SRS airbags41
Front passenger occupant
classification system..... 52
Safety information
for children.....58
Child restraint systems 59
Installing child restraints..... 63
Exhaust gas precautions71

1-2. Theft deterrent system

Engine immobilizer system.....72
Alarm74

Before driving

Floor mat

Use only floor mats designed specifically for vehicles of the same model and model year as your vehicle. Fix them securely in place onto the carpet.

- 1 Insert the retaining hooks (clips) into the floor mat eyelets.

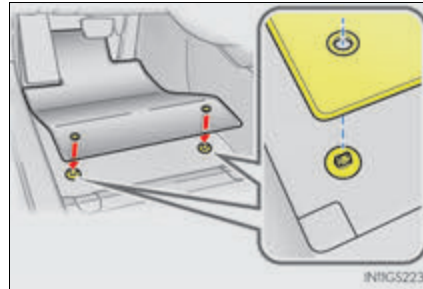

- 2 Turn the upper knob of each retaining hook (clip) to secure the floor mats in place.

*: Always align the \triangle marks.

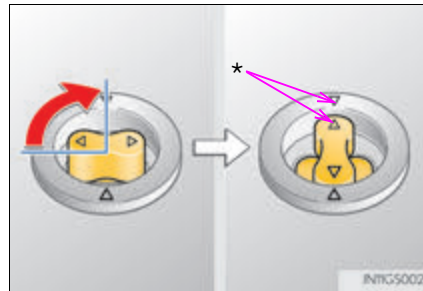

The shape of the retaining hooks (clips) may differ from that shown in the illustration.

⚠ WARNING

Observe the following precautions.

Failure to do so may cause the driver's floor mat to slip, possibly interfering with the pedals while driving. An unexpectedly high speed may result or it may become difficult to stop the vehicle. This could lead to an accident, resulting in death or serious injury.

■ When installing the driver's floor mat

- Do not use floor mats designed for other models or different model year vehicles, even if they are Lexus Genuine floor mats.
- Only use floor mats designed for the driver's seat.
- Always install the floor mat securely using the retaining hooks (clips) provided.
- Do not use two or more floor mats on top of each other.
- Do not place the floor mat bottom-side up or upside-down.

■ Before driving

- Check that the floor mat is securely fixed in the correct place with all the provided retaining hooks (clips). Be especially careful to perform this check after cleaning the floor.
- With the engine stopped and the shift lever in P, fully depress each pedal to the floor to make sure it does not interfere with the floor mat.



1

For safety and security

For safety drive

For safe driving, adjust the seat and mirror to an appropriate position before driving.

Correct driving posture

- ① Adjust the angle of the seatback so that you are sitting straight up and so that you do not have to lean forward to steer. (→P. 158)
- ② Adjust the seat so that you can depress the pedals fully and so that your arms bend slightly at the elbow when gripping the steering wheel. (→P. 158)
- ③ GS350/GS200t: Lock the head restraint in place with the center of the head restraint closest to the top of your ears. (→P. 165)
- ④ Wear the seat belt correctly. (→P. 36)

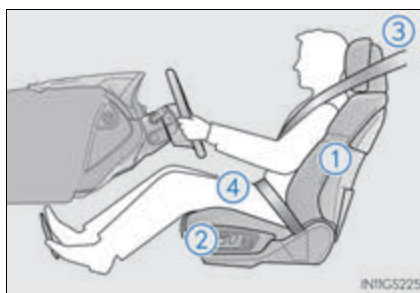

Correct use of the seat belts

Make sure that all occupants are wearing their seat belts before driving the vehicle. (→P. 36)

Use a child restraint system appropriate for the child until the child becomes large enough to properly wear the vehicle's seat belt. (→P. 59)

Adjusting the mirrors

Make sure that you can see backward clearly by adjusting the inside and outside rear view mirrors properly. (→P. 169, 171)

 **WARNING**

Observe the following precautions.
Failure to do so may result in death or serious injury.

- Do not adjust the position of the driver's seat while driving.
Doing so could cause the driver to lose control of the vehicle.
- Do not place a cushion between the driver or passenger and the seatback.
A cushion may prevent correct posture from being achieved, and reduce the effectiveness of the seat belt and head restraint.
- Do not place anything under the front seats.
Objects placed under the front seats may become jammed in the seat tracks and stop the seat from locking in place. This may lead to an accident and the adjustment mechanism may also be damaged.
- When driving over long distances, take regular breaks before you start to feel tired.
Also, if you feel tired or sleepy while driving, do not force yourself to continue driving and take a break immediately.

1

For safety and security

Seat belts

Make sure that all occupants are wearing their seat belts before driving the vehicle.

Correct use of the seat belts

- Extend the shoulder belt so that it comes fully over the shoulder, but does not come into contact with the neck or slide off the shoulder.
- Position the lap belt as low as possible over the hips.
- Adjust the position of the seatback. Sit up straight and well back in the seat.
- Do not twist the seat belt.



Fastening and releasing the seat belt

- ① To fasten the seat belt, push the plate into the buckle until a click sound is heard.
- ② To release the seat belt, press the release button.

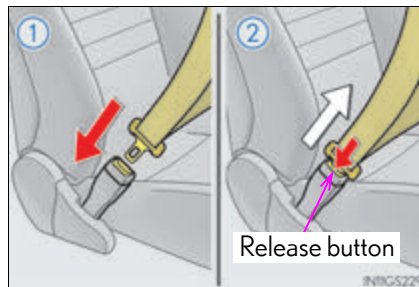

Adjusting the seat belt shoulder anchor height (front seats)

- ① Push the seat belt shoulder anchor down while pressing the release button.
- ② Push the seat belt shoulder anchor up.

Move the height adjuster up and down as needed until you hear a click.



Seat belt comfort guide (outboard rear seats)

For children or smaller-than-average people, slide the seat belt comfort guide forward so that the shoulder belt does not sit close to the person's neck.

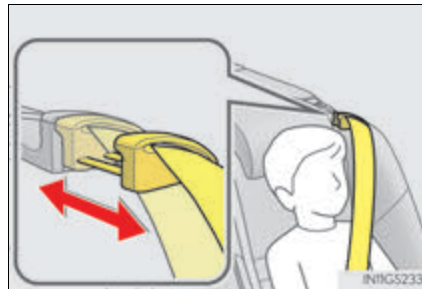

Seat belt pretensioners (front and outboard rear seats)

The pretensioner helps the seat belt to quickly restrain the occupant by retracting the seat belt when the vehicle is subjected to certain types of severe frontal collision.

The front seat pretensioners also activate when the vehicle is subjected to certain types of severe side collision.

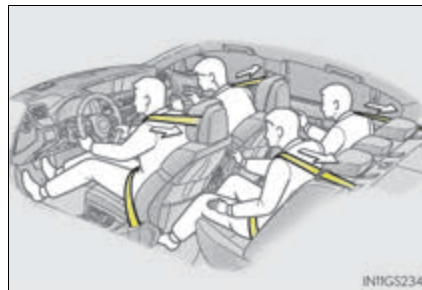

The pretensioner does not activate in the event of a minor frontal impact, a minor side impact, a rear impact or a vehicle rollover.

■ Emergency locking retractor (ELR)

The retractor will lock the belt during a sudden stop or on impact. It may also lock if you lean forward too quickly. A slow, easy motion will allow the belt to extend so that you can move around fully.

■ Automatic locking retractor (ALR)

When a passenger's shoulder belt is completely extended and then retracted even slightly, the belt is locked in that position and cannot be extended. This feature is used to hold the child restraint system (CRS) firmly. To free the belt again, fully retract the belt and then pull the belt out once more. (→P. 63)

■ Child seat belt usage

The seat belts of your vehicle were principally designed for persons of adult size.

- Use a child restraint system appropriate for the child, until the child becomes large enough to properly wear the vehicle's seat belt. (→P. 59)
- When the child becomes large enough to properly wear the vehicle's seat belt, follow the instructions regarding seat belt usage. (→P. 36)

■ Replacing the belt after the pretensioner has been activated

If the vehicle is involved in multiple collisions, the pretensioner will activate for the first collision, but will not activate for the second or subsequent collisions.

■ Seat belt extender

If your seat belts cannot be fastened securely because they are not long enough, a personalized seat belt extender is available from your Lexus dealer free of charge.

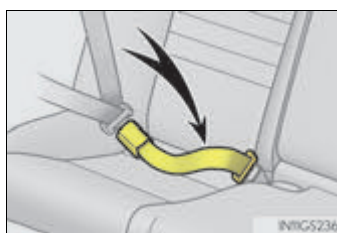

⚠ WARNING

Observe the following precautions to reduce the risk of injury in the event of sudden braking, sudden swerving or an accident.

Failure to do so may cause death or serious injury.

■ Wearing a seat belt

- Ensure that all passengers wear a seat belt.
- Always wear a seat belt properly.
- Each seat belt should be used by one person only. Do not use a seat belt for more than one person at once, including children.
- Lexus recommends that children be seated in the rear seat and always use a seat belt and/or an appropriate child restraint system.
- To achieve a proper seating position, do not recline the seat more than necessary. The seat belt is most effective when the occupants are sitting up straight and well back in the seats.
- Do not wear the shoulder belt under your arm.
- Always wear your seat belt low and snug across your hips.

⚠ WARNING**■ Pregnant women**

Obtain medical advice and wear the seat belt in the proper way. (→P. 36)

Women who are pregnant should position the lap belt as low as possible over the hips in the same manner as other occupants, extending the shoulder belt completely over the shoulder and avoiding belt contact with the rounding of the abdominal area.

If the seat belt is not worn properly, not only the pregnant woman, but also the fetus could suffer death or serious injury as a result of sudden braking or a collision.

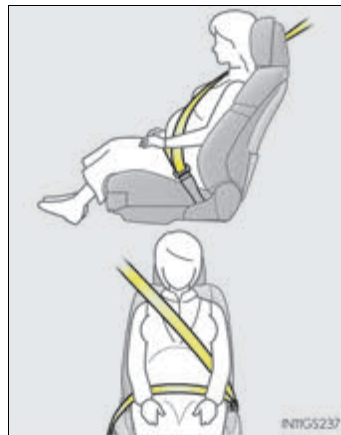
**■ People suffering illness**

Obtain medical advice and wear the seat belt in the proper way. (→P. 36)

■ When children are in the vehicle

Do not allow children to play with the seat belt. If the seat belt becomes twisted around a child's neck, it may lead to choking or other serious injuries that could result in death. If this occurs and the buckle cannot be unfastened, scissors should be used to cut the belt.

■ Seat belt pretensioners

- Do not place anything, such as a cushion, on the front passenger's seat. Doing so will disperse the passenger's weight, which prevents the sensor from detecting the passenger's weight properly. As a result, the seat belt pretensioner for the front passenger's seat may not activate in the event of a collision.
- If the pretensioner has activated, the SRS warning light will come on. In that case, the seat belt cannot be used again and must be replaced at your Lexus dealer.

■ Adjustable shoulder anchor

Always make sure the shoulder belt is positioned across the center of your shoulder. The belt should be kept away from your neck, but not falling off your shoulder. Failure to do so could reduce the amount of protection in an accident and cause death or serious injuries in the event of a sudden stop, sudden swerve or accident. (→P. 36)

 **WARNING****■ Seat belt damage and wear**

- Do not damage the seat belts by allowing the belt, plate, or buckle to be jammed in the door.
- Inspect the seat belt system periodically. Check for cuts, fraying, and loose parts. Do not use a damaged seat belt until it is replaced. Damaged seat belts cannot protect an occupant from death or serious injury.
- Ensure that the belt and plate are locked and the belt is not twisted.
If the seat belt does not function correctly, immediately contact your Lexus dealer.
- Replace the seat assembly, including the belts, if your vehicle has been involved in a serious accident, even if there is no obvious damage.
- Do not attempt to install, remove, modify, disassemble or dispose of the seat belts. Have any necessary repairs carried out by your Lexus dealer. Inappropriate handling may lead to incorrect operation.

■ Using a seat belt extender

- Do not wear the seat belt extender if you can fasten the seat belt without the extender.
- Do not use the seat belt extender when installing a child restraint system because the belt will not securely hold the child restraint system, increasing the risk of death or serious injury in the event of an accident.
- The personalized extender may not be safe on another vehicle, when used by another person, or at a different seating position other than the one originally intended.

 **NOTICE****■ When using a seat belt extender**

When releasing the seat belt, press on the buckle release button on the extender, not on the seat belt.
This helps prevent damage to the vehicle interior and the extender itself.

SRS airbags

The SRS airbags inflate when the vehicle is subjected to certain types of severe impacts that may cause significant injury to the occupants. They work together with the seat belts to help reduce the risk of death or serious injury.

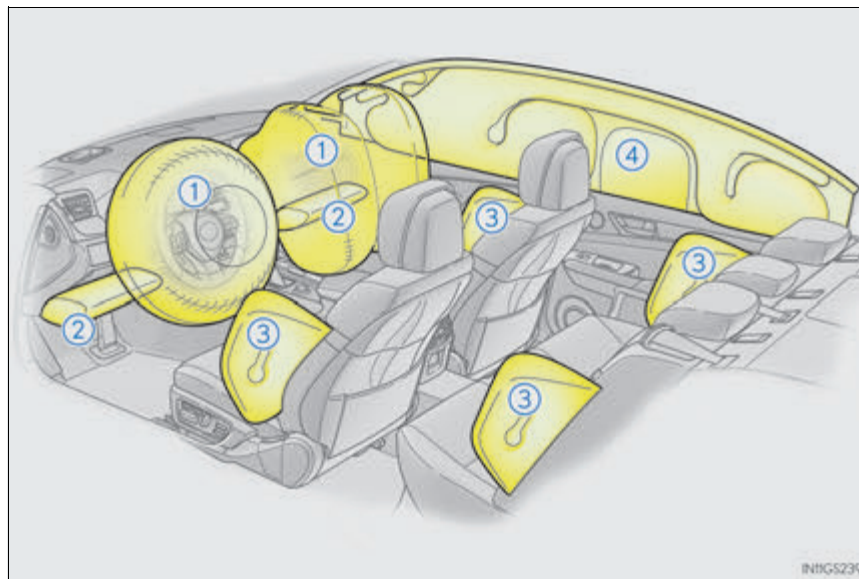

◆ SRS front airbags

- ① SRS driver airbag/front passenger airbag
Can help protect the head and chest of the driver and front passenger from impact with interior components
- ② SRS knee airbags
Can help provide driver and front passenger protection
An SRS knee airbag for the front passenger's seat is built into the glove box door.

1

For safety and security

◆ SRS side and curtain shield airbags

- ③ SRS front side airbags
 - Can help protect the torso of the front seat occupants
- SRS rear side airbags
 - Can help protect the torso of occupants in the rear outer seats
- ④ SRS curtain shield airbags
 - Can help protect primarily the head of occupants in the outer seats
 - Can prevent the occupants from being thrown from the vehicle in the event of vehicle rollover

SRS airbag system components

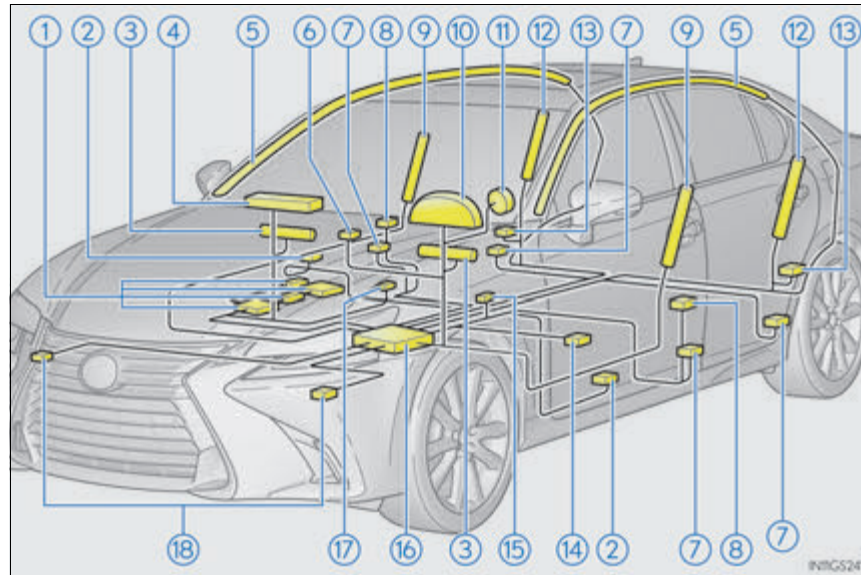

- | | |
|--------------------------------------------------------------------|---------------------------------------------|
| ① Front passenger occupant classification system (ECU and sensors) | ⑩ SRS warning light |
| ② Side impact sensors (front doors) | ⑪ Driver airbag |
| ③ Knee airbags | ⑫ Rear side airbags |
| ④ Front passenger airbag | ⑬ Side impact sensors (rear) |
| ⑤ Curtain shield airbags | ⑭ Driver's seat position sensor |
| ⑥ "AIR BAG ON" and "AIR BAG OFF" indicator lights | ⑮ Driver's seat belt buckle switch |
| ⑦ Seat belt pretensioners and force limiters | ⑯ Airbag sensor assembly |
| ⑧ Side impact sensors (front) | ⑰ Front passenger's seat belt buckle switch |
| ⑨ Front side airbags | ⑱ Front impact sensors |

Your vehicle is equipped with ADVANCED AIRBAGS designed based on the US motor vehicle safety standards (FMVSS208). The airbag sensor assembly (ECU) controls airbag deployment based on information obtained from the sensors etc. shown in the system components diagram above. This information includes crash severity and occupant information. As the airbags deploy, a chemical reaction in the inflators quickly fills the airbags with non-toxic gas to help restrain the motion of the occupants.

 **WARNING****■ SRS airbag precautions**

Observe the following precautions regarding the SRS airbags. Failure to do so may cause death or serious injury.

- The driver and all passengers in the vehicle must wear their seat belts properly. The SRS airbags are supplemental devices to be used with the seat belts.
- The SRS driver airbag deploys with considerable force, and can cause death or serious injury especially if the driver is very close to the airbag. The National Highway Traffic Safety Administration (NHTSA) advises:

Since the risk zone for the driver's airbag is the first 2 - 3 in. (50 - 75 mm) of inflation, placing yourself 10 in. (250 mm) from your driver airbag provides you with a clear margin of safety. This distance is measured from the center of the steering wheel to your breastbone. If you sit less than 10 in. (250 mm) away now, you can change your driving position in several ways:

- Move your seat to the rear as far as you can while still reaching the pedals comfortably.
- Slightly recline the back of the seat. Although vehicle designs vary, many drivers can achieve the 10 in. (250 mm) distance, even with the driver seat all the way forward, simply by reclining the back of the seat somewhat. If reclining the back of your seat makes it hard to see the road, raise yourself by using a firm, non-slippery cushion, or raise the seat if your vehicle has that feature.
- If your steering wheel is adjustable, tilt it downward. This points the airbag toward your chest instead of your head and neck.

The seat should be adjusted as recommended by NHTSA above, while still maintaining control of the foot pedals, steering wheel, and your view of the instrument panel controls.

 **WARNING**

■ **SRS airbag precautions**

- If the seat belt extender has been connected to the front seat belt buckles but the seat belt extender has not also been fastened to the latch plate of the seat belt, the SRS front airbags will judge that the driver and front passenger are wearing the seat belt even though the seat belt has not been connected. In this case, the SRS front airbags may not activate correctly in a collision, resulting in death or serious injury in the event of a collision. Be sure to wear the seat belt with the seat belt extender.



- The SRS front passenger airbag also deploys with considerable force, and can cause death or serious injury especially if the front passenger is very close to the airbag. The front passenger seat should be as far from the airbag as possible with the seatback adjusted, so the front passenger sits upright.
- Improperly seated and/or restrained infants and children can be killed or seriously injured by a deploying airbag. An infant or child who is too small to use a seat belt should be properly secured using a child restraint system. Lexus strongly recommends that all infants and children be placed in the rear seats of the vehicle and properly restrained. The rear seats are safer for infants and children than the front passenger seat. (→P. 59)

- Do not sit on the edge of the seat or lean against the dashboard.



- Do not allow a child to stand in front of the SRS front passenger airbag unit or sit on the knees of a front passenger.
- Do not allow the front seat occupants to hold items on their knees.



⚠ WARNING

■ **SRS airbag precautions**

- Do not lean against the door, the roof side rail or the front, side and rear pillars.



- Do not allow anyone to kneel on the passenger seat toward the door or put their head or hands outside the vehicle.



- Do not attach anything to or lean anything against areas such as the dashboard, steering wheel pad, lower portion of the instrument panel and door of the glove box. These items can become projectiles when the SRS driver, front passenger and knee airbags deploy.

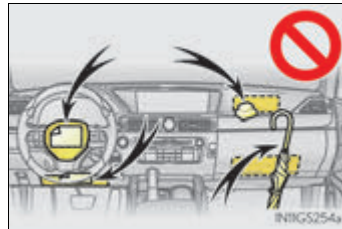

- Do not attach anything to areas such as a door, windshield glass, side door glass, front or rear pillar, roof side rail and assist grip. (Except for the speed limit sticker →P. 508)

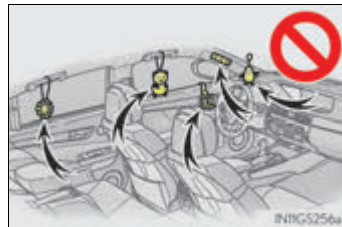

 **WARNING****■ SRS airbag precautions**

- Do not hang coat hangers or other hard objects on the coat hooks. All of these items could become projectiles and may cause death or serious injury, should the SRS curtain shield airbags deploy.
- If a vinyl cover is put on the area where the SRS knee airbag will deploy, be sure to remove it.
- Do not use seat accessories which cover the parts where the SRS side airbags inflate as they may interfere with inflation of the airbags. Such accessories may prevent the side airbags from activating correctly, disable the system or cause the side airbags to inflate accidentally, resulting in death or serious injury.
- Do not strike or apply significant levels of force to the area of the SRS airbag components.
Doing so can cause the SRS airbags to malfunction.
- Do not touch any of the component parts immediately after the SRS airbags have deployed (inflated) as they may be hot.
- If breathing becomes difficult after the SRS airbags have deployed, open a door or window to allow fresh air in, or leave the vehicle if it is safe to do so. Wash off any residue as soon as possible to prevent skin irritation.
- If the areas where the SRS airbags are stored, such as the steering wheel pad, door of the glove box and front and rear pillar garnishes are damaged or cracked, have them replaced by your Lexus dealer.
- Do not place anything, such as a cushion, on the front passenger's seat. Doing so will disperse the passenger's weight, which prevents the sensor from detecting the passenger's weight properly. As a result, the SRS front airbags for the front passenger may not deploy in the event of a collision.

■ Modification and disposal of SRS airbag system components

Do not dispose of your vehicle or perform any of the following modifications without consulting your Lexus dealer. The SRS airbags may malfunction or deploy (inflate) accidentally, causing death or serious injury.

- Installation, removal, disassembly and repair of the SRS airbags
- Repairs, modifications, removal or replacement of the steering wheel, instrument panel, dashboard, glove box, seats or seat upholstery, front, side and rear pillars or roof side rails
- Repairs or modifications of the front fender, front bumper, or side of the occupant compartment
- Installation of a grille guard (bull bars, kangaroo bar, etc.), snow plows, winches or roof luggage carrier
- Modifications to the vehicle's suspension system
- Installation of electronic devices such as mobile two-way radios and CD players
- Modifications to your vehicle for a person with a physical disability

■ If the SRS airbags deploy (inflate)

- Slight abrasions, burns, bruising etc., may be sustained from SRS airbags, due to the extremely high speed deployment (inflation) by hot gases.
- A loud noise and white powder will be emitted.
- Parts of the airbag module (steering wheel hub, airbag cover and inflator) as well as the seats, the glove box, parts of the front and rear pillars, and roof side rails may be hot for several minutes. The airbag itself may also be hot.
- The windshield may crack.
- For Lexus Enform Safety Connect subscribers, if the SRS airbags deploy or in the event of a severe rear-end collision, the system is designed to send an emergency call to the response center, notifying them of the vehicle's location (without needing to push the "SOS" button) and an agent will attempt to speak with the occupants to ascertain the level of emergency and assistance required. If the occupants are unable to communicate, the agent automatically treats the call as an emergency and helps to dispatch the necessary emergency services. (→P. 372)

■ SRS airbag deployment conditions (SRS front airbags)

- The SRS front airbags will deploy in the event of an impact that exceeds the set threshold level (the level of force corresponding to an approximately 12 - 18 mph [20 - 30 km/h] frontal collision with a fixed wall that does not move or deform).
However, this threshold velocity will be considerably higher in the following situations:
 - If the vehicle strikes an object, such as a parked vehicle or sign pole, which can move or deform on impact
 - If the vehicle is involved in an underride collision, such as a collision in which the front of the vehicle "underrides", or goes under, the bed of a truck
- Depending on the type of collision, it is possible that only the seat belt pretensioners will activate.
- The SRS front airbags for the front passenger will not activate if there is no passenger sitting in the front passenger seat. However, the SRS front airbags for the front passenger may deploy if luggage is put in the seat, even if the seat is unoccupied. (→P. 52)

■ SRS airbag deployment conditions (SRS side and curtain shield airbags)

- The SRS side and curtain shield airbags will deploy in the event of an impact that exceeds the set threshold level (the level of force corresponding to the impact force produced by an approximately 3300 lb. [1500 kg] vehicle colliding with the vehicle cabin from a direction perpendicular to the vehicle orientation at an approximate speed of 12 - 18 mph [20 - 30 km/h]).
- The SRS curtain shield airbags will deploy in the event of vehicle rollover.
- The SRS side and curtain shield airbags may also deploy in the event of a severe frontal collision.

■ Conditions under which the SRS airbags may deploy (inflate), other than a collision

The SRS front airbags, SRS side and curtain shield airbags may also deploy if a serious impact occurs to the underside of your vehicle. Some examples are shown in the illustration.

- Hitting a curb, edge of pavement or hard surface
- Falling into or jumping over a deep hole
- Landing hard or falling

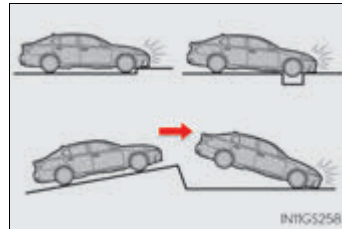

The SRS curtain shield airbags may also deploy under the situations shown in the illustration.

- The angle of vehicle tip-up is marginal.
- The vehicle skids and hits a curb stone.

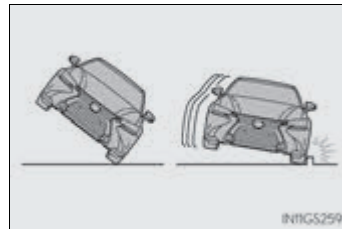

■ Types of collisions that may not deploy the SRS airbags (SRS front airbags)

The SRS front airbags do not generally inflate if the vehicle is involved in a side or rear collision, if it rolls over, or if it is involved in a low-speed frontal collision. But, whenever a collision of any type causes sufficient forward deceleration of the vehicle, deployment of the SRS front airbags may occur.

- Collision from the side
- Collision from the rear
- Vehicle rollover

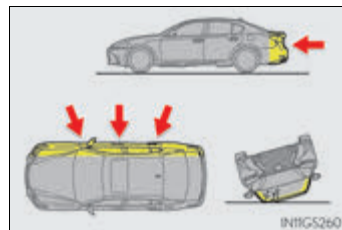

■ **Types of collisions that may not deploy the SRS airbags (SRS side and curtain shield airbags)**

The SRS side and curtain shield airbags may not activate if the vehicle is subjected to a collision from the side at certain angles, or a collision to the side of the vehicle body other than the passenger compartment.

- Collision from the side to the vehicle body other than the passenger compartment
- Collision from the side at an angle

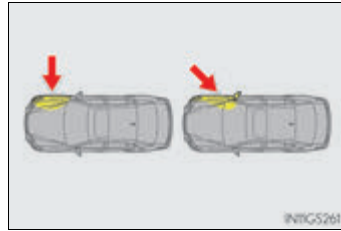

The SRS side airbags do not generally inflate if the vehicle is involved in a rear collision, if it rolls over, or if it is involved in a low-speed side or low-speed frontal collision.

- Collision from the rear
- Vehicle rollover

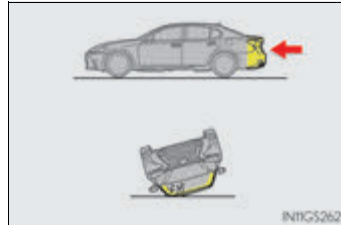

The SRS curtain shield airbags do not generally inflate if the vehicle is involved in a rear collision, if it pitches end over end, or if it is involved in a low-speed side or low-speed frontal collision.

- Collision from the rear
- Pitching end over end

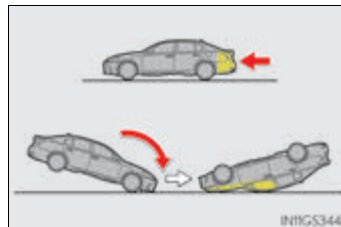

■ When to contact your Lexus dealer

In the following cases, the vehicle will require inspection and/or repair. Contact your Lexus dealer as soon as possible.

- Any of the SRS airbags have been inflated.
- The front of the vehicle is damaged or deformed, or was involved in an accident that was not severe enough to cause the SRS front airbags to inflate.
- A portion of a door or its surrounding area is damaged or deformed, or the vehicle was involved in an accident that was not severe enough to cause the SRS side and curtain shield airbags to inflate.
- The pad section of the steering wheel, dashboard near the front passenger airbag, lower portion of the instrument panel or door of the glove box is scratched, cracked, or otherwise damaged.
- The surface of the seats with the side airbag is scratched, cracked, or otherwise damaged.
- The portion of the front pillars, rear pillars or roof side rail garnishes (padding) containing the curtain shield airbags inside is scratched, cracked, or otherwise damaged.

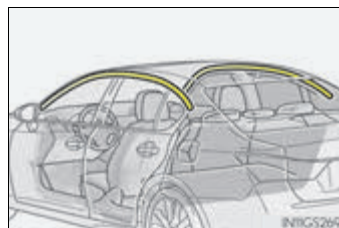
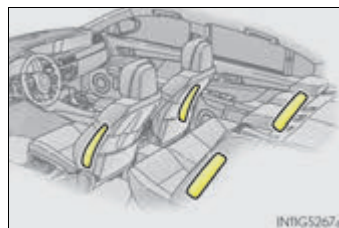
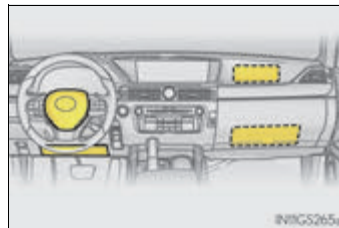
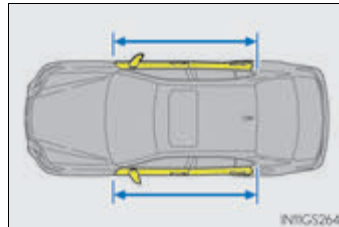
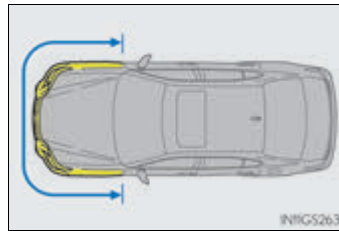

Front passenger occupant classification system

Your vehicle is equipped with a front passenger occupant classification system. This system detects the conditions of the front passenger seat and activates or deactivates the devices for the front passenger.



- ① Seat belt reminder light
- ② SRS warning light
- ③ "AIR BAG OFF" indicator light
- ④ "AIR BAG ON" indicator light

Condition and operation in the front passenger occupant classification system

■ Adult*¹

Indicator/ warning light	"AIR BAG ON" and "AIR BAG OFF" indicator lights	"AIR BAG ON"
	SRS warning light	Off
	Seat belt reminder light	Off* ² or flashing* ³
Devices	Front passenger airbag	Activated
	Side airbag on the front passenger seat	
	Curtain shield airbag in the front passenger side	
	Front passenger knee airbag	
	Front passenger's seat belt pretensioner	

■ Child*⁴

Indicator/ warning light	"AIR BAG ON" and "AIR BAG OFF" indicator lights	"AIR BAG OFF" or "AIR BAG ON"* ⁴
	SRS warning light	Off
	Seat belt reminder light	Off* ² or flashing* ³
Devices	Front passenger airbag	Deactivated or activated* ⁴
	Side airbag on the front passenger seat	Activated
	Curtain shield airbag in the front passenger side	
	Front passenger knee airbag	Deactivated or activated* ⁴
	Front passenger's seat belt pretensioner	Activated

1

For safety and security

■ Child restraint system with infant*⁵

Indicator/ warning light	"AIR BAG ON" and "AIR BAG OFF" indicator lights	"AIR BAG OFF"* ⁶
	SRS warning light	Off
	Seat belt reminder light	Off* ² or flashing* ³
Devices	Front passenger airbag	Deactivated
	Side airbag on the front passenger seat	Activated
	Curtain shield airbag in the front passenger side	
	Front passenger knee airbag	Deactivated
	Front passenger's seat belt pretensioner	Activated

■ Unoccupied

Indicator/ warning light	"AIR BAG ON" and "AIR BAG OFF" indicator lights	"AIR BAG OFF"
	SRS warning light	Off
	Seat belt reminder light	
Devices	Front passenger airbag	Deactivated
	Side airbag on the front passenger seat	Activated
	Curtain shield airbag in the front passenger side	
	Front passenger knee airbag	Deactivated
	Front passenger's seat belt pretensioner	Activated

■ There is a malfunction in the system

	"AIR BAG ON" and "AIR BAG OFF" indicator lights	"AIR BAG OFF"
Indicator/ warning light	SRS warning light	On
	Seat belt reminder light	
Devices	Front passenger airbag	Deactivated
	Side airbag on the front passenger seat	Activated
	Curtain shield airbag in the front passenger side	
	Front passenger knee airbag	Deactivated
	Front passenger's seat belt pretensioner	Activated

*1: The system judges a person of adult size as an adult. When a smaller adult sits in the front passenger seat, the system may not recognize him/her as an adult depending on his/her physique and posture.

*2: In the event the front passenger is wearing a seat belt.

*3: In the event the front passenger does not wear a seat belt

*4: For some children, child in seat, child in booster seat or child in convertible seat, the system may not recognize him/her as a child. Factors which may affect this can be the physique or posture.

*5: Never install a rear-facing child restraint system on the front passenger seat. A forward-facing child restraint system should only be installed on the front passenger seat when it is unavoidable. (→P. 59)

*6: In case the indicator light is not illuminated, consult this manual on how to install the child restraint system properly. (→P. 63)

 **WARNING****■ Front passenger occupant classification system precautions**

Observe the following precautions regarding the front passenger occupant classification system.

Failure to do so may cause death or serious injury.

- Wear the seat belt properly.
- Make sure the front passenger's seat belt plate has not been left inserted into the buckle before someone sits in the front passenger seat.
- Make sure the "AIR BAG OFF" indicator light is not illuminated when using the seat belt extender for the front passenger seat. If the "AIR BAG OFF" indicator light is illuminated, disconnect the extender tongue from the seat belt buckle, and reconnect the seat belt. Reconnect the seat belt extender after making sure the "AIR BAG ON" indicator light is illuminated. If you use the seat belt extender while the "AIR BAG OFF" indicator light is illuminated, the SRS airbags for the front passenger will not activate, which could cause death or serious injury in the event of a collision.
- Do not apply a heavy load to the front passenger seat or equipment (e.g. seatback pockets).
- Do not put weight on the front passenger seat by putting your hands or feet on the front passenger seat seatback from the rear passenger seat.
- Do not let a rear passenger lift the front passenger seat with their feet or press on the seatback with their legs.
- Do not put objects under the front passenger seat.
- Do not recline the front passenger seatback so far that it touches a rear seat. This may cause the "AIR BAG OFF" indicator light to be illuminated, which indicates that the SRS airbags for the front passenger will not activate in the event of a severe accident. If the seatback touches the rear seat, return the seatback to a position where it does not touch the rear seat. Keep the front passenger seatback as upright as possible when the vehicle is moving. Reclining the seatback excessively may lessen the effectiveness of the seat belt system.
- If an adult sits in the front passenger seat, the "AIR BAG ON" indicator light is illuminated. If the "AIR BAG OFF" indicator is illuminated, ask the passenger to sit up straight, well back in the seat, feet on the floor, and with the seat belt worn correctly. If the "AIR BAG OFF" indicator still remains illuminated, either ask the passenger to move to the rear seat, or if that is not possible, move the front passenger seat fully rearward.
- When it is unavoidable to install a forward-facing child restraint system on the front passenger seat, install the child restraint system on the front passenger seat in the proper order. (→P. 63)
- Do not modify or remove the front seats.
- Do not kick the front passenger seat or subject it to severe impact. Otherwise, the SRS warning light may come on to indicate a malfunction of the front passenger occupant classification system. In this case, contact your Lexus dealer immediately.

 **WARNING****■ Front passenger occupant classification system precautions**

- Child restraint systems installed on the rear seat should not contact the front seat-backs.
- Do not use a seat accessory, such as a cushion and seat cover, that covers the seat cushion surface.
- Do not modify or replace the upholstery of the front seat.
- Adjust the front passenger seat so that the head restraint does not touch the ceiling. If the head restraint is left in contact with the ceiling, the system may not detect the front passenger properly, leading to improper operation of the airbags.

1

For safety and security

Safety information for children

Observe the following precautions when children are in the vehicle.

Use a child restraint system appropriate for the child, until the child becomes large enough to properly wear the vehicle's seat belt.

- It is recommended that children sit in the rear seats to avoid accidental contact with the shift lever, wiper switch etc.
- Use the rear door child-protector lock or the window lock switch to avoid children opening the door while driving or operating the power window accidentally. (→P. 140, 175)
- Do not let small children operate equipment which may catch or pinch body parts, such as the power window, hood, trunk, seats etc.

WARNING

Never leave children unattended in the vehicle, and never allow children to have or use the key.

Children may be able to start the vehicle or shift the vehicle into neutral. There is also a danger that children may injure themselves by playing with the windows, the moon roof or other features of the vehicle. In addition, heat build-up or extremely cold temperatures inside the vehicle can be fatal to children.

Child restraint systems

A child restraint system for a small child or baby must itself be properly restrained on the seat with the LATCH anchors or the lap portion of the lap/shoulder belt.

The laws of all 50 states of the U.S.A. and Canada now require the use of child restraint systems.

Points to remember

Studies have shown that installing a child restraint on a rear seat is much safer than installing one on the front passenger seat.

- Choose a child restraint system that suits your vehicle and is appropriate to the age and size of the child.
- For installation details, follow the instructions provided with the child restraint system.

General installation instructions are provided in this manual. (→P. 63)

1

For safety and security

Types of child restraints

Child restraint systems are classified into the following 3 types according to the age and size of the child:

- ▶ Rear facing — Infant seat/convertible seat
- ▶ Forward facing — Convertible seat

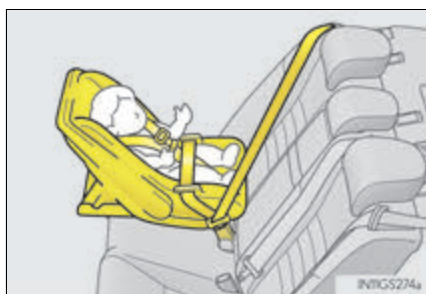

- ▶ Booster seat



■ Selecting an appropriate child restraint system

- Use a child restraint system appropriate for the child until the child becomes large enough to properly wear the vehicle's seat belt.
- If the child is too large for a child restraint system, sit the child on a rear seat and use the vehicle's seat belt. (→P. 36)

 **WARNING****■ Child restraint precautions**

- For effective protection in automobile accidents and sudden stops, a child must be properly restrained, using a seat belt or child restraint system depending on the age and size of the child. Holding a child in your arms is not a substitute for a child restraint system. In an accident, the child can be crushed against the windshield, or between you and the vehicle's interior.
- Lexus strongly urges the use of a proper child restraint system that conforms to the size of the child, installed on the rear seat. According to accident statistics, the child is safer when properly restrained in the rear seat than in the front seat.
- Never install a rear-facing child restraint system on the front passenger seat even if the "AIR BAG OFF" indicator light is illuminated.
In the event of an accident, the force of the rapid inflation of the front passenger airbag can cause death or serious injury to the child if the rear-facing child restraint system is installed on the front passenger seat.
- A forward-facing child restraint system may be installed on the front passenger seat only when it is unavoidable. A child restraint system that requires a top tether strap should not be used in the front passenger seat since there is no top tether strap anchor for the front passenger seat. Adjust the seatback as upright as possible and always move the seat as far back as possible even if the "AIR BAG OFF" indicator light is illuminated, because the front passenger airbag could inflate with considerable speed and force. Otherwise, the child may be killed or seriously injured.
- Do not use the seat belt extender when installing a child restraint system on the front or rear passenger seat. If installing a child restraint system with the seat belt extender connected to the seat belt, the seat belt will not securely hold the child restraint system, which could cause death or serious injury to the child or other passengers in the event of a sudden stop, sudden swerve or accident.
- Do not allow the child to lean his/her head or any part of his/her body against the door or the area of the seat, front and rear pillars or roof side rails from which the SRS side airbags or SRS curtain shield airbags deploy even if the child is seated in the child restraint system. It is dangerous if the SRS side airbags and curtain shield airbags inflate, and the impact could cause death or serious injury to the child.
- Make sure you have complied with all installation instructions provided by the child restraint manufacturer and that the system is properly secured. If it is not secured properly, it may cause death or serious injury to the child in the event of a sudden stop, sudden swerve or accident.

 **WARNING****■ When children are in the vehicle**

Do not allow children to play with the seat belt. If the seat belt becomes twisted around a child's neck, it may lead to choking or other serious injuries that could result in death. If this occurs and the buckle cannot be unfastened, scissors should be used to cut the belt.

■ When the child restraint system is not in use

- Keep the child restraint system properly secured on the seat even if it is not in use. Do not store the child restraint system unsecured in the passenger compartment.
- If it is necessary to detach the child restraint system, remove it from the vehicle or store it securely in the trunk. If a head restraint was removed when installing a child restraint system, always install the head restraint before driving. This will prevent it from injuring passengers in the event of a sudden stop, sudden swerve or accident.

Installing child restraints

Follow the child restraint system manufacturer's instructions. Firmly secure child restraints to the seats using the LATCH anchors or a seat belt. Attach the top tether strap when installing a child restraint.

The lap/shoulder belt can be used if your child restraint system is not compatible with the LATCH (Lower Anchors and Tethers for Children) system.

Child restraint LATCH anchors

LATCH anchors are provided for the outboard rear seats. (Buttons displaying the location of the anchors are attached to the seats.)

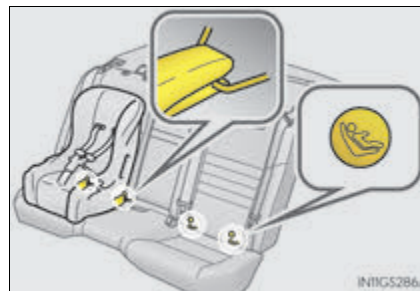

Seat belts equipped with a child restraint locking mechanism (ALR/ELR belts except driver's seat belt) (→P. 37)



Anchor brackets (for top tether strap)

Anchor brackets are provided for each rear seat.

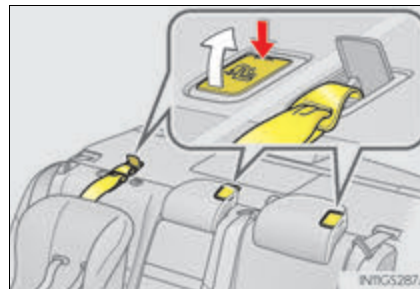

1

For safety and security

Installation with LATCH system

- 1 Remove the head restraint.

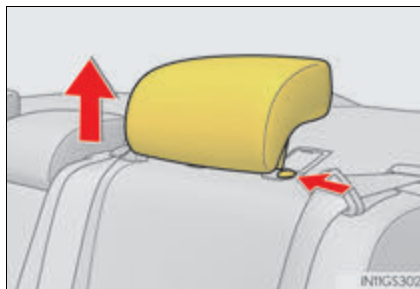

- 2 Widen the gap between the seat cushion and seatback slightly.

▶ Type A

- 3 Latch the hooks of the lower straps onto the LATCH anchors. If the child restraint has a top tether strap, the top tether strap should be latched onto the top tether strap anchor.

For owners in Canada:

The symbol on a child restraint system indicates the presence of a lower connector system.

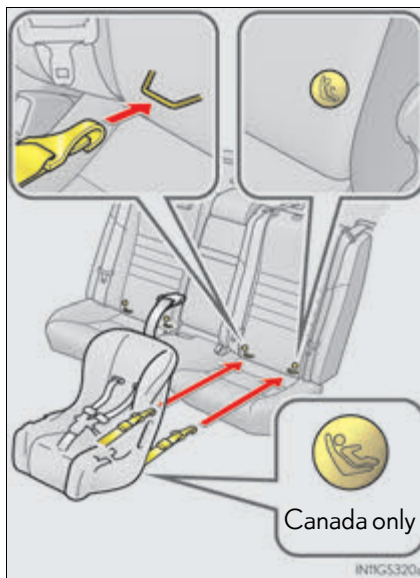

▶ Type B

- 3** Latch the buckles onto the LATCH anchors. If the child restraint has a top tether strap, the top tether strap should be latched onto the top tether strap anchor.

For owners in Canada:

The symbol on a child restraint system indicates the presence of a lower connector system.

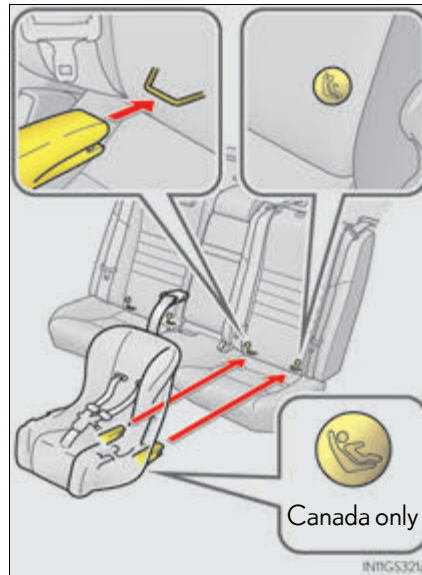

Installing child restraints using a seat belt (child restraint lock function belt)

■ Rear-facing—Infant seat/convertible seat

- 1** Place the child restraint system on the rear seat facing the rear of the vehicle.

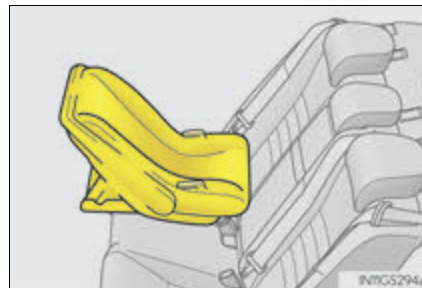

- 2** Run the seat belt through the child restraint system and insert the plate into the buckle. Make sure that the belt is not twisted.

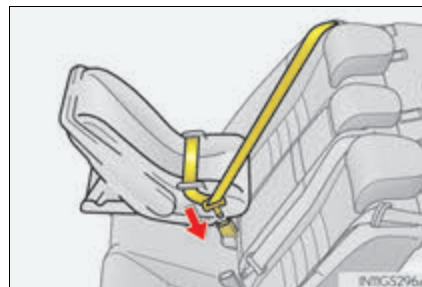

- 3** Fully extend the shoulder belt and allow it to retract to put it in lock mode. In lock mode, the belt cannot be extended.

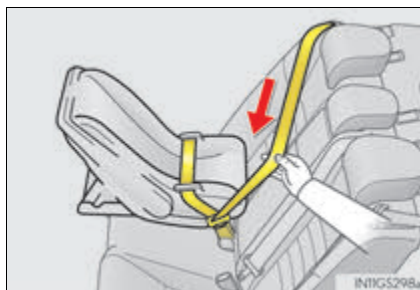

- 4** While pushing the child restraint system down into the rear seat, allow the shoulder belt to retract until the child restraint system is securely in place.

After the shoulder belt has retracted to a point where there is no slack in the belt, pull the belt to check that it cannot be extended.

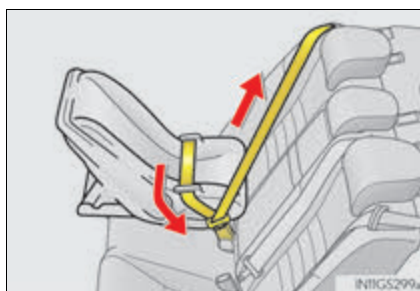

■ Forward-facing— Convertible seat

- 1** Rear outboard seats:
Remove the head restraint.

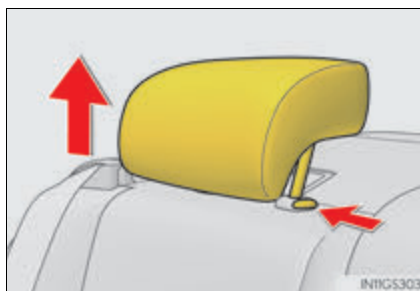

- 2** Place the child restraint system on the seat facing the front of the vehicle.

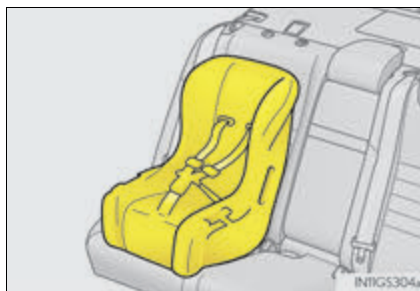

- 3 Run the seat belt through the child restraint system and insert the plate into the buckle. Make sure that the belt is not twisted.



- 4 Fully extend the shoulder belt and allow it to retract to put it in lock mode. In lock mode, the belt cannot be extended.



- 5 While pushing the child restraint system into the rear seat, allow the shoulder belt to retract until the child restraint system is securely in place.

After the shoulder belt has retracted to a point where there is no slack in the belt, pull the belt to check that it cannot be extended.



- 6 If the child restraint has a top tether strap, the top tether strap should be latched onto the top tether strap anchor. (→P. 68)

■ Booster seat

- 1 Place the child restraint system on the seat facing the front of the vehicle.



- 2 Sit the child in the child restraint system. Fit the seat belt to the child restraint system according to the manufacturer's instructions and insert the plate into the buckle. Make sure that the belt is not twisted.



Check that the shoulder belt is correctly positioned over the child's shoulder and that the lap belt is as low as possible. (→P. 36)

Removing a child restraint installed with a seat belt

Push the buckle release button and fully retract the seat belt.

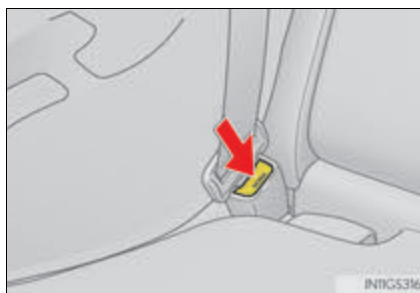

Child restraint systems with a top tether strap

- 1 Rear outboard seats:
Remove the head restraint.
- 2 Secure the child restraint system using the seat belt or LATCH anchors.

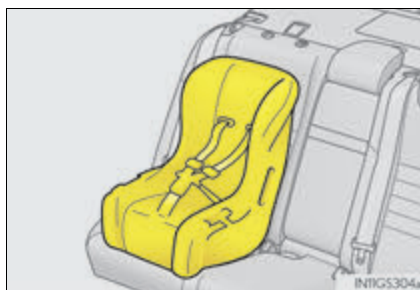
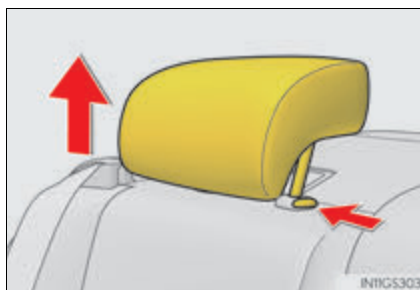

- 3 Open the anchor bracket cover, latch the hook onto the anchor bracket and tighten the top tether strap.

Make sure the top tether strap is securely latched.

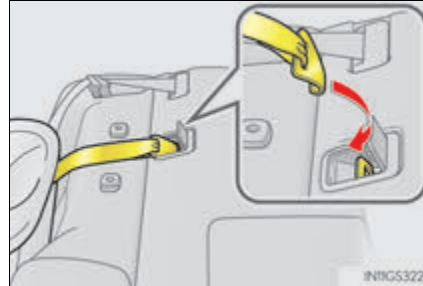

■ Laws and regulations pertaining to anchorages

The LATCH system conforms to FMVSS225 or CMVSS210.2.

Child restraint systems conforming to FMVSS213 or CMVSS213 specifications can be used.

This vehicle is designed to conform to the SAE J1819.

⚠ WARNING

■ When installing a booster seat

To prevent the belt from going into ALR lock mode, do not fully extend the shoulder belt. ALR mode causes the belt to tighten only. This could cause injury or discomfort to the child. (→P. 37)

■ When installing a child restraint system

Follow the directions given in the child restraint system installation manual and fix the child restraint system securely in place.

If the child restraint system is not correctly fixed in place, the child or other passengers may be seriously injured or even killed in the event of sudden braking, sudden swerving or an accident.

- If the driver's seat interferes with the child restraint system and prevents it from being attached correctly, attach the child restraint system to the right-hand rear seat.
- Adjust the front passenger seat so that it does not interfere with the child restraint system.

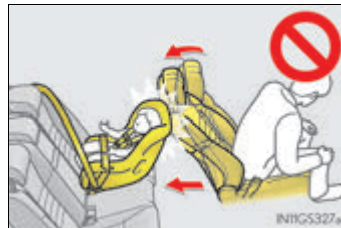

- Only put a forward-facing child restraint system on the front seat when unavoidable. When installing a forward-facing child restraint system on the front passenger seat, move the seat as far back as possible even if the "AIR BAG OFF" indicator light is illuminated. Failure to do so may result in death or serious injury if the airbags deploy (inflate).



 **WARNING****■ When installing a child restraint system**

- When a booster seat is installed, always ensure that the shoulder belt is positioned across the center of the child's shoulder. The belt should be kept away from the child's neck, but not so that it could fall off the child's shoulder. Failing to do so may result in death or serious injury in the event of sudden braking, sudden swerving or an accident.
- Ensure that the belt and plate are securely locked and the seat belt is not twisted.
- Shake the child restraint system left and right, and forward and backward to ensure that it has been securely installed.
- After securing a child restraint system, never adjust the seat.
- Follow all installation instructions provided by the child restraint system manufacturer.

■ Do not use a seat belt extender

If a seat belt extender is used when installing a child restraint system, the seat belt will not securely hold the child restraint system, which could cause death or serious injury to the child or other passengers in the event of sudden braking, sudden swerving or an accident.

■ To correctly attach a child restraint system to the anchors

When using the LATCH anchors, be sure that there are no foreign objects around the anchors and that the seat belt is not caught behind the child restraint system. Make sure the child restraint system is securely attached, or it may cause death or serious injury to the child or other passengers in the event of sudden braking, sudden swerving or an accident.

Exhaust gas precautions

Harmful substance to the human body is included in exhaust gases if inhaled.

WARNING

Exhaust gases include harmful carbon monoxide (CO), which is colorless and odorless. Observe the following precautions. Failure to do so may cause exhaust gases enter the vehicle and may lead to an accident caused by light-headedness, or may lead to death or a serious health hazard.

■ Important points while driving

- Keep the trunk lid closed.
- If you smell exhaust gases in the vehicle even when the trunk lid is closed, open the windows and have the vehicle inspected at your Lexus dealer as soon as possible.

■ When parking

- If the vehicle is in a poorly ventilated area or a closed area, such as a garage, stop the engine.
- Do not leave the vehicle with the engine running for a long time. If such a situation cannot be avoided, park the vehicle in an open space and ensure that exhaust fumes do not enter the vehicle interior.
- Do not leave the engine running in an area with snow build-up, or where it is snowing. If snowbanks build up around the vehicle while the engine is running, exhaust gases may collect and enter the vehicle.

■ Exhaust pipe

The exhaust system needs to be checked periodically. If there is a hole or crack caused by corrosion, damage to a joint or abnormal exhaust noise, be sure to have the vehicle inspected and repaired by your Lexus dealer.

Engine immobilizer system

The vehicle's keys have built-in transponder chips that prevent the engine from starting if a key has not been previously registered in the vehicle's on-board computer.

Never leave the keys inside the vehicle when you leave the vehicle.

This system is designed to help prevent vehicle theft but does not guarantee absolute security against all vehicle thefts.

The indicator light flashes after the engine switch has been turned off to indicate that the system is operating.

The indicator light stops flashing after the engine switch has been turned to ACCESSORY or IGNITION ON mode to indicate that the system has been canceled.

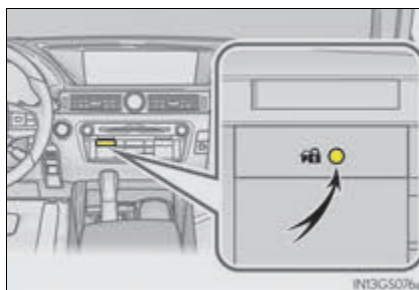

■ System maintenance

The vehicle has a maintenance-free type engine immobilizer system.

■ Conditions that may cause the system to malfunction

- If the grip portion of the key is in contact with a metallic object
- If the key is in close proximity to or touching a key to the security system (key with a built-in transponder chip) of another vehicle

■ **Certifications for the engine immobilizer system**

- For vehicles sold in the U.S. mainland, Hawaii, Guam and Puerto Rico

FCC ID: NI4TMIMB-3

This device complies with part 15 of the FCC Rules. Operation is subject to the following two conditions: (1) This device may not cause harmful interference, and (2) this device must accept any interference received, including interference that may cause undesired operation.

Changes or modifications not expressly approved by the party responsible for compliance could void the user's authority to operate the equipment.

- For vehicles sold in Canada

This device complies with Industry Canada licence-exempt RSS standard(s). Operation is subject to the following two conditions: (1) this device may not cause interference, and (2) this device must accept any interference, including interference that may cause undesired operation of the device.

Le présent appareil est conforme aux CNR d'Industrie Canada applicables aux appareils radio exempts de licence. L'exploitation est autorisée aux deux conditions suivantes : (1) l'appareil ne doit pas produire de brouillage, et (2) l'appareil doit accepter tout brouillage radioélectrique subi, même si le brouillage est susceptible d'en compromettre le fonctionnement.

 **WARNING**

■ **Certifications for the engine immobilizer system**

Changes or modifications not expressly approved by the party responsible for compliance could void the user's authority to operate the equipment.

 **NOTICE**

■ **To ensure the system operates correctly**

Do not modify or remove the system. If modified or removed, the proper operation of the system cannot be guaranteed.

1

For safety and security

Alarm

The alarm

The alarm uses light and sound to give an alert when an intrusion is detected.

The alarm is triggered in the following situations when the alarm is set:

- A locked door or trunk is unlocked or opened in any way other than using the entry function, wireless remote control or mechanical key. (The doors will lock again automatically.)
- The hood is opened.

Setting the alarm system

Close the doors, trunk and hood, and lock all the doors. The system will be set automatically after 30 seconds.

The indicator light changes from being on to flashing when the system is set.



Deactivating or stopping the alarm

Do one of the following to deactivate or stop the alarms:

- Unlock the doors or open the trunk.
- Turn the engine switch to ACCESSORY or IGNITION ON mode, or start the engine. (The alarm will be deactivated or stopped after a few seconds.)

■ System maintenance

The vehicle has a maintenance-free type alarm system.

■ Items to check before locking the vehicle

To prevent unexpected triggering of the alarm and vehicle theft, make sure of the following:

- Nobody is in the vehicle.
- The windows and moon roof are closed before the alarm is set.
- No valuables or other personal items are left in the vehicle.

■ Triggering of the alarm

The alarm may be triggered in the following situations:
(Stopping the alarm deactivates the alarm system.)

- A person inside the vehicle opens a door, the trunk or hood, or unlocks the vehicle using an inside lock button.
- The battery is recharged or replaced when the vehicle is locked. (→P. 526)

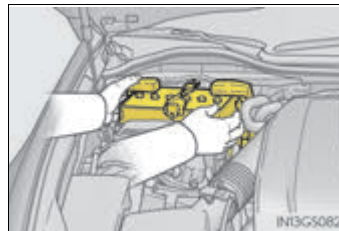

■ Alarm-operated door lock

In the following cases, the door may automatically lock:

- When a person remaining in the vehicle unlocks the door and the alarm is activated.
- While the alarm is activated, a person remaining in the vehicle unlocks the door.
- When recharging or replacing the battery.

NOTICE

■ To ensure the system operates correctly

Do not modify or remove the system. If modified or removed, the proper operation of the system cannot be guaranteed.

Instrument cluster

2

2. Instrument cluster

Warning lights and indicators	78
Gauges and meters (GS350/GS200t)	86
Gauges and meters (GS F)	92
Multi-information display (GS350/GS200t)	100
Multi-information display (GS F)	108
Head-up display	120
Fuel consumption information	127

Warning lights and indicators

The warning lights and indicators on the instrument cluster, center panel and outside rear view mirrors inform the driver of the status of the vehicle's various systems.

For the purpose of explanation, the following illustrations display all warning lights and indicators illuminated.

- ▶ GS350/GS200t (except F SPORT models)



- ▶ GS350/GS200t (F SPORT models)



▶ GSF



The units used on the meters and some indicators may differ depending on the target region.

2

Instrument cluster

Warning lights

Warning lights inform the driver of malfunctions in the indicated vehicle systems.

^{*1}  (U.S.A.)	Brake system warning light (→P. 452)	^{*1,3}  (If equipped)	PCS (Pre-Collision System) warning light (→P. 453)
^{*1}  (Canada)	Brake system warning light (→P. 452)	^{*1} 	Slip indicator (→P. 453)
^{*1,2} 	Charging system warning light (→P. 452)	^{*1,3,4}  (If equipped)	"AFS OFF" indicator (→P. 453)
^{*1}  (U.S.A.)	Malfunction indicator lamp (→P. 452)	^{*1,3,4} 	Brake hold operated indicator (→P. 453)
^{*1}  (Canada)	Malfunction indicator lamp (→P. 452)	^{*3}  (U.S.A.)	Parking brake indicator (→P. 454)
^{*1} 	SRS warning light (→P. 452)	^{*3}  (Canada)	Parking brake indicator (→P. 454)
^{*1}  (U.S.A.)	ABS warning light (→P. 452)	^{*1} 	Brake system warning light (→P. 454)
^{*1}  (Canada)	ABS warning light (→P. 452)	^{*5} 	Open door warning light (→P. 454)
^{*1} 	Electric power steering system warning light (→P. 453)		Low fuel level warning light (→P. 454)



Seat belt reminder light
(→P. 454)



^{*1} Tire pressure warning light
(→P. 454)



^{*1} Master warning light
(→P. 454)

^{*1}: These lights turn on when the engine switch is turned to IGNITION ON mode to indicate that a system check is being performed. They will turn off after the engine is started, or after a few seconds. There may be a malfunction in a system if a light does not come on, or turn off. Have the vehicle inspected by your Lexus dealer.

^{*2}: On some models

^{*3}: The light flashes to indicate a malfunction.

^{*4}: GS350/GS200t

^{*5}: GSF

Indicators

The indicators inform the driver of the operating state of the vehicle's various systems.



Turn signal indicator
(→P. 209)



(If equipped)

Dynamic radar cruise control indicator
(→P. 266, 278)



(U.S.A.)

Headlight indicator
(→P. 215)



Cruise control "SET" indicator
(→P. 266, 278, 290)



(Canada)

Tail light indicator
(→P. 215)



(If equipped)

LDA indicator (→P. 258)/
LKA indicator (→P. 249)



Headlight high beam indicator (→P. 215)



(If equipped)

^{*1} Intuitive parking assist indicator



(If equipped)

Automatic High Beam indicator (→P. 218)



(If equipped)

^{*2, 3} "AFS OFF" indicator
(→P. 216)















Cruise control indicator
(→P. 274, 286, 290)









^{*2, 4}

Slip indicator (→P. 310)

 *2	VSC OFF indicator (→P. 310)	 *9	Security indicator (→P. 72, 74)
 *2,5	TRAC OFF indicator (→P. 310)	 *10	Low outside temperature indicator (→P. 87, 94)
 *2,6 (If equipped)	PCS (Pre-Collision System) warning light (→P. 240)	 *2	Eco Driving Indicator Light (→P. 85)
 *7,8 (If equipped)	BSM (Blind Spot Monitor) outside rear view mirror indicators (→P. 298)	 *2	Parking brake indicator (→P. 210) (U.S.A.)
 *7,8 (If equipped)	BSM (Blind Spot Monitor) indicator (→P. 298)	 *2	Parking brake indicator (→P. 210) (Canada)
 *2,3	Brake hold standby indicator (→P. 212)	 *2,9	"AIR BAG ON/OFF" indicator (→P. 52)
 *2,3	Brake hold operated indicator (→P. 212)		

● Drive mode indicators

► GS350/GS200t (except F SPORT models)

 *2,3	Eco drive mode indicator (→P. 293)	 *2,3 (If equipped)	"SPORT" indicator (→P. 293)
 *2,3 (If equipped)	"SPORT S" indicator (→P. 293)	 *2,3 (If equipped)	"SPORT S+" indicator (→P. 293)
 *2,3 (If equipped)	"Customize" indicator (→P. 293)	 *2,3	Snow mode indicator (→P. 203)

▶ GS350/GS200t (F SPORT models)

Eco drive mode indicator
(→P. 293)"SPORT S" indicator
(→P. 293)"SPORT S+" indicator
(→P. 293)"CUSTOMIZE" indicator
(→P. 293)Snow mode indicator
(→P. 203)

▶ GS F

"NORMAL" indicator
(→P. 296)Eco drive mode indicator
(→P. 296)"SPORT S" indicator
(→P. 296)"SPORT S+" indicator
(→P. 296)"EXPERT" indicator
(→P. 296)Snow mode indicator
(→P. 203)

● TVD (Torque Vectoring Differential) control mode indicators (GS F)

"STANDARD" indicator
(→P. 306)"SLALOM" indicator
(→P. 306)"TRACK" indicator
(→P. 306)

*1: Refer to the "NAVIGATION AND MULTIMEDIA SYSTEM OWNER'S MANUAL".

*2: These lights turn on when the engine switch is turned to IGNITION ON mode to indicate that a system check is being performed. They will turn off after the engine is started, or after a few seconds. There may be a malfunction in a system if a light does not come on, or turn off. Have the vehicle inspected by your Lexus dealer.



*3: GS350/GS200t

*4: The light flashes to indicate that the system is operating.

*5: GS F

*6: The light turns on when the system is turned off.

*7: In order to confirm operation, the BSM outside rear view mirror indicators illuminate in the following situations:

- When the engine switch is in IGNITION ON mode, the BSM function is enabled on  of the multi-information display
- When the BSM function is enabled on  of the multi-information display, the engine switch is turned to IGNITION ON mode.

If the system is functioning correctly, the BSM outside rear view mirror indicators will turn off after a few seconds.

If the BSM outside rear view mirror indicators do not illuminate or do not turn off, there may be a malfunction in the system.

If this occurs, have the vehicle inspected by your Lexus dealer.

*8: This light illuminates on the outside rear view mirrors.

*9: This light illuminates on the center panel.

*10: When the outside temperature is approximately 37°F (3°C) or lower, the indicator will flash for approximately 10 seconds, then stay on.

■ Eco Driving Indicator

▶ GS350/GS200t

- ① Eco Driving Indicator Light
During Eco-friendly acceleration (Eco driving), the Eco Driving Indicator Light will turn on. When the acceleration exceeds the Zone of Eco driving, or when the vehicle is stopped, the light turns off.
- ② Eco Driving Indicator Zone Display
Suggests the Zone of Eco driving with current Eco driving ratio based on acceleration.
- ③ Eco driving ratio based on acceleration
If the acceleration exceeds the Zone of Eco driving, the right side of the Eco Driving Indicator Zone Display will illuminate.
- ④ Zone of Eco driving

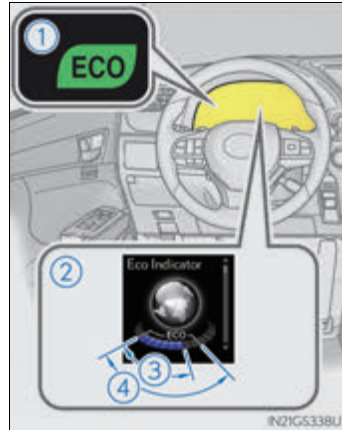

Eco Driving Indicator will not operate under the following conditions:

- The shift lever is in any position other than D.
 - A paddle shift switch is operated.
 - Neither normal mode nor Eco drive mode is selected. (→P. 293)
 - The vehicle speed is approximately 80 mph (130 km/h) or higher.
- ▶ GSF

During Eco-friendly acceleration (Eco driving), the Eco Driving Indicator Light will turn on. When the acceleration exceeds the Zone of Eco driving, or when the vehicle is stopped, the light turns off.



Eco Driving Indicator will not operate under the following conditions:

- The shift lever is in any position other than D.
- A paddle shift switch is operated.
- Neither normal mode nor Eco drive mode is selected. (→P. 293)
- The vehicle speed is approximately 80 mph (130 km/h) or higher.

⚠ WARNING

■ If a safety system warning light does not come on

Should a safety system light such as the ABS and SRS warning light not come on when you start the engine, this could mean that these systems are not available to help protect you in an accident, which could result in death or serious injury. Have the vehicle inspected by your Lexus dealer immediately if this occurs.

Gauges and meters (GS350/GS200t)

► Except F SPORT models



► F SPORT models

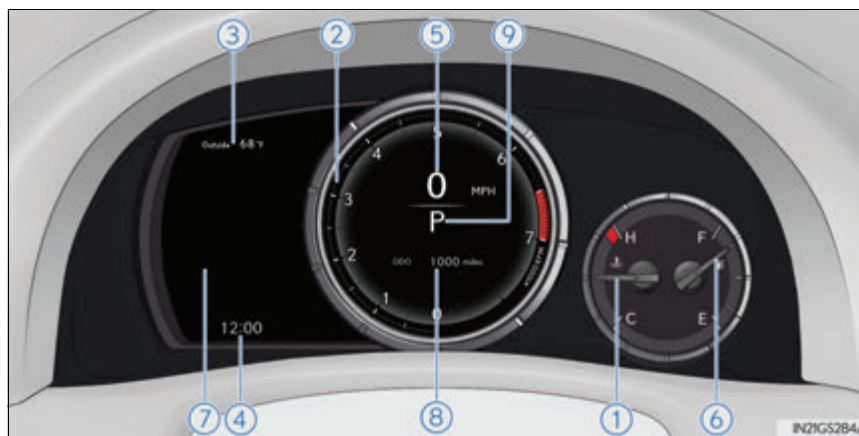

The units used on the speedometer may differ depending on the target region.

- ① Engine coolant temperature gauge
Displays the engine coolant temperature
- ② Tachometer
Displays the engine speed in revolutions per minute
- ③ Outside temperature
Displays the outside temperature within the range of -40°F (-40°C) to 122°F (50°C). Low outside temperature indicator comes on when the ambient temperature is 37°F (3°C) or lower.
- ④ Clock
Time displayed is linked to the analog clock on the instrument panel. (→P. 359)
- ⑤ Speedometer
Displays the vehicle speed
- ⑥ Fuel gauge
Displays the quantity of fuel remaining in the tank
- ⑦ Multi-information display
Presents the driver with a variety of driving-related data (→P.100)
Displays warning messages in case of a malfunction (→P. 459)
- ⑧ Odometer and trip meter display
Odometer:
Displays the total distance the vehicle has been driven
Trip meter:
Displays the distance the vehicle has been driven since the meter was last reset. Trip meters "A" and "B" can be used to record and display different distances independently.
Maintenance required information:
 - Displays the maintenance required information when the engine switch is in IGNITION ON mode.
 - It can be reset from  of the multi-information display. (→P.100)
- ⑨ Shift position and shift range
Displays the selected shift position or selected shift range (→P. 202)

■ Rev indicator (F SPORT models)

When the engine reaches a set speed, a ring-shaped indicator will be displayed on the tachometer.



■ Rev peak (F SPORT models)

The engine speed reaches or exceeds 5000 rpm, an afterimage of the tachometer will be displayed at the highest engine speed for approximately 1 seconds.



Changing the display

Switches between odometer, trip meter and maintenance required information displays. When the trip meter is displayed, pressing and holding the button will reset the trip meter.

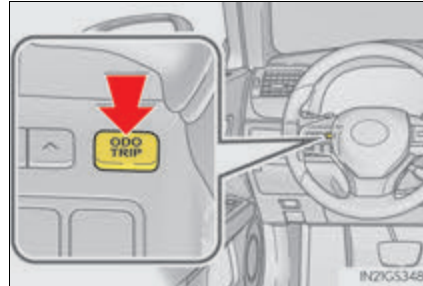

Instrument panel light control

The brightness of the instrument panel lights can be adjusted.

- ① Darker
- ② Brighter

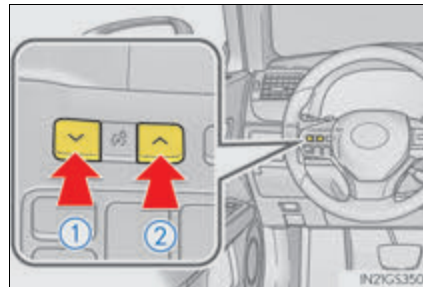

■ The meters and display illuminate when

The engine switch is in IGNITION ON mode.

■ Instrument panel brightness adjustment

The instrument panel brightness levels when the tail lights are on and off can be adjusted individually. However, when the surroundings are bright (daytime, etc.), turning on the tail lights will not change the instrument panel brightness. At this time, any adjustments made to the instrument panel brightness levels will be applied to both settings at once.

■ Limitation of brightness adjustment

The brightness of the instrument panel lights is automatically adjusted based on the light sensor detecting how bright the surroundings are. However, if the instrument panel brightness has been manually set to either the brightest or darkest setting, the automatic adjustment will not be performed.

■ **Outside temperature display**

- In the following situations, the correct outside temperature may not be displayed, or the display may take longer than normal to change.
 - When stopped, or driving at low speeds (less than 12 mph [20 km/h])
 - When the outside temperature has changed suddenly (at the entrance/exit of a garage, tunnel, etc.)
- When "--" or "E" is displayed, the system may be malfunctioning. Take your vehicle to your Lexus dealer.

■ **Pop-up display**

- In some situations, a pop-up display will be temporarily displayed on the multi-information display or the odometer/trip meter/maintenance required information screen.
- Some pop-up displays can be set on/off. (→P. 571)

■ **Liquid crystal display**

Small spots or light spots may appear on the display. This phenomenon is characteristic of liquid crystal displays, and there is no problem continuing to use the display.

■ **Clock settings**

If the screen shown to the right is displayed when trying to change the time display method through  (→P. 100) on the multi-information display, the system may be malfunctioning.

Have the vehicle inspected by your Lexus dealer.



■ **Customization**

The meter display can be customized on the multi-information display. (Customizable features: →P. 568)

⚠ WARNING

■ **The information display at low temperatures**

Allow the interior of the vehicle to warm up before using the liquid crystal information display. At extremely low temperatures, the information display monitor may respond slowly, and display changes may be delayed. For example, there is a lag between the driver's shifting and the new gear number appearing on the display. This lag could cause the driver to downshift again, causing rapid and excessive engine braking and possibly an accident resulting in death or injury.

 NOTICE**■ To prevent damage to the engine and its components**

- Do not let the indicator needle of the tachometer enter the red zone, which indicates the maximum engine speed.
- The engine may be overheating if the engine coolant temperature gauge is in the red zone (H). In this case, immediately stop the vehicle in a safe place, and check the engine after it has cooled completely. (→P. 528)

Gauges and meters (GS F)

If the drive mode is changed, some of the meter displays and the gauge layout will be changed.

► Normal mode

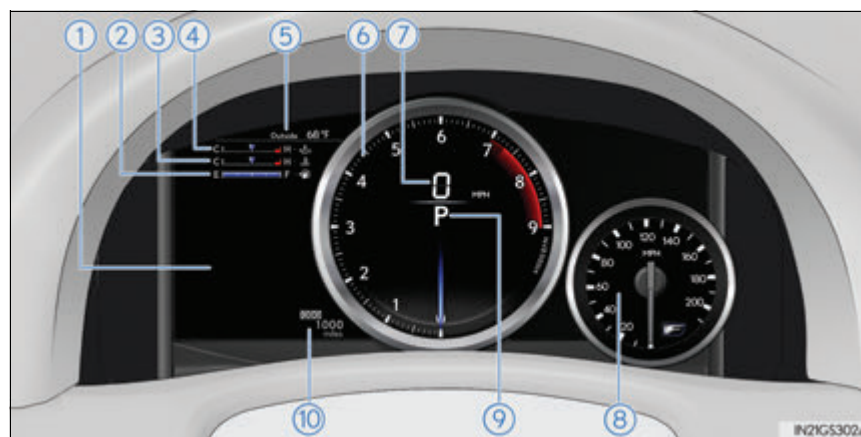

► Eco drive mode

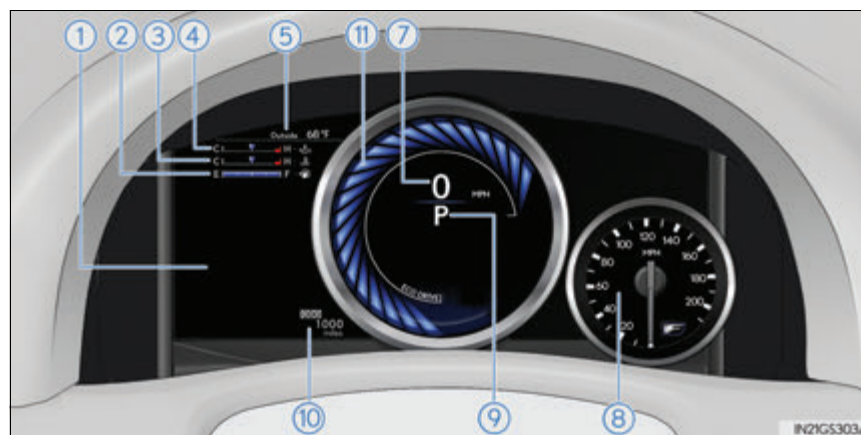

▶ SPORT S mode*

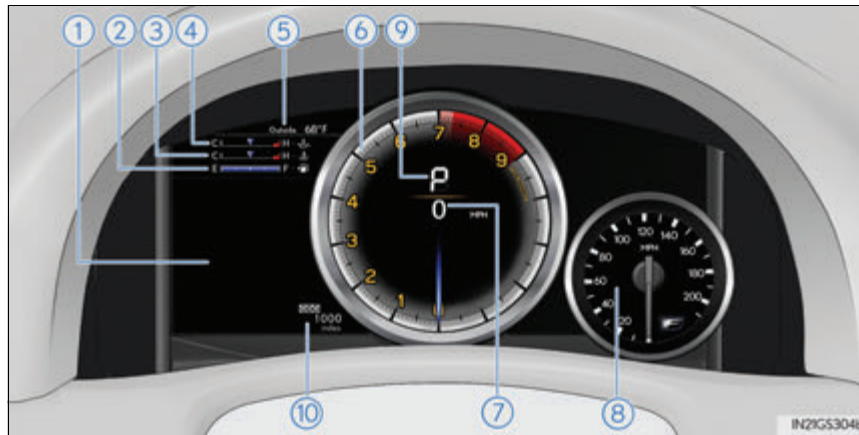



▶ SPORT S+ mode*



The units used on the meters may differ depending on the target region.

*: These illustrations show the default meter display for SPORT S mode and SPORT S+ mode. The meter displays for SPORT S mode and SPORT S+ mode can be changed on the settings display of the multi-information display.

- ① Multi-information display
Presents the driver with a variety of vehicle data (→P. 108)
Displays warning messages in case of a malfunction (→P. 459)
- ② Fuel gauge
- ③ Engine coolant temperature gauge
Displays the engine coolant temperature. If the engine coolant temperature gauge indicator () enters the red zone, a buzzer will sound and the indicator will turn red and start flashing. Also, a warning message will be displayed.
- ④ Engine oil temperature gauge
Displays the engine oil temperature. If the engine oil temperature gauge indicator () enters the red zone, the indicator will turn red and start flashing.
- ⑤ Outside temperature
Displays the outside temperature within the range of -40°F (-40°C) to 122°F (50°C). Low outside temperature indicator comes on when the ambient temperature is 37°F (3°C) or lower.
- ⑥ Tachometer
Displays the engine speed in revolutions per minute
- ⑦ Digital speedometer
- ⑧ Analog speedometer
- ⑨ Shift position and gear position
Displays the selected shift position or selected shift range (→P. 202)
- ⑩ Odometer and trip meter display
Odometer:
Displays the total distance the vehicle has been driven
Trip meter:
Displays the distance the vehicle has been driven since the meter was last reset. Trip meters "A" and "B" can be used to record and display different distances independently.
- ⑪ Eco driving meter
Displays the vehicle acceleration. The more rapidly the vehicle is accelerated, the lower the number of blue segments displayed, indicating that your driving is less eco-friendly. This meter is designed as a guideline to show the eco-friendliness of your driving.

■ Speed indicator

When the vehicle reaches the set speed, the displayed unit of speed measure will turn yellow.

The indicators will be displayed in yellow (corresponding to a speed set by a user) or red (fixed at 100 mph [160 km/h])^{*}.

This setting can be enabled on the multi-information display.

^{*}: Always observe the legal speed limit when driving on public roads.

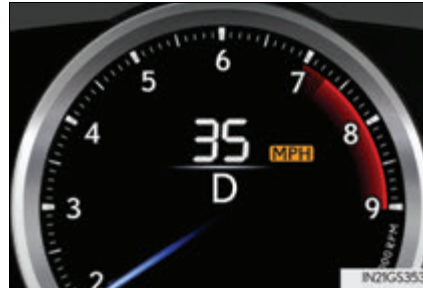

■ Rev indicator (SPORT S mode/SPORT S+ mode)

When the shift lever is in M, an indicator on the tachometer will be displayed in 3 steps. When the 3rd level indicator is displayed, the indicator will flash and a buzzer will sound to notify you of shift-up timing.

The indicator may be displayed when downshifting, depending on the engine speed.

These illustrations show the default meter display for SPORT S mode and SPORT S+ mode. The meter displays for SPORT S mode and SPORT S+ mode can be changed on the settings display of the multi-information display.



■ Rev peak (Normal mode/SPORT S mode)

The engine speed reaches or exceeds 3600 rpm, an afterimage of the tachometer will be displayed at the highest engine speed for approximately 1 second.

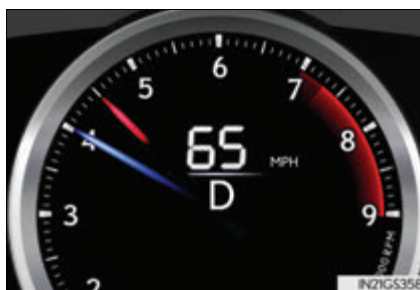

Changing the display

■ Odometer/Trip meter

Switches between odometer and trip meter displays. When the trip meter is displayed, pressing and holding the button will reset the trip meter.

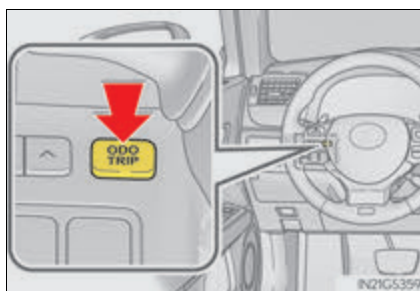

■ Meter display and layout

If the drive mode is changed, some of the meter displays and the gauge layout will be changed.

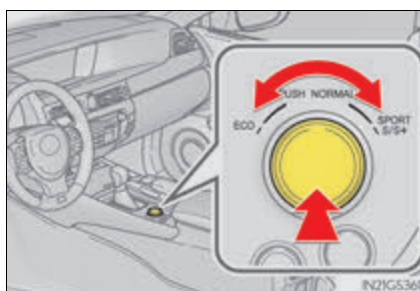

Instrument panel light control

The brightness of the instrument panel lights can be adjusted.

- ① Darker
- ② Brighter

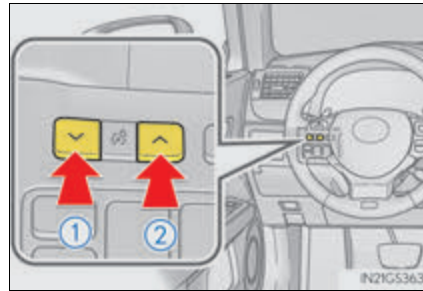

2

Instrument cluster

■ The meters and display illuminate when

The engine switch is in IGNITION ON mode.

■ Welcome illumination of the analog speedometer

- When the driver's door is opened, the analog speedometer will illuminate. Then, when the driver's door is closed, the analog speedometer will illuminate and go off (pulsate) 3 times.
- In the following situations, the analog speedometer will not pulsate even though the driver's door is opened and closed:
 - Within 60 seconds after the analog meter pulsation completes
 - Within 60 seconds of turning the engine switch off

■ Variable red zone

To help protect the engine, the engine speed is controlled by changing the starting position of the tachometer's red zone depending on the engine coolant temperature within a range from 3700 rpm to 7300 rpm.

Before driving under extremely high load conditions, make sure to sufficiently warm up the engine.

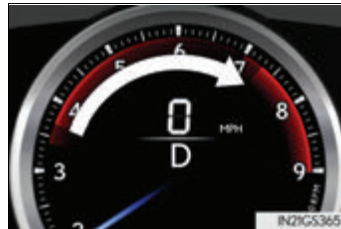

■ Eco driving meter

- The number of blue segments displayed on the eco driving meter decreases/increases depending on the vehicle acceleration. Use this meter as a guideline when you wish to drive in an eco-friendly manner that reduces fuel consumption. However, on a downward grade where the vehicle can accelerate without the accelerator pedal being depressed, the eco driving meter may not display the eco-driving state correctly.
- When the shift lever is moved to P, N or R, the segments will turn gray and the eco driving meter will not operate.

■ Instrument panel brightness adjustment

The instrument panel brightness levels when the tail lights are on and off can be adjusted individually. However, when the surroundings are bright (daytime, etc.), turning on the tail lights will not change the instrument panel brightness. At this time, any adjustments made to the instrument panel brightness levels will be applied to both settings at once.

■ Dimming the analog speedometer lighting

The analog speedometer lighting will be dimmed when the ambient light is bright, such as during the daytime, and SPORT S or SPORT S+ mode is selected.

■ Outside temperature display

- In the following situations, the correct outside temperature may not be displayed, or the display may take longer than normal to change.
 - When stopped, or driving at low speeds (less than 12 mph [20 km/h])
 - When the outside temperature has changed suddenly (at the entrance/exit of a garage, tunnel, etc.)
- When "--" or "E" is displayed, the system may be malfunctioning.
Take your vehicle to your Lexus dealer.

■ Pop-up display

- In some situations, such as when a switch operation is performed, a pop-up display will be temporarily displayed on the multi-information display.
- Some pop-up displays can be set on/off. (→P. 571)

■ Liquid crystal display

Small spots or light spots may appear on the display. This phenomenon is characteristic of liquid crystal displays, and there is no problem continuing to use the display.



■ Customization

The meter display can be customized on the multi-information display.
(Customizable features: →P. 568)

**WARNING****■ The information display at low temperatures**

Allow the interior of the vehicle to warm up before using the liquid crystal information display. At extremely low temperatures, the information display monitor may respond slowly, and display changes may be delayed.
For example, there is a lag between the driver's shifting and the new gear number appearing on the display. This lag could cause the driver to downshift again, causing rapid and excessive engine braking and possibly an accident resulting in death or injury.

 NOTICE**■ To prevent damage to the engine and its components**

- Do not let the indicator of the tachometer enter the red zone, as it represents the engine speed range which exceeds the maximum safe engine speed.
- In the following situations, the engine may be overheating. In this case, immediately stop the vehicle in a safe place, and check the engine after it has cooled completely. (→P. 528)
 - The engine coolant temperature gauge indicator () is in the red zone and flashing.
 - The engine oil temperature gauge indicator () is in the red zone and flashing.

Multi-information display (GS350/GS200t)

Display contents

The multi-information display presents the driver with a variety of vehicle data.

● Menu icons

▶ Except F SPORT models

▶ F SPORT models



Displays the following information when an icon is selected. (→P. 102)

Some of the information may be displayed automatically depending on the situation.



Drive information

Select to display various drive data. (→P. 102)



Navigation system-linked display (if equipped)

Select to display the following navigation system-linked information.

- Route guidance
- Compass display (north-up display/heading-up display)



Audio system-linked display

Select to enable selection of an audio source or track on the meter using the meter control switches.



Driving assist system information

Select to display the cruise control or dynamic radar cruise control with full-speed range/LKA (Lane-Keeping Assist) (if equipped) information, when the system is used. (→P. 249, 266, 290)



Warning message display

Select to display warning messages and measures to be taken if a malfunction is detected. (→P. 459)







Settings display

Select to change the meter display settings. (→P. 569)

Operating the meter control switches

The multi-information display is operated using the meter control switches.

- ①   : Switch menu
  : Change displayed content, scroll up/down the screen and move the cursor up/down

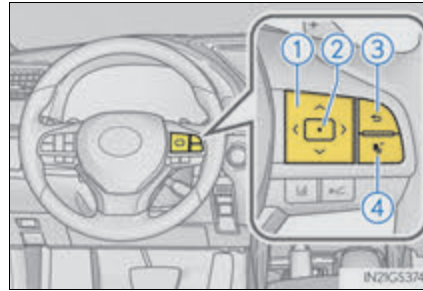

- ② Press: Enter/Set
 Press and hold: Reset
- ③ Return to the previous screen
- ④ Press: Displays the screen registered to 

When no screen has been registered, the drive information screen will be displayed.





Press and hold: Registers the currently displayed screen to  (→P. 569)

When the confirmation screen is displayed, select yes to register the screen. If the selected screen cannot be registered, a registration failure message will be shown.

2

Instrument cluster

Drive information

Items displayed can be switched by pressing  or  of the meter control switches to select  and pressing  or .

■ **Current fuel consumption***1

Displays the current rate of fuel consumption

■ **Average fuel economy (after reset*2/after start/after refuel)*1**

Displays the average fuel consumption since the function was reset, the engine was started, and the vehicle was refueled, respectively

Use the displayed average fuel consumption as a reference.

■ **Average speed (after reset*2/after start)*1**

Displays the average vehicle speed since the function was reset and the engine was started, respectively

■ **Elapsed time (after reset*2/after start)*1**

Displays the elapsed time since the function was reset and the engine was started, respectively

■ **Distance (range/after start)*1**

Displays the estimated maximum distance that can be driven with the quantity of fuel remaining and the distance driven after the engine was started respectively.

- This distance is computed based on your average fuel consumption. As a result, the actual distance that can be driven may differ from that displayed.
- When only a small amount of fuel is added to the tank, the display may not be updated.

When refueling, turn the engine switch off. If the vehicle is refueled without turning the engine switch off, the display may not be updated.

■ **Eco Driving Indicator Zone Display**

→P. 85

■ Boost meter/oil temperature gauge/oil pressure gauge (GS200t)

The boost pressure, engine oil temperature and oil pressure can be displayed.

① Boost meter

When the boost pressure reaches 15 psi (100 kPa) or higher, the color changes to amber.

② Oil temperature gauge

When the engine oil temperature reaches 284°F (140°C) or higher, the display flashes.

③ Oil pressure gauge

If the oil pressure drops, the buzzer sounds and a warning indicator is displayed. (→P. 472)

Actual vehicle conditions may differ from the displayed information depending on road conditions, temperature, vehicle speed and other factors.

Use this information as reference.

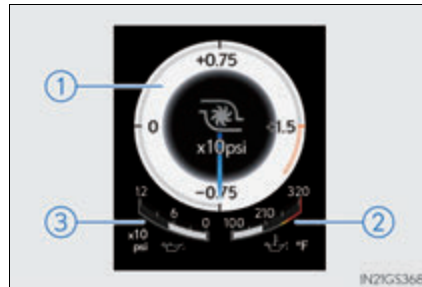

2

Instrument cluster

■ G-forces

Displays lateral G-forces on the vehicle

Also displays, around the periphery of the G-force display, the left and right steering amount, accelerator pedal input, and brake fluid pressure

① Acceleration G-force on the vehicle

② Current G-force value (analyzed value of front/rear and left/right G-forces)

③ Accelerator pedal input

④ Brake fluid pressure

⑤ Record of the maximum G-forces

⑥ Steering amount

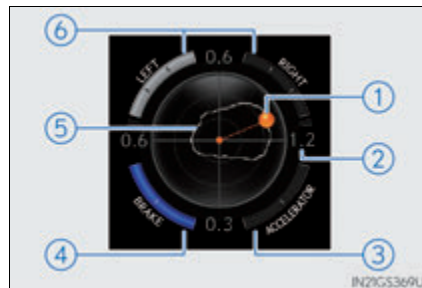

Actual vehicle conditions may differ from the displayed information depending on road conditions, temperature, vehicle speed and other factors.

Use this information as reference.

● Resetting the record of maximum G-forces

Press and hold  to reset the record.

● Peak hold function (F SPORT models)

If lateral G-forces of 0.5 G or greater are generated, the G-force value display will turn amber and be held for 2 seconds.

■ **Tire inflation pressure**

Displays inflation pressure of each tire.

The inflation pressure of the compact spare tire will not be displayed.

■ **LKA (Lane-Keeping Assist) vehicle sway warning (if equipped)**

→P. 249

■ **Display off**

A blank screen is displayed

*1: Displayed when the item is set in "Drive Info 1", "Drive Info 2" or "Drive Info 3".
(→P. 569)

*2: The function can be reset by pressing the  of the meter control switches for longer than 1 second when the item to reset is displayed.

If there is more than one item that can be reset, the item selection screen will appear.

Settings display

The settings of the following items can be changed, refer to P. 568

For functions that can be enabled or disabled, the function switches between on and off each time  is pressed.

■  **LKA** (Lane-Keeping Assist) (if equipped) (→P. 249)

■  **PCS** (Pre-Collision System) (if equipped) (→P. 237)

■  **AFS** (Adaptive Front-lighting System) (if equipped) (→P. 216)

■  **BSM** (Blind Spot Monitor) (if equipped) (→P. 298)



■  **Clock**

Select to set the display mode of the clock.

■ Vehicle Settings

- Scheduled Maintenance (→P. 386)
- Oil Maintenance (→P. 404)
- TPMS (Tire pressure warning system) (→P. 415)

■ Meter Settings

- Language
Select to change the language on the display.
- Units
Select to change the unit of measure.
- Eco Driving Indicator Light
Select to activate/deactivate the Eco Driving Indicator Light.
-  switch
Displays a procedure to register a desired screen to .
You can register 1 screen as a shortcut, which can be displayed by pressing .
- Drive information 1/2/3
Select to select up to 2 items that will be displayed on a Drive information screen, up to 3 Drive information screens can be set.
- Pop-up display
Select to set the following pop-up displays, which may appear in some situations, on/off.
 - Route guidance of the navigation system-linked display (if equipped)
 - Incoming call display of the hands-free phone system
 - Instrument panel brightness adjustment display
- Accent color (except F SPORT models)
Select to change the accent colors on the screen, such as the cursor color.
- Needle (F SPORT models)
Select to change the needle color for the tachometer.
- Rev indicator (F SPORT models)
Select to set the rev indicator on/off.
When set to on, proceed to set the engine speed at which the rev indicator will be displayed.
Selectable engine speed range:
GS350: 2000 rpm to 6800 rpm
GS200t: 2000 rpm to 6100 rpm
- Rev peak (F SPORT models)
Select to set the rev peak on/off.
- Default settings
Registered or changed meter settings will be deleted or returned to their default setting.

■ **G-force display**

- The G-force values may not be zero even when the vehicle is parked, such as when it is parked on an incline.
- Depending on the vehicle usage conditions, the brake fluid pressure display may not reach its maximum reading even though the brake pedal is fully depressed.
- If a battery terminal is disconnected and reconnected, the steering amount display may be disabled temporarily. After driving the vehicle for a while, the display will be enabled.

■ **System check display**

After turning the engine switch to IGNITION ON mode, opening image is displayed while system operation is checked. When the system check is complete, the normal screen will return.

■ **Suspension of the settings display**

In the following situations, the settings display using the meter control switches will be suspended.

- When a warning message appears on the multi-information display
- When the vehicle begins to move

■ **Tire inflation pressure**

- It may take a few minutes to display the tire inflation pressure after the engine switch is turned to IGNITION ON mode. It may also take a few minutes to display the tire inflation pressure after inflation pressure has been adjusted.
- “---” may be displayed if the tire information cannot be determined due to unfavorable radio wave conditions.
- Tire inflation pressure changes with temperature. The displayed values may also be different from the values measured using a tire pressure gauge.

■ **When disconnecting and reconnecting battery terminals**

The drive information will be reset.

■ **Liquid crystal display**

→P. 90

 WARNING
<p>■ Caution for use while driving</p> <ul style="list-style-type: none"> ● When operating the multi-information display while driving, pay extra attention to the safety of the area around the vehicle. ● Do not look continuously at the multi-information display while driving as you may fail to see pedestrians, objects on the road, etc. ahead of the vehicle. <p>■ Cautions during setting up the display</p> <p>As the engine needs to be operating during setting up the display, ensure that the vehicle is parked in a place with adequate ventilation. In a closed area such as a garage, exhaust gases including harmful carbon monoxide (CO) may collect and enter the vehicle. This may lead to death or a serious health hazard.</p>

 NOTICE

■ **During setting up the display**

To prevent battery discharge, ensure that the engine is operating while setting up the display features.

Multi-information display (GS F)

Display content

The multi-information display presents the driver with a variety of vehicle data.

● Menu icons

Displays the following information when an icon is selected. (→P. 109)

Some of the information may be displayed automatically depending on the situation.



Drive information

Select to display various drive data. (→P. 109)



"F" content

Select to display the lap timer, G-force, torque distribution and other useful functions for sporty driving. (→P. 111)



Navigation system-linked display (if equipped)

Select to display the following navigation system-linked information.

- Route guidance
- Compass display (north-up display/heading-up display)



Audio system-linked display

Select to enable selection of an audio source or track on the meter using the meter control switches.



Driving assist system information

Select to display the cruise control or dynamic radar cruise control/ LDA (Lane Departure Alert with steering control) (if equipped) information, when the system is used. (→P. 258, 278, 290)



Warning message display

Select to display warning messages and measures to be taken if a malfunction is detected. (→P. 459)



Settings display

Select to change the meter display settings. (→P. 571)

Operating the meter control switches

The multi-information display is operated using the meter control switches.

- ① : Switch menu
 : Change displayed content, scroll up/down the screen and move the cursor up/down

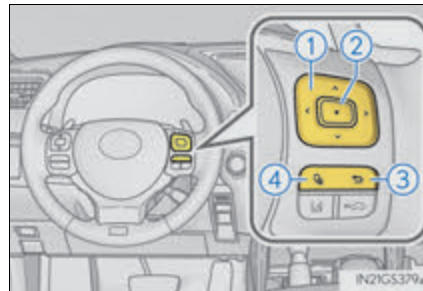

- ② Press: Enter/Set
 Press and hold: Reset
- ③ Return to the previous screen
- ④ Press: Displays the screen registered to

When no screen has been registered, the drive information screen will be displayed.
 Press and hold: Registers the currently displayed screen to (→P. 571)

When the confirmation screen is displayed, select yes to register the screen. If the selected screen cannot be registered, a registration failure message will be shown.

Drive information

Items displayed can be switched by pressing or of the meter control switches to select and pressing or .

■ Current fuel consumption*¹

Displays the current rate of fuel consumption

■ Average fuel economy (after reset*²/after start/after refuel)*¹

Displays the average fuel consumption since the function was reset, the engine was started, and the vehicle was refueled, respectively

Use the displayed average fuel consumption as a reference.

■ **Average speed (after reset^{*2}/after start)^{*1}**

Displays the average vehicle speed since the function was reset and the engine was started, respectively

■ **Elapsed time (after reset^{*2}/after start)^{*1}**

Displays the elapsed time since the function was reset and the engine was started, respectively

■ **Distance (range/after start)^{*1}**

Displays the estimated maximum distance that can be driven with the quantity of fuel remaining and the distance driven after the engine was started respectively.

- This distance is computed based on your average fuel consumption. As a result, the actual distance that can be driven may differ from that displayed.
- When only a small amount of fuel is added to the tank, the display may not be updated.

When refueling, turn the engine switch off. If the vehicle is refueled without turning the engine switch off, the display may not be updated.

■ **Tire inflation pressure**

Displays inflation pressure of each tire.

The inflation pressure of the spare tire will not be displayed.

■ **Gear positions**

Displays the current gear position when the shift lever is in D or M.

■ **LDA (Lane Departure Alert with steering control) vehicle sway warning (if equipped)**

→P. 258

■ **Display off**

A blank screen is displayed

^{*1}: Displayed when the item is set in "Drive Info 1", "Drive Info 2" or "Drive Info 3".
(→P. 571)

^{*2}: The function can be reset by pressing the  of the meter control switches for longer than 1 second when the item to reset is displayed.

If there is more than one item that can be reset, the item selection screen will appear.

“F” content

■ Lap timer

Measures and displays current lap time and previous lap times

● Reading the display

Measured lap times since the timer was last reset are displayed as follows:

- Multi-information display

- ① Total lap time
 - ② Past lap times
 - ③ Fastest lap (marked with a star)
- Main meter
- ④ Current lap time
 - ⑤ Most recent lap time

Lap time for the most recently completed lap.

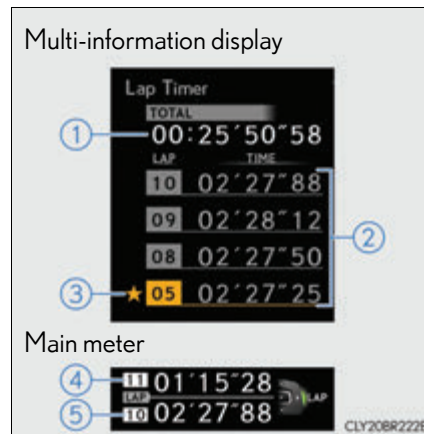

● Operating the meter control switches

- ① Press: Start/stop lap timer
Press and hold: Reset
- ② : Mark off one lap
 : Change displayed content

While a lap time is being measured, the display can be changed to show the following content:

- Torque distribution
- G-force
- Tire pressure

● Resetting/saving measured lap times

After stopping the lap timer, press and hold .

When a confirmation screen is displayed, select to reset/save the measured lap times.

When saved, the lap time data will be displayed on the history screen. (→P. 112)

■ History (Lap timer)

Displays the saved lap times

- Reading the display

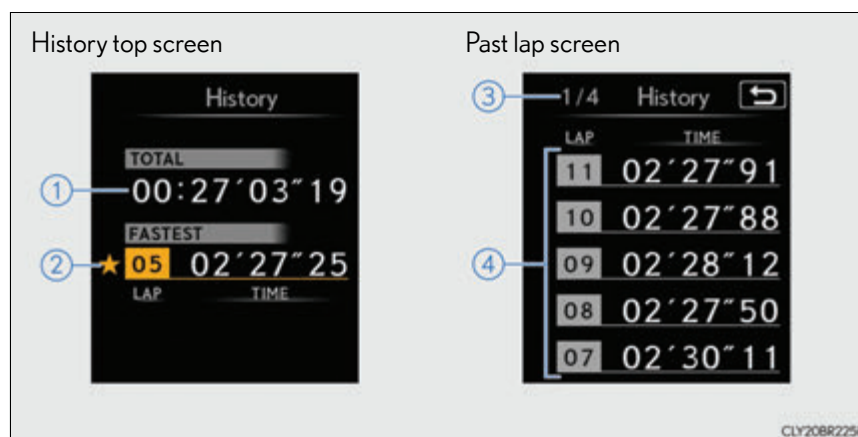

- History top screen

① Total lap time

② Fastest lap time

- Past lap screen

③ Page

④ Past lap times (20 most recent lap times)

Press / to scroll up and down the screen.

- Switching the display

To display the past lap screen, press .

To return to the history top screen, press .

- Deleting history

When the history top screen is displayed, press and hold to display a confirmation screen. To delete the history, follow the instructions displayed on the screen.

■ Torque distribution

Displays the distribution of driving torque between the left and right rear wheels

● Reading the display

• Normal display

Displays the amount of drive torque applied to the left and right rear wheels through bars that fluctuate in length on the multi-information display

• Advanced display

Displays the difference in torque applied to the left and right rear wheels through displayed segments on the main meter in addition to the bar display.

The greater the number of segments displayed, the greater the difference in torque is.

● Switching the display

To switch to advanced display, press .

To return to normal display, press .

● Peak hold function (advanced display only)

If the difference in torque of 4 segments or more is applied to the left or right rear wheel, a yellow outline will be displayed for the highest segment that was reached, for a certain amount of time.

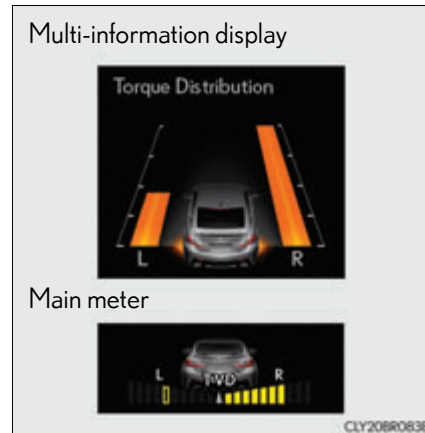

2

Instrument cluster

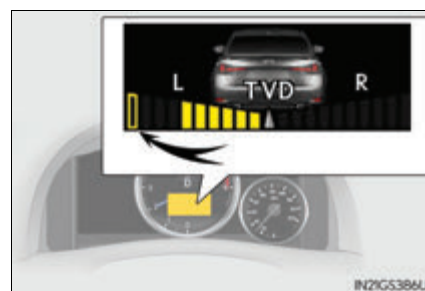

■ G-force

Displays lateral G-forces on the vehicle

Also displays, around the periphery of the G-force display, the left and right steering amount, accelerator pedal input, and brake fluid pressure

● Reading the display

- Normal display

Displays the following on the multi-information display

- ① Acceleration G-force on the vehicle
- ② Current G-force value (analyzed value of front/rear and left/right G-forces)
- ③ Accelerator pedal input
- ④ Brake fluid pressure
- ⑤ Steering amount

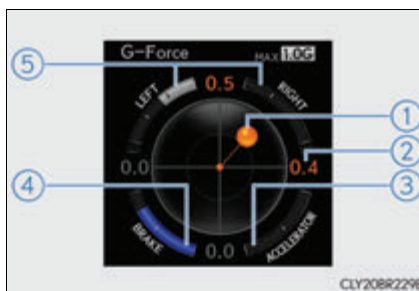

- Advanced display

Displays the following on the main meter and multi-information display

- ① Acceleration G-force on the vehicle
- ② Record of the maximum G-forces
- ③ Value of the maximum G-force since display reset (analyzed value of front/rear and left/right G-forces)
- ④ Accelerator pedal input
- ⑤ Brake fluid pressure
- ⑥ Steering amount
- ⑦ G-force direction
- ⑧ Current G-force value (analyzed value of front/rear and left/right G-forces)

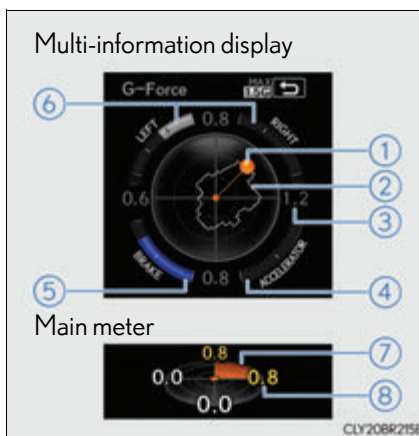

Actual vehicle conditions may differ from the displayed information depending on road conditions, temperature, vehicle speed and other factors. Use this information as reference.

- Switching the display

To switch to advanced display, press .

To return to normal display, press .

- Resetting the record of maximum G-forces

With the record of maximum G-forces displayed, press and hold  to reset the display.

- Peak hold function (advanced display only)

If lateral G-forces of 0.5 G or greater are generated, the G-force value displayed on the main meter will turn yellow and be held for 3 seconds.



2

Instrument cluster

- Tire inflation pressure

Displays the tire inflation pressure (→P. 414)

Unlike the tire pressure display on the drive information menu, the tire inflation pressure display of the "F" content menu can be displayed while lap time is being measured.

Settings display

The settings of the following items can be changed, refer to P. 568

For functions that can be enabled or disabled, the function switches between on and off each time  is pressed.

-  **LDA** (Lane Departure Alert with steering control) (if equipped) (→P. 258)

-  **PCS** (Pre-Collision System) (if equipped) (→P. 237)

-  **BSM** (Blind Spot Monitor) (if equipped) (→P. 298)



- **Speed Indicator** (→P. 95)

- Display of the indicator can be turned on or off.
- The speed at which the indicator is displayed can be set.

Selectable speed range:
30 mph to 100 mph (50 km/h to 160 km/h)*

*: Always observe the legal speed limit when driving on public roads.

- **Vehicle Settings**
 - Scheduled Maintenance (→P. 386)
 - TPMS (Tire pressure warning system) (if equipped) (→P. 415)

- **Meter Settings**
 - Language
 - Select to change the language on the display.
 - Units
 - Select to change the unit of measure.
 - Eco Driving Indicator Light
 - Select to activate/deactivate the Eco Driving Indicator Light
 -  switch
 - Displays a procedure to register a desired screen to .
 - You can register 1 screen as a shortcut, which can be displayed by pressing .
 - Drive information 1/2/3
 - Select to select up to 2 items that will be displayed on a Drive information screen, up to 3 Drive information screens can be set.

- Pop-up display

Select to set the following pop-up displays, which may appear in some situations, on/off.

- Route guidance of the navigation system-linked display (if equipped)
- Incoming call display of the hands-free phone system
- Instrument panel brightness adjustment display
- TVD control mode change display

- Rev indicator

Select to set the rev indicator on/off.

When set to on, proceed to set the engine speed at which the rev indicator will be displayed.

- Rev peak

Select to set the rev peak on/off.

- SPORT gauges

The SPORT S or SPORT S+ mode meter display can be selected and set as the customized display for either SPORT S or SPORT S+ mode.

- Default settings

Registered or changed meter settings will be deleted or returned to their default setting.

■ **Start-up display**

When the engine is started, the name of the vehicle is displayed on the multi-information display.

While the start-up display is being displayed, the meter display cannot be changed even if the drive mode is changed. When the start-up display is finished, the meter display for the currently selected mode will be displayed.

■ **Torque distribution display**

Torque distribution may not be displayed correctly in some cases, such as when the vehicle passes over road expansion joints.

■ **G-force display**

- The G-force values may not be zero even when the vehicle is parked, such as when it is parked on an incline.

- The steering amount, accelerator pedal input, and brake fluid pressure displays are disabled until the engine has warmed up (the variable red zone of the tachometer has retracted to 7300 rpm).

After the engine has warmed up, these displays will be enabled.

- Depending on the vehicle usage conditions, the brake fluid pressure display may not reach its maximum reading even though the brake pedal is fully depressed.

- If a battery terminal is disconnected and reconnected, the steering amount display may be disabled temporarily. After driving the vehicle for a while, the display will be enabled.

■ **Suspension of the settings display**

In the following situations, operation of the settings display will be temporarily suspended.

- When a warning message appears on the multi-information display

- When the vehicle begins to move

■ **Tire inflation pressure**

- It may take a few minutes to display the tire inflation pressure after the engine switch is turned to IGNITION ON mode. It may also take a few minutes to display the tire inflation pressure after inflation pressure has been adjusted.

- “---” may be displayed if the tire position information cannot be determined due to unfavorable radio wave conditions.

- Tire inflation pressure changes with temperature. The displayed values may also be different from the values measured using a tire pressure gauge.

■ **When disconnecting and reconnecting battery terminals**

The following information data will be reset:

- Lap timer: Measured lap times, history

- G-force: Record of the maximum G-forces

■ **Using the lap timer**

If the engine is stopped while a lap is being timed, the lap timer will stop and the lap time up to that point will be recorded.

■ **Liquid crystal display**

→P. 98

 **WARNING****■ Caution for use while driving**

- When operating the multi-information display while driving, pay extra attention to the safety of the area around the vehicle.
- Do not look continuously at the multi-information display while driving as you may fail to see pedestrians, objects on the road, etc. ahead of the vehicle.

■ Cautions during setting up the display

As the engine needs to be running during setting up the display, ensure that the vehicle is parked in a place with adequate ventilation. In a closed area such as a garage, exhaust gases including harmful carbon monoxide (CO) may collect and enter the vehicle. This may lead to death or a serious health hazard.

 **NOTICE****■ During setting up the display**

To prevent battery discharge, ensure that the engine is running while setting up the display features.

Head-up display*

Summary of functions

The head-up display can be used to project vehicle speed and other information onto the windshield.

- ① Head-up display
Display brightness will change automatically according to the brightness of the surrounding area.
- ② "HUD" button
- ③ Display brightness adjustment switch
Display brightness can be adjusted to the desired level.
- ④ Display position adjustment switch
- ⑤ "DISP" button



*: If equipped

Head-up display contents

- Vehicle speed
- Tachometer
- Shift position and shift range
 - Displays the selected shift position or selected shift range (→P. 202)
- Eco Driving Indicator (GS350/GS200t) (→P. 85)
- Head-up rev indicator (GS F) (→P. 124)
- Audio display*
 - Displays audio information for approximately 3 seconds when the audio system is operated
- Route guidance display (vehicles with navigation system) (→P. 124)
 - When approaching an intersection while the navigation system is giving route guidance, an arrow will automatically be displayed to indicate the direction of travel.
- Lexus Enform (if equipped)
 - Displays "LEXUS Enform" for approximately 3 seconds when LEXUS App Suite is operated
- Lane departure warning display (LDA [Lane Departure Alert with steering control], LKA [Lane-Keeping Assist]) (if equipped) (→P. 460)
- Approach warning display (dynamic radar cruise control, dynamic radar cruise control with full-speed range) (if equipped) (→P. 460)
- Pre-collision warning message (PCS [Pre-Collision System]) (if equipped) (→P. 460)
- Speed limit display (vehicles with navigation system) (→P. 125)

*: The default setting is off

Switching the head-up display

■ “HUD” button

Pressing the switch turns the head-up display on/off and changes the vehicle speed display units as follows:

- ▶ U.S.A.
OFF → ON (MPH) → OFF
ON (km/h) → OFF
- ▶ Canada
OFF → ON (km/h) → ON (MPH) → OFF

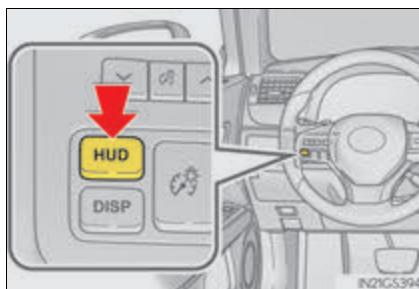

■ “DISP” button

Pressing the button changes the display items (except vehicle speed).

- ▶ GS350/GS200t
- ▶ GS F

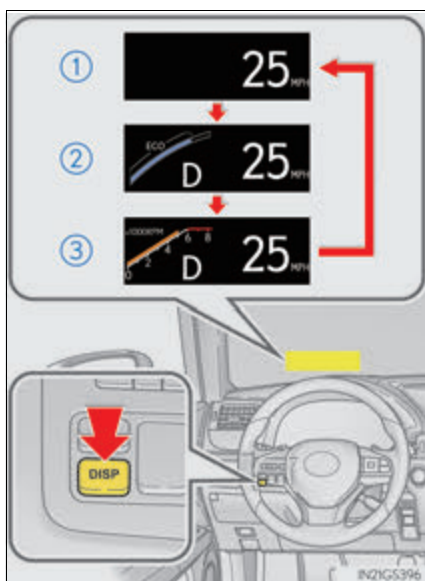

- ① Off
- ② Eco Driving Indicator
- ③ Tachometer

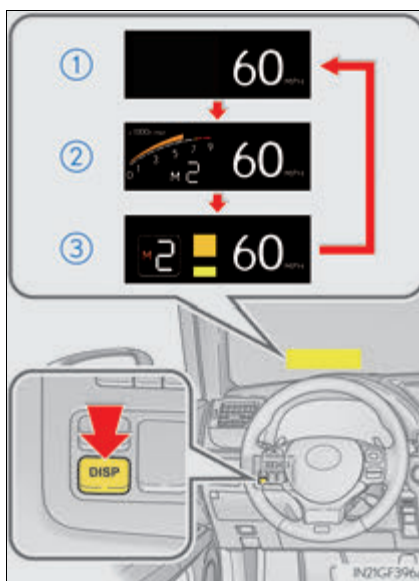

- ① Off
- ② Tachometer
- ③ Head-up rev indicator
Displayed when in sport mode with the shift lever in M

Making the display easier to see

■ Adjusting the display position

- ① Higher
- ② Lower

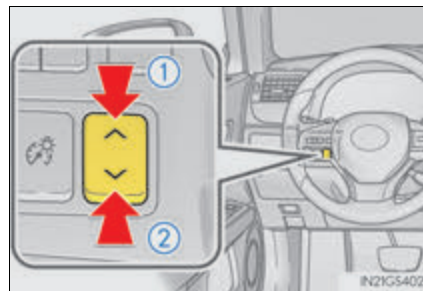

■ Setting the brightness

The brightness of the display is automatically adjusted in accordance with the brightness of the surrounding environment. However, the brightness can also be manually adjusted in 9 stages.

- ① Brighter
- ② Darker

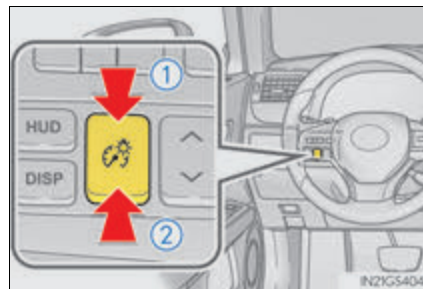

2

Instrument cluster

Eco Driving Indicator (GS350/GS200t)

① Eco Driving Indicator Zone Display

Suggests the Zone of Eco driving with current Eco driving ratio based on acceleration.

② Eco driving ratio based on acceleration

If the acceleration exceeds the Zone of Eco driving, the right side of the Eco Driving Indicator Zone Display will illuminate.

③ Zone of Eco driving

Eco Driving Indicator will not operate under the following conditions:

- The shift lever is in any position other than D.
- A paddle shift switch is operated.
- Neither normal mode nor Eco drive mode is selected. (→P. 293)
- The vehicle speed is approximately 80 mph (130 km/h) or higher.

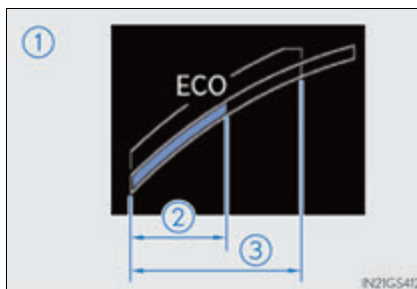

Head-up rev indicator (GS F)

While in sport mode with the shift lever in M, the display changes to one of 3 levels in response to the engine speed, notifying you of when to shift up.

This may also be displayed when shifting down as well, depending on the engine speed.

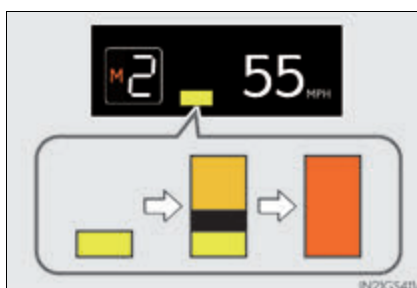

Route guidance display (vehicles with navigation system)

When the vehicle approaches an intersection, the direction the vehicle should go is guided by the arrow.

When the vehicle approaches an intersection, the route guidance will start and the distance* to the intersection will also be displayed.

*: The distance decreases in increments of 164 ft. (50 m) and the distance indication will disappear when the vehicle passes through the intersection.

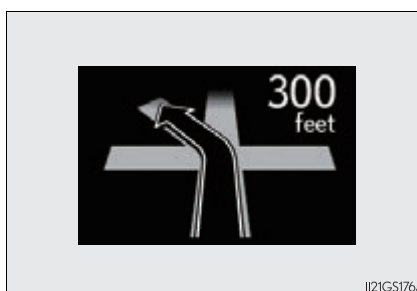

Speed limit display (vehicles with navigation system)

Displays the speed limit for the current road.



2

Display customization

Display of the following screens can be switched on or off.

- Audio display
- Route guidance display (vehicles with navigation system)

■ Changing the settings

- 1 Continue holding the “DISP” button until the screen changes, and repeat the process until the setting you want to change is displayed.

Customization can be performed when the head-up display is on and the vehicle is traveling at less than 5 mph (8 km/h).

- 2 Press the “DISP” button to switch between on and off.

On and off will be switched between each time the button is pressed.

If the button is left alone without being operated for a short time, setting will be finished automatically.

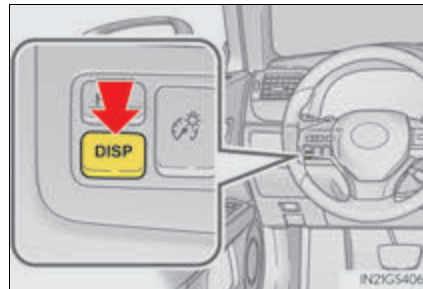

Instrument cluster

■ **Head-up display**

- The head-up display may seem dark and hard to see when viewed through sunglasses, especially polarized sunglasses.
Adjust the brightness of the head-up display or remove your sunglasses.
- When the head-up display is turned off, it will remain off even if the engine switch is turned to IGNITION ON mode after the engine switch has been turned off.
- The startup image will be displayed on the head-up display after the engine switch has been turned to IGNITION ON mode while the head-up display switch is set to on.

■ **Head-up rev indicator**

- The head-up display is linked to the rev indicator in the meter.
- Whether or not to display the rev indicator in the head-up display, as well as display timing, can be changed through the settings for the rev indicator in the meter. (→P. 117)

■ **When the battery is disconnected**

The customize settings of the head-up display will be reset.

■ **Head-up display automatic position adjustment**

If the display position is recorded into memory, the head-up display will be automatically adjusted to the desired position. (→P. 160)

⚠ WARNING

■ **Before using the head-up display**

Check that the position and brightness of the head-up display image does not interfere with safe driving. Incorrect adjustment of the image's position or brightness may obstruct the driver's view and lead to an accident, resulting in death or serious injury.

⚠ NOTICE

■ **To prevent damage to components**

- Do not place any drinks near the head-up display projector. If the projector gets wet, electrical malfunctions may result.
- Do not place anything on or put stickers onto the head-up display projector. Doing so could interrupt head-up display indications.
- Do not touch the inside of the head-up display projector or thrust sharp edges or the like into the projector. Doing so could cause mechanical malfunctions.



Fuel consumption information

Fuel consumption information can be displayed on the Remote Touch screen.
Vehicles with 12.3-inch display: The fuel consumption information can be displayed and operated on the side display.

- ① Remote Touch screen
- ② "MENU" button
- ③ Remote Touch knob
- ④ "ENTER" buttons

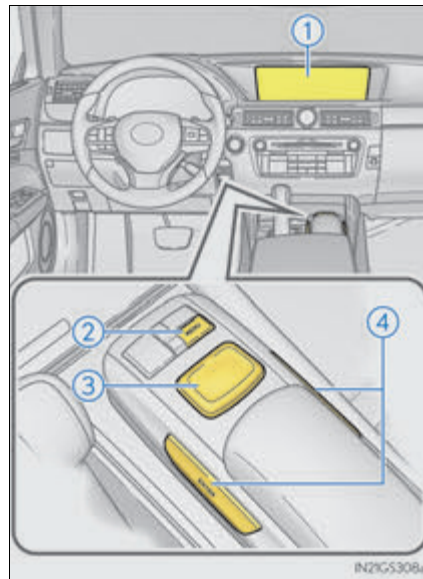

2

Instrument cluster

Fuel consumption

Press the “MENU” button on the Remote Touch, then select  on the “Menu” screen, and then select “Fuel Consumption”.

■ Trip information

If the “Past Record” screen is displayed, select “Trip Information”.

- ① Resetting the consumption data
- ② Fuel consumption in the past 15 minutes
- ③ Current fuel consumption
- ④ Average vehicle speed since the engine was started.
- ⑤ Elapsed time since the engine was started.
- ⑥ Cruising range (→P. 129)

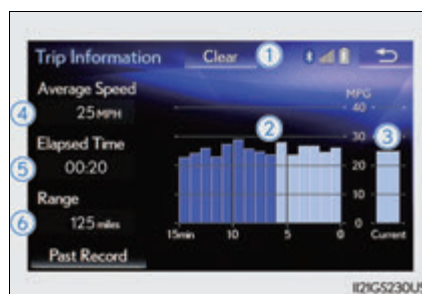

Average fuel consumption for the past 15 minutes is divided by color into past averages and averages attained since the engine switch was last turned to IGNITION ON mode. Use the displayed average fuel consumption as a reference. The image is an example only, and may vary slightly from actual conditions.

■ Past record

If the "Trip Information" screen is displayed, select "Past Record".

- ① Resetting the past record data
- ② Best recorded fuel economy
- ③ Average fuel consumption
- ④ Previous fuel consumption record
- ⑤ Updating the average fuel consumption data



The average fuel consumption history is divided by color into past averages and the average fuel consumption since the last reset. Use the displayed average fuel consumption as a reference.

The image is an example only, and may vary slightly from actual conditions.

■ Updating the past record data

Update the average fuel consumption by selecting "Update" to measure the current fuel consumption again.

■ Resetting the data

The fuel consumption data can be deleted by selecting "Clear".

■ Cruising range

Displays the estimated maximum distance that can be driven with the quantity of fuel remaining.

This distance is computed based on your average fuel consumption.

As a result, the actual distance that can be driven may differ from that displayed.

Using the side display (vehicles with 12.3-inch display)

Vehicle information can be displayed on the side display (→P. 327), then select **<** or **>** to select the desired screen.

▶ Fuel consumption

Displays the average fuel consumption for the past 10 minutes in 1 minute intervals, as well as the cruising range.

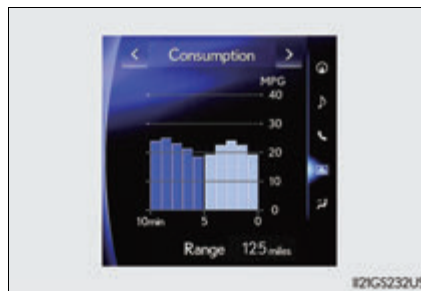

▶ Past record

Displays the average fuel consumption and highest fuel consumption.

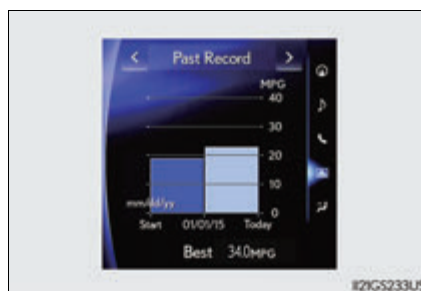

▶ Trip information

Displays the cruising range, average fuel consumption and the amount of time elapsed since the engine was started.

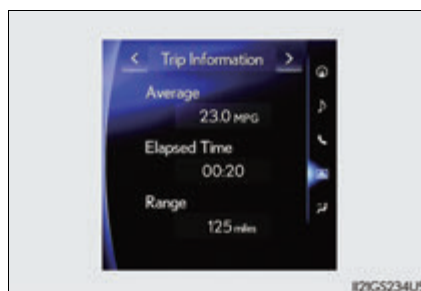

The image is an example only, and may vary slightly from actual conditions.

**Operation of
each component****3**

- 3-1. Key information**
 - Keys 132
- 3-2. Opening, closing and locking the doors and trunk**
 - Doors 137
 - Trunk 143
 - Smart access system with push-button start 150
- 3-3. Adjusting the seats**
 - Front seats 158
 - Driving position memory 160
 - Head restraints 165
- 3-4. Adjusting the steering wheel and mirrors**
 - Steering wheel 168
 - Inside rear view mirror 169
 - Outside rear view mirrors 171
- 3-5. Opening, closing the windows and moon roof**
 - Power windows 175
 - Moon roof 178

Keys

The keys

The following keys are provided with the vehicle.

- ① Electronic keys
 - Operating the smart access system with push-button start (→P. 150)
 - Operating the wireless remote control function
- ② Mechanical keys
- ③ Key number plate
- ④ Card key (electronic key) (if equipped)
 - Operating the smart access system with push-button start (→P. 150)

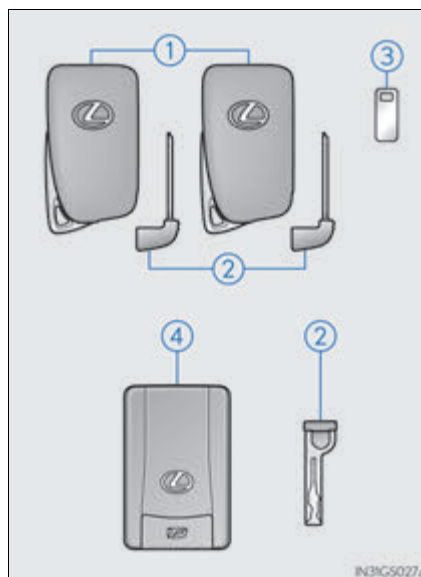

Wireless remote control

- ① Locks all the doors (→P. 137)
- ② Unlocks all the doors
- ③ Opens the windows and moon roof (→P. 137)*
- ④ Opens the trunk (→P. 144)
- ⑤ Sounds the alarm (→P. 134)

*: This setting must be customized at your Lexus dealer.

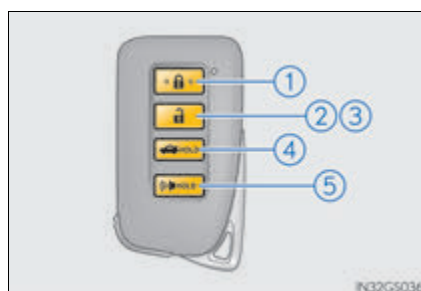

Using the mechanical key

To take out the mechanical key, push the release button and take the key out.

The mechanical key can only be inserted in one direction, as the key only has grooves on one side. If the key cannot be inserted in a lock cylinder, turn it over and re-attempt to insert it.

After using the mechanical key, store it in the electronic key. Carry the mechanical key together with the electronic key. If the electronic key battery is depleted or the entry function does not operate properly, you will need the mechanical key. (→P. 520)

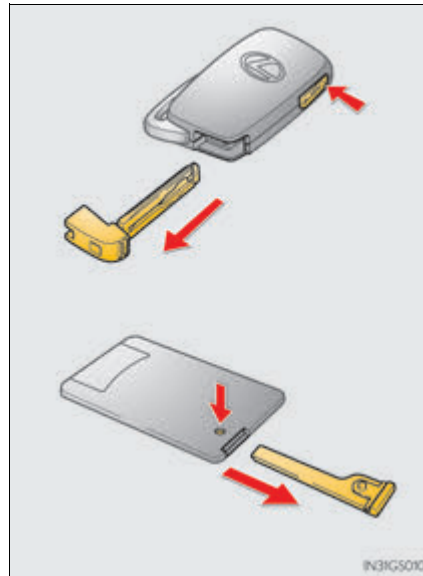

3

Operation of each component

■ Card key (if equipped)

- The card key is not waterproof.
- The mechanical key that is stored inside the card key should be used only if a problem arises, such as when the card key does not operate properly.
- If it is difficult to take out the mechanical key, push down the lock release button using a pen tip etc. If it is still difficult to pull it out, use a coin etc.
- To store the mechanical key in the card key, insert it while pressing the lock release button.

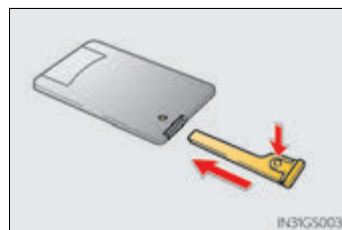

- If the battery cover is not installed and the battery falls out or if the battery was removed because the key got wet, reinstall the battery with the positive terminal facing the Lexus emblem.

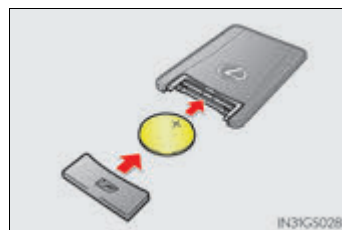

■ **Panic mode**

When  is pressed for longer than about one second, an alarm will sound intermittently and the vehicle lights will flash to deter any person from trying to break into or damage your vehicle.

To stop the alarm, press any button on the electronic key.



■ **When required to leave the vehicle's key with a parking attendant**

Turn the trunk opener main switch off, lock the glove box and armrest door as circumstances demand. (→P. 145, 351, 363)

Remove the mechanical key for your own use and provide the attendant with the electronic key only.

■ **If you lose your mechanical keys**

New genuine mechanical keys can be made by your Lexus dealer using the other mechanical key and the key number stamped on your key number plate. Keep the plate in a safe place such as your wallet, not in the vehicle.

■ **When riding in an aircraft**

When bringing an electronic key onto an aircraft, make sure you do not press any buttons on the electronic key while inside the aircraft cabin. If you are carrying an electronic key in your bag etc., ensure that the buttons are not likely to be pressed accidentally. Pressing a button may cause the electronic key to emit radio waves that could interfere with the operation of the aircraft.

■ **Electronic key battery depletion**

- The standard battery life is 1 to 2 years. (The card key battery life is about a year and a half.)
- If the battery becomes low, an alarm will sound in the cabin when the engine stops. (→P. 489)
- As the electronic key always receives radio waves, the battery will become depleted even if the electronic key is not used. The following symptoms indicate that the electronic key battery may be depleted. Replace the battery when necessary. (→P. 429)
 - The smart access system with push-button start or the wireless remote control does not operate.
 - The detection area becomes smaller.
 - The LED indicator on the key surface does not turn on.
- To avoid serious deterioration, do not leave the electronic key within 3 ft. (1 m) of the following electrical appliances that produce a magnetic field:
 - TVs
 - Personal computers
 - Cellular phones, cordless phones and battery chargers
 - Recharging cellular phones or cordless phones
 - Table lamps
 - Induction cookers

■ **Replacing the battery**

→P. 429

■ **Confirmation of the registered key number**

The number of keys already registered to the vehicle can be confirmed. Ask your Lexus dealer for details.

■ **If a wrong key is used**

The key cylinder rotates freely to isolate inside mechanism.

 **NOTICE**

■ **To prevent key damage**

- Do not drop the keys, subject them to strong shocks or bend them.
- Do not expose the keys to high temperatures for long periods of time.
- Do not get the keys wet or wash them in an ultrasonic washer etc.
- Do not attach metallic or magnetic materials to the keys or place the keys close to such materials.
- Do not disassemble the keys.
- Do not attach a sticker or anything else to the surface of the electronic key.
- Do not place the keys near objects that produce magnetic fields, such as TVs, audio systems and induction cookers.
- Do not place the keys near medical electrical equipment such as low-frequency therapy equipment or microwave therapy equipment, and do not receive medical attention with the keys on your person.

■ **Carrying the electronic key on your person**

Carry the electronic key 3.9 in. (10 cm) or more away from electric appliances that are turned on. Radio waves emitted from electric appliances within 3.9 in. (10 cm) of the electronic key may interfere with the key, causing the key to not function properly.

■ **In case of a smart access system with push-button start malfunction or other key-related problems**

Take your vehicle with all the electronic keys provided with your vehicle, including the card key, to your Lexus dealer.

■ **When an electronic key is lost**

If the electronic key remains lost, the risk of vehicle theft increases significantly. Visit your Lexus dealer immediately with all remaining electronic keys and the card key that was provided with your vehicle.

 NOTICE

■ Handling the card key

- Do not apply excess force when inserting the mechanical key into the card key. Doing so may damage the card key.
- If the battery or card key terminals get wet, the battery may corrode. If the key is dropped into water, or if drinking water etc. is spilled on the key, immediately remove the battery cover and wipe the battery and terminals. (To remove the battery cover, lightly grasp and pull it.) If the battery is corroded, have your Lexus dealer replace the battery.
- Do not crush the battery cover or use a screwdriver to remove the battery cover. Forcibly removing the battery cover may bend or damage the key.
- If the battery cover is frequently removed, the battery cover may become loose.
- When installing the battery, make sure to check the direction of the battery. Installing the battery in the wrong direction may cause the battery to deplete rapidly.
- The surface of the card key may be damaged, or its coating may peel off in the following situations:
 - The card key is carried together with hard objects, such as coins and keys.
 - The card key is scraped with a sharp object, such as the tip of a mechanical pencil.
 - The surface of the card key is wiped with thinner or benzene.

Doors

Unlocking and locking the doors from the outside

◆ Smart access system with push-button start

Carry the electronic key to enable this function.

- ① Grip the driver's door handle to unlock the door. Grip the passenger's door handle to unlock all the doors.*

Make sure to touch the sensor on the back of the handle.

The doors cannot be unlocked for 3 seconds after the doors are locked.

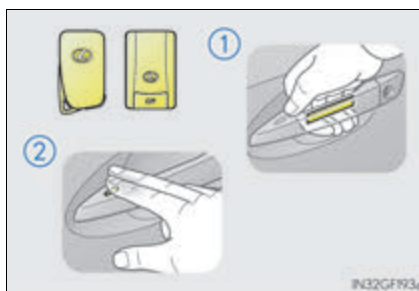

*: The door unlock settings can be changed. (→P. 568)

- ② Touch the lock sensor (the indentation on the upper part of the door handle) to lock all the doors.

Check that the door is securely locked.

◆ Wireless remote control

- ① Locks all the doors

Check that the door is securely locked.

- ② Unlocks all the doors

Pressing the button unlocks the driver's door. Pressing the button again within 5 seconds unlocks the other doors.

Press and hold to open the windows and moon roof.*

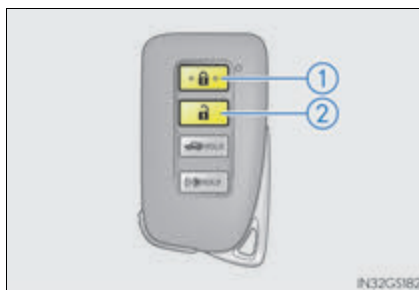

*: This setting must be customized at your Lexus dealer.

3

Operation of each component

■ **Operation signals**

A buzzer sounds and the emergency flashers flash to indicate that the doors have been locked/unlocked. (Locked: once; Unlocked: twice)

■ **Security feature**

If a door is not opened within approximately 60 seconds after the vehicle is unlocked, the security feature automatically locks the vehicle again.

■ **Welcome light illumination control**

The side marker, parking, tail and license plate lights automatically turn on at night when the doors are unlocked using the entry function or wireless remote control if the light switch is in the "AUTO" position.

■ **When the door cannot be locked by the lock sensor on the upper part of the door handle**

If the door will not lock even when the topside sensor area is touched, try touching both the topside and underside sensor areas at the same time.



■ **Door lock buzzer**

If an attempt to lock the doors is made when a door is not fully closed, a buzzer sounds continuously for 5 seconds. Fully close the door to stop the buzzer, and lock the vehicle once more.

■ **Setting the alarm**

Locking the doors will set the alarm system. (→P. 74)

■ **If the smart access system with push-button start or the wireless remote control does not operate properly**

- Use the mechanical key to lock and unlock the doors. (→P. 520)
- Replace the key battery with a new one if it is depleted. (→P. 429)

Unlocking and locking the doors from the inside

◆ Door lock switches

- ① Locks all the doors
- ② Unlocks all the doors

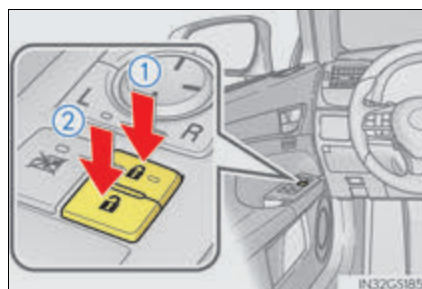

◆ Inside lock buttons

- ① Locks the door
- ② Unlocks the door

The front doors can be opened by pulling the inside handle even if the lock buttons are in the lock position.

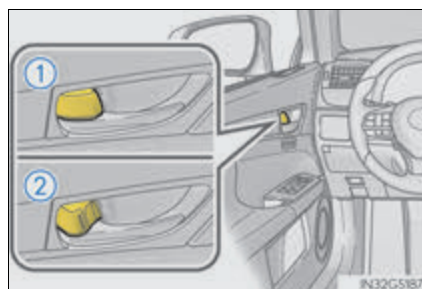

Locking the front doors from the outside without a key

- 1 Move the inside lock button to the lock position.
- 2 Close the door.

The door cannot be locked if the engine switch is in ACCESSORY or IGNITION ON mode, or the electronic key is left inside the vehicle. However, the key may not be detected correctly and the door may be locked.

3

Operation of each component

Rear door child-protector lock

The door cannot be opened from inside the vehicle when the lock is set.

- ① Unlock
- ② Lock

These locks can be set to prevent children from opening the rear doors. Push down on each rear door switch to lock both rear doors.

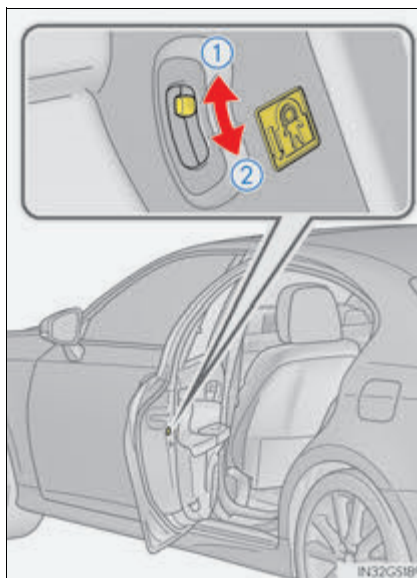

Automatic door locking and unlocking systems





The following functions can be set or canceled:

For instructions on customizing, refer to P. 568.



Function	Operation
Speed linked door locking function	All doors are automatically locked when vehicle speed is approximately 12 mph (20 km/h) or higher.
Shift position linked door locking function	All doors are automatically locked when shifting the shift lever to position other than P.
Shift position linked door unlocking function	All doors are automatically unlocked when shifting the shift lever to P.
Driver's door linked door unlocking function	All the doors are unlocked when the driver's door is opened within approximately 45 seconds after turning the engine switch off.

■ Switching the door unlock function

It is possible to set which doors the entry function unlocks using the wireless remote control.

- 1 Turn the engine switch off.
- 2 When the indicator light on the key surface is not on, press and hold  ,  or  for approximately 5 seconds while pressing and holding  .

The setting changes each time an operation is performed, as shown below. (When changing the setting continuously, release the buttons, wait for at least 5 seconds, and repeat step 2.)

Multi-information display	Unlocking function	Beep
	Holding the driver's door handle unlocks only the driver's door.	Exterior: Beeps 3 times Interior: Pings once
	Holding a passenger's door handle unlocks all the doors.	
	Holding a door handle unlocks all the doors.	Exterior: Beeps twice Interior: Pings once

To prevent unintended triggering of the alarm, unlock the doors using the wireless remote control and open and close a door once after the settings have been changed. (If a door is not opened within 60 seconds after  is pressed, the doors will be locked again and the alarm will automatically be set.)

In case that the alarm is triggered, immediately stop the alarm. (→P. 74)

■ Impact detection door lock release system

In the event that the vehicle is subject to a strong impact, all the doors are unlocked. Depending on the force of the impact or the type of accident, however, the system may not operate.

■ Using the mechanical key

The doors can also be locked and unlocked with the mechanical key. (→P. 520)

■ Conditions affecting the operation of the smart access system with push-button start or wireless remote control

→P. 152

■ Customization

Settings (e.g. unlocking function using a key) can be changed.
(Customizable features: →P. 568)

⚠ WARNING**■ To prevent an accident**

Observe the following precautions while driving the vehicle.

Failure to do so may result in a door opening and an occupant throwing out of the vehicle, resulting in death or serious injury.

- Ensure that all doors are properly closed and locked.
- Do not pull the inside handle of the doors while driving.
Be especially careful for the front doors, as the doors may be opened even if the inside lock buttons are in locked position.
- Set the rear door child-protector locks when children are seated in the rear seats.

Trunk

The trunk can be opened using the trunk opener, entry function or wireless remote control.

If the vehicle is equipped with a power trunk opener and closer, the trunk can be closed using the trunk closer.

Opening the trunk from inside the vehicle

Press the opener switch.

If the vehicle is equipped with a power trunk opener and closer, the trunk lid automatically opens fully.

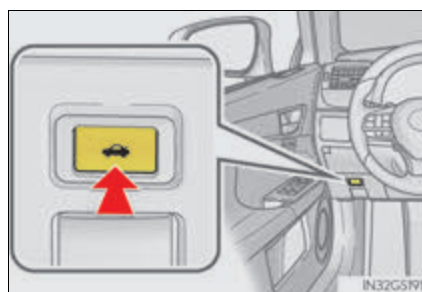

Opening the trunk from outside the vehicle

◆ Smart access system with push-button start

▶ GS350/GS200t

▶ GS F

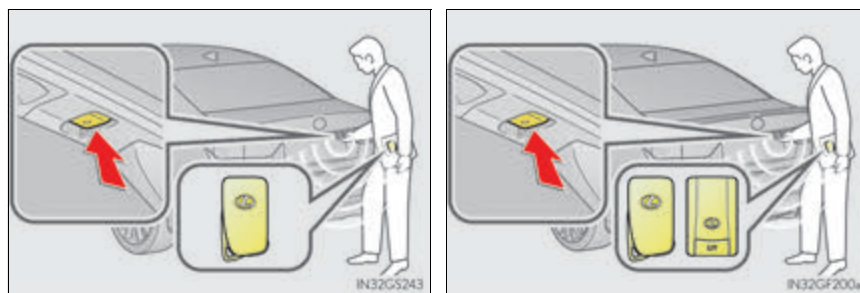

While carrying the electronic key, press the button.

When all the doors are unlocked with the power door lock system, the trunk can be opened without carrying the electronic key.

If the vehicle is equipped with a power trunk opener and closer, the trunk lid automatically opens fully.

◆ **Wireless remote control**

Press and hold the switch.

If the vehicle is equipped with a power trunk lid, the trunk lid automatically opens fully.



Trunk closer switch (vehicles with power trunk opener and closer)

Pressing the switch closes the trunk lid automatically. (A buzzer sounds.)

Pressing the switch while the trunk lid is closing opens the trunk lid again.

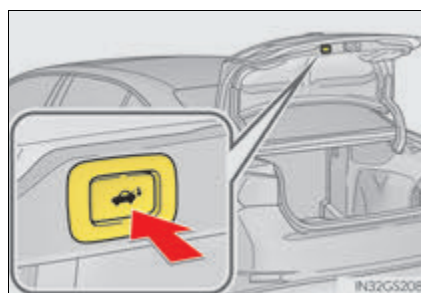

When closing the trunk

Using the trunk grip, lower the trunk without applying force to the side and push the trunk down from the outside to close it.

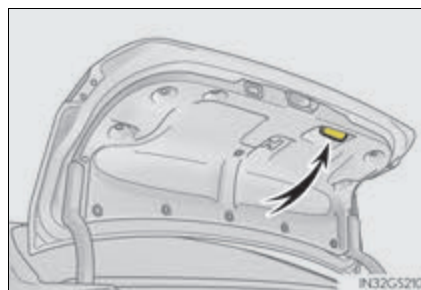

Luggage security system

The trunk opener switch can be temporarily disabled to protect luggage stored in the trunk against theft.

Turn the main switch in the glove box off to disable the trunk opener.

- ① On
- ② Off

The trunk lid cannot be opened even with the wireless remote control or the trunk release button.

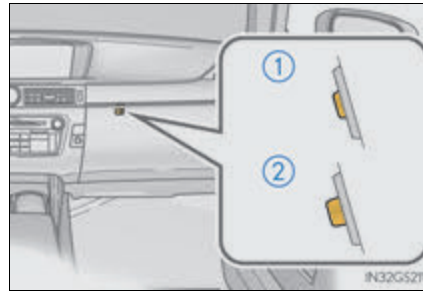

3

Operation of each component

■ Operation signals

Wireless remote control: A buzzer sounds to indicate that the trunk has been unlocked.

■ Trunk light

The trunk light turns on when the trunk is opened.

■ Trunk easy closer

In the event that the trunk lid is left slightly open, the trunk easy closer will automatically close it to the fully closed position.

■ Function to prevent the trunk being locked with the electronic key inside

- When all doors are being locked, closing the trunk lid with the electronic key left inside the trunk will sound an alarm.
In this case, the trunk lid can be opened pressing the trunk release button on the trunk lid.
- Even when the spare electronic key is put in the trunk with all the doors locked, the key confinement prevention function can be activated so the trunk can be opened. In order to prevent theft, take all electronic keys with you when leaving the vehicle.
- Even when the electronic key is put in the trunk with all the doors are locked, the key may not be detected depending on the places and the surrounding radio wave conditions. In this case, the key confinement prevention function cannot be activated, causing the doors to lock when the trunk is closed. Make sure to check where the key is before closing the trunk.
- The key confinement prevention function cannot be activated if any one of the doors is unlocked. In this case, open the trunk using the trunk opener.

■ Overload protection function (vehicles with power trunk opener and closer)

The trunk lid will not operate when excessive load is present on the top of the trunk lid.

■ Fall-down protection function (vehicles with power trunk opener and closer)

While the trunk lid is opening automatically, applying excessive force to it will stop the opening operation to prevent the trunk lid from rapidly falling down.

■ Jam protection function (vehicles with power trunk opener and closer)

While the trunk lid is closing automatically, the trunk lid will stop closing and open if something gets caught.

■ **Internal trunk release lever**

The trunk lid can be opened by pulling the glow-in-the-dark lever located on the inside of the trunk lid to the side.

The lever will continue to glow for some time after the trunk lid is closed.

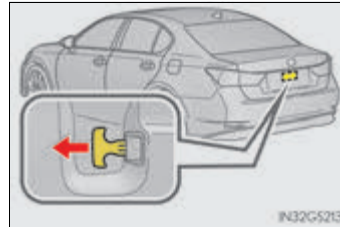

■ **If the smart access system with push-button start or the wireless remote control does not operate properly**

- Use the mechanical key to open the trunk. (→P. 520)
- Replace the key battery with a new one if it is depleted. (→P. 429)

■ **When leaving a key to the vehicle with a parking attendant**

→P. 134

■ **Customization**

The trunk unlocking operation can be changed. (Customizable features:→P. 568)

⚠ WARNING

Observe the following precautions.
Failure to do so may result in death or serious injury.

■ **Before driving**

- Make sure that the trunk lid is fully closed. If the trunk lid is not fully closed, it may open unexpectedly while driving and hit near-by objects or luggage in the trunk may be thrown out, causing an accident.
- Do not allow children to play in the trunk.
If a child is accidentally locked in the trunk, they could suffer from heat exhaustion, suffocation or other injuries.
- Do not allow a child to open or close the trunk lid.
Doing so may cause the trunk lid to open unexpectedly, or cause the child's hands, head, or neck to be caught by the closing trunk lid.

■ **Important points while driving**

Never let anyone sit in the trunk. In the event of sudden braking or a collision, they are susceptible to death or serious injury.

⚠ WARNING**■ Using the trunk**

Observe the following precautions.

Failure to do so may cause parts of the body to be caught, resulting in serious injury.

- Remove any heavy loads, such as snow and ice, from the trunk lid before opening it. Failure to do so may cause the trunk lid to suddenly shut again after it is opened.
- When opening or closing the trunk lid, thoroughly check to make sure the surrounding area is safe.
- If anyone is in the vicinity, make sure they are safe and let them know that the trunk is about to open or close.
- Use caution when opening or closing the trunk lid in windy weather as it may move abruptly in strong wind.
- The trunk lid may suddenly shut if it is not opened fully. It is more difficult to open or close the trunk lid on an incline than on a level surface, so beware of the trunk lid unexpectedly opening or closing by itself. Make sure that the trunk lid is fully open and secure before using the trunk.



- When closing the trunk lid, take extra care to prevent your fingers etc. from being caught.
- When closing the trunk lid, make sure to press it lightly on its outer surface. If the trunk grip is used to fully close the trunk lid, it may result in hands or arms being caught.



- Do not attach any accessories other than genuine Lexus parts to the trunk lid. Such additional weight on the trunk lid may cause the lid to suddenly shut again after it is opened.

3

Operation of each component

⚠ WARNING

■ **Trunk easy closer**

In the event that the trunk lid is left slightly open, the trunk easy closer will automatically close it to the fully closed position. It takes several seconds before the trunk easy closer begins to operate. Be careful not to catch fingers or anything else in the trunk lid, as this may cause bone fractures or other serious injuries.

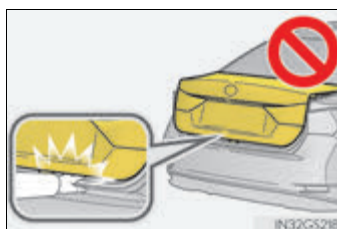

■ **Power trunk opener and closer (If equipped)**

Observe the following precautions when operating the power trunk opener and closer. Failure to do so may cause serious injury.

- Check the safety of the surrounding area to make sure there are no obstacles or anything that could cause any of your belongings to get caught.
- If anyone is in the vicinity, make sure they are safe and let them know that the trunk is about to open or close.
- If the trunk closer switch is pressed while the trunk lid is opening during automatic operation, the trunk lid stops opening. Take extra care when on an incline, as the trunk lid may open or close suddenly.
- On an incline, the trunk lid may suddenly shut after it opens automatically. Make sure the trunk lid is fully open and secure before using the trunk.
- In the following situations, the power trunk opener and closer may detect an abnormality and automatic operation may be stopped. In this case, the trunk lid has to be operated manually. Take extra care in this situation, as the stopped trunk lid may suddenly shut, causing an accident.
 - When the trunk lid contacts an obstacle
 - When the battery voltage suddenly drops, such as when the engine switch is turned to IGNITION ON mode or the engine is started during automatic operation
- Do not attach any accessories other than genuine Lexus parts to the trunk lid. The power trunk opener and closer may not operate, causing itself to malfunction, or the trunk lid may suddenly shut again after it is opened.

■ **Jam protection function (vehicles with power trunk opener and closer)**

Observe the following precautions. Failure to do so may cause serious injury.

- Never use any part of your body to intentionally activate the jam protection function.
- The jam protection function may not work if something gets caught just before the trunk lid fully closes. Be careful not to catch fingers or anything else in the trunk lid.
- The jam protection function may not work depending on the shape of the object that is caught. Be careful not to catch fingers or anything else.

 NOTICE**■ To prevent trunk easy closer malfunctions**

Do not apply force to the trunk lid while the trunk easy closer is operating.

■ To prevent damage to the power trunk opener and closer (vehicles with power trunk opener and closer)

● Make sure that there is no luggage or snow on the trunk lid before operating the power trunk opener and closer. In addition, make sure that there is no ice between the trunk lid and frame that prevents movement of the trunk lid. Operating the power trunk opener and closer when excessive load is present on the trunk lid may cause a malfunction.

● Do not apply excessive force to the trunk lid while the power trunk opener and closer is operating.

3

Operation of each component

Smart access system with push-button start

The following operations can be performed simply by carrying the electronic key (including the card key) on your person, for example in your pocket. The driver should always carry the electronic key.

- Locks and unlocks the doors (→P. 137)
- Opens the trunk (→P. 143)
- Starts the engine (→P. 197)

■ Antenna location

- ① Antennas outside the cabin
- ② Antennas inside the cabin
- ③ Antenna outside the trunk
- ④ Antenna inside the trunk

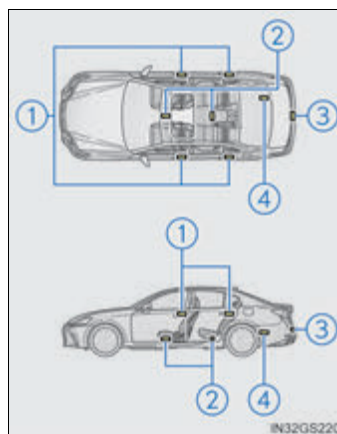

■ Effective range (areas within which the electronic key is detected)

- When locking or unlocking the doors
The system can be operated when the electronic key is within about 2.3 ft. (0.7 m) of an outside door handle. (Only the doors detecting the key can be operated.)
- When opening the trunk
The system can be operated when the electronic key is within about 2.3 ft. (0.7 m) of the trunk release button.
- When starting the engine or changing engine switch modes
The system can be operated when the electronic key is inside the vehicle.

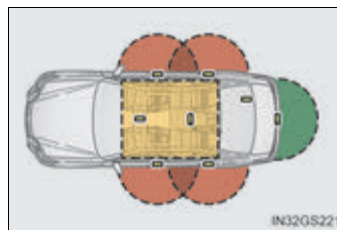

■ Alarms and warning indicators

An alarm sounds and warning message displays shown on the multi-information display are used to protect against unexpected accidents or theft of the vehicle resulting from erroneous operation. When a warning message is displayed, take appropriate measures based on the displayed message. (→P. 486)

When only an alarm sounds, circumstances and correction procedures are as follows.

Alarm	Situation	Correction procedure
Exterior alarm sounds once for 5 seconds	The trunk was closed while the electronic key was still inside the trunk and all the doors were locked.	Retrieve the electronic key from the trunk and close the trunk lid.
	An attempt was made to lock the vehicle while a door was open.	Close all of the doors and lock the doors again.
Interior alarm sounds continuously	The engine switch was turned to ACCESSORY mode while the driver's door was open (or the driver's door was opened while the engine switch was in ACCESSORY mode).	Turn the engine switch off and close the driver's door.



■ Battery-saving function

The battery-saving function will be activated in order to prevent the electronic key battery and the vehicle battery from being discharged while the vehicle is not in operation for a long time.

- In the following situations, the smart access system with push-button start may take some time to unlock the doors.
 - The electronic key has been left in an area of approximately 6 ft. (2 m) of the outside of the vehicle for 10 minutes or longer.
 - The smart access system with push-button start has not been used for 5 days or longer.
- If the smart access system with push-button start has not been used for 14 days or longer, the doors cannot be unlocked at any doors except the driver's door. In this case, take hold of the driver's door handle, or use the wireless remote control or the mechanical key, to unlock the doors.

■ **Electronic Key Battery-Saving Function**

When battery-saving mode is set, battery depletion is minimized by stopping the electronic key from receiving radio waves.

Press  twice while pressing and holding . Confirm that the electronic key indicator flashes 4 times.

While the battery-saving mode is set, the smart access system with push-button start cannot be used. To cancel the function, press any of the electronic key buttons.



■ **Conditions affecting operation**

The smart access system with push-button start uses weak radio waves. In the following situations, the communication between the electronic key and the vehicle may be affected, preventing the smart access system with push-button start, wireless remote control and engine immobilizer system from operating properly.
(Ways of coping: →P. 520)

- When the electronic key battery is depleted
- Near a TV tower, electric power plant, gas station, radio station, large display, airport or other facility that generates strong radio waves or electrical noise
- When the electronic key is in contact with, or is covered by the following metallic objects
 - Cards to which aluminum foil is attached
 - Cigarette boxes that have aluminum foil inside
 - Metallic wallets or bags
 - Coins
 - Hand warmers made of metal
 - Media such as CDs and DVDs
- When other wireless keys (that emit radio waves) are being used nearby
- When carrying the electronic key together with the following devices that emit radio waves
 - When carrying a portable radio, cellular phone, cordless phone or other wireless communication device
 - Another vehicle's electronic key or a wireless key that emits radio waves
 - Personal computers or personal digital assistants (PDAs)
 - Digital audio players
 - Portable game systems
- If window tint with a metallic content or metallic objects are attached to the rear window
- When the electronic key is placed near a battery charger or electronic devices

■ Note for the entry function

- Even when the electronic key is within the effective range (detection areas), the system may not operate properly in the following cases:
 - The electronic key is too close to the window or outside door handle, near the ground, or in a high place when the doors are locked or unlocked.
 - The electronic key is near the ground or in a high place, or too close to the rear bumper center when the trunk is opened.
 - The electronic key is on the instrument panel, rear package tray or floor, or in the door pockets or glove box when the engine is started or engine switch modes are changed.
- Do not leave the electronic key on top of the instrument panel or near the door pockets when exiting the vehicle. Depending on the radio wave reception conditions, it may be detected by the antenna outside the cabin and the door will become lockable from the outside, possibly trapping the electronic key inside the vehicle.
- As long as the electronic key is within the effective range, the doors may be locked or unlocked by anyone. However, only the doors detecting the electronic key can be used to unlock the vehicle.
- Even if the electronic key is not inside the vehicle, it may be possible to start the engine if the electronic key is near the window.
- The doors may unlock or lock if a large amount of water splashes on the door handle, such as in the rain or in a car wash when the electronic key is within the effective range. (The doors will automatically be locked after approximately 60 seconds if the doors are not opened and closed.)
- If the wireless remote control is used to lock the doors when the electronic key is near the vehicle, there is a possibility that the door may not be unlocked by the entry function. (Use the wireless remote control to unlock the doors.)
- Touching the door lock sensor while wearing gloves may delay or prevent lock operation.
- If the door handle becomes wet while the electronic key is within the effective range, the door may lock and unlock repeatedly. In that case, follow the following correction procedures to wash the vehicle:
 - Place the electronic key in a location 6 ft. (2 m) or more away from the vehicle. (Take care to ensure that the key is not stolen.)
 - Set the electronic key to battery-saving mode to disable the smart access system with push-button start. (→P. 152)
- If the electronic key is inside the vehicle and a door handle becomes wet during a car wash, a message may be shown on the multi-information display and a buzzer will sound outside the vehicle. To turn off the alarm, lock all the doors.
- The lock sensor may not work properly if it comes into contact with ice, snow, mud, etc. Clean the lock sensor and attempt to operate it again, or use the lock sensor on the lower part of the door handle.
- A sudden approach to the effective range or door handle may prevent the doors from being unlocked. In this case, return the door handle to the original position and check that the doors unlock before pulling the door handle again.
- Gripping the door handle when wearing a glove may not unlock the door.
- If there is another electronic key in the detection area, it may take slightly longer to unlock the doors after the door handle is gripped.

■ **When the vehicle is not driven for extended periods**

- To prevent theft of the vehicle, do not leave the electronic key within 6 ft. (2 m) of the vehicle.
- The smart access system with push-button start can be deactivated in advance. (→P. 568)

■ **To operate the system properly**

- Make sure to carry the electronic key when operating the system. Do not get the electronic key too close to the vehicle when operating the system from the outside of the vehicle.

Depending on the position and holding condition of the electronic key, the key may not be detected correctly and the system may not operate properly. (The alarm may go off accidentally, or the door lock prevention function may not operate.)

- Do not leave the electronic key inside the trunk.
The key confinement prevention function may not operate, depending on the location of the key (close to a spare tire, the inside edge of the trunk), conditions (inside a metal bag, close to metallic objects) and the radio waves in the surrounding area. (→P. 145)

■ **If the smart access system with push-button start does not operate properly**

- Locking and unlocking the doors and opening the trunk: Use the mechanical key. (→P. 520)
- Starting the engine: →P. 521

■ **Customization**

Settings (e. g. smart access system with push-button start) can be changed. (Customizable features: →P. 568)

■ **If the smart access system with push-button start has been deactivated in a customized setting**

- Locking and unlocking the doors and opening the trunk:
Use the wireless remote control or mechanical key. (→P. 137, 144, 520)
- Starting the engine and changing engine switch modes: →P. 521
- Stopping the engine: →P. 198

- Certification for the smart access system with push-button start
 - ▶ For vehicles sold in the U.S. mainland, Hawaii, Guam and Puerto Rico

FCC ID: NI4TMLF10-3

This device complies with part 15 of the FCC Rules. Operation is subject to the following two conditions: (1) This device may not cause harmful interference, and (2) this device must accept any interference received, including interference that may cause undesired operation.

Changes or modifications not expressly approved by the party responsible for compliance could void the user's authority to operate the equipment.

FCC ID: NI4TMLF10-51

This device complies with part 15 of the FCC Rules. Operation is subject to the following two conditions: (1) This device may not cause harmful interference, and (2) this device must accept any interference received, including interference that may cause undesired operation.

Changes or modifications not expressly approved by the party responsible for compliance could void the user's authority to operate the equipment.

FCC ID: HYQ23AAB
FCC ID: HYQ14FBA
FCC ID: HYQ14CBA

NOTE:

This device complies with part 15 of the FCC Rules. Operation is subject to the following two conditions: (1) This device may not cause harmful interference, and (2) this device must accept any interference received, including interference that may cause undesired operation.

FCC WARNING:

Changes or modifications not expressly approved by the party responsible for compliance could void the user's authority to operate the equipment.

- For vehicles sold in Canada

This device complies with Industry Canada licence-exempt RSS standard(s). Operation is subject to the following two conditions: (1) this device may not cause interference, and (2) this device must accept any interference, including interference that may cause undesired operation of the device.

Le présent appareil est conforme aux CNR d'Industrie Canada applicables aux appareils radio exempts de licence. L'exploitation est autorisée aux deux conditions suivantes : (1) l'appareil ne doit pas produire de brouillage, et (2) l'appareil doit accepter tout brouillage radioélectrique subi, même si le brouillage est susceptible d'en compromettre le fonctionnement.

NOTE:

This device complies with Industry Canada's licence-exempt RSSs. Operation is subject to the following two conditions:

- (1) This device may not cause interference; and
- (2) This device must accept any interference, including interference that may cause undesired operation of the device.

NOTE:

Le présent appareil est conforme aux CNR d'Industrie Canada applicables aux appareils radio exempts de licence. L'exploitation est autorisée aux deux conditions suivantes:

- (1) l'appareil ne doit pas produire de brouillage;
- (2) l'utilisateur de l'appareil doit accepter tout brouillage radioélectrique subi, même si le brouillage est susceptible d'en compromettre le fonctionnement.

 **WARNING****■ Caution regarding interference with electronic devices**

- People with implantable cardiac pacemakers, cardiac resynchronization therapy-pacemakers or implantable cardioverter defibrillators should keep away from the smart access system with push-button start antennas. (→P.150)
The radio waves may affect the operation of such devices. If necessary, the entry function can be disabled. Ask your Lexus dealer for details, such as the frequency of radio waves and timing of the emitted radio waves. Then, consult your doctor to see if you should disable the entry function.
- Users of any electrical medical device other than implantable cardiac pacemakers, cardiac resynchronization therapy-pacemakers or implantable cardioverter defibrillators should consult the manufacturer of the device for information about its operation under the influence of radio waves.
Radio waves could have unexpected effects on the operation of such medical devices.

Ask your Lexus dealer for details on disabling the entry function.

3

Operation of each component

Front seats

Adjustment procedure

► GS350/GS200t

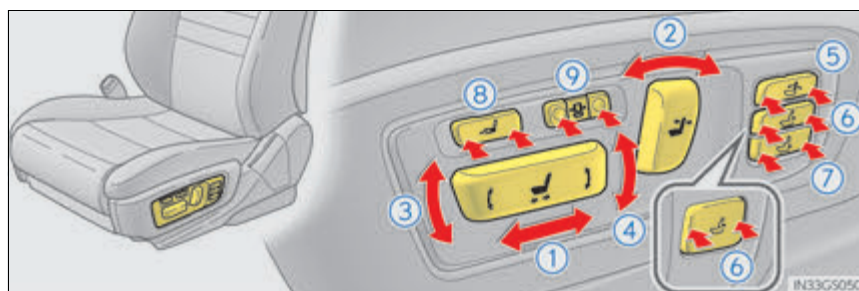

► GS F

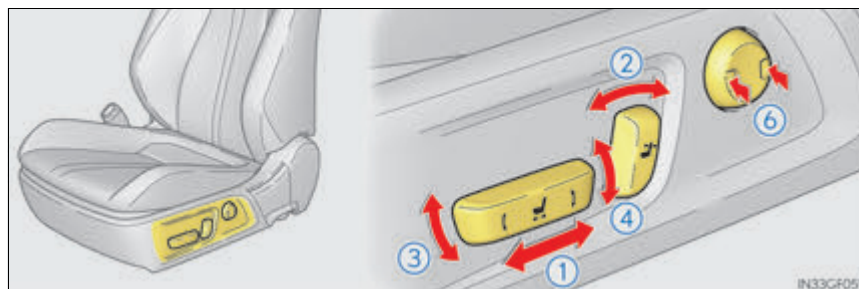

- | | |
|--------------------------------------------------------|---------------------------------------------------------|
| ① Seat position adjustment switch | ⑥ Lumbar support adjustment switch (if equipped) |
| ② Seatback angle adjustment switch | ⑦ Pelvic support adjustment switch (if equipped) |
| ③ Seat cushion (front) angle adjustment switch | ⑧ Seat cushion length adjustment switch (if equipped) |
| ④ Vertical height adjustment switch | ⑨ Seatback side support adjustment switch (if equipped) |
| ⑤ Seatback upper angle adjustment switch (if equipped) | |

■ When adjusting the seat

Take care when adjusting the seat so that the head restraint does not touch the ceiling.

■ Power easy access system

The driver's seat and steering wheel move in accordance with engine switch mode and the driver's seat belt condition. The passenger's seat moves when the passenger's door is opened. (→P.160)

⚠ WARNING**■ When adjusting the seat position**

- Take care when adjusting the seat position to ensure that other passengers are not injured by the moving seat.
- Do not put your hands under the seat or near the moving parts to avoid injury. Fingers or hands may become jammed in the seat mechanism.
- Make sure to leave enough space around the feet so they do not get stuck.

■ Seat adjustment

To reduce the risk of sliding under the lap belt during a collision, do not recline the seat more than necessary.

If the seat is too reclined, the lap belt may slide past the hips and apply restraint forces directly to the abdomen, or your neck may contact the shoulder belt, increasing the risk of death or serious injury in the event of an accident.

Adjustments should not be made while driving as the seat may unexpectedly move and cause the driver to lose control of the vehicle.

Driving position memory

This feature automatically adjusts the front seats, steering wheel and outside rear view mirrors to make entering and exiting the vehicle easier or to suit your preferences.

Power easy access system

The seat and steering wheel are automatically adjusted to allow the driver or front passenger to enter and exit the vehicle easily.

■ Driver's seat

When all of the following have been performed, the driver's seat and steering wheel are automatically adjusted to a position that allows driver to enter and exit the vehicle easily.

- The shift lever has been shifted to P.
- The engine switch has been turned off.
- The driver's seat belt has been unfastened.

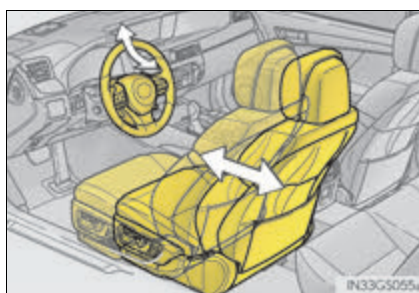

When any of the following has been performed, the driver's seat and steering wheel automatically return to their original positions.

- The engine switch has been turned to ACCESSORY mode or IGNITION ON mode.
- The driver's seat belt has been fastened.

■ Front passenger's seat (if equipped)

If the front passenger's door is opened while the vehicle is stopped, the adjusted lumbar support, side support (if equipped), etc. will return to its original position.

■ Operation of the power easy access system

When exiting the vehicle, the power easy access system may not operate if the seat is already close to the rearmost position, etc.

■ Customization

The seat movement amount settings of the power easy access system can be customized. (Customizable features: →P. 568)

Driving position memory

Your preferred driving position (the position of the driver's seat, steering wheel, outside rear view mirrors and HUD [head-up display] [if equipped]) can be recorded and recalled by pressing a button.

Three different driving positions can be recorded into memory.

■ Recording procedure

- 1 Check that the shift lever is in P.
- 2 Turn the engine switch to IGNITION ON mode.
- 3 Adjust the driver's seat, steering wheel, outside rear view mirrors and HUD (head-up display) (if equipped) to the desired positions.
- 4 While pressing the "SET" button, or within 3 seconds after the "SET" button is pressed, press button "1", "2" or "3" until the buzzer sounds.

If the selected button has already been preset, the previously recorded position will be overwritten.

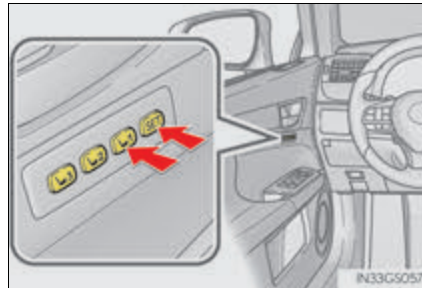

Vehicles with the driving position memory for the front passenger's seat: To record the position of the front passenger's seat, adjust the front passenger's seat to the desired position and perform step 4 using the buttons on the front passenger's side.

■ Recall procedure

- 1 Check that the shift lever is in P.
- 2 Turn the engine switch to IGNITION ON mode.
- 3 Press one of the buttons for the driving position you want to recall until the buzzer sounds.

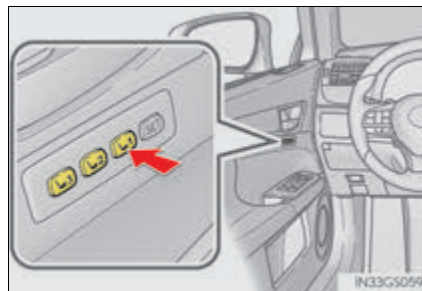

3

Operation of each component

■ **To stop the position recall operation part-way through**

Perform any of the following:

- Press the "SET" button.
- Press button "1", "2" or "3".
- Operate any of the seat adjustment switches (only cancels seat position recall).
- Operate the tilt and telescopic steering control switch (only cancels steering wheel position recall).
- Operate the head-up display position adjustment switch (if equipped) (only cancels head-up display position recall).

■ **Seat positions that can be memorized (→P. 158)**

- ▶ Vehicles without seatback side support adjustment switch

The adjusted positions other than the position adjusted by lumbar support switch can be recorded.

- ▶ Vehicles with seatback side support adjustment switch

All adjusted positions can be recorded.

■ **Operating the driving position memory after turning the engine switch off**

Driver's seat:

Recorded seat positions can be activated up to 180 seconds after the driver's door is opened and another 60 seconds after it is closed again.

Front passenger's seat:

Recorded seat positions can be activated up to 180 seconds after the front passenger's door is opened.

■ **In order to correctly use the driving position memory function**

If a seat position is already in the furthest possible position and the seat is operated in the same direction, the recorded position may be slightly different when it is recalled.

Memory recall function (driver's side only)

Each electronic key (including a card key) can be registered to recall your preferred driving position.

■ **Registering procedure**

Record your driving position to button "1", "2" or "3" before performing the following:

Carry only the key you want to register, and then close the driver's door.

If 2 or more keys are in the vehicle, the driving position cannot be recorded properly.

- 1 Check that the shift lever is in P.
- 2 Turn the engine switch to IGNITION ON mode.
- 3 Recall the driving position that you want to record.

- 4 While pressing the recalled button, press and hold the door lock switch (either lock or unlock) until the buzzer sounds.

If the button could not be registered, the buzzer sounds continuously for approximately 3 seconds.

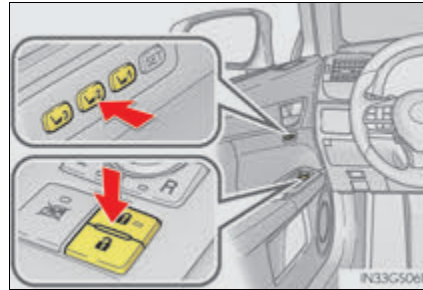

■ Recall procedure

- 1 Carry the electronic key that has been registered to the driving position, and then unlock and open the driver's door using the smart access system with push-button start or wireless remote control.

The driving position will move to the recorded position (not including the steering wheel and HUD [head-up display] [if equipped]). However, the seat will move to a position slightly behind the recorded position in order to make entering the vehicle easier.

If the driving position is in a position that has already been recorded, the seat and outside rear view mirrors will not move.

- 2 Turn the engine switch to ACCESSORY mode or IGNITION ON mode, or fasten a seat belt.

The seat, steering wheel and HUD (head-up display) (if equipped) will move to the recorded position.

■ Cancellation procedure

Carry only the key you want to cancel and then close the driver's door.

If 2 or more keys are in the vehicle, the driving position cannot be canceled properly.

- 1 Turn the engine switch to IGNITION ON mode.
- 2 While pressing the "SET" button, press and hold the door lock switch (either lock or unlock) until the buzzer sounds twice.

If the button could not be canceled, the buzzer sounds continuously for approximately 3 seconds.

■ Recalling the driving position using the memory recall function

- Different driving positions can be registered for each electronic key. Therefore, the driving position that is recalled may be different depending on the key being carried.
- If a door other than the driver's door is unlocked with the smart access system with push-button start, the driving position cannot be recalled. In this case, press the driving position button which has been set.

■ Customization

The unlock door settings of the memory recall function can be customized. (Customizable features: →P. 568)

 **WARNING**

■ **Seat adjustment caution**

Take care during seat adjustment so that the seat does not strike the rear passenger or squeeze your body against the steering wheel.

Head restraints

Head restraints are provided for all seats.

GS F: The head restraints of the front seats are integrated into the seatback and cannot be adjusted.

Front seats

- ▶ Vertical adjustment

① Up

Pull the head restraints up.

② Down

Push the head restraint down while pressing the lock release button.

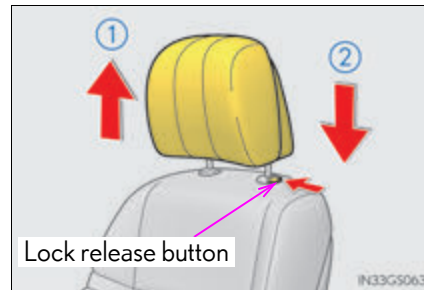

- ▶ Horizontal adjustment (if equipped)

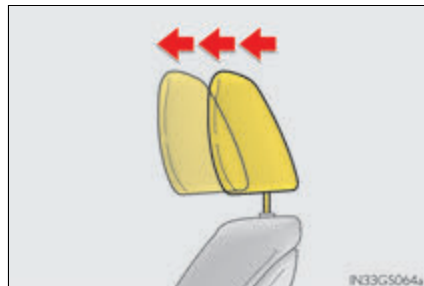

- ▶ Side support adjustment (if equipped)

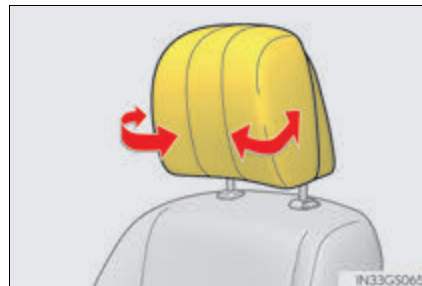

The position of the head restraint can be adjusted forward in 4 stages.

If the head restraint is pulled forward from the foremost position, it will return to the rearmost position.

3

Operation of each component

Rear seats

- ① Up
Pull the head restraints up.
- ② Down
Push the head restraint down while pressing the lock release button.

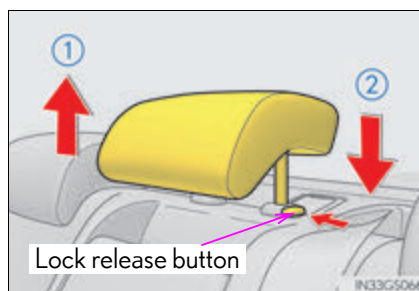

■ Removing the head restraints

Pull the head restraint up while pressing the lock release button.

Front seats: If the head restraint touches the ceiling, making the removal difficult, change the seat height or angle. (→P. 158)

Outboard rear seats (vehicles with rear sunshade): If the rear sunshade is raised, lower it before removing the head restraint. (→P. 361)

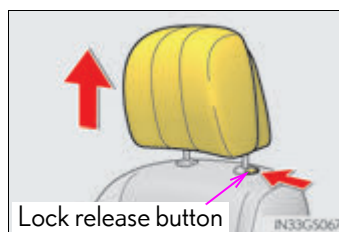

■ Installing the head restraints

► Front seats

Align the head restraint with the installation holes and push it down to the lock position. Press and hold the lock release button when lowering the head restraint.

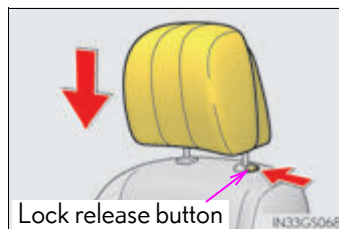

► Rear seats

Align the head restraint with the installation holes and push it down to the lowest lock position while pressing the lock release button.

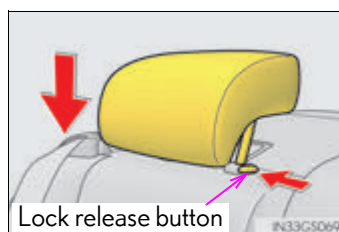

■ Adjusting the height of the head restraints

Make sure that the head restraints are adjusted so that the center of the head restraint is closest to the top of your ears.

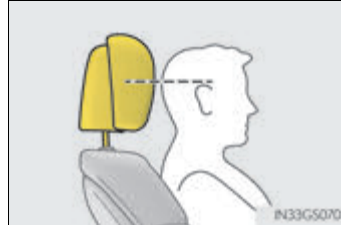
**■ Adjusting the rear seat head restraints**

Always raise the head restraint one level from the stowed position when using.

⚠ WARNING**■ Head restraint precautions**

Observe the following precautions regarding the head restraints. Failure to do so may result in death or serious injury.

- Use the head restraints designed for each respective seat.
- Adjust the head restraints to the correct position at all times.
- After adjusting the head restraints, push down on them and make sure they are locked in position.
- Do not drive with the head restraints removed.

3

Operation of each component

Steering wheel

Adjustment procedure

Operating the switch moves the steering wheel in the following directions:

- ① Up
- ② Down
- ③ Toward the driver
- ④ Away from the driver

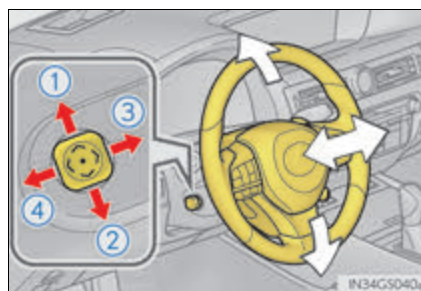

Horn

To sound the horn, press on or close to the  mark.



■ The steering wheel can be adjusted when

The engine switch is in ACCESSORY or IGNITION ON mode*.

*: If the driver's seat belt is fastened, the steering wheel can be adjusted regardless of engine switch mode.

■ Automatic adjustment of the steering position

A desired steering position can be entered to memory and recalled automatically by the driving position memory system. (→P. 160)

■ Power easy access system

The steering wheel and driver's seat move in accordance with engine switch mode and the driver's seat belt condition. (→P. 160)

WARNING

Do not adjust the steering wheel while driving.
Doing so may cause the driver to mishandle the vehicle and cause an accident, resulting in death or serious injury.

Inside rear view mirror

The rear view mirror's position can be adjusted to enable sufficient confirmation of the rear view.

Adjusting the height of rear view mirror

The height of the rear view mirror can be adjusted to suit your driving posture.

Adjust the height of the rear view mirror by moving it up and down.

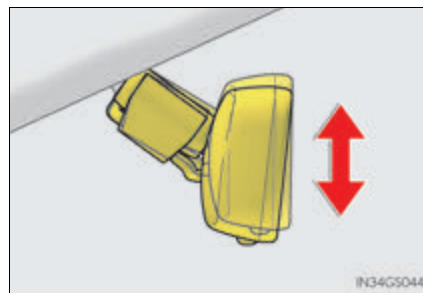

Anti-glare function

Responding to the level of brightness of the headlights of vehicles behind, the reflected light is automatically reduced.

Changing automatic anti-glare function mode

ON/OFF

When the automatic anti-glare function is in ON mode, the indicator illuminates. The function will set to ON mode each time the engine switch is turned to IGNITION ON mode.

Pressing the button turns the function to OFF mode. (The indicator also turns off.)

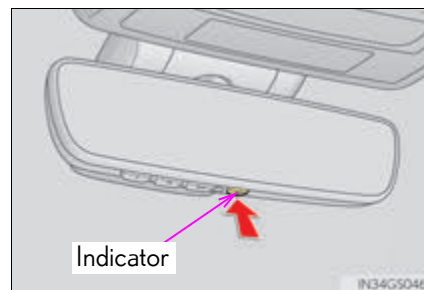

3

Operation of each component

■ To prevent sensor error

To ensure that the sensors operate properly, do not touch or cover them.

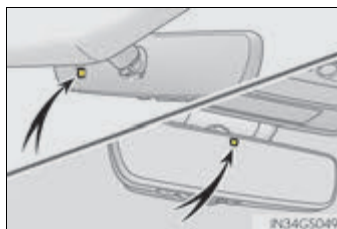

⚠ WARNING

Do not adjust the position of the mirror while driving. Doing so may lead to mishandling of the vehicle and cause an accident, resulting in death or serious injury.

Outside rear view mirrors

Adjustment procedure

- 1** To select a mirror to adjust, press the switch.

- ① Left
- ② Right

Pressing the same switch again will put the switch in neutral.

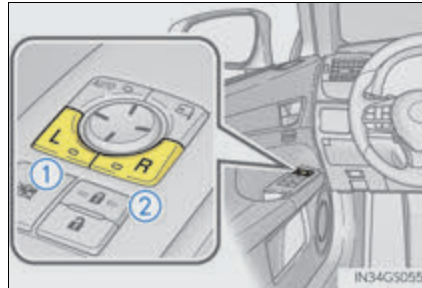

- 2** To adjust the mirror, press the switch.

- ① Up
- ② Right
- ③ Down
- ④ Left

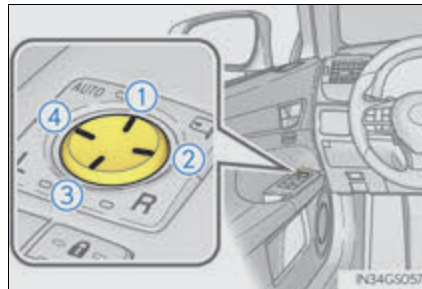

Manually folding and extending the mirrors (if equipped)

Push the mirror back in the direction of the vehicle's rear.

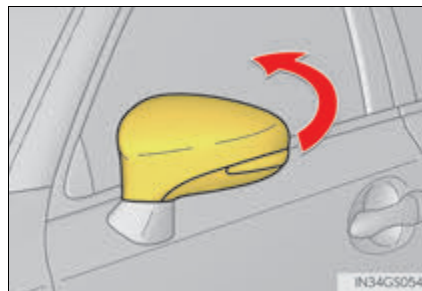

3

Operation of each component

Automatically folding and extending the mirrors (if equipped)

■ Using the switch

Press the switch to fold the mirrors.

Press it again to extend them to the original position.

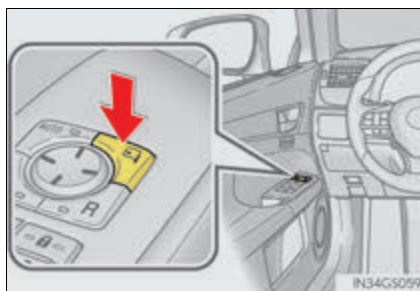

■ Setting automatic mode

Automatic mode allows the folding or extending of the mirrors to be linked to locking/unlocking of the doors.

Press the "AUTO" switch to set automatic mode.

The indicator will come on.
Pressing the switch once more will return to manual mode.

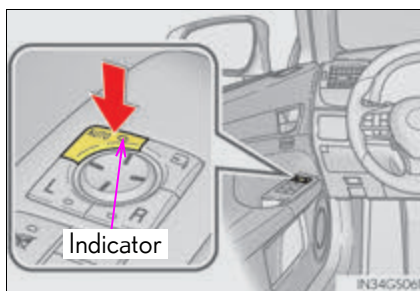

Linked mirror function when reversing

When either “L” or “R” of the mirror select switch is selected, the outside rear view mirrors will automatically angle downwards when the vehicle is reversing in order to give a better view of the ground. To disable this function, select neither “L” nor “R”.

■ Adjusting the mirror angle when the vehicle is reversing

With the shift lever in R, adjust the mirror angle at a desired position. The adjusted angle will be memorized and the mirror will automatically tilt to the memorized angle whenever the shift lever is shifted to R from next time.

The memorized downward tilt position of the mirror is linked to the normal position (angle adjusted with the shift lever in other than R). Therefore, if the normal position is changed after adjustment, the tilt position will also change.

When the normal position is changed, readjust the angle in reversing.

3

Operation of each component

■ Mirror angle can be adjusted when

The engine switch is in ACCESSORY or IGNITION ON mode.

■ When the mirrors are fogged up

The outside rear view mirrors can be cleared using the mirror defoggers. Turn on the rear window defogger to turn on the outside rear view mirror defoggers. (→P. 334)

■ Automatic adjustment of the mirror angle

A desired mirror face angle can be entered to memory and recalled automatically by the driving position memory. (→P. 160)

■ Auto anti-glare function

When the anti-glare inside rear view mirror is set to automatic mode, the outside rear view mirrors will activate in conjunction with the anti-glare inside rear view mirror to reduce reflected light. (→P. 169)

■ Using automatic mode in cold weather (if equipped)

When automatic mode is used in cold weather, the door mirror could freeze up and automatic stowing and return may not be possible. In this event, remove any ice and snow from the door mirror, then either operate the mirror using manual mode or move the mirror by hand.

 **WARNING****■ Important points while driving**

Observe the following precautions while driving.

Failure to do so may result in loss of control of the vehicle and cause an accident, resulting in death or serious injury.

- Do not adjust the mirrors while driving.
- Do not drive with the mirrors folded.
- Both the driver and passenger side mirrors must be extended and properly adjusted before driving.

■ When a mirror is moving

To avoid personal injury and mirror malfunction, be careful not to get your hand caught by the moving mirror.

■ When the mirror defoggers are operating

Do not touch the rear view mirror surfaces, as they can become very hot and burn you.

Power windows

Opening and closing procedures

The power windows can be opened and closed using the switches.

Operating the switch moves the windows as follows:

- ① Closing
- ② One-touch closing*
- ③ Opening
- ④ One-touch opening*

*: To stop the window partway, operate the switch in the opposite direction.

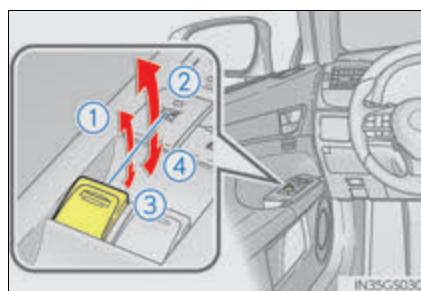

Window lock switch

Press the switch to lock the passenger window switches.

The indicator will come on.

Use this switch to prevent children from accidentally opening or closing a passenger window.

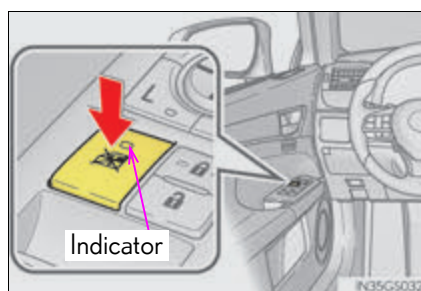

■ The power windows can be operated when

The engine switch is in IGNITION ON mode.

■ Operating the power windows after turning the engine off

The power windows can be operated for approximately 45 seconds even after the engine switch is turned to ACCESSORY mode or turned off. They cannot, however, be operated once either front door is opened.

■ Jam protection function

If an object becomes jammed between the window and the window frame while the window is closing, window movement is stopped and the window is opened slightly.

■ Catch protection function

If an object becomes caught between the door and window while the window is opening, window movement is stopped.

3

Operation of each component

■ When the window cannot be opened or closed

When the jam protection function or catch protection function operates unusually and the door window cannot be opened or closed, perform the following operations with the power window switch of that door.

- Stop the vehicle. With the engine switch in IGNITION ON mode, within 4 seconds of the jam protection function or catch protection function activating, continuously operate the power window switch in the one-touch closing direction or one-touch opening direction so that the door window can be opened and closed.
- If the door window cannot be opened and closed even when performing the above operations, perform the following procedure for function initialization.
 - 1 Turn the engine switch to IGNITION ON mode.
 - 2 Pull and hold the power window switch in the one-touch closing direction and completely close the door window.
 - 3 Release the power window switch for a moment, resume pulling the switch in the one-touch closing direction, and hold it there for approximately 6 seconds or more.
 - 4 Press and hold the power window switch in the one-touch opening direction. After the door window is completely opened, continue holding the switch for an additional 1 second or more.
 - 5 Release the power window switch for a moment, resume pressing the switch in the one-touch opening direction, and hold it there for approximately 4 seconds or more.
 - 6 Pull and hold the power window switch in the one-touch closing direction again. After the door window is completely closed, continue holding the switch for a further 1 second or more.

If you release the switch while the window is moving, start again from the beginning.

If the window reverse and cannot be fully closed or opened, have the vehicle inspected by your Lexus dealer.

■ Door lock linked window operation

- The power windows can be opened and closed using the mechanical key.* (→P. 520)
- The power windows can be opened using the wireless remote control.* (→P. 137)

*: These settings must be customized at your Lexus dealer.

■ When the battery is disconnected

The window lock switch is disabled. If necessary, press the window lock switch after reconnecting the battery.

■ Power windows open warning buzzer

The buzzer sounds and a message is shown on the multi-information display in the instrument cluster when the engine switch is turned off and the driver's door is opened with the power windows open.

■ Customization

Settings (e.g. linked door lock operation) can be changed.
(Customizable features: →P. 568)

⚠ WARNING

Observe the following precautions.
Failure to do so may result in death or serious injury.

■ Closing the windows

- The driver is responsible for all the power window operations, including the operation for the passengers. In order to prevent accidental operation, especially by a child, do not let a child operate the power windows. It is possible for children and other passengers to have body parts caught in the power window. Also, when riding with a child, it is recommended to use the window lock switch. (→P. 175)
- Check to make sure that all passengers do not have any part of their body in a position where it could be caught when a window is being operated.
- When using the mechanical key and operating the power windows, operate the power window after checking to make sure that there is no possibility of any passenger having any of their body parts caught in the window. Also do not let a child operate window by the mechanical key. It is possible for children and other passengers to get caught in the power window.
- When exiting the vehicle, turn the engine switch off, carry the key and exit the vehicle along with the child. There may be accidental operation, due to mischief, etc., that may possibly lead to an accident.

■ Jam protection function

- Never use any part of your body to intentionally activate the jam protection function.
- The jam protection function may not work if something gets jammed just before the window is fully closed.

■ Catch protection function

- Never use hands, arms, clothing, etc., to intentionally activate the catch protection function.
- The catch protection function may not operate if something gets caught just before the window is fully opened. Be careful not to get hands, arms, clothing, etc., caught in the window.

Moon roof

Use the overhead switches to open and close the moon roof and tilt it up and down.

Opening and closing

- ① Opens the moon roof*
The moon roof stops slightly before the fully open position to reduce wind noise. Press the switch again to fully open the moon roof.
- ② Closes the moon roof*
*: Lightly press either way of the moon roof switch to stop the moon roof part-way.

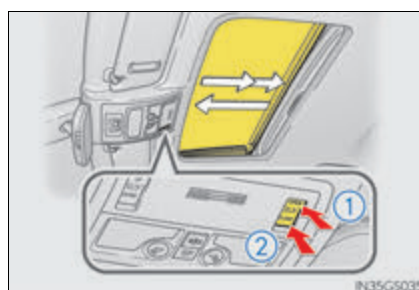

Tilting up and down

- ① Tilts the moon roof up*
- ② Tilts the moon roof down*
*: Lightly press either way of the moon roof switch to stop the moon roof part-way.



■ The moon roof can be operated when

The engine switch is in IGNITION ON mode.

■ Operating the moon roof after turning the engine off

The moon roof can be operated for approximately 45 seconds after the engine switch is turned to ACCESSORY mode or turned off. It cannot, however, be operated once either front door is opened.

■ Jam protection function

If an object is detected between the moon roof and the frame while the moon roof is closing or tilting down, travel is stopped and the moon roof opens slightly.

■ Sunshade

The sunshade can be opened and closed manually. However, the sunshade will open automatically when the moon roof is opened.

■ Door lock linked moon roof operation

- The moon roof can be opened and closed using the mechanical key. * (→P. 520)
- The moon roof can be opened using the wireless remote control. * (→P. 137)

*: These settings must be customized at your Lexus dealer.

■ When the moon roof does not close normally

Perform the following procedure:

- If the moon roof closes but then re-opens slightly

- 1 Stop the vehicle.
- 2 Press and hold the "CLOSE" switch.*1
The moon roof will close, reopen and pause for approximately 10 seconds.*2 Then it will close again, tilt up and pause for approximately 1 second. Finally, it will tilt down, open and close.
- 3 Check to make sure that the moon roof is completely closed and then release the switch.

- If the moon roof tilts down but then tilts back up

- 1 Stop the vehicle.
- 2 Press and hold the "UP" switch*1 until the moon roof moves into the tilt up position and stops.
- 3 Release the "UP" switch once and then press and hold the "UP" switch again.*1
The moon roof will pause for approximately 10 seconds in the tilt up position.*2 Then it will adjust slightly and pause for approximately 1 second. Finally, it will tilt down, open and close.
- 4 Check to make sure that the moon roof is completely closed and then release the switch.

*1: If the switch is released at the incorrect time, the procedure will have to be performed again from the beginning.

*2: If the switch is released after the above mentioned 10 second pause, automatic operation will be disabled. In that case, press and hold the "CLOSE" or "UP" switch, and the moon roof will tilt up and pause for approximately 1 second. Then it will tilt down, open and close. Check to make sure that the moon roof is completely closed and then release the switch.

If the moon roof does not fully close even after performing the above procedure correctly, have the vehicle inspected by your Lexus dealer.

■ Moon roof open warning buzzer

The buzzer sounds and a message is shown on the multi-information display in the instrument cluster when the engine switch is turned off and the driver's door is opened with the moon roof open.

■ Customization

Settings (e.g. linked door lock operation) can be changed.
(Customizable features: →P. 568)

**WARNING**

Observe the following precautions.
Failure to do so may cause death or serious injury.

■ Opening the moon roof

- Do not allow any passengers to put their hands or heads outside the vehicle while it is moving.
- Do not sit on top of the moon roof.

■ Closing the moon roof

- The driver is responsible for moon roof opening and closing operations.
In order to prevent accidental operation, especially by a child, do not let a child operate the moon roof. It is possible for children and other passengers to have body parts caught in the moon roof.
- Check to make sure that all passengers do not have any part of their body in a position where it could be caught when the moon roof is being operated.
- When using the mechanical key and operating the moon roof, operate the moon roof after checking to make sure that there is no possibility of any passenger having any of their body parts caught in the moon roof. Also, do not let a child operate moon roof by the mechanical key. It is possible for children and other passengers to get caught in the moon roof.
- When exiting the vehicle, turn the engine switch off, carry the key and exit the vehicle along with the child. There may be accidental operation, due to mischief, etc., that may possibly lead to an accident.

■ Jam protection function

- Never use any part of your body to intentionally activate the jam protection function.
- The jam protection function may not work if something gets caught just before the moon roof fully closes.

Driving

4

- 4-1. Before driving**
 - Driving the vehicle 182
 - Cargo and luggage 191
 - Vehicle load limits 194
 - Trailer towing 195
 - Dinghy towing 196
- 4-2. Driving procedures**
 - Engine (ignition) switch 197
 - Automatic transmission 202
 - Turn signal lever 209
 - Parking brake 210
 - Brake Hold
(GS350/GS200t) 212
 - ASC (Active Sound Control)
(GS F) 214
- 4-3. Operating the lights and wipers**
 - Headlight switch 215
 - Automatic High Beam 218
 - Windshield wipers
and washer 222
- 4-4. Refueling**
 - Opening the fuel tank cap 227
- 4-5. Using the driving support systems**
 - Lexus Safety System+ 231
 - PCS (Pre-Collision System) 237
 - LKA (Lane-Keeping Assist) 249
 - LDA (Lane Departure Alert with steering control) 258
 - Dynamic radar cruise control with full-speed range 266
 - Dynamic radar cruise control 278
 - Cruise control 290
 - Driving mode select switch 293
 - BSM (Blind Spot Monitor) 298
 - The Blind Spot Monitor function 301
 - The Rear Cross Traffic Alert function 303
 - TVD (Torque Vectoring Differential) (GS F) 306
 - Driving assist systems 308
- 4-6. Driving tips**
 - Winter driving tips 316

Driving the vehicle

The following procedures should be observed to ensure safe driving:

Starting the engine

→P. 197

Driving

- 1 With the brake pedal depressed, shift the shift lever to D. (→P. 202)
- 2 If the parking brake is in manual mode, release the parking brake. (→P. 210)
- 3 Gradually release the brake pedal and gently depress the accelerator pedal to accelerate the vehicle.

Stopping

- 1 With the shift lever in D, depress the brake pedal.
- 2 If necessary, set the parking brake.
If the vehicle is to be stopped for an extended period of time, shift the shift lever to P or N. (→P. 202)

Parking the vehicle

- 1 With the shift lever in D, depress the brake pedal.
- 2 Shift the shift lever to P. (→P. 202)
- 3 If the parking brake is in manual mode, set the parking brake. (→P. 210)
- 4 Press the engine switch to stop the engine.
- 5 Lock the door, making sure that you have the electronic key on your person.
If parking on a hill, block the wheels as needed.

Starting off on a steep uphill

- 1 Make sure that the parking brake is set and shift the shift lever to D.
- 2 Gently depress the accelerator pedal.
- 3 Release the parking brake.

■ When starting off on a uphill

The hill-start assist control is available. (→P. 308)

■ Driving in the rain

- Drive carefully when it is raining, because visibility will be reduced, the windows may become fogged-up, and the road will be slippery.
- Drive carefully when it starts to rain, because the road surface will be especially slippery.
- Refrain from high speeds when driving on an expressway in the rain, because there may be a layer of water between the tires and the road surface, preventing the steering and brakes from operating properly.

■ Engine speed while driving

In the following conditions, the engine speed may become high while driving. This is due to automatic up-shifting control or down-shifting implementation to meet driving conditions. It does not indicate sudden acceleration.

- The vehicle is judged to be driving uphill or downhill
- When the accelerator pedal is released
- When the brake pedal is depressed while sport mode is selected (→P. 293)

■ Restraining engine output (Brake Override System)

- When the accelerator and brake pedals are depressed at the same time, the engine output may be restrained.
- A warning message is displayed on the multi-information display while the system is operating. (→P. 480)

■ Restraining sudden start (Drive-Start Control)

- When the following unusual operation is performed, the engine output may be restrained.
 - When the shift lever is shifted from R to D, D to R, N to R, P to D, or P to R (D includes M) with the accelerator pedal depressed, a warning message appears on the multi-information display. (→P. 464)
 - When the accelerator pedal is depressed too much while the vehicle is in reverse.
- While Drive-Start Control is being activated, your vehicle may have trouble escaping from the mud or fresh snow. In such case, deactivate TRAC (→P. 310) to cancel Drive-Start Control so that the vehicle may become able to escape from the mud or fresh snow.

■ Breaking in your new Lexus

To extend the life of the vehicle, observing the following precautions is recommended:

- For the first 186 miles (300 km):
 - Avoid sudden stops.
- For the first 621 miles (1000 km):
 - Do not drive at extremely high speeds.
 - Avoid sudden acceleration.
 - Do not drive continuously in low gears.
 - Do not drive at a constant speed for extended periods.

■ **Drum-in-disc type parking brake system**

Your vehicle has a drum-in-disc type parking brake system. This type of brake system needs bedding-down of the brake shoes periodically or whenever the parking brake shoes and/or drum are replaced. Have your Lexus dealer perform the bedding down operation.

■ **Operating your vehicle in a foreign country**

Comply with the relevant vehicle registration laws and confirm the availability of the correct fuel. (→P. 541)

■ **Brake pads and discs (F SPORT models of GS350/GS200t, and GS F)**

The brake pads and discs are designed for use under high load conditions. Therefore, brake noise may be generated depending on the vehicle speed, braking force and vehicle environment (temperature, humidity, etc.).

■ **Idling time before engine stop (GS200t)**

To prevent damage to the turbocharger, allow the engine to idle immediately after high-speed driving or hill climbing.

Driving condition	Idling time
Normal city driving	Not necessary
High-speed driving (Constant speed of approx. 62 mph [100 km/h])	Approximately 1 minute
Steep hill driving or continuous driving at 62 mph (100 km/h) or more (race track driving etc.)	Approximately 2 minute

⚠ WARNING

Observe the following precautions.
Failure to do so may result in death or serious injury.

■ **When starting the vehicle**

Always keep your foot on the brake pedal while stopped with the engine running. This prevents the vehicle from creeping.

■ **When driving the vehicle**

- Do not drive if you are unfamiliar with the location of the brake and accelerator pedals to avoid depressing the wrong pedal.
 - Accidentally depressing the accelerator pedal instead of the brake pedal will result in sudden acceleration that may lead to an accident.
 - When backing up, you may twist your body around, leading to a difficulty in operating the pedals. Make sure to operate the pedals properly.
 - Make sure to keep a correct driving posture even when moving the vehicle only slightly. This allows you to depress the brake and accelerator pedals properly.
 - Depress the brake pedal using your right foot. Depressing the brake pedal using your left foot may delay response in an emergency, resulting in an accident.
- Do not drive the vehicle over or stop the vehicle near flammable materials. The exhaust system and exhaust gases can be extremely hot. These hot parts may cause a fire if there is any flammable material nearby.
- During normal driving, do not turn off the engine. Turning the engine off while driving will not cause loss of steering or braking control, but the power assist to these systems will be lost. This will make it more difficult to steer and brake, so you should pull over and stop the vehicle as soon as it is safe to do so. However, in the event of an emergency, such as if it becomes impossible to stop the vehicle in the normal way: →P. 443
- Use engine braking (downshift) to maintain a safe speed when driving down a steep hill. Using the brakes continuously may cause the brakes to overheat and lose effectiveness. (→P. 202)
- Do not adjust the positions of the steering wheel, the seat, or the inside or outside rear view mirrors while driving. Doing so may result in a loss of vehicle control.
- Always check that all passengers' arms, heads or other parts of their body are not outside the vehicle.
- Do not drive in excess of the speed limit. Even if the legal speed limit permits it, do not drive over 85 mph (140 km/h) unless your vehicle has high-speed capability tires. Driving over 85 mph (140 km/h) may result in tire failure, loss of control and possible injury. Be sure to consult a tire dealer to determine whether the tires on your vehicle are high-speed capability tires or not before driving at such speeds.

 **WARNING**

Observe the following precautions.
Failure to do so may result in death or serious injury.

■ When driving on slippery road surfaces

- Sudden braking, acceleration and steering may cause tire slippage and reduce your ability to control the vehicle.
- Sudden acceleration, engine braking due to shifting, or changes in engine speed could cause the vehicle to skid, resulting in an accident.
- After driving through a puddle, lightly depress the brake pedal to make sure that the brakes are functioning properly. Wet brake pads may prevent the brakes from functioning properly. If the brakes on only one side are wet and not functioning properly, steering control may be affected.

■ When shifting the shift lever

- Do not let the vehicle roll backward while the shift lever is in a driving position, or roll forward while the shift lever is in R.
Doing so may cause the engine to stall or lead to poor brake and steering performance, resulting in an accident or damage to the vehicle.
- Do not shift the shift lever to P while the vehicle is moving.
Doing so can damage the transmission and may result in a loss of vehicle control.
- Do not shift the shift lever to R while the vehicle is moving forward.
Doing so can damage the transmission and may result in a loss of vehicle control.
- Do not shift the shift lever to a driving position while the vehicle is moving backward.
Doing so can damage the transmission and may result in a loss of vehicle control.
- Moving the shift lever to N while the vehicle is moving will disengage the engine from the transmission. Engine braking is not available when N is selected.
- Be careful not to shift the shift lever with the accelerator pedal depressed. Shifting the shift lever to a gear other than P or N may lead to unexpected rapid acceleration of the vehicle that may cause an accident and result in death or serious injury.

■ If you hear a squealing or scraping noise (brake pad wear limit indicators) (GS350/GS200t)

Have the brake pads checked and replaced by your Lexus dealer as soon as possible.
Rotor damage may result if the pads are not replaced when needed.

Front brakes of F SPORT models: Moderate levels of brake pad and disc wear allow enhanced front braking power. As a result, the discs may wear more quickly than conventional brake discs. Therefore, when replacing the brake pads, Lexus recommends that you also have the thickness of the discs measured.

It is dangerous to drive the vehicle when the wear limits of the brake pads and/or those of the brake discs are exceeded.

⚠ WARNING

Observe the following precautions.
Failure to do so may result in death or serious injury.

■ If a brake pad wear warning message is displayed (GS F)

Have the brake pads checked and replaced by your Lexus dealer as soon as possible. Rotor damage may result if the pads are not replaced when needed. Moderate levels of the brake pad and disc wear allow enhanced braking power. As a result, the discs may wear more quickly than conventional brake discs. Therefore, when replacing the brake pads, Lexus recommends that you also have the thickness of the discs measured. It is dangerous to drive the vehicle when the wear limits of the brake pads and/or those of the brake discs are exceeded.

■ When the vehicle is stopped

- Do not race the engine.
If the vehicle is any gear other than P or N, the vehicle may accelerate suddenly and unexpectedly, causing an accident.
- In order to prevent accidents due to the vehicle rolling away, always keep depressing the brake pedal while the engine is running, and apply the parking brake as necessary.
- If the vehicle is stopped on an incline, in order to prevent accidents caused by the vehicle rolling forward or backward, always depress the brake pedal and securely apply the parking brake as needed.
- Avoid revving or racing the engine.
Running the engine at high speed while the vehicle is stopped may cause the exhaust system to overheat, which could result in a fire if combustible material is nearby.

 **WARNING**

Observe the following precautions.
Failure to do so may result in death or serious injury.

■ When the vehicle is parked

- Do not leave glasses, cigarette lighters, spray cans, or soft drink cans in the vehicle when it is in the sun.
Doing so may result in the following:
 - Gas may leak from a cigarette lighter or spray can, and may lead to a fire.
 - The temperature inside the vehicle may cause the plastic lenses and plastic material of glasses to deform or crack.
 - Soft drink cans may fracture, causing the contents to spray over the interior of the vehicle, and may also cause a short circuit in the vehicle's electrical components.
- Do not leave cigarette lighters in the vehicle. If a cigarette lighter is in a place such as the glove box or on the floor, it may be lit accidentally when luggage is loaded or the seat is adjusted, causing a fire.
- Do not attach adhesive discs to the windshield or windows. Do not place containers such as air fresheners on the instrument panel or dashboard. Adhesive discs or containers may act as lenses, causing a fire in the vehicle.
- Do not leave a door or window open if the curved glass is coated with a metallized film such as a silver-colored one. Reflected sunlight may cause the glass to act as a lens, causing a fire.
- Always apply the parking brake, shift the shift lever to P, stop the engine and lock the vehicle.
Do not leave the vehicle unattended while the engine is running.
- Do not touch the exhaust pipes while the engine is running or immediately after turning the engine off.
Doing so may cause burns.

■ When taking a nap in the vehicle

Always turn the engine off. Otherwise, if you accidentally move the shift lever or depress the accelerator pedal, this could cause an accident or fire due to engine overheating. Additionally, if the vehicle is parked in a poorly ventilated area, exhaust gases may collect and enter the vehicle, leading to death or a serious health hazard.

⚠ WARNING

Observe the following precautions.
Failure to do so may result in death or serious injury.

■ When braking

- When the brakes are wet, drive more cautiously.
Braking distance increases when the brakes are wet, and this may cause one side of the vehicle to brake differently than the other side. Also, the parking brake may not securely hold the vehicle.
- If the power brake assist function does not operate, do not follow other vehicles closely and avoid hills or sharp turns that require braking.
In this case, braking is still possible, but the brake pedal should be depressed more firmly than usual. Also, the braking distance will increase. Have your brakes fixed immediately.
- Do not pump the brake pedal if the engine stalls.
Each push on the brake pedal uses up the reserve for the power-assisted brakes.
- The brake system consists of 2 individual hydraulic systems; if one of the systems fails, the other will still operate. In this case, the brake pedal should be depressed more firmly than usual and the braking distance will increase. Have your brakes fixed immediately.

■ If the vehicle becomes stuck

Do not spin the wheels excessively when any of the tires is up in the air, or the vehicle is stuck in sand, mud, etc. This may damage the driveline components or propel the vehicle forward or backward, causing an accident.

⚠ NOTICE**■ When driving the vehicle**

- Do not depress the accelerator and brake pedals at the same time during driving, as this may restrain the engine output.
- Do not use the accelerator pedal or depress the accelerator and brake pedals at the same time to hold the vehicle on a hill.

■ When parking the vehicle

Always shift the shift lever to P. Failure to do so may cause the vehicle to move or the vehicle may accelerate suddenly if the accelerator pedal is accidentally depressed.

■ Avoiding damage to vehicle parts

- Do not turn the steering wheel fully in either direction and hold it there for an extended period of time.
Doing so may damage the power steering motor.
- When driving over bumps in the road, drive as slowly as possible to avoid damaging the wheels, underside of the vehicle, etc.
- GS200t: Make sure to idle the engine immediately after high speed driving or hill climbing. Stop the engine only after the turbocharger has cooled down. (→P.184)
Failure to do so may cause damage to the turbocharger.

 NOTICE

■ **If you get a flat tire while driving**

A flat or damaged tire may cause the following situations. Hold the steering wheel firmly and gradually depress the brake pedal to slow down the vehicle.

- It may be difficult to control your vehicle.
- The vehicle will make abnormal sounds or vibrations.
- The vehicle will lean abnormally.

Information on what to do in case of a flat tire (→P. 491, 502)

■ **When encountering flooded roads**

Do not drive on a road that has flooded after heavy rain etc. Doing so may cause the following serious damage to the vehicle:

- Engine stalling
- Short in electrical components
- Engine damage caused by water immersion

In the event that you drive on a flooded road and the vehicle is flooded, be sure to have your Lexus dealer check the following:

- Brake function
- Changes in quantity and quality of oil and fluid used for the engine, transmission, transfer (AWD models), differential, etc.
- Lubricant condition for the propeller shaft, bearings and suspension joints (where possible), and the function of all joints, bearings, etc.

Cargo and luggage

Take notice of the following information about storage precautions, cargo capacity and load:

Capacity and distribution

Cargo capacity depends on the total weight of the occupants.

(Cargo capacity) = (Total load capacity) – (Total weight of occupants)

Steps for Determining Correct Load Limit –

- (1) Locate the statement “The combined weight of occupants and cargo should never exceed XXX kg or XXX lbs.” on your vehicle’s placard.
- (2) Determine the combined weight of the driver and passengers that will be riding in your vehicle.
- (3) Subtract the combined weight of the driver and passengers from XXX kg or XXX lbs.
- (4) The resulting figure equals the available amount of cargo and luggage load capacity.
For example, if the “XXX” amount equals 1400 lbs. and there will be five 150 lb passengers in your vehicle, the amount of available cargo and luggage load capacity is 650 lbs. (1400 – 750 (5 × 150) = 650 lbs.)
- (5) Determine the combined weight of luggage and cargo being loaded on the vehicle. That weight may not safely exceed the available cargo and luggage load capacity calculated in Step 4.
- (6) If your vehicle will be towing a trailer, load from your trailer will be transferred to your vehicle. Consult this manual to determine how this reduces the available cargo and luggage load capacity of your vehicle. (→P. 194)

Lexus does not recommend towing a trailer with your vehicle. Your vehicle is not designed for trailer towing.

Calculation formula for your vehicle

- ① Cargo capacity
- ② Total load capacity (vehicle capacity weight) (→P. 538)

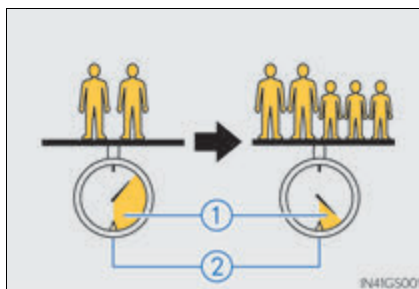

When 2 people with the combined weight of A lb. (kg) are riding in your vehicle, which has a total load capacity (vehicle capacity weight) of B lb. (kg), the available amount of cargo and luggage load capacity will be C lb. (kg) as follows:

$$B^{*2} \text{ lb. (kg)} - A^{*1} \text{ lb. (kg)} = C^{*3} \text{ lb. (kg)}$$

*1: A = Weight of people

*2: B = Total load capacity

*3: C = Available cargo and luggage load

In this condition, if 3 more passengers with the combined weight of D lb. (kg) get on, the available cargo and luggage load will be reduced E lb. (kg) as follows:

$$C \text{ lb. (kg)} - D^{*4} \text{ lb. (kg)} = E^{*5} \text{ lb. (kg)}$$

*4: D = Additional weight of people

*5: E = Available cargo and luggage load

As shown in the example above, if the number of occupants increases, the cargo and luggage load will be reduced by an amount that equals the increased weight due to the additional occupants. In other words, if an increase in the number of occupants causes an excess of the total load capacity (combined weight of occupants plus cargo and luggage load), you must reduce the cargo and luggage on your vehicle.

 **WARNING****■ Things that must not be carried in the trunk**

The following things may cause a fire if loaded in the trunk:

- Receptacles containing gasoline
- Aerosol cans

■ Storage precautions

Observe the following precautions.

Failure to do so may prevent the pedals from being depressed properly, may block the driver's vision, or may result in items hitting the driver or passengers, possibly causing an accident.

- Stow cargo and luggage in the trunk whenever possible.
- Do not place cargo or luggage in or on the following locations.
 - At the feet of the driver
 - On the front passenger or rear seats (when stacking items)
 - On the package tray
 - On the instrument panel
 - On the dashboard
 - In front of the Remote Touch screen
- Secure all items in the occupant compartment.

■ Capacity and distribution

- Do not exceed the maximum axle weight rating or the total vehicle weight rating.
- Even if the total load of occupant's weight and the cargo load is less than the total load capacity, do not apply the load unevenly. Improper loading may cause deterioration of steering or braking control which may cause death or serious injury.

Vehicle load limits

Vehicle load limits include total load capacity, seating capacity, towing capacity and cargo capacity.

◆ **Total load capacity (vehicle capacity weight):** →P. 538

Total load capacity means the combined weight of occupants, cargo and luggage.

◆ **Seating capacity: 5 occupants (Front 2, Rear 3)**

Seating capacity means the maximum number of occupants whose estimated average weight is 150 lb. (68 kg) per person.

◆ **Towing capacity**

Lexus does not recommend towing a trailer with your vehicle.

◆ **Cargo capacity**

Cargo capacity may increase or decrease depending on the weight and the number of occupants.

■ **Total load capacity and seating capacity**

These details are also described on the tire and loading information label. (→P. 422)

 **WARNING**

■ **Overloading the vehicle**

Do not overload the vehicle.

It may not only cause damage to the tires, but also degrade steering and braking ability, resulting in an accident.

Trailer towing

Lexus does not recommend towing a trailer with your vehicle. Lexus also does not recommend the installation of a tow hitch or the use of a tow hitch carrier for a wheelchair, scooter, bicycle, etc. Your vehicle is not designed for trailer towing or for the use of tow hitch mounted carriers.



4
Driving

Dinghy towing

Your vehicle is not designed to be dinghy towed (with 4 wheels on the ground) behind a motor home.

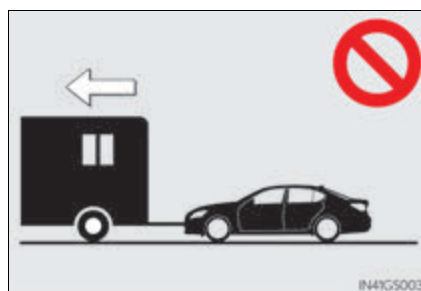

 NOTICE

- **To avoid serious damage to your vehicle**
Do not tow your vehicle with the four wheels on the ground.

Engine (ignition) switch

Performing the following operations when carrying the electronic key on your person starts the engine or changes engine switch modes.

Starting the engine

- 1 Press the parking brake switch to check that the parking brake is set.
(→P. 210)
Parking brake indicator will come on.
- 2 Check that the shift lever is in P.
- 3 Firmly depress the brake pedal.



and a message (GS F only) will be displayed on the multi-information display.

If it is not displayed, the engine cannot be started.

- 4 Press the engine switch.

The engine will crank until it starts or for up to 30 seconds, whichever is less.

Continue depressing the brake pedal until the engine is completely started.

The engine can be started from any engine switch mode.

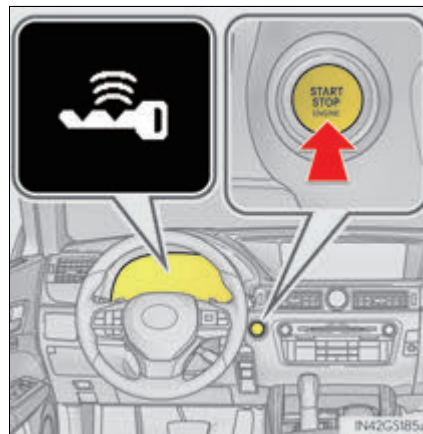

4

Driving

Stopping the engine

- 1 Stop the vehicle.
- 2 Shift the shift lever to P.
- 3 Set the parking brake. (→P. 210)
- 4 Press the engine switch.
- 5 Release the brake pedal and check that "POWER ON" on the multi-information display is off.

Changing engine switch modes

Modes can be changed by pressing the engine switch with brake pedal released. (The mode changes each time the switch is pressed.)

Off*

The emergency flashers can be used.
"POWER ON" will not be displayed on the multi-information display.

ACCESSORY mode

Some electrical components such as the audio system can be used.
"POWER ON" will be displayed on the multi-information display.

IGNITION ON mode

All electrical components can be used.
"POWER ON" will be displayed on the multi-information display.

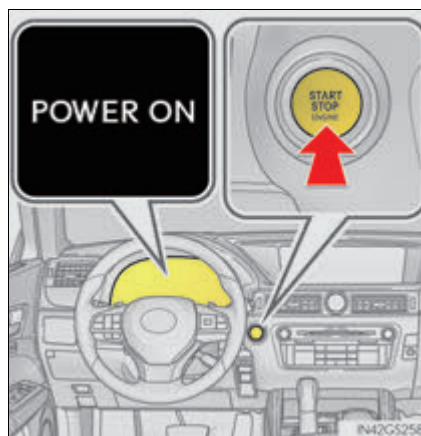

*: If the shift lever is in a position other than P when turning off the engine, the engine switch will be turned to ACCESSORY mode, not to off.

When stopping the engine with the shift lever in a position other than P

If the engine is stopped with the shift lever in a position other than P, the engine switch will not be turned off but instead be turned to ACCESSORY mode. Perform the following procedure to turn the switch off:

- 1 Check that the parking brake is set.
- 2 Shift the shift lever to P.
- 3 Check that "Turn Off Vehicle" is displayed on the multi-information display and then press the engine switch once.
- 4 Check that "Turn Off Vehicle" on the multi-information display is off.

■ Auto power off function

If the vehicle is left in ACCESSORY mode for more than 20 minutes or IGNITION ON mode (the engine is not running) for more than an hour with the shift lever in P, the engine switch will automatically turn off. However, this function cannot entirely prevent battery discharge. Do not leave the vehicle with the engine switch in ACCESSORY or IGNITION ON mode for long periods of time when the engine is not running.

■ Electronic key battery depletion

→P. 134

■ Conditions affecting operation

→P. 152

■ Notes for the entry function

→P. 153

■ If the engine does not start

- The engine immobilizer system may not have been deactivated. (→P. 72)
Contact your Lexus dealer.
- Check that the shift lever is securely set in P. The engine may not start if the shift lever is displaced out of P. "Shift to P position to Start" will be displayed on the multi-information display.

■ Steering lock

After turning the engine switch off and opening and closing the doors, the steering wheel will be locked due to the steering lock function. Operating the engine switch again automatically cancels the steering lock.

■ When the steering lock cannot be released

"Steering Lock active" will be displayed on the multi-information display.

Check that the shift lever is set in P. Press the engine switch while turning the steering wheel left and right.

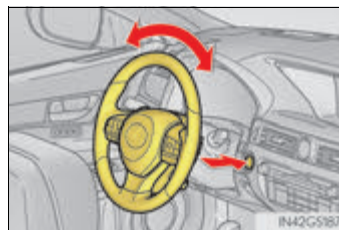

■ **Steering lock motor overheating prevention**

To prevent the steering lock motor from overheating, the motor may be suspended if the engine is turned on and off repeatedly in a short period of time. In this case, refrain from operating the engine. After about 10 seconds, the steering lock motor will resume functioning.

■ **When “Check Access System with Elec. Key” will be displayed on the multi-information display**

The system may be malfunctioning. Have the vehicle inspected by your Lexus dealer immediately.

■ **If the electronic key battery is depleted**

→P. 429

■ **Operation of the engine switch**

- When operating the engine switch, one short, firm press is enough. If the switch is pressed improperly, the engine may not start or the engine switch mode may not change. It is not necessary to press and hold the switch.
- If attempting to restart the engine immediately after turning the engine switch off, the engine may not start in some cases. After turning the engine switch off, please wait a few seconds before restarting the engine.

■ **If the smart access system with push-button start has been deactivated in a customized setting**

→P. 520

 **WARNING**

■ **When starting the engine**

Always start the engine while sitting in the driver's seat. Do not depress the accelerator pedal while starting the engine under any circumstances. Doing so may cause an accident resulting in death or serious injury.

■ **Caution while driving**

If engine failure occurs while the vehicle is moving, do not lock or open the doors until the vehicle reaches a safe and complete stop. Activation of the steering lock in this circumstance may lead to an accident, resulting in death or serious injury.

■ **Stopping the engine in an emergency**

If you want to stop the engine in an emergency while driving the vehicle, press and hold the engine switch for more than 2 seconds, or press it briefly 3 times or more in succession. (→P. 443)

However, do not touch the engine switch while driving except in an emergency. Turning the engine off while driving will not cause loss of steering or braking control, but the power assist to these systems will be lost. This will make it more difficult to steer and brake, so you should pull over and stop the vehicle as soon as it is safe to do so.

 NOTICE**■ To prevent battery discharge**

- Do not leave the engine switch in ACCESSORY or IGNITION ON mode for long periods of time without the engine running.
- If "POWER ON" is displayed on the multi-information display, the engine switch is not off. Exit the vehicle after turning the engine switch off.
- Do not stop the engine when the shift lever is in a position other than P. If the engine is stopped in another shift lever position, the engine switch will not be turned off but instead be turned to ACCESSORY mode. If the vehicle is left in ACCESSORY mode, battery discharge may occur.

■ When starting the engine

- Do not race a cold engine.
- If the engine becomes difficult to start or stalls frequently, have your vehicle checked by your Lexus dealer immediately.

■ Symptoms indicating a malfunction with the engine switch

If the engine switch seems to be operating somewhat differently than usual, such as the switch sticking slightly, there may be a malfunction. Contact your Lexus dealer immediately.

Automatic transmission

Shifting the shift lever

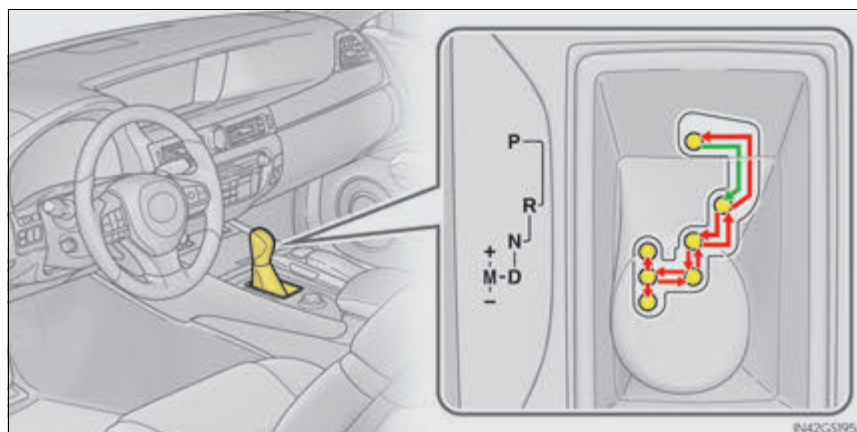

← While the engine switch is in IGNITION ON mode, move the shift lever with the brake pedal depressed.

When shifting the shift lever between P and D, make sure that the vehicle is completely stopped.

Shift position purpose

Shift position	Objective or function
P	Parking the vehicle/starting the engine
R	Reversing
N	Neutral (Condition in which the power is not transmitted)
D	Normal driving ^{*1}
M	M mode driving ^{*2} (→P. 205)

^{*1}: To improve fuel efficiency and reduce noises, set the shift lever in D for normal driving.

^{*2}: Any gear range can be fixed when driving in M mode.

Selecting the driving mode**■ Sport mode/Eco drive mode**

→P. 293

■ Snow mode

Snow mode can be selected to suit the conditions when driving on slippery road surfaces, such as on snow.

Press the switch.

Press the switch again to return to normal mode.

*1: Except F SPORT models of GS350/
GS200t, and GS F

*2: F SPORT models of GS350/
GS200t

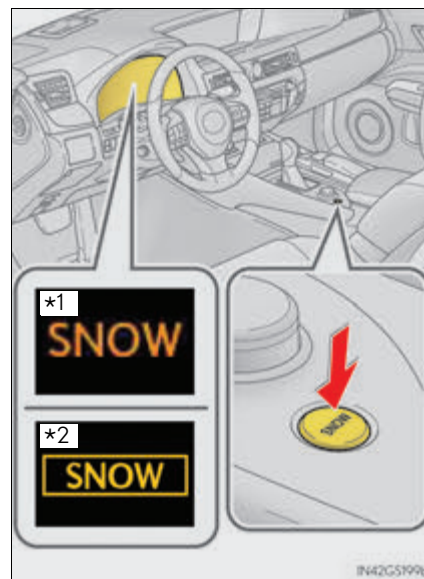

Selecting shift ranges in the D position

To drive using temporary shift range selection, operate the “-” or “+” paddle shift switch.

When the “-” paddle shift switch is operated, the shift range will be downshifted to a range that enables engine braking force that is suitable to driving conditions.

When the “+” paddle shift switch is operated, the shift range will be one gear upper than the gear in use during normal D position driving.

Changing the shift range allows restriction of the highest shift gear, preventing unnecessary upshifting and enabling the level of engine braking force to be selected.

▶ GS350/GS200t

▶ GSF

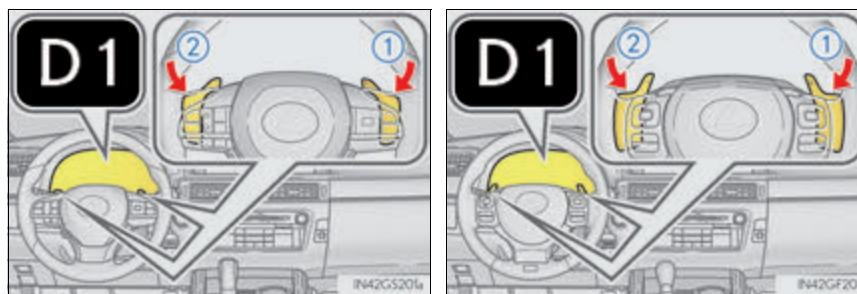

① Upshifting

② Downshifting

6-speed models: The selected shift range, from D1 to D6, will be displayed in the meter.

8-speed models: The selected shift range, from D1 to D8, will be displayed in the meter.

To return to normal D position driving, the “+” paddle shift switch must be held down for a period of time.

■ Shift ranges and their functions

Meter display		Function
6-speed models	8-speed models	
D2 - D6	D2 - D8	A gear in the range between 1 and the selected gear is automatically chosen depending on vehicle speed and driving conditions
D1		Setting the gear at 1

A lower shift range will provide greater engine braking forces than a higher shift range.

Selecting gears in the M position

To enter M mode, shift the shift lever to M. Gears can then be selected by operating the shift lever or paddle shift switches, allowing you to drive in the gear of your choosing.

▶ GS350/GS200t

▶ GS F

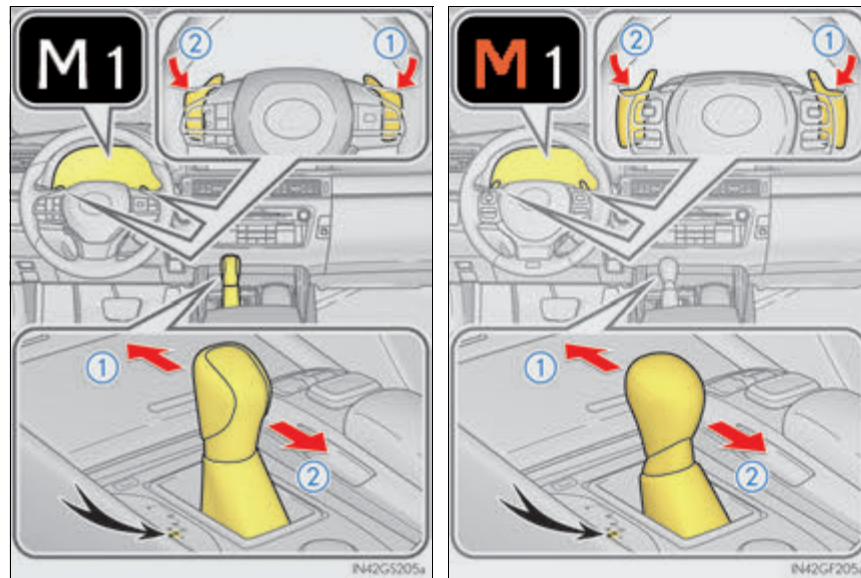

- ① Upshifting
- ② Downshifting

The gear changes once every time the shift lever or paddle shift switch is operated.

6-speed models: The selected gear, from M1 to M6, will be fixed and displayed in the meter.

8-speed models: The selected gear, from M1 to M8, will be fixed and displayed in the meter.

When in the M position, the gear will not change unless the shift lever or paddle shift switches are operated.

However, even when in the M position, the gears will be automatically changed in the following situation:

- When vehicle speed drops (downshift only).
- When the automatic transmission fluid or engine coolant temperature is low.
- GS350/GS200t: When automatic transmission fluid temperature is high.
- GS350/GS200t: When the needle of the tachometer is in the red zone (the range which exceeds the allowable revs of the engine).

In the following situations, the gear will not shift even if the shift lever or paddle shift switches are operated.

- “Slippery Road. Cannot Shift to Lower Gear.” is displayed on the multi-information display.
- The vehicle speed is low (upshift only).

■ Automatic deactivation of shift range selection in the D position

Shift range selection in the D position will be deactivated in the following situations:

- When the vehicle comes to a stop
- If the accelerator pedal is depressed for more than a certain period of time
- When the shift lever is shifted to other than D

■ To protect automatic transmission

When the temperature of the transmission fluid becomes high, protection control is performed temporarily. When “Transmission Fluid Temp High See Owner’s Manual” is displayed on the multi-information display, have the vehicle inspected by your Lexus dealer.

■ Downshifting restrictions warning buzzer

To help ensure safety and driving performance, downshifting operation may sometimes be restricted. In some circumstances, downshifting may not be possible even when the shift lever or paddle shift switch is operated. (A buzzer will sound twice.)

■ Snow mode automatic deactivation

Snow mode is automatically deactivated if the engine switch is turned off after driving in snow mode.

■ When driving with cruise control, dynamic radar cruise control or dynamic radar cruise control with full-speed range activated

Even when performing the following actions with the intent of enabling engine braking, engine braking will not activate because cruise control, dynamic radar cruise control or dynamic radar cruise control with full-speed range will not be canceled.

- 6-speed models: While driving in the D position, downshifting to 5 or 4. (→P. 266, 278, 290)
 - 8-speed models: While driving in the D position, downshifting to 7, 6, 5 or 4. (→P. 266, 278, 290)
 - When switching the driving mode to sport mode while driving in D position. (→P. 293)
- ### ■ Restraining sudden start (Drive-Start Control)
- When the following unusual operation is performed, the engine output may be restrained.
 - When the shift lever is shifted from R to D, D to R, N to R, P to D, or P to R (D includes M) with the accelerator pedal depressed, a warning message appears on the multi-information display. (→P. 459)
 - When the accelerator pedal is depressed too much while the vehicle is in reverse.

■ If the shift lever cannot be shifted from P

→P. 517

■ AI-SHIFT

- The AI-SHIFT automatically selects the suitable gear according to driver performance and driving conditions.

The AI-SHIFT automatically operates when the shift lever is in D. (Shifting the shift lever to the M position cancels the function.)

- 8-speed models: G AI-SHIFT automatically selects a suitable gear for sporty driving according to driver’s input and driving conditions. G AI-SHIFT operates automatically when the shift lever is in D and sport mode is selected for the driving mode. (Selecting normal mode with the driving mode select switch or shifting the shift lever to the M position cancels this function.)

 **WARNING**

■ **When driving on slippery road surfaces**

Be careful of downshifting and sudden acceleration, as this could result in the vehicle skidding to the side or spinning.

Turn signal lever

Operating instructions

The lever will return to its original position immediately after operation.

- ① Right turn
- ② Lane change to the right (move the lever partway and release it)
The right hand signals will flash 3 times.
- ③ Lane change to the left (move the lever partway and release it)
The left hand signals will flash 3 times.
- ④ Left turn



- **If the turn signals do not stop flashing after turning left or right, or if you want to stop them flashing**

Operate the lever in the opposite direction to either position ② or ③. If you move the lever to either position ① or ④, the selected turn signals will flash.

- **Turn signals can be operated when**

The engine switch is in IGNITION ON mode.

- **If the indicator flashes faster than usual**

Check that a light bulb in the front or rear turn signal lights has not burned out.

- **If the turn signals stop flashing before a lane change has been performed**

Operate the lever again.

Parking brake

A selections can be made as desired from the following modes.

Manual mode

- ① Sets the parking brake

The parking brake indicator light will come on. (→P. 211)

Press and hold the parking brake switch if an emergency occurs and it is necessary to operate the parking brake while driving.
- ② Releases the parking brake

Operate the parking brake switch while depressing the brake pedal. Make sure that the parking brake indicator light goes off.

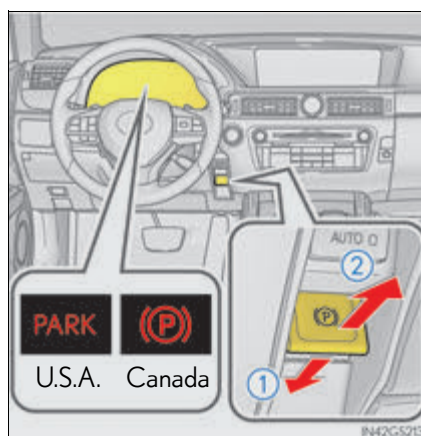

Automatic mode

The parking brake is set or released automatically according to shift lever operation.

Turns automatic mode on/off

- When the shift lever is moved out of P, the parking brake will be released.
- When the shift lever is moved into P, the parking brake will be set.

Operate the shift lever with the brake pedal depressed.



■ Parking brake operation

- When the engine switch is not in IGNITION ON mode, the parking brake cannot be released using the parking brake switch.
- When the engine switch is not in IGNITION ON mode, automatic mode (automatic brake setting and releasing) is not available.
- If the parking brake is operated repeatedly over a short period of time, the system may restrict operation to prevent overheating. If this happens, refrain from operating the parking brake. Normal operation will return after about 1 minute.
- In situations such as when parking on a steep slope*, the maximum amount of braking force can be used by pressing the parking brake switch with the parking brake already set.

*: Use wheel chocks when parking on a steep slope.

■ Parking brake operation sound

When the parking brake operates, a motor sound (whirring sound) may be heard. This does not indicate a malfunction.

■ Parking brake indicator light

- Depending on the engine switch mode, the parking brake indicator light will come on and stay on as described below:
IGNITION ON mode: Comes on until the parking brake is released.
Not in IGNITION ON mode: Stays on for approximately 15 seconds.
- When the engine switch is turned off with the parking brake set, the parking brake indicator light will stay on for about 15 seconds. This does not indicate a malfunction.

■ When there is a malfunction in the system

Warning lights and/or warning message will turn on or flash. (→P. 454, 460)
Depending on the condition, the parking brake indicator light may flash.

■ Parking brake engaged warning buzzer

→P. 463

■ Usage in winter time

→P. 317

 **NOTICE**
■ When parking the vehicle

Before you leave the vehicle, set the parking brake, shift the shift lever to P and make sure that the vehicle does not move.

■ When the system malfunctions

Stop the vehicle in a safe place and check the warning messages.

■ When the parking brake cannot be released due to a malfunction

Use the parking brake release tool to manually release the parking brake. (→P. 518)
Driving the vehicle with the parking brake set will lead to brake components overheating, which may affect braking performance and increase brake wear.

Brake Hold (GS350/GS200t)

The brake hold system keeps the brake applied when the shift lever is in D, M or N with the system on and the brake pedal has been depressed to stop the vehicle. The system releases the brake when the accelerator pedal is depressed with the shift lever in D or M to allow smooth start off.

Turns the brake hold system on

The brake hold standby indicator (green) comes on. While the system is holding the brake, the brake hold operated indicator (yellow) comes on.



■ Brake hold system operating conditions

The brake hold system cannot be turned on in the following conditions:

- The driver's door is not closed.
- The driver is not wearing the seat belt.
- "EPB Activation Stopped Incompletely" or "Electronic Parking Brake Malfunction Visit Your Dealer" is displayed on the multi-information display.

If any of the conditions above are detected when the brake hold system is enabled, the system will turn off and the brake hold standby indicator light will go off. In addition, if any of the conditions are detected while the system is holding the brake, a warning buzzer will sound and a message will be shown on the multi-information display. The parking brake will then be set automatically.

■ Brake hold function

- If the brake pedal is left released for a period of about 3 minutes after the system has started holding the brake, the parking brake will be set automatically. In this case, a warning buzzer sounds and a message is shown on the multi-information display.
- To turn the system off while the system is holding the brake, firmly depress the brake pedal and press the button again.
- The brake hold function may not hold the vehicle when the vehicle is on a steep incline. In this situation, it may be necessary for the driver to apply the brakes. A warning buzzer will sound and the multi-information display will inform the driver of this situation. (→P. 459)

■ **When the parking brake is set automatically while the system is holding the brakes**

The parking brake will not be released automatically. Perform one of the following procedures to release the parking brake and confirm that the parking brake indicator light turns off. (→P. 210)

- With the brake pedal depressed, operate the parking brake switch.
- Fasten your seat belt, check that the shift lever is in either D or R and slowly depress the accelerator pedal.

■ **Warning message and buzzers**

Warning messages and buzzers are used to indicate a system malfunction or to inform the driver of the need for caution. (→P. 459)

 **WARNING**

■ **When the vehicle is on a steep incline**

When using the brake hold system on a steep incline exercise caution. The brake hold function may not hold the vehicle in such a situation.

■ **When stopped on a slippery road**

The system cannot stop the vehicle when the gripping ability of the tires has been exceeded. Do not use the system when stopped on a slippery road.

 **NOTICE**

■ **When parking the vehicle**

The brake hold system is not designed for use when parking the vehicle for a long period of time. Turning the engine switch off while the system is holding the brake may release the brake, which would cause the vehicle to move. When operating the engine switch, depress the brake pedal, set the parking brake and shift the shift lever to P.

ASC (Active Sound Control) (GS F)

The ASC system directs certain sounds from the front and rear of the cabin to the vehicle interior, and harmonizes these sounds with the actual sound of the engine and exhaust in order to allow the driver to feel acceleration and the state of the engine more strongly.

The ASC system can be operated when the driving mode select switch is in sport mode. (→P. 296)

SPORT S mode: Sounds are output from the rear.

SPORT S+ mode: Sounds are output from the front and rear.

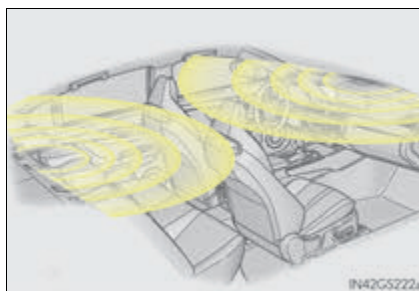

Disabling the ASC system

Press the ASC switch.

The indicator on switch will turn off.
Press the switch again to turn the system back on.

Even if the indicator is illuminated, when the driving mode select switch is in Normal or Eco drive mode, ASC does not operate.

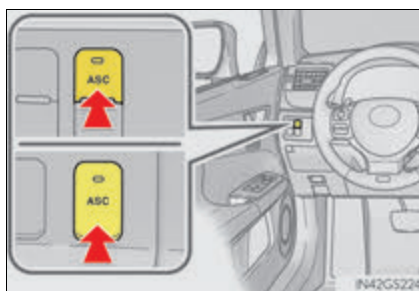

■ Automatic reactivation of ASC system



Even after the ASC system has been turned off, turning the engine off and then on again will automatically reactivate the ASC system.

Headlight switch

The headlights can be operated manually or automatically.

Operating instructions

Turning the end of the lever turns on the lights as follows:

- ①  The side marker, parking, tail, license plate and instrument panel lights turn on.
- ②  The headlights and all lights listed above turn on.
- ③ **AUTO** The headlights, daytime running lights (→P. 216) and all the lights listed above turn on and off automatically. (When the engine switch is in IGNITION ON mode.)
- ④ **DRL OFF** Off
(U.S.A.)
 - The daytime running lights (Canada) turn on. (→P. 216)

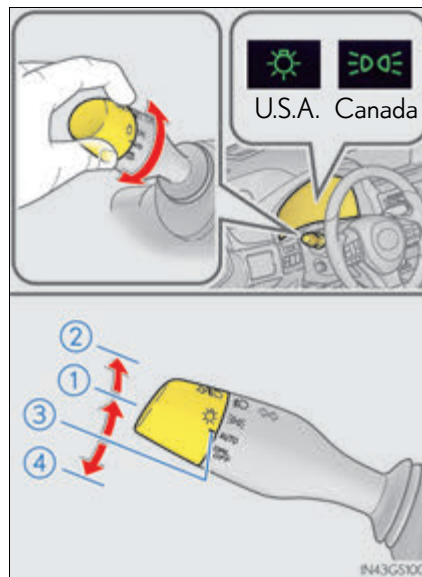

4

Driving

Turning on the high beam headlights

- ① With the headlights on, push the lever away from you to turn on the high beams.
Pull the lever toward you to the center position to turn the high beams off.
- ② Pull the lever toward you and release it to flash the high beams once.
You can flash the high beams with the headlights on or off.

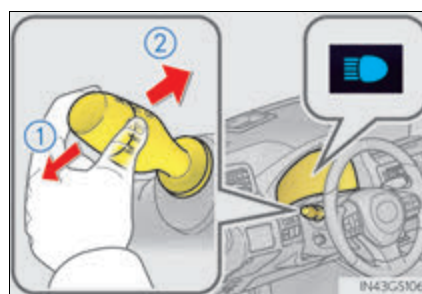

AFS (Adaptive Front-lighting System) (if equipped)

AFS (Adaptive Front-lighting System) secures excellent visibility at intersections and on curves by automatically adjusting the direction of the light axis of the headlights according to vehicle speed and the degree of the tire's angle as controlled by steering input.

AFS operates at speeds of 6 mph (10 km/h) or higher.

■ Deactivating AFS

Settings can be changed from  on the multi-information display (→P.100).

1 Press  or  on the meter control switch and select "AFS".

2 Press  on the meter control switch and select "Off".

The indicator turns on when the AFS is deactivated.



■ Daytime running light system

● To make your vehicle more visible to other drivers during daytime driving, the daytime running lights turn on automatically whenever the engine is started and the parking brake is released with the headlight switch in the  or "AUTO" position. (Illuminate brighter than the parking lights.) Daytime running lights are not designed for use at night.

For the U.S.A.: Daytime running lights can be turned off by operating the switch.

● Compared to turning on the headlights, the daytime running light system offers greater durability and consumes less electricity, so it can help improve fuel economy.

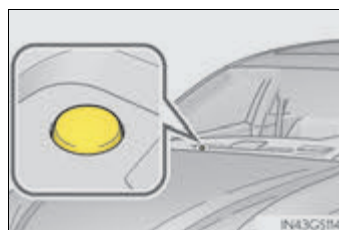

■ Headlight control sensor

The sensor may not function properly if an object is placed on the sensor, or anything that blocks the sensor is affixed to the windshield. Doing so interferes with the sensor detecting the level of ambient light and may cause the automatic headlight system to malfunction.



■ **Automatic light off system**

- When the headlights are on: The headlights and tail lights turn off 30 seconds after the engine switch is turned off and a door is opened and all of the doors and trunk are closed. (The lights turn off immediately if  on the key is pressed twice after all the doors are closed.)
- When only the tail lights are on: The tail lights turn off automatically if the engine switch is turned off and the driver's door is opened.

To turn the lights on again, turn the engine switch to IGNITION ON mode, or turn the light switch off once and then back to  or .

If any of the doors or trunk lid is kept open, the lights automatically turn off after 20 minutes.

■ **Light reminder buzzer**

A buzzer sounds when the engine switch is turned off or turned to ACCESSORY mode and the driver's door is opened while the lights are turned on.

■ **Automatic headlight leveling system**

The level of the headlights is automatically adjusted according to the number of passengers and the loading condition of the vehicle to ensure that the headlights do not interfere with other road users.

■ **If the "AFS OFF" indicator flashes**

It may indicate a malfunction in the system. Contact your Lexus dealer.

■ **Customization**

Settings (e.g. light sensor sensitivity) can be changed.
(Customizable features: →P. 568)

 **NOTICE**

■ **To prevent battery discharge**

Do not leave the lights on longer than necessary when the engine is not running.

Automatic High Beam*

The Automatic High Beam uses an in-vehicle camera sensor to assess the brightness of streetlights, the lights of vehicles ahead, etc., and automatically turns the high beam on or off as necessary.

WARNING

■ Limitations of the Automatic High Beam

Do not rely on the Automatic High Beam. Always drive safely, taking care to observe your surroundings and turning the high beam on or off manually if necessary.

■ To prevent incorrect operation of the Automatic High Beam system

Do not overload the vehicle.

Activating the Automatic High Beam system

- 1 Push the lever away from you with the headlight switch in the AUTO or  position.

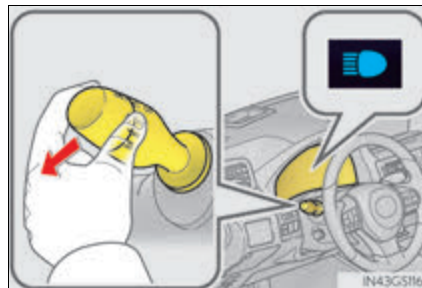

- 2 Press the Automatic High Beam switch.

The Automatic High Beam indicator will come on when the headlights are turned on automatically to indicate that the system is active.

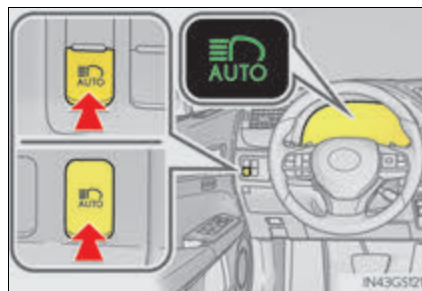

*: If equipped

Turning the high beam on/off manually

■ Switching to low beam

Pull the lever to the original position.

The Automatic High Beam indicator will turn off.

Push the lever away from you to activate the Automatic High Beam system again.

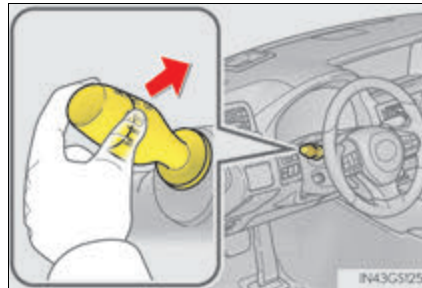

■ Switching to high beam

Press the Automatic High Beam switch.

The Automatic High Beam indicator will turn off and the high beam indicator will turn on.

Press the switch to activate the Automatic High Beam system again.

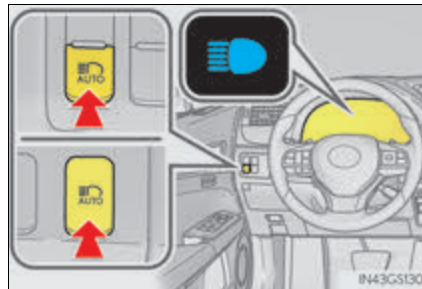

■ High beam automatic turning on or off conditions

- When all of the following conditions are fulfilled, the high beam will be automatically turned on:
 - Vehicle speed is above approximately 21 mph (34 km/h).
 - The area ahead of the vehicle is dark.
 - There are no vehicles ahead with headlights or tail lights turned on.
 - There are few streetlights on the road ahead.
- If any of the following conditions are fulfilled, high beam will be automatically turned off:
 - Vehicle speed drops below approximately 17 mph (27 km/h).
 - The area ahead of the vehicle is not dark.
 - Oncoming or preceding vehicles have headlights or tail lights turned on.
 - There are many streetlights on the road ahead.

■ Camera sensor detection information

- The high beam may not be automatically turned off in the following situations:
 - When oncoming vehicles suddenly appear from a curve
 - When the vehicle is cut in front of by another vehicle
 - When vehicles ahead are hidden from sight due to repeated curves, road dividers or roadside trees
 - When vehicles ahead appear from the faraway lane on wide road
 - When vehicles ahead have no lights
- The high beam may be turned off if a vehicle ahead that is using fog lights without using the headlights is detected.
- House lights, street lights, traffic signals, and illuminated billboards or signs may cause the high beam to switch to the low beams, or the low beams to remain on.
- The following factors may affect the amount of time taken to turn the high beam on or off:
 - The brightness of headlights, fog lights, and tail lights of vehicles ahead
 - The movement and direction of vehicles ahead
 - When vehicle ahead only has operational lights on one side
 - When vehicle ahead is a two-wheeled vehicle
 - The condition of the road (gradient, curve, condition of the road surface etc.)
 - The number of passengers and amount of luggage
- The high beam may be turned on or off when the driver does not expect it.
- Bicycles or similar objects may not be detected.
- In the situations shown below, the system may not be able to accurately detect surrounding brightness levels. This may cause the low beams to remain on or the high beams to cause problems for pedestrians, vehicles ahead or other parties. In these cases, manually switch between the high and low beams.
 - In bad weather (rain, snow, fog, sandstorms etc.)
 - The windshield is obscured by fog, mist, ice, dirt etc.
 - The windshield is cracked or damaged.
 - The camera sensor is deformed or dirty.
 - The camera sensor temperature is extremely high.
 - Surrounding brightness levels are equal to those of headlights, tail lights or fog lights.
 - Vehicles ahead have headlights that are either switched off, dirty, are changing color, or have are not aimed properly.
 - When driving through an area of intermittently changing brightness and darkness.
 - When frequently and repeatedly driving ascending/descending roads, or roads with rough, bumpy or uneven surfaces (such as stone-paved roads, gravel tracks etc.).
 - When frequently and repeatedly taking curves or driving on a winding road.
 - There is a highly reflective object ahead of the vehicle, such as a sign or a mirror.
 - The back of a vehicle ahead is highly reflective, such as a container on a truck.
 - The vehicle's headlights are damaged or dirty, or are not aimed properly.
 - The vehicle is listing or tilting, due to a flat tire, a trailer being towed etc.
 - The high beam and low beam are repeatedly being switched between in an abnormal manner.
 - The driver believes that the high beam may be causing problems or distress to other drivers or pedestrians nearby.

■ Temporarily lowering sensor sensitivity

The sensitivity of the sensor can be temporarily lowered.

- 1 Turn the engine switch off while the following conditions are met.
 - The headlight switch is in AUTO or .
 - The headlight switch lever is in high beam position.
 - Automatic High Beam switch is on.
- 2 Turn the engine switch to IGNITION ON mode.
- 3 Within 30 seconds after 2, repeat pulling the headlight switch lever to the original position then pushing it to the high beam position quickly 10 times, then leave the lever in high beam position.
- 4 If the sensitivity is changed, the Automatic High Beam indicator is turn on and off 3 times.

Automatic High Beam (headlights) may turn on even the vehicle is stopped.

■ Warning message

Warning messages are used to indicate a system malfunction or to inform the driver of the need for caution. (→P. 459)

Windshield wipers and washer

Operating the wiper lever

Operate the lever as follows to operate the wipers. The lever will return to its original position immediately after operation.

► Intermittent windshield wipers with interval adjuster

- ① OFF (U.S.A.) or OFF (Canada)
Move the lever up 2 levels
- ② Move the lever up 1 level
- ③ (U.S.A.) or (Canada)
Move the lever down 1 level
- ④ HI (U.S.A.) or HI (Canada)
Move the lever down 2 levels

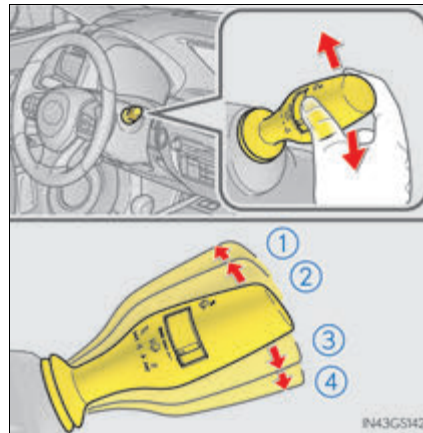

Operation Status before operation	OFF or OFF			
Off	Temporary operation	Temporary operation	Intermittent operation	High speed operation
Intermittent operation	Off	Off	Low speed operation	High speed operation
Low speed operation	Off	Intermittent operation	High speed operation	High speed operation
High speed operation	Off	Low speed operation	No change	No change

Wiper intervals can be adjusted when intermittent operation is selected.

- ⑤ Increases the intermittent windshield wiper frequency
- ⑥ Decreases the intermittent windshield wiper frequency

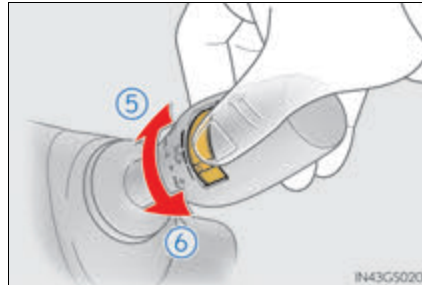

- ⑦ Washer/wiper dual operation
Wipers will automatically operate a couple of times after the washer squirts.
Vehicles with headlight cleaners:
When the headlights are on and the lever is pulled and held, the headlight cleaners will operate once. After this, the headlight cleaners will operate every 5th time the lever is pulled.

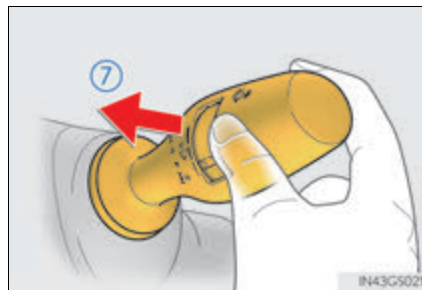

► Rain-sensing windshield wipers



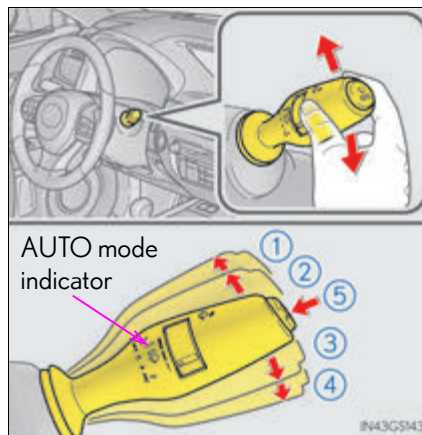

- ① OFF (U.S.A.) or (Canada)
Move the lever up 2 levels
- ② Move the lever up 1 level
- ③ (U.S.A.) or (Canada)
Move the lever down 1 level
- ④ HI (U.S.A.) or (Canada)
Move the lever down 2 levels
- ⑤ AUTO AUTO mode on/off switch



224 4-3. Operating the lights and wipers

With AUTO mode selected, the wipers will operate automatically when the sensor detects falling rain. The system automatically adjusts wiper timing in accordance with rain volume and vehicle speed.

AUTO mode indicator will turn on when AUTO mode is selected.

Operation		OFF or 		 or 	HI or 
Off		Temporary operation	Temporary operation	Low speed operation	High speed operation
Low speed operation		Off	Off	High speed operation	High speed operation
High speed operation		Off	Low speed operation	No change	No change
AUTO mode	Intermittent operation	Off	Temporary operation*1	Low speed operation*2	High speed operation*2
	Continuously		No change		

*1: After temporary operation, the mode will return to AUTO mode.

*2: AUTO mode will be canceled.

When AUTO mode is selected, the sensor sensitivity can be adjusted by turning the switch ring.

- ⑥ Increases the sensitivity
- ⑦ Decreases the sensitivity

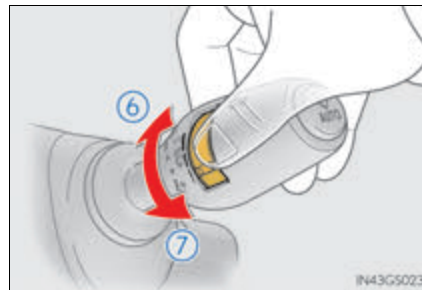

- ⑧ Washer/wiper dual operation

Wipers will automatically operate a couple of times after the washer squirts.

Vehicles with headlight cleaners:

When the headlights are on and the lever is pulled and held, the headlight cleaners will operate once. After this, the headlight cleaners will operate every 5th time the lever is pulled.

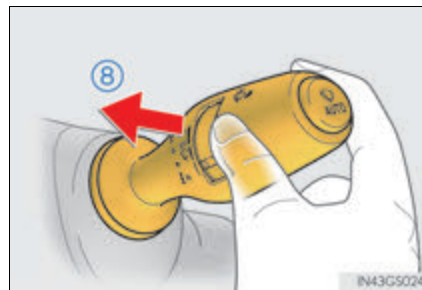

Switching between the intermittent windshield wipers and rain-sensing windshield wipers (vehicles with rain-sensing windshield wipers)

The wipers can be used as intermittent windshield wipers, which operate regardless of vehicle speed or amount of raindrops. The intermittent windshield wiper operation can be switched when the vehicle is stopped and the wiper is off. The wiper operation cannot be switched during AUTO mode or while the intermittent windshield wipers are operating.

Press and hold  until the AUTO mode indicator stops flashing.

If  is pressed and held until the AUTO mode indicator stops flashing again, it will return to its previous state.

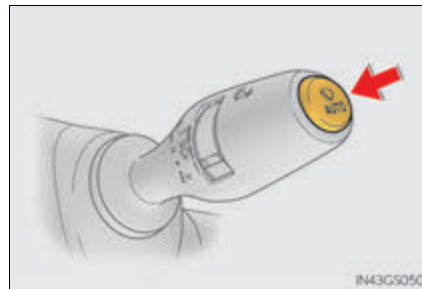

4

Driving

■ The windshield wiper and washer can be operated when

The engine switch is in IGNITION ON mode.

■ Dripping prevention wiper sweep

After washing and wiping operation several times, the wipers operate one more time after a short delay to prevent dripping.

However, the last sweep will not happen while the vehicle is moving.

■ Effects of vehicle speed on wiper operation

- Intermittent windshield wipers interval changes when the vehicle is stopped.
- With low speed operation selected, wiper operation will be switched from low speed to intermittent operation only when the vehicle is stationary.

■ Raindrop sensor

- The raindrop sensor judges the amount of raindrops.

An optical sensor is adopted. It may not operate properly when sunlight from the rising or setting of the sun intermittently strikes the windshield, or if bugs etc. are present on the windshield.

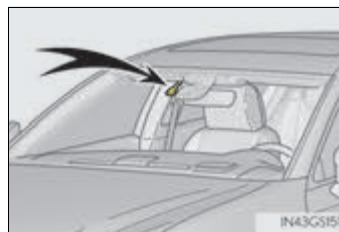

- If AUTO mode is selected while the engine switch is in IGNITION ON mode, the wipers will operate once to show that AUTO mode is activated.
- If the temperature of the raindrop sensor is 185°F (85°C) or higher, or -22°F (-30°C) or lower, automatic operation may not occur. In this case, operate the wipers in any mode other than AUTO mode.

■ **When the windshield wipers are in temporary operation**

AUTO mode cannot be activated even if  is pressed.

■ **If no windshield washer fluid sprays**

Check that the washer nozzles are not blocked if there is washer fluid in the windshield washer fluid reservoir.

 **WARNING**

■ **Caution regarding the use of windshield wipers in AUTO mode**

The windshield wipers may operate unexpectedly if the sensor is touched or the windshield is subject to vibration in AUTO mode. Take care that your fingers or anything else do not become caught in the windshield wipers.

■ **Caution regarding the use of washer fluid**

When it is cold, do not use the washer fluid until the windshield becomes warm. The fluid may freeze on the windshield and cause low visibility. This may lead to an accident, resulting in death or serious injury.

 **NOTICE**

■ **When the windshield is dry**

Do not use the wipers, as they may damage the windshield.

■ **When there is no washer fluid spray from the nozzle**

Damage to the washer fluid pump may be caused if the lever is pulled toward you and held continually.

■ **When a nozzle becomes blocked**

In this case, contact your Lexus dealer.

Do not try to clear it with a pin or other object. The nozzle will be damaged.

■ **When standing the windshield wipers up**

Raise the wipers in line with the windshield. (→P. 318)

Failure to do so may result in damage to the wipers and/or the hood.

Opening the fuel tank cap

Perform the following steps to open the fuel tank cap:

Before refueling the vehicle

- Turn the engine switch off and ensure that all the doors and windows are closed.
- Confirm the type of fuel.

■ Fuel types

→P. 555

■ Fuel tank opening for unleaded gasoline

To help prevent incorrect fueling, your vehicle has a fuel tank opening that only accommodates the special nozzle on unleaded fuel pumps.

WARNING

■ When refueling the vehicle

Observe the following precautions while refueling the vehicle. Failure to do so may result in death or serious injury.

- After exiting the vehicle and before opening the fuel door, touch an unpainted metal surface to discharge any static electricity. It is important to discharge static electricity before refueling because sparks resulting from static electricity can cause fuel vapors to ignite while refueling.
- Always hold the grips on the fuel tank cap and turn it slowly to remove it. A whooshing sound may be heard when the fuel tank cap is loosened. Wait until the sound cannot be heard before fully removing the cap. In hot weather, pressurized fuel may spray out the filler neck and cause injury.
- Do not allow anyone that has not discharged static electricity from their body to come close to an open fuel tank.
- Do not inhale vaporized fuel. Fuel contains substances that are harmful if inhaled.
- Do not smoke while refueling the vehicle. Doing so may cause the fuel to ignite and cause a fire.
- Do not return to the vehicle or touch any person or object that is statically charged. This may cause static electricity to build up, resulting in a possible ignition hazard.

■ When refueling

Observe the following precautions to prevent fuel overflowing from the fuel tank:

- Securely insert the fuel nozzle into the fuel filler neck.
- Stop filling the tank after the fuel nozzle automatically clicks off.
- Do not top off the fuel tank.

 NOTICE

■ Refueling

Do not spill fuel during refueling. Doing so may damage the vehicle, such as causing the emission control system to operate abnormally or damaging fuel system components or the vehicle's painted surface.

Opening the fuel tank cap

- 1 With the doors unlocked, press the center of the rear edge of the fuel filler door.

Push until you hear a click and take your hand away to slightly open the fuel filler door. Then open the door fully by hand.

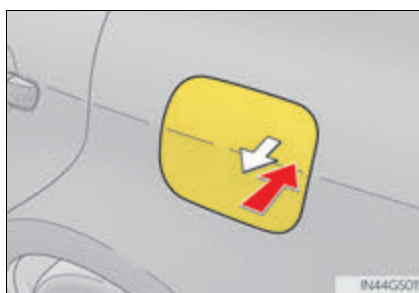

- 2 Turn the fuel tank cap slowly to remove it and put it into the holder on the fuel filler door.

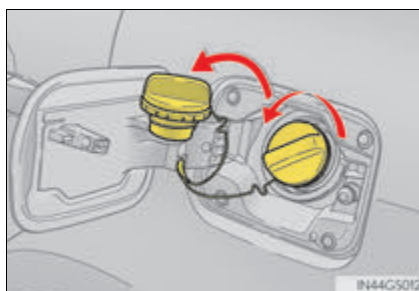

- When the fuel filler door cannot be opened by pressing the rearward of the fuel filler door

Remove the cover inside the trunk and pull the lever.

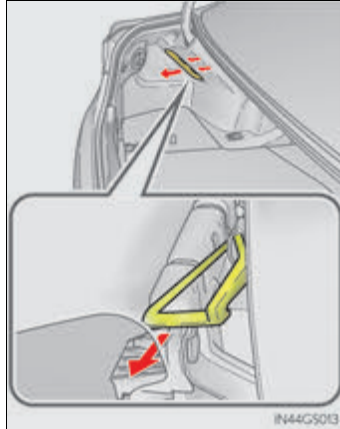

Closing the fuel tank cap

- 1 After refueling, turn the fuel tank cap until you hear a click. Once the cap is released, it will turn slightly in the opposite direction.

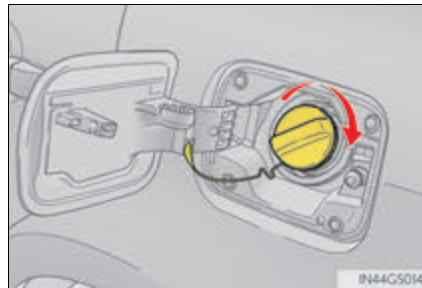

- 2 Close the fuel filler door, and press the center of the rear edge of the fuel filler door until you hear a click. When you lock the doors, the fuel filler door will lock also.

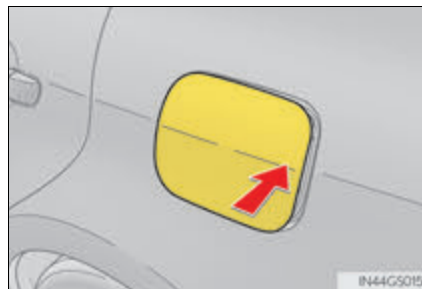

■ **Fuel filler door lock condition**

The fuel filler door may not be locked even when the vehicle's doors are locked in the following conditions:

- When operating the door lock button inside the vehicle
- When the automatic door locking system is operated (→P. 140)
- When the fuel filler door is closed after the vehicle's doors are locked

 **WARNING**

■ **When replacing the fuel tank cap**

Do not use anything but a genuine Lexus fuel tank cap designed for your vehicle. Doing so may cause a fire or other incident which may result in death or serious injury.

Lexus Safety System+*

The Lexus Safety System+ consists of the following drive assist systems and contributes to a safe and comfortable driving experience:

◆ PCS (Pre-Collision System)

→P. 237

◆ LKA (Lane-Keeping Assist)*

→P. 249

◆ LDA (Lane Departure Alert with steering control)*

→P. 258

◆ Automatic High Beam*

→P. 218

◆ Dynamic radar cruise control with full-speed range*

→P. 266

◆ Dynamic radar cruise control*

→P. 278

4

Driving

WARNING

■ Lexus Safety System+

The Lexus Safety System+ is designed to operate under the assumption that the driver will drive safely, and is designed to help reduce the impact to the occupants and the vehicle in the case of a collision or assist the driver in normal driving conditions.

As there is a limit to the degree of recognition accuracy and control performance that this system can provide, do not overly rely on this system. The driver is always responsible for paying attention to the vehicle's surroundings and driving safely.

*: If equipped

Vehicle data recording

The pre-collision system is equipped with a sophisticated computer that will record certain data, such as:

- Accelerator status
- Brake status
- Vehicle speed
- Operation status of the pre-collision system functions
- Information (such as the distance and relative speed between your vehicle and the vehicle ahead or other objects)
- Images from the camera sensor (available only when the pre-collision braking function was operating)

The pre-collision system does not record conversations or other sounds and does not record images of the inside of the vehicle.

● Data usage

Lexus may use the data recorded in this computer to diagnose malfunctions, conduct research and development, and improve quality.

Lexus will not disclose the recorded data to a third party except:

- With the consent of the vehicle owner or with the consent of the lessee if the vehicle is leased
- In response to an official request by the police, a court of law or a government agency
- For use by Lexus in a lawsuit
- For research purposes where the data is not tied to a specific vehicle or vehicle owner

● Recorded images can be erased using a specialized device.

The image information recording function can be disabled. However, if the function is disabled, data from when the pre-collision system operates will not be available.

Sensors

Two types of sensors, located behind the front grille and windshield, detect information necessary to operate the drive assist systems.

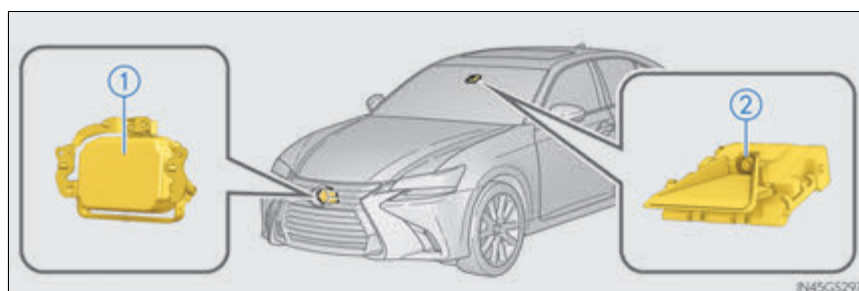

① Radar sensor

② Camera sensor

⚠ WARNING

■ To avoid malfunction of the radar sensor

Observe the following precautions.

Otherwise, the radar sensor may not operate properly, possibly leading to an accident resulting in death or serious injury.

- Keep the radar sensor and front grille emblem clean at all times.

- ① Radar sensor
- ② Front grille emblem

If the front of the radar sensor or the front or back of the front grille emblem is dirty or covered with water droplets, snow, etc., clean it.

Clean the radar sensor and front grille emblem with a soft cloth so you do not mark or damage them.

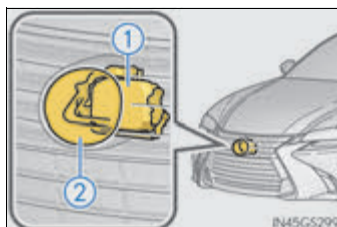

- Do not attach accessories, stickers (including transparent stickers), or other items to the radar sensor, front grille emblem or surrounding area.
- Do not subject the radar sensor or surrounding area to a strong impact.
If the radar sensor, front grille, or front bumper has been subjected to a strong impact, have the vehicle inspected by your Lexus dealer.
- Do not disassemble the radar sensor.
- Do not modify or paint the radar sensor, front grille emblem or surrounding area.
- If the radar sensor, front grille, or front bumper needs to be removed and installed, or replaced, contact your Lexus dealer.

⚠ WARNING

■ **To avoid malfunction of the camera sensor**
 Observe the following precautions.
 Otherwise, the camera sensor may not operate properly, possibly leading to an accident resulting in death or serious injury.

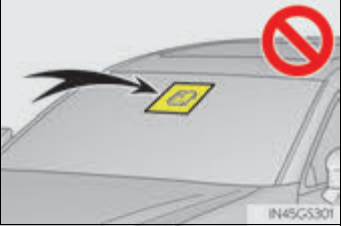
- Keep the windshield clean at all times.
 - If the windshield is dirty or covered with an oily film, water droplets, snow, etc., clear the windshield.
 - If a glass coating agent is applied to the windshield, it will still be necessary to use the windshield wipers to remove water droplets from the area of the windshield in front of the camera sensor.
 - If the inner side of the windshield where the camera sensor is installed is dirty, contact your Lexus dealer.
- Do not install an antenna or attach stickers (including transparent stickers) or other items to the area of the windshield in front of the camera sensor (shaded area in the illustration).
 
- If the part of the windshield in front of the camera sensor is fogged up or covered with condensation or ice, use the windshield defogger to remove the fog, condensation or ice. (→P. 334)
- If water droplets cannot be properly removed from the area of the windshield in front of the camera sensor by the windshield wipers, replace the wiper insert or wiper blade.
 If the wiper inserts or wiper blades need to be replaced, contact your Lexus dealer.
- Do not attach window tinting to the windshield.
- Replace the windshield if it is damaged or cracked.
 If the windshield needs to be replaced, contact your Lexus dealer.
- Do not get the camera sensor wet.
- Do not allow bright lights to shine into the camera sensor.
- Do not dirty or damage the camera sensor.
 When cleaning the inside of the windshield, do not allow glass cleaner to contact the lens. Also, do not touch the lens.
 If the lens is dirty or damaged, contact your Lexus dealer.
- Do not subject the camera sensor to a strong impact.
- Do not change the installation position or direction of the camera sensor or remove it.
- Do not disassemble the camera sensor.

⚠ WARNING

- Do not install an electronic device or device that emits strong electric waves near the camera sensor.
- Do not modify any components of the vehicle around the camera sensor (inside rear view mirror, etc.) or ceiling.
- Do not attach any accessories that may obstruct the camera sensor to the hood, front grille or front bumper. Contact your Lexus dealer for details.
- If a surfboard or other long object is to be mounted on the roof, make sure that it will not obstruct the camera sensor.
- Do not modify the headlights or other lights.

■ Certification

- ▶ For vehicles sold in the U.S.A., Hawaii, Guam, Puerto Rico and NATO Germany

FCC ID: HYQDNMWR008

NOTE:

This device complies with part 15 of the FCC Rules. Operation is subject to the following two conditions: (1) This device may not cause harmful interference, and (2) this device must accept any interference received, including interference that may cause undesired operation.

FCC WARNING:

Changes or modifications not expressly approved by the party responsible for compliance could void the user's authority to operate the equipment.

Radiofrequency radiation exposure Information:

This equipment complies with FCC radiation exposure limits set forth for an uncontrolled environment. This equipment should be installed and operated with minimum distance of 20 cm between the radiator (antenna) and your body. This transmitter must not be co-located or operating in conjunction with any other antenna or transmitter.

- For vehicles sold in Canada

NOTE:

This device complies with Industry Canada licence-exempt RSS standard(s). Operation is subject to the following two conditions: (1) this device may not cause interference, and (2) this device must accept any interference, including interference that may cause undesired operation of the device.

This equipment complies with IC radiation exposure limits set forth for an uncontrolled environment and meets RSS-102 of the IC radio frequency (RF) Exposure rules. This equipment should be installed and operated keeping the radiator at least 20 cm or more away from person's body.

NOTE:

Le présent appareil est conforme aux CNR d'Industrie Canada applicables aux appareils radio exempts de licence. L'exploitation est autorisée aux deux conditions suivantes : (1) l'appareil ne doit pas produire de brouillage, et (2) l'utilisateur de l'appareil doit accepter tout brouillage radioélectrique subi, même si le brouillage est susceptible d'en compromettre le fonctionnement.

Cet équipement est conforme aux limites d'exposition aux rayonnements énoncées pour un environnement non contrôlé et respecte les règles d'exposition aux fréquences radioélectriques (RF) CNR-102 de l'IC. Cet équipement doit être installé et utilisé en gardant une distance de 20 cm ou plus entre le dispositif rayonnant et le corps.

PCS (Pre-Collision System)*

The pre-collision system uses a radar sensor and camera sensor to detect vehicles and pedestrians*¹ in front of your vehicle. When the system determines that the possibility of a frontal collision with a vehicle or pedestrian is high, a warning operates to urge the driver to take evasive action and the potential brake pressure is increased to help the driver avoid the collision. If the system determines that the possibility of a frontal collision with a vehicle or pedestrian is extremely high, the brakes are automatically applied*² to help avoid the collision or help reduce the impact of the collision.

The pre-collision system can be disabled/enabled and the warning timing can be changed. (→P. 240)

*1: Depending on the region in which the vehicle was sold, the pedestrian detection function may not be available. Contact your Lexus dealer for details.

*2: Depending on the region in which the vehicle was sold, the pre-collision braking function (automatic braking function) may not be available. Contact your Lexus dealer for details.

◆ Pre-collision warning

When the system determines that the possibility of a frontal collision is high, a buzzer will sound and a warning message will be displayed on the multi-information display to urge the driver to take evasive action.

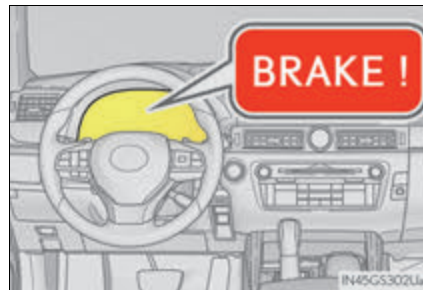

◆ Pre-collision brake assist

When the system determines that the possibility of a frontal collision is high, the system applies greater braking force in relation to how strongly the brake pedal is depressed.

4

Driving

*: If equipped

◆ Pre-collision braking*³

When the system determines that the possibility of a frontal collision is high, the system warns the driver. If the system determines that the possibility of a collision is extremely high, the brakes are automatically applied to help avoid the collision or reduce the collision speed.

*³: Depending on the region in which the vehicle was sold, the pre-collision braking function may not be available.

◆ Suspension control (if equipped)

When the system determines that the possibility of a frontal collision is high, the Adaptive Variable Suspension system (→P. 309) will control the damping force of the shock absorbers.

◆ Steering control (if equipped)

When the system determines that the possibility of a frontal collision is high and the driver is operating the steering wheel, the LDH system (→P. 309) will control the turning angle of the front and rear wheels and effort necessary to turn the steering wheel.

⚠ WARNING

■ Limitations of the pre-collision system

- The driver is solely responsible for safe driving. Always drive safely, taking care to observe your surroundings.
Do not use the pre-collision system instead of normal braking operations under any circumstances. This system will not prevent collisions or lessen collision damage or injury in every situation. Do not overly rely on this system. Failure to do so may lead to an accident, resulting in death or serious injury.
- Although this system is designed to help avoid a collision or help reduce the impact of the collision, its effectiveness may change according to various conditions, therefore the system may not always be able to achieve the same level of performance.
Read the following conditions carefully. Do not overly rely on this system and always drive carefully.
 - Conditions under which the system may operate even if there is no possibility of a collision: →P. 243
 - Conditions under which the system may not operate properly: →P. 246
- Do not attempt to test the operation of the pre-collision system yourself, as the system may not operate properly, possibly leading to an accident.

⚠ WARNING**■ Pre-collision braking *3**

- The pre-collision braking function may not operate if certain operations are performed by the driver. If the accelerator pedal is being depressed strongly or the steering wheel is being turned, the system may determine that the driver is taking evasive action and possibly prevent the pre-collision braking function from operating.
- In some situations, while the pre-collision braking function is operating, operation of the function may be canceled if the accelerator pedal is depressed strongly or the steering wheel is turned and the system determines that the driver is taking evasive action.
- A large amount of braking force is applied while the pre-collision braking function is operating. As the pre-collision braking function will be canceled after the vehicle has been stopped for approximately 2 seconds, the driver should depress the brake pedal as necessary.
- If the brake pedal is being depressed, the system may determine that the driver is taking evasive action and possibly delay the operation timing of the pre-collision braking function.

*3: Depending on the region in which the vehicle was sold, the pre-collision braking function may not be available.

■ When to disable the pre-collision system

In the following situations, disable the system, as it may not operate properly, possibly leading to an accident resulting in death or serious injury:

- When the vehicle is being towed
- When your vehicle is towing another vehicle
- When transporting the vehicle via truck, boat, train or similar means of transportation
- When the vehicle is raised on a lift with the engine running and the tires are allowed to rotate freely
- When inspecting the vehicle using a drum tester such as a chassis dynamometer or speedometer tester, or when using an on vehicle wheel balancer
- When a strong impact is applied to the front bumper or front grille, due to an accident or other reasons
- If the vehicle cannot be driven in a stable manner, such as when the vehicle has been in an accident or is malfunctioning
- When the vehicle is driven in a sporty manner or off-road
- When the tires are not properly inflated
- When the tires are very worn
- When tires of a size other than specified are installed
- When tire chains are installed
- GS350/GS200t: When a compact spare tire or an emergency tire puncture repair kit is used
- GS F: When a spare tire or an emergency tire puncture repair kit is used

4

Driving

Changing settings of the pre-collision system

■ Enabling/disabling the pre-collision system

The pre-collision system can be enabled/disabled on  (→P. 100, 108) of the multi-information display.

The system is automatically enabled each time the engine switch is turned to IGNITION ON mode.

If the system is disabled, the PCS warning light will turn on and a message will be displayed on the multi-information display.



■ Changing the pre-collision warning timing

The pre-collision warning timing can be changed on  (→P. 100, 108) of the multi-information display.

The operation timing setting is retained when the engine switch is turned off.

- ① Far
The warning will begin to operate earlier than with the default timing.
- ② Middle
This is the default setting.
- ③ Near
The warning will begin to operate later than with the default timing.

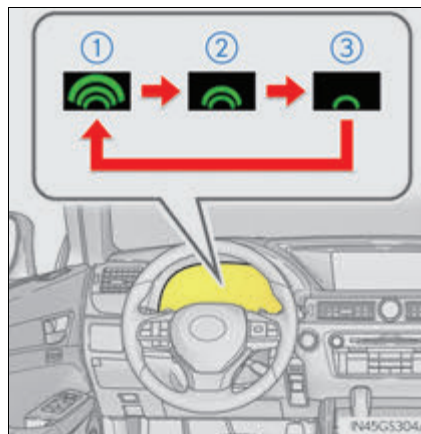

■ **Operational conditions**

Availability of the pedestrian detection function and pre-collision braking function depend on the region in which the vehicle was sold.

Regions	Function availability
Region A	The pedestrian detection function and pre-collision braking function are available
Region B	The pedestrian detection function is not available and the pre-collision braking function is available
Region C	The pedestrian detection function and pre-collision braking function are not available

Read the following for details:

► **Region A**

(The pedestrian detection function and pre-collision braking function are available)

The pre-collision system is enabled and the system determines that the possibility of a frontal collision with a vehicle or pedestrian is high.

Each function is operational at the following speeds:

- **Pre-collision warning:**
 - Vehicle speed is approximately 7 mph (10 km/h) or more. (For detecting a pedestrian, vehicle speed is between approximately 7 and 50 mph [10 and 80 km/h].)
 - The relative speed between your vehicle and the vehicle or pedestrian ahead is approximately 7 mph (10 km/h) or more.
- **Pre-collision brake assist:**
 - Vehicle speed is approximately 19 mph (30 km/h) or more. (For detecting a pedestrian, vehicle speed is between approximately 19 and 50 mph [30 and 80 km/h].)
 - The relative speed between your vehicle and the vehicle or pedestrian ahead is approximately 19 mph (30 km/h) or more.
- **Pre-collision braking:**
 - Vehicle speed is approximately 7 mph (10 km/h) or more. (For detecting a pedestrian, vehicle speed is between approximately 7 and 50 mph [10 and 80 km/h].)
 - The relative speed between your vehicle and the vehicle or pedestrian ahead is approximately 7 mph (10 km/h) or more.

The system may not operate in the following situations:

- If a battery terminal has been disconnected and reconnected and then the vehicle has not been driven for a certain amount of time
- If the shift lever is in R
- If VSC is disabled (only the pre-collision warning function will be operational)
- If the PCS warning light is flashing or illuminated



Driving

- ▶ Region B
(The pedestrian detection function is not available and the pre-collision braking function is available)

The pre-collision system is enabled and the system determines that the possibility of a frontal collision with a vehicle is high.

Each function is operational at the following speeds:

- Pre-collision warning:
 - Vehicle speed is approximately 10 mph (15 km/h) or more.
 - The relative speed between your vehicle and the vehicle or pedestrian ahead is approximately 7 mph (10 km/h) or more.
- Pre-collision brake assist:
 - Vehicle speed is approximately 19 mph (30 km/h) or more.
 - The relative speed between your vehicle and the vehicle or pedestrian ahead is approximately 19 mph (30 km/h) or more.
- Pre-collision braking:
 - Vehicle speed is approximately 10 mph (15 km/h) or more.
 - The relative speed between your vehicle and the vehicle or pedestrian ahead is approximately 7 mph (10 km/h) or more.

The system may not operate in the following situations:

- If a battery terminal has been disconnected and reconnected and then the vehicle has not been driven for a certain amount of time
- If the shift lever is in R
- If VSC is disabled (only the pre-collision warning function will be operational)
- If the PCS warning light is flashing or illuminated

- ▶ Region C
(The pedestrian detection function and pre-collision braking function are not available)

The pre-collision system is enabled and the system determines that the possibility of a frontal collision with a vehicle is high.

Each function is operational at the following speeds:

- Pre-collision warning:
 - Vehicle speed is approximately 10 mph (15 km/h) or more.
 - The relative speed between your vehicle and the vehicle or pedestrian ahead is approximately 7 mph (10 km/h) or more.
- Pre-collision brake assist:
 - Vehicle speed is approximately 19 mph (30 km/h) or more.
 - The relative speed between your vehicle and the vehicle or pedestrian ahead is approximately 19 mph (30 km/h) or more.

The system may not operate in the following situations:

- If a battery terminal has been disconnected and reconnected and then the vehicle has not been driven for a certain amount of time
- If the shift lever is in R
- If VSC is disabled (only the pre-collision warning function will be operational)
- If the PCS warning light is flashing or illuminated

■ Pedestrian detection function ^{*4}

The pre-collision system detects pedestrians based on the size, profile, and motion of a detected object. However, a pedestrian may not be detected depending on the surrounding brightness and the motion, posture, and angle of the detected object, preventing the system from operating properly. (→P. 247)



^{*4}: Depending on the region in which the vehicle was sold, the pedestrian detection function may not be available.

■ Cancellation of the pre-collision braking ^{*3}

- If either of the following occur while the pre-collision braking function is operating, it will be canceled:
 - The accelerator pedal is depressed strongly.
 - The steering wheel is turned sharply or abruptly.
- If the vehicle is stopped by the operation of the pre-collision braking function, the operation of the pre-collision braking function will be canceled after the vehicle has been stopped for approximately 2 seconds.

^{*3}: Depending on the region in which the vehicle was sold, the pre-collision braking function may not be available.

■ Conditions under which the system may operate even if there is no possibility of a collision

- In some situations such as the following, the system may determine that there is a possibility of a frontal collision and operate.
 - When passing a vehicle or pedestrian ^{*4}
 - When changing lanes while overtaking a preceding vehicle
 - When overtaking a preceding vehicle that is changing lanes
 - When overtaking a preceding vehicle that is making a left/right turn

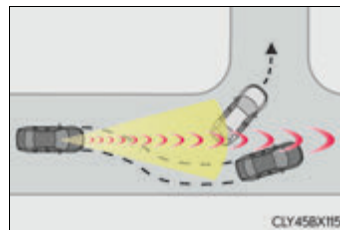

- When passing a vehicle in an oncoming lane that is stopped to make a right/left turn

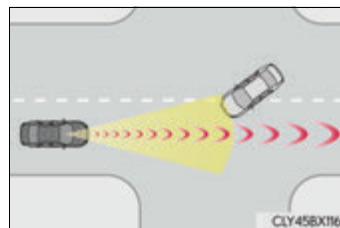

244 4-5. Using the driving support systems

- When driving on a road where relative location to vehicle ahead in an adjacent lane may change, such as on a winding road

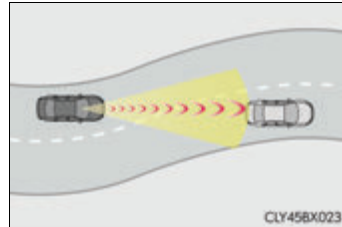

- When a preceding vehicle suddenly decelerates
- If the front of the vehicle is raised or lowered, such as when the road surface is uneven or undulating
- When approaching objects on the roadside, such as guardrails, utility poles, trees, or walls
- When there is a vehicle, pedestrian^{*4}, or object by the roadside at the entrance of a curve

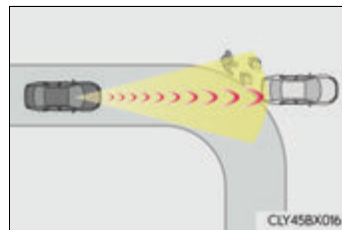

- When driving on a narrow path surrounded by a structure, such as in a tunnel or on an iron bridge
- When there is a metal object (manhole cover, steel plate, etc.), steps, or a protrusion on the road surface or roadside
- When a crossing pedestrian approaches very close to the vehicle^{*4}

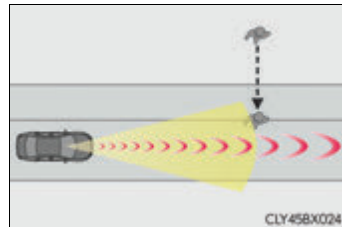

- When passing through a place with a low structure above the road (low ceiling, traffic sign, etc.)

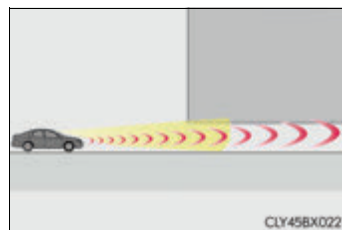

- When passing under an object (billboard, etc.) at the top of an uphill road

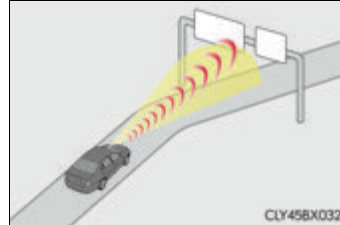

- When rapidly closing on an electric toll gate barrier, parking area barrier, or other barrier that opens and closes
- When using an automatic car wash
- When driving through or under objects that may contact the vehicle, such as thick grass, tree branches, or a banner

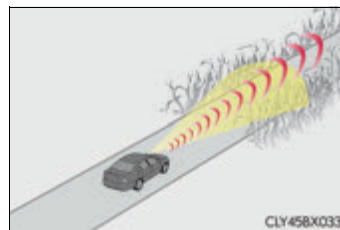

- When the vehicle is hit by water, snow, dust, etc. from a vehicle ahead
 - When driving through steam or smoke
 - When there are patterns or paint on the road or a wall that may be mistaken for a vehicle or pedestrian^{*4}
 - When driving near an object that reflects radio waves, such as a large truck or guardrail
 - When driving near a TV tower, broadcasting station, electric power plant, or other location where strong radio waves or electrical noise may be present
- ^{*4}: Depending on the region in which the vehicle was sold, the pedestrian detection function may not be available.

■ Situations in which the system may not operate properly

● In some situations such as the following, a vehicle may not be detected by the radar sensor and camera sensor, preventing the system from operating properly:

- If an oncoming vehicle is approaching your vehicle
- If a vehicle ahead is a motorcycle or bicycle
- When approaching the side or front of a vehicle
- If a preceding vehicle has a small rear end, such as an unloaded truck
- If a preceding vehicle has a low rear end, such as a low bed trailer

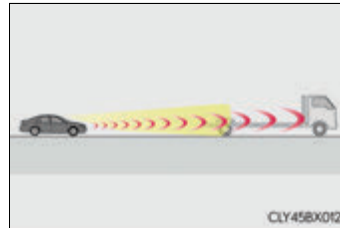

- If a vehicle ahead is carrying a load which protrudes past its rear bumper
- If a vehicle ahead has extremely high ground clearance

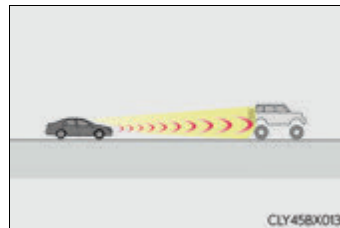

- If a vehicle ahead is irregularly shaped, such as a tractor or side car
- If the sun or other light is shining directly on a vehicle ahead
- If a vehicle cuts in front of your vehicle or emerges from beside a vehicle
- If a vehicle ahead makes an abrupt maneuver (such as sudden swerving, acceleration or deceleration)
- When suddenly cutting behind a preceding vehicle
- When a vehicle ahead is not directly in front of your vehicle

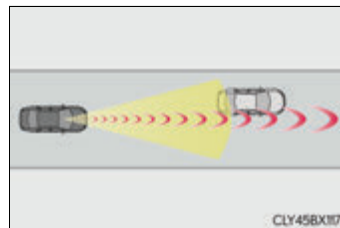

- When driving in inclement weather such as heavy rain, fog, snow or a sandstorm
- When the vehicle is hit by water, snow, dust, etc. from a vehicle ahead
- When driving through steam or smoke
- When driving in a place where the surrounding brightness changes suddenly, such as at the entrance or exit of a tunnel
- When a very bright light, such as the sun or the headlights of oncoming traffic, shines directly into the camera sensor
- When the surrounding area is dim, such as at dawn or dusk, or while at night or in a tunnel

- After the engine has started the vehicle has not been driven for a certain amount of time
 - While making a left/right turn and for a few seconds after making a left/right turn
 - While driving on a curve and for a few seconds after driving on a curve
 - If your vehicle is skidding
 - If the front of the vehicle is raised or lowered
 - If the wheels are misaligned
 - If a wiper blade is blocking the camera sensor
 - The vehicle is wobbling.
 - The vehicle is being driven at extremely high speeds.
 - When driving on a hill
 - If the radar sensor or camera sensor is misaligned
 - In some situations such as the following, sufficient braking force may not be obtained, preventing the system from performing properly:
 - If the braking functions cannot operate to their full extent, such as when the brake parts are extremely cold, extremely hot, or wet
 - If the vehicle is not properly maintained (brakes or tires are excessively worn, improper tire inflation pressure, etc.)
 - When the vehicle is being driven on a gravel road or other slippery surface
 - Some pedestrians such as the following may not be detected by the radar sensor and camera sensor, preventing the system from operating properly*4:
 - Pedestrians shorter than approximately 3.2 ft. (1 m) or taller than approximately 6.5 ft. (2 m)
 - Pedestrians wearing oversized clothing (a rain coat, long skirt, etc.), making their silhouette obscure
 - Pedestrians who are carrying large baggage, holding an umbrella, etc., hiding part of their body
 - Pedestrians who are bending forward or squatting
 - Pedestrians who are pushing a stroller, wheelchair, bicycle or other vehicle
 - Groups of pedestrians which are close together
 - Pedestrians who are wearing white and look extremely bright
 - Pedestrians in the dark, such as at night or while in a tunnel
 - Pedestrians whose clothing appears to be nearly the same color or brightness as their surroundings
 - Pedestrians near walls, fences, guardrails, or large objects
 - Pedestrians who are on a metal object (manhole cover, steel plate, etc.) on the road
 - Pedestrians who are walking fast
 - Pedestrians who are changing speed abruptly
 - Pedestrians running out from behind a vehicle or a large object
 - Pedestrians who are extremely close to the side of the vehicle (outside rear view mirror, etc.)
- *4: Depending on the region in which the vehicle was sold, the pedestrian detection function may not be available.

■ **If the PCS warning light flashes and a warning message is displayed on the multi-information display**

The pre-collision system may be temporarily unavailable or there may be a malfunction in the system.

● In the following situations, the warning light will turn off, the message will disappear and the system will become operational when normal operating conditions return:

- When the radar sensor or camera sensor or the area around either sensor is hot, such as in the sun
- When the radar sensor or camera sensor or the area around either sensor is cold, such as in an extremely cold environment
- When the radar sensor or front grille emblem is dirty or covered with snow, etc.
- If the camera sensor is obstructed, such as when the hood is open or a sticker is attached to the windshield near the camera sensor

● If the PCS warning light continues to flash or the warning message does not disappear, the system may be malfunctioning. Have the vehicle inspected by your Lexus dealer immediately.

■ **If VSC is disabled**

● If VSC is disabled (→P. 311), the pre-collision brake assist and pre-collision braking functions are also disabled.

● The PCS warning light will turn on and "VSC Turned Off Pre-Collision Brake System Unavailable" will be displayed on the multi-information display.

LKA (Lane-Keeping Assist)*

Summary of functions

When driving on highways and freeways with white or yellow lines, this function alerts the driver when the vehicle might depart from its lane and provides assistance by operating the steering wheel to keep the vehicle in its lane. Furthermore, the system also provides steering assistance when dynamic radar cruise control with full-speed range is operating to keep the vehicle in its lane.

The LKA system recognizes visible white or yellow lines with the camera sensor on the upper portion of the front windshield.



4

Driving

Functions included in LKA system

◆ Lane departure alert function

When the system determines that the vehicle might depart from its lane, a warning is displayed on the multi-information display, and either the warning buzzer sounds or the steering wheel vibrates to alert the driver.

When the warning buzzer sounds or the steering wheel vibrates, check the surrounding road situation and carefully operate the steering wheel to move the vehicle back to the center within the white (yellow) lines.

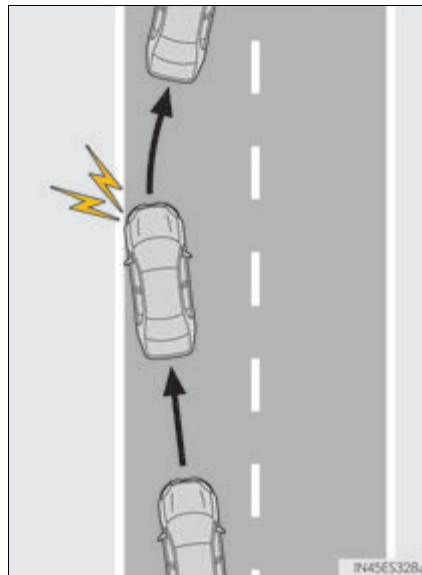

*: If equipped

◆ Lane departure control function

When the system determines that the vehicle might depart from its lane, the system provides assistance as necessary by operating the steering wheel in small amounts for a short period of time to keep the vehicle in its lane.

If the system detects that the steering wheel has not been operated for a fixed amount of time or the steering wheel is not being firmly gripped, a warning is displayed on the multi-information display and the warning buzzer sounds.

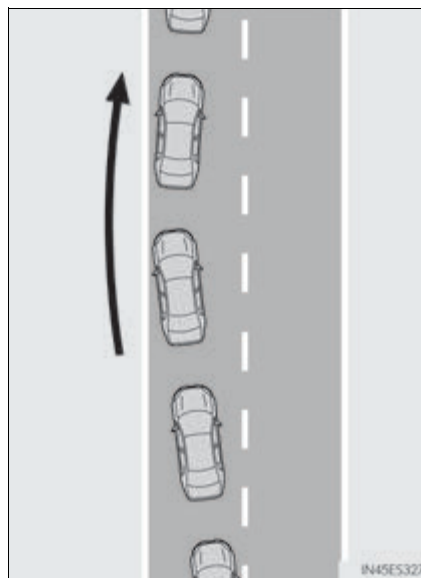

◆ Vehicle sway warning

When the vehicle is swaying or appears as if it may depart from its lane multiple times, the warning buzzer sounds and a message is displayed on the multi-information display to alert the driver.

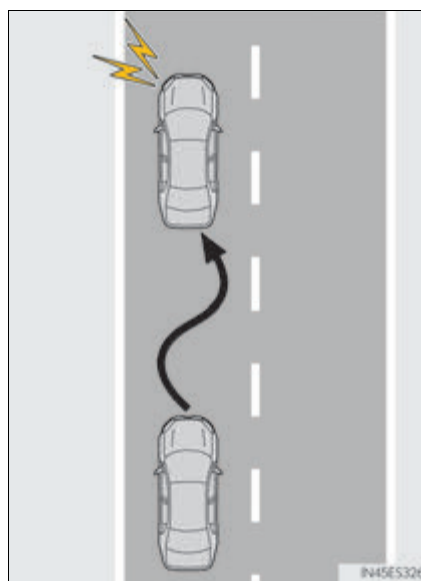

◆ Lane centering function

This function is linked with radar cruise control and provides the required assistance by operating the steering wheel to keep the vehicle in its current lane.

When radar cruise control is not operating, the lane centering function does not operate.

If the system detects that the steering wheel has not been operated for a fixed amount of time or the steering wheel is not being firmly gripped, a warning is displayed on the multi-information display and the warning buzzer sounds.

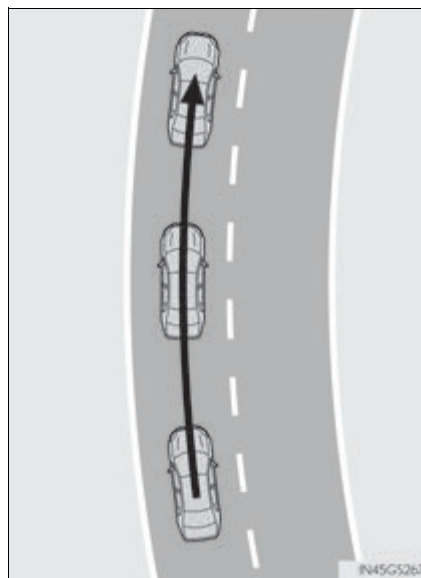

4

Driving

 **WARNING****■ Before using LKA system**

Do not rely solely upon the LKA system. LKA is not a system which automatically drives the vehicle or reduces the amount of attention that must be paid to the area in front of the vehicle. The driver must always assume full responsibility for driving safely by always paying careful attention to the surrounding conditions and operate the steering wheel to correct the path of the vehicle. Also, make sure to take adequate breaks when fatigued, such as from driving for a long period of time.

Failure to perform appropriate driving operations and pay careful attention may lead to an accident, resulting in death or serious injury.

■ To avoid operating LKA by mistake

When not using the LKA system, use the LKA switch to turn the system off.

■ Situations unsuitable for LKA

Do not use the LKA system in the following situations.

The system may not operate properly and lead to an accident, resulting in death or serious injury.

- A spare tire, tire chains, etc., are equipped.
- When the tires have been excessively worn, or when the tire inflation pressure is low.
- Tires which differ by structure, manufacturer, brand or tread pattern are used.
- Objects or patterns that could be mistaken for white (yellow) lines are present on the side of the road (guardrails, curbs, reflective poles, etc.).
- Vehicle is driven on a snow-covered road.
- White (yellow) lines are difficult to see due to rain, snow, fog, dust, etc.
- Asphalt repair marks, white (yellow) line marks, etc., are present due to road repair.
- Vehicle is driven in a temporary lane or restricted lane due to construction work.
- Vehicle is driven on a road surface which is slippery due to rainy weather, fallen snow, freezing, etc.
- Vehicle is driven in traffic lanes other than on highways and freeways.
- Vehicle is driven in a construction zone.
- Vehicle is towing a trailer or another vehicle.

■ Preventing LKA system malfunctions and operations performed by mistake

- Do not modify the headlights or place stickers, etc., on the surface of the lights.
- Do not modify the suspension etc. If the suspension etc. needs to be replaced, contact your Lexus dealer.
- Do not install or place anything on the hood or grille. Also, do not install a grille guard (bull bars, kangaroo bar, etc.).
- If your windshield needs repairs, contact your Lexus dealer.

Turning LKA system on

Press the LKA switch to turn the LKA system on.

The LKA indicator illuminates and a message is displayed on the multi-information display.

Press the LKA switch again to turn the LKA system off.

When the LKA system is turned on or off, operation of the LKA system continues in the same condition the next time the engine is started.



Indications on multi-information display

① LKA indicator

The illumination condition of the indicator informs the driver of the system operation status.

Illuminated in white:
LKA system is operating.

Illuminated in green:
Steering wheel assistance of the lane departure control function or lane-keeping assist function is operating.

Flashing in orange:
Lane departure alert function is operating.

② Operation display of steering wheel operation support

Indicates that steering wheel assistance of the lane departure control function or lane centering function is operating.

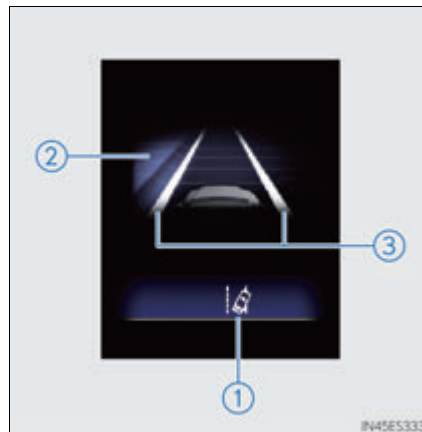

③ Lane departure alert function display

Displayed when the multi-information display is switched to the driving assist system information screen.

- ▶ Inside of displayed white lines is white
- ▶ Inside of displayed white lines is black



Indicates that the system is recognizing white (yellow) lines. When the vehicle departs from its lane, the white line displayed on the side the vehicle departs from flashes orange.

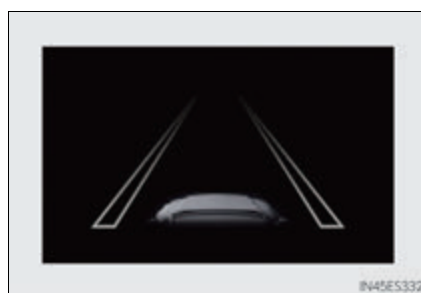

Indicates that the system is not able to recognize white (yellow) lines or is temporarily canceled.

■ Operation conditions of each function

● Lane departure alert function

This function operates when all of the following conditions are met.

- LKA is turned on.
- Vehicle speed is approximately 32 mph (50 km/h) or more.
- System recognizes white (yellow) lines.
- Width of traffic lane is approximately 9.8 ft. (3 m) or more.
- Turn signal lever is not operated.
- Vehicle is driven on a straight road or around a gentle curve with a radius of more than approximately 492 ft. (150 m).
- No system malfunctions are detected. (→P. 257)

● Lane departure control function

This function operates when all of the following conditions are met in addition to the operation conditions for the lane departure alert function.

- Setting for "Steering Assist" in  of the multi-information display is set to "On". (→P.100)
- Vehicle is not accelerated or decelerated by a fixed amount or more.
- Steering wheel is not operated with a steering force level suitable for changing lanes.
- ABS, VSC, TRAC and PCS (Pre-Collision System) are not operating.
- TRAC or VSC is not turned off.

- Vehicle sway warning

This function operates when all of the following conditions are met.

- Setting for "Sway Warning" in  of the multi-information display is set to "On". (→P. 100)
- Vehicle speed is approximately 32 mph (50 km/h) or more.
- Width of traffic lane is approximately 9.8 ft. (3 m) or more.
- No system malfunctions are detected. (→P. 257)

- Lane centering function

This function operates when all of the following conditions are met.

- LKA is turned on.
- Setting for "Steering Assist" and "Lane Center" in  of the multi-information display are set to "On". (→P. 100)
- System recognizes white (yellow) lines.
- Dynamic radar cruise control with full-speed range is operating.
- Width of traffic lane is approximately 8.2 to 13.5 ft. (2.5 to 4.1 m).
- Turn signal lever is not operated.
- Vehicle is driven on a straight road or around a gentle curve with a radius of more than approximately 656 ft. (200 m).
- No system malfunctions are detected. (→P. 257)
- Vehicle does not accelerate or decelerate by a fixed amount or more.
- Steering wheel is not operated with a steering force level suitable for changing lanes.
- ABS, VSC, TRAC and PCS (Pre-Collision System) are not operating.
- TRAC or VSC is not turned off.
- Lane departure control function is not operating.

- **Temporary cancellation of functions**

When operation conditions are no longer met, a function may be temporarily canceled. However, when the operation conditions are met again, operation of the function is automatically restored. (→P. 254)

- **Lane departure control function/lane centering function**

Depending on the vehicle speed, lane departure situation, road conditions, etc., the operation of the functions may not be recognized or the functions may not operate.

- **Lane departure alert function**

The warning buzzer may be difficult to hear due to external noise, audio playback, etc. Also, it may be difficult to feel steering wheel vibrations due to the road conditions, etc.

- **Hands off steering wheel alert**

When the system determines that the driver has removed their hands from the steering wheel while the lane departure control function or lane centering function is operating, a warning message is displayed on the multi-information display and the buzzer sounds.

- **White (yellow) lines are only on one side of road**

The LKA system will not operate for the side on which white (yellow) lines could not be recognized.

■ Conditions in which functions may not operate properly

In the following situations, the camera sensor may not detect white (yellow) lines and various functions may not operate normally.

- There are shadows on the road that run parallel with, or cover, the white (yellow) lines.
- The vehicle is driven in an area without white (yellow) lines, such as in front of a tollgate or checkpoint, or at an intersection, etc.
- The white (yellow) lines are cracked, "Botts' dots", "Raised pavement marker" or stones are present.
- The white (yellow) lines cannot be seen or are difficult to see due to sand, etc.
- The vehicle is driven on a road surface that is wet due to rain, puddles, etc.
- The traffic lines are yellow (which may be more difficult to recognize than lines that are white).
- The white (yellow) lines cross over a curb, etc.
- The vehicle is driven on a bright surface, such as concrete.
- The vehicle is driven on a surface that is bright due to reflected light, etc.
- The vehicle is driven in an area where the brightness changes suddenly, such as at the entrances and exits of tunnels, etc.
- Light from the headlights of an oncoming vehicle, the sun, etc., enters the camera.
- The vehicle is driven where the road diverges, merges, etc.
- The vehicle is driven on a slope.
- The vehicle is driven on a road which tilts left or right, or a winding road.
- The vehicle is driven on an unpaved or rough road.
- The vehicle is driven around a sharp curve.
- The traffic lane is excessively narrow or wide.
- The vehicle is extremely tilted due to carrying heavy luggage or having improper tire pressure.
- The distance to the preceding vehicle is extremely short.
- The vehicle is moving up and down a large amount due to road conditions during driving (poor roads or road seams).
- The headlight lenses are dirty and emit a faint amount of light at night, or the beam axis has deviated.
- The vehicle is struck by a crosswind.
- The vehicle has just changed lanes or crossed an intersection.
- Snow tires, etc., are equipped.

■ **Warning message**

Warning messages are used to indicate a system malfunction or to inform the driver of the need for caution while driving. (→P. 459)

■ **Customization**

The following settings can be changed.

Function	Setting details
Lane departure alert function	Adjust alert sensitivity
	Adjust alert type
Steering control function	Turn steering wheel assistance on and off
Vehicle sway warning	Turn function on and off
	Adjust alert sensitivity
Lane centering function	Turn function on and off

For how to change settings, refer to P. 568.

LDA (Lane Departure Alert with steering control)*

Summary of functions

When driving on highways and freeways with white (yellow) lines, this function alerts the driver when the vehicle might depart from its lane and provides assistance by operating the steering wheel to keep the vehicle in its lane.

The LDA system recognizes visible white (yellow) lines with the camera sensor on the upper portion of the front windshield.



Functions included in LDA system

◆ Lane departure alert function

When the system determines that the vehicle might depart from its lane, a warning is displayed on the multi-information display, and either the warning buzzer sounds or the steering wheel vibrates* to alert the driver.

When the warning buzzer sounds or the steering wheel vibrates*, check the surrounding road situation and carefully operate the steering wheel to move the vehicle back to the center within the white (yellow) lines.

*: If equipped

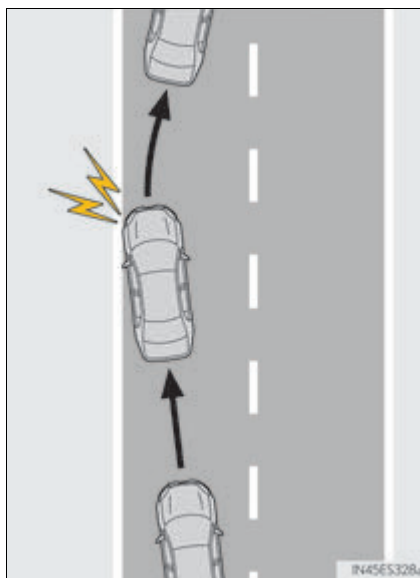

*: If equipped

◆ Steering control function

When the system determines that the vehicle might depart from its lane, the system provides assistance as necessary by operating the steering wheel in small amounts for a short period of time to keep the vehicle in its lane.

If the system detects that the steering wheel has not been operated for a fixed amount of time or the steering wheel is not being firmly gripped, a warning is displayed on the multi-information display and the warning buzzer sounds.

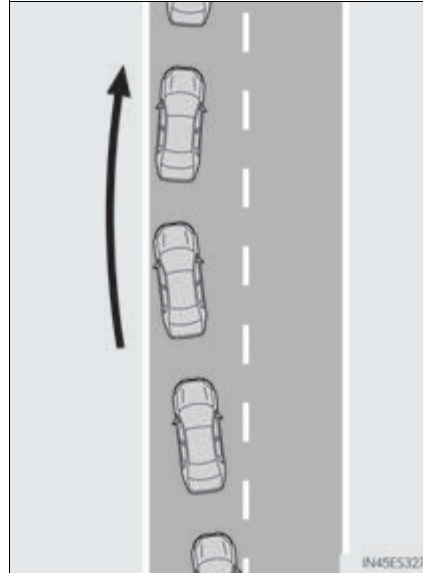

◆ Vehicle sway warning

When the vehicle is swaying or appears as if it may depart from its lane multiple times, the warning buzzer sounds and a message is displayed on the multi-information display to alert the driver.

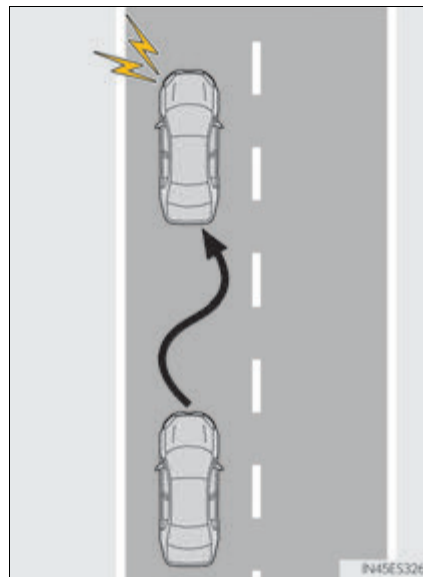

 **WARNING****■ Before using LDA system**

Do not rely solely upon the LDA system. LDA is not a system which automatically drives the vehicle or reduces the amount of attention that must be paid to the area in front of the vehicle. The driver must always assume full responsibility for driving safely by always paying careful attention to the surrounding conditions and operate the steering wheel to correct the path of the vehicle. Also, make sure to take adequate breaks when fatigued, such as from driving for a long period of time.

Failure to perform appropriate driving operations and pay careful attention may lead to an accident, resulting in death or serious injury.

■ To avoid operating LDA by mistake

When not using the LDA system, use the LDA switch to turn the system off.

■ Situations unsuitable for LDA

Do not use the LDA system in the following situations.

The system may not operate properly and lead to an accident, resulting in death or serious injury.

- A spare tire, tire chains, etc., are equipped.
- When the tires have been excessively worn, or when the tire inflation pressure is low.
- Tires which differ by structure, manufacturer, brand or tread pattern are used.
- Objects or patterns that could be mistaken for white (yellow) lines are present on the side of the road (guardrails, curbs, reflective poles, etc.).
- Vehicle is driven on a snow-covered road.
- White (yellow) lines are difficult to see due to rain, snow, fog, dust, etc.
- Asphalt repair marks, white (yellow) line marks, etc., are present due to road repair.
- Vehicle is driven in a temporary lane or restricted lane due to construction work.
- Vehicle is driven on a road surface which is slippery due to rainy weather, fallen snow, freezing, etc.
- Vehicle is driven in traffic lanes other than on highways and freeways.
- Vehicle is driven in a construction zone.
- Vehicle is towing a trailer or another vehicle.

■ Preventing LDA system malfunctions and operations performed by mistake

- Do not modify the headlights or place stickers, etc., on the surface of the lights.
- Do not modify the suspension etc. If the suspension etc. needs to be replaced, contact your Lexus dealer.
- Do not install or place anything on the hood or grille. Also, do not install a grille guard (bull bars, kangaroo bar, etc.).
- If your windshield needs repairs, contact your Lexus dealer.

Turning LDA system on

Press the LDA switch to turn the LDA system on.

The LDA indicator illuminates and a message is displayed on the multi-information display.

Press the LDA switch again to turn the LDA system off.

When the LDA system is turned on or off, operation of the LDA system continues in the same condition the next time the engine is started.



Indications on multi-information display

① LDA indicator

The illumination condition of the indicator informs the driver of the system operation status.

Illuminated in white:
LDA system is operating.

Illuminated in green:
Steering wheel assistance of the steering control function is operating.

Flashing in orange:
Lane departure alert function is operating.

② Operation display of steering wheel operation support

Indicates that steering wheel assistance of the steering control function is operating.

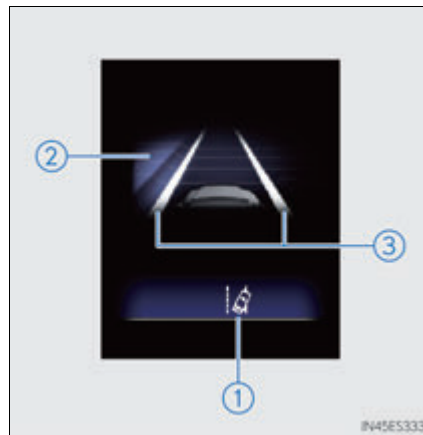

③ Lane departure alert function display

Displayed when the multi-information display is switched to the driving assist system information screen.

- ▶ Inside of displayed white lines is white
- ▶ Inside of displayed white lines is black



Indicates that the system is recognizing white (yellow) lines. When the vehicle departs from its lane, the white line displayed on the side the vehicle departs from flashes orange.

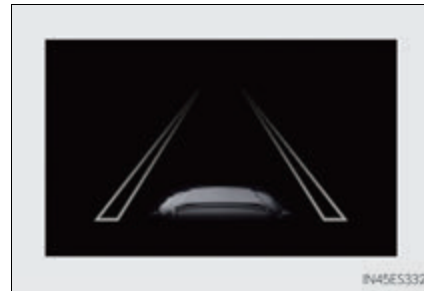

Indicates that the system is not able to recognize white (yellow) lines or is temporarily canceled.

■ Operation conditions of each function

● Lane departure alert function

This function operates when all of the following conditions are met.

- LDA is turned on.
- Vehicle speed is approximately 32 mph (50 km/h) or more.
- System recognizes white (yellow) lines.
- Width of traffic lane is approximately 9.8 ft. (3 m) or more.
- Turn signal lever is not operated.
- Vehicle is driven on a straight road or around a gentle curve with a radius of more than approximately 492 ft. (150 m).
- No system malfunctions are detected. (→P. 265)

- **Steering control function**

This function operates when all of the following conditions are met in addition to the operation conditions for the lane departure alert function.

- Setting for "Steering Assist" in  of the multi-information display is set to "On". (→P.108)
- Vehicle is not accelerated or decelerated by a fixed amount or more.
- Steering wheel is not operated with a steering force level suitable for changing lanes.
- ABS, VSC, TRAC and PCS (Pre-Collision System) are not operating.
- TRAC or VSC is not turned off.

- **Vehicle sway warning**

This function operates when all of the following conditions are met.

- Setting for "Sway Warning" in  of the multi-information display is set to "On". (→P.108)
- Vehicle speed is approximately 32 mph (50 km/h) or more.
- Width of traffic lane is approximately 9.8 ft. (3 m) or more.
- No system malfunctions are detected. (→P.265)

- **Temporary cancellation of functions**

When operation conditions are no longer met, a function may be temporarily canceled. However, when the operation conditions are met again, operation of the function is automatically restored. (→P.262)

- **Steering control function**

Depending on the vehicle speed, lane departure situation, road conditions, etc., the operation of the functions may not be recognized or the functions may not operate.

- **Lane departure alert function**

The warning buzzer may be difficult to hear due to external noise, audio playback, etc. Also, it may be difficult to feel steering wheel vibrations due to the road conditions, etc.

- **Hands off steering wheel alert**

When the system determines that the driver has removed their hands from the steering wheel while the steering control function is operating, a warning message is displayed on the multi-information display and the buzzer sounds.

- **White (yellow) lines are only on one side of road**

The LDA system will not operate for the side on which white (yellow) lines could not be recognized.

■ Conditions in which functions may not operate properly

In the following situations, the camera sensor may not detect white (yellow) lines and various functions may not operate normally.

- There are shadows on the road that run parallel with, or cover, the white (yellow) lines.
- The vehicle is driven in an area without white (yellow) lines, such as in front of a tollgate or checkpoint, or at an intersection, etc.
- The white (yellow) lines are cracked, “Botts’ dots”, “Raised pavement marker” or stones are present.
- The white (yellow) lines cannot be seen or are difficult to see due to sand, etc.
- The vehicle is driven on a road surface that is wet due to rain, puddles, etc.
- The traffic lines are yellow (which may be more difficult to recognize than lines that are white).
- The white (yellow) lines cross over a curb, etc.
- The vehicle is driven on a bright surface, such as concrete.
- The vehicle is driven on a surface that is bright due to reflected light, etc.
- The vehicle is driven in an area where the brightness changes suddenly, such as at the entrances and exits of tunnels, etc.
- Light from the headlights of an oncoming vehicle, the sun, etc., enters the camera.
- The vehicle is driven where the road diverges, merges, etc.
- The vehicle is driven on a slope.
- The vehicle is driven on a road which tilts left or right, or a winding road.
- The vehicle is driven on an unpaved or rough road.
- The vehicle is driven around a sharp curve.
- The traffic lane is excessively narrow or wide.
- The vehicle is extremely tilted due to carrying heavy luggage or having improper tire pressure.
- The distance to the preceding vehicle is extremely short.
- The vehicle is moving up and down a large amount due to road conditions during driving (poor roads or road seams).
- The headlight lenses are dirty and emit a faint amount of light at night, or the beam axis has deviated.
- The vehicle is struck by a crosswind.
- The vehicle has just changed lanes or crossed an intersection.
- Snow tires, etc., are equipped.

■ **Warning message**

Warning messages are used to indicate a system malfunction or to inform the driver of the need for caution while driving. (→P. 459)

■ **Customization**

The following settings can be changed.

Function	Setting details
Lane departure alert function	Adjust alert sensitivity
	Adjust alert type *
Steering control function *	Turn steering wheel assistance on and off
Vehicle sway warning	Turn function on and off
	Adjust alert sensitivity

*: If equipped

For how to change settings, refer to P. 568.

Dynamic radar cruise control with full-speed range*

Summary of functions

In vehicle-to-vehicle distance control mode, the vehicle automatically accelerates, decelerates and stops to match the speed changes of the preceding vehicle even if the accelerator pedal is not depressed. In constant speed control mode, the vehicle runs at a fixed speed.

Use the dynamic radar cruise control with full-speed range on freeways and highways.

- Vehicle-to-vehicle distance control mode (→P. 269)
- Constant speed control mode (→P. 274)

- ① Vehicle-to-vehicle distance button
- ② Display
- ③ Set speed
- ④ Indicators
- ⑤ Cruise control switch

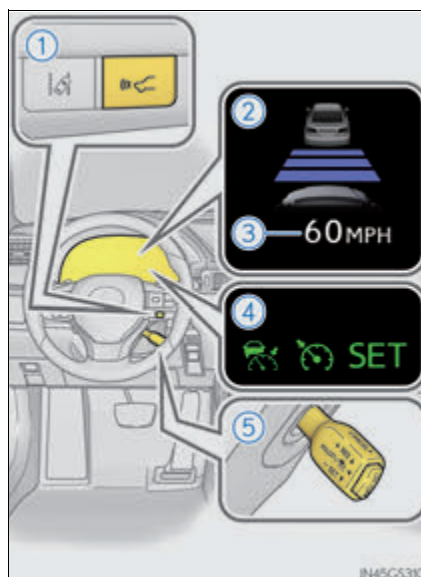

*: If equipped

⚠ WARNING**■ Before using dynamic radar cruise control with full-speed range**

Driving safely is the sole responsibility of the driver. Do not rely solely on the system, and drive safely by always paying careful attention to your surroundings.

The dynamic radar cruise control with full-speed range provides driving assistance to reduce the driver's burden. However, there are limitations to the assistance provided.

Even when the system is functioning normally, the condition of the preceding vehicle as detected by the system may differ from the condition observed by the driver. Therefore, the driver must always remain alert, assess the danger of each situation and drive safely. Relying on this system or assuming the system ensures safety while driving can lead to an accident, resulting in death or serious injury.

■ Cautions regarding the driving assist systems

Observe the following precautions, as there are limitations to the assistance provided by the system.

Failure to do so may cause an accident resulting in death or serious injury.

● Assisting the driver to measure following distance

The dynamic radar cruise control with full-speed range is only intended to help the driver in determining the following distance between the driver's own vehicle and a designated vehicle traveling ahead. It is not a mechanism that allows careless or inattentive driving, and it is not a system that can assist the driver in low-visibility conditions. It is still necessary for driver to pay close attention to the vehicle's surroundings.

● Assisting the driver to judge proper following distance

The dynamic radar cruise control with full-speed range determines whether the following distance between the driver's own vehicle and a designated vehicle traveling ahead is within a set range. It is not capable of making any other type of judgement. Therefore, it is absolutely necessary for the driver to remain vigilant and to determine whether or not there is a possibility of danger in any given situation.

● Assisting the driver to operate the vehicle

The dynamic radar cruise control with full-speed range has limited capability to prevent or avoid a collision with a vehicle traveling ahead. Therefore, if there is ever any danger, the driver must take immediate and direct control of the vehicle and act appropriately in order to ensure the safety of all involved.

■ To avoid inadvertent dynamic radar cruise control with full-speed range activation

Switch the dynamic radar cruise control with full-speed range off using the "ON/OFF" button when not in use.

 **WARNING****■ Situations unsuitable for dynamic radar cruise control with full-speed range**

Do not use dynamic radar cruise control with full-speed range in any of the following situations.

Doing so may result in inappropriate speed control and could cause an accident resulting in death or serious injury.

- Roads where there are pedestrians, cyclists, etc.
- In heavy traffic
- On roads with sharp bends
- On winding roads
- On slippery roads, such as those covered with rain, ice or snow
- On steep downhills, or where there are sudden changes between sharp up and down gradients
Vehicle speed may exceed the set speed when driving down a steep hill.
- At entrances to freeways and highways
- When weather conditions are bad enough that they may prevent the sensors from detecting correctly (fog, snow, sandstorm, heavy rain, etc.)
- When there is rain, snow, etc. on the front surface of the radar sensor or camera sensor
- In traffic conditions that require frequent repeated acceleration and deceleration
- When your vehicle is towing a trailer or during emergency towing
- When an approach warning buzzer is heard often

Driving in vehicle-to-vehicle distance control mode

This mode employs a radar sensor to detect the presence of vehicles up to approximately 400 ft. (120 m) ahead, determines the current vehicle-to-vehicle following distance, and operates to maintain a suitable following distance from the vehicle ahead.

Note that vehicle-to-vehicle distance will close in when traveling on long downhill slopes.

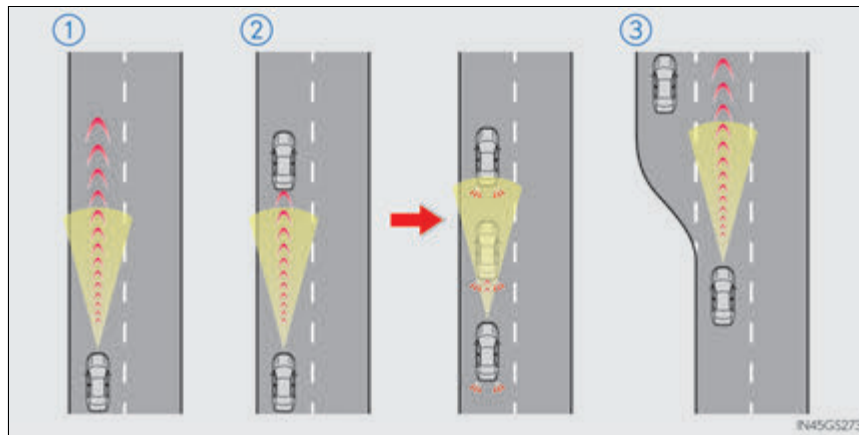

- ① Example of constant speed cruising
When there are no vehicles ahead

The vehicle travels at the speed set by the driver. The desired vehicle-to-vehicle distance can also be set by operating the vehicle-to-vehicle distance button.

- ② Example of deceleration cruising and follow-up cruising
When a preceding vehicle driving slower than the set speed appears

When a vehicle is detected running ahead of you, the system automatically decelerates your vehicle. When a greater reduction in vehicle speed is necessary, the system applies the brakes (the stop lights will come on at this time). The system will respond to changes in the speed of the vehicle ahead in order to maintain the vehicle-to-vehicle distance set by the driver. Approach warning warns you when the system cannot decelerate sufficiently to prevent your vehicle from closing in on the vehicle ahead.

When the vehicle ahead of you stops, your vehicle will also stop (vehicle is stopped by system control). After the vehicle ahead starts off, pushing the cruise control lever up or depressing the accelerator pedal will resume follow-up cruising.

- ③ Example of acceleration
When there are no longer any preceding vehicles driving slower than the set speed

The system accelerates until the set speed is reached. The system then returns to constant speed cruising.

Setting the vehicle speed (vehicle-to-vehicle distance control mode)

- 1 Press the "ON/OFF" button to activate the cruise control.

Radar cruise control indicator will come on and a message will be displayed on the multi-information display.

Press the button again to deactivate the cruise control.

If the "ON/OFF" button is pressed and held for 1.5 seconds or more, the system turns on in constant speed control mode. (→P. 274)

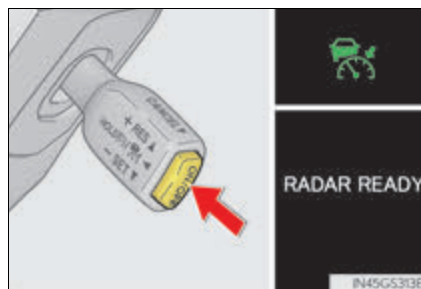

- 2 Accelerate or decelerate, with accelerator pedal operation, to the desired vehicle speed (above approximately 30 mph [50 km/h]) and push the lever down to set the speed.

Cruise control "SET" indicator will come on.

The vehicle speed at the moment the lever is released becomes the set speed.

If the lever is operated while the vehicle speed is below approximately 30 mph (50 km/h) and a preceding vehicle is present, the set speed will be adjusted to approximately 30 mph (50 km/h).

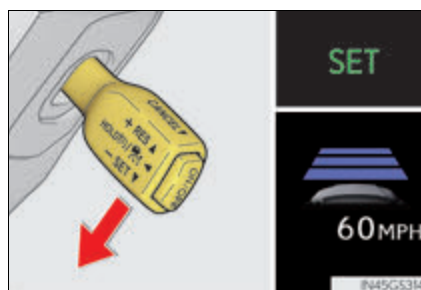

Adjusting the set speed

To change the set speed, operate the lever until the desired set speed is displayed.

① Increases the speed

(Except when the vehicle has been stopped by system control in vehicle-to-vehicle distance control mode)

② Decreases the speed

Fine adjustment: Momentarily move the lever in the desired direction.

Large adjustment: Hold the lever up or down to change the speed, and release when the desired speed is reached.

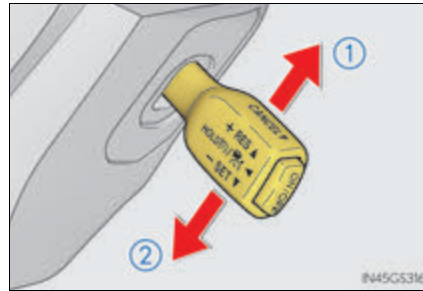

In the vehicle-to-vehicle distance control mode, the set speed will be increased or decreased as follows:

► For the U.S. mainland, Hawaii and NATO Germany

Fine adjustment: By 1 mph (1.6 km/h)^{*1} or 1 km/h (0.6 mph)^{*2} each time the lever is operated

Large adjustment: Increases or decreases in 1mph (1.6 km/h)^{*1} or 1 km/h (0.6 mph)^{*2} increments for as long as the lever is held

► For Canada, Guam, Saipan and Puerto Rico

Fine adjustment: By 1 mph (1.6 km/h)^{*1} or 1 km/h (0.6 mph)^{*2} each time the lever is operated

Large adjustment: Increases or decreases in 5 mph (8 km/h)^{*1} or 5 km/h (3.1 mph)^{*2} increments for as long as the lever is held

In the constant speed control mode (→P. 274), the set speed will be increased or decreased as follows:

Fine adjustment: By 1 mph (1.6 km/h)^{*1} or 1 km/h (0.6 mph)^{*2} each time the lever is operated

Large adjustment: The speed will continue to change while the lever is held.

*1: When the set speed is shown in "MPH"

*2: When the set speed is shown in "km/h"

Changing the vehicle-to-vehicle distance (vehicle-to-vehicle distance control mode)

Pressing the button changes the vehicle-to-vehicle distance as follows:

- ① Long
- ② Medium
- ③ Short

The vehicle-to-vehicle distance is set automatically to long mode when the engine switch is turned to IGNITION ON mode.

If a vehicle is running ahead of you, the preceding vehicle mark will also be displayed.

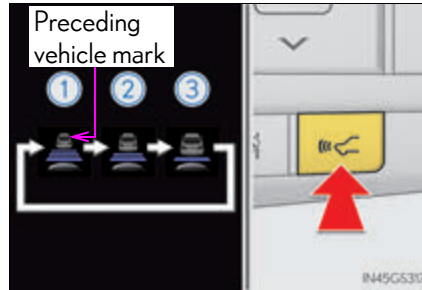

Vehicle-to-vehicle distance settings (vehicle-to-vehicle distance control mode)

Select a distance from the table below. Note that the distances shown correspond to a vehicle speed of 50 mph (80 km/h). Vehicle-to-vehicle distance increases/decreases in accordance with vehicle speed. When the vehicle is stopped by system control, the vehicle-to-vehicle distance will be about 16 ft. (5 m) to 23 ft. (7 m) regardless of the vehicle-to-vehicle distance setting.

Distance options	Vehicle-to-vehicle distance
Long	Approximately 160 ft. (50 m)
Medium	Approximately 130 ft. (40 m)
Short	Approximately 100 ft. (30 m)

Resuming follow-up cruising when the vehicle has been stopped by system control (vehicle-to-vehicle distance control mode)

After the vehicle ahead of you starts off, push the lever up.

Your vehicle will also resume follow-up cruising if the accelerator pedal is depressed after the vehicle ahead of you starts off.

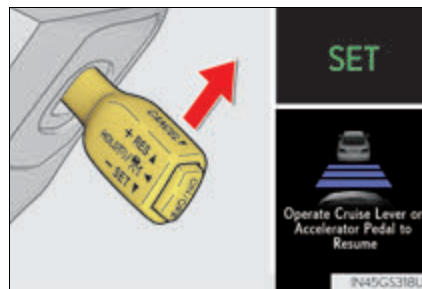

Canceling and resuming the speed control

- ① Pulling the lever toward you cancels the speed control.

The speed control is also canceled when the brake pedal is depressed.

(When the vehicle has been stopped by system control, depressing the brake pedal does not cancel the setting.)

- ② Pushing the lever up resumes the cruise control and returns vehicle speed to the set speed.

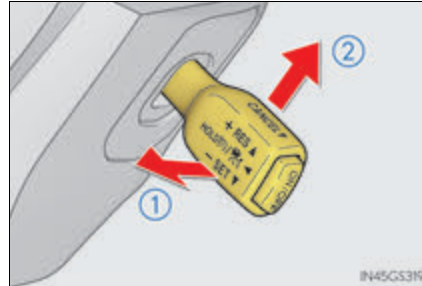

However, when a vehicle ahead is not detected, cruise control does not resume when the vehicle speed is approximately 25 mph (40 km/h) or less.

Approach warning (vehicle-to-vehicle distance control mode)

When your vehicle is too close to a vehicle ahead, and sufficient automatic deceleration via the cruise control is not possible, the display will flash and the buzzer will sound to alert the driver. An example of this would be if another driver cuts in front of you while you are following a vehicle. Depress the brake pedal to ensure an appropriate vehicle-to-vehicle distance.



■ Warnings may not occur when

In the following instances, warnings may not occur even when the vehicle-to-vehicle distance is small.

- When the speed of the preceding vehicle matches or exceeds your vehicle speed
- When the preceding vehicle is traveling at an extremely slow speed
- Immediately after the cruise control speed was set
- When depressing the accelerator pedal

Selecting constant speed control mode

When constant speed control mode is selected, your vehicle will maintain a set speed without controlling the vehicle-to-vehicle distance. Select this mode only when vehicle-to-vehicle distance control mode does not function correctly due to a dirty radar sensor, etc.

- 1 With the cruise control off, press and hold the "ON/OFF" button for 1.5 seconds or more.

Immediately after the "ON/OFF" button is pressed, the radar cruise control indicator will come on. Afterwards, it switches to the cruise control indicator.

Switching to constant speed control mode is only possible when operating the lever with the cruise control off.

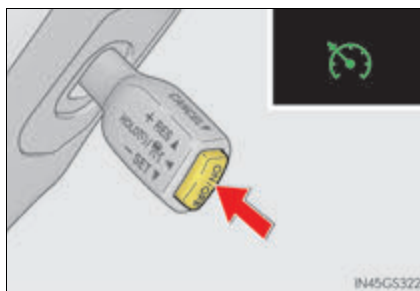

- 2 Accelerate or decelerate, with accelerator pedal operation, to the desired vehicle speed (above approximately 30 mph [50 km/h]) and push the lever down to set the speed.

Cruise control "SET" indicator will come on.

The vehicle speed at the moment the lever is released becomes the set speed.

Adjusting the speed setting: →P. 271

Canceling and resuming the speed setting: →P. 273

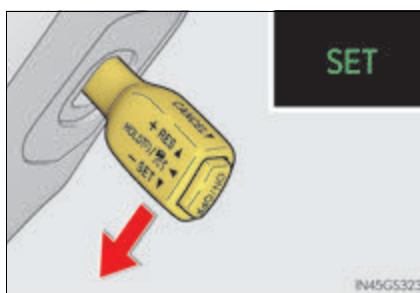

■ Dynamic radar cruise control with full-speed range can be set when

- The shift lever is in D.
- Range 4 or higher of D has been selected by using the paddle shift switch.
- Vehicle speed is above approximately 30 mph (50 km/h).
However, when a preceding vehicle is detected, the dynamic radar cruise control with full-speed range can be set even if the vehicle speed is at or below approximately 30 mph (50 km/h).

■ Accelerating after setting the vehicle speed

The vehicle can accelerate by operating the accelerator pedal. After accelerating, the set speed resumes. However, during vehicle-to-vehicle distance control mode, the vehicle speed may decrease below the set speed in order to maintain the distance to the preceding vehicle.

■ Automatic cancelation of vehicle-to-vehicle distance control mode

Vehicle-to-vehicle distance control mode is automatically canceled in the following situations.

- Actual vehicle speed falls below approximately 25 mph (40 km/h) when there are no vehicles ahead.
- The preceding vehicle leaves the lane when your vehicle is following at a vehicle speed below approximately 25 mph (40 km/h). Otherwise, the sensor can not properly detect the vehicle.
- VSC is activated.
- TRAC is activated for a period of time.
- When the VSC or TRAC system is turned off by pressing the VSC OFF switch.
- When snow mode is set.
- The sensor cannot detect correctly because it is covered in some way.
- Pre-collision braking is activated.
- The parking brake is operated.
- The vehicle is stopped by system control on a steep incline.
- The following are detected when the vehicle has been stopped by system control:
 - The driver is not wearing a seat belt.
 - The driver's door is opened.
 - The vehicle has been stopped for about 3 minutes

If vehicle-to-vehicle distance control mode is automatically canceled for any other reason, there may be a malfunction in the system. Contact your Lexus dealer.

■ Automatic cancelation of constant speed control mode

Constant speed control mode is automatically canceled in the following situations:

- Actual vehicle speed is more than approximately 10 mph (16 km/h) below the set vehicle speed.
- Actual vehicle speed falls below approximately 25 mph (40 km/h).
- VSC is activated.
- TRAC is activated for a period of time.
- When the VSC or TRAC system is turned off by pressing the VSC OFF switch.
- Pre-collision braking is activated.

If constant speed control mode is automatically canceled for any other reason, there may be a malfunction in the system. Contact your Lexus dealer.

■ **Warning messages and buzzers for dynamic radar cruise control with full-speed range**

Warning messages and buzzers are used to indicate a system malfunction or to inform the driver of the need for caution while driving. If a warning message is shown on the multi-information display, read the message and follow the instructions. (→P. 459)

■ **When the sensor may not be correctly detecting the vehicle ahead**

In the case of the following and depending on the conditions, operate the brake pedal when deceleration of the system is insufficient or operate the accelerator pedal when acceleration is required.

As the sensor may not be able to correctly detect these types of vehicles, the approach warning (→P. 273) may not be activated.

- Vehicles that cut in suddenly
- Vehicles traveling at low speeds
- Vehicles that are not moving in the same lane
- Vehicles with small rear ends (trailers with no load on board, etc.)

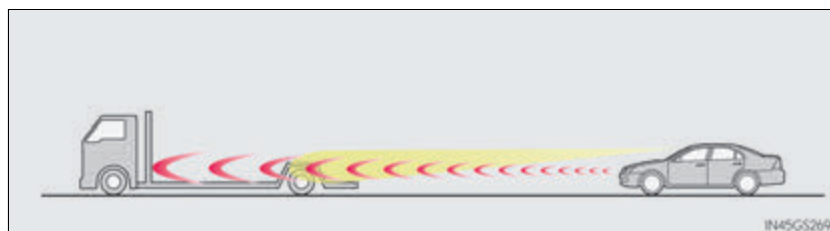

- Motorcycles traveling in the same lane
- When water or snow thrown up by the surrounding vehicles hinders the detecting of the sensor
- When your vehicle is pointing upwards (caused by a heavy load in the luggage compartment, etc.)

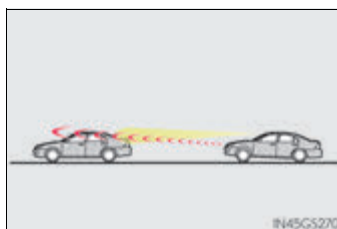

- Preceding vehicle has an extremely high ground clearance

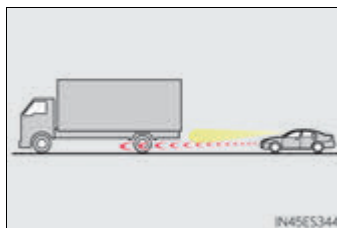

■ **Conditions under which the vehicle-to-vehicle distance control mode may not function correctly**

In the case of the following conditions, operate the brake pedal (or accelerator pedal, depending on the situation) as necessary.

As the sensor may not be able to correctly detect vehicles ahead, the system may not operate properly.

- When the road curves or when the lanes are narrow

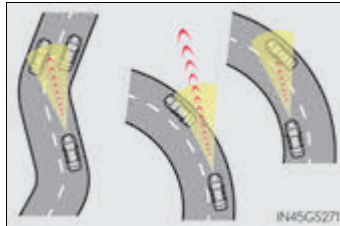

- When steering wheel operation or your position in the lane is unstable

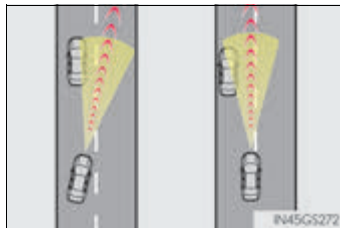

- When the vehicle ahead of you decelerates suddenly

Dynamic radar cruise control*

Summary of functions

In vehicle-to-vehicle distance control mode, the vehicle automatically accelerates and decelerates to match the speed changes of the preceding vehicle even if the accelerator pedal is not depressed. In constant speed control mode, the vehicle runs at a fixed speed.

Use the dynamic radar cruise control on freeways and highways.

- Vehicle-to-vehicle distance control mode (→P. 281)
- Constant speed control mode (→P. 286)

- ① Vehicle-to-vehicle distance button
- ② Display
- ③ Set speed
- ④ Indicators
- ⑤ Cruise control switch

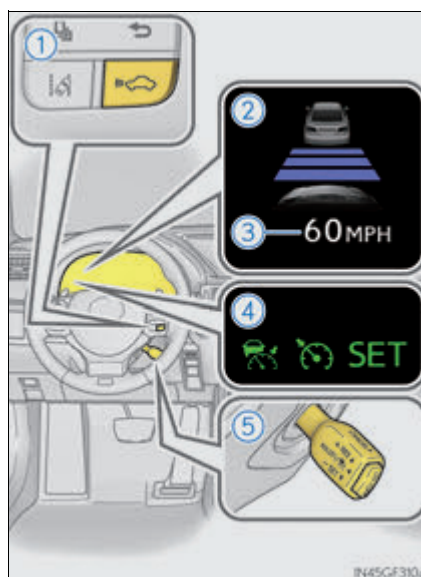

*: If equipped

⚠ WARNING**■ Before using dynamic radar cruise control**

Driving safely is the sole responsibility of the driver. Do not rely solely on the system, and drive safely by always paying careful attention to your surroundings.

The dynamic radar cruise control provides driving assistance to reduce the driver's burden. However, there are limitations to the assistance provided.

Even when the system is functioning normally, the condition of the preceding vehicle as detected by the system may differ from the condition observed by the driver. Therefore, the driver must always remain alert, assess the danger of each situation and drive safely. Relying on this system or assuming the system ensures safety while driving can lead to an accident, resulting in death or serious injury.

■ Cautions regarding the driving assist systems

Observe the following precautions, as there are limitations to the assistance provided by the system.

Failure to do so may cause an accident resulting in death or serious injury.

● Assisting the driver to measure following distance

The dynamic radar cruise control is only intended to help the driver in determining the following distance between the driver's own vehicle and a designated vehicle traveling ahead. It is not a mechanism that allows careless or inattentive driving, and it is not a system that can assist the driver in low-visibility conditions. It is still necessary for driver to pay close attention to the vehicle's surroundings.

● Assisting the driver to judge proper following distance

The dynamic radar cruise control determines whether the following distance between the driver's own vehicle and a designated vehicle traveling ahead is within a set range. It is not capable of making any other type of judgement. Therefore, it is absolutely necessary for the driver to remain vigilant and to determine whether or not there is a possibility of danger in any given situation.

● Assisting the driver to operate the vehicle

The dynamic radar cruise control has limited capability to prevent or avoid a collision with a vehicle traveling ahead. Therefore, if there is ever any danger, the driver must take immediate and direct control of the vehicle and act appropriately in order to ensure the safety of all involved.

■ To avoid inadvertent dynamic radar cruise control activation

Switch the dynamic radar cruise control off using the "ON/OFF" button when not in use.

 **WARNING****■ Situations unsuitable for dynamic radar cruise control**

Do not use dynamic radar cruise control in any of the following situations. Doing so may result in inappropriate speed control and could cause an accident resulting in death or serious injury.

- Roads where there are pedestrians, cyclists, etc.
- In heavy traffic
- On roads with sharp bends
- On winding roads
- On slippery roads, such as those covered with rain, ice or snow
- On steep downhill, or where there are sudden changes between sharp up and down gradients
Vehicle speed may exceed the set speed when driving down a steep hill.
- At entrances to freeways and highways
- When weather conditions are bad enough that they may prevent the sensors from detecting correctly (fog, snow, sandstorm, heavy rain, etc.)
- When there is rain, snow, etc. on the front surface of the radar sensor or camera sensor
- In traffic conditions that require frequent repeated acceleration and deceleration
- When your vehicle is towing a trailer or during emergency towing
- When an approach warning buzzer is heard often

Driving in vehicle-to-vehicle distance control mode

This mode employs a radar sensor to detect the presence of vehicles up to approximately 400 ft. (120 m) ahead, determines the current vehicle-to-vehicle following distance, and operates to maintain a suitable following distance from the vehicle ahead.

Note that vehicle-to-vehicle distance will close in when traveling on long downhill slopes.

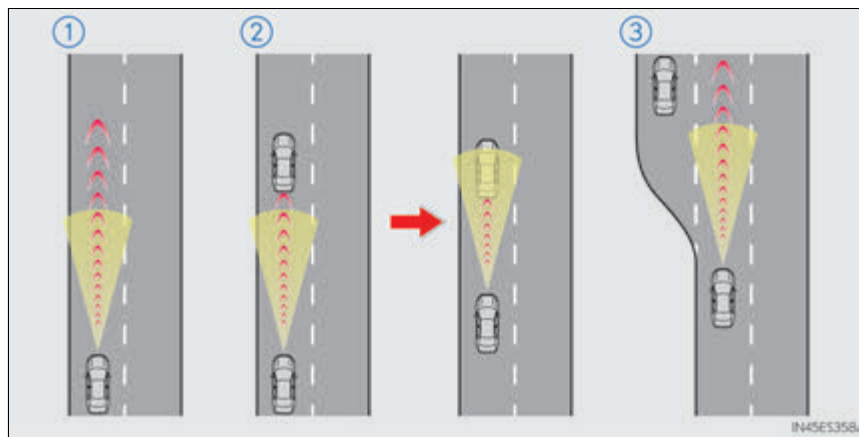

- ① Example of constant speed cruising
When there are no vehicles ahead

The vehicle travels at the speed set by the driver. The desired vehicle-to-vehicle distance can also be set by operating the vehicle-to-vehicle distance button.

- ② Example of deceleration cruising and follow-up cruising
When a preceding vehicle driving slower than the set speed appears

When a vehicle is detected running ahead of you, the system automatically decelerates your vehicle. When a greater reduction in vehicle speed is necessary, the system applies the brakes (the stop lights will come on at this time). The system will respond to changes in the speed of the vehicle ahead in order to maintain the vehicle-to-vehicle distance set by the driver. Approach warning warns you when the system cannot decelerate sufficiently to prevent your vehicle from closing in on the vehicle ahead.

- ③ Example of acceleration
When there are no longer any preceding vehicles driving slower than the set speed

The system accelerates until the set speed is reached. The system then returns to constant speed cruising.

Setting the vehicle speed (vehicle-to-vehicle distance control mode)

- 1 Press the "ON/OFF" button to activate the cruise control.

Radar cruise control indicator will come on and a message will be displayed on the multi-information display.

Press the button again to deactivate the cruise control.

If the "ON/OFF" button is pressed and held for 1.5 seconds or more, the system turns on in constant speed control mode. (→P. 274)

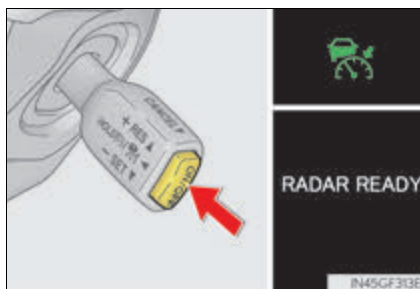

- 2 Accelerate or decelerate, with accelerator pedal operation, to the desired vehicle speed (above approximately 30 mph [50 km/h]) and push the lever down to set the speed.

Cruise control "SET" indicator will come on.

The vehicle speed at the moment the lever is released becomes the set speed.

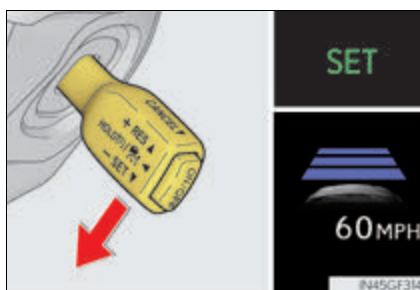

Adjusting the set speed

To change the set speed, operate the lever until the desired set speed is displayed.

- ① Increases the speed
- ② Decreases the speed

Fine adjustment: Momentarily move the lever in the desired direction.

Large adjustment: Hold the lever up or down to change the speed, and release when the desired speed is reached.

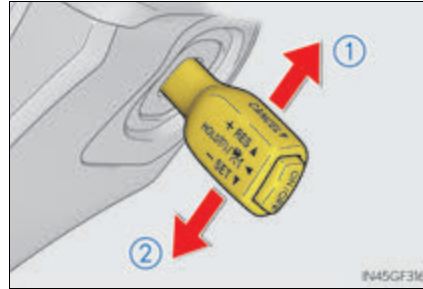

In the vehicle-to-vehicle distance control mode, the set speed will be increased or decreased as follows:

- ▶ For the U.S. mainland, Hawaii and NATO Germany

Fine adjustment: By 1 mph (1.6 km/h)^{*1} or 1 km/h (0.6 mph)^{*2} each time the lever is operated

Large adjustment: Increases or decreases in 1 mph (1.6 km/h)^{*1} or 1 km/h (0.6 mph)^{*2} increments for as long as the lever is held

- ▶ For Canada, Guam, Saipan and Puerto Rico

Fine adjustment: By 1 mph (1.6 km/h)^{*1} or 1 km/h (0.6 mph)^{*2} each time the lever is operated

Large adjustment: Increases or decreases in 5 mph (8 km/h)^{*1} or 5 km/h (3.1 mph)^{*2} increments for as long as the lever is held

In the constant speed control mode (→P. 286), the set speed will be increased or decreased as follows:

Fine adjustment: By 1 mph (1.6 km/h)^{*1} or 1 km/h (0.6 mph)^{*2} each time the lever is operated

Large adjustment: The speed will continue to change while the lever is held.

*1: When the set speed is shown in "MPH"

*2: When the set speed is shown in "km/h"

Changing the vehicle-to-vehicle distance (vehicle-to-vehicle distance control mode)

Pressing the button changes the vehicle-to-vehicle distance as follows:

- ① Long
- ② Medium
- ③ Short

The vehicle-to-vehicle distance is set automatically to long mode when the engine switch is turned to IGNITION ON mode.

If a vehicle is running ahead of you, the preceding vehicle mark will also be displayed.

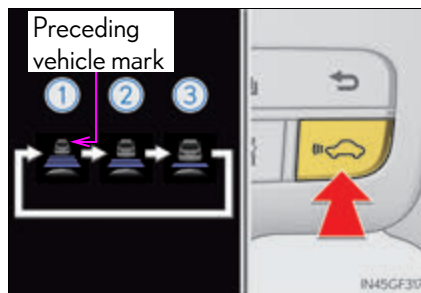

Vehicle-to-vehicle distance settings (vehicle-to-vehicle distance control mode)

Select a distance from the table below. Note that the distances shown correspond to a vehicle speed of 50 mph (80 km/h). Vehicle-to-vehicle distance increases/decreases in accordance with vehicle speed.

Distance options	Vehicle-to-vehicle distance
Long	Approximately 160 ft. (50 m)
Medium	Approximately 130 ft. (40 m)
Short	Approximately 100 ft. (30 m)

Canceling and resuming the speed control

- ① Pulling the lever toward you cancels the speed control.

The speed control is also canceled when the brake pedal is depressed.

- ② Pushing the lever up resumes the cruise control and returns vehicle speed to the set speed.

However, cruise control does not resume when the vehicle speed is approximately 25 mph (40 km/h) or less.

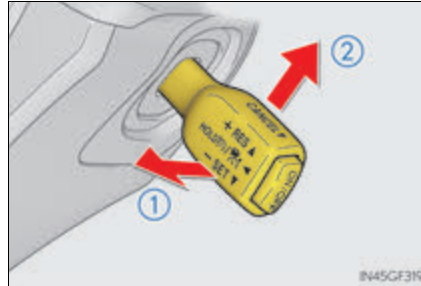

Approach warning (vehicle-to-vehicle distance control mode)

When your vehicle is too close to a vehicle ahead, and sufficient automatic deceleration via the cruise control is not possible, the display will flash and the buzzer will sound to alert the driver. An example of this would be if another driver cuts in front of you while you are following a vehicle. Depress the brake pedal to ensure an appropriate vehicle-to-vehicle distance.



4

Driving

■ Warnings may not occur when

In the following instances, warnings may not occur even when the vehicle-to-vehicle distance is small.

- When the speed of the preceding vehicle matches or exceeds your vehicle speed
- When the preceding vehicle is traveling at an extremely slow speed
- Immediately after the cruise control speed was set
- When depressing the accelerator pedal

Selecting constant speed control mode

When constant speed control mode is selected, your vehicle will maintain a set speed without controlling the vehicle-to-vehicle distance. Select this mode only when vehicle-to-vehicle distance control mode does not function correctly due to a dirty radar sensor, etc.

- 1 With the cruise control off, press and hold the "ON/OFF" button for 1.5 seconds or more.

Immediately after the "ON/OFF" button is pressed, the radar cruise control indicator will come on. Afterwards, it switches to the cruise control indicator.

Switching to constant speed control mode is only possible when operating the lever with the cruise control off.

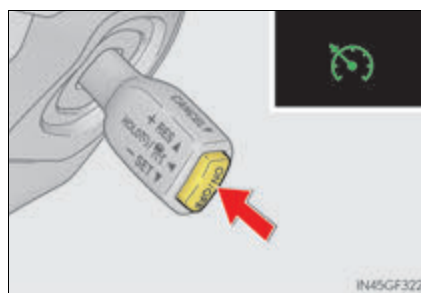

- 2 Accelerate or decelerate, with accelerator pedal operation, to the desired vehicle speed (above approximately 30 mph [50 km/h]) and push the lever down to set the speed.

Cruise control "SET" indicator will come on.

The vehicle speed at the moment the lever is released becomes the set speed.

Adjusting the speed setting: →P. 271

Canceling and resuming the speed setting: →P. 273

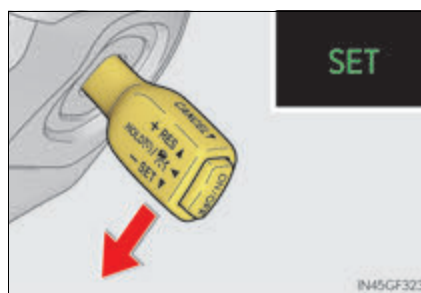

■ Dynamic radar cruise control can be set when

- The shift lever is in D.
- Range 4 or higher of D has been selected by using the paddle shift switch.
- Vehicle speed is above approximately 30 mph (50 km/h).

■ Accelerating after setting the vehicle speed

The vehicle can accelerate by operating the accelerator pedal. After accelerating, the set speed resumes. However, during vehicle-to-vehicle distance control mode, the vehicle speed may decrease below the set speed in order to maintain the distance to the preceding vehicle.

■ Automatic cancelation of vehicle-to-vehicle distance control mode

Vehicle-to-vehicle distance control mode is automatically canceled in the following situations.

- Actual vehicle speed falls below approximately 25 mph (40 km/h).
- VSC is activated.
- TRAC is activated for a period of time.
- When the VSC or TRAC system is turned off by pressing the VSC OFF switch.
- When snow mode is set.
- The sensor cannot detect correctly because it is covered in some way.
- Pre-collision braking is activated.

If vehicle-to-vehicle distance control mode is automatically canceled for any other reason, there may be a malfunction in the system. Contact your Lexus dealer.

■ Automatic cancelation of constant speed control mode

Constant speed control mode is automatically canceled in the following situations:

- Actual vehicle speed is more than approximately 10 mph (16 km/h) below the set vehicle speed.
- Actual vehicle speed falls below approximately 25 mph (40 km/h).
- VSC is activated.
- TRAC is activated for a period of time.
- When the VSC or TRAC system is turned off by pressing the VSC OFF switch.
- Pre-collision braking is activated.

If constant speed control mode is automatically canceled for any other reason, there may be a malfunction in the system. Contact your Lexus dealer.

■ Warning messages and buzzers for dynamic radar cruise control

Warning messages and buzzers are used to indicate a system malfunction or to inform the driver of the need for caution while driving. If a warning message is shown on the multi-information display, read the message and follow the instructions. (→P. 459)

■ When the sensor may not be correctly detecting the vehicle ahead

In the case of the following and depending on the conditions, operate the brake pedal when deceleration of the system is insufficient or operate the accelerator pedal when acceleration is required.

As the sensor may not be able to correctly detect these types of vehicles, the approach warning (→P. 285) may not be activated.

- Vehicles that cut in suddenly
- Vehicles traveling at low speeds
- Vehicles that are not moving in the same lane
- Vehicles with small rear ends (trailers with no load on board, etc.)



- Motorcycles traveling in the same lane
- When water or snow thrown up by the surrounding vehicles hinders the detecting of the sensor
- When your vehicle is pointing upwards (caused by a heavy load in the luggage compartment, etc.)

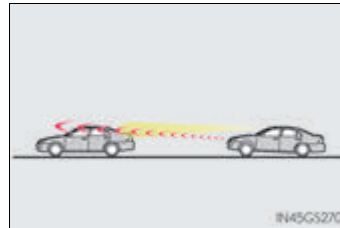

- Preceding vehicle has an extremely high ground clearance

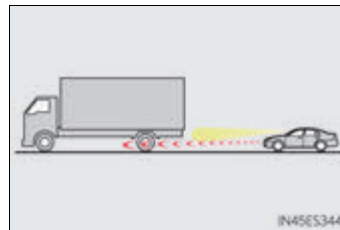

■ **Conditions under which the vehicle-to-vehicle distance control mode may not function correctly**

In the case of the following conditions, operate the brake pedal (or accelerator pedal, depending on the situation) as necessary.
As the sensor may not be able to correctly detect vehicles ahead, the system may not operate properly.

- When the road curves or when the lanes are narrow

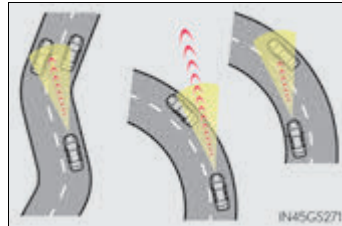

- When steering wheel operation or your position in the lane is unstable

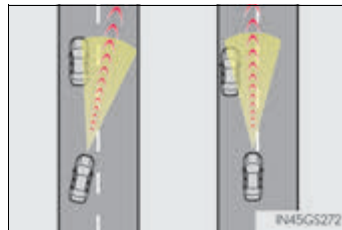

- When the vehicle ahead of you decelerates suddenly

Cruise control*

Summary of functions

Use the cruise control to maintain a set speed without depressing the accelerator pedal.

- ① Set speed
- ② Indicators
- ③ Cruise control switch

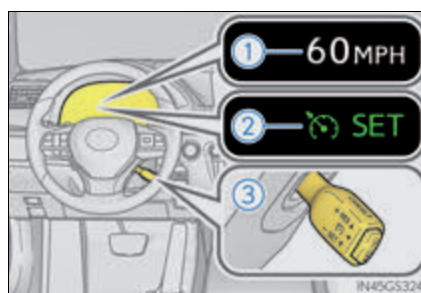

Setting the vehicle speed

- ① Press the "ON/OFF" button to activate the cruise control.

Cruise control indicator will come on.
Press the button again to deactivate the cruise control.

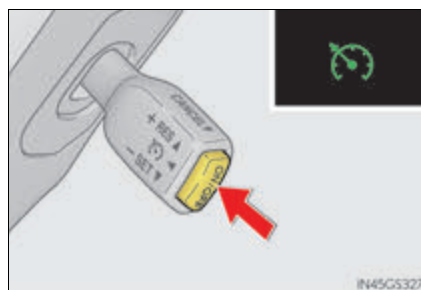

- ② Accelerate or decelerate the vehicle to the desired speed, and push the lever down to set the speed.

Cruise control "SET" indicator will come on.
The vehicle speed at the moment the lever is released becomes the set speed.

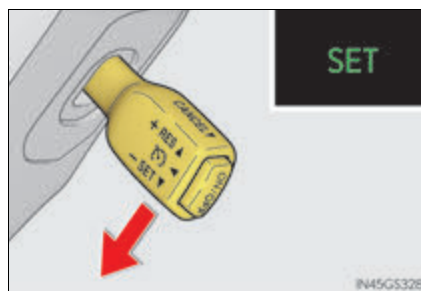

*: If equipped

Adjusting the set speed

To change the set speed, operate the lever until the desired set speed is obtained.

- ① Increases the speed
- ② Decreases the speed

Fine adjustment: Momentarily move the lever in the desired direction.

Large adjustment: Hold the lever in the desired direction.

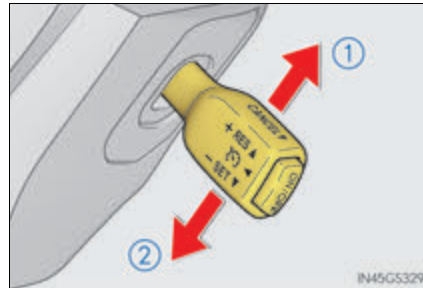

The set speed will be increased or decreased as follows:

Fine adjustment: By approximately 1 mph (1.6 km/h) each time the lever is operated.

Large adjustment: The set speed can be increased or decreased continually until the lever is released.

Canceling and resuming the constant speed control

- ① Pulling the lever toward you cancels the constant speed control.
- ② Pushing the lever up resumes the constant speed control.

The speed setting is also canceled when the brakes are applied.

Resuming is available when the vehicle speed is more than approximately 25 mph (40 km/h).

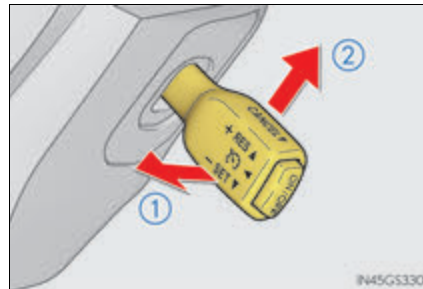

■ Cruise control can be set when

- The shift lever is in D.
- Range 4 or higher of D has been selected by using the paddle shift.
- Vehicle speed is above approximately 25 mph (40 km/h).

■ Accelerating after setting the vehicle speed

- The vehicle can be accelerated normally. After acceleration, the set speed resumes.
- Even without canceling the cruise control, the set speed can be increased by first accelerating the vehicle to the desired speed and then pushing the lever down to set the new speed.

■ **Automatic cruise control cancelation**

Cruise control will stop maintaining the vehicle speed in any of the following situations.

- Actual vehicle speed falls more than approximately 10 mph (16 km/h) below the preset vehicle speed.
At this time, the memorized set speed is not retained.
- Actual vehicle speed is below approximately 25 mph (40 km/h).
- VSC is activated.
- TRAC is activated for a period of time.
- When the VSC or TRAC system is turned off by pressing the VSC OFF switch.

■ **If the warning message for the cruise control is shown on the multi-information display**

Press the "ON/OFF" button once to deactivate the system, and then press the button again to reactivate the system.

If the cruise control speed cannot be set or if the cruise control cancels immediately after being activated, there may be a malfunction in the cruise control system. Have the vehicle inspected by your Lexus dealer.

<p> WARNING</p> <p>■ To avoid operating the cruise control by mistake Switch the cruise control off using the "ON/OFF" button when not in use.</p> <p>■ Situations unsuitable for cruise control Do not use cruise control in any of the following situations. Doing so may result in loss of control and could cause an accident resulting in death or serious injury.</p> <ul style="list-style-type: none">● In heavy traffic● On roads with sharp bends● On winding roads● On slippery roads, such as those covered with rain, ice or snow● On steep hills Vehicle speed may exceed the set speed when driving down a steep hill.● During emergency towing

Driving mode select switch

The driving modes can be selected to suit driving condition.

- ▶ GS350/GS200t (vehicles without Adaptive Variable Suspension system)

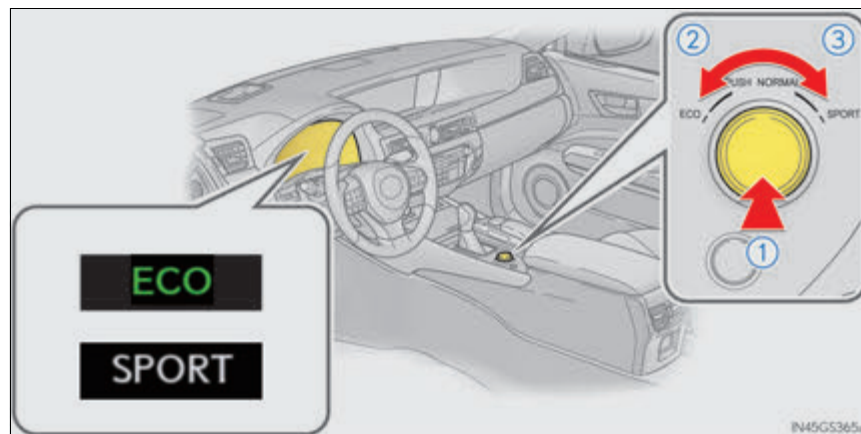

① Normal mode

For normal driving.

Press the switch to change the driving mode to normal mode when selected to Eco drive mode or sport mode.

② Eco drive mode

Use Eco drive mode to help achieve low fuel consumption during trips that involve frequent accelerating.

When not in Eco drive mode and the driving mode select switch is turned to the left, the "ECO" indicator comes on in the multi-information display.

③ Sport mode

Assists acceleration response by controlling the transmission, engine and steering. Suitable for when precise handling is desirable, for example when driving on mountain roads.

When not in sport mode and the driving mode select switch is turned to the right, the "SPORT" indicator comes on in the multi-information display.

▶ GS350/GS200t (vehicles with Adaptive Variable Suspension system)

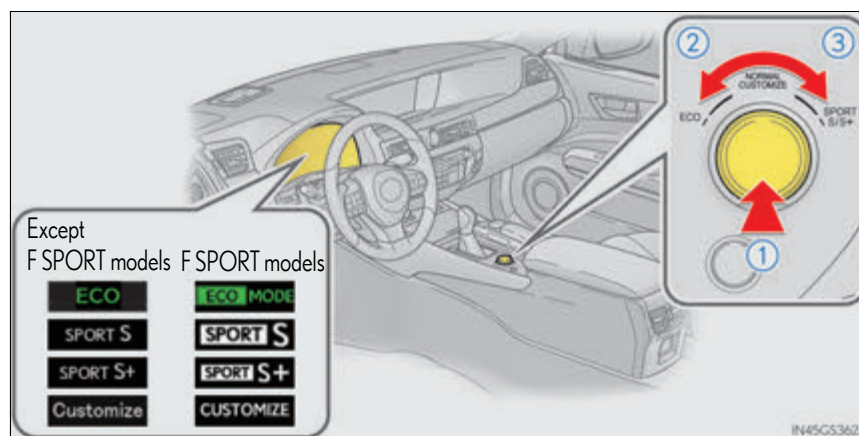

① Normal mode/Customized mode

Normal mode and customized mode are selected by pressing the driving mode select switch. Each time the switch is pressed, the driving mode changes between normal mode and customized mode. When customized mode is selected, the “Customize” or “CUSTOMIZE” indicator will be illuminated.

Press the switch to change the driving mode to normal mode when selected to Eco drive mode or sport mode.

- Normal mode

For normal driving.

- Customized mode

Allows you to drive with the power train, chassis and air conditioning system functions set to your preferred settings.

Customized mode settings can only be changed on the drive mode customization display of the Remote Touch screen. (→P. 578)

② Eco drive mode

Use Eco drive mode to help achieve low fuel consumption during trips that involve frequent accelerating.

When not in Eco drive mode and the driving mode select switch is turned to the left, the “ECO” or “ECO MODE” indicator comes on in the multi-information display.

③ Sport mode

- SPORT S mode

Assists acceleration response by controlling the transmission and engine.

When not in SPORT S mode and the driving mode select switch is turned to the right, the "SPORT S" indicator comes on in the multi-information display.

- SPORT S+ mode

Helps to ensure steering performance and driving stability by simultaneously controlling the steering and suspension in addition to the transmission and engine. Suitable for sporty driving.

When in SPORT S mode and the driving mode select switch is turned to the right, the "SPORT S+" indicator comes on in the multi-information display.

▶ GSF

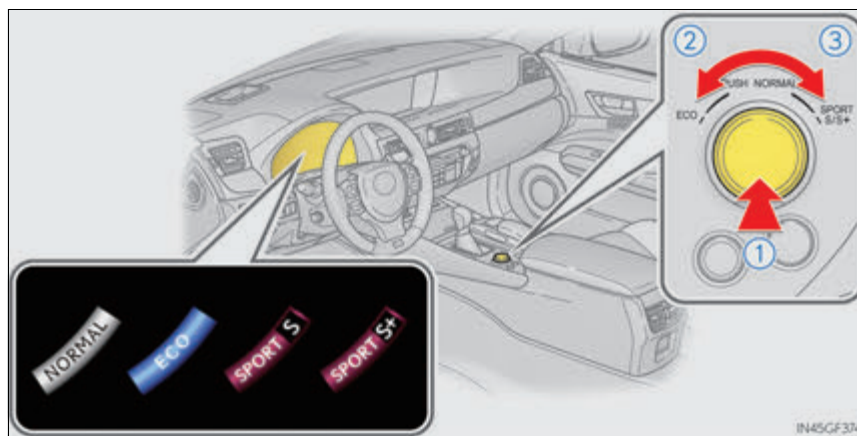

- ① Normal mode

For normal driving.

Press the switch to change the driving mode to normal mode when Eco drive mode or sport mode is selected. The normal mode indicator comes on in the meter.
- ② Eco drive mode

Use Eco drive mode to help achieve low fuel consumption during trips that involve frequent accelerating.

When not in Eco drive mode, if the driving mode select switch is turned to the left, the Eco drive mode indicator comes on in the meter.
- ③ Sport mode
 - SPORT S mode

Assists acceleration response by controlling the transmission and engine.

When not in SPORT S mode, if the driving mode select switch is turned to the right, the "SPORT S" indicator comes on in the meter.
 - SPORT S+ mode

Provides earlier downshift timing than SPORT S mode in order to maintain a high engine speed and provides faster gear changes. This mode also changes the steering feel and VDIM control, making it suitable for powerful sporty driving.

When in SPORT S mode, if the driving mode select switch is turned to the right, the "SPORT S+" indicator comes on in the meter.

■ Operation of the air conditioning system in Eco drive mode

Eco drive mode controls the heating/cooling operations and fan speed of the air conditioning system to enhance fuel efficiency. To improve air conditioning performance, perform the following operations:

- Turn off eco air conditioning mode (→P. 330)
- Adjust the fan speed (→P. 329)
- Turn off Eco drive mode

■ Automatic operation of the seat heater during Eco drive mode

Eco drive mode controls the heating operation and fan speed of the air conditioning system to enhance fuel efficiency. If the driving mode select switch is switched to Eco drive mode in cold temperatures, the seat heater will be automatically operated to assist heating performance.

■ Automatic deactivation of sport mode and customized mode

If the engine switch is turned off after driving in sport mode or customized mode, the drive mode will be changed to normal mode.

■ Driving mode pop-up display (12.3-inch display only)

When the driving mode is changed, the selected driving mode will be temporarily displayed on the side display. (→P. 326)

BSM (Blind Spot Monitor)*

Summary of the Blind Spot Monitor

The Blind Spot Monitor is a system that has 2 functions;

- The Blind Spot Monitor function
Assists the driver in making the decision when changing lanes
- The Rear Cross Traffic Alert function
Assists the driver when backing up

These functions use same sensors.

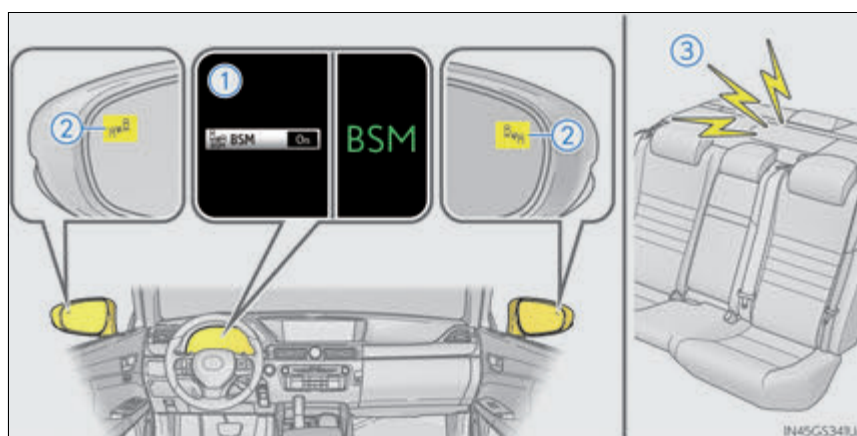

① Switching the BSM function

The Blind Spot Monitor function and Rear Cross Traffic Alert function can be switched on and off using the multi-information display. (→P. 299)

When switched on, the BSM indicator illuminates on the meter and the buzzer sounds.

② Outside rear view mirror indicators

Blind Spot Monitor function:

When a vehicle is detected in the blind spot, the outside rear view mirror indicator comes on while the turn signal lever is not operated and the outside rear view mirror indicator flashes while the turn signal lever is operated.

Rear Cross Traffic Alert function:

When a vehicle approaching from the right or left rear of the vehicle is detected, the outside rear view mirror indicators flash.

③ Rear Cross Traffic Alert buzzer (Rear Cross Traffic Alert function only)

When a vehicle approaching from the right or left rear of the vehicle is detected, a buzzer sounds from behind the rear seat.

*: If equipped

■ **The outside rear view mirror indicators visibility**

When under strong sunlight, the outside rear view mirror indicator may be difficult to see.

■ **Rear Cross Traffic Alert buzzer hearing**

Rear Cross Traffic Alert function may be difficult to hear over loud noises such as high audio volume.



■ **When there is a malfunction in the Blind Spot Monitor**

If a system malfunction is detected due to any of the following reasons, warning messages will be displayed: (→P. 459)

- There is a malfunction with the sensors
- The sensors have become dirty
- The outside temperature is extremely high or low
- The sensor voltage has become abnormal

■ **Switching the Blind Spot Monitor function and Rear Cross Traffic Alert function on and off**

Settings can be changed from  on the multi-information display (→P. 100, 108).

- 1 Press  or  on the meter control switch and select "BSM".
- 2 Each time  on the meter control switch is pressed, the function switches between "On" and "Off".

■ **Certification for the Blind Spot Monitor**

- ▶ For vehicles sold in the U.S.A.

FCC ID : QAYSRR2A

This device complies with part 15 of the FCC Rules. Operation is subject to the following two conditions:
 (1) This device may not cause harmful interference, and
 (2) this device must accept any interference received, including interference that may cause undesired operation.

FCC Warning

Changes or modifications not expressly approved by the party responsible for compliance could void the user's authority to operate the equipment.

- ▶ For vehicles sold in Canada

Applicable law : Canada 310

This device complies with Industry Canada licence-exempt RSS standard(s). Operation is subject to the following two conditions: (1) this device may not cause interference, and (2) this device must accept any interference, including interference that may cause undesired operation of the device.

Frequency bands : 24.05 - 24.25GHz

Output power : less than 20 milliwatts

⚠ WARNING

■ **Handling the radar sensor**

One Blind Spot Monitor sensor is installed inside the left and right side of the vehicle rear bumper respectively. Observe the following to ensure the Blind Spot Monitor can function correctly.

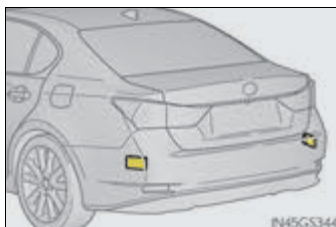

- Keep the sensor and its surrounding area on the bumper clean at all times.
- Do not subject the sensor or surrounding area on the bumper to a strong impact. If the sensor moves even slightly off position, the system may malfunction and vehicles that enter the detection area may not be detected. If the sensor or surrounding area is subject to a strong impact, always have the area inspected by your Lexus dealer.
- Do not disassemble the sensor.
- Do not attach accessories or stickers to the sensor or surrounding area on the bumper.
- Do not modify the sensor or surrounding area on the bumper.
- Do not paint the sensor or surrounding area on the bumper.

The Blind Spot Monitor function

The Blind Spot Monitor function uses radar sensors to detect vehicles that are traveling in an adjacent lane in the area that is not reflected in the outside rear view mirror (the blind spot), and advises the driver of the vehicle's existence via the outside rear view mirror indicator.

The Blind Spot Monitor function detection areas

The areas that vehicles can be detected in are outlined below.

The range of the detection area extends to:

- ① Approximately 11.5 ft. (3.5 m) from the side of the vehicle
The first 1.6 ft. (0.5 m) from the side of the vehicle is not in the detection area
- ② Approximately 9.8 ft. (3 m) from the rear bumper
- ③ Approximately 3.3 ft. (1 m) forward of the rear bumper

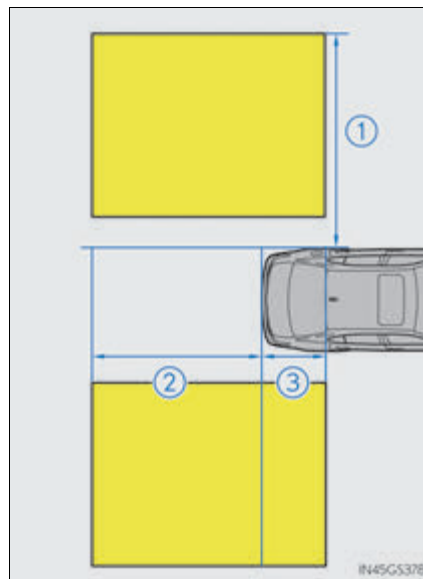

⚠ WARNING

■ Cautions regarding the use of the system

The driver is solely responsible for safe driving. Always drive safely, taking care to observe your surroundings.

The Blind Spot Monitor function is a supplementary function which alerts the driver that a vehicle is present in the blind spot. Do not overly rely on the Blind Spot Monitor function. The function cannot judge if it is safe to change lanes, therefore over reliance could cause an accident resulting in death or serious injury.

According to conditions, the system may not function correctly. Therefore the driver's own visual confirmation of safety is necessary.

■ **The Blind Spot Monitor function is operational when**

- The BSM function is turned on.
- Vehicle speed is greater than approximately 10 mph (16 km/h).

■ **The Blind Spot Monitor function will detect a vehicle when**

- A vehicle in an adjacent lane overtakes your vehicle.
- Another vehicle enters the detection area when it changes lanes.

■ **Conditions under which the Blind Spot Monitor function will not detect a vehicle**

The Blind Spot Monitor function is not designed to detect the following types of vehicles and/or objects:

- Small motorcycles, bicycles, pedestrians etc.*
- Vehicles traveling in the opposite direction
- Guardrails, walls, signs, parked vehicles and similar stationary objects*
- Following vehicles that are in the same lane*
- Vehicles driving 2 lanes across from your vehicle*

*: Depending on conditions, detection of a vehicle and/or object may occur.

■ **Conditions under which the Blind Spot Monitor function may not function correctly**

- The Blind Spot Monitor function may not detect vehicles correctly in the following conditions:
 - During bad weather such as heavy rain, fog, snow etc.
 - When ice or mud etc. is attached to the rear bumper
 - When driving on a road surface that is wet due to rain, standing water etc.
 - When there is a significant difference in speed between your vehicle and the vehicle that enters the detection area
 - When a vehicle is in the detection area from a stop and remains in the detection area as your vehicle accelerates
 - When driving up or down consecutive steep inclines, such as hills, a dip in the road etc.
 - When multiple vehicles approach with only a small gap between each vehicle
 - When vehicle lanes are wide, and the vehicle in the next lane is too far away from your vehicle
 - When the vehicle that enters the detection area is traveling at about the same speed as your vehicle
 - When there is a significant difference in height between your vehicle and the vehicle that enters the detection area
 - Directly after the BSM function is turned on
- Instances of the Blind Spot Monitor function unnecessarily detecting a vehicle and/or object may increase under the following conditions:
 - When there is only a short distance between your vehicle and a guardrail, wall etc.
 - When there is only a short distance between your vehicle and a following vehicle
 - When vehicle lanes are narrow and a vehicle driving 2 lanes across from your vehicle enters the detection area
 - When items such as a bicycle carrier are installed on the rear of the vehicle

The Rear Cross Traffic Alert function

The Rear Cross Traffic Alert functions when your vehicle is in reverse. It can detect other vehicles approaching from the right or left rear of the vehicle. It uses radar sensors to alert the driver of the other vehicle's existence through flashing the outside rear view mirror indicators and sounding a buzzer.

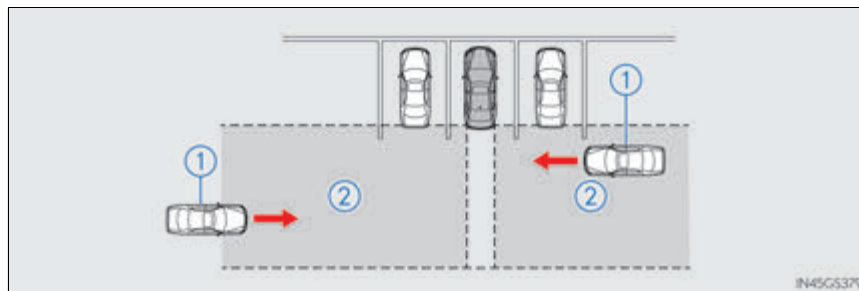

① Approaching vehicles

② Detection areas

⚠ WARNING

■ Cautions regarding the use of the system

The driver is solely responsible for safe driving. Always drive safely, taking care to observe your surroundings.

The Rear Cross Traffic Alert function is only an assist and is not a replacement for careful driving. The driver must be careful when backing up, even when using the Rear Cross Traffic Alert function. The driver's own visual confirmation of behind you and your vehicle is necessary and be sure there are no pedestrians, other vehicles etc. before backing up. Failure to do so could cause death or serious injury.

According to conditions, the system may not function correctly. Therefore the driver's own visual confirmation of safety is necessary.

4

Driving

The Rear Cross Traffic Alert function detection areas

The areas that vehicles can be detected in are outlined below.

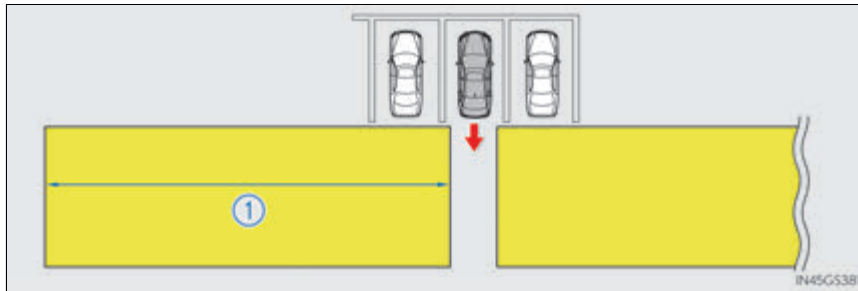

To give the driver a more consistent time to react, the buzzer can alert for faster vehicles from farther away.

Example:

Approaching vehicle	Speed	① Approximate alert distance
Fast	18 mph (28 km/h)	65 ft. (20 m)
Slow	5 mph (8 km/h)	18 ft. (5.5 m)

■ **The Rear Cross Traffic Alert function is operational when**

- The BSM function is turned on.
- The shift lever is in R.
- Vehicle speed is less than approximately 5 mph (8 km/h).
- Approaching vehicle speed is between approximately 5 mph (8 km/h) and 18 mph (28 km/h).

■ **Conditions under which the Rear Cross Traffic Alert function will not detect a vehicle**

The Rear Cross Traffic Alert function is not designed to detect the following types of vehicles and/or objects.

- Small motorcycles, bicycles, pedestrians etc.*
- Vehicles approaching from directly behind
- Guardrails, walls, signs, parked vehicles and similar stationary objects*
- Vehicles moving away from your vehicle
- Vehicles approaching from the parking spaces next to your vehicle*
- Vehicles backing up in the parking space next to your vehicle*

*: Depending on conditions, detection of a vehicle and/or object may occur.

■ Conditions under which the Rear Cross Traffic Alert function may not function correctly

The Rear Cross Traffic Alert function may not detect vehicles correctly in the following conditions:

- During bad weather such as heavy rain, fog, snow etc.
- When ice or mud etc. is attached to the rear bumper
- When multiple vehicles approach continuously
- Shallow angle parking
- When a vehicle is approaching at high speed
- When parking on a steep incline, such as hills, a dip in the road etc.
- Directly after the BSM function is turned on
- When items such as a bicycle carrier are installed on the rear of the vehicle
- Directly after the engine is started with the BSM function is turned on
- When the sensors cannot detect vehicles because of obstacles

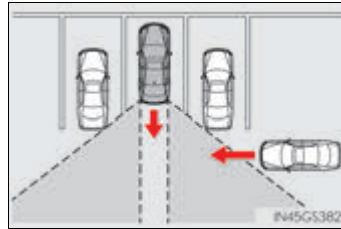

4

Driving

TVD (Torque Vectoring Differential) (GS F)

The TVD system distributes driving force (torque) between the right and left rear wheels automatically. This system contributes to enhanced steering response while cornering and increased traction when exiting a corner, providing an agile driving experience.

Changing TVD control modes

With the engine switch in IGNITION ON mode, pressing the TVD switch changes the TVD control mode.

The current TVD control mode will be displayed on the meters.

- ① STANDARD mode
This is the default mode and provides an optimum balance of driving agility and stability.
- ② SLALOM mode
This mode emphasizes enhanced steering response.
- ③ TRACK mode
This mode emphasizes stability for high speed sporty driving.

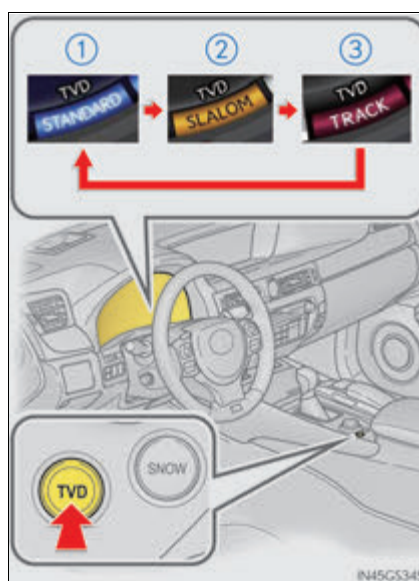

TVD control status on the multi-information display

The multi-information display shows the distribution of driving force between the right and left rear wheels. (→P. 113)

■ Automatic cancelation of the selected TVD control mode

SLALOM and TRACK mode are canceled when the engine switch is turned off. When the engine switch is turned to IGNITION ON mode, the TVD system will be in STANDARD mode.

■ Automatic disabling of the TVD system

If a malfunction is detected in the TVD system, a warning message will be displayed on the multi-information display (→P. 459) and the TVD system will be disabled automatically. If the system is disabled, driving force will not be distributed by the TVD but through normal differential operation.

■ To protect the system

If the TVD fluid temperature becomes excessively high due to driving for a long time under extremely high load conditions, a warning message will be displayed on the multi-information display. (→P. 459)

⚠ WARNING**■ Cautions regarding the use of the system**

The driver is solely responsible for safe driving. Do not overly rely on the TVD system. Always drive safely, taking care to observe your surroundings.

Driving assist systems

To help enhance driving safety and performance, the following systems operate automatically in response to various driving situations. Be aware, however, that these systems are supplementary and should not be relied upon too heavily when operating the vehicle.

◆ ABS (Anti-lock Brake System)

Helps to prevent wheel lock when the brakes are applied suddenly, or if the brakes are applied while driving on a slippery road surface

◆ Brake assist

Generates an increased level of braking force after the brake pedal is depressed when the system detects a panic stop situation

◆ VSC (Vehicle Stability Control)

Helps the driver to control skidding when swerving suddenly or turning on slippery road surfaces

◆ Enhanced VSC (Enhanced Vehicle Stability Control)

Provides cooperative control of the ABS, TRAC, VSC and EPS.

Helps to maintain directional stability when swerving on slippery road surfaces by controlling steering performance.

◆ TRAC (Traction Control)

Helps to maintain drive power and prevent the drive wheels from spinning when starting the vehicle or accelerating on slippery roads

◆ Hill-start assist control

Helps to prevent the vehicle from rolling backward when starting on an incline.

◆ VGRS (Variable Gear Ratio Steering) (if equipped)

Adjusts the front wheel turning angle in accordance with the vehicle speed and steering wheel movement

◆ DRS (Dynamic Rear Steering) (if equipped)

Contributes to the turning characteristics and responsiveness of the vehicle by slightly adjusting the rear wheel angle of the vehicle in accordance with steering wheel movement

◆ EPS (Electric Power Steering)

Employs an electric motor to reduce the amount of effort needed to turn the steering wheel

◆ AVS (Adaptive Variable Suspension system) (if equipped)

By independently controlling the damping force of the shock absorbers for each of the 4 wheels according to the road and driving conditions, this system helps riding comfort with superior steering stability, and helps good vehicle posture

When SPORT S+ mode is selected by the driving mode select switch, the damping force is suitable for sporty driving (→P. 293)

◆ LDH (Lexus Dynamic Handling system) (if equipped)

Provides independent control of the VGRS, DRS and EPS. Contributes to turning characteristics at low speeds, responsiveness at medium speeds and safety at high speeds by controlling the steering angle of the front and rear wheels in accordance with the steering wheel operation and vehicle speed

◆ VDIM (Vehicle Dynamics Integrated Management)

Provides integrated control of the ABS, brake assist, TRAC, VSC, hill-start assist control, EPS, VGRS (if equipped) and DRS (if equipped) systems

Helps to maintain vehicle stability when swerving on slippery road surfaces by controlling the brakes, engine output, steering assist, and steering ratio and rear wheel angle

When the TRAC/VSC systems are operating

The slip indicator light will flash while the TRAC/VSC systems are operating.

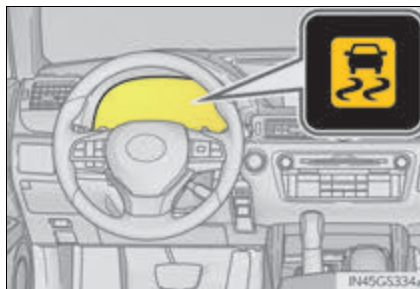

Disabling the TRAC system

If the vehicle gets stuck in mud, dirt or snow, the TRAC system may reduce power from the engine to the wheels. Pressing  to turn the system off may make it easier to rock the vehicle in order to free it.

▶ GS350/GS200t

▶ GS F



To turn the TRAC system off, quickly press and release .

GS350/GS200t: The "Traction Control Turned Off" will be shown on the multi-information display.

GS F: The "TRAC OFF" indicator light will come on.

Press  again to turn the system back on.

■ Turning off both TRAC/VSC systems

▶ GS350/GS200t

To turn the TRAC/VSC systems off, press and hold  for more than 3 seconds while the vehicle is stopped.

The VSC OFF indicator light will come on and the "Traction Control Turned Off" will be shown on the multi-information display.*1

Press  again to turn the systems back on.

▶ GS F

To turn the TRAC and VSC systems off, press and hold  for more than 3 seconds.

The "TRAC OFF" indicator light and the VSC OFF indicator light will come on.*2

Press  again to turn the systems back on.

*1: On vehicles with PCS (Pre-Collision System), pre-collision brake assist, pre-collision braking, and steering control (performed through cooperative control of PCS [Pre-Collision System] and LDH) (if equipped) will also be disabled. The pre-collision system warning light will come on and a message will be displayed on the multi-information display. (→P. 459)

*2: On vehicles with PCS (Pre-Collision System), pre-collision brake assist and pre-collision braking will also be disabled. The PCS (Pre-Collision System) warning light will come on and a message will be displayed on the multi-information display. (→P. 459)

■ Expert mode (GS F)

When expert mode is selected, it is possible to drive in a more sporty manner than other drive modes. Expert mode disables the TRAC and VSC systems but the engine and brakes may be controlled depending on the vehicle behavior.

To select expert mode, press  when in SPORT S+ mode.

The "EXPERT" indicator will come on together with the TRAC OFF and VSC OFF indicators.

To cancel expert mode, press  or use the driving mode select switch to select a driving mode other than SPORT S+ mode.



■ When the message is displayed on the multi-information display showing that TRAC has been disabled even if  has not been pressed (GS350/GS200t)

TRAC and hill-start assist control cannot be operated. Contact your Lexus dealer.

■ When the "TRAC OFF" indicator light comes on even if  has not been pressed (GS F)

TRAC and hill-start assist control cannot be operated. Contact your Lexus dealer.

■ VGRS is disabled when

VGRS may stop operating in the following situations.

In this event, the steering wheel may move from its straight forward position, but it will return when the system restarts.

- The steering wheel is operated for an extended period of time while the vehicle is stopped or is moving very slowly.
- When force is continuously applied for a long time with the steering wheel turned as far as it will go.

The center position of the steering wheel may change when VGRS is disabled. However, the position will return to normal after VGRS is reactivated.

■ When the battery is disconnected

The steering wheel may move from its straight forward position, but this will be corrected automatically when driving.

■ Sounds and vibrations caused by the ABS, brake assist, VSC, TRAC, Hill-start assist control and VGRS systems

- A sound may be heard from the engine compartment when the brake pedal is depressed repeatedly, when the engine is started or just after the vehicle begins to move. This sound does not indicate that a malfunction has occurred in any of these systems.
- Any of the following conditions may occur when the above systems are operating. None of these indicates that a malfunction has occurred.
 - Vibrations may be felt through the vehicle body and steering.
 - A motor sound may be heard after the vehicle comes to a stop.
 - The brake pedal may pulsate slightly after the ABS is activated.
 - The brake pedal may move down slightly after the ABS is activated.

■ EPS, VGRS and DRS operation sound

When the steering wheel is operated, a motor sound (whirring sound) may be heard. This does not indicate a malfunction.

■ Automatic reactivation of TRAC and VSC systems

After turning the TRAC and VSC systems off, the systems will be automatically re-enabled in the following situations:

- When the engine switch is turned off
 - If only the TRAC system is turned off, the TRAC will turn on when vehicle speed increases
- If both TRAC and VSC systems are turned off, automatic re-enabling will not occur when vehicle speed increases.

■ Reduced effectiveness of the EPS system

The effectiveness of the EPS system is reduced to prevent the system from overheating when there is frequent steering input over an extended period of time. The steering wheel may feel heavy as a result. Should this occur, refrain from excessive steering input or stop the vehicle and turn the engine off. The EPS system should return to normal within 10 minutes.

■ Operating conditions of hill-start assist control

When the following four conditions are met, the hill-start assist control will operate;

- The shift lever is in a position other than N or P (when starting off forward/backward on an upward incline).
- The vehicle is stopped.
- The accelerator pedal is not depressed.
- The parking brake is not engaged.

■ Automatic system cancelation of hill-start assist control

The hill-start assist control will be canceled in any of the following situations;

- The shift lever is shifted to N or P.
- The accelerator pedal is depressed.
- The parking brake is engaged.
- Approximately 2 seconds elapse after the brake pedal is released.

 **WARNING****■ The ABS does not operate effectively when**

- The limits of tire gripping performance have been exceeded. (such as excessively worn tires on a snow covered road).
- The vehicle hydroplanes while driving at high speed on wet or slick roads.

■ Stopping distance when the ABS is operating may exceed that of normal conditions

The ABS is not designed to shorten the vehicle's stopping distance. Always maintain a safe distance from the vehicle in front of you, especially in the following situations:

- When driving on dirt, gravel or snow-covered roads
- When driving with tire chains
- When driving over bumps in the road
- When driving over roads with potholes or uneven surfaces

■ TRAC may not operate effectively when

Directional control and power may not be achievable while driving on slippery road surfaces, even if the TRAC system is operating.

Drive the vehicle carefully in conditions where stability and power may be lost.

■ Hill-start assist control does not operate effectively when

- Do not overly rely on the hill-start assist control. The hill-start assist control may not operate effectively on steep inclines and roads covered with ice.
- Unlike the parking brake, hill-start assist control is not intended to hold the vehicle stationary for an extended period of time. Do not attempt to use hill-start assist control to hold the vehicle on an incline, as doing so may lead to an accident.

■ When the VSC is activated

The slip indicator light flashes. Always drive carefully. Reckless driving may cause an accident. Exercise particular care when the indicator light flashes.

⚠ WARNING**■ When the TRAC/VSC systems are turned off**

Be especially careful and drive at a speed appropriate to the road conditions. As these are the systems to help ensure vehicle stability and driving force, do not turn the TRAC/VSC systems off unless necessary.

■ Expert mode precautions (GS F)

- Do not use on public roads.
- Use only when the road conditions and safety of the surrounding area can be ensured.
- Proper use of expert mode requires a professional level of driving skill. When using expert mode, always check the road conditions and surrounding area and drive more carefully than usual.

■ Replacing tires

Make sure that all tires are of the specified size, brand, tread pattern and total load capacity. In addition, make sure that the tires are inflated to the recommended tire inflation pressure level.

The ABS, TRAC and VSC systems will not function correctly if different tires are installed on the vehicle.

Contact your Lexus dealer for further information when replacing tires or wheels.

■ Handling of tires and the suspension

Using tires with any kind of problem or modifying the suspension will affect the driving assist systems, and may cause a system to malfunction.

Winter driving tips

Carry out the necessary preparations and inspections before driving the vehicle in winter. Always drive the vehicle in a manner appropriate to the prevailing weather conditions.

Preparation for winter (GS350/GS200t)

- Use fluids that are appropriate to the prevailing outside temperatures.
 - Engine oil
 - Engine coolant
 - Washer fluid
- Have a service technician inspect the condition of the battery.
- Have the vehicle fitted with four snow tires or purchase a set of tire chains for the rear tires.*

Ensure that all tires are the specified size and brand, and that chains match the size of the tires.

*: Tire chains cannot be mounted on vehicles with front and rear tires of differing sizes and vehicles with LDH and 19-inch tires.

Preparation for winter (GS F)

- Use fluids that are appropriate to the prevailing outside temperatures.
 - Engine oil
 - Engine coolant
 - Washer fluid
- Have a service technician inspect the condition of the battery.
- Have the vehicle fitted with four snow tires.

Ensure that all tires are the specified size and brand.

Before driving the vehicle

Perform the following according to the driving conditions:

- Do not try to forcibly open a window or move a wiper that is frozen. Pour warm water over the frozen area to melt the ice. Wipe away the water immediately to prevent it from freezing.
- To ensure proper operation of the climate control system fan, remove any snow that has accumulated on the air inlet vents in front of the windshield.
- Check for and remove any excess ice or snow that may have accumulated on the exterior lights, vehicle's roof, chassis, around the tires or on the brakes.
- Remove any snow or mud from the bottom of your shoes before getting in the vehicle.

When driving the vehicle

Accelerate the vehicle slowly, keep a safe distance between you and the vehicle ahead, and drive at a reduced speed suitable to road conditions.

When parking the vehicle

Park the vehicle and move the shift lever to P without setting the parking brake. The parking brake may freeze up, preventing it from being released. If necessary, block the wheels to prevent inadvertent sliding or creeping.

Selecting tire chains (GS350/GS200t)

- ▶ Vehicles with front and rear tires of the same size except for the vehicles with LDH and 19 inch tires

Use the correct tire chain size when mounting the tire chains.

Chain size is regulated for each tire size.

- ① Side chain
(0.12 in. [3 mm] in diameter)
- ② Cross chain
(0.16 in. [4 mm] in diameter)

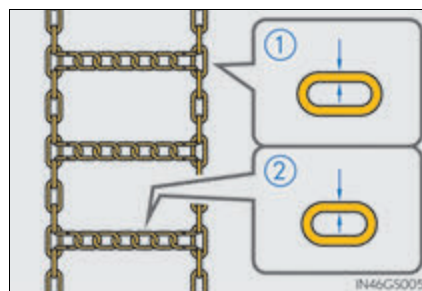

- ▶ Vehicles with front and rear tires of differing sizes and vehicles with LDH and 19 inch tires

Tire chains cannot be mounted.

Snow tires should be used instead.

Selecting tire chains (GS F)

Tire chains cannot be mounted.

Snow tires should be used instead.

Regulations on the use of tire chains

Regulations regarding the use of tire chains vary depending on location and type of road. Always check local regulations before installing chains.

Shifting the windshield wiper position

If heavy snow or icy condition is expected, shift the rest position manually.

Grip the hook section of the wiper arm firmly when shifting the wiper position.

■ To rest position

Raise the wiper in line with the windshield.

You can stand the wipers up for the rest position.

★: More than 3.9 in. (10 cm)

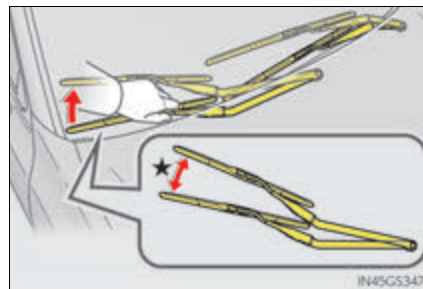

■ To retract position

Lower the wipers by pressing on the upper part of the hook section.

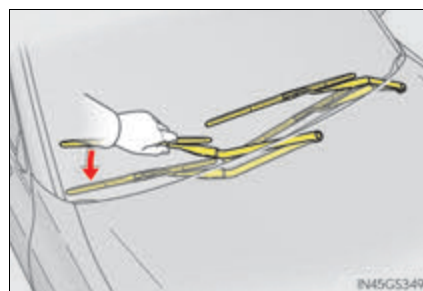

■ Tire chain installation

Observe the following precautions when installing and removing chains:

- Install and remove tire chains in a safe location.
- Install tire chains on the rear tires. Do not install tire chains on the front tires.
- Install tire chains on rear tires as tightly as possible. Retighten chains after driving 1/4 — 1/2 mile (0.5 — 1.0 km).
- Install tire chains following the instructions provided with the tire chains.

⚠ WARNING**■ Driving with snow tires**

Observe the following precautions to reduce the risk of accidents.
Failure to do so may result in a loss of vehicle control and cause death or serious injury.

- Use tires of the specified size.
- Maintain the recommended level of air pressure.
- Do not drive in excess of 75 mph (120 km/h), regardless of the type of snow tires being used.
- Use snow tires on all, not just some wheels.

■ Driving with tire chains (GS350/GS200t with front and rear tires of the same size except for the vehicles with LDH and 19 inch tires)

Observe the following precautions to reduce the risk of accidents.
Failure to do so may result in the vehicle being unable to be driven safely, and may cause death or serious injury.

- Do not drive in excess of the speed limit specified for the tire chains being used, or 30 mph (50 km/h), whichever is lower.
- Avoid driving on bumpy road surfaces or over potholes.
- Avoid sudden acceleration, abrupt steering, sudden braking and shifting operations that cause sudden engine braking.
- Slow down sufficiently before entering a curve to ensure that vehicle control is maintained.
- Do not use LKA (Lane-Keeping Assist) system. (if equipped)
- Do not use LDA (Lane Departure Alert with steering control) system. (if equipped)

⚠ NOTICE**■ Repairing or replacing snow tires**

Request repairs or replacement of snow tires from Lexus dealers or legitimate tire retailers.
This is because the removal and attachment of snow tires affects the operation of the tire pressure warning valves and transmitters.

■ Fitting tire chains (GS350/GS200t with front and rear tires of the same size except for the vehicles with LDH and 19 inch tires)

The tire pressure warning valves and transmitters may not function correctly when tire chains are fitted.

■ When standing the windshield wipers up

Raise the wipers in line with the windshield. (→P. 318)
Failure to do so may result in damage to the wipers and/or the hood.

Interior features

5

- | | |
|--------------------------------------------------------------------------------------------------------------------------------------------------------------------------------------------------------------------------------------------------------------------------------------------------------------------------|----------------------------------------------------------------------------------------------------------------------------------------------------------------------------------------------------------------------------------------------------------------------------------------------------------------------------------------------------------------------------------------------------------------------------------------------------------------------------------------------------------------------------------------------------------------------------------------------------------------------------------------------------------------------------------------------------------------------------------------------------------------------------------------------------------------------------------------------------------------------------------------|
| <p>5-1. Remote Touch screen
 Remote Touch/12.3-inch display322</p> <p>5-2. Using the air conditioning system and defogger
 Front automatic air conditioning system.....328
 Rear air conditioning system339
 Heated steering wheel/ seat heaters/seat ventilators342</p> | <p>5-3. Using the interior lights
 Interior lights list 347
 • Interior lights348
 • Personal lights348</p> <p>5-4. Using the storage features
 List of storage features350
 • Glove box 351
 • Console box..... 351
 • Cup holders 352
 • Auxiliary boxes353
 Trunk features 354</p> <p>5-5. Using the other interior features
 Other interior features358
 • Sun visors358
 • Vanity mirrors358
 • Clock359
 • Ashtrays359
 • Power outlets360
 • Armrest360
 • Rear sunshade/
 rear door sunshades361
 • Trunk storage extension363
 • Coat hooks364
 • Assist grips.....364
 • Garage door opener365
 • LEXUS Enform Safety Connect.....372</p> |
|--------------------------------------------------------------------------------------------------------------------------------------------------------------------------------------------------------------------------------------------------------------------------------------------------------------------------|----------------------------------------------------------------------------------------------------------------------------------------------------------------------------------------------------------------------------------------------------------------------------------------------------------------------------------------------------------------------------------------------------------------------------------------------------------------------------------------------------------------------------------------------------------------------------------------------------------------------------------------------------------------------------------------------------------------------------------------------------------------------------------------------------------------------------------------------------------------------------------------|

Remote Touch/12.3-inch display*

The Remote Touch can be used to operate the Remote Touch screens. Owners of models equipped with a navigation system should refer to the "NAVIGATION AND MULTIMEDIA SYSTEM OWNER'S MANUAL".

Remote Touch operation

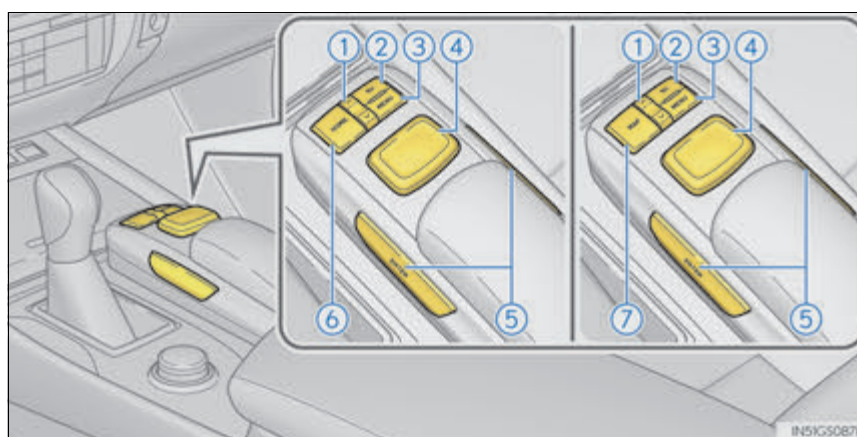

*: If equipped

- ① “∧•∨” button
Press this button to change map scale and scroll through lists.
- ② Back button
Press this button to display the previous screen.
- ③ “MENU” button
Press this button to display the “Menu” screen.
- ④ Remote Touch knob
Move in the desired direction to select a function, letter and screen button.
Press the knob to enter the selected function, letter or screen button.
- ⑤ “ENTER” buttons
Press this button to enter the selected function, letter or screen button.
- ⑥ “HOME” button (vehicles with 8-inch display)
Press this button to display the home screen.
- ⑦ “MAP” button (vehicles with 12.3-inch display)
Press this button to display the vehicle’s current position.

■ Using the Remote Touch knob

- ① Select: Move the knob in the desired direction.
- ② Enter: Press the knob or “ENTER” button.

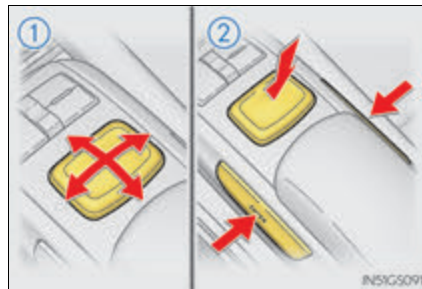

■ **Screen display during low temperatures**

When the ambient temperature is extremely low, screen response may be delayed even if the Remote Touch is operated.

 **WARNING**

■ **When using the Remote Touch**

- Do not allow fingers, fingernails or hair to become caught in the Remote Touch as this may cause an injury.
- Be careful when selecting the Remote Touch in extreme temperatures as it may become very hot or cold due to the temperature inside the vehicle.

 **NOTICE**

■ **To prevent damage to the Remote Touch**

- Do not allow the Remote Touch to come into contact with food, liquid, stickers or lit cigarettes as doing so may cause it to change color, emit a strange odor or stop functioning.
- Do not subject the Remote Touch to excessive pressure or strong impact as the knob may bend or break off.
- Do not allow coins, contact lenses or other such items to become caught in the Remote Touch as this may cause it to stop functioning.
- Items of clothing may rip if they become caught on the Remote Touch knob.
- If your hand or any object is on the Remote Touch knob when the engine switch is turned to ACCESSORY mode, the Remote Touch knob may not operate properly.

“Menu” screen

Press the “MENU” button on the Remote Touch to display the “Menu” screen.









The display may differ depending on the type of the system.

12.3-inch display: When an interruption screen is being displayed on the side display, the “Menu” screen will be shown on the main display.

▶ Vehicles with 8-inch display

▶ Vehicles with 12.3-inch display



Switch	Function
	Select to display the compass mode screen.*1
	Select to display the “Destination” screen.*1
	Select to display the radio control screen.*1
	Select to display the media control screen.*1
	Select to display the hands-free operation screen.*1
	Select to display the “LEXUS App Suite” screen.*1,2
	Select to display the “Information” screen.*1
	Select to display the air conditioning control screen. (→P.328)

Switch	Function
	Select to display the "Setup" screen. *1
"Display"	Select to adjust the contrast and brightness of the screens, turn the screen off, etc. *1

*1: Refer to the "NAVIGATION AND MULTIMEDIA SYSTEM OWNER'S MANUAL".

*2: If equipped

12.3-inch display operation

■ Full screen display

The following functions can be displayed full screen:

- Initial screen*
- "Menu" screen (→P. 325)
- Map screen*

*: Refer to the "NAVIGATION AND MULTIMEDIA SYSTEM OWNER'S MANUAL".

■ Split-screen display

Different information can be displayed on the left and right of the screen. For example, air conditioning system screen can be displayed and operated while the fuel consumption information screen is being displayed. The large screen on the left of the display is called the main display, and the small screen to the right is called the side display.

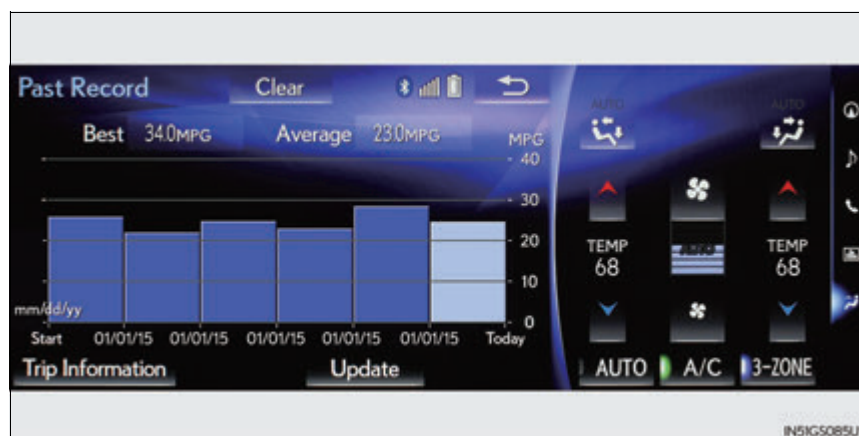

12.3-inch display function

For details of the functions and operation of the main display, refer to the respective section.

■ Display the side display

▶ Basic screens

The following functions can be displayed and operated on the side display.

Select the desired button.

- ① Navigation system*
- ② Audio*
- ③ Phone*
- ④ Vehicle information (→P. 130)
- ⑤ Air conditioning system (→P. 332)



To turn off the side display, press the “MAP” button on Remote Touch to display the map screen, and then press .

If the item displayed on the main display is full screen display compatible (→P. 326), it will be displayed full screen.

▶ Interruption screens

Each of the following screens is displayed automatically in accordance with conditions.

- Intuitive parking assist* (if equipped)
- Phone*
- Destination Assist*
- Driving mode (→P. 293)

*: Refer to the “NAVIGATION AND MULTIMEDIA SYSTEM OWNER’S MANUAL”.

Front automatic air conditioning system

Air outlets and fan speed are automatically adjusted according to the temperature setting.

Press the "MENU" button on the Remote Touch, then select  to display the air conditioning operation screen.

Vehicles with 12.3-inch display: The air conditioning system can be displayed and operated on the side display. (→P. 326)

The display and button positions will differ depending on the type of the system.

Control panel



■ Adjusting the temperature setting

Press “^” on  to increase the temperature and “v” to decrease the temperature.

▶ Without rear air conditioning system



When “DUAL” on the control screen is selected or the passenger’s side temperature control button is pressed, the temperature for the driver and passenger seats can be adjusted separately.

▶ With rear air conditioning system

When “3-ZONE” on the control screen is selected or the passenger’s side temperature control button is pressed, the temperature for the driver’s, front passenger’s and rear seats (→P. 339) can be adjusted separately.

The air conditioning system switches between individual and simultaneous modes each time 3-ZONE is selected.

■ Adjusting the fan speed setting

Press  to increase the fan speed and  to decrease the fan speed.

Press the “OFF” button to turn the fan off.

■ Change the airflow mode

To change the air outlets, press .

The air outlets used are switched each time the button is pressed. (→P. 330)

■ S-FLOW mode

Press .

When  is pressed, the airflow changes as follows.

Without rear air conditioning system: Air flows to the front seats only.*

With rear air conditioning system:

Air flows to the front seats only, and if the passenger seat is unoccupied, the set temperature, outside humidity and temperature inside the cabin are assessed, and air flows to the driver seat only.*

*: Air may also flow to the rear seats depending on the situation.

■ Other functions

- Switching between outside air and recirculated air modes (→P. 334)
- Defogging the windshield (→P. 334)
- Defogging the rear window and outside rear view mirrors (→P. 334)

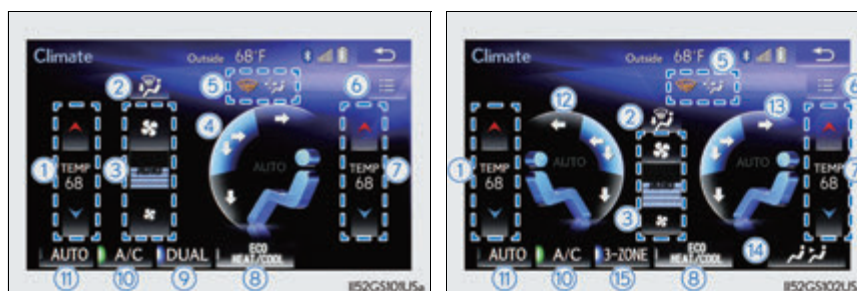

Control screen

- ▶ Without rear air conditioning system
- ▶ With rear air conditioning system



- ① Adjust the left-hand side temperature setting
- ② Select the air flow to the feet and operate the windshield defogger
- ③ Adjust the fan speed setting
- ④ Select the air flow mode* (the front seats)
- ⑤ Function on/off indicators on the option control screen
- ⑥ Display the option control screen (→P. 331)
- ⑦ Adjust the right-hand side temperature setting
- ⑧ Set eco air conditioning mode (→P. 337)
Air conditioning and heater output is limited to prioritize fuel economy.
- ⑨ Adjust the temperature for the driver's and front passenger's seats separately (DUAL mode) (→P. 329)
- ⑩ Set cooling and dehumidification function on/off
- ⑪ Select to set automatic mode on/off
- ⑫ Select the air flow mode* (the left-hand side)
- ⑬ Select the air flow mode* (the right-hand side)
- ⑭ Display the rear air conditioning operation screen (→P. 332)
- ⑮ Adjust the temperature for the driver's, front passenger's and rear seats (→P. 339) separately (3-ZONE mode) (→P. 329)

To adjust or select settings, move the Remote Touch knob to select the screen button, and then press the Remote Touch knob or the "ENTER" button of Remote Touch to enter the selected function.

- *:  — Air flows to the upper body
-  — Air flows to the upper body and feet
-  — Air flows to the feet

■ Option control screen

Select  on the control screen to display the option control screen. The functions can be switched on and off.

When the function is on, the indicator illuminates on the control screen.
(→P. 330)

- ① Prevent ice from building up on the windshield and wiper blades (if equipped) (→P. 334)
- ② Remove pollen from the air (Micro dust and pollen filter) (→P. 334)

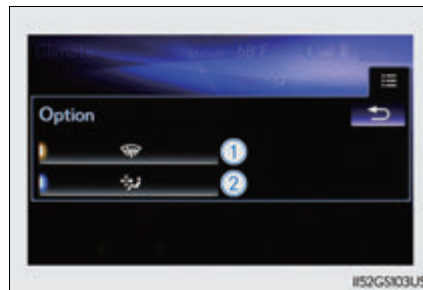

5

Interior features

■ Side display (vehicles with 12.3-inch display)

- ▶ Without rear air conditioning system ▶ With rear air conditioning system

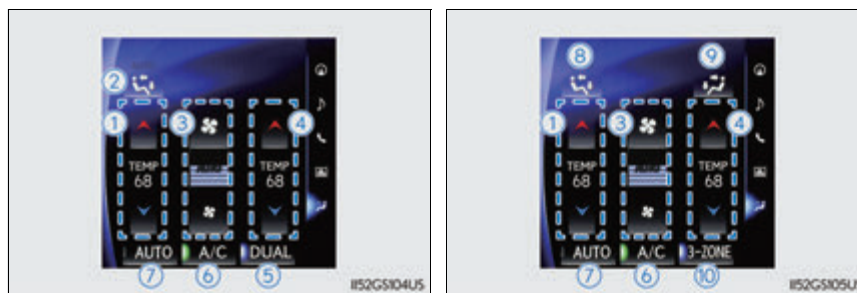

- ① Adjust the left-hand side temperature setting
- ② Select the air flow mode (the front seats)
- ③ Adjust the fan speed setting
- ④ Adjust the right-hand side temperature setting
- ⑤ Adjust the temperature for the driver's and front passenger's seats separately (DUAL mode) (→P. 329)
- ⑥ Set cooling and dehumidification function on/off
- ⑦ Select to set automatic mode on/off
- ⑧ Select the air flow mode (the left-hand side)
- ⑨ Select the air flow mode (the right-hand side)
- ⑩ Adjust the temperature for the driver's, front passenger's and rear seats (→P. 339) separately (3-ZONE mode) (→P. 329)

■ Rear air conditioning control screen (with rear air conditioning system)

- ① Adjust the rear seat temperature setting
- ② Disabling the switches on the rear armrest
- ③ Turn the fan off (rear seat)
- ④ Select to set automatic mode on/off (rear seat)



Air conditioning control

■ Using the automatic mode

- 1 Press  or select "AUTO" on the control screen.
- 2 Press  to switch to automatic air intake mode.

The air conditioning system automatically switches between outside air and recirculated air modes.

- 3 Adjust the temperature setting. (→P. 329)

To stop the operation, press the "OFF" button.

Air outlets and fan speed for the driver and passenger seats may be adjusted separately depending on the temperature setting.

When the front seat heaters and ventilators/rear seat heaters are set to AUTO mode, the system is operated automatically according to the set temperature, outside temperature, etc.



■ Automatic mode indicator

If the fan speed setting or air flow modes are operated, the automatic mode indicator goes off. However, automatic mode for functions other than that operated is maintained.

Other functions

■ Switching between outside air and recirculated air modes

Press .

The mode switches among  (recirculated air mode), automatic and  (outside air mode) modes each time the button is pressed.

When the system is switched to automatic mode, the air conditioning system operates automatically.

■ Defogging the windshield

Defoggers are used to defog the windshield and front side windows.

Press .

Set the outside/recirculated air mode button to outside air mode if the recirculated air mode is used. (It may switch automatically.)

To defog the windshield and the side windows early, turn the air flow and temperature up.

To return to the previous mode, press  again when the windshield is defogged.

■ Defogging the rear window and outside rear view mirrors

Defoggers are used to defog the rear window and to remove raindrops, dew and frost from the outside rear view mirrors.

Press .

The defoggers will automatically turn off after 15 to 60 minutes. The operation time changes according to the ambient temperature and vehicle speed.

■ Windshield wiper de-icer (if equipped)

This feature is used to prevent ice from building up on the windshield and wiper blades.

Select  on the option control screen.

The windshield wiper de-icer will automatically turn off after approximately 15 minutes.

■ Micro dust and pollen filter

Pollen is removed from the air and the air flows to the upper part of the body.

Select on the  option control screen.

Usually the system will turn off automatically.

In order to prevent the windshield from fogging up when the outside air is cold, the dehumidification function may operate.

The pollens are filtered out even if the micro dust and pollen filter is turned off.

Changing the rear seat settings (with rear air conditioning system)

Select  on the control screen to display the rear air conditioning control screen.

■ Using the automatic mode

- 1 Select "REAR AUTO" on the screen.



The air conditioning system will operate, and air outlets and speed will be set automatically.

When the rear seat heaters are set to automatic mode, the system is operated automatically according to the set temperature, outside temperature, etc.

- 2 Adjust the temperature setting.

To stop the operation, select "REAR OFF".

■ Adjusting the temperature setting

Select  to increase the temperature and  to decrease the temperature.

The air conditioning system switches between individual and simultaneous modes each time "3-ZONE" on the control screen is selected.

■ Disabling the switches on the rear armrest.

Select .

Rear seat heater switches (→P. 343) are also locked.

Air outlets

■ Location of air outlets

The air outlets and air volume changes according to the selected air flow mode.

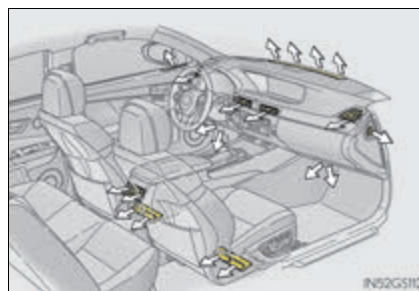

■ **Adjusting the position of and opening and closing the air outlets**

- ▶ Front center outlets and front side outlets
- ▶ Rear seat outlets

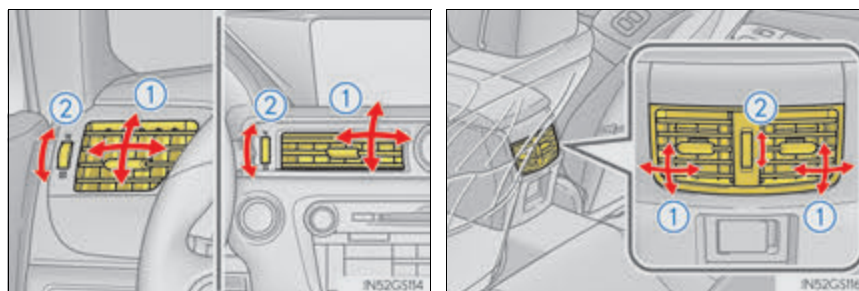

- ① Direct air flow to the left or right, up or down.
- ② Turn the knob to open or close the vent.

■ **Registering air conditioning settings to electronic keys**

- Unlocking the vehicle using an electronic key and turning the engine switch to IGNITION ON mode will recall that key's registered air conditioning settings.
- When the engine switch is turned off, the current air conditioning settings will automatically be registered to the electronic key that was used to unlock the vehicle.
- The system may not operate correctly if more than one electronic key is in the vicinity or if the smart access system with push-button start is used to unlock a passenger door.
- Settings for the electronic key and the corresponding door can be changed. Contact your Lexus dealer.

■ **Using automatic mode**

Fan speed is adjusted automatically according to the temperature setting and the ambient conditions.

Therefore, the fan may stop for a while until warm or cool air is ready to flow immediately after  is pressed.

Cool air may blow around the upper body even when the heater is on due to sunlight.

■ **Fogging up of the windows**

- The windows will easily fog up when the humidity in the vehicle is high. Turning "A/C" on will dehumidify the air from the outlets and defog the windshield effectively.
- If you turn "A/C" off, the windows may fog up more easily.
- The windows may fog up if the recirculated air mode is used.

■ **Outside/recirculated air mode**

- When driving on dusty roads such as tunnels or in heavy traffic, set the outside/recirculated air mode button to the recirculated air mode. This is effective in preventing outside air from entering the vehicle interior. During cooling operation, setting the recirculated air mode will also cool the vehicle interior effectively.
- Outside/recirculated air mode may automatically switch depending on the temperature setting or the inside temperature.

■ **When the outside temperature exceeds 75°F (24°C) and the air conditioning system is on**

- In order to reduce the air conditioning power consumption, the air conditioning system may switch to recirculated air mode automatically. This may also reduce fuel consumption.
- Recirculated air mode is selected as a default mode when the engine switch is turned on.
- It is possible to switch to outside air mode at any time by pressing .

■ **Automatic mode for air intake control**

In automatic mode, the system detects exhaust gas and other pollutants and automatically switches between outside air and recirculated air modes.

When the dehumidification function is off, and the fan is operating, turning automatic mode on will activate the dehumidification function.

■ **Operation of the air conditioning system in Eco drive mode**

In the Eco drive mode, the air conditioning system is controlled as follows to prioritize fuel efficiency:

- Engine speed and compressor operation controlled to restrict heating/cooling capacity
- Fan speed restricted when automatic mode is selected

To improve air conditioning performance, perform the following operations:

- Turn off eco air conditioning mode
- Adjust the fan speed
- Turn off Eco drive mode (→P. 293)

■ **Eco air conditioning mode**

When Eco drive mode is selected using the drive mode select switch, eco air conditioning mode turns on.

When a drive mode other than Eco drive mode is selected, eco air conditioning mode may turn off.

■ **When the S-FLOW mode operates**

If air flows to the driver's seat only, the temperature setting for the front passenger's seat is not displayed.

■ **When the outside temperature is low**

The dehumidification function may not operate even when "A/C" on the option control screen is selected.

■ **Ventilation and air conditioning odors**

- To let fresh air in, set the air conditioning system to the outside air mode.
- During use, various odors from inside and outside the vehicle may enter into and accumulate in the air conditioning system. This may then cause odor to be emitted from the vents.
- To reduce potential odors from occurring:
 - It is recommended that the air conditioning system be set to outside air mode prior to turning the vehicle off.
 - The start timing of the blower may be delayed for a short period of time immediately after the air conditioning system is started in automatic mode.

■ Air conditioning filter

→P. 427

■ Customization

Settings (e.g. exhaust gas sensor sensitivity) can be changed.
(Customizable features: →P. 568)

⚠ WARNING

■ To prevent the windshield from fogging up

- Do not use  during cool air operation in extremely humid weather. The difference between the temperature of the outside air and that of the windshield can cause the outer surface of the windshield to fog up, blocking your vision.
- Do not place anything on the instrument panel which may cover the air outlets. Otherwise, air flow may be obstructed, preventing the windshield defoggers from defogging.

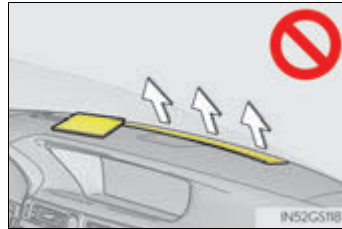

■ To prevent burns

- Do not touch the rear view mirror surfaces when the outside rear view mirror defoggers are on.
- Vehicles with windshield wiper de-icer: Do not touch the glass at lower part of the windshield or to the side of the front pillars when the windshield wiper de-icer is on.

⚠ NOTICE

■ To prevent battery discharge

Do not leave the air conditioning system on longer than necessary when the engine is stopped.

Rear air conditioning system*

Air outlets and fan speed are automatically adjusted according to the temperature setting.

Control panel

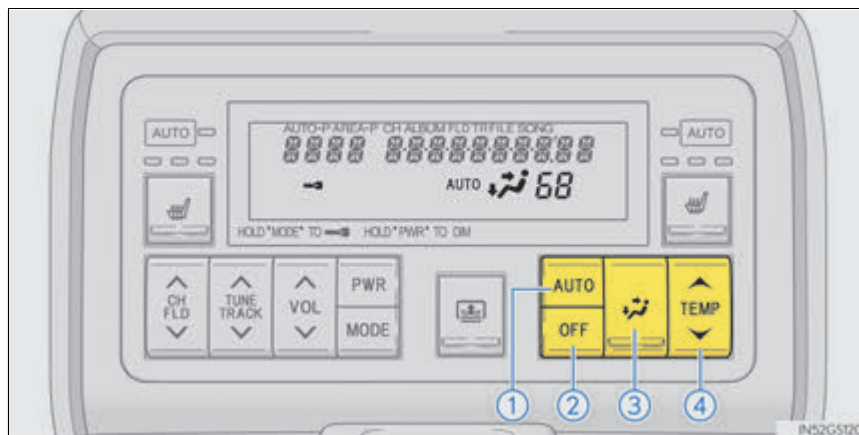

- ① Set automatic mode on/off
- ② Turn the fan off
- ③ Change the airflow mode
- ④ Adjust the temperature setting

■ Adjusting the temperature setting

Press “^” on **TEMP** to increase the temperature and “v” to decrease the temperature.

■ Changing the air outlets

Press .

The air outlets change as follows each time  is pressed.

 : Air flows to the upper body.

 : Air flows to the upper body and feet.

 : Air flows to the feet.

*: If equipped

Using automatic air conditioning system

- 1 Press **AUTO**.

The air conditioning system will operate, and air outlets and fan speed will be adjusted automatically.

"AUTO" will be displayed on the control panel.

- 2 Adjust the temperature setting.

When the rear seat heaters are set to "AUTO" mode, the system is operated automatically according to the set temperature, outside temperature, etc.

To stop the operation, press the "OFF" button.

Air outlets

■ Location of air outlets

The air outlets and air volume changes according to the selected air flow mode.

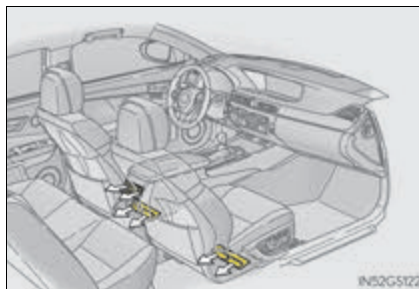

■ Adjusting the position of and opening and closing the air outlets

- ① Direct air flow to the left or right, up or down.
- ② Turn the knob to open or close the vent.

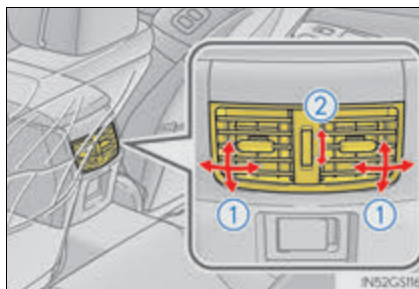

■ Button lock function

To prevent inadvertent operation, the buttons on the rear armrest can be locked. Press **MODE** until you hear a beep to lock the buttons. Pressing **MODE** again until you hear a beep will release the lock.

The indicator appears on the display when the buttons are locked.

**■ Rear control panel illumination off function**

Control panel illumination on the rear armrest can be turned off. Press **PWR** until you hear a beep to turn the illumination off. Pressing **PWR** again until you hear a beep will turn the illumination on.

 **NOTICE****■ To prevent battery discharge**

Do not leave the air conditioning system on longer than necessary when the engine is off.

Heated steering wheel* /seat heaters* /seat ventilators*

Heated steering wheel and seat heaters heat the side grips of the steering wheel and seats, respectively. Seat ventilators maintain good airflow by blowing air from the seats.

⚠ WARNING

- Care should be taken to prevent injury if anyone in the following categories comes in contact with the steering wheel or seats when the heater is on:
 - Babies, small children, the elderly, the sick and the physically challenged
 - Persons with sensitive skin
 - Persons who are fatigued
 - Persons who have taken alcohol or drugs that induce sleep (sleeping drugs, cold remedies, etc.)
- Observe the following precautions to prevent the minor burns or overheating:
 - Do not cover the seat with a blanket or cushion when using the seat heater.
 - Do not use seat heater more than necessary.

⚠ NOTICE

- To prevent damage to the seat heaters/seat ventilators, do not put heavy objects that have an uneven surface on the seat and do not stick sharp objects (needles, nails, etc.) into the seat.
- To prevent battery discharge, do not use the functions when the engine is off.

Heated steering wheel (If equipped)

Turns the heated steering wheel on/off

The indicator light comes on when the heater is operating.

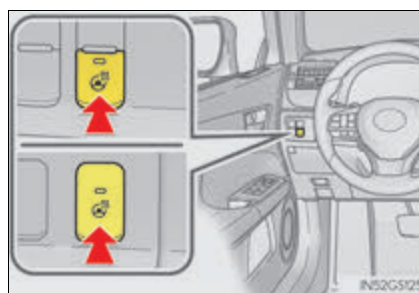

- The heated steering wheel can be used when the engine switch is in IGNITION ON mode.
- The heated steering wheel will automatically turn off after about 30 minutes.

*: If equipped

Seat heaters (if equipped)/seat ventilators (if equipped)

■ Front seat heaters and ventilators (if equipped)/rear seat heaters (if equipped)

▶ Front seats

▶ Rear seats

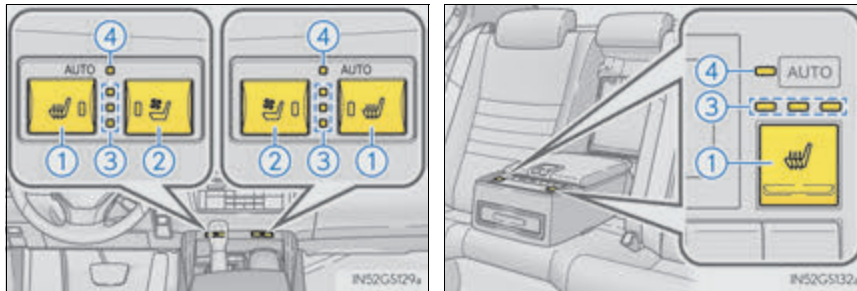

- ① Seat heater switches
The indicator light (yellow) on the switch comes on when the seat heater is operating.
- ② Seat ventilator switches (front seats only)
The indicator light (green) on the switch comes on when the seat ventilator is operating.
- ③ Level indicator lights
The seat heater temperature level or the seat ventilator fan speed level (for front seats only) is displayed.
- ④ "AUTO" indicator lights

● Modes and indicators

The mode can be changed by pressing the switch.

Mode	"AUTO" indicator light	Level indicator lights
Off	Off	Off
Automatic*	On	3 to 1, or off
Hi	Off	3
Mid	Off	2
Lo	Off	1

*: When automatic mode is selected, the level automatically changes depending on the air conditioning settings.

■ Seat heaters (without seat ventilators) (if equipped)

- ① Seat heater switches
- ② Level indicator lights

The seat heater temperature level is displayed.

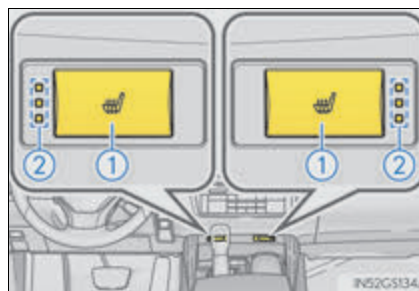

● Modes and indicators

The mode changes each time the switch is pressed as follows:

Mode	Level indicator lights	Automatic operation*
Off	Off	—
Hi	3	Hi → Mid → Lo
Mid	2	Mid → Lo
Lo	1	Lo

*: The mode changes automatically depending on the amount of time that has elapsed. The amount of time until the mode changes varies depending on the interior temperature when the seat heater was operated and other factors.

■ **Seat ventilators (without seat heaters) (if equipped)**

- ① Seat ventilator switches
 - ② Level indicator lights
- The seat ventilator fan speed level is displayed.



● **Modes and indicators**

The mode changes each time the switch is pressed as follows:

Mode	Level indicator lights
Off	Off
Hi	3
Mid	2
Lo	1

■ **The seat heaters/seat ventilators can be used when**

The engine switch is in IGNITION ON mode.

■ **Seat heater control (vehicles without automatic mode)**

The seat heater automatically changes operations. If the engine switch is turned off while the seat heater is operating, the starting operation of the heater differs depending on the amount of time that elapses before it is turned back on.

Current operation	Starting operation mode and amount of time elapsed until engine switch in IGNITION ON mode	
	0 to 15 minutes	Over 15 minutes
Hi	Hi	Hi
Mid	Mid	Hi
Lo	Lo	Hi

■ **Automatic operation of the seat heater during Eco drive mode**

If the driving mode select switch is switched to Eco drive mode in cold temperatures, the seat heater may be automatically operated to assist heating performance.

■ **Automatic operation during S-FLOW mode**

The front seat heater and ventilator or the rear seat heater may automatically turn off when S-FLOW mode is turned on during automatic mode. (→P. 329)

■ **Button lock function (vehicles with rear control panel)**

To prevent inadvertent operation, some buttons on the rear armrest can be locked. (→P. 341)

■ **When the switch is disabled (vehicles with rear control panel)**

When the rear control panel switch cannot be operated even though the button lock function is released, check whether the switch is disabled due to selecting  on Remote Touch screen. (→P. 335)

■ **Rear control panel illumination off function (vehicles with rear control panel)**

Control panel illumination on the rear armrest can be turned off. (→P. 341)

■ **Customization**

The automatic mode settings for the front seat heaters and ventilators or the rear seat heaters can be changed. (Customizable features: →P. 568)

Interior lights list

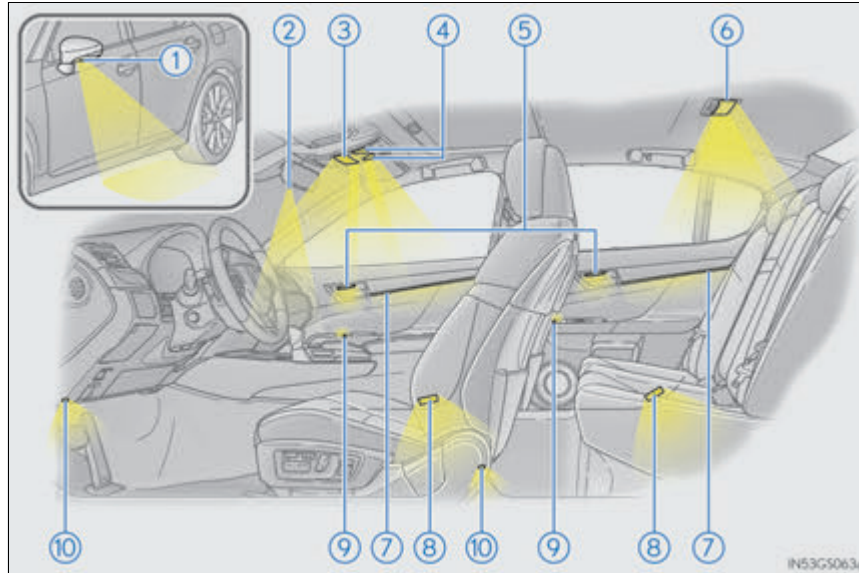

- | | |
|-----------------------------------|----------------------------------|
| ① Outer foot lights | ⑥ Rear personal lights (→P. 348) |
| ② Shift lever light | Rear interior light |
| ③ Front interior light (→P. 348) | ⑦ Ornament lights |
| ④ Front personal lights (→P. 348) | ⑧ Door courtesy lights |
| ⑤ Inside door handle lights | ⑨ Power window switch lights |
| | ⑩ Footwell lights |

When the instrument panel light control switch is turned to minimum and the tail lights are on, the inside door handle lights, the ornament lights and the footwell lights will turn off. (→P. 89)

Interior lights

- ① Turns the lights on/off
The rear interior light is also turned on/off.
- ② Turns the door position on/off

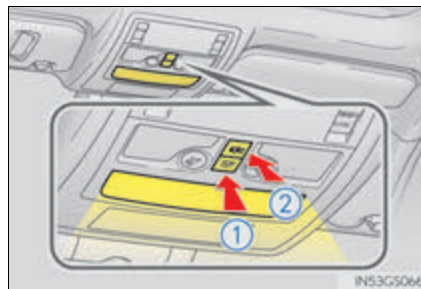

Personal lights

■ Front

Turns the light on/off

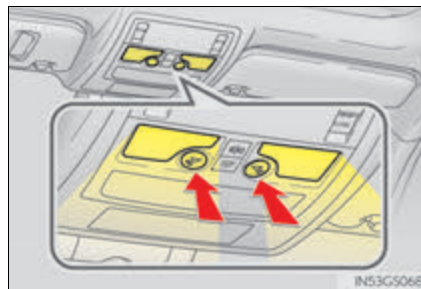

■ Rear

Turns the light on/off



- Illuminated entry system: The lights automatically turn on/off according to engine switch mode, the presence of the electronic key, whether the doors are locked/unlocked, and whether the doors are opened/closed.
- If the interior lights remain on when the engine switch is turned off, the lights will go off automatically after 20 minutes.
- Setting (e.g. the time elapsed before lights turn off) can be changed.
(Customizable features: →P. 568)

 NOTICE

To prevent battery discharge, do not leave the lights on longer than necessary when the engine is off.

List of storage features

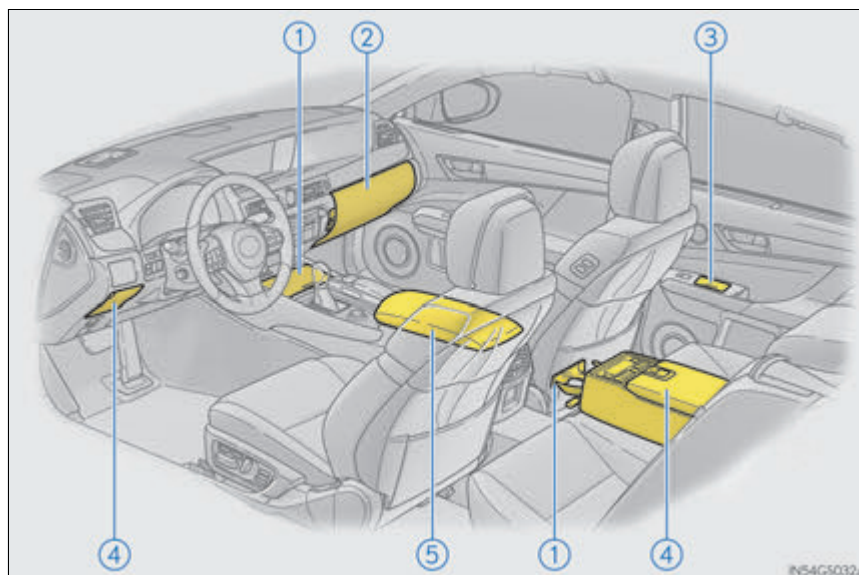

- | | | | |
|---------------------------------|-----------|-------------------|-----------|
| ① Cup holders | (→P. 352) | ④ Auxiliary boxes | (→P. 353) |
| ② Glove box | (→P. 351) | ⑤ Console box | (→P. 351) |
| ③ Auxiliary boxes (if equipped) | (→P. 353) | | |
| Ashtrays (if equipped) | (→P. 359) | | |

⚠ WARNING

- Do not leave glasses, lighters or spray cans in the storage spaces, as this may cause the following when cabin temperature becomes high:
 - Glasses may be deformed by heat or cracked if they come into contact with other stored items.
 - Lighters or spray cans may explode. If they come into contact with other stored items, the lighter may catch fire or the spray can may release gas, causing a fire hazard.
- When driving or when the storage compartments are not in use, keep the lids closed. In the event of sudden braking or sudden swerving, an accident may occur due to an occupant being struck by an open lid or the items stored inside.

Glove box

- ① Open (press the button)
- ② Unlock with the mechanical key
- ③ Lock with the mechanical key

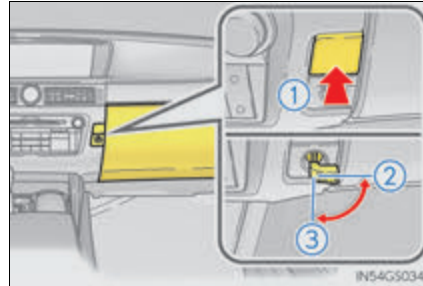

- The glove box light turns on when the tail lights are on.
- The trunk opener main switch is located in the glove box. (→P. 145)
- The insert inside the glove box can be removed.
- An SRS knee airbag for the front passenger's seat is built into the glove box door. (→P. 41)

Console box

- ① Using with half-open
Grip the knob to release the lock, and slide the armrest as far back.
- ② Using with fully open
Grip the knob to release the lock, and lift the armrest to open.

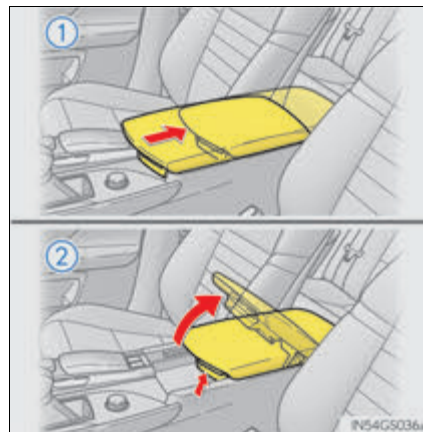

- The tray slides forward/backward and can be removed.

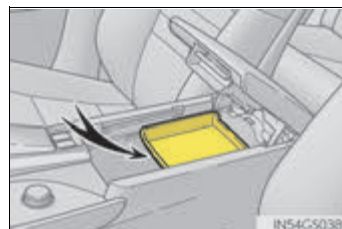

- The console box light turns on when the tail lights are on.

⚠ WARNING

When using the console box with half-open, do not apply too much load on the armrest. Doing so may damage the armrest and may cause you to injure yourself.

Cup holders

■ **Front**

To open, press down and release the cup holder lid.

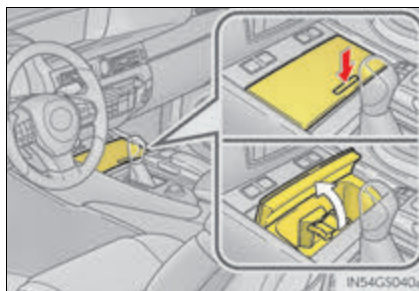

■ **Rear**

To open, pull down the armrest and press in and release the rear cup holder.

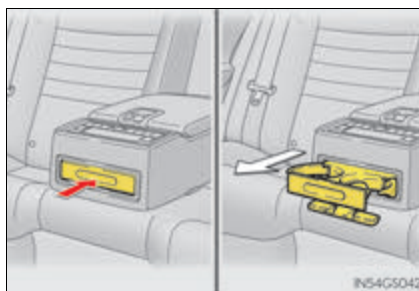

- Front cup holder: The cup holder insert may be removed for cleaning.

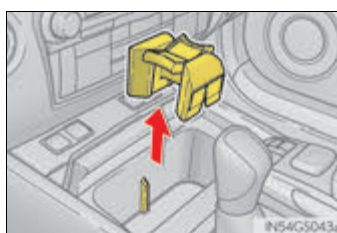

- Rear cup holder: When stowing the cup holder, stow the cup holder with the armrest down. The cup holder cannot be stowed if the armrest is not down.

⚠ WARNING

Do not place anything other than cups or beverage cans in the cup holders. Other items may be thrown out of the holders in the event of an accident or sudden braking, causing injury. If possible, cover hot drinks to prevent burns.

⚠ NOTICE

To prevent damage to the rear cup holder, stow the cup holder before stowing the arm-rest.

Auxiliary boxes

▶ Type A

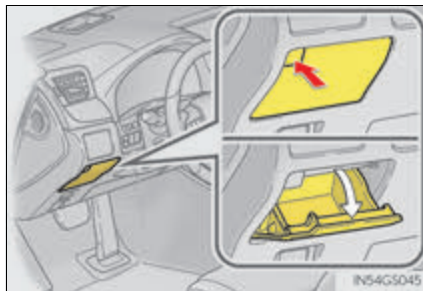

Press in the button.

▶ Type B

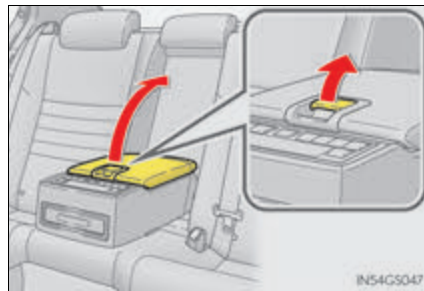

Pull up the lever to release the lock and lift the lid.

▶ Type C (if equipped)

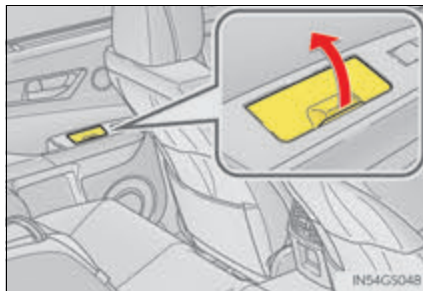

Open the lid.

⚠ WARNING

Type C: Do not use the auxiliary box as an ashtray. Doing so may cause a fire.

Trunk features

Cargo hooks

Raise the hooks when needed.

The cargo hooks are provided for securing loose items.

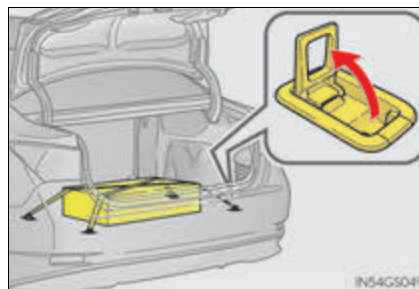

WARNING

To avoid injury, always return the cargo hooks to their stowed positions when not in use.

Luggage hook

Pull the strap when using the hook.

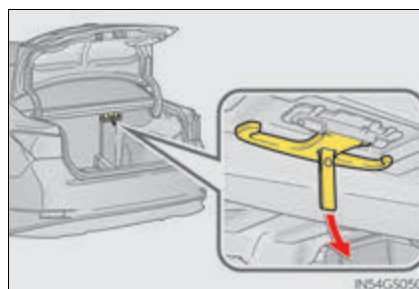

NOTICE

Do not hang any object heavier than 11 lb. (5 kg) on the luggage hook.

First-aid kit storage net

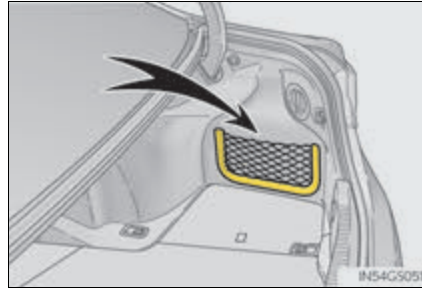

Luggage mat

■ Center

▶ Type A

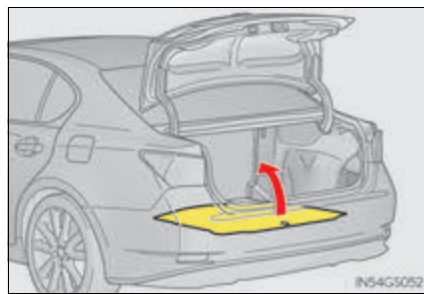

Pull the strap upwards to lift up the luggage mat.

▶ Type B

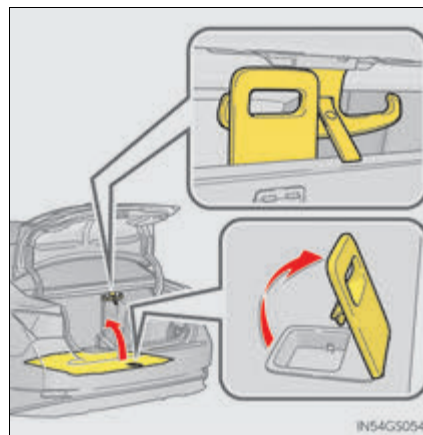

Pull the lever upwards to lift up the luggage mat.

The lever can be hooked on the luggage hook.

▶ Type C

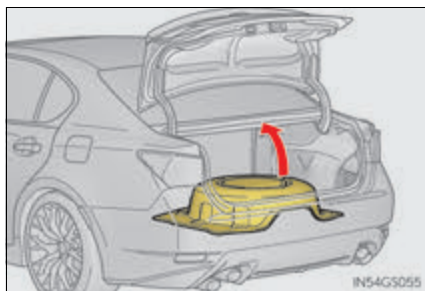

Pull the strap upwards to lift up the luggage mat.

■ Left side

Pull the strap upwards when lifting the luggage mat up.

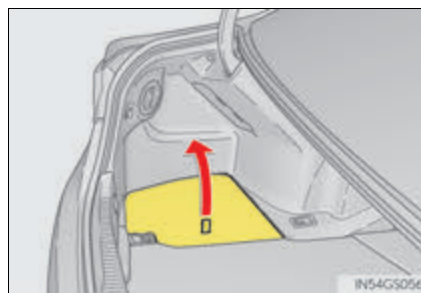

Warning reflector storage belt (if equipped)

- ① Loosen the belt
- ② Tighten the belt

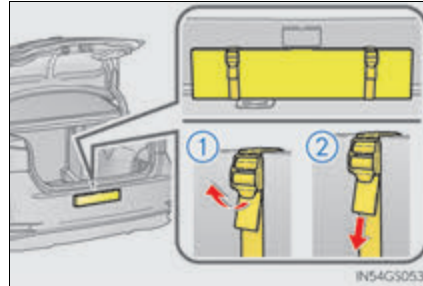

To prevent damage to the warning reflector storage belt when it is not in use, fold the belt (as shown in ①) and secure it with the clip (②).

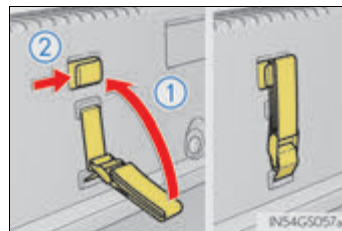

Other interior features

Sun visors

- ① To set the visor in the forward position, flip it down.
- ② To set the visor in the side position, flip down, unhook, and swing it to the side.
- ③ To use the side extender, place the visor in the side position, then slide it backward.

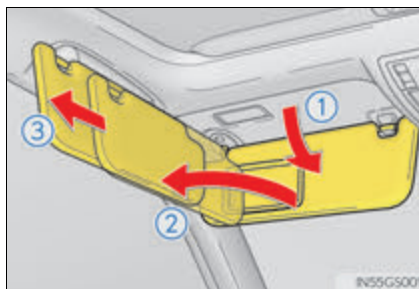

Vanity mirrors

Slide the cover to open.

The light turns on when the cover is opened.

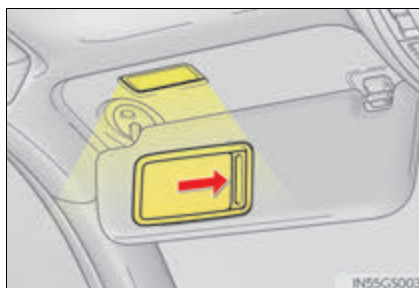

NOTICE

To prevent battery discharge, do not leave the vanity lights on for extended periods while the engine is off.

Clock

The GPS clock's time is automatically adjusted by utilizing GPS time information.

For details, refer to "NAVIGATION SYSTEM OWNER'S MANUAL".

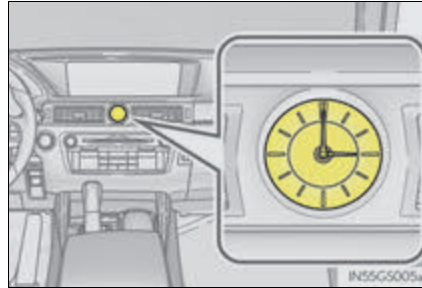

Ashtrays (if equipped)

Open the ashtray lid.

To remove the ashtray, pull the ashtray lid upwards.

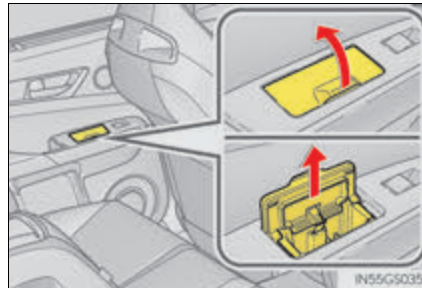

⚠ WARNING

- Keep the ashtray closed when not in use. In the event of sudden braking or sudden swerving, an accident may occur due to an occupant being struck by the open ashtray or ash flying out.
- To prevent fire
 - Fully extinguish matches and cigarettes before putting them in the ashtray, then make sure the ashtray is fully closed.
 - Do not place paper or any other type of flammable object in the ashtray.

Power outlets

Please use as a power supply for electronic goods that use less than 12 V DC / 10 A (power consumption of 120 W).

► Front



► Rear

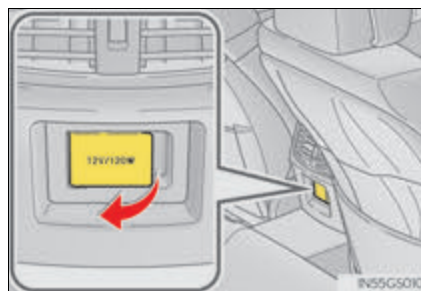

Open the lid.

The power outlets can be used when the engine switch is in ACCESSORY or IGNITION ON mode.

⚠ NOTICE

- To avoid damaging the power outlets, close the power outlet lids when the power outlets are not in use. Foreign objects or liquids that enter the power outlets may cause a short circuit.
- To prevent battery discharge, do not use the power outlets longer than necessary when the engine is off.

Armrest

Fold down the armrest for use.



⚠ NOTICE

To prevent damage to the armrest, do not apply too much load on the armrest.

Rear sunshade (if equipped)/rear door sunshades (if equipped)**■ Rear sunshade**

The rear sunshade can be raised and lowered by operating the button shown below.

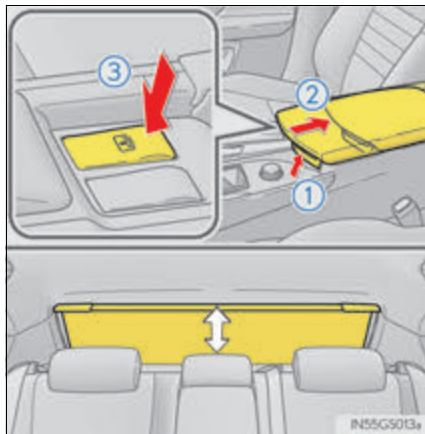
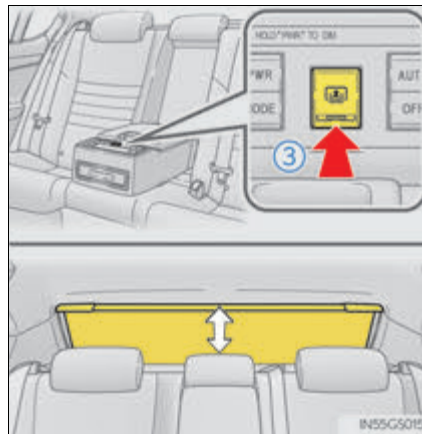
► From the front seats**► From the rear seats (if equipped)**

- ① Pull up the lever to release the lock.
- ② Slide the armrest.
- ③ Raise/lower

■ Rear door sunshades

Pull the tab of the rear door sunshade and hook the shade on using the anchors.

To retract the rear door sunshade, unhook the shade and retract it slowly.

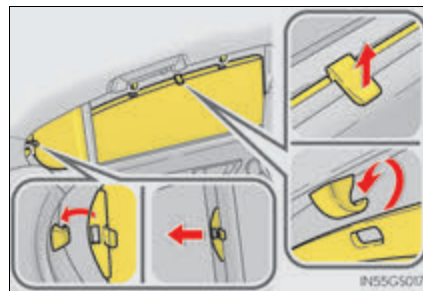

- The rear sunshade can be used when the engine switch is in IGNITION ON mode.
- The rear sunshade can be operated for approximately 1 minute even after the engine switch is turned to ACCESSORY mode or turned off.
- Reverse operation feature: To ensure adequate rear visibility, the rear sunshade automatically lowers when the shift lever is shifted to R.

However, the rear sunshade is raised again if any of the following occurs:

- The button is pressed again.*
- Shift the shift lever into P.
- The shift lever is shifted out of R, and the vehicle reaches a speed of 9 mph (15 km/h). If the engine is off when the rear sunshade has been lowered due to the reverse operation feature, it will not be raised even when the engine is turned on again and the vehicle reaches a speed of 9 mph (15 km/h). To raise the sunshade again, press the button.

*: Occasionally, the reverse function may not be carried out after the switch has been pressed. Repeat the above operation to operate the function.

- Vehicles with rear control panel: To prevent inadvertent operation, some buttons on the rear armrest can be locked. (→P. 341)
- Vehicles with rear control panel: Control panel illumination on the rear armrest can be turned off. (→P. 341)
- Time elapsed before the reverse operation feature activates can be changed. (Customizable features: →P. 568)

⚠ WARNING
When the rear sunshade is being operated, do not place fingers or other objects in the fastener section or in the opening. They may get caught, causing injury.

⚠ NOTICE
<ul style="list-style-type: none"> ● To prevent battery discharge, do not operate the rear sunshade when the engine is off. ● Observe the following precautions to ensure normal operation of the rear sunshade and rear door sunshades. <ul style="list-style-type: none"> • Do not place excessive load on the motor or other components of the rear sunshade. • Do not place objects where they may hinder opening and closing operations. • Do not attach items to the rear sunshade and rear door sunshades. • Keep the opening clean and clear of obstructions. • Do not operate the rear sunshade continuously for long periods of time.

Trunk storage extension

Long objects can be loaded into the vehicle by utilizing the trunk space and rear seat area.

- 1 Fold down the armrest.



- 2 Fold down the handle and open the armrest door.

The armrest door can be locked and unlocked using the mechanical key.

- 1 Unlock
- 2 Lock

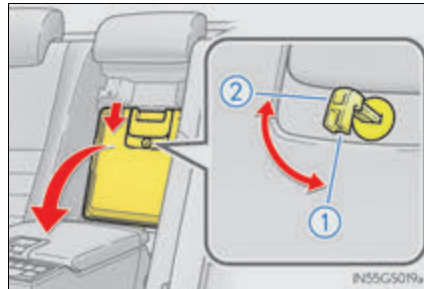
**⚠ WARNING**

Ensure that the armrest door is closed when not in use.
In the event of sudden braking, items stored in the trunk may be thrown forward into the cabin, resulting in injury.

Coat hooks

The coat hooks are provided with the rear assist grips.



WARNING

Do not hang coat hangers or other hard or sharp objects on the hook. If the SRS curtain shield airbags deploy, these items may become projectiles, causing death or serious injury.

Assist grips

An assist grip installed on the ceiling can be used to support your body while sitting on the seat.



WARNING

Do not use the assist grip when getting in or out of the vehicle or rising from your seat.

NOTICE

To prevent damage to the assist grip, do not hang any heavy object or put a heavy load on the assist grip.

Garage door opener

The garage door opener can be programmed to operate garage doors, gates, entry doors, door locks, home lighting systems, security systems, and other devices.

Programming HomeLink®

The HomeLink® wireless control system in your vehicle has 3 buttons which can be programmed to operate 3 different devices. Refer to the programming methods on the following pages to determine the method which is appropriate for the device.

- ① HomeLink® indicator light
- ② Garage door operation indicators
- ③ HomeLink® icon
Illuminates while HomeLink® is operating.
- ④ Buttons

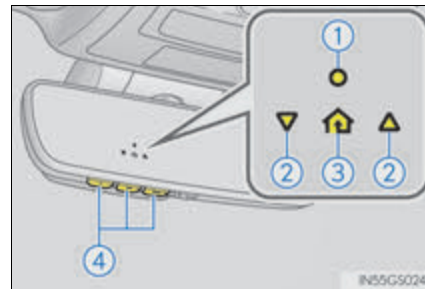

■ Before programming HomeLink®

- During programming, it is possible that garage doors, gates, or other devices may operate. For this reason, make sure that people and objects are clear of the garage door or other devices to prevent injury or other potential harm.
- It is recommended that a new battery be placed in the remote control transmitter for more accurate programming.
- Garage door opener motors manufactured after 1995 may be equipped with rolling code protection. If this is the case, you may need a stepladder or other sturdy, safe device to reach the “Learn” or “Smart” button on the garage door opener motor.

■ Programming HomeLink®

- 1 Press and release the HomeLink® button you want to program and check that the HomeLink® indicator light flashes (orange).

Perform 3 within 60 seconds of 1, or the indicator light will stop flashing and programming will not be able to be completed.

- 2 Point the remote control transmitter for the device at the rear view mirror, 1 to 3 in. (25 to 75 mm) from the HomeLink® buttons.

Keep the HomeLink® indicator light in view while programming.



► For U.S.A. owners

- 3 Press and hold the handheld transmitter button until the HomeLink® indicator light changes from slowly flashing orange to rapidly flashing green (rolling code) or continuously lit green (fixed code), then release the button.



► Programming an entry gate (for U.S.A. owners)/Programming a device in the Canadian market

- 3 Press and release the remote control transmitter button at 2 second intervals, repeatedly, until the HomeLink® indicator light changes from slowly flashing (orange) to rapidly flashing (green) (rolling code) or continuously lit (green) (fixed code).

- 4 Test the HomeLink® operation by pressing the newly programmed button and observing the indicator light:

- Device with fixed code: If the indicator light is solid/continuous, programming has been completed and your garage door or other device should operate when the HomeLink® button is pressed and released.
- Device with rolling code: If the indicator light flashes rapidly, your garage door opener motor (or other device) is equipped with a rolling code. Complete the programming process by firmly pressing and holding the programmed HomeLink® button for 2 seconds and then release the button.

- If the garage door or other device does not operate, proceed to “Programming a rolling code system”.

- 5 Repeat the steps above to program another device for any of the remaining HomeLink® buttons.

■ **Programming a rolling code system**

- 1 Locate the “Learn” or “Smart” button on the garage door opener motor in the garage.

This button can usually be found where the hanging antenna wire is attached to the unit. The name and color of the button may vary by manufacturer. Refer to the owner’s manual supplied with the garage door opener motor for details.

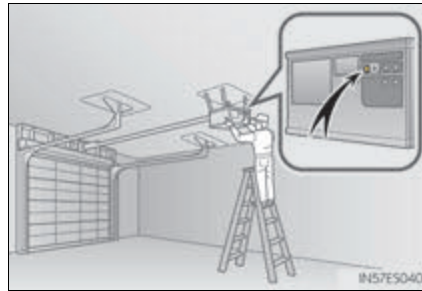

- 2 Press and release the “Learn” or “Smart” button.
Perform 3 within 30 seconds after performing 2.

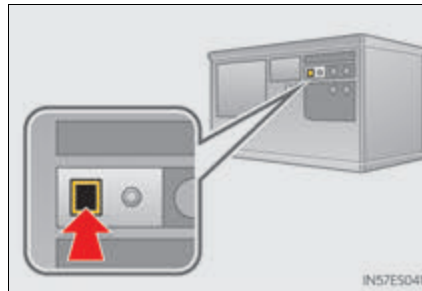

- 3 Press and hold the desired HomeLink® button (inside the vehicle) for 2 seconds and release it. Repeat this sequence (press/hold/release) up to 3 times to complete programming.

If the garage door opener motor operates when the HomeLink® button is pressed, the garage door opener motor recognizes the HomeLink® signal.

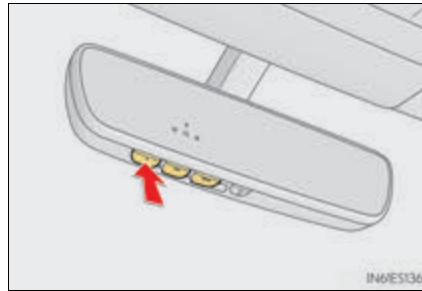

■ Enabling 2-way communication with a garage door (only available for compatible devices)

When enabled, 2-way communication allows you to check the status of the opening and closing of a garage door through indicators in your vehicle.

2-way communication is only available if the garage door opener motor used is a compatible device. (To check device compatibility, refer to www.HomeLink.com.)

- 1 Within 5 seconds after programming the garage door opener has been completed, if the garage door opener motor is trained to HomeLink[®], both garage door operation indicators will flash rapidly (green) and the light on the garage door opener motor will blink twice, indicating that 2-way communication is enabled.

If the indicators do not flash, perform **2** and **3** within the first 10 presses of the HomeLink[®] button after programming has been completed.

- 2 Press a programmed HomeLink[®] button to operate a garage door.
- 3 Within 1 minute of pressing the HomeLink[®] button, after the garage door operation has stopped, press the “Learn” or “Smart” button on the garage door opener motor. Within 5 seconds of the establishment of 2-way communication with the garage door opener, both garage door operation indicators in the vehicle will flash rapidly (green) and the light on the garage door opener motor will blink twice, indicating that 2-way communication is enabled.

■ Reprogramming a single HomeLink[®] button

When the following procedure is performed, buttons which already have devices registered to them can be overwritten:

- 1 With one hand, press and hold the desired HomeLink[®] button.
- 2 When the HomeLink[®] indicator starts flashing (orange), continue to hold the HomeLink[®] button and perform “Programming HomeLink[®]” **1** (it takes 20 seconds for the HomeLink[®] indicator to start flashing).

Operating HomeLink[®]

Press the appropriate HomeLink[®] button. The HomeLink[®] indicator light should turn on.

Garage door operation indicators

The status of the opening and closing of a garage door is shown by the indicators.

- ① Opening
- ② Closing

This function is only available if the garage door opener motor used is a compatible device. (To check device compatibility, refer to www.HomeLink.com.)



Color	Status
Orange (flashing)	Currently opening/closing
Green	Opening/closing has completed
Red (flashing)	Feedback signals cannot be received

The indicators can operate within approximately 820 ft. (250 m) of the garage door. However, if there are obstructions between the garage door and the vehicle, such as houses and trees, feedback signals from the garage door may not be received.

To recall the previous door operation status, press and release either

HomeLink® buttons  and  or  and  simultaneously.

The last recorded status will be displayed for 3 seconds.

Erasing the entire HomeLink® memory (all three codes)

Press and hold the 2 outside buttons for 10 seconds until the HomeLink® indicator light changes from continuously lit (orange) to rapidly flashing (green).

If you sell your vehicle, be sure to erase the programs stored in the HomeLink® memory.



5 Interior features

■ **Codes stored in the HomeLink® memory**

- The registered codes are not erased even if the battery cable is disconnected.
- If learning failed when registering a different code to a HomeLink® button that already has a code registered to it, the already registered code will not be erased.

■ **Before programming**

- Install a new battery in the transmitter.
- The battery side of the transmitter must be pointed away from the HomeLink®.

■ **Certification for the garage door opener**

- ▶ For vehicles sold in the U.S.A., Hawaii, Guam and Puerto Rico

NOTE:

This device complies with part 15 of the FCC Rules. Operation is subject to the following two conditions: (1) This device may not cause harmful interference, and (2) this device must accept any interference received, including interference that may cause undesired operation.

FCC WARNING:

changes or modifications not expressly approved by the party responsible for compliance could void the user's authority to operate the equipment.

- ▶ For vehicles sold in Canada

NOTE:

This device complies with Industry Canada licence-exempt RSS standard(s). Operation is subject to the following two conditions: (1) this device may not cause interference, and (2) this device must accept any interference, including interference that may cause undesired operation of the device.

REMARQUE:

Le présent appareil est conforme aux CNR d'Industrie Canada applicables aux appareils radio exempts de licence. L'exploitation est autorisée aux deux conditions suivantes : (1) l'appareil ne doit pas produire de brouillage, et (2) l'utilisateur de l'appareil doit accepter tout brouillage radioélectrique subi, même si le brouillage est susceptible d'en compromettre le fonctionnement.

■ **When support is necessary**

Visit on the web at www.homelink.com or call 1-800-355-3515.

⚠ WARNING**■ When programming a garage door or other remote control device**

The garage door or other device may operate, so ensure people and objects are out of danger to prevent potential harm.

■ Conforming to federal safety standards

Do not use the HomeLink[®] compatible transceiver with any garage door opener or device that lacks safety stop and reverse features as required by federal safety standards.

This includes any garage door that cannot detect an interfering object. A door or device without these features increases the risk of death or serious injury.

■ When operating or programming HomeLink[®]

Never allow a child to operate or play with the HomeLink[®] buttons.

LEXUS Enform Safety Connect*

Safety Connect is a subscription-based telematics service that uses Global Positioning System (GPS) data and embedded cellular technology to provide safety and security features to subscribers. Safety Connect is supported by Lexus' designated response center, which operates 24 hours per day, 7 days per week.

Safety Connect service is available by subscription on select, telematics hardware-equipped vehicles.

By using the Safety Connect service, you are agreeing to be bound by the Telematics Subscription Service Agreement and its Terms and Conditions, as in effect and amended from time to time, a current copy of which is available at Lexus.com. All use of the Safety Connect service is subject to such then-applicable Terms and Conditions.

System components

- ① "SOS" button
- ② LED light indicators
- ③ Microphone

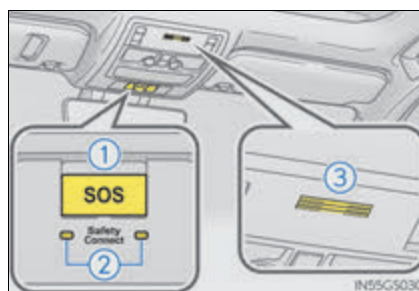

*: If equipped

Services

Subscribers have the following Safety Connect services available:

- Automatic Collision Notification*
Helps drivers receive necessary response from emergency service providers.
(→P. 374)
*: U.S. Patent No. 7,508,298 B2
- Stolen Vehicle Location
Helps drivers in the event of vehicle theft. (→P. 374)
- Emergency Assistance Button (“SOS”)
Connects drivers to response-center support. (→P. 374)
- Enhanced Roadside Assistance
Provides drivers various on-road assistance. (→P. 375)

Subscription

After you have signed the Telematics Subscription Service Agreement and are enrolled, you can begin receiving services.

A variety of subscription terms is available for purchase. Contact your Lexus dealer, call 1-800-25-LEXUS (1-800-255-3987) or push the “SOS” button in your vehicle for further subscription details.

■ Safety Connect Services Information

- Phone calls using the vehicles Bluetooth® technology will not be possible during Safety Connect.
- Contact with the Safety Connect response center is dependent upon the telematics device being in operative condition, cellular connection availability, and GPS satellite signal reception, which can limit the ability to reach the response center or receive emergency service support. Enrollment and Telematics Subscription Service Agreement required. A variety of subscription terms is available; charges vary by subscription term selected.
- Automatic Collision Notification, Emergency Assistance and Stolen Vehicle Location will function in the United States, including Hawaii and Alaska, and in Canada, and Enhanced Roadside Assistance will function in the United States (except Hawaii) and in Canada. No Safety Connect services will function outside of the United States in countries other than Canada.
- Safety Connect services are not subject to section 255 of the Telecommunications Act and the device is not TTY compatible.

■ Languages

The Safety Connect response center will offer support in multiple languages. The Safety Connect system will offer voice prompts in English and Spanish. Please indicate your language of choice when enrolling.

■ When contacting the response center

You may be unable to contact the response center if the network is busy.

Safety Connect LED light Indicators

When the engine switch is turned to IGNITION ON mode, the red indicator light comes on for 2 seconds then turns off. Afterward, the green indicator light comes on, indicating that the service is active.

The following indicator light patterns indicate specific system usage conditions:

- Green indicator light on = Active service
- Green indicator light flashing = Safety Connect call in process
- Red indicator light (except at vehicle start-up) = System malfunction (contact your Lexus dealer)
- No indicator light (off) = Safety Connect service not active

Safety Connect services

■ Automatic Collision Notification

In case of either airbag deployment or severe rear-end collision, the system is designed to automatically call the response center. The responding agent receives the vehicle's location and attempts to speak with the vehicle occupants to assess the level of emergency. If the occupants are unable to communicate, the agent automatically treats the call as an emergency, contacts the nearest emergency services provider to describe the situation, and requests that assistance be sent to the location.

■ Stolen Vehicle Location

If your vehicle is stolen, Safety Connect can work with local authorities to assist them in locating and recovering the vehicle. After filing a police report, call the Safety Connect response center at 1-800-25-LEXUS (1-800-255-3987) and follow the prompts for Safety Connect to initiate this service.

In addition to assisting law enforcement with recovery of a stolen vehicle, Safety-Connect-equipped vehicle location data may, under certain circumstances, be shared with third parties to locate your vehicle. Further information is available at Lexus.com.

■ Emergency Assistance Button ("SOS")

In the event of an emergency on the road, push the "SOS" button to reach the Safety Connect response center. The answering agent will determine your vehicle's location, assess the emergency, and dispatch the necessary assistance required.

If you accidentally press the "SOS" button, tell the response-center agent that you are not experiencing an emergency.

■ Enhanced Roadside Assistance

Enhanced Roadside Assistance adds GPS data to the already included warranty-based Lexus roadside service.

Subscribers can press the “SOS” button to reach a Safety Connect response-center agent, who can help with a wide range of needs, such as: towing, flat tire, fuel delivery, etc. For a description of the Roadside Assistance services and their limitations, please see the Safety Connect Terms and Conditions, which are available at Lexus.com.

Safety information for Safety Connect

Important! Read this information before using Safety Connect.

■ Exposure to radio frequency signals

The Safety Connect system installed in your vehicle is a low-power radio transmitter and receiver. It receives and also sends out radio frequency (RF) signals.

In August 1996, the Federal Communications Commission (FCC) adopted RF exposure guidelines with safety levels for mobile wireless phones. Those guidelines are consistent with the safety standards previously set by the following U.S. and international standards bodies.

- ANSI (American National Standards Institute) C95.1 [1992]
- NCRP (National Council on Radiation Protection and Measurement) Report 86 [1986]
- ICNIRP (International Commission on Non-Ionizing Radiation Protection) [1996]

Those standards were based on comprehensive and periodic evaluations of the relevant scientific literature. Over 120 scientists, engineers, and physicians from universities, and government health agencies and industries reviewed the available body of research to develop the ANSI Standard (C95.1).

The design of Safety Connect complies with the FCC guidelines in addition to those standards.

■ **Certification for Lexus Enform**

FCC ID: O6Y-CDMRF101

FCC ID: XOECDMRF101B

FCC ID: N7NGTM2

FCC WARNING:

This equipment complies with FCC radiation exposure limits set forth for an uncontrolled environment and meets the FCC radio frequency (RF) Exposure Guidelines in Supplement C to OET65. This equipment should be installed and operated keeping the radiator at least 20 cm or more away from person's body (excluding extremities: hands, wrists, feet and ankles).

Maintenance and care

6

- 6-1. Maintenance and care**
 - Cleaning and protecting the vehicle exterior 378
 - Cleaning and protecting the vehicle interior382
- 6-2. Maintenance**
 - Maintenance requirements...385
 - General maintenance..... 387
 - Emission inspection and maintenance (I/M) programs390
- 6-3. Do-it-yourself maintenance**
 - Do-it-yourself service precautions..... 391
 - Hood393
 - Positioning a floor jack..... 394
 - Engine compartment396
 - Tires..... 413
 - Tire inflation pressure 422
 - Wheels 425
 - Air conditioning filter427
 - Electronic key battery 429
 - Checking and replacing fuses..... 431
 - Headlight aim (vehicles with single-beam headlights)..... 435
 - Light bulbs..... 437

Cleaning and protecting the vehicle exterior

Perform the following to protect the vehicle and maintain it in prime condition:

- Working from top to bottom, liberally apply water to the vehicle body, wheel wells and underside of the vehicle to remove any dirt and dust.
- Wash the vehicle body using a sponge or soft cloth, such as a chamois.
- For hard-to-remove marks, use car wash soap and rinse thoroughly with water.
- Wipe away any water.
- Wax the vehicle when the waterproof coating deteriorates.
If water does not bead on a clean surface, apply wax when the vehicle body is cool.

■ CFRP (Carbon Fiber Reinforced Plastic) part (GS F)

CFRP is used for the parts shown in the illustration.

- As the CFRP parts may change color if they are exposed to ultraviolet rays for extended periods of time, Lexus recommends that your vehicle be stored in a place where it will not be exposed to direct sunlight.
- Do not use wax that contains abrasives.
- CFRP parts may get scratched when using an automatic car wash.

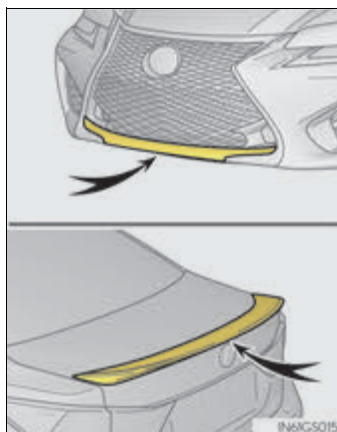

■ Self-restoring coat*

The vehicle body has a self-restoring coating that is resistant to small surface scratches caused in a car wash etc.

- The coating lasts for 5 to 8 years from when the vehicle is delivered from the plant.
- The restoration time differs depending on the depth of the scratch and outside temperature. The restoration time may become shorter when the coating is warmed by applying warm water.
- Deep scratches caused by keys, coins, etc. cannot be restored.
- Do not use wax that contain abrasives.

*: CFRP parts (GS F) do not have a self-restoring coat.

■ Automatic car washes

- Fold the mirrors before washing the vehicle. Start washing from the front of the vehicle. Make sure to extend the mirrors before driving.
- Brushes used in automatic car washes may scratch the vehicle surface and harm your vehicle's paint.
- Rear spoiler (if equipped) may not be washable in some automatic car washes. There may also be an increased risk of damage to vehicle.

■ High-pressure car washes

- Do not allow the nozzles of the car wash to come within close proximity of the windows.
- Before using the car wash, check that the fuel filler door on your vehicle is closed properly.

■ Notes for a smart access system with push-button start

If the door handle becomes wet while the electronic key is within the effective range, the door may lock and unlock repeatedly. In that case, follow the following correction procedures to wash the vehicle:

- Place the key in a position 6 ft. (2 m) or more separate from the vehicle while the vehicle is being washed. (Take care to ensure that the key is not stolen.)
- Set the electronic key to battery-saving mode to disable the smart access system with push-button start. (→P. 152)

■ Aluminum wheels

- Remove any dirt immediately by using a neutral detergent. Do not use hard brushes or abrasive cleaners. Do not use strong or harsh chemical cleaners. Use the same mild detergent and wax as used on the paint.
- Do not use detergent on the wheels when they are hot, for example after driving for long distance in the hot weather.
- Wash detergent from the wheels immediately after use.

■ Brake caliper coating (GS350/GS200t with orange brake calipers for F SPORT models, and GS F)

- When using detergent, use neutral detergent. Do not use hard brushes or abrasive cleaners, as they will damage the coating.
- Do not use detergent on the brake calipers when they are hot.
- Wash detergent off immediately after use.

■ Bumpers

Do not scrub with abrasive cleaners.

■ Front side windows water-repellent coating (if equipped)

- The following precautions can extend the effectiveness of the water-repellent coating.
 - Remove any dirt, etc. from the front side windows regularly.
 - Do not allow dirt and dust to accumulate on the windows for a long period. Clean the windows with a soft, damp cloth as soon as possible.
 - Do not use wax or glass cleaners that contain abrasives when cleaning the windows.
 - Do not use any metallic objects to remove condensation build up.
- When the water-repellent performance has become insufficient, the coating can be repaired. Contact your Lexus dealer.

⚠ WARNING

■ **When washing the vehicle**

Do not apply water to the inside of the engine compartment. Doing so may cause the electrical components etc. to catch fire.

■ **When cleaning the windshield (vehicles with rain-sensing windshield wipers)**

Turn off AUTO mode of the wiper to prevent the wiper from operating. (→P. 222)

If AUTO mode is selected, the wipers may operate unexpectedly in the following situations, and may result in hands being caught or other serious injuries and cause damage to the wiper blades.

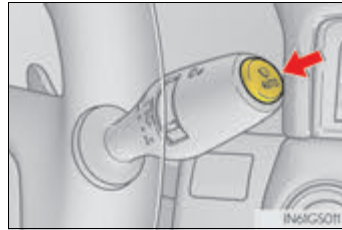

- When the upper part of the windshield where the raindrop sensor is located is touched by hand
- When a wet rag or similar is held close to the raindrop sensor
- If something bumps against the windshield
- If you directly touch the raindrop sensor body or if something bumps into the raindrop sensor

■ **Precautions regarding the exhaust pipes and rear bumper diffusers**

Exhaust gases cause the exhaust pipes and rear bumper diffusers to become quite hot. When washing the vehicle, be careful not to touch the pipes and rear bumper diffusers until they have cooled sufficiently, as touching hot exhaust pipes and rear bumper diffusers can cause burns.

■ **Precaution regarding the rear bumper with Blind Spot Monitor (if equipped)**

If the paint of the rear bumper is chipped or scratched, the system may malfunction. If this occurs, consult your Lexus dealer.

 NOTICE

■ **Application of coatings to the vehicle body (GS F)**

Do not apply any kind of coating to the vehicle body as doing so may damage the paint or reduce its durability.

■ **To prevent paint deterioration and corrosion on the body and components (aluminum wheels etc.)**

- Wash the vehicle immediately in the following cases:
 - After driving near the sea coast
 - After driving on salted roads
 - If coal tar, pollen or tree sap is present on the paint surface
 - If dead insects, insect droppings or bird droppings are present on the paint surface
 - After driving in an area contaminated with soot, oily smoke, mine dust, iron powder or chemical substances
 - If the vehicle becomes heavily soiled with dust or mud
 - If liquids such as benzene and gasoline are spilled on the paint surface
- If the paint is chipped or scratched, have it repaired immediately.
- To prevent the wheels from corroding, remove any dirt and store in a place with low humidity when storing the wheels.

■ **Cleaning the exterior lights**

- Wash carefully. Do not use organic substances or scrub with a hard brush. This may damage the surfaces of the lights.
- Do not apply wax to the surfaces of the lights. Wax may cause damage to the lenses.

■ **When using an automatic car wash (vehicles with rain-sensing windshield wipers)**

Turn off AUTO mode of the wiper to prevent the wiper from operating. (→P. 222)
If AUTO mode is selected, the wipers may operate and the wiper blades may be damaged.

■ **When using a high-pressure car wash**

- When washing the vehicle, do not let water from the high-pressure washer directly hit the camera or the area around the camera. Due to the shock from high-pressure water, it is possible that the device may not operate normally.
- Do not bring the nozzle tip close to boots (rubber or resin manufactured cover), connectors or the following parts. The parts may be damaged if they come into contact with high-pressure water.

- | | |
|--------------------------|------------------|
| • Traction related parts | • Steering parts |
| • Suspension parts | • Brake parts |

- GS F: Do not point the nozzle of a high pressure washer at the areas shown in the illustration, as high pressure water may damage the oil coolers.

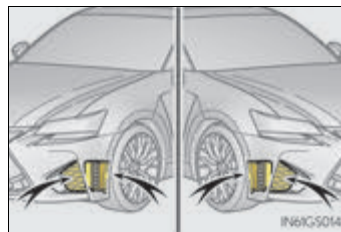

Cleaning and protecting the vehicle interior

The following procedures will help protect your vehicle's interior and keep it in top condition:

Protecting the vehicle interior

Remove dirt and dust using a vacuum cleaner. Wipe dirty surfaces with a cloth dampened with lukewarm water.

For surfaces that are still dirty, use a diluted water solution of approximately 1% neutral detergent. Afterward, firmly wring out any excess water from a cloth dampened with water, and then wipe off all remaining traces of detergent.

Cleaning the areas with satin-finish metal accents

- Remove dirt using a soft cloth or synthetic chamois dampened in a baking soda (sodium bicarbonate) solution.
Use a solution of approximately 9% baking soda dissolved in water.
- Wipe the surface with a dry, soft cloth to remove any remaining moisture.

Cleaning the leather areas

- Remove dirt and dust using a vacuum cleaner.
- Wipe off any excess dirt and dust with a soft cloth dampened with diluted detergent.
Use a diluted water solution of approximately 5% neutral wool detergent.
- Wring out any excess water from the cloth and thoroughly wipe off all remaining traces of detergent.
- Wipe the surface with a dry, soft cloth to remove any remaining moisture. Allow the leather to dry in a shaded and ventilated area.

Cleaning the synthetic leather areas

- Remove loose dirt using a vacuum cleaner.
- Apply a mild soap solution to the synthetic leather using a sponge or soft cloth.
- Allow the solution to soak in for a few minutes. Remove the dirt and wipe off the solution with a clean, damp cloth.

Cleaning the artificial leather (Alcantara®*) areas

- Brush the surfaces using a soft brush.
Do not brush hard as doing so may cause damage.
- Wipe the surfaces clean with a soft cloth that has been dampened in cold or lukewarm water and squeezed out.
- Allow the artificial leather (Alcantara®*) to dry in a shaded and ventilated area.

*: "Alcantara®" is a registered trademark of Alcantara S.p.A.

■ Caring for leather areas

Lexus recommends cleaning the interior of the vehicle at least twice a year to maintain the quality of the vehicle's interior.

■ Shampooing the carpets

There are several commercial foaming-type cleaners available. Use a sponge or brush to apply the foam. Rub in overlapping circles. Do not use water. Wipe dirty surfaces and let them dry. Excellent results are obtained by keeping the carpet as dry as possible.

■ Seat belts

Clean with mild soap and lukewarm water using a cloth or sponge. Also check the belts periodically for excessive wear, fraying or cuts.

■ When cleaning the carpeted portions of the glove box, console box, etc.

If a strong adhesive tape is used, there is a possibility that the surface of the carpet could be damaged.

WARNING

■ Water in the vehicle

- Do not splash or spill liquid in the vehicle.
Doing so may cause electrical components, etc. to malfunction or catch fire.
- Do not get any of the SRS components or wiring in the vehicle interior wet. (→P. 43)
An electrical malfunction may cause the airbags to deploy or not function properly, resulting in death or serious injury.

■ Cleaning the interior (especially instrument panel)

Do not use polish wax or polish cleaner. The instrument panel may reflect off the windshield, obstructing the driver's view and leading to an accident, resulting in death or serious injury.

 NOTICE**■ Cleaning detergents**

- Do not use the following types of detergent, as they may discolor the vehicle interior or cause streaks or damage to painted surfaces:
 - Non-seat portions: Organic substances such as benzene or gasoline, alkaline or acidic solutions, dye, and bleach
 - Seats: Alkaline or acidic solutions, such as thinner, benzene, and alcohol
- Do not use polish wax or polish cleaner. The instrument panel's or other interior part's painted surface may be damaged.

■ Preventing damage to leather surfaces

Observe the following precautions to avoid damage to and deterioration of leather surfaces:

- Remove any dust or dirt from leather surfaces immediately.
- Do not expose the vehicle to direct sunlight for extended periods of time. Park the vehicle in the shade, especially during summer.
- Do not place items made of vinyl, plastic, or containing wax on the upholstery, as they may stick to the leather surface if the vehicle interior heats up significantly.

■ Water on the floor

Do not wash the vehicle floor with water.

Vehicle systems such as the audio system may be damaged if water comes into contact with electrical components such as the audio system above or under the floor of the vehicle. Water may also cause the body to rust.

■ When cleaning the inside of the windshield (vehicles with Lexus Safety System+)

Do not allow glass cleaner to contact the lens. Also, do not touch the lens. (→P. 233)

■ Cleaning the inside of the rear window

- Do not use glass cleaner to clean the rear window, as this may cause damage to the rear window defogger heater wires or antenna. Use a cloth dampened with luke-warm water to gently wipe the window clean. Wipe the window in strokes running parallel to the heater wires or antenna.
- Be careful not to scratch or damage the heater wires or antenna.

Maintenance requirements

To ensure safe and economical driving, day-to-day care and regular maintenance are essential. It is the owner's responsibility to perform regular checks. Lexus recommends the following maintenance:

General maintenance

General maintenance should be performed on a daily basis. This can be done by yourself or by a Lexus dealer.

Scheduled maintenance

Scheduled maintenance should be performed at specified intervals according to the maintenance schedule.

For details about maintenance items and schedules, refer to the "Warranty and Service Guide", "Owner's Manual Supplement" or "Scheduled Maintenance".

Do-it-yourself maintenance

You can perform some maintenance procedures by yourself.

Please be aware that do-it-yourself maintenance may affect warranty coverage.

The use of Lexus repair manuals is recommended.

For details about warranty coverage, refer to the separate "Owner's Guide", "Warranty and Service Guide", "Owner's Manual Supplement" or "Warranty Booklet".

■ Repair and replacement

It is recommended that genuine Lexus parts be used for repairs to ensure performance of each system. If non-Lexus parts are used in replacement or if a repair shop other than a Lexus dealer performs repairs, confirm the warranty coverage.

■ **Resetting the message indicating maintenance is required (U.S.A. only)**

After the required maintenance is performed according to the maintenance schedule, please reset the message.

To reset the message, follow the procedure described below:

- 1 Press **<** or **>** of the meter control switch and select .
- 2 Press **▲** or **▼** of the meter control switch and select "Vehicle Settings". Then press **●**.
- 3 Press **▲** or **▼** of the meter control switch and select "Scheduled Maintenance". Then press **●**.
- 4 Select "Yes" and press **●**.
- 5 A message is displayed on the multi-information display.



■ **Allow inspection and repairs to be performed by a Lexus dealer**

- Lexus technicians are well-trained specialists and are kept up to date with the latest service information. They are well informed about the operations of all systems on your vehicle.
- Keep a copy of the repair order. It proves that the maintenance that has been performed is under warranty coverage. If any problem should arise while your vehicle is under warranty, your Lexus dealer will promptly take care of it.

<p> WARNING</p>
<p>■ If your vehicle is not properly maintained Improper maintenance could result in serious damage to the vehicle and possible death or serious injury.</p> <p>■ Handling of the battery</p> <ul style="list-style-type: none"> ● Engine exhaust, some of its constituents, and a wide variety of automobile components contain or emit chemicals known to the State of California to cause cancer and birth defects and other reproductive harm. Work in a well ventilated area. ● Oils, fuels and fluids contained in vehicles as well as waste produced by component wear contain or emit chemicals known to the State of California to cause cancer and birth defects or other reproductive harm. Avoid exposure and wash any affected area immediately. ● Battery posts, terminals and related accessories contain lead and lead compounds which are known to cause brain damage. Wash your hands after handling. (→P. 410)

General maintenance

Listed below are the general maintenance items that should be performed at the intervals specified in the “Warranty and Service Guide” or “Owner’s Manual Supplement”. It is recommended that any problem you notice should be brought to the attention of your Lexus dealer or qualified service shop for advice.

Engine compartment

Items	Check points
Battery	Check the battery fluid level and connections. (→P. 410)
Brake fluid	Is the brake fluid at the correct level? (→P. 409)
Engine coolant	Is the engine coolant at the correct level? (→P. 406)
Engine oil	Is the engine oil at the correct level? (→P. 401)
Exhaust system	There should not be any fumes or strange sounds.
Radiator/condenser	The radiator and condenser should be free from foreign objects. (→P. 408)
Washer fluid	Is there sufficient washer fluid? (→P. 412)

Vehicle interior

Items	Check points
Accelerator pedal	<ul style="list-style-type: none"> The accelerator pedal should move smoothly (without uneven pedal effort or catching).
Automatic transmission "Park" mechanism	<ul style="list-style-type: none"> When parked on a slope and the shift lever is in P, is the vehicle securely stopped?
Brake pedal	<ul style="list-style-type: none"> Does the brake pedal move smoothly? Does the brake pedal have appropriate clearance from the floor? (→P. 549) Does the brake pedal have the correct amount of free play? (→P. 549)
Brakes	<ul style="list-style-type: none"> The vehicle should not pull to one side when the brakes are applied. The brakes should work effectively. The brake pedal should not feel spongy. The brake pedal should not get too close to the floor when the brakes are applied.
Head restraints	<ul style="list-style-type: none"> Do the head restraints move smoothly and lock securely?
Indicators/buzzers	<ul style="list-style-type: none"> Do the indicators and buzzers function properly?
Lights	<ul style="list-style-type: none"> Do all the lights come on? Are the headlights aimed correctly? (→P. 435)
Parking brake	<ul style="list-style-type: none"> Moves smoothly? When parked on a slope and the parking brake is on, is the vehicle securely stopped?
Seat belts	<ul style="list-style-type: none"> Do the seat belts operate smoothly? The seat belts should not be damaged.
Seats	<ul style="list-style-type: none"> Do the seat controls operate properly?
Steering wheel	<ul style="list-style-type: none"> Does the steering wheel rotate smoothly? Does the steering wheel have the correct amount of free play? There should not be any strange sounds coming from the steering wheel.

Vehicle exterior

Items	Check points
Doors/trunk	<ul style="list-style-type: none"> • Do the doors/trunk operate smoothly?
Engine hood	<ul style="list-style-type: none"> • Does the engine hood lock system work properly?
Fluid leaks	<ul style="list-style-type: none"> • There should not be any signs of fluid leakage after the vehicle has been parked.
Tires	<ul style="list-style-type: none"> • Is the tire inflation pressure correct? • The tires should not be damaged or excessively worn. • Have the tires been rotated according to the maintenance schedule? • The wheel nuts should not be loose.
Windshield wipers	<ul style="list-style-type: none"> • The wiper blades should not show any signs of cracking, splitting, wear, contamination or deformation. • The wiper blades should clear the windshield without streaking or skipping.

⚠ WARNING

■ If the engine is running

Turn the engine off and ensure that there is adequate ventilation before performing maintenance checks.

Emission inspection and maintenance (I/M) programs

Some states have vehicle emission inspection programs which include OBD (On Board Diagnostics) checks. The OBD system monitors the operation of the emission control system.

If the malfunction indicator lamp comes on

The OBD system determines that a problem exists somewhere in the emission control system. Your vehicle may not pass the I/M test and may need to be repaired. Contact your Lexus dealer to service the vehicle.

Your vehicle may not pass the I/M test in the following situations:

- When the battery is disconnected or discharged
Readiness codes that are set during ordinary driving are erased. Also, depending on your driving habits, the readiness codes may not be completely set.
- When the fuel tank cap is loose
The malfunction indicator lamp comes on indicating a temporary malfunction and your vehicle may not pass the I/M test.

When the malfunction indicator lamp still remains on after several driving trips

The error code in the OBD system will not be cleared unless the vehicle is driven 40 or more times.

If your vehicle does not pass the I/M test

Contact your Lexus dealer to prepare the vehicle for re-testing.

Do-it-yourself service precautions

If you perform maintenance by yourself, be sure to follow the correct procedure as given in these sections.

Items	Parts and tools
Battery condition (→P. 410)	<ul style="list-style-type: none"> • Warm water • Baking soda • Grease • Conventional wrench (for terminal clamp bolts)
Brake fluid level (→P. 409)	<ul style="list-style-type: none"> • FMVSS No.116 DOT 3 or SAE J1703 brake fluid • Rag or paper towel • Funnel (used only for adding brake fluid)
Engine/intercooler coolant level (→P. 406)	<ul style="list-style-type: none"> • "Toyota Super Long Life Coolant" or a similar high quality ethylene glycol-based non-silicate, non-amine, non-nitrite and non-borate coolant with long-life hybrid organic acid technology For the U.S.A.: "Toyota Super Long Life Coolant" is pre-mixed with 50% coolant and 50% deionized water. For Canada: "Toyota Super Long Life Coolant" is pre-mixed with 55% coolant and 45% deionized water. • Funnel (used only for adding coolant)
Engine oil level (→P. 401)	<ul style="list-style-type: none"> • "Toyota Genuine Motor Oil" or equivalent • Rag or paper towel • Funnel (used only for adding engine oil)
Fuses (→P. 431)	<ul style="list-style-type: none"> • Fuse with same amperage rating as original
Headlight aim (→P. 435)	<ul style="list-style-type: none"> • Phillips-head screwdriver
Light bulbs (→P. 437)	<ul style="list-style-type: none"> • Bulb with same number and wattage rating as original • Phillips-head screwdriver • Flathead screwdriver • Wrench
Radiator and condenser (→P. 408)	—
Tire inflation pressure (→P. 422)	<ul style="list-style-type: none"> • Tire pressure gauge • Compressed air source
Washer fluid (→P. 412)	<ul style="list-style-type: none"> • Water or washer fluid containing antifreeze (for winter use) • Funnel (used only for adding water or washer fluid)

 **WARNING**

The engine compartment contains many mechanisms and fluids that may move suddenly, become hot, or become electrically energized. To avoid death or serious injury, observe the following precautions.

■ When working on the engine compartment

- Keep hands, clothing and tools away from the moving fan and engine drive belt.
- Be careful not to touch the engine, radiator, exhaust manifold, etc. right after driving as they may be hot. Oil and other fluids may also be hot.
- Do not leave anything that may burn easily, such as paper and rags, in the engine compartment.
- Do not smoke, cause sparks or expose an open flame to fuel or the battery. Fuel and battery fumes are flammable.
- Be extremely cautious when working on the battery. It contains poisonous and corrosive sulfuric acid.

■ When working near the electric cooling fans or radiator grille

Be sure the engine switch is off.

With the engine switch in IGNITION ON mode, the electric cooling fans may automatically start to run if the air conditioning is on and/or the coolant temperature is high. (→P. 408)

■ Safety glasses

Wear safety glasses to prevent flying or falling material, fluid spray, etc. from getting in your eyes.

 **NOTICE****■ If you remove the air cleaner filter**

Driving with the air cleaner filter removed may cause excessive engine wear due to dirt in the air.

Hood

Release the lock from the inside of the vehicle to open the hood.

- 1 Pull the hood lock release lever.
The hood will pop up slightly.

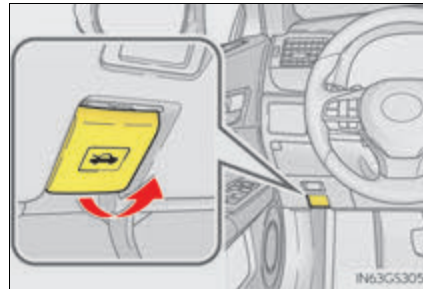

- 2 Pull up the auxiliary catch lever and lift the hood.

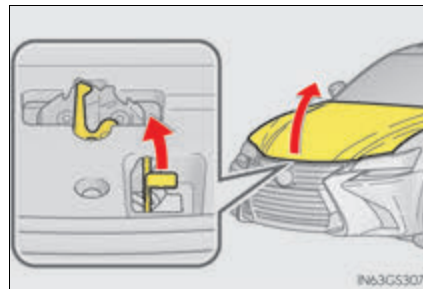

WARNING

■ Pre-driving check

Check that the hood is fully closed and locked.
If the hood is not locked properly, it may open while the vehicle is in motion and cause an accident, which may result in death or serious injury.

Positioning a floor jack

When using a floor jack, follow the instructions in the manual provided with the jack and perform the operation safely.

When raising your vehicle with a floor jack, position the jack correctly. Improper placement may damage your vehicle or cause injury.

◆ Front

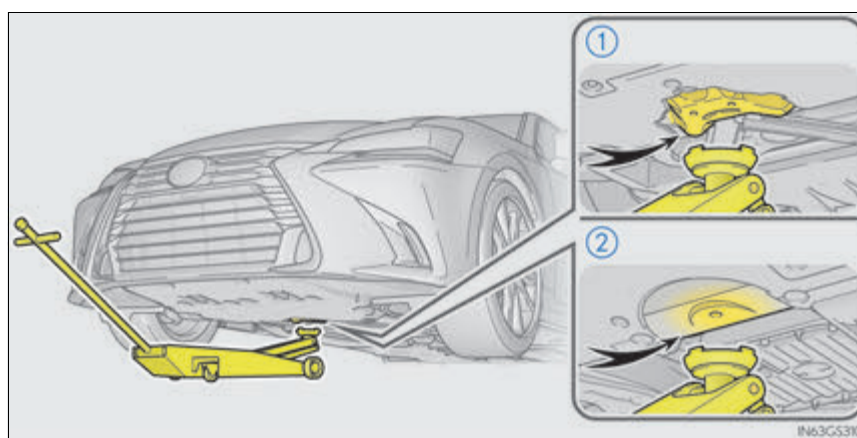

① 2WD models

② AWD models

◆ Rear

▶ GS350/GS200t

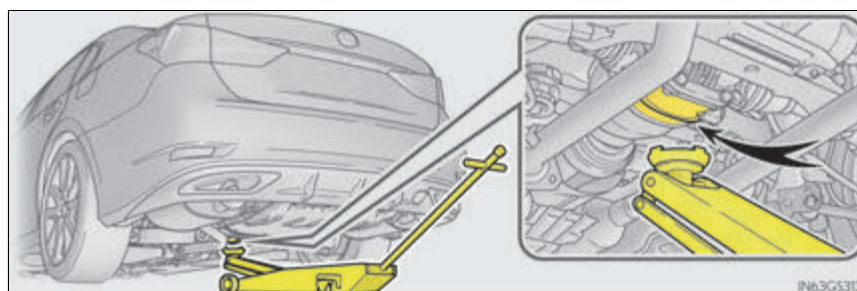

▶ GSF

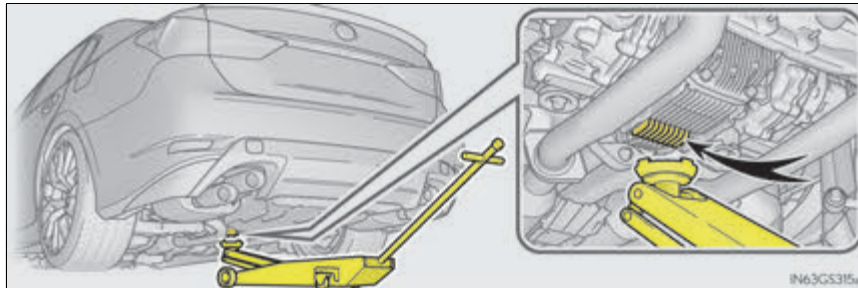
 NOTICE

■ When using a jack at the rear of the vehicle (GSF)

Do not set the jack in either of the positions indicated by the illustration.

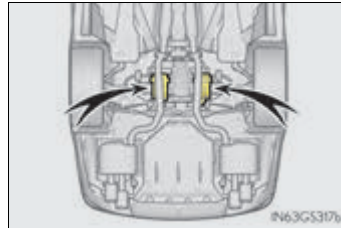

Engine compartment

► GS350

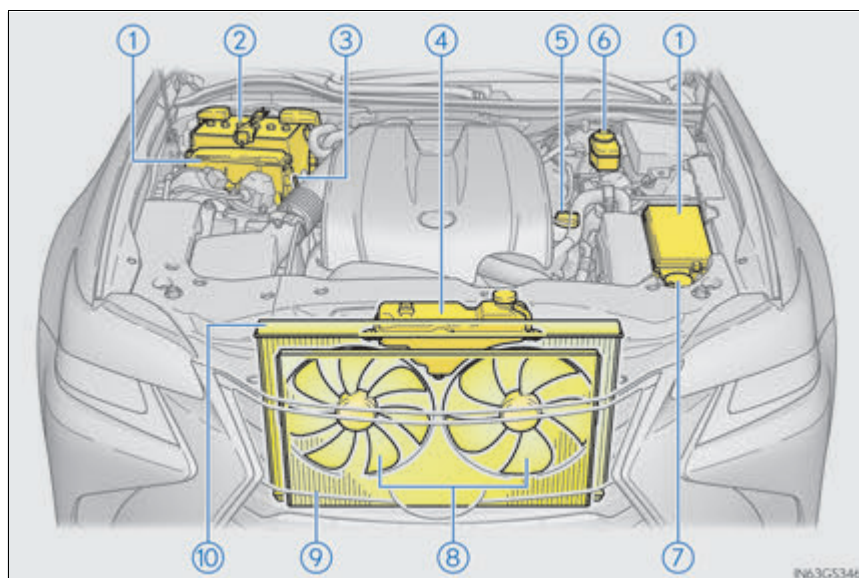

- | | | | |
|-----------------------------|-----------|-------------------------|-----------|
| ① Fuse boxes | (→P. 431) | ⑥ Brake fluid reservoir | (→P. 409) |
| ② Battery | (→P. 410) | ⑦ Washer fluid tank | (→P. 412) |
| ③ Engine oil level dipstick | (→P. 401) | ⑧ Electric cooling fans | |
| ④ Engine coolant reservoir | (→P. 406) | ⑨ Condenser | (→P. 408) |
| ⑤ Engine oil filler cap | (→P. 403) | ⑩ Radiator | (→P. 408) |

▶ GS200t

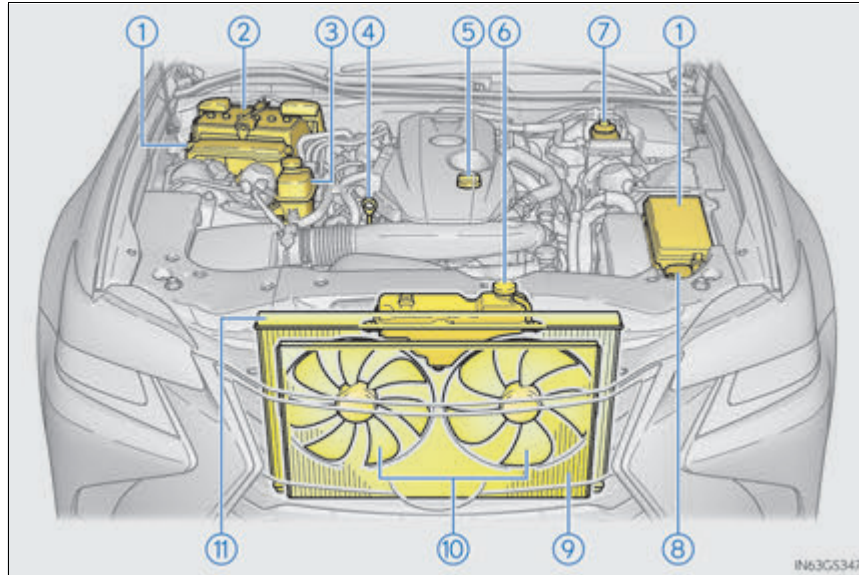

- | | | | |
|---------------------------------|-----------|----------------------------|-----------|
| ① Fuse boxes | (→P. 431) | ⑥ Engine coolant reservoir | (→P. 406) |
| ② Battery | (→P. 410) | ⑦ Brake fluid reservoir | (→P. 409) |
| ③ Intercooler coolant reservoir | (→P. 406) | ⑧ Washer fluid tank | (→P. 412) |
| ④ Engine oil level dipstick | (→P. 401) | ⑨ Condenser | (→P. 408) |
| ⑤ Engine oil filler cap | (→P. 403) | ⑩ Electric cooling fans | (→P. 408) |
| | | ⑪ Radiator | (→P. 408) |

▶ GSF

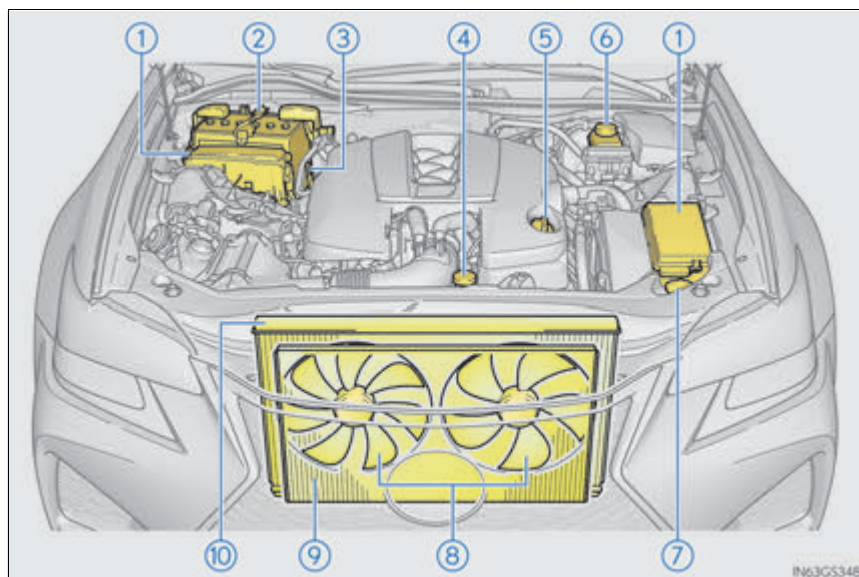

- | | | | |
|-----------------------------|-----------|-------------------------|-----------|
| ① Fuse boxes | (→P. 431) | ⑥ Brake fluid reservoir | (→P. 409) |
| ② Battery | (→P. 410) | ⑦ Washer fluid tank | (→P. 412) |
| ③ Engine oil level dipstick | (→P. 401) | ⑧ Electric cooling fans | |
| ④ Engine coolant reservoir | (→P. 406) | ⑨ Condenser | (→P. 408) |
| ⑤ Engine oil filler cap | (→P. 403) | ⑩ Radiator | (→P. 408) |

Engine compartment cover

■ Removing the engine compartment cover

- ▶ GS350/GS200t (Right-hand side)

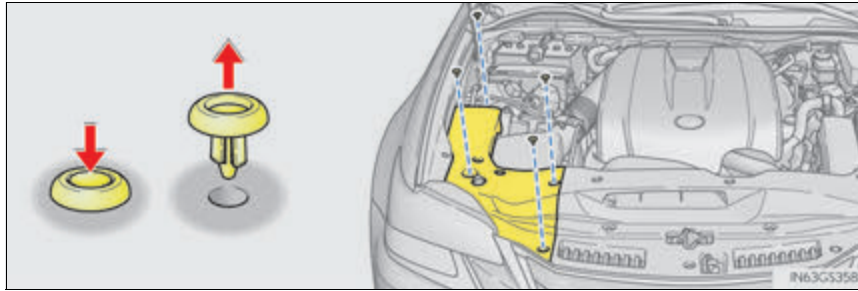

- ▶ GS350/GS200t (Center)

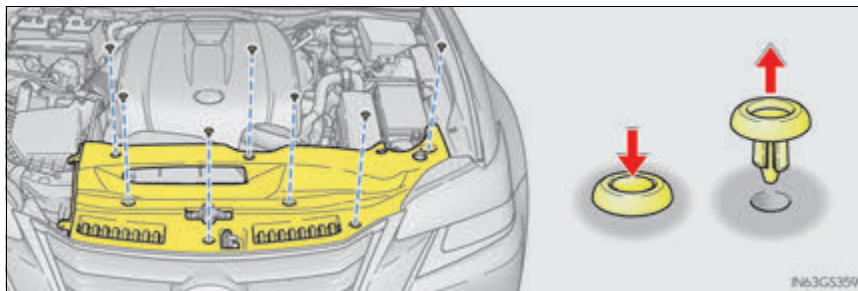

- ▶ GSF

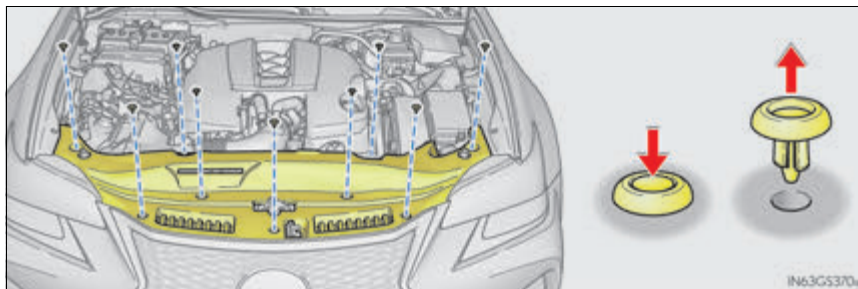

■ **Installing the clips**

- ① Push up center portion
- ② Insert
- ③ Press

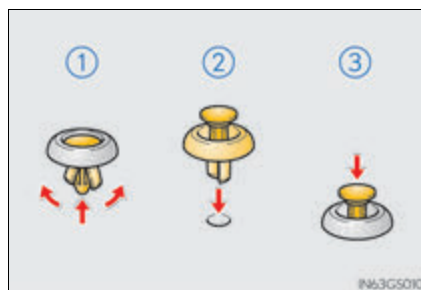

 **NOTICE**

■ **Checking the engine compartment cover after installation**

Make sure that the cover is securely installed in its original position.

Engine oil

With the engine at operating temperature and turned off, check the oil level on the dipstick.

■ Checking the engine oil

- 1 Park the vehicle on level ground. After warming up the engine and turning it off, wait more than 5 minutes for the oil to drain back into the bottom of the engine.
- 2 Holding a rag under the end, pull the dipstick out.

▶ GS350

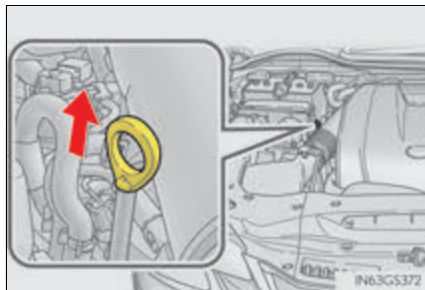

▶ GS200t

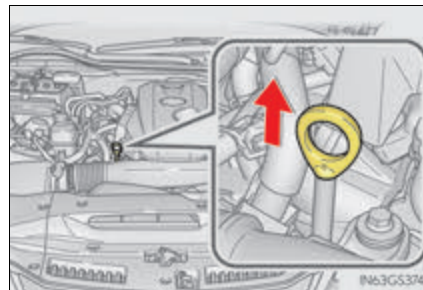

▶ GSF

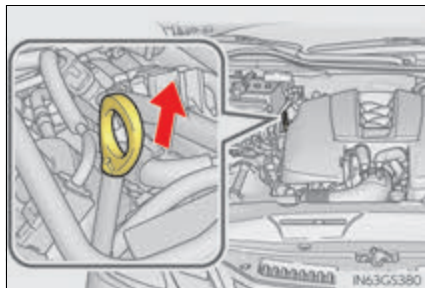

- 3 Wipe the dipstick clean.

402 6-3. Do-it-yourself maintenance

- 4 Reinsert the dipstick fully.
- 5 Holding a rag under the end, pull the dipstick out and check the oil level.
 - ① Low
 - ② Normal
 - ③ Excessive

► Flat dipstick

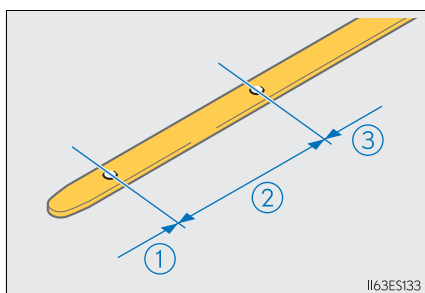

► Non-flat dipstick

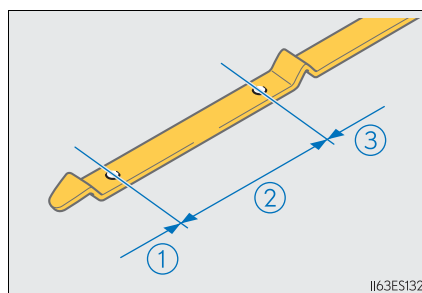

The shape of the dipstick may differ depending on the type of vehicle or engine.

- 6 Wipe the dipstick and reinsert it fully.

■ Adding engine oil

If the oil level is below or near the low level mark, add engine oil of the same type as that already in the engine.

▶ GS350

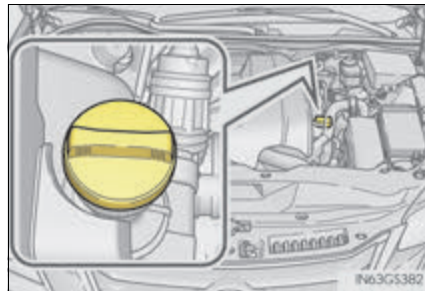

▶ GS200t

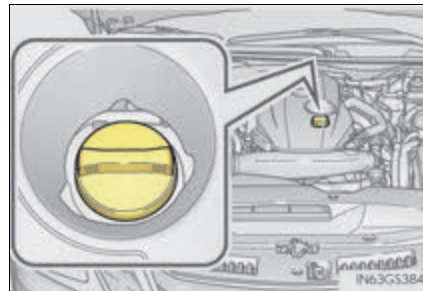

▶ GSF

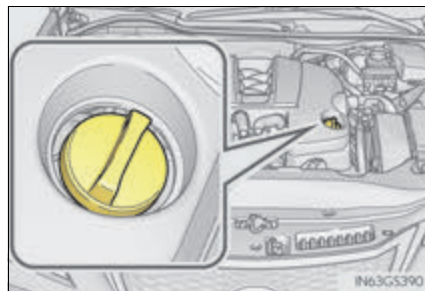

Make sure to check the oil type and prepare the items needed before adding oil.

Engine oil selection	→P. 542, 544, 545
Oil quantity (Low → Full)	1.6 qt. (1.5 L, 1.3 Imp.qt.)
Items	Clean funnel

- 1** Remove the oil filler cap by turning it counterclockwise.
- 2** Add engine oil slowly, checking the dipstick.
- 3** Install the oil filler cap by turning it clockwise.





■ **Engine oil consumption**

A certain amount of engine oil will be consumed while driving. In the following situations, oil consumption may increase, and engine oil may need to be refilled in between oil maintenance intervals.

- When the engine is new, for example directly after purchasing the vehicle or after replacing the engine
- If low quality oil or oil of an inappropriate viscosity is used
- When driving at high engine speeds or with a heavy load, or when driving while accelerating or decelerating frequently
- When leaving the engine idling for a long time, or when driving frequently through heavy traffic

■ **After changing the engine oil (GS350/GS200t)**

The engine oil maintenance data should be reset. Perform the following procedures:

- 1 Press **<** or **>** of the meter control switch and select .
- 2 Press **▲** or **▼** of the meter control switch and select "Vehicle Settings". Then press .
- 3 Press **▲** or **▼** of the meter control switch and select "Oil Maintenance". Then press .
- 4 Select "Yes" and press .
- 5 A message is displayed on the multi-information display.

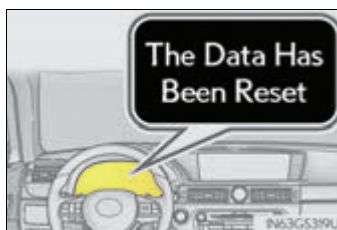

 WARNING
<p>■ Used engine oil</p> <ul style="list-style-type: none"> ● Used engine oil contains potentially harmful contaminants which may cause skin disorders such as inflammation and skin cancer, so care should be taken to avoid prolonged and repeated contact. To remove used engine oil from your skin, wash thoroughly with soap and water. ● Dispose of used oil and filters only in a safe and acceptable manner. Do not dispose of used oil and filters in household trash, in sewers or onto the ground. Call your Lexus dealer, service station or auto parts store for information concerning recycling or disposal. ● Do not leave used engine oil within the reach of children.

 NOTICE**■ To prevent serious engine damage**

Check the oil level on a regular basis.

■ When replacing the engine oil

- Be careful not to spill engine oil on the vehicle components.
- Avoid overfilling, or the engine could be damaged.
- Check the oil level on the dipstick every time you refill the vehicle.
- Be sure the engine oil filler cap is properly tightened.

Coolant

The coolant level is satisfactory if it is between the "FULL"/"F" and "LOW"/"L" lines on the reservoir when the engine is cold.

■ Engine coolant reservoir

- ① Reservoir cap
- ② "FULL" line
- ③ "LOW" line

▶ GS350

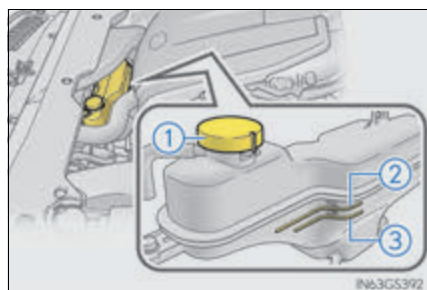

▶ GS200t

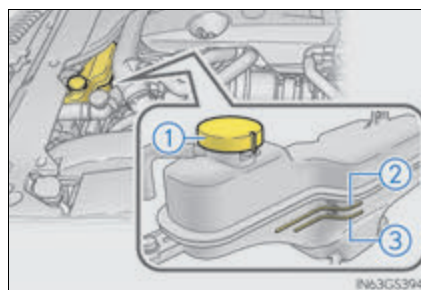

▶ GSF

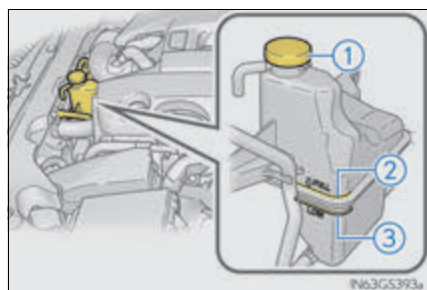

If the level is on or below the "LOW" line, add coolant up to the "FULL" line.
(→P. 528)

■ Intercooler coolant reservoir (GS200t only)

- ① Reservoir cap
- ② "F" line
- ③ "L" line

If the level is on or below the "L" line, add coolant up to the "F" line.
(→P. 528)

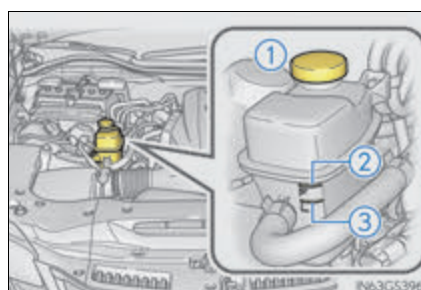

■ Coolant selection

Only use "Toyota Super Long Life Coolant" or a similar high quality ethylene glycol based non-silicate, non-amine, non-nitrite, and non-borate coolant with long-life hybrid organic acid technology.

U.S.A.:

"Toyota Super Long Life Coolant" is a mixture of 50% coolant and 50% deionized water. (Minimum temperature: -31°F [-35°C])

Canada:

"Toyota Super Long Life Coolant" is a mixture of 55% coolant and 45% deionized water. (Minimum temperature: -44°F [-42°C])

For more details about coolant, contact your Lexus dealer.

■ If the coolant level drops within a short time of replenishing

Visually check the radiator, hoses, engine coolant reservoir caps, drain cock and water pump.

If you cannot find a leak, have your Lexus dealer test the cap and check for leaks in the cooling system.

WARNING

■ When the engine is hot

Do not remove the engine coolant reservoir cap, the intercooler coolant reservoir cap or the coolant inlet cap. (→P. 532)

The cooling system may be under pressure and may spray hot coolant if the cap is removed, causing serious injuries, such as burns.

NOTICE

■ When adding coolant

Coolant is neither plain water nor straight antifreeze. The correct mixture of water and antifreeze must be used to provide proper lubrication, corrosion protection and cooling. Be sure to read the antifreeze or coolant label.

■ If you spill coolant

Be sure to wash it off with water to prevent it from damaging parts or paint.

Radiator and condenser

Check the radiator and condenser and clear away any foreign objects.
If either of the above parts is extremely dirty or you are not sure of their condition, have your vehicle inspected by your Lexus dealer.

 **WARNING**

 **When the engine is hot**

Do not touch the radiator or condenser as they may be hot and cause serious injuries, such as burns.

Brake fluid

■ Checking fluid level

The brake fluid level should be between the "MAX" and "MIN" lines on the tank.

▶ GS350/GS200t

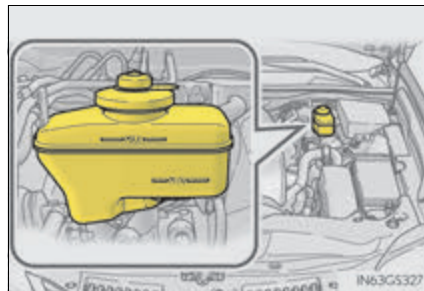

▶ GSF

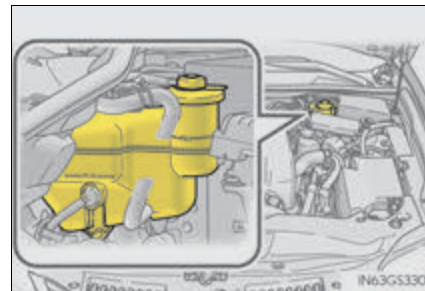

■ Adding fluid

Make sure to check the fluid type and prepare the necessary item.

Fluid type	FMVSS No.116 DOT 3 or SAE J1703 brake fluid
Items	Clean funnel

■ Brake fluid can absorb moisture from the air

Excess moisture in the brake fluid can cause a dangerous loss of braking efficiency. Use only newly opened brake fluid.

⚠ WARNING

■ When filling the reservoir

Take care as brake fluid can harm your hands and eyes and damage painted surfaces. If fluid gets on your hands or in your eyes, flush the affected area with clean water immediately. If you still experience discomfort, see a doctor.

⚠ NOTICE

■ If the fluid level is low or high

It is normal for the brake fluid level to go down slightly as the brake pads wear out or when the fluid level in the accumulator is high. If the reservoir needs frequent refilling, there may be a serious problem.

Battery

Check the battery as follows.

■ Battery exterior

Make sure that the battery terminals are not corroded and that there are no loose connections, cracks, or loose clamps.

- ① Terminals
- ② Hold-down clamp

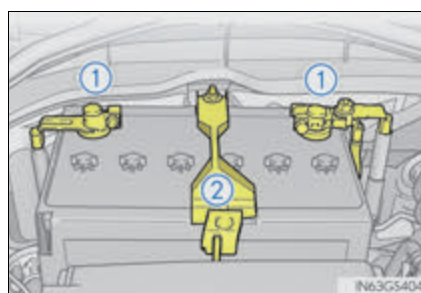

■ Before recharging

When recharging, the battery produces hydrogen gas which is flammable and explosive. Therefore, observe the following before recharging:

- If recharging with the battery installed on the vehicle, be sure to disconnect the ground cable.
- Make sure the power switch on the charger is off when connecting and disconnecting the charger cables to the battery.

■ After recharging/reconnecting the battery

The engine may not start. Follow the procedure below to initialize the system.

- 1 Shift the shift lever to P.
- 2 Open and close any of the doors.
- 3 Restart the engine.
 - Unlocking the doors using the smart access system with push-button start may not be possible immediately after reconnecting the battery. If this happens, use the wireless remote control or the mechanical key to lock/unlock the doors.
 - Start the engine with the engine switch in ACCESSORY mode. The engine may not start with the engine switch turned off. However, the engine will operate normally from the second attempt.
 - The engine switch mode is recorded by the vehicle. If the battery is reconnected, the vehicle will return the engine switch mode to the status it was in before the battery was disconnected. Make sure to turn off the engine before disconnect the battery. Take extra care when connecting the battery if the engine switch mode prior to discharge is unknown.

If the engine will not start even after multiple attempts at both methods, contact your Lexus dealer.

 **WARNING****■ Chemicals in the battery**

Batteries contain poisonous and corrosive sulfuric acid and may produce hydrogen gas which is flammable and explosive. To reduce the risk of death or serious injury, take the following precautions while working on or near the battery:

- Do not cause sparks by touching the battery terminals with tools.
- Do not smoke or light a match near the battery.
- Avoid contact with eyes, skin and clothes.
- Never inhale or swallow electrolyte.
- Wear protective safety glasses when working near the battery.
- Keep children away from the battery.

■ Where to safely charge the battery

Always charge the battery in an open area. Do not charge the battery in a garage or closed room where there is insufficient ventilation.

■ How to recharge the battery

Only perform a slow charge (5 A or less). The battery may explode if charged at a quicker rate.

■ Emergency measures regarding electrolyte

- If electrolyte gets in your eyes
Flush your eyes with clean water for at least 15 minutes and get immediate medical attention. If possible, continue to apply water with a sponge or cloth while traveling to the nearest medical facility.
- If electrolyte gets on your skin
Wash the affected area thoroughly. If you feel pain or burning, get medical attention immediately.
- If electrolyte gets on your clothes
It can soak through clothing on to your skin. Immediately take off the clothing and follow the procedure above if necessary.
- If you accidentally swallow electrolyte
Drink a large quantity of water or milk. Get emergency medical attention immediately.

 **NOTICE****■ When recharging the battery**

Never recharge the battery while the engine is running. Also, be sure all accessories are turned off.

Washer fluid

If any washer does not work or the warning message appears on the multi-information display, the washer tank may be empty. Add washer fluid.

▶ GS350/GS200t

▶ GSF

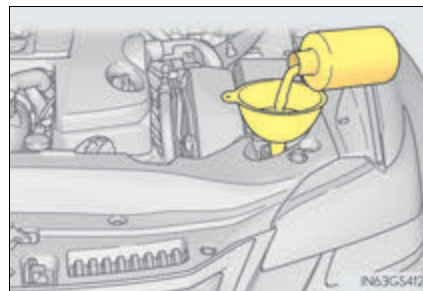
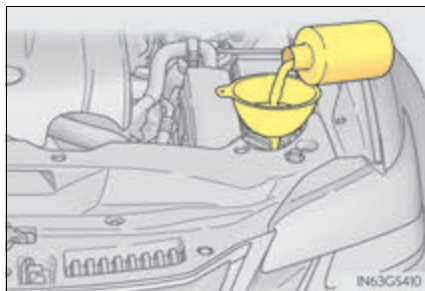

WARNING

■ **When adding washer fluid**

Do not add washer fluid when the engine is hot or running as washer fluid contains alcohol and may catch fire if spilled on the engine etc.

NOTICE

■ **Do not use any fluid other than washer fluid**

Do not use soapy water or engine antifreeze instead of washer fluid. Doing so may cause streaking on the vehicle's painted surfaces.

■ **Diluting washer fluid**

Dilute washer fluid with water as necessary. Refer to the freezing temperatures listed on the label of the washer fluid bottle.

Tires

Replace or rotate tires in accordance with maintenance schedules and treadwear.

Checking tires

Check if the treadwear indicators are showing on the tires. Also check the tires for uneven wear, such as excessive wear on one side of the tread.

Check the spare tire condition and pressure if not rotated.

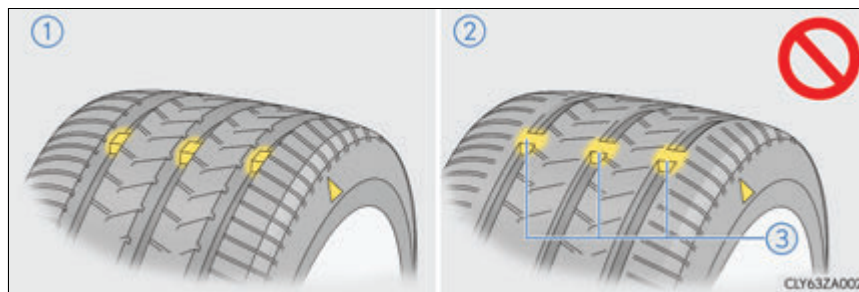

- ① New tread
- ② Worn tread
- ③ Treadwear indicator

The location of treadwear indicators is shown by the "TWI" or "Δ" mark, etc., molded into the sidewall of each tire.

Replace the tires if the treadwear indicators are showing on a tire.

Tire rotation

- ▶ Vehicles with front and rear tires of the same size

Rotate the tires in the order shown.

To equalize tire wear and extend tire life, Lexus recommends that tire rotation is carried out at the same interval as tire inspection.

Do not fail to initialize the tire pressure warning system after tire rotation.

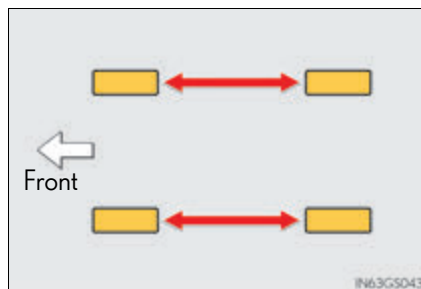

- ▶ Vehicles with front and rear tires of differing sizes

Tires cannot be rotated.

Tire pressure warning system

Your vehicle is equipped with a tire pressure warning system that uses tire pressure warning valves and transmitters to detect low tire inflation pressure before serious problems arise.

- If the tire pressure drops below a predetermined level, the driver is warned by the multi-information display and a warning light. (→P. 452, 459)
- The tire pressure detected by the tire pressure warning system can be displayed on the multi-information display. (→P. 100, 108)

The illustration used is intended as an example, and may differ from the image that is actually displayed on the multi-information display.

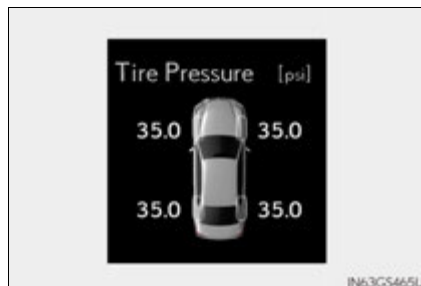

◆ Installing tire pressure warning valves and transmitters

When replacing tires or wheels, tire pressure warning valves and transmitters must also be installed.

When new tire pressure warning valves and transmitters are installed, new ID codes must be registered in the tire pressure warning computer and the tire pressure warning system must be initialized. Have tire pressure warning valve and transmitter ID codes registered by your Lexus dealer. (→P. 416)

◆ Initializing the tire pressure warning system

■ The tire pressure warning system must be initialized in the following circumstances:

- When rotating the tires.
- When the tire inflation pressure is changed such as when changing traveling speed or load weight.

When the tire pressure warning system is initialized, the current tire inflation pressure is set as the benchmark pressure.

■ How to initialize the tire pressure warning system



- 1 Park the vehicle in a safe place and turn the engine switch off.



Initialization cannot be performed while the vehicle is moving.



- 2 Adjust the tire inflation pressure to the specified cold tire inflation pressure level. (→P. 550)

Make sure to adjust the tire pressure to the specified cold tire inflation pressure level. The tire pressure warning system will operate based on this pressure level.

- 3 Turn the engine switch to IGNITION ON mode.

- 4 Press  or  on the meter control switch and select .

- 5 Press  or  on the meter control switch and select "Vehicle Settings". Then press .

- 6 Press  or  on the meter control switch and select "TPMS". Then press and hold  until a message is displayed.

The message will be displayed on the multi-information display and the tire pressure warning light will blink slowly 3 times.

When the message disappears, initialization is complete.



◆ **Registering ID codes**

The tire pressure warning valve and transmitter is equipped with a unique ID code. When replacing a tire pressure warning valve and transmitter, it is necessary to register the ID code. Have the ID code registered by your Lexus dealer.

■ **When to replace your vehicle's tires**

Tires should be replaced if:

- The treadwear indicators are showing on a tire.
- You have tire damage such as cuts, splits, cracks deep enough to expose the fabric, and bulges indicating internal damage
- A tire goes flat repeatedly or cannot be properly repaired due to the size or location of a cut or other damage

If you are not sure, consult with your Lexus dealer.

■ **Replacing tires and wheels**

If the ID code of the tire pressure warning valve and transmitter is not registered, the tire pressure warning system will not work properly. After driving for about 20 minutes, the tire pressure warning light blinks for 1 minute and stays on to indicate a system malfunction.

■ **Tire life**

Any tire over 6 years old must be checked by a qualified technician even if it has seldom or never been used or damage is not obvious.

■ **Routine tire inflation pressure checks**

The tire pressure warning system does not replace routine tire inflation pressure checks. Make sure to check tire inflation pressure as part of your routine of daily vehicle checks.

■ **When rotating the tires**

Make sure that the engine switch is off. If the tires are rotated while the engine switch is in IGNITION ON mode, the tire position information will not be updated.

If this accidentally occurs, either turn the engine switch to off and then to IGNITION ON mode, or initialize the system after checking that the tire pressure is properly adjusted.

■ **Low profile tires (except 225/50R17 tires)**

Generally, low profile tires will wear more rapidly and tire grip performance will be reduced on snowy and/or icy roads when compared to standard tires. Be sure to use snow tires or tire chains on snowy and/or icy roads and drive carefully at a speed appropriate for road and weather conditions. (→P. 317)

■ Maximum load of tire

Check that the maximum load of the replacement tire is greater than 1/2 of the Gross Axle Weight Ratings (GAWR) of either the front axle or the rear axle, whichever is greater.

For the GAWR, see the Certification Label. For the maximum load of the tire, see the load limit at maximum cold tire inflation pressure mentioned on the sidewall of the tire. (→P. 558)

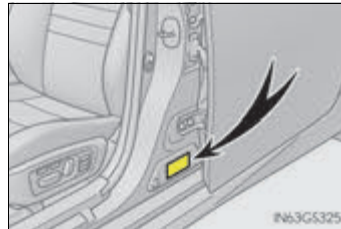
**■ Tire types****● Summer tires**

Summer tires are high-speed performance tires best suited to highway driving under dry conditions. Since summer tires do not have the same traction performance as snow tires, summer tires are inadequate for driving on snow-covered or icy roads. For driving on snow-covered roads or icy roads, the use of snow tires is recommended. When installing snow tires, be sure to replace all four tires.

● All season tires

All season tires are designed to provide better traction in snow and to be adequate for driving in most winter conditions as well as for use year-round. All season tires, however, do not have adequate traction performance compared with snow tires in heavy or loose snow. Also, all season tires fall short in acceleration and handling performance compared with summer tires in highway driving.

● Snow tires

For driving on snow-covered roads or icy roads, we recommend using snow tires. If you need snow tires, select tires of the same size, construction and load capacity as the originally installed tires. Since your vehicle has radial tires as original equipment, make sure your snow tires also have radial construction. Do not install studded tires without first checking local regulations for possible restrictions. Snow tires should be installed on all wheels. (→P. 316)

■ If the tread on snow tires wears down below 0.16 in. (4 mm)

The effectiveness of the tires as snow tires is lost.

■ **Situations in which the tire pressure warning system may not operate properly**

- In the following cases, the tire pressure warning system may not operate properly.
 - If non-genuine Lexus wheels are used.
 - A tire has been replaced with a tire that is not an OE (Original Equipment) tire.
 - A tire has been replaced with a tire that is not of the specified size.
 - Tire chains etc. are equipped.
 - An auxiliary-supported run-flat tire is equipped.
 - If a window tint that affects the radio wave signals is installed.
 - If there is a lot of snow or ice on the vehicle, particularly around the wheels or wheel housings.
 - If the tire inflation pressure is extremely higher than the specified level.
 - If wheel without the tire pressure warning valve and transmitter are used.
 - If the ID code on the tire pressure warning valves and transmitters is not registered in the tire pressure warning computer.
- Performance may be affected in the following situations.
 - Near a TV tower, electric power plant, gas station, radio station, large display, airport or other facility that generates strong radio waves or electrical noise
 - When carrying a portable radio, cellular phone, cordless phone or other wireless communication device

If tire position information is not correctly displayed due to the radio wave conditions, the display may be corrected by driving and changing the radio wave conditions.
- When the vehicle is parked, the time taken for the warning to start or go off could be extended.
- When tire inflation pressure declines rapidly for example when a tire has burst, the warning may not function.

■ **The initialization operation**

- Make sure to carry out initialization after adjusting the tire inflation pressure. Also, make sure the tires are cold before carrying out initialization or tire inflation pressure adjustment.
- If you have accidentally turned the engine switch off during initialization, it is not necessary to manually restart the initialization again, as initialization will restart automatically the next time the engine switch is turned to IGNITION ON mode.
- If you accidentally perform initialization when initialization is not necessary, adjust the tire inflation pressure to the specified level when the tires are cold, and conduct initialization again.

■ **When initialization of the tire pressure warning system has failed**

Initialization can be completed in a few minutes. However, in the following cases, the settings have not been recorded and the system will not operate properly. If repeated attempts to record tire inflation pressure settings are unsuccessful, have the vehicle inspected by your Lexus dealer.

- The initialization message is not displayed on the multi-information display when performing initialization.
- After carrying out the initialization procedure, the tire pressure warning light blinks for 1 minute then stays on after driving for 20 minutes.

■ Tire pressure warning system certification

- ▶ For vehicles sold in the U.S.A.
 - Transmitter
FCC ID: PAXPMVC010
 - Initiator
FCC ID: HYQ22AAA

NOTE:

This device complies with part 15 of the FCC Rules. Operation is subject to the following two conditions: (1) This device may not cause harmful interference, and (2) this device must accept any interference received, including interference that may cause undesired operation.

FCC WARNING:

Changes or modifications not expressly approved by the party responsible for compliance could void the user's authority to operate the equipment.

- ▶ For vehicles sold in Canada
 - Transmitter

NOTE:

Operation is subject to the following two conditions: (1) this device may not cause interference, and (2) this device must accept any interference, including interference that may cause undesired operation of the device.

- Initiator

NOTE:

This device complies with Industry Canada's licence-exempt RSSs.

Operation is subject to the following two conditions:

- (1) This device may not cause interference; and
- (2) This device must accept any interference, including interference that may cause undesired operation of the device.

⚠ WARNING

■ **When inspecting or replacing tires**

Observe the following precautions to prevent accidents.

Failure to do so may cause damage to parts of the drive train as well as dangerous handling characteristics, which may lead to an accident resulting in death or serious injury.

- Do not mix tires of different makes, models or tread patterns.
Also, do not mix tires of remarkably different treadwear.
- Do not use tire sizes other than those recommended by Lexus.
- Do not mix differently constructed tires (radial, bias-belted or bias-ply tires).
- Do not mix summer, all season and snow tires.
- Do not use tires that have been used on another vehicle.
Do not use tires if you do not know how they were used previously.
- Vehicles with spare tire: Do not tow if your vehicle has a spare tire installed.
- Vehicles with emergency tire puncture repair kit: Do not tow anything if a tire that has been repaired using the emergency tire puncture repair kit is installed. The load on the tire may cause unexpected damage to the tire.

■ **When initializing the tire pressure warning system**

Do not initialize tire inflation pressure without first adjusting the tire inflation pressure to the specified level. Otherwise, the tire pressure warning light may not come on even if the tire inflation pressure is low, or it may come on when the tire inflation pressure is actually normal.

■ **Caution regarding interference with electronic devices**

- People with implantable cardiac pacemakers, cardiac resynchronization therapy-pacemakers or implantable cardioverter defibrillators should not come within 17.7 in. (450 mm) of the tire pressure warning system initiators. The radio waves may affect the operation of such devices.

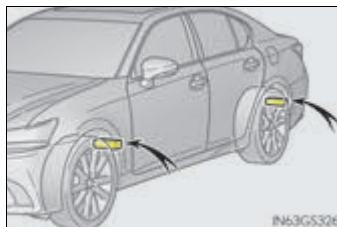

- Users of any electrical medical device other than implantable cardiac pacemakers, cardiac resynchronization therapy-pacemakers or implantable cardioverter defibrillators should consult the manufacturer of the device for information about its operation under the influence of radio waves.
Radio waves could have unexpected effects on the operation of such medical devices.

 NOTICE**■ Repairing or replacing tires, wheels, tire pressure warning valves, transmitters and tire valve caps**

- When removing or fitting the wheels, tires or the tire pressure warning valves and transmitters, contact your Lexus dealer as the tire pressure warning valves and transmitters may be damaged if not handled correctly.
- Make sure to install the tire valve caps. If the tire valve caps are not installed, water could enter the tire pressure warning valves and the tire pressure warning valves could be bound.
- When replacing tire valve caps, do not use tire valve caps other than those specified. The cap may become stuck.

■ To avoid damage to the tire pressure warning valves and transmitters

When a tire is repaired with liquid sealants, the tire pressure warning valve and transmitter may not operate properly. If a liquid sealant is used, contact your Lexus dealer or other qualified service shop as soon as possible. Make sure to replace the tire pressure warning valve and transmitter when replacing the tire. (→P. 414)

■ Driving on rough roads

Take particular care when driving on roads with loose surfaces or potholes. These conditions may cause losses in tire inflation pressure, reducing the cushioning ability of the tires. In addition, driving on rough roads may cause damage to the tires themselves, as well as the vehicle's wheels and body.

■ Low profile tires (except 225/50R17 tires)

Low profile tires may cause greater damage than usual to the tire wheel when sustaining impact from the road surface. Therefore, pay attention to the following:

- Be sure to use proper tire inflation pressure. If tires are under-inflated, they may be damaged more severely.
- Avoid potholes, uneven pavement, curbs and other road hazards. Failure to do so may lead to severe tire and wheel damage.

■ If tire inflation pressure of each tire becomes low while driving

Do not continue driving, or your tires and/or wheels may be ruined.

Tire inflation pressure

Tire inflation pressure

The recommended cold tire inflation pressure and tire size are displayed on the tire and loading information label. (→P. 550)

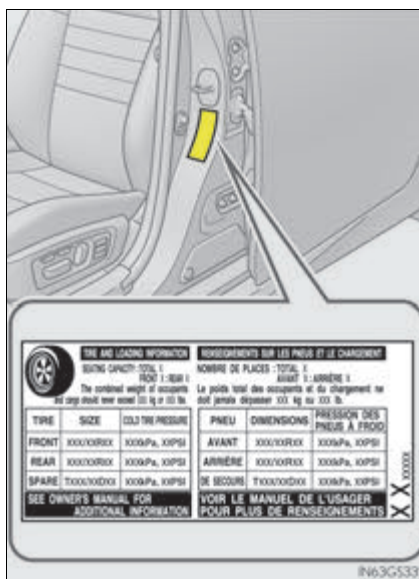

Inspection and adjustment procedure

- ① Tire valve
- ② Tire pressure gauge

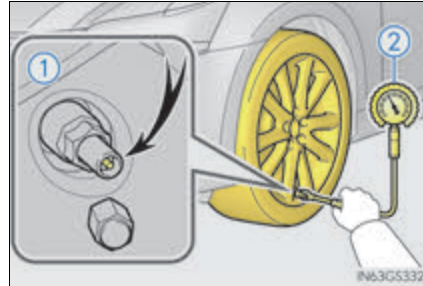

- 1 Remove the tire valve cap.
- 2 Press the tip of the tire pressure gauge onto the tire valve.
- 3 Read the pressure using the gauge gradations.
- 4 If the tire inflation pressure is not at the recommended level, adjust the pressure.
If you add too much air, press the center of the valve to deflate.
- 5 After completing the tire inflation pressure measurement and adjustment, apply soapy water to the valve and check for leakage.
- 6 Put the tire valve cap back on.

■ Tire inflation pressure check interval

You should check tire inflation pressure every two weeks, or at least once a month. Do not forget to check the spare.

■ Effects of incorrect tire inflation pressure

Driving with incorrect tire inflation pressure may result in the following:

- Reduced fuel economy
- Reduced driving comfort and poor handling
- Reduced tire life due to wear
- Reduced safety
- Damage to the drive train

If a tire needs frequent inflating, have it checked by your Lexus dealer.

■ **Instructions for checking tire inflation pressure**

When checking tire inflation pressure, observe the following:

- Check only when the tires are cold.
If your vehicle has been parked for at least 3 hours or has not been driven for more than 1 mile or 1.5 km, you will get an accurate cold tire inflation pressure reading.
- Always use a tire pressure gauge.
It is difficult to judge if a tire is properly inflated based only on its appearance.
- It is normal for the tire inflation pressure to be higher after driving as heat is generated in the tire. Do not reduce tire inflation pressure after driving.
- Never exceed the vehicle capacity weight.
Passengers and luggage weight should be placed so that the vehicle is balanced.

 **WARNING**

■ **Proper inflation is critical to save tire performance**

Keep your tires properly inflated.

If the tires are not properly inflated, the following conditions may occur which could lead to an accident resulting in death or serious injury:

- Excessive wear
- Uneven wear
- Poor handling
- Possibility of blowouts resulting from overheated tires
- Air leaking from between tire and wheel
- Wheel deformation and/or tire damage
- Greater possibility of tire damage while driving (due to road hazards, expansion joints, sharp edges in the road, etc.)

 **NOTICE**

■ **When inspecting and adjusting tire inflation pressure**

Be sure to put the tire valve caps back on.

If a valve cap is not installed, dirt or moisture may get into the valve and cause an air leak, resulting in decreased tire inflation pressure.

Wheels

If a wheel is bent, cracked or heavily corroded, it should be replaced. Otherwise, the tire may separate from the wheel or cause a loss of handling control.

Wheel selection

When replacing wheels, care should be taken to ensure that they are equivalent to those removed in load capacity, diameter, rim width and inset*.

Replacement wheels are available at your Lexus dealer.

*: Conventionally referred to as "offset".

Lexus does not recommend using the following:

- Wheels of different sizes or types
- Used wheels
- Bent wheels that have been straightened
- Steel wheels (2WD F SPORT models only)

Aluminum wheel precautions

- Use only Lexus wheel nuts and wrenches designed for use with your aluminum wheels.
- When rotating, repairing or changing your tires, check that the wheel nuts are still tight after driving 1000 miles (1600 km).
- Be careful not to damage the aluminum wheels when using tire chains.
- Use only Lexus genuine balance weights or equivalent and a plastic or rubber hammer when balancing your wheels.

■ When replacing wheels

The wheels of your vehicle are equipped with tire pressure warning valves and transmitters that allow the tire pressure warning system to provide advance warning in the event of a loss in tire inflation pressure. Whenever wheels are replaced, tire pressure warning valves and transmitters must be installed. (→P. 414)

 **WARNING**

■ **When replacing wheels**

- Do not use wheels that are a different size from those recommended in the Owner's Manual, as this may result in a loss of handling control.
- Never use an inner tube in a leaking wheel which is designed for a tubeless tire. Doing so may result in an accident, causing death or serious injury.
- 2WDF SPORT models: Do not install steel wheels.
The wheel contact surface could be damaged, and the wheel could come off while driving, which could lead to an accident resulting in death or serious injury.

■ **Use of defective wheels prohibited**

Do not use cracked or deformed wheels.
Doing so could cause the tire to leak air during driving, possibly causing an accident.

 **NOTICE**

■ **Replacing tire pressure warning valves and transmitters**

- Because tire repair or replacement may affect the tire pressure warning valves and transmitters, make sure to have tires serviced by your Lexus dealer or other qualified service shop. In addition, make sure to purchase your tire pressure warning valves and transmitters at your Lexus dealer.
- Ensure that only genuine Lexus wheels are used on your vehicle.
Tire pressure warning valves and transmitters may not work properly with non-genuine wheels.

Air conditioning filter

The air conditioning filter must be changed regularly to maintain air conditioning efficiency.

Removal method

- 1 Turn the engine switch off.
- 2 Open the glove box. Lift up the side with the stay, disconnect the stay tabs and remove the partition by pulling horizontally.
- 3 Press the tabs and remove the filter cover.
- 4 Press the tabs and remove the filter case.

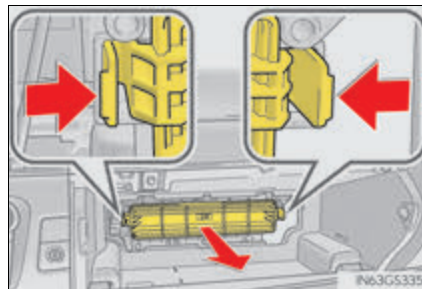
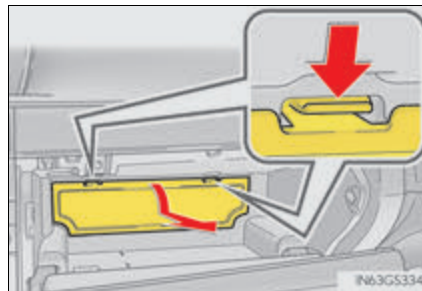
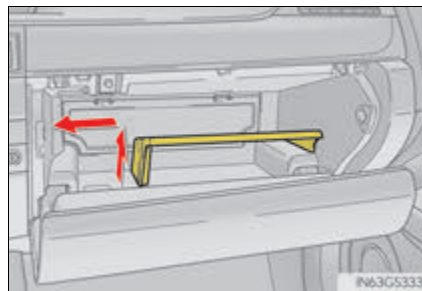

6

Maintenance and care

- 5 Remove the air conditioning filter from the filter case and replace it with a new one.

The “↑UP” marks shown on the filter and the filter case should be pointing up.

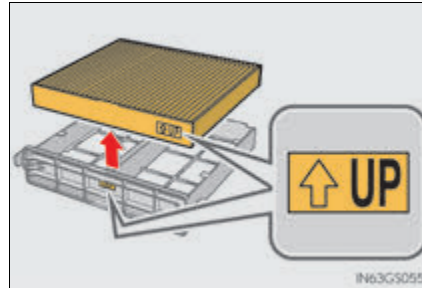

■ Changing interval

Inspect and replace the air conditioning filter according to the maintenance schedule. In dusty areas or areas with heavy traffic flow, early replacement may be required. (For scheduled maintenance information, please refer to the “Owner’s Manual Supplement” or “Scheduled Maintenance”.)

■ If air flow from the vents decreases dramatically

The filter may be clogged. Check the filter and replace if necessary.

■ Air conditioning filter with deodorizing function

When fragrances are placed in your vehicle, the deodorizing effect may become significantly weakened in a short period.

When an air conditioning odor comes out continuously, replace the air conditioning filter.

⚠ NOTICE

■ When using the air conditioning system

Make sure that a filter is always installed.

Using the air conditioning system without a filter may cause damage to the system.

Electronic key battery

Replace the battery with a new one if it is depleted.

You will need the following items:

- Flathead screwdriver
- Small flathead screwdriver
- Lithium battery CR2032

Replacing the battery

- 1** Take out the mechanical key.

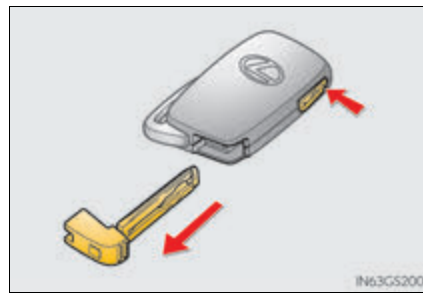

- 2** Remove the cover.

To prevent damage to the key, cover the tip of the screwdriver with a rag.

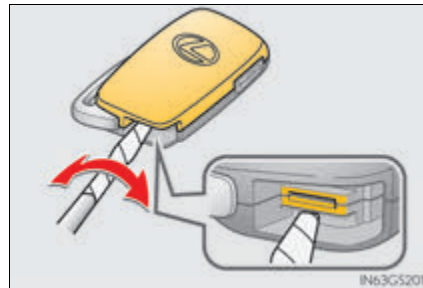

- 3** Remove the depleted battery.

Insert a new battery with the "+" terminal facing up.

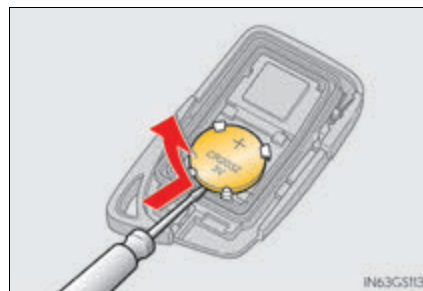

■ **Use a CR2032 lithium battery**

- Batteries can be purchased at your Lexus dealer, local electrical appliance shops or camera stores.
- Replace only with the same or equivalent type recommended by the manufacturer.
- Dispose of used batteries according to local laws.

■ **When the card key battery needs to be replaced (if equipped)**

The battery for the card key is available only at Lexus dealers. Your Lexus dealer can replace the battery for you.

■ **If the electronic key battery is depleted**

The following symptoms may occur:

- The smart access system with push-button start and wireless remote control will not function properly.
- The operational range will be reduced.

 WARNING
■ Removed battery and other parts These parts are small and if swallowed by a child, they can cause choking. Keep away from children. Failure to do so could result in death or serious injury.

 NOTICE
■ For normal operation after replacing the battery Observe the following precautions to prevent accidents: <ul style="list-style-type: none">● Always work with dry hands. Moisture may cause the battery to rust.● Do not touch or move any other component inside the remote control.● Do not bend either of the battery terminals.

Checking and replacing fuses

If any of the electrical components do not operate, a fuse may have blown. If this happens, check and replace the fuses as necessary.

1 Turn the engine switch off.

2 Open the fuse box cover.

▶ Engine compartment (type A fuse box)

▶ Engine compartment (type B fuse box)

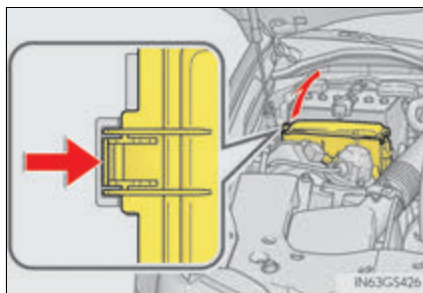

Push the tab in and lift the lid off.

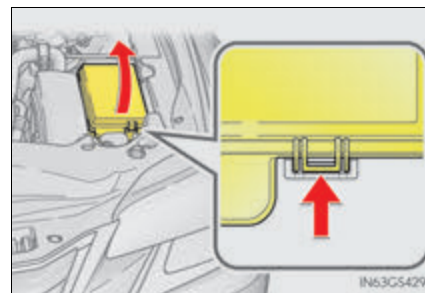

Push the tab in and lift the lid off.

▶ Driver's side instrument panel

▶ Passenger's side instrument panel

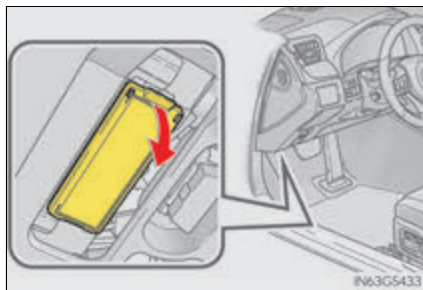

Remove the lid.

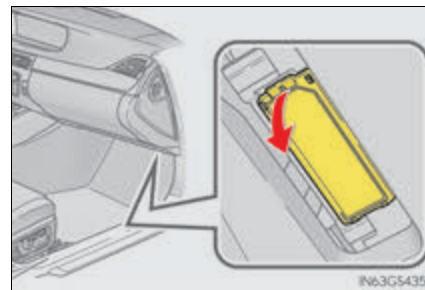

Remove the lid.

6

Maintenance and care

432 6-3. Do-it-yourself maintenance

▶ Trunk

Push the tab in and lift the lid off.

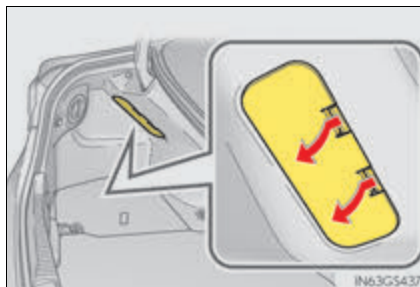

Remove the lid.

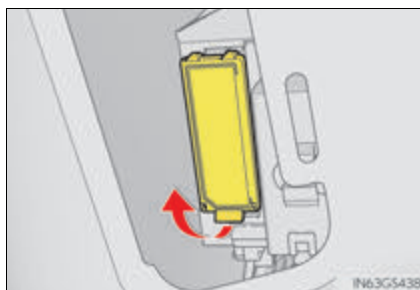

3 Remove the fuse with the pullout tool.

Only type A fuse can be removed using the pullout tool.



4 Check if the fuse is blown.

- ① Normal fuse
- ② Blown fuse

Type A and B:

Replace the blown fuse with a new fuse of an appropriate amperage rating. The amperage rating can be found on the fuse box lid.

Type C and D:

Contact your Lexus dealer.

▶ Type A

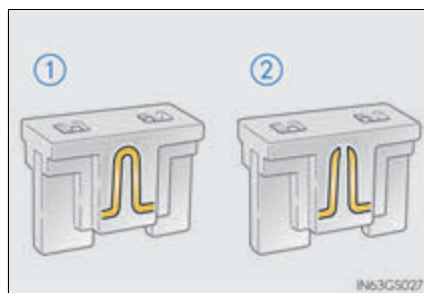

▶ Type B

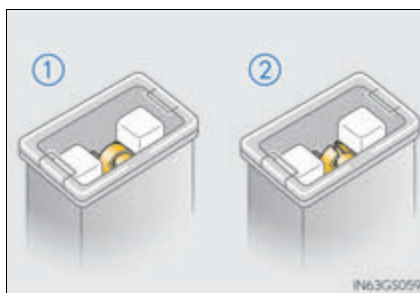

▶ Type C

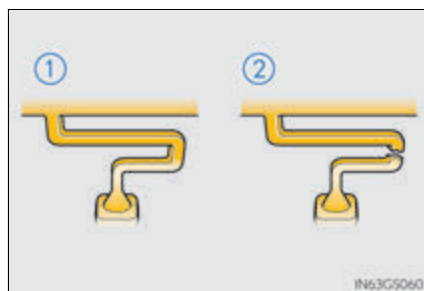

▶ Type D

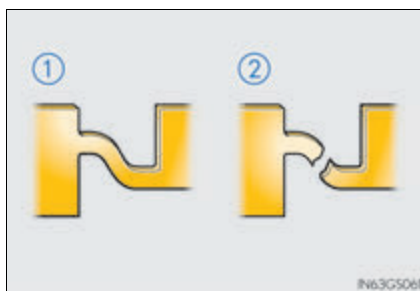

■ **After a fuse is replaced**

- If the lights do not turn on even after the fuse has been replaced, a bulb may need replacement. (→P. 437)
- If the replaced fuse blows again, have the vehicle inspected by your Lexus dealer.

■ **If there is an overload in a circuit**

The fuses are designed to blow, protecting the wiring harness from damage.

■ **When replacing light bulbs**

Lexus recommends that you use genuine Lexus products designed for this vehicle. Because certain bulbs are connected to circuits designed to prevent overload, non-genuine parts or parts not designed for this vehicle may be unusable.

 **WARNING**

■ **To prevent system breakdowns and vehicle fire**

Observe the following precautions.

Failure to do so may cause damage to the vehicle, and possibly a fire or injury.

- Never use a fuse of a higher amperage rating than that indicated, or use any other object in place of a fuse.
- Always use a genuine Lexus fuse or equivalent.
Never replace a fuse with a wire, even as a temporary fix.
- Do not modify the fuses or fuse boxes.

 **NOTICE**

■ **Before replacing fuses**

Have the cause of electrical overload determined and repaired by your Lexus dealer as soon as possible.

Headlight aim (vehicles with single-beam headlights)

Vertical movement adjusting bolts

- ① Adjustment bolt A
- ② Adjustment bolt B

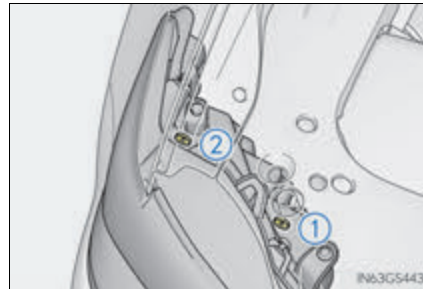

Before checking the headlight aim

- 1 Make sure the vehicle has a full tank of gasoline and the area around the headlight is not deformed.
- 2 Park the vehicle on level ground.
- 3 Sit in the driver's seat.
- 4 Bounce the vehicle several times.

Adjusting the headlight aim

- 1 Using a Phillips-head screwdriver, turn bolt A in either direction.

Remember the turning direction and the number of turns.

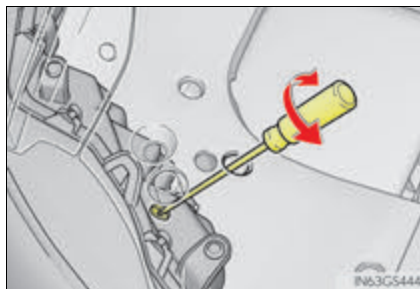

- 2 Turn bolt B the same number of turns and in the same direction as step 1.

If the headlight cannot be adjusted using this procedure, take the vehicle to your Lexus dealer to adjust the headlight aim.

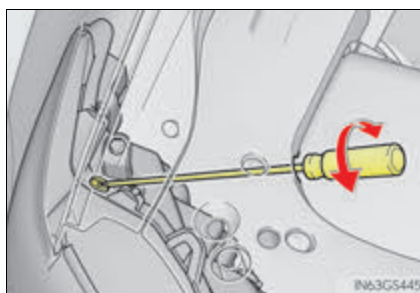

Light bulbs

You may replace the following bulbs by yourself. The difficulty level of replacement varies depending on the bulb. If necessary bulb replacement seems difficult to perform, contact your Lexus dealer.

For more information about replacing other light bulbs, contact your Lexus dealer.

Preparing for light bulb replacement

Check the wattage of the light bulb to be replaced. (→P. 554)

Removing the engine compartment covers

→P. 399

Bulb locations

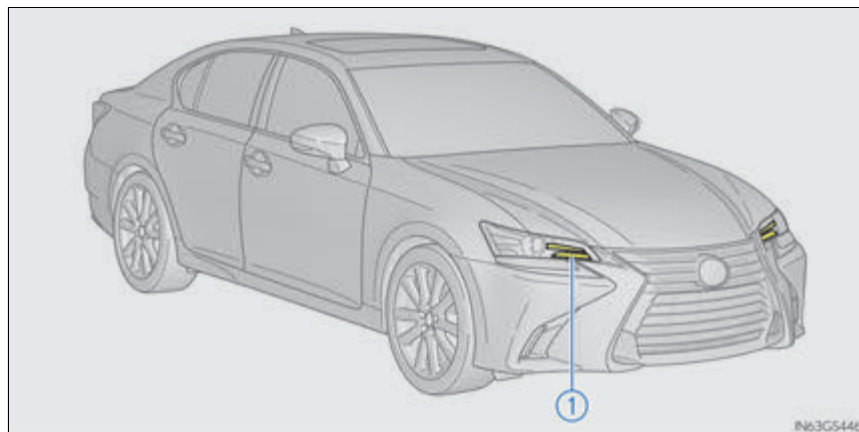

① Front turn signal light (vehicles with single-beam headlights)

Replacing light bulbs

■ Front turn signal light (vehicles with single-beam headlights)

- 1 For the left side only: Remove the bolt and move the washer fluid filler opening.

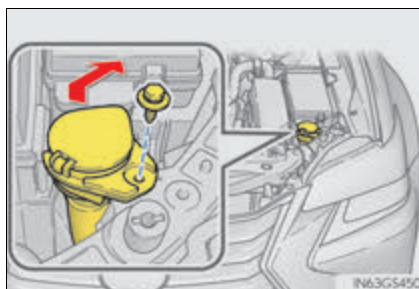

- 2 Turn the bulb base counterclockwise.

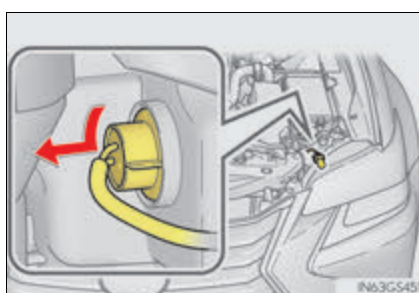

- 3 Remove the light bulb.

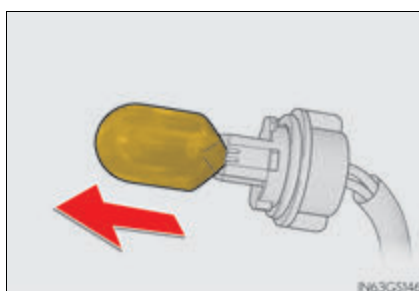

- 4** When installing, reverse the steps listed.

After installing the bulb base, secure the cord with the clips and if replacing the left side bulb, make sure to install the bolt for the washer fluid filler opening in its original position.

▶ Right side

▶ Left side

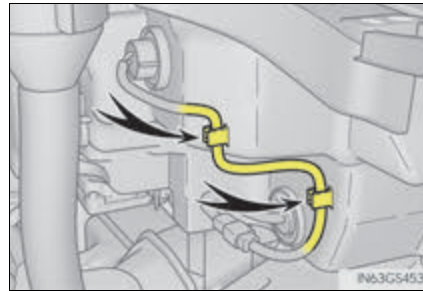
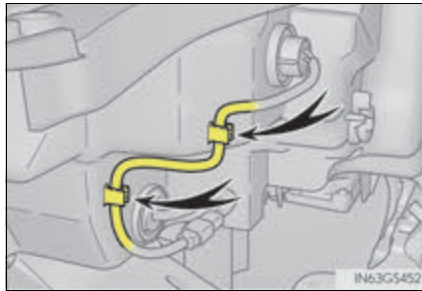

■ Replacing the following bulbs

If any of the lights listed below has burnt out, have it replaced by your Lexus dealer.

- Headlights
- Parking lights/daytime running lights
- Front side marker lights
- Front turn signal lights (vehicles with triple-beam headlights)
- Side turn signal lights
- Stop/tail lights
- Stop lights
- Rear side marker lights
- Rear turn signal lights
- Back-up lights
- High mounted stoplight
- License plate lights
- Outer foot lights

■ LED Lights

The lights other than the front turn signal light (vehicles with single-beam headlights) and outer foot lights each consist of a number of LEDs. If any of the LEDs burn out, take your vehicle to your Lexus dealer to have the light replaced.

■ Condensation build-up on the inside of the lens

Temporary condensation build-up on the inside of the headlight lens does not indicate a malfunction. Contact your Lexus dealer for more information in the following situations:

- Large drops of water have built up on the inside of the lens.
- Water has built up inside the headlight.

■ When replacing light bulbs

→P. 434

<p> WARNING</p>
<p>■ Replacing light bulbs</p> <ul style="list-style-type: none"> ● Turn off the lights. Do not attempt to replace the bulb immediately after turning off the lights. The bulbs become very hot and may cause burns. ● Do not touch the glass portion of the light bulb with bare hands. When it is unavoidable to hold the glass portion, use and hold with a clean dry cloth to avoid getting moisture and oils on the bulb. Also, if the bulb is scratched or dropped, it may blow out or crack. ● Fully install light bulbs and any parts used to secure them. Failure to do so may result in heat damage, fire, or water entering the headlight unit. This may damage the headlights or cause condensation to build up on the lens. <p>■ To prevent damage or fire</p> <ul style="list-style-type: none"> ● Make sure bulbs are fully seated and locked. ● Check the wattage of the bulb before installing to prevent heat damage.

When trouble arises

7

7-1. Essential information

Emergency flashers.....	442
If your vehicle has to be stopped in an emergency	443

**7-2. Steps to take in an
emergency**

If your vehicle needs to be towed.....	444
If you think something is wrong	450
Fuel pump shut off system	451
If a warning light turns on or a warning buzzer sounds.....	452
If a warning message is displayed.....	459
If you have a flat tire (vehicles with spare tire).....	491
If you have a flat tire (vehicles without spare tire).....	502
If the engine will not start	515
If the shift lever cannot be shifted from P	517
If the parking brake cannot be released	518
If the electronic key does not operate properly	520
If the vehicle battery is discharged	523
If your vehicle overheats	528
If the vehicle becomes stuck	534

Emergency flashers

The emergency flashers are used to warn other drivers when the vehicle has to be stopped in the road due to a breakdown, etc.

Press the switch.

All the turn signal lights will flash.
To turn them off, press the switch once again.

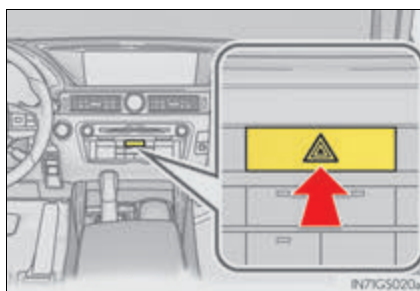

■ Emergency flashers

If the emergency flashers are used for a long time while the engine is not operating, the battery may discharge.

If your vehicle has to be stopped in an emergency

Only in an emergency, such as if it becomes impossible to stop the vehicle in the normal way, stop the vehicle using the following procedure:

- 1 Steadily step on the brake pedal with both feet and firmly depress it.
Do not pump the brake pedal repeatedly as this will increase the effort required to slow the vehicle.
- 2 Shift the shift lever to N.
 - ▶ If the shift lever is shifted to N
- 3 After slowing down, stop the vehicle in a safe place by the road.
- 4 Stop the engine.
 - ▶ If the shift lever cannot be shifted to N
- 3 Keep depressing the brake pedal with both feet to reduce vehicle speed as much as possible.
- 4 To stop the engine, press and hold the engine switch for 2 consecutive seconds or more, or press it briefly 3 times or more in succession.

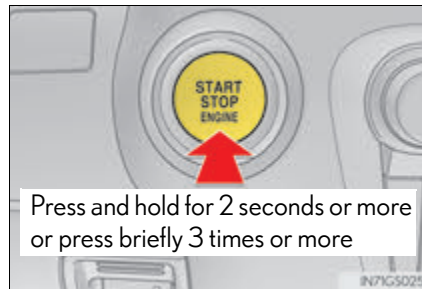

- 5 Stop the vehicle in a safe place by the road.

WARNING

■ If the engine has to be turned off while driving

Power assist for the brakes and steering wheel will be lost, making the brake pedal harder to depress and the steering wheel heavier to turn. Decelerate as much as possible before turning off the engine.

If your vehicle needs to be towed

If towing is necessary, we recommend having your vehicle towed by your Lexus dealer or commercial towing service, using a wheel-lift type truck or flatbed truck.

Use a safety chain system for all towing, and abide by all state/provincial and local laws.

Situations when it is necessary to contact dealers before towing

The following may indicate a problem with your transmission. Contact your Lexus dealer or commercial towing service before towing.

- The engine is running but the vehicle does not move.
- The vehicle makes an abnormal sound.

Towing with a sling-type truck

Do not tow with a sling-type truck to prevent body damage.



Towing with a wheel-lift type truck

▶ From the front

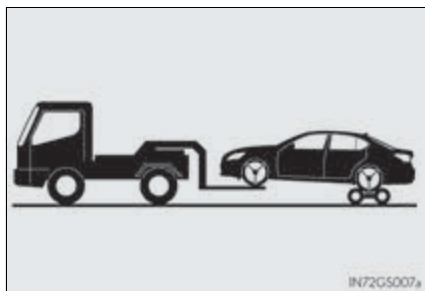

Use a towing dolly under the rear wheels.

▶ From the rear

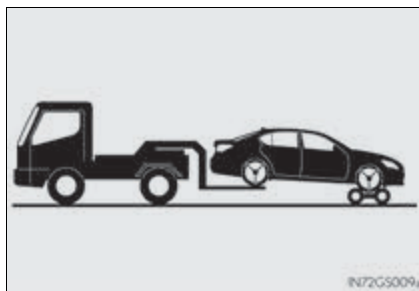

Use a towing dolly under the front wheels.

Using a flatbed truck

If your vehicle is transported by a flatbed truck, it should be tied down at the locations shown in the illustration.

▶ GS350/GS200t

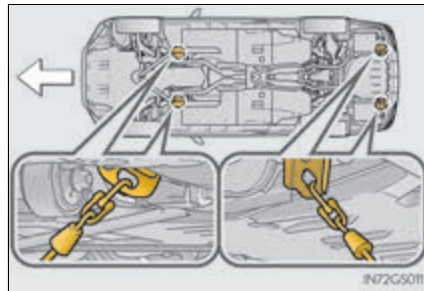

▶ GS F

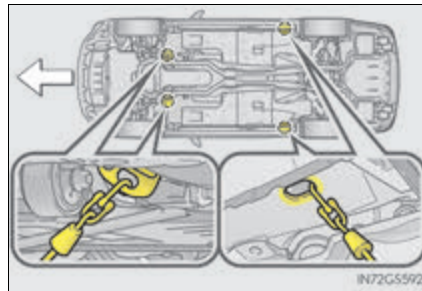

If you use chains or cables to tie down your vehicle, the angles shaded in black must be 45°.

Do not overly tighten the tie downs or the vehicle may be damaged.

▶ GS350/GS200t

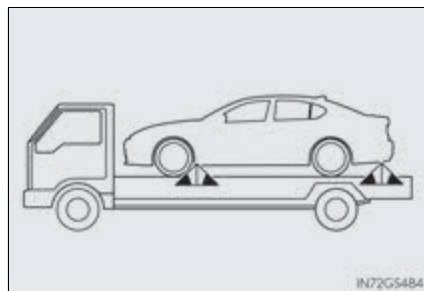

▶ GS F

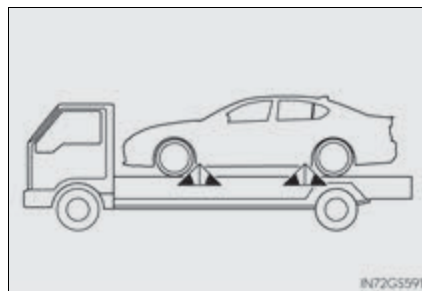

Emergency towing

If a tow truck is not available in an emergency, your vehicle may be temporarily towed using cables or chains secured to the emergency towing eyelets. This should only be attempted on hard surfaced roads for at most 50 miles (80 km) at under 18 mph (30 km/h).

A driver must be in the vehicle to steer and operate the brakes. The vehicle's wheels, drive train, axles, steering and brakes must be in good condition.

Emergency towing procedure

1 Take out the towing eyelet. (→P. 492, 503)

2 Remove the eyelet cover using a flathead screwdriver.

To protect the bodywork, place a rag between the screwdriver and the vehicle body as shown in the illustration.

▶ GS350/GS200t
(except F SPORT models)

▶ GS350/GS200t
(F SPORT models)

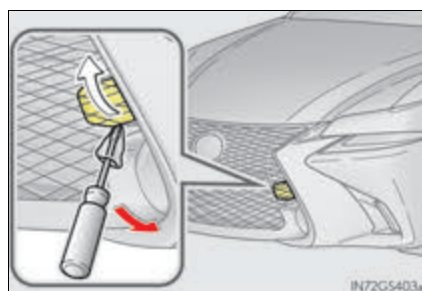
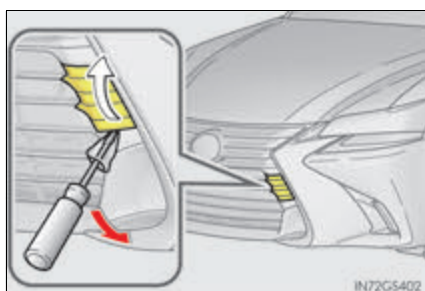

▶ GS F

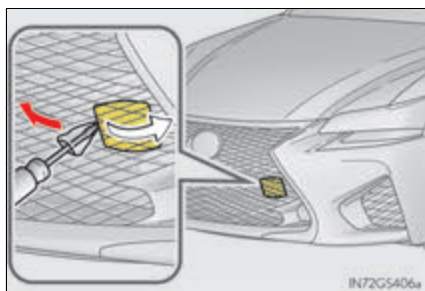

3 Insert the towing eyelet into the hole and tighten partially by hand.

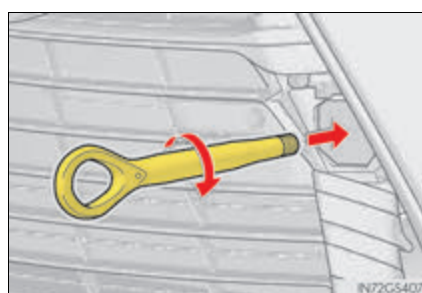

- 4 Tighten down the towing eyelet securely using a wheel nut wrench or hard metal bar.

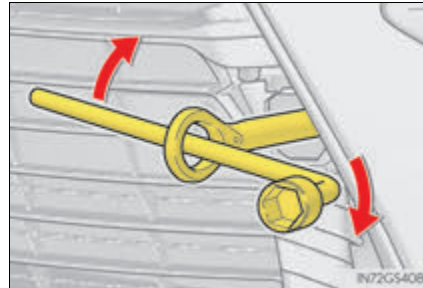

- 5 Securely attach cables or chains to the towing eyelet.
Take care not to damage the vehicle body.
- 6 Enter the vehicle being towed and start the engine.
If the engine does not start, turn the engine switch to IGNITION ON mode.
- 7 Shift the shift lever to N and release the parking brake.
When the shift lever cannot be shifted: →P. 517

■ While towing

If the engine is not running, the power assist for the brakes and steering will not function, making steering and braking more difficult.

■ Wheel nut wrench

Wheel nut wrench is installed in trunk. (→P. 492, 503)

WARNING

Observe the following precautions.
Failure to do so may result in death or serious injury.

■ **When towing the vehicle**

2WD models:

Be sure to transport the vehicle with all four wheels raised off the ground. If the vehicle is towed with the tires contacting the ground, the drivetrain and related parts may be damaged or an accident may occur due to a change in direction of the vehicle.

AWD models:

Be sure to transport the vehicle with all four wheels raised off the ground. If the vehicle is towed with the tires contacting the ground, the drivetrain or related parts may be damaged, the vehicle may fly off the truck.

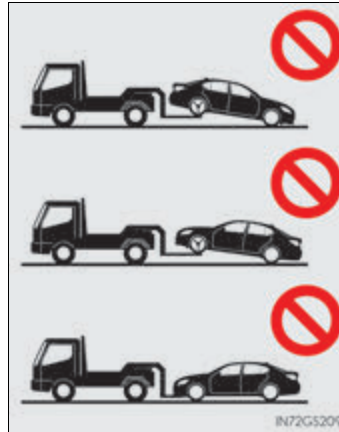

■ **While towing**

- When towing using cables or chains, avoid sudden starts, etc. which place excessive stress on the towing eyelets, cables or chains. The towing eyelets, cables or chains may become damaged, broken debris may hit people, and cause serious damage.
- Do not turn the engine switch off.
There is a possibility that the steering wheel is locked and cannot be operated.

■ **Installing towing eyelets to the vehicle**

Make sure that towing eyelets are installed securely.
If not securely installed, towing eyelets may come loose during towing.

 NOTICE**■ To prevent damage to the vehicle when towing using a wheel-lift type truck**

- Do not tow the vehicle from the rear when the engine switch is off. The steering lock mechanism is not strong enough to hold the front wheels straight.
- When raising the vehicle, ensure adequate ground clearance for towing at the opposite end of the raised vehicle. Without adequate clearance, the vehicle could be damaged while being towed.

■ To prevent damage to the vehicle when towing with a sling-type truck

Do not tow with a sling-type truck, either from the front or rear.

■ To prevent damage to the vehicle during emergency towing

Do not secure cables or chains to the suspension components.

■ Recreational towing (behind motor home, etc.)

Never dinghy tow your vehicle to prevent causing serious damage to the transfer (AWD models) and transmission.

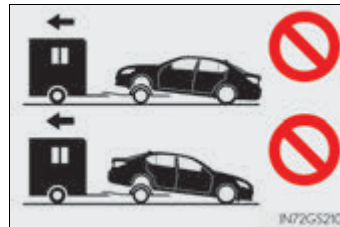

If you think something is wrong

If you notice any of the following symptoms, your vehicle probably needs adjustment or repair. Contact your Lexus dealer as soon as possible.

Visible symptoms

- Fluid leaks under the vehicle.
(Water dripping from the air conditioning after use is normal.)
- Flat-looking tires or uneven tire wear
- Engine coolant temperature gauge needle continually points higher than normal.

Audible symptoms

- Changes in exhaust sound
- Excessive tire squeal when cornering
- Strange noises related to the suspension system
- Pinging or other noises related to the engine

Operational symptoms

- Engine missing, stumbling or running roughly
- Appreciable loss of power
- Vehicle pulls heavily to one side when braking
- Vehicle pulls heavily to one side when driving on a level road
- Loss of brake effectiveness, spongy feeling, pedal almost touches the floor

Fuel pump shut off system

To minimize the risk of fuel leakage when the engine stalls or when an airbag inflates upon collision, the fuel pump shut off system stops the supply of fuel to the engine.

Follow the procedure below to restart the engine after the system is activated.

- 1 Turn the engine switch to ACCESSORY mode or turn it off.
- 2 Restart the engine.

NOTICE

■ Before starting the engine









Inspect the ground under the vehicle.





If you find that fuel has leaked onto the ground, the fuel system has been damaged and is in need of repair. Do not restart the engine.









If a warning light turns on or a warning buzzer sounds

Calmly perform the following actions if any of the warning lights comes on or flashes. If a light comes on or flashes, but then goes off, this does not necessarily indicate a malfunction in the system. However, if this continues to occur, have the vehicle inspected by your Lexus dealer.

Warning light and warning buzzer list

Warning light	Warning light/Details/Actions
 (U.S.A.)  (Canada)	Brake system warning light (warning buzzer) <ul style="list-style-type: none"> • Low brake fluid • Malfunction in the brake booster system → Immediately stop the vehicle in a safe place and contact your Lexus dealer. Continuing to drive the vehicle may be dangerous.
 (If equipped)	Charging system warning light Indicates a malfunction in the vehicle's charging system → Immediately stop the vehicle in a safe place and contact your Lexus dealer.
 (U.S.A.)  (Canada)	Malfunction indicator lamp Indicates a malfunction in: <ul style="list-style-type: none"> • The electronic engine control system; • The electronic throttle control system; or • The electronic automatic transmission control system → Have the vehicle inspected by your Lexus dealer immediately.
	SRS warning light Indicates a malfunction in: <ul style="list-style-type: none"> • The SRS airbag system; • The front passenger occupant classification system; or • The seat belt pretensioner system → Have the vehicle inspected by your Lexus dealer immediately.
 (U.S.A.)  (Canada)	ABS warning light Indicates a malfunction in: <ul style="list-style-type: none"> • The ABS; or • The brake assist system → Have the vehicle inspected by your Lexus dealer immediately.

Warning light	Warning light/Details/Actions
	<p>Electric power steering system warning light (warning buzzer) Indicates a malfunction in the EPS (Electric Power Steering) system → Have the vehicle inspected by your Lexus dealer immediately.</p>
 <p>(Flashes) (If equipped)</p>	<p>PCS (Pre-Collision System) warning light</p> <ul style="list-style-type: none"> ● When the warning light flashes (and a buzzer sounds): Indicates a malfunction in the PCS (Pre-Collision System) → Have the vehicle inspected by your Lexus dealer immediately. ● When the warning light flashes (and a buzzer does not sound): Indicates that the PCS (Pre-Collision System) is temporarily unavailable, possibly due to either of the following: <ul style="list-style-type: none"> • An area around the radar sensor or camera sensor being dirty or covered with condensation, ice, stickers, etc. → Clear the dirt, condensation, ice, stickers, etc. (→P. 233, 252, 260) • Radar sensor or camera sensor being outside of its operational condition range. (temperature etc.) → If operational condition (temperature etc.) is satisfied, PCS (Pre-Collision System) becomes to be available. ● When the warning light is illuminated: Either the VSC (Vehicle Stability Control) system or PCS (Pre-Collision System) is disabled or both are disabled. → To enable the PCS (Pre-Collision System), enable both the VSC system and PCS (Pre-Collision System). (→P. 248, 311)
	<p>Slip indicator Indicates a malfunction in:</p> <ul style="list-style-type: none"> • The VSC system; • The TRAC system; or • The hill-start assist control system <p>→ Have the vehicle inspected by your Lexus dealer immediately. The light will flash when the VSC or TRAC system is operating.</p>
 <p>(Flashes) (If equipped)</p>	<p>"AFS OFF" indicator Indicates a malfunction in the adaptive front-lighting system → Have the vehicle inspected by your Lexus dealer immediately.</p>
 <p>(Flashes) (GS350/GS200t only)</p>	<p>Brake hold operated indicator Indicates a malfunction in the brake hold system → Have the vehicle inspected by your Lexus dealer.</p>

Warning light	Warning light/Details/Actions
 <p>(Flashes) (U.S.A.)</p>  <p>(Flashes) (Canada)</p>	<p>Parking brake indicator Indicates a malfunction in the parking brake system → Have the vehicle inspected by your Lexus dealer immediately.</p>
	<p>Brake system warning light Indicates a malfunction in the parking brake system → Have the vehicle inspected by your Lexus dealer immediately.</p>
 <p>(GS F only)</p>	<p>Open door warning light (warning buzzer)*1 Indicates that a door or the trunk is not fully closed → Check that all the doors and the trunk are closed.</p>
	<p>Low fuel level warning light Except F SPORT models of GS350/GS200t, and GS F: Indicates remaining fuel is approximately 2.6 gal. (10.0 L, 2.2 Imp.gal.) or less F SPORT models of GS350/GS200t: Indicates remaining fuel is approximately 2.6 gal. (9.9 L, 2.2 Imp.gal.) or less → Refuel the vehicle.</p>
	<p>Seat belt reminder light (warning buzzer)*2 Warns the driver and/or front passenger to fasten their seat belts → Fasten the seat belt. If the front passenger's seat is occupied, the front passenger's seat belt also needs to be fastened to make the warning light (warning buzzer) off.</p>
	<p>Master warning light A buzzer sounds and the warning light comes on and flashes to indicate that the master warning system has detected a malfunction. → P. 459</p>
	<p>Tire pressure warning light When the light comes on: Low tire inflation pressure such as • Natural causes (→P. 456) • Flat tire (→P. 491, 502) → Adjust the tire inflation pressure to the specified level. The light will turn off after a few minutes. In case the light does not turn off even if the tire inflation pressure is adjusted, have the system checked by your Lexus dealer. When the light comes on after blinking for 1 minute: Malfunction in the tire pressure warning system → Have the system checked by your Lexus dealer.</p>

*1: Open door warning buzzer:

→P. 459

*2: Driver's seat belt buzzer:

The driver's seat belt buzzer sounds to alert the driver that his or her seat belt is not fastened. Once the engine switch is turned to IGNITION ON mode, the buzzer sounds for 6 seconds. If the vehicle reaches a speed of 12 mph (20 km/h), the buzzer sounds once. If the seat belt is still unfastened after 24 seconds, the buzzer will sound intermittently for 10 seconds. Then, if the seat belt is still unfastened, the buzzer will sound in a different tone for 20 more seconds.

Front passenger's seat belt buzzer:

The front passenger's seat belt buzzer sounds to alert the front passenger that his or her seat belt is not fastened. The buzzer sounds once if the vehicle reaches a speed of 12 mph (20 km/h). If the seat belt is still unfastened after 24 seconds, the buzzer will sound intermittently for 10 seconds. Then, if the seat belt is still unfastened, the buzzer will sound in a different tone for 20 more seconds.

■ SRS warning light

This warning light system monitors the airbag sensor assembly, front impact sensors, side impact sensors (front door), side impact sensors (front), side impact sensors (rear), driver's seat position sensor, driver's seat belt buckle switch, front passenger occupant classification system, "AIR BAG ON" indicator light, "AIR BAG OFF" indicator light, front passenger's seat belt buckle switch, seat belt pretensioner assemblies, airbags, interconnecting wiring and power sources. (→P. 43)

■ Front passenger detection sensor, seat belt reminder and warning buzzer

If luggage is placed on the front passenger seat, the front passenger detection sensor may cause the warning light to flash and the warning buzzer to sound even if a passenger is not sitting in the seat.

■ If the malfunction indicator lamp comes on while driving

First check the following:

- Is the fuel tank empty?
If it is, fill the fuel tank immediately.
- Is the fuel tank cap loose?
If it is, tighten it securely.

The light will go off after several driving trips.

If the light does not go off even after several trips, contact your Lexus dealer as soon as possible.

■ Electric power steering system warning light (warning buzzer)

When the battery charge becomes insufficient or the voltage temporarily drops, the electric power steering system warning light may come on and the warning buzzer may sound.

■ When the tire pressure warning light comes on

Check the tire inflation pressure and adjust to the appropriate level. Initializing the tire pressure warning system will not turn off the tire pressure warning light.

■ The tire pressure warning light may come on due to natural causes

The tire pressure warning light may come on due to natural causes such as natural air leaks and tire inflation pressure changes caused by temperature. In this case, adjusting the tire inflation pressure will turn off the warning light (after a few minutes).

■ When a tire is replaced with a spare tire

The compact spare tire is not equipped with a tire pressure warning valve and transmitter. If a tire goes flat, the tire pressure warning light will not turn off even though the flat tire has been replaced with the spare tire.

■ Conditions that the tire pressure warning system may not function properly

→P. 418

■ If the tire pressure warning light frequently comes on after blinking for 1 minute

If the tire pressure warning light frequently comes on after blinking for 1 minute when the engine switch is turned to IGNITION ON mode, have it checked by your Lexus dealer.

■ Warning buzzer

In some cases, the buzzer may not be heard because of noisy place or an audio sound.

■ Customization

The vehicle speed linked seat belt reminder buzzer can be disabled.
(Customizable features: →P. 568)

⚠ WARNING**■ If both the ABS and the brake system warning lights remain on**

Stop your vehicle in a safe place immediately and contact your Lexus dealer. The vehicle will become extremely unstable during braking, and the ABS system may fail, which could cause an accident resulting in death or serious injury.

■ When the electric power steering system warning light comes on

The steering wheel may become extremely heavy.
If the steering wheel becomes heavier than usual when operating, hold firmly and operate using more force than usual.

■ If the tire pressure warning light comes on

Be sure to observe the following precautions. Failure to do so could cause a loss of vehicle control and result in death or serious injury.

- Stop your vehicle in a safe place as soon as possible. Adjust the tire inflation pressure immediately.
- If the tire pressure warning light comes on even after tire inflation pressure adjustment, it is probable that you have a flat tire. Check the tires. If a tire is flat, change it with the spare tire and have the flat tire repaired by the nearest Lexus dealer.
- Avoid abrupt maneuvering and braking. If the vehicle tires deteriorate, you could lose control of the steering wheel or the brakes.

■ If a blowout or sudden air leakage should occur

The tire pressure warning system may not activate immediately.

 **WARNING****■ Maintenance of the tires**

Each tire, including the spare (if provided), should be checked monthly when cold and inflated to the inflation pressure recommended by the vehicle manufacturer on the vehicle placard or tire inflation pressure label (tire and load information label). (If your vehicle has tires of a different size than the size indicated on the vehicle placard or tire inflation pressure label [tire and load information label], you should determine the proper tire inflation pressure for those tires.)

As an added safety feature, your vehicle has been equipped with a tire pressure monitoring system (TPMS-tire pressure warning system) that illuminates a low tire pressure telltale (tire pressure warning light) when one or more of your tires is significantly under-inflated. Accordingly, when the low tire pressure telltale (tire pressure warning light) illuminates, you should stop and check your tires as soon as possible, and inflate them to the proper pressure. Driving on a significantly under-inflated tire causes the tire to overheat and can lead to tire failure. Under-inflation also reduces fuel efficiency and tire tread life, and may affect the vehicle's handling and stopping ability.

Please note that the TPMS (tire pressure warning system) is not a substitute for proper tire maintenance, and it is the driver's responsibility to maintain correct tire pressure, even if under-inflation has not reached the level to trigger illumination of the TPMS low tire pressure telltale (tire pressure warning light).

Your vehicle has also been equipped with a TPMS (tire pressure warning system) malfunction indicator to indicate when the system is not operating properly. The TPMS (tire pressure warning system) malfunction indicator is combined with the low tire pressure telltale (tire pressure warning light). When the system detects a malfunction, the telltale will flash for approximately one minute and then remain continuously illuminated. This sequence will continue upon subsequent vehicle start-ups as long as the malfunction exists. When the malfunction indicator is illuminated, the system may not be able to detect or signal low tire pressure as intended.

TPMS (tire pressure warning system) malfunctions may occur for a variety of reasons, including the installation of replacement or alternate tires or wheels on the vehicle that prevent the TPMS (tire pressure warning system) from functioning properly. Always check the TPMS (tire pressure warning system) malfunction telltale after replacing one or more tires or wheels on your vehicle to ensure that the replacement or alternate tires and wheels allow the TPMS (tire pressure warning system) to continue to function properly.

 **NOTICE****■ To ensure the tire pressure warning system operates properly**

Do not install tires with different specifications or markers, as the tire pressure warning system may not operate properly.

If a warning message is displayed

If a warning is shown on the multi-information display, stay calm and perform the following actions:

- ▶ GS350/GS200t
(except F SPORT models)

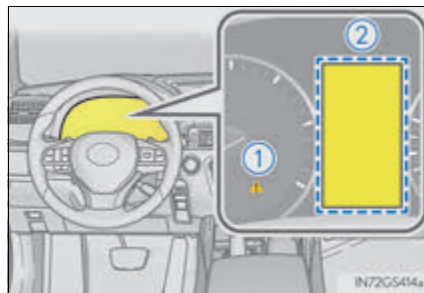

- ▶ GS350/GS200t
(F SPORT models)

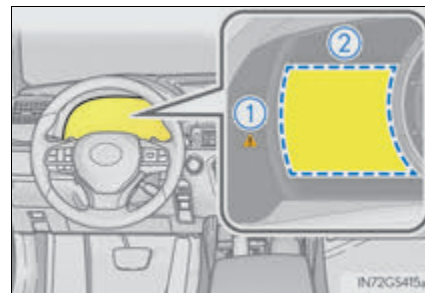

- ▶ GS F

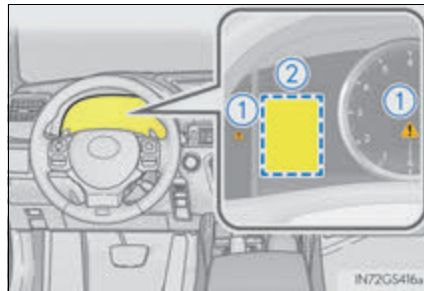











- ① Master warning light



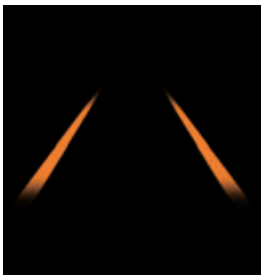



The master warning light also comes on or flashes in order to indicate that a message is currently being displayed on the multi-information display.





- ② Multi-information display





If any of the warning light comes on again after the following actions have been performed, contact your Lexus dealer.







Warning message and warning buzzer list



Warning message	Details/Actions
 <p>(If equipped)</p>	<p>Indicates that there is a high possibility of a frontal collision, or that the pre-collision braking function is operating</p> <p>At the same time,  will appear on the head-up display.</p> <p>A buzzer also sounds.</p> <p>→ Avoid the collision by decelerating using the brakes or taking other evasive actions.</p>
 <p>(If equipped)</p>	<p>Indicates that your vehicle is nearing the vehicle ahead (in vehicle-to-vehicle distance control mode)</p> <p>At the same time,  will appear on the head-up display (the image flashes).</p> <p>A buzzer also sounds.</p> <p>→ Slow the vehicle by applying the brakes.</p>
 <p>(If equipped)</p>	<p>Indicates that the vehicle has deviated from the lane (while the LKA [Lane-Keeping Assist] or LDA [Lane Departure Alert with steering control] system are operating)</p> <p>The lane line on the side the vehicle has deviated from flashes in amber.</p> <p>At the same time,  will appear on the head-up display (the image flashes).</p> <p>A buzzer also sounds.</p> <p>→ Check around the vehicle and back to inside of the lane lines.</p>
 <p>Braking Power Low</p> <p>Stop in a Safe Place</p> <p>See Owner's Manual</p>    <p>(U.S.A.) (Canada) (Flashes)</p>	<p>Indicates a malfunction in the brake system</p> <p>A buzzer also sounds.</p> <p>→ Have the vehicle inspected by your Lexus dealer immediately.</p> <p>Continuing to drive the vehicle may be dangerous.</p>

Warning message	Details/Actions
	<p>Indicates that hood or one or more of the doors or trunk are not fully closed The system also indicates which hood or doors or trunk are not fully closed. If the vehicle reaches a speed of 3 mph (5 km/h),  flashes and a buzzer sounds to indicate that the hood or door(s) or trunk are not yet fully closed. → Make sure that hood or all doors or trunk are closed.</p>
 <p>(GS350/GS200t) (GSF)</p> <p>Parking Assist Malfunction</p> <p></p> <p>(If equipped)</p>	<p>Indicates a malfunction in the intuitive parking assist All assist-sensors flash. A buzzer also sounds. → Have the vehicle inspected by your Lexus dealer.</p>
 <p>(GS350/GS200t) (GSF)</p> <p>Clean Parking Assist Sensor</p> <p></p> <p>(If equipped)</p>	<p>Indicates that intuitive parking assist sensor is dirty or covered with ice A buzzer also sounds. → Clean the sensor.</p>

Warning message	Details/Actions
<div data-bbox="392 477 654 768" style="background-color: black; color: white; padding: 10px; text-align: center;"> <p>EPB can't be Released</p> <p>Close Door and Fasten Your Seatbelt</p> </div> <div data-bbox="395 779 475 835" style="text-align: center;">  </div> <p data-bbox="408 837 462 857">(Flashes)</p>	<p>Indicates an attempt was made to release the parking brake with a door open or the front passenger's seat belt unfastened</p> <p>A buzzer also sounds.</p> <p>→ Close all doors and fasten the front passenger's seat belt before releasing the parking brake.</p>
<div data-bbox="392 891 654 1081" style="background-color: black; color: white; padding: 10px; text-align: center;"> <p>Shift to P Before Exiting Vehicle</p> </div> <div data-bbox="395 1093 475 1149" style="text-align: center;">  </div> <p data-bbox="408 1151 462 1171">(Flashes)</p>	<p>Indicates that the driver's door was opened with the shift position in any position other than P</p> <p>A buzzer also sounds.</p> <p>→ Shift the shift position to P.</p>
<div data-bbox="392 1205 654 1317" style="background-color: black; color: white; padding: 10px; text-align: center;"> <p>Check Power Steering System</p> </div> <div data-bbox="395 1328 563 1384" style="text-align: center;">   </div>	<p>Indicates a malfunction in the EPS (Electric Power Steering) system</p> <p>A buzzer also sounds.</p> <p>→ Have the vehicle inspected by your Lexus dealer.</p>



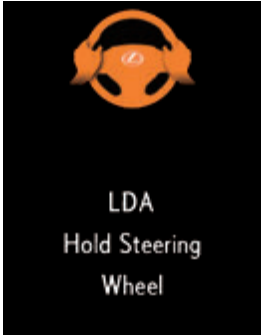
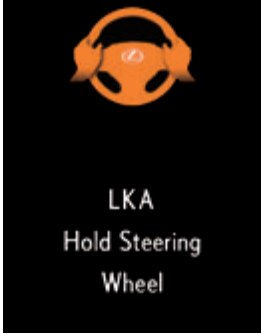





Warning message	Details/Actions
<p data-bbox="395 477 651 589">Release Parking Brake</p>  <p data-bbox="408 658 467 678">(Flashes)</p>	<p data-bbox="675 521 1233 577">Indicates that the vehicle is being driven at 3 mph (5 km/h) or more with the parking brake still engaged.</p> <p data-bbox="699 580 914 600">A buzzer also sounds.</p> <p data-bbox="675 602 978 622">→ Release the parking brake.</p>
<p data-bbox="395 712 651 846">Vehicle May Roll Shift to P</p>  <p data-bbox="408 916 467 936">(Flashes)</p>	<p data-bbox="675 768 1233 824">Indicates that the parking brake is engaged with the shift position not in P</p> <p data-bbox="699 826 914 846">A buzzer also sounds.</p> <p data-bbox="675 848 1010 869">→ Change the shift position to P.</p>
<p data-bbox="395 969 651 1216">Brake Hold Fault Depress Brake to Deactivate Visit Your Dealer</p>  <p data-bbox="448 1294 595 1314">(GS350/GS200t only)</p>	<p data-bbox="675 1059 1145 1079">Indicates a malfunction in the brake hold system</p> <p data-bbox="699 1081 914 1102">A buzzer also sounds.</p> <p data-bbox="675 1104 1233 1160">→ Depress the brake pedal to turn off the brake hold system.</p> <p data-bbox="699 1162 1233 1218">Have the vehicle inspected by your Lexus dealer immediately.</p>
<p data-bbox="395 1350 651 1552">Brake Hold Warning Depress Brake on Slope</p>  <p data-bbox="408 1621 467 1641">(Flashes)</p> <p data-bbox="448 1644 595 1664">(GS350/GS200t only)</p>	<p data-bbox="675 1440 1233 1496">Indicates that the brake hold system is turned on while on a steep slope</p> <p data-bbox="699 1498 914 1518">A buzzer also sounds.</p> <p data-bbox="675 1520 1233 1576">→ Do not use only the brake hold system on steep slopes. Be sure to also depress the brake pedal.</p>







Warning message	Details/Actions
<p data-bbox="395 477 651 589">EPB Activation Stopped Incompletely</p> <div data-bbox="395 600 651 694">    </div>	<p data-bbox="675 510 1233 566">Indicates a malfunction in the parking brake system A buzzer also sounds.</p> <p data-bbox="675 566 1233 645">→ Press the parking brake switch. If the warning message is still displayed, have the vehicle inspected by your Lexus dealer.</p>
<p data-bbox="395 728 651 907">Release Parking Brake while Depressing Brake</p>	<p data-bbox="675 750 1233 806">Indicates an attempt was made to release the parking brake without depressing the brake pedal A buzzer also sounds.</p> <p data-bbox="675 806 1233 884">→ Release the parking brake while depressing the brake pedal.</p>
<p data-bbox="395 952 651 1288"> Release Accelerator</p> <div data-bbox="395 1299 478 1377">  <p data-bbox="403 1355 475 1377">(Flashes)</p> </div>	<p data-bbox="675 1086 1233 1164">Indicates that the shift position was changed and drive start control was operated while depressing the accelerator pedal A buzzer also sounds.</p> <p data-bbox="675 1164 1233 1220">→ Momentarily release the accelerator pedal.</p>
<p data-bbox="395 1400 651 1579">Slippery Road. Cannot Shift to Lower Gear.</p> <div data-bbox="395 1590 478 1657">  </div>	<p data-bbox="675 1456 1233 1512">Indicates an attempt was made to shift to 1st gear with the shift position in M while on a slippery surface The vehicle will not shift down from 2nd gear. A buzzer also sounds.</p> <p data-bbox="675 1512 1233 1590">→ The vehicle will not shift down from 2nd gear.</p>

Warning message	Details/Actions
 <p>LDA Hold Steering Wheel</p> <p>(GSF only)</p>	<p>Indicates that the LDA (Lane Departure Alert with steering control) system has determined that the driver does not have their hands on the steering wheel while the steering control function is on → Firmly hold the steering wheel.</p>
 <p>LKA Hold Steering Wheel</p> <p>(If equipped)</p>	<p>Indicates that the LKA (Lane-Keeping Assist) system has determined that the driver does not have their hands on the steering wheel while the steering control function is on → Firmly hold the steering wheel.</p>
<p>Parking Brake Overheated</p> <p>Parking Brake Unavailable</p>  <p>(U.S.A.) (Canada)</p>	<p>Indicates that the parking brake system is overheating A buzzer also sounds. → Do not use the parking brake until the message disappears.</p>
<p>Check Engine</p> <p>Visit Your Dealer</p>  <p>(U.S.A.) (Canada)</p>	<p>Indicates an engine malfunction A buzzer also sounds. → Have the vehicle inspected by your Lexus dealer.</p>

7

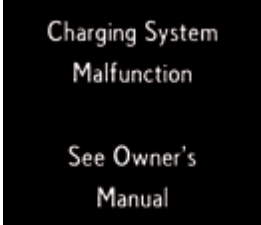



When trouble arises



Warning message	Details/Actions
<div style="background-color: black; color: white; padding: 10px; text-align: center;"> <p>Check Engine Reduced Engine Power</p> <p>Visit Your Dealer</p> </div> <div style="display: flex; justify-content: space-around; margin-top: 5px;"> <div style="text-align: center;">  <small>(U.S.A.)</small> </div> <div style="text-align: center;">  <small>(Canada)</small> </div> <div style="text-align: center;">  </div> </div>	<p>Indicates an engine malfunction A buzzer also sounds. → Have the vehicle inspected by your Lexus dealer.</p>
<div style="background-color: black; color: white; padding: 10px; text-align: center;"> <p>Reduced Engine Power</p> <p>Visit Your Dealer</p> </div> <div style="text-align: center; margin-top: 5px;">  </div>	<p>Indicates an engine malfunction A buzzer also sounds. → Have the vehicle inspected by your Lexus dealer.</p>
<div style="background-color: black; color: white; padding: 10px; text-align: center;"> <p>SRS Airbag System Malfunction</p> <p>Visit Your Dealer</p> </div> <div style="display: flex; justify-content: space-around; margin-top: 5px;"> <div style="text-align: center;">  </div> <div style="text-align: center;">  </div> </div>	<p>Indicates a malfunction in:</p> <ul style="list-style-type: none"> • The SRS airbag system; • The front passenger occupant classification system; <p style="text-align: center;">or,</p> <ul style="list-style-type: none"> • The seat belt pretensioner system <p>A buzzer also sounds. → Have the vehicle inspected by your Lexus dealer.</p>
<div style="background-color: black; color: white; padding: 10px; text-align: center;"> <p>Antilock Brake System Malfunction</p> <p>Visit Your Dealer</p> </div> <div style="display: flex; justify-content: space-around; margin-top: 5px;"> <div style="text-align: center;">  <small>(U.S.A.)</small> </div> <div style="text-align: center;">  <small>(Canada)</small> </div> </div>	<p>Indicates a malfunction in:</p> <ul style="list-style-type: none"> • The ABS; or • The brake assist system <p>A buzzer also sounds. → Immediately stop the vehicle in a safe place and contact your Lexus dealer. Continuing to drive the vehicle may be dangerous.</p>

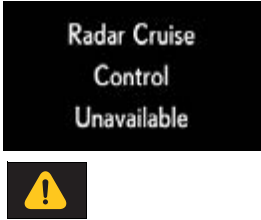

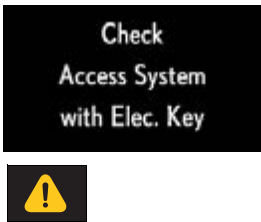





Warning message	Details/Actions
 <p>Engine Coolant Temp High</p> <p>Stop in a Safe Place</p> <p>See Owner's Manual</p> 	<p>Indicates that the engine coolant temperature is too high A buzzer also sounds. → P.528</p>
 <p>Charging System Malfunction</p> <p>See Owner's Manual</p>  <p>(GS350/GS200t only)</p>	<p>Indicates a malfunction in the vehicle's charging system. → Immediately stop the vehicle in a safe place and contact your Lexus dealer. Continuing to drive the vehicle may be dangerous.</p>
 <p>Radar Cruise Control Unavailable</p> <p>Clean Sensor</p>  <p>(If equipped)</p>	<p>Indicates that the radar sensor is dirty or covered with ice A buzzer also sounds. → Clean the sensor.</p>





7









When trouble arises





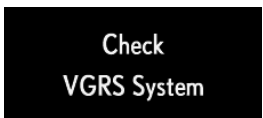

Warning message	Details/Actions
 <p>(If equipped)</p>	<p>Indicates that the dynamic radar cruise control system cannot be used temporarily due to bad weather A buzzer also sounds. → Use the radar cruise control system when it becomes available again.</p>
 <p>(If equipped)</p>	<p>Indicates that the radar cruise control system brake control function is temporarily unavailable → Depress the brake.</p>
 <p>(Flashes)</p>	<p>Indicates a malfunction in the smart access system with push-button start A buzzer also sounds. → Have the vehicle inspected by your Lexus dealer.</p>
 <p>(If equipped)</p>	<p>Indicates that a Blind Spot Monitor sensor or the surrounding area on the bumper is dirty or covered with ice A buzzer also sounds. → Clean the sensor and its surrounding area on the bumper.</p>



Warning message	Details/Actions
<p data-bbox="395 477 651 656">Cruise Control Malfunction Visit Your Dealer</p> 	<p data-bbox="675 506 1233 689">Indicates a malfunction in the cruise control system or dynamic radar cruise control system (if equipped) Press the "ON/OFF" button once to deactivate the system, and then press the button again to reactivate the system. A buzzer also sounds. → Have the vehicle inspected by your Lexus dealer.</p>
<p data-bbox="395 768 651 1048">Cruise Control Fault Press Brake to Deactivate Visit Your Dealer</p>  <p data-bbox="483 1137 563 1160">(If equipped)</p>	<p data-bbox="675 887 1233 1021">Indicates a malfunction in the dynamic radar cruise control with full-speed range Depress the brake pedal. A buzzer also sounds. → Have the vehicle inspected by your Lexus dealer.</p>
<p data-bbox="395 1200 651 1402">Lane Departure Alert Malfunction Visit Your Dealer</p>  <p data-bbox="483 1491 563 1514">(If equipped)</p>	<p data-bbox="675 1290 1233 1402">Indicates a malfunction in the LDA (Lane Departure Alert with steering control) system A buzzer also sounds. → Have the vehicle inspected by your Lexus dealer.</p>







Warning message	Details/Actions
 <p>Lane Keeping Assist Malfunction Visit Your Dealer</p>  <p>(If equipped)</p>	<p>Indicates a malfunction in the LKA (Lane-Keeping Assist) system A buzzer also sounds. → Have the vehicle inspected by your Lexus dealer.</p>
 <p>Forward Camera System Unavailable</p>  <p>(Flashes) (If equipped)</p>	<p>The operation conditions of the camera sensor (temperature, etc.) are not met. → When the operation conditions of the camera sensor (temperature, etc.) are met, the following systems will become available.</p> <ul style="list-style-type: none"> • PCS (Pre-Collision System) • LKA (Lane-Keeping Assist) system • LDA (Lane Departure Alert with steering control) system • Automatic High Beam
 <p>Lane Departure Alert Unavailable</p>  <p>(If equipped)</p>	<p>Indicates that the system is temporarily unavailable due to a malfunction in a sensor other than the camera sensor A buzzer also sounds. → Turn the LDA (Lane Departure Alert with steering control) system off, wait for a little while, and then turn the LDA (Lane Departure Alert with steering control) system back on.</p>
 <p>Lane Keeping Assist Unavailable</p>  <p>(If equipped)</p>	<p>Indicates that the system is temporarily unavailable due to a malfunction in a sensor other than the camera sensor A buzzer also sounds. → Turn the LKA (Lane-Keeping Assist) system off, wait for a little while, and then turn the LKA (Lane-Keeping Assist) system back on.</p>

Warning message	Details/Actions
<p style="text-align: center;">Forward Camera System Unavailable</p> <p style="text-align: center;">Clean Windshield</p>  <p>(Flashes)</p> <p style="text-align: center;">(If equipped)</p>	<p>Dirt, rain, condensation, ice, snow, etc., are present on the windshield in front of the camera sensor.</p> <p>The following systems will be temporarily unusable.</p> <ul style="list-style-type: none"> • PCS (Pre-Collision System) • LKA (Lane-Keeping Assist) system • LDA (Lane Departure Alert with steering control) system • Automatic High Beam <p>→ Turn the system off, remove any dirt, rain, condensation, ice, snow, etc., from the windshield, and then turn the system back on.</p>
<p style="text-align: center;">Pre-Collision System Malfunction</p> <p style="text-align: center;">Visit Your Dealer</p>   <p>(Flashes)</p> <p style="text-align: center;">(If equipped)</p>	<p>Indicates a malfunction in the PCS (Pre-Collision System)</p> <p>A buzzer also sounds.</p> <p>→ Have the vehicle inspected by your Lexus dealer.</p>
<p style="text-align: center;">Blind Spot Monitor System Malfunction</p> <p style="text-align: center;">Visit Your Dealer</p>  <p>(If equipped)</p>	<p>Indicates a malfunction in the BSM (Blind Spot Monitor) system</p> <p>A buzzer also sounds.</p> <p>→ Have the vehicle inspected by your Lexus dealer.</p>







Warning message	Details/Actions
 <p>Oil Pressure Low</p> <p>Stop in a Safe Place</p> <p>See Owner's Manual</p> 	<p>Indicates abnormal engine oil pressure A buzzer also sounds. → Immediately stop the vehicle in a safe place and contact your Lexus dealer.</p>
 <p>Transmission Fluid Temp High</p> <p>See Owner's Manual</p> 	<p>Indicates that the automatic transmission fluid temperature is too high A buzzer also sounds. → Immediately stop the vehicle in a safe place and contact your Lexus dealer.</p>
 <p>AWD System Malfunction</p> <p>2WD Mode Engaged</p> <p>Visit Your Dealer</p>  <p>(AWD models only)</p>	<p>Indicates a malfunction in the AWD system A buzzer also sounds. → Have the vehicle inspected by your Lexus dealer.</p>
 <p>Check VGRS System</p>  <p>(If equipped)</p>	<p>Indicates a malfunction in the VGRS (Variable Gear Ratio Steering) A buzzer also sounds. → Have the vehicle inspected by your Lexus dealer.</p>





Warning message	Details/Actions
<div style="background-color: black; color: white; padding: 5px; text-align: center;"> <p>Check DRS System</p> </div> <div style="text-align: center;">  </div> <p style="text-align: center; font-size: small;">(If equipped)</p>	<p>Indicates a malfunction in the DRS (Dynamic Rear Steering) A buzzer also sounds. → Have the vehicle inspected by your Lexus dealer.</p>
<div style="background-color: black; color: white; padding: 5px; text-align: center;"> <p>Braking Power Low</p> <p>Visit Your Dealer</p> </div> <div style="text-align: center;">  </div> <p style="text-align: center; font-size: small;">(GS350/GS200t only)</p>	<p>Indicates a malfunction in the electronically controlled brake system A buzzer also sounds. → Immediately stop the vehicle in a safe place and contact your Lexus dealer. Continuing to drive in this condition is dangerous.</p>
<div style="background-color: black; color: white; padding: 5px; text-align: center;"> <p>Parking Brake Unavailable</p> </div> <div style="display: flex; justify-content: center; gap: 10px;"> <div style="background-color: black; color: red; padding: 2px 5px; font-weight: bold; font-size: small;">PARK</div> <div style="text-align: center;">  </div> <div style="text-align: center;">  </div> </div> <p style="display: flex; justify-content: center; gap: 20px; font-size: x-small;"> (U.S.A.) (Canada) </p>	<p>Indicates an attempt was made to engage the parking brake while driving A buzzer also sounds. → Press the parking brake switch. If the warning message is still displayed, have the vehicle inspected by your Lexus dealer.</p>
<div style="background-color: black; color: white; padding: 5px; text-align: center;"> <p>Electronic Parking Brake Malfunction</p> <p>Visit Your Dealer</p> </div> <div style="display: flex; justify-content: center; gap: 10px;"> <div style="text-align: center;">  </div> <div style="text-align: center;">  </div> </div>	<p>Indicates a malfunction in the parking brake system A buzzer also sounds. → Press the parking brake switch. If the warning message is still displayed, have the vehicle inspected by your Lexus dealer.</p>

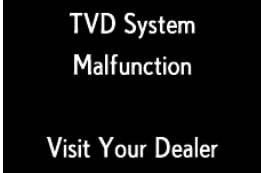



Warning message	Details/Actions
 <p>(If equipped)</p>	<p>Indicates that the LDA (Lane Departure Alert with steering control) system cannot be used as the vehicle speed is approximately 32 mph (50 km/h) or less → Drive the vehicle at approximately 32 mph (50 km/h) or more.</p>
 <p>(If equipped)</p>	<p>Indicates that LDA (Lane Departure Alert with steering control) system cannot be used due to the vehicle speed being too high → Slow down.</p>
 <p>(If equipped)</p>	<p>Indicates that LKA (Lane-Keeping Assist) system cannot be used due to the vehicle speed being too high → Slow down.</p>





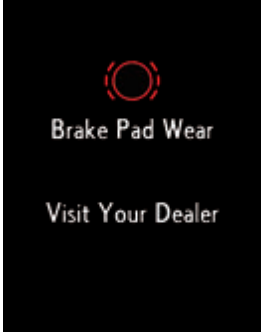

Warning message	Details/Actions
<p data-bbox="395 477 651 589">Turn Lights Off</p>  <p data-bbox="408 658 467 678">(Flashes)</p>	<p data-bbox="675 506 1233 640">Indicates that the engine switch is turned off or turned to ACCESSORY mode and the driver's door is opened while the lights are turned on A buzzer also sounds. → Turn the lights off.</p>
<p data-bbox="395 712 651 824">Moon Roof Open</p>  <p data-bbox="408 893 467 913">(Flashes)</p> <p data-bbox="483 920 563 940">(If equipped)</p>	<p data-bbox="675 763 1233 875">Indicates that the moon roof is not fully closed (with the engine switch off, and the driver's door open) A buzzer also sounds. → Close the moon roof.</p>
<p data-bbox="395 969 651 1081">Window Open</p>  <p data-bbox="408 1151 467 1171">(Flashes)</p>	<p data-bbox="675 1010 1233 1122">Indicates that the windows are not fully closed (with the engine switch off, and the driver's door open) A buzzer also sounds. → Close all the windows.</p>
<p data-bbox="395 1205 651 1317">Window / Moon Roof Open</p>  <p data-bbox="408 1386 467 1406">(Flashes)</p> <p data-bbox="483 1413 563 1433">(If equipped)</p>	<p data-bbox="675 1245 1233 1379">Indicates that the windows and the moon roof are not fully closed (with the engine switch off, and the driver's door open) A buzzer also sounds. → Close all the windows and the moon roof.</p>
<p data-bbox="395 1462 651 1641">Brake Hold Malfunction</p> <p data-bbox="435 1603 611 1637">Visit Your Dealer</p>   <p data-bbox="408 1722 467 1742">(Flashes)</p> <p data-bbox="451 1749 595 1769">(GS350/GS200t only)</p>	<p data-bbox="675 1559 1233 1671">Indicates a malfunction in the brake hold system A buzzer also sounds. → Have the vehicle inspected by your Lexus dealer immediately.</p>

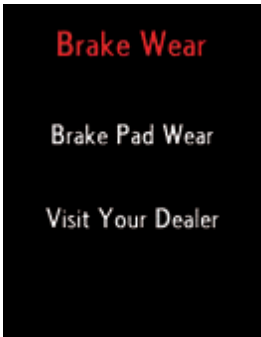

Warning message	Details/Actions
<div style="background-color: black; color: white; padding: 5px; text-align: center;"> <p>Brake Hold Active</p> <p>Depress Brake and Switch to Deactivate</p> </div> <p style="font-size: small; text-align: center;">(GS350/GS200t only)</p>	<p>Indicates that the brake hold system cannot be turned off A buzzer also sounds. → Depress the brake pedal.</p>
<div style="background-color: black; color: white; padding: 5px; text-align: center;"> <p>Brake Hold Unavailable</p> <p>Driver Door Open</p> <p>Brake Hold Unavailable</p> <p>Driver Seat Belt Unbuckled</p> </div> <p style="font-size: small; text-align: center;">(GS350/GS200t only)</p>	<p>Indicates that the brake hold system is not available The reason the brake hold system is not available may be displayed. A buzzer also sounds. → Close the driver's door. → Fasten the driver's seat belt.</p>
<div style="background-color: black; color: white; padding: 5px; text-align: center;"> <p>Depress Brake to Maintain Brake Hold</p> <p>Close Driver Door to Maintain Brake Hold</p> <p>Fasten Driver Seat Belt to Maintain Brake Hold</p> </div> <p style="font-size: small; text-align: center;">(GS350/GS200t only)</p>	<p>Indicates that the brake hold system is unable to continue brake hold function The reason the brake hold system is not continue may be displayed. A buzzer also sounds. → Depress the brake pedal. → Close the driver's door. → Fasten the driver's seat belt.</p>

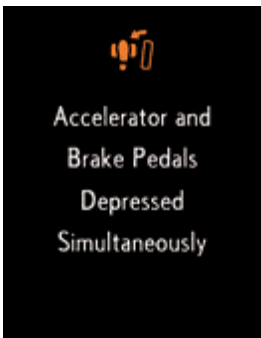
Warning message	Details/Actions
 <p>(GS350/GS200t only)</p>	<p>Indicates that the parking brake is set automatically while the brake hold system is holding the brakes A buzzer also sounds. → Release the parking brake.</p>
  <p>(Flashes) (AWD models only)</p>	<p>Indicates the AWD system has overheated A buzzer also sounds. → Reduce the vehicle speed or stop the vehicle in a safe place.</p>
  <p>(Flashes) (AWD models only)</p>	<p>Indicates the AWD system has overheated A buzzer also sounds. → Reduce the vehicle speed or stop the vehicle in a safe place.</p>
  <p>(GS F only)</p>	<p>Indicates a malfunction in the TVD (Torque Vectoring Differential) system A buzzer also sounds. → Have the vehicle inspected by your Lexus dealer.</p>

Warning message	Details/Actions
<div data-bbox="395 477 651 694" style="background-color: black; color: white; padding: 10px; text-align: center;"> <p>TVD System Overheated</p> <p>Reduce Engine Speed and Load</p> </div> <div data-bbox="395 705 478 761" style="text-align: center;">  </div> <p data-bbox="486 772 558 795" style="text-align: center; font-size: small;">(GSF only)</p>	<p>Indicates that the TVD (Torque Vectoring Differential) system has overheated</p> <p>This message may be displayed when driving under extremely high load conditions such as the following:</p> <ul style="list-style-type: none"> • Continuously driving at high speeds or through sharp turns • If either right or left rear tire loses traction and spins continuously <p>A buzzer also sounds.</p> <p>→ Drive the vehicle for a while, while avoiding extremely high load conditions.</p>
<div data-bbox="395 824 651 1153" style="background-color: black; color: white; padding: 10px; text-align: center;">  <p>Drive-Start Control Malfunction</p> <p>Visit Your Dealer</p> </div> <div data-bbox="395 1164 478 1220" style="text-align: center;">  </div>	<p>Indicates a malfunction in the drive start control system</p> <p>A buzzer also sounds.</p> <p>→ Have the vehicle inspected by your Lexus dealer immediately.</p>
<div data-bbox="395 1261 651 1590" style="background-color: black; color: white; padding: 10px; text-align: center;">  <p>Brake Override Malfunction</p> <p>Visit Your Dealer</p> </div> <div data-bbox="395 1601 478 1657" style="text-align: center;">  </div>	<p>Indicates a malfunction in the brake override system</p> <p>A buzzer also sounds.</p> <p>→ Have the vehicle inspected by your Lexus dealer.</p>





Warning message	Details/Actions
 <p>Engine Oil Level Low Add or Replace</p>	<p>Indicates that engine oil level is low This message may appear if the vehicle is stopped on a slope. Move the vehicle to a level surface and check to see if the message disappears. A buzzer also sounds. → Check the level of engine oil, and add if necessary.</p>
 <p>Headlight System Malfunction Visit Your Dealer</p> 	<p>Indicates a malfunction in:</p> <ul style="list-style-type: none"> • The Automatic High Beam system (if equipped); • The AFS (Adaptive Front-lighting System) (if equipped); or • The LED headlight system <p>A buzzer also sounds. → Have the vehicle inspected by your Lexus dealer.</p>
 <p>Brake Pad Wear Visit Your Dealer</p>  <p>(GSF for Canada only)</p>	<p>Indicates that the brake pads are worn out A buzzer also sounds → Have the vehicle inspected by your Lexus dealer.</p>

Warning message	Details/Actions
 <p>Brake Wear</p> <p>Brake Pad Wear</p> <p>Visit Your Dealer</p>  <p>(GS F for U.S.A. only)</p>	<p>Indicates that the brake pads are worn out A buzzer also sounds → Have the vehicle inspected by your Lexus dealer.</p>
 <p>Accelerator and Brake Pedals Depressed Simultaneously</p>  <p>(Flashes)</p>	<p>Indicates that the accelerator and brake pedals are being depressed simultaneously, and the brake override system is operating. → Release the accelerator or brake pedal. (→P.183)</p>
 <p>Tire Pressure [psi]</p> <p>35.0 23.0</p> <p>35.0 35.0</p> 	<p>Indicates that the tire inflation pressure is low → Check the tire inflation pressure, and adjust to the appropriate level.</p>

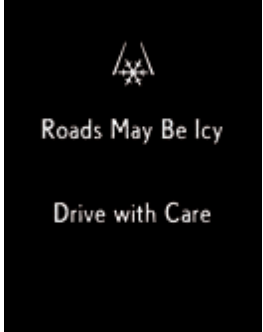

Warning message	Details/Actions
 <p>Tire Pressure</p> 	<p>Indicates a malfunction in the tire pressure warning system</p> <p>→ Stop the vehicle in a safe place and turn the engine switch off then on again. If the tire pressure warning indicator flashes for 1 minute then illuminates, there is a malfunction in the system. Have the vehicle inspected at your Lexus dealer.</p>
 <p>Tire Pressure [psi]</p>	<p>Indicates that the tire position information cannot be recognized</p> <p>→ Drive for a short while and check if the display updates.</p> <p>If the radio wave conditions improve, the display may return to normal. If the tire pressure is still not displayed after driving for several minutes, stop the vehicle in a safe place, turn the engine switch off then on again, and start driving. If the tire pressure is still not displayed even after repeating this process several times, have the vehicle inspected at your Lexus dealer.</p>
<p>Windshield Washer Fluid Low</p>	<p>Indicates that the washer fluid level is low</p> <p>→ Add washer fluid.</p>
<p>Fuel Low</p>	<p>Except F SPORT models of GS350/GS200t, and GS F: Indicates that remaining fuel is approximately 2.6 gal. (10.0 L, 2.2 Imp.gal.) or less</p> <p>F SPORT models of GS350/GS200t: Indicates remaining fuel is approximately 2.6 gal. (9.9 L, 2.2 Imp.gal.) or less</p> <p>→ Refuel the vehicle.</p>



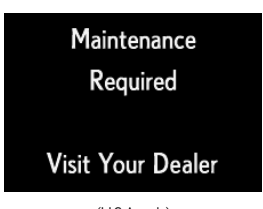



7

When trouble arises

Warning message	Details/Actions
	<p>Indicates that the outside temperature is approximately 37°F (3°C) or lower A buzzer also sounds. → Drive carefully, as the road may be icy.</p>
	<p>Indicates that the engine oil is scheduled to be changed → Check the engine oil and change if necessary. After changing the engine oil, the oil change system should be reset. (→P. 403) (The indicator will not work properly unless the oil maintenance data has been reset.)</p>
	<p>Indicates that all maintenance according to the driven distance on the maintenance schedule* should be performed soon. Comes on approximately 4500 miles (7200 km) after the message has been reset. → If necessary, perform maintenance.</p>
	<p>Indicates that the engine oil and oil filter should be changed → Have the engine oil and oil filter checked and/or changed by your Lexus dealer. After changing the engine oil, the oil change system should be reset. (→P. 403)</p>
	<p>Indicates that all maintenance is required to correspond to the driven distance on the maintenance schedule*. Comes on approximately 5000 miles (8000 km) after the message has been reset. (The message will not display properly unless the message has been reset.) → Perform the necessary maintenance. Please reset the message after the maintenance is performed. (→P. 386)</p>

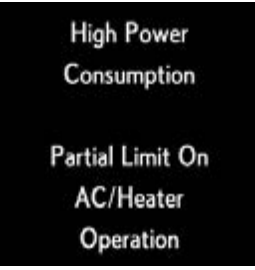
*: Refer to the separate "Scheduled Maintenance" or "Owner's Manual Supplement" for the maintenance interval applicable to your vehicle.

Warning message	Details/Actions
 <p>(If equipped)</p>	<p>Indicates that the Automatic High Beam switch was pressed while the low beams were on → Turn the high beam headlights on before pressing the automatic high beam switch.</p>
  <p>(If equipped)</p>	<p>Indicates that, since the VSC (Vehicle Stability Control) system was turned off, the pre-collision braking and pre-collision brake assist are stopped (The pre-collision warning function will be operational) → Turn the VSC on. (→P. 311)</p>

Warning message	Details/Actions
 <p>Pre-Collision System Unavailable</p>  <p>(Flashes)</p> <p>(If equipped)</p>	<p>Indicates that the PCS (Pre-Collision System) is temporarily unavailable → When conditions improve, the system resumes operation. If this item is displayed continuously, have the vehicle inspected by your Lexus dealer.</p>
 <p>High Power Consumption</p> <p>Partial Limit On AC/Heater Operation</p>  <p>(Flashes)</p>	<p>Air conditioning, heater and other operations are temporarily limited due to high power consumption → Turn off unnecessary electronic equipment to reduce power consumption. Please wait until the power supply returns to normal. If this item is frequently displayed, have the vehicle inspected at your Lexus dealer immediately.</p>
 <p>Pre-Collision System Unavailable</p> <p>Clean Sensor</p>  <p>(Flashes)</p> <p>(If equipped)</p>	<p>Indicates that part of the PCS (Pre-Collision System) sensor is dirty, covered with ice, etc. A buzzer also sounds. → Remove any dirt, ice, etc.</p>

■ Warning message in radar cruise mode (if equipped)

In the following cases, the warning message may not be displayed even if vehicle-to-vehicle distance decreases:







- When your vehicle and the vehicle ahead are traveling at the same speed or the vehicle ahead is traveling more quickly than your vehicle
- When the vehicle ahead is traveling at a very low speed
- Immediately after cruise control speed is set
- At the instant the accelerator pedal is depressed







■ Open door warning message (GS350/GS200t only)





The open door warning message continues to display until a door or the trunk is fully closed, even if the engine switch is turned off. However, approximately 20 minutes after a door or the trunk is not fully closed, the battery-saving function operates and the display turns off even though a door or the trunk is not fully closed.





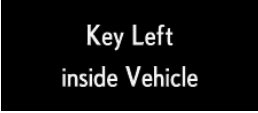

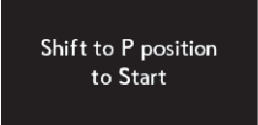
■ Warning buzzer

In some cases, the buzzer may not be heard because of noisy place or an audio sound.

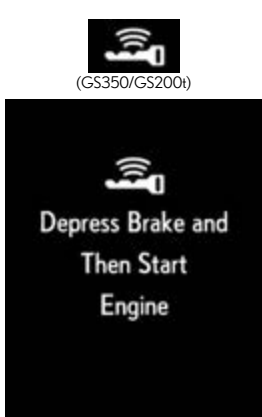
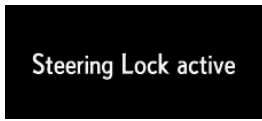

Interior buzzer	Exterior buzzer	Warning message	Details/Actions
Once	—	  (Flashes)	<p>The electronic key is not detected when an attempt is made to start the engine.</p> <p>→ Start the engine with the electronic key present.</p>
Once	3 times	  (Flashes)	<p>The electronic key was carried outside the vehicle and a door other than the driver's door was opened and closed while the engine switch was in a mode other than off.</p> <p>→ Bring the electronic key back into the vehicle.</p> <p>The driver's door was opened and closed while the electronic key was not in the vehicle, the shift lever was in P and the engine switch was not turned off.</p> <p>→ Turn the engine switch off or bring the electronic key back into the vehicle.</p>
Once	Continuous	  (Displayed alternately)	<p>An attempt was made to exit the vehicle with the electronic key and lock the doors without first turning the engine switch off when the shift lever was in P.</p> <p>→ Turn the engine switch off and lock the doors again.</p>

Interior buzzer	Exterior buzzer	Warning message	Details/Actions
9 times	—	  (Flashes)	<p>An attempt was made to drive when the regular key was not inside the vehicle.</p> <p>→ Confirm that the electronic key is inside the vehicle.</p>
Con- tinuous	—	  (Flashes)	<p>The driver's door was opened when the shift lever was not in P and the engine switch was not turned off.</p> <p>→ Shift the shift lever to P.</p>
Con- tinuous	Con- tinuous	  (Displayed alternately)	<p>The driver's door was opened and closed while the electronic key was not in the vehicle, the shift lever was not in P and the engine switch was not turned off.</p> <p>→ Shift the shift lever to P.</p> <p>→ Bring the electronic key back into the vehicle.</p>

Interior buzzer	Exterior buzzer	Warning message	Details/Actions
—	Continuous		<ul style="list-style-type: none"> An attempt was made to lock the doors using the smart access system with push-button start while the electronic key was still inside the vehicle. An attempt was made to lock either front door by opening a door and putting the inside lock button into the lock position, then closing the door with the electronic key still inside the vehicle. <p>→ Retrieve the electronic key from the vehicle and lock the doors again.</p>
Once	—		<ul style="list-style-type: none"> When the doors were unlocked with the mechanical key and then the engine switch was pressed, the electronic key could not be detected in the vehicle. The electronic key could not be detected in the vehicle even after the engine switch was pressed two consecutive times. <p>→ Touch the electronic key to the engine switch while depressing the brake pedal.</p>
Once	—	  (Flashes)	<p>An attempt was made to start the engine with the shift lever in an incorrect position.</p> <p>→ Shift the shift lever to P and start the engine.</p>
—	—		<p>Power was turned off due to the automatic power off function.</p> <p>→ Next time when starting the engine, increase the engine speed slightly and maintain that level for approximately 5 minutes to recharge the battery.</p>

Interior buzzer	Exterior buzzer	Warning message	Details/Actions
Once	—	 	The electronic key has a low battery. → Replace the electronic key battery. (→P. 429)
Once	—	 <small>(GSF)</small>	<p>The driver's door was opened and closed with the engine switch turned off and then the engine switch was put in ACCESSORY mode twice without the engine being started. → Press the engine switch while depressing the brake pedal.</p> <p>During an engine starting procedure in the event that the electronic key was not functioning properly (→P. 521), the engine switch was touched with the electronic key. → Press the engine switch within 10 seconds of the buzzer sounding.</p>
Once	—	  <small>(Flashes)</small>	The steering lock could not be released within 3 seconds of the engine switch being pressed. → Press the engine switch while depressing the brake pedal and moving the steering wheel left and right.
Once	—	  <small>(Flashes)</small>	The engine switch has been turned off with the shift lever in a position other than P or N. → Shift the shift lever to P.

490 7-2. Steps to take in an emergency

Interior buzzer	Exterior buzzer	Warning message	Details/Actions
Once	—	  (Flashes)	After the engine switch has been turned off with the shift lever in a position other than P, the shift lever has been shifted to P. → Turn the engine switch off.

■ **Warning buzzer**

In some cases, the buzzer may not be heard because of noisy place or an audio sound.

If you have a flat tire (vehicles with spare tire)

Your vehicle is equipped with a spare tire. The flat tire can be replaced with the spare tire.

For details about tires: →P. 413

WARNING

■ If you have a flat tire

Do not continue driving with a flat tire.

Driving even a short distance with a flat tire can damage the tire and the wheel beyond repair, which could result in an accident.

Before jacking up the vehicle

- Stop the vehicle on a hard, flat surface.
- Set the parking brake.
- Shift the shift lever to P.
- Stop the engine.
- Turn on the emergency flashers. (→P. 442)

Location of the spare tire, jack and tools

► Type A (GS350/GS200t)

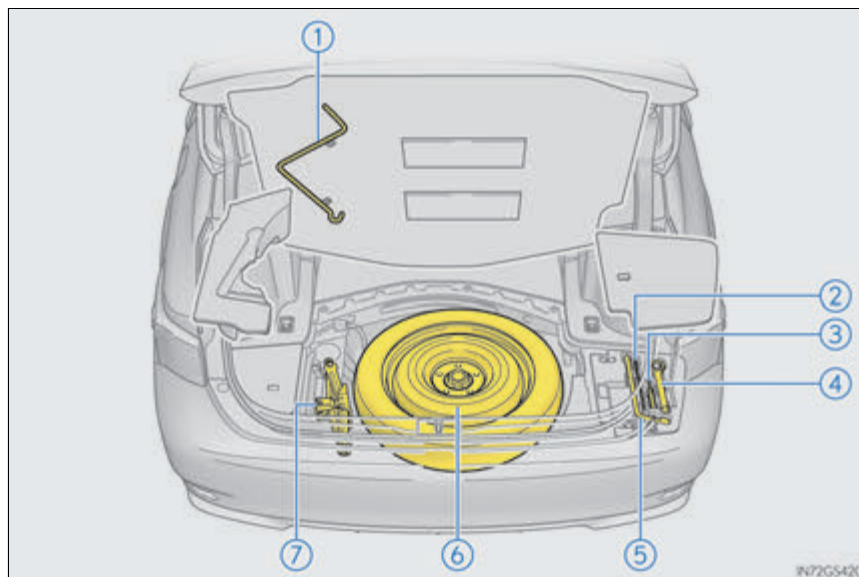

- | | |
|------------------------------|--------------------|
| ① Jack handle | ⑤ Wheel nut wrench |
| ② Parking brake release tool | ⑥ Spare tire |
| ③ Screwdriver | ⑦ Jack |
| ④ Towing eyelet | |

▶ Type B (GS F)

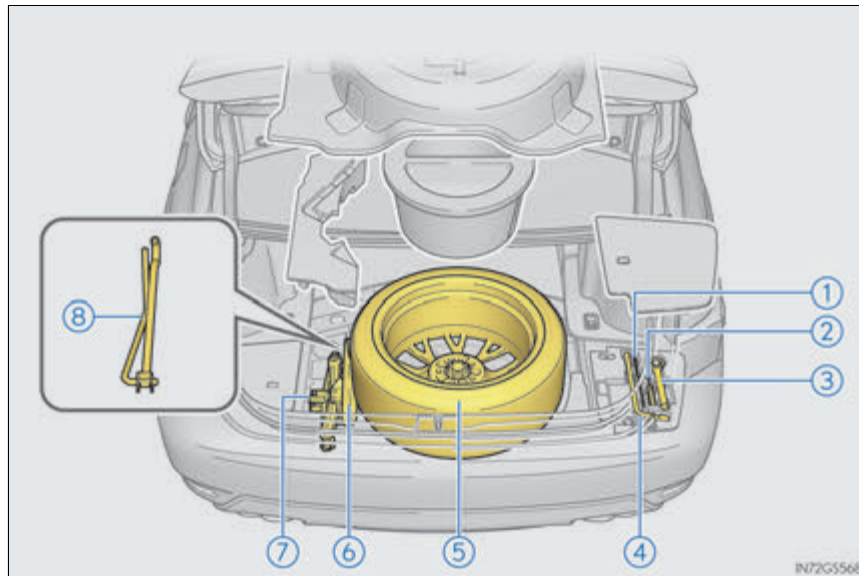

- | | |
|------------------------------|---------------|
| ① Parking brake release tool | ⑤ Spare tire |
| ② Screwdriver | ⑥ Tool bag |
| ③ Towing eyelet | ⑦ Jack |
| ④ Wheel nut wrench | ⑧ Jack handle |

 **WARNING****■ Using the tire jack**

Observe the following precautions.

Improper use of the tire jack may cause the vehicle to suddenly fall off the jack, leading to death or serious injury.

- Do not use the tire jack for any purpose other than replacing tires or installing and removing tire chains.
- Only use the tire jack that comes with this vehicle for replacing a flat tire.
Do not use it on other vehicles, and do not use other tire jacks for replacing tires on this vehicle.
- Put the jack properly in its jack point.
- Do not put any part of your body under the vehicle while it is supported by the jack.
- Do not start the engine or drive the vehicle while the vehicle is supported by the jack.
- Do not raise the vehicle while someone is inside.
- When raising the vehicle, do not put an object on or under the jack.
- Do not raise the vehicle to a height greater than that required to replace the tire.
- Use a jack stand if it is necessary to get under the vehicle.
- When lowering the vehicle, make sure that there is no-one near the vehicle. If there are people nearby, warn them vocally before lowering.

Taking out the jack and jack handle

- 1 Remove the center luggage mat. (→P. 355)
- 2 Remove the spacer and take out the jack handle.

▶ Type A

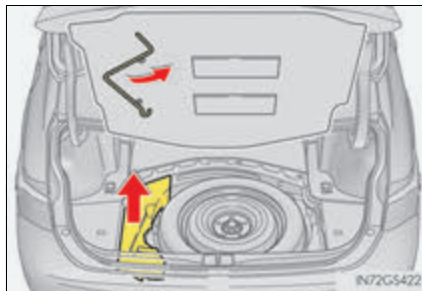

▶ Type B

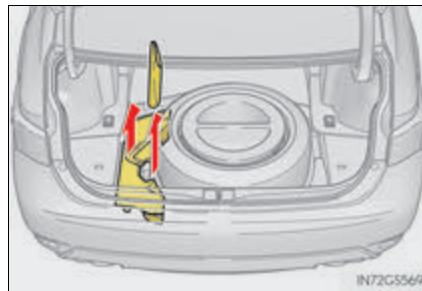

- 3 Take out the jack.
 - 1 For tightening
 - 2 For loosening

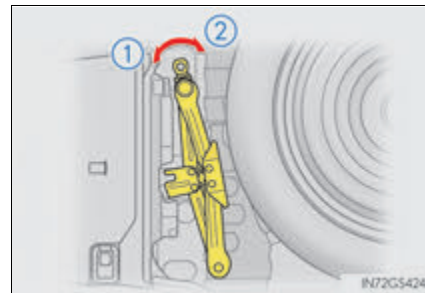

Taking out the spare tire

▶ Type A

- 1 Remove the center luggage mat. (→P. 355)
- 2 Loosen the center fastener that secures the spare tire.

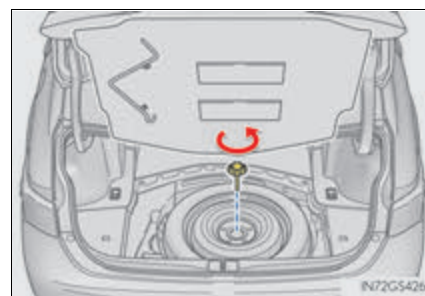

7

When trouble arises

▶ Type B

- 1 Remove the center luggage mat. (→P. 356)
- 2 Remove the center auxiliary box.

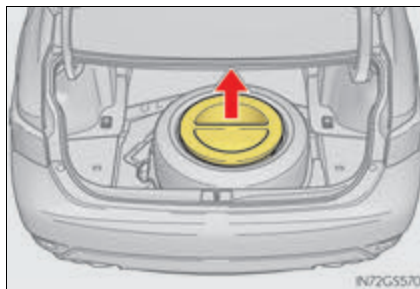

- 3 Loosen the center fastener that secures the spare tire.

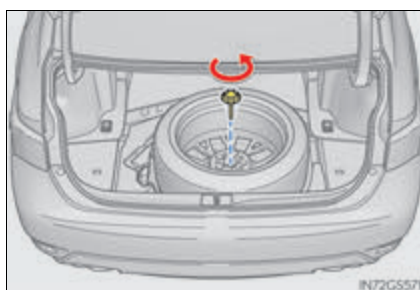

⚠ WARNING

■ **When storing the spare tire**

Be careful not to catch fingers or other body parts between the spare tire and the body of the vehicle.

Replacing a flat tire

- 1 Chock the tires.

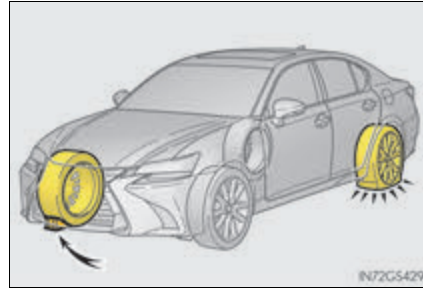

Flat tire		Wheel chock positions
Front	Left-hand side	Behind the rear right-hand side tire
	Right-hand side	Behind the rear left-hand side tire
Rear	Left-hand side	In front of the front right-hand side tire
	Right-hand side	In front of the front left-hand side tire

- 2 Slightly loosen the wheel nuts (one turn).

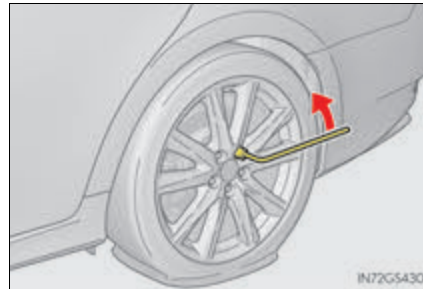

- 3 Turn the tire jack portion "A" by hand until the notch of the jack is in contact with the jack point.

The jack point guides are located under the rocker panel. They indicate the jack point positions.

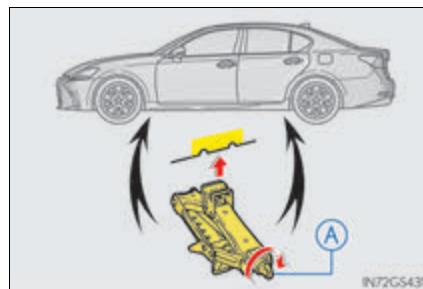

- 4 Raise the vehicle until the tire is slightly raised off the ground.

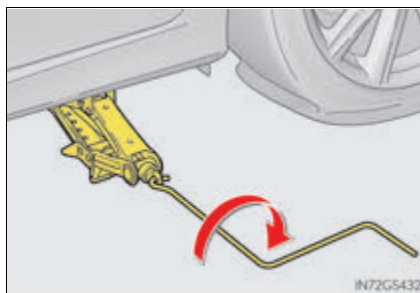

- 5 Remove all the wheel nuts and the tire.

When resting the tire on the ground, place the tire so that the wheel design faces up to avoid scratching the wheel surface.

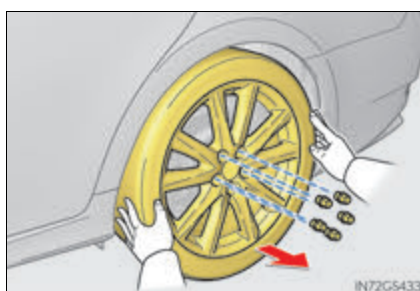

⚠ WARNING

■ **Replacing a flat tire**

- Do not touch the disc wheels or the area around the brakes immediately after the vehicle has been driven.
After the vehicle has been driven the disc wheels and the area around the brakes will be extremely hot. Touching these areas with hands, feet or other body parts while changing a tire, etc. may result in burns.
- Failure to follow these precautions could cause the wheel nuts to loosen and the tire to fall off, resulting in death or serious injury.
 - Never use oil or grease on the wheel bolts or wheel nuts.
Oil and grease may cause the wheel nuts to be excessively tightened, leading to bolt or disc wheel damage. In addition, the oil or grease can cause the wheel nuts to loosen and the wheel may fall off, causing a serious accident. Remove any oil or grease from the wheel bolts or wheel nuts.
 - Have the wheel nuts tightened with a torque wrench to 76 ft•lbf (103 N•m, 10.5 kgf•m) as soon as possible after changing wheels.
 - When installing a tire, only use wheel nuts that have been specifically designed for that wheel.
 - If there are any cracks or deformations in the bolt screws, nut threads or bolt holes of the wheel, have the vehicle inspected by your Lexus dealer.

Installing the spare tire

- 1 Remove any dirt or foreign matter from the wheel contact surface.

If foreign matter is on the wheel contact surface, the wheel nuts may loosen while the vehicle is in motion, causing the tire to come off.

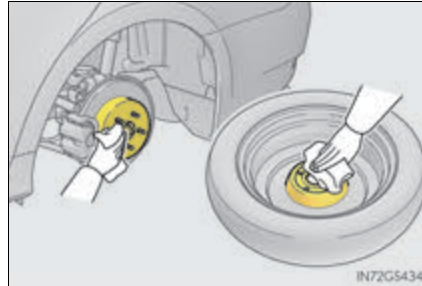

- 2 Install the spare tire and loosely tighten each wheel nut by hand by approximately the same amount.

When replacing an aluminum wheel with a steel wheel, tighten the wheel nuts until the tapered portion comes into loose contact with the disc wheel seat.

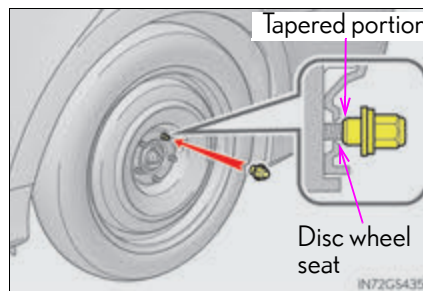

When replacing an aluminum wheel with an aluminum wheel, turn the wheel nuts until the washers come into contact with the disc wheel.

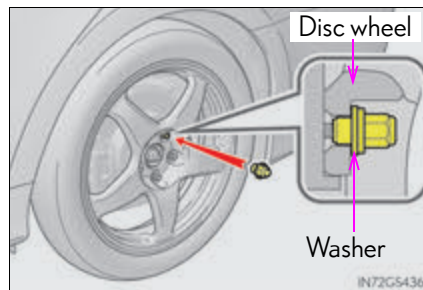

- 3 Lower the vehicle.

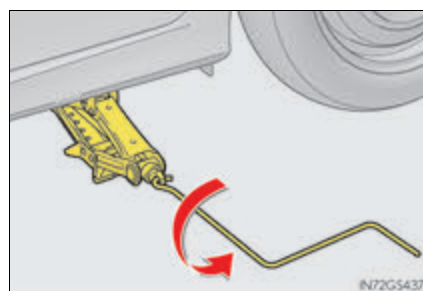

500 7-2. Steps to take in an emergency

- 4 Firmly tighten each wheel nut two or three times in the order shown in the illustration.

Tightening torque:
76 ft•lbf (103 N•m, 10.5 kgf•m)

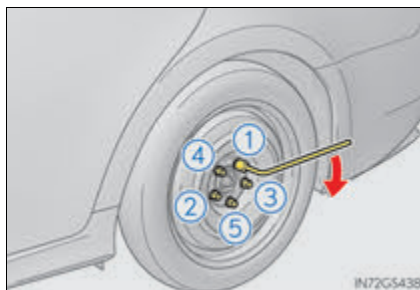

- 5 Stow the flat tire, tire jack and all tools.

■ The spare tire

- GS350/GS200t: The spare tire is identified by the label "TEMPORARY USE ONLY" on the tire sidewall.
- Use the spare tire temporarily, and only in an emergency.
- Make sure to check the tire inflation pressure of the spare tire. (→P. 550)

■ When using the spare tire

As the spare tire is not equipped with a tire pressure warning valve and transmitter, low inflation pressure of the spare tire will not be indicated by the tire pressure warning system. Also, if you replace the spare tire after the tire pressure warning light comes on, the light remains on.

■ When the spare tire is equipped

The vehicle may become lower when driving with the spare tire compared to when driving with standard tires.

■ If you have a flat rear tire on a road covered with snow or ice (vehicles with front and rear tires of the same size)

Install the compact spare tire on one of the front wheels of the vehicle. Perform the following steps and fit tire chains to the rear tires:

- 1 Replace a front tire with the compact spare tire.
- 2 Replace the flat rear tire with the tire removed from the front of the vehicle.
- 3 Fit tire chains to the rear tires.

⚠ WARNING

■ When using the spare tire

- Remember that the spare tire provided is specifically designed for use with your vehicle. Do not use your spare tire on another vehicle.
- Do not use more than one spare tire simultaneously.
- Replace the spare tire with a standard tire as soon as possible.
- Avoid sudden acceleration, abrupt steering, sudden braking and shifting operations that cause sudden engine braking.

⚠ WARNING**■ When the spare tire is attached**

The vehicle speed may not be correctly detected, and the following systems may not operate correctly:

- ABS & Brake assist
- VSC
- TRAC
- Cruise control
- Dynamic radar cruise control with full-speed range (if equipped)
- Dynamic radar cruise control (if equipped)
- PCS (Pre-Collision System) (if equipped)
- EPS
- AFS (if equipped)
- Adaptive Variable Suspension system (if equipped)
- LDA (Lane Departure Alert with steering control) (if equipped)
- LKA (Lane-Keeping Assist) (if equipped)
- Tire pressure warning system
- VDIM
- Lexus parking assist monitor
- Intuitive parking assist (if equipped)
- Navigation system (if equipped)
- DRS (if equipped)
- VGRS (if equipped)
- LDH (if equipped)

Also, not only can the following system not be utilized fully, but it may even negatively affect the drive-train components:

- AWD system

■ Speed limit when using the spare tire

Do not drive at speeds in excess of 50 mph (80 km/h) when a spare tire is installed on the vehicle.

The spare tire is not designed for driving at high speeds. Failure to observe this precaution may lead to an accident causing death or serious injury.

■ After using the tools and jack

Before driving, make sure all the tools and jack are securely in place in their storage location to reduce the possibility of personal injury during a collision or sudden braking.

⚠ NOTICE**■ Be careful when driving over bumps with the spare tire installed on the vehicle.**

The vehicle may become lower when driving with the spare tire compared to when driving with standard tires. Be careful when driving over uneven road surfaces.

■ Driving with tire chains and the spare tire

Do not fit tire chains to the spare tire.

Tire chains may damage the vehicle body and adversely affect driving performance.

■ When replacing the tires

When removing or fitting the wheels, tires or the tire pressure warning valve and transmitter, contact your Lexus dealer as the tire pressure warning valve and transmitter may be damaged if not handled correctly.

If you have a flat tire (vehicles without spare tire)

Your vehicle is not equipped with a spare tire, but instead is equipped with an emergency tire puncture repair kit.

A puncture caused by a nail or screw passing through the tire tread can be repaired temporarily with the emergency tire puncture repair kit.

WARNING

■ If you have a flat tire

Do not continue driving with a flat tire.

Driving even a short distance with a flat tire can damage the tire and the wheel beyond repair, which could result in an accident.

Driving with a flat tire may cause a circumferential groove on the side wall.

In such a case, the tire may explode when using a repair kit.

Before repairing the vehicle

- Stop the vehicle in a safe place on a hard, flat surface.
- Set the parking brake.
- Shift the shift lever to P.
- Stop the engine.
- Turn on the emergency flashers. (→P. 442)

Location of the emergency tire puncture repair kit, jack and tools

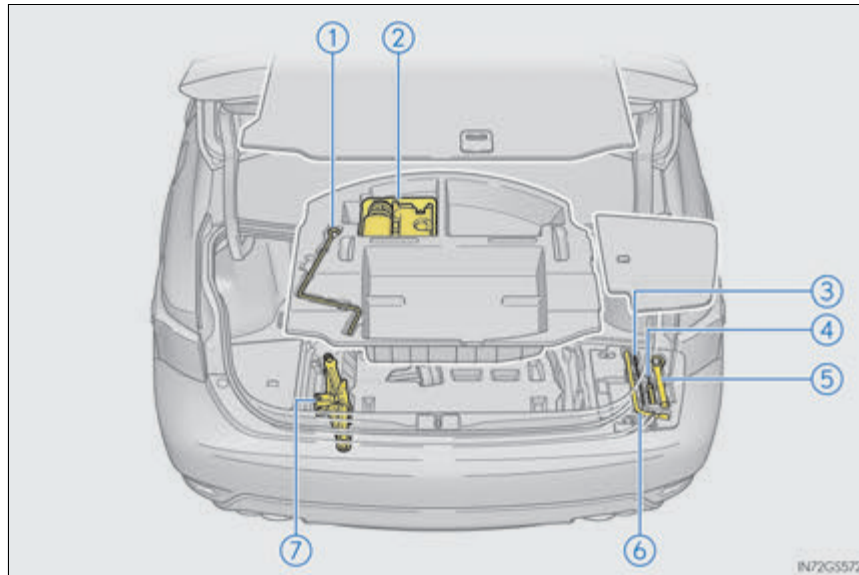

- ① Jack handle
- ② Emergency tire puncture repair kit
- ③ Parking brake release tool
- ④ Screwdriver
- ⑤ Towing eyelet
- ⑥ Wheel nut wrench
- ⑦ Jack*

*: Use of the jack (→P. 497)

Emergency tire puncture repair kit components

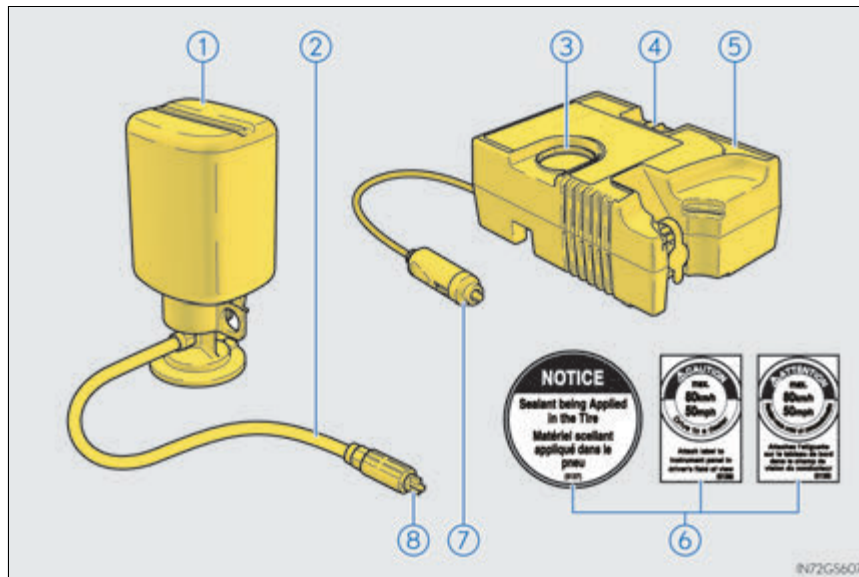

- ① Bottle
- ② Hose
- ③ Air pressure gauge
- ④ Compressor switch
- ⑤ Compressor
- ⑥ Stickers
- ⑦ Power plug
- ⑧ Air release cap

Taking out the emergency tire puncture repair kit

- 1 Remove the center luggage mat. (→P. 355)
- 2 Take out the emergency tire puncture repair kit.

**Taking out the jack**

- 1 Remove the center luggage mat. (→P. 355)
- 2 Remove the center auxiliary box.

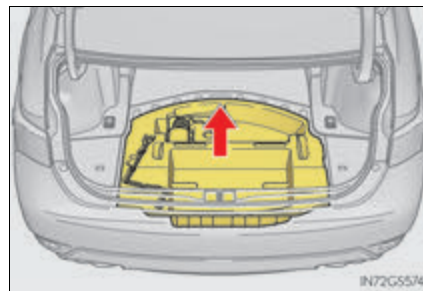

- 3 Take out the jack.
 - 1 For tightening
 - 2 For loosening

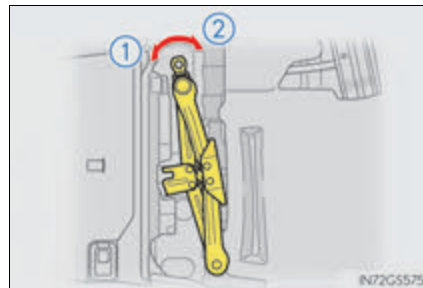

Before performing emergency repair

Check the degree of the tire damage.

A tire should only be repaired with the emergency tire puncture repair kit if the damage is caused by a nail or screw passing through the tire tread.

- Do not remove the nail or screw from the tire. Removing the object may widen the opening and disable emergency repair with the kit.
- To avoid sealant leakage, move the vehicle until the area of the puncture, if known, is positioned at the top of the tire.

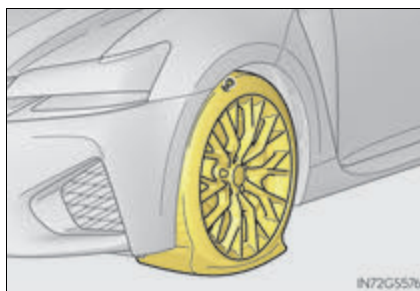

Emergency repair method

- 1 Remove the valve cap from the valve of the punctured tire.

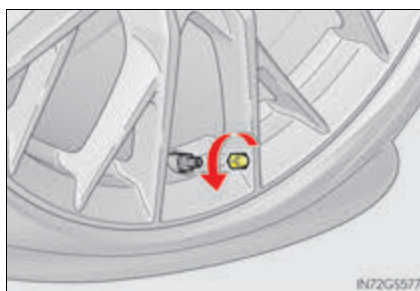

- 2 Remove the air release cap from the hose.
You will use the air release cap again. Therefore keep it in a safe place.

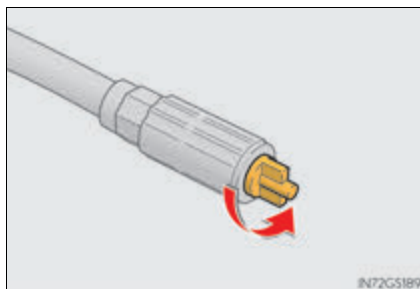

- 3** Connect the hose to the valve.
Screw the end of the hose clockwise as far as possible.

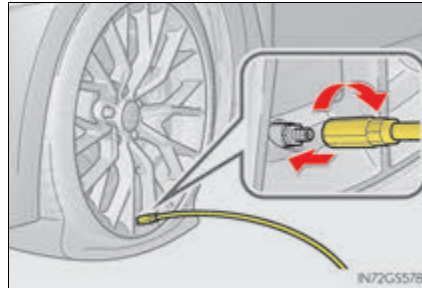

- 4** Make sure that the compressor switch is off.

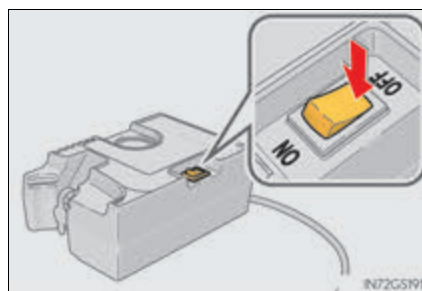

- 5** Remove the rubber stopper from the compressor.

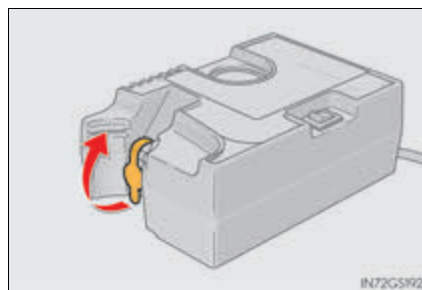

- 6** Connect the power plug to the power outlet socket.

► Inside of console box

► Backside of console box

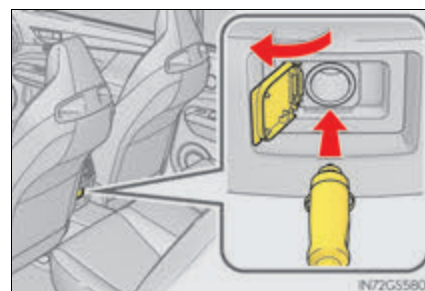
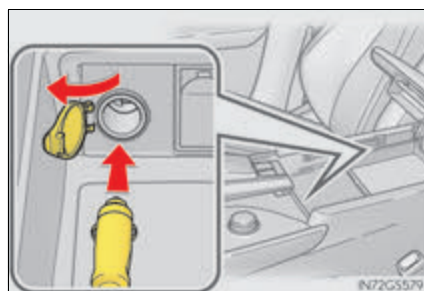

- 7 Connect the bottle to the compressor.

Connect by inserting the bottle straight into the compressor, and make sure that the protruding part of the bottle is properly aligned with the groove in the case.

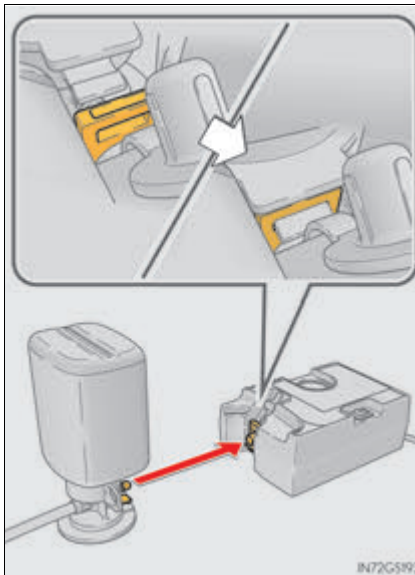

- 8 Attach the 2 stickers as shown.

Remove any dirt and moisture from the wheel before attaching the sticker.

If you are unable to apply the stickers, inform the nearest your Lexus dealer that sealant has been applied to the puncture when having the tire repaired or replaced.

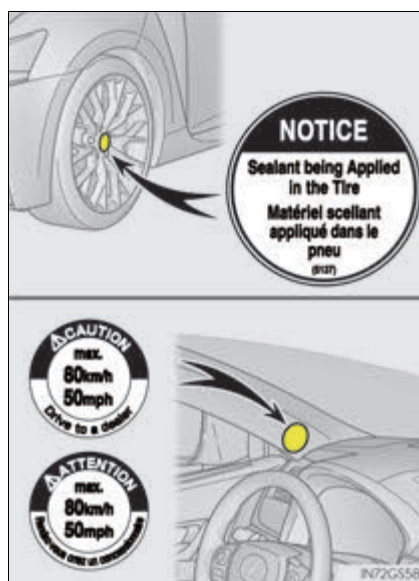

- 9** Check the specified tire inflation pressure.

Tire inflation pressure is specified on the label as shown. (→P. 550)

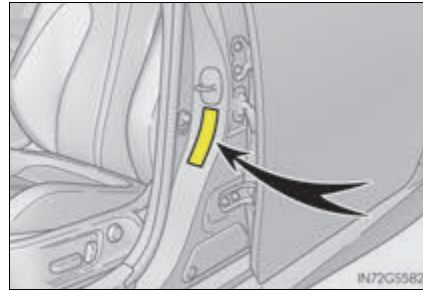

- 10** Start the engine. (→P. 197)

- 11** To inject the sealant and inflate the tire, turn the compressor switch on.

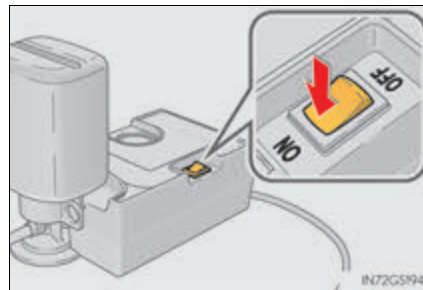

- 12** Inflate the tire until the recommended pressure is reached.

- ① The sealant will be injected and the pressure will spike to 44 psi (300 kPa, 3.0 kgf/cm² or bar) or 58 psi (400 kPa, 4.0 kgf/cm² or bar), and then gradually decrease.
- ② The air pressure gauge will display the actual tire inflation pressure about 1 minute (15 minutes at low temperature) after the switch is turned on.
- ③ Inject to recommended pressure.
 - Turn the compressor switch off and then check the tire inflation pressure. Being careful not to over inflate, check and repeat the inflation procedure until the specified tire inflation pressure is reached.

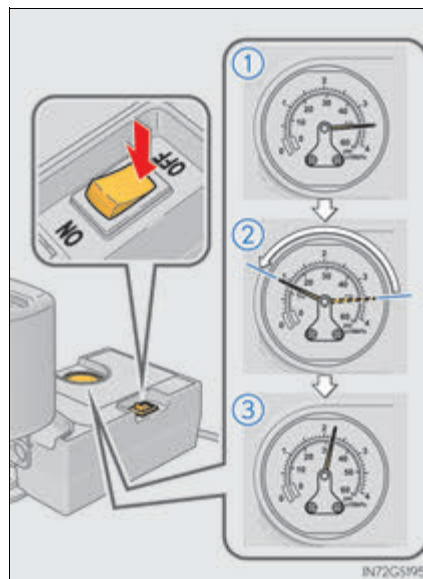

510 7-2. Steps to take in an emergency

- If the tire inflation pressure is still lower than the specified point after inflation for 10 minutes (35 minutes at low temperature) with the switch on, the tire is too damaged to be repaired. Turn the compressor switch off and contact your Lexus dealer.
- If the tire inflation pressure exceeds the recommended level, let out some air to adjust the tire inflation pressure. (→P. 512, 550)

13 With the compressor switch off, disconnect the hose from the valve on the tire and then pull out the power plug from the power outlet socket.

Some sealant may leak when the hose is removed.

14 Install the valve cap onto the valve of the emergency repaired tire.

15 Attach the air release cap to the end of the hose.

If the air release cap is not attached, the sealant may leak and the vehicle may get dirty.

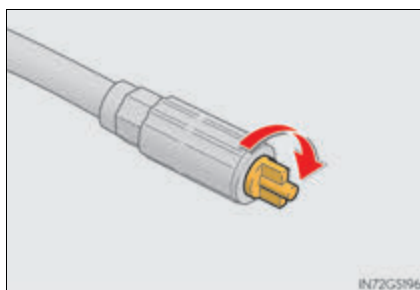

16 Temporarily store the bottle in the trunk while it is connected to the compressor.

17 To spread the liquid sealant evenly within the tire, immediately drive safely for about 3 miles (5 km) below 50 mph (80 km/h).

18 After driving for about 3 miles (5 km), stop your vehicle in a safe place on a hard, flat surface and remove the air release cap from the hose before reconnecting the repair kit.

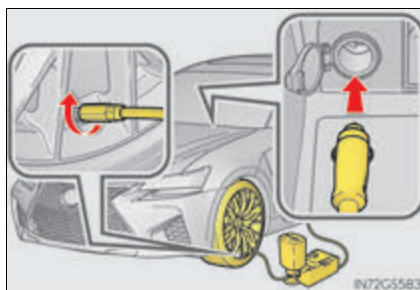

19 Turn the compressor switch on and wait for several seconds, and then turn it off. Check the tire inflation pressure.



① If the tire inflation pressure is under 19 psi (130 kPa, 1.3 kgf/cm² or bar): The puncture cannot be repaired. Contact your Lexus dealer.

② If the tire inflation pressure is 19 psi (130 kPa, 1.3 kgf/cm² or bar) or higher, but less than the recommended level: Proceed to step **20**.

③ If the tire inflation pressure is the recommended level: Proceed to step **21**.

20 Turn the compressor switch on to inflate the tire until the recommended tire inflation pressure is reached. Drive for about 3 miles (5 km) and then perform step **18**.

21 Attach the air release cap to the end of the hose.

If the air release cap is not attached, the sealant may leak and the vehicle may get dirty.

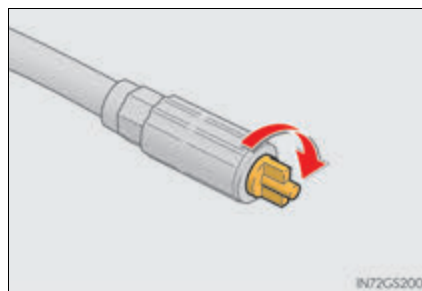

22 Store the bottle in the trunk while it is connected to the compressor.

23 Taking precautions to avoid sudden braking, sudden acceleration and sharp turns, drive carefully at under 50 mph (80 km/h) to your Lexus dealer that is less than 62 miles (100 km) away for tire repair or replacement.

■ In the following cases, the tire cannot be repaired with the emergency tire puncture repair kit. Contact your Lexus dealer.

- When the tire is damaged due to driving without sufficient air pressure
- When the tire lost air pressure due to a crack or damage in the tire sidewall
- When the tire is visibly separated from the wheel
- When the cut or damage to the tread is 0.16 in. (4 mm) long or more
- When the wheel is damaged
- When two or more tires have been punctured
- When there is more than one hole or cut in the damaged tire
- When the sealant has expired

■ **Emergency tire puncture repair kit**

- The sealant has a limited lifespan. The expiry date is shown on the bottle. The sealant should be replaced before the expiry date. Contact your Lexus dealer for replacement.
- The sealant stored in the emergency tire puncture repair kit can be used only once to temporarily repair a single tire. If the sealant has been used and need to be purchased, contact your Lexus dealer.
- The sealant can be used when the outside temperature is from -40 °F (-40 °C) to 140 °F (60 °C).
- The repair kit is exclusively designed for size and type of tires originally installed on your vehicle. Do not use it for tires that a different size than the original ones, or for any other purposes.
- If the sealant gets on your clothes, it may stain.
- If the sealant adheres to a wheel or the surface of the vehicle body, the stain may not be removable if it is not cleaned at once. Immediately wipe away the sealant with a wet cloth.
- During operation of the repair kit, a loud operation noise is produced. This does not indicate a malfunction.
- Do not use the emergency tire puncture repair kit to check or to adjust the tire pressure.

■ **If the tire is inflated to more than the recommended level**

- 1 Disconnect the hose from the valve.
- 2 Install the air release cap to the end of the hose and push the protrusion on the air release cap into the tire valve to let some air out.

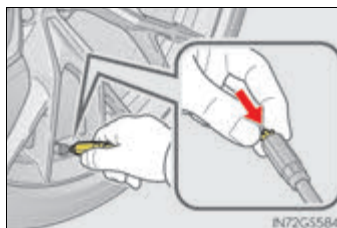

- 3 Disconnect the hose from the valve, remove the air release cap from the hose and then reconnect the hose.
- 4 Turn the compressor switch on and wait for several seconds, and then turn it off. Check that the air pressure indicator shows the recommended level. (→P. 550)
If the air pressure is lower than the recommended level, turn the compressor switch on again and repeat the inflation procedure until the recommended pressure is reached.

■ **The valve of a tire that has been repaired**

- After a tire is repaired with the emergency tire puncture repair kit, the valve should be replaced.
- After a tire is repaired with the emergency tire puncture repair kit, even if the tire inflation pressure is at the recommended level, the tire pressure warning light may come on/flash.

■ **Note for checking the emergency tire puncture repair kit**

Check the sealant expiry date occasionally.
The expiry date is shown on the bottle.
Do not use sealant whose expiry date has already passed. Otherwise, repairs conducted using the emergency tire puncture repair kit may not be performed properly.

⚠ WARNING**■ Caution while driving**

Observe the following precautions.
Failure to do so may cause an accident.

- The emergency tire puncture repair kit is made exclusively for your vehicle. Do not use it on other vehicles.
- Do not use the emergency tire puncture repair kit for tires that are a different size than the specified ones or for any other purpose. Doing so may cause the tires to not be repaired properly.

■ Precautions for use of the sealant

- Ingesting the sealant is hazardous to your health. If you ingest sealant, consume as much water as possible, and then immediately consult a doctor.
- If sealant gets in eyes or adheres to skin, immediately wash it off with water. If discomfort persists, consult a doctor.

■ When fixing the flat tire

- Stop your vehicle in a safe and flat area.
- Do not touch the wheels or the area around the brakes immediately after the vehicle has been driven.
After the vehicle has been driven, the wheels and the area around the brakes may be extremely hot. Touching these areas with hands, feet or other body parts may result in burns.
- Connect the valve and hose securely with the tire installed on the vehicle.
- If the hose is not properly connected to the valve, air leakage may occur or sealant may be sprayed out.
- If the hose comes off the valve while inflating the tire, there is a risk that the hose will move abruptly due to air pressure.
- After inflation of the tire has completed, the sealant may splatter when the hose is disconnected or some air is let out of the tire.
- Follow the operation procedure to repair the tire. If the procedures not followed, the sealant may spray out.
- Keep back from the tire while it is being repaired, as there is a chance of it bursting while the repair operation is being performed. If you notice any cracks or deformation of the tire, turn off the compressor switch and stop the repair operation immediately.
- The repair kit may overheat if operated for a long period of time. Do not operate the repair kit continuously for more than 35 minutes.
- Parts of the repair kit become hot during operation. Be careful handling the repair kit during and after operation. Do not touch the metal part connecting the bottle and the compressor. It will be extremely hot.
- Do not attach the vehicle speed warning sticker to an area other than the one indicated. If the sticker is attached to an area where an SRS airbag is located, such as the pad of the steering wheel, it may prevent the SRS air bag from operating properly.

⚠ WARNING**■ Driving to spread the liquid sealant evenly**

- Drive the vehicle carefully at a low speed. Be especially careful when turning and cornering.
- If the vehicle does not drive straight or you feel a pull through the steering wheel, stop the vehicle and check the following:
 - Tire condition. The tire may have separated from the wheel.
 - Tire inflation pressure. If tire inflation pressure is 19 psi (130 kPa, 1.3 kgf/cm² or bar) or less, the tire may be severely damaged.

⚠ NOTICE**■ When performing an emergency repair**

- Perform the emergency repair without removing the nail or screw that has punctured the tread of the tire. If the object that has punctured the tire is removed, repair by the emergency tire puncture repair kit may not be possible.
- The repair kit is not waterproof. Make sure that the repair kit is not exposed to water, such as when it is being used in the rain.
- Do not put the repair kit directly onto dusty ground such as sand at the side of the road. If the repair kit vacuums up dust etc., a malfunction may occur.

■ Handling the emergency tire puncture repair kit

- The repair kit power source should be 12 V DC suitable for vehicle use. Do not connect the repair kit to any other source.
- If gasoline splatters on the repair kit, the repair kit may deteriorate. Take care not to allow gasoline to contact it.
- Store the emergency tire puncture repair kit in the trunk.
The kit may be thrown around during sudden braking and so forth, damaging the kit.
- Store the repair kit in the trunk out of reach of children.
- Do not disassemble or modify the repair kit. Do not subject parts such as the air pressure indicator to impacts. This may cause a malfunction.

■ To avoid damage to the tire pressure warning valves and transmitters

When a tire is repaired with liquid sealants, the tire pressure warning valve and transmitter may not operate properly. If a liquid sealant is used, contact your Lexus dealer or other qualified service shop as soon as possible. Make sure to replace the tire pressure warning valve and transmitter when replacing the tire. (→P. 414)

If the engine will not start

If the engine will not start even though correct starting procedures are being followed (→P. 197), consider each of the following points:

The engine will not start even though the starter motor operates normally.

One of the following may be the cause of the problem:

- There may not be sufficient fuel in the vehicle's tank.
Refuel the vehicle.
- The engine may be flooded.
Try to restart the engine again following correct starting procedures.
(→P. 197)
- There may be a malfunction in the engine immobilizer system. (→P. 72)

The starter motor turns over slowly, the interior lights and headlights are dim, or the horn does not sound or sounds at a low volume.

One of the following may be the cause of the problem:

- The battery may be discharged. (→P. 523)
- The battery terminal connections may be loose or corroded.

The starter motor does not turn over

The engine starting system may be malfunctioning due to an electrical problem such as electronic key battery depletion or a blown fuse. However, an interim measure is available to start the engine. (→P. 516)

The starter motor does not turn over, the interior lights and headlights do not turn on, or the horn does not sound.

One of the following may be the cause of the problem:

- One or both of the battery terminals may be disconnected.
- The battery may be discharged. (→P. 523)
- There may be a malfunction in the steering lock system.

Contact your Lexus dealer if the problem cannot be repaired, or if repair procedures are unknown.

Emergency start function

When the engine does not start, the following steps can be used as an interim measure to start the engine if the engine switch is functioning normally.

- 1** Press the parking brake switch to check that the parking brake is set.
(→P. 210)
Parking brake indicator will come on.
- 2** Shift the shift lever to P.
- 3** Turn the engine switch to ACCESSORY mode.
- 4** Press and hold the engine switch for about 15 seconds while depressing the brake pedal firmly.

Even if the engine can be started using the above steps, the system may be malfunctioning. Have the vehicle inspected by your Lexus dealer.

If the shift lever cannot be shifted from P

If the shift lever cannot be shifted with your foot on the brake pedal, there may be a problem with the shift lock system (a system to prevent accidental operation of the shift lever). Have the vehicle inspected by your Lexus dealer immediately.

The following steps may be used as an emergency measure to ensure that the shift lever can be shifted:

- 1 Press the parking brake switch to check that the parking brake is set.
(→P. 210)

Parking brake indicator will come on.

- 2 Turn the engine switch to ACCESSORY mode.

- 3 Depress the brake pedal.

- 4 Pry the cover up with a flathead screwdriver or equivalent tool.

To prevent damage to the cover, cover the tip of the screwdriver with a rag.

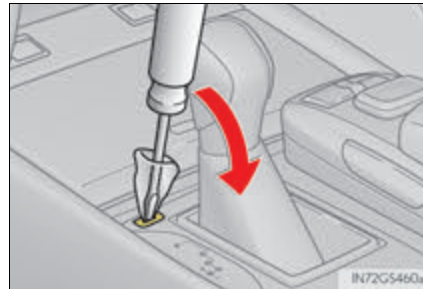

- 5 Press the shift lock override button.

The shift lever can be shifted while the button is pressed.

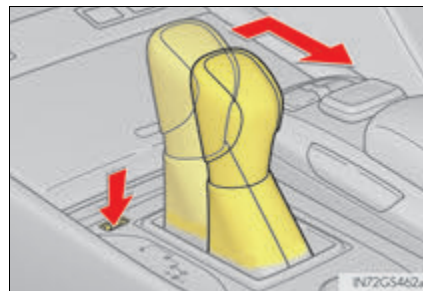

If the parking brake cannot be released

In the event that the battery is discharged or switch operation does not release the parking brake, the parking brake can be released manually using the procedure below. This procedure should be performed only if necessary, such as in an emergency.

If the switch cannot be operated even when the battery is normal, the parking brake system may be malfunctioning. Have the vehicle inspected by your Lexus dealer immediately.

Before releasing the parking brake manually

- Shift the shift lever to P.
- Turn the engine switch off.
- Check that the parking brake indicator is off.
- Chock the tires.

Releasing the parking brake manually

- 1 Take out the parking brake release tool and the screwdriver from the trunk. (→P. 492, 503)
Fit the parking brake release tool into the screwdriver handle.

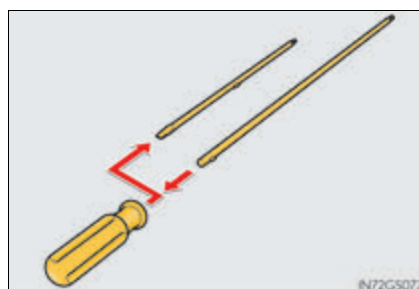

- 2 Vehicles with spare tire: Take out the spare tire. (→P. 495)
Vehicles without spare tire: Remove the center auxiliary box. (→P. 505)

- 3 Remove the plug.



- 4 Insert the tool and press it down firmly while turning it counterclockwise until it stops.

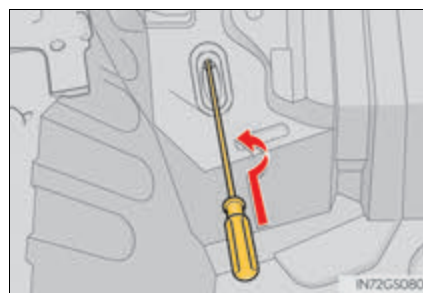

Manual operation of the parking brake

The parking brake cannot be set manually.

⚠ WARNING

■ When releasing the parking brake manually

- Shift the shift lever to P, turn the engine switch off and chock the tires. Failure to do so may cause the vehicle to move, resulting in an accident.
- Turn the engine switch off and check that the parking brake indicator is off. Failure to do so may cause the system to operate and turn the inserted parking brake release tool, resulting in an injury.

If the electronic key does not operate properly

If communication between the electronic key and vehicle is interrupted (→P. 152) or the electronic key cannot be used because the battery is depleted, the smart access system with push-button start and wireless remote control cannot be used. In such cases, the doors and trunk can be opened and the engine can be started by following the procedure below.

Locking and unlocking the doors, unlocking the trunk and key linked functions

■ Doors

Use the mechanical key (→P. 133) in order to perform the following operations:

- ① Locks all the doors
- ② Closes the windows and moon roof* (turn and hold)
- ③ Unlocks the door

Turning the key rearward unlocks the driver's door. Turning the key once again within 5 seconds unlocks the other doors.

- ④ Opens the windows and moon roof* (turn and hold)

*: This setting must be customized at your Lexus dealer.

■ Trunk

Turn the mechanical key clockwise to open.

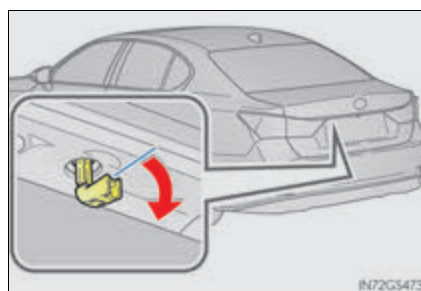
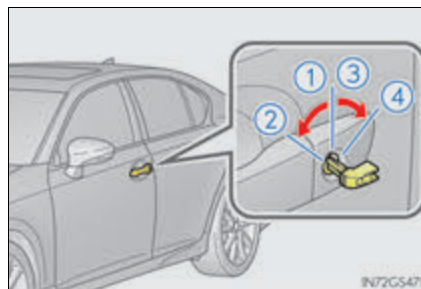

Starting the engine

- 1 Ensure that the shift lever is in P and depress the brake pedal.
- 2 Touch the Lexus emblem side of the electronic key to the engine switch.

When the electronic key is detected, a buzzer sounds and the engine switch will turn to IGNITION ON mode.

When the smart access system with push-button start is deactivated in customization setting, the engine switch will turn to ACCESSORY mode.

▶ GS350/GS200t

▶ GS F

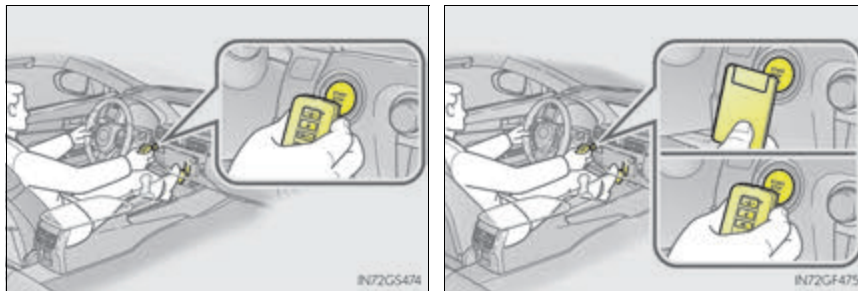

- 3 Firmly depress the brake pedal and check that  and a message (GS F only) are shown on the multi-information display.
- 4 Press the engine switch.

In the event that the engine still cannot be started, contact your Lexus dealer.

■ **Stopping the engine**

Shift the shift lever to P and press the engine switch as you normally do when stopping the engine.

■ **Replacing the key battery**

As the above procedure is a temporary measure, it is recommended that the electronic key battery be replaced immediately when the battery is depleted. (→P. 429)

■ **Changing engine switch modes**

Release the brake pedal and press the engine switch in step 3 above. The engine does not start and modes will be changed each time the switch is pressed. (→P. 198)

■ **When the electronic key does not work properly**

- Make sure that the smart access system with push-button start has not been deactivated in the customization setting. If it is off, turn the function on. (Customizable features: →P. 568)
- Check if battery-saving mode is set. If it is set, cancel the function. (→P. 151)

 **WARNING**

■ **When using the mechanical key and operating the power windows or moon roof**

Operate the power window or moon roof after checking to make sure that there is no possibility of any passenger having any of their body parts caught in the window or moon roof.

Also, do not allow children to operate the mechanical key. It is possible for children and other passengers to get caught in the power window or moon roof.

If the vehicle battery is discharged

The following procedures may be used to start the engine if the vehicle's battery is discharged.

You can also call your Lexus dealer or a qualified repair shop.

If you have a set of jumper (or booster) cables and a second vehicle with a 12-volt battery, you can jump start your vehicle by following the steps below.

- 1 Confirm that the electronic key is being carried.

▶ GS350/GS200t

▶ GS F

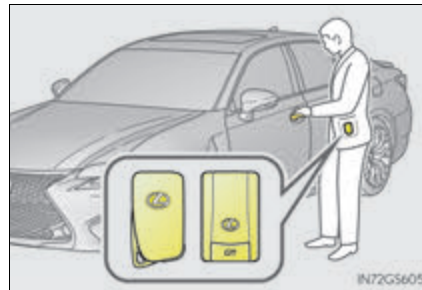
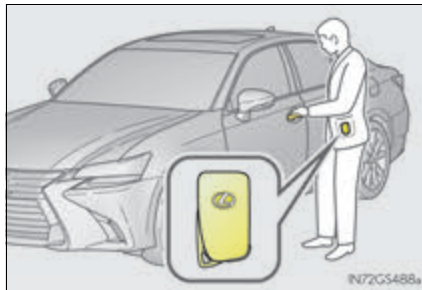

When connecting the jumper (or booster) cables, depending on the situation, the alarm may activate and doors locked. (→P. 75)

- 2 Open the hood. (→P. 393)

- 3 GS200t/GS F: Remove the engine cover.

▶ GS200t

▶ GS F

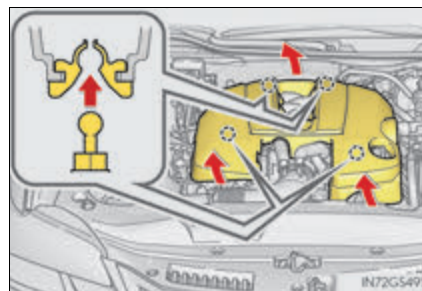
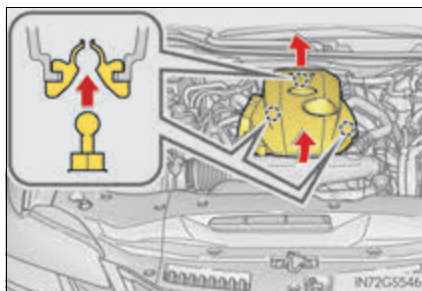

Raise the front of the engine cover to remove the front clips, and then raise the rear of the engine cover to remove the rear clips.

524 7-2. Steps to take in an emergency

4 Connect the jumper cables according to the following procedure:

▶ GS350

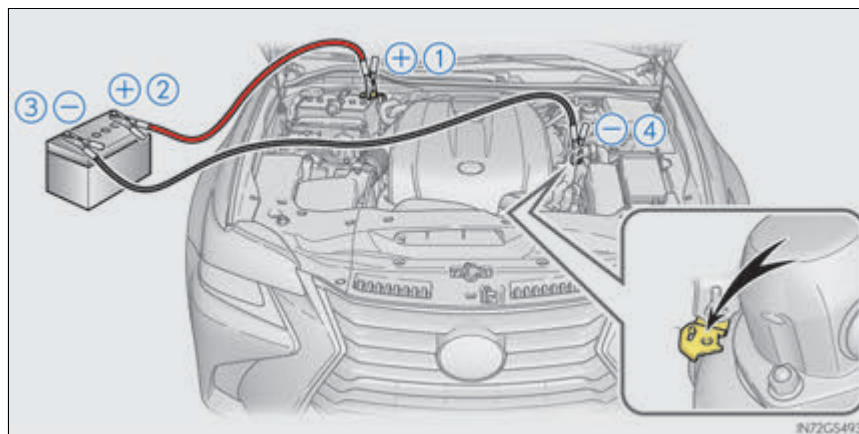

▶ GS200t

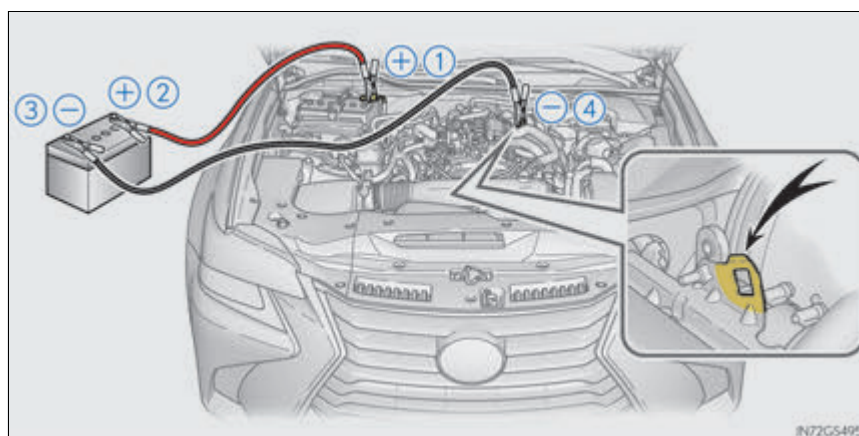

▶ GSF

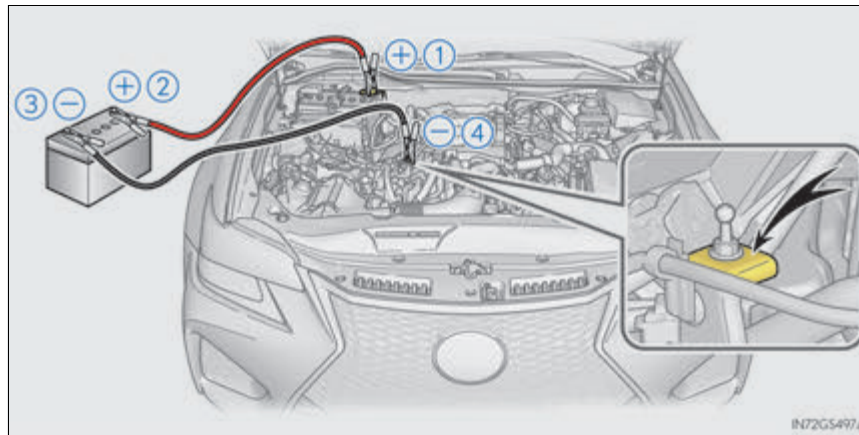

- ① Connect a positive jumper cable clamp to the positive (+) battery terminal on your vehicle
- ② Connect the clamp on the other end of the positive cable to the positive (+) battery terminal on the second vehicle
- ③ Connect a negative cable clamp to the negative (-) battery terminal on the second vehicle
- ④ Connect the clamp at the other end of the negative cable to a solid, stationary, unpainted metallic point away from the battery and any moving parts, as shown in the illustration.
- 5 Start the engine of the second vehicle. Increase the engine speed slightly and maintain at that level for approximately 5 minutes to recharge the battery of your vehicle.
- 6 Open and close any of the doors of your vehicle with the engine switch off.
- 7 Maintain the engine speed of the second vehicle and start the engine of your vehicle by turning the engine switch to IGNITION ON mode.
- 8 Once the engine has started, remove the jumper cables in the exact reverse order from which they were connected.

Once the engine starts, have the vehicle inspected at your Lexus dealer as soon as possible.

7

When trouble arises

■ **Starting the engine when the battery is discharged**

The engine cannot be started by push-starting.

■ **To prevent battery discharge**

- Turn off the headlights and the audio system while the engine is off.
- Turn off any unnecessary electrical components when the vehicle is running at a low speed for an extended period, such as in heavy traffic.

■ **Charging the battery**

The electricity stored in the battery will discharge gradually even when the vehicle is not in use, due to natural discharge and the draining effects of certain electrical appliances. If the vehicle is left for a long time, the battery may discharge, and the engine may be unable to start. (The battery recharges automatically during driving.)

■ **When recharging or replacing the battery**

- In some cases, it may not be possible to unlock the doors using the smart access system with push-button start when the battery is discharged. Use the wireless remote control or the mechanical key to lock or unlock the doors.
- The engine may not start on the first attempt after the battery has recharged but will start normally after the second attempt. This is not a malfunction.
- The engine switch mode is memorized by the vehicle. When the battery is reconnected, the system will return to the mode it was in before the battery was discharged. Before disconnecting the battery, turn the engine switch off. If you are unsure what mode the engine switch was in before the battery discharged, be especially careful when reconnecting the battery.

 **WARNING****■ Avoiding battery fires or explosions**

Observe the following precautions to prevent accidentally igniting the flammable gas that may be emitted from the battery:

- Make sure each jumper cable is connected to the correct terminal and that it is not unintentionally in contact with any other than the intended terminal.
- Do not allow the other end of the jumper cable connected to the “+” terminal to come into contact with any other parts or metal surfaces in the area, such as brackets or unpainted metal.
- Do not allow the + and - clamps of the jumper cables to come into contact with each other.
- Do not smoke, use matches, cigarette lighters or allow open flame near the battery.

■ Battery precautions

The battery contains poisonous and corrosive acidic electrolyte, while related parts contain lead and lead compounds. Observe the following precautions when handling the battery:

- When working with the battery, always wear safety glasses and take care not to allow any battery fluids (acid) to come into contact with skin, clothing or the vehicle body.
- Do not lean over the battery.
- In the event that battery fluid comes into contact with the skin or eyes, immediately wash the affected area with water and seek medical attention.
Place a wet sponge or cloth over the affected area until medical attention can be received.
- Always wash your hands after handling the battery support, terminals, and other battery-related parts.
- Do not allow children near the battery.

 **NOTICE****■ When handling jumper cables**

When connecting the jumper cables, ensure that they do not become entangled in the cooling fans or engine drive belt.

If your vehicle overheats

The following may indicate that your vehicle is overheating.

- The needle of the engine coolant temperature gauge (→P. 86, 92) enters the red zone or a loss of engine power is experienced. (For example, the vehicle speed does not increase.)
- “Engine Coolant Temp High Stop in a Safe Place See Owner’s Manual” is shown on the multi-information display.
- Steam is coming from under the hood.

Correction procedures

- 1 Stop the vehicle in a safe place and turn off the air conditioning system, and then stop the engine.
- 2 If you see steam:
Carefully lift the hood after the steam subsides.
If you do not see steam:
Carefully lift the hood.
- 3 After the engine has cooled down sufficiently, inspect the hoses and cooling core (radiator) for any leaks.

- 1 Radiator
- 2 Cooling fans

If a large amount of coolant leaks, immediately contact your Lexus dealer.

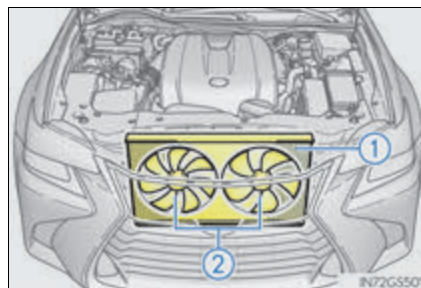

- 4 The coolant level is satisfactory if it is between the "FULL"/"F" and "LOW"/"L" lines on the reservoir.

- ① Engine coolant reservoir
- ② "FULL"/"F"
- ③ "LOW"/"L"
- ④ Coolant inlet cap
- ⑤ Intercooler coolant reservoir

► GS350

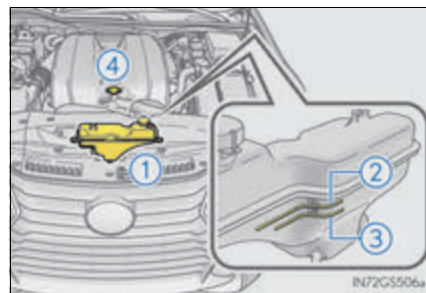

► GS F

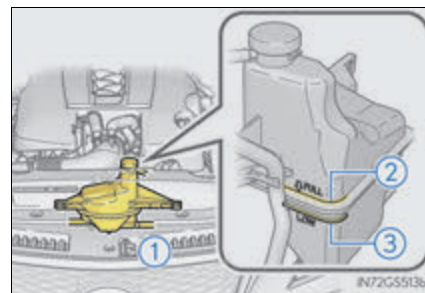

► GS200t

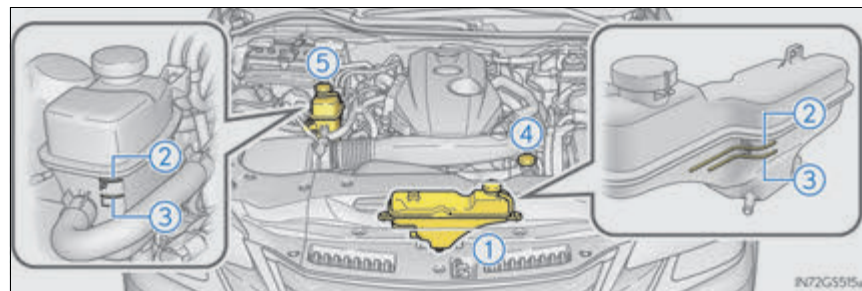

5 Add coolant if necessary.

Water can be used in an emergency if coolant is unavailable.

▶ GS350

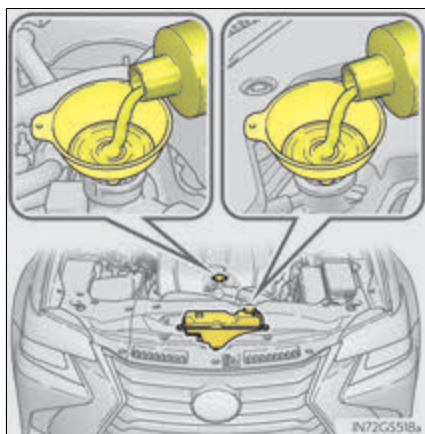

▶ GSF

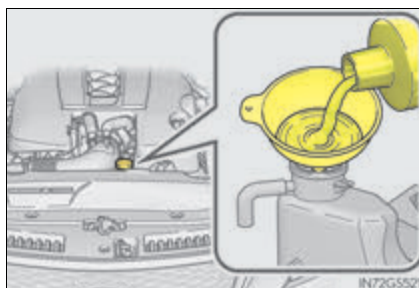

▶ GS200t

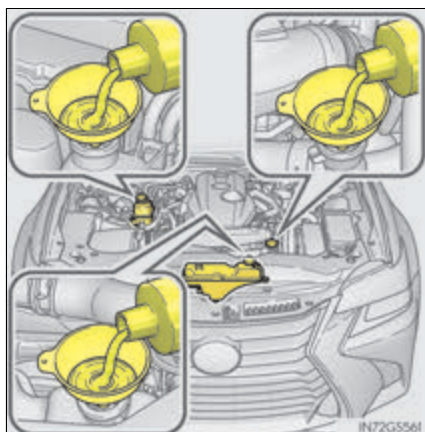

6 Start the engine and turn the air conditioning system on to check that the radiator cooling fans operate and to check for coolant leaks from the radiator or hoses.

The fans operate when the air conditioning system is turned on immediately after a cold start. Confirm that the fans are operating by checking the fan sound and air flow. If it is difficult to check these, turn the air conditioning system on and off repeatedly. (The fans may not operate in freezing temperatures.)

7 If the fans are not operating:

Stop the engine immediately and contact your Lexus dealer.

If the fans are operating:

Have the vehicle inspected at the nearest Lexus dealer.

■ When adding engine coolant (GS350/GS200t)

Add coolant in accordance with the following procedure.

- 1 Remove caps A and B.
- 2 Add engine coolant through the inlet of cap A up to the “[AR/GR] B” line, and then install cap A.
- 3 Add engine coolant through the inlet of cap B until it is full, and then install cap B.
GS200t only: When installing cap B, apply coolant to the O-ring on the end of cap B.

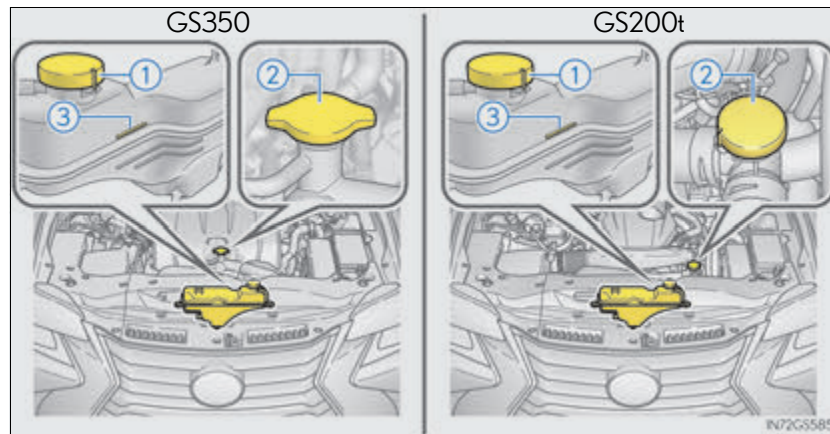

- 1 Cap A
- 2 Cap B
- 3 “[AR/GR] B” line (Target fill line)

⚠ WARNING

■ **When inspecting under the hood of your vehicle**

Observe the following precautions.

Failure to do so may result in serious injury such as burns.

- If steam is seen coming from under the hood, do not open the hood until the steam has subsided. The engine compartment may be very hot.
- Keep hands and clothing (especially a tie, a scarf or a muffler) away from the fans and belts. Failure to do so may cause the hands or clothing to be caught, resulting in serious injury.
- GS350: Do not loosen the coolant inlet cap or the engine coolant reservoir cap while the engine and radiator are hot. High temperature steam or coolant could spray out.

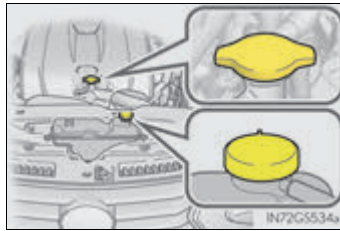

- GS F: Do not loosen the engine coolant reservoir cap while the engine and radiator are hot. High temperature steam or coolant could spray out.

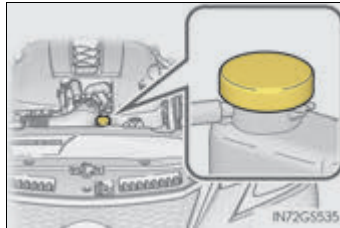

- GS200t: Do not loosen the coolant inlet cap, the engine coolant reservoir cap or the inter-cooler coolant reservoir cap while the engine and radiator are hot. High temperature steam or coolant could spray out.

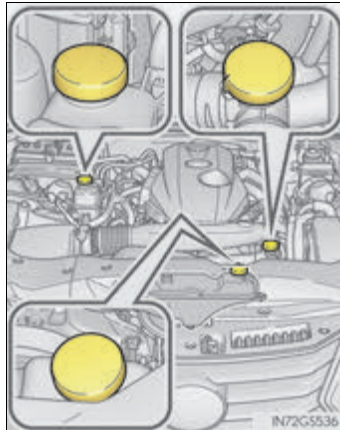

 NOTICE**■ When adding engine coolant**

Add coolant slowly after the engine has cooled down sufficiently. Adding cool coolant to a hot engine too quickly can cause damage to the engine.

■ To prevent damage to the cooling system

Observe the following precautions:

- Avoid contaminating the coolant with foreign matter (such as sand or dust etc.).
- Do not use any coolant additive.

If the vehicle becomes stuck

Carry out the following procedures if the tires spin or the vehicle becomes stuck in mud, dirt or snow:

- 1 Stop the engine. Set the parking brake and shift the shift lever to P.
- 2 Remove the mud, snow or sand from around the rear wheels.
- 3 Place wood, stones or some other material under the rear wheels to help provide traction.
- 4 Restart the engine.
- 5 Shift the shift lever to D or R and release the parking brake. Then, while exercising caution, depress the accelerator pedal.

■ When it is difficult to free the vehicle

Press  to turn off TRAC. (→P. 310)

▶ GS350/GS200t

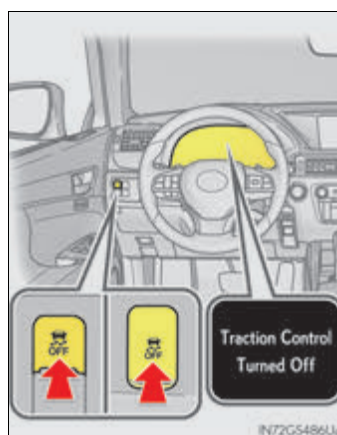

► GS F



⚠ WARNING

■ **When attempting to free a stuck vehicle**

If you choose to push the vehicle back and forth to free it, make sure the surrounding area is clear to avoid striking other vehicles, objects or people. The vehicle may also lunge forward or lunge back suddenly as it becomes free. Use extreme caution.

■ **When shifting the shift lever**

Be careful not to shift the shift lever with the accelerator pedal depressed. This may lead to unexpected rapid acceleration of the vehicle that may cause an accident resulting in death or serious injury.

⚠ NOTICE

■ **To avoid damaging the transmission and other components**

- Avoid spinning the rear wheels and depressing the accelerator pedal more than necessary.
- If the vehicle remains stuck even after these procedures are performed, the vehicle may require towing to be freed.

Vehicle specifications

8

537

8-1. Specifications

Maintenance data (fuel, oil level, etc.).....	538
Fuel information.....	555
Tire information.....	558

8-2. Customization

Customizable features	568
-----------------------------	-----

8-3. Initialization

Items to initialize	583
---------------------------	-----

Maintenance data (fuel, oil level, etc.)

Dimensions and weight

► GS350/GS200t

Overall length		190.9 in. (4850 mm)
Overall width		72.4 in. (1840 mm)
Overall height* ¹	2WD	57.3 in. (1455 mm)
	AWD	57.9 in. (1470 mm)
Wheelbase		112.2 in. (2850 mm)
Tread* ¹	Front	62.0 in. (1575 mm)
	Rear	62.6 in. (1590 mm) 61.4 in. (1560 mm)* ²
Vehicle capacity weight (Occupants + luggage)		825 lb. (370 kg)

*¹: Unladen vehicle

*²: Vehicles with 265/35R19 tires

► GSF

Overall length		193.5 in. (4915 mm)
Overall width		72.6 in. (1845 mm)
Overall height*		56.7 in. (1440 mm)
Wheelbase		112.2 in. (2850 mm)
Tread*	Front	61.2 in. (1555 mm)
	Rear	61.4 in. (1560 mm)
Vehicle capacity weight (Occupants + luggage)		865 lb. (390 kg)

*: Unladen vehicle

Vehicle identification

■ **Vehicle identification number**

The vehicle identification number (VIN) is the legal identifier for your vehicle. This is the primary identification number for your Lexus. It is used in registering the ownership of your vehicle.

This number is stamped on the top left of the instrument panel and in the engine compartment.

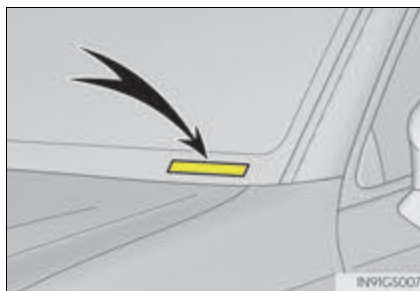

▶ GS350

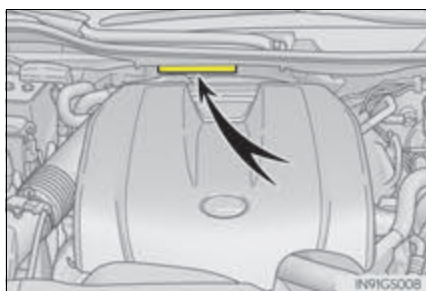

▶ GS200t

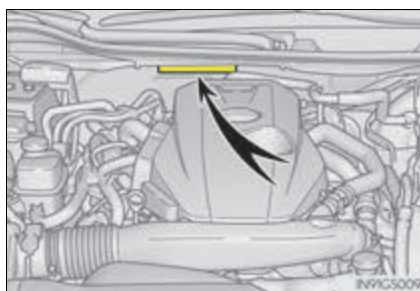

▶ GS F



540 8-1. Specifications

This number is also on the Certification Label.

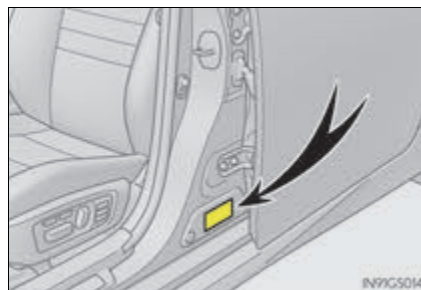

■ **Engine number**

The engine number is stamped on the engine block as shown.

▶ **GS350**

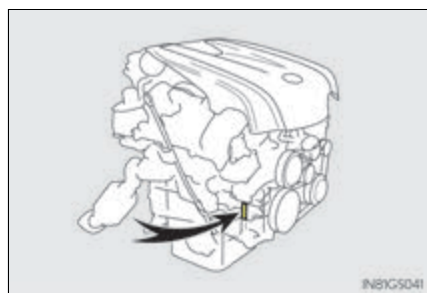

▶ **GS200t**

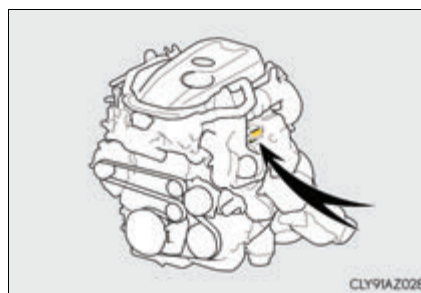

▶ **GSF**

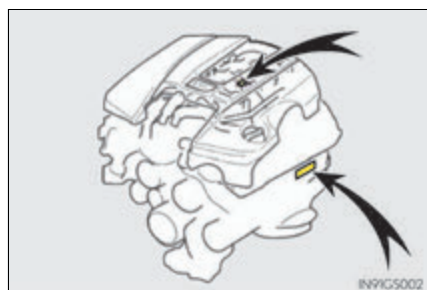

Engine

▶ GS350

Model	3.5 L 6-cylinder (2GR-FKS)
Type	6-cylinder V type, 4-cycle, gasoline
Bore and stroke	3.70 × 3.27 in. (94.0 × 83.0 mm)
Displacement	210.9 cu.in. (3456 cm ³)
Valve clearance	Automatic adjustment
Drive belt tension	

▶ GS200t

Model	2.0 L 4-cylinder with turbocharger (8AR-FTS)
Type	4-cylinder in line, 4-cycle, gasoline
Bore and stroke	3.39 × 3.39 in. (86.0 × 86.0 mm)
Displacement	121.9 cu. in. (1998 cm ³)
Valve clearance	Automatic adjustment
Drive belt tension	

▶ GS F

Model	5.0 L 8-cylinder (2UR-GSE)
Type	8-cylinder V type, 4-cycle, gasoline
Bore and stroke	3.70 × 3.52 in. (94.0 × 89.5 mm)
Displacement	303.2 cu. in. (4969 cm ³)
Valve clearance (engine cold)	Intake: 0.006 in. (0.15 mm) Exhaust: 0.009 in. (0.22 mm)
Drive belt tension	Automatic adjustment

Fuel

Fuel type	Unleaded gasoline only
Octane Rating	91 (Research Octane Number 96) or higher
Fuel tank capacity (Reference)	17.5 gal. (66.3 L, 14.6 Imp.gal.)

Lubrication system

▶ GS350

	2WD	AWD
Oil capacity (Drain and refill — reference [*])		
With filter	6.0 qt. (5.7 L, 5.0 Imp.qt.)	6.8 qt. (6.4 L, 5.6 Imp.qt.)
Without filter	5.8 qt. (5.5 L, 4.8 Imp.qt.)	6.3 qt. (6.0 L, 5.3 Imp.qt.)

^{*}: The engine oil capacity is a reference quantity to be used when changing the engine oil. Warm up and turn off the engine, wait more than 5 minutes, and check the oil level on the dipstick.

■ **Engine oil selection**

“Toyota Genuine Motor Oil” is used in your Lexus vehicle. Use Lexus approved “Toyota Genuine Motor Oil” or equivalent to satisfy the following grade and viscosity.

Oil grade: ILSAC GF-5 multigrade engine oil

Recommended viscosity: SAE 0W-20

SAE 0W-20 is the best choice for good fuel economy and good starting in cold weather.

If SAE 0W-20 is not available, SAE 5W-20 oil may be used. However, it must be replaced with SAE 0W-20 at the next oil change.

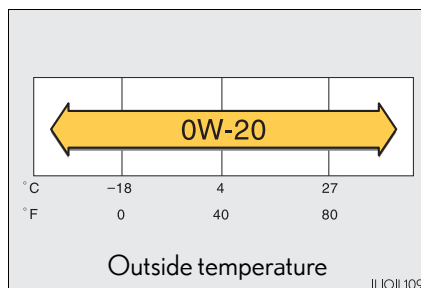

Oil viscosity (0W-20 is explained here as an example):

- The 0W in 0W-20 indicates the characteristic of the oil which allows cold startability. Oils with a lower value before the W allow for easier starting of the engine in cold weather.
- The 20 in 0W-20 indicates the viscosity characteristic of the oil when the oil is at high temperature. An oil with a higher viscosity (one with a higher value) may be better suited if the vehicle is operated at high speeds, or under extreme load conditions.

How to read oil container label:

The International Lubricant Specification Advisory Committee (ILSAC) Certification Mark is added to some oil containers to help you select the oil you should use.

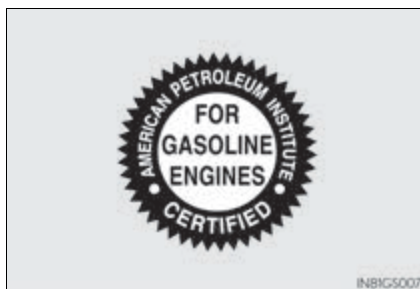

▶ GS200t

Oil capacity (Drain and refill – reference *)	
With filter	4.9 qt. (4.6 L, 4.0 Imp.qt.)
Without filter	4.5 qt. (4.3 L, 3.8 Imp.qt.)

*: The engine oil capacity is a reference quantity to be used when changing the engine oil. Warm up the engine and turn off the engine, wait more than 5 minutes, and check the oil level on the dipstick.

■ Engine oil selection

“Toyota Genuine Motor Oil SAE 0W-20 for Direct Injection Turbo Gasoline Engines” is used in your Lexus vehicle. Use Lexus approved “Toyota Genuine Motor Oil SAE 0W-20 for Direct Injection Turbo Gasoline Engines” or equivalent to satisfy the following grade and viscosity.

Oil grade: “Toyota Genuine Motor Oil SAE 0W-20 for Direct Injection Turbo Gasoline Engines” or ILSAC GF-5 multigrade engine oil

Recommended viscosity: SAE 0W-20

SAE 0W-20 is the best choice for good fuel economy and good starting in cold weather.

If SAE 0W-20 is not available, SAE 5W-20 oil may be used. However, it must be replaced with SAE 0W-20 at the next oil change.

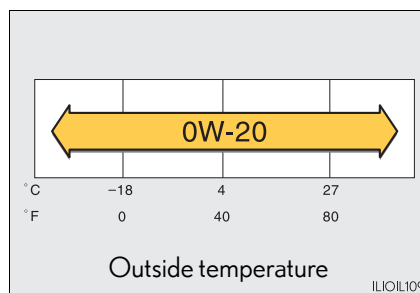

Oil viscosity (0W-20 is explained here as an example):

- The 0W in 0W-20 indicates the characteristic of the oil which allows cold startability. Oils with a lower value before the W allow for easier starting of the engine in cold weather.
- The 20 in 0W-20 indicates the viscosity characteristic of the oil when the oil is at high temperature. An oil with a higher viscosity (one with a higher value) may be better suited if the vehicle is operated at high speeds, or under extreme load conditions.

How to read oil container label:

The International Lubricant Specification Advisory Committee (ILSAC) Certification Mark is added to some oil containers to help you select the oil you should use.



► GSF

Oil capacity (Drain and refill – reference*)	
With filter	9.3 qt. (8.8 L, 7.7 Imp.qt.)
Without filter	8.3 qt. (7.9 L, 7.0 Imp.qt.)

*: The engine oil capacity is a reference quantity to be used when changing the engine oil. Warm up and turn off the engine, wait more than 5 minutes, and check the oil level on the dipstick.

■ Engine oil selection

“Toyota Genuine Motor Oil” is used in your Lexus vehicle. Use Lexus approved “Toyota Genuine Motor Oil” or equivalent to satisfy the following grade and viscosity.

Oil grade: ILSAC GF-5 multigrade engine oil

Recommended viscosity: SAE 5W-30

SAE 5W-30 is the best choice for good fuel economy and good starting in cold weather.

If SAE 5W-30 is not available, SAE 10W-30 oil may be used. However, it must be replaced with SAE 5W-30 at the next oil change.

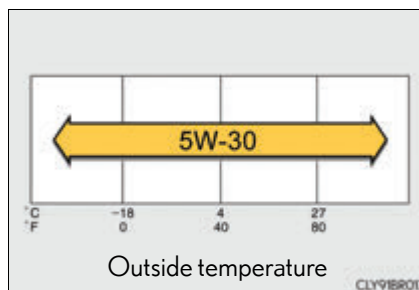

Oil viscosity (5W-30 is explained here as an example):

- The 5W in 5W-30 indicates the characteristic of the oil which allows cold startability. Oils with a lower value before the W allow for easier starting of the engine in cold weather.
- The 30 in 5W-30 indicates the viscosity characteristic of the oil when the oil is at high temperature. An oil with a higher viscosity (one with a higher value) may be better suited if the vehicle is operated at high speeds, or under extreme load conditions.

How to read oil container label:

The International Lubricant Specification Advisory Committee (ILSAC) Certification Mark is added to some oil containers to help you select the oil you should use.

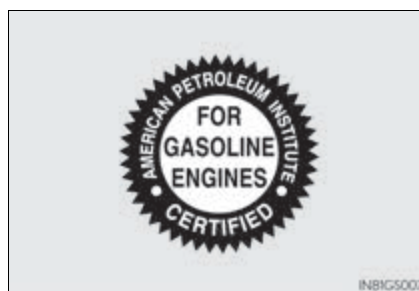

Cooling system

Capacity	GS350	9.9 qt.(9.4 L, 8.3 Imp.qt.)
	GS200t	<ul style="list-style-type: none"> ▶ Engine coolant 9.7 qt.(9.2 L, 8.1 Imp.qt.) ▶ Intercooler 2.3 qt.(2.2 L, 1.9 Imp.qt.)
	GS F	11.9 qt. (11.3 L, 9.9 Imp.qt.)
Coolant type	Use either of the following: <ul style="list-style-type: none"> • “Toyota Super Long Life Coolant” • Similar high-quality ethylene glycol-based non-silicate, non-amine, non-nitrite, and non-borate coolant with long-life hybrid organic acid technology Do not use plain water alone.	

Ignition system

	GS350	GS200t	GS F
Spark plug			
Make	DENSO	NGK	DENSO
Gap	FK20HBR8 0.031 in. (0.8 mm)	DILFR7K9G 0.04 in. (0.9 mm)	FK20HBR-J8 0.031 in. (0.8 mm)

 NOTICE

■ **Iridium-tipped spark plugs**

Use only iridium-tipped spark plugs. Do not adjust the spark plug gap.

Electrical system

Battery	
Open voltage at 68°F (20°C):	12.3 V or higher (Voltage is checked 20 minutes after the engine and all lights are turned off.)
Charging rates	5 A

Automatic transmission

Fluid capacity*	GS350 (2WD)	10.0 qt. (9.5 L, 8.4 Imp.qt.)
	GS350 (AWD)	10.6 qt. (10.0 L, 8.8 Imp.qt.)
	GS200t	9.2 qt. (8.7 L, 7.7 Imp.qt.)
	GS F	11.8 qt. (11.2 L, 9.9 Imp.qt.)
Fluid type	Toyota Genuine ATF WS	

*: The fluid capacity is the quantity of reference.
If replacement is necessary, contact your Lexus dealer.

NOTICE

■ Automatic transmission fluid type

Using transmission fluid other than “Toyota Genuine ATF WS” may cause deterioration in shift quality, locking up of your transmission accompanied by vibration, and ultimately damage the transmission of your vehicle.

Front differential (AWD models)

Oil capacity	0.74 qt. (0.70 L, 0.62 Imp.qt.)
Oil type and viscosity	Toyota Genuine Differential gear oil GL-5 or equivalent Above 0°F (-18°C): SAE90 Below 0°F (-18°C): SAE80W or SAE80W-90

Rear differential

▶ GS350/GS200t

Oil capacity	1.43 qt. (1.35 L, 119 Imp.qt.)
Oil type and viscosity	Toyota Genuine Differential gear oil LT 75W-85 GL-5 or equivalent*1

▶ GS F

	Differential	Torque transfer module*2
Oil capacity	1.43 qt. (1.35 L, 119 Imp. qt.)	Left-hand side: 0.74 qt. (0.70 L, 0.62 Imp. qt.) Right-hand side: 0.74 qt. (0.70 L, 0.62 Imp. qt.)
Oil type and viscosity	Toyota Genuine Differential gear oil LT 75W-85 GL-5 or equivalent*1	Toyota Genuine ATF WS*3

*1: Your Lexus vehicle is filled with "Toyota Genuine Differential Gear Oil" at the factory. Use Lexus approved "Toyota Genuine Differential Gear Oil" or an equivalent of matching quality to satisfy the above specification. Please contact your Lexus dealer for further details.

*2: Torque transfer modules are located on the right and left sides of the rear differential unit.

*3: Using torque transfer module fluid other than "Toyota Genuine ATF WS" may cause deterioration of performance, vibration, or ultimately damage the TVD system of your vehicle.

Brakes

Pedal clearance*	GS350/GS200t	4.0 in. (102 mm) Min.
	GS F	4.4 in. (112 mm) Min.
Pedal free play		0.04 – 0.24 in. (1.0 – 6.0 mm)
Brake pad wear limit		0.04 in. (1.0 mm)
Parking brake lining wear limit		0.04 in. (1.0 mm)
Fluid type		SAE J1703 or FMVSS No. 116 DOT 3

*: Minimum pedal clearance when depressed with a force of 112.4 lbf (500 N, 51.0 kgf) while the engine is running.

Steering

Free play	Less than 1.2 in. (30 mm)
-----------	---------------------------

Tires and wheels

► GS350/GS200t (type A)

Tire size	225/50R17 94W, T155/70D17 110M (spare)
Tire inflation pressure (Recommended cold tire inflation pressure)	<p>Driving under normal conditions Front: 35 psi (240 kPa, 2.4 kgf/cm² or bar) Rear: 35 psi (240 kPa, 2.4 kgf/cm² or bar) Spare: 60 psi (420 kPa, 4.2 kgf/cm² or bar)</p> <p>Driving at high speeds (above 118 mph [190 km/h]) (in countries where such speeds are permitted by law) Add 10 psi (70 kPa, 0.7 kgf/cm² or bar) to the front tires and rear tires. Never exceed the maximum cold tire inflation pressure indicated on the tire sidewall.</p>
Wheel size	17 × 7 1/2J, 17 × 4T (spare)
Wheel nut torque	76 ft•lbf (103 N•m, 10.5 kgf•m)

► GS350/GS200t (type B)

Tire size	225/50R17 94W, T145/70D18 107M (spare)
Tire inflation pressure (Recommended cold tire inflation pressure)	<p>Driving under normal conditions Front: 35 psi (240 kPa, 2.4 kgf/cm² or bar) Rear: 35 psi (240 kPa, 2.4 kgf/cm² or bar) Spare: 60 psi (420 kPa, 4.2 kgf/cm² or bar)</p> <p>Driving at high speeds (above 118 mph [190 km/h]) (in countries where such speeds are permitted by law) Add 10 psi (70 kPa, 0.7 kgf/cm² or bar) to the front tires and rear tires. Never exceed the maximum cold tire inflation pressure indicated on the tire sidewall.</p>
Wheel size	17 × 7 1/2J, 18 × 4T (spare)
Wheel nut torque	76 ft•lbf (103 N•m, 10.5 kgf•m)

► GS350/GS200t (type C)

Tire size	235/45R18 94Y, T155/70D17 110M (spare)
Tire inflation pressure (Recommended cold tire inflation pressure)	<p>Driving under normal conditions Front: 35 psi (240 kPa, 2.4 kgf/cm² or bar) Rear: 35 psi (240 kPa, 2.4 kgf/cm² or bar) Spare: 60 psi (420 kPa, 4.2 kgf/cm² or bar)</p> <p>Driving at high speeds (above 137 mph [220 km/h]) (in countries where such speeds are permitted by law) Add 10 psi (70 kPa, 0.7 kgf/cm² or bar) to the front tires and rear tires. Never exceed the maximum cold tire inflation pressure indicated on the tire sidewall.</p>
Wheel size	18 × 8J, 17 × 4T (spare)
Wheel nut torque	76 ft•lbf (103 N•m, 10.5 kgf•m)

► GS350/GS200t (type D)

Tire size	P235/45R18 94V, T145/70D18 107M (spare)
Tire inflation pressure (Recommended cold tire inflation pressure)	<p>Driving under normal conditions Front: 35 psi (240 kPa, 2.4 kgf/cm² or bar) Rear: 35 psi (240 kPa, 2.4 kgf/cm² or bar) Spare: 60 psi (420 kPa, 4.2 kgf/cm² or bar)</p> <p>Driving at high speeds (above 99 mph [160 km/h]) (in countries where such speeds are permitted by law) Add 10 psi (70 kPa, 0.7 kgf/cm² or bar) to the front tires and rear tires. Never exceed the maximum cold tire inflation pressure indicated on the tire sidewall.</p>
Wheel size	18 × 8J, 18 × 4T (spare)
Wheel nut torque	76 ft•lbf (103 N•m, 10.5 kgf•m)

► GS350/GS200t (type E)

Tire size	235/40R19 96Y XL, T155/70D17 110M (spare)
Tire inflation pressure (Recommended cold tire inflation pressure)	<p>Driving under normal conditions Front: 35 psi (240 kPa, 2.4 kgf/cm² or bar) Rear: 36 psi (250 kPa, 2.5 kgf/cm² or bar) Spare: 60 psi (420 kPa, 4.2 kgf/cm² or bar)</p> <p>Driving at high speeds (above 137 mph [220 km/h]) (in countries where such speeds are permitted by law) Add 10 psi (70 kPa, 0.7 kgf/cm² or bar) to the front tires, 9 psi (60 kPa, 0.6 kgf/cm² or bar) to the rear tires. Never exceed the maximum cold tire inflation pressure indicated on the tire sidewall.</p>
Wheel size	19 × 8J, 17 × 4T (spare)
Wheel nut torque	76 ft•lbf (103 N•m, 10.5 kgf•m)

► GS350/GS200t (type F)

Tire size	Front tires: 235/40R19 96Y XL Rear tires: 265/35R19 94Y Spare tire: T145/70D18 107M
Tire inflation pressure (Recommended cold tire inflation pressure)	<p>Driving under normal conditions Front: 35 psi (240 kPa, 2.4 kgf/cm² or bar) Rear: 36 psi (250 kPa, 2.5 kgf/cm² or bar) Spare: 60 psi (420 kPa, 4.2 kgf/cm² or bar)</p> <p>Driving at high speeds (above 137 mph [220 km/h]) (in countries where such speeds are permitted by law) Add 10 psi (70 kPa, 0.7 kgf/cm² or bar) to the front tires, 9 psi (60 kPa, 0.6 kgf/cm² or bar) to the rear tires. Never exceed the maximum cold tire inflation pressure indicated on the tire sidewall.</p>
Wheel size	Front wheels: 19 × 8J Rear wheels: 19 × 9J Spare wheel: 18 × 4T
Wheel nut torque	76 ft•lbf (103 N•m, 10.5 kgf•m)

► GS350/GS200t (type G)

Tire size	235/40R19 96V XL, T145/70D18 107M (spare)
Tire inflation pressure (Recommended cold tire inflation pressure)	<p>Driving under normal conditions Front: 35 psi (240 kPa, 2.4 kgf/cm² or bar) Rear: 36 psi (250 kPa, 2.5 kgf/cm² or bar) Spare: 60 psi (420 kPa, 4.2 kgf/cm² or bar)</p> <p>Driving at high speeds (above 99 mph [160 km/h]) (in countries where such speeds are permitted by law) Add 10 psi (70 kPa, 0.7 kgf/cm² or bar) to the front tires, 9 psi (60 kPa, 0.6 kgf/cm² or bar) to the rear tires. Never exceed the maximum cold tire inflation pressure indicated on the tire sidewall.</p>
Wheel size	19×8J, 18 × 4T (spare)
Wheel nut torque	76 ft•lbf (103 N•m, 10.5 kgf•m)

► GS F (type A)

Tire size	Front tires: 255/35ZR19 (92Y) Rear tires: 275/35ZR19 (96Y)
Tire inflation pressure (Recommended cold tire inflation pressure)	<p>Driving under normal conditions Front: 36 psi (250 kPa, 2.5 kgf/cm² or bar) Rear: 36 psi (250 kPa, 2.5 kgf/cm² or bar)</p> <p>Driving at high speeds (above 137 mph [220 km/h]) (in countries where such speeds are permitted by law) Add 8 psi (50 kPa, 0.5 kgf/cm² or bar) to the front tires and rear tires. Never exceed the maximum cold tire inflation pressure indicated on the tire sidewall.</p>
Wheel size	Front wheels: 19 × 9J Rear wheels: 19 × 10J
Wheel nut torque	76 ft•lbf (103 N•m, 10.5 kgf•m)

► GS F (type B)

Tire size	Front tires: 255/35ZR19 (92Y) Rear tires: 275/35ZR19 (96Y) Spare tire: 225/40ZR19 (93Y) XL
Tire inflation pressure (Recommended cold tire inflation pressure)	Driving under normal conditions Front: 36 psi (250 kPa, 2.5 kgf/cm ² or bar) Rear: 36 psi (250 kPa, 2.5 kgf/cm ² or bar) Spare: 42 psi (290 kPa, 2.9 kgf/cm ² or bar) Driving at high speeds (above 137 mph [220 km/h]) (in countries where such speeds are permitted by law) Add 8 psi (50 kPa, 0.5 kgf/cm ² or bar) to the front tires and rear tires. Never exceed the maximum cold tire inflation pressure indicated on the tire sidewall.
Wheel size	Front wheels: 19 × 9J Rear wheels: 19 × 10J Spare wheel: 19 × 8 1/2J
Wheel nut torque	76 ft•lbf (103 N•m, 10.5 kgf•m)

Light bulbs

	Light bulbs	Bulb No.	W	Type
Exterior	Front turn signal lights *	7444NA	28	A
	Outer foot lights	W5W	5	B
Interior	Vanity lights	—	8	B
	Trunk light	—	3.8	B

A: Wedge base bulbs (amber)

B: Wedge base bulbs (clear)

*: Vehicles with single-beam headlights

Fuel information

You must only use unleaded gasoline.

▶ GS350/GS F

Select premium unleaded gasoline with an octane rating of 91 (Research Octane Number 96) or higher required for optimum engine performance. If 91 octane cannot be obtained, you may use unleaded gasoline with an octane rating as low as 87 (Research Octane Number 91). Use of unleaded gasoline with an octane rating lower than 91 may result in engine knocking and significantly reduced performance. Persistent knocking can lead to engine damage and should be corrected by refueling with higher octane unleaded gasoline.

▶ GS200t

Select premium unleaded gasoline with an octane rating of 91 (Research Octane Number 96) or higher required for optimum engine performance. If 91 octane cannot be obtained, you may use unleaded gasoline with an octane rating as low as 87 (Research Octane Number 91). Use of unleaded gasoline with an octane rating lower than 91 may result in engine knocking and significantly reduced performance. Persistent knocking can lead to engine damage and should be corrected by refueling with higher octane unleaded gasoline.

At minimum, the gasoline you use should meet the specifications of ASTM D4814 in the U.S.A..

■ Gasoline quality

In very few cases, driveability problems may be caused by the brand of gasoline you are using. If driveability problems persist, try changing the brand of gasoline. If this does not correct the problem, consult your Lexus dealer.

■ Gasoline quality standards

- Automotive manufacturers in the U.S.A., Europe and Japan have developed a specification for fuel quality called the World-Wide Fuel Charter (WWFC), which is expected to be applied worldwide.
- The WWFC consists of four categories that are based on required emission levels. In the U.S., category 4 has been adopted.
- The WWFC improves air quality by lowering emissions in vehicle fleets, and improves customer satisfaction through better performance.

■ **Recommendation of the use of gasoline containing detergent additives**

- Lexus recommends the use of gasoline that contains detergent additives to avoid the build-up of engine deposits.
- All gasoline sold in the U.S.A. contains minimum detergent additives to clean and/or keep clean intake systems, per EPA's lowest additives concentration program.
- Lexus strongly recommends the use of Top Tier Detergent Gasoline. For more information on Top Tier Detergent Gasoline and a list of marketers, please go to the official website www.toptiergas.com.

■ **Recommendation of the use of low emissions gasoline**

Gasolines containing oxygenates such as ethers and ethanol, as well as reformulated gasolines, are available in some cities. These fuels are typically acceptable for use, providing they meet other fuel requirements.

Lexus recommends these fuels, since the formulations allow for reduced vehicle emissions.

■ **Non-recommendation of the use of blended gasoline**

- Use only gasoline containing up to 15% ethanol. DO NOT use any flex-fuel or gasoline that could contain more than 15% ethanol, including from any pump labeled E30, E50, E85 (which are only some examples of fuel containing more than 15% ethanol).

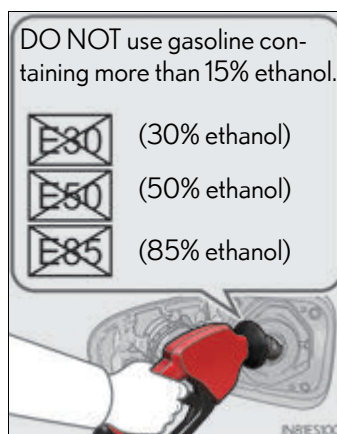

- If you use gasohol in your vehicle, be sure that it has an octane rating no lower than 87.
- Lexus does not recommend the use of gasoline containing methanol.

■ **Non-recommendation of the use of gasoline containing MMT**

Some gasoline contains an octane enhancing additive called MMT (Methylcyclopentadienyl Manganese Tricarbonyl).

Lexus does not recommend the use of gasoline that contains MMT. If fuel containing MMT is used, your emission control system may be adversely affected.

The malfunction indicator lamp on the instrument cluster may come on. If this happens, contact your Lexus dealer for service.

■ **If your engine knocks**

- Consult your Lexus dealer.
- You may occasionally notice light knocking for a short time while accelerating or driving uphill. This is normal and there is no need for concern.

 NOTICE**■ Notice on fuel quality**

- Do not use improper fuels. If improper fuels are used, the engine will be damaged.
- Do not use leaded gasoline.
Leaded gasoline can cause damage to your vehicle's three-way catalytic converters causing the emission control system to malfunction.
- Do not use gasohol other than the type previously stated.
Other gasohol may cause fuel system damage or vehicle performance problems.
- Using unleaded gasoline with an octane number or rating lower than the level previously stated will cause persistent heavy knocking.
At worst, this will lead to engine damage.

■ Fuel-related poor driveability

If poor driveability (poor hot starting, vaporization, engine knocking, etc.) is encountered after using a different type of fuel, discontinue the use of that type of fuel.

■ When refueling with gasohol

Take care not to spill gasohol. It can damage your vehicle's paint.

Tire information

Typical tire symbols

► Full-size tire

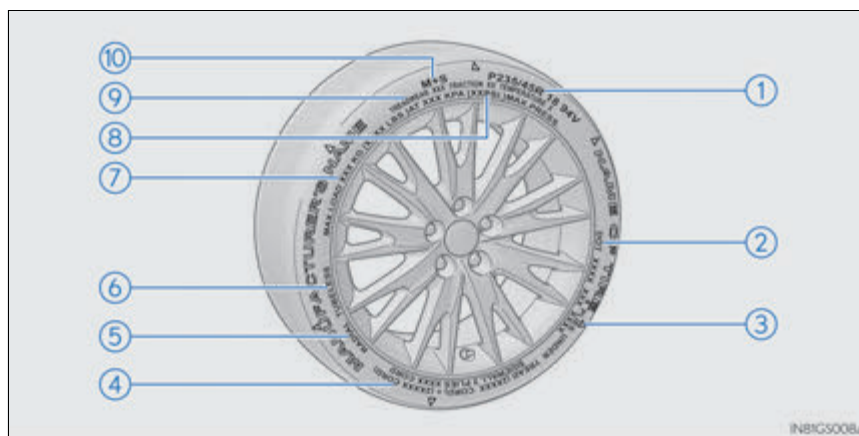

► Compact spare tire

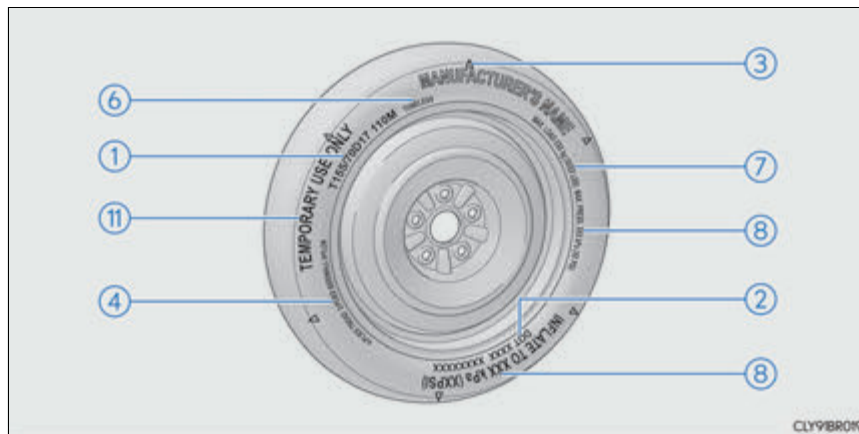

-
- ① Tire size (→P. 560)
 - ② DOT and Tire Identification Number (TIN) (→P. 560)
 - ③ Location of treadwear indicators (→P. 413)
 - ④ Tire ply composition and materials
Plies are layers of rubber-coated parallel cords. Cords are the strands which form the plies in a tire.
 - ⑤ Radial tires or bias-ply tires
A radial tire has "RADIAL" on the sidewall. A tire not marked "RADIAL" is a bias-ply tire.
 - ⑥ TUBELESS or TUBE TYPE
A tubeless tire does not have a tube and air is directly put into the tire. A tube type tire has a tube inside the tire and the tube maintains the air pressure.
 - ⑦ Load limit at maximum cold tire inflation pressure (→P. 563)
 - ⑧ Maximum cold tire inflation pressure (→P. 563)
This means the pressure to which a tire may be inflated.
 - ⑨ Uniform tire quality grading
For details, see "Uniform Tire Quality Grading" that follows.
 - ⑩ Summer tires or all season tires (→P. 417)
An all season tire has "M+S" on the sidewall. A tire not marked "M+S" is a summer tire.
 - ⑪ "TEMPORARY USE ONLY"
A compact spare tire is identified by the phrase "TEMPORARY USE ONLY" molded on its sidewall. This tire is designed for temporary emergency use only.

Typical DOT and Tire Identification Number (TIN)

- ① DOT symbol*
- ② Tire Identification Number (TIN)
- ③ Tire manufacturer's identification mark
- ④ Tire size code
- ⑤ Manufacturer's optional tire type code (3 or 4 letters)
- ⑥ Manufacturing week
- ⑦ Manufacturing year

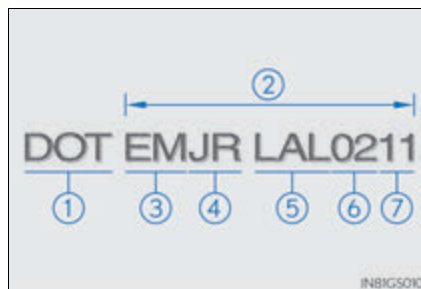

*: The DOT symbol certifies that the tire conforms to applicable Federal Motor Vehicle Safety Standards.

Tire size

■ Typical tire size information

The illustration indicates typical tire size.

- ① Tire use
(P = Passenger car,
T = Temporary use)
- ② Section width (millimeters)
- ③ Aspect ratio
(tire height to section width)
- ④ Tire construction code (R = Radial, D = Diagonal)
- ⑤ Wheel diameter (inches)
- ⑥ Load index (2 digits or 3 digits)
- ⑦ Speed symbol (alphabet with one letter)

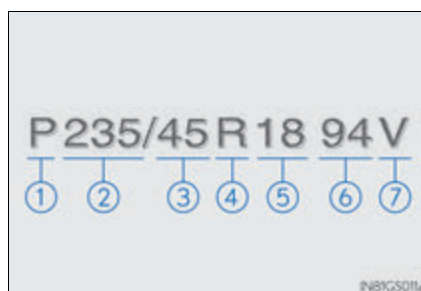

■ Tire dimensions

- ① Section width
- ② Tire height
- ③ Wheel diameter

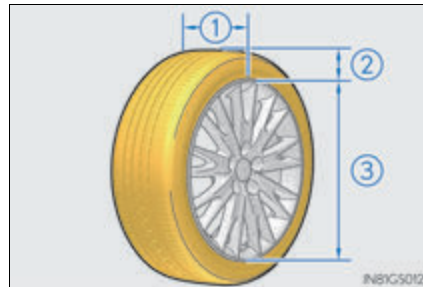

Tire section names

- ① Bead
- ② Sidewall
- ③ Shoulder
- ④ Tread
- ⑤ Belt
- ⑥ Inner liner
- ⑦ Reinforcing rubber
- ⑧ Carcass
- ⑨ Rim lines
- ⑩ Bead wires
- ⑪ Chafer

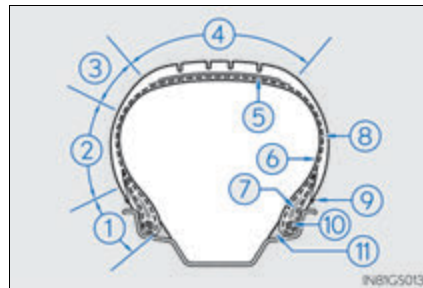

Uniform Tire Quality Grading

This information has been prepared in accordance with regulations issued by the National Highway Traffic Safety Administration of the U.S. Department of Transportation.

It provides the purchasers and/or prospective purchasers of Lexus vehicles with information on uniform tire quality grading.

Your Lexus dealer will help answer any questions you may have as you read this information.

■ DOT quality grades

All passenger vehicle tires must conform to Federal Safety Requirements in addition to these grades. Quality grades can be found where applicable on the tire sidewall between tread shoulder and maximum section width.

For example: Treadwear 200 Traction AA Temperature A

■ Treadwear

The treadwear grade is a comparative rating based on the wear rate of the tire when tested under controlled conditions on a specified government test course.

For example, a tire graded 150 would wear one and a half (1 - 1/2) times as well on the government course as a tire graded 100.

The relative performance of tires depends upon the actual conditions of their use. Performance may differ significantly from the norm due to variations in driving habits, service practices and differences in road characteristics and climate.

■ Traction AA, A, B, C

The traction grades, from highest to lowest, are AA, A, B and C, and they represent the tire's ability to stop on wet pavement as measured under controlled conditions on specified government test surfaces of asphalt and concrete.

A tire marked C may have poor traction performance.

Warning: The traction grade assigned to this tire is based on braking (straight ahead) traction tests and does not include cornering (turning) traction.

■ **Temperature A, B, C**

The temperature grades are A (the highest), B, and C, representing the tire's resistance to the generation of heat and its ability to dissipate heat when tested under controlled conditions on a specified indoor laboratory test wheel.

Sustained high temperature can cause the material of the tire to degenerate and reduce tire life, and excessive temperature can lead to sudden tire failure.

Grade C corresponds to a level of performance which all passenger car tires must meet under the Federal Motor Vehicle Safety Standard No. 109.

Grades B and A represent higher levels of performance on the laboratory test wheel than the minimum required by law.

Warning: The temperature grades of a tire assume that it is properly inflated and not overloaded.

Excessive speed, underinflation, or excessive loading, either separately or in combination, can cause heat buildup and possible tire failure.

Glossary of tire terminology

Tire related term	Meaning
Cold tire inflation pressure	Tire pressure when the vehicle has been parked for three hours or more, or has not been driven more than 1 mile or 1.5 km under that condition
Maximum inflation pressure	The maximum cold inflated pressure to which a tire may be inflated, shown on the sidewall of the tire
Recommended inflation pressure	Cold tire inflation pressure recommended by a manufacturer
Accessory weight	The combined weight (in excess of those standard items which may be replaced) of automatic transmission, power steering, power brakes, power windows, power seats, radio and heater, to the extent that these items are available as factory-installed equipment (whether installed or not)
Curb weight	The weight of a motor vehicle with standard equipment, including the maximum capacity of fuel, oil and coolant, and if so equipped, air conditioning and additional weight optional engine
Maximum loaded vehicle weight	The sum of: (a) Curb weight (b) Accessory weight (c) Vehicle capacity weight (d) Production options weight
Normal occupant weight	150 lb. (68 kg) times the number of occupants specified in the second column of Table 1* that follows

Tire related term	Meaning
Occupant distribution	Distribution of occupants in a vehicle as specified in the third column of Table 1* below
Production options weight	The combined weight of installed regular production options weighing over 5 lb. (2.3 kg) in excess of the standard items which they replace, not previously considered in curb weight or accessory weight, including heavy duty brakes, ride levelers, roof rack, heavy duty battery, and special trim
Rim	A metal support for a tire or a tire and tube assembly upon which the tire beads are seated
Rim diameter (Wheel diameter)	Nominal diameter of the bead seat
Rim size designation	Rim diameter and width
Rim type designation	The industry manufacturer's designation for a rim by style or code
Rim width	Nominal distance between rim flanges
Vehicle capacity weight (Total load capacity)	The rated cargo and luggage load plus 150 lb. (68 kg) times the vehicle's designated seating capacity
Vehicle maximum load on the tire	The load on an individual tire that is determined by distributing to each axle its share of the maximum loaded vehicle weight, and dividing by two
Vehicle normal load on the tire	The load on an individual tire that is determined by distributing to each axle its share of curb weight, accessory weight, and normal occupant weight (distributed in accordance with Table 1* below), and dividing by two
Weather side	The surface area of the rim not covered by the inflated tire
Bead	The part of the tire that is made of steel wires, wrapped or reinforced by ply cords and that is shaped to fit the rim
Bead separation	A breakdown of the bond between components in the bead
Bias ply tire	A pneumatic tire in which the ply cords that extend to the beads are laid at alternate angles substantially less than 90 degrees to the centerline of the tread
Carcass	The tire structure, except tread and sidewall rubber which, when inflated, bears the load
Chunking	The breaking away of pieces of the tread or sidewall
Cord	The strands forming the plies in the tire

Tire related term	Meaning
Cord separation	The parting of cords from adjacent rubber compounds
Cracking	Any parting within the tread, sidewall, or innerliner of the tire extending to cord material
CT	A pneumatic tire with an inverted flange tire and rim system in which the rim is designed with rim flanges pointed radially inward and the tire is designed to fit on the underside of the rim in a manner that encloses the rim flanges inside the air cavity of the tire
Extra load tire	A tire designed to operate at higher loads and at higher inflation pressures than the corresponding standard tire
Groove	The space between two adjacent tread ribs
Innerliner	The layer(s) forming the inside surface of a tubeless tire that contains the inflating medium within the tire
Innerliner separation	The parting of the innerliner from cord material in the carcass
Intended outboard sidewall	(a) The sidewall that contains a whitewall, bears white lettering, or bears manufacturer, brand, and/or model name molding that is higher or deeper than the same molding on the other sidewall of the tire, or (b) The outward facing sidewall of an asymmetrical tire that has a particular side that must always face outward when mounted on a vehicle
Light truck (LT) tire	A tire designated by its manufacturer as primarily intended for use on lightweight trucks or multipurpose passenger vehicles
Load rating	The maximum load that a tire is rated to carry for a given inflation pressure
Maximum load rating	The load rating for a tire at the maximum permissible inflation pressure for that tire
Maximum permissible inflation pressure	The maximum cold inflation pressure to which a tire may be inflated
Measuring rim	The rim on which a tire is fitted for physical dimension requirements
Open splice	Any parting at any junction of tread, sidewall, or innerliner that extends to cord material
Outer diameter	The overall diameter of an inflated new tire

Tire related term	Meaning
Overall width	The linear distance between the exteriors of the sidewalls of an inflated tire, including elevations due to labeling, decorations, or protective bands or ribs
Passenger car tire	A tire intended for use on passenger cars, multipurpose passenger vehicles, and trucks, that have a gross vehicle weight rating (GVWR) of 10,000 lb. or less.
Ply	A layer of rubber-coated parallel cords
Ply separation	A parting of rubber compound between adjacent plies
Pneumatic tire	A mechanical device made of rubber, chemicals, fabric and steel or other materials, that, when mounted on an automotive wheel, provides the traction and contains the gas or fluid that sustains the load
Radial ply tire	A pneumatic tire in which the ply cords that extend to the beads are laid at substantially 90 degrees to the centerline of the tread
Reinforced tire	A tire designed to operate at higher loads and at higher inflation pressures than the corresponding standard tire
Section width	The linear distance between the exteriors of the sidewalls of an inflated tire, excluding elevations due to labeling, decoration, or protective bands
Sidewall	That portion of a tire between the tread and bead
Sidewall separation	The parting of the rubber compound from the cord material in the sidewall
Snow tire	A tire that attains a traction index equal to or greater than 110, compared to the ASTM E-1136 Standard Reference Test Tire, when using the snow traction test as described in ASTM F-1805-00, Standard Test Method for Single Wheel Driving Traction in a Straight Line on Snow-and Ice-Covered Surfaces, and which is marked with an Alpine Symbol () on at least one sidewall

Tire related term	Meaning
Test rim	The rim on which a tire is fitted for testing, and may be any rim listed as appropriate for use with that tire
Tread	That portion of a tire that comes into contact with the road
Tread rib	A tread section running circumferentially around a tire
Tread separation	Pulling away of the tread from the tire carcass
Treadwear indicators (TWI)	The projections within the principal grooves designed to give a visual indication of the degrees of wear of the tread
Wheel-holding fixture	The fixture used to hold the wheel and tire assembly securely during testing

*: Table 1— Occupant loading and distribution for vehicle normal load for various designated seating capacities

Designated seating capacity, Number of occupants	Vehicle normal load, Number of occupants	Occupant distribution in a normally loaded vehicle
2 through 4	2	2 in front
5 through 10	3	2 in front, 1 in second seat
11 through 15	5	2 in front, 1 in second seat, 1 in third seat, 1 in fourth seat
16 through 20	7	2 in front, 2 in second seat, 2 in third seat, 1 in fourth seat

Customizable features

Your vehicle includes a variety of electronic features that can be personalized to your preferences. These preferences can be changed by using the meter control switches, by using the Remote Touch, or at your Lexus dealer.







Customizing vehicle features

■ Changing by using the Remote Touch

- 1 Press the "MENU" button on the Remote Touch.
- 2 Select  on the "Menu" screen and select "Vehicle".

Various setting can be changed. Refer to the list of settings that can be changed for details.

■ Changing by using the meter control switches

- 1 Press  or  of the meter control switches, select .
 - 2 Press  or  of the meter control switches, select the item or the desired setting, and then press .
- To go back to the previous screen, press .

Customizable features



Some function settings are changed simultaneously with other functions being customized. Contact your Lexus dealer for further details.

- ① Settings that can be changed using the Remote Touch
- ② Settings that can be changed using the meter control switches
- ③ Settings that can be changed by your Lexus dealer

Definition of symbols: ○ = Available, – = Not available

■ **Meters and multi-information display (→P. 100, 108)**

▶ GS350/GS200t

Function	Default setting	Customized setting	①	②	③
Language	English	French	○	○	–
		Spanish	○	○	–
Units*1	miles (MPG US)	miles (MPG Imperial)	○	○	–
		km (L/100 km)	○	○	–
		km (km/L)	○	○	–
Eco Driving Indicator Light	On (self-lighting)	Off	–	○	–
 switch settings	Drive information 1	Desired status screen*2	–	○	–
Drive information screen displayed on the first screen of  (Drive information 1)	Current fuel consumption	*3	–	○	–
	Average fuel economy (after reset)		–	○	–
Drive information screen displayed on the second screen of  (Drive information 2)	Distance (range)	*3	–	○	–
	Average speed (after reset)		–	○	–

Function	Default setting	Customized setting	①	②	③
Drive information screen displayed on the third screen of  (Drive information 3)	Average fuel economy (after refuel)	*3	-	○	-
	Elapsed time (after start)				
Pop-up display	On	Off	-	○	-
Accent color*4	Color 1	Color 2	○	○	-
Clock	12-hour display	24-hour display	-	○	-
Needle*5	Blue	Red	-	○	-
		White			
Rev indicator*5	5000 rpm	2000 to 6800 rpm*6	-	○	-
		2000 to 6100 rpm*7			
		OFF			
Rev peak*5	ON	OFF	-	○	-

*1: The default setting varies according to countries.

*2: Some status screens cannot be registered (indicated on the multi-information display)

*3: 2 of the following items: current fuel consumption, average fuel economy (after reset), average fuel economy (after refuel), average fuel economy (after start), average vehicle speed (after reset), average vehicle speed (after start), distance (driving range), distance (after start), elapsed time (after reset), elapsed time (after start), blank





*4: Except F SPORT models

*5: F SPORT models

*6: GS350

*7: GS200t

▶ GSF

Function	Default setting	Customized setting	①	②	③
Language	English	French	○	○	–
		Spanish			
Units *1	miles (MPG US)	km (km/L)	○	○	–
		km (L/100 km)			
		miles (MPG Imperial)			
Eco Driving Indicator Light	ON (self-lighting)	OFF	–	○	–
 switch settings	Drive information 1	Desired status screen *2	–	○	–
Drive information screen displayed on the first screen of  (Drive information 1)	Current fuel economy	*3	–	○	–
	Average fuel economy (after reset)				
Drive information screen displayed on the second screen of  (Drive information 2)	Distance (driving range)	*3	–	○	–
	Average vehicle speed (after reset)				
Drive information screen displayed on the third screen of  (Drive information 3)	Average fuel economy (after refuel)	*3	–	○	–
	Elapsed time (after start)				
Pop-up display	ON	OFF	–	○	–



Function		Default setting	Customized setting	①	②	③
Rev indicator		Setting 2	Setting 1	-	○	-
			Setting 3			
			OFF			
Rev peak		ON	OFF	-	○	-
Speed indicator		OFF	30 to 100 mph (50 to 160 km/h)	-	○	-
SPORT gauges	SPORT S	Type A	Type B	-	○	-
	SPORT S+	Type B	Type A	-	○	-

*1: The default setting varies according to country.

*2: Some status screens cannot be registered (indicated on multi-information display).



*3: 2 of the following items: current fuel consumption, average fuel economy (after reset), average fuel economy (after refuel), average fuel economy (after start), average vehicle speed (after reset), average vehicle speed (after start), distance (driving range), distance (after start), elapsed time (after reset), elapsed time (after start), blank.

■ LKA (Lane-Keeping Assist)* /LDA (Lane Departure Alert with steering control)*
(→P. 249, 258)

Function		Default setting	Customized setting	①	②	③
Lane centering function*		Off	On	-	○	-
Steering assist		On	Off	-	○	-
Adjust alert type*	 (Steering vibration)	 (Buzzer)		-	○	-
Alert sensitivity		High	Standard	-	○	-
Vehicle sway warning		On	Off	-	○	-
Vehicle sway warning sensitivity		Standard	Low	-	○	-
			High			

*: If equipped

■ PCS (Pre-Collision System)* (→P. 237)

Function	Default setting	Customized setting	①	②	③
PCS (Pre-Collision System)	On	Off	–	○	–
Adjust alert timing	 (Middle)	 (Far)	–	○	–
		 (Near)			

*: If equipped

■ BSM (Blind Spot Monitor)* (→P. 298)

Function	Default setting	Customized setting	①	②	③
BSM (Blind Spot Monitor)	On	Off	–	○	–

*: If equipped

■ AFS (Adaptive Front-lighting System)* (→P. 216)

Function	Default setting	Customized setting	①	②	③
AFS (Adaptive Front-lighting System)	On	Off	–	○	–

*: If equipped

■ Door lock (→P.137, 520)

Function	Default setting	Customized setting	①	②	③
Unlocking on second key turn (Allows all doors to be unlocked by turning the mechanical key twice in the driver's door)	On (Driver's door unlocked in one step, all doors unlocked in two steps)	Off (All doors unlocked in one step)	-	-	○
Automatic door lock	Shifting the shift lever to position other than P	Off	○	-	○
		Vehicle speed is approximately 12 mph (20 km/h) or higher			
Automatic door unlock	Shifting the shift lever to P	Off	○	-	○
		Driver's door is opened			
Locking/unlocking of the trunk when all doors are locked/unlocked	On	Off	-	-	○

■ Smart access system with push-button start and wireless remote control
(→P.132, 150)

Function	Default setting	Customized setting	①	②	③
Operation signal (Buzzers)	5	Off	○	–	○
		1 to 7	○	–	○
Operation signal (Emergency flashers)	On	Off	○	–	○
Time elapsed before automatic door lock function is activated if a door is not opened after being unlocked	60 seconds	Off	○	–	○
		30 seconds			
		120 seconds			
Open door reminder buzzer (When locking the vehicle)	On	Off	–	–	○

■ Smart access system with push-button start (→P.150)

Function	Default setting	Customized setting	①	②	③
Smart access system with push-button start	On	Off	○	–	○
Select doors to unlock	Driver's door	All the doors	○	–	○
Number of consecutive door lock operations	2 times	As many as desired	–	–	○

■ Wireless remote control (→P. 132)

Function	Default setting	Customized setting	①	②	③
Wireless remote control	On	Off	-	-	○
Unlocking operation	On (Driver's door unlocked in one step, all doors unlocked in two steps)	Off (All doors unlocked in one step)	○	-	○
Trunk unlocking operation	Press and hold (short)	One short press	-	-	○
		Push twice			
		Press and hold (long)			
		Off			
Alarm (panic mode)	On	Off	-	-	○

■ Front seats (→P. 158)

Function	Default setting	Customized setting	①	②	③
Driver's seat movement when exiting the vehicle	Standard	Off	○	-	○
		Partial			
Selecting the door linking driving position memory with door unlock operation	Driver's door	All doors	-	-	○

■ Outside rear view mirrors (→P. 171)

Function	Default setting	Customized setting	①	②	③
Automatic mirror folding and extending operation*	Linked to the locking/unlocking of the doors	Off	-	-	○
		Linked to operation of the engine switch			
Linked mirror function when reversing	On	Off	-	-	○

*: If equipped

■ Power windows and moon roof (→P. 175, 178)

Function	Default setting	Customized setting	①	②	③
Mechanical key linked operation	Off	On	-	-	○
Wireless remote control linked operation	Off	On (Open only)	-	-	○
Buzzer sounds if operated using wireless remote control	On	Off	-	-	○

■ Automatic light control system (→P. 215)

Function	Default setting	Customized setting	①	②	③
Light sensor sensitivity	Standard	-2 to 2	○	-	○
Time elapsed before the headlights automatically turn off	30 seconds	Off	○	-	○
		60 seconds			
		90 seconds			
Welcome light illumination control	On	Off	-	-	○

■ Lights (→P. 215)

Function	Default setting	Customized setting	①	②	③
Daytime running lights *	On	Off	○	-	○

*: U.S.A. only

■ Intuitive parking assist^{*1,2}

Function	Default setting	Customized setting	①	②	③
Detection distance of the front center sensor ^{*3}	Far	Near	○	–	○
Detection distance of the rear center sensor	Far	Near	○	–	○
Buzzer volume	3	1 to 5	○	–	○
Display setting (when intuitive parking assist is operating)	All sensors displayed	Display off	○	–	○

*1: If equipped

*2: Refer to the "NAVIGATION AND MULTIMEDIA SYSTEM OWNER'S MANUAL".

*3: GS350/GS200t

■ Driving mode select switch (vehicles with Adaptive Variable Suspension system)(→P. 294)

Function	Default setting	Customized setting	①	②	③
Power train control	Normal	Power	○	–	–
		Eco			
Chassis control	Normal	Sport	○	–	–
Air conditioning operation	Normal	Eco	○	–	–

■ Automatic air conditioning system (→P. 328)

Function	Default setting	Customized setting	①	②	③
A/C Auto switch operation	On	Off	<input type="radio"/>	-	<input type="radio"/>
Exhaust gas sensor information	Standard	-3 to 3	<input type="radio"/>	-	<input type="radio"/>

■ Front seat heaters (without seat ventilators)* (→P.344)

Function	Default setting	Customized setting	①	②	③
Automatic operation of front seat heater	Off	On	-	-	<input type="radio"/>

■ Front seat heaters and ventilators*¹/rear seat heaters*² (→P. 343)

Function	Default setting	Customized setting	①	②	③
Adjustment of the front seat heater temperature or the ventilator fan speed during automatic operation (individual seat adjustment available)	Level 3 (standard)	Level 1 (low) to level 5 (high)	<input type="radio"/>	-	<input type="radio"/>
Adjustment of the rear seat heater temperature during automatic operation (individual seat adjustment available)	Level 3 (standard)	Level 1 (low) to level 5 (high)	<input type="radio"/>	-	<input type="radio"/>
Rear seat heater start-up conditions when the engine switch is in IGNITION ON mode (individual seat adjustment available)	Off	On (AUTO)	<input type="radio"/>	-	<input type="radio"/>

*1: If both are equipped

*2: If equipped

■ Illumination (→P. 347)

Function	Default setting	Customized setting	①	②	③
Interior lights illumination control	On	Off	-	-	○
Time elapsed before the interior lights turn off	15 seconds	7.5 seconds	○	-	○
		30 seconds			
Operation after the engine switch is turned off	On	Off	-	-	○
Operation when the doors are unlocked	On	Off	-	-	○
Operation when you approach the vehicle with the electronic key on your person	On	Off	-	-	○
Footwell lighting	On	Off	-	-	○
Outer foot lights	On	Off	-	-	○
Time elapsed before the outer foot lights turn off	15 seconds	Off	○	-	○
		7.5 seconds			
		30 seconds			
Enable/disable operation of the outer foot lights when you approach the vehicle with the electronic key on your person	On	Off	-	-	○
Enable/disable operation of the outer foot lights when the doors are unlocked with the power door lock switch	On	Off	-	-	○

■ Rear sunshade* (→P.361)

Function	Default setting	Customized setting	①	②	③
Reverse operation	On	Off	-	-	○
Time elapsed before the reverse operation feature activates	0.7 seconds	0 second	-	-	○
		0.9 seconds			
		1.2 seconds			

*: If equipped

■ Seat belt reminder buzzer (→P.454)

Function	Default setting	Customized setting	①	②	③
Speed-linked seat belt reminder function	On	Off	-	-	○

■ Vehicle customization

- When the speed linked door locking function and shift position linked door locking function are both on, the door lock operates as follows.
 - When shifting the shift lever to any position other than P, all the doors will be locked.
 - If the vehicle is started with all the doors locked, the speed linked door locking function would not operate.
 - If the vehicle is started with any door unlocked, the speed linked door locking function will operate.
- When the smart access system with push-button start is off, the selecting door to unlock cannot be customized.
- When the doors remain closed after unlocking the doors and the automatic door lock function (time elapsed before the automatic door lock function is activated if a door is not opened after being unlocked) activates, the signals will be generated in accordance with the operation signal (buzzers) and the operation signal (emergency flashers) settings.
- Some settings can be changed using a switch or the Remote Touch screen. If a setting is changed using a switch, the changed setting will not be reflected on the Remote Touch screen until the engine switch is turned off and then to IGNITION ON mode.

■ When customizing using the Remote Touch

Stop the vehicle in a safe place, apply the parking brake, and shift the shift lever to P. Also, to prevent battery discharge, leave the engine running while customizing the features.

 **WARNING**

■ **During customization**

As the engine needs to be running during customization, ensure that the vehicle is parked in a place with adequate ventilation. In a closed area such as a garage, exhaust gases including harmful carbon monoxide (CO) may collect and enter the vehicle. This may lead to death or a serious health hazard.

 **NOTICE**

■ **During customization**

To prevent battery discharge, ensure that the engine is running while customizing features.

Items to initialize

The following items must be initialized for normal system operation after such cases as the battery being reconnected, or maintenance being performed on the vehicle:

Item	When to initialize	Reference
Message indicating maintenance is required*1	<ul style="list-style-type: none"> • After the maintenance is performed 	P. 386
Oil maintenance*2	<ul style="list-style-type: none"> • After the maintenance is performed 	P. 404
Tire pressure warning system	<ul style="list-style-type: none"> • When rotating the tires • When changing the tire inflation pressure by changing traveling speed or load weight, etc. 	P. 415

*1: U.S.A. only

*2: GS350/GS200t

	9		585
For owners			
		Reporting safety defects for U.S. owners.....	586
		Seat belt instructions for Canadian owners (in French)	587
		SRS airbag instructions for Canadian owners (in French)	589
		Headlight aim instructions for Canadian owners (in French) (vehicles with single-beam headlights).....	597

Reporting safety defects for U.S. owners

If you believe that your vehicle has a defect which could cause a crash or could cause injury or death, you should immediately inform the National Highway Traffic Safety Administration (NHTSA) in addition to notifying the Lexus Division of Toyota Motor Sales, U.S.A., Inc. (Toll-free: 1-800-25-LEXUS).

If NHTSA receives similar complaints, it may open an investigation, and if it finds that a safety defect exists in a group of vehicles, it may order a recall and remedy campaign. However, NHTSA cannot become involved in individual problems between you, your dealer, or Lexus Division of Toyota Motor Sales, U.S.A., Inc.

To contact NHTSA, you may call the Vehicle Safety Hotline toll-free at 1-888-327-4236 (TTY: 1-800-424-9153); go to <http://www.safercar.gov>; or write to: Administrator, NHTSA, 1200 New Jersey Ave, S.E., Washington, DC 20590. You can also obtain other information about motor vehicle safety from <http://www.safercar.gov>.

Seat belt instructions for Canadian owners (in French)

The following is a French explanation of seat belt instructions extracted from the seat belt section in this manual.

See the seat belt section for more detailed seat belt instructions in English.

Utilisation adéquate des ceintures de sécurité

- Tirez sur la ceinture épaulière jusqu'à ce qu'elle recouvre entièrement l'épaule; elle ne doit cependant pas toucher le cou ni glisser de l'épaule.
- Placez la ceinture abdominale le plus bas possible sur les hanches.
- Réglez la position du dossier. Tenez-vous assis bien au fond du siège, le dos droit.
- Ne vrillez pas la ceinture de sécurité.

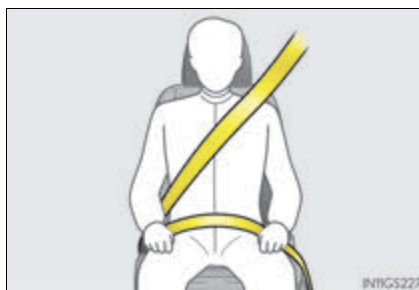

Guide de ceinture de sécurité (sièges latéraux arrière)

Pour les enfants ou les personnes de taille inférieure à la moyenne, faites glisser le guide de ceinture de sécurité vers l'avant, de sorte que la ceinture épaulière ne repose pas près du cou de cette personne.

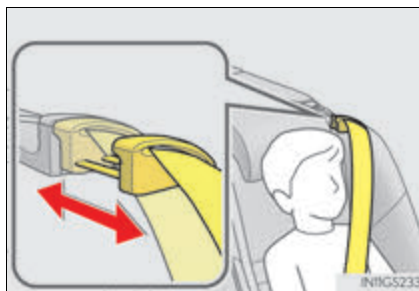

Entretien et soin

■ Ceintures de sécurité

Avec un chiffon ou une éponge, nettoyez à l'aide d'un savon doux et de l'eau tiède. Vérifiez aussi les ceintures régulièrement pour vous assurer qu'elles ne présentent pas d'usure excessive, d'effilochage ou de coupures.

AVERTISSEMENT

■ Dommages et usure de la ceinture de sécurité

Vérifiez périodiquement le système de ceintures de sécurité. Vérifiez qu'il n'y a pas de coupures, d'effilochures ni de pièces desserrées. N'utilisez pas une ceinture de sécurité endommagée avant qu'elle ne soit remplacée. Les ceintures de sécurité endommagées ne peuvent pas protéger les occupants contre les blessures graves, voire mortelles.

SRS airbag instructions for Canadian owners (in French)

The following is a French explanation of SRS airbag instructions extracted from the SRS airbag section in this manual.

See the SRS airbag section for more detailed SRS airbag instructions in English.

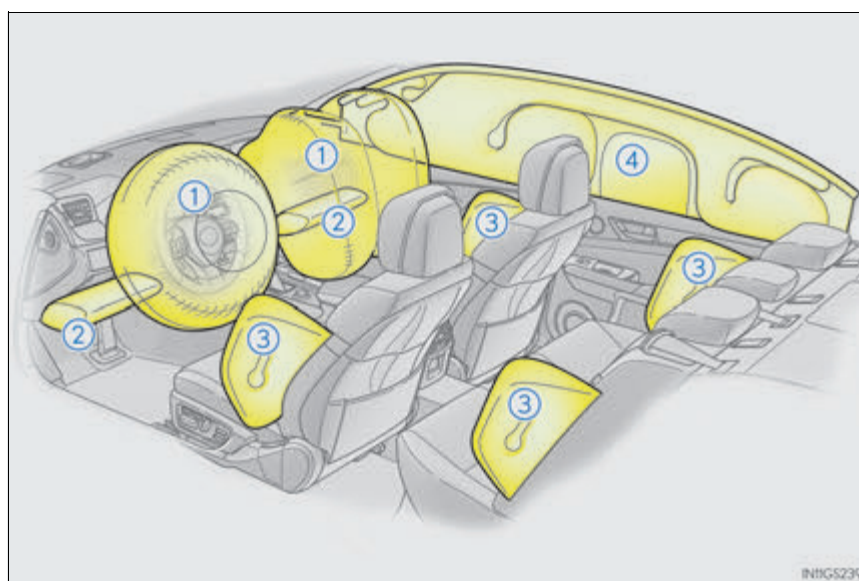

◆ Coussins gonflables SRS avant

- ① Coussin gonflable SRS du conducteur/du passager avant
Peuvent aider à protéger la tête et la poitrine du conducteur et du passager avant contre les impacts avec des composants intérieurs
- ② Coussins gonflables SRS de protection des genoux
Peuvent aider à protéger le conducteur et le passager avant
Un coussin gonflable SRS de protection des genoux pour le siège du passager avant est intégré dans la porte de la boîte à gants.

◆ Coussins gonflables SRS latéraux et en rideau

- ③ Coussins gonflables SRS latéraux avant
Peuvent aider à protéger le torse des occupants des sièges avant
Coussins gonflables SRS latéraux arrière
Peuvent aider à protéger le torse des occupants des sièges latéraux arrière
- ④ Coussins gonflables SRS en rideau
 - Peuvent aider à protéger principalement la tête des occupants des sièges latéraux
 - Peuvent empêcher les occupants d'être éjectés du véhicule en cas de tonneaux

Composants du système de coussins gonflables SRS

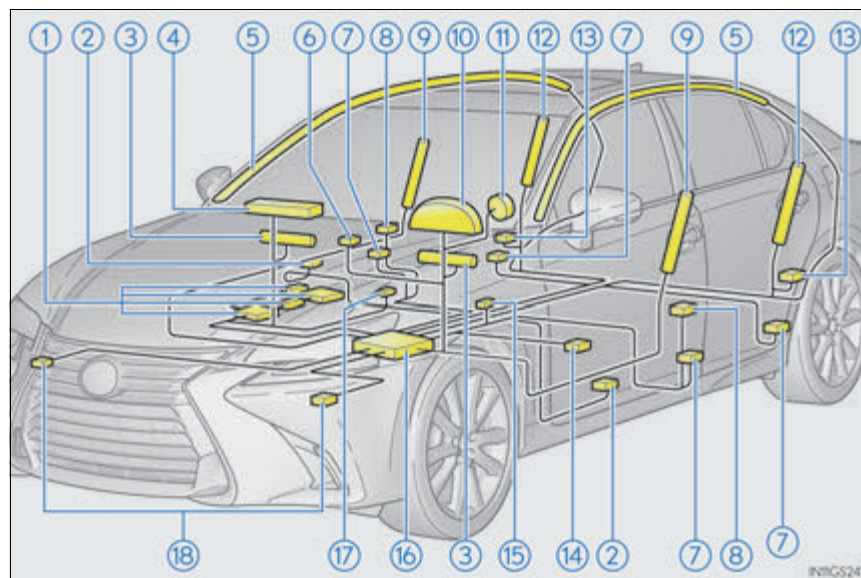

- | | |
|----------------------------------------------------------------------------------------|------------------------------------------------------------------|
| ① Système de classification de l'occupant du siège du passager avant (ECU et capteurs) | ⑨ Coussins gonflables latéraux avant |
| ② Capteurs d'impact latéral (portières avant) | ⑩ Lampe témoin SRS |
| ③ Coussins gonflables de protection des genoux | ⑪ Coussin gonflable du conducteur |
| ④ Coussin gonflable du passager avant | ⑫ Coussins gonflables latéraux arrière |
| ⑤ Coussins gonflables en rideau | ⑬ Capteurs d'impact latéral (arrière) |
| ⑥ Voyants "AIR BAG ON" et "AIR BAG OFF" | ⑭ Capteur de position du siège du conducteur |
| ⑦ Dispositifs de tension des ceintures de sécurité | ⑮ Contacteur de boucle de ceinture de sécurité du conducteur |
| ⑧ Capteurs d'impact latéral (avant) | ⑯ Module de capteur de coussin gonflable |
| | ⑰ Contacteur de boucle de ceinture de sécurité du passager avant |
| | ⑱ Capteurs d'impact avant |

Votre véhicule est doté de COUSSINS GONFLABLES ÉVOLUÉS dont la conception s'appuie sur les normes de sécurité des véhicules à moteur américains (FMVSS208). Le module de capteur de coussin gonflable (ECU) contrôle le déploiement des coussins gonflables en fonction des informations obtenues des capteurs et d'autres éléments affichés dans le diagramme des composants du système ci-dessus. Ces informations comprennent des données relatives à la gravité de l'accident et aux occupants. Au moment du déploiement des coussins gonflables, une réaction chimique se produit dans les gonfleurs de coussin gonflable et les coussins gonflables se remplissent rapidement d'un gaz non toxique pour aider à limiter le mouvement des occupants.

AVERTISSEMENT

■ Précautions relatives aux coussins gonflables SRS

Observez les précautions suivantes en ce qui concerne les coussins gonflables SRS. Les négliger pourrait occasionner des blessures graves, voire mortelles.

- Le conducteur et tous les passagers du véhicule doivent porter leur ceinture de sécurité de la manière appropriée. Les coussins gonflables SRS sont des dispositifs supplémentaires qui doivent être utilisés avec les ceintures de sécurité.

- Le coussin gonflable SRS du conducteur se déploie avec une force considérable et peut occasionner des blessures graves, voire mortelles, notamment lorsque le conducteur se trouve très près du coussin gonflable. La National Highway Traffic Safety Administration (NHTSA), aux États-Unis, fait les recommandations suivantes :

La zone à risque du coussin gonflable du conducteur couvre 2 à 3 in. (50 à 75 mm) de la zone de déploiement du coussin gonflable. Pour assurer une marge de sécurité suffisante, restez à 10 in. (250 mm) du coussin gonflable. Cette distance est mesurée depuis le centre du volant jusqu'à votre sternum. Si maintenant vous vous tenez assis à moins de 10 in. (250 mm), vous pouvez changer votre position de conduite de plusieurs manières :

- Reculez votre siège à la position maximale vous permettant d'atteindre encore aisément les pédales.
- Inclinez légèrement le dossier du siège. Même si les véhicules sont conçus différemment, la plupart des conducteurs peuvent maintenir une distance de 10 in. (250 mm), même si le siège se trouve complètement vers l'avant, simplement en inclinant un peu le dossier du siège vers l'arrière. Si la visibilité avant est moindre après avoir incliné le dossier de votre siège, utilisez un coussin ferme et non glissant pour être assis plus haut ou relevez le siège si cette option est disponible sur votre véhicule.
- Si votre volant est réglable en hauteur, inclinez-le vers le bas. Cela vous permet d'orienter le coussin gonflable vers votre buste plutôt que vers votre tête et vers votre cou.

Le siège doit être réglé de la manière recommandée ci-dessus par la NHTSA, tout en gardant le contrôle des pédales et du volant, ainsi que la vue sur les commandes du tableau de bord.

⚠ AVERTISSEMENT

■ **Précautions relatives aux coussins gonflables SRS**

● Si la rallonge de ceinture de sécurité a été reliée à la boucle des ceintures de sécurité des sièges avant sans avoir aussi été attachée à la plaque de blocage des ceintures de sécurité, les coussins gonflables SRS avant considéreront que le conducteur et le passager avant portent tout de même leur ceinture de sécurité même si les ceintures de sécurité ne sont pas attachées. Les coussins gonflables SRS avant peuvent alors ne pas s'activer correctement lors d'une collision, ce qui pourrait occasionner des blessures graves, voire mortelles, en cas de collision. Assurez-vous de toujours porter la ceinture de sécurité avec la rallonge de ceinture de sécurité.



● Le coussin gonflable SRS du passager avant se déploie également avec une force considérable et peut occasionner des blessures graves, voire mortelles, notamment lorsque le passager avant se trouve très près du coussin gonflable. Le siège du passager avant doit se trouver le plus loin possible du coussin gonflable et le dossier doit être réglé de manière à ce que le passager avant soit assis bien droit.

● Le déploiement d'un coussin gonflable risque d'infliger des blessures graves, voire mortelles, aux bébés et aux enfants mal assis et/ou mal attachés. Un bébé ou un enfant trop petit pour utiliser une ceinture de sécurité doit être correctement retenu à l'aide d'un dispositif de retenue pour enfants. Lexus recommande vivement de placer et d'attacher correctement tous les bébés et tous les enfants sur les sièges arrière du véhicule à l'aide de dispositifs de retenue adaptés. Les sièges arrière sont plus sécuritaires pour les bébés et les enfants que le siège du passager avant.

● N'installez jamais un dispositif de retenue pour enfants de type dos à la route sur le siège du passager avant, même si le voyant "AIR BAG OFF" est allumé. En cas d'accident, la force et la vitesse de déploiement du coussin gonflable du passager avant pourraient infliger à l'enfant des blessures graves, voire mortelles, si le dispositif de retenue pour enfants de type dos à la route était installé sur le siège du passager avant.

● Ne vous asseyez pas sur le bord du siège et ne vous appuyez pas sur la planche de bord.



⚠ AVERTISSEMENT

■ **Précautions relatives aux coussins gonflables SRS**

- Ne laissez pas un enfant se tenir face au coussin gonflable SRS du passager avant ni s'asseoir sur les genoux d'un passager avant.



- Ne laissez pas les occupants des sièges avant tenir des objets sur leurs genoux.

- Ne vous appuyez pas sur la portière ou sur le brancard de pavillon, ni sur les montants avant, latéraux ou arrière.



- Ne laissez personne s'agenouiller face à la portière sur le siège du passager ni sortir la tête ou les mains à l'extérieur du véhicule.



- Ne fixez et n'appuyez rien sur des zones telles que la planche de bord, le tampon de volant, la partie inférieure du tableau de bord et la porte de la boîte à gants. Ces objets peuvent se transformer en projectiles lorsque les coussins gonflables SRS du conducteur, du passager avant et de protection des genoux se déploient.

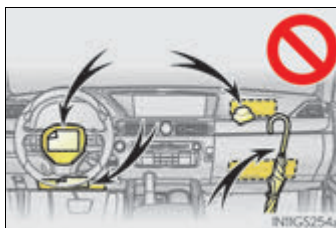

- Ne fixez rien sur des zones telles que les portières, le pare-brise, les glaces de portières, les montants avant ou arrière, le brancard de pavillon et la poignée de maintien. (Sauf pour l'autocollant de limite de vitesse)

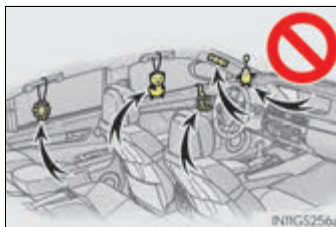

 **AVERTISSEMENT****■ Précautions relatives aux coussins gonflables SRS**

- N'accrochez pas de cintres ni d'autres objets rigides sur les crochets porte-vêtements. Tous ces objets pourraient se transformer en projectiles et vous occasionner des blessures graves, voire mortelles, en cas de déploiement des coussins gonflables SRS en rideau.
- Si un recouvrement de vinyle est placé sur la zone de déploiement du coussin gonflable SRS de protection des genoux, veillez à le retirer.
- N'utilisez pas d'accessoires recouvrant les parties du siège où les coussins gonflables SRS latéraux se déploient, car ces accessoires pourraient entraver le déploiement des coussins gonflables. De tels accessoires peuvent empêcher les coussins gonflables latéraux de se déployer correctement, rendre le système inopérant ou provoquer accidentellement le déploiement des coussins gonflables latéraux, occasionnant des blessures graves, voire mortelles.
- Ne frappez pas et n'appliquez pas une pression importante à l'emplacement des composants des coussins gonflables SRS.
Cela peut provoquer un mauvais fonctionnement des coussins gonflables SRS.
- Ne touchez à aucun composant des coussins gonflables SRS immédiatement après leur déploiement (gonflage), car ils pourraient être chauds.
- Si vous avez de la difficulté à respirer après le déploiement des coussins gonflables SRS, ouvrez une portière ou une glace pour laisser entrer l'air, ou quittez le véhicule si vous pouvez le faire en toute sécurité. Dès que possible, nettoyez tous les résidus afin d'éviter les irritations cutanées.
- Si les emplacements de stockage des coussins gonflables SRS, tels que le tampon de volant, la porte de la boîte à gants et les garnitures des montants avant et arrière, sont endommagés ou fissurés, faites-les remplacer par votre concessionnaire Lexus.
- Ne placez aucun objet, par exemple un coussin, sur le siège du passager avant. Cela disperserait le poids du passager, ce qui empêcherait le capteur de le détecter correctement. Cela pourrait empêcher le déploiement des coussins gonflables SRS du passager avant en cas de collision.

 **AVERTISSEMENT****■ Modification et mise au rebut des composants du système de coussins gonflables SRS**

Ne mettez pas votre véhicule au rebut et n'effectuez aucune des modifications suivantes sans d'abord consulter votre concessionnaire Lexus. Les coussins gonflables SRS pourraient fonctionner de manière incorrecte ou se déployer (gonfler) accidentellement, ce qui serait susceptible d'occasionner des blessures graves, voire mortelles.

- Installation, retrait, démontage et réparation des coussins gonflables SRS
- Réparations, modifications, retrait ou remplacement du volant, du tableau de bord, de la planche de bord, de la boîte à gants, des sièges ou du capitonnage des sièges, des montants avant, latéraux et arrière, ou des brancards de pavillon
- Réparations ou modifications de l'aile avant, du pare-chocs avant ou du côté de l'habitacle
- Installation d'une protection de calandre (barre safari, barre kangourou, etc.), de lames de déneigement, de treuils ou d'un porte-bagages de toit
- Modifications du système de suspension du véhicule
- Installation d'appareils électroniques tels qu'un émetteur-récepteur radio ou un lecteur de CD
- Modifications à votre véhicule pour une personne aux capacités physiques réduites

Headlight aim instructions for Canadian owners (in French) (vehicles with single-beam headlights)

The following is a French explanation of headlight aim instructions from the headlight aim section in this manual.

Boulons de réglage vertical

- ① Boulon de réglage A
- ② Boulon de réglage B

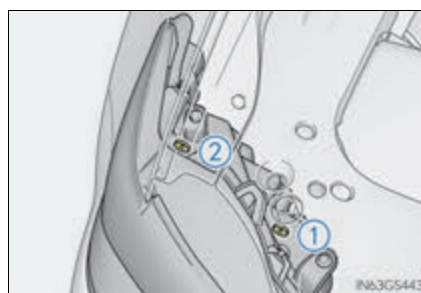

Avant de vérifier la portée des phares

- 1 Assurez-vous que le réservoir de carburant du véhicule est plein et que la partie de carrosserie située autour des phares n'est pas déformée.
- 2 Garez le véhicule sur un sol parfaitement horizontal.
- 3 Asseyez-vous sur le siège du conducteur.
- 4 Faites rebondir le véhicule à plusieurs reprises.

Réglage de la portée des phares

- 1 Tournez le boulon A vers la droite ou vers la gauche à l'aide d'un tournevis cruciforme.

Retenez le sens de rotation et le nombre de tours.

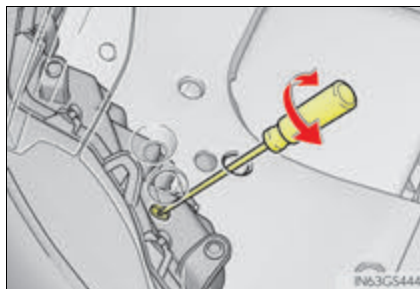

- 2 Tournez le boulon B du même nombre de tours et dans le même sens qu'à l'étape 1.

Si vous n'arrivez pas à régler vos phares en suivant cette procédure, apportez le véhicule chez votre concessionnaire Lexus afin qu'il règle la portée des phares.

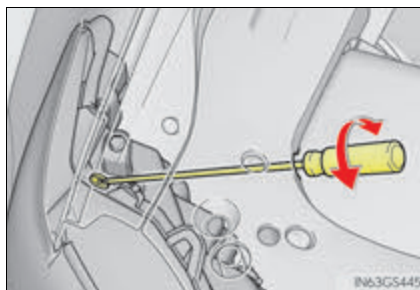

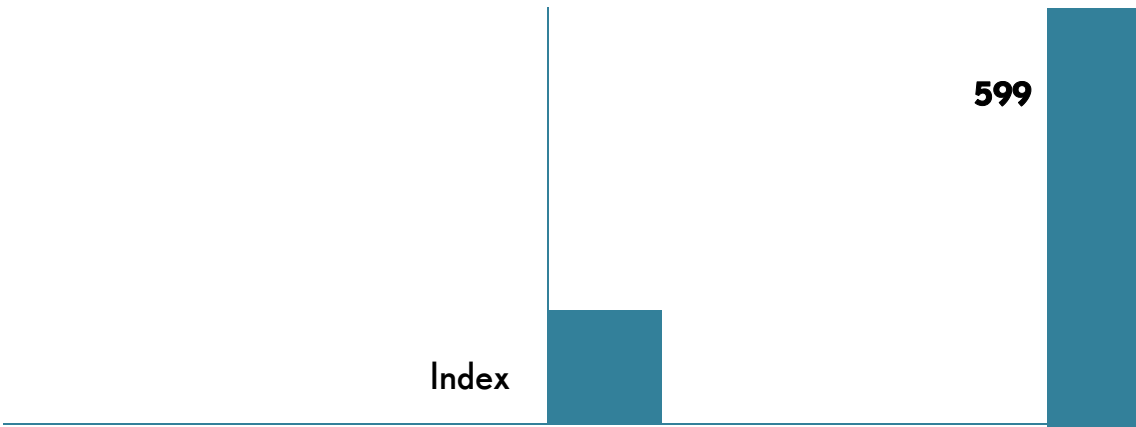

What to do if...
 (Troubleshooting)..... 600
 Alphabetical index.....604

For information regarding the equipment listed below, refer to the "NAVIGATION AND MULTIMEDIA SYSTEM OWNER'S MANUAL".

- Audio system
- Navigation system
- Intuitive parking assist
- Lexus parking assist monitor

What to do if... (Troubleshooting)

If you have a problem, check the following before contacting your Lexus dealer.

The doors cannot be locked, unlocked, opened or closed



You lose your keys

- If you lose your mechanical keys, new genuine mechanical keys can be made by your Lexus dealer. (→P. 134)
- If you lose your electronic keys, the risk of vehicle theft increases significantly. Contact your Lexus dealer immediately. (→P. 135)



The doors cannot be locked or unlocked

- Is the electronic key battery weak or depleted? (→P. 429)
- Is the engine switch in IGNITION ON mode?
When locking the doors, turn the engine switch off. (→P. 198)
- Is the electronic key left inside the vehicle?
When locking the doors, make sure that you have the electronic key on your person.
- The function may not operate properly due to the condition of the radio wave. (→P. 152)



The rear door cannot be opened

- Is the child-protector lock set?
The rear door cannot be opened from inside the vehicle when the lock is set. Open the rear door from outside and then unlock the child-protector lock. (→P. 140)



The trunk lid is closed with the electronic key left inside

- The function to prevent the electronic key from being left inside the trunk will operate and you can open the trunk as usual. Take the key out from the trunk. (→P. 145)

If you think something is wrong**The engine does not start**

- Did you press the engine switch while firmly depressing the brake pedal? (→P. 197)
- Is the shift lever in P? (→P. 199)
- Is the electronic key anywhere detectable inside the vehicle? (→P. 150)
- Is the steering wheel unlocked? (→P. 199)
- Is the electronic key battery weak or depleted?
In this case, the engine can be started in a temporary way. (→P. 521)
- Is the battery discharged? (→P. 523)

**The shift lever cannot be shifted from P even if you depress the brake pedal**

- Is the engine switch in IGNITION ON mode?
If you cannot release the shift lever by depressing the brake pedal with the engine switch in IGNITION ON mode (→P. 517)

**The steering wheel cannot be turned after the engine is stopped**

- It is locked automatically to prevent theft of the vehicle. (→P. 199)

**The windows do not open or close by operating the power window switches**

- Is the window lock switch pressed?
The power window except for the one at the driver's seat cannot be operated if the window lock switch is pressed. (→P. 175)

**The engine switch is turned off automatically**

- The auto power off function will be operated if the vehicle is left in ACCESSORY or IGNITION ON mode (the engine is not running) for a period of time. (→P. 199)

 **A warning buzzer sounds during driving**

- The seat belt reminder light is flashing
Are the driver and the front passenger wearing the seat belts? (→P. 454)
- The parking brake indicator is on
Is the parking brake released? (→P. 210)

Depending on the situation, other types of warning buzzer may also sound.
(→P. 452, 459)

 **An alarm is activated and the horn sounds**

- Did anyone inside the vehicle open a door during setting the alarm?
The sensor detects it and the alarm sounds. (→P. 74)

To stop the alarm, turn the engine switch to IGNITION ON mode or start the engine.

 **A warning buzzer sounds when leaving the vehicle**

- Is the electronic key left inside the vehicle or the moon roof opened?
Check the message on the multi-information display. (→P. 459)

 **A warning light turns on or a warning message is displayed**

- When a warning light turns on or a warning message is displayed, refer to P. 452, 459.

When a problem has occurred**If you have a flat tire**

- Vehicles with spare tire
Stop the vehicle in a safe place and replace the flat tire with the spare tire.
(→P. 491)
- Vehicles without spare tire
Stop the vehicle in a safe place and repair the flat tire temporarily with the emergency tire puncture repair kit. (→P. 502)

**The vehicle becomes stuck**

- Try the procedure for when the vehicle becomes stuck in mud, dirt, or snow.
(→P. 534)

Alphabetical index

A

A/C.....	328	Airbags.....	41
Air conditioning filter.....	427	Airbag operating conditions	48
Changing the rear seat		Airbag precautions	
settings.....	335	for your child.....	44
Front automatic air conditioning		Airbag warning light	452
system	328	Correct driving posture.....	34
Micro dust and pollen filter	334	Curtain shield airbag	
Rear air conditioning system.....	339	operating conditions	48
S-FLOW mode.....	329	Curtain shield airbag	
ABS (Anti-lock Brake System).....	308	precautions	46
Function	308	Front passenger occupant	
Warning light	452	classification system.....	52
Warning message.....	459	General airbag precautions	44
Active Sound Control (ASC)	214	Locations of airbags.....	41
Adaptive Front-lighting System		Modification and disposal	
(AFS).....	216	of airbags.....	47
Adaptive Variable Suspension		Side airbag operating	
system (AVS).....	309	conditions	48
AFS (Adaptive Front-lighting		Side airbag precautions	44
System).....	216	Side and curtain shield airbags	
Air conditioning filter	427	operating conditions	48
Air conditioning system.....	328	Side and curtain shield airbags	
Air conditioning filter.....	427	precautions	44
Changing the rear seat		SRS airbags	41
settings.....	335	Alarm	74
Front automatic air conditioning		Alarm.....	74
system	328	Warning buzzer.....	452, 459
Micro dust and pollen filter	334	Anchor brackets.....	63
Rear air conditioning system.....	339	Antennas (smart access system	
S-FLOW mode.....	329	with push-button start)	150
		Anti-lock Brake System (ABS)	308
		Function.....	308
		Warning light.....	452
		Warning message.....	459

Approach warning.....273, 285
 Armrest360
 Armrest door363
 ASC (Active Sound Control)214
 Ashtrays.....359
 Assist grips364
 Audio input*
 Audio system*
 Automatic headlight leveling
 system217
 Automatic light control system.....215
 Automatic transmission202
 If the shift lever cannot be
 shifted from P517
 M mode205
 Paddle shift switches204
 AUX port*
 Auxiliary boxes353
 AVS (Adaptive Variable
 Suspension system).....309

B

Back-up lights
 Replacing light bulbs.....439
 Battery.....410
 Battery checking.....410
 If the vehicle battery is
 discharged523
 Preparing and checking before
 winter316
 Warning light452

Blind Spot Monitor (BSM)298
 Blind Spot Monitor function.....301
 Rear Cross Traffic Alert
 function.....303
 Bluetooth®*
 Brake
 Fluid409
 Parking brake210
 Warning light.....452, 454
 Warning message.....459
 Brake assist308
 Brake Hold.....212
 Break-in tips183
 Brightness control
 Instrument panel light control89
 BSM (Blind Spot Monitor)298
 Blind Spot Monitor function.....301
 Rear Cross Traffic Alert
 function.....303

C

Card key132
 Care.....378, 382
 Aluminum wheels379
 Exterior378
 Interior382
 Seat belts.....383
 Cargo capacity194
 Cargo hooks354
 CD player*
 Chains.....317

*: Refer to the "NAVIGATION AND MULTIMEDIA SYSTEM OWNER'S MANUAL".

Dimensions	538	Drive info 1/Drive info 2/	
Dinghy towing.....	196	Drive info 3.....	105, 116
Display		Drive information.....	102, 109
12.3-inch display.....	326	Resetting	102, 109
Drive information	102, 109	Drive-start control.....	183, 207
Dynamic radar cruise control.....	278	Driver's seat position memory.....	160
Dynamic radar cruise control		Driving position memory.....	161
with full-speed range.....	266	Memory recall function	162
Energy monitor	127	Power easy access system.....	160
LDA (Lane Departure Alert		Driving	182
with steering control)	261	Break-in tips.....	183
LKA (Lane-Keeping Assist).....	253	Correct driving posture.....	34
Multi-information display	100, 108	Driving mode select switch.....	293
Trip information	78, 92	Procedures.....	182
Warning message.....	459	Winter drive tips	316
Do-it-yourself maintenance.....	391	DRS (Dynamic Rear Steering).....	309
Door courtesy lights		Function.....	309
Location.....	347	Warning message.....	459
Door lock		DVD player*	
Doors.....	137	Dynamic radar cruise control	
Smart access system with		Function.....	278
push-button start	150	Warning message.....	459
Wireless remote control.....	137	Dynamic radar cruise control	
Doors.....	137	with full-speed range	
Automatic door locking		Function.....	266
and unlocking system.....	140	Warning message.....	459
Door glasses	175	Dynamic Rear Steering (DRS).....	309
Door lock.....	139	Function.....	309
Open door warning buzzer.....	151	Warning message.....	459
Open door warning light.....	454		
Outside rear view mirrors.....	171		
Rear door child-protector.....	140		

*: Refer to the "NAVIGATION AND MULTIMEDIA SYSTEM OWNER'S MANUAL".

E

- Eco drive mode 293
- Eco Driving Indicator..... 85
- Eco driving meter..... 92
- EDR (Event data recorder).....10
- Electric Power Steering (EPS)309
 - Function 309
 - Warning light453
 - Warning message..... 459
- Electronic key 132
 - Battery-saving function..... 152
 - If the electronic key does not operate properly..... 520
 - Replacing the battery 429
- Emergency, in case of
 - If a warning buzzer sounds.....452
 - If a warning light turns on.....452
 - If a warning message is displayed..... 459
 - If the electronic key does not operate properly 520
 - If the engine will not start..... 515
 - If the parking brake cannot be released..... 518
 - If the shift lever cannot be shifted from P 517
 - If the vehicle battery is discharged.....523
 - If you have a flat tire491, 502
 - If you think something is wrong.....450
 - If your vehicle becomes stuck.....534
 - If your vehicle has to be stopped in an emergency443
 - If your vehicle needs to be towed444
 - If your vehicle overheats 528
- Emergency flashers442
- Emergency tire puncture repair kit 502
- Engine
 - Accessory mode 198
 - Compartment396
 - Engine switch197
 - Hood.....393
 - How to start the engine.....197
 - Identification number540
 - Ignition switch (engine switch.....197
 - Overheating.....528
- Engine compartment cover..... 399
- Engine coolant 406
 - Capacity 547
 - Checking406
 - Preparing and checking before winter.....316
- Engine coolant temperature gauge 86, 94
- Engine immobilizer system 72
- Engine oil 401
 - Capacity 542
 - Checking401
 - Oil level warning message459
 - Oil pressure warning message.....459
 - Preparing and checking before winter316

Engine oil maintenance data	386
Engine switch	197
Auto power off function.....	199
Changing the engine switch	
modes	198
If your vehicle has to be	
stopped in an emergency.....	443
Starting the engine	197
EPS (Electric Power Steering)	309
Function	309
Warning light	453
Warning message.....	459
Event data recorder (EDR).....	10
Expert mode.....	312

F

First-aid kit storage net	355
Flat tire	
Vehicles with spare tire	491
Vehicles without spare tire	502
Floor mats	32
Fluid	
Automatic transmission	548
Brake.....	549
Washer	412
Footwell light	347
Front passenger occupant	
classification system.....	52
Front personal lights.....	348

Front seats.....	158
Adjustment.....	158
Cleaning.....	382
Correct driving posture.....	34
Driving position memory.....	160
Head restraints	165
Power easy access system.....	160
Seat heaters.....	343
Seat position memory	160
Seat ventilators.....	343
Front side marker lights.....	215
Light switch.....	215
Replacing light bulbs	439
Welcome light illumination	
control.....	138
Front turn signal lights	209
Replacing light bulbs	438, 439
Turn signal lever	209
Wattage	554
Fuel	
Capacity.....	541
Fuel gauge	87, 94
Fuel pump shut off system	451
Information.....	555
Type.....	541
Warning light.....	454
Warning messages	459
Fuel consumption	
Average fuel	
consumption.....	102, 109
Average fuel consumption	
after refueling	102, 109
Current fuel consumption....	102, 109

Fuel filler door227
 When the fuel filler door
 cannot be opened229
 Fuel pump shut off system.....451
 Fuses431

G

Garage door opener365
 Gauges86, 92
 Glove box..... 351
 Glove box light 351

H

Hands-free system
 (for cellular phone)*
 HD Radio® system*
 Head restraints165
 Headlights215
 Adaptive Front-lighting
 System (AFS) 216
 Automatic High Beam system..... 218
 Headlight leveling
 warning message 459
 Light switch 215
 Replacing light bulbs.....439
 Headlights aim.....435, 597
 Head-up display..... 120
 Heated steering wheel..... 342

Heaters
 Air conditioning system328
 Heated steering wheel 342
 Seat heaters343
 Outside rear view mirrors334
 Hill-start assist control308
 Hood 393
 Open393
 Warning message.....459
 Hooks
 Cargo hooks354
 Coat hooks364
 Luggage hook.....354
 Retaining hooks (floor mat).....32
 Horn.....168

I

I/M test390
 Identification.....539
 Engine540
 Vehicle.....539
 Ignition switch (engine switch) 197
 Auto power off function199
 Changing the engine switch
 modes198
 If your vehicle has to be
 stopped in an emergency.....443
 Starting the engine.....198
 Illuminated entry system 349
 Immobilizer system72
 Indicators81

Initialization

Items to initialize..... 583
 Maintenance..... 386
 Moon roof 179
 Power windows 176
 Tire pressure
 warning system..... 415
**Initiators (tire pressure
 warning system)..... 420**
 Inside door handle lights 347
 Inside rear view mirror 169
 Instrument panel light control 89, 97
 Interior lights..... 347
Intuitive parking assist*
 Function*
 Warning message..... 459

J

Jack
 Positioning a floor jack..... 394
 Vehicle-equipped
 jack..... 492, 503
Jack handle 492, 503
Jam protection function
 Moon roof 179
 Power trunk opener
 and closer..... 145
 Power windows..... 175

K

Keyless entry..... 150
 Smart access system
 with push-button start..... 150
 Wireless remote control..... 137
Keys 132
 Battery-saving function 152
 Electronic key 132
 Engine switch 197
 If the electronic key
 does not operate properly..... 520
 If you lose your keys..... 134, 135
 Key number plate 132
 Keyless entry..... 137, 150
 Mechanical key..... 133
 Engine switch 197
 Replacing the battery 429
 Warning buzzer..... 151
 Wireless remote control key 137
Knee airbags 41

*: Refer to the "NAVIGATION AND MULTIMEDIA SYSTEM OWNER'S MANUAL".

L

Language (multi-information display)..... 569, 571

LATCH anchors 64

LDH (Lexus Dynamic Handling system) 309

Lever

- Auxiliary catch lever 393
- Hood lock release lever 393
- Internal trunk release lever 146
- Shift lever 202
- Turn signal lever 209
- Wiper lever 222

Lexus Dynamic Handling system (LDH)..... 309

Lexus Enform *

Lexus Enform Safety Connect..... 372

Lexus parking assist monitor *

Lexus Safety System+ 231

- Automatic High Beam 218
- Dynamic radar cruise control..... 278
- Dynamic radar cruise control with full-speed range 266
- LDA (Lane Departure Alert with steering control) 258
- LKA (Lane-Keeping Assist) 249
- PCS (Pre-Collision System) 237

License plate lights..... 215

- Light switch 215
- Replacing light bulbs..... 439
- Welcome light illumination control 138

Light bulbs

- Replacing..... 438
- Wattage 554

Lights

- Automatic High Beam system 218
- Headlight switch 215
- Illuminated entry system..... 349
- Interior light..... 348
- Interior lights list..... 347
- Personal lights 348
- Replacing light bulbs 438, 439
- Trunk light..... 145
- Turn signal lever 209
- Vanity lights 358
- Wattage 554
- Welcome light illumination control..... 138

LDA (Lane Departure Alert with steering control)..... 258

- Operation..... 261
- Warning messages 459

LKA (Lane-Keeping Assist) 249

- Operation..... 253
- Warning messages 459

Lock steering column..... 199

Low profile tire 416

Luggage hook 354

Luggage security system 145

M

Main display.....	326
Maintenance	
Do-it-yourself maintenance.....	391
General maintenance	387
Maintenance data.....	538
Maintenance requirements.....	385
Malfunction indicator lamp	452
Master warning light	454
Meter.....	86, 92
Head-up display.....	120
Indicators.....	81
Instrument panel light	
control.....	89, 97
Meters.....	86, 92
Multi-information display	100, 108
Warning lights.....	80
Micro dust and pollen filter	334
Mirrors	
Inside rear view mirror	169
Outside rear view mirror	
defoggers.....	334
Outside rear view mirrors.....	171
Vanity mirrors.....	358
Moon roof.....	178
Door lock linked	
moon roof operation.....	179
Jam protection function.....	179
Operation	178
Warning message.....	459
MP3 disc*	

Multi-information display.....	100, 108
Boost meter/oil temperature	
gauge/oil pressure gauge.....	103
Drive information.....	102, 109
Dynamic radar cruise control	278
Dynamic radar cruise control	
with full-speed range	266
“F” content.....	111
G-force	103, 114
Lap timer.....	111
LDA (Lane Departure Alert	
with steering control).....	258
LKA (Lane-Keeping Assist).....	249
Torque distribution	113

N

Navigation system*	
Noise from under vehicle	8

O

Odometer.....	87, 94
Oil	
Engine oil.....	542
Front differential oil	548
Rear differential oil	549
Opener	
Fuel filler door.....	227
Hood.....	393
Trunk.....	143

*: Refer to the “NAVIGATION AND MULTIMEDIA SYSTEM OWNER’S MANUAL”.

Outer foot lights
 Outer foot lights347
 Replacing light bulbs.....439
 Wattage.....554
 Outside rear view mirrors171
 Adjusting and folding.....171
 Blind Spot Monitor.....298
 Linked mirror function
 when reversing.....173
 Mirror position memory.....160
 Outside rear view
 mirror defoggers.....334
 Outside temperature display87, 94
 Overheating, Engine528

P

Paddle shift switches204
 Parking assist sensors
 (intuitive parking assist)*
 Parking brake.....210
 If the parking brake
 cannot be released.....518
 Operation210
 Parking brake engaged
 warning buzzer459
 Parking brake engaged
 warning message.....459
 Parking lights.....215
 Light switch.....215
 Replacing light bulbs.....439
 Welcome light
 illumination control138

PCS (Pre-Collision System).....237
 Function.....237
 Warning light.....453
 Warning message.....459
 Personal lights348
 Power easy access system.....160
 Pop-up display105, 117
 Power outlets.....360
 Power steering (Electric Power
 Steering system).....309
 Warning light.....453
 Warning message.....459
 Power trunk opener and closer143
 Power windows.....175
 Door lock linked
 window operation176
 Jam protection function.....175
 Operation.....175
 Window lock switch175
 Pre-Collision System (PCS).....237
 Function.....237
 Warning light.....453
 Warning message.....459

R

Radar cruise control (dynamic radar cruise control).....	278	Rear turn signal lights.....	209
Radar cruise control (dynamic radar cruise control with full-speed range).....	266	Replacing light bulbs.....	439
Radiator.....	408	Turn signal lever.....	209
Radio*		Rear view mirror	
RBDS (Radio Broadcast Data Systems)*		Inside rear view mirror.....	169
Rear air conditioning system.....	339	Outside rear view mirrors.....	171
Rear door sunshades.....	361	Rear view monitor system*	
Rear personal lights.....	348	Rear window defoggers.....	334
Rear side marker lights.....	215	Refueling.....	227
Light switch.....	215	Capacity.....	541
Replacing light bulbs.....	439	Fuel types.....	541
Welcome light		Opening the fuel tank cap.....	228
illumination control.....	138	When the fuel filler door cannot be opened.....	229
Rear seat heaters.....	343	Remote Touch*.....	322
Rear sunshade.....	361	Replacing	
Operation.....	361	Electronic key battery.....	429
Reverse operation feature.....	362	Fuses.....	431
		Light bulbs.....	437
		Tires.....	491
		Rev indicator.....	88, 95
		Rev peak.....	88, 96
		Reporting safety defects	
		for U.S. owners.....	586
		Resetting the message indicating maintenance is required.....	386

*: Refer to the "NAVIGATION AND MULTIMEDIA SYSTEM OWNER'S MANUAL".

S

Seat belts..... 36
 Adjusting the seat belt36
 Automatic Locking Retractor.....37
 Child restraint system
 installation.....65
 Cleaning and maintaining
 the seat belt383
 Emergency Locking
 Retractor (ELR)..... 37
 How to wear your seat belt36
 How your child should wear
 the seat belt38
 Pregnant women, proper
 seat belt use.....39
 Reminder light and buzzer454
 Seat belt extender.....38
 Seat belt pretensioners37
 SRS warning light.....452
Seat heaters 343
Seat position memory..... 160
Seat ventilators343
Seating capacity.....194

Seats158
 Adjustment..... 158
 Adjustment precautions.....159
 Child seats/child restraint
 system installation63
 Cleaning.....382
 Driving position memory..... 160
 Head restraints165
 Power easy access system..... 160
 Properly sitting in the seat..... 34
 Seat heaters.....343
 Seat position memory..... 160
 Seat ventilators.....343
Sensor
 Automatic headlight system216
 Inside rear view mirror.....170
 Intuitive parking assist*
 LDA (Lane Departure Alert
 with steering control).....258
 LKA (Lane-Keeping Assist)..... 249
 Radar sensor..... 233, 300
 Rain-sensing windshield
 wipers.....225
Service reminder indicators78

S-FLOW mode	329	Spare tire	491
Shift lever	202	Inflation pressure.....	550
Automatic transmission	202	Storage location.....	492
If the shift lever		Spark plug.....	547
cannot be shifted from P	517	Specifications.....	538
Shift lever light	347	Speed indicator.....	95
Shift lock system.....	517	Speedometer	87, 94
Side airbags	42	Sport mode.....	293
Side display	326	Steering lock	199
Side marker lights.....	215	Column lock release	199
Light switch.....	215	Steering lock system	
Replacing light bulbs.....	439	warning message.....	489
Welcome light illumination		Steering wheel	168
control.....	138	Adjustment.....	168
Side mirrors	171	Audio switches*	
Adjusting and folding.....	171	Heated steering wheel	342
BSM (Blind spot monitor).....	298	Power easy access system.....	160
Linked mirror function		Steering wheel	
when reversing.....	173	position memory	160
Mirror position memory.....	160	Stop lights	
Side turn signal lights	209	Replacing light bulbs	439
Replacing light bulbs.....	439	Storage feature	350
Turn signal lever	209	Storage precautions	350
Smart access system		Stuck	
with push-button start	150	If the vehicle becomes stuck.....	534
Antenna location.....	150	Sun shade	
Entry functions.....	137	Rear	361
Starting the engine	197	Rear door	361
Warning message.....	459	Roof.....	179
Snow mode	203	Sun visors.....	358
Snow tires	320		

*: Refer to the "NAVIGATION AND MULTIMEDIA SYSTEM OWNER'S MANUAL".

Switches

ASC (Active Sound Control)	
switch.....	214
Audio remote control switches *	
Automatic High Beam switch	218
Brake Hold.....	212
Cruise control	
switch.....	266, 278, 290
Door lock switches	139
Driving mode select switch	293
Driving position memory	
switches.....	160
Emergency flashers switch	442
Engine switch.....	197
Garage door opener	
switches.....	365
Heated steering wheel	
switch.....	342
HUD (Head-up display)	
switches.....	120
Ignition switch	197
Intuitive parking assist *	
Light switch	215
LDA (Lane Departure Alert	
with steering control) switch	261
LKA (Lane-Keeping Assist)	
switch.....	253
Meter control switches	101, 109
Moon roof switches.....	178
Outside rear view mirror	
switches.....	171
Paddle shift switches.....	204
Parking brake switches	210
Power door lock switch.....	139
Power window switches.....	175
Rear sunshade switch	361
Rear window and outside	
rear view mirror defoggers	
switch	334
Seat heater switches	343
Seat ventilator switches	343
Snow mode switch	203
"SOS" button	372
Talk switch *	
Telephone switches *	
Tilt and telescopic	
steering control switch.....	168
Tire pressure warning reset	
switch	415
Trunk closer switch.....	144
Trunk opener switch.....	143
Trunk opener main switch	145
TVD (Torque Vectoring	
Differential) switch.....	306
Vehicle-to-vehicle distance	
button.....	272, 284
VSC OFF switch.....	310
Window lock switch	175
Windshield wipers	
and washer switch.....	222

T

Tachometer	87, 94
Variable red zone.....	97
Tail lights.....	215
Light switch	215
Replacing light bulbs.....	439
Welcome light illumination control.....	138
Talk switch*	
Telephone switches*	
Theft deterrent system	
Alarm.....	74
Engine immobilizer system.....	72
Tire inflation pressure	550
Maintenance data.....	550
Tire inflation pressure display function.....	414
Warning light.....	454
Warning message.....	459
Tire information.....	558
Glossary	563
Size.....	560
Tire identification number.....	560
Uniform Tire Quality Grading.....	562
Tire pressure warning system	414
Function	414
Initializing.....	415
Installing tire pressure warning valves and transmitters.....	414
Registering ID codes	416
Warning light	454
Warning message.....	459
Tires	413
Chains	317
Checking	413
Emergency tire puncture repair kit.....	502
If you have a flat tire.....	491, 502
Inflation pressure.....	550
Information.....	558
Replacing.....	491
Rotating tires.....	414
Size	550
Snow tires.....	320
Spare tire.....	491
Tire inflation pressure display function.....	414
Tire pressure warning system.....	414
Warning light.....	454
Warning message.....	459
Tools	492
Top tether strap	68
Torque Vectoring Differential (TVD).....	306
Total load capacity.....	194
Towing	
Dinghy towing.....	196
Emergency towing	444
Towing eyelet	446
Trailer towing.....	195
TRAC (Traction Control)	
Function.....	308
TRAC OFF switch.....	310

*: Refer to the "NAVIGATION AND MULTIMEDIA SYSTEM OWNER'S MANUAL".

Transmission.....202
 Automatic transmission202
 Driving mode select switch293
 If the shift lever cannot be
 shifted from P 517
 M mode205
 Paddle shift switches204
Trip meters87, 94
Trunk.....143
 Internal trunk release lever..... 146
 Jam protection function.....145
 Luggage security system145
 Open trunk warning message...459
 Power trunk opener
 and closer..... 143
 Smart access system
 with push-button start 143
 Trunk closer switch144
 Trunk easy closer145
 Trunk features354
 Trunk grip 144
 Trunk light145
 Trunk opener main switch.....145
 Trunk opener switch143
 Trunk storage extension.....363
 Wireless remote control144
Trunk light145
 Trunk light145
 Wattage.....554
Turn signal lights209
 Replacing light bulbs..... 438, 439
 Turn signal lever209
 Wattage.....554
**TVD (Torque Vectoring
 Differential).....306**

U

USB port*

V

Vanity lights358
 Vanity lights358
 Wattage554
Vanity mirrors.....358
 Vanity lights358
**Variable Gear Ratio Steering
 (VGRS).....309**
 Function.....309
 Warning message.....459
**VDIM (Vehicle Dynamics
 Integrated Management).....309**
Vehicle data recordings.....9
**Vehicle Dynamics Integrated
 Management (VDIM).....309**
Vehicle identification number539
**Vehicle Stability Control
 (VSC).....308**
Ventilators (seat ventilators)343
**VGRS (Variable Gear Ratio
 Steering).....309**
 Function.....309
 Warning message.....459
Voice command system *
**VSC
 (Vehicle Stability Control).....308**

W

Warning buzzers

- Approach warning.....273, 285
- Brake system.....452
- Downshifting207
- Intuitive parking assist*
- Key reminder488
- Open door.....461
- Open moon roof475
- Open hood.....461
- Open trunk461
- Open window475
- Seat belt reminder.....454

Warning lights80

- ABS.....452
- AFS OFF indicator.....453
- Brake system.....452, 454
- Charging system.....452
- Electric power steering.....453
- Low fuel level454
- Malfunction indicator lamp.....452
- Master warning light.....454
- Open door.....454
- Parking brake indicator454
- Pre-collision system.....453
- Seat belt reminder light.....454
- Slip indicator453
- SRS.....452
- Tire pressure454

Warning messages.....459

Warning reflector storage belt357

Washer222

Checking412

Low washer fluid

warning message.....459

Preparing and checking

before winter316

Switch222

Washing and waxing378

Weight

Cargo capacity.....194

Load limits194

Weight538

Welcome light illumination

control138

Wheels

Replacing.....425

Size550

Window glasses.....175

Window lock switch.....175

Windows.....175

Power windows.....175

Rear window defogger334

Washer222

Windshield wiper de-icer334

Windshield wipers222

Position318

Rain-sensing windshield

wipers.....222

*: Refer to the "NAVIGATION AND MULTIMEDIA SYSTEM OWNER'S MANUAL".

Winter driving tips.....316
Wireless remote control key.....144
 Battery-Saving Function..... 152
 Locking/Unlocking.....132
 Replacing the battery.....429
WMA disc*

X

XM® Satellite Radio*

*: Refer to the "NAVIGATION AND MULTIMEDIA
SYSTEM OWNER'S MANUAL".

GAS STATION INFORMATION		
Auxiliary catch lever	Trunk opener	Fuel filler door
P. 393	P. 143	P. 228
Hood lock release lever	Tire inflation pressure	
P. 393	P. 550	
Fuel tank capacity (Reference)	17.5 gal. (66.3 L, 14.6 Imp.gal.)	
Fuel type	Unleaded gasoline only	P. 541
Cold tire inflation pressure		P. 550
Engine oil capacity (Drain and refill – reference)		P. 542
Engine oil type		P. 542