



owner.ford.com



ford.ca

2019 **TRANSIT** Owner's Manual



January 2019
Second Printing
Litho in U.S.A.



KK3J19A321 AB



The information contained in this publication was correct at the time of going to print. In the interest of continuous development, we reserve the right to change specifications, design or equipment at any time without notice or obligation. No part of this publication may be reproduced, transmitted, stored in a retrieval system or translated into any language in any form by any means without our written permission. Errors and omissions excepted.

© Ford Motor Company 2018

All rights reserved.

Part Number: KK3J 19A321 AB 201812 20181207104022

California Proposition 65



WARNING: Operating, servicing and maintaining a passenger vehicle or off-highway motor vehicle can expose you to chemicals including engine exhaust, carbon monoxide, phthalates, and lead, which are known to the State of California to cause cancer and birth defects or other reproductive harm. To minimize exposure, avoid breathing exhaust, do not idle the engine except as necessary, service your vehicle in a well-ventilated area and wear gloves or wash your hands frequently when servicing your vehicle. For more information go to www.P65Warnings.ca.gov/passenger-vehicle.



WARNING: Battery posts, terminals and related accessories contain lead and lead compounds, chemicals known to the State of California to cause cancer and reproductive harm.
Wash your hands after handling.

Table of Contents

Introduction

About This Manual	7
Symbols Glossary	7
Data Recording	9
Perchlorate	13
Ford Credit	13
Replacement Parts Recommendation	13
Special Notices	14
Mobile Communications Equipment	15
Export Unique Options	16

Environment

Protecting the Environment	17
----------------------------------	----

Child Safety

General Information	18
Installing Child Restraints	19
Booster Seats	35
Child Restraint Positioning	37
Child Safety Locks	39

Seatbelts

Principle of Operation	41
Fastening the Seatbelts	42
Seatbelt Height Adjustment	44
Seatbelt Warning Lamp and Indicator Chime	44
Seatbelt Reminder	45
Child Restraint and Seatbelt Maintenance	46
Seatbelt Extension	47

Supplementary Restraints System

Principle of Operation	48
Driver and Passenger Airbags	49
Side Airbags	55
Safety Canopy™	56

Crash Sensors and Airbag Indicator	57
Airbag Disposal	58

911 Assist

About 911 Assist	59
Emergency Call Requirements	59
Emergency Call Limitations	60

MyKey™

Principle of Operation	61
Creating a MyKey	62
Clearing All MyKeys	63
Checking MyKey System Status	63
Using MyKey With Remote Start Systems	65
MyKey – Troubleshooting	65

Keys and Remote Controls

Principle of Operation	67
General Information on Radio Frequencies	67
Remote Control - Vehicles Without: Passive Anti-Theft System (PATS)	68
Remote Control - Vehicles With: Passive Anti-Theft System (PATS)	69
Replacing a Lost Key or Remote Control	71

Doors and Locks

Locking and Unlocking	72
-----------------------------	----

Security

Passive Anti-Theft System	77
Anti-Theft Alarm	78

Steering Wheel

Adjusting the Steering Wheel	79
Horn	79

Table of Contents

Wipers and Washers

Windshield Wipers	80
Autowipers	80
Windshield Washers	81

Lighting

General Information	82
Lighting Control	82
Autolamps	83
Instrument Lighting Dimmer	84
Daytime Running Lamps	84
Direction Indicators	84
Interior Lamps	85
Cargo Lamps	86

Windows and Mirrors

Power Windows	87
Exterior Mirrors	88
Interior Mirror	89
Rear Quarter Windows	89

Instrument Cluster

Gauges	91
Warning Lamps and Indicators	93
Audible Warnings and Indicators	96

Information Displays

General Information	97
Trip Computer	100
Personalized Settings	100
Information Messages	101

Climate Control

Manual Climate Control	107
Hints on Controlling the Interior Climate	108
Rear Passenger Climate Controls	109
Heated Windows and Mirrors	109
Remote Start	110

Seats

Sitting in the Correct Position	111
Head Restraints	111
Manual Seats	112
Power Seats	114
Rear Seats	116
Heated Seats	119

Auxiliary Power Points

Auxiliary Power Points	120
Cigar Lighter	121

Storage Compartments

Cup Holders	123
Overhead Console	123
Bottle Holder	123
Front Door Storage Compartment	123

Starting and Stopping the Engine

General Information	124
Ignition Switch	124
Starting a Gasoline Engine	125
Starting a Diesel Engine	126
Switching Off the Engine	128
Engine Block Heater	128

Fuel and Refueling

Safety Precautions	130
Fuel Quality - Diesel	131
Fuel Quality - Gasoline	133
Fuel Quality - E85	134
Fuel Filler Funnel Location	135
Running Out of Fuel	135
Refueling	136
Fuel Consumption	138

Engine Emission Control

Emission Law	140
--------------------	-----

Table of Contents

Catalytic Converter - 3.5L/3.7L	141	Steering	172
Selective Catalytic Reductant System	142	Load Carrying	
Diesel Particulate Filter - 3.2L Diesel	145	Load Retaining Fixtures	174
Transmission		Load Limit	174
Automatic Transmission	151	Towing	
Tow/Haul	154	Towing a Trailer	179
Brakes		Trailer Sway Control	180
General Information	155	Recommended Towing Weights	180
Hints on Driving With Anti-Lock Brakes	155	Essential Towing Checks	183
Parking Brake - Vehicles With: Mechanical Parking Brake	156	Towing the Vehicle on Four Wheels	189
Parking Brake - Vehicles With: Push Down Parking Brake	156	Driving Hints	
Hill Start Assist	157	Breaking-In	191
Traction Control		Reduced Engine Performance	191
Principle of Operation	159	Economical Driving	191
Using Traction Control	159	Cold Weather Precautions	192
Stability Control		Driving Through Water	192
Principle of Operation	160	Floor Mats	192
Using Stability Control	161	Roadside Emergencies	
Parking Aids		Roadside Assistance	194
Principle of Operation	162	Hazard Flashers	195
Parking Aid	162	Emergency Exit	195
Rear View Camera	164	Fuel Shutoff	195
Cruise Control		Jump Starting the Vehicle	196
Principle of Operation	168	Post-Crash Alert System	198
Using Cruise Control	168	Transporting the Vehicle	198
Driving Aids		Towing Points	199
Speed Limiter	169	Customer Assistance	
Driver Alert	169	Getting the Services You Need	201
Lane Keeping System	170	In California (U.S. Only)	202
		The Better Business Bureau (BBB) Auto Line Program (U.S. Only)	203
		Utilizing the Mediation/Arbitration Program (Canada Only)	204
		Getting Assistance Outside the U.S. and Canada	204

Table of Contents

Ordering Additional Owner's Literature	206
Reporting Safety Defects (U.S. Only)	206
Reporting Safety Defects (Canada Only)	206

Fuses

Fuse Box Locations	208
Fuse Specification Chart - 3.2L Power Stroke Diesel	209
Fuse Specification Chart - 3.5L EcoBoost™/3.7L	218
Changing a Fuse	227

Maintenance

General Information	229
Opening and Closing the Hood	229
Under Hood Overview - 3.2L Power Stroke Diesel	231
Under Hood Overview - 3.5L EcoBoost™	232
Under Hood Overview - 3.7L	233
Engine Oil Dipstick - 3.2L Power Stroke Diesel	234
Engine Oil Dipstick - 3.5L EcoBoost™	234
Engine Oil Dipstick - 3.7L	234
Engine Oil Check	234
Changing the Engine Oil and Oil Filter	235
Oil Change Indicator Reset	236
Engine Cooling Fan - Diesel	236
Engine Cooling Fan - E85/Gasoline	236
Engine Coolant Check	236
Automatic Transmission Fluid Check	241
Brake Fluid Check	241
Power Steering Fluid Check	241
Washer Fluid Check	242
Draining the Fuel Filter Water Trap - 3.2L Power Stroke Diesel	242

Fuel Filter - Gasoline	244
Changing the 12V Battery	244
Checking the Wiper Blades	246
Changing the Front Wiper Blades	246
Adjusting the Headlamps	247
Removing a Headlamp	248
Changing a Bulb	249
Bulb Specification Chart	254
Changing the Engine Air Filter - 3.2L Power Stroke Diesel	255
Changing the Engine Air Filter - 3.5L EcoBoost™	256
Changing the Engine Air Filter - 3.7L	257
Drive Belt Routing - 3.2L Power Stroke Diesel	258
Drive Belt Routing - 3.5L EcoBoost™/3.7L	259

Vehicle Care

Cleaning Products	260
Cleaning the Exterior	261
Waxing	262
Cleaning the Engine	262
Cleaning the Windows and Wiper Blades	263
Cleaning the Interior	263
Cleaning the Instrument Panel and Instrument Cluster Lens	265
Repairing Minor Paint Damage	266
Cleaning the Wheels	266
Vehicle Storage	266

Wheels and Tires

General Information	269
Tire Care	270
Using Winter Tires	287
Using Snow Chains	287
Tire Pressure Monitoring System	288
Changing a Road Wheel	293
Technical Specifications	305

Table of Contents

Capacities and Specifications

Engine Specifications - 3.2L Power Stroke Diesel	307
Engine Specifications - 3.5L EcoBoost™	308
Engine Specifications - 3.7L	309
Motorcraft Parts - 3.2L Power Stroke Diesel	310
Motorcraft Parts - 3.5L EcoBoost™	310
Motorcraft Parts - 3.7L	312
Vehicle Identification Number	313
Vehicle Certification Label	314
Transmission Code Designation	314
Capacities and Specifications - 3.2L Power Stroke Diesel	315
Capacities and Specifications - 3.5L EcoBoost™	321
Capacities and Specifications - 3.7L	327

Audio System

General Information	333
Audio Unit - Vehicles With: AM/FM/CD/SYNC/Satellite Radio	334
Audio Unit - Vehicles With: Premium AM/FM/CD	336
Audio Unit - Vehicles With: AM/FM/CD/SYNC	338
Audio Unit - Vehicles With: AM/FM/USB Port/Bluetooth	340
Audio Unit - Vehicles With: AM/FM	346
Digital Radio	349
Satellite Radio	351
Audio Input Jack	354
USB Port	355
Media Hub	355

SYNC™

General Information	356
Using Voice Recognition	358
Using SYNC™ With Your Phone	360

SYNC™ Applications and Services	372
Using SYNC™ With Your Media Player	377
SYNC™ Troubleshooting	386

SYNC™ 3

General Information	394
Home Screen	401
Using Voice Recognition	401
Entertainment	406
Phone	416
Navigation	421
Apps	429
Settings	432
SYNC™ 3 Troubleshooting	446

Accessories

Accessories	459
Auxiliary Switches	460

Ford Protect

Ford Protect	462
--------------------	-----

Scheduled Maintenance

Scheduled Maintenance	464
General Maintenance Information	466
Normal Scheduled Maintenance	469
Special Operating Conditions Scheduled Maintenance	472
Scheduled Maintenance Record	474

Appendices

Electromagnetic Compatibility	485
End User License Agreement	487
Declaration of Conformity - Vehicles With: SYNC 3	512



Introduction

ABOUT THIS MANUAL

Thank you for choosing Ford. We recommend that you take some time to get to know your vehicle by reading this manual. The more that you know about your vehicle, the greater the safety and pleasure you will get from driving it.



WARNING: Driving while distracted can result in loss of vehicle control, crash and injury. We strongly recommend that you use extreme caution when using any device that may take your focus off the road. Your primary responsibility is the safe operation of your vehicle. We recommend against the use of any hand-held device while driving and encourage the use of voice-operated systems when possible. Make sure you are aware of all applicable local laws that may affect the use of electronic devices while driving.

Note: This manual describes product features and options available throughout the range of available models, sometimes even before they are generally available. It may describe options not fitted to the vehicle you have purchased.

Note: Some of the illustrations in this manual may show features as used in different models, so may appear different to you on your vehicle.

Note: Always use and operate your vehicle in line with all applicable laws and regulations.

Note: Pass on this manual when selling your vehicle. It is an integral part of your vehicle.

Note: Either Ford Motor Company or an authorized Ford dealer may have originally sold this incomplete vehicle to a vehicle modifier who upfitted it. As a result, it may have different options and features than described in this manual.

This manual may qualify the location of a component as left-hand side or right-hand side. The side is determined when facing forward in the seat.



E154903

- A Right-hand side.
- B Left-hand side.

SYMBOLS GLOSSARY

These are some of the symbols you may see on your vehicle.



Air conditioning system



Air conditioning system lubricant type



Anti-lock braking system



Avoid smoking, flames or sparks

Introduction



Battery



Engine oil



Battery acid



Explosive gas



Brake fluid - non petroleum based



Fan warning



Brake system



Fasten seatbelt



Brake system



Flammable



Cabin air filter



Front airbag



Check fuel cap



Front fog lamps



Child safety door lock or unlock



Fuel pump reset



Child seat lower anchor



Fuse compartment



Child seat tether anchor



Hazard flashers



Cruise control



Heated rear window



Do not open when hot



Windshield defrosting system



Engine air filter



Interior luggage compartment release



Engine coolant



Jack



Engine coolant temperature



Keep out of reach of children

Introduction



Lighting control



Low tire pressure warning



Maintain correct fluid level



Note operating instructions



Horn control



Panic alarm



Parking aid



Parking brake



Power steering fluid



Power windows front/rear



Power window lockout



Requires registered technician



Safety alert



See Owner's Manual



See Service Manual



Service engine soon



Passenger airbag activated



Passenger airbag deactivated



Side airbag



Shield the eyes



Stability control



Hill descent control



Trail control



Windshield wiping system



Windshield wash and wipe

DATA RECORDING

 **WARNING:** Do not connect wireless plug-in devices to the data link connector. Unauthorized third parties could gain access to vehicle data and impair the performance of safety related systems. Only allow repair facilities that follow our service and repair instructions to connect their equipment to the data link connector.

Introduction

We respect your privacy and are committed to protecting it. The information contained in this publication was correct at the time of going to print but as technology rapidly changes, we recommend that you visit the regional Ford website for the latest information.

Your vehicle has electronic control units that have data recording functionality and the ability to permanently or temporarily store data. This data could include information on the condition and status of your vehicle, vehicle maintenance requirements, events and malfunctions. The types of data that can be recorded are described in this section. Some of the data recorded is stored in event logs or error logs.

Note: *Error logs are reset following a service or repair.*

Note: *We may provide information in response to requests from law enforcement, other government authorities and third parties acting with lawful authority or through a legal process. Such information could be used by them in legal proceedings.*

Data recorded includes, for example:

- Operating states of system components, for example fuel level, tire pressure and battery charge level.
- Vehicle and component status, for example wheel speed, deceleration, lateral acceleration and seatbelt status.
- Events or errors in essential systems, for example headlamps and brakes.
- System responses to driving situations, for example airbag deployment and stability control.
- Environmental conditions, for example temperature.

Some of this data, when used in combination with other information, for example an accident report, damage to a vehicle or eyewitness statements, could be associated with a specific person.

Service Data

Service data recorders in your vehicle are capable of collecting and storing diagnostic information about your vehicle. This potentially includes information about the performance or status of various systems and modules in the vehicle, such as engine, throttle, steering or brake systems. In order to properly diagnose and service your vehicle, Ford Motor Company (Ford of Canada in Canada), and service and repair facilities may access or share among them vehicle diagnostic information received through a direct connection to your vehicle when diagnosing or servicing your vehicle. Additionally, Ford Motor Company (Ford of Canada, in Canada) may, where permitted by law, use vehicle diagnostic information for vehicle improvement or with other information we may have about you, (for example, your contact information), to offer you products or services that may interest you. Data may be provided to our service providers such as part suppliers that may help diagnose malfunctions, and who are similarly obligated to protect data. We retain this data only as long as necessary to perform these functions or to comply with law. We may provide information where required in response to official requests to law enforcement or other government authorities or third parties acting with lawful authority or court order, and such information may be used in legal proceedings. For U.S. only (if equipped), if you choose to use connected apps and services, you consent that certain diagnostic information may also be accessed electronically by Ford Motor

Introduction

Company and Ford authorized service facilities, and that the diagnostic information may be used to provide services to you, personalizing your experience, troubleshoot, and to improve products and services and offer you products and services that may interest you, where permitted by law. For Canada only, for more information, please review the Ford of Canada privacy policy at www.ford.ca, including our U.S. data storage and use of service providers in other jurisdictions who may be subject to legal requirements in Canada, the United States and other countries applicable to them, for example, lawful requirements to disclose personal information to governmental authorities in those countries.

Event Data

This vehicle is equipped with an event data recorder. The main purpose of an event data recorder is to record, in certain crash or near crash-like situations, such as an airbag deployment or hitting a road obstacle; this data will assist in understanding how a vehicle's systems performed. The event data recorder is designed to record data related to vehicle dynamics and safety systems for a short period of time, typically 30 seconds or less.

The event data recorder in this vehicle is designed to record such data as:

- How various systems in your vehicle were operating;
- Whether or not the driver and passenger seatbelts were buckled/fastened;
- How far (if at all) the driver was depressing the accelerator and/or the brake pedal; and
- How fast the vehicle was traveling; and
- Where the driver was positioning the steering wheel.

This data can help provide a better understanding of the circumstances in which crashes and injuries occur.

Note: *Event data recorder data is recorded by your vehicle only if a non-trivial crash situation occurs; no data is recorded by the event data recorder under normal driving conditions and no personal data or information (e.g., name, gender, age, and crash location) is recorded. However, parties, such as law enforcement, could combine the event data recorder data with the type of personally identifying data routinely acquired during a crash investigation.*

To read data recorded by an event data recorder, special equipment is required, and access to the vehicle or the event data recorder is needed. In addition to the vehicle manufacturer, other parties, such as law enforcement, that have such special equipment, can read the information if they have access to the vehicle or the event data recorder.

Comfort, Convenience and Entertainment Data

Your vehicle has electronic control units that have the ability to store data based on your personalized settings. The data is stored locally in the vehicle or on devices that you connect to it, for example, a USB drive or digital music player. You can delete some of this data and also choose whether to share it through the services to which you subscribe. See **Settings** (page 432).

Comfort and Convenience Data

Data recorded includes, for example:

- Seat and steering wheel position.
- Climate control settings.
- Radio presets.

Introduction

Entertainment Data

Data recorded includes, for example:

- Music, videos or album art.
- Contacts and corresponding address book entries.
- Navigation destinations.

Services That We Provide

If you use our services, we collect and use data, for example account information, vehicle location and driving characteristics, that could identify you. We transmit this data through a dedicated, protected connection. We only collect and use data to enable your use of our services to which you have subscribed, with your consent or where permitted by law. For additional information, see the terms and conditions of the services to which you have subscribed.

Services That Third Parties Provide

We recommend that you review the terms and conditions and data privacy information for any services to which you subscribe. We take no responsibility for services that third parties provide.

Vehicles With a Modem

The modem has a SIM. The modem periodically sends messages to stay connected to the cell phone network. These messages could include information that identifies your vehicle, the SIM and the electronic serial number of the modem. Cell phone network service providers could have access to additional information, for example cell phone network tower identification.

Note: *The modem continues to send this information unless you have all added value services deactivated. Contact the Ford Customer Relationship Center. Refer to the regional Ford website for contact information.*

Note: *The service can be unavailable or interrupted for a number of reasons, for example environmental or topographical conditions and data plan coverage.*

Vehicles With SYNC

Mobile Device Data

If you connect a mobile device to your vehicle, you can display data from your device on the touchscreen for example, music and album art. You can share your vehicle data with mobile apps on your device through the system. See **Apps** (page 429).

The mobile apps function operates by your connected device sending data to us in the United States. The data is encrypted and includes the vehicle identification number of your vehicle, the SYNC module serial number, odometer, enabled apps, usage statistics and debugging information. We retain it only as long as necessary to provide the service, to troubleshoot, for continuous improvement and to offer you products and services that may be of interest to you according to your preferences and where allowed by law.

If you connect a cell phone to the system, the system creates a profile that links to that cell phone. The cell phone profile enables more mobile features and efficient operation. The profile contains, for example data from your phonebook, read and unread text messages and call history, including history of calls when your cell phone was not connected to the system.

Introduction

If you connect a media device, the system creates and retains a media device index of supported media content. The system also records a short diagnostic log of approximately 10 minutes of all recent system activity.

The cell phone profile, media device index and diagnostic log remain in your vehicle unless you delete them and are generally accessible only in your vehicle when you connect your cell phone or media device. If you no longer plan to use the system or your vehicle, we recommend you use the master reset function to erase the stored information. See **Settings** (page 432).

System data cannot be accessed without special equipment and access to your vehicle's module.

For additional information about our privacy policy, see the regional Ford website.

PERCHLORATE

Certain components in your vehicle such as airbag modules, seatbelt pretensioners and remote control batteries may contain perchlorate material. Special handling may apply for service or vehicle end of life disposal.

For more information visit:

Web Address
www.dtsc.ca.gov/hazardouswaste/perchlorate

FORD CREDIT

US Only

Ford Credit offers a full range of financing and lease plans to help you acquire your vehicle. If you have financed or leased your vehicle through Ford Credit, thank you for your business.

We offer a number of convenient ways for you to contact us, and to manage your account.

Call 1-800-727-7000.

For more information about Ford Credit and access to Account Manager, go to www.ford.com/finance.

REPLACEMENT PARTS RECOMMENDATION

We have built your vehicle to the highest standards using quality parts. We recommend that you demand the use of genuine Ford and Motorcraft parts whenever your vehicle requires scheduled maintenance or repair. You can clearly identify genuine Ford and Motorcraft parts by looking for the Ford, FoMoCo or Motorcraft branding on the parts or their packaging.

Introduction

Scheduled Maintenance and Mechanical Repairs

One of the best ways for you to make sure that your vehicle provides years of service is to have it maintained in line with our recommendations using parts that conform to the specifications detailed in this Owner's Manual. Genuine Ford and Motorcraft parts meet or exceed these specifications.

Collision Repairs

We hope that you never experience a collision, but accidents do happen. Genuine Ford replacement collision parts meet our stringent requirements for fit, finish, structural integrity, corrosion protection and dent resistance. During vehicle development we validate that these parts deliver the intended level of protection as a whole system. A great way to know for sure you are getting this level of protection is to use genuine Ford replacement collision parts.

Warranty on Replacement Parts

Genuine Ford and Motorcraft replacement parts are the only replacement parts that benefit from a Ford Warranty. The Ford Warranty may not cover damage caused to your vehicle as a result of failed non-Ford parts. For additional information, refer to the terms and conditions of the Ford Warranty.

SPECIAL NOTICES

New Vehicle Limited Warranty

For a detailed description of what is covered and what is not covered by your vehicle's New Vehicle Limited Warranty, refer to the Warranty Manual that is provided to you along with your Owner's Manual.

Special Instructions

For your added safety, your vehicle is fitted with sophisticated electronic controls.



WARNING: You risk death or serious injury to yourself and others if you do not follow the instruction highlighted by the warning symbol. Failure to follow the specific warnings and instructions could result in personal injury.



WARNING: Never place front seat mounted rear-facing child or infant seats in front of an active passenger airbag.

On Board Diagnostics Data Link Connector



WARNING: Do not connect wireless plug-in devices to the data link connector. Unauthorized third parties could gain access to vehicle data and impair the performance of safety related systems. Only allow repair facilities that follow our service and repair instructions to connect their equipment to the data link connector.

Your vehicle has an OBD Data Link Connector (DLC) that is used in conjunction with a diagnostic scan tool for vehicle diagnostics, repairs and reprogramming services. Installing an aftermarket device that uses the DLC during normal driving for purposes such as remote insurance company monitoring, transmission of vehicle data to other devices or entities, or altering the performance of the vehicle, may cause

Introduction

interference with or even damage to vehicle systems. We do not recommend or endorse the use of aftermarket plug-in devices unless approved by Ford. The vehicle Warranty will not cover damage caused by an aftermarket plug-in device.

Notice to Owners of Pickup Trucks and Utility Type Vehicles



WARNING: Utility vehicles have a significantly higher rollover rate than other types of vehicles.

Before you drive your vehicle, please read this Owner's Manual carefully. Your vehicle is not a passenger car. As with other vehicles of this type, failure to operate this vehicle correctly may result in loss of vehicle control, vehicle rollover, personal injury or death.

Using Your Vehicle With a Snowplow

Do not use this vehicle for snowplowing.

Your vehicle is not equipped with a snowplowing package.

Using Your Vehicle as an Ambulance

If your light truck is equipped with the Ford Ambulance Preparation Package, it may be utilized as an ambulance. Ford urges ambulance manufacturers to follow the recommendations of the Ford Incomplete Vehicle Manual, Ford Truck Body Builder's Layout Book and the Qualified Vehicle Modifiers (QVM) Guidelines as well as pertinent supplements.

For additional information, please contact the Truck Body Builders Advisory Service:

Web Address
www.fleet.ford.com/truckbbas

You can also call us at
1-877-840-4338.

Other Vehicle Modifications

If converting or modifying your vehicle from production specification, refer to the Truck Body Builder Advisory website:

Web Address
www.fleet.ford.com/truckbbas

MOBILE COMMUNICATIONS EQUIPMENT



WARNING: Driving while distracted can result in loss of vehicle control, crash and injury. We strongly recommend that you use extreme caution when using any device that may take your focus off the road. Your primary responsibility is the safe operation of your vehicle. We recommend against the use of any hand-held device while driving and encourage the use of voice-operated systems when possible. Make sure you are aware of all applicable local laws that may affect the use of electronic devices while driving.

Introduction

Using mobile communications equipment is becoming increasingly important in the conduct of business and personal affairs. However, you must not compromise your own or others' safety when using such equipment. Mobile communications can enhance personal safety and security when appropriately used, particularly in emergency situations. Safety must be paramount when using mobile communications equipment to avoid negating these benefits. Mobile communication equipment includes, but is not limited to, cellular phones, pagers, portable email devices, text messaging devices and portable two-way radios.

EXPORT UNIQUE OPTIONS

For your particular global region, your vehicle may be equipped with features and options that are different from the features and options that are described in this Owner's Manual. A market unique supplement may be supplied that complements this book. By referring to the market unique supplement, if provided, you can properly identify those features, recommendations and specifications that are unique to your vehicle. This Owner's Manual is written primarily for the U.S. and Canadian Markets. Features or equipment listed as standard may be different on units built for export. **Refer to this Owner's Manual for all other required information and warnings.**

Environment

PROTECTING THE ENVIRONMENT

You should play your part in protecting the environment. Correct vehicle usage and the authorized disposal of waste, cleaning and lubrication materials are significant steps toward this aim.

For details about Ford Motor Company's sustainability progress and initiatives visit:

Web Address
www.sustainability.ford.com

Child Safety

GENERAL INFORMATION

See the following sections for directions on how to properly use safety restraints for children.



WARNING: Always make sure your child is secured properly in a device that is appropriate for their height, age and weight. Child safety restraints must be bought separately from your vehicle. Failure to follow these instructions and guidelines may result in an increased risk of serious injury or death to your child.



WARNING: All children are shaped differently. The National Highway Traffic Safety Administration and other safety organizations, base their recommendations for child restraints on probable child height, age and weight thresholds, or on the minimum requirements of the law. We recommend that you check with a NHTSA Certified Child Passenger Safety Technician

(CPST) to make sure that you properly install the child restraint in your vehicle and that you consult your pediatrician to make sure you have a child restraint appropriate for your child. To locate a child restraint fitting station and CPST, contact NHTSA toll free at 1-888-327-4236 or go to www.nhtsa.dot.gov. In Canada, contact Transport Canada toll free at 1-800-333-0371 or go to www.tc.gc.ca to find a Child Car Seat Clinic in your area. Failure to properly restrain children in child restraints made especially for their height, age and weight, may result in an increased risk of serious injury or death to your child.



WARNING: On hot days, the temperature inside the vehicle can rise very quickly. Exposure of people or animals to these high temperatures for even a short time can cause death or serious heat related injuries, including brain damage. Small children are particularly at risk.

Child Safety

Recommendations for Safety Restraints for Children

Child	Child size, height, weight, or age	Recommended restraint type
Infants or toddlers	Children weighing 40 lb (18 kg) or less (generally age four or younger).	Use a child safety seat (sometimes called an infant carrier, convertible seat, or toddler seat).
Small children	Children who have outgrown or no longer properly fit in a child safety seat (generally children who are less than 4 ft. 9 in. (1.45 m) tall, are greater than age four and less than age 12, and between 40 lb (18 kg) and 80 lb (36 kg) and upward to 100 lb (45 kg) if recommended by your child restraint manufacturer).	Use a belt-positioning booster seat.
Larger children	Children who have outgrown or no longer properly fit in a belt-positioning booster seat (generally children who are at least 4 ft. 9 in. (1.45 m) tall or greater than 80 lb (36 kg) or 100 lb (45 kg) if recommended by child restraint manufacturer).	Use a vehicle seatbelt having the lap belt snug and low across the hips, shoulder belt centered across the shoulder and chest, and seatback upright.

- You are required by law to properly use safety seats for infants and toddlers in the United States and Canada.
- Many states and provinces require that small children use approved booster seats until they reach age eight, a height of 4 feet 9 inches (1.45 meters) tall, or 80 lb (36 kg). Check your local and state or provincial laws for specific requirements about the safety of children in your vehicle.
- When possible, always properly restrain children 12 years of age and under in a rear seating position of your vehicle. Accident statistics suggest that children are safer when properly restrained in the rear seating positions than in a front seating position.

INSTALLING CHILD RESTRAINTS

Child Safety Restraint



E142594

Child Safety

Use a child safety restraint (sometimes called an infant carrier, convertible seat, or toddler seat) for infants, toddlers, or children weighing 40 lb (18 kg) or less (generally age four or younger).

Using Lap and Shoulder Belts



WARNING: Do not place a rearward facing child restraint in front of an active airbag. Failure to follow this instruction could result in personal injury or death.



WARNING: Properly secure children 12 years old and under in a rear seating position whenever possible. If you are unable to properly secure all children in a rear seating position, properly secure the largest child on the front seat. If you must use a forward facing child restraint on the front seat, move the seat as far back as possible. Failure to follow these instructions could result in personal injury or death.



WARNING: Depending on where you secure a child restraint, and depending on the child restraint design, you may block access to certain seatbelt buckle assemblies and LATCH lower anchors, rendering those features potentially unusable. To avoid risk of injury, make sure occupants only use seating positions where they are able to be properly restrained.

When installing a child safety restraint with combination lap and shoulder belts:

- Use the correct seatbelt buckle for that seating position.
- Insert the belt tongue into the correct buckle until you hear a distinct click and feel it latch. Make sure the tongue is securely fastened in the buckle.

- Keep the buckle release button pointing up and away from the safety restraint, with the tongue between the child restraint and the release button, to prevent accidental unbuckling.
- Place the vehicle seat upon which the child restraint will be installed in the upright position.
- Put the seatbelt in the automatic locking mode. See Step 5. Your vehicle does not require the use of a locking clip.

Perform the following steps when installing the child restraint with combination lap and shoulder belts:

Note: *Although the child restraint illustrated is a forward facing child restraint, the steps are the same for installing a rearward facing child restraint.*



E142528

1. Position the child safety restraint in a seat with a combination lap and shoulder belt.

Child Safety



E142529

2. Pull down on the shoulder belt and then grasp the shoulder belt and lap belt together.



E142530

3. While holding the shoulder and lap belt portions together, route the tongue through the child restraint according to the child restraint manufacturer's instructions. Make sure the belt webbing is not twisted.

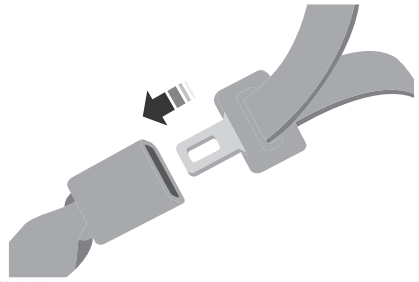

E142531

4. Insert the belt tongue into the correct buckle (the buckle closest to the direction the tongue is coming from) for that seating position until you hear a distinct click and feel the latch engage. Make sure the tongue is latched securely by pulling on it.



E142875

5. To put the retractor in the automatic locking mode, grasp the shoulder portion of the belt and pull downward until all of the belt is pulled out.

Note: *The automatic locking mode is available on the front passenger and rear seats.*

6. Allow the belt to retract to remove slack. The belt clicks as it retracts to indicate it is in the automatic locking mode.

Child Safety

7. Try to pull the belt out of the retractor to make sure the retractor is in the automatic locking mode (you should not be able to pull more belt out). If the retractor is not locked, unbuckle the belt and repeat Steps 5 and 6.



E142533

8. Remove remaining slack from the belt. Force the seat down with extra weight, for example, by pressing down or kneeling on the child restraint while pulling up on the shoulder belt. This is necessary to remove the remaining slack that exists once the extra weight of the child is added to the child restraint. It also helps to achieve the correct snugness of the child restraint to your vehicle. Sometimes, a slight lean toward the buckle helps to remove remaining slack from the belt.
9. Attach the tether strap (if the child restraint is equipped).



E142534

10. Before placing the child in the seat, forcibly move the seat forward and back to make sure the seat is securely held in place. To check this, grab the seat at the belt path and attempt to move it side to side and forward and back. There should be no more than 1 in (2.5 cm) of movement for correct installation.

We recommend checking with a NHTSA Certified Child Passenger Safety Technician to make certain the child restraint is correctly installed. In Canada, check with Transport Canada for referral to a Child Car Seat Clinic.

Using Lower Anchors and Tethers for Children (LATCH)



WARNING: Do not attach two child safety restraints to the same anchor. In a crash, one anchor may not be strong enough to hold two child safety restraint attachments and may break, causing serious injury or death.



WARNING: Depending on where you secure a child restraint, and depending on the child restraint design, you may block access to certain seatbelt buckle assemblies and LATCH lower anchors, rendering those features potentially unusable. To avoid risk of injury, make sure occupants only use seating positions where they are able to be properly restrained.

The LATCH system is composed of three vehicle anchor points: two lower anchors where the seat backrest and seat cushion meet (called the seat bight) and one top tether anchor behind that seating position.

Child Safety

LATCH compatible child safety restraints have two rigid or webbing mounted attachments that connect to the two lower anchors at the LATCH equipped seating positions in your vehicle. This type of attachment method eliminates the need to use seatbelts to attach the child

restraint, however the seatbelt can still be used to attach the child restraint. For forward-facing child restraints, the top tether strap must also be attached to the correct top tether anchor, if a top tether strap has been provided with your child restraint.

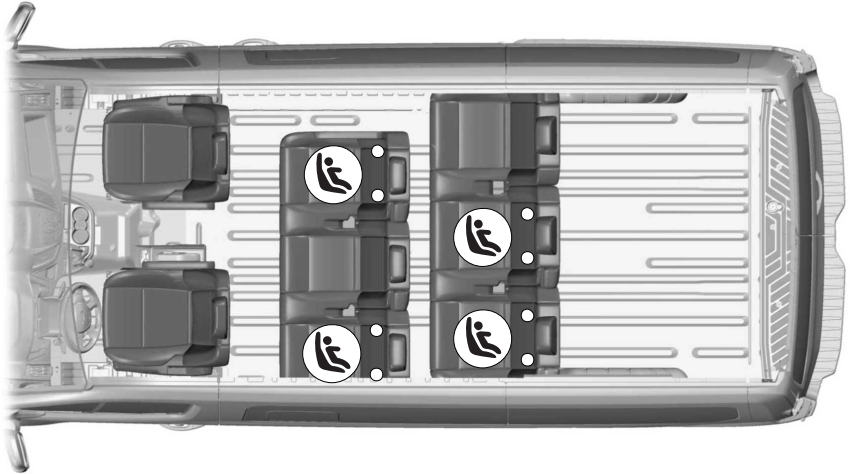

E258858

Child Safety

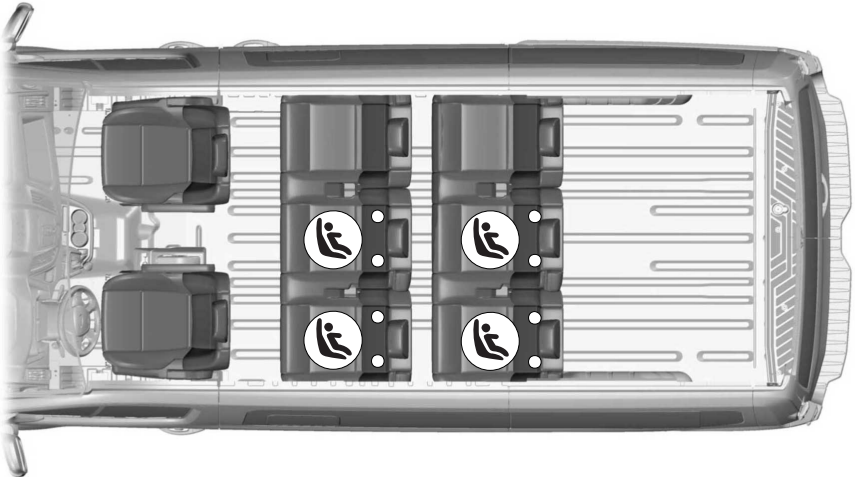

E254574

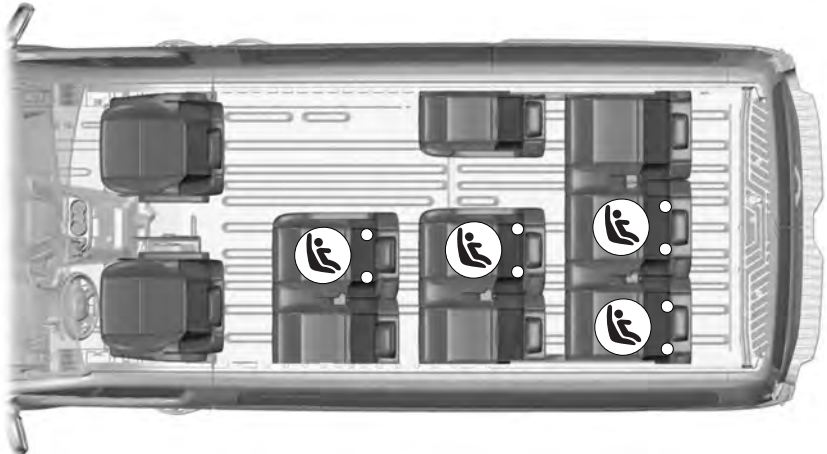

E258864

Child Safety

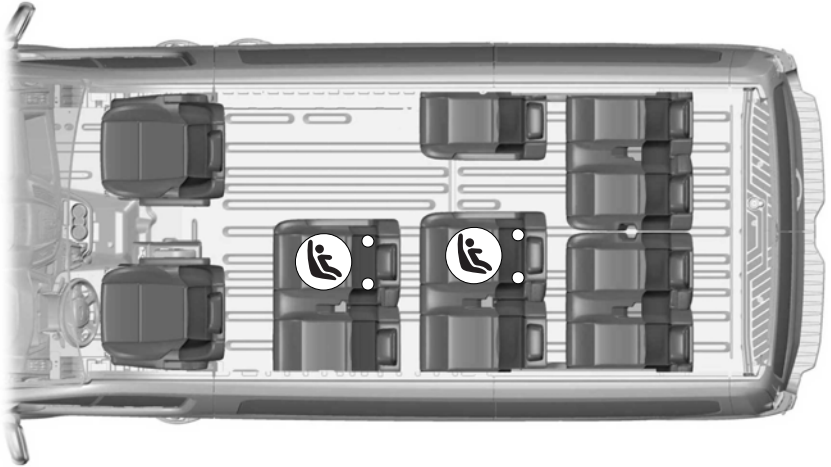

E282290

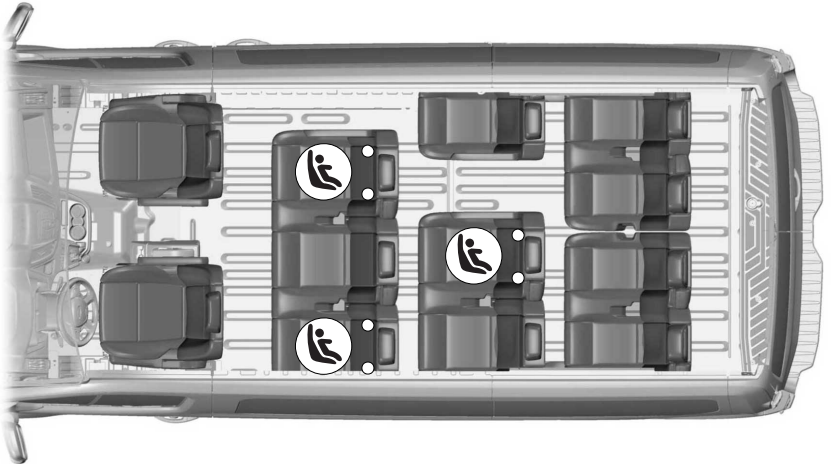

E254575

Child Safety



E266915

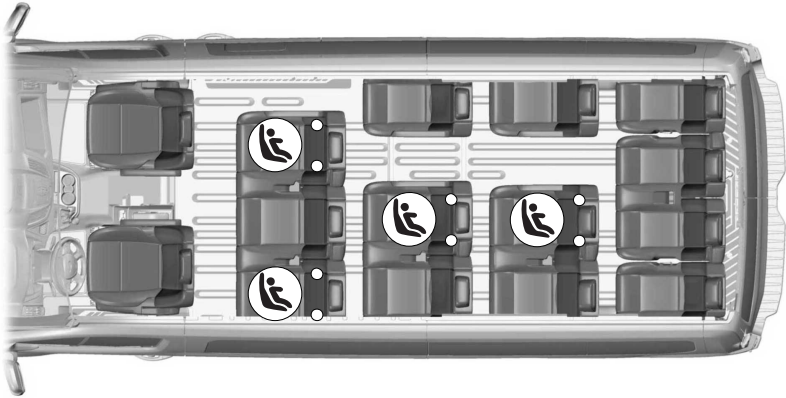

E254576

Child Safety

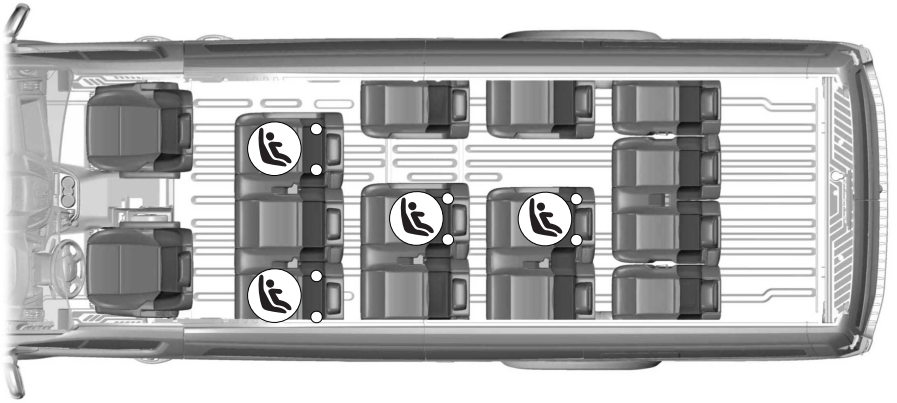

E258867

Your vehicle has LATCH lower anchors for child restraint installation at the seating positions marked with the child restraint symbol.

Note: In addition to those shown, other seating positions may also have LATCH lower anchor points. You can identify these with the child restraint symbol shown on those seating positions.



E177639

Child Safety

The LATCH anchors are at the rear section of the rear seat between the cushion and seat backrest above the symbols as shown. Follow the child restraint manufacturer's instructions to correctly install a child restraint with LATCH attachments. Follow the instructions on attaching child safety restraints with tether straps.

Attach LATCH lower attachments of the child restraint only to the anchors shown.

Use of Inboard Lower Anchors from the Outermost Seating Positions (Center Seating Use)



WARNING: The standardized spacing for LATCH lower anchors is 11 in (280 mm) center to center. Do not use LATCH lower anchors for the center seating position unless the child restraint manufacturer's instructions permit and specify using anchors spaced at least as far apart as those in this vehicle.

Do not attach a child restraint to any lower anchor if an adjacent child restraint is attached to that anchor.

Each time you use the safety restraint, check that the seat is correctly attached to the lower anchors and tether anchor, if applicable. Tug the child restraint from side to side and forward and back where it is secured to your vehicle. The seat should move less than 1 in (2.5 cm) when you do this for a correct installation.

If the safety restraint is not anchored correctly, the risk of a child being injured in a crash greatly increases.

Combining Seatbelt and LATCH Lower Anchors for Attaching Child Safety Restraints

When used in combination, either the seatbelt or the LATCH lower anchors may be attached first, provided a correct installation is achieved. Attach the tether strap afterward, if included with the child restraint.

Using Tether Straps



Many forward-facing child safety restraints include a tether strap which extends from the back of the child safety restraint and hooks to an anchoring point called the top tether anchor. Tether straps are available as an accessory for many older safety restraints.

Contact the manufacturer of your child restraint for information about ordering a tether strap, or to obtain a longer tether strap if the tether strap on the safety restraint does not reach the appropriate top tether anchor in your vehicle.

Once the child safety restraint has been installed using either the seatbelt, the lower anchors of the LATCH system, or both, you can attach the top tether strap.

The tether strap anchors in your vehicle are in the following positions (shown from top view):

Child Safety

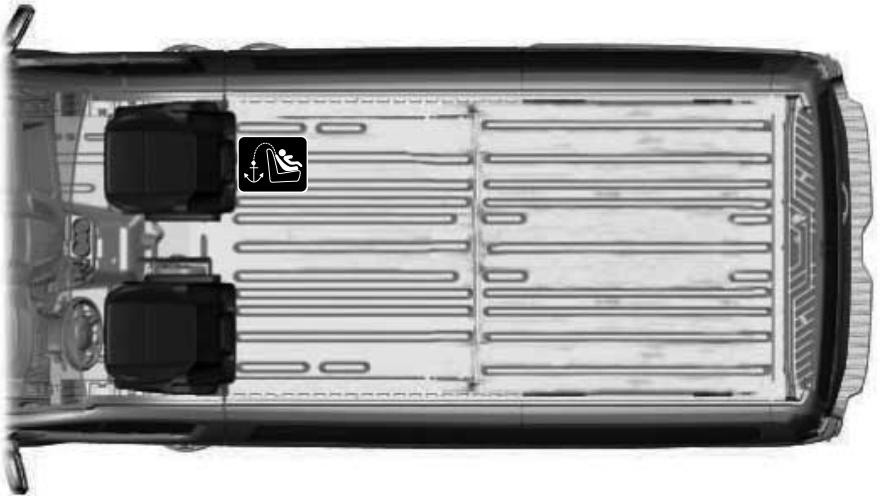

E254595

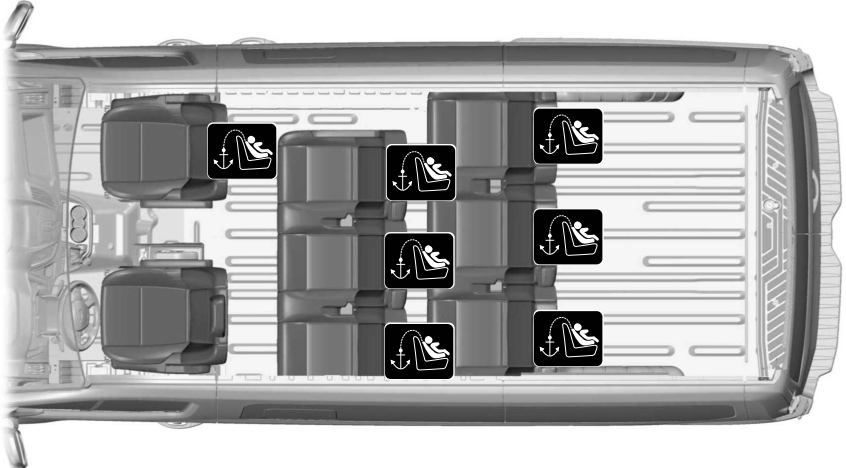

E258857

Child Safety

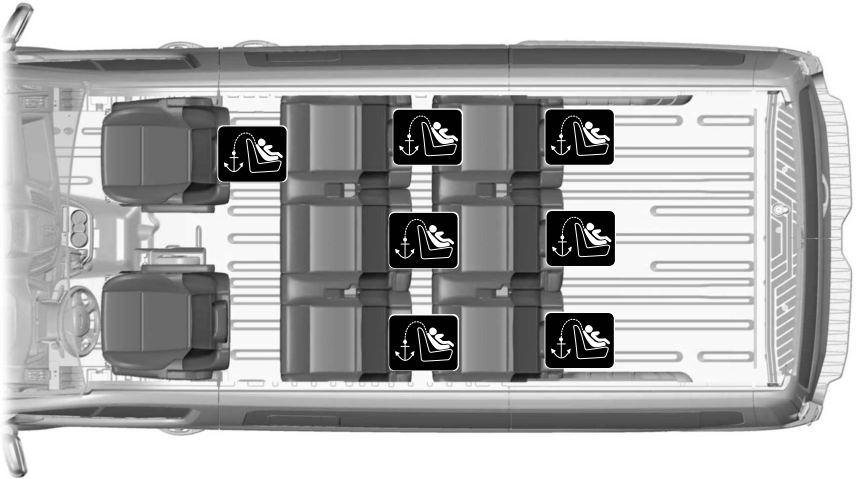

E258859

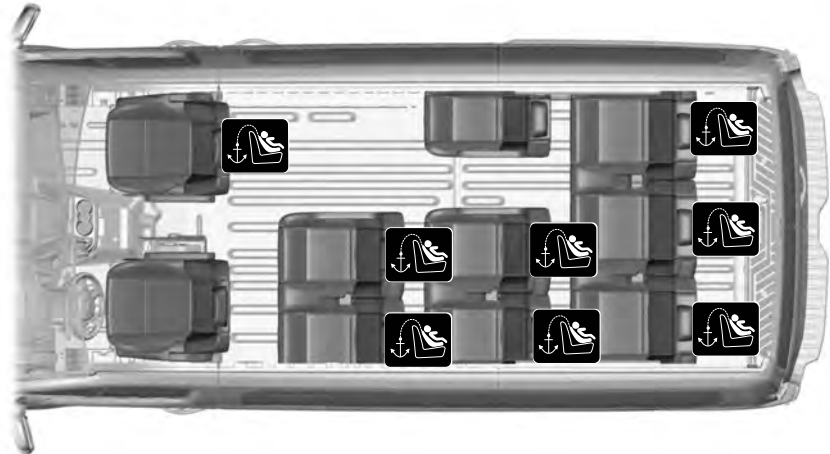

E258865

Child Safety

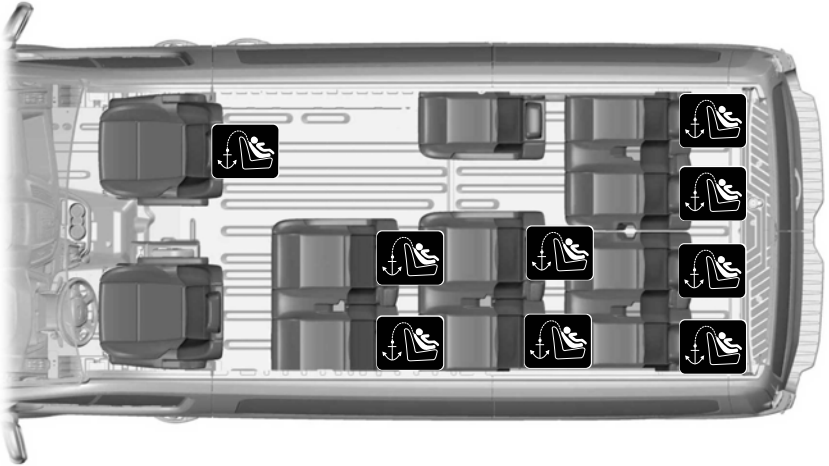

E282292

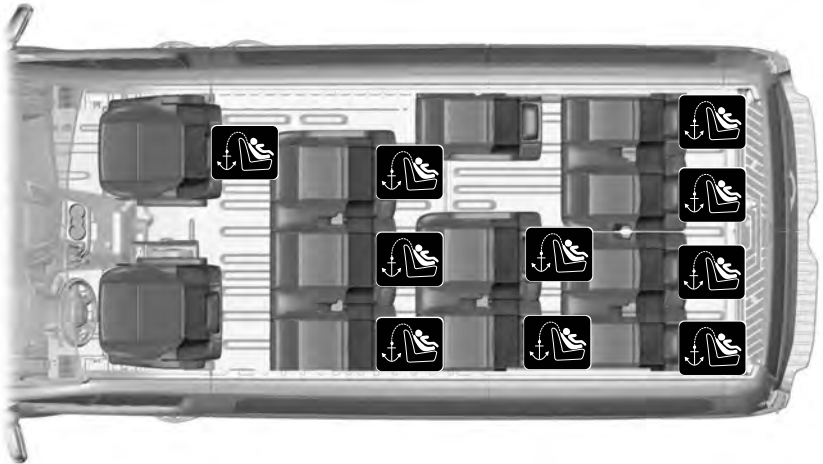

E258863

Child Safety

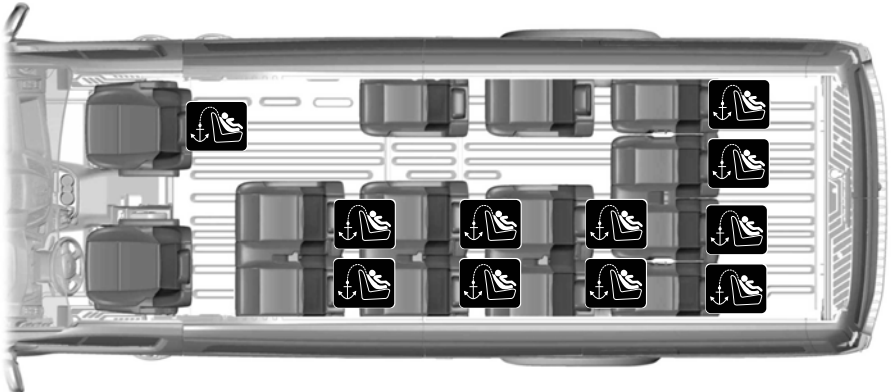

E267027



E258866

Child Safety



E258868

Perform the following steps to install a child safety restraint with tether anchors:

Note: *If you install a child restraint with rigid LATCH attachments, do not tighten the tether strap enough to lift the child restraint off your vehicle seat cushion when the child is seated in it. Keep the tether strap just snug without lifting the front of the child restraint. Keeping the child restraint just touching your vehicle seat gives the best protection in a severe crash.*

Front Passenger Seating Position

1. Adjust the front passenger seat fully forward.
2. Route the child safety restraint tether strap over the back of the seat, under the head restraint and between the head restraint posts.

Child Safety



3. Locate the correct anchor on the back panel of the rear seat for the selected seating position. The anchors are labeled with the tether strap symbol and are partially covered by the gap panel. Pull the panel back to fully expose the anchors.
4. Clip the tether strap to the anchor as shown.
5. Adjust the front passenger seat fully rearward.
6. Tighten the child safety restraint tether strap according to the manufacturer's instructions. If your child restraint system is equipped with a tether strap, and the child restraint manufacturer recommends its use, we also recommend its use.

Rear Seats

1. Route the child safety restraint tether strap over the back of the seat, under the head restraint and between the head restraint posts.

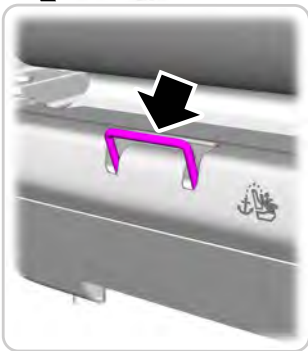

E178096

Child Safety

BOOSTER SEATS



E177640

 **WARNING:** Do not put the shoulder section of the seatbelt or allow the child to put the shoulder section of the seatbelt under their arm or behind their back. Failure to follow this instruction could reduce the effectiveness of the seatbelt and increase the risk of injury or death in a crash.

Use a belt-positioning booster seat for children who have outgrown or no longer properly fit in a child safety restraint (generally children who are less than 57 in (1.45 m) tall, are greater than age 4 and less than age 12, and between 40 lb (18 kg) and 80 lb (36 kg) and upward to 100 lb (45 kg) if recommended by your child restraint manufacturer). Many state and provincial laws require that children use approved booster seats until they reach age eight, a height of 57 in (1.45 m) tall, or 80 lb (36 kg).

2. Locate the correct anchor on the back panel of the rear seat for the selected seating position. The anchors are labeled with the tether strap symbol and are partially covered by the gap panel. Pull the panel back to fully expose the anchors.
3. Clip the tether strap to the anchor as shown.
4. Tighten the child safety restraint tether strap according to the manufacturer's instructions. If your child restraint system has a tether strap, and the child restraint manufacturer recommends its use, we also recommend its use.

Booster seats should be used until you can answer YES to ALL of these questions when seated without a booster seat:

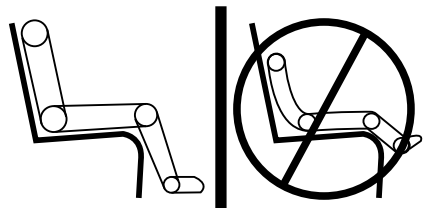

E142595

Child Safety

- Can the child sit all the way back against their vehicle seat backrest with knees bent comfortably at the edge of the seat cushion?
- Can the child sit without slouching?
- Does the lap belt rest low across the hips?
- Is the shoulder belt centered on the shoulder and chest?
- Can the child stay seated like this for the whole trip?

Always use booster seats in conjunction with your vehicle lap and shoulder belt.

Types of Booster Seats



E68924

- Backless booster seats

If your backless booster seat has a removable shield, remove the shield. If a vehicle seating position has a low seat backrest or no head restraint, a backless booster seat may place your child's head (as measured at the tops of the ears)

above the top of the seat. In this case, move the backless booster to another seating position with a higher seat backrest or head restraint and lap and shoulder belts, or consider using a high back booster seat.



E70710

- High back booster seats

If, with a backless booster seat, you cannot find a seating position that adequately supports your child's head, a high back booster seat would be a better choice.

Children and booster seats vary in size and shape. Choose a booster that keeps the lap belt low and snug across the hips, never up across the stomach, and lets you adjust the shoulder belt to cross the chest and rest snugly near the center of the shoulder. The following drawings compare the ideal fit (center) to a shoulder belt uncomfortably close to the neck and a shoulder belt that could slip off the shoulder. The drawings also show how the lap belt should be low and snug across the child's hips.

Child Safety



E142596



E142597

If the booster seat slides on the vehicle seat upon which it is being used, placing a rubberized mesh sold as shelf or carpet liner under the booster seat may improve this condition. Do not introduce any item thicker than this under the booster seat. Check with the booster seat manufacturer's instructions.

CHILD RESTRAINT POSITIONING



WARNING: Do not place a rearward facing child restraint in front of an active airbag. Failure to follow this instruction could result in personal injury or death.



WARNING: Properly secure children 12 years old and under in a rear seating position whenever possible. If you are unable to properly secure all children in a rear seating position, properly secure the largest child on the front seat. If you must use a forward facing child restraint on the front seat, move the seat as far back as possible. Failure to follow these instructions could result in personal injury or death.



WARNING: Always carefully follow the instructions and warnings provided by the manufacturer of any child restraint to determine if the restraint device is appropriate for your child's size, height, weight, or age. Follow

Child Safety

the child restraint manufacturer's instructions and warnings provided for installation and use in conjunction with the instructions and warnings provided by your vehicle manufacturer. A safety seat that is improperly installed or utilized, is inappropriate for your child's height, age, or weight or does not properly fit the child may increase the risk of serious injury or death.



WARNING: Do not allow a passenger to hold a child on their lap when your vehicle is moving. Failure to follow this instruction could result in personal injury or death in the event of a sudden stop or crash.



WARNING: Do not use pillows, books or towels to boost your child's height. Failure to follow this instruction could result in personal injury or death.



WARNING: Properly secure child restraints or booster seats when they are not in use. They could become projectiles in a sudden stop or crash. Failure to follow this instruction could result in personal injury or death.



WARNING: Do not put the shoulder section of the seatbelt or allow the child to put the shoulder section of the seatbelt under their arm or behind their back. Failure to follow this instruction could reduce the effectiveness of the seatbelt and increase the risk of injury or death in a crash.



WARNING: Do not leave children or pets unattended in your vehicle. Failure to follow this instruction could result in personal injury or death.

Child Safety

Recommendations for Attaching Child Safety Restraints for Children

Restraint Type	Combined Weight of Child and Child Restraint	Use Any Attachment Method as Indicated Below by X				
		LATCH (Lower Anchors and Top Tether Anchor)	LATCH (Lower Anchors Only)	Seatbelt and Top Tether Anchor	Seatbelt and LATCH (Lower Anchors and Top Tether Anchor)	Seatbelt Only
Rear facing child restraint	Up to 65 lb (29.5 kg)		X			X
Rear facing child restraint	Over 65 lb (29.5 kg)					X
Forward facing child restraint	Up to 65 lb (29.5 kg)	X		X	X	
Forward facing child restraint	Over 65 lb (29.5 kg)			X	X	

Note: The child restraint must rest tightly against the vehicle seat upon which it is installed. It may be necessary to lift or remove the head restraint. See **Seats** (page 111).

CHILD SAFETY LOCKS (IF EQUIPPED)

 **WARNING:** You cannot open the rear doors from inside if you have put the child safety locks on.

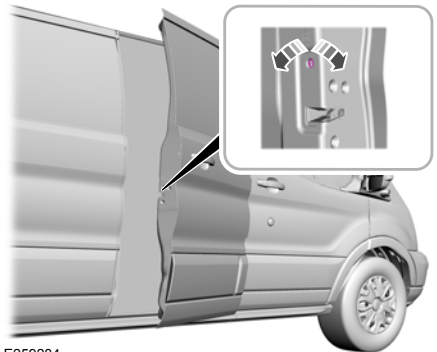

E259284

The child safety lock is on the rear side door.

Child Safety

Left-Hand Side

Turn the key counterclockwise to lock and clockwise to unlock.

Right-Hand Side

Turn the key clockwise to lock and counterclockwise to unlock.

Seatbelts

PRINCIPLE OF OPERATION



WARNING: Always drive and ride with the seatback upright and the lap belt snug and low across the hips.



WARNING: To reduce the risk of injury, make sure children sit where they can be properly restrained.



WARNING: Never let a passenger hold a child on his or her lap while your vehicle is moving. The passenger cannot protect the child from injury in a crash which may result in serious injury or death.



WARNING: All occupants of the vehicle, including the driver, should always properly wear their seatbelts, even when an airbag supplemental restraint system is provided. Failure to properly wear your seatbelt could seriously increase the risk of injury or death.



WARNING: It is extremely dangerous to ride in a cargo area, inside or outside of a vehicle. In a crash, people riding in these areas are more likely to be seriously injured or killed. Do not allow people to ride in any area of your vehicle that is not equipped with seats and seatbelts. Be sure everyone in your vehicle is in a seat and using a seatbelt properly.



WARNING: In a rollover crash, an unbelted person is significantly more likely to die than a person wearing a seatbelt.



WARNING: Each seating position in your vehicle has a specific seatbelt assembly which is made up of one buckle and one tongue that are designed to be used as a pair. 1) Use the shoulder belt on the outside shoulder only. Never wear the shoulder belt under the arm. 2) Never swing the seatbelt around your neck over the inside shoulder. 3) Never use a single belt for more than one person.



WARNING: When possible, all children 12 years old and under should be properly restrained in a rear seating position. Failure to follow this could seriously increase the risk of injury or death.



WARNING: Seatbelts and seats can become hot in a vehicle that has been closed up in sunny weather; they could burn a small child. Check seat covers and buckles before you place a child anywhere near them.



WARNING: Front and rear seat occupants, including pregnant women, should wear seatbelts for optimum protection in an accident.

All seating positions in this vehicle have lap and shoulder belts. All occupants of the vehicle should always properly wear their seatbelts, even when an airbag supplemental restraint system is provided.

The seatbelt system consists of:

- Lap and shoulder seatbelts.
- Shoulder seatbelt with automatic locking mode, (except driver seatbelt).
- Height adjuster at the front outboard seating positions.
- Seatbelt pretensioner at the front outboard seating positions.

Seatbelts



- Seatbelt warning light and chime.



- Crash sensors and monitoring system with readiness indicator.

The seatbelt pretensioners at the front seating positions are designed to tighten the seatbelts when activated. In frontal and near-frontal crashes, the seatbelt pretensioners may be activated alone or, if the crash is of sufficient severity, together with the front airbags. In side crashes and rollovers, the seatbelt pretensioners activate when the Safety Canopy is activated.

FASTENING THE SEATBELTS

The front outermost and rear safety restraints in your vehicle are combination lap and shoulder belts.



E142587

1. Insert the seatbelt tongue into the proper buckle (the buckle closest to the direction the tongue is coming from) until you hear a snap and feel it latch.

Note: Make sure that the seatbelt tongue is properly fastened in the seatbelt buckle.

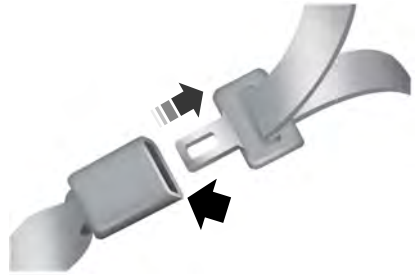

E142588

2. Press the button to release the seatbelt tongue.

Using Seatbelts During Pregnancy



WARNING: Always ride and drive with your seatback upright and properly fasten your seatbelt. Fit the lap portion of the seatbelt snugly and low across the hips. Position the shoulder portion of the seatbelt across your chest. Pregnant women must follow this practice. See the following figure.

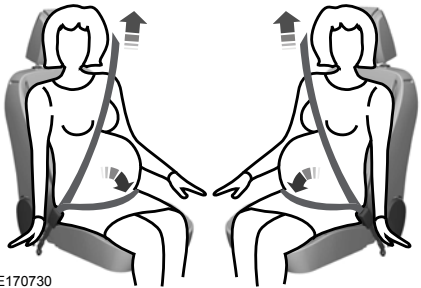

E170730

Seatbelts

Pregnant women should always wear their seatbelt. The lap belt portion of a combination lap and shoulder belt should be positioned low across the hips below the belly and worn as tight as comfort allows. The shoulder belt should be positioned to cross the middle of the shoulder and the center of the chest.

Seatbelt Locking Modes



WARNING: After a crash, have a qualified technician check all the seatbelts to make sure the seatbelts including the automatic locking retractor feature for child restraints operate properly. We recommend replacing any system that has damage or does not operate properly. Failure to do so can result in personal injury or death in the event of a sudden stop or another crash.



WARNING: You must replace the seatbelt if the automatic locking retractor or any other seatbelt function is not operating correctly. Failure to replace the seatbelt and retractor assembly could increase the risk of injury in a crash.

All seatbelts in your vehicle are combination lap and shoulder belts. The driver seatbelt has the first type of locking mode, and the front outermost passenger and rear seat seatbelts have both types of locking modes described as follows:

Vehicle Sensitive Mode

This is the normal retractor mode which allows free shoulder belt length adjustment to your movements and locking in response to vehicle movement. For example, if you brake suddenly or turn a corner sharply, or your vehicle receives an impact of approximately 5 mph (8 km/h) or more, the combination seatbelts lock to help reduce forward movement of the driver and passengers.

In addition, the retractor is designed to lock if you pull the webbing out too quickly. If the seatbelt retractor locks, slowly lower the height adjuster to allow the seatbelt to retract. If the retractor does not unlock, pull the seatbelt out slowly then feed a small length of webbing back toward the stowed position. For rear seatbelts, recline the rear seat backrest or push the seat backrest cushion away from the seatbelt. Feed a small length of webbing back toward the stowed position.

Automatic Locking Mode

In this mode, the shoulder belt automatically pre-locks. The seatbelt still retracts to remove any slack in the shoulder belt. The automatic locking mode is not available on the driver seatbelt.

Using Automatic Locking Mode

You should use automatic locking mode when a child safety seat, except a booster, is on the front passenger seat or rear seat. Children 12 years old and under should be correctly restrained in a rear seating position whenever possible. See **Child Safety** (page 18).

Seatbelts



E142591

1. Buckle the combination lap and shoulder belt.
2. Grasp the shoulder portion and pull downward until you pull the entire seatbelt out.
3. Let the seatbelt retract.

Note: As the seatbelt retracts, you will hear a clicking sound. This indicates the seatbelt is now in the automatic locking mode.

Disengaging Automatic Locking Mode

Unbuckle the combination lap and shoulder belt and allow it to retract completely to disengage the automatic locking mode and return the seatbelt to the vehicle sensitive mode.

SEATBELT HEIGHT ADJUSTMENT



WARNING: Position the seatbelt height adjuster so that the seatbelt rests across the middle of your shoulder. Failure to adjust the seatbelt correctly could reduce its effectiveness and increase the risk of injury in a crash.

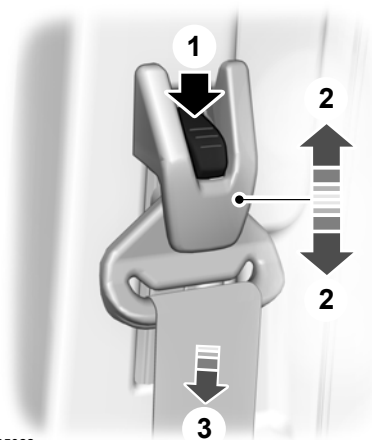

E165022

1. Press the button.
2. Slide the height adjuster up or down.
3. Release the button and pull down on the height adjuster to make sure it is locked in place.

SEATBELT WARNING LAMP AND INDICATOR CHIME



This lamp illuminates and an indicator chime will sound if the driver seatbelt has not been fastened when the vehicle's ignition is turned on.

Seatbelts

Conditions of operation

If	Then
The driver seatbelt is not buckled before the ignition switch is turned to the on position...	The seatbelt warning lamp illuminates and the indicator chime sounds for a few seconds.
The driver seatbelt is buckled while the warning lamp is illuminated and the indicator chime is sounding...	The seatbelt warning lamp and indicator chime turn off.
The driver seatbelt is buckled before the ignition switch is turned to the on position...	The seatbelt warning lamp and indicator chime remain off.

SEATBELT REMINDER

Belt-Minder®

This feature supplements the seatbelt warning function by providing additional reminders by intermittently sounding a chime and illuminating the seatbelt warning light when the driver seat is occupied and the seatbelt is unbuckled.

If...	Then...
The driver seatbelt is buckled before the ignition is switched on or less than two minutes have elapsed since the ignition was switched on.	The Belt-Minder feature will not turn on.
The driver seatbelt is not buckled when the vehicle has reached at least 6 mph (9.7 km/h) and two minutes have elapsed since the ignition was switched on.	The Belt-Minder feature is turned on - the seatbelt warning light illuminates and the warning chime sounds for six seconds every 25 seconds, repeating for about five minutes or until the driver seatbelt is buckled.
The driver seatbelt becomes unbuckled for about one minute while the vehicle is traveling at least 6 mph (9.7 km/h) and more than two minutes have elapsed since the ignition was switched on.	The Belt-Minder feature is turned on - the seatbelt warning light illuminates and the warning chime sounds for six seconds every 25 seconds, repeating for about five minutes or until the driver seatbelt is buckled.

Seatbelts

Switching the Belt-Minder on and off



WARNING: While the system allows you to switch it off, this system is designed to improve your chances of being safely belted and surviving a crash. We recommend you leave the system switched on. To reduce the risk of injury, do not switch the system on or off while driving your vehicle.

Read Steps 1 - 4 thoroughly before proceeding with the programming procedure.

The system can be switched on and off by carrying out the following procedure:

Before following the procedure, make sure that:

- The parking brake is set.
 - The transmission selector lever is in position park (P).
 - The ignition is switched off.
 - The driver seatbelt is unbuckled.
1. Switch the ignition on. Do not start the engine.
 2. Wait until the seatbelt warning light turns off (about one minute). After Step 2, wait an additional five seconds before proceeding with Step 3. Once Step 3 is started, the procedure must be completed within 30 seconds.
 3. Buckle then unbuckle the driver seatbelt three times at a moderate speed, ending in the unbuckled state. After Step 3, the seatbelt warning light will illuminate.
 4. While the seatbelt warning light is illuminated, buckle then unbuckle the driver seatbelt. After Step 4, the seatbelt warning light will flash for confirmation.

- This will disable the feature if it is currently enabled.
- This will enable the feature if it is currently disabled.

CHILD RESTRAINT AND SEATBELT MAINTENANCE

Inspect the vehicle seatbelts and child safety seat systems periodically to make sure they work properly and are not damaged. Inspect the vehicle and child restraint seatbelts to make sure there are no nicks, tears or cuts. Replace if necessary. All vehicle seatbelt assemblies, including retractors, buckles, front seatbelt buckle assemblies, buckle support assemblies (slide bar-if equipped), shoulder belt height adjusters (if equipped), shoulder belt guide on seat backrest (if equipped), child safety seat LATCH and tether anchors, and attaching hardware, should be inspected after a crash. Read the child restraint manufacturer's instructions for additional inspection and maintenance information specific to the child restraint.

We recommend that all seatbelt assemblies in use in vehicles involved in a crash be replaced. However, if the crash was minor and an authorized dealer finds that the belts do not show damage and continue to operate properly, they do not need to be replaced. Seatbelt assemblies not in use during a crash should also be inspected and replaced if either damage or improper operation is noted.

Properly care for seatbelts.

Seatbelts

SEATBELT EXTENSION



WARNING: Persons who fit into the vehicle's seatbelt should not use an extension. Unnecessary use could result in serious personal injury in the event of a crash.



WARNING: Only use extensions provided free of charge by Ford Motor Company dealers. The dealer will provide an extension designed specifically for this vehicle, model year and seating position. The use of an extension intended for another vehicle, model year or seating position may not offer you the full protection of your vehicle's seatbelt restraint system.



WARNING: Never use seatbelt extensions to install child restraints.



WARNING: Do not use a seatbelt extension with an inflatable seatbelt.





WARNING: Do not use extensions to change the fit of the belt across the torso, over the lap or to make the seatbelt buckle easier to reach.

If, because of body size or driving position, it is not possible to properly fasten the seatbelt over your lap and shoulder, an extension that is compatible with the seatbelts is available free of charge from Ford Motor Company dealers. Only Ford seatbelt extensions made by the original equipment seatbelts manufacturer should be used with Ford seatbelts. Ask your authorized dealer if your extension is compatible with your Ford vehicle restraint system.

Supplementary Restraints System

PRINCIPLE OF OPERATION

 **WARNING:** Airbags do not inflate slowly or gently, and the risk of injury from a deploying airbag is the greatest close to the trim covering the airbag module.

 **WARNING:** All occupants of your vehicle, including the driver, should always properly wear their seatbelts, even when an airbag supplemental restraint system is provided. Failure to properly wear your seatbelt could seriously increase the risk of injury or death.

 **WARNING:** Even with advanced restraints systems, properly restrain children 12 and under in a rear seating position. Failure to follow this could seriously increase the risk of injury or death.

 **WARNING:** Do not place your arms on the airbag cover or through the steering wheel. Failure to follow this instruction could result in personal injury.

 **WARNING:** Keep the areas in front of the airbags free from obstruction. Do not affix anything to or over the airbag covers. Objects could become projectiles during airbag deployment or in a sudden stop. Failure to follow this instruction could result in personal injury or death.

 **WARNING:** Airbags can kill or injure a child in a child restraint. Never place a rear-facing child restraint in front of an active airbag. If you must use a forward-facing child restraint in the front seat, move the seat upon which the child restraint is installed all the way back.

 **WARNING:** Do not attempt to service, repair, or modify the supplementary restraint system or associated components. Failure to follow this instruction could result in personal injury or death.

 **WARNING:** Several airbag system components get hot after inflation. To reduce the risk of injury, do not touch them after inflation.

 **WARNING:** If a supplementary restraint system component has deployed, it will not function again. Have the system and associated components inspected as soon as possible. Failure to follow this instruction could result in personal injury or death.

The airbags are a supplemental restraint system and are designed to work with the seatbelts to help protect the driver and right front passenger from certain upper body injuries. Airbags do not inflate slowly; there is a risk of injury from a deploying airbag.

Note: *You will hear a loud bang and see a cloud of harmless powdery residue if an airbag deploys. This is normal.*

The airbags inflate and deflate rapidly upon activation. After airbag deployment, it is normal to notice a smoke-like, powdery residue or smell the burnt propellant. This may consist of cornstarch, talcum powder (to lubricate the bag) or sodium compounds (for example, baking soda) that result from the combustion process that inflates the airbag. Small amounts of sodium hydroxide may be present which may irritate the skin and eyes, but none of the residue is toxic.

Supplementary Restraints System

While the system is designed to help reduce serious injuries, contact with a deploying airbag may also cause abrasions or swelling. Temporary hearing loss is also a possibility as a result of the noise associated with a deploying airbag. Because airbags must inflate rapidly and with considerable force, there is the risk of death or serious injuries such as fractures, facial and eye injuries or internal injuries, particularly to occupants who are not properly restrained or are otherwise out of position at the time of airbag deployment. Thus, it is extremely important that occupants be properly restrained as far away from the airbag module as possible while maintaining vehicle control.

Routine maintenance of the airbags is not required.

DRIVER AND PASSENGER AIRBAGS



WARNING: Keep the areas in front of the airbags free from obstruction. Do not affix anything to or over the airbag covers. Objects could become projectiles during airbag deployment. Failure to follow this instruction could result in personal injury or death.



WARNING: Do not place your arms on the airbag cover or through the steering wheel. Failure to follow this instruction could result in personal injury.



WARNING: Do not place a rearward facing child restraint in front of an active airbag. Failure to follow this instruction could result in personal injury or death.

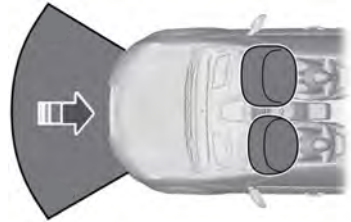

E151127

The driver and front passenger airbags will deploy during significant frontal and near frontal crashes.

The driver and passenger front airbag system consists of:

- Driver and passenger airbag modules.
- Crash sensors and monitoring system with readiness indicator. See **Crash Sensors and Airbag Indicator** (page 57).



Passenger Airbag On and Off Switch (If Equipped)



WARNING: Even with advanced restraints systems, properly restrain children 12 and under in a rear seating position. Failure to follow this could seriously increase the risk of injury or death.



WARNING: The front passenger airbag is not designed to offer protection to an occupant in the center seating position.

Supplementary Restraints System



WARNING: Your vehicle may have an airbag deactivation switch. Before driving, always look at the switch to make sure it is in the appropriate position. Failure to put the switch in the proper position can increase the risk of serious injury or death in a crash.

The front passenger airbag on and off switch has indicators that will illuminate, indicating that the front passenger frontal airbag is either on or off. The indicator lamp is located on the instrument panel.

Note: *The passenger airbag status indicator OFF and ON lamps illuminate for a short period of time when you switch the ignition on to confirm it is functional.*



E282245

Switch position	Passenger airbag status indicator	Passenger airbag
Off	OFF: Lit	Disabled
	ON: Unlit	
On	OFF: Unlit	Enabled
	ON: Lit	

Turning the Passenger Airbag Off



WARNING: If the light does not illuminate when the passenger airbag switch is off and you switch the ignition on, have the passenger airbag switch serviced immediately by a qualified technician.



WARNING: To avoid switching on the airbag, always remove the ignition key with the switch in the off position.



WARNING: Never place front seat mounted rear-facing child or infant seats in front of an active passenger airbag.



WARNING: You must switch the passenger airbag off when using a rearward facing child restraint on the front seat.

Supplementary Restraints System

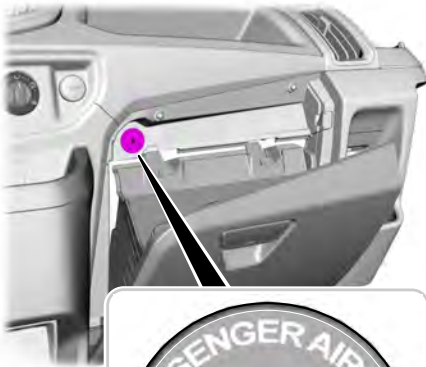

E181523





E181522

1. Insert the ignition key, turn the switch to OFF and hold in OFF while removing the key.

2. When the ignition is turned on, the pass airbag off light illuminates briefly, momentarily shuts off and then turns back on. This indicates that the passenger airbag is deactivated.

Turning the Passenger Airbag Back On

 **WARNING:** The seatbelts for the driver and right front passenger seating positions are specifically designed to operate together with the airbags in certain types of crashes. When you switch off your airbag, you not only lose the protection of the airbag, you also may reduce the effectiveness of your seatbelt system. If the passenger does not meet the requirements stated in the National Highway Traffic Safety Administration or Transport Canada deactivation criteria, switching off the airbag can increase the risk of serious injury or death in a crash.

 **WARNING:** If your vehicle has rear seats, always transport children who are 12 and younger in the rear seat. Always use seatbelts and child restraints properly. Do not place a child in a rear facing infant seat in the front seat unless your vehicle is equipped with an airbag on and off switch and the passenger airbag is turned off. This is because the back of the infant seat is too close to the inflating airbag and the risk of a fatal injury to the infant when the airbag inflates is substantial.

 **WARNING:** If the passenger airbag off light is illuminated when the passenger airbag switch is on and the ignition is on, have the passenger airbag switch serviced immediately by a qualified technician.

Supplementary Restraints System

The passenger airbag remains off until you turn it back on.



E181521

1. Insert the ignition key and turn the switch to ON.
2. The pass airbag off light will briefly illuminate when the ignition is turned to on. This indicates that the passenger airbag is operational.

The passenger side airbag should always be on (the pass airbag off light should not be illuminated) unless the passenger meets the requirements stated either in Category 1, 2 or 3 of the National Highway Traffic Safety Administration or Transport Canada deactivation criteria which follows.

The vast majority of drivers and passengers are much safer with an airbag than without. To do their job and reduce the risk of life threatening injuries, airbags must open with great force, and this force can pose a potentially deadly risk in some situations, particularly when a front seat passenger is not using the seatbelt correctly. The most effective way to reduce the risk of unnecessary airbag injuries without reducing the overall safety of your vehicle is to make sure all passengers are correctly restrained in the vehicle, especially in the front seat. This provides

the protection of seatbelts and permits the airbags to provide the additional protection they were designed to provide. If you choose to deactivate your airbag, you are losing the very significant risk reducing benefits of the airbag and you are also reducing the effectiveness of the seatbelts, because seatbelts in modern vehicles are designed to work as a safety system with the airbags.

National Highway Traffic Safety Administration Deactivation Criteria (Excluding Canada)



WARNING: This vehicle has special energy management seatbelts for the driver and right front passenger. These particular seatbelts are specifically designed to work with airbags to help reduce the risk of injury in a crash. The energy management seatbelt gives or releases additional seatbelt webbing in some accidents to reduce the concentration of force on an occupant's chest and to reduce the risk of certain bone fractures and injuries to underlying organs. In a crash, if the airbag is off, this energy management seatbelt might permit the passenger wearing the seatbelt to move forward enough to have a serious or fatal injury. The more severe the crash, and the heavier the occupant, the greater the risk. Make sure the airbag is on for any passenger who does not qualify under the National Highway Traffic Safety Administration deactivation criteria.

1. **Infant.** An infant (less than 1 year old) must ride in the front seat because:

Supplementary Restraints System

- The vehicle has no rear seat;
- The vehicle has a rear seat too small to accommodate a rear-facing infant seat; or
- The infant has a medical condition which, according to the infant's physician, makes it necessary for the infant to ride in the front so that the driver can constantly monitor the child's condition.

2. Child age 1 to 12. A child age 1 to 12 must ride in the front seat because:

- The vehicle has no rear seat;
- Although children ages 1 to 12 ride in the rear seat(s) whenever possible, children ages 1 to 12 sometimes must ride in the front because no space is available in the rear seat(s) of the vehicle; or
- The child has a medical condition which, according to the child's physician, makes it necessary for the child to ride in the front seat so that the driver can constantly monitor the child's condition.

3. Medical condition. A passenger has a medical condition which, according to his or her physician:

- Causes the passenger airbag to pose a special risk for the passenger;
- Makes the potential harm from the passenger airbag in a crash greater than the potential harm from turning off the airbag and allowing the passenger, even if belted, to hit the dashboard or windshield in a crash.

Transport Canada Deactivation Criteria (Canada Only)



WARNING: This vehicle has special energy management seatbelts for the driver and right front passenger. These particular seatbelts are specifically designed to work with airbags to help reduce the risk of injury in a crash. The energy management seatbelt gives or releases additional seatbelt webbing in some accidents to reduce the concentration of force on an occupant's chest and to reduce the risk of certain bone fractures and injuries to underlying organs. In a crash, if the airbag is off, this energy management seatbelt might permit the passenger wearing the seatbelt to move forward enough to have a serious or fatal injury. The more severe the crash, and the heavier the occupant, the greater the risk. Make sure the airbag is on for any passenger who does not qualify under the Transport Canada deactivation criteria.

1. Infant: An infant (less than 1 year old) must ride in the front seat because:

- My vehicle has no rear seat;
- The rear seat in my vehicle cannot accommodate a rear-facing infant seat;
- The infant has a medical condition which, according to the infant's physician, makes it necessary for the infant to ride in the front seat so that the driver can monitor the infant's condition.

2. Child age 12 or under: A child age 12 or under must ride in the front seat because:

Supplementary Restraints System

- My vehicle has no rear seat;
- Although children age 12 and under ride in the rear seat whenever possible, children age 12 and under have no option but to sometimes ride in the front seat because rear seat space is insufficient;
- The child has a medical condition that, according to the child's physician, makes it necessary for the child to ride in the front seat so that the driver can monitor the child's condition.

3. **Medical condition:** A passenger has a medical condition that, according to his or her physician:

- Poses a special risk for the passenger if the airbag deploys; and
- Makes the potential harm from the passenger airbag deployment greater than the potential harm from turning off the airbag and experiencing a crash without the protection offered by the airbag

Proper Driver and Front Passenger Seating Adjustment



WARNING: National Highway Traffic Safety Administration (NHTSA) recommends a minimum distance of at least 10 in (25 cm) between an occupant's chest and the driver airbag module.

To properly position yourself away from the airbag:

- Move your seat to the rear as far as you can while still reaching the pedals comfortably.
- Recline the seat slightly (one or two degrees) from the upright position.

After all occupants have adjusted their seats and put on seatbelts, it is very important that they continue to sit properly. Properly seated occupants sit upright, lean against the seat back, and center themselves on the seat cushion, with their feet comfortably extended on the floor. Sitting improperly can increase the chance of injury in a crash event. For example, if an occupant slouches, lies down, turns sideways, sits forward, leans forward or sideways, or puts one or both feet up, the chance of injury during a crash is greatly increased.

Children and Airbags



WARNING: Do not place a rearward facing child restraint in front of an active airbag. Failure to follow this instruction could result in personal injury or death.



WARNING: Properly secure children 12 years old and under in a rear seating position whenever possible. If you are unable to properly secure all children in a rear seating position, properly secure the largest child on the front seat. If you must use a forward facing child restraint on the front seat, move the seat as far back as possible. Failure to follow these instructions could result in personal injury or death.

Supplementary Restraints System



E142846

Children must always be properly restrained. Accident statistics suggest that children are safer when properly restrained in the rear seating positions than in the front seating position. Failure to follow these instructions may increase the risk of injury in a crash.

SIDE AIRBAGS (IF EQUIPPED)

WARNING: Do not place objects or mount equipment on or near the airbag cover, on the side of the seatbacks (of the front seats), or in front seat areas that may come into contact with a deploying airbag. Failure to follow these instructions may increase the risk of personal injury in the event of a crash.

WARNING: Do not use accessory seat covers. The use of accessory seat covers may prevent the deployment of the side airbags and increase the risk of injury in an accident.

WARNING: Do not lean your head on the door. The side airbag could injure you as it deploys from the side of the seatback.

WARNING: Do not attempt to service, repair, or modify the airbag, its fuses or the seat cover on a seat containing an airbag as you could be seriously injured or killed. Contact your authorized dealer as soon as possible.

WARNING: If the side airbag has deployed, the airbag will not function again. The side airbag system (including the seat) must be inspected and serviced by an authorized dealer. If the airbag is not replaced, the unrepaired area will increase the risk of injury in a crash.

The side airbags are located on the outboard side of the seatbacks of the front seats. In certain sideways crashes, the airbag on the side affected by the crash will be inflated. The airbag was designed to inflate between the door panel and occupant to further enhance the protection provided occupants in side impact crashes.



E152533

The system consists of the following:

- A label or embossed side panel indicating that side airbags are found on your vehicle.
- Side airbags located inside the seatback of the driver and front passenger seats.

Supplementary Restraints System



Crash sensors and monitoring system with readiness indicator. See **Crash Sensors and Airbag Indicator** (page 57).

The design and development of the side airbag system included recommended testing procedures that were developed by a group of automotive safety experts known as the Side Airbag Technical Working Group. These recommended testing procedures help reduce the risk of injuries related to the deployment of side airbags.

SAFETY CANOPY™ (IF EQUIPPED)



WARNING: Do not place objects or mount equipment on or near the headliner at the siderail that may come into contact with a deploying curtain airbag. Failure to follow these instructions may increase the risk of personal injury in the event of a crash.



WARNING: Do not lean your head on the door. The curtain airbag could injure you as it deploys from the headliner.



WARNING: Do not attempt to service, repair, or modify the supplementary restraint system or associated components. Failure to follow this instruction could result in personal injury or death.



WARNING: All occupants of your vehicle, including the driver, should always properly wear their seatbelts, even when an airbag supplemental restraint system is provided. Failure to properly wear your seatbelt could seriously increase the risk of injury or death.



WARNING: To reduce risk of injury, do not obstruct or place objects in the deployment path of the airbag.



WARNING: If a supplementary restraint system component has deployed, it will not function again. Have the system and associated components inspected as soon as possible. Failure to follow this instruction could result in personal injury or death.

The Safety Canopy deploys during significant side crashes or when a certain likelihood of a rollover event is detected by the rollover sensor. The Safety Canopy is mounted to the roof side rail sheet metal, behind the headliner, above each row of seats. In certain sideways crashes or rollover events, the Safety Canopy will be activated, regardless of which seats are occupied. The Safety Canopy is designed to inflate between the side window area and occupants to further enhance protection provided in side impact crashes and rollover events.

Supplementary Restraints System

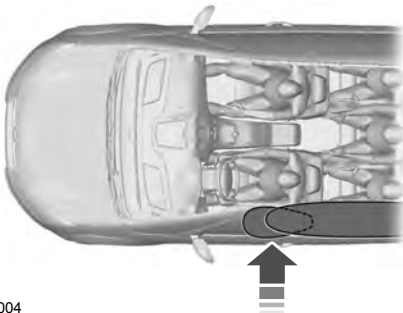

E75004

The system consists of the following:

- Safety Canopy curtain airbags above the trim panels over the front and rear side windows identified by a label or wording on the headliner or roof-pillar trim.
- A flexible headliner which opens above the side doors to allow air curtain deployment



• Crash sensors and monitoring system with a readiness indicator. See **Crash Sensors and Airbag Indicator** (page 57).

Properly restrain children 12 years old and under in the rear seats. The Safety Canopy will not interfere with children restrained using a properly installed child or booster seat because it is designed to inflate downward from the headliner above the doors along the side window opening.

The design and development of the Safety Canopy included recommended testing procedures that were developed by a group of automotive safety experts known as the Side Airbag Technical Working Group. These recommended testing procedures help reduce the risk of injuries related to the deployment of side airbags (including the Safety Canopy).

CRASH SENSORS AND AIRBAG INDICATOR



WARNING: Modifying or adding equipment to the front end of your vehicle (including hood, bumper system, frame, front end body structure, tow hooks and hood pins) may affect the performance of the airbag system, increasing the risk of injury. Do not modify or add equipment to the front end of your vehicle.

Your vehicle has a collection of crash and occupant sensors which provide information to the restraints control module which deploys (activates) the front safety belt pretensioners, driver airbag, passenger airbag, seat mounted side airbags, and the Safety Canopy®. Based on the type of crash (frontal impact, side impact or rollover), the restraints control module will deploy the appropriate safety devices.

The restraints control module also monitors the readiness of the above safety devices plus the crash and occupant sensors. The readiness of the safety system is indicated by a warning indicator light in the instrument cluster or by a backup tone if the warning light is not working. Routine maintenance of the airbags is not required.

A difficulty with the system is indicated by one or more of the following:



The readiness light will not illuminate immediately after the ignition is turned on.

Supplementary Restraints System

- The readiness light will either flash or stay lit.
- A series of five beeps will be heard. The tone pattern will repeat periodically until the problem, the light or both are repaired.

If any of these things happen, even intermittently, have the supplemental restraint system serviced at an authorized dealer immediately. Unless serviced, the system may not function properly in the event of a crash.

The fact that the safety belt pretensioners or front airbags did not activate for both front seat occupants in a crash does not mean that something is wrong with the system. Rather, it means the restraints control module determined the accident conditions (crash severity, belt usage) were not appropriate to activate these safety devices.

- The design of the front airbags is to activate only in frontal and near-frontal crashes (not rollovers, side impacts or rear impacts unless the crash causes sufficient frontal deceleration).
- The design of the safety belt pretensioners is to activate in frontal, near-frontal and side crashes, and in rollovers.
- The design of the side airbags is to inflate in certain side impact crashes or rollover events. Side airbags may activate in other types of crashes if the vehicle experiences sufficient sideways motion or deformation, or a certain likelihood of rollover.
- The design of the Safety Canopy is to inflate in certain side impact crashes or rollover events. The Safety Canopy may activate in other types of crashes if the vehicle experiences sufficient sideways motion or deformation, or a certain likelihood of rollover.

AIRBAG DISPOSAL

Contact your authorized dealer as soon as possible. Airbags must be disposed of by qualified personnel.

911 Assist

ABOUT 911 ASSIST



WARNING: Do not wait for 911 Assist to make an emergency call if you can do it yourself. Dial emergency services immediately to avoid delayed response time which could increase the risk of serious injury or death after a crash. If you do not hear 911 Assist within five seconds of the crash, the system or phone may be damaged or non-functional.



WARNING: Always place your phone in a secure location in your vehicle so it does not become a projectile or get damaged in a crash. Failure to do so may cause serious injury to someone or damage the phone which could prevent 911 Assist from working properly.

If a crash deploys an airbag (excluding knee airbags and rear inflatable seatbelts [if equipped]) or activates the fuel pump shut-off, your SYNC-equipped vehicle may be able to contact emergency services by dialing 911 through a paired and connected Bluetooth-enabled phone. You can learn more about the 911 Assist feature, by visiting:

Website
www.owner.ford.com www.syncmyride.ca

Website
www.syncmaroute.ca

Not all crashes will deploy an airbag or activate the fuel pump shut-off (the triggers for 911 Assist). If a connected cell phone sustains damage or loses its connection to SYNC during a crash, SYNC will search for and try to connect to a previously paired cell phone; SYNC will then attempt to call the emergency services.

Before making the call:

- SYNC provides a short window of time (about 10 seconds) to cancel the call. If you fail to cancel the call, SYNC attempts to dial 911.
- SYNC says the following, or a similar message: "SYNC will attempt to call 911, to cancel the call, press Cancel on your screen or press and hold the phone button on your steering wheel."

If you do not cancel the call, and SYNC makes a successful call, a pre-recorded message plays for the 911 operator, and then the occupant(s) in your vehicle is able to talk with the operator. Be prepared to provide your name, phone number and location immediately, because not all 911 systems are capable of receiving this information electronically.

EMERGENCY CALL REQUIREMENTS



WARNING: Unless the 911 Assist setting is set on before a crash, the system will not dial for help which could delay response time, potentially increasing the risk of serious injury or death after a crash.

911 Assist

Note: The SYNC 911 Assist feature must be set on before the incident.

Note: Before setting this feature on, make sure that you read the 911 Assist Privacy Notice later in this section for important information.

Note: If any user sets 911 Assist to on or off, that setting applies for all paired phones. If 911 Assist is switched off and the phone is connected to SYNC, an icon displays on the status bar.

Note: Every phone operates differently. While SYNC 911 Assist works with most cellular phones, some may have trouble using this feature.

- SYNC must be powered and working properly at the time of the incident and throughout feature activation and use.
- The 911 Assist feature must be set on before the incident.
- You must pair and connect a Bluetooth-enabled and compatible cell phone to SYNC.
- A connected Bluetooth-enabled phone must have the ability to make and maintain an outgoing call at the time of the incident.
- A connected Bluetooth-enabled phone must have adequate network coverage, battery power and signal strength.
- The vehicle must have battery power and be located in the U.S., Canada or in a territory in which 911 is the emergency number.

EMERGENCY CALL LIMITATIONS

The SYNC 911 Assist feature only operates in the U.S., Canada or in a territory in which 911 is the emergency number.

PRINCIPLE OF OPERATION

MyKey allows you to program keys with restricted driving modes to promote good driving habits. You can program the restrictions to all keys except one. Any keys that you did not program are administrator keys or admin keys.

You can use admin keys to:

- Create a MyKey with certain vehicle restrictions.
- Program certain MyKey settings.
- Clear all MyKey restrictions.

After you program a MyKey, you can view the following information through the information display:

- The total number of admin keys and MyKeys for your vehicle.
- The total distance a MyKey driver traveled with your vehicle.

Note: Every MyKey receives the same restrictions and settings. You cannot program them individually.

Note: For vehicles equipped with a push-button start switch: When both a MyKey and an admin key are present when you start your vehicle, the system recognizes the admin key only.

Standard Settings

Not every vehicle includes the features listed below. If your vehicle has this equipment, then you cannot change the following settings when using a MyKey:

- Seatbelt reminder or Belt-Minder™. MyKey mutes the audio system until drivers, and in some instances, passengers, fasten their seatbelts.
Note: If your vehicle includes an AM/FM radio or a very basic audio system, then the radio may not mute.
- Earlier low-fuel warning. The low-fuel warning activates earlier for MyKey drivers, giving them more time to refuel.
- Certain driver alerts, stability systems or parking aids turn on automatically when you use the MyKey system. For example, Blind Spot Information System (BLIS), cross traffic alert, lane departure warning or forward collision warning. **Note:** MyKey drivers may be able to turn the lane departure warning feature off, but this feature turns back on automatically with every new key cycle.
- Restricted touchscreen operation in some markets. For example, MyKey may prevent manual navigation destination input while the vehicle is in any gear other than park (P) or when the vehicle reaches a certain rate of speed.
- Satellite radio adult content restrictions, if this feature is available in your market.

Optional Settings

You can configure certain vehicle feature settings when you first create a MyKey. You can also change the settings afterward with an admin key.

Note: *Not every feature applies to every vehicle in every market. When they are available for your vehicle, then they appear in your information display, providing choices to switch them on or off, or to select a more specific setting.*

- Various vehicle speed limits so the MyKey driver cannot exceed certain speeds. The information display shows warnings followed by an audible tone when the MyKey driver reaches the set speed. You cannot override the set speed by fully depressing the accelerator pedal.



WARNING: Do not set MyKey maximum speed limit to a limit that will prevent the driver from maintaining a safe speed considering posted speed limits and prevailing road conditions. The driver is always responsible to drive in accordance with local laws and prevailing conditions. Failure to do so could result in accident or injury.

- Various vehicle speed reminders so MyKey drivers know when their vehicle speed approaches the limits. Warnings appear in your information display and a tone sounds when the MyKey drivers exceed the set vehicle speed.
- The audio system's maximum volume limits to 45% so MyKey drivers can concentrate on the road. A message appears in the information display when MyKey drivers attempt to exceed the limited volume. MyKey also disables the automatic volume control. **Note:** If your vehicle includes an AM/FM radio or a very basic audio system, then the radio may not limit.
- Always on setting. This setting forces certain features to remain on and active for MyKey drivers. For example, E911 or emergency assistance and the do not disturb features stay on even if a MyKey driver uses the feature's control to switch it off. When you select, you will not be able to turn off Advance Trac or traction control (if your vehicle has this feature).

CREATING A MYKEY

Use the information display to create a MyKey:

1. Insert the key you want to program into the ignition. See **Starting a Gasoline Engine** (page 125). If your vehicle is equipped with a push-button start, place the remote control into the backup slot. See **Passive Anti-Theft System** (page 77).
2. Switch the ignition on.

3. Access the main menu in the information display and then scroll through the menus to change the settings of your MyKey. From the MyKey menu select the option **Create MyKey**. See **Information Displays** (page 97).
4. When prompted, hold the **OK** button until you see a message informing you to label this key as a MyKey. The programmed restrictions apply when you key off, open and close the driver door and restart your vehicle with the programmed key or transmitter.

MyKey is successfully created. Make sure you label it so you can distinguish it from the admin keys.

You can also program configurable settings for the key(s). See **Programming and Changing Configurable Settings**.

Programming and Changing Configurable Settings

Use the information display to access your configurable MyKey settings.

1. Switch the ignition on using an admin key or transmitter you want to program.
2. Access the main menu in the information display and then scroll through the menus to change the settings of your MyKey. See **Information Displays** (page 97).
3. Follow the instructions in the display.

Note: You can clear or change your MyKey settings at any time during the same key cycle as you created the MyKey. Once you have switched the vehicle off, however, you will need an admin key to change or clear your MyKey settings.

CLEARING ALL MYKEYS

When you clear your MyKeys, you remove all restrictions and return all MyKeys to their original admin key status at once. To clear all MyKeys of all MyKey settings, use the information display.

1. Switch the ignition on using an admin key.
2. Access the main menu in the information display and then scroll through the menus to begin clearing your MyKey programming. See **Information Displays** (page 97).
3. Follow the instructions in the display.
4. A confirmation message appears in the display after you finish clearing your MyKeys.

Note: When you clear your MyKeys, you remove all restrictions and return all MyKeys to their original admin key status. You cannot remove the MyKey restrictions individually.

CHECKING MYKEY SYSTEM STATUS

You can find information on programmed MyKey(s) using the information display control on the steering wheel. See **Information Displays** (page 97).

MyKey™ (If Equipped)

To find information on programmed MyKey(s), press the left arrow button to access the main menu and scroll to:

Message	Description
Settings	Press the OK button.
MyKey	Press the OK button.
Select one of the following:	
MyKey Dist.	Tracks the distance when drivers use a MyKey. The only way to delete the accumulated distance is by using an admin key to clear your MyKeys. If the distance does not accumulate as expected, then the intended user is not using the MyKey, or an admin key user recently cleared and then recreated a MyKey.
{0} MyKeys	Indicates the number of MyKeys programmed to your vehicle. Use this feature to detect how many MyKeys you have for your vehicle and determine when a MyKey has been deleted.
{0} Admin Keys	Indicates how many admin keys are programmed to your vehicle. Use this feature to determine how many unrestricted keys you have for your vehicle, and detect if an additional MyKey has been programmed.

MyKey™ (If Equipped)

USING MYKEY WITH REMOTE START SYSTEMS

MyKey is not compatible with non

Ford-approved, aftermarket remote start systems. If you choose to install a remote start system, see an authorized dealer for a Ford-approved remote start system.

MYKEY – TROUBLESHOOTING

Condition	Potential Causes
I cannot create a MyKey.	<ul style="list-style-type: none">• The key or transmitter used to start the vehicle does not have admin privileges.• The key or transmitter used to start the vehicle is the only admin key (there always has to be at least one admin key).• Vehicles with keyless start: The keyless start transmitter is not placed in the backup position. See Passive Anti-Theft System (page 77).• SecuriLock passive anti-theft system is disabled or in unlimited mode.
I cannot program the configurable settings.	<ul style="list-style-type: none">• The key or transmitter used to start your vehicle does not have admin privileges.• No MyKeys are created. See Creating a MyKey (page 62).
I cannot clear the MyKeys.	<ul style="list-style-type: none">• The key or transmitter used to start your vehicle does not have admin privileges.• No MyKeys are created. See Creating a MyKey (page 62).
I lost the only admin key.	Purchase a new key from an authorized dealer.

MyKey™ (If Equipped)

Condition	Potential Causes
I lost a key.	Program a spare key. See Passive Anti-Theft System (page 77).
MyKey distances do not accumulate.	<ul style="list-style-type: none">• The MyKey user is not using the MyKey.• An admin key holder cleared the MyKeys and created new MyKeys.• The key system has been reset.
No MyKey functions with the keyless entry transmitter.	<ul style="list-style-type: none">• An admin transmitter is present at vehicle start.• No MyKeys are created. See Creating a MyKey (page 62).

Keys and Remote Controls

PRINCIPLE OF OPERATION

The remote control allows you to:

- remotely lock or unlock the vehicle doors
- unlock the doors without actively using a key or remote control (intelligent access only)
- remotely open the power liftgate (if equipped)
- remotely start or stop the engine (if equipped)
- arm and disarm the anti-theft system
- activate the panic alarm.

GENERAL INFORMATION ON RADIO FREQUENCIES

This device complies with Part 15 of the FCC Rules and with Licence exempt RSS Standards of Industry Canada. Operation is subject to the following two conditions:

- This device may not cause harmful interference, and
- This device must accept any interference received, including interference that may cause undesired operation.



WARNING: Changes or modifications not expressly approved by the party responsible for compliance could void the user's authority to operate the equipment. The term "IC:" before the radio certification number only signifies that Industry Canada technical specifications were met.

The typical operating range for your transmitter is approximately 33 ft (10 m). Vehicles with the remote start feature will have a greater range. One of the following could cause a decrease in operating range:

- Weather conditions.
- Nearby radio towers.
- Structures around the vehicle.
- Other vehicles parked next to your vehicle.

Other short distance radio transmissions, for example amateur radios, medical equipment, wireless headphones, remote controls and alarm systems can also use the radio frequency used by your remote control. If the frequencies are jammed, you will not be able to use your remote control. You can lock and unlock the doors with the key.

Note: *Make sure to lock your vehicle before leaving it unattended.*

Note: *If you are in range, the remote control will operate if you press any button unintentionally.*

Note: *The remote control contains sensitive electrical components. Exposure to moisture or impact may cause permanent damage.*

Keys and Remote Controls

REMOTE CONTROL-VEHICLES WITHOUT: PASSIVE ANTI-THEFT SYSTEM (PATS)

Integrated Keyhead Transmitter (If Equipped)



E177585

Use the key blade to start your vehicle and unlock or lock the driver door from outside your vehicle.



E138615

Note: Your vehicle keys came with a security label that provides important key cut information. Keep the label in a safe place for future reference.

Programming a New Remote Control

Read and understand the entire procedure before you begin.

Make sure all new and existing remote controls are present before beginning this procedure. This procedure erases all existing programmed remote controls. Reprogram all the existing remote controls during this procedure.

1. Unlock the vehicle with the power door unlock control.
2. Switch the ignition from off to on eight times within six seconds, finishing in the off position. A tone sounds to indicate that it is now possible to program a remote control.
3. Press and hold any button on the remote control within 10 seconds. A tone sounds as confirmation.
4. Repeat step 3 within 10 seconds for each remote control.

Note: Programming ends when you switch the ignition on, or after 10 seconds.

If you have successfully programmed the remote control, it operates the remote entry system.

If programming was unsuccessful, wait 10 seconds and repeat the process.

Note: You can program a maximum of eight remote controls to your vehicle.

Changing the Remote Control Battery

The remote control uses one coin-type three-volt lithium battery CR2032 or equivalent.

Note: Refer to local regulations when disposing of remote control batteries.

Note: Do not wipe off any grease on the battery terminals or on the back surface of the circuit board.

Note: Replacing the battery does not erase the programmed remote control from your vehicle. The remote control should operate normally.

Keys and Remote Controls

Integrated Keyhead Transmitter



E138619

1. Twist a thin coin in the slot of the transmitter near the key ring to remove the battery cover.
2. Remove the old battery.

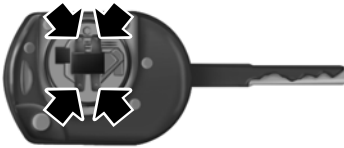

E138620

3. Insert the new battery. Refer to the instructions inside the transmitter for the correct orientation of the battery. Press the battery down to make sure it is fully in the housing.
4. Reinstall the battery housing cover onto the transmitter.

Locating Your Vehicle

Press the lock button on the remote control twice within three seconds. The horn sounds and the direction indicators flash.

Note: If locking was not successful, any door is open, or if the hood is open on vehicles with an alarm or remote start then the horn sounds but the direction indicators do not flash.

Switching the Panic Alarm On and Off



Press the button on the remote control to switch the panic alarm on. Press the button again or switch the ignition on to switch the panic alarm off.

We recommend you do not use this method to locate your vehicle.

Note: The panic alarm only operates when the ignition is off.

REMOTE CONTROL-VEHICLES WITH: PASSIVE ANTI-THEFT SYSTEM (PATS)

Integrated Keyhead Transmitter (If Equipped)



E177585

Use the key blade to start your vehicle and unlock or lock the driver door from outside your vehicle.

Keys and Remote Controls



E138615

Note: Your vehicle keys came with a security label that provides important key cut information. Keep the label in a safe place for future reference.

Programming a New Remote Control

To program a new remote control, See **Passive Anti-Theft System** (page 77).

Changing the Remote Control Battery

The remote control uses one coin-type three-volt lithium battery CR2032 or equivalent.

Note: Refer to local regulations when disposing of remote control batteries.

Note: Do not wipe off any grease on the battery terminals or on the back surface of the circuit board.

Note: Replacing the battery does not erase the programmed remote control from your vehicle. The remote control should operate normally.

Integrated Keyhead Transmitter



E138619

1. Twist a thin coin in the slot of the transmitter near the key ring to remove the battery cover.
2. Remove the old battery.

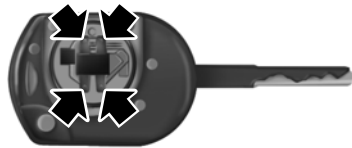

E138620

3. Insert the new battery. Refer to the instructions inside the transmitter for the correct orientation of the battery. Press the battery down to make sure it is fully in the housing.
4. Reinstall the battery housing cover onto the transmitter.

Locating Your Vehicle

Press the lock button on the remote control twice within three seconds. The horn sounds and the direction indicators flash.

Keys and Remote Controls

Note: *If locking was not successful, any door is open, or if the hood is open on vehicles with an alarm or remote start then the horn sounds but the direction indicators do not flash.*

Switching the Panic Alarm On and Off



Press the button on the remote control to switch the panic alarm on. Press the button again or switch the ignition on to switch the panic alarm off.

We recommend you do not use this method to locate your vehicle.

Note: *The panic alarm only operates when the ignition is off.*

REPLACING A LOST KEY OR REMOTE CONTROL

You can purchase replacement keys or remote controls from an authorized dealer. Authorized dealers can program remote controls for your vehicle. See **Remote Control** (page 68).

To re-program the passive anti-theft system see an authorized dealer.

Doors and Locks

LOCKING AND UNLOCKING

Locking

Locking With the Key

Turn the top of the key toward the rear of your vehicle.

Locking With the Remote Control



Press the button once. The direction indicators will flash. Press the button again within three seconds to confirm that all the doors are closed. The horn sounds and the direction indicators flash.

Note: You can lock the driver door with the key. Use the key when the remote control is not functioning.

Note: Make sure you have locked your vehicle before leaving it unattended.

Note: Do not leave the keys in your vehicle.

Unlocking

Unlocking With the Key

Turn the top of the key toward the front of your vehicle.

Unlocking With the Remote Control



Press the button once. The direction indicators will flash.

Note: You can unlock the driver door with the key. Use the key when the remote control is not functioning.

Note: When you leave your vehicle unattended for several weeks, the remote control turns off.

Note: Unlock your vehicle and start the engine using the key. Unlocking and starting your vehicle once enables the remote control.

Unlocking the Rear Cargo Doors



Press the button.

Reprogramming the Unlocking Function

Note: When you press the unlock button, either all the doors are unlocked or only the driver and passenger doors are unlocked.

You can program the unlocking function so that all doors are unlocked.

Press and hold the unlock and lock buttons on the remote control simultaneously for at least four seconds with the ignition off. The direction indicators flash twice to confirm the change.

To return to the original unlocking function, repeat the process.

You can also change between the unlocking modes in the information display. See **General Information** (page 97).

Locking and Unlocking the Doors From Inside

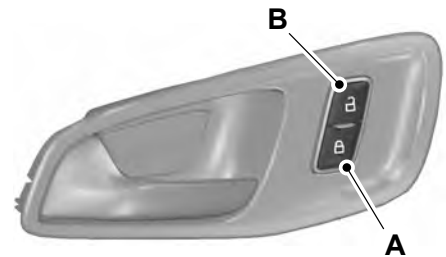

E148829

- A Lock.
- B Unlock.

Doors and Locks

Opening and Closing the Sliding Door

Opening the Sliding Door

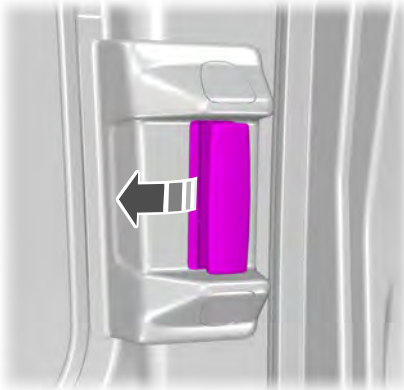

1. Lift the locking button up.
2. Pull the interior door handle to open the door.

Closing the Sliding Door

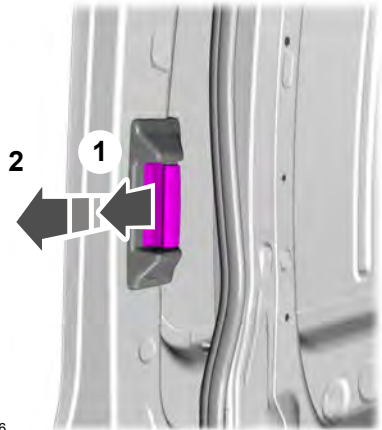

E171966

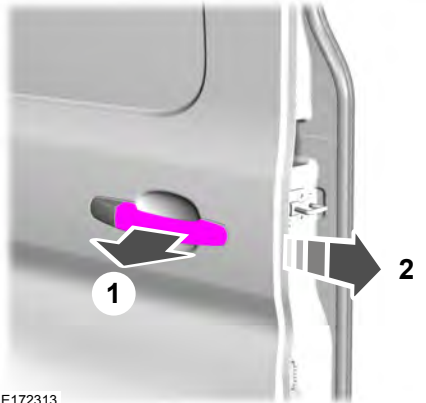

E172313

1. Pull the door handle to release the door check feature.
2. Slide the door to close.

Doors and Locks

Opening the Double Rear Doors



E148805

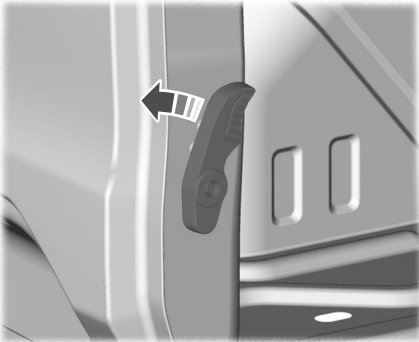

E148806

Fully Opening the Double Rear Doors

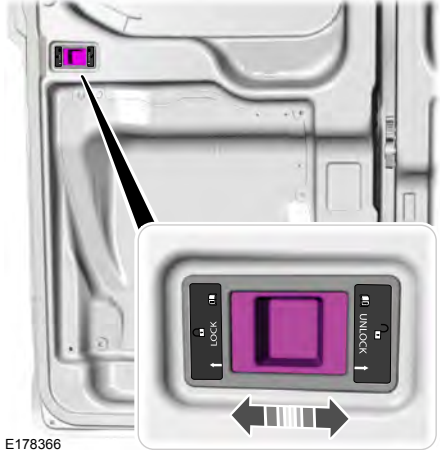

E178366

1. Slide the lever to release the catch.
2. Fully open the cargo door.

Unlocking and Opening the Double Rear Doors From Inside

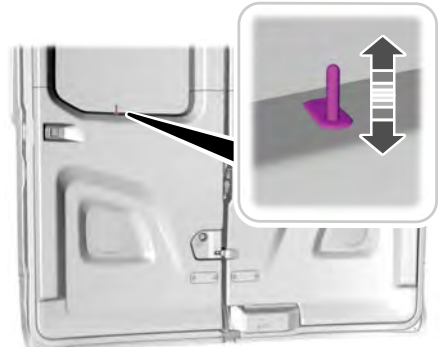

E175828

1. Lift the locking button up.

Doors and Locks

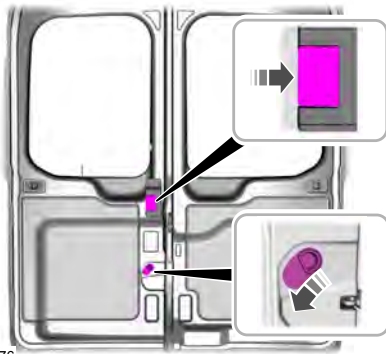

E255876

2. Pull the upper release lever toward you or slide the lower release lever downward to open the door.

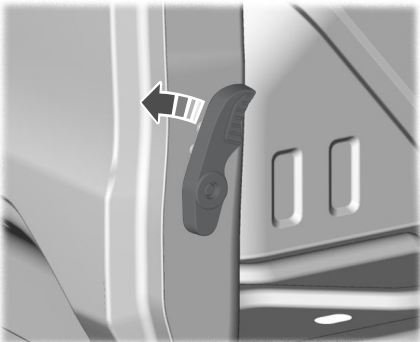

E148806

3. Pull the release lever to open the other door.

Rear Emergency Exit Wagon and Bus

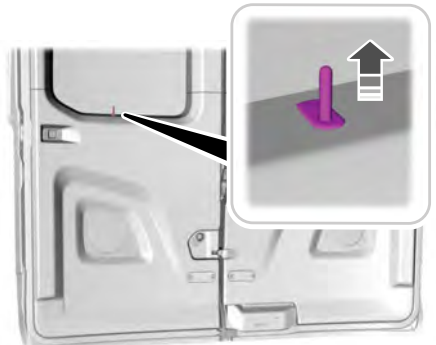

E236264

1. Lift the locking button up.

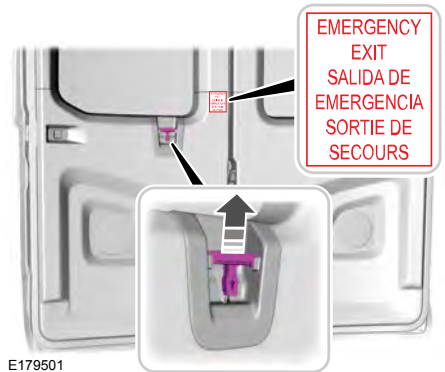

E179501

2. Pull the interior handle up to open the door in an emergency.

Autolock (If Equipped)

Autolock locks all the doors when all of the following occur:

- All doors are closed.
- The ignition is on.

Doors and Locks

- You shift into any gear putting your vehicle in motion.
- Your vehicle reaches a speed greater than 5 mph (8 km/h).

Use the interior door unlock button or switch the ignition off and use the key or remote control to unlock the rear or sliding door.

Autounlock

Autounlock unlocks all doors within 10 minutes of the end of a drive cycle, when the driver door is opened and the ignition is off.

Enabling or Disabling Autounlock

You can enable or disable autounlock in the information display. See **Information Displays** (page 97).

One-Stage Unlocking

You can switch on this function using the information display. See **Information Displays** (page 97).

If you have switched on this function, you unlock all doors including the rear doors and the sliding door.

You unlock all of the doors when you:

- Press the unlock button on the remote control once.
- Press the interior unlock button once.

Two-Stage Unlocking

You unlock the front doors when you:

- Press the unlock button on the remote control once.
- Press the interior unlock button once.

You unlock the front doors and cargo area when you:

- Press the unlock button on the remote control once.
- Press the unlock button on the remote control twice within three seconds.

Zone Re-Locking (If Equipped)

If you enable zone re-locking and open one door, all other doors remain locked. See an authorized dealer for further information.

The locks on van, bus or wagon have two zones, cabin and cargo. For van, the cargo area includes the rear doors and the sliding door. For bus or wagon, the cargo area includes the rear doors.

- Exit your vehicle and press the lock button.
- Press the unlock button or the cargo area unlock button once to open the respective zone.

If you now open a door within the unlocked zone, the other doors in that zone automatically lock.

Configurable Unlocking

Configurable unlocking is set when you purchase your vehicle. It allows you to select which doors unlock when you press, once or twice, the unlock button or the cargo area unlock button on your remote control. You cannot switch this feature back on if you had it switched off. See an authorized dealer for further information.

Security

PASSIVE ANTI-THEFT SYSTEM (IF EQUIPPED)

Note: *The system is not compatible with non-Ford aftermarket remote start systems. Use of these systems may result in vehicle starting problems and a loss of security protection.*

Note: *Metallic objects, electronic devices or a second coded key on the same key chain may cause vehicle starting problems if they are too close to the key when starting the engine. Prevent these objects from touching the coded key while starting the engine. Switch the ignition off, move all objects on the key chain away from the coded key and restart the engine if a problem occurs.*

Note: *Do not leave a duplicate coded key in the vehicle. Always take your keys and lock all doors when leaving the vehicle.*

SecuriLock®

The system is an engine immobilization system. It is designed to help prevent the engine from being started unless a correctly coded key for your vehicle is used. Using an incorrectly coded key may prevent the engine from starting. A message may appear in the information display.

If you are unable to start the engine with a correctly coded key, a malfunction has happened and a message may appear in the information display.

Automatic Arming

The engine immobilization system arms immediately after you switch the ignition off.

Automatic Disarming

Switching the ignition on with a correctly coded key disarms the engine immobilization system.

Replacement Keys

The integrated keyhead transmitter functions as a programmed ignition key that operates all the locks and starts your vehicle, as well as a remote control.

If your keys are lost or stolen and you do not have a spare correctly coded key, you will need to have your vehicle towed to an authorized dealer. You need to erase the coded keys from your vehicle and program new coded keys.

Store an extra correctly coded key away from the vehicle in a safe place to help prevent any inconveniences. See an authorized dealer to purchase additional spare or replacement keys.

Programming a Spare Integrated Keyhead Transmitter

You can program your own integrated keyhead transmitter or standard SecuriLock coded keys to your vehicle. This procedure will program both the engine immobilizer keycode and the remote entry portion of the remote control to your vehicle.

Only use integrated keyhead transmitters or standard SecuriLock keys.

You must have two previously programmed correctly coded keys and the new unprogrammed key readily accessible. See an authorized dealer to have the spare key programmed if two previously programmed correctly coded keys are not available.

Read and understand the entire procedure before you begin.

1. Insert the first previously programmed correctly coded key into the ignition.

Security

2. Switch the ignition from off to on. Keep the ignition on for at least three seconds, but no more than 10 seconds.
3. Switch the ignition off and remove the first correctly coded key from the ignition.
4. After three seconds but within 10 seconds of switching the ignition off, insert the second previously correctly coded key into the ignition.
5. Switch the ignition from off to on. Keep the ignition on for at least three seconds, but no more than 10 seconds.
6. Switch the ignition off and remove the second previously programmed correctly coded key from the ignition.
7. After three seconds but within 10 seconds of switching the ignition off and removing the previously programmed correctly coded key, insert the new unprogrammed key into the ignition.
8. Switch the ignition from off to on. Keep the ignition on for at least six seconds.
9. Remove the newly programmed correctly coded key from the ignition.

If the key has been successfully programmed it will start the engine and operate the remote entry system (if the new key is an integrated keyhead transmitter).

If the key was not successfully programmed, wait 10 seconds and repeat Steps 1 through 8. If you are still unsuccessful, take your vehicle to an authorized dealer.

Note: *You can program a maximum of eight coded keys to your vehicle. All eight can be integrated keyhead transmitters.*

ANTI-THEFT ALARM

Alarm System

The perimeter alarm is a deterrent against unauthorized access to your vehicle through the doors, luggage compartment and the hood.

Triggering the Alarm

Once armed, the alarm is triggered in any of the following ways:

- If someone opens a door, cargo area or the hood without a valid key or remote control.
- If you switch the ignition on without a valid key.

If the alarm is triggered, the horn will sound for 30 seconds and the hazard warning flasher will flash for five minutes.

Any further attempts to perform one of the above will trigger the alarm again.

Arming the Alarm

To arm the alarm, lock your vehicle. See **Doors and Locks** (page 72).

Disarming the Alarm

Disarm and silence the alarm by unlocking the doors with the key and switching the ignition on with a correctly coded key within 12 seconds, or by unlocking the doors or the cargo area with the remote control.

Steering Wheel

ADJUSTING THE STEERING WHEEL



WARNING: Do not adjust the steering wheel when your vehicle is moving.

Note: Make sure that you are sitting in the correct position. See **Sitting in the Correct Position** (page 111).



E95178

1. Unlock the steering column.
2. Adjust the steering wheel to the desired position.



E95179

3. Lock the steering column.

HORN



Wipers and Washers

WINDSHIELD WIPERS

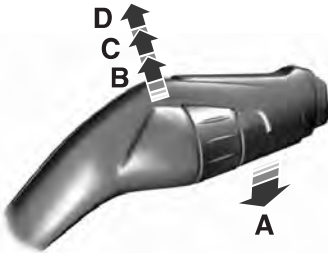

E197525

- A Single wipe.
- B Intermittent wipe.
- C Normal wipe.
- D High-speed wipe.

Note: Fully defrost the windshield before you switch the windshield wipers on.

Note: Make sure that you switch the windshield wipers off before entering a car wash.

Note: If streaks or smears appear on the windshield, clean the windshield and the wiper blades. See **Checking the Wiper Blades** (page 246). If that does not resolve the issue, install new wiper blades. See **Changing the Front Wiper Blades** (page 246).

Note: Do not operate the wipers on a dry windshield. This may scratch the glass or damage the wiper blades. Always use the windshield washers before wiping a dry windshield.

Intermittent Wipe

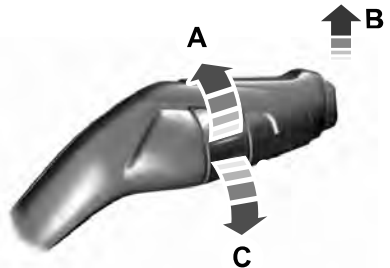

E197526

- A Short wipe interval.
- B Intermittent wipe.
- C Long wipe interval.

Use the rotary control to adjust the intermittent wipe interval.

Note: When your vehicle speed increases, the interval between intermittent wipes may decrease.

AUTOWIPERS

Autowipers uses a rain sensor in the area around the interior mirror. The wipers operate when the rain sensor detects water on the windshield in front of it. The rain sensor continues to monitor the amount of water and adjusts the speed of the wipers.

Note: The wipers remain in a slightly raised position during operation and only return to the park position a short time after the rain sensor detects no water on the windshield.

You can switch autowipers off in the information display. If you switch autowipers off, the windshield wipers operate in intermittent mode.

Wipers and Washers

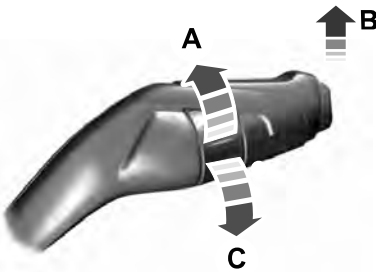

E197526

- A High sensitivity.
- B Autowipers on.
- C Low sensitivity.

Move the wiper lever upward to the first position to switch autowipers on.

Use the rotary control to adjust the sensitivity of the autowipers. When you select low sensitivity, the wipers operate when the sensor detects a large amount of water on the windshield. When you select high sensitivity, the wipers operate when the sensor detects a small amount of water on the windshield.

Note: Keep the outside of the windshield clean. The rain sensor is very sensitive and the wipers may operate if dirt, mist or insects hit the windshield.

If you leave autowipers on, it may not operate when you switch the ignition on during freezing temperatures. This is because the system has deactivated the rain sensor to prevent damage to the windshield wipers. Defrost the windshield before reactivating the rain sensor. You can reactivate the rain sensor by moving the rotary control or switching autowipers off and on.

Note: Fully defrost the windshield before you switch the windshield wipers on.

Note: Make sure that you switch the windshield wipers off before entering a car wash.

Wet or winter weather conditions could cause unexpected wiping or smearing.

To keep the windshield clear:

- Lower the sensitivity of the autowipers to reduce the amount of smearing on the windshield.
- Switch autowipers off.

Note: If streaks or smears appear on the windshield, clean the windshield and the wiper blades. If that does not resolve the issue, install new wiper blades. See **Changing the Front Wiper Blades** (page 246).

WINDSHIELD WASHERS



E144498

Pull the lever toward you to operate the windshield washers. When you release the lever, the wipers operate for a short time.

Note: Do not operate the washers when the washer reservoir is empty. This may cause the washer pump to overheat.

Lighting

GENERAL INFORMATION

Condensation in the Exterior Front Lamps and Rear Lamps

Exterior front lamps and rear lamps have vents to accommodate normal changes in air pressure.

Condensation can be a natural by-product of this design. When moist air enters the lamp assembly through the vents, there is a possibility that condensation can occur when the temperature is cold. When normal condensation occurs, a fine mist can form on the interior of the lens. The fine mist eventually clears and exits through the vents during normal operation.

Clearing time may take as long as 48 hours under dry weather conditions.

Examples of acceptable condensation are:

- The presence of a fine mist (no streaks, drip marks or large droplets).
- A fine mist covers less than 50% of the lens.

Examples of unacceptable condensation are:

- A water puddle inside the lamp.
- Streaks, drip marks or large droplets present on the interior of the lens.

If you see any unacceptable condensation, have your vehicle checked by an authorized dealer.

LIGHTING CONTROL

Lighting Control Positions



E287784

- A Lamps off.
- B Parking lamps, instrument panel lamps and license plate lamps.
- C Headlamps.
- D Autolamps.

Switching All of the Parking Lamps On

1. Switch the ignition off.
2. Set the lighting control to the parking lamps position.

Note: Prolonged use of the parking lamps causes the battery to run out of charge.

Note: Parking lamps could turn off to prevent the vehicle battery from running out of charge.

Switching the Left-Hand Side or the Right-Hand Side Parking Lamps On (If Equipped)

1. Switch the ignition off.

Lighting



E162681

2. Push the lever up or down to switch the parking lamps on.

Note: Prolonged use of the parking lamps causes the battery to run out of charge.

Note: Parking lamps could turn off to prevent the vehicle battery from running out of charge.

Switching High Beam Headlamps On and Off



E163718

Push the lever away from you to switch the high beam headlamps on.

Push the lever forward again or pull the lever toward you to switch the high beam headlamps off.

Note: If you switch the autolamps on, you cannot switch the high beam headlamps on until the system turns the headlamps on.

Flashing High Beam Headlamps



E163719

Pull the lever toward you and release it to flash the high beam headlamps.

AUTOLAMPS

⚠ WARNING: The autolamps switch position may not activate the headlamps in all low visibility conditions, such as daytime fog. Always ensure that your headlamps are switched to auto or on, as appropriate, during all low visibility conditions. Failure to do so may result in a crash.

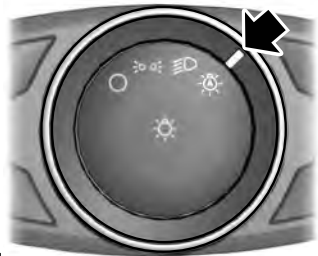

E142451

When the lighting control is in the autolamps position, the headlamps automatically turn on in low light situations or when the wipers turn on.

Lighting

The headlamps remain on for a period of time after you switch the ignition off. Use the information display controls to adjust the period of time that the headlamps remain on. See **Information Displays** (page 97).

Note: If you switch autolamps on, you can only switch the high beam headlamps on when the autolamps turn the headlamps on.

Windshield Wiper Activated Headlamps

The windshield wiper activated headlamps turn on within 10 seconds when you switch the windshield wipers on and the lighting control is in the autolamps position. They turn off approximately 60 seconds after you switch the windshield wipers off.

The headlamps will not turn on by wiper activation:

- During a mist wipe.
- When the wipers are on to clear washer fluid during a wash condition.
- If the wipers are in intermittent mode.

Note: If you switch autolamps and autowipers on, the headlamps will automatically turn on when the windshield wipers continuously operate.

INSTRUMENT LIGHTING DIMMER

The instrument lighting dimmer buttons are on the lighting control.



Repeatedly press one of the buttons to adjust the brightness.



DAYTIME RUNNING LAMPS



WARNING: The daytime running lamps system does not activate the rear lamps and may not provide adequate lighting during low visibility driving conditions. Also, the autolamps switch position may not activate the headlamps in all low visibility conditions, such as daytime fog. Make sure the headlamps are switched to auto or on, as appropriate, during all low visibility conditions. Failure to do so may result in a crash.

The daytime running lamps turn on when:

1. The ignition is switched to the on position.
2. The transmission is not in park (P) for vehicles with automatic transmissions or the parking brake is released for vehicles with manual transmissions.
3. The lighting control is in the off or autolamps positions.
4. The headlamps are off.

DIRECTION INDICATORS



E162681

Push the lever up or down to use the direction indicators.

Lighting

Note: Tap the lever up or down to make the direction indicators flash three times to indicate a lane change.

INTERIOR LAMPS

Courtesy Lamp

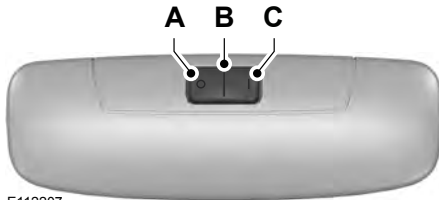

E112207

- A Off
- B Door contact
- C On

If you set the switch to position B, the courtesy lamp will switch on when you unlock your vehicle or open a door. If you leave a door open with the ignition switched off, the courtesy lamp will switch off automatically after a short period of time to prevent your vehicle battery from losing charge. To switch it back on, switch the ignition on for a short period of time.

The courtesy lamp will also switch on when you switch the ignition off. It will switch off automatically after a short period of time or when you start the engine.

If you set the switch to position C with the ignition switched off, the courtesy lamp will switch on. It will switch off automatically after a short period of time to prevent your vehicle battery from losing charge. To switch it back on, switch the ignition on for a short period of time.

Reading Lamps



E112208

If you switch the ignition off, the reading lamps will switch off automatically after a short period of time to prevent your vehicle battery from losing charge. To switch them back on, switch the ignition on for a short period of time.

Entrance Lamps

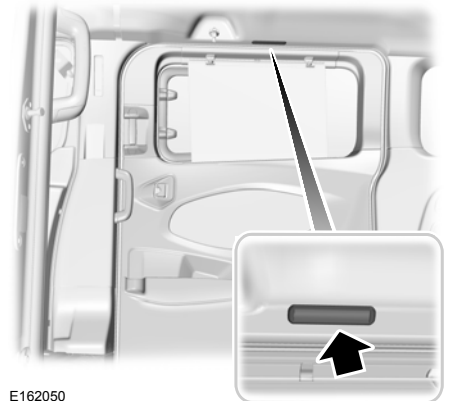

E162050

The lamps are located above the rear doors and sliding door. They will switch on and off automatically when you open and close the doors. If you unlock the doors with the remote control, they will switch on. They will switch off automatically after a short period of time.

CARGO LAMPS

Switching the Cargo Lamps Off

Press the button to switch the cargo lamps off when a door is open.

Note: *The cargo lamps switch only operates when the ignition is off.*

The switch is inside the cargo area, behind the left-hand rear door.

The cargo lamps turn off after a short period of time to prevent the battery from running out of charge.

Switching the Cargo Lamps On

Press the button to switch the cargo lamps on.

If the cargo lamps turned off to prevent the battery from running out of charge or you switched them off by pressing the button, reset the switch first.

Resetting the Switch

To reset the switch, do one of the following:

- Lock or unlock a door.
- Open or close a front door.
- Switch the ignition on then off.

Press the button to switch the cargo lamps on.

Windows and Mirrors

POWER WINDOWS



WARNING: To avoid risk of injury, do not leave children or pets unattended in your vehicle.



WARNING: When closing the power windows, you should verify they are free of obstructions and make sure that children and pets are not in the proximity of the window openings.



E146043

Press the control to open the window. The window will stop if you release the switch before the window fully opens.

Lift the control to close the window. The window will stop if you release the switch before the window fully closes.

Note: You may hear a pulsing noise when just one of the windows is open. Lower the opposite window slightly to reduce this noise.

Accessory Delay

You can use the window switches for several minutes when you switch the ignition off or until you open any door.

Driver Side One-Touch Down

Press the control fully and release it. Press again or lift it to stop the window.

Driver Side One-Touch Up

Lift the control fully and release it. Press again or lift it to stop the window.

Bounce-Back

The window will automatically stop and reverse some distance if it detects an obstacle while closing.

Overriding the Bounce-Back Feature



WARNING: When you override the bounce-back feature the window will not reverse if it detects an obstacle. Take care when closing the windows to avoid personal injury or damage to your vehicle.

To override this protection feature when there is a resistance, for example in winter:

1. Close the window twice until it reaches the point of resistance and let it reverse.
2. Close the window a third time to the point of resistance. Bounce-back is now disabled and you can close the window manually. The window will go past the point of resistance and you can close it fully.

If the window does not close after the third attempt the system requires service.

Resetting the Bounce-Back Feature



WARNING: The bounce-back feature remains turned off until it is reset.

Windows and Mirrors

1. Lift and hold the switch until the window is fully closed.
2. Release the switch.
3. Lift the switch again for one second.
4. Release the switch.
5. Lift the switch again for one second.
6. Open the window and then try to close using the one-touch feature.
7. Repeat the procedure if the window does not close using the one-touch feature.

Note: If you disconnect the battery, you must reset the bounce-back memory.

EXTERIOR MIRRORS

Power Exterior Mirrors



WARNING: Do not adjust the mirrors when your vehicle is moving. This could result in the loss of control of your vehicle, serious personal injury or death.

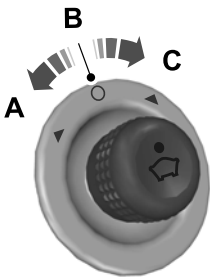

E71280

- A Left-hand mirror
- B Off
- C Right-hand mirror

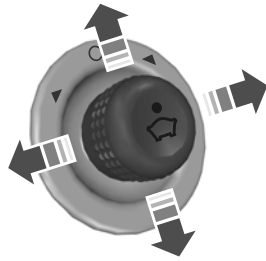

E71281

Move the controller in the direction of the arrows to adjust the mirror.

Power Folding Mirrors (If Equipped)

Folding and Unfolding

The power folding mirrors operate with the ignition on, and for several minutes after you switch the ignition off.

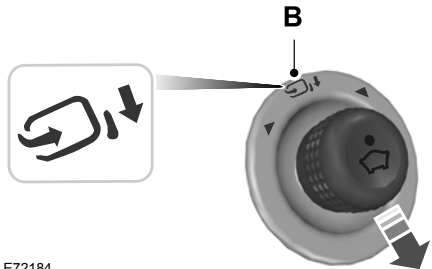

E72184

Move the controller downward to fold or unfold the mirrors.

Note: You can only fold the mirrors when the controller is set to position B.

Note: If you fold and unfold the mirrors several times within one minute, the power fold function may turn off to protect the motors from overheating.

Do not manually fold or unfold power folding mirrors.

Windows and Mirrors

Loose Mirror

If your power-folding mirrors are manually folded, they may not work properly even after you re-position them. You need to reset them if:

- The mirrors vibrate when you drive.
- The mirrors feel loose.
- The mirrors do not stay in the folded or unfolded position.
- One of the mirrors is not in its normal driving position.

To reset the power-fold feature, use the power-folding mirror control to fold and unfold the mirrors. You may hear a loud noise as you reset the power-folding mirrors. This sound is normal. Repeat this process as needed each time the mirrors are manually folded.

Fold-Away Exterior Mirrors

Push the mirror toward the door window glass. Make sure that you fully engage the mirror in its support when you unfold it.

INTERIOR MIRROR

Manual Dimming Mirror



WARNING: Do not adjust the mirrors when your vehicle is moving. This could result in the loss of control of your vehicle, serious personal injury or death.

Pull the tab below the mirror toward you to reduce the effect of bright light from behind.

Automatic Dimming Mirror (If Equipped)



WARNING: Do not adjust the mirrors when your vehicle is moving. This could result in the loss of control of your vehicle, serious personal injury or death.

The mirror dims to reduce the effect of bright light from behind. It returns to normal when the bright light from behind is no longer present or if you shift into reverse (R).

Do not block the sensors on the front and back of the mirror.

Note: A rear center passenger or raised rear center head restraint could prevent light from reaching the sensor.

REAR QUARTER WINDOWS

Opening the Rear Quarter Windows

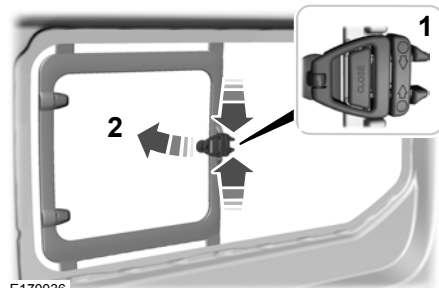

E170036

1. Press the unlock button to release the catch.

Note: Depending on the lock type fitted, you will have to either press the unlock buttons together or down to release the catch.

2. Hold the catch and push the window open. Make sure the catch engages.

Windows and Mirrors

Note: *There is an audible click when the catch engages.*

Closing the Rear Quarter Windows

1. Hold and pull the catch to close the window.
2. Press the catch to engage the lock.

Note: *There is an audible click when the lock engages.*

Instrument Cluster

GAUGES

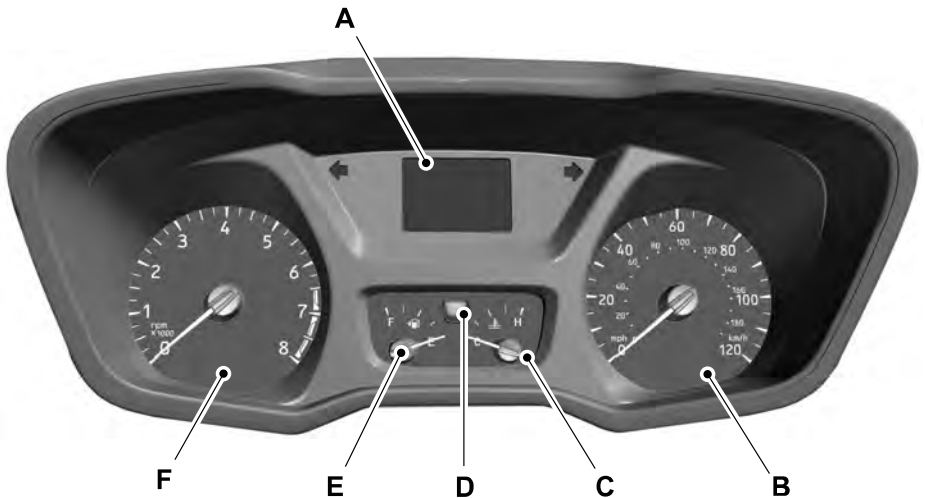

E184961

- A Information display. See **Information Displays** (page 97).
- B Speedometer.
- C Engine coolant temperature gauge.
- D Tripmeter reset and distance to empty toggle button.
- E Fuel gauge.
- F Tachometer.

Information Display

Odometer

Registers the distance your vehicle has traveled.

Outside Air Temperature

Shows the outside air temperature.

Trip Computer

See **Trip Computer** (page 100).

Vehicle Settings and Personalization

See **General Information** (page 97).

Engine Coolant Temperature Gauge



WARNING: Never remove the coolant reservoir cap while the engine is running or hot.

Instrument Cluster

At normal operating temperature, the needle will remain in the center section.

If the needle enters the red section, the engine is overheating. Stop your vehicle as soon as it is safe to do so and switch the engine off. Determine the cause once the engine has cooled down. See **Engine Coolant Check** (page 236).

Note: Do not restart the engine until the cause of overheating has been determined and resolved.

Tripmeter Reset and Distance to Empty (If Equipped)

Press the button to change between the tripmeter and distance to empty information. Press and hold the button to reset the tripmeter.

Fuel Gauge

Note: The fuel gauge may vary slightly when your vehicle is moving or on a gradient.

Switch the ignition on. The fuel gauge will indicate approximately how much fuel is in the fuel tank. The arrow adjacent to the fuel pump symbol indicates on which side of your vehicle the fuel filler door is located.

The needle should move toward F when you refuel your vehicle. If the needle points to E after adding fuel, this indicates your vehicle needs service soon.

After refueling some variability in needle position is normal:

- It may take a short time for the needle to reach F after leaving the gas station. This is normal and depends upon the slope of pavement at the gas station.
- The fuel amount dispensed into the tank is a little less or more than the gauge indicated. This is normal and depends upon the slope of pavement at the gas station.
- If the gas station nozzle shuts off before the tank is full, try a different gas pump nozzle.

Low Fuel Reminder

A low fuel reminder triggers when the fuel gauge needle is at 1/16th.

Variations:

Driving type (fuel economy conditions)	Fuel gauge position	Distance-to-empty
Highway driving	1/16th	35 miles to 80 miles (56 km to 129 km)
Severe duty driving (trailer towing, extended idle)	1/16th	35 miles (56km)

Instrument Cluster

WARNING LAMPS AND INDICATORS

The following warning lamps and indicators alert you to a vehicle condition that may become serious. Some lamps illuminate when you start your vehicle to make sure they work. If any lamps remain on after starting your vehicle, refer to the respective system warning lamp for further information.

Note: *Some warning indicators appear in the information display and operate the same as a warning lamp but do not illuminate when you start your vehicle.*

Airbag Warning Lamp



If it does not illuminate when you switch the ignition on, continues to flash or remains on when the engine is running, this indicates a malfunction. Have your vehicle checked as soon as possible.

Anti-Lock Brake System Warning Lamp



If it illuminates when you are driving, this indicates a malfunction. Your vehicle continues to have normal braking without the anti-lock brake system function. Have your vehicle checked as soon as possible.

It momentarily illuminates when you switch the ignition on to confirm the lamp is functional. If it does not illuminate when you switch the ignition on, or begins to flash at any time, have your vehicle checked as soon as possible.

Battery Charging Condition Warning Lamp



It illuminates when you switch the ignition on.

If it illuminates when the engine is running this indicates a malfunction. Have your vehicle checked as soon as possible.

Brake System Warning Lamp



WARNING: Driving extended distances with the parking brake engaged can cause brake failure and the risk of personal injury.



It illuminates when you engage the parking brake and the ignition is on.

If it illuminates when your vehicle is moving, make sure the parking brake is disengaged. If the parking brake is disengaged, this indicates low brake fluid level or a brake system fault. Have your vehicle immediately checked.

It momentarily illuminates when you switch the ignition on to confirm the lamp is functional. If it does not illuminate when you switch the ignition on, or begins to flash at any time, have your vehicle checked as soon as possible.

Diesel Warning Lamps (If Equipped)

Diesel Exhaust Fluid Warning Lamp



It illuminates when the diesel exhaust fluid is low.

If it illuminates, the information display message advises whether it is diesel exhaust fluid level related or due to a system malfunction. If the diesel exhaust fluid level is sufficient, this indicates a system malfunction. Have your vehicle checked as soon as possible.

Instrument Cluster

Glow Plug Indicator



If it illuminates, wait until it turns off before starting.

Water In Fuel Warning Lamp



If it illuminates when the engine is running this indicates there is excess water in the fuel filter.

This occurs when approximately 7 fl oz (200 ml) of water accumulates in the fuel filter water trap. Have your vehicle checked as soon as possible.

Alternatively you may be able to drain the fuel filter water trap.

See **Draining the Fuel Filter Water Trap** (page 242).

Note: *If it illuminates when the engine is running after draining the fuel filter water trap, this indicates a fuel filter service is required. Have your vehicle checked as soon as possible.*

Direction Indicator



It illuminates when you switch a direction indicator or the hazard flashers on. Flashes during operation. An increase in the rate of flashing warns of a failed indicator bulb.

Note: *An increase in the rate of flashing could also indicate that the trailer tow system has detected a fault that requires service. Have your vehicle checked as soon as possible.*

Door Ajar



It illuminates when you switch the ignition on and remains on if any door or the hood is open.

Engine Coolant Temperature Warning Lamp



If it illuminates when your vehicle is moving, this indicates that the engine is overheating. Stop your vehicle as soon as it is safe to do so and switch the engine off. Have your vehicle checked as soon as possible.

Engine Warning Lamps



Powertrain Warning Lamp

If it illuminates when the engine is running this indicates a malfunction. Drive in a moderate fashion (avoid heavy acceleration and deceleration). Continuing to drive your vehicle may cause reduced power or the engine to stop. Switch the ignition off and attempt to restart the engine. Have your vehicle checked as soon as possible.



Malfunction Indicator Lamp

If it illuminates when the engine is running this indicates a malfunction. The On Board Diagnostics system has detected a malfunction of the vehicle emission control system.

If it flashes, engine misfire may be occurring. Increased exhaust gas temperatures could damage the catalytic converter or other vehicle components. Drive in a moderate fashion (avoid heavy acceleration and deceleration) and have your vehicle immediately serviced.

It illuminates when you switch the ignition on prior to engine start to check the bulb and to indicate whether your vehicle is ready for Inspection and Maintenance (I/M) testing.

Instrument Cluster

Normally, it illuminates until the engine is cranked and automatically turns off if no malfunctions are present. However, if after 15 seconds it flashes eight times, this indicates that your vehicle is not ready for Inspection and Maintenance (I/M) testing. See **Engine Emission Control** (page 140).

Fasten Seatbelt Warning Lamp



It illuminates and a chime sounds until you fasten the seatbelts.

Headlamp High Beam Indicator



It illuminates when you switch the headlamp high beam on.

Lamps on Indicator



It illuminates when you switch the headlamp low beam or the side and rear lamps on.

Lane Departure Warning Indicator



It illuminates when you switch the system off.

It illuminates when the system is not available and may indicate that the system requires service. Have your vehicle checked as soon as possible.

Low Fuel Level Warning Lamp



If it illuminates when you are driving, refuel as soon as possible.

Low Tire Pressure Warning Lamp

(If Equipped)



It illuminates if the tire pressure in one or more tires is below the correct tire pressure.

If it does not illuminate when you switch the ignition on, or flashes when the engine is running, this indicates a malfunction. Have your vehicle checked as soon as possible. See **Tire Pressure Monitoring System** (page 288).

Low Washer Fluid Level Warning Lamp



It illuminates when the washer fluid is low.

Message Center Indicator



It illuminates when a new message is stored in the information display.

The indicator is red or amber depending on the severity of the condition and it remains on until the condition is resolved. See **Information Messages** (page 101).

Oil Pressure Warning Lamp

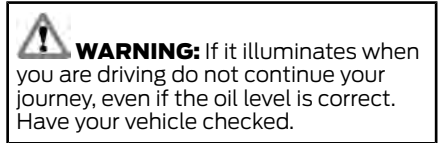

WARNING: If it illuminates when you are driving do not continue your journey, even if the oil level is correct. Have your vehicle checked.



If it illuminates when the engine is running this indicates a malfunction. Stop your vehicle as soon as it is safe to do so and switch the engine off.

Check the engine oil level. If the oil level is sufficient, this indicates a system malfunction. Have your vehicle immediately checked.

Instrument Cluster

Stability Control and Traction Control Indicator



Flashes during operation.

If it does not illuminate when you switch the ignition on, or remains on when the engine is running, this indicates a malfunction. Have your vehicle checked as soon as possible.

Note: *The system automatically turns off if there is a malfunction.*

See **Stability Control** (page 160). See **Traction Control** (page 159).

Stability Control and Traction Control Off Warning Lamp



It illuminates when you switch the system off.

Tow/Haul Warning Lamp



It illuminates when you switch the system on.

If it flashes when the engine is running this indicates a malfunction and could lead to transmission damage that may not be covered by the vehicle Warranty. Have your vehicle checked as soon as possible.

AUDIBLE WARNINGS AND INDICATORS

Airbag Secondary Warning

Sounds when the airbag system and the airbag warning lamp requires service.

Door Ajar

Sounds when a door is not fully closed and your vehicle is moving.

Exterior Lamps On

Sounds when you open the driver door and the exterior lamps are on.

Transmission Selector Lever Not in park (P)

Sounds when you open the driver door and the transmission is not in park (P).

Key in Ignition

Sounds when the driver door is open and the key is in the ignition.

Parking Brake On

Sounds when the parking brake is on and your vehicle is moving. If the warning chime remains on after you have released the parking brake, the system has detected a fault that requires service. Have your vehicle immediately checked.

Seatbelt Reminder



WARNING: Do not sit on top of a fastened seatbelt to prevent the seatbelt reminder from coming on. The occupant protection system will only provide optimum protection when you use the seatbelt properly.

Sounds when a seatbelt is unfastened in an occupied seat and your vehicle is moving.

Information Displays

GENERAL INFORMATION

 **WARNING:** Driving while distracted can result in loss of vehicle control, crash and injury. We strongly recommend that you use extreme caution when using any device that may take your focus off the road. Your primary responsibility is the safe operation of your vehicle. We recommend against the use of any hand-held device while driving and encourage the use of voice-operated systems when possible. Make sure you are aware of all applicable local laws that may affect the use of electronic devices while driving.

You can control various systems on your vehicle using the information display controls on the steering wheel.

The information display shows the corresponding information.

Information Display Controls



E138659

- Press the up and down arrow buttons to scroll through and highlight the options within a menu.
- Press the right arrow button to enter a submenu.
- Press the left arrow button to exit a submenu.
- Press the **OK** button to choose and confirm settings or messages.

Menu Structure

You can access the menu using the information display control.

 This icon gives you the ability to switch a feature on or off. A check in the box indicates the feature is enabled, and unchecked indicates the feature is disabled.

Note: Some options may appear slightly different or not at all if the items are optional.

Main Menu

Trip computer 1
Trip computer 2
Information
Settings

Information Displays

Trip computer 1		
Trip computer 2		
All Values ¹		
Speed		
Trip Odometer		
Average Fuel	Ford EcoMode	Gear Shifting
		Anticipation
		Speed
		Information
Distance to E		
Trip Timer		
Outside Temp.		

¹ This feature is seen on high level clusters.

Note: The trip computer readings can be reset independently. See **Trip Computer** (page 100).

Information
Driver Alert
DEF Level
Exhaust Filter
Engine Hours
Engine Hours
Trailer Brake
MyKey
MyKey Info
System Check

Information Displays

Settings		
Driver Assist	Traction Ctrl	
	Auto Exh.Clean	
	Driver Alert	
	Tire Monitor	
	Power Step	Auto
		Deploy
		Off
	Trailer Brake	Electric
Elec.-Hydraulic		
Lane Keeping		
Display	Navigation info	
	Language	Choose your applicable setting.
	Distance	Choose your applicable setting.
	Temperature	Choose your applicable setting.
Convenience	Compass	Display
		Calibrate
	Locks	Autolock
		Autounlock
		Global Unlock
		Custom Lock
MyKey	Create MyKey	Create MyKey
	Traction Ctrl	Always On
		User selectable
	Max Speed	Choose your applicable setting.
		Off
Speed Warning	Choose your applicable setting.	

Information Displays

Settings	
	Off
Volume Limiter	
Clear MyKeys	Clear MyKey

System Check

All active warnings will display first if applicable. The system check menu may appear different based upon equipment options and current vehicle status. Use the up and down arrow buttons to scroll through the list. See **Information Messages** (page 101).

TRIP COMPUTER

Resetting the Trip Computer

Press and hold **OK** on the current screen to reset the respective trip, distance, time and average fuel consumption information.

All Values

Indicates all the respective trip, distance, time and average fuel consumption information.

Average Fuel Consumption

Indicates the average fuel consumption since the function was last reset.

Distance to Empty

Indicates the approximate distance your vehicle will travel on the fuel remaining in the tank. Changes in driving pattern may cause the value to vary.

Outside Air Temperature

Shows the outside air temperature.

Trip Odometer

Registers the distance traveled of individual journeys.

Trip Timer

Registers the elapsed time of individual journeys or the total time since the function was last reset.

Digital Speedometer

Provides a digital display of the current vehicle speed.

PERSONALIZED SETTINGS

Measure Units

You can choose personalized settings using the information display control on the steering wheel. See **Information Displays** (page 97).

Information Displays

To swap between imperial and metric units, scroll to:

Message	Action and Description
Display	Press the OK button.
Measure unit	<p>Choose your applicable setting. Press the OK button.</p> <p>Swapping between imperial and metric units will affect the following displays:</p> <ul style="list-style-type: none"> • Average fuel consumption. • Distance to empty. • Odometer. • Outside temperature units. • Trip odometer. • Digital Speedometer.

INFORMATION MESSAGES



E130248

Press the **OK** button to acknowledge and remove some messages from the information display. The information display will automatically remove other messages after a short period of time.

You need to confirm certain messages before you can access the menus.



The message indicator illuminates to supplement some messages.

The indicator is red or amber depending on the severity of the condition and it remains on until the condition is resolved.

A system-specific symbol with a message indicator may supplement some messages.

Note: *Depending on your vehicle options and instrument cluster type, not all of the messages will display or be available. The information display may abbreviate or shorten certain messages.*

Airbag

Message	Action
Airbag fault Service now	Have your vehicle checked as soon as possible.

Information Displays

Battery and Charging System

Message	Action
Electrical system over-voltage Stop safely	Stop your vehicle as soon as it is safe to do so and switch the engine off. Have your vehicle checked as soon as possible.
Battery low See manual	Displays if the battery is low or has no charge. Switch off all unnecessary electrical equipment. Have your vehicle checked as soon as possible.

Diesel Exhaust Fluid Level

Message	Action
DEF level low Range XXX mi Refill now	Indicates the approximate distance remaining before the diesel exhaust fluid tank will be empty. Refill the diesel exhaust fluid tank as soon as possible.
DEF level empty YY MPH max in XXX mi	Indicates the approximate distance remaining before the diesel exhaust fluid tank will be empty and when it will restrict your vehicle speed. Refill the diesel exhaust fluid tank as soon as possible.
DEF level empty Speed limited to YY MPH	Indicates that the diesel exhaust fluid tank is empty and that your vehicle speed is being restricted. Refill the diesel exhaust fluid tank as soon as possible.
DEF level empty YY MPH max Upon restart	Indicates that the diesel exhaust fluid tank is empty and that your vehicle speed will be restricted when you restart your vehicle. Refill the diesel exhaust fluid tank as soon as possible.
DEF level empty Engine idled soon	Indicates that the diesel exhaust fluid tank is empty and that the engine will soon be restricted to idle operation.
DEF level empty Engine idled See manual	Indicates that the diesel exhaust fluid tank is empty and that the engine is restricted to idle operation.

Note: When filling the diesel exhaust fluid tank from empty, there may be a short period before the increased diesel exhaust fluid level is registered. The system must register the increased diesel exhaust fluid level before your vehicle will return to full power.

Diesel Exhaust Fluid System Malfunction

Message	Action
DEF fault YY MPH max in XXXX mi	Indicates that your vehicle speed will soon be restricted.

Information Displays

Message	Action
	The system has detected a fault that requires service. Have your vehicle checked as soon as possible.
DEF fault Speed limited to YY MPH	Indicates that your vehicle speed is restricted. The system has detected a fault that requires service. Have your vehicle checked as soon as possible.
DEF fault Engine idled soon	Indicates that the engine will soon be restricted to idle operation. The system has detected a fault that requires service. Have your vehicle checked as soon as possible.
DEF fault Engine idled See manual	Indicates that the engine is restricted to idle operation. The system has detected a fault that requires service. Have your vehicle checked as soon as possible.
DEF level empty YY MPH max Upon restart	Indicates that your vehicle speed will be restricted when you restart your vehicle. The system has detected a fault that requires service. Have your vehicle checked as soon as possible.

Door Open

Message	Action
Driver door ajar	Stop your vehicle as soon as it is safe to do so, shift into park (P), apply the parking brake and close the door.
Driver side rear door ajar	Stop your vehicle as soon as it is safe to do so, shift into park (P), apply the parking brake and close the door.
Passenger door ajar	Stop your vehicle as soon as it is safe to do so, shift into park (P), apply the parking brake and close the door.
Passenger side rear door ajar	Stop your vehicle as soon as it is safe to do so, shift into park (P), apply the parking brake and close the door.
Hood open	Stop your vehicle as soon as it is safe to do so, shift into park (P), apply the parking brake and close the hood.
Rear load compartment door ajar	Stop your vehicle as soon as it is safe to do so, shift into park (P), apply the parking brake and close the door.

Information Displays

Engine

Message	Action
Engine fault Service now	Have your vehicle checked as soon as possible.
High engine temperature Stop safely	Displays when the engine temperature is too high. Stop your vehicle as soon as it is safe to do so, switch the engine off and allow it to cool. If the problem persists, have your vehicle checked as soon as possible. See Engine Coolant Check (page 236).

Lighting

Message	Action
Brake lamp Bulb fault	Displays if a brake lamp bulb fails. See Maintenance (page 229).
Low beam Bulb fault	Displays if a low beam bulb fails. See Maintenance (page 229).
Headlamp fault Service required	Displays if an electrical malfunction occurs with the headlamp system. Have your vehicle checked as soon as possible.

Maintenance

Message	Action
Oil change required	Displays when the engine oil life is depleted and your vehicle requires an oil change. See Engine Oil Check (page 234).
Water detected in fuel Service required	Displays if the system detects there is excess water in the fuel filter. See Draining the Fuel Filter Water Trap (page 242).
Brake fluid level low Service now	Displays if the brake fluid level is low or if there is a brake system fault. Have your vehicle checked immediately. See Brake Fluid Check (page 241).
Washer fluid level low	Displays when the washer fluid is low and needs to be refilled. See Washer Fluid Check (page 242).

Information Displays

Occupant Protection

Message	Action
Service Beltminder	The system has detected a fault that requires service. Have your vehicle checked as soon as possible.

Parking Aid

Message	Action
Parking aid fault Service required	The system has detected a fault that requires service. Have your vehicle checked as soon as possible.

Parking Brake

Message	Action
Park brake applied	Displays when the parking brake is set, the engine is running and your vehicle speed is above 3 mph (5 km/h). If the warning message remains on after you have released the parking brake, the system has detected a fault that requires service. Have your vehicle checked as soon as possible.

Starting System

Message	Action
Press brake to start	Displays when you start your vehicle as a reminder to fully press the brake pedal. See Starting and Stopping the Engine (page 124).
Cranking time exceeded	Displays if your vehicle fails to start. See Starting and Stopping the Engine (page 124).

Tire Pressure Monitoring System

Message	Action
Low Tire Pressure	Displays if the tire pressure in one or more tires is below the correct pressure.

Information Displays

Message	Action
	See Tire Pressure Monitoring System (page 288).
Tire Pressure Monitor Fault	The system has detected a fault that requires service. Have your vehicle checked as soon as possible. See Tire Pressure Monitoring System (page 288).
Tire Pressure Sensor Fault	Displays if the system detects a fault with a tire pressure sensor or the spare tire is in use. See Tire Pressure Monitoring System (page 288). If the warning message remains on after you have checked the tire pressures, the system has detected a fault that requires service. Have your vehicle checked as soon as possible.

Climate Control

MANUAL CLIMATE CONTROL

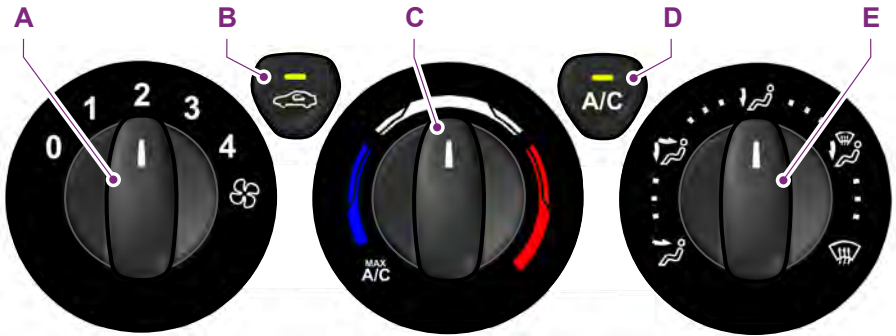

E147011

- A **Fan speed control:** Controls the volume of air circulated in your vehicle. Adjust to select the desired fan speed or switch off. If you switch the fan off, the windshield may fog up.
- B **Recirculated air:** Press the button to switch between outside air and recirculated air. When you select recirculated air, the air currently in the passenger compartment recirculates. This can reduce the time needed to cool the interior, when used with **A/C**, and reduce unwanted odors from entering your vehicle.
Note: Recirculation air may turn off automatically, or be prevented from turning on in all airflow modes except **MAX A/C** to reduce risk of fogging. Recirculated air may also turn on and off automatically in instrument panel or instrument panel and floor airflow modes during hot weather to improve cooling efficiency.
- C **Temperature control:** Controls the temperature of the air circulated in your vehicle. Adjust to select the desired temperature. If you select **MAX A/C**, the system distributes recirculated air through the instrument panel air vents. This mode is more economical and efficient than normal air conditioning. Turn the temperature control to maximum heat to turn the auxiliary heater on
- D **Air conditioning:** Press the button to switch the air conditioning on or off. To improve air conditioning when starting your vehicle, drive with the windows open for two to three minutes.
- E **Air distribution control:** Adjust to select the desired air distribution.



Select to distribute air through the instrument panel air vents.



Select to distribute air through the instrument panel air vents and footwell air vents.

Climate Control



Select to distribute air through the footwell air vents.



Select to distribute air through the windshield air vents and footwell air vents.



Select to distribute air through the windshield air vents. You can also use this setting to defog or clear the windshield of a thin covering of ice. You can also increase the temperature and fan speed to improve clearing.

HINTS ON CONTROLLING THE INTERIOR CLIMATE

General Hints

Note: *Prolonged use of recirculated air may cause the windows to fog up.*

Note: *A small amount of air may be felt from the footwell air vents regardless of the air distribution setting.*

Note: *To reduce humidity build-up inside your vehicle, do not drive with the system switched off or with recirculated air always switched on.*

Note: *Do not place objects under the front seats as this may interfere with the airflow to the rear seats.*

Note: *Keep the air intakes in front of the windshield free from obstruction (such as snow or leaves) to allow the climate control system to function effectively.*

Note: *To reduce fogging of the windshield during humid weather, adjust the air distribution control to the windshield air vents position. Increase the temperature and fan speed and press the A/C button to improve clearing, if required.*

Heating the Interior Quickly

- Adjust the fan speed to the highest speed setting.
- Adjust the temperature control to the highest setting.
- Adjust the air distribution control to the footwell air vents position.

Recommended Settings for Heating

- Adjust the fan speed to the second speed setting.
- Adjust the temperature control to the midway point of the hot settings.
- Adjust the air distribution control to the footwell and windshield air vents position.

Cooling the Interior Quickly

- Adjust the fan speed to the highest speed setting.
- Adjust the temperature control to the **MAX A/C** position.
- Adjust the air distribution control to the instrument panel air vents position.

Recommended Settings for Cooling

- Adjust the fan speed to the second speed setting.
- Adjust the temperature control to the midway point of the cold settings.
- Adjust the air distribution control to the instrument panel air vents position.

Vehicle Stationary for Extended Periods During Extreme High Ambient Temperatures

- Apply the parking brake.
- Move the transmission selector lever to position **P** or neutral.

Climate Control

- Adjust the temperature control to the **MAX A/C** position.
- Adjust the fan speed to the lowest speed setting.

Side Window Defogging in Cold Weather

- Adjust the air distribution control to the instrument panel and windshield air vents positions.
- Press the **A/C** button.
- Adjust the temperature control to the desired setting.
- Adjust the fan speed to the highest setting.
- Direct the instrument panel side air vents toward the side windows.
- Close the instrument panel vents.

Maximum Cooling Performance in Instrument Panel or Instrument Panel and Footwell Positions

- Adjust the temperature control to the lowest setting.
- Press the **A/C** and recirculated air buttons.
- Adjust the fan speed to the highest setting initially and then adjust it to suit the desired comfort level.

REAR PASSENGER CLIMATE CONTROLS

Adjusting the Blower Motor Speed



Directing Air to the Overhead Air Vents



When you direct air to the overhead air vents, the system distributes cold air.

Directing Air to the Footwell Air Vents



When you direct air to the footwell air vents, the system distributes hot air.

Directing Air to the Overhead Air Vents and the Footwell Air Vents



When you direct air to the Overhead and footwell air vents, the system distributes warm air.

HEATED WINDOWS AND MIRRORS

Heated Rear Window (if Equipped)

Note: Make sure the engine is running before operating the heated windows.

Note: The heated rear window button is located on the instrument panel, near the instrument cluster.



Press the button to clear the heated rear window of thin ice and fog. The heated rear window will automatically turn off after a short period of time.

Note: Do not use razor blades or other sharp objects to clean or remove decals from the inside of the heated rear window. The vehicle warranty does not cover damage caused to the heated rear window grid lines.

Climate Control

Heated Exterior Mirrors



When you switch the heated rear window on, the heated exterior mirrors will automatically turn

on.

Note: *Do not remove ice from the mirrors with a scraper or adjust the mirror glass when it is frozen in place.*

Note: *Do not clean the mirror housing or glass with harsh abrasives, fuel or other petroleum-based cleaning products.*

Note: *On vehicles without a heated exterior mirror button, the mirrors turn on automatically when you switch the heated rear window on.*

REMOTE START (IF EQUIPPED)

When you remote start your vehicle using a Ford Original Accessory remote start system, the engine shuts down if you do any of the following:

- Unlock your vehicle and open any door.
- Insert the key in the ignition.
- Press the brake pedal.

For more information, refer to the separate **Vehicle Security and Remote Start Systems Owner's Manual** provided with your vehicle or contact an authorized dealer.

Seats

SITTING IN THE CORRECT POSITION

 **WARNING:** Do not recline the seatback too far as this can cause the occupant to slide under the seatbelt, resulting in serious injury in the event of a collision.

 **WARNING:** Always sit upright against your seatback with your feet on the floor.

 **WARNING:** Do not place objects higher than the top of the seat backrest. Failure to follow this instruction could result in personal injury or death in the event of a sudden stop or crash.

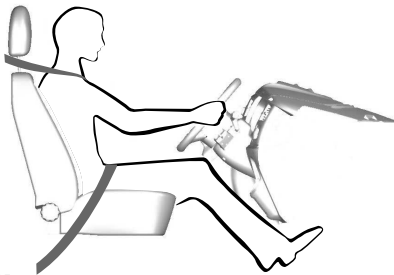

E68595

When you use them properly, the seat, head restraint, seatbelt and airbags will provide optimum protection in the event of a crash.

We recommend that you follow these guidelines:

- Sit in an upright position with the base of your spine as far back as possible.
- Do not recline the seat backrest so that your torso is more than 30° from the upright position.
- Adjust the head restraint so that the top of it is level with the top of your head and as far forward as possible. Make sure that you remain comfortable.
- Keep sufficient distance between yourself and the steering wheel. We recommend a minimum of 10 in (25 cm) between your breastbone and the airbag cover.
- Hold the steering wheel with your arms slightly bent.
- Bend your legs slightly so that you can press the pedals fully.
- Position the shoulder strap of the seatbelt over the center of your shoulder and position the lap strap tightly across your hips.

Make sure that your driving position is comfortable and that you can maintain full control of your vehicle.

HEAD RESTRAINTS

 **WARNING:** The adjustable head restraint is a safety device. Whenever possible it should be installed and correctly adjusted when the seat is occupied. An incorrectly adjusted head restraint may provide reduced protection to an occupant during certain rear impacts.

Seats

The head restraint consists of:

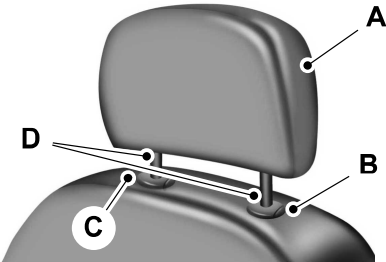

E215998

- A Energy absorbing head restraint.
- B Guide sleeve adjust and unlock button.
- C Guide sleeve unlock and remove button.
- D Steel stems.

Adjusting the Head Restraint

 **WARNING:** Adjust the head restraints for all passengers before you drive your vehicle. This will help minimize the risk of neck injury in the event of a crash. Do not adjust the head restraints when your vehicle is moving.

Note: Adjust the seat backrest to an upright driving position before adjusting the head restraint. Adjust the head restraint so that the top of it is level with the top of your head and as far forward as possible.

Raising the Head Restraint

Lift the head restraint up.

Lowering the Head Restraint

1. Press and hold button B.
2. Push the head restraint down.

Removing the Head Restraint

 **WARNING:** Do not remove the head restraint from an occupied seat.

1. Lift the head restraint up until it reaches its highest position.
2. Press and hold buttons B and C.
3. Remove the head restraint.

Installing the Head Restraint

 **WARNING:** Install head restraints correctly to help minimize the risk of neck injury in the event of a crash.

1. Align the steel stems into the guide sleeves.
2. Press and hold buttons B and C.
3. Push the head restraint down.

MANUAL SEATS

Moving the Seat Backward or Forward

 **WARNING:** Do not place cargo or any objects behind the seat backrest before returning it to the original position. Pull on the seat backrest to make sure that it has fully latched after returning the seat backrest to its original position. An unlatched seat may become dangerous if you stop suddenly or have a crash.

 **WARNING:** Do not adjust the driver seat when your vehicle is moving. This may result in sudden seat movement, causing the loss of control of your vehicle.

Seats



WARNING: Make sure the driver seat fully locks into place by rocking it backward and forward.



E177638

1. Lift the handle.
2. Move the seat backward or forward to attain the desired position.
3. Release the handle.

Note: The driver seat has removable stop bolts on the track to enable access to the vehicle battery. See **Changing the 12V Battery** (page 244).

Adjusting the Lumbar Support (if Equipped)



E146386

1. Rotate the handle clockwise or counter clockwise to attain the desired lumbar support.

Recline Adjustment



WARNING: Do not adjust the driver seat backrest when your vehicle is moving. This may result in sudden seat movement, causing the loss of control of your vehicle.



WARNING: Do not adjust the recliner from inside your vehicle if the seat is unoccupied. The seat back may move suddenly and cause personal injury.

Seats

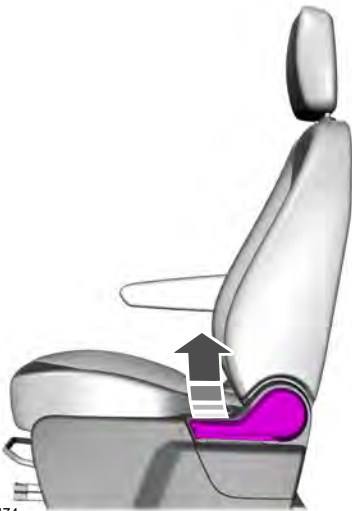

E175474

1. Lift the handle.
2. Move the seat back backward or forward to attain the desired position.
3. Release the handle.

Adjusting the Armrest

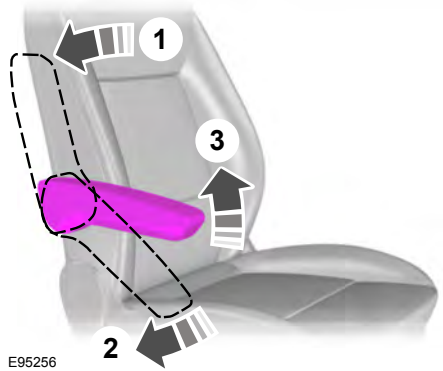

E95256

1. Raise the armrest fully.
2. Lower the armrest to the stowed position.
3. Raise the armrest to attain the desired position.

POWER SEATS (IF EQUIPPED)



WARNING: Do not adjust the driver seat when your vehicle is moving.



WARNING: Do not place cargo or any objects behind the seat backrest before returning it to the original position.



WARNING: The driver seat has removable stop bolts on the track to enable access to the vehicle battery. See **Changing the 12V Battery** (page 244).

Seats

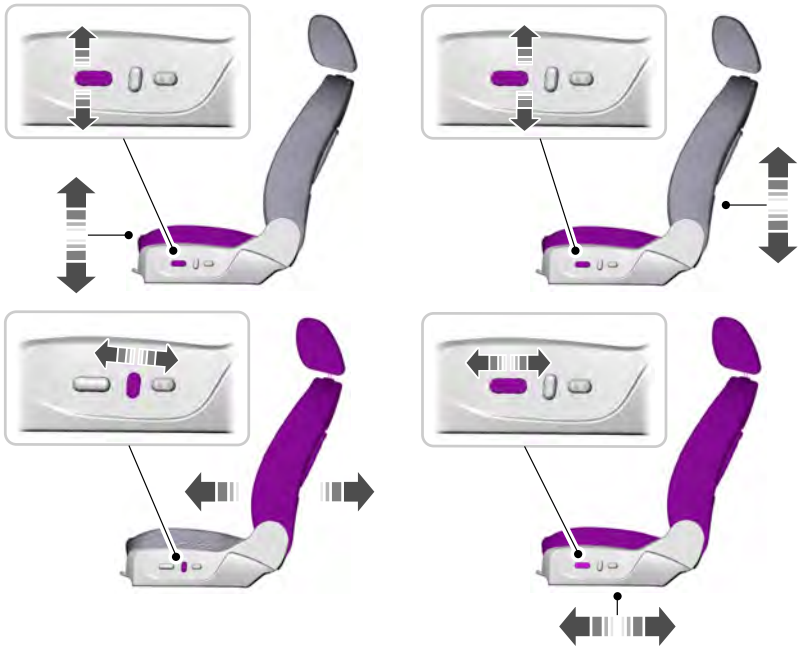

E138647

Seats

Power Lumbar



E138648

REAR SEATS

WARNING: Do not use the bench seats as a bed when your vehicle is moving. Failure to follow this warning could result in serious personal injury or death.

WARNING: Do not place any objects on a folded seat. Hard objects may become projectiles in a crash or sudden stop, which may increase the risk of serious personal injury.

Note: Rear seat arrangements vary depending on the vehicle.

Recline Adjustment (If Equipped)

WARNING: When reclining the seat backrest forward and backward, take care not to get your hands caught between the seat backrest and the frame, catches or mechanism. Failure to take care may result in personal injury.

WARNING: Make sure that any cargo or objects are not trapped behind the seat backrest. Make sure the seatbelts are not trapped in any way when unfolding the seat backrest up. Failure of an occupant to be able to use a trapped seatbelt increases the risk of serious personal injury or death.

WARNING: Make sure that the seat backrest is fully engaged in its catch. A seat backrest which is not fully engaged in its catch could move in the event of an accident. This may result in serious personal injury or death.

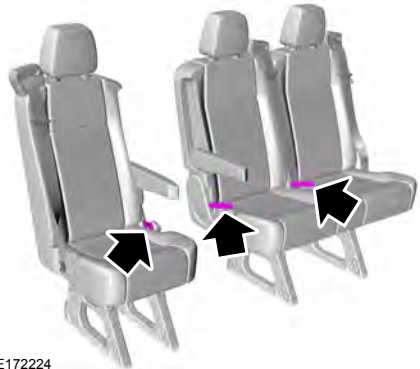

E172224

With the seat occupied, pull the lever or strap to recline or raise the seat backrest.

Seats

Removing Seats (Passenger Vehicles)



WARNING: Seats can weigh up to 176 lb (80 kg). Do not attempt to lift or carry a seat on your own.



WARNING: Do not use the release handles to lift or carry the seat.

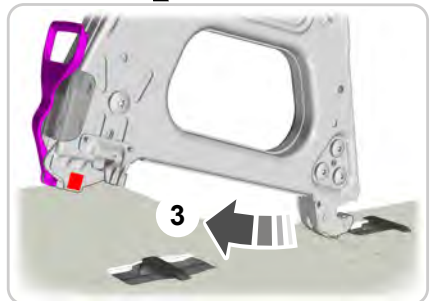
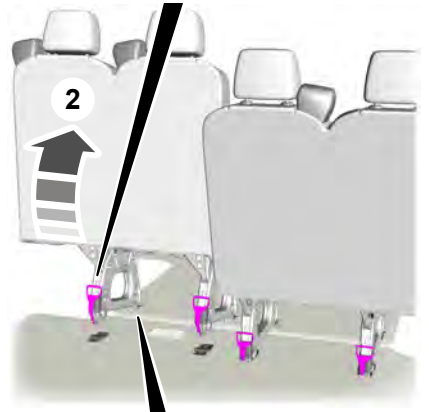
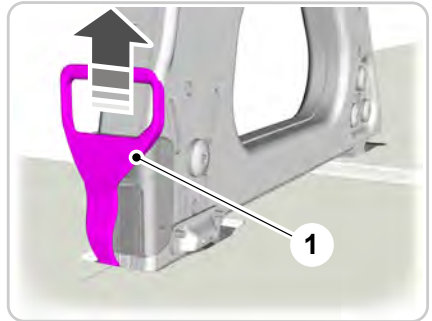

E173870

1. Pull the release handle up at an angle from the floor.

Seats

2. While holding the handle in this position, tilt the top of the seat forward to release the seat frame rear catches from the floor.
3. When the rear seat latches are clear of the floor, release the handle.
4. Pull the seat backward to release the seat frame front catches.
5. Remove the seat from the vehicle.

Note: Two persons are required to release the seat handles and remove the seat.

Note: You can only remove seats that have integral release handles.

Note: The seatback does not fold forward.

Installing the Seats



WARNING: Make sure that the floor catches are free from foreign material before installing the seats.



WARNING: Make sure that you securely fasten the seat catches when installing. Check the latches are correctly engaged by checking the red latch indicators.



1. Align the seat frame front catches.
2. Push the seat forward to engage the seat frame front catches.
3. Align the seat frame rear catches.
4. Allow the seat to drop under its own weight for the last 6-8 in (15-20 cm).

Seats

HEATED SEATS



WARNING: Use caution when using the heated seat if you are unable to feel pain to your skin because of advanced age, chronic illness, diabetes, spinal cord injury, medication, alcohol use, exhaustion or other physical conditions. The heated seat could cause burns even at low temperatures, especially if used for long periods of time. Failure to follow this instruction could result in personal injury.



WARNING: Do not place anything on the seat that blocks the heat, for example a seat cover or a cushion. This could cause the seat to overheat. Failure to follow this instruction could result in personal injury.



WARNING: Do not poke sharp objects into the seat cushion or seat backrest. This could damage the heated seat element and cause it to overheat. Failure to follow this instruction could result in personal injury.

Do not switch the heated seat on if the seat is wet.



E278736

Press the button to switch the heated seat on or off.

Auxiliary Power Points

12 Volt DC Power Point



WARNING: Do not plug optional electrical accessories into the cigar lighter socket. Incorrect use of the cigar lighter can cause damage not covered by the vehicle warranty, and can result in fire or serious injury.



WARNING: Do not use a power point for operating a cigar lighter. Incorrect use of the power points can cause damage not covered by the vehicle warranty, and can result in fire or serious injury.

Note: When you switch the ignition on, you can use the socket to power 12 volt appliances with a maximum current rating of 15 amps.

If the power supply does not work after you switch the ignition off, switch the ignition on.

Note: Do not hang any accessory from the accessory plug.

Note: Do not use the power point over the vehicle capacity of 12 volt DC 180 watts or a fuse may blow.

Note: Always keep the power point caps closed when not in use.

Do not insert objects other than an accessory plug into the power point. This will damage the power point and blow the fuse.

Run the vehicle for full capacity use of the power point.

To prevent the battery from running out of charge:

- Do not use the power point longer than necessary when the vehicle is not running.
- Do not leave devices plugged in overnight or when you park your vehicle for extended periods.

Locations



E185878

Power points may be in the following locations:

- On the instrument panel.
- Inside the cargo area.

AC Power Point (If Equipped)



WARNING: Do not keep electrical devices plugged in the power point whenever the device is not in use. Do not use any extension cord with the 110 volt AC power point, since it will defeat the safety protection design. Doing so may cause the power point to overload due to powering multiple devices that can reach beyond the 150 watt load limit and could result in fire or serious injury.

Note: The power point will turn off when the ignition is switched off or the battery voltage drops below 11 volts.

Auxiliary Power Points

Use the power point for powering electric devices that require up to 150 watts. It is under the parking brake lever.



E143941

When the indicator light on the power point is:

- On: The power point is working, the ignition is on and a device is plugged in.
- Off: The power point is off, the ignition is off or no device is plugged in.
- Flashing: The power point is in fault mode.

The power outlet temporarily turns off power when in fault mode if the device exceeds the 150 watt limit. Unplug your device and switch the ignition off. Switch the ignition back on, but do not plug your device back in. Let the system cool off and switch the ignition off to reset the fault mode. Switch the ignition back on and make sure the indicator light remains on.

Do not use the power point for certain electric devices, including:

- Cathode-ray, tube-type televisions.
- Motor loads, such as vacuum cleaners, electric saws and other electric power tools or compressor-driven refrigerators.

- Measuring devices, which process precise data, such as medical equipment or measuring equipment.
- Other appliances requiring an extremely stable power supply such as microcomputer-controlled electric blankets or touch-sensor lamps.

CIGAR LIGHTER



WARNING: Do not plug optional electrical accessories into the cigar lighter socket. Incorrect use of the cigar lighter can cause damage not covered by the vehicle warranty, and can result in fire or serious injury.

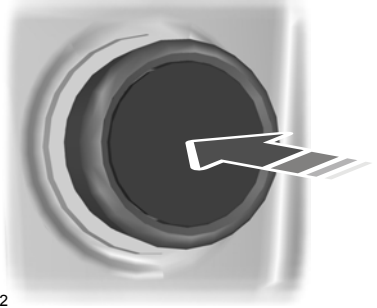

E103382

Press the element in to use the cigar lighter. It pops out after a short period of time.

Do not hold the cigar lighter element pressed in.

Note: *If the power supply does not work after you switch the ignition off, switch the ignition on.*

Note: *If you use the socket when the engine is not running, the battery may run out of charge.*

Auxiliary Power Points

Note: *When you switch the ignition on, you can use the socket to power 12 volt appliances with a maximum current rating of 15 amps.*

Storage Compartments

CUP HOLDERS



WARNING: Do not place hot drinks in the cup holders when your vehicle is moving.



WARNING: Make sure that cups placed in the holders do not obstruct your vision while driving.

OVERHEAD CONSOLE (IF EQUIPPED)

Overhead Storage Compartments Overhead Console



WARNING: Do not place heavy objects in the overhead console. Heavy objects may become projectiles in a crash or sudden stop and may increase the risk of serious injury.



E189357

BOTTLE HOLDER



WARNING: Do not place glass objects in the bottle holder.



E171160

FRONT DOOR STORAGE COMPARTMENT (IF EQUIPPED)

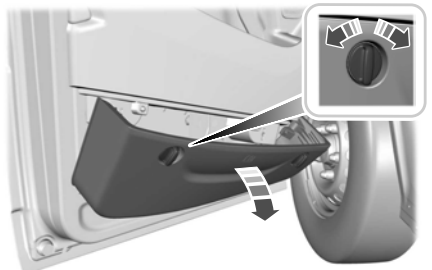

E169150

Turn the retaining clips counterclockwise to open the storage compartment.

Starting and Stopping the Engine

GENERAL INFORMATION



WARNING: Extended idling at high engine speeds can produce very high temperatures in the engine and exhaust system, creating the risk of fire or other damage.



WARNING: Do not park, idle or drive your vehicle on dry grass or other dry ground cover. The emission system heats up the engine compartment and exhaust system, creating the risk of fire.



WARNING: Do not start the engine in a closed garage or in other enclosed areas. Exhaust fumes can be toxic. Always open the garage door before you start the engine.



WARNING: Exhaust leaks may result in entry of harmful and potentially lethal fumes into the passenger compartment. If you smell exhaust fumes inside your vehicle, have your vehicle inspected immediately. Do not drive if you smell exhaust fumes.

If you disconnect the battery, your vehicle may exhibit some unusual driving characteristics for approximately 5 mi (8 km) after you reconnect it. This is because the engine management system must realign itself with the engine. You can disregard any unusual driving characteristics during this period.

The powertrain control system meets all Canadian interference-causing equipment standard requirements regulating the impulse electrical field or radio noise.

When you start the engine, avoid pressing the accelerator pedal before and during operation. Only use the accelerator pedal when you have difficulty starting the engine.

IGNITION SWITCH

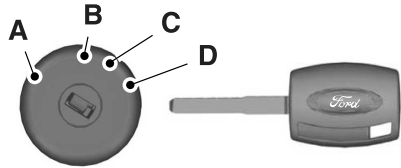

E180794

A (off) - The ignition is off.

Note: When you switch the ignition off and leave your vehicle, do not leave your key in the ignition. This could cause your vehicle battery to lose charge.

Note: To switch the engine off when your vehicle is moving, move the transmission selector lever to position **N**. Use the brakes to bring the vehicle to a safe stop. After your vehicle has stopped, switch the engine off and move the transmission selector lever to position **P**. Turn the key to position **A** or **B**.

B (accessory) - Allows the electrical accessories such as the radio to operate while the engine is not running.

Note: Do not leave the ignition key in this position for too long. This could cause your vehicle battery to lose charge.

C (on) - All electrical circuits operational. Warning lamps and indicators illuminate.

D (start) - cranks the engine. Release the key as soon as the engine starts.

Starting and Stopping the Engine

STARTING A GASOLINE ENGINE

The speed at which the engine idles immediately after starting is optimized to minimize vehicle emissions and maximize cabin comfort and fuel economy.

Note: *You can only attempt to start the engine for a limited amount of time before the starting system temporarily disables. If you exceed the starting time limit, a message may appear and you cannot attempt to start the engine for at least 15 minutes.*

Before starting your vehicle, check the following:

- Make sure the headlamps and electrical accessories are off.
- Make sure the parking brake is on.
- Make sure the transmission is in park (P).

Starting the Engine

1. Fully press the brake pedal.

Note: *Do not touch the accelerator pedal.*

2. Turn the key to position **III**.

Note: *The engine may continue cranking for up to 15 seconds or until it starts.*

Note: *The engine takes longer to start at lower temperatures. It may crank for several seconds when very cold.*

Failure to Start

If you cannot start the engine after 3 attempts, wait 10 seconds and do the following:

1. Fully press the brake pedal.
2. Apply the parking brake.
3. Shift into park (P).
4. Fully press the accelerator pedal and hold it there.

5. Turn the key to position **III** and wait until the engine stops.
6. Release the accelerator pedal.
7. Start the engine.

Stopping the Engine When Your Vehicle is Stationary

1. Shift into park (P).
2. Turn the key to position **0**.
3. Apply the parking brake.

Stopping the Engine When Your Vehicle is Moving



WARNING: Switching off the engine when your vehicle is still moving results in a significant decrease in braking assistance. Higher effort is required to apply the brakes and to stop your vehicle. A significant decrease in steering assistance could also occur. The steering does not lock, but higher effort could be required to steer your vehicle. When you switch the ignition off, some electrical circuits, for example airbags, also turn off. If you unintentionally switch the ignition off, shift into neutral (N) and restart the engine.

1. Shift into neutral and use the brakes to bring your vehicle to a safe stop.
2. Shift into park (P).
3. Turn the key to position **0**.
4. Apply the parking brake.

Starting and Stopping the Engine

Guarding Against Exhaust Fumes



WARNING: Exhaust leaks may result in entry of harmful and potentially lethal fumes into the passenger compartment. If you smell exhaust fumes inside your vehicle, have your vehicle inspected immediately. Do not drive if you smell exhaust fumes.

Important Ventilating Information

If you stop your vehicle and then leave the engine idling for long periods, we recommend that you do one of the following:

- Open the windows at least 1 in (3 cm).
- Set your climate control to outside air.

Engine Warning Lamps



Malfunction Indicator Lamp
Check Engine

If it illuminates when the engine is running this indicates a malfunction. The On Board Diagnostics system has detected a malfunction of the vehicle emission control system.

If it flashes, engine misfire may be occurring. Increased exhaust gas temperatures could damage the catalytic converter or other vehicle components. Avoid heavy acceleration and deceleration and have your vehicle immediately serviced.



Powertrain Warning Lamp

If it illuminates when the engine is running this indicates a malfunction. If it flashes when you are driving, immediately reduce the vehicle speed. Avoid heavy acceleration and deceleration and have your vehicle immediately serviced.

If both lamps illuminate when the engine is running, stop your vehicle as soon as it is safe to do so. Continuing to drive your vehicle may cause reduced power or the engine to stop. Switch the ignition off and attempt to restart the engine. Have your vehicle immediately checked.

STARTING A DIESEL ENGINE



WARNING: Do not use starting fluid, for example ether, in the air intake system. Such fluid could cause immediate explosive damage to the engine and possible personal injury.

Before starting your vehicle, check the following:

- Make sure the headlamps and electrical accessories are off.
- Make sure the parking brake is on.
- Make sure the transmission is in park (P).

Starting the Engine

1. Turn the key to position **II**.
2. Wait until the glow plug indicator turns off.

3. Fully press the brake pedal.

Note: Do not touch the accelerator pedal.

4. Turn the key to position **III**.

Note: Releasing the brake pedal when the engine is starting stops the engine cranking and the ignition returns to on.

Note: When the temperature is below 5°F (-15°C), you may need to crank the engine for up to 10 seconds.

Starting and Stopping the Engine

Note: You can only attempt to start the engine for a limited amount of time before the starting system temporarily disables. If you exceed the starting time limit, a message may appear and you cannot attempt to start the engine for at least 15 minutes.

Failure to Start

If the engine does not start, do the following:

1. Fully press the brake pedal.
2. Apply the parking brake.
3. Shift into park (P).
4. Turn the key to position **III** until the engine starts.

Stopping the Engine When Your Vehicle is Stationary

1. Shift into park (P).
2. Turn the key to position **O**.
3. Apply the parking brake.

Stopping the Engine When Your Vehicle is Moving



WARNING: Switching off the engine when your vehicle is still moving results in a significant decrease in braking assistance. Higher effort is required to apply the brakes and to stop your vehicle. A significant decrease in steering assistance could also occur. The steering does not lock, but higher effort could be required to steer your vehicle. When you switch the ignition off, some electrical circuits, for example airbags, also turn off. If you unintentionally switch the ignition off, shift into neutral (N) and restart the engine.

1. Shift into neutral and use the brakes to bring your vehicle to a safe stop.

2. Shift into park (P).
3. Turn the key to position **O**.
4. Apply the parking brake.

Guarding Against Exhaust Fumes



WARNING: Exhaust leaks may result in entry of harmful and potentially lethal fumes into the passenger compartment. If you smell exhaust fumes inside your vehicle, have your vehicle inspected immediately. Do not drive if you smell exhaust fumes.

Important Ventilating Information

If you stop your vehicle and then leave the engine idling for long periods, we recommend that you do one of the following:

- Open the windows at least 1 in (3 cm).
- Set your climate control to outside air.

Glow Plug Indicator



If it illuminates, wait until it turns off before starting.

Engine Warning Lamps



Malfunction Indicator Lamp
Check Engine

If it illuminates when the engine is running this indicates a malfunction. The On Board Diagnostics system has detected a malfunction of the vehicle emission control system.

Starting and Stopping the Engine

If it flashes, engine misfire may be occurring. Increased exhaust gas temperatures could damage the diesel particulate filter or other vehicle components. Avoid heavy acceleration and deceleration and have your vehicle immediately serviced.



Powertrain Warning Lamp

If it illuminates when the engine is running this indicates a malfunction. If it flashes when you are driving, immediately reduce the vehicle speed. Avoid heavy acceleration and deceleration and have your vehicle immediately serviced.

If both lamps illuminate when the engine is running, stop your vehicle as soon as it is safe to do so. Continuing to drive your vehicle may cause reduced power or the engine to stop. Switch the ignition off and attempt to restart the engine. Have your vehicle immediately checked.

SWITCHING OFF THE ENGINE

Vehicles With a Turbocharger



WARNING: Do not switch the engine off when it is running at high speed. If you do, the turbocharger will continue running after the engine oil pressure has dropped to zero. This will lead to premature turbocharger bearing wear.

Release the accelerator pedal. Wait until the engine has reached idle speed and then switch it off.

ENGINE BLOCK HEATER (IF EQUIPPED)



WARNING: Failure to follow engine block heater instructions could result in property damage or serious personal injury.



WARNING: Do not use your heater with ungrounded electrical systems or two-pronged adapters. There is a risk of electrical shock.



WARNING: Do not fully close the hood, or allow it to drop under its own weight when using the engine block heater. This could damage the power cable and may cause an electrical short resulting in fire, injury and property damage.

Note: *The heater is most effective when outdoor temperatures are below 0°F (-18°C).*

The heater acts as a starting aid by warming the engine coolant. This allows the climate control system to respond quickly. The equipment includes a heater element (installed in the engine block) and a wire harness. You can connect the system to a grounded 120-volt AC electrical source.

We recommend that you do the following for a safe and correct operation:

- Use a 16-gauge outdoor extension cord that is product certified by Underwriter's Laboratory (UL) or Canadian Standards Association (CSA). This extension cord must be suitable for use outdoors, in cold

Starting and Stopping the Engine

temperatures, and be clearly marked Suitable for Use with Outdoor Appliances. Do not use an indoor extension cord outdoors. This could result in an electric shock or become a fire hazard.

- Use as short an extension cord as possible.
- Do not use multiple extension cords.
- Make sure that when in operation, the extension cord plug and heater cord plug connections are free and clear of water. This could cause an electric shock or fire.
- Make sure your vehicle is parked in a clean area, clear of combustibles.
- Make sure the heater, heater cord and extension cord are firmly connected.
- Check for heat anywhere in the electrical hookup once the system has been operating for approximately 30 minutes.
- Make sure the system is unplugged and properly stowed before starting and driving your vehicle. Make sure the protective cover seals the prongs of the block heater cord plug when not in use.
- Make sure the heater system is checked for proper operation before winter.

Using the Engine Block Heater

Make sure the receptacle terminals are clean and dry prior to use. Clean them with a dry cloth if necessary.

The heater uses 0.4 to 1.0 kilowatt-hours of energy per hour of use. The system does not have a thermostat. It achieves maximum temperature after approximately three hours of operation. Using the heater longer than three hours does not improve system performance and unnecessarily uses electricity.

Fuel and Refueling

SAFETY PRECAUTIONS

 **WARNING:** Do not overfill the fuel tank. The pressure in an overfilled tank may cause leakage and lead to fuel spray and fire.

 **WARNING:** The fuel system may be under pressure. If you hear a hissing sound near the fuel filler inlet, do not refuel until the sound stops. Otherwise, fuel may spray out, which could cause serious personal injury.

 **WARNING:** Fuels can cause serious injury or death if misused or mishandled.

 **WARNING:** Fuel may contain benzene, which is a cancer-causing agent.

 **WARNING:** When refueling always shut the engine off and never allow sparks or open flames near the fuel tank filler valve. Never smoke or use a cell phone while refueling. Fuel vapor is extremely hazardous under certain conditions. Avoid inhaling excess fumes.

- Avoid inhaling fuel vapors. Inhaling fuel vapor can lead to eye and respiratory tract irritation. In severe cases, excessive or prolonged breathing of fuel vapor can cause serious illness and permanent injury.
- Avoid getting fuel in your eyes. If you splash fuel in your eyes, immediately remove contact lenses (if worn), flush with water for 15 minutes and seek medical attention. Failure to seek proper medical attention could lead to permanent injury.
- Fuels can be harmful if absorbed through the skin. If you splash fuel on your skin, clothing or both, promptly remove contaminated clothing and thoroughly wash your skin with soap and water. Repeated or prolonged skin contact causes skin irritation.
- Be particularly careful if you are taking Antabuse or other forms of Disulfiram for the treatment of alcoholism. Breathing fuel vapors could cause an adverse reaction, serious personal injury or sickness. Immediately call a physician if you experience any adverse reactions.

Follow these guidelines when refueling:

- Extinguish all smoking materials and any open flames before refueling your vehicle.
- Always switch the engine off before refueling.
- Automotive fuels can be harmful or fatal if swallowed. Fuel is highly toxic and if swallowed can cause death or permanent injury. If fuel is swallowed immediately call a physician, even if no symptoms are immediately apparent. The toxic effects of fuel may not be apparent for hours.

Fuel and Refueling

FUEL QUALITY - DIESEL

Fuel Requirements - Choosing the Right Fuel: Vehicles Operated Where Ultra-Low Sulfur Diesel Fuel is Required (United States/Canada/Puerto Rico/U.S. Virgin Islands and Other Locales)



WARNING: Only use Ultra-Low Sulfur Diesel fuel (ULSD) containing a maximum of 15 ppm sulfur and up to 20% biodiesel (B20). These fuels should meet the diesel specifications defined by American Society for Testing and Materials (ASTM) D975 for diesel and by ASTM D7467 for B6-B20 blends, or an equivalent local market specification.



WARNING: Do not mix diesel with oil, kerosene, paraffin, gasoline or other liquids to diesel. This can cause damage to the fuel system.



WARNING: Do not use home heating oil, agricultural fuel, raw fats, oils, waste cooking greases, biodiesel fuels greater than 20% or any diesel fuel not intended for highway use.



WARNING: The vehicle warranty will not cover damage caused by using an improper type of fuel or fuel additive.

Note: Do not blend used engine oil with diesel fuel under any circumstances. Blending used oil with the fuel will significantly increase your vehicle's exhaust emissions and reduce engine life due to increased internal wear.

Fuel Requirements - Choosing The Right Fuel: Vehicles Operated Where Ultra-Low Sulfur Diesel Fuel Is Not Required

Use only a diesel engine configured for use with high sulfur diesel fuel in markets with diesel fuel that has sulfur content greater than 15 ppm. Using low sulfur diesel fuel (16–500 ppm) or high sulfur diesel fuel (greater than 500 ppm) in a diesel engine designed to use only ultra-low sulfur diesel fuel may result in damage to engine emission control devices and the after-treatment system, potentially rendering your vehicle inoperable.

For the engine to operate reliably on low sulfur or high sulfur diesel fuel, the engine must be a factory built high sulfur engine (available as a dealer order option for select markets) or an ultra-low sulfur diesel fuel configured engine that has been retrofitted for high sulfur diesel fuel using Ford Motor Company dealer service parts. Failure to use retrofit components other than those available through your authorized dealer will result in coolant system damage, engine overheating, selective catalyst reduction system or diesel particulate filter damage and possible base engine damage.

Vehicles with engines configured for use with high sulfur diesel fuel are only available for sale in countries where ultra-low sulfur diesel fuel is generally not available or mandated by the government. Vehicles originally sold in a ultra-low sulfur diesel fuel market that are subsequently exported to non ultra-low sulfur diesel fuel markets will need to be retrofitted (at the customer's expense using Ford authorized dealer service parts) in order to be reliably operated on non ultra-low sulfur diesel fuel.

Fuel and Refueling

Biodiesel

You may operate your vehicle on diesel fuels containing up to 20% biodiesel, also known as B20.

Biodiesel fuel is a chemically converted product from renewable fuel sources, such as vegetable oils, animal fats and waste cooking greases.

To help achieve acceptable engine performance and durability when using biodiesel in your vehicle:

- Confirm the biodiesel content of the fuel to be B20 (20% biodiesel) or less by checking the label on the fuel pump.
- Only use biodiesel fuel of good quality that complies with applicable industry standards ASTM D975 for diesel and ASTM D7467 for B6-B20 blends.
- Follow the recommended service maintenance intervals. See **Normal Scheduled Maintenance** (page 469).
- Do not store biodiesel fuel in the fuel tank for more than one month.
- Do not use raw oils, fats or waste cooking greases.

System Messages

Message	Action and Description
Fuel Pressure Low	Consider changing brands or reducing biodiesel content if you have cold temperature fuel gelling issues or this message frequently appears.

Use of biodiesel in concentrations greater than 20% may cause damage to your vehicle, including engine or exhaust after-treatment hardware (exhaust catalyst and particulate filter) failures. Using biodiesel in concentrations greater than 20% can also cause fuel filter

restrictions that may result in a lack of power or damage to fuel system components, including fuel pump and fuel injector failures. See **Special Operating Conditions Scheduled Maintenance** (page 472).

Look for a label on the fuel pump to confirm the amount of biodiesel contained in a diesel fuel. Biodiesel fuel blends with greater than 5% must be labeled.

Biodiesel content is often indicated with the letter B followed by the percent of biodiesel in the fuel. For example, B20 indicates a fuel containing 20% biodiesel. Ask the service station attendant to confirm the biodiesel content of a diesel fuel if you do not see a label on the fuel pump.

Biodiesel fuels degrade more easily than diesel fuels not containing biodiesel and should not be stored in the fuel tank for more than one month. If you plan to park or store your vehicle for more than one month, then you should empty your vehicle fuel tank of biodiesel fuel. You should fill the tank with a pure petroleum-based diesel fuel and run your vehicle for a minimum of 30 minutes.

If you intend to store your vehicle for more than two months, we recommend that you seek advice from an authorized dealer.

Note: *Degraded or oxidized biodiesel can damage fuel system seals and plastics and corrode steel parts.*

Fuel companies adjust diesel fuel formulations for cold temperatures. Diesel fuel which has not been correctly formulated for cold ambient temperatures may gel and block the fuel filters. An indication that the fuel filters are blocked is the engine starts, stalls after a short time and then does not restart. If you have been using biodiesel, you may need to use a fuel with lower biodiesel content or discontinue using biodiesel.

Fuel and Refueling

Do not use alcohol based fuel additives to correct fuel gelling. This may damage the fuel injectors or fuel system. This may also degrade vehicle performance and could lead to fuel system damage that may not be covered by the vehicle Warranty. Only use an anti-gel and performance improvement product. We recommend Motorcraft® Anti-Gel & Performance Improver.

Diesel Fuel Additives

It should not be necessary to add any aftermarket additives to your fuel if you use a high quality diesel fuel that conforms to ASTM industry specifications. Aftermarket additives can damage the fuel injector system or engine.

Use Motorcraft Cetane Booster or an equivalent cetane booster additive if you suspect fuel has low cetane. Use Motorcraft Anti-Gel & Performance Improver or an equivalent additive if there is fuel gelling during cold weather.

Do not use alcohol-based additives to improve cetane quality, to prevent fuel gelling or any other use. The use of alcohol additives may result in damage to the fuel injectors and system.

The vehicle Warranty may not cover repairs needed to correct the effects of using any aftermarket product that does not meet Ford specifications.

FUEL QUALITY - GASOLINE

Choosing the Right Fuel

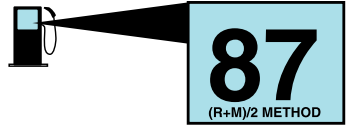

E161513

Your vehicle is designed to operate on regular unleaded gasoline with a minimum pump (R+M)/2 octane rating of 87.

Some fuel stations, particularly those in high altitude areas, offer fuels posted as regular unleaded gasoline with an octane rating below 87. The use of these fuels could result in engine damage that will not be covered by the vehicle warranty.

For best overall vehicle and engine performance, premium fuel with an octane rating of 91 or higher is recommended. The performance gained by using premium fuel is most noticeable in hot weather as well as other conditions, for example when towing a trailer. See **Towing** (page 179).

Do not be concerned if the engine sometimes knocks lightly. However, if the engine knocks heavily while using fuel with the recommended octane rating, contact an authorized dealer to prevent any engine damage.

We recommend Top Tier detergent gasolines, where available to help minimize engine deposits and maintain optimal vehicle and engine performance. For additional information, refer to www.toptiergas.com.

Fuel and Refueling

Note: Use of any fuel for which the vehicle was not designed can impair the emission control system, cause loss of vehicle performance, and cause damage to the engine which may not be covered by the vehicle Warranty.

Do not use:

- Diesel fuel.
- Fuels containing kerosene or paraffin.
- Fuel containing more than 15% ethanol or E85 fuel.
- Fuels containing methanol.
- Fuels containing metallic-based additives, including manganese-based compounds.
- Fuels containing the octane booster additive, methylcyclopentadienyl manganese tricarbonyl (MMT).
- Leaded fuel, using leaded fuel is prohibited by law.

The use of fuels with metallic compounds such as methylcyclopentadienyl manganese tricarbonyl (commonly known as MMT), which is a manganese-based fuel additive, will impair engine performance and affect the emission control system.

FUEL QUALITY - E85

Choosing the Right Fuel - Flex Fuel Vehicles

Flex fuel vehicles have one of the following identifiers:

- Yellow fuel filler cap.
- Yellow bezel around the fuel filler inlet.
- Yellow fuel filler housing.
- Yellow E85 label on the fuel tank filler door.

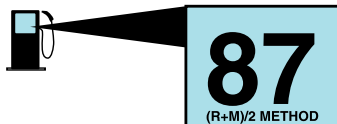

E161513

Your vehicle is designed to operate on regular unleaded gasoline with a minimum pump (R+M)/2 octane rating of 87 or regular unleaded gasoline blended with a maximum of 85% ethanol (E85).

Some fuel stations, particularly those in high altitude areas, offer fuels posted as regular unleaded gasoline with an octane rating below 87. The use of these fuels could result in engine damage that will not be covered by the vehicle warranty.

For best overall vehicle and engine performance, premium fuel with an octane rating of 91 or higher is recommended. The performance gained by using premium fuel is most noticeable in hot weather as well as other conditions, for example when towing a trailer. See **Towing** (page 179).

Do not be concerned if the engine sometimes knocks lightly. However, if the engine knocks heavily while using fuel with the recommended octane rating, contact an authorized dealer to prevent any engine damage.

We recommend Top Tier detergent gasolines, where available to help minimize engine deposits and maintain optimal vehicle and engine performance. For additional information, refer to www.toptiergas.com.

Note: Use of any fuel for which the vehicle was not designed can impair the emission control system, cause loss of vehicle performance, and cause damage to the engine which may not be covered by the vehicle Warranty.

Fuel and Refueling

Do not use:

- Diesel fuel.
- Fuels containing kerosene or paraffin.
- Fuels containing more than 85% ethanol or E100 fuel.
- Fuels containing methanol.
- Fuels containing metallic-based additives, including manganese-based compounds.
- Fuels containing the octane booster additive, methylcyclopentadienyl manganese tricarbonyl (MMT).
- Leaded fuel, using leaded fuel is prohibited by law.

The use of fuels with metallic compounds such as methylcyclopentadienyl manganese tricarbonyl (commonly known as MMT), which is a manganese-based fuel additive, will impair engine performance and affect the emission control system.

Switching Between E85 and Gasoline

We do not recommend repeatedly alternating between E85 and gasoline. If you switch from using E85 to gasoline, or from gasoline to E85, add as much fuel as possible, at least half a tank. Drive your vehicle immediately for a minimum of 5 mi (8 km) to allow it to adapt to the change in ethanol concentration. If you use E85 exclusively, we recommend that you fill the fuel tank with regular unleaded gasoline at each scheduled oil change.

FUEL FILLER FUNNEL LOCATION

The fuel filler funnel is in the glove compartment or in the front right-hand side stepwell storage compartment.

RUNNING OUT OF FUEL

Running out of fuel can cause damage not covered by the vehicle Warranty.

If your vehicle runs out of fuel:

- Add a minimum of 1.3 gal (5 L) of fuel to restart the engine.
- You may need to switch the ignition from off to on several times after refueling to allow the fuel system to pump the fuel from the tank to the engine. When restarting, cranking time takes a few seconds longer than normal.

Note: *If your vehicle is on a steep slope, more fuel may be required.*

Filling a Portable Fuel Container

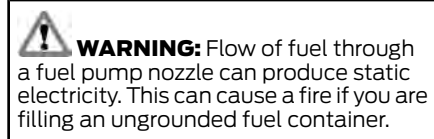



Use the following guidelines to avoid electrostatic charge build-up, which can produce a spark, when filling an ungrounded fuel container:

- Only use an approved fuel container to transfer fuel to your vehicle. Place the container on the ground when filling it.
- Do not fill a fuel container when it is inside your vehicle (including the cargo area).
- Keep the fuel pump nozzle in contact with the fuel container when filling it.
- Do not use a device that holds the fuel pump nozzle lever in the fill position.

Fuel and Refueling

Adding Fuel From a Portable Fuel Container

 **WARNING:** Do not insert the nozzle of a fuel container or an aftermarket funnel into the fuel filler neck. This may damage the fuel system filler neck or its seal and cause fuel to run onto the ground.

 **WARNING:** Do not try to pry open or push open the capless fuel system with foreign objects. This could damage the fuel system and its seal and cause injury to you or others.

 **WARNING:** Do not dispose of fuel in the household refuse or the public sewage system. Use an authorized waste disposal facility.

When refueling the vehicle fuel tank from a fuel container, use the fuel filler funnel included with your vehicle. See **Fuel Filler Funnel Location** (page 135).

Note: Do not use aftermarket funnels as they may not work with the capless fuel system and can damage it.

When refueling the vehicle fuel tank from a fuel container, do the following:

1. Fully open the fuel filler door.
2. Fully insert the fuel filler funnel into the fuel filler inlet.





E157452

3. Add fuel to your vehicle from the fuel container.
4. Remove the fuel filler funnel.
5. Fully close the fuel filler door.
6. Clean the fuel filler funnel and place it back in your vehicle or correctly dispose of it.

Note: Extra funnels can be purchased from an authorized dealer if you choose to dispose of the funnel.

REFUELING

 **WARNING:** Do not overfill the fuel tank. The pressure in an overfilled tank may cause leakage and lead to fuel spray and fire.

 **WARNING:** Do not try to pry open or push open the capless fuel system with foreign objects. This could damage the fuel system and its seal and cause injury to you or others.

 **WARNING:** Do not remove the fuel pump nozzle from its fully inserted position when refueling.

Fuel and Refueling



WARNING: When refueling always shut the engine off and never allow sparks or open flames near the fuel tank filler valve. Never smoke or use a cell phone while refueling. Fuel vapor is extremely hazardous under certain conditions. Avoid inhaling excess fumes.



WARNING: Wait at least 10 seconds before removing the fuel pump nozzle to allow any residual fuel to drain into the fuel tank.



WARNING: Stop refueling when the fuel pump nozzle automatically shuts off for the first time. Failure to follow this will fill the expansion space in the fuel tank and could lead to fuel overflowing.

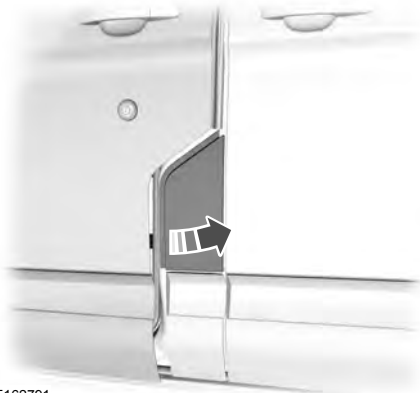

E162791

1. Open the left-hand front door.
2. Fully open the fuel filler door.

Note: Your vehicle does not have a fuel filler cap.

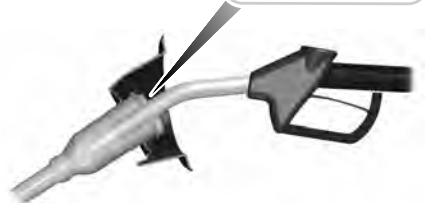
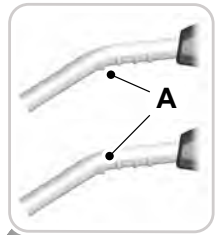

E139202

3. Insert the fuel pump nozzle up to the first notch on the nozzle A. Keep it resting on the cover of the fuel tank filler pipe opening.

Note: The fuel filler nozzle inhibitor only opens when you insert the correct fuel pump nozzle.

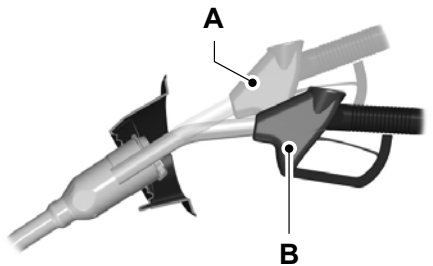

E139203

4. Hold the fuel pump nozzle in position B when refueling. Holding the fuel pump nozzle in position A could affect the flow of fuel and shut off the fuel pump nozzle before the fuel tank is full.

Fuel and Refueling



E162792

5. Operate the fuel pump nozzle within the area shown.



E119081

6. Slightly raise the fuel pump nozzle and then slowly remove it.
7. Fully close the fuel filler door.

Note: Do not attempt to start the engine if you have filled the fuel tank with incorrect fuel. Incorrect fuel use can cause damage not covered by the vehicle Warranty. Have your vehicle immediately checked.

System Warnings (If Equipped)

If the fuel filler nozzle inhibitor does not fully close a warning message appears in the information display.

1. Stop your vehicle as soon as it is safe to do so and switch the engine off.
2. Shift into park (P) or neutral (N).
3. Apply the parking brake.
4. Open the left-hand front door.
5. Fully open the fuel filler door.
6. Check the fuel filler inlet and the area around it for any items or debris that may be obstructing its movement.
7. Fully insert a fuel pump nozzle or the fuel filler funnel provided with your vehicle into the fuel filler inlet. See **Fuel Filler Funnel Location** (page 135). This action should dislodge any debris that may be preventing the fuel filler inlet from fully closing.
8. Remove the fuel pump nozzle or fuel filler funnel from the fuel filler inlet.
9. Fully close the fuel filler door.

Note: If this action corrects the problem the message may not immediately reset. If the message remains and the service engine soon warning lamp illuminates, have your vehicle checked as soon as possible.

FUEL CONSUMPTION

Advertised Capacity

The advertised capacity is the maximum amount of fuel that you can add to the fuel tank when the fuel gauge indicates empty. See **Capacities and Specifications** (page 315).

In addition, the fuel tank contains an empty reserve. The empty reserve is an unspecified amount of fuel that remains in the fuel tank when the fuel gauge indicates empty.

Note: The amount of fuel in the empty reserve varies and should not be relied upon to increase driving range.

Fuel and Refueling

Filling the Fuel Tank

For consistent results when refueling:

- Turn the ignition off before fueling; an inaccurate reading results if the engine is left running.
- Use the same fill rate (low-medium-high) each time the tank is filled.
- Allow no more than one automatic shut-off when refueling.

Results are most accurate when the filling method is consistent.

Calculating Fuel Economy

Your vehicle calculates fuel economy figures through the trip computer average fuel function. See **Information Displays** (page 97).

The first 1,000 mi (1,500 km) of driving is the break-in period of the engine. A more accurate measurement is obtained after 2,000 mi (3,000 km).

1. Completely fill the fuel tank and record the initial odometer reading. See **Refueling** (page 136).
2. Each time you fill the fuel tank, record the amount of fuel added.
3. After at least three fill ups, fill the fuel tank and record the current odometer reading.
4. Subtract your initial odometer reading from the current odometer reading.

To calculate L/100 km (liters per 100 kilometers) fuel consumption, multiply the liters used by 100, then divide by kilometers traveled. To calculate MPG (miles per gallon) fuel consumption, divide miles traveled by gallons used.

Keep a record for at least one month and record the type of driving, for example city or highway. This provides an accurate estimate of your vehicle's fuel economy under current driving conditions. Keeping records during summer and winter shows how temperature impacts fuel economy.

Conditions

- Heavily loading your vehicle reduces fuel economy.
- Carrying unnecessary weight in your vehicle may reduce fuel economy.
- Avoid adding accessories that increase aerodynamic drag to your vehicle such as bug deflectors, car top carriers and ski or bike racks.
- Using fuel blended with alcohol may lower fuel economy.
- Fuel economy may decrease with lower temperatures.
- Fuel economy may decrease when driving short distances.
- You will get better fuel economy when driving on flat terrain than when driving on hilly terrain.

Engine Emission Control

EMISSION LAW



WARNING: Do not remove or alter the original equipment floor covering or insulation between it and the metal floor of the vehicle. The floor covering and insulation protect occupants of the vehicle from the engine and exhaust system heat and noise. On vehicles with no original equipment floor covering insulation, do not carry passengers in a manner that permits prolonged skin contact with the metal floor. Failure to follow these instructions may result in fire or personal injury.

U.S. federal laws and certain state laws prohibit removing or rendering inoperative emission control system components. Similar federal or provincial laws may apply in Canada. We do not approve of any vehicle modification without first determining applicable laws.



Tampering with emissions control systems including related sensors or the Diesel

Exhaust Fluid system can result in reduced engine power and the illumination of the service engine soon light.

Tampering With a Noise Control System

Federal laws prohibit the following acts:

- Removal or rendering inoperative by any person other than for purposes of maintenance.
- Repair or replacement of any device or element of the design incorporated into a new vehicle for the purpose of noise control prior to its sale or delivery to the ultimate purchaser or while it is in use.
- The use of the vehicle after any person removes or renders inoperative any device or element of the design.

The U.S. Environmental Protection Agency may presume to constitute tampering as follows:

- Removal of hood blanket, fender apron absorbers, fender apron barriers, underbody noise shields or acoustically absorptive material.
- Tampering or rendering inoperative the engine speed governor, to allow engine speed to exceed manufacturer specifications.

If the engine does not start, runs rough, experiences a decrease in engine performance, experiences excess fuel consumption or produces excessive exhaust smoke, check for the following:

- A plugged or disconnected air inlet system hose.
- A plugged engine air filter element.
- Water in the fuel filter and water separator.
- A clogged fuel filter.
- Contaminated fuel.
- Air in the fuel system, due to loose connections.
- An open or pinched sensor hose.
- Incorrect engine oil level.

Engine Emission Control

- Incorrect fuel for climatic conditions.
- Incorrect engine oil viscosity for climactic conditions.

Note: *Some vehicles have a lifetime fuel filter that is integrated with the fuel tank. Regular maintenance or replacement is not needed.*

Note: *If these checks do not help you correct the concern, have your vehicle checked as soon as possible.*

Noise Emissions Warranty, Prohibited Tampering Acts and Maintenance

On January 1, 1978, Federal regulation became effective governing the noise emission on trucks over 10,000 lb (4,536 kg) Gross Vehicle Weight Rating (GVWR). The preceding statements concerning prohibited tampering acts and maintenance, and the noise warranty found in the Warranty Guide, are applicable to complete chassis cabs over 10,000 lb (4,536 kg) GVWR.

CATALYTIC CONVERTER - 3.5L/3.7L



WARNING: Do not park, idle or drive your vehicle on dry grass or other dry ground cover. The emission system heats up the engine compartment and exhaust system, creating the risk of fire.



WARNING: The normal operating temperature of the exhaust system is very high. Never work around or attempt to repair any part of the exhaust system until it has cooled. Use special care when working around the catalytic converter. The catalytic converter heats up to a very high temperature after only a short period of engine operation and stays hot after the engine is switched off.



WARNING: Exhaust leaks may result in entry of harmful and potentially lethal fumes into the passenger compartment. If you smell exhaust fumes inside your vehicle, have your vehicle inspected immediately. Do not drive if you smell exhaust fumes.

Your vehicle has various emission control components and a catalytic converter that enables it to comply with applicable exhaust emission standards.

To avoid damaging the catalytic converter:

- Do not crank the engine for more than 10 seconds at a time.
- Do not run the engine with a spark plug lead disconnected.
- Do not push-start or tow-start your vehicle. Use booster cables. See **Jump Starting the Vehicle** (page 196).
- Do not switch the ignition off when your vehicle is moving.
- Do not use leaded fuel.
- Avoid running out of fuel.

Note: *Resulting component damage may not be covered by the vehicle Warranty.*

Engine Emission Control

On-Board Diagnostics System

Your vehicle has an on-board diagnostics system that monitors the emission control system. If any of the following warning lamps illuminate, this may indicate that the on-board diagnostics system has detected an emission control system malfunction.

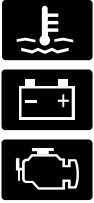

Continuing to drive your vehicle may cause reduced power or the engine to stop. Failure to respond to a warning lamp may cause component damage not covered by the vehicle Warranty. Have your vehicle checked as soon as possible.

See **Warning Lamps and Indicators** (page 93).

SELECTIVE CATALYTIC REDUCTANT SYSTEM

Your vehicle has a selective catalytic reductant system to help reduce exhaust emission levels by injecting diesel exhaust fluid into the exhaust system. The engine may not start if you tamper with or disable the selective catalytic reductant system.

For the system to correctly operate, you must maintain the fluid level. The minimum fluid refill quantity required to restart the engine is 1.51 gal (5.7 L).

Note: *If your vehicle is on a gradient, the minimum fluid refill quantity required to restart the engine may be greater than 1.51 gal (5.7 L).*

Diesel Exhaust Fluid Guidelines

- Do not put in the vehicle fuel tank. This can cause engine damage not covered by the vehicle Warranty.
- Do not overfill the tank.
- Do not dilute with water or any other liquid.
- Do not re-use an empty fluid container.
- Do not store in direct sunlight.
- Store at temperatures between 23°F (-5°C) and 68°F (20°C).
- Do not store fluid containers in your vehicle.
- The fluid is non-flammable, non-toxic, colorless and water-soluble.

Filling the Diesel Exhaust Fluid Tank



E204215

The diesel exhaust fluid tank filler pipe is next to the fuel tank filler pipe and has a blue cap. Fill the tank using a fluid pump at a diesel exhaust fluid filling station or a diesel exhaust fluid container.

Engine Emission Control



E163354

Only use diesel exhaust fluid that is certified by the American Petroleum Institute (API). Non-certified diesel exhaust fluid use can cause damage not covered by the vehicle Warranty.

Note: Wash off any fluid that may have spilled on to a painted surface with soapy water.

Filling in Cold Climates

Diesel exhaust fluid may freeze when the temperature is below 12°F (-11°C). Your vehicle has a preheating system which allows the fluid to operate below 12°F (-11°C). If you overfill the diesel exhaust fluid tank and the fluid freezes, it may cause damage not covered by the vehicle Warranty.

Filling the Diesel Exhaust Fluid Tank Using a Fuel Station Pump



WARNING: Keep diesel exhaust fluid out of reach of children. Avoid contact with skin, eyes or clothing. In case of contact with your eyes, flush immediately with water and get prompt medical attention. In case of contact with your skin, clean immediately with soap and water. If you swallow any diesel exhaust fluid, drink plenty of water, call a physician immediately.



WARNING: Only refill the diesel exhaust fluid tank in a well ventilated area. When you remove the diesel exhaust fluid tank filler cap or a diesel exhaust fluid container cap, ammonia vapors may escape. Ammonia vapors can be irritating to skin, eyes and mucous membranes. Inhaling ammonia vapors can cause burning to the eyes, throat and nose and cause coughing and watery eyes.

Filling the diesel exhaust fluid tank using a fuel station pump is similar to refueling your vehicle.

1. Fully open the fuel filler door.

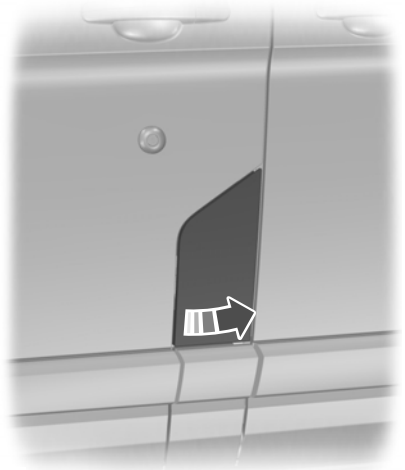

E144358

2. Remove the diesel exhaust fluid tank filler cap.
3. Fully insert the diesel exhaust fluid pump nozzle.

Engine Emission Control

Filling the Diesel Exhaust Fluid Tank Using a Container

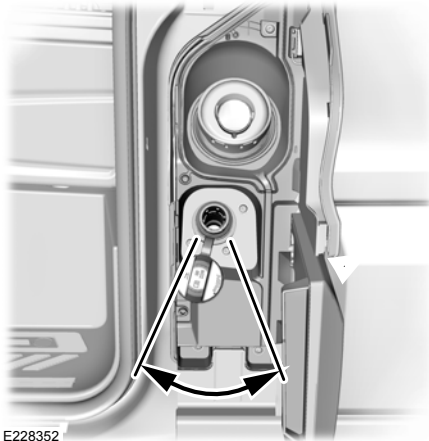

E228352

4. Operate the pump nozzle within the area shown.

Note: *The pump nozzle shuts off when the tank is full.*

5. Slightly raise the diesel exhaust fluid pump nozzle and then slowly remove it.
6. Replace the diesel exhaust fluid tank filler cap. Turn it clockwise until you feel a strong resistance.

Do not attempt to start the engine if you have filled the diesel exhaust fluid tank with incorrect fluid. Incorrect diesel exhaust fluid use could cause damage not covered by the vehicle Warranty. Have your vehicle immediately checked.



WARNING: Keep diesel exhaust fluid out of reach of children. Avoid contact with skin, eyes or clothing. In case of contact with your eyes, flush immediately with water and get prompt medical attention. In case of contact with your skin, clean immediately with soap and water. If you swallow any diesel exhaust fluid, drink plenty of water, call a physician immediately.



WARNING: Only refill the diesel exhaust fluid tank in a well ventilated area. When you remove the diesel exhaust fluid tank filler cap or a diesel exhaust fluid container cap, ammonia vapors may escape. Ammonia vapors can be irritating to skin, eyes and mucous membranes. Inhaling ammonia vapors can cause burning to the eyes, throat and nose and cause coughing and watery eyes.

Always follow the manufacturer's instructions.

1. Remove the fluid container cap.
2. Place the spout on to the container and tighten it until you feel a strong resistance.

Engine Emission Control

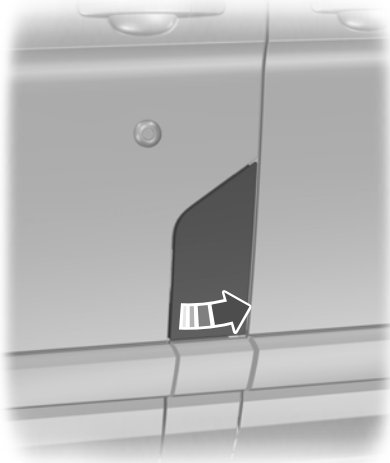

E144358

3. Remove the diesel exhaust fluid tank filler cap.
4. Insert the spout into the diesel exhaust fluid tank filler pipe until the seal on the spout fully seats.
5. Pour the fluid into the tank.

Note: *The fluid stops flowing when the tank is full.*

6. Return the container to the vertical position slightly below the diesel exhaust fluid tank filler pipe.
7. Allow any fluid remaining in the spout to drain back into the container.
8. Remove the spout from the diesel exhaust fluid tank filler pipe.
9. Remove the spout from the diesel exhaust fluid container and replace the cap.
10. Replace the diesel exhaust fluid tank filler cap. Turn it clockwise until you feel a strong resistance.

Do not attempt to start the engine if you have filled the diesel exhaust fluid tank with incorrect fluid. Incorrect diesel exhaust fluid use could cause damage not covered by the vehicle Warranty. Have your vehicle immediately checked.

Selective Catalytic Reductant System Warning Lamp



The warning lamp illuminates if the system detects the diesel exhaust fluid level is low or if there is a system malfunction.

If the warning lamp illuminates, the information display messages give you an indication whether the concern is fluid related or if there is a selective catalytic reductant system malfunction. If the warning lamp illuminates when your vehicle is moving, and the fluid is at a sufficient level, this indicates a system malfunction. Have your vehicle checked as soon as possible.

Note: *When filling the diesel exhaust fluid tank from empty, there may be a short period before the increased diesel exhaust fluid level is registered.*

DIESEL PARTICULATE FILTER - 3.2L DIESEL



WARNING: Do not park or idle your vehicle over dry leaves, dry grass or other combustible materials. The regeneration process creates very high exhaust gas temperatures and the exhaust will radiate a considerable amount of heat during and after regeneration and after you have switched the engine off. This is a potential fire hazard.

Engine Emission Control



WARNING: The normal operating temperature of the exhaust system is very high. Never work around or attempt to repair any part of the exhaust system until it has cooled. Use special care when working around the diesel oxidation catalytic converter or the diesel particulate filter. The diesel oxidation catalytic converter and the diesel particulate filter heat up to very high temperatures after only a short period of engine operation and remain hot after you switch the engine off.



Engine coolant temperature warning lamp.



Ignition warning lamp.



Malfunction indicator lamp.



Powertrain warning Lamp.



Water in fuel warning lamp.

Your vehicle has various emission control components and a diesel particulate filter that enables it to comply with applicable exhaust emission standards. It filters harmful diesel particulates, for example soot from the exhaust gas.

To avoid damaging the diesel particulate filter:

- Do not crank the engine for more than 10 seconds at a time.
- Do not push-start or tow-start your vehicle. Use booster cables. See **Jump Starting the Vehicle** (page 196).
- Do not switch the ignition off when your vehicle is moving.
- Do not ignore warning lamps or information messages regarding exhaust system cleaning and regeneration.

Note: *This could result in damage not covered by the vehicle Warranty.*

On-Board Diagnostics System

Your vehicle has an on-board diagnostics system that monitors the emission control system. If any of the following warning lamps illuminate, this indicates that the on-board diagnostics system has detected an emission control system malfunction.

If you continue to drive your vehicle when the warning lamp is illuminated, the engine could stop without warning. This could result in damage not covered by the vehicle Warranty. Have your vehicle checked as soon as possible.

See **Warning Lamps and Indicators** (page 93).

Diesel Particulate Filter Automatic Regeneration



WARNING: Do not park or idle your vehicle over dry leaves, dry grass or other combustible materials. The regeneration process creates very high exhaust gas temperatures and the exhaust will radiate a considerable amount of heat during and after regeneration and after you have switched the engine off. This is a potential fire hazard.



WARNING: The normal operating temperature of the exhaust system is very high. Never work around or attempt to repair any part of the exhaust system until it has cooled. Use special care when working around the diesel oxidation catalytic converter or the diesel

Engine Emission Control

particulate filter. The diesel oxidation catalytic converter and the diesel particulate filter heat up to very high temperatures after only a short period of engine operation and remain hot after you switch the engine off.

The diesel particulate filter on your vehicle requires periodic regeneration to maintain correct operation. The emission control system automatically carries out this process. As soot gathers in the system it begins to restrict the filter. The soot that gathers inside the filter is cleaned in two different ways, passive regeneration and active regeneration. Both methods occur automatically and require no actions from the driver. During automatic regeneration, the system cleans the diesel particulate filter by oxidizing the soot. Cleaning happens during normal engine operating conditions at varying levels depending on driving conditions.



Diesel particulate filter warning lamp.

If the diesel particulate filter is near or at saturation, a warning lamp or information message appears in the information display. Drive your vehicle in a manner to allow effective diesel particulate filter cleaning.

The warning lamp continues to illuminate until the automatic regeneration process completes. Continue to drive your vehicle in a manner to allow effective diesel particulate filter cleaning until the warning lamp turns off.

Failure to carry out regeneration when required could result in a clogged diesel particulate filter. If the diesel particulate filter fills beyond the regeneration threshold, the system disables the ability to carry out regeneration. This could result in damage not covered by the vehicle Warranty.

Where vehicle use meets any of the following conditions:

- Driving short distances.
- Prolonged engine idling.
- Frequently switching the engine on and off.
- High levels of acceleration and deceleration.

We recommend you assist the regeneration process by:

- Avoiding prolonged engine idling.
- Drive your vehicle in a manner to allow effective cleaning. Drive at a steady vehicle speed of 30 mph (48 km/h) or above for approximately 20 minutes.



If the warning lamp illuminates the diesel particulate filter could have become overloaded. Have your vehicle checked as soon as possible.

Automatic regeneration raises the exhaust temperature to eliminate the soot particles. During cleaning soot particles are converted to harmless gasses. Once cleaned the diesel particulate filter continues to trap harmful diesel particles.

If you are driving your vehicle in a manner that allows effective cleaning, a message may appear in the information display to indicate automatic regeneration is in progress.

If you are not driving your vehicle in a manner that allows effective cleaning, a message may appear in the information display to instruct you to drive in a manner that allows automatic regeneration.

Engine Emission Control

The automatic regeneration process is most effective when you drive at a steady vehicle speed of 30 mph (48 km/h) or above for approximately 20 minutes. The frequency and duration of the regeneration process varies by how you drive your vehicle, the outside air temperature and altitude. Frequency varies between 100 mi (160 km) and 310 mi (500 km) and each regeneration process lasts between 10 and 20 minutes.

Note: *Changes in the engine or exhaust sound may be heard during the regeneration process.*

Note: *During regeneration at low speed or engine idle, you could smell a hot metallic odor and could notice a clicking metallic sound. This is due to the high temperatures reached during the regeneration process. This is normal.*

Diesel Particulate Filter Manual Regeneration (If Equipped)



WARNING: Do not park or idle your vehicle over dry leaves, dry grass or other combustible materials. The regeneration process creates very high exhaust gas temperatures and the exhaust will radiate a considerable amount of heat during and after regeneration and after you have switched the engine off. This is a potential fire hazard.



WARNING: The normal operating temperature of the exhaust system is very high. Never work around or attempt to repair any part of the exhaust system until it has cooled. Use special care when working around the diesel oxidation catalytic converter or the diesel

particulate filter. The diesel oxidation catalytic converter and the diesel particulate filter heat up to very high temperatures after only a short period of engine operation and remain hot after you switch the engine off.



Diesel particulate filter warning lamp.

If the diesel particulate filter is near or at saturation, the warning lamp appears advising you to initiate diesel particulate filter manual regeneration.

Before you start manual regeneration, do the following:

- Park your vehicle outside of any enclosed structure.
- Make sure the transmission is in park (P) or neutral (N).
- Make sure the parking brake is on.
- Park your vehicle a minimum of 10 ft (3 m) from any obstructions and materials that can easily combust or melt, for example, paper, leaves, fuels, plastics and other dry organic material.
- Make sure there is a minimum of 3.2 gal (12 L) of fuel in the fuel tank.
- Check the engine oil level.
- Check the engine coolant level.

Manual Regeneration

Where vehicle use has significant engine idle operation, frequent vehicle speed less than 25 mph (40 km/h), or driving short distances where the engine does not fully warm up, manual regeneration allows you to start diesel particulate filter cleaning when the engine is idling.

Engine Emission Control

Use the manual regeneration feature when:

- You are not able to drive in a manner that allows effective automatic cleaning. See **Diesel Particulate Filter Automatic Regeneration**.
- You choose to manually start the regeneration process when the engine is idling.

Note: Changes in the engine or exhaust sound may be heard during the regeneration process.

Note: During regeneration at low speed or engine idle, you may smell a hot metallic odor and could notice a clicking metallic sound. This is due to the high temperatures reached during the regeneration process. This is normal.

Starting Manual Regeneration

You can only start manual regeneration with the engine running at normal operating temperature using the information display. See **Information Messages** (page 101).

Note: During the use of manual regeneration, you may observe a light amount of white smoke. This is normal.

Note: If you press any pedal during manual regeneration the engine may turn off. To protect the exhaust system you may not be able to restart the engine for 10 minutes.



If a warning illuminates you may not be able to start manual regeneration.

To start manual regeneration, from the main menu scroll to:

Message	Action and Description
Settings	Press the OK button or the right arrow button.
Exhaust Filter Full Clean Soon	Press the OK button or the right arrow button.
Select one of the following:	
Exhaust Filter at Limit Clean Now	Press the OK button or the right arrow button. Follow the prompts regarding exhaust position as required to start manual regeneration. Make sure you understand each prompt. The information display confirms that regeneration has started and when it is completed.
Exhaust Filter Overloaded Clean Now	Press the OK button or the right arrow button. Follow the prompts regarding exhaust position as required to start manual regeneration. Make sure you understand each prompt. The information display confirms that regeneration has started and when it is completed.

Note: You cannot use the manual regeneration until the diesel particulate filter load percentage has reached 100 percent. The diesel particulate filter load percentage fluctuates when driving due to automatic regeneration.

Engine Emission Control

When you start manual regeneration the engine speed rises to approximately 2000–2500 rpm and the cooling fan speed increases. A change in engine noise due to the cooling fan and engine speed increase may be heard during the regeneration process.

Depending on the amount of soot collected by the diesel particulate filter, the regeneration process varies depending on the outside air temperature and altitude. Manual regeneration may last up to 40 minutes.

When manual regeneration is complete the cooling fan and engine speed return to normal idling. The exhaust system remains very hot for several minutes after regeneration is complete. Do not reposition the vehicle over dry leaves, dry grass or other combustible materials until the exhaust system has had sufficient time to cool.

Interrupt or Cancel Manual Regeneration

You can interrupt or cancel manual regeneration by switching the engine off. It may be possible to interrupt or cancel manual regeneration by pressing any pedal.

Note: *To protect the exhaust system you may not be able to restart the engine for 10 minutes.*

Depending on the amount of time allowed for manual regeneration to operate, soot may not have had sufficient time to be eliminated. The exhaust system may still be very hot for several minutes after regeneration.

If you switch the engine off during manual regeneration, turbo charger flutter occurs. This is a consequence of switching a diesel engine off during turbo charger boost operation, which is normal.

Manual Regeneration with Automatic Regeneration Control

Where vehicle use has significant engine idle operation, frequent vehicle speed less than 25 mph (40 km/h), or driving short distances where the engine does not fully warm up, automatic regeneration could not sufficiently clean the diesel particulate filter. You can switch automatic regeneration off until you can drive your vehicle in a manner to allow effective cleaning, for example at a steady vehicle speed of 30 mph (48 km/h) or above for approximately 20 minutes. You can then switch automatic regeneration back on to clean the diesel particulate filter.

To switch the automatic regeneration control on and off, from the main menu scroll to:

Message	Action and Description
Information	Press the OK button or the right arrow button.
Driver Assist	Press the OK button or the right arrow button.
Auto Exhaust Cleaning Off	Check the box to switch automatic regeneration off. Uncheck the box to switch automatic regeneration on.

Transmission

AUTOMATIC TRANSMISSION



WARNING: Always fully apply the parking brake. Make sure you shift into park (P) for vehicles with an automatic transmission. Switch the ignition off and remove the key whenever you leave your vehicle.



WARNING: Do not apply the brake pedal and accelerator pedal simultaneously. Applying both pedals simultaneously for more than a few seconds will limit engine performance, which may result in difficulty maintaining speed in traffic and could lead to serious injury.

Understanding the Positions of Your Automatic Transmission

Putting your vehicle in gear:

1. Fully press down the brake pedal.
2. Move the selector lever into the desired gear.
3. Come to a complete stop.
4. Move the selector lever and securely latch it in park (P).



E175317

Park (P)

This position locks the transmission and prevents the wheels from turning.

Reverse (R)

With the selector lever in reverse (R), your vehicle moves backward. Always come to a complete stop before shifting into and out of reverse (R).

Neutral (N)

With the selector lever in neutral (N), your vehicle can be started and is free to roll. Hold the brake pedal down while in this position.

Drive (D)

Drive (D) is the normal driving position for the best fuel economy. The overdrive function allows automatic upshifts and downshifts through gears one through six.

Manual (M)

With the selector lever in manual (M), you can change gears up or down as desired by using buttons on the shift lever. See **SelectShift Automatic™ Transmission** later in this section.

Transmission

To return to normal drive (D) position, move the shift lever back from manual (M) to drive (D).

SelectShift Automatic™ Transmission (If Equipped)

Your vehicle is equipped with a SelectShift Automatic transmission selector lever. The SelectShift Automatic transmission gives you the ability to change gears up or down (without a clutch) as desired.

In order to prevent the engine from running at too low an RPM, which may cause it to stall, SelectShift still automatically makes some downshifts if it has determined that you have not downshifted in time. Although SelectShift makes some downshifts for you, it still allows you to downshift at any time as long as the SelectShift determines that damage will not be caused to the engine from over-revving.

Note: Engine damage may occur if you maintain excessive engine revving without shifting.

SelectShift does not automatically upshift, even if the engine is approaching the RPM limit. It must be shifted manually by pressing the + button.

- Press the (+) button to upshift.
- Press the (-) button to downshift.



E175317

The system determines when temporary manual control is no longer in use and returns to automatic control. The instrument cluster displays your currently selected gear.

Note: The system stays in manual control until you make another shift selection (for example, drive [D]).

Brake-Shift Interlock



WARNING: Do not drive your vehicle until you verify that the stoplamps are working.



WARNING: When doing this procedure, you need to take the transmission out of park (P) which means your vehicle can roll freely. To avoid unwanted vehicle movement, always fully apply the parking brake prior to doing this procedure. Use wheels chocks if appropriate.



WARNING: If the parking brake is fully released, but the brake warning lamp remains illuminated, the brakes may not be working properly. Have your vehicle checked as soon as possible.

Transmission

Note: See your authorized dealer as soon as possible if this procedure is used.

This prevents you from shifting the selector lever from the park (P) position, unless the brake pedal is pressed.

In the event of an electrical malfunction, or if the vehicle battery has run out of charge, use the following procedure to shift the selector lever from the park (P) position.

1. Apply the parking brake and switch the ignition off.

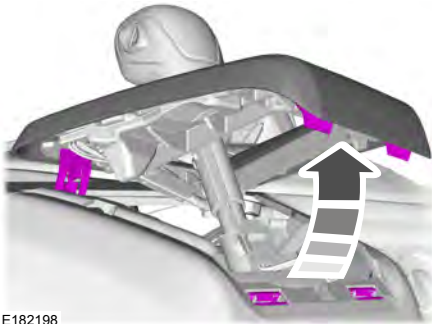

E182198

2. Use a suitable tool, for example a screwdriver, to carefully remove the housing cover.

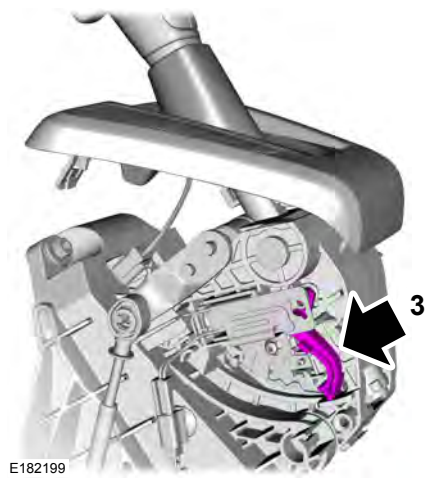

E182199

3. Locate the white lever, situated on the left hand side of the selector lever.



E174827

4. Move the white lever toward the rear of your vehicle.
5. Shift into neutral (N).
6. Replace the selector lever housing cover.

Transmission

7. Apply the brake pedal and switch the ignition on.
8. Release the parking brake.

Note: *Alternatively, we recommend that you seek advice from your dealer.*

Automatic Transmission Adaptive Learning

This feature may increase durability and provide consistent shift feel over the life of your vehicle. A new vehicle or transmission may have firm shifts, soft shifts or both. This operation is considered normal and does not affect function or durability of the transmission. Over time, the adaptive learning process fully updates transmission operation.

If Your Vehicle Gets Stuck in Mud or Snow

Note: *Do not rock the vehicle if the engine is not at normal operating temperature or damage to the transmission may occur.*

Note: *Do not rock the vehicle for more than a minute or damage to the transmission and tires may occur, or the engine may overheat.*

If your vehicle gets stuck in mud or snow, you may rock it out by shifting between forward and reverse gears, stopping between shifts in a steady pattern. Press lightly on the accelerator in each gear.

TOW/HAUL



WARNING: Do not use tow/haul when the road surface is slippery. Failure to follow this instruction could result in the loss of control of your vehicle.



WARNING: Do not use diesel engine exhaust braking when the road surface is slippery. Failure to follow this instruction could result in the loss of control of your vehicle.



To activate tow/haul, press the button near the gearshift lever once. The TOW HAUL indicator light illuminates in the instrument cluster.

The tow/haul feature:

- Delays upshifts to reduce the frequency of transmission shifting.
- Provides engine braking in all forward gears, which will slow your vehicle and assist you in controlling your vehicle when descending a grade.
- Depending on driving conditions and load conditions, may downshift the transmission, slow your vehicle and control your vehicle speed when descending a hill, without pressing the accelerator pedal. The amount of downshift braking provided will vary based upon the amount the brake pedal is pressed.

The tow/haul feature improves transmission operation when towing a trailer or a heavy load. All transmission gear ranges are available when using tow/haul.

To deactivate the tow/haul feature and return to normal driving mode, press the button near the gearshift lever twice. The TOW HAUL light will deactivate. Tow/haul also deactivates when you power down your vehicle.

Brakes

GENERAL INFORMATION

Note: Occasional brake noise is normal. If a metal-to-metal, continuous grinding or continuous squeal sound is present, the brake linings may be worn-out. Have the system checked by an authorized dealer. If your vehicle has continuous vibration or shudder in the steering wheel while braking, have it checked by an authorized dealer.

Note: Brake dust may accumulate on the wheels, even under normal driving conditions. Some dust is inevitable as the brakes wear and does not contribute to brake noise. See **Cleaning the Wheels** (page 266).



See **Warning Lamps and Indicators** (page 93).

Wet brakes result in reduced braking efficiency. Gently press the brake pedal a few times when driving from a car wash or standing water to dry the brakes.

Brake Over Accelerator

In the event the accelerator pedal becomes stuck or entrapped, apply steady and firm pressure to the brake pedal to slow the vehicle and reduce engine power. If you experience this condition, apply the brakes and bring your vehicle to a safe stop. Move the gearshift lever to park (P), switch the engine off and apply the parking brake. Inspect the accelerator pedal for any interference. If none are found and the condition persists, have your vehicle towed to the nearest authorized dealer.

Brake Assist

Brake assist detects when you brake rapidly by measuring the rate at which you press the brake pedal. It provides maximum braking efficiency as long as you press the pedal, and can reduce stopping distances in critical situations.

Anti-lock Brake System

This system helps you maintain steering control during emergency stops by keeping the brakes from locking.



This lamp momentarily illuminates when you turn the ignition on. If the light does not illuminate during start up, remains on or flashes, the system may be disabled. Have the system checked by an authorized dealer.



If the system is disabled, normal braking is still effective. If the brake warning lamp illuminates when you release the parking brake, have the system checked by an authorized dealer.

HINTS ON DRIVING WITH ANTI-LOCK BRAKES

The anti-lock braking system does not eliminate the risks when:

- You drive too closely to the vehicle in front of you.
- Your vehicle is hydroplaning.
- You take corners too fast.
- The road surface is poor.

Note: If the system activates, the brake pedal may pulse and may travel further. Maintain pressure on the brake pedal. You may also hear a noise from the system. This is normal.

Brakes

PARKING BRAKE - VEHICLES WITH: MECHANICAL PARKING BRAKE

Center Parking Brake



E172225

To apply the parking brake:

1. Press the foot brake pedal firmly.
2. Pull the parking brake lever up to its fullest extent.

To release the parking brake:

1. Press the foot brake pedal firmly.
2. Pull the parking brake lever up slightly.
3. Press the release button and push the parking brake lever down.

Note: If you park your vehicle facing uphill turn the steering wheel away from the curb.

Note: If you park your vehicle facing downhill turn the steering wheel toward the curb.

Note: Do not press the release button while pulling the parking brake lever up.

PARKING BRAKE - VEHICLES WITH: PUSH DOWN PARKING BRAKE



E172225

To apply the parking brake:

1. Firmly press the brake pedal.
2. Pull the parking brake lever upward to its fullest extent.

Note: Do not press the release button when pulling the parking brake lever upward.

Brakes

Note: If you park your vehicle on a hill and facing uphill, shift into park (P) and turn the steering wheel away from the curb.

Note: If you park your vehicle on a hill and facing downhill, shift into park (P) and turn the steering wheel toward the curb.

Note: If required, you can lower the parking brake lever to the fully down position, for example to swivel the seat. Push the parking brake lever downward without pressing the release button. The parking brake remains applied until you release it.

Note: A warning lamp illuminates when you apply the parking brake.

To release the parking brake:

1. Firmly press the brake pedal.
2. Pull the parking brake lever upward to its fullest extent.
3. Press the release button and push the parking brake lever downward.

HILL START ASSIST



WARNING: The system does not replace the parking brake. When you leave your vehicle, always apply the parking brake.



WARNING: You must remain in your vehicle when the system turns on. At all times, you are responsible for controlling your vehicle, supervising the system and intervening, if required. Failure to take care may result in the loss of control of your vehicle, serious personal injury or death.



WARNING: The system will turn off if a malfunction is apparent or if you rev the engine excessively. Failure to take care may result in the loss of control of your vehicle, serious personal injury or death.

The system makes it easier to pull away when your vehicle is on a slope without the need to use the parking brake.

When the system is active, your vehicle will remain stationary on the slope for two to three seconds after you release the brake pedal. This allows time to move your foot from the brake to the accelerator pedal.

The system releases the brakes automatically once the engine has developed sufficient drive to prevent your vehicle from rolling down the slope. This is an advantage when pulling away on a slope, for example from a car park ramp, traffic lights or when reversing uphill into a parking space.

Note: The system will not operate if the parking brake is applied.

Note: There is no warning light to indicate the system is either on or off.

Using Hill Start Assist

1. Press the brake pedal to bring your vehicle to a complete standstill. Keep the brake pedal pressed.
2. If the sensors detect that your vehicle is on a slope, the system will activate automatically.
3. When you remove your foot from the brake pedal, your vehicle will remain on the slope without rolling away for approximately two to three seconds. This hold time will automatically be extended if you are in the process of driving off.

Brakes

4. Drive off in the normal manner. The system will release the brakes automatically.

Note: *When you remove your foot from the brake pedal and press the pedal again when the system is active, you will experience significantly reduced brake pedal travel. This is normal.*

Switching the System On and Off

Vehicles with Manual Transmission

You can switch this feature on or off in the information display. The system remembers the last setting when you start your vehicle.

Vehicles with Automatic Transmission

You cannot turn the system on or off. When you switch the ignition on, the system automatically turns on.

Traction Control

PRINCIPLE OF OPERATION

The traction control system helps avoid drive wheel spin and loss of traction.

If your vehicle begins to slide, the system applies the brakes to individual wheels and, when needed, reduces engine power at the same time. If the wheels spin when accelerating on slippery or loose surfaces, the system reduces engine power in order to increase traction.

USING TRACTION CONTROL



WARNING: The stability and traction control light illuminates steadily if the system detects a failure. Make sure you did not manually disable the traction control system using the information display controls or the switch. If the stability control and traction control light is still illuminating steadily, have the system serviced by an authorized dealer immediately. Operating your vehicle with the traction control disabled could lead to an increased risk of loss of vehicle control, vehicle rollover, personal injury and death.

The system automatically turns on each time you switch the ignition on.

If your vehicle is stuck in mud or snow, switching traction control off may be beneficial as this allows the wheels to spin.

Note: *When you switch traction control off, stability control remains fully active.*

Switching the System Off

When you switch the system off or on, a message appears in the information display showing system status.

You can switch the system off by either using the information display controls or the switch.

Using the Information Display Controls

You can switch this feature off or on in the information display. See **General Information** (page 97).

Using a Switch (If Equipped)

Use the traction control switch on the instrument panel to switch the system off or on.

System Indicator Lights and Messages



The stability and traction control light:

- Temporarily illuminates on engine start-up.
- Flashes when a driving condition activates either of the systems.
- Illuminates if a problem occurs in either of the systems.



The stability and traction control off light temporarily illuminates on engine start-up and stays on when you switch the traction control system off.

Stability Control

PRINCIPLE OF OPERATION



WARNING: Vehicle modifications involving braking system, aftermarket roof racks, suspension, steering system, tire construction and wheel and tire size may change the handling characteristics of your vehicle and may adversely affect the performance of the electronic stability control system. In addition, installing any stereo loudspeakers may interfere with and adversely affect the electronic stability control system. Install any aftermarket stereo loudspeaker as far as possible from the front center console, the tunnel, and the front seats in order to minimize the risk of interfering with the electronic stability control sensors. Reducing the effectiveness of the electronic stability control system could lead to an increased risk of loss of vehicle control, vehicle rollover, personal injury and death.



WARNING: Remember that even advanced technology cannot defy the laws of physics. It's always possible to lose control of a vehicle due to inappropriate driver input for the conditions. Aggressive driving on any road condition can cause you to lose control of your vehicle increasing the risk of personal injury or property damage. Activation of the electronic stability control system is an indication that at least some of the tires have exceeded their ability to grip the road; this could reduce the operator's ability to control the vehicle potentially resulting in a loss of vehicle control, vehicle rollover, personal injury and death. If your electronic stability control system activates, SLOW DOWN.

The system automatically turns on each time you switch the ignition on.

If the stability control or traction control system detects a fault, the following may occur:

- The stability and traction control light illuminates steadily.
- The stability control and traction control systems do not enhance your vehicle's ability to maintain traction of the wheels.

If the stability control or traction control system activates, the following may occur:

- The stability and traction control light flashes.
- Your vehicle slows down.
- Reduced engine power.
- A vibration in the brake pedal.
- The brake pedal is stiffer than usual.
- If the driving condition is severe and your foot is not on the brake pedal, the pedal may move as the system applies higher brake force.

The stability control system has several features built into it to help you maintain control of your vehicle.

Electronic Stability Control

The system helps to prevent your vehicle skidding or laterally sliding by individually applying the brakes to one or more wheels and, if necessary, reducing engine power.

Roll Stability Control

The system helps to prevent rollovers by detecting your vehicle's roll motion, and individually applying the brakes to one or more wheels.

Stability Control

Side-Wind Stabilization

The system applies the brakes on one side of your vehicle to reduce the effect of a sudden side-wind gust on your vehicle's path. When the system turns on, the stability and traction control light flashes, and a message may appear in the information display. You may notice a slight deceleration and may still need to make a steering correction to maintain the intended vehicle path. The system does not turn on for a continuous side-wind or during turns.

Traction Control

The system enhances your vehicle's ability to maintain traction of the wheels by detecting and controlling wheel spin. See **Using Traction Control** (page 159).

USING STABILITY CONTROL

The system automatically turns on each time you switch the ignition on.

You cannot switch the stability control and roll stability control systems off, but when you shift into reverse (R), the systems deactivate.

You can switch the traction control system off or on. See **Using Traction Control** (page 159).

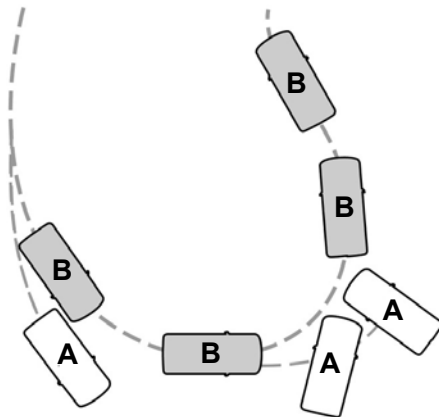

E72903

- A Vehicle without stability control skidding off its intended route.
- B Vehicle with stability control maintaining control on a slippery surface.

Parking Aids (If Equipped)

PRINCIPLE OF OPERATION



WARNING: To help avoid personal injury, always use caution when in reverse (R) and when using the sensing system.



WARNING: The system may not detect objects with surfaces that absorb reflection. Always drive with due care and attention. Failure to take care may result in a crash.



WARNING: Traffic control systems, inclement weather, air brakes, external motors and fans may affect the correct operation of the sensing system. This may cause reduced performance or false alerts.



WARNING: The system may not detect small or moving objects, particularly those close to the ground.

Note: If your vehicle has MyKey™, the sensing system cannot be switched off when a MyKey™ is present. See **Principle of Operation** (page 61).

Note: Keep the sensors on the bumper or fascia free from snow, ice and large accumulations of dirt. If the sensors are covered, the system's accuracy can be affected. Do not clean the sensors with sharp objects.

Note: If your vehicle sustains damage to the bumper or fascia, leaving it misaligned or bent, the sensing zone may be altered causing inaccurate measurement of obstacles or false alerts.

Note: Certain add-on devices installed around the bumper or fascia may create false alerts. For example, large trailer hitches, bike or surfboard racks, license plate brackets, bumper covers or any other device that may block the normal detection zone of the system. Remove the add-on device to prevent false alerts.

Note: When you connect a trailer to your vehicle, the rear parking aid may detect the trailer and therefore provide an alert. Disable the rear parking aid when you connect a trailer to prevent the alert.

The sensing system warns the driver of obstacles within a certain range of your vehicle. The system turns on automatically whenever you switch the ignition on.

You can switch the system off through the information display menu or from the pop-up message that appears once you shift the transmission into reverse (R). See **General Information** (page 97). If your vehicle has a parking aid button, you can switch the system off by pressing the button.

If a fault is present in the system, a warning message appears in the information display. See **Information Messages** (page 101).

PARKING AID



WARNING: The parking aid system can only assist you to detect objects when your vehicle is moving at parking speeds. To help avoid personal injury you must take care when using the parking aid system.

Parking Aids (If Equipped)



WARNING: Traffic control systems, inclement weather, air brakes, external motors and fans may affect the correct operation of the sensing system. This may cause reduced performance or false alerts.



WARNING: The system may not detect small or moving objects, particularly those close to the ground.

The system warns you of objects that are within the detection zone of the bumper areas. When you switch the ignition on, the system automatically turns on. The system becomes active when you shift into reverse (R) and the speed of your vehicle is 7 mph (12 km/h) or less.



E130178

A Rear detection zone: Up to 72 in (180 cm) from the rear bumper.

Note: Accessories that block the detection zone of the system may create false alerts.

Note: Keep the sensors free from snow, ice and large accumulations of dirt.

Note: If your vehicle sustains damage leaving the sensors misaligned, this will cause inaccurate measurements or false alerts.

A tone will sound in the following manner when objects are near the front or rear bumpers:

- Objects detected by the rear sensors produce a low-pitched tone.
- An alert will only sound for three seconds if an object is further than 12 in (30 cm) from the side of your vehicle.

The system detects objects when you shift into reverse (R) and:

- Your vehicle is moving toward a stationary object at a speed of 3 mph (5 km/h) or less.
- Your vehicle is stationary but an object is approaching your vehicle at a speed of 3 mph (5 km/h) or less.
- Your vehicle is moving at a speed of 3 mph (5 km/h) or less, and an object is approaching your vehicle at a speed of 3 mph (5 km/h) or less.

Note: The rate of the tone increases as your vehicle moves closer to an object.

When the parking aid system sounds a tone, the audio system may reduce the set volume. When the warning ends, the audio system returns to the previously set volume.

Note: Volume reduction is not a standard feature of all audio systems.

Parking Aids (If Equipped)

Switching the Parking Aid System Off



E177143

Press the button to switch the system off. The system remains off until you switch the ignition off.

REAR VIEW CAMERA



WARNING: The rear view camera system is a reverse aid supplement device that still requires the driver to use it in conjunction with the interior and exterior mirrors for maximum coverage.



WARNING: Objects that are close to either corner of the bumper or under the bumper, might not be seen on the screen due to the limited coverage of the camera system.



WARNING: Reverse your vehicle slowly. Failure to follow this instruction could result in the loss of control of your vehicle, personal injury or death.

The rear view camera provides an image of the area behind your vehicle. During operation, lines appear in the display that represents the path of your vehicle and proximity to objects behind it.

Rear View Camera Locations



WARNING: Use caution when the rear cargo door is ajar. If the rear cargo door is ajar, the camera will be out of position and the video image may be incorrect. All guidelines disappear when the rear cargo door is ajar. Failure to follow this instruction could result in personal injury.

Note: Where the rear view camera is below the central high mounted stop lamp, it does not move out of position when the rear cargo door is ajar.

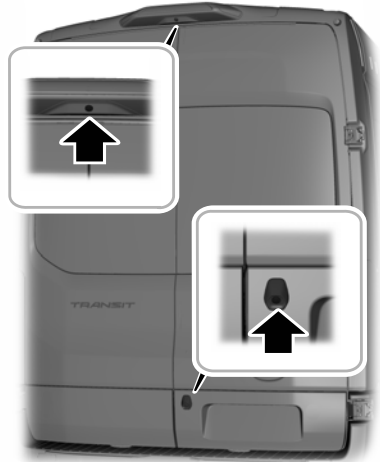



E254267

The rear view camera is below the central high mounted stop lamp or on the rear cargo door.

Parking Aids (If Equipped)

Using the Rear View Camera System

 **WARNING:** The operation of the camera may vary depending on the ambient temperature, vehicle and road conditions.

 **WARNING:** Objects above the camera may not be visible. Check the area behind your vehicle when necessary.

 **WARNING:** To help avoid personal injury always use caution when in reverse (R) and when using the rear view camera.

The rear view camera system displays what is behind your vehicle when you place the transmission in reverse (R).

Note: *If the transmission is in reverse (R) and the rear cargo door is open, no rear view camera features display.*

Note: *When towing, the camera only sees what you are towing. This might not provide adequate coverage as it usually provides in normal operation and you might not see some objects. In some vehicles, the guidelines may disappear when you connect the trailer tow connector.*

The camera may not operate correctly under the following conditions:

- Nighttime or dark areas if one or both reverse lamps are not operating.
- Mud, water or debris obstructs the camera's view. Clean the lens with a soft, lint-free cloth and non-abrasive cleaner.
- The rear of your vehicle is hit or damaged, causing the camera to become misaligned.

Camera Guidelines

Distance markers are only a guide and are calculated for unloaded vehicles on an even road surface.

Note: *Guidelines are only available when the transmission is in reverse (R).*

Note: *Guidelines do not display when the rear cargo door is ajar.*

The system uses three types of guides to help you see what is behind your vehicle:

- Active guidelines: Show the intended path of your vehicle when reversing.
- Fixed guidelines: Show the actual path your vehicle is moving in when you reverse in a straight line. This can be helpful when backing into a parking space or aligning your vehicle with another object behind you.
- Centerline: Helps align the center of your vehicle with an object (for example, a trailer).

Parking Aids (If Equipped)

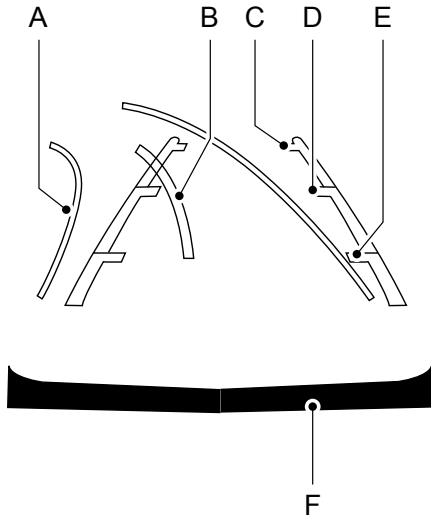

E142436

- A Active guidelines.
- B Centerline.
- C Fixed guideline: Green zone.
- D Fixed guideline: Yellow zone.
- E Fixed guideline: Red zone.
- F Rear bumper.

Active guidelines are only available with fixed guidelines. To use active guidelines, turn the steering wheel to point the guidelines toward an intended path. If you change the steering wheel position when driving in reverse (R), your vehicle might deviate from the original intended path.

The fixed and active guidelines fade in and out depending on the steering wheel position. When the steering wheel position is straight the active guidelines are not visible. Objects in the red zone are closest to your vehicle and objects in the green zone are further from your vehicle.

Objects are getting closer to your vehicle as they move from the green zone to the yellow or red zones. Use the side view mirrors and rear view mirror to get better coverage on both sides and rear of the vehicle.

Manual Zoom



WARNING: When manual zoom is on, the full area behind your vehicle may not show. Be aware of your surroundings when using the manual zoom feature.

Manual zoom is only available when you shift the transmission into reverse (R).

Selectable settings for this feature are Zoom in (+) and Zoom out (-). Press the symbol in the camera screen to change the view. The default setting is Zoom OFF.

This allows you to get a closer view of an object behind your vehicle. The zoomed image keeps the bumper in the image to provide a reference. The zoom is only active while the transmission is in reverse (R).

Note: *Only the centerline shows when you switch on manual zoom.*

Rear View Camera Delay



WARNING: Use caution when turning camera features on or off when the transmission is not in park (P). Make sure your vehicle is not moving.

Parking Aids (If Equipped)

You can switch this feature on or off using the vehicle settings menu in the information display. The default setting is off.

When shifting the transmission out of reverse (R) and into any gear other than park (P), the camera image remains in the display until:

- Your vehicle speed sufficiently increases.
- You shift your vehicle into park (P).

Vehicles with Parking Aid

The system uses red, yellow and green colored distance bars that indicate the approximate distance of an object from the rear bumper. The distance bars appear on the camera guidelines when the sensing system detects an object.

Cruise Control

PRINCIPLE OF OPERATION

Cruise control lets you maintain a set speed without keeping your foot on the accelerator pedal. You can use cruise control when your vehicle speed is greater than 20 mph (30 km/h).

USING CRUISE CONTROL



WARNING: Do not use cruise control on winding roads, in heavy traffic or when the road surface is slippery. This could result in loss of vehicle control, serious injury or death.



WARNING: When you are going downhill, your vehicle speed could increase above the set speed. The system does not apply the brakes.

Note: Cruise control disengages if the vehicle speed decreases more than 10 mph (16 km/h) below the set speed while driving uphill.



E142437

The cruise controls are on the steering wheel.

Switching Cruise Control On

Press **ON**.



The indicator displays in the instrument cluster.

Setting the Cruise Speed

1. Drive to desired speed.
2. Press **SET+** or **SET-**.
3. Take your foot off the accelerator pedal.

Changing the Set Speed

- Press **SET+** or **SET-** to change the set speed in small increments.
- Press the accelerator or brake pedal until you reach the desired speed. Press **SET+** or **SET-**.
- Press and hold **SET+** or **SET-**. Release the control when you reach the desired speed.

Note: If you accelerate by pressing the accelerator pedal, the set speed does not change. When you release the accelerator pedal, your vehicle returns to the speed that you previously set.

Canceling the Set Speed

Pull **CAN** or tap the brake pedal. The set speed does not erase.

Resuming the Set Speed

Pull **RES**.

Switching Cruise Control Off

Press **OFF** when the system is in stand by mode, or switch the ignition off.

Note: You erase the set speed when you switch the system off.

Driving Aids

SPEED LIMITER

Engine Speed Limiter

Engine speed is limited to protect the engine.

Vehicle Speed Limiter - Fixed

The system prevents you from driving faster than a programmed speed.

DRIVER ALERT

Principle of Operation



WARNING: The system is designed to aid the driver. It is not intended to replace your attention and judgment. You are still responsible to drive with due care and attention.



WARNING: At all times, you are responsible for controlling your vehicle, supervising the system and intervening, if required. Failure to take care may result in the loss of control of your vehicle, serious personal injury or death.



WARNING: The system may not function if the sensor is blocked.



WARNING: Take regular rest breaks if you feel tired. Do not wait for the system to warn you.



WARNING: Certain driving styles may result in the system warning you even if you are not feeling tired.



WARNING: In cold and severe weather conditions the system may not function. Rain, snow and spray can all limit sensor performance.



WARNING: The system will not operate if the sensor cannot track the road lane markings.



WARNING: If damage occurs in the immediate area surrounding the sensor, have your vehicle checked as soon as possible.



WARNING: The system may not correctly operate if your vehicle is fitted with a suspension kit not approved by US.

Note: Keep the windshield free from obstructions for example bird droppings, insects and snow or ice.

Note: The system assists you when driving on fast main roads and freeways.

Note: The system calculates an alertness level at vehicle speeds above approximately 40 mph (65 km/h).

The system automatically monitors your driving behavior.

The system is designed to alert you if it detects that you are becoming drowsy or if your driving deteriorates.

Using Driver Alert

Switching the System On and Off

Switch the system on using the information display. See **Information Displays** (page 97).

Note: The system remains on or off depending on how it was last set.

The system calculates your alertness level based upon your driving behavior in relation to the lane markings and other factors.

Driving Aids

System Warnings

Note: *The system does not warn you if the vehicle speed falls below approximately 40 mph (65 km/h).*

The warning system has two stages:

1. A temporary warning is issued to advise you to take a rest. This message only appears for a short time.
2. If you do not rest and the system continues to detect that your driving deteriorates, it issues a further warning. This remains in the information display until you cancel it. See **Information Messages** (page 101).

Press **OK** on the steering wheel control to remove the warning.

System Display

When active the system runs automatically in the background and only issue warnings if required. You can view the status at any time using the information display. See **General Information** (page 97).

The alertness level is shown by six steps as a colored bar.

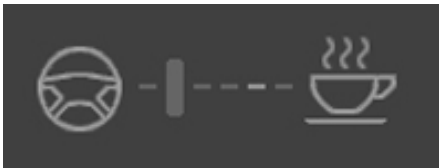

E131358

Alertness level is fine, no rest required.

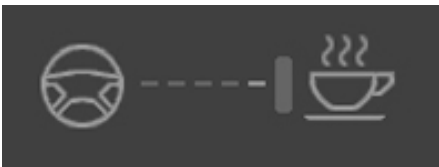

E131359

Alertness level is critical, indicating that you should take a rest as soon as it is safe to do so.

The status bar travels from left to right as the calculated alertness level decreases. As the rest icon is approached, the color turns from green to yellow and then finally red when a rest break must be taken.

- Green: No rest required.
- Yellow: First (temporary) warning.
- Red: Second warning.

Your alertness level will be shown in gray if:

- The sensor cannot track the road lane markings.
- The vehicle speed falls below approximately 40 mph (65 km/h).

Resetting the System

You can reset the system by:

- Switching the ignition off and on.
- Stopping your vehicle and then opening and closing the driver door.

LANE KEEPING SYSTEM

Lane Keeping Alert

Principle of Operation



WARNING: Always drive with due care and attention when using and operating the controls and features on your vehicle.



WARNING: At all times, you are responsible for controlling your vehicle, supervising the system and intervening, if required. Failure to take care may result in the loss of control of your vehicle, serious personal injury or death.

Driving Aids



WARNING: The system may not function if the sensor is blocked.



WARNING: The sensor may incorrectly track lane markings as other structures or objects. This can result in a false or missed warning.



WARNING: In cold and severe weather conditions the system may not function. Rain, snow and spray can all limit sensor performance.



WARNING: The system will not operate if the sensor cannot track the road lane markings.



WARNING: If damage occurs in the immediate area surrounding the sensor, have your vehicle checked as soon as possible.



WARNING: The system may not correctly operate if your vehicle is fitted with a suspension kit not approved by us.

Note: Keep the windshield free from obstructions for example bird droppings, insects and snow or ice.

Note: The system may assist you when driving on fast main roads and freeways.

Note: The system may not operate on roads with sharp bends, narrow lanes, areas under construction, during hard braking or acceleration and when you are intentionally steering your vehicle.

Note: Do not carry out windshield repairs in the immediate area surrounding the sensor.

Note: The system operates with a minimum of one tracked lane marking.

Note: The system only operates above vehicle speeds of approximately 40 mph (65 km/h).

The sensor is behind the interior mirror. It continuously monitors conditions to alert you of unintentional lane drifting at high speeds.

The system automatically detects and tracks the lane markings on the road. If the system detects that your vehicle is unintentionally drifting toward the lane markings, a warning is shown in the information display. There is also a warning given in the form of a vibration felt through the steering wheel.

Note: The vibration intensity from the steering wheel may decrease depending on the quality of the road surface.

Using Lane Keeping Alert

Switching the System On and Off



E132099

Switch the system on and off using the button on the direction indicator stalk.

Press the button once to turn the system on. Press the button again to turn the system off.

Note: When you switch the system off, a warning indicator may remain illuminated in the information display. See **Warning Lamps and Indicators** (page 93).

Driving Aids

Setting the Steering Wheel Vibration Level

The system has three intensity levels which you can set using the information display. See **General Information** (page 97).

Setting the System Sensitivity

Some vehicles can adjust how quickly the system warns you. The system has two sensitivity levels which you can set using the information display. See **General Information** (page 97).

System Warnings



E152382

When you switch the system on, an image of a vehicle showing lane markings appears in the information display. When you switch the system off, the image does not display.

When the system is on, the color of the lane markings will change to indicate the system status.

The lane markings are color coded as follows:

- Green: The system is ready to warn you of any unintentional lane departure.
- Red: Your vehicle is approaching or is too close to the detected lane boundary. Take immediate safe action to reposition your vehicle.
- Gray: The system will suppress the relevant lane boundary.

Instances where a lane boundary may be suppressed:

- The sensor may not detect the lane markings on the road.
- You turn the direction indicator for that side of your vehicle on.
- If you apply direct steering, accelerate fast or brake hard.
- Your vehicle speed is outside the operating limits.
- If there is an anti-lock brake or stability control intervention.
- Narrow lane width.

If the lane markings in the display turn red or you feel a vibration through the steering wheel you must take immediate and safe action to align your vehicle. Correct any unintended lane drift immediately.

STEERING

To help prevent damage to the power steering system:

- Never hold the steering wheel at its furthest turning points (until it stops) for more than three to five seconds when the engine is running.
- Do not operate the vehicle with a low power steering pump fluid level (below the MIN mark on the reservoir).

Driving Aids

- Some noise is normal during operation. If excessive, check for low power steering pump fluid level before seeking service by your dealer.
- Heavy or uneven efforts may be caused by low power steering fluid. Check for low power steering pump fluid level before seeking service by your dealer.
- Do not fill the power steering pump reservoir above the MAX mark on the reservoir, as this may result in leaks from the reservoir.

If the power steering system breaks down (or if the engine is turned off), you can steer the vehicle manually, but it takes more effort.

If the steering wanders or pulls, check for:

- an improperly inflated tire
- uneven tire wear
- loose or worn suspension components
- loose or worn steering components
- improper vehicle alignment

If any steering components are serviced or replaced, install new fasteners (many are coated with thread adhesive or have prevailing torque features which may not be re-used). Never re-use a bolt or nut. Torque fasteners to specifications.

A high crown in the road or high crosswinds may also make the steering seem to wander or pull.

Load Carrying

LOAD RETAINING FIXTURES

Securing Cargo

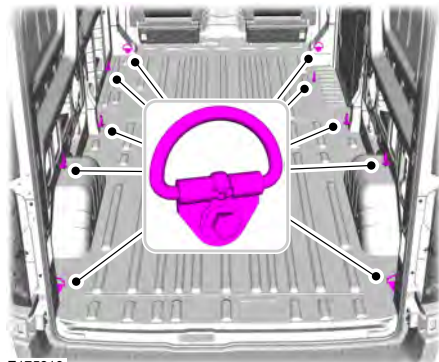

E175810

Variant	Maximum Load Value
All Van	1,125 lb (5,000 N)

Note: The number of load retaining fixtures may vary depending on your vehicle model.

LOAD LIMIT

Vehicle Loading - with and without a Trailer

This section guides you in the proper loading of your vehicle, trailer, or both. Keep your loaded vehicle weight within its design rating capability, with or without a trailer. Properly loading your vehicle provides maximum return of vehicle design performance. Before you load your vehicle, become familiar with the

following terms for determining your vehicle's weight rating, with or without a trailer, from the vehicle's Tire and Loading Information label or Safety Compliance Certification label.

Tire and Loading Label Information Example:



TIRE AND LOADING INFORMATION

SEATING CAPACITY TOTAL: 5 FRONT: 2 REAR: 3

The combined weight of occupants and cargo should never exceed 385 kg or 850 lbs.

TIRE	SIZE	COLD TIRE PRESSURE	SEE OWNERS MANUAL FOR ADDITIONAL INFORMATION
FRONT	235/45R18 94V	235 KPA, 34 PSI	
REAR	235/45R18 94V	235 KPA, 34 PSI	
SPARE	NONE	NONE	



TIRE AND LOADING INFORMATION RENSEIGNEMENTS SUR LES PNEUS ET LE CHARGEMENT

SEATING CAPACITY / NOMBRE DE PLACES TOTAL 5 FRONT AVANT 2 REAR ARRIERE 3

The combined weight of occupants and cargo should never exceed 396 kg or 875 lbs.
Le poids total des occupants et du chargement ne doit jamais dépasser 396 kg ou 875 lbs.

TIRE PNEU	SIZE DIMENSIONS	COLD TIRE PRESSURE PRESSION DES PNEUS A FROID	SEE OWNER'S MANUAL FOR ADDITIONAL INFORMATION VOIR LE MANUEL DE L'USAGER POUR PLUS DE RENSEIGNEMENTS
FRONT AVANT	235/40R19 96V	255 KPA, 37 PSI	
REAR ARRIERE	235/40R19 96V	255 KPA, 37 PSI	
SPARE DE SECOURS	T125/80R16 97M	415 KPA, 60 PSI	

E198719

Payload

Payload is the combined weight of cargo and passengers that your vehicle is carrying. The maximum payload for your vehicle appears on the Tire and Loading label. The label is either on the B-pillar or the edge of the driver door. Vehicles exported outside the US and

Load Carrying

Canada may not have a tire and loading label. Look for “The combined weight of occupants and cargo should never exceed XXX kg OR XXX lb” for maximum payload. The payload listed on the Tire and Loading Information label is the maximum payload for your vehicle as built by the assembly plant. If you install any additional equipment on your vehicle, you must determine the new payload. Subtract the weight of the equipment from the payload listed on the Tire and Loading label. When towing, trailer tongue weight or king pin weight is also part of payload.



WARNING: The appropriate loading capacity of your vehicle can be limited either by volume capacity (how much space is available) or by payload capacity (how much weight the vehicle should carry). Once you have reached the maximum payload of your vehicle, do not add more cargo, even if there is space available. Overloading or improperly loading your vehicle can contribute to loss of vehicle control and vehicle rollover.

GAWR (Gross Axle Weight Rating)

GAWR is the maximum allowable weight that a single axle (front or rear) can carry. These numbers are on the Safety Compliance Certification label. The label is located on the door hinge pillar, door-latch post, or the door edge that meets the door-latch post, next to the driver seating position.

The total load on each axle must never exceed its Gross Axle Weight Rating.

GVWR (Gross Vehicle Weight Rating)

GVWR is the maximum allowable weight of the fully loaded vehicle. This includes all options, equipment, passengers and cargo. It appears on the Safety Compliance Certification label. The label is located on the door hinge pillar, door-latch post, or the door edge that meets the door-latch post, next to the driver seating position.

The gross vehicle weight must never exceed the Gross Vehicle Weight Rating.

Load Carrying

Safety Compliance Certification Label Example:

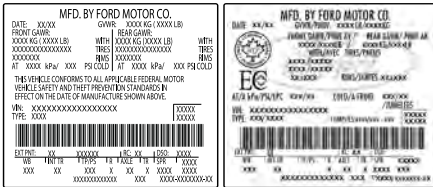

619822

 **WARNING:** Exceeding the Safety Compliance Certification label vehicle weight limits can adversely affect the performance and handling of your vehicle, cause vehicle damage and can result in the loss of control of your vehicle, serious personal injury or death.

Maximum Loaded Trailer Weight

Maximum loaded trailer weight is the highest possible weight of a fully loaded trailer the vehicle can tow. Consult an authorized dealer (or the RV and Trailer Towing Guide available at an authorized dealer) for more detailed information.

GCWR (Gross Combined Weight Rating)

GCWR is the maximum allowable weight of the vehicle and the loaded trailer, including all cargo and passengers, that the vehicle can handle without risking damage. (Important: The towing

vehicle's braking system is rated for operation at Gross Vehicle Weight Rating, not at Gross Combined Weight Rating.) Separate functional brakes should be used for safe control of towed vehicles and for trailers where the Gross Combined Weight of the towing vehicle plus the trailer exceed the Gross Vehicle Weight Rating of the towing vehicle.

The gross combined weight must never exceed the Gross Combined Weight Rating.

Note: For trailer towing information refer to the *RV and Trailer Towing Guide* available at an authorized dealer.

 **WARNING:** Do not exceed the GVWR or the GAWR specified on the certification label.

 **WARNING:** Do not use replacement tires with lower load carrying capacities than the original tires because they may lower your vehicle's GVWR and GAWR limitations. Replacement tires with a higher limit than the original tires do not increase the GVWR and GAWR limitations.

Load Carrying



WARNING: Exceeding any vehicle weight rating can adversely affect the performance and handling of your vehicle, cause vehicle damage and can result in the loss of control of your vehicle, serious personal injury or death.

Steps for determining the correct load limit:

1. Locate the statement "The combined weight of occupants and cargo should never exceed XXX kg or XXX lb." on your vehicle's placard.
2. Determine the combined weight of the driver and passengers that will be riding in your vehicle.
3. Subtract the combined weight of the driver and passengers from XXX kg or XXX lb.
4. The resulting figure equals the available amount of cargo and luggage load capacity. For example, if the "XXX" amount equals 1,400 lb. and there will be five 150 lb. passengers in your vehicle, the amount of available cargo and luggage load capacity is 650 lb. $(1400 - 750 (5 \times 150) = 650 \text{ lb.})$
5. Determine the combined weight of luggage and cargo being loaded on the vehicle. That weight may not safely exceed the available cargo and luggage load capacity calculated in Step 4.
6. If your vehicle will be towing a trailer, load from your trailer will be transferred to your vehicle. Consult this manual to determine how this reduces the available cargo and luggage load capacity of your vehicle.

Helpful examples for calculating the available amount of cargo and luggage load capacity

Suppose your vehicle has a 1400-pound (635-kilogram) cargo and luggage capacity. You decide to go golfing. Is there enough load capacity to carry you, four of your friends and all the golf bags? You and four friends average 220 pounds (99 kilograms) each and the golf bags weigh approximately 30 pounds (13.5 kilograms) each. The calculation would be: $1400 - (5 \times 220) - (5 \times 30) = 1400 - 1100 - 150 = 150$ pounds. Yes, you have enough load capacity in your vehicle to transport four friends and your golf bags. In metric units, the calculation would be: $635 \text{ kilograms} - (5 \times 99 \text{ kilograms}) - (5 \times 13.5 \text{ kilograms}) = 635 - 495 - 67.5 = 72.5$ kilograms.

Load Carrying

Suppose your vehicle has a 1400-pound (635-kilogram) cargo and luggage capacity. You and one of your friends decide to pick up cement from the local home improvement store to finish that patio you have been planning for the past two years. Measuring the inside of the vehicle with the rear seat folded down, you have room for twelve 100-pound (45-kilogram) bags of cement. Do you have enough load capacity to transport the cement to your home? If you and your friend each weigh 220 pounds (99 kilograms), the calculation would be: $1400 - (2 \times 220) - (12 \times 100) = 1400 - 440 - 1200 = -240$ pounds. No, you do not have enough cargo capacity to carry that much weight. In metric units, the calculation would be: $635 \text{ kilograms} - (2 \times 99 \text{ kilograms}) - (12 \times 45 \text{ kilograms}) = 635 - 198 - 540 = -103$ kilograms. You will need to reduce the load weight by at least 240 pounds (104 kilograms). If you remove three 100-pound (45-kilogram) cement bags, then the load calculation would be: $1400 - (2 \times 220) - (9 \times 100) = 1400 - 440 - 900 = 60$ pounds. Now you have the load capacity to transport the cement and your friend home. In metric units, the calculation would be: $635 \text{ kilograms} - (2 \times 99 \text{ kilograms}) - (9 \times 45 \text{ kilograms}) = 635 - 198 - 405 = 32$ kilograms.

The above calculations also assume that the loads are positioned in your vehicle in a manner that does not overload the front or the rear gross axle weight rating specified for your vehicle on the Safety Compliance Certification label.

Special Loading Instructions for Owners of Pick-up Trucks and Utility-type Vehicles



WARNING: When loading the roof racks, we recommend you evenly distribute the load, as well as maintain a low center of gravity. Loaded vehicles, with higher centers of gravity, may handle differently than unloaded vehicles. Take extra precautions, such as slower speeds and increased stopping distance, when driving a heavily loaded vehicle.

Towing

TOWING A TRAILER



WARNING: Towing trailers beyond the maximum recommended gross trailer weight exceeds the limit of your vehicle and could result in engine damage, transmission damage, structural damage, loss of vehicle control, vehicle rollover and personal injury.



WARNING: Do not exceed the GVWR or the GAWR specified on the certification label.

Note: See **Recommended Towing Weights** (page 180).

Your vehicle may have electrical items, such as fuses or relays, related to towing. See **Fuses** (page 208).

Your vehicle's load capacity designation is by weight, not by volume, so you cannot necessarily use all available space when loading a vehicle or trailer.

Towing a trailer places an extra load on your vehicle's engine, transmission, axle, brakes, tires and suspension. Inspect these components periodically during, and after, any towing operation.

Load Placement

To help minimize how trailer movement affects your vehicle when driving:

- Load the heaviest items closest to the trailer floor.
- Load the heaviest items centered between the left and right side trailer tires.
- Load the heaviest items above the trailer axles or just slightly forward toward the trailer tongue. Do not allow the final trailer tongue weight to go above or below 10-15% of the loaded trailer weight.
- Select a ball mount with the correct rise or drop and load capacity. When both the loaded vehicle and trailer are connected, the trailer frame should be level, or slightly angled down toward your vehicle, when viewed from the side.

When driving with a trailer or payload, a slight takeoff vibration or shudder may be present due to the increased payload weight. Additional information regarding proper trailer loading and setting your vehicle up for towing is located in another chapter of this manual. See **Load Limit** (page 174).

You can also find information in the **RV & Trailer Towing Guide** available at your authorized dealer, or online.

Towing

RV & Trailer Towing Guide Online

Website <http://www.fleet.ford.com/towing-guides/>

TRAILER SWAY CONTROL

Note: This feature does not prevent trailer sway, but reduces it once it begins.

Note: This feature cannot stop all trailers from swaying.

Note: In some cases, if your vehicle speed is too high, the system may turn on multiple times, gradually reducing your vehicle speed.

This feature applies your vehicle brakes at individual wheels and if necessary, reduces engine power. If the trailer begins to sway, the traction control warning lamp flashes and a message will appear in the information display. Slow your vehicle down, pull safely to the side of the road and check for correct load distribution. See **Load Carrying** (page 174).

RECOMMENDED TOWING WEIGHTS

Note: Make sure to take into consideration trailer frontal area. Vehicles equipped with the Trailer Tow Package or the Heavy Duty Payload Package should not exceed 55 ft² (5.1 m²) trailer frontal area.

Note: Exceeding this limitation may significantly reduce the performance of your towing vehicle. Selecting a trailer with a low aerodynamic drag and rounded front design helps optimize performance and fuel economy.

Note: For high altitude operation, reduce the gross combined weight by 2% per 1,000 ft (300 m) starting at the 1,000 ft (300 m) elevation point.

Note: Certain states require electric trailer brakes for trailers over a specified weight. Be sure to check state regulations for this specified weight. The maximum trailer weights listed may be limited to this specified weight, as your vehicle's electrical system may not include the wiring connector needed to use electric trailer brakes.

Your vehicle may tow a trailer provided the maximum trailer weight is less than or equal to the maximum trailer weight listed for your vehicle configuration on the following charts.

Towing

Van and Chassis Cab				
Engine	Final Drive Ratio	Rear Wheels	Maximum GCWR lb (kg)	Maximum Loaded Trailer Weight lb (kg) *
3.2L Power Stroke Diesel	3.31	Single Rear Wheels	10,600 (4,809)	4,800 (2,155)
3.2L Power Stroke Diesel	3.73	Single Rear Wheels	13,500 (6,125)	7,500 (3,403)
3.2L Power Stroke Diesel	3.73	Dual Rear Wheels	13,500 (6,125)	7,500 (3,403)
3.5L EcoBoost	3.31	Single Rear Wheels	11,200 (5,080)	5,700 (2,586)
3.5L EcoBoost	3.73	Single Rear Wheels	12,600 (5,716)	7,200 (3,244)
3.5L EcoBoost	3.73	Dual Rear Wheels	13,000 (5,900)	7,200 (3,244)
3.7L	3.73	Single Rear Wheels	10,800 (4,900)	5,400 (2,427)
3.7L	4.10	Single Rear Wheels	12,000 (5,445)	6,700 (3,040)
3.7L	4.10	Dual Rear Wheels - Van	11,200 (5,081)	6,700 (3,040)
3.7L	4.10	Dual Rear Wheels - Chassis Cab	12,000 (5,445)	6,700 (3,040)

*Calculated with SAE J2807 method.

Towing

Bus				
Engine	Final Drive Ratio	Rear Wheels	Maximum GCWR lb (kg)	Maximum Loaded Trailer Weight lb (kg) *
3.2L Power Stroke Diesel	3.31	Single Rear Wheels	10,600 (4,809)	3,300 (1,497)
3.2L Power Stroke Diesel	3.73	Single Rear Wheels	11,200 (5,080)	4,400 (1,996)
3.2L Power Stroke Diesel	3.73	Dual Rear Wheels	11,200 (5,080)	4,400 (1,996)
3.5L EcoBoost	3.31	Single Rear Wheels	11,200 (5,080)	4,200 (1,906)
3.5L EcoBoost	3.73	Single Rear Wheels	11,200 (5,080)	5,000 (2,269)
3.5L EcoBoost	3.73	Dual Rear Wheels	11,200 (5,080)	5,000 (2,269)
3.7L	3.73	Single Rear Wheels	10,800 (4,900)	3,900 (1,770)
3.7L	4.10	Single Rear Wheels	11,200 (5,080)	4,400 (1,996)
3.7L	4.10	Dual Rear Wheels	11,200 (5,080)	4,400 (1,996)

*Calculated with SAE J2807 method.

Towing

Calculating the Maximum Loaded Trailer Weight for Your Vehicle

1. Start with the gross combined weight rating for your vehicle model and axle ratio. See the previous charts.
2. Subtract all of the following that apply to your vehicle:
 - Vehicle curb weight
 - Hitch hardware weight, such as a draw bar, ball, locks or weight distributing hardware
 - Driver weight
 - Passenger(s) weight
 - Payload, cargo and luggage weight
 - Aftermarket equipment weight.

This equals the maximum loaded trailer weight for this combination.

Note: *The trailer tongue load is considered part of the payload for your vehicle. Reduce the total payload by the final trailer tongue weight.*

Note: *Consult an authorized dealer to determine the maximum trailer weight allowed for your vehicle if you are not sure.*

ESSENTIAL TOWING CHECKS

Follow these guidelines for safe towing:

- Do not tow a trailer until your vehicle has covered at least 1,000 mi (1,600 km). See **Breaking-In** (page 191).
- Consult your local motor vehicle laws for towing a trailer.
- See the instructions included with towing accessories for the correct installation and adjustment specifications.
- Service your vehicle more frequently if you tow a trailer. See **Scheduled Maintenance** (page 464).
- If you use a rental trailer, follow the instructions the rental agency gives you.

Refer to **Load Carrying** for load specification terms found on the tire label, Safety Compliance label and instructions on calculating your vehicle's maximum load. See **Load Limit** (page 174).

Remember to account for the trailer tongue weight as part of your vehicle load when calculating the total vehicle weight.

Trailer Towing Connector (If Equipped)



E163167

Your vehicle is fitted with both a 7 pin and 4 pin trailer wiring connector.

Towing

When attaching the trailer wiring connector to your vehicle, only use a correctly fitting connector that works with the vehicle and trailer functions. Some seven-position connectors may have the SAE J2863 logo, which confirms that it is the correct wiring connector and works correctly with your vehicle.

Color	Function
Yellow	Left turn signal and brake lamp.
White	Ground (-).
Blue	Electric brakes.
Green	Right turn signal and brake lamp.
Orange	Battery (+).
Brown	Running lamps.
Grey	Reverse lamps.

Tow Hitch



WARNING: Do not exceed the lowest rating capacity for your vehicle or trailer hitch. Overloading your vehicle or trailer hitch can impair your vehicle stability and handling. Failure to follow this instruction could result in the loss of control of your vehicle, personal injury or death.



WARNING: Do not cut, drill, weld or modify the trailer hitch. Modifying the trailer hitch could reduce the hitch rating.

Do not use a tow hitch that either clamps on to the bumper or attaches to the axle. You must distribute the load in your trailer so that between 10% and 15% of the total weight of the trailer is on the tongue.

Weight Distributing Hitches

A weight distribution hitch is not recommended for use with your vehicle.

Safety Chains

Always connect the safety chains to the frame or hook retainers of your vehicle's tow hitch.

To connect the safety chains, cross the chains under the trailer tongue and allow enough slack for turning tight corners. Do not allow the chains to drag on the ground.

Note: Do not attach safety chains to the bumper.

Trailer Brakes (If Equipped)



WARNING: Do not connect a trailer's hydraulic brake system directly to your vehicle's brake system. Your vehicle may not have enough braking power and your chances of having a collision greatly increase.

Electric, manual, automatic or surge-type trailer brakes are safe if you install them correctly and adjust them to the manufacturer's specifications. Trailer brakes must meet local and federal regulations.

The rating for the tow vehicle's braking system operation is at the gross vehicle weight rating, not the gross combined weight rating.

Separate functioning brake systems are required for safe control of towed vehicles and trailers weighing more than 1,500 lb (680 kg) when loaded.

Towing

Integrated Trailer Brake Controller



WARNING: Use the integrated trailer brake controller to properly adjust the trailer brakes and check all connections before towing a trailer. Failure to follow this instruction could result in the loss of control of your vehicle, personal injury or death.

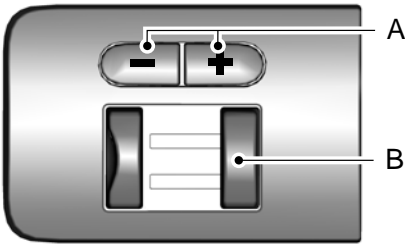

E163166

- A Gain adjustment buttons.
- B Manual control lever.

When used correctly, the trailer brake controller assists in smooth and effective trailer braking by powering the trailer's electric or electric-over-hydraulic brakes with a proportional output based on the towing vehicle's brake pressure

Slide the manual control lever to the left to turn on the trailer's electric brakes. They work independently of the tow vehicle's braking system. See **Procedure for Adjusting the Gain Setting** for instructions on correct use of this feature. If you use the manual control while the brake is also applied, the greater of the two inputs determines the power sent to the trailer brakes.

1. Press the **+** and **-** buttons to adjust the brake controller's power output to the trailer brakes in 0.5 increments. You can increase the gain setting to 10 (maximum trailer braking) or decrease it to zero (no trailer braking). Pressing and holding a button raises or lowers the setting continuously.

The gain setting displays in the information display as:

Message
Trailer Brake
Gain:

Note: *Using the manual control lever illuminates the trailer's brake lamps and your vehicle's brake lamps, except the center high-mounted brake lamp, if you make the correct electrical connection to the trailer.*

Towing

The controller shows gain setting, output bar graph and the trailer connectivity status in the information display as follows:

Message	Action and Description
Trailer Brake Gain: No Trailer	Displays the current gain setting during a given ignition cycle and when adjusting the gain setting. This also displays if you use the manual control lever or make gain adjustments with no trailer connected.
Trailer Brake Gain: Output:	Displays when you press your vehicle's brake pedal, or upon use of the manual control lever. Bar indicators illuminate in the information display to indicate the amount of power going to the trailer brakes relative to the brake pedal or manual control input. One bar indicates the least amount of output; six bars indicate maximum output.
Trailer Connected	Displays when the system senses a correct trailer wiring connection during a given ignition cycle. For example a trailer with electric trailer brakes.
Trailer Disconnected	Displays when the system senses a trailer connection and then a disconnection, either intentional or unintentional, during a given ignition cycle, this is accompanied by a single audible tone. It also displays if a vehicle or trailer-wiring fault occurs causing the trailer to appear disconnected. This message can also display if you use the manual control lever without a trailer connected.

Procedure for Adjusting the Gain Setting

The gain setting sets the trailer brake controller for the specific towing condition. You should change the setting as towing conditions change. Changes to towing conditions include trailer load, vehicle load, road conditions and weather.

The gain should be set to provide the maximum trailer braking assistance while making sure the trailer wheels do not lock when using the brakes. Locked trailer wheels may lead to trailer instability.

Note: Only carry out this procedure in a traffic-free environment at speeds of approximately 20-25 mph (30-40 km/h).

1. Make sure the trailer brakes are in good working condition, functioning normally and correctly adjusted. See a trailer dealer if necessary.
2. Hook up the trailer and make the electrical connections according to the trailer manufacturer's instructions.
3. Use the gain adjustment **+** and **-** buttons to increase or decrease the gain setting to the desired starting point. A gain setting of six is a good starting point for heavier loads.
4. In a traffic-free environment, tow the trailer on a dry, level surface at a speed of 20-25 mph (30-40 km/h) and slide the manual control lever completely.

Towing

5. If the trailer wheels lock, indicated by squealing tires, reduce the gain setting. If the trailer wheels turn freely, increase the gain setting. Repeat steps four and five until the gain setting is at a point just below trailer wheel lock. If towing a heavier trailer, trailer wheel lock may not be attainable even with the maximum gain setting of 10.

System Warning Messages

Message	Action and Description
Trailer Brake Module Fault	Displays in response to faults sensed by the trailer brake controller, accompanied by a single tone. If this message appears, contact an authorized dealer as soon as possible for diagnosis and repair. The controller may still function, but performance may be degraded.
Wiring Fault on Trailer	Displays when there is a short circuit on the electric brake output wire. If the message displays, accompanied by a single tone, with no trailer connected, the problem is with your vehicle wiring between the trailer brake controller and the 7-pin connector. If the message only displays with a trailer connected, the problem is with the trailer wiring. Consult a trailer dealer for assistance. This can be a short to ground, for example a chaffed wire, short to voltage, for example a pulled pin on trailer emergency breakaway battery or the trailer brakes may be drawing too much current.

Note: An authorized dealer can diagnose the trailer brake controller to determine exactly which trailer fault has occurred. However, the Ford Warranty does not cover this diagnosis if the fault is with the trailer.

Points to Remember

- Do not attempt removal of the trailer brake controller without consulting the Workshop Manual. Damage to the unit may result.
- Adjust gain setting before using the trailer brake controller for the first time.
- Adjust gain setting, using the procedure above, whenever road, weather and trailer or vehicle loading conditions change from when the gain was initially set.
- Only use the manual control lever for correct adjustment of the gain during trailer setup. Misuse, such as application during trailer sway, could cause instability of trailer or tow vehicle.
- Avoid towing in adverse weather conditions. The trailer brake controller does not provide anti-lock control of the trailer wheels. Trailer wheels can lock up on slippery surfaces, resulting in instability of trailer or tow vehicle.

Towing

- The trailer brake controller is fitted with a feature that reduces output at vehicle speeds below 11 mph (18 km/h) so trailer and vehicle braking is not jerky or harsh. This feature is only available when applying the brakes using your vehicle's brake pedal, not the controller.
- The controller interacts with the brake control system and powertrain control system of your vehicle to provide the best performance on different road conditions.
- Your vehicle's brake system and the trailer brake system work independently of each other. Changing the gain setting on the controller does not affect the operation of your vehicle's brake system whether you attach a trailer or not.
- When you switch the engine off, the controller output is disabled and the display and module shut down. The controller module and display turn on when you switch the ignition on.
- The trailer brake controller is only a factory-installed or dealer-installed item. Ford is not responsible for warranty or performance of the controller due to misuse or customer installation.

Trailer Lamps



WARNING: Never connect any trailer lamp wiring to the vehicle's tail lamp wiring; this may damage the electrical system resulting in fire. Contact your authorized dealer as soon as possible for assistance in proper trailer tow wiring installation. Additional electrical equipment may be required.

Trailer lamps are required on most towed vehicles. Make sure all running lamps, brake lamps, turn signals and hazard warning lamps are working.

Before Towing a Trailer

Practice turning, stopping and backing up to get the feel of your vehicle-trailer combination before starting on a trip. When turning, make wider turns so the trailer wheels clear curbs and other obstacles.

When Towing a Trailer

- Do not drive faster than 70 mph (113 km/h) until you drive your vehicle at least 495 mi (800 km). See **Breaking-In** (page 191).
- Do not make full-throttle starts.
- Check the tow hitch, electrical connections and trailer wheel lug nuts thoroughly after you have traveled 50 mi (80 km).
- When stopped in congested or heavy traffic during hot weather, place the gearshift in position park (**P**) to aid engine and transmission cooling and to help A/C performance.
- Turn off the speed control with heavy loads or on hilly terrain. The speed control may turn off automatically when you are towing on long, steep grades.
- Shift to a lower gear when driving down a long or steep hill. Do not apply the brakes continuously, as they may overheat and become less effective.
- If the transmission is fitted with a Grade Assist, **Tow/Haul** feature, use this feature when towing. This provides engine braking and helps eliminate excessive transmission shifting for optimum fuel economy and transmission cooling.

Towing

- If your vehicle is fitted with AdvanceTrac with roll stability control (RSC), this system may turn on during typical cornering maneuvers with a heavily loaded trailer. This is normal. Turning the corner at a slower speed while towing may reduce this tendency.
- If you are towing a trailer frequently in hot weather, hilly conditions, at the gross combined weight rating (or any combination of these factors), consider refilling your vehicle's rear axle with synthetic gear lubricant (if the axle is not already filled with it). See **Capacities and Specifications** (page 307).
- Allow more distance for stopping with a trailer attached. Anticipate stops and brake gradually.
- Avoid parking on a grade. However, if you must park on a grade:
 - Turn the steering wheel to point your vehicle tires away from traffic flow.
 - Set your vehicle parking brake.
 - Place the automatic transmission in position park (**P**).
 - Place wheel chocks in front of and at the back of the trailer wheels. (Trailer wheel chocks are not included with your vehicle.)

Launching or Retrieving a Boat or Personal Water Craft (PWC)

When backing down a ramp during boat launching or retrieval:

- Do not allow the static water level to rise above the bottom edge of the rear bumper.
- Do not allow waves to break higher than 6 in (15 cm) above the bottom edge of the rear bumper.

Note: *Disconnect the wiring to the trailer before backing the trailer into the water.*

Note: *Reconnect the wiring to the trailer after the trailer is removed from the water.*

Exceeding these limits may allow water to enter vehicle components:

- Causing internal damage to the components.
- Affecting driveability, emissions, and reliability.

Replace the rear axle lubricant anytime the rear axle has been submerged in water. Water may have contaminated the rear axle lubricant, which is not normally checked or changed unless a leak is suspected or other axle repair is required.

TOWING THE VEHICLE ON FOUR WHEELS

Emergency Towing



You can flat-tow (all wheels on the ground, regardless of the powertrain or transmission configuration) your disabled vehicle (without access to wheel dollies or vehicle transport trailer) under the following conditions:

- Your vehicle is facing forward so you tow it in a forward direction.
- You shift into Neutral (N). If you cannot shift into Neutral (N), you may need to override the transmission. See **Transmission** (page 151).
- Maximum speed is 35 mph (56 km/h).
- Maximum distance is 50 mi (80 km).

Towing

Recreational Towing

Note: *Put your climate control system in recirculated air mode to prevent exhaust fumes from entering the vehicle. See **Climate Control** (page 107).*

Follow these guidelines if you have a need for recreational (RV) towing. An example of recreational towing would be towing your vehicle behind a motorhome. These guidelines are to make sure you do not damage the transmission during towing.

Do not tow your vehicle with any wheels on the ground, as vehicle or transmission damage may occur. It is recommended to tow your vehicle with all four wheels off the ground, for example when using a vehicle transport trailer. Otherwise, you cannot tow your vehicle.

Driving Hints

BREAKING-IN

You need to break in new tires for approximately 300 mi (480 km). During this time, your vehicle may exhibit some unusual driving characteristics. The engine also needs to break in. Avoid hard accelerations and driving too fast for the first 1,000 mi (1,600 km). If possible, avoid carrying heavy loads up steep grades during the break-in period.

REDUCED ENGINE PERFORMANCE



WARNING: If you continue to drive your vehicle when the engine is overheating, the engine could stop without warning. Failure to follow this instruction could result in the loss of control of your vehicle.

If the engine coolant temperature gauge needle moves to the upper limit position, the engine is overheating. See **Gauges** (page 91).

You must only drive your vehicle for a short distance if the engine overheats. The distance you can travel depends on ambient temperature, vehicle load and terrain. The engine continues to operate with limited power for a short period of time.

If the engine temperature continues to rise, the fuel supply to the engine reduces. The air conditioning switches off and the engine cooling fan operates continually.

1. Gradually reduce your speed and stop your vehicle as soon as it is safe to do so.
2. Immediately switch the engine off to prevent severe engine damage.
3. Wait for the engine to cool down.

4. Check the coolant level. See **Engine Coolant Check** (page 236).
5. Have your vehicle checked as soon as possible.

ECONOMICAL DRIVING

The following helps to improve fuel consumption:

- Regularly check your tire pressures and make sure that they are inflated to the correct pressure. See **Technical Specifications** (page 305).
- Follow the recommended maintenance schedule and carry out the recommended checks.
- Plan your journey and check the traffic before you set off.
- Avoid idling the engine in cold weather or for extended periods. Start the engine only when you are ready to set off.
- Do not carry unnecessary weight in your vehicle as extra weight wastes fuel.
- Do not add unnecessary accessories to the exterior of your vehicle, for example running boards. If you use a roof rack, remember to fold it down or remove it when not in use.
- Drive smoothly, accelerate gently and anticipate the road ahead to avoid heavy braking.
- Switch off all electric systems when not in use, for example air conditioning. Make sure that you unplug any accessories from the auxiliary power points when not in use.

Driving Hints

COLD WEATHER PRECAUTIONS

The functional operation of some components and systems can be affected at temperatures below -13°F (-25°C).

DRIVING THROUGH WATER



WARNING: Do not drive through flowing or deep water as you may lose control of your vehicle.

Note: *Driving through standing water can cause vehicle damage.*

Note: *Engine damage can occur if water enters the air filter.*

Before driving through standing water, check the depth. Never drive through water that is higher than the bottom of the wheel hubs.

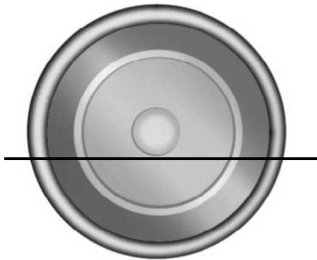

E176913

When driving through standing water, drive very slowly and do not stop your vehicle. Your brake performance and traction may be limited. After driving through water and as soon as it is safe to do so:

- Lightly press the brake pedal to dry the brakes and to check that they work.
- Check that the horn works.

- Check that the exterior lights work.
- Turn the steering wheel to check that the steering power assist works.

FLOOR MATS (IF EQUIPPED)



WARNING: Use a floor mat designed to fit the footwell of your vehicle that does not obstruct the pedal area. Failure to follow this instruction could result in the loss of control of your vehicle, personal injury or death.



WARNING: Pedals that cannot move freely can cause loss of vehicle control and increase the risk of serious personal injury.



WARNING: Secure the floor mat to both retention devices so that it cannot slip out of position and interfere with the pedals. Failure to follow this instruction could result in the loss of control of your vehicle, personal injury or death.



WARNING: Do not place additional floor mats or any other covering on top of the original floor mats. This could result in the floor mat interfering with the operation of the pedals. Failure to follow this instruction could result in the loss of control of your vehicle, personal injury or death.



WARNING: Always make sure that objects cannot fall into the driver foot well while your vehicle is moving. Objects that are loose can become trapped under the pedals causing a loss of vehicle control.

Driving Hints



E142666

To install the floor mats, position the floor mat eyelet over the retention post and press down to lock in position.

To remove the floor mat, reverse the installation procedure.

Note: *Regularly check the floor mats to make sure they are secure.*

Roadside Emergencies

ROADSIDE ASSISTANCE

Vehicles Sold in the United States: Getting Roadside Assistance

To fully assist you should you have a vehicle concern, Ford Motor Company offers a complimentary roadside assistance program. This program is separate from the New Vehicle Limited Warranty.

The service is available:

- 24 hours a day, seven days a week.
- For the coverage period listed on the Roadside Assistance Card included in your Owner's Manual portfolio.

Roadside Assistance covers:

- A flat tire change with a good spare (except vehicles supplied with a tire inflation kit).
- Battery jump start.
- Lock-out assistance (key replacement cost is the customer's responsibility).
- Fuel delivery — independent service contractors, if not prohibited by state, local or municipal law, shall deliver up to 2 gal (8 L) of gasoline or 5 gal (20 L) of diesel fuel to a disabled vehicle. Roadside Assistance limits fuel delivery service to two no-charge occurrences within a 12-month period.
- Winch out — available within 100 ft (30 m) of a paved or county maintained road, no recoveries.

- Towing — independent service contractors, if not prohibited by state, local or municipal law, shall tow Ford eligible vehicles to an authorized dealer within 35 mi (56 km) of the disablement location or to the nearest authorized dealer. If a member requests a tow to an authorized dealer that is more than 35 mi (56 km) from the disablement location, the member shall be responsible for any mileage costs in excess of 35 mi (56 km).
- Roadside Assistance includes up to \$200 for a towed trailer if the disabled eligible vehicle requires service at the nearest authorized dealer. If the towing vehicle is operational but the trailer is not, then the trailer does not qualify for any roadside services.

Vehicles Sold in the United States: Using Roadside Assistance

Complete the roadside assistance identification card and place it in your wallet for quick reference. This card is in the owner's information portfolio in the glove compartment.

United States vehicle customers who require Roadside Assistance, call 1-800-241-3673.

If you need to arrange roadside assistance for yourself, Ford Motor Company reimburses a reasonable amount for towing to the nearest dealership within 35 mi (56 km). To obtain reimbursement information, United States vehicle customers call 1-800-241-3673. Customers need to submit their original receipts.

Roadside Emergencies

Vehicles Sold in Canada: Getting Roadside Assistance

To fully assist you should you have a vehicle concern, Ford Motor Company of Canada, Limited offers a complimentary roadside assistance program. This program is eligible within Canada or the continental United States.

The service is available 24 hours a day, seven days a week.

This program is separate from the New Vehicle Limited Warranty, but the coverage is concurrent with the powertrain coverage period of your vehicle. Canadian roadside coverage and benefits may differ from the U.S. coverage.

If you require more information, please call us in Canada at 1-800-665-2006, or visit our website at www.ford.ca.

HAZARD FLASHERS



The hazard warning button is located on the instrument panel. Switch the hazard warning

flashers on when your vehicle is creating a safety hazard.

Press the button to switch the hazard warning flashers on. The front and rear direction indicators will flash.

Press the button again to switch the hazard warning flashers off.

Note: *Prolonged use of the hazard warning flashers will cause the battery to run out of charge. There may be insufficient power to restart the engine.*

EMERGENCY EXIT



WARNING: Make sure that the roof rack and its load do not obstruct the emergency exit. Ask your dealer for advice on roof racks suitable for your vehicle.

Break the glass with the hammer in an emergency.

FUEL SHUTOFF



WARNING: If your vehicle has been involved in a crash, have the fuel system checked. Failure to follow this instruction could result in fire, personal injury or death.

In the event of a moderate to severe crash, your vehicle is fitted with a fuel pump shut-off feature that stops the flow of fuel to the engine. Not every impact will cause a shut-off.

Should the engine turn off after a crash, you may restart the engine by carrying out the following.

Ignition Switch

1. Switch the ignition off.
2. Switch the ignition to position **III**.
3. Switch the ignition off.
4. Switch the ignition on again to re-enable the fuel pump.

Note: *Various system checks are automatically carried out before the vehicle will restart. If your vehicle fails to restart after the third attempt, the system has detected a fault that requires service. We recommend you contact an authorized dealer.*

Roadside Emergencies

JUMP STARTING THE VEHICLE



WARNING: The gases around the battery can explode if exposed to flames, sparks or lit cigarettes. An explosion could result in personal injury or vehicle damage.



WARNING: Batteries contain sulfuric acid which can burn skin, eyes and clothing, if contacted.



WARNING: Use only an adequate-sized cable with insulated clamps.

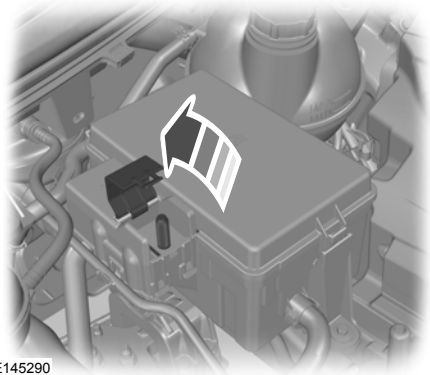

E145290

The negative (-) terminal is a post, located on the driver side, near the hood hinge. It is a grounding connection point, so you will need to remove the rubber covering first.

Preparing Your Vehicle

Note: Do not attempt to push-start your automatic transmission vehicle. Automatic transmissions do not have push-start capability. Attempting to push-start a vehicle with an automatic transmission may cause transmission damage.

Note: Use only a 12-volt supply to start your vehicle.

Note: Do not disconnect the battery of the disabled vehicle as this could damage the vehicle's electrical system.

Park the booster vehicle close to the hood of the disabled vehicle, making sure the two vehicles do not touch, and switch off all accessories.

Your vehicle has a positive (+) access terminal and a negative (-) grounding connection point that you can access under the hood, even though the actual battery is under the driver seat. You can jump your vehicle using these points.

The positive (+) access terminal is next to the fuse box, under a red cap. To access the positive (+) terminal, lift the red cap up.

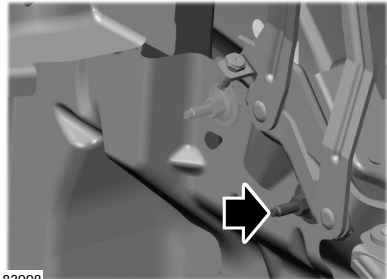

E183998

Roadside Emergencies

Connecting the Jumper Cables



WARNING: Do not attach the cables to fuel lines, engine rocker covers, the intake manifold or electrical components as grounding points. Stay clear of moving parts. To avoid reverse polarity connections, make sure that you correctly identify the positive (+) and negative (-) terminals on both the disabled and booster vehicles before connecting the cables.

Note: In the illustration, the bottom vehicle represents the booster vehicle.

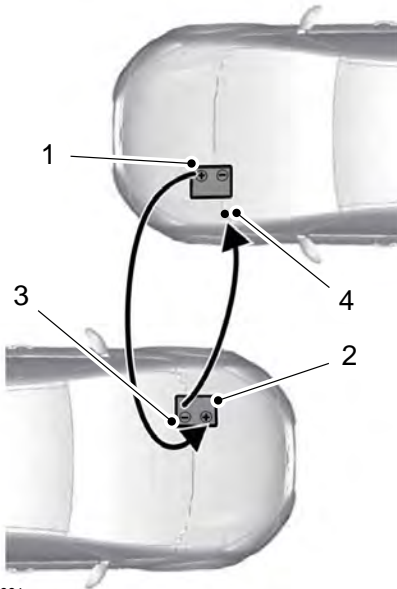

E142664

1. Connect the positive (+) jumper cable to the positive (+) access terminal of the vehicle with the discharged battery.

2. Connect the other end of the positive (+) cable to the positive (+) terminal of the assisting battery.
3. Connect the negative (-) cable to the negative (-) terminal of the assisting battery.
4. Make the final connection of the negative (-) cable to the grounding connection point of the vehicle with the discharged battery.



WARNING: Do not connect the end of the second cable to the negative (-) terminal of the battery to be jumped. A spark may cause an explosion of the gases that surround the battery.

Jump Starting

1. Start the engine of the booster vehicle and rev the engine moderately, or press the accelerator gently to keep your engine speed between 2000 and 3000 rpms, as shown in your tachometer.
2. Start the engine of the disabled vehicle.
3. Once you start the disabled vehicle, run both vehicle engines for an additional three minutes before disconnecting the jumper cables.

Removing the Jumper Cables

Remove the jumper cables in the reverse order that they were connected.

Roadside Emergencies

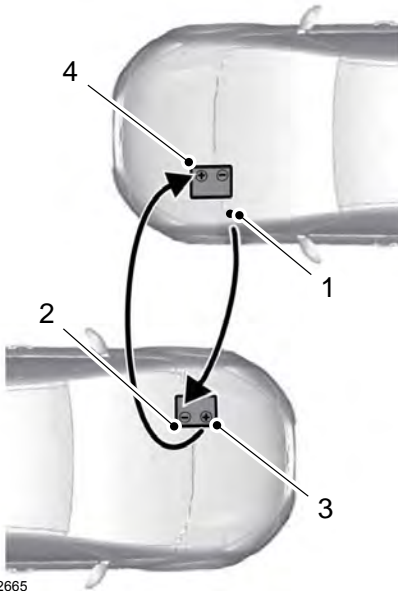

E142665

1. Remove the jumper cable from the grounding connection point of the vehicle with the discharged battery.
2. Remove the jumper cable on the negative (-) terminal of the booster vehicle's battery.
3. Remove the jumper cable from the positive (+) terminal of the booster vehicle's battery.
4. Remove the jumper cable from the positive (+) access terminal of the vehicle with the discharged battery.

After you start the disabled vehicle and remove the jumper cables, allow your vehicle to idle for several minutes so the battery can recharge.

POST-CRASH ALERT SYSTEM

The system flashes the direction indicators and sounds the horn (intermittently) in the event of a serious impact that deploys an airbag (front, side, side curtain or Safety Canopy) or the seatbelt pretensioners.

The horn and indicators turn off when:

- You press the hazard control button.
- You press the panic button on the remote entry transmitter (if equipped).
- Your vehicle runs out of power.
- Sounding of the horn is only enabled in specific markets.

TRANSPORTING THE VEHICLE

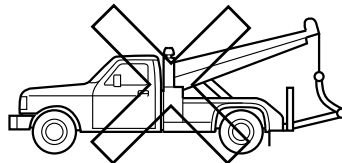
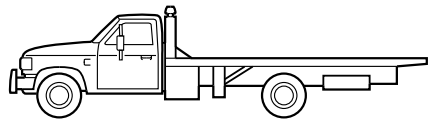
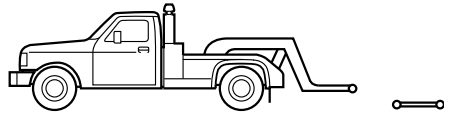

E143886

Roadside Emergencies

If you need to have your vehicle towed, contact a professional towing service or, if you are a member of a roadside assistance program, your roadside assistance service provider.

We recommend the use of a wheel lift and dollies or flatbed equipment to tow your vehicle. Do not tow with a slingbelt. Ford Motor Company has not approved a slingbelt towing procedure. Vehicle damage may occur if towed incorrectly, or by any other means.

Ford Motor Company produces a towing manual for all authorized tow truck operators. Have your tow truck operator refer to this manual for proper hook-up and towing procedures for your vehicle.

It is acceptable to have your front-wheel drive vehicle towed from the front if using proper wheel lift equipment to raise the front wheels off the ground. When towing in this manner, the rear wheels can remain on the ground.

Front-wheel drive vehicles must have the front wheels placed on a tow dolly when towing your vehicle from the rear using wheel lift equipment. This prevents damage to the transmission.

Towing an all-wheel or four-wheel drive vehicle requires that all wheels be off the ground, such as using a wheel lift and dollies or flatbed equipment. This prevents damage to the transmission, all-wheel or four-wheel drive system and vehicle.

TOWING POINTS

Front Towing Point



WARNING: Make sure that the towing eye is fully tightened. Failure to follow this instruction could result in personal injury.



WARNING: You must switch the ignition on when your vehicle is being towed.



E146426

1. Carefully remove the cover.
2. Install the towing eye.

Note: It has a left-hand thread. Turn it counterclockwise to install it.

Rear Towing Point



E142319

Roadside Emergencies

Towing Eye Location

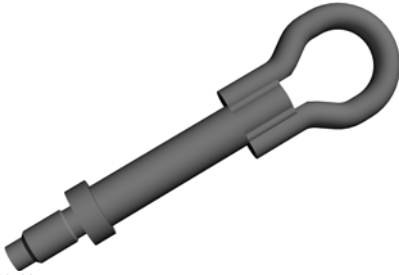

E265227

The towing eye may be found:

- Secured to the floor under the passenger seat.
- Secured to the rear of the seat base under the passenger seat.
- Secured under the second row passenger seat.
- Inside the driver door storage compartment.
- Inside the toolkit within the front step storage compartment.

Note: *You must carry the towing eye in your vehicle at all times.*

Customer Assistance

GETTING THE SERVICES YOU NEED

Warranty repairs to your vehicle must be performed by an authorized dealer. While any authorized dealer handling your vehicle line will provide warranty service, we recommend you return to your selling authorized dealer who wants to ensure your continued satisfaction.

Please note that certain warranty repairs require special training and equipment, so not all authorized dealers are authorized to perform all warranty repairs. This means that, depending on the warranty repair needed, you may have to take your vehicle to another authorized dealer.

A reasonable time must be allowed to perform a repair after taking your vehicle to the authorized dealer. Repairs will be made using Ford or Motorcraft® parts, or remanufactured or other parts that are authorized by Ford.

Away From Home

If you are away from home when your vehicle needs service, contact the Ford Customer Relationship Center or use the online resources listed below to find the nearest authorized dealer.

In the United States:

Mailing address

Ford Motor Company
Customer Relationship Center
P.O. Box 6248
Dearborn, MI 48126

Telephone

1-800-392-3673 (FORD)
(TDD for the hearing impaired:
1-800-232-5952)

Additional information and resources are available online:

Website
www.owner.ford.com

These are some of the items that can be found online:

- U.S. dealer locator by Dealer Name, City/State or Zip Code.
- Owner Manuals.
- Maintenance Schedules.
- Recalls.
- Ford Extended Service Plans.
- Ford Genuine Accessories.
- Service specials and promotions.

In Canada:

Mailing address

Customer Relationship Centre
Ford Motor Company of Canada, Limited
P.O. Box 2000
Oakville, Ontario L6K 0C8

Telephone

1-800-565-3673 (FORD)

Website
www.ford.ca

Twitter

@FordServiceCA (English Canada)
@FordServiceQC (Quebec)

Additional Assistance

If you have questions or concerns, or are unsatisfied with the service you are receiving, follow these steps:

1. Contact your Sales Representative or Service Advisor at your selling or servicing authorized dealer.

Customer Assistance

2. If your inquiry or concern remains unresolved, contact the Sales Manager, Service Manager or Customer Relations Manager.
3. If you require assistance or clarification on Ford Motor Company policies, please contact the Ford Customer Relationship Center.

In order to help us serve you better, please have the following information available when contacting a Customer Relationship Center:

- Vehicle Identification Number.
- Your telephone number (home and business).
- The name of the authorized dealer and city where located.
- The vehicle's current odometer reading.

In some states within the United States, you must directly notify Ford in writing before pursuing remedies under your state's warranty laws, and Ford is also allowed a final repair attempt.

Additionally, in some states within the United States, a consumer has the option of submitting a warranty dispute to the BBB Auto Line before taking action under the Magnuson-Moss Warranty Act, or to the extent allowed by state law, before pursuing replacement or repurchase remedies provided by certain state laws. This dispute handling procedure is not required prior to enforcing state created rights or other rights which are independent of the Magnuson-Moss Warranty Act or state replacement or repurchase laws.

IN CALIFORNIA (U.S. ONLY)

California Civil Code Section 1793.2(d) requires that, if a manufacturer or its representative is unable to repair a motor vehicle to conform to the vehicle's applicable express warranty after a reasonable number of attempts, the manufacturer shall be required to either replace the vehicle with one substantially identical or repurchase the vehicle and reimburse the buyer in an amount equal to the actual price paid or payable by the consumer (less a reasonable allowance for consumer use). The consumer has the right to choose whether to receive a refund or replacement vehicle.

California Civil Code Section 1793.22(b) presumes that the manufacturer has had a reasonable number of attempts to conform the vehicle to its applicable express warranties if, within the first 18 months of ownership of a new vehicle or the first 18,000 mi (29,000 km), whichever occurs first:

1. Two or more repair attempts are made on the same non-conformity likely to cause death or serious bodily injury OR
2. Four or more repair attempts are made on the same nonconformity (a defect or condition that substantially impairs the use, value or safety of the vehicle) OR
3. The vehicle is out of service for repair of nonconformities for a total of more than 30 calendar days (not necessarily all at one time).

In the case of 1 or 2 above, the consumer must also notify the manufacturer of the need for the repair of the nonconformity at the following address:

Ford Motor Company
16800 Executive Plaza Drive
Mail Drop 3NE-B
Dearborn, MI 48126

Customer Assistance

You are required to submit your warranty dispute to BBB AUTO LINE before asserting in court any rights or remedies conferred by California Civil Code Section 1793.22(b). You are also required to use BBB AUTO LINE before exercising rights or seeking remedies created by the Federal Magnuson-Moss Warranty Act, 15 U.S.C. sec. 2301 et seq. If you choose to seek redress by pursuing rights and remedies not created by California Civil Code Section 1793.22(b) or the Magnuson-Moss Warranty Act, resort to BBB AUTO LINE is not required by those statutes.

THE BETTER BUSINESS BUREAU (BBB) AUTO LINE PROGRAM (U.S. ONLY)

Your satisfaction is important to Ford Motor Company and to your dealer. If a warranty concern has not been resolved using the three-step procedure outlined earlier in this chapter in the Getting the Services you need section, you may be eligible to participate in the BBB AUTO LINE program.

The BBB AUTO LINE program consists of two parts – mediation and arbitration. During mediation, a representative of the BBB will contact both you and Ford Motor Company to explore options for settlement of the claim. If an agreement is not reached during mediation or you do not want to participate in mediation, and if your claim is eligible, you may participate in the arbitration process. An arbitration hearing will be scheduled so that you can present your case in an informal setting before an impartial person. The arbitrator will consider the testimony provided and make a decision after the hearing.

Disputes submitted to the BBB AUTO LINE program are usually decided within forty days after you file your claim with the BBB. You are not bound by the decision, and may reject the decision and proceed to court where all findings of the BBB Auto Line dispute, and decision, are admissible in the court action. Should you choose to accept the BBB AUTO LINE decision, Ford is then bound by the decision, and must comply with the decision within 30 days of receipt of your acceptance letter.

BBB AUTO LINE Application: Using the information provided below, please call or write to request a program application. You will be asked for your name and address, general information about your new vehicle, information about your warranty concerns, and any steps you have already taken to try to resolve them. A Customer Claim Form will be mailed that will need to be completed, signed and returned to the BBB along with proof of ownership. Upon receipt, the BBB will review the claim for eligibility under the Program Summary Guidelines.

You can get more information by calling BBB AUTO LINE at 1-800-955-5100, or writing to:

**BBB AUTO LINE
3033 Wilson Boulevard, Suite 600
Arlington, Virginia 22201**

BBB AUTO LINE applications can also be requested by calling the Ford Motor Company Customer Relationship Center at 1-800-392-3673.

Note: *Ford Motor Company reserves the right to change eligibility limitations, modify procedures, or to discontinue this process at any time without notice and without obligation.*

Customer Assistance

UTILIZING THE MEDIATION/ARBITRATION PROGRAM (CANADA ONLY)

For vehicles delivered to authorized Canadian dealers. In those cases where you continue to feel that the efforts by Ford of Canada and the authorized dealer to resolve a factory-related vehicle service concern have been unsatisfactory, Ford of Canada participates in an impartial third party mediation/arbitration program administered by the Canadian Motor Vehicle Arbitration Plan (CAMVAP).

The CAMVAP program is a straight forward and relatively speedy alternative to resolve a disagreement when all other efforts to produce a settlement have failed. This procedure is without cost to you and is designed to eliminate the need for lengthy and expensive legal proceedings.

In the CAMVAP program, impartial third-party arbitrators conduct hearings at mutually convenient times and places in an informal environment. These impartial arbitrators review the positions of the parties, make decisions and, when appropriate, render awards to resolve disputes. CAMVAP decisions are fast, fair, and final as the arbitrator's award is binding on both you and Ford of Canada.

CAMVAP services are available in all Canadian territories and provinces. For more information, without charge or obligation, call your CAMVAP Provincial Administrator directly at 1-800-207-0685 or visit www.camvap.ca.

GETTING ASSISTANCE OUTSIDE THE U.S. AND CANADA

Before exporting your vehicle to a foreign country, contact the appropriate foreign embassy or consulate. These officials can inform you of local vehicle registration regulations and where to find unleaded fuel or petrol/gas engines or the proper sulfur fuel for diesel engines.

If you cannot find the proper fuel recommended for your vehicle, contact our Customer Relationship Center.

The use of improper fuels in your vehicle without proper conversion may damage the effectiveness of your emission control system and may cause engine knocking or serious engine damage. Ford Motor Company or Ford of Canada is not responsible for any damage caused by use of improper fuel. Using improper fuels may also result in difficulty importing your vehicle back into the United States.

If your vehicle must be serviced while you are traveling or living in Asia-Pacific Region, Sub-Saharan Africa, U.S. Virgin Islands and/or Puerto Rico, Central America, the Caribbean, and Israel and the Middle East, contact the nearest authorized dealer. If the authorized dealer cannot help you, contact the corresponding Ford Customer Assistance Center:

FORD MOTOR COMPANY

Customer Relationship Centers in:

Customer Assistance

Customer Relationship Center	Phone	Fax	E-mail
Asia Pacific	N/A	N/A	apemcrc@ford.com
Caribbean and Central America	+1 313 594 4857	-	expcac@ford.com
Middle East	Ford 80004443673	971 4 3327 266	menacac@ford.com
	Lincoln 80004441067		
	UAE 80004441066		
	Saudi Arabia 8008443673		
	Mobily and Zain cell phone users in Saudi 800850078		
	Kuwait 22280384		
North Africa	N/A	N/A	nafcrc@ford.com
Puerto Rico and U.S. Virgin Islands	+1-800-841-3673	N/A	prcac@ford.com
Sub-Saharan Africa	N/A	N/A	ssacrc@ford.com
South Korea	+82-02-1600-6003	N/A	infokr1@ford.com or infokr@lincoln.com

If you buy your vehicle in North America and then relocate to any of the above locations, register your vehicle identification number (VIN) and new address with Ford Global Trade Services by emailing, expcso@ford.com.

If you are in another foreign country, contact the nearest authorized dealer. In the event your inquiry is unresolved, communicate your concern with the dealership's Sales Manager, Service Manager or Customer Relations Manager. If you require additional assistance or clarification, please contact the respective Customer Relationship Center as previously listed.

Customers in the U.S. should call 1-800-392-3673.

Customer Assistance

ORDERING ADDITIONAL OWNER'S LITERATURE

To order the publications in this portfolio, contact Helm, Incorporated at:

HELM, INCORPORATED
47911 Halyard Drive
Plymouth, Michigan 48170
Attention: Customer Service

Or to order a free publication catalog, call toll free: 1-800-782-4356

Monday-Friday 8:00 a.m. - 6:00 p.m. EST

Helm, Incorporated can also be reached by their website:

www.helminc.com

(Items in this catalog may be purchased by credit card, check or money order.)

Obtaining a French Owner's Manual

French Owner's Manual can be obtained from your authorized dealer or by contacting Helm, Incorporated using the contact information listed previously in this section.

REPORTING SAFETY DEFECTS (U.S. ONLY)

If you believe that your vehicle has a defect which could cause a crash or could cause injury or death, you should immediately inform the National Highway Traffic Safety Administration (NHTSA) in addition to notifying Ford Motor Company.

If NHTSA receives similar complaints, it may open an investigation, and if it finds that a safety defect exists in a group of vehicles, it may order a recall and remedy campaign. However, NHTSA cannot become involved in individual problems between you, your dealer, or Ford Motor Company.

To contact NHTSA, you may call the Vehicle Safety Hotline toll-free at 1-888-327-4236 (TTY: 1-800-424-9153); go to <http://www.safercar.gov>; or write to:

Administrator

1200 New Jersey Avenue,
Southeast

Washington, D.C. 20590

You can also obtain other information about motor vehicle safety from <http://www.safercar.gov>.

REPORTING SAFETY DEFECTS (CANADA ONLY)

If you believe that your vehicle has a defect which could cause a crash or could cause injury or death, you should immediately inform Transport Canada and Ford of Canada.

Customer Assistance

Transport Canada Contact Information

Website	http://www.tc.gc.ca/eng/motorvehiclesafety/reporting-defects-motor-vehicles.html (English)
Website	http://www.tc.gc.ca/fra/securiteautomobile/signaler-defauts-vehicules-automobiles.html (French)
Phone	1-800-333-0510

Ford of Canada Contact Information

Website	www.ford.ca
Phone	1-800-565-3673

Fuses

FUSE BOX LOCATIONS

Engine Compartment Fuse Box

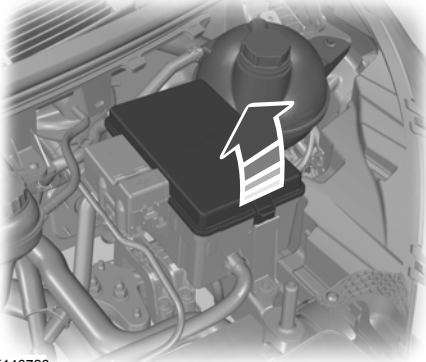

E146726

Passenger Compartment Fuse Box

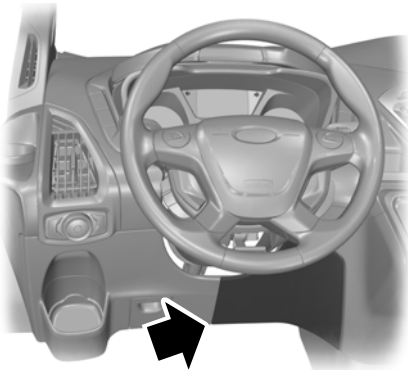

E152513

This is located behind the removable trim panel.

Pre-fuse Box

This is located under the driver seat.

Body Control Module



E152512

This is located behind the removable trim panel.

Fuses

FUSE SPECIFICATION CHART - 3.2L POWER STROKE DIESEL Engine Compartment Fuse Box

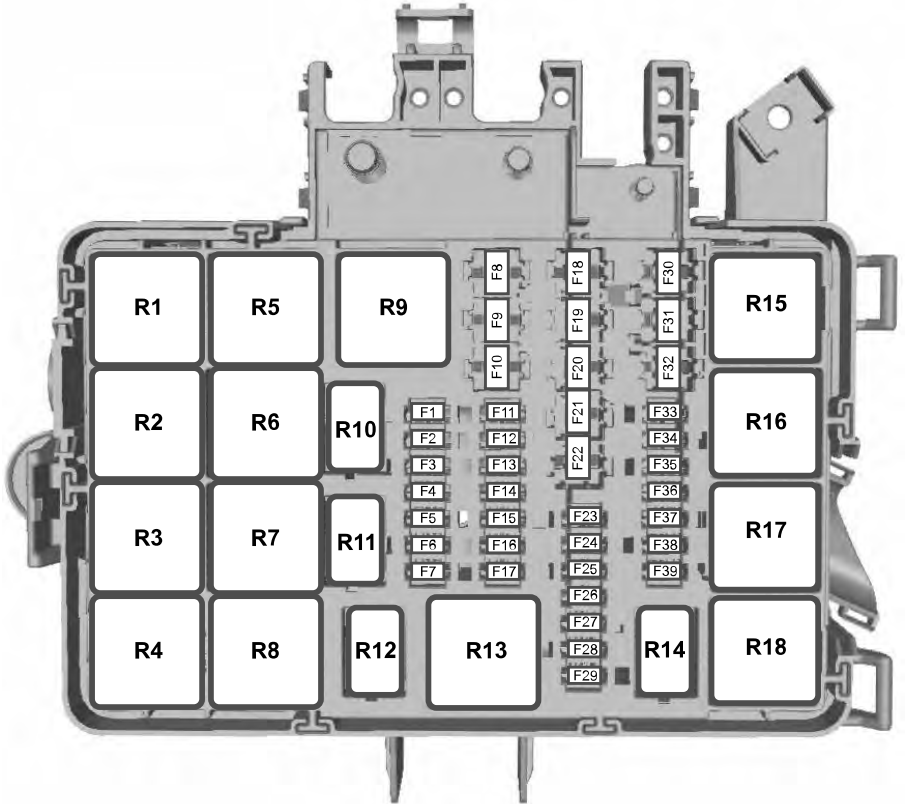

E148826

Fuse Number	Fuse Rating	Protected Component
F1	10 A	Selective catalytic reduction system.
F2	15 A	Selective catalytic reduction system.
F3	15 A	Selective catalytic reduction system.

Fuses

Fuse Number	Fuse Rating	Protected Component
F4	10 A	Selective catalytic reduction system.
F5	3 A	Diesel particulate filter vaporizer. Glow plug monitor.
F6	-	Not used.
F7	7.5 A	Automatic transmission module.
F8	-	Not used.
F9	-	Not used.
F10	30 A	Power step. Heated seats.
F11	10 A	Air conditioning clutch.
F12	20 A	Diesel particulate filter vaporizer glow plug.
F13	-	Not used.
F14	3 A	Selective catalytic reduction system.
F15	-	Not used.
F16	10 A	Fuel pump relay.
F17	15 A	Automatic transmission module.
F18	30 A	Fuel pump relay. Automatic transmission module.
F19	30 A	Starter motor solenoid.
F20	60 A	Glow plugs.
F21	60 A	Ignition relay 3.
F22	40 A	Selective catalytic reduction system.
	-	Not used.
F23	10 A	Spare.
F24	-	Not used.
F25	10 A	Spare.
F26	20 A	Spare.
F27	-	Not used.

Fuses

Fuse Number	Fuse Rating	Protected Component
F28	7.5 A	Crankcase pressure sensor.
F29	-	Not used.
	7.5 A	Positive crankcase ventilation valve heater element.
F30	60 A	Cooling fan.
	-	Not used.
F31	-	Not used.
F32	30 A	Windshield wiper motor.
F33	-	Not used.
F34	-	Not used.
F35	15 A	Powertrain control module.
F36	15 A	Particulate matter sensor. Selective catalytic reduction system. Nitrogen oxides sensor.
F37	7.5 A	Fuel volume control valve.
F38	-	Not used.
	7.5 A	Air conditioning clutch.
F39	15 A	Exhaust gas temperature sensor. Fuel vaporizer system fuel pump. Coolant bypass solenoid valve. Low-speed cooling fan. High-speed cooling fan.

Relay Number	Protected Component
R1	Ignition relay 3.
R2	Not used.
R3	Not used.
R4	Not used.
R5	Not used.
R6	Windshield wiper on/off relay.

Fuses

Relay Number	Protected Component
R7	Windshield wiper high/low speed relay.
R8	Not used.
R9	Starter motor.
R10	Air conditioning clutch.
R11	Fuel vaporizer system glow plug.
R12	Fuel injection pump.
R13	Not used.
R14	Not used.
R15	Low-speed and high-speed cooling fan relay.
R16	Selective catalytic reduction system.
R17	Powertrain control module.
R18	High-speed cooling fan.

Passenger Compartment Fuse Box

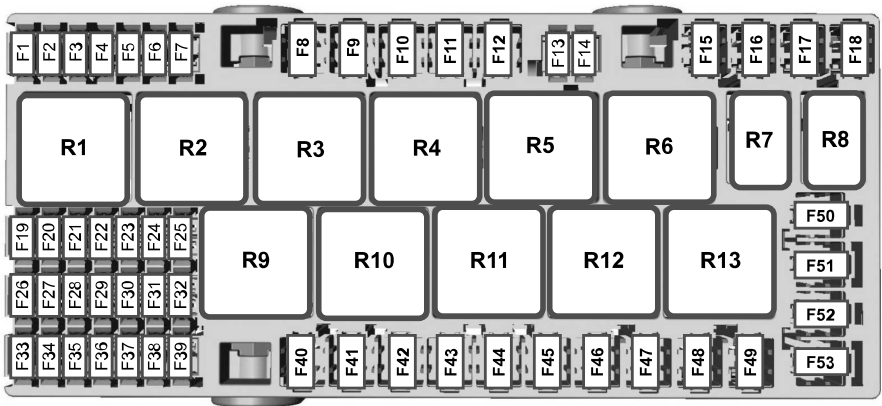

E148827

Fuses

Fuse Number	Fuse Rating	Protected Component
F1	10 A	Restraints control module.
F2	4 A	Anti-lock brake system with electronic stability control. Parking brake.
F3	7.5 A	Interior lighting. Power point relay control.
F4	10 A	Trailer tow reversing lamp relay.
F5	20 A	Modified vehicle connections.
F6	-	Not used.
F7	10 A	Battery saver relay.
F8	40 A	Direct current/alternating current inverter.
F9	30 A	Trailer brake control module.
F10	30 A	Driver power seat.
F11	30 A	Passenger power seat.
F12	30 A	Trailer lamps.
F13	25 A	Anti-lock brake system with electronic stability control.
F14	5 A	Powertrain control module.
F15	40 A	Powertrain control module relay.
F16	40 A	Body control module.
F17	40 A	Anti-lock brake system.
F18	40 A	Modified vehicle connections.
F19	5 A	Trailer module.
F20	5 A	Heated exterior mirror relay. Heated rear window. Direct current/alternating current inverter.
F21	10 A	Modified vehicle connections.
F22	-	Not used.
F23	7.5 A	Air conditioning control module.

Fuses

Fuse Number	Fuse Rating	Protected Component
F24	10 A	Modified vehicle connections.
F25	15 A	Body control module.
F26	10 A	Heated exterior mirrors.
F27	20 A	Heated rear window.
F28	20 A	Heated rear window.
F29	10 A	Rear parking aid camera. Lane keeping system. Interior rear view mirror.
F30	-	Not used.
F31	10 A	Trailer brake ignition feed.
F32	10 A	Interior lighting.
F33	10 A	Driver heated seat.
F34	10 A	Passenger heated seat.
F35	5 A	Exterior mirrors. Driver door window control switch.
F36	20 A	Horn.
F37	7.5 A	SYNC module. Global positioning system module.
F38	5 A	Blower motor relay. Horn relay. Windshield wiper relay.
F39	7.5 A	Remote keyless entry. Rear heating, ventilation and air conditioning. Trailer tow backup relay coil. Parking lamp.
F40	40 A	Front blower motor.
F41	40 A	Rear blower motor.
F42	40 A	Heated rear window.
F43	30 A	Trailer socket. Trailer tow module.
F44	60 A	Auxiliary power points.

Fuses

Fuse Number	Fuse Rating	Protected Component
F45	40 A	Trailer tow module.
F46	30 A	Power windows.
F47	20 A	Cigar lighter socket.
F48	20 A	Rear auxiliary power points.
F49	20 A	Front auxiliary power points.
F50	60 A	Ignition relay 1.
F51	60 A	Power step. Heated seats.
F52	40 A	Modified vehicle connections.
F53	40 A	Modified vehicle connections.

Relay Number	Protected Component
R1	Spare.
R2	Auxiliary power points.
R3	Trailer lamps.
R4	Not used.
R5	Power windows.
R6	Ignition relay 1.
R7	Horn.
R8	Trailer tow reversing lamp.
R9	Front blower motor.
R10	Rear blower motor.
R11	Heated rear window. Heated exterior mirrors.
R12	Heated seats.
R13	Modified vehicle connections.

Fuses

Body Control Module

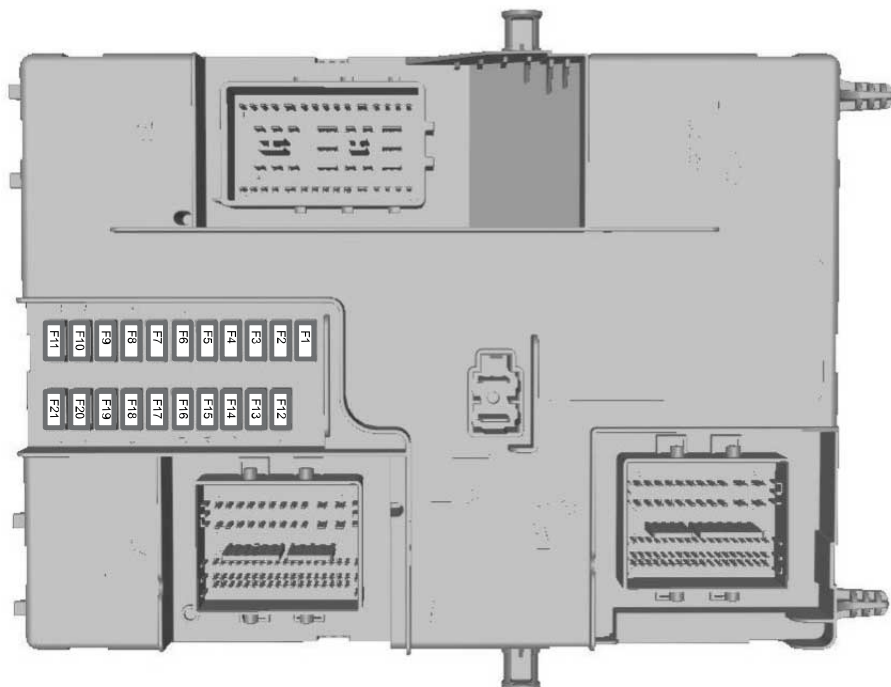

E148830

Fuse Number	Fuse Rating	Protected Component
F1	15 A	Central locking system.
F2	15 A	Central locking system.
F3	15 A	Ignition switch.
F4	5 A	Parking assist control module. Brake shift interlock.
F5	5 A	Rain sensor module.
F6	15 A	Windshield washer pump.

Fuses

Fuse Number	Fuse Rating	Protected Component
F7	7.5 A	Exterior mirrors.
F8	-	Not used.
F9	10 A	Right-hand high beam.
F10	10 A	Left-hand high beam.
F11	25 A	Right-hand exterior lamps. Left-hand headlamp.
F12	-	Not used.
F13	15 A	Secondary On-Board Diagnostic Control Module A. Battery saver.
F14	25 A	Direction indicators. Power windows. Heated windshield element.
F15	25 A	Left-hand exterior lamps. Right-hand headlamp. Central high mounted stoplamp.
F16	20 A	Audio unit. Navigation unit.
F17	7.5 A	Instrument panel cluster. Auxiliary heater control module.
F18	10 A	Headlamp switch. Steering wheel module. Stoplamp switch.
F19	5 A	Front control/display interface module.
F20	5 A	Ignition passive anti-theft system.
F21	3 A	Spare.

Fuses

FUSE SPECIFICATION CHART - 3.5L ECOBOOST™/3.7L

Engine Compartment Fuse Box

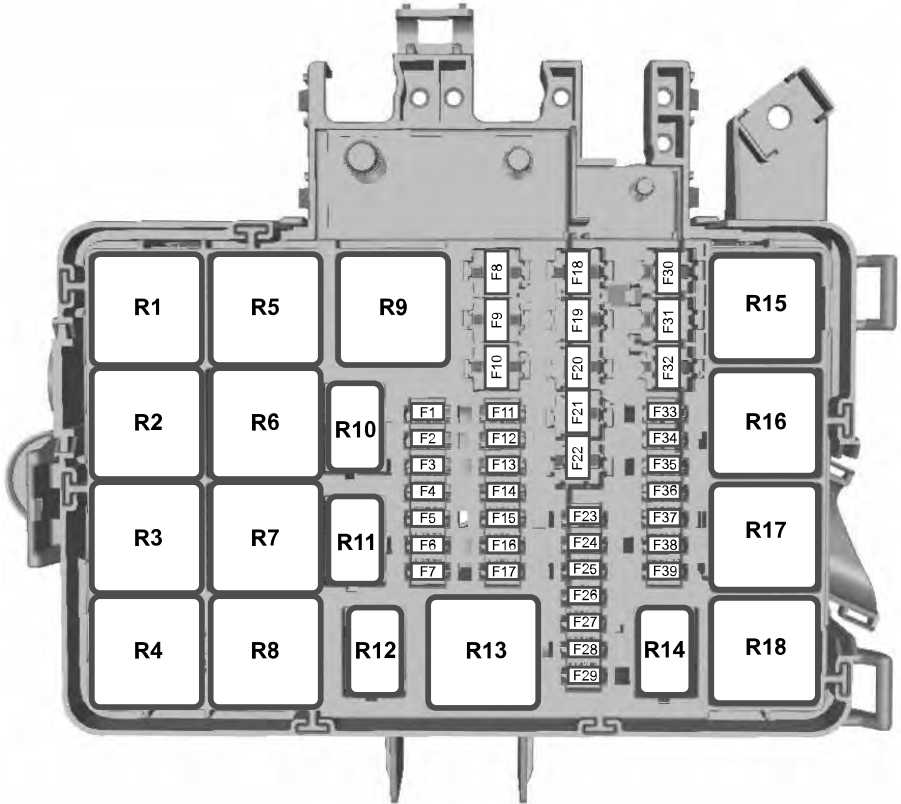

E148826

Fuse Number	Fuse Rating	Protected Component
F1	-	Not used.
F2	-	Not used.
F3	-	Not used.

Fuses

Fuse Number	Fuse Rating	Protected Component
F4	-	Not used.
F5	-	Not used.
F6	-	Not used.
F7	7.5 A	Automatic transmission module.
F8	30 A	Cooling fan.
F9	-	Not used.
F10	30 A	Power step. Heated seats.
F11	10 A	Air conditioning clutch.
F12	-	Not used.
F13	-	Not used.
F14	-	Not used.
F15	-	Not used.
F16	20 A	Fuel pump relay.
F17	-	Not used.
F18	30 A	Anti-lock brake system. Fuel pump relay.
F19	30 A	Starter motor solenoid.
F20	-	Not used.
F21	60 A	Ignition relay 3.
F22	40 A	Selective catalytic reduction system catalyst. Brake vacuum pump relay.
F23	10 A	Spare.
F24	-	Not used.
F25	10 A	Spare.
F26	20 A	Spare.
F27	-	Not used.
F28	-	Not used.

Fuses

Fuse Number	Fuse Rating	Protected Component
F29	3 A	Audio unit.
F30	40 A	Cooling fan.
F31	40 A	Cooling fan.
F32	30 A	Windshield wiper motor.
F33	-	Not used.
F34	-	Not used.
F35	20 A	Powertrain control module.
F36	20 A	Mass air flow sensor.
F37	-	Not used.
F38	20 A	Air conditioning clutch.
F39	7.5 A	Exhaust gas temperature sensor -3.7L. Fuel vaporizer system fuel pump -3.7L. Coolant bypass solenoid valve -3.7L. Low-speed cooling fan -3.7L. High-speed cooling fan -3.7L.
	10 A	Exhaust gas temperature sensor - 3.5L Ecoboost. Fuel vaporizer system fuel pump - 3.5L Ecoboost. Coolant bypass solenoid valve - 3.5L Ecoboost. Low-speed cooling fan - 3.5L Ecoboost. High-speed cooling fan - 3.5L Ecoboost.

Relay Number	Protected Component
R1	Ignition relay 3.
R2	Not used.
R3	Not used.
R4	Not used.
R5	Cooling fan.
R6	Windshield wiper on/off relay.
R7	Windshield wiper high/low speed relay.
R8	Brake vacuum pump.

Fuses

Relay Number	Protected Component
R9	Starter motor.
R10	Air conditioning clutch.
R11	Not used.
R12	Fuel injection pump.
R13	Not used.
R14	Not used.
R15	Low-speed and high-speed cooling fan relay.
R16	Not used.
R17	Powertrain control module.
R18	High-speed cooling fan.

Passenger Compartment Fuse Box

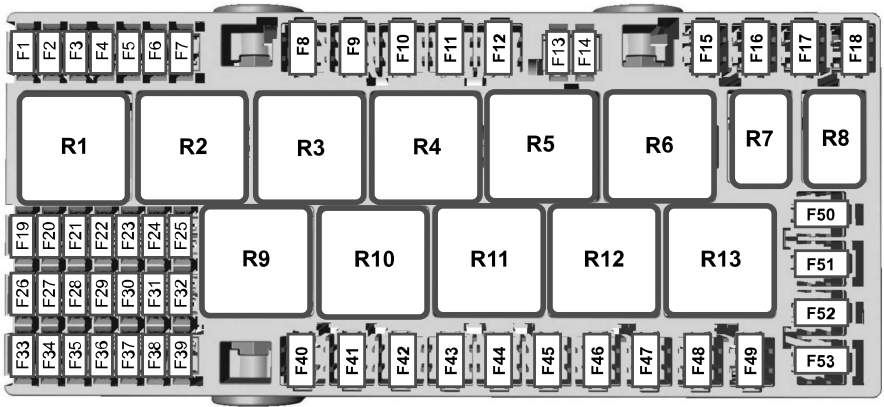

E148827

Fuses

Fuse Number	Fuse Rating	Protected Component
F1	10 A	Restraints control module.
F2	4 A	Anti-lock brake system with electronic stability control.
F3	7.5 A	Interior lighting. Power point relay control.
F4	10 A	Trailer tow reversing lamp relay.
F5	20 A	Modified vehicle connections.
F6	-	Not used.
F7	10 A	Battery saver.
F8	40 A	Direct current/alternating current inverter.
F9	30 A	Trailer brake control module.
F10	30 A	Driver power seat.
F11	30 A	Passenger power seat.
F12	30 A	Trailer lamps.
F13	25 A	Anti-lock brake system with electronic stability control.
F14	5 A	Powertrain control module.
F15	40 A	Powertrain control module relay.
F16	40 A	Body control module.
F17	40 A	Anti-lock brake system.
F18	40 A	Modified vehicle connections.
F19	5 A	Trailer module.
F20	5 A	Heated exterior mirror relay. Heated rear window. Direct current/alternating current inverter.
F21	10 A	Modified vehicle connections.
F22	-	Not used.
F23	7.5 A	Air conditioning control module.

Fuses

Fuse Number	Fuse Rating	Protected Component
F24	10 A	Modified vehicle connections.
F25	15 A	Body control module.
F26	10 A	Heated exterior mirrors.
F27	20 A	Heated rear window.
F28	20 A	Heated rear window.
F29	10 A	Rear parking aid camera. Lane keeping system. Interior rear view mirror.
F30	-	Not used.
F31	10 A	Trailer brake ignition feed.
F32	10 A	Interior lighting.
F33	10 A	Driver heated seat.
F34	10 A	Passenger heated seat.
F35	5 A	Exterior mirrors. Driver door window control switch.
F36	20 A	Horn.
F37	7.5 A	SYNC module. Global positioning system module.
F38	5 A	Blower motor relay. Horn relay. Windshield wiper relay.
F39	7.5 A	Remote keyless entry. Rear heating, ventilation and air conditioning. Trailer tow backup relay coil. Parking lamp.
F40	40 A	Front blower motor.
F41	40 A	Rear blower motor.
F42	40 A	Heated rear window.
F43	30 A	Trailer socket. Trailer tow module.
F44	60 A	Auxiliary power points.

Fuses

Fuse Number	Fuse Rating	Protected Component
F45	40 A	Trailer tow module.
F46	30 A	Power windows.
F47	20 A	Cigar lighter socket.
F48	20 A	Rear auxiliary power points.
F49	20 A	Front auxiliary power points.
F50	60 A	Ignition relay 1.
F51	60 A	Power step. Heated seats.
F52	40 A	Modified vehicle connections.
F53	40 A	Modified vehicle connections.

Relay Number	Protected Component
R1	Spare.
R2	Auxiliary power points.
R3	Trailer lamps.
R4	Not used.
R5	Power windows.
R6	Ignition relay 1.
R7	Horn.
R8	Trailer tow reversing lamp.
R9	Front blower motor.
R10	Rear blower motor.
R11	Heated rear window. Heated exterior mirrors.
R12	Heated seats.
R13	Modified vehicle connections.

Fuses

Body Control Module

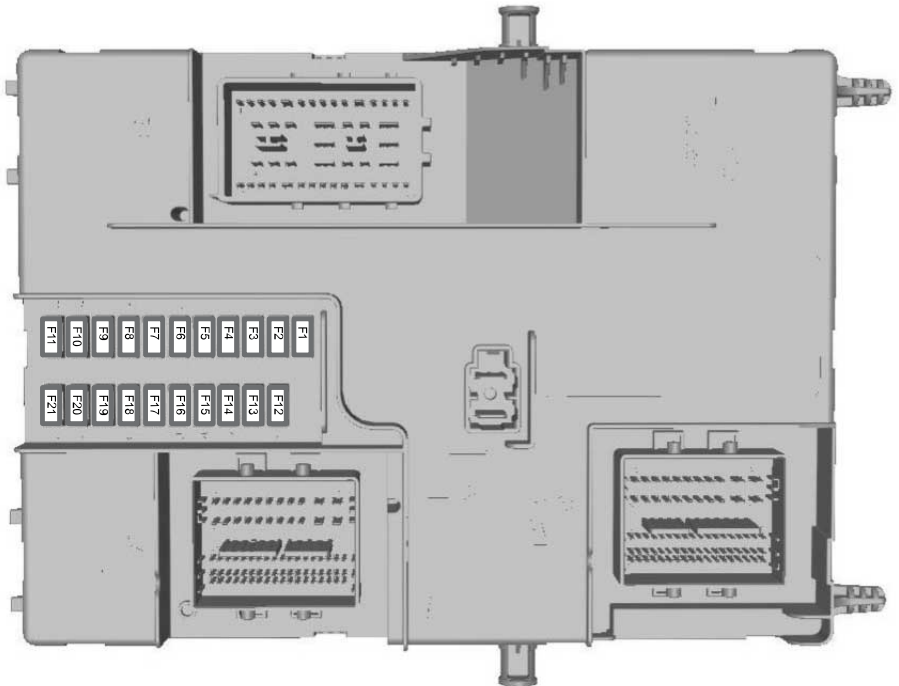

E148830

Fuse Number	Fuse Rating	Protected Component
F1	15 A	Central locking system.
F2	15 A	Central locking system.
F3	15 A	Ignition switch.
F4	5 A	Parking assist control module. Brake shift interlock.
F5	5 A	Rain sensor module.

Fuses

Fuse Number	Fuse Rating	Protected Component
F6	15 A	Windshield washer pump.
F7	7.5 A	Exterior mirrors.
F8	-	Not used.
F9	10 A	Right-hand high beam.
F10	10 A	Left-hand high beam.
F11	25 A	Right-hand exterior lamps. Left-hand headlamp.
F12	-	Not used.
F13	15 A	Secondary On-Board Diagnostic Control Module A. Battery saver.
F14	25 A	Direction indicators. Power windows. Heated windshield element.
F15	25 A	Left-hand exterior lamps. Right-hand headlamp. Central high mounted stoplamp.
F16	20 A	Audio unit. Navigation unit.
F17	7.5 A	Instrument panel cluster. Auxiliary heater control module.
F18	10 A	Headlamp switch. Steering wheel module. Stoplamp switch.
F19	5 A	Front control/display interface module.
F20	5 A	Ignition passive anti-theft system.
F21	3 A	Spare.

Fuses

CHANGING A FUSE

Fuses



WARNING: Always replace a fuse with one that has the specified amperage rating. Using a fuse with a higher amperage rating can cause severe wire damage and could start a fire.



E217331

If electrical components in the vehicle are not working, a fuse may have blown. Blown fuses are identified by a broken wire within the fuse. Check the appropriate fuses before replacing any electrical components.

Fuse Types

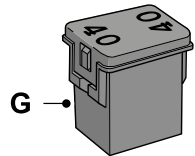
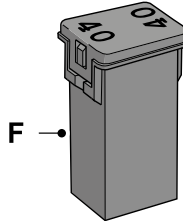
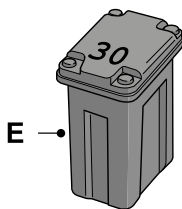
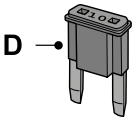
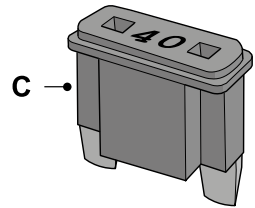
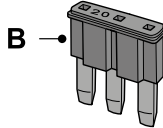
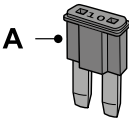

E207206

Callout	Fuse Type
A	Micro 2
B	Micro 3
C	Maxi
D	Mini

Fuses

Callout	Fuse Type
E	M Case
F	J Case
G	J Case Low Profile

Maintenance

GENERAL INFORMATION

Have your vehicle serviced regularly to help maintain its roadworthiness and resale value. There is a large network of authorized dealers that are there to help you with their professional servicing expertise. We believe that their specially trained technicians are best qualified to service your vehicle properly and expertly. They are supported by a wide range of highly specialized tools developed specifically for servicing your vehicle.

If your vehicle requires professional service, an authorized dealer can provide the necessary parts and service. Check your warranty information to find out which parts and services are covered.

Use only recommended fuels, lubricants, fluids and service parts conforming to specifications. Motorcraft® parts are designed and built to provide the best performance in your vehicle.

Precautions

- Do not work on a hot engine.
- Make sure that nothing gets caught in moving parts.
- Do not work on a vehicle with the engine running in an enclosed space, unless you are sure you have enough ventilation.
- Keep all open flames and other burning material (such as cigarettes) away from the battery and all fuel related parts.

Working with the Engine Off

1. Set the parking brake and shift the transmission to park (P).
2. Switch off the engine.
3. Block the wheels.

Working with the Engine On

 **WARNING:** To reduce the risk of vehicle damage and personal burn injuries, do not start your engine with the air cleaner removed and do not remove it while the engine is running.

1. Set the parking brake and shift the transmission to park (P).
2. Block the wheels.

OPENING AND CLOSING THE HOOD

Opening the Hood

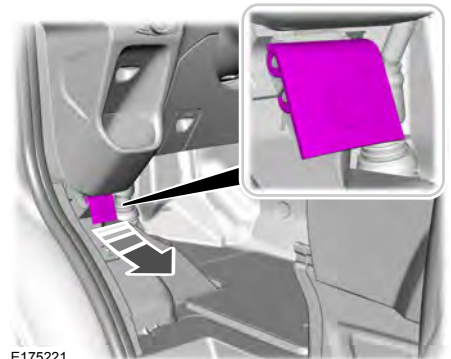

E175221

1. Pull the hood release lever.

Maintenance

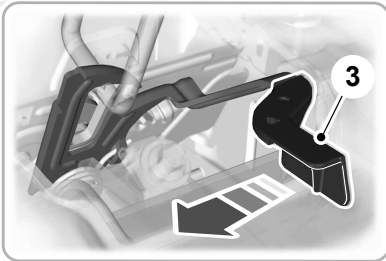
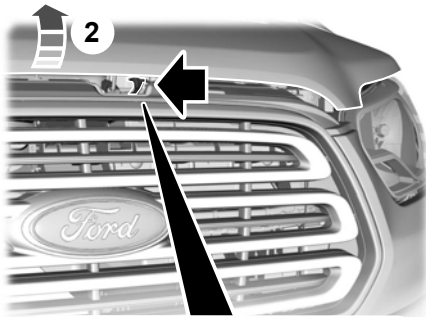

E217707

2. Slightly lift the hood.
3. Move the catch to the left.



E87786

4. Open the hood. Support the hood with the strut.

Closing the Hood

1. Remove the strut from the catch and secure it correctly in the clip.
2. Lower the hood and allow it to drop under its own weight for the last 8–12 in (20–30 cm).

Note: Make sure that the hood is correctly closed.

Maintenance

UNDER HOOD OVERVIEW - 3.2L POWER STROKE DIESEL

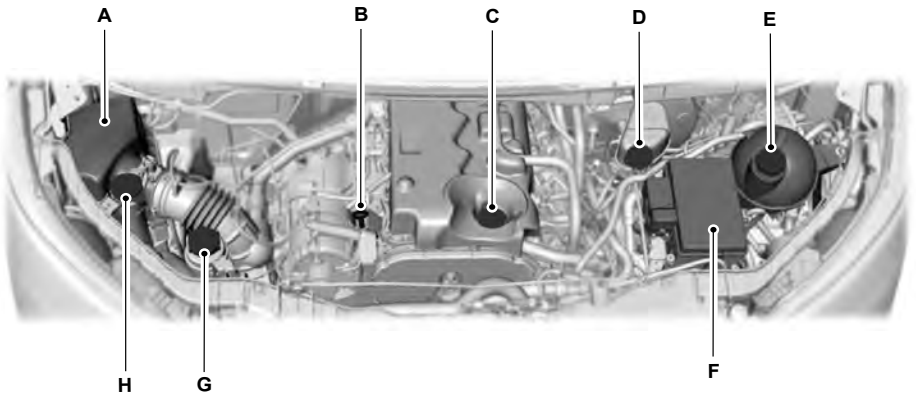

E174603

- A Air cleaner. See **Changing the Engine Air Filter** (page 255).
- B Engine oil dipstick*. See **Engine Oil Dipstick** (page 234).
- C Engine oil filler cap*. See **Engine Oil Check** (page 234).
- D Brake and clutch fluid reservoir*. See **Brake Fluid Check** (page 241).
- E Engine coolant reservoir*. See **Engine Coolant Check** (page 236).
- F Engine compartment fuse box. See **Fuses** (page 208).
- G Power steering fluid reservoir*. See **Power Steering Fluid Check** (page 241).
- H Washer fluid reservoir*. See **Washer Fluid Check** (page 242).

* The filler caps and the engine oil dipstick are colored for easy identification.

Maintenance

UNDER HOOD OVERVIEW - 3.5L ECOBOOST™

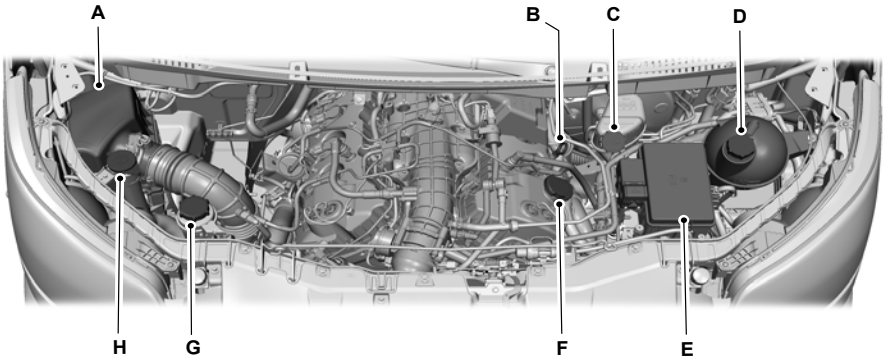

E174601

- A Air cleaner. See **Changing the Engine Air Filter** (page 256).
- B Engine oil dipstick*. See **Engine Oil Dipstick** (page 234).
- C Brake fluid reservoir*. See **Brake Fluid Check** (page 241).
- D Engine coolant reservoir*. See **Engine Coolant Check** (page 236).
- E Engine compartment fuse box. See **Fuses** (page 208).
- F Engine oil filler cap*. See **Engine Oil Check** (page 234).
- G Power steering fluid reservoir*. See **Power Steering Fluid Check** (page 241).
- H Washer fluid reservoir*. See **Washer Fluid Check** (page 242).

* The filler caps and the engine oil dipstick are colored for easy identification.

Maintenance

UNDER HOOD OVERVIEW - 3.7L

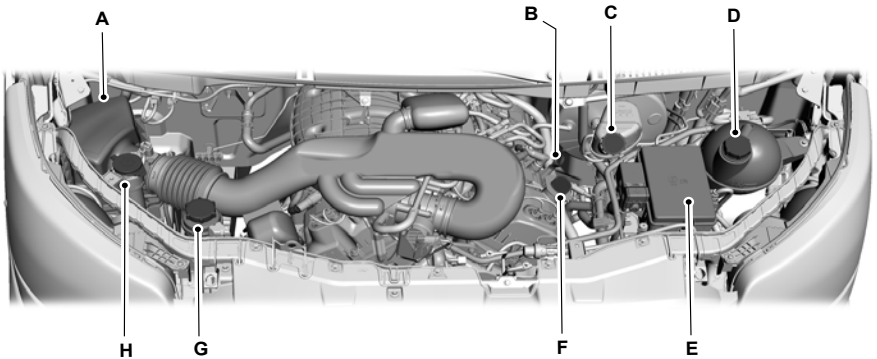

E174602

- A Air cleaner. See **Changing the Engine Air Filter** (page 257).
- B Engine oil dipstick*. See **Engine Oil Dipstick** (page 234).
- C Brake fluid reservoir*. See **Brake Fluid Check** (page 241).
- D Engine coolant reservoir*. See **Engine Coolant Check** (page 236).
- E Engine compartment fuse box. See **Fuses** (page 208).
- F Engine oil filler cap*. See **Engine Oil Check** (page 234).
- G Power steering fluid reservoir*. See **Power Steering Fluid Check** (page 241).
- H Washer fluid reservoir*. See **Washer Fluid Check** (page 242).

* The filler caps and the engine oil dipstick are colored for easy identification.

Maintenance

ENGINE OIL DIPSTICK - 3.2L POWER STROKE DIESEL

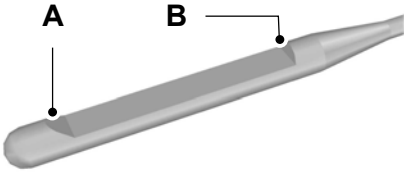

E71362

- A Minimum
- B Maximum

ENGINE OIL DIPSTICK - 3.7L

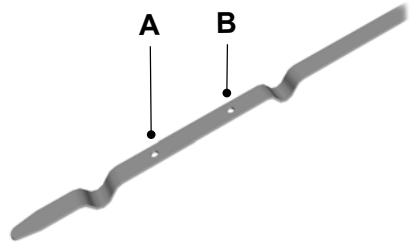

E174604

- A Minimum
- B Maximum

ENGINE OIL DIPSTICK - 3.5L ECOBOOST™

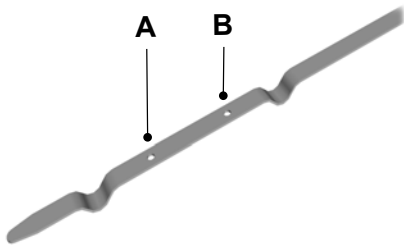

E174604

- A Minimum
- B Maximum

ENGINE OIL CHECK

1. Make sure that your vehicle is on level ground.
2. Switch off the engine and wait 10 minutes for the oil to drain into the oil pan.
3. Remove the dipstick and wipe it with a clean, lint free cloth. Replace the dipstick and remove it again to check the oil level.

If the oil level is at the minimum mark, add oil immediately. See **Capacities and Specifications** (page 307).

Note: Check the oil level before starting the engine.

Note: Make sure that the oil level is between the minimum and the maximum marks.

Note: Do not use oil additives or other engine treatments. Under certain conditions, they could damage the engine.

Note: The oil consumption of new engines reaches its normal level after approximately 3,000 mi (5,000 km).

Maintenance

Adding Engine Oil



WARNING: Only add oil when the engine is cold. If the engine is hot, wait 10 minutes for the engine to cool down.



WARNING: Do not remove the filler cap when the engine is running.

1. Remove the engine oil filler cap.
2. Add engine oil that meets Ford specifications. See **Capacities and Specifications** (page 307).
3. Replace the engine oil filler cap. Turn it until you feel a strong resistance.

Note: Do not add oil further than the maximum mark. Oil levels above the maximum mark may cause engine damage.

Note: Soak up any spillage with an absorbent cloth immediately.

CHANGING THE ENGINE OIL AND OIL FILTER



WARNING: Prolonged and repeated skin contact with mineral oil will result in the removal of natural fats from the skin, leading to dryness, irritation and dermatitis. In addition, used engine oil contains potentially harmful contaminants, which may cause skin cancer. If skin contact occurs, wash the area thoroughly with soap or skin cleanser and water immediately.



WARNING: Do not dispose of engine oils or oil filters in the household refuse or the public sewage system. Use an authorized waste disposal facility.



WARNING: Do not remove the oil pan drain plug when the engine is running.



WARNING: Do not remove the oil filter when the engine is running.

1. Remove the oil pan drain plug and wait for the oil to drain into a suitable container.
2. Renew the oil filter.
3. Reinstall the oil pan drain plug.
4. Refill the engine with new oil that meets Ford specifications. See **Capacities and Specifications** (page 307).

Note: Do not add oil further than the maximum mark. Oil levels above the maximum mark may cause engine damage.

Note: Soak up any spillage with an absorbent cloth immediately.

5. Reset the Intelligent Oil Life Monitor. See **Oil Change Indicator Reset** (page 236).

Engine Lubrication for Severe Service Operation

The following conditions define severe service operation. The Intelligent Oil Life Monitor will determine engine oil and oil filter change intervals.

- Frequent or extended idling.
- Frequent low-speed operation at 25 mph (40 km/h) or less.
- Frequent severe dust condition operation.
- Frequent off-road operation.
- Sustained ambient temperatures of -9°F (-23°C) or below.
- Sustained ambient temperatures of 100°F (38°C) or above.

Maintenance

- Sustained towing operation above 1,000 mi (1,600 km).
- Sustained high-speed driving at Gross Vehicle Weight Rating (maximum loaded weight for vehicle operation).
- Sustained use of diesel fuel other than ultra-low sulfur diesel (ULSD).

OIL CHANGE INDICATOR RESET

Only reset the system after changing the engine oil and oil filter.

Resetting the Oil Life Monitoring System

1. Switch the ignition on. Do not start the engine.
2. Fully press the accelerator and brake pedals at the same time.
3. Keep the accelerator and brake pedals fully pressed.
4. After three seconds, a message appears confirming that the reset is in progress.
5. After 25 seconds, a message appears confirming that the reset is complete.
6. Release the accelerator and brake pedals.
7. Switch the ignition off.

ENGINE COOLING FAN - DIESEL



WARNING: Keep your hands and clothing clear of the engine cooling fan.

Under certain conditions, the engine cooling fan may continue to run for several minutes after you switch your vehicle off. This could happen in low ambient temperatures and independent of the engine coolant temperature, for example short journeys or low coolant temperature. See **Diesel Particulate Filter** (page 145).

ENGINE COOLING FAN - E85/ GASOLINE



WARNING: Keep your hands and clothing clear of the engine cooling fan.

Under certain conditions, the engine cooling fan may continue to run for several minutes after you switch your vehicle off.

ENGINE COOLANT CHECK



WARNING: Do not remove the coolant reservoir cap when the engine is on or the cooling system is hot. Wait 10 minutes for the cooling system to cool down. Cover the coolant reservoir cap with a thick cloth to prevent the possibility of scalding and slowly remove the cap. Failure to follow this instruction could result in personal injury.



WARNING: Do not put coolant in the windshield washer reservoir. If sprayed on the windshield, coolant could make it difficult to see through the windshield.

Maintenance



WARNING: To reduce the risk of personal injury, make sure the engine is cool before unscrewing the coolant pressure relief cap. The cooling system is under pressure. Steam and hot liquid can come out forcefully when you loosen the cap slightly.



WARNING: Do not add coolant further than the **MAX** mark.

When the engine is cold, check the concentration and level of the coolant at the intervals listed in the scheduled maintenance information. See **Scheduled Maintenance** (page 464).

Note: Make sure that the coolant level is between the **MIN** and **MAX** marks on the coolant reservoir.

Note: Coolant expands when it is hot. The level may extend beyond the **MAX** mark.

Maintain coolant concentration within 48% to 50%, which equates to a freeze point between -29°F (-34°C) and -35°F (-37°C). Coolant concentration should be checked using a refractometer. We do not recommend the use of hydrometers or coolant test strips for measuring coolant concentration.

Adding Coolant



WARNING: Do not add engine coolant when the engine is hot. Failure to follow this instruction could result in personal injury.



WARNING: Do not remove the coolant reservoir cap when the engine is on or the cooling system is hot. Wait 10 minutes for the cooling system to cool down. Cover the coolant reservoir cap with a thick cloth to prevent the possibility of scalding and slowly remove the cap. Failure to follow this instruction could result in personal injury.



WARNING: Do not put coolant in the windshield washer reservoir. If sprayed on the windshield, coolant could make it difficult to see through the windshield.

Note: Do not use stop leak pellets, cooling system sealants, or non-specified additives as they can cause damage to the engine cooling or heating systems. Resulting component damage may not be covered by the vehicle Warranty.

Note: Automotive fluids are not interchangeable.

It is very important to use prediluted coolant approved to the correct specification in order to avoid plugging the small passageways in the engine cooling system. See **Capacities and Specifications** (page 307). Do not mix different colors or types of coolant in your vehicle. Mixing of engine coolants or using an incorrect coolant may harm the engine or cooling system components and may not be covered by the vehicle Warranty.

Note: If prediluted coolant is not available, use the approved concentrated coolant diluting it to 50/50 with distilled water. See **Capacities and Specifications** (page 307). Using water that has not been deionised may contribute to deposit formation, corrosion and plugging of the small cooling system passageways.

Maintenance

Note: *Coolants marketed for all makes and models may not be approved to our specifications and may cause damage to the cooling system. Resulting component damage may not be covered by the vehicle Warranty.*

If the coolant level is at or below the minimum mark, add prediluted coolant immediately.

To top up the coolant level do the following:

1. Unscrew the cap slowly. Any pressure escapes as you unscrew the cap.
2. Add prediluted coolant approved to the correct specification. See **Capacities and Specifications** (page 307).
3. Add enough prediluted coolant to reach the correct level.
4. Replace the coolant reservoir cap, turn it clockwise until you feel a strong resistance.
5. Check the coolant level in the coolant reservoir the next few times you drive your vehicle. If necessary, add enough prediluted engine coolant to bring the coolant level to the correct level.

If you have to add more than 1.1 qt (1 L) of engine coolant per month, have your vehicle checked as soon as possible. Operating an engine with a low level of coolant can result in engine overheating and possible engine damage.

In case of emergency, you can add a large amount of water without engine coolant in order to reach a vehicle service location. In this instance, qualified personnel:

1. Must drain the cooling system.
2. Chemically clean the coolant system.
3. Refill with engine coolant as soon as possible.

Water alone, without engine coolant, can cause engine damage from corrosion, overheating or freezing.

Do not use the following as a coolant substitute:

- Alcohol.
- Methanol.
- Brine.
- Any coolant mixed with alcohol or methanol antifreeze.

Alcohol and other liquids can cause engine damage from overheating or freezing.

Do not add extra inhibitors or additives to the coolant. These can be harmful and compromise the corrosion protection of the coolant.

Recycled Coolant

We do not recommend the use of recycled coolant as an approved recycling process is not yet available.

Note: *Dispose of used coolant in the appropriate manner.*

Follow your community's regulations and standards for recycling and disposing of automotive fluids.

Severe Climates

If you drive in extremely cold climates:

- It may be necessary to increase the coolant concentration above 50%.
- A coolant concentration of 60% provides improved freeze point protection. Coolant concentrations above 60% decrease the overheat protection characteristics of the coolant and may cause engine damage.

Maintenance

If you drive in extremely hot climates:

- You can decrease the coolant concentration to 40%.
- Coolant concentrations below 40% decrease the freeze and corrosion protection characteristics of the coolant and may cause engine damage.

Vehicles driven year-round in non-extreme climates should use prediluted coolant for optimum cooling system and engine protection.

Coolant Change

At specific mileage intervals, as listed in the scheduled maintenance information, the coolant should be changed. Add prediluted coolant approved to the correct specification. See **Capacities and Specifications** (page 307).

Fail-Safe Cooling

Fail-safe cooling allows you to temporarily drive your vehicle before any incremental component damage occurs. The fail-safe distance depends on ambient temperature, vehicle load and terrain.

How Fail-Safe Cooling Works



If the engine begins to overheat, the coolant temperature gauge moves toward the red zone:



A warning lamp illuminates and a message may appear in the information display.

If the engine reaches a preset over-temperature condition, the engine automatically switches to alternating cylinder operation. Each disabled cylinder acts as an air pump and cools the engine.

When this occurs, your vehicle still operates, however:

- Engine power is limited.
- The air conditioning system turns off.

Continued operation increases the engine temperature, causing the engine to completely shut down. Your steering and braking effort increases in this situation.

When the engine temperature cools, you can re-start the engine. Have your vehicle checked as soon as possible to minimize engine damage.

When Fail-Safe Mode Is Activated



WARNING: Fail-safe mode is for use during emergencies only. Operate your vehicle in fail-safe mode only as long as necessary to bring your vehicle to rest in a safe location and seek immediate repairs. When in fail-safe mode, your vehicle will have limited power, will not be able to maintain high-speed operation, and may completely shut down without warning, potentially losing engine power, power steering assist, and power brake assist, which may increase the possibility of a crash resulting in serious injury.



WARNING: Do not remove the coolant reservoir cap when the engine is on or the cooling system is hot. Wait 10 minutes for the cooling system to cool down. Cover the coolant reservoir cap with a thick cloth to prevent the possibility of scalding and slowly remove the cap. Failure to follow this instruction could result in personal injury.

Your vehicle has limited engine power when in the fail-safe mode, drive your vehicle with caution. Your vehicle does not maintain high-speed operation and the engine may operate poorly.

Maintenance

Remember that the engine is capable of automatically shutting down to prevent engine damage. In this situation:

1. Pull off the road as soon as safely possible and switch the engine off.
2. If you are a member of a roadside assistance program, we recommend that you contact your roadside assistance service provider.
3. If this is not possible, wait for a short period of time for the engine to cool.
4. Check the coolant level. If the coolant level is at or below the minimum mark, add prediluted coolant immediately.
5. When the engine temperature cools, you can re-start the engine. Have your vehicle checked as soon as possible to minimize engine damage.

Note: *Driving your vehicle without repair increases the chance of engine damage.*

Engine Coolant Temperature Management (If Equipped)



WARNING: To reduce the risk of crash and injury, be prepared that the vehicle speed may reduce and the vehicle may not be able to accelerate with full power until the coolant temperature reduces.

If you tow a trailer with your vehicle, the engine may temporarily reach a higher temperature during severe operating conditions, for example ascending a long or steep grade in high ambient temperatures.

At this time, you may notice the coolant temperature gauge moves toward the red zone and a message may appear in the information display.

You may notice a reduction in vehicle speed caused by reduced engine power in order to manage the engine coolant temperature. Your vehicle may enter this mode if certain high-temperature and high-load conditions take place. The amount of speed reduction depends on vehicle loading, grade and ambient temperature. If this occurs, there is no need to stop your vehicle. You can continue to drive.

The air conditioning may automatically turn on and off during severe operating conditions to protect the engine from overheating. When the coolant temperature decreases to the normal operating temperature, the air conditioning turns on.

If the coolant temperature gauge moves fully into the red zone, or if the coolant temperature warning or service engine soon messages appear in your information display, do the following:

1. Stop your vehicle as soon as it is safe to do so. Fully apply the parking brake, shift into park (P) or neutral (N).
2. Leave the engine running until the coolant temperature gauge needle returns to the normal position. If the temperature does not drop after several minutes, follow the remaining steps.
3. Switch the engine off and wait for it to cool. Check the coolant level.
4. If the coolant level is at or below the minimum mark, add prediluted coolant immediately.
5. If the coolant level is normal, restart the engine and continue.

Maintenance

AUTOMATIC TRANSMISSION FLUID CHECK

The automatic transmission does not have a transmission fluid dipstick.

Have an authorized dealer check and change the transmission fluid at the correct service interval. See **Scheduled Maintenance** (page 464). Your transmission does not consume fluid. However, if the transmission slips, shifts slowly or if you notice a sign of leaking fluid, contact an authorized dealer.

Do not use supplemental transmission fluid additives, treatments or cleaning agents. The use of these materials may affect transmission operation and result in damage to internal transmission components.

BRAKE FLUID CHECK



WARNING: Do not use any fluid other than the recommended brake fluid as this will reduce brake efficiency. Use of incorrect fluid could result in the loss of vehicle control, serious personal injury or death.



WARNING: Only use brake fluid from a sealed container. Contamination with dirt, water, petroleum products or other materials may result in brake system damage or failure. Failure to adhere to this warning could result in the loss of vehicle control, serious personal injury or death.



WARNING: Do not allow the fluid to touch your skin or eyes. If this happens, rinse the affected areas immediately with plenty of water and contact your physician.



WARNING: A fluid level between the **MAX** and **MIN** lines is within the normal operating range and there is no need to add fluid. A fluid level not in the normal operating range could compromise the performance of the system. Have your vehicle checked immediately.



E170684

To avoid fluid contamination, the reservoir cap must remain in place and fully tight, unless you are adding fluid.

Only use fluid that meets Ford specifications.

POWER STEERING FLUID CHECK



WARNING: Do not allow the fluid to touch your skin or eyes. This could cause serious personal injury. Rinse the affected areas immediately with plenty of water and consult a physician.

Maintenance

If the power steering fluid level is not between the **MAX** and **MIN** marks, add power steering fluid that meets the correct specification. See **Capacities and Specifications** (page 321).

Adding Power Steering Fluid

1. Remove the filler cap.
2. Add power steering fluid to the **MAX** mark. Do not overfill.
3. Replace the filler cap. Turn it until you feel a strong resistance.

WASHER FLUID CHECK

When adding fluid, use a mixture of washer fluid and water to help prevent freezing in cold weather and improve the cleaning capability. For information on fluid dilution, refer to the product instructions. We recommend that you only use high quality washer fluid.

Note: *The reservoir supplies the front and rear washer systems.*

DRAINING THE FUEL FILTER WATER TRAP - 3.2L POWER STROKE DIESEL



WARNING: Do not dispose of fuel in the household refuse or the public sewage system. Use an authorized waste disposal facility.

Your vehicle is fitted with a diesel fuel conditioner module located behind the fuel tank.



A warning lamp will illuminate and a message will be displayed when approximately 3.38 fl oz (100 ml) of water accumulates in the module. If you allow the water level to exceed this level, the water may pass through to the engine and may cause fuel injection equipment damage.

Note: *To drain the fuel filter water trap, access the underside of your vehicle.*

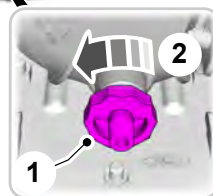
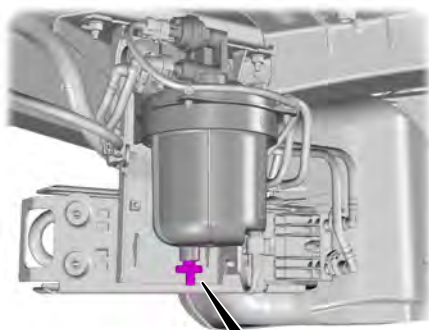

E177378

1. Attach a tube to the drain plug and place the end of the tube into a suitable container.
2. Loosen the drain plug by turning counterclockwise one to two turns and allow the water to drain.

Note: *The drain plug will rise when opening.*

3. Tighten the drain plug by turning clockwise until you feel a strong resistance.

Note: *The drain plug will lower when closing.*

Maintenance

When you start the engine the water in fuel indicator lamp turns off after a short period of time.

Changing the Fuel Filter

Note: To drain the fuel filter, access the underside of your vehicle.

1. Drain the fuel from the filter housing.

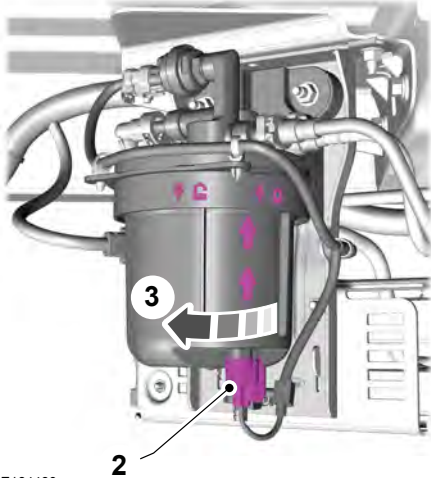

E184430

2. Disconnect the electrical connector.
3. Rotate the housing counterclockwise to the unlock position.
4. Remove the housing and filter.
5. Replace the housing seal and lubricate.
6. Insert the new filter into housing and refit aligning the arrows in the unlock position.

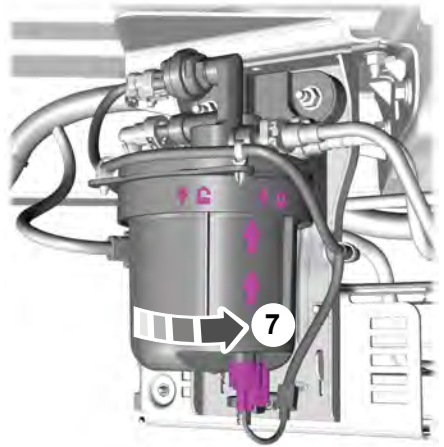

E184789

7. Rotate the housing clockwise aligning the arrows in the lock position.
8. Purge air from the system.

Note: Only add fuel that meets the Ford specification. See **Fuel and Refueling** (page 130).

Purging Air From the Fuel System

1. Switch the ignition on for at least 30 seconds then switch the ignition off.
2. Repeat this process six times.
3. Start the engine and maintain engine speed at 1500 RPM.
4. Wait 20 seconds.
5. If the engine is running smoothly, reduce the engine speed to idle.
6. Check for leaks.
7. Switch the ignition off.

Maintenance

If the Engine Does Not Start or Runs Rough

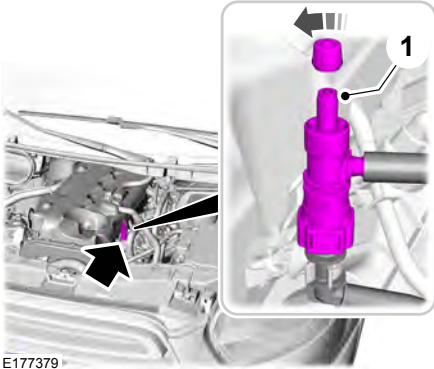

E177379

1. Remove the Schrader valve cap.
2. Attach suitable tool with a tube to the Schrader valve and place the end of the tube into a suitable container.
3. Open the Schrader valve.
4. Switch the ignition on until a steady stream of fuel can be seen coming out of the tube.
5. Switch the ignition off.
6. Remove the tool from the Schrader valve.
7. Refit the Schrader valve cap.
8. Switch the ignition on for at least 30 seconds then switch the ignition off.
9. Repeat this process three times.
10. Start the engine.

FUEL FILTER - GASOLINE

Your vehicle is equipped with a lifetime fuel filter that is integrated with the fuel tank. Regular maintenance or replacement is not needed.

CHANGING THE 12V BATTERY

The battery is under the driver seat.

Note: If you have power seats and the battery has no charge, jump-start your vehicle to move the seat. See **Jump Starting the Vehicle** (page 196).

Removing the Battery

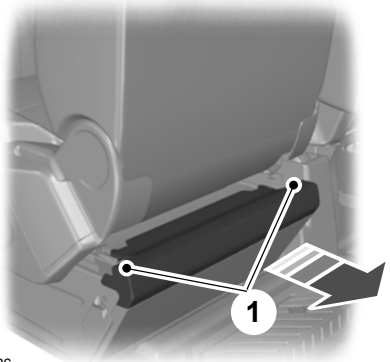

E152526

1. Fully raise the driver seat and move it fully forward. Pull the tabs upward and remove the cover.

Note: Your vehicle may not have this cover.

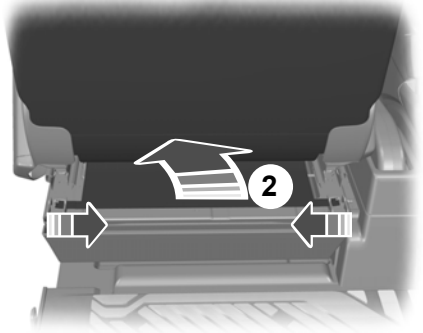

E152529

Maintenance

- Unhook the cover and tuck it under the seat.

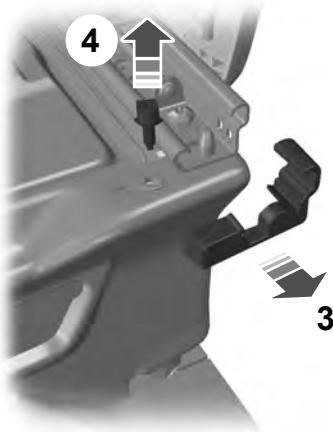

E146781

- Remove both seat track end caps.

Note: Your vehicle may not have these end caps.

- Remove both seat adjustment end stop bolts at the front of the seat.

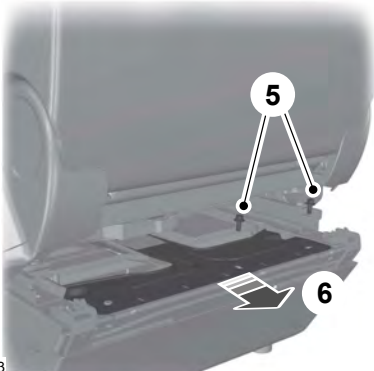

E146773

- Remove the battery clamp and cover bolts.
- Remove the battery clamp and cover.

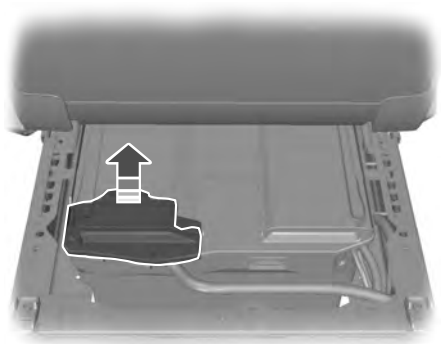

E162774

- Remove the battery terminal cover and remove the negative (-) terminal.

Note: Single batteries could be mounted the opposite way around in the battery tray. The negative terminal is toward the rear of your vehicle.

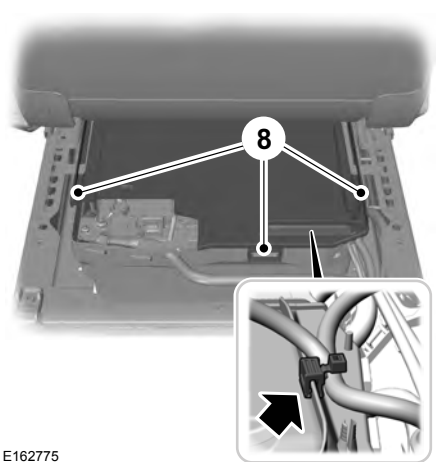

E162775

- Release the retaining clips and remove the cover.
- Remove the cable securing clips from the cover.

Maintenance

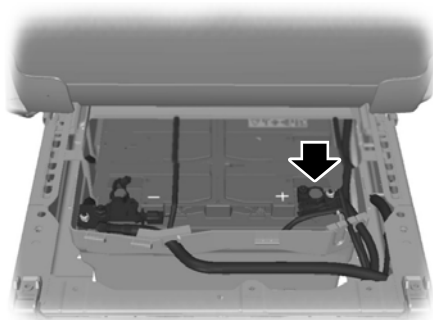

E162776

10. Remove the positive (+) terminal and remove the battery.

Note: Batteries are heavy.

11. Move the second battery toward the rear of your vehicle and remove the negative (-) terminal.
12. Remove the positive (+) terminal and remove the battery.

Replacing the Battery



WARNING: Make sure that you securely fasten the seat runner bolts before installing the covers.

You must replace the battery with one of exactly the same specification.

To install, reverse the removal procedure.

Note: Make sure that you correctly install the battery terminal covers, battery cover and battery cable clips.

CHECKING THE WIPER BLADES



E142463

Run the tip of your fingers over the edge of the blade to check for roughness.

Clean the wiper blades with washer fluid or water applied with a soft sponge or cloth.

CHANGING THE FRONT WIPER BLADES

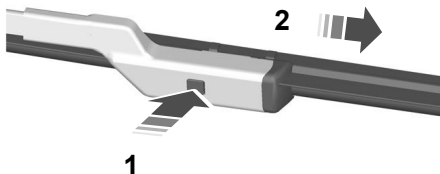

E72899

1. Lift the wiper arm. Press the wiper blade locking button.

Note: Do not hold the wiper blade when lifting the wiper arm.

2. Remove the wiper blade.

Note: Make sure that the wiper arm does not spring back against the glass when the wiper blade is not attached.

3. To install, reverse the removal procedure.

Note: Make sure that the wiper blade locks into place.

Maintenance

ADJUSTING THE HEADLAMPS

Vertical Aim Adjustment

If your vehicle has been involved in a crash, have the aim of the headlamp beam checked by an authorized dealer.

Headlamp Aiming Target

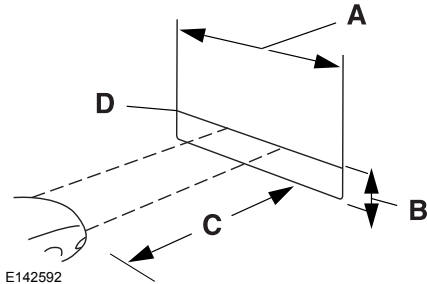

- A 8 ft (2.4 m)
- B Ground to the center of the headlamp low beam bulb
- C 25 ft (7.6 m)
- D Horizontal reference line

Vertical Aim Adjustment Procedure

1. Park your vehicle on level ground approximately 25 ft (7.6 m) from a wall or screen.
2. Measure the distance from the ground to the center of the headlamp low beam bulb and mark an 8 ft (2.4 m) long horizontal reference line on the wall or screen at this height.

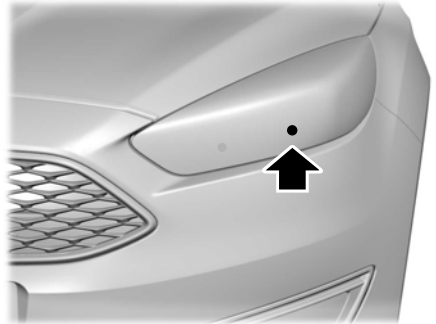

E199411

Note: There may be an identifying mark on the lens to help you locate the center of the bulb.

Note: To see a clearer light pattern while adjusting one headlamp, you may want to block the light from the other headlamp.

3. Switch on the low beam headlamps and open the hood.

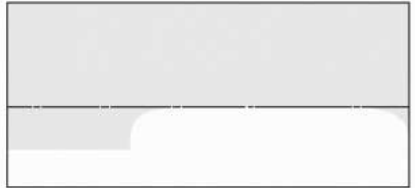

E142465

4. On the wall or screen you will observe a flat zone of high intensity light located at the top of the beam pattern. If the top edge of the flat zone of high intensity light is not on the horizontal reference line, adjust the aim of the headlamp beam.

Maintenance

REMOVING A HEADLAMP



WARNING: Switch all of the lamps and the ignition off. Failure to follow this warning could result in serious personal injury.

1. Open the hood. See **Opening and Closing the Hood** (page 229).

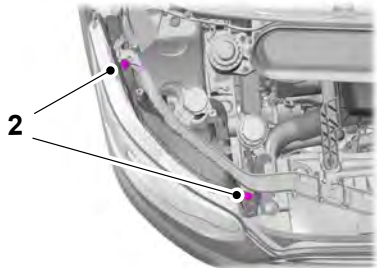

E169198

2. Remove the screws.

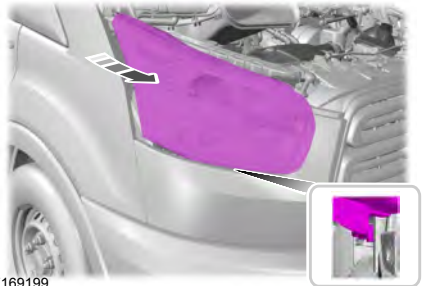

E169199

3. Pull the headlamp toward the front of your vehicle to disengage it from its locating points and then lift the headlamp up.

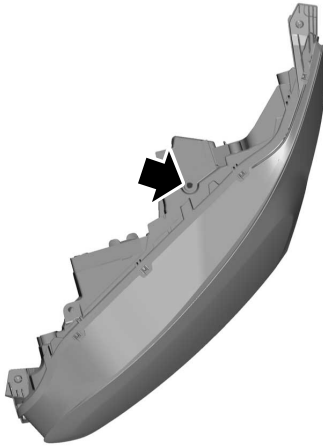

E164485

5. Locate the vertical adjuster on each headlamp. Use a suitable tool, for example a screwdriver or hexagonal socket, to turn the adjuster clockwise or counterclockwise to adjust the vertical aim of the headlamp. The horizontal edge of the brighter light should touch the horizontal reference line.
6. Close the hood and switch off the lamps.

Horizontal Aim Adjustment

The horizontal aim of the headlamp beam on your vehicle is not adjustable.

Maintenance

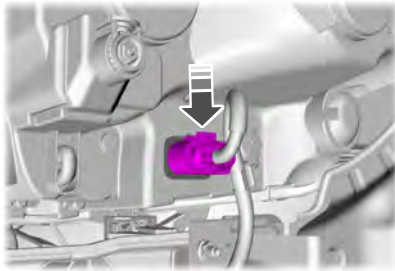

E169200

4. Disconnect the electrical connectors.

Note: When you install the headlamp, make sure that you correctly attach the electrical connector.

Note: When you install the headlamp, make sure that you correctly engage its locating points.

CHANGING A BULB



WARNING: Switch all of the lamps and the ignition off. Failure to follow this warning could result in serious personal injury.



WARNING: Bulbs become hot when in use. Let them cool down before you remove them.

Use the correct specification bulb. See **Bulb Specification Chart** (page 254).

The following instructions describe how to remove the bulbs. Install in the reverse order unless otherwise stated.

Note: LED lamps are not serviceable. See an authorized dealer.

Headlamp

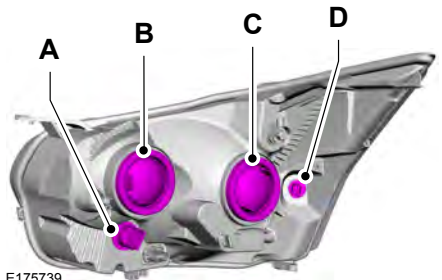

E175739

- A Parking lamp and direction indicator lamp.
- B Headlamp high beam.
- C Headlamp low beam and daytime running lamp.
- D Side marker lamp.

Note: You may have to remove a cover to gain access to the bulb.

Side Marker Lamp

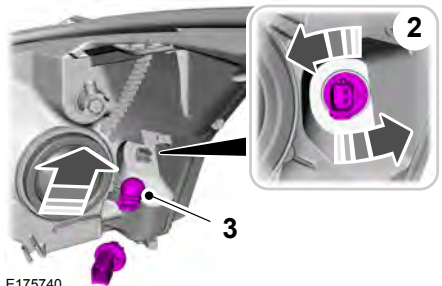

E175740

1. Remove the headlamp. See **Removing a Headlamp** (page 248).
2. Turn the bulb holder counterclockwise and remove it.
3. Remove the bulb by pulling it straight out.

Maintenance

Parking Lamp and Direction Indicator Lamp



E175741

1. Remove the headlamp. See **Removing a Headlamp** (page 248).
2. Turn the bulb holder counterclockwise and remove it.
3. Remove the bulb by pulling it straight out.

Headlamp Low Beam and Daytime Running Lamp

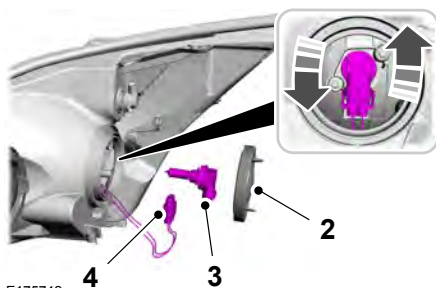

E175742

1. Remove the headlamp. See **Removing a Headlamp** (page 248).
2. Remove the cover.
3. Turn the bulb counterclockwise and remove it.
4. Disconnect the electrical connector.

Note: Do not touch the bulb glass.

Note: You cannot separate the bulb from the bulb holder.

Headlamp High Beam

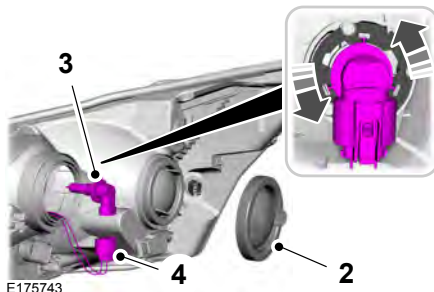

E175743

1. Remove the headlamp. See **Removing a Headlamp** (page 248).
2. Remove the cover.
3. Turn the bulb counterclockwise and remove it.
4. Disconnect the electrical connector.

Note: Do not touch the bulb glass.

Note: You cannot separate the bulb from the bulb holder.

Maintenance

Front Clearance Lamp (If Equipped)

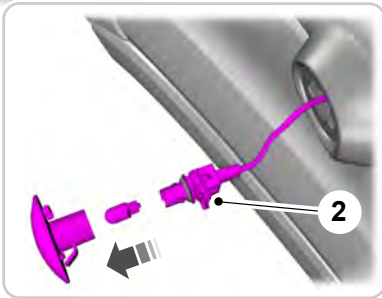
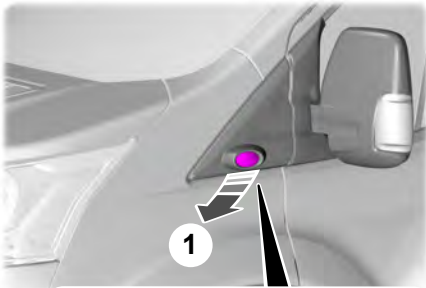

E181397

1. Carefully remove the lamp.
2. Turn the bulb holder counterclockwise and remove it.
3. Remove the bulb by pulling it straight out.

Side Direction Indicator (If Equipped)

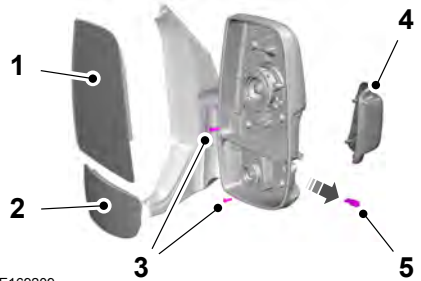

E169209

1. Remove the large mirror glass. Tilt the mirror glass fully up, pull the mirror glass toward you from the bottom.
2. Remove the small mirror glass. Tilt the mirror glass fully down, pull the mirror glass toward you from the top.
3. Remove the screws.
4. Remove the lamp lens.
5. Remove the bulb.

Rear Lamps

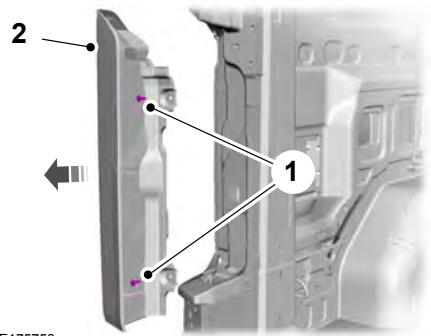

E175758

1. Remove the screws.
2. Remove the lamp.

Maintenance



E175745

3. Turn the bulb holder counterclockwise and remove it.

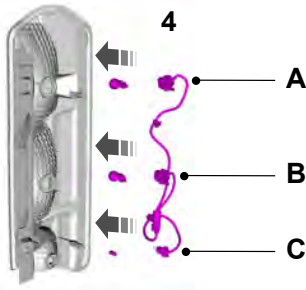

E175746

- A Tail and brake lamp.
- B Reversing lamp.
- C Rear clearance lamp.

4. Remove the bulb by pulling it straight out.

Central High Mounted Brake Lamp

This is not a serviceable item, see an authorized dealer if it fails.

License Plate Lamp

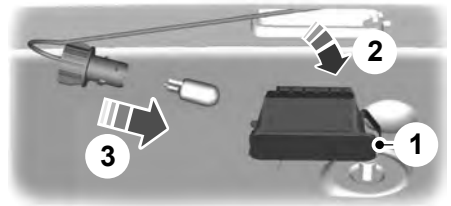

E72789

1. Carefully release the spring clip.
2. Remove the lamp.
3. Turn the bulb holder counterclockwise and remove it. Pull the bulb straight out.

Interior Lamp

Vehicles with Interior Sensors



E154370

1. Carefully remove the lens.
2. Remove the bulb.

Maintenance

Reading Lamps

Vehicles with Interior Sensors

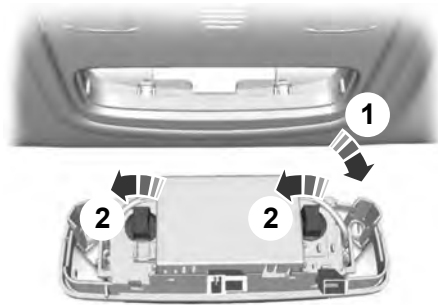

E72786

1. Carefully remove the lamp.
2. Turn the bulb holder counterclockwise and remove it.



E73939

3. Remove the bulb.

Vehicles without Interior Sensors

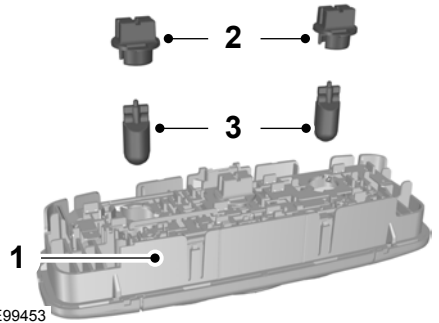

E99453

1. Carefully remove the lamp.
2. Turn the bulb holder counterclockwise and remove it.
3. Remove the bulb.

Sun Visor Mirror Lamp

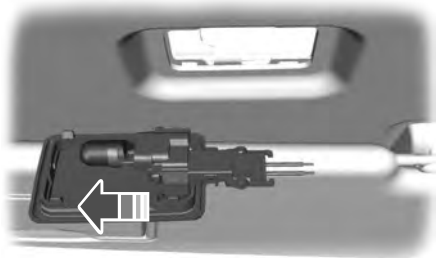

E72785

1. Carefully remove the lamp.
2. Remove the bulb.

Maintenance

BULB SPECIFICATION CHART

Exterior Lamps

Lamp	Specification	Power (Watt)
Front side marker lamp.	168	5
Front I.D. lamp.	W5W	5
Headlamp low beam and Daytime running lamp.	H11	55
Headlamp high beam.	9005	60
Front direction indicator.	3457NAK	21
Side direction indicator.	W5W	5
Front clearance lamp (Exterior mirror).	W5W	5
Brake, rear and direction indicator lamp.	3057K	26/6
Rear clearance lamp.	168	5
Reversing lamp.	3057K	26
License plate lamp.	W5W	5

Note: If your vehicle is fitted with LED lamps these are not serviceable items, see an authorized dealer if they fail.

Interior Lamps

Lamp	Specification	Power (watt)
Front interior lamp.	W6W	6
Front interior lamp. Vehicles with category 1 alarm.	Festoon	6
Map lamp.	W6W	6
Side door entrance lamp.	211 Festoon	10
Luggage compartment lamp.	211 Festoon	10

Note: If your vehicle is fitted with LED lamps these are not serviceable items, see an authorized dealer if they fail.

Maintenance

CHANGING THE ENGINE AIR FILTER - 3.2L POWER STROKE DIESEL



WARNING: To reduce the risk of vehicle damage and personal burn injuries, do not start your engine with the air cleaner removed and do not remove it while the engine is running.

Note: Failure to use the correct air filter element may result in severe engine damage. The vehicle warranty may be void for any damage to the engine if the correct air filter element is not used.

Note: After operating the vehicle up to 200 mi (320 km) in heavy snowfall, we recommend that you open the hood at the earliest opportunity and clear the snow and ice from air filter housing. Do not remove the foam filter.



The foam filter must be in place at all times.

Only use the specified air filter. See **Capacities and Specifications** (page 307).

Change the air filter element and foam filter at the proper interval. See **Scheduled Maintenance** (page 464).

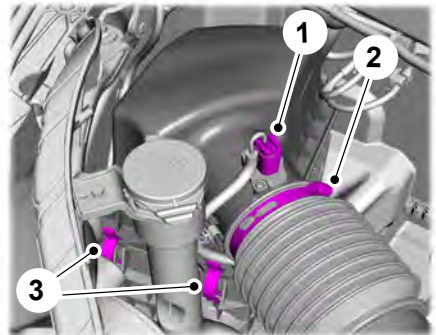

E174609

1. Disconnect the mass air flow sensor electrical connector and cable from the air filter cover.
2. Clean the area around the air tube to air filter cover connection to prevent debris from entering the system and then loosen the bolt on the air tube clamp so the clamp is no longer snug to the air tube. It is not necessary to completely remove the clamp. Pull the air tube off from the air filter cover.
3. Release the clamps that secures the air filter cover to the air filter housing.

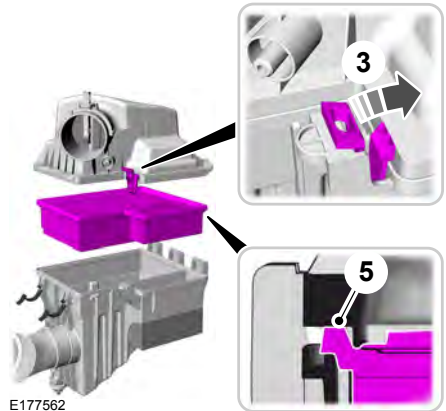

E177562

Maintenance

- Carefully lift the air filter housing cover. Remove the air filter element from the air filter housing.
- Install a new air filter element. Make sure that the groove seal on the pleated paper filter traps both sides of the vertical partition of the air box.
- Replace the air filter housing. Engage the clamps that secure the air filter housing cover to the air filter housing. Be careful not to crimp the filter element edges between the air filter housing and cover. Make sure that the tabs on the edge are correctly aligned into the slots.
- Slip the air tube onto the air filter cover and snugly tighten the bolt on the air tube clamp, but do not overtighten.
- Reconnect the mass air flow sensor electrical connector to the outlet tube. Make sure the locking tab on the connector is in the locked position.

CHANGING THE ENGINE AIR FILTER - 3.5L ECOBOOST™



WARNING: To reduce the risk of vehicle damage and personal burn injuries, do not start your engine with the air cleaner removed and do not remove it while the engine is running.

Note: Failure to use the correct air filter element may result in severe engine damage. The vehicle Warranty may be void for any damage to the engine if the correct air filter element is not used.

Only use the specified air filter. See **Capacities and Specifications** (page 307).

Change the air filter element at the proper interval. See **Scheduled Maintenance** (page 464).

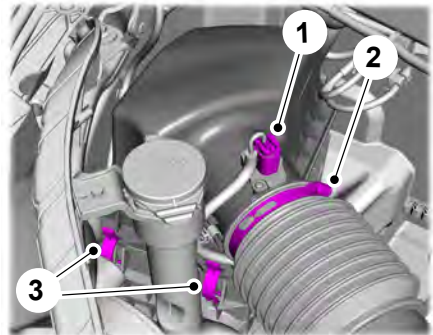

E174607

- Disconnect the intake air temperature sensor electrical connector and cable from the air filter cover.
- Clean the area around the air tube to air filter cover connection to prevent debris from entering the system and then loosen the bolt on the air tube clamp so the clamp is no longer snug to the air tube. It is not necessary to completely remove the clamp. Pull the air tube off from the air filter cover.
- Release the clamps that secure the air filter cover to the air filter housing.

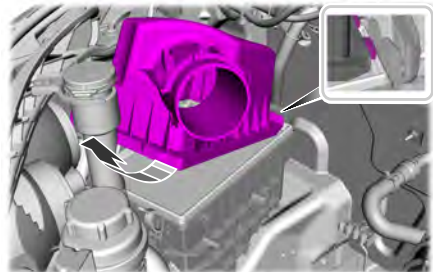

E174669

- Carefully lift the air filter housing cover. Remove the air filter element from the air filter housing.
- Install a new air filter element.

Maintenance

6. Replace the air filter housing cover. Engage the clamps that secure the air filter housing cover to the air filter housing. Be careful not to crimp the filter element edges between the air filter housing and cover. Make sure that the tabs on the edge are correctly aligned into the slots.
7. Slip the air tube onto the air filter cover and snugly tighten the bolt on the air tube clamp, but do not overtighten.
8. Reconnect the intake air temperature sensor electrical connector to the outlet tube. Make sure the locking tab on the connector is in the locked position.

CHANGING THE ENGINE AIR FILTER - 3.7L



WARNING: To reduce the risk of vehicle damage and personal burn injuries, do not start your engine with the air cleaner removed and do not remove it while the engine is running.

Note: Failure to use the correct air filter element may result in severe engine damage. The vehicle Warranty may be void for any damage to the engine if the correct air filter element is not used.

Only use the specified air filter. See **Capacities and Specifications** (page 307).

Change the air filter element at the proper interval. See **Scheduled Maintenance** (page 464).

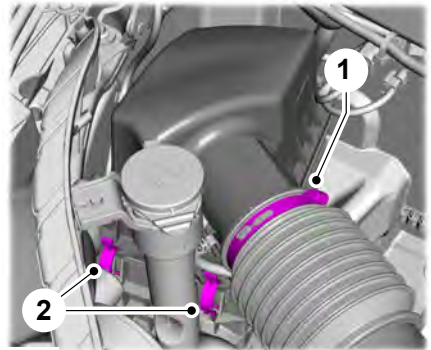

E174608

1. Clean the area around the air tube to air filter cover connection to prevent debris from entering the system and then loosen the bolt on the air tube clamp so the clamp is no longer snug to the air tube. It is not necessary to completely remove the clamp. Pull the air tube off from the air filter cover.
2. Release the clamps that secure the air filter cover to the air filter housing.

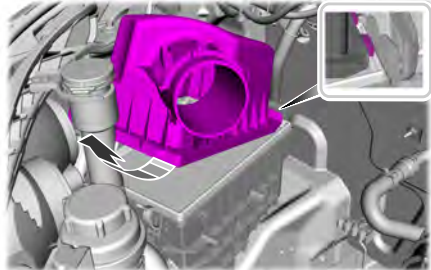

E174669

3. Carefully lift the air filter housing cover. Remove the air filter element from the air filter housing.
4. Install a new air filter element.

Maintenance

5. Replace the air filter housing cover. Engage the clamps that secure the air filter housing cover to the air filter housing. Be careful not to crimp the filter element edges between the air filter housing and cover. Make sure that the tabs on the edge are correctly aligned into the slots.
6. Slip the air tube onto the air filter cover and snugly tighten the bolt on the air tube clamp, but do not overtighten.

DRIVE BELT ROUTING - 3.2L POWER STROKE DIESEL

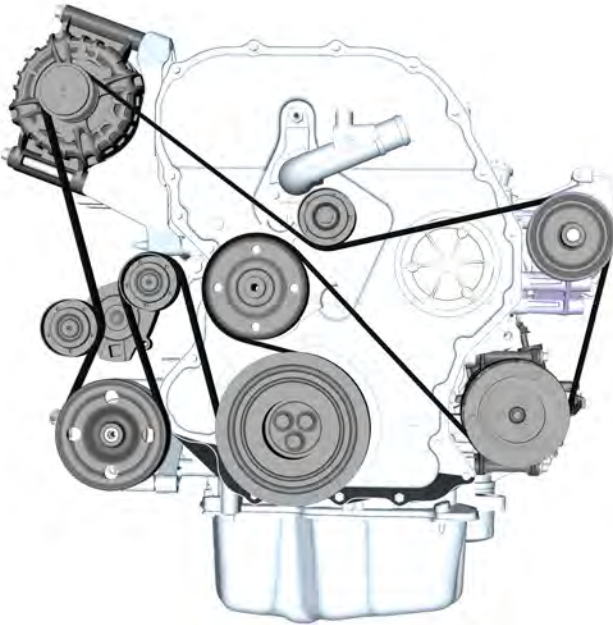

E251183

Maintenance

DRIVE BELT ROUTING - 3.5L ECOBOOST™/3.7L

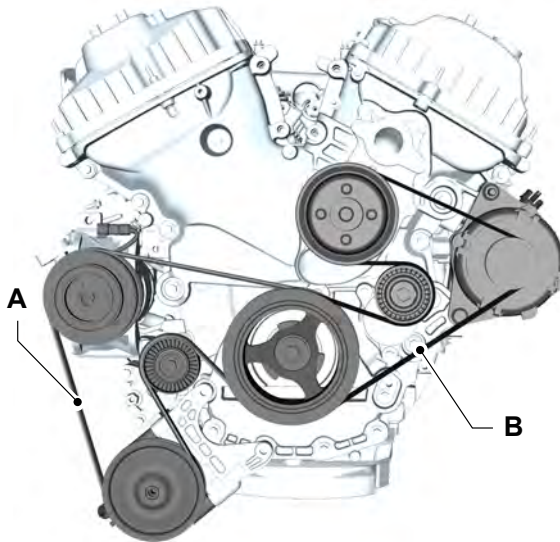

E251184

- A Drives the air conditioning compressor and has one idler pulley.
- B Drives the water pump and the alternator and has one idler pulley.

Vehicle Care

CLEANING PRODUCTS

For best results, use the following products or products of equivalent quality:

Materials

Name	Specification
Motorcraft® Bug and Tar Remover (U.S.) Motorcraft® Bug and Tar Remover / Dissolvant de goudron et éliminateur d'insectes Motorcraft® (Canada) ZC-42 (U.S. & Canada)	-
Motorcraft® Custom Bright Metal Cleaner (U.S.) Motorcraft® Custom Bright Metal Cleaner / Nettoyant pour métal brillant Motorcraft® (Canada) ZC-15 (U.S. & Canada)	ESR-M5B194-B
Motorcraft® Detail Wash (U.S.) Motorcraft® Detail Wash / Shampooing superfin Motorcraft® (Canada) ZC-3-A (U.S. & Canada)	ESR-M14P4-A
Motorcraft® Engine Shampoo and Degreaser (U.S.) (Canada) ZC-20 (U.S.)	ESR-M14P3-A
(U.S.) Motorcraft® Engine Shampoo / Shampooing pour moteur Motorcraft® (Canada) CXC-66-A (Canada)	-
(U.S.) Motorcraft® Multi-Purpose Cleaner / Nettoyant multi-usage Motorcraft® (Canada) CXC-101 (Canada)	-
Motorcraft® Premium Windshield Wash Concentrate with Bitterant (U.S.) Motorcraft® Premium Quality Windshield Washer Fluid / Liquide lave-glace de haute qualité Motorcraft® (Canada) ZC-32-B2 (U.S.) CXC-37-A/B/D/F (Canada)	WSS-M14P19-A
Motorcraft® Professional Strength Carpet & Upholstery Cleaner (U.S.)	-

Vehicle Care

Name	Specification
Motorcraft® Professional Strength Carpet & Upholstery Cleaner / Nettoyant professionnel pour sellerie et moquette Motorcraft® (Canada) ZC-54 (U.S. & Canada)	
Motorcraft® Spot and Stain Remover (U.S.) (Canada) ZC-14 (U.S.)	-
Motorcraft® Ultra-Clear Spray Glass Cleaner (U.S.) Motorcraft® Premium Glass Cleaner / Nettoie-vitres de qualité supérieure Motorcraft® (Canada) ZC-23 (U.S.) CXC-100 (Canada)	ESR-M14P5-A
Motorcraft® Wheel and Tire Cleaner (U.S.) Motorcraft® Wheel and Tire Cleaner / Nettoyant pour roues et pneus Motorcraft® (Canada) ZC-37-A (U.S. & Canada)	-

CLEANING THE EXTERIOR

We recommend that you wash your vehicle with a sponge and lukewarm water containing a car shampoo.

Note: *If you use a car wash with a waxing cycle, make sure that you remove the wax from the windshield and the wiper blades.*

Note: *Before using a car wash, check that it is suitable for your vehicle.*

Note: *Some car washes use water at high pressure. Due to this, water droplets may enter inside your vehicle and could also damage certain parts of your vehicle.*

Note: *Remove the antenna before using an automatic car wash.*

Note: *Switch the blower motor off to prevent contamination of the cabin air filter.*

Cleaning the Headlamps

Note: *Do not scrape the headlamps.*

Note: *Do not use abrasives, alcoholic solvents or chemical solvents to clean the headlamps.*

Note: *Do not wipe the headlamps when they are dry.*

Cleaning the Rear Window

Note: *Do not scrape the inside of the rear window.*

Note: *Do not use abrasives, alcoholic solvents or chemical solvents to clean the inside of the rear window.*

Clean the inside of the rear window with a soft, lint-free cloth and non-abrasive cleaner

Cleaning the Chrome Trim

Note: *Do not use abrasives, alcoholic solvents or chemical solvents to clean the chrome trim. Use soapy water.*

Dry the chrome trim with a clean, soft cloth

Vehicle Care

Note: Do not apply cleaning product to hot surfaces and do not leave cleaning product on chrome surfaces for a period of time exceeding that which is recommended.

Note: Industrial-strength (heavy-duty) cleaners, or cleaning chemicals, may cause damage over a period of time.

Body Paintwork Preservation

Frequently remove particles such as bird droppings, tree sap, insect deposits, tar spots, road salt and industrial fallout to avoid paint surface damage.

Frequently wash the underbody of your vehicle if salt is applied on the road.

We recommend that you wax the paintwork once or twice a year.

Note: Do not apply polish in strong sunlight as this dries the polish too quickly.

Note: Do not allow polish to come in contact with plastic surfaces as it can be difficult to remove.

Note: Do not apply polish to the windshield or rear window. A contaminated windshield or contaminated wiper blades may lead to increased wiper noise, reduced wipe quality or reduced rain sensor performance.

Sliding Door Tracks



WARNING: Do not open or close the sliding doors when your hands are near the tracks or rollers.

To clean the sliding door tracks, wipe the surface using a clean, cotton cloth with a mild soap and water solution.

Do not use a commercial or high-pressure washer.

WAXING

Regular waxing is necessary to protect your car's paint from the elements. We recommend that you wash and wax the painted surface once or twice a year.

When washing and waxing, park your vehicle in a shaded area out of direct sunlight. Always wash your vehicle before applying wax.

- Use a quality wax that does not contain abrasives.
- Follow the manufacturer's instructions to apply and remove the wax.
- Apply a small amount of wax in a back-and-forth motion, not in circles.
- Do not allow wax to come in contact with any non-body (low-gloss black) colored trim. The wax will discolor or stain the parts over time.
 - Roof racks.
 - Bumpers.
 - Grained door handles.
 - Side moldings.
 - Mirror housings.
 - Windshield cowl area.
- Do not apply wax to glass areas.
- After waxing, your car's paint should feel smooth, and be free of streaks and smudges.

CLEANING THE ENGINE

Engines are more efficient when they are clean because grease and dirt buildup keep the engine warmer than normal.

Vehicle Care

When washing:

- Take care when using a power washer to clean the engine. The high-pressure fluid could penetrate the sealed parts and cause damage.
- Do not spray a hot engine with cold water to avoid cracking the engine block or other engine components.
- Spray Motorcraft Engine Shampoo and Degreaser on all parts that require cleaning and pressure rinse clean. In Canada, use Motorcraft Engine Shampoo.

Note: *If your vehicle has an engine cover remove the cover before application of Motorcraft Engine Shampoo and Degreaser. Immediately rinse away any over spray.*

- Never wash or rinse the engine while it is hot or running; water in the running engine may cause internal damage.
- Never wash or rinse any ignition coil, spark plug wire or spark plug well, or the area in and around these locations.
- Cover the battery, power distribution box, and air filter assembly to prevent water damage when cleaning the engine.

CLEANING THE WINDOWS AND WIPER BLADES

Car wash chemicals and environmental fallout can result in windshield and wiper blade contamination. Dirty windshield and wipers will result in poor windshield wiper operation. Keep the windshield and wiper blades clean to maintain windshield wiper performance.

To clean the windshield and wiper blades:

- Clean the windshield with a non-abrasive glass cleaner. When cleaning the interior of the windshield, avoid getting any glass cleaner on the instrument panel or door panels. Wipe any glass cleaner off these surfaces immediately.
- For windshields contaminated with tree sap, chemicals, wax or bugs, clean the entire windshield using steel wool (no greater than 0000 grade) in a circular motion and rinse with water.
- Clean the wiper blades with isopropyl rubbing alcohol or windshield washer concentrate.

Note: *Do not use razor blades or other sharp objects to clean or remove decals from the inside of the heated rear window. The vehicle warranty does not cover damage caused to the heated rear window grid lines.*

CLEANING THE INTERIOR

Note: *Do not allow air fresheners and hand sanitizers to spill on interior surfaces. If a spill occurs, wipe off immediately. Damage may not be covered by the vehicle Warranty.*

Note: *Do not use household cleaning products or glass cleaners, which can stain and discolor the fabric and affect the flame retardant abilities of the seat materials.*

Note: *We recommend distilled water when cleaning.*

Fabric, Carpets, Cloth Seats, Headliners and Floor Mats

Note: *Avoid soaking any surface. Do not use excessive amounts of water to clean the vehicle interior.*

Note: *To avoid spots or discoloration, clean the entire surface.*

Vehicle Care

To clean:

- Remove dust and loose dirt with a vacuum cleaner or brush.
- Wipe the surface with a soft, damp cloth and a mild soap and water solution. Dry the area with a clean, soft cloth.
- If a ring forms on the fabric after spot cleaning, clean the entire area immediately, but do not soak or the ring will set.

Seatbelts



WARNING: Do not use cleaning solvents, bleach or dye on the vehicle's seatbelts, as these actions may weaken the belt webbing.



WARNING: On vehicles equipped with seat-mounted airbags, do not use chemical solvents or strong detergents. Such products could contaminate the side airbag system and affect performance of the side airbag in a crash.

Note: Do not use abrasives, or chemical solvents to clean them.

Note: Do not allow moisture to penetrate the seatbelt retractor mechanism.

Cleaning may safely be carried out using mild soap and water. Let them dry naturally, away from artificial heat.

Leather Interior (If Equipped)

Note: Follow the same procedure as cleaning leather seats for cleaning leather instrument panels and leather interior trim surfaces.

For routine cleaning, wipe the surface with a soft, damp cloth and a mild soap and water solution. Dry the area with a clean, soft cloth.

For cleaning and removing stains such as dye transfer, use a leather cleaning product for automotive interiors.

Do not use the following products as these may damage the leather:

- Oil and petroleum or silicone-based leather conditioners.
- Household cleaners.
- Alcohol solutions.
- Solvents or cleaners intended specifically for rubber, vinyl and plastics.

Suede Micro Fiber Fabric (If Equipped)

Note: Do not steam clean.

Note: To avoid spots or discoloration, clean the entire surface.

Do not use the following products:

- Leather care products.
- Household cleaners.
- Alcoholic solutions.
- Spot removers.
- Shoe polish.

To clean:

- Remove dust and loose dirt with a vacuum cleaner.
- Wipe the surface with a soft, damp cloth and a mild soap and water solution. Dry the area with a clean, soft cloth.
- If a ring forms on the fabric after spot cleaning, clean the entire area immediately, but do not soak or the ring will set.

Vehicle Care

Instrument Cluster Screens, LCD Screens and Radio Screens

Note: Do not use abrasives, alcoholic solvents or chemical solvents to clean the instrument cluster screens, LCD screens or radio screens. These cleaning products can damage the screens.

Clean the instrument panel and cluster lens with a clean, damp and soft cloth, then use a clean, dry and soft cloth to dry these areas.

Do not spray any liquid directly onto the screens.

Do not use a microfiber cloth to clean the bezel around the display screens as it could damage the surface.

Rear Windows

Note: Do not use any abrasive materials to clean the interior of the rear windows.

Note: Do not install stickers or labels to the interior of the rear windows.

Mirrors

Do not clean the housing or glass of any mirror with harsh abrasives, fuel or other petroleum or ammonia-based cleaning products.

Storage Compartments, Cup Holders and Ashtrays

To clean:

- Take out any removable inserts.
- Wipe the surface with a soft, damp cloth and a mild soap and water solution. Dry the area with a clean, soft cloth.

CLEANING THE INSTRUMENT PANEL AND INSTRUMENT CLUSTER LENS

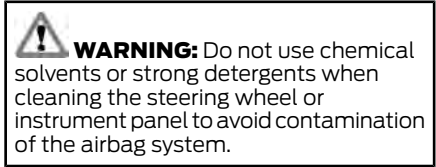

Note: Follow the same procedure as cleaning leather seats for cleaning leather instrument panels and leather interior trim surfaces. See **Cleaning the Instrument Panel and Instrument Cluster Lens** (page 265).

Clean the instrument panel and cluster lens with a clean, damp and soft cloth, then use a clean, dry and soft cloth to dry these areas.

- Avoid cleaners or polishes that increase the gloss of the upper portion of the instrument panel. The dull finish in this area helps protect you from undesirable windshield reflection.
- Do not use any household cleaning products or glass cleaners as these may damage the finish of the instrument panel, interior trim and cluster lens.
- Wash or wipe your hands clean if you have been in contact with certain products such as insect repellent and suntan lotion to avoid possible damage to the interior painted surfaces.
- Do not allow air fresheners and hand sanitizers to spill onto interior surfaces. If a spill occurs, wipe off immediately. Your warranty may not cover these damages.

If a staining liquid like coffee or juice has been spilled on the instrument panel or on interior trim surfaces:

Vehicle Care

1. Wipe up spilled liquid using a clean, soft cloth as quickly as possible.
2. Use Motorcraft Premium Leather and Vinyl Cleaner or a commercially available leather cleaning product for automotive interiors. Test any cleaner or stain remover on an inconspicuous area.
3. Alternatively, wipe the surface with a clean, soft cloth and a mild soap and water solution. Dry the area with a clean, soft cloth.
4. If necessary, apply more soap and water solution or cleaning product to a clean, soft cloth and press it onto the soiled area. Allow this to set at room temperature for 30 minutes.
5. Remove the soaked cloth, then with a clean, damp cloth, use a rubbing motion for 60 seconds on the soiled area.
6. Dry the area with a clean, soft cloth.

REPAIRING MINOR PAINT DAMAGE

Authorized dealers have touch-up paint to match your vehicle's color. Your vehicle color code is printed on a sticker on the front, left-hand side door jamb. Take your color code to your authorized dealer to make sure you get the correct color.

Before repairing minor paint damage, use a cleaner such as Motorcraft Bug and Tar Remover to remove particles such as bird droppings, tree sap, insect deposits, tar spots, road salt and industrial fallout.

Always read the instructions before using cleaning products.

CLEANING THE WHEELS

1. Regularly clean them with a wheel cleaner. We recommend that you use Ford approved wheel cleaner if available.
2. Remove dirt and brake dust with a sponge.
3. Remove tar and grease with a bug and tar remover. We recommend that you use Ford approved bug and tar remover if available.
4. Thoroughly rinse the wheels with water after cleaning.

If you intend on parking your vehicle for an extended period after cleaning the wheels with a wheel cleaner, drive your vehicle for a few minutes before doing so. This reduces the risk of corrosion of the brake discs, brake pads and linings.

Do not clean the wheels when they are hot.

Note: *Some car washes could damage wheel rims and covers.*

Note: *Using non-recommended cleaners, harsh cleaning products, chrome wheel cleaners or abrasive materials could damage wheel rims and covers.*

VEHICLE STORAGE

If you plan on storing your vehicle for 30 days or more, read the following maintenance recommendations to make sure your vehicle stays in good operating condition.

We engineer and test all motor vehicles and their components for reliable, regular driving. Under various conditions, long-term storage may lead to degraded engine performance or failure unless you use specific precautions to preserve engine components.

Vehicle Care

General

- Store all vehicles in a dry, ventilated place.
- Protect from sunlight, if possible.
- If vehicles are stored outside, they require regular maintenance to protect against rust and damage.

Body

- Wash your vehicle thoroughly to remove dirt, grease, oil, tar or mud from exterior surfaces, rear-wheel housing and the underside of front fenders.
- Periodically wash your vehicle if it is stored in exposed locations.
- Touch-up exposed or primed metal to prevent rust.
- Cover chrome and stainless steel parts with a thick coat of auto wax to prevent discoloration. Re-wax as necessary when you wash your vehicle.
- Lubricate all hood, door and luggage compartment hinges and latches with a light grade oil.
- Cover interior trim to prevent fading.
- Keep all rubber parts free from oil and solvents.

Engine

- Change the engine oil and filter prior to storage because used engine oil contains contaminants which may cause engine damage.
- Start the engine every 15 days for a minimum of 15 minutes. Run at fast idle with the climate controls set to defrost until the engine reaches normal operating temperature.

- With your foot on the brake, shift through all the gears while the engine is running.
- We recommend that you change the engine oil before you use your vehicle again.

Fuel system

- Fill the fuel tank with high-quality fuel until the first automatic shutoff of the fuel pump nozzle.

Cooling system

- Protect against freezing temperatures.
- When removing your vehicle from storage, check coolant fluid level. Confirm that there are no cooling system leaks and that fluid is at the recommended level.

Battery

- Check and recharge as necessary. Keep connections clean.
- If storing your vehicle for more than 30 days without recharging the battery, we recommend that you disconnect the battery cables to maintain battery charge for quick starting.

Note: *It is necessary to reset memory features if battery cables are disconnected.*

Brakes

- Make sure the brakes and parking brake release fully.

Tires

- Maintain recommended air pressure.

Vehicle Care

Miscellaneous

- Make sure all linkages, cables, levers and pins under your vehicle are covered with grease to prevent rust.
- Move vehicles at least 25 ft (7,5 m) every 15 days to lubricate working parts and prevent corrosion.

Removing Vehicle From Storage

When your vehicle is ready to come out of storage, do the following:

- Wash your vehicle to remove any dirt or grease film build-up on window surfaces.
- Check windshield wipers for any deterioration.
- Check under the hood for any foreign material that may have collected during storage such as mice or squirrel nests.
- Check the exhaust for any foreign material that may have collected during storage.
- Check tire pressures and set tire inflation per the Tire Label.
- Check brake pedal operation. Drive your vehicle 15 ft (4.5 m) back and forth to remove rust build-up.
- Check fluid levels (including coolant, oil and gas) to make sure there are no leaks, and fluids are at recommended levels.
- If you remove the battery, clean the battery cable ends and check for damage.

Contact an authorized dealer if you have any concerns or issues.

Wheels and Tires

GENERAL INFORMATION

Notice to Utility Vehicle, Van and Truck Owners



WARNING: Utility vehicles have a significantly higher rollover rate than other types of vehicles. To reduce the risk of serious injury or death from a rollover or other crash you must avoid sharp turns and abrupt maneuvers, drive at safe speeds for the conditions, keep tires properly inflated, never overload or improperly load your vehicle, and make sure every passenger is properly restrained.



WARNING: In a rollover crash, an unbelted person is significantly more likely to die than a person wearing a seat belt. All occupants must wear seat belts. Children and infants must use appropriate restraints to minimize the risk of injury or ejection.

Utility vehicles and trucks handle differently than passenger cars in the various driving conditions that are encountered on streets, highways and off-road. Utility vehicles and trucks are not designed for cornering at speeds as high as passenger cars any more than low-slung sports cars are designed to perform satisfactorily under off-road conditions.

How Your Vehicle Differs from Other Vehicles

Sport-utility vehicles, vans and trucks can differ from some other vehicles in a few noticeable ways. Your vehicle may be:



E145298

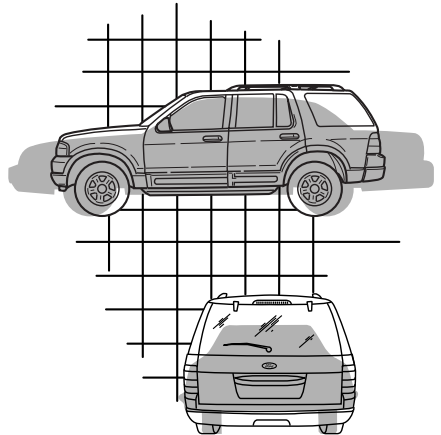

E145299

Wheels and Tires

- Higher - to allow higher load carrying capacity and to allow it to travel over rough terrain without getting hung up or damaging underbody components.
- Shorter - to give it the capability to approach inclines and drive over the crest of a hill without getting hung up or damaging underbody components. All other things held equal, a shorter wheelbase may make your vehicle quicker to respond to steering inputs than a vehicle with a longer wheelbase.
- Narrower - to provide greater maneuverability in tight spaces, particularly in off-road use.

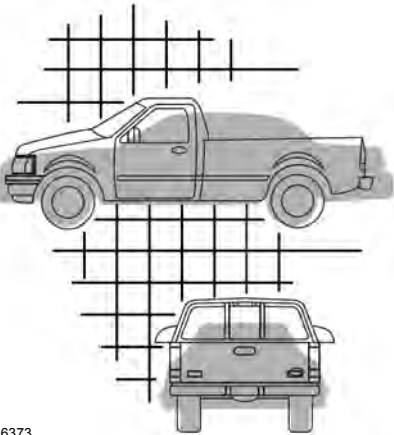

E166373

As a result of the above dimensional differences, sport-utility vehicles, vans and trucks often will have a higher center of gravity and a greater difference in center of gravity between the loaded and unloaded condition.

These differences that make your vehicle so versatile also make it handle differently than an ordinary passenger car.

TIRE CARE

Information About Uniform Tire Quality Grades



E142542

Tire Quality Grades apply to new pneumatic passenger car tires. The tire Quality Grades can be found where applicable on the tire sidewall between tread shoulder and maximum section width. For example: **Treadwear 200 Traction AA Temperature A.** They do not apply to deep tread, winter-type snow tires, space-saver or temporary use spare tires, light truck or LT type tires, tires with nominal rim diameters of 10 to 12 inches or limited production tires as defined in Title 49 Code of Federal Regulations Part 575.104 ©)(2).

Tire Quality Grades are determined by standards that the United States Department of Transportation has set.

Wheels and Tires

United States Department of Transportation Tire Quality Grades

The United States of America Department of Transportation requires Ford Motor Company to give you the following information about tire grades exactly as the government has written it.

Treadwear

The treadwear grade is a comparative rating based on the wear rate of the tire when tested under controlled conditions on a specified government test course. For example, a tire graded 150 would wear 1½ times as well on the government course as a tire graded 100. The relative performance of tires depends upon the actual conditions of their use, however, and may depart significantly from the norm due to variations in driving habits, service practices, and differences in road characteristics and climate.

Traction AA A B C



WARNING: The traction grade assigned to this tire is based on straight-ahead braking traction tests, and does not include acceleration, cornering, hydroplaning or peak traction characteristics.

The traction grades, from highest to lowest are AA, A, B, and C. The grades represent the tire's ability to stop on wet pavement as measured under controlled conditions on specified government test surfaces of asphalt and concrete. A tire marked C may have poor traction performance.

Temperature A B C



WARNING: The temperature grade for this tire is established for a tire that is properly inflated and not overloaded. Excessive speed, underinflation, or excessive loading, either separately or in combination, can cause heat buildup and possible tire failure.

The temperature grades are A (the highest), B and C, representing the tire's resistance to the generation of heat and its ability to dissipate heat when tested under controlled conditions on a specified indoor laboratory test wheel. Sustained high temperature can cause the material of the tire to degenerate and reduce tire life, and excessive temperature can lead to sudden tire failure. The grade C corresponds to a level of performance which all passenger car tires must meet under the

Wheels and Tires

Federal Motor Vehicle Safety Standard No. 139. Grades B and A represent higher levels of performance on the laboratory test wheel than the minimum required by law.

Glossary of Tire Terminology

- **Tire label:** A label showing the OE (Original Equipment) tire sizes, recommended inflation pressure and the maximum weight the vehicle can carry.
- **Tire Identification Number (TIN):** A number on the sidewall of each tire providing information about the tire brand and manufacturing plant, tire size and date of manufacture. Also referred to as DOT code.
- **Inflation pressure:** A measure of the amount of air in a tire.
- **Standard load:** A class of P-metric or Metric tires designed to carry a maximum load at set pressure. For example: for P-metric tires 35 psi (2.4 bar) and for Metric tires 36 psi (2.5 bar). Increasing the inflation pressure beyond this pressure will not increase the tire capability.
- **Extra load:** A class of P-metric or Metric tires designed to carry a heavier maximum load at 42 psi (2.9 bar). Increasing the inflation pressure beyond this pressure will not increase the tire's load carrying capability.
- **bar** Metric unit of atmospheric pressure.
- **kPa:** Kilopascal, a metric unit of air pressure.
- **PSI:** Pounds per square inch, a standard unit of air pressure.
- **Cold tire pressure:** The tire pressure when the vehicle has been stationary and out of direct sunlight for an hour or more and prior to the vehicle being driven for 1 mi (1.6 km).
- **Recommended inflation pressure:** The cold inflation pressure found on the Safety Compliance Certification Label (affixed to either the door hinge pillar, door-latch post, or the door edge that meets the door-latch post, next to the driver seating position) or Tire Label located on the B-Pillar or the edge of the driver door.
- **B-pillar:** The structural member at the side of the vehicle behind the front door.
- **Bead area of the tire:** Area of the tire next to the rim.
- **Sidewall of the tire:** Area between the bead area and the tread.
- **Tread area of the tire:** Area of the perimeter of the tire that contacts the road when mounted on the vehicle.
- **Rim:** The metal support (wheel) for a tire or a tire and tube assembly upon which the tire beads are seated.

Wheels and Tires

Information Contained on the Tire Sidewall

United States of America, and Canada Federal regulations require tire manufacturers to place standardized information on the sidewall of all tires. This information identifies and describes the fundamental characteristics of the tire and also provides a United States of America DOT Tire Identification Number for safety standard certification and in case of a recall.

P Type Tires

P215/65R15 95H is an example of a tire size, load index and speed rating. The definitions of these items are listed below.

Note: *Tire size, load index and speed rating for your vehicle may be different from the following example.*

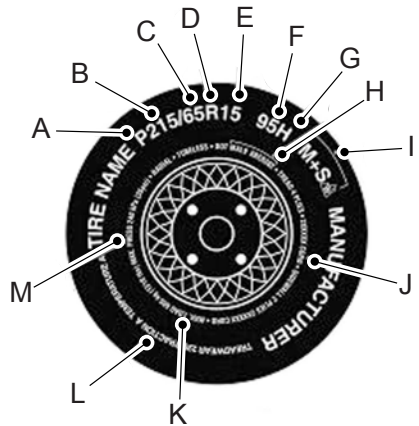

E142543

- A **P:** Indicates a tire, designated by the Tire and Rim Association, that may be used for service on cars, sport utility vehicles, minivans and light trucks.
- B **215:** Indicates the nominal width of the tire in millimeters from sidewall edge to sidewall edge. In general, the larger the number, the wider the tire.
- C **65:** Indicates the aspect ratio which gives the tire's ratio of height to width.
- D **R:** Indicates a radial type tire.

Wheels and Tires

E 15: Indicates the wheel or rim diameter in inches. If you change the wheel size, you will have to purchase new tires to match the new wheel diameter.

F 95: Indicates the tire's load index. It is an index that relates to how much weight a tire can carry. You may find this information in the Owner's Guide. If not, contact a local tire dealer.

G H: Indicates the tire's speed rating. The speed rating denotes the speed at which a tire is designed to be driven for extended periods of time under a standard condition of load and inflation pressure. The tires on your vehicle may operate at different conditions for load and inflation pressure. These speed ratings may need to be adjusted for the difference in conditions. The ratings range from 81 mph (130 kph) to 186 mph (299 kph). These ratings are listed in the following chart.

H United States of America DOT Tire Identification Number (TIN): This begins with the letters DOT and indicates that the tire meets all federal standards. The next two numbers or letters are the plant code designating where it was manufactured, the next two are the tire size code and the last four numbers represent the week and year the tire was built. For example, the numbers 317 mean the 31st week of 1997. After 2000 the numbers go to four digits. For example, 2501 means the 25th week of 2001. The numbers in between are identification codes used for traceability. This information is used to contact customers if a tire defect requires a recall.

I M+S or M/S: Mud and Snow, **AT:** All Terrain, **AS:** All Season.

J Tire Ply Composition and Material Used: Indicates the number of plies or the number of layers of rubber-coated fabric in the tire tread and sidewall. Tire

Wheels and Tires

manufacturers also must indicate the ply materials in the tire and the sidewall, which include steel, nylon, polyester, and others.

K

Maximum Load:

Indicates the maximum load in kilograms and pounds that can be carried by the tire. Refer to the Safety Compliance Certification Label (affixed to either the door hinge pillar, door-latch post, or the door edge that meets the door-latch post, next to the driver seating position), for the correct tire pressure for your vehicle.

L

Treadwear, Traction and Temperature Grades:

Treadwear The treadwear grade is a comparative rating based on the wear rate of the tire when tested under controlled conditions on a specified government test course. For example, a tire graded 150 would wear one and one-half times as well on the government course as a tire graded 100. **Traction:** The traction grades, from highest to lowest are AA, A, B, and C. The grades represent the tire's ability to stop on wet pavement

as measured under controlled conditions on specified government test surfaces of asphalt and concrete. A tire marked C may have poor traction performance.

Temperature: The temperature grades are A (the highest), B and C, representing the tire's resistance to the generation of heat and its ability to dissipate heat when tested under controlled conditions on a specified indoor laboratory test wheel.

M

Maximum Inflation

Pressure: Indicates the tire manufacturer's maximum permissible pressure or the pressure at which the maximum load can be carried by the tire. This pressure is normally higher than the manufacturer's recommended cold inflation pressure, which can be found on the Safety Compliance Certification Label (affixed to either the door hinge pillar, door-latch post, or the door edge that meets the door-latch post, next to the driver seating position), or Tire Label which is located on the B-Pillar or the edge of

Wheels and Tires

the driver door. The cold inflation pressure should never be set lower than the recommended pressure on the vehicle label.

Note: *If the tire size does not begin with a letter, this may mean it is designated by either ETRTO (European Tire and Rim Technical Organization) or JATMA (Japan Tire Manufacturing Association). You may not find this information on all tires because it is not required by federal law.*

Note: *The tire suppliers may have additional markings, notes or warnings, for example standard load, radial tubeless, etc.*

T Type Tires

T145/80D16 is an example of a tire size. T type tires have some additional information beyond those of P type tires. The definitions of these items are listed below.

Note: *The temporary tire size for your vehicle may be different from this example. Tire Quality Grades do not apply to this type of tire.*

Tire speed ratings	
Letter rating	mph (km/h)
M	81 mph (130 km/h)
N	87 mph (140 km/h)
Q	99 mph (159 km/h)
R	106 mph (171 km/h)
S	112 mph (180 km/h)
T	118 mph (190 km/h)
U	124 mph (200 km/h)
H	130 mph (210 km/h)
V	149 mph (240 km/h)
W	168 mph (270 km/h)
Y	186 mph (299 km/h)

Note: *For tires with a maximum speed capability over 149 mph (240 km/h), tire manufacturers sometimes use the letters ZR. For those with a maximum speed capability over 186 mph (299 km/h), tire manufacturers always use the letters ZR.*

Wheels and Tires

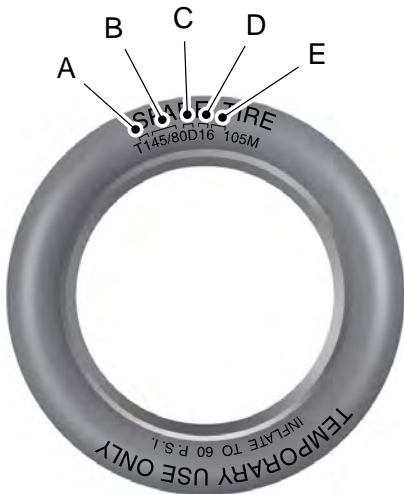

E142545

- A **T:** Indicates a type of tire, designated by the Tire and Rim Association, that is intended for temporary service on cars, sport-utility vehicles, minivans and light trucks.
- B **145:** Indicates the nominal width of the tire in millimeters from sidewall edge to sidewall edge. In general, the larger the number, the wider the tire.

- C **80:** Indicates the aspect ratio which gives the tire's ratio of height to width. Numbers of 70 or lower indicate a short sidewall.
- D **D:** Indicates a diagonal type tire. **R:** Indicates a radial type tire.
- E **16:** Indicates the wheel or rim diameter in inches. If you change the wheel size, you will have to purchase new tires to match the new wheel diameter.

Additional Information for LT Type Tires

LT235/85 R16 is an example of a tire size. LT type tires have some additional information beyond those of P type tires. The definitions of these items are listed below.

Note: *Tire Quality Grades do not apply to this type of tire.*

Wheels and Tires

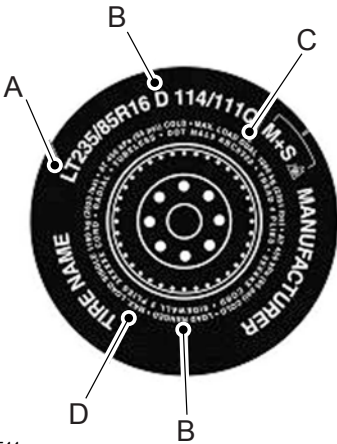

E142544

- A **LT:** Indicates a tire, designated by the Tire and Rim Association (T&RA), that is intended for service on light trucks.
- B **Load Range and Load Inflation Limits:** Indicates the tire's load-carrying capabilities and its inflation limits.

- C **Maximum Load Dual lb (kg) at psi (kPa) cold:** Indicates the maximum load and tire pressure when the tire is used as a dual, defined as four tires on the rear axle (a total of six or more tires on the vehicle).
- D **Maximum Load Single lb (kg) at psi (kPa) cold:** Indicates the maximum load and tire pressure when the tire is used as a single, defined as two tires (total) on the rear axle.

Additional Information for ETRTO Euro-Metric Commercial Vehicle Tires

Euro-metric commercial vehicle tires end in the letter "C" (for example, 235/65R16**C**). The "C" does not signify the tire's Load Range like the T&RA LT tire dimension (for example, LT245/75R17**E**).

Tire Load Capacities are identified by the Single/Dual Load indexes that follow the tire size on the tire's sidewall (for example, 235/65R16C **121/119**).

Note: *Tire Quality Grades do not apply to this type of tire.*

Wheels and Tires

United States of America DOT Tire Identification Number (TIN)

United States of America, and Canada Federal regulations require tire manufacturers to place standardized information on the sidewall of all tires. This information identifies and describes the fundamental characteristics of the tire and also provides a United States of America DOT Tire Identification Number for safety standard certification and in case of a recall.

This begins with the letters DOT and indicates that the tire meets all federal standards. The next two numbers or letters are the plant code designating where it was manufactured, the next two are the tire size code and the last four numbers represent the week and year the tire was built. For example, the numbers 317 mean the 31st week of 1997. After 2000 the numbers go to four digits. For example, 2501 means the 25th week of 2001. The numbers in between are identification codes used for traceability. This information is used to contact customers if a tire defect requires a recall.

Location of the Tire Label

You will find a Tire Label containing tire inflation pressure by tire size and other important information located on the B-Pillar or the edge of the driver's door.

Inflating the Tires



WARNING: Under-inflation is the most common cause of tire failures and may result in severe tire cracking, tread separation or blowout, with unexpected loss of vehicle control and increased risk of injury. Under-inflation increases sidewall flexing and rolling resistance, resulting in heat buildup and internal damage to the tire. It also may result in unnecessary tire stress, irregular wear, loss of vehicle control and accidents. A tire can lose up to half of its air pressure and not appear to be flat!

Safe operation of your vehicle requires that the tires are correctly inflated.

Every day before you drive, check the tires. If one looks lower than the others, use a tire gauge to check pressure of all tires and adjust if required.

At least once a month and before long trips inspect each tire including the spare tire. Check the tire pressure with a tire pressure gauge. Inflate all tires to the correct inflation pressure.

Wheels and Tires

You are strongly urged to buy a reliable tire pressure gauge, as automatic service station gauges may be inaccurate. We recommend the use of a digital or dial-type tire pressure gauge rather than a stick-type tire pressure gauge.

Use the recommended cold inflation pressure for optimum tire performance and wear. Under-inflation or over-inflation may cause uneven treadwear patterns.

Always inflate the tires to the recommended inflation pressure even if it is less than the maximum inflation pressure information found on the tire. The recommended tire inflation pressure is found on the Safety Compliance Certification Label (affixed to either the door hinge pillar, door-latch post, or the door edge that meets the door-latch post, next to the driver seating position), or Tire Label which is located on the B-Pillar or the edge of the driver door. Failure to follow the tire pressure recommendations can cause uneven treadwear patterns and adversely affect the way your vehicle handles

Note: *Do not reduce tire pressure to change the ride characteristics of your vehicle. If you do not maintain the tire pressures as specified by Ford, your vehicle may experience a condition known as shimmy. This will cause severe vibration and oscillations in the steering wheel when your vehicle travels over a bump or dip in the road and is unable to dampen out by itself. Significantly under-inflated tires, incorrect tire usage or any vehicle modifications such as lift-kits can cause your vehicle to shimmy. If your vehicle begins to shimmy, slowly reduce the speed of your vehicle by pressing the brake pedal or releasing the accelerator pedal. As your vehicle speed reduces the shimmy will cease.*

The maximum inflation pressure is the tire manufacturer's maximum permissible pressure or the pressure at which the maximum load can be carried by the tire. This pressure is normally higher than the manufacturer's recommended cold inflation pressure, which can be found on the Safety Compliance Certification Label (affixed to either the door hinge pillar, door-latch post, or the door edge that meets the door-latch post, next to the driver seating position), or Tire Label which is located on the B-Pillar or the edge

Wheels and Tires

of the driver door. The cold inflation pressure should never be set lower than the recommended pressure on the Safety Compliance Certification Label or Tire Label.

When weather temperature changes occur, tire inflation pressures also change. A 10°F (6°C) temperature drop can cause a corresponding drop of 1 psi (7 kPa) in inflation pressure. Check the tire pressures frequently and adjust them to the correct pressure which can be found on the Safety Compliance Certification Label or Tire Label.

To check the tire pressures:

1. Make sure the tires are cool, meaning they are not hot from driving even a mile.
2. Remove the cap from the valve on one tire, then firmly press the tire gauge onto the valve and measure the tire pressure.
3. Add enough air to reach the recommended tire pressure.
4. Replace the valve cap.
5. Repeat this procedure for each tire, including the spare.
6. Visually inspect the tires to make sure there are no nails or other objects embedded that could poke a hole in the tire and cause an air leak.
7. Check the sidewalls to make sure there are no gouges, cuts or bulges.

Note: *If you are checking tire pressure when the tire is hot, for example you have driven more than 1.0 mi (1.6 km), never bleed or reduce tire pressure. The tires are hot from driving and it is normal for pressures to increase above recommended cold pressures. A hot tire at or below recommended cold inflation pressure could be significantly under-inflated.*

Note: *If you have to drive a distance to get air for the tires, check and record the tire pressure first and add the appropriate air pressure when you get to the pump. It is normal for tires to heat up and the tire pressure to increase as you drive.*

Note: *If you over inflate the tire, release air by pressing on the metal stem in the center of the valve. Then recheck the pressure with your tire gauge.*

Note: *Some spare tires operate at a higher inflation pressure than the other tires. For T-type mini-spare tires, refer to the Dissimilar spare wheel and tire assembly information for a description. Store and maintain at 60 psi (4.15 bar). For full-size and dissimilar spare tires, refer to the Dissimilar spare wheel and tire assembly information for a description. Store and maintain at the higher of the front and rear inflation pressure as shown on the Tire Label.*

Wheels and Tires

Inspecting the Tires and Wheel Valve Stems

Periodically inspect the tire treads for uneven or excessive wear and remove objects, for example stones, nails or glass that may be wedged in the tread grooves. Check the tire and valve stems for holes, cracks, or cuts that may permit air leakage and repair or replace the tire and replace the valve stem. Inspect the tire sidewalls for cracking, cuts, bruises and other signs of damage or excessive wear. If internal damage to the tire is suspected, have the tire removed and inspected in case it needs to be repaired or replaced. For your safety, tires that are damaged or show signs of excessive wear should not be used because they are more likely to blow out or fail.

Incorrect or inadequate vehicle maintenance can cause tires to wear abnormally. Inspect all the tires, including the spare, frequently, and replace them if one or more of the following conditions exist:

Tire Wear

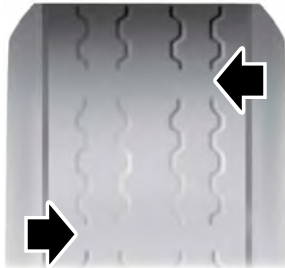

E142546

When the tread is worn down to 0.08 in (2 mm), tires must be replaced to help prevent your vehicle from skidding and hydroplaning. Built-in treadwear indicators, or wear bars, which look like narrow strips of smooth rubber across the tread will appear on the tire when the tread is worn down to 0.08 in (2 mm).

When the tire tread wears down to the same height as these wear bars, the tire is worn out and must be replaced.

Tire Damage

Periodically inspect the tire treads and sidewalls for damage, for example bulges in the tread or sidewalls, cracks in the tread groove or separation in the tread or sidewall. If damage is observed or suspected have the tire inspected by a tire professional. Tires can be damaged during off-road use, so inspection after off-road use is also recommended.

Wheels and Tires

Tire Age



WARNING: Tires degrade over time depending on many factors such as weather, storage conditions, and conditions of use (load, speed, inflation pressure) the tires experience throughout their lives.



WARNING: In general, tires should be replaced after six years regardless of tread wear. However, heat caused by hot climates or frequent high loading conditions can accelerate the aging process and may require tires to be replaced more frequently.



WARNING: You should replace your spare tire when you replace the road tires or after six years due to aging even if it has not been used.

Label (affixed to either the door hinge pillar, door-latch post, or the door edge that meets the door-latch post, next to the driver's seating position), or the Tire Label which is located on the B-Pillar or edge of the driver's door. If this information is not found on these labels, then you should contact your authorized dealer as soon as possible. Use of any tire or wheel not recommended by Ford can affect the safety and performance of your vehicle, which could result in an increased risk of loss of vehicle control, vehicle rollover, personal injury and death.



WARNING: Always inflate steel carcass tires with a remote air fill with the person inflating standing at a minimum of 12 ft (3.66 m) away from the wheel and tire assembly.

Tire Replacement Requirements



WARNING: Only use replacement tires and wheels that are the same size, load index, speed rating and type (such as P-metric versus LT-metric or all-season versus all-terrain) as those originally provided by Ford. The recommended tire and wheel size may be found on either the Safety Compliance Certification

Your vehicle is fitted with tires designed to provide a safe ride and handling capability.

We recommend that the two front tires or two rear tires generally be replaced as a pair.

Note: *The wheel valve stems must also be replaced when the road tires are replaced on your vehicle.*

Wheels and Tires

Fitting Replacement Tires



WARNING: To reduce the risk of serious injury, when mounting replacement tires and wheels, you should not exceed the maximum pressure indicated on the sidewall of the tire to set the beads without additional precautions listed below. If the beads do not seat at the maximum pressure indicated, re-lubricate and try again.



WARNING: When inflating the tire for mounting pressures up to 20 psi (1.38 bar) greater than the maximum pressure on the tire sidewall, the following precautions must be taken to protect the person mounting the tire:

1. Make sure that you have the correct tire and wheel size.
2. Lubricate the tire bead and wheel bead seat area again.
3. Stand at a minimum of 12 ft (3.66 m) away from the wheel and tire assembly.
4. Use both eye and ear protection.

Tire Pressure Monitoring System (If Equipped)

The use of wheels or tires not recommended by Ford Motor Company may affect the operation of the tire pressure monitoring system. If the tire pressure monitoring system indicator is flashing, the tire pressure monitoring system is malfunctioning. The replacement tire might be incompatible with the tire pressure monitoring system, or a component of the tire pressure monitoring system may be damaged. See **Tire Pressure Monitoring System** (page 288).

The tire pressure sensors mounted in the wheels (originally installed on your vehicle) are not designed to be used in aftermarket wheels.

Tire Safety Practices



WARNING: If your vehicle is stuck in snow, mud or sand, do not rapidly spin the tires; spinning the tires can tear the tire and cause an explosion. A tire can explode in as little as three to five seconds.

Wheels and Tires



WARNING: Do not spin the wheels at over 34 mph (55 km/h). The tires may fail and injure a passenger or bystander.

Driving habits have a great deal to do with your tire mileage and safety:

- Observe posted speed limits.
- Avoid fast starts, stops and turns.
- Avoid potholes and objects on the road.
- Do not run over curbs or hit the tire against a curb when parking.

Highway Hazards

No matter how carefully you drive there is always the possibility that you may eventually have a flat tire on the highway. Drive slowly to the closest safe area out of traffic. This may further damage the flat tire, but your safety is more important.

If you feel a sudden vibration or ride disturbance while driving, or you suspect a tire or your vehicle has been damaged, immediately reduce your speed. Drive with caution until you can safely pull off the road. Stop and inspect the tires for damage. If a tire is under-inflated or damaged, deflate it, remove wheel and

replace it with the spare tire and wheel. If you cannot detect a cause, have the vehicle towed to the nearest repair facility or tire dealer to have the vehicle inspected.

Tire and Wheel Alignment

A bad jolt from hitting a curb or pothole can cause the front end of your vehicle to become misaligned or cause damage to the tires. If your vehicle seems to pull to one side when you are driving, the wheels may be out of alignment. Have an authorized dealer check the wheel alignment periodically.

Wheel misalignment in the front or the rear can cause uneven and rapid treadwear of the tires and should be corrected by an authorized dealer. Front-wheel drive vehicles and those with an independent rear suspension may require alignment of all four wheels.

The tires should also be balanced periodically. An unbalanced tire and wheel assembly may result in irregular tire wear.

Tire Rotation



WARNING: If the tire label shows different tire pressures for the front and rear tires and the vehicle has a tire pressure monitoring system, then you need to update the settings for

Wheels and Tires

the system sensors. Always perform the system reset procedure after tire rotation. If you do not reset the system, it may not provide a low tire pressure warning when necessary. See **Tire Pressure Monitoring System** (page 288).

Rotating the tires at the recommended interval detailed in the Scheduled Maintenance chapter will help the tires wear more evenly, providing better tire performance and longer tire life.

Sometimes irregular tire wear can be corrected by rotating the tires.

Note: After rotating the tires the inflation pressure must be checked and adjusted to the vehicle requirements.

Note: If the tires show uneven wear ask an authorized dealer to check for and correct any wheel misalignment, tire imbalance or mechanical problem involved before tire rotation.

Note: Your vehicle may have a dissimilar spare wheel and tire assembly. A dissimilar spare wheel and tire assembly is defined as a spare wheel and tire assembly that is different in brand, size or appearance from the road tires and wheels. If you have a dissimilar spare wheel and tire assembly it is intended for temporary use only and should not be used in a tire rotation.

Rear-wheel drive and four-wheel drive vehicles with single rear wheels (front tires at left of diagram).

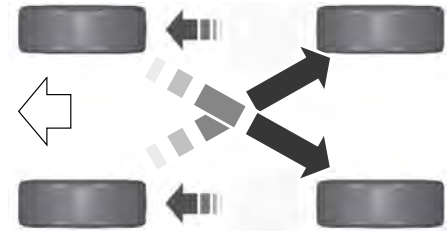

E142548

Wheels and Tires

Rear-wheel drive and four-wheel drive vehicles with dual rear wheels.

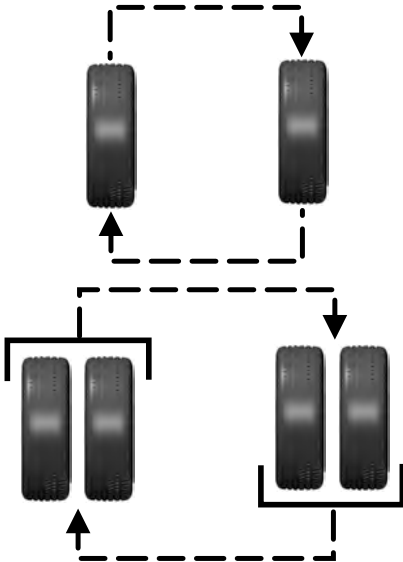

E166988

USING WINTER TIRES



WARNING: If you choose to install snow tires on your vehicle, they must be the same size, construction, and load range as the original tires listed on the tire placard, and they must be installed on all four wheels. Mixing tires of different size or construction on your vehicle can adversely affect your vehicle's handling and braking, and may lead to loss of vehicle control.

Your vehicle has all-season tires that are optimized for use in all weather conditions. As the seasons change you may choose to use winter tires or snow tires. Winter tires and snow tires are available to purchase from an authorized dealer.

We recommend that you use winter tires when the temperature is 45°F (7°C) or lower, or in snow and ice conditions.

If you use winter tires or snow tires, inflate them to the recommended tire pressures listed on the tire information label. The label is on the driver side B-pillar.

USING SNOW CHAINS



WARNING: Snow tires must be the same size, load index and speed rating as those originally provided by Ford. Use of any tire or wheel not recommended by Ford can affect the safety and performance of your vehicle, which could result in an increased risk of loss of control, vehicle rollover, personal injury and death. Additionally, the use of non-recommended tires and wheels can cause steering, suspension, axle, transfer case or power transfer unit failure. Follow the Ford recommended tire inflation pressure found on the Safety Compliance Certification Label (on the door hinge pillar, door latch post or the door edge that meets the door latch post, next to the driver seat), or Tire Label on the B-Pillar or the edge of the driver door. Failure to follow the tire pressure recommendations can cause uneven treadwear patterns and adversely affect the way your vehicle handles.

Wheels and Tires



WARNING: If you choose to install snow tires on your vehicle, they must be the same size, construction, and load range as the original tires listed on the tire placard, and they must be installed on all four wheels. Mixing tires of different size or construction on your vehicle can adversely affect your vehicle's handling and braking, and may lead to loss of vehicle control.



WARNING: Only fit snow chains to specified tires.

The tires on your vehicle have all-weather treads to provide traction in rain and snow. However, in some climates, you may need to use snow tires, snow chains or cables.

If you use snow chains or cables, we recommend that steel wheels of the same size and specifications are used, snow chains or cables may damage alloy wheels.

Follow these guidelines when using snow chains or cables:

- Avoid fully loading your vehicle.
- Only certain snow chains or cables have been approved by Ford as safe for use on vehicles with either 235/65 R16C or 195/75 R16C tires.
- Snow chains or cables must be mounted in pairs on the rear tires only.
- Do not use snow chains or cables on dual rear alloy wheels.
- Install snow chains or cables securely, make sure they do not touch any wiring, brake lines or fuel lines.
- Use only SAE Class S snow chains, snow cables or equivalent that measure 0.4 in (10 mm) or less in dimension as measured on the sidewall of the tire.

- Do not exceed 30 mph (48 km/h) or the maximum speed recommended by the snow chains or cables manufacturer, whichever is less.
- Purchase snow chains or cables from a manufacturer that clearly labels the body to tire dimension restrictions.
- Remove the snow chains or cables when they are no longer needed.
- Do not use snow chains or cables on dry roads.
- If you have any questions regarding snow chains or cables, see an authorized dealer.

TIRE PRESSURE MONITORING SYSTEM (IF EQUIPPED)



WARNING: The tire pressure monitoring system is not a substitute for manually checking tire pressures. You should periodically check tire pressures using a pressure gauge. Failure to correctly maintain tire pressures could increase the risk of tire failure, loss of control, vehicle rollover and personal injury.



WARNING: Do not use tire sealants as they may damage the tire pressure monitoring system.



WARNING: If the tire pressure monitor sensor becomes damaged it may not function.

Wheels and Tires



Each tire, including the spare (if provided), should be checked monthly when cold and inflated to the inflation pressure recommended by the vehicle manufacturer on the vehicle placard or tire inflation pressure label. (If your vehicle has tires of a different size than the size indicated on the vehicle placard or tire inflation pressure label, you should determine the proper tire inflation pressure for those tires).

As an added safety feature, your vehicle has been equipped with a Tire Pressure Monitoring System (TPMS) that illuminates a low tire pressure telltale when one or more of your tires is significantly under-inflated. Accordingly, when the low tire pressure telltale illuminates, you should stop and check your tires as soon as possible, and inflate them to the proper pressure. Driving on a significantly under-inflated tire causes the tire to overheat and can lead to tire failure. Under-inflation also reduces fuel efficiency and tire tread life, and may affect the vehicle's handling and stopping ability.

Please note that the TPMS is not a substitute for proper tire maintenance, and it is the driver's responsibility to maintain correct tire pressure, even if under-inflation has not reached the level to trigger illumination of the TPMS low tire pressure telltale.

Your vehicle has also been equipped with a TPMS malfunction indicator to indicate when the system is not operating properly. The TPMS malfunction indicator is combined with the low tire pressure telltale. When the system detects a malfunction, the telltale will flash for approximately one minute and then remain continuously illuminated. This sequence will continue upon subsequent vehicle start-ups as long as the malfunction exists.

When the malfunction indicator is illuminated, the system may not be able to detect or signal low tire pressure as intended. TPMS malfunctions may occur for a variety of reasons, including the installation of replacement or alternate tires or wheels on the vehicle that prevent the TPMS from functioning properly. Always check the TPMS malfunction telltale after replacing one or more tires or wheels on your vehicle to ensure that the replacement or alternate tires and wheels allow the TPMS to continue to function properly.

This device complies with Part 15 of the FCC Rules and with Licence exempt RSS Standards of Industry Canada. Operation is subject to the following two conditions:

- This device may not cause harmful interference.
- This device must accept any interference received, including interference that may cause undesired operation.



WARNING: Changes or modifications not expressly approved by the party responsible for compliance could void the user's authority to operate the equipment. The term "IC:" before the radio certification number only signifies that Industry Canada technical specifications were met.

Wheels and Tires

Changing Tires With a Tire Pressure Monitoring System



E142549

Note: Each road tire is equipped with a tire pressure sensor located inside the wheel and tire assembly cavity. The pressure sensor is attached to the valve stem. The pressure sensor is covered by the tire and is not visible unless the tire is removed. Take care when changing the tire to avoid damaging the sensor.

You should always have your tires serviced by an authorized dealer.

Check the tire pressure periodically (at least monthly) using an accurate tire gauge. See **When Inflating the Tires** in this chapter.

Understanding the Tire Pressure Monitoring System



E250820

The tire pressure monitoring system measures pressure in your road tires and sends the tire pressure readings to your vehicle. You can view the tire pressure readings through the information display. See **General Information** (page 269). The low tire pressure warning light will turn on if the tire pressure is significantly low. Once the light is illuminated, your tires are under-inflated and need to be inflated to the manufacturer's recommended tire pressure. Even if the light turns on and a short time later turns off, your tire pressure still needs to be checked.

When the Temporary Spare Tire is Installed

If one of the road wheels and tire needs to be replaced with the temporary spare wheel and tire, the system will continue to identify a defect. This is to remind you that the damaged road wheel and tire must be repaired and refitted to your vehicle.

To restore the correct operation of the system, you must have the repaired road wheel and tire assembly refitted to your vehicle. For additional information, see **Changing Tires with a Tire Pressure Monitoring System** in this section.

When You Believe the System is Not Operating Correctly

The main function of the system is to warn you when the tire pressures are low. It can also warn you in the event the system is no longer capable of operating correctly. See the following chart for information concerning the system:

Wheels and Tires

Low tire pressure warning light	Possible cause	Customer action required
Solid warning light	Tire(s) under-inflated	Make sure tires are at the proper pressure. See Inflating your tires in this chapter. After inflating your tires to the manufacturer's recommended pressure as shown on the Tire Label (located on the edge of driver's door or the B-Pillar), the vehicle must be driven for at least two minutes over 20 mph (32 km/h) before the light turns off.
	Spare tire in use	Repair the damaged road wheel and tire assembly and reinstall it on the vehicle to restore system function. For a description on how the system functions, see When Your Temporary Spare Tire is Installed in this section.
	TPMS malfunction	If the tires are properly inflated and the spare tire is not in use but the light remains on, contact your authorized dealer as soon as possible.
Flashing warning light	Spare tire in use	Repair the damaged road wheel and tire assembly and reinstall it on the vehicle to restore system function. For a description on how the system functions, see When Your Temporary Spare Tire is Installed in this section.
	TPMS malfunction	If the tires are properly inflated and the spare tire is not in use but the light remains on, contact your authorized dealer as soon as possible.

When Inflating the Tires



WARNING: Do not use the tire pressure displayed in the information display as a tire pressure gauge. Failure to follow this instruction could result in personal injury or death.

When inflating the tires (for example; at a gas station), the system may not respond immediately to the air added to the tires.

It may take up to two minutes of driving over 20 mph (32 km/h) for the light to turn off after you have filled your tires to the recommended inflation pressure.

Wheels and Tires

How Temperature Affects the Tire Pressures

While driving in a normal manner, tire pressures may increase up to 4 psi (30 kPa) from a cold start situation. If the vehicle is stationary overnight and the temperature significantly lower than the daytime temperature, tire pressures may decrease up to 3 psi (20 kPa) for a drop of 30°F (17°C) in ambient temperature. This lower pressure value will be detected by the system as being significantly lower than the correct inflation pressure and the warning light will illuminate.

If the warning light is on:

- Check each tire to verify that none are flat.
- If one or more tires are flat, repair as necessary.
- Check the tire pressures and inflate all the tires to the correct pressure.

Tire Pressure Monitoring System Reset Procedure

Carry out the tire pressure monitoring system reset procedure after:

- Every tire rotation.
- Each tire replacement, only when the sensor stays the same and does not change.

Note: *The tire pressure monitoring system reset procedure will not work with a new sensor until an authorized dealer programs the new sensor.*

Overview



WARNING: To determine the required pressure(s) for your vehicle, see the Safety Compliance Certification Label (on the door hinge pillar, door-latch post or the door edge that meets the door-latch post, next to the driver seat) or the Tire Label on the B-Pillar or the edge of the driver door.

To maintain your vehicle's load carrying capability, this vehicle requires different tire pressures in the front tires compared to the rear tires. The system on your vehicle is designed to illuminate the warning light at different pressures for the front and rear tires.

The tires need to be periodically rotated to provide consistent performance and maximum tire life, the system needs to know when the tires have been rotated to determine which set of tires are on the front and rear axles. With this information, the system can detect and correctly warn of low tire pressures.

System Reset Tips:

- To reduce the chance of interference from another vehicle, the system reset procedure should be carried out at least three feet (one meter) away from another Ford vehicle undergoing the system reset procedure.
- Do not wait more than two minutes between resetting each tire sensor or the system will time-out and the entire procedure will have to be repeated on all four wheels. A double horn chirp indicates the need to repeat the procedure.

Carrying Out the System Reset Procedure

Read the entire procedure before carrying out a system reset.

Wheels and Tires

1. Drive your vehicle above 20 mph (32 km/h) for at least two minutes and then park in a safe location where you can easily get to all four tires and have access to a tire inflation pump.
2. Switch the ignition off.
3. Switch the ignition on with the engine off.
4. Turn the hazard flashers on then off three times, this must be completed within 10 seconds. If the reset mode has been entered successfully, the horn will chirp once and the system indicator will flash. If this does not occur, repeat the procedure from step 2. If after repeated attempts to enter the reset mode, the horn does not chirp and the system indicator does not flash, have your vehicle checked by an authorized dealer as soon as possible.
5. Train the system sensors in the tires using the following reset sequence starting with the left front tire and following a clockwise order: Left front, right front, right rear, left rear.
6. Remove the valve cap from the valve stem on the left front tire. Decrease the air pressure until the horn chirps.
Note: *The single horn chirp confirms that the sensor identification code has been learned by your vehicle for this position. If a double horn chirp is heard, the reset procedure was unsuccessful and must be repeated.*
7. Remove the valve cap from the valve stem on the right front tire. Decrease the air pressure until the horn chirps.
8. Remove the valve cap from the valve stem on the right rear tire. Decrease the air pressure until the horn chirps.
9. Remove the valve cap from the valve stem on the left rear tire. Decrease the air pressure until the horn chirps. Training is complete when the horn chirps after the last system sensor (left rear) has been trained and the system indicator stops flashing.
10. Switch the ignition off. If two short horn chirps are heard, the reset procedure was unsuccessful and must be repeated.
Note: *If after repeating the procedure two short horn chirps are heard again, have your vehicle checked by an authorized dealer as soon as possible.*
11. Set all four tires to the correct pressure. See **Maintenance** (page 229), or the tire inflation pressure label (located on the edge of driver door or the B-Pillar).

CHANGING A ROAD WHEEL



WARNING: Do not use tire sealants as they may damage the tire pressure monitoring system.



WARNING: If the tire pressure monitor sensor becomes damaged it may not function.

Note: *The tire pressure monitoring system indicator light will illuminate when the spare tire is in use. To restore the full function of the monitoring system, all road wheels equipped with tire pressure monitoring sensors must be mounted on this vehicle.*

If you get a flat tire while driving, do not apply the brake heavily. Instead, gradually decrease your speed. Hold the steering wheel firmly and slowly move to a safe place on the side of the road.

Wheels and Tires

Have a flat serviced by an authorized dealer in order to prevent damage to the system sensors. See **Tire Pressure Monitoring System** (page 288). Replace the spare tire with a road tire as soon as possible. During repairing or replacing of the flat tire, have the authorized dealer inspect the system sensor for damage.

Dissimilar Spare Wheel and Tire Assembly Information



WARNING: Failure to follow these guidelines could result in an increased risk of loss of vehicle control, injury or death.

If you have a dissimilar spare wheel and tire, then it is intended for temporary use only. This means that if you need to use it, you should replace it as soon as possible with a road wheel and tire assembly that is the same size and type as the road tires and wheels that were originally provided by Ford. If the dissimilar spare tire or wheel is damaged, it should be replaced rather than repaired.

A dissimilar spare wheel and tire assembly is defined as a spare wheel and tire assembly that is different in brand, size or appearance from the road tires and wheels and can be one of three types:

- 1. T-type mini-spare:** This spare tire begins with the letter T for tire size and may have Temporary Use Only molded in the sidewall.
- 2. Full-size dissimilar spare with label on wheel:** This spare tire has a label on the wheel that states: THIS WHEEL AND TIRE ASSEMBLY FOR TEMPORARY USE ONLY.

When driving with one of the dissimilar spare tires listed above, do not:

- Exceed 50 mph (80 km/h).
- Load the vehicle beyond maximum vehicle load rating listed on the Safety Compliance Label.
- Tow a trailer.
- Use snow chains on the end of the vehicle with the dissimilar spare tire.
- Use more than one dissimilar spare tire at a time.
- Use commercial car washing equipment.
- Try to repair the dissimilar spare tire.

Use of one of the dissimilar spare tires listed above at any one wheel location can lead to impairment of the following:

- Handling, stability and braking performance.
- Comfort and noise.
- Ground clearance and parking at curbs.
- Winter weather driving capability.
- Wet weather driving capability.
- All-wheel driving capability.

3. Full-size dissimilar spare without label on wheel

When driving with the full-size dissimilar spare wheel and tire assembly, do not:

- Exceed 70 mph (113 km/h).
- Use more than one dissimilar spare wheel and tire assembly at a time.
- Use commercial car washing equipment.
- Use snow chains on the end of the vehicle with the dissimilar spare wheel and tire assembly.

The usage of a full-size dissimilar spare wheel and tire assembly can lead to impairment of the following:

- Handling, stability and braking performance.
- Comfort and noise.

Wheels and Tires

- Ground clearance and parking at curbs.
- Winter weather driving capability.
- Wet weather driving capability.
- All-wheel driving capability.

When driving with the full-size dissimilar spare wheel and tire assembly additional caution should be given to:

- Towing a trailer.
- Driving vehicles equipped with a camper body.
- Driving vehicles with a load on the cargo rack.

Drive cautiously when using a full-size dissimilar spare wheel and tire assembly and seek service as soon as possible.

Locking Lug Nuts

You can obtain replacement locking lug nuts or a locking lug nut key using the reference number certificate.

Vehicles With a Spare Wheel

The spare wheel is under the rear of your vehicle.

If the spare wheel is the same type and size as your vehicle road wheel, you can fit the spare wheel and continue to drive in the normal manner.

If the spare wheel is not the same type and size as your vehicle road wheel, it has a label showing the maximum driving speed limit.

Note: *If your vehicle is fitted with a tire pressure monitoring system, the warning indicator will flash if you fit the spare wheel to your vehicle. To restore the correct operation of the tire pressure monitoring system, you must have the repaired road wheel and tire assembly refitted to your vehicle. See **Tire Pressure Monitoring System** (page 288). To prevent damage occurring to the tire pressure monitoring system sensors, make sure you have a damage tire repaired or replaced by a tire professional.*

Van, Bus or Wagon



E145138

1. Open the rear doors. Remove the grommet and insert the flat end of the lug wrench into the socket. Turn counterclockwise until the spare wheel rests on the ground and the cable is loose.

Wheels and Tires



E146811

2. Raise the cable end cover.



E146812

3. Rotate the cable through 90 degrees. Slide the cable through the slot to release the spare wheel bracket from the winch.



E146813

4. Remove the retaining nut to release the spare wheel bracket.
5. Leave the cable extended; it will be used to stow the flat wheel and tire assembly.

Note: Do not raise the spare wheel bracket without a wheel attached. Damage to the winch mechanism could occur.

Chassis Cab and Cutaway

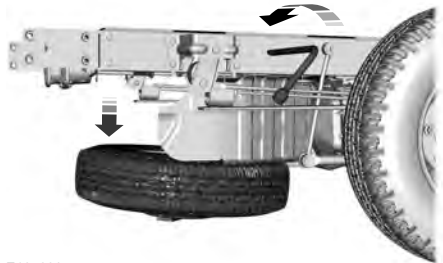

E184880

1. Insert the flat end of the lug wrench into the socket. Turn counterclockwise until the spare wheel rests on the ground and the cable is loose.

Wheels and Tires



E146811

2. Raise the cable end cover.



E146812

3. Rotate the cable through 90 degrees. Slide the cable through the slot to release the spare wheel bracket from the winch.





E146813

4. Remove the retaining nut to release the spare wheel bracket.
5. Leave the cable extended; it will be used to stow the flat wheel and tire assembly.

Note: Do not raise the spare wheel bracket without a wheel attached. Damage to the winch mechanism could occur.

Vehicle Jack

 **WARNING:** When one of the front wheels is off the ground, the transmission alone will not prevent the vehicle from moving or slipping off the jack, even if the transmission is in park (P).

 **WARNING:** To help prevent your vehicle from moving when changing a wheel, shift the transmission into park (P), set the parking brake and use an appropriate block or wheel chock to secure the wheel diagonally opposite to the wheel being changed. For example, when changing the front left wheel, place an appropriate block or wheel chock on the right rear wheel.

Wheels and Tires

WARNING: Do not work on your vehicle when the jack is the only support. If the vehicle slips off the jack, you or someone else could be seriously injured.

WARNING: Do not attempt to change a tire on the side of the vehicle close to moving traffic. Pull far enough off the road to avoid the danger of being hit when operating the jack or changing the wheel.

WARNING: Always use the jack provided as original equipment with your vehicle. If using a jack other than the one provided, make sure the jack capacity is adequate for the vehicle weight, including any vehicle cargo or modifications. If you are unsure if the jack capacity is adequate, contact the authorized dealer.

WARNING: Switch off the running boards before jacking or placing any object under your vehicle. Never place your hand between the extended running board and your vehicle. A moving running board may cause injury.

Vehicle Jack Storage

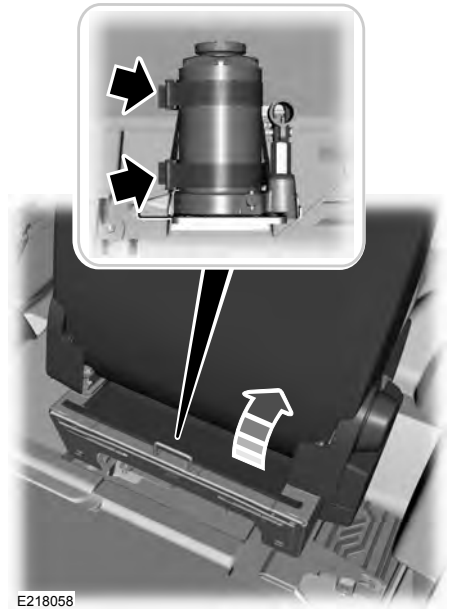

Note: Passengers should not remain in the vehicle when the vehicle is being jacked.

Note: Vehicles with a Temporary Mobility Kit do not have a vehicle jack or a lug wrench.

Wheels and Tires

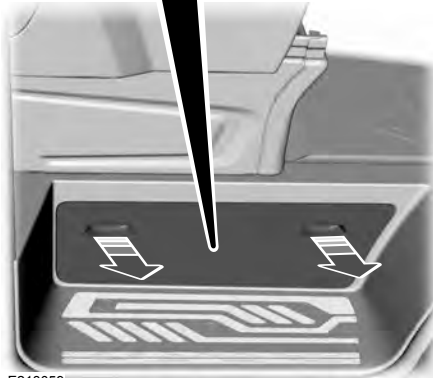

E218059

The vehicle jack is under the front passenger seat. Adjust the seat forward to access the jack. The jack handle and lug wrench are in the storage compartment in the front right-hand side stepwell.

Note: *The vehicle jack is in the load space area on vehicles with rear climate control.*

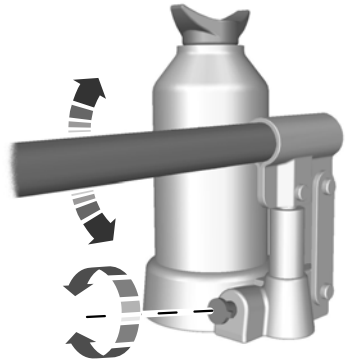

E70959

1. Assemble the jack handle.
2. Insert the jack handle onto the release valve and rotate clockwise until you feel a strong resistance.
3. Insert the jack handle into the pump and use a pumping action to raise your vehicle.
4. Insert the jack handle into the release valve and rotate counterclockwise to lower your vehicle.

Front Jacking Points

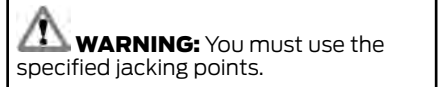

Note: *If your vehicle has rear air conditioning make sure the vehicle jack does not come in contact with the air conditioning lines.*

Wheels and Tires

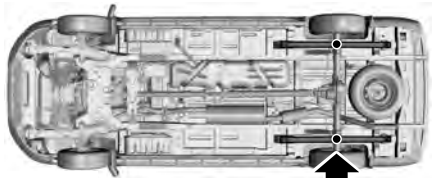
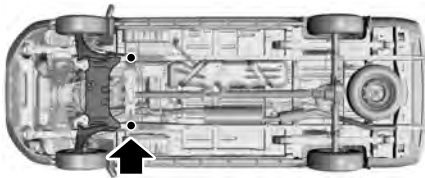
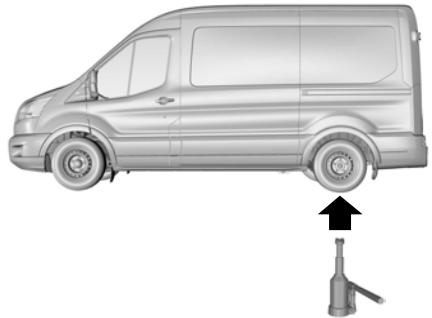
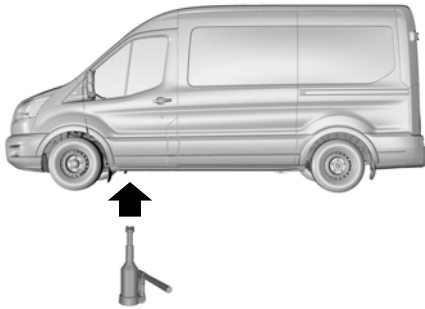

E171405

Position the head of the vehicle jack under the protrusions at the rear of front sub-frame.

E171406

Position the head of the vehicle jack under the rear axle.

Rear Jacking Points



WARNING: You must use the specified jacking points.

Removing a Wheel Trim (If Equipped)

Vehicles With Steel Wheels

1. Insert the flat end of the lug wrench between the wheel rim and the wheel trim.
2. Carefully remove the wheel trim.

Wheels and Tires

Vehicles With Dual Rear Alloy Wheels

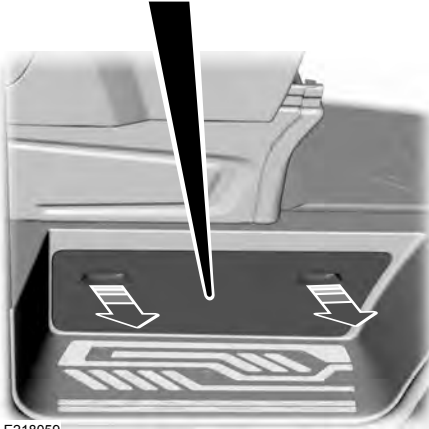

E218059



E256347

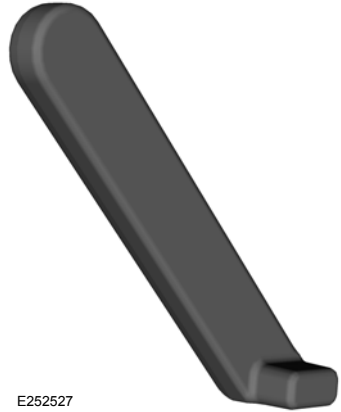

E252527

The wheel trim removal tool is in the storage compartment in the front right-hand side stepwell near the lug wrench.

Front Wheel Trim

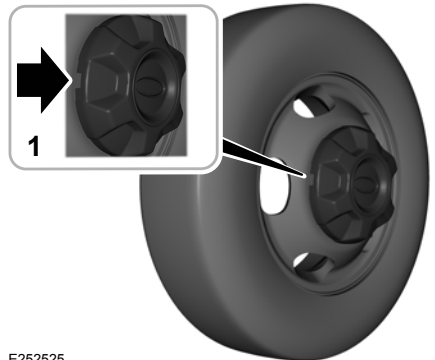

E252525

1. Locate the notch in the wheel trim.

Wheels and Tires

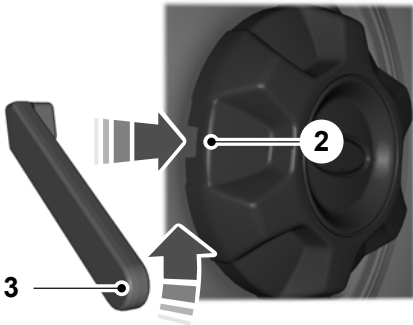

E252535

2. Insert the wheel trim removal tool into the notch in the wheel trim.
3. Rotate the wheel trim removal tool and remove the wheel trim.

Rear Wheel Trim

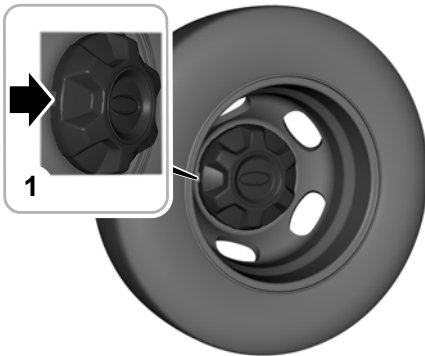

E252526

1. Locate the notch in the wheel trim.

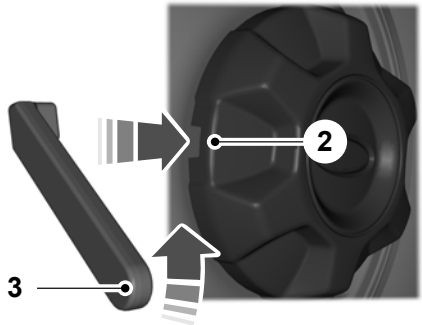

E252535

2. Insert the wheel trim removal tool into the notch in the wheel trim.
3. Rotate the wheel trim removal tool and remove the wheel trim.

Removing a Road Wheel

 **WARNING:** Park your vehicle so that you do not obstruct the flow of traffic or place yourself in any danger and set up a warning triangle.

 **WARNING:** Switch the ignition off and apply the parking brake.

 **WARNING:** If your vehicle has a manual transmission, shift into first or reverse gear. If your vehicle has an automatic transmission, shift into park (P).

 **WARNING:** Make sure all passengers are out of your vehicle.

 **WARNING:** Make sure that your vehicle is on firm and level ground with the front wheels pointing straight ahead.

Wheels and Tires



WARNING: Chock the diagonally opposite wheel to the punctured tire with an appropriate block or wheel chock. A wheel chock may be in the B-pillar or in a storage compartment in the front right-hand side stepwell.



WARNING: Make sure that the arrows on directional tires point in the direction of rotation when your vehicle is moving forward. If you have to fit a spare tire with the arrows pointing in the opposite direction have the tire refitted as soon as possible.

1. Use the locking lug nut key to loosen the locking lug nut.
2. Loosen the remaining lug nuts, but do not remove them.
3. Raise your vehicle until the tire is clear of the ground.
4. Remove the lug nuts and the road wheel.

Note: *Do not lay alloy road wheels face down on the ground.*

Installing a Road Wheel



WARNING: Use only approved wheel and tire sizes. Using other sizes could damage your vehicle and will make the National Type Approval invalid.



WARNING: Make sure there is no grease or oil on the threads or the surface between the wheel lugs and nuts. This can cause the lug nuts to loosen while driving.



WARNING: When you install a wheel, always remove any corrosion, dirt or foreign materials present on the mounting surfaces of the wheel or the surface of the wheel hub, brake drum or brake disc that contacts the wheel. Make sure to secure any fasteners that attach the rotor to the hub so they do not interfere with the mounting surfaces of the wheel. Installing wheels without correct metal-to-metal contact at the wheel mounting surfaces can cause the wheel nuts to loosen and the wheel to come off while your vehicle is in motion, resulting in loss of vehicle control, personal injury or death.



WARNING: Only use the specific lug nuts and wheels supplied with your vehicle. If in doubt, contact an authorized dealer.



WARNING: Do not install alloy wheels using lug nuts designed for use with steel wheels.



WARNING: The lug nuts of alloy wheels and spoked steel wheels can also be used for the steel spare wheel for a short time (maximum two weeks).

1. Install the wheel.

Wheels and Tires

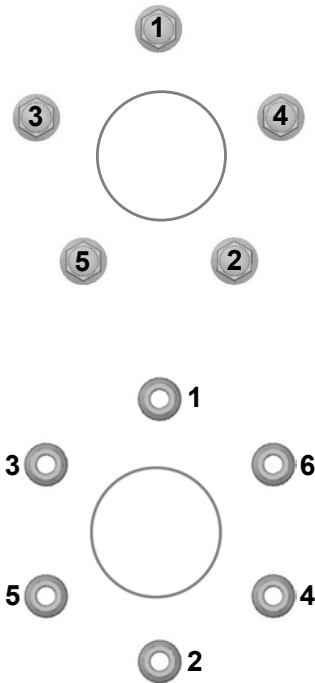

E70961

2. Install all of the lug nuts and partially tighten them in the sequence shown.
3. Lower your vehicle and remove the vehicle jack.
4. Fully tighten all of the lug nuts in the sequence shown. See **Technical Specifications** (page 305).
5. Install the wheel trim.

Note: Make sure that the lug nuts are fully seated against the wheel.

Note: Alloy wheel lug nuts are suitable for use on a steel spare wheel.

Note: If the spare wheel is not the same type and size as your vehicle road wheel replace it as soon as possible.

Note: Check the lug nuts for correct tightness and check the tire pressure as soon as possible. See **Technical Specifications** (page 305).

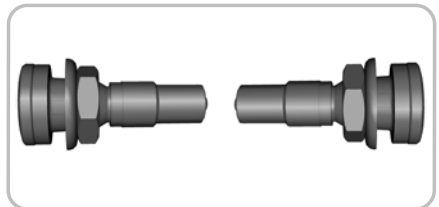

E227387

Note: When installing 17-inch dual rear wheels, align the valve stems facing each other.

Stowing the Wheel and Vehicle Jack

Note: Do not raise the spare wheel bracket without a wheel attached. Damage to the winch mechanism could occur.

1. Attach the spare wheel bracket to the wheel using the retaining nut.

Wheels and Tires

- Slide the cable through the slot and attach the spare wheel bracket to the winch.
- Rotate the cable through 90 degrees and lower the cable end cover.
- Insert the flat end of the lug wrench into the socket. Turn it clockwise until you feel a strong resistance. Make sure the wheel is secure.
- Stow the vehicle jack, jack handle and lug wrench in their correct locations and secure them with the straps.

TECHNICAL SPECIFICATIONS

Wheel Lug Nut Torque Specifications



WARNING: When a wheel is installed, always remove any corrosion, dirt or foreign materials present on the mounting surfaces of the wheel or the surface of the wheel hub, brake drum or brake disc that contacts the wheel. Make sure that any fasteners that attach the rotor to the hub are secured so they do not interfere with the mounting surfaces of the wheel. Installing wheels without correct metal-to-metal contact at the wheel mounting surfaces can cause the wheel nuts to loosen and the wheel to come off while your vehicle is in motion, resulting in loss of control.

Bolt size	lb-ft (Nm)*
M14 x 1.5	148 lb.ft (200 Nm)

*Torque specifications are for nut and bolt threads free of dirt and rust. Use only Ford recommended replacement fasteners.

Retighten the lug nuts to the specified torque within 100 miles (160 kilometers) after any wheel disturbance, for example tire rotation, changing a flat tire or wheel removal.

Wheels and Tires



E145950

A Wheel pilot bore

Inspect the wheel pilot bore and mounting surface prior to installation. Remove any visible corrosion or loose particles.

Capacities and Specifications

ENGINE SPECIFICATIONS - 3.2L POWER STROKE DIESEL

Engine	3.2L Power Stroke Diesel
Cubic inches	195
Required fuel	No. 2 Diesel
Firing order	1-2-4-5-3
Compression ratio	15.4:1

Capacities and Specifications

ENGINE SPECIFICATIONS - 3.5L ECOBOOST™

Engine	3.5L V6 EcoBoost
Cubic inches	214
Required fuel	Minimum 87 octane
Firing order	1-4-2-5-3-6
Ignition system	Coil on plug
Spark plug gap	.030-.033 in. (.75-.85 mm)
Compression ratio	10.0:1

Capacities and Specifications

ENGINE SPECIFICATIONS - 3.7L

Engine	3.7 V6
Cubic inches	226
Firing order	1-4-2-5-3-6
Ignition system	Coil on plug
Spark plug gap	.049-.053 in. (1.25-1.35 mm)
Compression ratio	10.5:1

Capacities and Specifications

MOTORCRAFT PARTS - 3.2L POWER STROKE DIESEL

3.2L Power Stroke Diesel

Component	Part number
Diesel Foam Pre air filter.	FA-1921
Air filter element.	FA-1916
Automatic transmission fluid filter.	FT-161
Dual battery.	BAGM-48H6-760
Oil filter.	FL-500S
Fuel filter.	FD-4621
Windshield wiper blades - vehicles with medium low roof.	WW-2955 - driver side WW-2112 - passenger side
Windshield wiper blades - vehicles with low, medium or high roof.	WW-2901 - driver side WW-2049 - passenger side

Motorcraft replacement parts are recommended for scheduled maintenance and are available at an authorized dealer or at fordparts.com. These parts meet or exceed Ford Motor Company's specifications, and are engineered for your vehicle. Use of other parts may impact vehicle performance, emissions and durability. Your vehicle Warranty may be void for any damage related to use of other parts.

Should a Motorcraft oil filter not be available, use an oil filter that meets industry performance specification SAE/USCAR-36.

MOTORCRAFT PARTS - 3.5L ECOBOOST™

3.5L V6 EcoBoost

Component	Part number
Air filter element	FA-1916
Automatic transmission fluid filter	FT-161
Battery	BXT-48H6-610
Oil filter	FL-500S

Capacities and Specifications

Component	Part number
Spark plugs	SP-534
Windshield wiper blades - roof med-low	WW-2955 - driver side WW-2112 - passenger side
Windshield wiper blades - roof low, medium & high	WW-2901 - driver side WW-2049 - passenger side

We recommend Motorcraft replacement parts available at your Ford dealer or at fordparts.com for scheduled maintenance. These parts meet or exceed Ford Motor Company's specifications and are engineered for your vehicle. Use of other parts may impact vehicle performance, emissions and durability. Your warranty may be void for any damage related to use of other parts.

If a Motorcraft oil filter is not available, use an oil filter that meets industry performance specification SAE/USCAR-36.

For spark plug replacement, contact an authorized dealer. Replace the spark plugs at the appropriate intervals. See **Normal Scheduled Maintenance** (page 469).

Capacities and Specifications

MOTORCRAFT PARTS - 3.7L

3.7L Duratec

Component	Part number
Air filter element	FA-1916
Automatic transmission fluid filter	FT-161
Battery	BXT-48H6-610
Oil filter	FL-500S
Spark plugs	SP-520
Windshield wiper blades - roof med-low	WW-2955 - driver side WW-2112 - passenger side
Windshield wiper blades - roof low, medium & high	WW-2901 - driver side WW-2049 - passenger side

We recommend Motorcraft replacement parts available at your Ford dealer or at fordparts.com for scheduled maintenance. These parts meet or exceed Ford Motor Company's specifications and are engineered for your vehicle. Use of other parts may impact vehicle performance, emissions and durability. Your warranty may be void for any damage related to use of other parts.

If a Motorcraft oil filter is not available, use an oil filter that meets industry performance specification SAE/USCAR-36.

For spark plug replacement, contact an authorized dealer. Replace the spark plugs at the appropriate intervals. See **Normal Scheduled Maintenance** (page 469).

Capacities and Specifications

VEHICLE IDENTIFICATION NUMBER

The vehicle identification number is located on the left-hand side of the instrument panel.



E142476

Please note that in the graphic, XXXX is representative of your vehicle identification number.

The Vehicle Identification Number contains the following information:

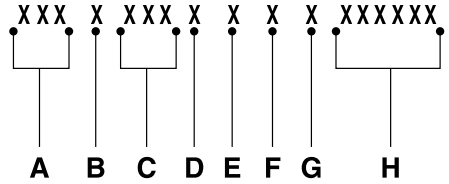

E142477

- A World manufacturer identifier
- B Brake system, Gross Vehicle Weight Rating, Restraint Devices and their locations
- C Make, vehicle line, series, body type
- D Engine type
- E Check digit
- F Model year
- G Assembly plant
- H Production sequence number

Capacities and Specifications

VEHICLE CERTIFICATION LABEL

MFD. BY FORD MOTOR CO.

DATE: XX/XX GVWR: XXXX KG (XXXX LB)
 FRONT GAWR: REAR GAWR:
 XXXX KG (XXXX LB) WITH XXXX KG (XXXX LB) WITH
 XXXXXXXXXXXXXXXXXXXX TIRES XXXXXXXXXXXXXXXXXXXX TIRES
 XXXXXXXX RIMS XXXXXXXX RIMS
 AT XXXX kPa/ XXX PSI COLD AT XXXX kPa/ XXX PSI COLD

THIS VEHICLE CONFORMS TO ALL APPLICABLE FEDERAL MOTOR VEHICLE SAFETY AND THEFT PREVENTION STANDARDS IN EFFECT ON THE DATE OF MANUFACTURE SHOWN ABOVE.

VIN: XXXXXXXXXXXXXXXXXXXX XXXXX
 TYPE: XXXX XXXXX



EXT PNT: XX XXXXXX RC: XX DSO: XXXX
 WB INT TR TTP/PS TR AXLE TR SPR XXXX
 XXX XX XXX X XX X XXXX XXXX
 XXXXXXXXXXXXXXXX XXX XXXX-XXXXXXXX-XX

E167469

The National Highway Traffic Safety Administration Regulations require that a Safety Compliance Certification Label be affixed to a vehicle and prescribe where the Safety Compliance Certification Label may be located. The Safety Compliance Certification Label shall be affixed to either the door hinge pillar, the door latch post, or the edge of the door near the door latch, next to the driver's seating position.

TRANSMISSION CODE DESIGNATION

MFD. BY FORD MOTOR CO.

DATE: XX/XX GVWR: XXXX KG (XXXX LB)
 FRONT GAWR: REAR GAWR:
 XXXX KG (XXXX LB) WITH XXXX KG (XXXX LB) WITH
 XXXXXXXXXXXXXXXXXXXX TIRES XXXXXXXXXXXXXXXXXXXX TIRES
 XXXXXXXX RIMS XXXXXXXX RIMS
 AT XXXX kPa/ XXX PSI COLD AT XXXX kPa/ XXX PSI COLD

THIS VEHICLE CONFORMS TO ALL APPLICABLE FEDERAL MOTOR VEHICLE SAFETY AND THEFT PREVENTION STANDARDS IN EFFECT ON THE DATE OF MANUFACTURE SHOWN ABOVE.

VIN: XXXXXXXXXXXXXXXXXXXX XXXXX
 TYPE: XXXX XXXXX



EXT PNT: XX XXXXXX RC: XX DSO: XXXX
 WB INT TR TTP/PS TR AXLE TR SPR XXXX
 XXX XX XXX X XX X XXXX XXXX
 XXXXXXXXXXXXXXXX XX =XXXX-XXXXXXXX-XX

E167814

The transmission code is on the Safety Compliance Certification Label. The following table shows the transmission code along with the transmission description.

Description	Code
Six-speed automatic transmission 6R80E	6

Capacities and Specifications

CAPACITIES AND SPECIFICATIONS - 3.2L POWER STROKE DIESEL

Use oil and fluid that meets the defined specification and viscosity grade.

If you do not use oil and fluid that meets the defined specification and viscosity grade, it could result in:

- Component damage not covered by the vehicle Warranty.
- Longer engine cranking periods.
- Increased emission levels.

- Reduced engine performance.
- Reduced fuel economy.
- Reduced brake performance.

Air Conditioning System



WARNING: The air conditioning refrigerant system contains refrigerant under high pressure. Only qualified personnel should service the air conditioning refrigerant system. Opening the air conditioning refrigerant system can cause personal injury.

Capacities

Variant	Refrigerant	Refrigerant Oil
Vehicles with rear air conditioning.	39.2 oz (1.11 kg)	9.5 fl oz (280 ml)
Vehicles without rear air conditioning.	28.2 oz (0.8 kg)	5.4 fl oz (160 ml)

Materials

Name	Specification
Motorcraft® R-134a Refrigerant (U.S.) R-134a Refrigerant / Frigorigène R-134a (Canada) YN-19 (U.S.) CYN-19-R (Canada)	WSH-M17B19-A
Motorcraft® PAG Refrigerant Compressor Oil (U.S.) Motorcraft® PAG Refrigerant Compressor Oil / Huile PAG pour compresseur frigorifique Motorcraft® (Canada) YN-12-D (U.S. & Canada)	WSH-MIC231-B

Engine

Engine Oil

We recommend that you use Motorcraft oil and fluids for your vehicle. Only use fluid that meets Ford specifications.

Capacities and Specifications

Capacities

Variant	Including the Oil Filter
All.	12.0 qt (11.4 L)

Note: The quantity of engine oil required to raise the indicated level on the dipstick from minimum to maximum is 2.6 qt (2.5 L).

Materials

Name	Specification
Motorcraft® SAE 5W-40 Full Synthetic Diesel Motor Oil (U.S.) (Canada) XO-5W40-5Q3SD (U.S.)	WSS-M2C171-F1

Alternative Engine Oil for Extremely Cold Climates

To improve engine cold start performance, we recommend that you use the following alternative engine oil in extremely cold climates, where the ambient temperature reaches -22.0°F (-30°C) or below.

Materials

Name	Specification
Motorcraft® SAE 0W-40 Full Synthetic Diesel Motor Oil (U.S.) (Canada) XO-0W40-DAS (U.S.)	WSS-M2C171-F1

Capacities and Specifications

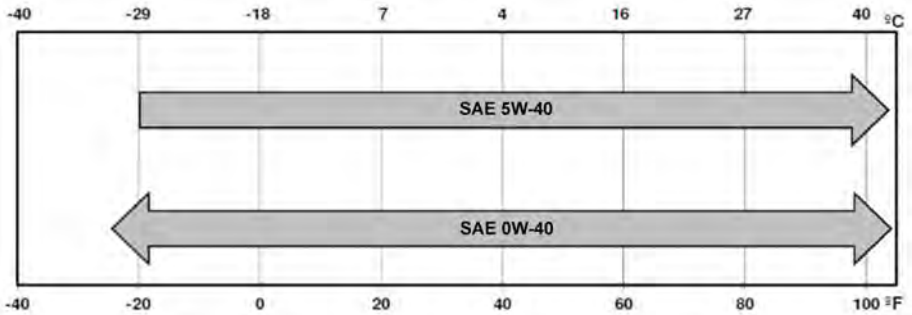

E279556

Engine Coolant

Capacities

Variant	Quantity
Vehicles with auxiliary heater.	15.3 qt (14.5 L)
Vehicles without auxiliary heater.	13.9 qt (13.2 L)

Materials

Name	Specification
Motorcraft® Yellow Prediluted Antifreeze/Coolant (U.S.) Motorcraft® Yellow Prediluted Antifreeze/Coolant / Antigel/liquide de refroidissement prédilué jaune Motorcraft® (Canada) VC-13DL-G (U.S.) CVC-13DL-G (Canada)	WSS-M97B57-A2

Fuel Tank

Capacities

Variant	Quantity
All.	25.1 gal (95 L)

Capacities and Specifications

Diesel Exhaust Fluid

Capacities

Variant	Quantity
All.	5.5 gal (21 L)

Materials

Name	Specification
Motorcraft® Diesel Exhaust Fluid (U.S.) Motorcraft® Diesel Exhaust Fluid / Fluide pour échappement diesel Motorcraft® (Canada) PM-27-GAL, PM-27-JUG (U.S.) CPM-27-J (Canada)	WSS-M99C130-A

Washer Reservoir

Capacities

Variant	Quantity
All.	4.8 qt (4.5 L)

Materials

Name	Specification
Motorcraft® Premium Windshield Wash Concentrate with Bitterant (U.S.) Motorcraft® Premium Quality Windshield Washer Fluid / Liquide lave-glace de haute qualité Motorcraft® (Canada) ZC-32-B2 (U.S.) CXC-37-A/B/D/F (Canada)	WSS-M14P19-A

Brake System

Capacities and Specifications

Materials

Name	Specification
Motorcraft® DOT 4 LV High Performance Motor Vehicle Brake Fluid (U.S.) Motorcraft® DOT 4 LV High Performance Motor Vehicle Brake Fluid / Liquide de frein automobile haute performance DOT 4 LV Motorcraft® (Canada) PM-20 (U.S. & Canada)	WSS-M6C65-A2

Rear Axle

Capacities

Variant	Quantity
Rear axle fluid, vehicles with limited slip differential.	2.9 qt (2.72 L)
Rear axle fluid, vehicles with conventional differential.	3.0 qt (2.84 L)
Rear axle friction modifier.	0.1 qt (118 ml)

Note: Ford rear axles contain a synthetic lubricant that does not require changing unless you submerge the axle in water.

Materials

Name	Specification
Motorcraft® SAE 75W-85 Premium Synthetic Hypoid Gear Lubricant (U.S.) Motorcraft® SAE 75W-85 Premium Synthetic Hypoid Gear Lubricant / Huile synthétique de haute qualité pour engrenages hypoides SAE 75W-85 Motorcraft® (Canada) XY-75W85-QL (U.S. & Canada)	WSS-M2C942-A
Motorcraft® Additive Friction Modifier (U.S.) Motorcraft® Additive Friction Modifier / Additif modificateur de friction Motorcraft® (Canada) XL-3 (U.S.) CXL-3 (Canada)	EST-M2C118-A

Capacities and Specifications

Automatic Transmission

automatic transmission that requires MERCON® LV transmission fluid.

You must use the correct fluid for

Capacities

Variant	Quantity
All.	13.1 qt (12.4 L)

Materials

Name	Specification
Motorcraft® MERCON® LV Automatic Transmission Fluid (U.S.) Motorcraft® MERCON® LV Automatic Transmission Fluid / Huile pour boîte automatique MERCON® LV Motorcraft® (Canada) XT-10-QLVC (U.S.) CXT-10-LV6 (Canada)	MERCON® LV WSS-M2C938-A

Locks

Materials

Name	Specification
Motorcraft® Penetrating and Lock Lubricant (U.S.) Motorcraft® Penetrating Fluid / Liquide dégrissant Motorcraft® (Canada) XL-1 (U.S.) CXC-51-A (Canada)	-

Grease

Materials

Name	Specification
Motorcraft® Premium Long-Life Grease (U.S.) Motorcraft® Premium Long-Life Grease / Graisse longue durée de qualité première Motorcraft® (Canada) XG-1-E1 (U.S. & Canada)	ESA-M1C75-B

Capacities and Specifications

CAPACITIES AND SPECIFICATIONS - 3.5L ECOBOOST™

Use oil and fluid that meets the defined specification and viscosity grade.

If you do not use oil and fluid that meets the defined specification and viscosity grade, it could result in:

- Component damage not covered by the vehicle Warranty.
- Longer engine cranking periods.
- Increased emission levels.

- Reduced engine performance.
- Reduced fuel economy.
- Reduced brake performance.

Air Conditioning System



WARNING: The air conditioning refrigerant system contains refrigerant under high pressure. Only qualified personnel should service the air conditioning refrigerant system. Opening the air conditioning refrigerant system can cause personal injury.

Capacities

Variant	Refrigerant	Refrigerant Oil
Vehicles with rear air conditioning.	39.2 oz (1.11 kg)	9.5 fl oz (280 ml)
Vehicles without rear air conditioning.	28.2 oz (0.8 kg)	5.4 fl oz (160 ml)

Materials

Name	Specification
Motorcraft® R-134a Refrigerant (U.S.) R-134a Refrigerant / Frigorigène R-134a (Canada) YN-19 (U.S.) CYN-19-R (Canada)	WSH-M17B19-A
Motorcraft® PAG Refrigerant Compressor Oil (U.S.) Motorcraft® PAG Refrigerant Compressor Oil / Huile PAG pour compresseur frigorifique Motorcraft® (Canada) YN-12-D (U.S. & Canada)	WSH-MIC231-B

Capacities and Specifications

Engine

Engine Oil



E142732



E276075

An oil that displays this symbol conforms to current engine, emission system and fuel economy performance standards of the International Lubricants Specification Advisory Committee (ILSAC).

We recommend Motorcraft® motor oil for your vehicle. If Motorcraft® oil is not available, use motor oils of the recommended viscosity grade that meet API SN PLUS requirements and display the API Certification Mark for gasoline engines. Do not use oil labeled with API SN service category unless the label also displays the API certification mark.

Capacities

Variant	Including the Oil Filter
All.	5.9 qt (5.6 L)

Note: The quantity of engine oil required to raise the indicated level on the dipstick from minimum to maximum is 1.0 qt (0.9 L).

Capacities and Specifications

Materials

Name	Specification
Engine Oil - SAE 5W-30 - Synthetic Blend Motor Oil (U.S.) Engine Oil - SAE 5W-30 - Super Premium Motor Oil / Huile moteur de très haute qualité SAE 5W-30 Motorcraft® (Canada) XO-5W30-Q1SP (U.S.) CXO-5W30-LSP6 (Canada)	WSS-M2C946-B1

Note: Do not use more than 0.3 gal (1L) of the alternative engine oil between scheduled service intervals.

Alternative Engine Oil for Extremely Cold Climates

To improve engine cold start performance, we recommend that you use the following alternative engine oil where the ambient temperature reaches -22°F (-30°C) or below.

Materials

Name	Specification
Engine Oil - SAE 0W-30	WSS-M2C953-B1

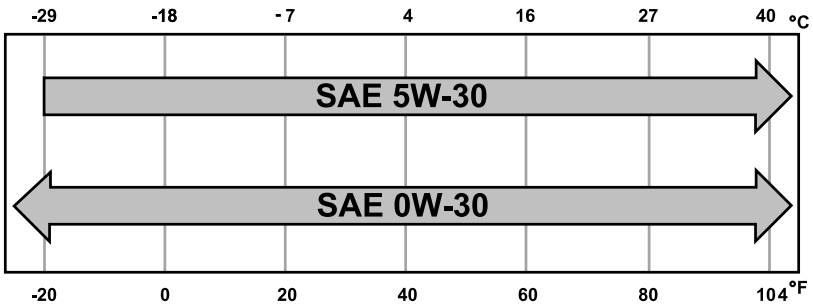

Capacities and Specifications

Engine Coolant

Capacities

Variant	Quantity
Vehicles with auxiliary heater.	16.4 qt (15.5 L)
Vehicles without auxiliary heater.	14.9 qt (14.1 L)

Materials

Name	Specification
Motorcraft® Yellow Prediluted Antifreeze/Coolant (U.S.) Motorcraft® Yellow Prediluted Antifreeze/Coolant / Antigel/liquide de refroidissement prédilué jaune Motorcraft® (Canada) VC-13DL-G (U.S.) CVC-13DL-G (Canada)	WSS-M97B57-A2

Fuel Tank

Capacities

Variant	Quantity
All.	25.1 gal (95 L)

Washer Reservoir

Capacities

Variant	Quantity
All.	4.8 qt (4.5 L)

Capacities and Specifications

Materials

Name	Specification
Motorcraft® Premium Windshield Wash Concentrate with Bitterant (U.S.) Motorcraft® Premium Quality Windshield Washer Fluid / Liquide lave-glacé de haute qualité Motorcraft® (Canada) ZC-32-B2 (U.S.) CXC-37-A/B/D/F (Canada)	WSS-M14P19-A

Brake System

Materials

Name	Specification
Motorcraft® DOT 4 LV High Performance Motor Vehicle Brake Fluid (U.S.) Motorcraft® DOT 4 LV High Performance Motor Vehicle Brake Fluid / Liquide de frein automobile haute performance DOT 4 LV Motorcraft® (Canada) PM-20 (U.S. & Canada)	WSS-M6C65-A2

Rear Axle

Capacities

Variant	Quantity
Rear axle fluid, vehicles with limited slip differential.	2.9 qt (2.72 L)
Rear axle fluid, vehicles with conventional differential.	3.0 qt (2.84 L)
Rear axle friction modifier.	0.1 qt (118 ml)

Note: Ford rear axles contain a synthetic lubricant that does not require changing unless you submerge the axle in water.

Capacities and Specifications

Materials

Name	Specification
Motorcraft® SAE 75W-85 Premium Synthetic Hypoid Gear Lubricant (U.S.) Motorcraft® SAE 75W-85 Premium Synthetic Hypoid Gear Lubricant / Huile synthétique de haute qualité pour engrenages hypoides SAE 75W-85 Motorcraft® (Canada) XY-75W85-QL (U.S. & Canada)	WSS-M2C942-A
Motorcraft® Additive Friction Modifier (U.S.) Motorcraft® Additive Friction Modifier / Additif modificateur de friction Motorcraft® (Canada) XL-3 (U.S.) CXL-3 (Canada)	EST-M2C118-A

Automatic Transmission

You must use the correct fluid for automatic transmission that requires MERCON® LV transmission fluid.

Capacities

Variant	Quantity
All.	13.1 qt (12.4 L)

Materials

Name	Specification
Motorcraft® MERCON® LV Automatic Transmission Fluid (U.S.) Motorcraft® MERCON® LV Automatic Transmission Fluid / Huile pour boîte automatique MERCON® LV Motorcraft® (Canada) XT-10-QLVC (U.S.) CXT-10-LV6 (Canada)	MERCON® LV WSS-M2C938-A

Locks

Capacities and Specifications

Materials

Name	Specification
Motorcraft® Penetrating and Lock Lubricant (U.S.) Motorcraft® Penetrating Fluid / Liquide dégrissant Motorcraft® (Canada) XL-1 (U.S.) CXC-51-A (Canada)	-

Grease

Materials

Name	Specification
Motorcraft® Premium Long-Life Grease (U.S.) Motorcraft® Premium Long-Life Grease / Graisse longue durée de qualité première Motorcraft® (Canada) XG-1-E1 (U.S. & Canada)	ESA-MIC75-B

CAPACITIES AND SPECIFICATIONS - 3.7L

Use oil and fluid that meets the defined specification and viscosity grade.

If you do not use oil and fluid that meets the defined specification and viscosity grade, it could result in:

- Component damage not covered by the vehicle Warranty.
- Longer engine cranking periods.
- Increased emission levels.

- Reduced engine performance.
- Reduced fuel economy.
- Reduced brake performance.

Air Conditioning System



WARNING: The air conditioning refrigerant system contains refrigerant under high pressure. Only qualified personnel should service the air conditioning refrigerant system. Opening the air conditioning refrigerant system can cause personal injury.

Capacities

Variant	Refrigerant	Refrigerant Oil
Vehicles with rear air conditioning.	39.2 oz (1.11 kg)	9.5 fl oz (280 ml)
Vehicles without rear air conditioning.	28.2 oz (0.8 kg)	5.4 fl oz (160 ml)

Capacities and Specifications

Materials

Name	Specification
Motorcraft® R-134a Refrigerant (U.S.) R-134a Refrigerant / Frigorigène R-134a (Canada) YN-19 (U.S.) CYN-19-R (Canada)	WSH-M17B19-A
Motorcraft® PAG Refrigerant Compressor Oil (U.S.) Motorcraft® PAG Refrigerant Compressor Oil / Huile PAG pour compresseur frigorifique Motorcraft® (Canada) YN-12-D (U.S. & Canada)	WSH-M1C231-B

Engine

Engine Oil



E142732



E275759

An oil that displays this symbol conforms to current engine, emission system and fuel economy performance standards of the International Lubricants Specification Advisory Committee (ILSAC).

We recommend Motorcraft® motor oil for your vehicle. If Motorcraft® oil is not available, use motor oils of the recommended viscosity grade that meet API SN PLUS requirements and display the API Certification Mark for gasoline engines. Do not use oil labeled with API SN service category unless the label also displays the API certification mark.

Capacities and Specifications

Capacities

Variant	Including the Oil Filter
All.	6.0 qt (5.7 L)

Note: The quantity of engine oil required to raise the indicated level on the dipstick from minimum to maximum is 1.0 qt (0.9 L).

Materials

Name	Specification
Engine Oil - SAE 5W-20 - Synthetic Blend Motor Oil (U.S.) Engine Oil - SAE 5W-20 - Super Premium Motor Oil / Huile moteur de très haute qualité SAE 5W-20 Motorcraft® (Canada) XO-5W20-Q1SP (U.S.) CXO-5W20-LSP6 (Canada)	WSS-M2C945-B1

Engine Coolant

Capacities

Variant	Quantity
Vehicles with auxiliary heater.	16.4 qt (15.5 L)
Vehicles without auxiliary heater.	14.9 qt (14.1 L)

Materials

Name	Specification
Motorcraft® Yellow Prediluted Antifreeze/Coolant (U.S.) Motorcraft® Yellow Prediluted Antifreeze/Coolant / Antigel/liquide de refroidissement prédilué jaune Motorcraft® (Canada) VC-13DL-G (U.S.) CVC-13DL-G (Canada)	WSS-M97B57-A2

Capacities and Specifications

Fuel Tank

Capacities

Variant	Quantity
All.	25.1 gal (95 L)

Washer Reservoir

Capacities

Variant	Quantity
All.	4.8 qt (4.5 L)

Materials

Name	Specification
Motorcraft® Premium Windshield Wash Concentrate with Bitterant (U.S.) Motorcraft® Premium Quality Windshield Washer Fluid / Liquide lave-glace de haute qualité Motorcraft® (Canada) ZC-32-B2 (U.S.) CXC-37-A/B/D/F (Canada)	WSS-M14P19-A

Brake System

Materials

Name	Specification
Motorcraft® DOT 4 LV High Performance Motor Vehicle Brake Fluid (U.S.) Motorcraft® DOT 4 LV High Performance Motor Vehicle Brake Fluid / Liquide de frein automobile haute performance DOT 4 LV Motorcraft® (Canada) PM-20 (U.S. & Canada)	WSS-M6C65-A2

Capacities and Specifications

Rear Axle

Capacities

Variant	Quantity
Rear axle fluid, vehicles with limited slip differential.	2.9 qt (2.72 L)
Rear axle fluid, vehicles with conventional differential.	3.0 qt (2.84 L)
Rear axle friction modifier.	0.1 qt (118 ml)

Note: Ford rear axles contain a synthetic lubricant that does not require changing unless you submerge the axle in water.

Materials

Name	Specification
Motorcraft® SAE 75W-85 Premium Synthetic Hypoid Gear Lubricant (U.S.) Motorcraft® SAE 75W-85 Premium Synthetic Hypoid Gear Lubricant / Huile synthétique de haute qualité pour engrenages hypoides SAE 75W-85 Motorcraft® (Canada) XY-75W85-QL (U.S. & Canada)	WSS-M2C942-A
Motorcraft® Additive Friction Modifier (U.S.) Motorcraft® Additive Friction Modifier / Additif modificateur de friction Motorcraft® (Canada) XL-3 (U.S.) CXL-3 (Canada)	EST-M2C118-A

Automatic Transmission

You must use the correct fluid for automatic transmission that requires MERCON® LV transmission fluid.

Capacities

Variant	Quantity
All.	13.1 qt (12.4 L)

Capacities and Specifications

Materials

Name	Specification
Motorcraft® MERCON® LV Automatic Transmission Fluid (U.S.) Motorcraft® MERCON® LV Automatic Transmission Fluid / Huile pour boîte automatique MERCON® LV Motorcraft® (Canada) XT-10-QLVC (U.S.) CXT-10-LV6 (Canada)	MERCON® LV WSS-M2C938-A

Locks

Materials

Name	Specification
Motorcraft® Penetrating and Lock Lubricant (U.S.) Motorcraft® Penetrating Fluid / Liquide dégrissant Motorcraft® (Canada) XL-1 (U.S.) CXC-51-A (Canada)	-

Grease

Materials

Name	Specification
Motorcraft® Premium Long-Life Grease (U.S.) Motorcraft® Premium Long-Life Grease / Graisse longue durée de qualité première Motorcraft® (Canada) XG-1-E1 (U.S. & Canada)	ESA-MIC75-B

Audio System

GENERAL INFORMATION

Radio Frequencies and Reception Factors

AM and FM frequencies are established by the Federal Communications Commission (FCC) and the Canadian Radio and Telecommunications Commission (CRTC). Those frequencies are:

- AM: 530, 540-1700, 1710 kHz
- FM: 87.9-107.7, 107.9 MHz

Radio Reception Factors	
Distance and strength	The further you travel from an AM or FM station, the weaker the signal and the weaker the reception.
Terrain	Hills, mountains, tall buildings, bridges, tunnels, freeway overpasses, parking garages, dense tree foliage and thunderstorms can interfere with the reception.
Station overload	When you pass a ground-based broadcast repeating tower, a stronger signal may overtake a weaker one and result in the audio system muting.

CD and CD Player Information

Note: *CD units play commercially pressed 5 in (12 cm) audio compact discs only. Due to technical incompatibility, certain recordable and re-recordable compact discs may not function correctly when used in Ford CD players.*

Note: *Do not insert CDs with homemade paper (adhesive) labels into the CD player as the label may peel and cause the CD to become jammed. You should use a permanent felt tip marker rather than adhesive labels on your homemade CDs. Ballpoint pens may damage CDs. Please contact an authorized dealer for further information.*

Note: *Do not use any irregularly shaped discs or discs with a scratch protection film attached.*

Always handle discs by their edges only. Clean the disc with an approved CD cleaner only. Wipe it from the center of the disc toward the edge. Do not clean in a circular motion.

Do not expose discs to direct sunlight or heat sources for extended periods.

MP3 and WMA Track and Folder Structure

Audio systems capable of recognizing and playing MP3 and WMA individual tracks and folder structures work as follows:

- There are two different modes for MP3 and WMA disc playback: MP3 and WMA track mode (system default) and MP3 and WMA folder mode.
- MP3 and WMA track mode ignores any folder structure on the MP3 and WMA disc. The player numbers each MP3 and WMA track on the disc (noted by the MP3 or WMA file extension) from T001 to a maximum of T255. The maximum number of playable MP3 and WMA files may be less depending on the structure of the CD and exact model of radio present.

Audio System

- MP3 and WMA folder mode represents a folder structure consisting of one level of folders. The CD player numbers all MP3 and WMA tracks on the disc (noted by the MP3 or WMA file extension) and all folders containing MP3 and WMA files, from F001 (folder) T001 (track) to F253 T255.
- Creating discs with only one level of folders helps with navigation through the disc files.

If you are burning your own MP3 and WMA discs, it is important to understand how the system reads the structures you create. While various files may be present (files with extensions other than MP3 and WMA), only files with the MP3 and WMA extension are played; other files are ignored by the system. This enables you to use the same MP3 and WMA disc for a variety of tasks on your work computer, home computer and your in-vehicle system.

In track mode, the system displays and plays the structure as if it were only one level deep (all MP3 and WMA files play, regardless of being in a specific folder). In folder mode, the system only plays the MP3 and WMA files in the current folder.

AUDIO UNIT - VEHICLES WITH: AM/FM/CD/SYNC/SATELLITE RADIO



WARNING: Driving while distracted can result in loss of vehicle control, crash and injury. We strongly recommend that you use extreme caution when using any device that may take your focus off the road. Your primary responsibility is the safe operation of your vehicle. We recommend against the use of any hand-held device while driving and encourage the use of voice-operated systems when possible. Make sure you are aware of all applicable local laws that may affect the use of electronic devices while driving.

Note: *You can use the system for up to an hour after you switch the ignition off. Press the on and off control to operate the system with the ignition turned off. The system automatically turns off after one hour.*

Note: *Some features, such as SIRIUS satellite radio, may not be available in your location. Check with an authorized dealer.*

Audio System

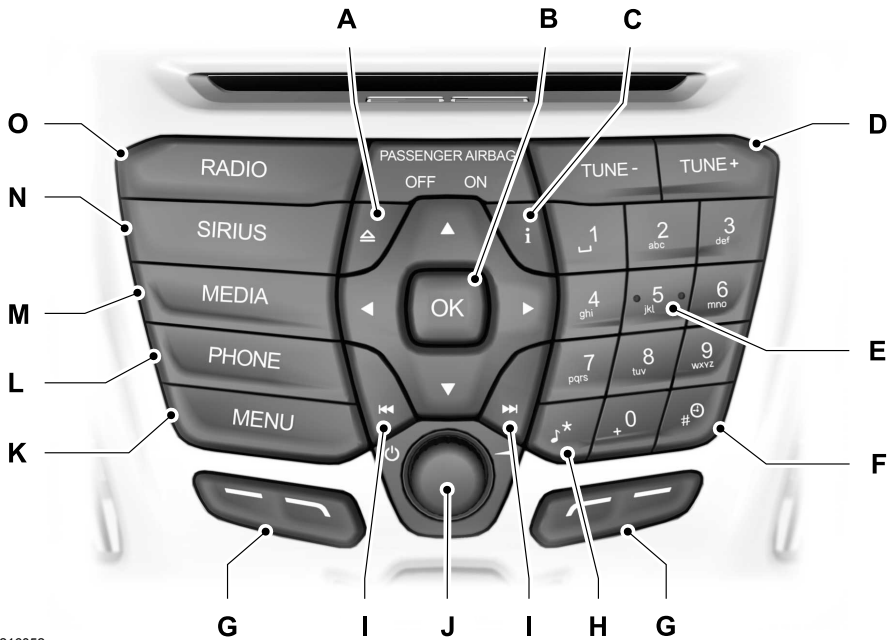

E216052

- A **Eject:** Press to eject a CD.
- B **OK and Arrow buttons:** Press **OK** to confirm menu selections. Press to scroll through the menu choices.
- C **Information:** Press to access any available radio or CD information.
- D **TUNE:** Press to manually search through the radio frequency band.
- E **Number block:** In radio mode, you can store your favorite radio stations. To store a radio station, tune to the station, then press and hold a preset button until sound returns. In CD mode, select a track. In phone mode, enter a phone number.
- F **CLOCK:** If not in phone mode, press to display the clock.
- G **Function buttons:** Select different functions of the audio system depending on which mode you are in (such as Radio mode or CD mode).

Audio System

- H **SOUND:** Press to access settings for Treble, Midrange, Bass, Fade or Balance. Use the up and down arrow buttons to select the various settings. When you make your selection, press the left and right arrow buttons to change the settings. Press **OK** to set or press **MENU** to exit. Sound settings can be set for each audio source independently.
- I **Seek, Fast Forward and Reverse:** In radio mode, select a frequency band and press either button. The system stops at the first station it finds in that direction. Press and hold to quickly seek up or down the frequency band. In media mode, press to select the previous or next track. Press and hold either button to move quickly forward or backward through the current track.
- J **VOL and Power:** Press to switch the system on and off. Turn to adjust the volume.
- K **MENU:** Press to access different audio system features. See **Menu Structure** later in this chapter.
- L **PHONE:** Press to access the phone features of the SYNC system. See your SYNC information.
- M **MEDIA:** Press to open the media source menu. You can press this multiple times to change to CD or to a SYNC-Media device or scroll through the media sources using the arrow buttons. Press **OK** to select a source.
- N **SIRIUS:** Press to listen to SIRIUS satellite radio.
- O **RADIO:** Press this multiple times to select a radio band. Press and hold to select the autostore function. Press to return to the main screen of the active radio band.

AUDIO UNIT - VEHICLES WITH: PREMIUM AM/FM/CD



WARNING: Driving while distracted can result in loss of vehicle control, crash and injury. We strongly recommend that you use extreme caution when using any device that may take your focus off the road. Your

primary responsibility is the safe operation of your vehicle. We recommend against the use of any hand-held device while driving and encourage the use of voice-operated systems when possible. Make sure you are aware of all applicable local laws that may affect the use of electronic devices while driving.

Note: *The touchscreen system controls most of the audio features. See **SYNC™ 3** (page 394).*

Audio System

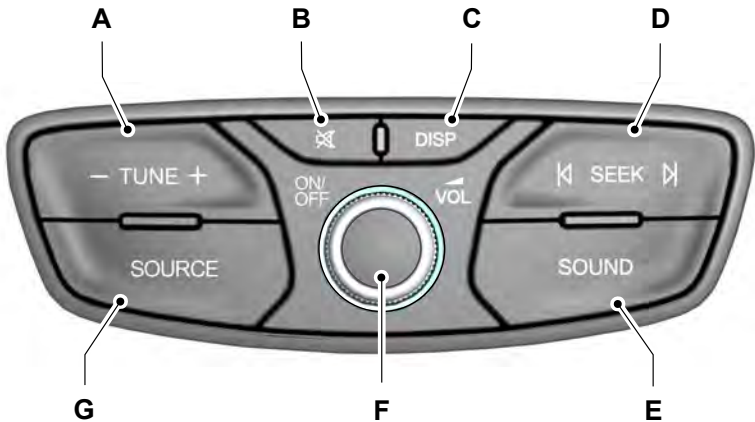

E177140

- A **TUNE:** In radio mode, press to manually search through the radio frequency band. In SIRIUS mode, press to find the previous or next available satellite radio station.
- B **Mute:** Press to mute the sound.
- C **DISP:** Press to switch the display screen on and off.
- D **Seek, Fast Forward and Reverse:** In radio mode, select a frequency band and press either button. The system stops at the first station it finds in that direction. Press and hold to quickly seek up or down the frequency band. In media mode, press to select the previous or next track. Press and hold either button to move quickly forward or backward through the current track. In SIRIUS mode, press to select the next or previous satellite radio station. If a specific category is selected (such as Jazz, Rock or News), use this button to find the next or previous in the selected category.
- E **SOUND:** Press to access settings for Treble, Midrange, Bass, Fade or Balance.
- F **VOL and Power:** Press to switch the system on and off. Turn to adjust the volume.
- G **SOURCE:** Press to access different audio modes, such as AM, FM, Satellite Radio and Line in.

Audio System

AUDIO UNIT - VEHICLES WITH: AM/FM/CD/SYNC



WARNING: Driving while distracted can result in loss of vehicle control, crash and injury. We strongly recommend that you use extreme caution when using any device that may take your focus off the road. Your primary responsibility is the safe operation of your vehicle. We recommend against the use of any

hand-held device while driving and encourage the use of voice-operated systems when possible. Make sure you are aware of all applicable local laws that may affect the use of electronic devices while driving.

Note: You can use the system for up to an hour after you switch the ignition off. Press the on and off control to operate the system with the ignition turned off. The system automatically turns off after one hour.

Note: Depending on your vehicle option package, your system may look different from what you see here.

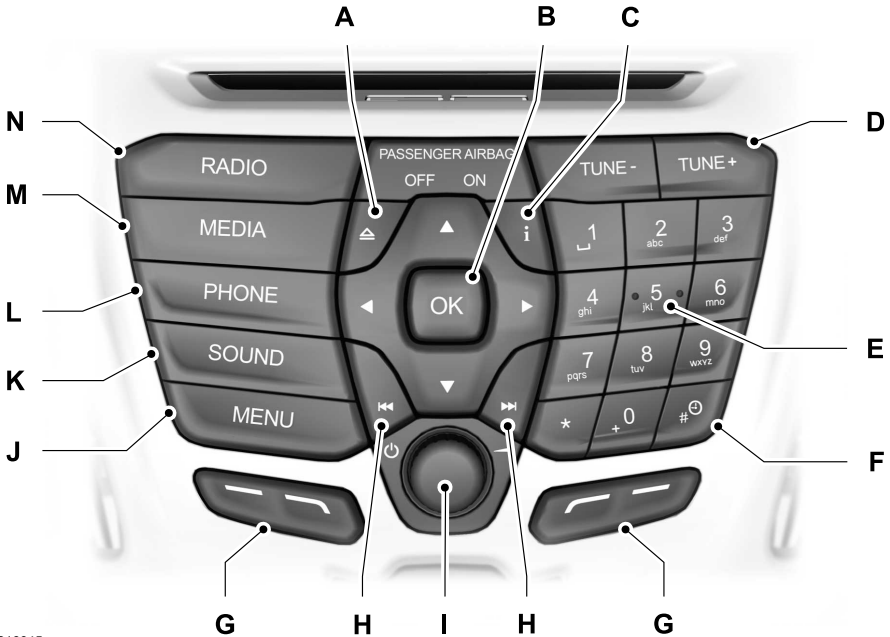

E216045

Audio System

- A **Eject:** Press to eject a CD.
- B **OK and Arrow buttons:** Press **OK** to confirm menu selections. Press to scroll through the menu choices.
- C **Information:** Press to access any available radio or CD information.
- D **TUNE:** Press to manually search through the radio frequency band.
- E **Number block:** In radio mode, you can store your favorite radio stations. To store a radio station, tune to the station, then press and hold a preset button until sound returns. In CD mode, select a track. In phone mode, enter a phone number.
- F **CLOCK:** If not in phone mode, press to display the clock.
- G **Function buttons:** Select different functions of the audio system depending on which mode you are in (such as Radio mode or CD mode).
- H **Seek, Fast Forward and Reverse:** In radio mode, select a frequency band and press either button. The system stops at the first station it finds in that direction. Press and hold to quickly seek up or down the frequency band. In media mode, press to select the previous or next track. Press and hold either button to move quickly forward or backward through the current track.
- I **VOL and Power:** Press to switch the system on and off. Turn to adjust the volume.
- J **MENU:** Press to access different audio system features. See **Menu Structure** later in this chapter.
- K **SOUND:** Press to access settings for Treble, Midrange, Bass, Fade or Balance. Use the up and down arrow buttons to select the various settings. When you make your selection, press the left and right arrow buttons to change the settings. Press **OK** to set or press **MENU** to exit. Sound settings can be set for each audio source independently.
- L **PHONE:** Press to access the phone features of the SYNC system. See your SYNC information.
- M **MEDIA:** Press to open the media source menu. You can press this multiple times to change to CD or to a SYNC-Media device or scroll through the media sources using the arrow buttons. Press **OK** to select a source.
- N **RADIO:** Press this multiple times to select a radio band. Press and hold to select the autostore function. Press to return to the main screen of the active radio band.

Audio System

AUDIO UNIT - VEHICLES WITH: AM/FM/USB PORT/ BLUETOOTH



WARNING: Driving while distracted can result in loss of vehicle control, crash and injury. We strongly recommend that you use extreme

caution when using any device that may take your focus off the road. Your primary responsibility is the safe operation of your vehicle. We recommend against the use of any hand-held device while driving and encourage the use of voice-operated systems when possible. Make sure you are aware of all applicable local laws that may affect the use of electronic devices while driving.

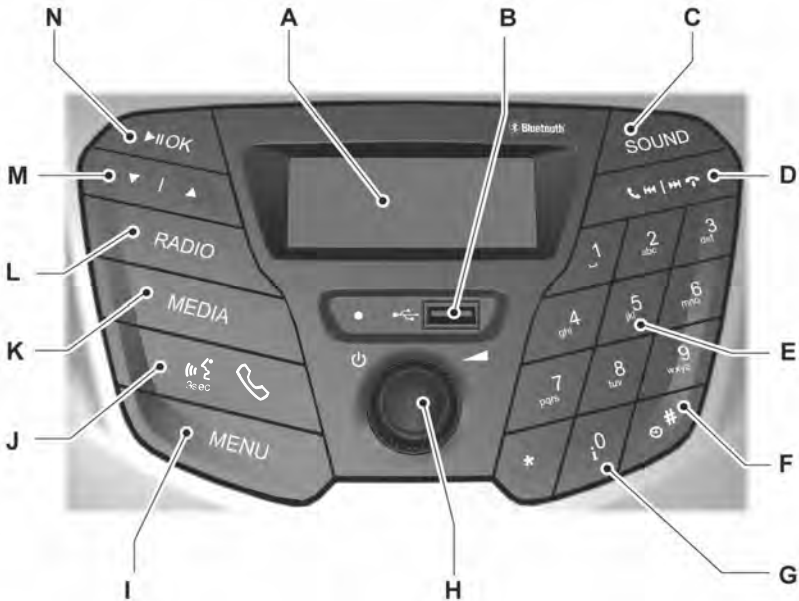

E211745

- A **Display:** Shows the status of the current mode selected.
- B **USB socket:** Insert to play audio from a compatible external device or memory stick.

Audio System

- C **SOUND:** Press the button to adjust the sound settings for bass, treble, balance and fade.
- D **Seek, Fast Forward and Reverse:** In radio mode, select a frequency band and press either button. The system stops at the first station it finds in that direction. Press and hold to quickly seek up or down the frequency band. In media mode, press to select the previous or next track. Press and hold either button to move quickly forward or backward through the current track.
- D **Dial and end call:** Press the button to make or end a call.
- E **Numeric keypad:** Press the button to recall a previously stored station. To store a favorite station press and hold until the sound returns. In **Phone** mode, use these keys to dial the number.
- F **Clock:** Press the button to select clock setup.
- G **Information:** Press the button to access the complete information if it does not fit the display.
- H **On, Off and Volume:** Press the button to switch the audio system on or off. Turn the dial to adjust the volume.
- I **MENU:** Press the button to access different audio system features, depending on which mode has been selected.
- J **Voice Pass-Through and Phone:** Press the button to say commands to your cell phone or to access the Bluetooth phone feature of the system by pressing **PHONE** then **MENU**. When paired further presses of this button will display phone name, signal strength and the battery level.
- K **MEDIA:** Press the button to access Bluetooth audio streaming, USB or Aux input playback.
- L **RADIO:** Press the button to select different radio bands. Press to cancel the menu or list browsing.
- M **Cursor up and down:** Press a button to scroll through on-screen choices. In radio mode press to manual tune.
- N **OK, Play and Pause:** Press the button to confirm on-screen selections. Press to play or pause during playback with compatible external devices.

Sound Button

This allows you to adjust the sound settings (for example bass, treble, balance and fade).

1. Press the **MIN** button.
2. Use the up and down arrow buttons to select the required level.

Waveband Button

Press the **MIN** button to select from the wavebands available (AM, FM1, FM2). You can use the button to return to radio reception when you have been listening to another source.

Audio System

Station Tuning Control

Seek Tuning

Select a waveband and briefly press one of the seek buttons. The unit stops at the first station it finds in the direction you have chosen.

Manual Tuning

Use the up and down arrow buttons to tune down or up the waveband in small increments or press and hold to increment quickly, until you find a station you want to listen to.

Station Preset Buttons

This allows you to store your favorite stations. They can be recalled by selecting the appropriate waveband and pressing one of the preset buttons.

1. Select a waveband.
2. Tune to the station required.
3. Press and hold one of the preset buttons. A progress bar and message will appear. When the progress bar completes the station has been stored. The audio unit will also mute momentarily as confirmation.

You can repeat this on each waveband and for each preset button.

Phone and Voice Pass-Through

Note: Using the system with the engine off will drain the battery.

Note: As no common agreement exists, cell phone manufacturers are able to implement a variety of profiles in their Bluetooth devices. Because of this, an incompatibility can occur between the phone and hands free system, which in some cases may significantly degrade the system performance. To avoid this situation, only recommended phones should be used. To check your cell phone's compatibility, refer to your device's manual or visit the regional Ford website.

This section describes the functions and features of the Bluetooth cell phone hands free system.

The Bluetooth cell phone part of the system provides interaction with the audio system and your cell phone. It allows you to use the audio system to make and receive calls without having to hold your cell phone.

The Voice Pass-Through allows access to the voice recognition commands on your cell phone.

Bluetooth Setup

Note: Up to five Bluetooth devices can be paired to the system.

Note: If there is an ongoing call when the phone in use is selected as the new active phone, the call is transferred to the vehicle audio system.

Note: Even if connected to the system, your phone can still be used in the usual way.

Note: A call will be disconnected if the audio unit is switched off. If the ignition is switched off the phone call will remain in progress.

Before you can use your cell phone with your vehicle it must be paired to the audio system.

The following procedure is required before an initial Bluetooth phone connection can be made.

Audio System

The information display may show your cell phone's battery charge level and signal strength.

Using the device

1. Press the **PHONE** button and then keep pressing the **MENU** button to scroll to the **ADD DEVICE** display. Press the **OK** button.
2. Select the **VIA DEVICE** and press **OK**.
3. Once **VIA DEVICE** has been selected, **FIND FORD BT** is displayed on the radio display.
4. Note the six digit number displayed.
5. Search for Bluetooth devices using the cell phone. For information on phone settings, refer to your phone user guide.
6. Select **FORD BT** from the list of Bluetooth devices found by your phone.
7. Check if the number on the radio display matches the number displayed on your phone and confirm pairing if prompted.
8. Once pairing has been successful **SET PRIMARY** will be displayed on the radio display.
9. Press the **OK** button twice to confirm your phone as the primary device for all future connections.
10. **LOAD PHONEBK** is then displayed on the audio unit. Press the **OK** button twice to confirm that the contents of your phonebook are downloaded to the system.
11. The Bluetooth device name is displayed on the audio unit.

When you press and hold the **Voice Pass-Through** button, the screen displays the message **VR-APP ACTIV**, a tone sounds and you can give a command with a clear and natural voice.

Note: *Some devices may not accept this pairing procedure. If these instructions do not work for your device, follow the instructions using the radio.*

Using the radio

1. Enable Bluetooth in your cell phone. For information on phone settings, refer to your phone user guide.
2. Press the **PHONE** button and then keep pressing the **MENU** button to scroll to the **ADD DEVICE** display. Press the **OK** button.
3. Select the **VIA RADIO** and press **SEARCHING** will be displayed on the radio display.
4. Select **VIA RADIO** and press **SEARCHING** will be displayed on the radio display.
5. Select the desired Bluetooth device from the list found by your audio unit and press **OK**.
6. Type any PIN number in the radio with 6 digits.
7. Check if the number on the radio display matches the number displayed on your phone and confirm pairing if prompted.
8. Once pairing has been successful **SET PRIMARY** will be displayed on the radio display.
9. Press the **OK** button twice to confirm your phone as the primary device for all future connections.
10. **LOAD PHONEBK** will then be displayed on the audio unit. Press the **OK** button twice to confirm that the contents of your phonebook are downloaded to the system.
11. The Bluetooth device name is displayed on the audio unit.

Audio System

Phonebook Downloading

If your phonebook was not downloaded during initial Bluetooth pairing follow this process:

1. Press the **PHONE** button and then keep pressing the **MENU** button to scroll to the **LOAD PHONEBK** display.
2. Press the **OK** button.

Deleting a Paired Device or Phone

To remove a paired device follow this process:

1. Press the **PHONE** button and then keep pressing the **MENU** button to scroll to the **DEL DEVICE** display.
2. Press the **OK** button. The first paired device name will be shown. Scroll to the required device name using the up and down arrow. Once choose the device, press **OK**, the message "**DEL DEVICE**" will appear. Press **OK**, **Scroll** to select "**YES**" and press **OK** to confirm. Select delete all to erase all paired devices.
3. Press the **OK** button multiple times to unpair the device from the audio unit.

Privacy Mode

You can transfer a call from hands free to private mode during an active call.

Press the **MENU** button until **PRIVACY** appears, then press the **OK** button to transfer. To return to hands free mode, press the dial button.

Phone Menu Options

Press the **PHONE** button to select phone mode. Press the **PHONE** button again to display information such as phone name, signal strength and battery level.

When in phone mode, press the **MENU** button to scroll through the various phone options:

- Dial.
- Phonebook.
- Call History.
- Add Device.
- Select Device.
- Set Primary.
- Delete Device.
- Bluetooth on and off.
- Load Phonebook.
- Reject on or off.

Press the **OK** button to select the required option, and use the up and down arrows to change features.

Making and Receiving Calls

Outgoing calls can be made by:

- Entering a number using the keys on the radio.
- Saying a command to call someone after pressing the **Voice Pass-Through** button.
- Selecting a contact from the downloaded phonebook.
- Selecting a number or contact from the call history log.
- Using quick dial by pressing one of the radio preset buttons.
- Using the redial function.
- Using the cell phone.

Incoming calls can be answered by:

- Pressing the call pickup button on the audio unit.
- Using the cell phone.

Calls can be rejected using the end call button on the audio unit or by using the cell phone directly.

Audio System

USB

Note: Only use USB Mass-Storage device compliant devices.

Note: Always switch your audio unit to a different source (for example the radio) before unplugging the USB device.

Note: Do not install or connect USB hubs or splitters.

Note: The system is only designed to recognize and read suitable audio files from a USB device that conforms to the USB Mass-Storage device class or an iPod. Not all available USB devices can be guaranteed to function with the system.

Note: It is possible to connect compatible devices with a trailing USB lead as well as those that plug into the USB socket directly (for example USB memory sticks and pen drives).

Note: Some USB devices with a higher power consumption may not be compatible (for example some larger hard drives).

Note: Access time to read the files on the external device will vary depending upon factors such as the file structure, size and device content.

The audio unit supports a range of external devices. Once connected, control of the external device is possible via the audio unit.

Operating the USB Device

Note: USB playback will start automatically when you connect a compatible device. To turn this feature off, select **AUTOPL** and then select **OFF** using the menu function.

Connect the device to the audio unit.

Select the USB device as the audio source by pressing the **MEDIA** button until the USB screen appears in the display. After first connecting the USB device, the first track within the first folder will start to play automatically. Following audio source switching, the position of playback on the USB device is remembered.

Press the seek up and down keys to skip backward and forward through tracks. Press and hold to fast forward and reverse through the track.

iPod

Connect the iPod to the audio unit.

Select the iPod as the audio source by pressing the **MEDIA** button until **IPOD** appears in the display. After first connecting the iPod, the first track within the first folder will start to play automatically. Following audio source switching, the position of playback on the iPod is remembered.

Press the seek up and down keys to skip backward and forward through tracks.

Press and hold the seek keys to enable fast rewind or fast forward through track content.

Various functions may be controlled from the audio unit including:

- Next and previous track select.
- Track seek.
- Shuffle.
- Repeat.

Bluetooth Audio Streaming

Note: Make sure the device is paired before using this feature.

Compatible Bluetooth devices can be connected to the audio unit to playback using the vehicle audio system.

Audio System

Select the device as the audio source by pressing the **MEDIA** button until **BT AUDIO** appears in the display.

The device playback can be controlled using the audio unit buttons play, pause, next and previous track.

AUDIO UNIT - VEHICLES WITH: AM/FM



WARNING: Driving while distracted can result in loss of vehicle control, crash and injury. We strongly recommend that you use extreme caution when using any device that may take your focus off the road. Your

primary responsibility is the safe operation of your vehicle. We recommend against the use of any hand-held device while driving and encourage the use of voice-operated systems when possible. Make sure you are aware of all applicable local laws that may affect the use of electronic devices while driving.

Note: Depending on your vehicle option package, your system may look different from what you see here.

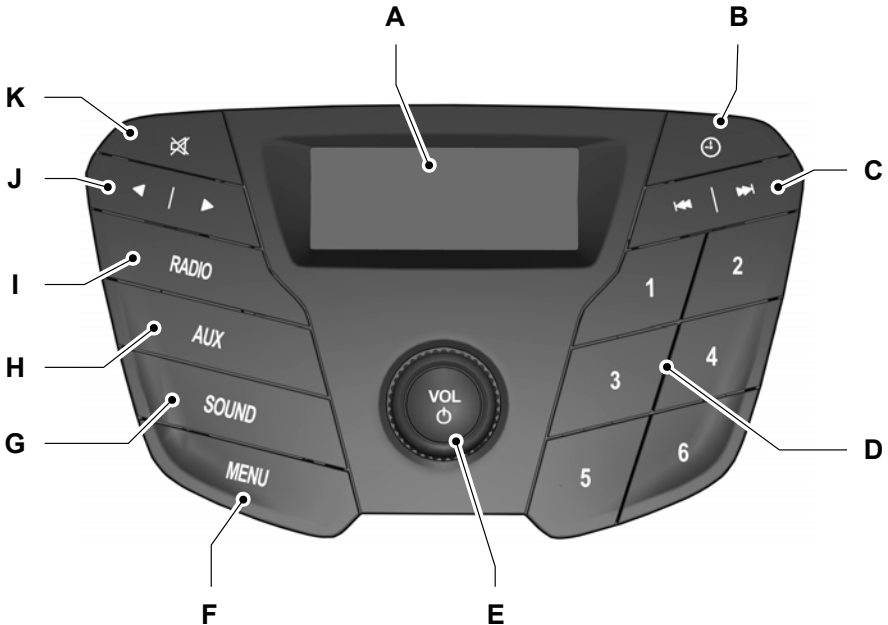

E175058

Audio System

- A **Display:** Shows the status of the current mode selected.
- B **Clock:** Press to display the clock.
- C **Seek, Fast Forward and Reverse:** In radio mode, select a frequency band and press either button. The system stops at the first station it finds in that direction. Press and hold to quickly seek up or down the frequency band. In media mode, press to select the previous or next track. Press and hold either button to move quickly forward or backward through the current track.
- D **Numeric keypad:** In radio mode, you can store your favorite radio stations. To store a radio station, tune to the station, then press and hold a preset button until sound returns.
- E **VOL and Power:** Press to switch the system on and off. Turn to adjust the volume.
- F **MENU:** Press to access different audio system features.
- G **SOUND:** Press to access settings for Treble, Midrange, Bass, Fade or Balance.
- H **AUX:** Press to access the auxiliary features, it will also cancel the menu or list browsing.
- I **RADIO:** Press this multiple times to select a radio band. Press and hold to select the autostore function. Press to return to the main screen of the active radio band.
- J **Arrow left and right:** Press to scroll through the menu choices.
- K **Mute:** Press to mute the sound.

Clock Button

This allows you to adjust the clock settings.

Press the Clock button until the following message is displayed.

Message	Action and Description
Set Hour	Use the cursor up or down arrow buttons to set the correct hour.
Press the Clock button again until the following message is displayed.	
Set Minutes	Use the cursor up or down arrow buttons to set the correct minutes.

Audio System

Setting 24 Hour or 12 Hour Display

Press the Menu button until the following message is displayed.

Message	Action and Description
24 Hour	Use the cursor up or down arrow buttons to select one of the following: 12 Hour 24 Hour

Note: *The default setting is 24 hour.*

Station Tuning Buttons

Seek Tuning

Select a frequency band and briefly press one of the seek buttons. The unit will stop at the first station it finds in the direction you have chosen.

Manual Tuning

Use the cursor up or down arrow buttons to tune up or down the frequency band in small increments. To increment quickly, press and hold until you find a station you want to listen to.

Station Preset Buttons

This allows you to store your favorite stations. They can be recalled by selecting the appropriate frequency band and pressing one of the preset buttons.

1. Select a frequency band.
2. Tune to the station required.
3. Press and hold one of the preset buttons. The audio unit will also mute momentarily as confirmation.

You can repeat this on each frequency band and for each preset button.

Menu Button

This allows you to adjust all of the audio system settings. Press the button repeatedly until the required setting is displayed. Use the cursor up or down arrow buttons to adjust the following settings:

- Clock hour.
- Clock minutes.
- 24 hour, 12 hour.
- Bass.
- Treble.
- Balance.
- Fade.
- RDS.

Sound Button

This allows you to adjust the sound settings for bass, treble, balance or fade.

1. Press the sound button until the required setting is displayed.
2. Use the cursor up or down arrow buttons to select the required level.

Note: *Fade settings are only adjustable if there are speakers in the rear of your vehicle.*

AUX Button

Connect your media device to the audio unit. See **USB Port** (page 355).

Audio System

Select your media device as the audio source by pressing the **AUX** button. After connecting your media device, the first track will start to play automatically.

DIGITAL RADIO

Note: *HD Radio broadcasts are not available in all markets.*

HD Radio technology is the digital evolution of analog AM/FM radio. Your system has a special receiver that allows it to receive digital broadcasts (where available) in addition to the analog broadcasts, it already receives. Digital broadcasts provide a better sound quality than analog broadcasts with free, crystal-clear audio and no static or distortion. For more information, and a guide to available stations and programming, please visit www.hdradio.com.

When HD Radio is on and you tune to a station broadcasting HD Radio technology, you may notice the HD Radio logo on your screen. When this logo is available, you may also see Title and Artist fields on-screen.

The multicast indicator appears in FM mode (only) if the current station is broadcasting multiple digital broadcasts. The highlighted numbers signify available digital channels where new or different content is available. HD1 signifies the main programming status and is available in analog and digital broadcasts. Other multicast stations (HD2 through HD7) are only available digitally.

When HD Radio broadcasts are active, you can access the following functions:

- **Scan** allows you to hear a brief sampling of all available stations. This feature still works when HD Radio reception is on, although it does not scan for HD2-HD7 channels. You may see the HD logo appear if the station has a digital broadcast.
- **Memory presets** allow you to save an active channel as a memory preset. Touch and hold a memory preset slot until the sound returns. There is a brief mute while the radio saves the station. Sound returns when finished. When switching to an HD2 or HD3 memory preset, the sound mutes before the digital audio plays, because the system has to reacquire the digital signal.

Note: *As with any saved radio station, you cannot access the saved station if your vehicle is outside the station's reception area.*

Audio System

HD Radio Reception and Station Troubleshooting

Potential reception issues	
Reception area	If you are listening to a multicast station and you are on the fringe of the reception area, the station may mute due to weak signal strength.
	If you are listening to HD1, the system switches back to the analog broadcast until the digital broadcast is available again. However, if you are listening to any of the possible HD2-HD7 multicast channels, the station mutes and stays muted unless it is able to connect to the digital signal again.
Station blending	When the system first receives a station (aside from HD2-HD7 multicast stations), it first plays the station in the analog version. Once the receiver verifies the station is an HD Radio station, it shifts to the digital version. Depending on the station quality, you may hear a slight sound change when the station changes from analog to digital. Blending is the shift from analog to digital sound or digital back to analog sound.

In order to provide the best possible experience, use the contact form to report any station issues found while listening to a station broadcasting with HD Radio technology. Independent entities own and operate each station. These stations are responsible for ensuring all audio streams and data fields are accurate.

Audio System

Potential station issues		
Issues	Cause	Action
Echo, stutter, skip or repeat in audio. Increase or decrease in audio volume.	This is poor time alignment by the radio broadcaster.	No action required. This is a broadcast issue.
Sound fading or blending in and out.	The radio is shifting between analog and digital audio.	No action required. The reception issue may clear up as you continue to drive.
There is an audio mute delay when selecting HD2 or HD3, multicast preset or Direct Tune .	The digital multicast is not available until the HD Radio broadcast is decoded. Once decoded, the audio is available.	No action required. This is normal behavior. Wait until the audio is available.
Cannot access HD2 or HD3 multicast channel when recalling a preset or from a direct tune.	The previously stored multicast preset or direct tune is not available in your current reception area.	No action required. The station is not available in your current location.
Text information does not match currently playing audio.	Data service issue by the radio broadcaster.	Fill out the station issue form at website listed below.*
There is no text information shown for currently selected frequency.	Data service issue by the radio broadcaster.	Fill out the station issue form at website listed below.*
HD2-HD7 stations not found when Scan is pressed.	Pressing Scan disables HD2-HD7 channel search.	No action required. This is normal behavior.

* http://www.ibiquity.com/automotive/report_radio_station_experiences

HD Radio Technology manufactured under license from iBiquity Digital Corp. U.S. and foreign patents. HD Radio and the HD and HD Radio logos are proprietary trademarks of iBiquity Digital Corp. Ford Motor Company and iBiquity Digital Corp. are not responsible for the content sent using HD Radio technology. Content may be changed, added or deleted at any time at the station owner's discretion.

SATELLITE RADIO (IF EQUIPPED)

SiriusXM® Satellite Radio broadcasts a variety of music, news, sports, weather, traffic and entertainment satellite radio channels. For more information and a complete list of SiriusXM satellite radio channels, visit www.siriusxm.com in the United States, www.siriusxm.ca in Canada, or call SiriusXM at 1-888-539-7474.

Audio System

Note: This receiver includes the eCos real-time operating system. eCos is published under the eCos License.

Satellite Radio Reception Factors

Potential satellite radio reception issues	
Antenna obstructions	For optimal reception performance, keep the antenna clear of snow and ice build-up and keep luggage and other material as far away from the antenna as possible.
Terrain	Hills, mountains, tall buildings, bridges, tunnels, freeway overpasses, parking garages, dense tree foliage and thunderstorms can interfere with your reception.
Station overload	When you pass a ground-based broadcast-repeating tower, a stronger signal may overtake a weaker one and the audio system may mute.
Satellite radio signal interference	Your display may show ACQUIRING . . . to indicate the interference and the audio system may mute.

SiriusXM Satellite Radio Service

Note: SiriusXM reserves the unrestricted right to change, rearrange, add or delete programming including canceling, moving or adding particular channels, and its prices, at any time, with or without notice to you. Ford Motor Company shall not be responsible for any such programming changes.

SiriusXM satellite radio is a subscription-based satellite radio service that broadcasts a variety of music, sports, news, weather, traffic and entertainment programming. Your factory-installed SiriusXM satellite radio system includes hardware and a limited subscription term, which begins on the date of sale or lease of your vehicle. See an authorized dealer for availability.

For more information on extended subscription terms (a service fee is required), the online media player and a complete list of SiriusXM satellite radio channels, and other features, please visit www.siriusxm.com in the United States, www.siriusxm.ca in Canada, or call SiriusXM at 1-888-539-7474.

Satellite Radio Electronic Serial Number (ESN)

You need your ESN to activate, modify or track your satellite radio account. When in satellite radio mode, tune to channel 0.



E208625

Audio System

Troubleshooting

Message	Condition	Action
Acquiring...	Radio requires more than two seconds to produce audio for the selected channel.	No action required. This message should disappear shortly.
Satellite antenna fault SIRIUS system failure	There is an internal module or system failure present.	If this message does not clear shortly, or with an ignition key cycle, your receiver may have a fault. See an authorized dealer for service.
Invalid Channel	The channel is no longer available.	Tune to another channel or choose another preset.
Unsubscribed Channel	Your subscription does not include this channel.	Contact SiriusXM at 1-888-539-7474 to subscribe to the channel, or tune to another channel.
No Signal	The signal is lost from the SiriusXM satellite or SiriusXM tower to your vehicle antenna.	The signal is blocked. When you move into an open area, the signal should return.
Updating...	Update of channel programming in progress.	No action required. The process may take up to three minutes.
Questions? Call 1-888-539-7474	Your satellite service is no longer available.	Contact SiriusXM at 1-888-539-7474 to resolve subscription issues.
None found Check Channel Guide	All the channels in the selected category are either skipped or locked.	Use the channel guide to turn off the Lock or Skip function on that station.
Subscription Updated	SiriusXM has updated the channels available for your vehicle.	No action required.

Audio System

AUDIO INPUT JACK



WARNING: Driving while distracted can result in loss of vehicle control, crash and injury. We strongly recommend that you use extreme caution when using any device that may take your focus off the road. Your primary responsibility is the safe operation of your vehicle. We recommend against the use of any hand-held device while driving and encourage the use of voice-operated systems when possible. Make sure you are aware of all applicable local laws that may affect the use of electronic devices while driving.



WARNING: Always place your device in a secure location in your vehicle so it does not become a projectile in a sudden stop or crash. Failure to follow this instruction could result in personal injury.

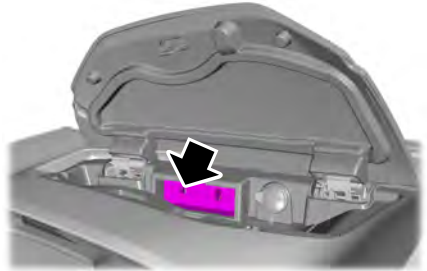

E169601

The auxiliary input jack allows you to connect and play music from your portable music player through your vehicle speakers. You can use any portable music player designed for use with headphones. Your audio extension cable must have male 1/8 inch (3.5mm) connector at each end.

1. Make sure your vehicle is stationary with the radio and portable music players turned off.
2. Plug the extension cable from the portable music player into the auxiliary input jack.
3. Switch the radio on. Select either a tuned FM station or a CD.
4. Adjust the volume as desired.
5. Switch the portable music player on and adjust its volume to half its maximum level.
6. Select the auxiliary input mode on the audio unit. You should hear music from your device even if it is low.
7. Adjust the volume on your portable music player until it reaches the volume level of the FM station or CD. Do this by switching back and forth between the AUX and FM or CD controls.

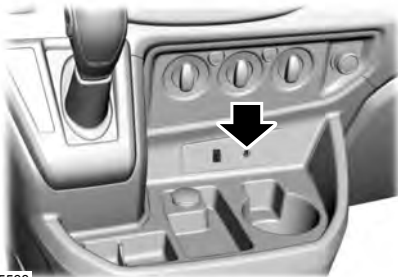

E185568

Audio System

USB PORT



WARNING: Driving while distracted can result in loss of vehicle control, crash and injury. We strongly recommend that you use extreme caution when using any device that may take your focus off the road. Your primary responsibility is the safe operation of your vehicle. We recommend against the use of any hand-held device while driving and encourage the use of voice-operated systems when possible. Make sure you are aware of all applicable local laws that may affect the use of electronic devices while driving.



E201595

See **SYNC™ 3** (page 394).

USB Ports could be in the following locations:

- In the instrument panel storage bin.
- On the instrument panel below the climate controls.

The USB port allows you to plug in media playing devices, memory sticks and charge devices. See **General Information** (page 356).

The audio extension cable must be long enough to allow the device to be safely stored when your vehicle is moving.

MEDIA HUB (IF EQUIPPED)

The media hub is located in the center console and has the following features:

GENERAL INFORMATION

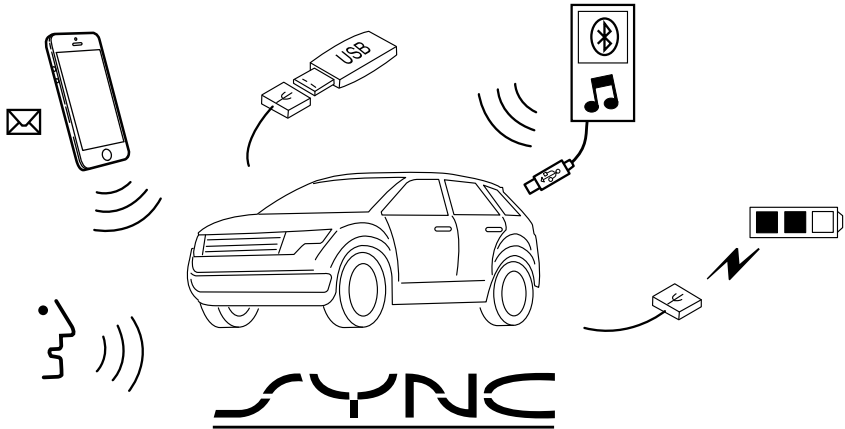

E198355

SYNC is an in-vehicle communications system that works with your Bluetooth-enabled cellular phone and portable media player.

This allows you to:

- Make and receive calls.
- Access and play music from your portable music player.
- Use 911 Assist and applications, via SYNC Applink.*
- Access phonebook contacts and music using voice commands.
- Stream music from your connected phone.
- Text message.

- Use the advanced voice recognition system.
- Charge your USB device (if your device supports this).

*These features are not available in all markets and may require activation. Available AppLink enabled apps vary by market.

Make sure that you review your device's manual before using it with SYNC.

Support

The SYNC support team is available to help you with any questions you cannot answer on your own.

Monday-Saturday, 8:30am-9:00pm EST.

Sunday, 10:30am-7:30pm EST.

In the United States, call 1-800-392-3673.

In Canada, call 1-800-565-3673.

Times are subject to change due to holidays.

SYNC Owner Account

Why do I need a SYNC owner account?

- Essential for keeping up with the latest software downloads available for SYNC.
- Access to customer support for any questions you may have.

Driving Restrictions

For your safety, certain features are speed-dependent and restricted when your vehicle is traveling over 3 mph (5 km/h).

Safety Information



WARNING: Driving while distracted can result in loss of vehicle control, crash and injury. We strongly recommend that you use extreme caution when using any device that may take your focus off the road. Your primary responsibility is the safe operation of your vehicle. We recommend against the use of any hand-held device while driving and encourage the use of voice-operated systems when possible. Make sure you are aware of all applicable local laws that may affect the use of electronic devices while driving.

When using SYNC:

- Do not operate playing devices if the power cords or cables are broken, split or damaged. Place cords and cables out of the way, so they do not interfere with the operation of pedals, seats, compartments or safe driving abilities.
- Do not leave playing devices in your vehicle during extreme conditions as it could cause them damage. See your device's manual for further information.
- Do not attempt to service or repair the system. See an authorized dealer.

Privacy Information

When a cellular phone is connected to SYNC, the system creates a profile within your vehicle that is linked to that cellular phone. This profile is created in order to offer you more cellular features and to operate more efficiently. Among other things, this profile may contain data about your cellular phone book, text messages (read and unread), and call history, including history of calls when your cellular phone was not connected to the system. In addition, if you connect a media device, the system creates and retains an index of supported media content. The system also records a short development log of approximately 10 minutes of all recent system activity. The log profile and other system data may be used to improve the system and help diagnose any problems that may occur.

The cellular profile, media device index, and development log will remain in the vehicle unless you delete them and are generally accessible only in the vehicle when the cellular phone or media player is connected. If you no longer plan to use the system or the vehicle, we recommend you perform a Master Reset to erase all stored information.

System data cannot be accessed without special equipment and access to the vehicle's SYNC module. Ford Motor Company and Ford of Canada will not access the system data for any purpose other than as described absent consent, a court order, or where required by law enforcement, other government authorities, or other third parties acting with lawful authority. Other parties may seek to access the information independently of Ford Motor Company and Ford of Canada. For further privacy information, see the section on 911 Assist. See **SYNC™ Applications and Services** (page 372).

USING VOICE RECOGNITION

This system helps you control many features using voice commands. This allows you to keep your hands on the wheel and focus on what is around you.

Initiating a Voice Session



Press the voice button. A list of available voice commands appears in the display.

Global Voice Commands

These voice commands are always available. You can say them at any time.

Global voice commands	
(cancel exit)	This command ends the voice session. You can also cancel a session by holding the voice button for two or more seconds.
help	This command provides you with hints, examples and instructions.
(main menu start again)	This command restarts the voice session from the initial starting point.

You can say any of the voice commands that appear within open and close brackets that are separated by |. For example, where; (cancel | exit) appears you say; cancel or exit.

Helpful Hints

- Make sure the interior of your vehicle is as quiet as possible. Wind noise from open windows and road vibrations may prevent the system from correctly recognizing spoken commands.
- Before giving a voice command, wait for the system announcement to finish, followed by a single tone. Any command spoken before this does not register with the system.
- Speak naturally, without long pauses between words.
- You can interrupt the system at any time while it is speaking by pressing the voice button. You can cancel a voice session by pressing and holding the voice button.

System Interaction and Feedback

The system provides feedback through audible tones, prompts, questions and spoken confirmations depending on the situation and the chosen level of interaction. You can customize the voice recognition system to provide more or less instruction and feedback.

The default setting is to a higher level of interaction in order to help you learn to use the system. You can change these settings at any time.

Adjusting the Interaction Level



Press the voice button. When prompted, say:

Voice Command	Action and Description
voice settings	
Then either of the following:	
interaction mode novice	Provides more detailed interaction and guidance. (Recommended for first time users.)
interaction mode advanced	Provides less audible interaction and guidance.

Confirmation Prompts

Confirmation prompts are short questions the system asks when it is not sure of your request or when there is more than one possible response to your request.

To adjust this setting press the voice button, when prompted say:

Voice Command	Action and Description
voice settings	
Then either of the following:	
confirmation prompts off	Make a best guess from the command; you may still occasionally be asked to confirm settings.
confirmation prompts on	Clarify your voice command with a short question.

Phone Confirmation

Using phone confirmations the system asks you to verify before placing any calls.

To adjust this setting press the voice button, when prompted say:

Voice Command	Action and Description
voice settings	
Then any of the following:	
phone confirmation on	When enabled, this feature will prompt you to confirm any voice initiated call command prior to the call being placed.
phone confirmation off	The system will make a best guess; you may still occasionally be asked to confirm settings.

Changing the Voice Settings

In addition to using voice commands to change the voice settings, you can also use the menu in the audio display.

To change the voice settings press the Menu button then select:

Menu Item
SYNC-Settings
Voice settings

Note: Depending on the current climate control settings, the fan speed may automatically go down while issuing voice commands or while making and receiving phone calls via SYNC to reduce the amount of background noise in the vehicle. The fan speed will automatically return to normal operation once the voice session ends. Fan speed can also be adjusted normally during a voice session, simply press fan buttons (or turn fan knob) to increase or decrease fan speed to desired setting.

To disable this automatic fan speed reduction feature during voice sessions, press and hold the climate control AC and Recirculated air buttons simultaneously, release and then increase fan speed within 2 seconds. To re-enable this feature, repeat the above sequence.

USING SYNC™ WITH YOUR PHONE

Hands-free calling is one of the main features of SYNC. While the system supports a variety of features, many are dependent on your cellular phone's functionality. At a minimum, most cellular phones with Bluetooth wireless technology support the following functions:

- Answering an incoming call.
- Ending a call.
- Using privacy mode.
- Dialing a number.
- Redialing.
- Call waiting notification.
- Caller ID.

Other features, such as text messaging using Bluetooth and automatic phonebook download, are phone-dependent features. To check your phone's compatibility, see your phone's manual and visit www.SYNCMyRide.com, www.SYNCMyRide.ca or www.syncmaroute.ca.

Pairing a Phone for the First Time

Wirelessly pairing your phone with SYNC allows you to make and receive hands-free calls.

Note: SYNC can support downloading up to approximately 4000 entries per Bluetooth-enabled cellular phone.

Note: Make sure to switch on the ignition and the radio. Shift the transmission into park (P) for automatic transmission or first gear for manual transmission.

Using the Audio System

Note: To scroll through the menus, press the up and down arrows on your audio system.

1. Make sure to switch on your phone's Bluetooth feature before starting the search. See your device's manual if necessary.
2. Press the **PHONE** button. When the audio display indicates there is no paired phone, select the option to add.
3. When a message to begin pairing appears in the audio display, search for SYNC on your phone to start the pairing process.

4. When prompted on your cell phone's display, confirm that the PIN provided by SYNC matches the PIN displayed on your cell phone. Your phone is now paired and the display indicates that the pairing was successful. If you are prompted to enter a PIN on your device, enter the PIN displayed on the screen. The display indicates when the pairing is successful.

Depending on your phone's capability and your market, the system may prompt you with questions, such as setting the current phone as the primary phone (the phone SYNC automatically tries to connect with first upon vehicle start-up) and downloading your phonebook.

Using Voice Commands



Make sure to switch on your phone's Bluetooth feature before starting the search. See your device's manual if necessary.

Press the voice and when prompted say:

Voice Command	Action and Description
(pair ([Bluetooth] device phone Bluetooth audio) add phone)	Follow the instructions on the audio display.

You can say any of the voice commands that appear within open and close brackets that are separated by |. For example, where; (what's | what is) appears you say; what's or what is.

The commands that have [] around the word means that the word is optional.

Depending on your phone's capability and your market, the system may prompt you with questions, such as setting the current phone as the primary phone (the phone SYNC automatically tries to connect with first upon vehicle start-up) and downloading your phonebook.

Pairing Subsequent Phones

Note: Make sure to switch on the ignition and the radio. Shift the transmission into park (P) for automatic transmission or first gear for manual transmission.

Note: To scroll through the menus, press the up and down arrows on your audio system.

1. Make sure to switch on your phone's Bluetooth feature before starting the search. See your device's manual if necessary.
2. Press the **PHONE** button.
3. Select the option for Bluetooth Devices.
4. Press the **OK** button.
5. Select the option to add. This starts the pairing process.
6. When a message to begin pairing appears in the audio display, search for SYNC on your device.
7. When prompted on your cell phone's display, confirm that the PIN provided by SYNC matches the PIN displayed on your cell phone. Your phone is now paired and the display indicates that the pairing was successful. If you are prompted to enter a PIN on your device, enter the PIN displayed on the screen. The display indicates when the pairing is successful.

SYNC may prompt you with more cell phone options. Your cell phone may also prompt you to give SYNC permission to access information. For more information on your cell phone's capability, see your cell phone's manual and visit the website.

Phone Voice Commands



Press the voice button. When prompted, say any of the following:

Voice Command	
(phone Blackberry iPhone)	
Then say any of the following:	
call (___)	
call ___ at home	
call ___ ((in at) [the] office at work)	
call ___ on (cell mobile)	
call ___ on other	
dial [[a] number]	1
([go to] privacy transfer to phone privacy on)	2
(hold call [on] place call on hold)	2
join (calls call)	2
mute call [on]	2
(mute call off un-mute call)	2
(turn ringer on silent mode off)	
(turn ringer off silent mode [on])	

Voice Command
[text] (messages message) ³
help

___ is a dynamic listing that should be the name of a contact in your phonebook. For example you could say "Call Home".

¹ See **Dial** table below.

² These commands are only valid while in a phone call.

³ See the text message table below.

Dial Commands

Press the voice button and when prompted say any of the following commands:

Voice Commands
411 (four-one-one), 911 (nine-one-one)
700 (seven hundred)
800 (eight hundred)
900 (nine hundred)
Clear (deletes all entered digits)
Delete (deletes last set of digits entered)
Number <0-9>
Plus
Pound (#)
Star (*)

Note: To exit dial mode, press and hold the phone button or press any button on the audio system.

To access text messages say:

Voice Command
[text] (messages message)
Then say any of the following:
(listen to read) ([text] message)
forward (text [text] message)
reply to (text [text] message)
call [sender]

Phonebook Hints

To hear how the SYNC system speaks a name browse phonebook, select a contact and press:

Menu Item
Hear it

Changing Devices Using Voice Commands

Using SYNC, you can easily access multiple phones, ipods, or USB devices. to switch devices say:

Voice Command	
(connect device) ____	You can state the name of the desired device, such as “My iPhone”, “My Galaxy” or “My iPod”. SYNC may ask you to confirm the type of device (Phone, USB, or Bluetooth Audio).

Making Calls



Press the voice button. When prompted, say:

Voice Command	
call [[a] name]	
dial [[a] number]	SYNC prompts you to say the numbers that you wish to dial. After you say the numbers, the system confirms it. You can then say:

When the system has stated the number, you say any of the following:

Voice Command	
(dial send)	This initiates the call.
(delete correct)	This erases the spoken digits.

To end the call, press the end call button

on the steering wheel or select the end call option in the audio display.

Receiving Calls

Accepting calls

When receiving a call, you can answer the call by pressing the accept call button on the steering wheel or use the screen.

To use the screen to accept a call select:

Menu Item
Accept

Rejecting Calls

When receiving a call, you can reject the call by pressing the reject call button on the steering wheel or use the screen.

To use the screen to reject a call select:

Menu Item
Reject

Ignore the call by doing nothing.

Phone Options during an Active Call

During an active call, you have more menu features that become available, such as putting a call on hold or joining calls.

To access this menu, choose one of the options available at the bottom of the audio display or select **More** to choose from the following options:

Menu Item	Description and action
Mic. off	Switch your vehicle's microphone off. To switch the microphone on, select the option again.
Privacy	Switch a call from an active hands-free environment to your cellular phone for a more private conversation. When selected, the audio display indicates the call is private.
Hold	Put an active call on hold. When selected, the audio display indicates the call is on hold.
Dial a number	Enter numbers using the audio system's numeric keypad (for example, numbers for passwords).
Join calls	Join two separate calls. The system supports a maximum of three callers on a multiparty or conference call. 1. Select the More option. 2. Access the desired contact through the system or use voice commands to place the second call. Once actively in the second call, select the More option. 3. Scroll to the option to join calls and press the OK button.
Phonebook	Access your phonebook contacts. 1. Select the More option. 2. Scroll to the option for phonebook and press the OK button. 3. Scroll through your phonebook contacts. 4. Press the OK button again when the desired contact appears in the audio display. 5. Press the OK button or dial button to call the selection.
Call History	Access your call history log. 1. Select the More option. 2. Scroll to the option for call history and press the OK button. 3. Scroll through your call history options (incoming, outgoing or missed). 4. Press the OK button again when the desired selection appears in the audio display. 5. Press the OK button or dial button to call the selection.

Accessing Features through the Phone Menu

You can access your call history, phonebook, sent text messages, as well as access phone and system settings.

1. Press the **PHONE** button to enter the phone menu.
2. Select one of the options available.

Display	Description and action
Dial a number	Enter numbers using the audio system's numeric keypad.
Phonebook	Access your downloaded phonebook. 1. Press the OK button to confirm and enter. You can use the options at the bottom of the screen to access an alphabetical category quickly. You can also use the letters on the audio system's numeric keypad to jump in the list. 2. Scroll through your phonebook contacts. 3. Press the OK button again when the desired selection appears in the audio display. 4. Press the OK button or dial button to call the selection.
Call History	Access any previously dialed, received or missed calls. 1. Press the OK button to select. 2. Scroll to select incoming, outgoing or missed calls. Press the OK button to make your selection. 3. Press the OK button or dial button to call the selection.
Speed Dial	Select 1 of 10 speed dial entries. To set a speed dial entry, go to the phonebook and then press and hold one of the numbers on the audio system's numeric keypad.
Text messaging	Send, download and delete text messages.
BT Devices	Access the option for Bluetooth Device menu listings (add, connect, set as primary, on or off, delete).
Phone settings	View various settings and features on your phone.

Text Messaging

Note: This is a phone-dependent feature.

SYNC allows you to receive, send, download and delete text messages. The system can also read incoming text messages to you so that you do not have to take your eyes off the road.

Receiving a Text Message

Note: This is a phone-dependent feature. Your phone must support downloading text messages using Bluetooth to receive incoming text messages.

Note: This is a speed-dependent feature and is only available when your vehicle is traveling at 3 mph (5 km/h) or less.

When a new message arrives, an audible tone sounds and the audio display indicates you have a new message.

To hear the message you can say:

Voice command	Description and action
(listen to read) ([text] message)	Select this option to have the system read the message to you.

Using the screen you also have the following options:

Menu Item	Description and action	
Ignore	Select this option, or do nothing, and the message goes into your text message inbox.	
View	Select the view option to open the text message. Once selected, you have the ability to have the message read to you, to view other messages. For additional options select:	
	More...	If you select this option, use the arrow button to scroll through the following options:
	Reply to sender	Press the OK button to access, and then scroll through a list of pre-defined messages to send.
	Call sender	Press the OK button to call the sender of the message.
	Forward msg.	Press the OK button to forward the message to anyone in your phonebook or call history. You can also choose to enter a number.

Sending, Downloading and Deleting Your Text Messages

1. Press the **PHONE** button.

2. Select the text messaging option, and then press the **OK** button.

Choose from the following options:

Menu Item	Description and action
New	Allows you to send a new text message based on a pre-defined set of 15 messages.
View	Allows you to read the full message and, in addition, provides the option to have the system read the message to you. To go to the next message, select the More option. This allows you to reply to the sender, call the sender or forward the message.
Delete	Allows you to delete current text messages from the system (not your cellular phone). The audio display indicates when the system has deleted all your text messages.
More...	Allows you to delete all messages or manually trigger a download of all unread messages from your cellular phone.

Sending a Text Message

Note: You can only send a text message to one recipient at a time.

1. Select the send option when the desired selection highlights in the audio display.
2. Select the confirmation option when the contact appears.
3. Press the OK button again to confirm when the system asks if you want to send the message. A pre-defined signature appears on each text message.

Note: You can send text messages either by choosing a contact from the phonebook and selecting the text option from the audio display or by replying to a received message in the inbox.

Accessing Your Phone Settings

These are phone-dependent features. Your phone settings allow you to access and adjust features such as your ring tone and text message notification, modify your phonebook, and set up automatic download.

1. Press the **PHONE** button.
2. Scroll until the phone settings option appears, and then press the **OK** button.

Scroll to select from the following options:

Menu Item	Description and action
Set as master	If this option is checked, the system uses the cellular phone as the master when there is more than one cellular phone paired to the system. This option can be changed for all cellular phones (not only the active phone) using the Bluetooth Devices menu.
Phone status	See the cellular phone name, provider name, cellular phone number, and signal level. When done, press the left arrow buttons to return to the phone status menu.
Set ringtone	Select which ringtone sounds during an incoming call (one of the system's tones or your cellular phone's). If your phone supports in-band ringing, your phone's ringtone sounds when you choose the cellular phone ringtone option. 1. Press the OK button to select and scroll to hear each ringtone. 2. Press the OK button to select a ringtone.
Text msg notify	Have the option of hearing an audible tone to notify you when a text message arrives. Press the OK button to switch the audible tone off or on.
Phonebook pref.	Modify the contents of your phonebook (such as add, delete or download). Press the OK button to select and scroll between the choices in the phonebook preferences table below.

Menu Item	Phonebook preferences	
Add contacts	Push the desired contacts on your cellular phone. See your device's manual on how to push contacts. Press the OK button to add more contacts from your phonebook.	
Delete	When a message asking you to delete appears, select the option to confirm. Press the OK button to delete the current phonebook and call history. The system takes you back to the menu for phone settings.	
Download now	Press the OK button to select and download your phonebook to the system.	
Auto-download	When automatic download is on, the system deletes any changes (additions or deletions) saved in the system since your last download.	
	When automatic download is off, the system does not download your phonebook when your cellular phone connects to SYNC.	
	You can only access your phonebook, call history and text messages when your paired cellular phone connects to the system. Check or uncheck this option to download your phonebook automatically each time your phone connects to the system. Download times are phone-dependent and quantity-dependent.	
Sorting Pref.	Enabling this feature allows you to select how your contacts are displayed. You can select:	
	<table border="1" style="width: 100%; border-collapse: collapse;"> <tr> <td style="width: 50%; text-align: center;">First/Last name</td> <td style="width: 50%; text-align: center;">Last/First name</td> </tr> </table>	First/Last name
First/Last name	Last/First name	

Bluetooth Devices

The Bluetooth Devices menu allows you to add, connect and delete devices as well as set a phone as primary.

1. Press the **PHONE** button.
2. Scroll until Bluetooth Devices appears, and then press the **OK** button.

Select from the following options:

Menu Item	Description and action
Add	Pair additional phones to the system. 1. Select the option to add to start the pairing process.

Menu Item	Description and action
	<p>2. When a message to begin pairing appears in the audio display, search for SYNC on your phone. See your phone's manual if necessary.</p> <p>3. When prompted on your cell phone's display, confirm that the PIN provided by SYNC matches the PIN displayed on your cell phone. Skip the next step. If you are prompted to enter a PIN on your device, it does not support Secure Simple Pairing. To pair, enter the PIN displayed on the screen. The display indicates when the pairing is successful.</p> <p>4. When the option to set the phone as primary appears, select either yes or no.</p> <p>5. SYNC may prompt you with more cell phone options. Your cell phone may also prompt you to give SYNC permission to access information. For more information on your cell phone's capability, see your cell phone's manual and visit the website.</p>
Delete	<p>Select the delete option and confirm when the system asks to delete the selected device. After deleting a phone from the list, you have to repeat the pairing process to pair it again.</p>
Master	<p>The system attempts to connect with the primary cellular phone each time you switch on the ignition. When you select a cellular phone as primary, it appears first in the list, marked with an asterisk. Set a previously paired phone as master by selecting the master option and confirming it as the primary.</p>
Conn.	<p>Connect a previously connected phone. You can only have one phone connected at a time to use the phone's functionality. When you connect another phone, the previous phone disconnects from the telephone services. The system allows you to use different Bluetooth devices for the cellular phone functionality and the Bluetooth audio music playback feature at the same time.</p>
Discon.	<p>Disconnects the selected cellular phone. Select this option and confirm when asked. After disconnecting a phone, you can reconnect it again without repeating the full pairing process.</p>

System Settings

1. Press the **MENU** button.

2. Select the SYNC settings option, and then press the **OK** button.

Scroll to select from the following options:

Display	Description and action
Bluetooth on	Check or uncheck this option to switch the system's Bluetooth interface off or on. Select this option, and then press the OK button to change the option's status.
Set defaults	Return to the factory default settings without erasing your indexed information (such as phonebook, call history, text messages and paired devices). Select this option and confirm when prompted in the audio display.
Master reset	Completely erase all information stored in the system (such as phonebook, call history, text messages and paired devices) and return to factory default settings.
Install on SYNC	Install downloaded applications or software updates. Select this option and confirm when prompted in the audio display. There must be a valid SYNC application or update available on the USB drive in order to finish an installation successfully.
System info	Display the system's version numbers as well as its serial number. Press the OK button to select.
Voice settings	The voice settings submenu contains various options. See Using Voice Recognition (page 358).
Browse USB	Browse the actual menu structure of the connected USB device. Press the OK button and use the up and down arrow buttons to scroll through the folders and files. Use the left or right arrow buttons to enter or leave a folder. You can select media content for playback from this menu.

SYNC™ APPLICATIONS AND SERVICES (IF EQUIPPED)

In order for the following features to work, your cellular phone must be compatible with SYNC. To check your phone's compatibility, visit www.SYNCMYRide.com, www.SYNCMYRide.ca or www.syncmaroute.ca.

- 911 Assist: Can alert 911 in the event of an emergency.
- SYNC AppLink: Allows you to connect to and use certain applications (if your phone is compatible).

These features may require activation. Available AppLink enabled apps vary by market.

911 Assist



WARNING: Unless the 911 Assist setting is set on before a crash, the system will not dial for help which could delay response time, potentially increasing the risk of serious injury or death after a crash.



WARNING: Do not wait for 911 Assist to make an emergency call if you can do it yourself. Dial emergency services immediately to avoid delayed response time which could increase the risk of serious injury or death after a crash. If you do not hear 911 Assist within five seconds of the crash, the system or phone may be damaged or non-functional.



WARNING: Always place your phone in a secure location in your vehicle so it does not become a projectile or get damaged in a crash. Failure to do so may cause serious injury to someone or damage the phone which could prevent 911 Assist from working properly.

Note: *The SYNC 911 Assist feature must be set on before the incident.*

Note: *The SYNC 911 Assist feature only operates in the U.S., Canada or in a territory in which 911 is the emergency number.*

Note: *Before setting this feature on, make sure that you read the 911 Assist Privacy Notice later in this section for important information.*

Note: *If any user switches 911 Assist to on or off, that setting applies for all paired phones. If you switch on 911 Assist, either a voice message plays or a display message or an icon comes on when you start your vehicle and after a previously paired phone connects.*

Note: *Every phone operates differently. While SYNC 911 Assist works with most cellular phones, some may have trouble using this feature.*

If a crash deploys an airbag (excluding knee airbags and rear inflatable safety belts [if equipped]) or activates the fuel pump shut-off, your SYNC-equipped vehicle may be able to contact emergency services by dialing 911 through a paired and connected Bluetooth enabled phone. You can learn more about the 911 Assist feature, visit www.SYNCMYRide.com, www.SYNCMYRide.ca or www.syncmaroute.ca.

See **Supplementary Restraints System** (page 48). Important information about airbag deployment is in this chapter.

See **Roadside Emergencies** (page 194). Important information about the fuel pump shut-off is in this chapter.

Setting 911 Assist On or Off

Press Menu then select

Menu Item	Action and Description
SYNC-Applications	
911 Assist	Select the desired option, on or off.

If you choose not to activate this feature you will have the following options:

Menu Item	Action and Description
Voice Reminder ON	Provides a display and voice reminder at phone connection at vehicle start.
Voice Reminder OFF	Provides a display reminder only without a voice reminder at phone connection.

To make sure that 911 Assist works properly:

- SYNC must be powered and working properly at the time of the incident and throughout feature activation and use.
- The 911 Assist feature must be set on before the incident.
- You must pair and connect a Bluetooth enabled and compatible cell phone to SYNC.
- A connected Bluetooth enabled phone must have the ability to make and maintain an outgoing call at the time of the incident.

- A connected Bluetooth enabled phone must have adequate network coverage, battery power and signal strength.
- The vehicle must have battery power and be located in the U.S., Canada or in a territory in which 911 is the emergency number.

In the Event of a Crash

Not all crashes deploy an airbag or activate the fuel pump shut-off (the triggers for 911 Assist). If a connected cell phone sustains damage or loses its connection to SYNC during a crash, SYNC searches for and tries to connect to a previously paired cell phone; SYNC then attempts to call the emergency services.

Before making the call:

- SYNC provides a short window of time (about 10 seconds) to cancel the call. If you fail to cancel the call, SYNC attempts to dial 911.
- SYNC says the following, or a similar message: "SYNC will attempt to call 911, to cancel the call, press Cancel on your screen or press and hold the phone button on your steering wheel".

If you do not cancel the call, and SYNC makes a successful call, a pre-recorded message plays for the 911 operator, and then the occupant(s) in your vehicle is able to talk with the operator. Be prepared to provide your name, phone number and location immediately, because not all 911 systems are capable of receiving this information electronically.

911 Assist May Not Work If

- Your cellular phone or 911 Assist hardware sustains damage in a crash.
- The vehicle's battery or the SYNC system has no power.
- The phone(s) thrown from your vehicle are the ones paired and connected to the system.

911 Assist Privacy Notice

When you switch on 911 Assist, it may disclose to emergency services that your vehicle has been in a crash involving the deployment of an airbag or activation of the fuel pump shut-off. Certain versions or updates to 911 Assist may also be capable of electronically or verbally disclosing to 911 operators your vehicle location or other details about your vehicle or crash to assist 911 operators to provide the most appropriate emergency services. If you do not want to disclose this information, do not switch the feature on.

SYNC Mobile Apps

The system enables voice and steering wheel control of SYNC AppLink enabled smartphone apps. When an app is running through AppLink, you can control main features of the app through voice commands and steering wheel controls.

Note: You must pair and connect your smartphone to SYNC to access AppLink.

Note: iPhone users need to connect the phone to the USB port.

Note: Android users need to connect the phone to SYNC using Bluetooth.

Note: For information on available apps, supported smartphone devices and troubleshooting tips please visit the local website.

Note: Availability of SYNC AppLink enabled Apps will vary by region.

Note: Make sure you have an active account for the app that you have downloaded. Some apps work automatically with no setup. Other apps want you to configure your personal settings and personalize your experience by creating stations or favorites. We recommend you do this at home or outside of your vehicle.

Note: AppLink is not available if your vehicle is equipped with the MyFord Touch system.

To Access Using the SYNC Menu

Press the MENU button to access the menu on-screen. Then select:

Menu Item	Action and Description
SYNC-Apps	
Mobile Apps	Scroll through the list of available applications and select a particular app or select:
	Find New Apps

Note: If you cannot find a compatible SYNC AppLink app, make sure the required app is running on the mobile device.

Accessing an App's Menu

When an app is running through SYNC, press the right arrow button on the steering wheel control to access the app menu.

You can access various app features from here, for example thumbs up and thumbs down.

Press the left arrow button on the steering wheel control to exit the app menu.

To Access Using Voice Commands

Press the voice button then when prompted say:

Menu Item	Action and Description
mobile (apps applications)	Say the name of the application after the tone. The app should start. When an app is running through SYNC, you can press the voice button and speak commands specific to the app, for example "Play Playlist Road Trip".
help	Use this command to discover the available voice commands.

SYNC Mobile App Voice Commands

The following voice commands are always available:

Menu Item	Action and Description
mobile (apps applications)	SYNC prompts you to say the name of an app to start it on SYNC.
list [mobile] (apps applications)	SYNC lists all of the currently available mobile apps.
find [new] [mobile] (apps applications)	Searches your connected mobile device for SYNC-compatible mobile apps.
help	
You can say the name of a mobile app at any time to start the mobile app on SYNC.	

App Permissions

The system organizes app permissions by groups. You can grant these group permissions individually. You can change a permission group status any time when not driving, by using the settings menu.

When you launch an app using SYNC, the system may ask you to grant certain permissions, for example:

- To allow your vehicle to provide vehicle information to the app such as, but not limited to: Fuel level, fuel economy, fuel consumption, engine speed, rain sensor, odometer, VIN, external temperature, gear position, tire pressure, and head lamp status.
- To allow your vehicle to provide driving characteristic information such as, but not limited to: MyKey, seat belt status, engine revolutions per minute, gear position, braking events, steering wheel angle, and accelerator pedal position.

- To allow your vehicle to provide location information, including: GPS and speed.
- To allow the app to send push notifications using the vehicle display and voice capabilities while running in a background state. Push notifications may be particularly useful for news or

location based apps.

Note: You only need to grant permissions the first time you use an app with SYNC.

Note: We are not responsible or liable for any damages or loss of privacy relating to usage of an app, or dissemination of any vehicle data that you approve us to provide to an app.

Enabling and Disabling App Permissions Using the SYNC Menu

Press the MENU button to access the SYNC menu then select:

Menu Item	Action and Description
SYNC-Apps	
Mobile Apps	
All Apps	You can also select a specific app. If the app supports push notifications, this setting is listed. Select to enable or disable the feature as required.

Enabling SYNC Mobile Apps

In order to enable mobile apps, SYNC requires user consent to send and receive app authorization information and updates using the data plan associated with the connected device.

Data is sent to us in the United States through the connected device. The information is encrypted and includes your VIN, SYNC module number, anonymous usage statistics and debugging information. Updates may take place.

Note: You must enable mobile apps for each connected device the first time you select a mobile app using the system.

Note: Standard data rates apply. We are not responsible for any additional charges you may receive from your service provider, when your vehicle sends or receives data through the connected device. This includes any additional charges incurred due to driving in areas when roaming out of a home network.

App Status

You can view the current status of an app in the settings menu.

There are three possible statuses:

Menu Item	Action and Description
Update Needed	The system has detected a new app requiring authorization or a general permissions update.
Up-To-Date	No update is required.
Updating...	The system is trying to receive an update.

Update settings

Menu Item	Action and Description
Request Update	Select this option from the settings menu to manually preform a needed update.
Disable Updates	Select this option from the settings menu to disable automatic updates. Doing so also disables the use of Mobile Apps on SYNC.

USING SYNC™ WITH YOUR MEDIA PLAYER

You can access and play music from your digital music player over your vehicle's speaker system using the system's media menu or voice commands. You can also sort and play your music by specific categories, such as artist and album.

Note: *The system is capable of indexing up to 15,000 songs.*

SYNC is capable of hosting nearly any digital media player including: iPod, Zune, plays from device players, and most USB drives. SYNC also supports audio formats, such as MP3, WMA, WAV and ACC.

Confirm that the USB device has been formatted correctly and has the following specifications:

- USB 2.0.
- File format must be FAT16/32.

The format of the audio files on the USB device must be:

- MP3.
- Non DRM protected WMA.
- WAV.
- AAC.

Connecting Your Digital Media Player to the USB Port

Note: *If your digital media player has a power switch, make sure you switch it on before plugging it in.*

To Connect Using Voice Commands

Plug the device into one of the vehicle's USB ports.

Press the voice button and when prompted, say:

Voice Command	Action and Description
(USB [stick] iPod MP3 [player])	You can now play music by saying any of the appropriate voice commands. See the media voice commands.

Words in brackets [] are optional and do not have to be spoken for the system to understand the command. For example, for where (USB [stick] | IPOD | MP3 [player]) appears, you can say USB or USB stick.

To view USB content select:

Message	Description and Action
Browse USB	Depending on how many media files are on your connected device, an indexing message may appear in the display. When indexing is complete, the selected source starts to playback audio automatically.

You can browse the files on the USB device in categories. Select BROWSE from the buttons at the bottom of the audio display and choose from the following:

Message
Play all
Playlists
Songs
Artists

To Connect Using the System Menu

1. Plug the device into one of the vehicle's USB ports.
2. Press the **MEDIA** button and select either USB 1 or USB 2 from the media source list in the audio display.

Message
Albums
Genres
Browse USB
Reset USB

Media Voice Commands



Press the voice button and when prompted say:

Voice Command	Description and Action
(USB [stick] iPod MP3 [player])	You can now play music by saying any of the appropriate voice commands.

You can say any of the voice commands that appear within open and close brackets that are separated by |. For example, where; (what's | what is) appears you say; what's or what is.

You must say any of the voice commands that appear outside of open and close brackets. For example, where; (what's | what is) playing, you must say either "what's playing" or "what is playing".

Command	Description and Action
pause	Pauses device playback.
play	Resumes device playback.
play [album] ___	
play all	Play all media on the device from the first track to the last.
play [artist] ___	
play [genre] ___	
play [playlist] ___	
next [track title song file podcast chapter episode]	Plays the next track on the current media.
previous [track title song file podcast chapter episode]	Plays the previous track on current media.
[play] (similar music more like this)	Creates a playlist with a similar genre to the one currently playing.
play [song track title file] ___	
repeat off	
repeat (one track) [on]	Repeats the current track.

Command	Description and Action
shuffle [all] [on]	Plays the current playlist in a random order. (Not all devices support this command.)
shuffle off	
((who's who is) this who plays this (what's what is) playing [now] (what which) (song track artist) is this (who's who is) playing (what's what is) this)	At any time during playback, you can press the voice button and ask the system what is playing. The system reads the metadata tags (if populated) of the current track.

___ is a dynamic listing, meaning that it could be the name of anything, such as a group, artist or song. For example you could say "Play artist The Beatles".

Examples of USB Commands

SYNC provides the user with many intuitive ways to find and play a song using voice. For example, if we have a song called "Penny Lane" from the album "Magical Mystery Tour" we can say the following to play this song:

- Play song "Penny Lane".
- Play "Penny Lane".

If we wanted to play the entire album, we can say:

- Play album "Magical Mystery Tour".
- Play "Magical Mystery Tour".

Bluetooth Audio

The system is also capable of playing music from your cellular phone through Bluetooth.

To switch the Bluetooth Audio on, press the MEDIA button and select:

Menu Item
BT audio

Then any of the following:

Voice Command
pause
play
next [track title song file podcast chapter episode]
previous [track title song file podcast chapter episode]

Media Menu Features

The media menu allows you to select how to play your music (such as by artist, genre, shuffle or repeat), find similar music or reset the index of your USB devices.

Press the **MEDIA** button and select either USB 1 or USB 2 from the media source list in the audio display to start USB playback.

Message	Description and Action
Options	This will enter the media menu.

Then any of the following:

Message	Description and Action
Shuffle	Choose to shuffle or repeat your music. Once you make your choice, it remains on until you switch it off.
Repeat track	Choose to shuffle or repeat your music. Once you make your choice, it remains on until you switch it off.
Similar music	You can play similar types of music to the current playlist from the USB port. The system uses the metadata information of each track to compile a playlist. The system then creates a new list of similar tracks and then begins playing. Each track must have the metadata tags populated for this feature. With certain playing devices, if your metadata tags are not populated, the tracks will not be available in voice recognition, the play menu or this option. However, if you place these tracks onto your playing device in mass storage device mode they are available in voice recognition, the play menu or this option. The system places unknowns into any unpopulated metadata tag.
Reset USB	Resets the USB index. After the new indexing is complete you can choose what to play from the USB song library.

Accessing Your USB Song Library

1. Plug the device into your vehicle's USB port.

2. Press the **MEDIA** button (next to the audio display) to select USB playback.

Message	Description and Action
Browse USB	This menu allows you to select and play your media files by artist, album, genre, playlist or track.

If there are no media files to access, the display indicates there is no media.

If there are media files, you have the following options:

Display	Description and Action
Play all	Play all indexed media files from your device one at a time in numerical order.* Press the OK button to select. The first track title appears in the display.
Playlists	Access your playlists (from formats like ASX, M3U, WPL, or MTP).* 1. Press the OK button to select. 2. Scroll to select the desired playlist, and then press the OK button.
Songs	Search for and play a specific indexed track.* 1. Press the OK button to select. 2. Scroll to select the desired track, and then press the OK button.
Artists	Sort all indexed media files by artist. The system then lists and plays all artists and tracks alphabetically.* 1. Press the OK button to select. 2. Scroll to select the desired artist, and then press the OK button.
Albums	Sort all indexed media files by album.* 1. Press the OK button to select. 2. Scroll to select the desired album, and then press the OK button.
Genres	Sort all indexed media files by genre (category) type.* 1. Press the OK button to select. 2. Scroll to select the desired genre, and then press the OK button.
Browse USB	Browse all supported media files on your media player connected to the USB port. You can only view media files that are compatible with SYNC. (Other files are not visible.) 1. Press the OK button to select.

Display	Description and Action
	2. Scroll to browse indexed media files on the device, and then press the OK button.
Reset USB	Resets the USB index. After the new indexing is complete, you can choose what to play from the USB song library.

*You can use the buttons at the bottom of the audio display to jump to a certain alphabetical category quickly. You can also use the letters on the audio system's numeric keypad to jump in the list.

Using Voice Commands

You can access and view your USB songs using voice commands.

Plug the device into your vehicle's USB port.

Press the voice button and when prompted, say any of the following commands:

Accessing and Viewing USB Media
(browse search show) all (album albums)
(browse search show) all (artist artists)
(browse search show) all (genre genres)
(browse search show) all (playlist playlists)
(browse search show) all (song songs title titles file files track tracks)
(browse search show) album ____
(browse search show) artist ____
(browse search show) genre ____
(browse search show) playlist ____

USB 2 (If Equipped)

Your vehicle may come equipped with an additional USB port. If so, USB 1 is located at the front of the vehicle at the bottom of the instrument panel. USB 2 is located inside the storage compartment of the vehicle's center console.

You can plug in an additional USB device into the second USB port.

You can access both USB devices by using voice commands.

To access a USB device press the voice button and when prompted say:

Voice command
USB 1
USB 2

Note: SYNC only supports one connected iOS (Apple) devices at a time (whichever one you plug in first). When you connect a second iOS device, the systems charges it, but does not support playback from it.

Bluetooth Devices and System Settings

You can access these menus using the audio display. See **Using SYNC™ With Your Phone** (page 360).

Voice Commands for Audio Sources

Your voice system allows you to change audio sources with a simple voice command.



Press the voice button and when prompted say:

Voice Command
(music audio entertainment) [system]
Below are a few examples of voice commands you can use.
[tune [to]] AM
[tune [to]] AM1
[tune [to]] AM (autostore AST autose)
[tune [to]] AM 2
Bluetooth (audio stereo)
(disc CD [player]) play
[tune [to]] FM
[tune [to]] FM1
[tune [to]] FM (autostore AST autose)
[tune [to]] FM 2
Radio
tune [to] SAT *
Sirius *
(USB [stick] iPod MP3 [player])

Voice Command
((who's who is) this who plays this (what's what is) playing [now] (what which) (song track artist) is this (who's who is) playing (what's what is) this)
help

* If equipped.

Radio Voice Commands



If you are listening to the radio, press the voice button, and then say any of the commands in the following table.

If you are not listening to the radio, press the voice button and, after the tone, say:

Voice Command
Radio
You can then say any of the following commands.
[tune [to]] AM
[tune [to]] AM1
[tune [to]] AM (autostore AST autose)
[tune [to]] AM 2
[tune [to]] (AM ___ ___ [AM])
[tune [to]] AM preset ___
[tune [to]] AM1 preset ___
[tune [to]] FM
[tune [to]] FM1
[tune [to]] FM (autostore AST autose) preset ___

Voice Command
[tune [to]] FM 2
[tune [to]] (FM ___ ___ [FM])
[tune [to]] FM preset ___
FM ___ HD ___ *
[tune [to]] FM 2 preset ___
HD ___ *
[tune [to]] preset ___
Tune
help

* If equipped.

Sirius Satellite Radio Voice Commands (If equipped)



To listen to Sirius satellite radio, press the voice button and, after the tone, say:

Voice Commands
Sirius

When you are listening to Sirius satellite radio, you can press the voice button, and say any of the commands in the following table.

Voice Commands
tune [to] SAT
[tune [to]] SAT 1
[tune [to]] SAT 2
[tune [to]] SAT 3
[tune [to]] preset ___
[tune [to]] SAT 1 preset ___

Voice Commands	
[tune [to]] SAT 2 preset ___	
[tune [to]] SAT 3 preset ___	
tune [to] [Sirius]	
Help	
[tune [to]] Sirius [channel] ___	You can say the channel number (0-233) to listen to that Sirius station.

CD Voice Commands



If you are listening to a CD, press the voice button, and then say any of the commands in the following table.

If you are not listening to a CD, press the voice button and, after the tone, say:

Voice Command
(disc CD [player]) play
You can then say any of the following commands.
pause
play
[play] next track
[play] previous track
[play change to] track [number] ___
repeat (track song) [on]
repeat folder [on]
repeat off
(shuffle random mix) [on (tracks songs) [on]]

Voice Command
(shuffle random mix) (CD [player] disc) [on]
(shuffle random mix) folder [on]
shuffle off

Use the website at any time to check your phone's compatibility, register your account and set preferences as well as access a customer representative via an online chat (during certain hours). Visit www.SYNCMyRide.com, www.SYNCMyRide.ca or www.syncmaroute.ca for more information.

SYNC™ TROUBLESHOOTING

Your SYNC system is easy to use. However, should questions arise, see the tables below.

Phone issues		
Issue	Possible cause(s)	Possible solution(s)
There is excessive background noise during a phone call.	The audio control settings on your phone may be affecting SYNC performance.	Review your phone's manual about audio adjustments.
During a call, I can hear the other person but they cannot hear me.	This may be a possible phone malfunction.	Try turning off the device, resetting the device, removing the device's battery, then trying again.
SYNC is not able to download my phonebook.	This is a phone-dependent feature. This may be a possible phone malfunction.	Go to the website to review your phone's compatibility. Try turning off the device, resetting the device or removing the device's battery, then trying again. Try pushing your phonebook contacts to SYNC by using the Add Contacts feature. Use the SYNCmyphone feature available on the website.
The system says Phonebook Downloaded but the phonebook in SYNC is empty or missing contacts.	This may be a limitation on your phone's capability.	Try pushing your phonebook contacts to SYNC by using the Add Contacts feature.

SYNC™

Phone issues		
Issue	Possible cause(s)	Possible solution(s)
		<p>If the missing contacts are stored on your SIM card, try moving them to the device memory.</p> <p>Remove any pictures or special ring tones associated with the missing contact.</p> <p>Depending upon your phone, you may have to grant SYNC permission to access your phonebook contacts. Make sure to confirm when prompted by your phone during the phonebook download.</p>
<p>I am having trouble connecting my phone to SYNC.</p>	<p>This is a phone-dependent feature.</p> <p>This may be a possible phone malfunction.</p>	<p>Go to the website to review your phone's compatibility.</p> <p>Try turning off the device, resetting the device or removing the device's battery, then trying again.</p> <p>Try deleting your device from SYNC, deleting SYNC from your device and trying again.</p> <p>Check the security and auto accept and prompt always settings relative to the SYNC Bluetooth connection on your phone.</p> <p>Update your device's firmware.</p>

SYNC™

Phone issues		
Issue	Possible cause(s)	Possible solution(s)
		Turn off the Auto phone-book download setting.
Text messaging is not working on SYNC.	This is a phone-dependent feature. This may be a possible phone malfunction.	Go to the website to review your phone's compatibility. Try turning off the device, resetting the device or removing the device's battery, then trying again.

USB and media issues		
Issue	Possible cause(s)	Possible solution(s)
I am having trouble connecting my device.	This may be a possible device malfunction.	Try turning off the device, resetting the device, removing the device's battery, then trying again. Make sure you are using the manufacturer's cable. Make sure you insert the USB cable correctly into the device and the USB port. Make sure that the device does not have an auto-install program or active security settings.
SYNC does not recognize my device when I turn on the car.	This is a device limitation.	Make sure you are not leaving the device in your vehicle during very hot or cold temperatures.
Bluetooth audio does not stream.	This is a phone-dependent feature.	Review the device compatibility chart on the SYNC website to confirm your phone supports the Bluetooth audio streaming function.

SYNC™

USB and media issues		
Issue	Possible cause(s)	Possible solution(s)
	The device is not connected.	Make sure you correctly connect the device to SYNC, and that you have pressed play on your device.
SYNC does not recognize music that is on my device.	<p>Your music files may not contain the correct artist, song title, album or genre information.</p> <p>The file may be corrupted.</p> <p>The song may have copy-right protection, which does not allow it to play.</p>	<p>Make sure that all song details are populated.</p> <p>Some devices require you to change the USB settings from mass storage to MTP class.</p>

Voice command issues		
Issue	Possible cause(s)	Possible solution(s)
SYNC does not understand what I am saying.	<p>You may be using the wrong voice commands.</p> <p>You may be speaking too soon or at the wrong time.</p>	<p>Review the phone voice commands and the media voice commands at the beginning of their respective sections.</p> <p>After pressing the voice icon, wait until after the tone sounds and Listening appears before saying a command. Any command spoken before this does not register with the system.</p>
SYNC does not understand the name of a song or artist.	You may be using the wrong voice commands.	Review the media voice commands at the beginning of the media section.

Voice command issues		
Issue	Possible cause(s)	Possible solution(s)
	<p>You may be saying the name differently than the way you saved it.</p> <p>The system may not be reading the name the same way you are saying it.</p>	<p>Say the song or artist exactly as listed. If you say "Play Artist Prince", the system does not play music by Prince and the Revolution or Prince and the New Power Generation.</p> <p>Make sure you are saying the complete title, such as "California remix featuring Jennifer Nettles".</p> <p>If the song titles are in all CAPS, you have to spell them. LOLA requires you to say "L-O-L-A".</p> <p>Do not use special characters in the title. The system does not recognize them.</p>
<p>SYNC does not understand or is calling the wrong contact when I want to make a call.</p>	<p>You may be using the wrong voice commands.</p> <p>You may be saying the name differently than the way you saved it.</p>	<p>Review the Phone voice commands at the beginning of the phone section.</p> <p>Make sure you are saying the contacts exactly as they are listed. For example, if you save a contact as Joe Wilson, say "Call Joe Wilson".</p> <p>Using the SYNC phone menu, open the phonebook and scroll to the name SYNC is having trouble understanding. SYNC will read the name to you, giving you some idea of the pronunciation SYNC is expecting.</p>

SYNC™

Voice command issues		
Issue	Possible cause(s)	Possible solution(s)
	<p>The system may not be reading the name the same way you are saying it.</p> <p>Contacts in your phonebook may be very short and similar, or they may contain special characters.</p> <p>Your phonebook contacts may be in CAPS.</p>	<p>The system works better if you list full names, such as "Joe Wilson" rather than "Joe".</p> <p>Do not use special characters, such as 123 or ICE, as the system does not recognize them.</p> <p>If a contact is in CAPS, you have to spell it. JAKE requires you to say "Call J-A-K-E".</p>

AppLink issues		
Issue	Possible cause(s)	Possible solution(s)
<p>AppLink Mobile Applications: When I select "Find New Apps," SYNC does not find any applications.</p>	<p>An AppLink capable phone is not connected to SYNC.</p>	<p>Ensure you have a compatible smartphone; an Android with OS 2.3 or higher or an iPhone 3GS or newer with iOS 5.0 or higher. Additionally, ensure your phone is paired and connected to SYNC in order to find AppLink-capable apps on your device. iPhone users must also connect to SYNC's USB port with an Apple USB cable.</p>
<p>My phone is connected, but I still cannot find any apps.</p>	<p>AppLink-enabled apps are not installed and running on your mobile device.</p>	<p>Ensure you have downloaded and installed the latest version of the app from your phone's app store. Ensure the app is running on your phone. Some apps require you to register or</p>

AppLink issues		
Issue	Possible cause(s)	Possible solution(s)
		login on the app on the phone before using them with AppLink. Also, some may have a "Ford SYNC" setting, so check the app's settings menu on the phone.
My phone is connected, my app(s) are running, but I still cannot find any apps.	Sometime apps do not properly close and re-open their connection to SYNC, over ignition cycles, for example.	<p>Closing and restarting apps may help SYNC find the application if you cannot discover it inside the vehicle.</p> <p>On an Android device, if apps have an "Exit" or 'Quit' option, select that then restart the app. If the app does not have that option, you can also manually "Force Close" the app by going to the phone's settings menu, selecting 'Apps.' then finding the particular app and choosing 'Force stop.' Don't forget to restart the app afterwards, then select "Find New Apps" on SYNC.</p> <p>On an iPhone with iOS7+, to force close an app, double tap the home button then swipe up on the app to close it. Tab the home button again, then select the app again to restart it. After a few seconds, the app should then appear in SYNC's Mobile App's Menu.</p>
My Android phone is connected, my app(s) are running, I restarted them, but I still cannot find any apps.	There is a Bluetooth bug on some older versions of the Android operating system that may cause apps that were found on your previous vehicle drive to not be found again if you have not turned off Bluetooth.	Reset the Bluetooth on your phone by turning it off and then turning Bluetooth back on. If you are in your vehicle, SYNC should be able to automatically re-connect to your phone if you press the "Phone" button.

SYNC™

AppLink issues		
Issue	Possible cause(s)	Possible solution(s)
My iPhone phone is connected, my app is running, I restarted the app but I still cannot find it on SYNC.	The USB connection to SYNC may need to be reset.	Unplug the USB cable from the phone, wait a moment, and plug the USB cable back in to the phone. After a few seconds, the app should appear in SYNC's Mobile Apps Menu. If not, "Force Close" the application and restart it.
I have an Android phone. I found and started my media app on SYNC, but there is no sound or the sound is very low.	The bluetooth volume on the phone may be low.	Try increasing the Bluetooth volume of the device by using the device's volume control buttons which are most often found on the side of the device.
I can only see some of the AppLink apps running on my phone listed in SYNC's Mobile Apps Menu.	Some Android devices have a limited number of bluetooth ports apps can use to connect. If you have more AppLink apps on your phone than the number of available Bluetooth ports, you will not see all of your apps listed in SYNC's mobile apps menu.	Force close or uninstall the apps you do not want SYNC to find. If the app has a "Ford SYNC" setting, disable that setting in the app's settings menu on the phone.

SYNC System Reset
The SYNC system in your vehicle has System Reset feature that can be performed if the function of a SYNC feature is lost. This reset is intended to restore functionality and will not erase any information previously stored in the system (Such as paired devices, phonebook, call history, text messages, or user settings). To perform a System Reset, press and hold the Seek Up (>>) button while pressing and holding the Radio Power button. Release both buttons after 2-3 seconds. Please allow a few minutes for the reset to complete. After a few minutes has passed you can resume using the SYNC system.

SYNC™ 3

GENERAL INFORMATION

WARNING: Driving while distracted can result in loss of vehicle control, crash and injury. We strongly recommend that you use extreme caution when using any device that may take your focus off the road. Your primary responsibility is the safe operation of your vehicle. We recommend against the use of any hand-held device while driving and encourage the use of voice-operated systems when possible. Make sure you are aware of all applicable local laws that may affect the use of electronic devices while driving.

Using the Touchscreen

To operate the touchscreen, you can simply touch the item or option that you want to select. The button changes color when you select it.

The SYNC 3 layout allows you to quickly select the feature you wish to use.

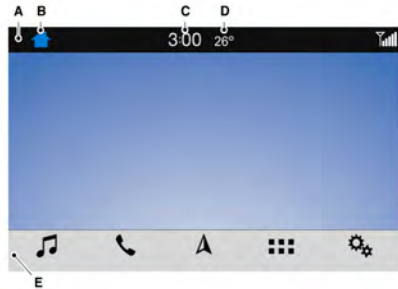

Getting to Know Your System

The SYNC 3 system allows you to interact with a variety of features using the touchscreen and voice commands. By integrating with your Bluetooth-enabled phone, the touchscreen provides easy interaction with audio, multimedia, climate control, navigation, and your phone's SYNC 3 compatible apps.

Item	Menu Item	Action and Description
A	Status Bar	This bar displays icons and messages pertaining to current system activities including climate settings, voice commands and phone functions such as text messages.
B	Home	This button is available on the main screens. Pressing it takes you to the home screen view.
C	Clock	This shows the current time. You can set the clock manually or have it controlled by the vehicle's GPS location. See Settings (page 432).
D	Outside Temperature	This displays the current outside temperature.
E	Feature Bar	You can touch any of the buttons on this bar to select a feature.

SYNC™ 3

The touchscreen allows you quick access to all of your comfort, navigation, communication and entertainment options. Using the status and feature bar you can quickly select the feature you want to use.

Note: *Your system is equipped with a feature that allows you to access and control audio features for 10 minutes after you switch the ignition off (and no doors open).*

The Status Bar

Additional icons also display in the status bar depending on market, vehicle options and current operation. If a feature is not active, the icon does not display. Certain icons may move to the left or right depending on what options are active.



Cell phone microphone muted.



Audio system muted.



Software update installed.



Wi-Fi connected.



Cell phone roaming.



Text message received.



911 Assist off.



Cell phone network signal strength.

Messages may also appear in the status bar to provide you with notifications. You can select the message to view the associated feature.

Feature Bar

Feature Bar Item	Functions
Audio	Allows you to control the media playing in your vehicle. You can control all audio features including AM, FM and satellite radio, CDs, and media streaming over a Bluetooth device or through a USB connection.
Phone	Allows you to make calls, receive calls, and access the phonebook of your connected device.
Navigation	Allows you to see your vehicle's location on a virtual road map, get driving directions to your destination and find points of interest along your route.

SYNC™ 3

Feature Bar Item	Functions
(If equipped)	
Apps	Connect and control SYNC 3 compatible apps running on your iPhone or Android device. Also, access built-in additional features such as SiriusXM Traffic and Travel Link (if equipped).
Settings	You can customize your system with various settings for the touchscreen display, feature preferences, and how you want to interact with your vehicle.

Cleaning the Touchscreen

You can remove fingerprints with a dry, clean, soft cloth.

If dirt or fingerprints are still on the screen, apply a small amount of alcohol to the cloth and try to clean it again.

Note: Do not use detergent or any type of solvent to clean the touchscreen.

Note: Do not pour or spray alcohol onto the touchscreen.

Using Voice Recognition

Using voice commands allows you to keep your hands on the wheel and focus on what is in front of you. The system provides feedback through audible tones, prompts, questions and spoken confirmations depending on the situation and the chosen level of interaction (voice settings).

The system also asks short questions (confirmation prompts) when it is not sure of your request or when there are multiple possible responses to your request.

When using voice commands, words and icons may appear in the status bar indicating the status of the voice command session. See **Using Voice Recognition** (page 401).

Using the Controls on the Steering Wheel

Depending on your vehicle and option package, you can use different controls on your steering wheel to interact with the touchscreen system in different ways.

VOL: Control the volume of audio output.

Mute: Mute the audio output.

Voice: Press to start a voice session. Press again to stop the voice prompt and immediately begin speaking. Press and hold to end a voice session.

SEEK NEXT:

- While in radio mode, press to seek between memory presets.
- While in USB, Bluetooth Audio or CD mode, press to seek between songs or press and hold to fast seek.

SEEK PREVIOUS:

- While in radio mode, press to seek between memory presets.
- While in USB, Bluetooth Audio or CD mode, press to seek between songs or press and hold to fast seek.

PHONE ACCEPT: Press to answer a call or switch between calls.

PHONE REJECT: Press to end a call or reject an incoming call.

Note: On some models, **SEEK NEXT** may be combined with **PHONE REJECT** and **SEEK PREVIOUS** may be combined with **PHONE ACCEPT**.

M: Touch the control repeatedly to switch between media sources (modes).

See **Steering Wheel** (page 79).

Using Your Bezel Controls

Depending on your vehicle and option package, you may also have these controls on your instrument panel:

- **Power:** Switch the audio system on and off.
- **VOL:** Control the volume of playing audio.
- **Seek** and **Tune:** Use as you normally would in audio modes.
- **Eject:** Eject a CD from the audio system.
- **SOURCE** or **MEDIA:** Press repeatedly to advance through available media modes.
- **SOUND:** Press to access the Sound menu where you can adjust sound and other audio settings.
- **1-6:** Press and hold to store or press to select an AM, FM or SIRIUS memory preset. See **Audio System** (page 333).
- **DISP:** Switch the display on or off. You can also touch the screen to switch the display back on.
- **Temperature, fan and climate control buttons:** Control the temperature, fan speed or settings of the climate control system. See **Climate Control** (page 107).

Safety Information



WARNING: Driving while distracted can result in loss of vehicle control, crash and injury. We strongly recommend that you use extreme caution when using any device that may take your focus off the road. Your primary responsibility is the safe operation of your vehicle. We recommend against the use of any hand-held device while driving and encourage the use of voice-operated systems when possible. Make sure you are aware of all applicable local laws that may affect the use of electronic devices while driving.

- Do not attempt to service or repair the system. Have an authorized dealer check your vehicle.
- Do not operate playing devices if the power cords or cables are broken, split or damaged. Place cords and cables out of the way, so they do not interfere with the operation of pedals, seats, compartments or safe driving abilities.
- Do not leave playing devices in your vehicle during extreme conditions as it could cause them damage. See your device's user guide for further information.
- For your safety, some SYNC 3 functions are speed-dependent. Their use is limited to when your vehicle is traveling at speeds under 3 mph (5 km/h). Make sure that you review your device's manual before using it with SYNC 3.

Speed-restricted Features

Some features of this system may be too difficult to use while your vehicle is moving so they are restricted from use unless your vehicle is stationary.

SYNC™ 3

- Screens crowded with information, such as Point of Interest reviews and ratings, SiriusXM Traffic and Travel Link sports scores, movie times or ski conditions.
- Any action that requires you to use a keyboard is restricted, such as entering a navigation destination or editing information.
- All lists are limited so the user can view fewer entries (such as phone contacts or recent phone call entries).

See the following table for more specific examples.

Restricted features	
Cellular Phone	Pairing a Bluetooth phone.
	Browsing of list entries is limited for phone contacts and recent phone calls.
System Functionality	Editing the keypad code.
	Enabling Valet Mode.
	Editing settings while the rear view camera or active park assist are active.
Wi-Fi	Editing Wi-Fi settings.
	Editing the list of wireless networks.
	Connecting to a new Wi-Fi network.
Text Messages	Viewing received text messages.
Navigation	Using the keyboard to enter a destination.
	Adding or editing Navigation Favorites entries or Avoid Areas.

Creating a SYNC Owner Account

Why do I need a SYNC owner account?

- Essential for keeping up with the latest software and connected features.
- Access to customer support for any questions you may have.
- Maintain account permissions.

Visit the website to sign up and register.

Website

www.owner.ford.com
www.syncmyride.ca
www.syncmaroute.ca

Updating Your System

You can choose to download the update onto a USB drive or use Wi-Fi to deliver automatic updates.

USB Updates

To use the USB update you need to log into your owner account and visit the SYNC software update page.

Website
www.owner.ford.com www.syncmyride.ca www.syncmaroute.ca

The website notifies you if an update is available. You can then select to download the update.

You will need an empty USB drive. Please check the website for minimum requirements. Once you have inserted the USB drive into your computer, choose to start the download. Follow the instructions provided to download the files to the USB drive.

The installation of most files occurs in the background, and does not interrupt your use of the system. Navigation updates cannot be installed in the background, because the files are too large.

To install the update in your vehicle, remove anything that is plugged in the USB ports on the media hub and plug in the USB drive containing the update. When the USB drive is plugged in, the installation should begin immediately. After a successful installation, the update is available the next time the vehicle is started.

Please refer to the website for any further actions.

Updating Over Wi-Fi

To update your System over Wi-Fi your vehicle must be within the range of a Wi-Fi access point. Data rates may apply.

To connect your system to Wi-Fi, select:

Menu Item	
Settings	
Wi-Fi	
Available Wi-Fi Networks	You can then select your Wi-Fi network. You may have to enter the security code if the network is secured. The system confirms when it has connected to the network.

You must also give the system permission to update automatically. Upon vehicle delivery, the System asks you if you would like to use the automatic update feature. If you agree to automatic updates, you can press OK to confirm. If this selection does not appear upon vehicle delivery you can access it through the General Settings. See **Settings** (page 432). You can also perform a master reset. See **SYNC™ 3 Troubleshooting** (page 446).

If you would like to switch this feature on later, select:

Menu Item	
Settings	
General	
Automatic System Updates	From this menu, you can enable automatic updates. If you have not done so already, the system prompts you to set up a Wi-Fi connection when you enable this feature.

When Wi-Fi and automatic updates are enabled, your system checks for software updates periodically. If a new version is available, it downloads at that time. Software downloads can take place for up to 30 minutes after you have switched your vehicle off. The updates do not interrupt the normal use of your SYNC 3 system. If a download does not complete for any reason, the download continues where it left off at the next Wi-Fi connected opportunity. Upon activation of an update, a banner displays on the touchscreen indicating the system update. Select the icon to see more detail. This icon displays for two ignition cycles.

To switch this feature off:

Menu Item	
Settings	
General	
Automatic System Updates	In this menu selection, you can change the selection for automatic updates to OFF.

Customer Assistance

The SYNC support team is available to help you with any questions you are not able to answer on your own.

Monday-Saturday, 8:30am-8:00pm EST.

United States: 1-800-392-3673.

Canada: 1-800-565-3673.

Times are subject to change due to holidays.

Privacy Information

When you connect a cellular phone to SYNC 3, the system creates a profile within your vehicle that links to that cellular phone. This profile helps in offering you more cellular features and operating more efficiently. Among other things, this profile may contain data about your cellular phone book, text messages (read and unread), and call history, including history of calls when your cell phone was not connected to the system. In addition, if you connect a media device, the system creates and retains an index of supported media content. The system also records a short diagnostic log of approximately 10 minutes of all recent system activity. The log profile and other system data may be used to improve the system and help diagnose any problems that may occur.

The cellular profile, media device index, and diagnostic log remain in your vehicle unless you delete them and are generally accessible only in your vehicle when the cellular phone or media player is connected.

If you no longer plan to use the system or your vehicle, we recommend you perform a Master Reset to erase all stored information. You can find more information about the Master Reset in General Settings. See **Settings** (page 432). System data cannot be accessed without special equipment and access to your vehicle's SYNC 3 module. Ford Motor Company and Ford of Canada do not access the system data for any purpose other than as described absent consent, a court order, or where required by law enforcement, other government authorities, or other third parties acting with lawful authority. Other parties may seek to access the information independently of Ford Motor Company and Ford of Canada.

HOME SCREEN

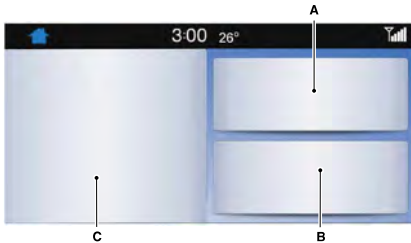

- A See **Entertainment** (page 406).
- B See **Phone** (page 416).
- C See **Navigation** (page 421).



Press the voice control button on the steering wheel and wait for the voice prompt.

Note: Press the voice control button again to interrupt a voice prompt and begin speaking.

Note: Turn the volume control when a voice prompt plays to adjust the volume.

Note: Press and hold the voice control button on the steering wheel to use Siri on your iOS device.

The following voice commands are designed to help you from any screen:

- **List of Commands**
- **Help**

The following tables list some of the more frequently used voice commands. For a complete list of voice commands, refer to the local Ford website.

USING VOICE RECOGNITION

The system allows you to interact with the entertainment, information and communication systems on your vehicle using voice commands. This allows you to keep your hands on the steering wheel and focus on what is in front of you.

General

Voice Command	Description
___ List of Commands	Get a list of voice commands for a specific feature. ¹
Cancel	Cancel an active voice session.
___ Help	Get a list of voice commands for a specific feature. ¹
Go back	Return to the previous screen.
Main Menu	Go to the main menu.
Next Page	Go to the next page.
Previous Page	Go to the previous page.

¹ Add the name of the feature to the command.

SYNC™ 3

Entertainment

Audio Source

Voice Command	Description
Radio	Use the radio.
CD Player	Use the CD player.
Bluetooth Stereo	Use a Bluetooth device.
USB	Use a USB or media player.

Radio

Voice Command	Description
AM	Listen to AM radio.
AM ____	Tune to a specific AM frequency. ¹
DAB	Listen to DAB radio.
FM	Listen to FM radio.
FM ____	Tune to a specific FM frequency. ¹

¹ Add the radio frequency to two decimal places to the command.

USB and Media Player

Voice Command	Description
Play Album ____	Play your music by category. ¹
Play Artist ____	
Play Genre ____	
Play Playlist ____	
Play Song ____	
Browse All Albums	Browse music on a USB device.
Browse All Artists	
Browse All Audiobooks	

SYNC™ 3

Voice Command	Description
Browse All Genres	Browse your music by category on a USB device. ¹
Browse All Playlists	
Browse All Podcasts	
Browse All Songs	
Browse Album ____	
Browse Artist ____	
Browse Audiobook ____	
Browse Genre ____	
Browse Playlist ____	
Browse Podcast ____	

¹ Add an album name, artist name, audiobook name, genre name, playlist name, podcast name or track name to the command. Say the name exactly as it appears on your device.

Climate Control

Note: Not available through the system on all models.

Voice Command	Description
Set Temperature ____	Set a temperature between 60°F (15.5°C) and 85°F (29.5°C). ¹
Max	Set the temperature to maximum.
Min	Set the temperature to minimum.

¹ Add the required temperature to the command.

Phone

Voice Command	Description
Pair Phone	Pair a cell phone or Bluetooth enabled device.
Redial	Redial the last number that you dialed.
Dial ____	Dial a number. ¹

SYNC™ 3

Voice Command	Description
Call ___	Call a specific contact from your phonebook. ²
Call ___ ___	Call a specific contact from your phonebook at a specific location. ³
Listen to Message	Listen to a text message.
Listen to Message ___	Listen to a specific text message from a list of text messages.
Reply to Message	Reply to the last text message.

¹ Add the number you want to dial to the command.

² Add a contact name from your phonebook to the command. Say the name exactly as it appears on your device.

³ Add a contact name and location from your phonebook to the command. Say the first and the last name of your contact exactly as it appears on your device.

Navigation (If Equipped)

Setting a Destination

Voice Command	Description
Find an Address	Enter a destination address. When prompted, provide the house number, the street and city.
Find a POI	Search for a point of interest by name or by category.
Destination Nearest ___	Search for a nearby point of interest by category. ¹
Find a POI Category	Search for a point of interest category. ¹
Drive Home	Set your saved home address as your destination.
Drive to Work	Set your saved place of work as your destination.
Show Previous Destinations	Display and select from a list of previous destinations.
Show Favorites	Display and select from a list of favorite destinations.

¹ Add a point of interest category or the name of a major brand or chain to the command.

SYNC™ 3

Route Guidance

Voice Command	Description
Cancel Route	Cancel the current route.
Detour	Select an alternate route.
Repeat Instruction	Repeat the last guidance prompt.
Show Route	Display an overview of the route.
Show Traffic	Display a list of traffic events on your route.
Show All Traffic	Display a list of all traffic events.
Show Map	Display the map on the touchscreen.
North Up	Display a two-dimensional map with north toward the top of the touchscreen.
Heading Up	Display a two-dimensional map with the direction you are traveling toward the top of the touchscreen.
Show 3D	Display a three-dimensional map with the direction you are traveling toward the front.

Apps

General

Voice Command	Description
Mobile Applications	Start an app. The system prompts your for the app name.
List Applications	Get a list of apps running on your device.
Find Applications	Search and connect to apps running on your device.

Active App

Voice Command	Description
___ Help	Get a list of voice commands for a specific app. ¹
Exit ___	Close an app. ¹

¹ Add an app name to the command.

Voice Settings

Voice Command	Description
Voice Settings	Go to the voice settings menu.
Interaction Mode Novice	Switch long voice prompts on.
Interaction Mode Advanced	Switch short voice prompts on.
Phone Confirmation On	Switch call confirmation on. The system prompts you to confirm before making a call.
Phone Confirmation Off	Switch call confirmation off. The system does not prompt you to confirm before making a call.
Voice Command Lists On	Switch the display of voice commands on.
Voice Command Lists Off	Switch the display of voice commands off.

Automatic Blower Motor Speed Reduction

If necessary, the system decreases the blower motor speed when you are using voice commands to reduce the amount of background noise in your vehicle. It returns to normal when you are finished.

Switching Automatic Blower Motor Speed Reduction Off

Simultaneously press the **A/C** and recirculated air buttons.

ENTERTAINMENT

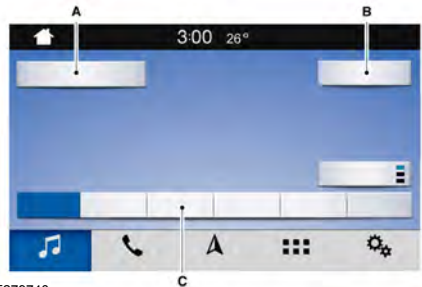

E279740

Message	Message and description
A	Sources
B	Direct Tune
C	Presets

You can access these options using the touchscreen or voice commands.

SYNC™ 3

Sources

Press this button to select the source of media you want to listen to.

Menu item	
AM	
FM	
SIRIUS *	
CD	
USB	The name of the USB that is plugged in displays here.
Bluetooth Stereo	
Apps	If you have SYNC 3 compatible apps on your connected smart phone, they display here as individual source selections.

* This feature may not be available in all markets and requires an active subscription.

AM/FM Radio

Tuning a Station

You can use the tune or seek controls on the radio bezel to select a station.

To tune a station using the touchscreen, select:

Menu item
Direct Tune

A pop up appears, allowing you to type in the frequency of a station. You can only enter a valid station for the source you are currently listening to.

You can press the backspace button to delete the previously entered number.

Once you have entered the station's call numbers, you can select:

Menu item	Action and description
Enter	Press to begin playing the station you have entered.
Cancel	Press to exit without changing the station.

Presets

To set a new preset, tune to the station and then press and hold one of the memory preset buttons. The audio mutes briefly while the system saves the station and then returns.

There are two preset banks available for AM and three banks for FM. To access additional presets, tap the preset button. The indicator on the preset button shows which bank of presets you are currently viewing.

SiriusXM® Satellite Radio (If Activated)

Note: This feature may not be available in all markets and requires an active subscription.



E234451

SiriusXM satellite radio is a subscription-based satellite radio service that broadcasts a variety of music, sports, news, weather, traffic and entertainment programming. Your factory-installed SiriusXM satellite radio system includes hardware and a limited subscription term that begins on the date of sale or lease of your vehicle. See an authorized dealer for availability.

For more information on extended subscription terms (a service fee is required), the online media player and a list of SiriusXM satellite radio channels, and other features, please visit www.siriusxm.com in the United States, www.siriusxm.ca in Canada, or call SiriusXM at 1-888-539-7474.

Note: SiriusXM reserves the unrestricted right to change, rearrange, add or delete programming. This includes canceling, moving or adding particular channels, and its prices, at any time, with or without notice to you. Ford Motor Company shall not be responsible for any such programming changes.

Note: This receiver includes the eCos real-time operating system. eCos is published under the eCos License.

The following buttons are available for SiriusXM:

Menu item	Action and description	
Browse	Touch this button to see a list of available stations.	
Direct Tune	A pop-up appears, allowing you to type in the call numbers of a station. Once you enter the stations call numbers, you can select:	
	Enter	The system tunes to the station you select.
	Cancel	You exit the pop-up and the current station continues to play.
	You can press the backspace button to delete the previous number.	

SYNC™ 3

Menu item	Action and description	
Replay	Replay audio on the current channel. You can replay approximately 45 minutes of audio as long as you remain tuned to the current station. Changing stations erases the previous audio.	
	Live	When you are in replay mode, you are not able to select a different preset until you return to live audio. Pressing this button returns you to the live broadcast.
ALERT	Save the current song, artist, or team as a favorite. The system alerts you when it plays again on any channel. Selecting this button allows you to enable and edit alerts. See Settings (page 432).	

Memory Presets

To set a preset, tune to the station then press and hold one of the memory preset buttons. The audio mutes briefly while the system saves the station and returns once the station is stored.

There are three preset banks available for SiriusXM. To access additional presets, tap the preset button. The indicator on the preset button shows which bank of presets you are currently viewing.

Satellite Radio Electronic Serial Number (ESN)

You need your ESN to activate, modify or track your satellite radio account. See **Settings** (page 432).

SiriusXM Satellite Radio Reception Factors and Troubleshooting

Potential reception issues	
Antenna obstructions	For optimal reception performance, keep the antenna clear of snow and ice build-up and keep luggage and other materials as far away from the antenna as possible.
Terrain	Hills, mountains, tall buildings, bridges, tunnels, freeway overpasses, parking garages, dense tree foliage and thunderstorms can interfere with your reception.
Station overload	When you pass a ground-based broadcast-repeating tower, a stronger signal may overtake a weaker one and the audio system may mute.
Satellite radio signal interference	Your display may show ACQUIRING... to indicate the interference and the audio system may mute.

SYNC™ 3

Troubleshooting tips		
Message	Cause	Action
Acquiring Signal	Radio requires more than two seconds to produce audio for the selected channel.	No action required. This message should disappear shortly.
Satellite antenna fault SIRIUS system failure	There is an internal module or system failure present.	If this message does not clear shortly, or with an ignition key cycle, your receiver may have a fault. See an authorized dealer for service.
Invalid Channel	The channel is no longer available.	Tune to another channel or choose another preset.
Unsubscribed Channel	Your subscription does not include this channel.	Contact SiriusXM at 1-888-539-7474 to subscribe to the channel, or tune to another channel.
Satellite acquiring signal...	The signal is lost from the SiriusXM satellite or SiriusXM tower to your vehicle antenna.	The signal is blocked. When you move into an open area, the signal should return.
Updating...	Update of channel programming in progress.	No action required. The process may take up to three minutes.
Questions? Call 1-888-539-7474	Your satellite service is no longer available.	Contact SiriusXM at 1-888-539-7474 to resolve subscription issues.
None found. Check channel guide.	All the channels in the selected category are either skipped or locked.	Use the channel guide to turn off the Lock or Skip function on that station.
SIRIUS Subscription updated	SiriusXM has updated the channels available for your vehicle.	No action required.

HD Radio™ Information (If Available)

Note: This feature may not be available in all markets.

To activate HD radio, please see the Radio Settings in the Settings Chapter. See **Settings** (page 432).

Note: HD Radio broadcasts are not available in all markets.

HD Radio technology is the digital evolution of analog AM/FM radio. Your system has a special receiver that allows it to receive digital broadcasts (where available) in addition to the analog broadcasts, it already receives. Digital broadcasts provide a better sound quality than analog broadcasts with free, crystal-clear audio and no static or distortion. For more information, and a guide to available stations and programming, please visit:

Website
www.hdradio.com

When HD Radio is on and you tune to a station broadcasting HD Radio technology, you may notice the following indicators on your screen:



E142616

The HD logo is grey when acquiring a digital station, and then changes to orange when digital audio is playing. When this logo is available, you may also see Title and Artist fields on-screen.

The multicast indicator appears in FM mode (only) if the current station is broadcasting multiple digital broadcasts. The highlighted numbers signify available digital channels where new or different content is available. HD1 signifies the main programming status and is available in analog and digital broadcasts. Other multicast stations (HD2 through HD7) are only available digitally.

Note: *There is also an additional feature for stations that have more than 1 HD multicast (For example, HD1 or HD2). The HD logo and Radio text appears as a button. Pressing this button allows you to cycle through all of the HD stations on that specific frequency. For example, if you are on 101.1 and it has HD1, HD2, HD3, pressing the button repeatedly causes the radio to cycle through the HD stations in a cyclic increasing order.*

When HD Radio broadcasts are active, you can access the following functions:

Message	Action and description
Presets	Allows you to save an active channel as a memory preset. Touch and hold a memory preset slot until the sound returns. There is a brief mute while the radio saves the station. Sound returns when the channel saves. When switching to an HD2 or HD3 memory preset, the sound mutes before the digital audio plays, because the system has to reacquire the digital signal.

Note: *As with any station you save, you cannot access the saved station if your vehicle is outside the station's reception area.*

SYNC™ 3

HD Radio Reception and Station Troubleshooting

Potential reception issues	
Reception area	<p>If you are listening to a multicast station and you are on the fringe of the reception area, the station may mute due to weak signal strength.</p> <p>If you are listening to HD1, the system changes back to the analog broadcast until the digital broadcast is available again. However, if you are listening to any of the possible HD2-HD7 multicast channels, the station mutes and stays muted unless it is able to connect to the digital signal again.</p>
Station blending	<p>When the system first receives a station (aside from HD2-HD7 multicast stations), it first plays the station in the analog version. Once the receiver verifies the station is an HD Radio station, it shifts to the digital version. Depending on the station quality, you may hear a slight sound change when the station changes from analog to digital. Blending is the shift from analog to digital sound or digital back to analog sound.</p>

In order to provide the best possible experience, use the contact form to report any station issues found while listening to a station broadcasting with HD Radio technology. Independent entities own and operate each station. These stations are responsible for ensuring all audio streams and data fields are accurate.

Potential station issues		
Issues	Cause	Action
Echo, stutter, skip or repeat in audio. Increase or decrease in audio volume.	This is poor time alignment by the radio broadcaster.	No action required. This is a broadcast issue.
Sound fading or blending in and out.	The radio is shifting between analog and digital audio.	No action required. The reception issue may clear up as you continue to drive.
There is an audio mute delay when selecting HD2 or HD3, multicast preset or Direct Tune.	The digital multicast is not available until the HD Radio broadcast is decoded. Once decoded, the audio is available.	No action required. This is normal behavior. Wait until the audio is available.

SYNC™ 3

Potential station issues		
Issues	Cause	Action
Cannot access HD2 or HD3 multicast channel when recalling a preset or from a direct tune.	The previously stored multicast preset or direct tune is not available in your current reception area.	No action required. The station is not available in your current location.
Text information does not match currently playing audio.	Data service issue by the radio broadcaster.	Fill out the station issue form. *
There is no text information shown for currently selected frequency.	Data service issue by the radio broadcaster.	Fill out the station issue form. *

HD Radio Technology manufactured under license from DTS Inc. U.S. and foreign patents. HD Radio and the HD and HD Radio logos are proprietary trademarks of DTS Inc. Ford Motor Company and DTS Inc. are not responsible for the content sent using HD Radio technology. Content may be changed, added or deleted at any time at the station owner's discretion.

* You can find the form here:

Website
http://hdradio.com/stations/feedback

CD

Once you select this option, the system returns you to the main audio screen.

The current audio information appears on the screen.

The following buttons are also available:

Button	Function
Browse	You can use the browse button to select a track.
Repeat	Select this button and a small number one displays to indicate the track is set to repeat. For MP3 CDs, this button allows you to toggle through repeat off, repeat one track (a small number one displays), and repeat current folder (a small folder displays).
Shuffle	Select the shuffle symbol to have the audio on the disk play in random order.

You can use the forward, reverse, pause or play buttons to control the audio playback.

SYNC™ 3

Bluetooth Stereo or USB

Bluetooth Stereo and USB allow you to

access media that you store on your Bluetooth device or USB device such as music, audio books or podcasts.

The following buttons are available for Bluetooth and USB:

Button	Function
Repeat	Pressing the repeat button toggles the repeat setting through three modes: repeat off (button not highlighted), repeat all (button highlighted) and repeat track (button highlighted with a small number one).
Shuffle	Play the tracks in random order.

You can use the forward, reverse, pause or play buttons to control the audio playback.

To get more information about the currently playing track, press the cover art or Info button.

For some devices, SYNC 3 is able to provide 30-second skip buttons when you listen to audio books or podcasts. These buttons allow you to skip forward or backward within a track.

While playing audio from a USB device you can look for certain music by selecting the following:

Button	Function
Browse	If available, displays the list of tracks in the Now Playing playlist.
New Search	This option, which is available under browse, allows you to play all tracks or to filter the available media into one of the below categories.
	Play All
	Playlists
	Artist
	Albums
	Songs
	Genres
	Podcasts
Audio books	

SYNC™ 3

Button	Function
	Composers
A-Z Jump	This button allows you to choose a specific letter to view within the category you are browsing.
Explore Device	If available, this allows you to browse the folders and files on your USB device.

USB Ports

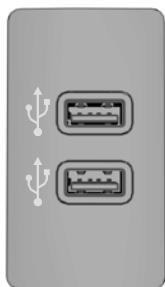

E211463

The USB ports are in the center console or behind a small access door in the instrument panel.

This feature allows you to plug in USB media devices, memory sticks, flash drives or thumb drives, and charge devices if they support this feature.

Select this option to play audio from your USB device.

Apps

The system supports the use of certain audio apps such as Pandora or iHeartRadio through a USB or Bluetooth enabled device.

Each app gives you different on-screen options depending on the app's content. See **Apps** (page 429).

Supported Media Players, Formats and Metadata Information

The system is capable of hosting nearly any digital media player, including iPod, iPhone, and most USB drives.

Supported audio formats include MP3, WMA, WAV, AAC, and FLAC.

Supported audio file extensions include MP3, WMA, WAV, M4A, M4B, AAC, and FLAC.

Supported USB file systems include: FAT, exFAT, and NTFS.

SYNC 3 is also able to organize the media from your USB device by metadata tags. Metadata tags, which are descriptive software identifiers embedded in the media files, provide information about the file.

If your indexed media files contain no information embedded in these metadata tags, SYNC 3 may classify the empty metadata tags as unknown.

SYNC 3 is capable of indexing up to 50,000 songs per USB device, for up to 10 devices.

PHONE



WARNING: Driving while distracted can result in loss of vehicle control, crash and injury. We strongly recommend that you use extreme caution when using any device that may take your focus off the road. Your primary responsibility is the safe operation of your vehicle. We recommend against the use of any hand-held device while driving and encourage the use of voice-operated systems when possible. Make sure you are aware of all applicable local laws that may affect the use of electronic devices while driving.

Hands-free calling is one of the main features of the system. Once you pair your cell phone, you can access many options using the touchscreen or voice commands. While the system supports a variety of features, many are dependent on your cell phone's functionality.

Pairing Your Cell Phone for the First Time

Pair your Bluetooth enabled phone with the system before using the functions in hands-free mode.

Switch on Bluetooth on your device to begin pairing. See your phone's manual if necessary.

To add a phone, select:

Menu Item
Add Phone

1. Follow the on-screen instructions.
2. A prompt alerts you to search for the system on your phone.

3. Select your vehicle's make and model as it displays on your phone.
4. Confirm that the six-digit number appearing on your phone matches the six-digit number on the touchscreen.
5. The touchscreen indicates when the pairing is successful.
6. Your phone may prompt you to give the system permission to access information. To check your phone's compatibility, see your phone's manual or visit the website.

Alternatively, to add a phone, select:

Menu Item
Add Phone
Then select:
Discover Other Bluetooth Devices

1. Follow the on-screen instructions.
2. Select your phone's name when it appears on the touchscreen.
3. Confirm that the six-digit number appearing on your phone matches the six-digit number on the touchscreen.
4. The touchscreen indicates when the pairing is successful.
5. Your phone may prompt you to give the system permission to access information. To check your phone's compatibility, see your phone's manual or visit the website.

At a minimum, most cell phones with Bluetooth wireless technology support the following functions:

- Answering an incoming call.
- Ending a call.
- Dialing a number.
- Call waiting notification.
- Caller identification.

SYNC™ 3

Other features, such as text messaging using Bluetooth and automatic phonebook download, are phone-dependent features.

To check your phone's compatibility, see your phone's manual or visit the website:

Websites
owner.ford.com

Websites
www.syncmyride.ca www.syncmaroute.ca

Phone Menu

This menu becomes available after pairing a phone.

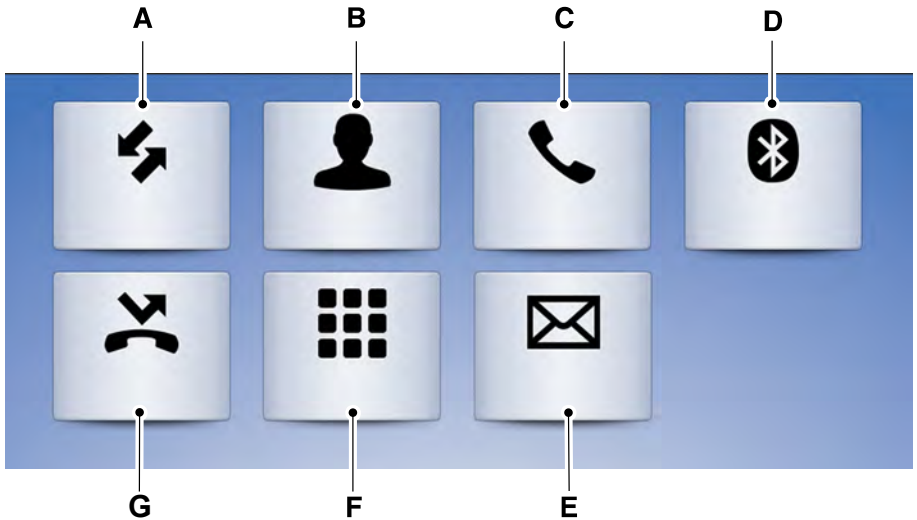

E251249

Item	Menu Item	Action and Description
A	Recent Call List	Displays your recent calls. You can place a call by selecting an entry from this list.

SYNC™ 3

Item	Menu Item	Action and Description			
		You can also sort the calls by selecting the drop down menu at the top of the screen. You can choose:			
		All	Incoming	Outgoing	Missed
B	Contacts	All of your contacts from your phone display in alphabetical order.			
		A-Z Jump		Selecting this button allows you to choose a specific letter to view.	
C	Phone Settings	Displays the name of your phone and takes you to the phone settings options. From this menu, you can pair subsequent devices, set ring tones and alerts.			
D	Change Device	Gives you access to the list of paired or connected Bluetooth devices allowing you to change or select a device.			
E	Text Messages	Displays all recent text messages.			
F	Phone Keypad	Use this keypad to dial in a phone number. Use the backspace button to delete numbers.			
		Call		Press this button to begin a call.	
G	Do Not Disturb	Touch this button to reject all incoming calls automatically. Text message notifications do not display on the screen. All ringtones and alerts are set to silent.			

Users with phones having voice services may see a button to access the feature. For example, iPhone users see a Siri button. A press and hold of the voice button on the steering wheel also accesses this feature.

Making Calls

There are many ways to make calls from the SYNC 3 system, including using voice commands. See **Using Voice Recognition** (page 401). You can use the touchscreen to place calls as well.

To call a number in your contacts, select:

Menu Item	Action and Description
Contacts	You can then select the name of the contact you want to call. Any numbers stored for that contact display along with any stored contact photos. You can then select the number that you want to call. The system begins the call.

To call a number from your recent calls, select:

Menu Item	Action and Description
Recent Call List	You can then select an entry that you want to call. The system begins the call.

To call a number that is not stored in your phone, select:

Menu Item	Action and Description
Phone Keypad	Select the digits of the number you wish to call.
Call	The system begins the call.

Pressing the backspace button deletes the last digit you typed.

Receiving Calls

During an incoming call, an audible tone sounds. Caller information appears in the display if it is available.

To accept the call, select:

Menu Item
Accept

Note: You can also accept the call by pressing the phone button on the steering wheel.

To reject the call, select:

Menu Item
Reject

Note: You can also reject the call by pressing the phone button on the steering wheel.

Ignore the call by doing nothing. SYNC 3 logs it as a missed call.

During a Phone Call

During a phone call, the contacts name and number display on the screen along with the call duration.

The phone status items are also visible:

- Signal Strength.
- Battery.
- 911 Assist (United States and Canada only). See **Settings** (page 432).

You can select any of the following during an active phone call:

SYNC™ 3

Item	
End Call	Immediately end a phone call. You can also press the button on the steering wheel.
Keypad	Press this to access the phone keypad.
Mute	You can switch the microphone off so the caller does not hear you.

Item	
Privacy	Transfer the call to the cell phone or back to SYNC 3.

Text Messaging

Note: Downloading and sending text messages using Bluetooth are cell phone-dependent features.

Note: Certain features in text messaging are speed-dependent and not available when your vehicle is traveling at speeds over 3 mph (5 km/h).

Receiving a Text Message

When a new message arrives, an audible tone sounds and the screen displays a pop-up with the caller name and ID, if supported by your cell phone. You can select:

Menu Item	Action and Description
Hear It	Have SYNC 3 read the message to you.
View	View the text on the touchscreen.
Call	To call the sender.
Reply	You can select from 15 preset messages. Press the message that you would like to use and confirm to send the message. SYNC 3 confirms when the message is sent successfully.
Close	To exit the screen.

Smartphone Connectivity (If Equipped)

SYNC 3 allows you to use Apple CarPlay and Android Auto to access your phone.

When you use Apple CarPlay or Android Auto, you can:

- Make calls.
- Send and receive messages.
- Listen to music.
- Use your phone's voice assistant.

Apple CarPlay and Android Auto disable some SYNC 3 features.

Most Apple CarPlay and Android Auto features use mobile data.

Apple CarPlay

Apple CarPlay requires an iPhone 5 or newer with iOS 7.1 or newer. Updating to the latest iOS version is recommended.

1. Plug your phone into a USB port. See **USB Port** (page 355).

- Follow the prompts on the touchscreen.
- Follow the prompts that appear on your phone to allow access to Apple CarPlay.

After completing the setup, your phone connects to CarPlay automatically when plugged into a USB port.

To disable this feature from the Settings screen, select:

Menu Item
Apple CarPlay Preferences
Your device is listed if SYNC detects Apple CarPlay. Select the name of your device and select:
Disable

To return to SYNC 3, go to the Apple CarPlay home screen and select the SYNC app.

Note: Contact Apple for Apple CarPlay support.

Android Auto

Android Auto is compatible with most devices with Android 5.0 or newer.

- Download the Android Auto app to your device from Google Play to prepare your device (this may require mobile data usage).

Note: The Android Auto App may not be available within your current market.

- Plug your device into a USB port. See **USB Port** (page 355).
- To switch this feature on from the Settings screen, scroll left on the screen and select:

Menu Item
Android Auto Preferences
Enable Android Auto

Note: Android Auto must be switched on after plugging in your device.

To disable this feature from the Settings screen, select:

Menu Item
Android Auto Preferences
Your device is listed if SYNC detects Android Auto. Select the name of your device and select:
Disable

Note: You may need to slide your Settings screen to the left to select **Apple CarPlay Preferences** or **Android Auto Preferences**.

To return to SYNC 3, select the speedometer icon in the Android Auto menu bar at the bottom of the touchscreen, and then touch the option to return to SYNC.

Note: Contact Google for Android Auto support.

NAVIGATION

Your navigation system is comprised of two main features, destination mode and map mode.

Map Mode

Map mode shows advanced viewing comprised of 2D city maps, 3D landmarks and 3D city models (when available). 2D city maps show detailed outlines of buildings, visible land use, landscape features, and detailed railroad infrastructure for the most essential cities around the globe.

3D landmarks appear as clear, visible objects that are typically recognizable and have a certain tourism value.

3D city models are complete 3D models of entire city areas including navigable roads, parks, rivers and rendered buildings. 3D landmarks and city models appear in 3D map mode only. Coverage of these varies and improves with updated map releases.

 Select the zoom in icon to see a closer view of the map.

 Select the zoom out icon to see a farther away view of the map.

You can adjust the view in preset increments. You can also pinch to zoom in or out of the map.

The information bar tells you the names of streets, cities or landmarks as you hover over them with the crosshair cursor.

You can change your view of the map by tapping on the location indicator icon on the right hand side of the screen. You can choose from the following options:

 **Heading up (2D map)** This always shows the direction of forward travel to be upward on the screen. This view is available for map scales up to 3 mi (5 km).

 **North up (2D map)** always shows the northern direction to be upward on the screen.

 **3D map mode** provides an elevated perspective of the map. Adjust this viewing angle and rotate the map 180 degrees by touching the map twice, and then dragging your finger along the shaded bar with arrows at the bottom of the map.

 Re-center the map by pressing this icon whenever you scroll the map away from your vehicle's current location.

 **Mute:** Press to mute the audio navigation guidance. Press the button again to un-mute the guidance.



 **Points of Interest (POI) grouping icon:** You can choose up to three POI icons to display on the map. If the chosen POIs are located close together or are

at the same location a box is used to display a single category icon instead of repeating the same icon, in order to reduce clutter. When you select the box on the map, a pop-up appears indicating how many POIs are in this location. Select the pop up to see a list of the available POIs. You can scroll through and select POIs from this list.

If your vehicle is low on charge or fuel, station icons automatically display on the map.

SYNC™ 3

If you have subscribed to SiriusXM Traffic and Travel Link (where available), traffic flow will be indicated on the map by green (clear), yellow (slowing), and red (stopped) road highlights. Traffic flow is indicated where the information is available and varies across the US.

You can choose to display traffic icons on the map representing twelve different types of incidents. See **Settings** (page 432).

You can set a destination by hovering above a location and selecting:

Button
Start

Destination Mode

To set a destination, press:

Menu Item	Description
Destination	
Enter a navigation destination in any of the following formats:	
Search	Street Address (number, street, city, state) For example "12 Mainstreet Dearborn MI"
	Partial Address (number, street) if searching in current state (number, street and zip code (or postal code in Canada)) if searching out of state You can enter unique addresses that contain door number prefixes with or without the prefix. For example, you could enter "6N340 Fairway Lane" or "340 Fairway Lane".
	City (name or zip code)
	Point of Interest (name or category)
	Intersection (street 1 / street 2) (street 1 and street 2) (street 1 & street 2) (street 1 @ street 2) (street 1 at street 2)

SYNC™ 3

Menu Item	Description	
	<p>Latitude and Longitude (##.##### , ##.#####) This is in a decimal degrees format, one to six decimal places are accepted.</p> <p>You are given autocomplete options below the address bar to select as you type. If you do not give an exact destination, a menu displays with your possible selections.</p>	
Previous Destina- tions	<p>Collections of your last 40 navigation destinations display here. You can select any option from the list to select it as your destination.</p>	
	Delete All	Select this option to remove all previous destinations.
Home	<p>Select to navigate to your set Home destination. The time it takes to travel from your current location to Home displays. To set your Home, press:</p>	
	Home	A prompt appears asking if you would like to create a favorite for home. Select:
	Yes	Enter a location into the search bar and press:
	Save	
Work	<p>Select to navigate to your set Work destination. The time it takes to travel from your current location to Work displays. To set your Work:</p>	
	Work	A prompt appears asking if you would like to create a favorite for work. Select:
	Yes	Enter a location into the search bar and press:
	Save	
Favorites	<p>Favorites include any location you have previously saved. To add Favorites:</p>	
	Add a Favorite	Select this button and enter a location into the destination bar.
	Search	Select this option to have the system locate the address you have entered.
	Save	Select this button when the address you have entered appears on the screen.

SYNC™ 3

Menu Item	Description	
	The address saves as a favorite and you see the favorites screen. You can now select this address from the favorites screen.	
Point of Interest (POI) Categories	POI categories that may display (based on market and vehicle configuration):	
	Food	
	Fuel	
	Hotel	
	ATM	
	See All	Press to view additional categories. Once you have selected a category, follow the menus to find what you are looking for.
	Inside of these categories you can search by:	
	Nearby	
	Along Route	
	Near Destination	
In a City		

Once you have chosen your destination, press:

Menu Item	Action and Description	
Save	This saves the destination to your favorites.	
Start	This shows you a map of your entire route. You can then choose your route from three different options.	
	Fastest	Uses the fastest moving roads possible.
	Shortest	Uses the shortest distance possible.
	Economical Route	Uses the most fuel-efficient route.
	The time and distance for each route also displays.	
Cancel	On the route screen, you can choose to cancel the current navigation. The system asks for confirmation then returns you to the map mode screen.	

SYNC™ 3

Once you have chosen your destination, press:

Menu Item	Action and Description
Start	<p>The system uses a variety of screens and prompts to guide you to your destination.</p> <p>During Route guidance, you can press the maneuver arrow icon on the map if you want the system to repeat route guidance instructions. When the system repeats the last guidance instruction, it updates the distance to the next guidance instruction, since it detects that the vehicle is moving.</p> <p>The navigation map shows your estimated time of arrival, remaining travel time and the distance to your destination.</p> <p>SYNC 3 may not always announce vehicle arrival at the exact point of your destination and you may have to cancel a route manually.</p>

Navigation Menu

In map mode and during active navigation you can access the navigation menu.

During active navigation, touch the bottom of the screen to view the menu and other buttons.

To access the Navigation menu, press:

Button		
Menu		
You can then select:		
Screen View	Full Map	A full screen map displays during navigation.
	Highway Exit Info	<p>Highway exit information displays on the right hand side of the screen during navigation.</p> <p>Points of interest icons display for restaurants, hotels, fuel stations and ATMs when they are present at the exit. You can select the POI icons to receive a listing of specific locations. You can select the POI location as a waypoint or destination if desired.</p>
	Turn List	<p>Only available during an active route. Displays all of the turns on the current route.</p> <p>You can choose to avoid any road on the turn list by selecting the road from the list. A screen then appears and you can press:</p>
Avoid		The system calculates a new route and displays a new turn list.

SYNC™ 3

Button				
Traffic List	You can find the SiriusXM Traffic and Travel Link information by pressing this button. This information requires an active subscription to SiriusXM Traffic and Travel Link. When a route is not active, a list of nearby traffic incidents displays (if any are present). When a route is active, you can choose to display a list of traffic nearby or on the route.			
Navigation Settings	Press this button to adjust your preferences. See Settings (page 432).			
Where Am I?	Provides your current location city and the nearest road.			
The following are only available on the menu during an active navigation route:				
Cancel Route	The system asks for confirmation and then returns you to the map mode screen.			
View Route	Press this to see a map of the full route.			
Detour	An alternate route displays in comparison with the current route.			
Edit Waypoints	Only available if you have an active waypoint on your route. See Waypoints later in this section for information on how to set waypoints.			
	Use this button to re-order or remove your waypoints.			
	<table border="1" style="width: 100%;"> <tr> <td style="width: 30%;">You can also have the system set the order for you by pressing:</td> <td>Optimize Order</td> </tr> <tr> <td>To return to your route press:</td> <td>Go</td> </tr> </table>	You can also have the system set the order for you by pressing:	Optimize Order	To return to your route press:
You can also have the system set the order for you by pressing:	Optimize Order			
To return to your route press:	Go			

Waypoints

You can add a waypoint to a navigation route as a destination along your route.

To add a waypoint:

1. Select the search icon (magnifying glass) while on an active route. This brings up the destination menu.
2. Set your destination using any of the given methods. Once the destination has been selected, the screen allows you to set the destination as a waypoint by selecting:

Menu Item	
Add Waypoint	The waypoint list then appears and you are able to re-order all of your waypoints by selecting the menu icon on the right hand side of the location. You can select up to five waypoints.
You can also have the system set the order for you by pressing:	Optimize Order
To return to your route, press:	Go

SYNC AppLink

The AppLink app allows you to use some SYNC 3 navigation features on your phone.

First Mile Navigation

When you switch your ignition off, the location of your vehicle is recorded and sent to your SYNC AppLink app. The location of your vehicle can be viewed within the app. You can also view walking directions to your vehicle.

Last Mile Navigation

When you park near your destination, the system provides walking directions to your destination.

POI Search

Your paired phone can be used to access additional points of interest (POI). These points of interest can only be access when your phone is paired.

Send To Car

You can send destinations to your navigation system using a computer or phone using AppLink.

cityseeker (If Equipped)

Note: *cityseeker point of interest (POI) information is limited to approximately 1,110 cities (1,049 in the United States, 36 in Canada and 15 in Mexico).*



E225487

cityseeker, when available, is a service that provides more information about certain points of interest such as restaurants, hotels and attractions.

When you have selected a point of interest, the location and information appear, such as address, phone number and a star rating.

Press **More Information** to see a photo, a review, a list of services and facilities, the average room or meal price and the web address. This screen displays the point of interest icons.

SYNC™ 3

For restaurants, cityseeker can provide information such as star rating, average cost, review, handicap access, hours of operation, and website address.

For hotels, cityseeker can provide information such as star rating, price category, review, check-in and checkout times, hotel service icons and website address. Hotel service icons include:

- Restaurant
- Business center
- Handicap facilities
- Laundry
- Refrigerator
- 24 hour room service
- Fitness center
- Internet access
- Pool
- Wi-Fi

Attractions include nearby landmarks, amusement parks, historic buildings and more. cityseeker can provide information such as star rating, reviews, hour of operation and admission price.

SiriusXM Traffic and Travel Link (if Equipped)

SiriusXM Traffic and Travel Link is available on vehicles equipped with navigation and only in select markets. You must activate and subscribe to receive SiriusXM Traffic and Travel Link information. It helps you locate the best gas prices, find movie listings, get current traffic alerts, view the weather map, get accurate ski conditions and see current sports scores. See **Apps** (page 429).

The system calculates a reasonable efficient route based on available speed limits, traffic, and road conditions. You may know a local short cut that is more efficient at a given time than the route provided by SYNC 3, but you should expect a slight difference in minutes or miles with the SYNC 3 route.

Navigation Map Updates

Annual navigation map updates are available for purchase through your dealership, by calling 1-866-462-8837 in the United States and Canada or 01-800-557-5539 in Mexico. You can also visit:

Website
www.navigation.com/sync

You need to specify the make and model of your vehicle to determine if there is an update available.

HERE is the digital map provider for the navigation application. If you find map data errors, you may report them directly to HERE by going to www.here.com/mapcreator. HERE evaluates all reported map errors and responds with the result of their investigation by e-mail.

Map coverage includes the USA (including Puerto Rico and the US Virgin Islands), Canada and Mexico.

APPS

The system enables voice, steering wheel, and touch screen control of SYNC 3 AppLink enabled smartphone apps.

Once an app is running through AppLink, you can control main features of the app through voice commands and steering wheel controls.

SYNC™ 3

Note: Available AppLink enabled apps will vary by market.

Note: You must pair and connect your smartphone via Bluetooth to SYNC 3 to access AppLink.

Note: iPhone users may have to connect the phone to a USB port with an Apple USB cable.

Note: For information on available apps, supported smartphone devices and troubleshooting tips please visit:

Websites
<p>owner.ford.com www.syncmyride.ca www.syncmaroute.ca</p>

Note: Make sure you have an active account for the app that you have downloaded. Some apps will work automatically with no setup. Other apps will want you to configure your personal settings and personalize your experience by creating stations or favorites. We recommend you do this at home or outside of your vehicle.

Note: We encourage you to review the smartphone app's terms of service and privacy policies because Ford is not responsible for your app or its use of data.

Note: AppLink is a native SYNC system feature. Accessing mobile apps through AppLink is only possible when Android Auto or Apple CarPlay are disabled. Some apps may only be accessible in the car through AppLink and others only through Android Auto or Apple CarPlay. Please refer to the Smartphone Connectivity information to disable Android Auto or Apple CarPlay.

Note: In order to use an app with SYNC 3, the app needs to be running in the background of your phone. If you shut down the app on your phone, it shuts down the app on SYNC 3 as well.

Note: If a SYNC 3 AppLink compatible app is not shown in the Apps Domain, make sure the required app is running on the mobile device.

Menu Item	Action and Description
Find Mobile Apps	SYNC 3 will search and connect to compatible app(s) running on your mobile device.

Enabling SYNC 3 Mobile Apps

In order to enable mobile apps, SYNC 3 requires user consent to send and receive app authorization information and updates using the data plan associated with the connected device.

The connected device sends data to Ford in the United States. The information is encrypted and includes your VIN, SYNC 3 module number, odometer, usage statistics and debugging information. We retain this data for only as long as necessary to provide this service, troubleshoot, and improve products and services and to offer you products and services that may interest you where allowed by law.

Note: You must enable mobile apps for each connected device the first time you select a mobile app using the system.

Note: Ford reserves the right to limit functionality or deactivate mobile apps at any time.

Note: Standard data rates apply. Ford is not responsible for any additional charges you may receive from your service provider, when your vehicle sends or receives data through the connected device. This includes any additional charges incurred due to driving in areas when roaming out of a home network.

You can enable and disable apps through settings. See **Settings** (page 432).

App Permissions

The system organizes the App permissions into groups. You can grant these group permissions individually. You can change a permission group status any time when not driving, by using the settings menu. While in the settings menu, you can also see the data included in each group.

When you launch an app using SYNC 3, the system may ask you to grant certain permissions, for example Vehicle information, Driving characteristics, GPS and Speed, and/or Push notifications. You can enable all groups or none of them during the initial app permissions prompts. The settings menu offers individual group permission control.

Note: You are only prompted to grant permissions the first time you use an app with SYNC 3.

Note: If you disable group permissions, apps will still be enabled to work with SYNC 3 unless you deactivate All Apps in the settings menu.

SiriusXM Traffic and Travel Link (if Equipped)



WARNING: Driving while distracted can result in loss of vehicle control, crash and injury. We strongly recommend that you use extreme caution when using any device that may take your focus off the road. Your

primary responsibility is the safe operation of your vehicle. We recommend against the use of any hand-held device while driving and encourage the use of voice-operated systems when possible. Make sure you are aware of all applicable local laws that may affect the use of electronic devices while driving.

Note: SiriusXM Traffic and Travel Link may not be available in all markets.

Note: In order to use SiriusXM Traffic and Travel Link, your vehicle must have navigation.

Note: A paid subscription is required to access and use these features. Go to www.siriusxm.com/travellink for more information.

Note: Visit www.siriusxm.com/traffic and click on Coverage map and details for a complete listing of all traffic areas covered by SiriusXM Traffic and Travel Link.

Note: Neither Sirius nor Ford is responsible for any errors or inaccuracies in the SiriusXM Traffic and Travel Link services or its use in vehicles.

When you subscribe to SiriusXM Traffic and Travel Link, it can help you locate the best gas prices, find movie listings, get current traffic alerts, view the current weather map, get accurate ski conditions and see scores to current sports games.

SYNC™ 3

Menu Item	Action and Description	
Traffic on Route	Touch these buttons to identify traffic incidents on your route, near your vehicle's current location or near any of your favorite places, if programmed.	
Traffic Nearby		
Fuel Prices	Touch this button to view fuel prices at stations close to your vehicle's location or on an active navigation route.	
Movie Listings	Touch this button to view nearby movie theaters and their show times, if available.	
Weather	Touch this button to view the nearby weather, current weather, or the five-day forecast for the chosen area.	
	Map	Select to see the weather map, which can show storms, radar information, charts and winds.
	Area	Select to choose from a listing of weather locations.
Sports Info	Touch this button to view scores and schedules from a variety of sports. You can also save up to 10 favorite teams for easier access. The score automatically refreshes when a game is in progress.	
Ski Conditions	Touch this button to view ski conditions for a specific area.	

Sound

Pressing this button allows you to adjust the following:

SETTINGS

Under this menu, you can access and adjust the settings for many of the system features. To access additional settings, swipe the screen left or right.

Sound Settings	
Reset All	Returns Treble, Midrange, and Bass sound settings to factory levels.
Treble	Adjusts the high frequency level.
Midrange	Adjusts the middle frequency level.
Bass	Adjusts the low frequency level.
Balance / Fade	Adjusts the sound ratio from side to side or front to back.

SYNC™ 3

Sound Settings	
Speed Compensated Vol.	Adjusts the amount the audio system volume increases with speed, or turns the feature off.
Occupancy Mode	Optimizes the sound based on the location of the listeners.
Sound Settings	Stereo
	Surround

Your vehicle might not have all of these features.

Media Player

This button is available when a media device such as a Bluetooth Stereo or USB device is the active audio source. Pressing the button allows you to access the following options for active devices only.

Menu Item	Action and Description		
Podcast Speed	For some USB devices, SYNC 3 can adjust the playback speed of podcasts. When a podcast is playing, you can choose:		
	Slower	Normal	Faster
Audiobook Speed	For some USB devices, SYNC 3 can adjust the playback speed of audiobooks. When an audiobook is playing, you can choose:		
	Slower	Normal	Faster
Cover Art Priority	Media Player	Cover art displays from your device's music files. If no cover art for the files exists on the device, then the Gracenote Database provides cover art.	
	Gracenote®	The Gracenote Database supplied cover art is used for your music files. This overrides any cover art from your device.	
Gracenote® Management	Switches on and off Gracenote® to provide metadata information such as genre, artist, album.		

SYNC™ 3

Menu Item	Action and Description
Gracenote® Database Info	This allows you to view the version level of the Gracenote Database.
Device Information	This allows you to view the manufacturer and model number of your media device.
Update Media Index	Erase the stored in media information in order to re-index.

You can adjust the following features:

Clock

To adjust the time, select the up and down arrows on either side of the screen. The arrows on the left adjust the hour and arrows on the right adjust the minute. You can then select AM or PM.

Menu Item	Action and Description
Clock Format	Select how time displays.
Auto Time Zone Update	When active, the clock adjusts to time zone changes. This feature is only available in vehicles with navigation.
Reset Clock to GPS Time	When selected, the vehicle clock resets to GPS satellite time.

The system automatically saves any updates you make to the settings.

Bluetooth

Pressing this button allows you to access the following:

Menu Item	Action
Bluetooth	Turning Bluetooth off disconnects all devices and does not permit new connections.

You must activate Bluetooth to pair a Bluetooth-enabled device.

The processes of pairing a Bluetooth device is the same as pairing a phone. **See Pairing a Device** in Phone settings for how to pair a device and the available options.

Phone

Pair your Bluetooth-enabled phone with the system before using the functions in hands-free mode.

Switch on Bluetooth on your device to begin pairing. See your phone's manual if necessary.

SYNC™ 3

To add a phone, select:

Menu Item
Add Phone

1. Follow the on-screen instructions.
2. A prompt alerts you to search for the system on your phone.
3. Select your vehicle's make and model as it displays on your phone.
4. Confirm that the six-digit number appearing on your phone matches the six-digit number on the touchscreen.
5. The touchscreen indicates when the pairing is successful.
6. Your phone may prompt you to give the system permission to access information. To check your phone's compatibility, see your phone's manual or visit the website.

Alternatively, to add a phone, select:

Menu Item
Add Phone
Then select:
Discover Other Bluetooth Devices

1. Follow the on-screen instructions.
2. Select your phone's name when it appears on the touchscreen.
3. Confirm that the six-digit number appearing on your phone matches the six-digit number on the touchscreen.
4. The touchscreen indicates when the pairing is successful.
5. Your phone may prompt you to give the system permission to access information. To check your phone's compatibility, see your phone's manual or visit the website.

Other features, such as text messaging using Bluetooth and automatic phonebook download, are phone-dependent features.

To check your phone's compatibility, see your phone's manual or visit the website:

Website
owner.ford.com www.syncmyride.ca www.syncmaroute.ca

Once you have paired a device you can adjust the following options.

Menu Item	Action and Description
View Devices	
You can then select:	
Add a Bluetooth Device	You can add a Bluetooth-enabled device by following the steps in the previous table.
You can select a phone by touching the name of the phone on the screen. You then have the following options:	
Connect	Depending on the status of the device, you can select either of these options to interact with the selected device.

SYNC™ 3

Menu Item	Action and Description
Disconnect	
Make Primary	Allows you to select this device to be your preferred device.
Delete	Removes the selected device from the system.

Pressing the info icon next to the device name allows you to see phone and device information

Menu Item	Action and Description		
Manage Contacts			
You can then select:			
Auto-Download Contacts	Enable this option to have SYNC 3 periodically re-download your phonebook to keep your contact list up to date.		
Sort By:	Choose how you would like the system to display your contacts. You can choose:		
	<table border="1"> <tr> <td>First Name</td> <td>Last Name</td> </tr> </table>	First Name	Last Name
First Name	Last Name		
Re-download Contacts	Select this option to re-download your contact list manually.		
Delete Contacts	Select this option to delete the in vehicle contact list. Deleting the in vehicle list does not erase the contact list on the connected phone.		

Menu Item	Action and Description
Set Phone Ringtone	
You can then select:	
No Ringtone	No sound plays when a call comes to your phone.
Use Phone Ringtone	The currently selected ringtone on your phone plays when you receive a call. This option may not be available for all phones. If this option is available, it is the default setting.
You can also select one of the three available ringers.	

SYNC™ 3

Menu Item	Action and Description
Text Messaging	
You can then select:	
No Alert (Silence)	No sound plays when a message comes to your phone.
You can select one of the three available notification sounds.	
Voice Readout	When enabled, a voice prompt alerts you when you receive a new message.

You can enable and disable the following options as well:

Menu Item	Action and Description
Mute Audio in Privacy	When enabled, vehicle audio (such as radio or apps) is muted for the duration of the phone call even when the phone call is in privacy.
Roaming Warning	When enabled, an alert displays that your phone is roaming when you attempt to place a call.
Low Battery Notification	When enabled, a message displays when the battery on your phone is running low.

911 Assist

Note: *This service is only available in the United States and Canada.*

Select this button to modify the on or off setting for this feature. If the mobile phone's contacts have been downloaded, you can adjust the following option:

Menu Item	Action and Description
Set Emergency Contacts	You can select up to two numbers from your mobile device's phone-book as emergency contacts for quick access at the end of the 911 Assist call process.

Radio

This button is available if a Radio source such as AM or FM is the active media source. Pressing the button allows you to access the following features:

SYNC™ 3

Menu Item	Action and Description
FM HD Radio AM HD Radio (Dependent on current radio source, If Available)	Activation of this feature allows you to listen to HD radio broadcasts.
Radio Text	This feature is available when FM Radio is your active media source. Activate this feature to have the system display radio text.
Autoset Presets (AST)	Refresh Selecting this option stores the six strongest stations in your current location to the last preset bank of the currently tuned source.

Sirius XM (If equipped)

Menu Item	Action and Description
Set Category for Seek	After selecting a category, the seek function only stops on channels that are inside that selected category.
Parental Lockout	Select to create a personal identification number (PIN). This allows you to lock or unlock channels. Your initial PIN is 1234.
Edit Alerts	Select to switch on, off or delete alerts.

The Electronic Serial Number is on this screen. This number is necessary to activate, modify or track your account through Sirius XM.

Navigation

You can adjust many of the Navigation preferences by selecting the following menus.

SYNC™ 3

Map Preferences

Menu Item	Action and Description	
Map Preferences		
Then select any of the following:		
3D City Model	When this option is active, the system shows 3D renderings of buildings.	
Breadcrumbs	When enabled, your vehicle's previously traveled route displays with white dots.	
POI Icons	Enable this feature to display up to 3 POI icons on the navigation map. A rest area POI icon may display on the map regardless of this setting.	
	When this feature is active you can select the icons you want displayed by selecting:	Select POIs
Incident Map Icons	This menu allows you to choose which incident icons you would like to have displayed on the navigation map.	

Route Preferences

Menu Item	Second Level Messages, Actions and Descriptions		
Route Preferences			
Then select any of the following:			
Preferred Route	Choose to have the system display your chosen route type.		
	Shortest	Fastest	Eco
Always Use ____ Route	Bypass route selection in destination programming. The system only calculates one route based on your preferred route setting. When activated, the system uses your selected route type to calculate only one route to the desired destination.		
Use HOV Lanes	The system selects High Occupancy Vehicle or car pool lanes when providing route guidance.		
Automatically Find Parking	The system searches for and displays available parking locations as you approach your destination.		
Eco Time Penalty	Select a level of cost for the calculated Eco Route. The higher the setting, the longer the time allotment is for the route.		

SYNC™ 3

Menu Item	Second Level Messages, Actions and Descriptions
Dynamic Route Guidance	Enable or disable considering traffic information when planning a route. The system can find a faster route based on heavy traffic flow information or detect a Road Closed incident and find a detour route if possible.
Avoid Freeways	If selected, SYNC 3 avoids freeways when computing a navigation route.
Avoid Toll Roads	If selected, SYNC 3 avoids Toll Roads when computing a navigation route.
Avoid Ferries/Car Trains	If selected, SYNC 3 avoids the use of Ferries or Trains when computing a navigation route.

Navigation Preferences

Menu Item	Action and Description
Navigation Preferences	
Guidance Prompts	You can adjust how the system provides prompts.
Then select any of the following:	
Voice and Tones	A tone sounds followed by voice instructions.
Voice Only	Only voice instructions are given.
Tones Only	Only a tone sounds to prompt you.

Mobile Apps

You can enable the control of compatible mobile apps running on your Bluetooth or USB device on SYNC 3. In order to enable mobile apps, SYNC 3 requires user consent to send and receive app authorization information and updates using the data plan associated with the connected device.

The connected devices send data to us in the United States. The encrypted information includes your VIN, SYNC 3 module number, anonymous usage statistics and debugging information. Updates may take place.

Note: *All Mobile Apps may not be compatible with the system.*

SYNC™ 3

Note: Standard data rates will apply. We are not responsible for any additional charges you may receive from your service provider, when your vehicle sends or receives data through the connected device. This includes any additional charges incurred due to driving in areas when roaming out of a home network.

Menu Item	Action and Description		
Mobile Apps	Enable or disable the use of mobile apps on SYNC 3. Disabling mobile apps in the settings menu disables automatic updates and the use of mobile apps on SYNC 3.		
	You can view the status of mobile app permissions in the settings menu.		
Once Mobile Apps is enabled, you have the following options:			
Update Mobile Apps	This provides information on the current state of available app updates.		
	There are three possible statuses:		
	Update Needed	Up-To-Date	Updating Mobile Apps...
	The system has detected a new app requiring authorization or a general permissions update is required.	No update is required.	The system is trying to receive an update.
	Request Update		Select this button if an update is required and you want to request this update manually. For example, when your mobile device is connected to a Wi-Fi hotspot, select:

SYNC™ 3

Menu Item	Action and Description
	Request Update
All Apps	Grant or deny permissions to all apps at once.
There may also be SYNC 3 enabled apps listed under these options.	Grant or deny an individual app particular permissions. App permissions are organized into groups. By pressing the info book icon, you can see which signals are included in each group.

Note: *We are not responsible or liable for any damages or loss of privacy relating to usage of an app, or dissemination of any vehicle data that you give us approval to provide to an app.*

General

Access and adjust the system settings, voice features, as well as phone, navigation and wireless settings.

Menu Item	
Language	Select to have the touchscreen display in English, Spanish or French.
Distance	Select to display units in kilometers or miles.
Temperature	Select to display units in Celsius or Fahrenheit.
Touch Panel Beep	Select to have the system beep to confirm choices made through the touchscreen.
Automatic System Updates	When you activate this option, the system automatically updates when you have an available Internet connection through a Wi-Fi network or mobile connection.
About SYNC	Information pertaining to the system and its software.
Software Licenses	Documentation of the software license for the system.
Master Reset	Select to restore factory defaults. This erases all personal settings and personal data.

Wi-Fi & Hotspot

Access SYNC Wi-Fi and Vehicle Hotspot settings and information.

System Wi-Fi

You can access the following:

SYNC™ 3

Menu Item	Action and Description
Wi-Fi	Enable this option to connect to Wi-Fi for SYNC 3 vehicle software updates.
Available Networks	This provides you with a list of available Wi-Fi networks within range.
	Clicking on a network from the list allows you to connect or disconnect from that network. The system may require a security code to connect.
	When you click the information button next to a network, more information about the network displays such as the signal strength, connection status and security type.
Wi-Fi Available Notifications	The system alerts you when your vehicle is parked and a Wi-Fi network is within range if SYNC is not already connected.

Vehicle Hotspot (If Equipped)

You can access the following:

Menu Item	Action and Description
Wi-Fi Hotspot On/Off	Allows you to turn the hotspot on and off.
Settings	Allows you to view and edit hotspot settings such as the SSID and password.
Data Usage	Allows you to view your vehicle's hotspot plan and data usage.
Manage Devices	Allows you to manage devices connected to your hotspot.

Note: *The Vehicle Wi-Fi Hotspot (Vehicle Hotspot) may be operational while ignition is On and may remain operational while the ignition is Off.*

Note: *The vehicle network carrier provides Vehicle Hotspot services, subject to your vehicle network carrier agreement, coverage and availability.*

Note: *It is the account owner's responsibility to remove the vehicle from the vehicle network carrier account when ownership of the vehicle is transferred. If the owner would like to remove the vehicle from the account for any reason, please contact your vehicle network carrier for more information.*

Note: Data you share, e.g. the Vehicle Identification Number (VIN), SIM Card ID, and data plan usage, between us and the vehicle network carrier is used to provide the Vehicle Hotspot service in accordance with your vehicle network carrier agreement, coverage and availability, and may be used to enable a seamless transition from an old to new embedded modem and to confirm any successfully delivered updates.

Note: For your convenience data usage may be available for monitoring under Settings but may not reflect actual or current usage. The vehicle network carrier is responsible for providing information about your account. Please contact the vehicle network carrier for more information.

Note: We may need to update operating system software on your vehicle, including security updates and bug fixes, to keep connected services current, like Vehicle Hotspot, without prior notice to you.

Note: If you do not have an active vehicle hotspot data plan, open your web browser and go to a website using the HTTP protocol to be automatically redirected to the vehicle network carrier landing page where you can purchase data. Websites using HTTPS will not automatically redirect.

Camera Settings

To make adjustments using the touchscreen, select:

Message	Action and Description
Camera Settings	
Then select from the following:	
Enhanced Park Aids	When the reverse sensing system detects an object, it displays red, yellow and green highlights at the top of the image.
Rear Camera Delay	You can enable or disable this option using the slider.

You can find more information on the rear-view camera system in the parking aids chapter of your owner manual.

Ambient Lighting (If Equipped)

Tap a color once to active ambient lighting. This sets the color to the highest intensity.

You can drag the colors up and down to increase or decrease the intensity.

To switch ambient lighting off, press the active color once or drag the active color all the way down to zero intensity.

Vehicle

Note: Your vehicle may not have all of these features.

You can select the following features to update their settings.

Door Keypad Code (If equipped)

Select this button to add or erase a personal door keypad code. To add or erase a personal code, you first need to enter the five-digit factory set code. You can find this code on the owner's wallet card in the glove box or from your authorized dealer.

SYNC™ 3

Onboard Modem Serial Number (ESN)

Selecting this button on the settings menu

shows you the ESN number for your system. You need this number for certain registrations such as Satellite Radio.

Display

To make adjustments using the touchscreen, select:

Menu Item	Action and Description	
Display Off	The screen goes black and does not display anything. To switch the screen back on, simply tap the screen.	
Brightness	Make the screen display brighter or dimmer.	
Calm Screen	Enable this option to have your screen display minimal content. Pressing anywhere on the screen, using the reverse camera, or touching an interactive icon returns the screen to normal content.	
Background	Allows you to select a screen background color.	
Mode	You can select:	
	Auto	The screen automatically switches between day and night modes based on the outside light level.
	Day	The screen displays with a light background to enhance daytime viewing.
Night	The screen displays with a darker background to make nighttime viewing easier.	
Auto Dim	Enable this option to automatically dim the display brightness based on ambient lighting conditions.	

Voice Control

You can adjust the voice control settings by selecting the following options.

SYNC™ 3

Menu Item	
Advanced Mode	Enable this option to remove additional voice prompts and confirmations.
Phone Confirmation	Enable this option to have the system confirm a contacts name with you before making a call.
Voice Command List	Enable this option to have the system display a list of available voice commands when the voice button is pressed.

Valet Mode

Valet mode allows you to lock the system. No information is accessible until the system is unlocked with the correct PIN.

When you select valet mode a pop up appears informing you that a four digit code must be entered to enable and disable valet mode. You can use any PIN you chose but you must use the same PIN to disable valet mode. The system asks you to input the code.

Note: *If the system is locked and you cannot remember the PIN, please contact the Customer Relationship Center.*

*United States: 1-800-392-3673
Canada: 1-800-565-3673*

To enable valet mode, enter your chosen PIN. The system then asks to confirm your PIN by reentering it. The system then locks.

To unlock the system, enter the same pin number. The system reconnects to your phone and all of your options are available again.

SYNC™ 3 TROUBLESHOOTING

Your SYNC 3 system is easy to use. However, should questions arise, please refer to the tables below.

To check your cell phone's compatibility, visit the Ford website.

Website
owner.ford.com www.syncmyride.ca www.syncmaroute.ca

SYNC™ 3

Cell phone issues		
Issue	Possible cause	Possible solution
There is back-ground noise during a phone call.	The audio control settings on your cell phone may be affecting SYNC 3 performance.	Refer to your device's manual about audio adjustments.
During a call, I can hear the other person but they cannot hear me.	Possible cell phone malfunction.	Try switching your cell phone off, resetting it or removing the battery, then try again. Make sure that the microphone for SYNC 3 is not set to off. Look for the microphone icon on the phone screen.
During a call, I cannot hear the other person and they cannot hear me.	The system may need to be restarted.	To restart your system, shut down the engine, open and close the door, and then lock the door and wait for 2-3 minutes. Make sure that your SYNC 3 screen is black and the lighted USB port is off.
SYNC 3 is not able to download my phone-book.	This is a cell phone-dependent feature.	Check your cell phone's compatibility.
	Possible cell phone malfunction.	Make sure you allow SYNC 3 to retrieve contacts from your phone. Refer to your cell manual.
		You must switch on your cell phone and the automatic phonebook download feature on SYNC 3.
The system says "Phone-book down-loaded" but my SYNC 3 phone-book is empty or is missing contacts.	Limitations on your cell phone's capability.	Try switching your cell phone off, resetting it or removing the battery, then try again.
		Make sure you allow SYNC 3 to retrieve contacts from your phone. Refer to your cell manual.
		If the missing contacts are stored on your SIM card, move them to your cell phone's memory.
		You must switch on your cell phone and the automatic phonebook download feature on SYNC 3.

SYNC™ 3

Cell phone issues		
Issue	Possible cause	Possible solution
I am having trouble connecting my cell phone to SYNC 3.	This is a cell phone-dependent feature.	Check your cell phone's compatibility.
	Possible cell phone malfunction.	Try switching your cell phone off, resetting it or removing the battery, then try again.
		Try deleting your device from SYNC 3 and deleting SYNC from your device, then trying again.
		Always check the security and auto accept prompt settings relative to the SYNC 3 Bluetooth connection on your cell phone.
		Update your cell phone's firmware.
		Switch the auto download setting off.
Text messaging is not working on SYNC 3.	This is a cell phone-dependent feature.	Check your cell phone's compatibility.
	Possible cell phone malfunction.	Try switching your cell phone off, resetting it or removing the battery, then try again.
	iPhone	<ul style="list-style-type: none"> • Go to your cell phone's Settings. • Go to the Bluetooth Menu. • Press the blue circle to the right of the device named with your vehicle make and model to enter the next menu. • Turn Show Notifications on. • Disconnect then reconnect your iPhone from the SYNC 3 system to activate this settings update. <p>Your iPhone is now set up to forward incoming text messages to SYNC 3. Repeat these steps for every other SYNC 3 vehicle that you connect. Your iPhone will only forward incoming text messages to SYNC 3 if the iPhone is not unlocked in the messaging application. Replying to text messages using SYNC 3 is not supported by iPhone.</p>

SYNC™ 3

Cell phone issues		
Issue	Possible cause	Possible solution
		Text messages from WhatsApp and Facebook Messenger are not supported.
Audible text messages do not work on my cell phone.	This is a cell phone-dependent feature.	Your cell phone must support downloading text messages through Bluetooth to receive incoming text messages.
	This is a cell phone limitation.	Because each cell phone is different, refer to your device's manual for the specific cell phone you are pairing. In fact, there can be differences between cell phones due to brand, model, service provider and software version.

USB and Bluetooth Stereo issues		
Issue	Possible cause	Possible solution
I am having trouble connecting my device.	Possible device malfunction.	Disconnect the device from SYNC 3. Try switching your device off, resetting it or removing the battery, then reconnect it to SYNC 3.
		Make sure you are using the manufacturer's cable.
		Make sure to correctly insert the USB cable into the device and your vehicle's USB port.
	The device has a lock screen enabled.	Make sure that the device does not have an auto-install program or active security settings.
SYNC 3 does not recognize my device when I start my vehicle.	The device has a lock screen enabled.	Make sure your device is unlocked before connecting it to SYNC 3.
Bluetooth audio does not stream.	This is a device-dependent feature.	Make sure you are not leaving the device in your vehicle during very hot or cold temperatures.
		Make sure you connect the device to SYNC 3 and that you have started the media player on your device.

SYNC™ 3

USB and Bluetooth Stereo issues		
Issue	Possible cause	Possible solution
	The device is not connected.	
SYNC 3 does not recognize music that is on my device.	Your music files may not contain the correct artist, song title, album or genre information.	Make sure that all song details are populated.
	The file may be corrupted.	Try replacing the corrupt file with a new version.
	The song may have copyright protection that does not allow it to play.	Some devices require you to change the USB settings from mass storage to media transfer protocol class.
	The file format is not supported by SYNC 3.	Convert the file to a supported format. See Entertainment (page 406).
	The device needs to be re-indexed.	Update media index. See Settings (page 432).
	The device has a lock screen enabled.	Make sure your device is unlocked before connecting it to SYNC 3.
When I connect my device, I sometimes do not hear any sound.	This is a device limitation.	Disconnect the device from SYNC 3. Try switching your device off, resetting it or removing the battery, then connect it back to SYNC 3.
		To listen to Apple devices through USB, select AirPlay from the devices Control Center, then select Dock Connector.
		To listen to Apple devices through Bluetooth Stereo, select AirPlay from the devices Control Center, then select SYNC.

SYNC™ 3

Wi-Fi Issues		
Issue	Possible cause	Possible solution
Failed connection.	Password error.	Verify password.
	Weak signal.	Check for a poor Wi-Fi signal.
	Multiple Access points within range with the same SSID.	Use a unique name for your SSID, don't use the default name unless it contains a unique identifier, such as part of the MAC address.
Disconnecting after successful connection.	Weak signal probably due to distance from the hotspot, obstruction or high interference.	Position the vehicle close to the hotspot with the front of the vehicle facing the hotspot direction and remove obstacles if possible. Other Wi-Fi, Bluetooth, microwave and cordless phones may cause interference.
Poor signal seen by SYNC 3 despite being near a hotspot.	There may be an obstruction between SYNC 3 and the hotspot.	If the vehicle is equipped with heated windshield, try positioning the vehicle so that the windshield is not facing the hotspot. If you have metallic window tinting but not on the windshield, position the vehicle to face the hotspot. If all windows are tinted, you can open the windows in the direction of the hotspot if that is feasible. Try to remove other obstructions that may impact signal quality such as opening the garage door.
A hotspot is not listed in the list of available networks.	The hotspot was defined as a hidden network.	Please set the network to visible and try again.

SYNC™ 3

Wi-Fi Issues		
Issue	Possible cause	Possible solution
SYNC 3 is not seen when searching for Wi-Fi networks from your phone or other devices.	SYNC 3 does not currently provide a hotspot.	SYNC 3 currently does not provide a hotspot
Software download takes too long.	Poor signal strength, too far from the hotspot, hotspot is supporting multiple connections, slow Internet connection or other problems.	Check the signal quality (under network details), if SYNC 3 indicates good or excellent, test with another high-speed equipped hotspot where the environment is more predictable.
SYNC 3 seems to connect with a hotspot and the signal strength is excellent but the software is not being updated.	It is possible that there is no new software. The connected hotspot may be a managed one and it requires either a subscription or agreeing to the terms and conditions.	Test the connection with another device, if the hotspot requires a subscription, you may contact the service provider.

AppLink issues		
Issue	Possible cause(s)	Possible solution(s)
AppLink Mobile Applications: When I select "Connect Mobile Apps," SYNC 3 does not find any applications.	You did not connect an AppLink Compatible phone to SYNC 3.	Make sure you have a compatible smartphone; an Android with OS 2.3 or higher or an iPhone 3GS or newer with iOS 5.0 or higher. Additionally, make sure you pair and connect your phone

SYNC™ 3

AppLink issues		
Issue	Possible cause(s)	Possible solution(s)
		to SYNC 3 in order to find AppLink-capable apps on your device. iPhone users must also connect to a USB port with an Apple USB cable.
My phone is connected, but I still cannot find any apps.	AppLink-enabled apps are not installed and running on your mobile device.	Make sure you have downloaded and installed the latest version of the app from your phone's app store. Make sure the app is running on your phone. Some apps require you to register or login to the app on the phone before using them with AppLink. Also, some may have a "Ford SYNC" setting, so check the app's settings menu on the phone.
My phone is connected, my app(s) are running, but I still cannot find any apps.	Sometimes apps do not properly close and re-open their connection to SYNC 3, over ignition cycles, for example.	Closing and restarting apps may help SYNC 3 find the application if you cannot discover it inside the vehicle. On an Android device, if apps have an 'Exit' or 'Quit' option, then select it and restart the app. If the app does not have that option, select the phone's settings menu and select 'Apps', then find the particular app and choose 'Force stop.' Do not forget to restart the app afterward, then select "Connect Mobile Apps" on SYNC 3.

SYNC™ 3

AppLink issues		
Issue	Possible cause(s)	Possible solution(s)
		On an iPhone with iOS7+, to force close an app, double tap the home button then swipe up on the app to close it. Tap the home button again, then select the app again to restart it. After a few seconds, the app should then appear in SYNC 3's Mobile App's Menu.
My Android phone is connected, my app(s) are running, I restarted them, but I still cannot find any apps.	There is a Bluetooth issue on some older versions of the Android operating system that may cause apps that were found on your previous vehicle drive to not be found again if you did not switch Bluetooth off.	Switch Bluetooth off and then on to reset it on your phone. If you are in your vehicle, SYNC 3 should be able to automatically re-connect to your phone if you press the "Phone" button.

SYNC™ 3

AppLink issues		
Issue	Possible cause(s)	Possible solution(s)
My iPhone is connected, my app is running, I restarted the app but I still cannot find it on SYNC 3.	You may need to reset the USB connection to SYNC 3.	Unplug the USB cable from the phone, wait a moment, and plug the USB cable back in to the phone. After a few seconds, the app should appear in SYNC 3's Mobile Apps Menu. If not, "Force Close" the application and restart it.
I have an Android phone. I found and started my media app on SYNC 3, but there is no sound or the sound is very low.	The Bluetooth volume on the phone may be low.	Increase the Bluetooth volume of the device by using the device's volume control buttons which are most often found on the side of the device.
I can only see some of the AppLink apps running on my phone listed in the SYNC 3 Mobile Apps Menu.	Some Android devices have a limited number of Bluetooth ports that apps can use to connect. If you have more AppLink apps on your phone than the number of available Bluetooth ports, you will not see all of your apps listed in the SYNC 3 mobile apps menu.	Force close or uninstall the apps you do not want SYNC 3 to find. If the app has a "Ford SYNC" setting, disable that setting in the app's settings menu on the phone.

Voice command issues		
Issue	Possible cause	Possible solution
SYNC 3 does not understand what I am saying.	You may be using the wrong voice commands.	Review the cell phone voice commands and the media voice commands at the beginning of their respective sections.
	You may be speaking too soon or at the wrong time.	Refer to the audio display during an active voice session to find a list of voice commands there. Wait for the system to prompt you before you state your command.

SYNC™ 3

Voice command issues		
Issue	Possible cause	Possible solution
SYNC 3 does not understand the name of a song or artist.	You may be using the wrong voice commands.	Review the media voice commands at the beginning of the media section.
	You may not be saying the name exactly as it appears on your device.	Say the song or artist name exactly as it is displayed on your device. For example, say "Play Artist Prince" or "Play song Purple Rain".
		Make sure you are saying the complete title such as "California remix featuring Jennifer Nettles".
		If there are any abbreviations in the name, like ESPN or CNN, you have to spell those: "E-S-P-N" or "C-N-N".
The song or artist name may have some special characters that are not being recognized by SYNC 3.	Make sure that song titles, artists, album, and playlists names do not have any special characters like *, - or +.	
SYNC 3 does not understand or is calling the wrong contact when I want to make a call.	You may not be saying the name exactly as it appears on your phone-book.	Make sure that you are saying the name exactly as it appears on your phone. For example, if your contact is "Joe Wilson", say "Call Joe Wilson". If your contact name is "Mom", say "Call Mom".
	The contact name may contain special characters.	Make sure that your contact names do not have any special characters like *, - or +.
The SYNC 3 voice control system is having trouble recognizing foreign names stored on my cell phone.	You may not be saying the name exactly as it appears on your phone-book.	SYNC 3 applies the phonetic pronunciation rules of the selected language to the contact names stored on your cell phone.
		Helpful Hint: You can select your contact manually. Press PHONE . Select the option for phonebook and then contact name. Press the soft-key option to hear it. SYNC 3 will read the contact name to you, giving you some idea of the pronunciation it is expecting.

SYNC™ 3

Voice command issues		
Issue	Possible cause	Possible solution
The SYNC 3 voice control system is having trouble recognizing foreign tracks, artists, albums, genres and playlist names from my media player or USB flash drive.	You may be saying the foreign names using the currently selected language for SYNC 3.	SYNC 3 applies the phonetic pronunciation rules of the selected language to the names stored on your media player or USB flash drive. It is able to make some exceptions for very popular artist names (for example, U2) such that you can always use the English pronunciation for these artists.
The system generates voice prompts and the pronunciation of some words may not be accurate for my language.	SYNC 3 uses text-to-speech voice prompt technology.	SYNC 3 uses a synthetically generated voice rather than pre-recorded human voice.
		SYNC 3 offers several new voice control features for a wide range of languages. Dialing a contact name directly from the phonebook without pre-recording (for example, "call John Smith") or selecting a track, artist, album, genre or playlist directly from your media player (for example, "play artist Madonna").

SYNC™ 3

General		
Issue	Possible cause	Possible solution
The language selected for the instrument cluster and information and entertainment display does not match the SYNC 3 language (phone, USB, Bluetooth audio, voice control and voice prompts).	SYNC 3 does not support the currently selected language for the instrument cluster and information and entertainment display.	SYNC 3 supports multiple languages in a single module for text display, voice control and voice prompts. The country where you bought your vehicle dictates the languages based on the most popular languages spoken. If the selected language is not available, SYNC 3 remains in the current active language.
		SYNC 3 offers several new voice control features for a wide range of languages. Dialing a contact name directly from the phonebook without pre-recording (for example, "call John Smith") or selecting a track, artist, album, genre or playlist directly from your media player (for example, "play artist Madonna").

SYNC 3 System Reset
The system has a System Reset feature that can be performed if the function of a SYNC 3 feature is lost. This reset is intended to restore functionality and will not erase any information previously stored in the system (such as paired devices, phonebook, call history, text messages, or user settings). To perform a System Reset, press and hold the Seek Up (>>) button while pressing and holding the Radio Power button. After approximately 5 seconds the screen will go black. Allow 1-2 minutes for the system reset to complete. You may then resume using the SYNC 3 system.

For additional assistance with SYNC 3 troubleshooting please call or visit the Ford Website.

Ford Support	
Customer Relationship Center	United States: 1-800-392-3673
	Canada: 1-800-565-3673
Website	owner.ford.com www.syncmyride.ca www.syncmaroute.ca

Accessories

For a complete listing of the accessories that are available for your vehicle, please contact your authorized dealer or visit the online store web site:

Web Address (United States)

www.Accessories.Ford.com
--

Web Address (Canada)

www.Accessories.Ford.ca
--

Ford Motor Company will repair or replace any properly authorized dealer-installed Ford Original Accessory found to be defective in factory-supplied materials or workmanship during the warranty period, as well as any component damaged by the defective accessories.

Ford Motor Company will warrant your Ford accessory through the warranty that provides the greatest benefit:

- 24 months, unlimited mileage.
- The remainder of your new vehicle limited warranty.

Contact an authorized dealer for details and a copy of the warranty.

Exterior Style

- Hood protector.*
- Side window deflectors.*
- Splash guards.
- Step bars.
- Wheel covers.*
- Wheelhouse liners.

Interior Style

- Floor liners.
- Ambient lighting.
- Carpeted floor mats.

Lifestyle

- Ash cup and smokers packages.
- Cargo area illumination.
- Cargo area mats.
- Cargo liners.
- Cargo organizers.
- Device holder.*
- Hitch and towing accessories.
- Roof racks.
- Seat covers.*
- Window grilles.

Peace of Mind

- Back-up alarm.*
- Hitch scan rear park assist sensor.*
- Roadside assistance kits.*
- Keyless entry keypad.
- Remote start.
- Telematics.*
- Vehicle security system.
- Wheel locks.

*The accessory manufacturer designs, develops and therefore warrants Ford Licensed Accessories, and does not design or test these accessories to Ford Motor Company engineering requirements. Contact an authorized Ford dealer for the manufacturer's limited warranty details and request a copy of the Ford Licensed Accessories product limited warranty from the accessory manufacturer.

Accessories

For maximum vehicle performance, keep the following information in mind when adding accessories or equipment to your vehicle:

- When adding accessories, equipment, passengers and luggage to your vehicle, do not exceed the total weight capacity of the vehicle or of the front or rear axle (GVWR or GAWR as indicated on the Safety Compliance Certification label). Ask an authorized dealer for specific weight information.
- The Federal Communications Commission (FCC) and Canadian Radio Telecommunications Commission (CRTC) regulate the use of mobile communications systems that are equipped with radio transmitters, for example two-way radios, telephones and anti-theft alarms. Any such equipment installed in your vehicle should comply with Federal Communications Commission (FCC) and Canadian Radio Telecommunications Commission (CRTC) regulations and should be installed only by an authorized dealer.
- Mobile communications systems may harm the operation of your vehicle, particularly if they are not properly designed for automotive use.
- If you or an authorized Ford dealer add any non-Ford electrical or electronic accessories or components to your vehicle, you may adversely affect battery performance and durability, and may adversely affect the performance of other electrical systems in the vehicle.

AUXILIARY SWITCHES

The auxiliary switchboard on the center console makes aftermarket customization easier, with four prewired switches attached to the power distribution box for electrical accessories.



E163431

When using the auxiliary switches for an extended period of time, we recommend that the engine is running to prevent the battery from running out of charge.

A fuse and relay kit is included with this option. The kit contains fuses and relays for the pre-fusebox, located under the driver's seat. Refer to the instructions included with the kit. See an authorized dealer for service.

There is one power lead connector for each switch. These can be found at either the 43-way connector for the AUX 1 and AUX 2 switches or the 6-way connector for the AUX 3 and AUX 4 switches. Both connectors are behind the passenger side cup holder.

Accessories

The relays are coded as follows:

	Circuit Number	Wire Color	Fuse Rating
AUX 1 ¹	CAC05	Yellow	20A
AUX 2 ¹	CAC06	Green with brown trace	20A
AUX 3 ¹	CAC13	Blue with orange trace	40A
AUX 4 ²	CAC14	Yellow with orange trace	40A

¹ Operates when you switch the ignition on.

² Operates only when the engine is running.

If different switch functionality is required please contact the Truck Body Builders Advisory Service. See **Special Notices** (page 14).

Ford Protect

PROTECT YOURSELF FROM THE RISING COST OF VEHICLE REPAIRS WITH A FORD PROTECT EXTENDED SERVICE PLAN.

Ford Protect Extended Service Plans (U.S. Only)

Ford Protect extended service plan means peace of mind. It's the extended service plan backed by Ford Motor Company, and provides more protection beyond the New Vehicle Limited Warranty coverage. When you visit your Ford Dealer, Insist on Ford Protect extended service plans!

Ford Protect Can Quickly Pay for Itself

One trip to the Service Center could easily exceed the price of your Ford Protect extended service plan. With Ford Protect extended service plan you minimize your risk for unexpected repair bills and rising repair costs.

Up to 1,000+ Covered Vehicle Components

There are four mechanical Ford Protect extended service plans with different levels of coverage. Ask your authorized dealer for details.

1. PremiumCARE - Our most comprehensive coverage. With over 1,000 covered components, this plan is so complete it's probably easier to list what's not covered.
2. ExtraCARE - Covers 113 components, and includes many high-tech items.
3. BaseCARE - Covers 84 components.
4. PowertrainCARE - Covers 29 critical components.

Ford Protect extended service plans are honored by all authorized Ford dealers in the U.S., Canada and Mexico.

That means you get:

- Reliable, quality service at any Ford or Lincoln dealership.
- Repairs performed by factory trained technicians, using genuine parts.

Rental Car Reimbursement

1st day Rental Benefit

If you bring your car into your dealer for service, we'll give you a loaner to use for the day.

Extended Rental Benefits

If your vehicle is kept overnight for covered repairs, you are eligible for rental car coverage, including warranty repairs, and Field Service Actions.

Roadside Assistance

Exclusive 24/7 roadside assistance, including:

- Towing, flat-tire change and battery jump starts.
- Out of fuel and lock-out assistance.
- Travel expense reimbursement for lodging, meals and rental car.
- Assistance for taxi, shuttle, rental car coverage or other transportation.

Transferable Coverage

If you sell your vehicle before your Ford Protect extended service plan coverage expires, you can transfer any remaining coverage to the new owner. Which should give you and your potential buyer a little more peace of mind.

Ford Protect

Less Cost to Properly Maintain Your Vehicle

Ford Protect extended service plan also offers a Premium Maintenance Plan that covers all scheduled maintenance, and selected wear items. The coverage is prepaid, so you never have to worry about the cost of your vehicle's maintenance.

Covered maintenance includes:

- Windshield wiper blades.
- Spark plugs.
- The clutch disc (if equipped).
- Brake pads and linings.
- Shock absorbers.
- Struts.
- Engine Belts.
- Engine coolant hoses, clamps and o-rings.
- Diesel exhaust fluid replenishment (if equipped).
- Cabin air filter replacement every 20,000 mi (32,000 km) (electric vehicles only).

Interest Free Finance Options

Just a 10% down payment will provide you with an affordable, no interest, no fee payment program allowing you all the security and benefits Ford Protect extended service plan has to offer while paying over time. You are pre-approved with no credit check or hassles. To learn more, call our Ford Protect extended service plan specialists at 800-367-3377.

Ford Protect Extended Service Plan
P.O. Box 321067
Detroit, MI 48232

Ford Protect Extended Service Plan (CANADA ONLY)

You can get more protection for your vehicle by purchasing a Ford Protect extended service plan. Ford Protect extended service plan is the only service contract backed by Ford Motor Company of Canada, Limited. Depending on the plan you purchase, Ford Protect extended service plan provides benefits such as:

- Rental reimbursement.
- Coverage for certain maintenance and wear items.
- Protection against repair costs after your New Vehicle Limited Warranty Coverage expires.
- Roadside Assistance benefits.

There are several Ford Protect extended service plans available in various time, distance and deductible combinations. Each plan is tailored to fit your own driving needs, including reimbursement for towing and rental. When you purchase Ford Protect extended service plan, you receive added peace-of-mind protection throughout Canada, the United States and Mexico, provided by a network of participating authorized Ford Motor Company dealers.

Note: *Repairs performed outside of Canada, the United States and Mexico are not eligible for Ford Protect extended service plan coverage.*

This information is subject to change. For more information; visit your local Ford of Canada dealer or www.ford.ca to find the Ford Protect extended service plan that is right for you.

Scheduled Maintenance

Intelligent Oil-Life Monitor™

Your vehicle is equipped with an Intelligent Oil-Life Monitor that determines when you should change the engine oil based on how your vehicle is used. By using several important factors in its calculations, the monitor helps reduce the cost of owning

your vehicle and reduces environmental waste at the same time.

The following table provides examples of vehicle use and its impact on oil change intervals. It is a guideline only. Actual oil change intervals depend on several factors and generally decrease with severity of use.

When to expect the oil change message	
Interval	Vehicle use and example
7500-10000 miles (12000-16000 km)	Normal
	Normal commuting with highway driving. No, or moderate, load or towing. Flat to moderately hilly roads. No extended idling.
5000-7499 miles (8000-11999 km)	Severe
	Moderate to heavy load or towing. Mountainous or off-road conditions. Extended idling. Extended hot or cold operation.
3000-4999 miles (4800-7999 km)	Extreme
	Maximum load or towing. Extreme hot or cold operation.

Normal Maintenance Intervals

At every oil change interval as indicated by the information display*
Change engine oil and filter.**
Rotate tires, inspect tire wear and measure tread depth.
Perform a multi-point inspection (recommended).
Inspect the automatic transmission fluid level (if equipped with dipstick). Consult your dealer for requirements.
Inspect the brake pads, shoes, rotors, drums, brake linings, hoses and parking brake.
Inspect the engine cooling system strength and hoses.

Scheduled Maintenance

At every oil change interval as indicated by the information display*
Inspect the exhaust system and heat shields.
Inspect front axle and U-joints. Lubricate if equipped with grease fittings.
Inspect the steering linkage, ball joints, suspension, tire-rod ends, driveshaft and U-joints. Lubricate any areas with grease fittings.
Diesel engine fill diesel exhaust fluid.
Inspect the wheels and related components for abnormal noise, wear, looseness or drag.

* Do not exceed one year or 10000 miles (16000 kilometers) between service intervals.

** Reset the Intelligent Oil-Life Monitor after engine oil and filter changes.

Other maintenance items¹	
Every 30000 miles (48000 km)	Torque rear axle U-bolts to specification.
	Diesel engine replace fuel filter. ²
	Replace engine air filter.
Every 45000 miles (70000 km)	Change diesel foam air filter.
Every 100000 miles (160000 km)	Replace spark plugs.
	Inspect accessory drive belt(s). ³
Every 150000 miles (240000 km)	Change automatic transmission fluid and filter.
	Change rear axle fluid.

Scheduled Maintenance

Other maintenance items ¹	
	Replace accessory drive belt(s).
Every 200000 miles (320000 km)	Change engine coolant ⁴

¹ Perform these maintenance items within 3000 miles (4800 kilometers) of the last engine oil and filter change. Do not exceed the designated distance for the interval.

² Replace early if indicated by per Water In Fuel warning lamp. See **Warning Lamps and Indicators** (page 93).

³ After initial inspection, inspect every other oil change until replaced.

⁴ Initial replacement at ten years or 200000 miles (320000 km), then every five years or 100000 miles (160000 km).

GENERAL MAINTENANCE INFORMATION

Why Maintain Your Vehicle?

Carefully following the maintenance schedule helps protect against major repair expenses resulting from neglect or inadequate maintenance and may help to increase the value of your vehicle when you sell or trade it. Keep all receipts for completed maintenance with your vehicle.

We have established regular maintenance intervals for your vehicle based upon rigorous testing. It is important that you have your vehicle serviced at the correct times. These intervals serve two purposes; one is to maintain the reliability of your vehicle and the second is to keep the cost of owning your vehicle down.

It is your responsibility to have all scheduled maintenance performed and to make sure that the materials used meet the specifications identified in this owner's manual. See **Capacities and Specifications** (page 307).

Failure to perform scheduled maintenance invalidates warranty coverage on parts affected by the lack of maintenance.

Why Maintain Your Vehicle at Your Dealership?

Factory-trained Technicians

Service technicians participate in extensive factory-sponsored certification training to help them become experts on the operation of your vehicle. Ask your dealership about the training and certification their technicians have received.

Genuine Ford and Motorcraft Replacement Parts

Dealerships stock Ford, Motorcraft and Ford-authorized branded re-manufactured replacement parts. These parts meet or exceed our specifications. Parts installed at your dealership carry a nationwide 12-month or 12,000 mi (20,000 km) parts and labor limited warranty.

If you do not use Ford authorized parts they may not meet our specifications and depending on the part, it could affect emissions compliance.

Scheduled Maintenance

Convenience

Many dealerships have extended evening and Saturday hours to make your service visit more convenient and they offer one stop shopping. They can perform any services that are required on your vehicle, from general maintenance to crash repairs.

Note: *Not all dealers have extended hours or body shops. Please contact your dealer for details.*

Protecting Your Investment

Maintenance is an investment that pays dividends in the form of improved reliability, durability and resale value. To maintain the correct performance of your vehicle and its emission control systems, make sure you have scheduled maintenance performed at the designated intervals.

Vehicles with a 3.2L, 3.5L or 3.7L Engine

Your vehicle is equipped with the Intelligent Oil-Life Monitor system, which displays a message in the information display at the correct oil change interval. This interval may be up to one year or 10,000 mi (16,000 km).

When the oil change message appears in the information display, it is time for an oil change. Make sure you perform the oil change within two weeks or 500 miles (800 kilometers) of the message appearing. Make sure you reset the Intelligent Oil-Life Monitor after each oil change. See **Changing the Engine Oil and Oil Filter** (page 235).

If your information display resets prematurely or becomes inoperative, you should perform the oil change interval at six months or 5,000 mi (8,000 km) from your last oil change. Never exceed one year or 10,000 mi (16,000 km) between oil change intervals.

All Vehicles

Your vehicle is very sophisticated and built with multiple, complex, performance systems. Every manufacturer develops these systems using different specifications and performance features. That is why it is important to rely upon your dealership to correctly diagnose and repair your vehicle.

Ford Motor Company has recommended maintenance intervals for various parts and component systems based upon engineering testing. Ford Motor Company relies upon this testing to determine the most appropriate mileage for replacement of oils and fluids to protect your vehicle at the lowest overall cost to you and recommends against maintenance schedules that deviate from the scheduled maintenance information.

We strongly recommend the use of only genuine Ford, Motorcraft or Ford-authorized re-manufactured replacement parts engineered for your vehicle.

Additives and Chemicals

This owner's manual and the Ford Workshop Manual list the recommended additives and chemicals for your vehicle. We do not recommend using chemicals or additives not approved by us as part of your vehicle's normal maintenance. Please consult your warranty information.

Scheduled Maintenance

Oils, Fluids and Flushing

In many cases, fluid discoloration is a normal operating characteristic and, by itself, does not necessarily indicate a concern or that the fluid needs to be changed. However, a qualified expert, such as the factory-trained technicians at your dealership, should inspect discolored fluids that also show signs of overheating or foreign material contamination immediately.

Make sure to change your vehicle's oils and fluids at the specified intervals or in conjunction with a repair. Flushing is a viable way to change fluid for many vehicle sub-systems during scheduled maintenance. It is critical that systems are flushed only with new fluid that is the same as that required to fill and operate the system or using a Ford-approved flushing chemical.

Owner Checks and Services

Make sure you perform the following basic maintenance checks and inspections every month or at six-month intervals.

Check every month
Engine oil level.
Function of all interior and exterior lights.
Tires (including spare) for wear and correct pressure.
Windshield washer fluid level.

Check every six months
Battery connections. Clean if necessary.
Body and door drain holes for obstructions. Clean if necessary.
Cooling system fluid level and coolant strength.

Check every six months
Door weatherstrips for wear. Lubricate if necessary.
Front door check arms for correct operation.
Hinges, latches and outside locks for correct operation. Lubricate if necessary.
Parking brake for correct operation.
Seatbelts and seat latches for wear and function.
Safety warning lamps (brake, ABS, airbag and seatbelt) for operation.
Washer spray and wiper operation. Clean or replace blades as necessary.

Multi-point Inspection

In order to keep your vehicle running correctly, it is important to have the systems on your vehicle checked regularly. This can help identify potential issues and prevent major problems. We recommend having the following multi-point inspection performed at every scheduled maintenance interval to help make sure your vehicle keeps running correctly.

Multi-point inspection
Accessory drive belt(s).
Battery performance.
Engine air filter.
Exhaust system.
Exterior lamps and hazard warning system operation.
Fluid levels [*] ; fill if necessary.
For oil and fluid leaks.

Scheduled Maintenance

Multi-point inspection
Horn operation.
Radiator, cooler, heater and A/C hoses.
Suspension component for leaks or damage.
Steering and linkage.
Tires (including spare) for wear and correct pressure**.
Windshield for cracks, chips or pits.
Washer spray and wiper operation.

* Brake, coolant recovery reservoir, automatic transmission, power steering (if equipped with hydraulic power assist steering) and window washer.

**If your vehicle is equipped with a temporary mobility kit, check the tire sealant expiration Use By date on the canister. Replace as needed.

Be sure to ask your dealership service advisor or technician about the multi-point vehicle inspection. It is a comprehensive way to perform a thorough inspection of your vehicle. Your checklist gives you immediate feedback on the overall condition of your vehicle.

NORMAL SCHEDULED MAINTENANCE

Intelligent Oil-Life Monitor™

Your vehicle is equipped with an Intelligent Oil-Life Monitor that determines when you should change the engine oil based on how your vehicle is used. By using several important factors in its calculations, the monitor helps reduce the cost of owning your vehicle and reduces environmental waste at the same time.

The following table provides examples of vehicle use and its impact on oil change intervals. It is a guideline only. Actual oil change intervals depend on several factors and generally decrease with severity of use.

When to expect the oil change message	
Interval	Vehicle use and example
7500-10000 miles (12000-16000 km)	Normal
	Normal commuting with highway driving. No, or moderate, load or towing. Flat to moderately hilly roads. No extended idling.
5000-7499 miles (8000-11999 km)	Severe
	Moderate to heavy load or towing. Mountainous or off-road conditions. Extended idling.

Scheduled Maintenance

When to expect the oil change message	
Interval	Vehicle use and example
	Extended hot or cold operation.
3000-4999 miles (4800-7999 km)	Extreme
	Maximum load or towing. Extreme hot or cold operation.

Normal Maintenance Intervals

At every oil change interval as indicated by the information display*
Change engine oil and filter.**
Rotate tires, inspect tire wear and measure tread depth.
Perform a multi-point inspection (recommended).
Inspect the automatic transmission fluid level (if equipped with dipstick). Consult your dealer for requirements.
Inspect the brake pads, shoes, rotors, drums, brake linings, hoses and parking brake.
Inspect the engine cooling system strength and hoses.
Inspect the exhaust system and heat shields.
Inspect front axle and U-joints. Lubricate if equipped with grease fittings.
Inspect the steering linkage, ball joints, suspension, tire-rod ends, driveshaft and U-joints. Lubricate any areas with grease fittings.
Diesel engine fill diesel exhaust fluid.
Inspect the wheels and related components for abnormal noise, wear, looseness or drag.

* Do not exceed one year or 10000 miles (16000 kilometers) between service intervals.

** Reset the Intelligent Oil-Life Monitor after engine oil and filter changes.

Scheduled Maintenance

Other maintenance items ¹	
Every 30000 miles (48000 km)	Torque rear axle U-bolts to specification.
	Diesel engine replace fuel filter. ²
	Replace engine air filter.
Every 45000 miles (70000 km)	Change diesel foam air filter.
At 100000 miles (160000 km)	Change engine coolant. ³
Every 100000 miles (160000 km)	Replace spark plugs.
	Inspect accessory drive belt(s). ⁴
Every 150000 miles (240000 km)	Change automatic transmission fluid and filter.
	Change rear axle fluid.
	Replace accessory drive belt(s).

¹ Perform these maintenance items within 3000 miles (4800 kilometers) of the last engine oil and filter change. Do not exceed the designated distance for the interval.

² Replace early if indicated by per Water In Fuel warning lamp. See **Warning Lamps and Indicators** (page 93).

³ Initial replacement at six years or 100000 miles (160000 kilometers), then every three years or 50000 miles (80000 kilometers).

⁴ After initial inspection, inspect every other oil change until replaced.

Scheduled Maintenance

SPECIAL OPERATING CONDITIONS SCHEDULED MAINTENANCE

If you operate your vehicle **primarily** in any of the following conditions, you need to perform extra maintenance as indicated. If you operate your vehicle **occasionally** under any of these conditions, it is not necessary to perform the extra maintenance. For specific recommendations, see your dealership service advisor or technician.

Perform the services shown in the following tables when specified or within 3000 miles (4800 kilometers) of the oil change required message appearing in the information display.

- **Example 1:** The message appears at 28,750 mi (46,270 km). Perform the 30,000 mi (48,000 km) automatic transmission fluid replacement.
- **Example 2:** The message does not appear, but the odometer reads 30,000 mi (48,000 km) (for example, the Intelligent Oil-Life Monitor was reset at 25,000 mi (40,000 km)). Perform the engine air filter replacement.

Towing a trailer or using a car-top carrier	
As required	Change engine oil and filter as indicated by the information display and perform services listed in the Normal Scheduled Maintenance chart.
Inspect frequently, service as required	Inspect and lubricate U-joints.
	See axle maintenance items under Exceptions .
Every 60000 miles (96000 km)	Replace spark plugs.

Extensive idling or low-speed driving for long distances, as in heavy commercial use (such as delivery, taxi, patrol car or livery)	
As required	Change engine oil and filter as indicated by the information display and perform services listed in the Normal Scheduled Maintenance chart.
Inspect frequently, service as required	Replace engine air filter.
Every 60000 miles (96000 km)	Replace spark plugs.

Scheduled Maintenance

Operating in dusty or sandy conditions (such as unpaved or dusty roads)	
Inspect frequently, service as required	Replace engine air filter.
Every 5000 miles (8000 km)	Inspect the wheels and related components for abnormal noise, wear, looseness or drag.
	Rotate tires, inspect tires for wear and measure tread depth.
Every 5000 miles (8000 km) or six months	Change engine oil and filter.*

*Reset your Intelligent Oil-Life Monitor after each engine oil and filter change.

Off-road operation	
Inspect frequently, service as required	Inspect steering linkage, ball joints and U-joints. Lubricate if equipped with grease fittings.
	Replace engine air filter.
Every 5000 miles (8000 km) or six months	Change engine oil and filter.*
	Inspect the wheels and related components for abnormal noise, wear, looseness or drag.
	Rotate tires, inspect tires for wear and measure tread depth.

*Reset your Intelligent Oil-Life Monitor after each engine oil and filter change.

Exclusive use of E85 (Flex fuel vehicles only)	
Every oil change interval	If ran exclusively on E85, fill the fuel tank full with regular unleaded fuel.

Exceptions

There are several exceptions to the Normal Schedule:

Axle and Transfer Case Maintenance

Axle(s) and transfer case (Four-wheel drive vehicles) fluid changes or level checks are not required unless a leak is suspected or the assembly has been submerged in water. Contact an authorized dealer for service.

Scheduled Maintenance

California fuel filter replacement

If you register your vehicle in California, the California Air Resources Board has determined that the failure to perform this maintenance item does not nullify the emission warranty or limit recall liability before the completion of your vehicle's useful life. Ford Motor Company, however, urges you to have all recommended maintenance services performed at the specified intervals and to record all vehicle service.

Hot climate oil change intervals

Vehicles operating in the Middle East, North Africa, Sub-Saharan Africa or locations with similar climates using an American Petroleum Institute (API) Certified for Gasoline Engines (Certification mark) oil of SM or SN quality, the normal oil change interval is 5,000 mi (8,000 km).

If the available API SM or SN oils are not available, then the oil change interval is 3,000 mi (4,800 km).

Engine air filter replacement

The life of the engine air filter is dependent on exposure to dusty and dirty conditions. Vehicles operated in these conditions require frequent inspection and replacement of the engine air filter.

SCHEDULED MAINTENANCE RECORD

<input type="radio"/> Repair Order #:	<p>Dealer stamp</p>
<input type="radio"/> Distance:	
<input type="radio"/> Engine hours (optional):	
<input type="radio"/> Multi-point inspection (recommended): <input type="checkbox"/>	
<input type="radio"/> Signature:	

Scheduled Maintenance

<input type="radio"/> Repair Order #:	Dealer stamp
<input type="radio"/> Distance:	
<input type="radio"/> Engine hours (optional):	
<input type="radio"/> Multi-point inspection (recommended): <input type="checkbox"/>	
<input type="radio"/> Signature:	

<input type="radio"/> Repair Order #:	Dealer stamp
<input type="radio"/> Distance:	
<input type="radio"/> Engine hours (optional):	
<input type="radio"/> Multi-point inspection (recommended): <input type="checkbox"/>	
<input type="radio"/> Signature:	

Scheduled Maintenance

<input type="radio"/> Repair Order #:	Dealer stamp
<input type="radio"/> Distance:	
<input type="radio"/> Engine hours (optional):	
<input type="radio"/> Multi-point inspection (recommended): <input type="checkbox"/>	
<input type="radio"/> Signature:	

<input type="radio"/> Repair Order #:	Dealer stamp
<input type="radio"/> Distance:	
<input type="radio"/> Engine hours (optional):	
<input type="radio"/> Multi-point inspection (recommended): <input type="checkbox"/>	
<input type="radio"/> Signature:	

Scheduled Maintenance

<input type="radio"/> Repair Order #:	<p>Dealer stamp</p>
<input type="radio"/> Distance:	
<input type="radio"/> Engine hours (optional):	
<input type="radio"/> Multi-point inspection (recommended): <input type="checkbox"/>	
<input type="radio"/> Signature:	

<input type="radio"/> Repair Order #:	<p>Dealer stamp</p>
<input type="radio"/> Distance:	
<input type="radio"/> Engine hours (optional):	
<input type="radio"/> Multi-point inspection (recommended): <input type="checkbox"/>	
<input type="radio"/> Signature:	

Scheduled Maintenance

<input type="radio"/> Repair Order #:	Dealer stamp
<input type="radio"/> Distance:	
<input type="radio"/> Engine hours (optional):	
<input type="radio"/> Multi-point inspection (recommended): <input type="checkbox"/>	
<input type="radio"/> Signature:	

<input type="radio"/> Repair Order #:	Dealer stamp
<input type="radio"/> Distance:	
<input type="radio"/> Engine hours (optional):	
<input type="radio"/> Multi-point inspection (recommended): <input type="checkbox"/>	
<input type="radio"/> Signature:	

Scheduled Maintenance

<input type="radio"/> Repair Order #:	<p>Dealer stamp</p>
<input type="radio"/> Distance:	
<input type="radio"/> Engine hours (optional):	
<input type="radio"/> Multi-point inspection (recommended): <input type="checkbox"/>	
<input type="radio"/> Signature:	

<input type="radio"/> Repair Order #:	<p>Dealer stamp</p>
<input type="radio"/> Distance:	
<input type="radio"/> Engine hours (optional):	
<input type="radio"/> Multi-point inspection (recommended): <input type="checkbox"/>	
<input type="radio"/> Signature:	

Scheduled Maintenance

<input type="radio"/> Repair Order #:	Dealer stamp
<input type="radio"/> Distance:	
<input type="radio"/> Engine hours (optional):	
<input type="radio"/> Multi-point inspection (recommended): <input type="checkbox"/>	
<input type="radio"/> Signature:	

<input type="radio"/> Repair Order #:	Dealer stamp
<input type="radio"/> Distance:	
<input type="radio"/> Engine hours (optional):	
<input type="radio"/> Multi-point inspection (recommended): <input type="checkbox"/>	
<input type="radio"/> Signature:	

Scheduled Maintenance

<input type="radio"/> Repair Order #:	<p>Dealer stamp</p>
<input type="radio"/> Distance:	
<input type="radio"/> Engine hours (optional):	
<input type="radio"/> Multi-point inspection (recommended): <input type="checkbox"/>	
<input type="radio"/> Signature:	

<input type="radio"/> Repair Order #:	<p>Dealer stamp</p>
<input type="radio"/> Distance:	
<input type="radio"/> Engine hours (optional):	
<input type="radio"/> Multi-point inspection (recommended): <input type="checkbox"/>	
<input type="radio"/> Signature:	

Scheduled Maintenance

<input type="radio"/> Repair Order #:	Dealer stamp
<input type="radio"/> Distance:	
<input type="radio"/> Engine hours (optional):	
<input type="radio"/> Multi-point inspection (recommended): <input type="checkbox"/>	
<input type="radio"/> Signature:	

<input type="radio"/> Repair Order #:	Dealer stamp
<input type="radio"/> Distance:	
<input type="radio"/> Engine hours (optional):	
<input type="radio"/> Multi-point inspection (recommended): <input type="checkbox"/>	
<input type="radio"/> Signature:	

Scheduled Maintenance

<input type="radio"/> Repair Order #:	Dealer stamp
<input type="radio"/> Distance:	
<input type="radio"/> Engine hours (optional):	
<input type="radio"/> Multi-point inspection (recommended): <input type="checkbox"/>	
<input type="radio"/> Signature:	

<input type="radio"/> Repair Order #:	Dealer stamp
<input type="radio"/> Distance:	
<input type="radio"/> Engine hours (optional):	
<input type="radio"/> Multi-point inspection (recommended): <input type="checkbox"/>	
<input type="radio"/> Signature:	

Scheduled Maintenance

<input type="radio"/> Repair Order #:	Dealer stamp
<input type="radio"/> Distance:	
<input type="radio"/> Engine hours (optional):	
<input type="radio"/> Multi-point inspection (recommended): <input type="checkbox"/>	
<input type="radio"/> Signature:	

Appendices

ELECTROMAGNETIC COMPATIBILITY



WARNING: Do not place objects or mount equipment on or near the airbag cover, on the side of the seatbacks (of the front seats), or in front seat areas that may come into contact with a deploying airbag. Failure to follow these instructions may increase the risk of personal injury in the event of a crash.



WARNING: Do not fasten antenna cables to original vehicle wiring, fuel pipes and brake pipes.



WARNING: Keep antenna and power cables at least 4 in (10 cm) from any electronic modules and airbags.

Note: We test and certify your vehicle to meet electromagnetic compatibility legislation (UNECE Regulation 10 or other applicable local requirements). It is your responsibility to make sure that any equipment an authorized dealer installs on your vehicle complies with applicable local legislation and other requirements.

Note: Any radio frequency transmitter equipment in your vehicle (such as cellular telephones and amateur radio transmitters) must keep to the parameters in the following table. We do not provide special provisions or conditions for installations or use.

Car

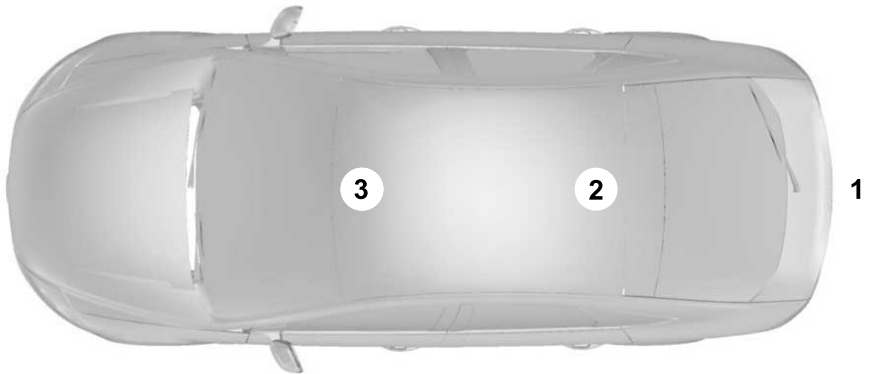

E239120

Appendices

Van



E239122

Truck

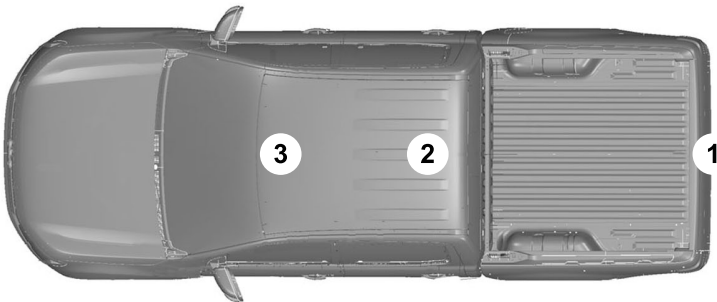

E239121

486



Appendices

Frequency Band MHz	Maximum output power Watt (Peak RMS)	Antenna Positions
1-30	50	1
50-54	50	2, 3
68-88	50	2, 3
142-176	50	2, 3
380-512	50	2, 3
806-870	10	2, 3

Note: After the installation of radio frequency transmitters, check for disturbances from and to all electrical equipment in your vehicle, both in the standby and transmit modes.

Check all electrical equipment:

- With the ignition ON.
- With the engine running.
- During a road test at various speeds.

Check that electromagnetic fields generated inside your vehicle cabin by the transmitter installed do not exceed applicable human exposure requirements.

END USER LICENSE AGREEMENT

VEHICLE SOFTWARE END USER LICENSE AGREEMENT (EULA)

- You ("You" or "Your" as applicable) have acquired a vehicle having several devices, including SYNC ® and various control modules, ("DEVICES") that include software licensed or owned by Ford Motor Company and its affiliates ("FORD MOTOR COMPANY"). Those software products of FORD MOTOR COMPANY origin, as well as associated media, printed materials, and "online" or electronic documentation ("SOFTWARE") are protected by international intellectual property laws and treaties. The SOFTWARE is licensed, not sold. All rights reserved.
- The SOFTWARE may interface with and/or communicate with, or may be later upgraded to interface with and/or communicate with additional software and/or systems provided by FORD MOTOR COMPANY.

Appendices

IF YOU DO NOT AGREE TO THIS END USER LICENSE AGREEMENT ("EULA") DO NOT USE THE DEVICES OR COPY THE SOFTWARE. ANY USE OF THE SOFTWARE, INCLUDING BUT NOT LIMITED TO USE ON THE DEVICES, WILL CONSTITUTE YOUR AGREEMENT TO THIS EULA (OR RATIFICATION OF ANY PREVIOUS CONSENT).

GRANT OF SOFTWARE LICENSE: This EULA grants you the following license:

- You may use the SOFTWARE as installed on the DEVICES and as otherwise interfacing with systems and/or services provide by or through FORD MOTOR COMPANY or its third party software and service providers.

Description of Other Rights and Limitations

- **Speech Recognition:** If the SOFTWARE includes speech recognition component(s), you should understand that speech recognition is an inherently statistical process and that recognition errors are inherent in the process. Neither FORD MOTOR

COMPANY nor its suppliers shall be liable for any damages arising out of errors in the speech recognition process. It is your responsibility to monitor any speech recognition functions included in the system.

- **Limitations on Reverse Engineering, Decompilation and Disassembly:**

You may not reverse engineer, decompile, translate, disassemble or attempt to discover any source code or underlying ideas or algorithms of the SOFTWARE nor permit others to reverse engineer, decompile or disassemble the SOFTWARE, except and only to the extent that such activity is expressly permitted by applicable law notwithstanding this limitation or to the extent as may be permitted by the licensing terms governing use of any open source components included with the SOFTWARE.

- **Limitations on Distributing, Copying, Modifying and Creating Derivative Works:** You may not distribute, copy, make modifications to or create derivative works based on the SOFTWARE, except and only to the extent that such activity is expressly permitted by applicable law notwithstanding this limitation or to the extent as may be permitted by the licensing terms governing use of any open source components included with the SOFTWARE.

- **Single EULA:** The end user documentation for the DEVICES and related systems and services may contain multiple EULAs, such as multiple translations and/or multiple media versions (e.g., in the user documentation and in the software). Even if you receive multiple EULAs, you are licensed to use only one (1) copy of the SOFTWARE.

Appendices

- **SOFTWARE Transfer:** You may permanently transfer your rights under this EULA only as part of a sale or transfer of the DEVICES, provided you retain no copies, you transfer all of the SOFTWARE (including all component parts, the media and printed materials, any upgrades, and, if applicable, the Certificate(s) of Authenticity), and the recipient agrees to the terms of this EULA. If the SOFTWARE is an upgrade, any transfer must include all prior versions of the SOFTWARE.
- **Termination:** Without prejudice to any other rights, FORD MOTOR COMPANY may terminate this EULA if you fail to comply with the terms and conditions of this EULA.
- **Internet-Based Services Components:** The SOFTWARE may contain components that enable and facilitate the use of certain Internet-based services. You acknowledge and agree that FORD MOTOR COMPANY, third party software and service suppliers, its affiliates and/or its designated agent may automatically check the version of the SOFTWARE and/or its components that you are utilizing and may provide upgrades or supplements to the SOFTWARE that may be automatically downloaded to your DEVICES.
- **Additional Software/Services:** The SOFTWARE may permit FORD MOTOR COMPANY, third party software and service suppliers, its affiliates and/or its designated agent to provide or make available to you SOFTWARE updates, supplements, add-on components, or Internet-based services components of the SOFTWARE after the date you obtain your initial copy of the SOFTWARE ("Supplemental Components.") SOFTWARE updates may cause you to incur additional charges from your wireless service provider. If FORD MOTOR COMPANY or third party software and services suppliers provide or make available to you Supplemental Components and no other EULA terms are provided along with the Supplemental Components, then the terms of this EULA shall apply. FORD MOTOR COMPANY, its affiliates and/or its designated agent reserve the right to discontinue without liability any Internet-based services provided to you or made available to you through the use of the SOFTWARE.
- **Links to Third Party Sites:** The SOFTWARE may provide you with the ability to link to third party sites. The third party sites are not under the control of FORD MOTOR COMPANY, its affiliates and/or its designated agent. Neither FORD MOTOR COMPANY nor its affiliates nor its designated agent are responsible for (i) the contents of any third party sites, any links contained in third party sites, or any changes or updates to third party sites, or (ii) webcasting or any other form of transmission received from any third party sites. If the SOFTWARE provides links to third party sites, those links are provided to you only as a convenience, and the inclusion of any link does not imply an endorsement of the third party site by FORD MOTOR COMPANY, its affiliates and/or its designated agent.
- **Obligation to Drive Responsibly:** You recognize your obligation to drive responsibly and keep attention on the road. You will read and abide with the DEVICES operating instructions particularly as they pertain to safety and you agree to assume any risk associated with the use of the DEVICES.

Appendices

UPGRADES AND RECOVERY MEDIA:

If the SOFTWARE is provided by FORD MOTOR COMPANY separate from the DEVICES on media such as a ROM chip, CD ROM disk(s) or via web download or other means, and is labeled "For Upgrade Purposes Only" or "For Recovery Purposes Only" you may install one (1) copy of such SOFTWARE onto the DEVICES as a replacement copy for the existing SOFTWARE, and use it in accordance with this EULA, including any additional EULA terms accompanying the upgrade SOFTWARE.

INTELLECTUAL PROPERTY RIGHTS:

All title and intellectual property rights in and to the SOFTWARE (including but not limited to any images, photographs, animations, video, audio, music, text and "applets" incorporated into the SOFTWARE), the accompanying printed materials, and any copies of the SOFTWARE, are owned by FORD MOTOR COMPANY, or its affiliates or suppliers. The SOFTWARE is licensed, not sold. You may not copy the printed materials accompanying the SOFTWARE. All title and intellectual property rights in and to the content which may be accessed through use of the SOFTWARE is the property of the respective content owner and may be protected by applicable copyright or other intellectual property laws and treaties. This EULA grants you no rights to use such content outside its intended use. All rights not specifically granted under this EULA are reserved by FORD MOTOR COMPANY, its affiliates, and third party software and service providers and suppliers. Use of any on-line services which may be accessed through the SOFTWARE may be governed by the respective terms of use relating to such services. If this SOFTWARE contains documentation that is provided only in electronic form, you may print one copy of such electronic documentation.

EXPORT RESTRICTIONS: You acknowledge that the SOFTWARE is subject to U.S. and European Union export jurisdiction. You agree to comply with all applicable international and national laws that apply to the SOFTWARE, including the U.S. Export Administration Regulations, as well as end-user, end-use and destination restrictions issued by U.S. and other governments.

TRADEMARKS: This EULA does not grant you any rights in connection with any trademarks or service marks of FORD MOTOR COMPANY, its affiliates, and third party software and service providers.

PRODUCT SUPPORT: Please refer to FORD MOTOR COMPANY instructions provided in the documentation for the DEVICES product support, such as the vehicle owner guide.

Should you have any questions concerning this EULA, or if you desire to contact FORD MOTOR COMPANY for any other reason, please refer to the address provided in the documentation for the DEVICES.

No Liability for Certain Damages:

EXCEPT AS PROHIBITED BY LAW, FORD MOTOR COMPANY, ANY THIRD PARTY SOFTWARE OR SERVICES SUPPLIERS, AND THEIR AFFILIATES SHALL HAVE NO LIABILITY FOR ANY INDIRECT, SPECIAL, CONSEQUENTIAL OR INCIDENTAL DAMAGES ARISING FROM OR IN CONNECTION WITH THE USE OR PERFORMANCE OF THE SOFTWARE. THIS LIMITATION SHALL APPLY EVEN IF ANY REMEDY FAILS OF ITS ESSENTIAL PURPOSE. THERE ARE NO WARRANTIES OTHER THAN THOSE THAT MAY BE EXPRESSLY PROVIDED FOR YOUR NEW VEHICLE.

Appendices

SYNC® Automotive Important Safety Information Read and follow instructions:

- Before using your SYNC® system, read and follow all instructions and safety information provided in this end user manual ("Owner Guide".) Not following precautions found in the Owner Guide can lead to an accident or other serious injuries.

General Operation

- **Voice Command Control:** Certain functions within the SYNC® system may be accomplished using voice commands. Using voice commands while driving helps you to operate the system without removing your hands from the wheel or eyes from the road.
- **Prolonged Views of Screen:** Do not access any function requiring a prolonged view of the screen while you are driving. Pull over in a safe and legal manner before attempting to access a function of the system requiring prolonged attention.
- **Volume Setting:** Do not raise the volume excessively. Keep the volume at a level where you can still hear outside traffic and emergency signals while driving. Driving while unable to hear these sounds could cause an accident.
- **Navigation Features:** Any navigation features included in the system are intended to provide turn by turn instructions to get you to a desired destination. Please make certain all persons using this system carefully read and follow instructions and safety information fully.
- **Distraction Hazard:** Any navigation features may require manual (non-verbal) setup. Attempting to perform such set-up or insert data while driving can distract your attention and could cause an accident or other serious injury. Stop the vehicle in a safe and legal manner before attempting these operations.
- **Let Your Judgment Prevail:** Any navigation features are provided only as an aid. Make your driving decisions based on your observations of local conditions and existing traffic regulations. Any such feature is not a substitute for your personal judgment. Any route suggestions made by this system should never replace any local traffic regulations or your personal judgment or knowledge of safe driving practices.
- **Route Safety:** Do not follow the route suggestions if doing so would result in an unsafe or illegal maneuver, if you would be placed in an unsafe situation, or if you would be directed into an area that you consider unsafe. The driver is ultimately responsible for the safe operation of the vehicle and therefore, must evaluate whether it is safe to follow the suggested directions.
- **Potential Map Inaccuracy:** Maps used by this system may be inaccurate because of changes in roads, traffic controls or driving conditions. Always use good judgment and common sense when following the suggested routes.
- **Emergency Services:** Do not rely on any navigation features included in the system to route you to emergency services. Ask local authorities or an emergency services operator for these locations. Not all emergency services such as police, fire stations, hospitals and clinics are likely to be contained in the map database for such navigation features.

Appendices

Your Responsibilities and Assumptions of Risk

- You agree to each of the following: (a) Any use of the SOFTWARE while driving an automobile or other vehicle in violation of applicable law or otherwise driving in an unsafe manner presents a significant risk of distracted driving and should not be attempted under any circumstances; (b) Use of the SOFTWARE at excessive volume poses a significant risk of hearing damage and should not be attempted under any circumstances; (c) The SOFTWARE may not be compatible with new or different versions of an operating system, third party software, or third party services, and the SOFTWARE may potentially cause a critical failure of an operating system, third party software, or third party service. (d) Any third party service accessed by or third party software used with the SOFTWARE (i) may charge an additional fee for access, (ii) may not work correctly, on an uninterrupted basis, or error free, (iii) may change streaming formats or discontinue operation, (iv) may contain adult, profane or offensive content; and (v) may contain inaccurate, false or misleading traffic, weather, financial or safety information or other content; and (e) Use of the SOFTWARE may cause you to incur additional charges from your wireless service provider (WSP) and any data or minute calculators that may be included in the software program are for reference only, are not warranted in any way and should not be relied upon in anyway.
- When using the SOFTWARE, you agree to be responsible for and assume the entire risk to the items set forth in Section (a) – (e) above.

Disclaimer of Warranty

YOU EXPRESSLY ACKNOWLEDGE AND AGREE THAT USE OF THE DEVICES AND SOFTWARE IS AT YOUR SOLE RISK AND THAT THE ENTIRE RISK AS TO SATISFACTORY QUALITY, PERFORMANCE, COMPATIBILITY, ACCURACY AND EFFORT IS WITH YOU. TO THE MAXIMUM EXTENT PERMITTED BY APPLICABLE LAW, THE SOFTWARE AND ANY THIRD PARTY SOFTWARE OR THIRD-PARTY SERVICES ARE PROVIDED "AS IS" AND "AS AVAILABLE", WITH ALL FAULTS AND WITHOUT WARRANTY OF ANY KIND, AND FORD MOTOR COMPANY HEREBY DISCLAIMS ALL WARRANTIES AND CONDITIONS WITH RESPECT TO THE SOFTWARE, THIRD PARTY SOFTWARE, AND THIRD-PARTY SERVICES, EITHER EXPRESS, IMPLIED OR STATUTORY, INCLUDING, BUT NOT LIMITED TO, THE IMPLIED WARRANTIES AND/OR CONDITIONS OF MERCHANTABILITY, OF SATISFACTORY QUALITY, OF FITNESS FOR AN PARTICULAR PURPOSE, OF ACCURACY, OF QUIET ENJOYMENT, AND NON-INFRINGEMENT OF THIRD-PARTY RIGHTS. FORD MOTOR COMPANY DOES NOT WARRANT (a) AGAINST INTERFERENCE WITH YOUR ENJOYMENT OF THE SOFTWARE, THIRD PARTY SOFTWARE, OR THIRD-PARTY SERVICES, (b) THAT THE SOFTWARE, THIRD PARTY SOFTWARE, OR THIRD-PARTY SERVICES WILL MEET YOUR REQUIREMENTS, (c) THAT THE OPERATION OF THE SOFTWARE, THIRD PARTY SOFTWARE, OR THIRD-PARTY SERVICES WILL BE UNINTERRUPTED OR ERROR-FREE, (d) OR THAT DEFECTS IN THE SOFTWARE, THIRD PARTY SOFTWARE, OR THIRD-PARTY SERVICES WILL BE CORRECTED. NO ORAL OR WRITTEN INFORMATION OR ADVICE GIVEN BY FORD MOTOR COMPANY OR ITS AUTHORIZED REPRESENTATIVE SHALL

Appendices

CREATE A WARRANTY. SHOULD THE SOFTWARE, THIRD PARTY SOFTWARE, OR THIRD-PARTY SERVICES PROVE DEFECTIVE, YOU ASSUME THE ENTIRE COST OF ALL NECESSARY SERVICING, REPAIR OR CORRECTION. SOME JURISDICTIONS DO NOT ALLOW THE DISCLAIMER OF IMPLIED WARRANTIES OR LIMITATIONS ON APPLICABLE STATUTORY RIGHTS OF A CONSUMER, SO THE ABOVE DISCLAIMER MAY NOT FULLY APPLY TO YOU. THE SOLE WARRANTY PROVIDED BY FORD MOTOR COMPANY SHALL BE FOUND IN THE WARRANTY INFORMATION INCLUDING WITH YOUR OWNER GUIDE. TO THE EXTENT THAT THERE IS ANY CONFLICT BETWEEN THE TERMS OF THIS SECTION AND THE WARRANTY BOOKLET, THE WARRANTY BOOKLET SHALL CONTROL.

Applicable Law, Venue, Jurisdiction

- The laws of the State of Michigan govern this EULA and Your use of the SOFTWARE. Your use of the SOFTWARE may also be subject to other local, state, national, or international laws. Any litigation arising out of or related to this EULA shall be brought and maintained exclusively in a court of the State of Michigan located in Wayne County or in the United States District Court for the Eastern District of Michigan. You hereby consent to submit to the personal jurisdiction of a court in the State of Michigan located in Wayne County and the United States District Court for the Eastern District of Michigan for any dispute arising out of or relating to this EULA.

Binding Arbitration and Class Action Waiver

(a) Application. This Section applies to any dispute EXCEPT IT DOES NOT INCLUDE A DISPUTE RELATING TO COPYRIGHT INFRINGEMENT, OR TO THE ENFORCEMENT OR VALIDITY OF YOUR, FORD MOTOR COMPANY, OR ANY OF FORD MOTOR COMPANY'S LICENSORS' INTELLECTUAL PROPERTY RIGHTS.

Dispute means any dispute, action, or other controversy between You and FORD MOTOR COMPANY, other than the exceptions listed above, concerning the SOFTWARE (including its price) or this EULA, whether in contract, warranty, tort, statute, regulation, ordinance, or any other legal or equitable basis.

(b) Notice of Dispute. In the event of a Dispute, You or FORD MOTOR COMPANY must give the other a "Notice of Dispute", which is a written statement of the name, address, and contact information of the party giving it, the facts giving rise to the dispute, and the relief requested. You and FORD MOTOR COMPANY will attempt to resolve any dispute through informal negotiation within 60 days from the date the Notice of Dispute is sent. After 60 days, You or FORD MOTOR COMPANY may commence arbitration.

(c) Small claims court. You may also litigate any dispute in small claims court in your county of residence or FORD MOTOR COMPANY'S principal place of business, if the dispute meets all requirements to be heard in the small claims court. You may litigate in small claims court whether or not You negotiated informally first.

(d) Binding arbitration. If You and FORD MOTOR COMPANY, do not resolve any dispute by informal negotiation or in small claims court, any other effort to resolve the dispute will be conducted exclusively by binding arbitration. You are giving up

Appendices

the right to litigate (or participate in as a party or class member) all disputes in court before a judge or jury. Instead, all disputes will be resolved before a neutral arbitrator, whose decision will be final except for a limited right of appeal under the Federal Arbitration Act. Any court with jurisdiction over the parties may enforce the arbitrator's award.

(e) Class action waiver. Any proceedings to resolve or litigate any dispute in any forum will be conducted solely on an individual basis. Neither you nor FORD MOTOR COMPANY, will seek to have any dispute heard as a class action, as a private attorney general action, or in any other proceeding in which any party acts or proposes to act in a representative capacity. No arbitration or proceeding will be combined with another without the prior written consent of all parties to all affected arbitrations or proceedings.

(f) Arbitration procedure. Any arbitration will be conducted by the American Arbitration Association (the "AAA"), under its Commercial Arbitration Rules. If You are an individual and use the SOFTWARE for personal or vehicle use, or if the value of the dispute is \$75,000 or less whether or not You are an individual or how You use the SOFTWARE, the AAA Supplementary Procedures for Consumer-Related Disputes will also apply. To commence arbitration, submit a Commercial Arbitration Rules Demand for Arbitration form to the AAA. You may request a telephonic or in-person hearing by following the AAA rules. In a dispute involving \$10,000 or less, any hearing will be telephonic unless the arbitrator finds good cause to hold an in-person hearing instead. For more information, see adr.org or call 1-800-778-7879. You agree to commence arbitration only in your county of residence or FORD MOTOR COMPANY'S principal place of business. The arbitrator

may award the same damages to You individually as a court could. The arbitrator may award declaratory or injunctive relief only to You individually, and only to the extent required to satisfy Your individual claim.

(g) Arbitration fees and incentives.

- I. Disputes involving \$75,000 or less. FORD MOTOR COMPANY will promptly reimburse your filing fees and pay the AAA's and arbitrator's fees and expenses. If you reject FORD MOTOR COMPANY'S last written settlement offer made before the arbitrator was appointed ("last written offer"), your dispute goes all the way to an arbitrator's decision (called an "award"), and the arbitrator awards you more than the last written offer, FORD MOTOR COMPANY will give you three incentives: (1) pay the greater of the award or \$1,000; (2) pay twice your reasonable attorney's fees, if any; and (3) reimburse any expenses (including expert witness fees and costs) that your attorney reasonably accrues for investigating, preparing, and pursuing your claim in arbitration. The arbitrator will determine the amounts.
- ii. Disputes involving more than \$75,000. The AAA rules will govern payment of filing fees and the AAA's and arbitrator's fees and expenses.
- iii. Disputes involving any amount. In any arbitration you commence, FORD MOTOR COMPANY will seek its AAA or arbitrator's fees and expenses, or Your filing fees it reimbursed, only if the arbitrator finds the arbitration frivolous or brought for an improper purpose. In any arbitration FORD MOTOR COMPANY commences, it will pay all

Appendices

filing, AAA, and arbitrator's fees and expenses. It will not seek its attorney's fees or expenses from you in any arbitration. Fees and expenses are not counted in determining how much a dispute involves.

(h) Claims or disputes must be filed within one year. To the extent permitted by law, any claim or dispute under this EULA to which this Section applies must be filed within one year in small claims court (Section c) or in arbitration (Section d). The one-year period begins when the claim or dispute first could be filed. If such a claim or dispute is not filed within one year, it is permanently barred.

(i) Severability. If the class action waiver (Section e) is found to be illegal or unenforceable as to all or some parts of a dispute, then that portion of Section e will not apply to those parts. Instead, those parts will be severed and proceed in a court of law, with the remaining parts proceeding in arbitration. If any other provision of that portion Section e is found to be illegal or unenforceable, that provision will be severed with the remainder of Section e remaining in full force and effect.

Telenav Software End User License Agreement

Please read these terms and conditions carefully before you use the TeleNav Software. Your use of the TeleNav Software indicates that you accept these terms and conditions. If you do not accept these terms and conditions, do not break the seal of the package, launch, or otherwise use the TeleNav Software. TeleNav may revise this Agreement and the privacy policy at any time, with or without notice to you. You agree to visit <http://www.telenav.com> from time to time to review the then current version of this Agreement and of the privacy policy.

1. Safe and Lawful Use

You acknowledge that devoting attention to the TeleNav Software may pose a risk of injury or death to you and others in situations that otherwise require your undivided attention, and you therefore agree to comply with the following when using the TeleNav Software:

- (a) observe all traffic laws and otherwise drive safely;
 - (b) use your own personal judgment while driving. If you feel that a route suggested by the TeleNav Software instructs you to perform an unsafe or illegal maneuver, places you in an unsafe situation, or directs you into an area that you consider to be unsafe, do not follow such instructions;
 - (c) do not input destinations, or otherwise manipulate the TeleNav Software, unless your vehicle is stationary and parked;
 - (d) do not use the TeleNav Software for any illegal, unauthorized, unintended, unsafe, hazardous, or unlawful purposes, or in any manner inconsistent with this Agreement;
 - (e) arrange all GPS and wireless devices and cables necessary for use of the TeleNav Software in a secure manner in your vehicle so that they will not interfere with your driving and will not prevent the operation of any safety device (such as an airbag).
- You agree to indemnify and hold TeleNav harmless against all claims resulting from any dangerous or otherwise inappropriate use of the TeleNav Software in any moving vehicle, including as a result of your failure to comply with the directions above.

Appendices

2. Account Information

You agree: (a) when registering the TeleNav Software, to provide TeleNav with true, accurate, current, and complete information about yourself, and (b) to inform TeleNav promptly of any changes to such information, and to keep it true, accurate, current and complete.

3. Software License

- Subject to your compliance with the terms of this Agreement, TeleNav hereby grants to you a personal, non-exclusive, non-transferable license (except as expressly permitted below in connection with your permanent transfer of the TeleNav Software license), without the right to sublicense, to use the TeleNav Software (in object code form only) in order to access and use the TeleNav Software. This license shall terminate upon any termination or expiration of this Agreement. You agree that you will use the TeleNav Software only for your personal business or leisure purposes, and not to provide commercial navigation services to other parties.

3.1 License Limitations

- **(a)** reverse engineer, decompile, disassemble, translate, modify, alter or otherwise change the TeleNav Software or any part thereof; **(b)** attempt to derive the source code, audio library or structure of the TeleNav Software without the prior express written consent of TeleNav; **(c)** remove from the TeleNav Software, or alter, any of TeleNav's or its suppliers' trademarks, trade names, logos, patent or copyright notices, or other notices or markings; **(d)**

distribute, sublicense or otherwise transfer the TeleNav Software to others, except as part of your permanent transfer of the TeleNav Software; or **(e)** use the TeleNav Software in any manner that

- i. infringes the intellectual property or proprietary rights, rights of publicity or privacy or other rights of any party,
- ii. violates any law, statute, ordinance or regulation, including but not limited to laws and regulations related to spamming, privacy, consumer and child protection, obscenity or defamation, or
- iii. is harmful, threatening, abusive, harassing, tortuous, defamatory, vulgar, obscene, libelous, or otherwise objectionable; and (f) lease, rent out, or otherwise permit unauthorized access by third parties to the TeleNav Software without advanced written permission of TeleNav.

4. Disclaimers

- To the fullest extent permissible pursuant to applicable law, in no event will TeleNav, its licensors and suppliers, or agents or employees of any of the foregoing, be liable for any decision made or action taken by you or anyone else in reliance on the information provided by the TeleNav Software. TeleNav also does not warrant the accuracy of the map or other data used for the TeleNav Software. Such data may not always reflect reality due to, among other things, road closures, construction, weather, new roads and other changing conditions. You are responsible for the entire risk arising out of your use of the TeleNav Software. For example but without limitation, you agree not to rely on the TeleNav Software for critical navigation in areas where the well-being or survival of you or others

Appendices

is dependent on the accuracy of navigation, as the maps or functionality of the TeleNav Software are not intended to support such high risk applications, especially in more remote geographical areas.

- TELENAV EXPRESSLY DISCLAIMS AND EXCLUDES ALL WARRANTIES IN CONNECTION WITH THE TELENAV SOFTWARE, WHETHER STATUTORY, EXPRESS OR IMPLIED, INCLUDING ALL WARRANTIES WHICH MAY ARISE FROM COURSE OF DEALING, CUSTOM OR TRADE AND INCLUDING, BUT NOT LIMITED TO, THE IMPLIED WARRANTIES OF MERCHANTABILITY, FITNESS FOR A PARTICULAR PURPOSE AND NON-INFRINGEMENT OF THIRD PARTY RIGHTS WITH RESPECT TO THE TELENAV SOFTWARE.
- Certain jurisdictions do not permit the disclaimer of certain warranties, so this limitation may not apply to you.

5. Limitation of Liability

- TO THE EXTENT PERMITTED UNDER APPLICABLE LAW, UNDER NO CIRCUMSTANCES SHALL TELENAV OR ITS LICENSORS AND SUPPLIERS BE LIABLE TO YOU OR TO ANY THIRD PARTY FOR ANY INDIRECT, INCIDENTAL, CONSEQUENTIAL, SPECIAL OR EXEMPLARY DAMAGES (INCLUDING IN EACH CASE, BUT NOT LIMITED TO, DAMAGES FOR THE INABILITY TO USE THE EQUIPMENT OR ACCESS DATA, LOSS OF DATA, LOSS OF BUSINESS, LOSS OF PROFITS, BUSINESS INTERRUPTION OR THE LIKE) ARISING OUT OF THE USE OF OR INABILITY TO USE THE TELENAV SOFTWARE, EVEN IF TELENAV HAS BEEN ADVISED OF THE POSSIBILITY OF SUCH DAMAGES. NOTWITHSTANDING ANY DAMAGES THAT YOU MIGHT INCUR FOR ANY

REASON WHATSOEVER (INCLUDING, WITHOUT LIMITATION, ALL DAMAGES REFERENCED HEREIN AND ALL DIRECT OR GENERAL DAMAGES IN CONTRACT, TORT (INCLUDING NEGLIGENCE) OR OTHERWISE), THE ENTIRE LIABILITY OF TELENAV AND OF ALL OF TELENAV'S SUPPLIERS SHALL BE LIMITED TO THE AMOUNT ACTUALLY PAID BY YOU FOR THE TELENAV SOFTWARE. SOME STATES AND/OR JURISDICTIONS DO NOT ALLOW THE EXCLUSION OR LIMITATION OF INCIDENTAL OR CONSEQUENTIAL DAMAGES, SO THE ABOVE LIMITATIONS OR EXCLUSIONS MAY NOT APPLY TO YOU.

6. Arbitration and Governing Law

- You agree that any dispute, claim or controversy arising out of or relating to this Agreement or the TeleNav Software shall be settled by independent arbitration involving a neutral arbitrator and administered by the American Arbitration Association in the County of Santa Clara, California. The arbitrator shall apply the Commercial Arbitration Rules of the American Arbitration Association, and the judgment upon the award rendered by the arbitrator may be entered by any court having jurisdiction. Note that there is no judge or jury in an arbitration proceeding and the decision of the arbitrator shall be binding upon both parties. You expressly agree to waive your right to a jury trial. This Agreement and performance hereunder will be governed by and construed in accordance with the laws of the State of California, without giving effect to its conflict of law provisions. To the extent judicial action is necessary in connection with the binding arbitration, both TeleNav and you agree to submit

Appendices

to the exclusive jurisdiction of the courts of the County of Santa Clara, California. The United Nations Convention on Contracts for the International Sale of Goods shall not apply.

7. Assignment

- You may not resell, assign, or transfer this Agreement or any of your rights or obligations, except in totality, in connection with your permanent transfer of the TeleNav Software, and expressly conditioned upon the new user of the TeleNav Software agreeing to be bound by the terms and conditions of this Agreement. Any such sale, assignment or transfer that is not expressly permitted under this paragraph will result in immediate termination of this Agreement, without liability to TeleNav, in which case you and all other parties shall immediately cease all use of the TeleNav Software. Notwithstanding the foregoing, TeleNav may assign this Agreement to any other party at any time without notice, provided the assignee remains bound by this Agreement.

8. Miscellaneous

8.1

This Agreement constitutes the entire agreement between TeleNav and you with respect to the subject matter hereof.

8.2

Except for the limited licenses expressly granted in this Agreement, TeleNav retains all right, title and interest in and to the TeleNav Software, including without limitation all related intellectual property rights. No licenses or other rights which are not expressly granted in this Agreement are intended to, or shall be, granted or

conferred by implication, statute, inducement, estoppel or otherwise, and TeleNav and its suppliers and licensors hereby reserve all of their respective rights other than the licenses explicitly granted in this Agreement.

8.3

By using the TeleNav Software, you consent to receive from TeleNav all communications, including notices, agreements, legally required disclosures or other information in connection with the TeleNav Software (collectively, "Notices") electronically. TeleNav may provide such Notices by posting them on TeleNav's Website or by downloading such Notices to your wireless device. If you desire to withdraw your consent to receive Notices electronically, you must discontinue your use of the TeleNav Software.

8.4

TeleNav's or your failure to require performance of any provision shall not affect that party's right to require performance at any time thereafter, nor shall a waiver of any breach or default of this Agreement constitute a waiver of any subsequent breach or default or a waiver of the provision itself.

8.5

If any provision herein is held unenforceable, then such provision will be modified to reflect the intention of the parties, and the remaining provisions of this Agreement will remain in full force and effect.

Appendices

8.6

The headings in this Agreement are for convenience of reference only, will not be deemed to be a part of this Agreement, and will not be referred to in connection with the construction or interpretation of this Agreement. As used in this Agreement, the words "include" and "including" and variations thereof, will not be deemed to be terms of limitation, but rather will be deemed to be followed by the words "without limitation".

9. Other Vendors Terms and Conditions

- The Telenav Software utilizes map and other data licensed to Telenav by third party vendors for the benefit of you and other end users. This Agreement includes end-user terms applicable to these companies (included at the end of this Agreement), and thus your use of the Telenav Software is also subject to such terms. You agree to comply with the following additional terms and conditions, which are applicable to Telenav's third party vendor licensors::

9.1 End User Terms Required by HERE North America, LLC

The data ("Data") is provided for your personal, internal use only and not for resale. It is protected by copyright, and is subject to the following terms and conditions which are agreed to by you, on the one hand, and Telenav ("Telenav") and its licensors (including their licensors and suppliers) on the other hand.

© 2013 HERE. All rights reserved.

The Data for areas of Canada includes information taken with permission from Canadian authorities, including: © Her Majesty the Queen in Right of Canada, © Queen's Printer for Ontario, © Canada Post Corporation, GeoBase®, © Department of Natural Resources Canada.

HERE holds a non-exclusive license from the United States Postal Service® to publish and sell ZIP+4® information.

©United States Postal Service® 2014. Prices are not established, controlled or approved by the United States Postal Service®. The following trademarks and registrations are owned by the USPS: United States Postal Service, USPS, and ZIP+4

The Data for Mexico includes certain data from Instituto Nacional de Estadística y Geografía.

9.2 End User Terms Required by NAV2 (Shanghai) Co., Ltd

The data ("Data") is provided for your personal, internal use only and not for resale. It is protected by copyright, and is subject to the following terms and conditions which are agreed to by you, on the one hand, and NAV2 (Shanghai) Co., Ltd ("NAV2") and its licensors (including their licensors and suppliers) on the other hand. 20xx. All rights reserved

Terms and Conditions

Permitted Use. You agree to use this Data together with the Telenav Software solely for the internal business and personal purposes for which you were licensed, and not for service bureau, time-sharing or other similar purposes. Accordingly, but subject to the restrictions set forth in the following paragraphs, you agree not to otherwise reproduce, copy, modify, decompile, disassemble, create any derivative works of, or reverse engineer any portion of this Data, and may not transfer or distribute it in any form, for any purpose, except to the extent permitted by mandatory laws.

Appendices

Restrictions. Except where you have been specifically licensed to do so by Telenav, and without limiting the preceding paragraph, you may not use this Data (a) with any products, systems, or applications installed or otherwise connected to or in communication with vehicles, capable of vehicle navigation, positioning, dispatch, real time route guidance, fleet management or similar applications; or (b) with or in communication with any positioning devices or any mobile or wireless-connected electronic or computer devices, including without limitation cellular phones, palmtop and handheld computers, pagers, and personal digital assistants or PDAs.

Warning. The Data may contain inaccurate or incomplete information due to the passage of time, changing circumstances, sources used and the nature of collecting comprehensive geographic data, any of which may lead to incorrect results.

No Warranty. This Data is provided to you “as is,” and you agree to use it at your own risk. Telenav and its licensors (and their licensors and suppliers) make no guarantees, representations or warranties of any kind, express or implied, arising by law or otherwise, including but not limited to, content, quality, accuracy, completeness, effectiveness, reliability, fitness for a particular purpose, usefulness, use or results to be obtained from this Data, or that the Data or server will be uninterrupted or error-free.

Disclaimer of Warranty: TELENAV AND ITS LICENSORS (INCLUDING THEIR LICENSORS AND SUPPLIERS) DISCLAIM ANY WARRANTIES, EXPRESS OR IMPLIED, OF QUALITY, PERFORMANCE, MERCHANTABILITY, FITNESS FOR A

PARTICULAR PURPOSE OR NON-INFRINGEMENT. Some States, Territories and Countries do not allow certain warranty exclusions, so to that extent the above exclusion may not apply to you.

Disclaimer of Liability: TELENAV AND ITS LICENSORS (INCLUDING THEIR LICENSORS AND SUPPLIERS) SHALL NOT BE LIABLE TO YOU: IN RESPECT OF ANY CLAIM, DEMAND OR ACTION, IRRESPECTIVE OF THE NATURE OF THE CAUSE OF THE CLAIM, DEMAND OR ACTION ALLEGING ANY LOSS, INJURY OR DAMAGES, DIRECT OR INDIRECT, WHICH MAY RESULT FROM THE USE OR POSSESSION OF THE INFORMATION; OR FOR ANY LOSS OF PROFIT, REVENUE, CONTRACTS OR SAVINGS, OR ANY OTHER DIRECT, INDIRECT, INCIDENTAL, SPECIAL OR CONSEQUENTIAL DAMAGES ARISING OUT OF YOUR USE OF OR INABILITY TO USE THIS INFORMATION, ANY DEFECT IN THE INFORMATION, OR THE BREACH OF THESE TERMS OR CONDITIONS, WHETHER IN AN ACTION IN CONTRACT OR TORT OR BASED ON A WARRANTY, EVEN IF TELENAV OR ITS LICENSORS HAVE BEEN ADVISED OF THE POSSIBILITY OF SUCH DAMAGES. Some States, Territories and Countries do not allow certain liability exclusions or damages limitations, so to that extent the above may not apply to you.

Export Control. You shall not export from anywhere any part of the Data or any direct product thereof except in compliance with, and with all licenses and approvals required under, applicable export laws, rules and regulations, including but not limited to the laws, rules and regulations administered by the Office of Foreign Assets Control of the U.S. Department of Commerce and the Bureau of Industry and Security of the U.S. Department of Commerce. To the extent that any such

Appendices

export laws, rules or regulations prohibit HERE from complying with any of its obligations hereunder to deliver or distribute Data, such failure shall be excused and shall not constitute a breach of this Agreement.

Entire Agreement. These terms and conditions constitute the entire agreement between Telenav (and its licensors, including their licensors and suppliers) and you pertaining to the subject matter hereof, and supersedes in their entirety any and all written or oral agreements previously existing between us with respect to such subject matter.

Governing Law. The above terms and conditions shall be governed by the laws of the State of Illinois [insert "Netherlands" where European HERE Data is used], without giving effect to (i) its conflict of laws provisions, or (ii) the United Nations Convention for Contracts for the International Sale of Goods, which is explicitly excluded. You agree to submit to the jurisdiction of the State of Illinois [insert "The Netherlands" where European HERE Data is used] for any and all disputes, claims and actions arising from or in connection with the Data provided to you hereunder.

Government End Users. If the Data is being acquired by or on behalf of the United States government or any other entity seeking or applying rights similar to those customarily claimed by the United States government, this Data is a "commercial item" as that term is defined at 48 C.F.R. ("FAR") 2.101, is licensed in accordance with these End-User Terms, and each copy of Data delivered or otherwise furnished shall be marked and embedded as appropriate with the following "Notice of Use," and shall be treated in accordance with such Notice:

NOTICE OF USE
CONTRACTOR (MANUFACTURER/SUPPLIER) NAME: HERE
CONTRACTOR (MANUFACTURER/SUPPLIER) ADDRESS: c/o Nokia, 425 West Randolph Street, Chicago, Illinois 60606
This Data is a commercial item as defined in FAR 2.101 and is subject to these End-User Terms under which this Data was provided.
© 1987 – 2014 HERE – All rights reserved.

If the Contracting Officer, federal government agency, or any federal official refuses to use the legend provided herein, the Contracting Officer, federal government agency, or any federal official must notify HERE prior to seeking additional or alternative rights in the Data.

I. US/Canada Territory

A. United States Data. The End-User Terms for any Application containing Data for the United States shall contain the following notices:

"HERE holds a non-exclusive license from the United States Postal Service® to publish and sell ZIP+4® information."

"©United States Postal Service® 20XX. Prices are not established, controlled or approved by the United States Postal Service®. The following trademarks and registrations are owned by the USPS: United States Postal Service, USPS, and ZIP+4."

Appendices

B. Canada Data. The following provisions apply to the Data for Canada, which may include or reflect data from third party licensors (“Third Party Data”), including Her Majesty the Queen in Right of Canada (“Her Majesty”), Canada Post Corporation (“Canada Post”) and the Department of Natural Resources of Canada (“NRCan”):

1. Disclaimer and Limitation: Client agrees that its use of the Third Party Data is subject to the following provisions:

a. Disclaimer: The Third Party Data is licensed on an “as is” basis. The licensors of such data, including Her Majesty, Canada Post and NRCan, make no guarantees, representations or warranties respecting such data, either express or implied, arising by law or otherwise, including but not limited to, effectiveness, completeness, accuracy or fitness for a particular purpose.

b. Limitation on Liability: The Third Party Data licensors, including Her Majesty, Canada Post and NRCan, shall not be liable: (i) in respect of any claim, demand or action, irrespective of the nature of the cause of the claim, demand or action alleging any loss, injury or damages, direct or indirect, which may result from the use or possession of such Data; or (ii) in any way for loss of revenues or contracts, or any other consequential loss of any kind resulting from any defect in the Data.

2. Copyright Notice: In connection with each copy of all or any portion of the Data for the Territory of Canada, Client shall affix in a conspicuous manner the following copyright notice on at least one of: (i) the label for the storage media of the copy; (ii) the packaging for the copy; or (iii) other materials packaged with the copy, such as user manuals or end user license agreements: “This data includes information taken with permission from Canadian authorities, including © Her Majesty the Queen in Right of Canada, © Queen’s Printer for Ontario, © Canada Post Corporation, GeoBase®, © The Department of Natural Resources Canada. All rights reserved.”

3. End-User Terms: Except as otherwise agreed by the parties, in connection with the provision of any portion of the Data for the Territory of Canada to End-Users as may be authorized under the Agreement, Client shall provide such End-Users, in a reasonably conspicuous manner, with terms (set forth with other end user terms required to be provided under the Agreement, or as otherwise may be provided, by Client) which shall include the following provisions on behalf of the Third Party Data licensors, including Her Majesty, Canada Post and NRCan:

The Data may include or reflect data of licensors, including Her Majesty the Queen in the Right of Canada (“Her Majesty”), Canada Post Corporation (“Canada Post”) and the Department of Natural Resources Canada (“NRCan”). Such data is licensed on an “as is” basis. The licensors, including Her Majesty, Canada Post and NRCan, make no guarantees, representations or warranties respecting such data,

Appendices

either express or implied, arising by law or otherwise, including but not limited to, effectiveness, completeness, accuracy or fitness for a particular purpose. The licensors, including Her Majesty, Canada Post and NRCan, shall not be liable in respect of any claim, demand or action, irrespective of the nature of the cause of the claim, demand or action alleging any loss, injury or damages, direct or indirect, which may result from the use or possession of the data or the Data. The licensors, including Her Majesty, Canada Post and NRCan, shall not be liable in any way for loss of revenues or contracts, or any other consequential loss of any kind resulting from any defect in the data or the Data.

End User shall indemnify and save harmless the licensors, including Her Majesty, Canada Post and NRCan, and their officers, employees and agents from and against any claim, demand or action, irrespective of the nature of the cause of the claim, demand or action, alleging loss, costs, expenses, damages or injuries (including injuries resulting in death) arising out of the use or possession of the data or the Data.

4. Additional Provisions: The terms contained in this Section are in addition to all of the rights and obligations of the parties under the Agreement. To the extent that any of the provisions of this Section are inconsistent with, or conflict with, any other provisions of the Agreement, the provisions of this Section shall prevail.

II. Mexico. The following provision applies to the Data for Mexico, which includes certain data from the Instituto Nacional de Estadística y Geografía (“INEGI”):

A. Any and all copies of the Data and/or packaging containing Data for Mexico shall contain the following notice: “Fuente: INEGI (Instituto Nacional de Estadística y Geografía)”

III. Latin America Territory

A. Third Party Notices. Any and all copies of the Data and/or packaging relating thereto shall include the respective Third Party Notices set forth below and used as described below corresponding to the Territory (or portion thereof) included in such copy:

Territory	Notice
Argentina	IGN “INSTITUTO GEOGRAFICO NACIONAL ARGENTINO”
Ecuador	“INSTITUTO GEOGRAFICO MILITAR DEL ECUADOR AUTORIZACION N° IGM-2011-01- PCO-01 DEL 25 DE ENERO DE 2011” “source: © IGN 2009 - BD TOPO ®”
Guadeloupe, French Guiana and Martinique Mexico	“Fuente: INEGI (Instituto Nacional de Estadística y Geografía)”

IV. Middle East Territory

Appendices

A. Third Party Notices. Any and all copies of the Data and/or packaging relating thereto shall include the respective Third Party Notices set forth below and used as described below corresponding to the Territory (or portion thereof) included in such copy:

Country	Notice
Jordan	“© Royal Jordanian Geographic Centre”. The foregoing notice requirement for Jordan Data is a material term of the Agreement. If Client or any of its permitted sublicensees (if any) fail to meet such requirement, HERE shall have the right to terminate Client’s license with respect to the Jordan Data.

B. Jordan Data. Client and its permitted sublicensees (if any) are restricted from licensing and/or otherwise distributing HERE’s database for the country of Jordan (“Jordan Data”) for use in Enterprise Applications to (i) non-Jordanian entities for use of the Jordan Data solely in Jordan or (ii) Jordan-based customers. In addition, Client, its permitted sublicensees (if any) and End-Users are restricted from using the Jordan Data in Enterprise Applications if such party is (i) a non-Jordanian entity using the Jordan Data solely in Jordan or (ii) a Jordan-based customer. For purposes of the foregoing, “Enterprise Applications” shall mean Geomarketing applications, GIS applications, mobile business asset management applications, call center applications, telematics applications, public organization Internet applications or for providing geocoding services.

V. Europe Territory

A. Use of Certain Traffic Codes in Europe

1. General Restrictions Applicable to Traffic Codes. Client acknowledges and agrees that in certain countries of the Europe Territory, Client will need to obtain rights directly from third party RDS-TMC code providers to receive and use the Traffic Codes in the Data and to deliver to End-Users Transactions in any way derived from or based on such Traffic Codes. For such countries, HERE shall deliver the Data incorporating Traffic Codes to Client only after receiving certification from Client of its having obtained such rights.

2. Display of Third Party Rights Legends for Belgium. Client shall, for each Transaction that uses Traffic Codes for Belgium, provide the following notice to the End-User: “Traffic Codes for Belgium are provided by the Ministerie van de Vlaamse Gemeenschap and the Ministère de l’Equipeement et des Transports.”

B. Paper Maps. With respect to any license granted to Client relating to making, selling or distributing paper maps (i.e., a map fixed on a paper or paper-like medium): (a) such license with respect to Data for the Territory of Great Britain is conditioned on Client’s entering into and complying with a separate written agreement with the Ordnance Survey (“OS”) to create and sell paper maps, Client’s paying to the OS any and all applicable paper map royalties, and Client’s complying with the OS copyright notice requirements; (b) such license for selling or otherwise distributing for charge with respect to Data for the Territory of Czech Republic

Appendices

is conditioned on Client's obtaining prior written consent from Kartografie a.s.; (c) such license for selling or distributing with respect to Data for the Territory of Switzerland is conditioned on Client's obtaining a permit from Bundesamt für Landestopografie of Switzerland; (d) Client is restricted from using Data for the Territory of France to create paper maps with a scale between 1:5,000 and 1:250,000; and (e) Client is restricted from using any Data to create, sell or distribute paper maps that are the same or substantially similar, in terms of data content and specific use of color, symbols and scale, to paper maps published by the European national mapping agencies, including without limitation, Landervermessungämter of Germany, Topografische Dienst of the Netherlands, Nationaal Geografisch Instituut of Belgium, Bundesamt für Landestopografie of Switzerland, Bundesamt für Eich-und Vermessungswesen of Austria, and the National Land Survey of Sweden.

C. OS Enforcement. Without limiting Section IV(B) above, with respect to Data for the Territory of Great Britain, Client acknowledges and agrees that the Ordnance Survey ("OS") may bring a direct action against Client to enforce compliance with the OS copyright notice (see Section IV(D) below) and paper map requirements (see Section IV(B) above) contained in this Agreement.

D. Third Party Notices. Any and all copies of the Data and/or packaging relating thereto shall include the respective Third Party Notices set forth below and used as described below corresponding to the Territory (or portion thereof) included in such copy:

Country(ies) Notice

Austria	"© Bundesamt für Eich-und Vermessungswesen"
Croatia Cyprus, Estonia, Latvia, Lithuania, Moldova, Poland, Slovenia and/or Ukraine	"© EuroGeographics"
France	"source: © IGN 2009 – BD TOPO ®"
Germany	"Die Grundlagendaten wurden mit Genehmigung der zuständigen Behörden entnommen"
Great Britain	"Contains Ordnance Survey data © Crown copyright and database right 2010 Contains Royal Mail data © Royal Mail copyright and database right 2010"
Greece	"Copyright Geomatics Ltd."
Hungary	"Copyright © 2003; Top-Map Ltd."
Italy	"La Banca Dati Italiana è stata prodotta usando quale riferimento anche cartografia numerica ed al tratto prodotta e fornita dalla Regione Toscana."
Norway	"Copyright © 2000; Norwegian Mapping Authority"
Portugal	"Source: IgeoE – Portugal"

Appendices

Spain "Información geográfica propiedad del CNIG"

Sweden "Based upon electronic data © National Land Survey Sweden."

Switzerland "Topografische Grundlage: © Bundesamt für Landestopographie."

E. Respective Country Distribution. Client acknowledges that HERE has not received approvals to distribute map data for the following countries in such respective countries: Albania, Belarus, Kyrgyzstan, Moldova and Uzbekistan. HERE may update such list from time to time. The license rights granted to Client under this TL with respect to the Data for such countries are contingent upon Client's compliance with all applicable laws and regulations, including, without limitation, any required licenses or approvals to distribute the Application incorporating such Data in such respective countries.

VI. Australia Territory

A. Third Party Notices. Any and all copies of the Data and/or packaging relating thereto shall include the respective Third Party Notices set forth below and used as described below corresponding to the Territory (or portion thereof) included in such copy:

Copyright. Based on data provided under license from PSMA Australia Limited (www.pasma.com.au).

Product incorporates data which is © 20XX Telstra Corporation Limited, GM Holden Limited, Intelomatics Australia Pty Ltd and Continental Pty Ltd.

B. Third Party Notices for Australia. In addition to the foregoing, the End-User Terms for any Application containing RDS-TMC Traffic Codes for Australia shall contain the following notice: "Product incorporates traffic location codes which is © 20XX Telstra Corporation Limited and its licensors."

AT&T Vehicle Network Carrier Telematics Disclosure

END USER FOR PURPOSES OF THIS SECTION MEANS YOU AND YOUR HEIRS, EXECUTORS, LEGAL PERSONAL REPRESENTATIVES AND PERMITTED ASSIGNS. FOR PURPOSES OF THIS SECTION "UNDERLYING WIRELESS SERVICE CARRIER" INCLUDES ITS AFFILIATES AND CONTRACTORS AND THEIR RESPECTIVE OFFICERS, DIRECTORS, EMPLOYEES, SUCCESSORS AND ASSIGNS. END USER HAS NO CONTRACTUAL RELATIONSHIP WITH THE UNDERLYING WIRELESS SERVICE CARRIER AND END USER IS NOT A THIRD PARTY BENEFICIARY OF ANY AGREEMENT BETWEEN FORD AND UNDERLYING CARRIER. END USER UNDERSTANDS AND AGREES THAT THE UNDERLYING CARRIER HAS NO LEGAL, EQUITABLE, OR OTHER LIABILITY OF ANY KIND TO END USER. IN ANY EVENT, REGARDLESS OF THE FORM OF THE ACTION, WHETHER FOR BREACH OF CONTRACT, WARRANTY, NEGLIGENCE, STRICT LIABILITY IN TORT OR OTHERWISE, END USER'S EXCLUSIVE REMEDY FOR CLAIMS ARISING IN ANY WAY IN CONNECTION WITH THIS AGREEMENT, FOR ANY CAUSE WHATSOEVER, INCLUDING BUT NOT LIMITED TO ANY FAILURE OR

Appendices

DISRUPTION OF SERVICE PROVIDED HEREUNDER, IS LIMITED TO PAYMENT OF DAMAGES IN AN AMOUNT NOT TO EXCEED THE AMOUNT PAID BY END USER FOR THE SERVICES DURING THE TWO-MONTH PERIOD PRECEDING THE DATE THE CLAIM AROSE.

(ii) END USER AGREES TO INDEMNIFY AND HOLD HARMLESS THE UNDERLYING WIRELESS SERVICE CARRIER AND ITS OFFICERS, EMPLOYEES, AND AGENTS AGAINST ANY AND ALL CLAIMS, INCLUDING WITHOUT LIMITATION CLAIMS FOR LIBEL, SLANDER, OR ANY PROPERTY DAMAGE, PERSONAL INJURY OR DEATH, ARISING IN ANY WAY, DIRECTLY OR INDIRECTLY, IN CONNECTION WITH THIS AGREEMENT OR THE USE, FAILURE TO USE, OR INABILITY TO USE THE DEVICE EXCEPT WHERE THE CLAIMS RESULT FROM THE UNDERLYING CARRIER'S GROSS NEGLIGENCE OR WILLFUL MISCONDUCT. THIS INDEMNITY WILL SURVIVE THE TERMINATION OF THE AGREEMENT.

(iii) END USER HAS NO PROPERTY RIGHT IN ANY NUMBER ASSIGNED TO THE DEVICE.

(iv) END USER UNDERSTANDS THAT FORD AND THE UNDERLYING CARRIER CANNOT GUARANTY THE SECURITY OF WIRELESS TRANSMISSIONS, AND WILL NOT BE LIABLE FOR ANY LACK OF SECURITY RELATING TO THE USE OF THE SERVICES

THE SERVICE IS FOR [END USER'S] USE ONLY AND END USER MAY NOT RESELL THE SERVICE TO ANY OTHER PARTY END USER UNDERSTANDS THAT THE UNDERLYING CARRIER DOES NOT GUARANTEE ANY END USER UNINTERRUPTED SERVICE OR COVERAGE. THE UNDERLYING CARRIER DOES NOT WARRANT THAT END USERS CAN OR WILL BE LOCATED USING THE SERVICE. THE UNDERLYING CARRIER

MAKES NO WARRANTY, EXPRESS OR IMPLIED, OF MERCHANTABILITY OR FITNESS FOR A PARTICULAR PURPOSE, SUITABILITY, OR PERFORMANCE REGARDING ANY SERVICES OR GOODS, AND IN NO EVENT SHALL AT&T BE LIABLE, WHETHER OR NOT DUE TO ITS OWN NEGLIGENCE, FOR ANY: (A) ACT OR OMISSION OF A THIRD PARTY; (B) MISTAKES, OMISSIONS, INTERRUPTIONS, ERRORS, FAILURES TO TRANSMIT, DELAYS, OR DEFECTS IN THE SERVICE PROVIDED BY OR THROUGH THE UNDERLYING CARRIER; (C) DAMAGE OR INJURY CAUSED BY SUSPENSION OR TERMINATION BY THE UNDERLYING CARRIER; OR (D) DAMAGE OR INJURY CAUSED BY A FAILURE OR DELAY IN CONNECTING A CALL TO ANY ENTITY, INCLUDING 911 OR ANY OTHER EMERGENCY SERVICE. TO THE FULL EXTENT ALLOWED BY LAW, THE END USER RELEASES, INDEMNIFIES AND HOLDS THE UNDERLYING CARRIER HARMLESS FROM AND AGAINST ANY AND ALL CLAIMS OF ANY PERSON OR ENTITY FOR DAMAGES OF ANY NATURE ARISING IN ANY WAY FROM OR RELATING TO, DIRECTLY OR INDIRECTLY, SERVICES PROVIDED BY THE UNDERLYING CARRIER OR ANY PERSON'S USE THEREOF, INCLUDING CLAIMS ARISING IN WHOLE OR IN PART FROM THE ALLEGED NEGLIGENCE OF THE UNDERLYING CARRIER.

VII. China Territory

Personal Use Only

You agree to use this Data together with [insert name of Client Application] for the solely personal, non-commercial purposes for which you were licensed, and not for service bureau, time-sharing or other similar purposes. Accordingly, but subject to the restrictions set forth in the following paragraphs, you may copy this Data only as necessary for your personal use to (i)

Appendices

view it, and (ii) save it, provided that you do not remove any copyright notices that appear and do not modify the Data in any way. You agree not to otherwise reproduce, copy, modify, decompile, disassemble or reverse engineer any portion of this Data, and may not transfer or distribute it in any form, for any purpose, except to the extent permitted by mandatory laws.

Restrictions

Except where you have been specifically licensed to do so by NAV2, and without limiting the preceding paragraph, you may not (a) use this Data with any products, systems, or applications installed or otherwise connected to or in communication with vehicles, capable of vehicle navigation, positioning, dispatch, real time route guidance, fleet management or similar applications; or (b) with or in communication with any positioning devices or any mobile or wireless-connected electronic or computer devices, including without limitation cellular phones, palmtop and handheld computers, pagers, and personal digital assistants or PDAs. You agree to cease using this Data if you fail to comply with these terms and conditions.

Limited Warranty

NAV2 warrants that (a) the Data will perform substantially in accordance with the accompanying written materials for a period of ninety (90) days from the date of receipt, and (b) any support services provided by NAV2 shall be substantially as described in applicable written materials provided to you by NAV2, and NAV2's support engineers will make commercially reasonable efforts to solve any problem issues.

rigCustomer Remedies

NAV2 and its suppliers' entire liability and your exclusive remedy shall be, at NAV2's sole discretion, either (a) return of the price paid, if any, or (b) repair or replacement of the Data that do not meet NAV2's Limited Warranty and that are returned to NAV2 with a copy of your receipt. This Limited Warranty is void if failure of the Data has resulted from accident, abuse, or misapplication. Any replacement Data will be warranted for the remainder of the original warranty period or thirty (30) days, whichever is longer. Neither these remedies nor any product support services offered by NAV2 are available without proof of purchase from an authorized international source.

No Other Warranty:

EXCEPT FOR THE LIMITED WARRANTY SET FORTH ABOVE AND TO THE EXTENT PERMITTED BY APPLICABLE LAW, NAV2 AND ITS LICENSORS (INCLUDING THEIR LICENSORS AND SUPPLIERS) DISCLAIM ANY WARRANTIES, EXPRESS OR IMPLIED, OF QUALITY, PERFORMANCE, MERCHANTABILITY, FITNESS FOR A PARTICULAR PURPOSE, OWNERSHIP OR NON-INFRINGEMENT. Certain warranty exclusions may not be permitted under applicable law, so to that extent the above exclusion may not apply to you.

Limited Liability:

TO THE EXTENT PERMITTED BY APPLICABLE LAW, NAV2 AND ITS LICENSORS (INCLUDING THEIR LICENSORS AND SUPPLIERS) SHALL NOT BE LIABLE TO YOU: IN RESPECT OF ANY CLAIM, DEMAND OR ACTION, IRRESPECTIVE OF THE NATURE OF THE CAUSE OF THE CLAIM, DEMAND OR ACTION ALLEGING ANY LOSS, INJURY OR DAMAGES, DIRECT OR INDIRECT, WHICH MAY RESULT FROM THE USE OR POSSESSION OF THE INFORMATION; OR

Appendices

FOR ANY LOSS OF PROFIT, REVENUE, CONTRACTS OR SAVINGS, OR ANY OTHER DIRECT, INDIRECT, INCIDENTAL, SPECIAL OR CONSEQUENTIAL DAMAGES ARISING OUT OF YOUR USE OF OR INABILITY TO USE THIS INFORMATION, ANY DEFECT IN THE INFORMATION, OR THE BREACH OF THESE TERMS OR CONDITIONS, WHETHER IN AN ACTION IN CONTRACT OR TORT OR BASED ON A WARRANTY, EVEN IF NAV2 OR ITS LICENSORS HAVE BEEN ADVISED OF THE POSSIBILITY OF SUCH DAMAGES. UNDER NO CIRCUMSTANCES SHALL NAV2'S OR ITS SUPPLIERS' LIABILITY HEREUNDER EXCEED THE PRICE PAID. Certain liability exclusions may not be permitted under applicable law, so to that extent the above exclusion may not apply to you.

Export Control

You agree not to export to anywhere any part of the Data provided to you or any direct product thereof except in compliance with, and with all licenses and approvals required under, applicable export laws, rules and regulations.

IP Protection

The Data are owned by NAV2 or its suppliers and are protected by applicable copyright and other intellectual property law and treaties. The Data are provided solely on the basis of a license to use, not sale.

Entire Agreement

These terms and conditions constitute the entire agreement between NAV2 (and its licensors, including their licensors and suppliers) and you pertaining to the subject matter hereof, and supersedes in their entirety any and all written or oral agreements previously existing between us with respect to such subject matter.

Governing Law.

The above terms and conditions shall be governed by the laws of the People's Republic of China, without giving effect to (i) its conflict of laws provisions, or (ii) the United Nations Convention for Contracts for the International Sale of Goods, which is explicitly excluded. Any dispute arising from or in connection with the Data provided to you hereunder shall be submitted to the Shanghai International Economic and Trade Arbitration Commission for arbitration.

Gracenote® Copyright

CD and music-related data from Gracenote, Inc., copyright©

2000-2007 Gracenote. Gracenote Software, copyright © 2000-2007 Gracenote. This product and service may practice one or more of the following U.S. Patents 5,987,525; 6,061,680; 6,154,773; 6,161,132; 6,230,192; 6,230,207; 6,240,459; 6,330,593 and other patents issued or pending. Some services supplied under license from Open Globe, Inc. for U.S. Patent 6,304,523.

Gracenote and CDDB are registered trademarks of Gracenote. The Gracenote logo and logotype, and the "Powered by Gracenote™" logo are trademarks of Gracenote.

Gracenote® End User License Agreement (EULA)

This device contains software from Gracenote, Inc. of 2000 Powell Street Emeryville, California 94608 ("Gracenote").

The software from Gracenote (the "Gracenote Software") enables this device to do disc and music file identification and obtain music-related information, including name, artist, track, and title information ("Gracenote Data") from online servers

Appendices

("Gracenote Servers"), and to perform other functions. You may use Gracenote Data only by means of the intended End User functions of this device. This device may contain content belonging to Gracenote's providers. If so, all of the restrictions set forth herein with respect to Gracenote Data shall also apply to such content and such content providers shall be entitled to all of the benefits and protections set forth herein that are available to Gracenote. You agree that you will use the content from Gracenote ("Gracenote Content"), Gracenote Data, the Gracenote Software, and Gracenote Servers for your own personal, non-commercial use only. You agree not to assign, copy, transfer or transmit the Gracenote Content, Gracenote Software or any Gracenote Data (except in a Tag associated with a music file) to any third party. YOU AGREE NOT TO USE OR EXPLOIT GRACENOTE CONTENT, GRACENOTE DATA, THE GRACENOTE SOFTWARE, OR GRACENOTE SERVERS, EXCEPT AS EXPRESSLY PERMITTED HEREIN.

You agree that your non-exclusive licenses to use the Gracenote Content, Gracenote Data, the Gracenote Software, and Gracenote Servers will terminate if you violate these restrictions. If your licenses terminate, you agree to cease any and all use of the Gracenote Content, Gracenote Data, the Gracenote Software, and Gracenote Servers.

Gracenote, respectively, reserve all rights in Gracenote Data, the Gracenote Software, and the Gracenote Servers and Gracenote Content, including all ownership rights. Under no circumstances will either Gracenote become liable for any payment to you for any information that you provide,

including any copyrighted material or music file information. You agree that Gracenote may enforce its respective rights, collectively or separately, under this agreement against you, directly in each company's own name.

Gracenote uses a unique identifier to track queries for statistical purposes. The purpose of a randomly assigned numeric identifier is to allow Gracenote to count queries without knowing anything about who you are. For more information, see the web page at www.gracenote.com for the Gracenote Privacy Policy.

THE GRACENOTE SOFTWARE, EACH ITEM OF GRACENOTE DATA AND THE GRACENOTE CONTENT ARE LICENSED TO YOU "AS IS". NEITHER GRACENOTE MAKES ANY REPRESENTATIONS OR WARRANTIES, EXPRESS OR IMPLIED, REGARDING THE ACCURACY OF ANY GRACENOTE DATA FROM THE GRACENOTE SERVERS OR GRACENOTE CONTENT. GRACENOTE COLLECTIVELY AND SEPARATELY RESERVE THE RIGHT TO DELETE DATA AND/OR CONTENT FROM THE COMPANIES' RESPECTIVE SERVERS OR, IN THE CASE OF GRACENOTE, CHANGE DATA CATEGORIES FOR ANY CAUSE THAT GRACENOTE DEEMS SUFFICIENT. NO WARRANTY IS MADE THAT EITHER GRACENOTE CONTENT OR THE GRACENOTE SOFTWARE OR GRACENOTE SERVERS ARE ERROR-FREE OR THAT THE FUNCTIONING OF THE GRACENOTE SOFTWARE OR GRACENOTE SERVERS WILL BE UNINTERRUPTED. GRACENOTE IS NOT OBLIGATED TO PROVIDE YOU WITH ANY ENHANCED OR ADDITIONAL DATA TYPES THAT GRACENOTE MAY CHOOSE TO PROVIDE IN THE FUTURE AND IS FREE TO DISCONTINUE ITS ONLINE SERVICES AT ANY TIME. GRACENOTE DISCLAIM ALL WARRANTIES EXPRESS OR IMPLIED, INCLUDING, BUT NOT LIMITED TO,

Appendices

IMPLIED WARRANTIES OF MERCHANTABILITY, FITNESS FOR A PARTICULAR PURPOSE, TITLE, AND NON-INFRINGEMENT. NEITHER GRACENOTE WARRANTS THE RESULTS THAT WILL BE OBTAINED BY YOUR USE OF THE GRACENOTE SOFTWARE OR ANY GRACENOTE SERVER. IN NO CASE WILL GRACENOTE BE LIABLE FOR ANY CONSEQUENTIAL OR INCIDENTAL DAMAGES OR FOR ANY LOST PROFITS OR LOST REVENUES FOR ANY REASON WHATSOEVER. © Gracenote 2007.

Taiwan Territory

Note: In accordance with the management approach of low-power radio wave radiation motors:

Article 12: For approved and certified low-power radiation motor models, companies, firms or users must not alter the frequency, increase the power or change the characteristics and functions of the original design without authorization.

Article 14: The usage of low-power radio-frequency motors must not affect aviation safety and interfere with legal telecommunications. Should interference be detected, immediately stop using the device and only resume usage after ensuring that there is no longer any interference. For the legal telecommunication and wireless telecommunication of the telco, the low-power radio frequency motor must be able to tolerate legal limits of interference from telecommunication, industrial, scientific and radio wave equipment.

SUNA TRAFFIC CHANNEL – TERMS AND CONDITIONS

By activating, using and/or accessing the SUNA Traffic Channel, SUNA Predictive or other content or material provided by Intellematics (together, **SUNA Products and/or Services**), you must accept certain terms and conditions. The following is a brief summary of the terms and conditions that apply to you. To view the full terms and conditions relevant to your use of the SUNA Products and/or Services, please consult:

Website
www.sunatrafic.com.au/termsandconditions/

1. Acceptance

By using SUNA Products and/or Services, you will be deemed to have accepted and agreed to be bound by the terms and conditions fully detailed at:

Website
www.sunatrafic.com.au/termsandconditions/

2. Intellectual Property

SUNA Products and/or Services are for your personal use. You may not record, or retransmit the content, nor use the content in association with any other traffic information or route guidance service or device not approved by Intellematics. You obtain no right of ownership in any Intellectual Property Rights (including copyright) in the data that is used to provide SUNA Products and/or Services.

3. Appropriate Use

Appendices

SUNA Products and/or Services are intended as an aid to personal motoring and travel planning, and do not provide comprehensive or accurate information on all occasions. On occasions, you may experience additional delay as a result of using SUNA Products and/or Services. You acknowledge that it is not intended, or suitable, for use in applications where time of arrival or driving directions may impact the safety of the public or yourself.

4. Use of SUNA Products and Services while driving

You, and other authorised drivers of the vehicle in which SUNA Products and/or Services are available or installed and active, remain at all times responsible for observing all relevant laws and codes of safe driving. In particular, you agree to only actively operate SUNA Products and/or Services when the Vehicle is at a complete stop and it is safe to do so.

5. Service Continuity and Reception of the SUNA Traffic Channel

We will use reasonable endeavours to provide the SUNA Traffic Channel 24 hours a day, 365 days a year. The SUNA Traffic Channel may occasionally be unavailable for technical reasons or for planned maintenance. We will try to perform maintenance at times when congestion is light. We reserve the right to withdraw SUNA Products and/or Services at any time.

Also, we cannot assure the uninterrupted reception of the SUNA Traffic Channel RDS-TMC signal at any particular location.

6. Limitation of Liability

Neither Intelematics (nor its suppliers or the manufacturer of your device (the “Suppliers”)) shall be liable to you or to any third party for any damages either direct, indirect, incidental, consequential or otherwise arising out of the use of or inability to use SUNA Products and/or Services even if Intelematics or a Supplier has been advised of the possibility of such damages. You also acknowledge that the neither Intelematics nor any Supplier guarantees nor make any warranties that relate to the availability, accuracy or completeness of SUNA Products and/or Services, and to the extent which it is lawful to do so, both Intelematics and each Supplier excludes any warranties which might otherwise be implied by any State or Federal legislation in relation to SUNA Products and/or Services.

7. Please Note

Great care has been taken in preparing this manual. Constant product development may mean that some information is not entirely up-to-date. The information in this document is subject to change without notice.

DECLARATION OF CONFORMITY - VEHICLES WITH: SYNC 3

Radio Frequency Statement

SYNC Version	FCC Identification Number	IC Identification Number
3.0	ACJ-SYNCG3-L	216B-SYNCG3-L
3.1	ACJ-FA-170-BCARHS	216B-FA170BCARHS
3.2	ACJ-FG-185-SG32MH	216B-FG185SG32MH

Appendices



WARNING: Changes or modifications not expressly approved by the party responsible for compliance could void the user's authority to operate the equipment. The term "IC:" before the radio certification number only signifies that Industry Canada technical specifications were met.

These devices comply with Part 15 of the FCC Rules and with RSS-210 of Industry Canada. Operation is subject to the following two conditions:

1. The device does not cause harmful interference.
2. The device accepts any interference received, including interference that could cause undesired operation.



Index

9

911 Assist.....59

A

A/C

See: Climate Control.....107

About 911 Assist.....59

About This Manual.....7

ABS

See: Brakes.....155

ABS driving hints

See: Hints on Driving With Anti-Lock

Brakes.....155

Accessories.....459

Exterior Style.....459

Interior Style.....459

Lifestyle.....459

Peace of Mind.....459

Accessories

See: Replacement Parts

Recommendation.....13

Adjusting the Headlamps.....247

Horizontal Aim Adjustment.....248

Vertical Aim Adjustment.....247

Adjusting the Steering Wheel.....79

Airbag Disposal.....58

Air Conditioning

See: Climate Control.....107

Air Filter

See: Changing the Engine Air Filter - 3.2L

Power Stroke Diesel.....255

See: Changing the Engine Air Filter - 3.5L

Ecoboost™.....256

See: Changing the Engine Air Filter -

3.7L.....257

Alarm

See: Anti-Theft Alarm.....78

Anti-Theft Alarm.....78

Alarm System.....78

Arming the Alarm.....78

Disarming the Alarm.....78

Triggering the Alarm.....78

Appendices.....485

Apps.....429

.....429

SiriusXM Traffic and Travel Link.....431

Audible Warnings and Indicators.....96

Airbag Secondary Warning.....96

Door Ajar.....96

Exterior Lamps On.....96

Key in Ignition.....96

Parking Brake On.....96

Seatbelt Reminder.....96

Transmission Selector Lever Not in park

(P).....96

Audio Input Jack.....354

Audio System.....333

General Information.....333

Audio Unit - Vehicles With: AM/FM/CD/

SYNC/Satellite Radio.....334

Audio Unit - Vehicles With: AM/FM/CD/

SYNC.....338

Audio Unit - Vehicles With: AM/FM/USB

Port/Bluetooth.....340

Bluetooth Audio Streaming.....345

iPod.....345

Making and Receiving Calls.....344

Phone and Voice Pass-Through.....342

Phone Menu Options.....344

Sound Button.....341

Station Preset Buttons.....342

Station Tuning Control.....342

USB.....345

Waveband Button.....341

Audio Unit - Vehicles With: AM/

FM.....346

AUX Button.....348

Clock Button.....347

Menu Button.....348

Sound Button.....348

Station Preset Buttons.....348

Station Tuning Buttons.....348

Audio Unit - Vehicles With: Premium

AM/FM/CD.....336

Autolamps.....83

Windshield Wiper Activated

Headlamps.....84

Automatic Transmission.....151

Automatic Transmission Adaptive

Learning.....154

Brake-Shift Interlock.....152

If Your Vehicle Gets Stuck in Mud or

Snow.....154

Index

SelectShift Automatic™ Transmission.....	152
Understanding the Positions of Your Automatic Transmission.....	151
Automatic Transmission Fluid Check.....	241
Autowipers.....	80
Auxiliary Power Points.....	120
12 Volt DC Power Point.....	120
AC Power Point.....	120
Locations.....	120
Auxiliary Switches.....	460

B

Battery See: Changing the 12V Battery.....	244
Bonnet Lock See: Opening and Closing the Hood.....	229
Booster Seats.....	35
Types of Booster Seats.....	36
Bottle Holder.....	123
Brake Fluid Check.....	241
Brakes.....	155
General Information.....	155
Breaking-In.....	191
Bulb Specification Chart.....	254

C

Capacities and Specifications - 3.2L Power Stroke Diesel.....	315
Air Conditioning System.....	315
Automatic Transmission.....	320
Brake System.....	318
Diesel Exhaust Fluid.....	318
Engine.....	315
Engine Coolant.....	317
Fuel Tank.....	317
Grease.....	320
Locks.....	320
Rear Axle.....	319
Washer Reservoir.....	318
Capacities and Specifications - 3.5L Ecoboost™.....	321
Air Conditioning System.....	321
Automatic Transmission.....	326
Brake System.....	325

Engine.....	322
Engine Coolant.....	324
Fuel Tank.....	324
Grease.....	327
Locks.....	326
Rear Axle.....	325
Washer Reservoir.....	324
Capacities and Specifications - 3.7L.....	327
Air Conditioning System.....	327
Automatic Transmission.....	331
Brake System.....	330
Engine.....	328
Engine Coolant.....	329
Fuel Tank.....	330
Grease.....	332
Locks.....	332
Rear Axle.....	331
Washer Reservoir.....	330
Capacities and Specifications.....	307
Cargo Lamps.....	86
Switching the Cargo Lamps Off.....	86
Switching the Cargo Lamps On.....	86
Car Wash See: Cleaning the Exterior.....	261
Catalytic Converter - 3.5L/3.7L.....	141
On-Board Diagnostics System.....	142
Changing a Bulb.....	249
Central High Mounted Brake Lamp.....	252
Front Clearance Lamp.....	251
Headlamp.....	249
Interior Lamp.....	252
License Plate Lamp.....	252
Reading Lamps.....	253
Rear Lamps.....	251
Side Direction Indicator.....	251
Sun Visor Mirror Lamp.....	253
Changing a Fuse.....	227
Fuses.....	227
Changing a Road Wheel.....	293
Dissimilar Spare Wheel and Tire Assembly Information.....	294
Front Jacking Points.....	299
Installing a Road Wheel.....	303
Locking Lug Nuts.....	295
Rear Jacking Points.....	300
Removing a Road Wheel.....	302
Removing a Wheel Trim.....	300

Index

Stowing the Wheel and Vehicle Jack.....	304
Vehicle Jack.....	297
Vehicles With a Spare Wheel.....	295
Changing the 12V Battery.....	244
Removing the Battery.....	244
Replacing the Battery.....	246
Changing the Engine Air Filter - 3.2L Power Stroke Diesel.....	255
Changing the Engine Air Filter - 3.5L Ecoboost™.....	256
Changing the Engine Air Filter - 3.7L.....	257
Changing the Engine Oil and Oil Filter.....	235
Engine Lubrication for Severe Service Operation.....	235
Changing the Front Wiper Blades.....	246
Checking MyKey System Status.....	63
Checking the Wiper Blades.....	246
Child Restraint and Seatbelt Maintenance.....	46
Child Restraint Positioning.....	37
Child Safety.....	18
General Information.....	18
Child Safety Locks.....	39
Left-Hand Side.....	40
Right-Hand Side.....	40
Cigar Lighter.....	121
Cleaning Products.....	260
Cleaning the Engine.....	262
Cleaning the Exterior.....	261
Body Paintwork Preservation.....	262
Cleaning the Chrome Trim.....	261
Cleaning the Headlamps.....	261
Cleaning the Rear Window.....	261
Sliding Door Tracks.....	262
Cleaning the Instrument Panel and Instrument Cluster Lens.....	265
Cleaning the Interior.....	263
Fabric, Carpets, Cloth Seats, Headliners and Floor Mats.....	263
Instrument Cluster Screens, LCD Screens and Radio Screens.....	265
Leather Interior.....	264
Mirrors.....	265
Rear Windows.....	265
Seatbelts.....	264
Storage Compartments, Cup Holders and Ashtrays.....	265
Suede Micro Fiber Fabric.....	264
Cleaning the Wheels.....	266
Cleaning the Windows and Wiper Blades.....	263
Clearing All MyKeys.....	63
Climate Control.....	107
Cold Weather Precautions.....	192
Coolant Check See: Engine Coolant Check.....	236
Crash Sensors and Airbag Indicator.....	57
Creating a MyKey.....	62
Programming and Changing Configurable Settings.....	63
Cruise Control.....	168
Principle of Operation.....	168
Cruise control See: Using Cruise Control.....	168
Cup Holders.....	123
Customer Assistance.....	201
D	
Data Recording.....	9
Comfort, Convenience and Entertainment Data.....	11
Event Data.....	11
Service Data.....	10
Services That Third Parties Provide.....	12
Services That We Provide.....	12
Vehicles With a Modem.....	12
Vehicles With SYNC.....	12
Daytime Running Lamps.....	84
Declaration of Conformity - Vehicles With: SYNC 3.....	512
Radio Frequency Statement.....	512
Diesel Particulate Filter - 3.2L Diesel.....	145
Diesel Particulate Filter Automatic Regeneration.....	146
Diesel Particulate Filter Manual Regeneration.....	148
On-Board Diagnostics System.....	146
Digital Radio.....	349
HD Radio Reception and Station Troubleshooting.....	350
Direction Indicators.....	84

Index

Doors and Locks.....	72	Engine Cooling Fan - Diesel.....	236
Draining the Fuel Filter Water Trap - 3.2L Power Stroke Diesel.....	242	Engine Cooling Fan - E85/ Gasoline.....	236
Changing the Fuel Filter.....	243	Engine Emission Control.....	140
Purging Air From the Fuel System.....	243	Engine Immobilizer See: Passive Anti-Theft System.....	77
Drive Belt Routing - 3.2L Power Stroke Diesel.....	258	Engine Oil Check.....	234
Drive Belt Routing - 3.5L EcoBoost™/ 3.7L.....	259	Adding Engine Oil.....	235
Driver Alert.....	169	Engine Oil Dipstick - 3.2L Power Stroke Diesel.....	234
Principle of Operation.....	169	Engine Oil Dipstick - 3.5L EcoBoost™.....	234
Using Driver Alert.....	169	Engine Oil Dipstick - 3.7L.....	234
Driver and Passenger Airbags.....	49	Engine Specifications - 3.2L Power Stroke Diesel.....	307
Children and Airbags.....	54	Engine Specifications - 3.5L EcoBoost™.....	308
Passenger Airbag On and Off Switch.....	49	Engine Specifications - 3.7L.....	309
Proper Driver and Front Passenger Seating Adjustment.....	54	Entertainment.....	406
Driving Aids.....	169	AM/FM Radio.....	407
Driving Hints.....	191	Apps.....	415
Driving Through Water.....	192	Bluetooth Stereo or USB.....	414
DRL See: Daytime Running Lamps.....	84	CD.....	413
E			
Economical Driving.....	191	HD Radio™ Information (If Available).....	410
Electromagnetic Compatibility.....	485	SiriusXM® Satellite Radio (If Activated).....	408
Emergency Call Limitations.....	60	Sources.....	407
Emergency Call Requirements.....	59	Supported Media Players, Formats and Metadata Information.....	415
Emergency Exit.....	195	USB Ports.....	415
Emission Law.....	140	Environment.....	17
Noise Emissions Warranty, Prohibited Tampering Acts and Maintenance.....	141	Essential Towing Checks.....	183
Tampering With a Noise Control System.....	140	Before Towing a Trailer.....	188
End User License Agreement.....	487	Launching or Retrieving a Boat or Personal Water Craft (PWC).....	189
VEHICLE SOFTWARE END USER LICENSE AGREEMENT (EULA).....	487	Safety Chains.....	184
Engine Block Heater.....	128	Tow Hitch.....	184
Using the Engine Block Heater.....	129	Trailer Brakes.....	184
Engine Coolant Check.....	236	Trailer Lamps.....	188
Adding Coolant.....	237	Trailer Towing Connector.....	183
Coolant Change.....	239	When Towing a Trailer.....	188
Engine Coolant Temperature Management.....	240	Event Data Recording See: Data Recording.....	9
Fail-Safe Cooling.....	239	Export Unique Options.....	16
Recycled Coolant.....	238	Exterior Mirrors.....	88
Severe Climates.....	238	Fold-Away Exterior Mirrors.....	89
		Power Exterior Mirrors.....	88

Index

Power Folding Mirrors.....	88	Fuel Quality - Gasoline.....	133
F		Choosing the Right Fuel.....	133
Fan		Fuel Shutoff.....	195
See: Engine Cooling Fan - Diesel.....	236	Ignition Switch.....	195
See: Engine Cooling Fan - E85/ Gasoline.....	236	Fuse Box Locations.....	208
Fastening the Seatbelts.....	42	Body Control Module.....	208
Seatbelt Locking Modes.....	43	Engine Compartment Fuse Box.....	208
Using Seatbelts During Pregnancy.....	42	Passenger Compartment Fuse Box.....	208
Flat Tire		Pre-fuse Box.....	208
See: Changing a Road Wheel.....	293	Fuses.....	208
Floor Mats.....	192	Fuse Specification Chart - 3.2L Power Stroke Diesel.....	209
Ford Credit.....	13	Body Control Module.....	216
US Only.....	13	Engine Compartment Fuse Box.....	209
Ford Protect.....	462	Passenger Compartment Fuse Box.....	212
Ford Protect Extended Service Plan (CANADA ONLY).....	463	Fuse Specification Chart - 3.5L Ecoboost™/3.7L.....	218
Ford Protect Extended Service Plans (U.S. Only).....	462	Body Control Module.....	225
Front Door Storage Compartment.....	123	Engine Compartment Fuse Box.....	218
Front Wiper Blades		Passenger Compartment Fuse Box.....	221
See: Changing the Front Wiper Blades.....	246	G	
Fuel and Refueling.....	130	Gauges.....	91
Fuel Consumption.....	138	Engine Coolant Temperature Gauge.....	91
Advertised Capacity.....	138	Fuel Gauge.....	92
Calculating Fuel Economy.....	139	Information Display.....	91
Filling the Fuel Tank.....	139	Tripmeter Reset and Distance to Empty.....	92
Fuel Filler Funnel Location.....	135	Gearbox	
Fuel Filter - Gasoline.....	244	See: Transmission.....	151
Fuel Quality - Diesel.....	131	General Information on Radio	
Biodiesel.....	132	Frequencies.....	67
Diesel Fuel Additives	133	General Maintenance Information.....	466
Fuel Requirements - Choosing The Right Fuel: Vehicles Operated Where Ultra-Low Sulfur Diesel Fuel Is Not Required	131	Multi-point Inspection.....	468
Fuel Requirements - Choosing the Right Fuel: Vehicles Operated Where Ultra-Low Sulfur Diesel Fuel Is Required (United States/Canada/Puerto Rico/U.S. Virgin Islands and Other Locales).....	131	Owner Checks and Services.....	468
Fuel Quality - E85.....	134	Protecting Your Investment.....	467
Choosing the Right Fuel - Flex Fuel Vehicles.....	134	Why Maintain Your Vehicle?.....	466
Switching Between E85 and Gasoline.....	135	Why Maintain Your Vehicle at Your Dealership?.....	466
		Getting Assistance Outside the U.S. and Canada.....	204
		Getting the Services You Need.....	201
		Away From Home.....	201

Index

H	
Handbrake	
See: Parking Brake - Vehicles With:	
Mechanical Parking Brake.....	156
See: Parking Brake - Vehicles With: Push	
Down Parking Brake.....	156
Hazard Flashers.....	195
Headlamp Adjusting	
See: Adjusting the Headlamps.....	247
Headlamp Removal	
See: Removing a Headlamp.....	248
Headrest	
See: Head Restraints.....	111
Head Restraints.....	111
Adjusting the Head Restraint.....	112
Installing the Head Restraint	112
Removing the Head Restraint.....	112
Heated Seats.....	119
Heated Windows and Mirrors.....	109
Heated Exterior Mirrors.....	110
Heated Rear Window.....	109
Heating	
See: Climate Control.....	107
Hill Start Assist.....	157
Switching the System On and Off.....	158
Using Hill Start Assist.....	157
Hints on Controlling the Interior	
Climate.....	108
Cooling the Interior Quickly.....	108
General Hints.....	108
Heating the Interior Quickly.....	108
Maximum Cooling Performance in	
Instrument Panel or Instrument Panel	
and Footwell Positions.....	109
Recommended Settings for Cooling	108
Recommended Settings for Heating.....	108
Side Window Defogging in Cold	
Weather.....	109
Vehicle Stationary for Extended Periods	
During Extreme High Ambient	
Temperatures.....	108
Hints on Driving With Anti-Lock	
Brakes.....	155
Home Screen.....	401
Hood Lock	
See: Opening and Closing the Hood.....	229
Horn.....	79
I	
Ignition Switch.....	124
In California (U.S. Only).....	202
Information Displays.....	97
General Information.....	97
Information Messages.....	101
Installing Child Restraints.....	19
Child Safety Restraint.....	19
Using Lap and Shoulder Belts.....	20
Using Lower Anchors and Tethers for	
Children (LATCH).....	22
Using Tether Straps.....	28
Instrument Cluster.....	91
Instrument Lighting Dimmer.....	84
Interior Lamps.....	85
Courtesy Lamp.....	85
Entrance Lamps.....	85
Reading Lamps.....	85
Interior Mirror.....	89
Automatic Dimming Mirror.....	89
Manual Dimming Mirror.....	89
Introduction.....	7
J	
Jump Starting the Vehicle.....	196
Connecting the Jumper Cables.....	197
Jump Starting.....	197
Preparing Your Vehicle.....	196
Removing the Jumper Cables.....	197
K	
Keys and Remote Controls.....	67
Principle of Operation.....	67
L	
Lane Keeping System.....	170
Lane Keeping Alert.....	170
Lighting Control.....	82
Flashing High Beam Headlamps.....	83
Lighting Control Positions.....	82
Switching All of the Parking Lamps	
On.....	82
Switching High Beam Headlamps On and	
Off.....	83

Index

Switching the Left-Hand Side or the Right-Hand Side Parking Lamps On.....	82
Lighting.....	82
General Information.....	82
Load Carrying.....	174
Load Limit.....	174
Special Loading Instructions for Owners of Pick-up Trucks and Utility-type Vehicles.....	178
Vehicle Loading - with and without a Trailer.....	174
Load Retaining Fixtures.....	174
Securing Cargo.....	174
Locking and Unlocking.....	72
Autolock.....	75
Autounlock.....	76
Configurable Unlocking.....	76
Locking.....	72
Locking and Unlocking the Doors From Inside.....	72
One-Stage Unlocking.....	76
Opening and Closing the Sliding Door.....	73
Opening the Double Rear Doors.....	74
Rear Emergency Exit.....	75
Two-Stage Unlocking.....	76
Unlocking.....	72
Zone Re-Locking.....	76
Lug Nuts	
See: Changing a Road Wheel.....	293
M	
Maintenance.....	229
General Information.....	229
Manual Climate Control.....	107
Manual Seats.....	112
Adjusting the Armrest.....	114
Adjusting the Lumbar Support.....	113
Moving the Seat Backward or Forward.....	112
Recline Adjustment.....	113
Media Hub.....	355
Message Center	
See: Information Displays.....	97
Mirrors	
See: Heated Windows and Mirrors.....	109
See: Windows and Mirrors.....	87
Mobile Communications Equipment.....	15
Motorcraft Parts - 3.2L Power Stroke Diesel.....	310
Motorcraft Parts - 3.5L Ecoboost™.....	310
Motorcraft Parts - 3.7L MyKey™ - Troubleshooting.....	65
MyKey™.....	61
Principle of Operation.....	61
N	
Navigation.....	421
cityseeker.....	428
Destination Mode.....	423
Map Mode.....	422
Navigation Map Updates.....	429
Navigation Menu.....	426
SiriusXM Traffic and Travel Link.....	429
SYNC AppLink.....	428
Waypoints.....	427
Normal Scheduled Maintenance.....	469
Intelligent Oil-Life Monitor™.....	469
Normal Maintenance Intervals.....	470
O	
Oil Change Indicator Reset.....	236
Resetting the Oil Life Monitoring System.....	236
Oil Check	
See: Engine Oil Check.....	234
Opening and Closing the Hood.....	229
Closing the Hood.....	230
Opening the Hood.....	229
Ordering Additional Owner's Literature.....	206
Obtaining a French Owner's Manual.....	206
Overhead Console.....	123
Overhead Storage Compartments.....	123
P	
Parking Aid.....	162
Switching the Parking Aid System Off.....	164
Parking Aids.....	162
Principle of Operation.....	162

Index

Parking Brake - Vehicles With:	
Mechanical Parking Brake.....	156
Center Parking Brake.....	156
Parking Brake - Vehicles With: Push	
Down Parking Brake.....	156
Passive Anti-Theft System.....	77
SecuriLock®.....	77
PATS	
See: Passive Anti-Theft System.....	77
Perchlorate.....	13
Personalized Settings.....	100
Measure Units.....	100
Phone.....	416
During a Phone Call.....	419
Making Calls.....	418
Pairing Your Cell Phone for the First	
Time.....	416
Phone Menu.....	417
Receiving Calls.....	419
Smartphone Connectivity.....	420
Text Messaging.....	420
Post-Crash Alert System.....	198
Power Door Locks	
See: Locking and Unlocking.....	72
Power Seats.....	114
Power Lumbar.....	116
Power Steering Fluid Check.....	241
Adding Power Steering Fluid.....	242
Power Windows.....	87
Accessory Delay.....	87
Bounce-Back.....	87
Driver Side One-Touch Down.....	87
Driver Side One-Touch Up.....	87
Protecting the Environment.....	17
Puncture	
See: Changing a Road Wheel.....	293
R	
Rear Passenger Climate Controls.....	109
Adjusting the Blower Motor Speed.....	109
Directing Air to the Footwell Air	
Vents.....	109
Directing Air to the Overhead Air	
Vents.....	109
Directing Air to the Overhead Air Vents and	
the Footwell Air Vents.....	109
Rear Quarter Windows.....	89
Closing the Rear Quarter Windows.....	90
Opening the Rear Quarter Windows.....	89
Rear Seats.....	116
Installing the Seats.....	118
Recline Adjustment.....	116
Removing Seats (Passenger	
Vehicles).....	117
Rear View Camera.....	164
Manual Zoom.....	166
Rear View Camera Delay.....	166
Rear View Camera Locations.....	164
Using the Rear View Camera System.....	165
Vehicles with Parking Aid.....	167
Rear View Camera	
See: Rear View Camera.....	164
Recommended Towing Weights.....	180
Calculating the Maximum Loaded Trailer	
Weight for Your Vehicle.....	183
Reduced Engine Performance.....	191
Refueling.....	136
System Warnings.....	138
Remote Control - Vehicles With: Passive	
Anti-Theft System (PATS).....	69
Changing the Remote Control Battery.....	70
Integrated Keyhead Transmitter.....	69
Locating Your Vehicle.....	70
Programming a New Remote Control.....	70
Switching the Panic Alarm On and Off.....	71
Remote Control - Vehicles Without:	
Passive Anti-Theft System	
(PATS).....	68
Changing the Remote Control Battery.....	68
Integrated Keyhead Transmitter.....	68
Locating Your Vehicle.....	69
Programming a New Remote Control.....	68
Switching the Panic Alarm On and	
Off.....	69
Remote Start.....	110
Removing a Headlamp.....	248
Repairing Minor Paint Damage.....	266
Replacement Parts	
Recommendation.....	13
Collision Repairs.....	14
Scheduled Maintenance and Mechanical	
Repairs.....	14
Warranty on Replacement Parts.....	14

Index

Replacing a Lost Key or Remote Control.....	71
Reporting Safety Defects (Canada Only).....	206
Reporting Safety Defects (U.S. Only).....	206
Roadside Assistance.....	194
Vehicles Sold in Canada: Getting Roadside Assistance.....	195
Vehicles Sold in the United States: Getting Roadside Assistance.....	194
Vehicles Sold in the United States: Using Roadside Assistance.....	194
Roadside Emergencies.....	194
Running-In	
See: Breaking-In.....	191
Running Out of Fuel.....	135
Adding Fuel From a Portable Fuel Container.....	136
Filling a Portable Fuel Container.....	135
S	
Safety Canopy™.....	56
Safety Precautions.....	130
Satellite Radio.....	351
Satellite Radio Electronic Serial Number (ESN).....	352
Satellite Radio Reception Factors.....	352
SiriusXM Satellite Radio Service.....	352
Troubleshooting.....	353
Scheduled Maintenance Record.....	474
Scheduled Maintenance.....	464
Intelligent Oil-Life Monitor™.....	464
Normal Maintenance Intervals.....	464
Seatbelt Extension.....	47
Seatbelt Height Adjustment.....	44
Seatbelt Reminder.....	45
Belt-Minder®.....	45
Seatbelts.....	41
Principle of Operation.....	41
Seatbelt Warning Lamp and Indicator	
Chime.....	44
Conditions of operation.....	45
Seats.....	111
Security.....	77
Selective Catalytic Reductant System.....	142
Diesel Exhaust Fluid Guidelines.....	142
Filling the Diesel Exhaust Fluid Tank.....	142
Filling the Diesel Exhaust Fluid Tank Using a Container.....	144
Filling the Diesel Exhaust Fluid Tank Using a Fuel Station Pump.....	143
Selective Catalytic Reductant System Warning Lamp.....	145
Settings.....	432
911 Assist.....	437
Ambient Lighting.....	444
Bluetooth.....	434
Clock.....	434
Display.....	445
General.....	442
Media Player.....	433
Mobile Apps.....	440
Navigation.....	438
Phone.....	434
Radio.....	437
Sound.....	432
Valet Mode.....	446
Vehicle.....	444
Voice Control.....	445
Wi-Fi & Hotspot.....	442
Side Airbags.....	55
Sitting in the Correct Position.....	111
Snow Chains	
See: Using Snow Chains.....	287
Spare Wheel	
See: Changing a Road Wheel.....	293
Special Notices.....	14
New Vehicle Limited Warranty.....	14
Special Operating Conditions Scheduled Maintenance.....	472
Exceptions.....	473
Speed Control	
See: Cruise Control.....	168
Speed Limiter.....	169
Engine Speed Limiter.....	169
Vehicle Speed Limiter - Fixed.....	169
Stability Control.....	160
Principle of Operation.....	160
Starter Switch	
See: Ignition Switch.....	124

Index

Starting a Diesel Engine.....	126	Tire Care.....	270
Engine Warning Lamps.....	127	Glossary of Tire Terminology.....	272
Failure to Start.....	127	Inflating the Tires.....	279
Glow Plug Indicator.....	127	Information About Uniform Tire Quality	
Guarding Against Exhaust Fumes.....	127	Grades.....	270
Important Ventilating Information.....	127	Information Contained on the Tire	
Starting the Engine.....	126	Sidewall.....	273
Stopping the Engine When Your Vehicle is		Inspecting the Tires and Wheel Valve	
Moving.....	127	Stems.....	282
Stopping the Engine When Your Vehicle is		Location of the Tire Label.....	279
Stationary.....	127	Tire Age.....	283
Starting a Gasoline Engine.....	125	Tire and Wheel Alignment.....	285
Engine Warning Lamps.....	126	Tire Damage.....	282
Failure to Start.....	125	Tire Pressure Monitoring System.....	284
Guarding Against Exhaust Fumes.....	126	Tire Replacement Requirements.....	283
Important Ventilating Information.....	126	Tire Rotation.....	285
Starting the Engine.....	125	Tire Safety Practices.....	284
Stopping the Engine When Your Vehicle is		Tire Wear.....	282
Moving.....	125	United States Department of	
Stopping the Engine When Your Vehicle is		Transportation Tire Quality Grades.....	271
Stationary.....	125	Tire Pressure Monitoring System.....	288
Starting and Stopping the Engine.....	124	Changing Tires With a Tire Pressure	
General Information.....	124	Monitoring System.....	290
Steering.....	172	Tire Pressure Monitoring System Reset	
Steering Wheel.....	79	Procedure.....	292
Storage Compartments.....	123	Understanding the Tire Pressure Monitoring	
Supplementary Restraints System.....	48	System.....	290
Principle of Operation.....	48	Tires	
Switching Off the Engine.....	128	See: Wheels and Tires.....	269
Vehicles With a Turbocharger.....	128	Tow/Haul.....	154
Symbols Glossary.....	7	Towing a Trailer.....	179
SYNC™ 3.....	394	Load Placement.....	179
General Information.....	394	Towing Points.....	199
SYNC™ 3 Troubleshooting.....	446	Front Towing Point.....	199
SYNC™ Applications and Services.....	372	Rear Towing Point.....	199
911 Assist.....	372	Towing Eye Location.....	200
SYNC Mobile Apps.....	374	Towing the Vehicle on Four	
SYNC™.....	356	Wheels.....	189
General Information.....	356	Emergency Towing.....	189
SYNC™ Troubleshooting.....	386	Recreational Towing.....	190
T		Towing.....	179
Technical Specifications		Traction Control.....	159
See: Capacities and Specifications.....	307	Principle of Operation.....	159
The Better Business Bureau (BBB) Auto		Trailer Sway Control.....	180
Line Program (U.S. Only).....	203	Transmission Code Designation.....	314
		Transmission.....	151
		Transporting the Vehicle.....	198

Index

Trip Computer.....	100	Text Messaging.....	366
All Values.....	100	Using Traction Control.....	159
Average Fuel Consumption.....	100	Switching the System Off.....	159
Digital Speedometer.....	100	System Indicator Lights and Messages.....	159
Distance to Empty.....	100	Using a Switch.....	159
Outside Air Temperature.....	100	Using the Information Display Controls.....	159
Resetting the Trip Computer.....	100	Using Voice Recognition.....	358
Trip Odometer.....	100	Apps.....	405
Trip Timer.....	100	Automatic Blower Motor Speed Reduction.....	406
U		Climate Control.....	403
Under Hood Overview - 3.2L Power Stroke Diesel.....	231	Entertainment.....	402
Under Hood Overview - 3.5L Ecoboost™.....	232	General.....	401
Under Hood Overview - 3.7L.....	233	Initiating a Voice Session.....	358
USB Port.....	355	Navigation.....	404
Using Cruise Control.....	168	Phone.....	403
Switching Cruise Control Off.....	168	System Interaction and Feedback.....	359
Switching Cruise Control On.....	168	Voice Settings.....	406
Using MyKey With Remote Start Systems.....	65	Using Winter Tires.....	287
Using Snow Chains.....	287	Utilizing the Mediation/Arbitration Program (Canada Only).....	204
Using Stability Control.....	161	V	
Using SYNC™ With Your Media Player.....	377	Vehicle Care.....	260
Accessing Your USB Song Library.....	381	Vehicle Certification Label.....	314
Bluetooth Devices and System Settings.....	383	Vehicle Identification Number.....	313
Connecting Your Digital Media Player to the USB Port.....	377	Vehicle Storage.....	266
Media Menu Features.....	380	Battery.....	267
Media Voice Commands.....	378	Body.....	267
USB 2.....	383	Brakes.....	267
Voice Commands for Audio Sources.....	384	Cooling system.....	267
Using SYNC™ With Your Phone.....	360	Engine.....	267
Accessing Features through the Phone Menu.....	365	Fuel system.....	267
Accessing Your Phone Settings.....	368	General.....	267
Bluetooth Devices.....	369	Miscellaneous.....	268
Making Calls.....	364	Removing Vehicle From Storage.....	268
Pairing a Phone for the First Time.....	361	Tires.....	267
Pairing Subsequent Phones.....	362	Ventilation	
Phone Options during an Active Call.....	364	See: Climate Control.....	107
Phone Voice Commands.....	362	VIN	
Receiving Calls.....	364	See: Vehicle Identification Number.....	313
System Settings.....	370		

Index

W

Warning Lamps and Indicators.....	93
Airbag Warning Lamp.....	93
Anti-Lock Brake System Warning Lamp.....	93
Battery Charging Condition Warning Lamp.....	93
Brake System Warning Lamp.....	93
Diesel Warning Lamps.....	93
Direction Indicator.....	94
Door Ajar.....	94
Engine Coolant Temperature Warning Lamp.....	94
Engine Warning Lamps.....	94
Fasten Seatbelt Warning Lamp.....	95
Headlamp High Beam Indicator.....	95
Lamps on Indicator.....	95
Lane Departure Warning Indicator.....	95
Low Fuel Level Warning Lamp.....	95
Low Tire Pressure Warning Lamp.....	95
Low Washer Fluid Level Warning Lamp.....	95
Message Center Indicator.....	95
Oil Pressure Warning Lamp.....	95
Stability Control and Traction Control Indicator.....	96
Stability Control and Traction Control Off Warning Lamp.....	96
Tow/Haul Warning Lamp.....	96
Washer Fluid Check.....	242
Washers	
See: Cleaning the Exterior.....	261
Waxing.....	262
Wheel Nuts	
See: Changing a Road Wheel.....	293
Wheels and Tires.....	269
General Information.....	269
Technical Specifications.....	305
Windows and Mirrors.....	87
Windshield Washers.....	81
Windshield Wipers.....	80
Intermittent Wipe.....	80
Winter Tires	
See: Using Winter Tires.....	287
Wiper Blades	
See: Checking the Wiper Blades.....	246
Wipers and Washers.....	80