

# K'NEX



## BUILDING SET

# 50 MODELS



8+

Building System  
Système De Construction

**WARNING:**  
CHOKING HAZARD – Small Parts.  
Not for children under 3 years.

**AVERTISSEMENT:**  
DANGER D'ÉTOUFFEMENT – Pièces de petite taille.  
Ne pas donner aux enfants de moins de 3 ans.

# Contents

<b>Welcome</b> . . . . .	<b>2</b>	Roly Poly . . . . .	<b>68</b>
<b>Introduction to K'NEX</b> . . . . .	<b>3</b>	Row Boat . . . . .	<b>74</b>
<b>Ready, Set, Build</b> . . . . .	<b>4</b>	Umbrella Ride . . . . .	<b>78</b>
<b>Models To Build</b>		Elastic Powered Plane . . . . .	<b>82</b>
Snail . . . . .	<b>5</b>	Windmill . . . . .	<b>86</b>
Sailboat . . . . .	<b>5</b>	<b>Racing Car</b> . . . . .	<b>92</b>
Ant . . . . .	<b>5</b>	Tomcat . . . . .	<b>97</b>
Parrot . . . . .	<b>6</b>	Plane Launcher . . . . .	<b>106</b>
Race Car . . . . .	<b>7</b>	The Rejector . . . . .	<b>111</b>
Tractor . . . . .	<b>8</b>	Fan . . . . .	<b>118</b>
Croc . . . . .	<b>9</b>	Helicopter . . . . .	<b>123</b>
Rabbit . . . . .	<b>10</b>	Sea Turtle . . . . .	<b>130</b>
Frog Coaster . . . . .	<b>11</b>	Wing Flapping Bird . . . . .	<b>139</b>
Mini Jet . . . . .	<b>12</b>	Boom Ride . . . . .	<b>146</b>
<b>Hand Drill</b> . . . . .	<b>13</b>	Super Car . . . . .	<b>150</b>
Sporty Car . . . . .	<b>14</b>	Tornado Ride . . . . .	<b>156</b>
Trike . . . . .	<b>16</b>	Giant Inch Worm . . . . .	<b>165</b>
<b>Letter Rack</b> . . . . .	<b>18</b>	Shark . . . . .	<b>174</b>
Praying Mantis . . . . .	<b>20</b>	Crane . . . . .	<b>182</b>
Balance . . . . .	<b>22</b>	Piranha . . . . .	<b>188</b>
Tool Box . . . . .	<b>26</b>	Submarine . . . . .	<b>197</b>
Desert Racer . . . . .	<b>28</b>	Robot . . . . .	<b>203</b>
Camera . . . . .	<b>31</b>	Chinook Helicopter . . . . .	<b>217</b>
The Claw . . . . .	<b>34</b>	<b>What's Next?</b> . . . . .	<b>225</b>
Speed Boat . . . . .	<b>38</b>	<b>Ready for more K'NEX</b>	
Hot Air Balloon . . . . .	<b>42</b>	<b>Challenges?</b> . . . . .	<b>225</b>
Dumper Truck . . . . .	<b>45</b>	(F) French Language . . . . .	<b>226</b>
Super Bike . . . . .	<b>50</b>	(E) Spanish Language . . . . .	<b>227</b>
Speedway Trike . . . . .	<b>55</b>	(D) German Language . . . . .	<b>227</b>
Moon Buggy . . . . .	<b>60</b>	(NL) Dutch Language . . . . .	<b>227</b>
Racing Truck . . . . .	<b>64</b>		



**Welcome!**

**The fun is about to begin!**

I designed the K'NEX building system for kids like you – kids who want to build in a whole new way. Using our snap-together Rods, Connectors and color-coded instructions, you can build the models we've designed – or you can use your imagination and build cool models of your own! That's what K'NEX is all about – getting an idea and making it happen. Just like I did when I invented K'NEX!

*Joel Glickman  
Inventor of K'NEX*

## About the Set

This **50 MODEL Building Set** is perfect for builders of all ages! Get ready to build a variety of cool models, each with realistic movement! The **BONUS Motor** brings many of the models to life! Look for this Special Button next to those special models!



Build as many as you can - it's up to you! Build the Sea Turtle, Speed Boat, Mini Jet, Racing Car and more!

## Why K'NEX

IT'S THE SPECIAL **ROD 'n CONNECTOR** SYSTEM!

- Snap-Together Pieces That Stay Together!
- Shapes And Lengths That Let You Build Bigger!
- Special Connections For Models That Move!
- Color-Coded Parts And Instructions To Make Building Easier!

## What's Included

Before you start building, be sure to compare the parts in your case with the parts listed. If anything is missing, look at the back cover of this instructions booklet to contact us. We're here to help!

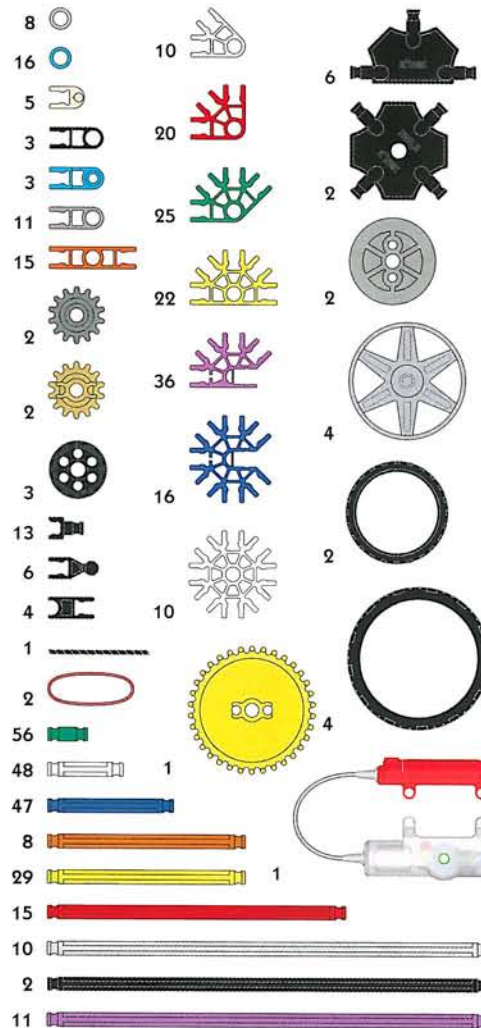

## Building with K'NEX

Hi! I'm your K'NEX building buddy. The instructions in this book will help



you build 50 models to start you on your way to being a K'NEXpert! You'll find models for three levels of building. Look for me before each build, holding up a sign to show you how difficult each model will be, ... check this out:



**Friendly Challenge**



**Moderate Challenge**



**Greater Challenge**

## Ready, Set, Build

To begin your model, find the **1** and follow the numbers. Each piece has its own shape and color. Just look at the picture, find the pieces in your set that

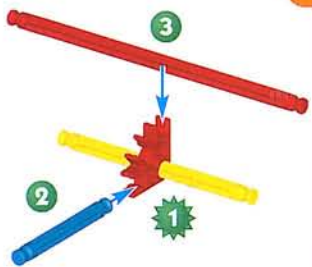

match what you see, and snap them together. Try to hold your model in the same direction as in the picture so you'll attach your pieces to the right place.

## Movin' On

The faded colors tell you this section is already built. You'll want to connect the new section to the place where the arrows are pointing. This piece will be in full color.

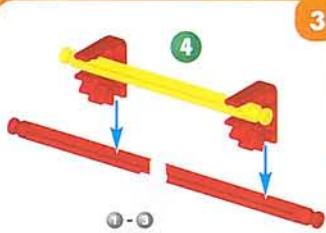

## Spacers

There are places in your model where you need to add blue and silver Spacers. Be sure to count them carefully.



## Connectors

It's very important to position blue and purple Connectors in a specific direction. Pay close attention to the instructions, and position these Connectors horizontally or vertically exactly as they are shown. Push together tightly until you hear a "click".

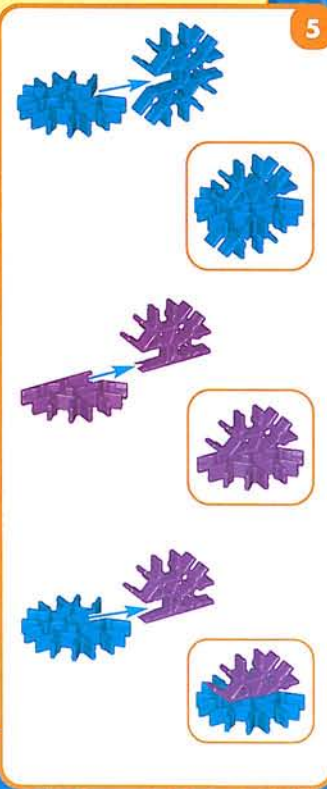

## Flexi-Rods

A Flexi-Rod is a Rod that you can bend to make curves. It will be easier to attach to your model if you bend it back and forth first.

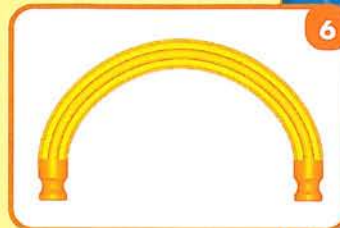

## ⚠ Caution:

Rubber Bands can cause injury from snap-back, breaking, or loss of control. While assembling models shown in instructions, hold Rubber Band tightly, and do not overstretch. Use Rubber Bands only as shown in these instructions. **DO NOT USE FRAYED OR TORN RUBBER BANDS.** Caution: Keep Rubber Bands away from face and eyes.

# Snail

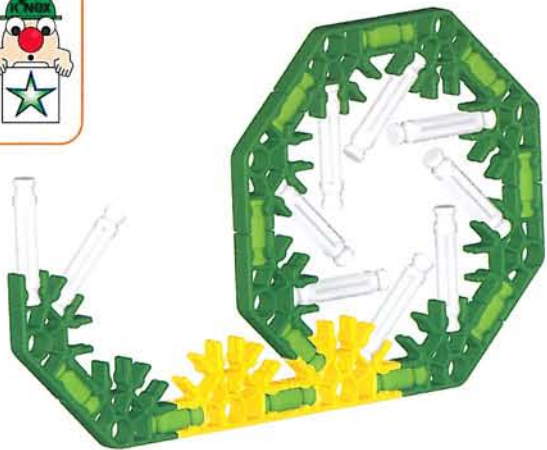

# Ant

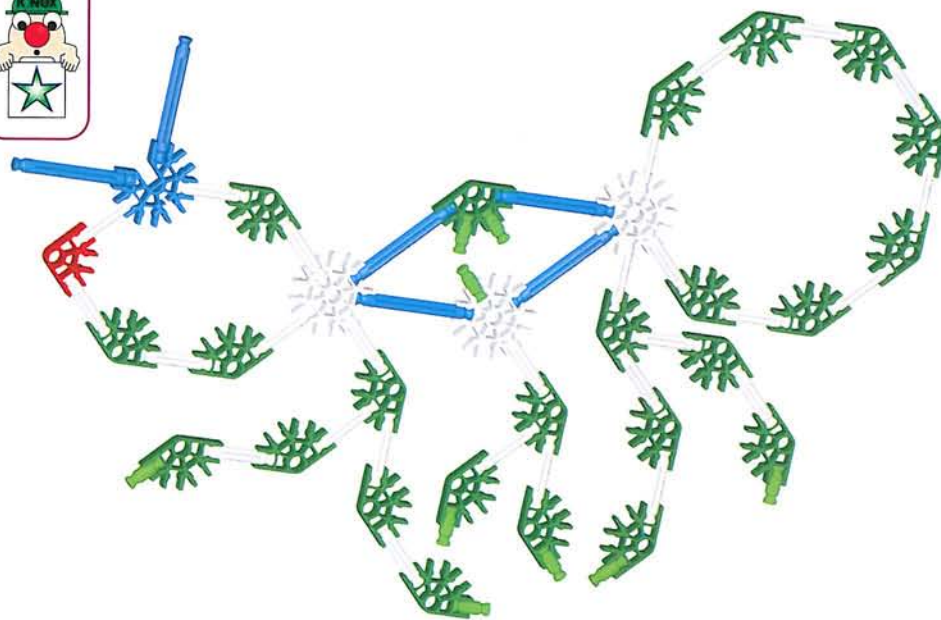

# Sailboat

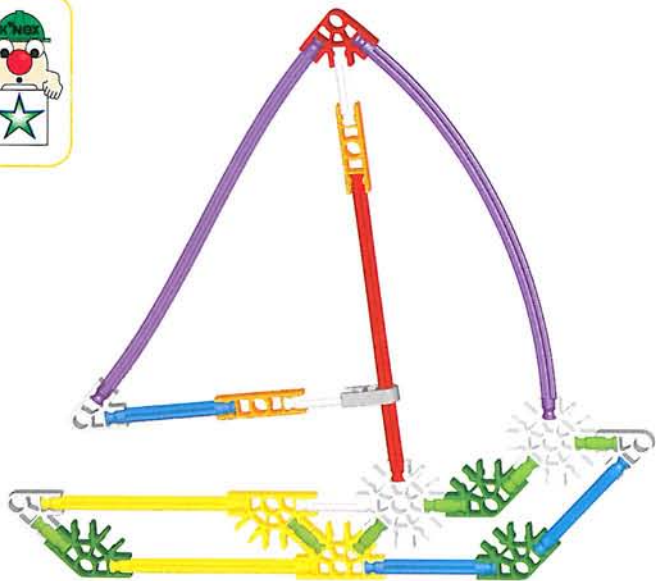

# Parrot

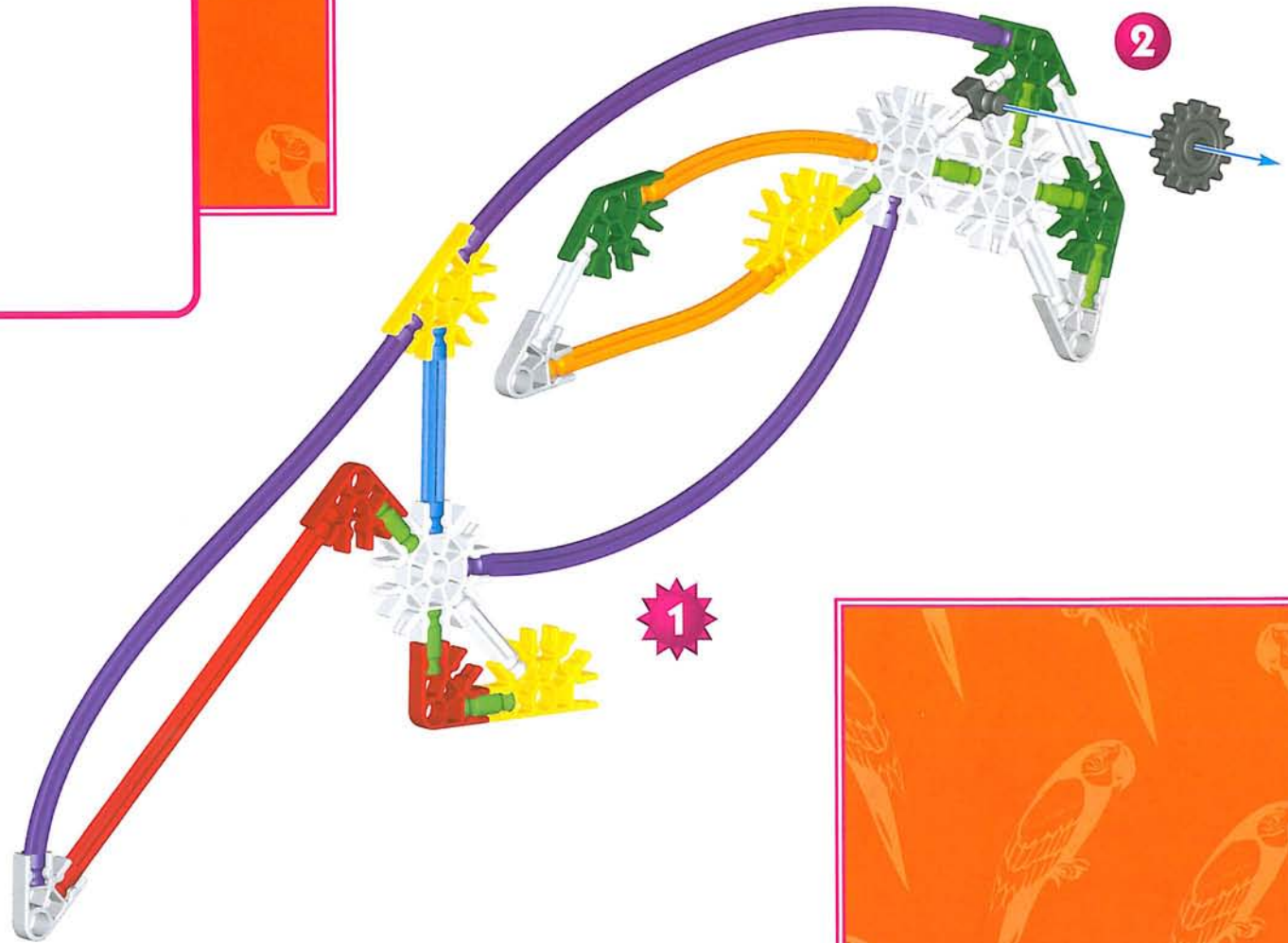
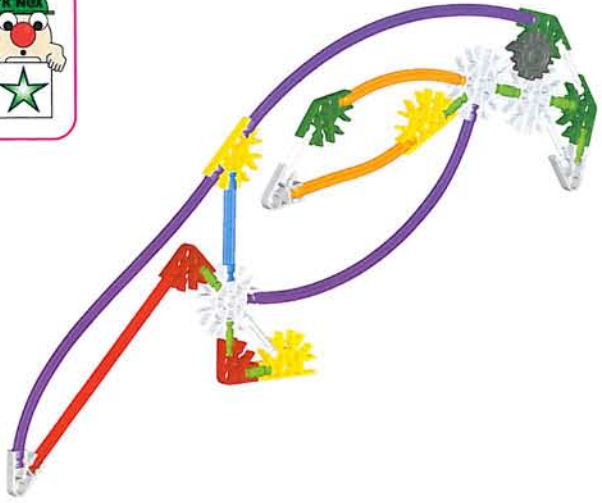

# Race Car

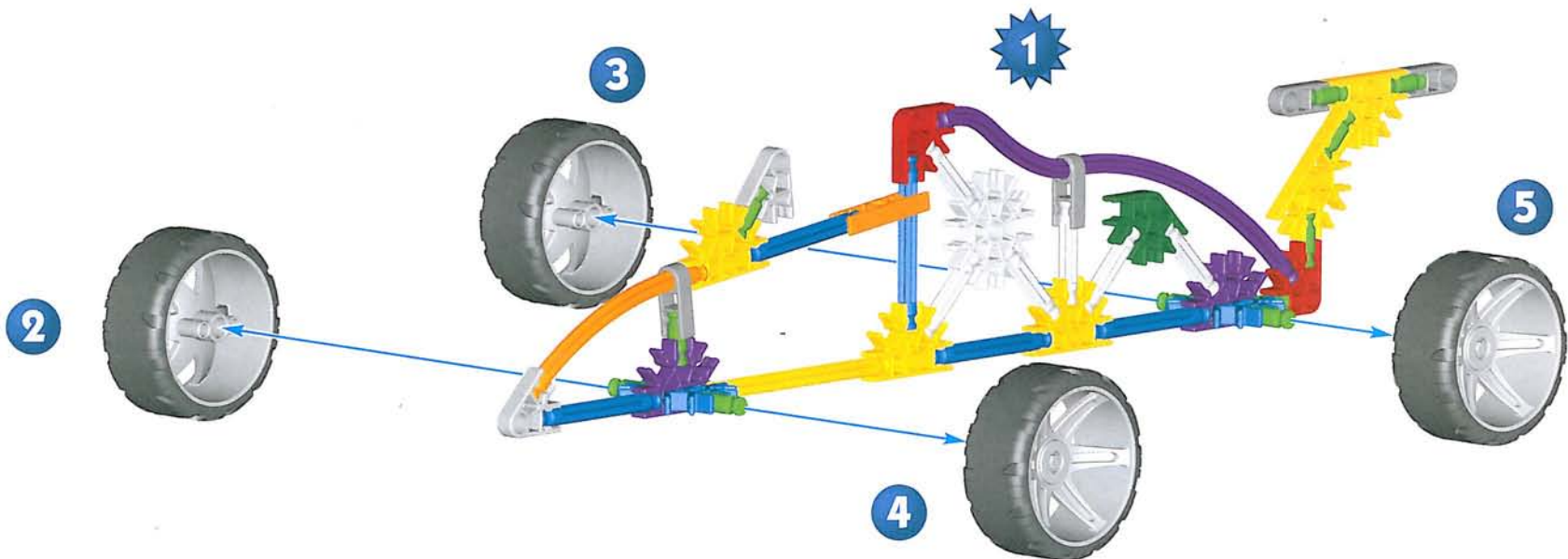
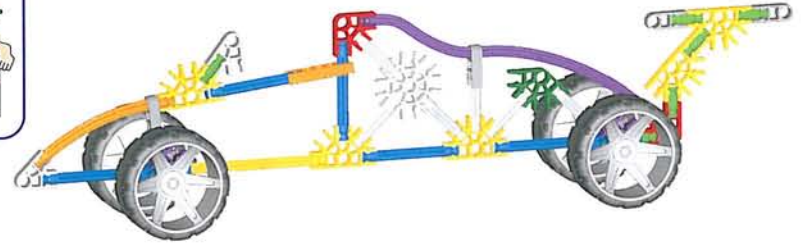

# Tractor

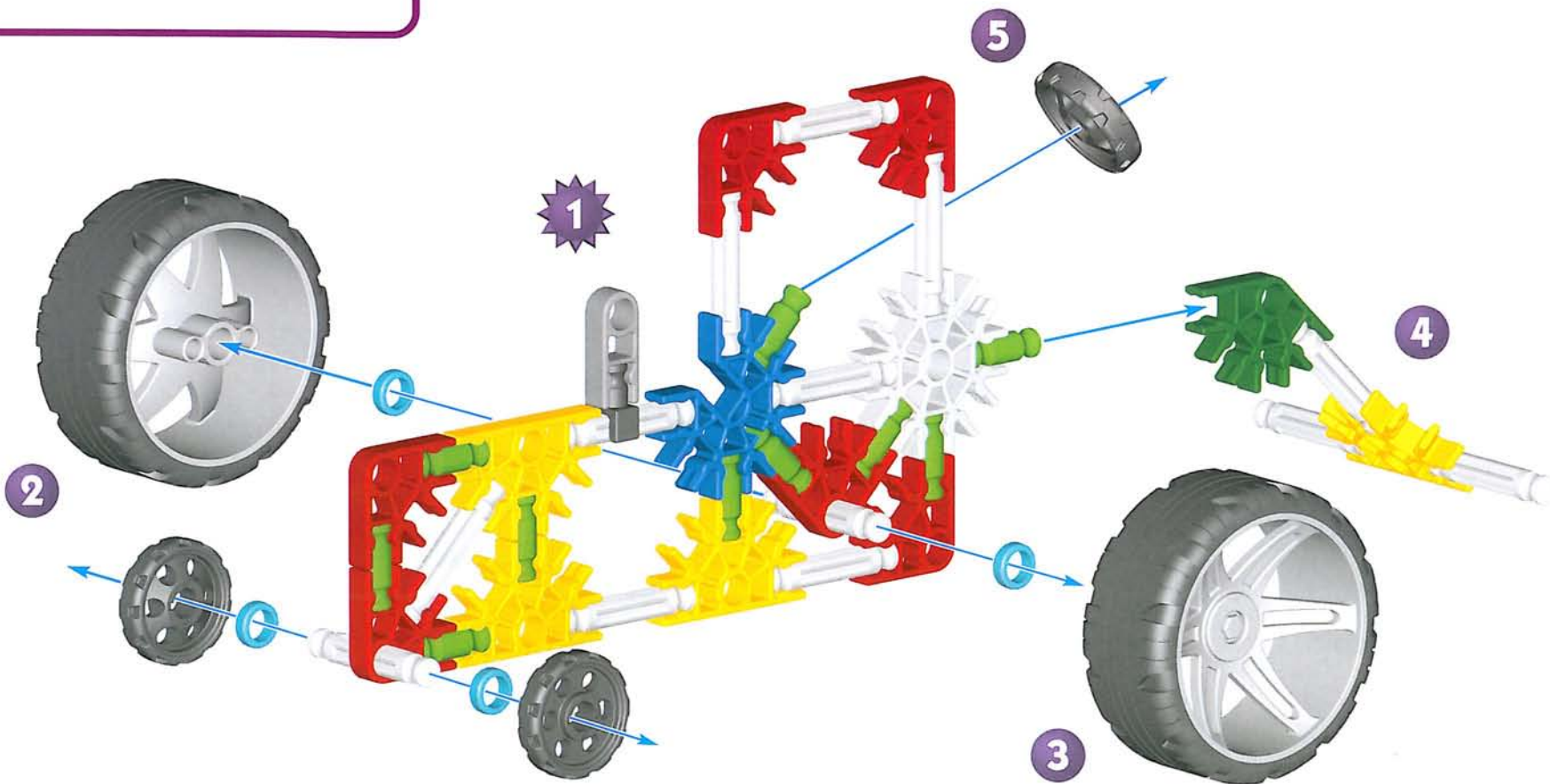



# Croc

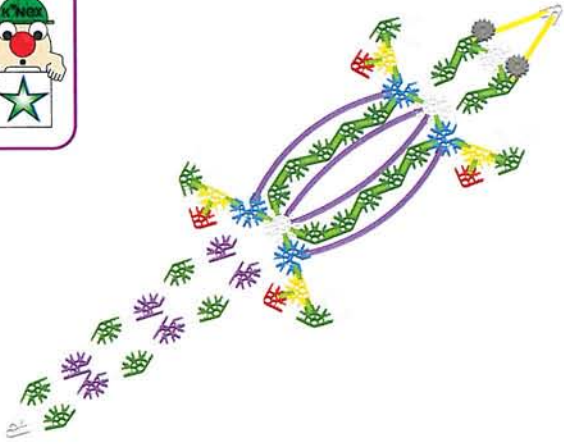

1

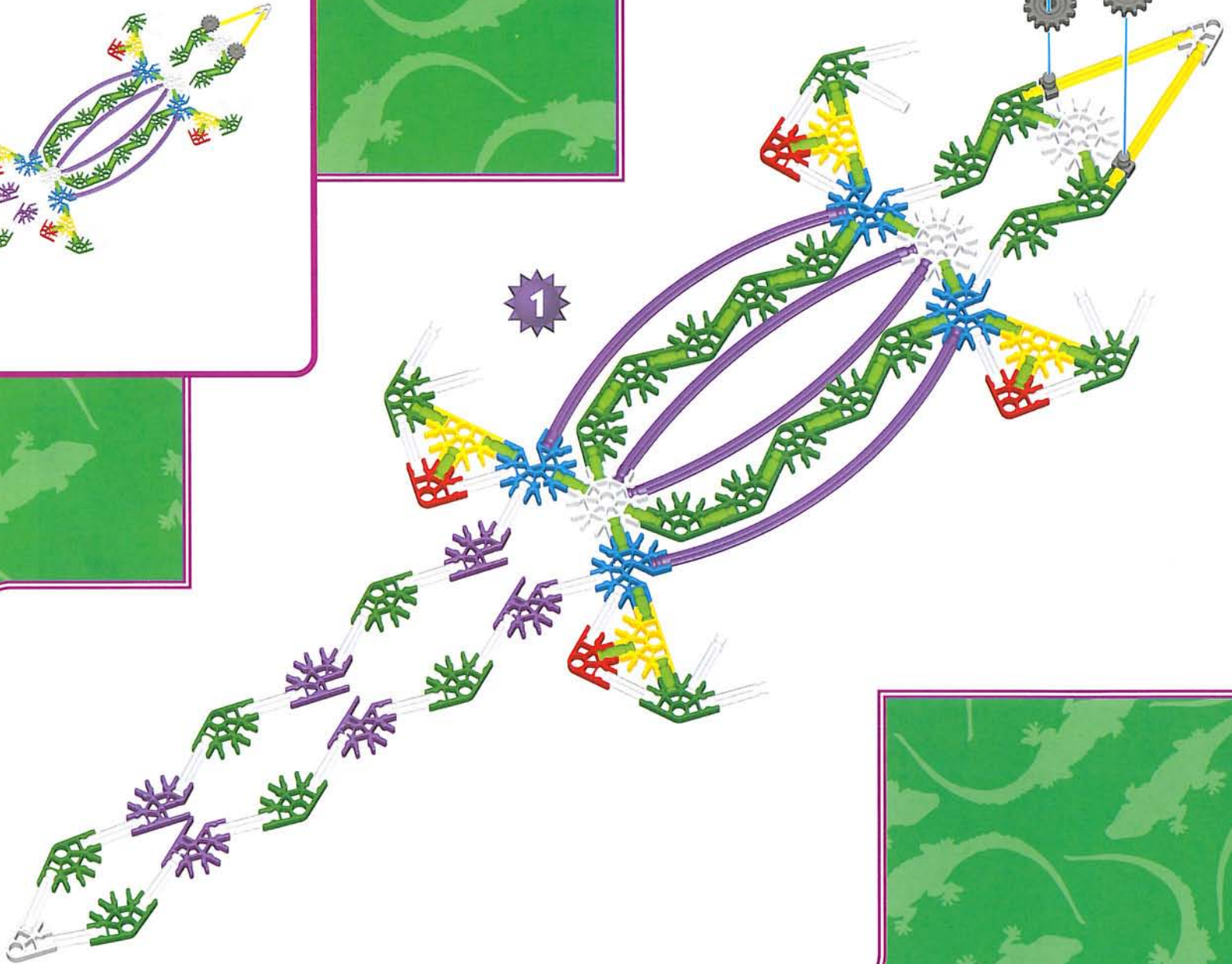

2

# Rabbit

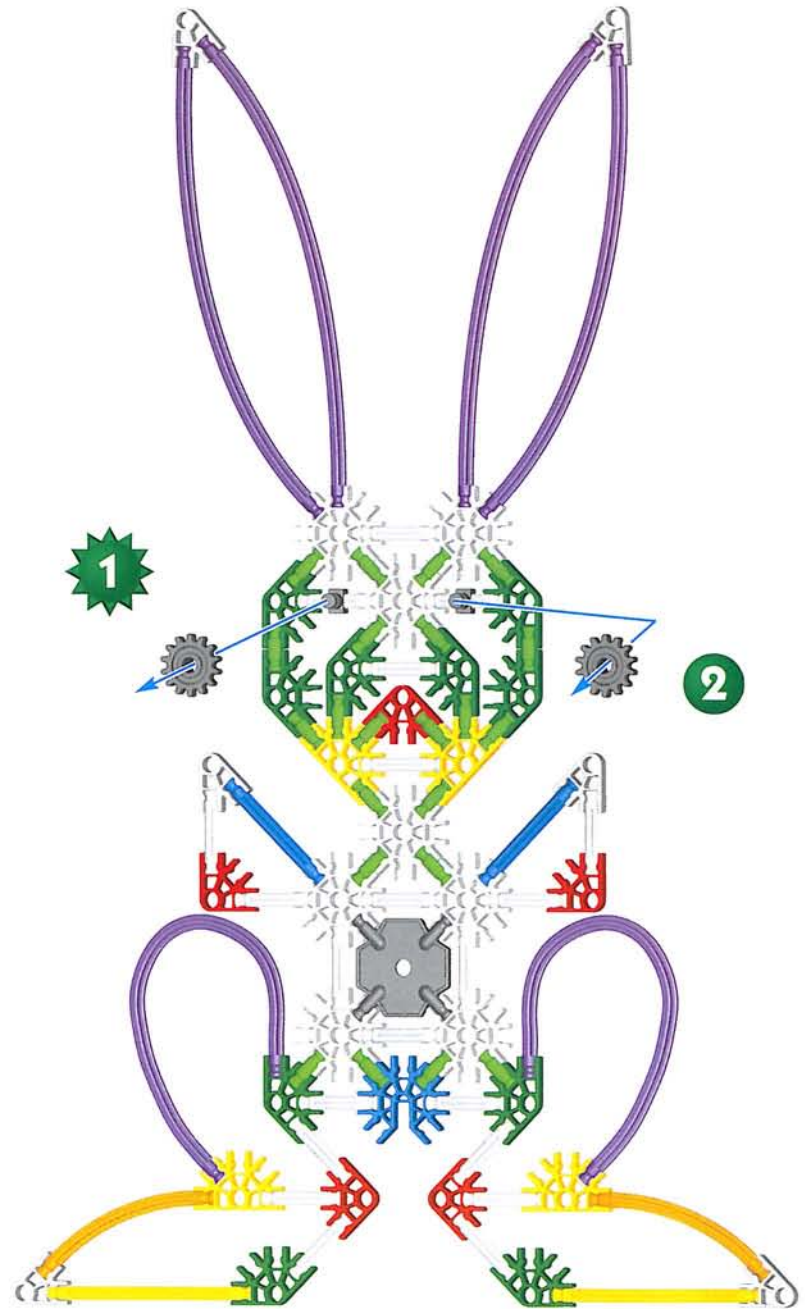
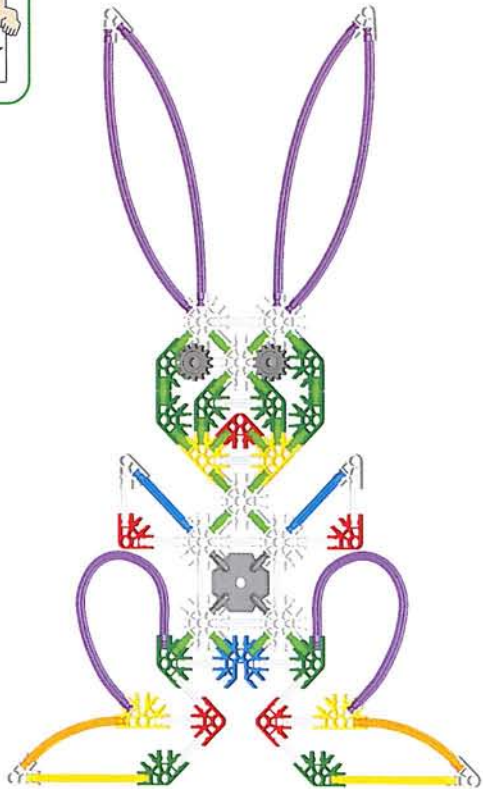

# Frog Coaster

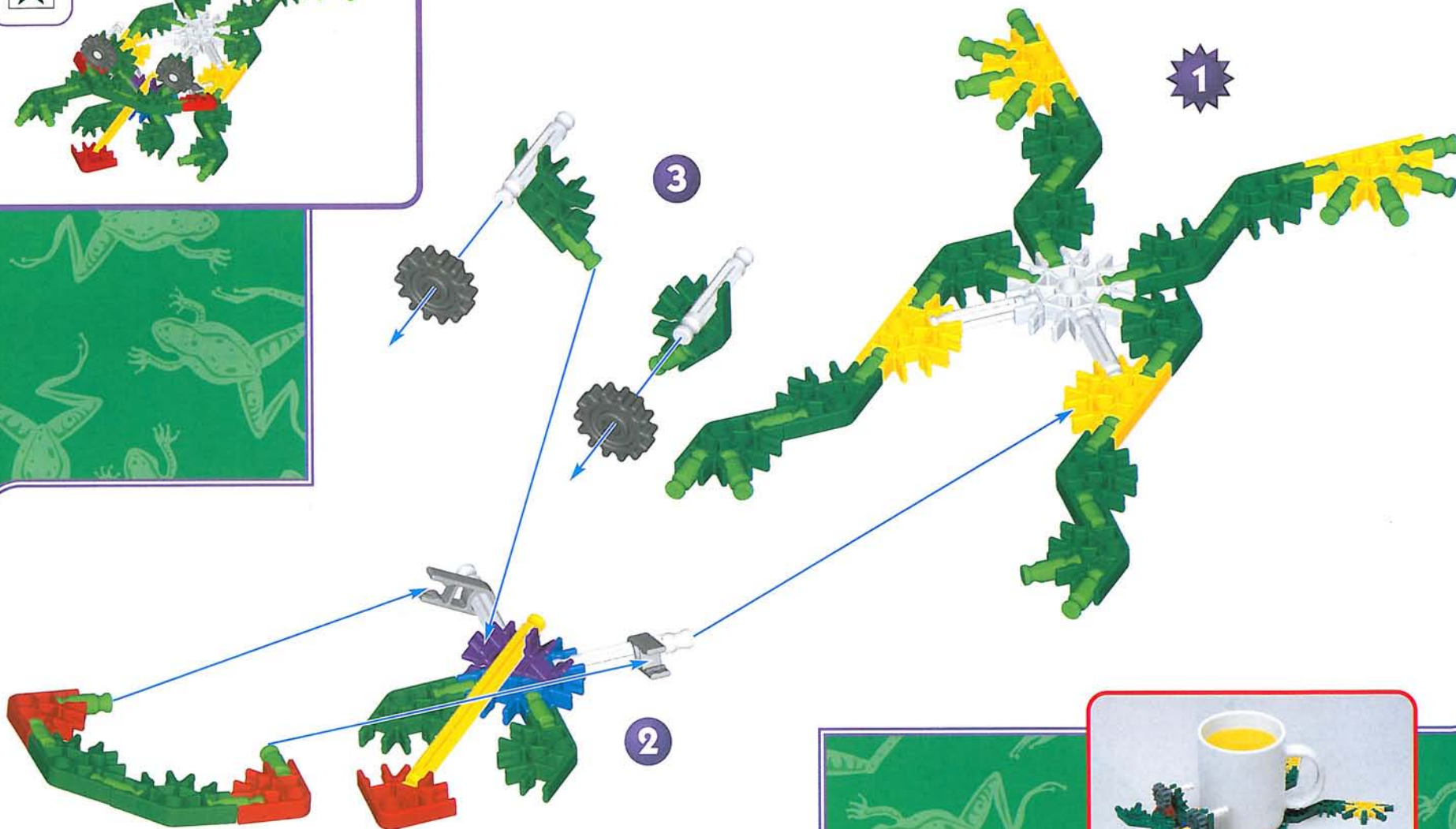
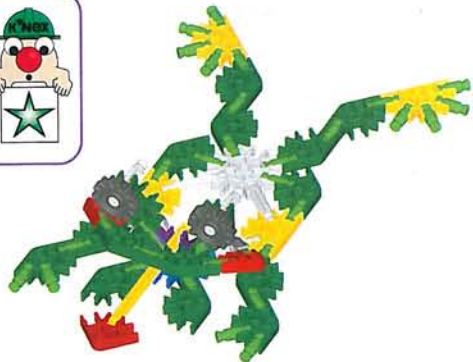

4

2

3

1



# Mini Jet

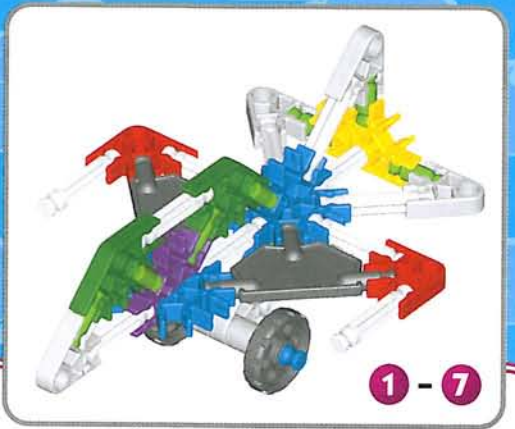
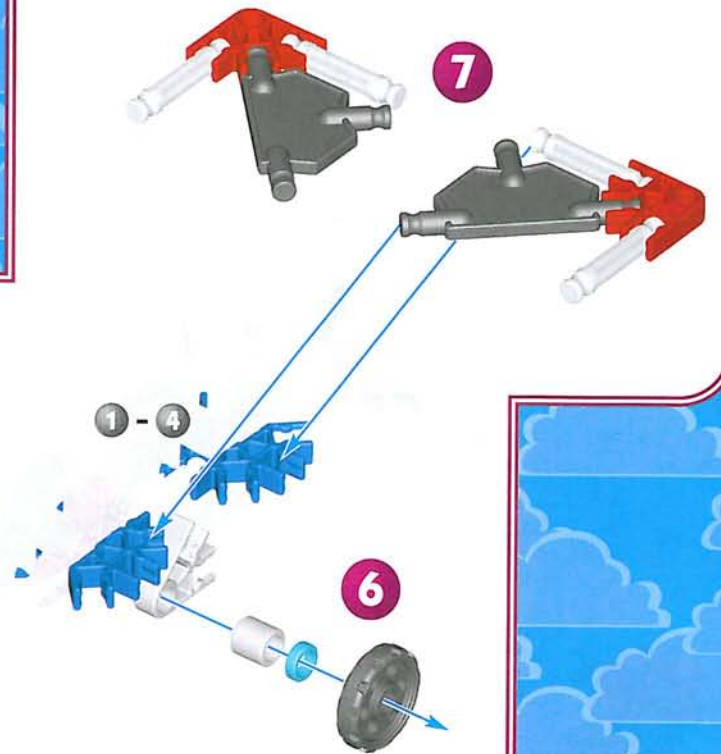
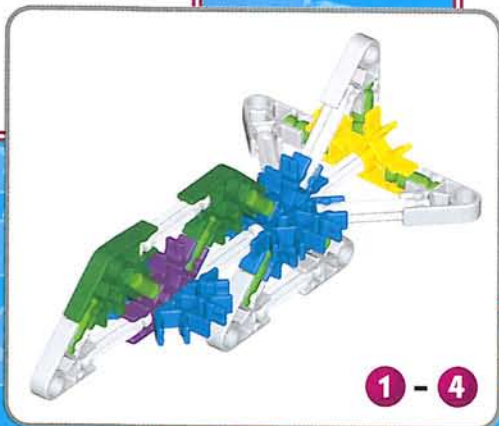
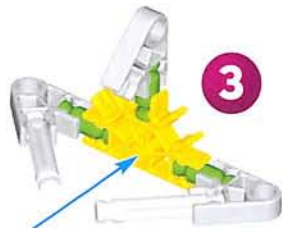
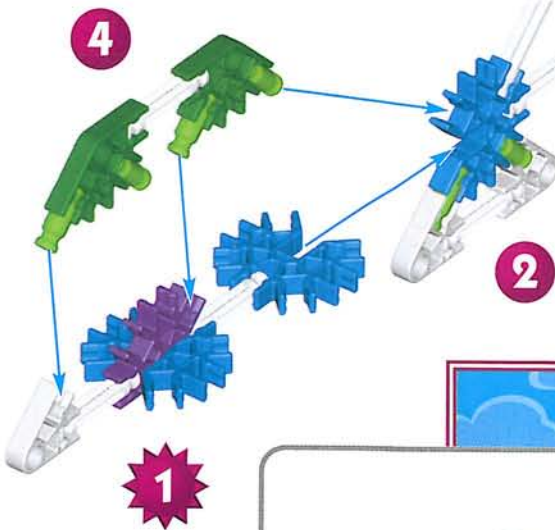

# Hand Drill

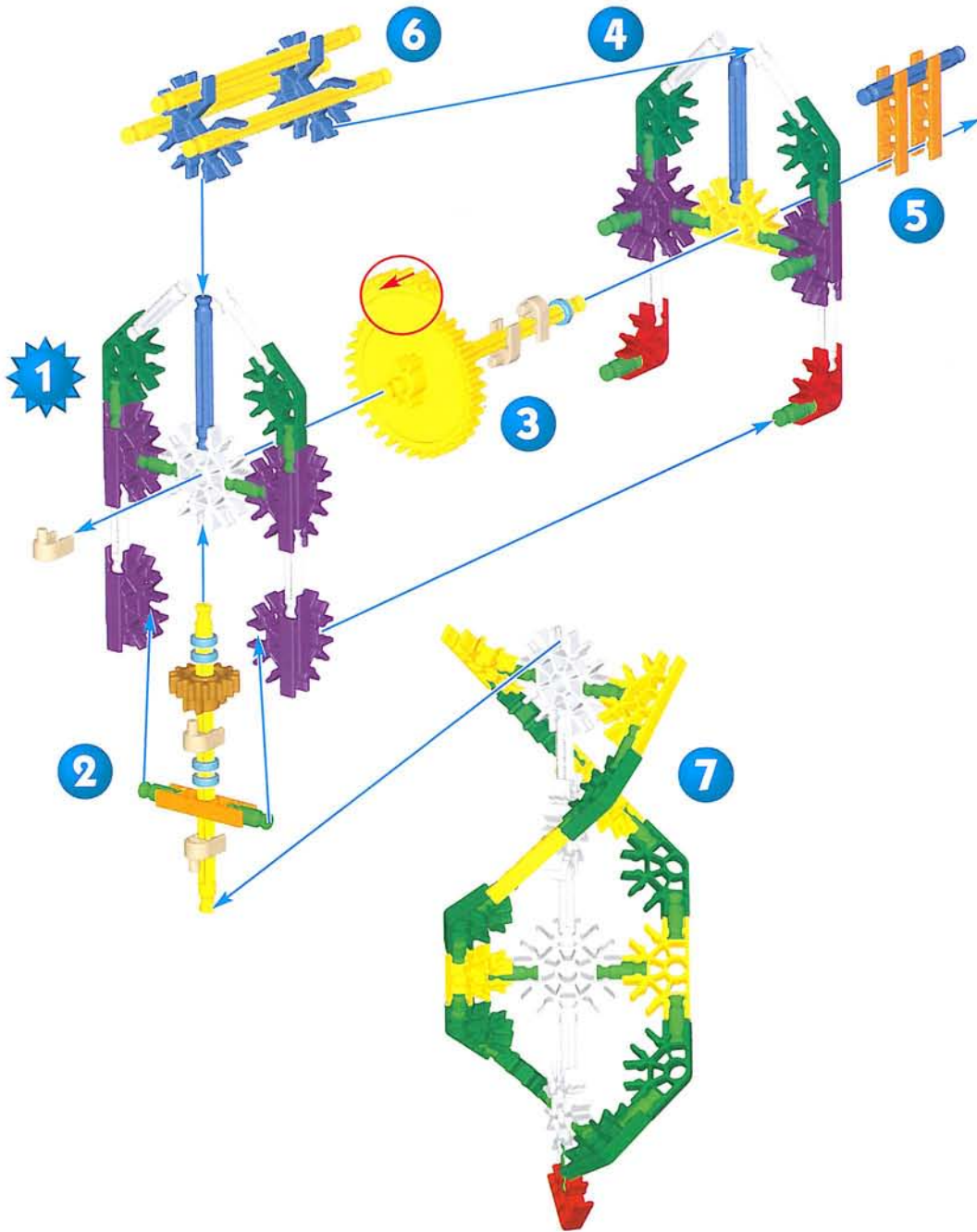

# Sporty Car

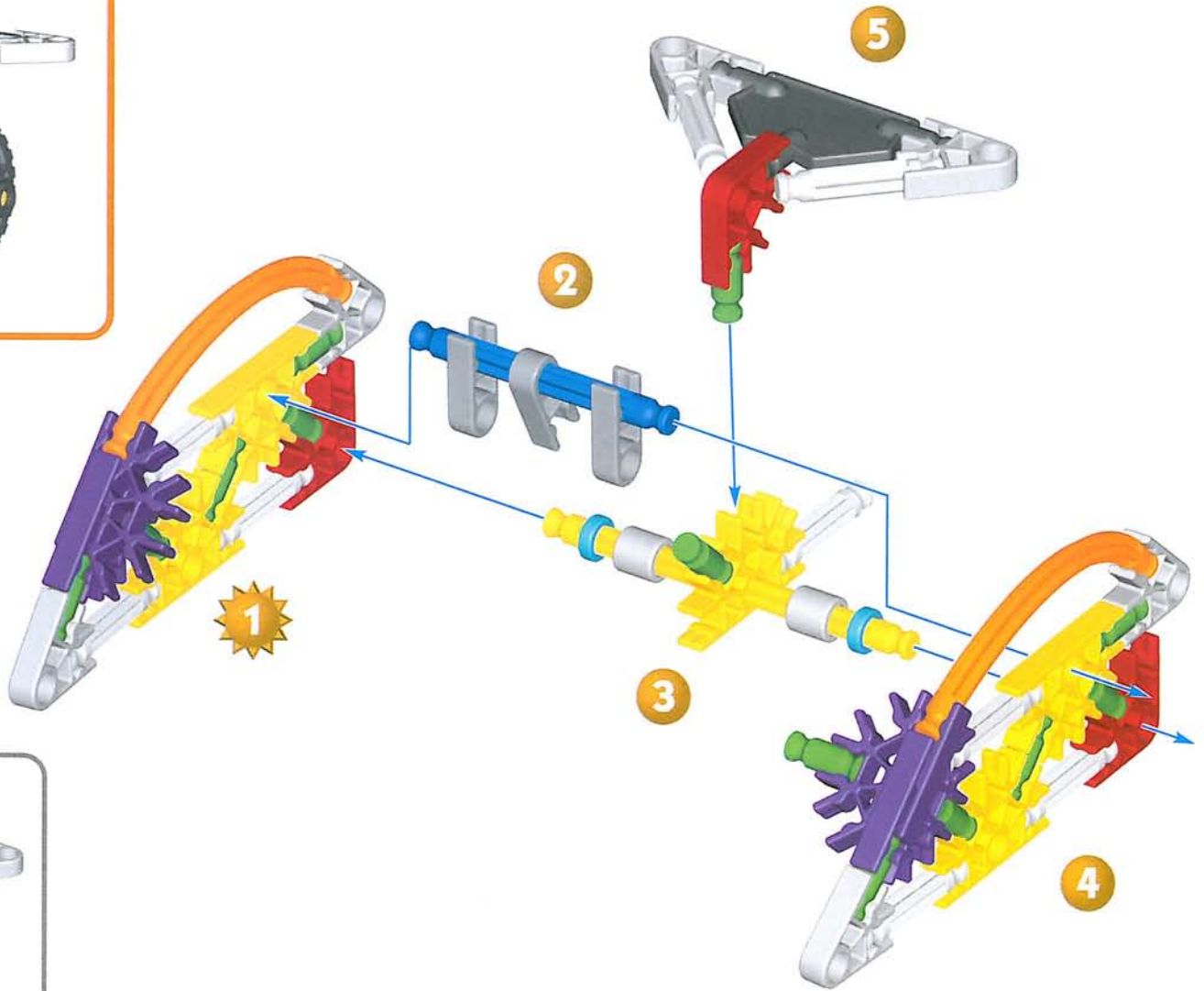

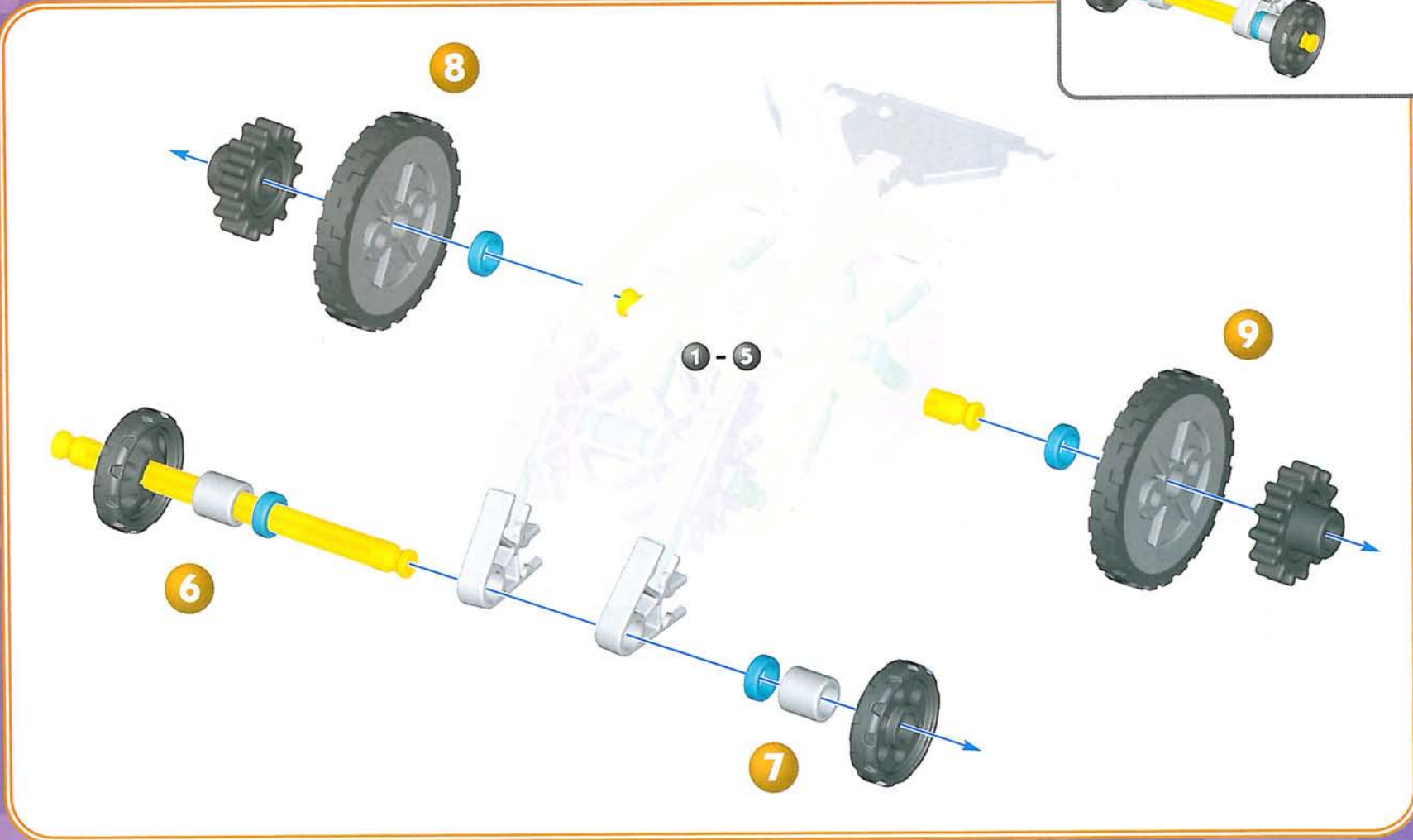
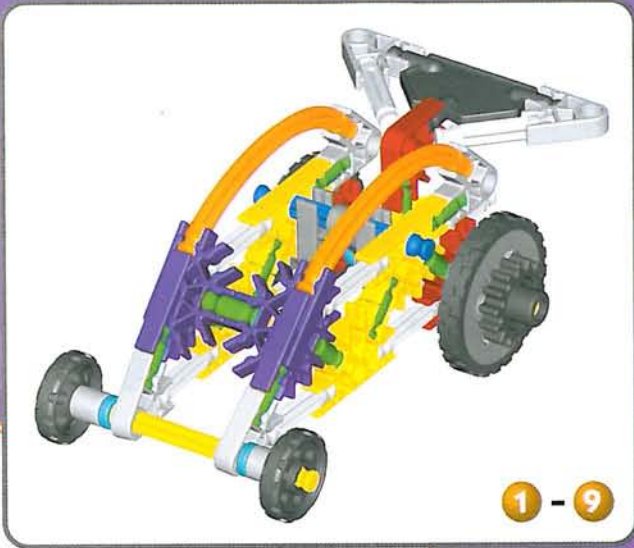

# Trike

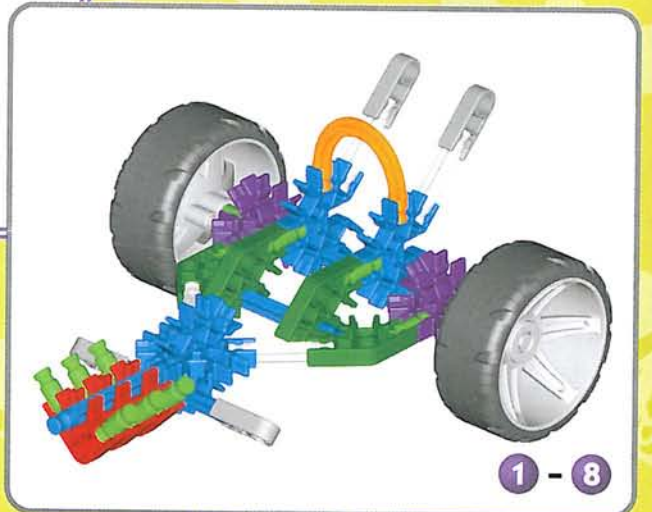
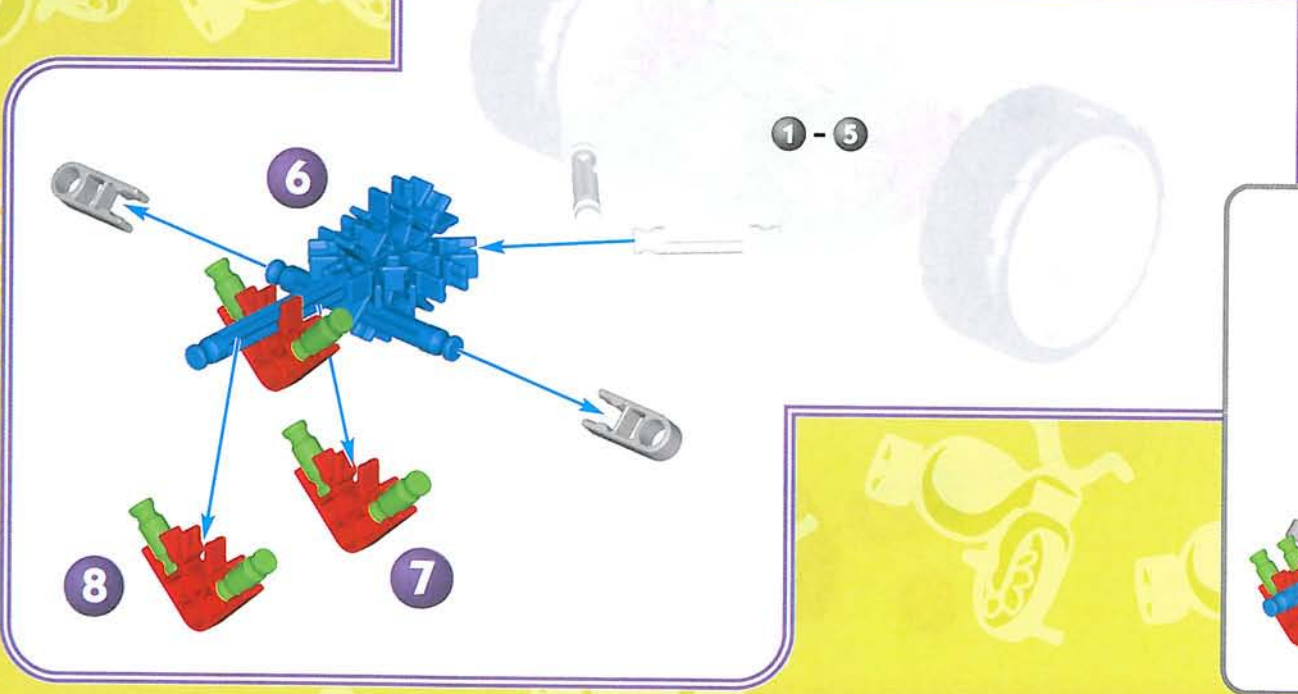
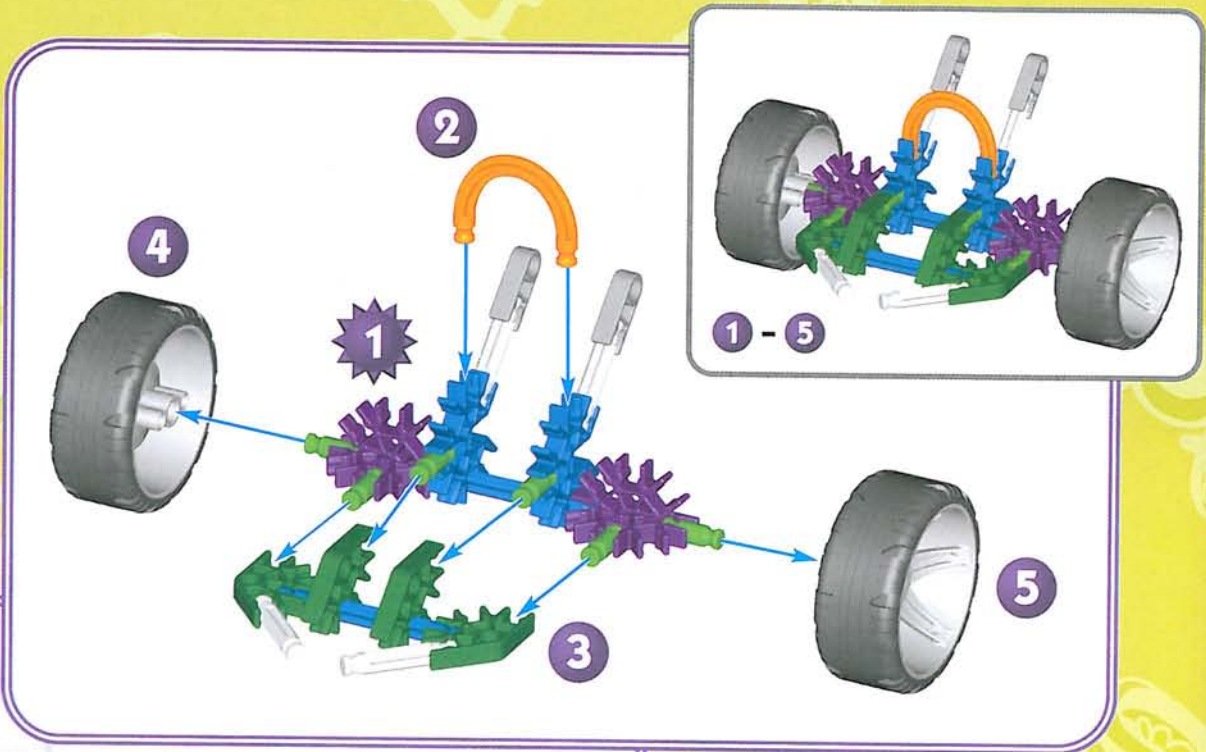
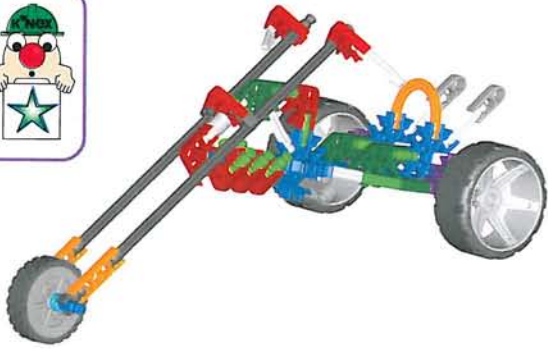



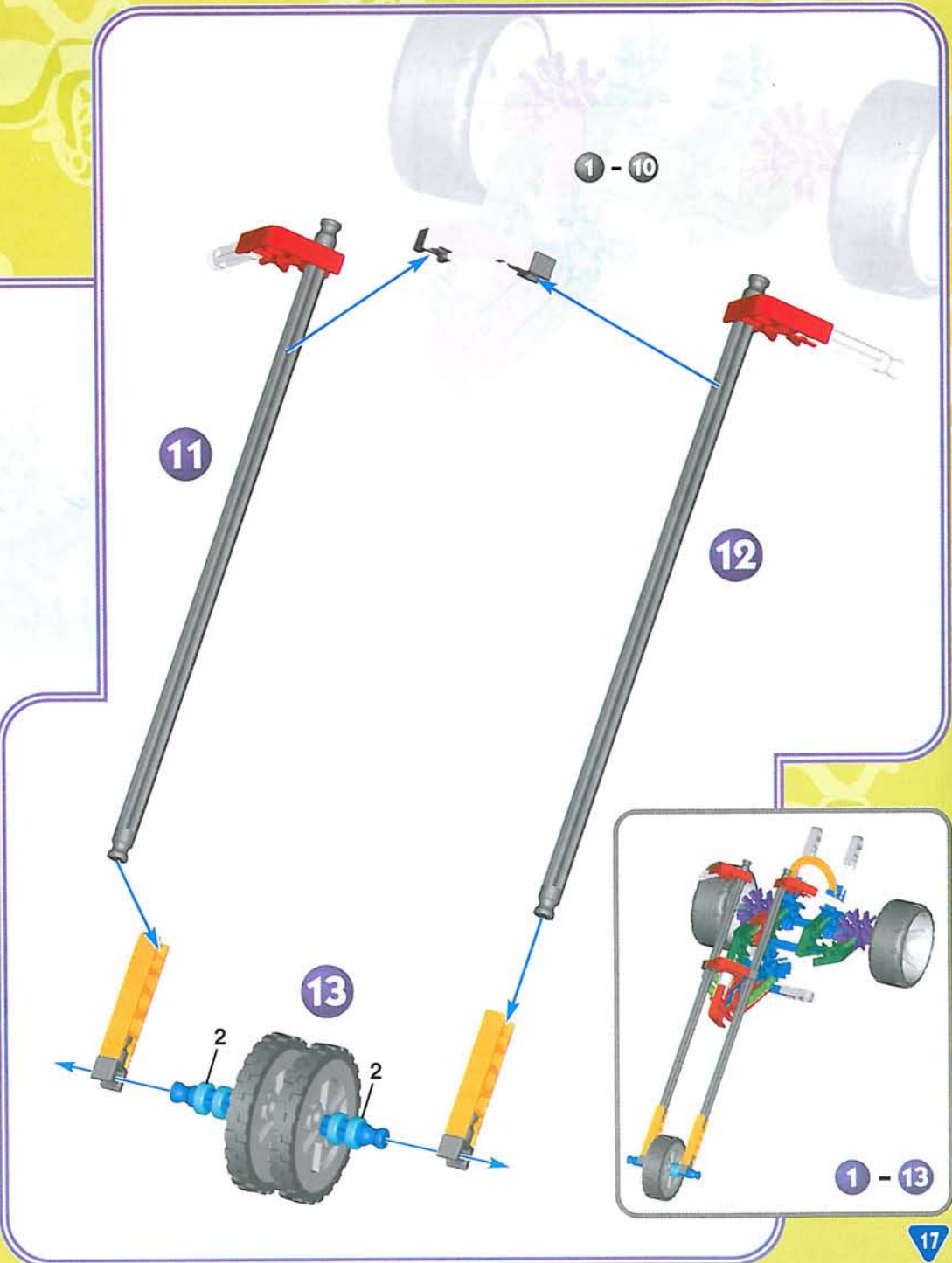
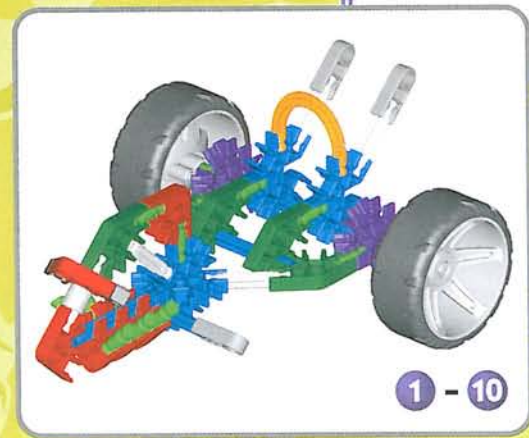
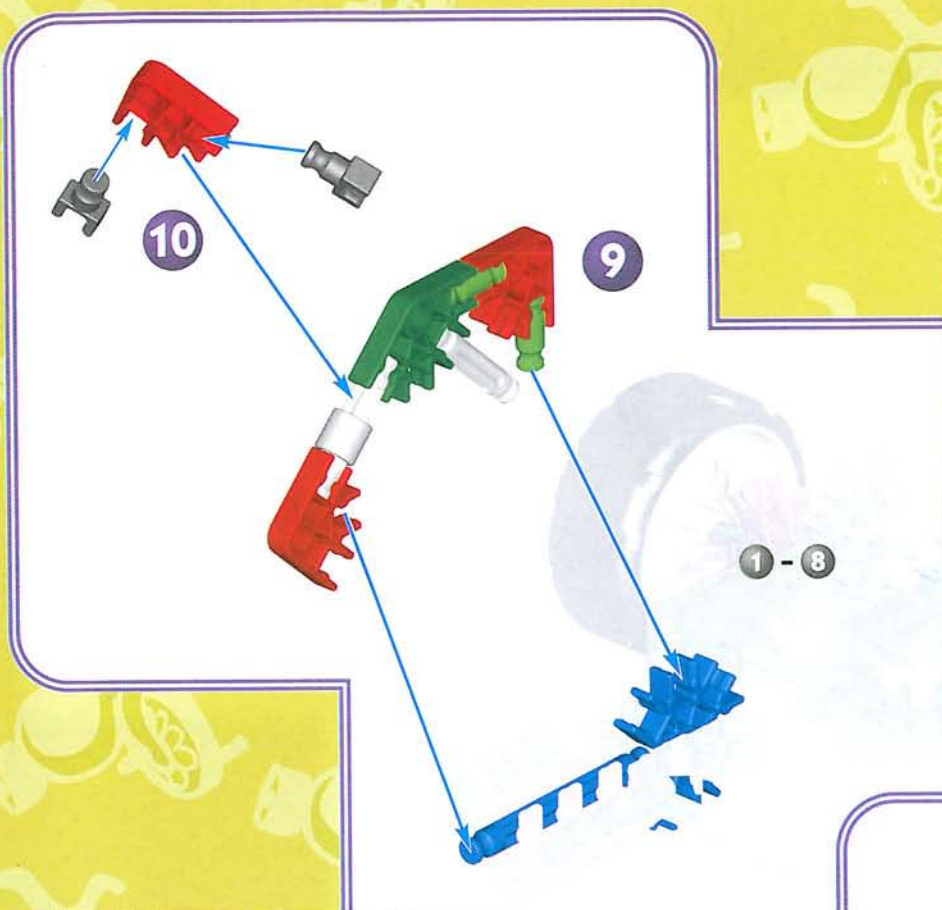

# Letter Rack



3

2

4

5

3

1

1 - 5

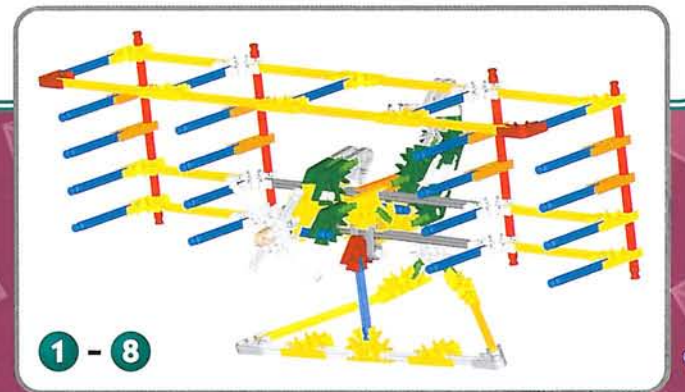
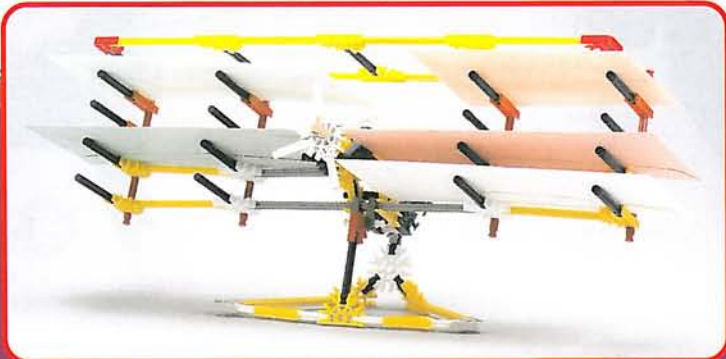
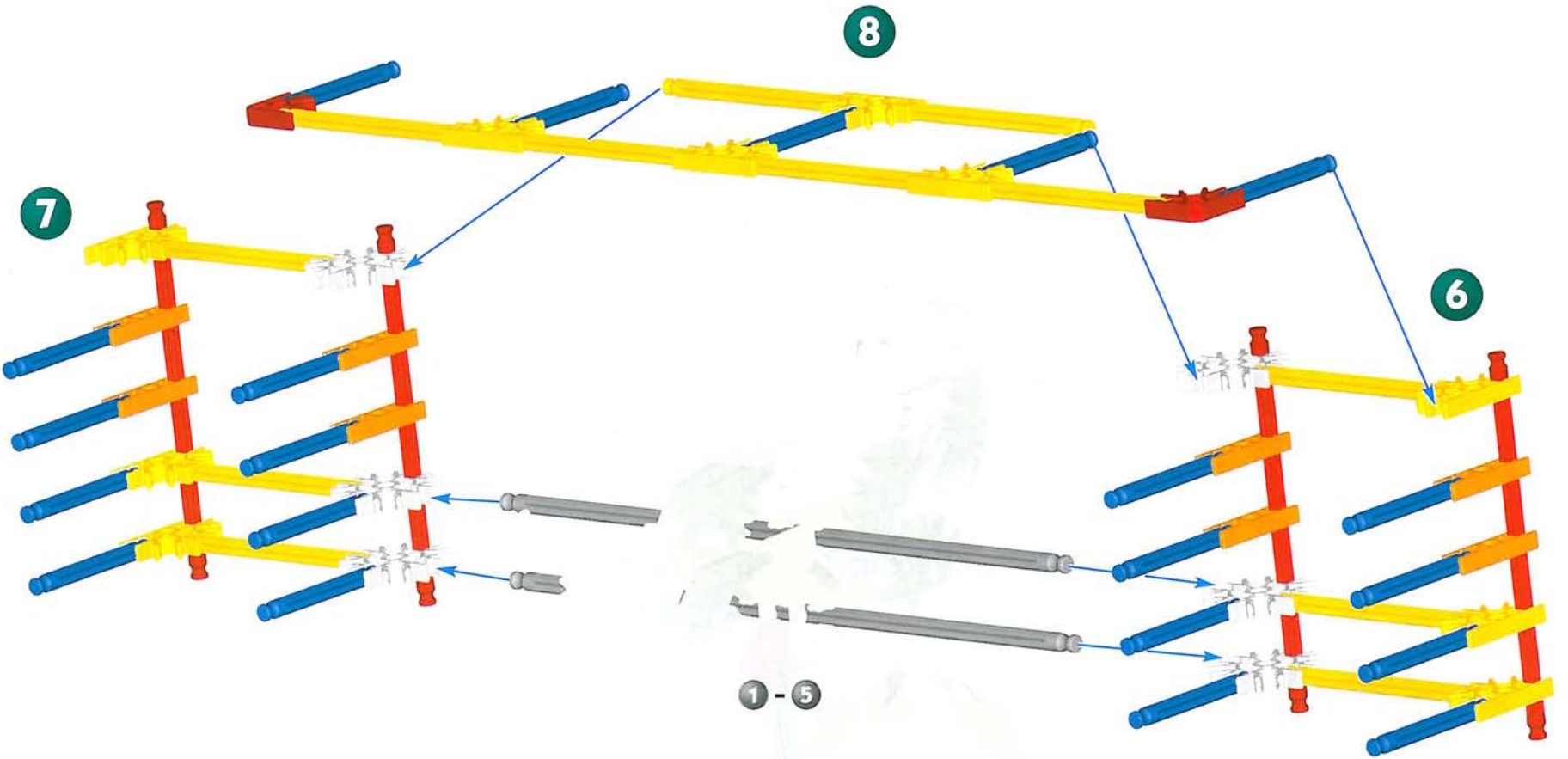

# Praying Mantis

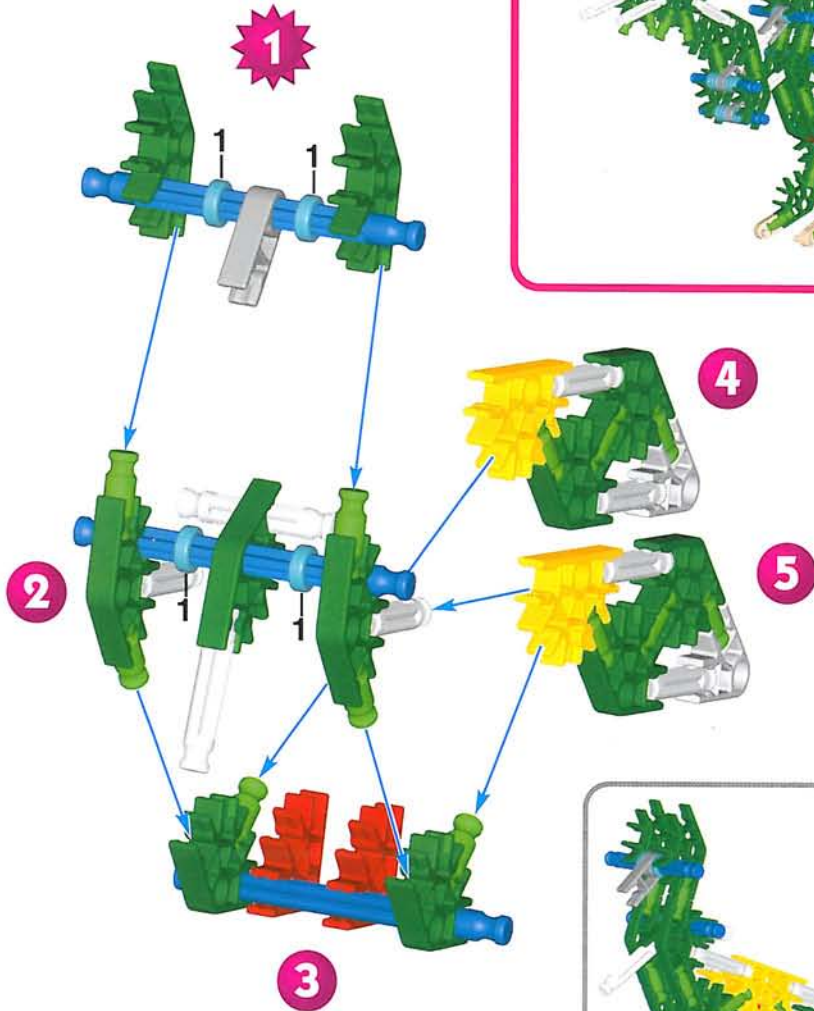
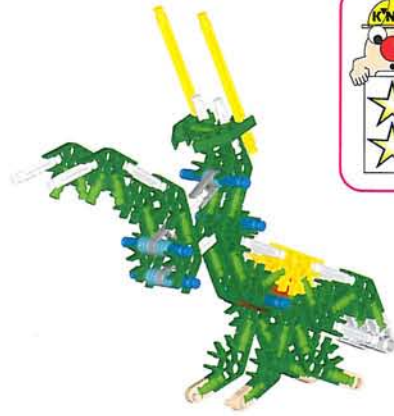

1 - 5

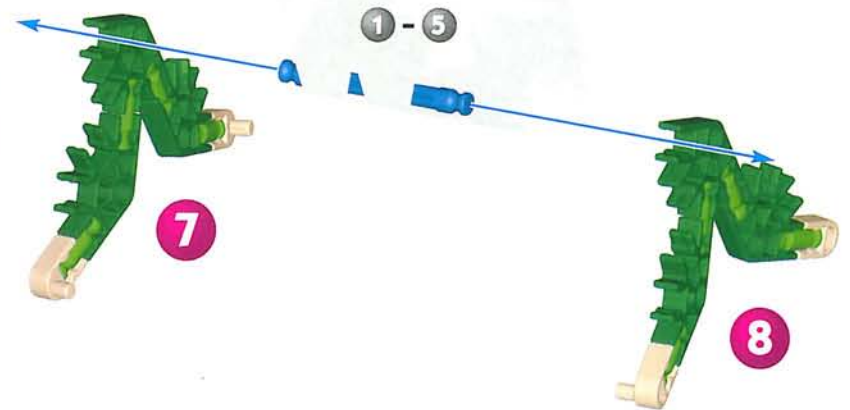
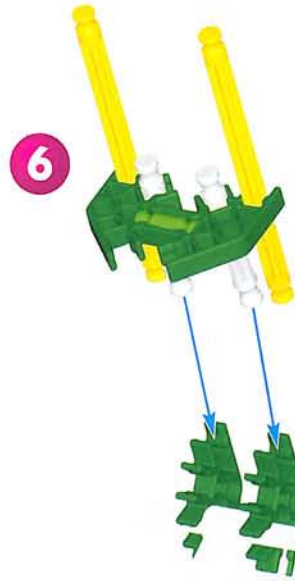

1 - 8

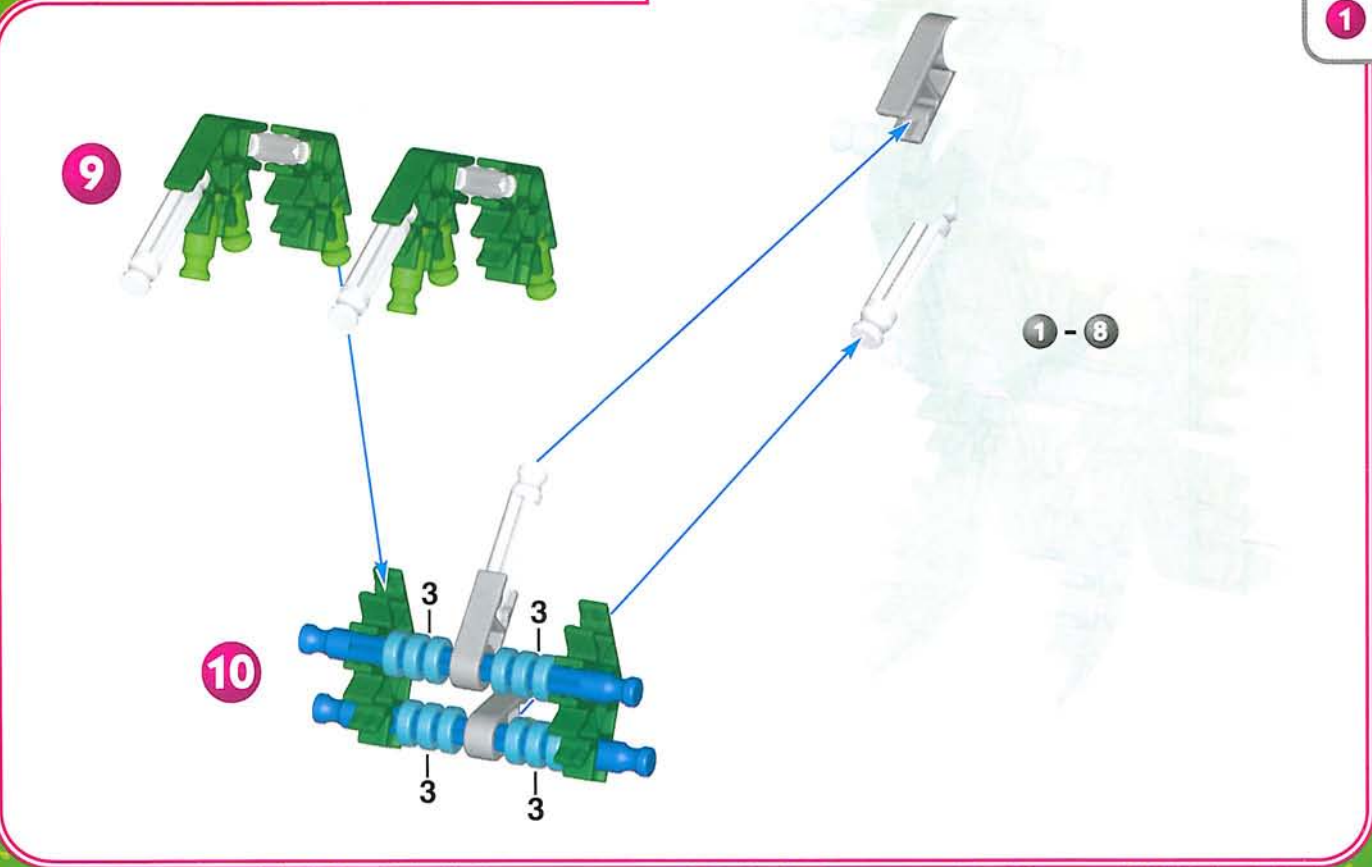

# Balance

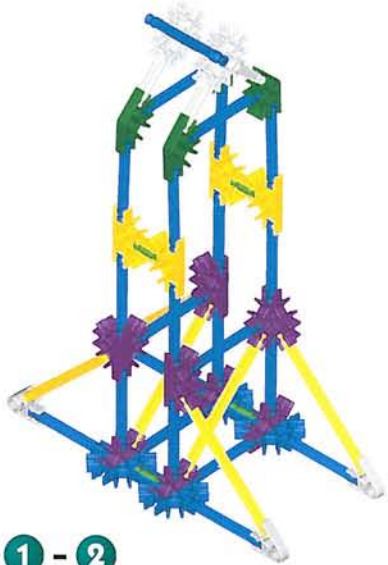
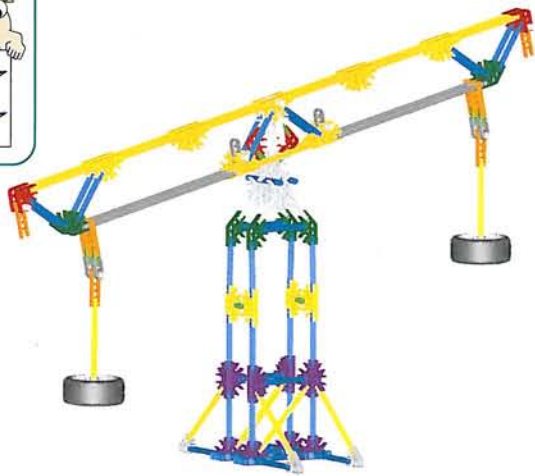

1 - 2

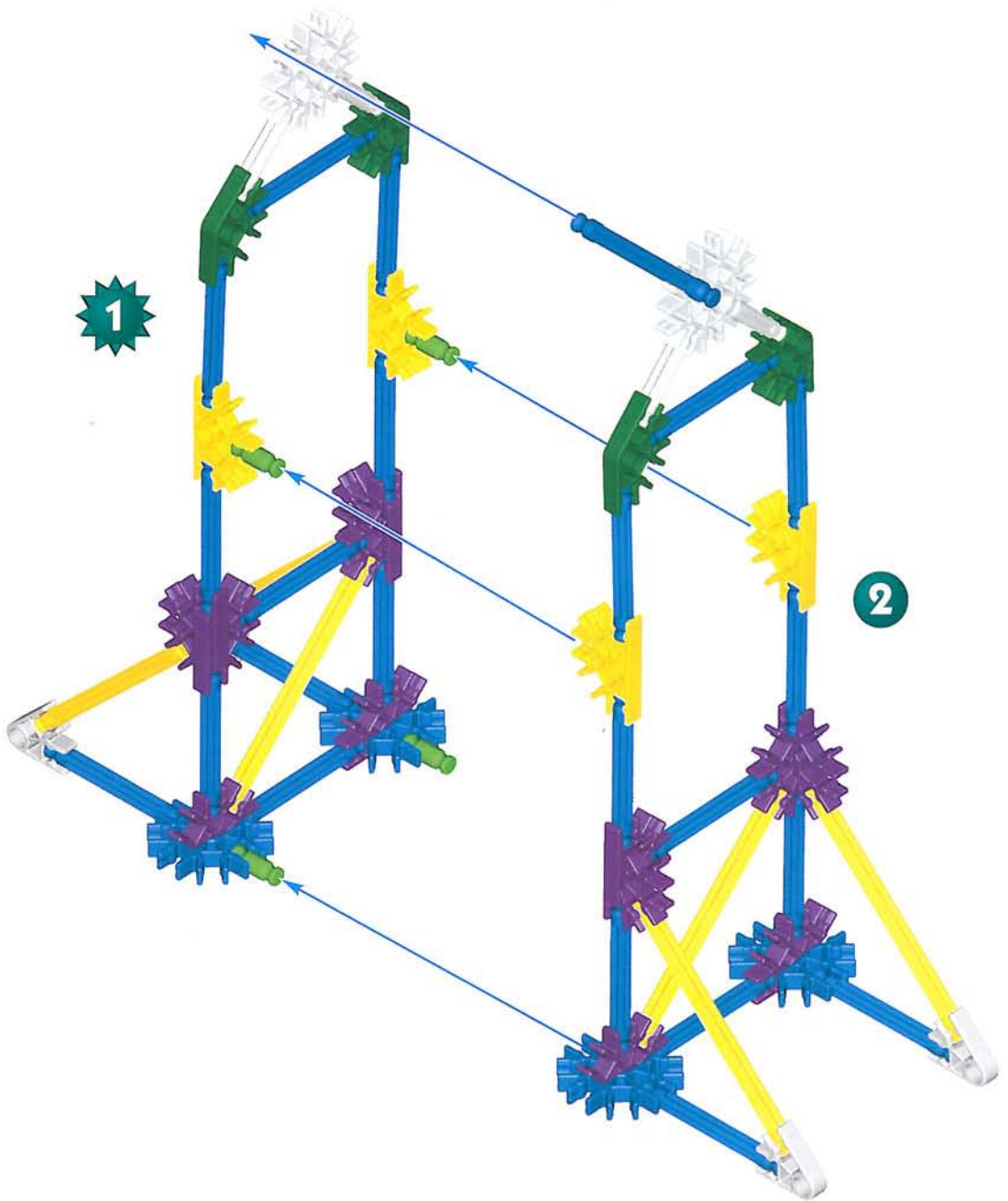

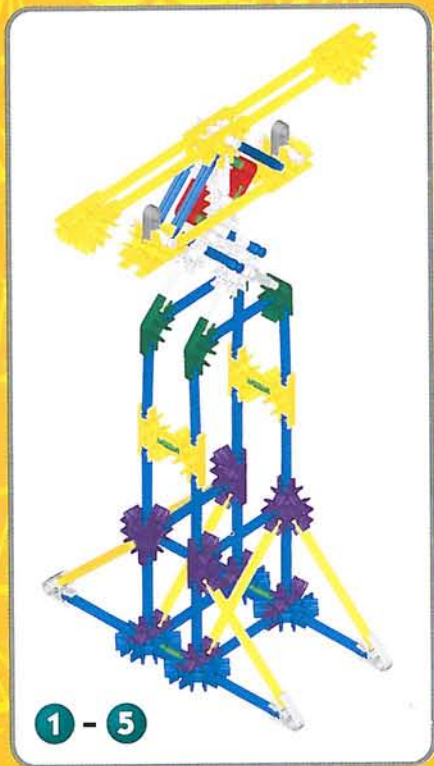
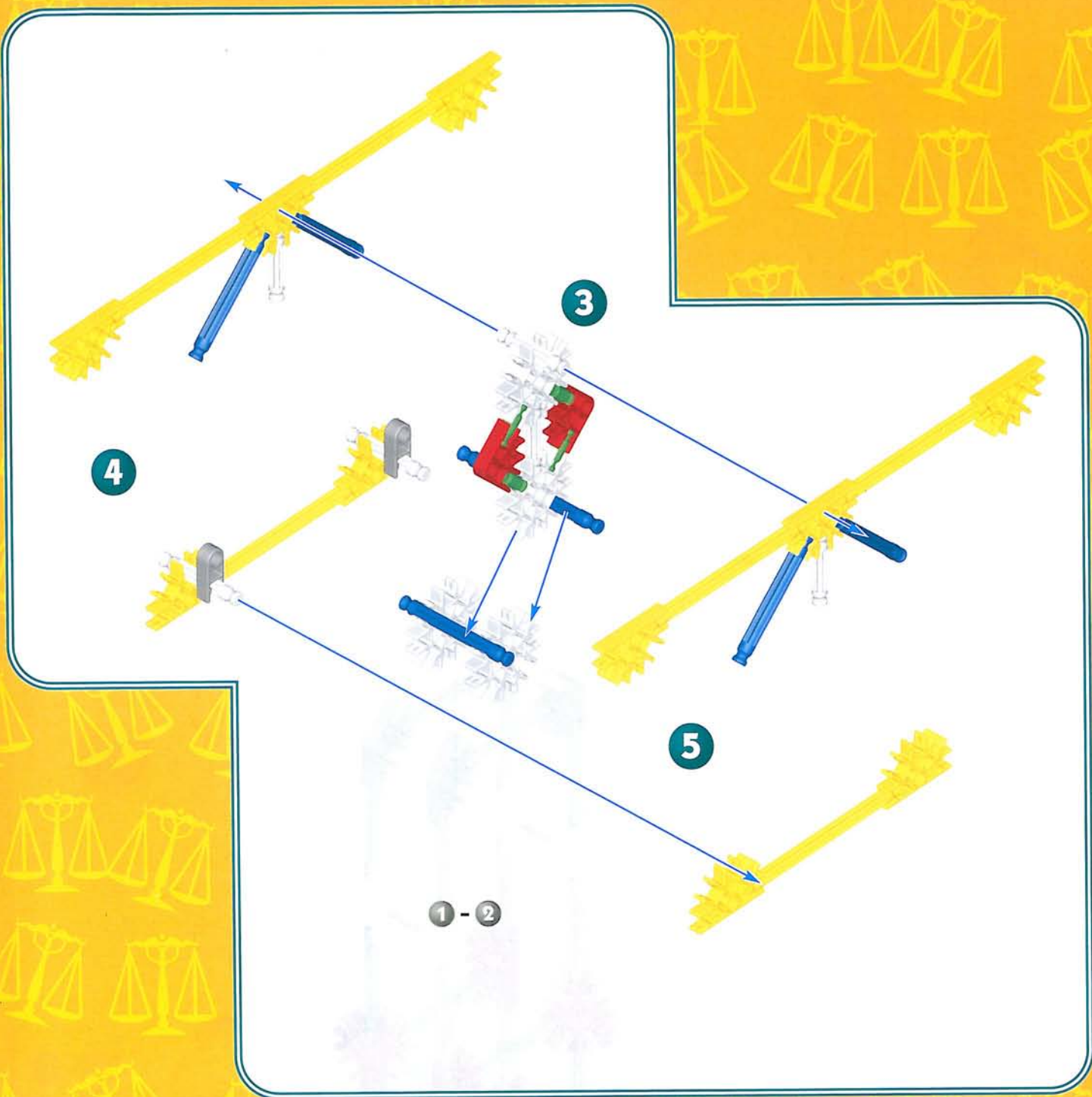





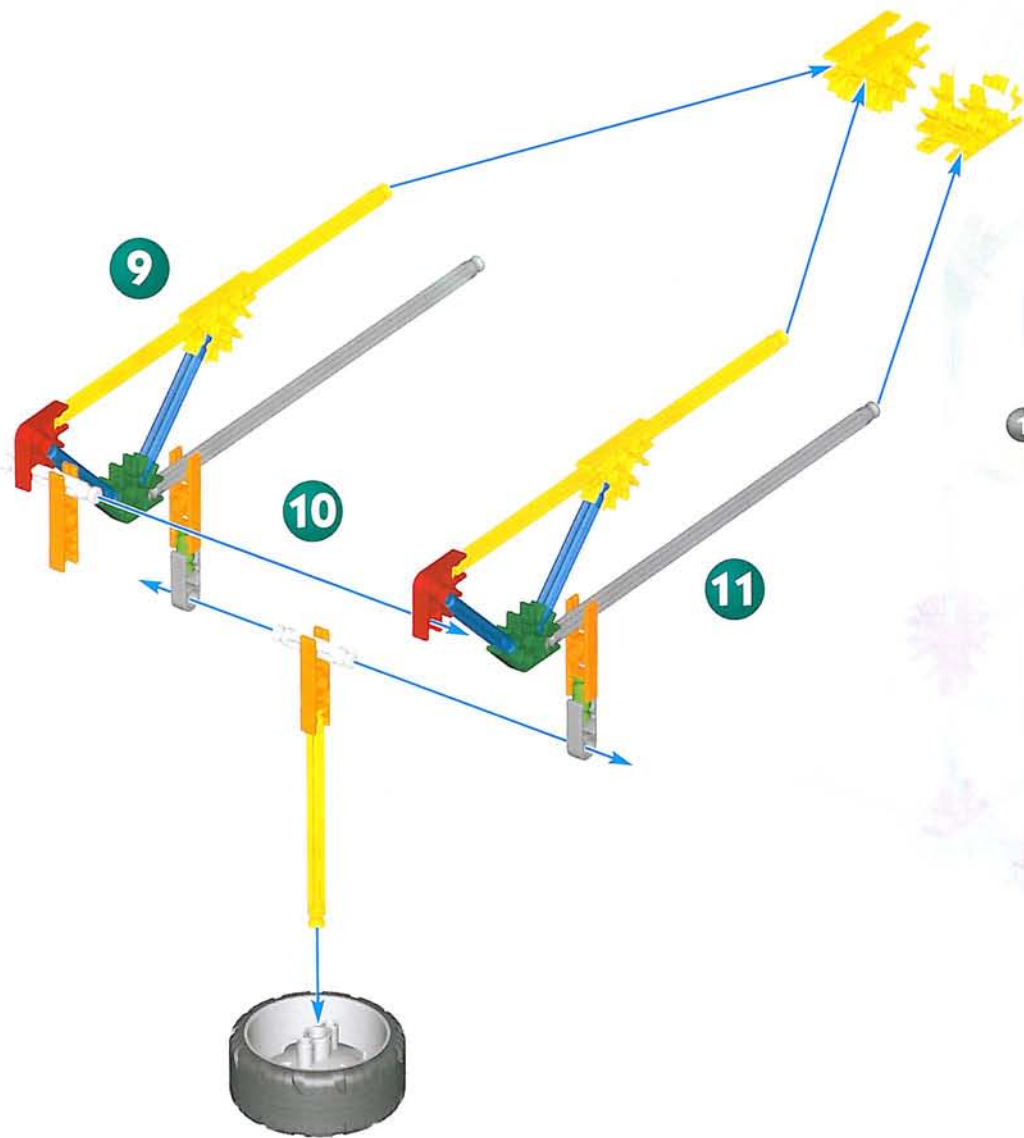

1 - 8

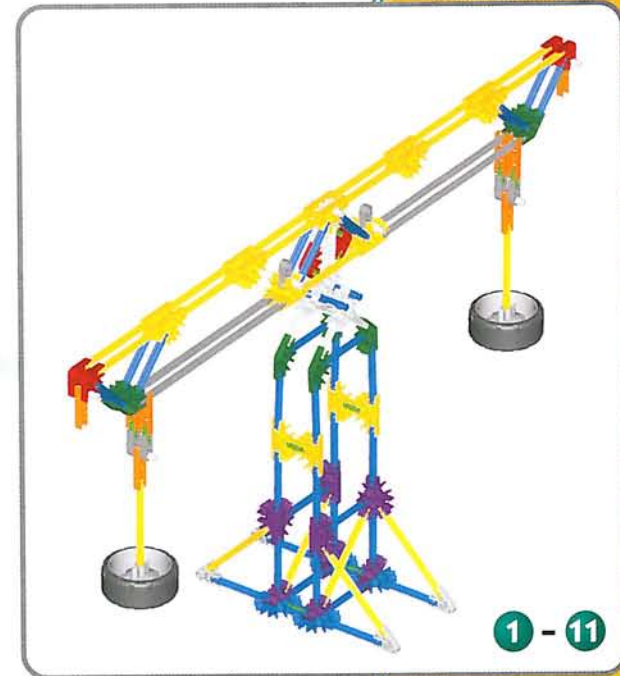

# Tool Box

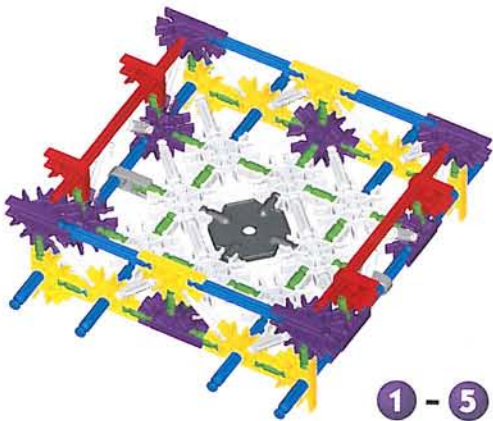

1 - 5

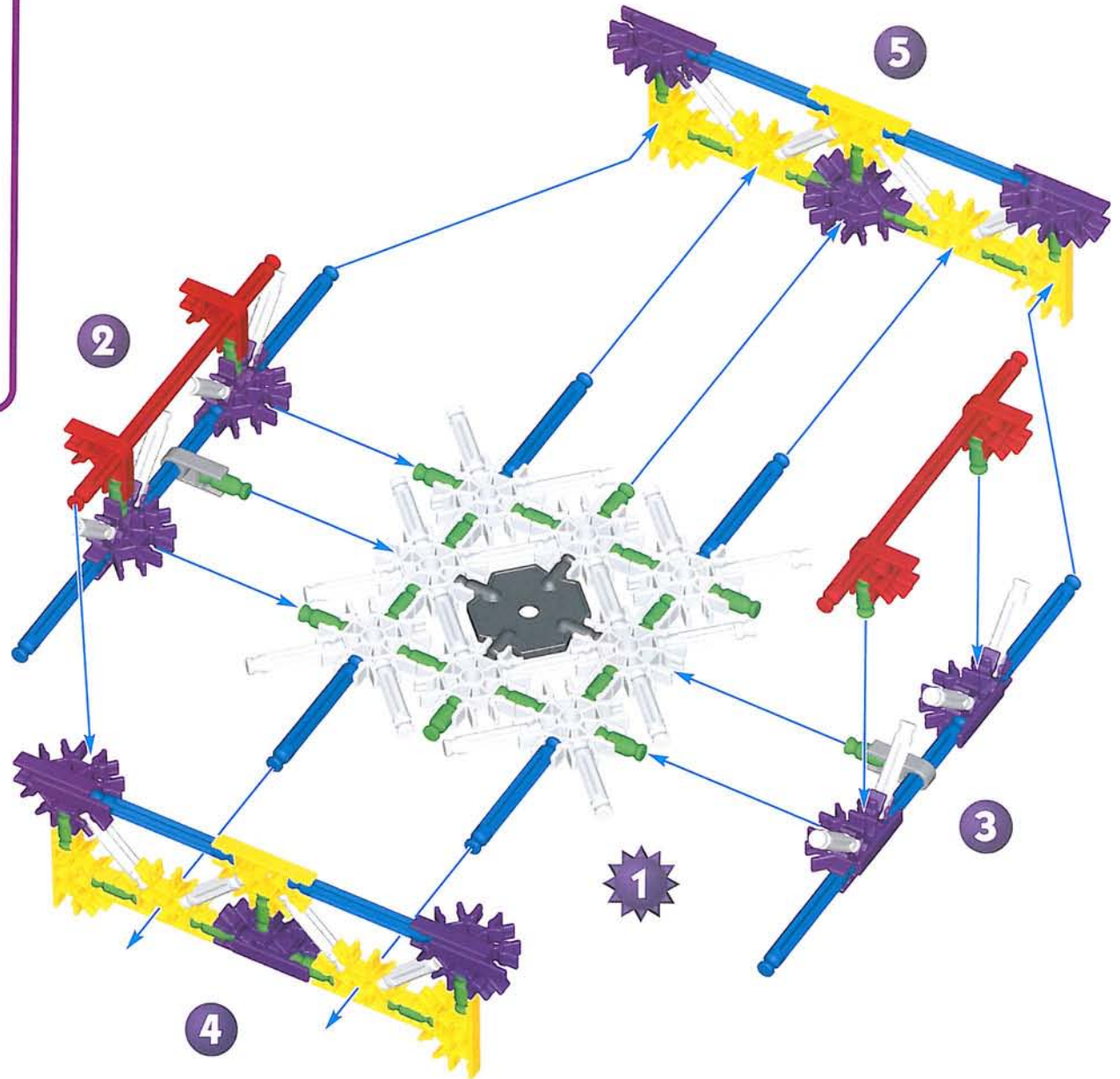

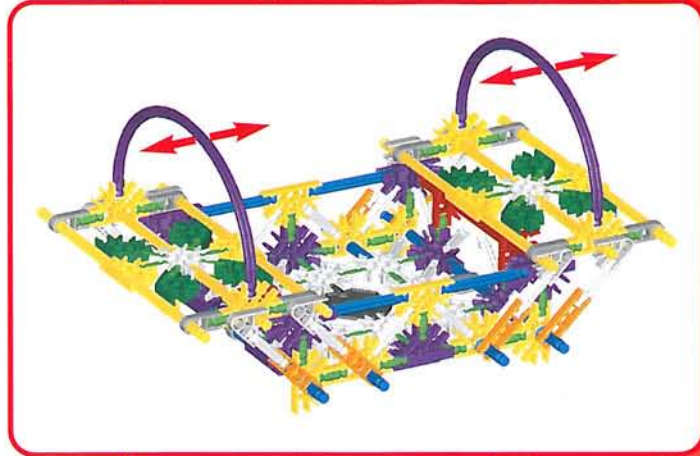
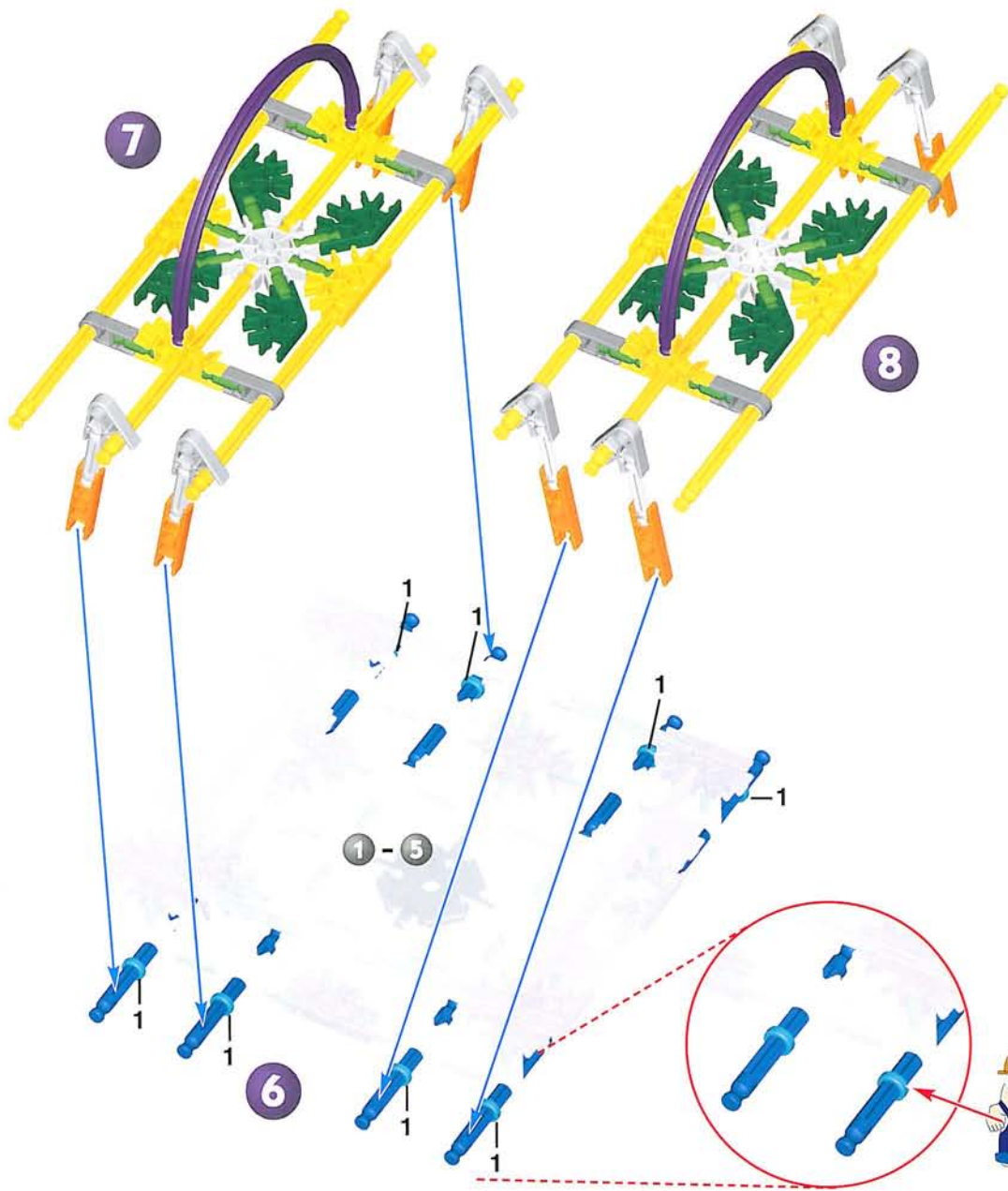

# Desert Racer

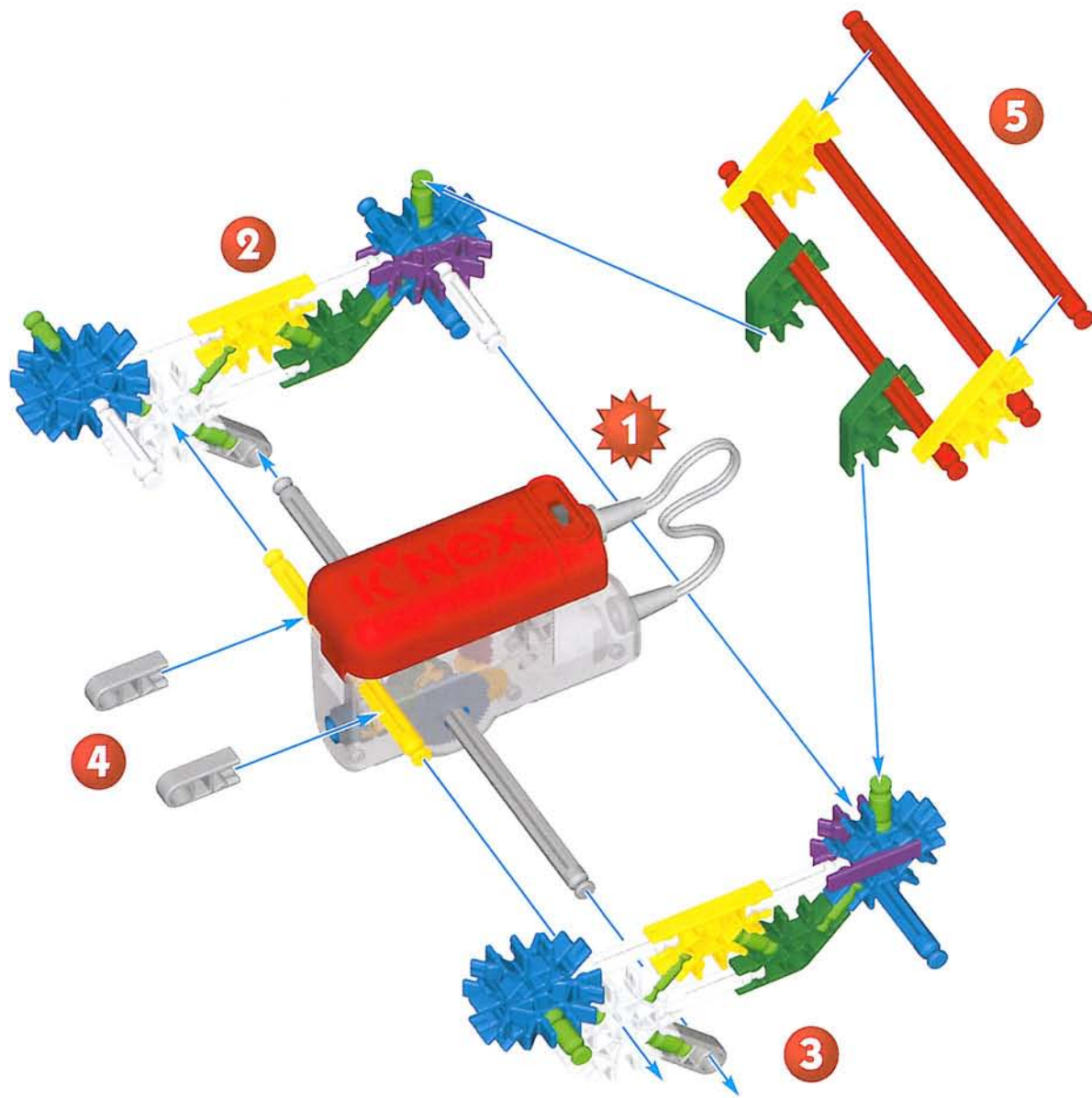

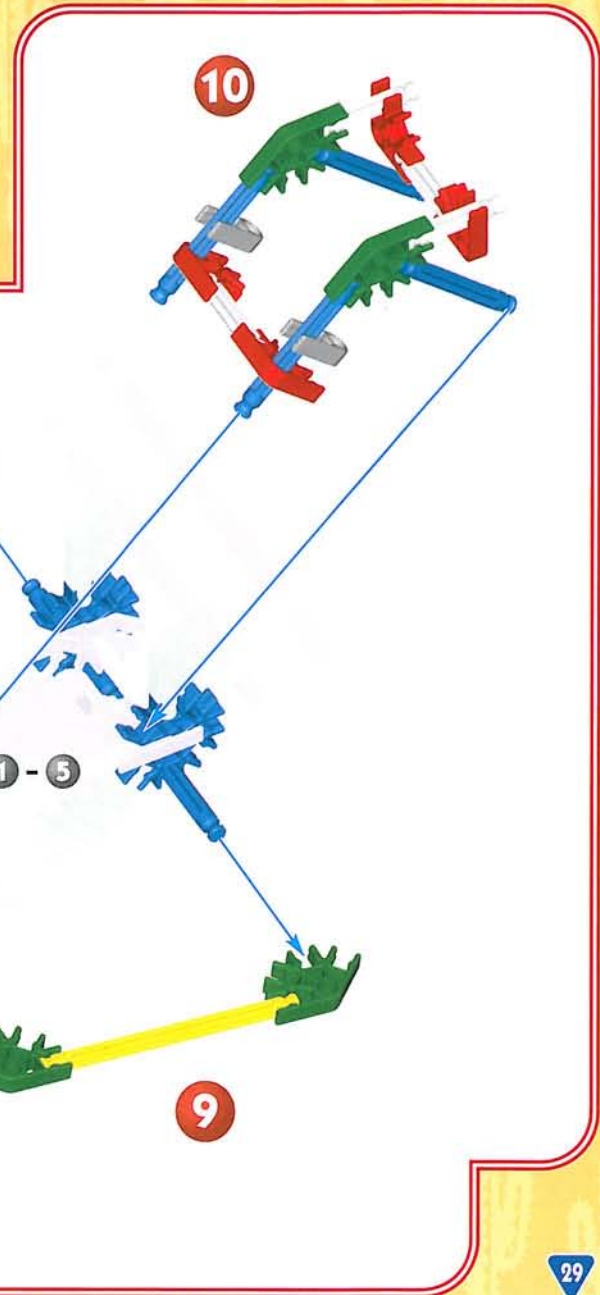
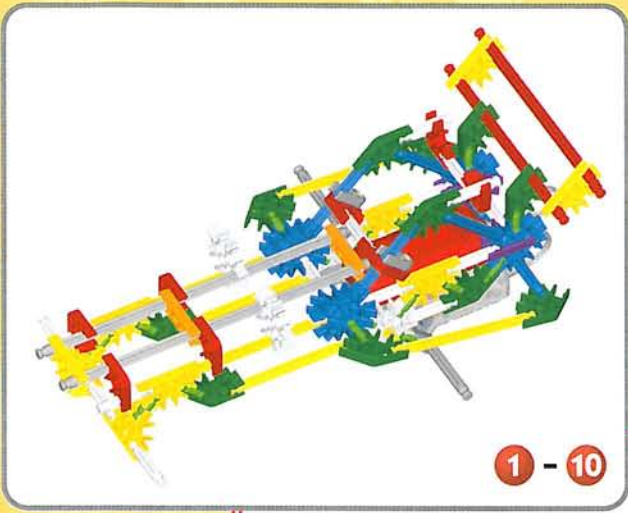

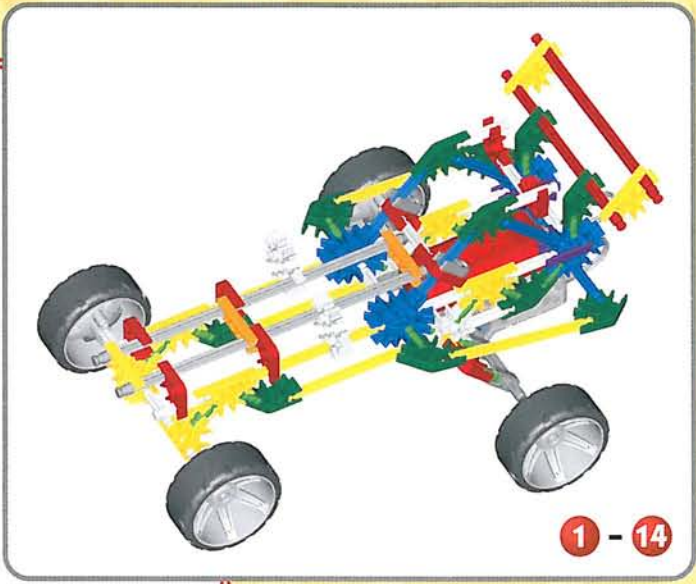
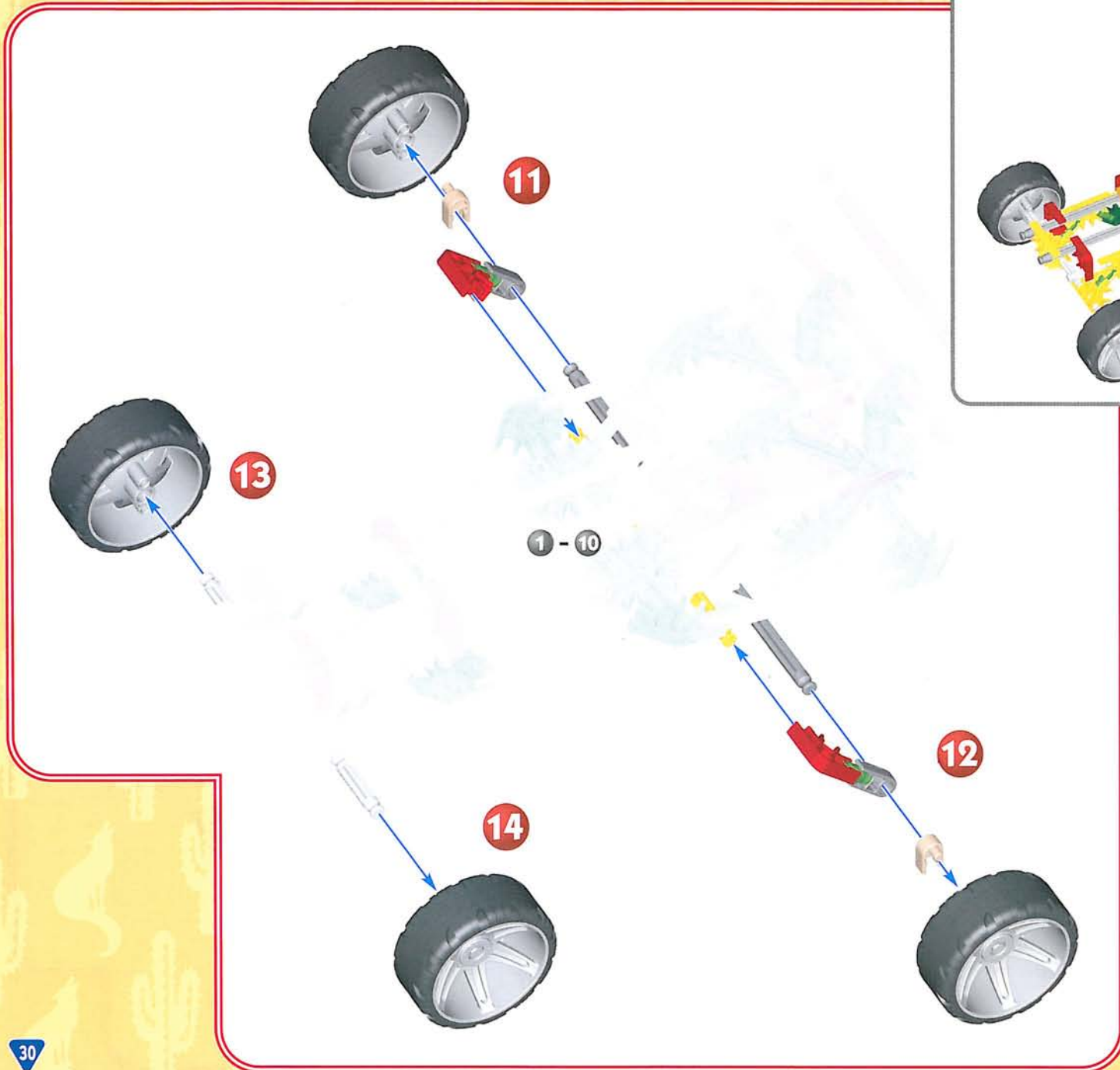

# Camera

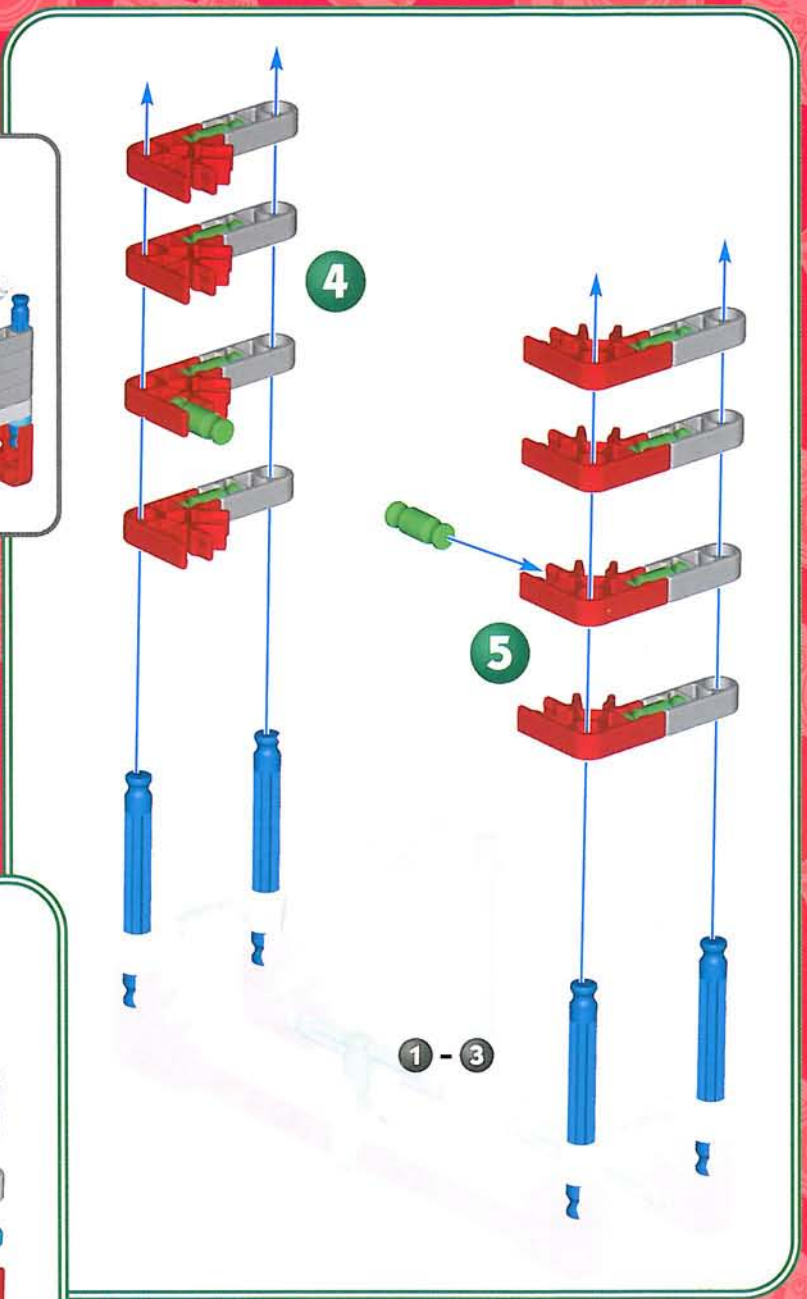
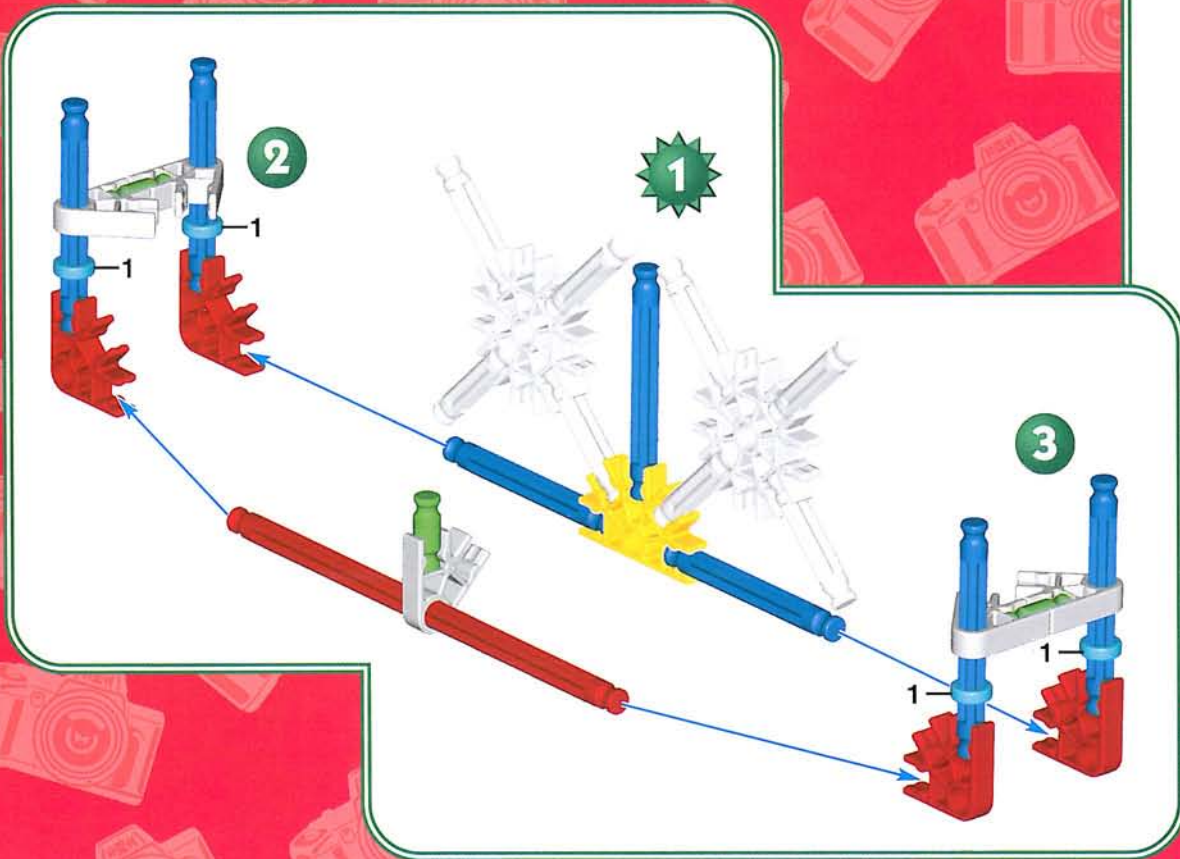
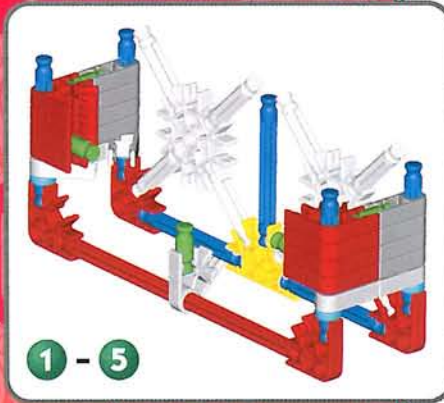
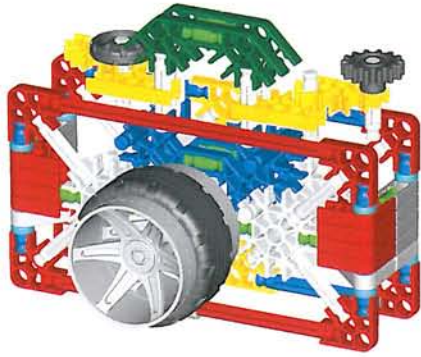

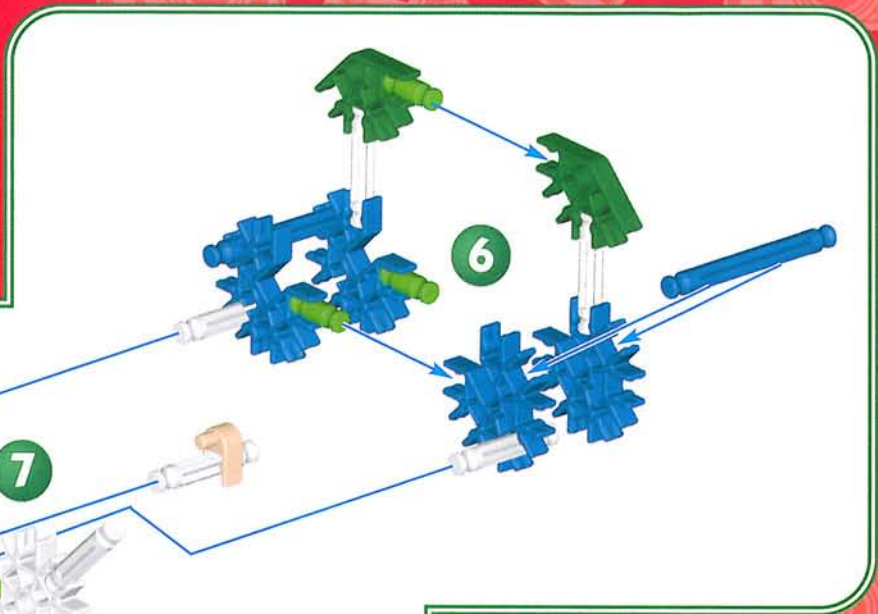
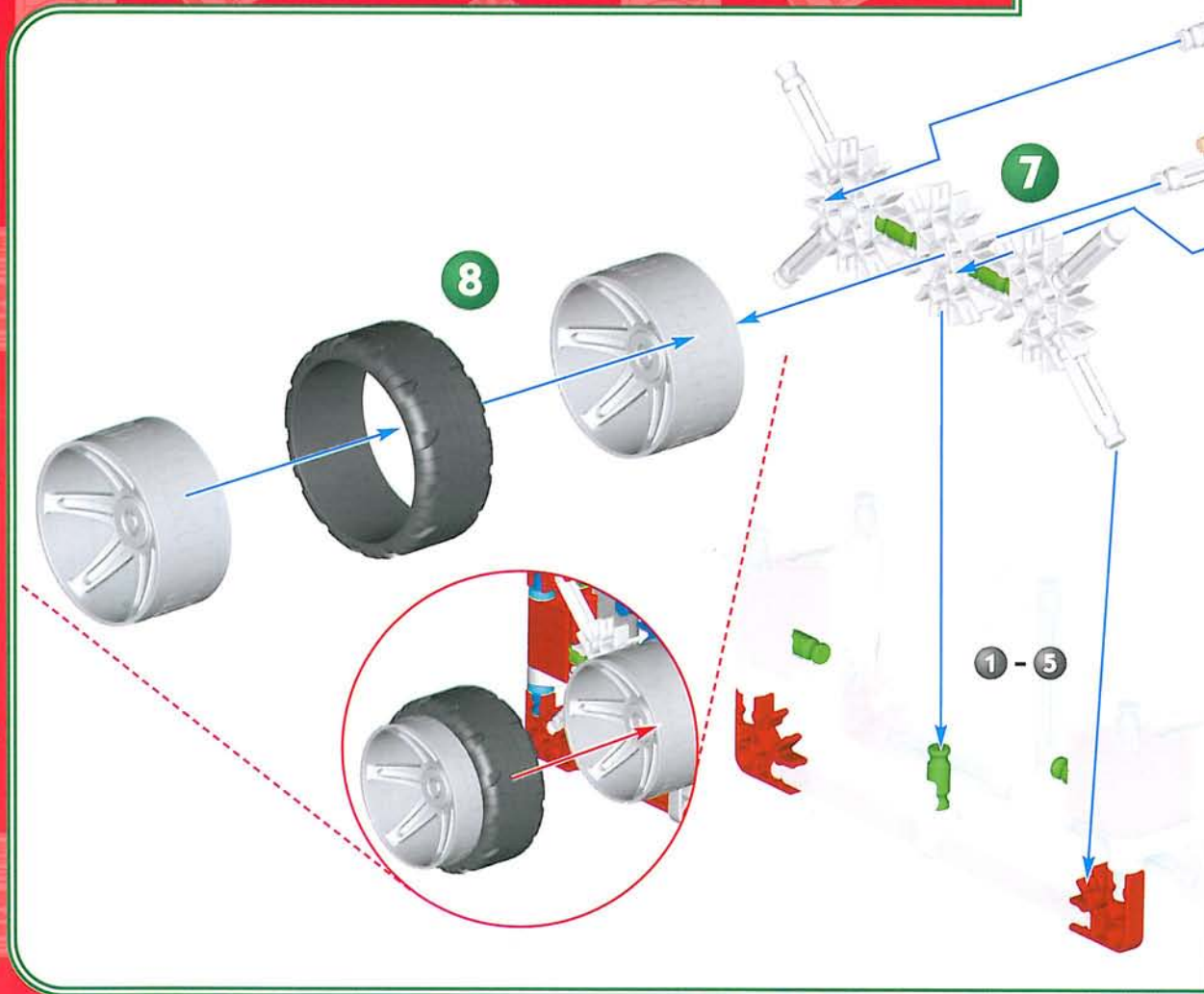



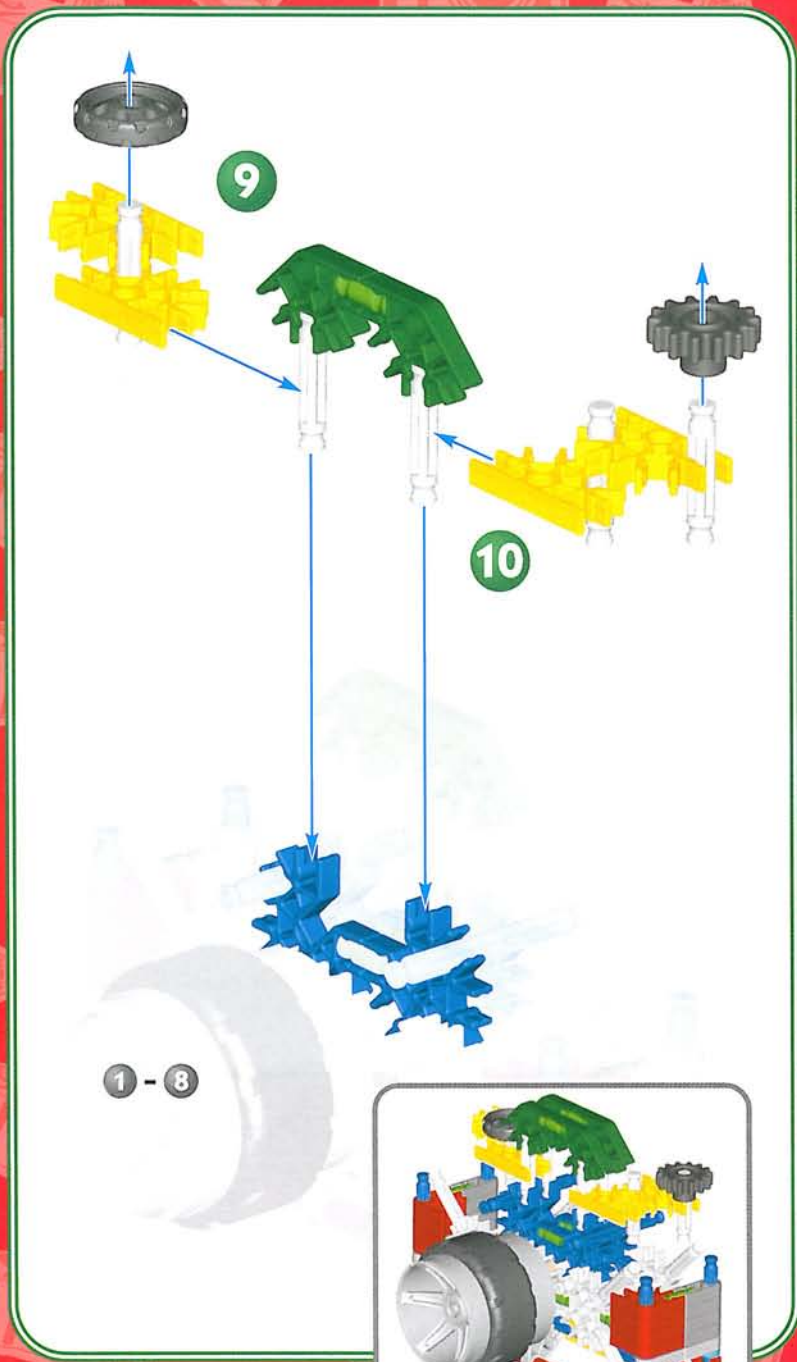

1 - 8



1 - 10

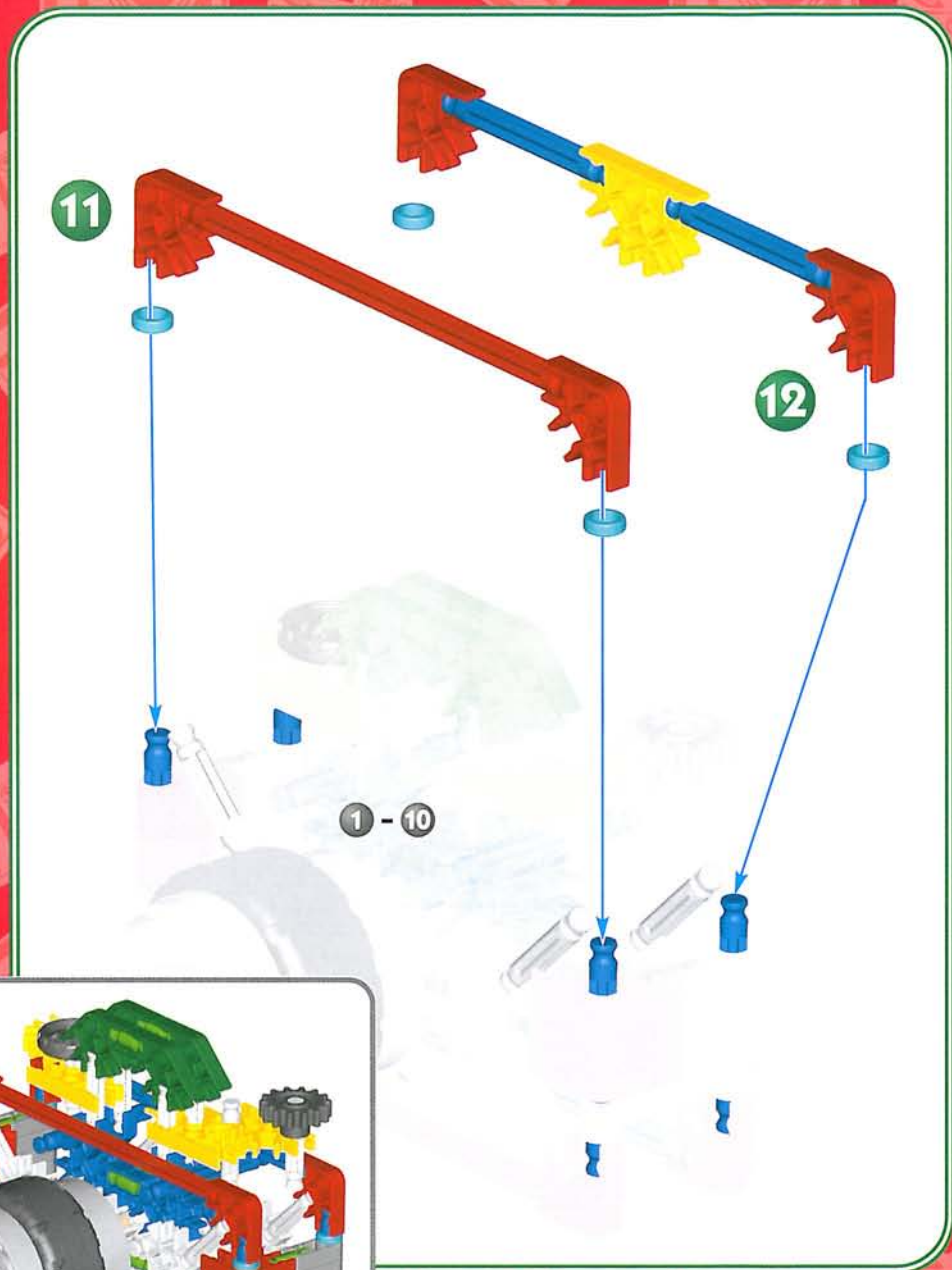

11

12

1 - 10



1 - 12

# The Claw

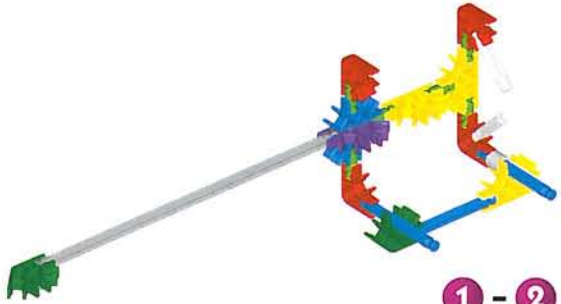

1 - 2

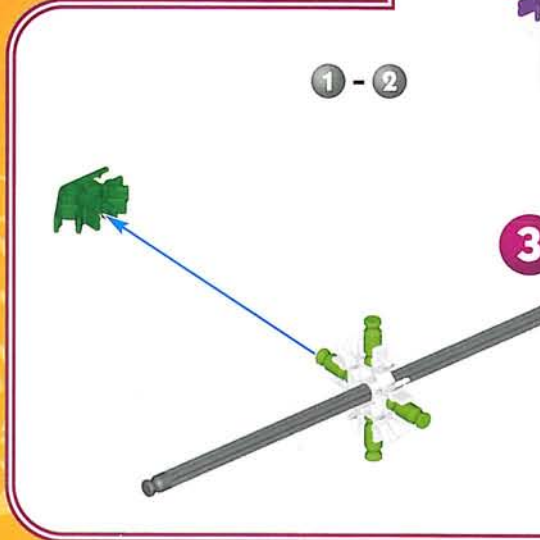

1 - 2

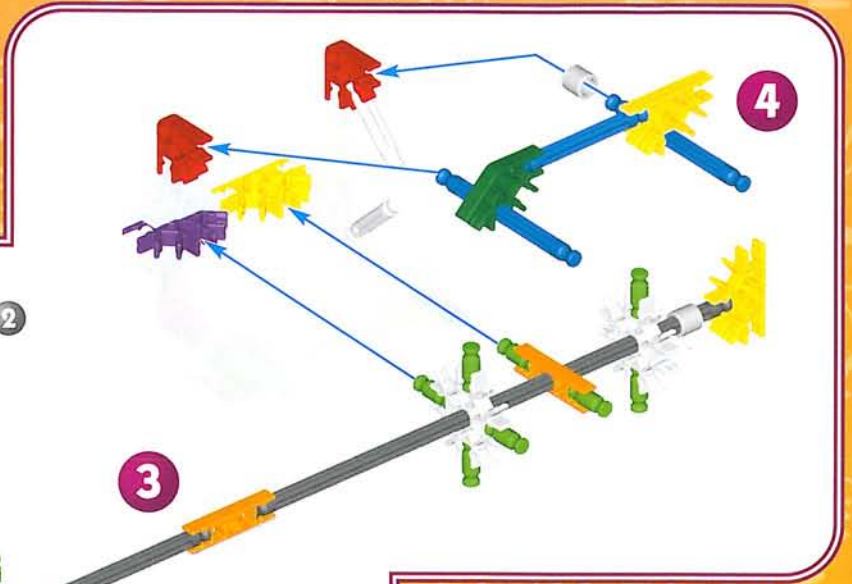

3

4

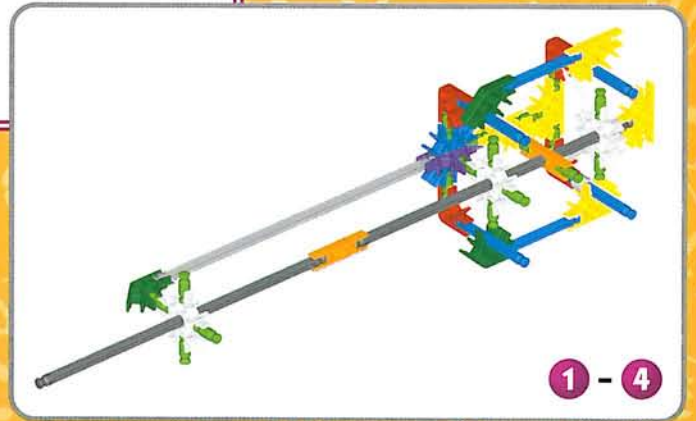

1 - 4

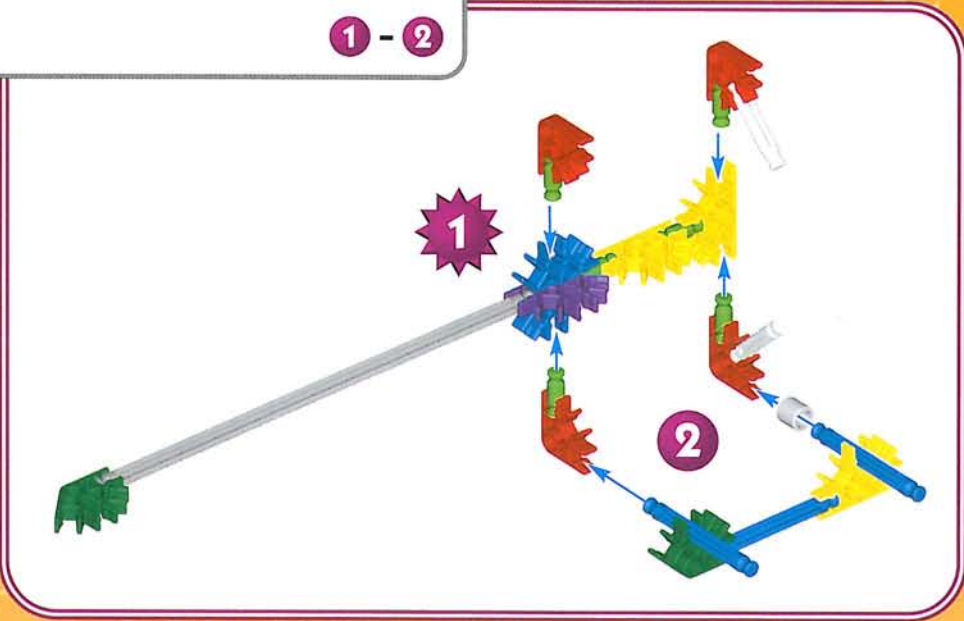

1

2

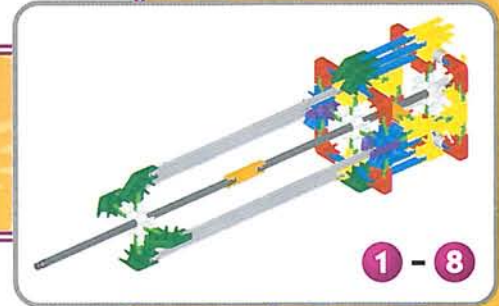
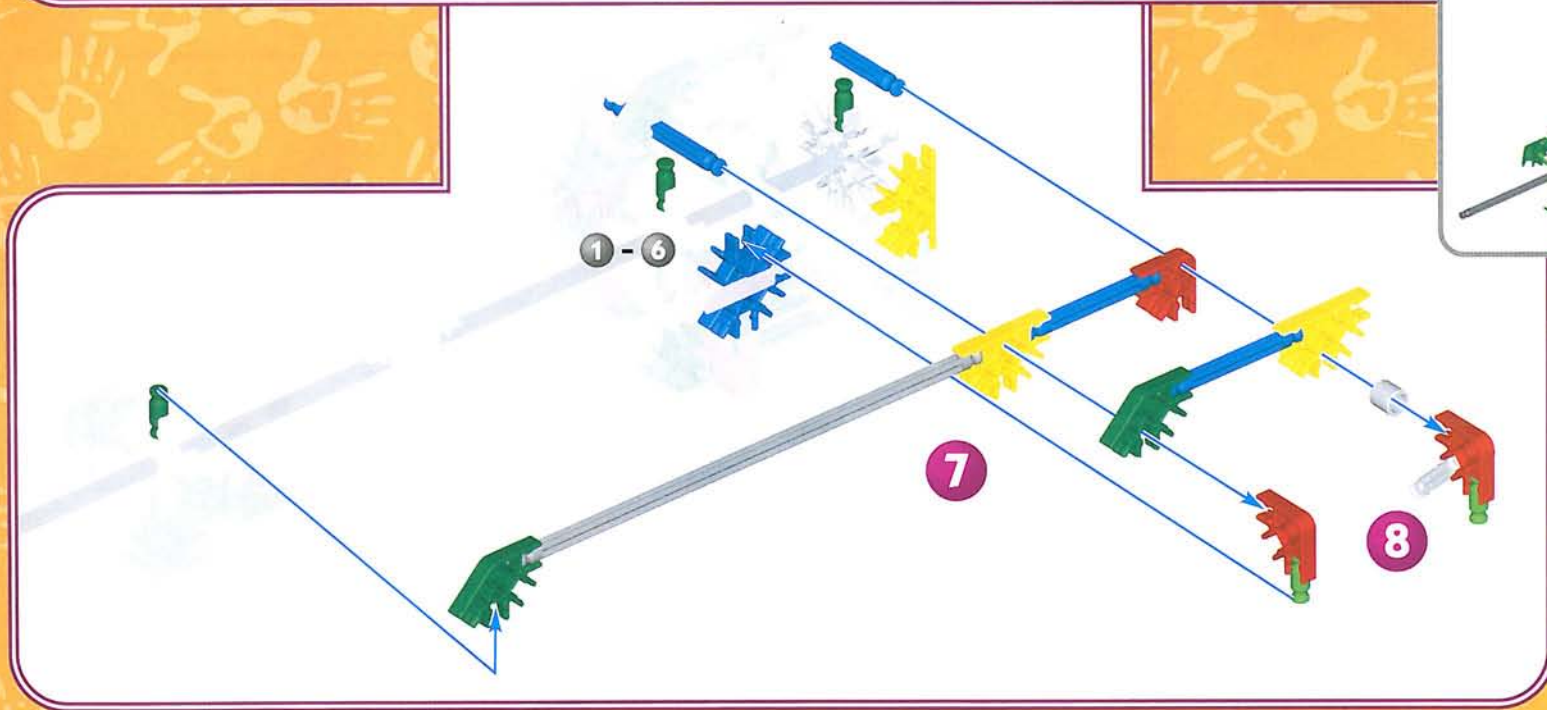
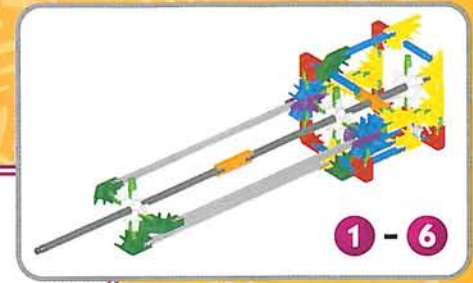
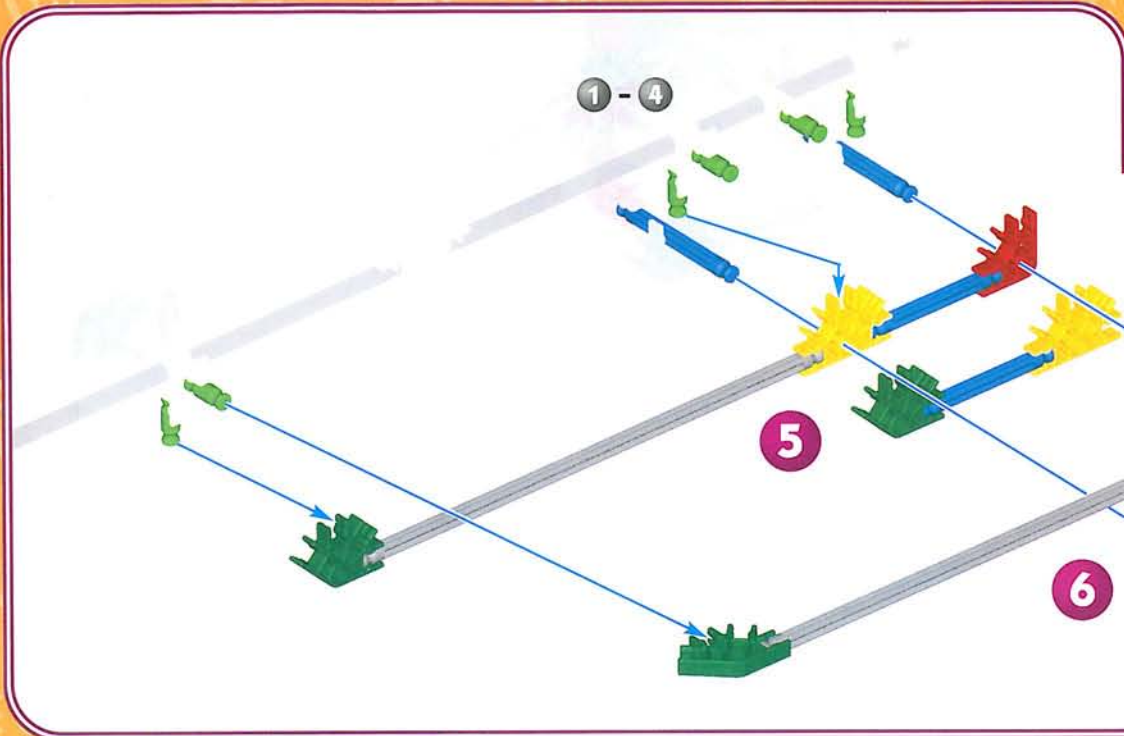

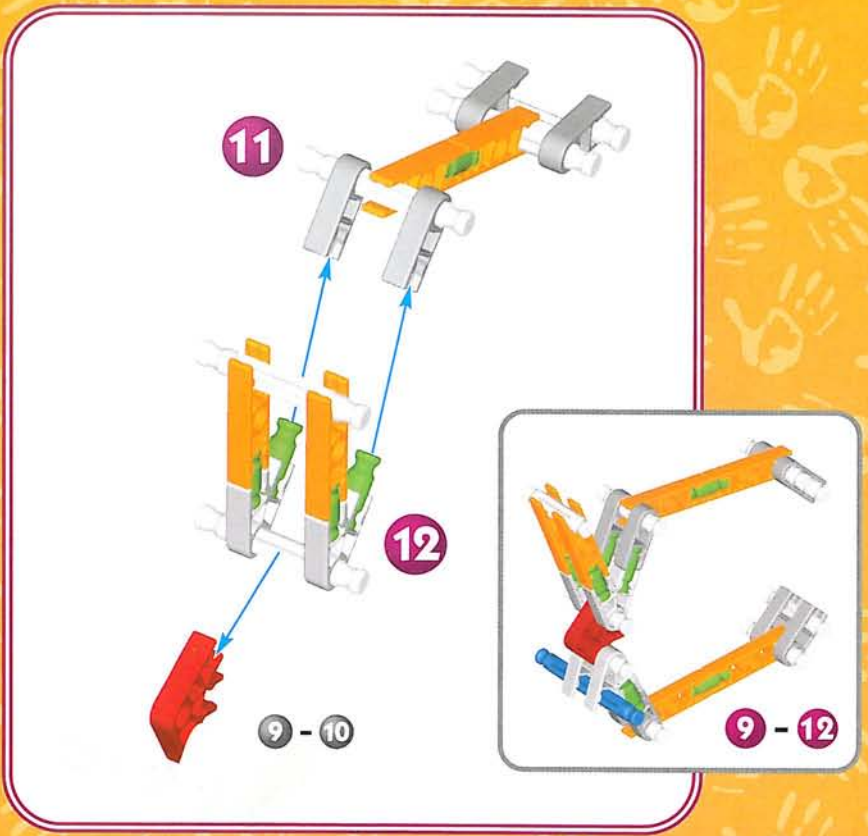
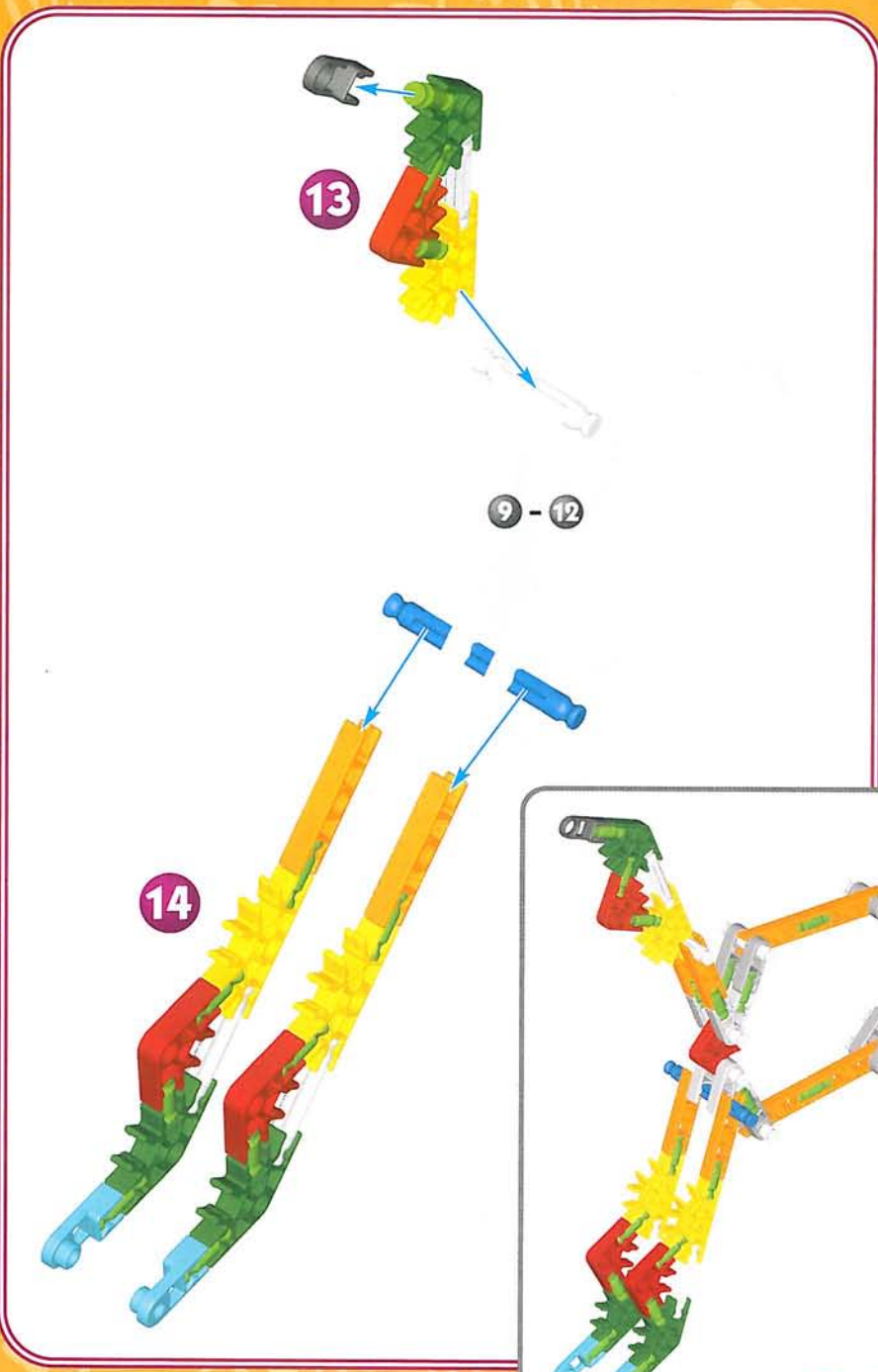
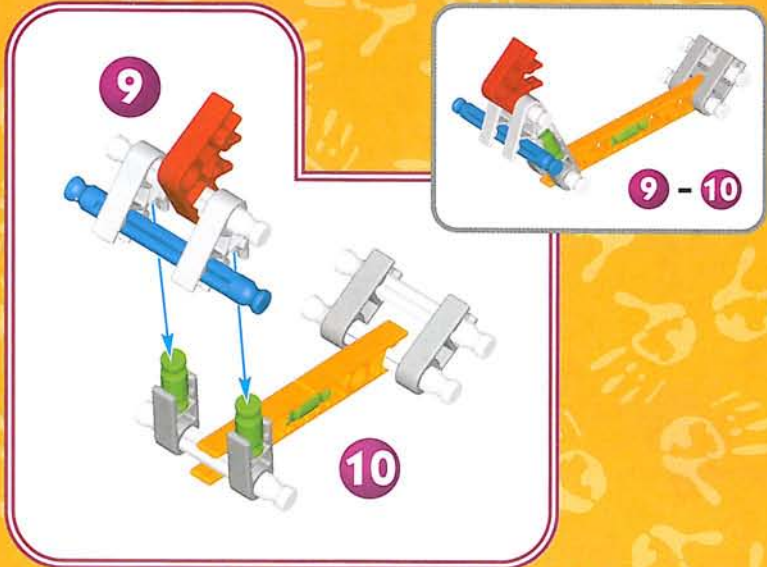

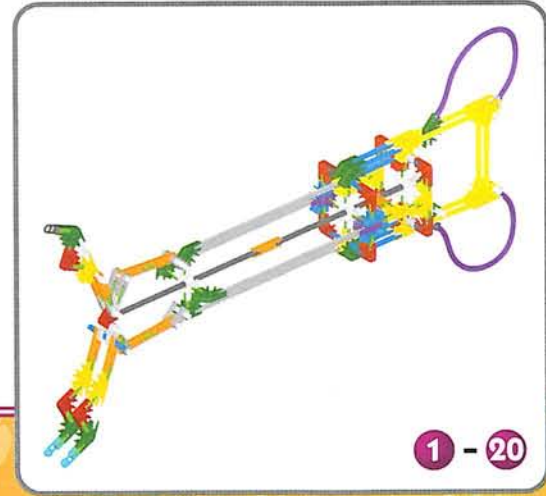
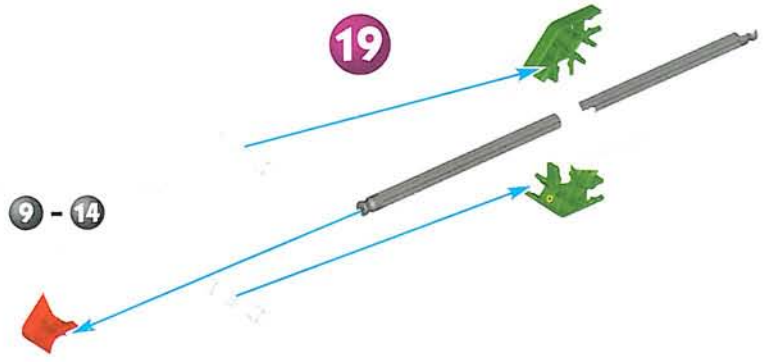
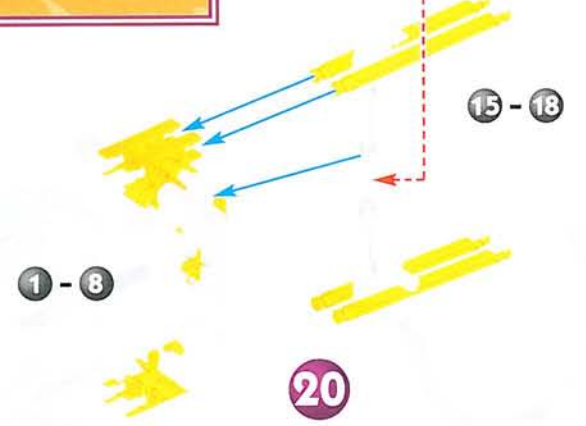
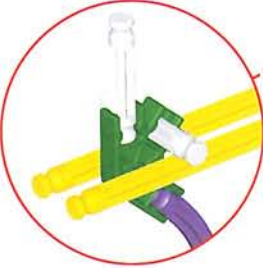
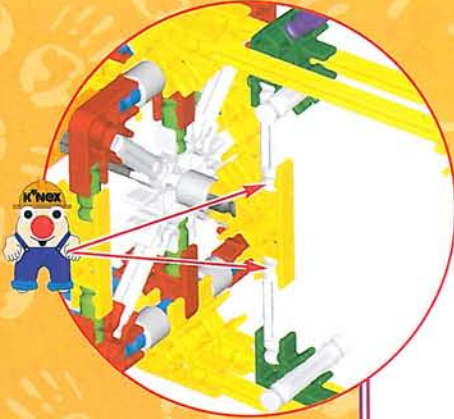
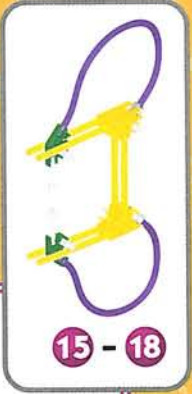
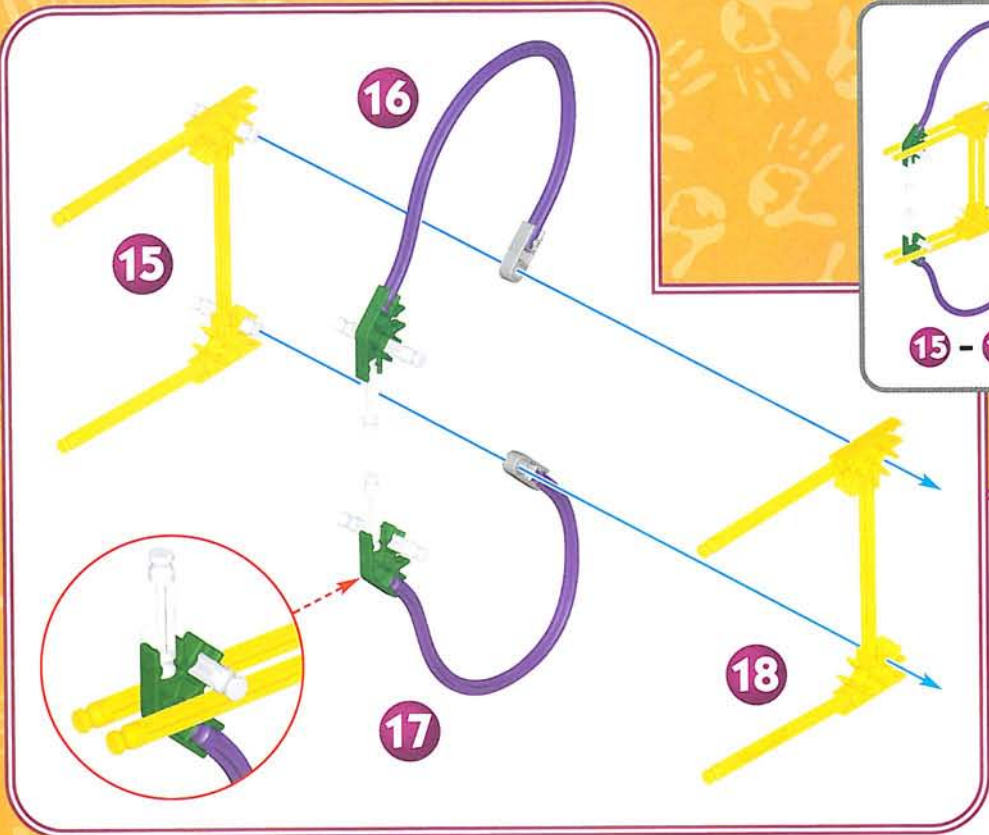

# Speed Boat

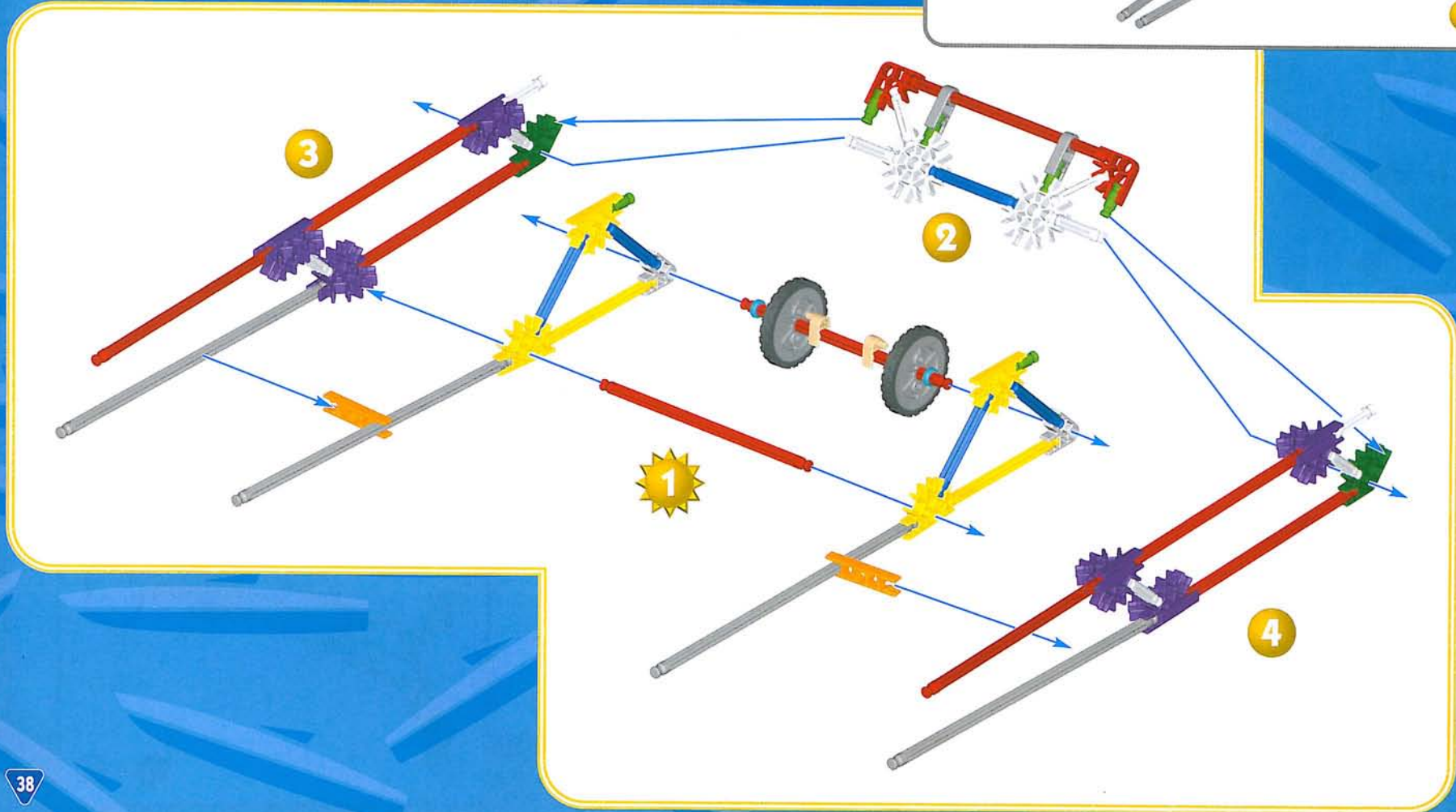
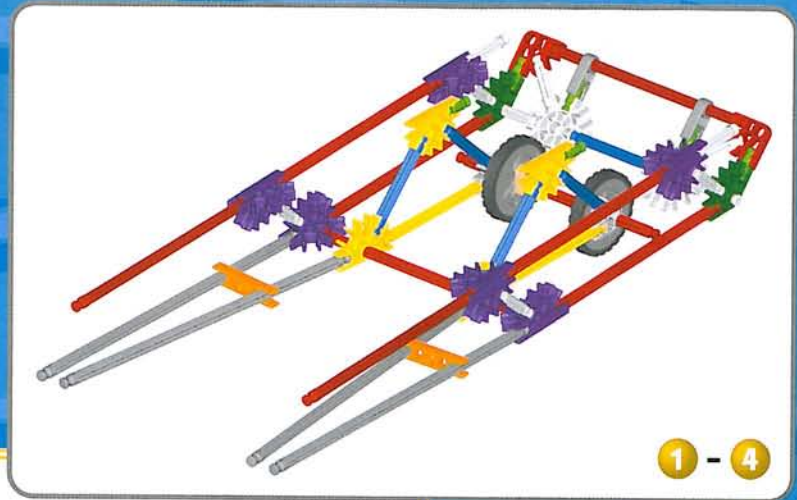

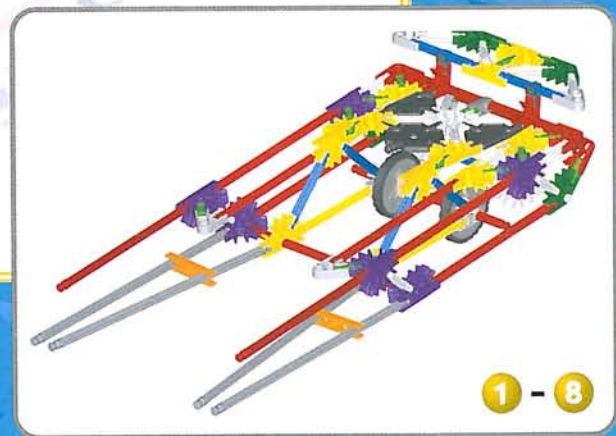
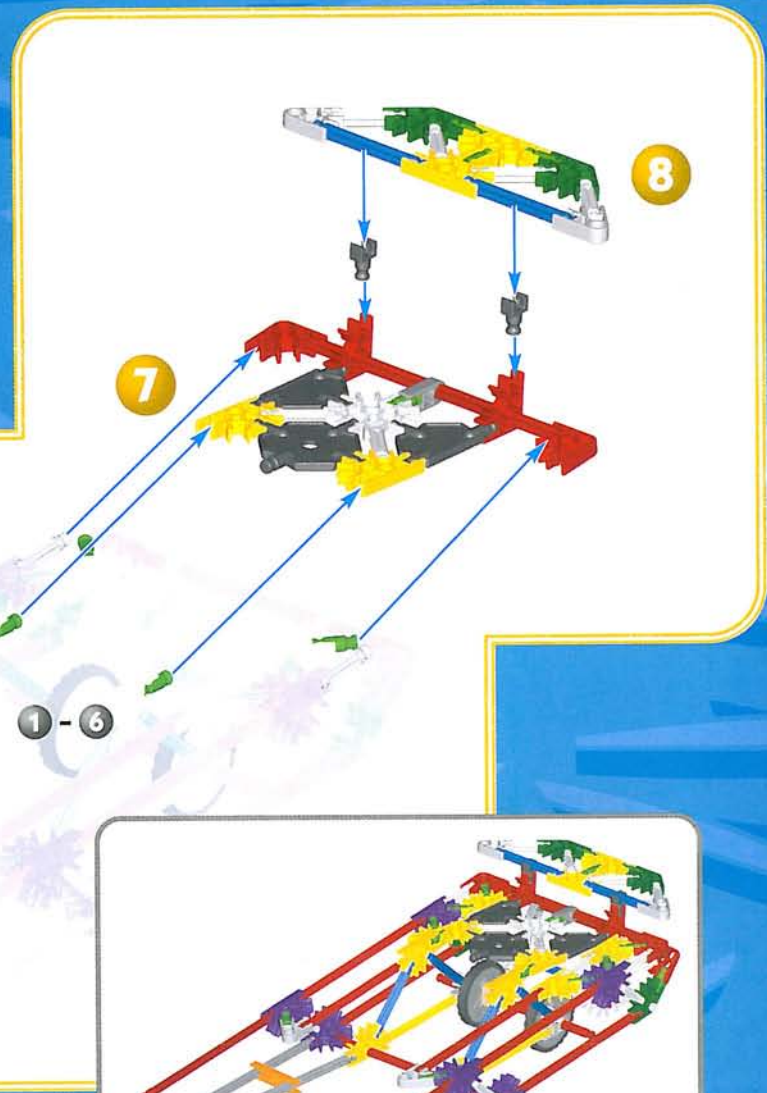
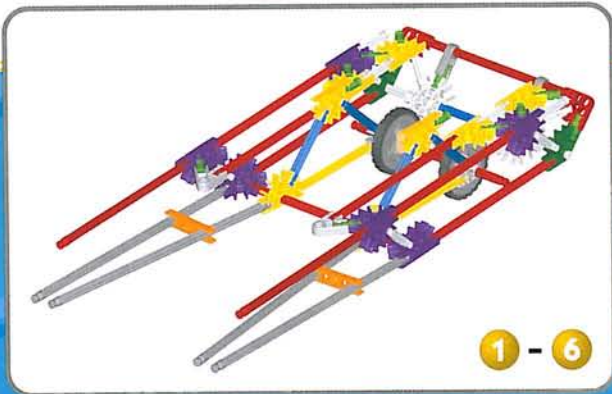
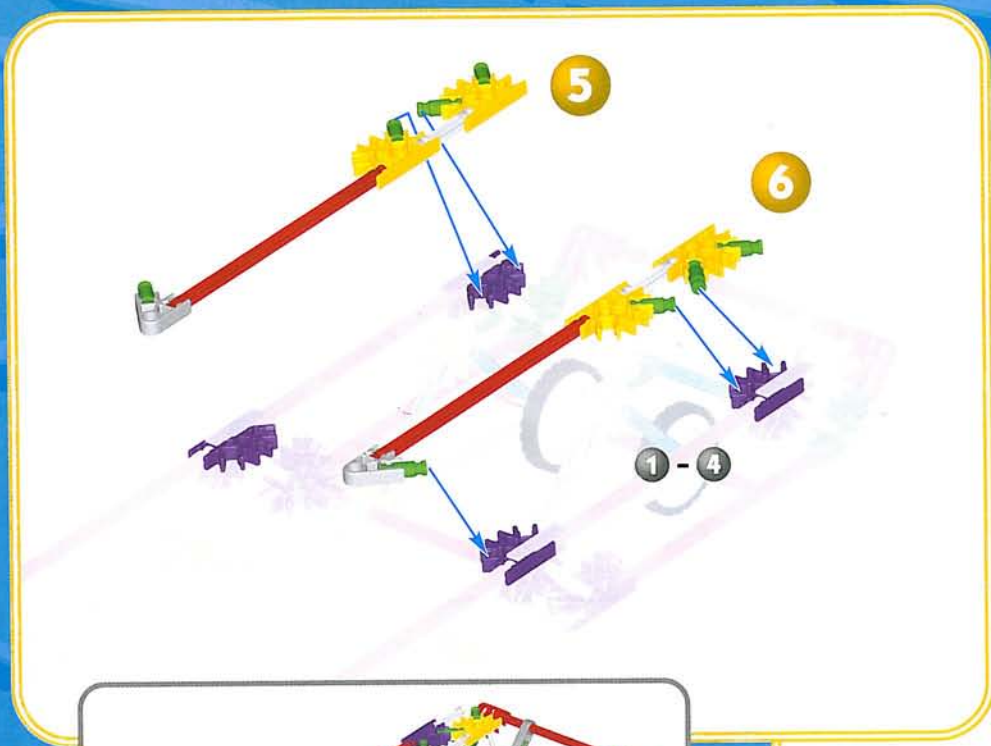

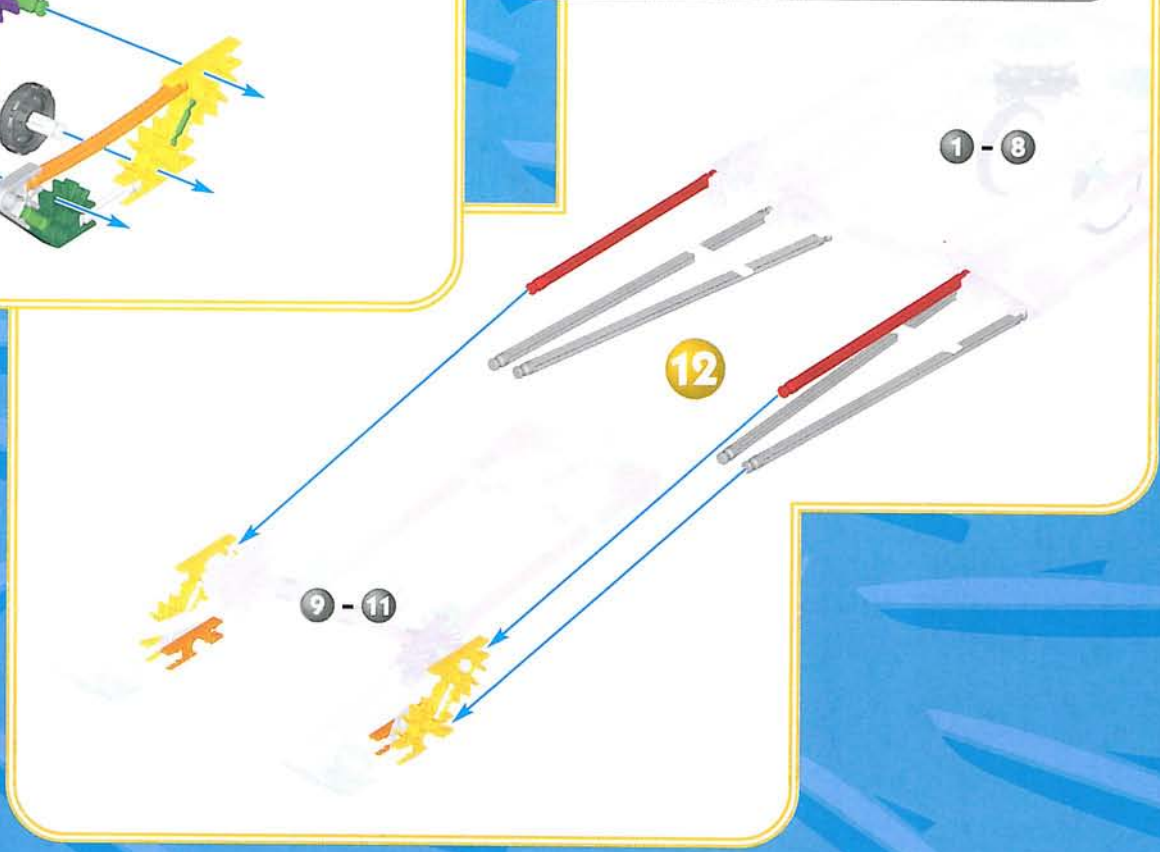
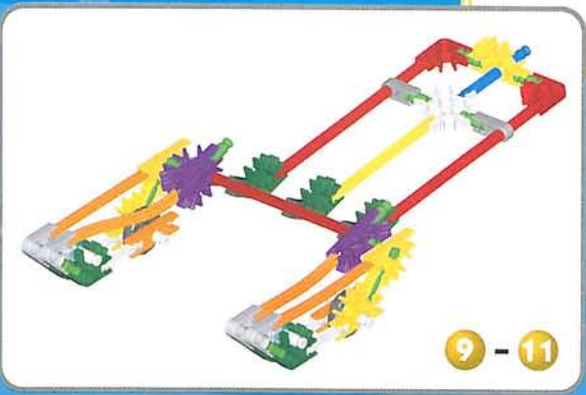
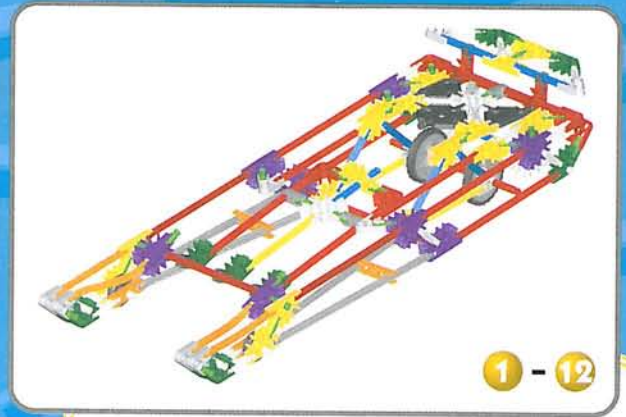
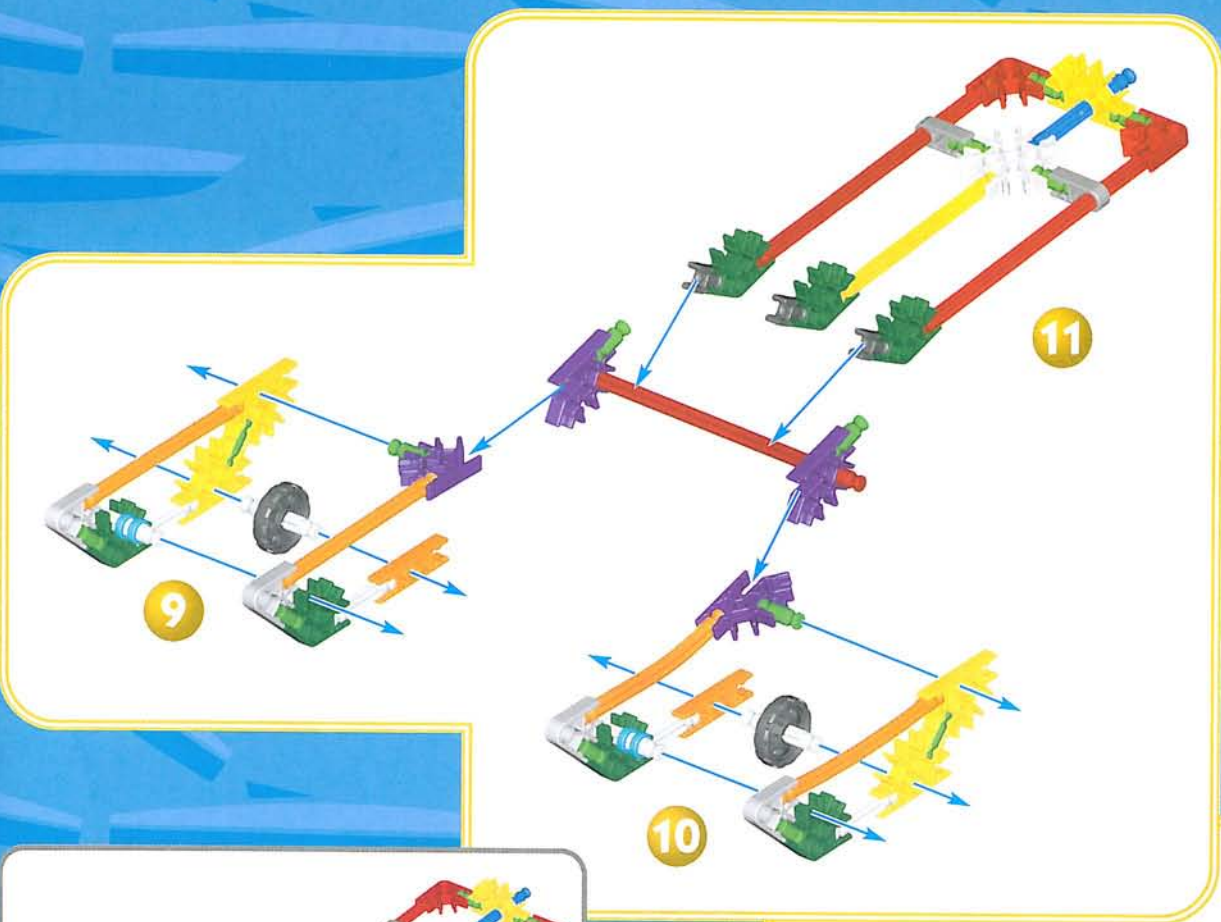



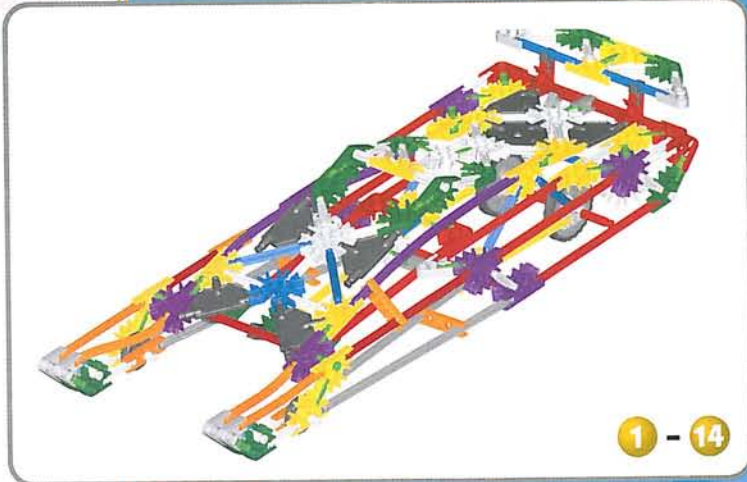
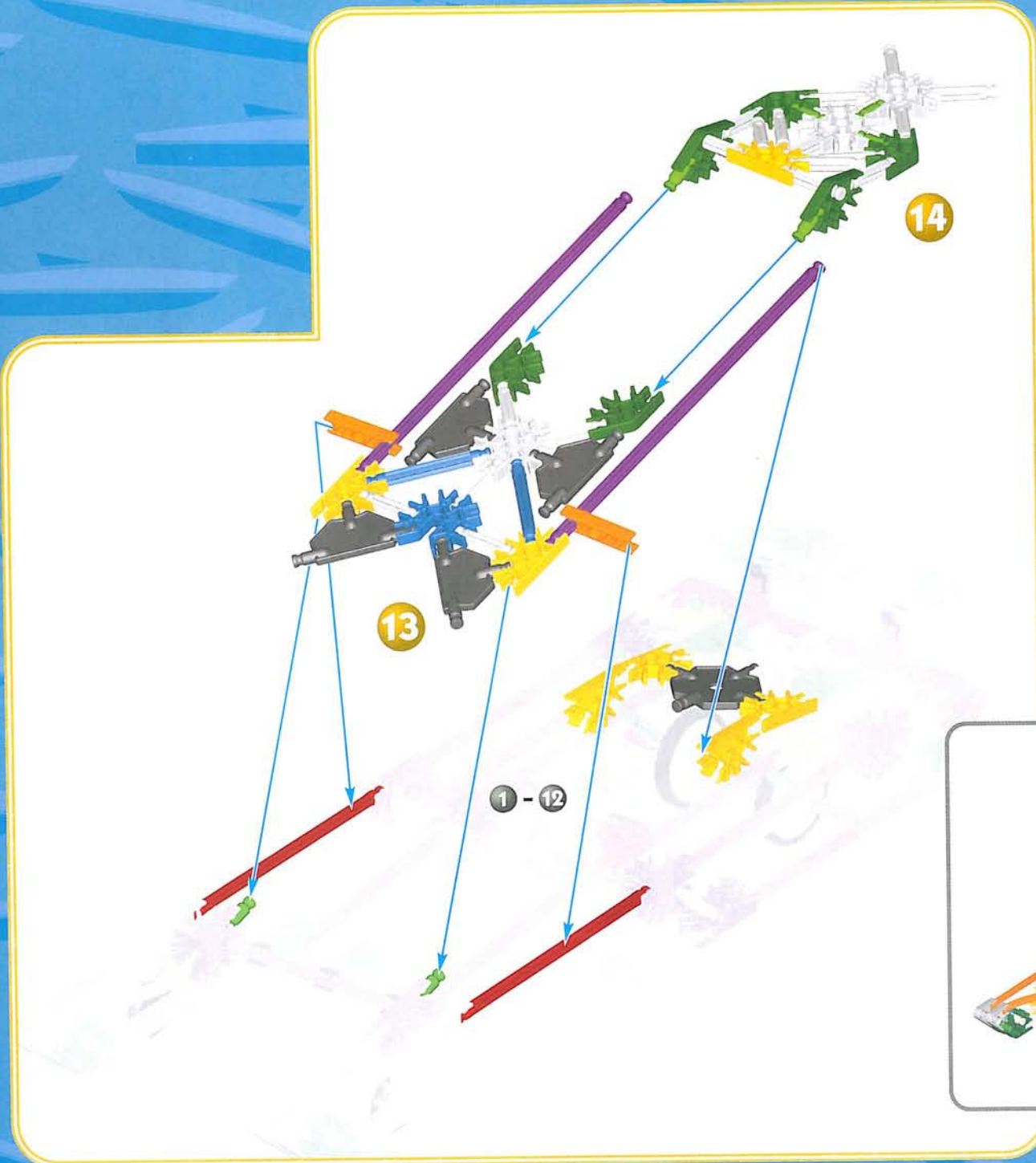

# Hot Air Balloon

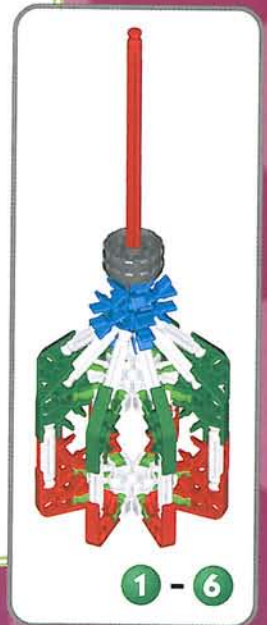
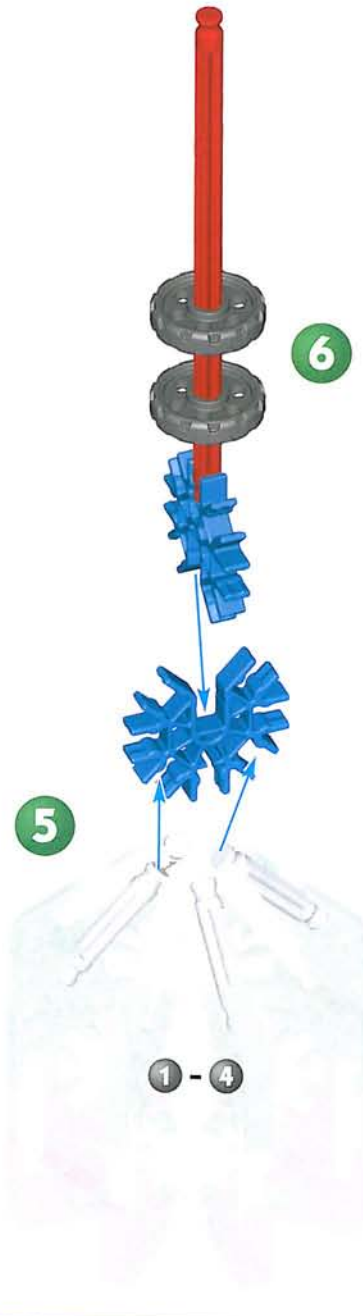
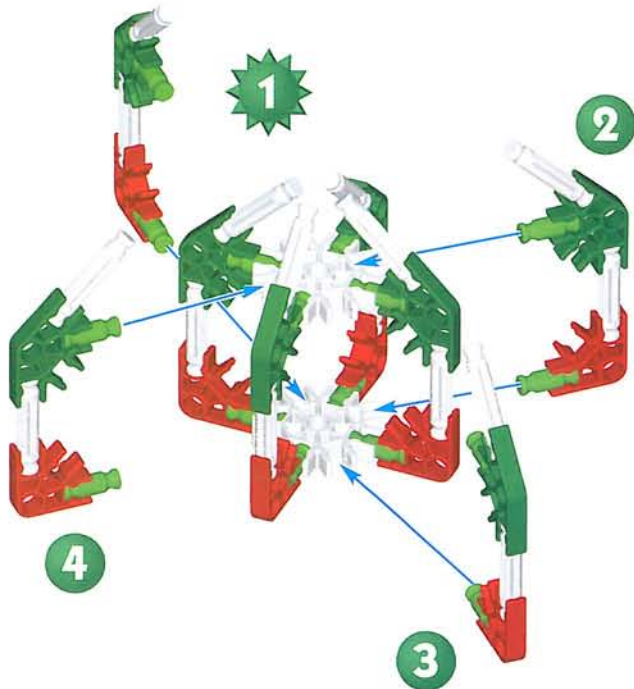



x8

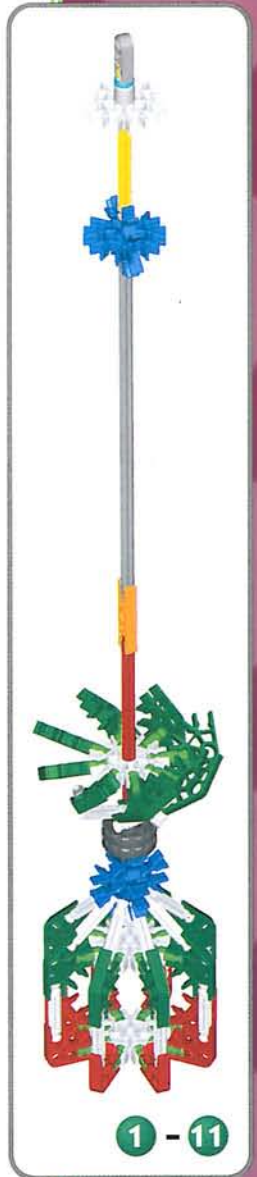
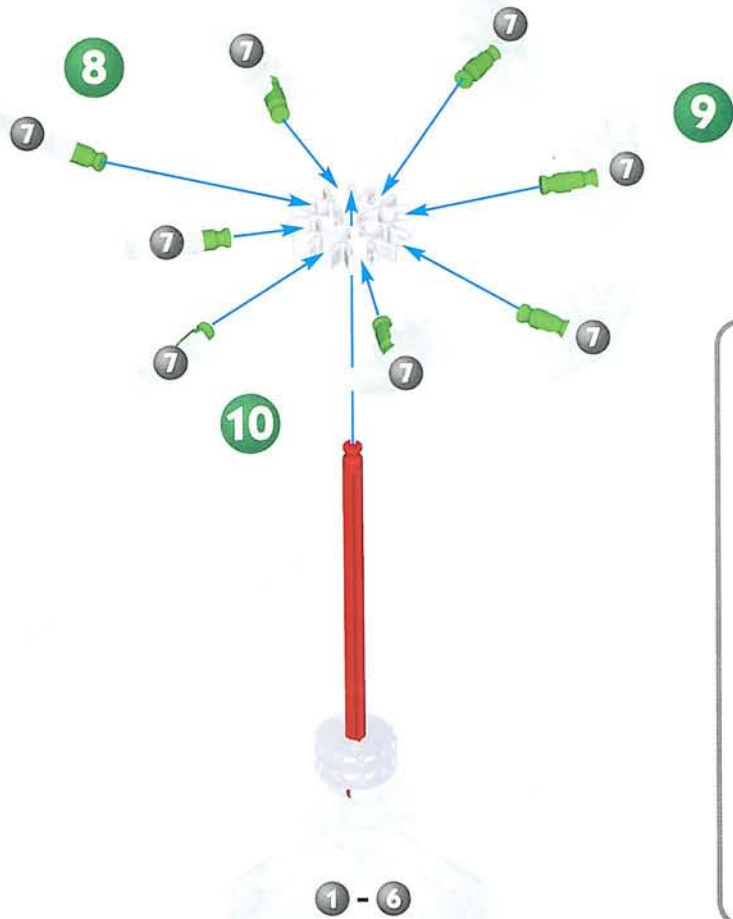

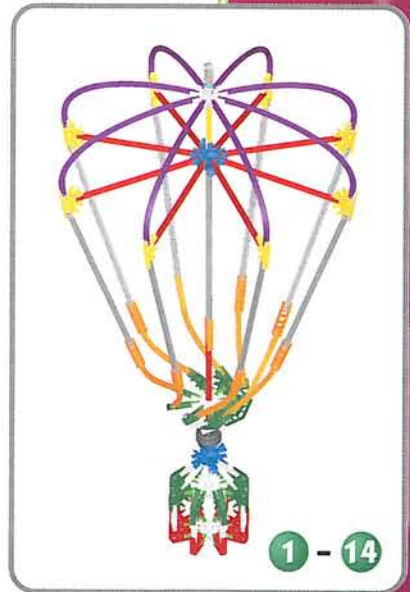
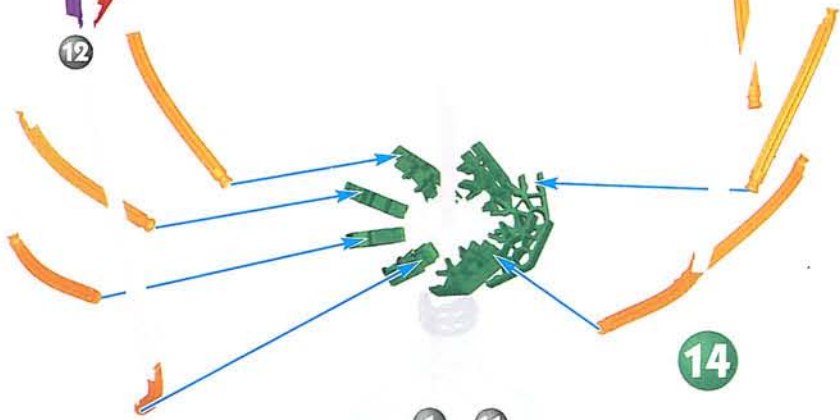
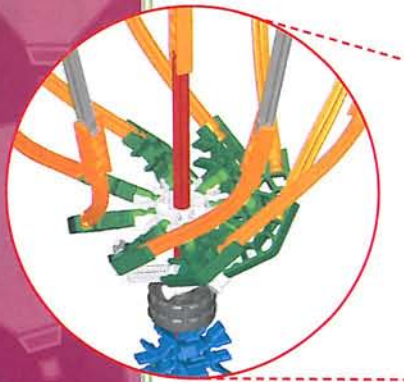
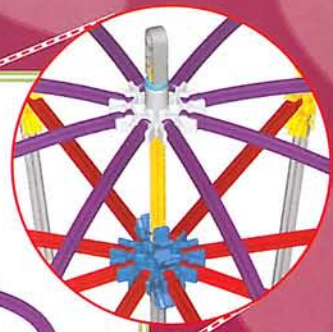
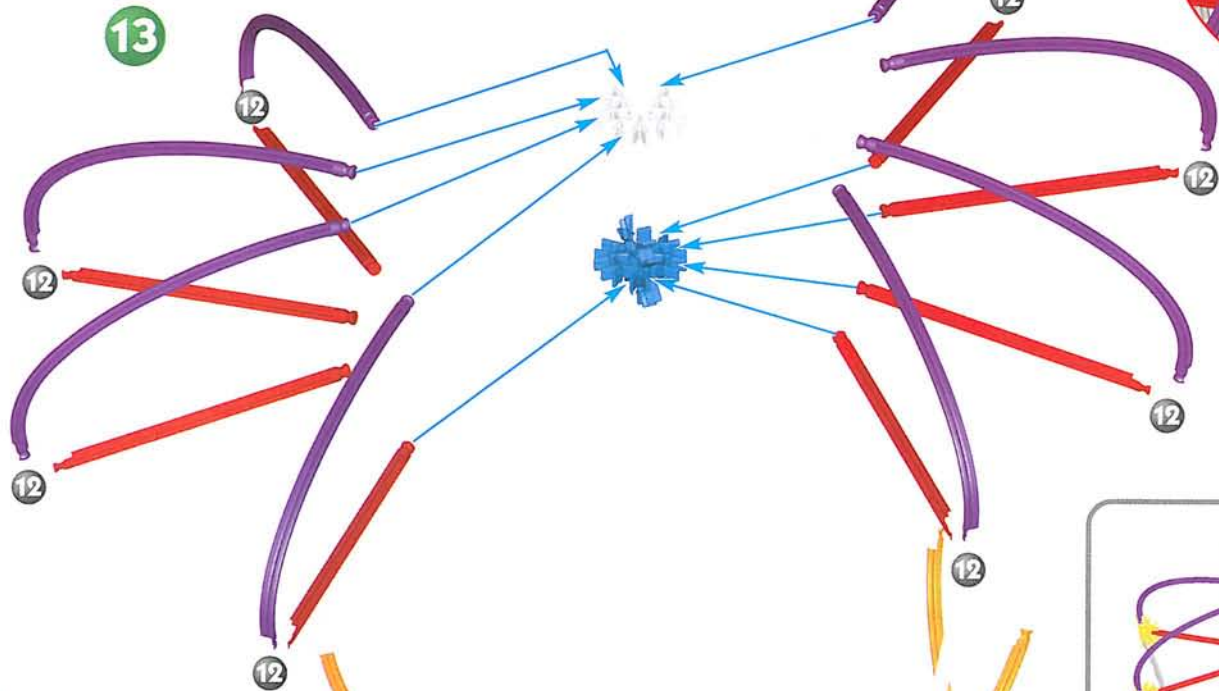

# Dumper Truck

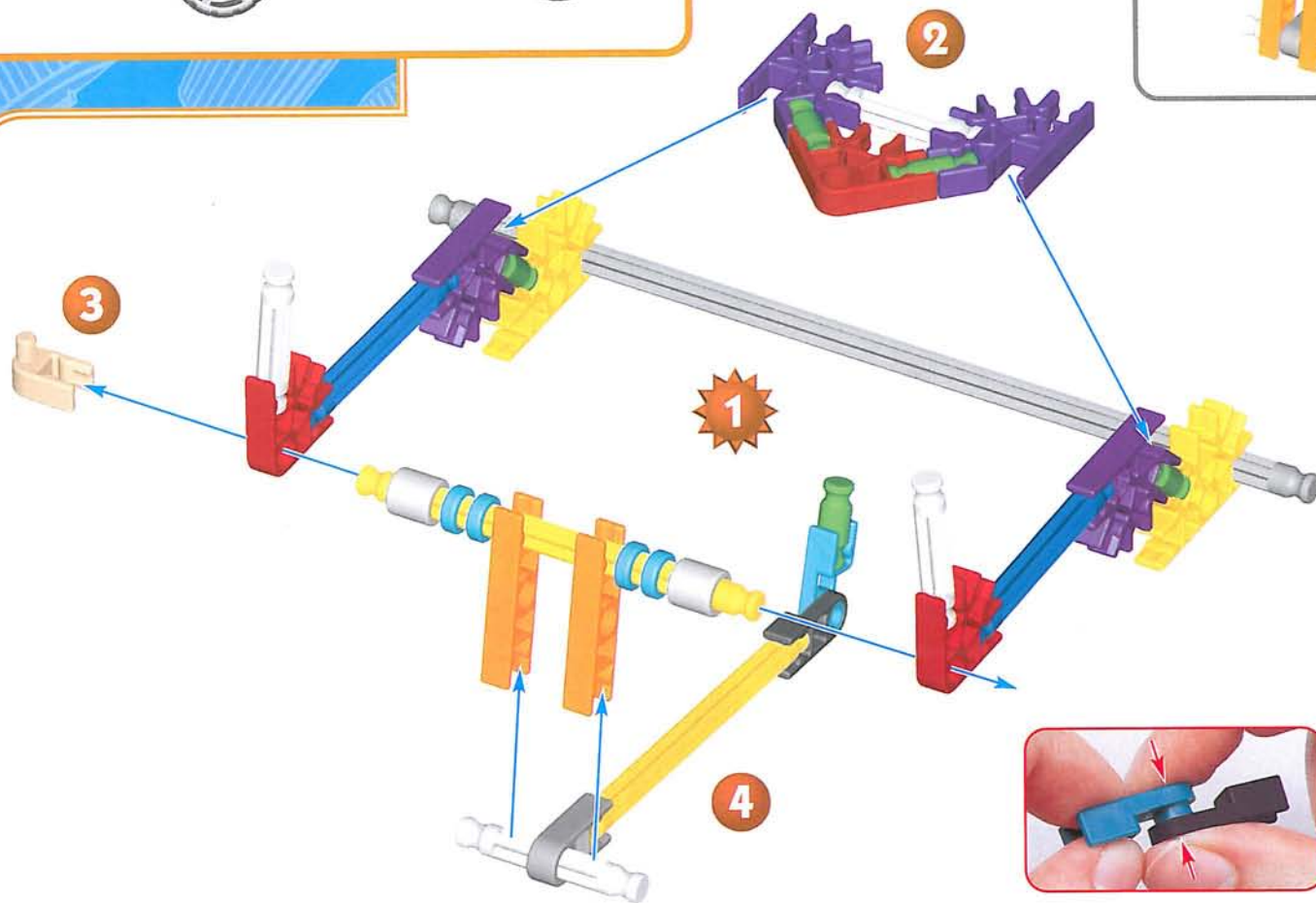
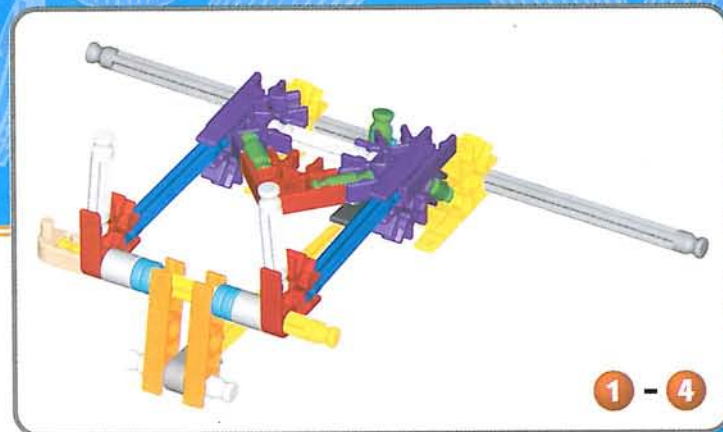
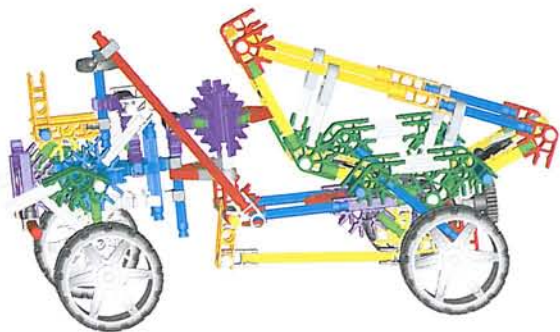

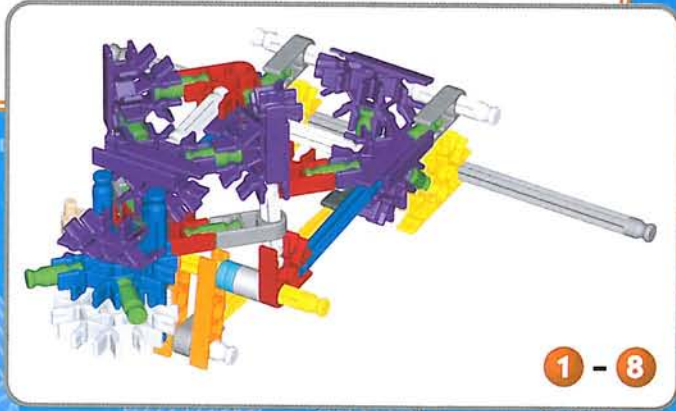
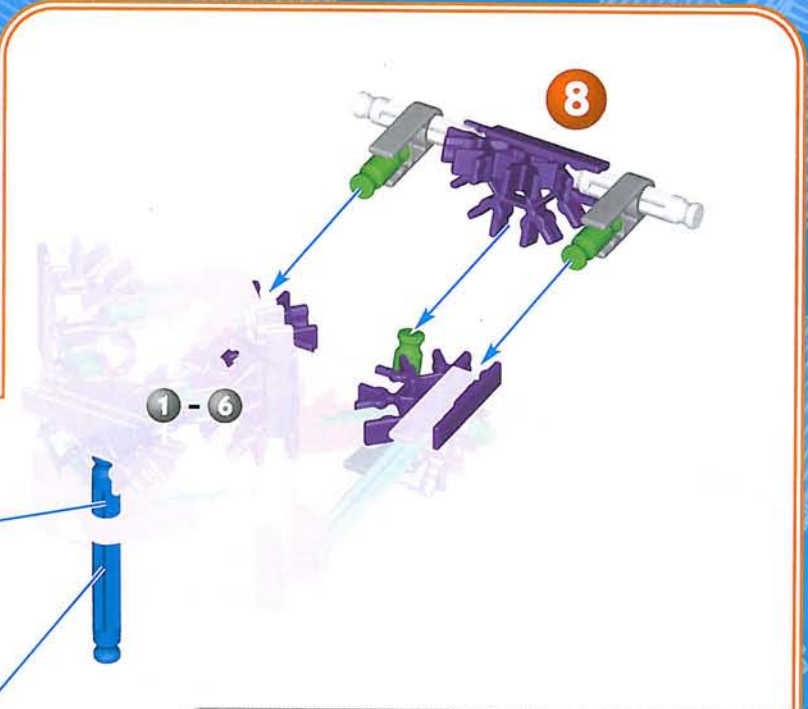
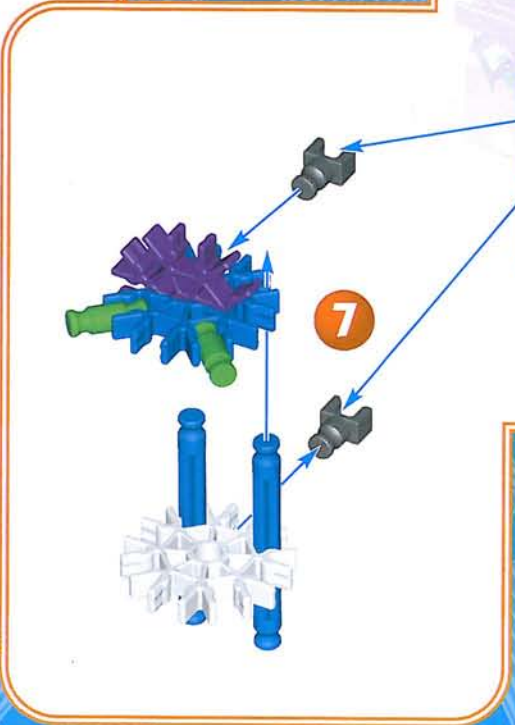
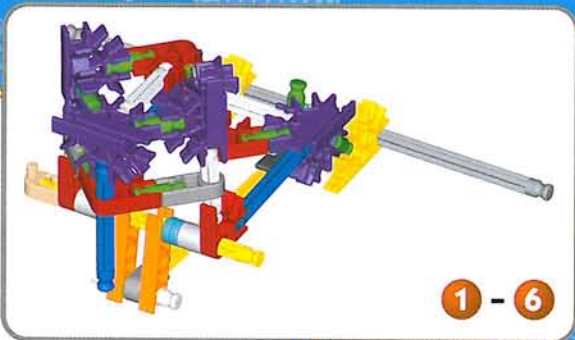
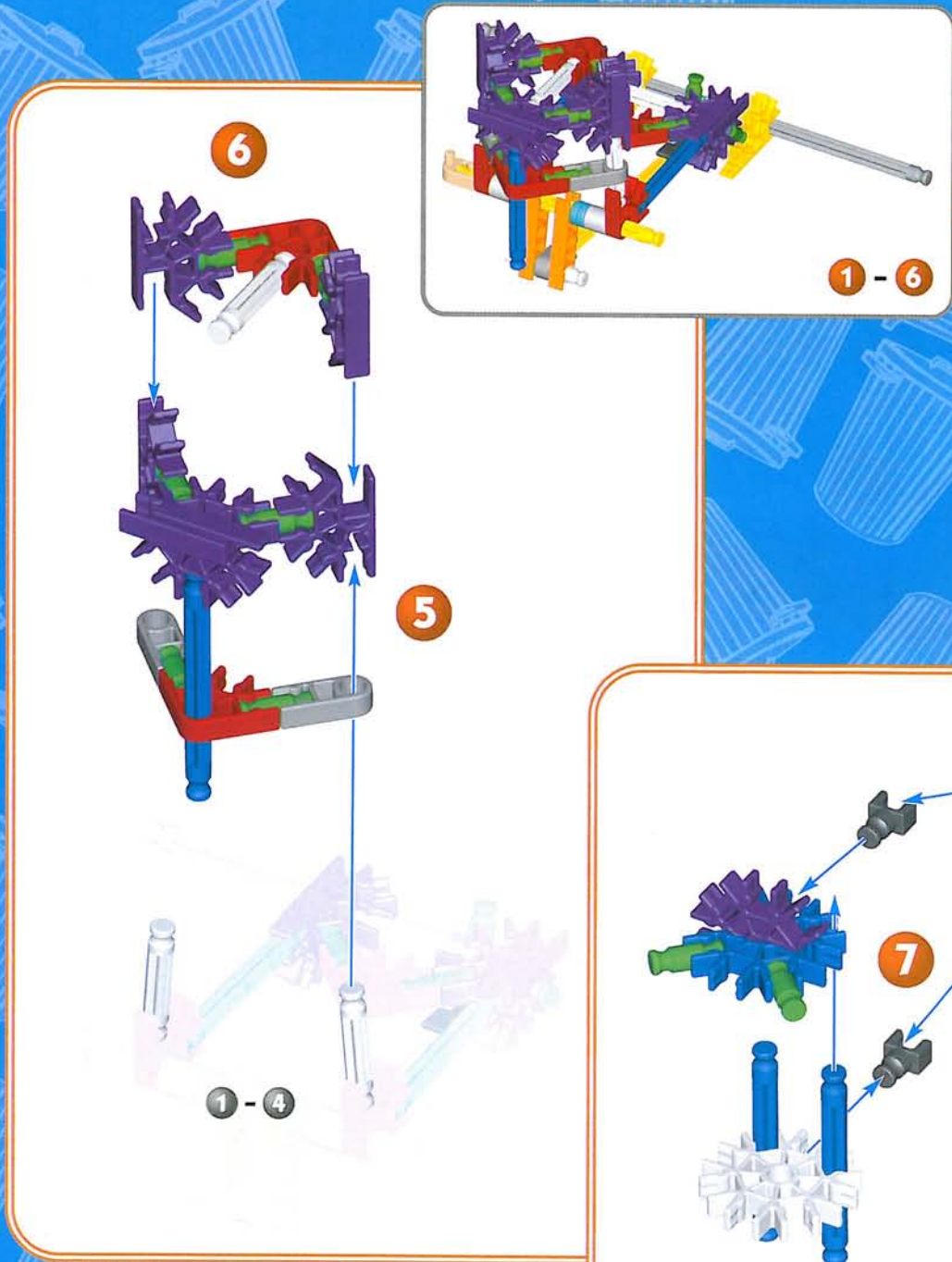

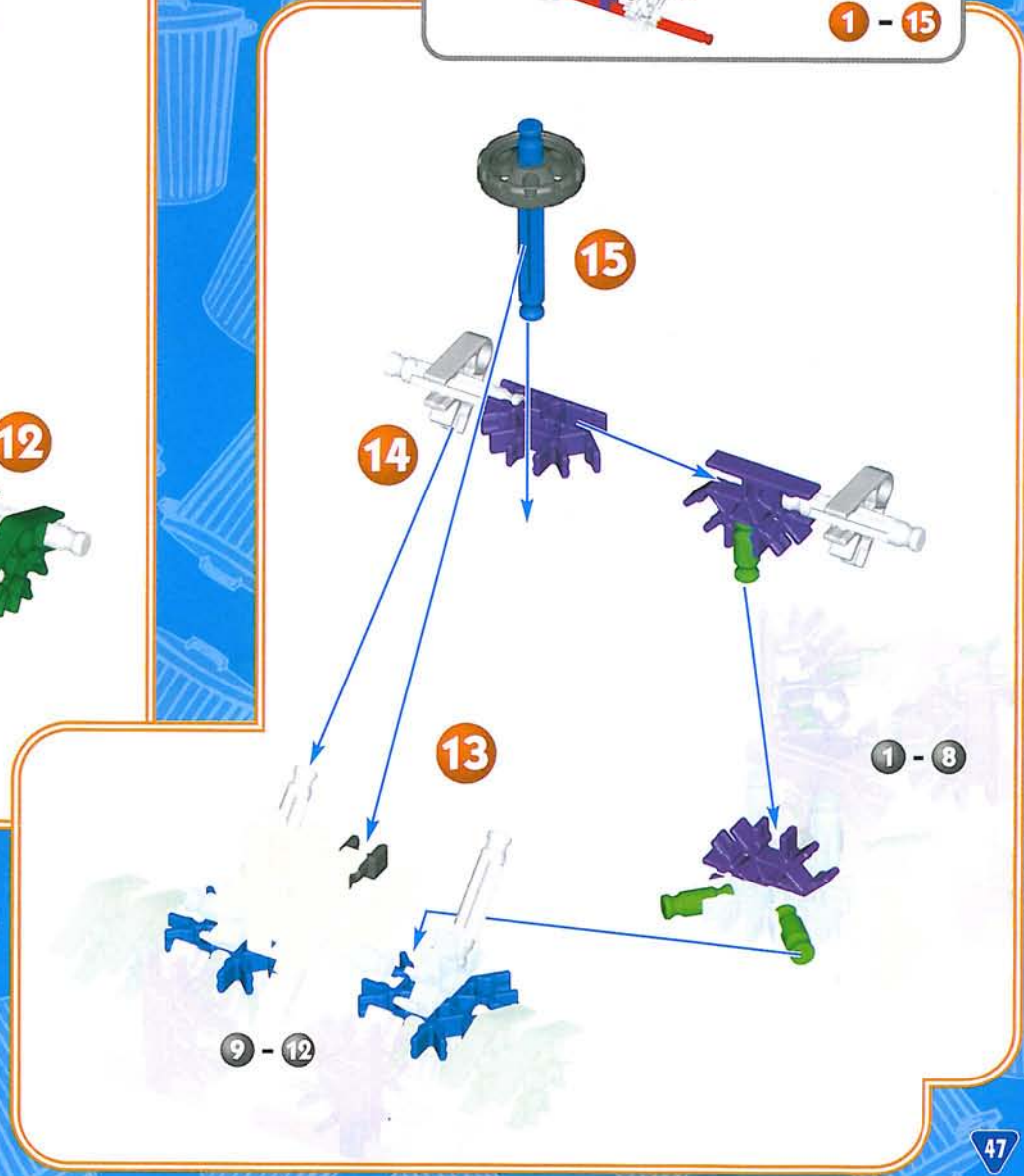
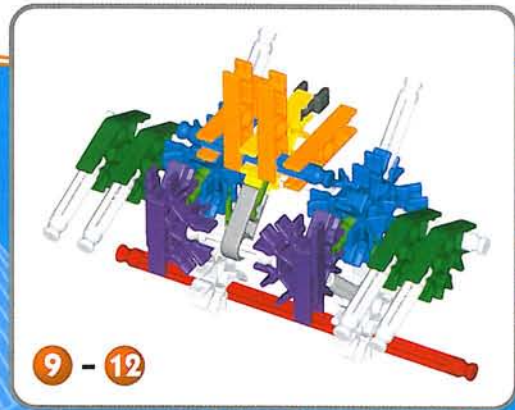
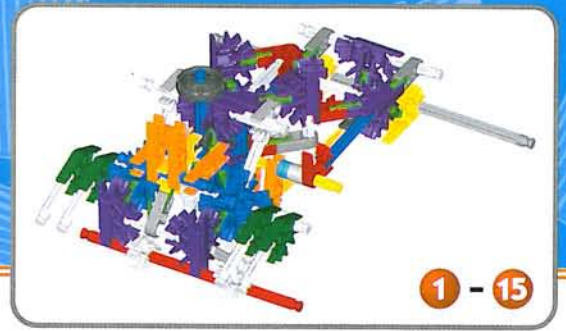
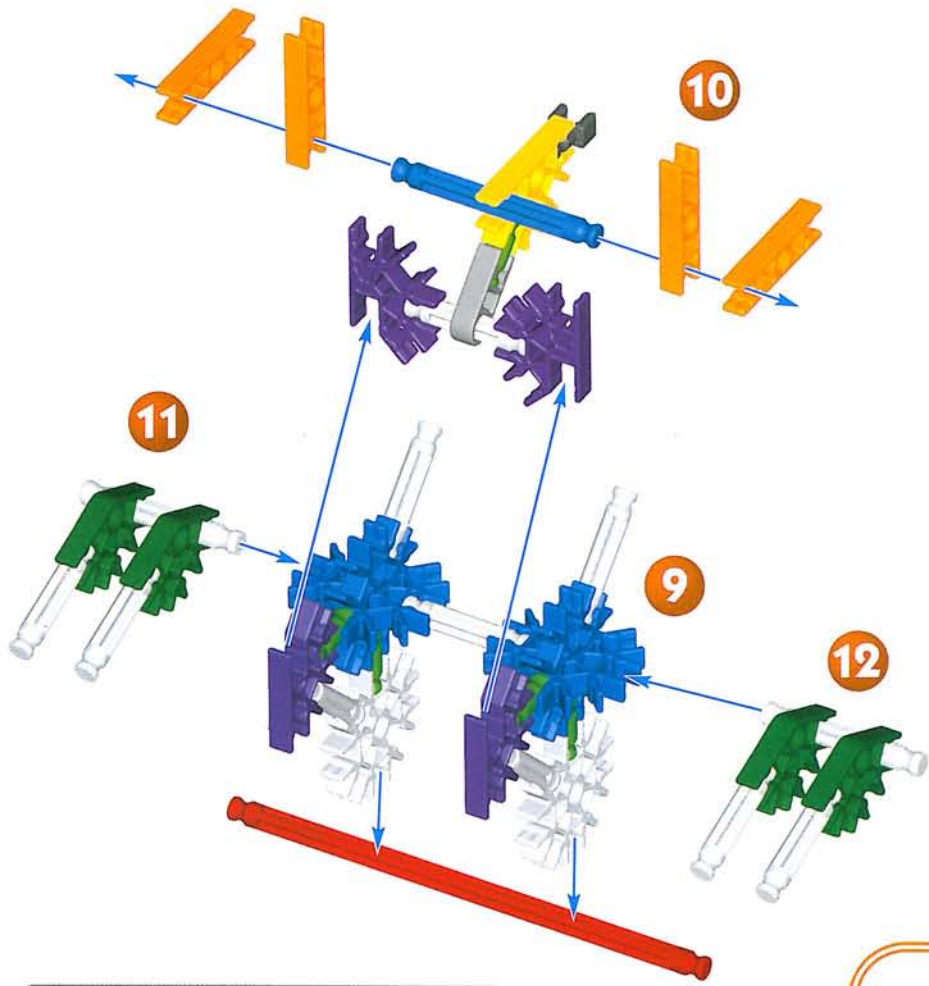

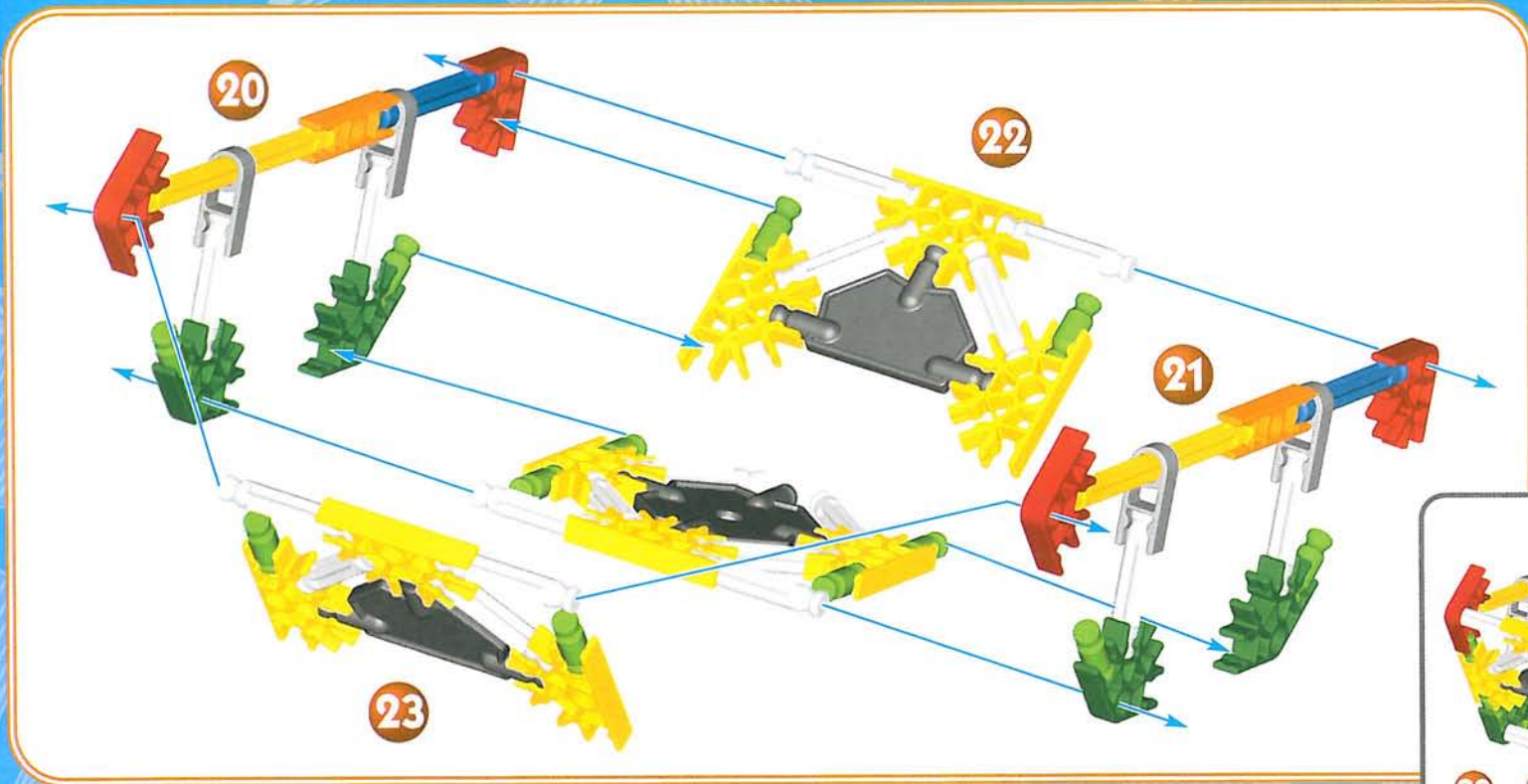
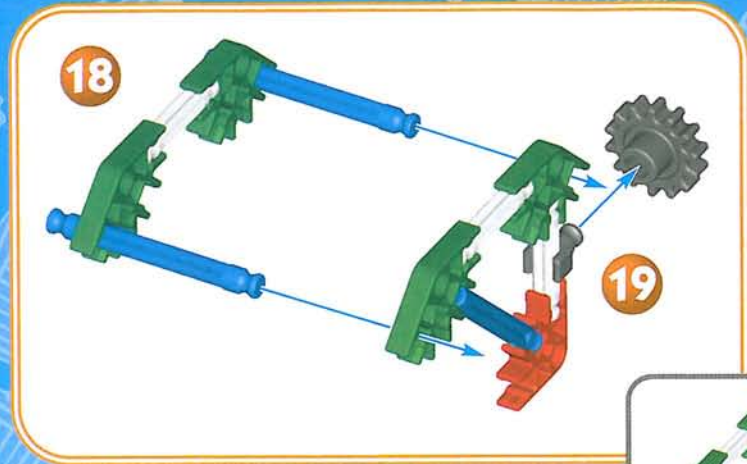
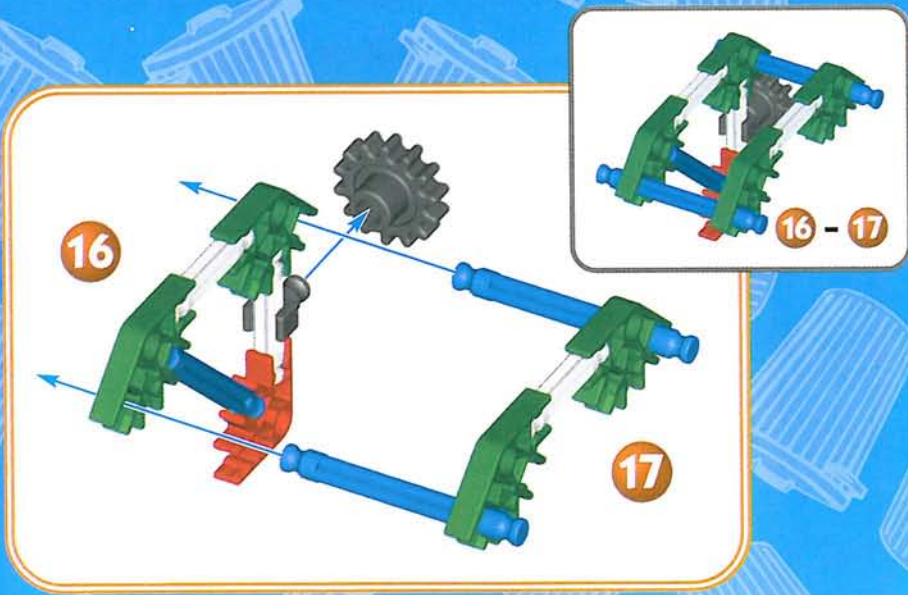



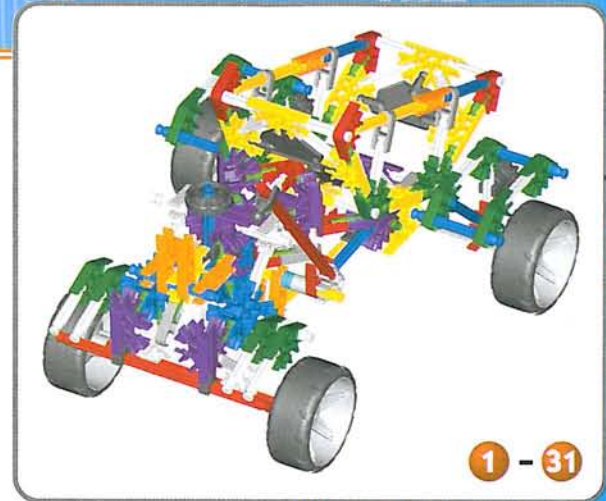
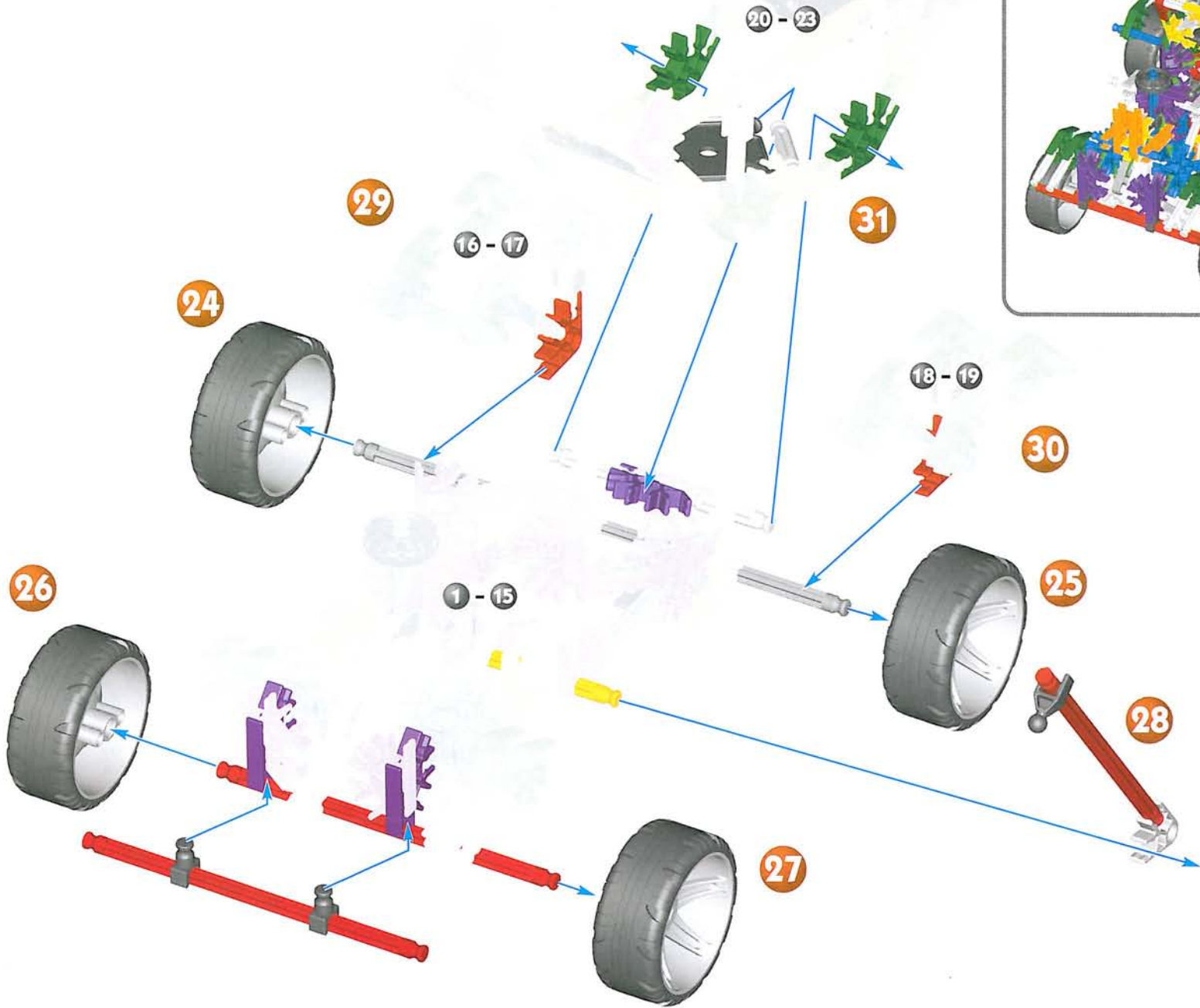

# Super Bike

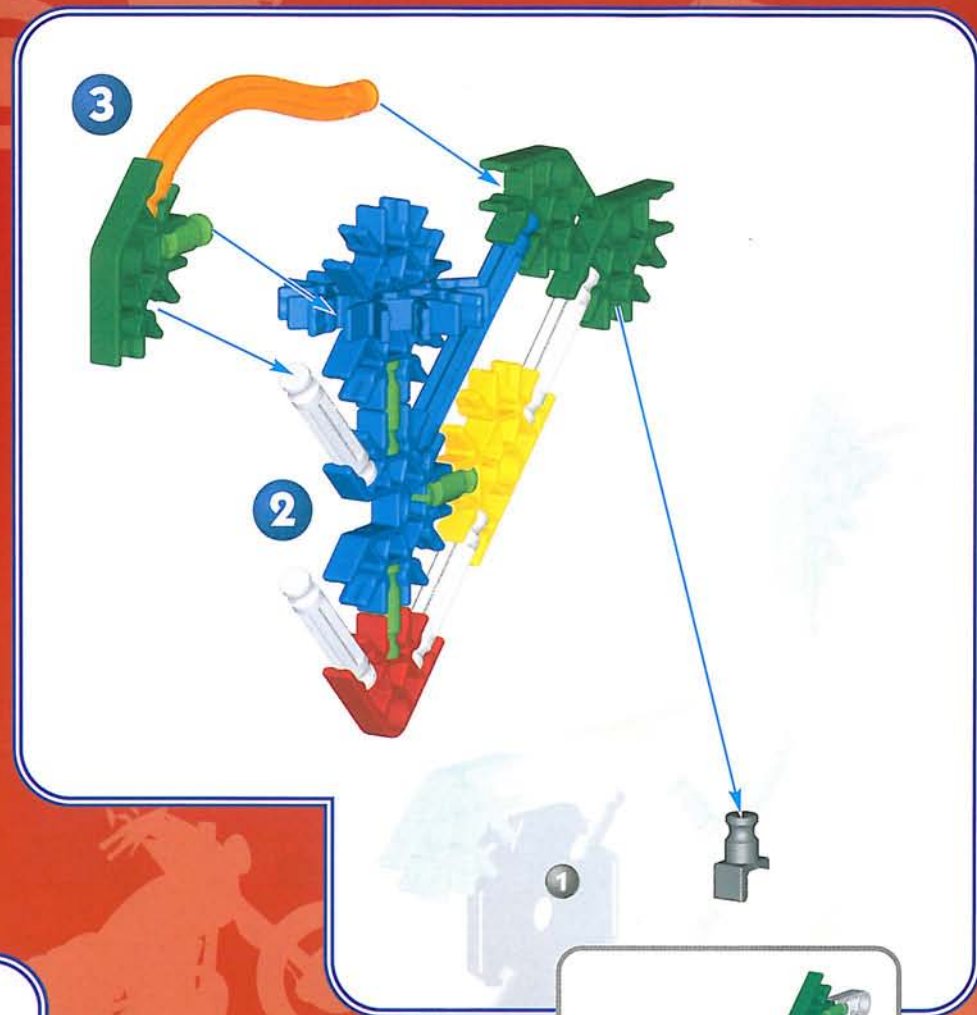
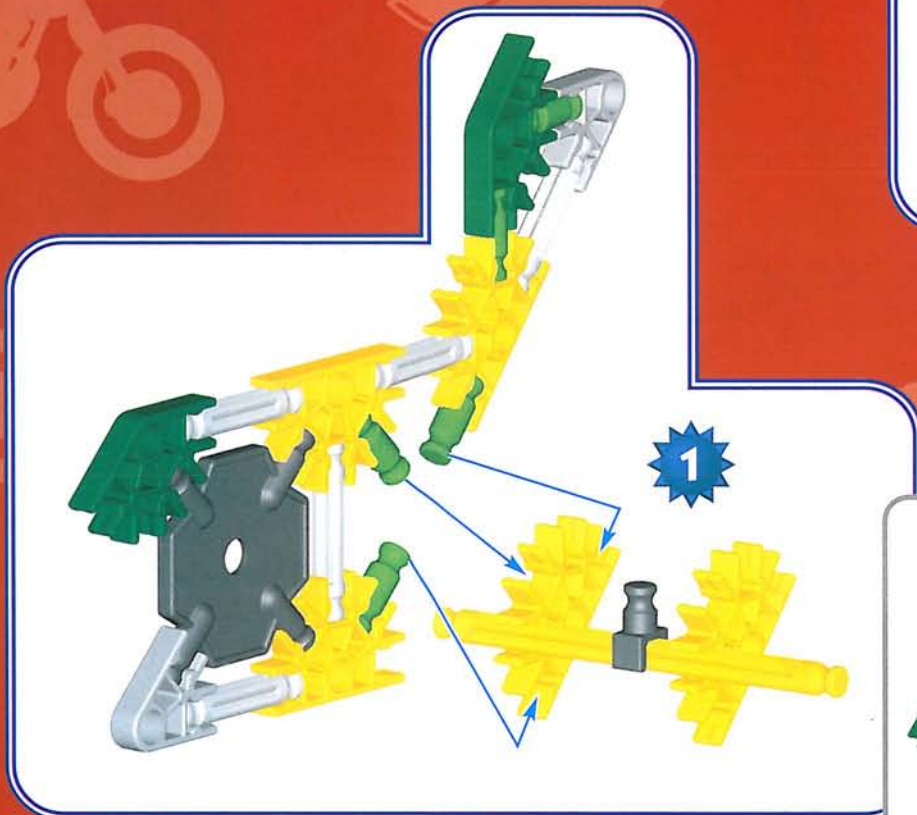
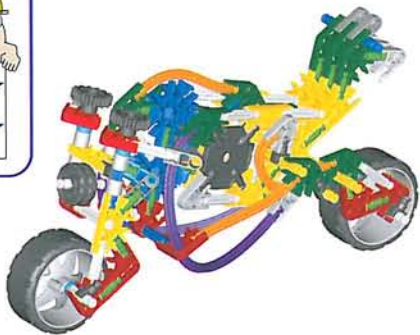

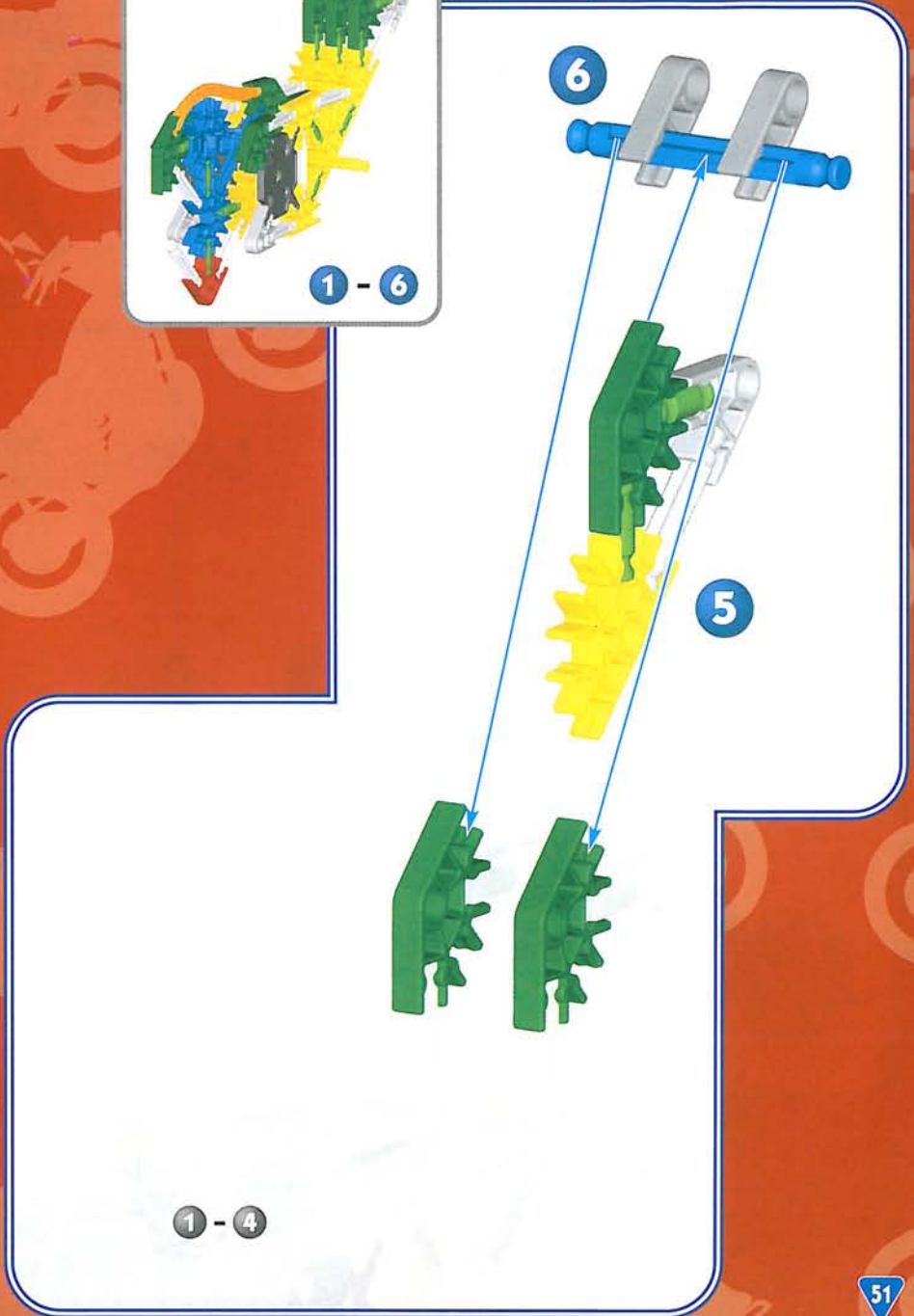
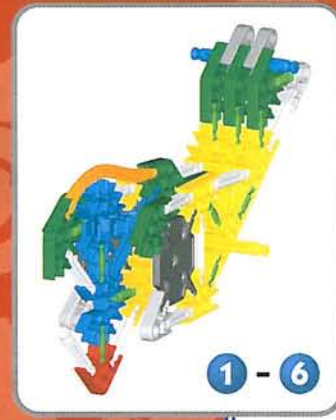
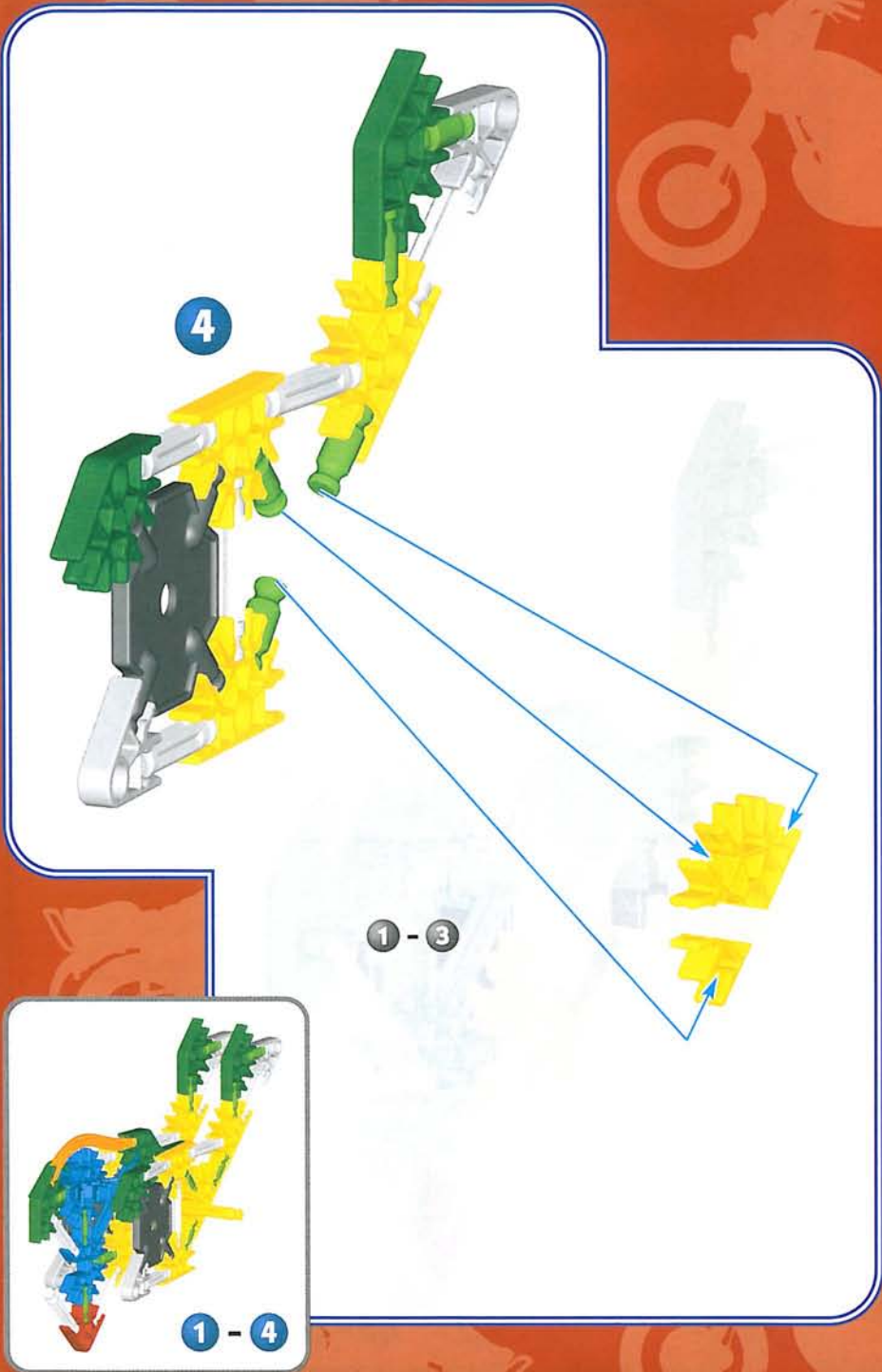

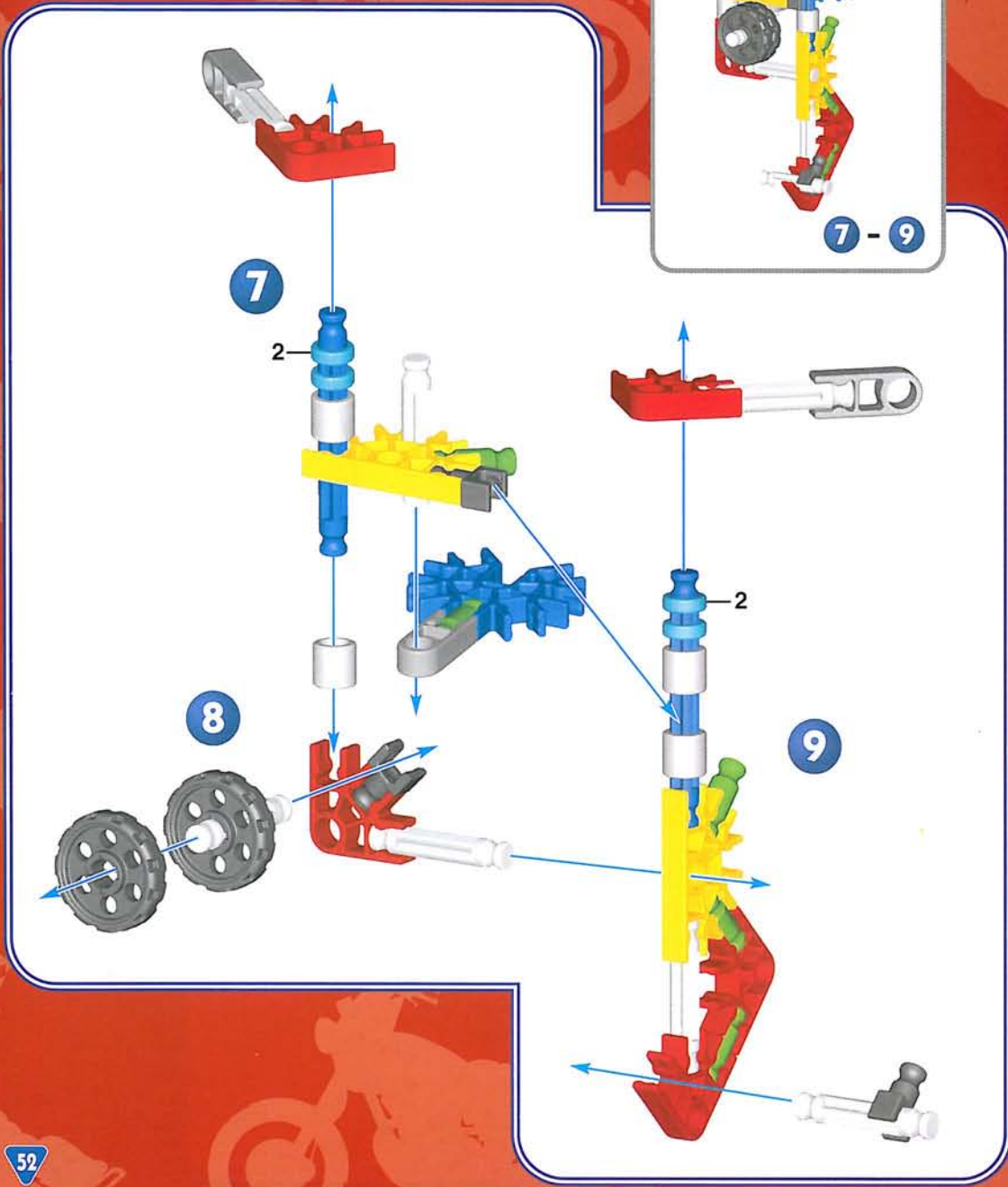

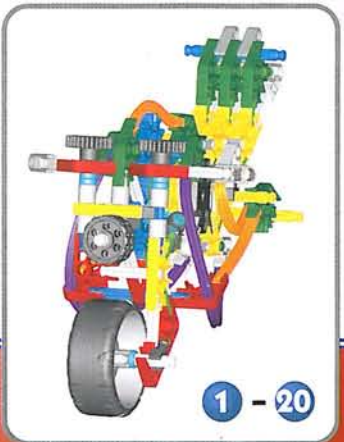
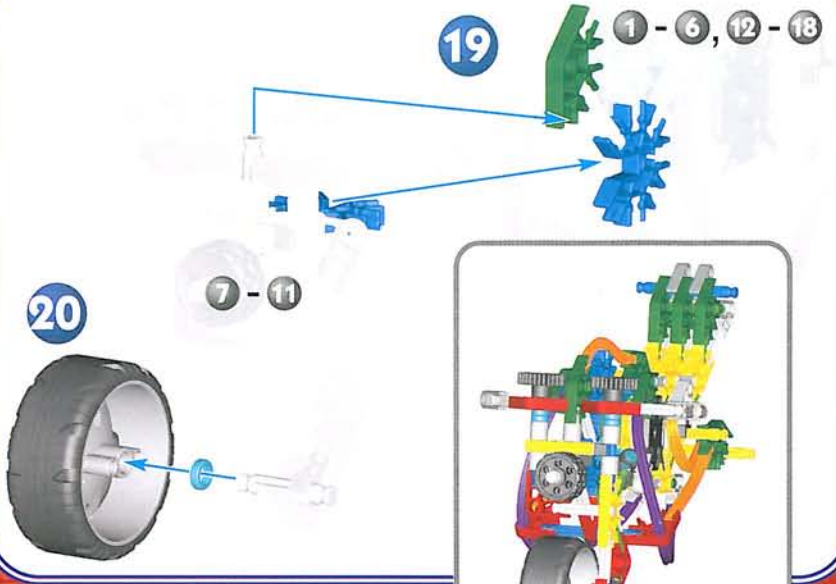
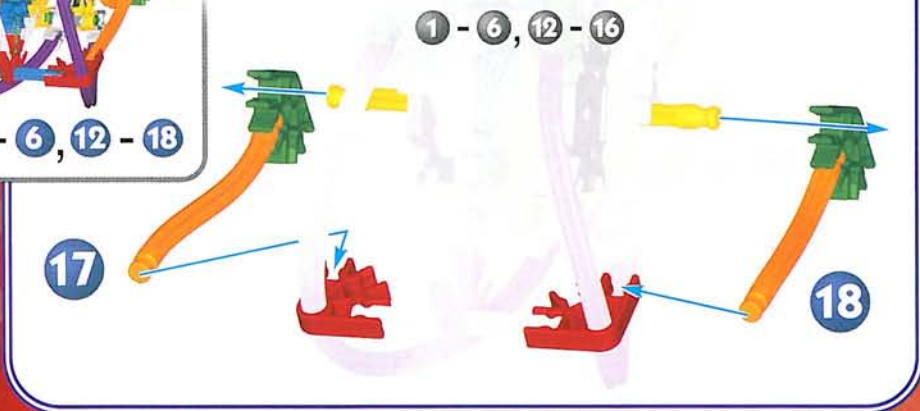
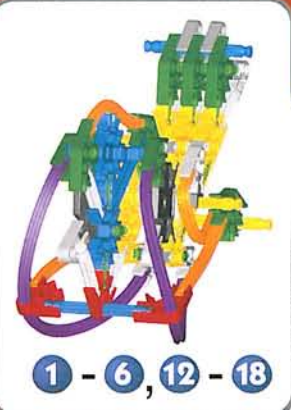
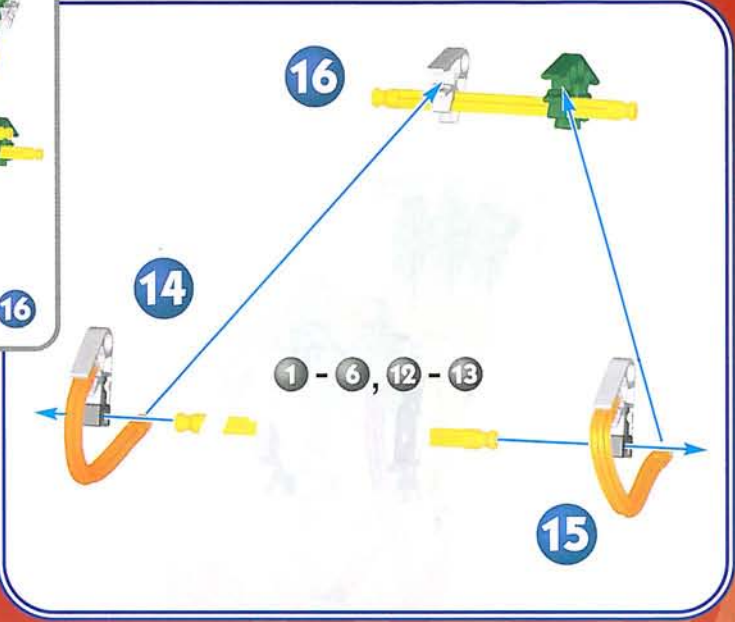
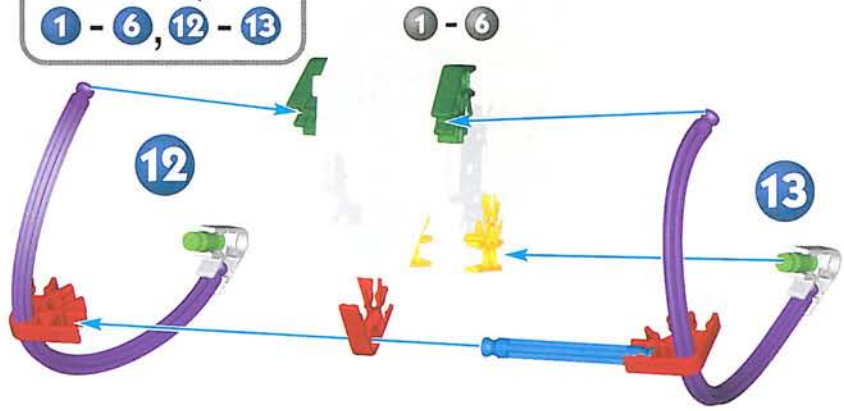
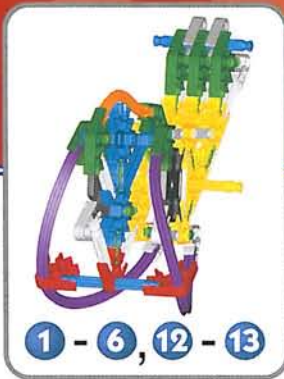

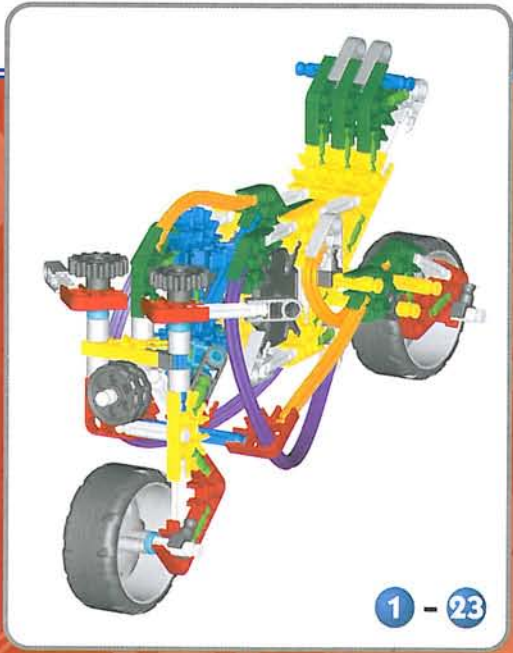
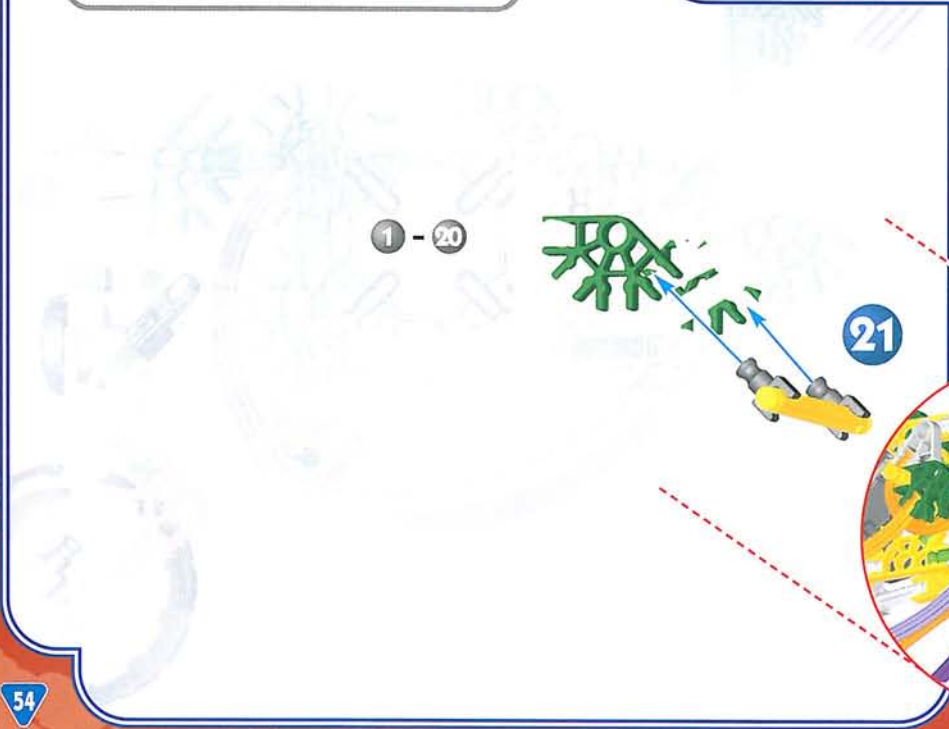
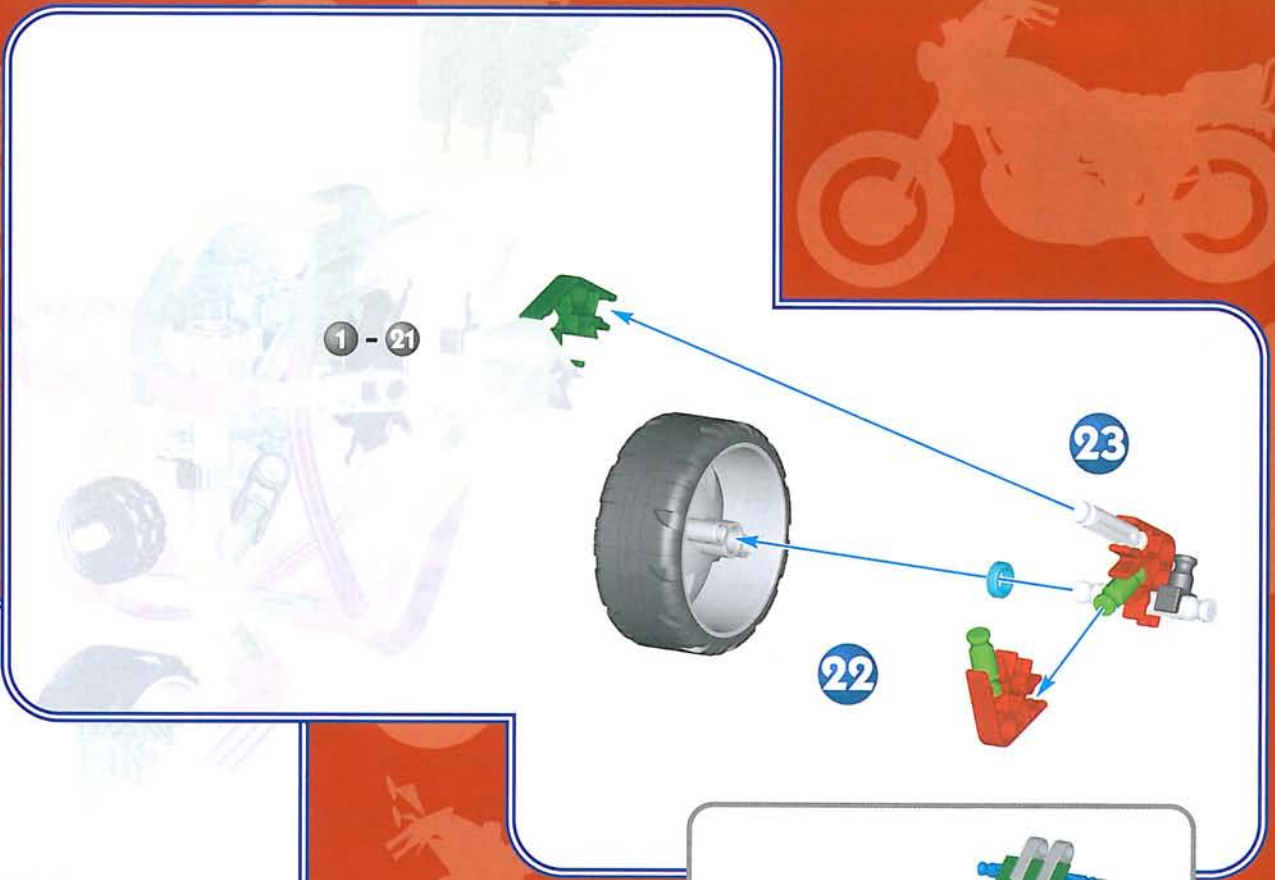
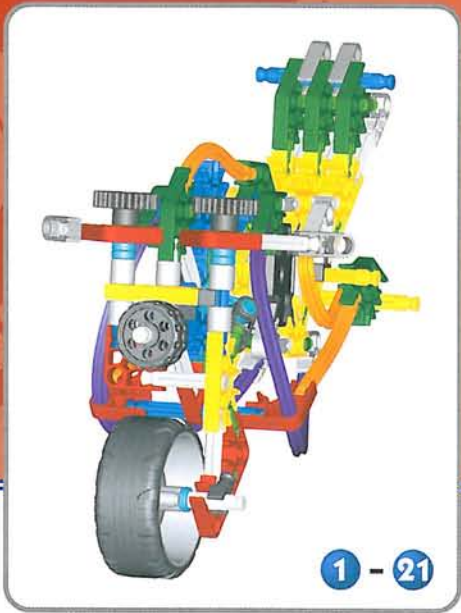

# Speedway Trike

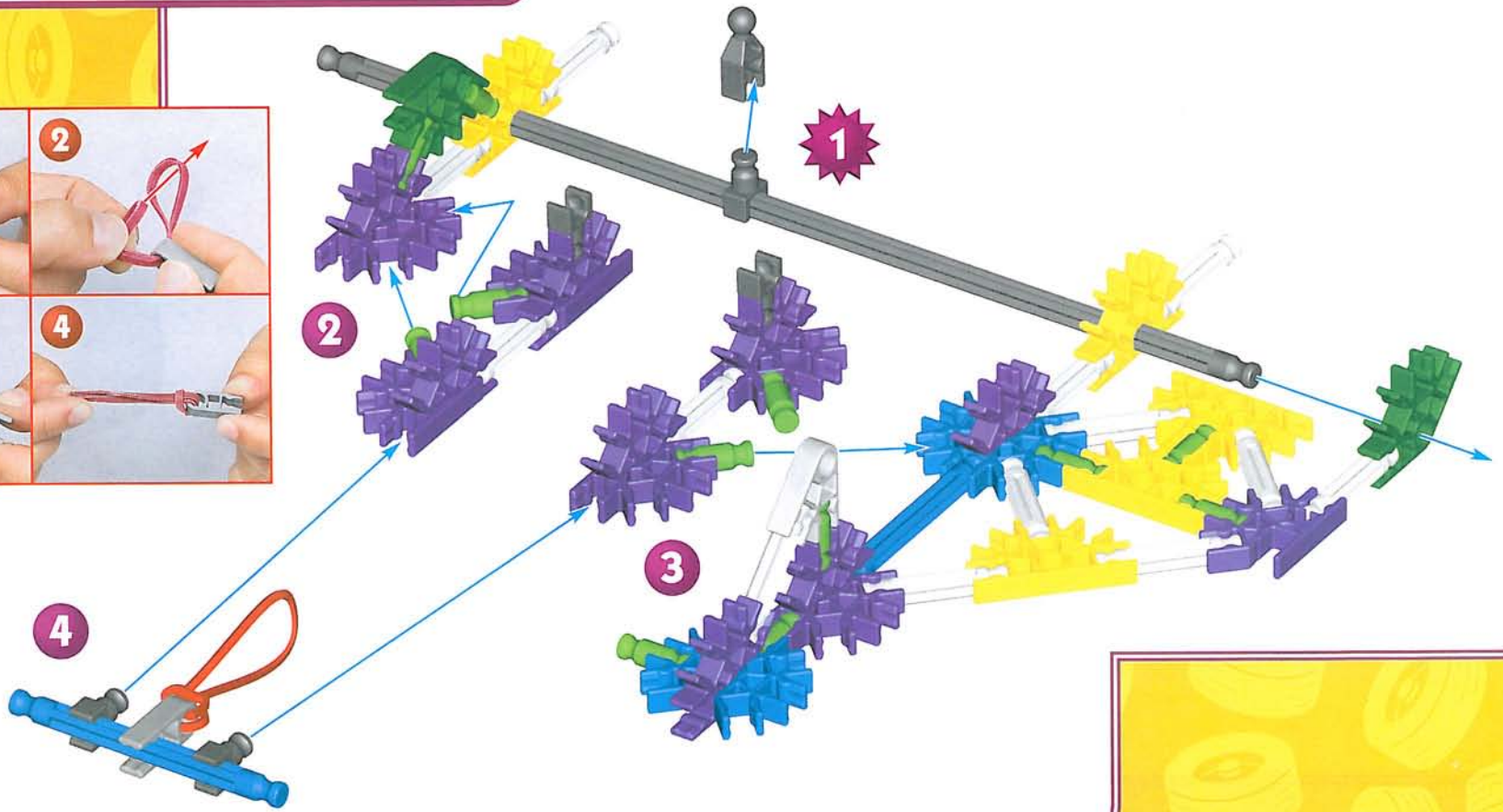
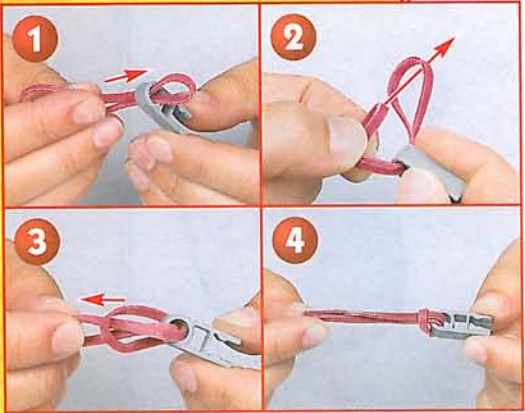
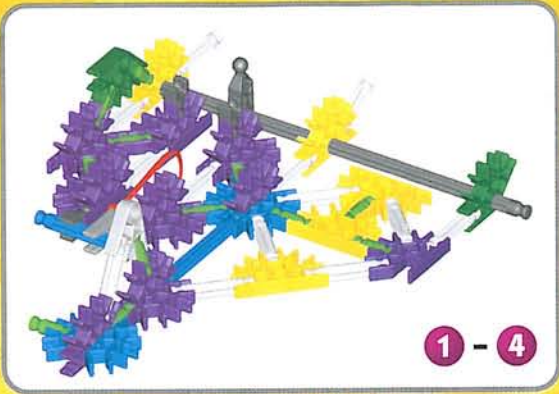
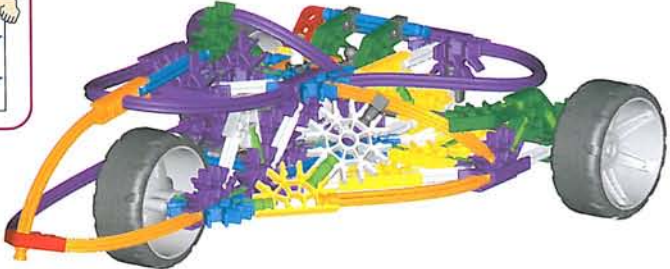

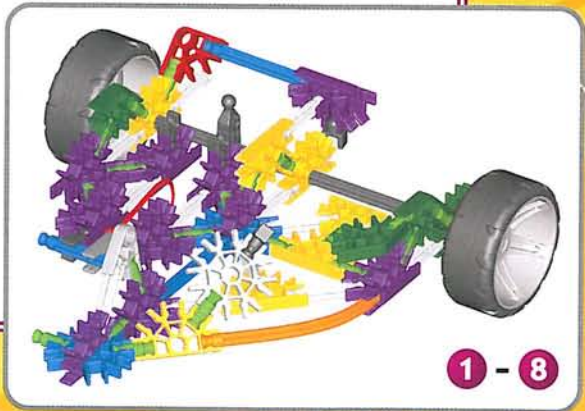
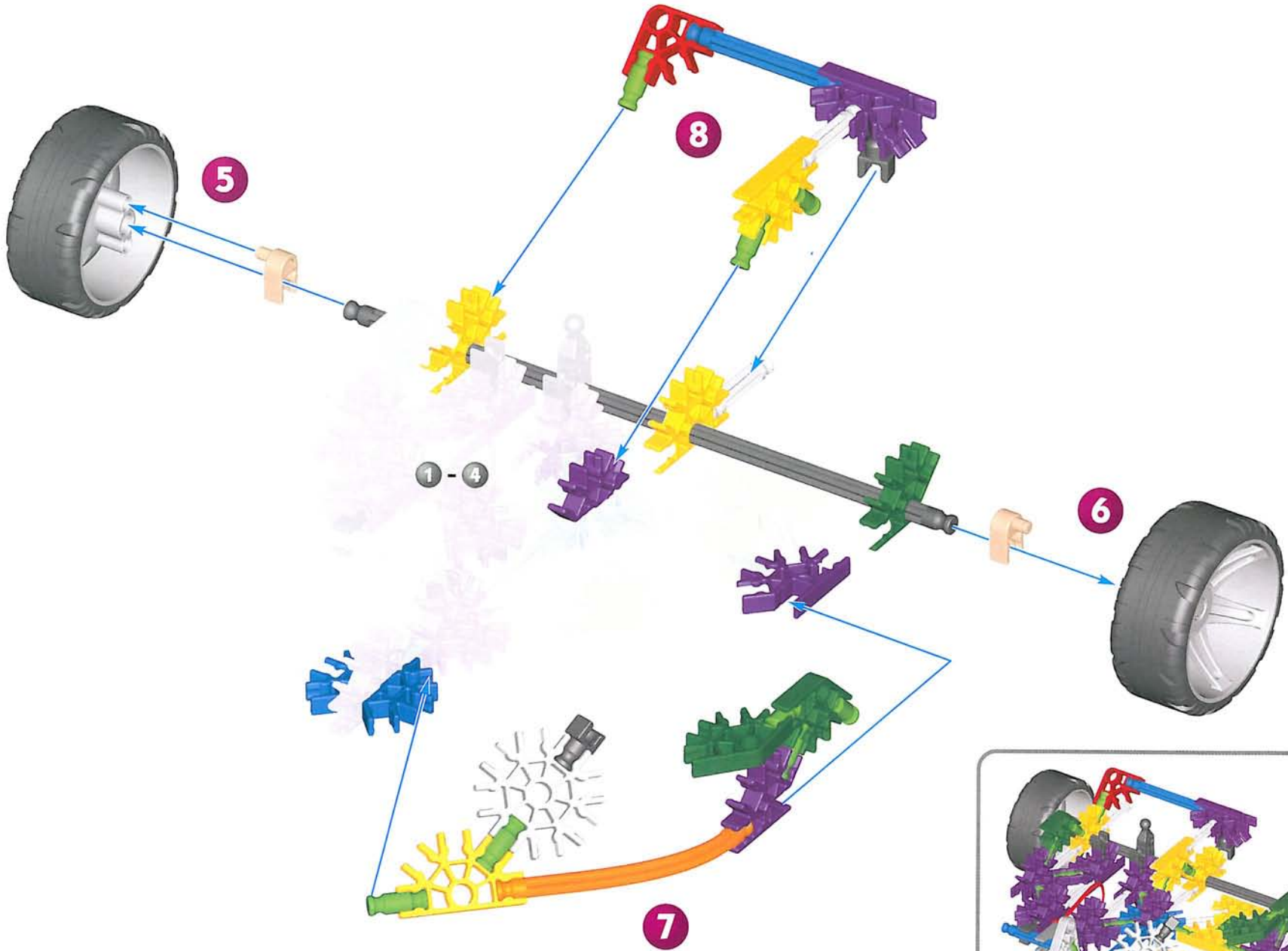



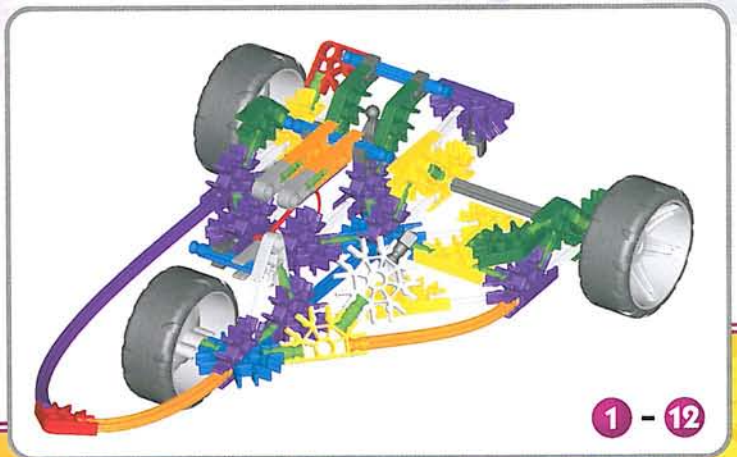
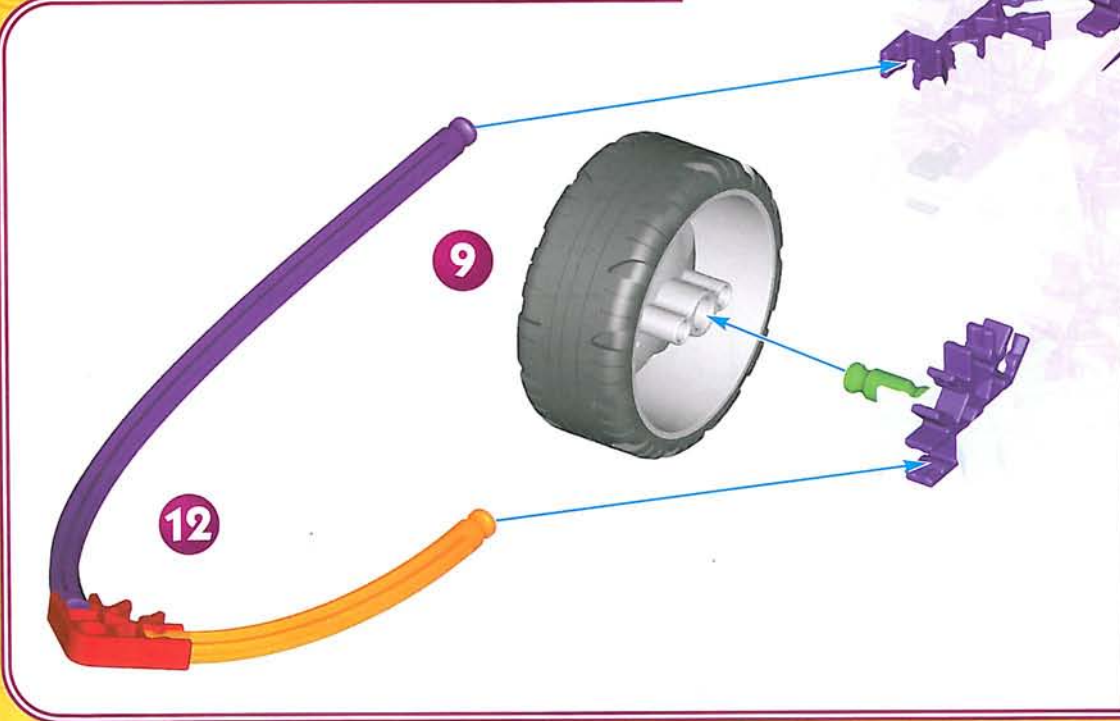
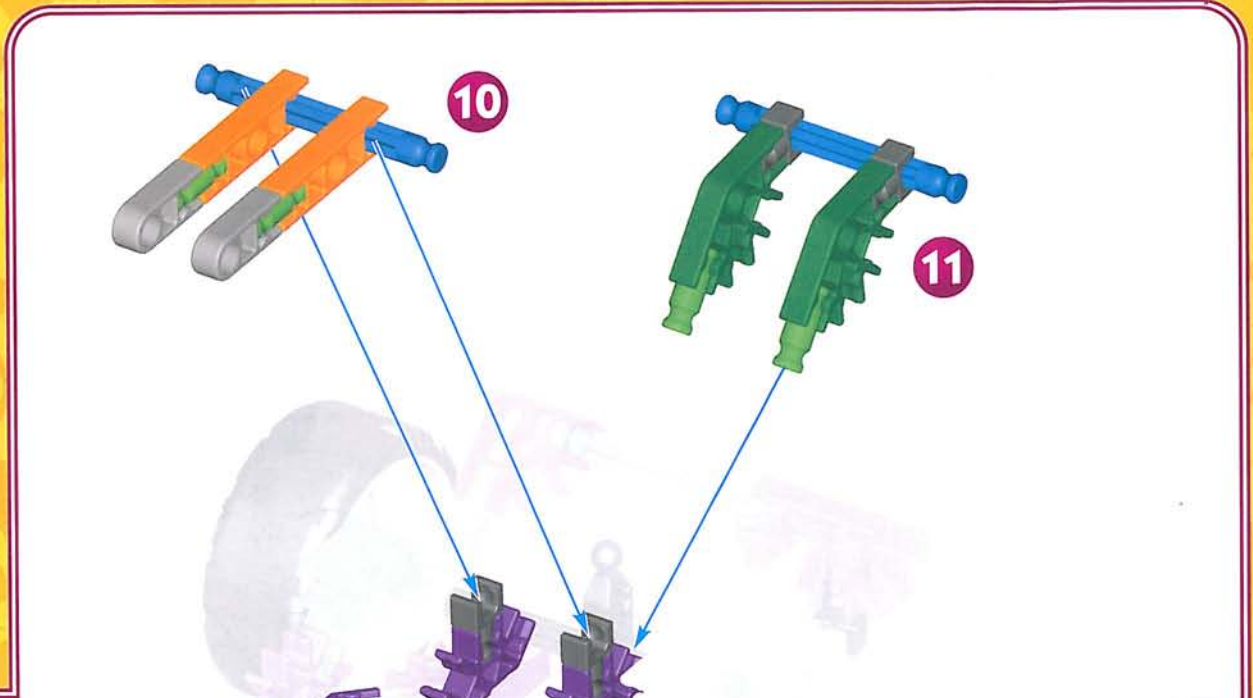

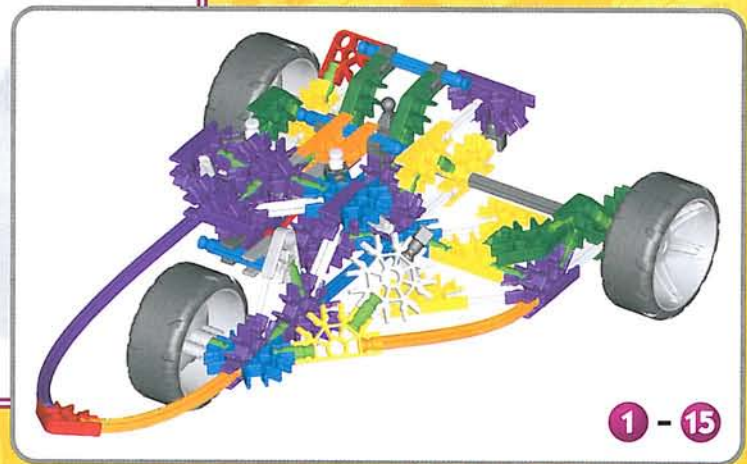
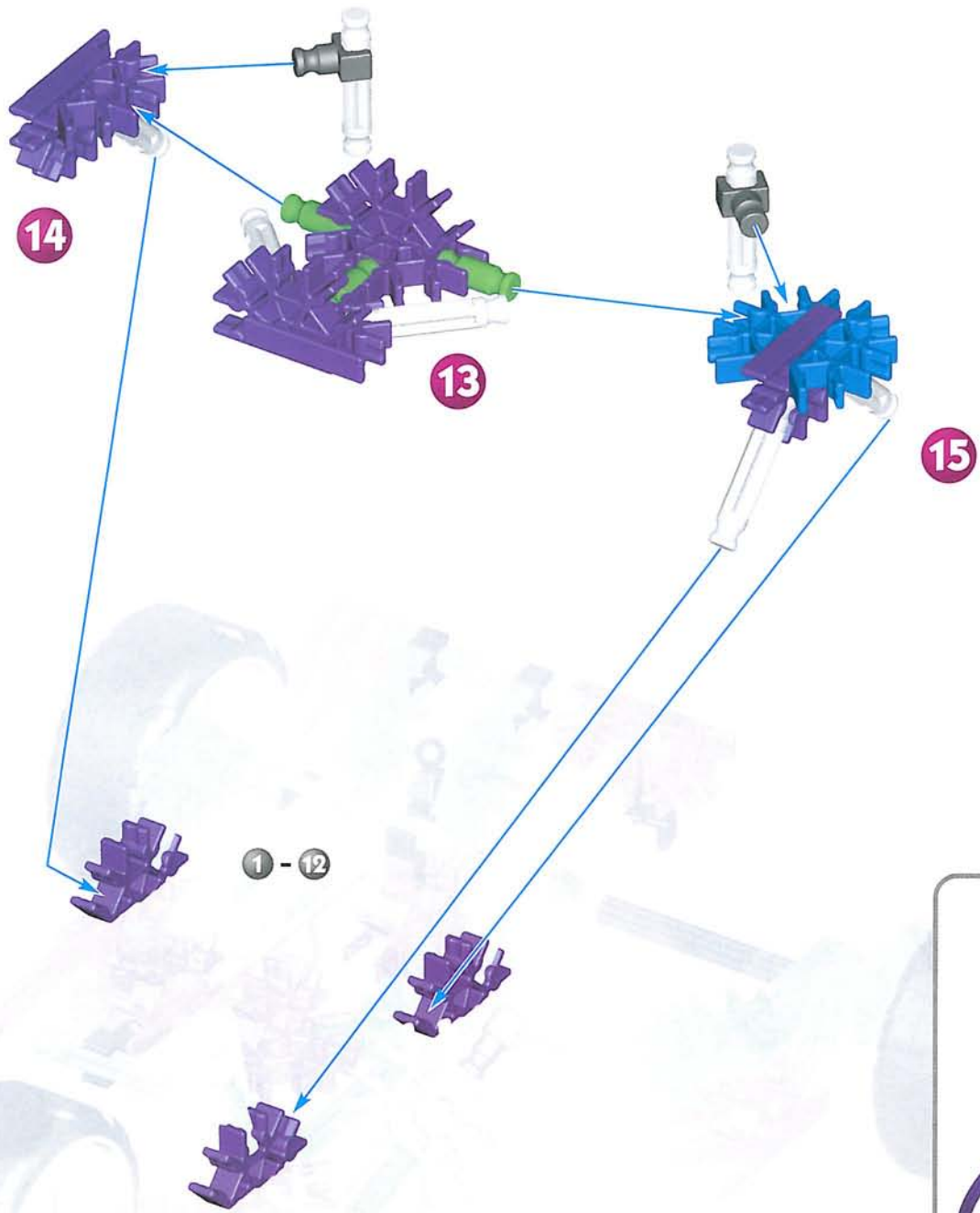

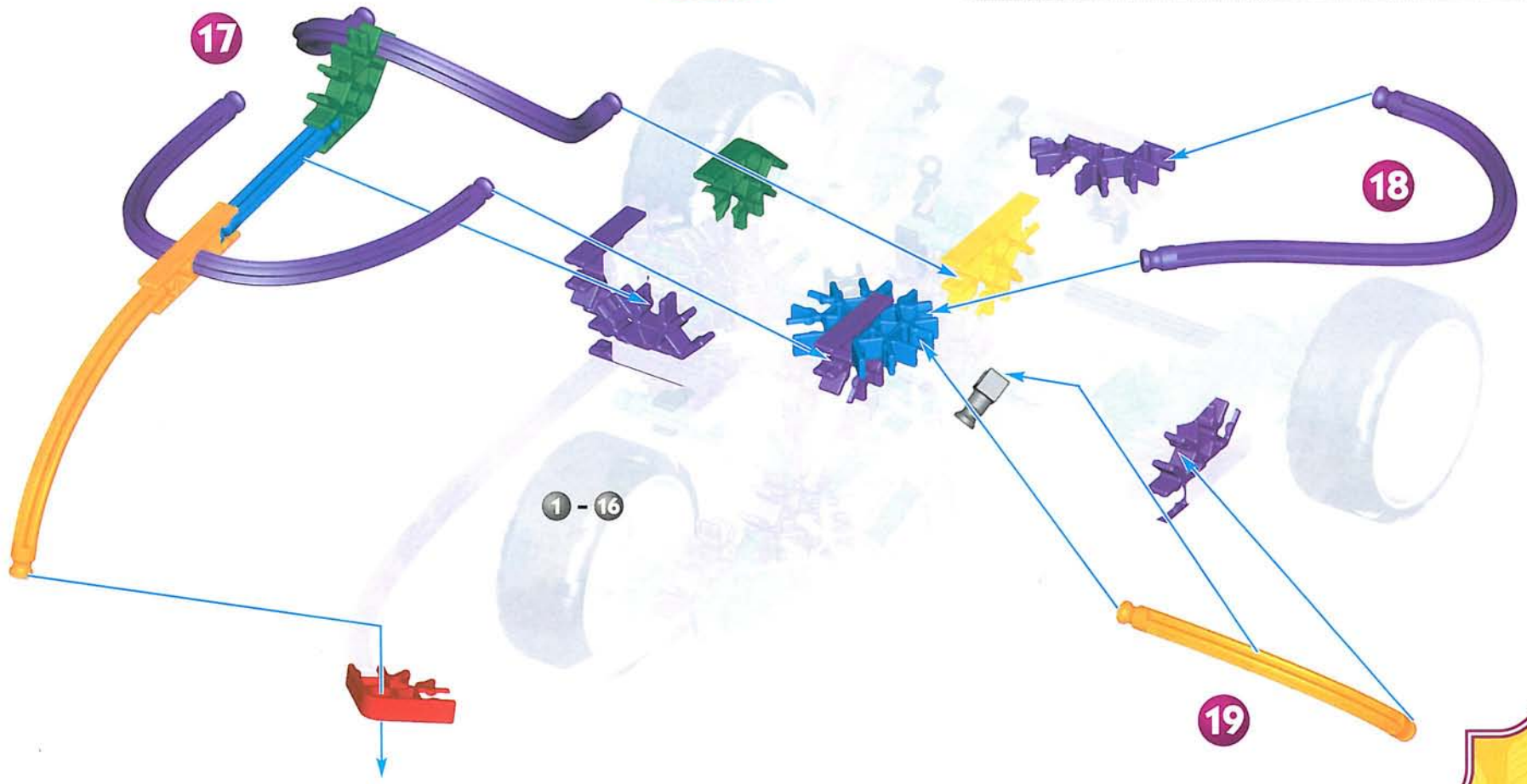
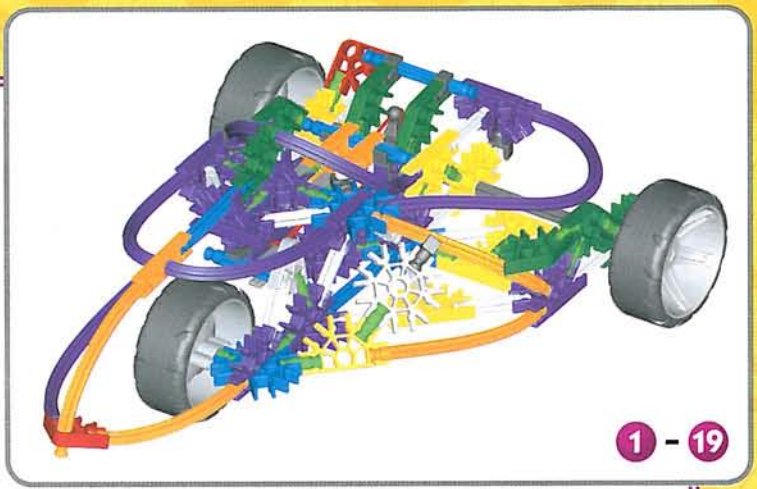
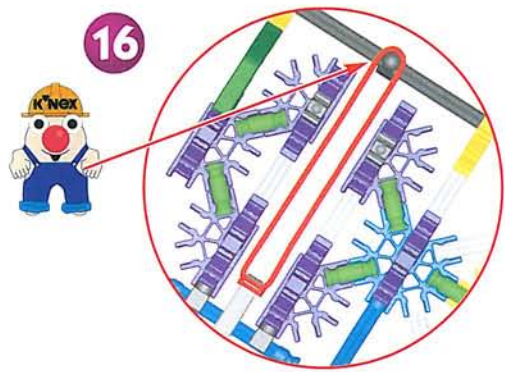

# Moon Buggy

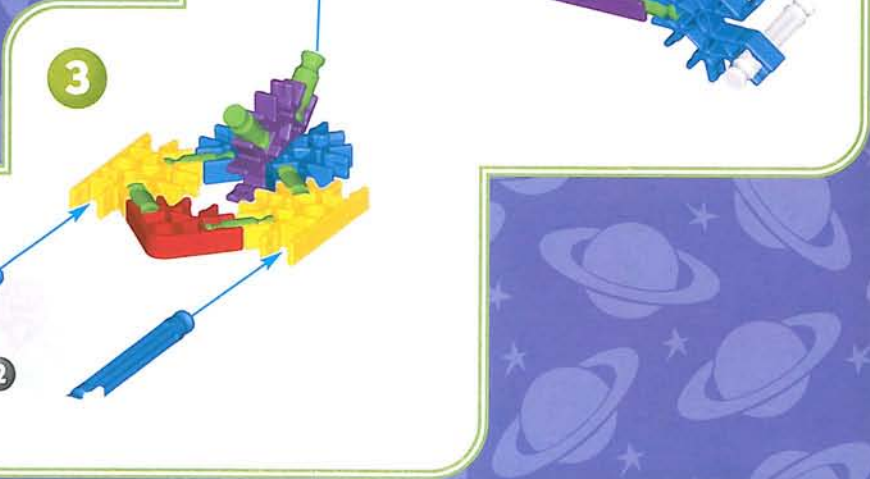
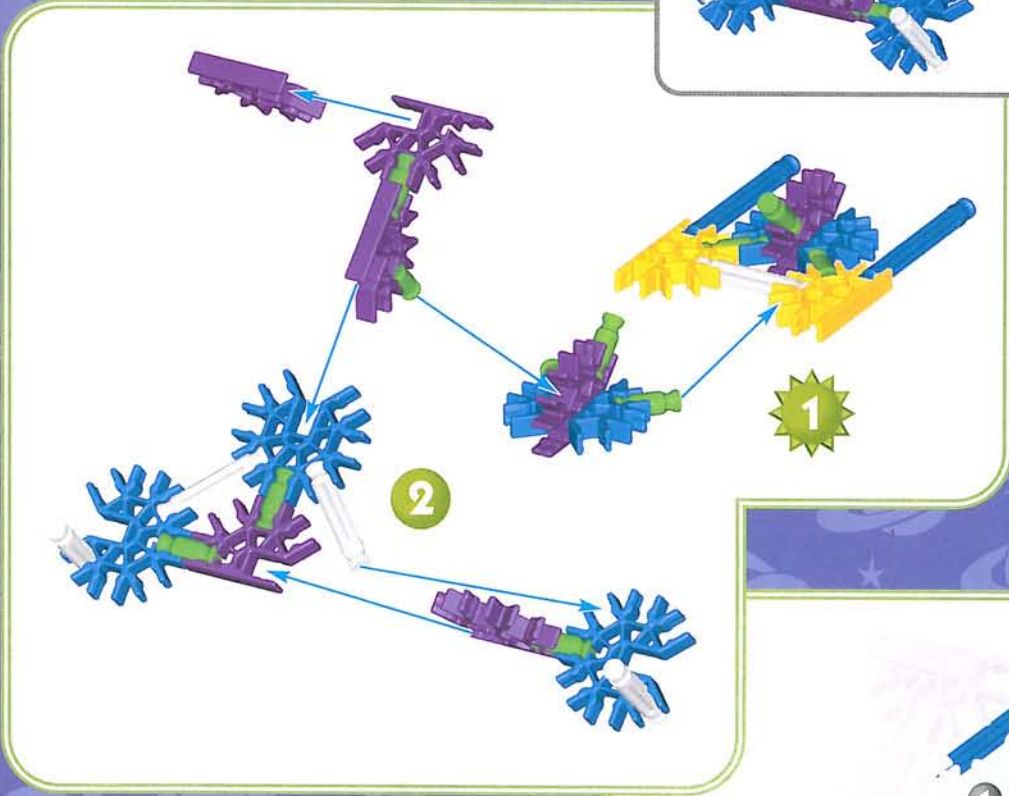
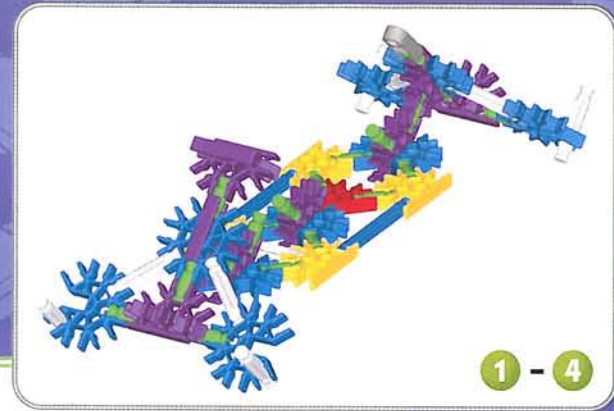
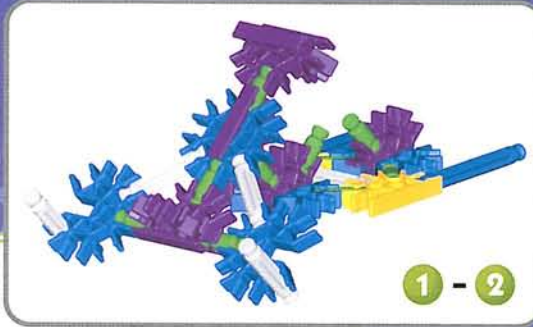

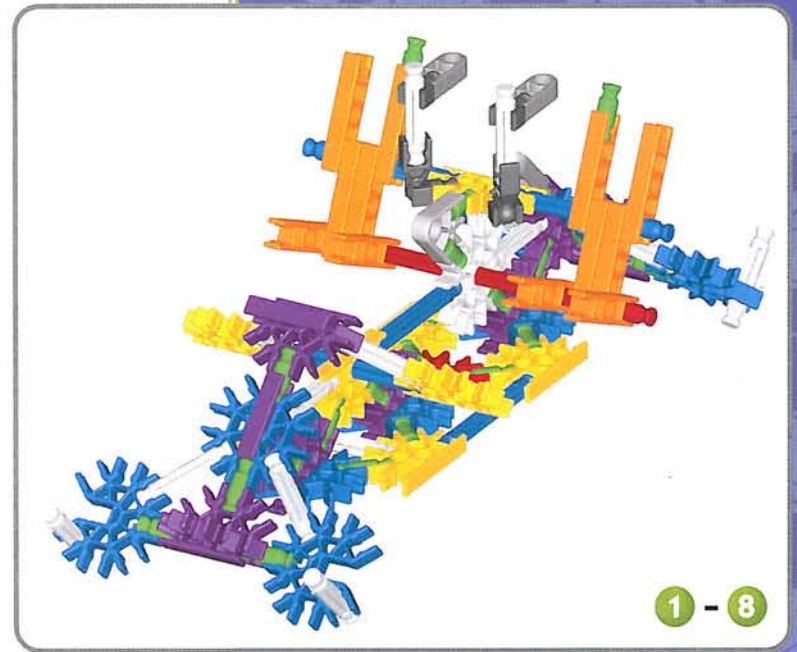
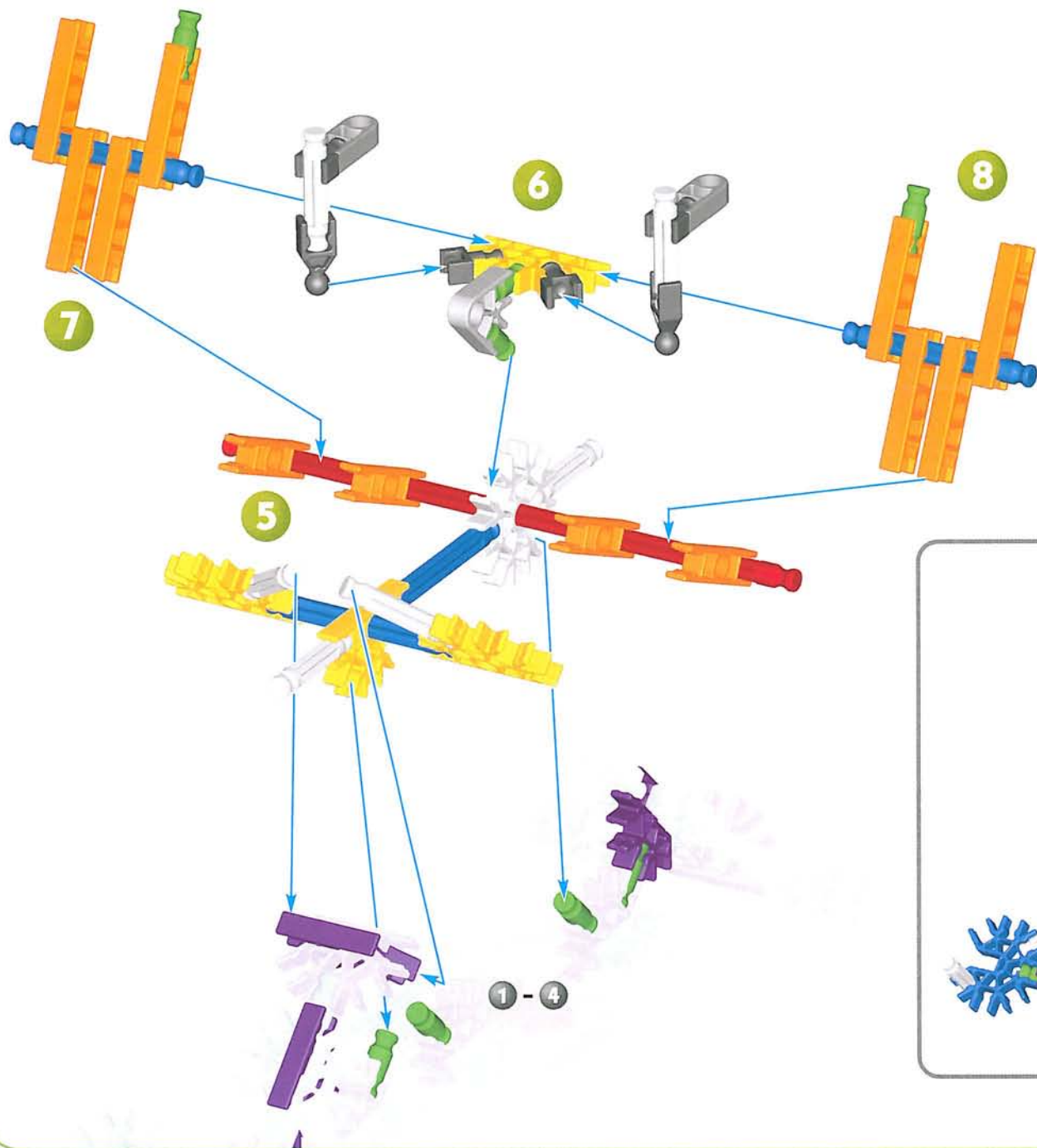

x2

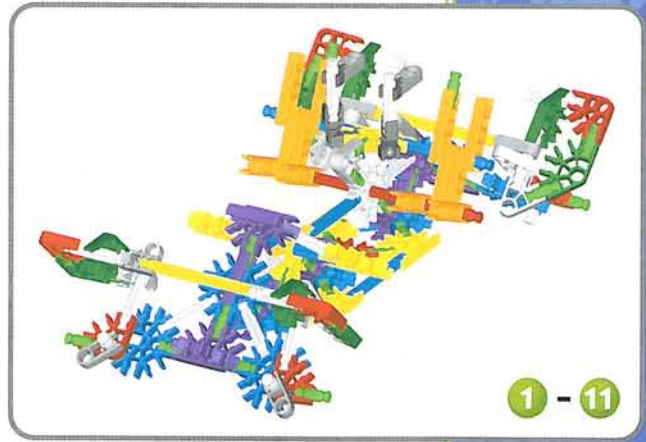
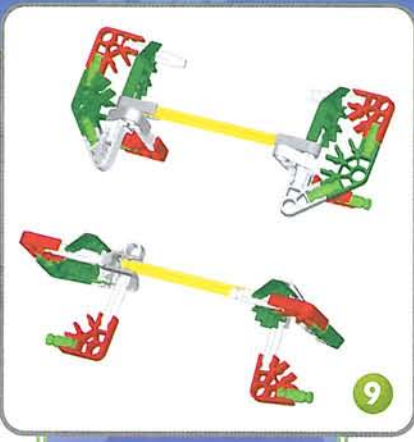
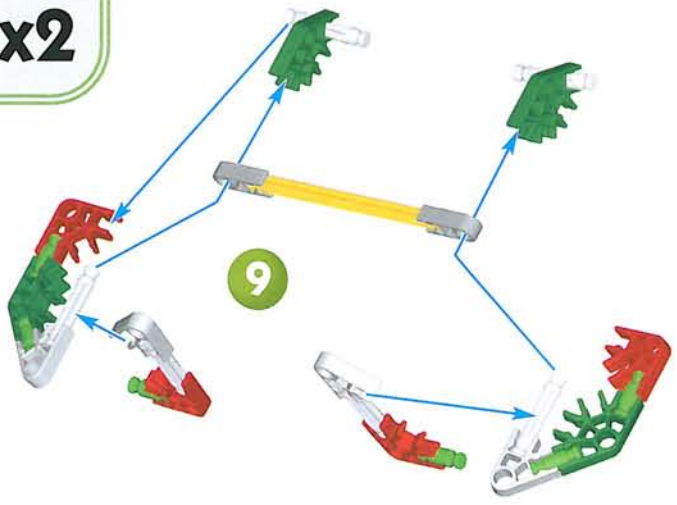

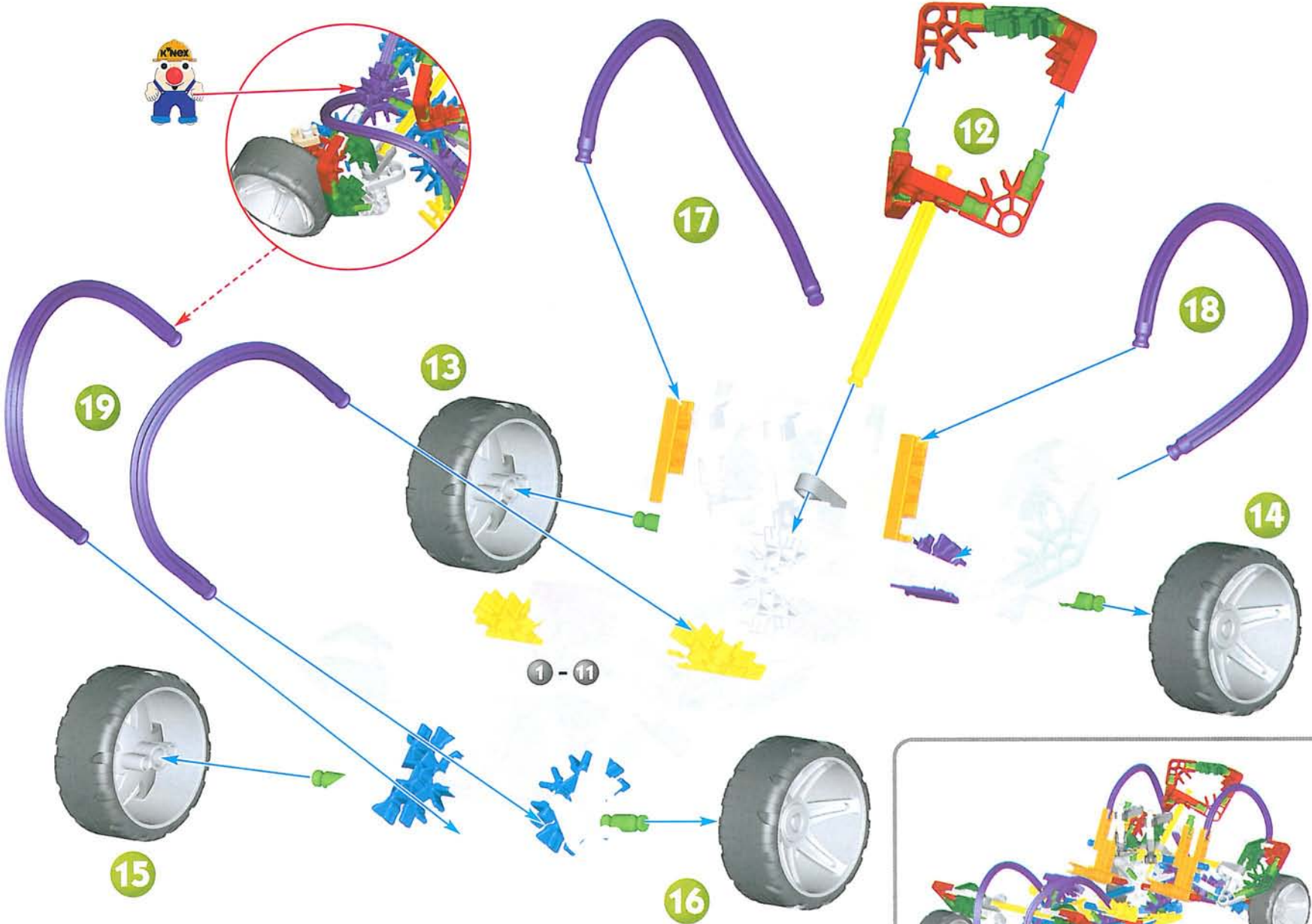
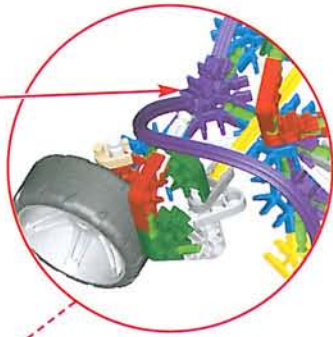

# Racing Truck

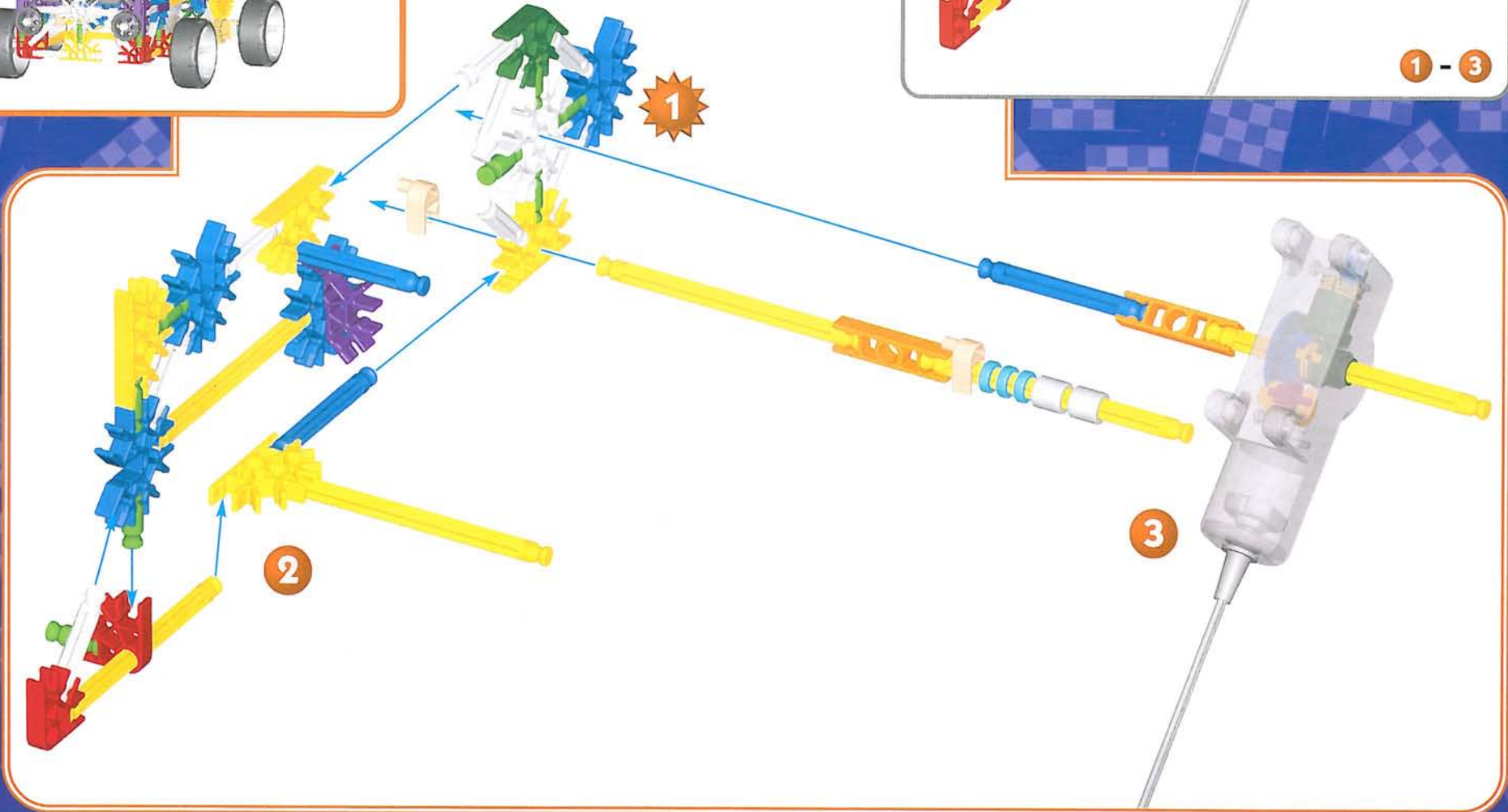
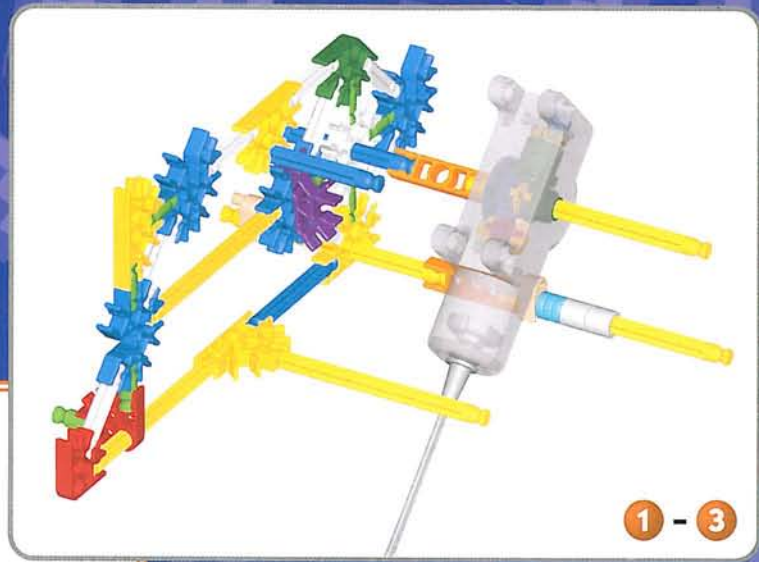
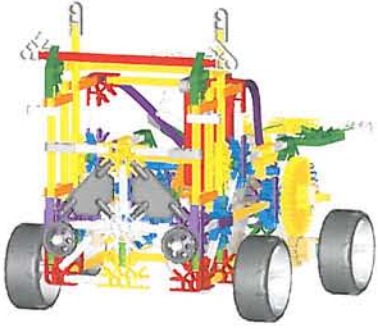



1 - 3

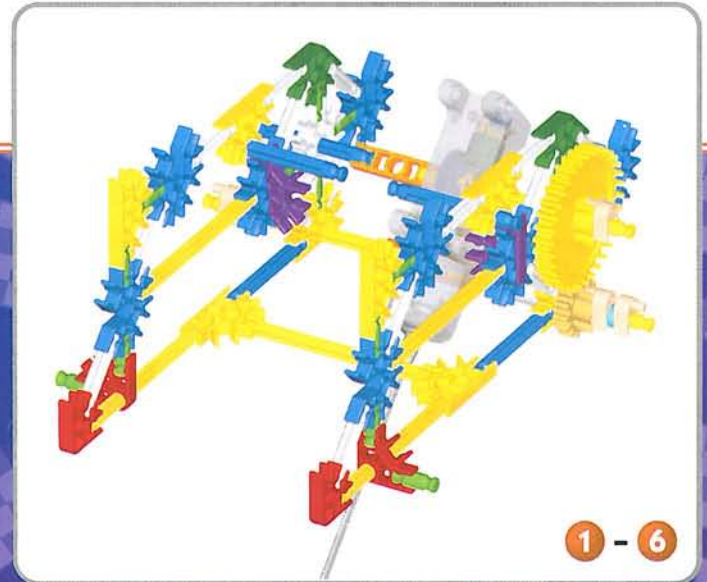
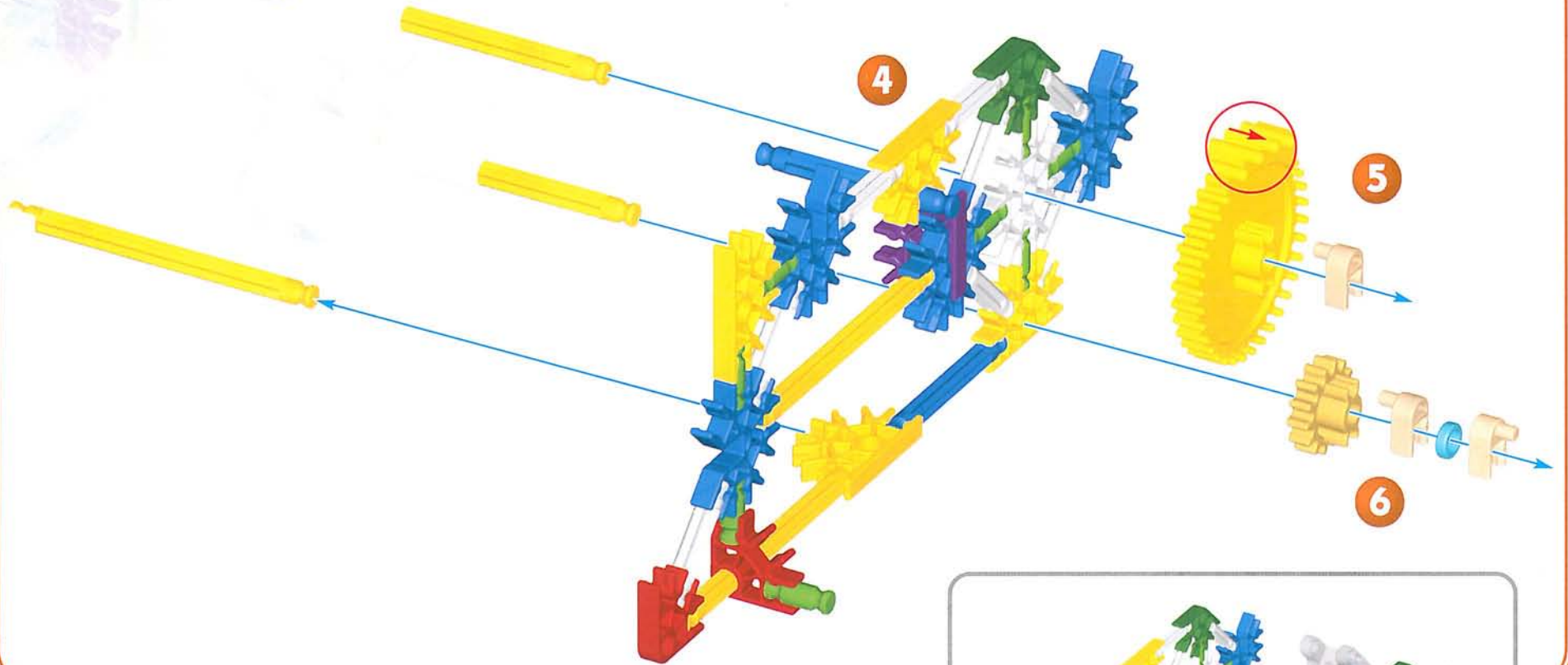

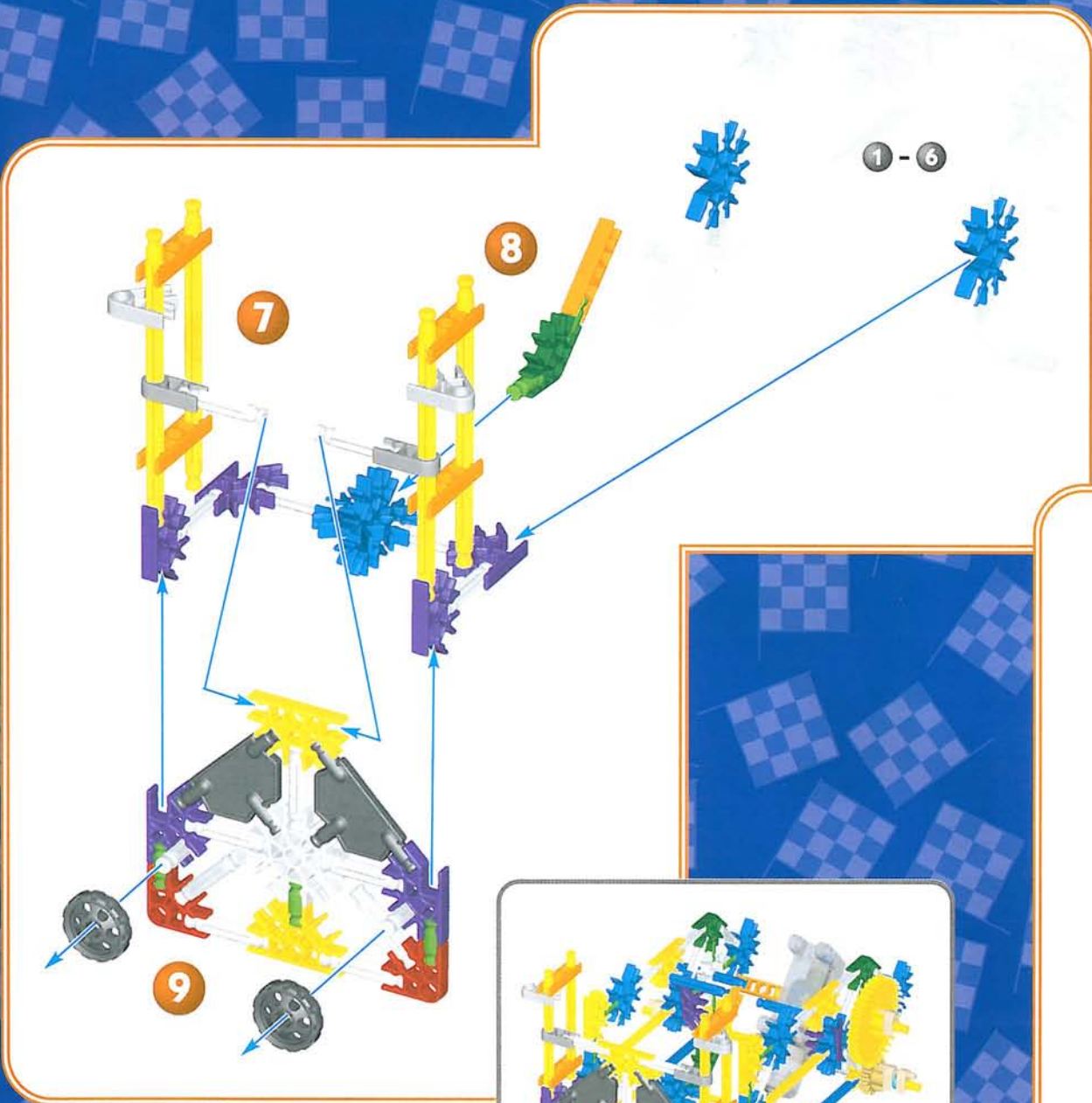

1 - 6

7

8

9



1 - 11

11

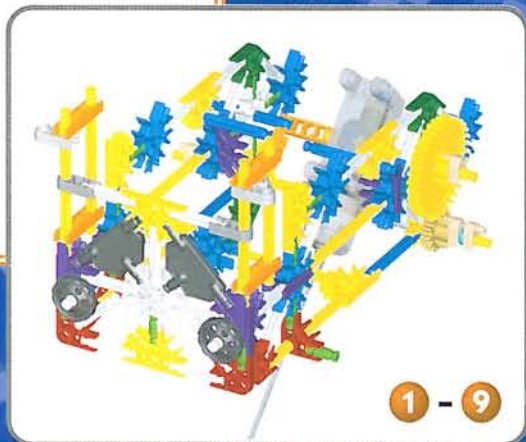

1 - 9

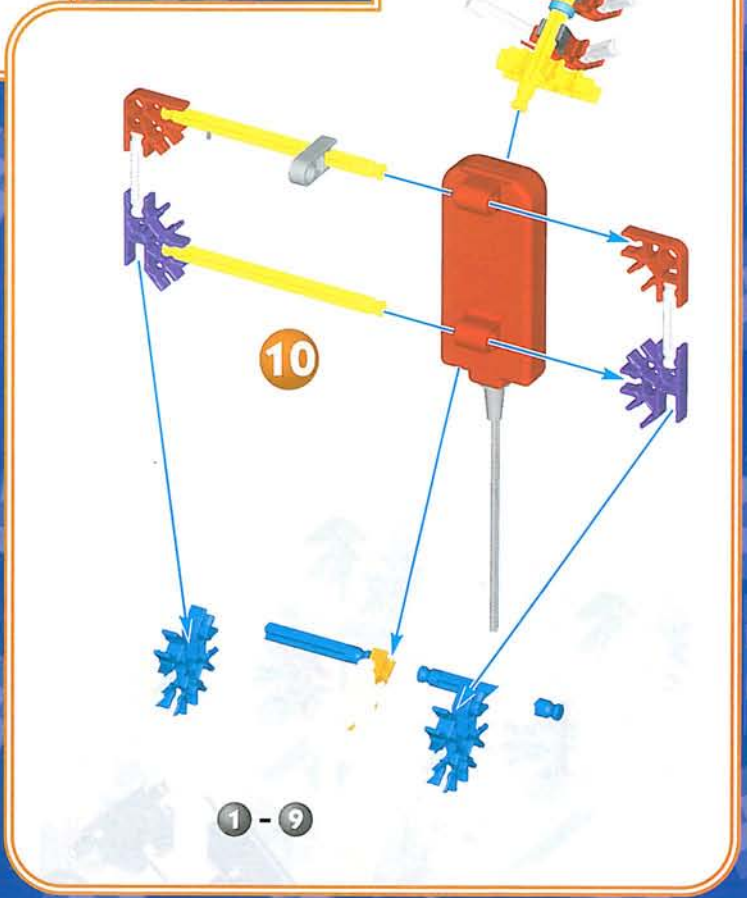

10

1 - 9

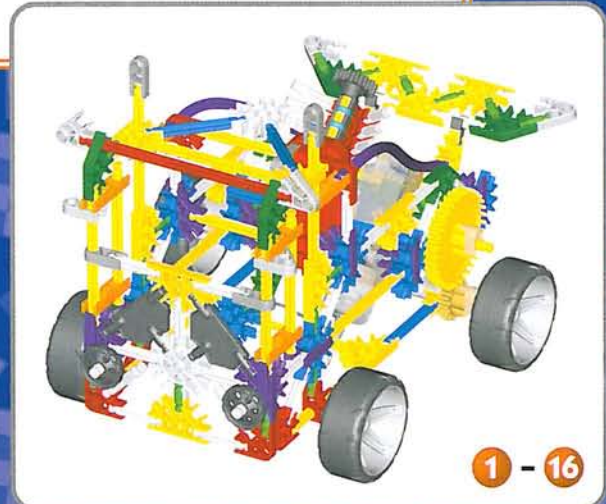
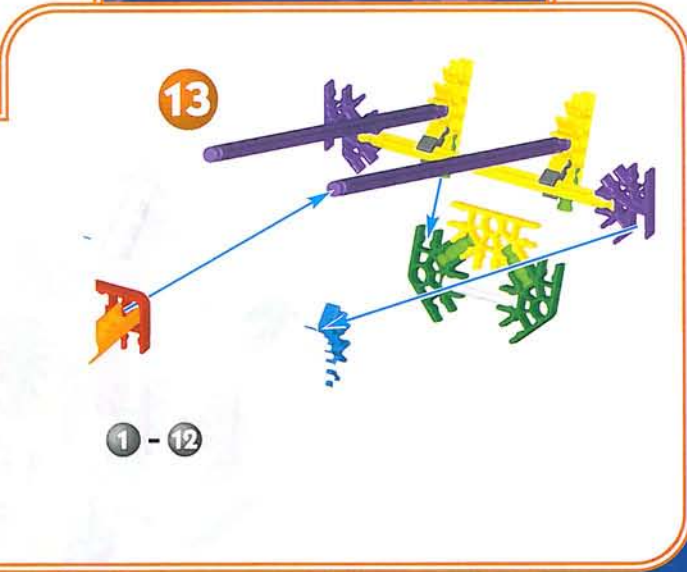
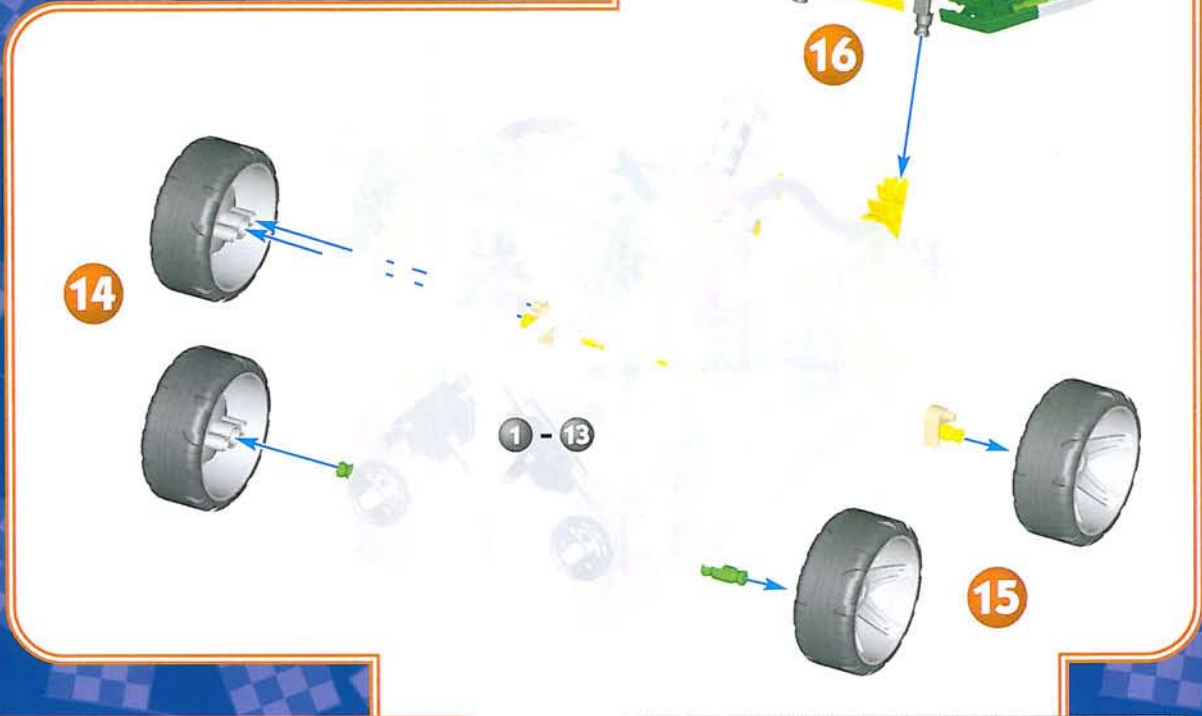
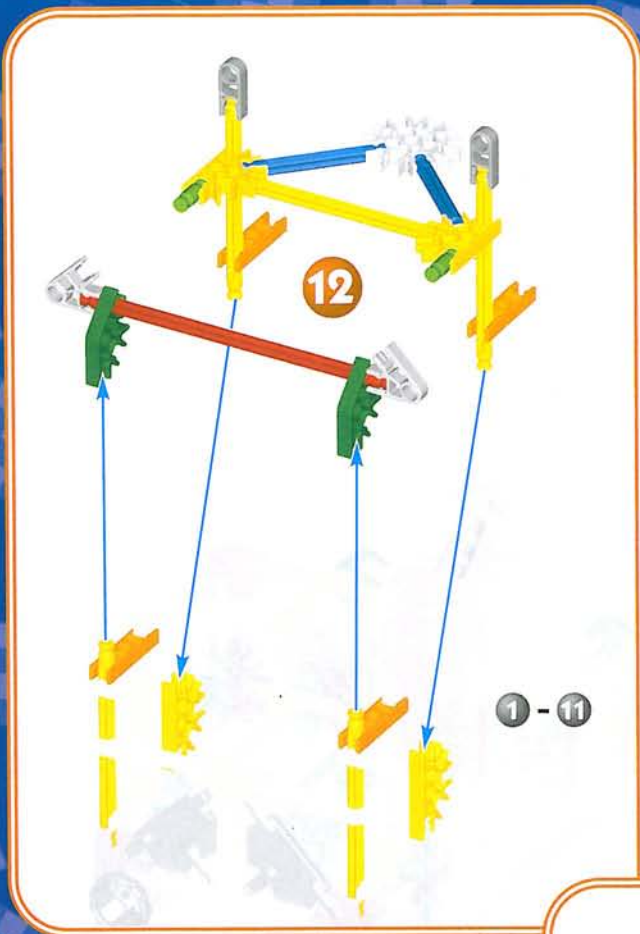



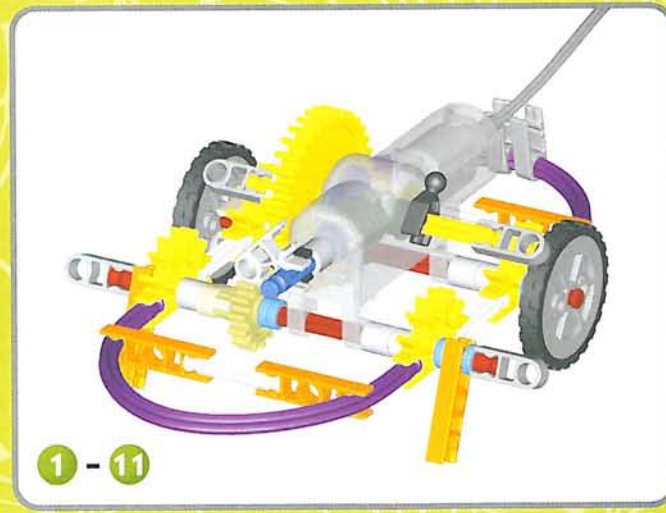
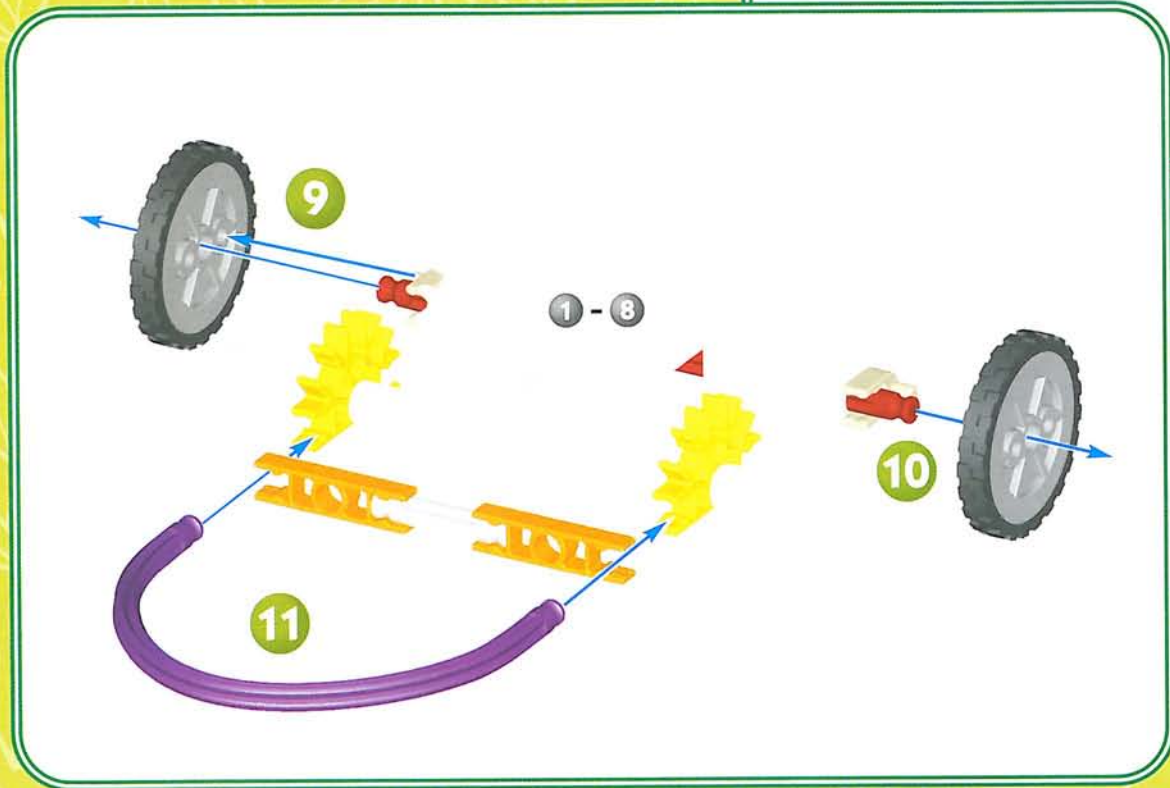
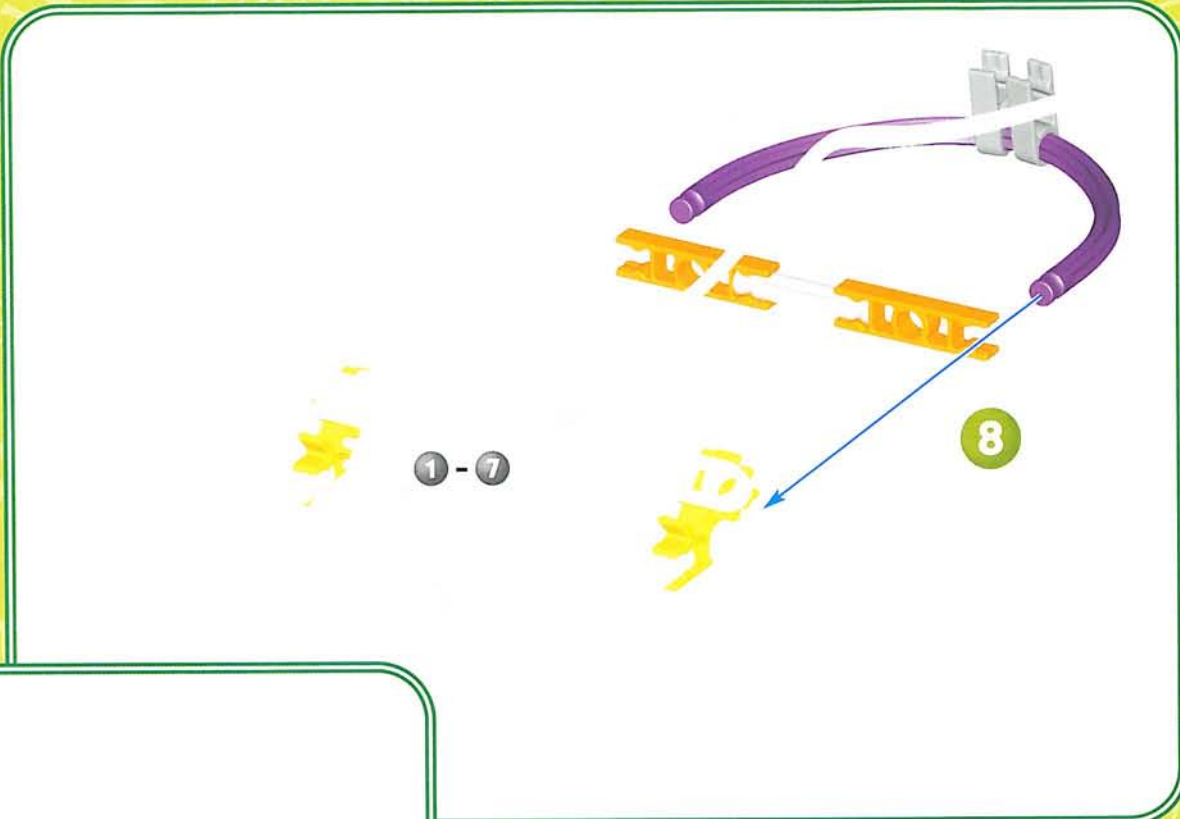

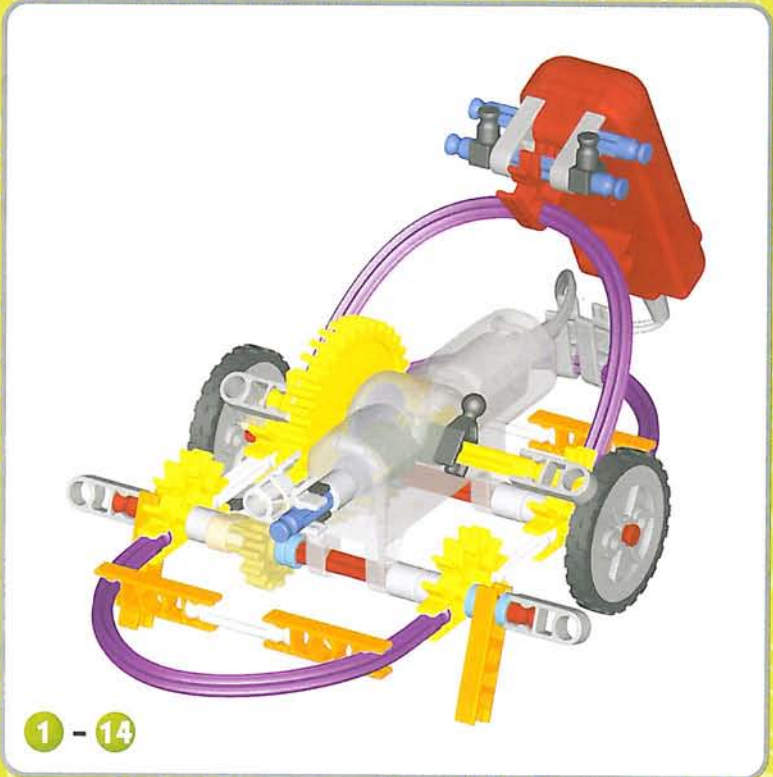
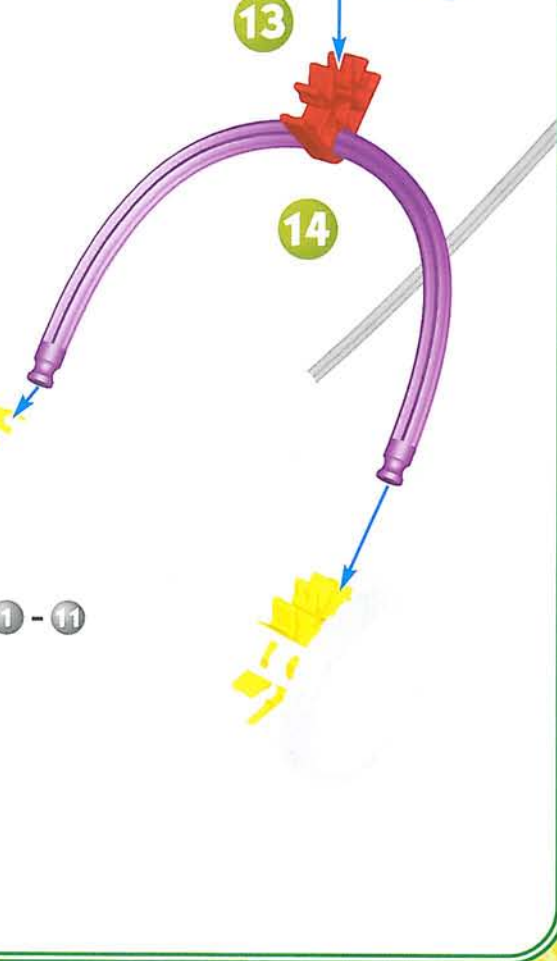
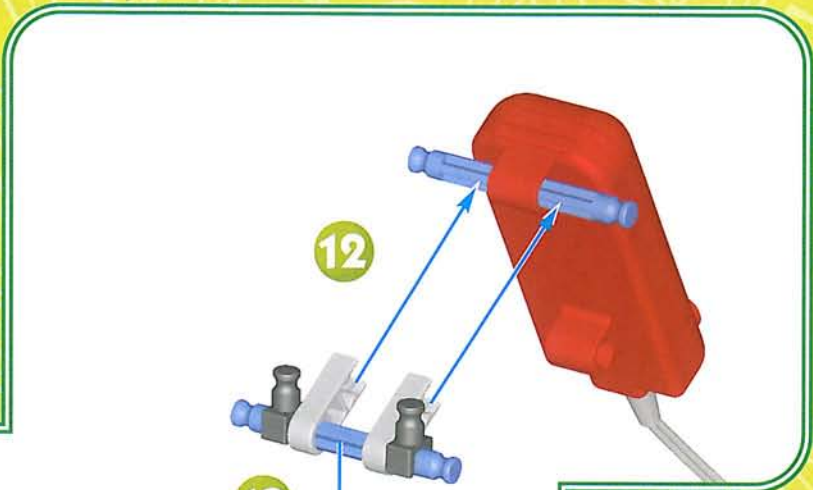

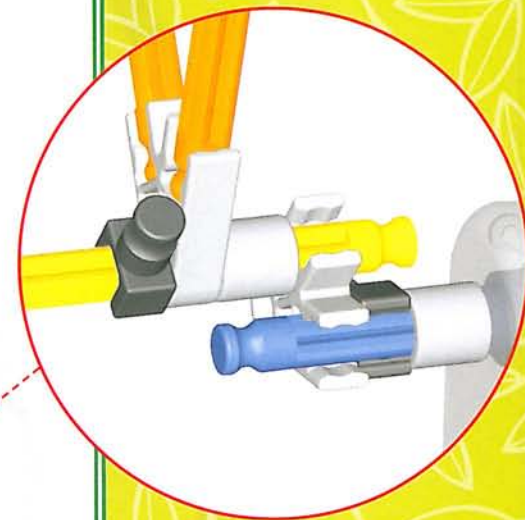
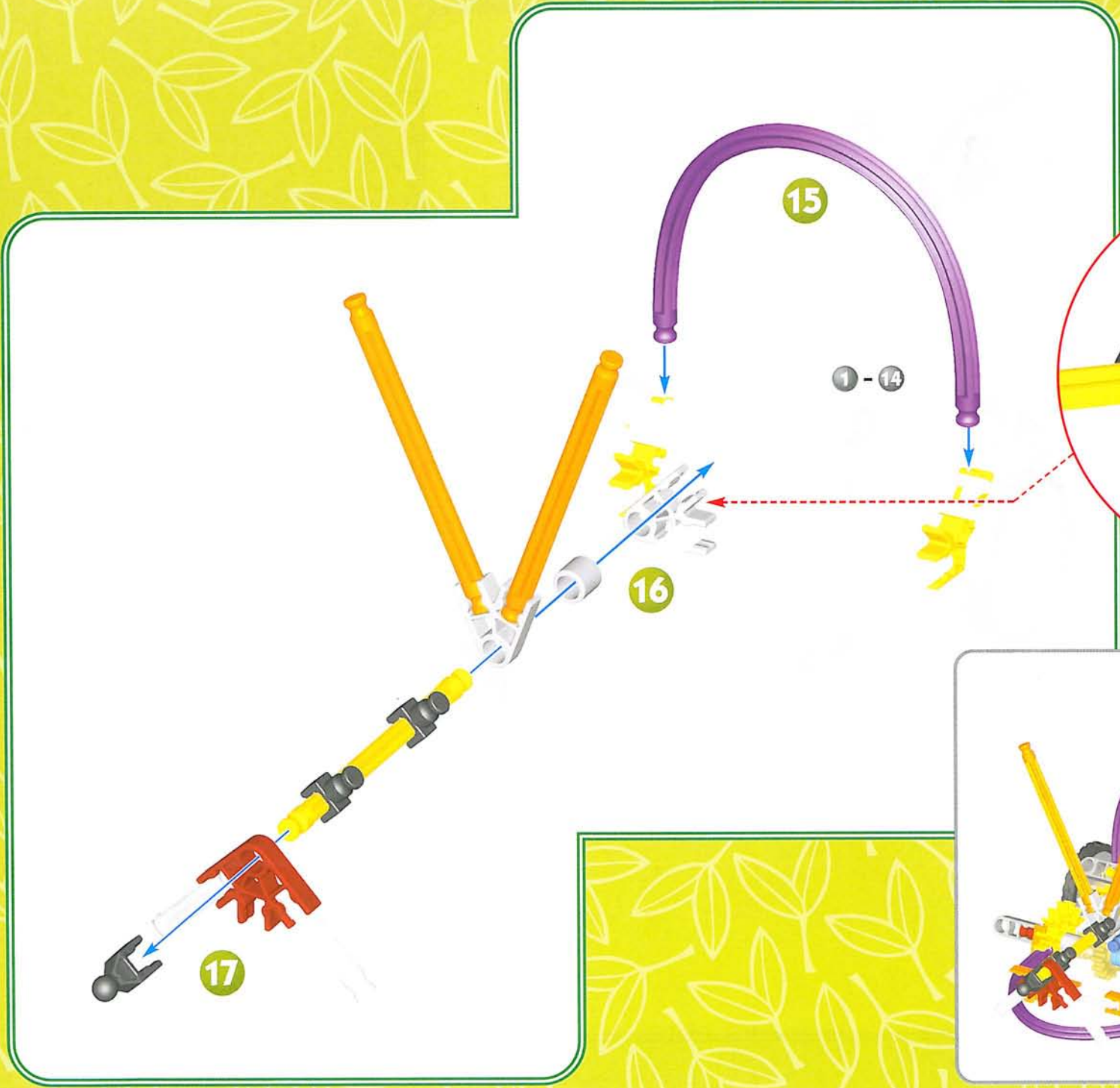

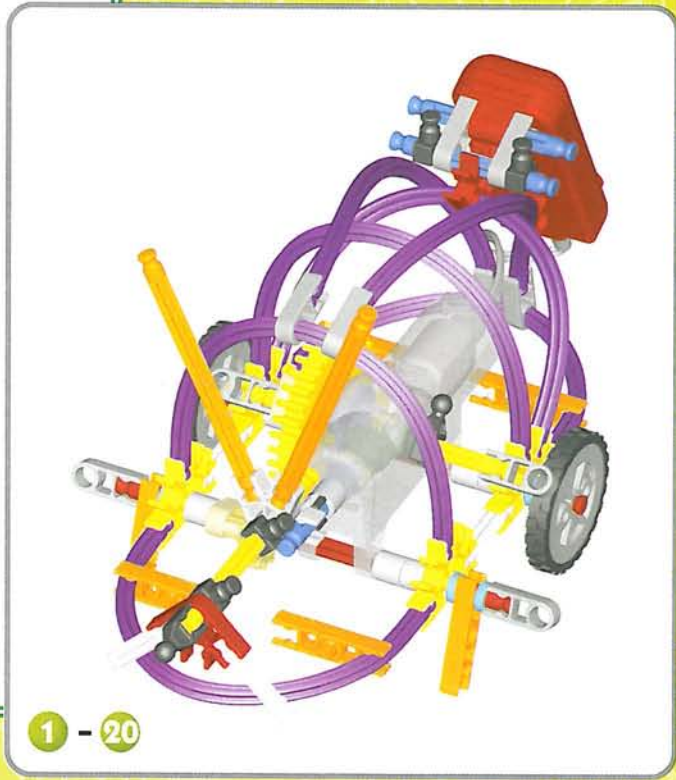
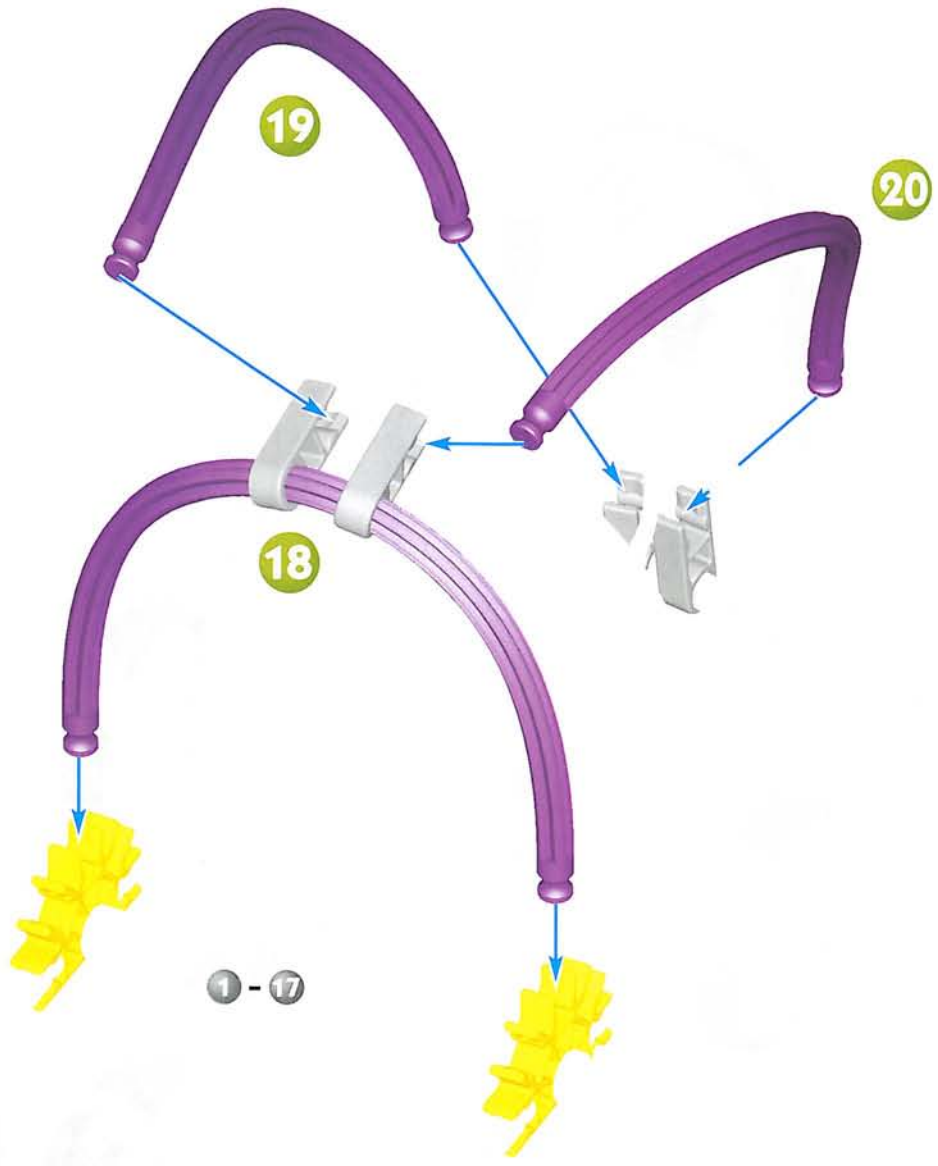



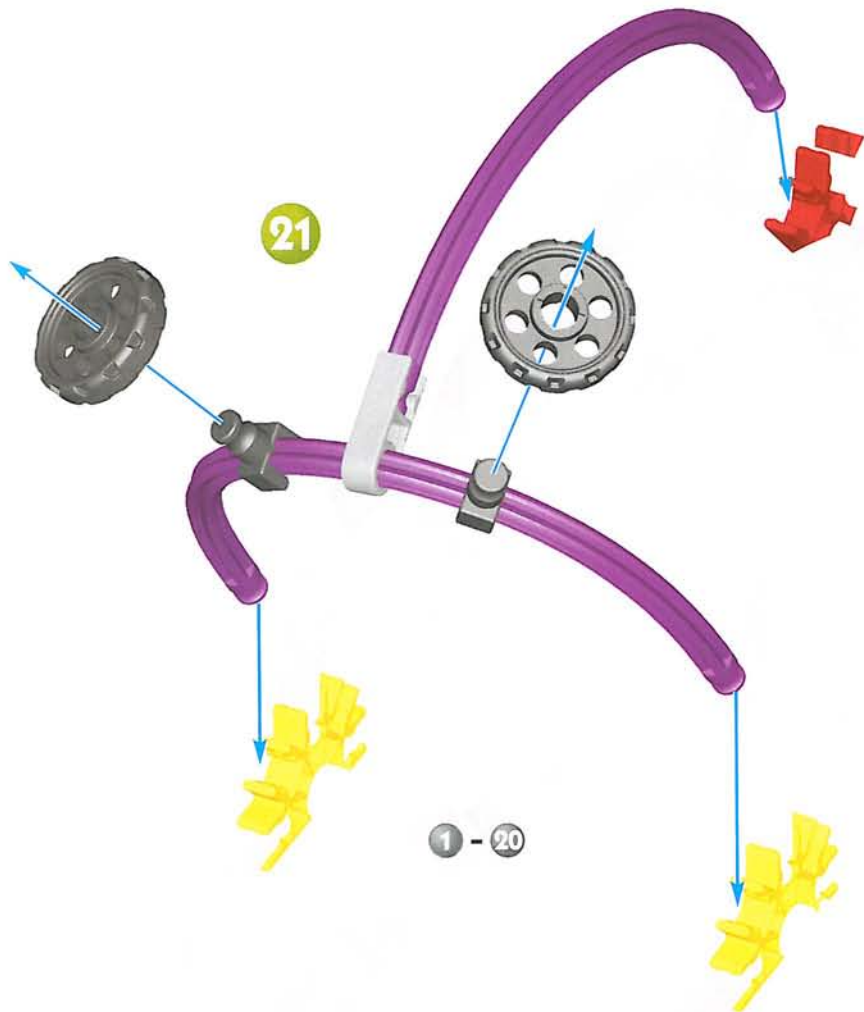

# Row Boat

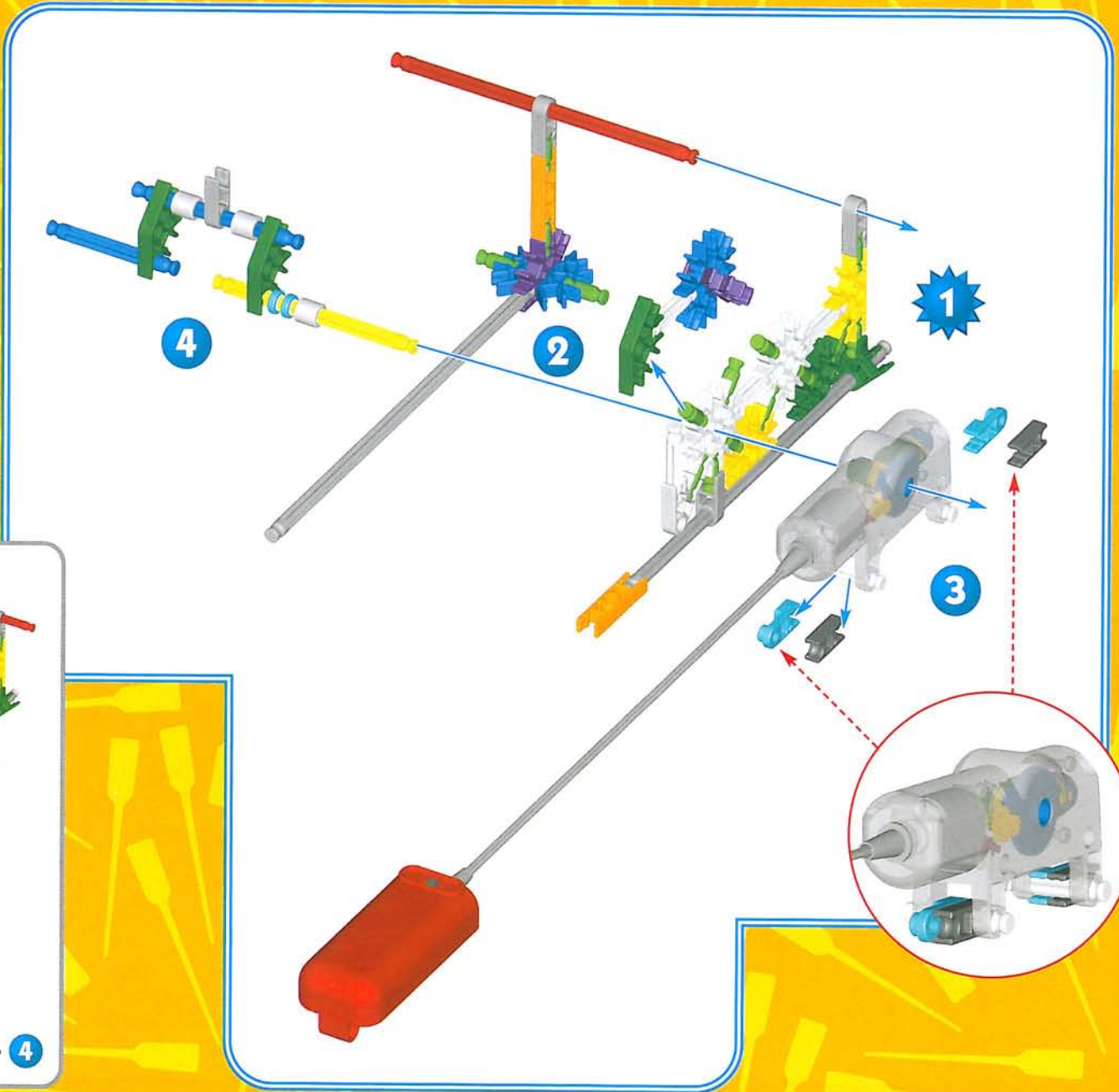
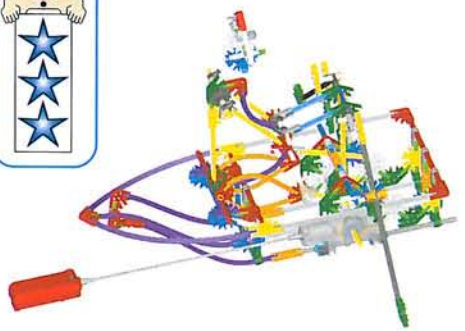
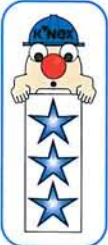

1 - 4



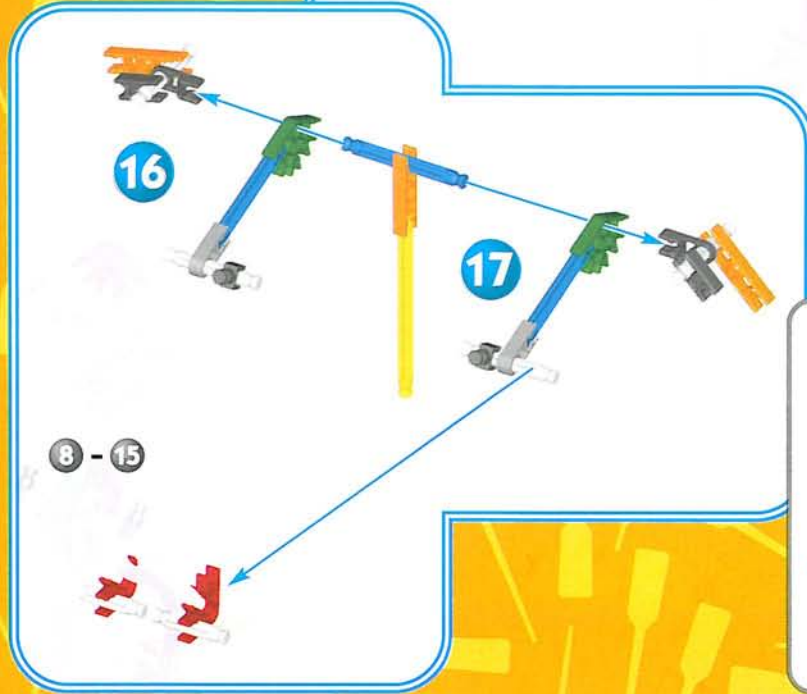
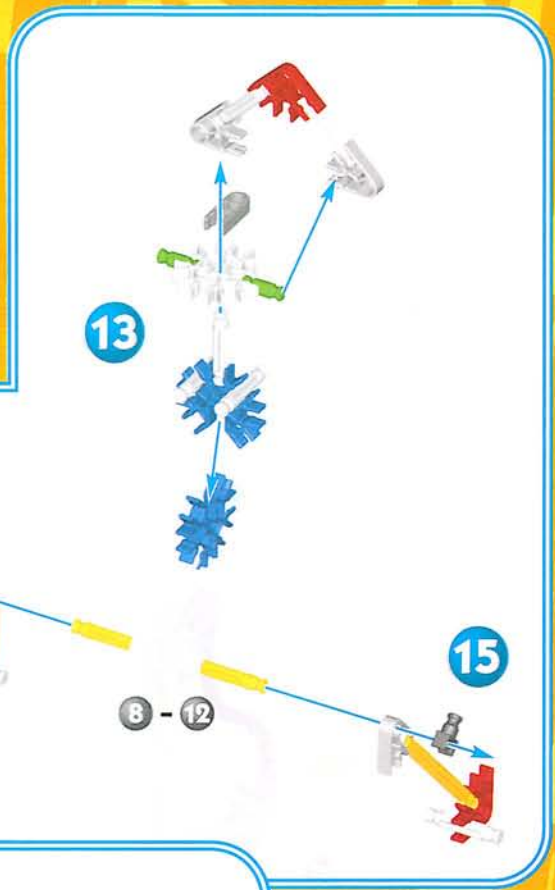
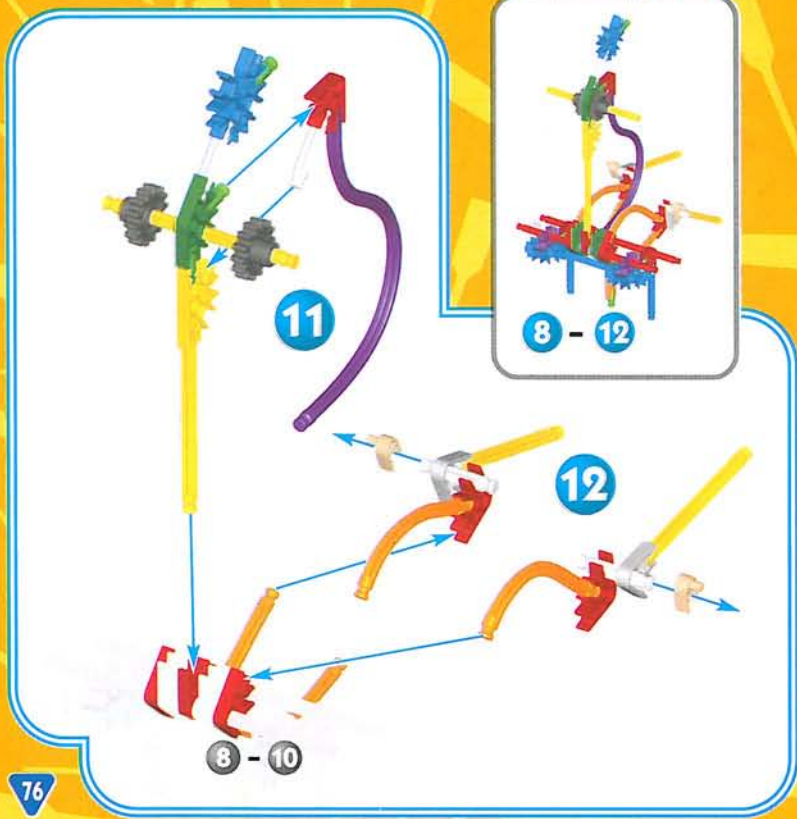
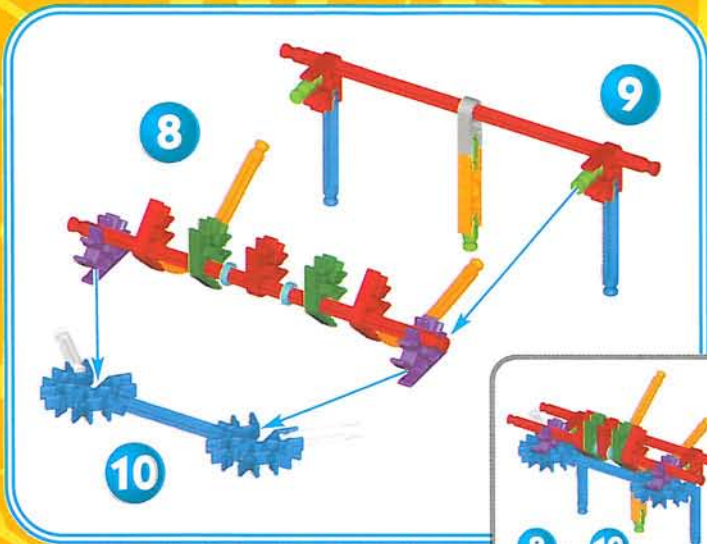

8 - 17

19

21

1 - 20

22

20

18

1 - 7

1 - 20

1 - 22

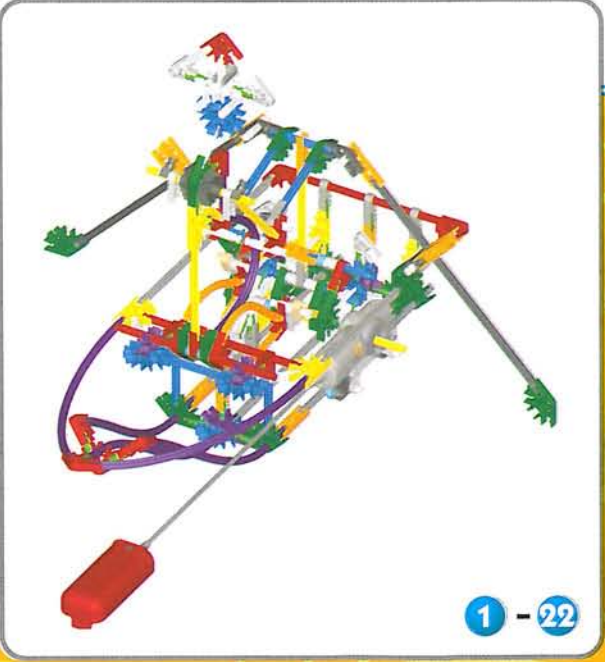
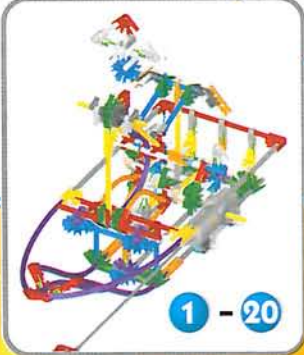
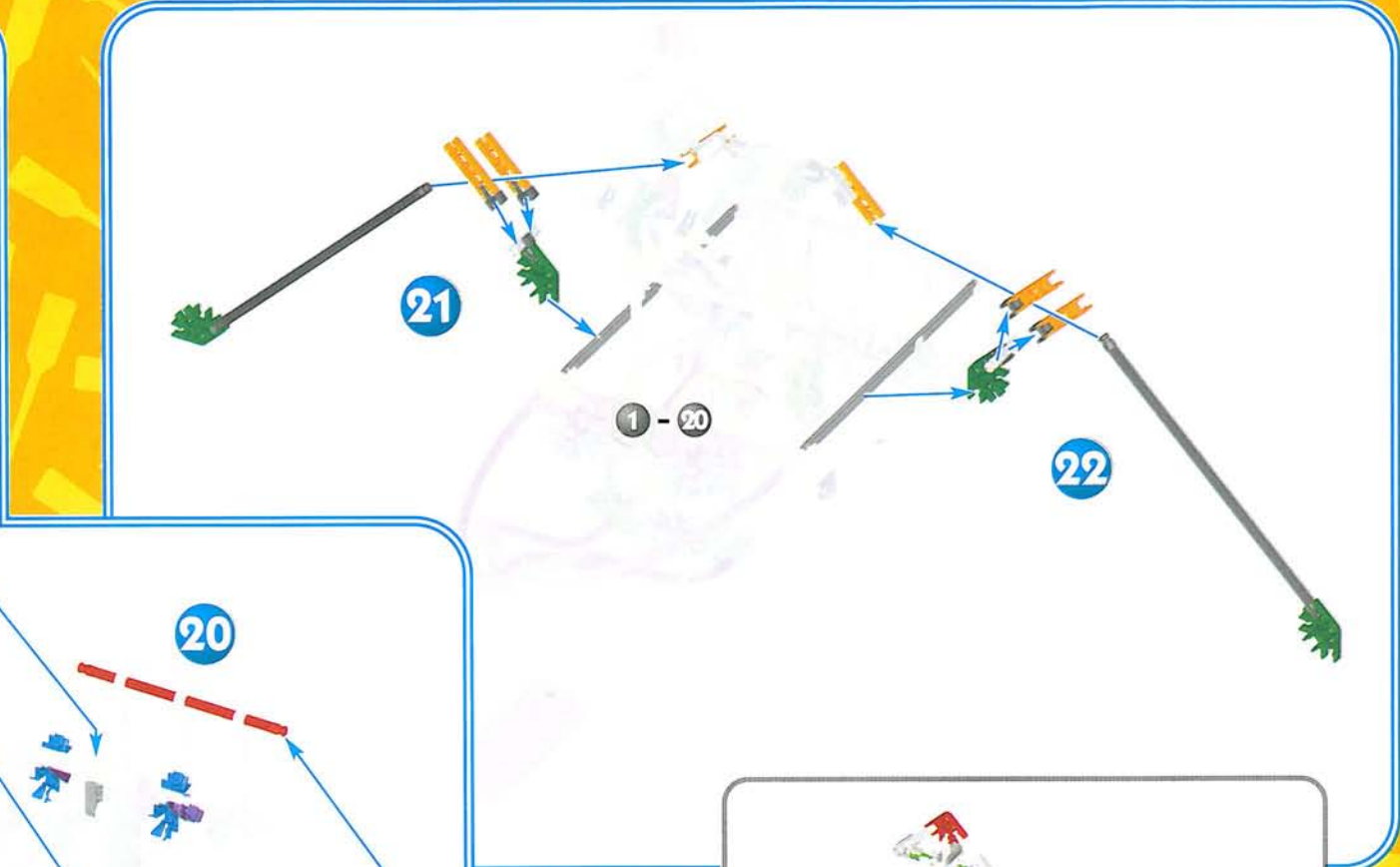
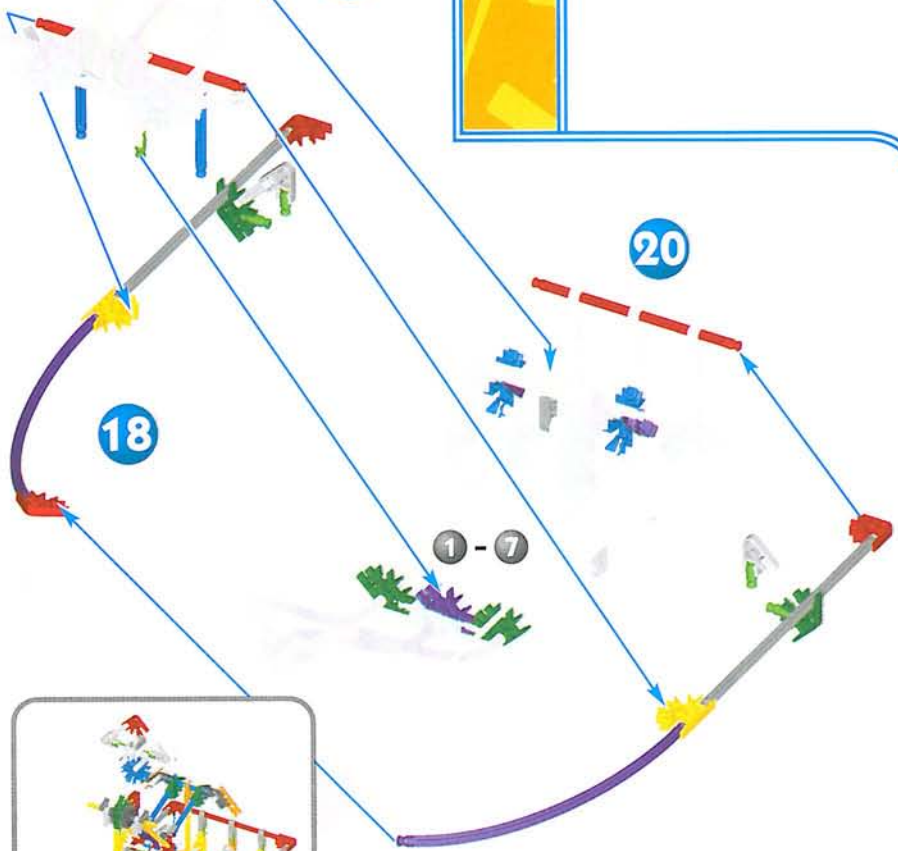

# Umbrella Ride

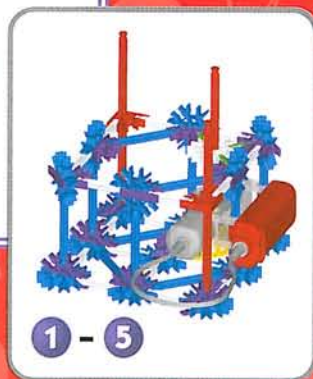
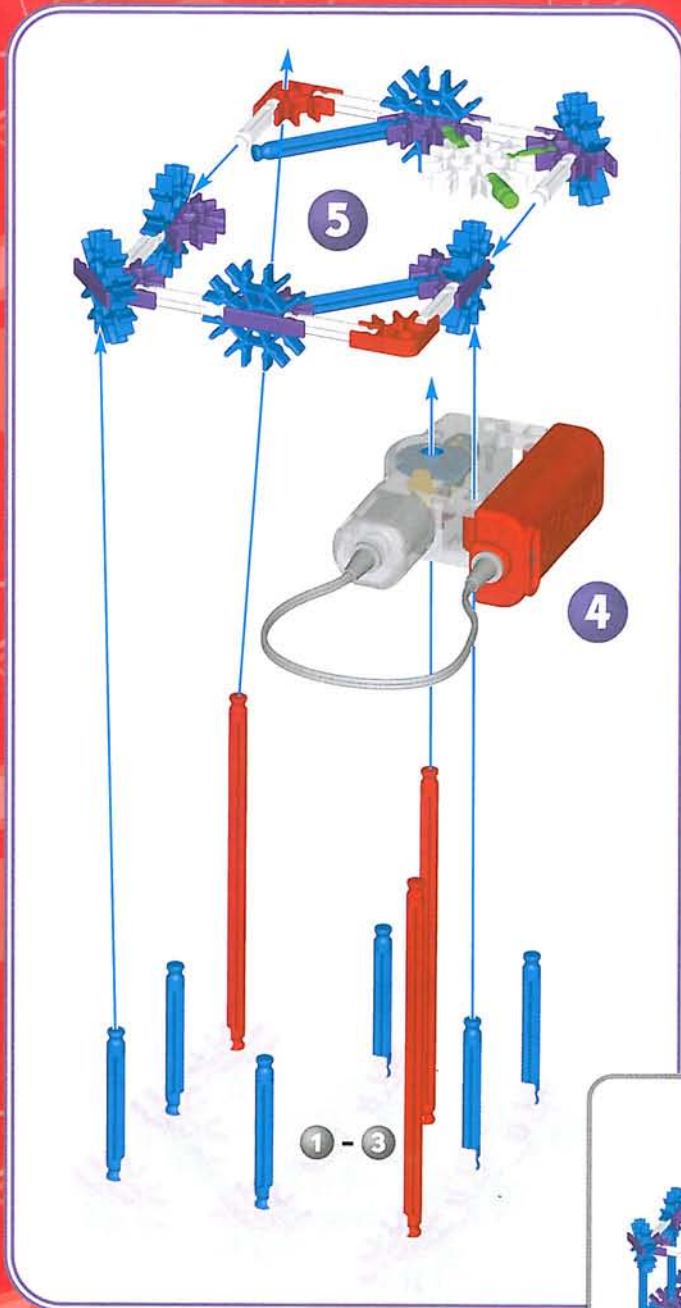
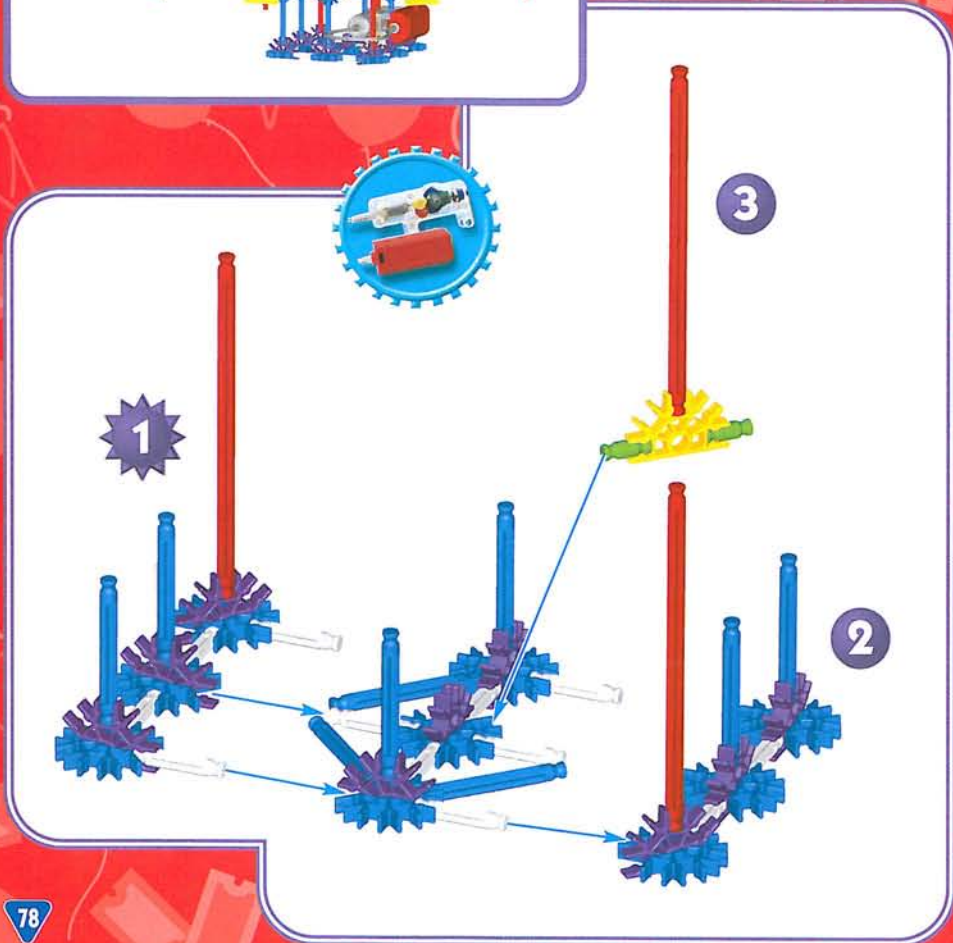
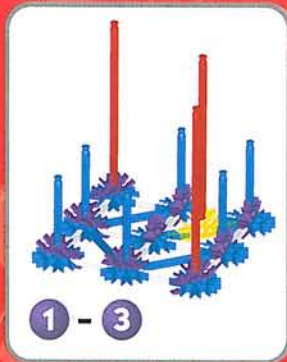

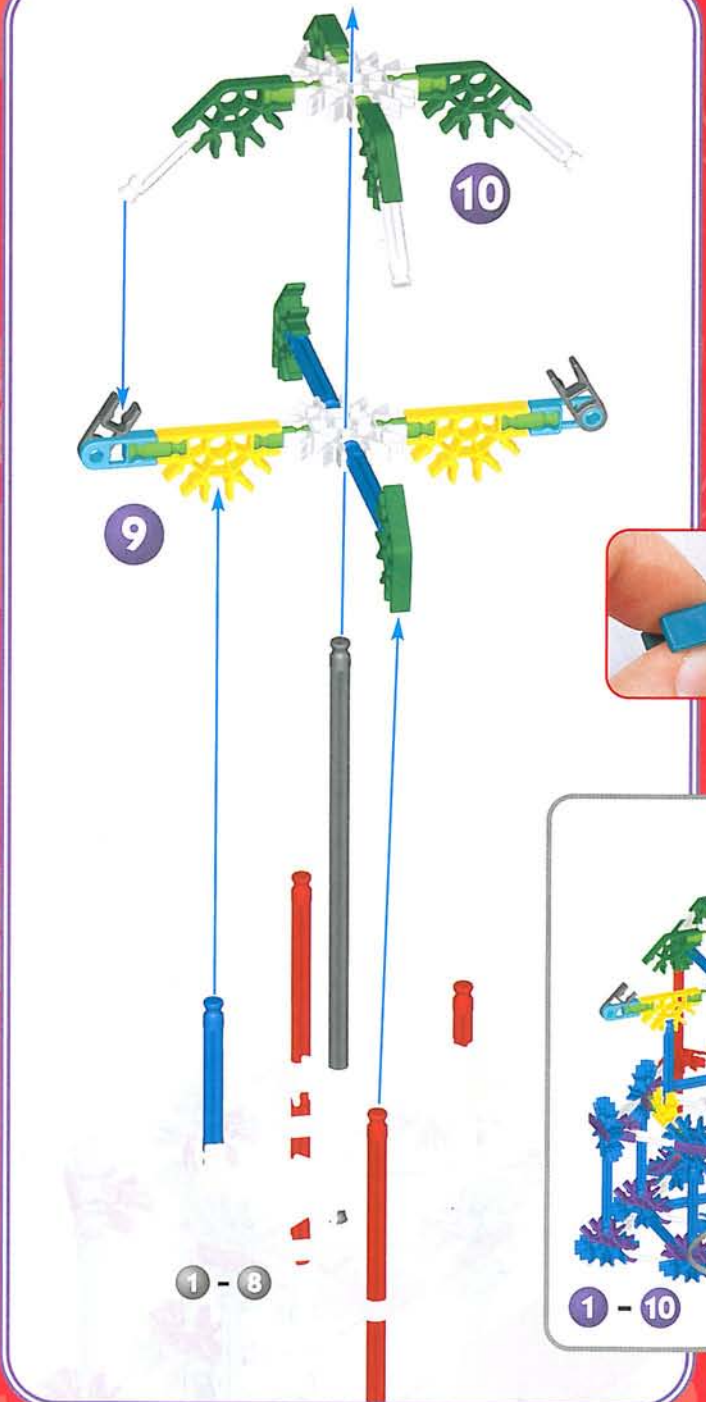
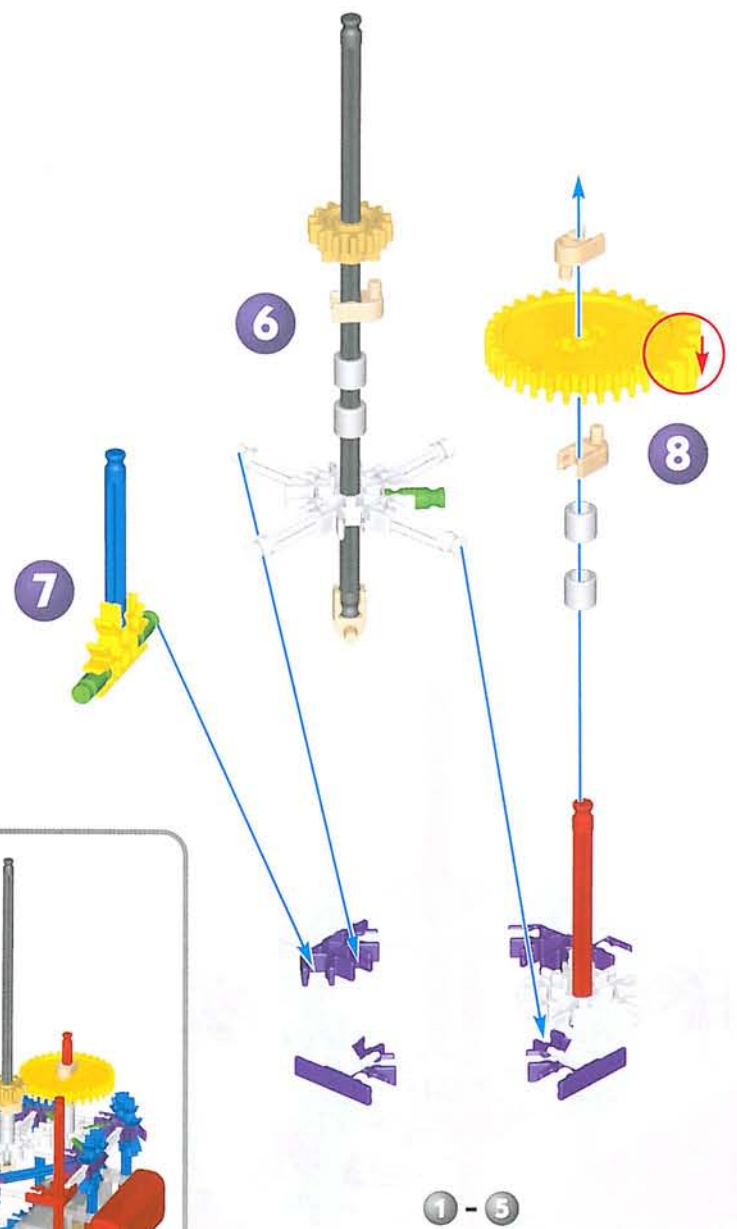
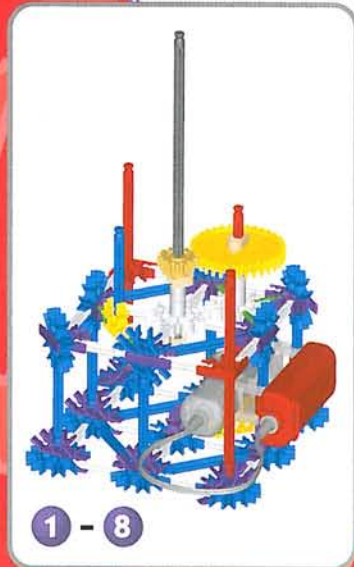

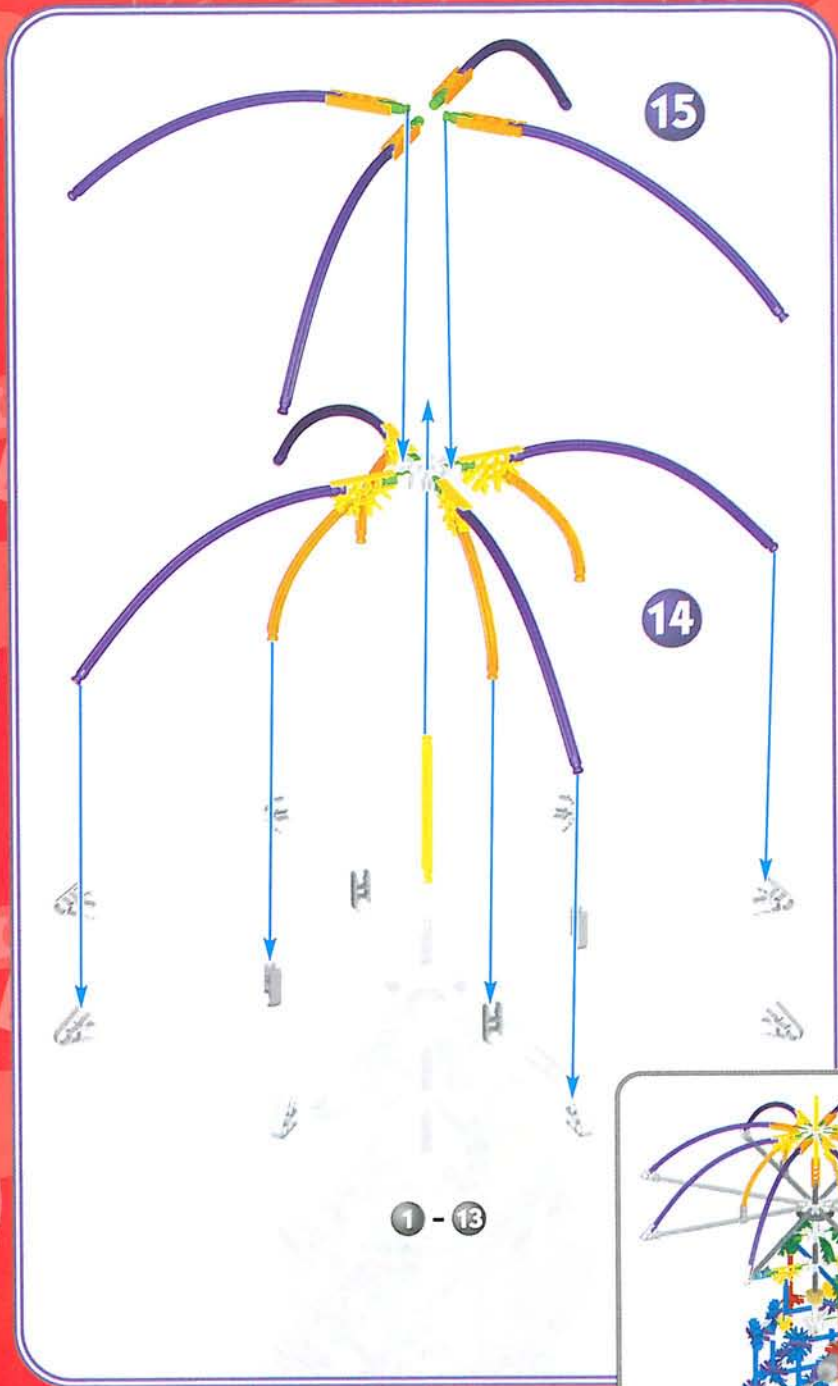
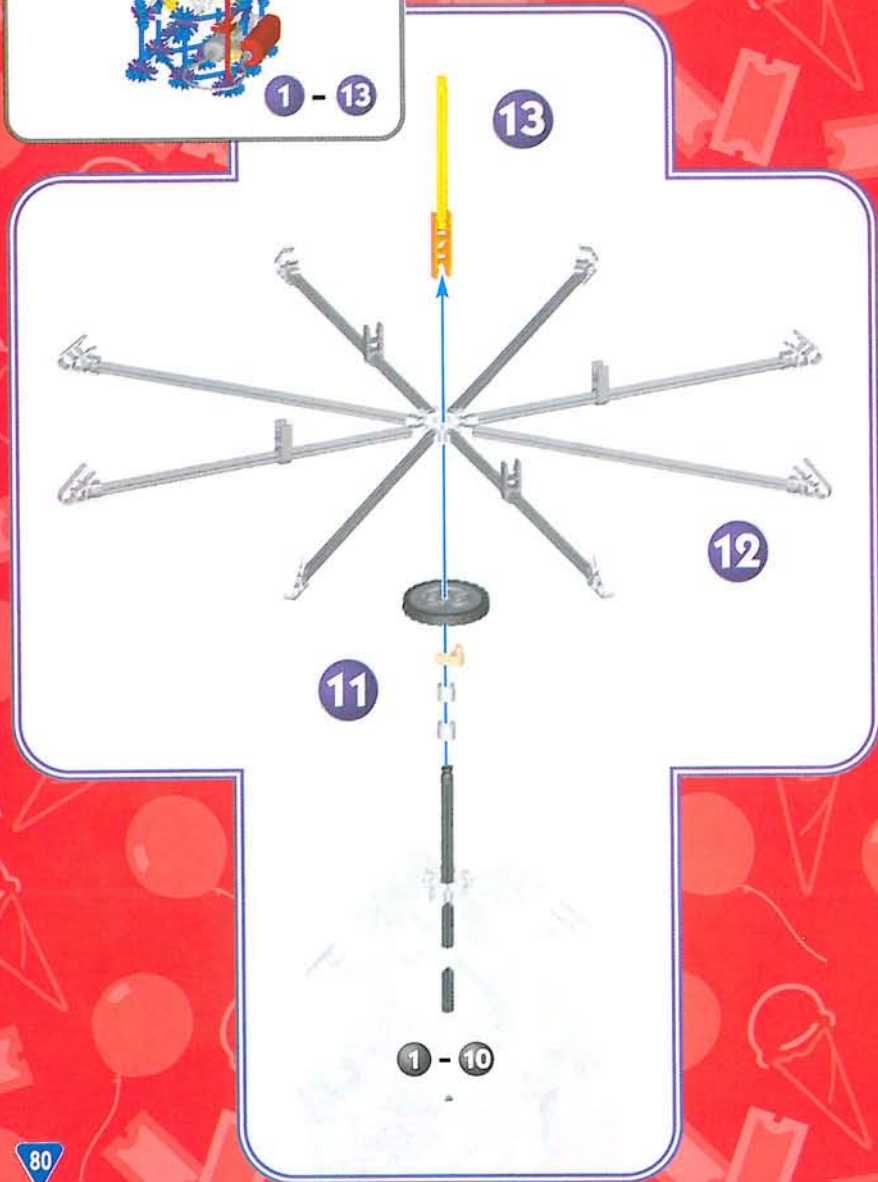



x8

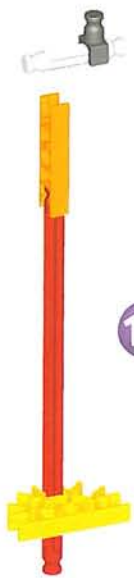

16

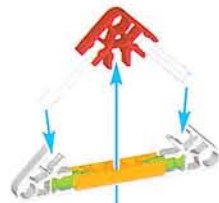

18



1 - 18

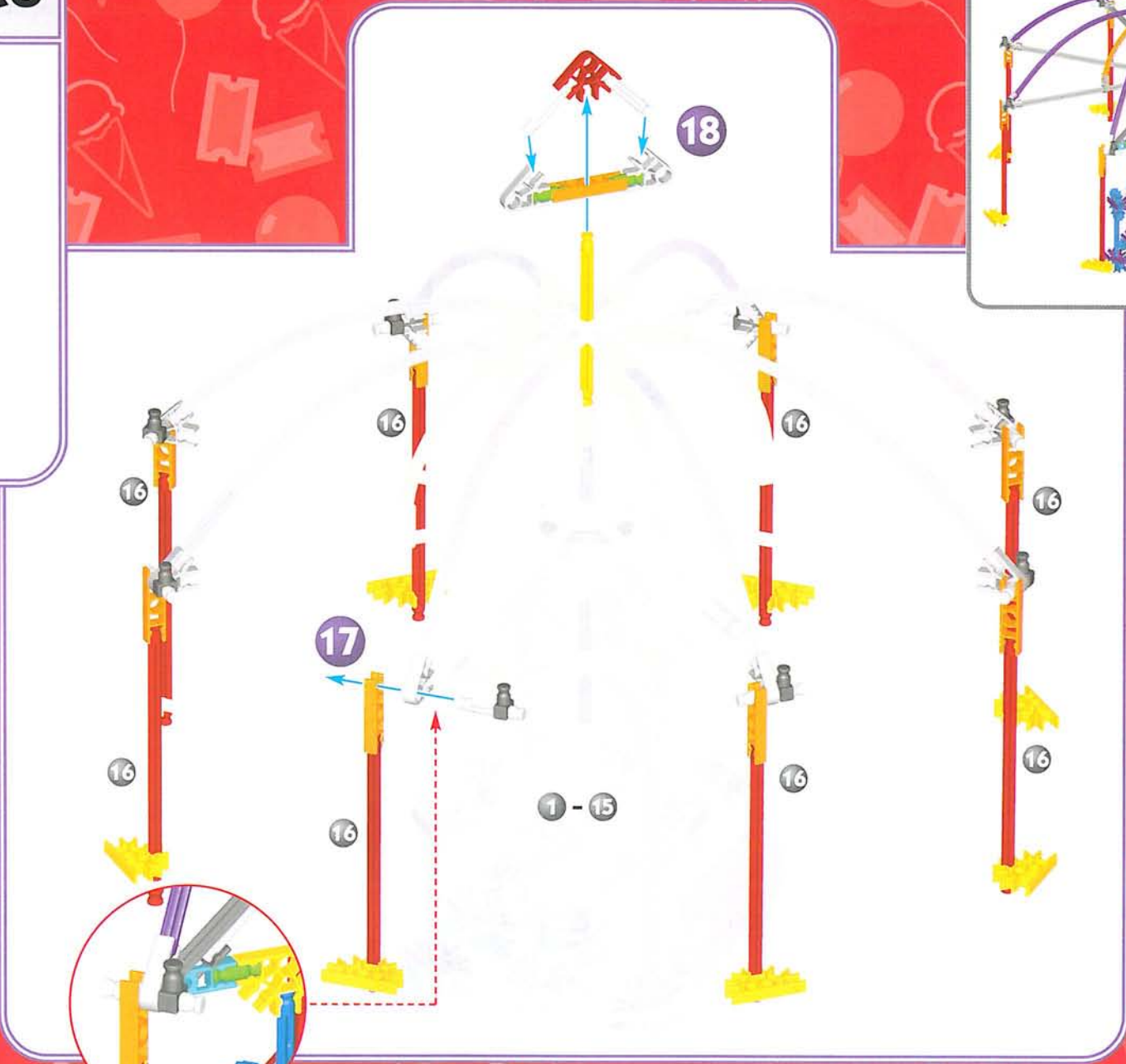

17

1 - 15

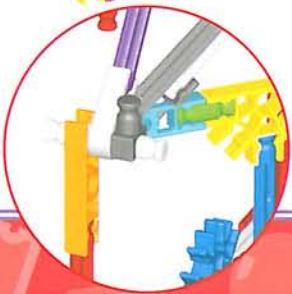

# Elastic Powered Plane

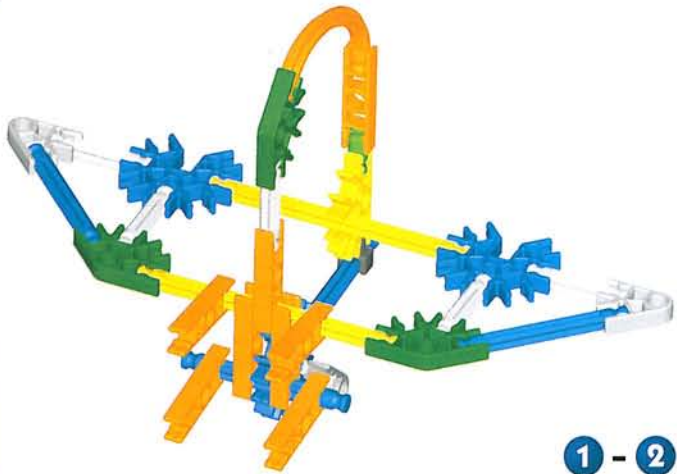
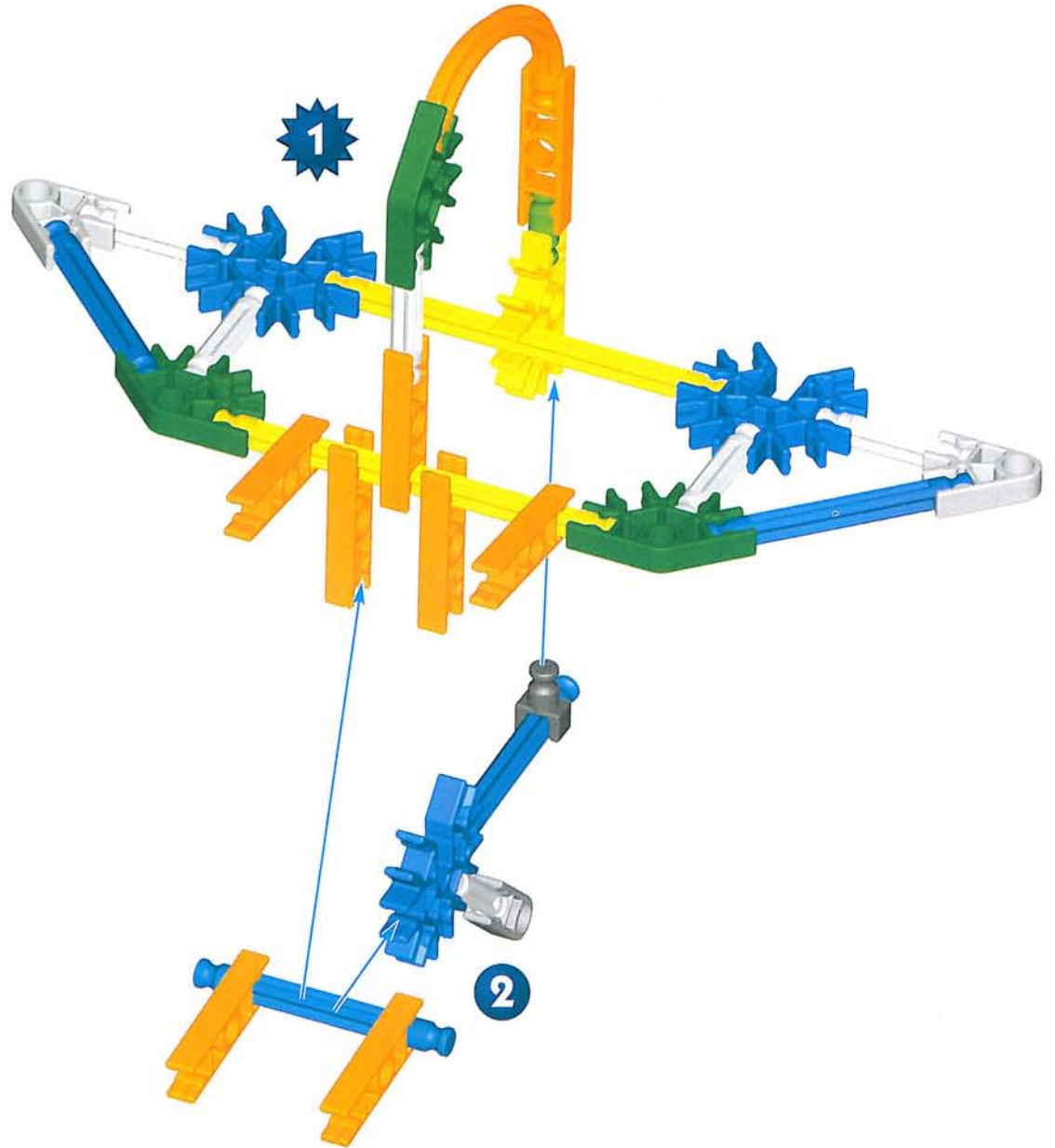
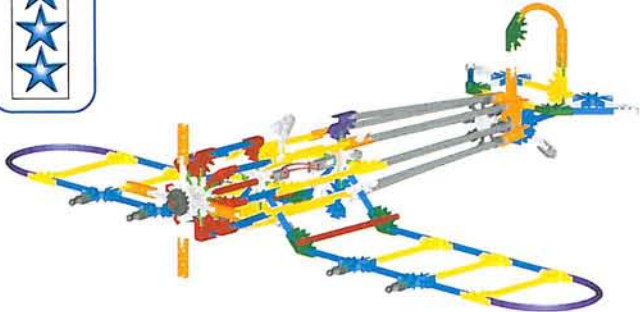

1 - 2

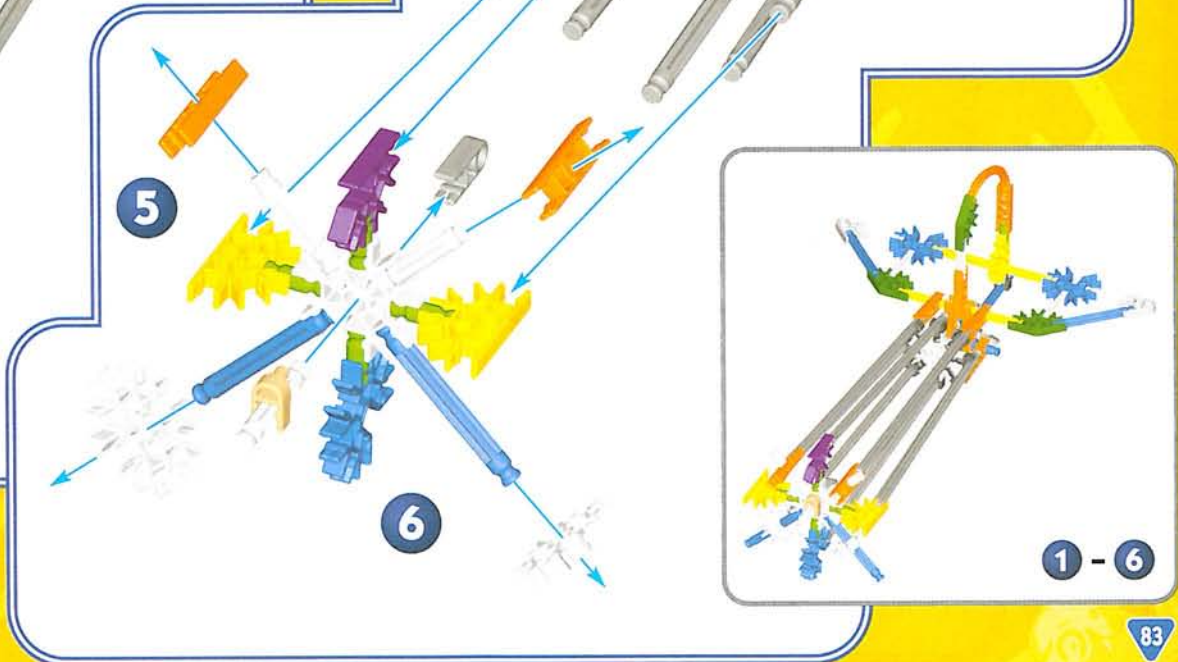
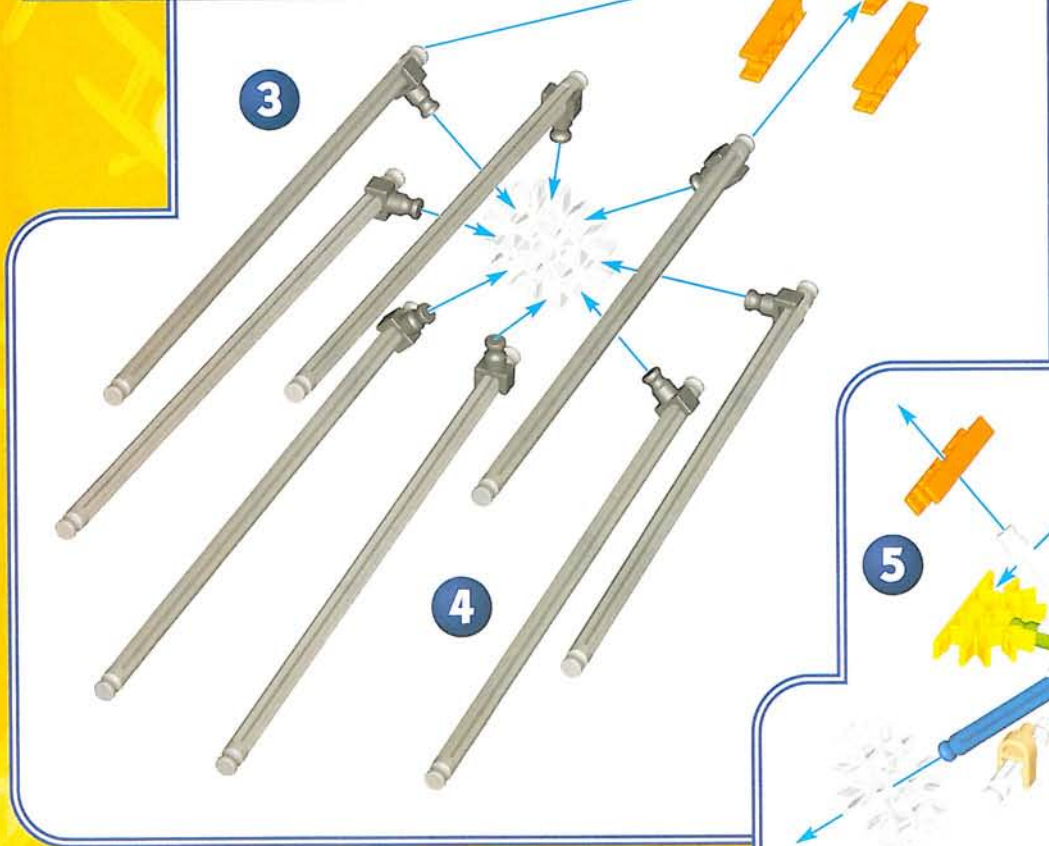

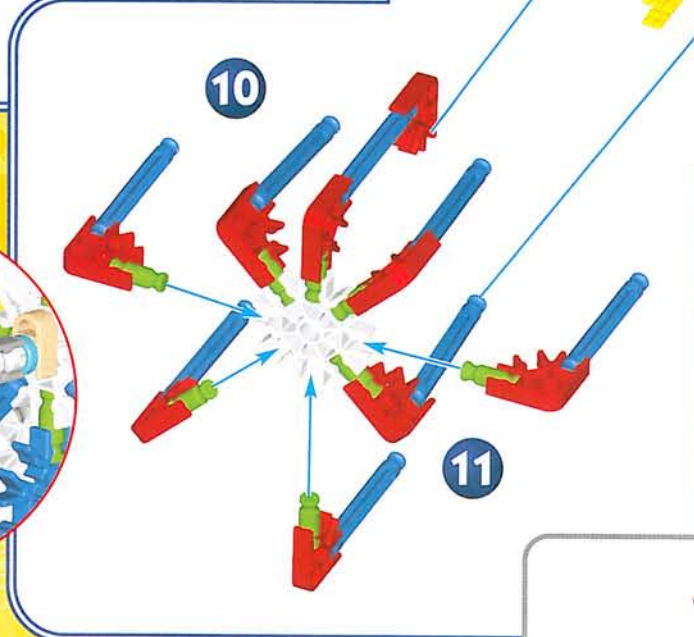
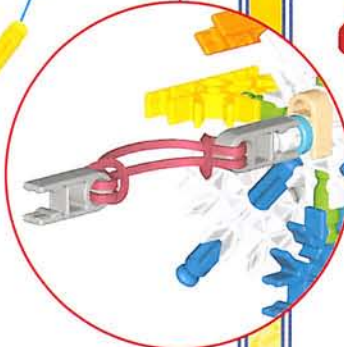
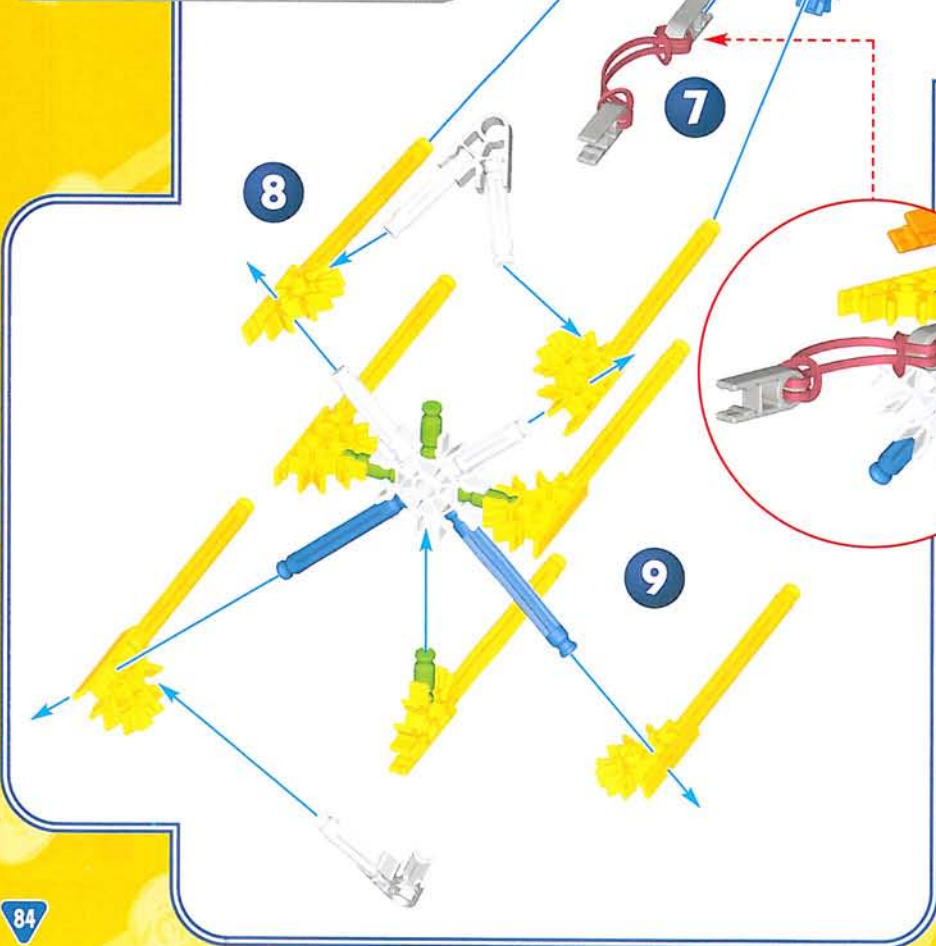
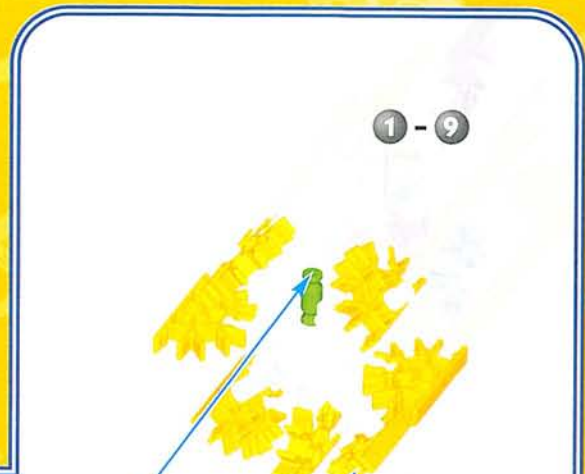

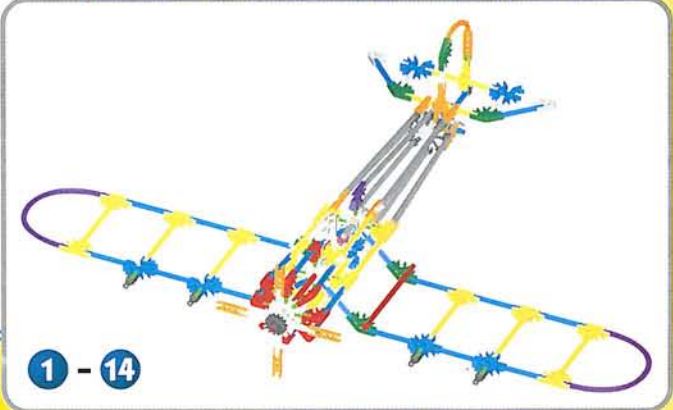
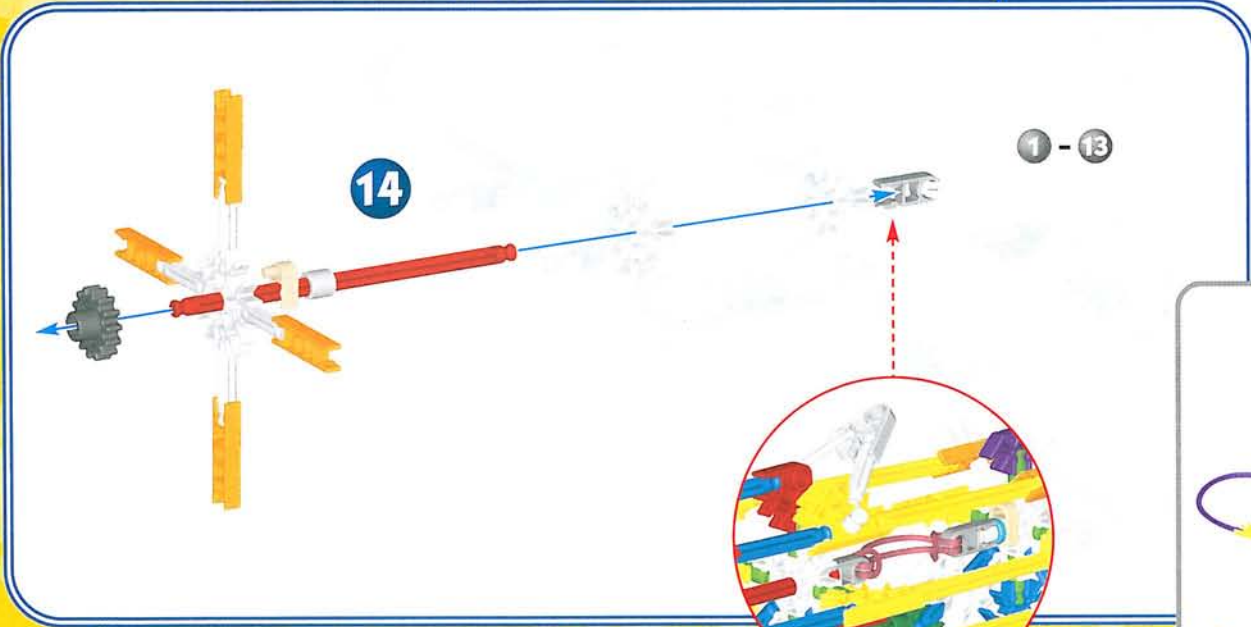
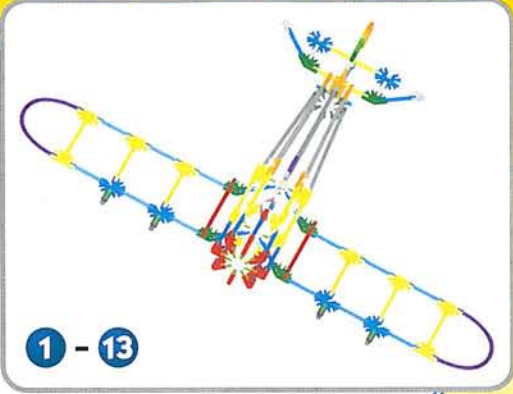
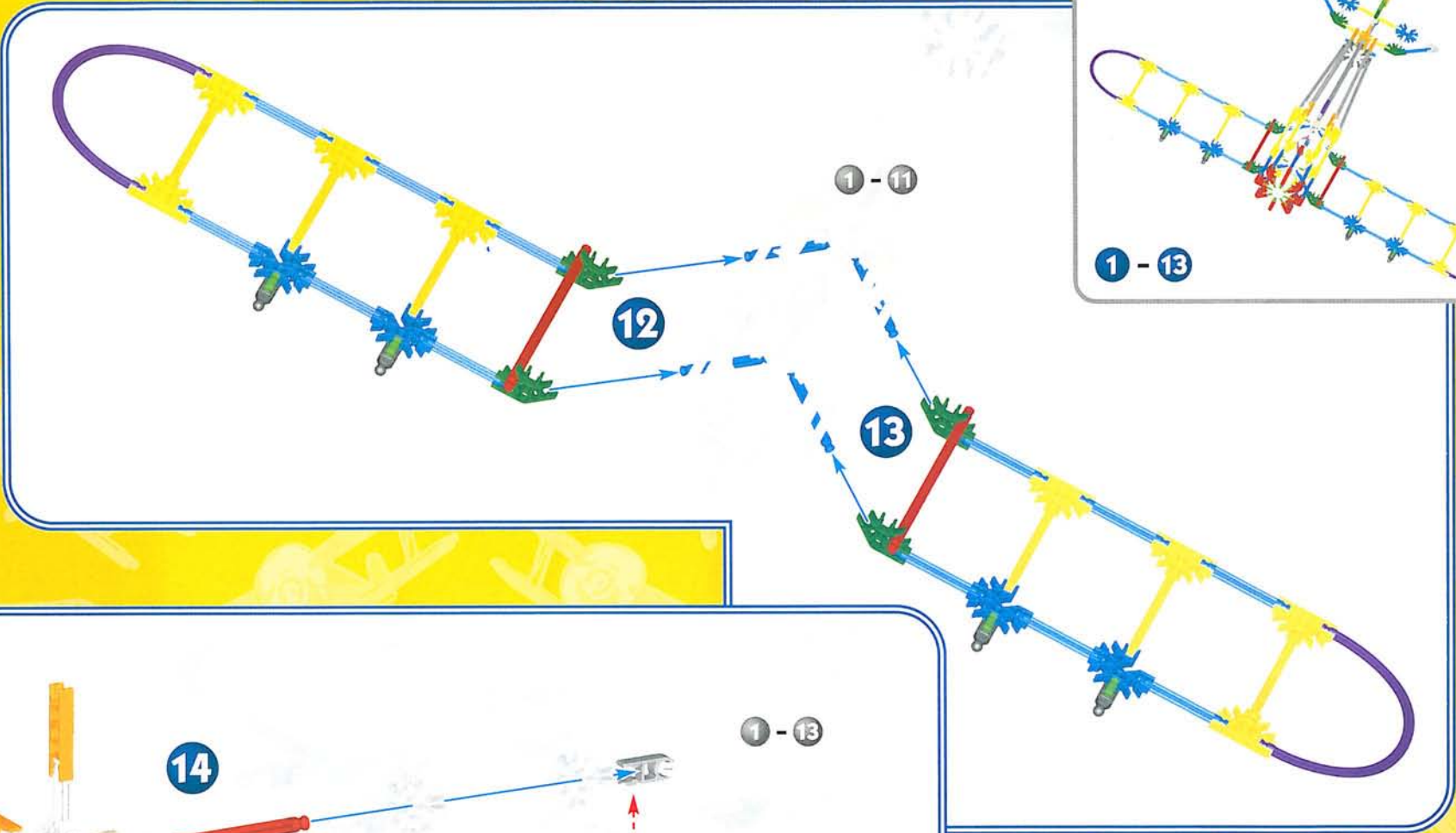

# Windmill

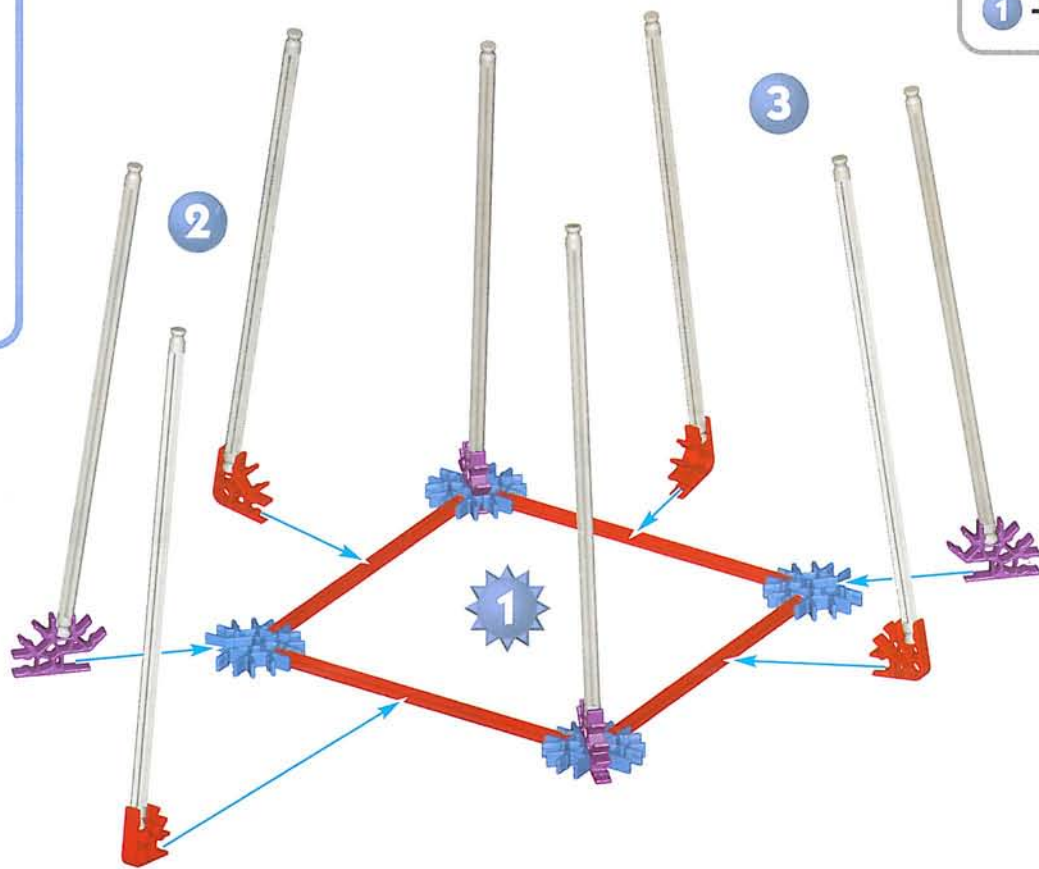
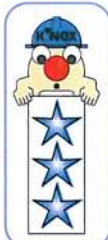

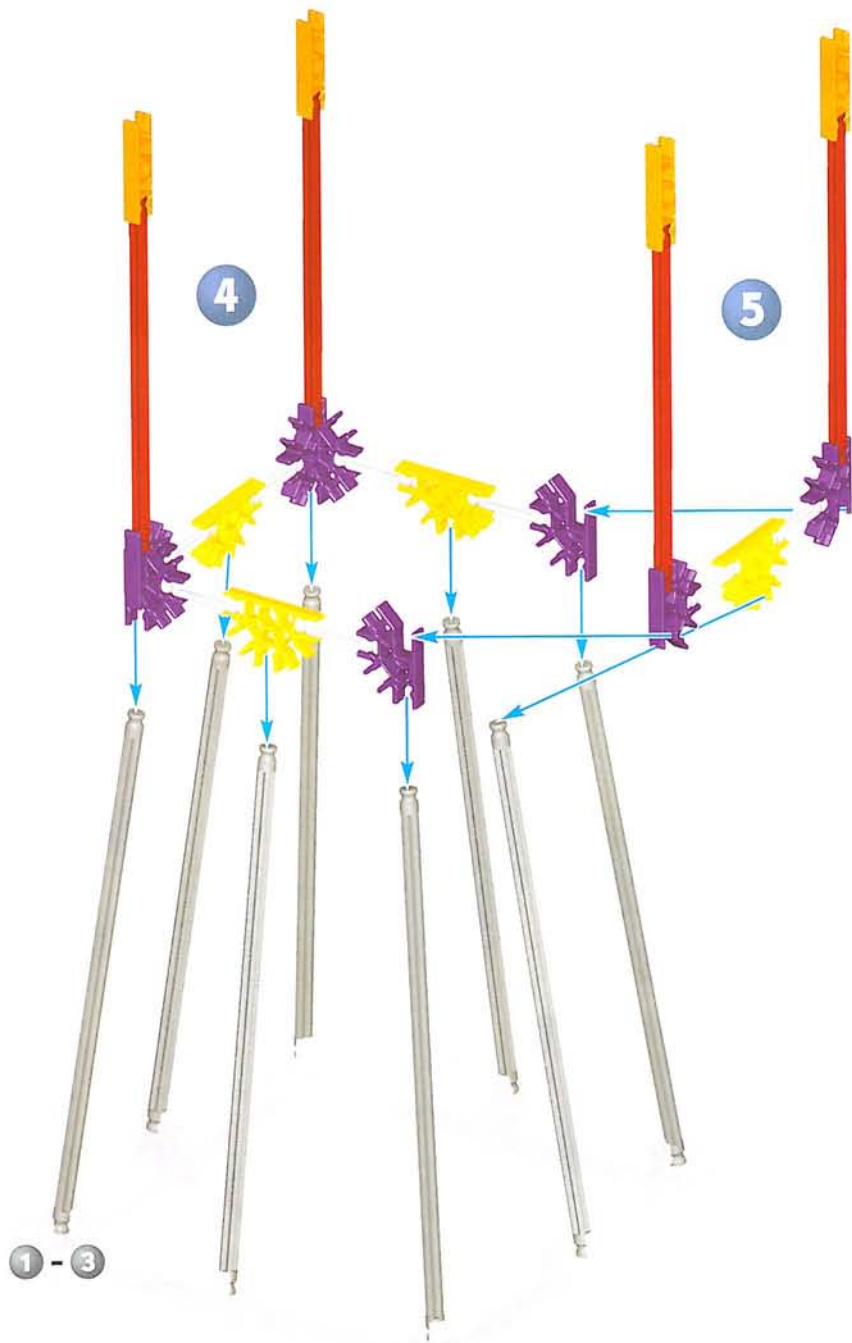

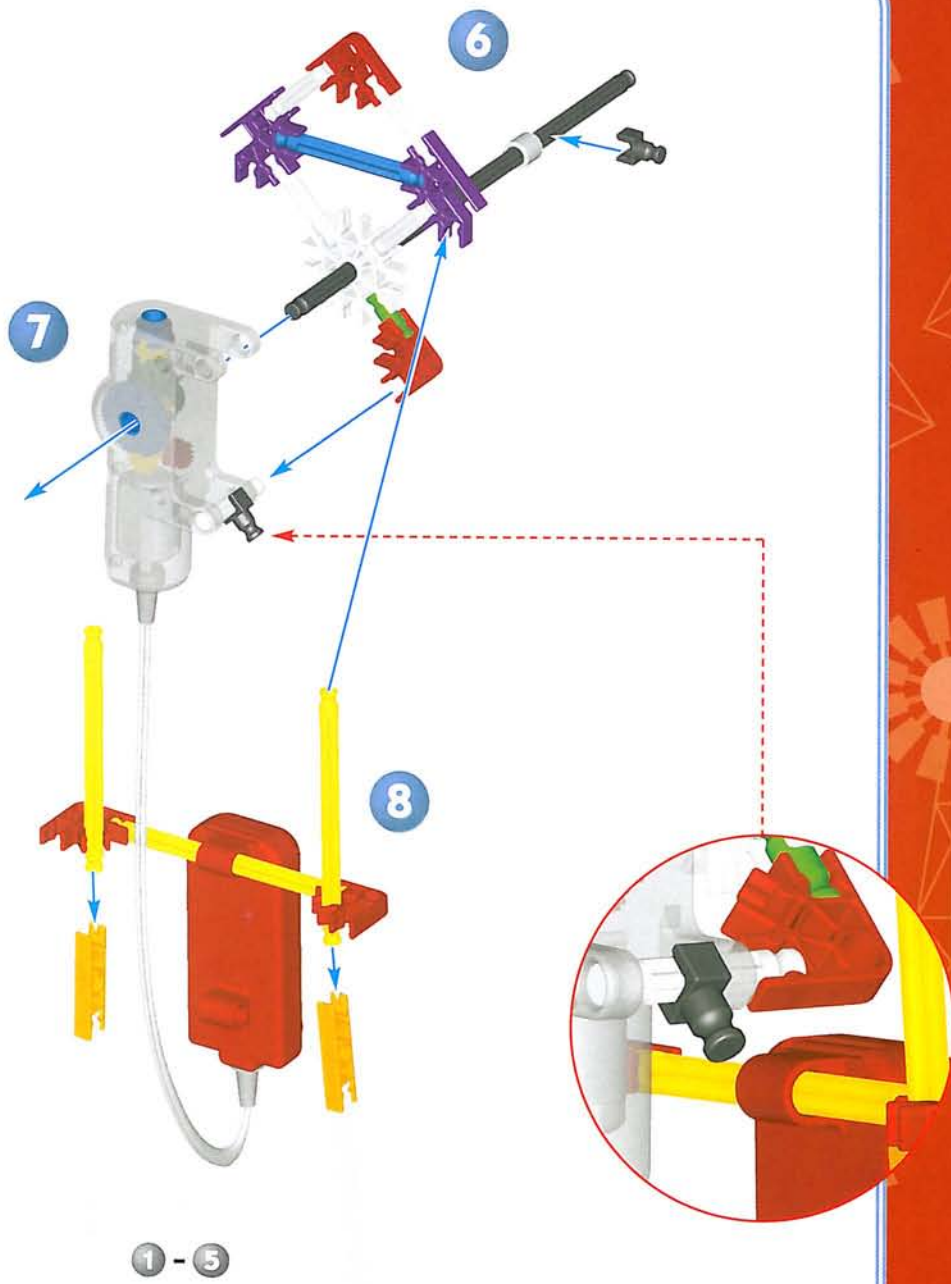



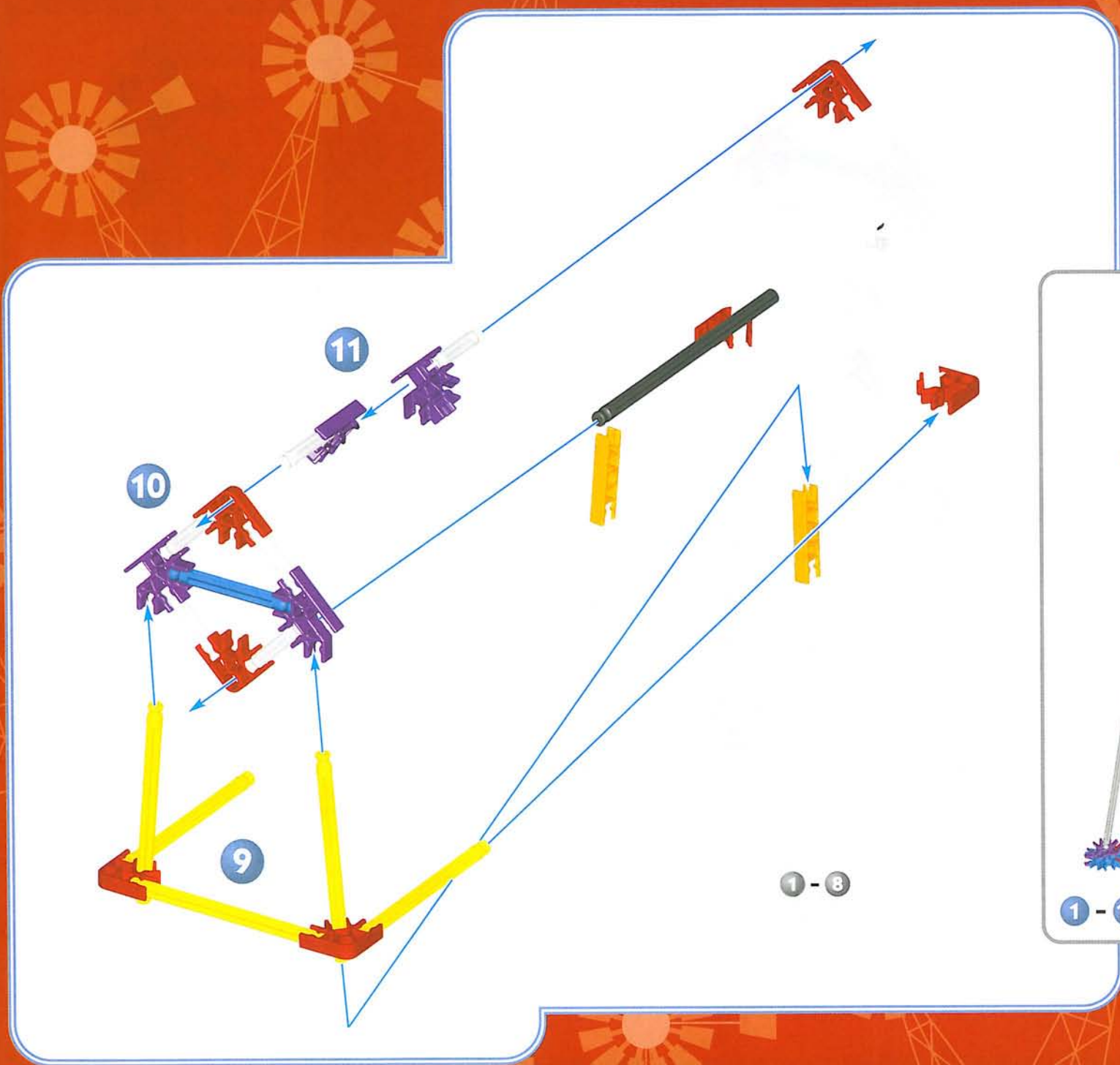

x2

12

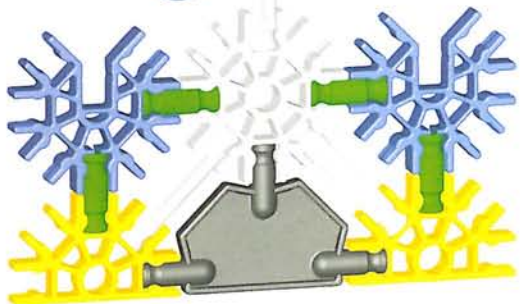

13

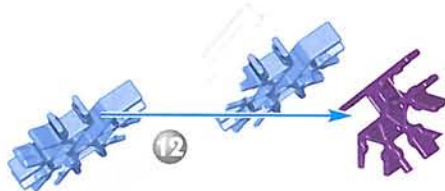

12

1 - 11

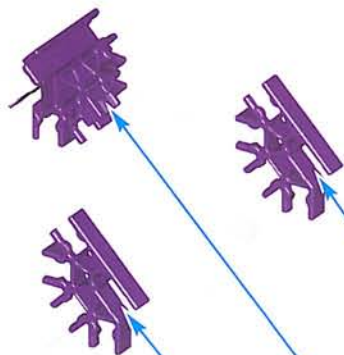

14

12

1 - 14



x4



15

1 - 14

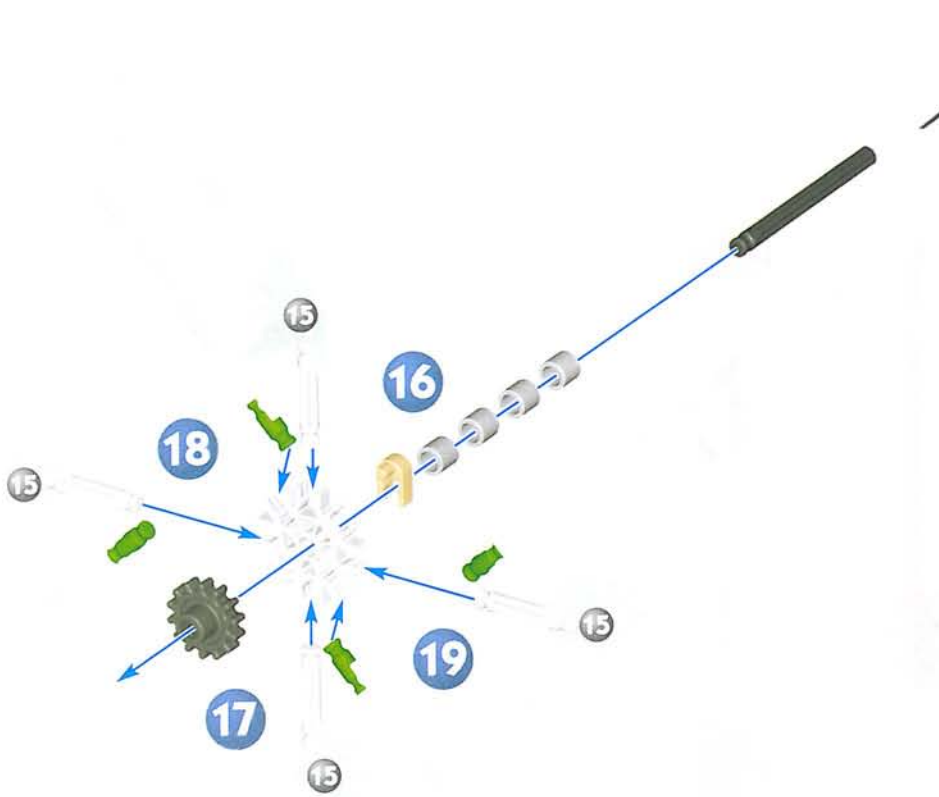

1 - 19

# Racing Car

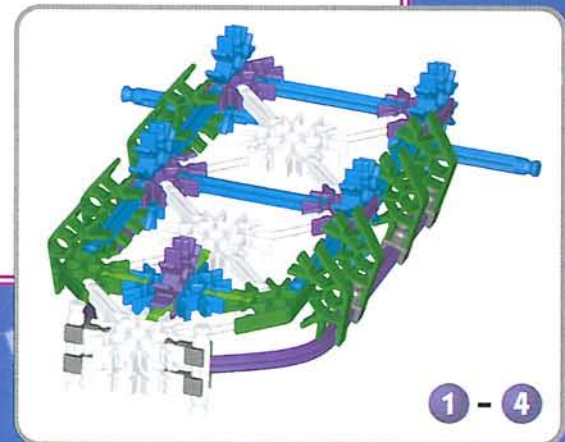
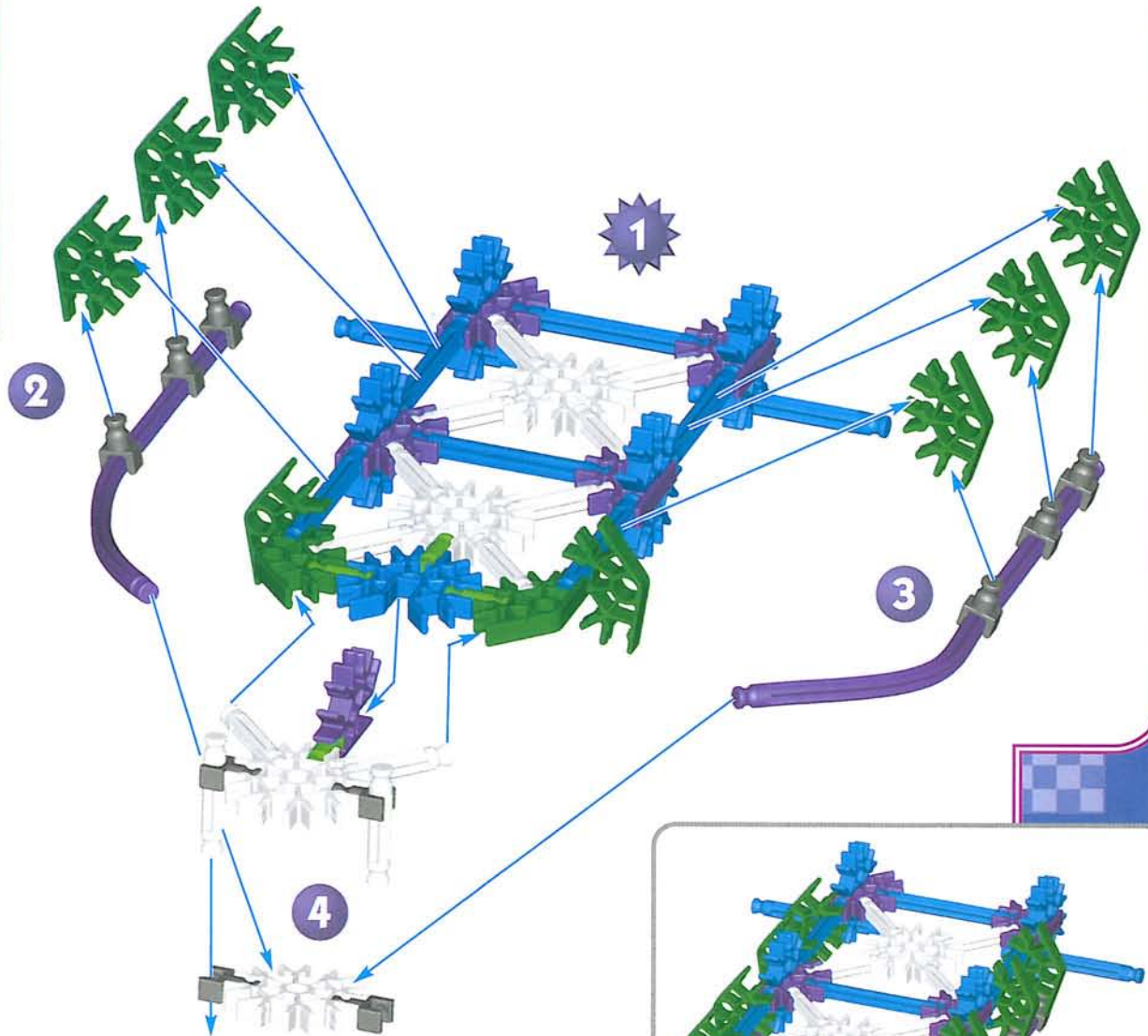

1 - 4

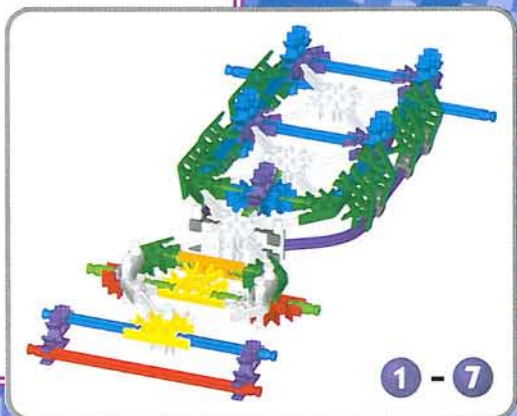
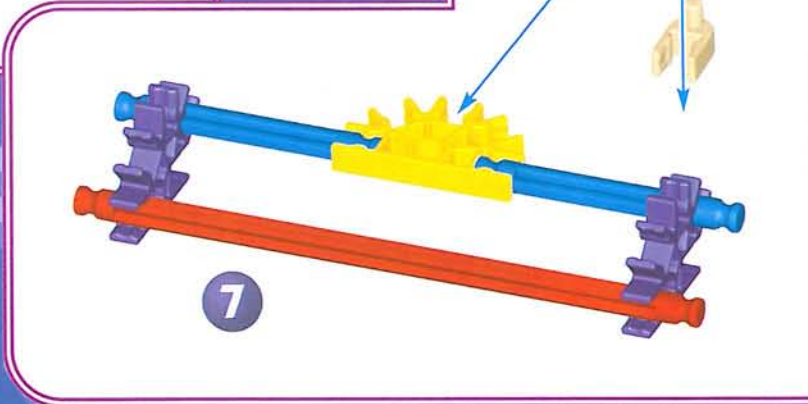
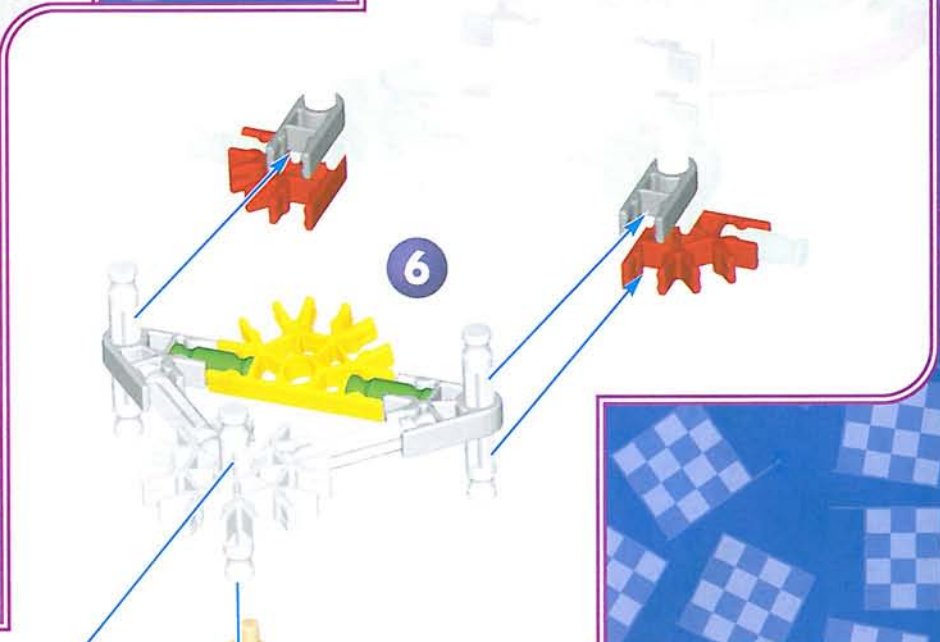
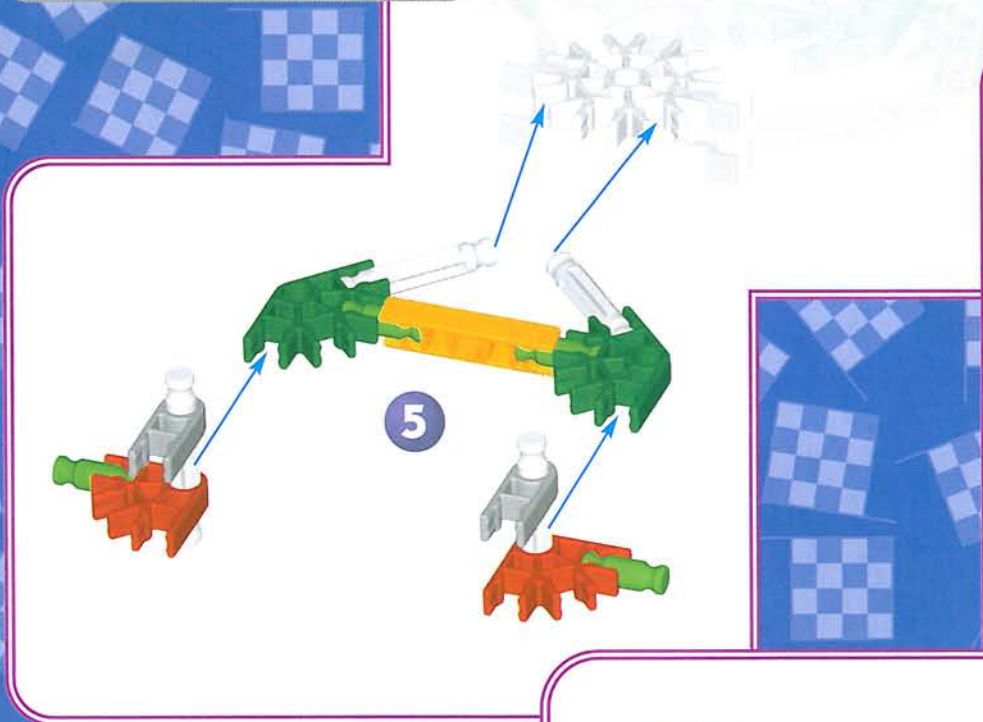
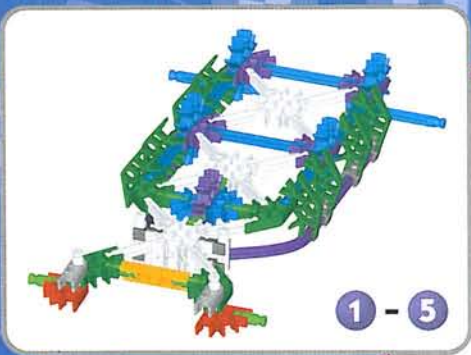

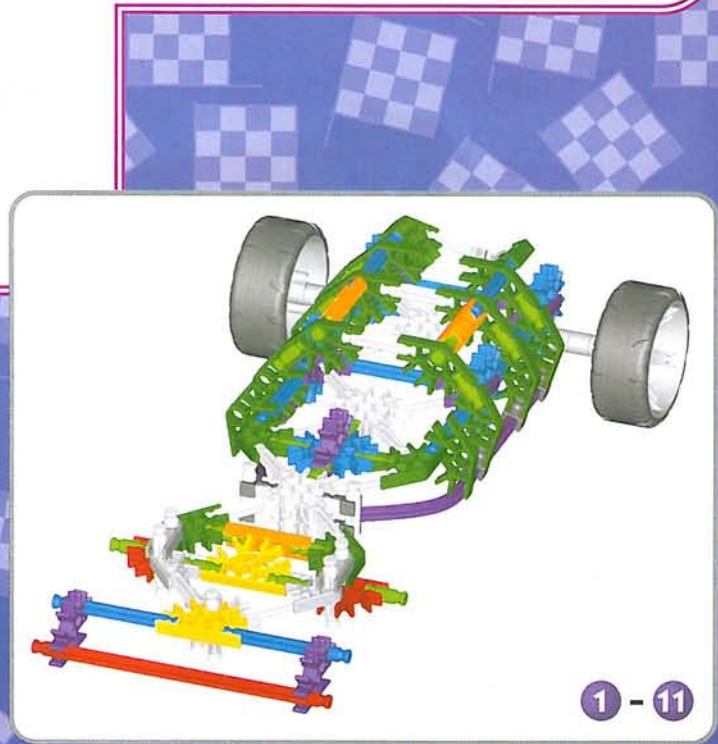
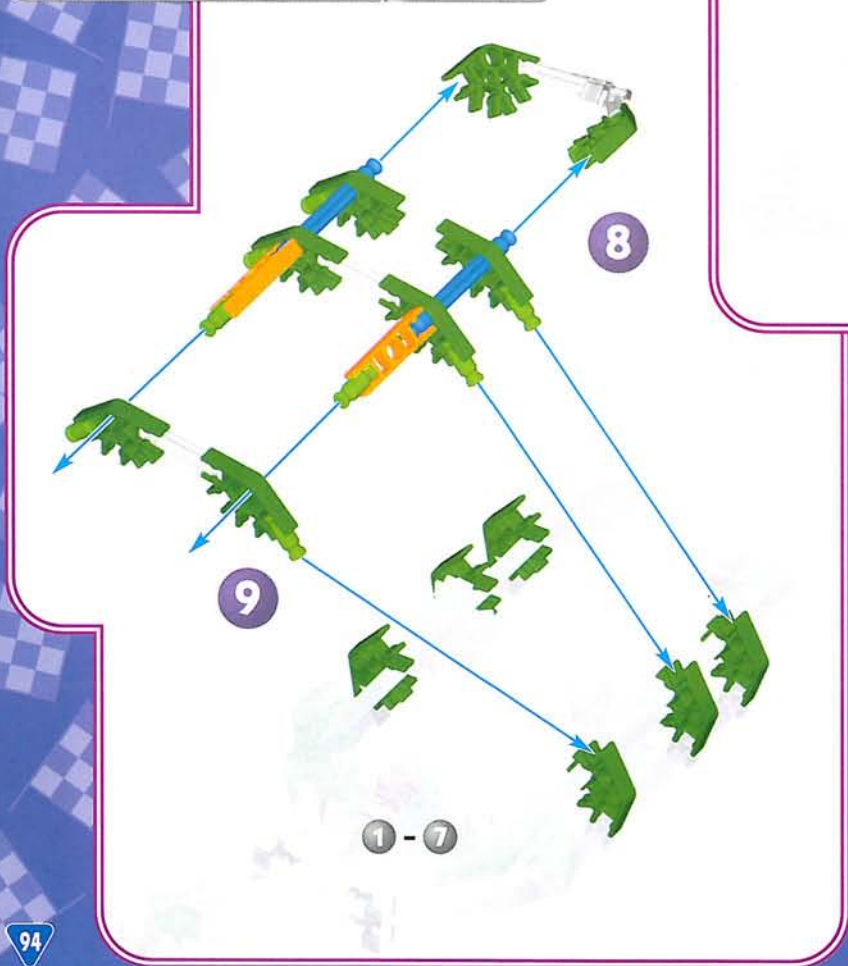
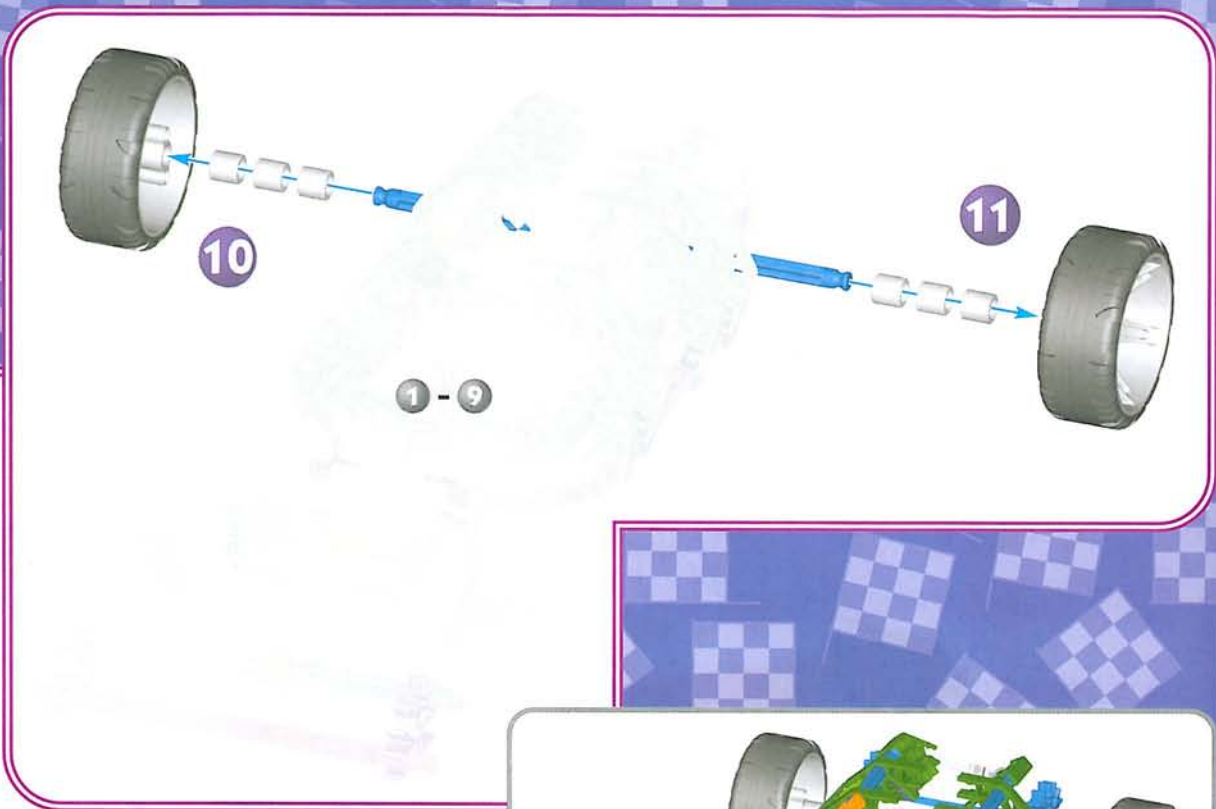
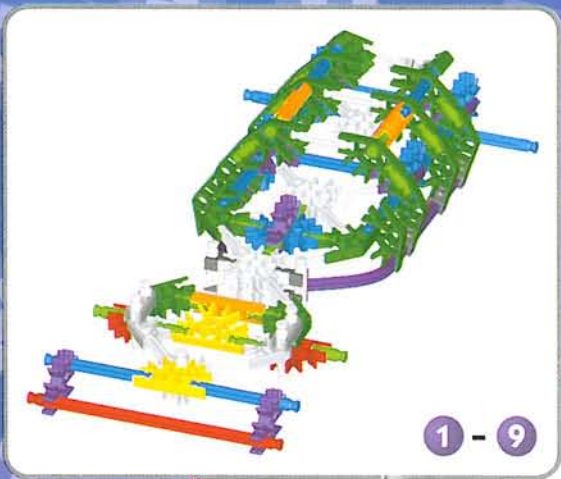

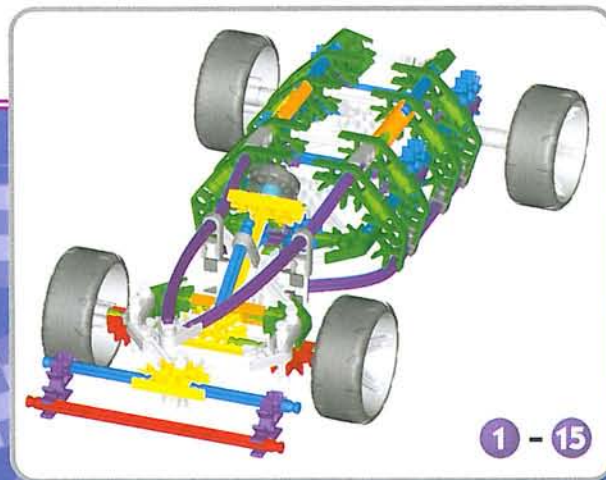
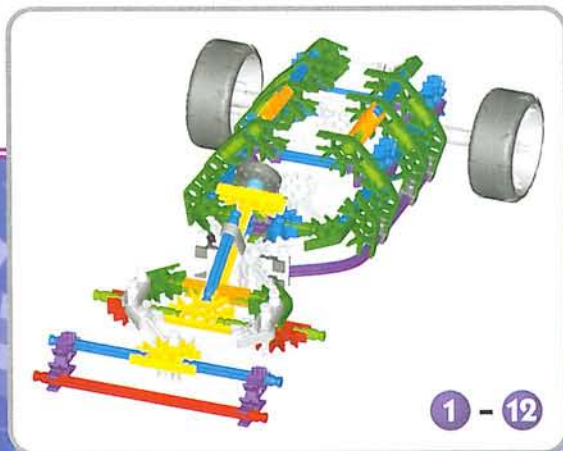
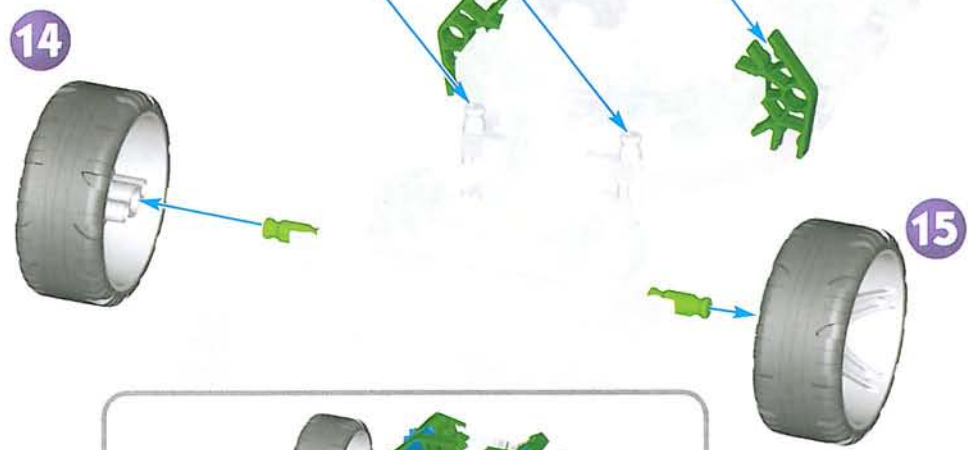
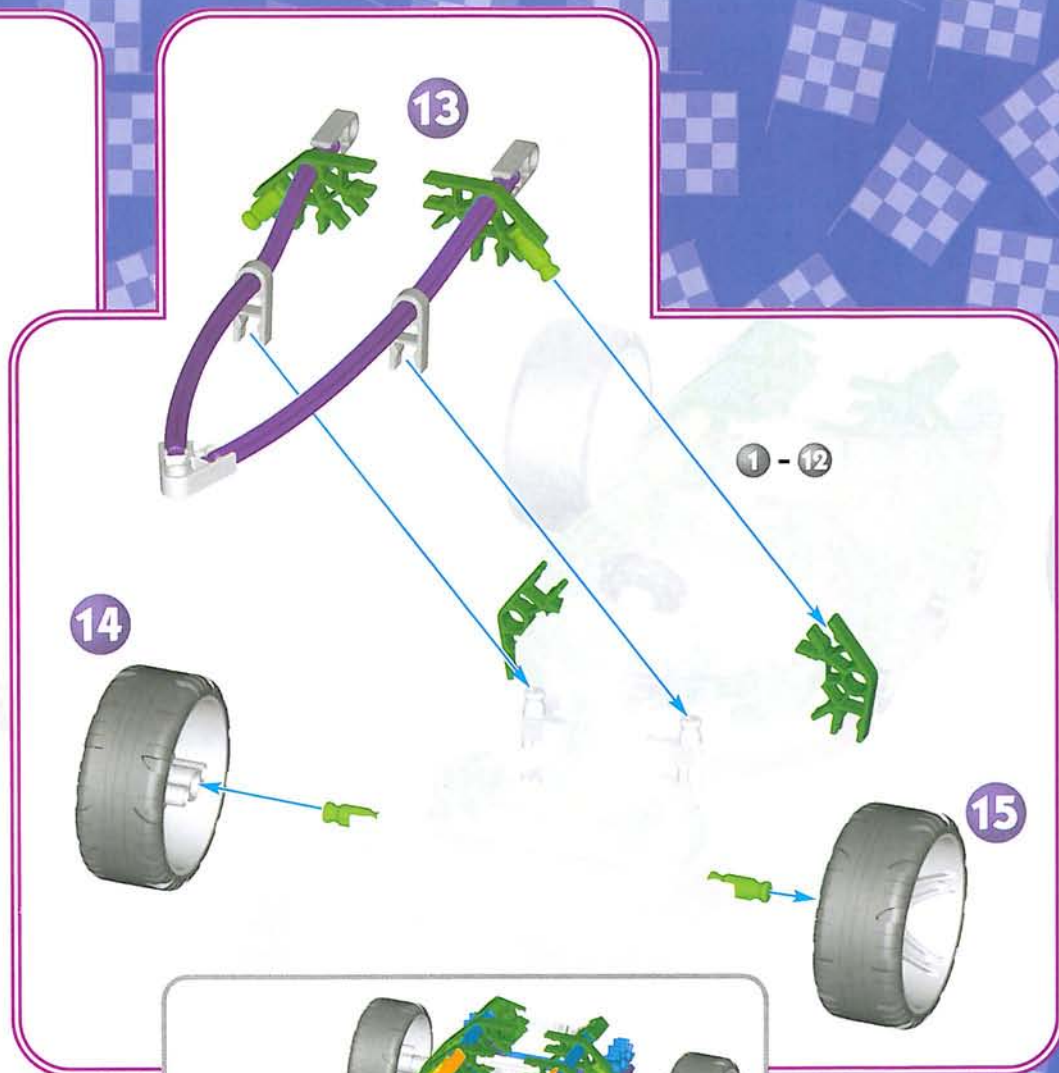
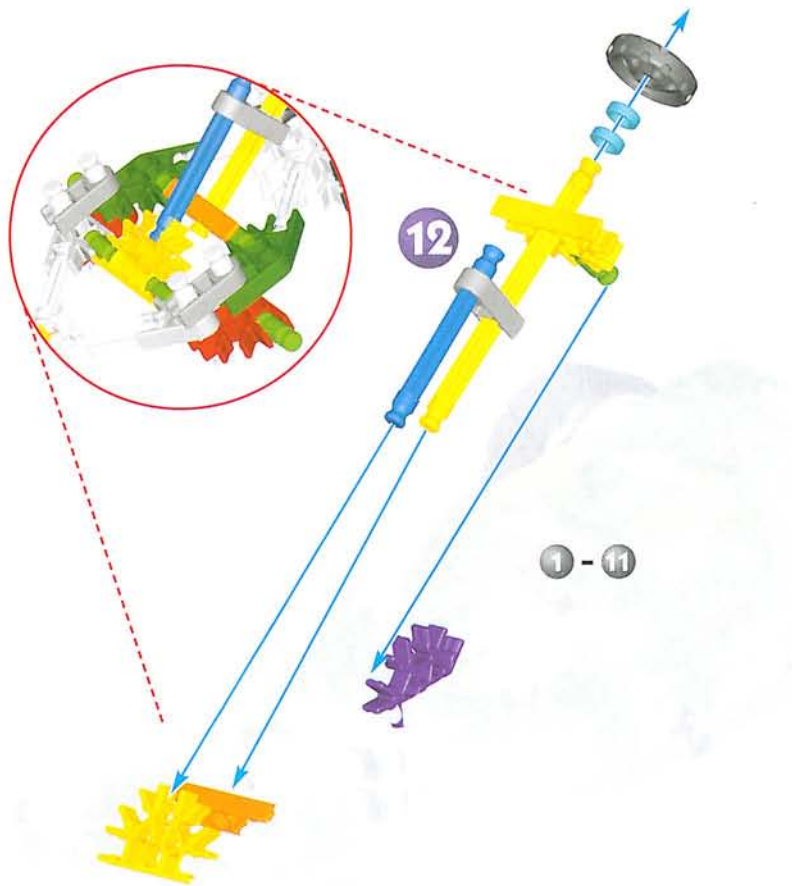

16

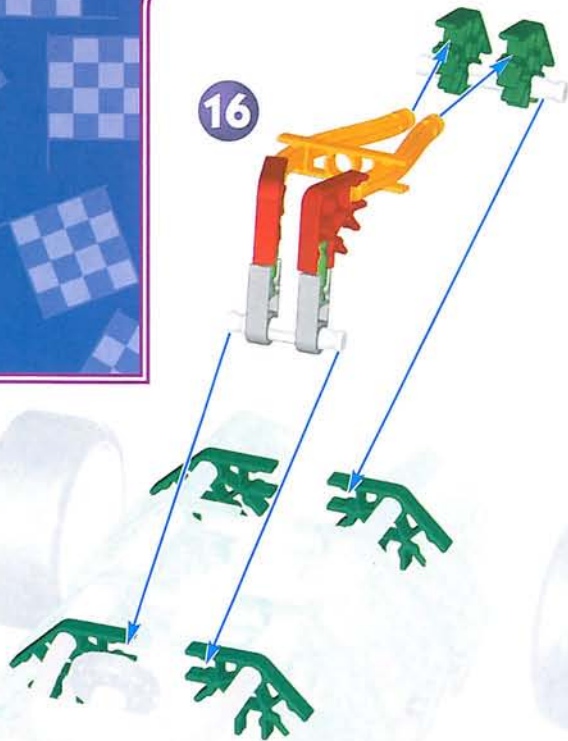

1 - 15

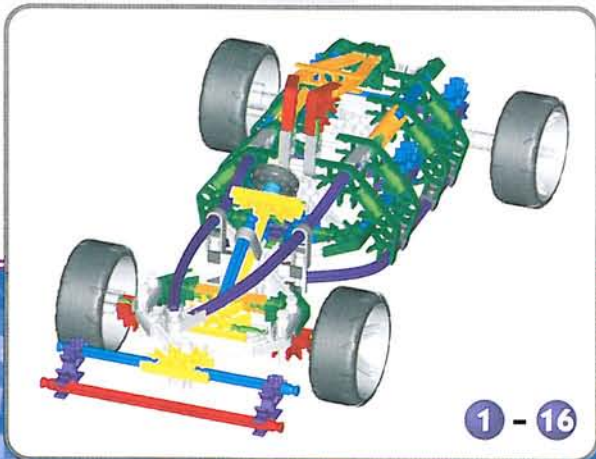

1 - 16

17

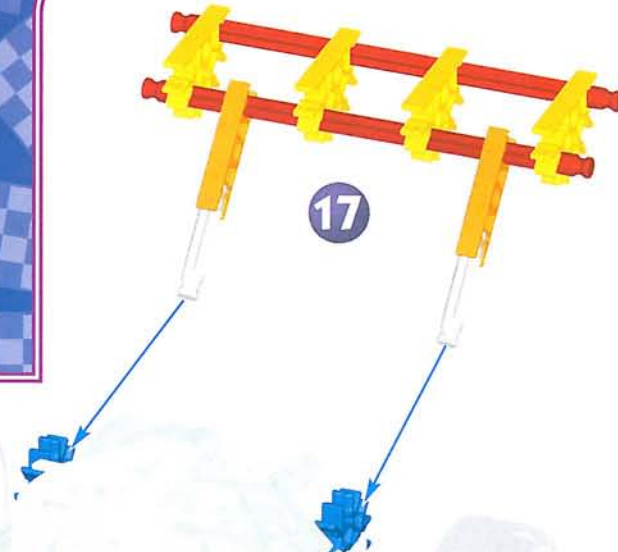

1 - 16

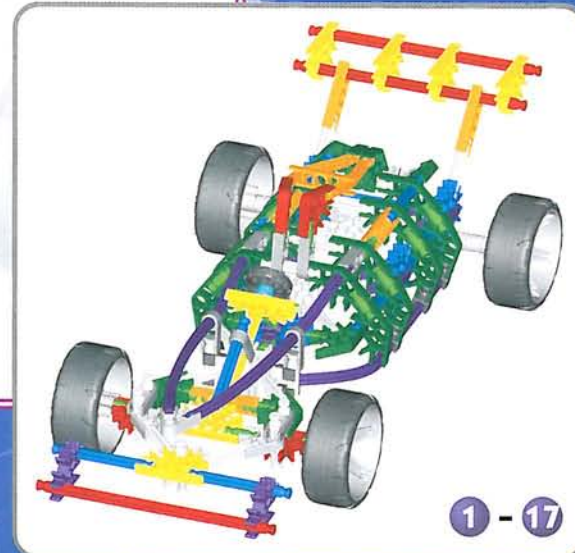

1 - 17



# Tomcat

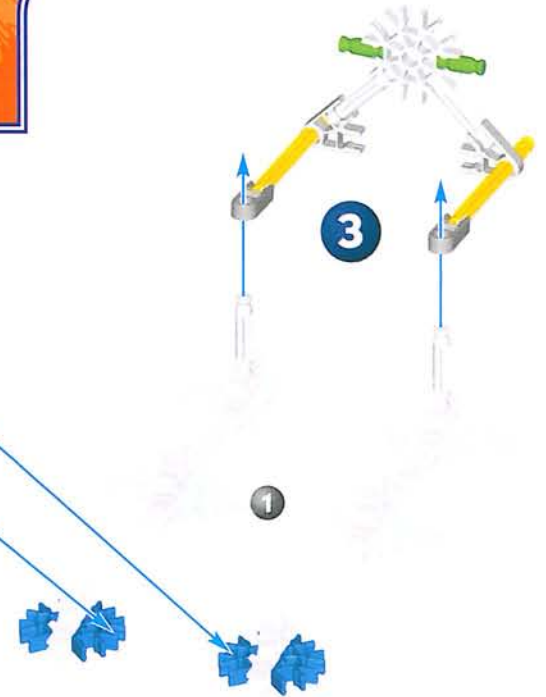
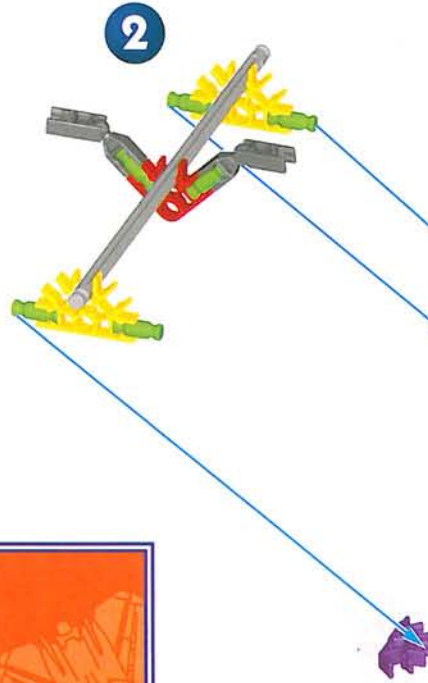
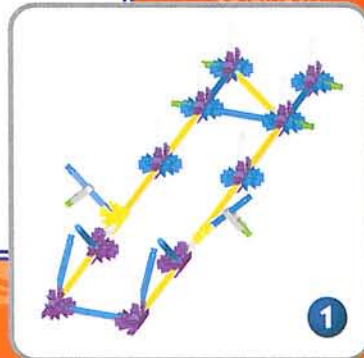
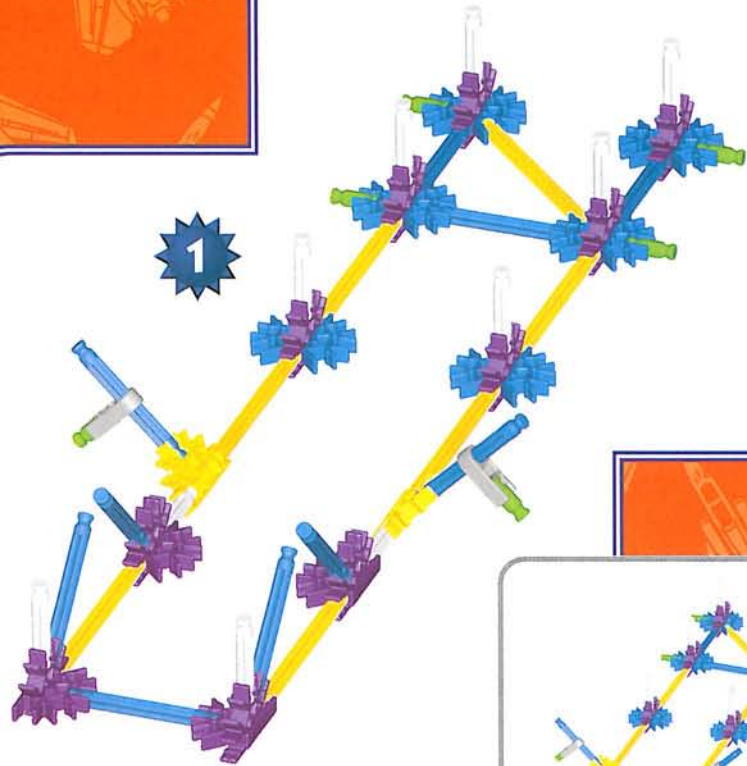
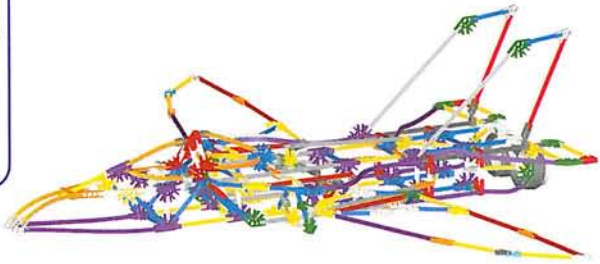
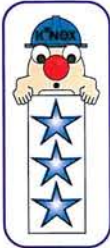

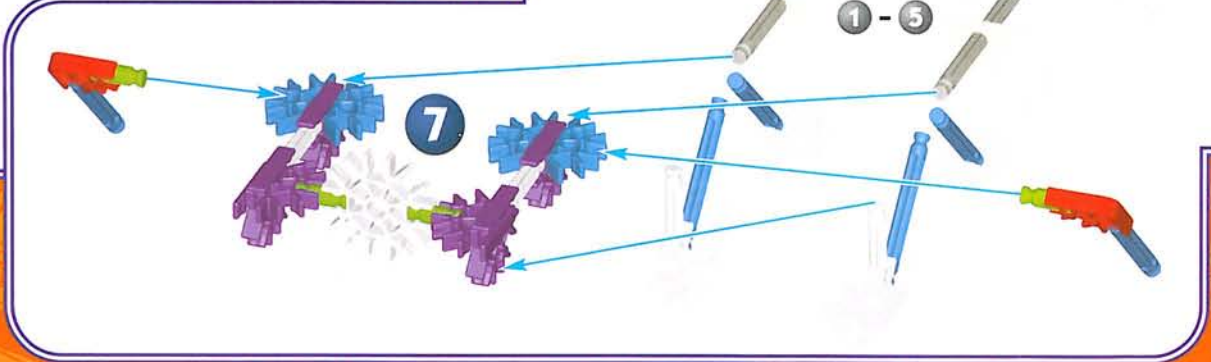
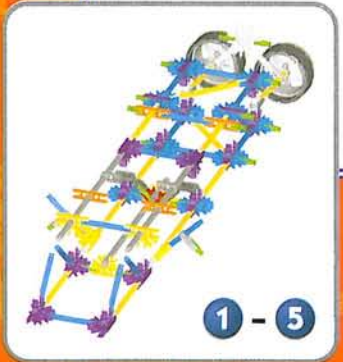
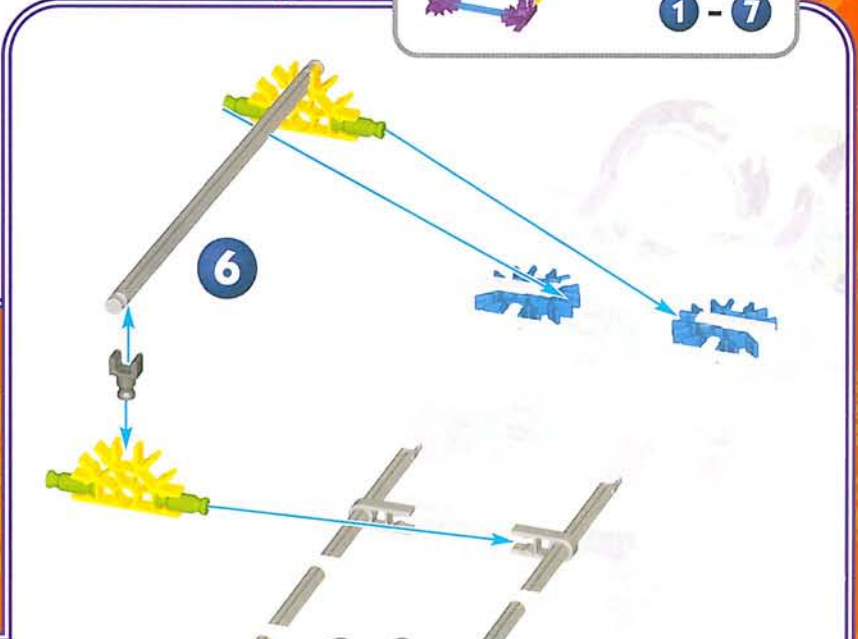
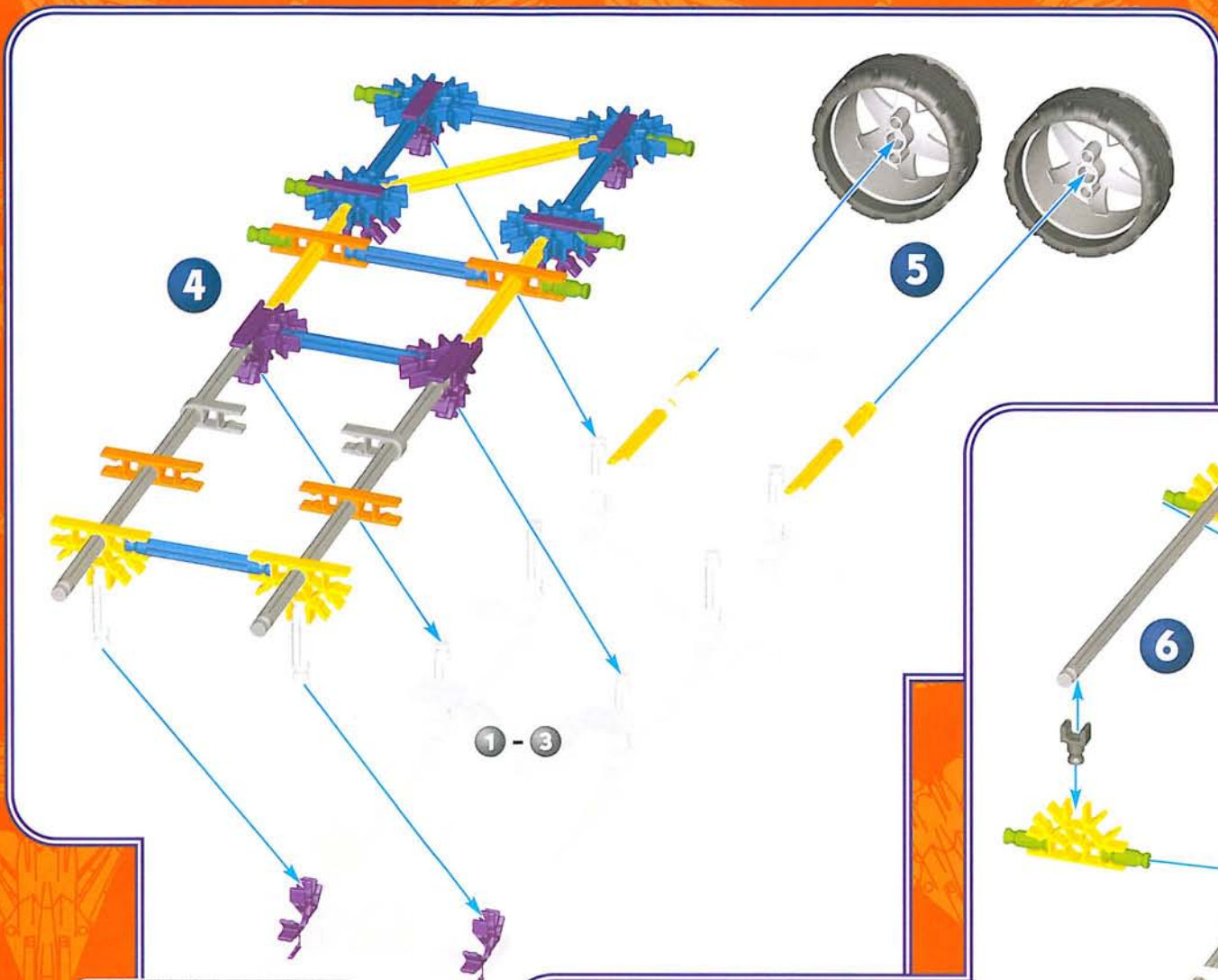

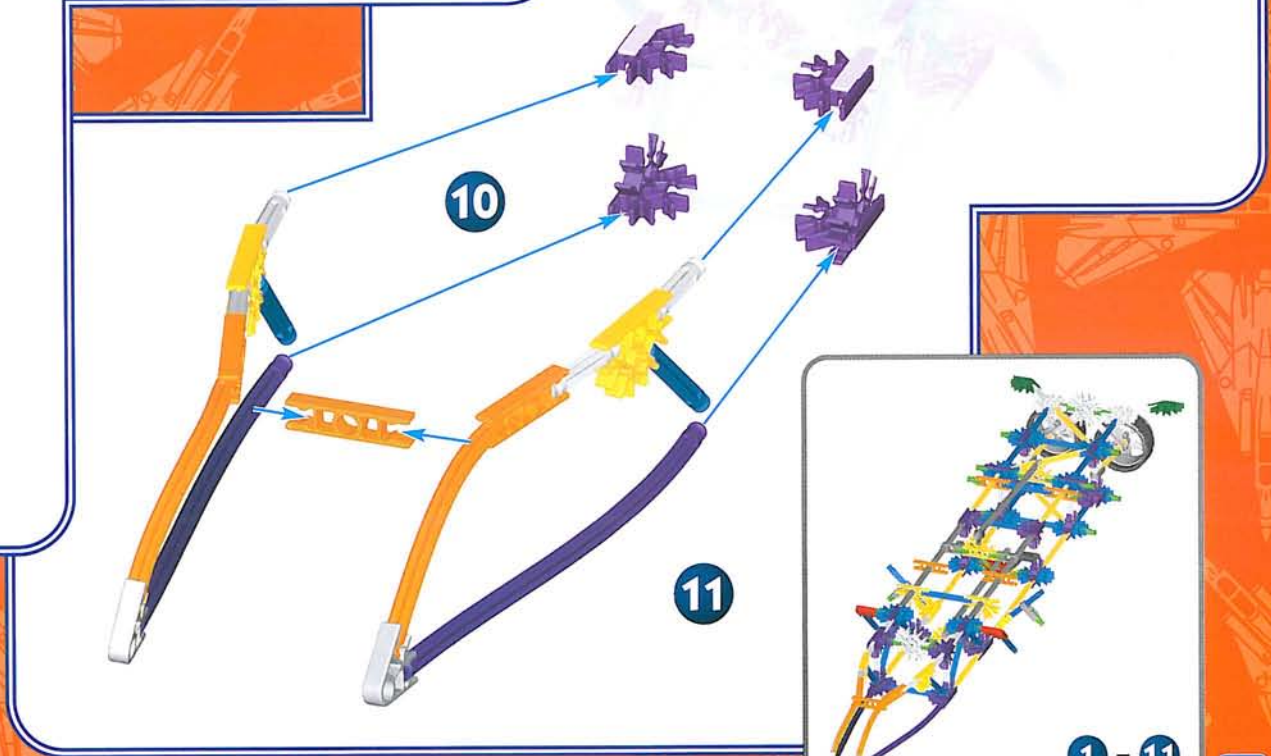
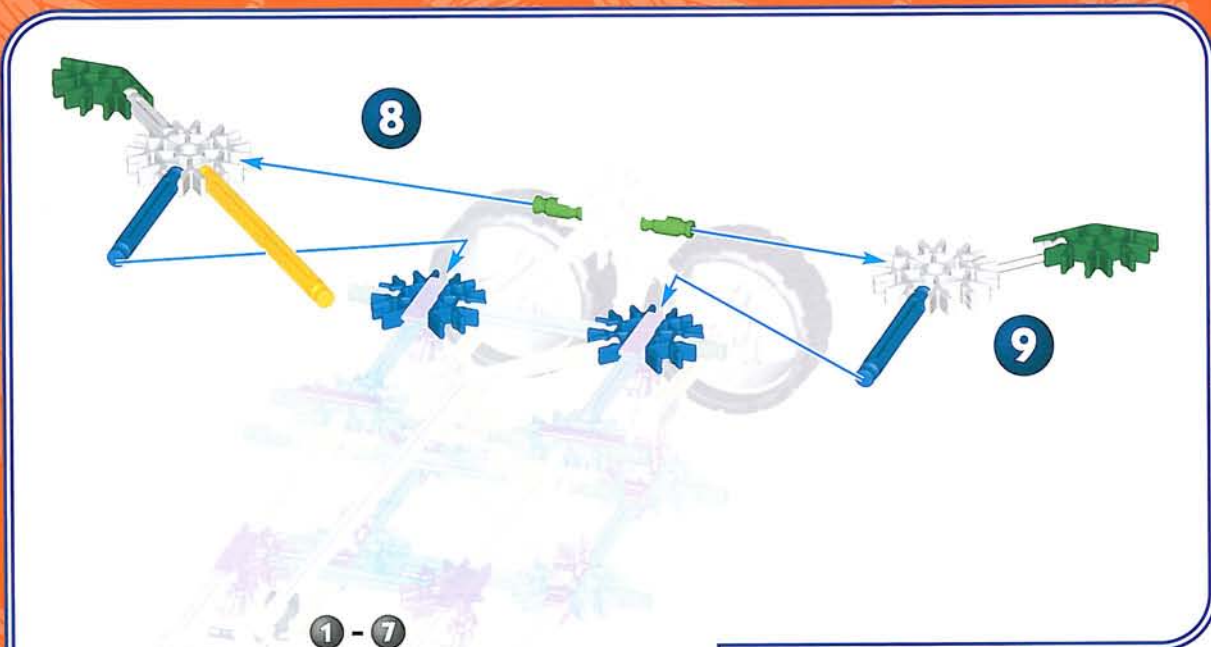

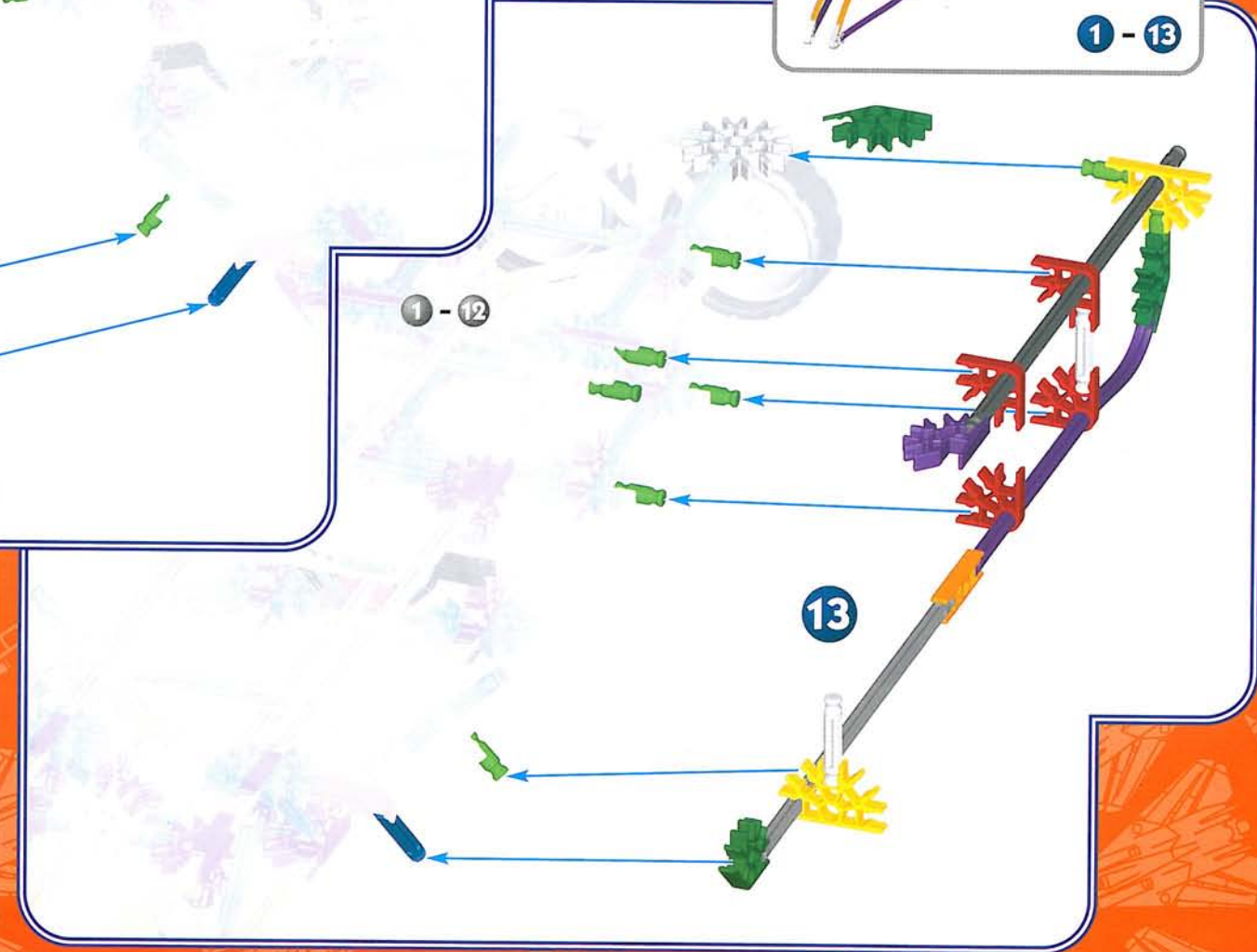
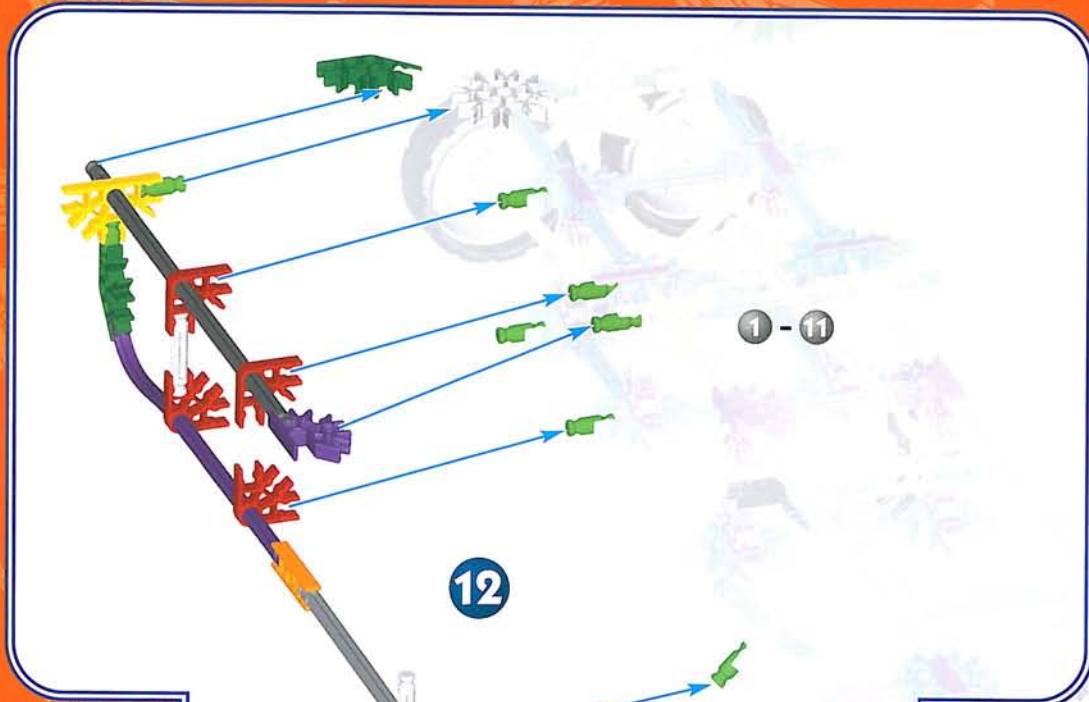

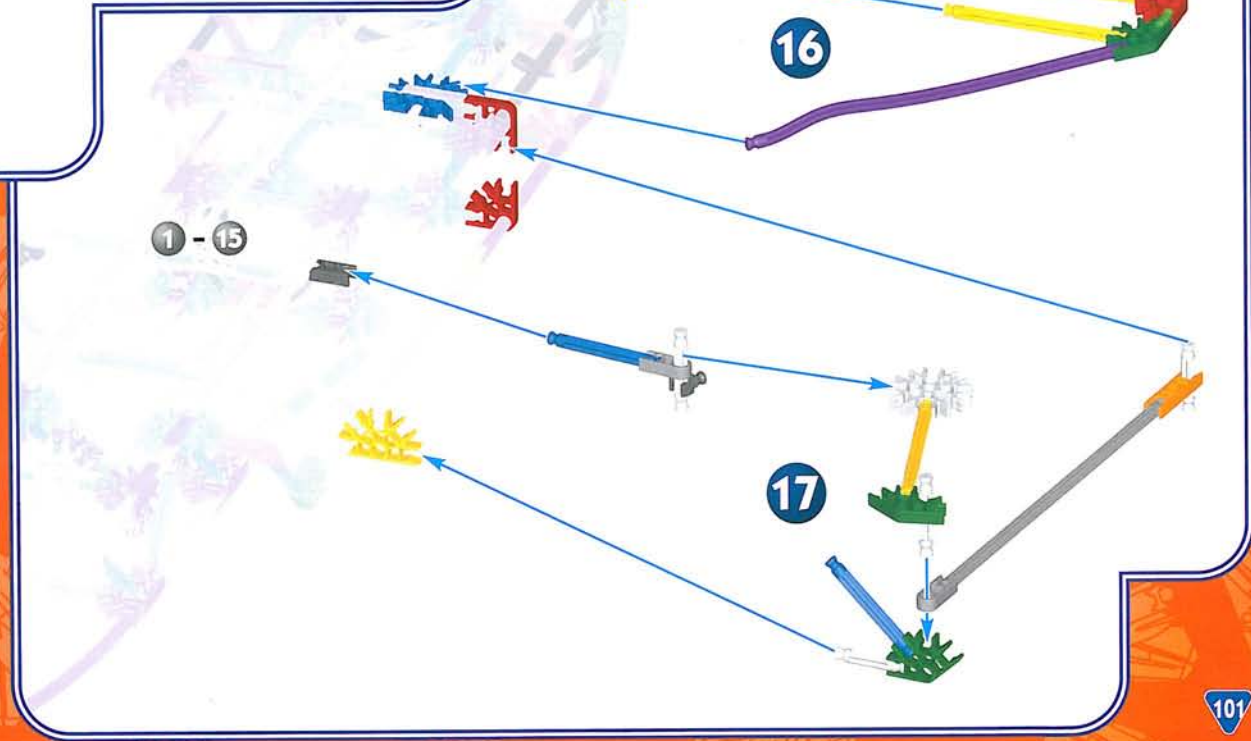
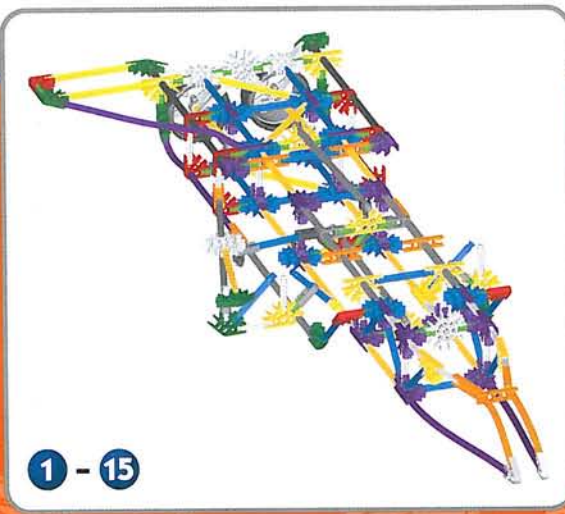
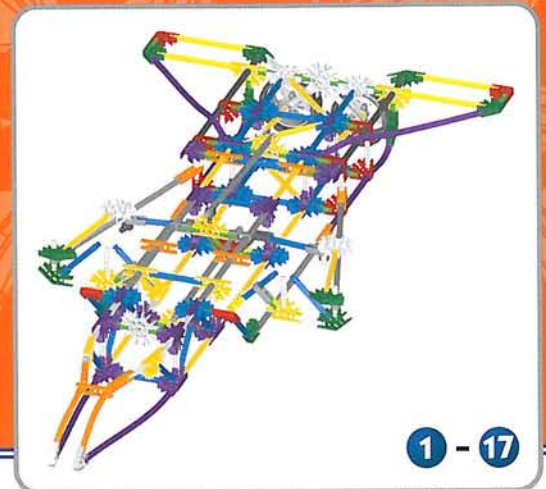
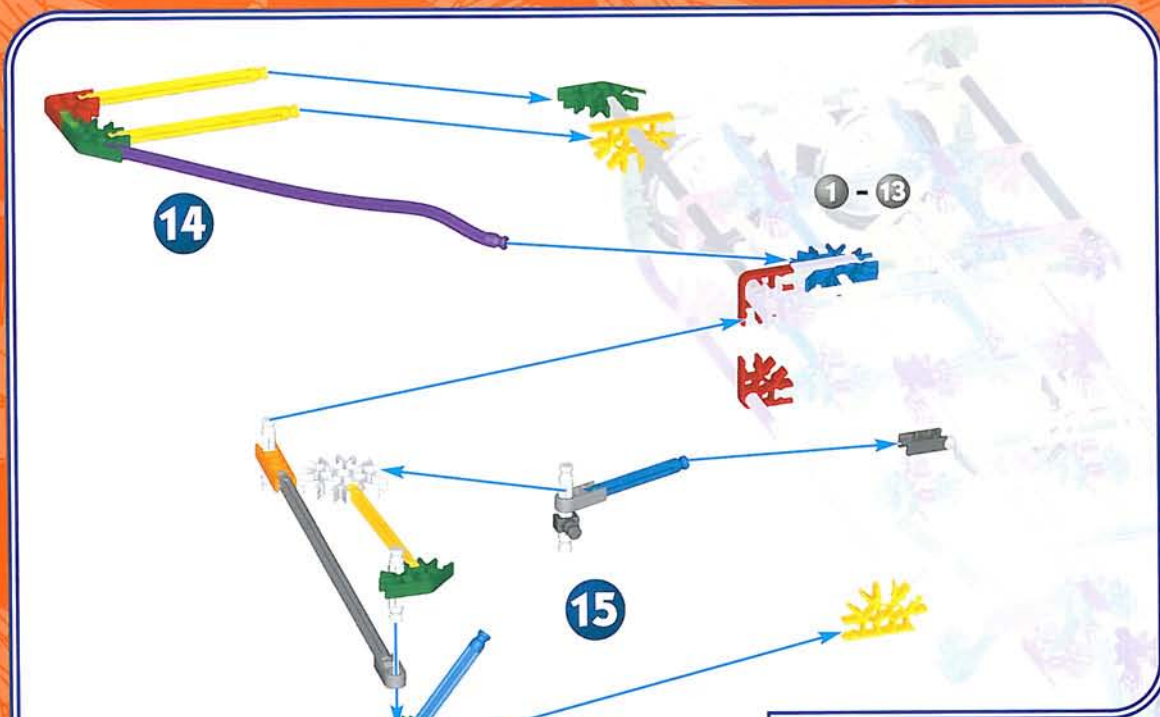

1 - 17

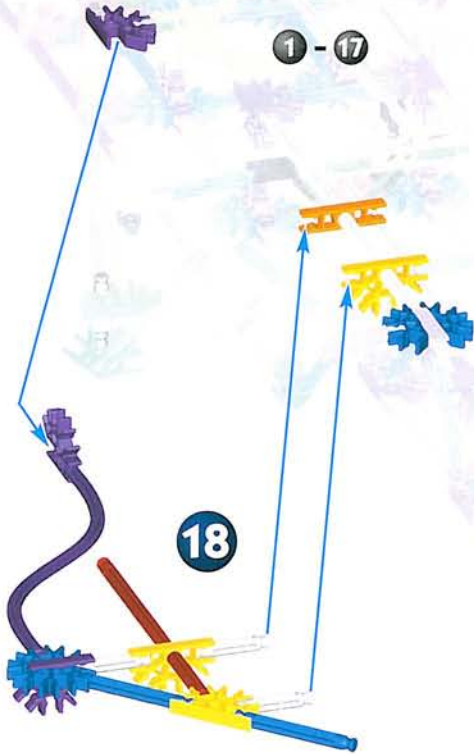

18

1 - 19

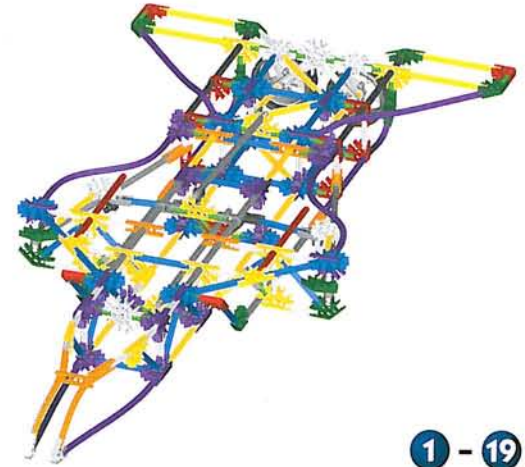

1 - 18

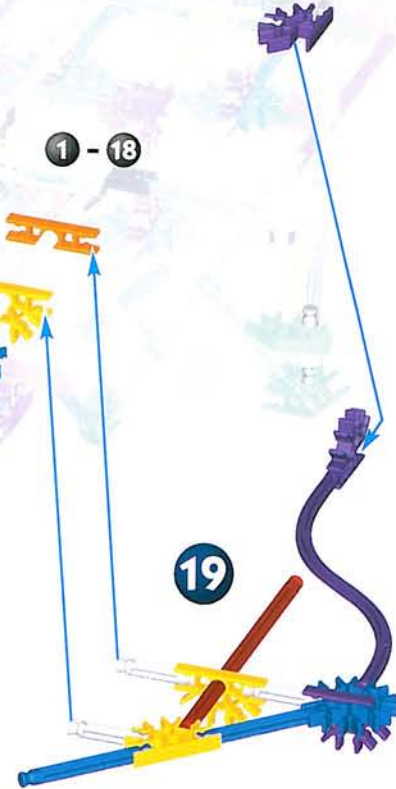

19

1 - 18



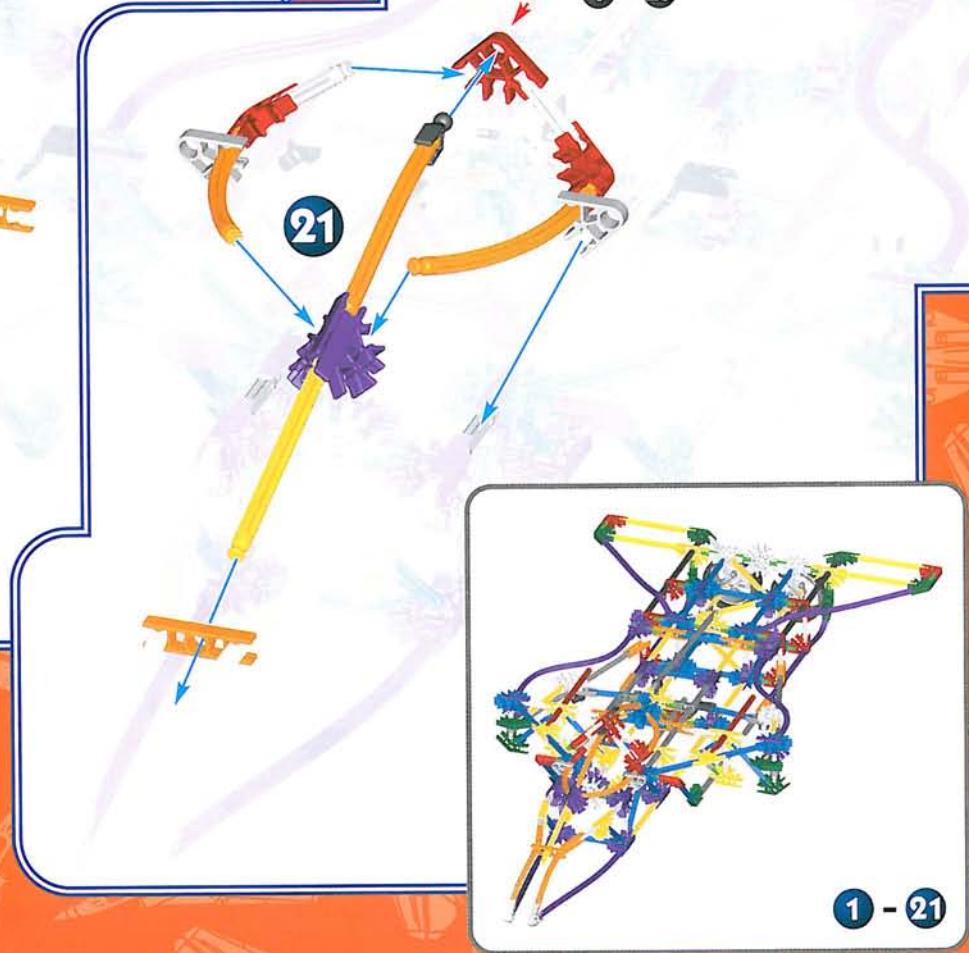
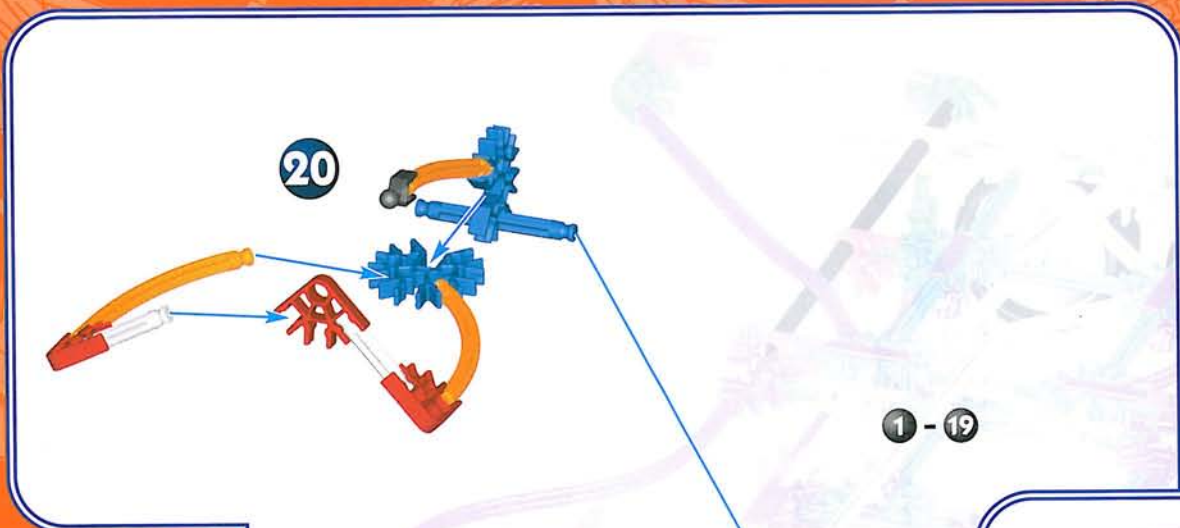



1 - 21

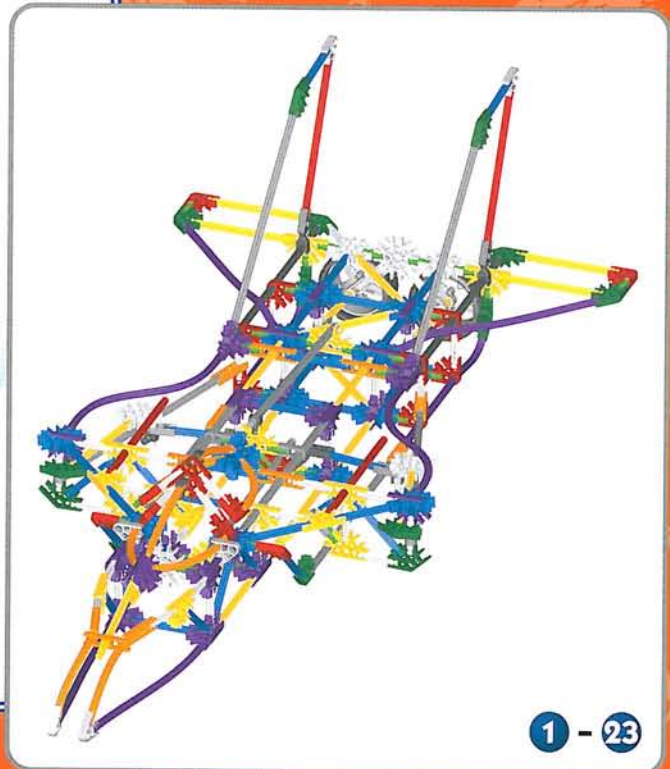



24

1 - 23

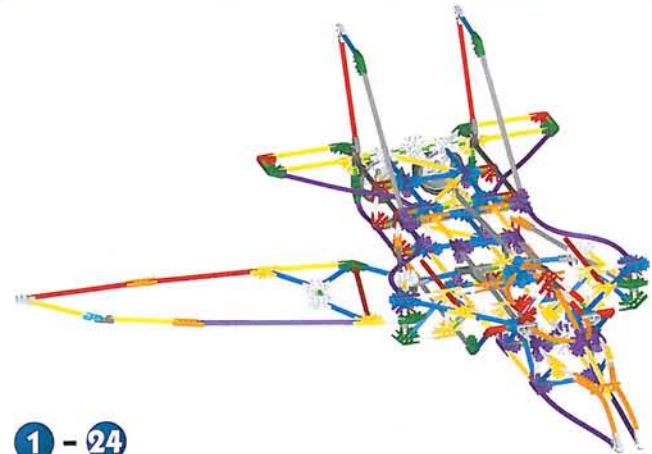
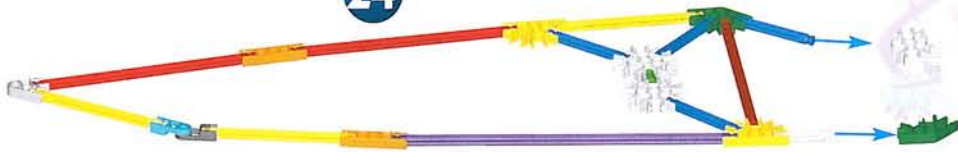

1 - 24

1 - 24

25

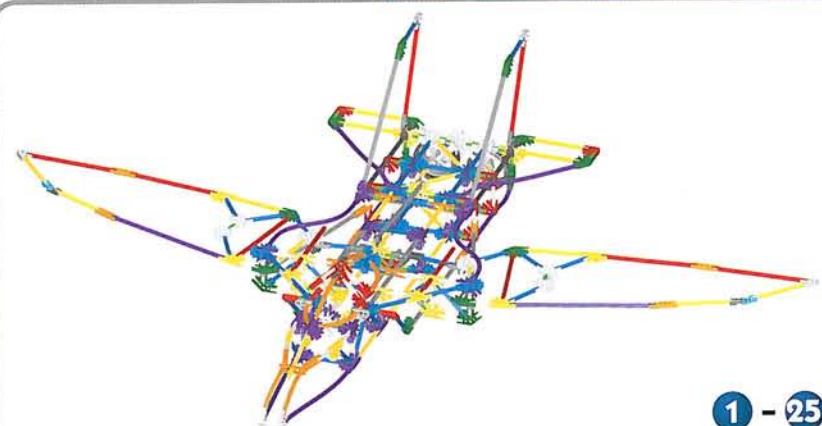
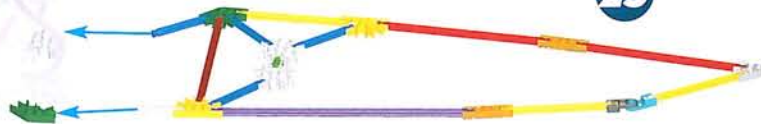

1 - 25

# Plane Launcher

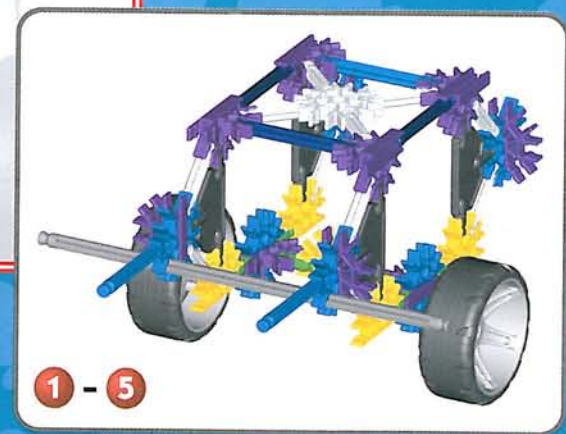
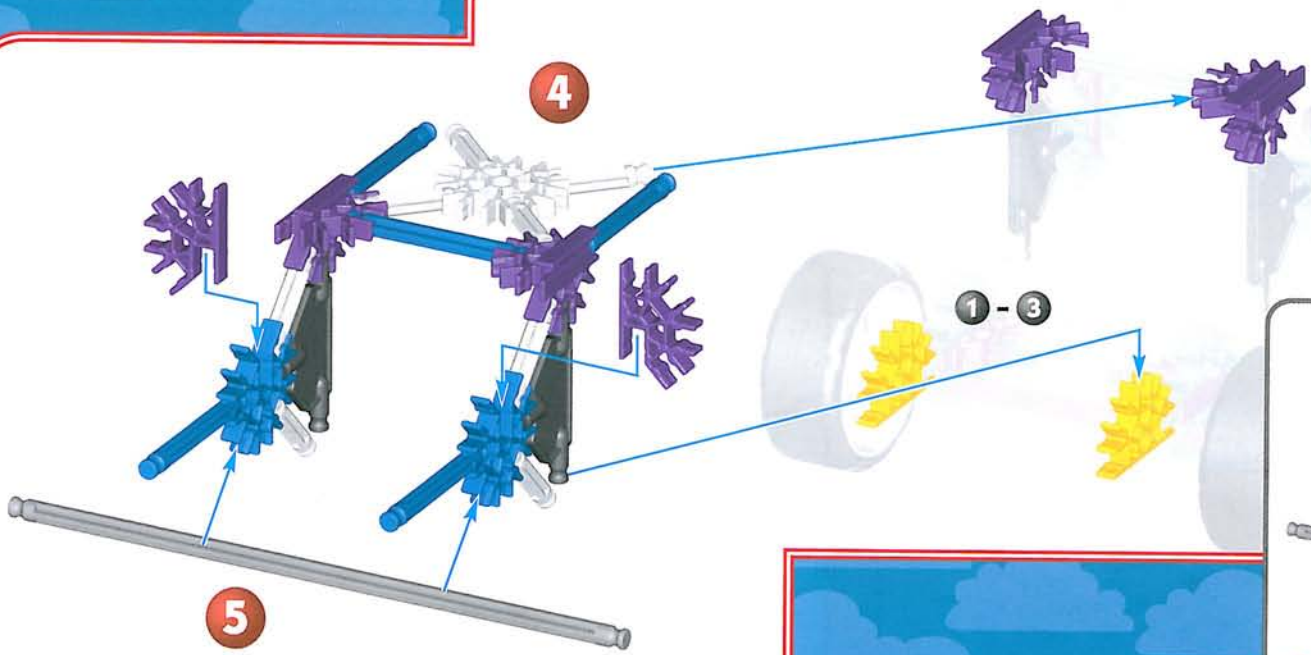
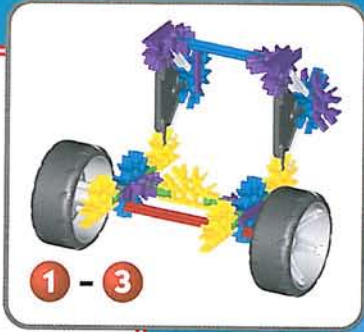
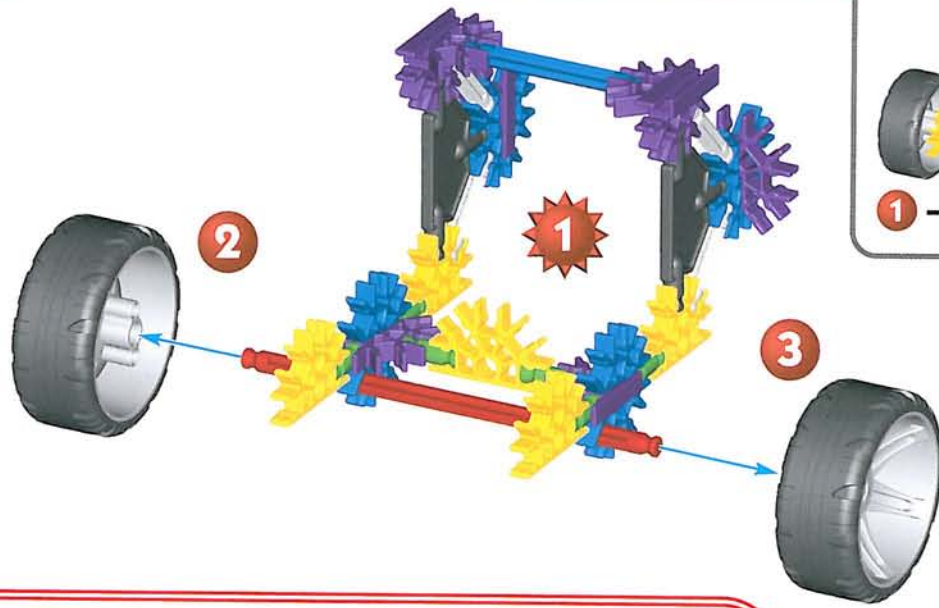
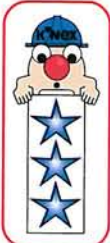

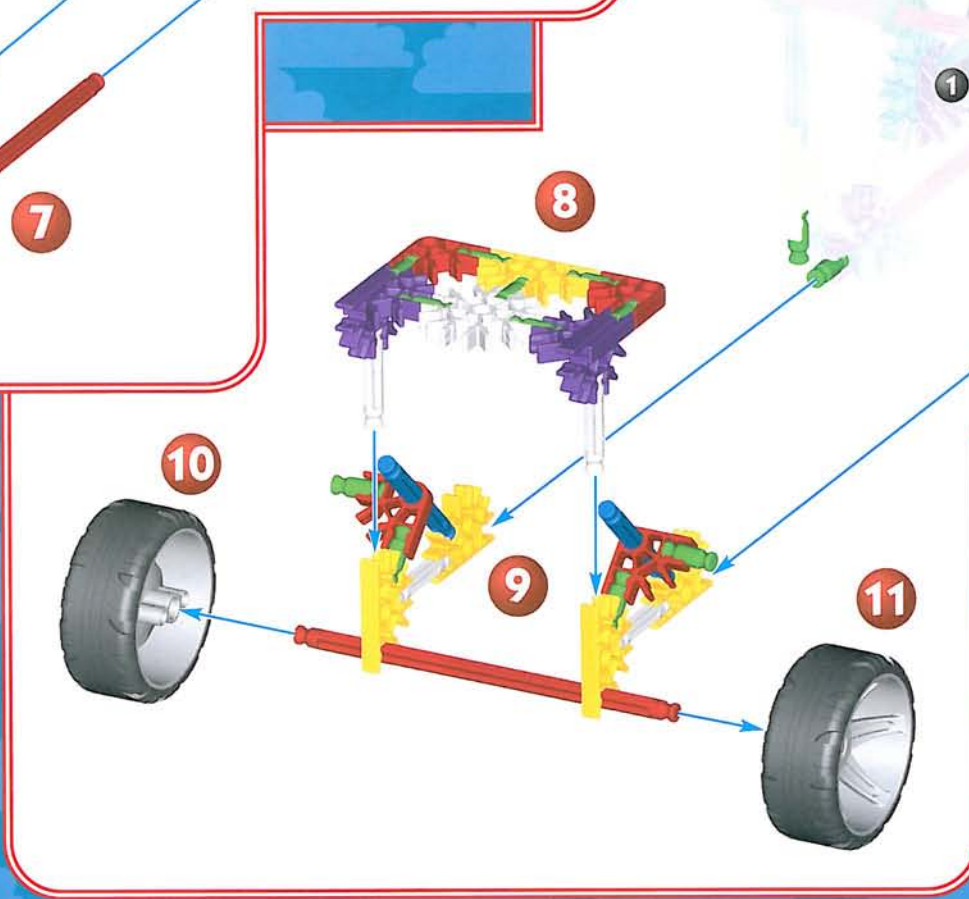
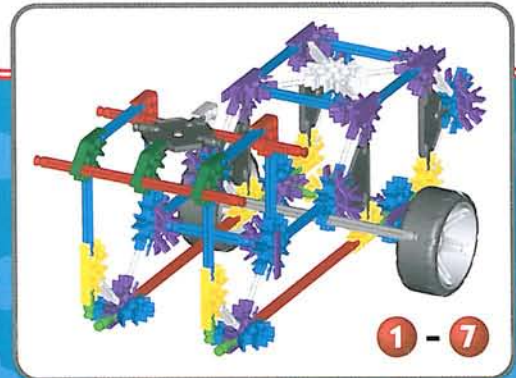
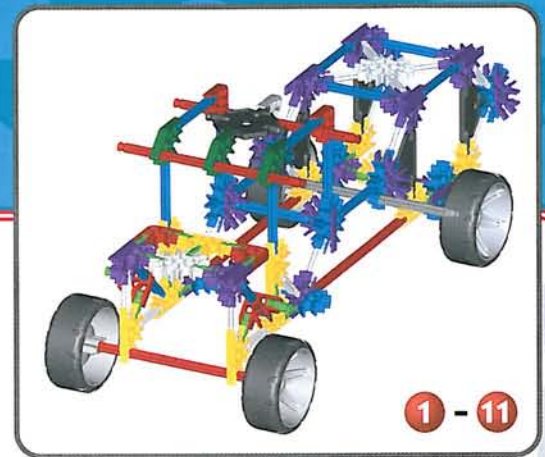
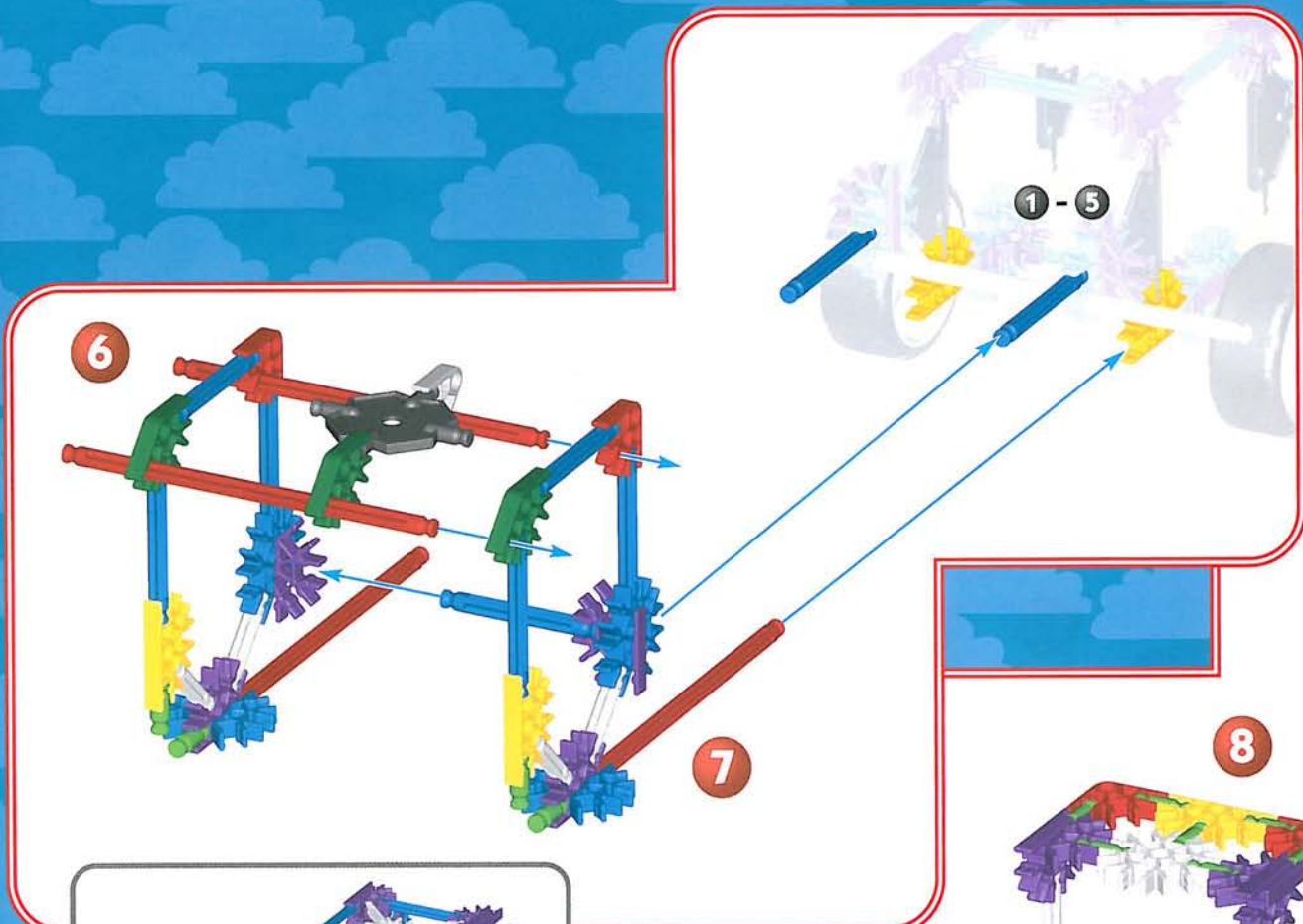

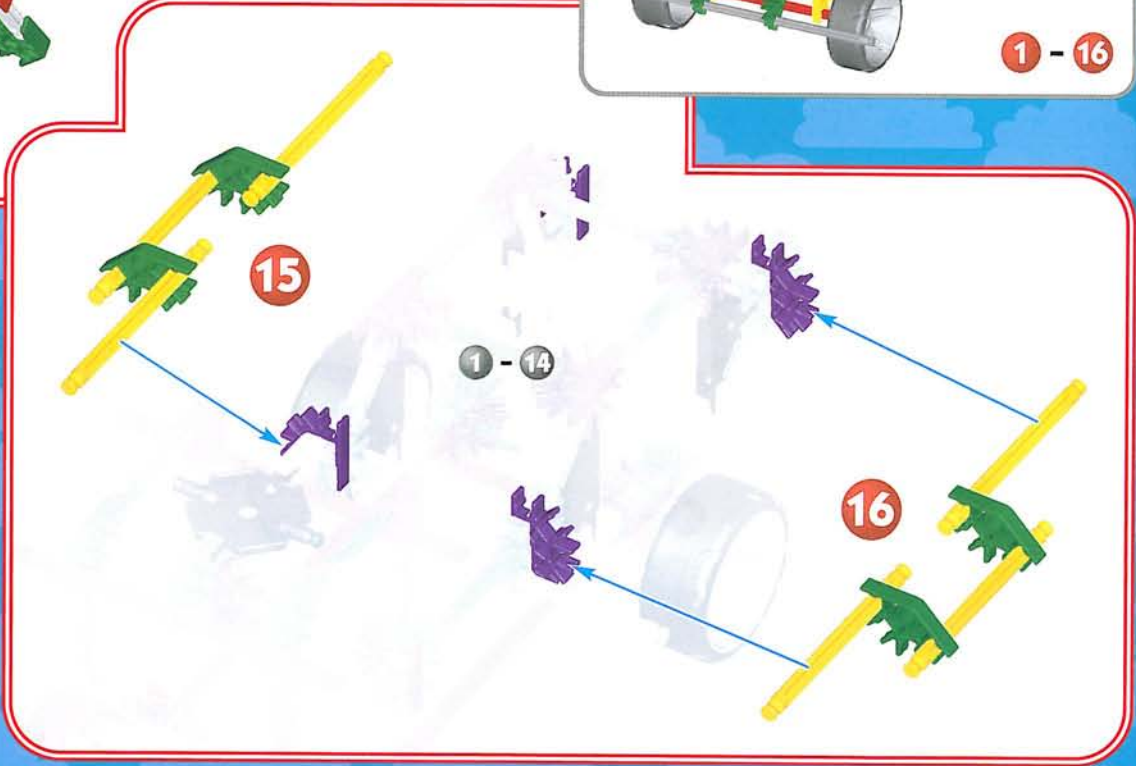
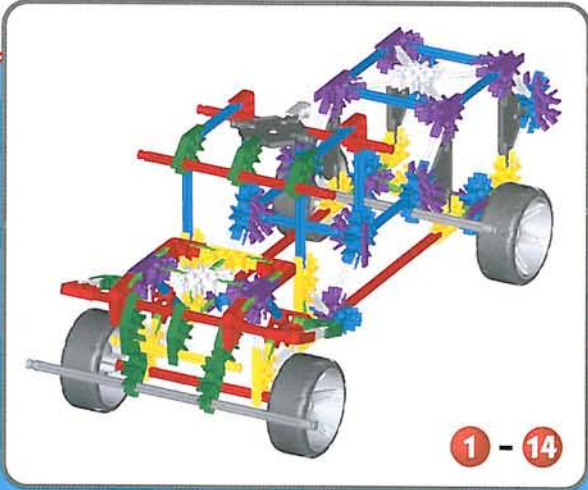
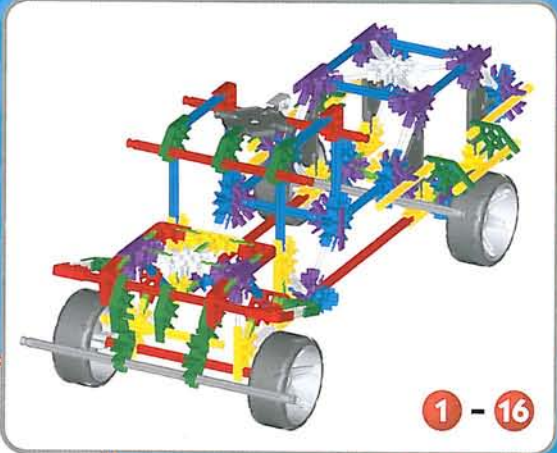
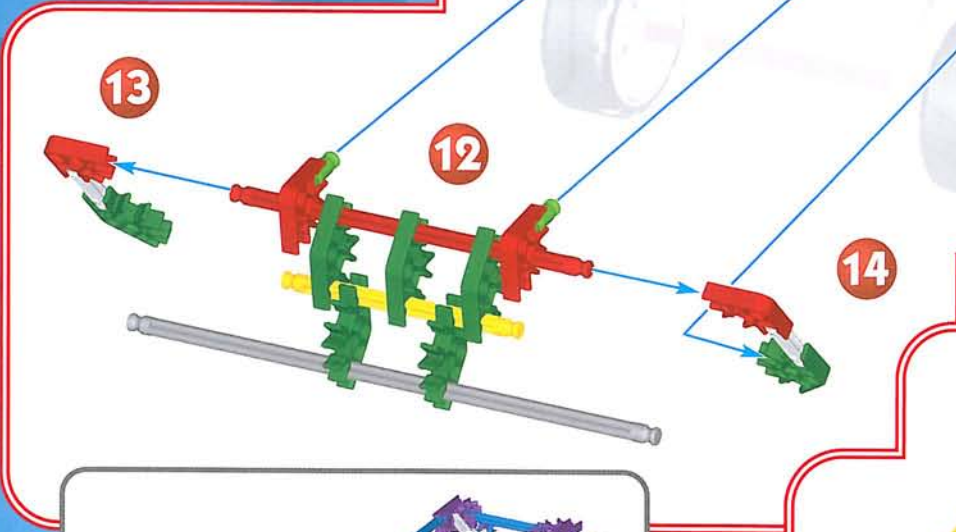
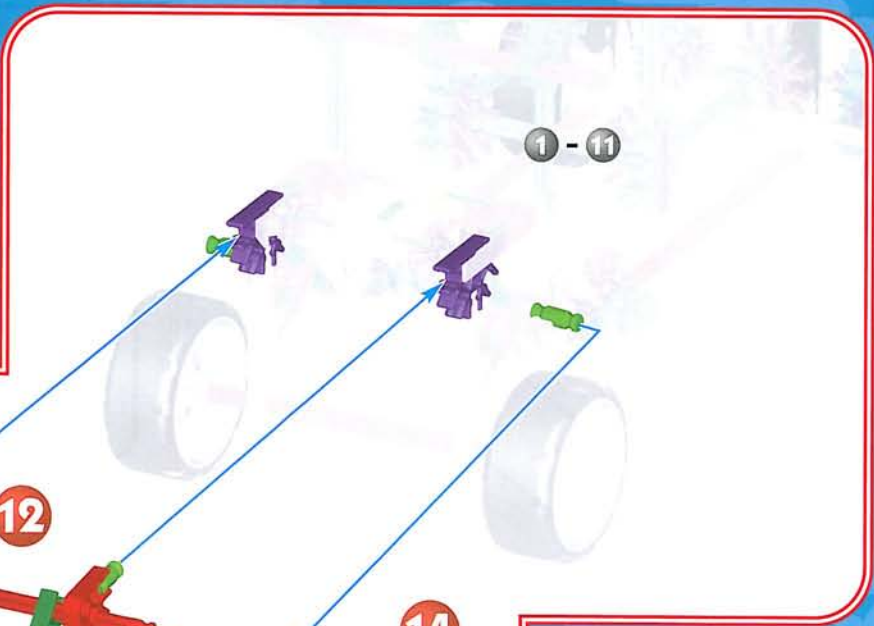



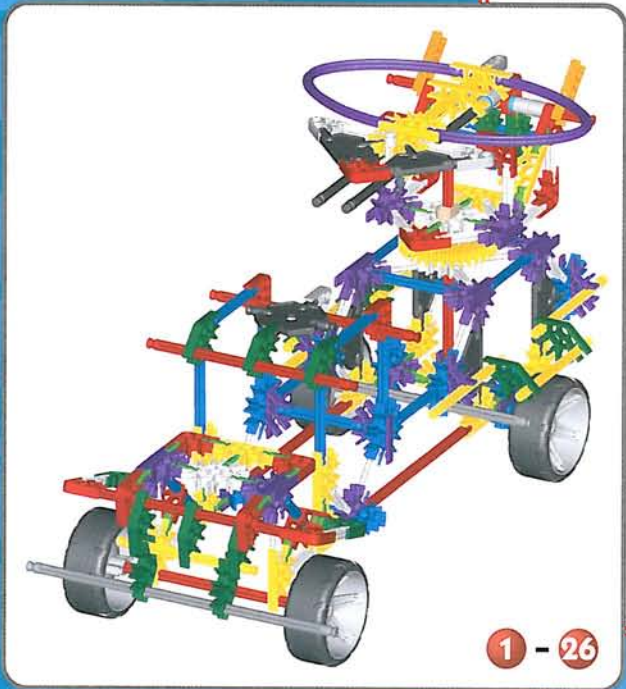
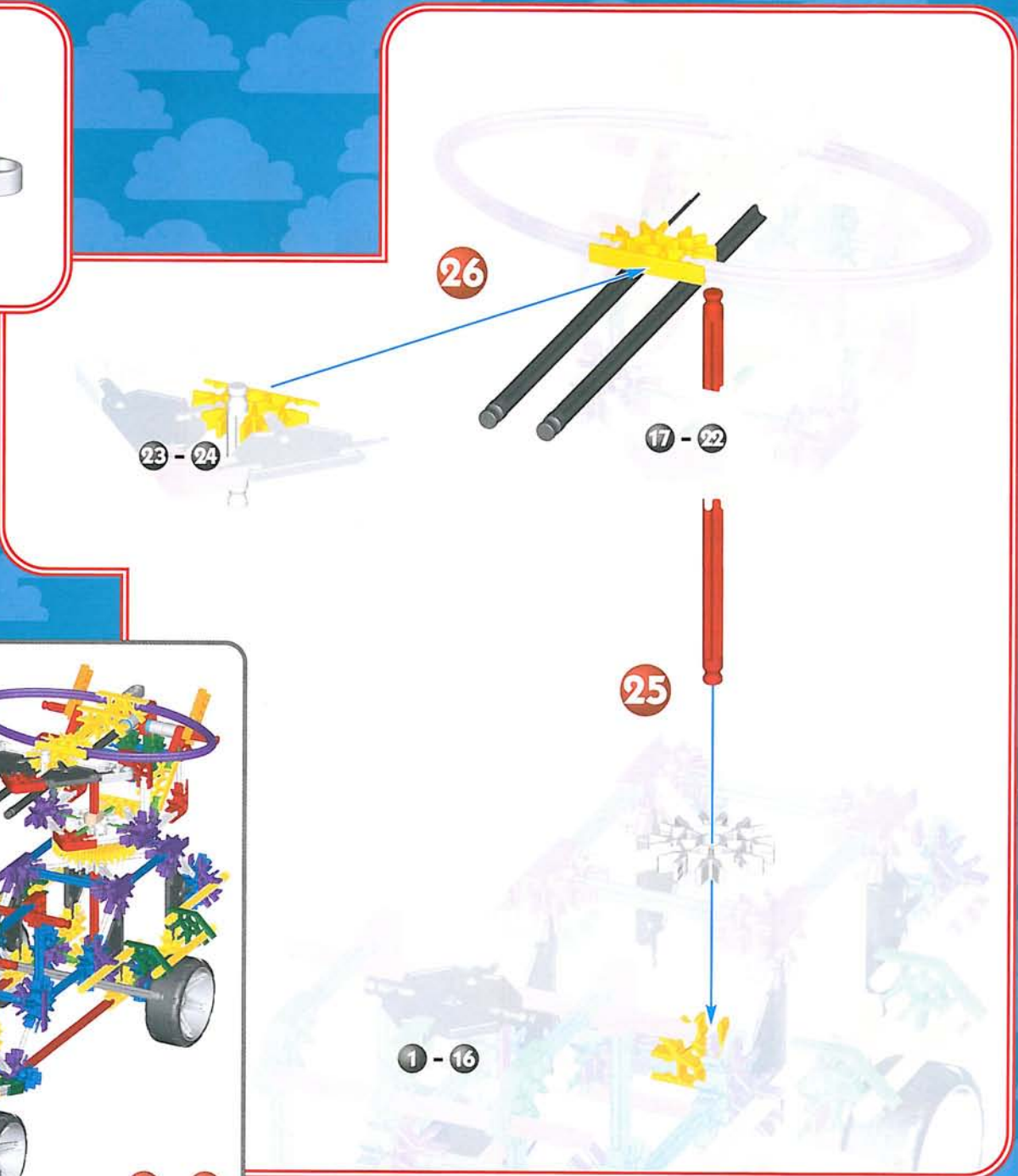
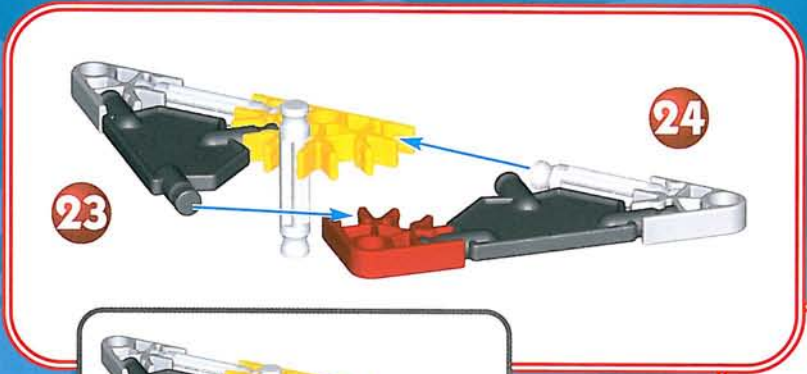

# The Rejector

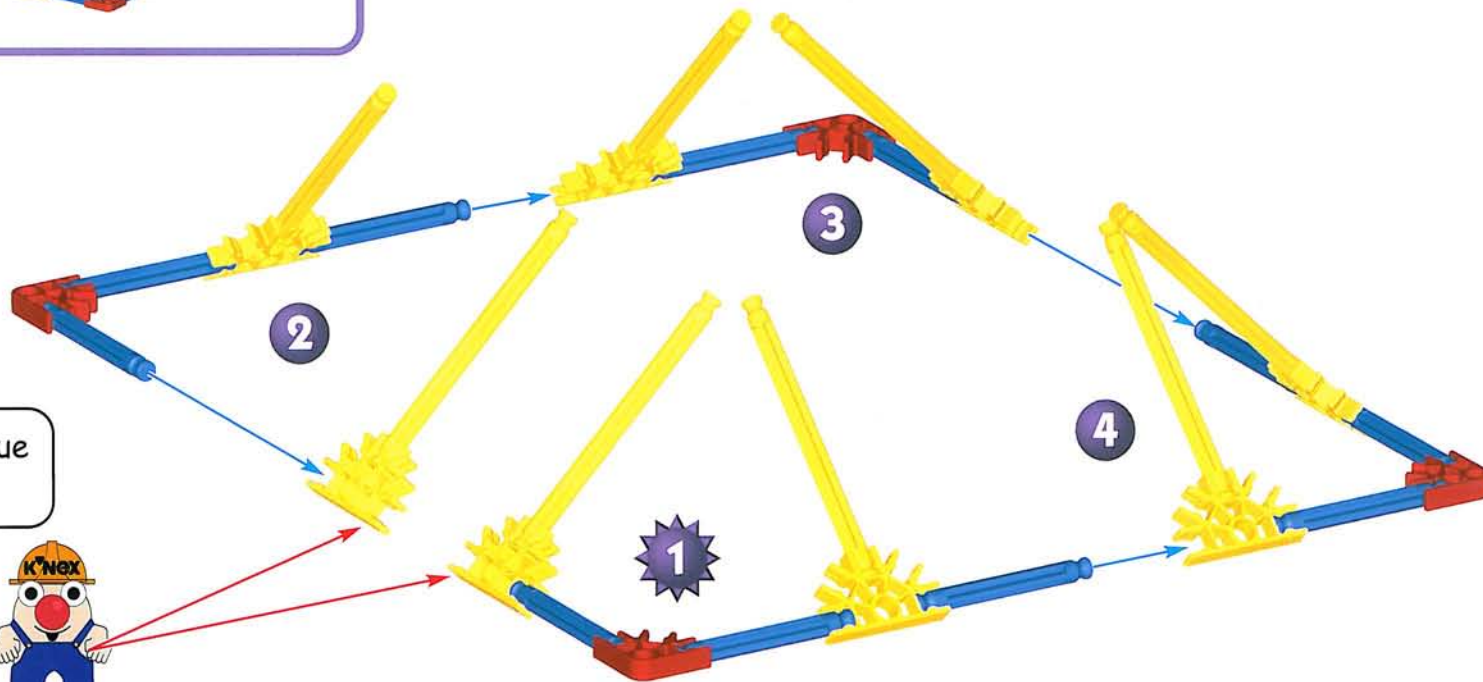
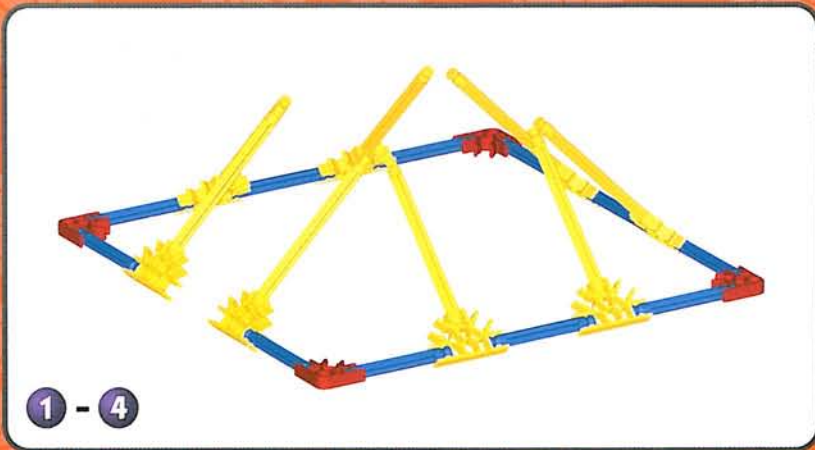
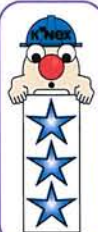

Don't put the blue Rod in yet!



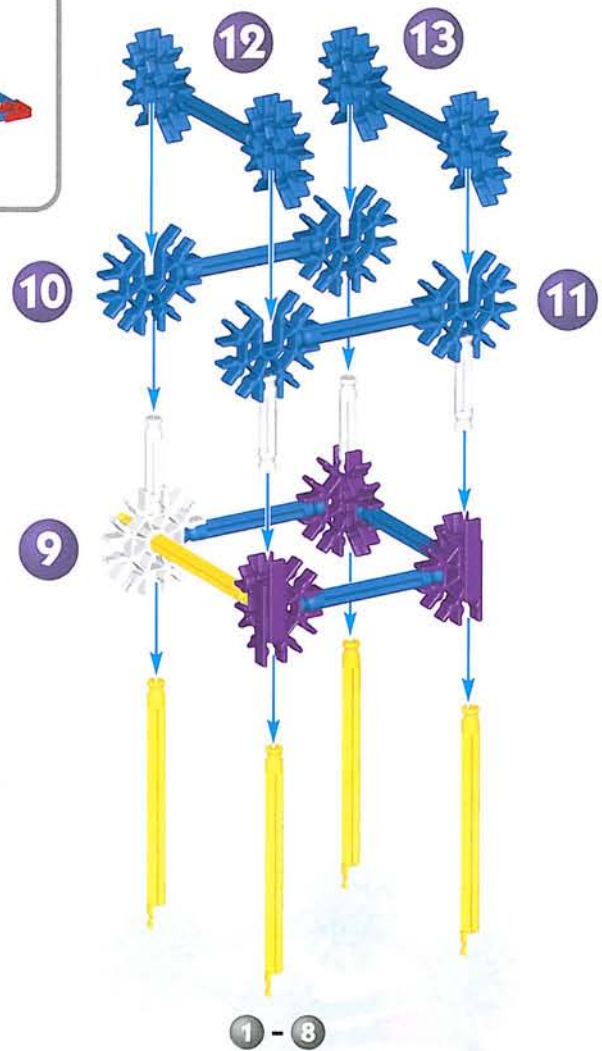
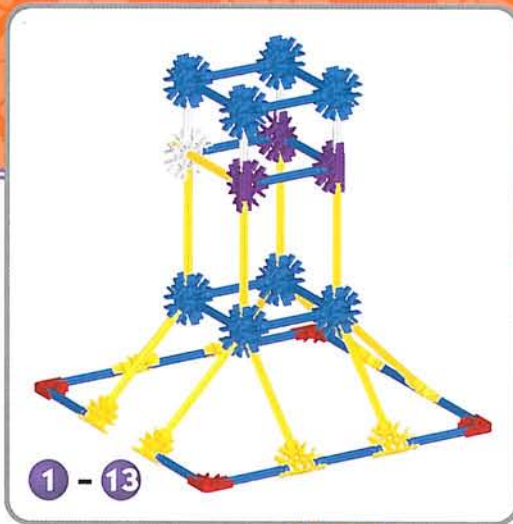
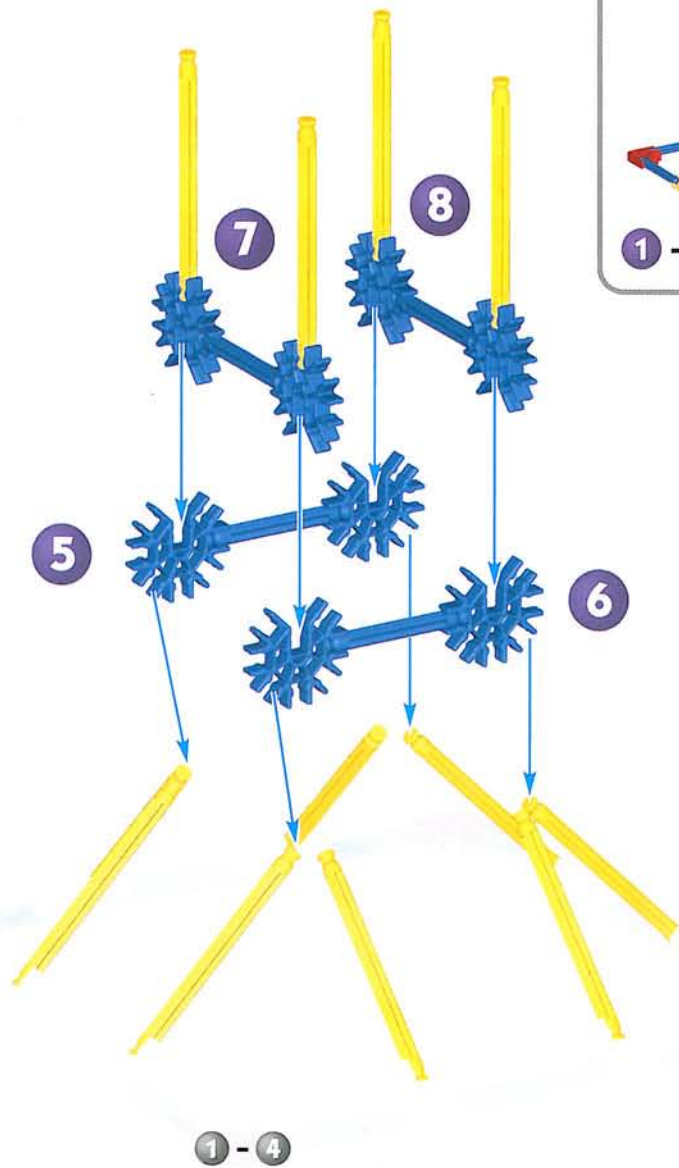



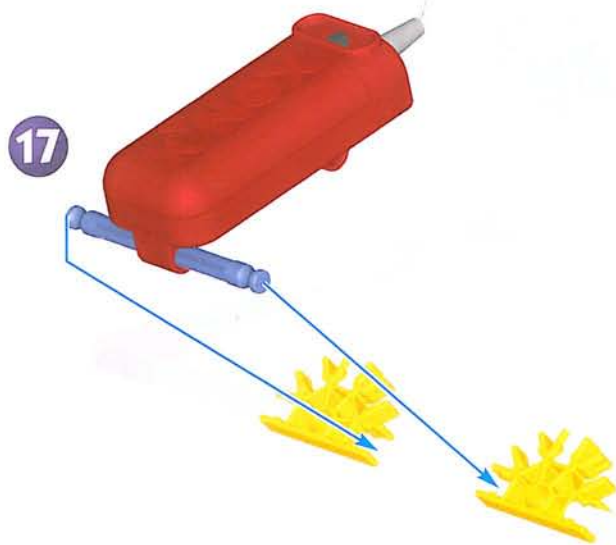
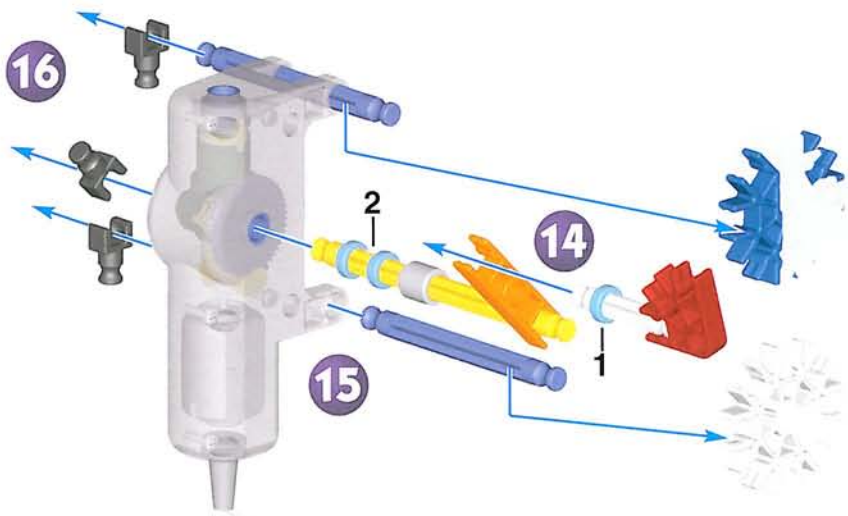

1 - 13

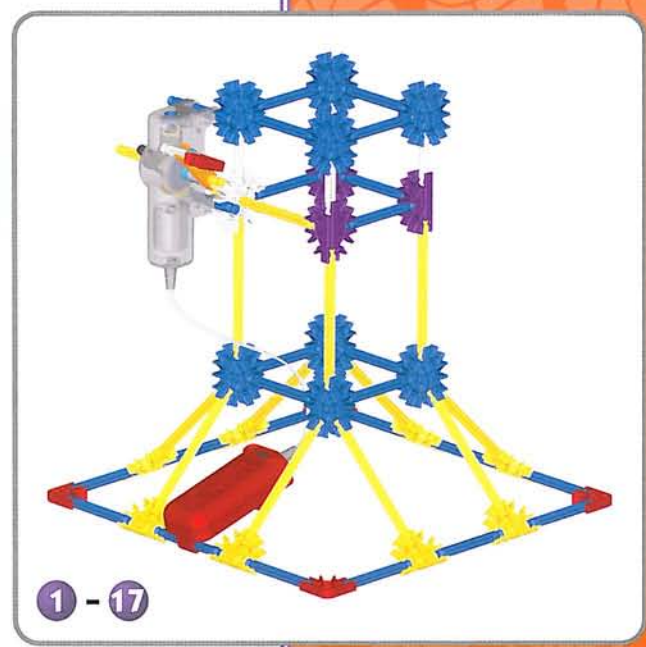

1 - 17

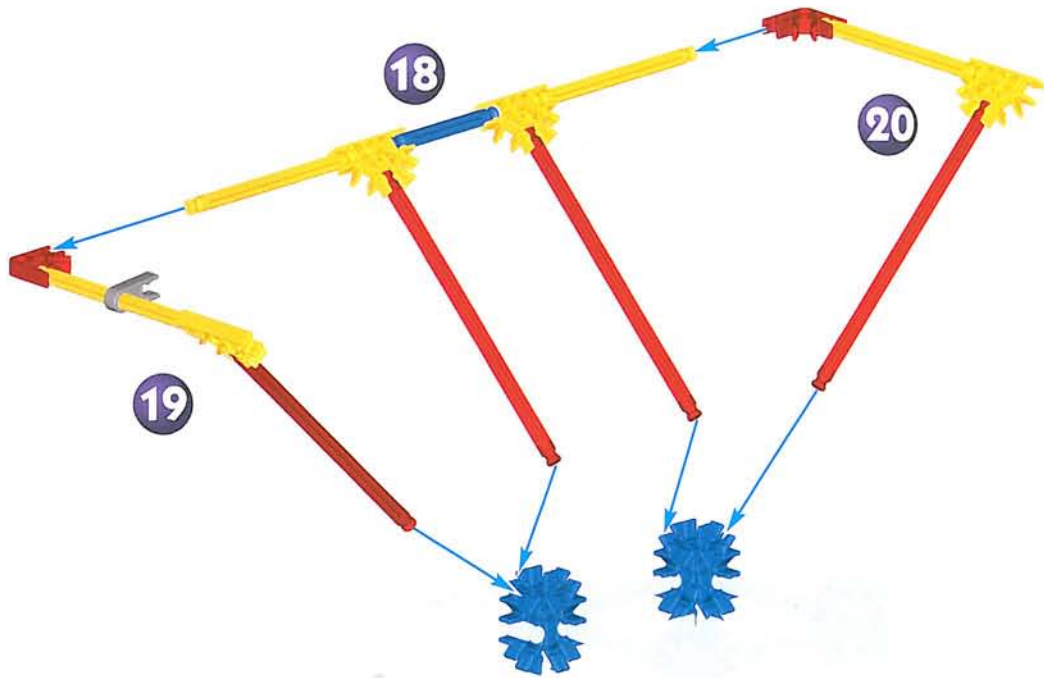

1 - 17

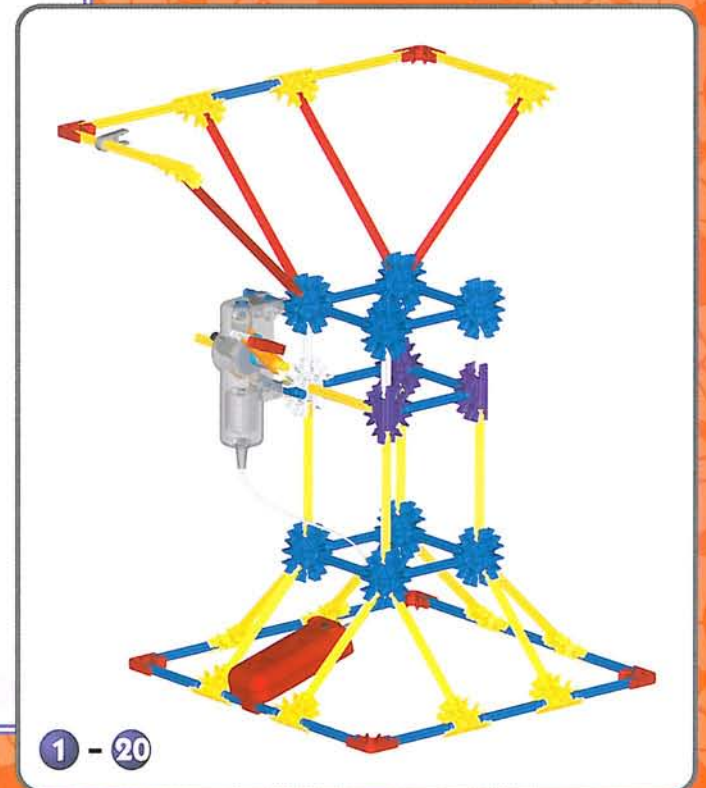

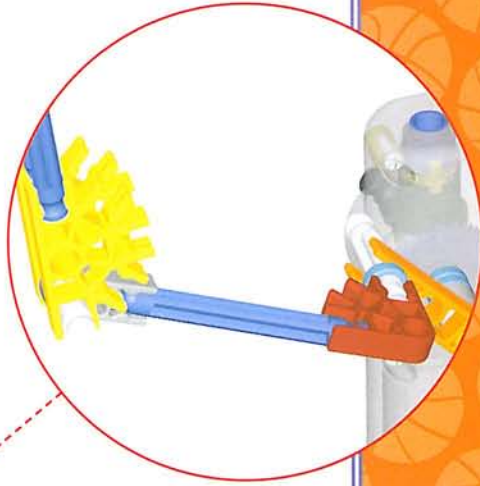
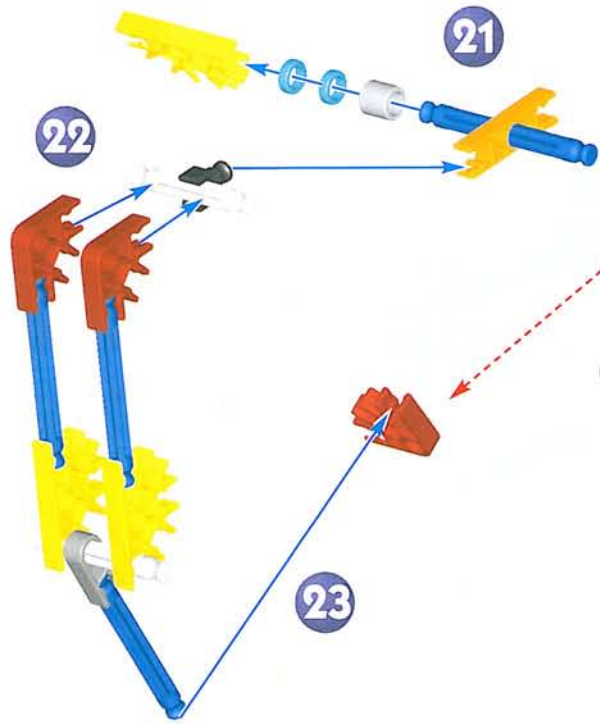

1 - 20



1 - 23



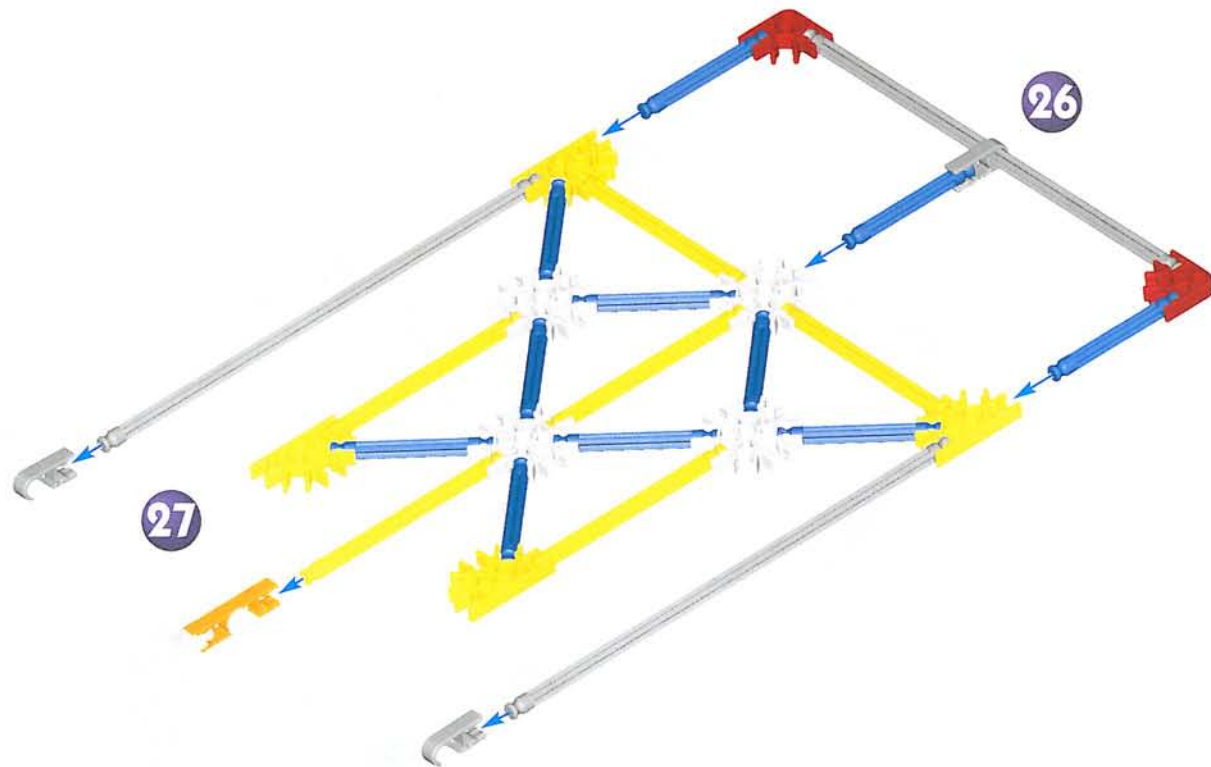

1 - 25



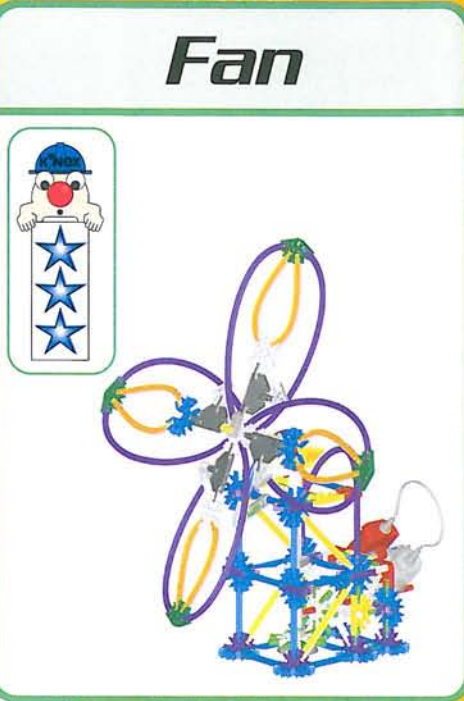
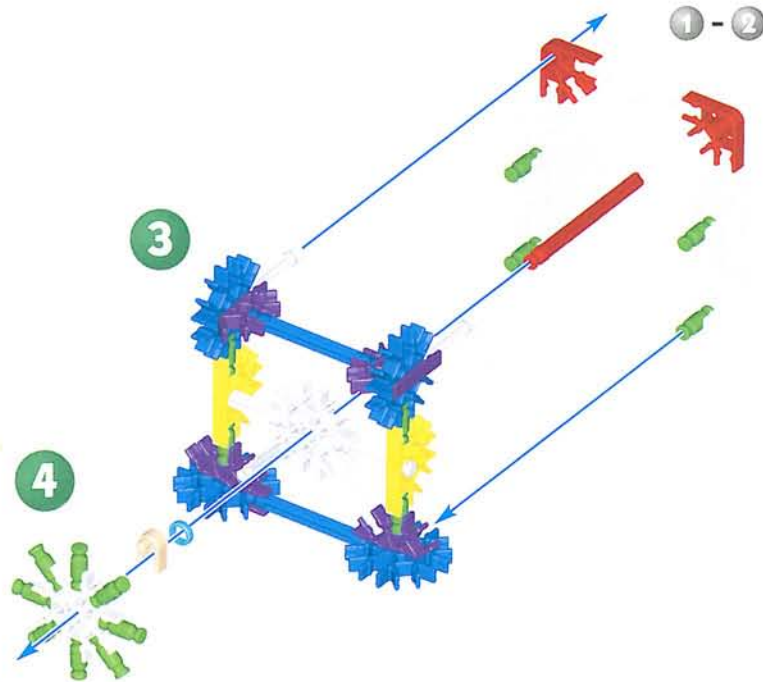
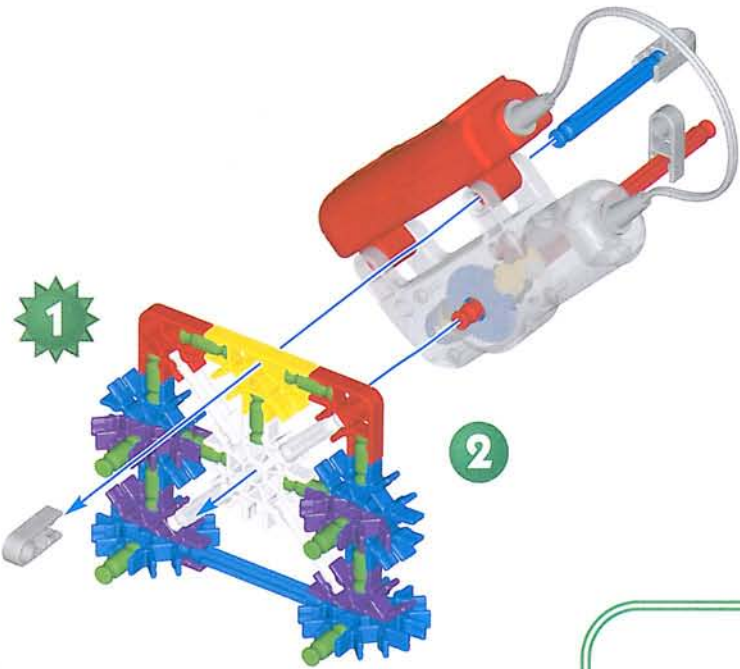

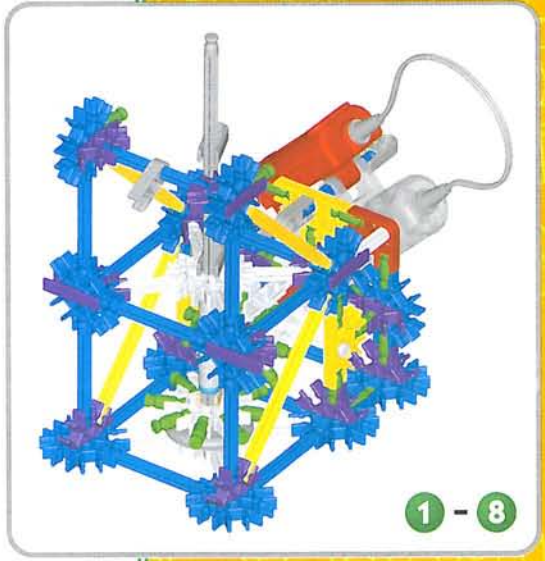
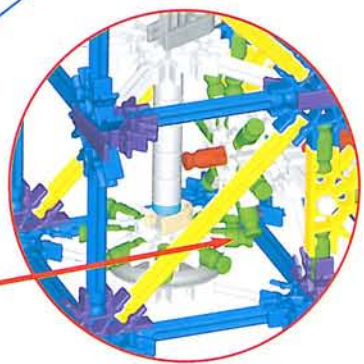
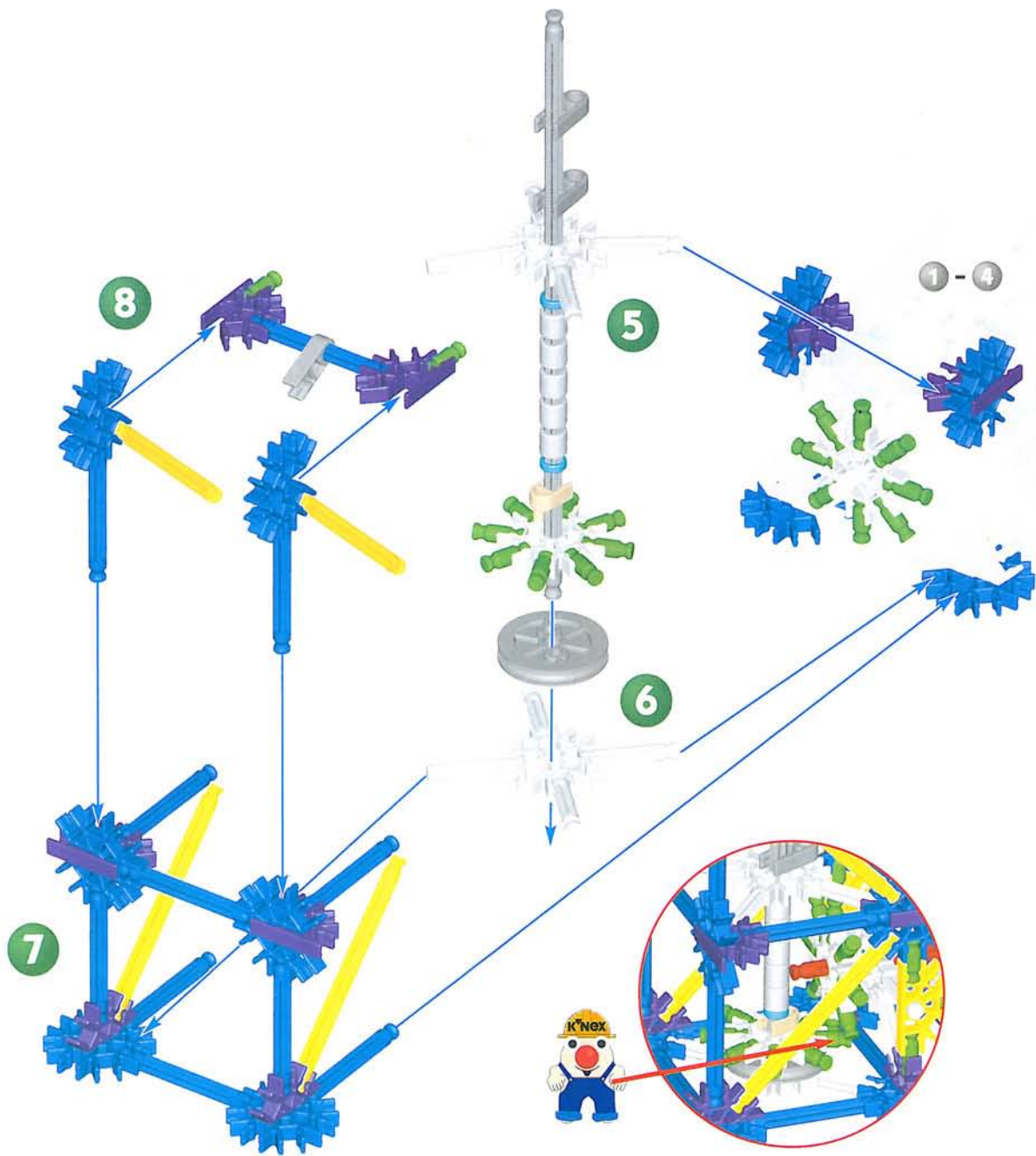

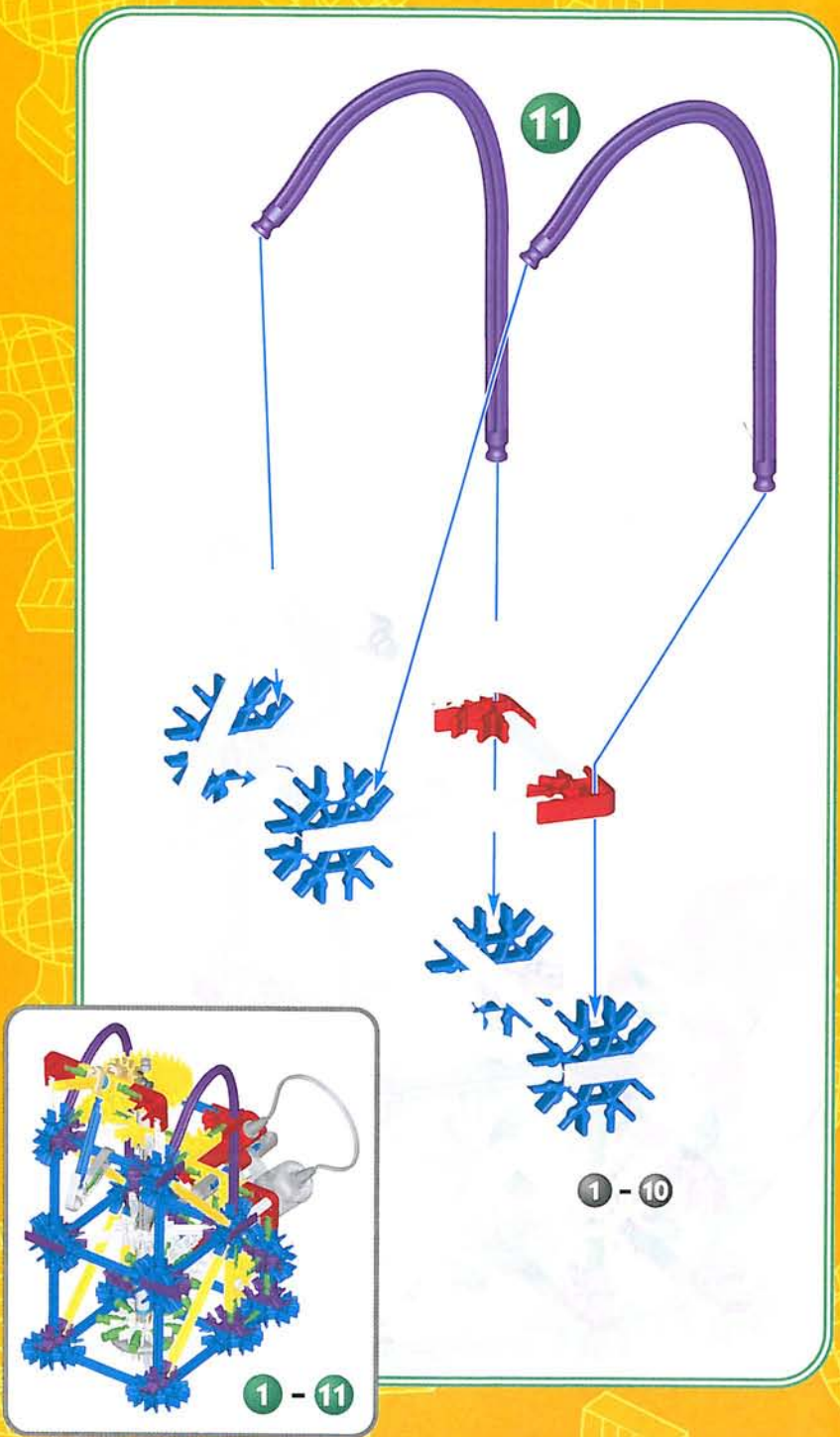
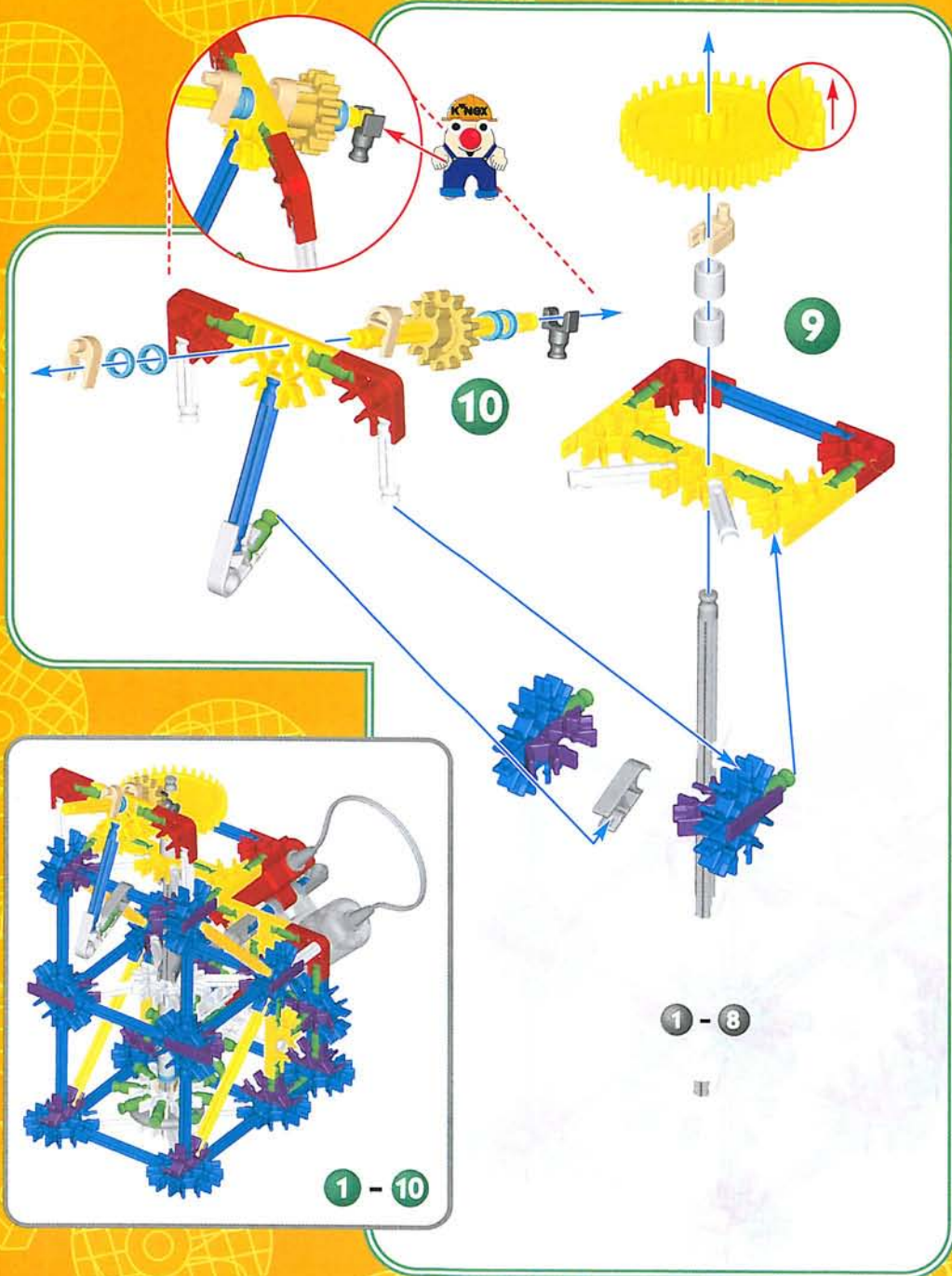



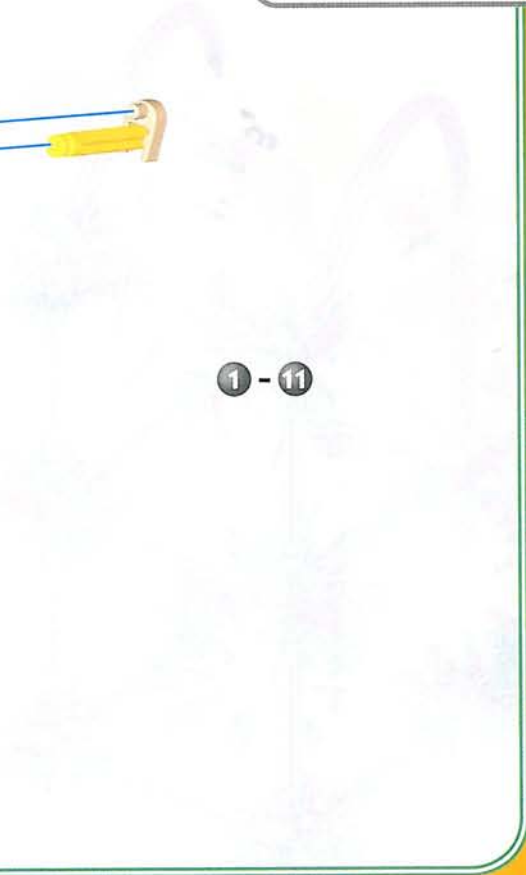
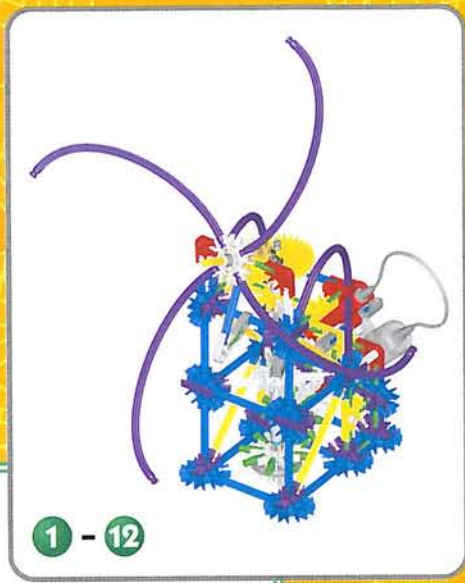
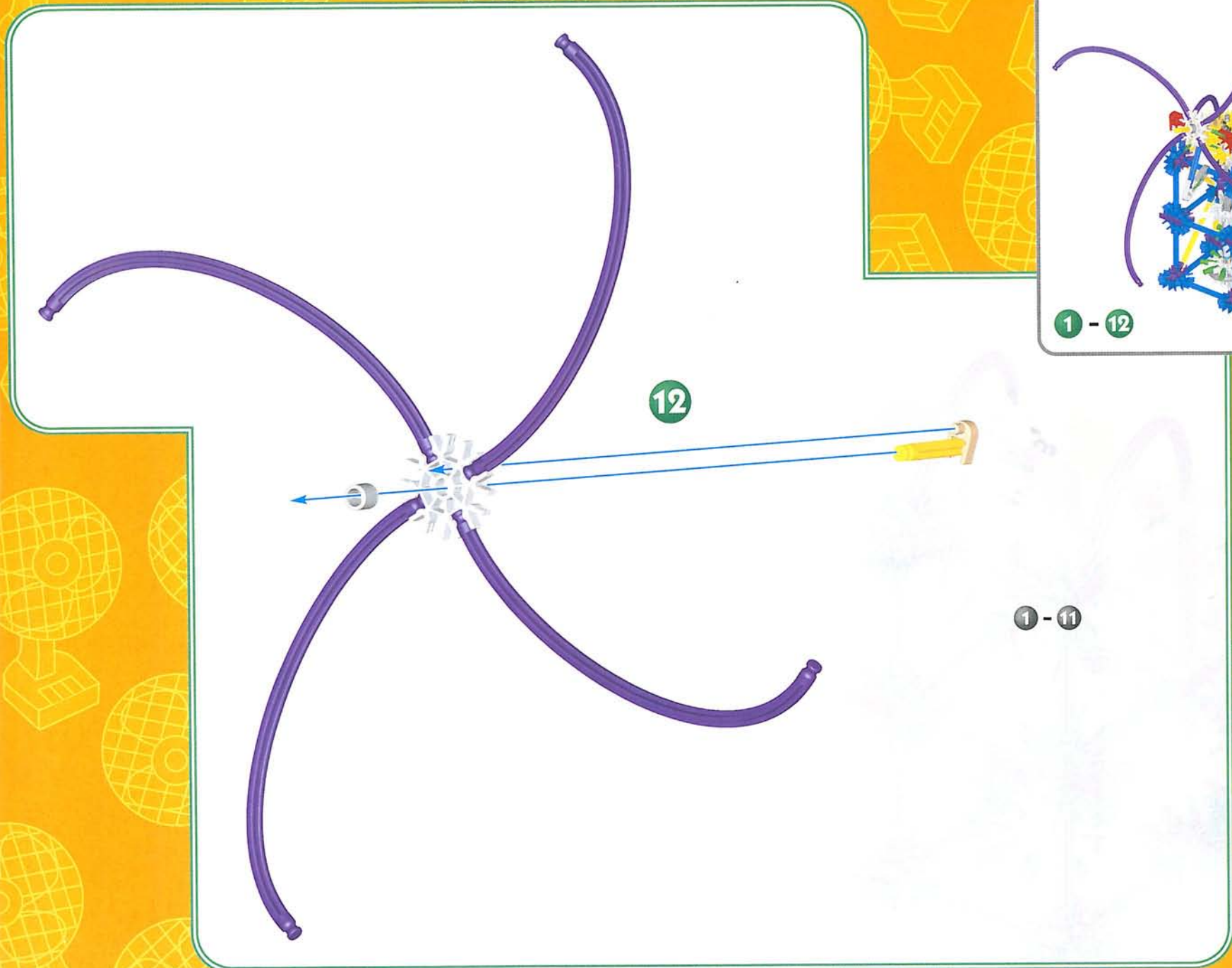

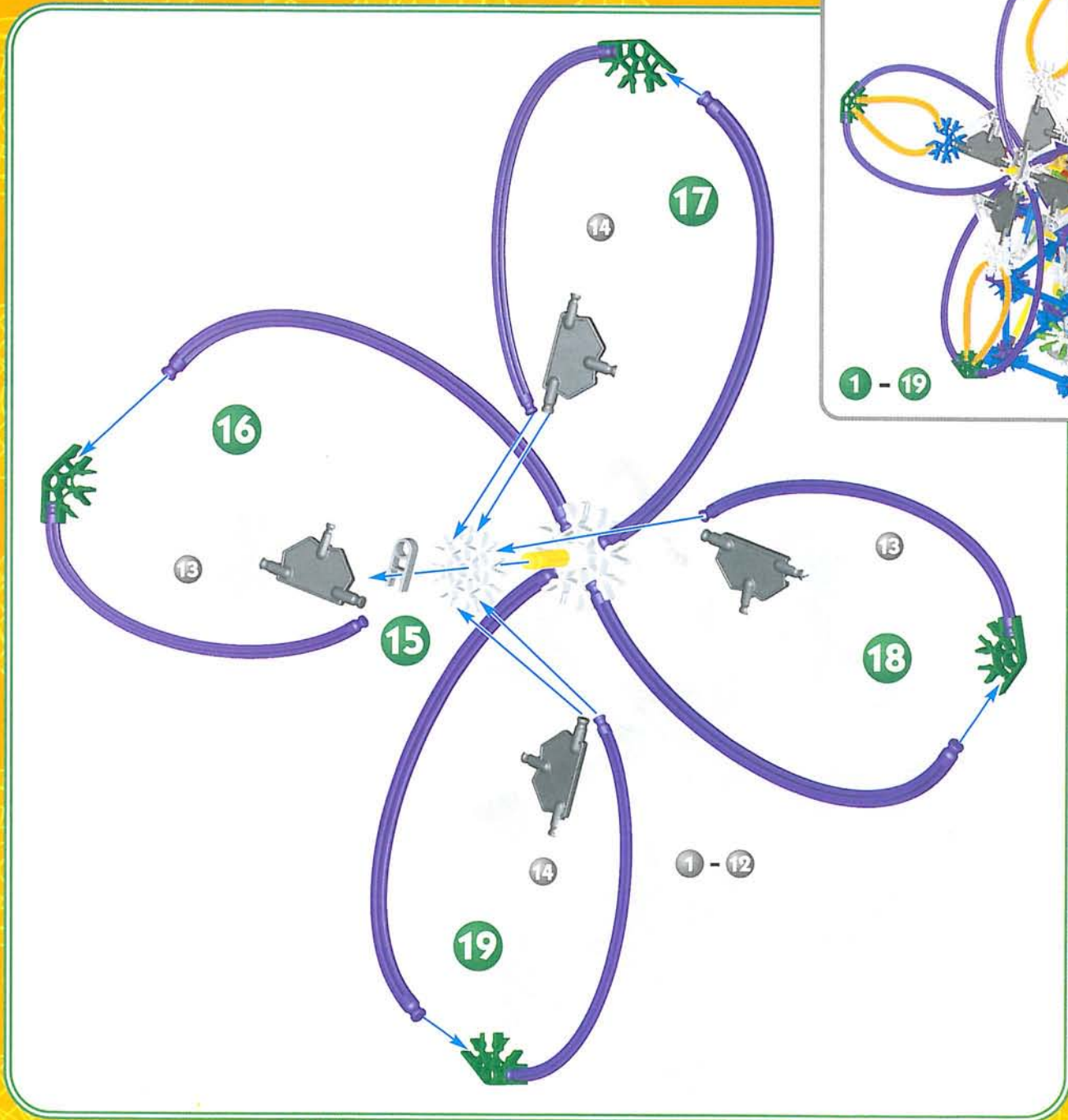
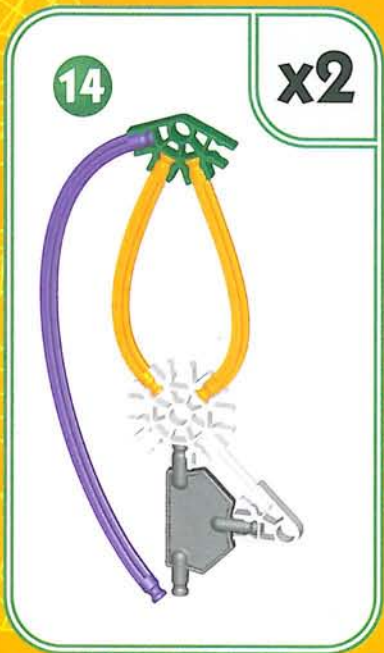
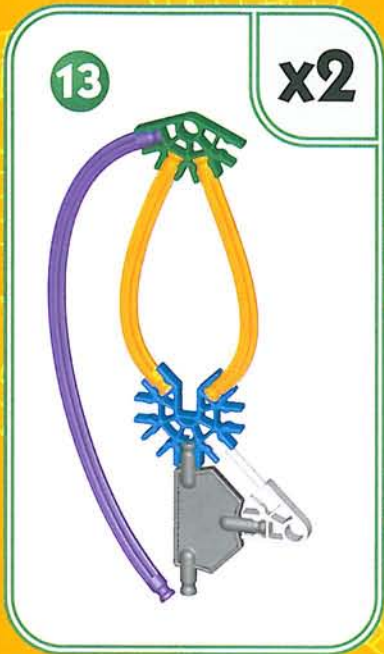

# Helicopter

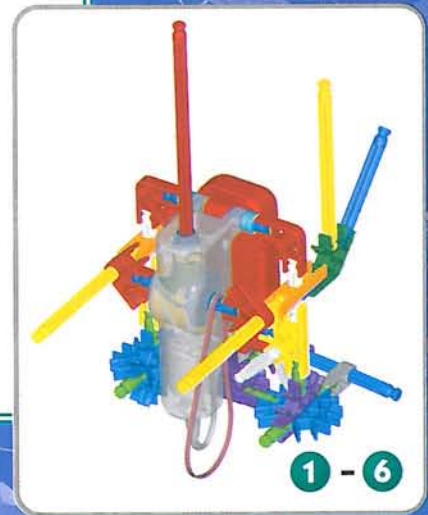
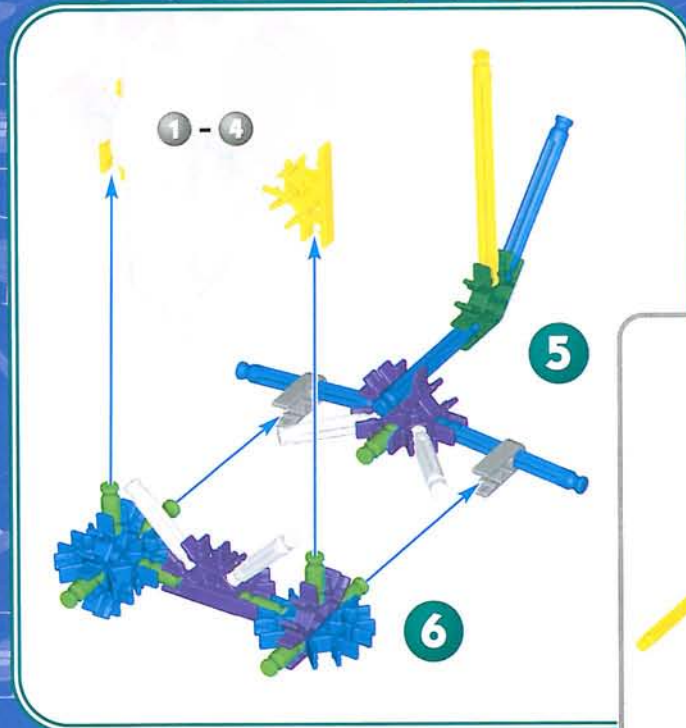
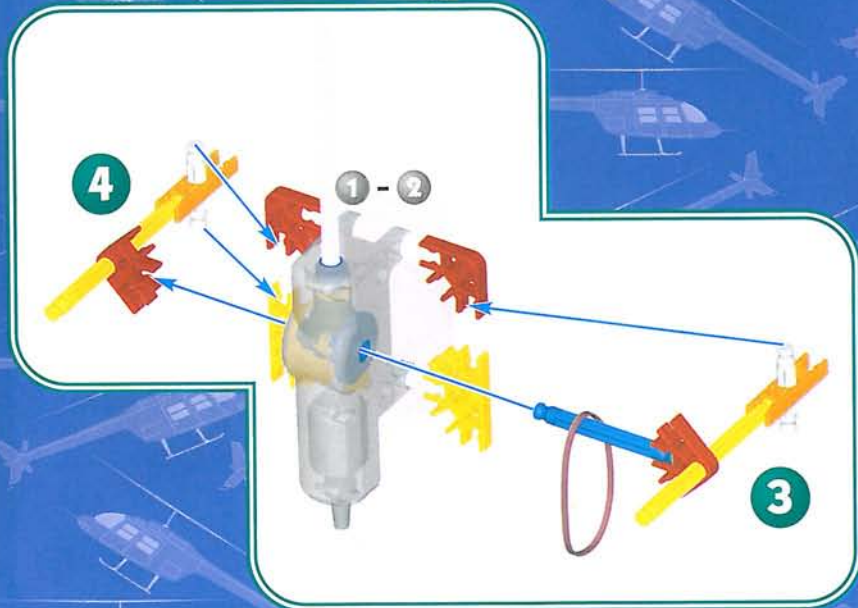
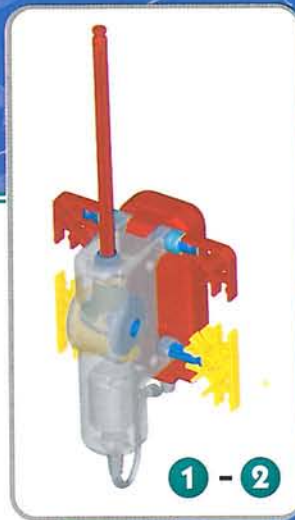
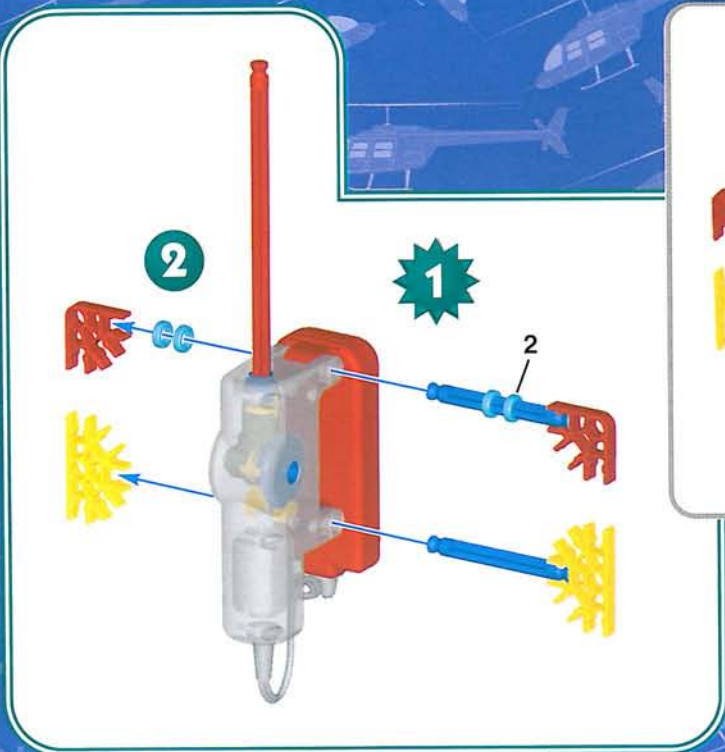
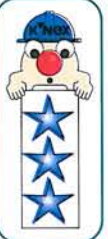

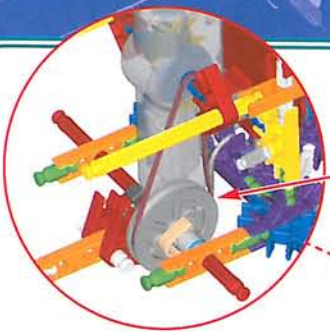

1 - 6

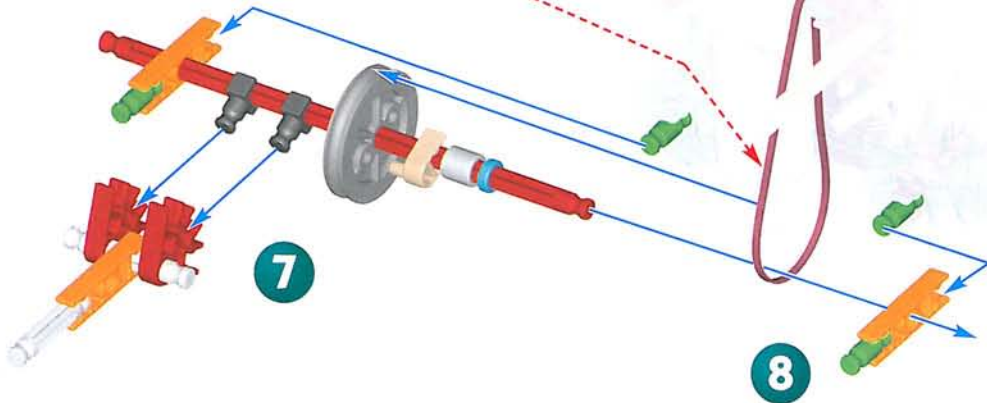

7

8

1 - 8

9

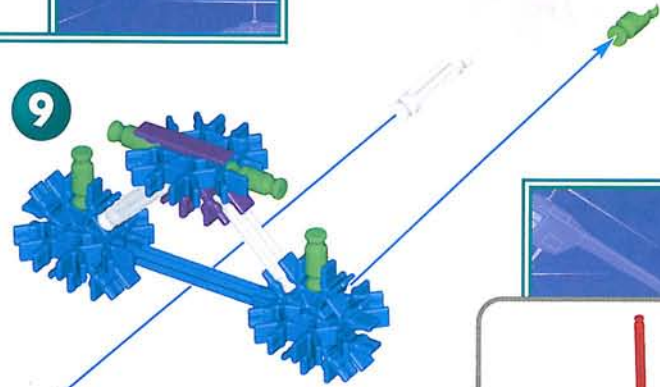

10

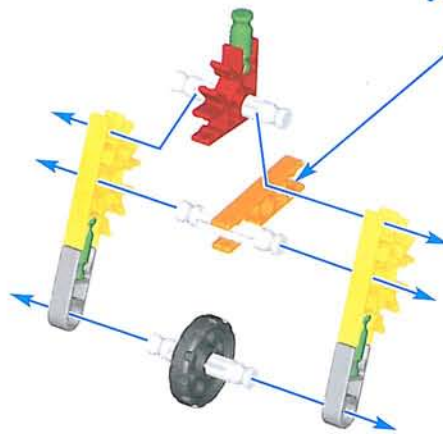

1 - 8

1 - 10

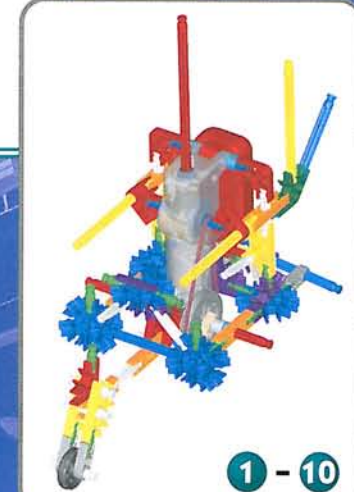

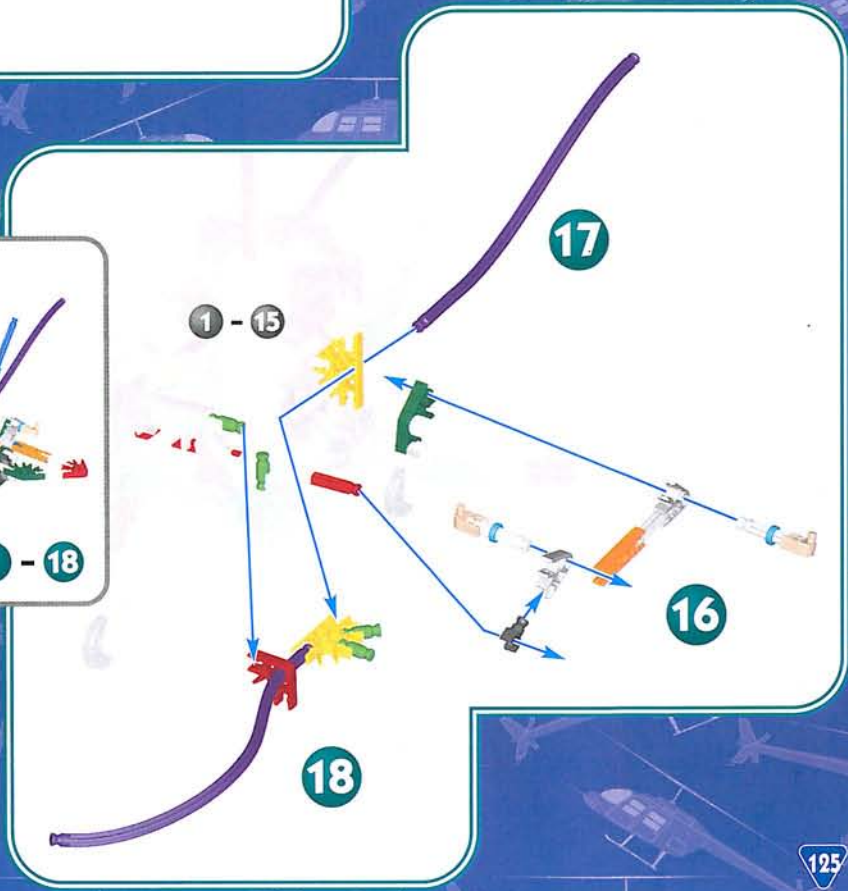
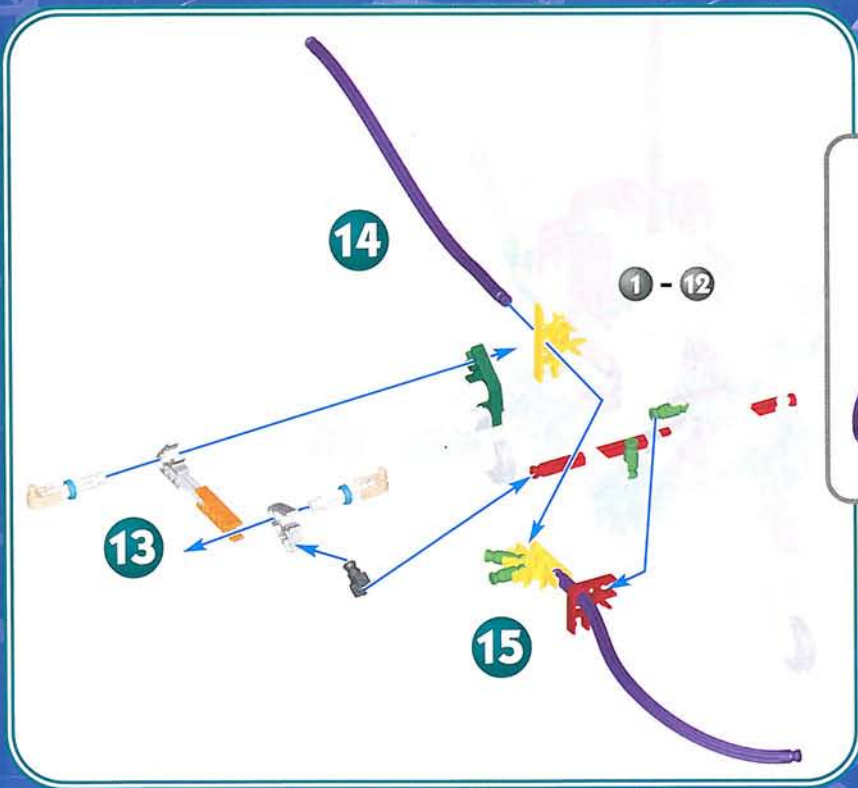
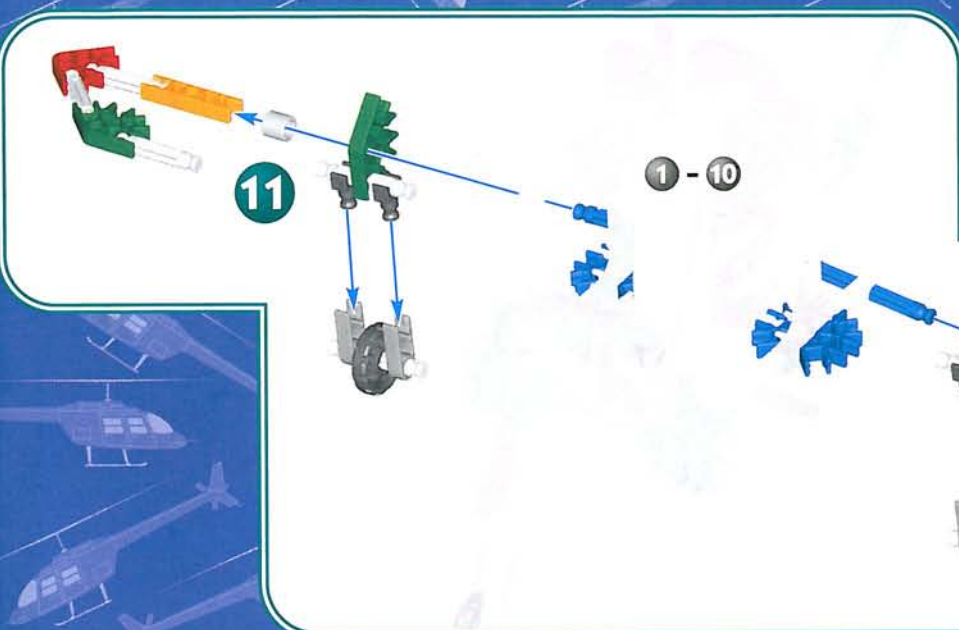

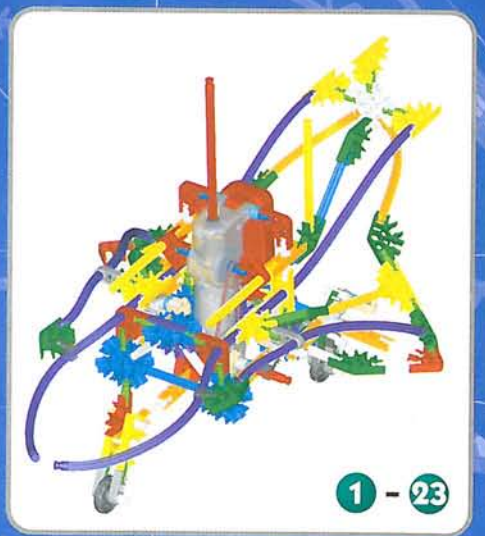
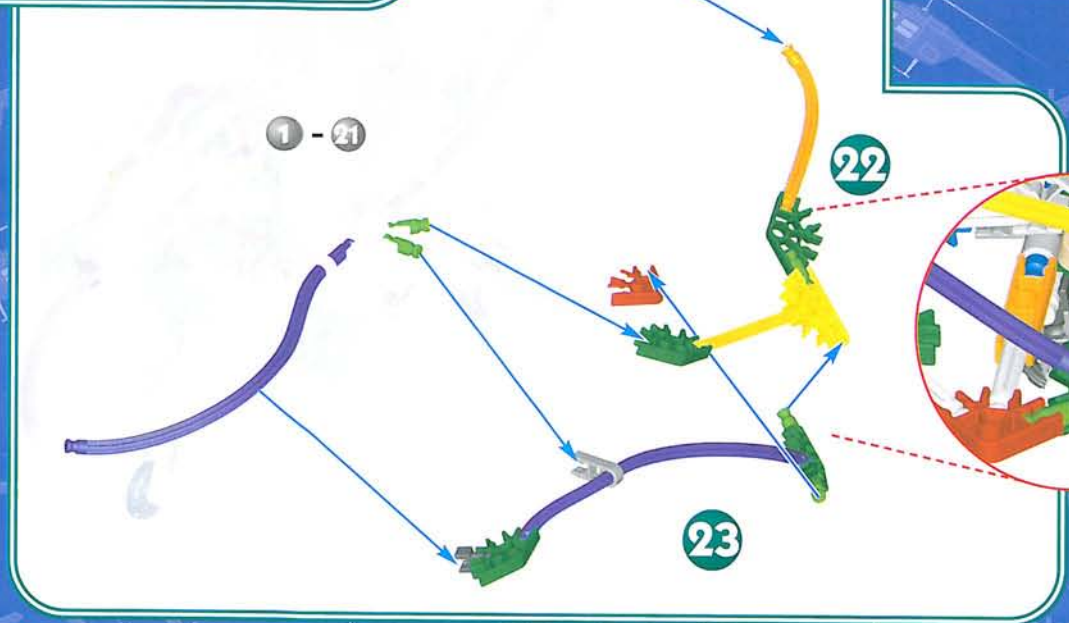
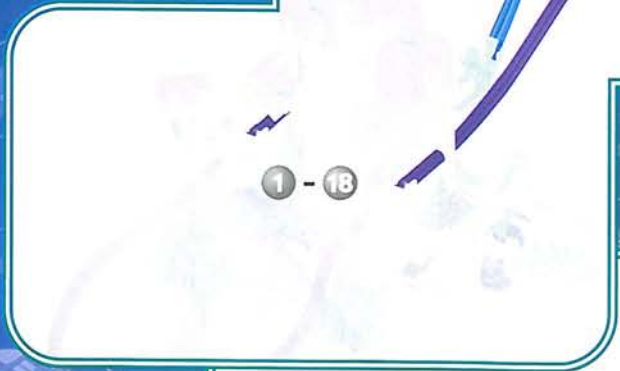
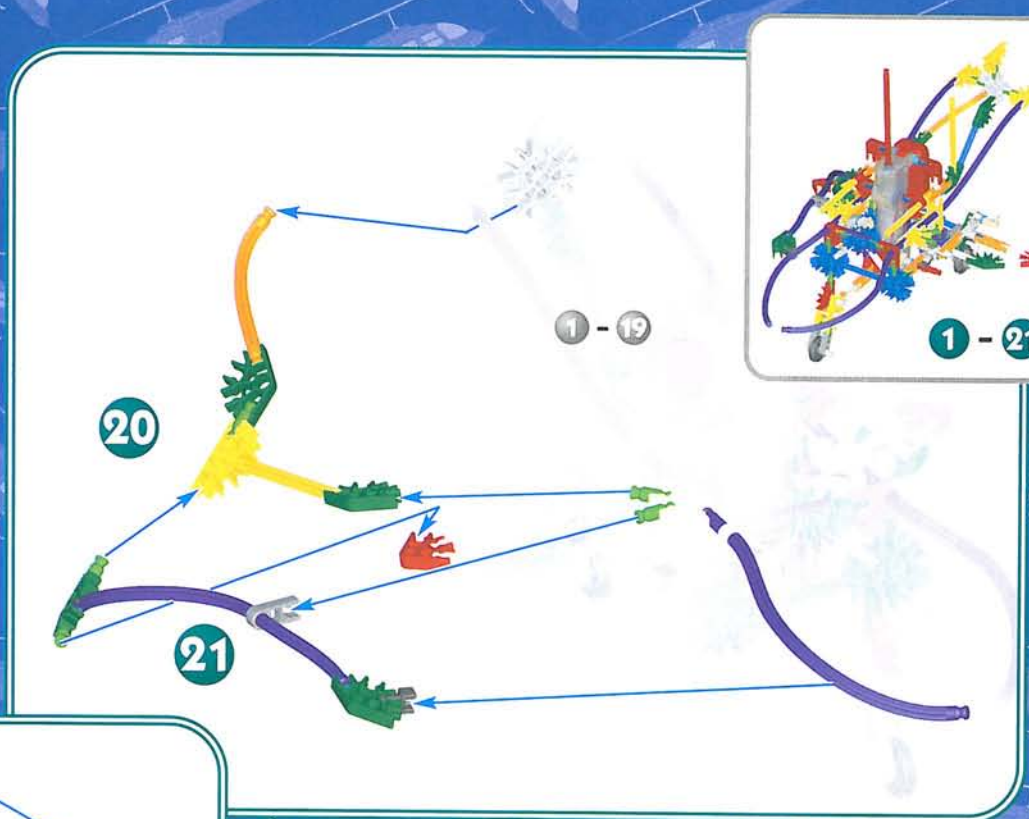
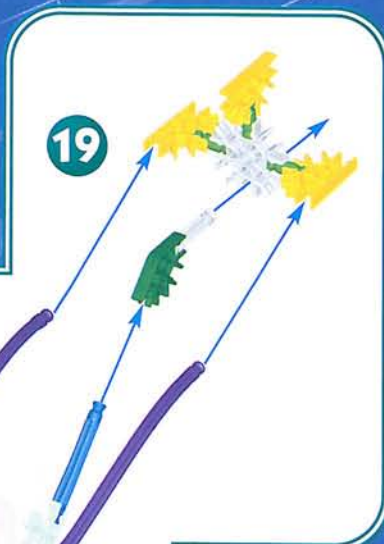
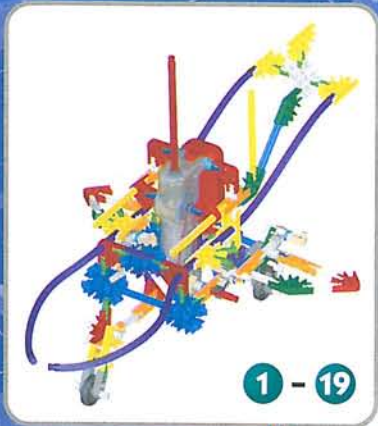

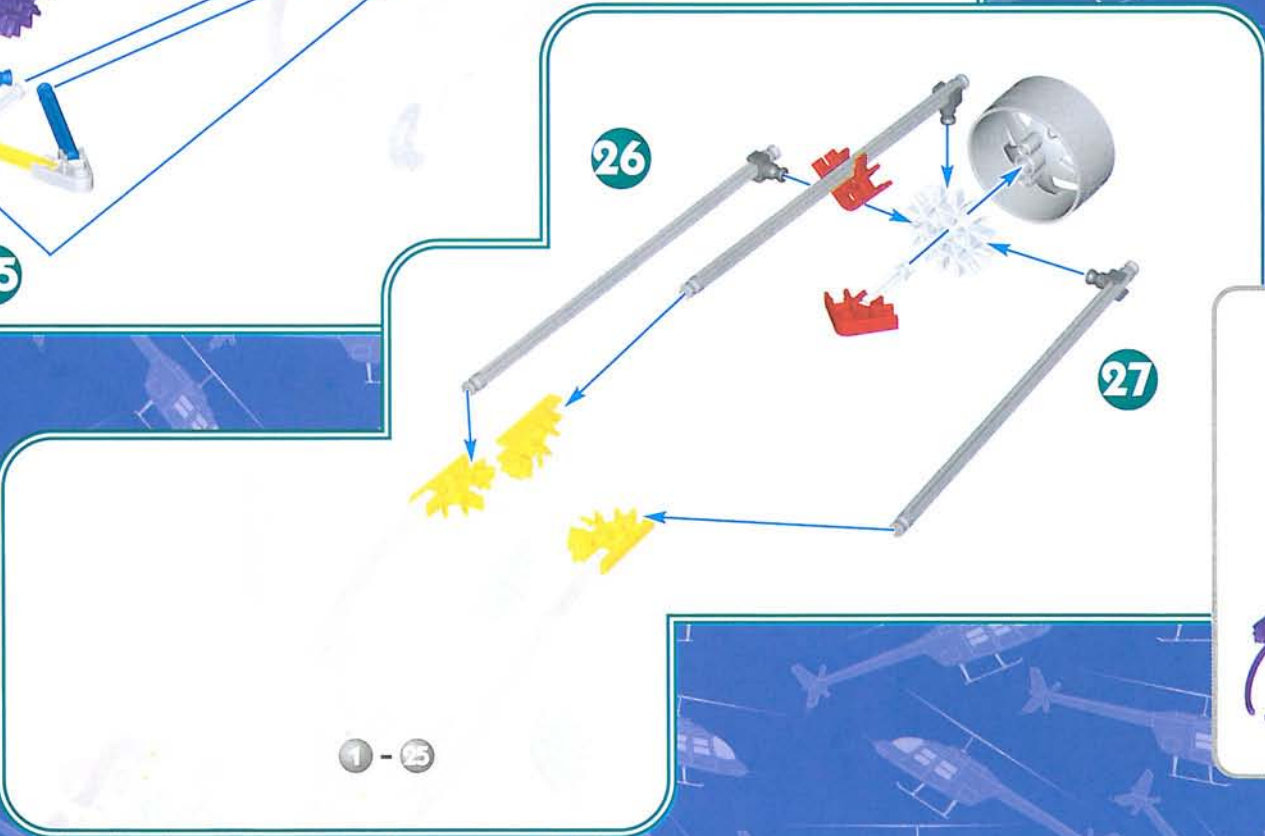
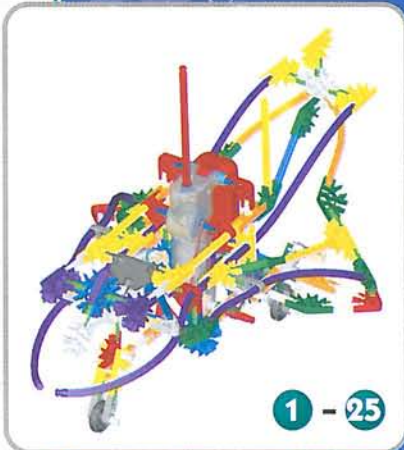
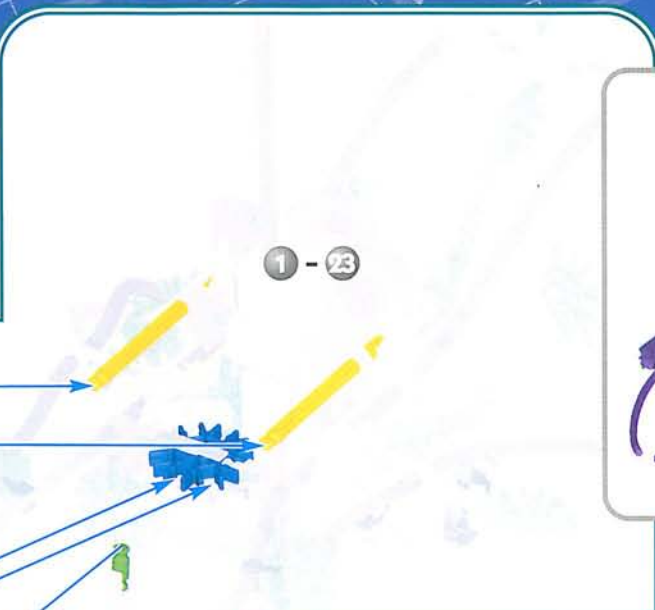
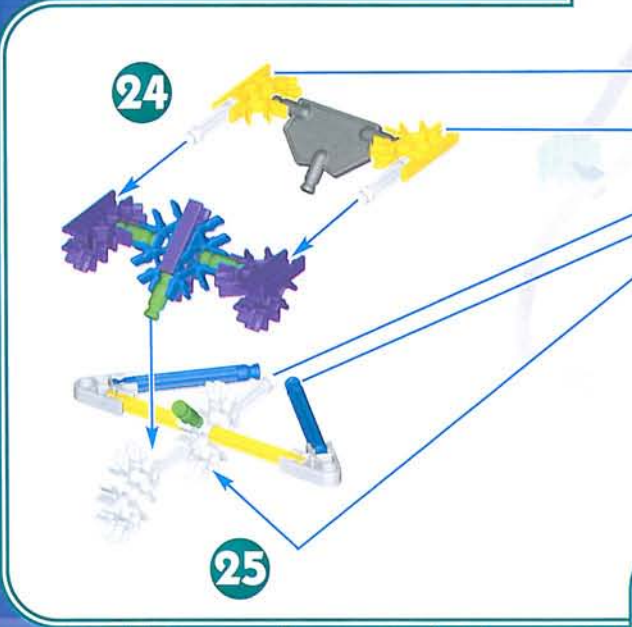

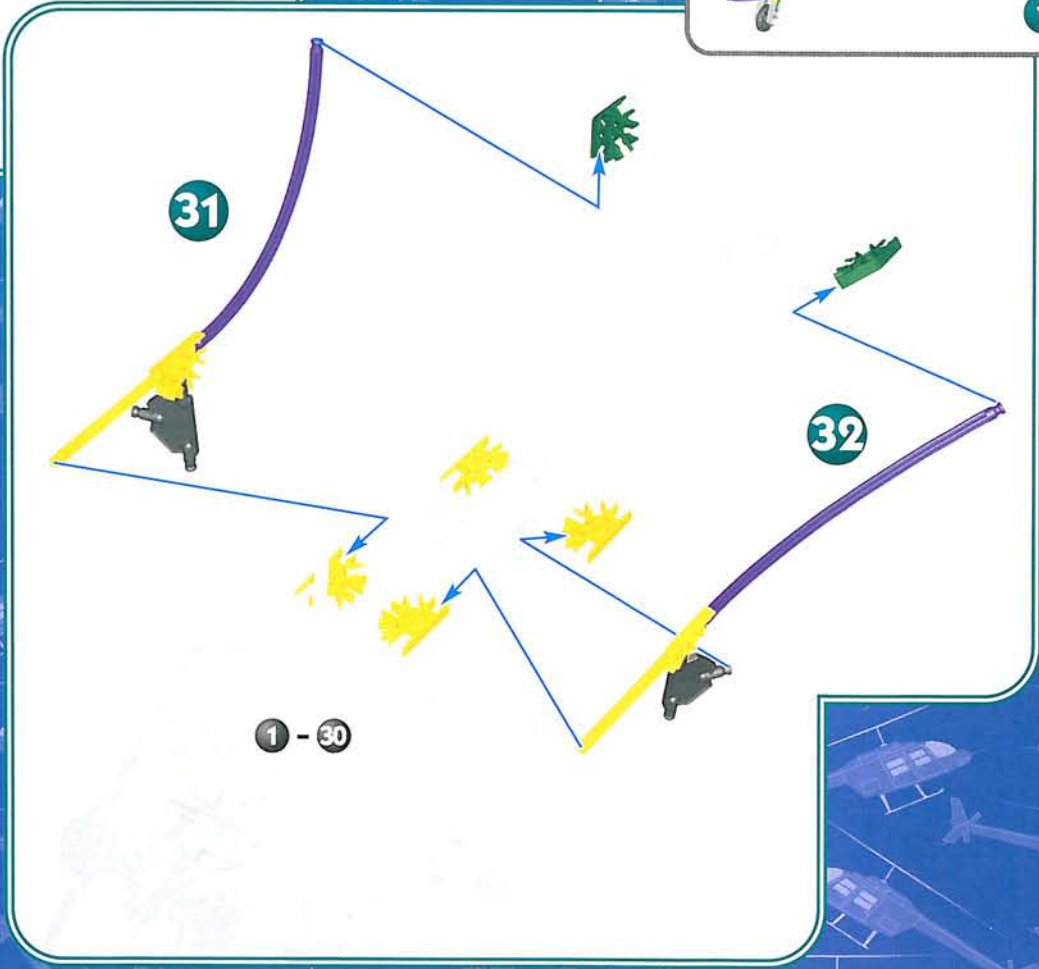
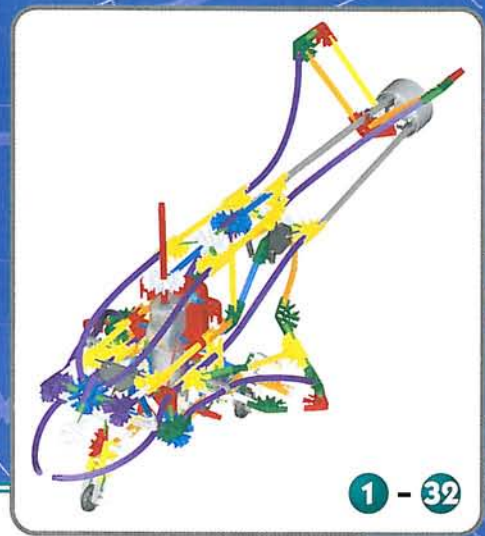
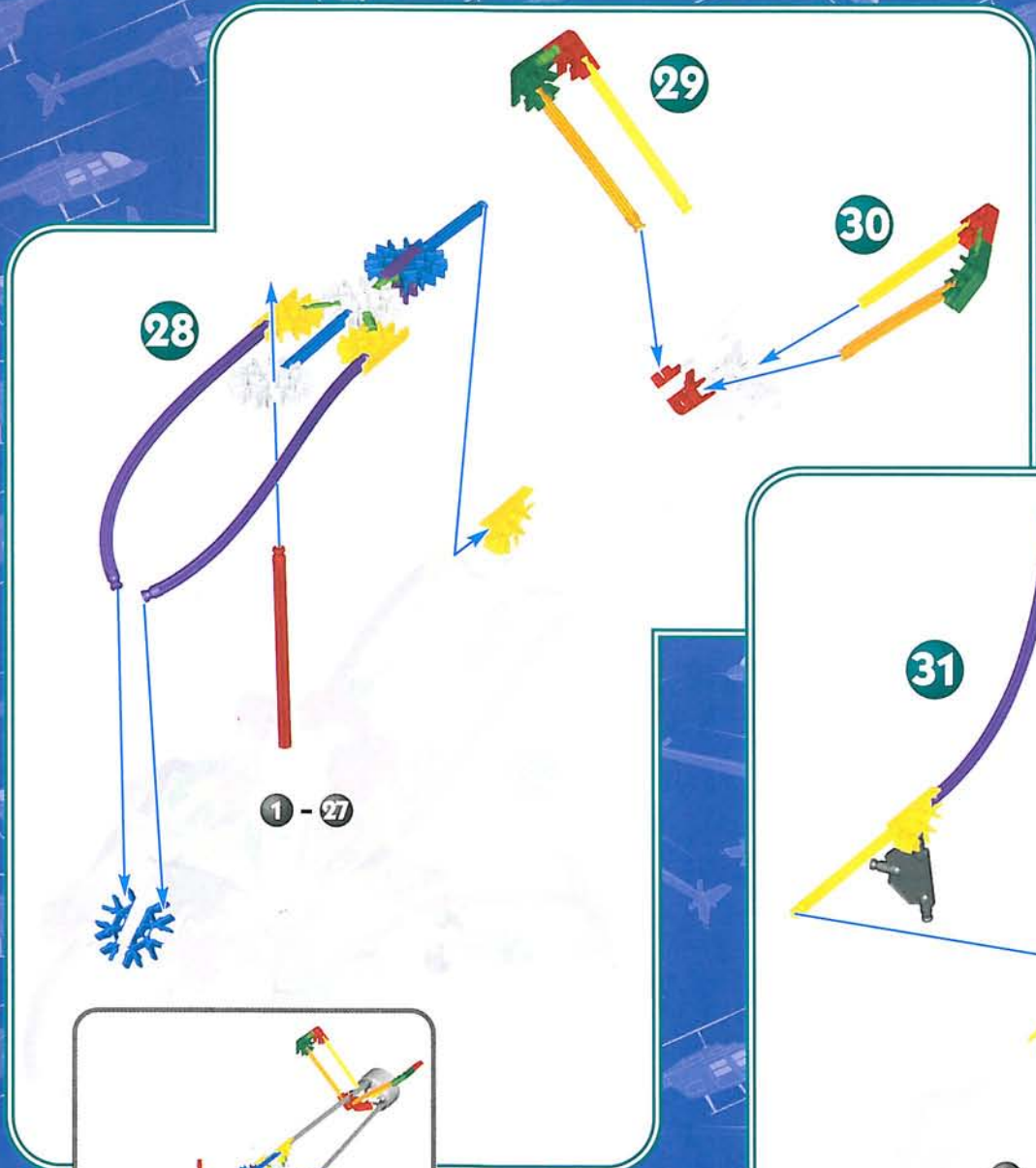



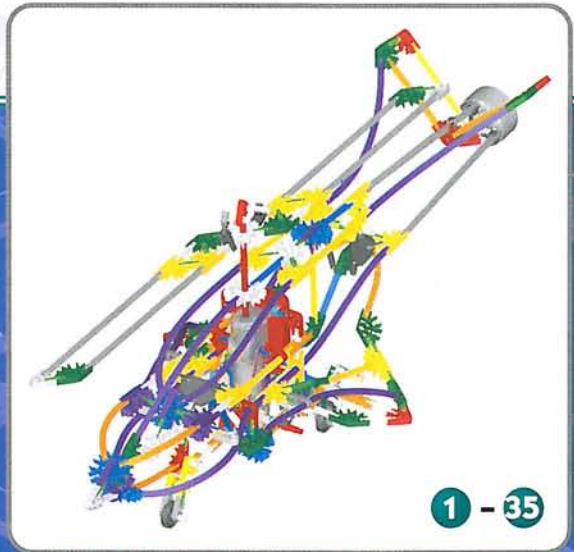
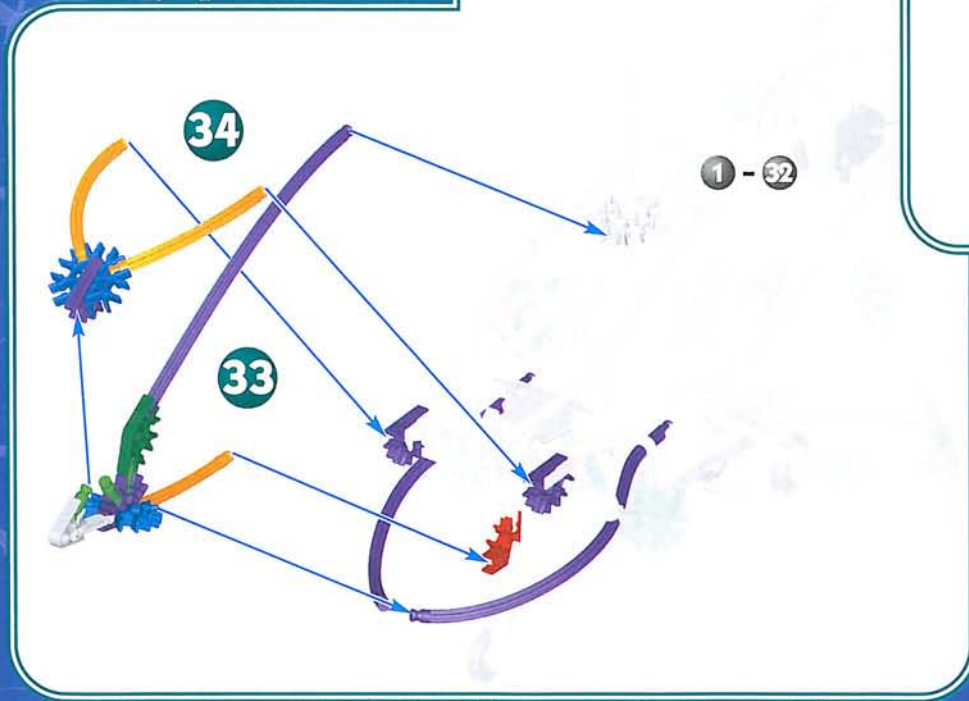
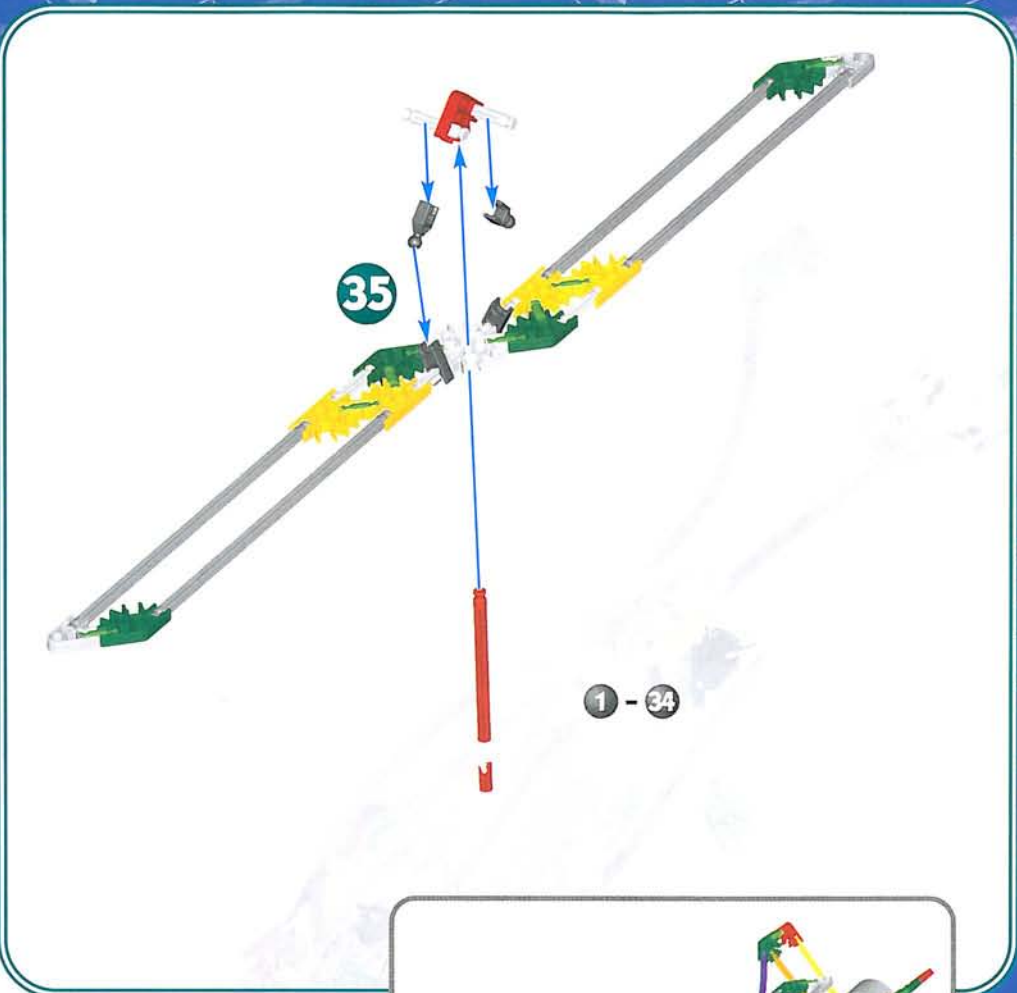
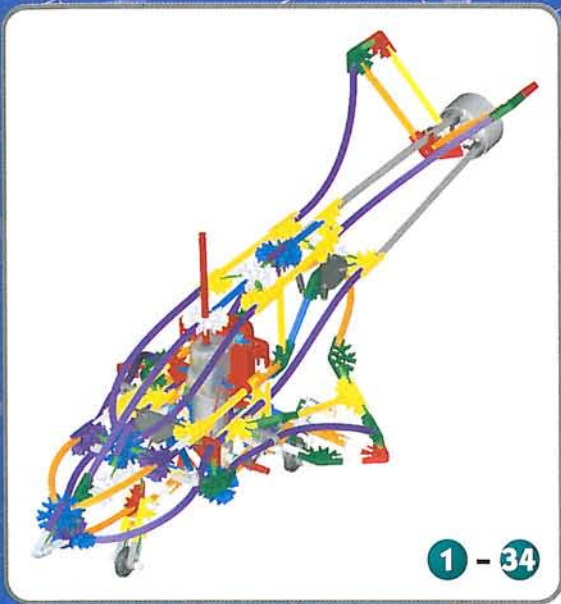



# Sea Turtle

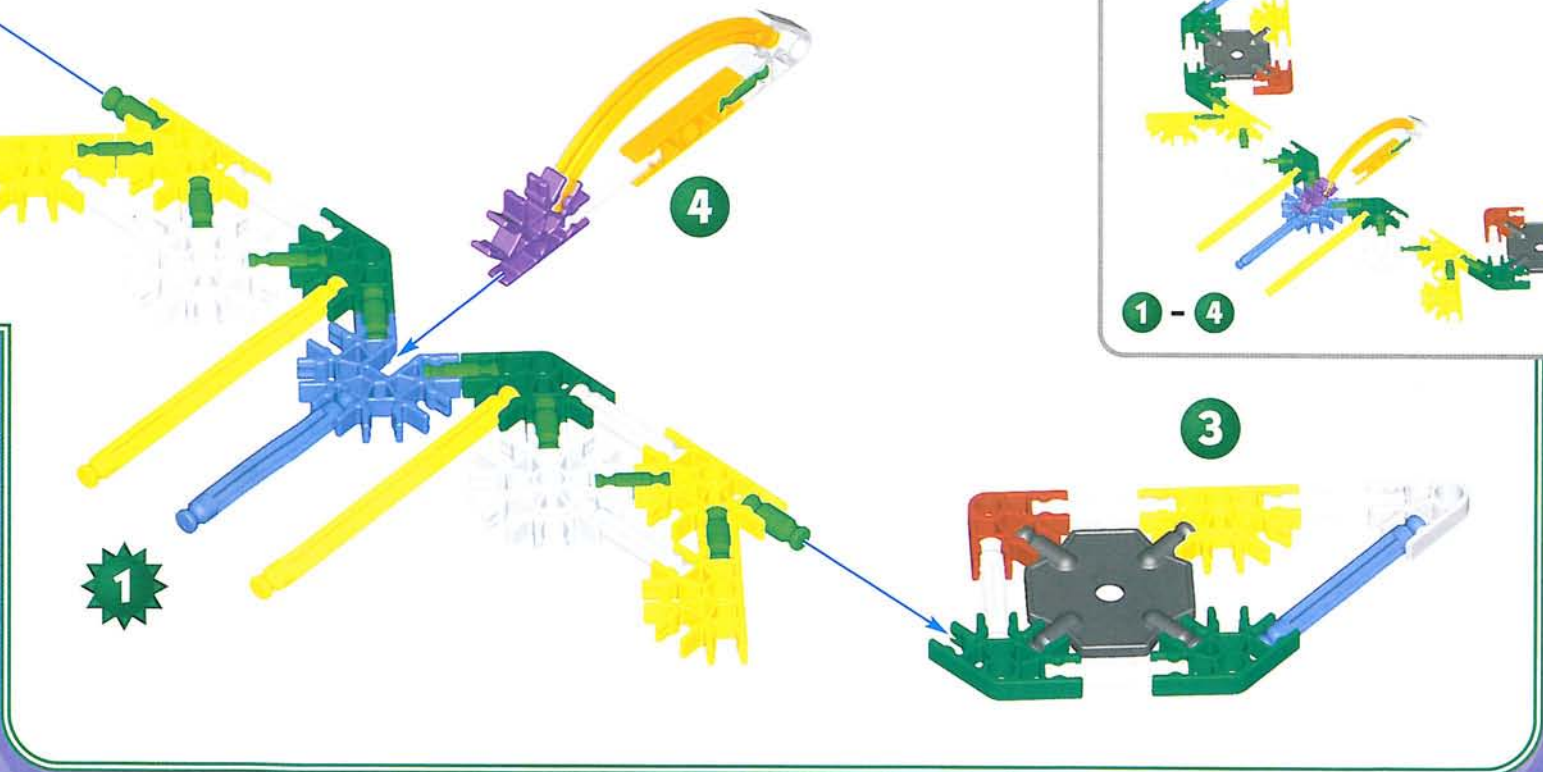
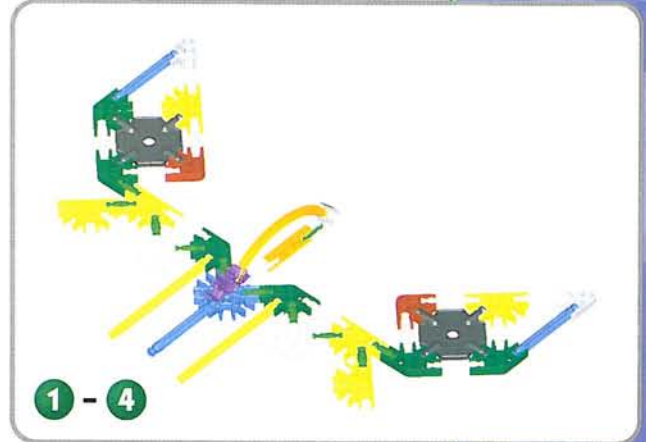
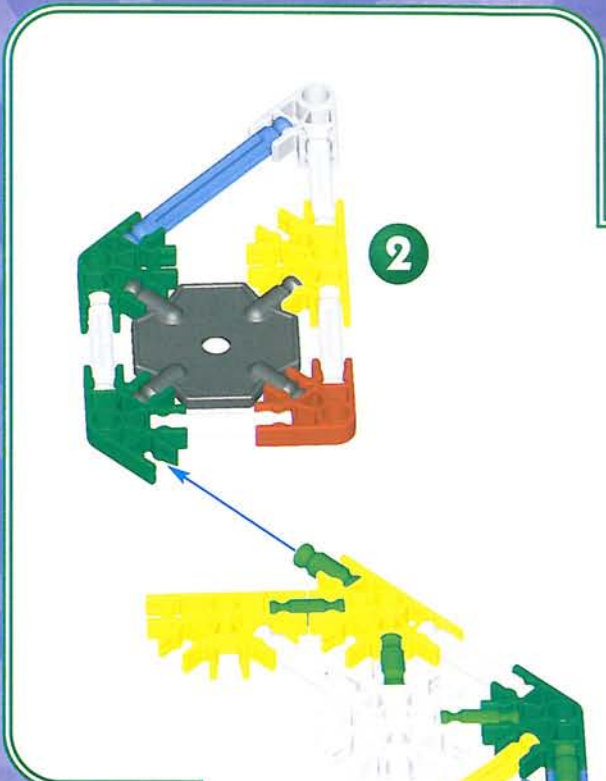
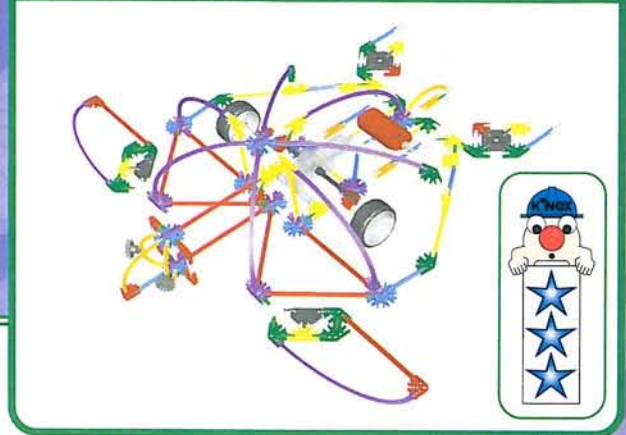

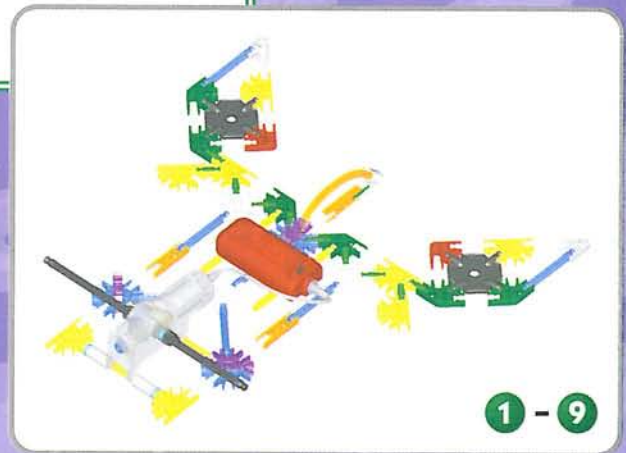
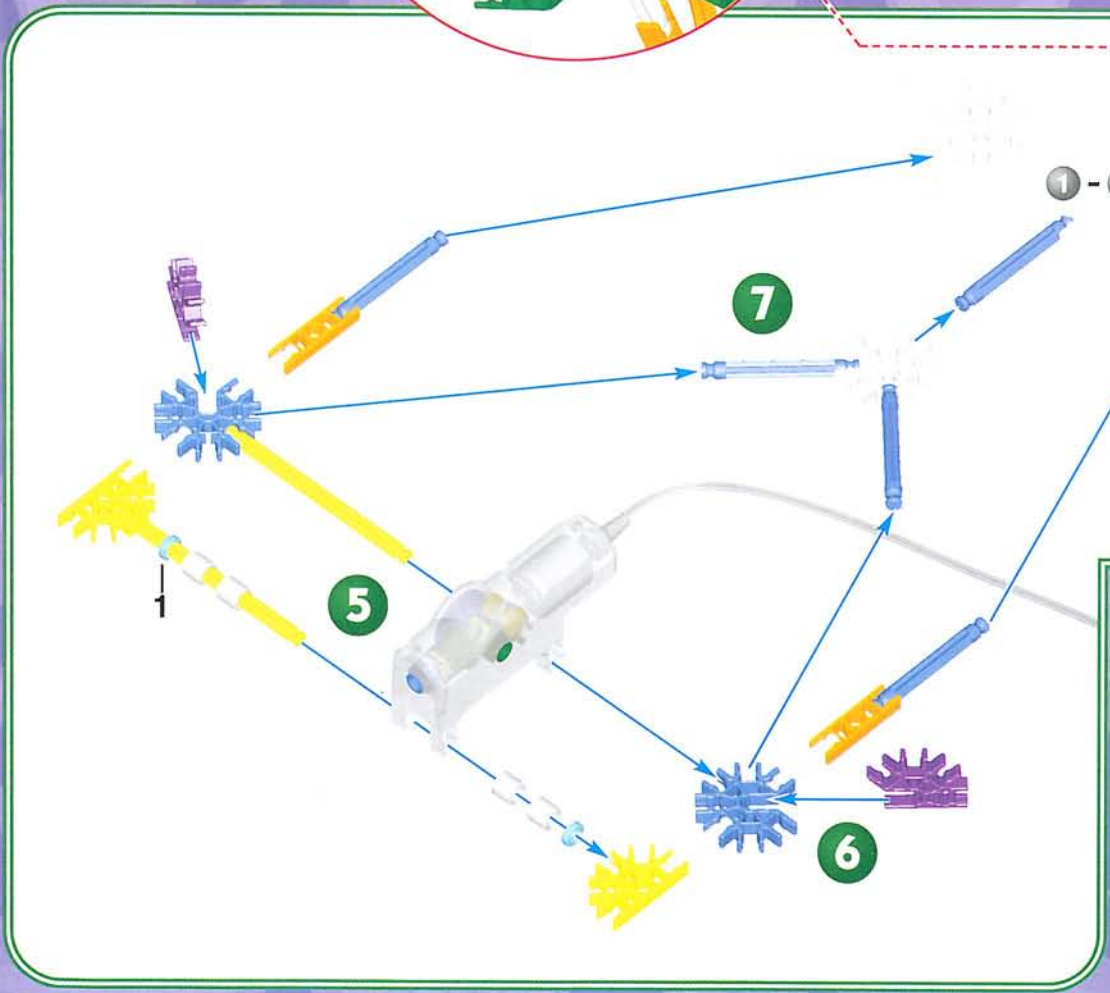
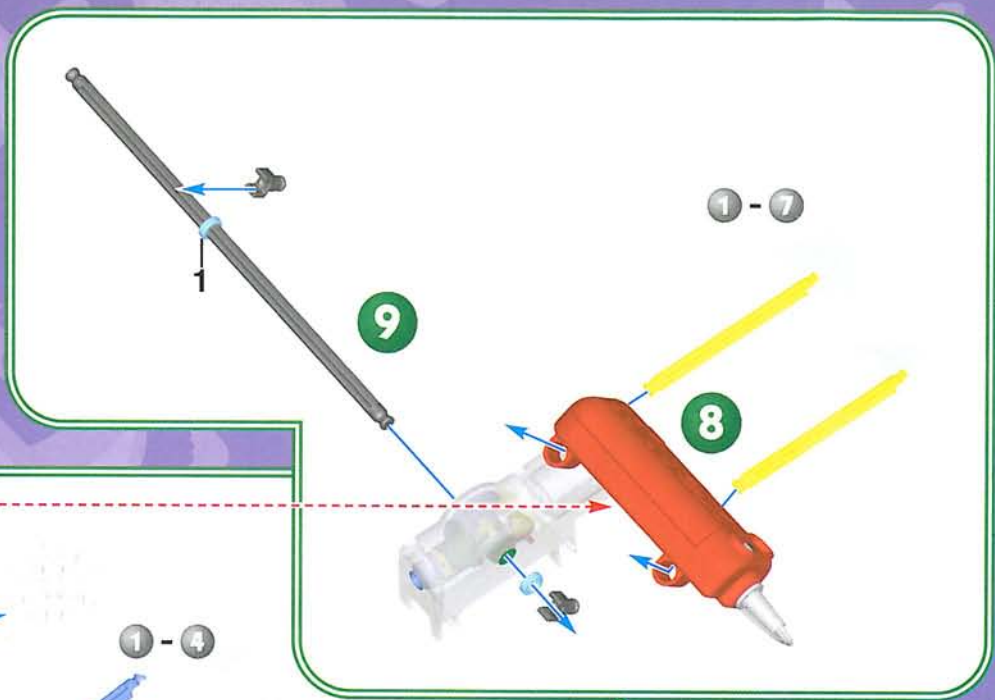
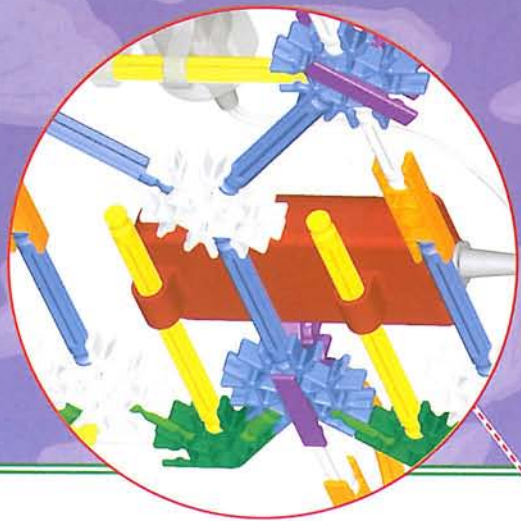

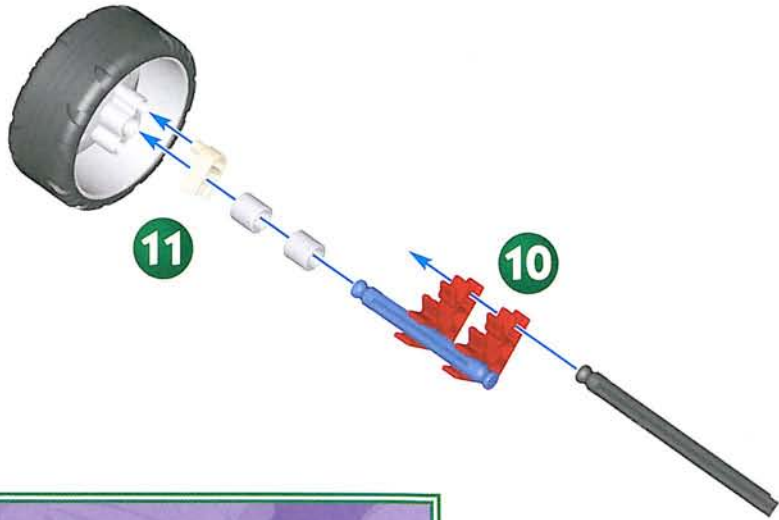

11

10

1 - 9

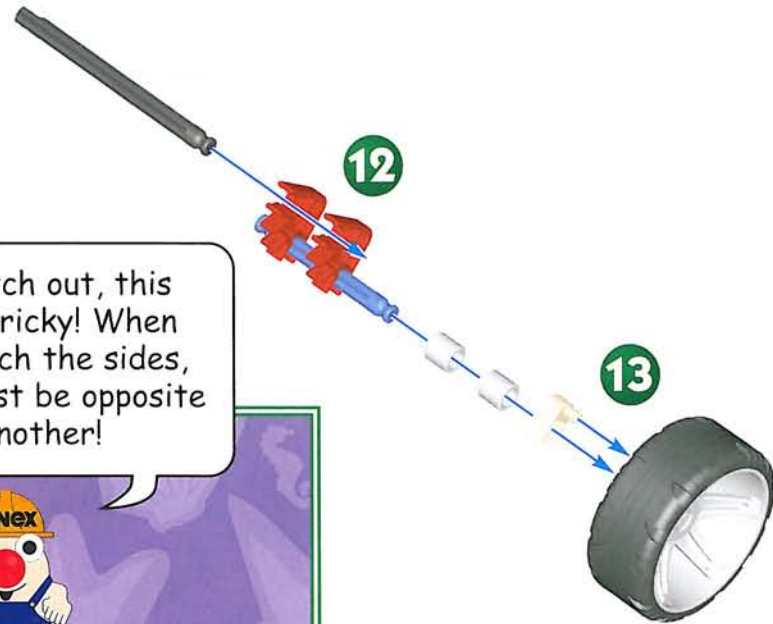

12

13

Now watch out, this step is tricky! When you attach the sides, they must be opposite of one another!



1 - 13

1 - 13

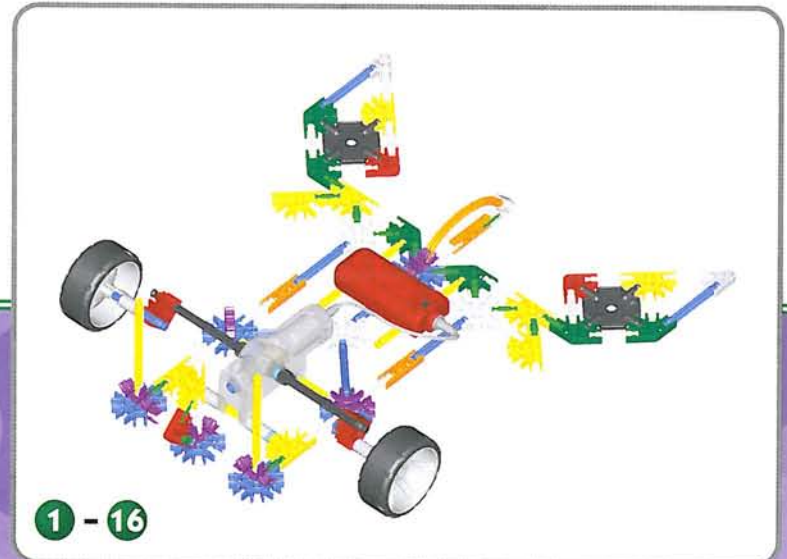
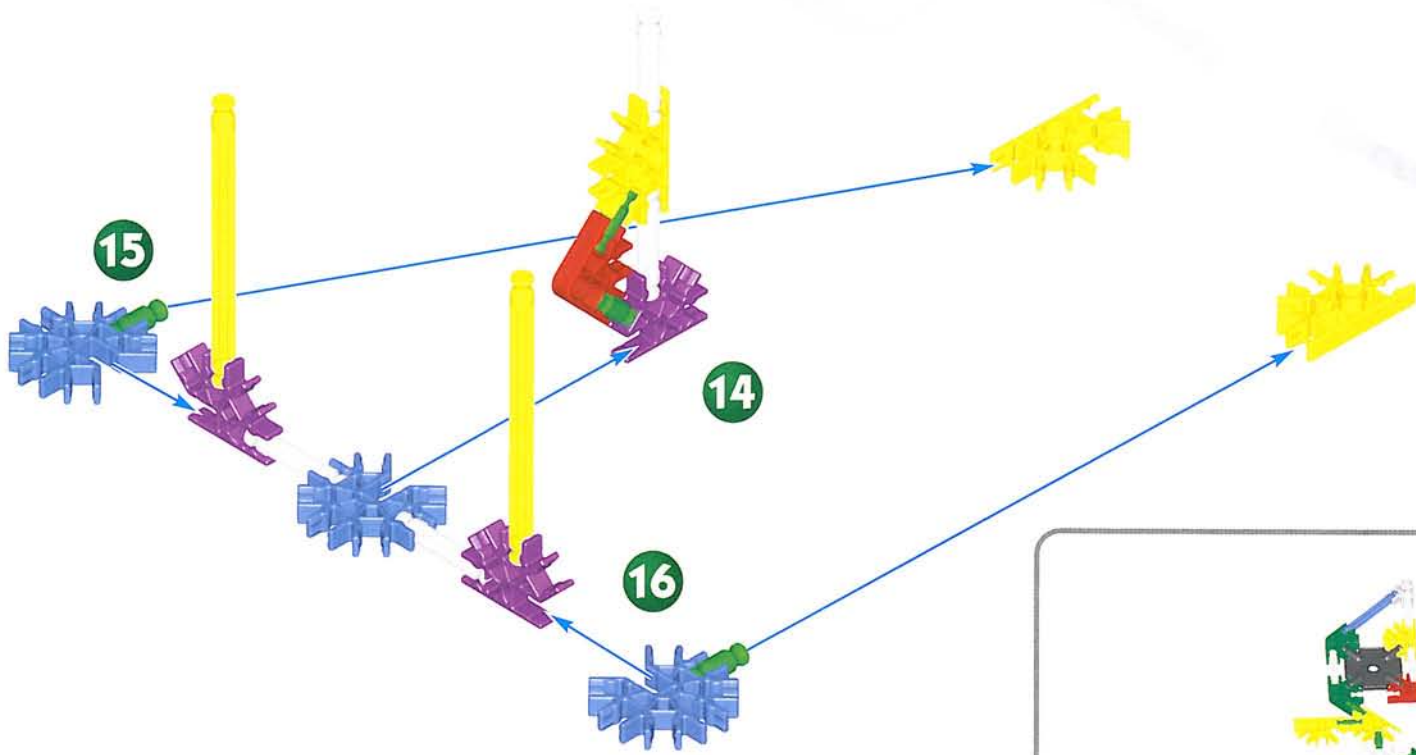

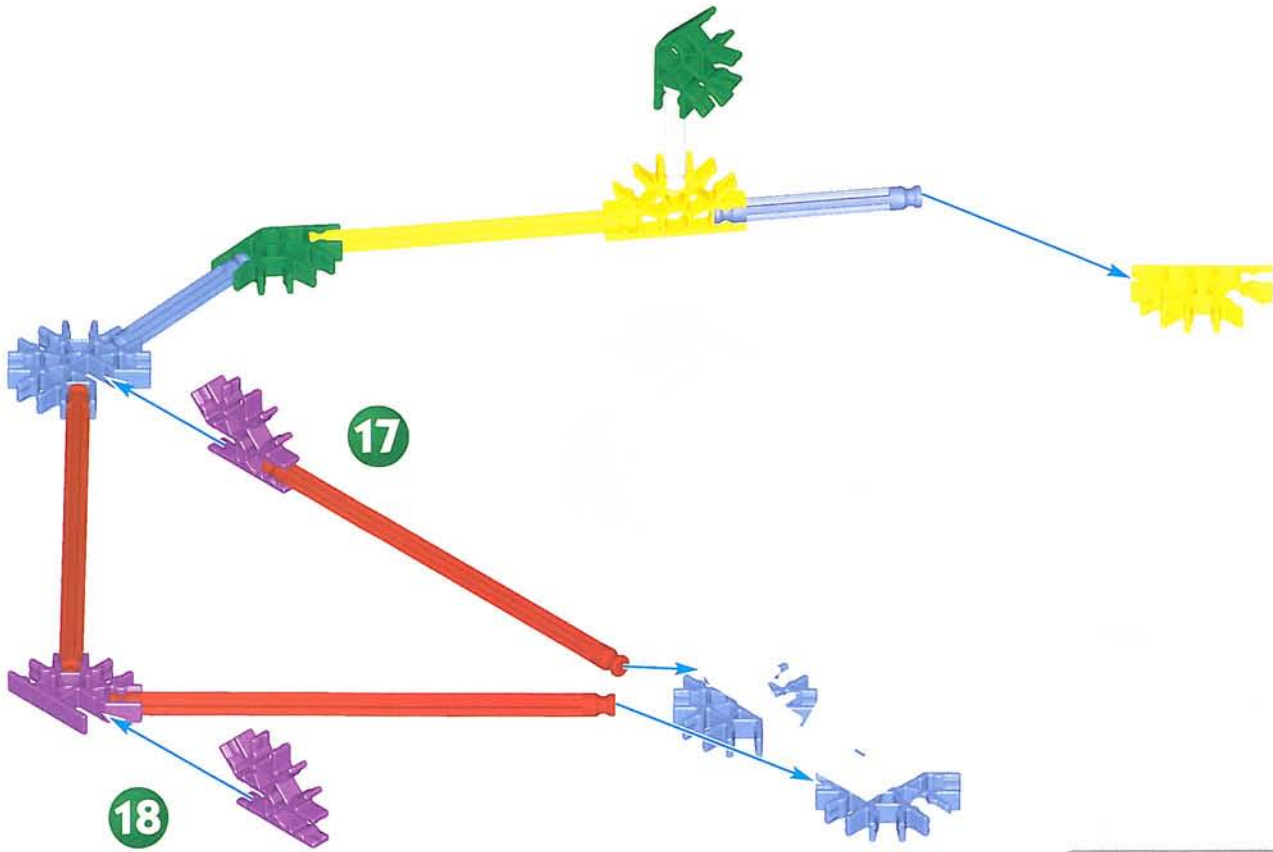

1 - 16

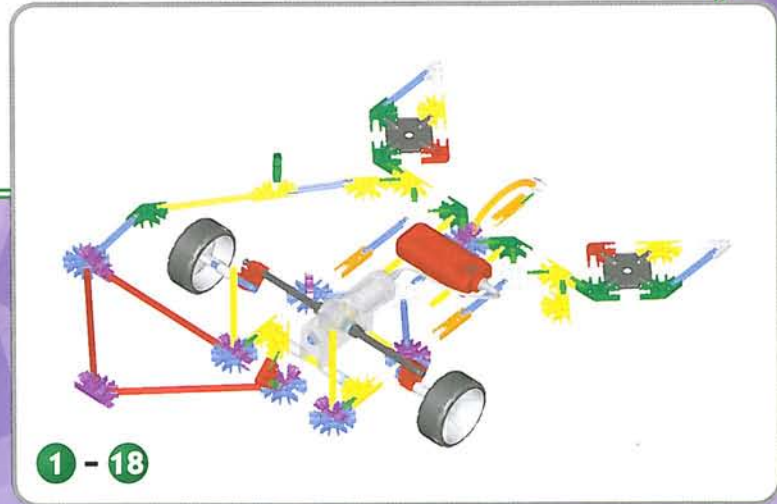



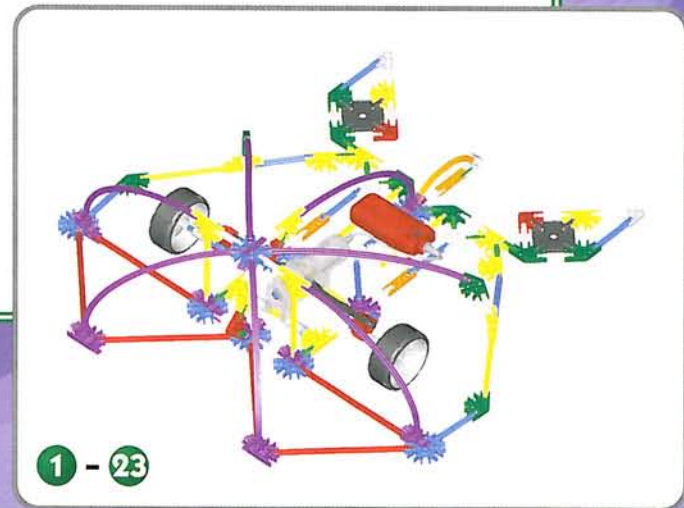
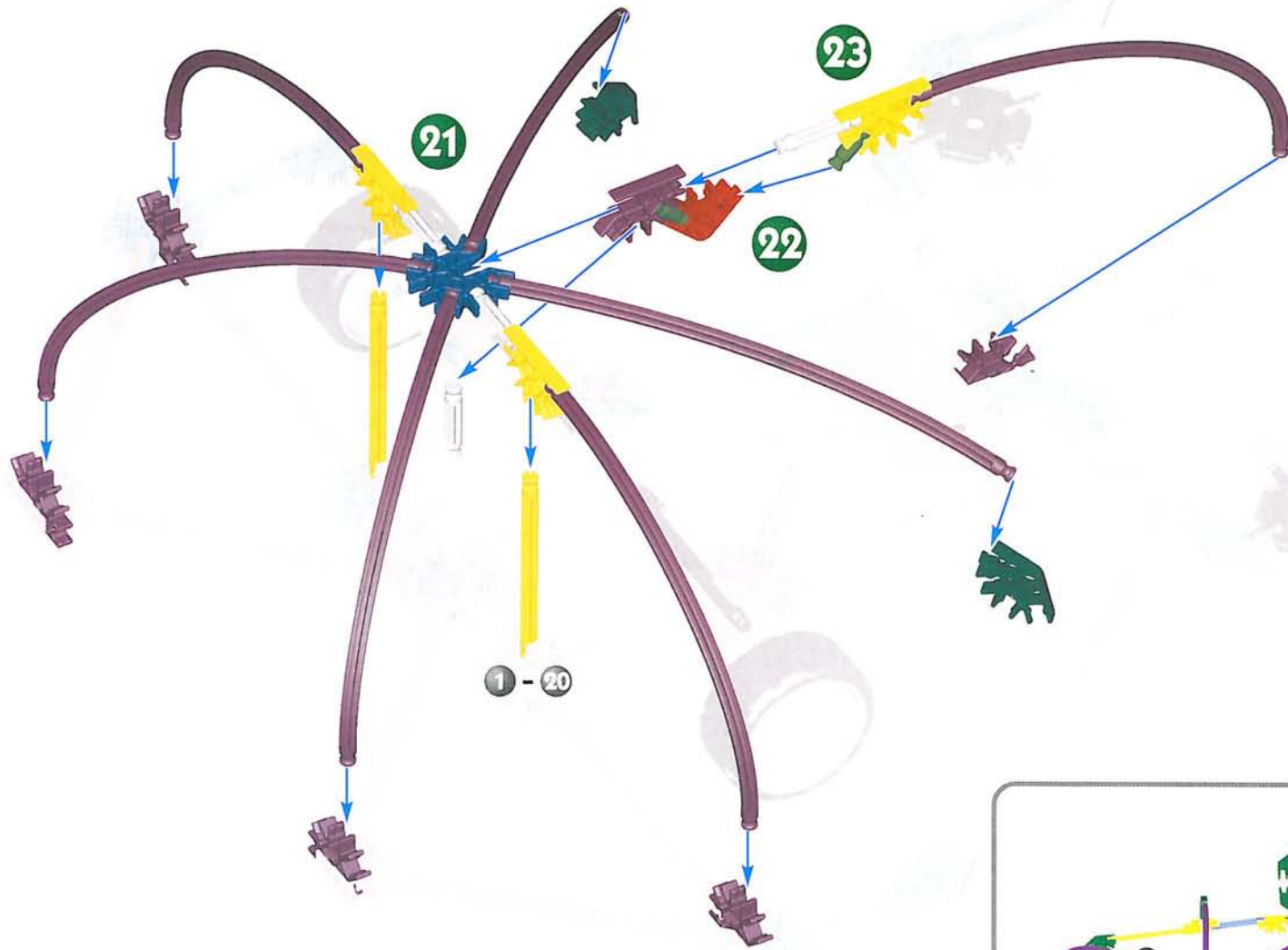



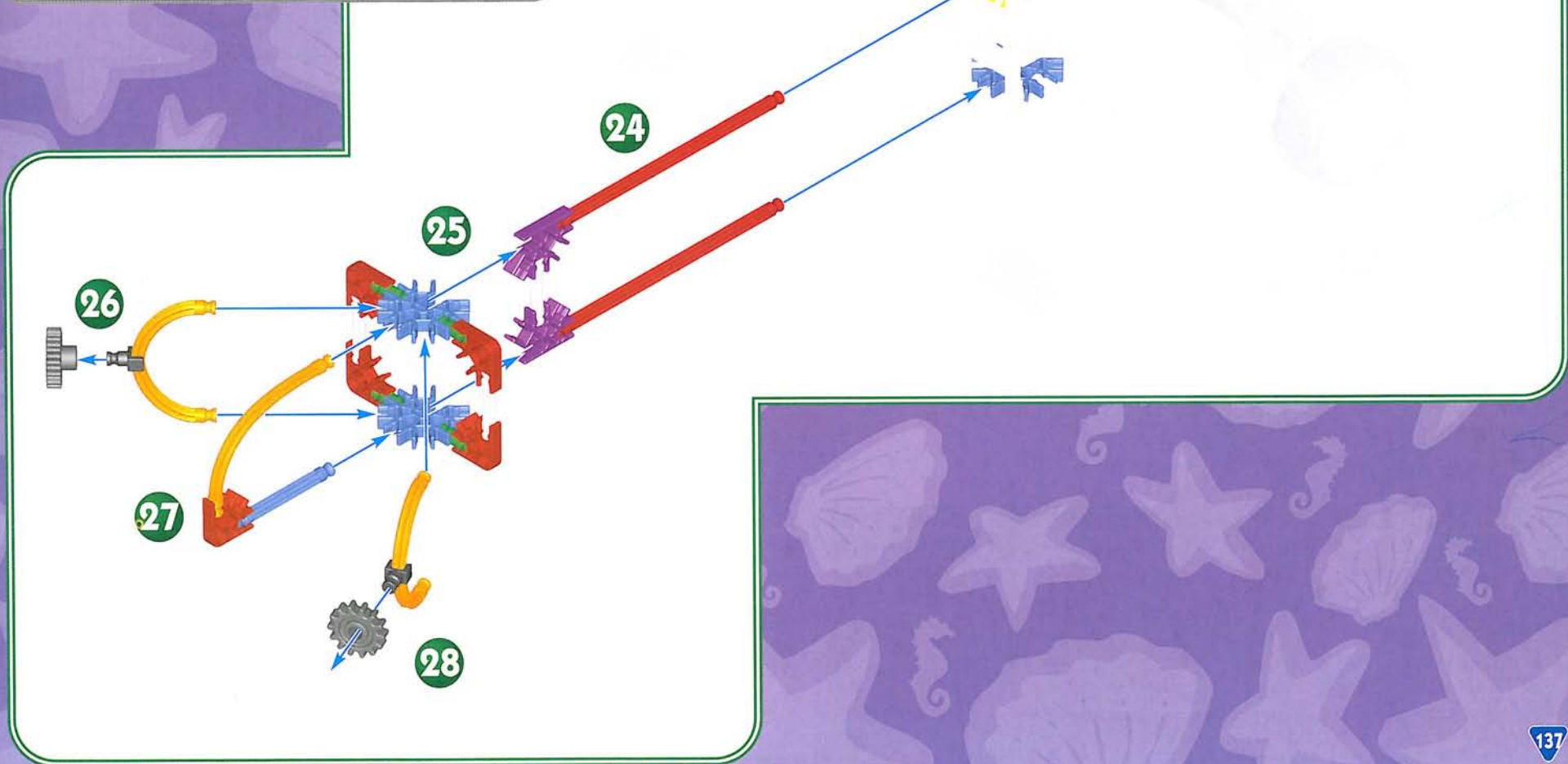
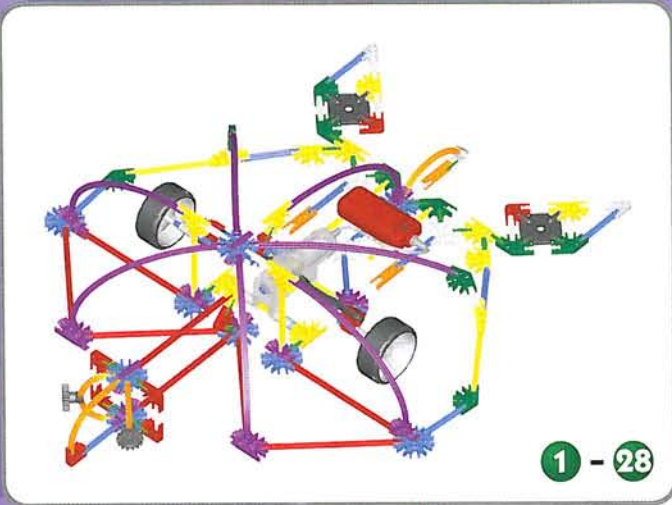



1 - 28

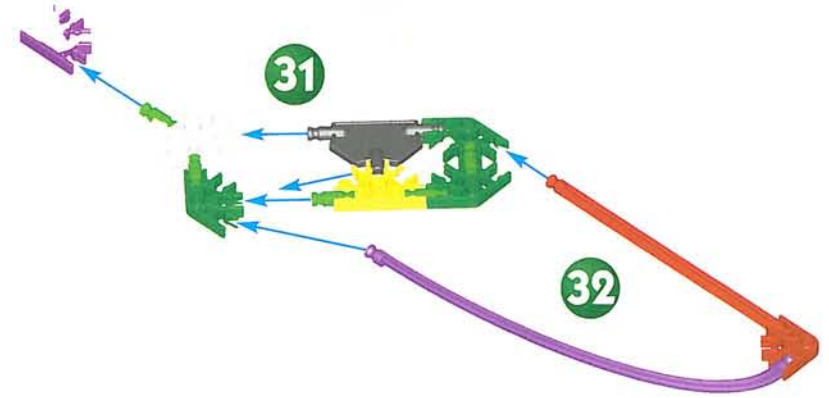
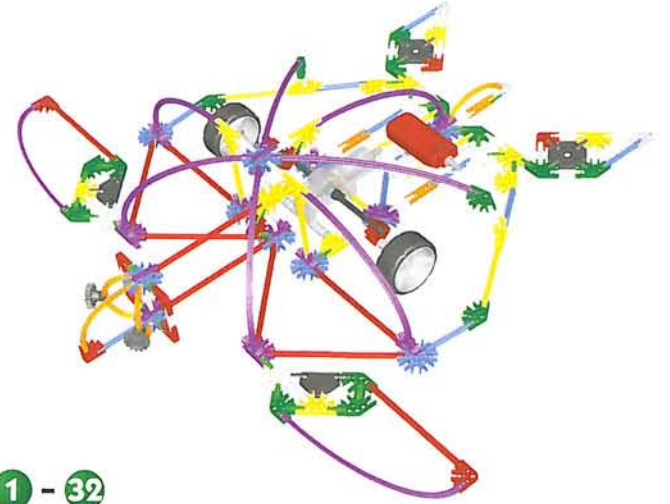

# Wing Flapping Bird

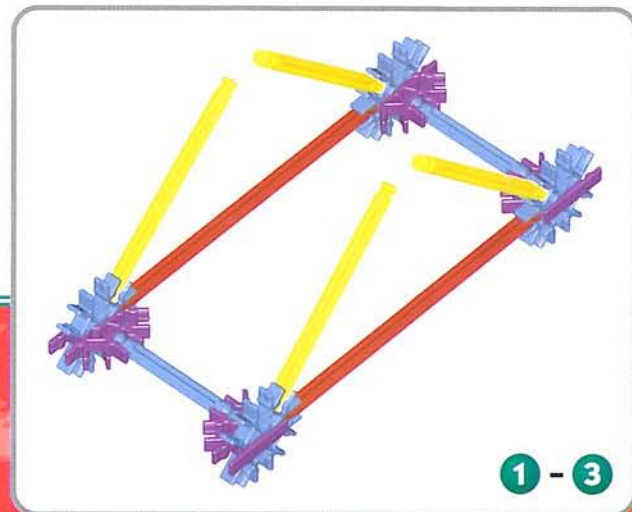
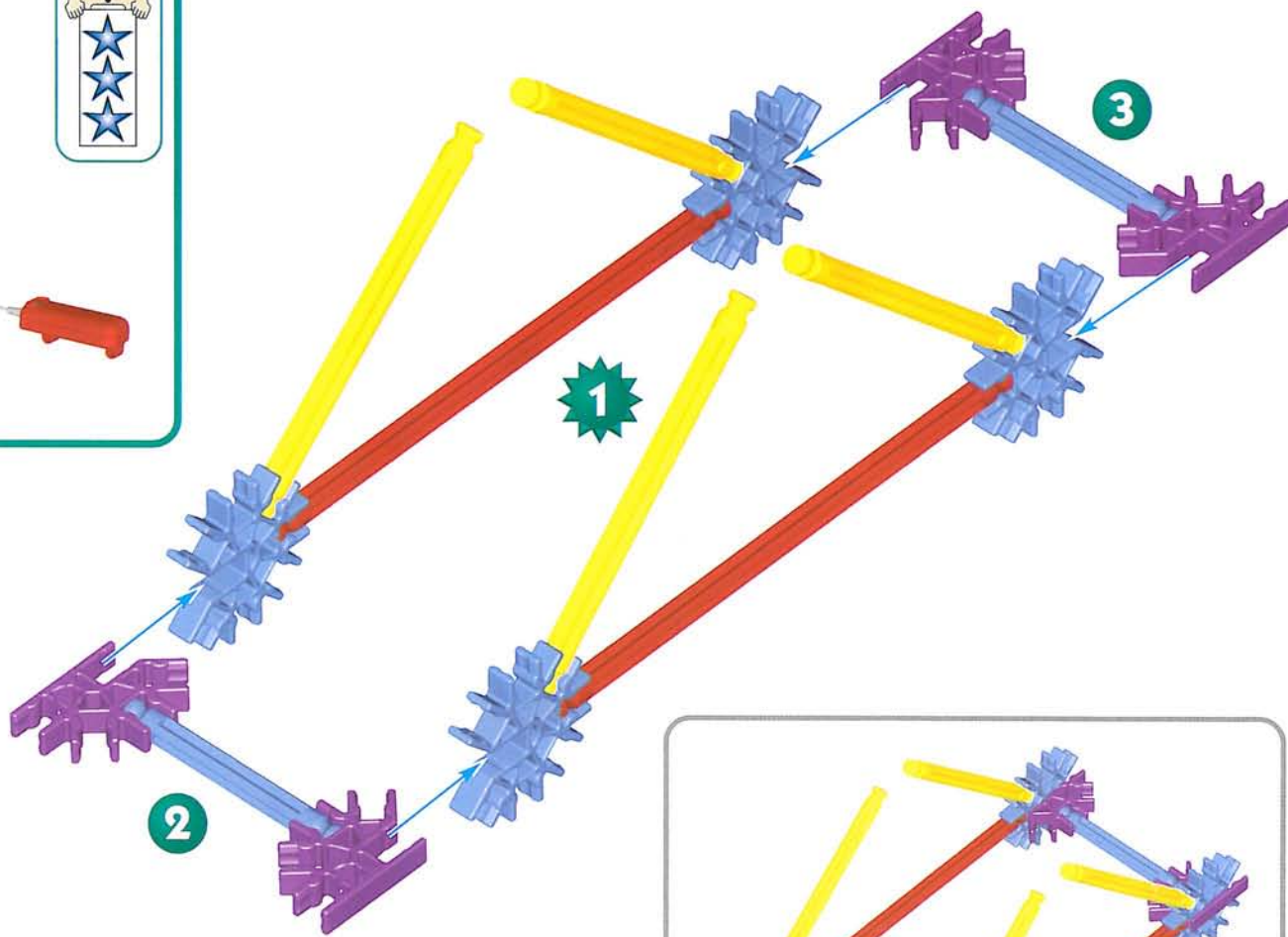
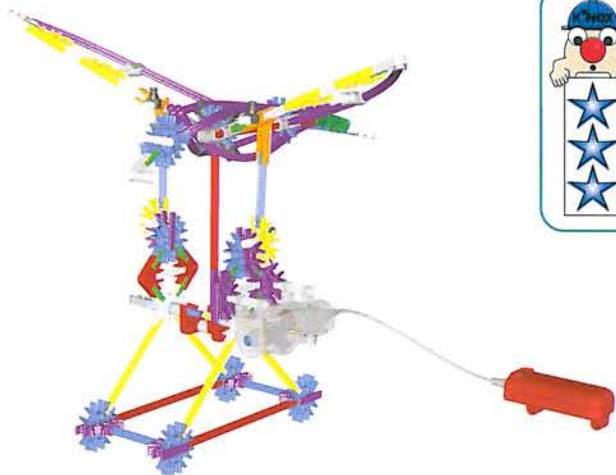

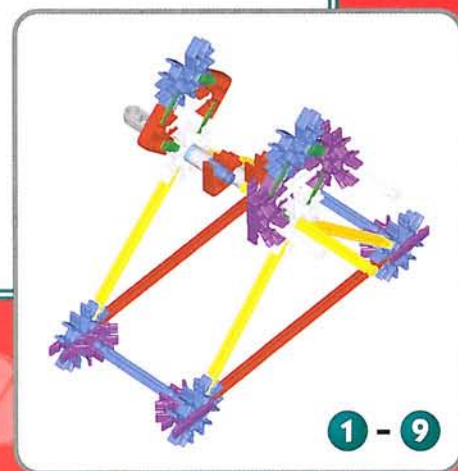
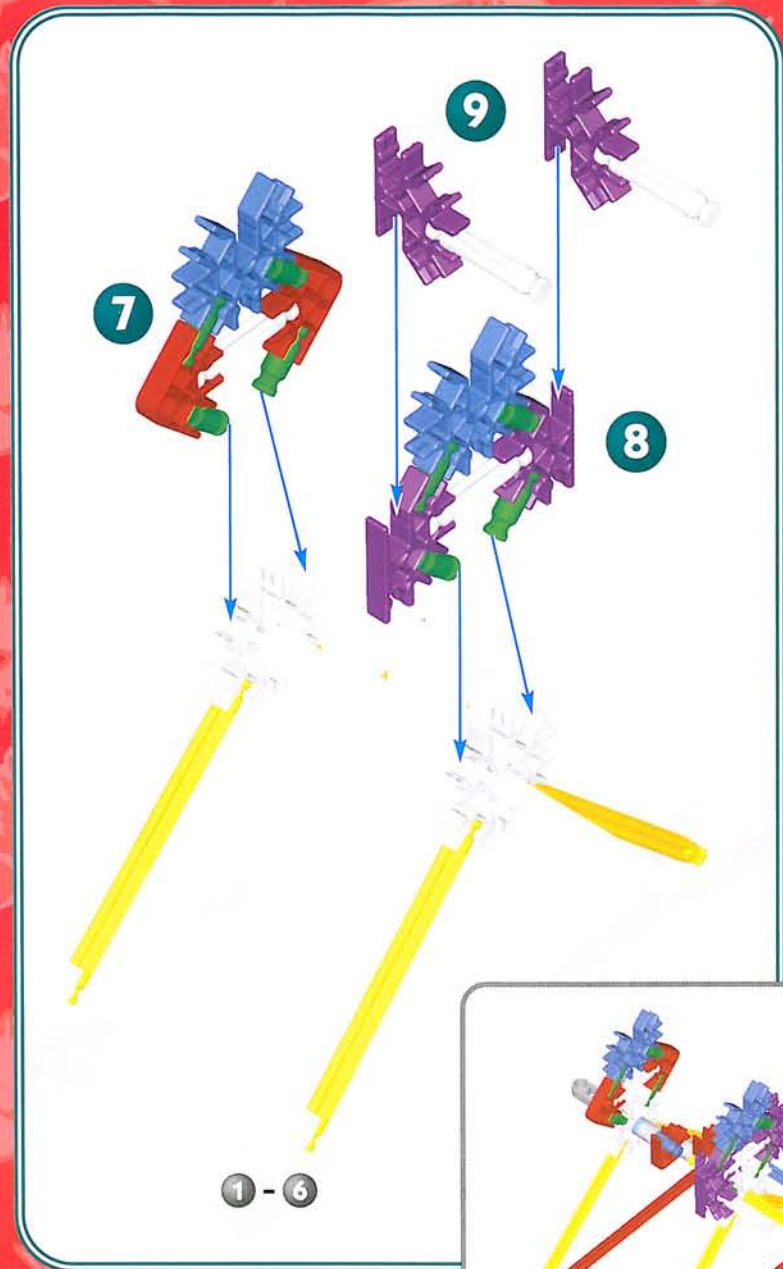
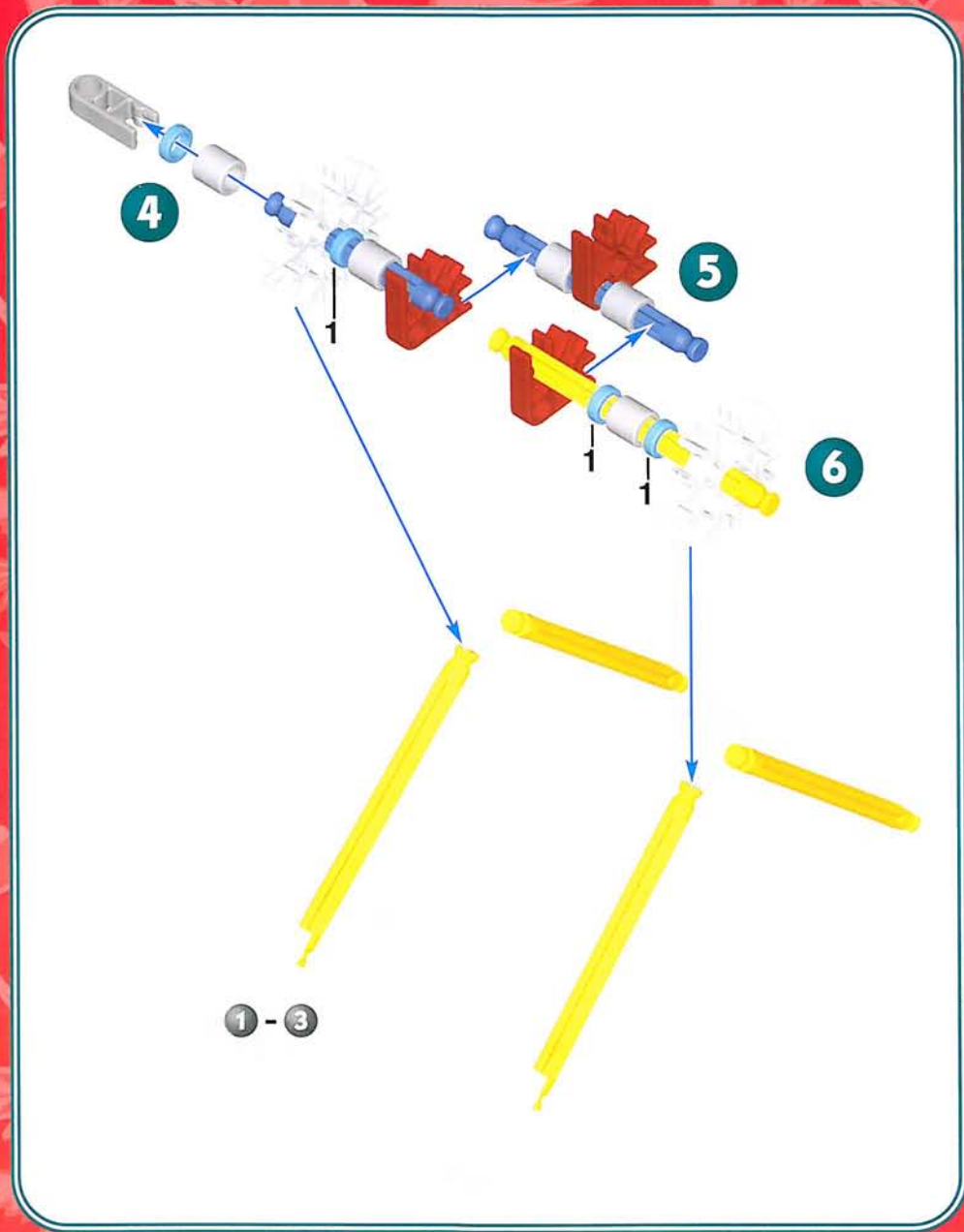

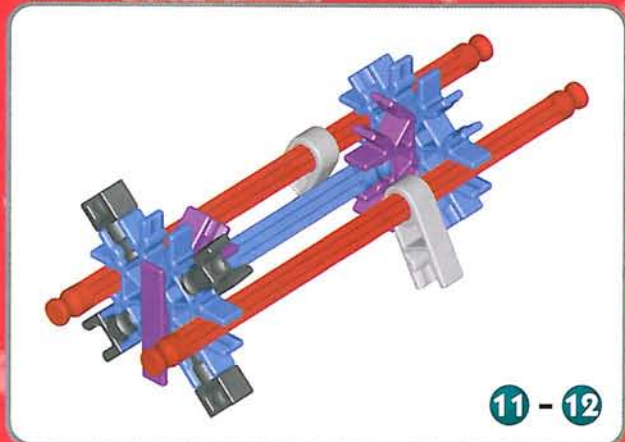
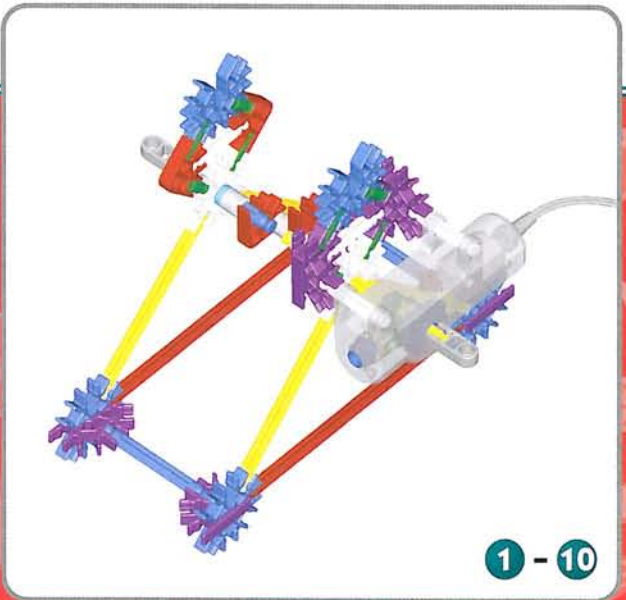
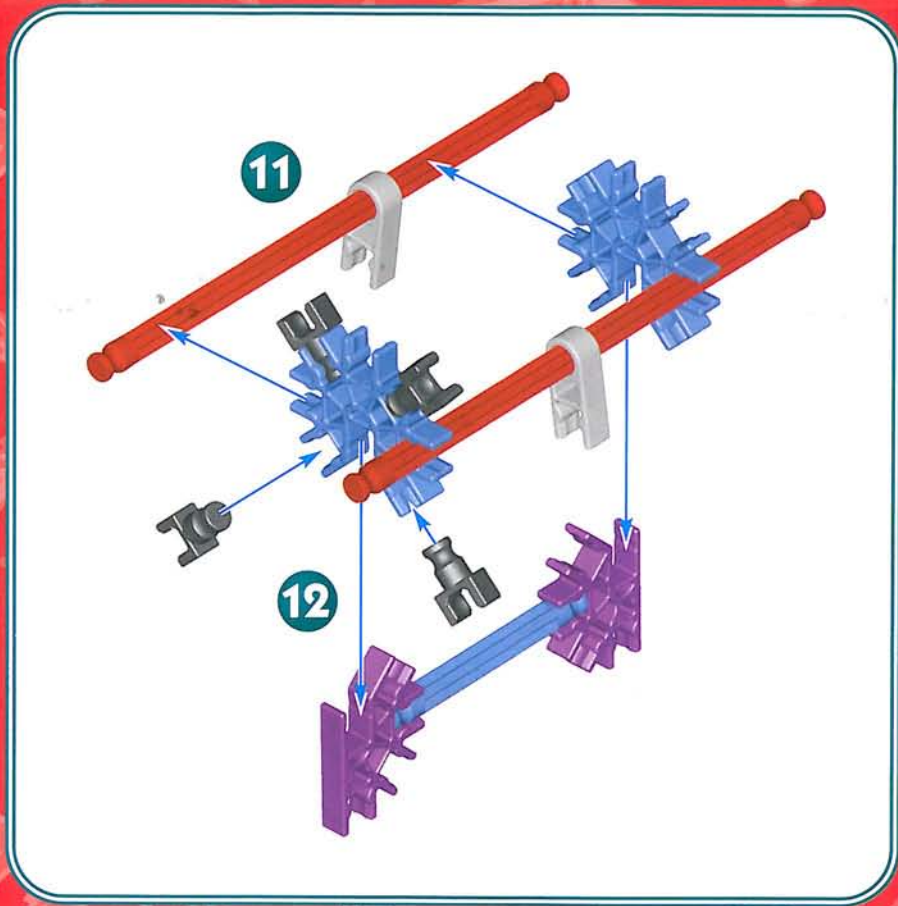
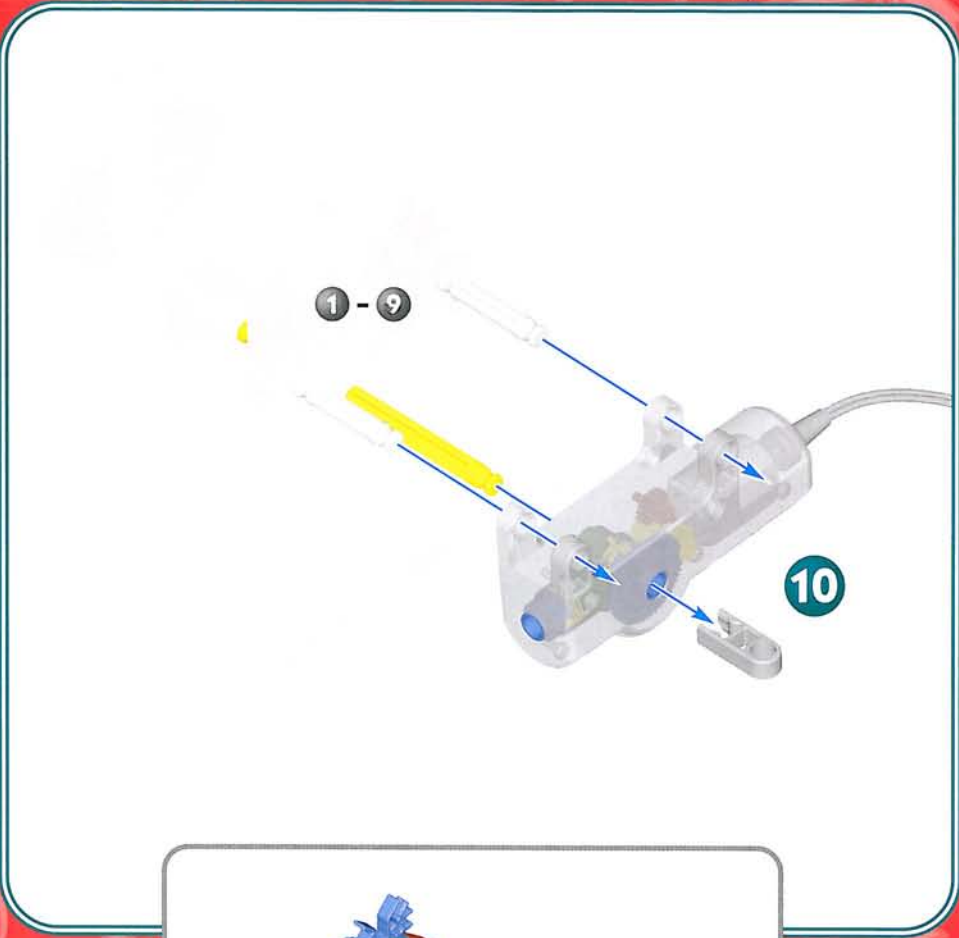

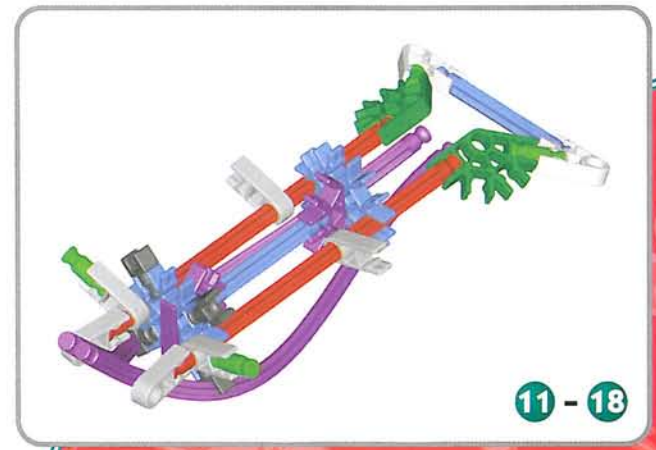
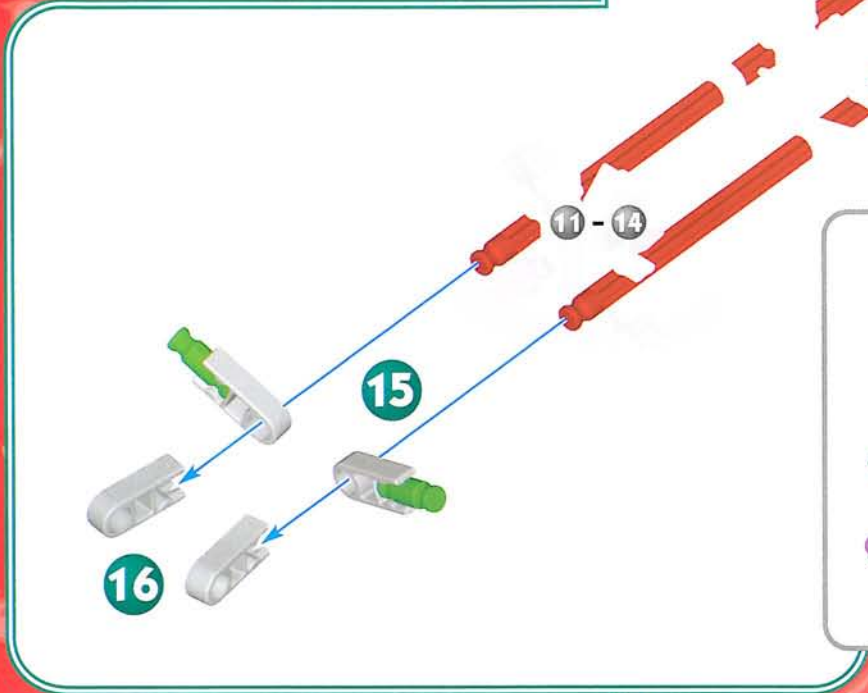
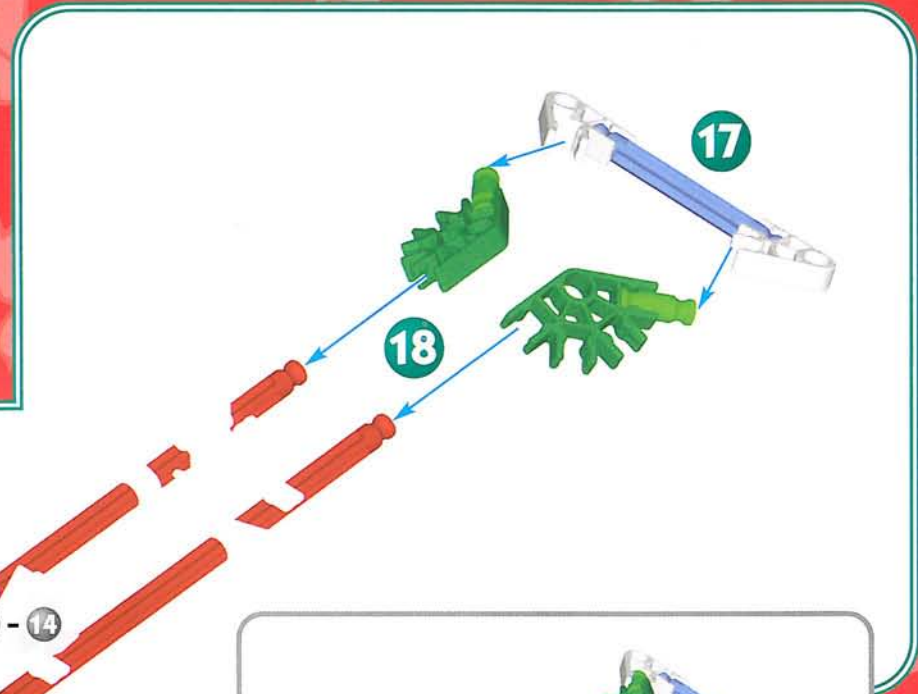
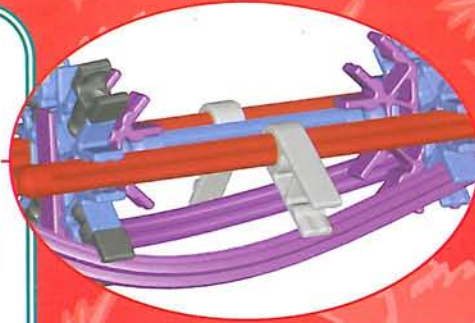
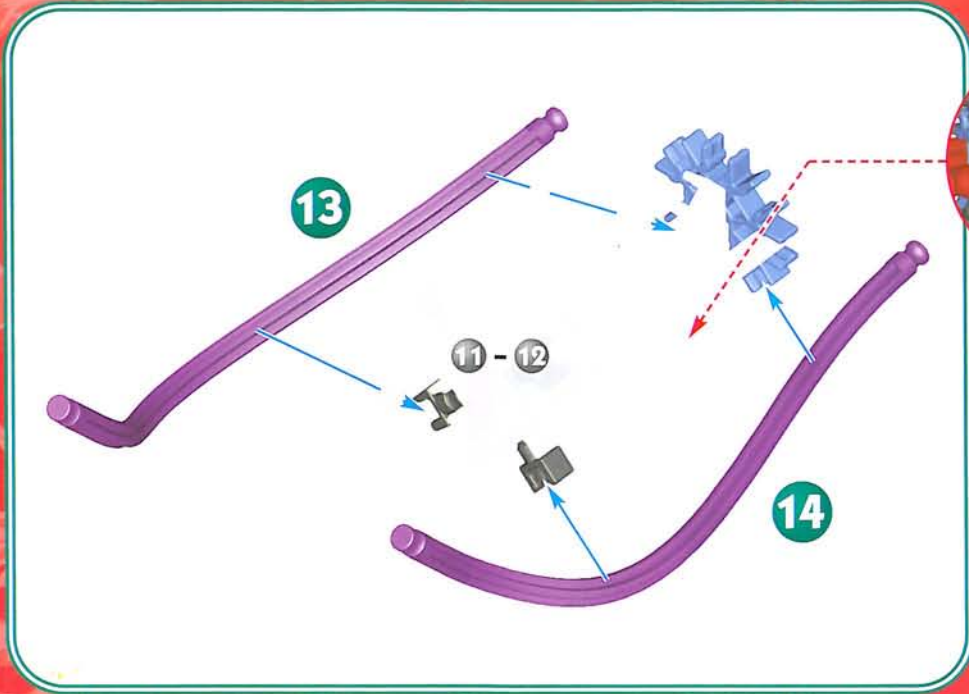

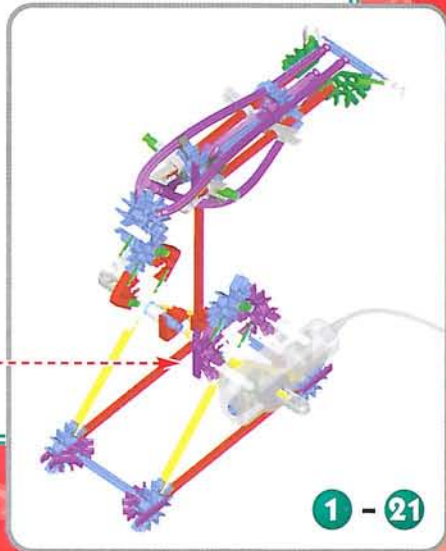
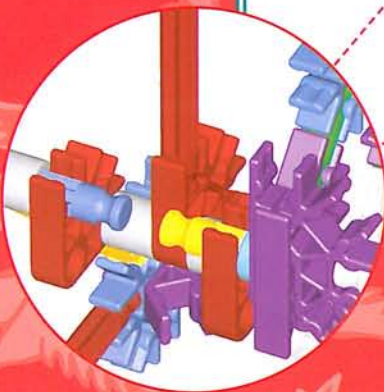
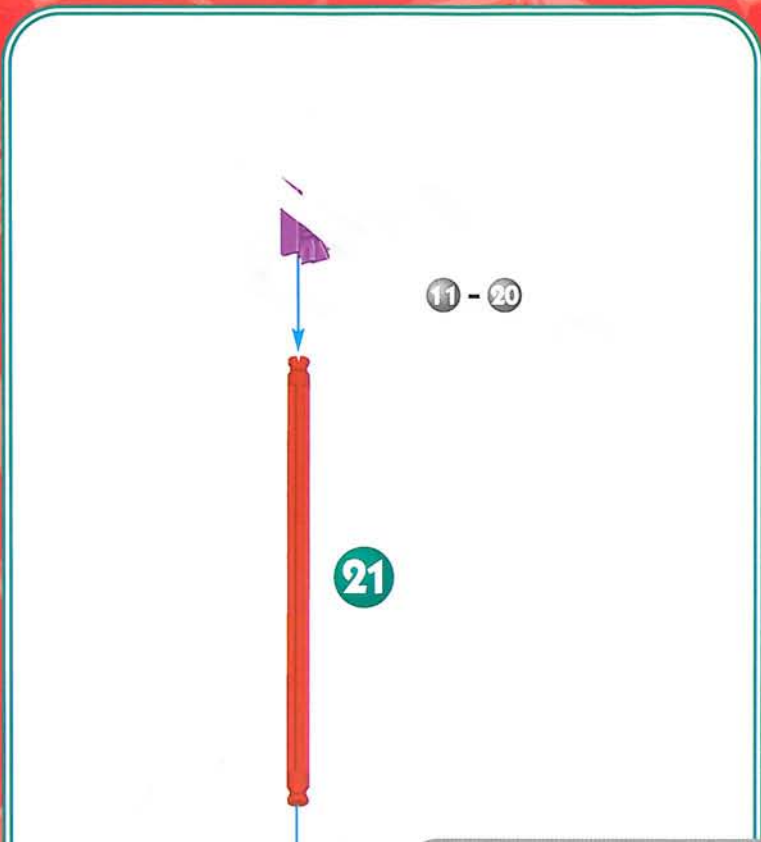
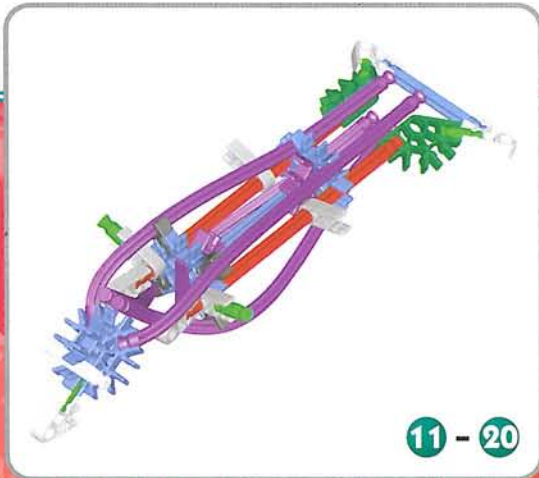
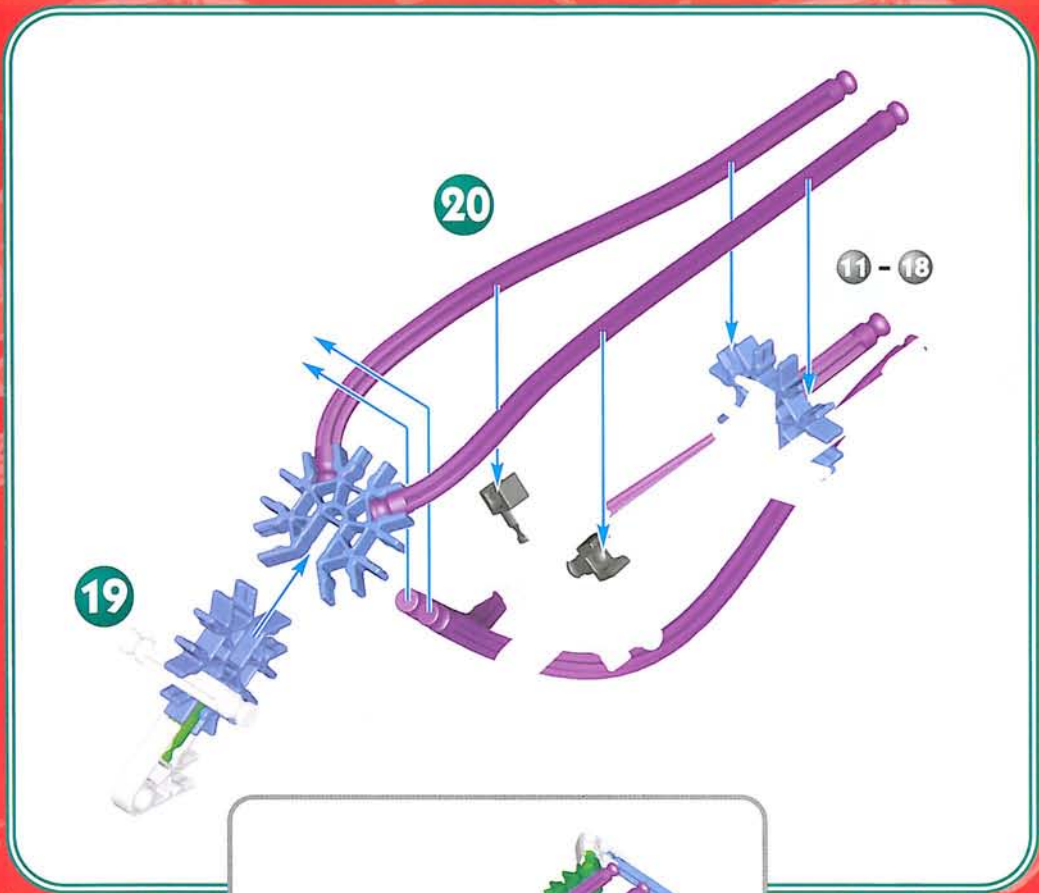





1 - 24

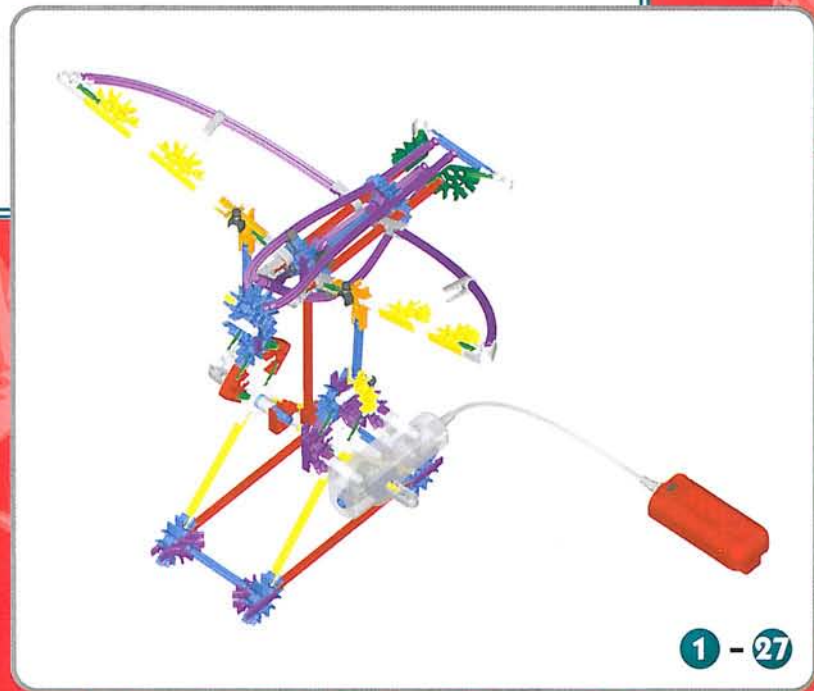
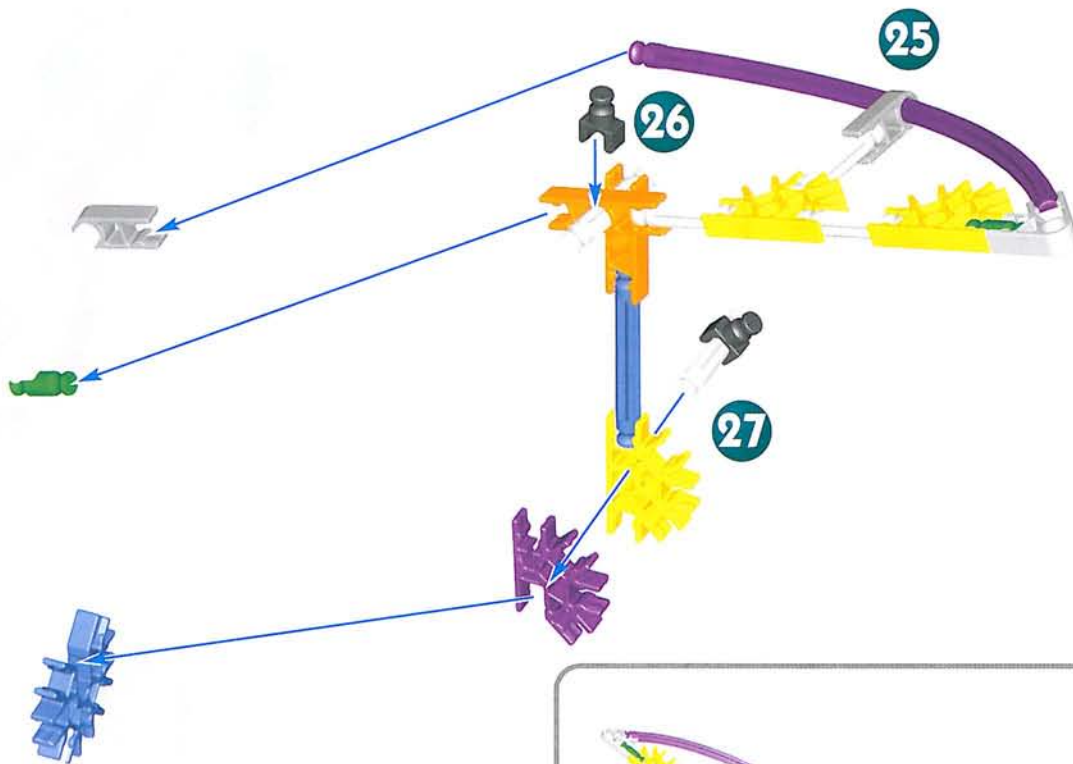

1 - 27

# Boom Ride

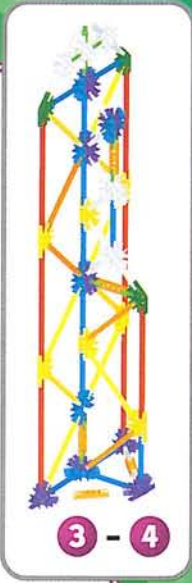
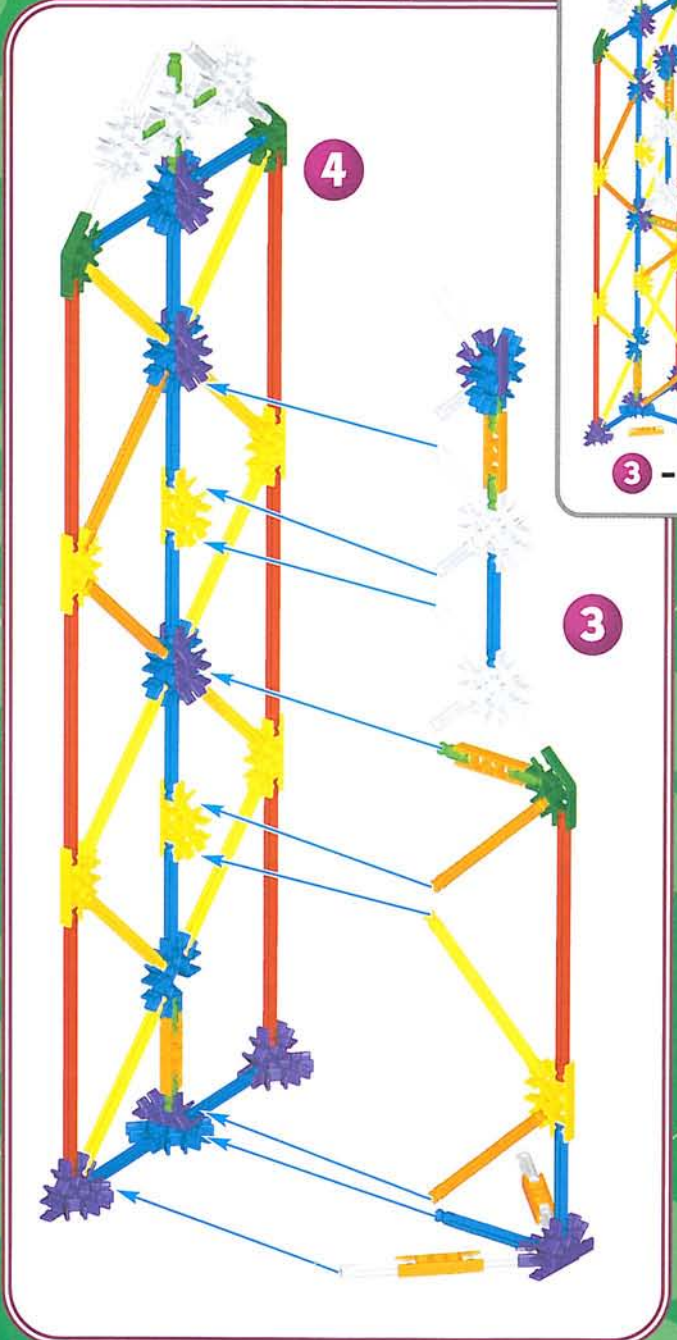
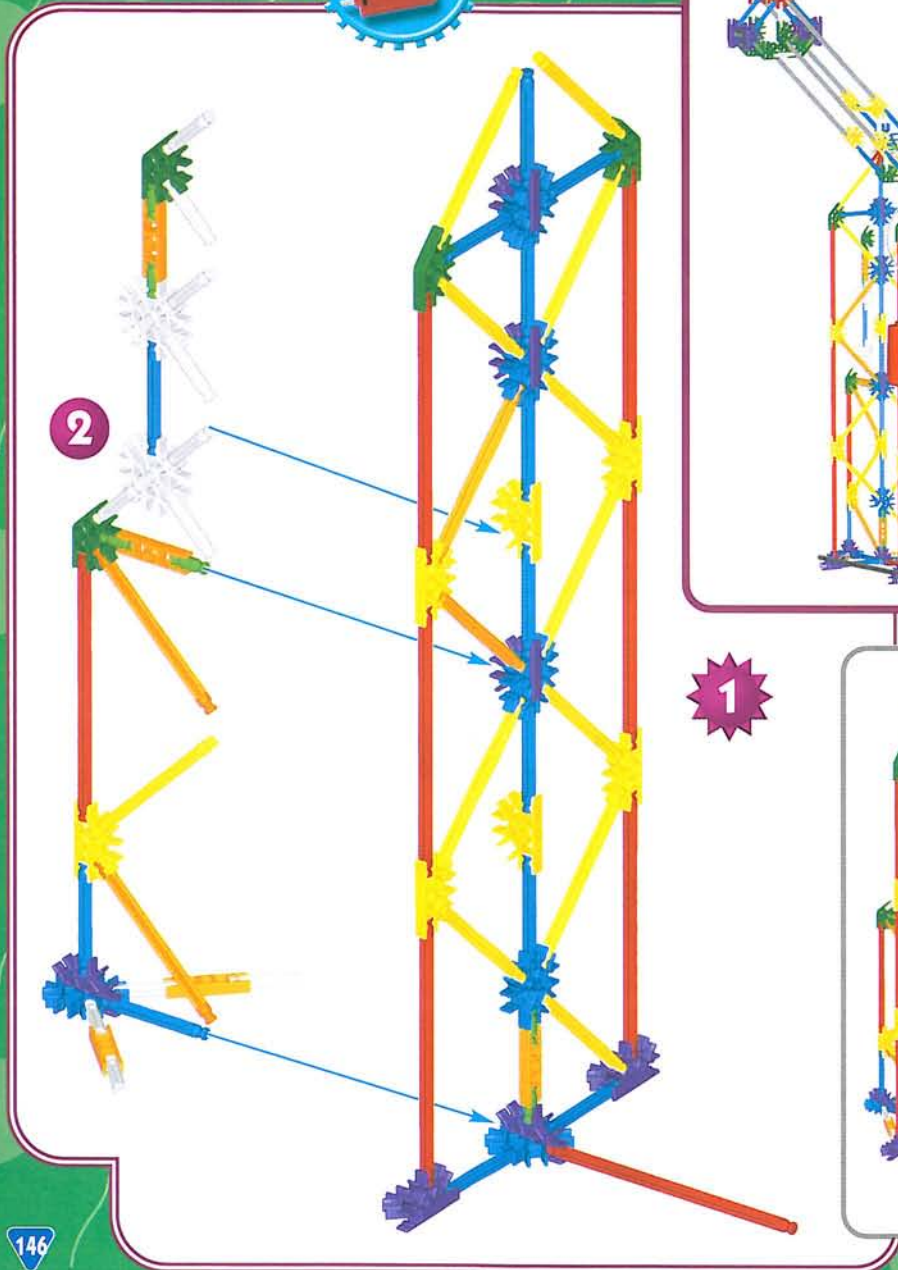
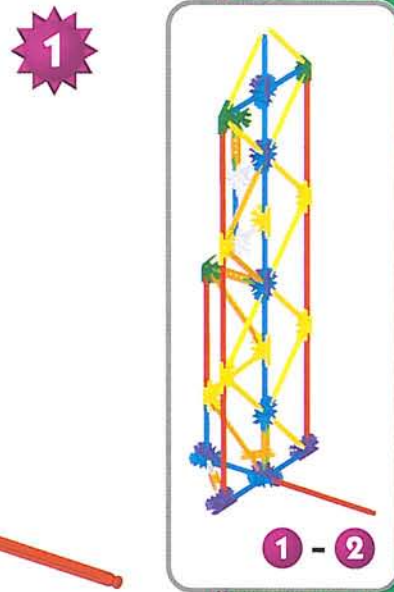
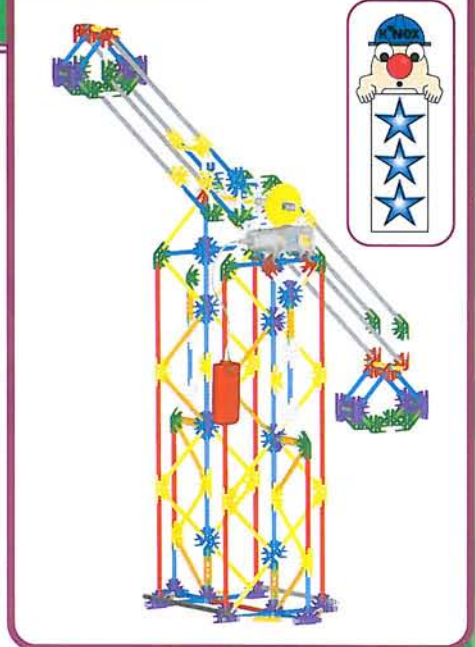

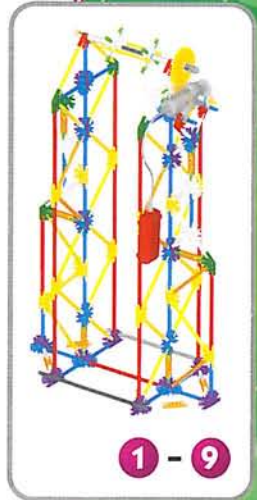
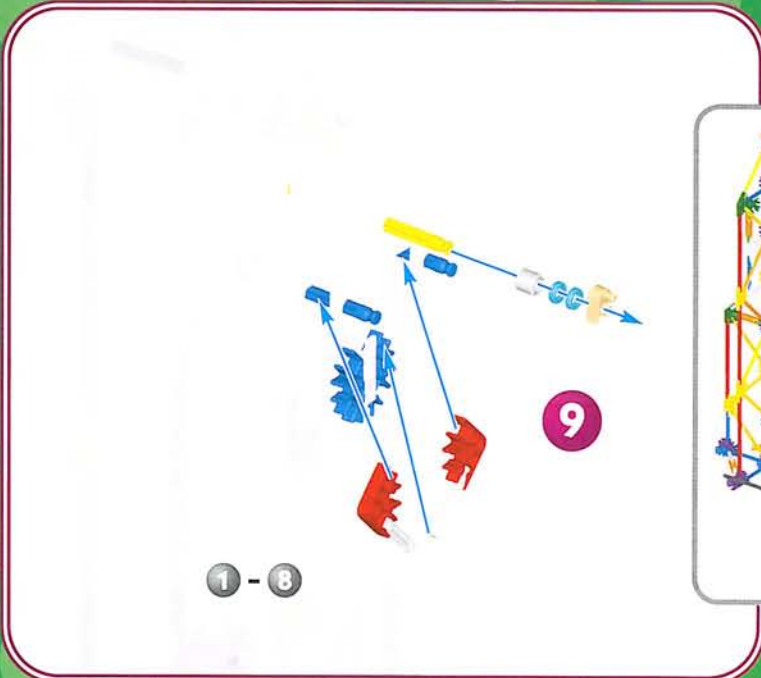
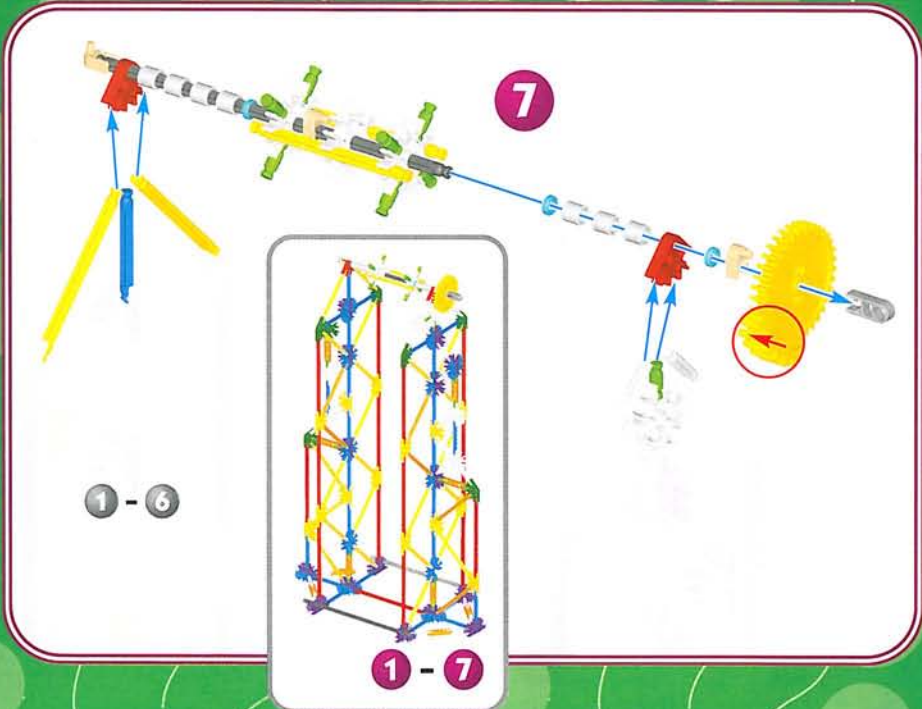
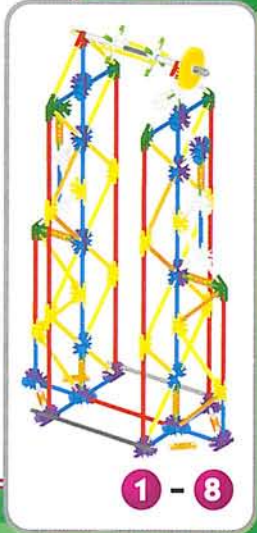
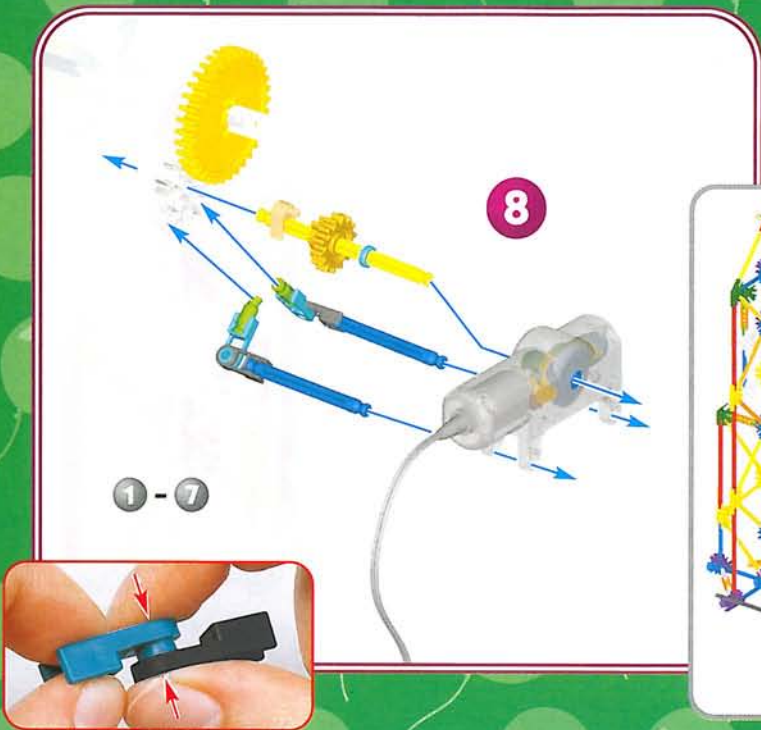
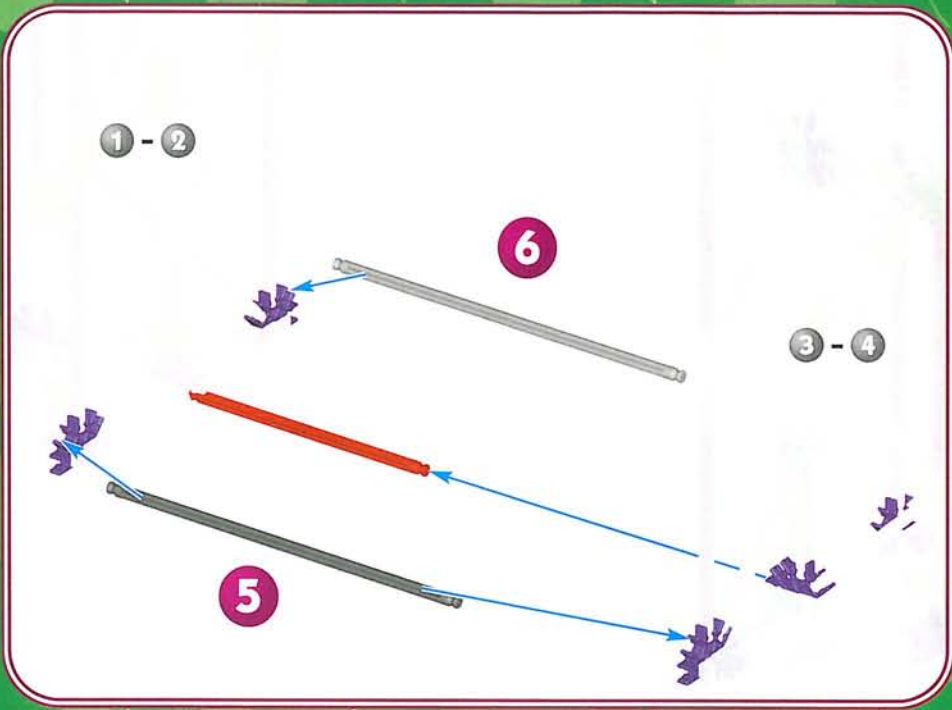



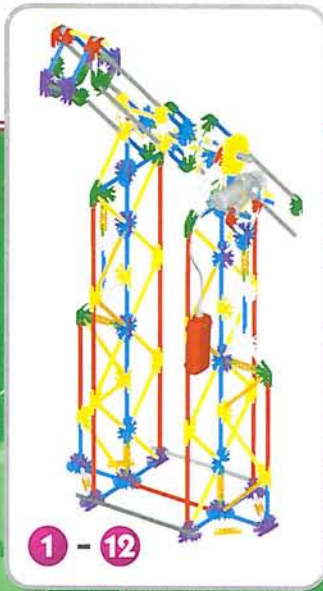
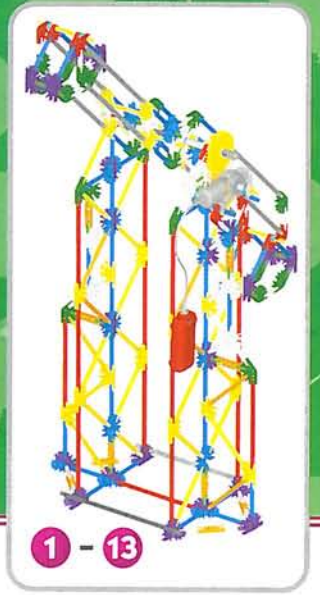
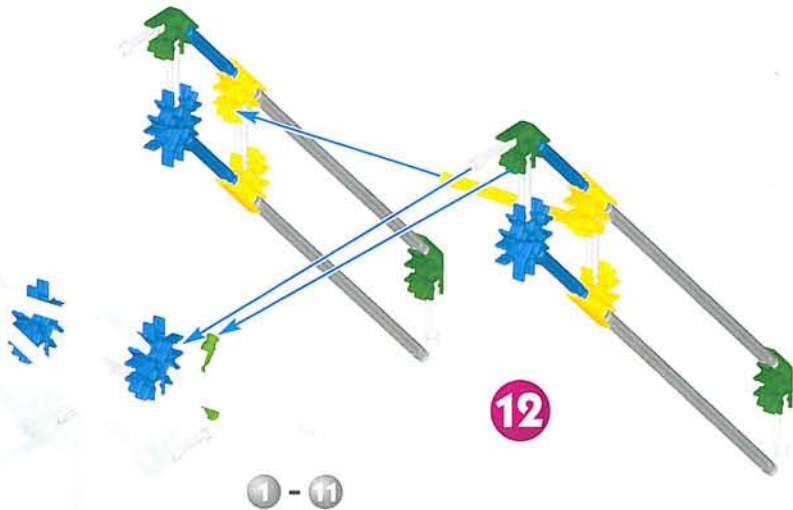

1 - 12

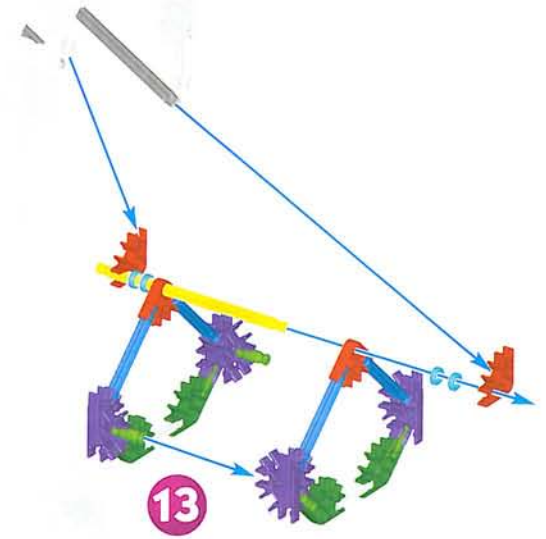

# Super Car

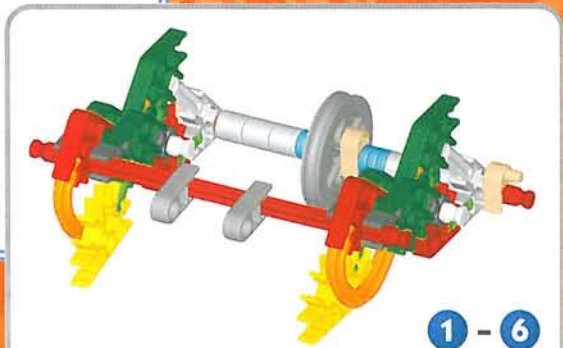
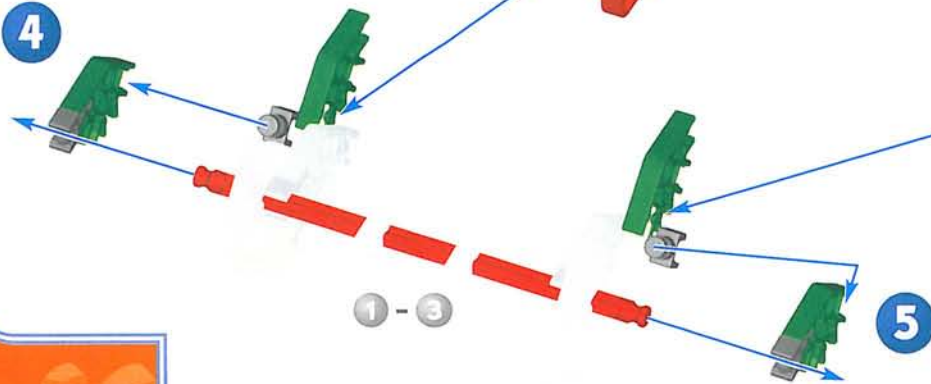
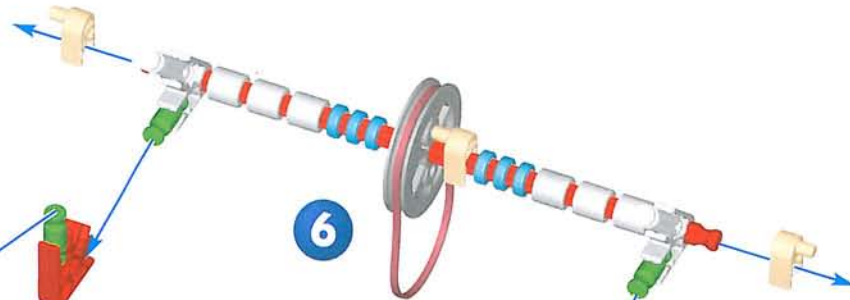
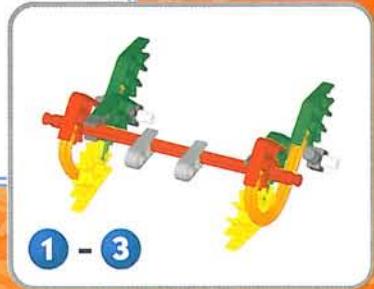
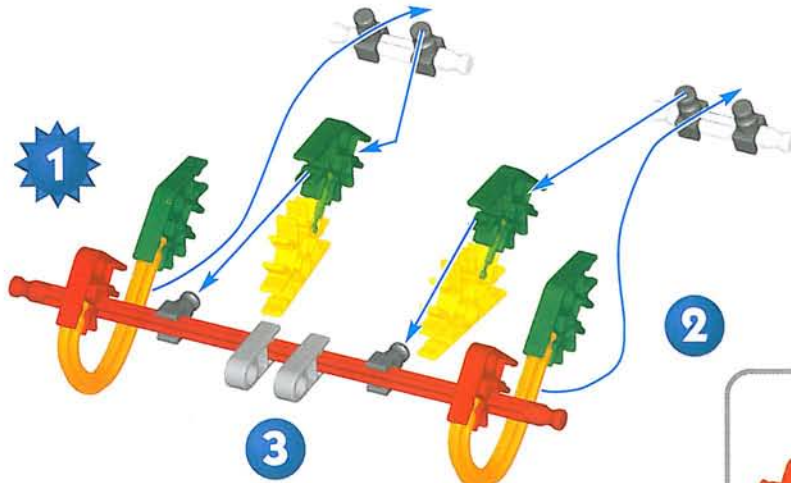

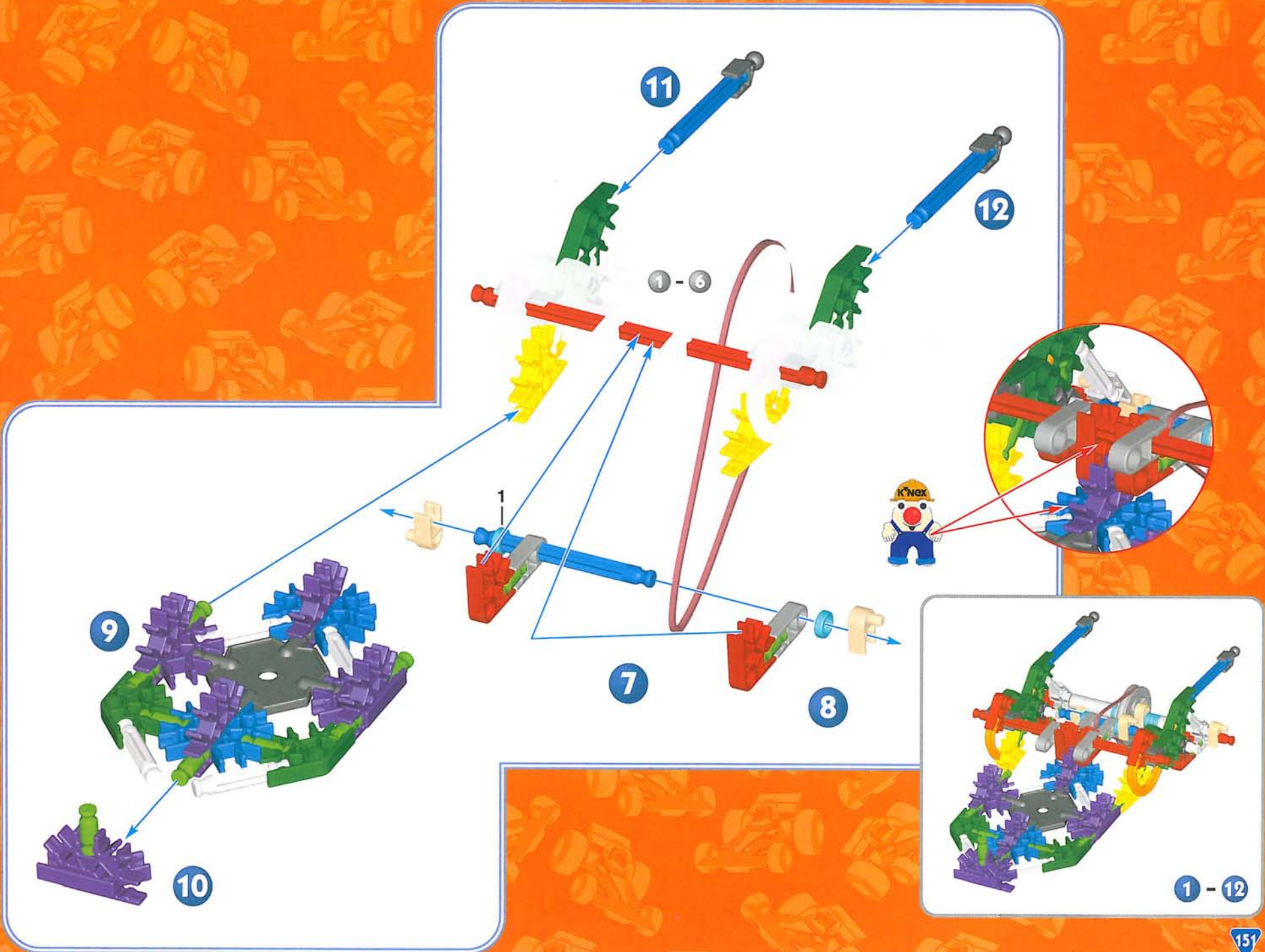

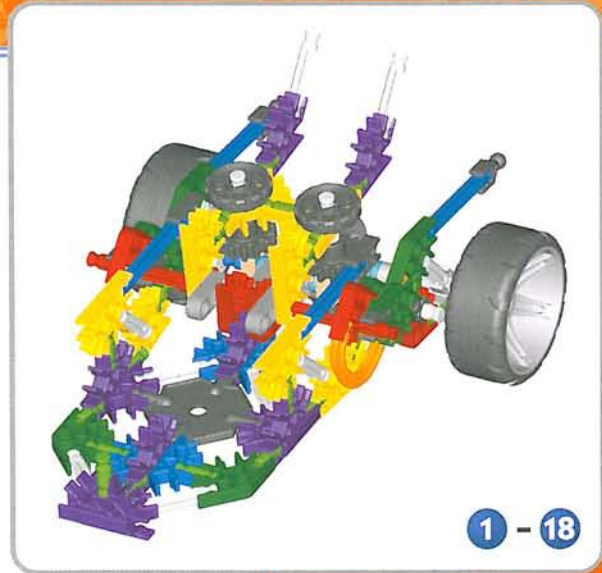
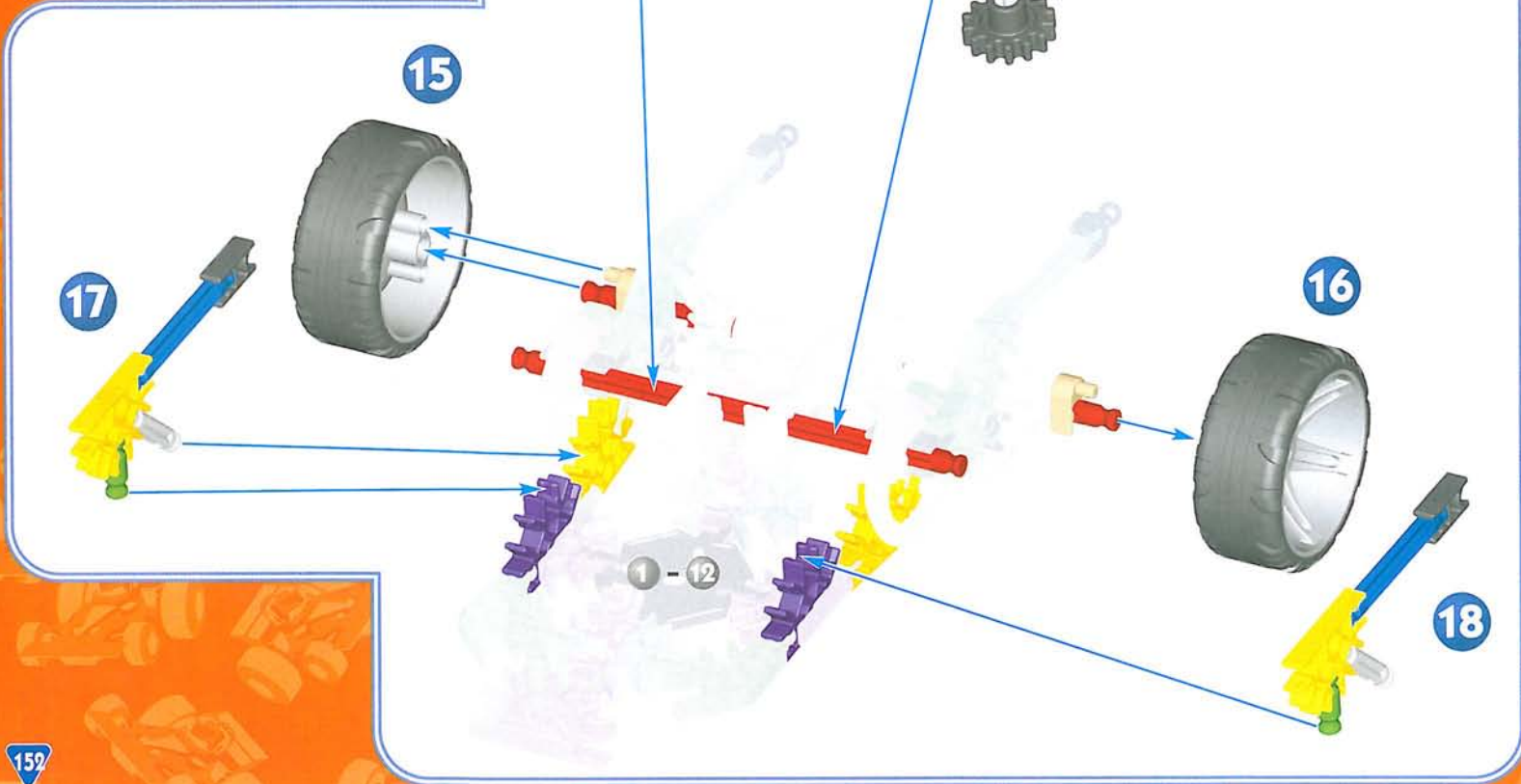



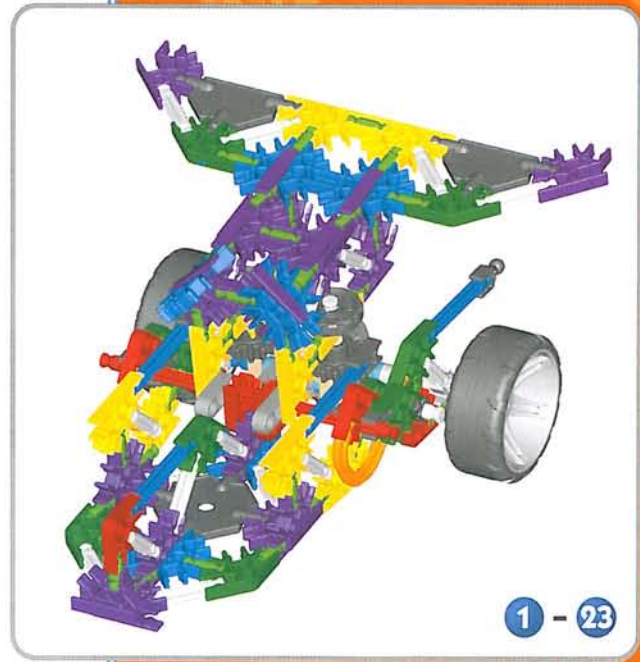
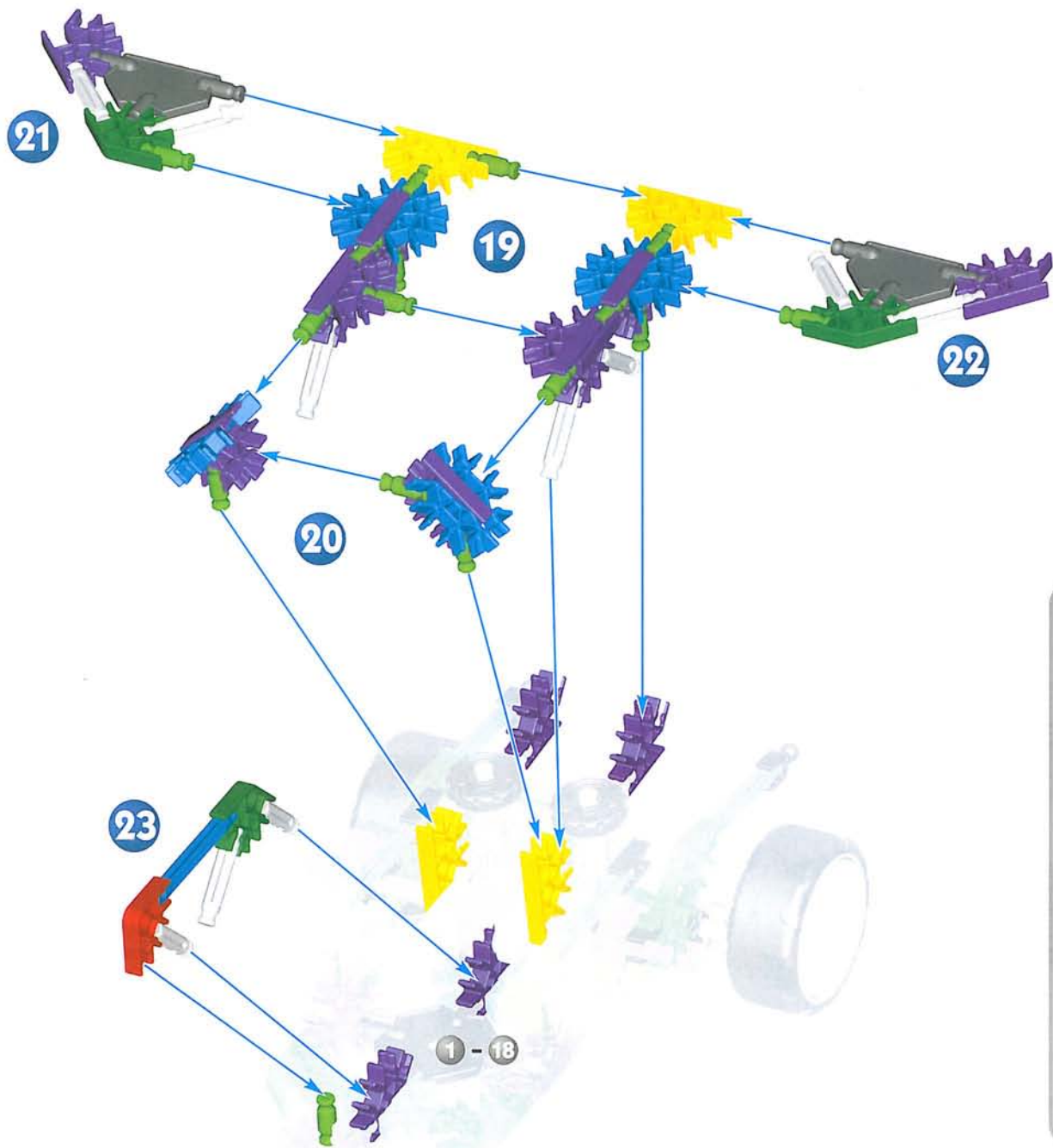

1 - 23

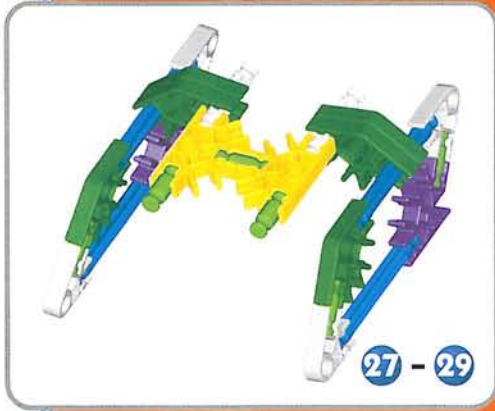
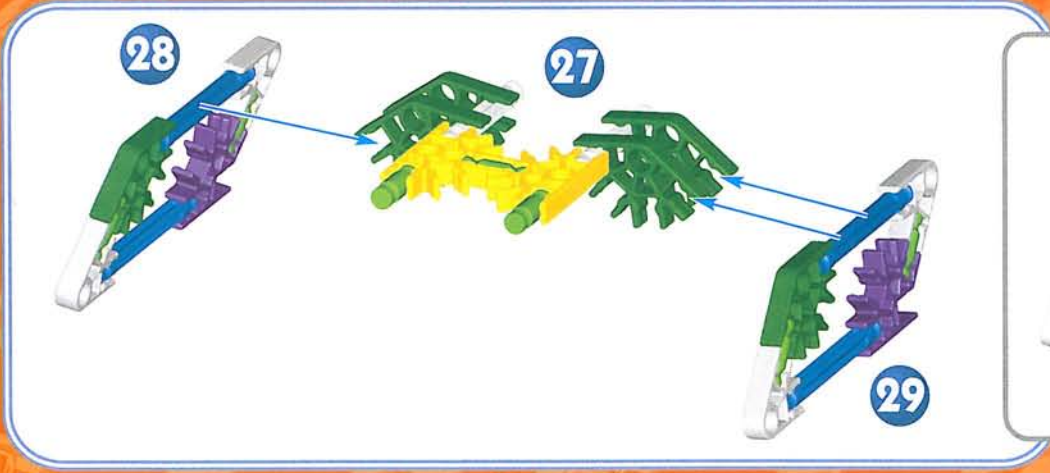
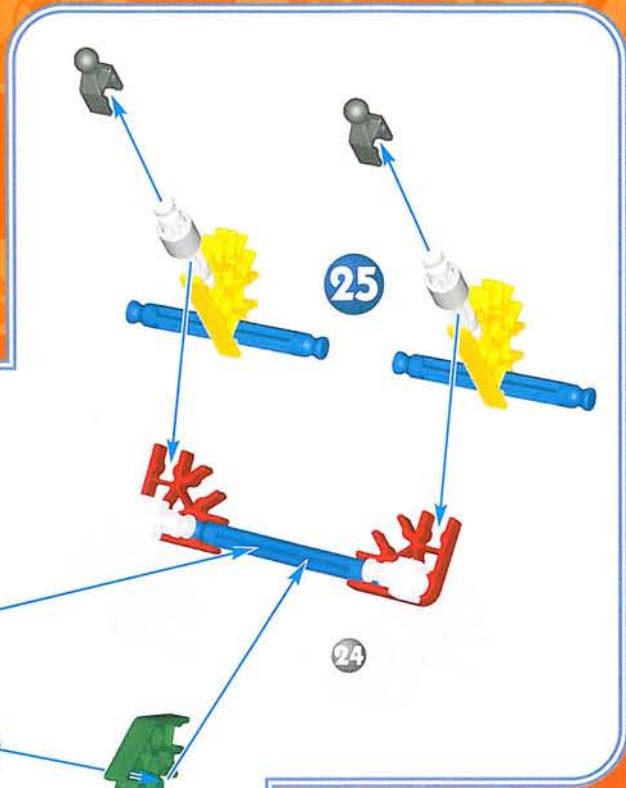
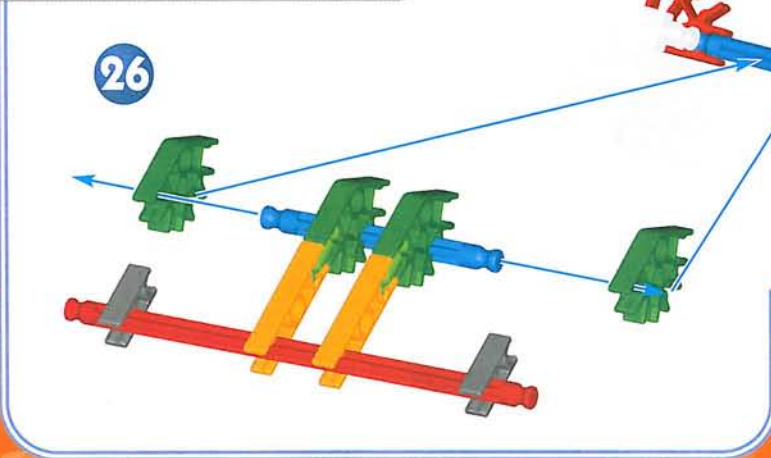
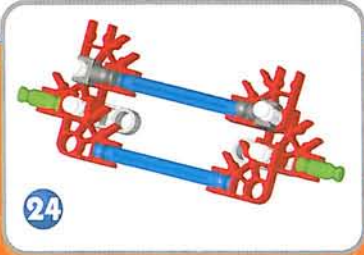
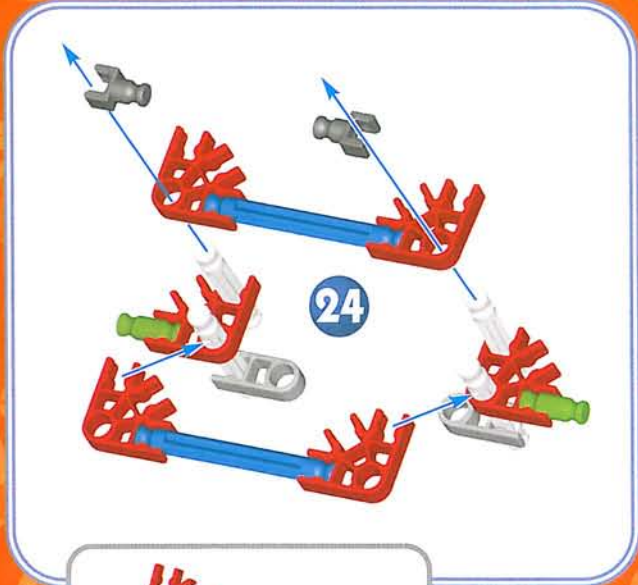

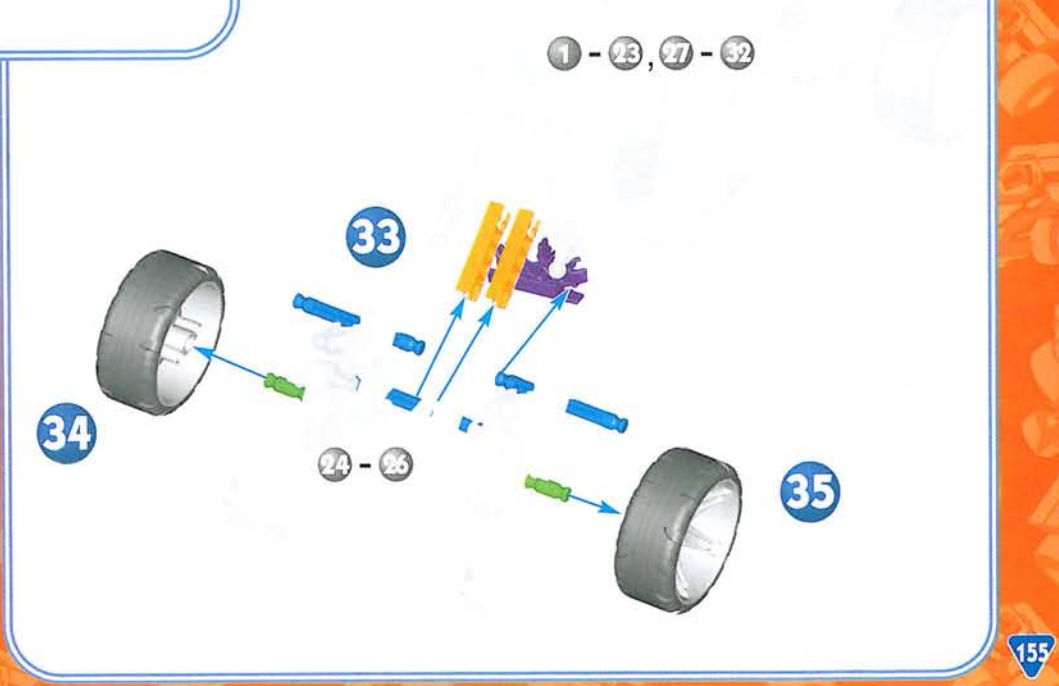
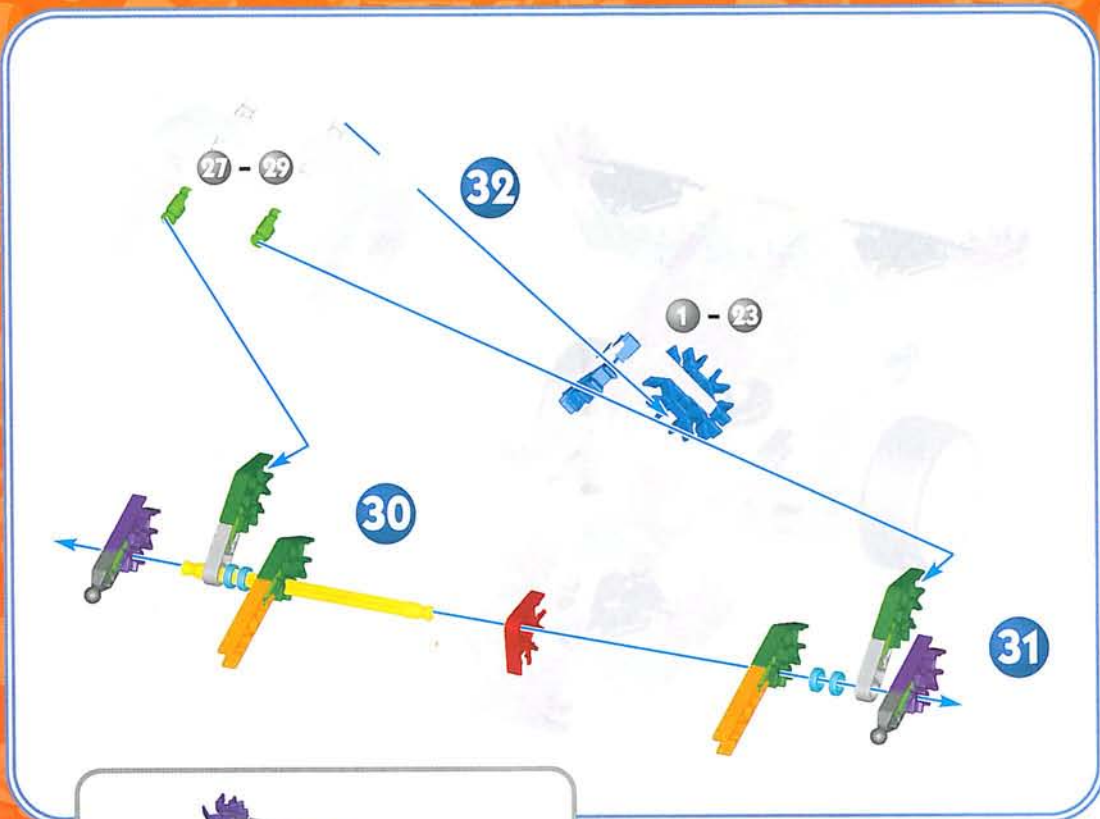



# Tornado Ride

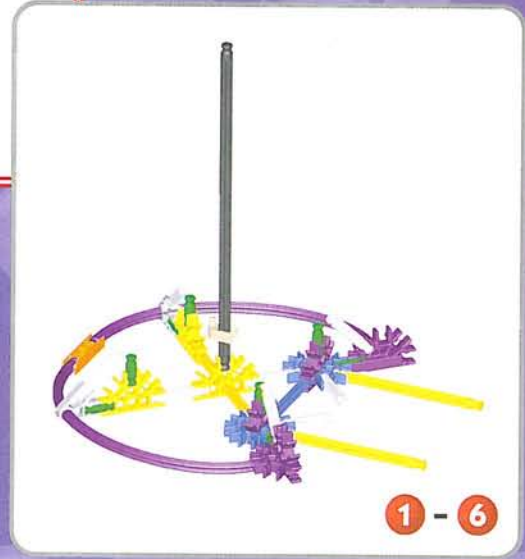
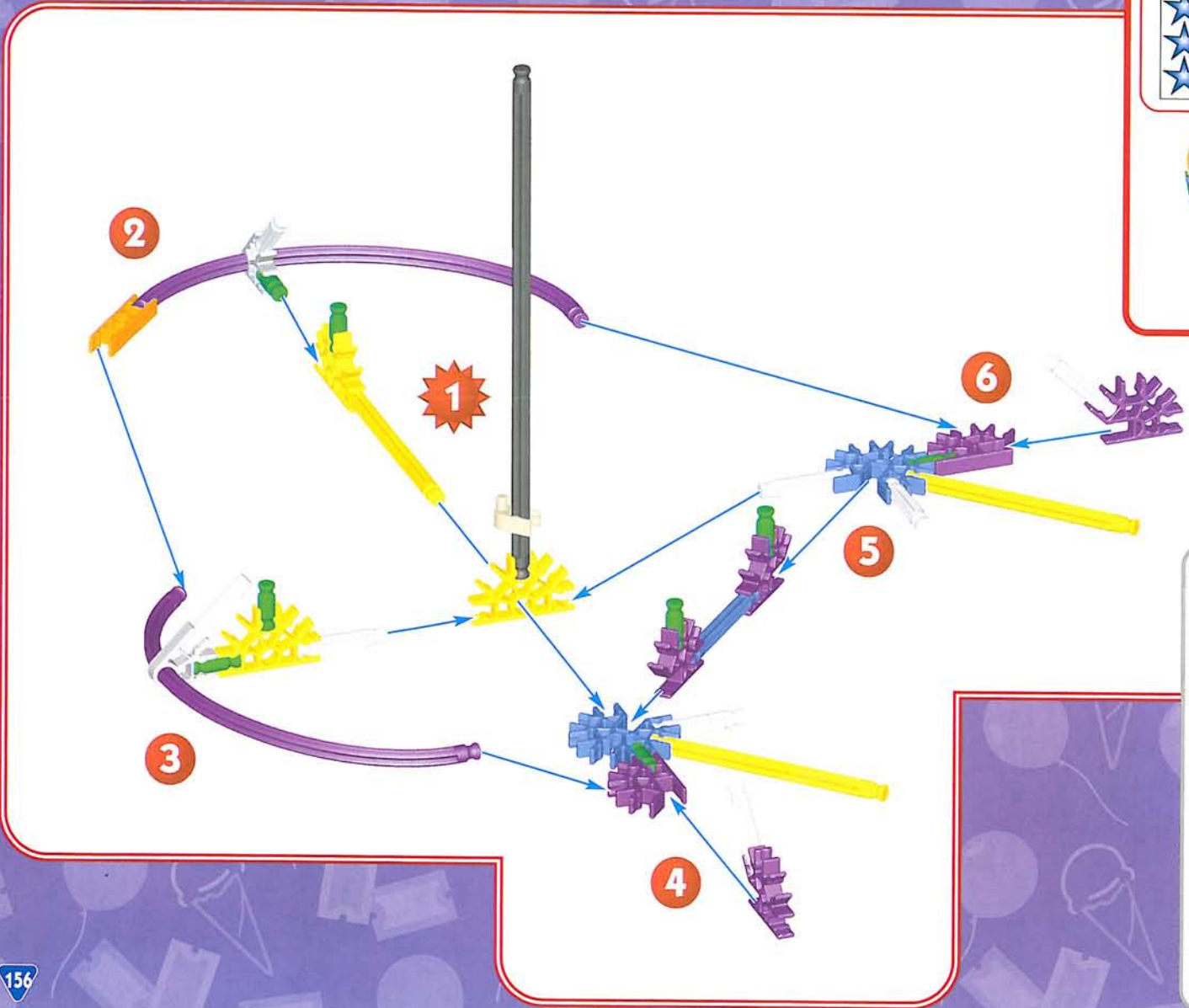
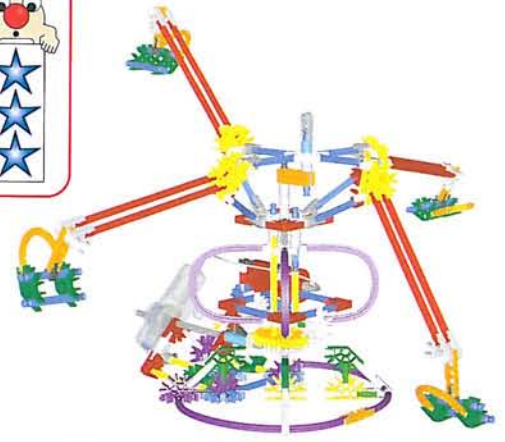
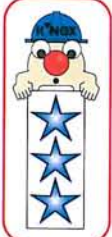

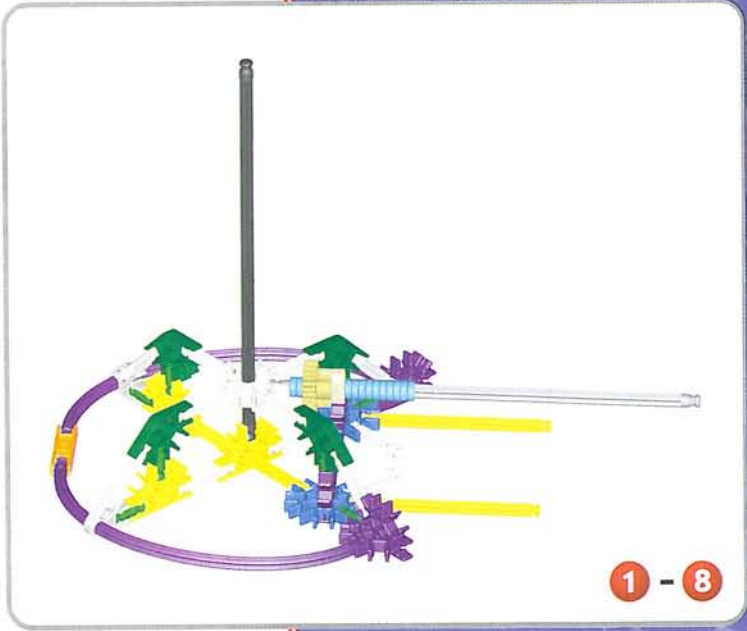
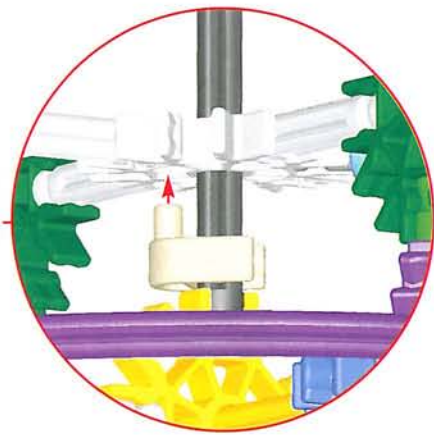
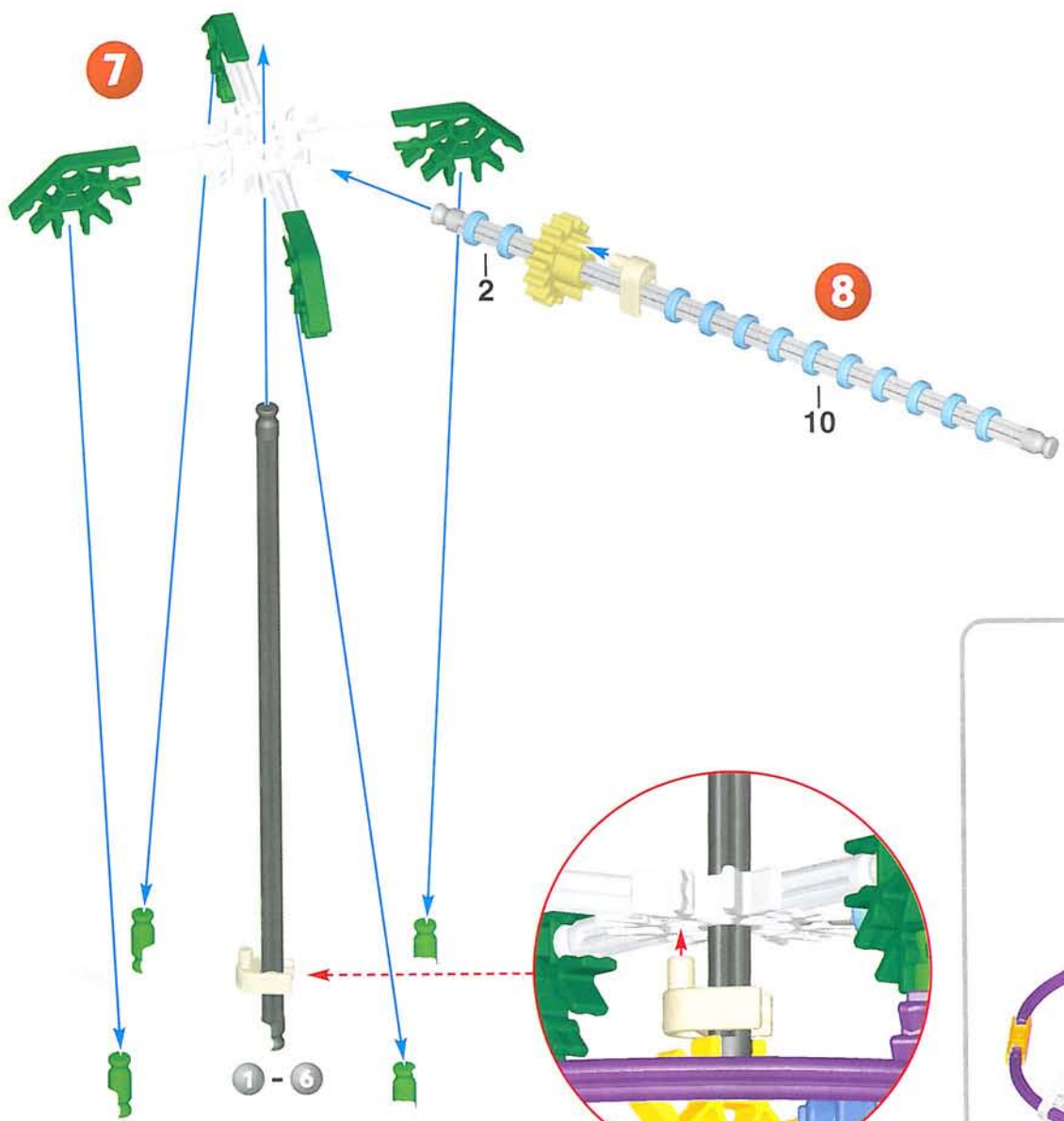

1 - 8

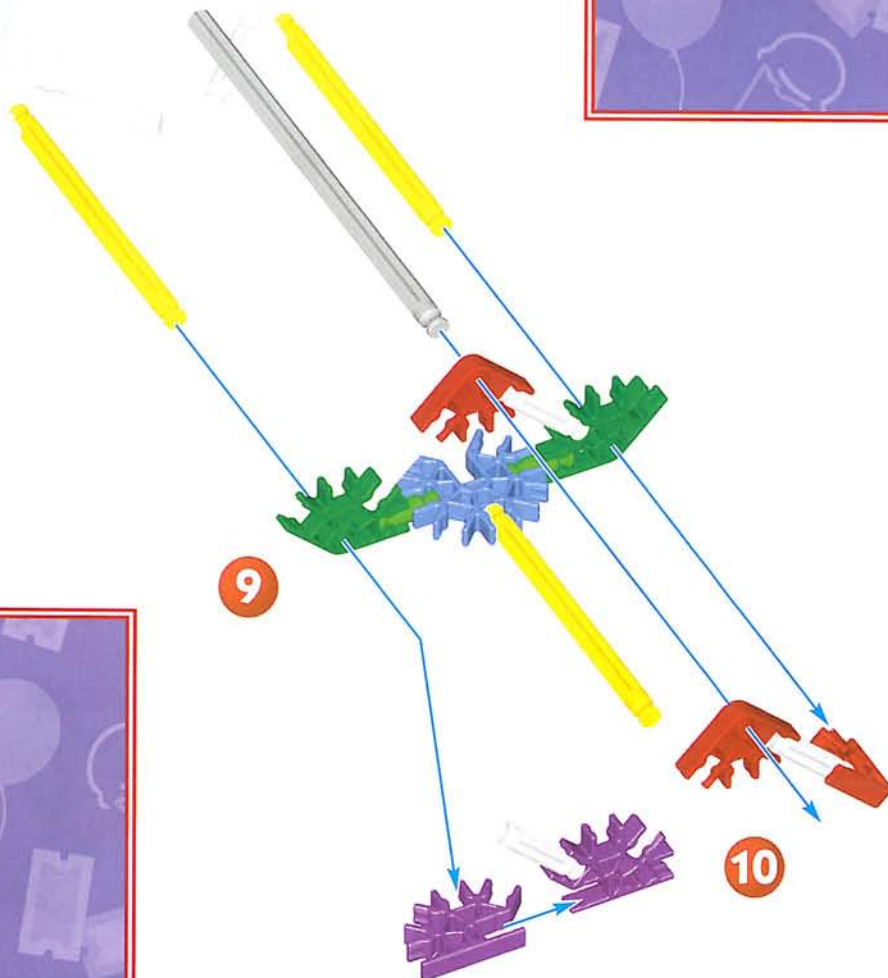

1 - 10

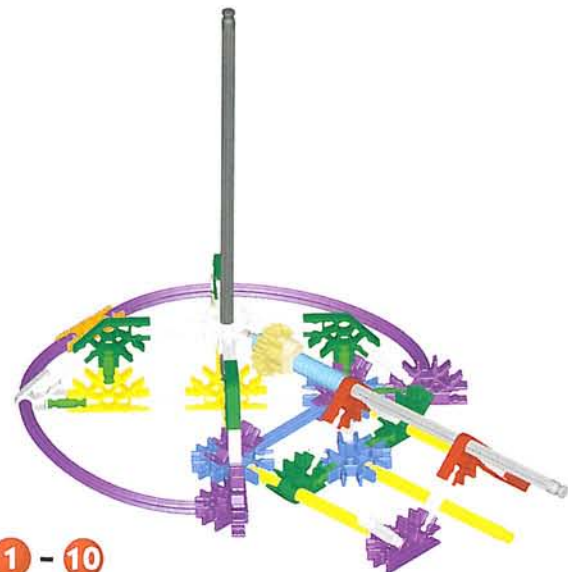

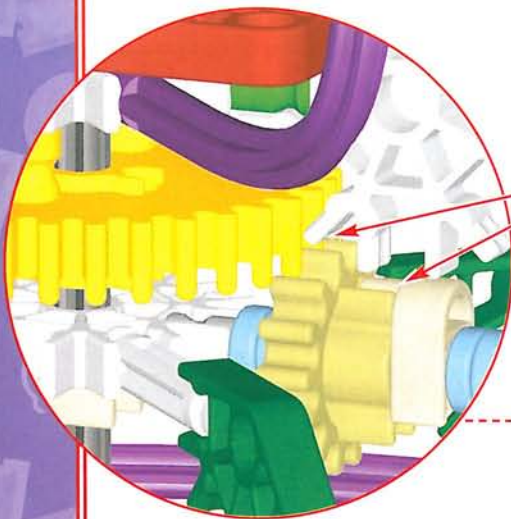
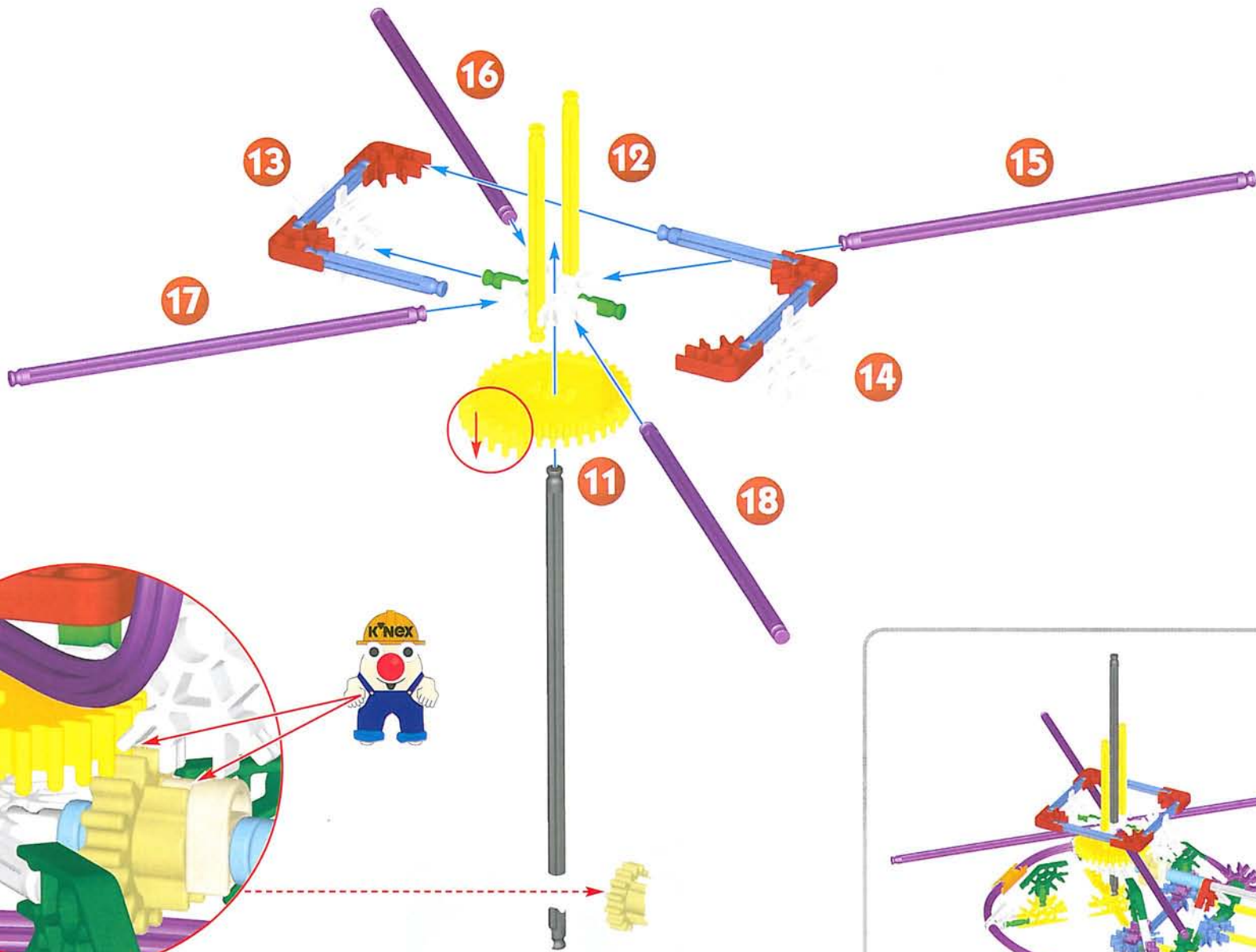

1 - 10

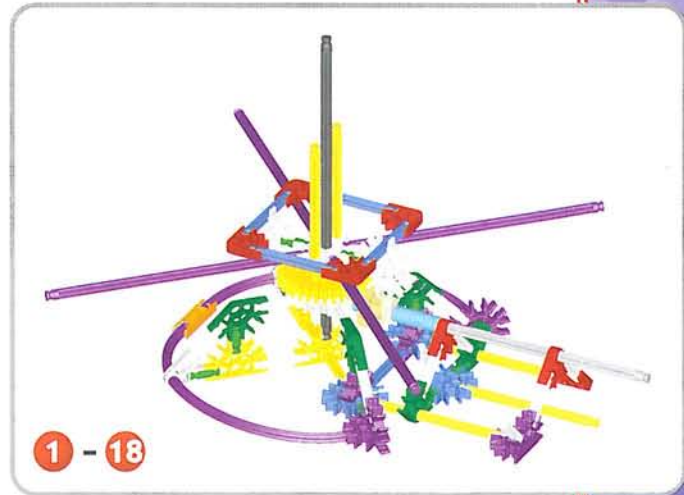

1 - 18

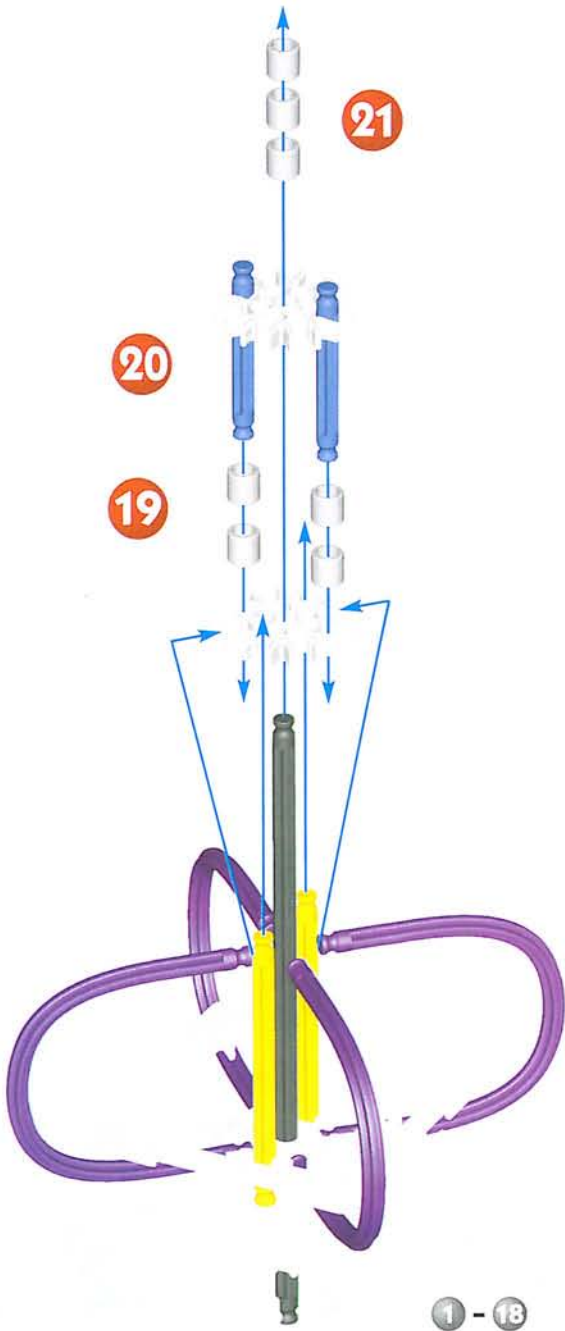

1 - 18

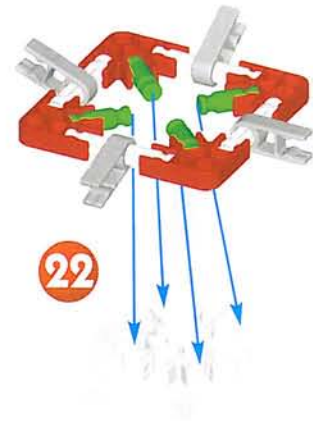

22

1 - 21



1 - 22



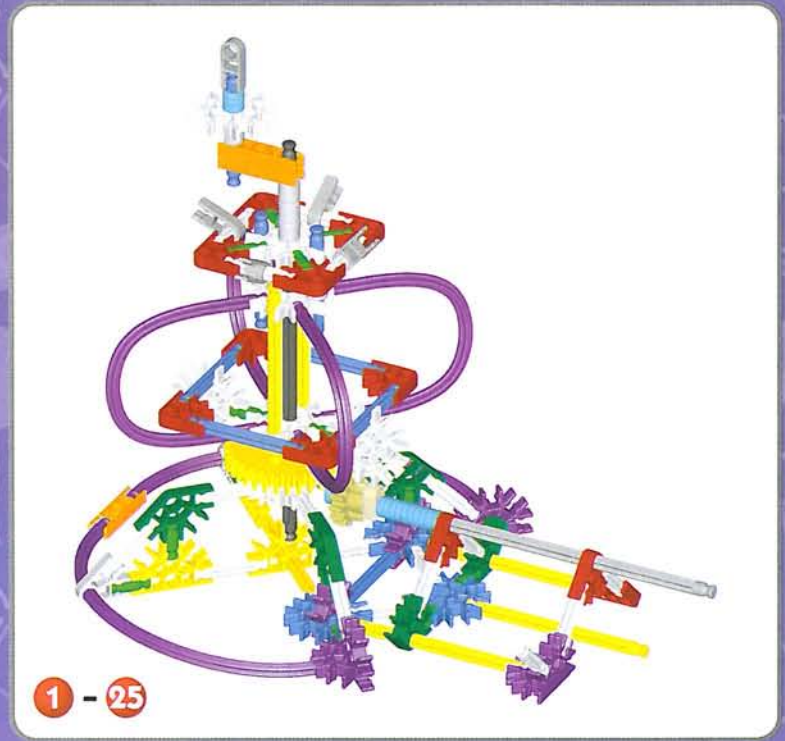

x4

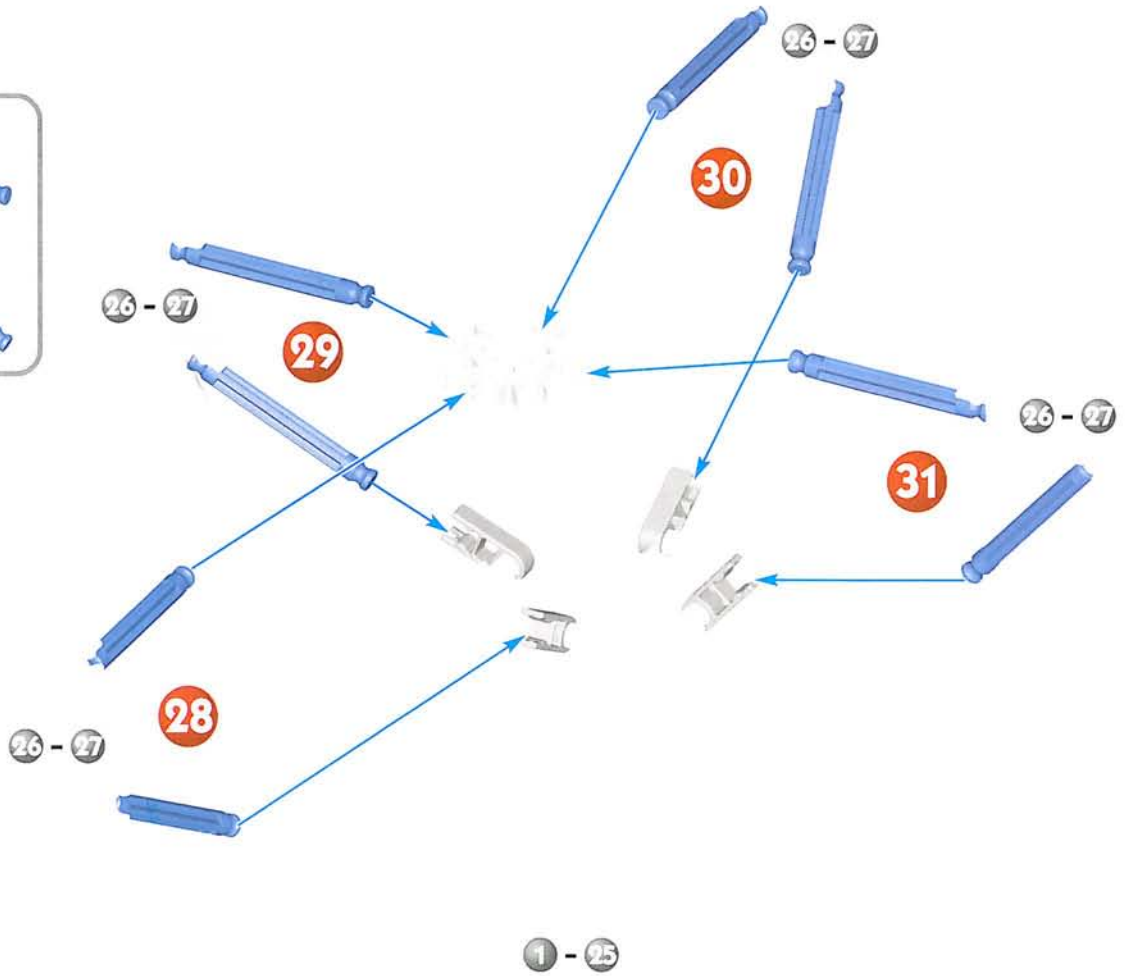

x4

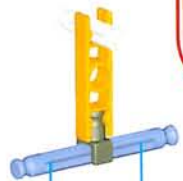

32

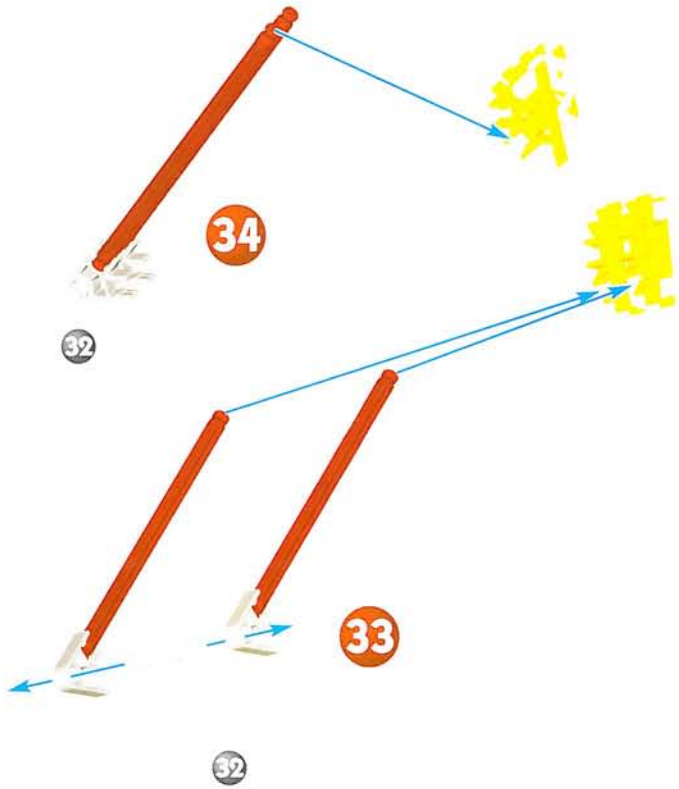
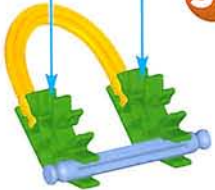

34

33

1 - 31

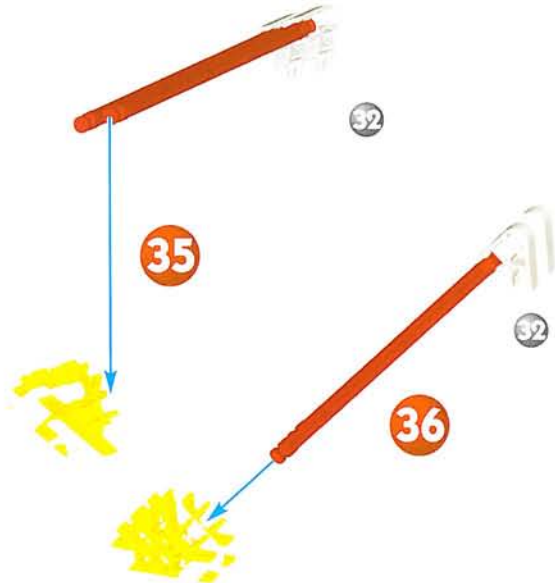

35

36

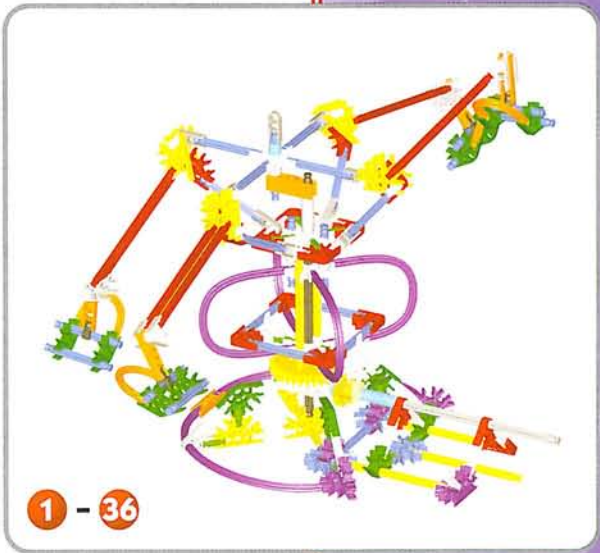

1 - 36

1 - 36

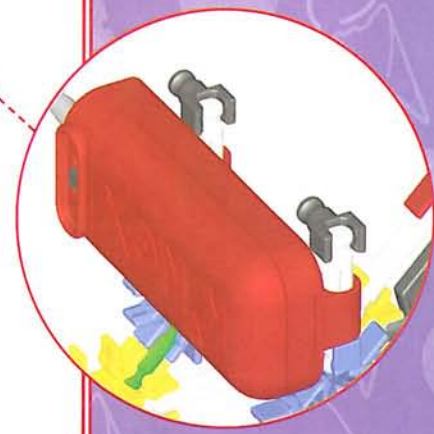
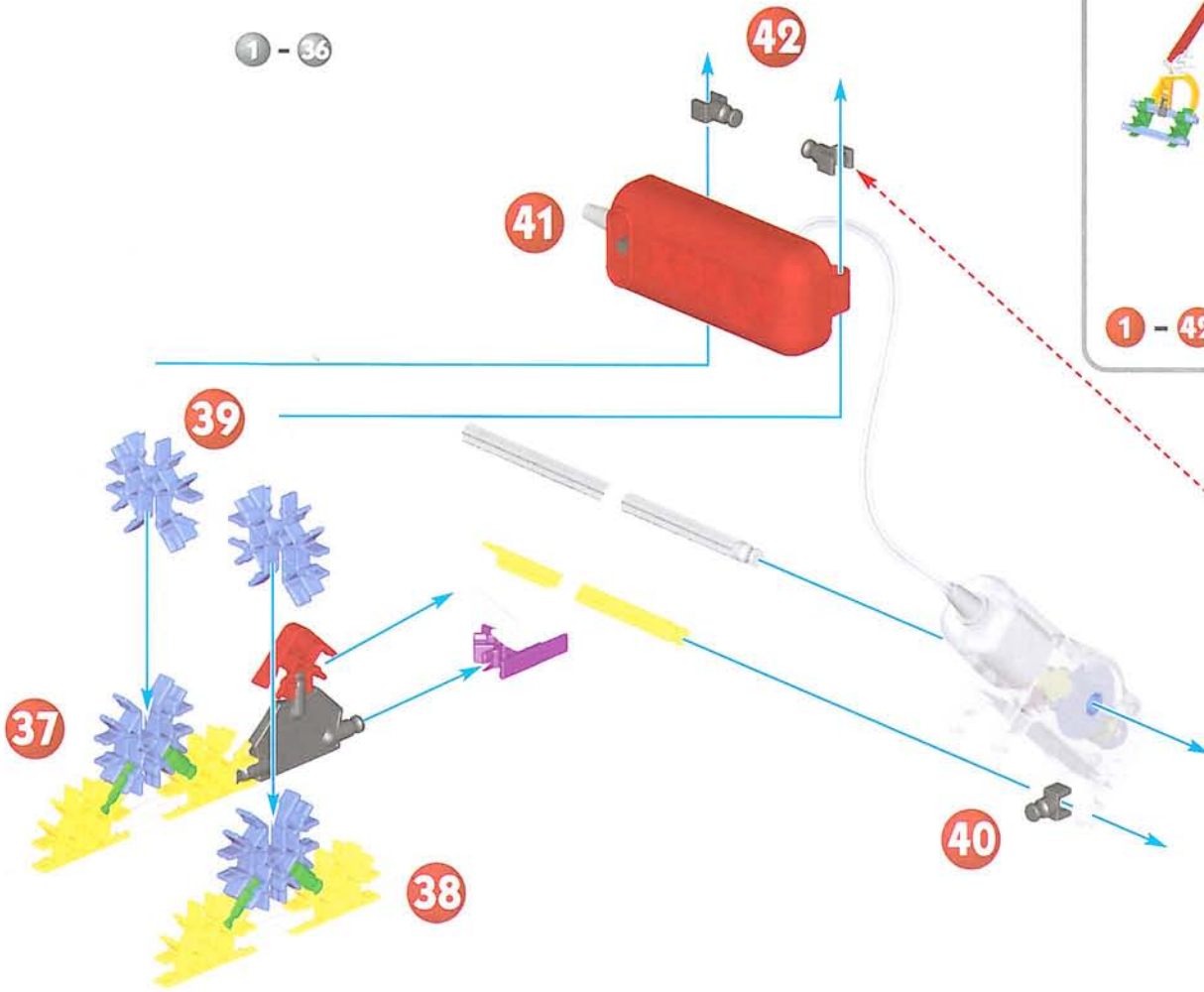

# Giant Inch Worm

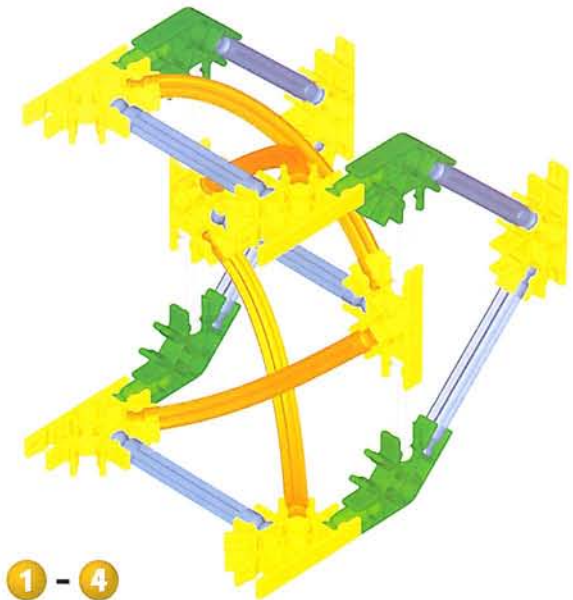
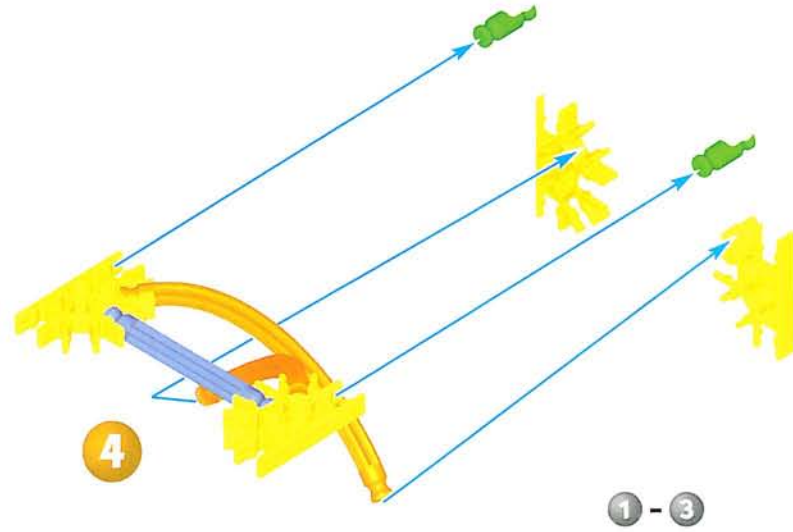
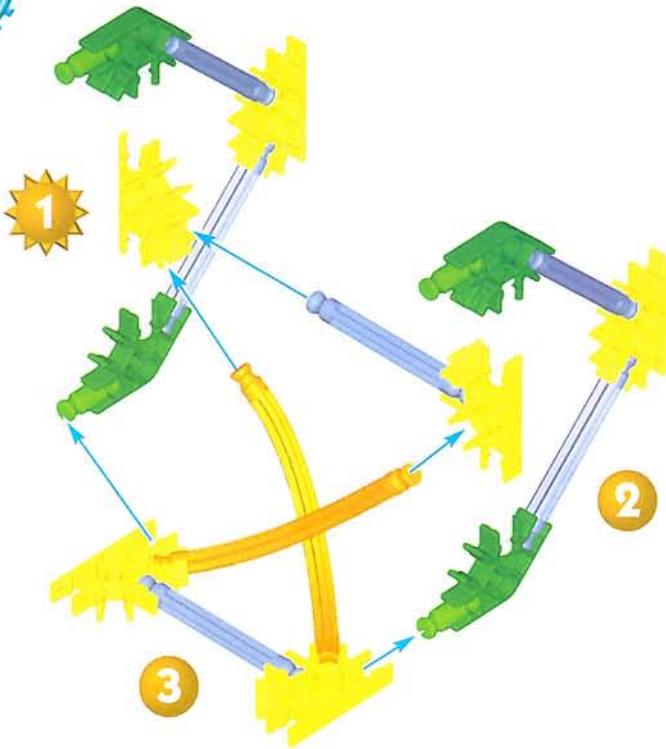
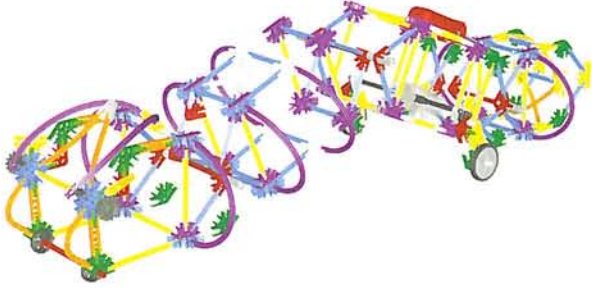

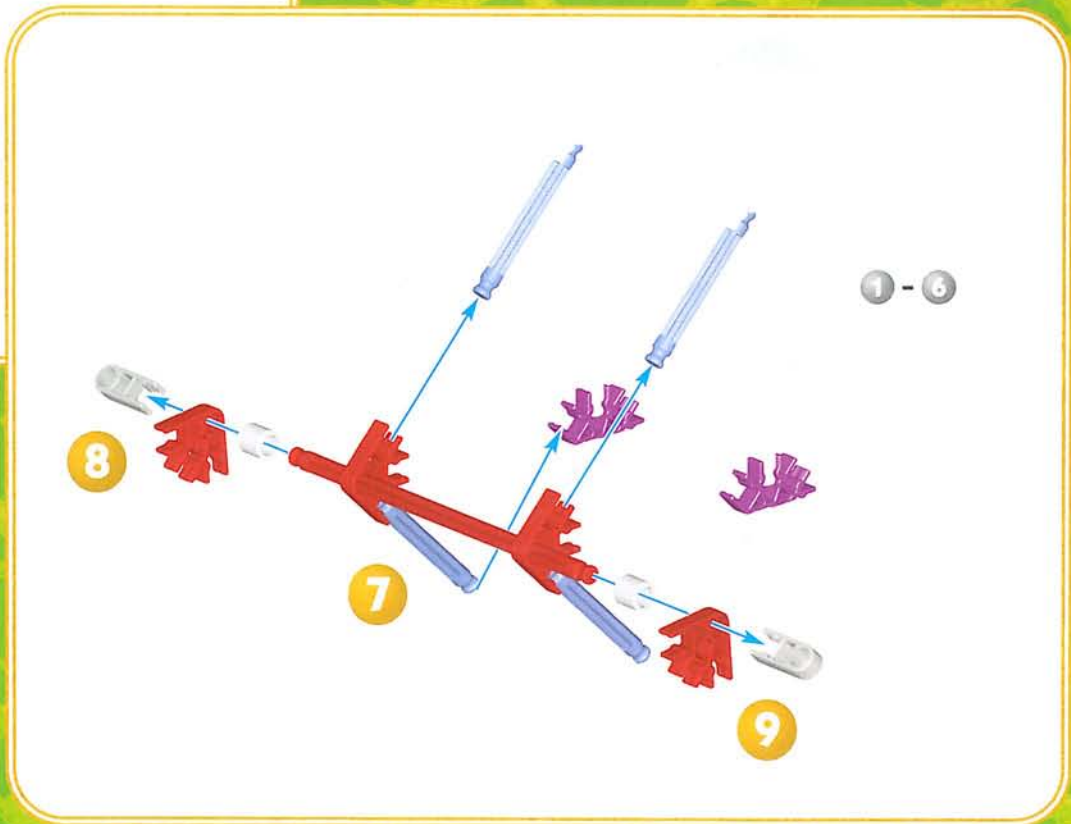
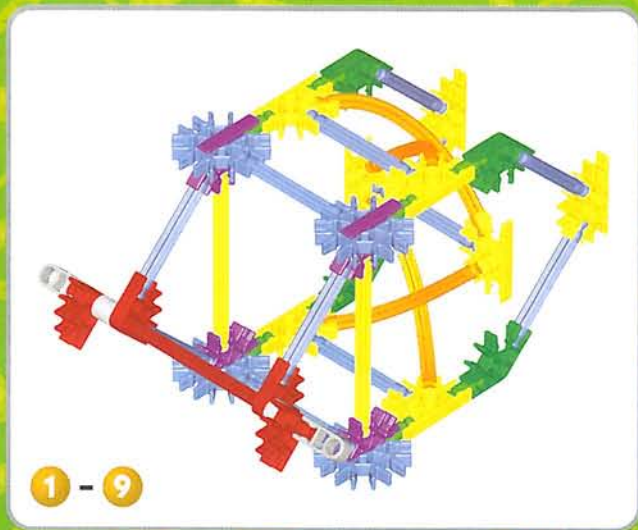
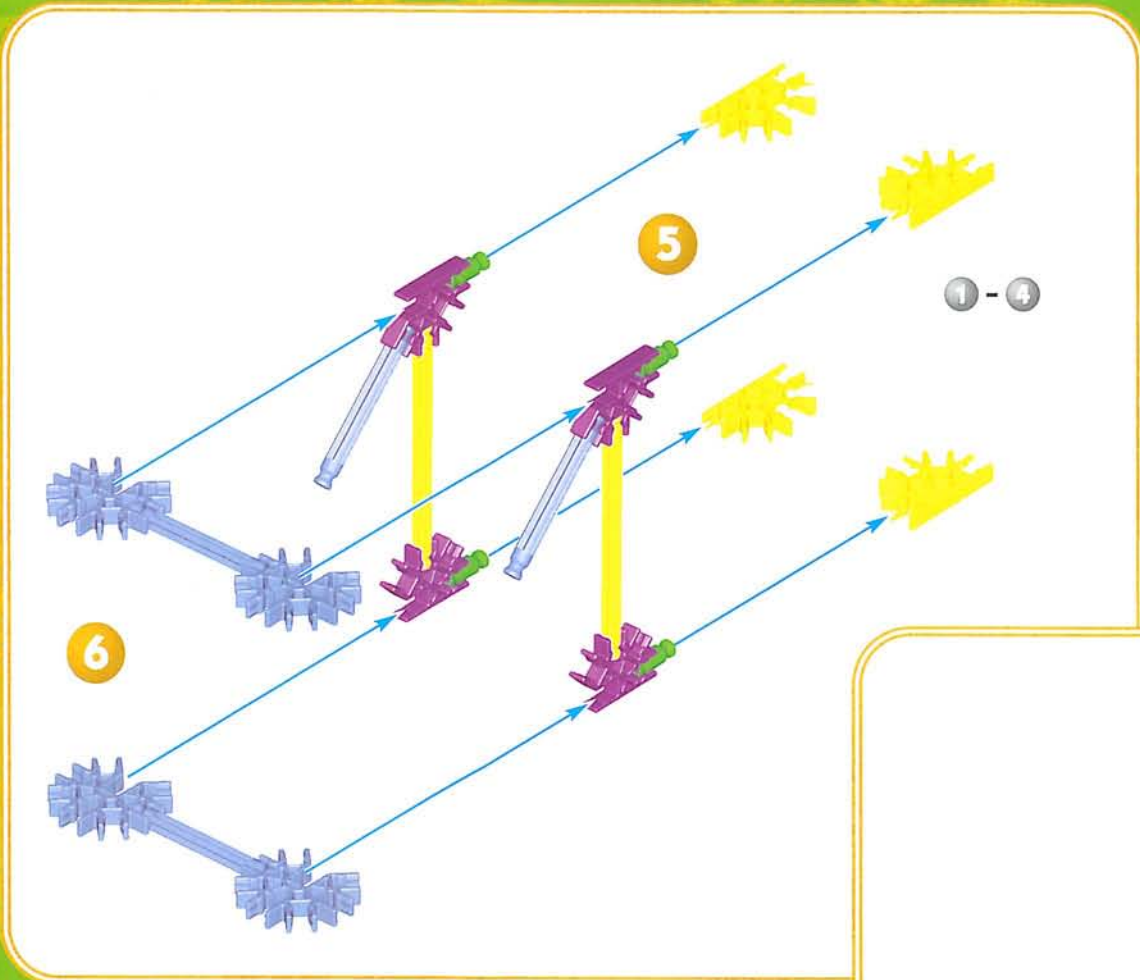

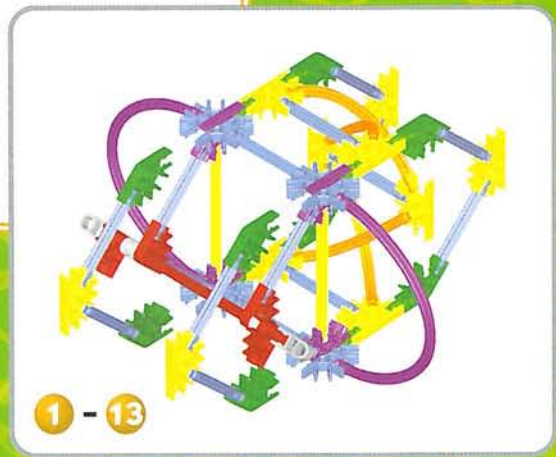
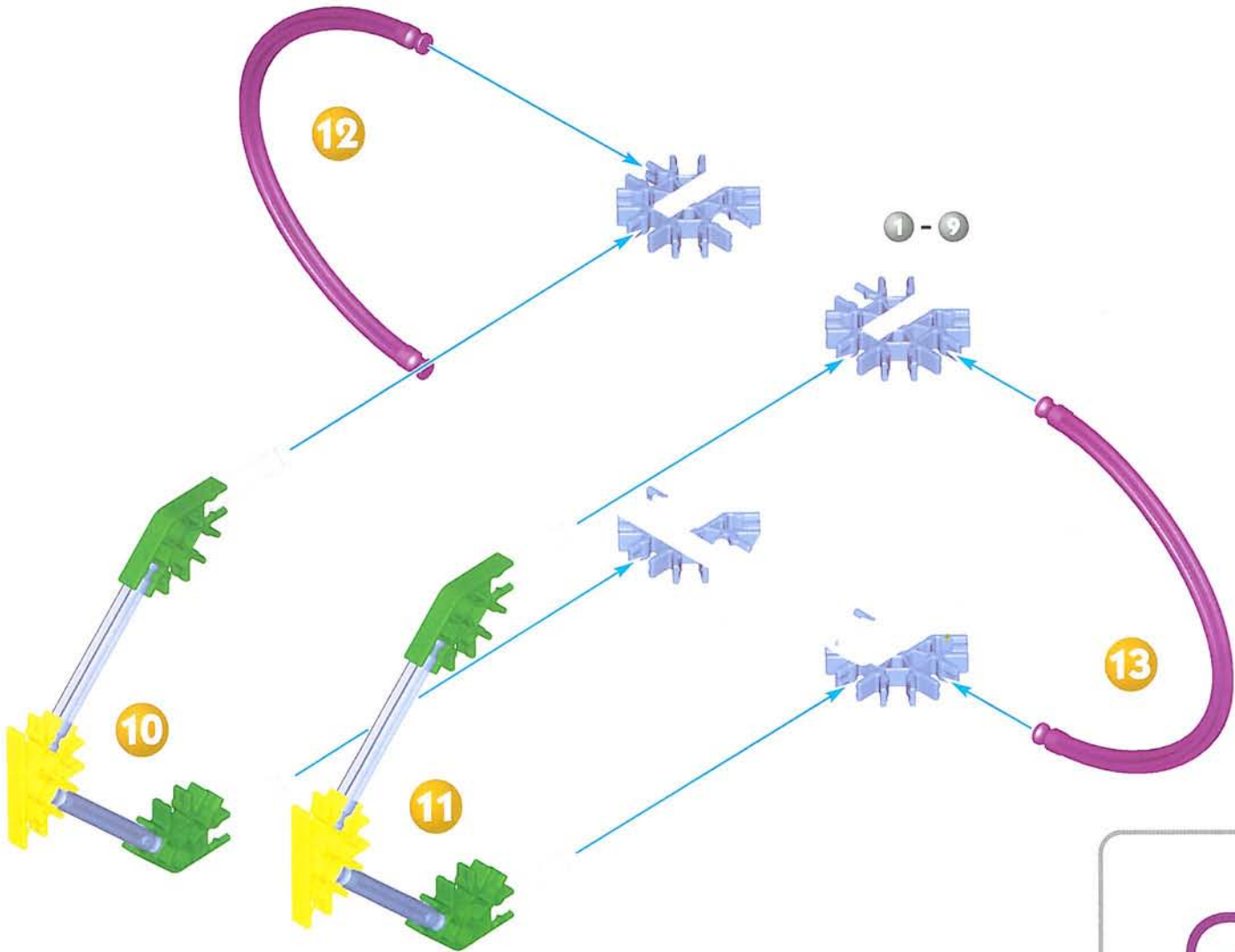





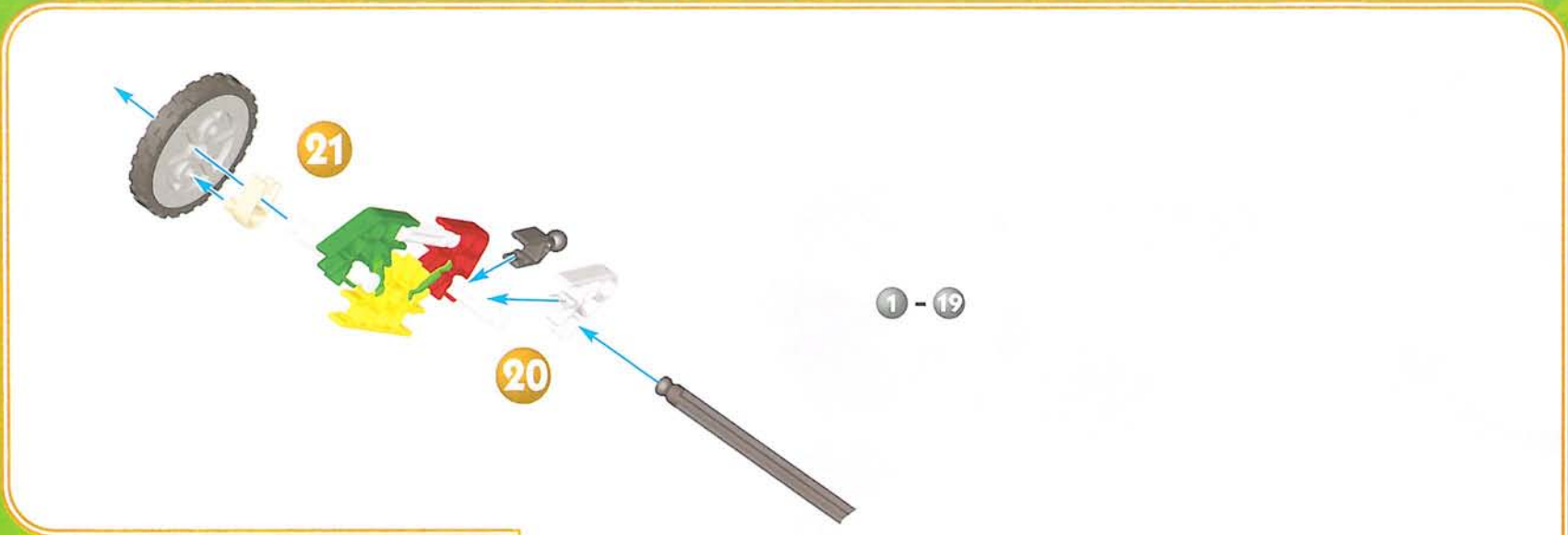

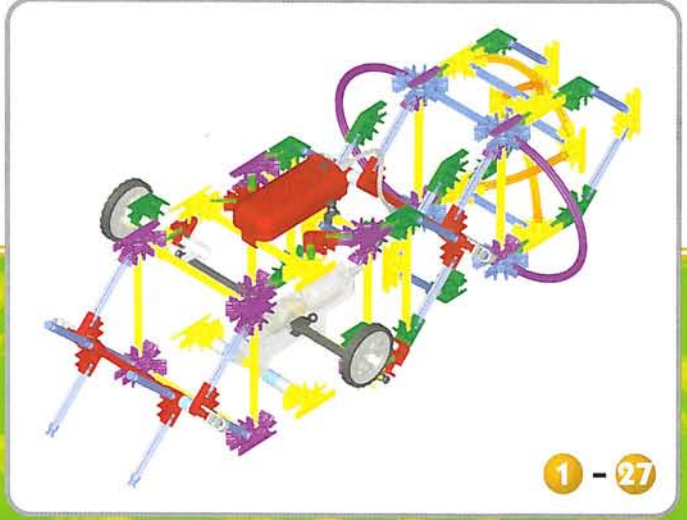
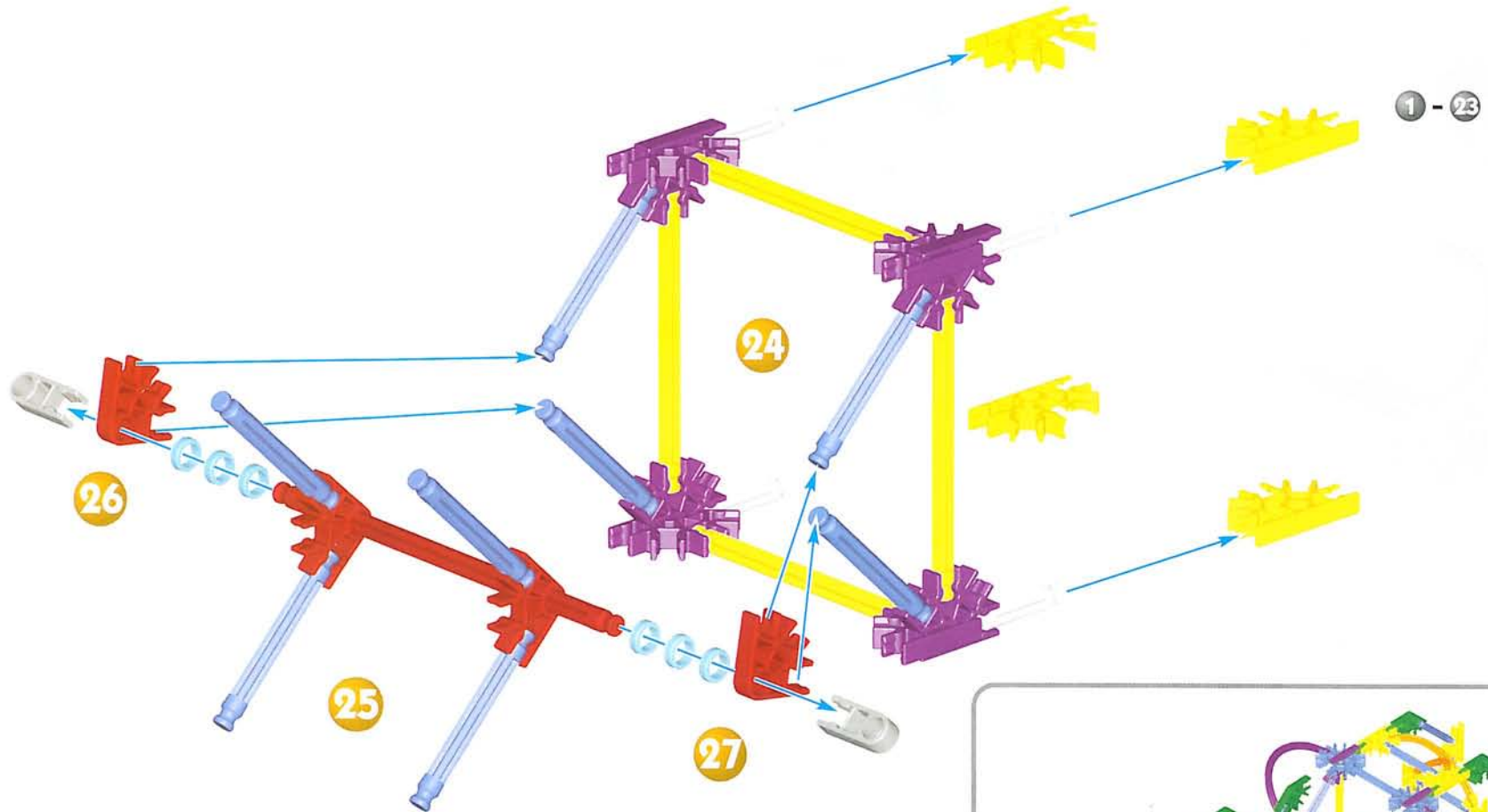

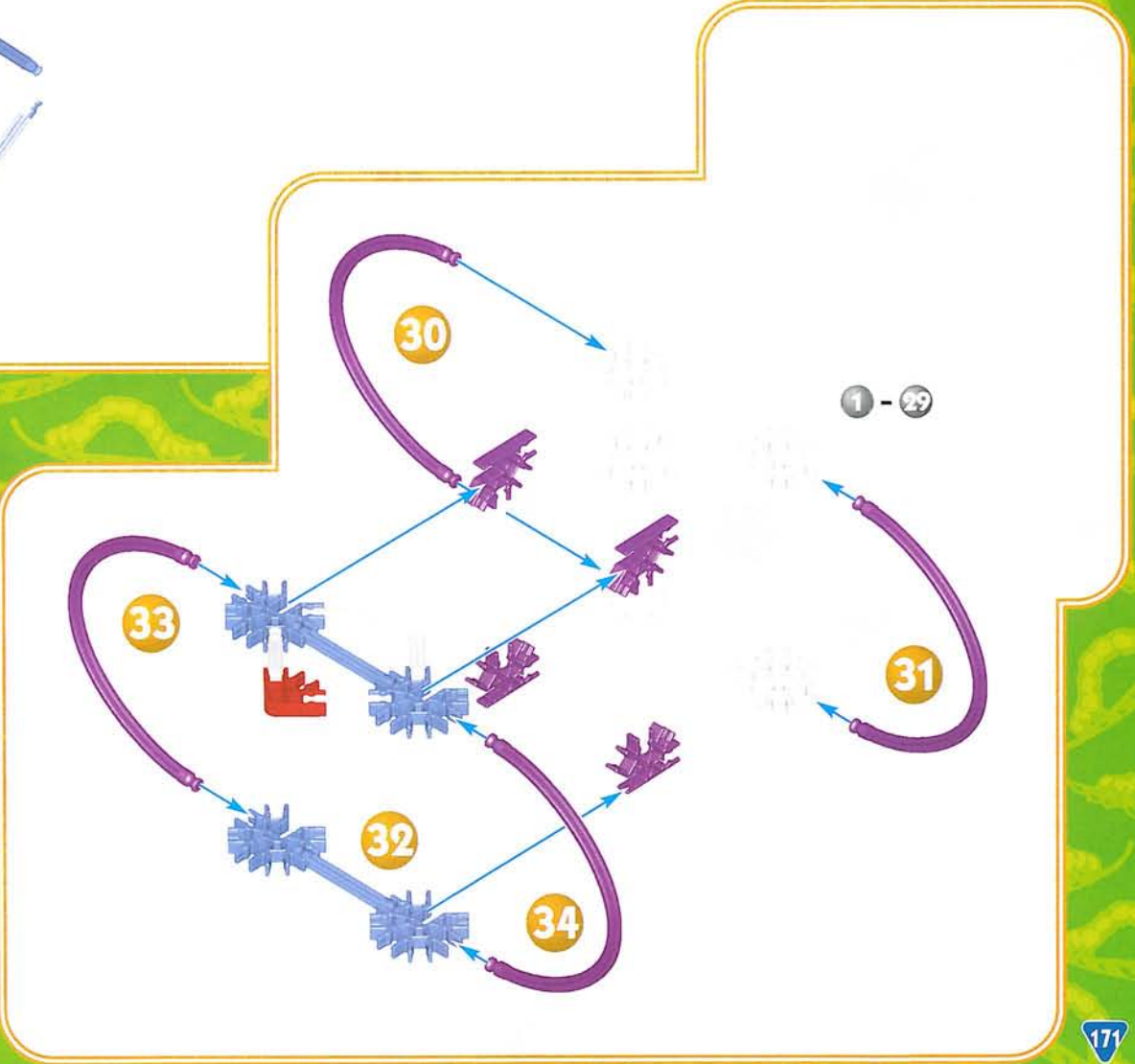
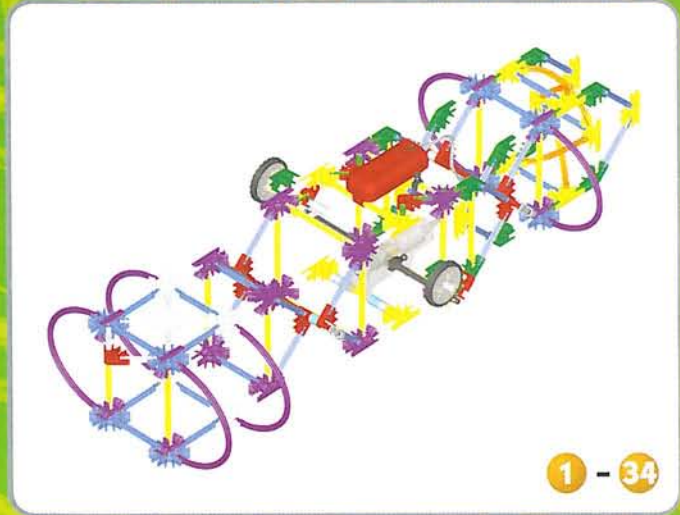
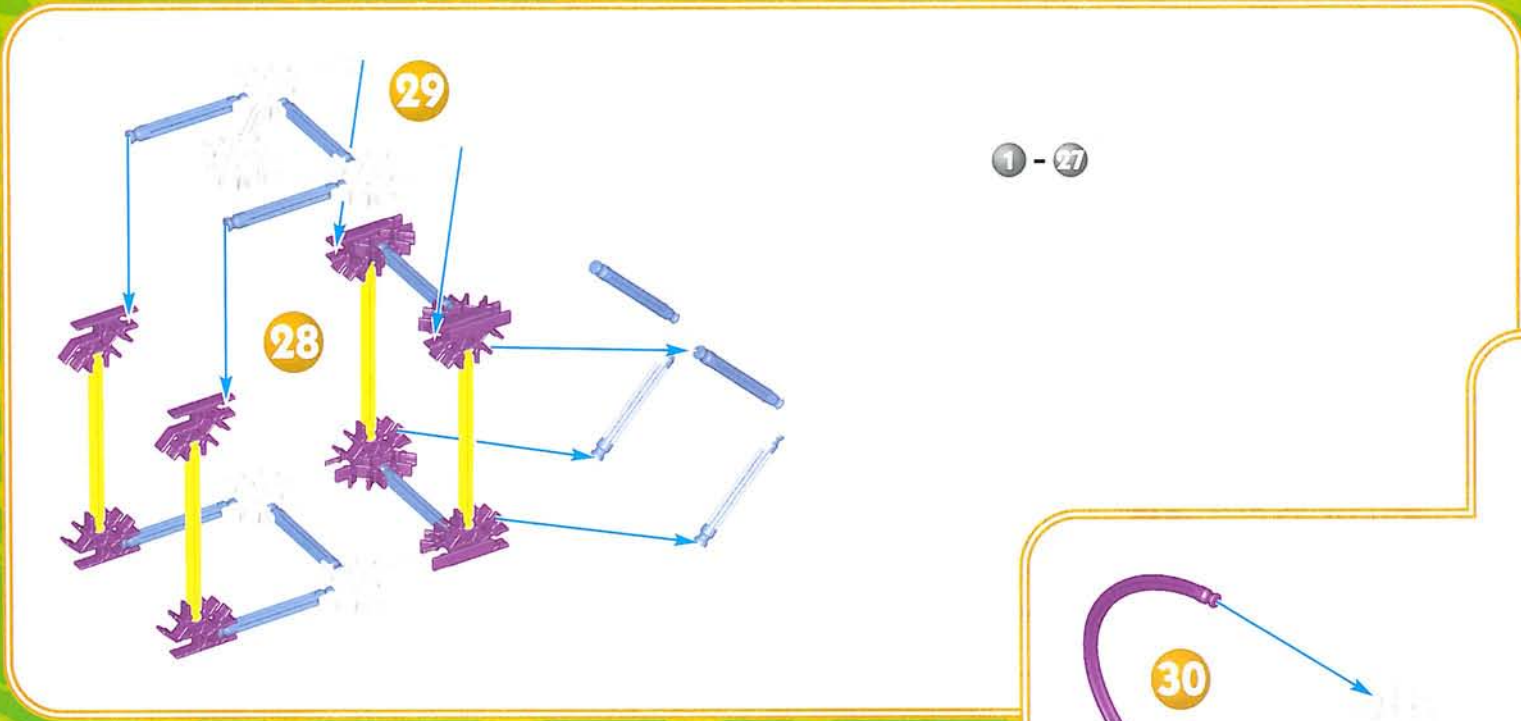

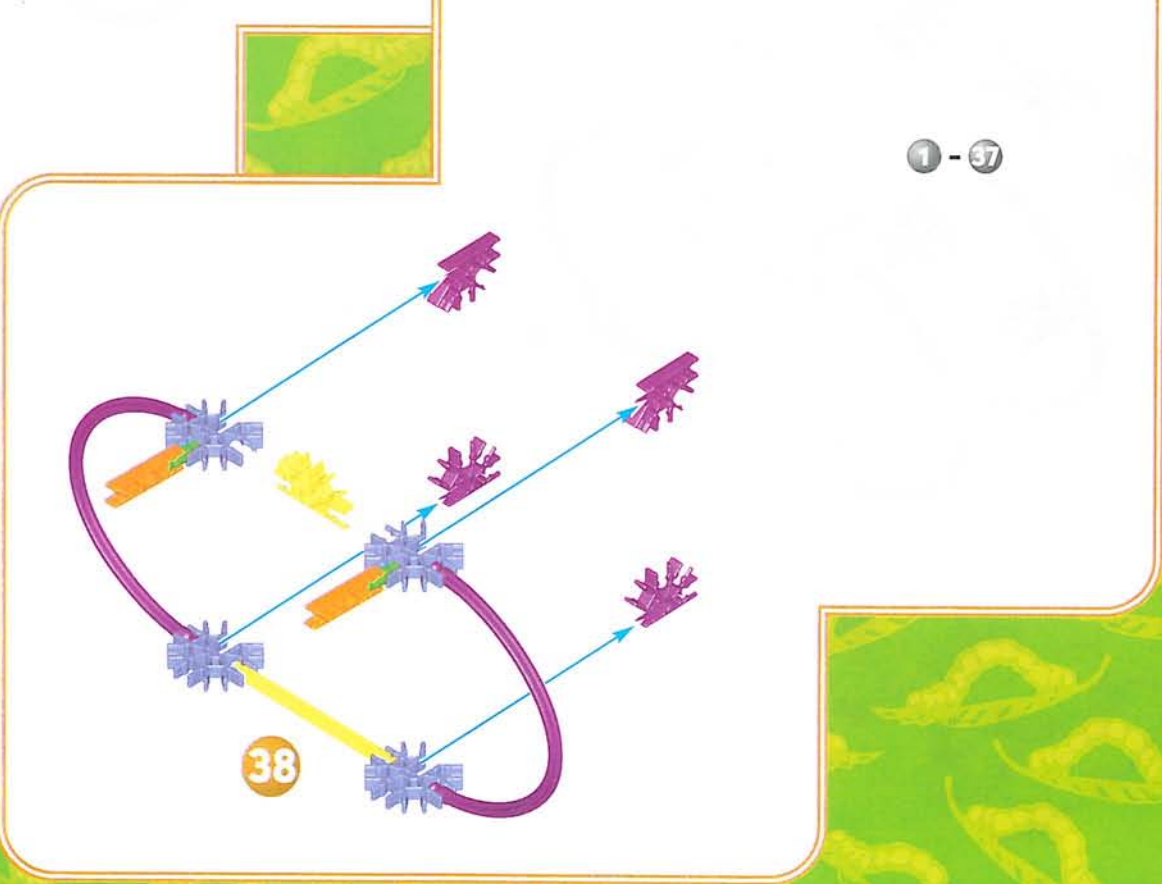
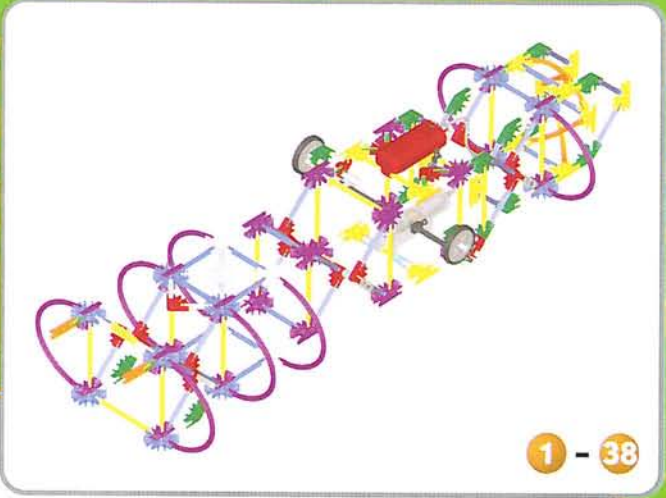
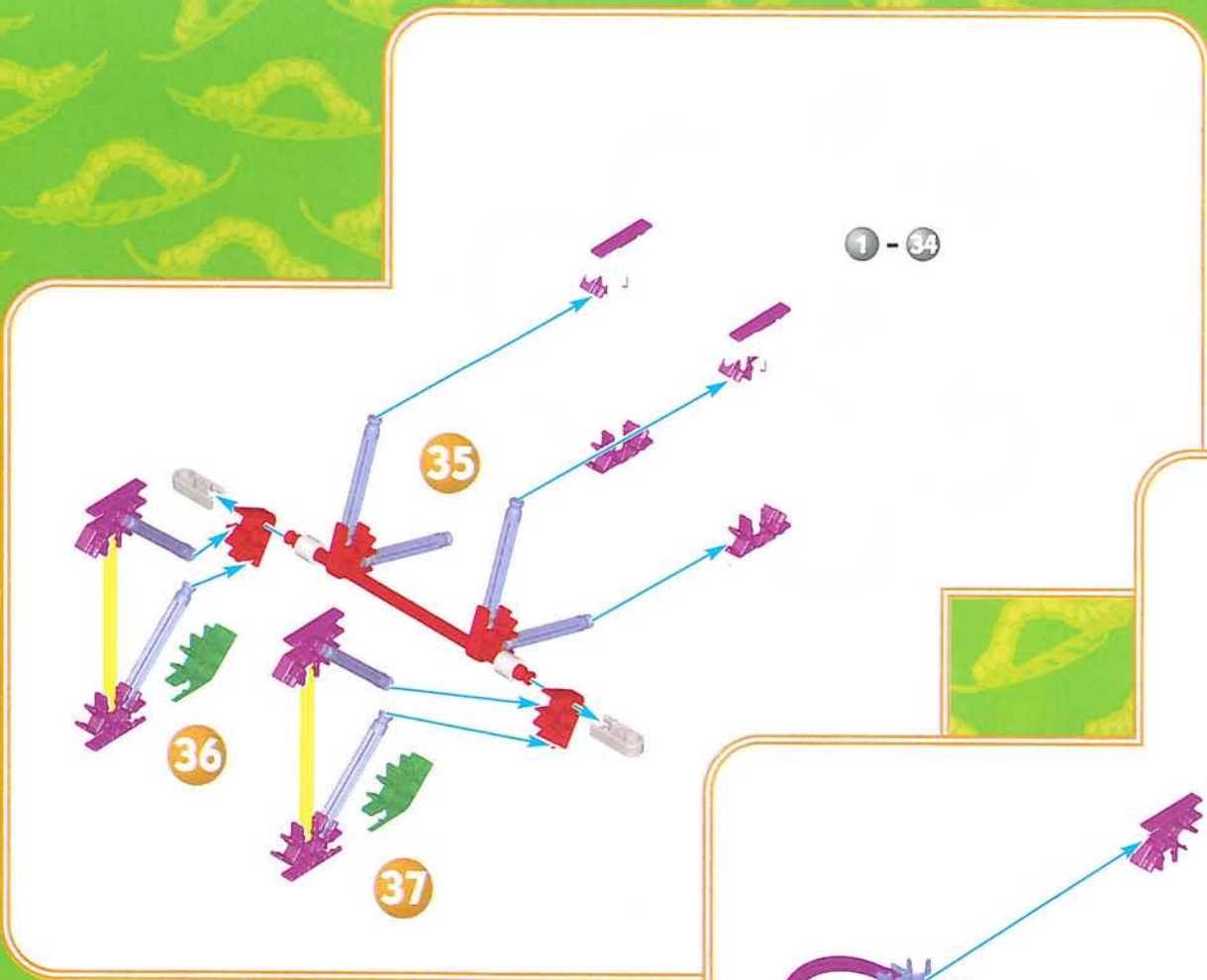

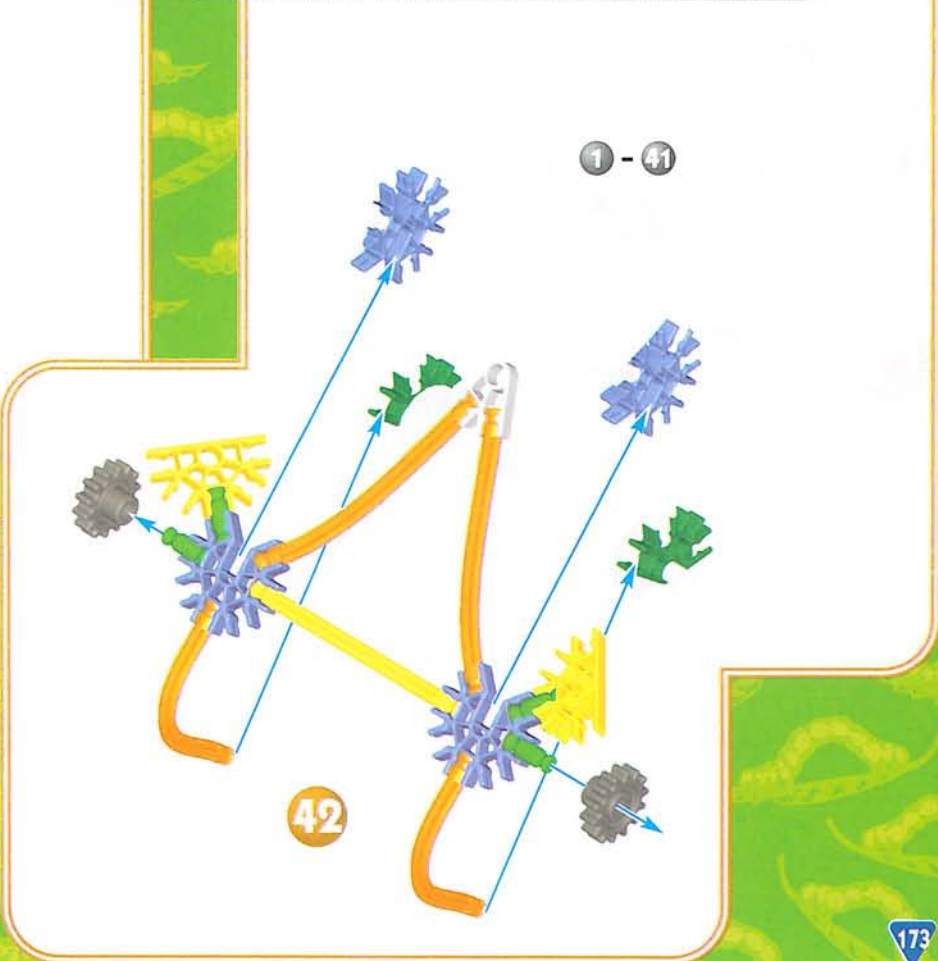
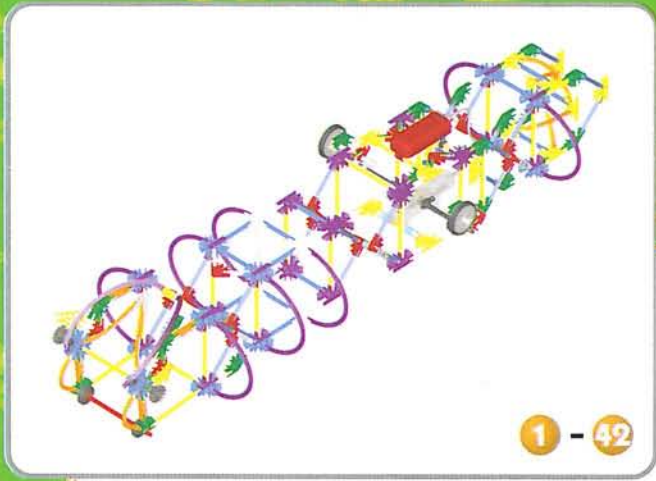
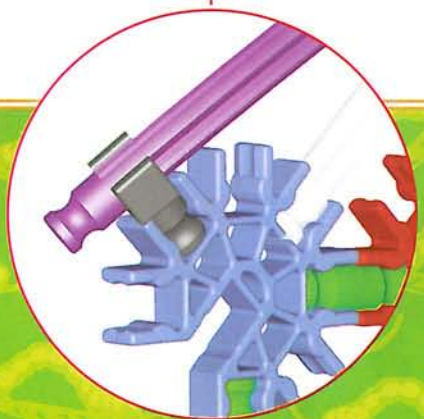
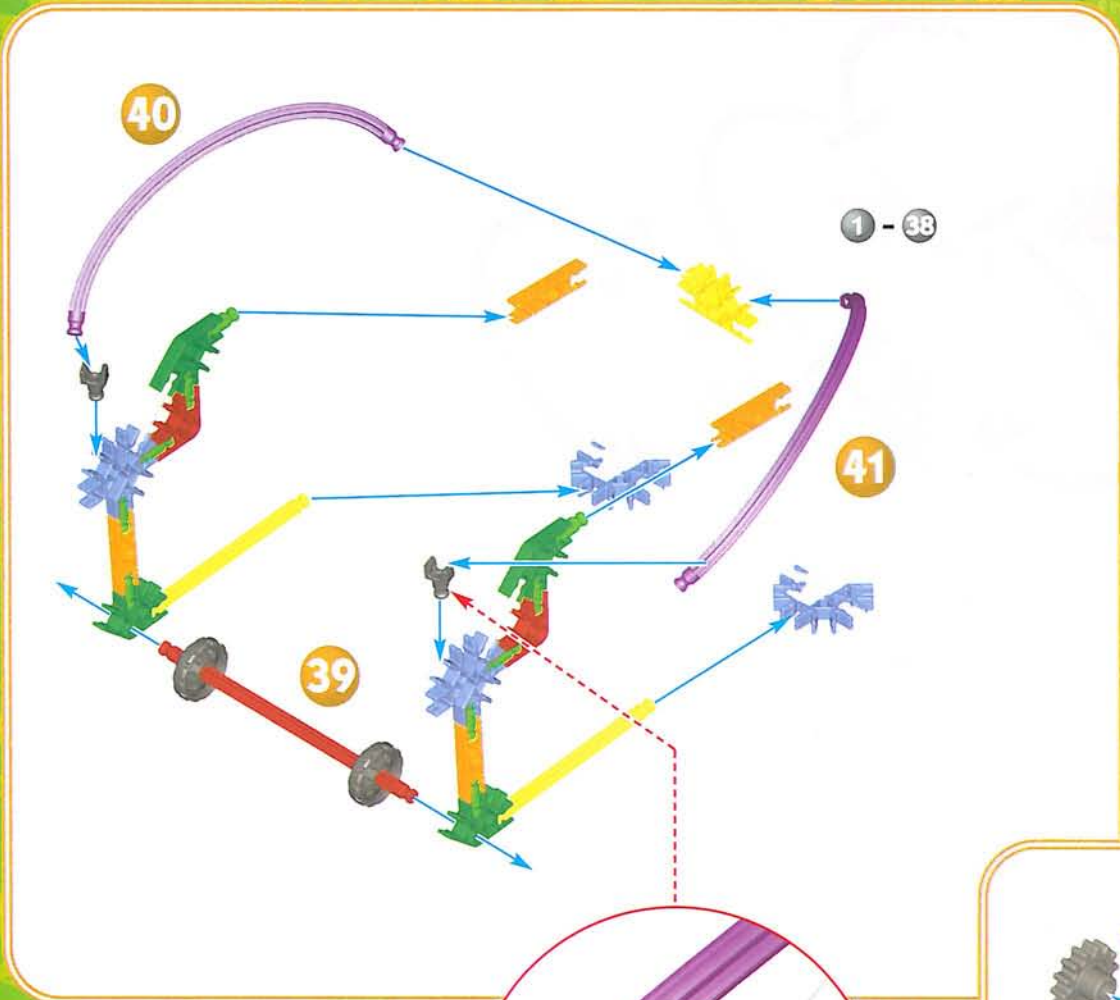

# Shark

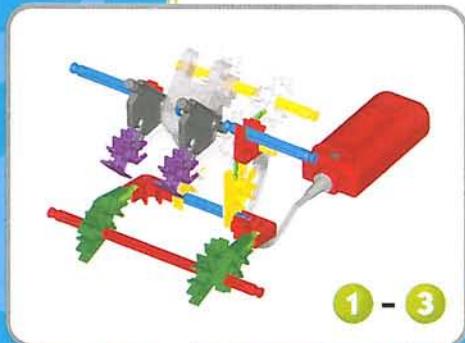
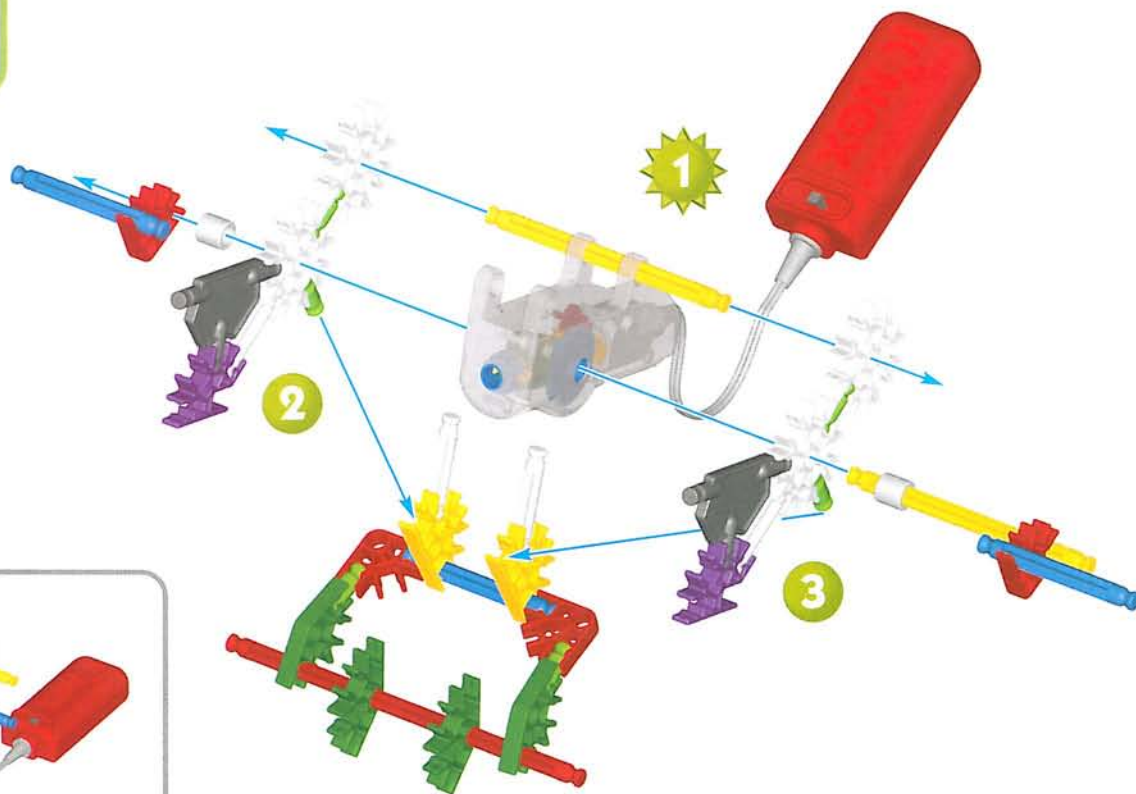
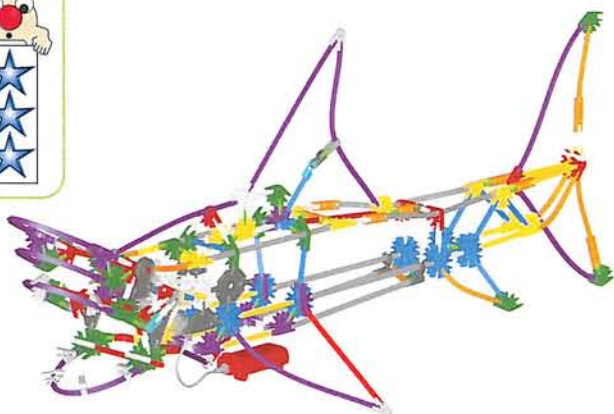
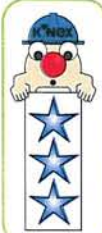

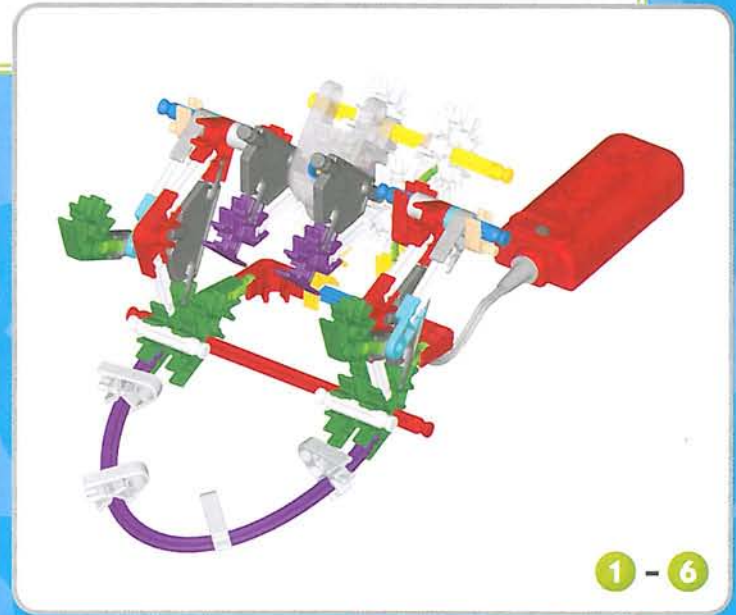
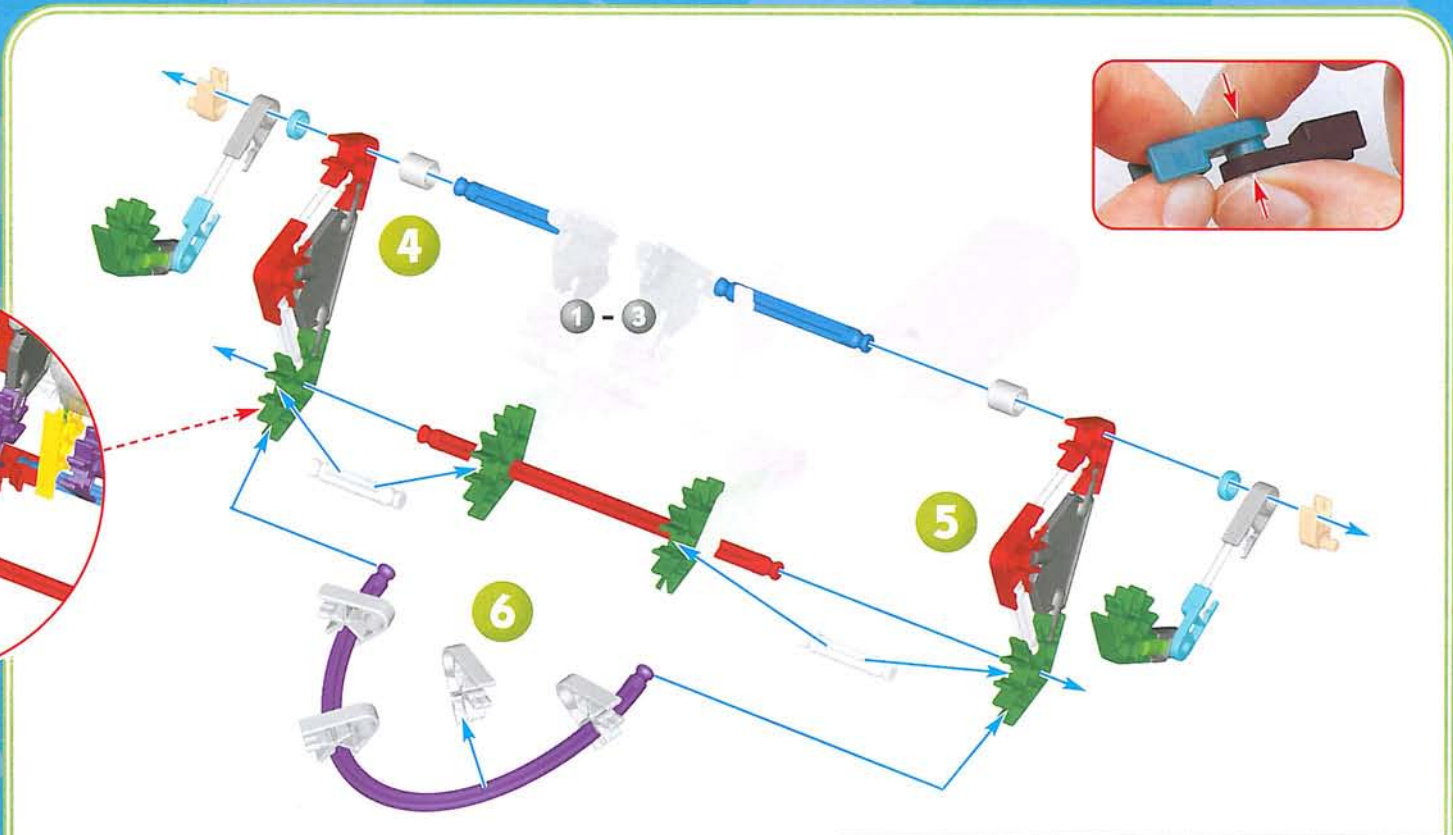
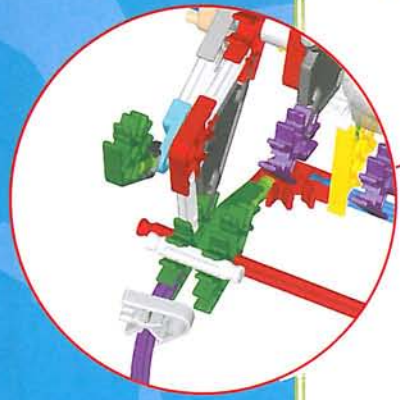

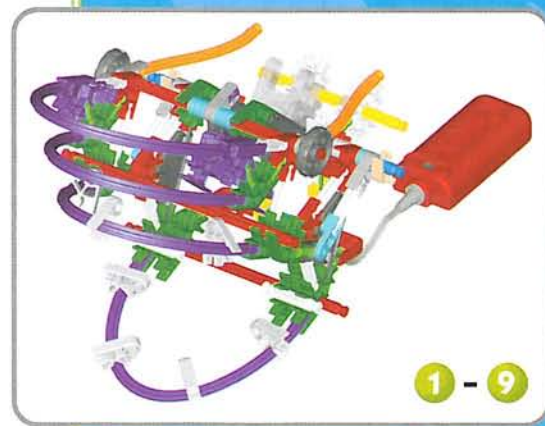
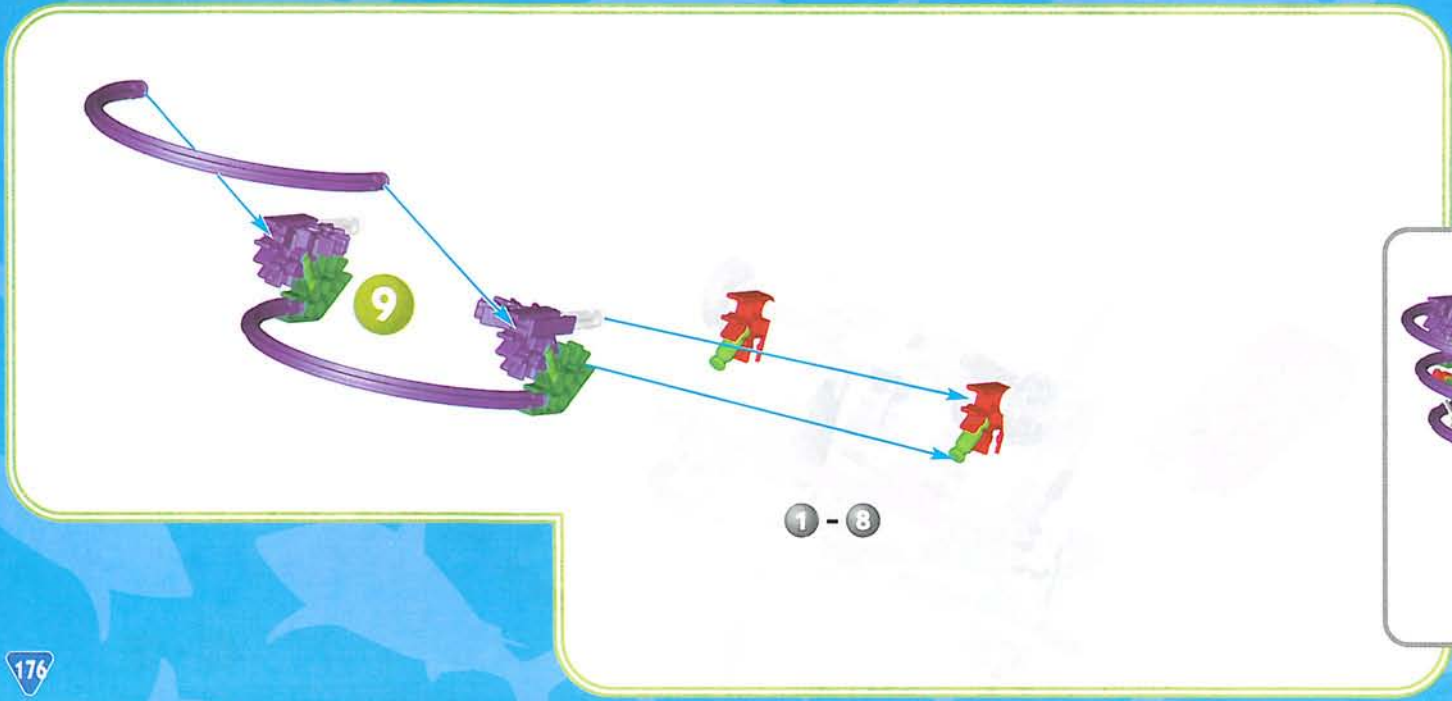
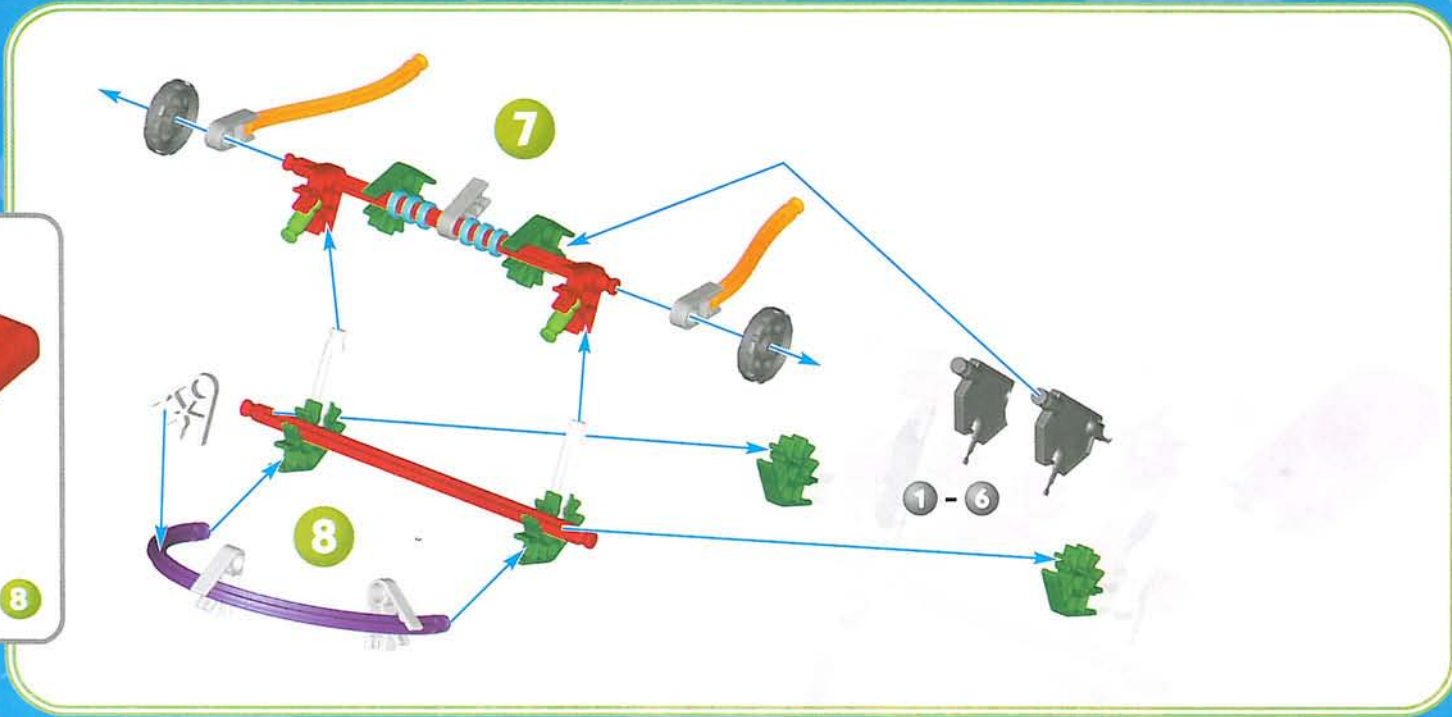
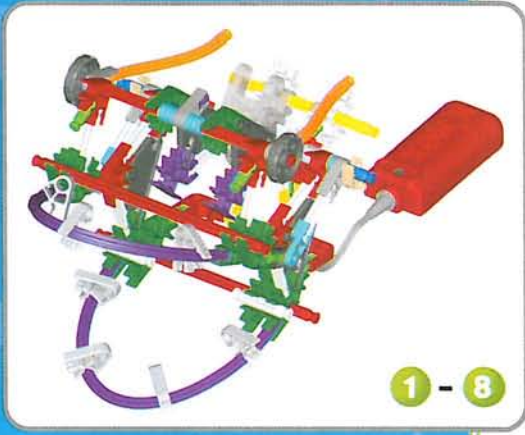



1 - 9

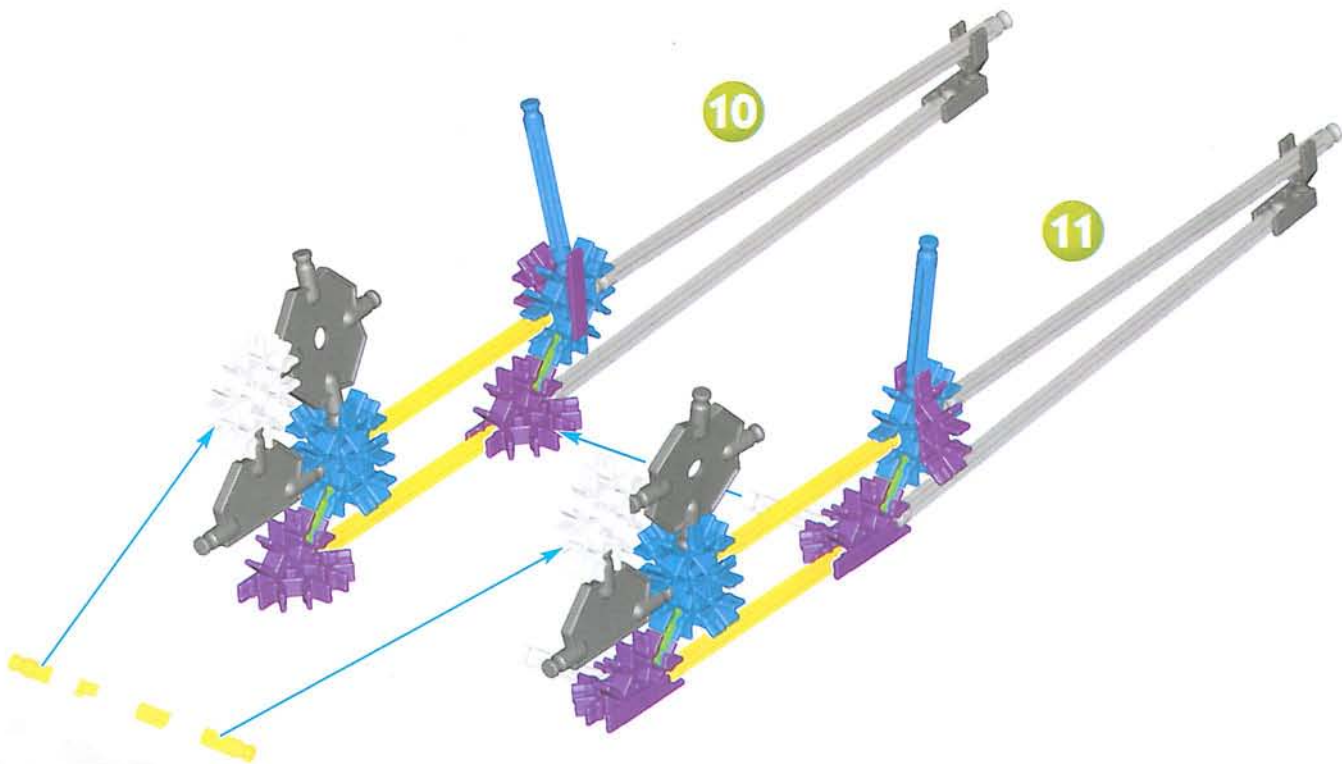

10

11



1 - 11

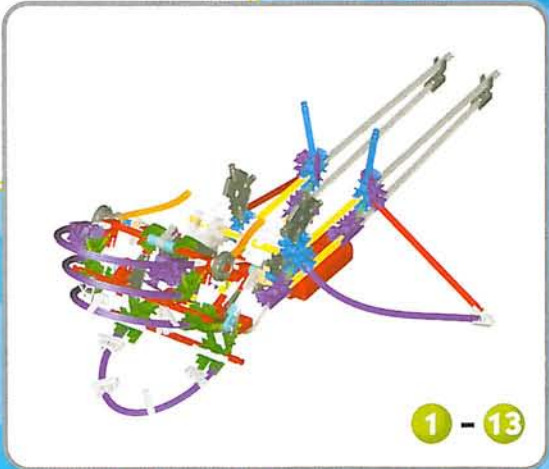

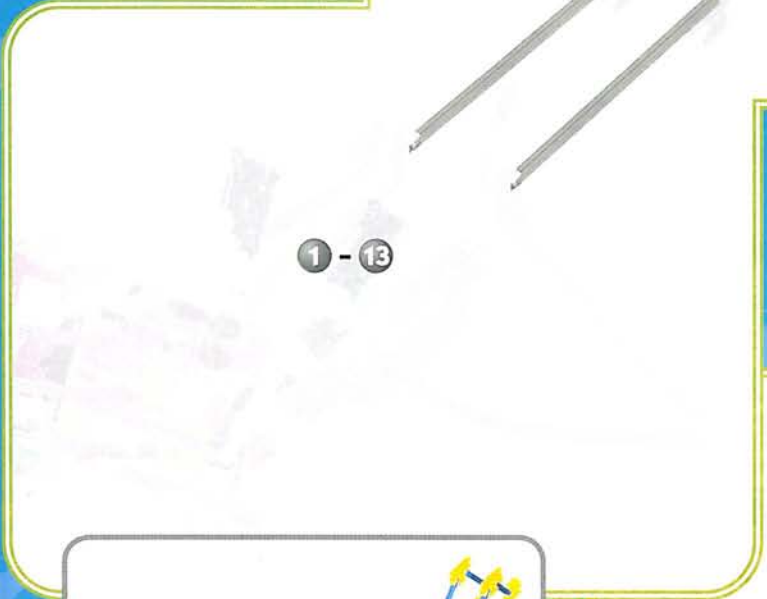
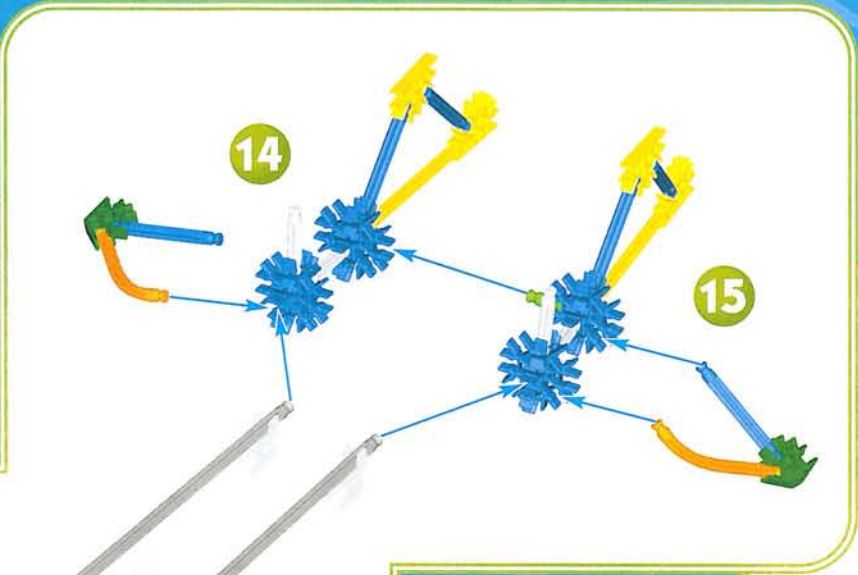

1 - 13



1 - 15

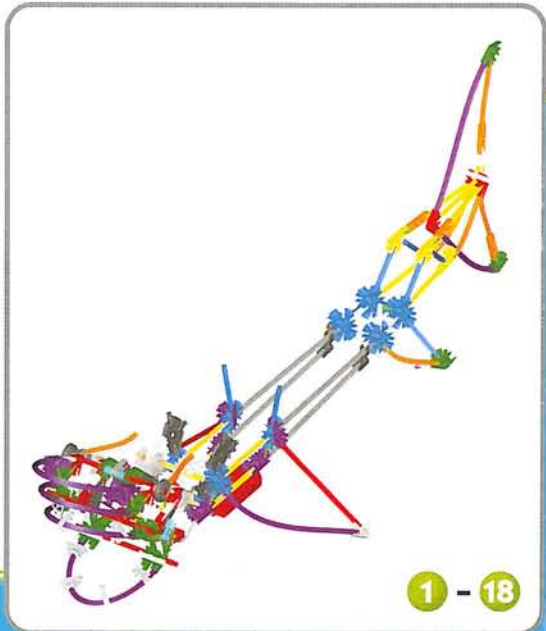
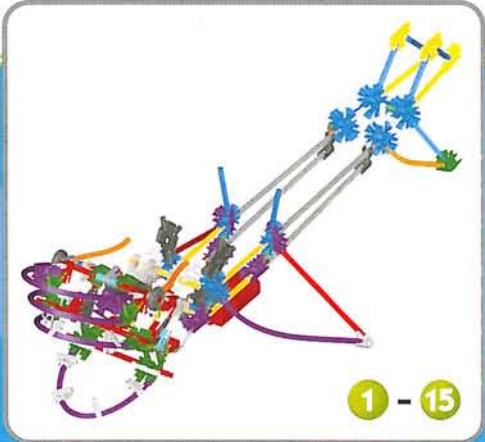

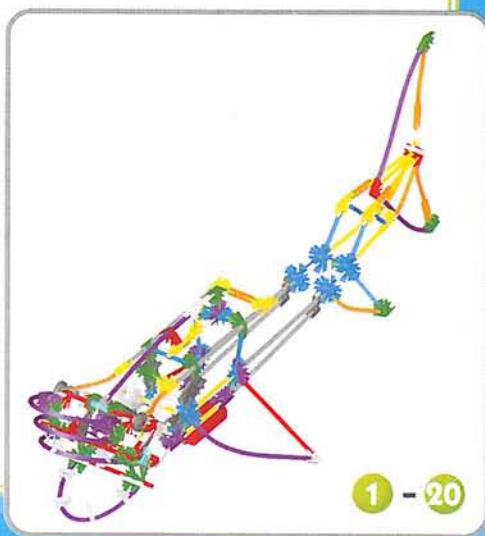
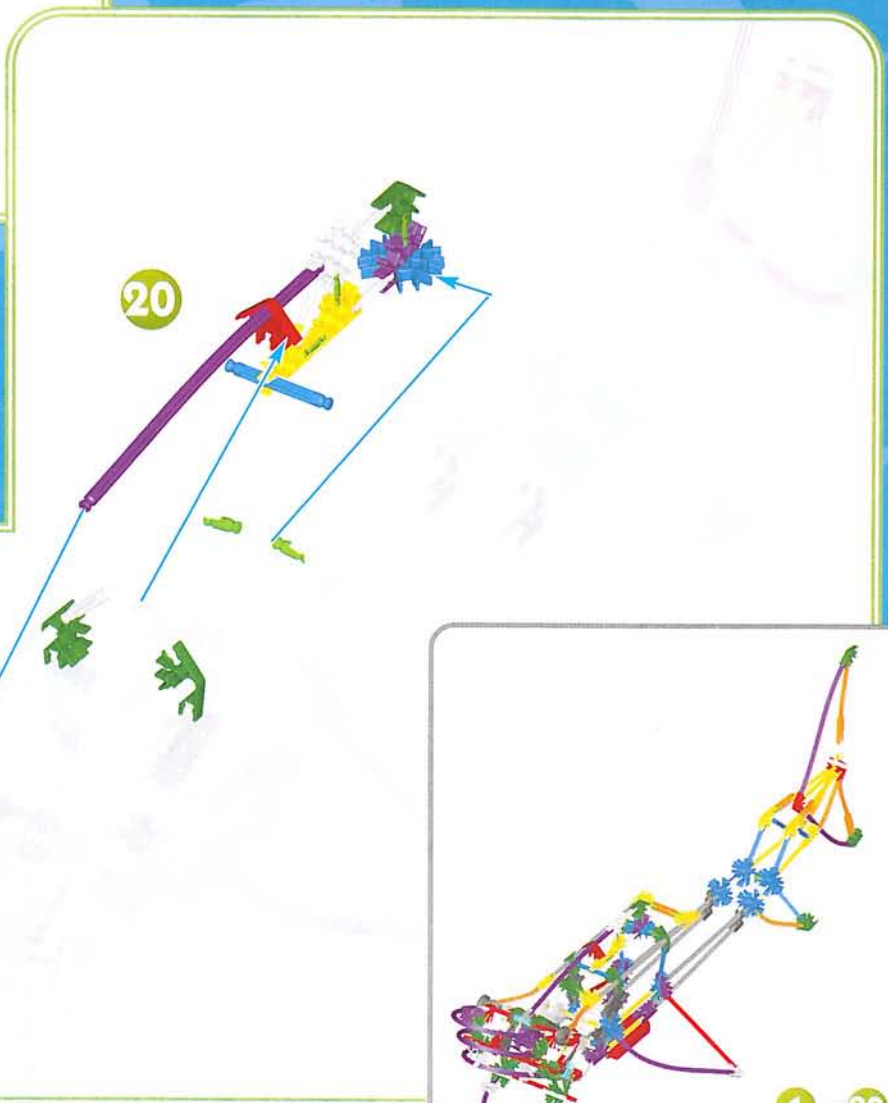

21

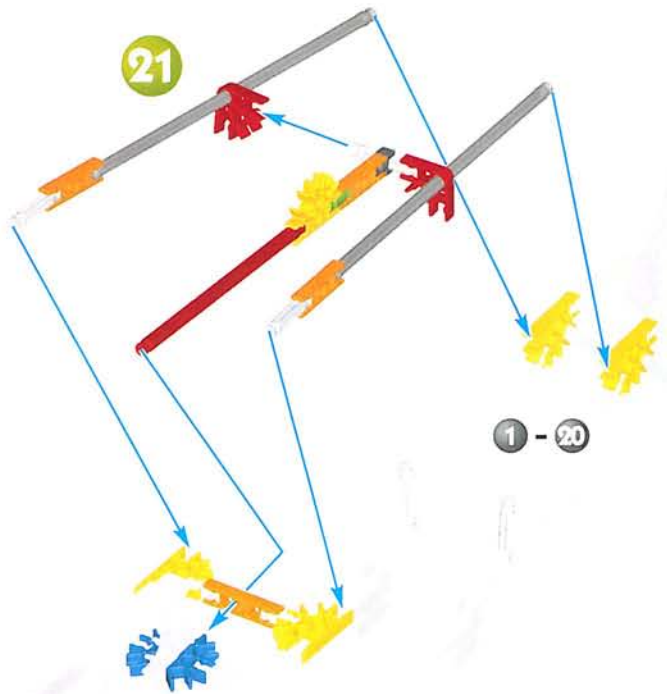

1 - 20

22

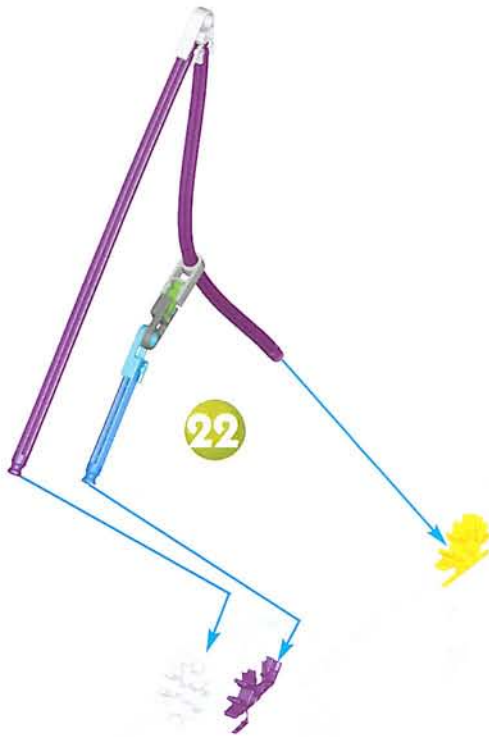

1 - 21

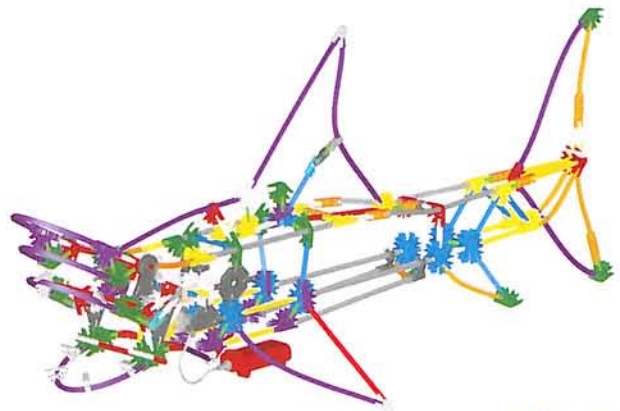

1 - 21

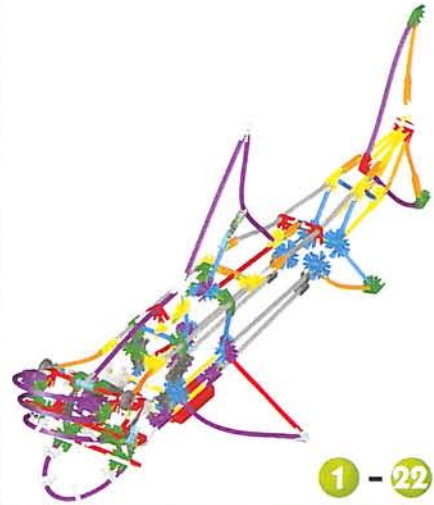

1 - 22

# Crane

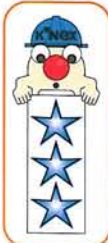

1 - 4

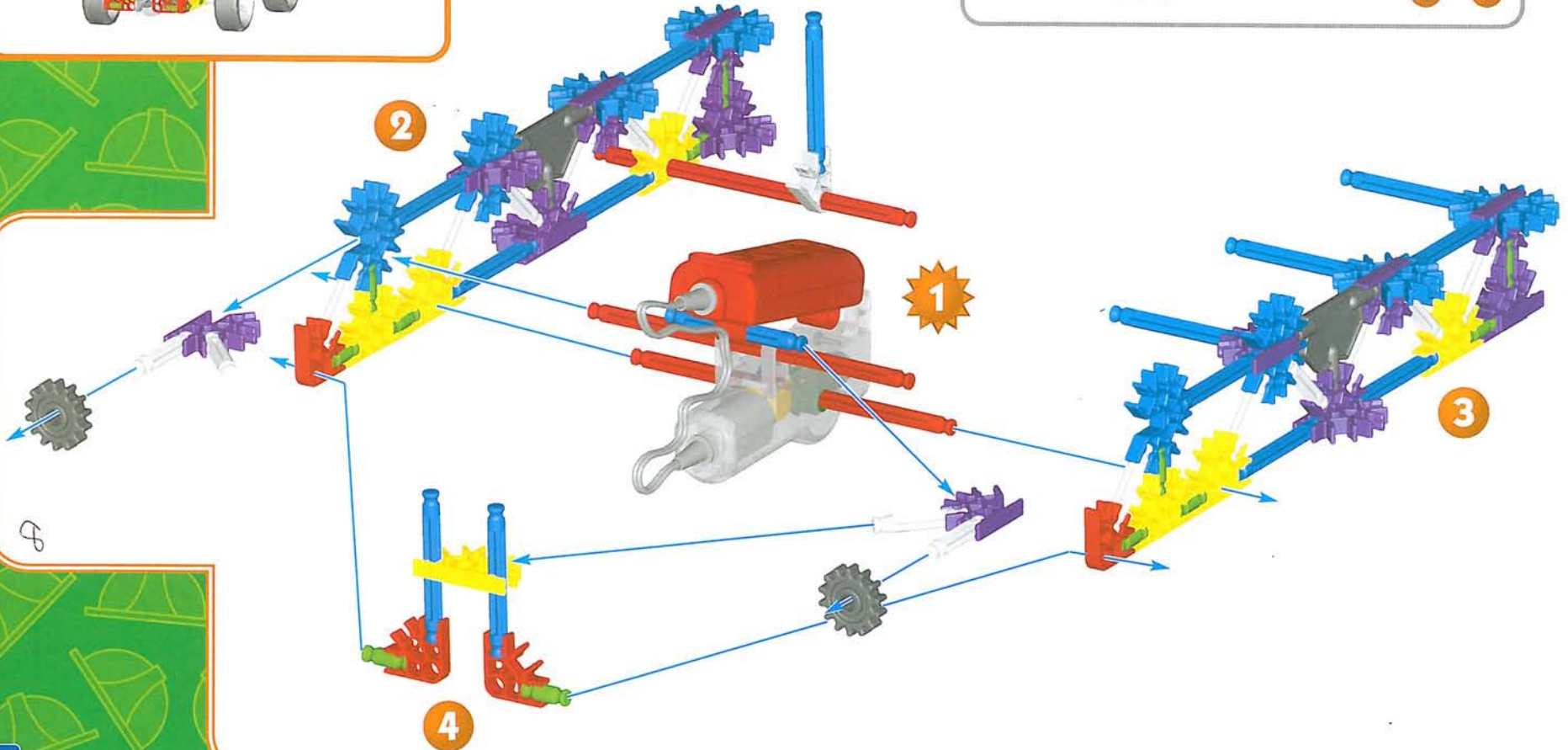

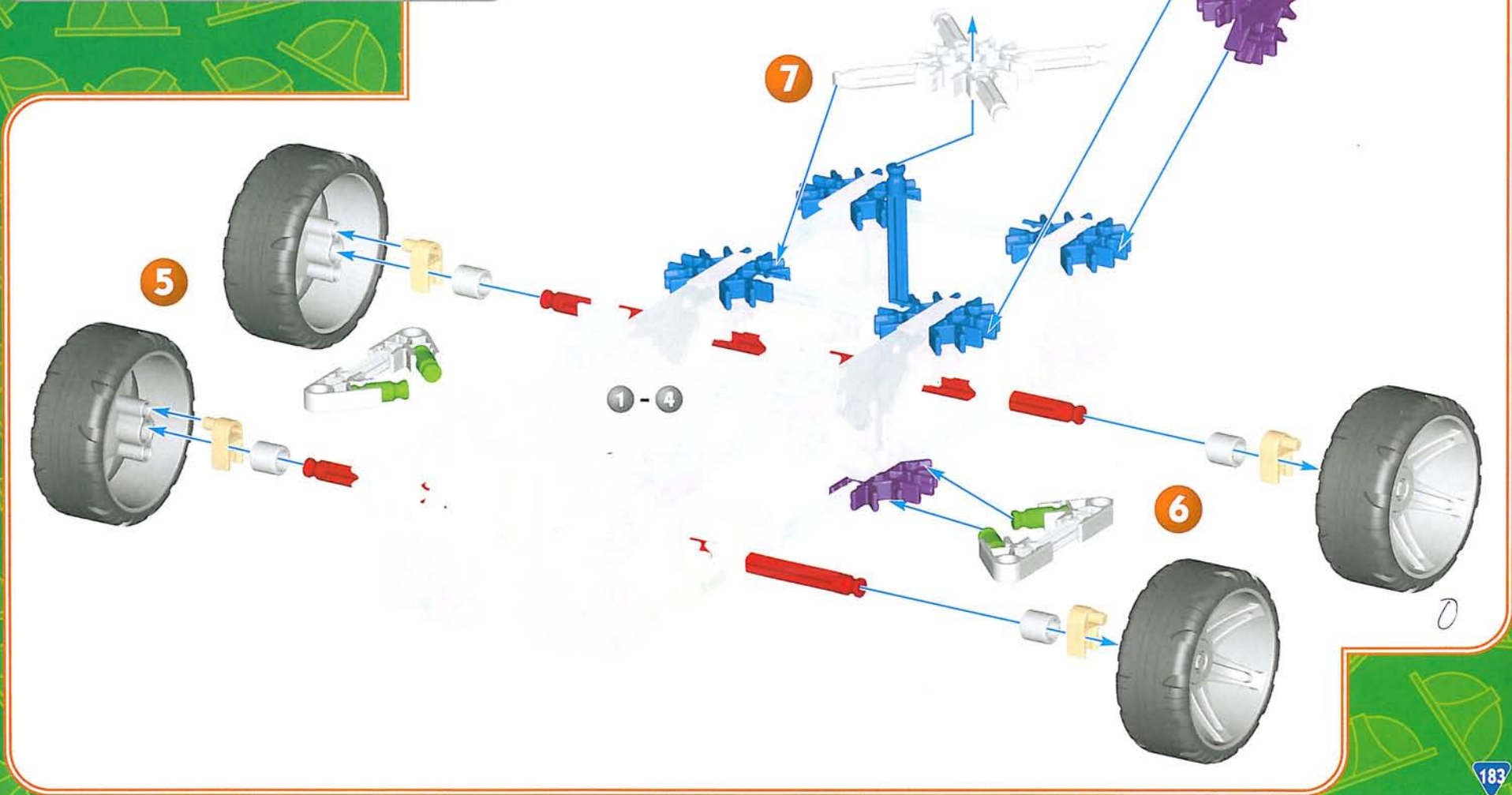
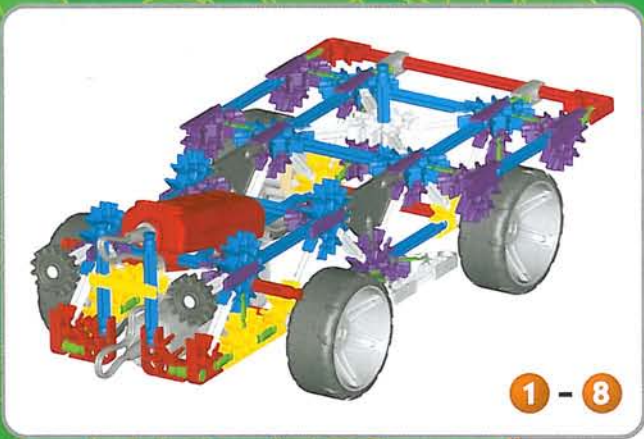

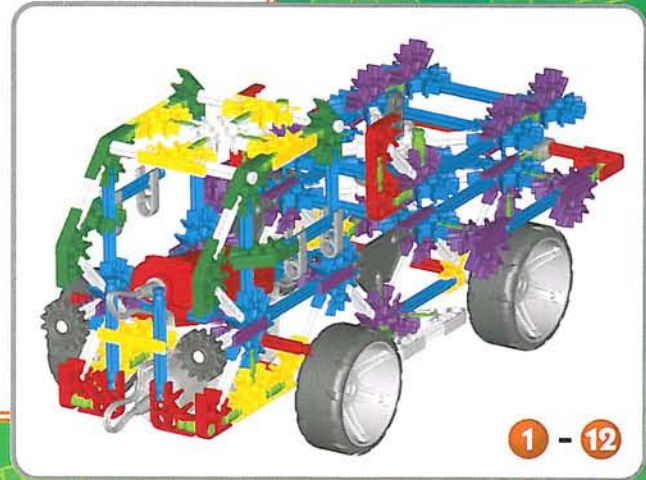
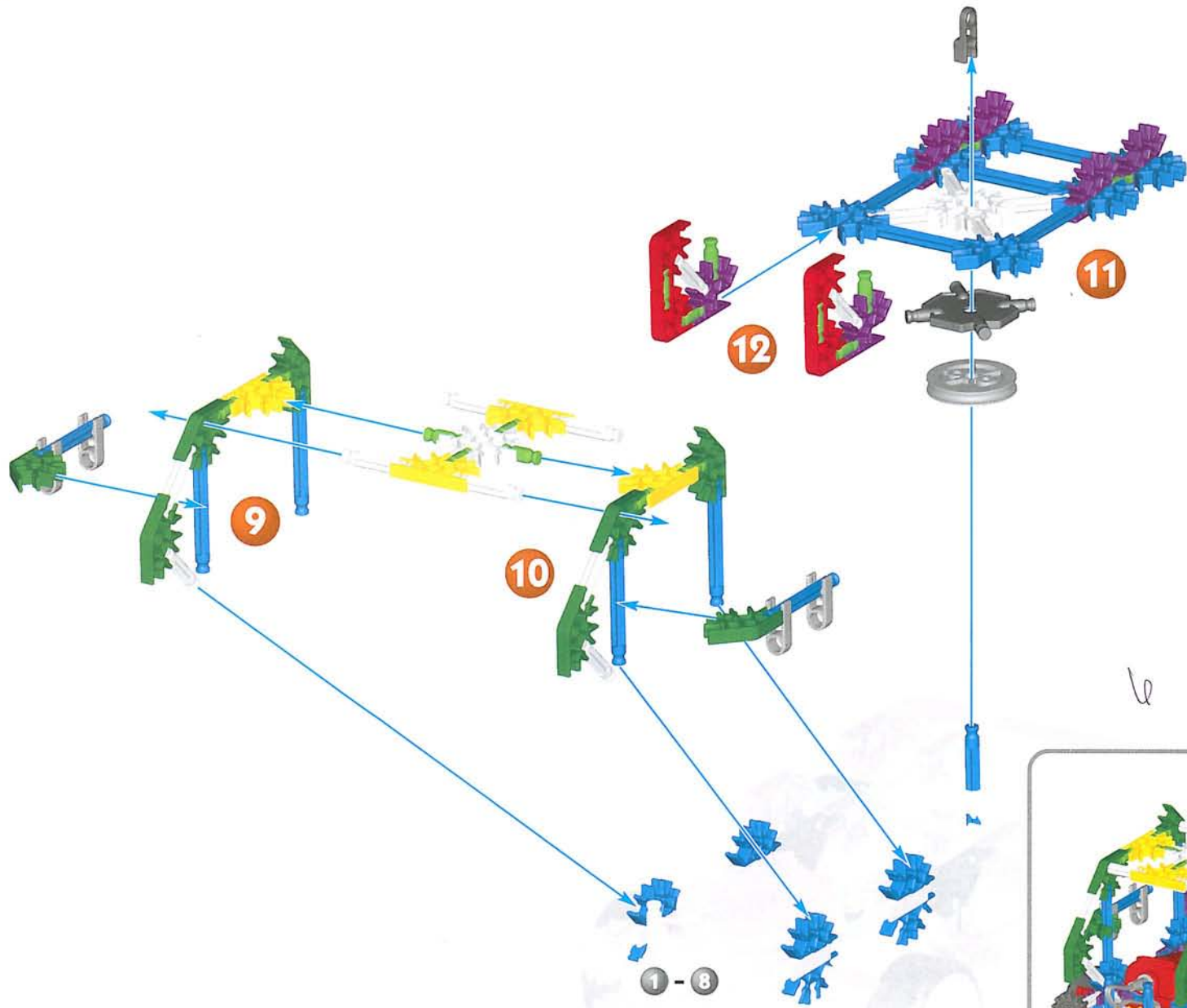



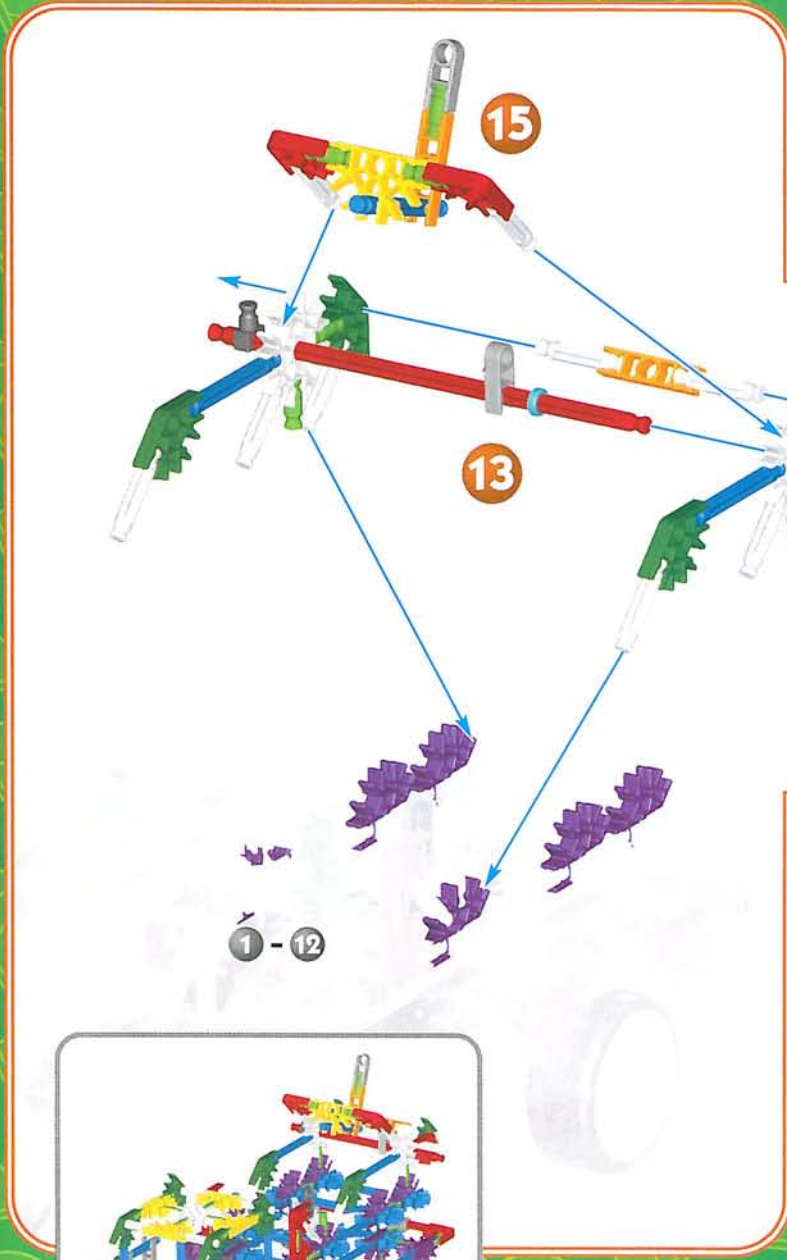

15

13

14

1 - 12

1 - 15

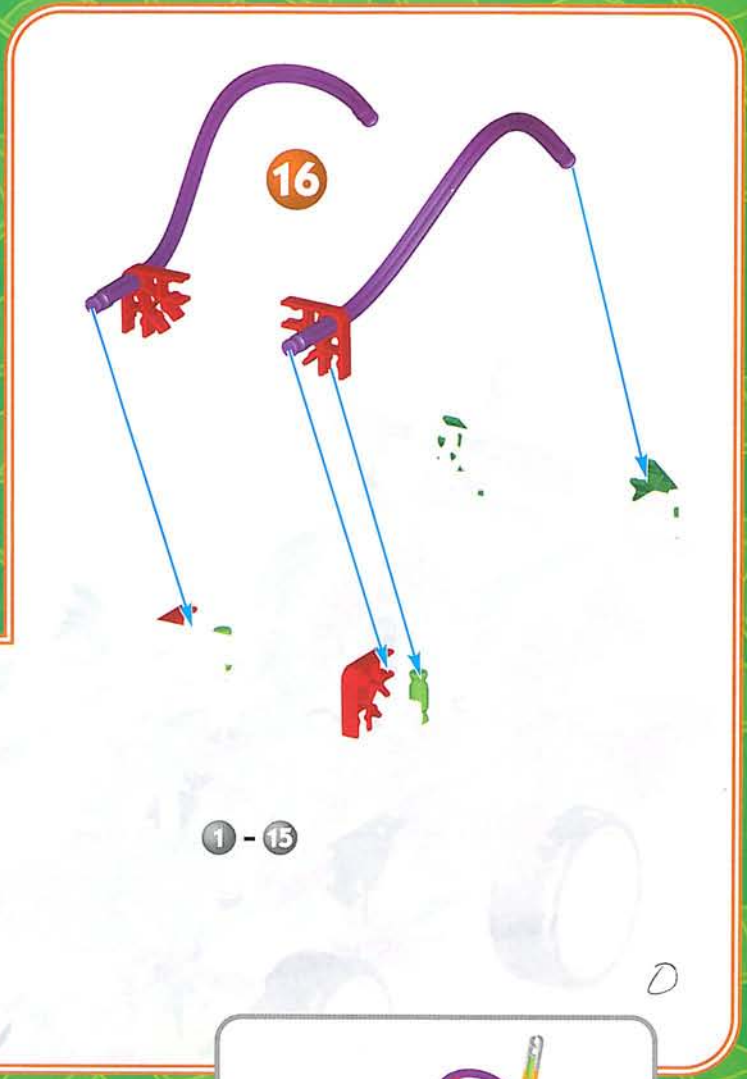

16

1 - 15

1 - 16

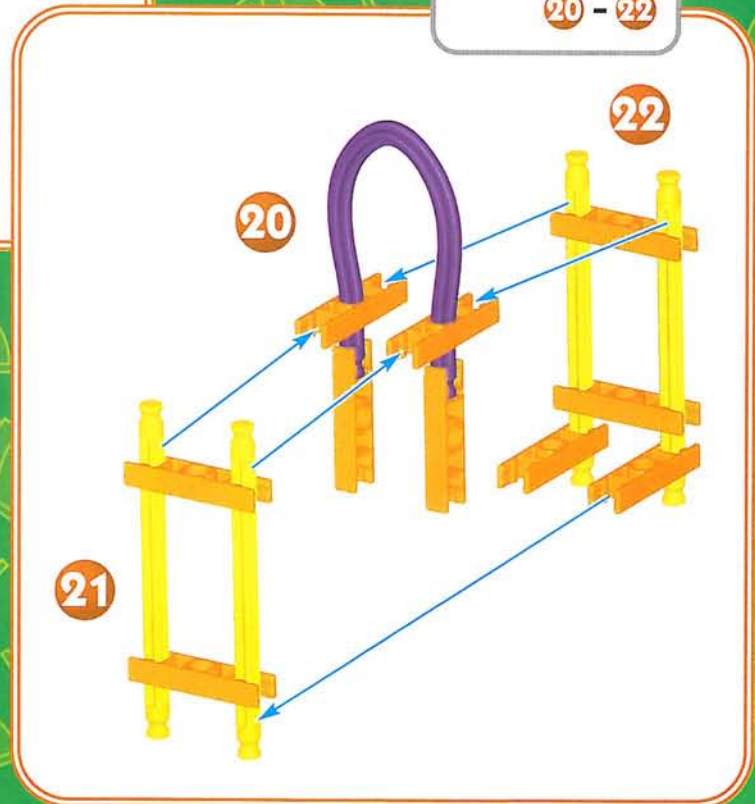
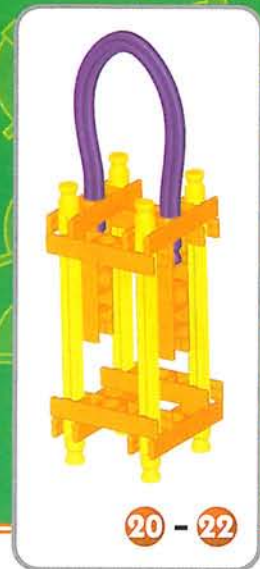
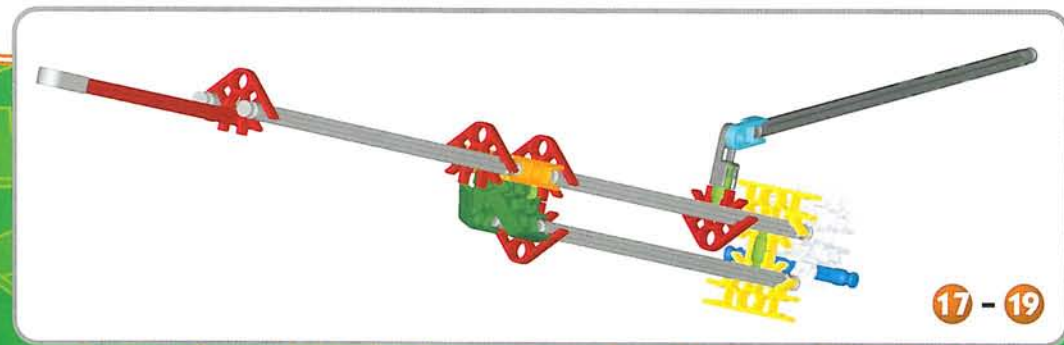
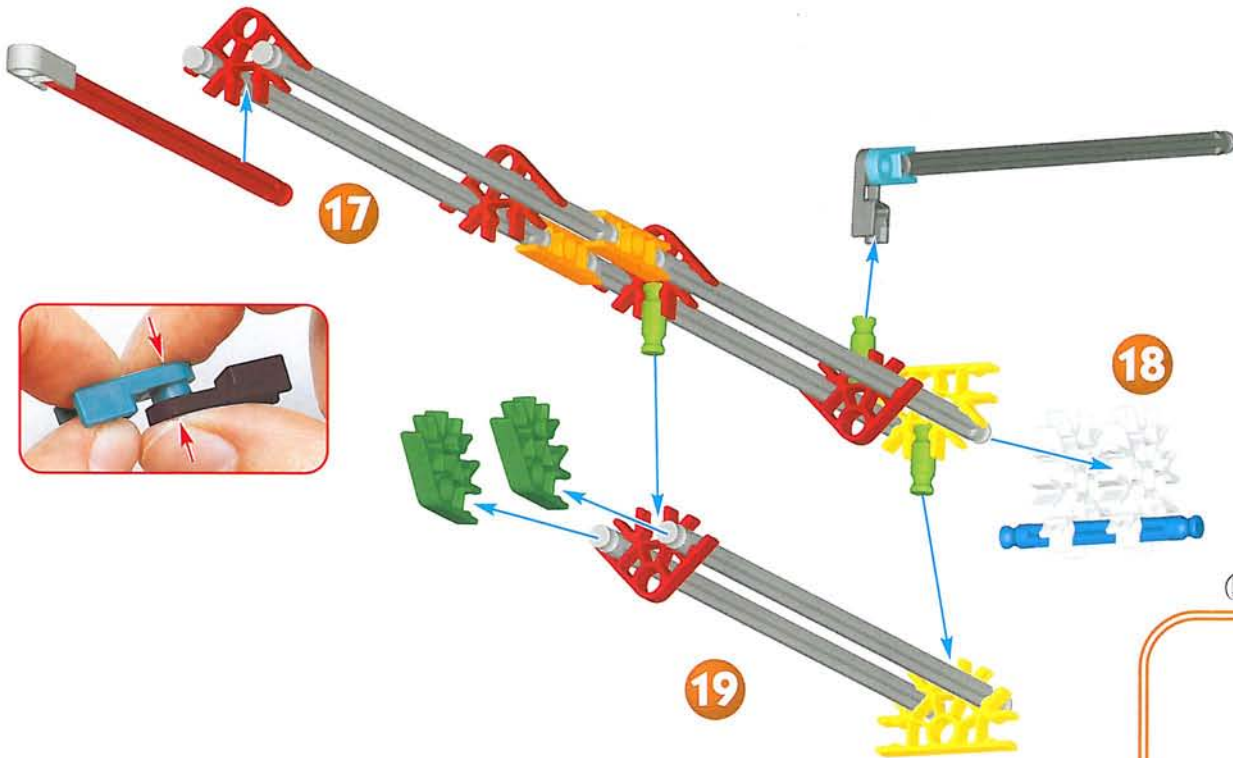

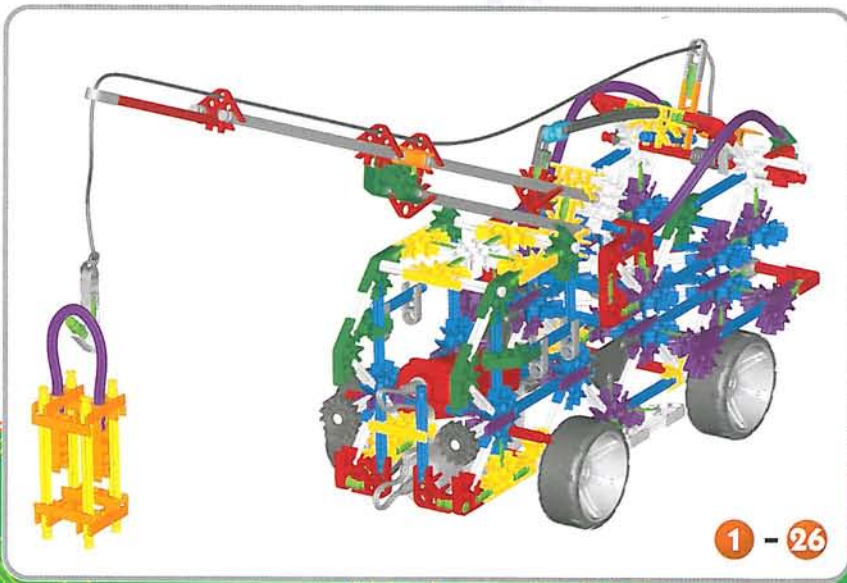
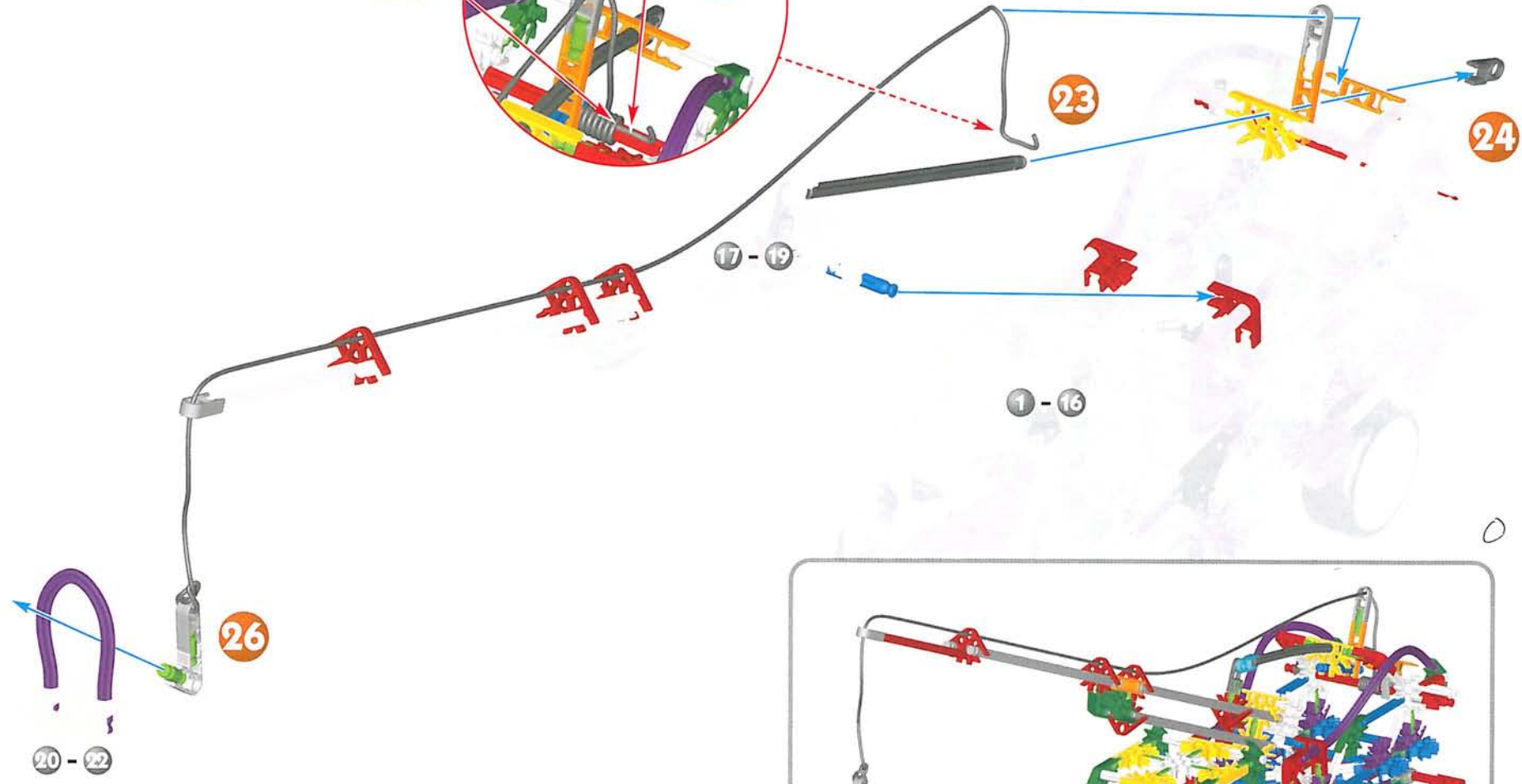

# Piranha

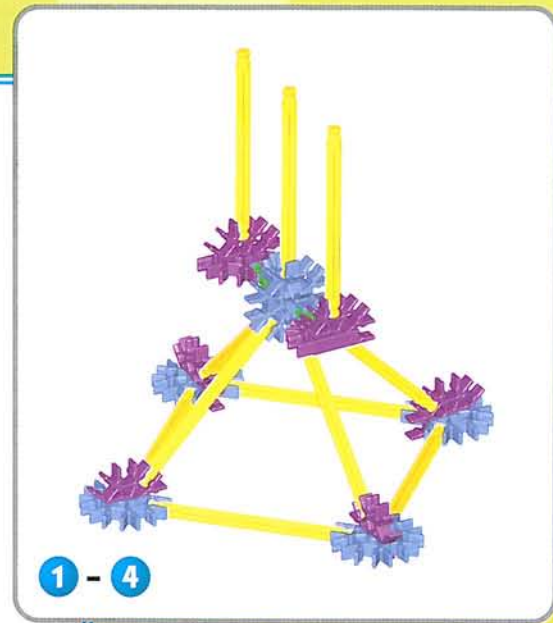
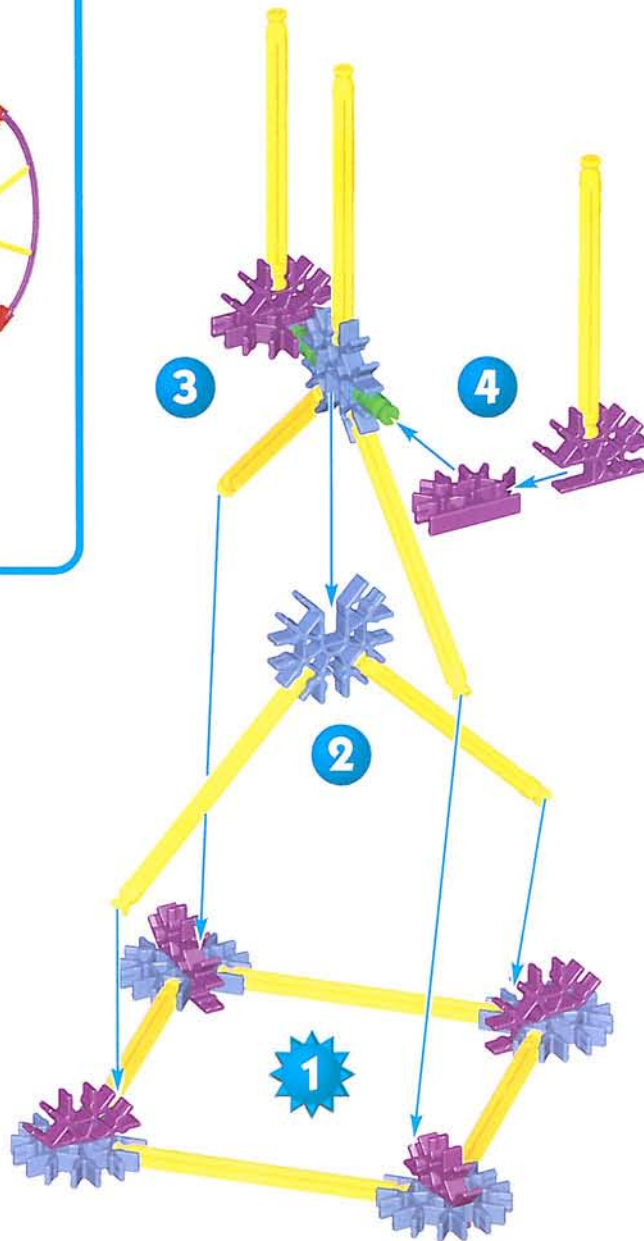
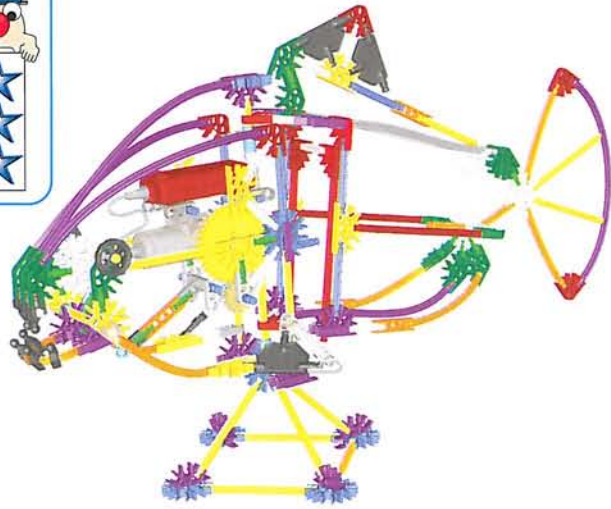

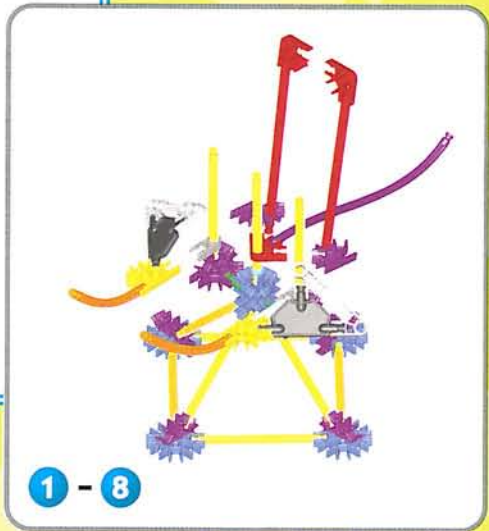
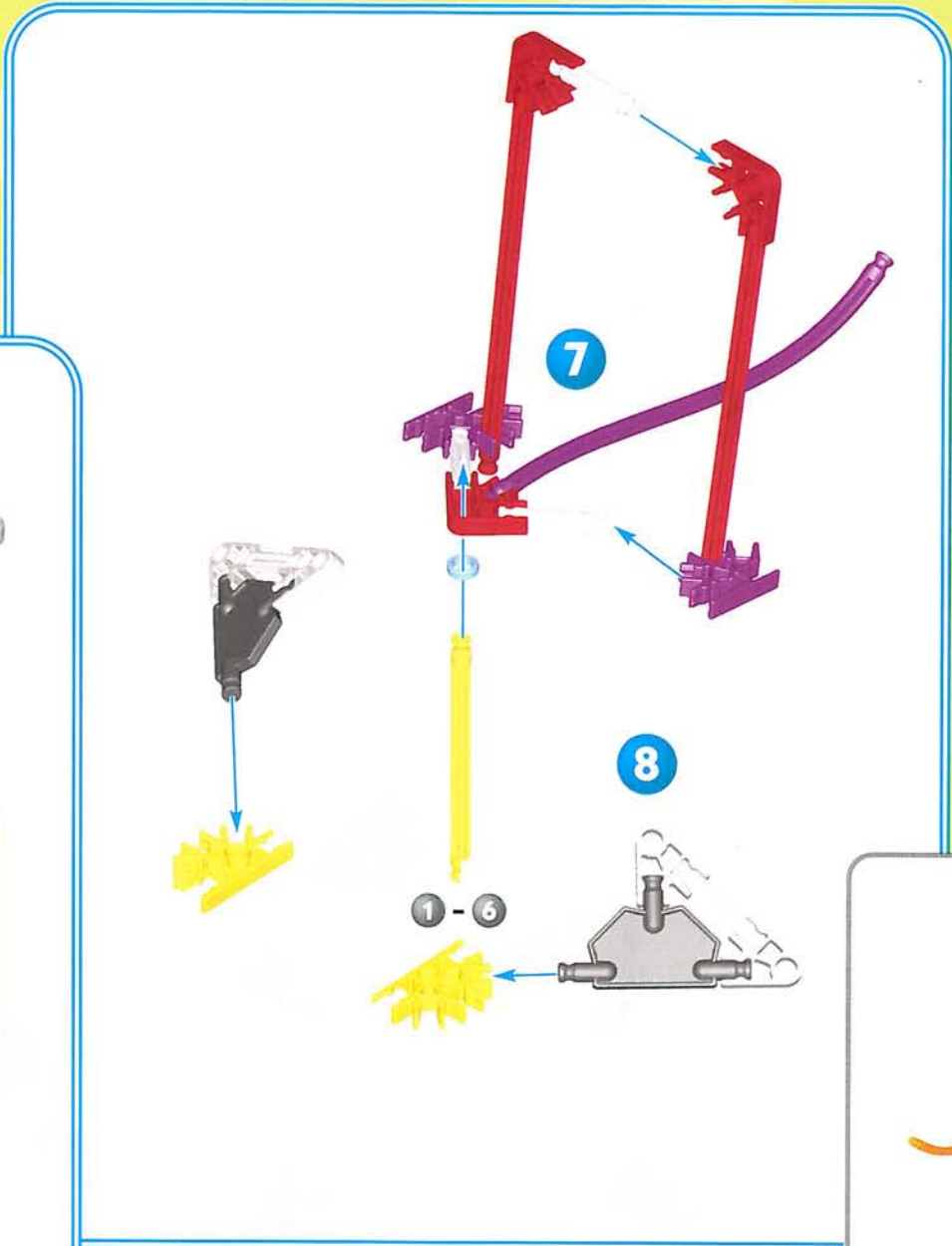
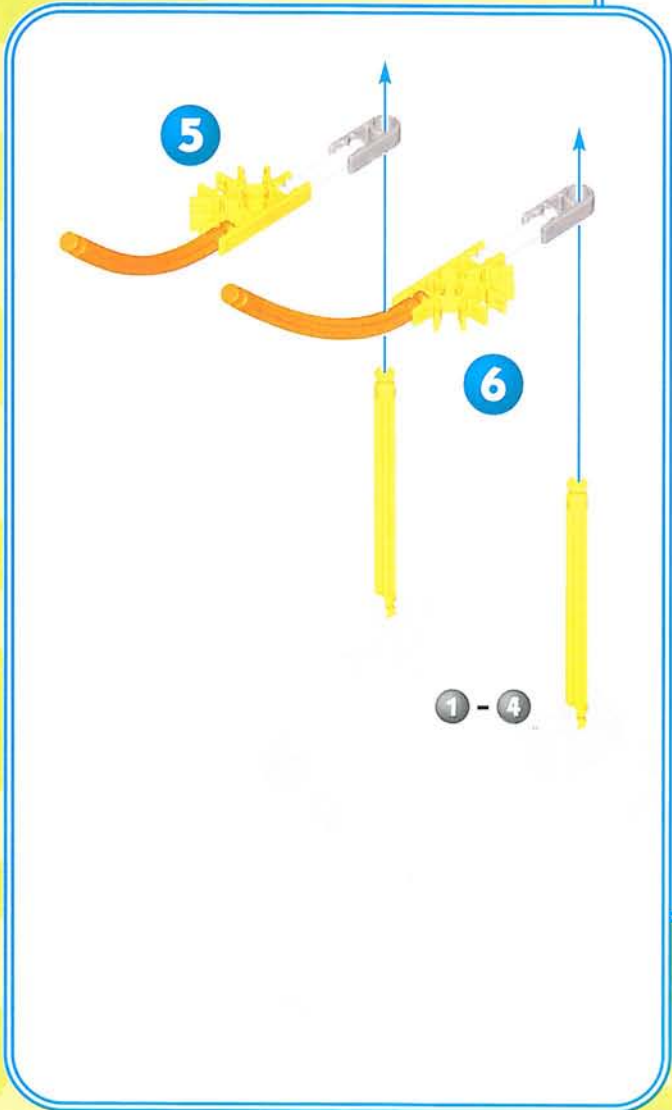

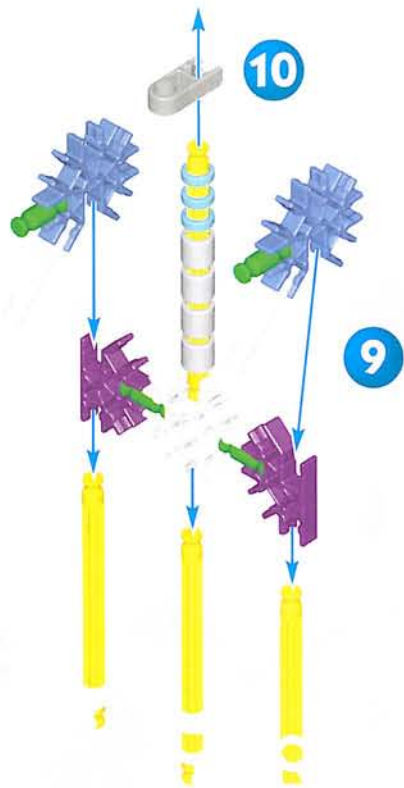

1 - 8

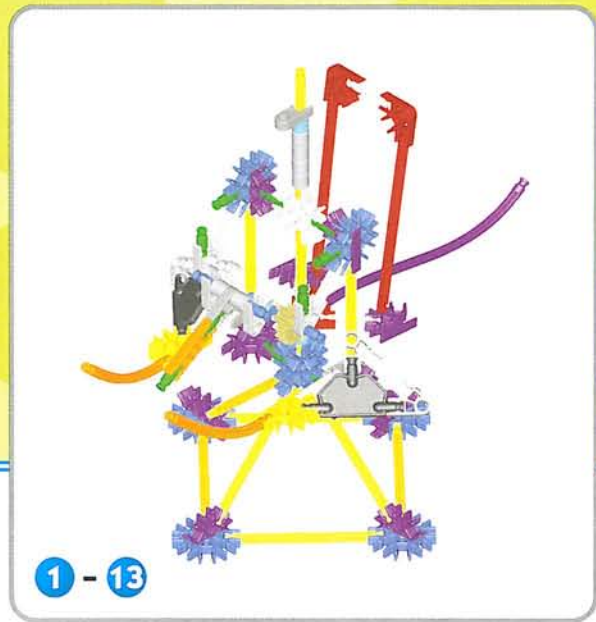

1 - 13

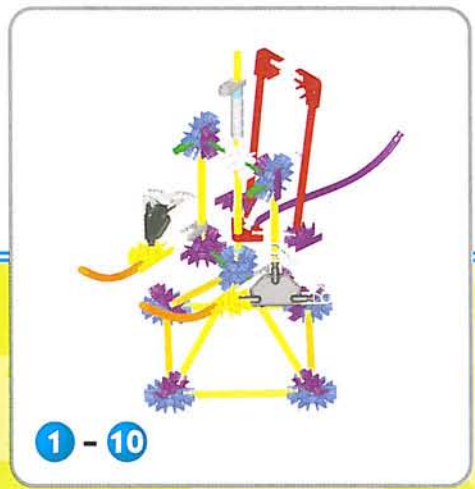

1 - 10

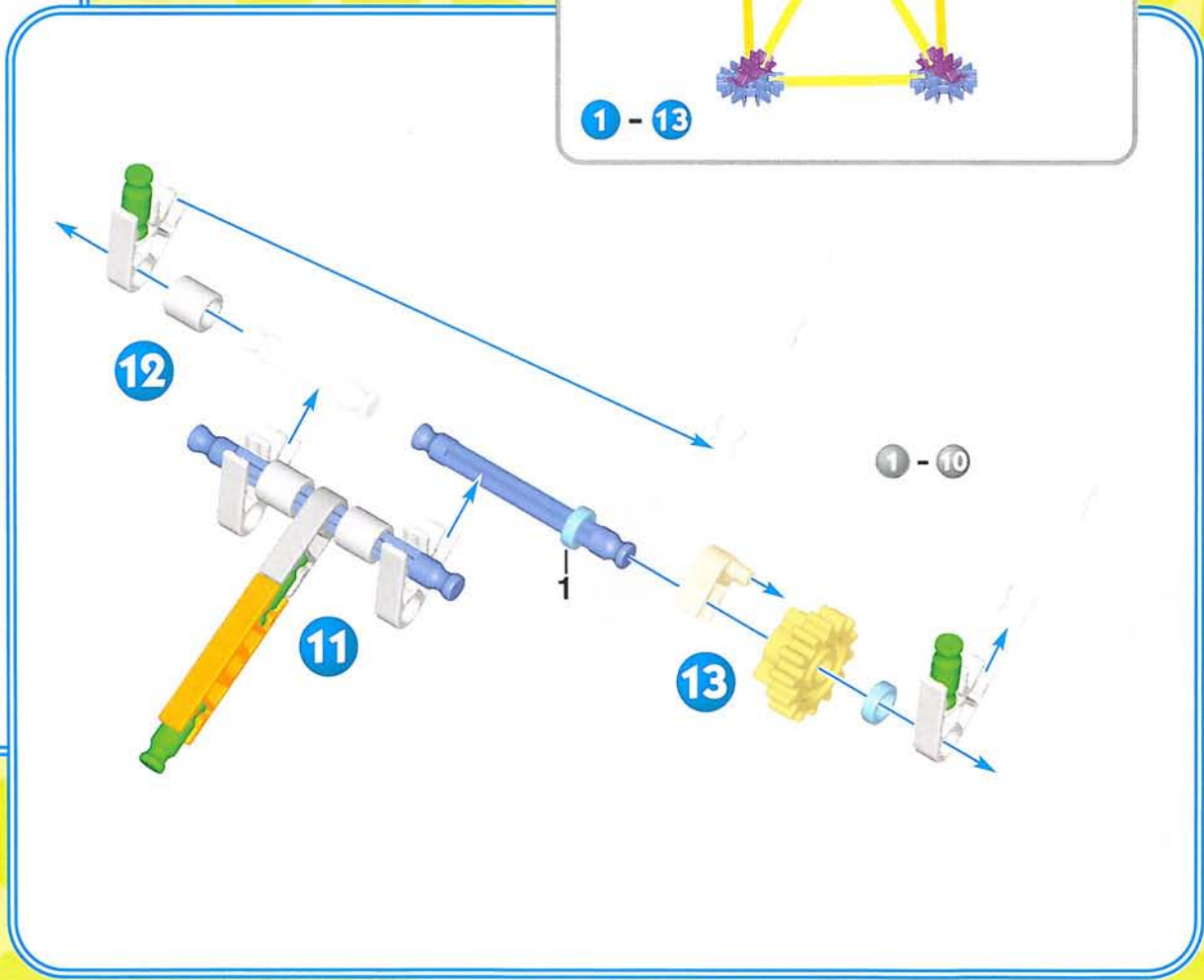

12

11

13

1 - 10



This is the back of the model.

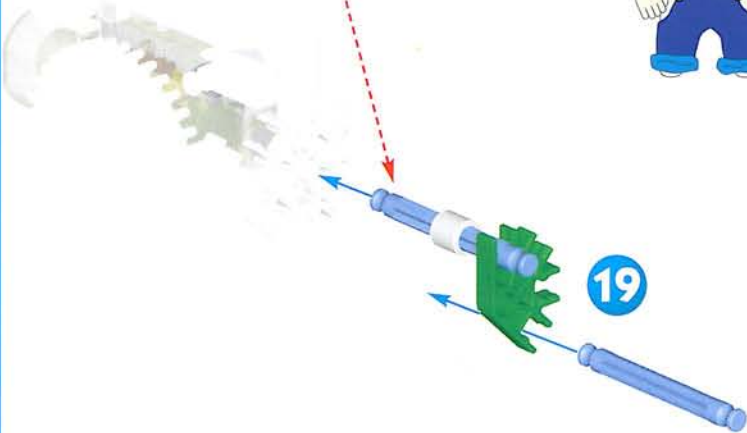

19

1 - 18

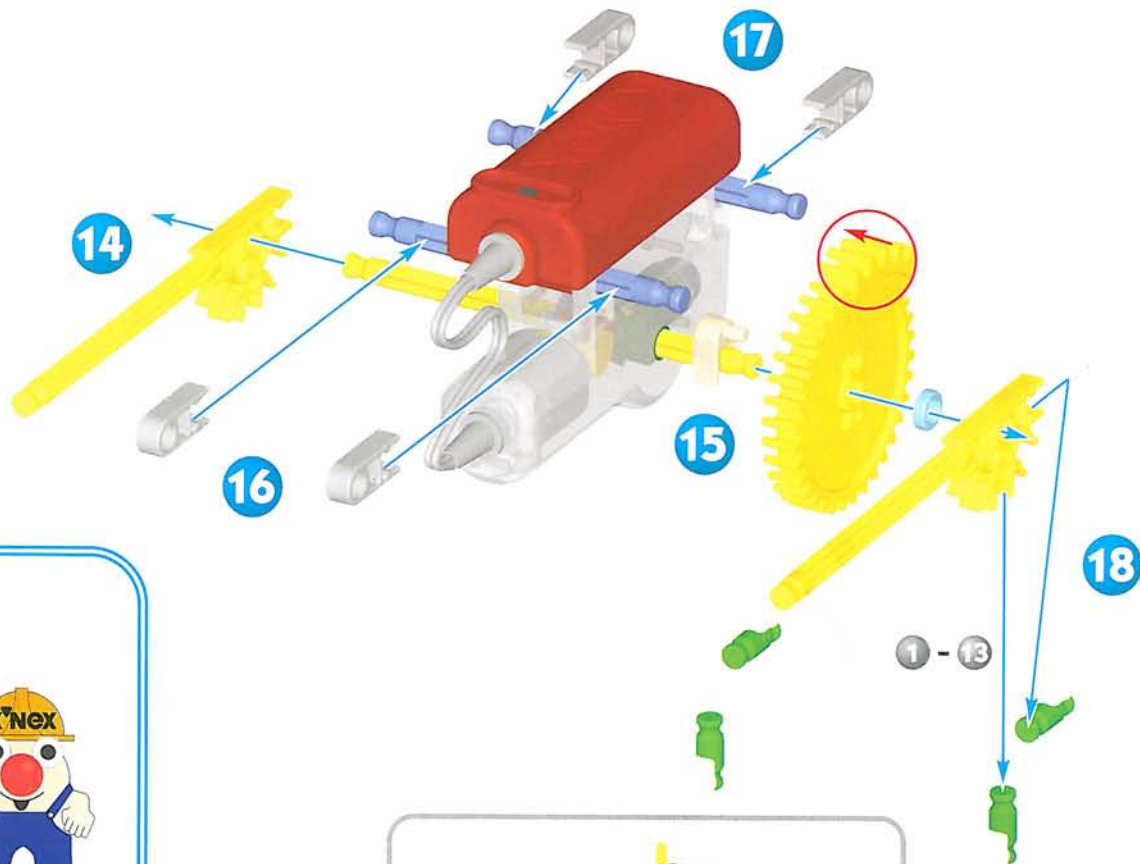

1 - 19

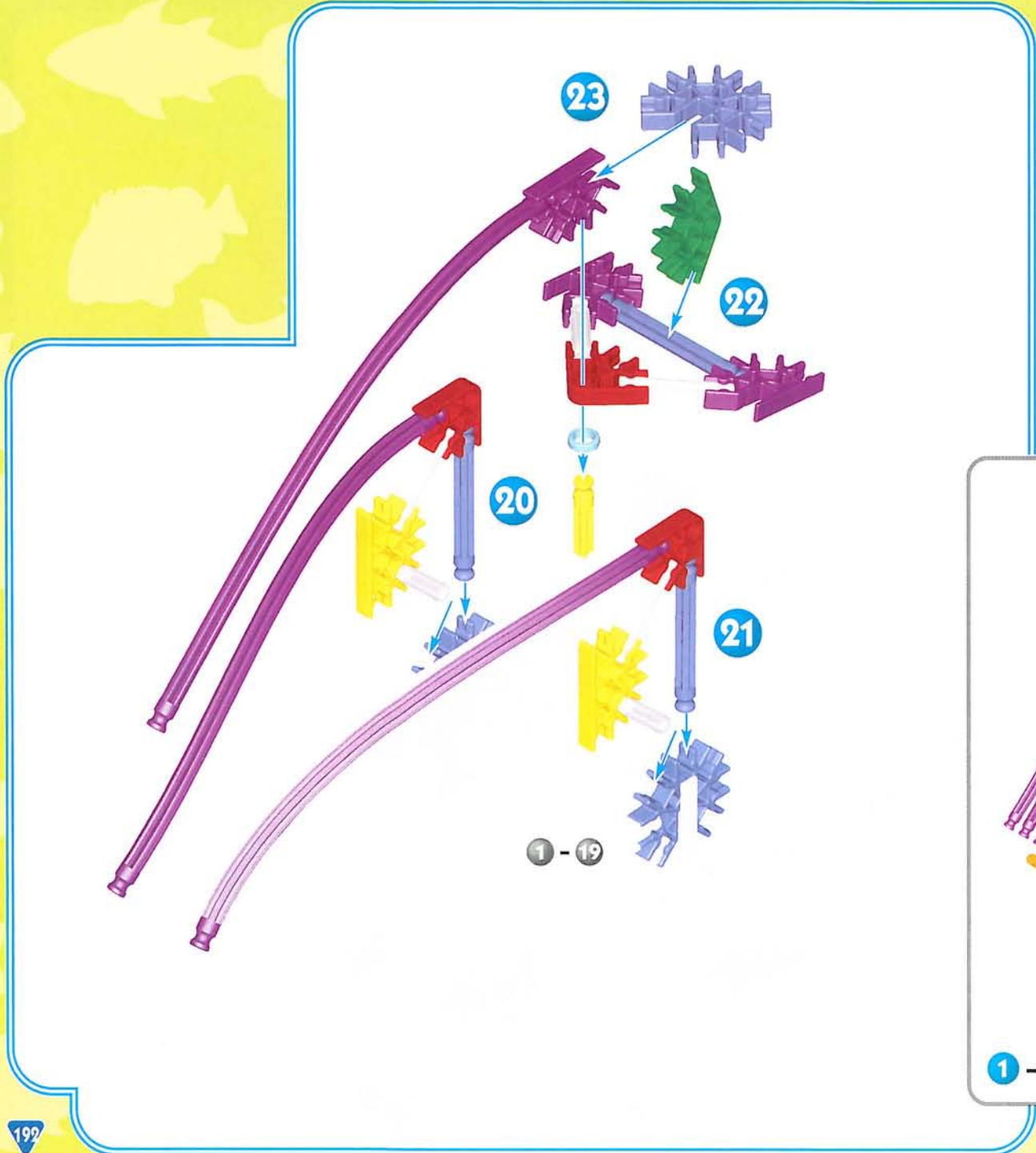



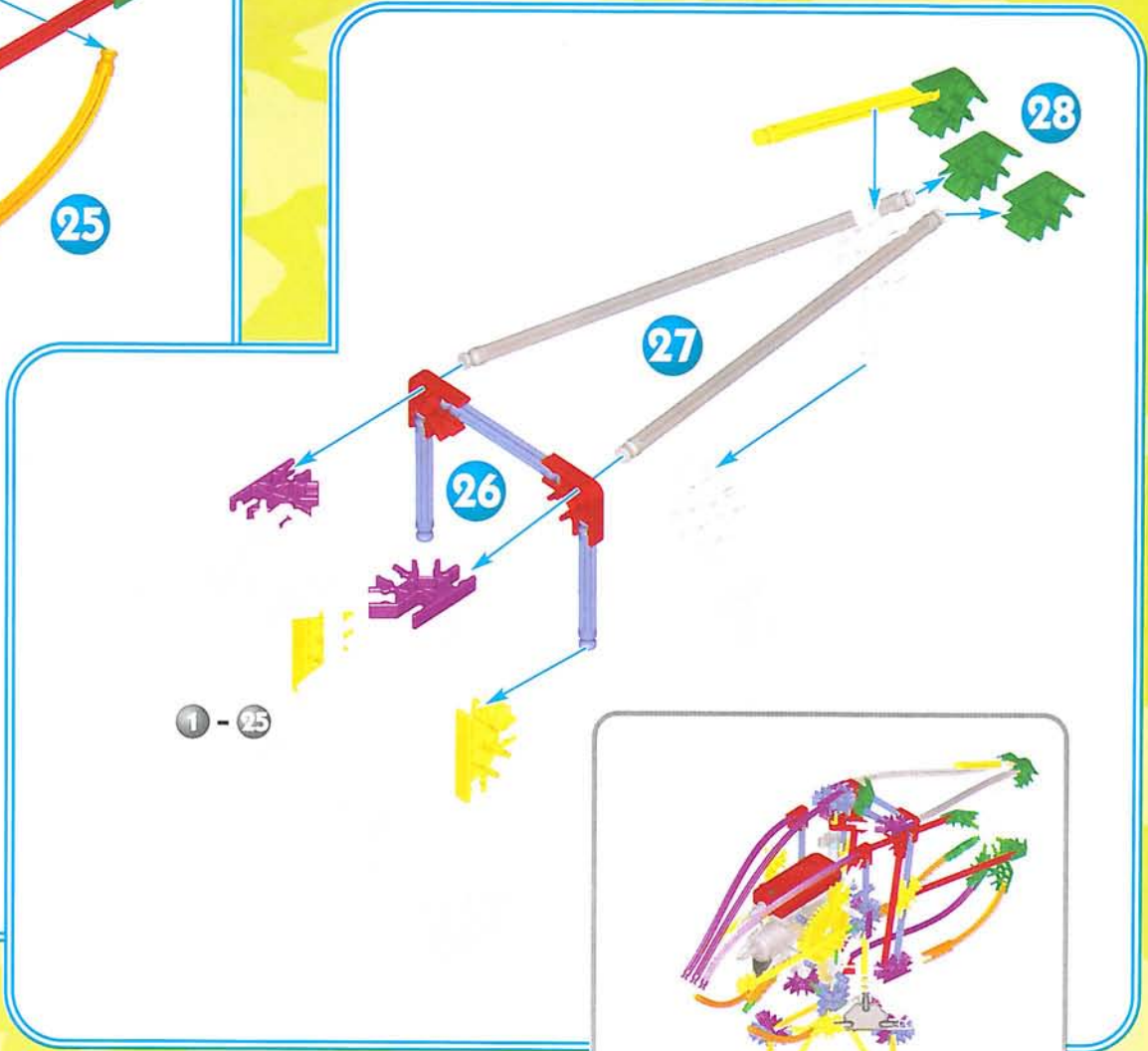
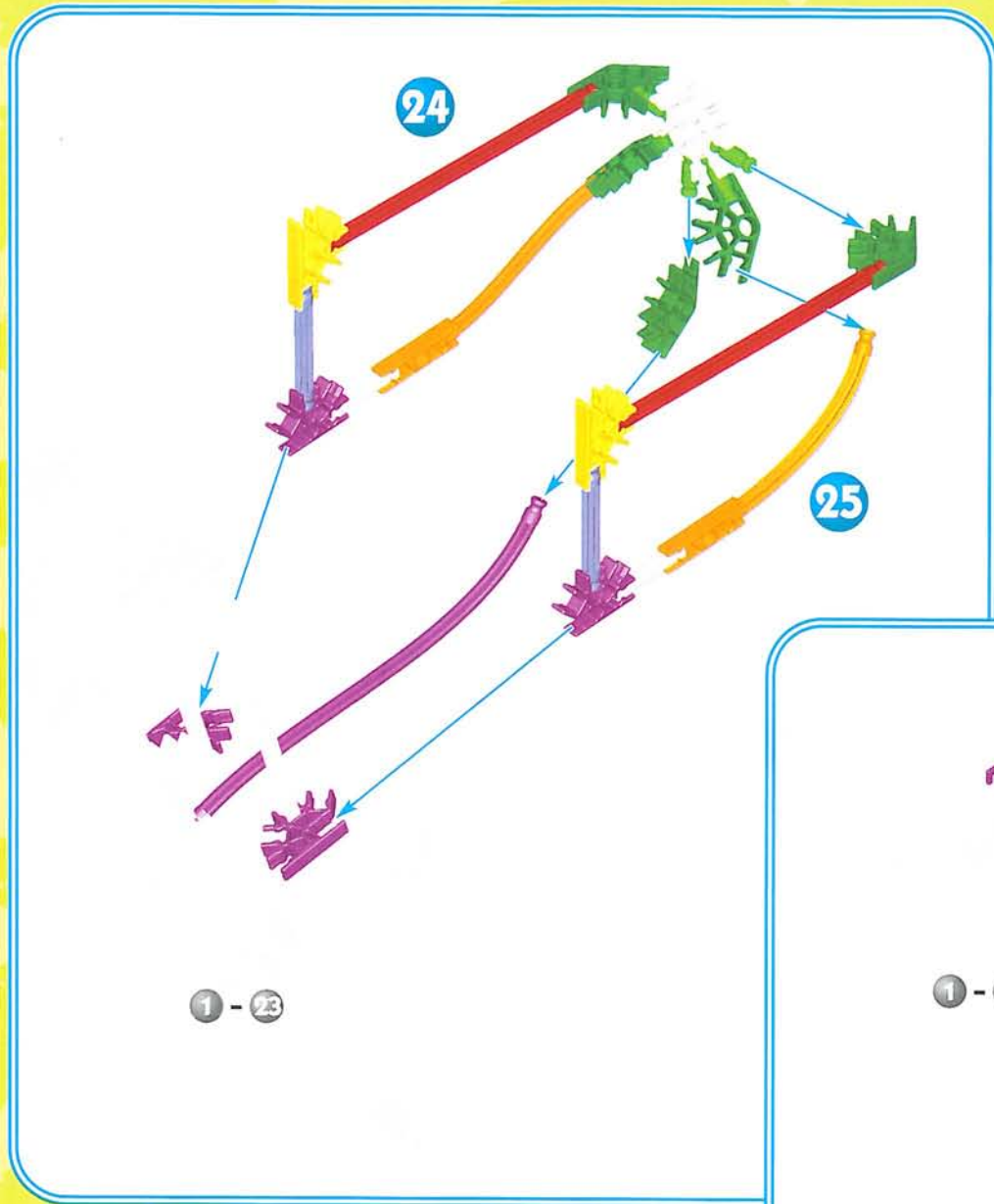

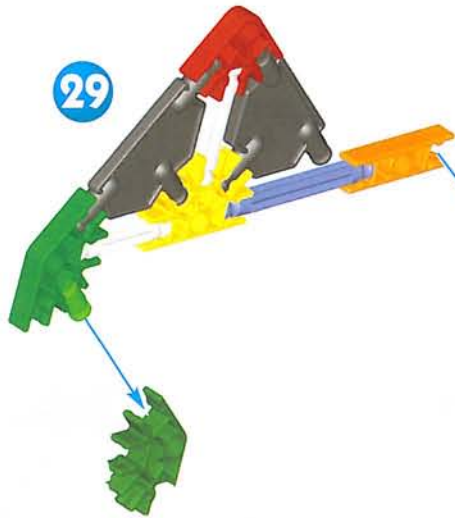

1 - 28

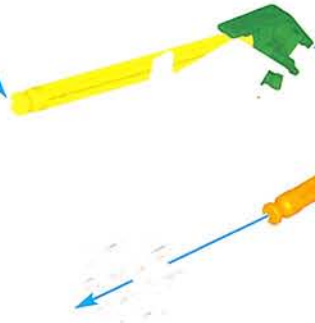

30

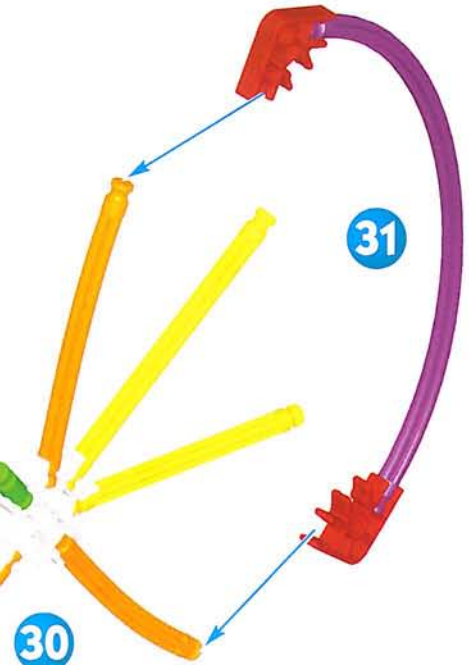

31



1 - 31



1 - 31

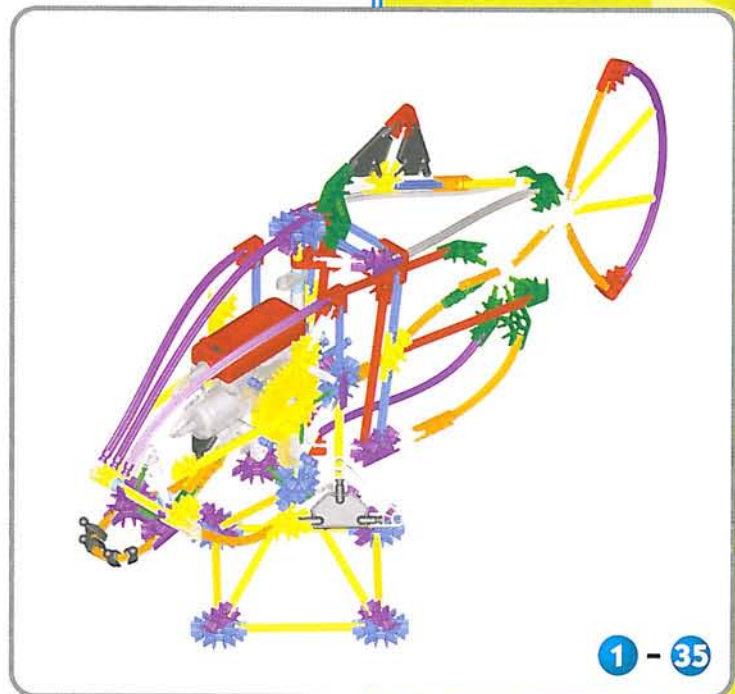
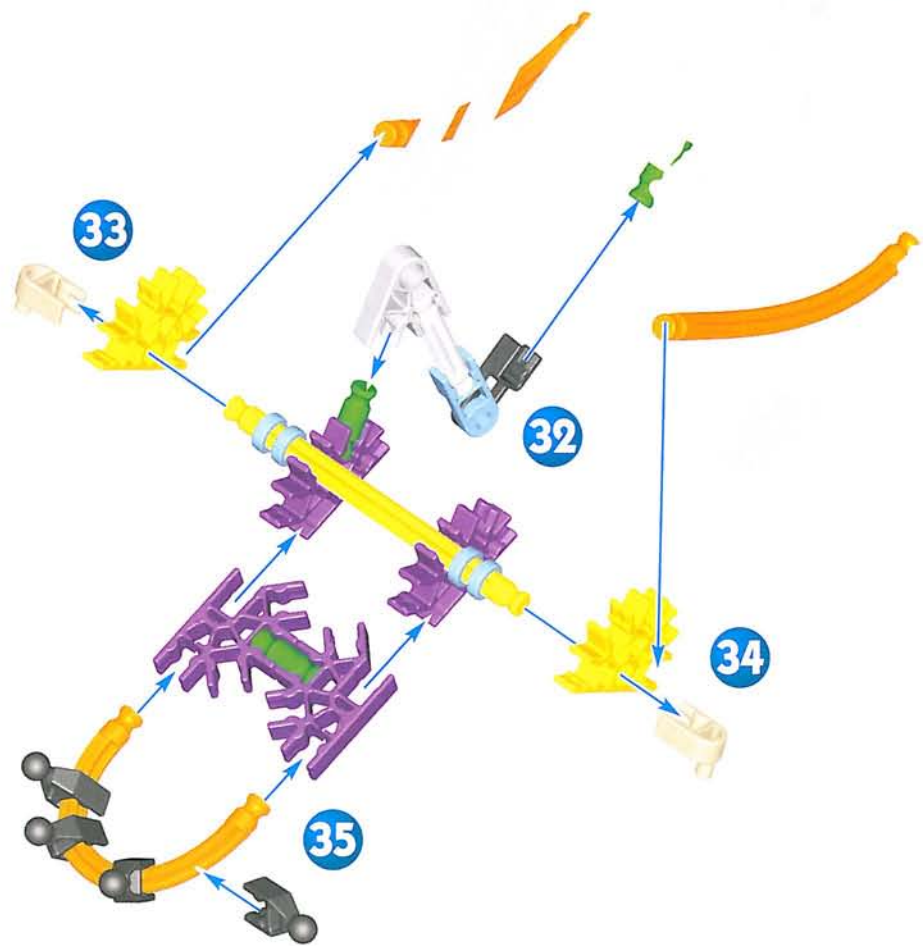

1 - 35

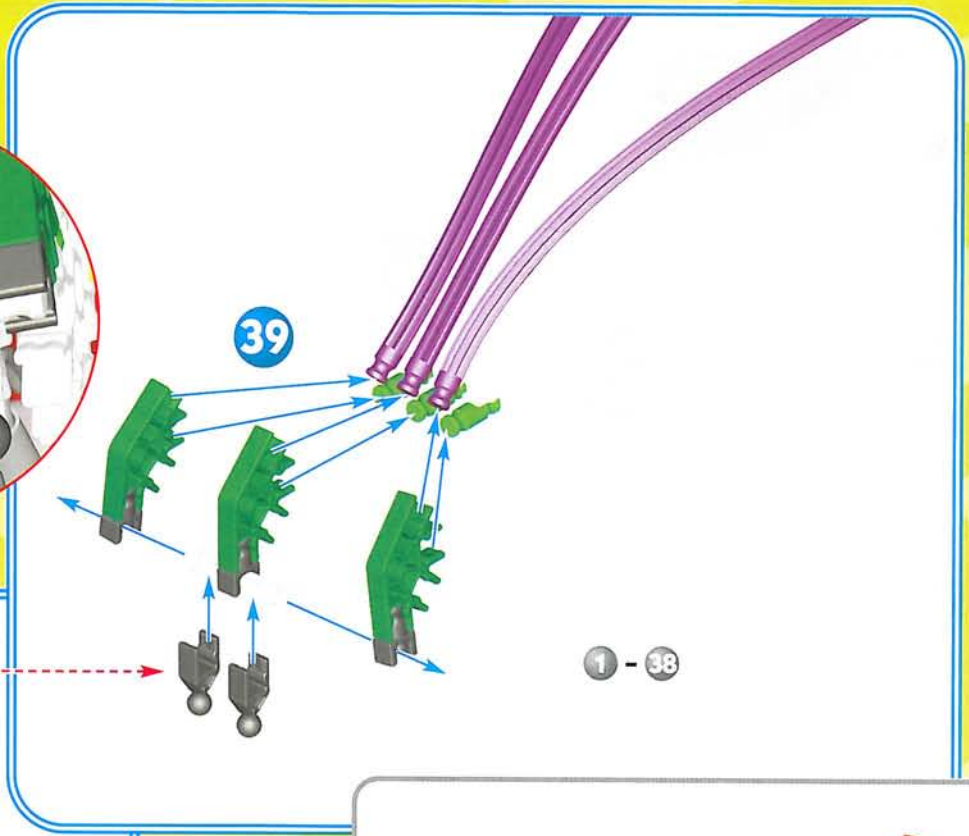
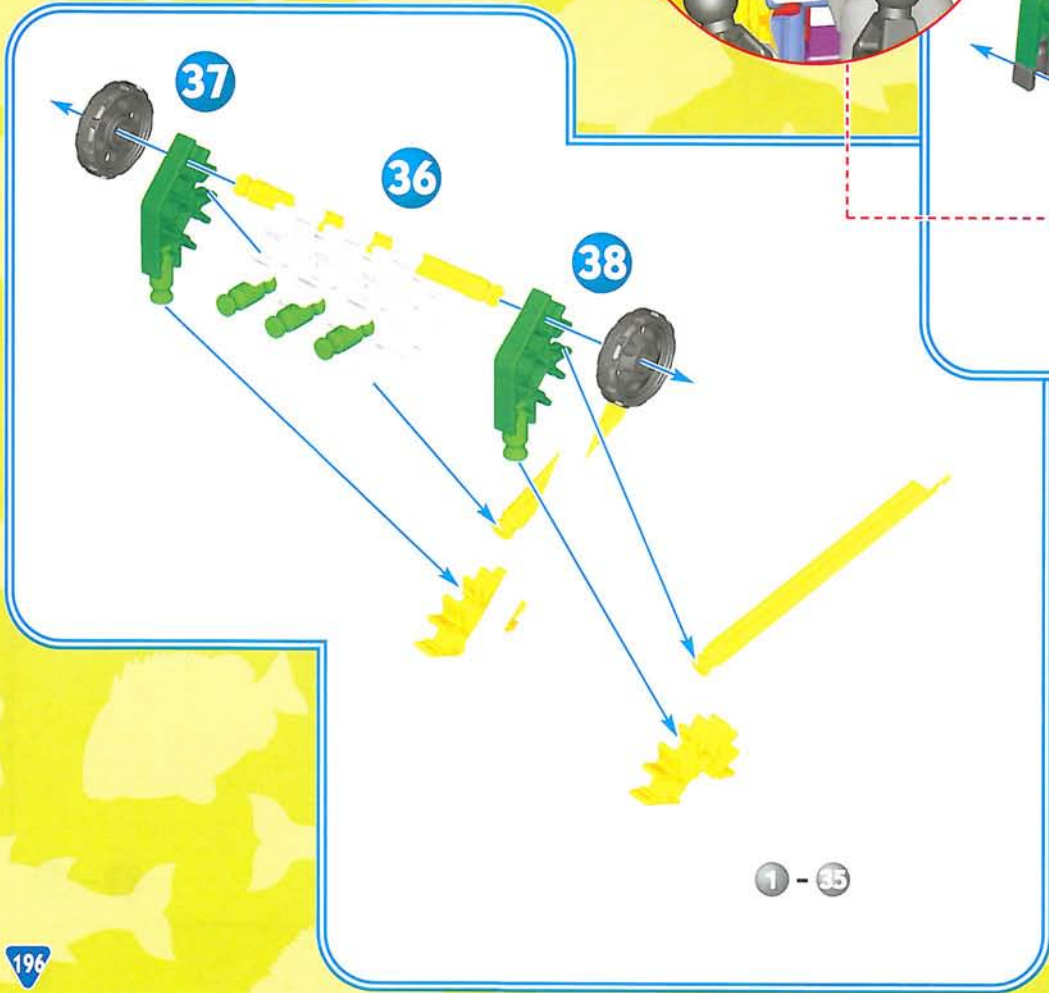

# Submarine

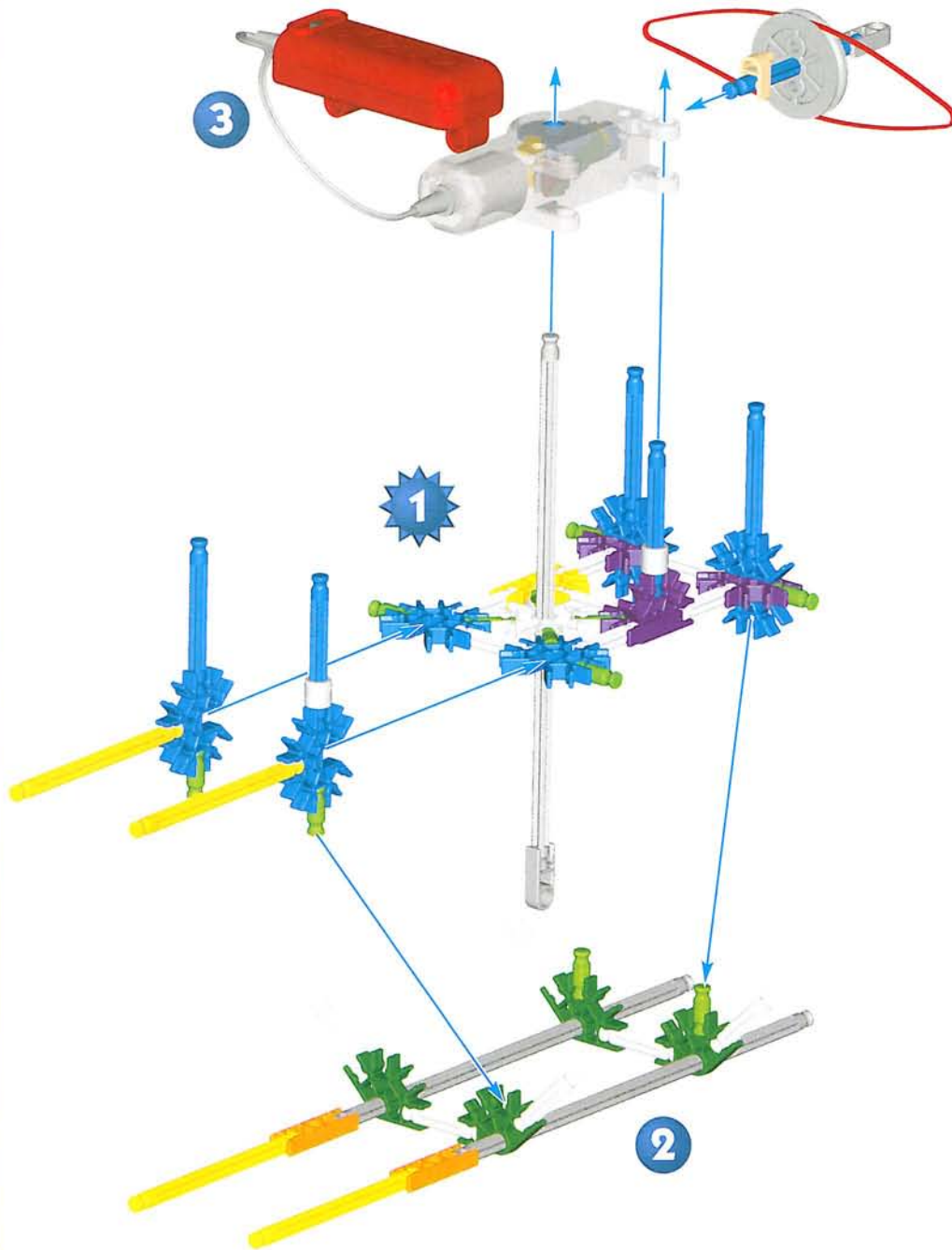
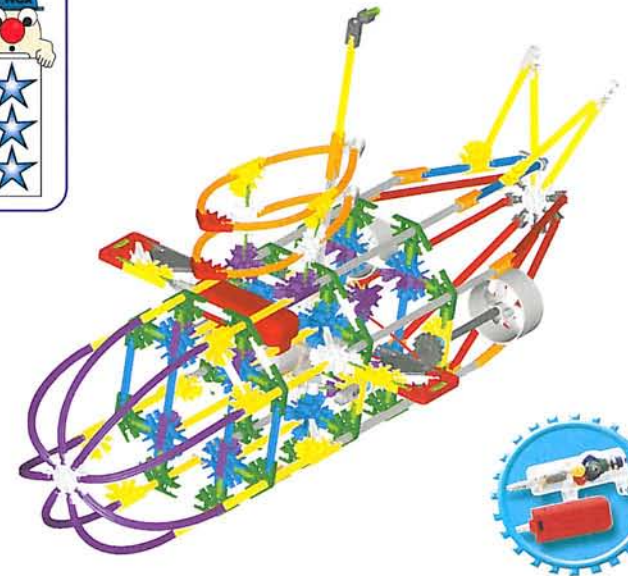
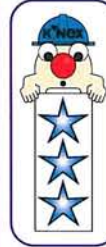

1 - 3

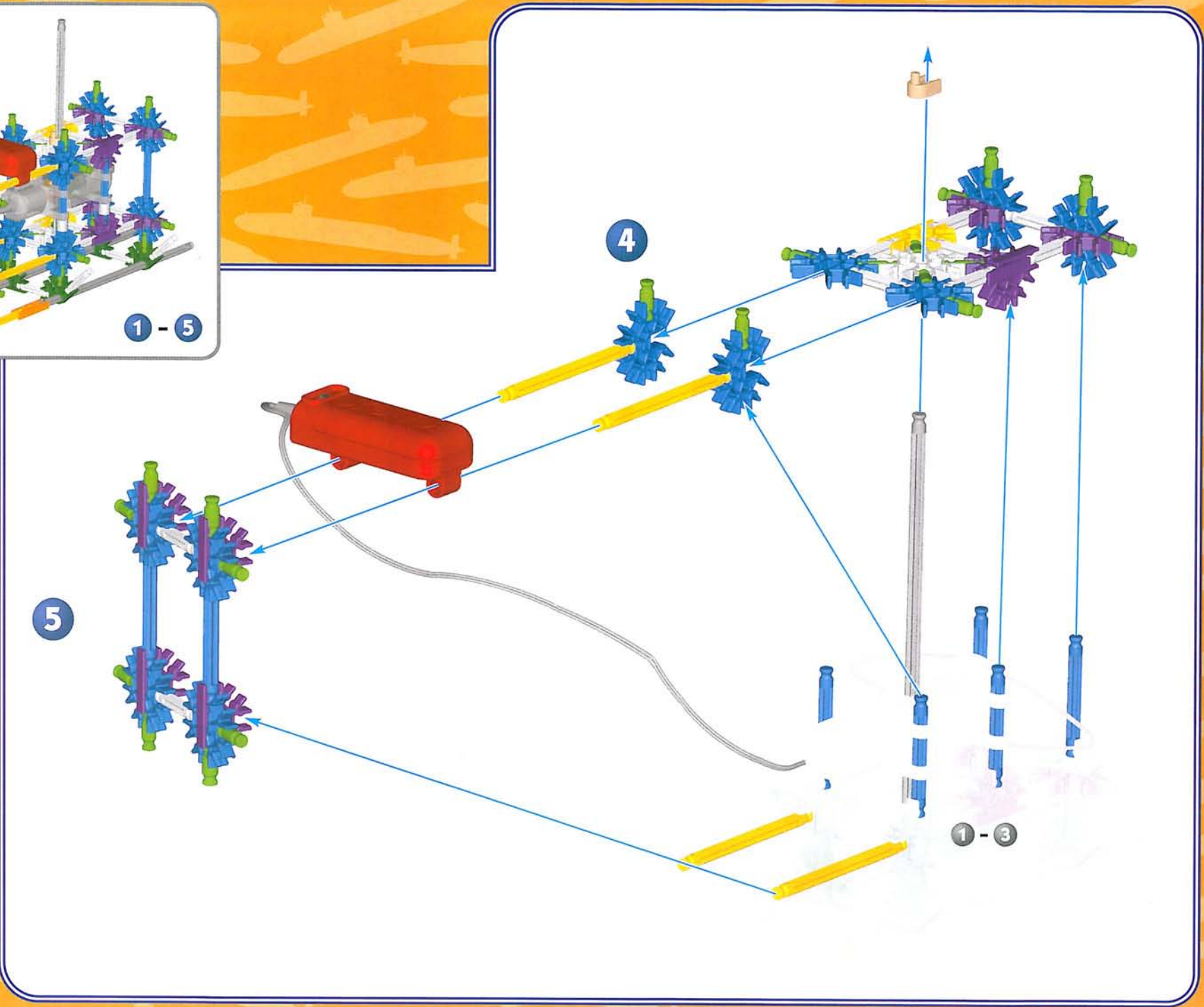
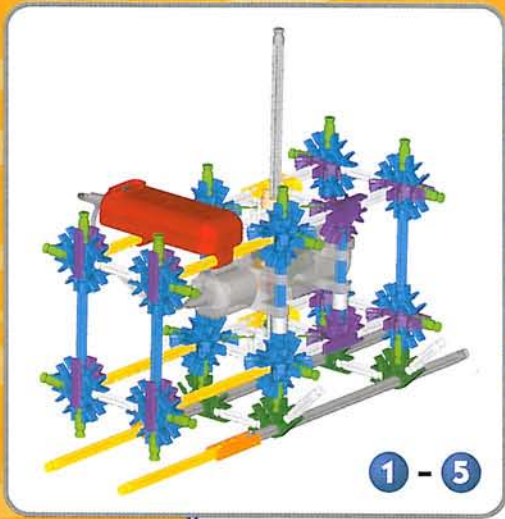

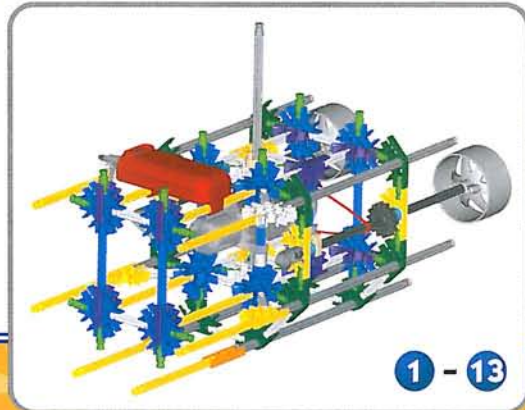
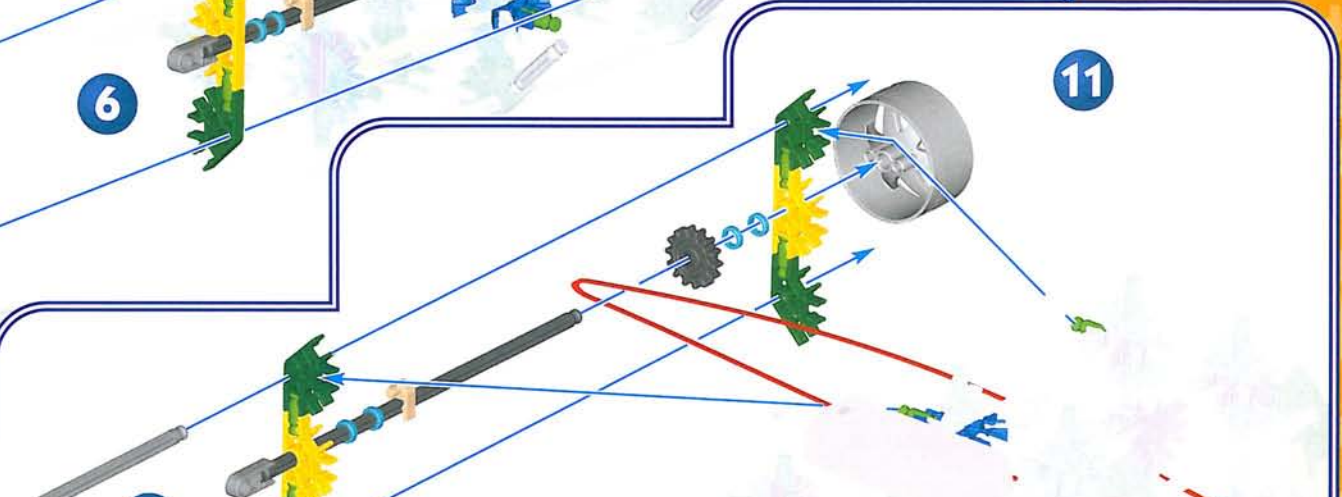
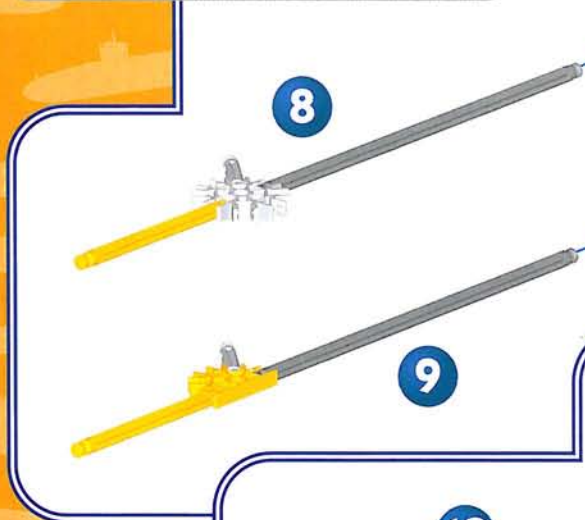
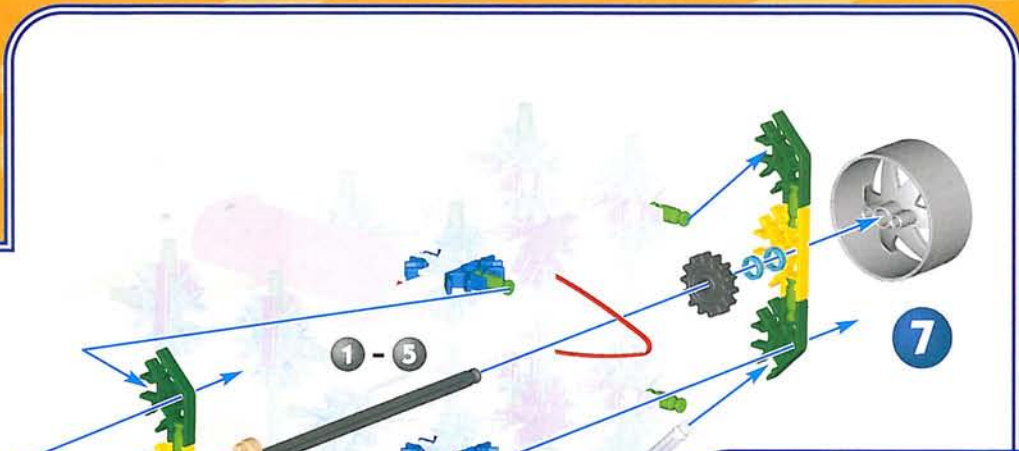
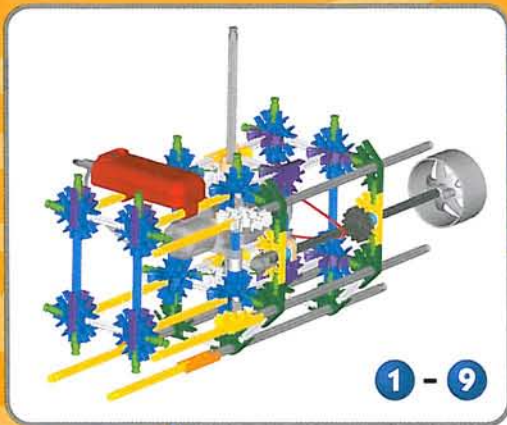

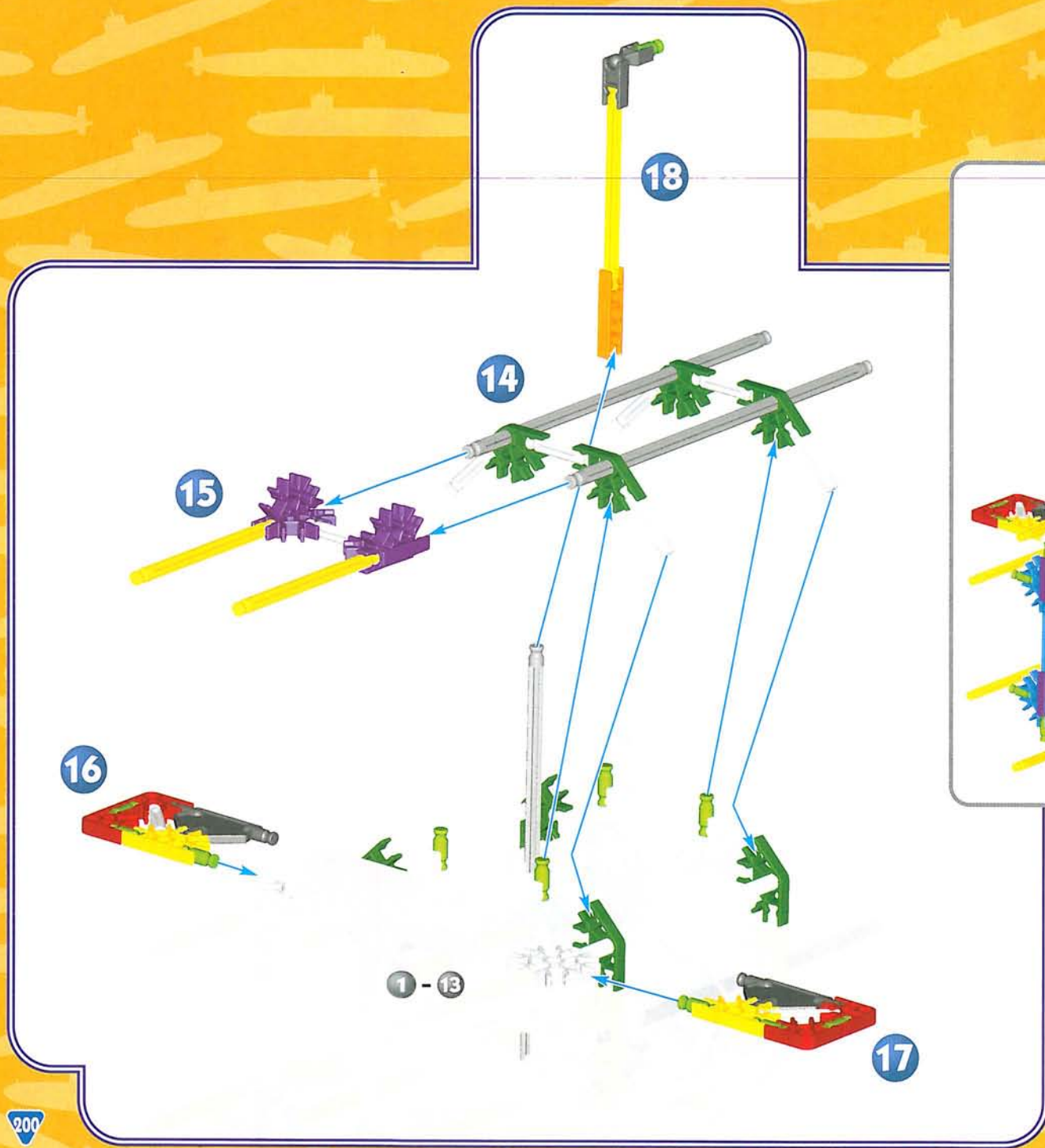



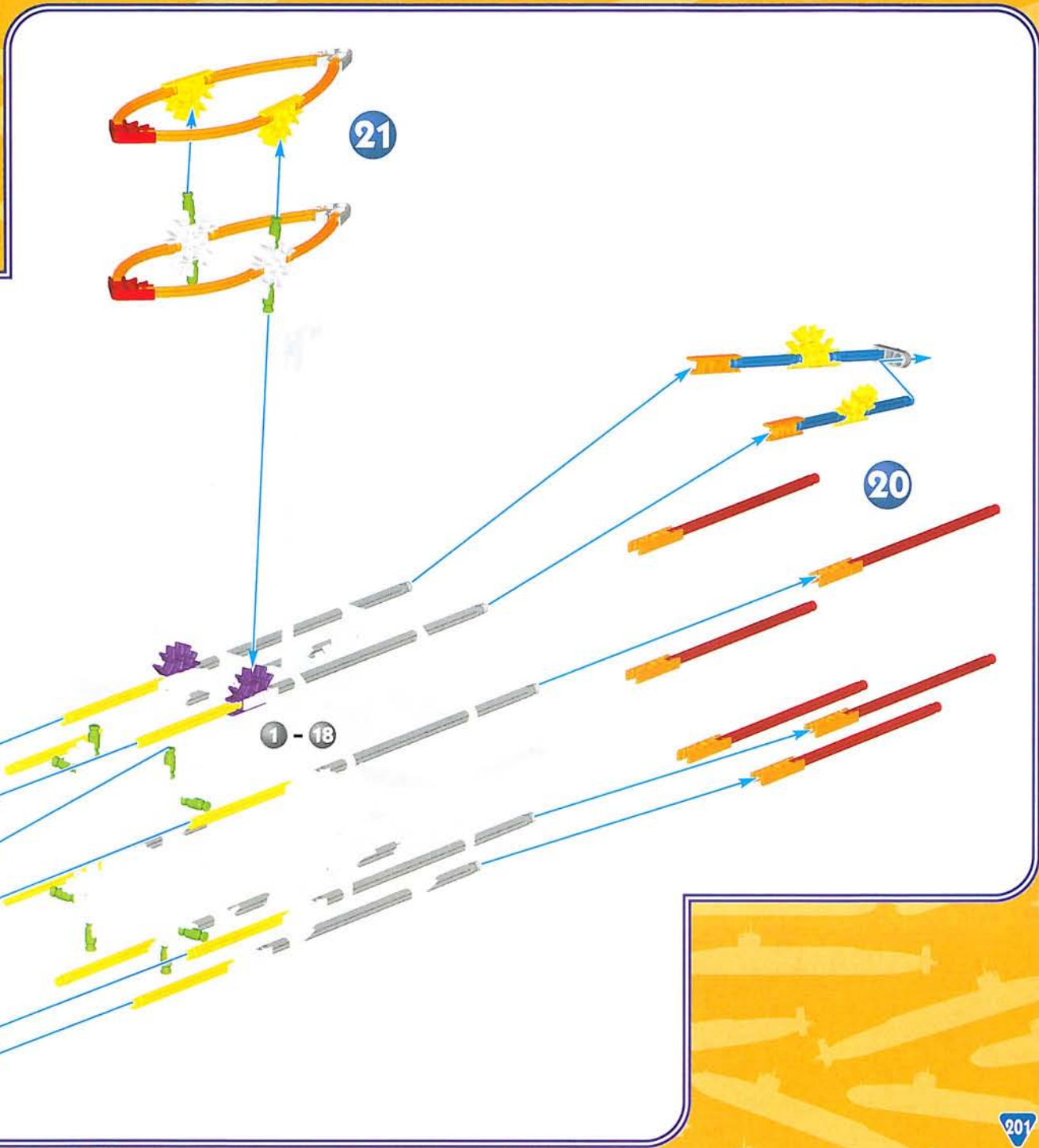

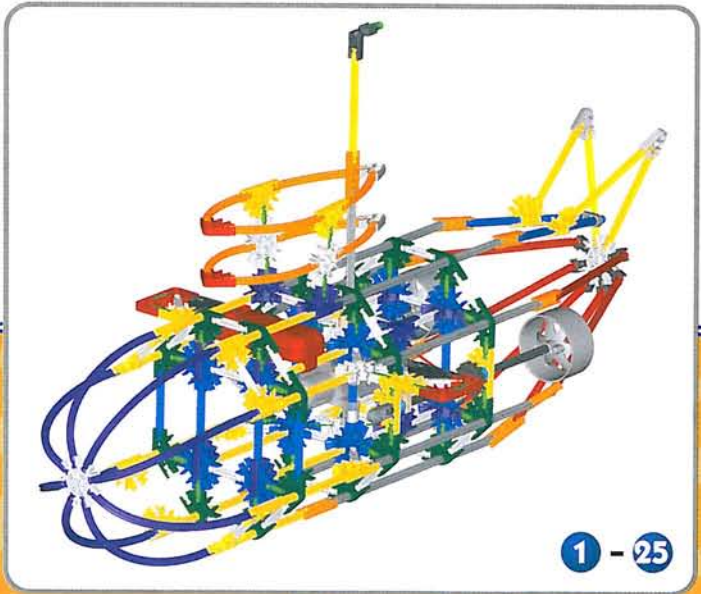

# Robot

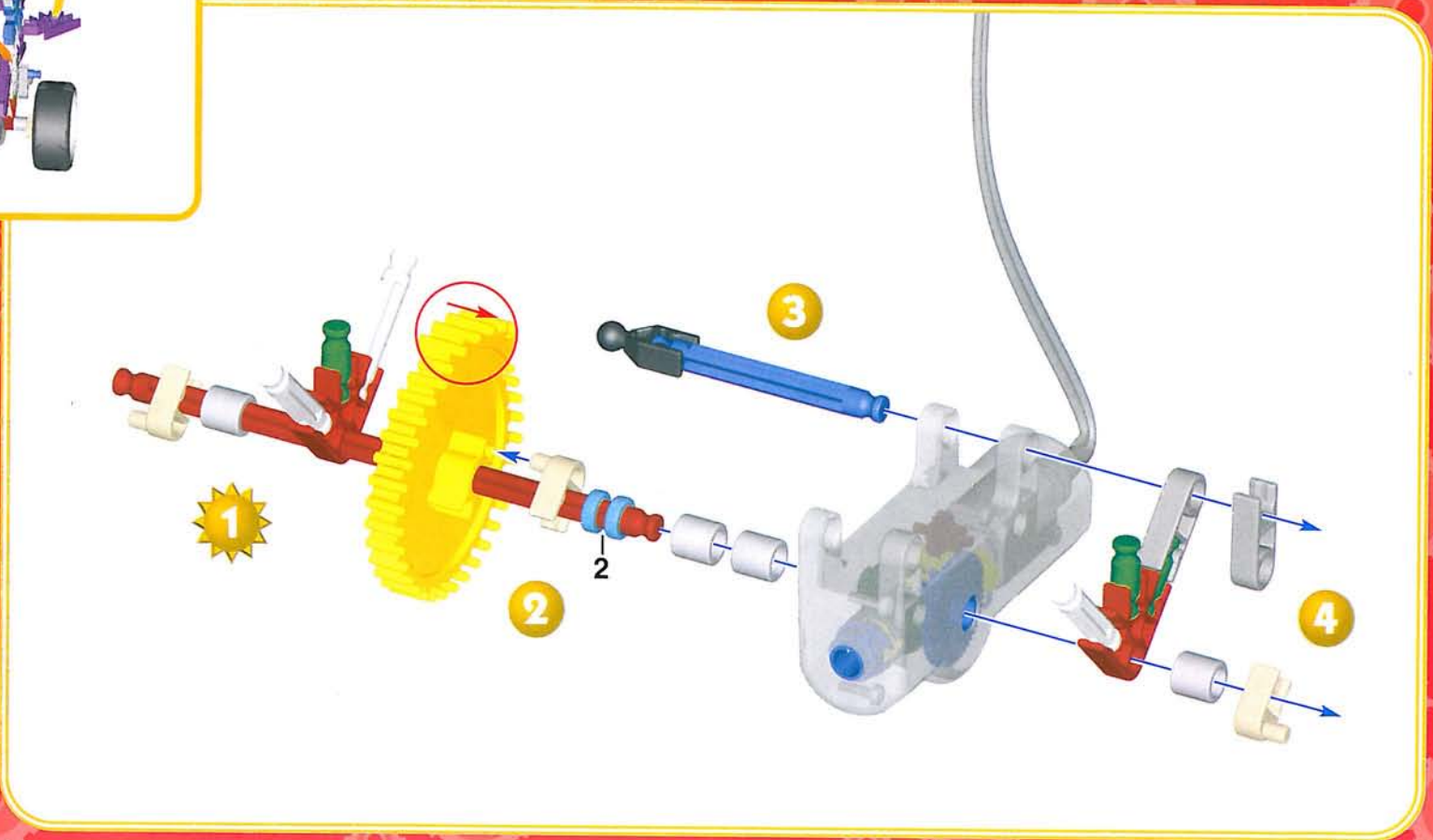
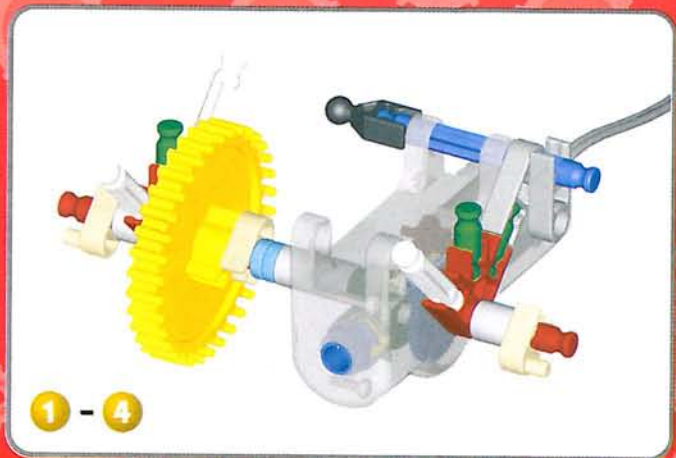
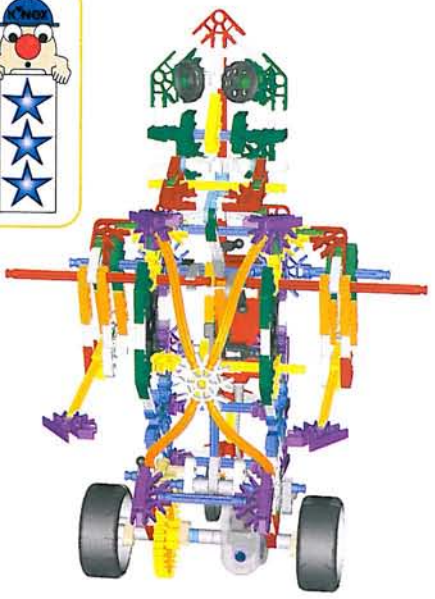

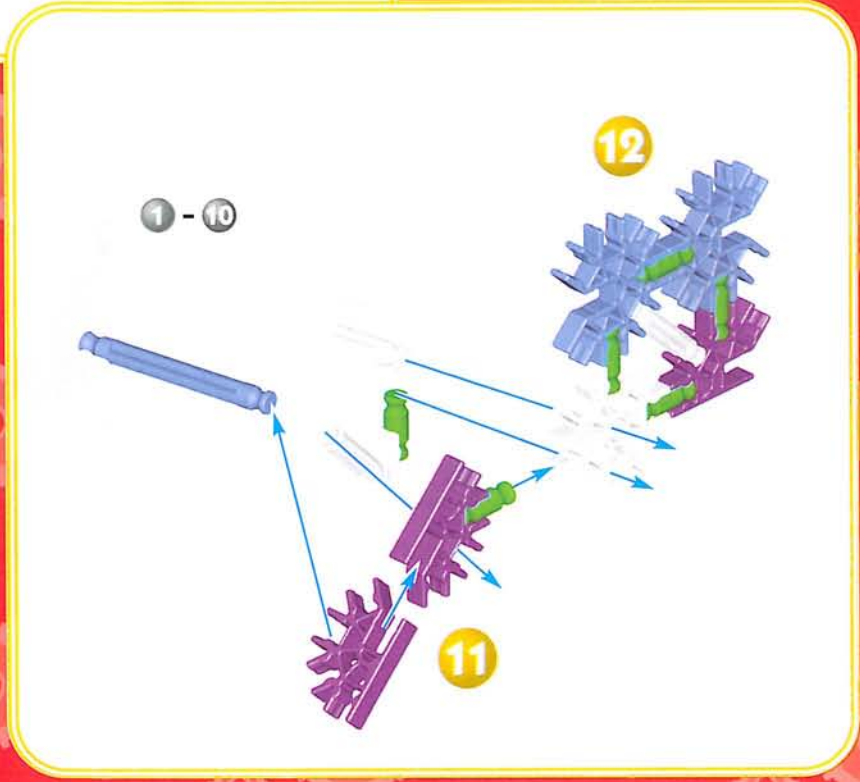
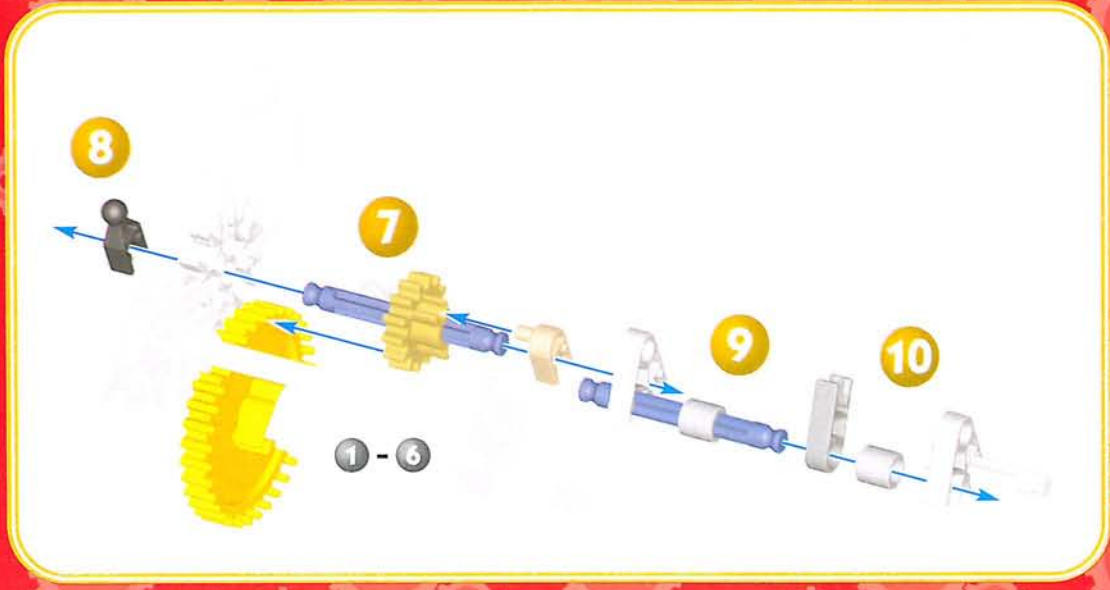
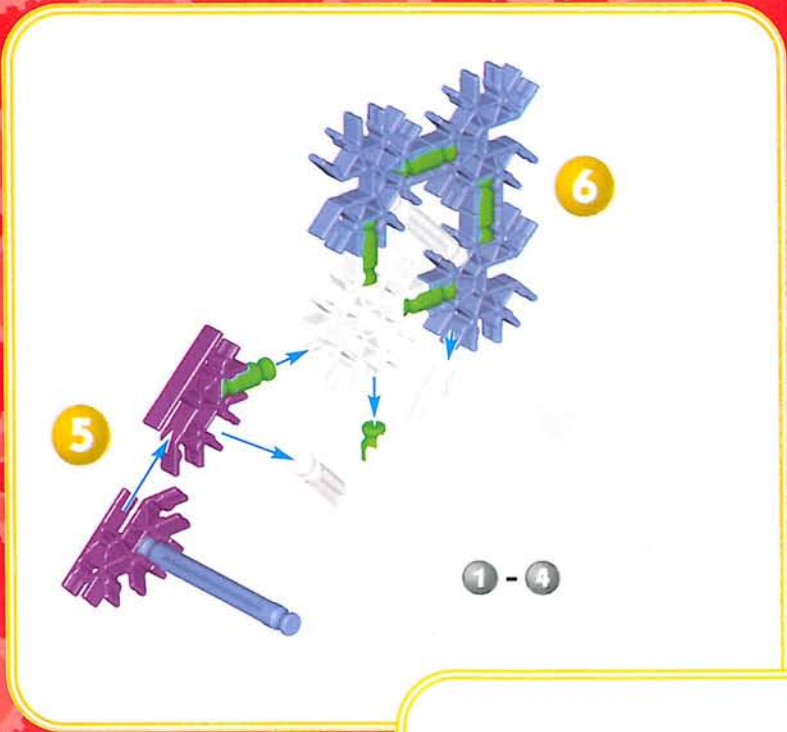

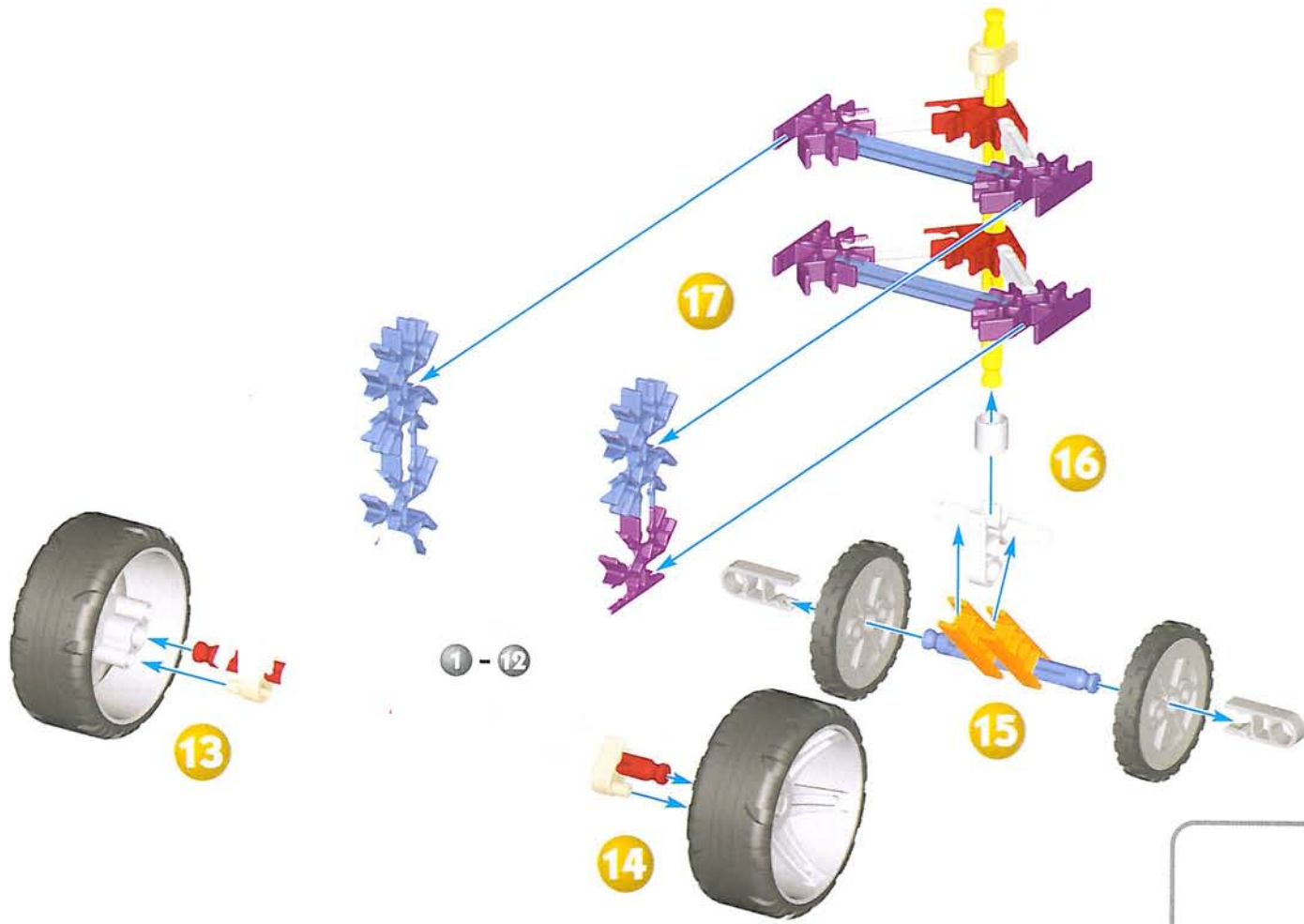

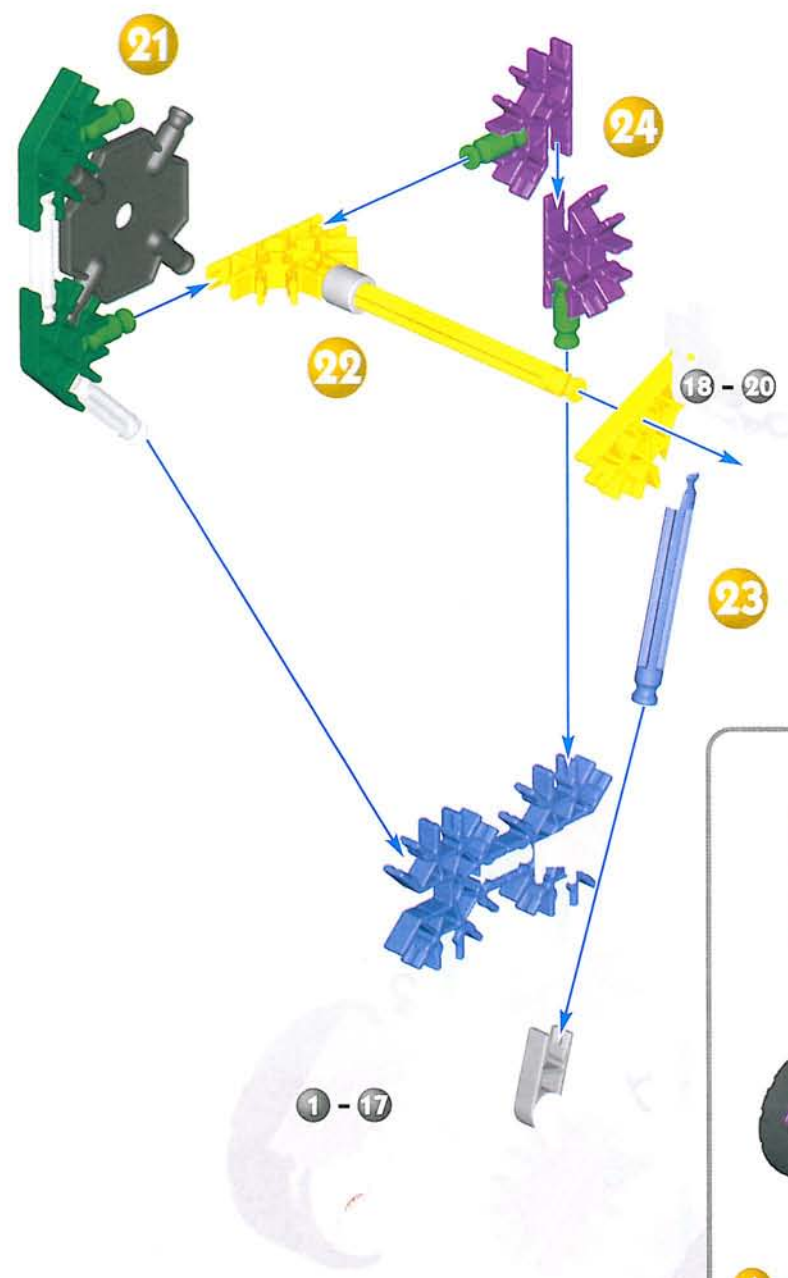

25

1 - 24

26

1 - 26

27

1 - 27

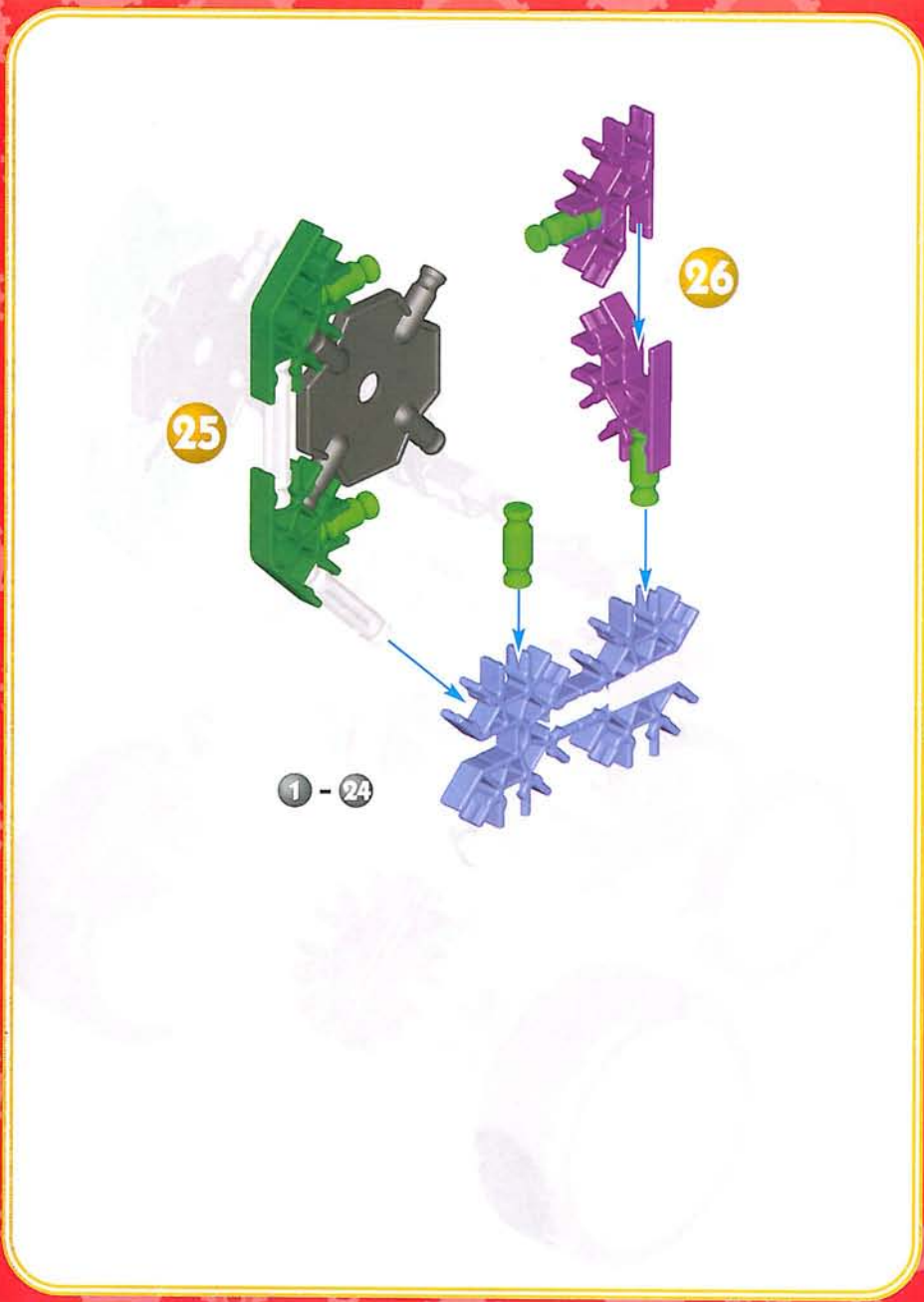

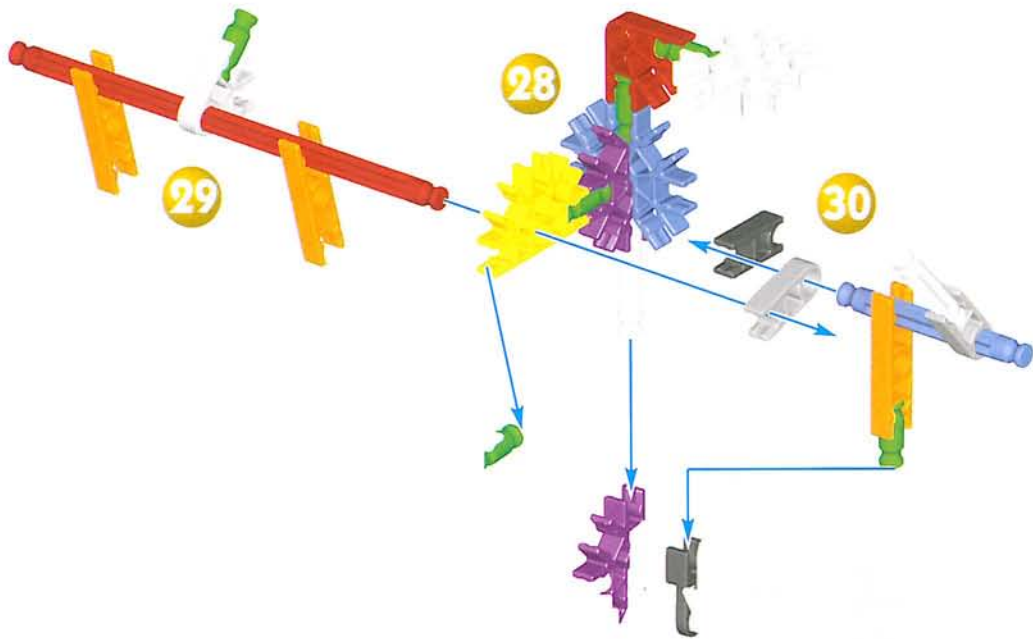

1 - 27

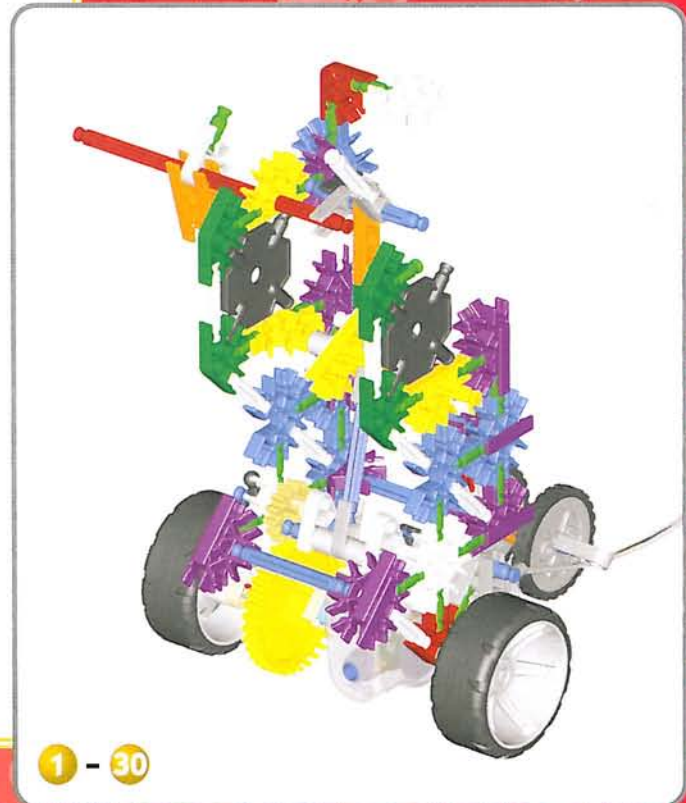

1 - 30



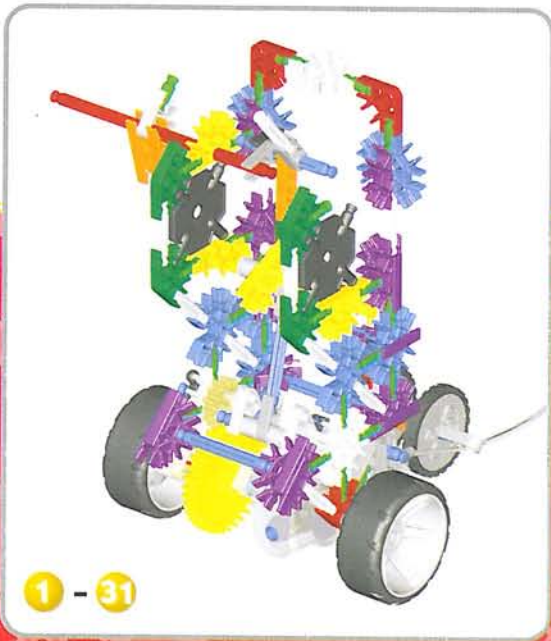
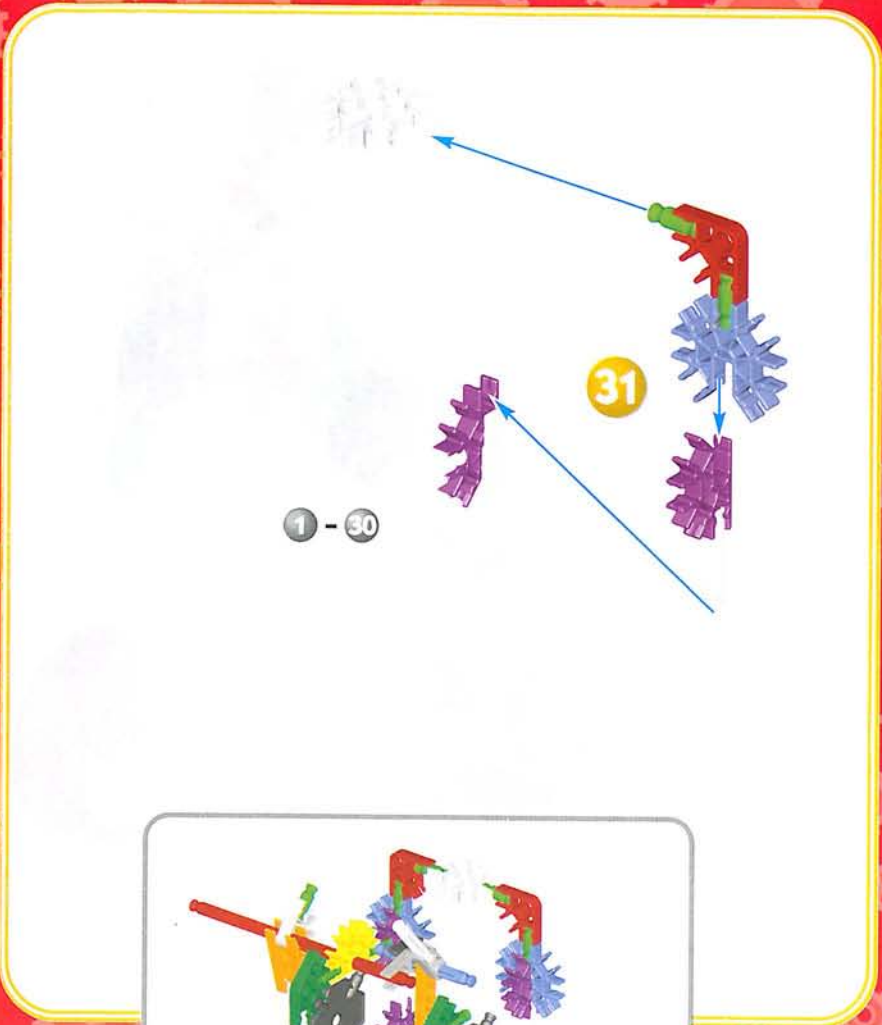

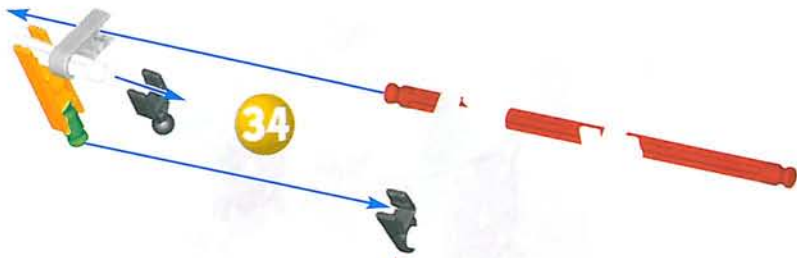

1 - 33

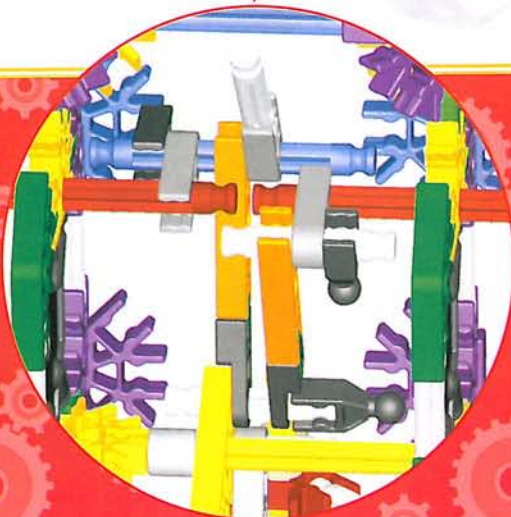

This is the back of the Robot!

1 - 35

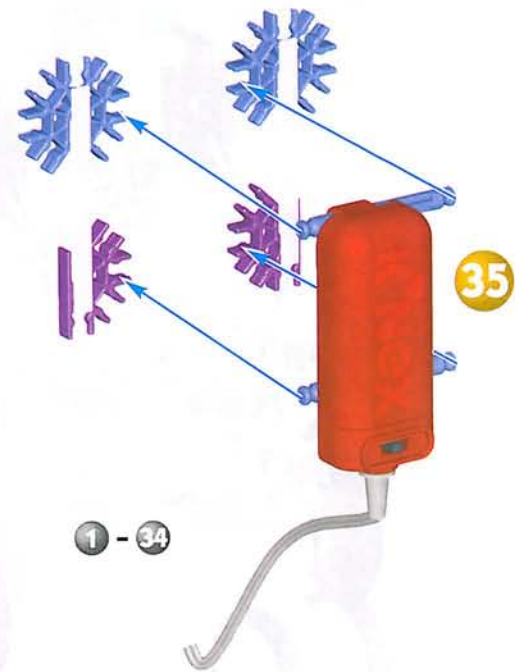

36

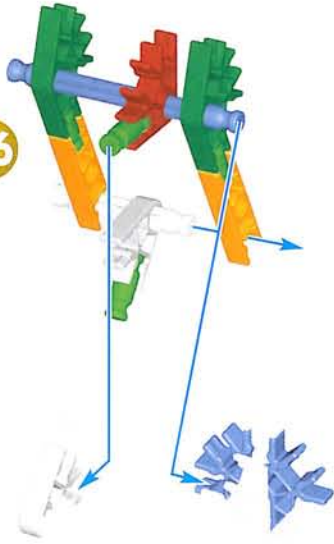

1 - 35

This is the front of the Robot!



37

38

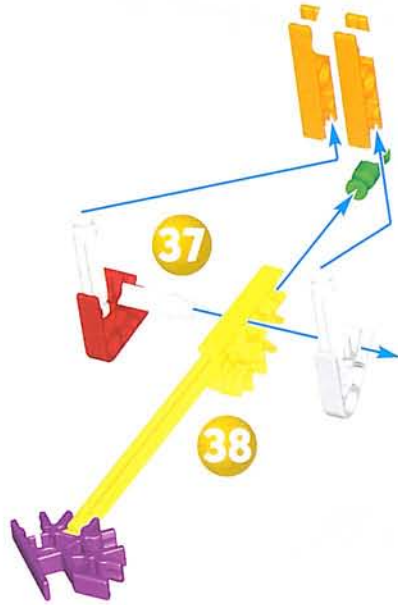

1 - 36

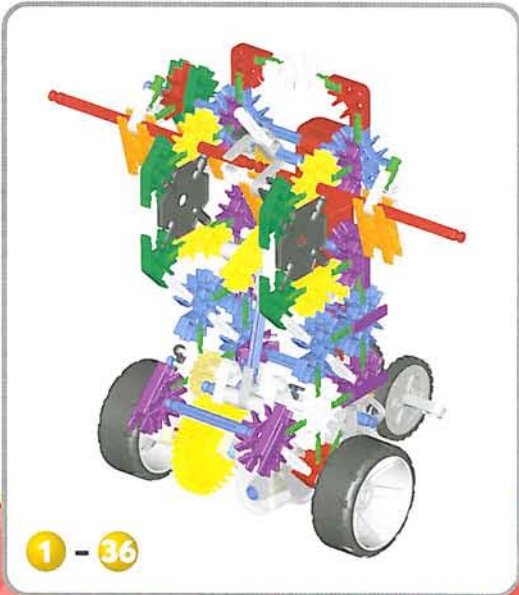

1 - 36



1 - 38

1 - 38

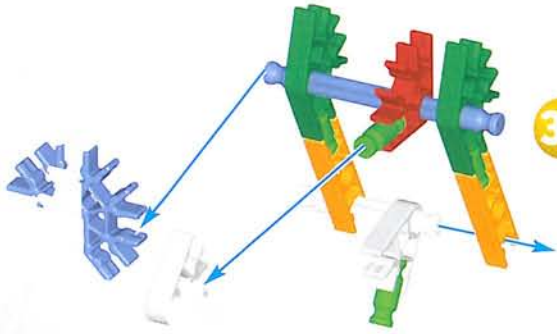

39

1 - 41



1 - 39

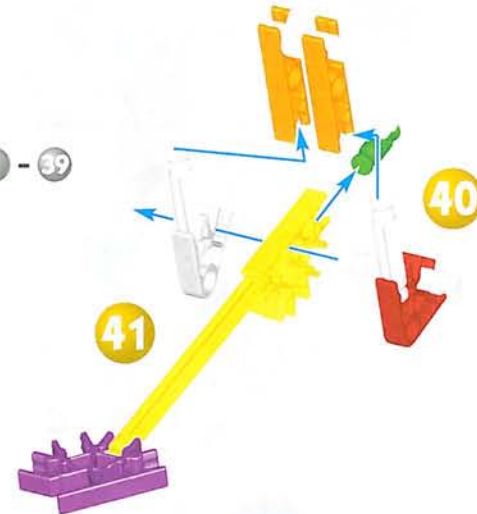

40

41

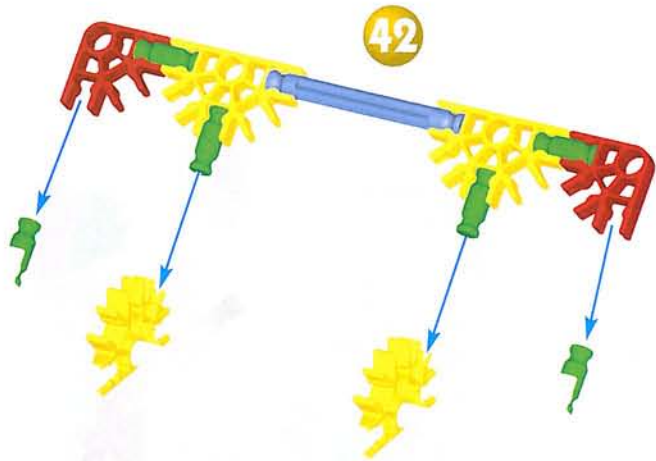

1 - 41

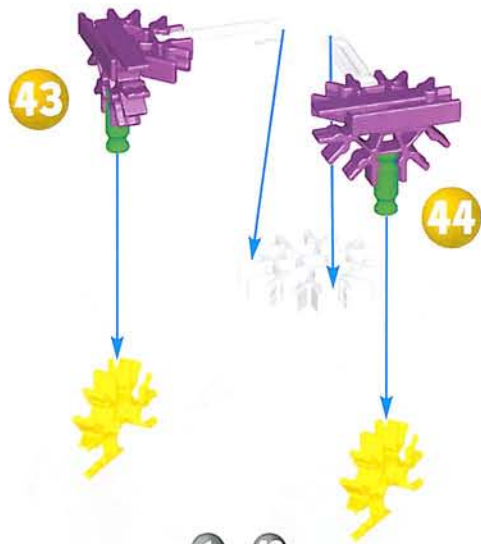

1 - 42



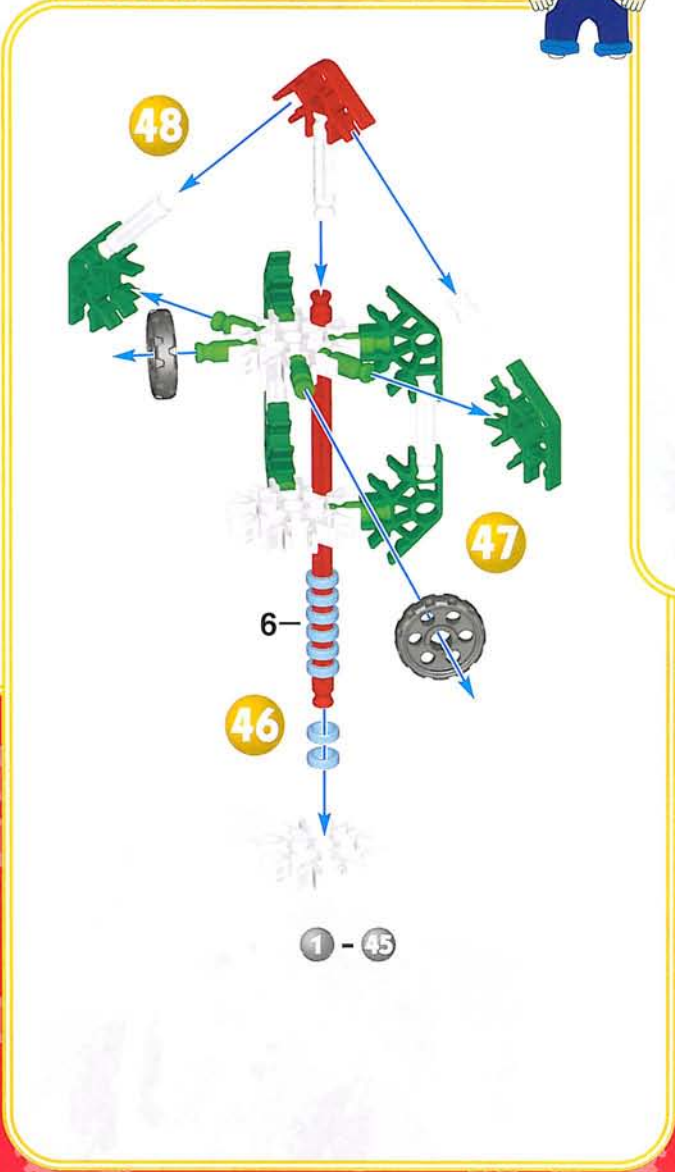
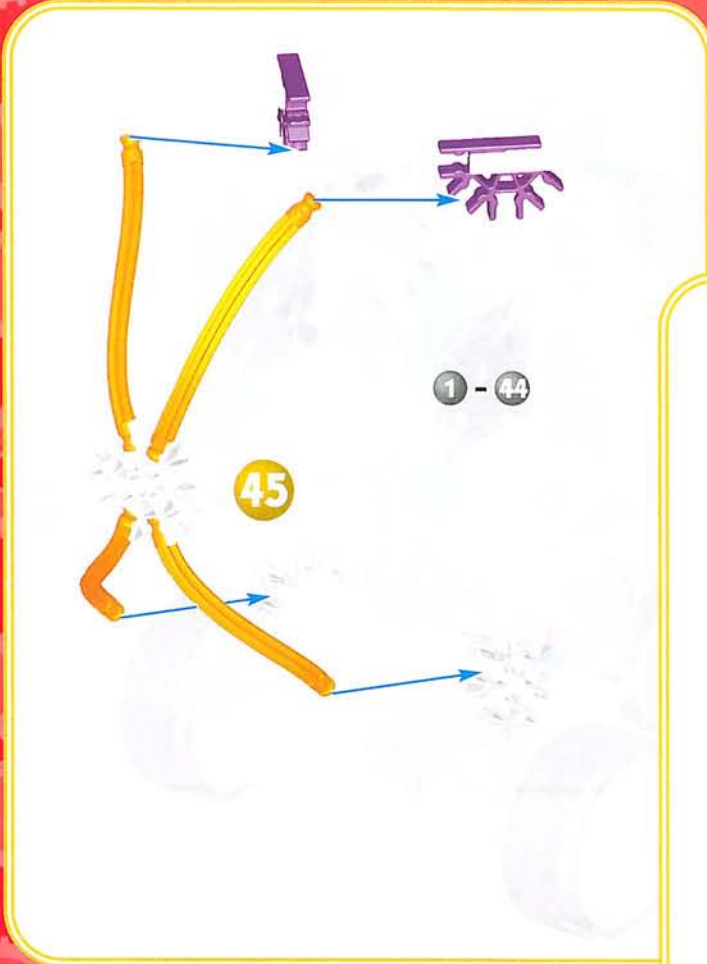

This is the back of the Robot!

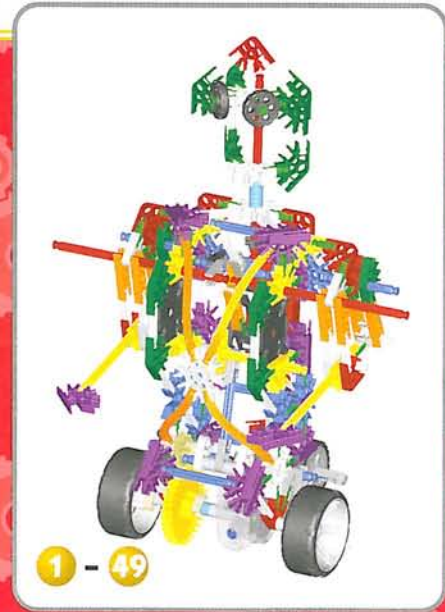
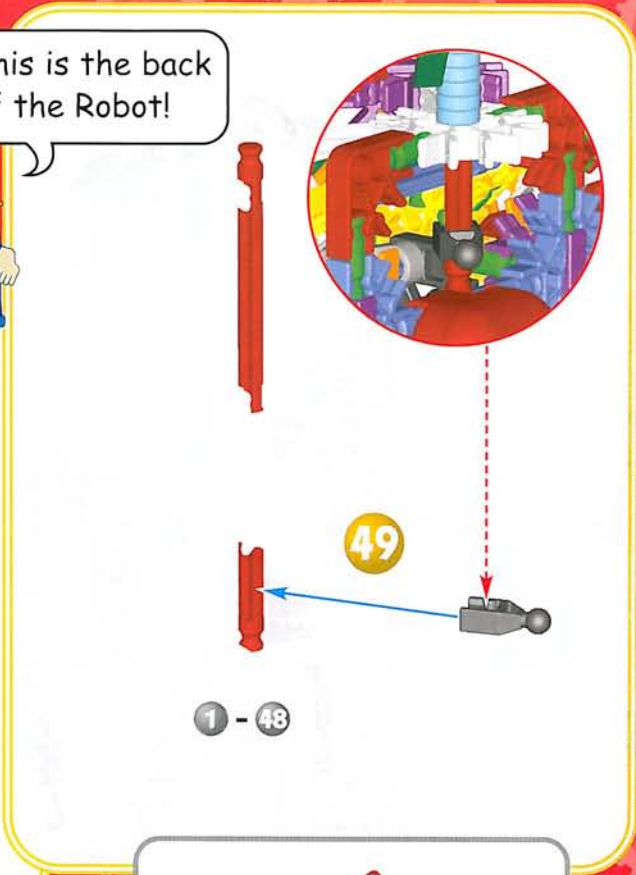

50

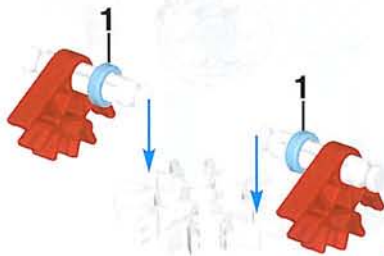

51

1 - 49

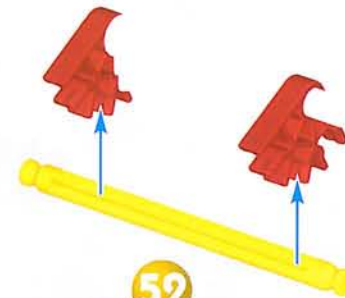

52

1 - 51

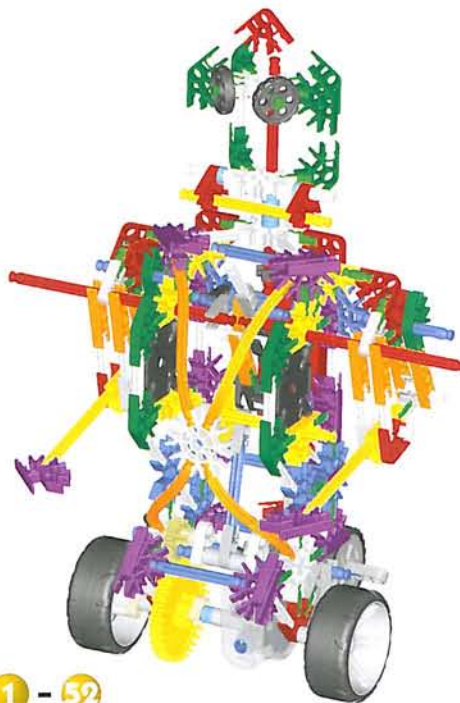

1 - 52

53

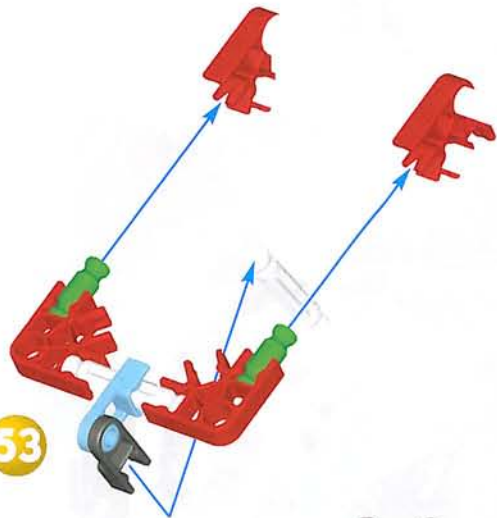

1 - 52



54

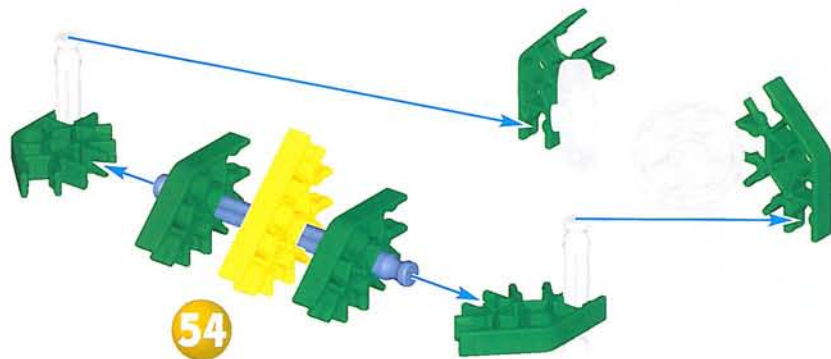

1 - 53

1 - 54

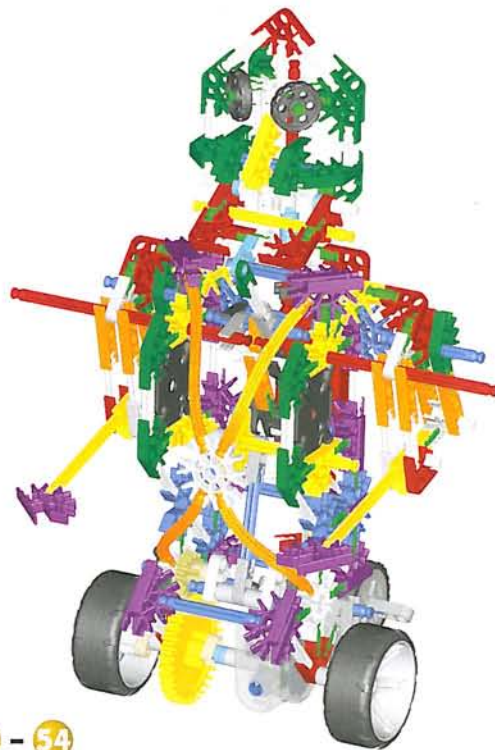



# Chinook Helicopter

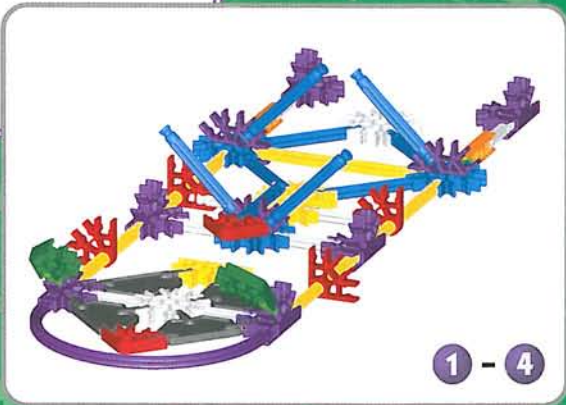
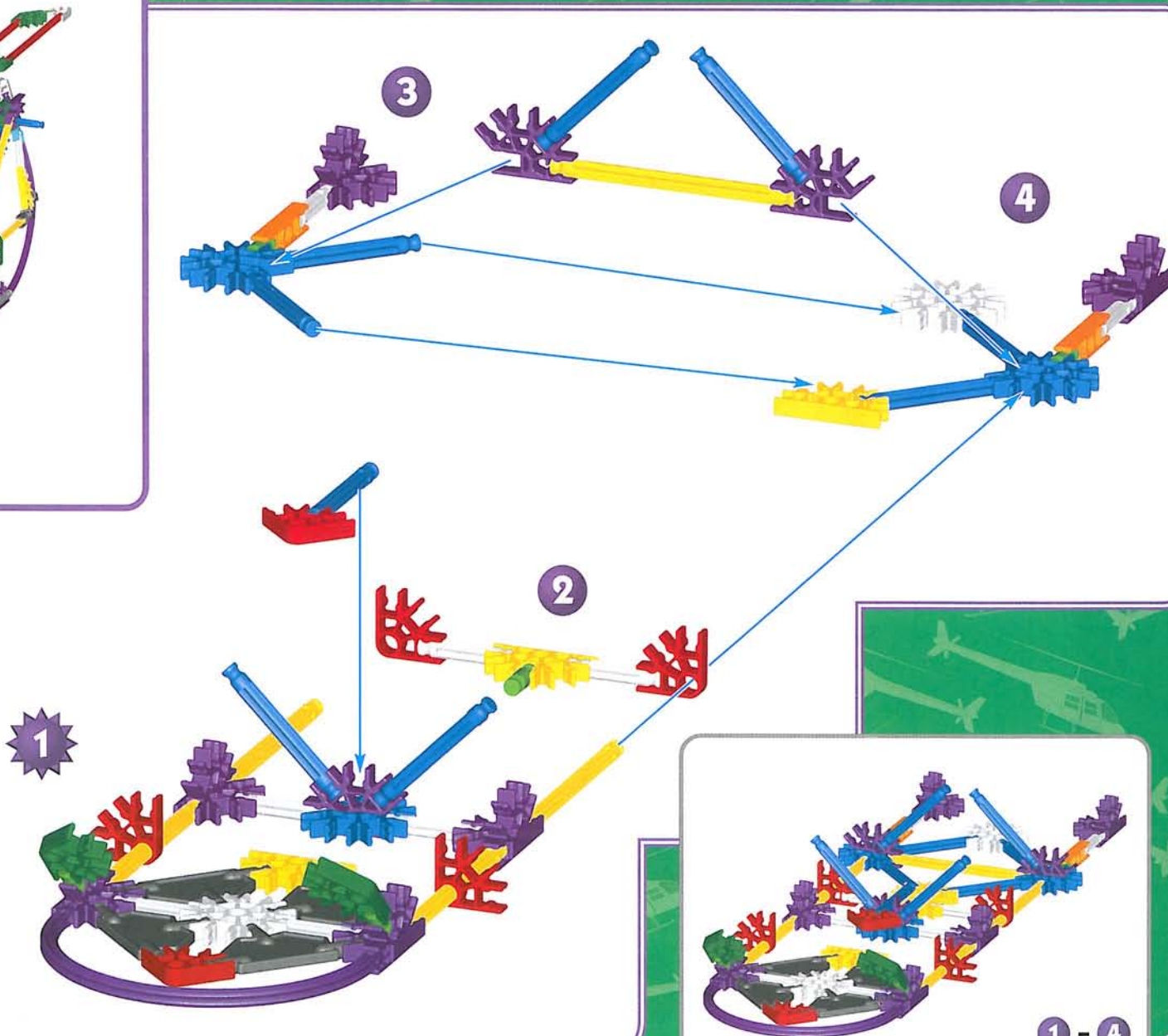
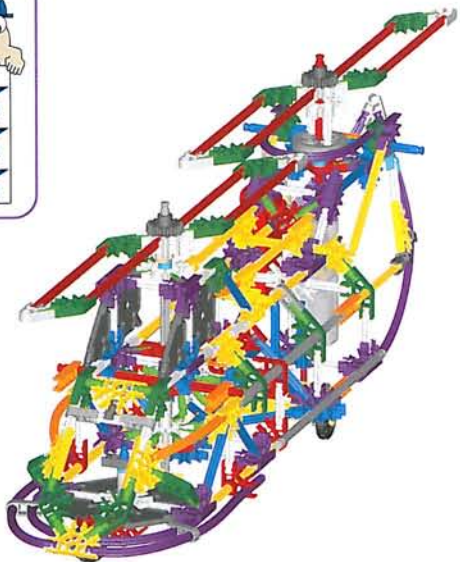
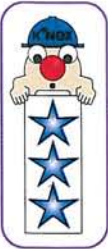

1 - 4

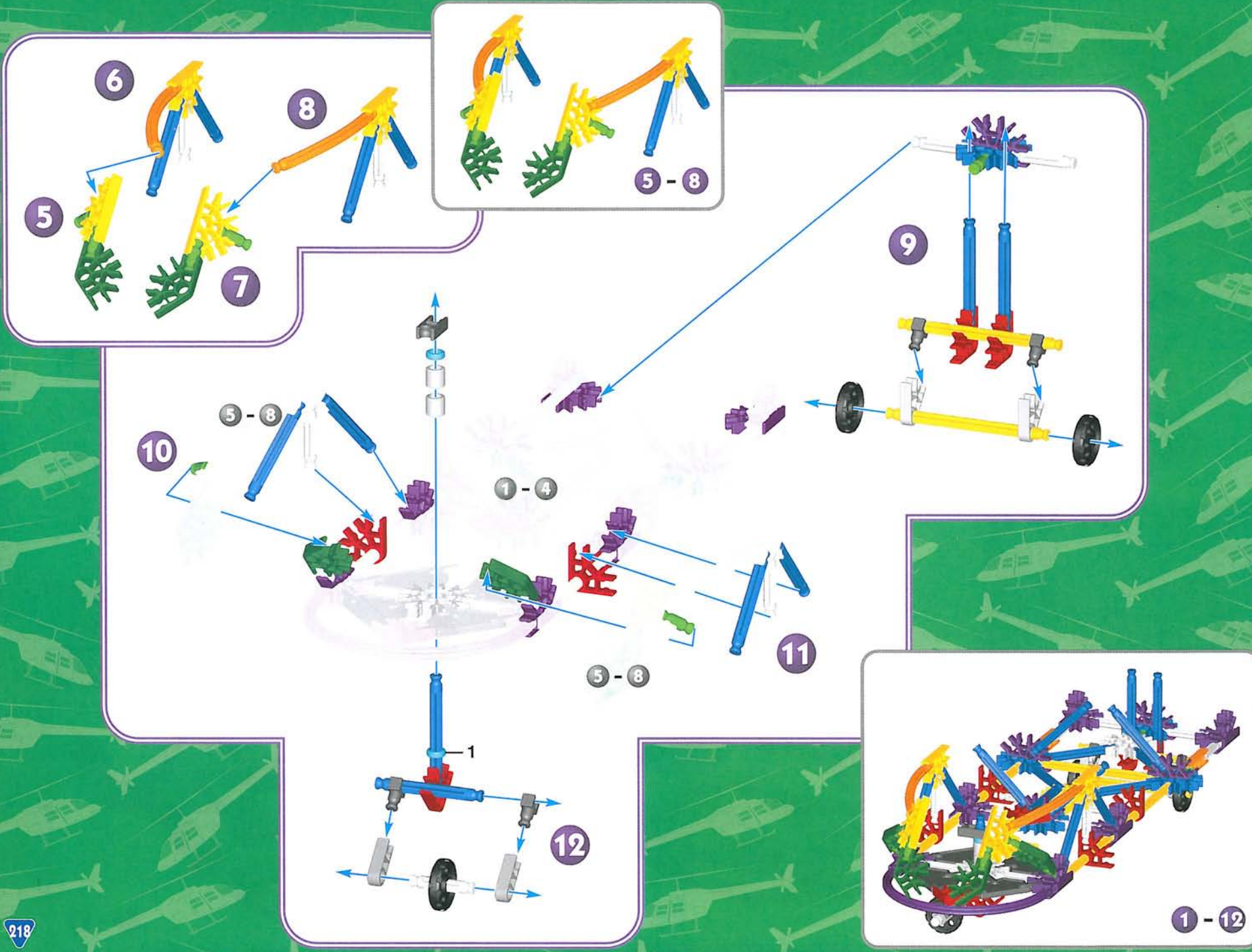

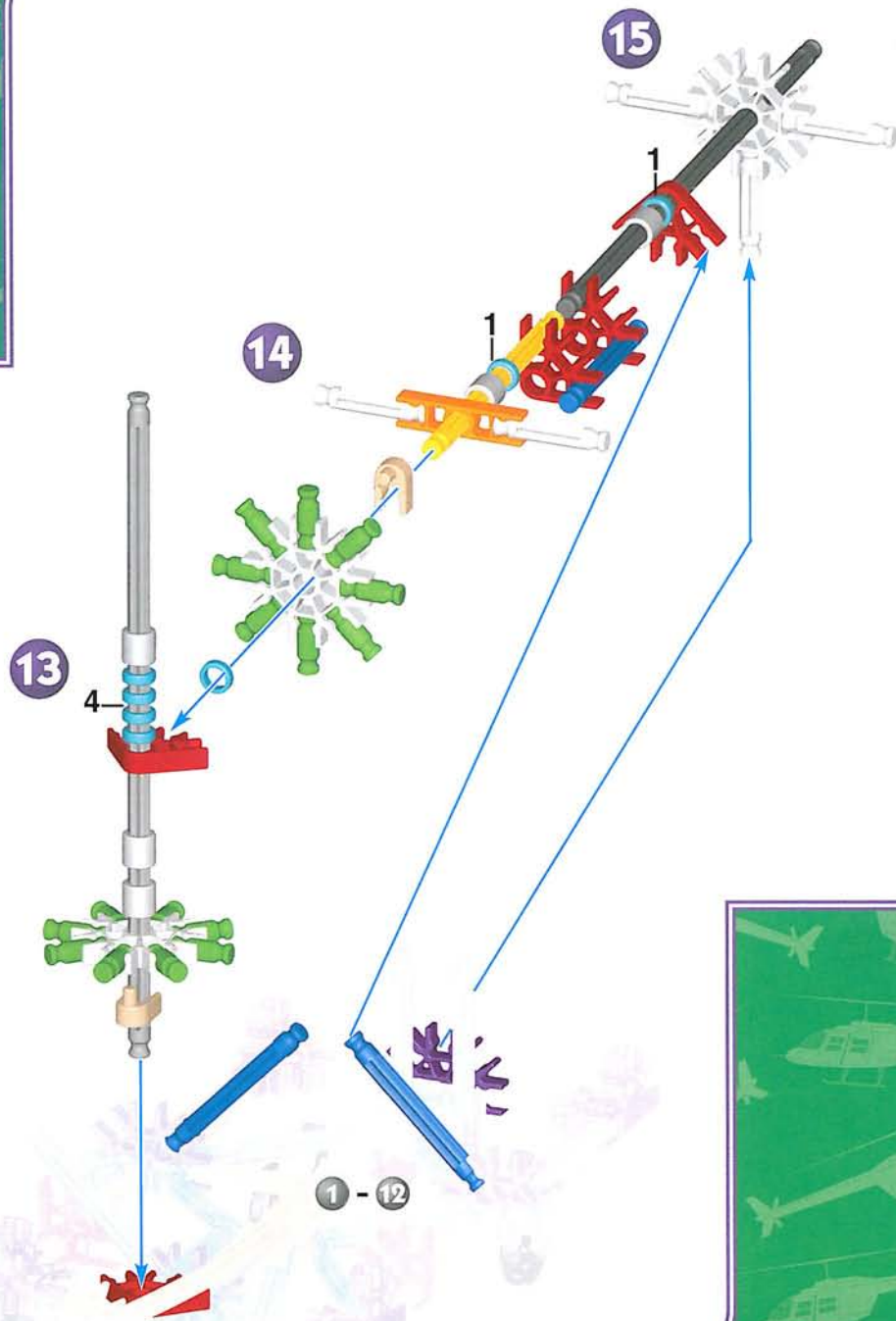

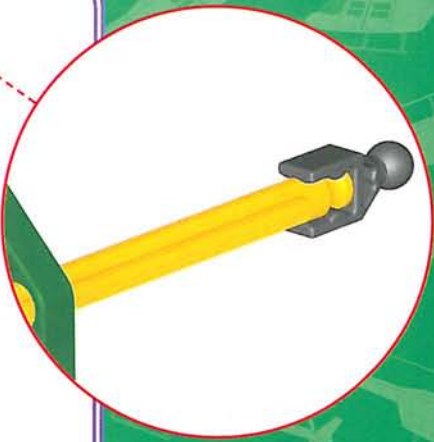
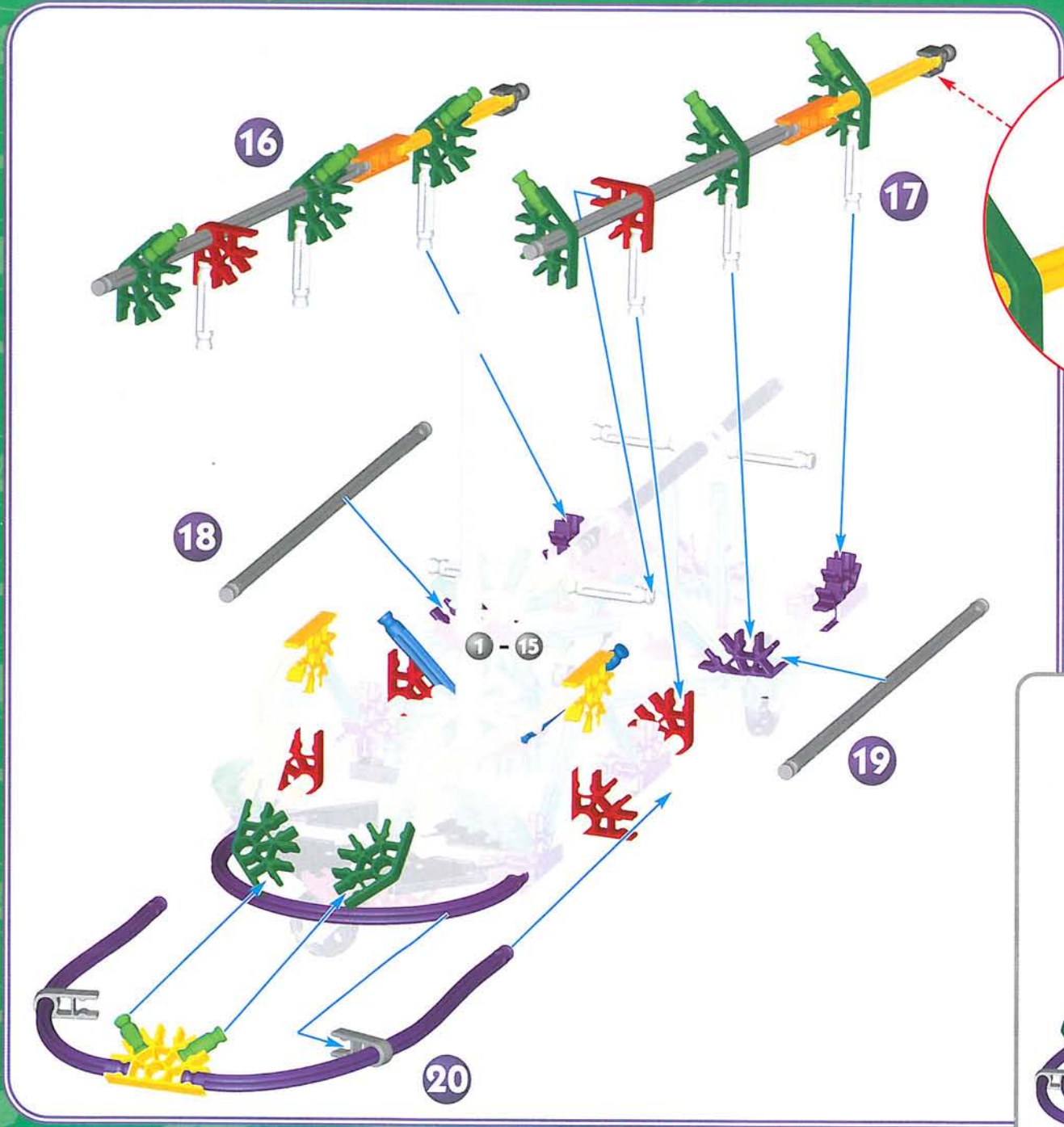

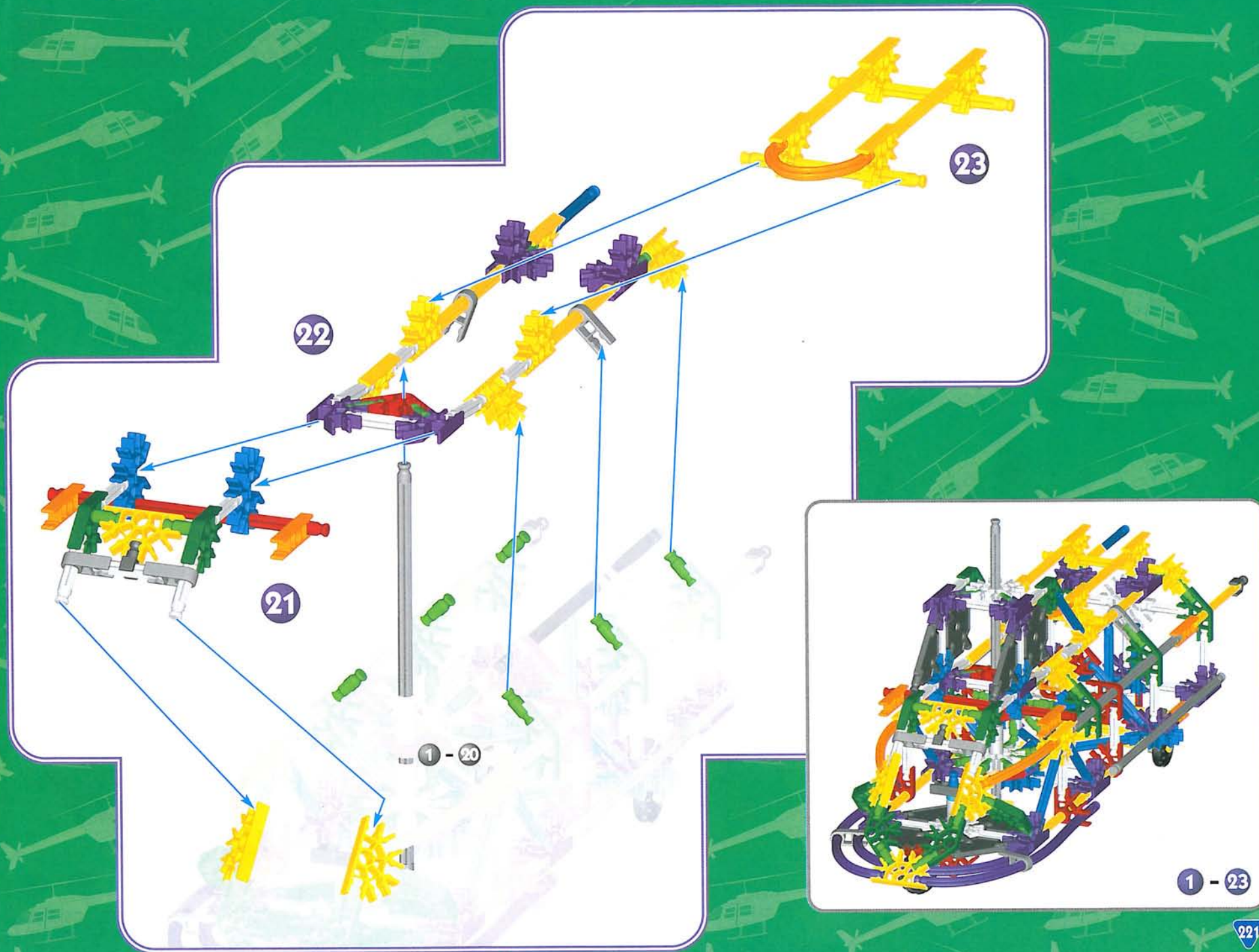

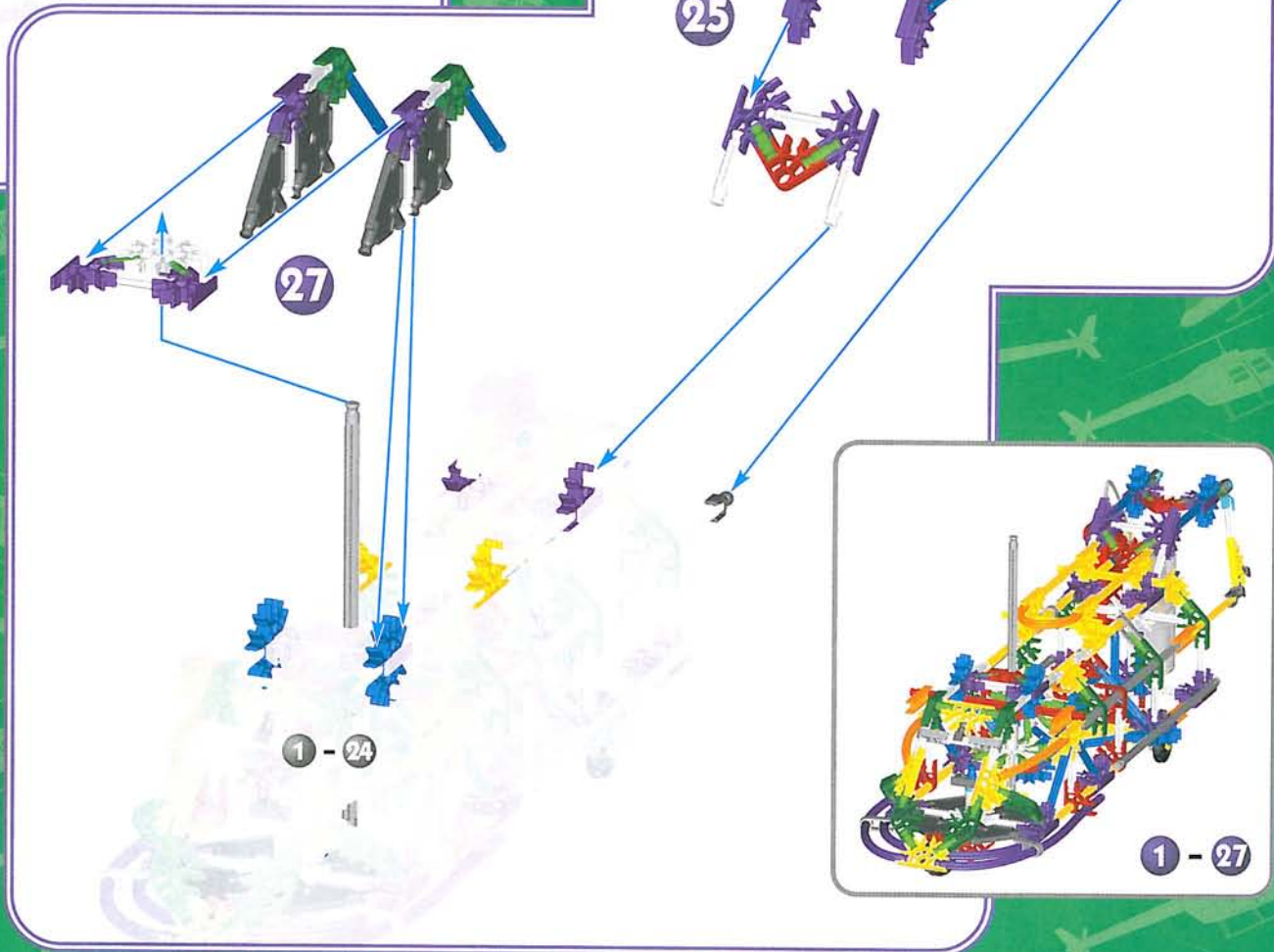
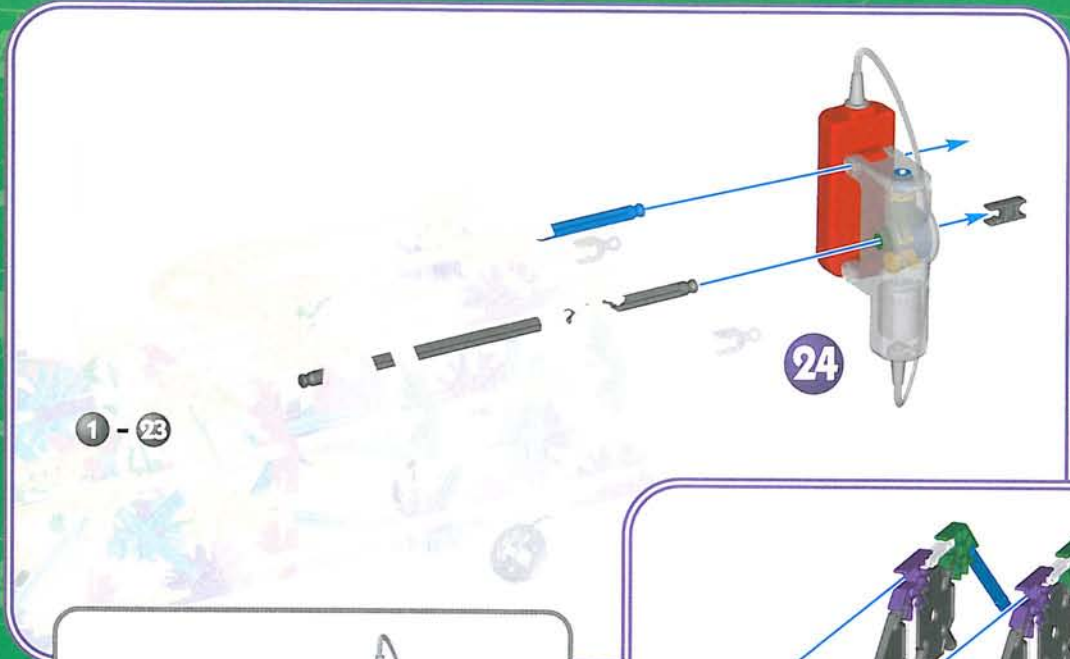

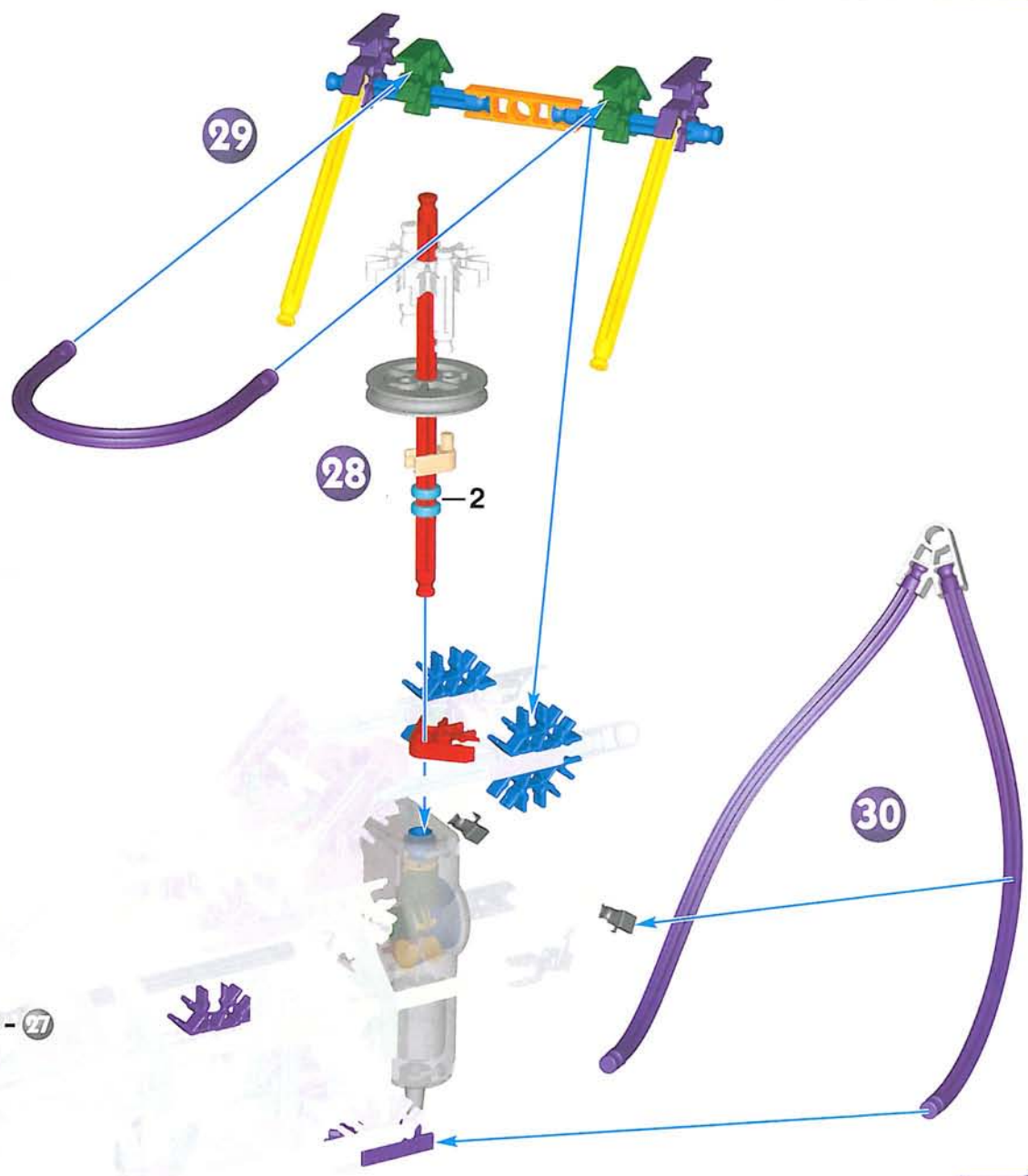
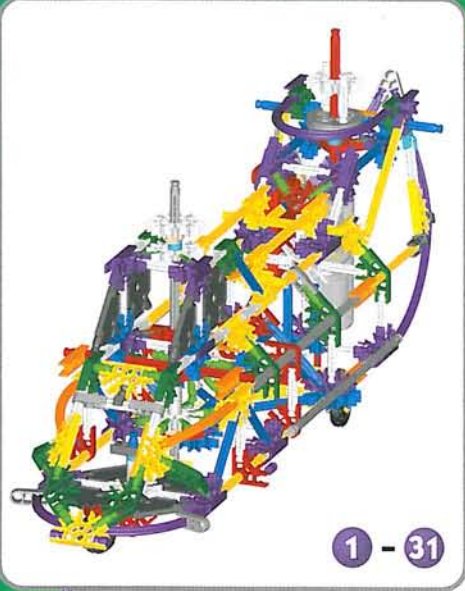

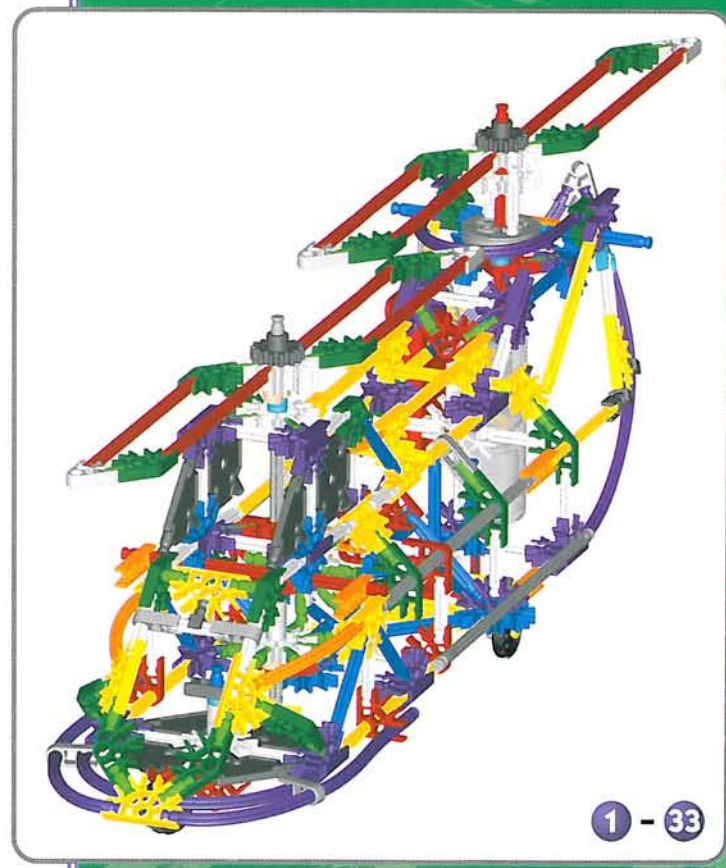
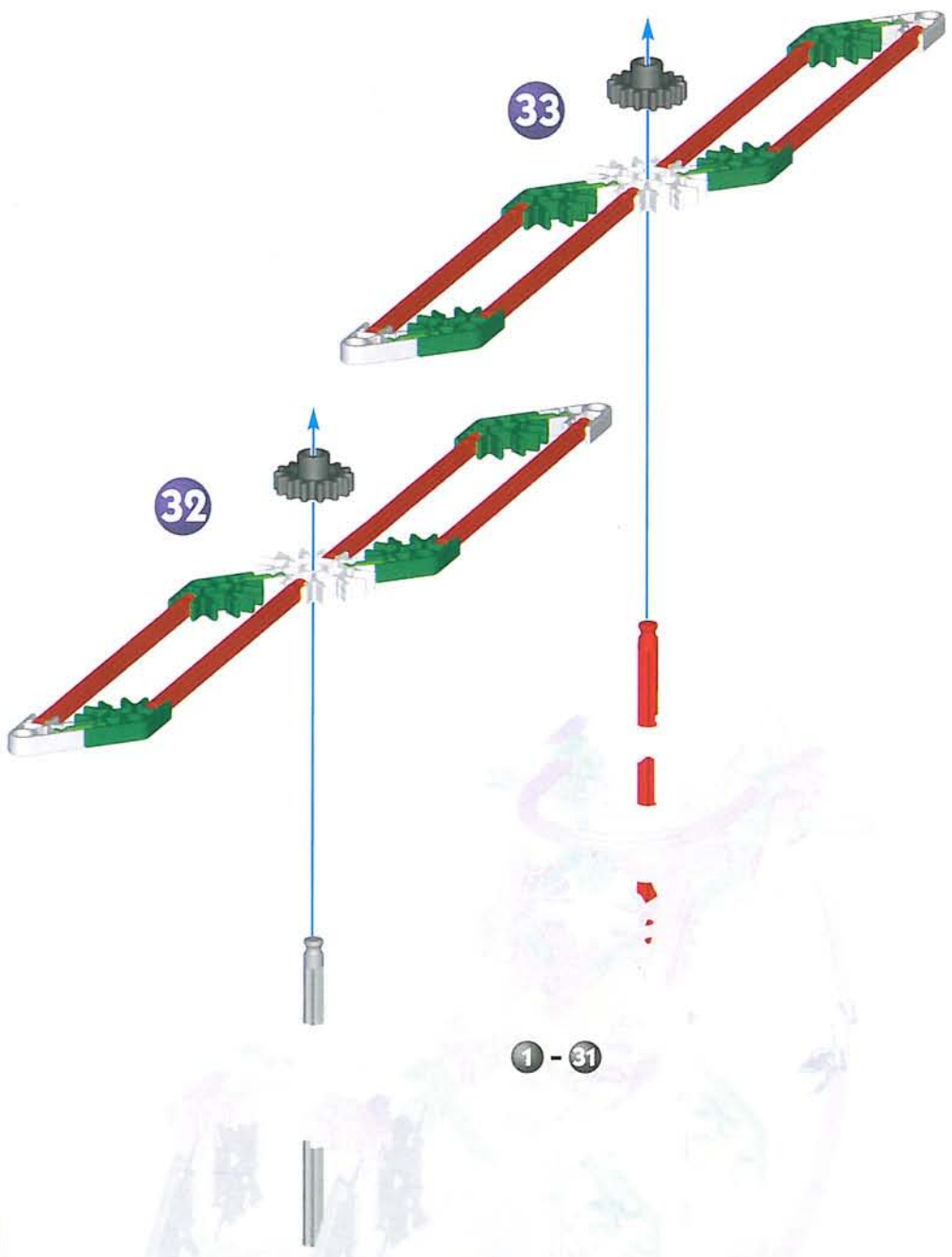



## What's Next?

Congratulations, you've mastered the **50 MODEL Building Set!** But don't forget, some of the best ideas come from your own imagination.

**What other things can you think of to build?** Begin with the models you made from this set and turn them into your own designs by changing parts around. It's that easy. What can you come up? Change the color of your **Moon Buggy** by using different K'NEX parts. You can even turn the models into something totally different. Turn the **Frog Coaster** into a **Dog Coaster!** For ideas, look around the room or outside your window and try to build what you see. You can with K'NEX!

**What's next after the models are built?** Show them off to your family and friends or find new ways to play with your K'NEX models using other toys or things around the house. For example, play a new game by tossing a ball into **The Rejector**. What ideas can you think of?

## Ready for More K'NEX Challenges?

There is a whole world of K'NEX challenges waiting for you – from vehicles that move, to big contraptions, to robots that come to life! Building fun for the whole family! Look for other K'NEX sets at your favorite store or on-line at [www.knex.com](http://www.knex.com).

[www.knex.com](http://www.knex.com)

Check it out!

- Games & Contests!
- Free Downloads!
- New Models to Build!



MAKE BELIEVE FUN  
*Turn the Chopper  
into a Space Shuttle!*

SILLY FUN  
*Change the ears on the  
Rabbit to a different shape.*

FOR YOUR ROOM  
*Build a cage out of  
Popsicle™ sticks for your Parrot!*



## Bonjour!

**F** Le plaisir va commencer! J'ai conçu le système de construction K'NEX pour des enfants comme toi—des enfants qui veulent construire d'une façon tout à fait différente. À l'aide de nos tiges qui s'enclenchent, de connecteurs et d'instructions à code de couleur, tu peux construire et monter les modèles que nous avons conçus—ou bien, tu peux utiliser ton imagination et construire de fabuleux modèles de ta création personnelle! C'est ce que représente K'NEX—se former une idée et la réaliser. Je l'ai fait moi-même quand j'ai inventé K'NEX!

Joel Glickman  
Inventeur de K'NEX

## À propos de la série

Ce 50 MODEL Building Set est parfait pour les constructeurs de tout âge ! Préparez-vous à construire plein de modèles différents, tous plus fantastiques les uns que les autres, et pouvant en plus bouger de manière très réaliste ! Le moteur qui est un BONUS permet de donner vie à de nombreux modèles ! Cherchez le bouton spécial situé à côté de ces modèles particuliers !



Construisez-en autant que vous pouvez - C'est vous qui décidez ! Construisez la Sea Turtle, le Speed Boat, le Mini Jet, la Racing Car, et d'autres choses encore !

## Pourquoi K'NEX ?

C'est l'unique système à tiges et connecteurs !

- Avec des éléments s'emboîtent solidement les uns dans les autres !
- Avec toutes sortes de formes et de longueurs te permettant de construire toujours plus grand !
- Avec des connexions toutes spéciales pour les modèles mobiles !
- Avec des éléments chromocodés (codés par couleur) et des instructions pour te faciliter la tâche !

## Montage avec K'NEX

**1.** Bonjour! Je suis là pour t'aider à monter ton K'NEX. Les directives de ce livret vont t'aider à construire 50 modèles, te mettant sur la voie pour devenir un K'NEXpert ! Tu trouveras des modèles pour trois niveaux de difficulté. Cherche-moi sur la boîte avant de construire, je brandis un panneau pour t'indiquer le niveau de difficulté de chaque modèle...Regarde :



Défi amical



Défi modéré



Plus grand défi

## Prépare-toi à construire

**2.** Pour commencer le modèle, trouve le numéro **1** et suis les chiffres. Chaque pièce a sa propre forme et couleur. Il suffit de regarder l'illustration, de trouver les pièces dans ton jeu qui correspondent à ce que tu vois et de les enclencher. Essaie de tenir le modèle dans le même sens que dans l'illustration. Ainsi, tes pièces seront attachées correctement.

## Continuation

**3.** Les couleurs affaiblies indiquent que cette partie est déjà montée. Tu dois raccorder la nouvelle partie à l'endroit indiqué par les flèches. Ces pièces seront en pleine couleur.

## Pièces d'écartement

**4.** Il y a des endroits dans ton modèle où tu dois ajouter des pièces d'écartement bleues et argentées. Assure-toi d'utiliser la couleur exacte et de compter les pièces avec soin.

## Connecteurs

**5.** Tu trouveras des connecteurs bleus et violets comportant des fentes extra-longues. Ils se glissent l'un dans l'autre tel qu'illustré. Pousse les pièces ensemble jusqu'à ce que tu entendes un "déclit".

## Tiges flexibles

**6.** Une tige flexible est une tige orange ou violette que tu peux courber. Elle s'attachera plus facilement à ton modèle si tu la courbes d'abord plusieurs fois avant son installation.

## ⚠ Attention:

**7.** Les élastiques peuvent causer des blessures en claquant, en se cassant ou quand on les manipule imprudemment. Tenez fermement l'élastique lors de l'assemblage du modèle en veillant à ne pas trop le tendre. N'utilisez les élastiques que selon les instructions. **N'UTILISEZ PAS D'ÉLASTIQUES ÉRAILLÉS OU DÉCHIRÉS.** Attention: Tenez les élastiques en caoutchouc à l'écart du visage et des yeux.

## Et après ?

Félicitations, le 50 Model Building Set n'a plus de secrets pour vous ! Mais n'oubliez pas que les meilleures idées peuvent parfois sortir tout droit de votre imagination.

Que pourriez-vous bien construire d'autre ? Commencez par les modèles que vous avez construits à partir de cette série et transformez-les en changeant les pièces de place. Ce n'est pas plus difficile que cela. Que pouvez-vous inventer ? Changez la couleur de votre Moon Buggy en utilisant différentes pièces K'NEX. Changez la forme des oreilles du Rabbit. Vous pouvez même complètement

transformer les modèles. Transformez le Frog Coaster en un Dog Coaster ou bien le Chopper en une Space Shuttle ! Si vous êtes à court d'idées, regardez dans votre chambre ou par la fenêtre et essayez de construire des trucs que vous voyez. Avec K'NEX, c'est possible !

es modèles une fois construits, qu'est-ce que je fais ? Montrez-les à votre famille et vos amis ou bien trouvez d'autres façons de jouer avec vos modèles K'NEX en vous servant d'autres jouets ou d'objets qui traînent chez vous. Vous pouvez par exemple inventer un nouveau jeu en lançant une balle dans The Rejector ou construire une cage pour votre Parrot avec des bâtonnets en bois. Que pouvez-vous bien imaginer ?

## Prêt à relever d'autres défis K'NEX ?

C'est tout un univers qui vous attend avec K'NEX n de véhicules pouvant se déplacer à des robots animés en passant par de grosses machines ! De quoi s'amuser pour toute la famille !

Cherchez d'autres séries K'NEX dans votre magasin préféré ou rendez-nous visite en ligne à [www.knex.com](http://www.knex.com).

## E Qué se incluye

Antes de empezar a construir, asegúrate de comparar las partes que hay en tu caja con las partes que hay en la lista de la página 4. Si alguna cosa falta, en la contraportada de este folleto de instrucciones encontrarás la manera de ponerte en contacto con nosotros. ¡Estamos aquí para ayudarte!

## Construcción con K'NEX

- ¡Hola! Soy tu compañero en la construcción. Las instrucciones que ves en este libro te ayudarán a construir 50 modelos que te pondrán en camino de ser un K'NEXpert. Encontrarás modelos para tres niveles de construcción. Búscame antes de cada construcción, estaré sosteniendo un cartel que te dirá cuánto puede ser difícil.



Amigable desafío



Moderado desafío



Enorme desafío

## Todo listo, comienza a construir

2. Para comenzar tu modelo, busca el y sigue los números. Cada pieza tiene su propia forma y color. Simplemente mira los dibujos, busca las piezas correspondientes en tu juego y después concéctalas. Mientras construyes, trata de colocar tu modelo en la misma dirección que se muestra en las instrucciones.

## Continúa

3. Los colores desteñidos muestran que esta sección ya está construida. Conecta las nuevas secciones en los lugares señalados por las flechas. Las nuevas piezas que agregues estarán en colores vivos.

## Espaciadores

4. Hay lugares en tu modelo donde tendrás que agregar Espaciadores azules y plateados. Cerciórate de usar el color correcto y cuéntalos con cuidado.

## Conectores

5. Hay conectores azules y plateados con ranuras largas especiales. Se enganchan deslizándose como ves en los dibujos. Conecta estas piezas empujándolas hasta que oigas "clic".

## Varillas Flexibles

6. Una Varilla Flexible es una Varilla que se puede doblar para formar curvas. Serán más fáciles de conectar a tu modelo si primero las doblas hacia atrás y hacia adelante.

## ⚠ Precaución:

7. Las gomas pueden causar daños si se sueltan con fuerza, se rompen o se pierde su control. Al construir los modelos que se muestran en las instrucciones, sujetar bien la goma y no estirarla demasiado. Las gomas deben usarse únicamente como se indica en las instrucciones. **NO USAR GOMAS QUE ESTÉN DESGASTADAS NI RASGADAS.** Precaución: Mantenga las gomas elásticas alejadas de la cara y los ojos.

## D Inhalt

Bevor du mit dem Bau beginnst, solltest du unbedingt die Teile in deinem Baukasten mit denen, die auf Seite 4 aufgelistet sind, vergleichen. Bitte setze dich mit uns in Verbindung, falls der Inhalt unvollständig ist (siehe Rückseite dieser Broschüre). Wir helfen dir dann!

## Bauen mit K'NEX



- Hallo, ich bin dein K'NEX-Bauhelfer. Die Anleitungen in diesem Heft helfen dir 50 Modelle zu bauen, damit du ein K'NEXpert werden kannst! Es gibt drei Schwierigkeitsstufen. Schau nach mir bevor du mit dem Bau eines Modells beginnst. Auf einem Schild zeige ich dir den Schwierigkeitsgrad für jedes Modell:



einfach



mittel



schwieriger

## Achtung - und los geht's

2. Um mit dem Bau deines Modells zu beginnen, suchst du zuerst das Teil mit der Nummer , dann das mit der Nummer 2 und so weiter. Jedes Teil hat eine bestimmte Form und Farbe. Schau einfach auf das Bild und suche dann die gleichen Teile in deinem Bausatz. Dann steckst du die Teile zusammen. Am besten ist es, wenn du die Teile im selben Winkel hältst, wie in der Abbildung, damit du sie an der richtigen Stelle anbringst.

## Und weiter geht's

3. An den blassen Farben kannst du erkennen, welcher Teil bereits fertig ist. Das neue Teil gehört da hin, wo Pfeile hin zeigen. Dieser Teil ist in bunter Farbe.

## Abstandsstücke

4. An bestimmten Stellen in deinem Modell musst du Abstandhalter, sogenannte Spacer, einbauen. Diese Abstandhalter sind blau und silberfarben. Achte darauf, dass du die richtige Farbe wählst und dass du die richtige Anzahl davon verwendest.

## Verbindungsstücke

5. Blaue und silberfarbene Steckanschlüsse haben besonders lange Schlitze. Wie du auf der Abbildung sehen kannst, lassen sie sich ineinander schieben. Achte beim Aneinanderfügen dieser Teile darauf, dass du ein Klickgeräusch hörst. Erst dann sind die Teile fest miteinander verbunden.

## Flexi-Laschen

6. Eine Flexi-Lasche ist eine Lasche, die du zu einer Kurve zurechtbiegen kannst. Sie lassen sich leichter an dein Modell anschließen, wenn du sie mehrmals hin- und herbiegst, um sie flexibler zu machen, bevor du sie das erste Mal benutzt.

## ⚠ Vorsicht:

7. Gummibänder können Verletzungen hervorrufen, wenn sie reißen, zurückspringen oder wenn sie nicht vorsichtig gehandhabt werden. Halten Sie die Gummibänder während des Zusammenbaus der Modelle fest, ohne sie jedoch zu überdehnen. Verwenden Sie die Gummibänder gemäß den Anweisungen. **VERWENDEN SIE NIEMALS AUSGEFRANSTE ODER ZERRISSENE GUMMIBÄNDER.** Vorsicht: Gummibänder bitte von Augen und Gesicht fernhalten.

## NL Wat zit erin

Voor je begint te bouwen, verzeker je ervan de onderdelen in je doos na te kijken ten opzichte van de op page 4 aangeduide onderdelen. Wanneer iets afwezig is, kijk naar de achterkant van dit boekje om contact met ons op te nemen. We zijn er om je te helpen!

## Bouwen met K'NEX



- Hoi! Ik ben je K'NEX bouwvriend. De aanwijzingen in dit boekje zullen je helpen met 50 modellen te bouwen en om je op weg te brengen om een K'NEXpert te worden! Je vindt modellen voor drie bouwpeilen. Voor je begint te bouwen, kijk even naar me uit met mijn kenteken om je aan te tonen hoe moeilijk elk model zal zijn ... kijk maar:



Niet moeilijk



Nogal moeilijk



Zeker moeilijk

## Klaar - Bouwen maar

2. Om met je model te beginnen, zoek naar en volg de nummers. Elk onderdeel heeft dezelfde vorm en kleur. Kijk gewoonweg naar de afbeelding, vind in je geheel de stukken die overeenstemmen met wat je ziet en druk ze in mekaar. Tracht je model in dezelfde richting te behouden als op de afbeelding zodat je de stukken op de juiste plaats zult vastmaken.

## Verder ...

3. De vage kleuren duiden aan dat dit gedeelte reeds opgebouwd is. Het nieuwe deel moet aangebracht worden op de plaats waarop de peilen gericht zijn. Dit stuk zal in volle kleur aangetoond zijn.

## Afstandsstukken

4. In je model zijn er plaatsen waar blauwe en zilveren tussenstukken moeten toegevoegd worden. Verzeker je ervan de juiste kleur te gebruiken en tel ze zorgvuldig.

## Koppelstukken

5. Er zijn blauwe en zilveren koppelstukken met speciale lange gleuven. Ze schuiven in mekaar zoals je kunt zien op de afbeeldingen. Duw deze onderdelen in mekaar tot je een "klik" hoort.

## Flexi-Rods

6. Een Flexi-Rod is een stang die kan gebogen worden om bochten of curves te maken. Ze maken zich gemakkelijker vast aan je model wanneer je ze eerst een paar keer heen en weer buigt.

## ⚠ Let op:

7. De elastiekjes kunnen letsel veroorzaken door terugklappen, breken of doordat je er de controle over verliest. Bij het in elkaar zetten van de modellen het elastiekje stevig vasthouden en het niet te ver uitrekken. De elastiekjes uitsluitend gebruiken zoals in deze aanwijzingen aangegeven. **GEEN ELASTIEKJES MET RAFELS OF SCHEUREN GEBRUIKEN.** Let op: Houd de elastiekjes uit de buurt van handen en ogen.



US Printed in China

Product and colors may vary.  
Models can be built one at a time.  
K'NEX is a registered trademark of K'NEX  
Industries, Inc.

Manufactured under U.S. Patents 5,061,219;  
5,137,486; 5,199,919; 5,238,438; 5,346,420;  
5,350,331; 5,368,514; 5,421,762; 5,423,707;  
5,427,559; 5,518,435; D383,509; D388,475;  
D389,203; D391,843; D391,921; D392,555.

Other U.S. and foreign patents pending.  
Conforms to the Requirements of ASTM  
Standard Consumer Safety Specification on  
Toy Safety, F963-96a.

F Imprimerie aux China

Le produit et les couleurs peuvent varier.  
La plupart des modèles peuvent être construits  
un à la fois.  
K'NEX est une marque déposée de K'NEX  
Industries, Inc.

Fabriqué sous brevets américains 5,061,219;  
5,137,486; 5,199,919; 5,238,438; 5,346,420;  
5,350,331; 5,368,514; 5,421,762; 5,423,707;  
5,427,559; 5,518,435; D383,509; D388,475;  
D389,203; D391,843; D391,921; D392,555.

Autres brevets américains et étrangers en  
instance.  
Conforme aux spécifications de sécurité du  
consommateur sur la sécurité des jouets de la  
norme ASTM F963-96a.

©2002 K'NEX Industries, Inc.  
P.O. Box 700  
Hatfield, PA 19440-0700



15109-V1-02/02

US Keep this important information for future reference.

- Do not connect model to more than one PowerPack™.
- Remove rechargeable batteries from model before charging; they must be charged only under adult supervision.
- Non-rechargeable batteries must not be recharged.
- Do not mix different types of batteries; do not mix alkaline, standard (carbon-zinc), or rechargeable (nickel-cadmium) batteries. Do not mix new and used batteries.

F Conservez ces renseignements pour utilisation ultérieure.

- Ne branchez pas la maquette à plus d'un PowerPack™.
- Enlevez les piles rechargeables de la maquette avant de les charger. Elles ne doivent être chargées que sous la supervision d'un adulte.
- Les piles non rechargeables ne doivent pas être rechargées.
- Ne mélangez pas les différents types de piles. Ne mélangez pas les piles alcalines, les piles standard (zinc-carbone) ni les piles rechargeables (nickel-cadmium). Ne mélangez pas des piles neuves et des piles usées. Il est recommandé de n'utiliser que des piles du même type ou de type équivalent.

E Guarde esta importante información para consultarla más adelante.

- No conecte el modelo a más de un PowerPack™.
- Saque las pilas recargables del modelo antes de cargarlas; solamente deben cambiarse con la supervisión de una persona adulta.
- Las pilas no recargables no deben recargarse.
- No mezcle diferentes tipos de pilas; no mezcle pilas alcalinas, estándar (carbono-zinc) o recargables (níquel-cadmio). No mezcle las pilas nuevas y las usadas. Solamente deben usarse pilas del mismo tipo recomendado o equivalente.

D Diese wichtigen Informationen zum Nachschlagen gut aufbewahren.

- Das Modell an nicht mehr als ein PowerPack™ anschließen.
- Aufladbare Batterien vor dem Laden aus dem Modell entfernen; sie dürfen nur unter der Aufsicht von Erwachsenen geladen werden.
- Nicht aufladbare Batterien dürfen nicht wieder aufgeladen werden.
- Keine verschiedenen Batterientypen mischen; Alkalibatterien, Standard-(Kohlenstoff-Zink-) oder aufladbare (Nickel-Kadmium) Batterien nicht mischen. Keine neuen undgebrauchten Batterien mischen. Nur Batterien vom gleichen oder empfohlenen gleichwertigen Typ sollten verwendet werden.

NL Bewaar deze belangrijke informatie voor later.

- Sluit het model niet op meer dan één PowerPack™ aan.
- Verwijder de oplaadbare batterijen uit het model om ze op te laden; ze mogen alleen onder toezicht van een volwassene worden opgeladen.
- Niet-oplaadbare batterijen mogen niet opnieuw worden opgeladen.
- Verskillende soorten batterijen niet door elkaar gebruiken; geen alkali-, standaard (koolzink) of oplaadbare (nikkel-cadmium) batterijen door elkaar gebruiken. Geen nieuwe en gebruikte batterijen door elkaar gebruiken. Alleen batterijen van hetzelfde of soortgelijk aanbevolen type mogen worden gebruikt.
- Plaats batterijen met de juiste polariteit (+/-) zoals aangegeven.
- Legge batterijen uit het model halen; voedingsklemmen niet kortsluiten.
- Het PowerPack™ stofvrij houden; niet onderdompelen of in water gebruiken.
- Alkali-batterijen AA (LR6) worden aanbevolen.
- Plaats geen groene staafjes in de openingen van het PowerPack™; zij zouden de motor beschadigen en kunnen niet worden verwijderd.

Only batteries of the same or equivalent type recommended should be used.

- Insert batteries with correct polarity (+/-) as shown.
- Remove exhausted batteries from model; do not short-circuit supply terminals.
- Keep PowerPack™ free of dust; do not immerse or use in water.
- Alkaline batteries AA (LR6) are recommended.
- Do not put small green Rods in any openings of the PowerPack™; they will damage the motor, and cannot be removed.

- Insérez les piles en respectant la polarité (+/-), comme illustré.
- Enlevez les piles usées de la maquette et prenez soin de ne pas court-circuiter les bornes des piles.
- Maintenez le PowerPack™ propre et sans poussière. Ne l'immergez pas et ne l'utilisez pas dans l'eau.
- Il est recommandé d'utiliser des piles alcalines AA (LR6).
- Ne mettez pas les petites tiges vertes dans les trous du PowerPack™, elles endommageraient le moteur et il n'est pas possible de les enlever.

- Inserte las pilas con los polos (+/-) en posición correcta, tal como se indica.
- Saque del modelo las pilas gastadas; asegúrese de no provocar un cortocircuito en el terminal de alimentación.
- Mantenga el PowerPack™ libre de polvo; no lo sumerja ni lo use en agua.
- Se recomiendan baterías alcalinas AA (LR6).
- No meta las varillas verdes pequeñas en los orificios del PowerPack™, ya que dañarían el motor y no se podrían sacar.

- Die Batterien laut Abbildung mit der korrekten Polarität (+/-) einsetzen.
- Die leeren Batterien aus dem Modell nehmen; die Versorgungsklemmen nicht kurz schließen.
- Das PowerPack™ staubfrei halten; es darf nicht in Wasser eingetaucht oder benutzt werden.
- Wir empfehlen die Verwendung von Alkalibatterien AA (LR6).
- In keine der Öffnungen des PowerPack™ kleine grüne Stangen einsetzen; sie beschädigen den Motor und können nicht entfernt werden.



US 1-800-KID-KNEX US/CANADA only  
(English only)

GB 00800-22427276 UK/IRELAND only

F E D NL + 1-215-996-4823



US Consumer Services  
K'NEX Industries, Inc.  
P.O. Box 700  
Hatfield, PA 19440-0700



GB K'NEX  
Newport Consumer Services  
Hasbro UK Ltd., Caswell Way  
Newport, Gwent NP9 0YH



www.knex.com



email@knex.com