

xantech®

INSTALLATION INSTRUCTIONS

MX88

**EIGHT ZONE – EIGHT SOURCE
AUDIO & AUDIO/VIDEO CONTROLLER/AMPLIFIER**



IMPORTANT SAFETY INSTRUCTIONS - READ BEFORE OPERATING EQUIPMENT



The lightning flash with arrowhead symbol, within an equilateral triangle, is intended to alert the user to the presence of un-insulated “dangerous voltage” within the product’s enclosure that may be of sufficient magnitude to constitute a risk of electric shock to persons.



The exclamation point within an equilateral triangle is intended to alert the user to the presence of important operating and maintenance (servicing) instructions in the literature accompanying the appliance.

WARNING TO REDUCE THE RISK OF FIRE OR ELECTRIC SHOCK, DO NOT EXPOSE THIS APPLIANCE TO RAIN OR MOISTURE.

This product was designed and manufactured to meet strict quality and safety standards. There are, however, some installation and operation precautions, which you should be particularly aware of.

1. **Read Instructions** – All the safety and operating instructions should be read before the appliance is operated.
 2. **Retain Instructions** – The safety and operating instructions should be retained for future reference.
 3. **Heed Warnings** – All warnings on the appliance and in the operating instructions should be adhered to.
 4. **Follow Instructions** – All operating and use instructions should be followed.
 5. **Water and Moisture** – The appliance should not be used near water – for example, near a bathtub, washbowl, kitchen sink, laundry tub, in a wet basement, or near a swimming pool, etc.
 6. **Carts and Stands** – The appliance should be used only with a cart or stand that is recommended by the manufacturer. An appliance and cart combination should be moved with care. Quick stops, excessive force, and uneven surfaces may cause the appliance and cart combination to overturn.
-
7. **Wall or Ceiling Mounting** – The appliance should be mounted to a wall or ceiling only as recommended by the manufacturer.
 8. **Ventilation** – The appliance should be situated so that its location or position does not interfere with its proper ventilation. For example, the appliance should not be situated on a bed, sofa, rug, or similar surface that may block the ventilation openings; or, placed in a built-in installation, such as a bookcase or cabinet that may impede the flow of air through the ventilation openings.
 9. **Heat** – Do not install near any heat sources such as radiators, heat registers, stoves, or other apparatus (including amplifiers) that produce heat.
 10. **Power Sources** – The appliance should be connected to a power supply only of the type described in the operating instructions or as marked on the appliance.
 11. **Grounding or Polarization** – Do not defeat the safety purpose of the polarized or grounding-type plug. A polarized plug has two blades with one wider than the other. A grounding type plug has two blades and a third grounding prong. The wide blade or the third grounding prong are provided for your safety. If the provided plug does not fit into your outlet, consult an electrician for replacement of the obsolete outlet.
 12. **Power-Cord Protection** – Power- supply cords should be routed so that they are not likely to be walked on or pinched by items placed upon or against them, paying particular attention to cords at plugs, convenience receptacles, and the point where they exit from the appliance.

13. **Cleaning** – Clean only with dry cloth.
14. **Power Lines** – An outdoor antenna should be located away from the power lines.
15. **Nonuse Periods** – The power cord of the appliance should be unplugged from the outlet when left unused for a long period of time.
16. **Accessories:** Only use attachments/accessories specified by the manufacturer.
17. **Object and Liquid Entry** – Care should be taken so that objects do not fall and liquids are not spilled into the enclosure through openings.
18. **Damage Requiring Service** – The appliance should be serviced by qualified service personnel when:
 - A. The Power-supply cord or the plug has been damaged; or
 - B. Objects have fallen, or liquid has spilled into the appliance; or
 - C. The appliance has been exposed to rain; or
 - D. The appliance does not appear to operate normally or exhibits a marked change in performance; or
 - E. The appliance has been dropped, or the enclosure damaged.
19. **Servicing** – The user should not attempt to service the appliance beyond that described in the operating instructions. All other servicing should be referred to qualified service personnel.

Section 1: General Information & Features

GENERAL INFORMATION

The Xantech MX88 System sets a new standard in whole-house audio/video distribution, audio amplification, and control/automation. The MX88 System consists of the MX88 controller/amplifier, keypads (such as MRKP1/1E or MRKP2/2E) or touch-panels (such as the Xantech SmartPanel™) to control each zone, and wireless or wired web-enabled devices such as the Apple® iPad® for controlling all zones and the entire system. When combined with IR, RS232, or IP controlled (IP on select models only) meta-data-rich audio/video sources and home automation components, the MX88 becomes a powerful system capable of controlling virtually everything within a household.

The MX88 can be used as a stand-alone unit or in conjunction with another MX88 to provide 16 Zones of A/V/Control distribution.

MX88 models include:

MX88vi: Audio/Video/Control distribution, IP-enabled

MX88ai: Audio/Control distribution, IP-enabled

MX88a: Audio/Control distribution (no IP)

Each MX88 package contains :

- One MX88 Controller/Amplifier
- Eight IR Emitters part no. 283D
- One part no. 05913410 gray-colored DB9 male-to-female programming cable to connect to the RS232 serial port on your PC
- Two part no. 05913665 DB15 male to DB9 female cables for connecting MX88 rear ports 1 and 2 to RS232 devices
- One part no. 05913555 male DB15 to male DB15 cable with null modem for linking two MX88 Controllers in Expansion Mode
- Eight speaker WECO connector plugs
- Two rack ears
- Three sets of screws and washers for attaching the rack ears to MX88
- One US AC Cord
- One European AC Cord
- One UK AC Cord
- One Australia/New Zealand AC Cord

Companion products available for the MX88 (sold separately):

- Keypads: MRKP1, MRKP1E, MRKP2, MRKP2E, MRC88KP/MRC88DJKP (limited availability)
- Touch-panels: Xantech SmartPanel™ SP35G, (C)SP43, (C)SP70, (C)SPLCD39, (C)SPLCD64
- MREM (simple card type remote – no programming required)
- MRC44CB1 Connecting Block
- CSM1 Current Sensing Module
- RS2321X8 Router: Serial Router expanding a single MX88 RS232 output to 8 Serial Ports
- Part no. 05913560: Black-colored DB9 male-to-male Null-Modem cable to connect to the RS232 serial port of an external device (that requires a null-modem connection) to the MX88, through the DB15 to DB9 cables that are included within the MX88.
- ZAIP Zone Audio Input Kit: For use with Zone Audio Inputs. Send and Receive Stereo Audio over CAT5
- External IR Receivers: Xantech IR Receiver models, such as DL/HL/ML/WL85, or DL/HL/ML/WL95

IMPORTANT NOTES:

1. The MX88 System can be a single controller with keypads for up to Eight zones or two connected controllers and keypads for up to Sixteen zones.

All the set up details for a MX88 are stored in a file called "Project".

The MX88 can be set up without a PC, using the QuickConfig protocol, via the keypad or touchpanel connected to the Zone 1 keypad port of the MX88. By using QuickConfig, you can set up an eight zone or an expanded 16 zone MX88 system without ever having to hook up a PC.

However, please note that Projects created by QuickConfig cannot be retrieved and/or edited in Universal Dragon.

The MX88 can also be set up and customized using Xantech's Universal Dragon Windows® software.

There are two different setup modes in the Universal Dragon:

- The **Advanced** mode allows customization of system configuration for functions such as zone linking, monitor lockout, unique IR programming by zone, etc.
- The **Expanded** mode allows programming of systems with more than eight zones using two linked MX88 Controllers.

Each section of this manual will indicate which sections apply to the different programming modes and setups.

In the **Expanded** mode, the controller for zones 1-8 will be referred to as the PRIMARY CONTROLLER. The controller for zones 9-16 will be referred to as the SECONDARY CONTROLLER.

2. All programming and features of the **MX88** directly apply to all models except:

Video Distribution and Video Sensing applies to MX88vi models only

Ethernet/IP applies to MX88vi or MX88ai

SYSTEM OVERVIEW

In a MX88-based whole house audio/video/control system, the MX88 controller/amplifier acts as the server and the keypads, touch-panels, and compatible web-enabled devices (such as the Apple® iPad®) act as the clients. The end users interact with these clients in order to control all aspects of audio/video distribution and control. This system allows the end user to accomplish the following: 1) Distribute amplified audio and video from eight independent Sources to eight separate zones. 2) Control the volume, mute, bass, treble, and balance for each of the eight zones. 3) Control most standard source components via IR and/or RS232 and/or IP (certain MX88 models only) commands. Two MX88s can be linked to create systems with up to sixteen zones.

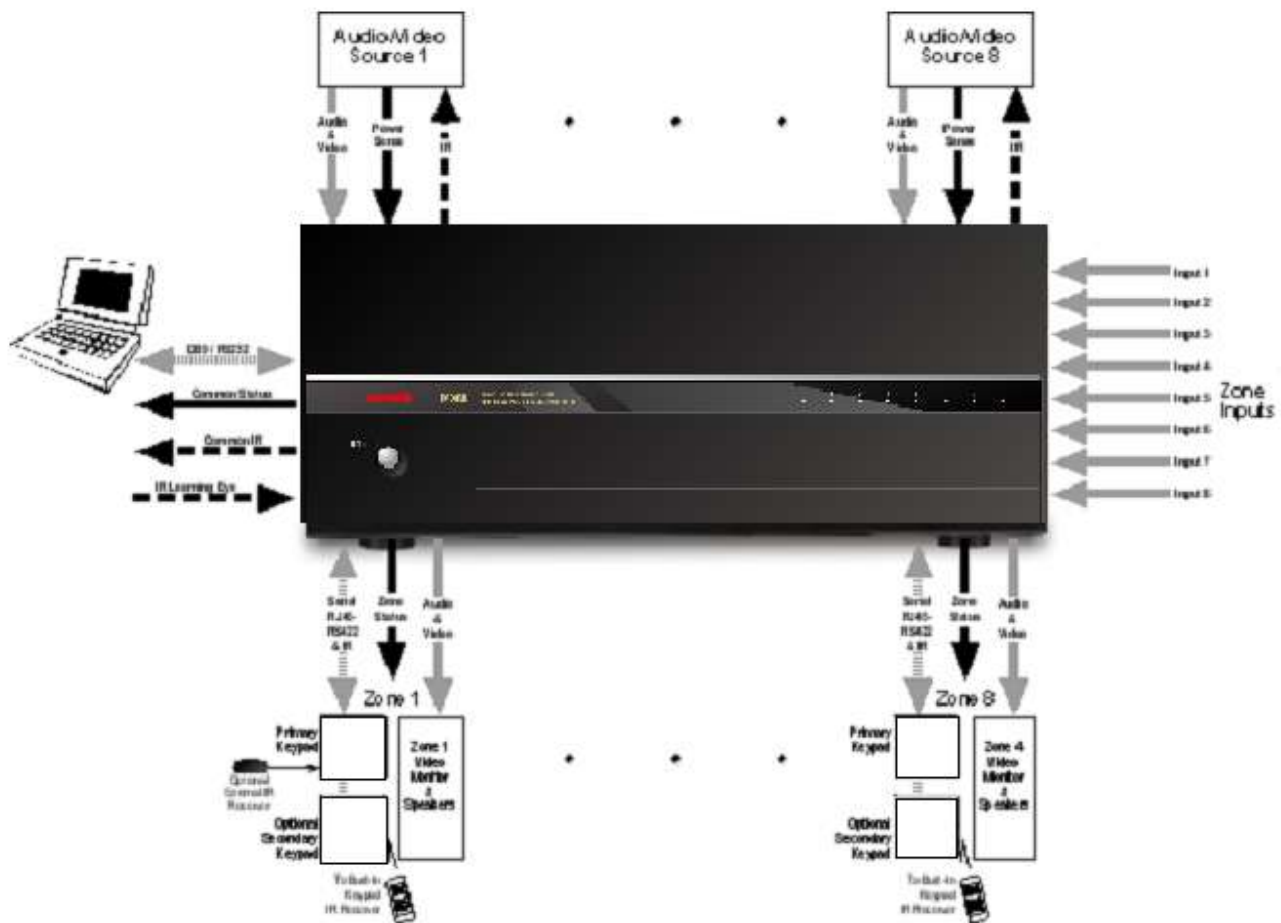

Figure 1 - System Block Diagram

There are many ways in which the MX88 can be controlled or to control audio, video and home control systems:

- By pressing the buttons on the MX88 keypad or touch-panel
- From signals received from an Infrared (IR) remote at the keypads IR Receiver eye
- From RS232 control from a touch screen panel or other RS232 controller device

- Via IP (MX88vi and MX88ai only), using almost any web-enabled device with a browser, such as an Apple® iPad®, a Windows® or Android™ tablet, or a PC.

There are three types of commands that can be associated with the MX88 Keypad buttons:

- Source component commands such as BluRay Player Power, Play, Track Skip, etc.
- MX88 Controller/Amplifier “INTERNAL AMPLIFIER COMMANDS” such as Zone Source Select, Zone Power, VOL+, VOL- etc.
- RS232 Command Strings for controlling sophisticated control systems such as Lighting, HVAC, etc. utilizing the MX88 Controller’s RS232 COM PORT output
- RS232-over-IP (MX88vi and MX88ai only) Command Strings for controlling sophisticated control systems such as Lighting, HVAC, etc. utilizing the MX88 Controller’s IP PORT – This feature is currently in use on a very limited basis, and is reserved for future upgrades.

CONTROLLER/AMPLIFIER FEATURES

- **Zones:** Eight, expandable to sixteen-zones with the addition of a second MX88 and additional keypads
- **Sources:** Eight audio (MX88a or MX88ai) or eight audio/video (MX88vi). Any zone can select any source. Any source can be selected in multiple zones. Several modes of control:
 - **Whole-house mode** – selection and control of any source from any zone.
 - **Priority mode** – any zone can select and monitor a source, but only the first zone to select that source can control it.
 - **Link mode** – multiple zones can be linked together to act as a single zone for source selection and control. Each zone maintains independent volume and mute controls.
 - **Monitor lockout** – prevents certain zones from selecting certain sources.
- **Local Zone Audio Inputs:** Eight zone-specific audio inputs. When activated, overrides source-one audio inputs allowing each zone to have its own dedicated Audio Source by selecting source-one.
- **IR Learning:** IR commands can be learned from external hand-held remotes through the Controller/Amplifier's built-in IR learning eye or they can be generated from the MX88's built-in IR code library.
- **Internal IR Code Library:** Built in IR Code Library. Contains all Major Brand Component IR commands. No need to 'learn' commands.
- **Macros:** can be built using IR, audio control, RS232, repeat or delay commands and associated with a specific button or event. They can be triggered by a keypad button press, an RC68+ IR code, an MX88 compatible keypad command, control sense status, video sense status or by RS232. Up to 40 IR commands can be issued in a single Macro.
- **Audio/Video loop-through** on all eight source inputs (video applies to MX88vi only)
- **Power Management:** Keeps all components' power states in sync with Zone Power Status
 - All eight video source inputs have built-in NTSC/PAL sync sensing (MX88v only)
 - All eight sources have current sense inputs for use with a CSM1 Current Sensor.
- **Preamp level audio outputs** for all eight zones
 - Frequency response: 12 Hz to 55KHz (± 3 dB)
 - THD: <0.08%.
 - Signal-to-noise ratio: > 96dB A-weighted
- **Amplification:** Zones 1 through 8 have built-in stereo audio amplifiers at 50 Watts per channel. Zones 7 and 8 are also designed to be used with external amplifiers in case higher power output is desired. CO1 and CO2 Control Outputs provide on/off or mute trigger signals to external amps used for zones 7 and 8.
- **Video outputs** for all eight zones (MX88vi only)
- **IR Emitter Outputs:** Eight source-specific IR emitter outputs
 - One common IR emitter output
 - Eight zone-specific IR emitter outputs

Eight in-the-zone IR emitter outputs via a MX88-compatible keypad rear panel emitter output - permitting IR commands originating in the zone to be looped back to the zone allowing the MX88 to control components physically located in the zone.

- **Status Outputs:** Eight zone-specific 12V status outputs
One common 12V status output (Labeled Control Out)
- **RS232/USB programming ports (Front Panel):** Communications port used to program the system using Universal Dragon software.
- **RS232 COM PORTs 1 and 2 (Rear):** Allow the MX88 to be controlled by a PC or another RS232 device, or to control other devices that communicate via RS232 such as certain home theater components, lighting or HVAC devices. These ports facilitate connection to another MX88 for 16 Zones of seamless control.
- **Keypad connections:** One for each zone – RJ45 connector, CAT5/5e/6/7 cable.
- **Ethernet port:** RJ45 connector, standard Ethernet cable (MX88vi or MX88ai only).

MX88 CONTROLLER/AMPLIFIER PANEL AND FEATURE DESCRIPTIONS

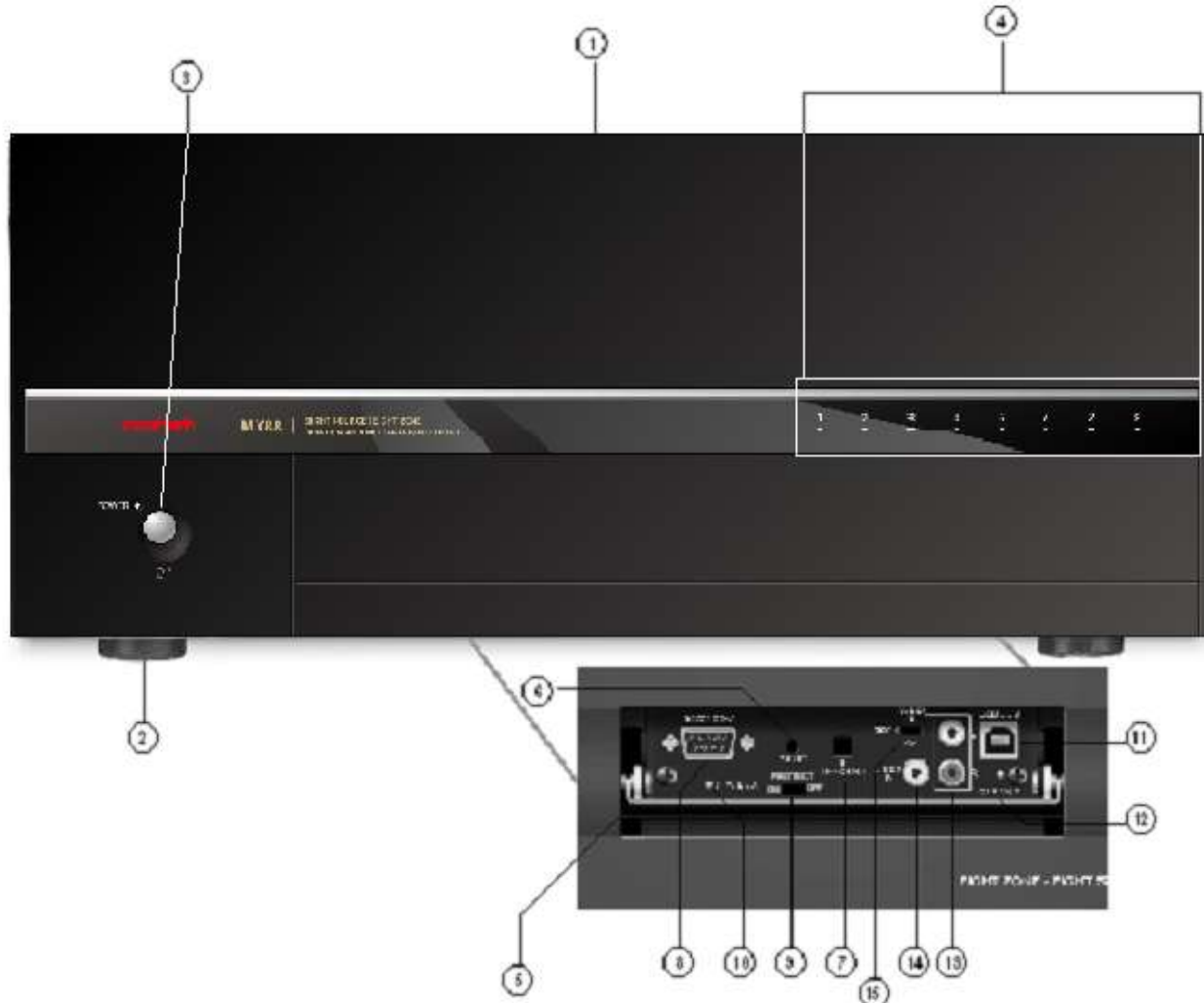

Figure 2 – The Model MX88 Controller/Amplifier – Front Panel Features and Functions

MX88 FRONT PANEL FEATURES AND CONNECTIONS:

1. **Front Panel.**
2. **Chassis Feet.** Set high enough to provide through-chassis cooling by natural convection.
3. **Master AC Line On/Off Switch.** Turns AC power On/Off to the entire unit.
4. **Power and Status LED Indicators.** Eight indicators, one for each Zone, provide the following status information:

System Status (Power-Up Mode)

 - a) Slow Pink Blink – indicates general initialization is occurring.
 - b) Fast White Blink – indicates that a keypad on the associated zone is currently being initialized.
 - c) Fast Red Blink – indicates that the master keypad on the associated zone is not responding to initialization.
 - d) Fast Pink Blink – indicates that the slave keypad on the associated zone is not responding to initialization.
 - e) All Lights Off – initialization is done, system is ready for operation.

Zone Status (Active-Operational Mode)

- a) Steady White – indicates that the Zone is Active (Keypad ON), is not muted and is not within 5 dB of MAX-V (Maximum Volume).
- b) Steady Red – indicates that the Zone is Active, is not muted and is within 5 dB of MAX-V.
- c) Slow White Blink – indicates that the Zone is in the Active, is muted and is not within 5 dB of MAX-V.
- d) Slow Red Blink – indicates that the Zone is Active, is muted and is within 5 dB of MAX-V.
- e) Fast White Blink – indicates that Zone is Active, is being Ramped Up or Down and is not within 5 dB of MAX-V.
- f) Fast Red Blink – indicates that the Zone is Active, is being Ramped Up or Down and is within 5 dB of MAX-V.
- f) Off to indicate that Zone is in Not Active (Keypad OFF).

5. **Front Panel Access Door.** Push gently on lower half of door to open. Allows access to programming connections, Level Reset and Front Panel Source 8 A/V Input.
6. **Level Reset.** Pressing this button twice within 1 second restores all of the Factory Default Settings for all zones. The Factory Defaults are as follows:
 - Mute Off
 - Treble and Bass Flat
 - Balance Centered
 - Z-Adjust Treble and Bass Flat
 - Z-Adjust Balance Centered
 - Z-Adjust Max-V Cleared
 - Z-Adjust Max-On-V Cleared
 - Trim Levels Cleared
 - IR Code Group set to A8**NOTE:** The MX88 will always return to last set values (plus any unaltered factory defaults) after main power shut down or after any power interruptions.
7. **IR Learning Eye.** The IR Eye on the MX88 Controller front panel allows teaching IR Codes to Dragon Drop-IR™ via the Control Amp when connected to a PC 's com port.
8. **RS232 Com Port.** DB9 Connector. Used to program the MX88 Controller or perform firmware updates from a PC, using the Xantech Universal Dragon Software.
9. **PROTECT On/Off Switch.** Selects between Programming Mode (OFF position) and PROTECT (ON) position to keep program secure in memory.
10. **STATUS A Led.** Green Activity LED, lights during Program Download from Universal Dragon Software, during IR Learning and for firmware updates when using the RS232 Port located on the front panel
11. **USB Com Port.** Used to program the MX88 Controller or perform firmware updates from a PC, using the Xantech Universal Dragon Software.
12. **STATUS B Led.** Green Activity LED, lights during Program Download from Universal Dragon Software, during IR Learning and for firmware updates when using the USB Port located on the front panel.
13. **Source 8 AUDIO IN L/R.** Front panel Source 8 line level audio input. Gold-plated RCA Jacks for use with any desired A/V source component such as camcorder, video game console, or other.
14. **Source 8 VIDEO IN (MX88vi only).** Front panel Source 8 composite video input. Gold-plated RCA Jacks for use with any desired A/V source component such as camcorder, video game console, or other.
15. **Source 8 Front/Rear Selector Switch.** Selects whether the Source 8 Audio/Video inputs will come from the Front (F) or Rear (R) panel jacks.

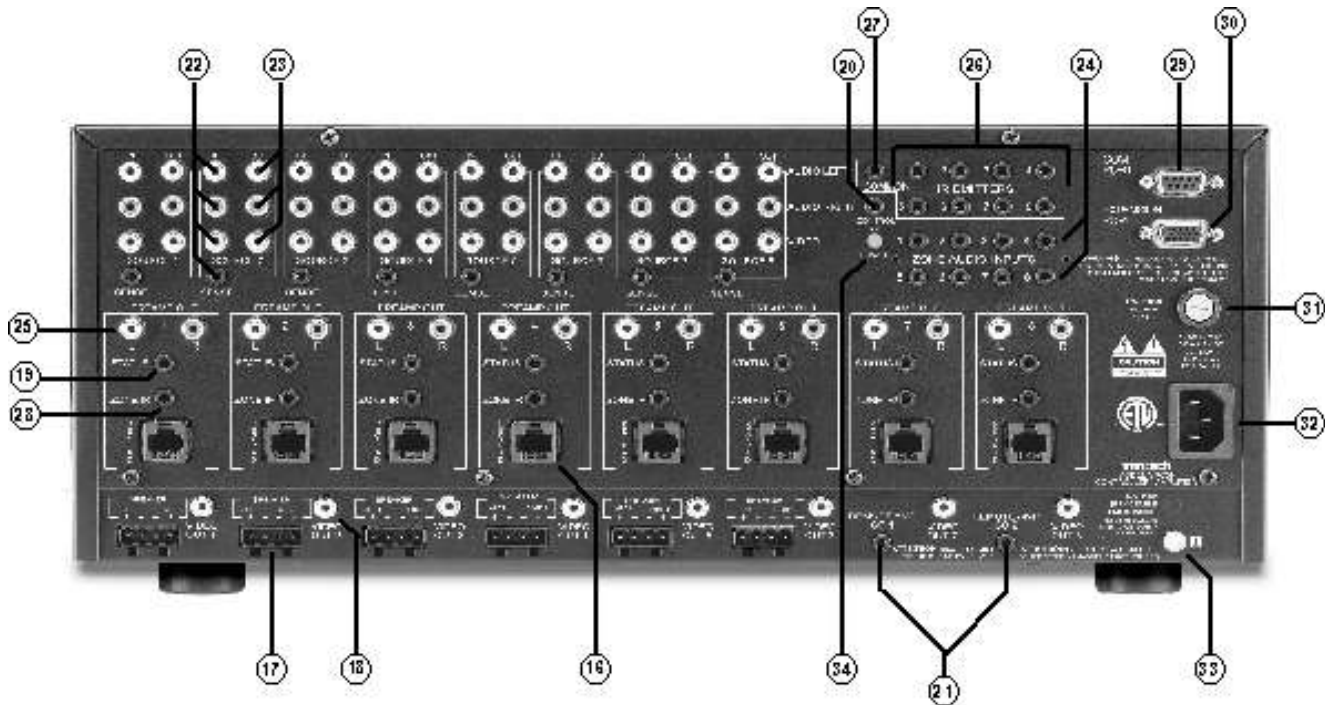

Figure 3 – The Model MX88 Controller/Amplifier – Rear Panel Connections and Functions

MX88 REAR PANEL FEATURES AND CONNECTIONS:

- 16. Keypad Terminals (8).** Each Zone has one RJ-45 jack for Keypad Interface. Each connector interfaces the following: Power (Enough for 1 Primary & up to 4 Secondary Keypads per Zone), RS-485 Data I/O, and IR Input.
- 17. Speaker Terminals (8).** Plug-in 4-terminal screw type connectors for zones 1 thru 6, permit speaker wire sizes up to 12AWG.
- 18. Composite Video Output (8).** RCA type connector sends zone selected, source video to the composite video input on a zone TV or modulator (applies to MX88v(i) only).
- 19. Status Out (8).** Provides a control output of +12 VDC that turns on and off with the zone to drive voltage sensing relay modules and AC strips.
- 20. Control Out (8).** Mono 3.5mm Mini Phone Jack provides a Control Output that goes high (+12 volts) when any Zone is first turned ON and goes low (0 volts) when the last Zone is turned OFF. [Tip=+VDC; Shield=GND]
- 21. Remote Amp Control Out (CO1 & CO2).** Stereo 3.5mm Mini Phone Jack connects to CONTROL IN jack of Remote Amp PA435X or PA4100X. Provides STANDBY and MUTE Control of remote Amp from Zone 7 (CO1) and Zone 8 (CO2). [Tip = STANDBY Logic; Ring = MUTE Logic; Shield = GND]
- 22. Source Component Input Connections (8)**
- Source Audio Inputs.** Gold-plated RCA Jacks for Stereo/Dolby Pro line level audio input from source components.
 - Source Video Inputs.** Gold-plated RCA Jacks for composite video input from source components (Applies to MX88 only).
 - Sense Inputs.** 3.5mm Stereo Mini Phone Jacks for use with the CSM1 MX88 Current Sense Module.

23. Source Loop-Thru Connections (8).

- a) **Audio Loop-Thru.** Parallel Connection to Audio Inputs for connecting Audio Source to another MRC-88 in Expanded Mode or to other local devices. This is not an active output.
- b) **Video Loop-Thru (MX88vi only).** Buffered Video Connection for connecting Input Video Source to another MX88vi in Expanded Mode or to other local devices. **NOTE:** Since this is a *Buffered* video connection, this loop-thru is not active when POWER is removed from the MX88vi.

24. Zone Audio Inputs (8). 3.5mm stereo mini phone jack for zone specific stereo audio source Inputs. Zone Audio Inputs override rear panel, Source 1 connection. Allows each of the 8 zones to have a dedicated source output by selecting Source 1 on keypad.

25. Zone Audio Pre-Amp Out (8). Gold-plated RCA jacks for connecting Zone Audio Output to an external amplifier. For use with applications where either more power is required for zone or passing to a Dolby Surround compatible receiver for theater quality audio in zone.

26. IR Emitters (1-8). 3.5mm mono mini phone jacks. These mini jacks are for the connection of IR emitters to control individually the eight source components. These jacks are “steerable” with Universal Dragon Software for IR Routing and Priority Lockout. IR received from a Zone will be routed to the emitter port corresponding to that zone’s active source selection. Can also be configured as 8 common emitter ports using Universal Dragon.

27. IR Emitter (Common). 3.5mm mono mini phone jacks. Single Common IR output that can be used to control devices such as Multi Zone Audio Server, motorized drapery systems, TV lifts and lighting systems or any other IR controlled component. IR Received from any zone keypad will be output the Common emitter port *regardless* of source selection.

28. Zone IR Out (8). 3.5mm mono mini phone jacks. IR received from a zone will always be passed to the corresponding Zone IR output. This can be used to control *Zone Specific* components not located in the zone.

29 and 30. Com Ports 1 and 2. DB15 (DB15-to-DB9 adaptors included) Bi-Directional RS232 Ports allow full control of all Internal Amplifier Commands of the MX88 Controller and the ability to trigger programmed IR Macros for control of devices connected to the Controllers emitter ports, from an external PC. The Com Ports can also be used to send ASCII/Hex commands out to control an external RS232 device directly from the MX88 Keypad and/or handheld remote, and receive status information and metadata from the device. Port 1 is also used for system expansion, where the port 1’s of two MX88’s allow them to be connected together, via included Expansion Cable, to provide an 8 Source/16 Zone system with full control between units.

31. User Replaceable Fuse. 10 AMP L 250 VAC.

32. AC Power Input. Standard IEC 3-Conductor AC line cord to be used with a 3-conductor power line cord.

33. Grounding Screw. “Knurled Screw” provides a means for chassis connection to earth ground or to other Audio/Video products to aid in the reduction of system noise.

34. Power On/Off LED. This LED will be lit in white when the MX88 is on.

35. Ethernet Port (MX88vi and MX88ai only): Connects to a Local Area Network, and allows the control of all the zones of a MX88vi or ai from almost any wired or wireless IP-enabled device with web browsing capabilities, such as the Apple® iPad®, Windows® and Android™ tablets, and PCs. It also allows for some limited 2-way external device interface, subject to expansion in the future. This port is also used for setting configuring the IP address and performing firmware updates for the MX88vi/MX88ai’s built-in web server, using the Xantech MRIP Installer Software.

Section 2: Installation & Connections

INSTALLATION

Installing an MX88 system involves completely planning the system from hardware, installation, and programming standpoint, before the actual installation begins.

We strongly recommend, before physical installation begins, that all the actual components to be used as part of the MX88 system are physically connected and tested individually first, and then tested again as a system with a fully programmed and configured MX88. This added effort can become a valuable investment in quick and effective troubleshooting in case any issues are encountered after installation.

We also recommend that all installed wiring is checked thoroughly and systematically for continuity and integrity, using proper test equipment designed for the specific type of wiring.

OPERATION: OUT-OF-THE-BOX PRE-TEST

The MX88 is shipped to operate basic functions 'Out-Of-The-Box' without any programming. Simply by plugging in keypads via standard CAT-5 RJ45 terminated patch cable and powering the controller 'on', you can control Source Selection, Volume Up/Down and speaker Mute capabilities.

Completing the Out-Of-The-Box Pre-Test will verify that all sources and zone components are working properly to select and distribute audio and video prior to programming via QuickConfig or with the Universal Dragon. This will ensure that the unit is indeed functioning correctly 'prior' to fixed installation and allow proper troubleshooting procedures if a problem is encountered. Instructions regarding full programming for specific components and features will follow.

Notes:

- For Expanded, 16-zone configuration, test both units individually as outlined below.
- For simplicity of test set-up, only one Source Component, one pair of speakers, and one TV/Video Monitor will be necessary.

For the pre-test the MX88, you will need the following:

- 8-RJ45 Terminated CAT5 cables. (Pre test cables prior to use – See  Caution below)
- 1-Audio/Video Source Component (i.e. BluRay or DVD player, etc.) [Will be used to test ALL Source Inputs]
- 1 Audio/Video RCA Harness (Capable of Audio Left/Right and Video)
- 1-Pair of speakers with Speaker Cable properly terminated into the included 4 conductor WECO-style plug [Will be used to test Speaker outputs]
- 1-TV or Video Monitor [Will be used to test ALL Video Outputs – MX88 only]
- 8-283D Blink Emitter
- All 8 MX88-compatible keypads or touch-screens
- AC Cord

1. Connect MX88 Controller/Amplifier as shown in **Figure 6** to:
 - a) All MX88 keypads via CAT5 Cables
 - c) Audio/Video Source to SOURCE 1 Audio Left/Right and Video Input terminals
 - d) TV or Monitor to Video Out 1 (MX88 Only).
 - e) Speakers to Speaker Output #1
 - f) All 8 IR emitters to IR Emitter Ports 1 thru 8 (Figure 3, item 26)
 - g) AC Power for MX88 Controller and Audio/Video Source Component

2. Press "Power On" button on the front of the MX88 Controller/Amplifier (wait for front panel power LED to turn on, and the 8 zone LED's to stop flashing – usually less than 2 minutes).
3. Power ON the Zone 1 TV/monitor and select the appropriate input (on the TV or monitor).
4. Power ON the Source Component and press play.
5. Place the emitter from IR Emitter Port 1 near the front of the Source Components IR Sensor window.
6. Press "POWER" on the Zone 1 Keypad.
7. Select "SRC1" on the Zone 1 MX88 Keypad.
 - a) If Source 1 is an Audio/Video component, the video content of the source connected to the Source 1 inputs should be seen on the zone 1 TV/monitor.
 - b) Press "VOL+" on the Zone 1 Keypad. The Volume bar should move on the Keypad and the audio content of the source connected to the Source 1 inputs should be heard through the Zone 1 speakers.
 - c) Press "MUTE" on the Zone 1 Keypad. The Zone 1 speakers will mute. Press MUTE again and the speakers will un-mute. (Pressing VOL+ or VOL- will also un-mute the speakers).
 - d) Use the source 1 original equipment remote and verify that all source functions operate when aiming the remote at the Zone 1 Keypad IR sensor.
 - e) Press "POWER" on the Zone 1 Keypad and verify ALL Status LED's on the Controller Front Panel are OFF.
8. Move the Audio/Video Source component to SOURCE 2 Audio Left/Right and Video Input terminals; Speakers to Speaker Output #2 and the TV/Video Monitor to Video Out #2.
9. Repeat Steps 5 thru 8 for source/Zone 2 thru 8

Caution: Power voltage for the keypad is transmitted along the CAT5 cable! **Incorrect wiring on this cable can destroy the keypad or touch-panel.** Please test the cable connections using a proper CAT5 cable tester or using a multimeter to check Pin to Pin continuity and for possible shorts. Using either method, it is advisable to measure pins 3 and 6 to verify proper voltage with a multimeter. A 12Vdc measurement should be read when the positive probe is on pin 6 and the negative probe is on pin 3. See **Figure 10**.



MX88 CONTROLLER/AMPLIFIER PHYSICAL LOCATION

1. The MX88 is convection cooled. It depends on the natural free flow of air up through its slot perforations in and over the internal heat dissipating fins for adequate cooling.
2. Should adequate cooling be desired, external fans and other means of air ventilation can be used.
3. Once installed, your MX88 will have large bundles of wire and cable to accommodate audio, video and speaker connections. Be sure to allow enough room for the leads and dress them in such a manner so as not to block airflow.
4. The MX88 is designed for mounting on flat horizontal surfaces.
5. Do not remove chassis feet. They are necessary to provide proper ventilation.

CONNECTING THE MX88 CONTROLLER/AMPLIFIER

IMPORTANT!

- a. The MX88 comes with detachable IEC-type AC cords. The mains plug end of the AC cord or its MX88 back-panel attached AC inlet are the disconnect device from mains, and shall remain readily accessible by the end-user.
- b. When making connections to the MX88 Controller be sure the power cord is unplugged. Proceed as follows, referring to **Figure 3** and **Figure 6 or 7** for a typical MX88 system layout and interconnections.

SOURCE RELATED CONNECTIONS

The following relates to all source related connections to the MX88 Controller Unit (A/V In/Out, IR Control, Sense Inputs etc.)

SOURCE COMPONENT CONNECTIONS

Audio Connections

8-zone system:

Using good quality RCA-type patch cables connect the LEFT and RIGHT OUTPUT jacks of the source component (DVD, CD, Satellite receiver, etc.) to the appropriate source AUDIO LEFT and AUDIO RIGHT INPUT jacks on the MX88 - **Figure 3 item 22**. Do this for each source component.

Expanded, 16-zone system:

Using good quality RCA-type patch cables connect the source AUDIO LEFT and AUDIO RIGHT OUTPUT Jacks of the 'Primary Controller' - **Figure 3 item 23**, to the corresponding source AUDIO LEFT and AUDIO RIGHT INPUT jacks on the 'Secondary Controller' - **Figure 3 item 22**.

Video Connections (MX88vi Only)

8-zone system:

Using good quality RCA-type video patch cables connect the VIDEO OUTPUT jacks of the source component to the VIDEO INPUT jacks on the MX88 - **Figure 3 item 22**. Do this for each source Component.

Expanded, 16-zone system:

Using good quality RCA-type patch cables connect the source VIDEO OUTPUT jacks of the 'Primary controller' [**Figure 3 item 23**] to the corresponding source VIDEO INPUT jacks on the Secondary Controller - **Figure 3 item 22**.

ZONE AUDIO INPUTS

NOTE: The Zone Audio Input feature is enabled via Universal Dragon software only and cannot be done via QuickConfig.

Use a "3.5mm stereo mini jack to stereo RCA plug adapter" to connect Zone Specific audio sources (i.e. an audio source located in a zone) to the appropriate Zone Audio Input - **Figure 3 item 24**. The 3.5mm stereo jack is wired as follows: Tip = Right Audio Input; Ring = Left Audio Input; Sleeve = GND. When enabled, the Zone Audio Input will override the Source 1 Input connected at the Audio Left/Right RCA Input terminals - **Figure 3 item 22**. The Zone Input feature is audio-only regardless of the model version of MX88.

Expanded, 16-zone system:

For Zones 1-8, connect to the Primary Controller's Zone Audio Inputs. For Zones 9-16 connect to the Secondary Controller's Zone Audio Input.

IR CONTROL CONNECTIONS

8-zone system:

Plug the supplied 283D IR emitters into the appropriate IR Emitter jacks - **Figure 3-(26)**. Take care to match the source audio and video connection number on the MX88 to the IR Emitter jack number. This will ensure that the IR control signal will be routed to the correct source component. Find the IR sensor window on the source component and attach the emitter to the components sensor window after removing the protective paper cover on the flat side of the emitter head. A Common IR jack is also provided for connection to other auxiliary devices that are not source specific - **Figure 3 item 27**.

Expanded, 16-zone system:

Connect the emitters to the Primary Controller's IR Emitter jacks - **Figure 3 item 26** as noted above.

Note: The appropriate source IR Emitter of the Secondary Controller will also flash regardless of what zones keypad issues the command but it is recommended to use the emitter jacks of the Primary unit.

SENSE INPUT CONNECTIONS

8-zone system:

The sense input connection will typically be used to sense the power state of a source component using any of the Xantech Sense Modules (sold separately). Plug the 3.5mm mini plug from the Xantech sensor into the appropriate sense jack – **Figure 3 item 22**. Take care to match the source audio and video connection number on the MX88 to the appropriate sense jack number. Please refer to instructions included with the specific sensor that you are using for set up and any necessary adjustments.

Expanded, 16-zone system:

Connect the Xantech sensors as described above to the Primary Controller. Sense inputs on the Secondary Controller are inactive and are not to be used.

BI-DIRECTIONAL CONTROL PORTS

RS232 Ports 1 and 2:

These DB15 ports, when used with the included DB15-to-DB9 adaptor cables, can be used for controlling and receiving status information/metadata from external devices and components, or for allowing external devices to control the MX88. Port 1 can also be used to link one MX88 to another, using the supplied DB15-to-DB15 expansion cable, creating a 8 source/16-zone "Expanded" system.

Ethernet jack (MX88vi and MX88ai only):

Used for connection to a Local Area Network, and allowing control of all the zones of MX88vi or ai from almost any wired or wireless IP-enabled device with web browsing capabilities, such as the Apple® iPad®, Windows® and Android™ tablets, and PCs. It also allows for some limited 2-way external device control, subject to expansion in the future. The MX88 comes with DHCP enabled so that it can be accessed through a dynamically enabled network. Its address should be fixed to a fixed IP address that is supported by your Local Area Network, using the "MRIP Installer" program that can be downloaded at <http://www.xantech.com/Audio/AVDistribution/AVDistribution/MX88/> . Please see the "MX88 MRIP Quick Start" document at the same URL for details.

ZONE RELATED WIRING CONNECTIONS

In typical applications, each zone will have at least one MX88 keypad or touch-panel, and a pair of speakers. In zones with both audio and video (MX88vi), at least one video monitor or television will also be used. In order to make these connections, the minimum requirement is home runs of one CAT5 cable for each zone's keypad(s), two pairs of 12-18AWG wire for each pair of speakers, and one coaxial cable for a TV or monitor (MX88vi) from each zone to the MX88 Controller/Amplifier location.

SPEAKER CONNECTIONS

1. Using good quality speaker wire, connect the individual speaker leads to the 4-terminal "SPEAKER" connectors on the MX88 as shown in **Figure 3 item 22**.

2. The MX88 Speaker Terminals (amplifier outputs) are 4-Ohm compatible. Make sure the combined impedance presented to the speaker terminals by the speakers (or any combination of speakers) is 4-Ohms minimum.
3. Be sure to observe correct polarity by connecting the "+" and "-" terminal from each channel on the MX88 to the corresponding "+" and "-" terminals on each speaker. This will ensure proper speaker polarity and have the left and right speakers operate "in phase". These connectors are removable, so you may unplug them for ease of speaker wire lead assembly.
4. As a rule of thumb, use 18 gauge speaker wire for speaker runs up to 30' (9m), 16 gauge up to 70' (21m), and 14 gauge up to 150' (39m). The 4-terminal connectors accept wire sizes up to 12-gauge.
5. Strip the insulation back about 1/4" (6mm) and twist the strands on each lead to prevent fraying.
6. Speaker Polarity: To obtain stable imaging and full bass response, it is imperative that stereo speakers be connected "in phase" with each other. You can verify this as follows:
 - a) If the "+" (positive) and "-" (negative) terminals on your speakers are correctly marked, and visible, and you have wired the system with the positive connector on the rear of the MX88 Controller/Amplifier connected to the positive connector on the speaker and the negative connector on the rear of the MX88 Controller/Amplifier connected to the negative connector on the speaker, then the system will be "in phase". No further action is required. Most manufacturers identify the positive terminal with a red binding post, a "+" sign, or a red dot.
 - b) If you are unsure of the markings, you can verify that your speakers are in phase (but not the absolute polarity of each speaker). Using a mono sound source, such as AM radio, alternately reverse the leads to one of the speakers. Pick the connection that delivers a solid center image between the speakers as well as best bass response.



CAUTION: After lead ends are inserted and the screws tightened down, be sure there are no free strands that could cause shorting!

MX88 KEYPAD CAT5 CABLE CONNECTIONS AT THE MX88 CONTROLLER/AMPLIFIER

NOTE: While we use the term CAT5 throughout this manual, CAT5/5e/6/7 may be used to connect the MX88 to Xantech keypads and touch-panels. Bear in mind that cable quality may reduce maximum lengths quoted throughout this manual or in the keypad or touch-panel manuals.

The MX88 utilizes 'Pin-to-Pin' CAT5 cabling for its wired zone controllers (MX-compatible keypad or touch-panel) that can be purchased pre-fabricated at fixed lengths or self-assembled to custom lengths. The color-coded wiring standard is EIA/TIA 568B as shown in **Figure 4**. The plastic connector on the end of the CAT5 wire is "registered jack" RJ45.

1. See **Figure 4** for proper termination of the CAT5 cables to the RJ45 connectors.
2. Connect the zone keypad to the appropriate zone Keypad connector on the rear of the MX88 Controller/Amplifier – **Figure 3 item 16**.



Caution: Operating voltage for the keypad is transmitted along this cable! **Incorrect wiring on this cable can destroy the keypad or the touchpanel!** Be sure to test cable for proper connections **before** making connections.

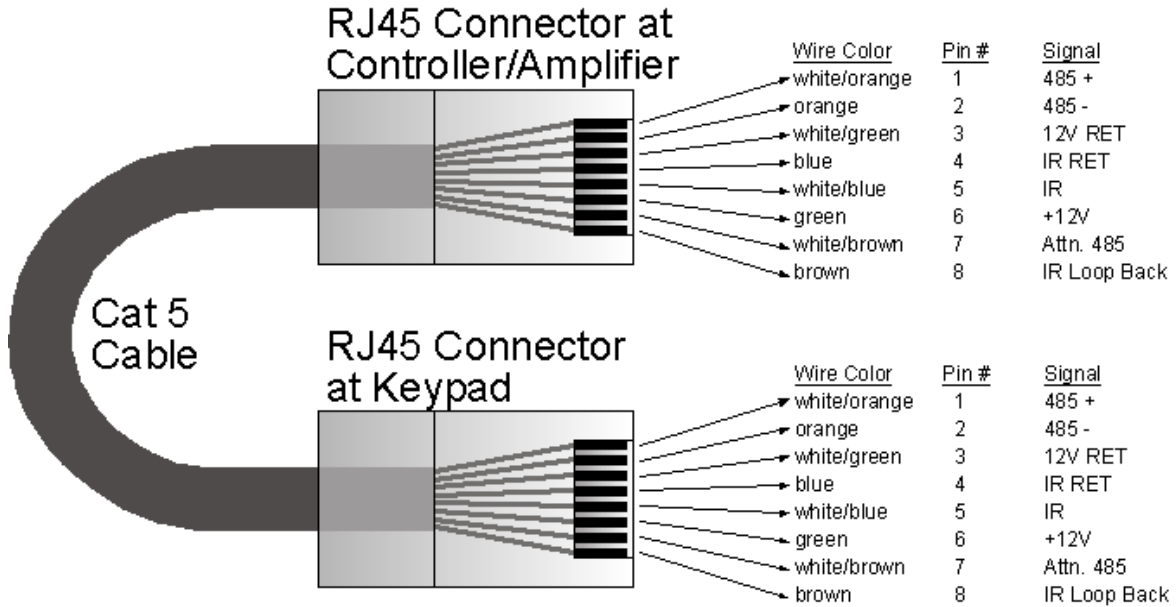

Figure 4 - CAT5 Pin Assignments (per EIA/TIA 568B) Pinned 1:1

VIDEO CONNECTIONS (MX88vi ONLY)

1. When running composite video to a TV or monitor, use RG6 coaxial or RG59 quad-shield cable with RCA-type phono plugs on each end. This connection can be run up to 150 feet, as this is a buffered video output from the MX88 Controller/Amplifier.
2. Connect the zone video cable to the appropriate zone video jack on the rear of the MX88vi Controller/Amplifier – **Figure 3 item 18**.

STATUS CONNECTIONS AND COMMON CONTROL OUT

Status

Each zone has a Status Output –**Figure 3 item 19**, that provides a control output of +12 VDC, 50mA that turns ON and OFF with the zone ON/OFF condition. ON = +12VDC, OFF = 0VDC. Using a 3.5mm mono mini phone connector, this control can be used to close a relay, such as a Xantech CC12, to raise a TV lift or drop a projection screen automatically when a zone is turned ON. Connect one end of the 3.5mm Mono Mini jack to the appropriate zone Status connector on the rear of the MX88 Controller/Amplifier and the other end to the device to control. Tip=Control Voltage; Sleeve=GND

Control Out

A single Common Control Output is provided on the rear of the MX88 Controller/Amplifier –**Figure 3 item 20**. When the Common Control Output is High (+12VDC, 50mA max.), this indicates that ‘at least’ one zone is powered ON. When the Common Control Output is Low (0VDC), this indicates that ‘all’ zones are OFF. Using a 3.5mm mono mini phone connector, this control can be used to close relays (such as Xantech CC12) or turn on an AC outlet (such as Xantech AC1 or AC2) for activity common to the system. Connect one end of the 3.5mm Mono Mini jack and the other end to the device to control. Tip=Control Voltage; Sleeve=GND

Expanded, 16-zone system:

When at least one zone on either the PRIMARY or SECONDARY controller is turned ON, the Control Out on the PRIMARY Controller is High (+12VDC, 50mA max.). The Control Out on the Secondary Controller is inactive in Expanded mode.

PREAMP OUT

Each zone has a Preamp Out to send 'zone selected' audio to an outboard power amplifier such as the Xantech PA4100x. This may be needed for powering a sub-zone, or for use in zones that require more than 50W a channel, or for sending audio to another amplifier with Dolby™ surround decoding for 'theater quality' audio in that zone.

Using good quality RCA-type patch cables, connect the Preamp Out, Left (L) and Right (R) connectors – **Figure 3 item 25**, to the desired external amplifiers Audio Left and Right Input connectors.

CO1 AND CO2 (ZONES 7 & 8)

Zones 7 and 8 have a Remote Mute/Standby output for interfacing and controlling an external power amplifier, such as the higher powered PA4100x. The control is provided via a Stereo Mini Jack with the "tip" of the mini-phone connector controlling "standby" logic (Power On = +12VDC, Power Off = 0VDC) and the "ring" controlling "mute" logic (Mute = +12VDC, Un-Mute = 0VDC).

Using a 3.5mm stereo mini Jack to 3.5mm stereo mini Jack cable, plug one end into the CO1 (or CO2) output jack on the rear of the MX88 Controller/Amplifier – **Figure 3 item 21** and the other end into the corresponding jack labeled CO1 (or CO2) on the Xantech power amplifier.

NOTE: If using a Xantech PA4100X amplifier, be sure to set the Control In (CI) switch to ON located on the rear panel of the amp.

ZONE IR

Using Xantech emitters (282D, 283D, 284D, 286D, etc.), plug the 3.5mm mono mini jack into the appropriate zones Zone IR connector – **Figure 3 item 28**. Affix the emitter side to the desired *zone related* component you wish to control. If more than one device needs to be controlled, use a mono mini to stripped-ends wire (p/n 6015900) wired to a Xantech 791-44 Amplified Connecting block. Any IR from the zone (generated by the touch-panel, received at the keypad or touch-panel and passed through, or routed from another zone (set up via Universal Dragon only) will be outputted from this emitter port.

AC POWER CONNECTIONS

Use one of the supplied AC power cords specific to your region or country, insert it into the AC inlet on the back panel of the MX88, and plug into a power source capable of delivering the rated current and power stated on the back panel of the MX88.

CONNECTIONS AT THE ZONE LOCATION

KEYPAD CONNECTIONS AND JUMPER SETTINGS

Single Keypad CAT5 Connections

1. Refer to **Figure 4** for proper termination at the zone-end of the CAT5 cable.
2. Set Keypad Address, using specific instructions provided in the manual for that specific keypad.
2. Connect the CAT5 cable from the MX88 Controller/Amplifier into the RJ45 jack marked "Controller" on the rear of the MX88 keypad.



Caution: Power voltage for the keypad is transmitted along this cable! **Incorrect wiring on this cable can destroy the keypad or touch-panel!** Be sure to test cable for proper connections **before** making connections.

Multiple Keypad Connections

1. For a second keypad in the same zone, terminate the CAT5 cable in the same way as shown in **Figure 4**.
2. Connect the CAT5 coming from the MX88 Controller to the "CONTROLLER" jack on the Primary Keypad. Plug a CAT5 cable into the "EXPANSION" jack on the Primary Keypad and connect it to the

“CONTROLLER” jack on the Secondary Keypad. Repeat for all keypads in zone (up to a total of 4 Keypads). Each of the 4 keypads or touch-panels within a zone must have a unique address that is not shared by the other three keypads.

Zone Termination

The LAST keypad connected in the zone (Keypad with no other keypad plugged into its EXPANSION port) must have the **Zone Termination** Jumper installed. Please see the keypad or touch-panel's manual for specifics.

Sensor Enable

To disable the keypad or touch-panel's on-board IR Receiver, remove the **Sensor Enable** jumper on the rear of the keypad. Please see the keypad or touch-panel's manual for specifics.

External IR Terminal Block

To conveniently add other Xantech IR Receivers or IR keypads (such as SmartPad or WaterPad) in conjunction with the MX88 Keypads, you may wire 18AWG-24AWG 4-conductor wire, directly to the terminal block on the rear of the Keypad. Please see the keypad or touch-panel manual for specifics. A 4-conductor connector is provided to safely wire the +12V, STATUS, IR IN and GND to the rear of a compatible keypad or touch-panel. This might be useful when adding an external IR Receiver or adding a sub-zone keypad either outdoors or in a bathroom (such as the WaterPad).

Note: The 12VDC output terminal is rated at 100mA and can power up to one SmartPad/WaterPad or up to 4 IR Receivers. Any more than this will require the use of an external power supply. **Do not wire the external power supply to the MX88 keypad. Wire directly to the units to be powered.**

The STATUS line is an output and is active High (+12VDC) when the MX88 Keypad is powered on and is Low (0VDC) when the Keypad is off. Use this to provide Bank Tracking LED on the SmartPad, WaterPad or another compatible device.

In Zone IR

To wire *local* emitters in-the-zone (emitters used to control components in the same general area as the keypad), wire the IR OUT and GND terminals on the rear of the keypad or touch-panel to the IR (white stripe) and GND of the emitter cable. To control numerous components in the same area, wire these terminals to an amplified connecting block (such as Xantech 791-44) using 18-20AWG 2-conductor cable.

ZONE EXPANSION (CONNECTING TWO MX88 CONTROLLERS)

For systems greater than 8 Zones, two MX88 Controller/Amplifiers can be linked together for systems up to 16 Zones.

LINKING TWO MX88 CONTROLLER/AMPLIFIER UNITS

To connect two systems, simply connect the supplied DB15 Expansion Cable to Port 1 on the rear of one unit to the Port 2 on the other – **Figure 3 item 30**. Either and both of the Port 2's can be used for source/device control, with or without RS2321x8 router.

CONNECTING SOURCE COMPONENTS

When connecting two units together, designate one unit as the PRIMARY Unit (Zones 1-8) and the other unit as the SECONDARY Unit (Zones 9-16). All source components should be connected directly to the PRIMARY Units Source A/V Inputs – **Figure 3 item 22**. Use the PRIMARY Unit's Audio and Video Loop-Thru connectors – **Figure 3 item 23** to feed the source component inputs of the SECONDARY Unit – **Figure 3 item 22**.

All of the source components emitters should be connected to the PRIMARY Unit's IR Emitter Output Ports – **Figure 3 item 26**. This rule applies to the Sense Inputs also.

CONNECTING KEYPADS OR TOUCH-PANELS:

- While we use the term CAT5 throughout this manual, CAT5/5e/6/7 may be used to connect the MX88 to Xantech keypads and touch-panels. Bear in mind that cable quality may reduce maximum lengths quoted throughout this manual or in the keypad or touch-panel manuals.
- The maximum cable length for CAT5 connections to a single keypad and/or multiple keypads varies depending on the keypad being used. In certain applications, external power supplies and/or the MRC44CB1 connecting block may be needed.
- Most Xantech touch-panels require an external power supply. In such cases the length of CAT5 will not be limited due to power requirements of the touch-panel, but by the maximum length allowed by the MX88 keypad interface bus. When using self-powered zone controllers only in a zone, the maximum CAT5 length from MX88 to the last controller should be 500ft or less.
- If any keypad in the zone is using an external IR receiver, or if an outdoor keypad (such as WaterPad) or an IR-only keypad (such as a SmartPad) is necessary in a sub-zone, the 4-pin EXTERNAL IR SENSOR CONNECTING BLOCK on the back of Xantech keypads and touch-panels can be used to power this IR device. The Maximum cable run to the external IR receiver/keypad in each of the above cases can be up to 125 feet from the keypad depending upon type and gauge of wire used.
- MRC88KP and MRC88DJKP keypads are older, legacy products that will work with the MX88, but cannot be mixed with MRKP1/MRKP1E/MRKP2/MRKP2E or the Xantech touchpanels within the same zone, due to using a different communications protocol.
- If no MX88-compatible wired keypads or touch-panels are used in a particular zone, IR Receivers and/or IR based Keypads may be used as shown in **Figure 6** below, using the MRC44CB1 Connecting Block. This set up works for:
 1. Zones with IR Receiver ONLY
 2. Zones where a WaterPad, SmartPad, and/or IR Receiver is used

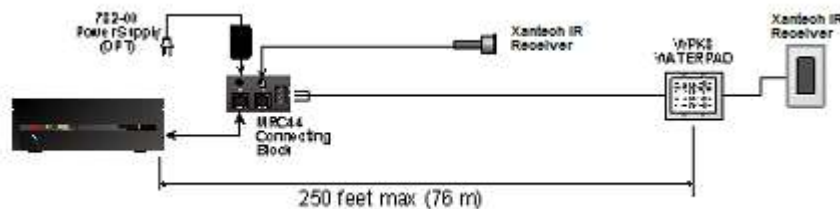

FIGURE 5

Using a CAT5 wire, connect one end into the desired Zone output of the MX88 controller and connect the other end to the RJ45 connector labeled CONTROLLER on the MRC44CB1 connecting block. IR Receivers terminated with a Stereo Mini Jack can be directly connected to the MRC44CB1 connector labeled IR IN. For all others IR Receivers with bare wire or the IR keypads, use 24AWG or larger cable and connect using the +12V, GND, and SIG screw terminals. A separate power supply is required for configurations in which the current load will approach 100mA. In fact, we recommend that an AC Adaptor/Power Supply is always used whenever possible. Consult the MRC44CB1 manual for complete instructions.

SPEAKER CONNECTIONS

SPEAKER POLARITY: TO OBTAIN STABLE IMAGING AND FULL BASS RESPONSE, IT IS IMPERATIVE THAT STEREO SPEAKERS BE CONNECTED "IN PHASE" WITH EACH OTHER. YOU CAN VERIFY THIS AS FOLLOWS:

1. If the "+" (positive) and "-" (negative) terminals on your speakers are correctly marked, and visible, and you have wired the system with the positive speaker connector on the rear of the MX88 Controller/Amplifier connected to the positive connector on the speaker and the negative speaker connector on the rear of the MX88 Controller/Amplifier connected to the negative connector on the speaker, then the system will be "in phase". No further action is required. Most manufacturers identify the positive terminal with a red binding post, a "+" sign, or a red dot.
2. If you are unsure of the markings, you can verify that the two speakers are connected in phase. Using a mono sound source, such as AM radio, alternately reverse the leads to one of the speakers. Pick the connection that delivers a solid center image between the speakers as well as best bass response.



CAUTION: After lead ends are inserted and the screws tightened down, be sure there are no free strands that could cause a short!

VIDEO CONNECTIONS – MX88vi ONLY

Composite Video

The buffered, composite video output from the MX88vi Controller/Amplifier will drive a VIDEO INPUT on a TV or monitor directly. Use RG6 coaxial or RG59 quad-shield cable with RCA-type phono plugs on each end. This connection can be run for 100 feet.

SETTING-UP THE MX88 SYSTEM

8-zone system:

To better demonstrate the ease and versatility of programming the MX88, **Figure 6** will be used to illustrate setup for a typical application.

Expanded, 16-zone system:

For setup of an expanded system, see **Figure 7**.

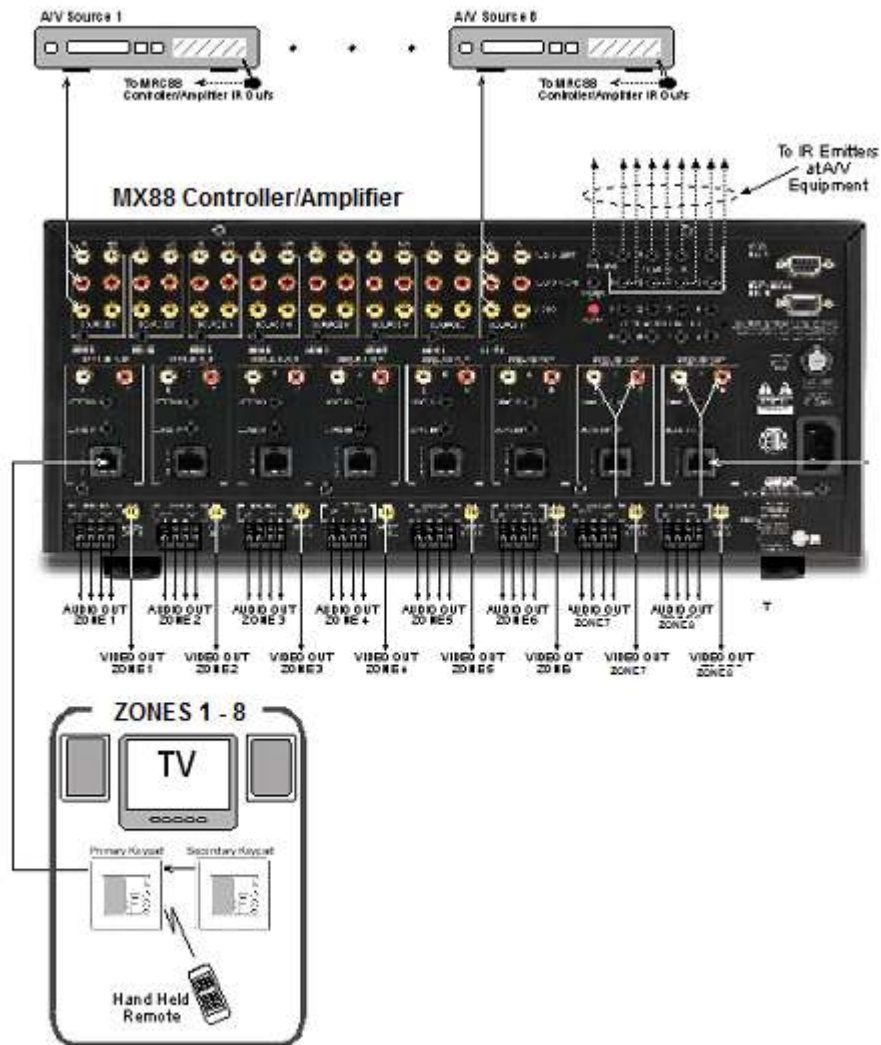

Figure 6 –Typical 8-Zone MX88 System

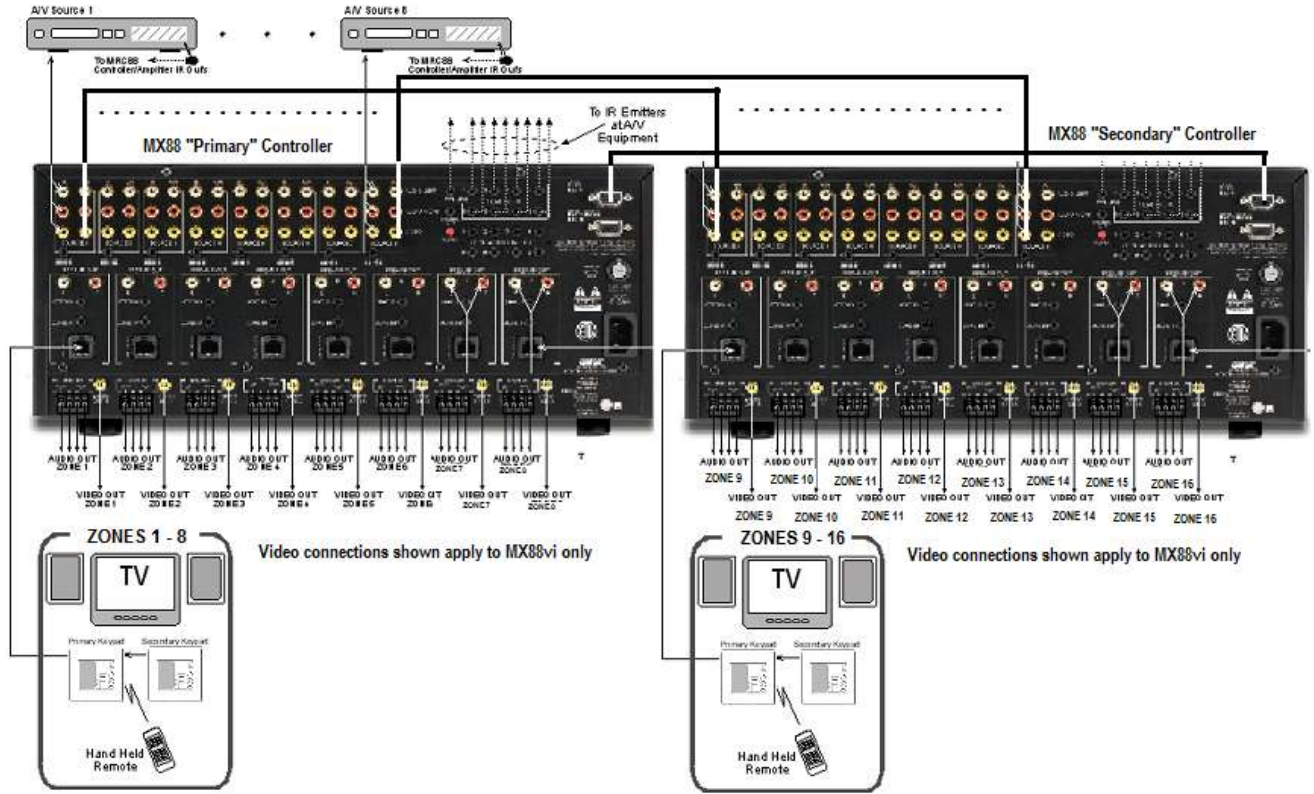

Figure 7 –Typical 16-Zone “Expanded” MX88 System

Section 3: Firmware and Programming

Always install the latest and most current available firmware for your MX88 and its web-server (MX88vi or MX88ai only).

Firmware version for the MX88 and its web-server (called MRIP) – if so-equipped, can be accessed by tapping your finger or clicking your mouse on the top banner of the web-interface page, or by using the Xantech Universal Dragon programming software.

The latest MX88 firmware can be downloaded from <http://www.xantech.com/Downloads/Firmware/>

The latest web-server (MRIP) firmware can be downloaded from <http://www.xantech.com/Audio/AVDistribution/AVDistribution/MX88/>. You will need the “MRIP Internal vx.xx.s.xx” and also the “Web Buffer Zipped Folder”, and will need to use the “MRIP Installer” program to load it. Please see “MX88 MRIP Quick Start” document at the same URL for details.

As stated earlier, the MX88 can be programmed without a PC, using the Xantech QuickConfig feature. It can also be customized using a PC and the Xantech Universal Dragon Windows® program.

To set up the MX88 using QuickConfig, please see the “QuickConfig Guide” at <http://www.xantech.com/Audio/AVDistribution/AVDistribution/MX88/>

To set up the MX88 using Universal Dragon, please see the following documents at <http://www.xantech.com/Audio/AVDistribution/AVDistribution/MX88/>

- Universal Dragon Programming Guide (programming directions for MX88 are same as MRC88)
- Universal Dragon MX88 Programming Instructions for MRKP2 MRKP2E
- MRKP1 Programming with Universal Dragon
- MRC88m – Auto Configuration Guide

MX88ai and MX88vi are IP-enabled and feature a built-in web-server and IP interface. To program this interface, please see “MX88 MRIP Quick Start” at <http://www.xantech.com/Audio/AVDistribution/AVDistribution/MX88/>

A system programmed using QuickConfig will allow for the following features to be utilized:

1. Basic Controller/Amplifier control including: Zone Power On/Off, Source Selection, Speaker Volume, Speaker Mute, Speaker Balance control, EQ Treble/Bass adjustment from the keypad,
2. IR Code programming from the built in IR library and IR learning, for control of all source components from the keypad function buttons as well as via the keypads’ built-in IR Receiver.
3. 2-way RS232 programming of select Xantech-supported sources.
4. Source Power Management (Video or Current Sense) for each source connected.
5. Expanded, 16-zone system activation.

A system programmed using the Universal Dragon will allow for the following additional features to be utilized:

1. Icon Editor
2. RS232 Control of additional external components
3. RS232 Control of the MX88 Controller/Amplifier from external devices such as PC’s
4. Programming of Internal Amplifier Commands
5. Static and Dynamic Linking of Zones
6. Priority Lockout Enable/Disable as well as Monitor Lockout

7. IR Routing Enable/Disable
8. Use of Zone Audio Inputs
9. RC68+ IR Macro Generator
10. Configurable LCD backlight time-out settings (for MRC88KP and MRC88DJKP only).

All of the IR Codes (Palettes or IR Command Groups) and RS232 commands should be confirmed and tested before completing programming.

PLANNING THE SYSTEM

Before attempting any programming, plan the system configuration first. This should include the following:

1. Determine the brand and type of all source components to be used.

Source 1: _____ IR File Name: _____ <input type="checkbox"/> IR Library <input type="checkbox"/> Palette	Source 5: _____ IR File Name: _____ <input type="checkbox"/> IR Library <input type="checkbox"/> Palette
Source 2: _____ IR File Name: _____ <input type="checkbox"/> IR Library <input type="checkbox"/> Palette	Source 6: _____ IR File Name: _____ <input type="checkbox"/> IR Library <input type="checkbox"/> Palette
Source 3: _____ IR File Name: _____ <input type="checkbox"/> IR Library <input type="checkbox"/> Palette	Source 7: _____ IR File Name: _____ <input type="checkbox"/> IR Library <input type="checkbox"/> Palette
Source 4: _____ IR File Name: _____ <input type="checkbox"/> IR Library <input type="checkbox"/> Palette	Source 8: _____ IR File Name: _____ <input type="checkbox"/> IR Library <input type="checkbox"/> Palette
Zone Audio Source 1: _____ IR File Name: _____ <input type="checkbox"/> IR Library <input type="checkbox"/> Palette	Zone Audio Source 5: _____ IR File Name: _____ <input type="checkbox"/> IR Library <input type="checkbox"/> Palette
Zone Audio Source 2: _____ IR File Name: _____ <input type="checkbox"/> IR Library <input type="checkbox"/> Palette	Zone Audio Source 6: _____ IR File Name: _____ <input type="checkbox"/> IR Library <input type="checkbox"/> Palette
Zone Audio Source 3: _____ IR File Name: _____ <input type="checkbox"/> IR Library <input type="checkbox"/> Palette	Zone Audio Source 7: _____ IR File Name: _____ <input type="checkbox"/> IR Library <input type="checkbox"/> Palette
Zone Audio Source 4: _____ IR File Name: _____ <input type="checkbox"/> IR Library <input type="checkbox"/> Palette	Zone Audio Source 8: _____ IR File Name: _____ <input type="checkbox"/> IR Library <input type="checkbox"/> Palette

CAUTION: See caution card (included) for the latest information regarding code compatibility before finalizing the system as there may be some IR code incompatibilities.

2. Determine the components to be used in each zone. Some sources may not be available in all zones.
3. Perform the Out-of-Box PRE TEST as outlined in Section 2.
4. Assemble the components into a working MX88 system such as that shown in **Figure 6 or 7**.
5. Decide whether the MX88 System will be programmed using QuickConfig or Universal Dragon

QuickConfig **Universal Dragon**

6. If using Universal Dragon:

- Program the MX88 System using the latest version of the Universal Dragon, available at <http://www.xantech.com/Downloads/Software/>
- Transfer the System Project to the MX88 Controller(s)

7. Confirm all functions in all zones.

Appendix

RS232 CONTROL

This document describes the bi-directional RS232 interface of the MX88 using the two COM PORTs on the rear of the system (**Fig. 3 item 29**). This interface allows an external RS232 device to control the MX88 via a set of ASCII text commands. It is also possible to control any IR device *connected* to the MX88 system as well by triggering individual IR Commands and/or IR Macros via ASCII strings.

TYPES OF COMMANDS

There are two types of information that can be sent to the MX88 Controller: **COMMANDS** and **QUERIES**. **COMMANDS** are ASCII strings used to *set* a specific parameter in the system (i.e. Select a Source, turn a zone ON, start a DVD player etc...). **QUERIES** are requests for system *status* information and result in the MX88 controller sending back a *reply* to the string being sent (i.e. seeing what zones are on, which sources are selected and volume settings etc....)

INTERFACING TO THE RS232 COM PORTS

The RS232 Com Ports on the rear of the MX88 Controller, when used with the included DB15-DB9 adaptors, are wired as a '*null modem*' end, meaning the Transmit and Receive line have already been interchanged for direct communication with a PC. What this means is when connecting to a standard PC's Com Port, **no Null Modem cable is necessary**.

The pin out configuration for this connector is:

COM PORT (with DB15-DB9 adaptor)	
PIN #	FUNCTION
1, 7, 8, & 9	NC
2	Tx
3	Rx
4	DSR
5	GND
6	DTR

Rear Com Port Connector Pin Out

ASCII STRING 'INITIATING' AND 'TERMINATING' CHARACTERS

The parsing of incoming data on the COM PORT can be disabled via a setting in the Universal Dragon project. This might be necessary if the COM port is to be used to control an external device and any incoming data from that device is to be ignored. This setting can be found with the settings for configuring the COM port.

For the MX88 system to recognize incoming ASCII **command** strings, the string must begin with an '!' and for data queries the string must begin with a '?'. All strings must end with a '+'. This way it can determine the beginning and end of the string for processing.

When a proper command is sent, an ASCII acknowledgement string of **OK** is returned to the issuing device. If an unrecognizable string is received, an ASCII string of **ERROR** is returned to the issuing device.

Example #1: (Issuing a Command String);

To turn Zone 7 ON:

Send ASCII string: **!7PR1+**

MX88 Controller Reply: **OK**

Example #2: (Query Request)

To see what Source is currently selected in Zone 5:

Send ASCII string: **?5SS+**

MX88 Controller Reply: **?5SS3+** indicating Source #3 is currently selected in Zone 5

COMMANDS

Note: An explanation of items in parenthesis ({}) can be found below.

NAME	COMMAND	EXAMPLES/COMMENTS
Zone Power	!{z#}PR{0/1}+	To turn on Zone 2: !2PR1+ To turn off Zone1: !1PR0+
Zone Power Toggle	!{z#}PT+	
All Zones Off	!AO+	
Input (Source) Select	!{z#}SS{s#}+	To set Zone 1 to Source Input 5: !1SS5+
Volume	!{z#}VO{v#}+	
Volume Increment	!{z#}VI+	
Volume Decrement	!{z#}VD+	
Mute	!{z#}MU{0/1}+	To mute Zone 3: !3MU1+ To unmute Zone 4: !4MU0+
Mute Toggle	!{z#}MT+	
Treble	!{z#}TR{bt#}+	
Treble Increment	!{z#}TI+	
Treble Decrement	!{z#}TD+	
Bass	!{z#}BS{bt#}+	
Bass Increment	!{z#}BI+	
Bass Decrement	!{z#}BD+	
Balance	!{z#}BA{b#}+	
Balance Step Left	!{z#}BL+	
Balance Step Right	!{z#}BR+	
Execute RS232 Macro	!{m#}MC+	
Execute Keypad Button	!{z#}MK{k#}X{i#}+	

QUERIES

Note: An explanation of items in parenthesis ({ }) can be found below.

NAME	QUERY	RESPONSE	EXAMPLE RESPONSE	EXPLANATION
Zone Power	?{z#}PR+	?{z#}PR{0/1}+	?7PR0+	Power in zone 7 is OFF.
Input Select	?{z#}SS+	?{z#}SS{s#}+	?5SS3+	Zone 5 currently has source 3 selected.
Volume	?{z#}VO+	?{z#}VO{v#}+	?4VO49+	Zone 4 is currently at volume level 49.
Mute	?{z#}MU+	?{z#}MU{0/1}+	?8MU1+	Zone 8 is currently muted.
Treble	?{z#}TR+	?{z#}TR{bt#}+	?1TR7+	Zone 1 currently has a treble value of 7 (flat)
Bass	?{z#}BS+	?{z#}BS{bt#}+	?1BS7+	Zone 1 currently has a bass value of 7 (flat)
Balance	?{z#}BA+	?{z#}BA{t#}+	?2BA31+	Zone 2 currently has a balance value of 31 (even)

Where:

{z#} - Zone Number. Range is 1..8 (1..16 if expanded)

{s#} - Source Input Number. Range is 1..8

{0/1} - Either 0 (zero) or 1 (one). 0 - Off, 1 - On.

{v#} - Volume Setting. Range is 0..38. See VOLUME LEVEL table below.

{bt#} - Bass/Treble Setting. Range is 0..14. See BASS/TREBLE LEVEL table below.

{b#} - Balance Setting. Range is 0..63. See BALANCE LEVEL table below.

{m#} - Macro Number. Range is 0..256.

{k#} - Keypad Address. Range is 0..3.

{i#} - Keypad Button ID. Range is 3..40 See KEYPAD BUTTON ID table below.

VOLUME LEVEL (39 Steps)

MX88 SETTING	ATTENUATION LEVEL (in dB)
38	0
37	-1.25
36	-2.50
35	-3.75
34	-5.00
33	-6.25
32	-7.50
31	-8.75
30	-10.00
29	-11.25
28	-12.50
27	-13.75
26	-15.00
25	-16.25
24	-17.50
23	-18.75
22	-20.00
21	-21.25
20	-22.50
19	-23.75
18	-25.00
17	-27.50
16	-30.00
15	-32.50
14	-35.00
13	-37.50
12	-40.00
11	-42.50
10	-45.00
9	-47.50
8	-50.00
7	-52.50
6	-56.25
5	-60.00
4	-63.75
3	-67.50
2	-71.25
1	-75.00
0	-78.75

KEYPAD BUTTON ID

MX88 SETTING	Keypad Button Label
1	NOT AVAILABLE
2	NOT AVAILABLE
3	Source Select 1
4	Source Select 2
5	Source Select 3
6	Source Select 4
7	Source Select 5
8	Source Select 6
9	Source Select 7
10	Source Select 8
11	CH +
12	CH -
13	POWER
14	NOT AVAILABLE
15	MUTE
16	PAUSE
17	STOP
18	FF
19	REW
20	SELECT/PLAY
21	NOT AVAILABLE
22	NOT AVAILABLE
23	Tier 2 Source Select 1
24	Tier 2 Source Select 2
25	Tier 2 Source Select 3
26	Tier 2 Source Select 4
27	Tier 2 Source Select 5
28	Tier 2 Source Select 6
29	Tier 2 Source Select 7
30	Tier 2 Source Select 8
31	Tier 2 CH +
32	Tier 2 CH -
33	Tier 2 POWER
34	NOT AVAILABLE
35	Tier 2 MUTE
36	Tier 2 PAUSE
37	Tier 2 STOP
38	Tier 2 FF
39	Tier 2 REW
40	Tier 2 SELECT/PLAY

BASS/TREBLE LEVEL

MX88 SETTING	LEVEL (in dB)
14	+14
13	+12
12	+10
11	+8
10	+6
9	+4
8	+2
7	0
6	-2
5	-4
4	-6
3	-8
2	-10
1	-12
0	-14

BALANCE LEVEL

(63 steps)

MX88 Setting	Left Speaker Attenuation (in dB)	Right Speaker Attenuation (in dB)
0	0	Mute
1	0	-37.5
2	0	-36.25
...
29	0	-2.5
30	0	-1.25
31	0	0
32	0	0
33	-1.25	0
34	-2.5	0
...
62	-37.5	0
63	Mute	0

TROUBLESHOOTING

If you encounter problems, review each of the following items and take corrective action as described. If problems persist, contact Xantech Technical Support.

PROBLEM	PROBABLE CAUSE AND SOLUTION
<p>The MX88, after a successful Transfer from Universal Dragon, will not send out any IR commands.</p> <p>A corrupted or incorrectly learned IR code has been transferred to the keypad.</p>	<ul style="list-style-type: none"> a) Open all palettes that you used for the project. Click Edit Palette, on the first palette. When Palette Editor opens, retest each IR command to see that they operate the controlled equipment. b) Close the Palette Editor and click Edit Palette on the next palette. Repeat this procedure for each palette. c) When you find the defective command "re-teach" it again using the Learning IR Commands procedure. d) Before going further, test the relearned command to see that it operates the controlled equipment. e) In the Palette Editor, right click the defective command on the right and delete it from the associated palette. f) Place the corrected command in the palette using the Add >> function. g) Close the Palette Editor and open the palette. h) Click the button on the virtual keypad that has the bad command and remove the command with a right click. i) Place the corrected command on the keypad button by clicking it on the palette. j) Redo the Transfer procedure. <p>CAUTION: Always test all commands before transferring to the MX88!</p>
<p>I have made hardware connections as shown in Figure 6 or 7. However, when attempting to learn IR commands, the "Waiting for IR from your Remote" display times out with the "No IR Recorded" dialog box.</p> <p>Your computer is not recognizing or finding the serial port connection to the MX88.</p>	<p>Try the following in the order listed:</p> <ul style="list-style-type: none"> a) The default serial port selection (1) in Dragon Drop may already be in use by another device in your computer system (such as a mouse). Refer to SERIAL PORT SELECTION, page 36, and perform the procedure listed there and in the following section VERIFYING COM PORT COMMUNICATION. b) Check and replace, if necessary, the connecting cables and the DB9-to-DB25 adaptor. c) The serial COM port settings, such as port addressing and IRQ parameters, may not be set correctly in Windows.

PROBLEM	PROBABLE CAUSE AND SOLUTION
<p>Unit will not learn IR commands from certain brands and models of remotes.</p>	<p>a) Because of the wide variety of IR coding and timing relationships (there are no industry standards), there are some IR commands that are not learnable by the Dragon Drop-IR™.</p> <p>Be sure to test all components first to see that their IR command codes are learnable by Dragon Drop-IR and are executable by the MX88 before selecting final components for the system. To aid you in this selection, see CAUTION card included with these instructions for the latest information relating to code compatibility.</p> <p>NOTE: Certain IR commands that are not normally learnable, or those that operate more correctly when learned with special techniques at Xantech, are available on the CD ROM that comes with Dragon. These, and the most recent updates to these files, are available on the Xantech web site at www.xantech.com. Contact Technical Support for details.</p> <p>b) Components using IR carriers higher than 71 kHz cannot be learned directly. Most are learnable, however, when down-converted by Xantech products such as the 291P, PMS12, 291-455, MS455, etc. Refer to the Xantech Product Catalog and contact Technical Support for details. Be sure you have the Make and Model number of the component and its remote before contacting Technical Support.</p>
<p>"Record ERROR, try again" shows on screen while learning IR commands or "No IR Recorded" message is displayed.</p> <p>Sometimes the command "takes" but does not operate the device.</p> <p>This may occur if you hold the "teaching" remote too far away, too close, or at too great an angle to the front of the MX88, or, IR interference is present.</p> <p>Also, with some remotes, you may be holding down the buttons for too long or too short a period of time when "teaching" the commands.</p>	<p>Do the following:</p> <p>a) Repeat the Learning procedures. You may have to experiment with the distance the remote is held away from the IR SENSOR on the front of the MX88. For most cases it will need to be within one inch of the Learning eye.</p> <p>b) Vary the amount of time you hold down the "teaching" remote's buttons. Most of the time only a brief tap is necessary.</p> <p>c) Be sure there are no sources of strong IR interference near the MX88 (such as CFL lamps, TVs, Your Computer Monitor, Neon lighting, etc.). Shade or move the location of the MX88 as necessary.</p>

PROBLEM	PROBABLE CAUSE AND SOLUTION
<p>When Transferring the project to a MX88, the transfer stops with a "Transfer aborted-Receiver Stopped Responding" or a "Communications Error---" message.</p>	<p>The following items may have interfered with the transfer of data. Check each one in the order listed, then redo the transfer.</p> <ol style="list-style-type: none"> Click on Preferences under the FILE menu and verify proper Com Port is selected Make sure no other software is running that also requires the Com Port Conduct a "Base Unit – Who Am I" to verify proper communication with the MX88. Check the COM PORT interface cable for continuity on each of its 9 leads. This is a Pin to Pin, 1:1 configuration. Replace if necessary. Your computer may have run out of system resources (memory). Quit other open applications and restart Windows with the MX88 connect to the PC
<p>After transferring commands to the MX88, it works fine ... except at certain times the MX88 refuses to output any commands at all.</p>	<p>IR noise may be on the IR bus-line coming from an IR receiver in another room or rooms, preventing a clean IR signal from arriving at the controlled component.</p> <ol style="list-style-type: none"> Temporarily disconnect each MX88 Keypad one at a time, until you find the one causing the interference. Look for sources of IR interference near the IR receiver(s) [such as PLASMA, CFL lamps, TVs, Neon lighting, etc.]. Move or shade the IR receiver(s) or take other steps as necessary.
<p>The STATUS LED under the POWER button on the Keypad is never illuminated GREEN or flickers constantly.</p>	<p>Again. IR noise is probably the problem. Adjust the Input Sensitivity of the IR Receiver might be too sensitive. Back off (turn CCW) on the IR Sensitivity Adj. on the rear of the keypad until the GREEN LED comes on steady. If a PLASMA is nearby, you might need to disable the Keypad IR Receiver and add a Plasma Friendly unit to the system.</p>

PROBLEM	PROBABLE CAUSE AND SOLUTION
Problems Controlling the MX88 via the RS232 port on the rear of the system.	<ol style="list-style-type: none"> 1. Check the cabling between the controlling unit and the MX88. 2. Verify proper command is being sent to the MX88. Refer to Appendix A and section on RS232 Translator for recognized ASCII commands. 3. Verify RS232 Port settings are set properly for both devices (i.e. Baud Rate, Data Bits, Stop Bit etc..) 4. Verify pin out from controlling device and the MX88 to be sure proper handshaking between the Tx and Rx lines exist. <p>NOTE: Tx and Rx lines on the MX88 are reversed from a standard PC. This allows communication between the MX88 and a standard PC Com Port without a Null Modem cable.</p>
Problems controlling an External Device via the MX88 rear Com Port	<ol style="list-style-type: none"> 1. Check the cabling between the controlling unit and the MX88. 2. Verify RS232 Port settings are set properly for both devices (i.e. Baud Rate, Data Bits, Stop Bit etc..) 3. Verify pin out from controlling device and the MX88 to be sure proper handshaking between the Tx and Rx lines exist. <p>NOTE: Tx and Rx lines on the MX88 are reversed from a standard PC. This allows communication between the MX88 and a standard PC Com Port without a Null Modem cable.</p> <ol style="list-style-type: none"> 4. Verify the MX88 is sending the appropriate commands out of the rear RS232 Port. This can be done by connecting the rear RS232 Port directly to a PC's Com Port running Hyperterminal. View the command in Hyperterminal to see if the exact commands is being output correctly. 5. Check the manufactures manual for the correct ASCII/Hex commands. <p>NOTE: Sometimes a Carriage Return (0D Hex) and even possibly a Line Feed (0A) is required as terminating characters.</p>

RS232 AND EXPANSION PIN OUT INFORMATION

MX88			
RS232 COM PORT*		EXPANSION PORT	
PIN #	FUNCTION	PIN #	FUNCTION
1	NC	1	IR Source 1
2	Tx	2	IR Source 2
3	Rx	3	IR Source 3
4	DSR	4	IR Source 4
5	GND	5	IR Source 5
6	DTR	6	IR Source 6
7	NC	7	IR Source 7
8	NC	8	IR Source 8
9	NC	9	NC
		10	IR Common
		11	Tx Out
		12	Common
		13	Rx In
		14	Sig Out
		15	Sig In

* With DB9-DB16 adaptor attached

SPECIFICATIONS

Audio (each channel)

Min Input:250mV for full rated Output
 Input Overload:>2.2 V RMS (@ max VC)
 Input Impedance: > 20 k ohms
 Power Output:..... 50 Watts RMS @ 4 ohms
 Load Impedance:..... 4 or 8 ohms
 Signal to Noise:.....>96dB A-Weighted
 THD (VC -10dB):..... <0.08% at 2V input level
 Frequency Response (\pm 1dB):.....20 Hz to 20 kHz
 Bass Control Range (@ 100Hz):..... \pm 14dB (in 2 dB steps)
 Treble Control Range (@ 10kHz):..... \pm 14dB (in 2 dB steps)

Video (MX88vi only)

Input/Output Impedance:75 Ohms
 Video Insertion Loss: 0 dB (50 Hz to 6 MHz)

IR Sensor

IR Modulation Frequency Bandwidth:30 Hz to 100 kHz
 Nominal Reception Range:..... >30 feet
 Nominal Reception Angle:40 degrees off axis

General

RC68 Code Group Number: A8
 Control Output: 12 V @ 50 mA max.
 Status Output:..... 12 V @ 50 mA max.
 Power Requirements: 100~120V or 220~240V AC (Automatic Switching), 50/60 Hz
 Gold Plated RCA type phono jacks All A/V inputs/outputs
 Dimensions 17" W x 7.625" H x 11.75" D (432mm x 194mm x 298mm)
 Net Weight 25 lbs (20.4 kg)

Xantech® and Xantech SmartPanel® are registered trademarks of Xantech LLC
Apple® and iPad® are registered trademarks of Apple Inc.
Windows® and Microsoft® are registered trademarks of Microsoft Corporation.
Android™ is a trademark of Google, Inc.
IBM® is a registered trademark of International Business Machines Corporation.
All other trademarks are the properties of their registered owners.

Xantech LLC
1969 Kellogg Ave, Carlsbad, CA 92008 USA | Xantech.com
Installation Instructions, MX88 © 2011 Xantech LLC
p/n 08905298 v0.4

This document is copyright protected. No part of this manual may be copied or reproduced in any form without prior written consent from Xantech LLC. Xantech LLC shall not be liable for operational, technical, or editorial errors/omissions made in this document.