

2007 MDX

Navigation Manual (Unlinked)

This document does not contain hyperlinks and may be formatted for printing instead of web us. This is due to changes in content and specifications of the vehicle that happen throughout the model year. This manual will be replaced with a hyperlinked version at the end of the model year.

Introduction	4	Traffic Display Legend.....	22	By Map Input.....	45
Manual Overview	4	Real Time Traffic Display	23	<i>Showing the Map of Current</i>	
System Overview	4	<i>Viewing Flow Data</i>	23	<i>Position.....</i>	45
Accessories Precautions	5	<i>Viewing Incident Reports.....</i>	24	<i>Showing the Map of City.....</i>	46
Important Safety Information.....	5	System Function Diagram	26	<i>Showing the Map of State</i>	46
Map Overview	6	Entering a Destination	27	<i>Showing the Map of Continental</i>	
<i>Current Street</i>	6	By Address	28	<i>USA.....</i>	47
<i>Verified/Unverified Street.....</i>	6	<i>Selecting the State or Province.....</i>	28	By Today's Destinations.....	47
User Agreement	8	<i>Selecting the City</i>	28	<i>Editing Today's Destination List</i>	48
Getting Started	10	<i>Selecting the Street</i>	30	<i>Adding Destinations to the List.....</i>	48
System Controls	10	<i>Entering the Street Number</i>	32	By Go Home	49
Voice Control Basics.....	13	By Address Book	32	Driving to Your Destination	50
<i>Using the Voice Control System.....</i>	14	<i>Adding Addresses to the Personal</i>		Driving to Your Destination	50
<i>Improving Voice Recognition.....</i>	14	<i>Address Book.....</i>	33	Calculate Route to Screen.....	50
Selecting an Item (Button) on the		By Places	33	<i>Changing the Routing Method.....</i>	51
Screen	15	<i>Finding the Place by Category.....</i>	34	<i>Viewing the Routes.....</i>	51
Selecting an Item in a List.....	15	<i>Finding the Place by Name.....</i>	38	<i>Viewing the Destination Map</i>	53
Entering Information	16	<i>Finding the Place by Phone</i>		Map Screen	53
System Start-up	17	<i>Number.....</i>	38	<i>Route Line.....</i>	53
HandsFreeLink™	18	<i>Finding the Place by Zagat 2006.....</i>	38	<i>Map Screen Legend</i>	54
Remote Keyless Entry Setting	18	By Intersection.....	39	Guidance Screen	55
Map Screen Legend.....	20	<i>Selecting the State or Province.....</i>	39	<i>Guidance Screen Legend</i>	55
Map Screen Description	21	<i>Selecting the City</i>	40	Distance and Time to	
<i>Zoom In/Out.....</i>	21	<i>Selecting the Street</i>	41	Destination.....	56
<i>Map Scrolling</i>	21	By Previous Destinations.....	44	Map Menu.....	56
Displaying Current Location	21			<i>Voice Guidance Prompts</i>	57

Table of Contents

Direction List.....	57
<i>EXIT INFO</i>	
<i>(Freeway Exit Information)</i>	58
Split Screen Guidance	58
Map Scale	60
Map Orientation	61
Destination Icon	62
Landmark and Incident Icons	62
<i>Showing Icons on the Map</i>	65
<i>Icon Options</i>	65
Going Off the Route	67
Off-road Tracking.....	67
Viewing/Saving the Current	
Location.....	68
Pop-ups and Disclaimers	69
Changing the Route	70
<i>Change Route By Screen</i>	70
<i>Cancel Current Route</i>	70
<i>Change Routing Method</i>	70
<i>Detour</i>	70
<i>Avoid Streets</i>	71
<i>Search Waypoint on Route</i>	71
<i>Back to Current Route</i>	72
Changing Your Destination	73
<i>Find Nearest (Voice command)</i>	73
<i>Go Home (Voice command)</i>	73

<i>Using Interface Dial to Change</i>	
<i>Destination</i>	73
<i>Entering a Destination from the Menu</i>	
<i>Screen (while on route)</i>	74
Continue Trip Screen.....	74
AcuraLink Messages	75
Information Features	76
Information Screen	76
Messages.....	76
Voice Command Help	76
Cellular Phonebook	77
Map Legend.....	77
Calendar	78
<i>Entering Your Schedule</i>	78
Key to Zagat Ratings	79
Calculator.....	80
<i>Unit Conversion</i>	81
Roadside Assistance	81
System Set-up.....	82
Setup Mode	82
Setup Screen (first)	82
<i>Brightness</i>	82
<i>Contrast</i>	83
<i>Black Level</i>	83
<i>Volume</i>	83
<i>Interface Dial Feedback</i>	83

<i>Guidance Prompts</i>	83
Setup Screen (second).....	84
Personal Information	84
<i>Address Book</i>	85
<i>Edit/Delete an Address</i>	88
<i>Home Address</i>	88
<i>PIN Number</i>	88
<i>Previous Destinations</i>	89
Basic Settings	90
<i>Units (mile or km)</i>	90
<i>Voice Recognition Feedback</i>	90
<i>Voice</i>	90
Routing & Guidance	91
<i>Rerouting</i>	91
<i>Unverified Area Routing</i>	92
<i>Edit Avoid Area</i>	96
<i>Edit Waypoint Search Area</i>	98
<i>Guidance Mode</i>	99
Clock Adjustment	99
<i>Auto Daylight</i>	100
<i>Auto Time Zone</i>	100
<i>Time Adjustment</i>	101
Vehicle	101
<i>Off-road Tracking</i>	101
<i>Correct Vehicle Position</i>	102
Color	103
<i>Map Color</i>	103
<i>Menu Color</i>	103

<i>Switching Display Mode</i> 104	Coverage Areas 118	Single DVD Voice Commands (for DVD Player).....148
AcuraLink/Messages 107	Map Coverage..... 118	Single MP3/WMA Voice Commands (for DVD Player)...149
System Information 107	<i>U.S. Detailed Coverage Areas</i> 118	Rear Radio Voice Commands150
Rear View Camera 107	<i>Canada Detailed Coverage Areas</i> . 122	Rear CD Voice Commands (for 6 Disc Changer) 150
<i>Rear View Camera Brightness</i> <i>Adjustment</i> 108	Frequently Asked Questions... 128	Rear DVD Voice Commands (for 6 Disc Changer) 151
System Initialization 109	Troubleshooting 136	Rear MP3/WMA Voice Commands (for 6 Disc Changer) 152
System Initialization..... 109	Glossary 137	Rear Single CD Voice Commands (for DVD Player)...152
Entering the Security Code..... 109	Glossary 137	Rear Single DVD Voice Commands (for DVD Player)...153
GPS Initialization 110	Voice Command Index 140	Rear Single MP3/WMA Voice Commands (for DVD Player)...154
Map Matching 110	Global Commands 140	Information Screen Voice Commands 155
System Limitations 111	Navigation General Commands... 140	Setup Screen (first) Commands...155
Database Limitations 113	Navigation Display Commands... 141	On-Screen Commands 156
Client Assistance 114	Find Place Commands 142	<i>On-Screen Spelling Assist</i> 156
Reporting Errors 114	Climate Control Commands 143	Index 160
Acura Automobile Client Service 114	Temperature Voice Commands .. 144	
Visiting Your Dealer 115	Radio Voice Commands..... 145	
Obtaining a Navigation Update DVD 116	CD Voice Commands..... 145	
Changing the DVD 116	DVD Voice Commands (for 6 Disc Changer)..... 146	
PC Card 117	MP3/WMA Voice Commands (for 6 Disc Changer)..... 146	
	Single CD Voice Commands (for DVD Player)..... 147	

Introduction

Manual Overview

The manual is divided into the following sections:

- Getting started - A basic introduction that discusses the controls and how to communicate with the system.
- Entering a Destination - How to enter an address or locate a point of interest (POI).
- Driving to your Destination - An explanation of the map features, guidance, and cautions.
- Information Features - Message, Voice Command Help, Cellular Phonebook, Map Legend, Calendar, Key to Zagat Ratings, Calculator, and Roadside Assistance.
- System Set-up - How to set up and tailor the system for your personal use and use the Address Book.

The back of this manual contains:

- Map Coverage (page 118)
- Cities with Traffic Coverage (page 126)
- Frequently Asked Questions (FAQs) (page 128)
- Troubleshooting Guide (page 136)
- Glossary of Terms (page 137)
- Voice Command List (page 140)

System Overview

Your navigation system is a highly sophisticated location system with voice control that uses satellites and a map database to show you where you are and to help guide you to a desired destination.

The navigation system receives signals from the global positioning system (GPS), a network of 24 satellites in orbit around the earth. By receiving signals from several of these satellites, the navigation system can determine the latitude, longitude, and elevation of your vehicle. In addition, a gyroscopic yaw sensor and a vehicle speed sensor in your vehicle keep track of the direction and speed of travel at all times.

The navigation system applies this location, direction, and speed information to the maps and calculates a route to the destination you enter. As you drive to that destination, the system provides map and voice guidance.

The navigation system is easy to use. The locations of many places of business and entertainment are already entered in the system. You can select any of them as a destination by using the Interface Dial or voice control.

There are several ways to enter a destination, such as by point of interest (POI), by address, by phone number, and by selecting it from the map. The last 50 destinations are saved for reuse at a later date. The system also allows you to store a home address to simplify returning home from your destination.

Accessories Precautions

If you have front window tinting installed, be aware that if the tint has metallic properties, it can seriously degrade or prevent GPS reception. This is because the GPS antenna is located under the dashboard.

If you plan to install electronic components such as radar detectors, vehicle location devices, remote starters, additional amplifiers, or other audio components, ensure that they are not located near the navigation control unit under the driver's seat, near the navigation display in the dash, or near the GPS antenna under the dashboard. Signal noise emanating from these devices can cause intermittent disruption of the navigation system.

Important Safety Information

The navigation system can distract your attention from the road if you focus on the screen or operate the system's controls while driving.

Enter as much information as possible into the system before you begin driving, or when the vehicle is stopped. Then, as you drive, listen to the audio instructions and use voice commands when possible.

WARNING

Using the navigation system while driving can take your attention away from the road, causing a crash in which you could be seriously injured or killed.

Follow all operating instructions and safety information in this manual.

While driving, do not look at the screen or operate the system controls for more than a second or so at a time, and only after deciding you can do so safely. Pull to the side of the road if you need more time to look at the screen or operate the controls.

The navigation system is designed to provide route information to help you reach your destination. However, this route guidance may sometimes conflict with current road conditions such as street closures, road construction, detours, and out-of-date map data.

Additionally, the system itself has certain limitations (see page 111). Therefore, you must verify the audio and visual route information provided by the system by carefully observing the roadway, signs and signals, etc. If you are unsure, proceed with caution. Always use your own good judgment, and obey traffic laws while driving.

Map Overview

Current Street

The current street on which your vehicle is, appears at the bottom of the map screen (see page 20). A message saying “Not on a digitized road” may appear instead when you drive half a mile away from a mapped road. For more details, see *Off-road Tracking* on page 67.

Verified/Unverified Street

Your navigation system has two kinds of streets: verified (dark colored) and unverified (light colored). The differences between the two types of streets are contrasted in the chart on page 7.



	Verified streets (dark colored)	Unverified streets (light colored)
When displayed	These roads are found within metropolitan areas, and include interstate freeways and major roads connecting cities.	These roads are found in rural areas, and typically include residential streets away from the center of a town.
Street color	Shown on daytime map screen as black or red, such as interstate freeways.	Shown on the daytime map screen as light brown.
Map Quality	The database vendor has verified these streets. Information like turn restrictions, average speed, and whether it is a one way street have been gathered and used when creating your route to a destination.	These streets have not been verified by the database vendor. The system does not contain information on one-way streets, turn restrictions, or the road's average speed. They are shown on the map for reference and can have errors in map location, naming, and address range.
Routing differences	While driving to your destination, the displayed route line is solid blue. The system provides voice and map guidance to your destination.	Your route line is either a blue dotted "vector line," or a dashed pink/blue line. For information on selecting this option, and the routing differences, see <i>Unverified Area Routing</i> on page 92.
Cautions	There are no pop up boxes urging extra caution during a route. However, because roads constantly change, you are urged to use common sense, and always obey posted traffic restrictions.	Regardless of whether the user chooses route guidance, there are cautionary screens before and during the route urging the user to be extra cautious, and obey all traffic restrictions. see <i>Unverified Area Routing</i> on page 92.
Guidance voice	Voice guidance issues maneuvers such as "In a half mile make a right turn."	The suffix "if possible" is added to each guidance maneuver. For example: "In a half mile make a right turn, if possible."
Time and distance "to go"	The time and distance "to go," displayed while on route to a destination, is based on the average speed and distance for the roads used for your route.	Because the average speed of these roads is not known, the time and distance "to go" is based on a fixed average speed of 25 mph for these roads.

User Agreement

In using this DVD “Satellite Linked Navigation System” (the “DVD”), which includes HONDA MOTOR CO., LTD. software, ALPINE ELECTRONICS, INC. software, NAVTEQ database contents, INFO USA CORPORATION database, ZAGAT SURVEY database contents, and ZENRIN CO. database contents (hereinafter referred to as “Licensors”), you are bound by the terms and conditions set forth below.

By using your copy of the DVD, you have expressed your Agreement to the terms and conditions of this Agreement. You should, therefore, make sure that you read and understand the following provisions. If for any reason you do not wish to be bound by the terms of this Agreement, please return the DVD to your dealer.

- The DVD may not be copied, duplicated, or otherwise modified, in whole or in part, without the express written permission of the Licensors.
- The DVD may not be transferred or sublicensed to any third party for profit, rent or loan, or licensed for reuse in any manner.
- The DVD may not be decompiled, reverse engineered or otherwise disassembled, in whole or in part.
- The DVD may not be used in a network or by any other manner of simultaneous use in multiple systems.
- The DVD is intended solely for personal use (or internal use where the end-user is a business) by the consumer. The DVD is not to be used for commercial purposes.
- The Licensors do not guarantee to the client that the functions included in the DVD meet the specific objectives of the user.
- Licensor shall not be responsible for any damages caused by the use of the DVD to the actual user or to any third party.
- The warranty on the DVD shall not extend to an exchange or refund due to misspelling, omission of letters, or any other cosmetic discrepancy in the contents of the DVD.
- The right to use the DVD shall expire either when the user destroys the DVD or software, or when any of the terms of this Agreement are violated and the Licensors exercise the option to revoke the license to use the DVD or software.

- The terms and conditions hereof apply to all subsequent users and owners as well as to the original purchaser.
- The use of oil company logos in the display are for your information and convenience, and in no way implies any sponsorship, approval or endorsement of these companies, or their products. The logos are trademarks of their respective owners.

The user shall indemnify and save harmless the Licensors, and their officers, employees and agents, from and against any claim, demand or action, irrespective of the nature of the cause of the claim, demand or action, alleging loss, costs, expense, damages or injuries (including injuries resulting in death) arising out of the use or possession of the DVD or software.

Use, duplication, or disclosure of this DVD by or on behalf of the United States government is subject to “Restricted Rights” as set forth at FAR 52.227-14, -19 or DFARS 252.227-7013, as applicable. Manufacturers are the Licensors, including HONDA MOTOR CO., LTD., 2-1-1 Minami Aoyama Minato-Ku Tokyo 107-8556 JAPAN., Alpine Electronics, Inc., 20-1 Yoshima Kogyodanchi, Iwaki, Fukushima 970-1192 JAPAN., NAVTEQ Corporation, 222 Merchandise Mart, Suite 900, Chicago, IL, 60654, INFO USA CORPORATION, 5711 South 86th Circle, Omaha, NE 68127., Zagat Survey, LLC, 4 Columbus Circle, New York, NY, 10019., and ZENRIN CO., LTD., 1-1-1 Muromachi, Kokurakita-ku, Kitakyushu, Fukuoka 803-8630, JAPAN.

Getting Started

System Controls

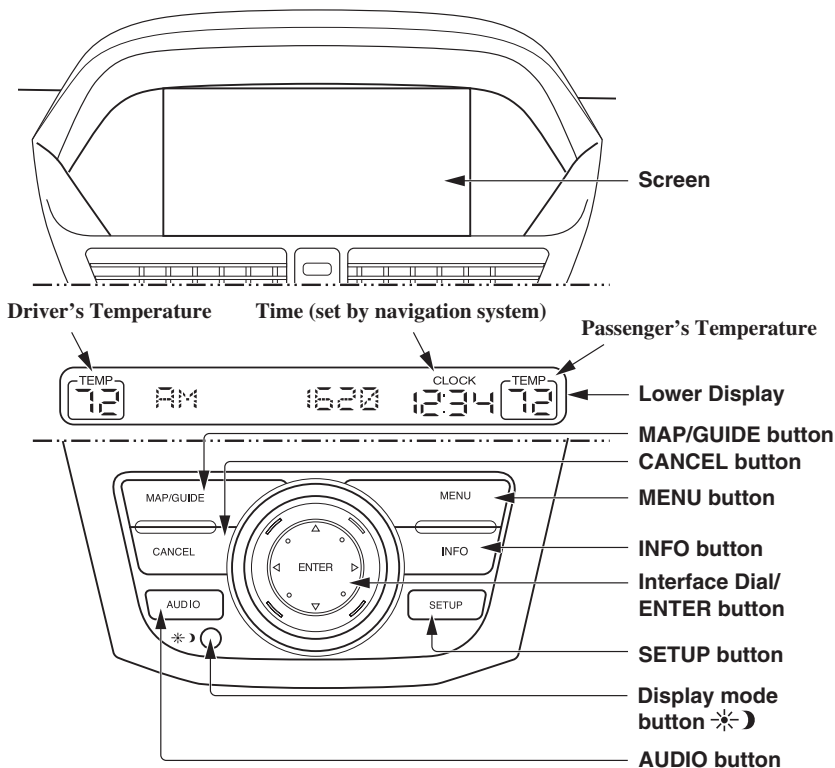

MAP/GUIDE button

Displays the map. When on a route, switches between the map and guidance screens. See page 20 or 54.

CANCEL button

Cancels the current screen and returns to the previous screen display.

NOTE:

The **NAVI BACK** button performs the same basic function.

MENU button

Displays the Enter destination by screen. When on a route, displays the Change route by screen. See page 27.

INFO button

Displays the screen for selecting Message, Voice Command Help, Cellular Phonebook, Map Legend, Calendar, Key to Zagat Ratings, Calculator, and Roadside Assistance. See page 76.

SETUP button

Displays the Setup screens to change and update information in the system. See page 82.

Display mode button

Switches the display between Day mode, Night mode, and OFF. See page 104.

AUDIO button

Press to display the audio screen. For more information on audio system features, see the *Audio* section of the Owner's Manual.

Interface Dial/ENTER button

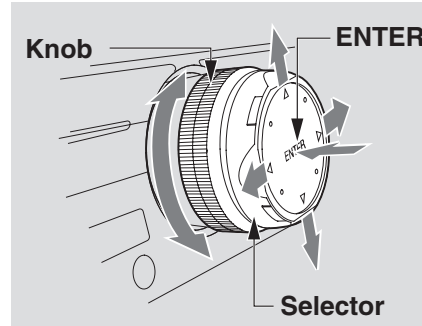

The **Interface Dial** moves left, right, up, and down. Use the **Interface Dial** to look around a displayed map. Moving the **Interface Dial** up or down can also be used to scroll up or down a page in a list. You can also rotate the **Interface Dial knob** to move the highlighting around the display or to scroll through a list. After making a selection in a menu or list, push in on the **Interface Dial (ENTER button)** to enter the selection into the system.

In almost all cases, you can enter a selection into the system by pushing in on the **Interface Dial**.

When you are displaying a map, rotating the **Interface Dial knob** allows you to change the scale. Rotating it clockwise reduces the scale, showing less area with greater detail. Rotating it counterclockwise increases the scale, showing more area with less detail.

Getting Started

Screen

All selections and instructions are displayed on the screen. The Display is not a “touch screen” - you enter information into the system either by voice or by using the **Interface Dial**.

Clean the screen with a soft, damp cloth. You may use a mild cleanser intended for use on liquid crystal displays (LCDs). Harsher chemicals may damage the screen.

NOTE:

Whenever you shift to R (reverse), the rear view is shown on the navigation system screen. See page 107.

Lower Display

Shows a summary of the audio and climate control information, as well as the time. This summary is helpful as a confirmation when adjusting audio or climate by voice.

The audio summary consists of the radio, frequency, and volume.

The climate status consists of the driver’s and passenger’s temperature displays. The time is automatically set by the navigation system. Settings can be adjusted in Setup (see *Clock Adjustment* on page 99).

Voice Control Basics

Your vehicle has a voice control system that allows hands-free operation of most of the navigation system functions. You can also control the audio system and the climate control system. The voice control system uses the **NAVI TALK** and **NAVI BACK** buttons on the steering wheel and a microphone near the map light on the ceiling.

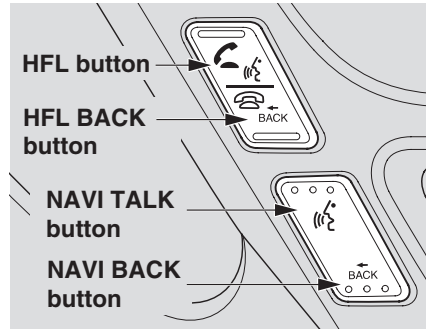

NOTE:

While using the voice control system, all of the speakers (except the RES headphones) are muted.

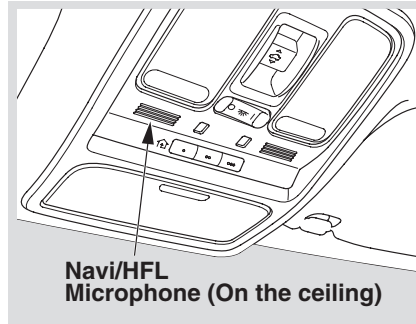

NAVI TALK button

This button activates the voice control system. Press and release it when you want to give a voice command. See *Voice Command Index* on page 140 for a list of voice commands.

NAVI BACK button

This button has the same function as the **CANCEL** button. When you press and release it, the display returns to the previous screen. When the previous screen appears, the system replays the last prompt. This button is enabled for the navigation system commands only. However, it can be used to cancel an audio or climate control voice command up to one second after the command confirmation.

NOTE:

- On the Enter phone number screen, you can delete the entered number entirely by pushing the **NAVI BACK** button.
- The **NAVI TALK** and **NAVI BACK** buttons are deactivated while using the HandsFreeLink feature. See your vehicle Owner's manual and the official web site (www.handsfreelink.com) for information on this system.

Getting Started

Using the Voice Control System

You should use the voice control system as much as possible, and consider manual entry using the **Interface Dial** as a “back-up” method of entry.

Most of the system’s functions can be controlled by voice commands activated with the **NAVI TALK** button. To control your navigation system by voice:

- Press and release the **NAVI TALK** button.
- Wait for the beep.
- Give a voice command.

Once the microphone picks up your command, the system changes the display in response to the command and prompts you for the next command. Using the **NAVI TALK** button, answer the prompts as required.

If the system does not understand a command or you wait too long to give a command, it responds with “Pardon,” “Please repeat,” or “Would you say again.” If the system cannot perform a command or the command is not appropriate for the screen you are on, it sounds a beep.

Anytime you are not sure of what voice commands are available on a screen, you can always say “Help” at any screen. The system can then read the list of commands to you.

When you speak a command, the system generally either repeats the command as a confirmation or asks you for further information. If you do not wish to hear this feedback, you can turn it off. However, hearing the feedback will familiarize you with the way the system expects commands to be phrased. See the **Voice Recognition Feedback** setting in Setup.

If you hear a prompt such as “Please use the Interface Dial to...” or “Please choose an area with the Interface Dial,” the system is asking for input that cannot be performed using the voice control system.

Improving Voice Recognition

To achieve optimum voice recognition, the following guidelines should be followed:

NOTE:

Make sure the correct screen is displayed for the voice command that you are using. See Voice Command Index on page 140.

- Adjust the air flow from both the dashboard and side vents so they do not blow against the microphone on the ceiling. Place your hand over the microphone; if you feel any airflow, adjust the vents.
- Close the windows and the sunroof.
- Higher fan speeds will be automatically lowered during voice recognition operation.

- Press and release the **NAVI TALK** button, wait for the beep, then give a voice command.
- Give a voice command in a clear, natural speaking voice without pausing between words.
- If the system cannot recognize your command because of background noise, speak louder.
- If more than one person is speaking at the same time, the system may misinterpret your command.
- If you are still having trouble with the voice control system, refer to **Voice Command Help** on the Information screen.

Selecting an Item (Button) on the Screen

On most screens, there are items that can be selected (like buttons with titles such as **OK** or **Return**). To select an item on any screen, do one of the following:

- Use the voice control system and say the name of the desired item. Almost all selectable items on the screen, including some listed items, are recognized by the voice control system.
- Move the highlighting to the desired item with the **Interface Dial** or its **knob**, then push in on the **Interface Dial**.

Tip:

If items are grayed out (very dark colored), this means that they cannot be selected.

Selecting an Item in a List

To scroll through a list, do one of the following:

- Rotate the **Interface Dial knob** to scroll one item at a time.
- Use the voice control system to scroll page by page. For example, to scroll up, say, “Up” or “Previous.” To scroll down, say “Next” or “Down.”
- Move the **Interface Dial** up or down to scroll through the list page by page.

If you cannot find the desired name, or have made an error, return to the previous screen by pressing the **CANCEL** or the **NAVI BACK** button.

To select the desired item in the list, do one of the following:

- Use the voice control system, and say the item number of the desired item.
- Rotate the **Interface Dial knob** to move the highlighting to the item, then push in on the **Interface Dial**.

Getting Started

Entering Information

When the system needs input from you, the display changes to a screen similar to the one at the right. You can then use the displayed letters, numbers, or symbols to enter information. You can enter your keyboard input in either of the following ways:

- Say the desired letter, number, or symbol on the screen if you are entering a City Street name.
- Move the highlighting to the desired letter, number, or symbol by rotating the **Interface Dial knob**, then push in on the **Interface Dial**.

Each entered letter will appear at the top of the display. Move the **Interface Dial** right to enter a space between words. If necessary, move it to the left to delete an entry.

When entering an address, the system searches the database for words that match the letters you are entering. As a result, you will notice that some letters are no longer available.

When the system finds only one entry that matches, it completes the name entry for you. If the system finds more than one entry that matches your input, a list of these matches is displayed.

Tip:

*When entering a name of city, street, or place, if you are unsure of the spelling of the name, enter the letters that you are sure of, then move the **Interface Dial** up to select **LIST**. The system will display a list of names that most closely match your input.*

NOTE:

The voice command names that can be used for each letter are shown below. For additional keyboard symbols, see page 156.



Say	Or say "..."	Say	Or say "..."	Say	Or say "..."	Say	Or say "..."
A	Alpha/Apple	H	Hotel/Henry	O	Oscar	V	Victor
B	Bravo/Boy	I	India/Igloo	P	Papa/Paul	W	Whiskey/William
C	Charlie	J	Juliet/John	Q	Quebec/Queen	X	X-Ray
D	Delta/Dog	K	Kilo/King	R	Romeo/Robert	Y	Yankee/Yellow
E	Echo/Edward	L	Lima/Larry	S	Sierra/Sam	Z	Zulu/Zebra
F	Foxtrot/Frank	M	Mike/Mary	T	Tango/Tom	←	Enter
G	Golf/George	N	November/Nancy	U	Uniform/Uncle		

System Start-up

When you turn the ignition to ON (II), it takes several seconds for the navigation system to boot up.

The first screen to appear is the navigation system globe screen. The screen then changes to the Disclaimer screen:

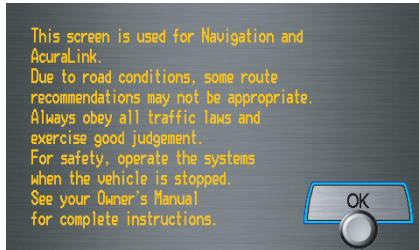

NOTE:

- The **OK** button does not appear immediately. It appears after the software is loaded.
- The  symbol is explained on page 18.

Read this disclaimer carefully so you understand it before continuing. Push in on the **Interface Dial** to select **OK**, and the map screen will appear on the display. The “OK” cannot be activated by voice.

If you do not push in on the **Interface Dial**, the screen will go dark after 30 seconds. To return to the Disclaimer screen, press any navigation or voice control button.

NOTE:

*If you do not select **OK**, and then enter the Setup or Information screens, some items are not available, and will show up as darkened buttons (grayed out). See System Function Diagram on page 26.*

If you have entered any Calendar reminders, they are displayed after you select **OK**.

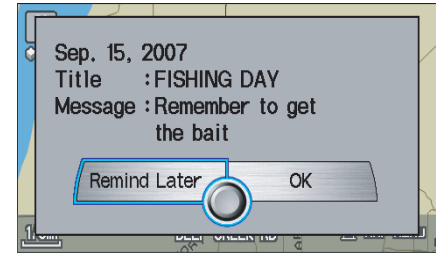

The Calendar reminder screen remains displayed until you select **OK** or **Remind Later** by rotating the **Interface Dial knob** and pushing in on the **Interface Dial**, or press the **CANCEL** button.

If you select **OK** and push in on the **Interface Dial**, the reminder will not show up again. If you wish to have the reminder show up again later in the day, select **Remind Later** and push in on the **Interface Dial**.

Getting Started

If you press the **CANCEL** button, the message will be displayed the next time you start the vehicle.

NOTE:

The system will display the current message and any older or previously unread messages, with the newest message listed first.

HandsFreeLink™

If you have a Bluetooth compatible cell phone that is “paired and turned on,” then **CALL** on the Calculate route to screen is enabled.

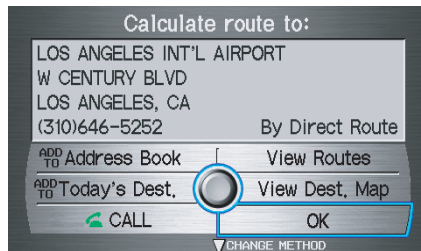

When you select **CALL**, the system dials the number shown on the screen. If **CALL** is not available (grayed out), and your phone is “paired,” then make sure the HFL is not in use; press the **HFL BACK** button.

For more information on HandsFreeLink™, see the vehicle Owner's manual and the official web site (www.handsfreelink.com).

Remote Keyless Entry Setting

When you unlock the door and enter the vehicle, the Multi-Information Display (MID) in the gauge assembly welcomes you with one of the following displays: “Welcome Driver 1,” “Welcome Driver 2,” or just “Welcome.” The vehicle “senses” the driver number, based on which Remote Keyless Entry is used to unlock the vehicle.

NOTE:

- Remote transmitters 1 and 2 are respectively identified on the back with **MEMORY 1** and **MEMORY 2** labels.
- If only “Welcome” is displayed, then all Setup settings revert to factory defaults, and all personal data (such as Address Book or Calendar) are not available.

The navigation system uses the driver number (as recognized by the MID) to personalize the navigation system. For example, if Driver 1 unlocks the vehicle, the “Driver 1” Personal address book and other navigation settings are automatically loaded when the vehicle is started. There is no way to change from one driver’s settings to the others while driving.

Throughout this manual, the icon  is used to indicate features that are dependent on the “Driver number” as displayed on the MID “Welcome” display.

When the Remote Keyless Entry is deliberately “unlinked,” (as when giving the key to a valet) the MID will display “Welcome.” Then the following occurs:

- Some settings (e.g., the “Personal Address Book” and the “Calendar” Information feature), are not selectable (buttons grayed out).
- Setup values (like volume, brightness, etc.) may be changed but are not remembered the next time you restart the vehicle.

NOTE:

The MDX Owner’s Manual has additional information regarding “linking” and “unlinking” for the Remote Keyless Entry.

Getting Started

Map Screen Legend

Map Orientation (see page 61)

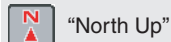

"North Up"



"Heading Up"

GPS Signal Strength



Best Reception



Good Reception

Missing: Poor/No Reception

Vehicle Position (see page 68)

(Use voice command "Display the current location." or use the Interface Dial to show current location.)

Current Street (see page 6)

(see page 6)

Map Scale (see page 60)

(see page 60)

Map Scale Adjustment

(Mile or km per half inch appears only when you zoom in or out by rotating the Interface Dial knob.)

NOTE:

See **Map Legend** on the Information screen for further explanation.



"Breadcrumbs"

(see *Off-road Tracking* on page 67)

Streets

(see *Map Overview* on page 6)
Dark Red: Interstates or Freeways
Black: Verified Streets
Light Brown: Unverified Streets

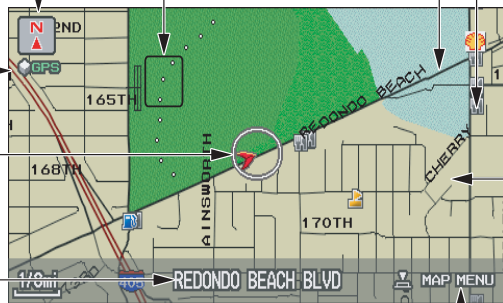

Map Menu

(see page 60)
(Push in on the Interface Dial to view.)

Landmark Icon (see page 62)



Honda Dealer



Hospital



Grocery Store



Gas Station



Hotel/Lodging



Parking Garage



Freeway Exit Information



Acura Dealer



School



Restaurant



ATM



Parking Lot



Post Office

Incident Icon



Accident / Incident (other)



Construction



Weather

Map Features

Dark Green: Park
Light Blue: Hospital
Brown: Shopping Mall
Light Brown: Indian Reservation
Green: Golf Course
Gray: Airport/Stadium/Business
Blue: Body of Water
Blue/Green: Cemetery
Matte Blue: University

NOTE:

If you move the Interface Dial over an area (map features shown above), the name is displayed on the screen.

Map Screen Description

Zoom In/Out

Rotate the **Interface Dial knob** to change the map scale. Zooming in increases the detail, while zooming out gives you a wide area view. After changing the scale, give the system a few moments to update the display.

Map Scrolling

To view other map areas, move the **Interface Dial** left, right, up, or down. The map will shift in that direction. To return the map to your current location, press either the **MAP/GUIDE**, the **CANCEL**, or the **NAVI BACK** button.

The display automatically changes to the map screen when you reach your destination. Press the **MENU** button to return to the Enter destination by screen.

Displaying Current Location

You can see the current address, latitude, longitude and elevation at any time by doing one of the following:

- Use the voice control system and say “Display current location.”
- Push in on the **Interface Dial**, select **Show Icon on Map**, push in on the **Interface Dial** again, and then move the **Interface Dial** left to select the **CURRENT LOCATION**.

The Current location screen will appear on the display.

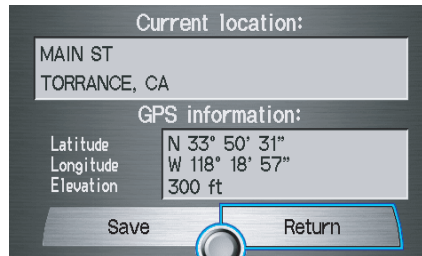

NOTE:

The elevation will not appear when the system is temporarily lacking proper GPS information. The system elevation may not agree with elevations shown on roadside elevation signs, and may fluctuate plus or minus 100 feet or more.

You can save the current location in your Address Book by doing one of the following:

- Use the voice control system and say “Save current position.”
- Push in on the **Interface Dial** and select **Save**, and then push in on the **Interface Dial** again.

Select **Return** to return to the previous screen.



Getting Started

Traffic Display Legend

Viewing Incident Details:

To view the incident details, use the **Interface Dial** to position the cursor (round red circle below) over an incident icon and push in.

Incident Icons

-  Accident / Incident (other)
-  Construction
-  Weather

Incident Icon Update Details:

- Typically M–F, 5:00 AM – 7:00 PM (varies by metropolitan area)
- Continuously updated signal is received.

Map Scale

Traffic flow and incident icons are only displayed for the following scales: 1/2, 1, 2, 5 mile (or 800m, 1600m, 3km, 8km).

NOTE:

When driving to a destination on freeways that have traffic flow data, the route line is used to display moderate and heavy traffic flow status instead of the colored bands on the side of the road. The route line color indicates the following conditions:

- **Free Flow Traffic** - a section of the blue route line will be bordered with a light green line (this may be difficult to see)
- **Moderate Traffic Flow** - a section of the route line will change from blue to orange
- **Heavy Traffic Flow** - a section of the route line will change from blue to red
- **Unknown Traffic Flow** - a section of the route line is blue

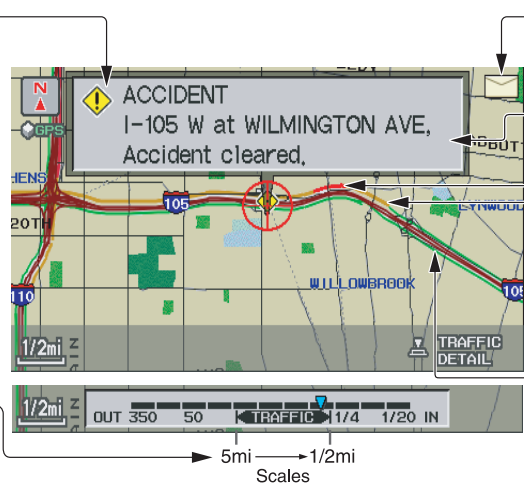

Message Icon

Indicates that you have a message. View messages by pushing in on the **Interface Dial**. See page 75.



Hearing Incident Details:

To have the message read to you, push in on the **Interface Dial** a second time.



To return to current position, say, or select Return.

Traffic Flow Data (using bands parallel to the road)

-  Heavy traffic: 0 – 27 mph (approx.)
-  Moderate traffic: 27 – 52 mph (approx.)
-  Free flow traffic: 52 + mph (approx.)

(shown for both sides of the freeway where available)

Traffic Flow Data Update Details:

- Available 24 hrs a day, 7 days a week
- Continuously updated

Real Time Traffic Display

The navigation screen can display up-to-the-minute traffic information when available including flow (traffic speed), accidents, and construction on freeways in more than 40 major metro areas. See page 126 for a list of the current US cities that offer traffic information.

The display of traffic flow and incidents on your **map** screen is optional and can be turned On/Off by selecting the “Traffic” icon on the Icon bar (see *Showing Icons on the Map* on page 65).

The current metropolitan areas that have traffic coverage can be seen on page 126. For more current metro coverage information, visit www.acura.com/realtimetraffic. This link offers additional information on real-time information, including the following:

- The latest list of metro areas that have Nav-Traffic
- Detailed coverage information for each metro area
- An XM-Nav-Traffic demonstration
- Frequently asked questions (FAQs)

Viewing Flow Data

Traffic flow data is displayed as colored bands on either side of the freeway (see *Traffic Display Legend* on page 22). The different color bands represent the average road speeds as determined by “under-road sensors.”

While driving to your destination on a road, that has traffic flow data, your route line color is used to display the traffic flow data. This means that when the map scale is set to one of the traffic scales (1/2 through 5 mile scale), your blue route line may appear as alternating orange, red or blue segments (see *Traffic Display Legend* on page 22).

NOTE:

A blue route line segment on a freeway can mean one of two things:

- *The under road sensors indicate free flow traffic.*
- *The road has no sensors, and traffic conditions are unknown (they could be congested).*

Getting Started

Naturally, only roads with these sensors will show traffic information. The amount of flow data varies considerably from one city to another. This map display is refreshed continuously. You can only view traffic information in the city where you are located.

NOTE:

- *Traffic flow, and incident icons are only displayed the 1/2, 1, 2, and 5 miles scales (800m, 1600m, 3km, 8km scales)*
- *Not all freeways within a metropolitan area have traffic flow data (colored bands on the side of the freeways) - this is normal, and you cannot assume that a lack of data implies no traffic.*
- *Not all cities have traffic flow information. See cities listed on page 126.*
- *Due to freeway maintenance and construction, traffic flow may be available only for one side of a road, or to be missing entirely for some portion of the freeway.*

- *The displayed traffic flow may disagree with the information from other audio or Internet based traffic displays.*
- *If traffic flow is not showing, verify that the "TRAFFIC" selection for the Icon Bar is ON, and that the icon options for traffic are both ON. (see page 65).*

Viewing Incident Reports

Incident reports appear as small diamond shaped icons (see *Traffic Display Legend* on page 22 for examples). There are three ways to view traffic incidents:

- Selects an incident icon from the map
- By voice control, say "Display traffic incidents."
- Select "Traffic Incidents" from the map menu.

Selecting an Incident Icon from the Map Screen

Zoom in or out so that you are between the 1/2 and 5 mile scales. (The map must be on the 1/2 to 5 mile scales to view the incident icons.) To view the details of a specific incident, use the **Interface Dial** to position the cursor (round red circle) over the incident icon you are interested in. Then push in on the **Interface Dial** to view a pop-up box summary describing the incident. To see and hear the incident details, push in on the **Interface Dial** a second time. To return to your current position map screen, say or select **Return**. To continue viewing incidents in your "scrolled to" location, press the **CANCEL** button.

Listing Traffic Incidents by Voice Control

From the map screen (any scale), say “Display traffic incidents,” or “Display traffic list.” A list of all incidents within the metro traffic area will be displayed. Incidents are listed by distance from your current position outward in all directions. To view an incident details, select an incident from the list, and push in on the **Interface Dial**.



Listing Traffic Incidents from the “Map Menu”

Select **Traffic Incidents** from the Map menu. A list of all incidents within the metro traffic area will be displayed. See *Map Menu* on page 56.

No Traffic within 30 Miles

If you say “Display traffic incidents” or select **Traffic Incidents** but there are no incidents within 30 miles of your current location, the following screen will be displayed.

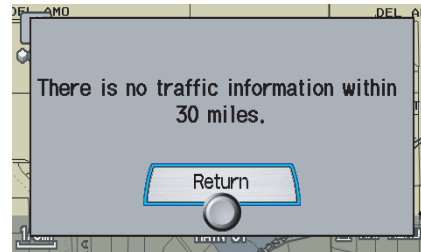

NOTE:

- Incident reports may be displayed on roads that have no traffic flow data available
- Freeway incident reports can lag behind the actual incident, or remain displayed after an incident has cleared. This is normal, and is dependant on the reporting agency, and the speed at which the data is updated.
- The displayed incidents may disagree with the information from other audio or internet based traffic information displays.

Getting Started

System Function Diagram

This diagram shows the navigation system features, starting at the center and working outward in layers. The navigation program starts at “Key ON,” and then displays the globe screen (blue). If **OK** is selected on the Disclaimer screen, the functions in the yellow segments of the diagram become available in the Setup and Information screen. The white segments of the diagram are available anytime, even if you do not select **OK**.

The items above the map screen show various methods to begin driving to your destination (orange). You are provided with map/voice guidance, routing cautions, and a direction list. While driving to your destination, use the voice control system as much as possible to interact with the navigation, audio, and climate control systems (green).

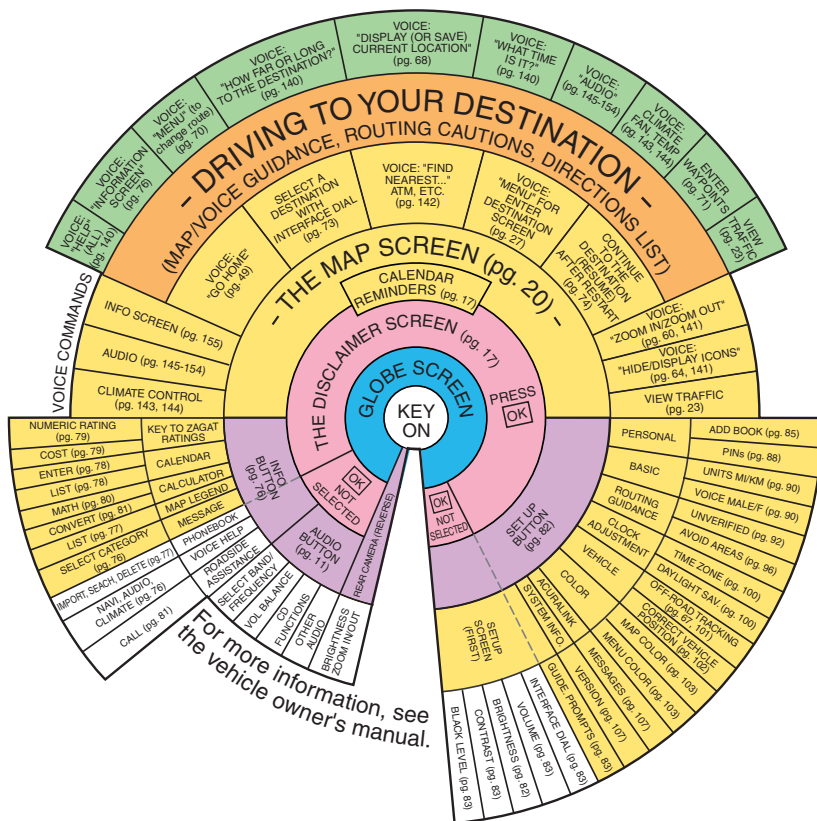

When you press the **MENU** button, the display changes to:



Address (see page 28)

This selection requires you to enter the city (and possibly the state), and the address that you want to go to.

Address Book (see page 32)

This selection allows you to select a stored address. The system can store up to a combined total of 200 Driver 1 and Driver 2 addresses.

Places (see page 33)

The system has been programmed with the locations of many businesses, parks, hospitals, etc. This selection lets you search these by category, name, phone number, or Zagat 2006 (for restaurant).

Intersection (see page 39)

This selection allows you to enter the names of two intersecting streets in a city. This is useful if you know the general location of your destination, but not the exact address.

Previous Destinations (see page 44)

When you enter a destination with any of the available selections (except **Address Book** and **Go Home**), the last 50 destinations are saved by the system. Use this selection to choose a destination again.

NOTE:

*If **Previous Destinations** is grayed out, there is no Previous Destination entered.*

Map Input (see page 45)

This selection allows you to point to a destination on the map using the **Interface Dial**. This allows you to enter a destination or address that may not be listed in the database.

Today's Destinations (see page 47)

You can enter and sort up to five destinations and store them in the Today's Destination list. You can then use the Today's Destinations selection.

NOTE:

*If **Today's Destinations** is grayed out, there is no Today's Destination entered.*

Go Home (see page 49)

This selection allows you to select your home or a common place as a destination.

NOTE:

If you have no home address entered, the system prompts you for one.

Entering a Destination

By Address

After you select **Address** from the Enter destination by screen, the display changes to:



Tip:

- When entering an address by voice, it is more efficient to say the city name first, then the street name.
- When entering an address by the **Interface Dial**, it is usually easier to enter the street first. A city or cities that the street appears in will be displayed. For your convenience, you do not have to enter both city and street.

NOTE:

- If you find that your city is not listed, it may be part of a larger metropolitan area. Try entering the street first.
- Prior to departure, you can set areas to avoid. The system then includes them in its calculations for the destination you have entered. See *Edit Avoid Area* on page 96.

Selecting the State or Province

The state you are in is displayed at the top of the screen. If your desired destination is in another state, select **CHANGE STATE** by moving the **Interface Dial** down.

The display then changes to the **Select a state** screen. Use the voice control system and say the name of the state, or rotate the **Interface Dial knob** to select the state.

Selecting the City

The city you are in is displayed on the screen. If the city you want is displayed on the screen, say “Select current city.” If your desired destination is in another city, say or enter that city.

By Voice Control:

Say “City” on the Find address by screen, and the display changes to the Say city name screen. Say the city name and the searching will begin.



NOTE:

To improve voice recognition, when saying the city name, pronounce the syllables as clearly as possible.

To enter the city name by voice spelling, say or select **CHANGE TO SPELL MODE** on the **Say city name** screen, and the display will change to the **Enter city name** screen.

Say the city name by saying individual letters, one at a time.



The system has a talkback function. If your spoken letter is not recognized, the system will talk back to you. For example, if you say “E” but the system does not recognize the command, it will ask you “Please select the number of the input letter from the list” and the following pop-up box will appear:

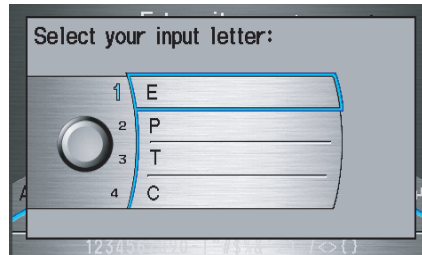

You should select a letter by saying the number.

Alternately, to improve voice recognition, you can say “Echo” or “Edward” instead of “E.” See page 16 for a list of available words for each letter.

By Interface Dial:

This is helpful if the street runs through several cities, and you know what city the street is in. Select **City**, and the display then changes to the **Enter city name** screen. Use the **Interface Dial** to enter the name of the city.

The system will display a list of city names, with the closest match to the name you entered at the top of the list. Select the number (1-6) of the desired city from the list.



Entering a Destination

If the system does not find an exact match, select **LIST** when you finish entering the name of the city. Most of the cities and towns for that state are listed.

Listings of cities and towns in the non-detailed coverage area may have an asterisk "*" next to their names. If you select one, no detailed street data is available, and an address cannot be entered. Try entering the street first, and then select the city if available.

Select **View Dest. Map** and use the **Interface Dial** to select an icon, approximate area, or street you wish to choose as your destination. Otherwise, a central location of the city will be selected. If you select a point of interest (POI) or road in an unverified area, you may or may not have routing in these areas. See *Map Overview* on page 6.

Selecting the Street

By Voice Control:

After you have selected the city, or if you say "Street" on the Find address by screen, the display changes to the Say street name screen. Say the street name and the searching will begin.

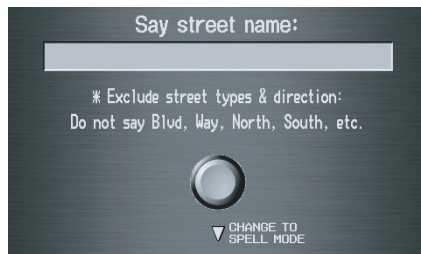

To enter the street name by voice spelling, say or select **CHANGE TO SPELL MODE** on the Say street name screen, and the display will change to the Enter street name screen.

Say the street name by saying individual letters or numbers, or words that represent the letters, one at a time.



The system has a talkback function. If your spoken letter is not recognized, the system will talk back to you. For example, if you say “E” but the system does not recognize the command, it will ask you “Please select the number of the input letter from the list” and the following pop-up box will appear:

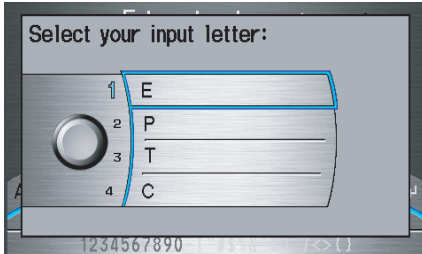

You should select a letter by saying the number.

Alternately, to improve voice recognition, you can say “Echo” or “Edward” instead of “E.” See page 16 for a list of available words for each letter.

By Interface Dial:

After you have selected the city, or if you selected **Street** in the beginning, the display changes to the **Enter street name** screen. Use the **Interface Dial** to enter the name of the street (like ELM or 42ND) that is your destination.

To enter the name of a major highway, you must use the full name, including a hyphen. For interstates, use an “I” (I-10). For U.S. highways, use US (US-18). For state highways, use the two character state designation (CA-101). For county roads, use the appropriate designation (G-2, for example).

Tip:

When entering a street, you do not need to enter the direction (N, S, E, W) or the type (St, Ave, etc.). The system will automatically determine that for you, based on your entered city and street number.

The system will display a list of street names, with the closest match to the name you entered at the top of the list. Select the number (1-6) of the desired street from the list.



Entering a Destination

Entering the Street Number

After you have completed the street name, the display changes to the **Enter street number** screen. Use the voice control system and say the address number as a continuous string of numbers. For example, the address 1527 should be spoken as “One, five, two, seven.” You can also use the **Interface Dial** to enter the street number.

If you try to enter a number outside that range using the voice control system, you will hear beeps. The system displays the acceptable address range.

If you did not select a city in the beginning, the street name you selected might appear in more than one city. The system will give you a list of cities that the street appears in. Select the desired city from the list. The system then displays the **Calculate route** to screen (see *Driving to Your Destination* on page 50).

Tip:

*If the particular address you want cannot be found, select **Map Input** on the **Enter destination by screen** and use the **Interface Dial** to select the appropriate location on the map (see *Map Input* on page 45).*

Select **View Dest. Map** and use the **Interface Dial** to select an icon, approximate area, or street you wish to choose as your destination. Otherwise, a central location of the street will be selected. If you select a point of interest (POI) or road in an unverified area, you may or may not have routing in these areas. See *Map Overview* on page 6.

By Address Book

This selection allows you to choose a personal address entry for a destination. After you select **Address Book** from the **Enter destination by screen**, the display changes to:

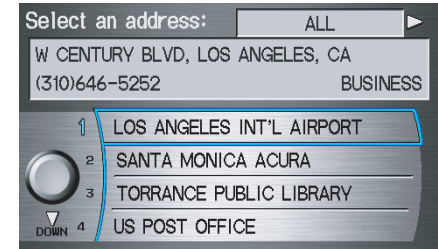

If you have entered a PIN Number in Setup, the system prompts you to enter your PIN.

The system then displays a list of the places entered in your personal Address Book. You can sort the displayed addresses by Category: **ALL**, **BUSINESS**, **PERSONAL**, or by other categories you may create.

Scroll through the list to find your desired destination. After you select it, the system then displays the **Calculate route** to screen (see *Driving to Your Destination* on page 50).

Adding Addresses to the Personal Address Book

There are two ways to enter addresses to the personal Address Book:

- Entering them in the personal Address Book feature in Setup (See page 85).
- Adding them in the Address Book directly from the **Calculate route** to screen (See page 50).

NOTE:

- *Destinations chosen from the Address Book do not show up in Previous Destinations.*
- *Prior to departure, you can set areas to avoid. The system then includes them in its calculations for the destination you have entered. See Edit Avoid Area on page 96.*
- *For information on the available voice commands, see Voice Command Index on page 140.*

By Places

After you select **Places** from the **Enter destination by** screen, the display changes to:



There are four ways to find a place or point of interest (POI), by **Category**, **Name**, **Phone Number**, or **ZAGAT 2006**.

Let's assume you want to find a coffee shop (restaurant) called "Bucks."

- If you know the phone number of the coffee shop, select **Phone Number**, then enter the 10-digit number with area code. This is the quickest way to find it.

- The second best method is to select **Category**, then **Restaurant**, and enter the keyword "Bucks." The list will include all restaurants that have the letters "bucks" anywhere in the name.
- You can try to enter "Bucks" using **Name**, but you may have to search through a list that might include Bucks Welding, Bucks Surplus, etc.

NOTE:

- *Prior to departure, you can set areas to avoid. The system then includes them in its calculations for the destination you have entered. See Edit Avoid Area on page 96.*
- *You can enter the desired destination using the voice control system. For information on the available voice commands, see Voice Command Index on page 140.*

Entering a Destination

Finding the Place by Category

The **Category** option gives you a list of categories or types of businesses to select from with the following screen:



Tip:

If you are not sure of the spelling of a place, the best way to find it is to use the keyword search. Select **Category**, choose a category and subcategory from the menus, then select **Place Name by Keyword**, and enter the partial name.

Auto Service

The subcategories are: Acura Dealers, Honda Dealers, Gas Stations, etc.

Banking

The subcategories are: ATM, Bank, etc.

Community

The subcategories are: City Hall, Civic/Community Center, Convention/Exhibition Center, Court House, Higher Education, Library, Post Office, and School, etc.

Emergency

The subcategories are: Hospital, Police Station, Roadside Assistance, etc.

Lodging

The subcategories are: Bed & Breakfast, Hotel/Motel, etc.

Leisure

The subcategories are: Amusement Park, Golf Course, Historical Monument, Marina, Movie Theater, Museum, Park/Recreation Area, Performing Arts, Sports Complex, and Tourist Attraction.

Restaurant

This category is broken down into types of food, giving you a selection by each type: All Types, American, French, Japanese, etc.

The ZAGAT SURVEY for some restaurants is available in the system. See the Information screen, “Key to Zagat Ratings” for an explanation of these ratings (see page 79).



On the Select a place screen, restaurants with a Zagat Rating have a “Z” icon at the end of the line. To list only restaurants with Zagat Reviews, say or select **ZAGAT 2006**. You can view the complete Zagat Review for a selected restaurant by selecting the “Z” icon.

By voice, select the “Z” icon by saying “Zagat list number X” (where x is the line number 1-3). Alternately use the **Interface Dial** to first select the line item, and push the dial to the right to view the survey.

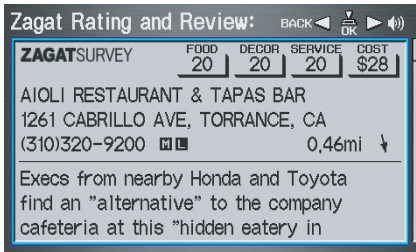

Say “Read List” or move the **Interface Dial** right, and the review will be read to you. Say **OK** or push in on the **Interface Dial** to display the Calculate route to screen. See *Key to Zagat Ratings* on page 79 for details on the key to ratings.

Tip:

When trying to find a specific restaurant, select the category “All Types.” Some restaurants may be miscategorized.

Shopping (Retail)

The subcategories are: All Shopping, Accessories/Jewellery, Auto Parts & Electronics, Books/Music/Video, Clothing, Groceries, Home Improvement, Mall/Department Store, Office Supplies/Electronics, Pharmacy/Drug Store, Pet Food/Supplies, Sewing/Linen, Shoes/Bags, Sporting Goods, and Toys/Arts/Crafts.

Tip:

When trying to find a specific shopping store, select the category “All Shopping.” Some stores may not be in the right category.

Travel

The subcategories are: Airport, Automobile Club, Bed & Breakfast, Bus Station, Camping, Commuter Rail Station, Ferry Terminal, Hotel/Motel, Named Place, Park & Ride, Parking Garage/House, Parking Lot, Rental Car Agency, Resort, Rest Area, Ski Area, Tourist Attraction, Tourist Information, Train Station, Travel Agency, Track Stop/Plaza.

Advanced (Wholesale and Misc. Retail)

If you do not find the category or subcategory you need in the other options, you can find the categories with a keyword. When you select this option, the display changes to the Enter keyword for category screen. Enter the keyword using the **Interface Dial**.

When the system finds the categories with the keyword you entered, the display changes to the Select a category screen. Select the desired category.

Entering a Destination

After selecting a category, the system will give you the options of **Place Name by Keyword**, **Sort by Distance to Travel**, **City Vicinity**, or **Place Name**.

With the following screen:

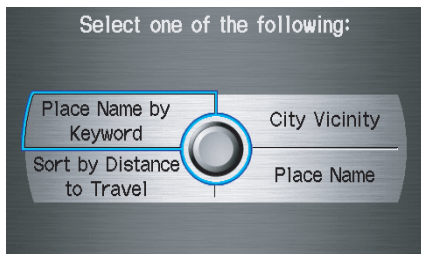

Place Name by Keyword

If you do not know the exact name of the destination, you can find the place with a keyword. When you select this option, the display changes to:



You can find your destination with keyword using the **Sort by Distance to Travel** option or **City Vicinity** option.

If you select the **Sort by Distance to Travel** option, the Enter keyword for place screen appears. Enter the keyword using the **Interface Dial**. If the system does not find an exact match, select **LIST** when you finish entering the keyword. The system starts searching for places that match the entered keyword. If you see your desired place, select it from the list. If not, scroll through the list to find the desired place.

If you select the **City Vicinity** option, the Enter city name screen appears. Enter the name of the city using the **Interface Dial**. The system will display a list of city names, with the closest match to the name you entered at the top of the list. Select your desired city name from the list. Once you have selected your desired city name, the Enter keyword for place screen appears. Enter the keyword using the **Interface Dial** to specify the desired place.

Once you select a place, the system then displays the Calculate route to screen (see *Driving to Your Destination* on page 50).

Sort by Distance to Travel

When you select this option, the system gives you a list of all the places in the subcategory. This list is arranged by distance from your current location, with the closest at the top of the list.

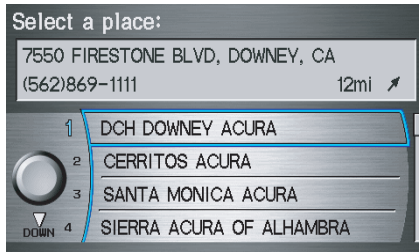

The distance and direction to the destination at the top of the list are shown in the screen. The distance shown is straight line distance (as the crow flies), not driving distance. Say or select the number (1-4) of the desired destination from the list.

Once you select a place, the system then displays the **Calculate route** to screen (see *Driving to Your Destination* on page 50).

City Vicinity

The system allows you to find points of interest in the vicinity of the city you entered. When you select this option, the display changes to **Enter city name** screen. Enter the name of the city using the **Interface Dial**. If the system does not find an exact match, select **LIST** when you finish entering the name of the city. Select a desired city from the list.

Once you have selected the city, the display changes to **Enter a place name** screen. Enter the name of the place using the **Interface Dial**.

Once you select a place, the system then displays the **Calculate route** to screen (see *Driving to Your Destination* on page 50).

Place Name

When you select this option, the display changes to **Enter a place name** screen. Enter your selection using the **Interface Dial**.

Once you select a place, the system then displays the **Calculate route** to screen (see *Driving to Your Destination* on page 50).

Entering a Destination

Finding the Place by Name

The **Name** option allows you to enter the name of a business, and then shows you a list of businesses with the same or similar names to select from. Use the name option only if you know the exact spelling of the place. If unsure, use the **Category** option.

Finding the Place by Phone Number

The **Phone Number** option allows you to select a destination by its telephone number. Only telephone numbers stored in the system under the **Places** (of business) option are recognized. The system does not contain residential telephone numbers, or numbers you may have entered in your personal Address Book.

Tip:

If you know the phone number of a point of interest (POI), its uniqueness makes it the fastest entry method. When using the voice control system, the entry should be spoken as a continuous string of numbers. For example, the telephone number (310) 555-4000 should be spoken as “Three, one, zero, five, five, five, four, zero, zero, zero.”

Finding the Place by Zagat 2006

The **ZAGAT 2006** option allows you to find a restaurant by the Zagat Rating information.

The system lets you select several items (such as metro area, region, and neighborhood) to search the restaurant you like. When you select a type of food, the following display appears:



Name - When you select **Name**, the restaurants will be listed by alphabetical order.

Food, Decor, Service - When you select **Food**, **Decor**, or **Service**, the restaurant will be listed by rating value.

Cost - When you select **Cost**, the restaurant will be listed by the average cost of a meal (including drink and tip).

When you select a sorting method, the list of restaurants will appear.

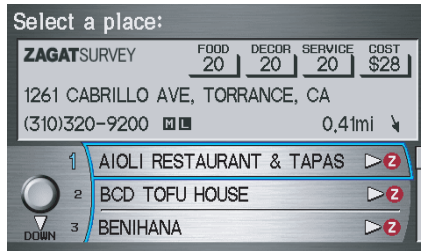

You can see the survey for a listed item by moving the dial to the right, or by saying “Zagat list number X” (where X is the number 1-3).

Once you select a restaurant, the system then displays the **Calculate route** to screen (see *Driving to Your Destination* on page 50).

NOTE

See *Key to Zagat Ratings* on page 79 for details on the key to ratings.

By Intersection

After you select **Intersection** from the **Enter destination** by screen, the display changes to:



Tip:

When entering an address, it is usually easier to enter the street first. A city or cities that the street appears in will be displayed. For your convenience, you do not have to enter both city and street.

NOTE:

- If you find that your city is not listed, it may be part of a larger metropolitan area. Try entering the street first.
- Prior to departure, you can set areas to avoid. The system then includes them in its calculations for the destination you have entered. See *Edit Avoid Area* on page 96.

Selecting the State or Province

The state you are in is displayed at the top of the screen. If your desired destination is in another state, select **CHANGE STATE** by moving the **Interface Dial** down.

The display then changes to the **Select a state** screen. Use the voice control system and say the name of the state, or rotate the **Interface Dial knob** to select the state.

Entering a Destination

Selecting the City

This is helpful if the street runs through several cities, and you know what city includes the street. The city you are in is displayed on the screen. If the city you want is displayed on the screen, say “Select current city.” If your desired destination is in another city, say or select another city.

By Voice Control:

Say “City” on the Find intersection by screen, and the display changes to the Say city name screen. Say the city name and searching will begin.



To enter the city name by voice spelling, say or select **CHANGE TO SPELL MODE** on the Say city name screen, and the display will change to the Enter city name screen.

Say the city name by saying individual letters, or words that represents the letters, one at a time.



The system has a talkback function. If your spoken letter is not recognized, the system will talk back to you. For example, if you say “E” but the system does not recognize the command, it will ask you “Please select the number of the input letter from the list” and the following pop-up box will appear:

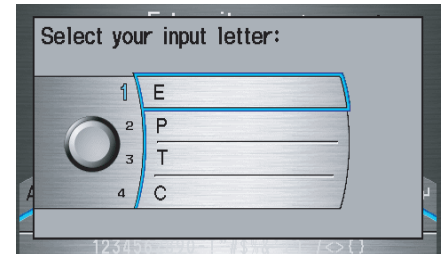

You should select a letter by saying the number.

Alternately, to improve voice recognition, you can say “Echo” or “Edward” instead of “E.” See page 16 for a list of available words for each letter.

By Interface Dial:

Select **City**, and the display then changes to the **Enter city name** screen. Use the **Interface Dial** to enter the name of the city.

The system will display a list of city names, with the closest match to the name you entered at the top of the list. Select the number (1-6) of the desired city from the list.



If the system does not find an exact match, select **LIST** when you finish entering the name of the city. Most of the cities and towns for that state are listed.

Listings of cities and towns in the non-detailed coverage area may have an asterisk "*" next to their names. If you select one, no detail street data is available, and an address cannot be entered. See *Map Coverage* on page 118.

Select **View Dest. Map** and use the **Interface Dial** to select an icon, approximate area, or street you wish to choose as your destination. Otherwise, a central location of the city will be selected. If you select a point of interest (POI) or road in an unverified area, you may or may not have routing in these areas. See *Map Overview* on page 6

Selecting the Street

By Voice Control:

After you have selected the city, or if you say "Street" on the Find intersection by screen, the display changes to the **Say street name** screen. Say the street name and the searching will begin.



To enter the street name by voice spelling, say or select **CHANGE TO SPELL MODE** on the **Say street name** screen, and the display will change to the **Enter street name** screen.

Entering a Destination

Say the street name by saying individual letters or numbers, or words that represents the letters, one at a time.



After you have completed the first name, the display changes to the **Say intersecting street** screen. Say the name of the other intersecting street.

The system has a talk back function. If your spoken letter is not recognized, the system will talk back to you. For example, if you say “E” but the system does not recognize the command, it will ask you “Please select the number of the input letter from the list” and the following pop-up box will appear:

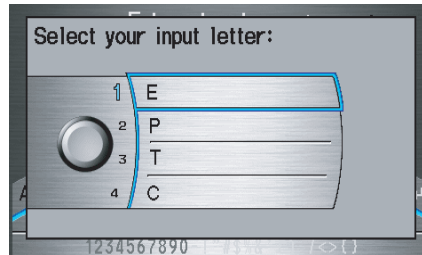

You should select a letter by saying the number.

Alternately, to improve voice recognition, you can say “Echo” or “Edward” instead of “E.” See page 16 for a list of available words for each letter.

By Interface Dial:

After you have selected the city, or if you select **Street** in the beginning, the display changes to the **Enter street name** screen. Use the **Interface Dial** to enter one of the names (like ELM or 42ND) of the intersecting streets.

To enter the name of a major highway, you must use the full name, including a hyphen. For interstates, use an “I” (I-10). For U.S. highways, use US (US-18). For state highways, use the two character state designation (CA-101). For county roads, use the appropriate designation (G-2, for example).

Tip:

When entering a street, you do not need to enter the direction (N, S, E, W) or the type (St, Ave, etc.). The system will automatically determine that for you.

The system will display a list of street names, with the closest match to the name you entered at the top of the list. Select the number (1-6) of the desired street from the list.



After you have completed the first street name, the display changes to the **Enter intersecting street** screen. Enter the name of the other intersecting street by saying the item number, or selecting the item number using the **Interface Dial**.

If you did not select a city in the beginning, and the intersection appears in more than one city, you will see the **Select a city** screen. The system will give you a list of cities that the intersection appears in. Select the desired city from the list. If more than one intersection appears in the city, select the desired intersection from the **Select an intersection** screen. The system then displays the **Calculate route** to screen (see *Driving to Your Destination* on page 50).

Tip:

*If the particular intersection you want cannot be found, select **Map Input** and use the **Interface Dial** to select the appropriate location on the map (see *By Map Input* on page 45).*

Select **View Dest. Map** and use the **Interface Dial** to select an icon, approximate area, or street you wish to choose as your destination. Otherwise, a central location of the street will be selected. If you select a point of interest (POI) or road in an unverified area, you may or may not have routing in these areas. See *Map Overview* on page 6.

Entering a Destination

By Previous Destinations

Every time you route to a destination, that destination is saved by the system. Up to 50 destinations can be stored. Select **Previous Destinations** from the Enter destination by screen to choose one of those destinations.

After you select **Previous Destinations**, the display lists the last 50 destinations entered, with the most recent appearing first.



NOTE:

- *If **Previous Destinations** is grayed out, there is no Previous Destination entered.*
- *When finishing a “Today’s Destinations” trip, the Today’s Destination list entries are stored to this list, beginning with the date (e.g., item 1 shown above).*
- *Because both the Home and personal Address Book list can be protected by a PIN, they do not show up in the previous destination list.*

Scroll through the list and say the line number (1-6) of the destination, or select the desired destination you want.

Once you select the desired destination, the system then displays the **Calculate route to screen** (see *Driving to Your Destination* on page 50).

NOTE:

- *Prior to departure, you can set areas to avoid. The system then includes them in its calculations for the destination you have entered. See *Edit Avoid Area* on page 96.*
- *For information on the available voice commands, see *Voice Command Index* on page 140.*

By Map Input

After you select **Map Input** from the Enter destination by screen, the display changes to:

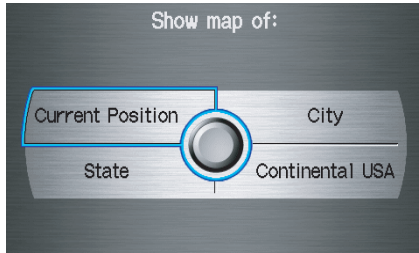

NOTE:

- Prior to departure, you can set areas to avoid. The system then includes them in its calculations for the destination you have entered. See *Edit Avoid Area on page 96*.
- For information on the available voice commands, see *Voice Command Index on page 140*.

Showing the Map of Current Position

The **Current Position** selection assumes that you are looking for a destination in the immediate area. The display changes to:

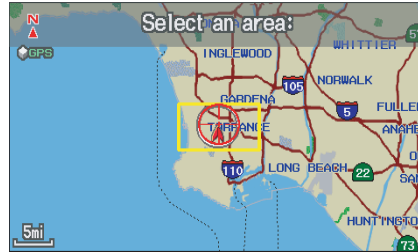

The red arrow indicates your vehicle position. Find your desired destination by moving the **Interface Dial** left, right, up, or down. The map and cross hairs will move in the same direction.

If desired, rotate the **Interface Dial knob** to change the map scale. When you have the cross hairs on the desired icon, map feature, or road. Then push in on the **Interface Dial**. The address of the road segment will appear at the top of the screen.

The yellow box indicates the area you will see when you click on the current map with the Interface Dial.

NOTE:

The address of the road segment will be displayed on the 1/20, 1/8, 1/4, or 1/2 mile (80, 200, 400, or 800 m) scale map.

If this is the desired destination, push in on the **Interface Dial** again. If not, use the **Interface Dial** to reposition the cross hairs, then push in on the **Interface Dial** again to display the new address.

Once you select an address, the system then displays the **Calculate route** to screen (see *Driving to Your Destination on page 50*).

Entering a Destination

Showing the Map of City

With the **City** selection, the display changes to the Enter city name screen.

When you have entered the desired city, the display changes to a map. The starting location will be the central position in the selected city.

See *Showing the Map of Current Position* on page 45 for instructions on finding and entering your desired destination.

Showing the Map of State

With the **State** selection, the display changes to the Select a state screen.

After you select the desired state, the display changes to a map of the state, with the cross hairs located near the middle.



Use the **Interface Dial** to move the cross hairs to the area of the state close to your intended destination. If desired, rotate the **Interface Dial knob** to change the map scale. When you have the cross hairs in the desired area, push in on the **Interface Dial**. The map scale changes to a closer view.

Move the cross hairs to the desired destination, then push in on the **Interface Dial**. The address of the location you have selected will appear at the top of the screen.

The yellow box indicates the area you will see when you click on the current map with the Interface Dial.

NOTE:

The address of the location will be displayed on the 1/20, 1/8, 1/4, or 1/2 mile (80, 200, 400, or 800 m) scale map.

If this is the desired address, push in on the **Interface Dial** again. If not, use the **Interface Dial** to reposition the cross hairs, then push in on the **Interface Dial** again to display the new address.

Once you select an address, the system then displays the **Calculate route** to screen (see *Driving to Your Destination* on page 50).

Showing the Map of Continental USA

With the **Continental USA** selection, the display changes to:



Use the **Interface Dial** to move the cross hairs to the area of the country close to your intended destination. Then push in on the **Interface Dial**. The map scale changes to display a closer view of the area you selected.

If desired, rotate the **Interface Dial knob** to change the map scale. Use the **Interface Dial** to move the cross hairs on the desired icon, map feature, or road, then push in on the **Interface Dial**. The address of the location you have selected will appear at the top of the screen.

The yellow box indicates the area you will see when you click on the current map with the Interface Dial.

NOTE:

The address of the location will be displayed on the 1/20, 1/8, 1/4, or 1/2 mile (80, 200, 400, or 800 m) scale map.

If this is the desired address, push in on the **Interface Dial** again. If not, use the **Interface Dial** to reposition the cross hairs, then push in on the **Interface Dial** again to display the new address.

Once you select an address, the system then displays the **Calculate route** to screen (see *Driving to Your Destination* on page 50).

By Today's Destinations

You can create a "trip" by combining multiple destinations previously selected on the Calculate route to screen.

Select **Today's Destinations** from the Enter destination by screen and the display changes to:

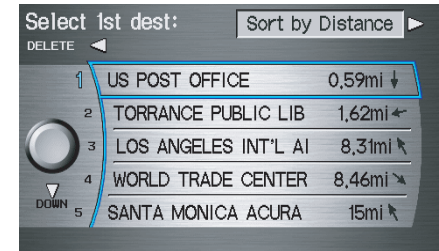

NOTE:

*If **Today's Destinations** is grayed out, there is no Today's Destination entered.*

Entering a Destination

Editing Today's Destination List

If you change your plans, you can modify the Today's Destination list order by distance, or by order of entry.

Say or select **Sort by Entry** to sort the list by the entry order, and say or select **Sort by Distance** to sort the list by the distance order. To delete a destination, say or select **DELETE** and the display changes to **Select a destination to delete** screen. Select the destination to delete. Say or select **DONE** to perform the deletion, and the display returns to the previous screen. To cancel the deletion, press the **CANCEL** button.

NOTE:

For information on the available voice commands, see *Voice Command Index* on page 140.

Adding Destinations to the List

After you have used any of the other selections from the **Enter destination** by screen to select a destination, the display changes to:

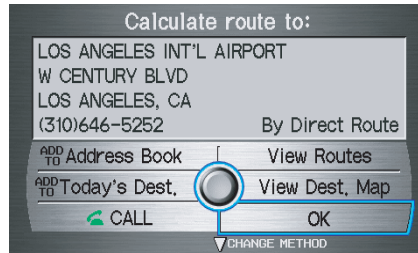

To add this to the Today's Destination list, select **ADD TO Today's Dest.**

NOTE:

If **ADD TO Today's Dest.** is grayed out, you already have the maximum numbered (5) of today's destinations entered.

The display then changes to show you all the current entries on the Today's Destination list. Select **DONE** to return to the **Enter destination** by screen.

The system automatically sorts the destinations stored in the Today's Destination list for the best path.

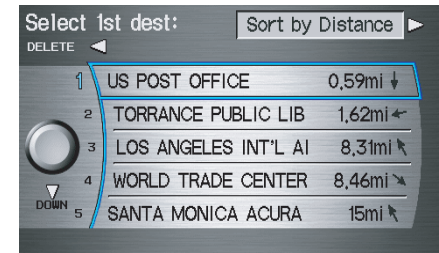

If the displayed list shows your plans, select the first destination. The system will guide you to the destination according to the order of the list. When you reach the destination, it will be automatically removed from the list.

NOTE:

When finishing a “Today’s Destinations” trip, the Today’s Destination list entries are stored to the Previous Destination list, beginning with the date (e.g., item 1 shown below). This entry contains all the destinations that were included in the Today’s Destinations itinerary. This allows you to re-select the entire Today’s Destinations content at a later date.



By Go Home

Selecting **Go Home** from the Enter destination by screen takes you home or to a frequently used address you have chosen. The displayed address will correspond to which Remote Keyless Entry (Driver 1, Driver 2) is being used.

If a **PIN Number** has been set, the system prompts you to enter your PIN. Say or enter your PIN, and say or select **DONE**. The system will then display the Calculate route to screen (see *Driving to Your Destination* on page 50).

If a **PIN Number** has not been set, the system displays the Calculate route to screen after you select **Go Home** (see *Driving to Your Destination* on page 50).

NOTE:

- To edit Home Address, see Home Address in System Set-up on page 88.
- Prior to departure, you can set areas to avoid. The system then includes them in its calculations for the destination you have entered. See Edit Avoid Area on page 96.
- PINs are optional. If you choose to use a PIN, make sure you remember it. If you forget your PIN, your dealer will have to reset it for you.
- If a PIN is desired, enter it using the Personal preference PIN number feature in Setup.

Driving to Your Destination

Driving to Your Destination

A route typically has three phases.

- Initial route calculation (Calculate route to screen) (see page 50)
- Change the route while en route (see page 70).
- Resume the route when restarting the engine (see *Continue Trip Screen* on page 74).

Calculate Route to Screen

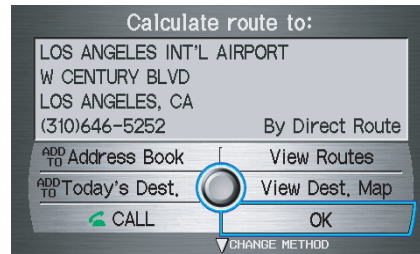

Say or select **OK**. The system calculates the route using the method shown on the screen (see *Map Screen* on page 53).

NOTE:

- Prior to departure, you can set areas to avoid. The system then includes them in its calculations for the destination you have entered. See *Edit Avoid Area* on page 96.
- For information on the available voice commands, see *Voice Command Index* on page 140

Further selections from the Calculate route to screen include:

ADD TO Address Book

Allows you to add the destination to your Address Book. See *By Address Book* on page 32.

NOTE:

If the button is grayed out, the destination is already in your Address Book.

ADD TO Today's Destinations

Allows you to add the destination to your Today's Destination list. See *By Today's Destinations* on page 47.

NOTE:

If the button is grayed out, the Today's Destination list is already full (five destinations have been stored).

CALL

Dials the number on the screen when available. See *HandsFreeLink™* on page 18.

Changing the Routing Method

The system lets you select the way you want to drive to your destination. Select **CHANGE METHOD** by moving the **Interface Dial** down.

The following methods are available to change after you have set a destination: While on a map screen, press the **MENU** button. The Change route by screen will be displayed. Say or select **Change Routing Method**, and the screen change to:

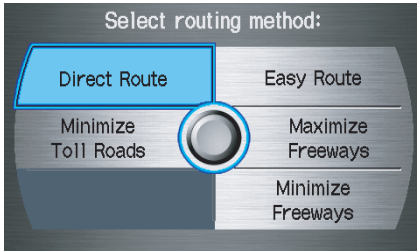

- "Direct Route" (the factory default) is the route that is the quickest (least time) and is usually the best choice. If you choose any other method, it becomes the new default for all future routing. Make sure to check the routing method if the displayed route is not what you expected to see.

NOTE:

- "Easy Route" produces a route with the least turns.
- "Maximize Freeways", "Minimize Freeways", and "Minimize Toll Roads" are also available.

NOTE:

If the trip is greater than 100 miles, then "Minimize Freeways" and "Minimize Toll Roads" may be grayed out. This is normal.

The generated route may not be the route you would choose. For safety reasons, the system generally applies the following rules to your route:

- It tries to avoid "short cuts" through residential areas.
- Right turns are favored over left turns or U-turns.
- Restricted turns (turns that cannot be made during certain hours), are not used for routing during any time of the day.

Viewing the Routes

Selecting **View Routes** allows you to scroll through and view the various routes (Direct, Easy, Maximize Freeways, etc.) to your destination. If you select **View Routes**, the display changes to:

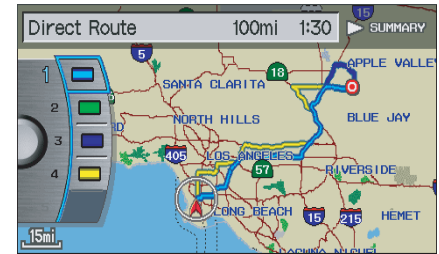

You can change the method for calculating the route by using the **Interface Dial**. The system will display another calculated route.

Driving to Your Destination

NOTE:

- It may take several minutes (the system displays an hour glass while it is calculating) to show all route methods, and it is not unusual for the different methods to pick the same route. Voice commands cannot be used while the system is calculating.
- If the trip is greater than 100 miles, then “Minimize Toll Roads” and “Minimize Freeways” may be grayed out. This is normal.
- Zoom IN/OUT to view route details or traffic conditions is not available on this screen. After you choose a “route method,” you can then zoom in or out on the map screen to view your route in detail.

Say or select **SUMMARY** to display the distance and time to go for each route. Based on the summary data, you can change the routing method by rotating the **Interface Dial knob**. Once you confirm your selection, say the number of the desired routing method or push in on the **Interface Dial**.

NOTE:

Distances and times show for each method in the Summary are approximate.

After calculating the route with the new method, the system displays a map of your current location. The calculated route will be highlighted as a blue line, and a voice prompt will tell you how to proceed along the highlighted route. Push in on the **Interface Dial** and select **Voice** to have the guidance repeated.

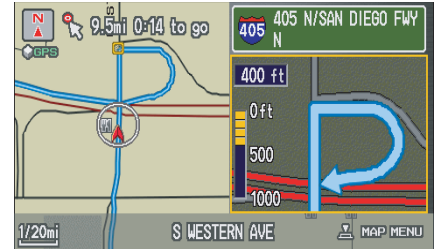

Viewing the Destination Map

Selecting **View Dest. Map** displays a map of the destination vicinity. Press the **CANCEL** or **NAVI BACK** button to return. You can view the destination map anytime while on route saying “Display destination map.”

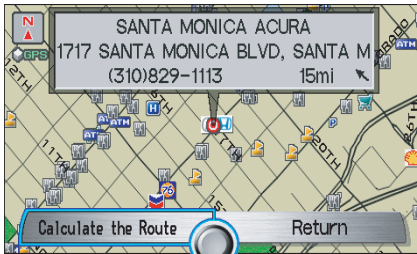

Map Screen

When you select **OK** on the Calculate route to screen, the map screen appears, showing your highlighted route in real time.

Route Line

When driving to a destination on verified roads in a metropolitan area, the route line is displayed as a blue line. When driving in rural areas on unverified streets (light brown color), the route line changes to either a blue dotted “vector line” pointing to your destination, or a blue-pink line. See *Unverified Area Routing* on page 92 for a detailed explanation of how to enable unverified routing, and the related cautions and disclaimers.

NOTE:

- You can always view the entire route by simply saying, “Display entire route.”
- When your route line uses streets that display traffic information, the route line may consist of orange or red segments. This is normal. See *Traffic Display Legend* on page 22, and *Viewing Flow Data* on page 23.



“Vector line” (unverified routing off)

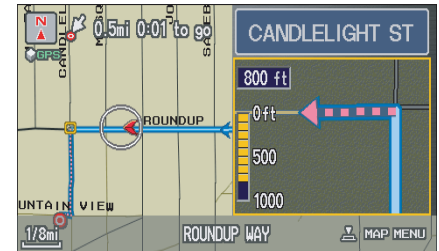

Blue-pink unverified route line (unverified routing on)

Driving to Your Destination

Map Screen Legend

Map Orientation

(see page 61)

Streets

(see *Map Overview* on page 83, or *Unverified Area Routing* on page 92)

Dark Red: Interstates or Freeways

Black: Verified Street

Light Brown: Unverified Street

"Breadcrumbs"

(see page 67)

Vehicle Position

(see page 68)

Current Street

(see page 68)

Map Scale

(see page 60)

Map Scale Adjustment

(Mile or km per half inch appears only when you zoom in or out by rotating the **Interface Dial knob.**) (see page 60)

Direction of Destination

(when on route) (see page 56)

Distance to Destination

(see page 56)

Time to Destination

(see page 56)

Waypoints

(see page 71)

Blue Line

Calculated route

Landmark Icon

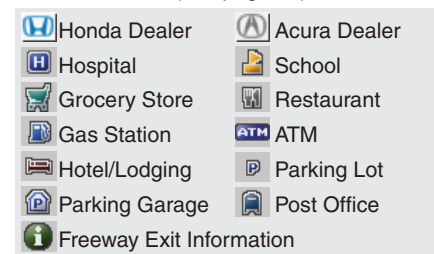

Destination Icon

(see page 62)

Map Features

Dark Green: Park

Light Blue: Hospital

Brown: Shopping Mall

Light Brown: Indian Reservation

Green: Golf Course

Gray: Airport/Stadium/Business

Blue: Body of Water

Blue/Green: Cemetery

Matte Blue: University

NOTE:

If you move the Interface Dial over an area (map features shown above), the name is displayed on the screen.

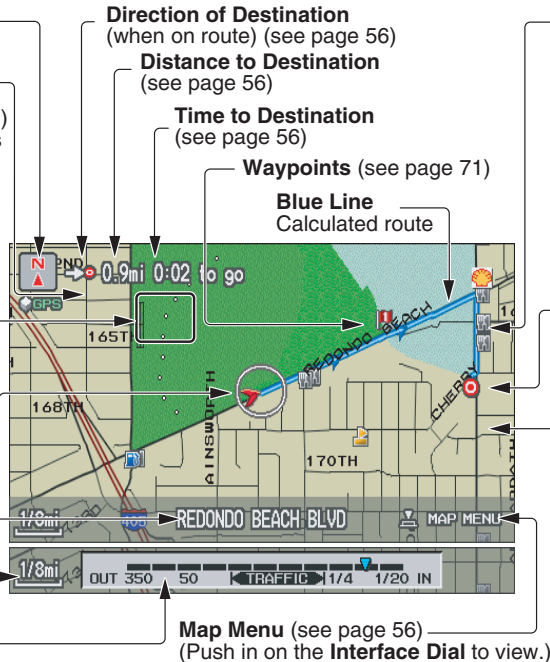

NOTE:

See **Map Legend** on the Information screen for further explanation (see page 77).

Guidance Screen

The guidance screen offers an alternative way to view your route information. Many of the icons and screen features are similar to those on the map screen. While driving to your destination, press the **MAP/GUIDE** button to switch between the map and guidance screens. The guidance screen shows you:

Milestone to Destination - the position of the small circular icon shows your trip progress. As you get closer to your destination, the indicator will approach "DEST."

Vehicle Heading - the black portion of the compass symbol indicates north.

NOTE:

- *The map and voice guidance in unverified areas differ from those in verified areas.*
- *Current maneuvers and those within 1000 feet will show on the Countdown bar, indicating the distance until the next maneuver.*

Guidance Screen Legend

Milestone to Destination (see page 55)

Direction of Destination, "as the crow flies" (see page 56)

Vehicle Heading (black indicates North) (see page 61)

Distance to Next Driving Maneuver

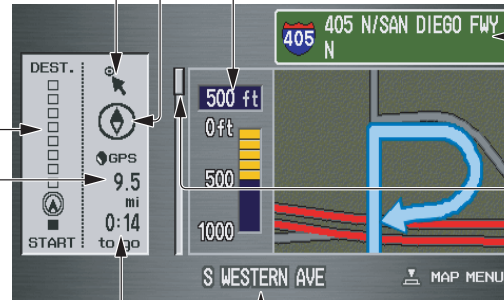

Street Name of Next Driving Maneuver

Scroll: to view guidance maneuvers (move Interface Dial up or down)

Current Street (see page 6)

Time to Destination (see page 56)

Distance to Destination (see page 56)

Driving to Your Destination

Distance and Time to Destination

When you select a destination, the distance to the destination is the actual road distance of the calculated route, and “not as the crow flies.” When viewing a list of destinations (points of interest), such as restaurants, the distance is “as the crow flies” (see *Sort by Distance to Travel* on page 37).

The displayed time to destination may differ from the actual travel time because the time is calculated based on the posted road speed data and your current speed. If part of your route includes unverified roads, the “distance” and “time to go” for that portion is estimated using 25 mph as an average speed.

Map Menu

When the map screen is displayed, pressing in on the **Interface Dial** displays the **Map menu**. If the map is scrolled, the **Map menu** will not appear. Move the **Interface Dial** left, and press the **CANCEL** button to return to the basic map screen.

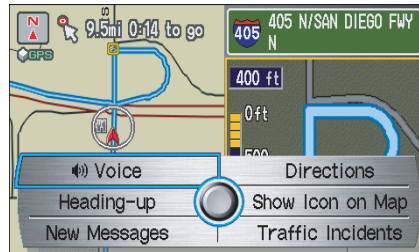

Voice - button shown if currently on a route. Select to hear the next guidance maneuver (see page 57).

Directions - button shown if currently on a route. Select to see a list of directions to your destination (see page 57).

North-up/Heading-up - Select **Heading-up** or **North-up** button to change map orientation. See *Map Orientation* on page 61 for details. On scales greater than 1 mile, this button is “grayed out” (North up only mode).

Show Icon on Map - allows you to select the icons displayed on the map (for a thorough description of this feature, see *Showing Icons on the Map* on page 65).

New Messages - button indicates that there are AcuraLink messages for you to read. These messages consist of quick tips, and other information communicated to you by Acura. If the button is grayed out, you have no messages. See page 75 for more information on this feature.

Traffic Incidents - select this button to display a list of the traffic incidents within a 30-mile radius of your current position. You can view this same list by saying “Display traffic incidents.” See page 24 for a discussion of this feature.

Voice Guidance Prompts

As you get near the maneuver, you will hear a voice reminder, and see a pop-up window showing you the maneuver. The number of reminders that you will hear before a maneuver is determined by **Guidance Prompts** in Setup on page 83.

With the factory default (NORMAL), typically you will hear two prompts:

- The first is about 1/4 mile from the maneuver.
- The final prompt is close to your actual turn.

If the distance between the next two driving maneuvers is very small, both maneuvers are displayed on the screen in a single window, and the voice will remind you of both of them at the same time.

NOTE:

- *You can say “Voice” at any time, or select **Voice** after pushing on the **Interface Dial** to be reminded of the next maneuver.*
- *Typically a pop-up guidance window shows your next turn, and a voice guidance prompt is heard. The timing of these prompts varies, depending on the type of road you are on, and the distance to your next maneuver.*

When given guidance in unverified areas, the words, “If Possible,” are inserted before each guidance prompt. See *Unverified Area Routing* on page 92 for more details about unverified routing.

Direction List

If you select **Directions** from the Map menu, the display changes to:



NOTE:

- *The map and voice guidance in unverified areas differ from those in verified areas. See *Unverified Area Routing* on page 92.*
- *Only maneuvers that occur at freeway exits or contain freeway exit information will show the exit info icon (“i” icon) on the right end of the items in the direction list. If no exit info icon is shown on the list, the **EXIT INFO** is not displayed.*

Driving to Your Destination

You can see the direction list and the distance to each maneuver. Press the **MAP/GUIDE** button to return to the previous screen.

You can scroll through the direction list screen by screen by moving the **Interface Dial** up or down, or one instruction at a time by rotating the **Interface Dial knob**.

EXIT INFO (Freeway Exit Information)

You can search freeway exit information and add new destinations or waypoints to the calculated route as a new destination or waypoint. The exit info icon (“i” icon) on the right end of the items in the direction list indicates that there is freeway exit information available. Say or select **EXIT INFO**, and choose the exit and place to set as a new destination or waypoint.

On the **map** screen, you can display freeway exit information using the **Interface Dial**. The exit info icon will only be displayed on the **map** screen if there is any freeway exit information available. Choose the 1/4, 1/2, and 1 mile scale, then move the cross hairs to the desired exit info icon and push in on the **Interface Dial**. Choose a place from the list and set as a new destination or waypoint.

NOTE:

*To turn on “Freeway exit information” on the **map** screen display the icon bar and select the “i” icon (see page 65).*

Split Screen Guidance

When on route to a destination, you have two display options: single screen mode (the factory default) and the split screen mode.

Single screen mode - a map is displayed with occasional guidance pop-up windows as you approach a maneuver.

Split screen mode - the map is always displayed on the left of the screen, and the maneuver or direction list is displayed on the right hand side of the screen.

Guidance mode can be changed in either Setup (see *Guidance Mode* on page 99), or by accessing the icon bar (see *CHANGE GUIDANCE MODE* on page 65).

When you get near the maneuver, the map screen changes to:

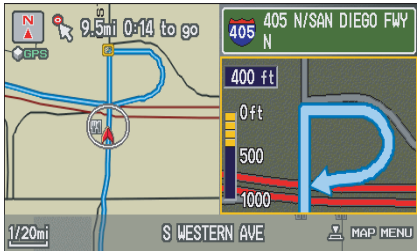

On the map screen, the location of the maneuver is marked with a small yellow square. The guidance window is simply an enlargement of the area indicated by the yellow square. After you complete the maneuver, the display returns to a full map screen when the single screen mode is set, or to a map and direction list screen when the split screen mode is set.

Driving to Your Destination

Map Scale

Rotate the **Interface Dial knob** or a voice command such as “Display 1/2 mile scale” (see page 141) to change the scale of the map. Zooming in increases the detail, while zooming out gives you a view of a wider area. After changing the scale, give the system a few moments to update the display.

Functions available at various map scales

Map Scale (English and Metric) For selecting units, see page 90.		1/20 mi.	1/8 mi.	1/4 mi.	1/2 mi.	1 mi.	2 mi.	5 mi.	15 mi.	50 mi.	150 mi.	350 mi.
		80 m	200 m	400 m	800 m	1.6 km	3 km	8 km	24 km	80 km	240 km	560 km
POI icon symbols (like ATM)	page 62	X	X									
Breadcrumbs (off-road tracking dots)	page 67	X	X	X	X							
Freeway exit information icons	page 62			X	X	X						
Unverified road display (light brown)	page 92	X	X	X								
Map orientation “Heading up”	page 61	X	X	X	X	X						
Map orientation “North up”	page 61	X	X	X	X	X	X	X	X	X	X	X
Map features (like park, golf course)	page 54	X	X	X	X	X	X	X	X	X	X	
Avoid area shown on map	page 96	X	X	X								
Avoid area scales (when creating)	page 96	X	X	X								
Waypoint “flag” icons	page 70	X	X	X	X	X	X	X	X	X	X	X
Traffic speed	page 22				X	X	X	X				
Traffic incident	page 22				X	X	X	X				

NOTE:

- You can change between miles or kilometers in Setup (see Units on page 90).
- For information on the available voice commands, see Voice Command Index on page 140.

Map Orientation

The map can be orientated two ways:

- North-up: North pointing up as you would normally view a paper map.
- Heading-up: The map constantly rotates so the road you are driving on always points up (as you see the road through your front windshield).

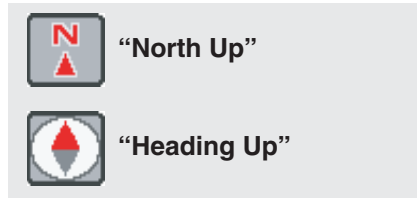

NOTE:

The red arrow in both heading symbols always shows the direction north.

Push in on the **Interface Dial** on the **map** or **guidance** screen and select **North-up** or **Heading-up** to switch between the available orientation, or say “Display heading up” or “Display north up.”

In the larger map scales (above 1 mile or 1.6 kilometer), the map is always oriented with north facing upward. You cannot change the orientation.

To view other areas on the map, move the **Interface Dial** left, right, up, or down. The map will shift in that direction. To return the map to your current location, press either the **MAP/GUIDE**, the **CANCEL**, or the **NAVI BACK** button on the steering wheel.

The display automatically changes to the **map** screen when you reach your destination. Press the **MENU** button to return to the **Enter destination** by screen.

NOTE:

- For information on the available voice commands, see *Voice Command Index* on page 140.
- If you are on a route and the **Interface Dial** is moved, the “Time to Destination” and “Distance to Destination” indications are replaced with an indicator showing distance from the current vehicle location.

Driving to Your Destination

Destination Icon

The destination icon only shows the approximate location of the destination. This occurs because a city block can have as many as 100 possible addresses (for example, the 1400 block is followed by the 1500 block.) Since most cities use only a portion of the 100 possible addresses (for example, in the 1400 block, the addresses may only go up to 1425 before the 1500 block starts). Therefore, the address 1425 will be shown a quarter of the way down the block by the system instead of near the end of the block where the destination is actually located.

Tip:

When on a route, you can view a map showing your destination. Using voice control, say “Display destination map.”

Landmark and Incident Icons

Landmark icons are shown in the map screen on 1/20 and 1/8 mile scale, or 80 and 200 meter scale. The Freeway exit information is displayed on the 1/4, 1/2, and 1 mile scales. Incident icons are displayed on the 1/2 through 5 mile scales. The icons are:

Landmark icon

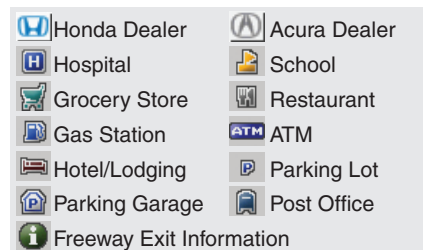

Incident icon

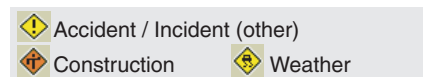

Some icons can be turned on or off; you can either display them or hide them by pushing in on the **Interface Dial** on the map or guidance screen and select **Show Icon on Map** (see page 65), or by using voice commands (see page 140).

You can select most landmark and incident icons with the **Interface Dial** to display the icon's information. See the table on the following page for exceptions.

NOTE:

- *The same icon list can be viewed on the screen by selecting **Map Legend** from the Information screen.*
- *When there are overlapping landmark icons, a list of the points of interest (POIs) is displayed.*
- *For information on the available voice commands, see **Voice Command Index** on page 140.*

For some icons you can choose either to show or hide them on the map, while others like Acura Dealers, are always shown. The table below shows the features for each icon type. Some Points of Interest (POIs) like Police Stations are not shown as an icon, but you can still locate the nearest one with the voice command, “Find nearest Police station.”

Landmark icon

POI type	Icon can be manually displayed	Icon can be manually hidden	Icon selection by voice	Icon can be selected as a destination on the map screen with the Interface Dial	POI can be found on the map screen using voice command “Find...”
Honda/Acura dealer	Yes, always	No	No	Yes	Yes
Hospital	Yes	Yes	Yes	Yes	Yes
School	Yes	Yes	Yes	Yes	Yes
ATM	Yes	Yes	Yes	Yes	Yes
Gas station *1	Yes	Yes	Yes	Yes	Yes
Restaurants *2	Yes	Yes	Yes	Yes	Yes
Post office	Yes	Yes	Yes	Yes	Yes
Grocery store	Yes	Yes	Yes	Yes	Yes
Hotel/ Lodging	Yes	Yes	Yes	Yes	Yes
Police station	No icon	No icon	No	No	Yes
Shopping, Tourist attraction, Bank	No icon	No icon	No	No	Yes
Parking garage	Yes	Yes	Yes	Yes	Yes
Parking lot	Yes	Yes	Yes	Yes	Yes
Freeway exit information	Yes	Yes	Yes	Yes (choose POI)	No

Driving to Your Destination

Incident icon

POI type	Icon can be manually displayed	Icon can be manually hidden	Icon selection by voice	Icon can be selected as a destination on the map screen with the Interface Dial	POI can be found on the map screen using voice command “Find...”
Traffic Speed	Yes	Yes	Yes	No	No
Traffic Incident	Yes	Yes	Yes	No	Yes *3

*1. When gas station icons are selected for view on the map, some icons are shown as “brand icons.”

*2. When selecting **Restaurant** on the **Select** category for icon settings screen (see *Icon Options* on page 65), specialty types of restaurants, like Chinese or Italian, can be individually displayed or hidden. See *Show Icon on Map* on page 139. Also see the *Voice Command Index* on page 140 for the “Display,” “Hide,” and “Find” commands.

*3. You can display the nearest traffic incidents by saying, “Display traffic incidents.”

Showing Icons on the Map

Selecting **Show Icon on Map** from the Map menu (see page 56) displays the following screen:

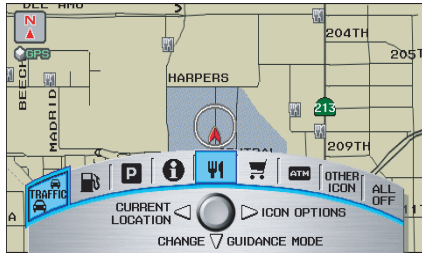

The screen consists of the following items:

Icon Bar (curved row of icon symbols)

Allows you manually select the icons that are displayed on the map (see page 62 for a list of these icons). In the screen above, both traffic and restaurants are selected. Rotate the **Interface Dial knob** and push in to select (goes blue) or remove them (symbol is gray). You can also display or hide the same icons by using the “Display” or “Hide” voice commands (see page 141)

CURRENT LOCATION (Interface Dial Left)

This allows you to display and/or save your current location. See page 68 for more information.

ICON OPTIONS (Interface Dial Right)

This feature allows you to “fine tune” some of the icons on the Icon bar (See *Icon Options* below for more information).

CHANGE GUIDANCE MODE (Interface Dial Down)

When on route, this item allows you to select between a single screen (with occasional pop-up guidance windows), or a split screen (containing one half map, and one half guidance/directions list window). See page 58 for an explanation of this feature, and see page 99 for Setup.

Exit Screen

Press the **CANCEL** button to return to the map screen.

Icon Options

Selecting **ICON OPTIONS** from the Icon bar displays the following screen:

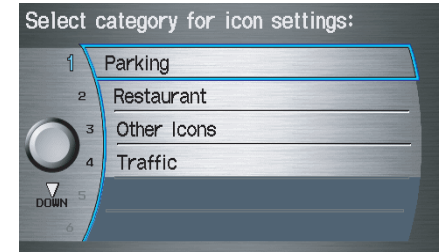

This feature allows you to “fine tune” some of the icons on the Icon bar. The four icon choices, “Parking” (lot or garage), “Restaurant” (specific type or types of food), “Other icons” (hospitals, schools, etc.), and “Traffic” (traffic speeds or traffic icons), can each be tailored to your needs.

Driving to Your Destination

For instance, let's assume that your real-time traffic is not displayed on the map, and you want to make sure that your settings are correct. You would do the following:

- First you would ensure that the “Traffic” button on the Icon bar is blue (See *Icon Bar* above).
- Second, you select **ICON OPTIONS** and verify that both traffic options are also on (blue). This procedure is explained below.

If you select **Traffic** from the Select category for icon settings screen, the traffic icon options are displayed:

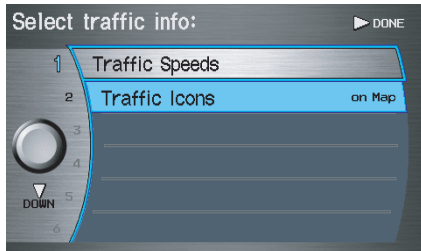

In the example above, only **Traffic Icons** is selected and will show up on the map. To also see **Traffic Speeds** flow on the map, this would need to be turned on by first selecting it and then pushing in on the **Interface Dial** to select it so it appears as below.

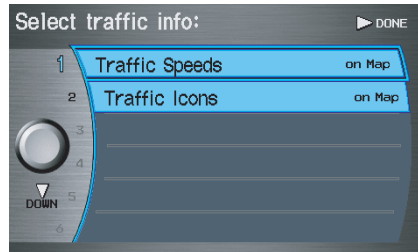

Exit, and save your settings by moving the **Interface Dial** to the right (**DONE**).

NOTE:

- *When viewing the map screen, you can turn some icons on using voice control.*
- *“Traffic Speeds” and “Traffic Icons” must be selected in the “Traffic” choice of “Icon options” to enable the traffic display on the map screen.*
- *You can use voice commands, “Display (or hide) traffic icons,” or “Display (or hide) traffic speeds.” See page 141.*

Going Off the Route

If you leave the calculated route, “Recalculating...” is displayed at the top of the screen. The system will recalculate the route from your current location and direction to the desired destination then give you a new route instruction. This is done automatically if you have set **Rerouting to AUTOMATIC** on the Setup screen (second) (see page 91).

If the **Rerouting** option in Setup is set to **MANUAL**, “Off route” appears at the top of the screen when you leave the calculated route. Say “Recalculate,” or select **Recalculation** whenever you wish the system to perform a recalculation.

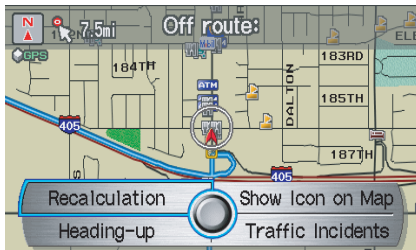

Off-road Tracking

If you drive more than half a mile from a mapped road, “Not on a digitized road.” appears at the bottom of the screen.



The map screen starts displaying a series of dots (breadcrumbs) to show the path you have taken if **Off-road Tracking** on the Setup screen (second) is set to **ON** (see page 101).

By following the dots, you can backtrack to the mapped road you originally left. “Breadcrumbs” may occasionally be displayed in urban areas, such as large parking lots in shopping malls, or in new subdivisions where the roads are not yet in the database. In other cases you may see dots, if the system temporarily goes off route, like in a parking garage where the GPS signal is unavailable.

These dots appear only in the 1/20, 1/8, 1/4, and 1/2 mile (or 80, 200, 400, and 800 meter) map scales. Rotate the **Interface Dial knob** to change scales if necessary.

Tracking continues for approximately 150 miles; dots at the beginning of the trail will start disappearing when you exceed that distance. When you reach a mapped road, the system stops displaying dots.

Driving to Your Destination

Viewing/Saving the Current Location

Whenever you are on a map screen, you can always obtain your current location either by pushing in on the **Interface Dial**, selecting **Show Icon on Map**, and selecting **Current Location**; or by using the voice control system and saying “Display current location.” A screen pops up which shows the address of your current location, as well as the latitude, longitude, and elevation.

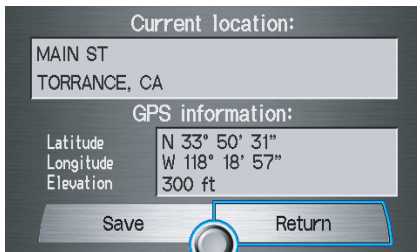

NOTE:

The elevation will not appear when the system is temporarily lacking proper GPS information. The system elevation may not agree with elevations shown on roadside elevation signs, and may fluctuate plus or minus 100 feet or more.

You can store the current location for later use. It does not change or cancel your current route.

For example, you are following the system's directions to get to a destination. While sitting at a stoplight you notice a curio shop on the corner, but do not have time to visit it right now. You can save the location to select as a destination at a later date.

To save the location, say “Save current location,” or select **Save** on the **Current location** screen. The **Edit address book** screen with the current location data will appear. You can edit the name, phone number, or category name to be set in your personal **Address Book**.

After the location is saved, select **Return** to return to the map screen. You can then use **Address Book** from the **Enter destination** by screen to select the saved location, and return to the same spot.

Pop-ups and Disclaimers

When you say “OK” in the Calculate Route to screen, or if you change your route, the system checks your route and provides you with “pop-up” messages for the following situation:

- Your route takes you into an area that you previously set as an “Avoid Area” (see *Edit Avoid Area* on page 96).

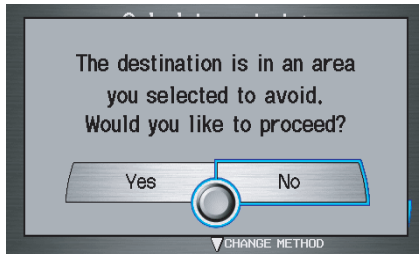

- Your route passes near or bypasses unverified areas (see *Unverified Area Routing* on page 92).

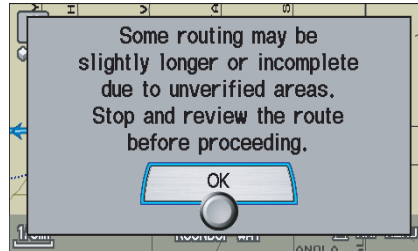

- Your route includes unverified areas (see *Unverified Area Routing* on page 92).

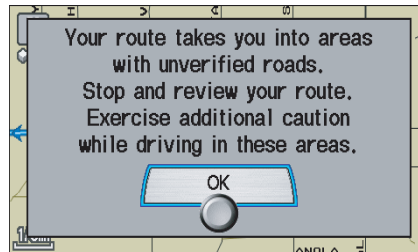

- You are about to enter an unverified area (see *Unverified Area Routing* on page 92).

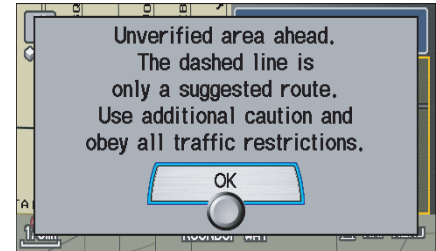

- You actually entered an unverified area (see *Unverified Area Routing* on page 92).



Driving to Your Destination

Changing the Route

While on route, you may wish to alter your route, add an interim “Waypoint” (pit stop), choose a different destination, or cancel your current destination.

To change your present route, you can do any of the following:

Say “Menu,” or press the **MENU** button to view the Change route by screen:

- Cancel the current route (page 70).
- Change routing method (page 70).
- Detour (page 70).
- Avoid a certain street or streets (page 71).
- Add a Waypoint or pit stop (page 71).
- Back to the current route (page 72).

Choose a different destination (other methods):

- Saying, “Find nearest...” to find a POI (page 73).

- Saying, “Go home” (page 73).
- Using the **Interface Dial** to select a different POI or address on the map (page 73).
- Pressing the **MENU** button twice to get to the Enter destination by screen (page 74).

Change Route By Screen

Pressing the **MENU** button displays the Change route by screen:

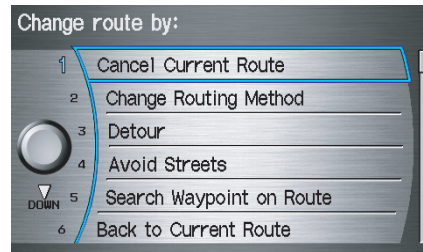

Cancel Current Route

Cancels the current route (and any waypoints) and returns you to the map screen.

Change Routing Method

From the Change route by screen, if you say or select **Change Routing Method**, then the Select routing method screen is displayed. See *Changing the Routing Method* on page 51 for details.

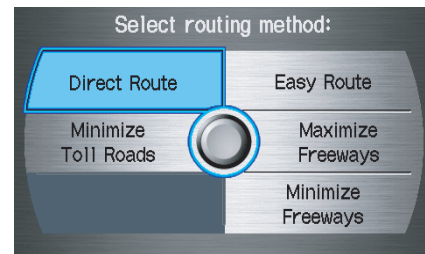

Detour

Calculates a detour route for you if you encounter an unexpected obstacle such as a closed road or extremely heavy traffic congestion. If detour is selected, the system will attempt to re-calculate a new route, avoiding the next 2 miles (while on a freeway) or 1/2 mile (while on a surface street).

Avoid Streets

From the **Change route by screen**, if you say or select **Avoid Streets**, the system displays a list of streets that will get you to your destination. This feature allows you to avoid a street or streets along your route. This is helpful if you know of road construction, closures, or excessive traffic along the route. Simply select the street or streets you wish to avoid. You cannot avoid your current street, or the streets of your waypoint(s) or destination (system beeps if selected).

NOTE:

Although you can choose streets to avoid, you cannot choose specific streets you want to use.

Search Waypoint on Route

Waypoints allow you to add an interim “pit stop” while traveling to a destination. For instance, you may want to stop for gas or food, and then continue on to your destination. Although you can enter up to 5 waypoints at a time, typically you may never use more than one at a time. Waypoints are routed to in the order they were entered (number 1 first, etc.), with your final destination routed to last. If you wish to create a custom route of several destinations, and then control the order of routing, the function “Today’s Destinations” is probably a better choice (see *By Today’s Destinations* on page 47).

When you enter waypoints, they appear on the map screen as small red flags numbered 1-5.

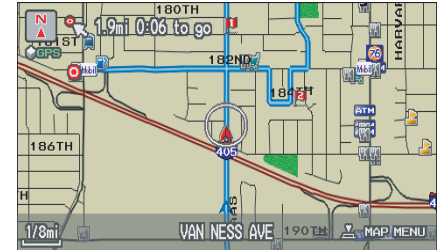

Driving to Your Destination

Adding Waypoints

From the **Change route** by screen, if you say or select **Search Waypoint on Route**, then the **Select a search method** screen is displayed. Select either **Places Along the Route** or **Places Around the Destination**.



Next, select your “Waypoint Category,” then follow the menu prompts to select a destination. When the system performs a search from **Places Along the Route**, it displays matches that lie within a corridor on either side and in front of you, along your route. From **Places Around the Destination**, the system displays matches in a spiral pattern outward from the destination. The search “corridor” distance value can be changed in **Edit Waypoint Search Area** in Setup (see page 98).

To add another waypoint, press the **MENU** button and repeat the procedure. If **Search Waypoint on Route** is grayed out, the maximum of 5 waypoints has been entered.

NOTE:

The system does not allow you to select the roads you want to use to get to a destination. However, after you enter a destination, you can select intersections or POI “waypoints” that the system will use to “tailor” your route.

Deleting Waypoints

From the **Change route** by screen, if you say “Delete” or select **Delete Waypoint**, then the **Select a waypoint to delete** screen is displayed. Say the line number of the waypoint(s) you wish to delete, or select them by using the **Interface Dial**. Say or select **DONE** to return to the map screen.

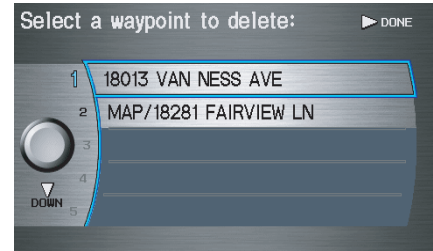

The route is re-calculated to reflect the changes you made to the waypoint(s).

Back to Current Route

Returns you to the original map screen.

Changing Your Destination

There are other methods by which you can change or add a waypoint to your route. These are:

Find Nearest (Voice command)

From the map screen, say one of the “Find Nearest...” voice commands to locate the nearest gas station, ATM, restaurant or other point of interest. See the “Find Nearest” voice commands listing on page 142.

Go Home (Voice command)

From the map screen, say, “Go home.” If you have entered a “Go home” address, then the system will display a confirmation screen.

Using Interface Dial to Change Destination

While following a calculated route, you can select a new destination with the map screen and the **Interface Dial**.

With the map screen displayed, use the **Interface Dial** to move the position icon. It will change to cross hairs. Use the **Interface Dial** to position the cross hair on your desired new destination, street, or icon, then push in on the **Interface Dial**. The address within the cross hairs will be displayed. If this is not your desired new destination, reposition the cross hairs with the **Interface Dial**, then push in on the **Interface Dial** again to see the new address.

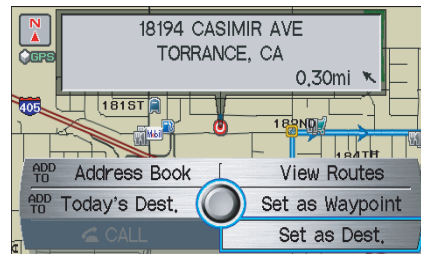

When you push in on the **Interface Dial** on a new destination, you will see a pop-up menu as well as the address display. Say or select either **Set as Dest.**, or **Set as Waypoint** on the pop-up menu. The system will return to the map screen and recalculate the route to your new destination or waypoint.

NOTE:

When you scroll the map screen while on route to a destination, some voice controls will not function. These include:

- Display “Heading up”
- Display “North up”

Driving to Your Destination

Entering a Destination from the Menu Screen (while on route)

If you say “Menu” or press the **MENU** button twice, the system displays the Enter destination by screen. Follow the procedure described in *Entering a Destination*, which begins on page 27. After selecting **OK** to the Calculate route to screen, your new location can be used either as a waypoint or as a replacement destination.

Continue Trip Screen

If you restart the vehicle, without having completed your prior trip, you will see the following screen:

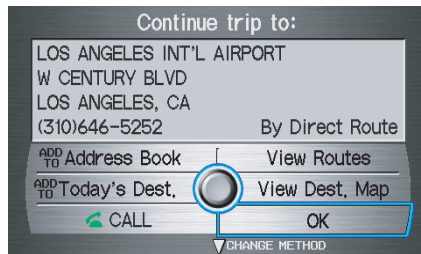

- To continue to your destination or other waypoints, say or select **OK**.
- To cancel your destination, press the **CANCEL** button or the **NAVI BACK** button on the steering wheel, or using the voice control system, say “Cancel” or “Back.”
- If you wish to change the routing method, say or select **CHANGE METHOD** by moving the **Interface Dial** down.

- For additional information on changing the routing method, see *Changing the Routing Method* on page 51.

AcuraLink Messages

AcuraLink enhances your ownership experience by providing a direct communication link between you and Acura. AcuraLink messages are displayed on the Navigation screen. Working through the XM Satellite Radio, AcuraLink works in conjunction with your vehicle's Navigation, HandsFreeLink™ (HFL), and audio systems to send and receive several kinds of message. These include:

- Operating tips and information on your vehicle's features.
- Important recall and safety information.
- Maintenance information to keep your vehicle in top condition.
- Diagnostic information to provide information about any problems with your vehicle.

NOTE:

See your vehicle's Owner's manual for more details on this feature.

When service information is received from your vehicle or AcuraLink, an envelope icon is displayed in the upper right corner of the Navigation screen.



The **Interface Dial** controls most AcuraLink functions. For more information on AcuraLink, refer to:

- The Quick Start Guide for features and a function overview.
- The vehicle Owner's manual for a detailed explanation of the system.

Information Features

Information Screen

When you say “Information” or press the **INFO** button, the display changes to:



NOTE:

If some items appear to be grayed out, and cannot be selected, it is because you did not select **OK** on the initial Disclaimer screen. See *System Start-up* on page 17.

Messages

See *AcuraLink Messages* on page 75.

Voice Command Help

When you say or select **Voice Command Help**, you will see the following screen:

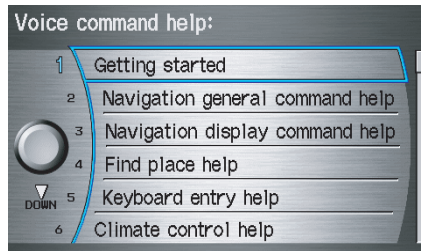

NOTE:

You can select an item by saying either the line number or the item name.

There is a tutorial available for the voice command help. Say or select **Getting started**, and the display changes to:

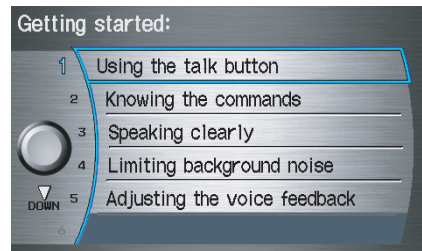

Select the line number of the desired tutorial you want to view, and the tutorial will automatically be read out. Select **STOP** by moving the **Interface Dial** right to stop the reading.

When you make a selection, you will see the help commands that can be used with the voice control. You can say “Read List” or select  by moving the **Interface Dial** right, and the system will read the list to you.

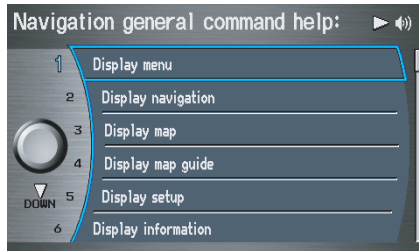

For a listing of all voice commands, see *Voice Command Index* on page 140.

Cellular Phonebook

The **Cellular Phonebook** option allows you to store up to 1,000 names and 10,000 phone numbers in the phonebook of HandsFreeLink from your cellular phonebook. With the HFL, you can then automatically dial any name or number in the phonebook. Say or select **Cellular Phonebook** from the **Information** screen, and the display changes to:

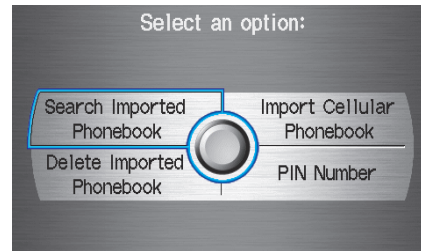

NOTE:

- For more information on this feature, see your vehicle's *Owner's manual*.
- For questions about the HFL Cellular Phonebook, call Acura Client Relations at 1-888-9-ACURA-9.

Map Legend

You can use the Map legend screens to learn the meaning of map features, icons, colors, etc. used in this system. When you say or select **Map Legend**, the display changes to:

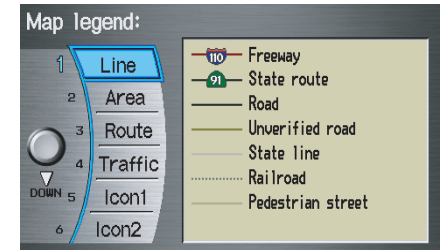

Say or select the desired item or item number to view each section of the map legend.

Information Features

Calendar

The **Calendar** option allows you to enter events and be reminded of them in the future. When you say or select **Calendar**, the system shows the calendar with the current calendar day highlighted.



Dates with an icon indicate there is a schedule entry for that date.

You can scroll through the calendar day by day by rotating the **Interface Dial knob**, or select the day by voice. When you move the **Interface Dial** up or down, you can also scroll through the calendar week by week. To change the month, say “Next month” or “Previous month,” or move the **Interface Dial** right or left.

Entering Your Schedule

Set your schedule by selecting the day on the calendar, and the display changes to:

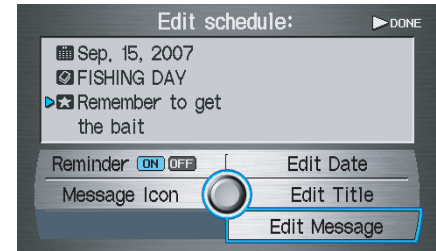

Reminder

The default for Reminder is **ON**. This allows the system to remind you of the calendar item the next time you start the vehicle. See *System Start-up* on page 17.

Edit Date

This allows you to move your calendar entry to a different date. If you say or select **Edit Date**, the **Calendar** screen is displayed with existing entries grayed out. Select a new day and the **Edit** schedule screen is re-displayed with the new date.

Edit Title

Say or select **Edit Title**, then enter the name of your title using the **Interface Dial**. Once you have entered the title, say or select **DONE**. The title will be displayed on the specified date of the Calendar screen.

Edit Message

Say or select **Edit Message**, and the system will show the **Edit Message** screen. You can enter a message on two lines. Use  to change the line. Once you have entered the message, say or select **DONE**. The message will be displayed on the specified date of the Calendar screen.

Message Icon

Say or select **Message Icon**, and the system displays a list of icons you can select to help identify the type of message you entered. The message icon you choose will be displayed alongside the specified date on the **Calendar** screen.

Delete

From the **Calendar** screen, select the date of the schedule you wish to remove. To remove the schedule, say or select **DELETE**.

Done

Once you have finished entering the schedule, say or select **DONE**. The **Calendar** screen is re-displayed and the entered schedule is displayed.

NOTE:

- *You can only enter one message per day.*
- *A maximum of 50 entries can be stored in the schedule.*
- *To re-activate a previous message, turn the Reminder setting from **OFF** to **ON**. If it is not turned on, the reminder will not be displayed when you start vehicle.*
- *The system displays active calendar entries only after you answer **OK** on the Disclaimer screen.*
- *For more information, refer to System Start-up on page 17.*

Key to Zagat Ratings

When you display data for a Zagat surveyed restaurant on the **Select a place** screen, you will see the description of ratings as follows:



By saying or selecting **Key to Zagat Ratings** on the **Information** screen, you can see the explanation of the data displayed for the Zagat surveyed restaurants.

- “Food,” “Decor,” and “Service” categories (red circle) are rated using numbered values (e.g., 0-9, 10-15, etc.)
- “Cost” (white circle) is the average cost of a meal (including drink and tip).

Information Features

- The symbols, if displayed (blue circle), indicates the following information:

- open on Sunday
- closed on Sunday
- open on Monday
- closed on Monday
- open for lunch
- lunch not served
- serving after 11 PM
- no credit card accepted

Use the **Interface Dial** to scroll through the Key to Zagat Ratings screens.

Key to Zagat Ratings:

The values below are used to rate the categories: Food, Decor and Service,
0-9 ...poor to fair
10-15 ...fair to good
16-19 ...good to very good
20-25 ...very good to excellent
26-30 ...extraordinary to perfection

Key to Zagat Ratings:

Cost: Average cost of a meal (including a drink and tip). If unavailable then estimated cost symbols are shown:
| ...\$25 and below
M ...\$26 to \$40
E ...\$41 to \$65
VE ...\$66 or more

Key to Zagat Ratings:

If displayed, the Zagat Symbols imply:

- open on Sunday
- closed on Sunday
- open on Monday
- closed on Monday
- open for lunch
- lunch not served

Calculator

When you say or select **Calculator**, the display changes to:

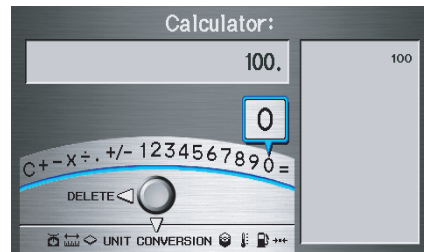

Use the **Interface Dial** and its **Knob** to use the following features:

Calculator

The calculator function operates like a standard hand held calculator.

Unit Conversion

Values entered on the calculator can be converted from one unit to another (e.g., inches-to-millimeters).

Unit Conversion

To perform a conversion:

1. Enter a numeric value to be converted (for example, 100).
2. Move the **Interface Dial** down to select **UNIT CONVERSION**. The screen changes to:

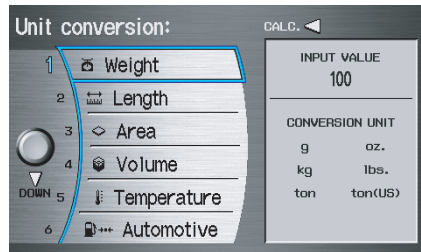

3. Rotate the **Interface Dial knob** to select the type of unit you want to convert (for example, weight) and push in on the dial to select. The screen for that conversion type appears (see illustration in step 4).

4. Select the base unit (like pounds) that you wish to convert to some other unit. So, in the example below, 100 lbs converts to 1600 ounces, 0.05 ton (US), etc.

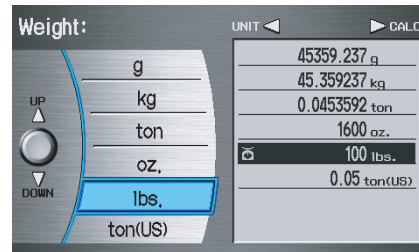

NOTE:

- *If you do not enter a value to be converted, only “Temperature” units are selectable.*
- *Conversions using negative values may produce meaningless or physically impossible values.*

Roadside Assistance

When you say or select **Roadside Assistance**, you will see the following screen:



An Acura Roadside Assistance number is provided as a courtesy to Acura clients. If you have a “paired” Bluetooth phone and it is ON, then you can call Acura Roadside Assistance by using your system. Select **CALL** by voice or by using the **Interface Dial**, and then select **Yes** on the confirmation screen.

System Set-up

Setup Mode

The Setup function consists of two main screens, that allows you to change and update information in the system. To display the Setup screens, use the voice control system and say “Setup” or press the **SETUP** button, and then select an item, or say or select **MORE** in the upper right corner of the screen.

On any of the Setup screens, you can use the voice control system to select any item on the screen.

NOTE:

- *If some items appear to be grayed out, and cannot be selected, it is because you did not select **OK** on the initial Disclaimer screen. See System Start-up on page 17.*
- *Setup items in this manual with the  symbol indicate that the display settings depend on what “Driver #” was displayed on the MID when the vehicle was started. See Remote Keyless Entry Setting on page 18.*
- *If only “Welcome” is displayed, then all Setup settings revert to factory defaults, and all personal data (such as Address Book or Calendar) are not available.*
- *For information on the available voice commands, see Voice Command Index on page 155.*

Setup Screen (first)

From any screen, say “Setup screen” or press the **SETUP** button, and the following screen appears:



Brightness

The screen brightness has 11 settings. To change the brightness, use the voice control system and say “Brightness up” or “Brightness down.” You can also select **Brightness** and change the setting by rotating the **Interface Dial knob**.

Tip:

If you are having trouble viewing the screen in bright lighting conditions, try increasing the brightness.

Contrast

The screen contrast has 11 settings. To adjust the contrast, use the voice control system and say “Contrast up” or “Contrast down.” You can also select **Contrast** and change the setting by rotating the **Interface Dial knob**.

Black Level

The screen black level has 11 settings. To change the black level, use the voice control system and say “Black level up” or “Black level down.” You can also select **Black Level** and change the setting by rotating the **Interface Dial knob**.

NOTE:

You can have separate daytime and nighttime settings for *Brightness, Contrast, and Black Level*. Adjust each setting when the display is in either daytime or nighttime mode. Use the **Display mode button**  (page 11 and 104) to select Daytime or Nighttime mode.

Volume

The navigation voice volume can be adjusted by:

- Using the voice control system and saying “Volume up” or “Volume down.”
- Selecting **Volume** and changing the setting by rotating the **Interface Dial knob**.
- Saying “Volume Off,” or selecting **Volume** and then **OFF**.

NOTE:

If you turn the volume off, you will not hear route guidance or voice command confirmations.

Interface Dial Feedback

This setting allows you to control when (and if) the system will read the current selection you choose with the **Interface Dial**. The purpose of this feature is to minimize the need to look at the screen while operating the dial. You can set the one of three settings explained in the following table. The factory default is **AUTO**.

Setting	Degree of assistance
ON	When selection is made, the system always reads what is selected.
AUTO (factory default)	The system reads selection only when moving.
OFF	No voice assistance when selecting.

Guidance Prompts

While you drive to your destination, the system displays and announces guidance prompts for your next maneuver. This setting allows you to adjust the number of guidance prompts before each maneuver. The settings **MIN**, **NORMAL**, and **MAX** are described below. The factory default is **NORMAL**, so you can adequately prepare for the next maneuver. If you wish to change the number of guidance prompts, select your preferred setting, as shown in the following table.

System Set-up

Setting	Distance before maneuver		
	About 1/2 mile	About 1/4 mile	Just before maneuver
MIN		Yes	
NORMAL (factory default)		Yes	Yes
MAX	Yes*	Yes*	Yes*

* Uses street name in guidance phrase.

NOTE:

To temporarily turn off voice guidance prompts, select **OFF** for the **Volume** setting in Setup.

Setup Screen (second)

Say or select **MORE** to view additional Setup functions and the following screen appears:

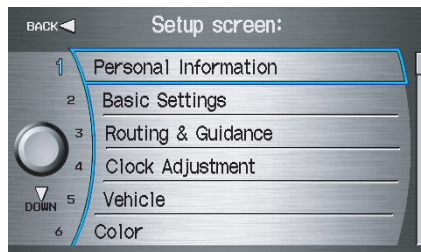

to

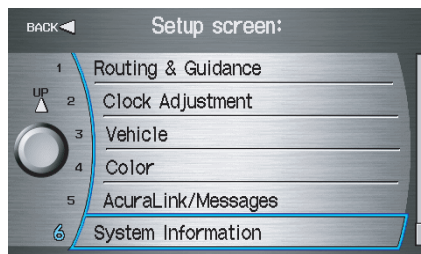

Personal Information

From the Setup screen (second), say or select **Personal Information** and the following screen appears:

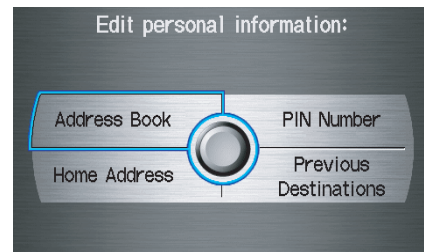

NOTE:

If the most items in “Personal Information” are grayed out, then you must link the Remote Keyless Entry. Setup settings will not be saved if the Remote Keyless Entry is unlinked (see page 18).

Address Book

The Address Book function allows for up to a total of 200 address entries. After 200 entries, the **ADD TO Address Book** button is grayed out. The 200 addresses are shared between Driver 1 and Driver 2. For example, if Driver 1 has 150 addresses, Driver 2 can only have 50.

You can add, modify, and delete information in the personal Address Book list.

You may choose to use a Personal Identification Number (PIN) to protect your privacy. However, PINs are optional, and if you decide to use one, record it in case you forget the number (see page 88).

You can do the following functions in the address book:

- Entering an address (see page 85)
- Edit an existing address (see page 88)
- Delete an existing address (see page 88)

Accessing the Address Book List

After selecting **Address Book**, if a PIN has been set, the system prompts you to enter your PIN. After entering your PIN correctly by voice or by using the **Interface Dial**, and the system displays your Address Book.

If no PIN has been set, the system displays your Address Book after selecting **Address Book**.

NOTE:

If the Remotes Keyless Entry is unlinked, this feature is unavailable.

Entering an Address Book

After you select Address Book, your Address Book list appears:

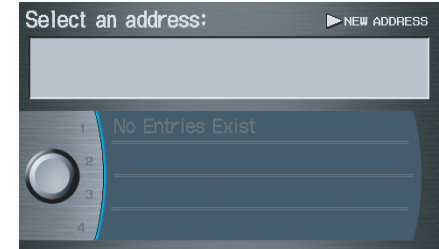

Select **NEW ADDRESS** in the upper right corner on the screen by moving the **Interface Dial** right when beginning to build your Address Book list.

System Set-up

Edit Name

You may use the “Name” field to give the entry a name or title that you will recognize later, such as “Doctor Smith” or “Broadway Theatre.” If you do not give the address a name, the system will assign one (Address 001, etc.).



Say or select **Edit Name**. Then use the **Interface Dial** to enter the name. Select **DONE** when finished.

NOTE:

You can always re-enter, edit, or make changes to any entry. “Address” is the only required field.

Edit Address

When you say or select **Edit Address**, the display changes to:

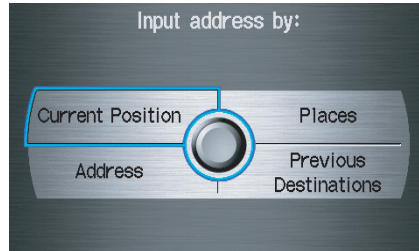

Current Position - Allows you to use your current position as the address.

Address - Requires you to enter the city and address you wish to store. The operation is the same as selecting **Address** from the Enter destination by screen (see page 27).

Places - Allows you to select one of the Point of Interest (POI) locations already stored in the system as one of your personal addresses. This operation is the same as selecting **Places** from the Enter destination by screen (see page 33).

Previous Destinations - Allows you to choose one of the locations in the Previous Destination list for your Address Book list. This operation is the same as selecting **Previous Destinations** from the Enter destination by screen (see page 44).

After you have used one of these four options to enter the address, the initial screen for entering the personal address is re-displayed, with the address shown in the “Address” field. If you have entered the address using **Places**, the phone number corresponding to the address also appears in the “Phone Number” field.

Edit Phone Number

You can enter the telephone number of the address. If the address was chosen with **Places**, and it has a telephone number, that number is entered automatically.

Say or select **Edit Phone Number** to display the **Enter phone number** screen. Enter the telephone number, including the area code, by using the voice control system (say the entire phone number one digit at a time), or by using the **Interface Dial**. Say or select **DONE** when finished.

Edit Category

If desired, you can specify the category of the address. Say or select **Edit Category** to display the **Select a category** screen.



Scroll the screen and select a category by saying the number next to your choice, or by pushing in on the **Interface Dial**.

If you wish to set, add, or edit a new category, select **EDIT CATEGORY** in the upper right corner on the screen. The system will show the **Select a category to edit** screen. Follow the on-screen prompts to add, change or delete a category. If you delete a category that was used to categorize addresses, the category for those addresses becomes “UNFILED.”

NOTE:

You may have up to 100 categories. These are shared between Driver 1 and Driver 2.

The system will then display everything that you have entered.

If all the information is correct, say or select **Done**. This will return you to the Address Book list.

If you want to enter another address, select **NEW ADDRESS** in the upper right corner on the screen, then repeat the procedures above. If not, press the **CANCEL** button.

System Set-up

Edit/Delete an Address

This feature allows you to select an address to edit or delete. Once the address is selected, choose the appropriate function and push in on the **Interface Dial** to select.

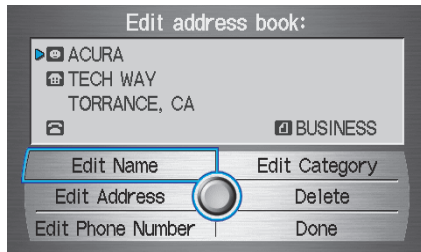

Home Address

This feature lets you return “Home” from any location simply by saying “Go home” at the **map** screen. Alternately, you can select **Go Home** on the **Enter destination by screen** (see *By Go Home* on page 49).

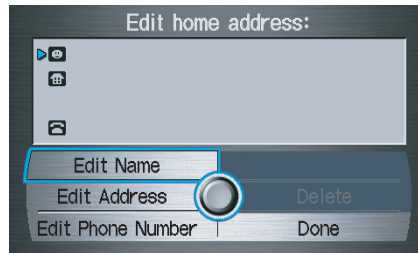

Enter the Name, address, and phone number in the same way as entering a personal address, then say or select **Done**. To leave the screen, press the **CANCEL** button.

NOTE:

If your Home address cannot be found in the system then, while located on the street close to your home, select “Current Position” when entering the “Edit Address” field.

PIN Number

You can set a four-digit PIN (Personal Identification Number) for accessing the following features, if desired:

- Setup:
 - Address Book
 - Home Address
 - PIN Number
- Enter destination by screen:
 - Address Book
 - Go Home
- Map screen:
 - Go Home (by voice control)
- Information screen
 - Calendar

Once you set your PIN, the system will ask you to enter the PIN when you access these features.

1. Select **PIN Number**. The display changes to:

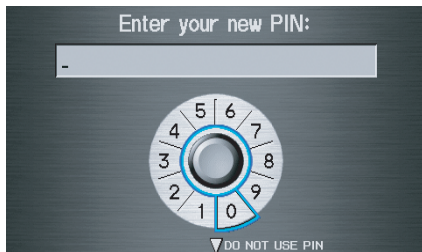

2. Enter your new four-digit PIN. If you do not wish to use a PIN, select **DO NOT USE PIN**.

NOTE:

The factory default is no PIN.

3. When you have entered your PIN, the display changes to the **Please re-enter new PIN** screen. Enter the same number to validate the number you have selected.

4. If you have entered the same number both times, the display returns to the **Edit personal information** screen. If not, "INCORRECT PIN" appears. Enter your PIN again.

NOTE:

- If you start the vehicle and the MID displays only "Welcome," this function is unavailable.
- If you wish to remove your PIN, return to the same screen and, after entering your PIN correctly, select **DO NOT USE PIN**.
- PINs are optional. If you choose to use a PIN, make sure you remember it. If you forget your PIN, your dealer will have to reset it for you.

Previous Destinations

Allows you to delete some or all of your previous destinations.

1. Select this option, and the display changes to:



NOTE:

Normally, moving the **Interface Dial** left exits most screens. However, for this screen, moving the dial left deletes all of your previous destinations.

System Set-up

2. Scroll through the list and find the address you want to delete.
3. Select the address to delete by saying the line number, or by using the **Interface Dial**.

NOTE:

To cancel the deletion of *Previous Destinations*, press the **CANCEL** button before performing step 4.

4. Say or select **DONE** to perform the deletion and the display returns to the previous screen.

Tip:

You can delete all addresses by selecting **DELETE ALL**.

Basic Settings

From the **Setup** screen (second), say or select **Basic Settings** and the following screen appears:



Units (mile or km)

Allows you to select the units for the entire system (**mile** or **km**).

Voice Recognition Feedback



Allows you to turn voice control system prompts **ON** or **OFF**. When **OFF**, you will not hear the voice control system confirmations or prompts.

Voice

Allows you to select the guidance voice: **FEMALE** or **MALE**.

Routing & Guidance

From the Setup screen (second), say or select **Routing & Guidance** and the following screen appears:



to

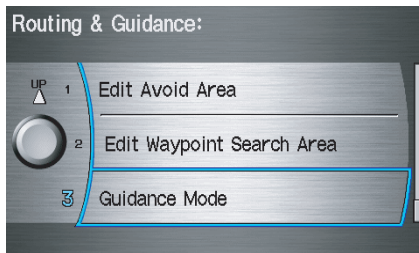

Rerouting

If **Rerouting** is set to **AUTOMATIC** and you deviate from the route, you will see “Recalculating...” at the top of the screen for several seconds as the system calculates a new route. This is followed by new routing instructions.

If **Rerouting** is set to **MANUAL**, you will hear a tone when the “Off route” message is displayed. Say “Recalculate” or select **Recalculation** on the screen to make the system recalculate your new route.

NOTE:

- *If you live in an area with poor mapping, you may wish to set **Rerouting** to **MANUAL** to avoid constant recalculation. However, you will have to manually select **Recalculation** on the screen to have the system plot a new route.*
- *It is strongly recommended that you leave the system set to the factory default (Automatic).*

System Set-up

Unverified Area Routing

Allows you to receive turn-by-turn map and voice guidance in unverified areas when on route to a destination (see *Map Overview* on page 6). The chart below illustrates the routing differences with this setting **ON** or **OFF**.

	Unverified Area Routing: OFF (factory default)	Unverified Area Routing: ON
Decision: Why choose ON or OFF?	The driver wishes to navigate manually by using the navigation map and choosing the streets that lead to the destination. The driver understands that unverified roads may not be accurate, and can contain errors in location, naming, and address range.	The driver chooses to let the navigation system suggest possible routing. The driver understands that in some cases guidance may not be appropriate. Unverified roads may not be accurate, and can contain errors in location, naming, and address range.
What you will see...	A blue dotted vector line is displayed on the map that continually points to your destination. The driver should stop and then use the map to select streets that lead to the destination.	A blue-pink dashed route line highlights suggested unverified streets on the map while traveling to your destination. This is in sharp contrast to the normal blue route line displayed in verified areas.
Cautionary messages	There are cautionary pop-up screens and voice announcements, before and during the route. These serve as reminders that you should obey all traffic restrictions.	There are cautionary pop-up screens and voice announcements, before and during the route. These serve as reminders that you should exercise additional caution, and obey all traffic restrictions.
Guidance (map/voice)	There is no turn-by-turn map or voice guidance.	Voice guidance commands end with the words “If possible.” This is to remind the driver to verify all traffic restrictions before making a maneuver.
Directions list	A direction list is typically not available. However, depending on your route, directions are provided to help you reach the first available verified road.	A direction list is provided showing street names and turn symbols in pink.

Unverified Area Routing

When driving to your destination, you have the choice of using or not using “unverified” roads. You make this choice in the **Setup** screen. The next few pages contain an example of a route to a destination in an unverified area explaining the routing differences found in unverified areas.

With **Unverified Area Routing OFF**, the system tries to use verified roads whenever possible. In this example, since only verified streets are used, it created a longer route than necessary.

With **Unverified Area Routing ON**, the route is shorter, but consists of unverified (light colored) streets that may not be accurate. Because the streets are unverified, there may be errors in street location, name, or address range. Additional caution is recommended in these areas. Always obey posted traffic restrictions.

Because both routes bypass or use unverified streets, an initial Disclaimer screen is provided. It is recommended that you stop and review the map.

Unverified Area Routing “OFF”

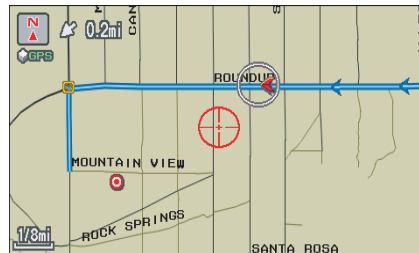
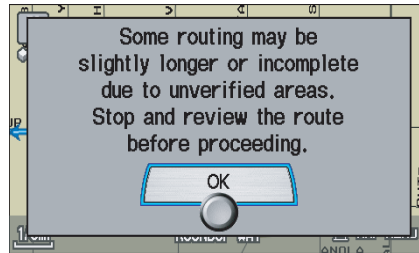

Unverified Area Routing “ON”

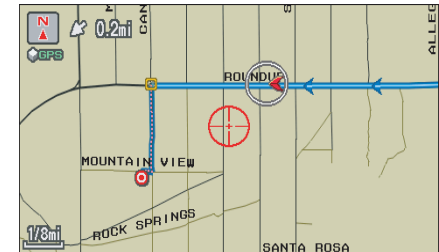
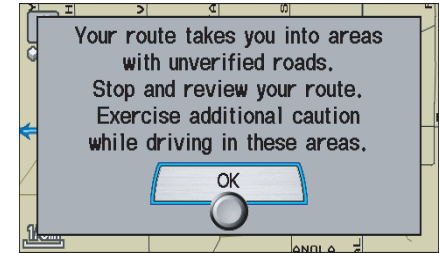

NOTE:

Unverified roads are shown only when viewing the map in the 1/20, 1/8 and 1/4 mile map scales, or the 80, 200 and 400 meter map scales.

System Set-up

With **Unverified Area Routing OFF**, the driver chose to take a shortcut, and avoid the long route. The moment you enter an unverified street, a caution box appears on the screen, and is read by the voice. This lets you know that you are about to enter an unverified area and that you will be following a dotted “vector line” that points to your destination.

With **Unverified Area Routing ON**, a caution box appears on the screen and is read by the voice. In this case you will be presented with a dashed blue/pink line instead of the regular blue route line. You cannot assume that all guidance is appropriate. This is your signal to pay attention to posted traffic restrictions.

In both cases, when you actually enter the unverified street, a short caution will remind you. You will see and hear this short caution message whenever you enter unverified areas.

Unverified Area Routing “OFF”

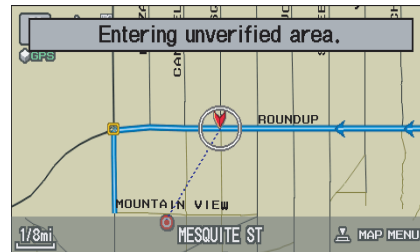
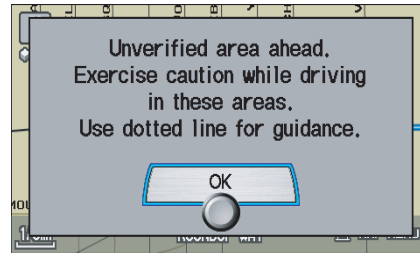

Unverified Area Routing “ON”

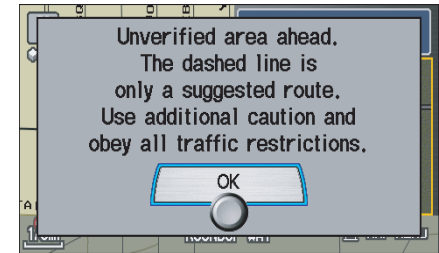

With **Unverified Area Routing OFF**, you are presented with a blue “vector line” that always points to the destination. You must manually choose streets from the map that will lead to your destination. No guidance is provided, and there are no directions to the destination.

With **Unverified Area Routing ON**, a blue/pink route line is shown for unverified segments. Voice guidance commands in unverified areas always end with “if possible.” This is your signal that you should use additional caution, and obey all traffic restrictions. The maneuver window “arrow” shows any portions of unverified turns in blue/pink dashes.

These guidance maneuvers are only a suggestion. You should always confirm that the maneuver is possible. A direction list is also provided that shows any unverified roads in a blue color, with pink arrows pointing to the next maneuver.

Unverified Area Routing “OFF”



NOTE:

For the pop-up menu displayed when pushing in on the **Interface Dial** from the map screen, **Voice and Directions are grayed out.** With **Unverified Area Routing “OFF,” no Direction List is provided.**

Unverified Area Routing “ON”

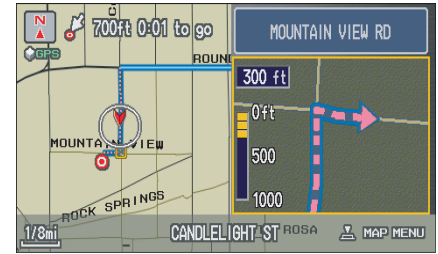

Direction list:

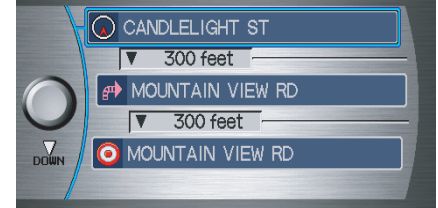

System Set-up

Edit Avoid Area

This function allows you to select areas you wish to avoid when calculating a route to your destination. You can select up to 5 areas to avoid. You may wish to set up an “avoid area” to route around long term road construction, closures, or any area you wish to avoid. If you enter a route that takes you through or into an “avoid area,” a pop-up box will warn you that your route takes you into one of these areas. However, you can still choose destinations in an avoided area.

When you select **Edit Avoid Area**, the following list screen is displayed.



You can select **NEW AREA**, or select one of your existing areas to modify. If you choose **NEW AREA**, the following screen is displayed:

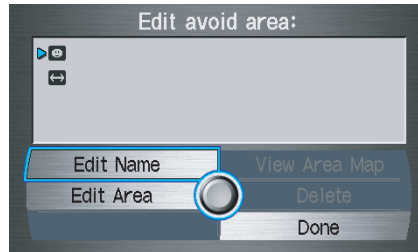

Say or select **Edit Name**, and use the **Interface Dial** to enter the name on the **Enter avoid area name** screen (19 characters max). Say or select **DONE** to return to the previous screen.

Say or select **Edit Area**, to create the area to be avoided. The following screen appears.



Either select **Address** or **Map Input** on the **Enter avoid area by** screen. Each choice provides a slightly different way to locate the approximate map display for drawing the area you wish to avoid.

After selecting the choice, a map screen will be displayed.



Rotate the **Interface Dial knob** to select the map scale (available scales are 1/20, 1/8, and 1/4 mile scales). Use the **Interface Dial** to move the crosshairs (red circle) to the desired start point and push in on the **Interface Dial** to “set” the start point. Then move the **Interface Dial** in a straight or diagonal direction to encompass the area to be avoided.



NOTE:

The maximum size of the “Avoid area” is 1/4 of the navigation display screen regardless of the map scale setting.

The selected area will be displayed as a shaded box with an orange border. Push in on the **Interface Dial** to set the end point of the avoided area. To “re-draw” the area, select **CANCEL** and repeat the area selection process.

Say or select **DONE** to return to the **Edit avoid area** screen.

If your selected area contains a freeway, the system will prompt you with a pop-up box saying, “Do you want to avoid freeways?” Answering “No” allows you to enter a route through an avoided area on a freeway, and skip the “Avoid area caution box” (See *Pop-ups and Disclaimers* on page 69).

When you return to the **Edit avoid area** screen, the “Vicinity” field is automatically filled in by the system. Re-edit the area “Name” if desired. Select **Done** on the **Edit avoid area** screen to finish editing. Your new avoided area will now appear on the “Avoid area” list, and be viewable on the map screen.

System Set-up

NOTE:

- You can select areas to avoid, however you cannot select roads or areas that you want the system to use for routing.
- If you are drawing a box around a road as an area to avoid, ensure the following: When you draw the box, make sure that the road or portion of a road that you encircled includes an intersection. For instance, in the example below, highway 213 will be avoided, but Van Ness will not be avoided because it lacks an intersection in the enclosed box.

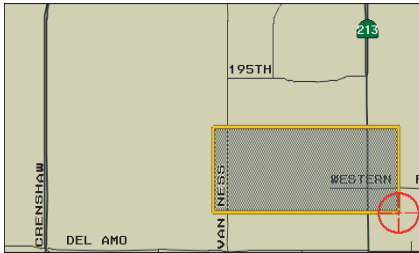

Edit Waypoint Search Area



When driving on route to your destination, you can select a temporary destination “waypoint” (marked with a small flag on the map) along your route for gas, a restaurant, or other POI. When you resume your trip from the “waypoint,” the system continues the trip to your original destination. To use this feature, see *Search Waypoint on Route* on page 71.

This Setup item allows you to select the distance from your highlighted route line (on either side of your route), that the system will search for a “waypoint.” From the *Routing & Guidance* screen, select **Edit Waypoint Search Area**, and then choose the desired search distance for either “On Freeways” or “On Surface Street.”

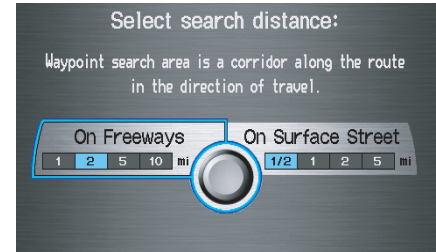

The diagram below shows how the system handles the search for places “Along the route” or “Around the destination” (see *Search Waypoint on Route* on page 71).



For “Places along the route,” the system looks in front of you within a corridor width specified by your values for “On Freeways” or “On Surface Street.” The system checks the upcoming area, based on your input.

For “Places around the destination,” the system searches outwards in a spiral from the destination. In this case, specific search values are not needed; the matches are displayed in order of distance from destination.

NOTE:

These settings do not affect the search range used for the voice commands like, “Find nearest gas station,” that are also available when viewing the map screen.

Guidance Mode 

Allows you to select the guidance display mode: **Single Screen** or **Split Screen**.

To get to Guidance Mode from the Setup screen, select in sequence, "More", "Routing & Guidance", and "Guidance Mode".

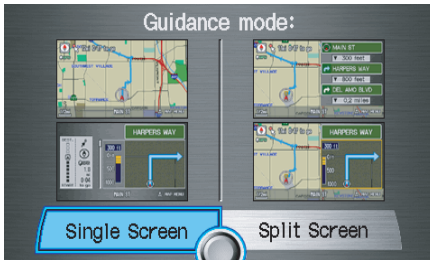

The factory default is **Single Screen**.

NOTE:

The Guidance Mode can also be selected on the Icon Selection screen. See Showing Icons on the Map on page 65.

Clock Adjustment 

From the Setup screen (second), say or select **Clock Adjustment** and the following screen appears:



This screen allows you to set or adjust the following:

- Daylight Saving Time (DST) (Default = On)
- Auto Time Zone by GPS (Default = On)
- DST selection (Change DST schedule)
- Time adjustment (Adjust your clock)
- Reset button (resets this screen’s settings to factory defaults)

System Set-up

Auto Daylight

Sets automatic daylight saving time **On** or **Off**. If set to **On** the navi clock will automatically "spring ahead" or "fall behind" by one hour when a daylight savings time change occurs. If you reside in a state or area where daylight saving time is not used, then you may want to turn this feature off.

NOTE:

If you set Auto Daylight to **ON**, the Auto Daylight function is activated even in an area that does not adopt the Auto Daylight system.

The federal government has mandated that, starting in 2007, daylight savings time will change in March & November instead of the old schedule in April & October. The new government daylight savings time schedule is subject to review and possible cancellation in 2008.

The dates that the navi switches between standard and daylight savings time are stored in the navi software, and is not triggered by GPS satellite signals. Therefore your navi clock will change based on the daylight savings time schedule.

*If you need to adjust the clock for daylight savings time, go to the Clock adjustment screen in the Setup. Select **Time Adjustment** and simply adjust the navi time using the **Interface Dial** by one hour.*

Auto Time Zone

Sets automatic time zone selection by GPS to **ON** or **OFF**. If you are driving across the country and passing through time zones, then this feature will automatically set the time to the time zone you are traveling through. However, if you live and work in two different time zones, you may want to turn this feature off.

NOTE:

When driving near a time zone boundary, the displayed time zone may fluctuate between the two zone times.

DST selection (Change DST schedule)

This option lets you select the schedule (**April–October**, or **March–November**) when daylight saving time will automatically occur in your navi. The system default is the new 2007 "**March–November**" schedule as mandated by the US government. During 2008–2009, it is possible that this new change will be canceled by the government, and returned back to the previous "**April–October**" schedule. If so, simply change the schedule in this setting.



Time Adjustment

Adjusts the current time in hours and minutes. Switch **HOUR** and **MINUTE** by moving the **Interface Dial** left or right, and change value by rotating the **Interface Dial knob**. Selecting **DONE** returns you to the previous screen. You can reset the adjustment by selecting **RESET**.

NOTE:

Selecting **RESET** also clears any changes you made to “Auto Daylight” or “Auto Time Zone” settings. Depending on your location, you may need to adjust these settings.

Vehicle

From the **Setup** screen (second), say or select **Vehicle** and the following screen appears:

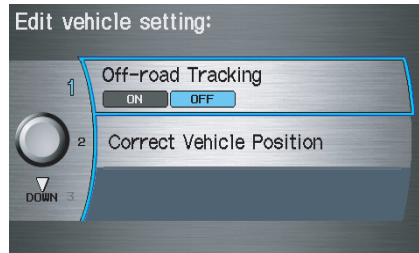

Off-road Tracking

With this **ON**, the system will provide white off-road tracking dots (“breadcrumbs”) on the **map** screen whenever you drive into an area where the map does not show any roads. See *Map Screen Legend* on page 20.

After you have traveled approximately 1/2 mile away from a mapped road, the system will display a series of white dots on the **map** screen to show the path you have traveled. This is provided so you can follow the dots to backtrack to the mapped road you originally left. Tracking continues until you reach a mapped road. See *Off-road Tracking* on page 67.

Tracking is shown only in the 1/20, 1/8, 1/4, and 1/2 mile, or the 80, 200, 400, and 800 meter scales. Rotate the **Interface Dial knob** to change the scales if necessary.

NOTE:

To clear existing dots, turn this feature off and exit **Setup**. To re-enable this feature, return to **Setup** and turn it on again.

System Set-up

Correct Vehicle Position

The system relies on satellites for positioning information. Buildings, tunnels, and other objects can block or reflect these signals, requiring the system to use “dead reckoning” to determine your location and direction. This can sometimes lead to small errors in positioning, such as showing you on an adjacent street.

NOTE:

Using this function to adjust vehicle position is not recommended. When the system acquires a GPS signal, it will automatically place the vehicle in the correct location.

If you choose to do this, follow these steps:

1. Stop the vehicle.

2. Select **Correct Vehicle Position**, and the system will display a map adjustment screen.

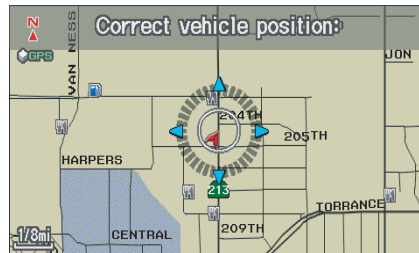

3. Use the **Interface Dial** to move the vehicle position arrowhead to the correct location, and push in on the **Interface Dial**. The display will change to:

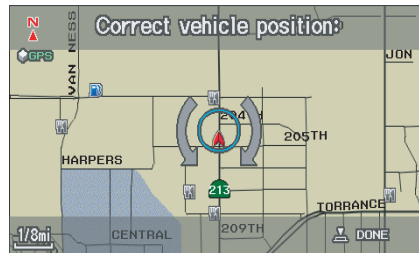

4. Rotate the **Interface Dial knob** so the vehicle position arrowhead is pointing in the correct direction, and push in on the **Interface Dial**. The display will return to the previous screen.

NOTE:

If you continually have to do this, there are either problems in the database or GPS reception problems. See Accessories Precautions on page 5.

5. As you drive, the current road will be displayed at the bottom of the screen.

Color

From the Setup screen (second), say or select **Color** and the following screen appears:

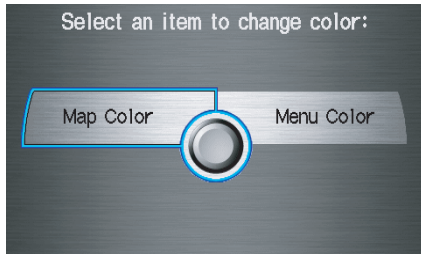

Map Color

Allows you to choose the map color from one of four colors for the **Day** and **Night** mode.



Say “Return” or press the **CANCEL** button to return to the previous screen.

NOTE:

- Choose “White” (factory default is beige) as the **Day** color to obtain the best daytime display contrast.
- Choose “Black” (factory default) as the **Night** color to obtain the best nighttime display contrast.

Menu Color

Allows you to choose the menu color from one of five colors for the **Day** and **Night** mode.



Say “Return” or press the **CANCEL** button to return to the previous screen.

NOTE:

- Choose “Silver metal” (factory default) as the **Day** color to obtain the best display contrast.
- Choose “Black metal” (factory default) as the **Night** color to obtain the best display contrast.

System Set-up



Switching Display Mode

Pressing the **Display mode** button  allows you to toggle through the screen display modes: **Day**, **Night** or **Off**. This button is the overriding control for the day/night display mode, and is the simplest way to control the display mode. If the display is turned **Off**, press any navi button to cancel the **Off** position.

See the chart below for an explanation of other day/night display mode adjustment and how they interact with each other.



(Factory default screen colors shown)

Illumination control	Priority	Operation	Override conditions
Display mode button  (see page 11)	1	Allows selection of Day , Night or Off display mode. This button has the highest priority and overrides all other display control adjustments listed below.	When the car is restarted, the display mode previously selected by this button is canceled, and the display mode is determined by one of the controls below.
Sunlight Sensor (Middle of dash near the windshield). (See owner's manual for location)	2	If the sunlight sensor detects daylight and the headlights are turned on, the navi automatically overrides (cancels) the Night display and displays the Day display mode once the vehicle begins to move.	If desired, use the Display mode button  to override this automatic choice.
Dash illumination adjustment button (See Owner's manual for location)	3	When headlights are turned on, and you wish to have the Day display mode, then adjust the illumination to the full bright setting (beeps).	When the headlights are turned ON , adjust the dash brightness down (counterclockwise) from the maximum brightness position.
Headlights (On/Off)	4	When turned on, it changes the display to the Night display mode. The previous 3 controls listed above can "cancel" this function.	Use the Display mode button  , or adjust the dash illumination to full bright to set the display to your desired choice.
Map Day/Night screen color choice (see page 103 for the Day and Night color choices)	N/A	The user can select the color of the screen that will be displayed for the Day , and Night display modes described above.	For best contrast, ensure that the Map "color" is white for Day , and black for Night .

Recommended Display mode Day/Night settings:

- With the headlights on, select mid range for the dash illumination (see Owner's manual for location of knob).
- With the headlights off, select mid range for the dash illumination (see Owner's manual for location of knob).
- On the Setup "Color" adjustment screen, choose White for the map **Day** display, and black for the map **Night** display (see page 103). Inappropriate adjustment of these colors can cause the **Day/Night** modes to appear inoperative.

System Set-up

- To allow the Sunlight sensor to function properly, avoid blocking the sensor with loose articles (see Owner's manual for location of sensor).
- Remember that once the **Display mode** button  is selected, the other display mode controls are overridden until the vehicle is restarted.

NOTE:

Loose articles in the center dash can block or interfere with the operation of the sunlight sensor. See the MDX Owner's manual for additional information regarding the dash brightness adjustment.

AcuraLink/Messages

For complete details on setting up your AcuraLink messaging, refer to the *AcuraLink* section in your Owner's manual. Or, you can go to the *Owner Link* section on the MDX page in www.acura.com.

System Information

From the **Setup** screen (second), say or select **System Information** and the following screen appears:

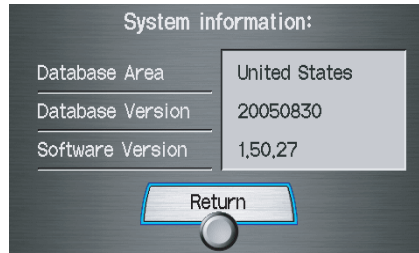

Displays the information on the navigation system software. This information is for dealer use only. For ordering updates, use the version number stamped on the label (as Ver. X.XX) of the navigation DVD. See *Obtaining a Navigation Update DVD* on page 116.

When finished, say or select **Return** to return to the previous screen.

Rear View Camera

Your vehicle is equipped with a rear view camera as shown in the illustration.

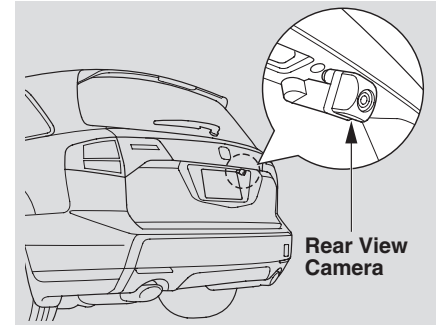

Whenever you shift to R (Reverse) with the ignition switch in the ON (II) position, the rear view is shown on the navigation system screen. For the best image, always keep the rear view camera lens clean, and be sure it is not covered.

Since the rear view camera display area is limited, you should always back up slowly and carefully, and look behind you for obstacles.

System Set-up

Rear View Camera Brightness Adjustment

When in reverse, the Navi “hard” buttons are locked out, except the rotating portion of the **Interface Dial (knob)**. Rotate the **knob** clockwise to make the camera image brighter, and counterclockwise to darken the image. This brightness adjustment is independent of the screen brightness adjustment in Setup.

NOTE:

- *The camera brightness cannot be adjusted by voice control.*
- *Slight delays can occur when switching to the camera image, or switching back to the map/menu screen. This is normal.*

System Initialization

If for any reason, you lose power to the navigation system (like the battery was disconnected), the navigation system will require initialization. Once completed, your system will be ready to use.

This initialization requires the following:

- Entry of the 4-digit anti-theft security code to “unlock” the navigation system.
- GPS initialization (may not be needed depending on the length of time the system was without power).
- Map matching to align the GPS coordinates to a place on the map (displays current street at the bottom of the map).

Entering the Security Code

If the battery goes dead or is disconnected for any reason, you will have to enter a security code for both the audio system and the navigation system before you can use it again.

When you purchased the vehicle, you should have received two cards that have the audio and navigation system’s security codes and serial numbers. Keep these cards in a safe place in case you need the codes. If you lose the cards, you must obtain the security codes from your dealer.



Enter the four-digit security code. If you have entered it correctly, the display changes to the Disclaimer screen. If you make a mistake, the system will display “INCORRECT PIN.” Re-enter your 4-digit security code. You have ten chances to enter the correct code. If all ten are incorrect, turn the ignition to OFF, then back to ON (II) to have ten more chances to enter the correct code.

Follow the instructions in the vehicle Owner’s manual to enter the 5-digit audio code. The navigation voice will not operate if the audio code is not entered.

NOTE:

The anti-theft security code is unrelated to your optional Navigation system PIN (for Personal or Home Address).

System Initialization

GPS Initialization

Depending on the length of time the battery was disconnected, your system may require GPS initialization. If it does, the following screen appears:

** Wait **

The system is acquiring its GPS signal.
This could take up to 10 minutes.

- * Engine must be running.
- * Vehicle must be parked outside away from buildings.
- * Do not move the vehicle at this time.

If this procedure is not necessary, the system proceeds directly to the **Disclaimer** screen (see page 17). During initialization, the system searches for all available GPS satellites, and obtains their orbital information. During this procedure the vehicle should be out in the open with a clear view of the sky.

If the navigation system finds the satellites properly, this box clears, and changes to the **Disclaimer** screen. If within ten minutes the system fails to locate a sufficient number of satellites to locate your position, the following screen appears:

Navigation system is unable to acquire a proper GPS signal.

- Move vehicle to another location.
- Turn the ignition switch off.
- Disconnect the battery for 30 minutes to clear the GPS receiver's memory.
- Reconnect the battery and follow the screen prompts.

After 30 minutes with this screen displayed, turn off the engine and restart the car. If you now see the **Disclaimer** screen, the GPS initialization is complete. The green GPS icon should appear in the upper left corner of the screen.

NOTE:

- *The average acquiring time is less than 10 minutes, but it can take as long as 45 minutes.*
- *If the system is still unable to acquire a signal, follow the instructions on the screen, or contact your local dealer for assistance.*

Map Matching

This part of the initialization matches the GPS coordinates found above with a road on the **map** screen. To perform this part of the procedure, ensure that the navigation system is displaying a map, and drive the vehicle on a mapped road (a road shown on the **map** screen). Do not enter a destination at this time. When the name of the current road you are driving on appears at the bottom of the screen, the entire procedure is complete. Your system is now ready to use.

Although your navigation system is one of the most highly sophisticated pieces of equipment you will find in a modern automobile, you may find during its use, that it has certain limitations.

The system uses signals from the Global Positioning System (GPS) to aid in determining its current location. The GPS is operated by the U.S. Department of Defense. For security reasons, there are certain inaccuracies built into the GPS that the navigation system must constantly compensate for. This can cause occasional positioning errors of up to several hundred feet.

For example, in urban areas where streets are close together, this could cause the system to show that you are traveling on a street that parallels the street you are actually on. The system will, under most circumstances, correct itself while you drive.

Also, depending on your current view of the sky and the position of the satellites, the elevation may be shown incorrectly. You may also notice some delay of the vehicle position icon at intersections; this is normal.

GPS Reception Issues

The signals received from the GPS satellites are extremely weak (less than a millionth of the strength of a local FM station), and require an unobstructed view of sky. The signal can easily be interrupted or interfered with by the following:

- After-market metallic window tint above or to the sides of the GPS antenna (located under the dash)
- Cell phones, PDAs, or other electronic devices docked in a cradle or laying loose on the dash
- Radar detectors mounted on the dash
- Remote starters, or “hidden” vehicle location systems mounted near the navigation unit

- Other after-market audio electronic devices mounted near the navigation unit
- Trees, tall buildings, freeway overpasses, tunnels or overhead electrical power wires

Although the system will direct you to your desired destination, it may not always generate what you consider to be the most direct route. Try changing the method of routing. See *Changing the Routing Method* on page 51. You may also have Unverified Area Routing set to “OFF.” See *Unverified Area Routing* on page 92.

Additionally, the mapping database contains verified and unverified maps. See *Map Overview* on page 6. A Disclaimer screen will warn you if your route includes unverified streets. Unverified streets may be missing from the map, in the wrong location, or have an incorrect name or address range. Exercise additional caution when driving in these unverified areas.

System Limitations

The destination icon shows the approximate location of the destination. This occurs because a city block can have as many as 100 possible addresses (for example, the 1400 block is followed by the 1500 block.) Since most cities use only a portion of the 100 possible addresses (for example, in the 1400 block, the addresses may only go up to 1425 before the 1500 block starts), the address 1425 will be shown a quarter of the way down the block by the system instead of at the end of the block where the destination is actually located.

You may find that the system occasionally “reboots.” This is indicated by the display returning to the globe screen. A reboot can be caused by a number of things, such as extreme temperatures or shock from bumpy roads. It does not necessarily indicate a problem that requires service. If this happens frequently, please see your dealer.

You will find that some points of interest (POI) may be missing when you search the database. This can be caused if at the time the database was gathered, the name was misspelled, the place was improperly categorized, or the POI change is not yet in the database. This means you may not find places listed that you know exist. This is also true for police agencies and hospitals. In outlying areas, facilities listed may not be the closest. Always check with local information sources if you need law enforcement or hospital services.

Every effort has been made to verify that the system's database was accurate at the time it was created. However, businesses do fail or move to new locations, and new businesses start in the old locations. For this reason, you may occasionally find "inaccurate" information when you select and drive to a point of interest (for example, a restaurant is now a jewelry store). The number of these inaccuracies increases the longer you go without an update.

The digitized map database reflects conditions as they existed at various points in time before production. Accordingly, your DVD may contain inaccurate or incomplete data or information due to the passage of time, road construction, changing conditions, or other causes.

In addition, this database does not include, analyze, process, consider, or reflect any of the following categories of information:

- Neighborhood quality or safety
- Population density
- Availability or proximity of law enforcement
- Emergency, rescue, medical, or other assistance
- Construction work, zones, or hazards
- Road and lane closures
- Legal restrictions (such as vehicular type, weight, load, height, and speed restrictions)
- Road slope or grade

- Bridge height, width, weight, or other limits
- Road, traffic or traffic facilities safety, or conditions
- Weather conditions
- Special events
- Pavement characteristics or conditions
- Traffic congestion
- Travel time

We assume no liability for any incident that may result from an error in the program, or from changed conditions not noted above.

Copyrights

- infoUSA-Data: Certain business data provided by infoUSA, Inc., Omaha, Nebraska, Copyright © 2003, All Rights Reserved.
- EXIT-Data: © ZENRIN CO., LTD. 2003. All Rights Reserved.
- ZAGAT SURVEY: Copyright © [2003] Zagat Survey, LLC. All rights reserved.

Client Assistance

Reporting Errors

Occasionally, you may encounter database errors.

- If the error pertains to freeways and main “verified” roads shown in black on the map, then report it either online at <http://update.navteq.com/>, or to Acura Client Services.
- If the error involves a light brown “unverified” road, then do not report it. These areas have not been verified, and are provided for reference only (see *Map Overview* on page 6).
- For errors in points of interest (POI), like a business that has changed their name, do not report them. Keep in mind that depending on when the data was collected, and when your DVD was purchased, the database can be out of date. The business may have not reported the change(s), or not be in the database at all. Update Navigation DVDs are available for purchase, usually in the fall of each year.

- If the error does not involve the database, such as if the vehicle position icon does not follow the road, screen error messages, or other GPS related errors, see *Frequently Asked Questions* on page 128, *System Limitations* on page 111, or *Troubleshooting* on page 136.

Acura Automobile Client Service

Telephone: (800) 382-2238
Fax: (310) 783-3535

Acura Navi

America Honda Motor Co., Inc.
Acura Client Services
MS 500-2N-7E
1919 Torrance Blvd.
Torrance, CA 90501-2746

Visiting Your Dealer

We strive to make this manual as complete as possible and to answer all questions regarding operation of the system. Occasionally you may run into a specific issue that you cannot find in the book. You may save yourself a trip to the dealer by first consulting the following resources:

- The Troubleshooting section (see page 136)
- The Frequently Asked Questions (FAQs) section (see page 128)
- The navi FAQs found on the on-line DVD order site (see “Obtaining a DVD”)
- For detailed questions regarding HFL, Audio, or other systems that interact with the navigation system, see the main vehicle Owner’s manual, or the Quick Start Guide
- For traffic related issues, see the “Real Time Traffic Display” section (on page 23) and FAQs (on page 128)

- Call Acura Client Relations (see “Acura Automobile Client Service”)
- For database or POI issues, follow the guidelines in the “Reporting Errors” section (see page 114)

If your question is still unanswered and you wish to visit the dealer, please be prepared to demonstrate the issue to the service writer. That way, the writer can document the issue for the factory to allow more efficient troubleshooting. Some issues may at first seem random, but you may notice a pattern, like it only occurs when you enter some specific address, or when driving on a certain road, or just when it’s cold. This information is very useful to the service writer. Be patient, the tech may be unfamiliar with your specific issue.

If you need to visit your Acura dealer for a navigation related issue, ensure that you have the “Key Fob” that was in use when the problem occurred. Each driver (1, or 2) can have their own navigation and other vehicle settings. In order for the dealer to properly diagnose the problem, the correct key fob is necessary to troubleshoot the issue.

Obtaining a Navigation Update DVD

Acura is continually expanding the scope of the navigation system. Upgraded software may be made available to navigation system owners periodically, usually in the fall of each year.

To purchase an updated DVD or a replacement DVD, call the Acura Navigation Disc Fulfillment Center at (888) 549-3798. You can also order on-line by going to www.acura.com and selecting in order: "Acura Store", "Navigation DVD Updates", "Shop Navigation DVDs", and "Order Navigation DVD".

NOTE:

- *DVDs are not available at your dealer. However, the dealer may order a DVD for you as a courtesy. There is no program for free DVD updates.*
- *The DVD order line staff cannot answer technical questions regarding navigation operation, coverage, or POIs.*

Changing the DVD

NOTE:

The system's database is stored on a removable DVD. The system will not work without the DVD. Ensure the door remains closed at all times.

1. Remove the DVD while the ignition switch is in the Accessory (I) position or in the ON (II) position.
2. Locate the control unit. It is under the driver's seat.
3. Push the **OPEN** button. An error message will display on the screen. This is normal.

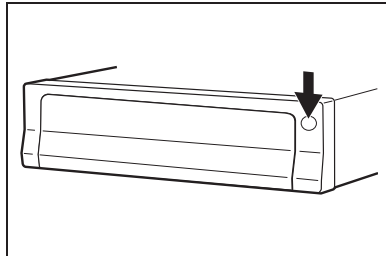

4. Push the **Eject** button. The DVD will automatically come out.

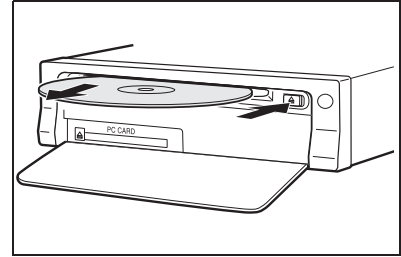

5. Pull the DVD straight out. Hold the DVD by the edges. Fingerprints, scratches, or other contamination on the playing surface can make the DVD unreadable.

To install the Navigation DVD, make sure the white label is facing up. Slide the DVD into the slot. The DVD is automatically pulled into the control unit. Make sure you close the door.

NOTE:

- *The system will not play movies or other video/audio discs.*
- *Never “sneak preview” a newer white labeled DVD in the system unless you plan to keep it. The system cannot automatically “revert back” to a prior version DVD. If you must revert to a previous version DVD after loading a newer version, see your dealer for assistance.*
- *If you see the error message “Navigation unit door is open...,” close the door. The system will reboot. This is normal.*

PC Card

A PC card is not supplied. The PC card slot is for factory use only. This slot cannot be used to play audio files.

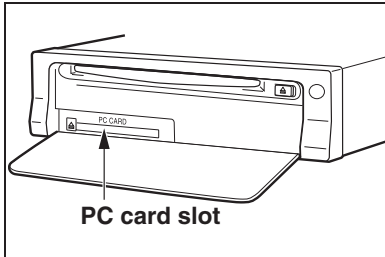

Coverage Areas

Map Coverage

The system provides map coverage for the following 48 US states, and southern Canada. The US map coverage consists of accurately mapped (verified) metropolitan areas (in the following list), and a less accurate (unverified) rural database. Canada coverage consists of major metropolitan areas, and major roads connecting the metropolitan areas within about 100 miles north of the U.S. border. If you need additional North Canada coverage, you may purchase the gray Canadian DVD (see *Obtaining a Navigation Update DVD* on page 116). See *Map Overview* on page 6 for a discussion of map coverage.

The cities and metropolitan areas in the following list are fully mapped. Only major streets, roads, and freeways have been verified outside these areas. If your route passes through these areas, routing may be limited in these areas, depending on your routing choices. See *Unverified Area Routing* on page 92.

U.S. Detailed Coverage Areas

Alabama

Birmingham/Tuscaloosa
Huntsville
Mobile

Arizona

Phoenix Metro
Sedona
Tucson

Arkansas

Fayetteville
Hot Springs
Little Rock

California

Bakersfield
Fresno
Los Angeles/San Diego Metro
Merced
Modesto
Sacramento Metro
San Francisco Bay (*approximately Monterey to Sonoma*) - including *Monterey County and Hollister*
San Luis Obispo
Stockton

Colorado

Denver/Boulder/Colorado Springs/
Ski Resorts Metro area - including
Ft. Collins

Connecticut

Bridgeport
Danbury
Hartford Metro
New Haven Metro
Norwalk
Stamford

Delaware

Entire state - including *Dover, Wilmington Metro area, New Castle County*

Florida

Cape Canaveral/Cocoa Beach/
Titusville
Florida Keys
Fort Myers Metro area - including
Naples
Fort Pierce
Gainesville
Jacksonville Metro - including *St. Johns County*
Miami/Fort Lauderdale/West Palm
Beach Metro
Orlando/Daytona Beach/Melbourne
area - including *Osceola County*

Pensacola
Tallahassee
Tampa Bay/St. Petersburg Metro
- including Pasco and Manatee
Counties
Vero Beach

Georgia

Athens
Atlanta Metro
Augusta/Aiken Metro
Macon

Idaho

Boise
Sun Valley Ski Resorts

Illinois

Chicago Metro (*to Wisconsin border*)
- including *Lake County, IN and
DeKalb County, IL*
East St. Louis Metro
Moline
Rock Island
Rockford
Springfield

Indiana

Fort Wayne
Gary/Hammond Metro
Indianapolis Metro
Kokomo Metro
Northwest Indiana
South Bend/Elkhart/Goshen

Iowa

Cedar Rapids
Davenport
Des Moines
Iowa City

Kansas

Kansas City/Leavenworth Metro
Wichita

Kentucky

Lexington
Louisville

Louisiana

Baton Rouge
New Orleans Metro
Shreveport

Maine

Bangor
Bar Harbor/Acadia National Park
Portland/Lewiston/Auburn

Maryland

Baltimore/Washington D.C. Metro
- including *Charles and Carroll
Counties*
Ocean City

Massachusetts

Boston/Cape Cod Metro
Cape Cod
Springfield Metro area
*Complete coverage of all cities in
Barnstable, Berkshire, Bristol, Essex,
Hampshire, Hampden, Middlesex,
Norfolk, Plymouth, Suffolk, and
Worcester Counties*

Michigan

Detroit Metro area - including *Ann
Arbor, Pontiac, Flint, Clinton, Eaton,
and Monroe Counties*
Grand Rapids Metro
Kalamazoo
Lansing Metro
Northern Michigan Resort area -
*including Traverse City, Elk Rapids,
Petoskey, Charlevoix, Boyne City,
and Harbor Springs*

Coverage Areas

Minnesota

Minneapolis/St. Paul Metro
- including cities in Anoka Scott and
Carver Counties
Moorhead
Rochester

Mississippi

Biloxi/Gulfport
Jackson

Missouri

Branson
Columbia
Kansas City (KS-MO) Metro
- including Platte County
St Louis Metro (IL-MO) - including
additional cities in Jefferson County

Montana

Billings

Nebraska

Lincoln (Lancaster County)
Omaha

Nevada

Las Vegas Metro
Reno/Lake Tahoe

New Hampshire

Manchester
Nashua

New Jersey

Southern New Jersey - including
Atlantic City/Cape May/Cumberland
Metro
Camden Metro
Newark Metro
Trenton Metro - including Ocean and
Hunterdon Counties

New Mexico

Albuquerque
Santa Fe
Taos Ski Resorts

New York

The Adirondack
Binghamton
Buffalo - including Erie and Niagara
Counties
Cooperstown
Eastern New York - including New
York City Metro, Albany, Glen Falls,
Schenectady, Troy
Ithaca
Lake Placid
Oneonta
Rochester - including cities in
Monroe County
Syracuse
Utica

North Carolina

Asheville
Charlotte Metro
Hickory
Morgantown
Raleigh-Durham Metro
Wilmington
Winston-Salem/Greensboro Metro

North Dakota

Fargo Metro

Ohio

Akron
Columbus/Marysville Metro
Cincinnati Metro - including Butler
County
Cleveland Metro - including Geauga
County
Dayton
Toledo (Lucas County)

Oklahoma

Oklahoma City
Tulsa

Oregon

Bend
Eugene
Portland/Salem Metro

Pennsylvania

Allentown
Erie
Gettysburg
Harrisburg
Lancaster
Philadelphia Metro
Pittsburgh Metro - *including Washington County*
Reading
State College/University Park
Wilkes-Barre/Scranton
York

Rhode Island

Newport
Providence Metro

South Carolina

Beaufort
Charleston
Columbia
Greenville/Spartanburg - *including additional cities in Greenville and Spartanburg Counties*
Myrtle Beach Metro
Rock Hill Metro

South Dakota

Sioux Falls

Tennessee

Chattanooga
Johnson City/Kingsport/Bristol
Knoxville/Farragut Metro
Memphis Metro - *including Desoto and Tunica Counties*
Nashville

Texas

Austin Metro
Big Bend
Bryan/College Station
Corpus Christi
Dallas/Fort Worth Metro - *including additional cities in Grayson County*
El Paso
Houston Metro - *including additional cities in Galveston County*
Midland/Odessa Metro
San Antonio Metro
South Padre Island

Utah

Moab
Ogden
Park City
Salt Lake City Metro

Vermont

Burlington
Montpelier

Virginia

Washington D.C. detailed area
- *including Alexandria, Arlington, Fairfax, Falls Church, Fauquier County, Fredericksburg City, Manassas, and additional cities in Loudoun and Prince William Counties*
Bristol
Charlottesville
Lynchburg
Richmond Metro
Roanoke
Shenandoah National Park
Williamsburg/Norfolk/Virginia Beach Metro - *including Charles City, Hopewell, Kent, and Prince George Counties*
Winchester

Washington

Bellingham
Seattle/Tacoma/Olympia Metro
- *including Island County*
Spokane
Tri-Cities
Whatcom
Point Roberts (community)

Coverage Areas

West Virginia

Charleston
Harper's Ferry Metro

Wisconsin

Appleton
Beloit
Green Bay
Janesville
Kenosha County
Madison
Lake Geneva
Milwaukee Metro - *including Milwaukee, Ozaukee, Washington, and Waukesha Counties*
Neenah
Oshkosh
Racine
Sheboygan
Wausau

Wyoming

Cheyenne
Jackson Ski Resorts

Canada Detailed Coverage Areas

NOTE:

The blue colored city names are not included in the USA South DVD. To obtain coverage for cities listed in blue, you may purchase the gray Canada DVD (see Obtaining a Navigation Update DVD on page 116). DVDs are not available at your dealer.

ALBERTA

Banff
Canmore
Airdrie
Calgary
Cochrane
Crossfield
Chestermere
Edmonton
Lethbridge
Medicine Hat

BRITISH COLUMBIA

Greater Vancouver

Anmore
Belcarra
Bowen Island
Burnaby
Coquitlam
Delta
Langley
Langley Twp
Lions Bay
Maple Ridge
New Westminster
North Vancouver
North Vancouver District
Pitt Meadows
Port Coquitlam
Port Moody
Richmond
Surrey
Squamish
Vancouver
West Vancouver
White Rock

Whatcom, WA

Point Roberts (Community) *also listed in USA Washington St Cities*

Fraser Valley

Abbotsford
Chilliwack
Mission

Victoria

Capital

Central Saanich
Colwood
Esquimalt
Highlands
Langford
Metchosin
North Saanich
Oak Bay
Saanich
Sidney
Sooke
Victoria
View Royal

Squamish-Lillooet

[Whistler](#)
[Kamloops](#)

MANITOBA

East St Paul
Headingley
West St Paul
Winnipeg

NOVA SCOTIA

Halifax (*partial*)

ONTARIO

Barrie
Kingston
Ottawa-Gatineau
Stratford

Dufferin

Orangeville

Durham

Ajax
Brock
Clarington
Oshawa
Pickering
Scugog
Uxbridge
Whitby

Halton

Burlington
Halton Mills
Milton
Oakville

Hamilton

Hamilton

Niagara

Fort Erie
Grimsby
Lincoln
Niagara-on-the-Lake
Niagara Falls
Pelham
Port Colborne
St Catharines
Thorold
Wainfleet
Welland
West Lincoln

Peel

Brampton
Caledon
Mississauga

Simcoe

Bradford West Gwillimbury

Toronto

Toronto

Waterloo

Cambridge
Kitchener
North Dumfries
Waterloo

Coverage Areas

Wellington

Guelph
Puslinch

York

Aurora
East Gwillimbury
Georgina
King
Markham
Newmarket
Richmond Hill
Vaughan
Whitchurch-Stouffville

Windsor

Essex

Lasalle
Tecumseh
Windsor

Inter-Town (partial) Coverage

Counties/Districts/Regional Municipalities

Brant
Bruce
Chatham-Kent
Dufferin
Elgin
Essex

Frontenac
Gray
Haldimand-Norfolk
Haliburton
Hastings
Huron
Kawartha Lakes
Lambton
Lanark
Leeds and Granville
Lennox and Addington
Middlesex
Muskoka
Northumberland
Oxford
Perth
Peterborough
Prescott and Russell
Prince Edward
Simcoe
Stormont, Dundas and Glengarry
Waterloo
Wellington

QUÉBEC

Municipalites Regionales de Comte

Beauharnois-Salaberry
Brome-Missisquoi
Coaticook
La Haute-Yamaska
La Vallee-du-Richelieu
Le Haut-Richelieu
Le Haut-St-Laurent
Les Jardins-de-Napierville
Memphremagog
Roussillon
Rouville
Vaudreuil-Soulanges

Montreal

Deux-Montagnes

Deux-Montagnes
Oka
Oka Paroisse
Pointe-Calumet
St-Eustache
St-Joseph-du-Lac
Ste-Marthe-sur-le-Lac

L'assomption

Charlemagne
Le Gardeur
Repentigny

La Vallée-du-Richelieu

Beloil
Caringnan
Chambly
Longueuil
McMasterville
Mont-St-Hilaire
Otterburn Park
St-Basile-le-Grand
St-Mathieu-de-Beloil
Longueuil
Ste-Julie

Laval

Laval

Les Moulins

Lachenaie
Mascouche
Terrebonne

Longueuil

Longueuil

Montreal

Montreal
Rousillon
Candiac
Chateauguay
Delson
La Prairie
Lery
Ste-Catherine
St-Constant

Therese-de-Blainville

Blainville
Boisbriand
Bois-des-Filion
Lorraine
Rosemere
Ste-Therese

Vaudreuil-Soulanges

Hudson
L'Ile-Cadieux
L'Ile-Perrot
Notre-Dame-de-l'Ile-Perrot
Pincourt
St-Lazare
Terrasse-Vaudreuil
Vaudreuil-Dorion
Vaudreuil-sur-le-Lac

Québec

Québec

CANADA CONNECTOR ROADS

The Cross-Canada Connector Road allows for travel between the provinces of British Columbia and Quebec in DCA 11. Major metropolitan city Points of interest are also included.

Road Inclusion

Roads in the province of British Columbia

Hwy-1/Trans Canada Hwy from Alberta/BC boundary to Vancouver detailed city.
Hwy-3/Crowsnest Hwy from Hwy-1/ Trans Canada Hwy (Hope) to Hwy-5/ Coquihalla Hwy (Hope)
Hwy-5/Coquihalla Hwy (in Hope) to Hwy-1/Trans Canada Hwy (in Kamloops)
Hwy-99 between Vancouver and Whistler

Coverage Areas

Roads in the province of Alberta

Hwy-1/Trans Canada Hwy across whole province
Hwy-1A from Cochrane to Canmore
Hwy-1X from Hwy-1A to Hwy-1/Trans Canada Hwy
Morley Road from Hwy-1/Trans Canada Hwy
Hwy-3/Crowsnest Hwy (at Medicine Hat) to Lethbridge
Hwy-4 (at Lethbridge) to 1-15 (US border)
Hwy-36 between Hwy-3 (in Taber) and Hwy-4 (in Warner)
Hwy-3/Crowsnest Hwy (in Lethbridge) to Hwy-2 (in Fort Macleod)
Hwy-2 (in Fort Macleod) to Hwy-1/Trans Canada Hwy (in Calgary)

Roads in the province of Saskatchewan

Hwy-1/Trans Canada Hwy across whole province

Roads in the province of Manitoba

Hwy-1/Trans Canada Hwy across whole province
Hwy-100/Trans Canada Hwy in Winnipeg (partial beltway)
Hwy-75 from Hwy-100/Trans Canada Hwy (Winnipeg) south to link with 1-29 (US border)

Roads in the province of Ontario

Hwy-69/Trans Canada Hwy from Muskoka district to Sudbury
Hwy-17/Trans Canada Hwy from Ottawa Detailed Area Coverage to Manitoba border
Hwy-17B at Sault Ste Marie to link with 1-75 (US border)
Hwy-61 from Hwy-17 at Thunder Bay to link with US-61 (US border)
Hwy-11 from Muskoka district to North Bay
Hwy-60 and Hwy-127 in Nipissing County

Cities with available real-time in-car traffic information

The following cities currently have available real-time traffic information.

Atlanta, GA
Austin, TX
Baltimore, MD
Boston, MA
Buffalo - Niagara Falls, NY
Charlotte, NC
Chicago, IL
Cincinnati, OH
Cleveland, OH
Columbus, OH
Dallas - Ft. Worth, TX
Denver - Boulder, CO
Detroit, MI
Hartford - New Britain - Middletown, CT
Houston - Galveston, TX
Indianapolis, IN
Kansas City, KS
Las Vegas, NV
Los Angeles, CA
Memphis, TN
Miami - Ft. Lauderdale - Hollywood, FL
Milwaukee - Racine, WI
Minneapolis - St. Paul, MN
Nashville, TN
New York, NY

Newfork - Virginia Beach - Newport News, VA
Orlando, FL
Philadelphia, PA
Phoenix, AZ
Pittsburgh, PA
Portland, OR
Providence - Warwick - Pawtucket, RI
Sacramento, CA
Sarasota - Bradenton, FL
San Antonio, TX
San Diego, CA
San Francisco - Oakland, CA
San Jose, CA
Seattle - Tacoma, WA
St. Louis, MO
Tampa - St. Petersburg - Clearwater, FL
Washington, DC
West Palm Beach - Boca Raton, FL
Wilmington, DE

Coverage may expand to other cities as traffic information in those cities becomes available. For the latest traffic coverage details for each metropolitan area, check www.acura.com/realtimetrffic. This site provides traffic coverage for each city, a demonstration video and FAQs.

If you desire additional map coverage information, contact Acura Client Services or go to www.acura.com and select in order: "Acura Store", "Navigation DVD Updates", "Shop Navigation DVDs", and "View Current Coverage Map". Enter your vehicle model and model year, then select the state in which you want to check map coverage.

Frequently Asked Questions

Map, and Features, Voice Operation, Entering Addresses

Problem	Solution
Why does the Disclaimer screen need to be displayed every time I start the car? I am the only driver.	The Disclaimer screen reminds you and your guest drivers to always operate the navigation system in a safe manner.
The Setup or Information screen has “grayed out” items that I cannot select. Why?	You need to select OK on the Disclaimer screen to view these items. See <i>System Function Diagram</i> on page 26.
I tried entering an address, but the city or street could not be found. Is there any other way to route to the location?	Some cities are lumped in with a major metro area Try entering the street first. In rural “unverified” areas or new subdivisions, streets may be missing, or only partially numbered. Try selecting the destination directly from the map. See <i>By Map Input</i> on page 45.
When I enter an address, some letters become grayed out. Is this normal?	Yes, as you enter each letter in an address or a point of interest (POI), the system looks in the database to see what letters are possible and “grays out” letters that do not apply.
How do I delete Personal Address, Previous Destinations, or the Home Address?	This is done in Setup, under “Personal Information.” See page 84.
I cannot hear the navigation system voice.	1) Ensure that Volume in the Setup screen (first) is not OFF . See page 83. 2) Go to “Basic Settings” in the Setup screen (second), and set Voice Recognition Feedback to ON . See page 90.
The voice control system is having difficulty recognizing my Voice commands.	Ensure that the vents are not blowing on the microphone on the ceiling, the vehicle is as quiet as possible, and that you are using the correct command when speaking (See <i>Improving Voice Recognition</i> on page 14). Say “Help” at any screen to see a list of the applicable voice commands.
When the system pronounces the street name in the guidance command, or reads the destination address it sounds strange. What causes this?	The basic guidance phrase uses a studio-recorded voice, but the street name is pronounced by the system using a machine-generated voice. Consequently, the name may be mispronounced or sound strange at times.
When I drive at night, the screen is bright and will not switch to the night display mode. Why?	Verify the following: The display mode in Setup is set to Night mode, the dash brightness is not set to maximum, and Map Color in Setup is set to Black for Night. See <i>Switching Display Mode</i> on page 104.

Frequently Asked Questions

Problem	Solution
The daytime map screen is dark like the night display mode, and it is hard to see. Why?	Verify the following: The display mode in Setup is set to Day mode, and Map Color in Setup is set to White for Day. See <i>Switching Display Mode</i> on page 104.
During the day, I turned on the lights because it started to rain, but the screen went dark. How can I make it still display day mode?	Adjust the dash brightness (+) knob to full brightness. Remember to set it back to a medium setting, or at night, the screen will be bright. See <i>Switching Display Mode</i> on page 104.
How can I input my destination using map coordinates?	The navigation system was not designed for this. However, you can view the coordinates of an address by pushing in on the Interface Dial , selecting Show Icon on Map , and moving the Interface Dial left to select Current Location . See <i>Displaying Current Location</i> on page 21
How do I change or remove my PIN?	Go to “Personal Information” in the Setup screen (second), and select PIN Number . Enter your existing PIN, and then you have the choice to change or remove the PIN. See page 88.
I forget the PIN. How do I reset it?	PINs are optional. See information regarding PINs on page 88. Your dealer can reset the PIN for you.
I change my setup settings, but they are not saved when I restart the vehicle.	Verify that your Remote Keyless Entry is linked (The MID shows “Welcome drive 1” or “Welcome driver 2”). See page 18 for additional information.
I cannot access my Calendar or Address Book. Why?	
CALL is not available on the Calculate route to screen. Why?	Your phone is not “paired” to the HFL, or if your phone is “paired,” it is in use; press HFL BACK button.

Frequently Asked Questions

Traffic

Problem	Solution
My Real-Time Traffic is missing and is not displaying properly. What is wrong?	<p>Verify the following:</p> <ul style="list-style-type: none">• Check the traffic icon on the icon bar, and the icon options for traffic. page 65 walks you through the verification steps.• Ensure that you have the correct remote (the settings for driver 1 and driver 2 are set independently by each driver).• Your XM “Nav Traffic” subscription may have expired. Call XM at (800) 967-2346 and verify your account status. If your subscription has lapsed, you may need to request a “rapid refresh” after XM performs the refresh, then leave the vehicle running outside for 30 minutes to receive the refresh.• It is possible that there is a temporary technical problem with your metropolitan area traffic. You can call Acura Client Services to see if there is an outage (page 114).• If the situation persists, see your Acura dealer for assistance.

Guidance, Routing

Problem	Solution
The navi does not route me the same way I would go, or the way some other mapping program displays. Why is this?	The navigation system attempts to generate the optimum route. See <i>Changing the Routing Method</i> on page 51.
Why is the street I'm on not shown on the map? It has been here for more than a year.	The mapping database is constantly undergoing revision. See page 116 for ways to obtain the latest detailed coverage information.
The vehicle position icon is not following the road and the "GPS icon" text in the upper left hand corner of the screen is white or missing.	<ul style="list-style-type: none"> • The GPS antenna (located under the center of the dash) may be blocked by personal items. For best reception, remove items from the dash, such as radar detectors, cell phones, or loose articles. • Metallic tinting or other after-market devices can interfere with the GPS reception. Please see your dealer. Also see <i>System Limitations</i> on page 111.
I entered a destination, but the blue highlighted route and voice guidance stopped, or turned into a blue/purple dashed line before I got to my destination. Why is this?	Your route has entered an unverified area. See <i>Unverified Area Routing</i> on page 92.
The map rotates while I make a turns, How can I stop this?	Select the "North-up" map orientation by voice, or by selecting "North-up" from the map menu. See <i>Map Orientation</i> on page 61.
Sometimes I cannot select between the North-up, and Heading-up map orientations, why is this?	The "Heading-up" map orientation can only be shown in the lower scales (1/20 - 1 mile scales). See <i>Map Scale</i> on page 60.
While driving to my destination, the "time to go" display sometimes increases even though I am getting closer.	The "Time to go" is based on actual road speeds. However if you speed slows down when you encounter slower traffic, the system updates the "Time to go" based of your actual speed to give you a better estimate of arrival time.
The vehicle position icon on the map "lags" a short distance behind especially when I arrive at an intersection. Is there anything wrong?	No, when at an intersection, the system is unaware of the width of the intersecting road. Large differences in vehicle position can indicate a temporary loss of the GPS signal. See <i>GPS Reception Issues</i> on page 111.

Frequently Asked Questions

Problem	Solution
While I drive, my screen shows white dots (“breadcrumbs”) on it. What do they mean?	These are called “breadcrumbs.” If you drive more than 1/2 mile from mapped roads, the off-road tracking feature begins to function. See <i>Off-road Tracking</i> on page 67 and 101.
How can I get rid of the white dots (“breadcrumbs”) from my screen?	Go to “Vehicle” in the Setup screen (second), and set Off-road Tracking to OFF , then return to the map. See page 101.
A road that I selected to avoid is being used when routing. What is wrong?	When you “draw” your area to avoid, make sure to select sections of roads that include at least one intersection. See page 96.
When I arrive at my destination, the “bulls-eye” is shown at a different location on the street. Why?	The system calculates the “bulls-eye” location based on the street address range allocated for that street. See <i>Destination Icon</i> on page 62 for an example.
My elevation (shown when I display the current position) seems to fluctuate even though my elevation has not changed.	This is normal, and due to errors in satellite position. The elevation can vary +/- 100 feet. See <i>System Limitations</i> on page 111.
My elevation is missing on the “current position” screen. Why?	If the GPS antenna cannot receive at least 4 satellites, the elevation is not displayed. Try moving the vehicle into an open area. If the elevation is zero, or below sea level, the elevation is also not displayed.

Ordering a Navi DVD, Coverage, Map Errors, Limitations

Problem	Solution
I want to buy a new DVD. How do I purchase one?	You cannot obtain a new DVD from the dealer. See <i>Obtaining a Navigation Update DVD</i> on page 116.
I want to order a DVD. How can I determine the DVD version in my navigation system?	The version is on the label of your DVD. It starts with “Ver:.” See <i>Changing the DVD</i> on page 116.
I got a Navi DVD from a “friend,” but it does not work. Why?	Your vehicle was designed to use a white DVD. DVDs with different colored labels, or from different manufacturers, will not operate correctly. Always obtain DVDs from the DVD order desk. See page 116.
When is my city going to become part of a fully verified detailed coverage area?	The mapping database vendor is constantly revising map coverage. See page 116 for ways to obtain the latest detailed coverage information.
Will the navigation system work outside North America?	The navigation system contains maps only for the lower 48 states, and portions of southern Canada. The system will not work in Mexico, Hawaii, Alaska, or overseas. Canada coverage is limited. See <i>Map Coverage</i> on page 118.
Can I play video DVDs in my navigation system?	No. The navigation system is designed only to read the white DVD provided with your vehicle. Map discs for other vehicle manufacturers, or PC map programs will not work.
I found some errors in the database. How do I report them?	Minor errors are bound to occur in a large database. If you encounter major errors, you can report them following the instructions on page 114.

Frequently Asked Questions

Display, Accessories

Problem	Solution
The display appears dim when starting the car in real cold weather. Is there a problem?	No, this is normal, and will become brighter after a few minutes.

Rear Camera

Problem	Solution
When I shift gears, the rear camera image is delayed.	When shifting into or out of reverse, you may experience delays when the screen image switches between the navi screen and the rear camera image. This is normal.
The rear camera image is too dark or too bright, how do I adjust the brightness.	While the camera image is displayed, use the Zoom In/Zoom Out controls to adjust the brightness. This adjustment does not affect the Setup screen brightness adjustments.

Miscellaneous Other Questions

Problem	Solution
My clock frequently changes forward and backward by one hour. Why is this?	The clock is being automatically set based on your GPS location. If you live and work on the boundary between two time zones, you can turn off this feature. See page 100.
When driving near a time zone border, the time changes even though I am not near the time zone. Why is this?	The time zone borders are only approximated in the system. Depending on the geography of the time zone boundary, the switch to a different zone can be erratic. See page 100.
My state does not observe daylight savings time. How do I turn off this feature?	You can turn off this feature. See page 100.

Frequently Asked Questions

Problem	Solution
Daylight savings time occurred, but the navigation system did not change time even though Setup shows “Auto Daylight” is “ON.”	Go to the Clock Adjustment screen in Setup and simply turn off the auto daylight savings time feature, select Time Adjustment , and adjust your clock <i>using the Interface Dial</i> by one hour. For more information, see <i>Clock Adjustment</i> on page 99.
The navigation system automatic daylight time feature is not switching the navigation system clock on the correct dates. Why is this?	The navigation system is designed to switch to daylight savings time according to the schedule in effect at the time your vehicle was produced. For more information, see <i>Clock Adjustment</i> on page 99.
The navigation system clock switched by one hour for no apparent reason. What can cause this?	<ol style="list-style-type: none"> 1) You may be near a time zone boundary...(Covered in the other “clock” FAQs) 2) The navigation system does not, or incorrectly switches between standard and Daylight savings time. Set the “Auto Daylight” to “OFF” on the Clock Adjustment screen in Setup. Manually adjust the clock by one hour as needed. See page 99 for more information.
My battery was disconnected, or went dead, and the navigation system is asking for a code. Where do I find this code?	There should have been a card in the glove box with the anti-theft code for the navigation/audio system. This card contains the 4-digit security code and serial number. If you cannot find it, your dealer can help you out.
I speak a language other than English. When will other languages be available for the navigation system?	This is being considered as a future enhancement.

Troubleshooting

Screen Error Message	Solution
Navigation system is unable to acquire a proper GPS signal.	Make sure there is nothing on the dash blocking the GPS antenna (after-market metallic window tinting or after-market devices placed on the dash, like radar detectors, cell phones, or loose items). If the dashboard is clear of objects, move the vehicle to an open space away from tall buildings, trees, etc.
Navigation unit door is open or No DVD disc is inserted. Please check system.	Make sure that the navigation DVD disc is inserted with the label side up and the navigation unit door is fully snapped closed (see page 116).
No DVD disc. Please check system.	Check that the navigation DVD disc is inserted with the label side up (page 116). If the problem persists, see your dealer.
DVD disc reading error (unformatted). Please consult your dealer.	Check the DVD disc surface for deep scratches or other damage. Make sure you are using a Navigation DVD (white colored label). The system cannot read other mapping databases or video DVDs. If the problem persists, see your dealer.
Display temp is too high. System will shut down until display cools down.	This message will appear briefly when the display temperature is too high, and then the display will turn off until the temperature cools down. The system will turn back on when the display cools down.
Outside temperature is low. System will take awhile to start up.	The temperature is below -22°F and the navigation ECU has difficulty reading the DVD. The system will start up when the temperature warms up.
Route has not been completed. Please try again from a different location.	This message will appear when you are routing to or from a place (new area) that is not in the database. Try planning a different route to or from a different location.*
No alternate route found. Original route will be followed.	No alternative route method was found. The original route method will be used.* Ensure that a road name is displayed at the bottom of the map.
This destination cannot be found in database.	The destination was not found in the database. Try another destination nearby, or select the destination with the Interface Dial .*

* If the error persists, or is shown for a wide area, see your dealer.

Glossary

The following is a glossary of terms pertaining to the voice recognition navigation system.

Average Fuel - The average fuel economy value as displayed by the Trip computer screen.

Avoid Area - Areas you wish to avoid can be entered into the system, and will be avoided while routing.

Breadcrumbs - Off road tracking dots that can be followed on the map to retrace your route back to a mapped (digitized) road. This function can be turned on/off in Setup screen (second).

Database - This consists of the map data, and the POI (Points Of Interest) data stored on the DVD.

DCA - Detailed Coverage Area. The main metropolitan areas in the lower 48 states, and southern Canada are mapped to this level. See page 118 for a list of these areas.

Digitized Road - A road that appears on the navigation screen. The road name will appear at the bottom of the navigation screen. If the user drives "off road," the navigation system will display "breadcrumbs," depending on how far you drive from a mapped road.

Disclaimer Screen - Screen containing cautionary information. It is meant to be read carefully and acknowledged by the client when using the navigation system.

DVD or DVD-ROM - Digital Versatile Disc. The navigation program and database resides on this disc. For information on how to order a replacement or update DVD, see page 116.

Elapsed Time - Elapsed Time for the current trip as displayed by the Trip computer screen.

FAQ - Frequently Asked Questions. See page 128 for a list of the client FAQs, and troubleshooting information.

GPS - Global Positioning System. A network of 24 satellites in orbit around the earth. The navigation system can simultaneously receive signals from up to 12 satellites to accurately position the vehicle on the map.

GPS Antenna - Located in the center of the dash. Electronic items operating in this general location can interfere with the GPS signal.

HFL - HandsFreeLink. Your vehicle is equipped with this feature, which uses Bluetooth technology as a wireless link between the vehicle and your Bluetooth compatible cell phone.

Icon - Symbol representing Points of Interest (POI) that can be displayed on the map.

Glossary

Initialization - This refers to the period needed to reacquire the GPS satellite orbital information whenever the navigation system power has been disconnected. This can take 10 to 45 minutes with the vehicle out in an open area.

Instant Fuel - The current instantaneous fuel economy value as displayed by the Trip computer screen.

LCD - Liquid Crystal Display. The navigation screen.

Map Matching - The received GPS information allows the navigation system to position the vehicle on the map. Map matching has occurred if the map screen is displaying the current street name in the bottom-shaded area.

Mic - Abbreviation for the microphone used for receiving voice commands. It is located near the map light in the ceiling.

Multi-Information Display (MID) - Located in the gauge assembly. See the Owner's manual for additional information.

MW - Maneuver Window. While on-route to a destination, this window displays information about the next maneuver.

Navi - Abbreviation for the navigation system.

North Pointer - The map symbol showing the map orientation. See page 61.

Off Route - This occurs when the user leaves mapped roads. Off road tracking dots ("breadcrumbs") are displayed if the option is enabled in the Setup screen. The user can use them to return to a mapped road. The bottom of the navigation screen will say "Not on a digitized road"

Outlying Areas - These are rural areas that typically have only their main roads mapped. All other roads are shown in light brown for reference only, since they have not been verified.

PIN - Personal Identification Number. A random 4-digit number created by the client to protect personal information.

POI - Point Of Interest. These are the businesses, schools etc. found under the **Places** option on the Enter destination by screen. See page 51.

Polygon - Colored areas on the map screen denoting parks, schools etc. See *Map Screen* "features" for a list of the assigned colors. See page 51.

Reminder - Automatic "pop-up" Calendar message. See *Calendar* on page 78.

Remote Keyless Entry - Allows you to lock/unlock the doors, unlock the tailgate, and link/unlink Driver 1/ Driver 2 settings.

RES - Rear Entertainment System. (Factory installed)

Security Code - Code needed to activate the navigation system or audio system. See *Entering the Security Code* on page 109.

Unverified Streets - These streets have not been verified for turn restrictions, one-way, etc. They are shown in light brown on the map. Unverified streets may be missing from the map, shown in the wrong location, or have an incorrect name or address range.

Vehicle Speed Sensor - Provides speed signal to the navigation system for moving the VP icon on the map.

Verified Streets - These streets consist of the detailed metropolitan coverage areas, and all other inter-town connection roads. These roads are shown in black on the map.

Voice Control - See VR.

VP - Vehicle Position. When in map mode, this circular icon shows the vehicle position on the map. Push in on the **Interface Dial**, select **Show Icon on Map**, move the **Interface Dial** left to select **Current Position**. It shows the latitude, longitude, and elevation of your current position.

VR - Voice Recognition. This allows voice control of many of the navigation functions. The hardware consists of the microphone, voice control switch (**NAVI TALK/NAVI BACK** buttons), and the front speakers.

Waypoint - A temporary destination you may enter with on route (e.g., a gas station, ATM, etc.). See page 71.

Yaw Rate Sensor - Senses when the vehicle makes a turn, which makes the VP change direction on the map as you turn.

Zagat Ratings - Restaurant ratings information provided by Zagat Survey. See **Information** screen on page 76 for an explanation of the ratings.

Voice Command Index

Global Commands

The system accepts these commands on any screen.

Help (reads list of the commands for the displayed screen)

Setup (displays **Setup** screen (first))

Display map (displays the **map** screen)

Display menu (displays the **Enter destination by** screen)

Display audio screen

Information (displays the **Information** screen)

Back (to previous screen, same as **CANCEL** or **NAVI BACK** button)

Cancel (cancels current activity)

What time is it?

The “Voice Command Help” option on the **Information** screen lists many of the following controls. To avoid distraction while you are driving, the system can read the commands for you.

The commands are accessible at any time while driving and can be read to you so that you do not need to memorize all of them.

Navigation General Commands

The system accepts these commands on a **map/guidance** screen.

Display menu (if on route, displays the **Change route by** screen)

Display navigation (if on route, displays the **Change route by** screen)

Display map

Display map guide (when on route, shows the next maneuver)

Display setup (or just *Setup*)

Display information (or just *Information*)

Display audio screen

Cancel

Backward (or just *Back*)

What time is it?

Repeat voice (repeats the screen prompt)

Help (reads list of **Navigation General** and **Navigation Display Commands** at any screen)

Voice command help

How long to the destination? (when on route, tells the time to destination)*

How far to the destination? (when on route, tells the distance to destination)*

Display destination map (when on route, shows the map of the destination)

Display entire route (when on route, adjusts the map scale so that the entire route is displayed)

Display current location (shows current latitude, longitude, and elevation)

Register the current location (puts current location in the personal Address Book)

Display traffic incidents (or *Display traffic list*)

* These commands are not available if you scroll the map while on route to a destination.

Navigation Display Commands

The system accepts these commands on a map/guidance screen.

Display current location

Display north up

Display heading up

Display zoom in

Display zoom out

Display: (the selected scale)

1/20 mile (80 m) scale

1/8 mile (200 m) scale

1/4 mile (400 m) scale

1/2 mile (800 m) scale

1 mile (1600 m) scale

2 mile (3 km) scale

5 mile (8 km) scale

15 mile (24 km) scale

50 mile (80 km) scale

150 mile (240 km) scale

350 mile (560 km) scale

Max zoom in

Max zoom out

Go home

Messages

Display: (display the selected icon on the screen)

ATM

gas station

restaurant

post office

grocery store

lodging (hotel, motel)

parking garage

parking lot

school

hospital

freeway exit information

Traffic (displays both traffic icons and speed flow. See page 22)

Traffic speeds (displays the traffic flow bands alongside the road. See page 22)

Traffic icons (shows traffic icons. See page 22)

Traffic incidents (displays a list of traffic incidents. See page 24)

Voice Command Index

Hide: (hide the selected icon from the screen)

ATM

gas station

restaurant

post office

grocery store

lodging (hotel, motel)

parking garage

parking lot

school

hospital

freeway exit information

Traffic (hides both traffic icons and speed flow. See page 22)

Traffic speeds (hides the traffic flow bands alongside the road. See page 22)

Traffic icons (hides the traffic icons. See page 22)

Find Place Commands

The system accepts these commands on a map/guidance screen.

Find nearest: (find the nearest selection)

ACURA dealers

HONDA dealers

gas station

hydrogen station

ATM

bank

post office

hospital

police station

hotel

tourist attraction

shopping (all shopping types)

parking garage

parking lot

other car dealers

auto parts & electronics

auto repair & maintenance

car wash & detailing

motorcycle dealers

roadside assistance

check cashing

currency exchange

veterinarian

business

civic center

convention center

library

school

city hall

court house

higher education

amusement park

golf course

historical monument

marina

movie theater

museum

park

performing arts

sports complex

bed & breakfast

accessory store

book store

clothing store

grocery store

home improvement store

mall

office supply store
pharmacy
pet food store
sewing store
shoe store
sporting goods store
toy store
airport
automobile club
bus station
camping
commuter rail station
ferry terminal
named place
park & ride
rental car agency
resort
rest area
ski area
tourist information
train station
travel agency
truck stop
restaurant (all restaurant types)
American restaurant
Californian restaurant

Chinese restaurant
continental restaurant
fast food
French restaurant
German restaurant
Greek restaurant
Indian restaurant
Italian restaurant
Japanese restaurant
Korean restaurant
Mexican restaurant
seafood restaurant
Thai restaurant
vegetarian restaurant
Vietnamese restaurant
Zagat restaurant
other restaurant

Climate Control Commands

The system accepts these commands on most screens.

Climate control full automatic
(controls temperature to 72 degrees F)

Climate control automatic (controls temperature to your selection)

Climate control off

Air conditioner on

Air conditioner off

*Air conditioner**

Climate control defrost on

Climate control defrost off

*Climate control defrost**

Rear defrost on

Rear defrost off

*Rear defrost**

Climate control fresh air

Climate control recirculate

Climate control vent

Climate control bi-level (vent and floor)

Climate control floor

Climate control floor and defrost

Fan speed up

Fan speed down

Voice Command Index

Fan speed # (#:1-7) (for best voice control, keep fan speed at 1 or 2)

Front climate control automatic

Front climate control off

Rear climate control automatic

Rear climate control off

Rear climate control vent

Rear climate control floor

Rear fan speed up

Rear fan speed down

Rear fan speed # (#:1-5)

(for best voice control, keep fan speed at 1 or 2)

* Repeating these commands switches (toggles) the function between On and Off.

Temperature Voice Commands

The system accepts these commands on most screens.

Temperature # degrees (#: 57 to 87 degrees F)

Temperature up

Temperature down

Temperature max hot (displays HI)

Temperature max cold (displays LO)

Temperature balance

Temperature dual mode on

Temperature dual mode off

*Temperature dual mode**

Temperature sync on

Temperature sync off

Temperature sync

Driver temperature # degrees
(#: 57 to 87 degrees F)

Passenger temperature # degrees
(#: 57 to 87 degrees F)

Rear temperature # degrees
(#: 57-87)

Rear temperature up

Rear temperature down

* Repeating these commands switches (toggles) the function between On and Off.

Radio Voice Commands

The system accepts these commands on most screens.

Audio on

Audio off

*Audio**

Radio on (or Radio play)

Radio off

*Radio**

Radio select FM1

Radio select FM2

Radio select AM

Radio # FM (#: frequency. Example

Radio 95.5 FM)

Radio # AM (#: frequency. Example

Radio 1020 AM)

Radio seek up

Radio seek down

Radio next station (same as Radio seek)

Radio preset # (#: 1-6)

Radio FM preset # (#: 1-6)

Radio FM1 preset # (#: 1-6)

Radio FM2 preset # (#: 1-6)

Radio AM preset # (#: 1-6)

*Radio auto select**

*Radio scan**

Radio select XM1

Radio select XM2

XM channel # (#: 1-255)

XM channel up

XM channel down

XM category up

XM category down

XM preset # (#: 1-6)

XM1 preset # (#: 1-6)

XM2 preset # (#: 1-6)

*XM scan**

*XM category scan**

*XM channel scan**

XM category mode

XM channel mode

* Repeating these commands switches (toggles) the function between On and Off.

CD Voice Commands

The system accepts these commands on most screens.

CD play

CD play disc # (#: 1-6)

CD play track # (#: 1-30)

CD play disc #1 track #2
(#1: 1-6, #2: 1-30)

CD skip forward

CD skip back

CD play next disc

CD play previous disc

*CD track random**

*CD track repeat**

*CD disc repeat**

*CD track scan**

*CD disc scan**

CD normal play (resumes “Play” from these commands: “CD track random,” “CD track repeat,” and “CD disc repeat”)

CD track list

*CD folder random**

*CD folder repeat**

*CD folder scan**

CD folder list

Voice Command Index

- * Repeating these commands switches (toggles) the function between On and Off.

DVD Voice Commands (for 6 Disc Changer)

The system accepts these commands on most screens.

DVD play
DVD play disc # (#: 1-6)
DVD play track # (#: 1-30)
DVD play disc #1 track #2
(#1: 1-6, #2: 1-30)
DVD skip forward
DVD skip back
DVD play next disc
DVD play previous disc
*DVD track random**
*DVD track repeat**
*DVD disc repeat**
*DVD track scan**
*DVD disc scan**
DVD normal play (resumes “Play” from these commands: “DVD track random,” “DVD track repeat,” and “DVD disc repeat”)
DVD track list

- * Repeating these commands switches (toggles) the function between On and Off.

MP3/WMA Voice Commands (for 6 Disc Changer)

The system accepts these commands on most screens.

MP3 play
MP3 play disc # (#: 1-6)
MP3 play track # (#: 1-30)
MP3 play disc #1 track #2
(#1: 1-6, #2: 1-30)
MP3 skip forward
MP3 skip back
MP3 play next disc
MP3 play previous disc
*MP3 track random**
*MP3 track repeat**
*MP3 disc repeat**
*MP3 track scan**
*MP3 disc scan**
MP3 normal play (resumes “Play” from these commands: “MP3 track random,” “MP3 track repeat,” “MP3 disc repeat,” “MP3 folder random,” and “MP3 folder repeat”)
MP3 track list
*MP3 folder random**
*MP3 folder repeat**
*MP3 folder scan**
MP3 folder list

WMA play

WMA play disc # (#: 1-6)

WMA play track # (#: 1-30)

WMA play disc #1 track #2
(#1: 1-6, #2: 1-30)

WMA skip forward

WMA skip back

WMA play next disc

WMA play previous disc

*WMA track random**

*WMA track repeat**

*WMA disc repeat**

*WMA track scan**

*WMA disc scan**

WMA normal play (resumes “Play”
from these commands: “WMA
track random,” “WMA track
repeat,” “WMA disc repeat,”
“WMA folder random,” and
“WMA folder repeat”)

WMA track list

*WMA folder random**

*WMA folder repeat**

*WMA folder scan**

WMA folder list

* Repeating these commands switches
(toggles) the function between On
and Off.

Single CD Voice Commands (for DVD Player)

The system accepts these commands on
most screens.

NOTE:

*These commands are available for a
vehicle with factory RES.*

Single CD play

Single CD pause

*Single CD title up***

*Single CD title down***

*Single CD next title***

*Single CD previous title***

Single CD chapter up

Single CD chapter down

Single CD next chapter

Single CD previous chapter

*Single CD title # (#:1-30)***

Single CD chapter # (#:1-30)

Single CD title #1 chapter #2
(#1:1-30 #2:1-30)

Single CD play track # (#:1-30)

Single CD skip forward

Single CD skip back

*Single CD track random**

Voice Command Index

*Single CD track repeat**

*Single CD track scan**

Single CD normal play

*Single CD folder random**

*Single CD folder repeat**

*Single CD folder scan**

* Repeating these commands switches (toggles) the function between On and Off.

** The title commands select the main menu items, called “titles” (e.g., “Play movie” or “Extras”). Some CDs do not support selecting these features by voice command.

Single DVD Voice Commands (for DVD Player)

The system accepts these commands on most screens.

NOTE:

These commands are available for a vehicle with factory RES.

Single DVD play

Single DVD pause

*Single DVD title up***

*Single DVD title down***

*Single DVD next title***

*Single DVD previous title***

Single DVD chapter up

Single DVD chapter down

Single DVD next chapter

Single DVD previous chapter

*Single DVD title # (#:1-30)***

Single DVD chapter # (#:1-30)

*Single DVD title #1 chapter #2
(#1:1-30 #2:1-30)*

Single DVD play track # (#:1-30)

Single DVD skip forward

Single DVD skip back

*Single DVD track random**

*Single DVD track repeat**

*Single DVD track scan**

Single DVD normal play

* Repeating these commands switches (toggles) the function between On and Off.

** The title commands select the main menu items, called “titles” (e.g., “Play movie” or “Extras”). Some DVDs do not support selecting these features by voice command.

Single MP3/WMA Voice Commands (for DVD Player)

The system accepts these commands on most screens.

NOTE:

These commands are available for a vehicle with factory RES.

Single MP3 play
Single MP3 pause
*Single MP3 title up***
*Single MP3 title down***
*Single MP3 next title***
*Single MP3 previous title***
Single MP3 chapter up
Single MP3 chapter down
Single MP3 next chapter
Single MP3 previous chapter
*Single MP3 title # (#:1-30)***
Single MP3 chapter # (#:1-30)
Single MP3 title #1 chapter #2 (#1:1-30 #2:1-30)
Single MP3 play track # (#:1-30)
Single MP3 skip forward
Single MP3 skip back
*Single MP3 track random**

*Single MP3 track repeat**
*Single MP3 track scan**
Single MP3 normal play
*Single MP3 folder random**
*Single MP3 folder repeat**
*Single MP3 folder scan**
Single WMA play
Single WMA pause
*Single WMA title up***
*Single WMA title down***
*Single WMA next title***
*Single WMA previous title***
Single WMA chapter up
Single WMA chapter down
Single WMA next chapter
Single WMA previous chapter
*Single WMA title # (#:1-30)***
Single WMA chapter # (#:1-30)
Single WMA title #1 chapter #2 (#1:1-30 #2:1-30)
Single WMA play track # (#:1-30)
Single WMA skip forward
Single WMA skip back
*Single WMA track random**
*Single WMA track repeat**
*Single WMA track scan**

Single WMA normal play
*Single WMA folder random**
*Single WMA folder repeat**
*Single WMA folder scan**
* Repeating these commands switches (toggles) the function between On and Off.
** The title commands select the main menu items, called “titles” (e.g., “Play movie” or “Extras”). Some MP3/WMAs do not support selecting these features by voice command.

Voice Command Index

Rear Radio Voice Commands

The system accepts these commands on most screens.

NOTE:

These commands are available for a vehicle with factory RES.

Rear audio on
Rear audio off
*Rear audio**
Rear radio on
Rear radio off
*Rear radio**
Rear radio select FM1
Rear radio select FM2
Rear radio select AM
Rear radio # FM (#: frequency)
Rear radio # AM (#: frequency)
Rear radio seek up
Rear radio seek down
Rear radio next station
(same as radio seek)
Rear radio preset # (#: 1-6)
Rear radio FM preset # (#: 1-6)
Rear radio FM1 preset # (#: 1-6)

Rear radio FM2 preset # (#: 1-6)
Rear radio AM preset # (#: 1-6)
*Rear radio auto select**
*Rear radio scan**
Rear radio select XM1
Rear radio select XM2
Rear XM channel up
Rear XM channel down
Rear XM channel # (#:1-255)
Rear XM preset # (#: 1-6)
Rear XM1 preset # (#: 1-6)
Rear XM2 preset # (#: 1-6)
*Rear XM scan**
Rear XM category up
Rear XM category down
*Rear XM category scan**
*Rear XM channel scan**
Rear XM category mode
Rear XM channel mode

* Repeating these commands switches (toggles) the function between On and Off.

Rear CD Voice Commands (for 6 Disc Changer)

The system accepts these commands on most screens.

NOTE:

These commands are available for a vehicle with factory RES.

Rear CD play (use “normal play”)
Rear CD play disc # (#: 1-6)
Rear CD play track # (#: 1-30)
Rear CD play disc #1 track #2 (#1: 1-6, #2: 1-30)
Rear CD skip forward
Rear CD skip back
Rear CD play next disc
Rear CD play previous disc
*Rear CD track random**
*Rear CD track repeat**
*Rear CD disc repeat**
*Rear CD track scan**
*Rear CD disc scan**
Rear CD normal play
*Rear CD folder random**
*Rear CD folder repeat**
*Rear CD folder scan**

- * Repeating these commands switches (toggles) the function between On and Off.

Rear DVD Voice Commands (for 6 Disc Changer)

The system accepts these commands on most screens.

NOTE:

These commands are available for a vehicle with factory RES.

Rear DVD play
Rear DVD play disc # (#:1-6)
Rear DVD play track # (#:1-30)
Rear DVD play disc #1 track #2
(#1:1-6 #2:1-30)
Rear DVD skip forward
Rear DVD skip back
Rear DVD play next disc
Rear DVD play previous disc
*Rear DVD track random**
*Rear DVD track repeat**
*Rear DVD disc repeat**
*Rear DVD track scan**
*Rear DVD disc scan**
Rear DVD normal play

- * Repeating these commands switches (toggles) the function between On and Off.

Rear MP3/WMA Voice Commands (for 6 Disc Changer)

The system accepts these commands on most screens.

NOTE:

These commands are available for a vehicle with factory RES.

Rear MP3 play
Rear MP3 play disc # (#:1-6)
Rear MP3 play track # (#:1-30)
Rear MP3 play disc #1 track #2
(#1:1-6 #2:1-30)
Rear MP3 skip forward
Rear MP3 skip back
Rear MP3 play next disc
Rear MP3 play previous disc
*Rear MP3 track random**
*Rear MP3 track repeat**
*Rear MP3 track scan**
*Rear MP3 disc repeat**
*Rear MP3 disc scan**
Rear MP3 normal play
*Rear MP3 folder random**
*Rear MP3 folder repeat**

Voice Command Index

*Rear MP3 folder scan**

Rear WMA play

Rear WMA play disc # (#:1-6)

Rear WMA play track # (#:1-30)

*Rear WMA play disc #1 track #2
(#1:1-6 #2:1-30)*

Rear WMA skip forward

Rear WMA skip back

Rear WMA play next disc

Rear WMA play previous disc

*Rear WMA track random**

*Rear WMA track repeat**

*Rear WMA track scan**

*Rear WMA disc repeat**

*Rear WMA disc scan**

Rear WMA normal play

*Rear WMA folder random**

*Rear WMA folder repeat**

*Rear WMA folder scan**

- * Repeating these commands switches (toggles) the function between On and Off.

Rear Single CD Voice Commands (for DVD Player)

The system accepts these commands on most screens.

NOTE:

These commands are available for a vehicle with factory RES.

Rear single CD play

Rear single CD pause

*Rear single CD title up***

*Rear single CD title down***

*Rear single CD next title***

*Rear single CD previous title***

Rear single CD chapter up

Rear single CD chapter down

Rear single CD next chapter

Rear single CD previous chapter

*Rear single CD title # (#:1-30)***

Rear single CD chapter # (#:1-30)

*Rear single CD title #1 chapter #2
(#1:1-30 #2:1-30)*

Rear single CD play track # (#:1-30)

Rear single CD skip forward

Rear single CD skip back

*Rear single CD track random**

*Rear single CD track repeat**

*Rear single CD track scan**

Rear single CD normal play

*Rear single CD folder random**

*Rear single CD folder repeat**

*Rear single CD folder scan**

- * Repeating these commands switches (toggles) the function between On and Off.
- ** The title commands select the main menu items, called “titles” (e.g., “Play movie” or “Extras”). Some CDs do not support selecting these features by voice command.

Rear Single DVD Voice Commands (for DVD Player)

The system accepts these commands on most screens.

NOTE:

These commands are available for a vehicle with factory RES.

Rear single DVD play
Rear single DVD pause
*Rear single DVD title up***
*Rear single DVD title down***
*Rear single DVD next title***
*Rear single DVD previous title***
Rear single DVD chapter up
Rear single DVD chapter down
Rear single DVD next chapter
Rear single DVD previous chapter
*Rear single DVD title # (#:1-30)***
Rear single DVD chapter # (#:1-30)
Rear single DVD title #1 chapter #2
(#1:1-30 #2:1-30)
Rear single DVD play track #
(#:1-30)
Rear single DVD skip forward
Rear single DVD skip back

*Rear single DVD track random**
*Rear single DVD track repeat**
*Rear single DVD track scan**
Rear single DVD normal play
Rear single DVD folder random
Rear single DVD folder repeat
Rear single DVD folder scan

- * Repeating these commands switches (toggles) the function between On and Off.
- ** The title commands select the main menu items, called “titles” (e.g., “Play movie” or “Extras”). Some DVDs do not support selecting these features by voice command.

Rear Single MP3/WMA Voice Commands (for DVD Player)

The system accepts these commands on most screens.

NOTE:

These commands are available for a vehicle with factory RES.

Rear single MP3 play
Rear single MP3 pause
*Rear single MP3 title up***
*Rear single MP3 title down***
*Rear single MP3 next title***
*Rear single MP3 previous title***
Rear single MP3 chapter up
Rear single MP3 chapter down
Rear single MP3 next chapter
Rear single MP3 previous chapter
*Rear single MP3 title # (#:1-30)***
Rear single MP3 chapter # (#:1-30)
Rear single MP3 title #1 chapter #2
(#1:1-30 #2:1-30)
Rear single MP3 play track #
(#:1-30)
Rear single MP3 skip forward
Rear single MP3 skip back

Voice Command Index

*Rear single MP3 track random**
*Rear single MP3 track repeat**
*Rear single MP3 track scan**
Rear single MP3 normal play
*Rear single MP3 folder random**
*Rear single MP3 folder repeat**
*Rear single MP3 folder scan**
Rear single WMA play
Rear single WMA pause
*Rear single WMA title up***
*Rear single WMA title down***
*Rear single WMA next title***
*Rear single WMA previous title***
Rear single WMA chapter up
Rear single WMA chapter down
Rear single WMA next chapter
Rear single WMA previous chapter
*Rear single WMA title # (#:1-30)***
Rear single WMA chapter # (#:1-30)
Rear single WMA title #1 chapter #2
(#1:1-30 #2:1-30)
Rear single WMA play track #
(#:1-30)
Rear single WMA skip forward
Rear single WMA skip back
*Rear single WMA track random**

*Rear single WMA track repeat**
*Rear single WMA track scan**
Rear single WMA normal play
*Rear single WMA folder random**
*Rear single WMA folder repeat**
*Rear single WMA folder scan**

- * Repeating these commands switches (toggles) the function between On and Off.
- ** The title commands select the main menu items, called “titles” (e.g., “Play movie” or “Extras”). Some MP3/WMA do not support selecting these features by voice command.

Information Screen Voice Commands

These are additional commands not found on the **Voice Command Help** screen available when viewing the Information screen. Follow the voice prompts.

Messages

Cellular Phonebook

Voice command help (the system read and lists all of the commands, starting with Navigation General Commands)

Map legend

Calendar

Key to Zagat ratings

Calculator

Roadside assistance

Setup Screen (first) Commands

The system accepts these commands on Setup screen (first). (For Setup screen (second), simply say what is written on the screen, and follow the voice prompts)

Brightness up

Brightness down

Brightness minimum/min.

Brightness maximum/max.

Contrast up

Contrast down

Contrast minimum/min.

Contrast maximum/max.

Black level up

Black level down

Black level minimum/min.

Black level maximum/max.

Volume up (tone indicates volume)

Volume down (tone indicates volume)

Volume minimum/min. (tone indicates volume)

Volume maximum/max. (tone indicates volume)

Volume off

Interface dial feedback off

Interface dial feedback auto

Interface dial feedback on

Guidance prompts minimum/min.

Guidance prompts normal

Guidance prompts maximum/max.

On-Screen Commands

The system accepts these commands on any screen. There are over 100 on-screen commands. Just say what is written on the screen (this excludes listed items).

Next (or “Down”)

Previous (or “Up”)

Return

OK (except at Disclaimer screen)

Delete

Done

etc.

Voice Command Index

On-Screen Spelling Assist

When speaking the letters or using “spell mode,” you can substitute the name that represents each letter or symbol. This improves recognition. For example:

- To select the letter “A”:
Say “**A**,” “**Alpha**,” or “**Apple**.”
- To select the letter “M”:
Say “**M**,” “**Mary**,” or “**Mike**.”

The system will respond to the names shown in the following tables.

NOTE:

- *The system will only respond to the names shown in the following tables.*
- *To select the letter “A,” you can also; select the “A” by using the **Interface Dial**.*
- *To select the number “1,” say “One” or “Number One,” or select the “1” by using the **Interface Dial**.*
- *To select the symbol “- (hyphen),” say “Hyphen” or “Symbol Hyphen,” or select the “-” by using the **Interface Dial**.*
- *When selecting letters using the voice control system, a confirmation box may pop up to confirm the letter.*

Letters Assist Definitions:



Say	Or say "..."	Say	Or say "..."	Say	Or say "..."	Say	Or say "..."
A	Alpha/Apple	H	Hotel/Henry	O	Oscar	V	Victor
B	Bravo/Boy	I	India/Igloo	P	Papa/Paul	W	Whiskey/William
C	Charlie	J	Juliet/John	Q	Quebec/Queen	X	X-Ray
D	Delta/Dog	K	Kilo/King	R	Romeo/Robert	Y	Yankee/Yellow
E	Echo/Edward	L	Lima/Larry	S	Sierra/Sam	Z	Zulu/Zebra
F	Foxtrot/Frank	M	Mike/Mary	T	Tango/Tom	↵	Enter
G	Golf/George	N	November/Nancy	U	Uniform/Uncle		

Voice Command Index

Symbol Assist Definitions:



Symbols	Say "...” or “Symbol ...”	Symbols	Say "...” or “Symbol ...”	Symbols	Say "...” or “Symbol ...”
À	A grave	î	I circumflex	_	Underscore
Á	A circumflex	ï	I umlaut	`	Back quote
Â	A umlaut	Ô	O circumflex	,	Comma
Ç	C cedilla	Û	U grave	.	Dot
È	E grave	Û	U circumflex	?	Question Mark
É	E acute	Ü	U umlaut	:	Colon
Ê	E circumflex	@	At sign	;	Semi colon
Ë	E umlaut	^	Caret	+	Plus
Ì	I grave	*	Asterisk	↵	Enter

NOTE:

The term “grave” (used for symbols À, È, Ì, and Û) is pronounced like “save.”

Numbers and Additional Symbol Assist Definitions:



Numbers	Say “...” or “Number ...”	Symbols	Say “...” or “Symbol ...”	Symbols	Say “...” or “Symbol ...”
1	One	-	Hyphen	~	Tilde
2	Two	!	Exclamation point	/	Slash
3	Three	”	Double quote	<	Less than
4	Four	#	Pound	>	Greater than
5	Five	\$	Dollar	{	Open brace
6	Six	%	Percent	}	Close brace
7	Seven	&	Ampersand	↵	Enter
8	Eight	'	Apostrophe		
9	Nine	(Open parenthesis		
0	Zero)	Close parenthesis		

Index

A

Accessing the Address Book List	85
AcuraLink/Messages	75, 76, 107
ADD TO Today's Destinations	48, 50
Adding Destinations to the List	48
Address	27, 28, 86
Address Book	27, 32, 85
Advanced	35
Auto Daylight	100
Auto Service	34
Auto Time Zone	100
Avoid Streets	71

B

Back to Current Route	72
Banking	34
Basic Settings	90
Black Level	83
Breadcrumbs	20, 67
Brightness	82
By Address	28
By Address Book	32
By Go Home	49
By Intersection	39
By Map Input	45
By Places	33

By Previous Destinations	44
By Today's Destinations	47

C

Calculator	80
Calendar	17, 78
CALL	18, 50
CANCEL button	10
Cancel Current Route	70
Category	33, 34, 87
CD Voice Commands	145
Cellular Phonebook	77
Change Method	51
Change Routing Method	70
Change State	28, 39
Changing the DVD	116
Changing the Route	70
Changing the Routing Method	51
Changing Your Destination	73
City	28, 40, 46
City Vicinity	37
Client Assistance	114
Climate Control Commands	143
Clock Adjustment	99
Color	103
Community	34
Continental USA	47
Contrast	83

Convert (Unit)	81
Correct Vehicle Position	102
Coverage Areas	118
Current Location	21, 68
Current Position	45, 86
Current Street	6

D

Database Limitations	113
Delete Previous Destinations	89
Delete Waypoints	72
Destination	27, 50, 73
Destination Icon	62
Destination Map	53
Detailed Coverage Areas	118, 122
Detour	70
Direct Route	51
Direction List	57
Display mode button	11
Driving to Your Destination	50
DVD Voice Commands	146

E

Easy Route	51
Edit Avoid Area	96
Edit Waypoint Search Area	98
Edit/Delete Address	88

Editing Today's Destination List.....	48
Emergency	34
Entering a Destination	27
Entering Address Book.....	85
Entering Schedule	78
Entering Security Code.....	109
Entering the Street Number.....	32
Entering Your Schedule.....	78
Error Message.....	136
Exit Info	58

F

Find Place Commands.....	142
Frequently Asked Questions	128

G

Getting Started.....	10
Global Commands	140
Glossary	137
Go Home.....	27, 49
Going Off the Route.....	67
GPS Initialization.....	110
Guidance Mode.....	99
Guidance Prompts.....	57, 83
Guidance Screen	55

H

HandsFreeLink™.....	18
Home Address	88
Hotel/Motel (Lodging)	34

I

Icon Bar	65
Incident Icons	20, 62
INFO button	10, 76
Information Screen.....	76
Information Screen Voice Commands.....	154
Interface Dial	11
Interface Dial Feedback.....	83
Interface Dial knob.....	11
Intersection.....	27, 39

K

Key to Zagat Ratings.....	79
---------------------------	----

L

Landmark Icons	62
Leisure	34
Lodging (Hotel/Motel)	34
Lower Display	12

M

Map Color	103
Map Coverage.....	118
Map Input.....	27, 45
Map Legend.....	20, 54, 77
Map Matching.....	110
Map Orientation.....	61
Map Scale.....	60
Map Screen.....	20, 54
MAP/GUIDE button.....	10, 55
Maximize Freeways	51
MENU button	10
Menu Color	103
Message	78
Messages.....	75, 76, 107
Microphone	13
Minimize Freeways	51
Minimize Tool Roads	51
MP3/WMA Voice Commands	146

N

Name	33, 38
NAVI BACK button.....	13
NAVI TALK button	13
Navigation Display Commands.....	141
Navigation General Commands.....	140

Index

O

- Off-road Tracking67, 101
- On-Screen Commands155
- On-Screen Spelling Assist156

P

- PC Card.....117
- Personal Information84
- Phone Number33, 38
- PIN Number88
- Place Name36, 37
- Place Name by Keyword36
- Places.....27, 33, 86
- Previous Destinations27, 44, 86

R

- Radio Voice Commands145
- Read List35, 77
- Rear CD Voice Commands150
- Rear DVD Voice Commands151
- Rear MP3/WMA Voice Commands.....151
- Rear Radio Voice Commands150
- Rear Single CD Voice Commands..152
- Rear Single DVD Voice
Commands.....153

- Rear Single MP3/WMA Voice
Commands.....153
- Rear View Camera12, 107
- Recalculation67, 91
- Reporting Errors114
- Rerouting91
- Restaurant34
- Roadside Assistance81
- Route50, 53, 67, 70
- Routing & Guidance.....91
- Routing Method51

S

- Save Current Location68
- Schedule.....78
- Screen12
- Search Waypoint on Route.....71
- Security Code109
- Selecting the City28, 40
- Selecting the State28, 39
- Selecting the Street.....30, 41
- SET UP button.....10
- Setup Screen (first) Commands155
- Shopping35
- Show Icon on Map62
- Single CD Voice Commands147
- Single DVD Voice Commands.....148

- Single MP3/WMA Voice
Commands.....149
- Sort by Distance to Travel.....37
- Split Screen Guidance58
- State28, 39, 46
- Street.....30, 41
- Switching Display Mode.....104
- System Controls10
- System Function Diagram.....26
- System Information107
- System Initialization.....109
- System Limitations.....111
- System Set-up82
- System Start-up.....17

T

- Temperature Voice Commands144
- Time Adjustment101
- Today's Destination List.....48
- Today's Destinations27, 47
- Traffic Display Legend.....22
- Traffic Flow.....23
- Traffic Incident24, 64
- Traffic Speed64
- Travel.....35
- Troubleshooting.....136

U

Unit Conversion.....	81
Units (mile or km).....	90
Unverified Area Routing	92
Unverified streets.....	7
Update DVD.....	116
Using the Voice Control System	14

V

Vehicle.....	101
Verified streets.....	7
View Routes	51
Visiting Your Dealer	115
Voice	90
Voice Command Help	76
Voice Command Index	140
Voice Control Basics.....	13
Voice Recognition Feedback.....	90
Voice Recognition, Improving	14
Volume	83

W

Waypoints	98
WMA Voice Commands	146

Z

Zagat 2006.....	34, 38
-----------------	--------

License notice

You have acquired a device (“DEVICE”) that includes software licensed by ALPINE ELECTRONICS, INC., from an affiliate of Microsoft Corporation (collectively “MS”). Those installed software products of MS origin, as well as associated media, printed materials, and “online” or electronic documentation (“SOFTWARE”) are protected by international intellectual property laws and treaties. The SOFTWARE is licensed, not sold. All rights reserved.

IF YOU DO NOT AGREE TO THIS END USER LICENSE AGREEMENT (“EULA”), DO NOT USE THE DEVICE OR COPY THE SOFTWARE. INSTEAD, PROMPTLY CONTACT ALPINE ELECTRONICS, INC., FOR INSTRUCTIONS ON RETURN OF THE UNUSED DEVICE(S) FOR A REFUND. ANY USE OF THE SOFTWARE, INCLUDING BUT NOT LIMITED TO USE ON THE DEVICE, WILL CONSTITUTE YOUR AGREEMENT TO THIS EULA (OR RATIFICATION OF ANY PREVIOUS CONSENT).

GRANT OF SOFTWARE LICENSE.

This EULA grants you the following license;

You may use the SOFTWARE only on the DEVICE.

NOT FAULT TOLERANT. THE SOFTWARE IS NOT FAULT TOLERANT. ALPINE ELECTRONICS, INC., HAS INDEPENDENTLY DETERMINED HOW TO USE THE SOFTWARE IN THE DEVICE, AND MS HAS RELIED UPON ALPINE ELECTRONICS, INC., TO CONDUCT SUFFICIENT TESTING TO DETERMINE THAT THE SOFTWARE IS SUITABLE FOR SUCH USE.

NO WARRANTIES FOR THE SOFTWARE. THE SOFTWARE is provided “AS IS” and with all faults. THE ENTIRE RISK AS TO SATISFACTORY QUALITY, PERFORMANCE, ACCURACY, AND EFFORT (INCLUDING LACK OF NEGLIGENCE) IS WITH YOU. ALSO, THERE IS NO WARRANTY AGAINST INTERFERENCE WITH YOUR ENJOYMENT OF THE SOFTWARE OR AGAINST INFRINGEMENT. IF YOU HAVE RECEIVED ANY WARRANTIES REGARDING THE DEVICE OR THE SOFTWARE, THOSE WARRANTIES DO

NOT ORIGINATE FROM, AND ARE NOT BINDING ON, MS.

No Liability for Certain Damages. EXCEPT AS PROHIBITED BY LAW, MS SHALL HAVE NO LIABILITY FOR ANY INDIRECT, SPECIAL, CONSEQUENTIAL OR INCIDENTAL DAMAGES ARISING FROM OR IN CONNECTION WITH THE USE OR PERFORMANCE OF THE SOFTWARE. THIS LIMITATION SHALL APPLY EVEN IF ANY REMEDY FAILS OF ITS ESSENTIAL PURPOSE. IN NO EVENT SHALL MS BE LIABLE FOR ANY AMOUNT IN EXCESS OF U.S.TWO HUNDRED FIFTY DOLLARS (U.S.\$250.00).

Limitations on Reverse Engineering, Decompilation, and Disassembly. You may not reverse engineer, decompile, or disassemble the SOFTWARE, except and only to the extent that such activity is expressly permitted by applicable law notwithstanding this limitation.

Additional Software/Services. The SOFTWARE may permit ALPINE ELECTRONICS, INC., MS, Microsoft Corporation or their affiliates to provide or make available to you SOFTWARE updates, supplements, add-on components, or Internet-based services components of

the SOFTWARE after the date you obtain your initial copy of the SOFTWARE (“Supplemental Components”).

- If ALPINE ELECTRONICS,INC., provides or makes available to you Supplemental Components and no other EULA terms are provided along with the Supplemental Components, then the terms of this EULA shall apply.
- If MS, Microsoft Corporation or their affiliates make available Supplemental Components, and no other EULA terms are provided, then the terms of this EULA shall apply, except that the MS, Microsoft Corporation or affiliate entity providing the Supplemental Component(s) shall be the licensor of the Supplemental Component(s).

ALPINE ELECTRONICS,INC., MS, Microsoft Corporation and their affiliates reserve the right to discontinue any Internet-based services provided to you or made available to you through the use of the SOFTWARE.

RECOVERY MEDIA. If SOFTWARE is provided by ALPINE ELECTRONICS,INC., on separate media and labeled “Recovery Media” you may use the Recovery Media solely to restore or reinstall the SOFTWARE originally installed on the DEVICE.

SOFTWARE TRANSFER ALLOWED BUT WITH RESTRICTIONS. You may permanently transfer rights under this EULA only as part of a permanent sale or transfer of the Device, and only if the recipient agrees to this EULA. If the SOFTWARE is an upgrade, any transfer must also include all prior versions of the SOFTWARE.

EXPORT RESTRICTIONS. You acknowledge that SOFTWARE is of US-origin. You agree to comply with all applicable international and national laws that apply to the SOFTWARE, including the U.S.Export Administration Regulations, as well as end-user, end-use and country destination restrictions issued by U.S. and other governments. For additional information on exporting the SOFTWARE, see <http://www.microsoft.com/exporting/>.