

KNEX

Imagine • Build • Play™

7+

DESIGNED BY KIDS

30+ MODEL
BUILDING SET™



- Brittany C., 8

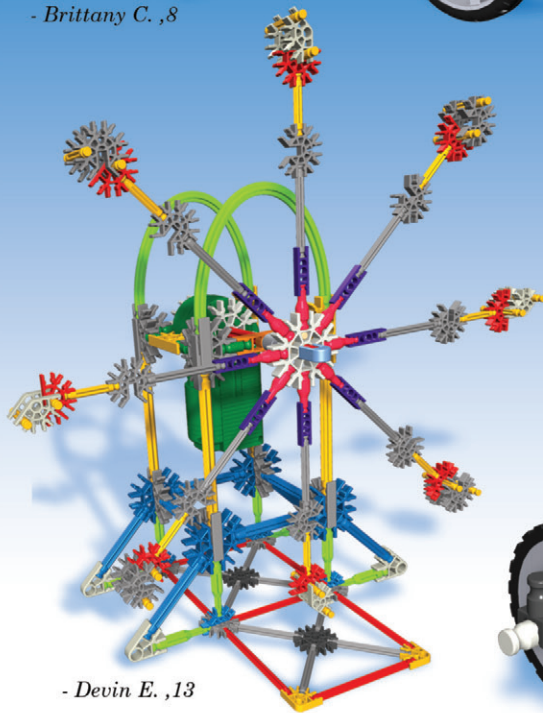

- Devin E., 13



- Casey D., 12



WARNING:

CHOKING HAZARD - Small parts.
Not for children under 3 years.



AVERTISSEMENT:

DANGER D'ÉTOUFFEMENT - Pièces de petite taille.
Ne pas donner aux enfants de moins de 3ans.



13502/77985

CONTENTS

Box Car	4
Dog	5
Turtle	5
Flowers	5
Car.....	6
Spaceship	8
Race Car.....	8
Playground	8
K'NEX Rocket	11
Jewelry Holder	11
Picture Frame	12
Bike	14
Sword	14
Chopper	14
Racer.....	14
Hot Rod	16
Van	16
Mouse.....	16
Lawn Mower.....	17
Ferris Wheel.....	19
Motorcycle.....	24
Plane	27
Bridge	27
Crane	30
Carpet Crawler	36
Monster Fish	37
Car	37
Walking Bird.....	39
Stunt Bike	39
Amusement Park.....	45
Dragster	45

IMPORTANT STUFF FOR PARENTS & KIDS

Keep these instructions in a handy location. They contain important safety information.

⚠ WARNING: CHOKING HAZARD - Small parts. Not for Children under 3 years.

- Product and colors may vary.
- While you're building make sure you face your model in the same direction as the pictures show in the instructions.

Read all warnings and instructions before you start to build and operate the model.

CAUTION: Keep hands, face, hair and clothing away from all moving parts.

- Be sure to install batteries into the motor before you start building your motorized models.
- Take your time to enjoy the building process. Don't rush!

BATTERY INFORMATION

CAUTION: To Avoid Battery Leakage

- Be sure to insert the batteries correctly and always follow the toy and battery manufacturers' instructions.
- Do not mix old and new batteries or alkaline, standard (carbon-zinc) or rechargeable (nickel-cadmium) batteries. Only batteries of the same or equivalent type recommended should be used.
- Always remove weak or dead batteries from the product; do not short-circuit supply terminals.
- Insert batteries with correct polarity (+/-) as shown.

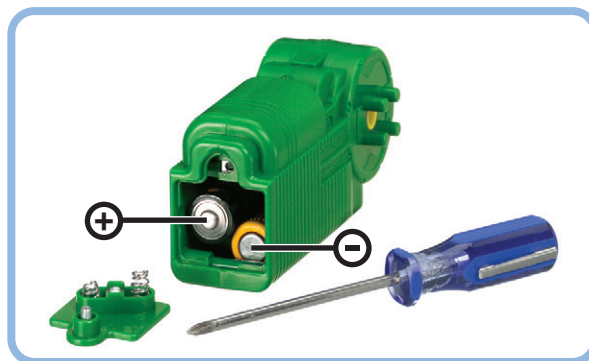

IMPORTANT TIPS:

- Alkaline batteries AA (LR6) are recommended.
- Rechargeable batteries are not recommended.
- Remove rechargeable batteries from toy before charging; they must be charged only under adult supervision.
- Non-rechargeable batteries must not be recharged.
- Keep components free of dust; do not immerse or use in water.
- Do not dispose of batteries in a fire; they could leak or explode and cause injury.
- Remove all batteries if the toy will not be used for a long period of time.
- Do not put Rods smaller than 2 inches in any openings of the motor; they will damage the motor, and cannot be removed.

HOW TO INSERT AND REMOVE BATTERIES:

- Use a small Phillips head screwdriver to loosen the screw. Insert 2 fresh AA batteries (LR6) into the compartment with the correct polarity (+/-) as shown here.

Parts Count:

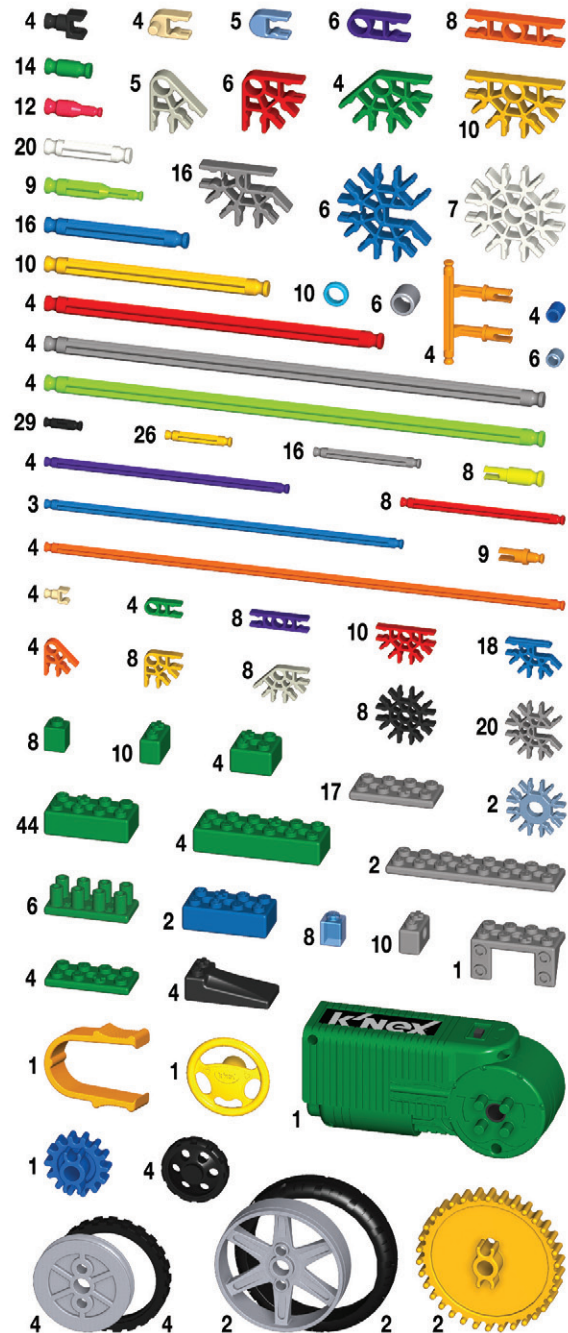

BUILDING BASICS

Getting Started:

To begin your model, find the **1** and follow the numbers. Each piece has its own shape and color. Just look at the pictures, find the pieces in your set that match and then connect them together. Try to face your model in the same direction as the instructions while you build. Faded colors show you this section is already built. You'll want to connect the new section to the place where the arrows are pointing.

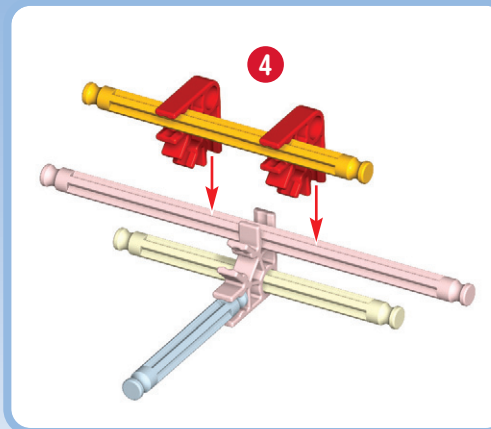
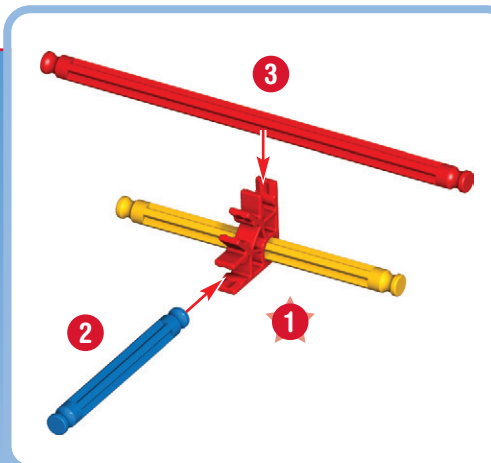

Connectors:

There are blue and gray Connectors with special long slots. They slide together as you see in the pictures. Push these parts together until you hear a "click."

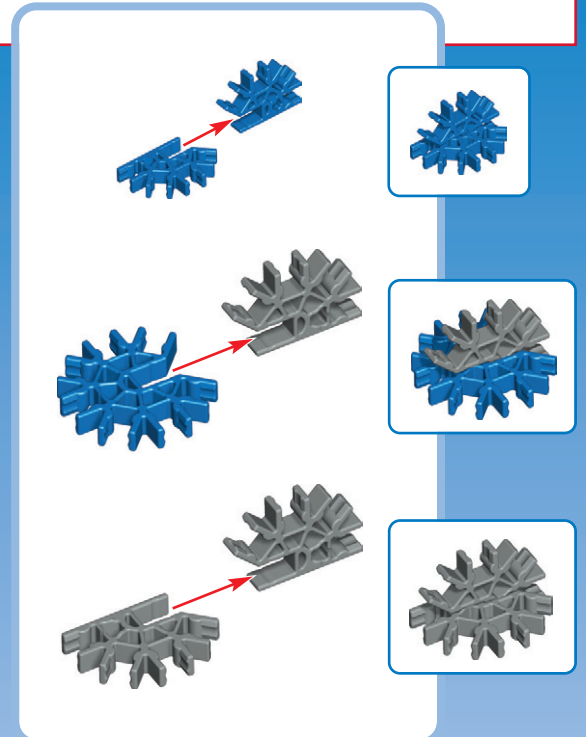

Spacers:

There are places in your model where you need to add blue and silver Spacers. Be sure to use the right color and count them carefully.

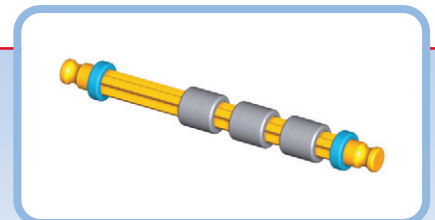

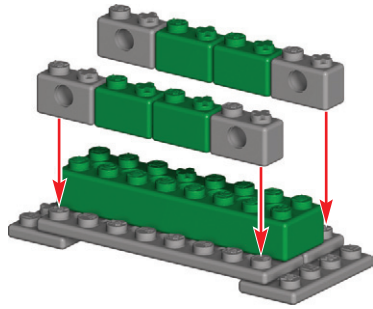

1

Aiden K. - age 6 from Missouri

- I started building with K'NEX at the age 4.
- My most challenging build was the "Big Air Ball Tower" because it was so large.

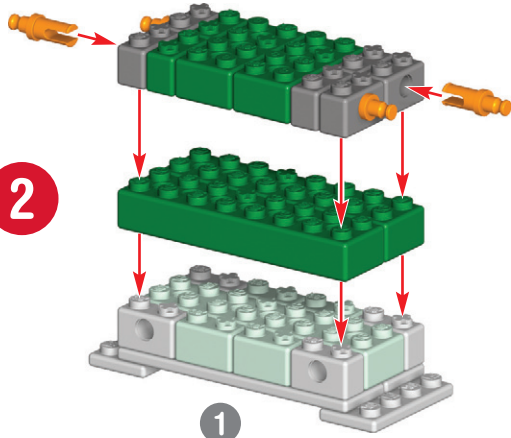

2

1

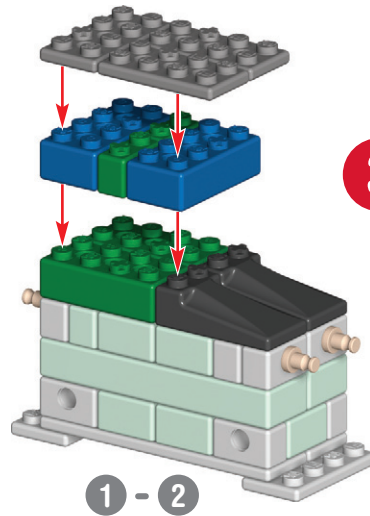

3

1 - 2



Aiden's
Box Car

1 - 4

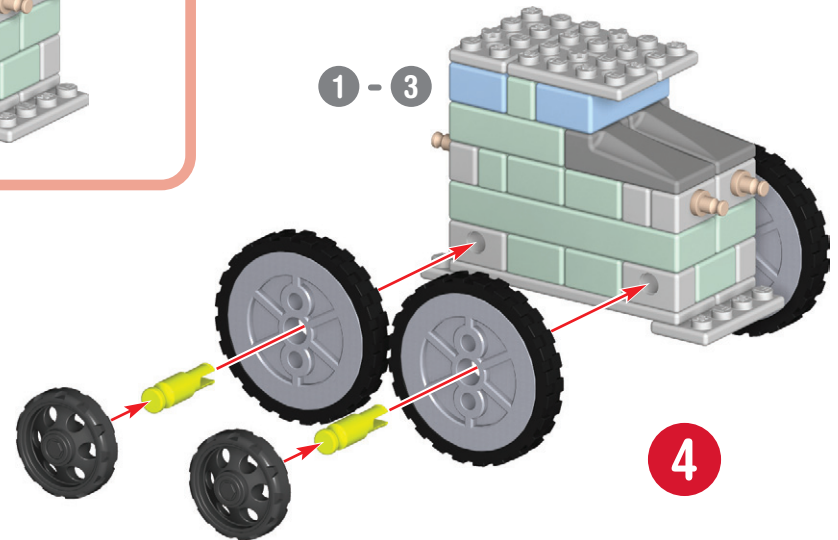

4

**Eric C. - age 12
from British Columbia**

- I started playing with K'NEX when I was five.
- The most challenging model I built was "Bones". I used anatomy books to get ideas of how a skeleton should look.

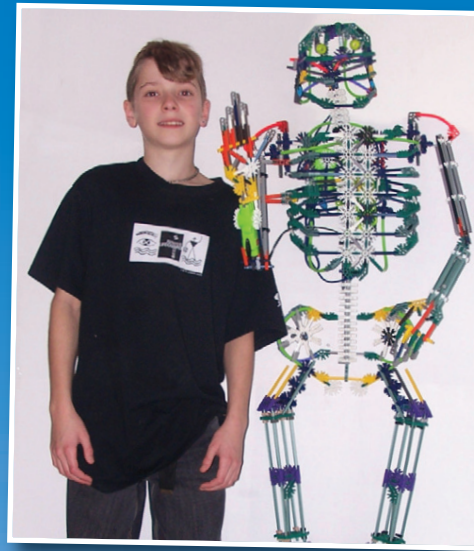

For instructions
of these models go to
www.knex.com/instructions
and enter code 13502

Eric's Flowers



**Jake's
Dog**



& Turtle



Jake S. - age 11 from Delaware

- I started building with K'NEX when I was 3.
- My most challenging model was my own version of the "Big Air Ball Tower" because of all of the alignments and fallouts.



Harry D. - age 13 from Massachusetts

- I was 4 years old when I started playing with K'NEX.
- The most challenging model I built was the K'NEX "Classic Roller Coaster" because I had trouble getting the tracks to line up.

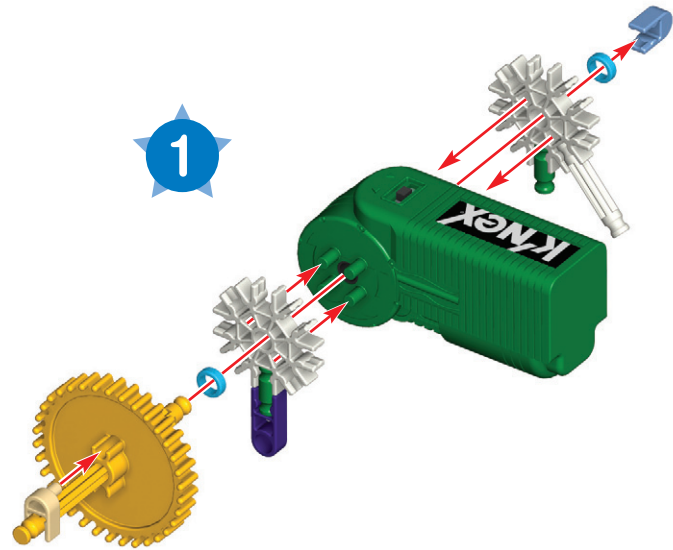

Did you install 2 AA (or LR6) batteries in the Motor?

- FR** Est-ce que tu as installé 2 piles AA (ou LR6) dans le moteur ?
- ES** ¿Instalaste dos pilas AA (o LR6) en el Motor?
- DE** Heb je 2 AA (of LR6) batterijen gestoken in de motor?
- IT** Hai installato 2 batterie AA (o LR6) nel motore?
- PT** Foram instaladas as pilhas 2 AA (ou LR6) no Motor?
- NL** Heb je er 2 AA (of LR6) batterijen ingestoken?
- SV** Installerade du 2AA (eller LR6) batterier?
- DA** Har du sat 2 AA (eller LR6) batterier i?
- NO** Har du installert 2AA (eller LR6) batteriene?
- FI** Oletko asentanut 2AA (tai LR6) -paristot?

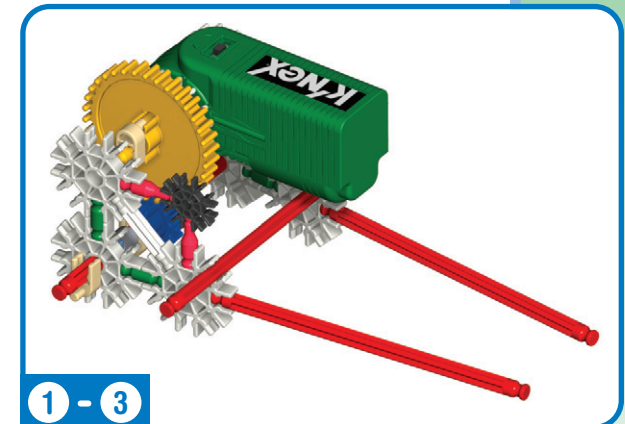
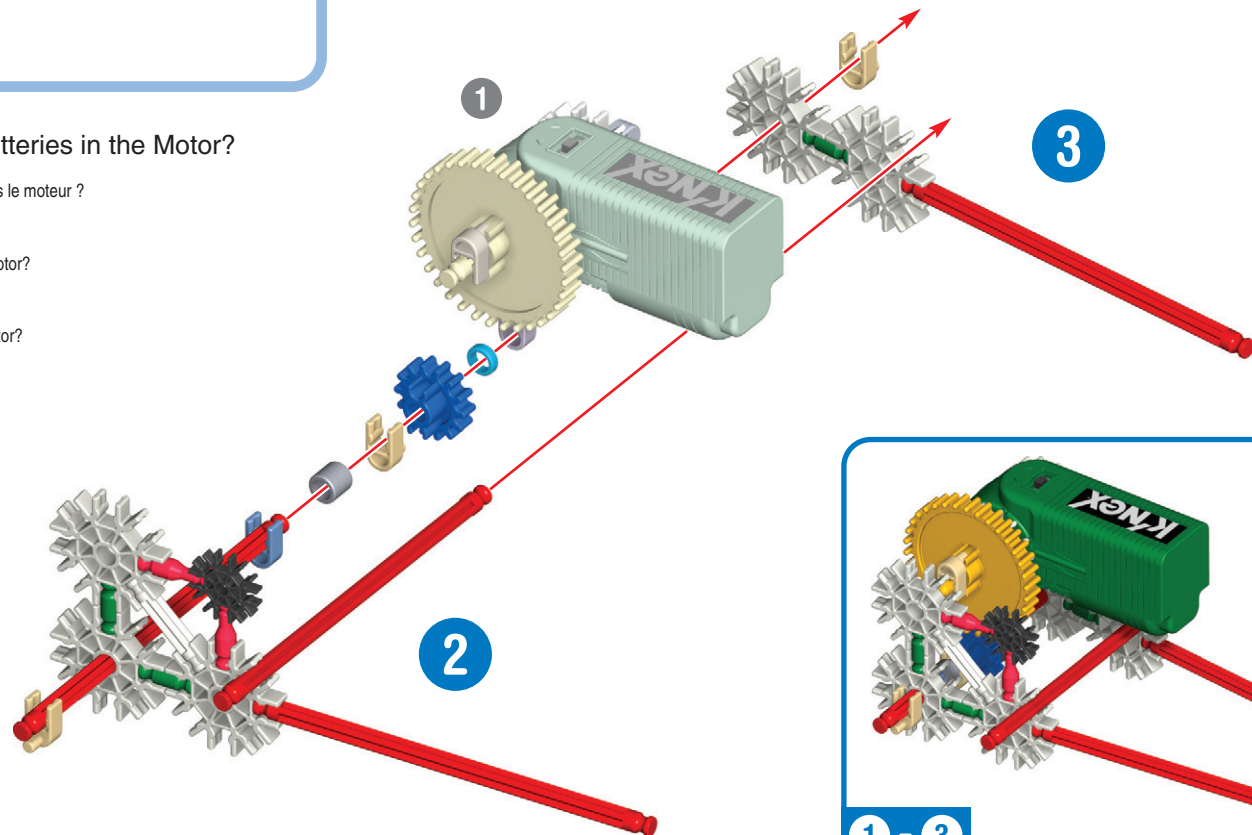

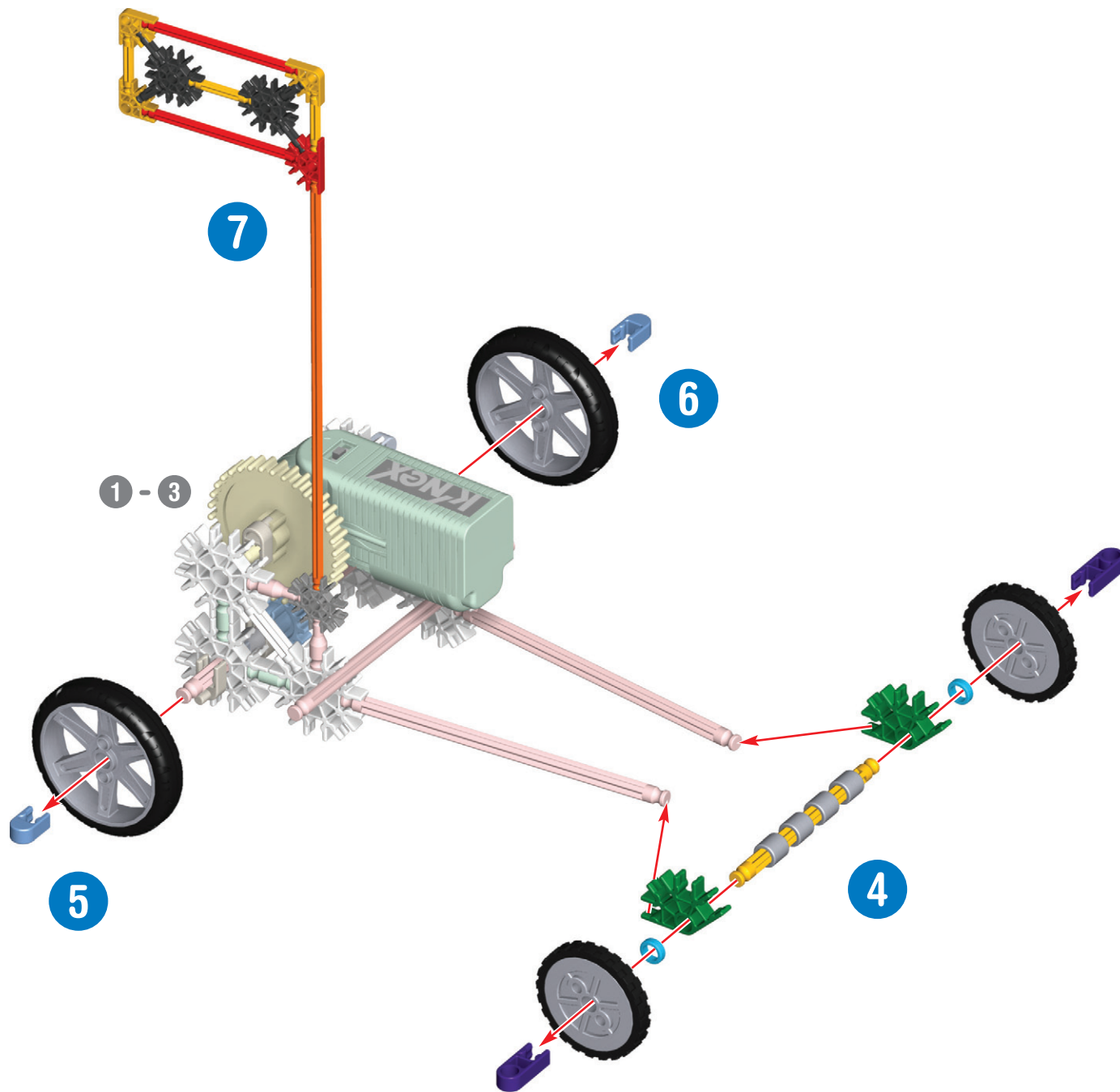

Jeremiah W. - age 13 from Pennsylvania

- My parents guess that I was 6 or 7 years old when I started building with K'NEX.
- My most challenging build was the huge "Ball Tower" because it had so many pieces.



Playground



Spaceship



Jeremiah's Models

For instructions
of these models go to
www.knex.com/instructions
and enter code 13502

Race Car



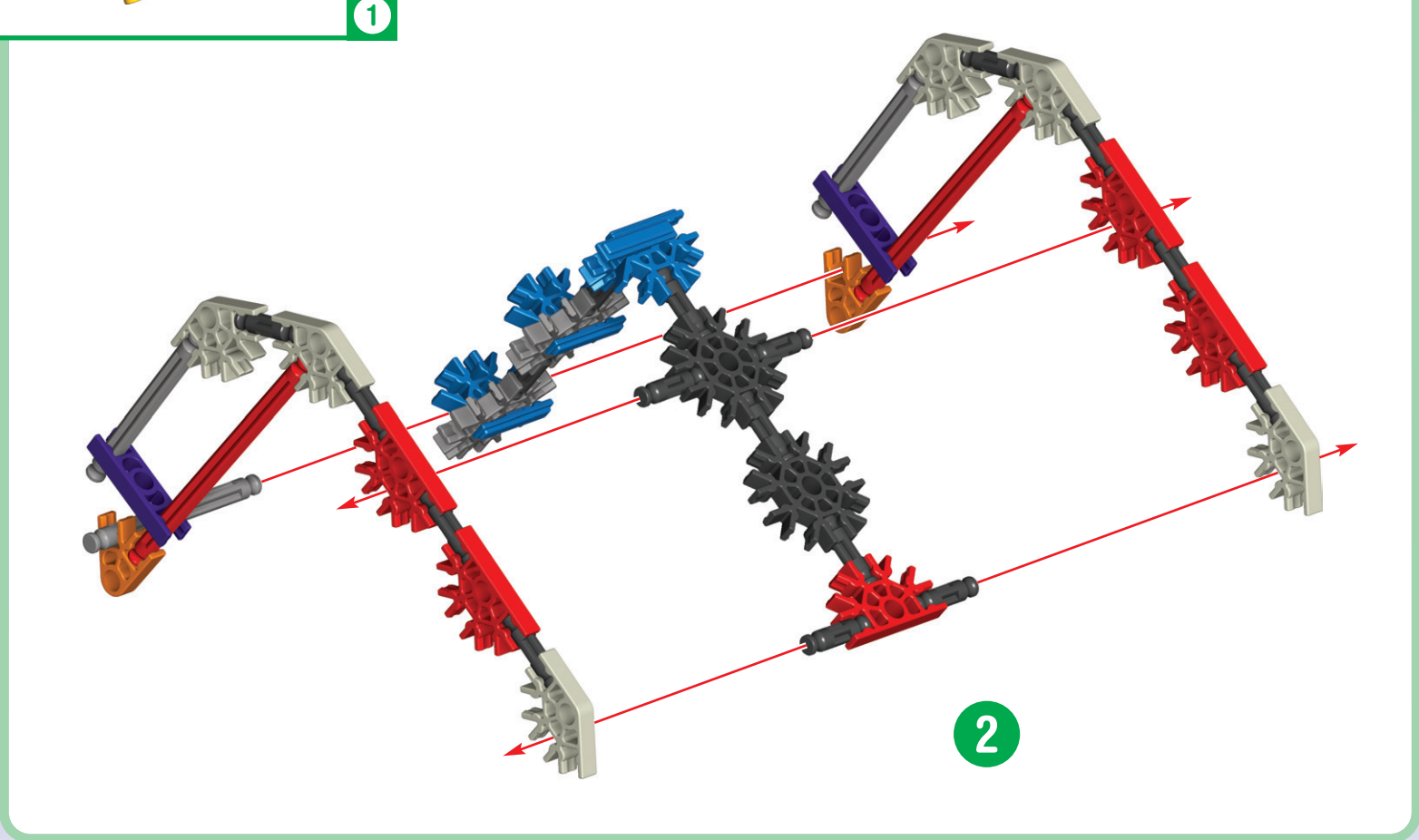
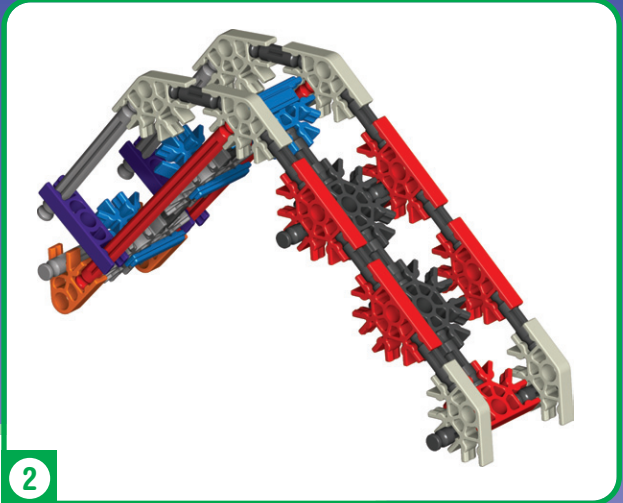

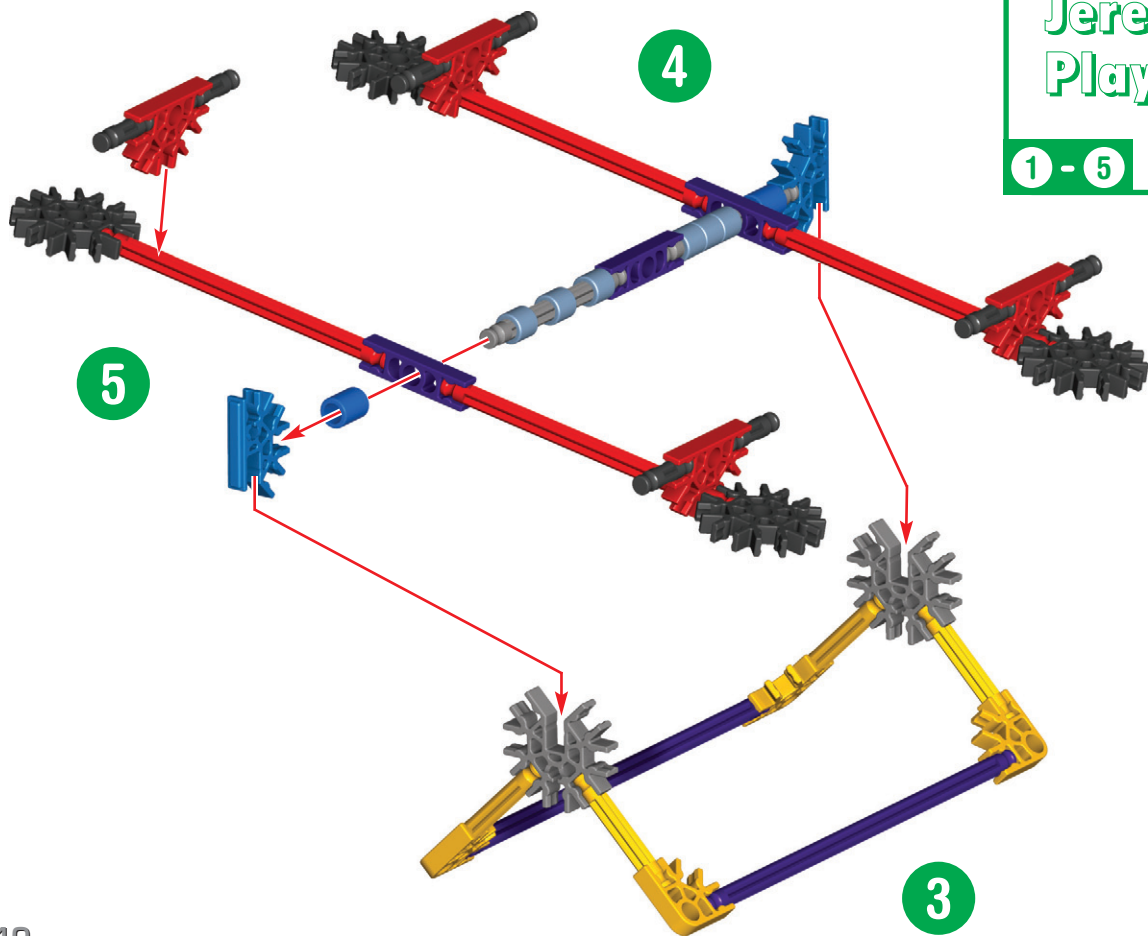

**Hannah W. - age 11
from New Jersey**

- I started building with K'NEX when I was 3 or 4 years old.
- The most challenging K'NEX set I built was the "Trampoline Tower" because it was taller than me!



**Hannah's
Models**

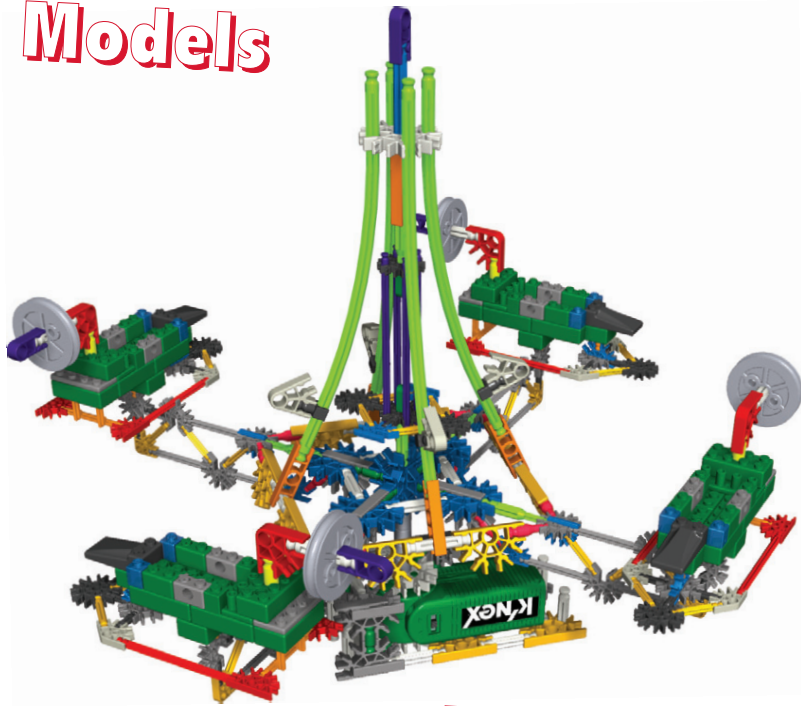

K'NEX Rocket

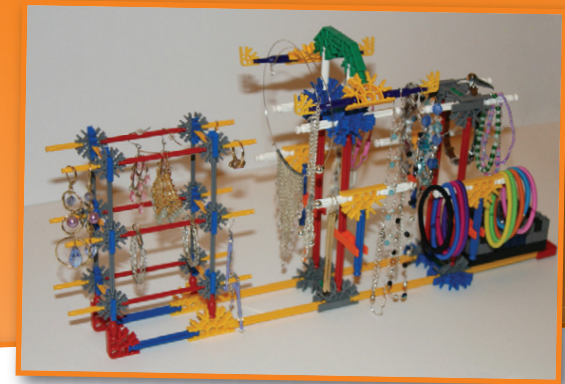

**Jewelry
Holder**

For instructions
of these models go to
www.knex.com/instructions
and enter code 13502

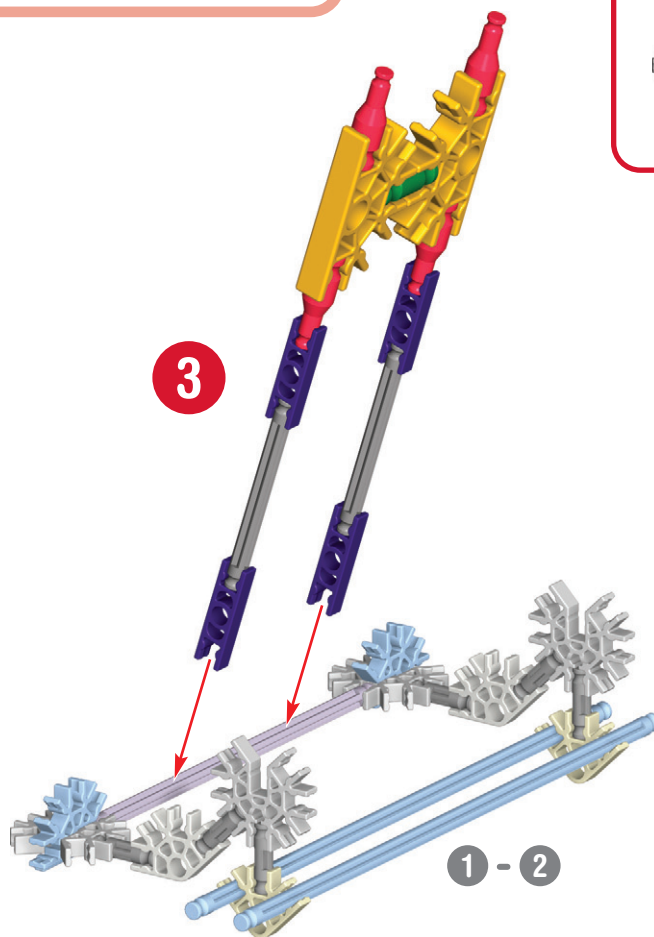
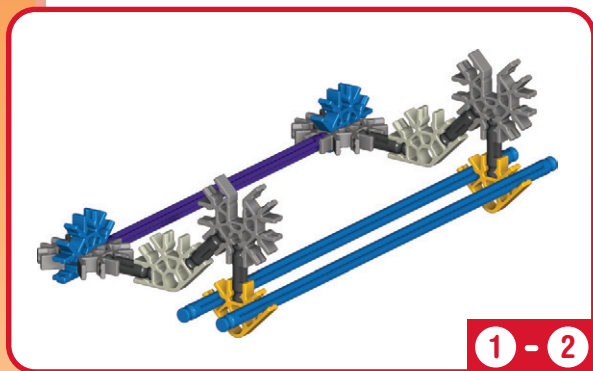
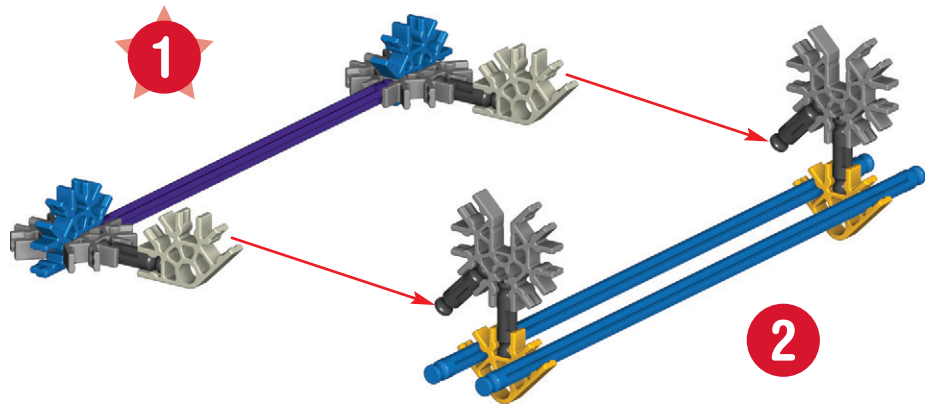

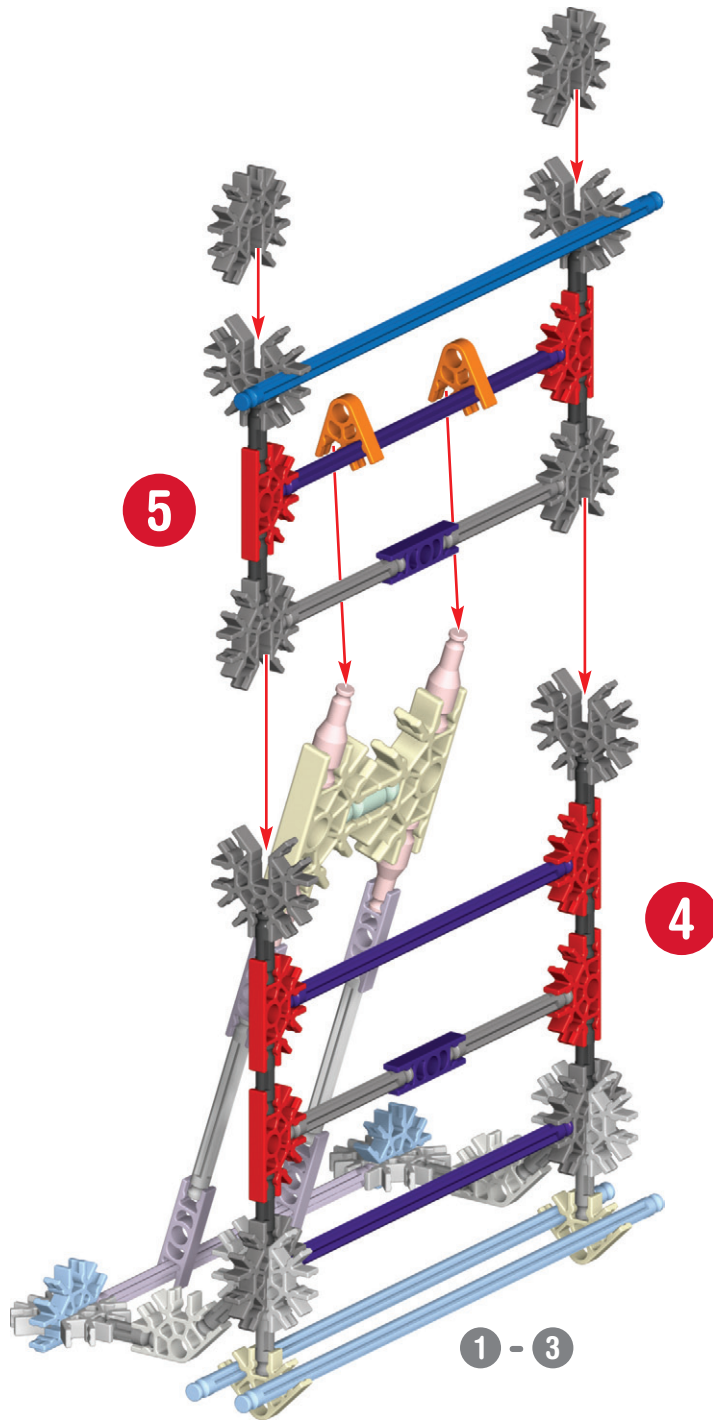

Hannah's Picture Frame

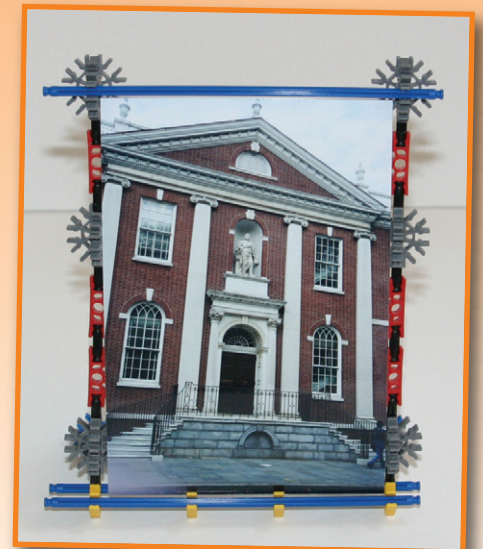
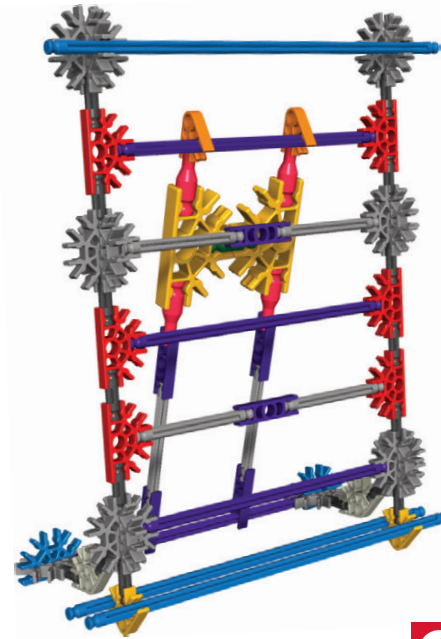

Jacob L. - age 10 from California

- I was 5 years old when I started building with K'NEX.
- My most challenging model was the "Big Air Ball Tower" because of all the ramps and chutes.

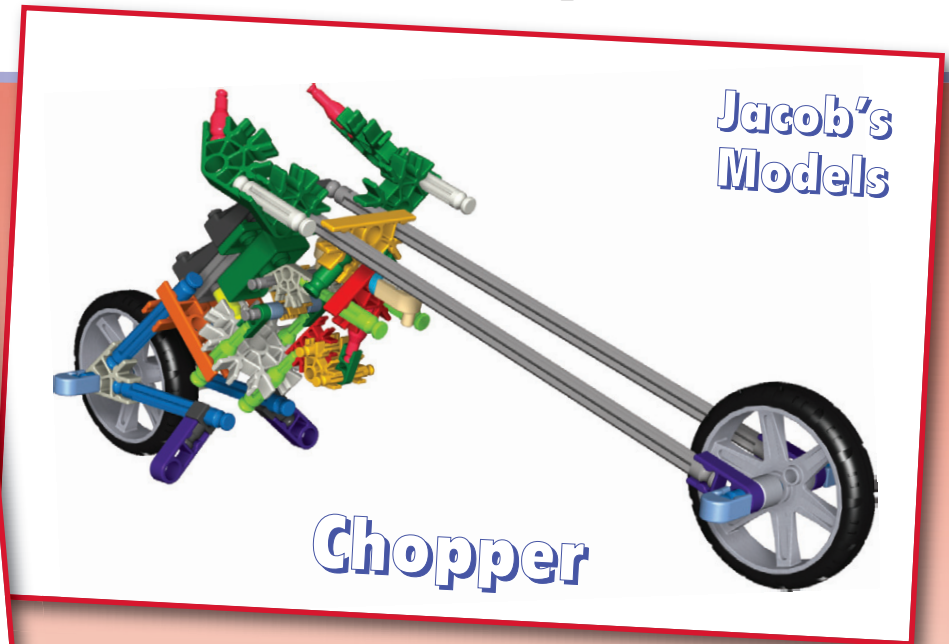

Did you install 2 AA (or LR6) batteries in the Motor?

- (FR) Est-ce que tu as installé 2 piles AA (ou LR6) dans le moteur ?
 (ES) ¿Instalaste dos pilas AA (o LR6) en el Motor?
 (DE) Heb je 2 AA (of LR6) batterijen gestoken in de motor?

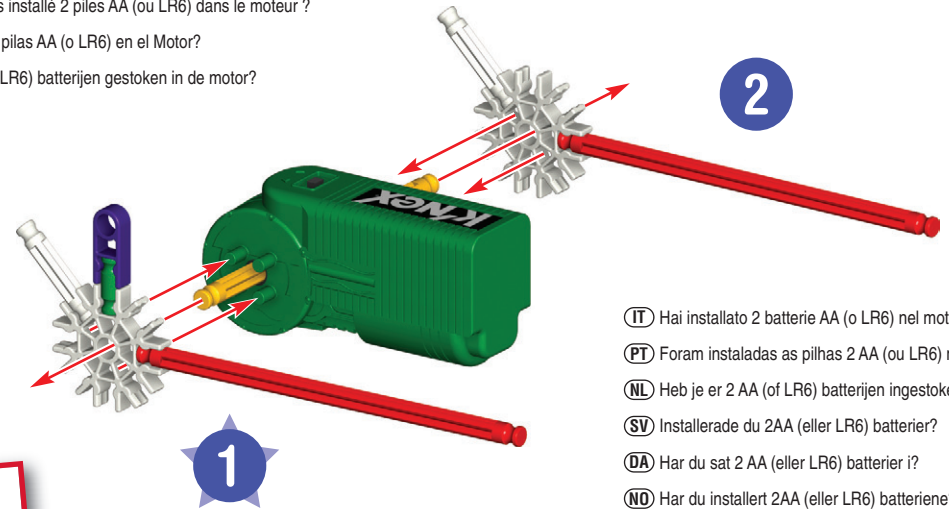

- (IT) Hai installato 2 batterie AA (o LR6) nel motore?
 (PT) Foram instaladas as pilhas 2 AA (ou LR6) no Motor?
 (NL) Heb je er 2 AA (of LR6) batterijen ingestoken?
 (SV) Installerade du 2AA (eller LR6) batterier?
 (DA) Har du sat 2 AA (eller LR6) batterier i?
 (NO) Har du installert 2AA (eller LR6) batteriene?
 (FI) Oletko asentanut 2AA (tai LR6) -paristot?

For instructions
of these models go to
www.knex.com/instructions
and enter code 13502

**Kyler K. - age 9
from Texas**

- I was 5 years old when I started building with K'NEX.
- The "Ultimate Big Air Ball Tower" was the most difficult model I ever built because it wasn't stable enough.



Van



**Kyler's
Models**



Hot Rod



Mouse

For instructions of these models go to
www.knex.com/instructions
and enter code 13502

Lawn Mower

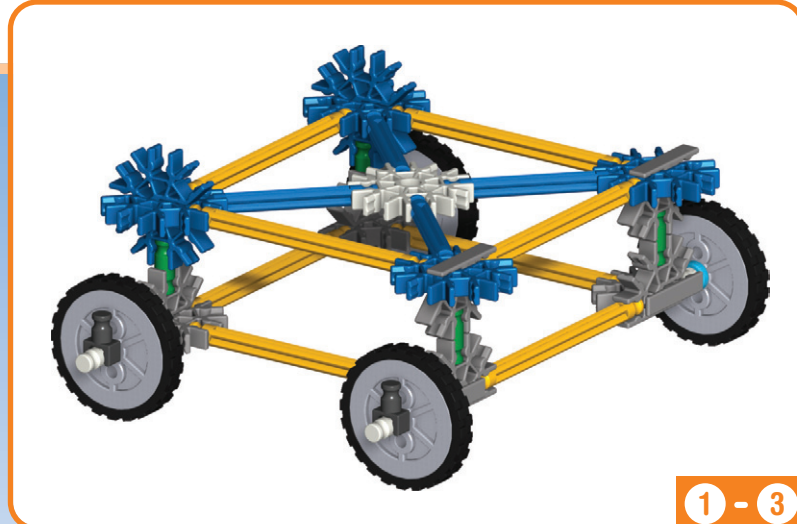
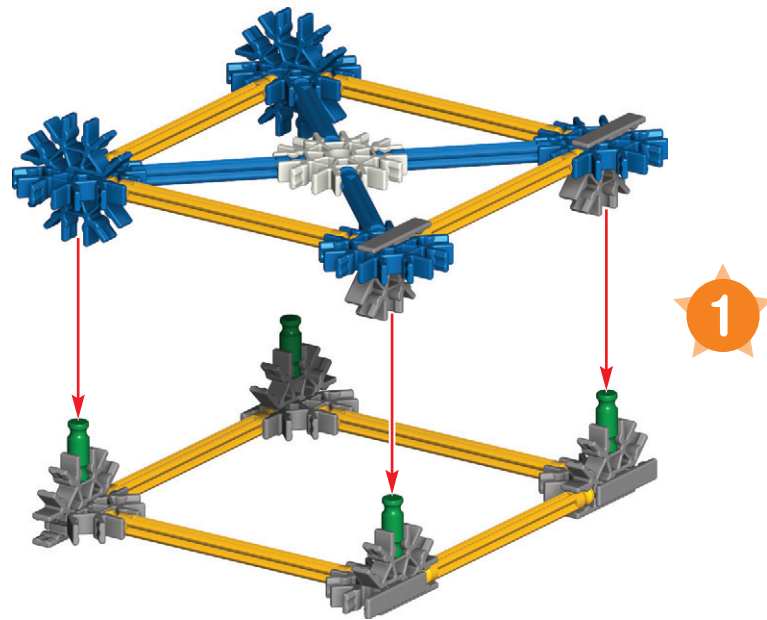
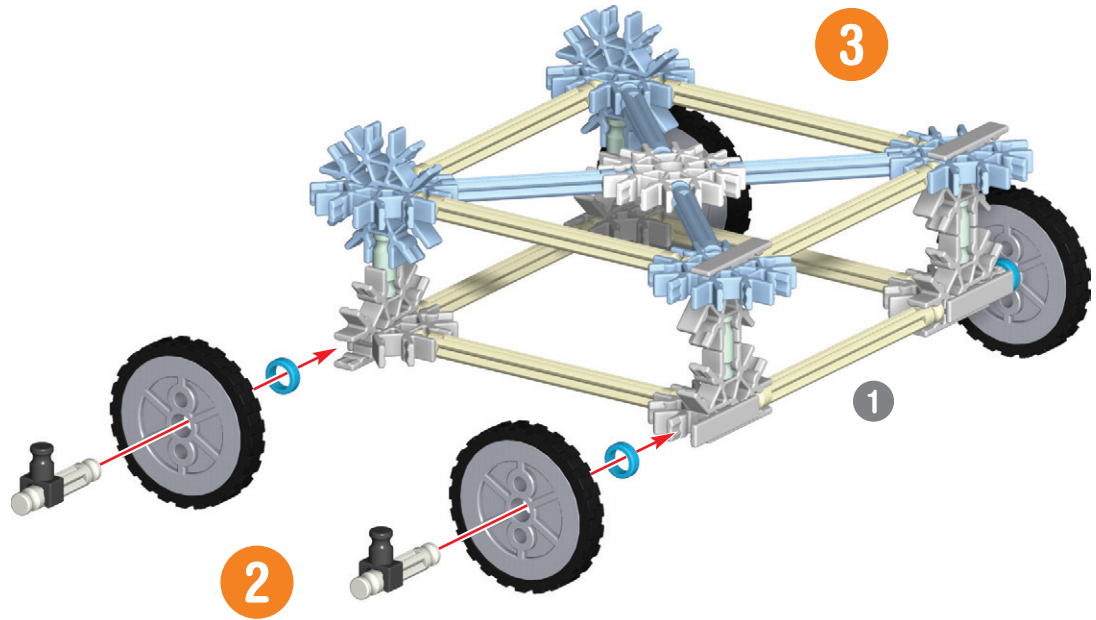

Did you install 2 AA (or LR6) batteries in the Motor?

(FR) Est-ce que tu as installé 2 piles AA (ou LR6) dans le moteur ?

(ES) ¿Instalaste dos pilas AA (o LR6) en el Motor?

(DE) Heb je 2 AA (of LR6) batterijen gestoken in de motor?

(IT) Hai installato 2 batterie AA (o LR6) nel motore?

(PT) Foram instaladas as pilhas 2 AA (ou LR6) no Motor?

(NL) Heb je er 2 AA (of LR6) batterijen ingestoken?

(SV) Installerade du 2AA (eller LR6) batterier?

(DA) Har du sat 2 AA (eller LR6) batterier i?

(NO) Har du installert 2AA (eller LR6) batteriene?

(FI) Oletko asentanut 2AA (tai LR6) -paristot?

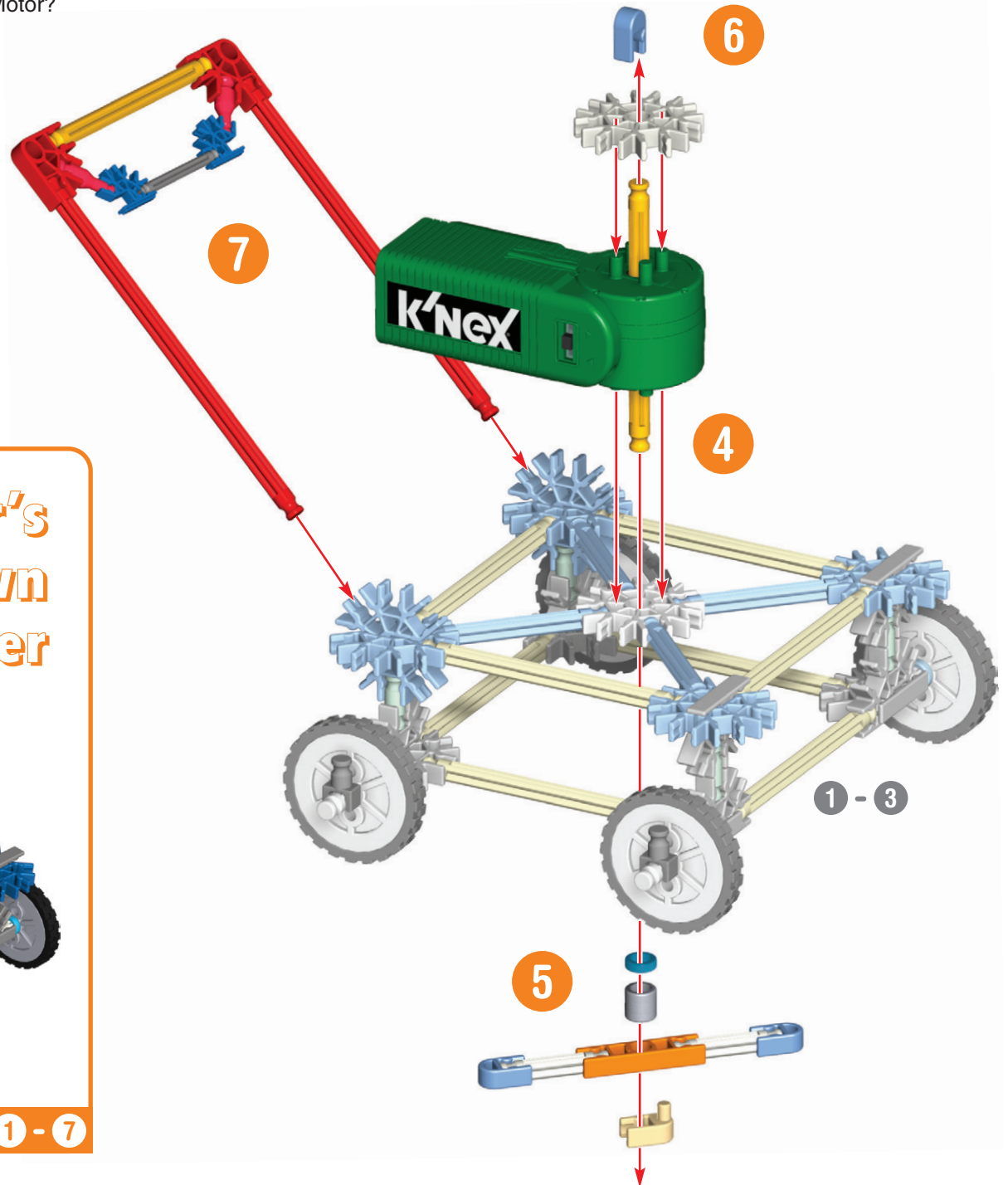

Devin E. - age 13 from Ontario

- I think I was age 6 or 7 when I started building with K'NEX.
- The “Warp 25” was my most challenging build. I struggled to get the curves and tracks just right.

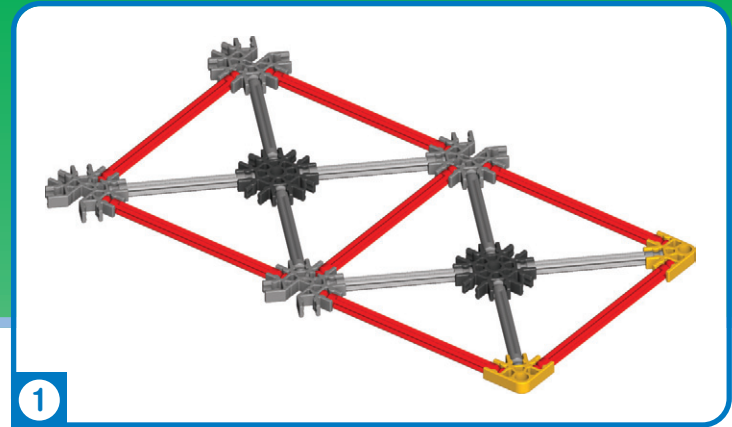

Devin's Ferris Wheel

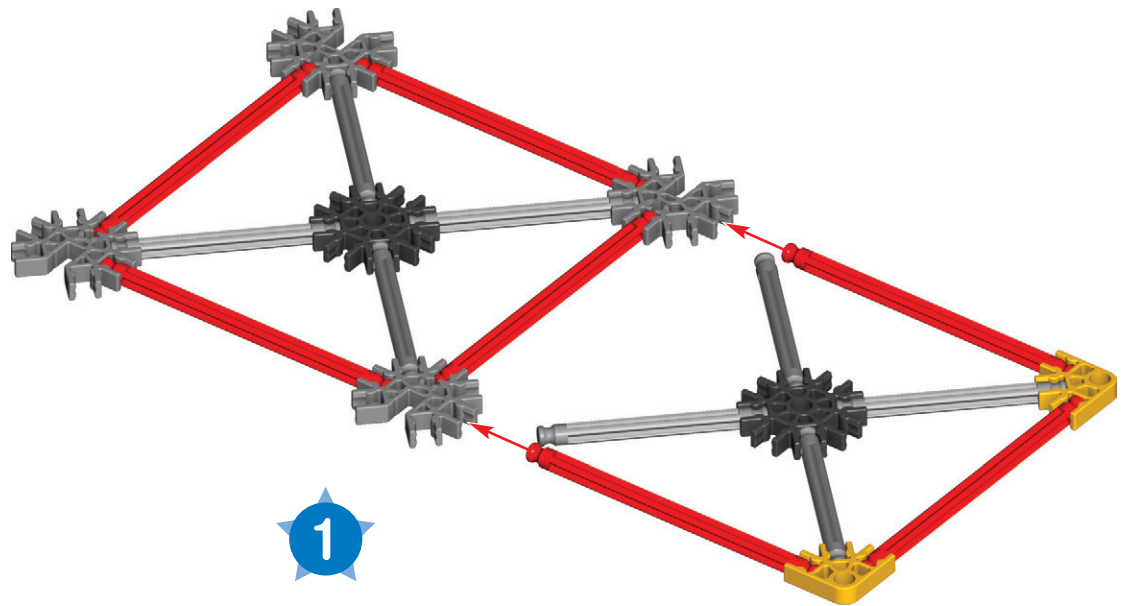
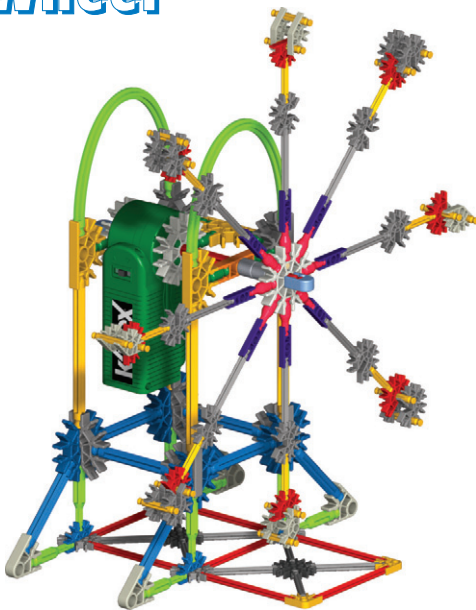

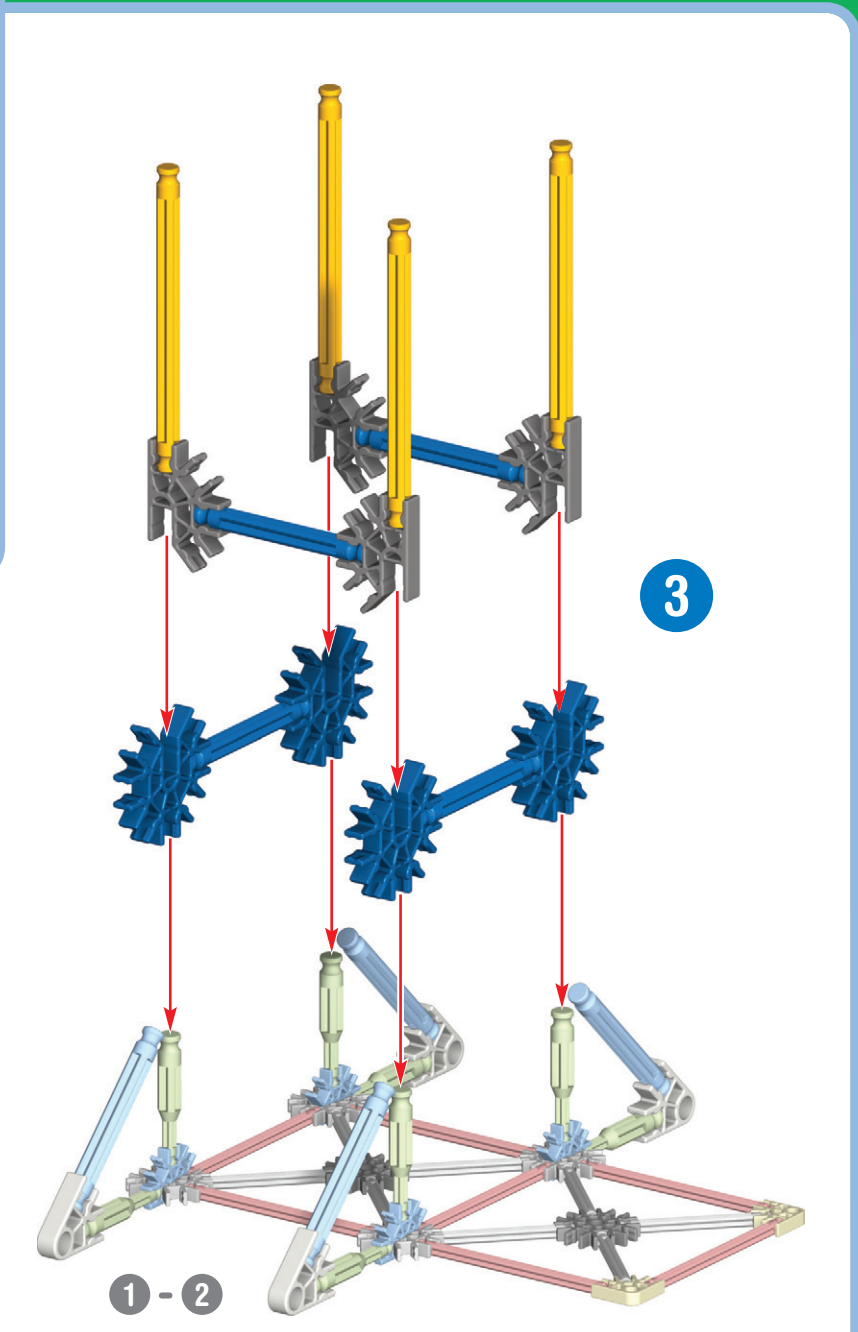
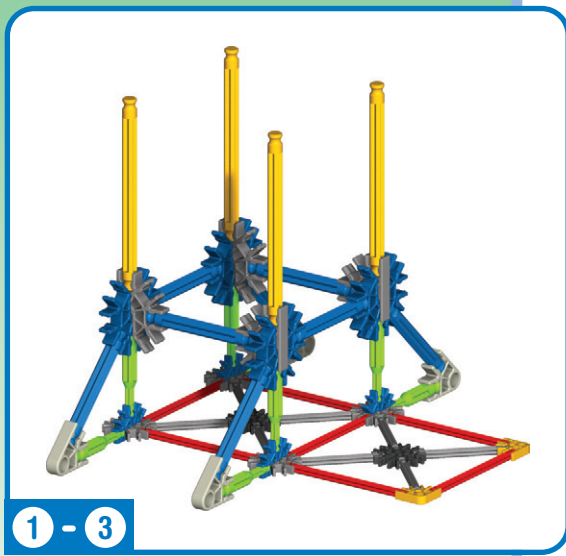
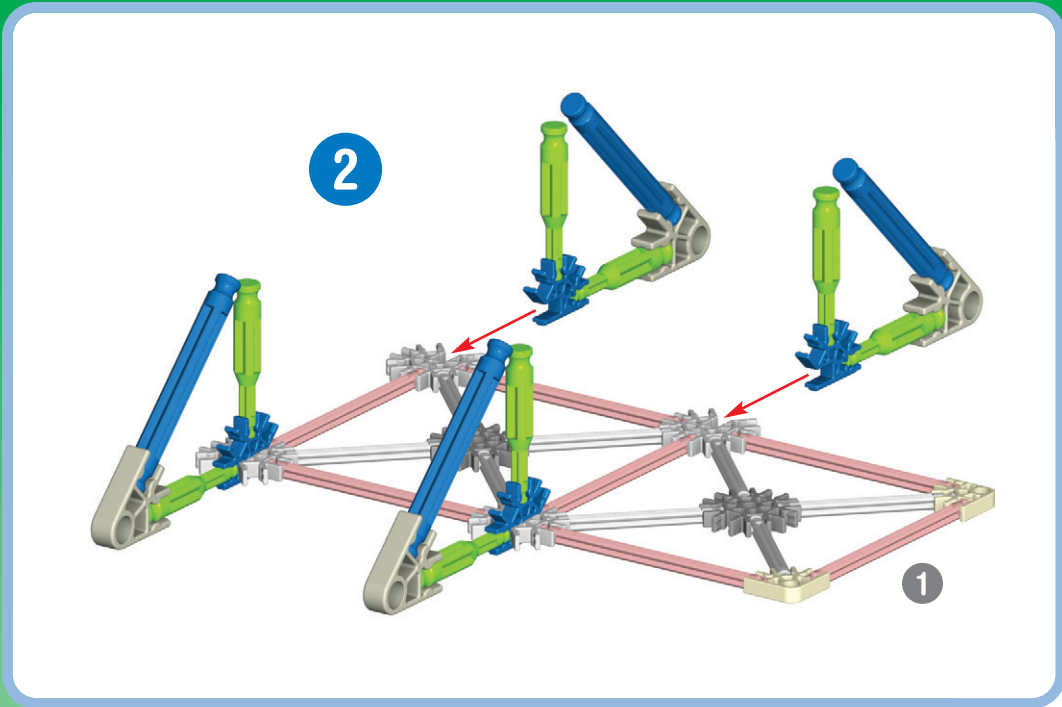

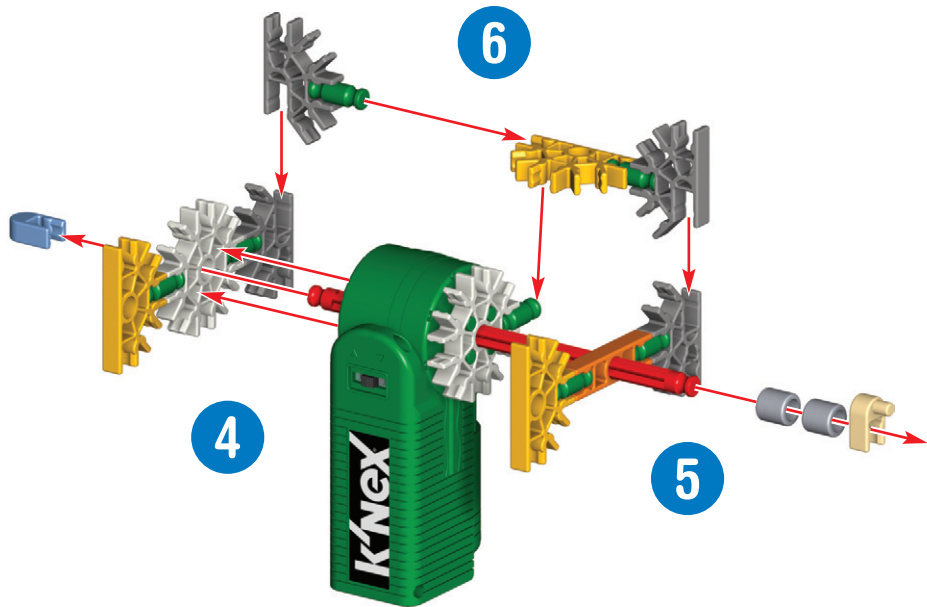

Did you install 2 AA (or LR6) batteries in the Motor?

FR Est-ce que tu as installé 2 piles AA (ou LR6) dans le moteur ?

ES ¿Instalaste dos pilas AA (o LR6) en el Motor?

DE Heb je 2 AA (of LR6) batterijen gestoken in de motor?

IT Hai installato 2 batterie AA (o LR6) nel motore?

PT Foram instaladas as pilhas 2 AA (ou LR6) no Motor?

NL Heb je er 2 AA (of LR6) batterijen ingestoken?

SV Installerade du 2AA (eller LR6) batterier?

DA Har du sat 2 AA (eller LR6) batterier !?

NO Har du installert 2AA (eller LR6) batteriene?

FI Oletko asentanut 2AA (tai LR6) -paristot?

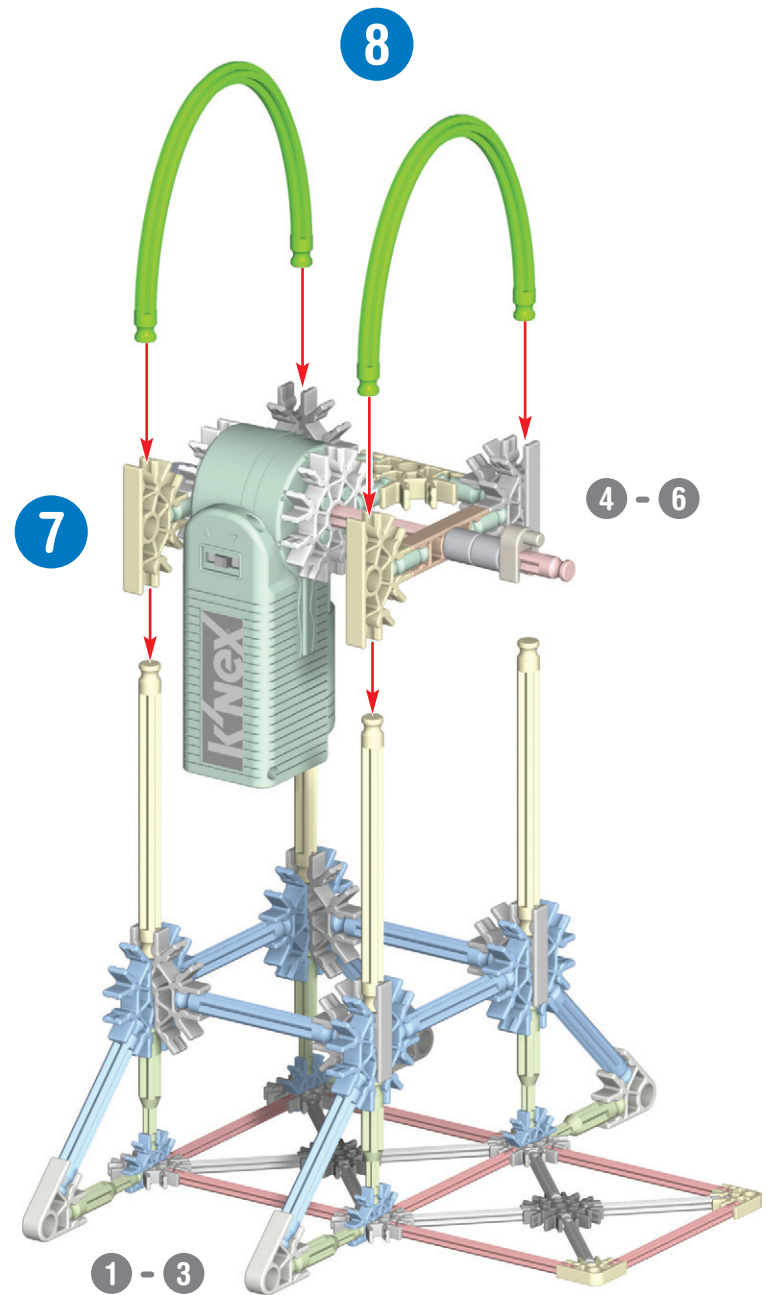

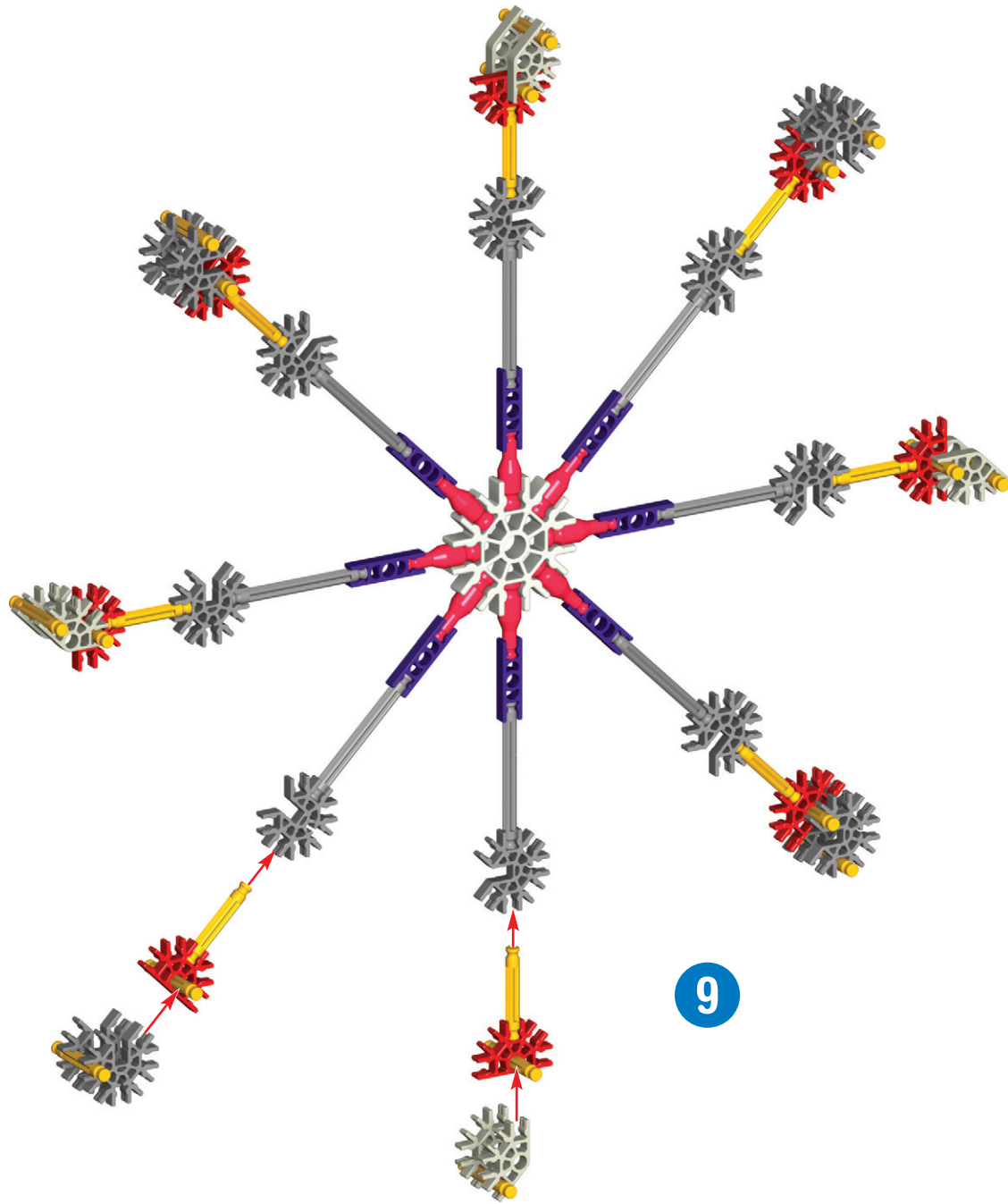

9

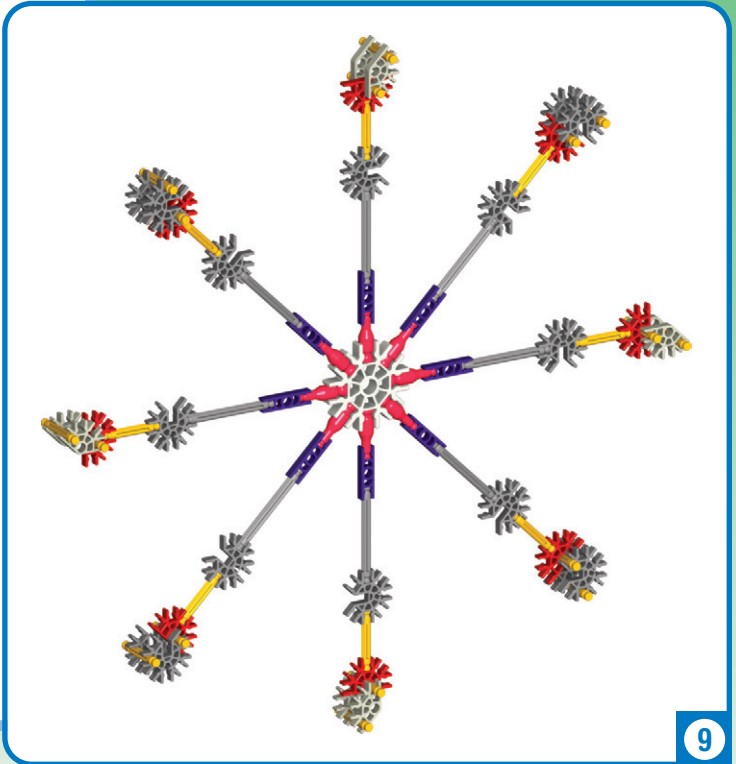

9

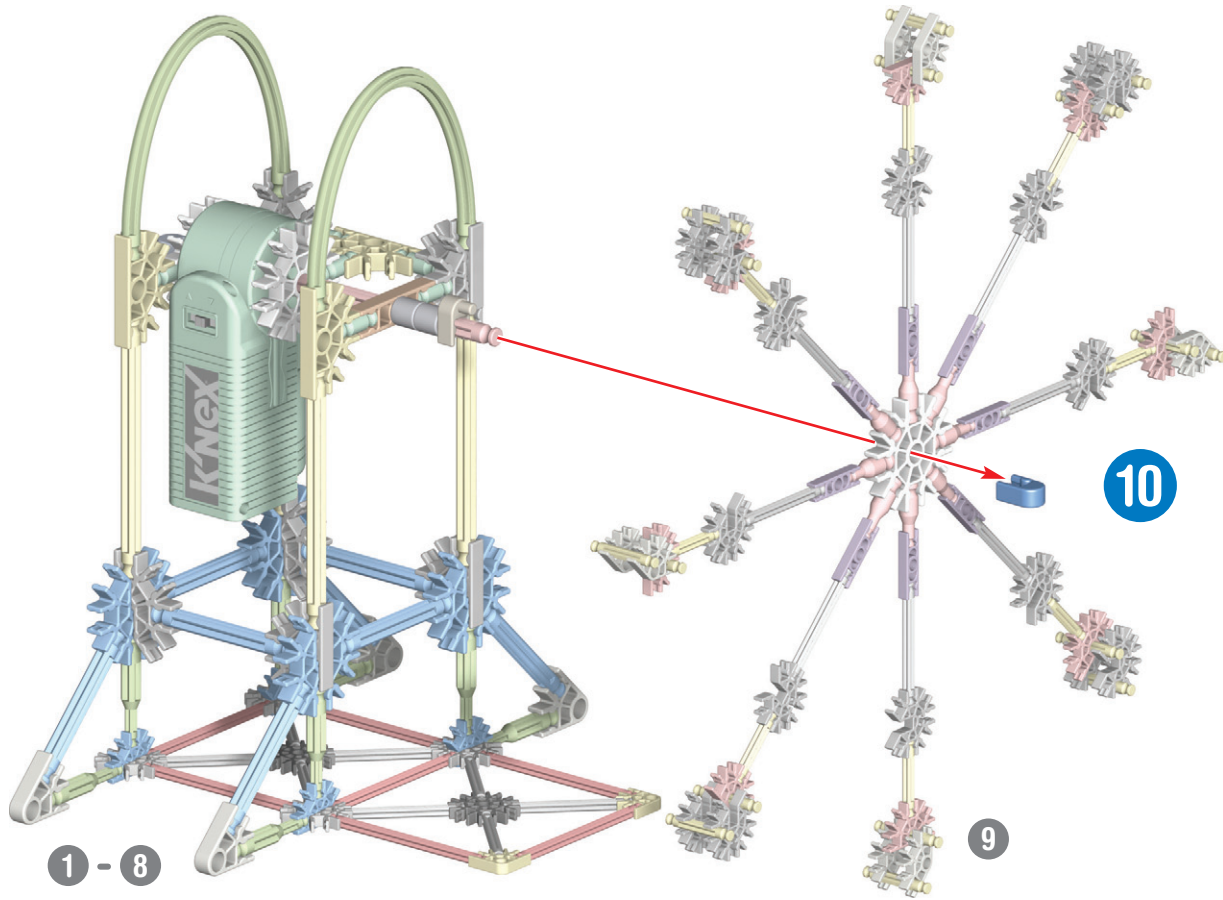

Devin's Ferris Wheel

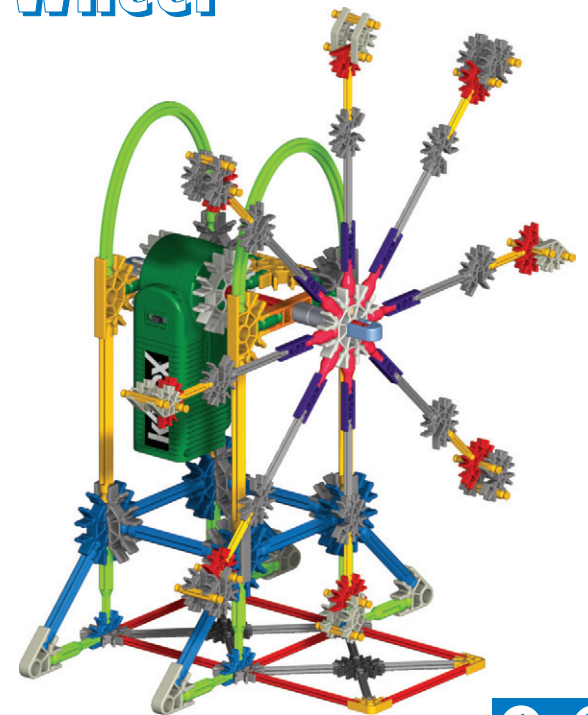

1 - 10



Brittany C. - age 8 from Ohio

- I was 6 years old when I started playing with K'NEX.
- The most challenging model was my K'NEXpert winning model "Soarin' Sky Ride" because it was difficult to get it to work and run smoothly.

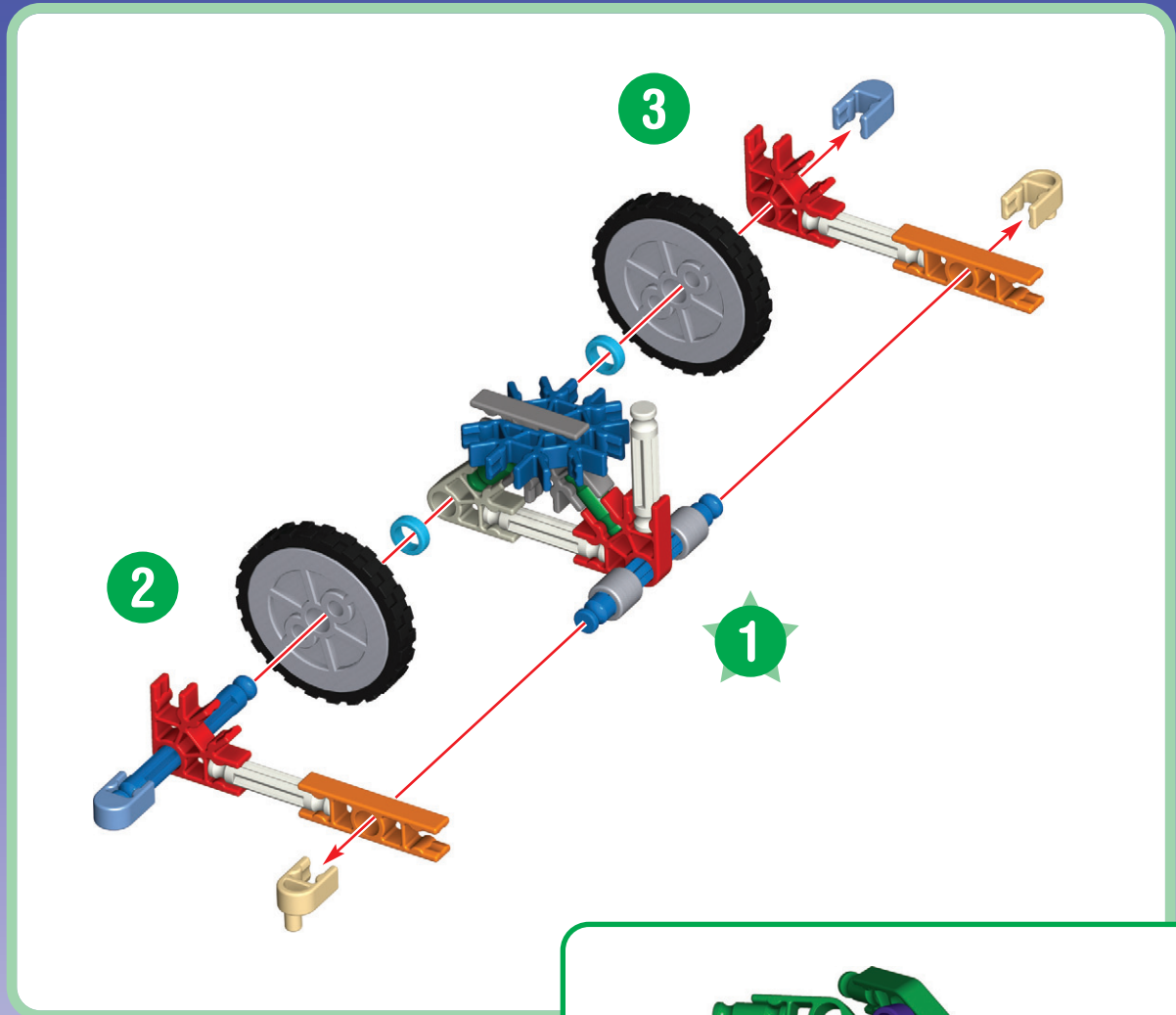

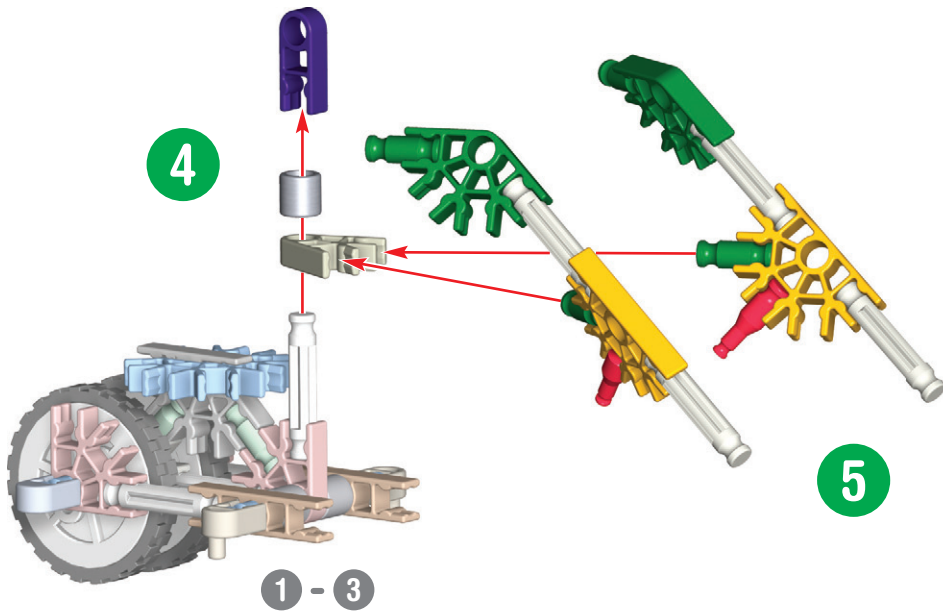
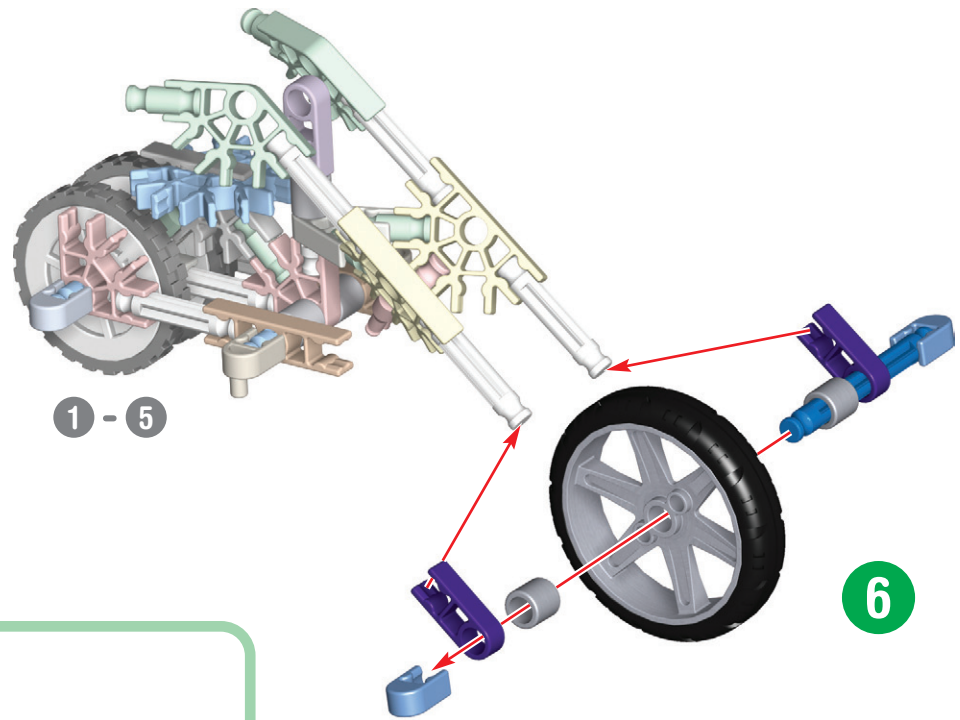

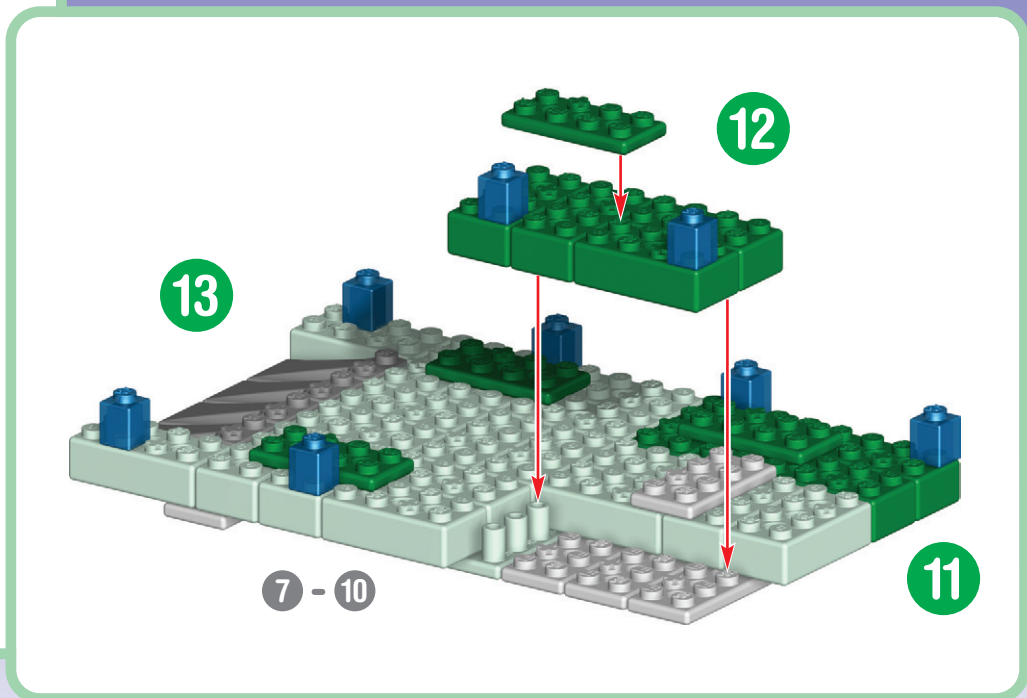
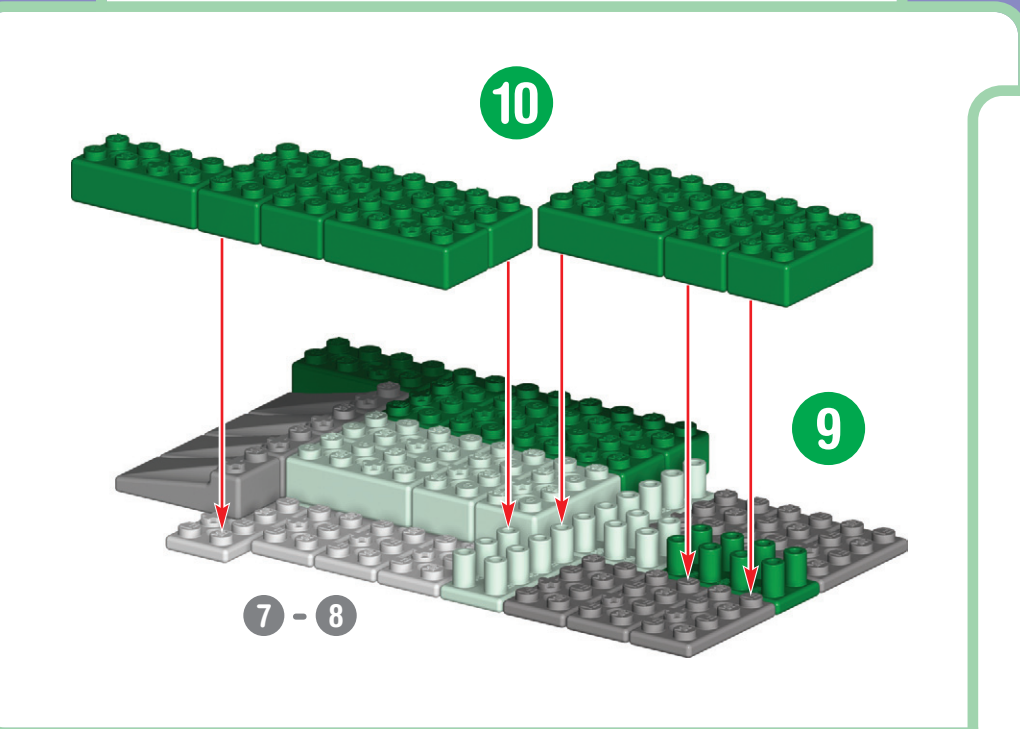
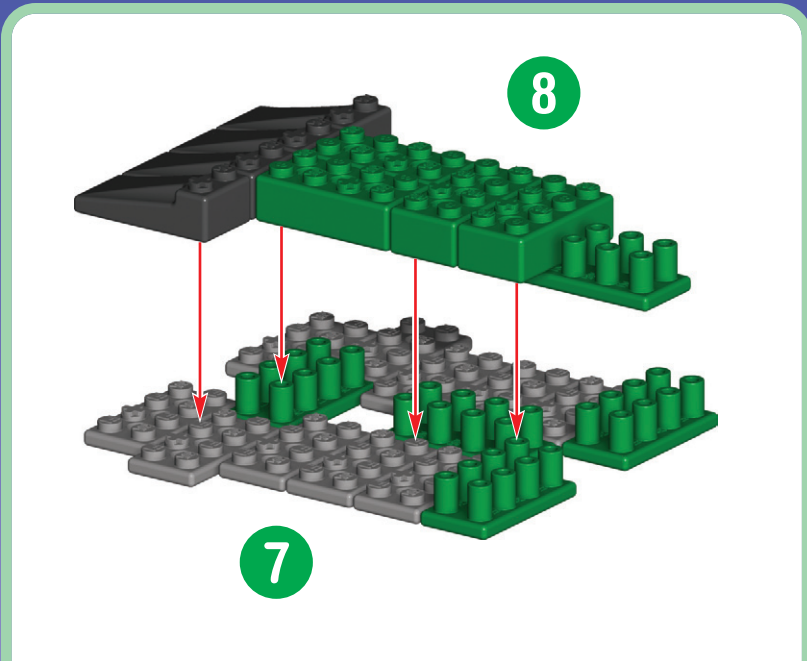

Casey D. - age 12 from California

- I was about 9 years old when I started building with K'NEX.
- My "Eiffel Tower" replica that I made for the K'NEXpert contest was a difficult build because the angles were very challenging to make.



Casey's Bridge

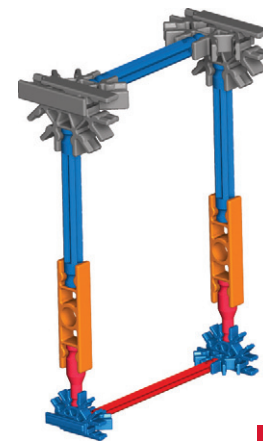

1

Casey's Plane

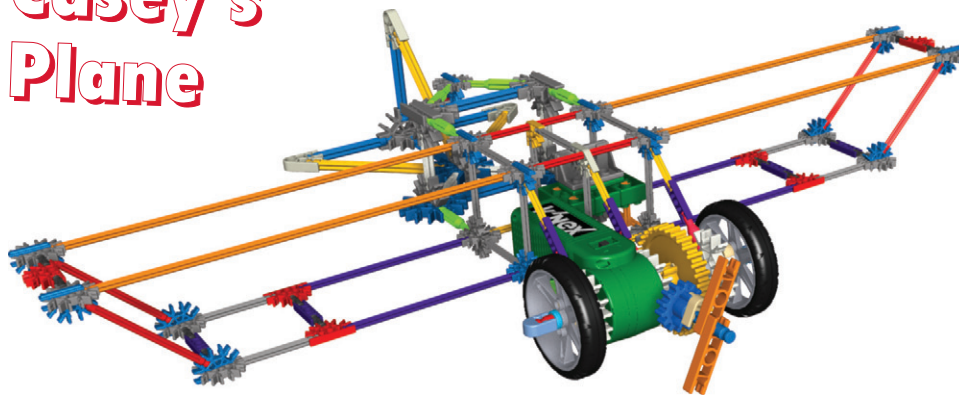

For instructions of this model go to
www.knex.com/instructions
and enter code 13502

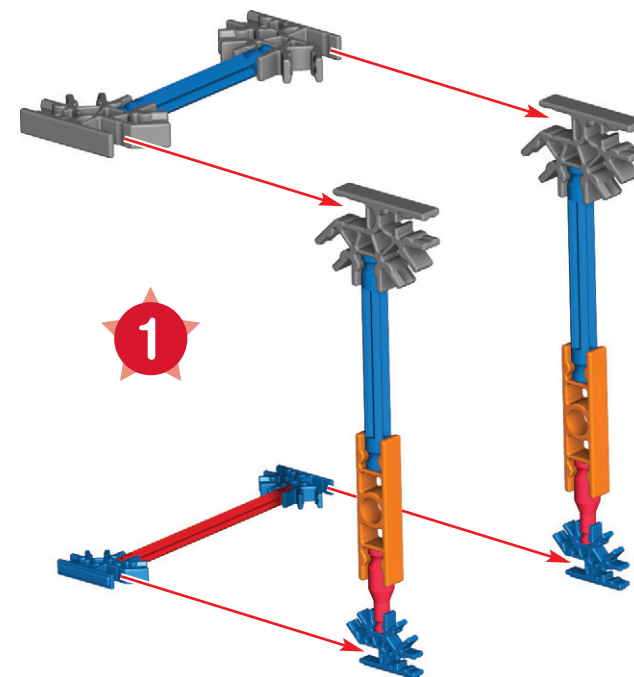

1

x2

2 - 3

x2

2

3

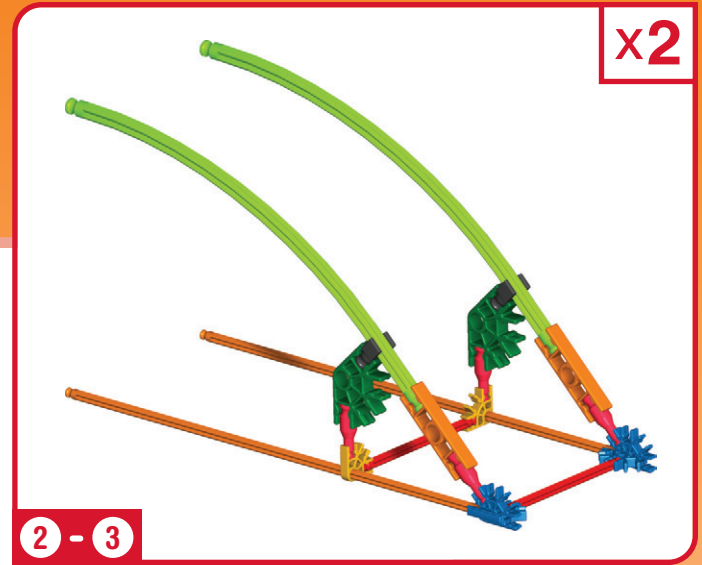
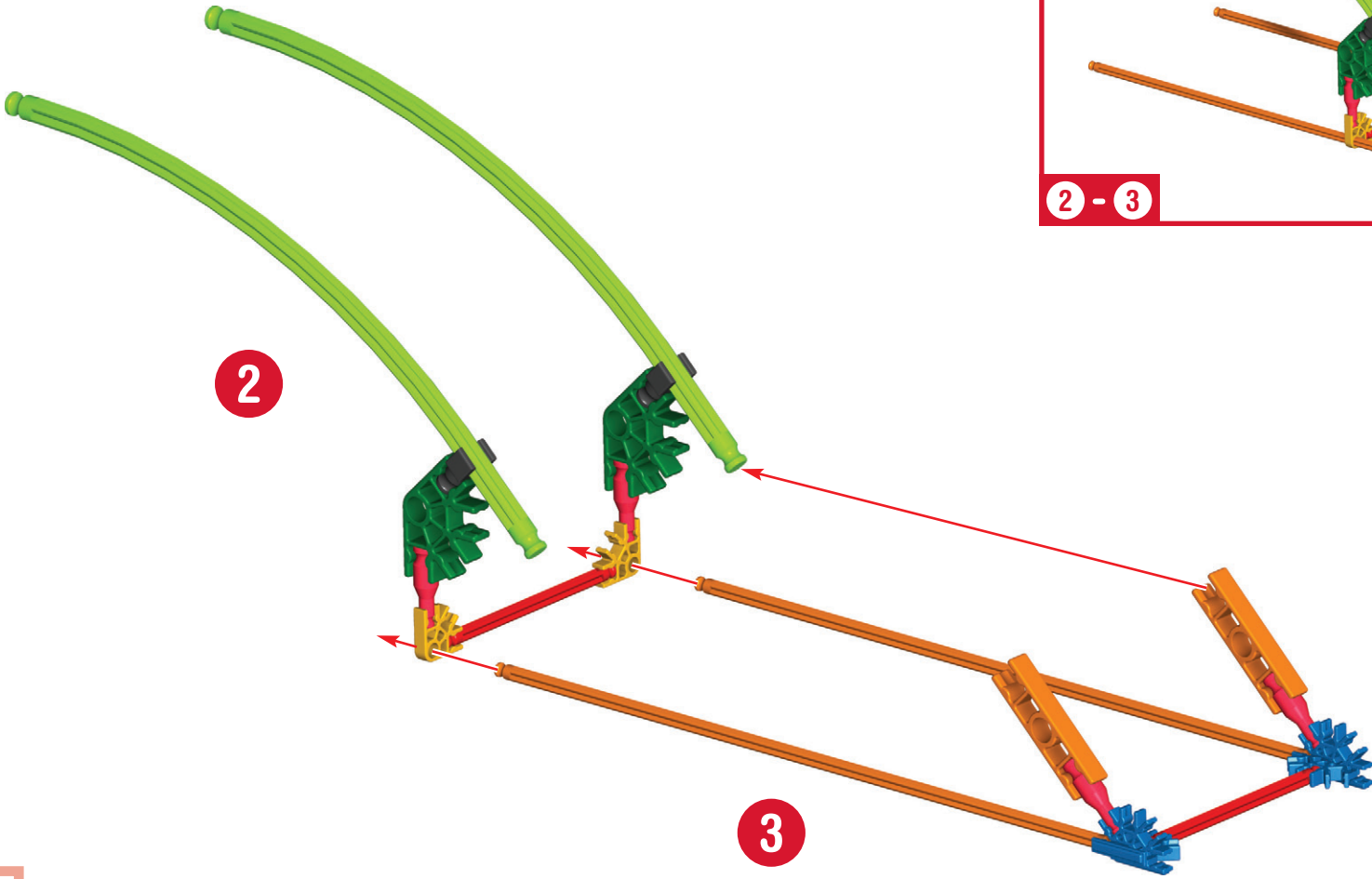

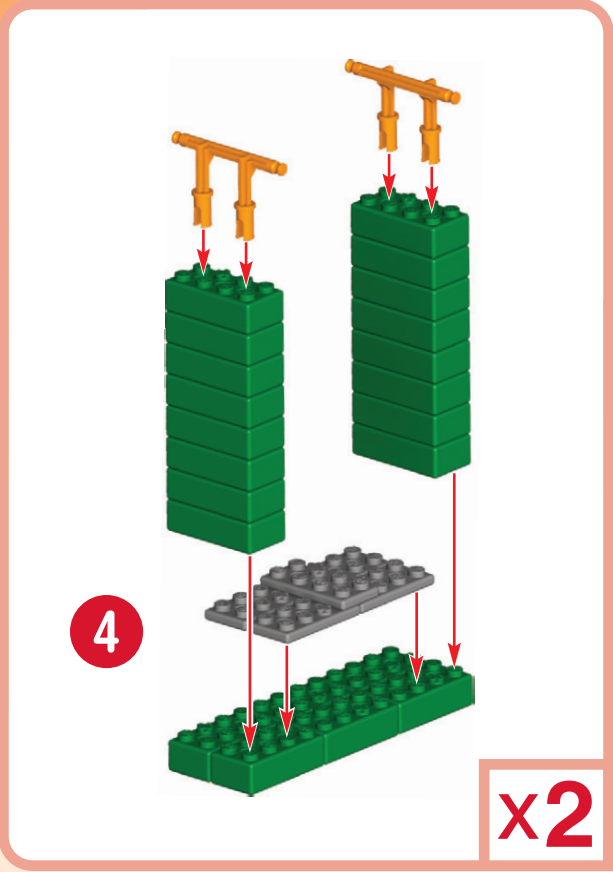
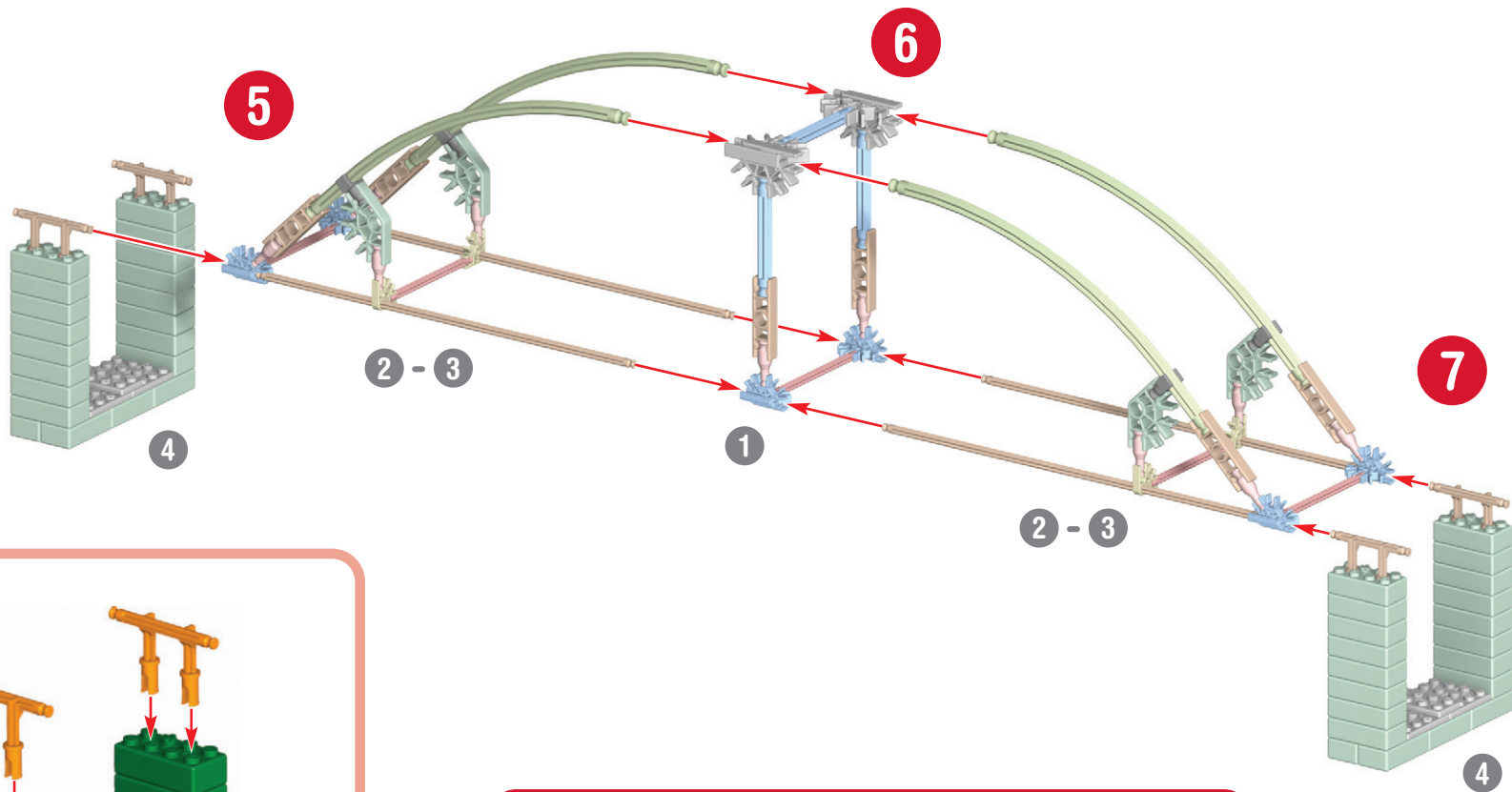

Casey's Crane

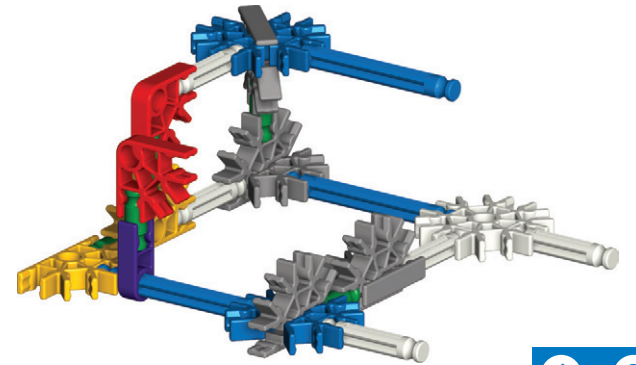
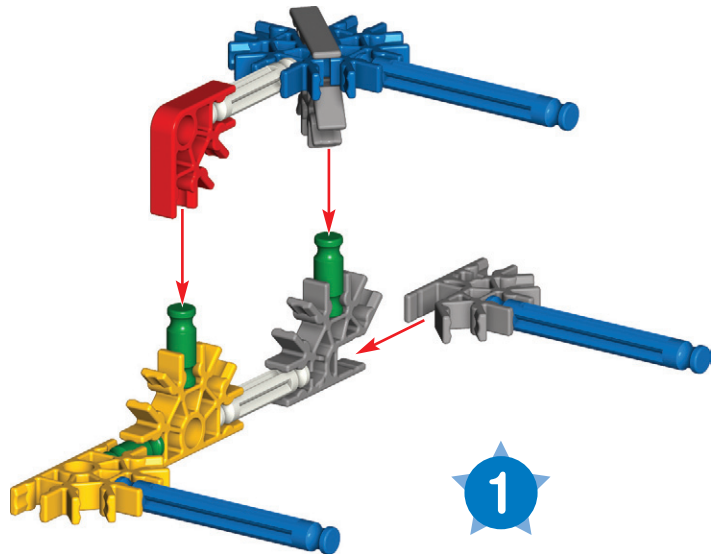
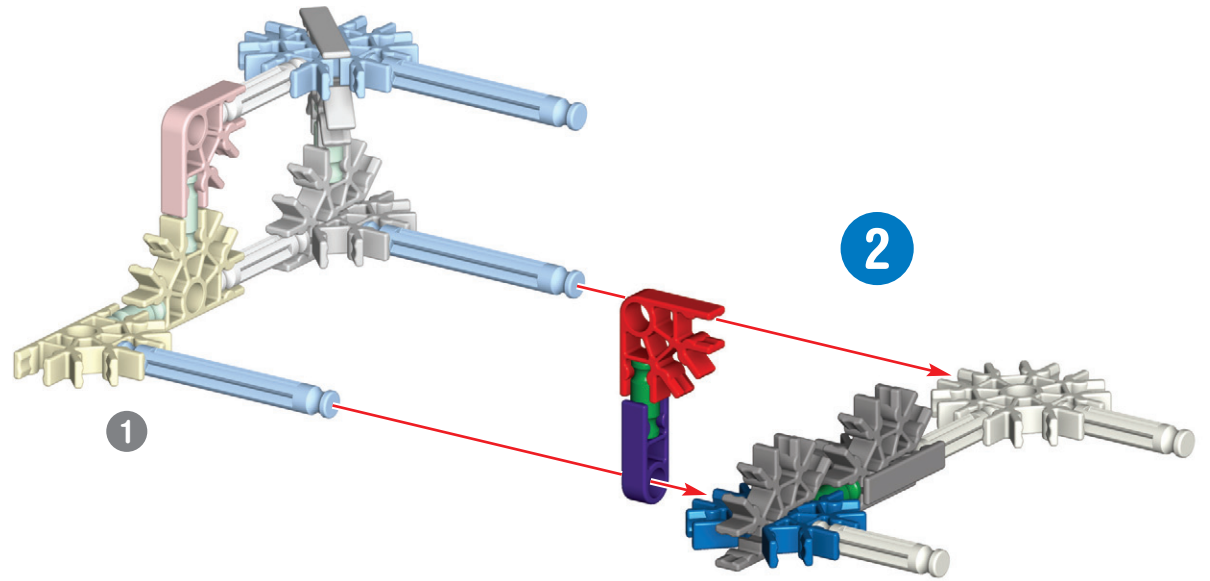

Did you install 2 AA (or LR6) batteries in the Motor?

FR Est-ce que tu as installé 2 piles AA (ou LR6) dans le moteur ?

ES ¿Instalaste dos pilas AA (o LR6) en el Motor?

DE Heb je 2 AA (of LR6) batterijen gestoken in de motor?

IT Hai installato 2 batterie AA (o LR6) nel motore?

PT Foram instaladas as pilhas 2 AA (ou LR6) no Motor?

NL Heb je er 2 AA (of LR6) batterijen ingestoken?

SV Installerade du 2AA (eller LR6) batterier?

DA Har du sat 2 AA (eller LR6) batterier i?

NO Har du installert 2AA (eller LR6) batteriene?

FI Oletko asentanut 2AA (tai LR6) -paristot?

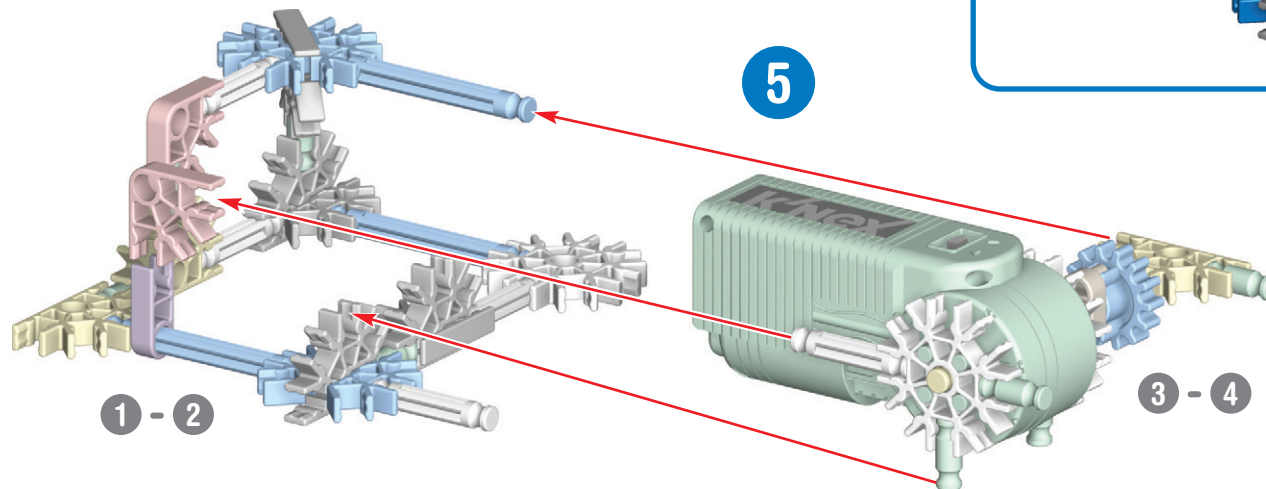
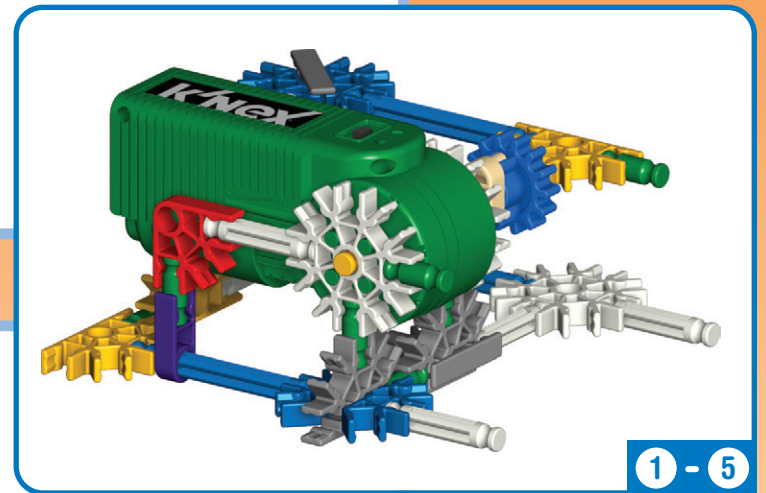
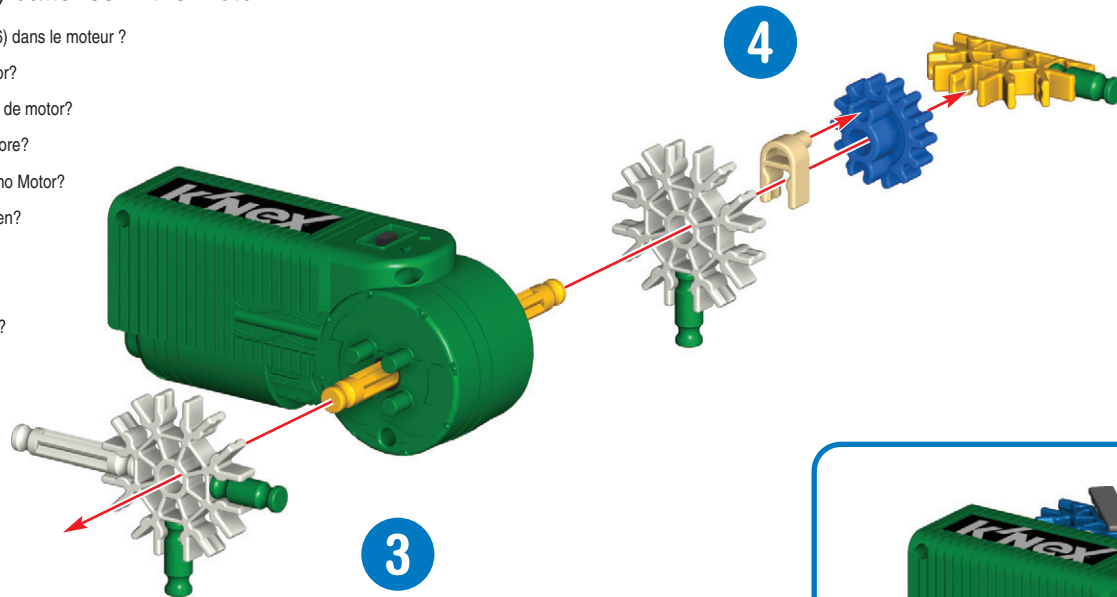

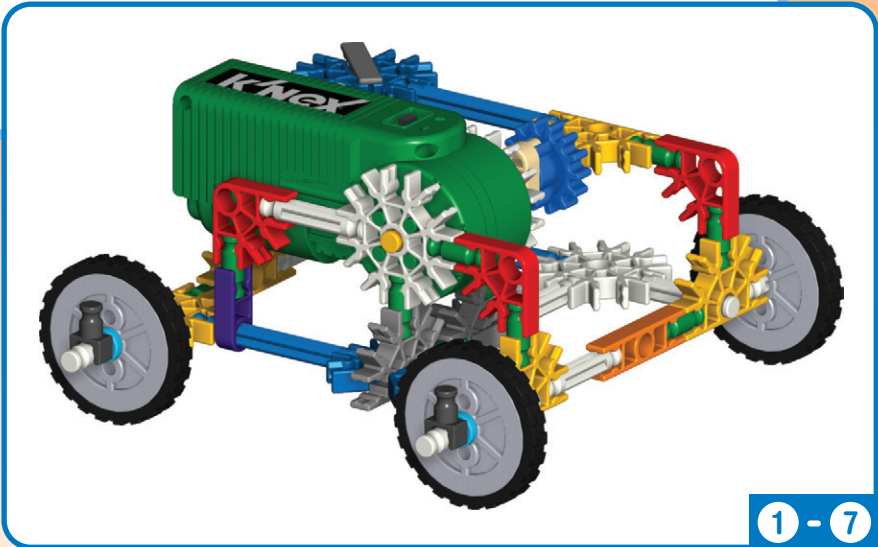
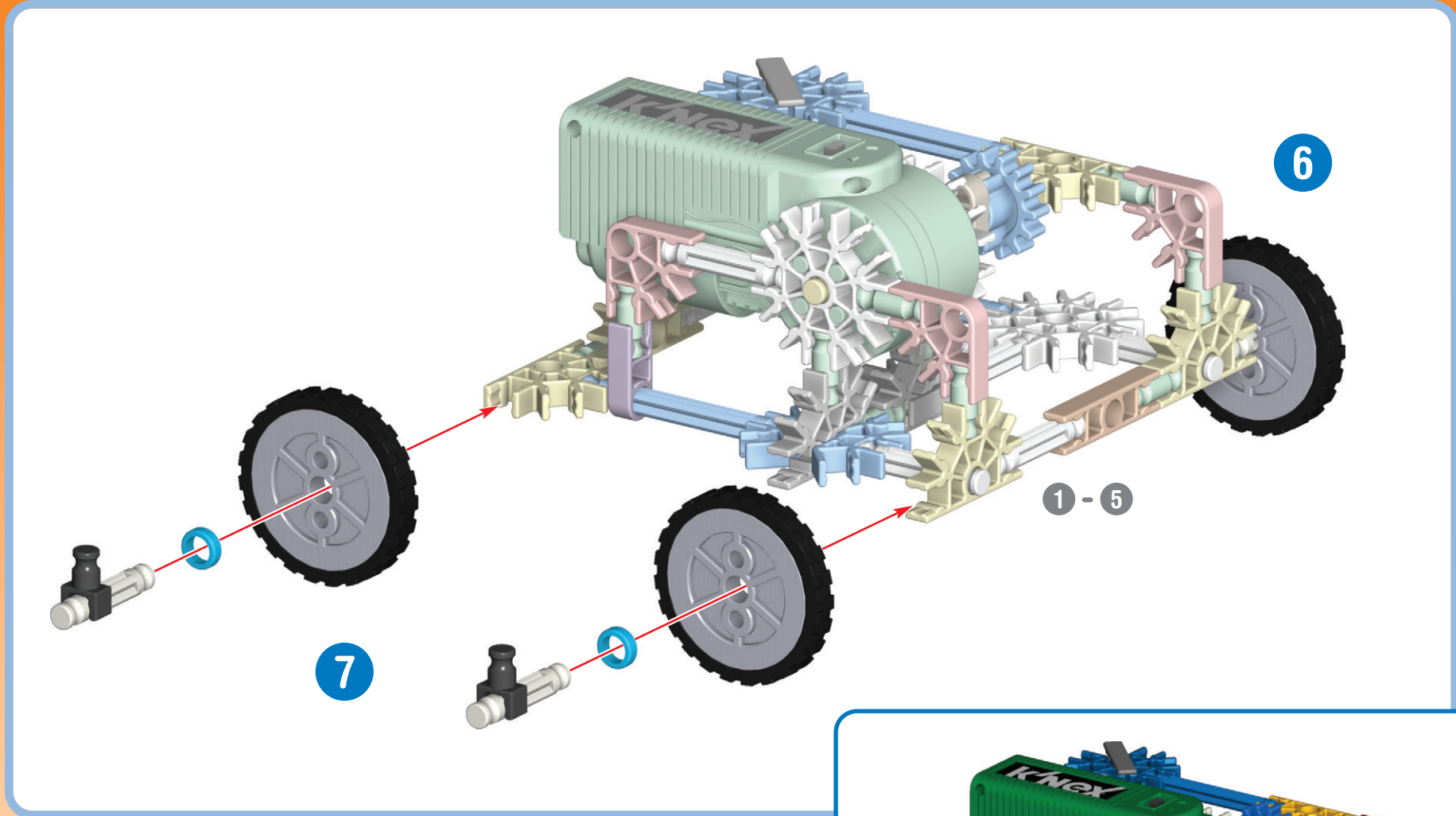

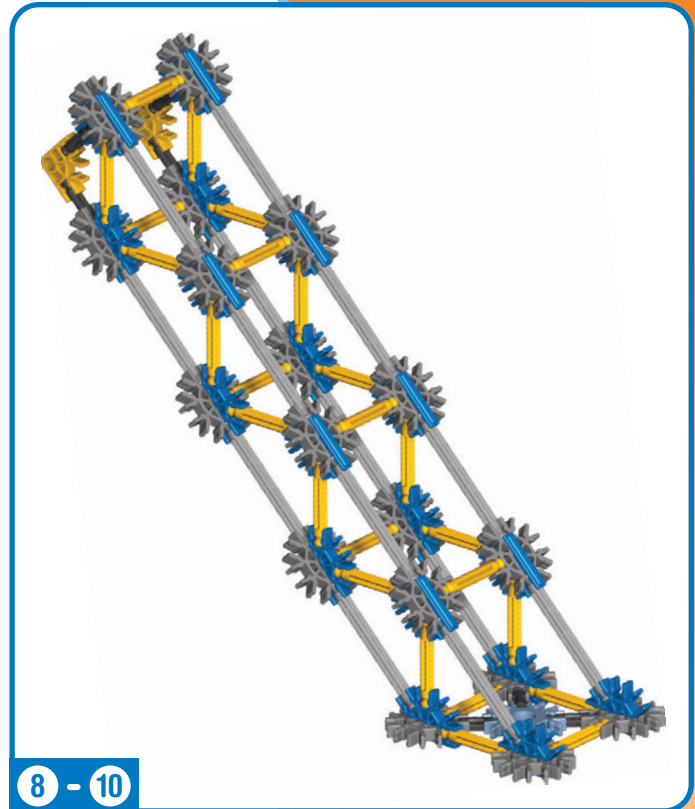
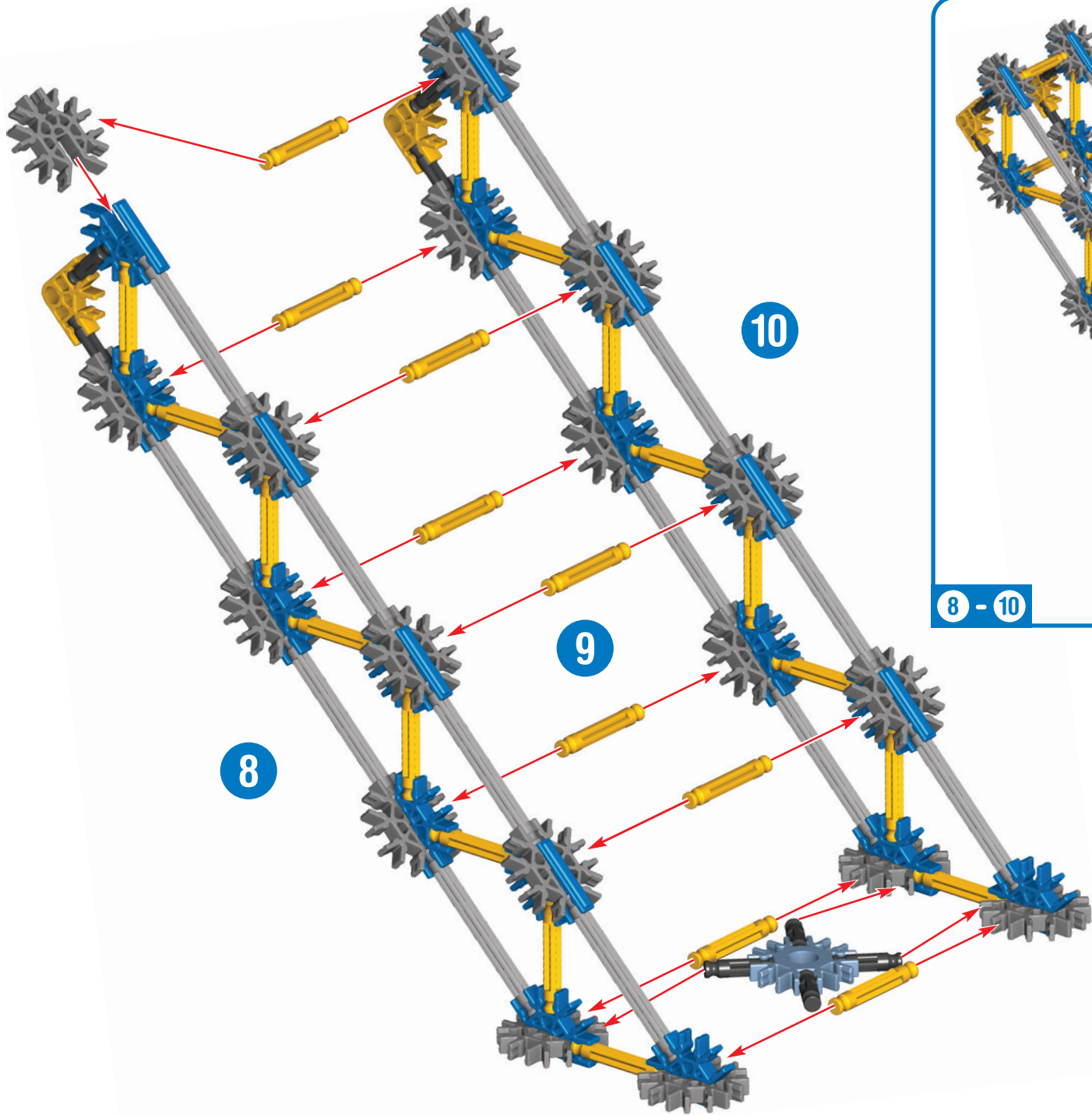

8 - 10

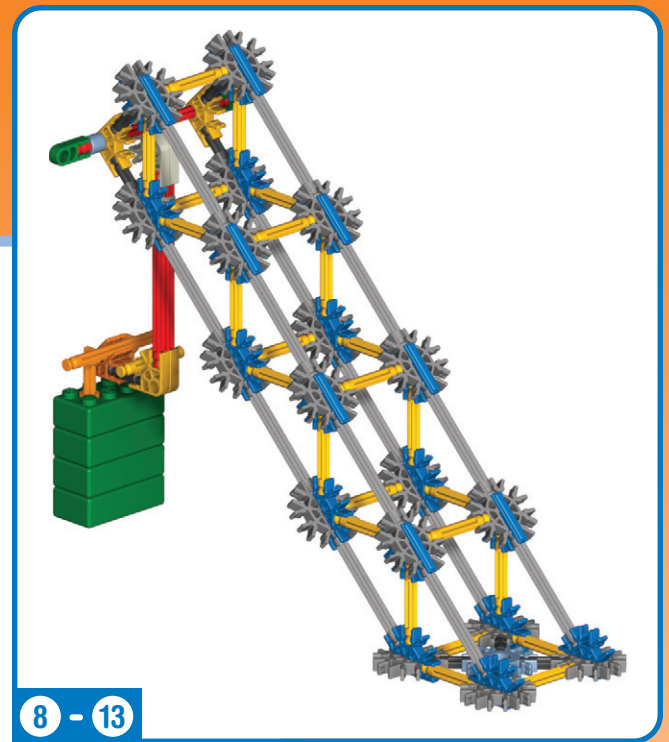
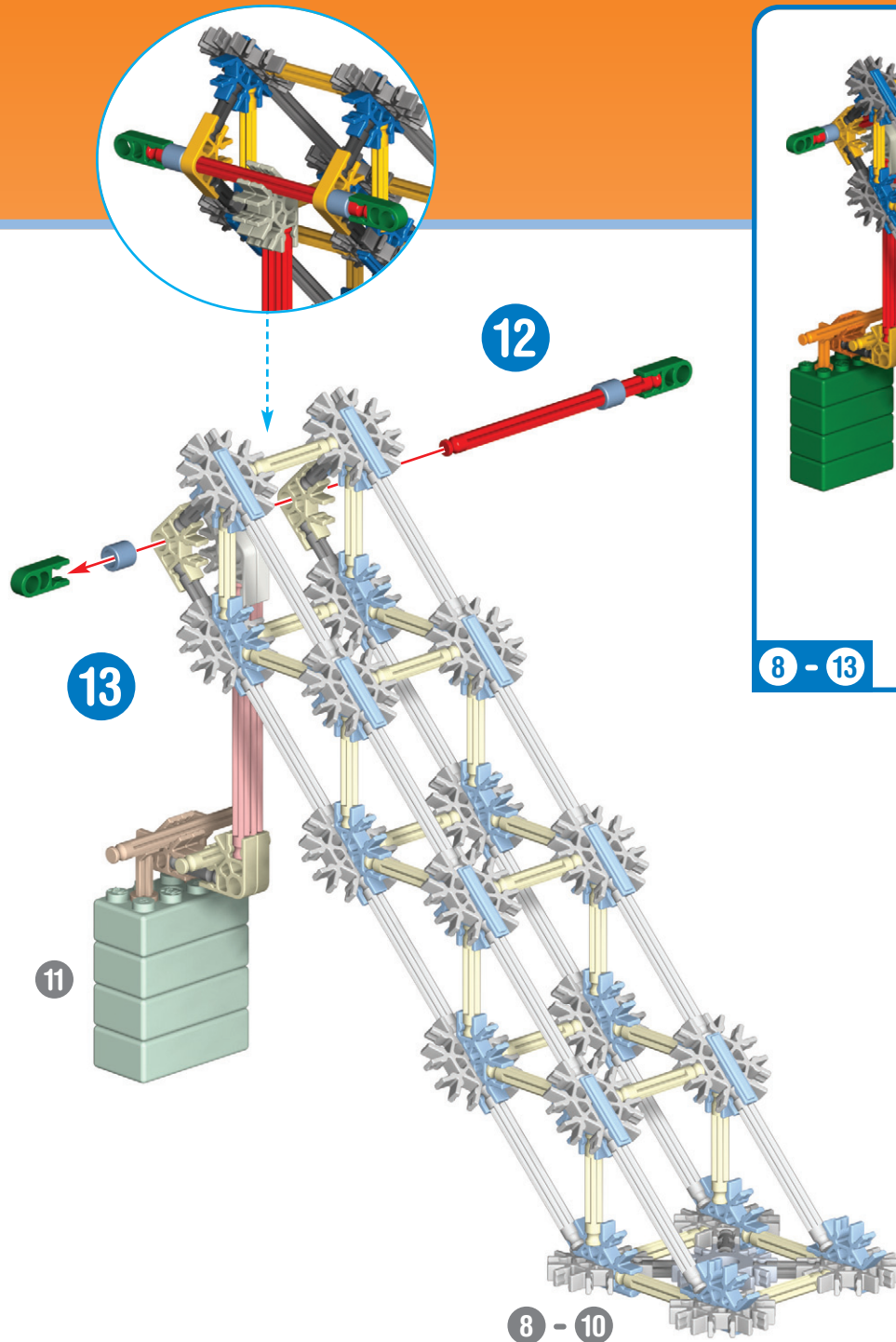
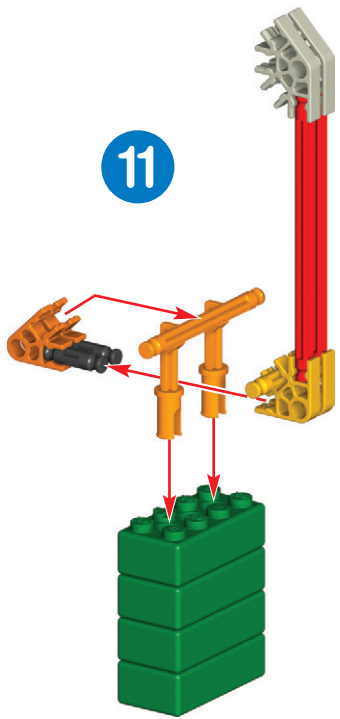

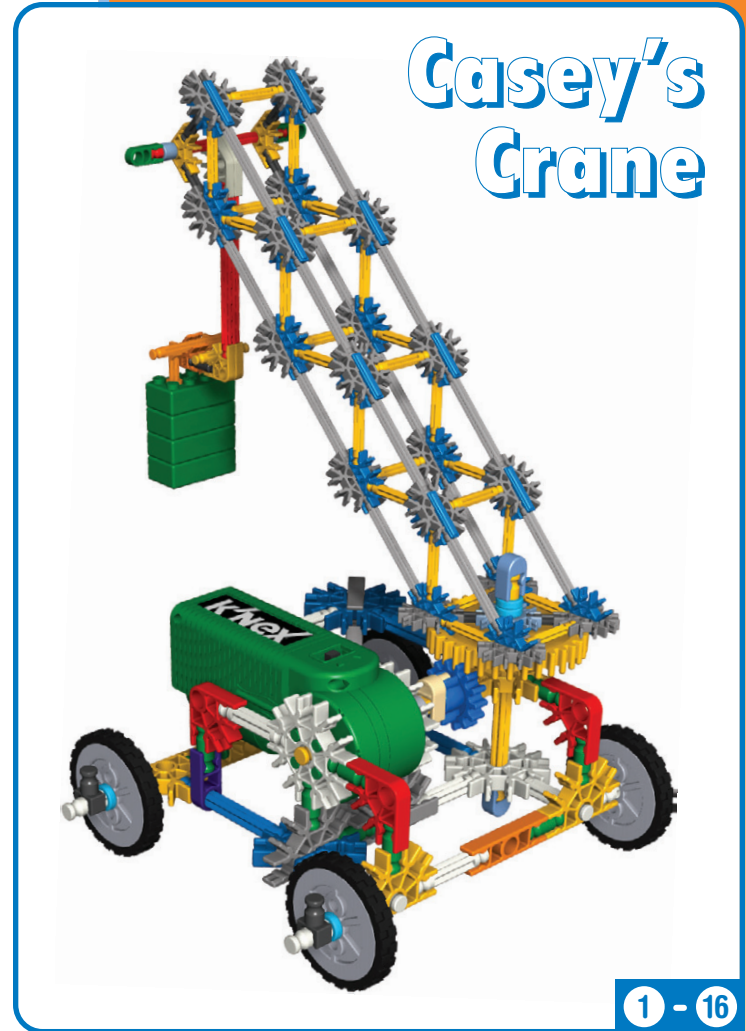
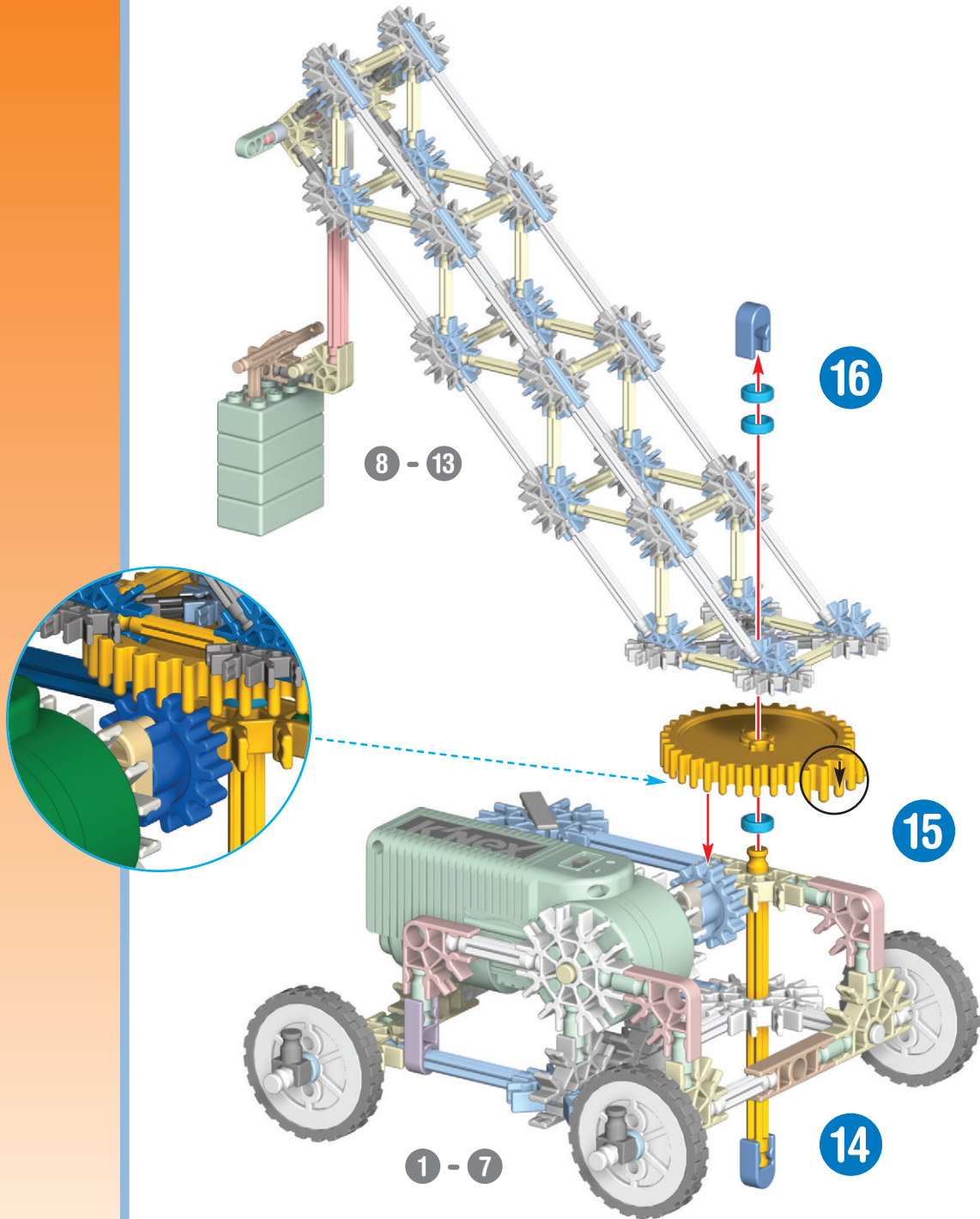

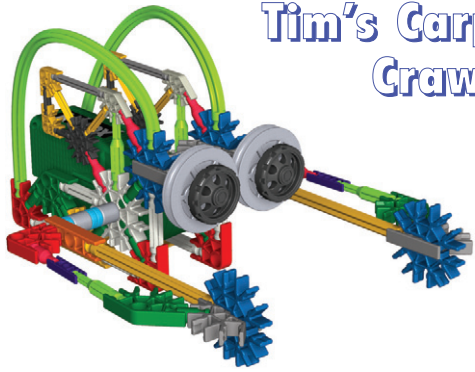

Tim's Carpet Crawler

Tim G. - age 11 from Pennsylvania

- I was 5 when I started building with K'NEX.
- My "Titanic" replica was the most challenging model I've built because it was so big.



Did you install 2 AA (or LR6) batteries in the Motor?

- (FR)** Est-ce que tu as installé 2 piles AA (ou LR6) dans le moteur ?
- (ES)** ¿Instalaste dos pilas AA (o LR6) en el Motor?
- (DE)** Heb je 2 AA (of LR6) batterijen gestoken in de motor?
- (IT)** Hai installato 2 batterie AA (o LR6) nel motore?
- (PT)** Foram instaladas as pilhas 2 AA (ou LR6) no Motor?
- (NL)** Heb je er 2 AA (of LR6) batterijen ingestoken?
- (SV)** Installerade du 2AA (eller LR6) batterier i?
- (DA)** Har du sat 2 AA (eller LR6) batterier i?
- (NO)** Har du installert 2AA (eller LR6) batteriene?
- (FI)** Oletko asentanut 2AA (tai LR6) -paristol?

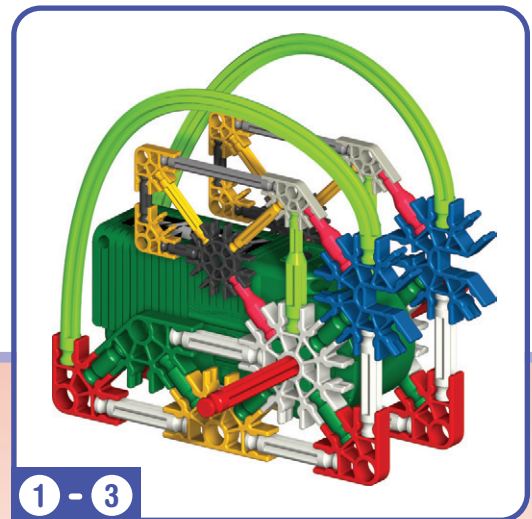
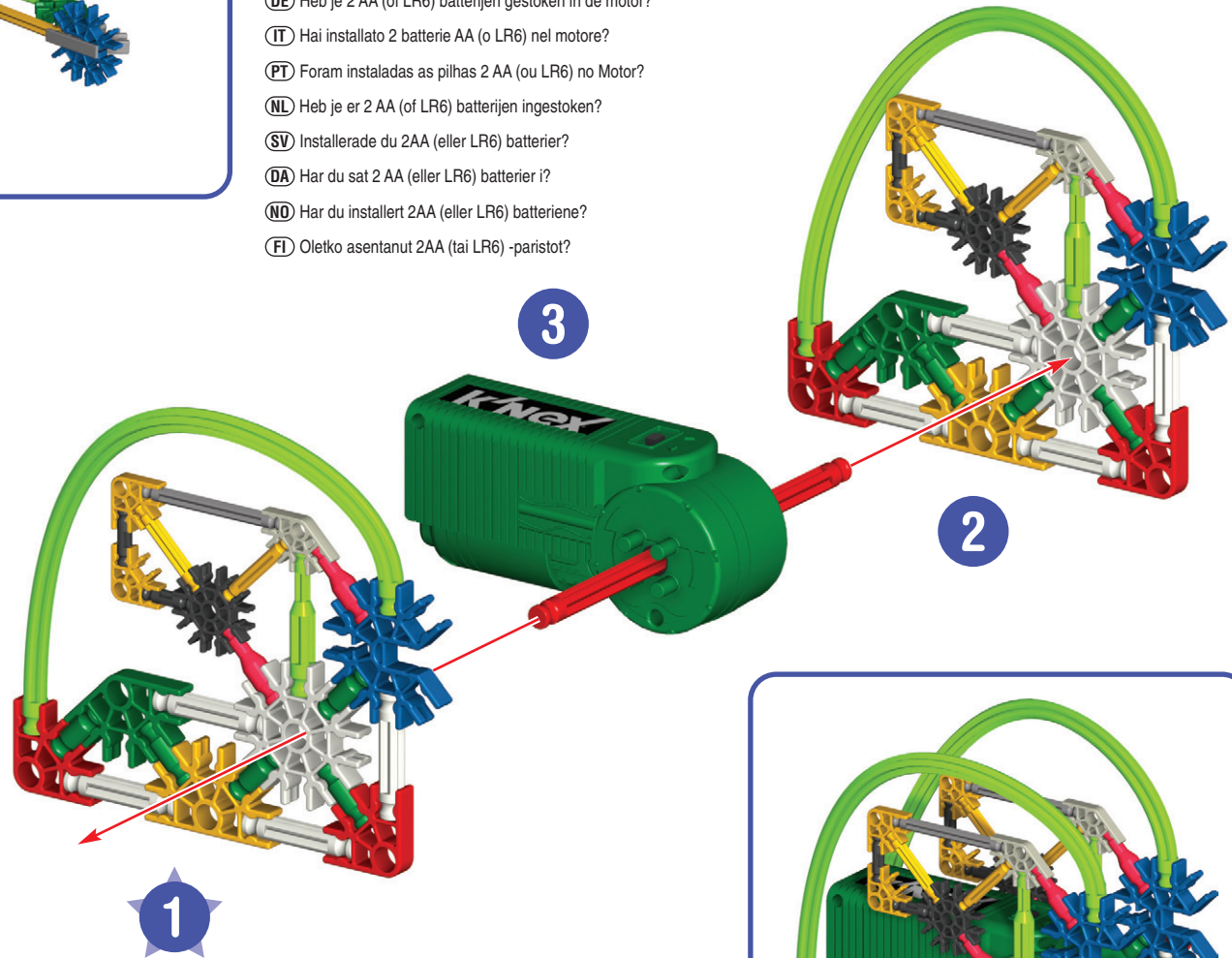

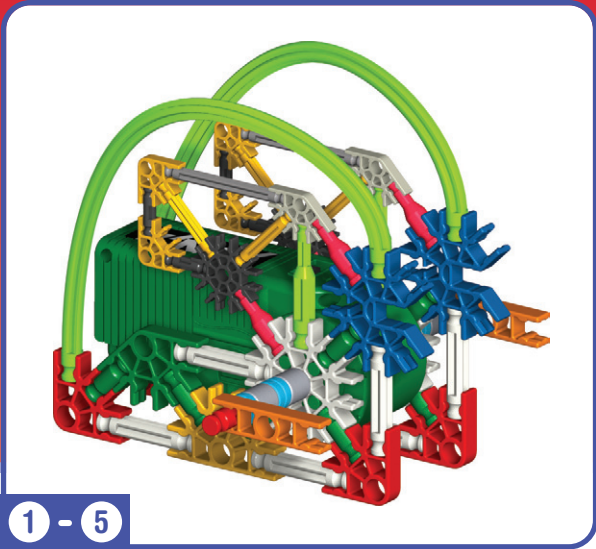

For instructions of these models go to www.knex.com/instructions and enter code 13502

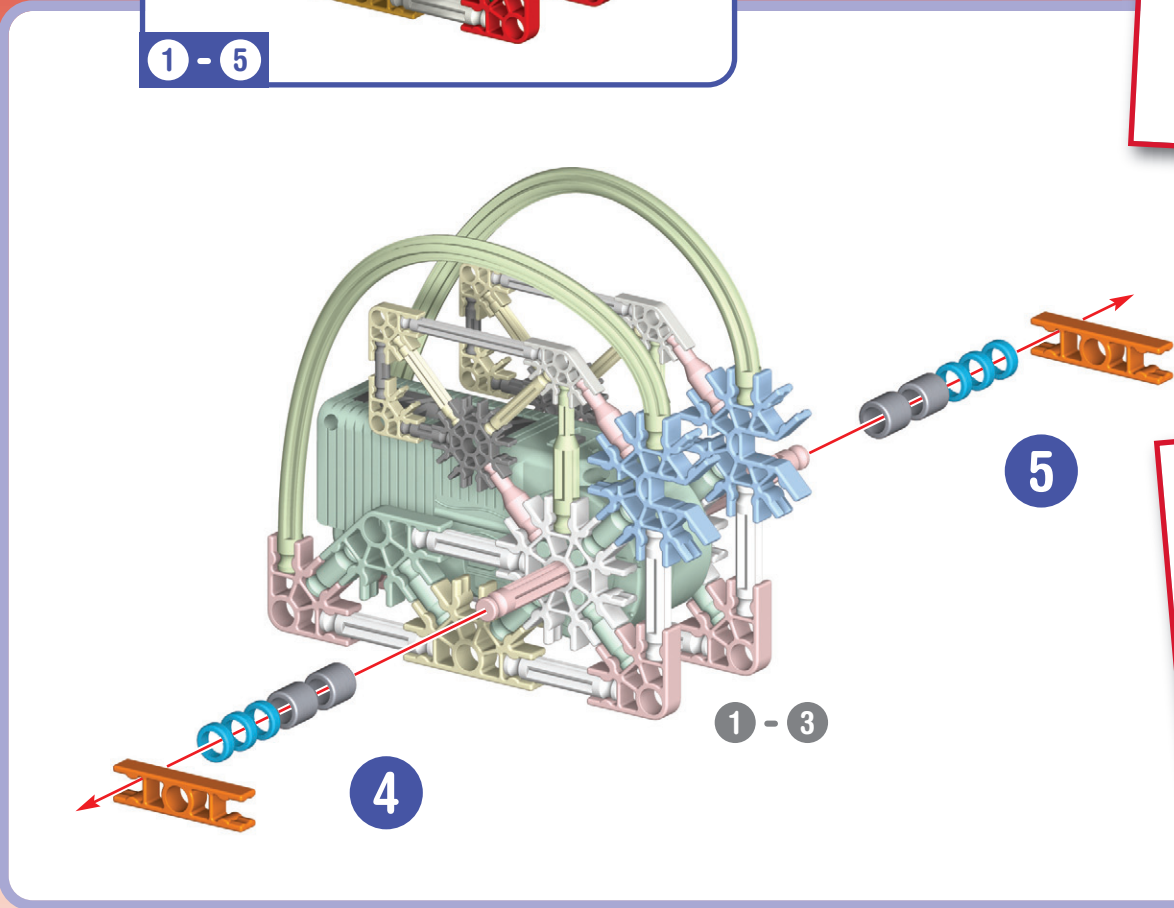

Tim's Carpet Crawler

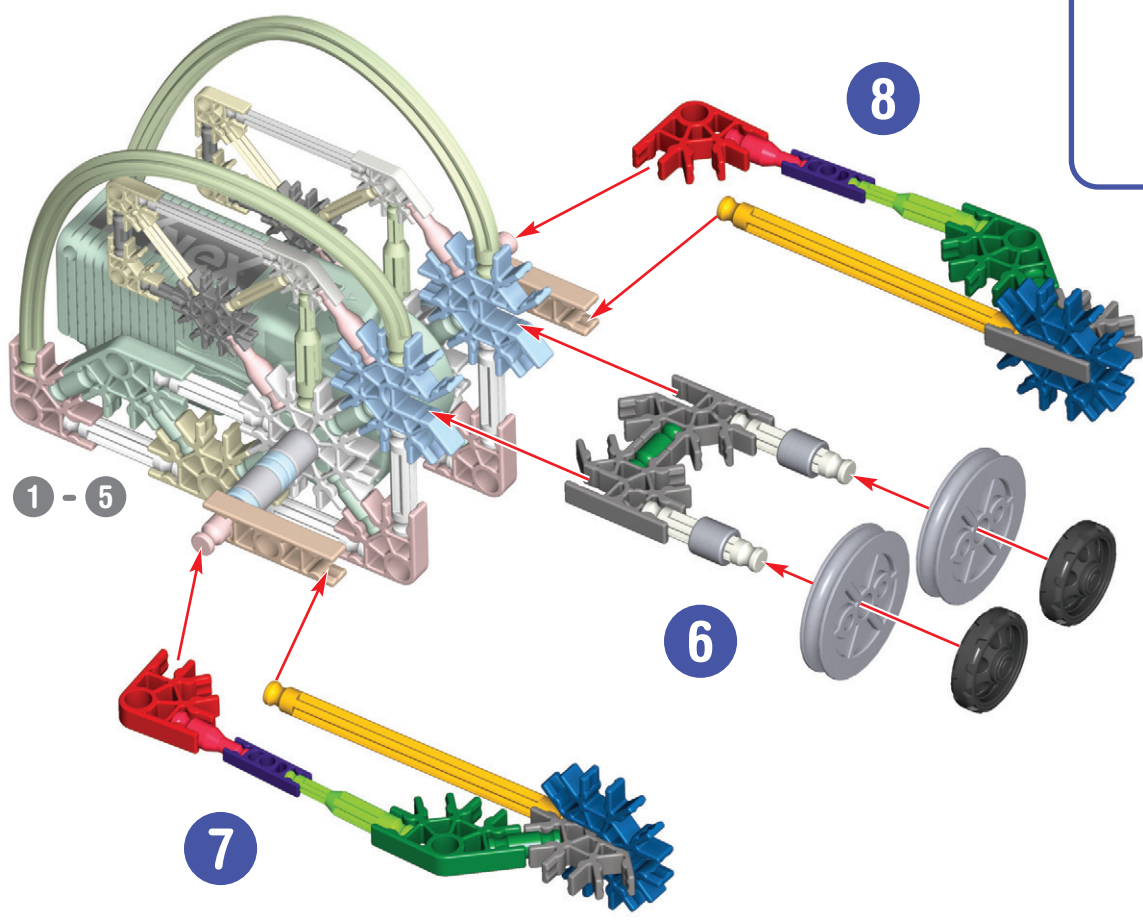
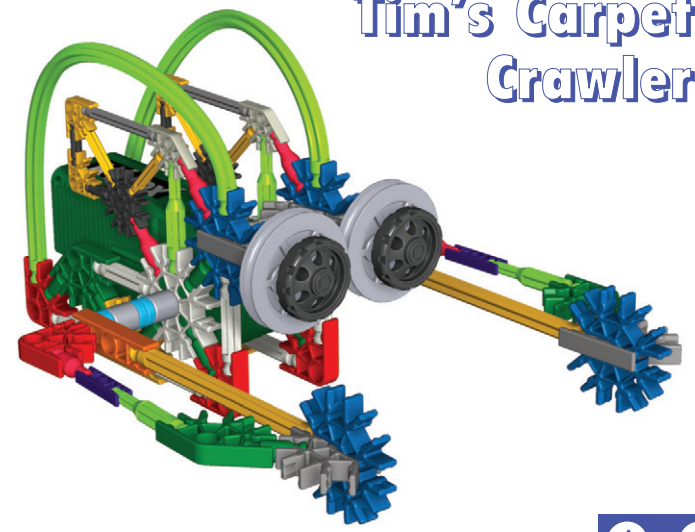

Ross P. - age 10 from Florida

- I was 5 years old when I started building with K'NEX.
- The most difficult set I've built was the "Hyperspace Training Tower" because it had 8 different functions and many parts.

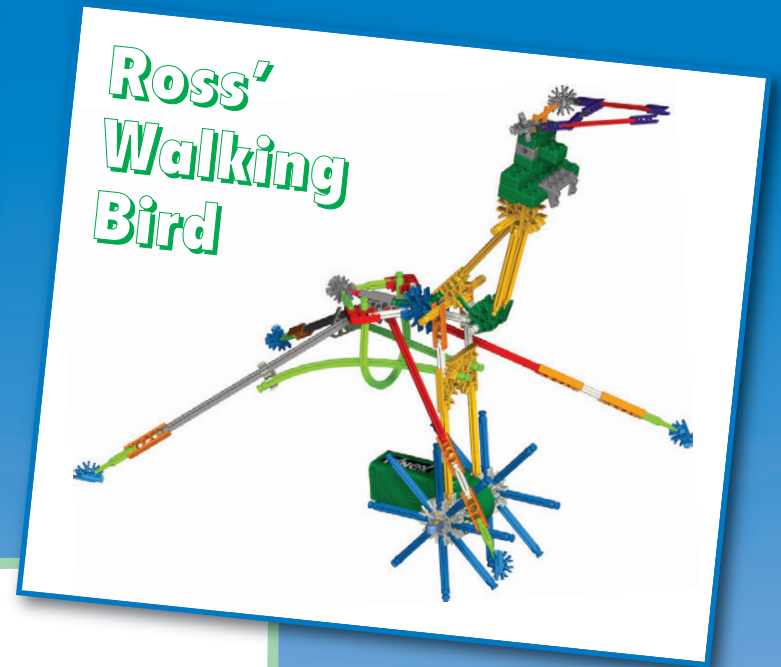

Ross' Walking Bird

For instructions of this model go to www.knex.com/instructions and enter code 13502



Ross' Stunt Bike

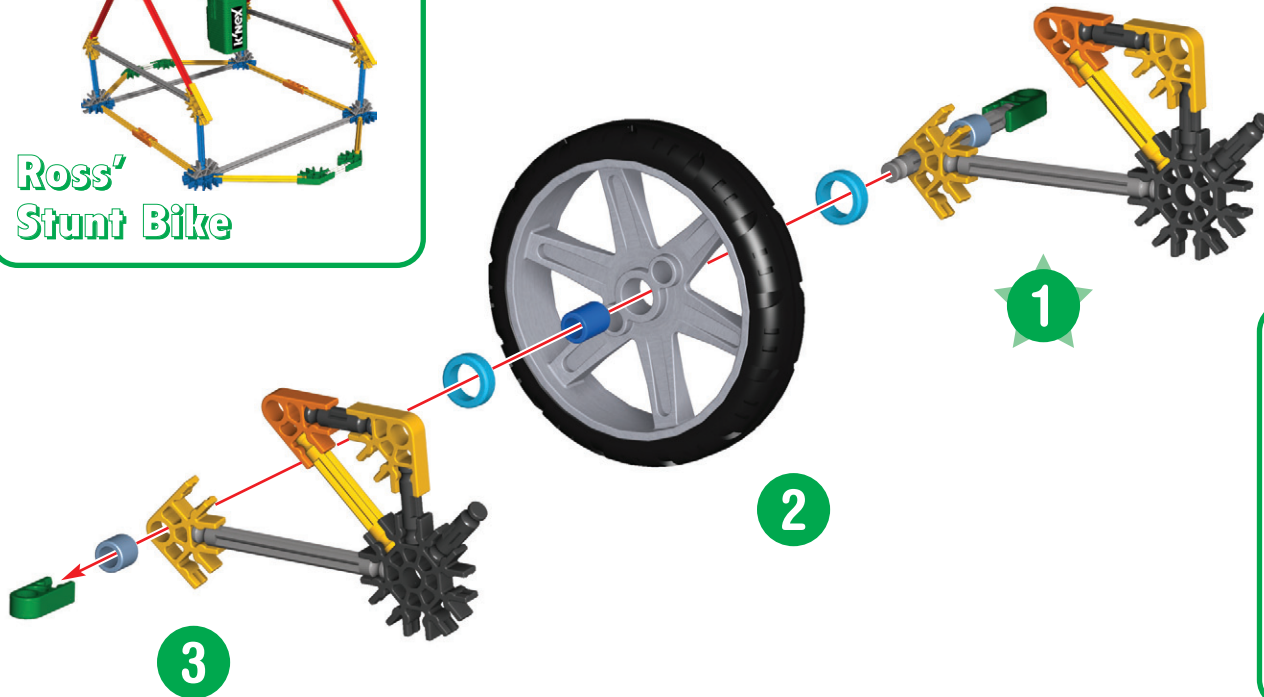

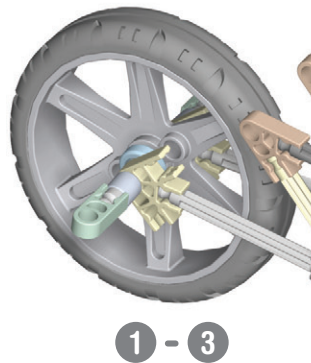
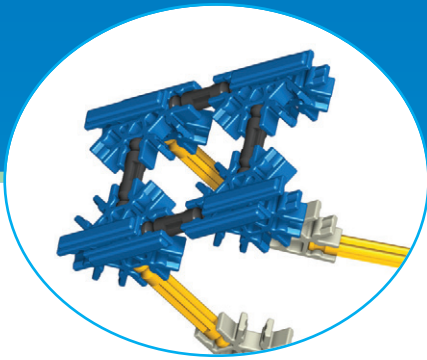

1 - 3

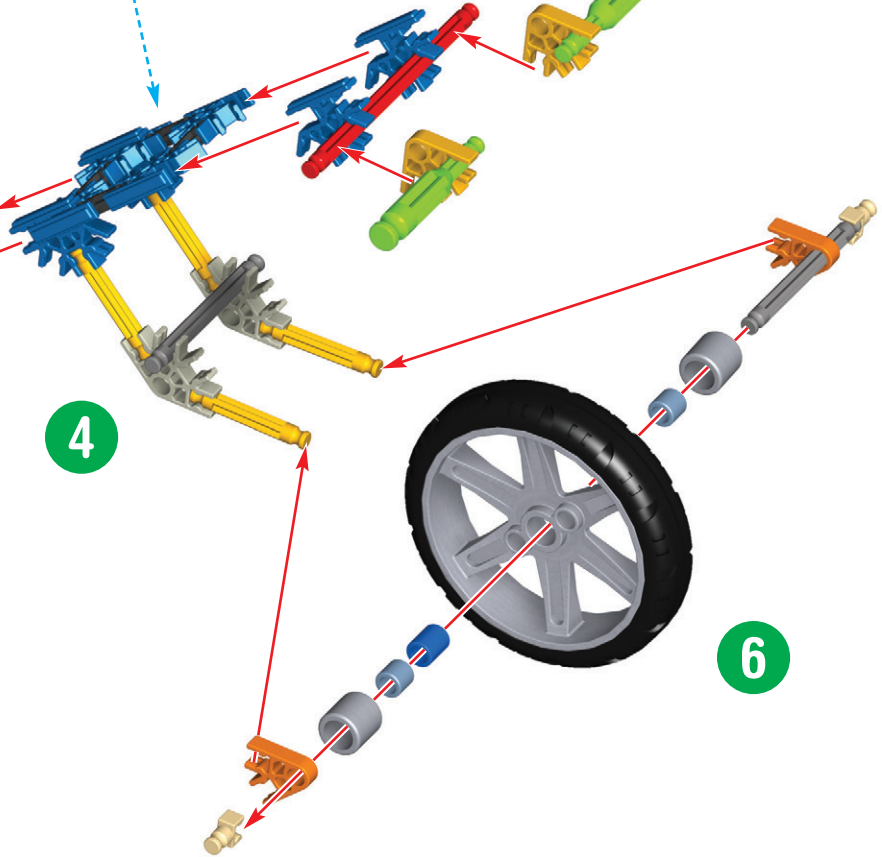

4

5

6

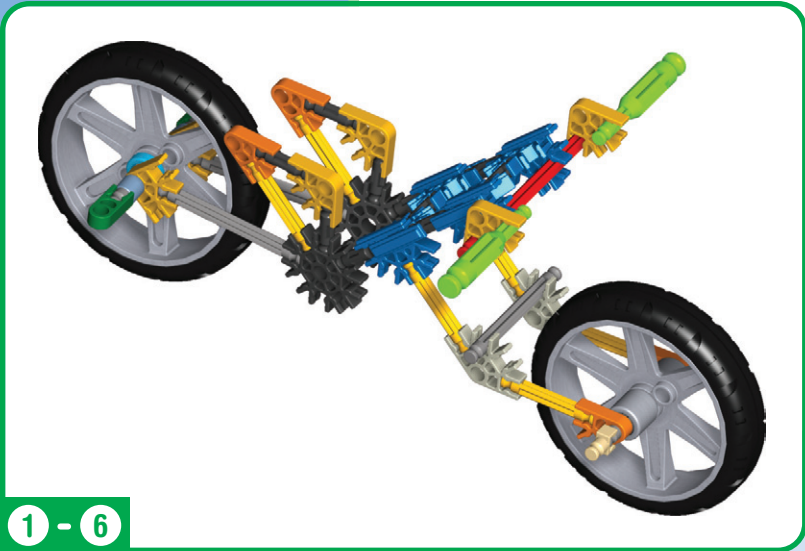

1 - 6

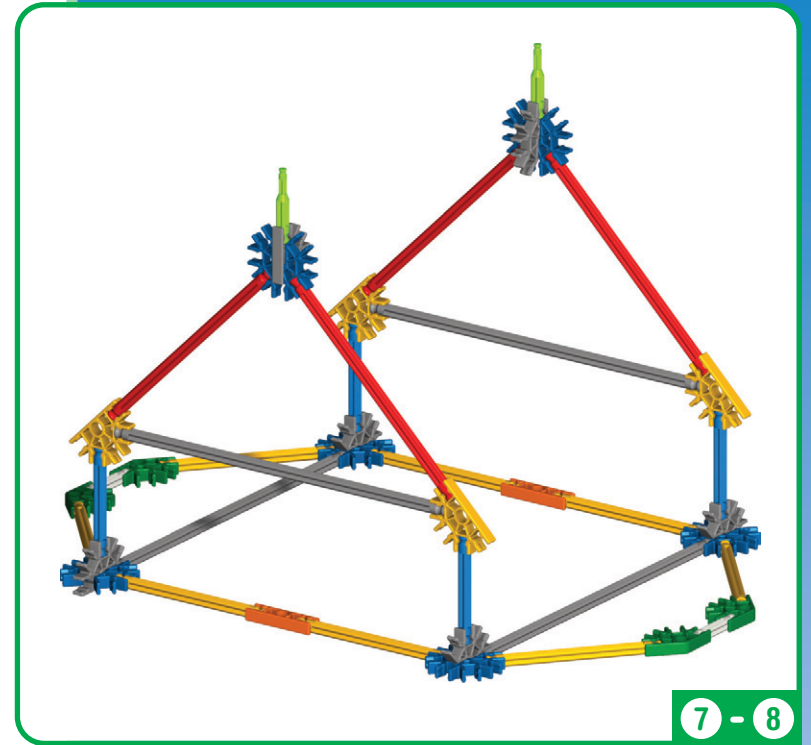
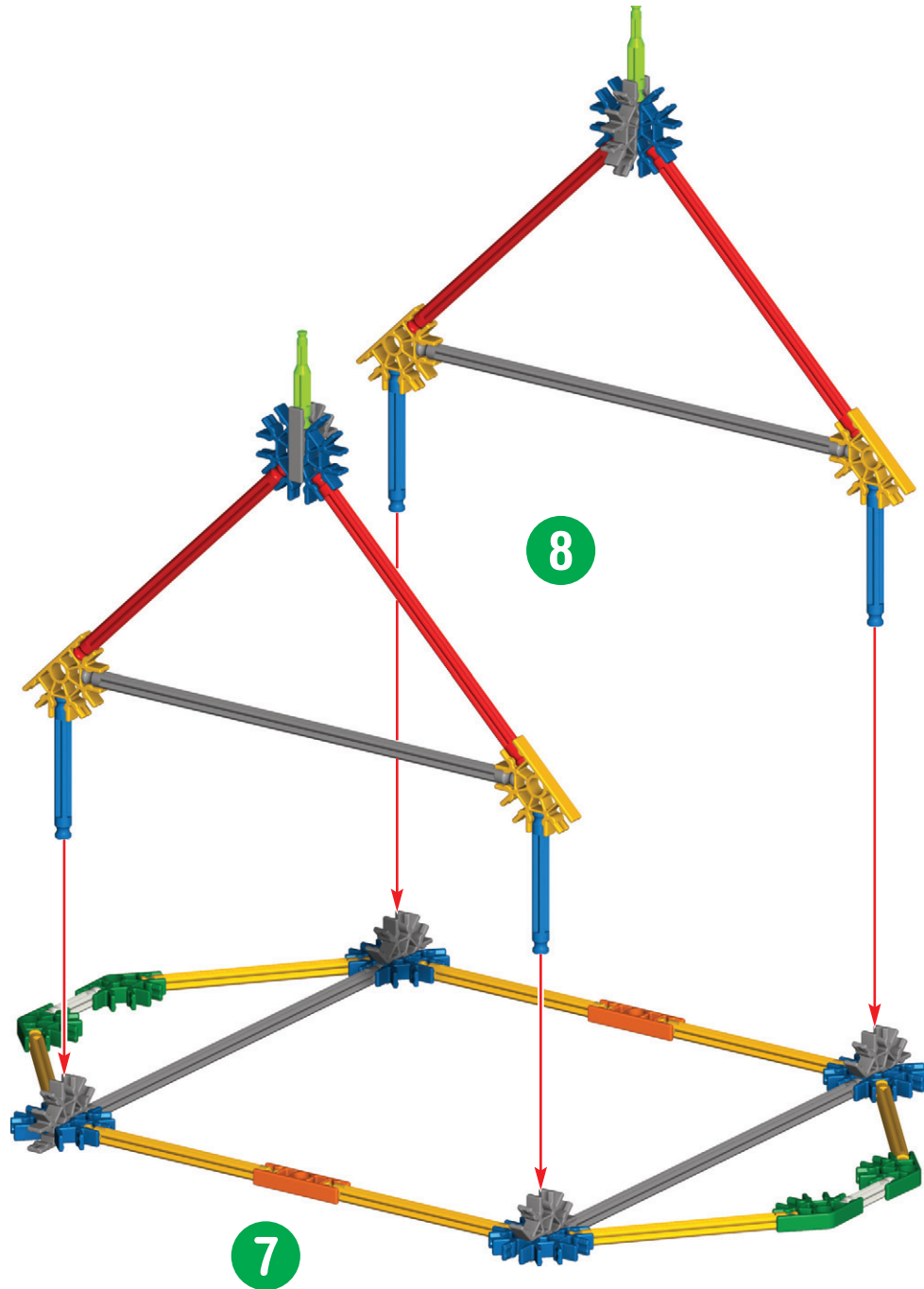

Did you install 2 AA (or LR6) batteries in the Motor?

- ⒻⓇ Est-ce que tu as installé 2 piles AA (ou LR6) dans le moteur ?
- ⒺⓈ ¿Instalaste dos pilas AA (o LR6) en el Motor?
- ⒹⒺ Heb je 2 AA (of LR6) batterijen gestoken in de motor?
- ⒾⒿ Hai installato 2 batterie AA (o LR6) nel motore?
- ⓅⒿ Foram instaladas as pilhas 2 AA (ou LR6) no Motor?
- ⓃⒻ Heb je er 2 AA (of LR6) batterijen ingestoken?
- ⓈⓋ Installerade du 2AA (eller LR6) batterier?
- ⒹⒶ Har du sat 2 AA (eller LR6) batterier i?
- ⓃⒹ Har du installert 2AA (eller LR6) batteriene?
- ⒻⒿ Oletko asentanut 2AA (tai LR6) -paristot?

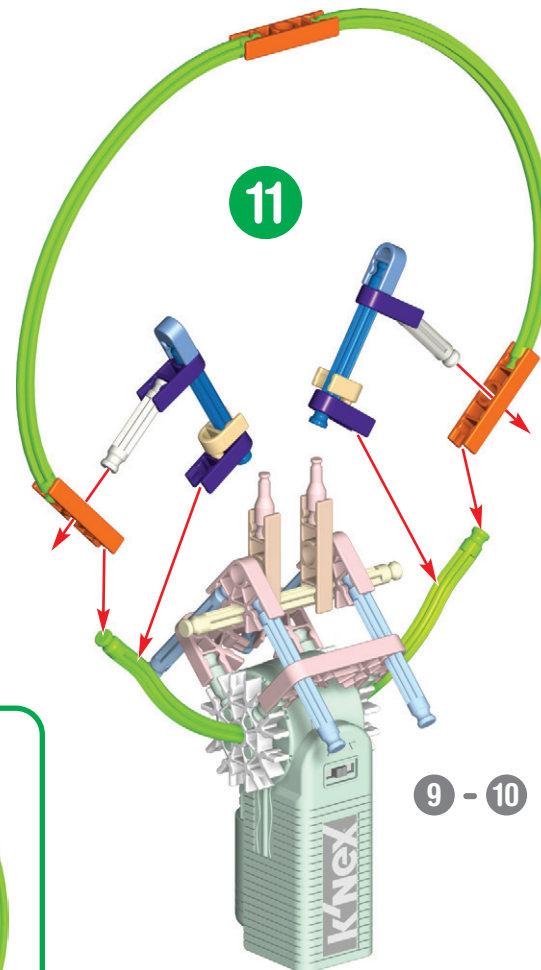
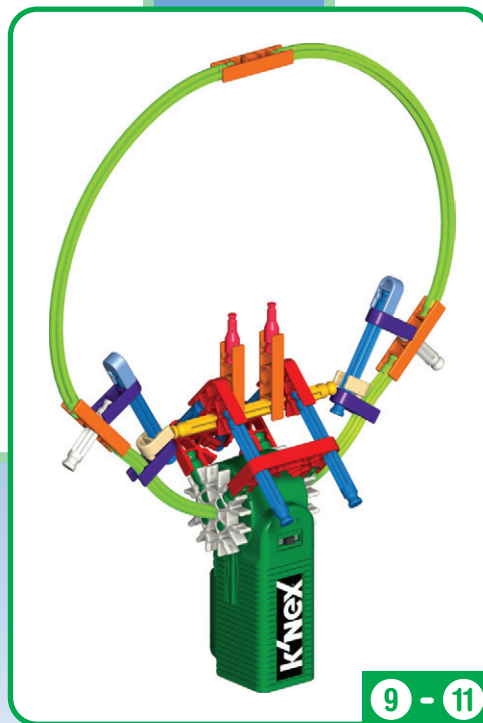
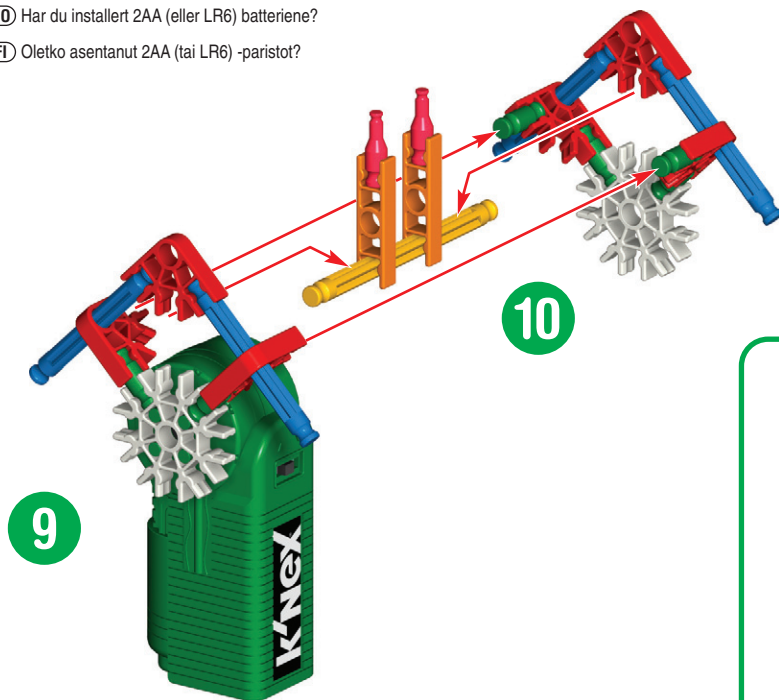

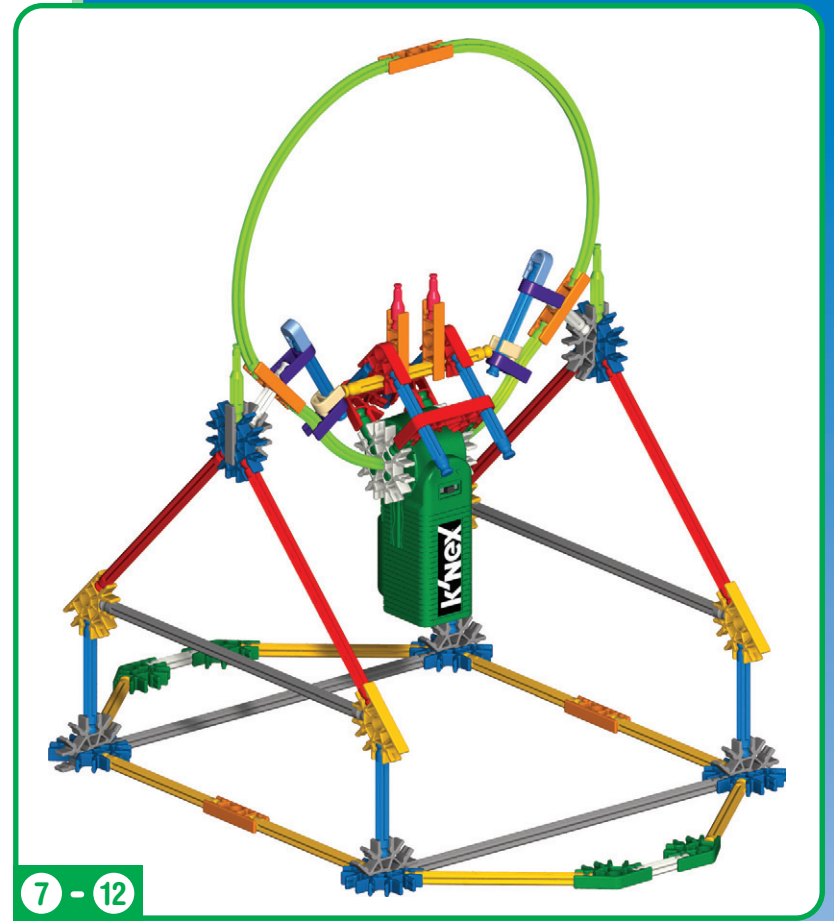
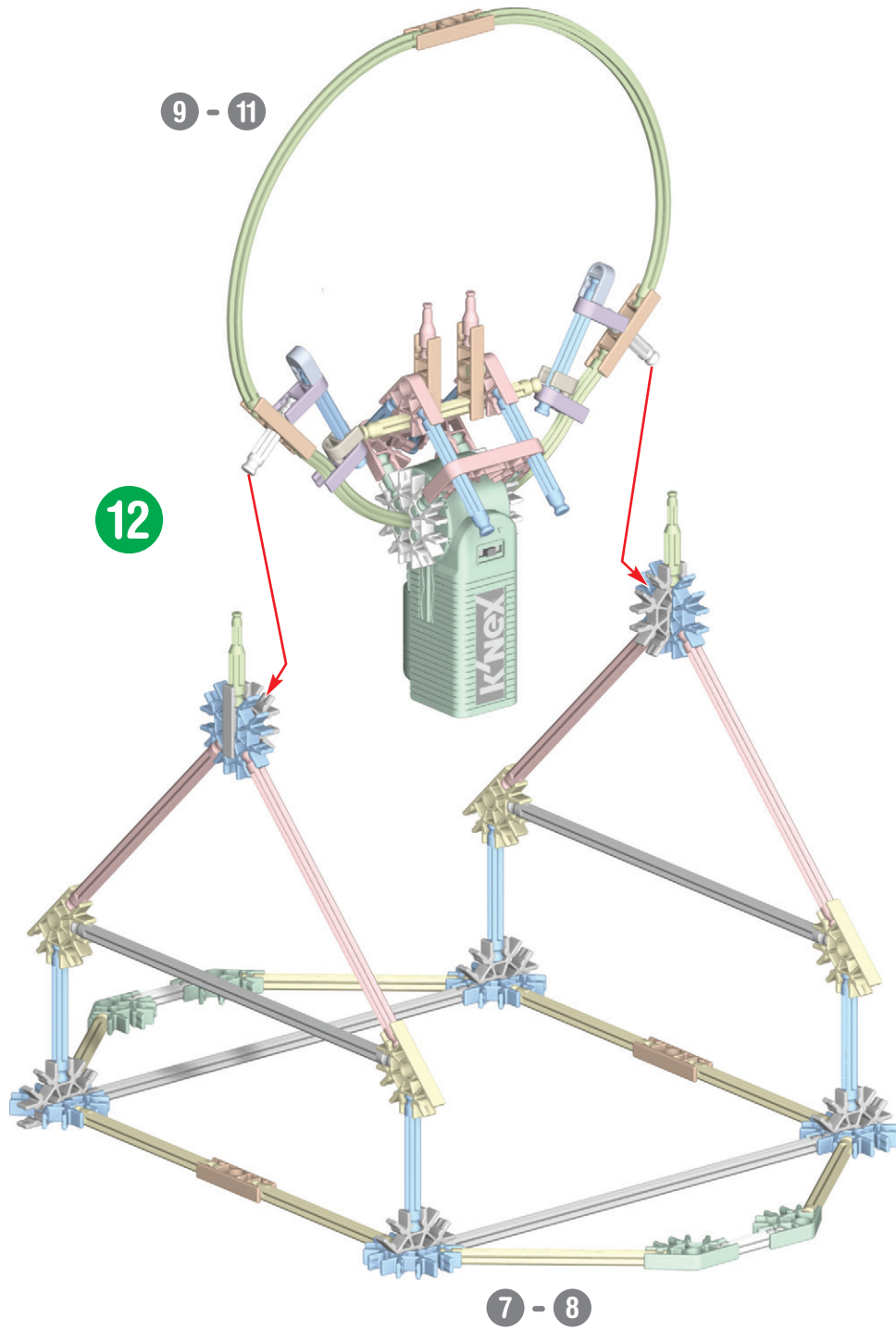

1 - 6

13

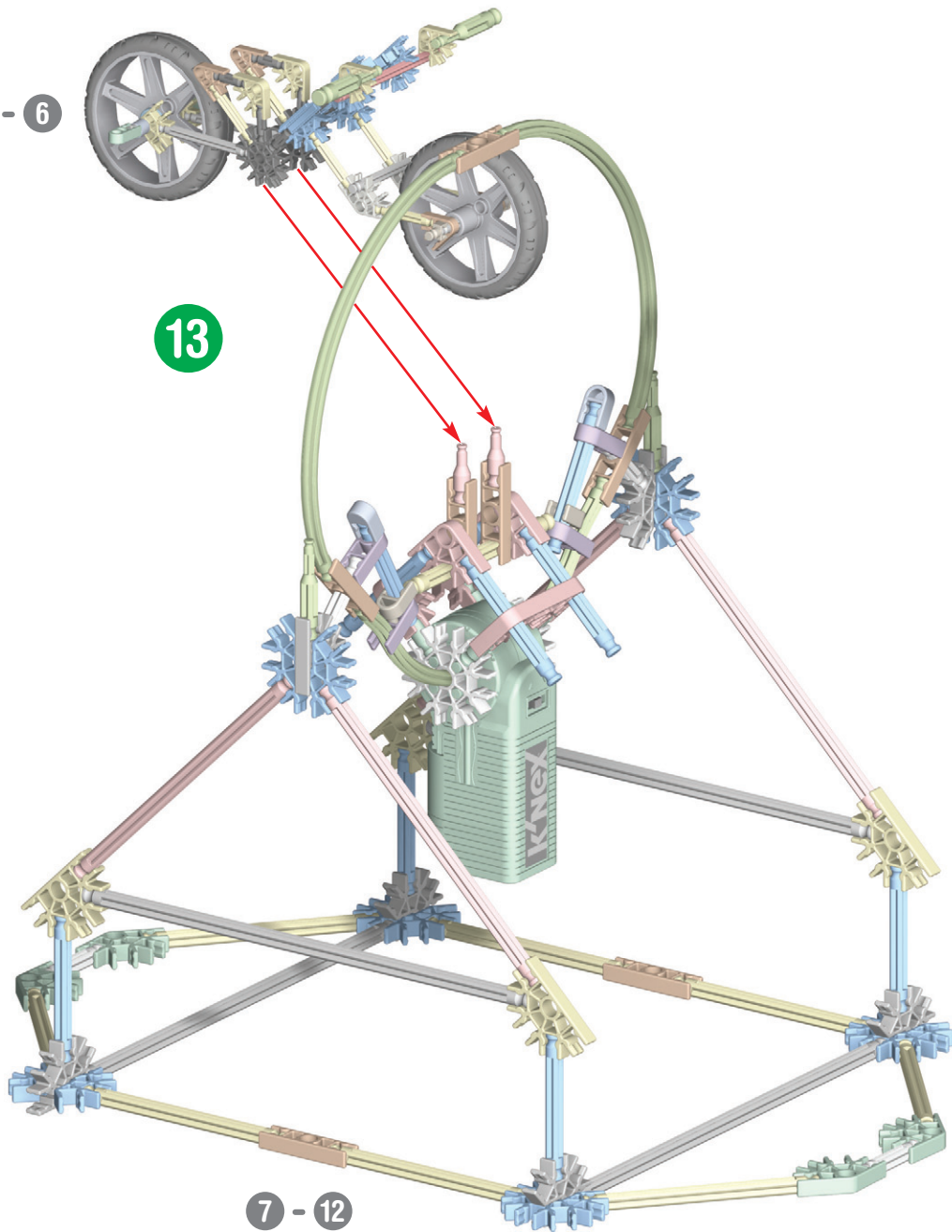

7 - 12

Ross' Stunt Bike

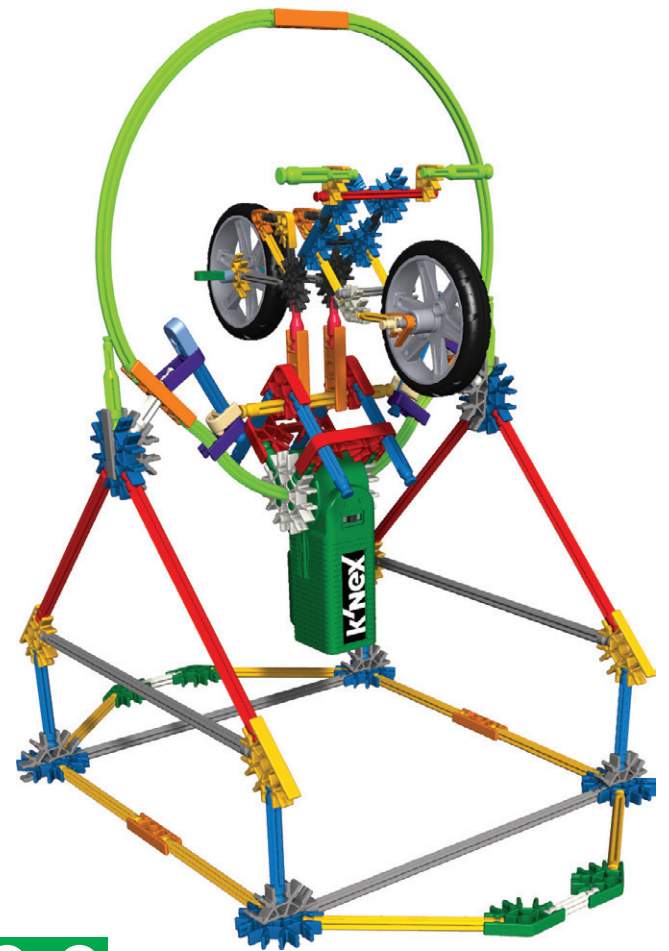

1 - 13

Lucas' Amusement Park Ride

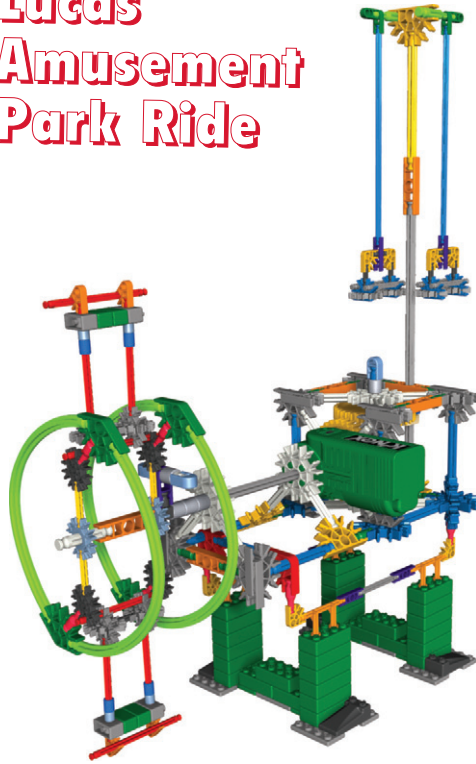

Lucas B. - age 11 from Colorado

- I was 4 years old when I started building with K'NEX.
- The "Hyperspeed Roller Coaster" I built for the K'NEXpert contest was my toughest build because I had to modify and test the parts many times.

For instructions of these models go to www.knex.com/instructions and enter code 13502



William K. - age 7 from Alabama

- When I started building with K'NEX I was 5 years old.
- My most challenging K'NEX model was the "Big Air Ball Tower".



William's Dragster

(**FR**) **Français** (Página 2)

Informações importantes pour les parents et les enfants

Garde ces instructions à portée de la main. Elles comportent d'importantes informations de sécurité.

Lis tous les avertissements et les instructions avant de commencer le montage et l'exploitation du modèle.

AVERTISSEMENT : DANGER D'ÉTOUFFEMENT - Petites pièces. Ne convient pas aux enfants de moins de 3 ans.

ATTENTION : Garde les cheveux, les doigts, la figure et les vêtements à l'écart de toutes les pièces mobiles.

ATTENTION : Faire attention de ne pas renverser le modèle. Le modèle devrait être placé sur une surface plate et dure.

• Partage l'expérience K'NEX avec ton enfant et fais du montage K'NEX un agréable projet de famille.

• Prends ton temps lors du montage. Ne te presse pas.

• L'aide d'un adulte est recommandée.

• Essaie de situer ton modèle dans le même sens que les instructions durant le montage.

• Le produit et les couleurs peuvent varier.

Informations Pile

ATTENTION :

• S'assurer d'installer les piles correctement et de suivre toujours les directives des fabricants du jouet et des piles.

• Ne pas mélanger des piles neuves avec des piles usées. Ne pas mélanger des pilesalcalines avec des piles standard (Leclanché), ou des piles rechargeables (au nickel-cadmium). Il convient d'utiliser uniquement des piles du type recommandé ou d'un type équivalent.

• Retirer toujours les piles faibles ou mortes du produit ; ne pas faire court-circuiter lesterminaux.

• Installer les piles en respectant la polarité (+/-) comme l'indique le schéma.

Conseils importants

• Les piles alcalines sont recommandées.

• I est déconseillé d'utiliser des piles rechargeables.

• Retirer les piles rechargeables du jouet avant de les recharger; elles doivent être chargées exclusivement en présence d'un adulte.

• Les piles qui ne sont pas rechargeables ne doivent pas être rechargées.

• Veiller à ce que les éléments restent à fabri de la poussière ; ne pas les plonger dans l'eau ; ne pas utiliser dans l'eau.

• Ne pas jeter les piles dans le feu ; elles risqueraient de fuir ou d'exploser et d'entraîner des blessures.

• Retirer toutes les piles si le jouet restera inutilisé pendant longtemps.

• Ne mettez pas les petites tiges dans les trous du moteur, elles endommageraient le moteur et il n'est pas possible de les enlever.

Comment mettre et retirer des piles

• Introduis deux piles AA (ou LR6) comme l'indique le schéma.

(Page 3)

Notions de base K'NEX pour le montage

Commence la construction: Pour commencer ton modèle, trouve le 1 et suis les chiffres. Chaque pièce a sa propre forme et sa propre couleur. Il suffit de regarder les illustrations pour retrouver les pièces correspondantes dans le jeu et de les connecter ensemble. Essaie de situer ton modèle dans le même sens que les instructions durant le montage. Les couleurs dégradées indiquent que cette section est déjà montée. Tu dois connecter la section suivante à l'endroit indiqué par les flèches.

Connecteurs: Il y a des connecteurs bleus et argentés comportant de longues fentes. Ils s'ajustent l'un dans l'autre comme l'indique l'illustration. Pousse ces pièces ensemble jusqu'à ce que tu entendes un "clic".

Entretoises: Dans ton modèle, il y a des endroits où il faudra ajouter des entretoises bleues et argentées. Assure-toi d'utiliser la couleur correcte et compte-les soigneusement.

(**ES**) **Español** (Página 2)

Información importante para los padres y niños

Guarda estas instrucciones en un sitio conveniente. Contienen información importante de seguridad.Lee todas las advertencias e instrucciones antes de comenzar a construir y operar este modelo.

ADVERTENCIA: PELIGRO DE ASFIXIA - Piezas pequeñas. No es para niños menores de 3 años.

PRECAUCIÓN: Mantén el cabello, los dedos, la cara y la ropa alejada de las piezas móviles.

PRECAUCIÓN: Tenga cuidado para no inclinar el modelo sobre. El modelo se debe colocar en una superficie plana y dura.

• Compartan la experiencia K'NEX con su niño y hagan que la construcción con K'NEX sea una divertida aventura de toda la familia.

• Dedica tiempo a disfrutar el proceso de construcción. ¡No te apresures!

• Se recomienda la ayuda de un adulto.

• Mientras construyes, trata de colocar tu modelo en la misma dirección que se muestra en las instrucciones.

• El producto y los colores pueden variar.

Información acerca de las pilas

PRECAUCIÓN:

• Asegúrese de insertar las pilas correctamente y de siempre seguir las instrucciones del fabricante del juguete y de las pilas.

• No mezcle pilas viejas con nuevas, ni pilas alcalinas, estándar (carbón-cinc) o recargables (níquel-cadmio).

• Se debe usar solamente pilas del mismo tipo, o las que se recomiendan como equivalentes.

• Siempre retire las pilas débiles o gastadas del producto; no forme cortocircuito en los puntos de intercambio.

• Inserte las pilas de acuerdo con los esquemas de polaridad (+/-).

Consejos importantes

• Se recomiendan las pilas alcalinas.

• No se recomiendan las pilas recargables.

• Retire las pilas recargables del juguete antes de cargarlas; éstas deben ser cargadas solamente bajo la supervisión de un adulto.

• No se debe recargar las pilas que no son recargables.

• Mantenga los componentes sin polvo; no sumerja ni use en agua.

• No deseche las pilas en el fuego ya que pueden tener fugas, explotar y causar lesiones personales.

• Retire todas las pilas si el juguete no se usará por mucho tiempo.

• No meta las vanillas pequeñas en los orificios del motor ya que dañarían el motor y no se podrían sacar.

Cómo insertar y quitar las pilas

• Insertar 2 pilas AA (o LR6) tal como se muestra.

(Página 3)

Consejos básicos de construcción de K'NEX

Empieza a construir: Para comenzar tu modelo, busca el 1 y sigue los números. Cada pieza tiene su propia forma y color. Simplemente mira los dibujos, busca las piezas correspondientes en tu juego y después conéctalas. Mientras construyes, trata de colocar tu modelo en la misma dirección que se muestra en las instrucciones. Los colores desteñidos muestran que esta sección ya está construida. Conecta las nuevas secciones en los lugares señalados por las flechas. Las nuevas piezas que agregues estarán en colores vivos.
Conectores: Hay conectores azules y plateados con ranuras largas especiales. Se enganchan deslizándose como ves en los dibujos. Conecta estas piezas empujándolas hasta que oigas "clic".

Espaciadores: Hay lugares en tu modelo donde tendrás que agregar Espaciadores azules y plateados. Cer-ciórate de usar el color correcto y cuéntalos con cuidado.

(**DE**) **Deutsch** (Seite 2)

Was Eltern und Kinder unbedingt wissen sollten

Halte diese Anleitungen stets griffbereit. Sie enthalten alle wichtigen Sicherheitshinweise.

Lies bitte alle Warnhinweise und Anleitungen, bevor du mit dem Bauen und Spielen beginnst.

WARNHINWEIS: ERSTICKUNGSGEFAHR - Vorsicht Kleinteile! Nicht für Kinder unter 3 Jahren geeignet.

VORSICHT: Haare, Finger, Gesicht und Kleidungsstücke nicht mit beweglichen Teilen in Berührung kommen lassen.

VORSICHT: Seien Sie vorsichtig, das Modell über zu nicht neigen. Modell sollte auf eine Wohnung und harte Oberfläche gestellt werden.

• Helfen Sie Ihrem Kind beim Bauen mit K'NEX und machen Sie aus diesem Bauprojekt ein Abenteuer mit Spaß und guter Laune für die gesamte Familie.

• Das Zusammenbauen macht Spaß, also nehmen Sie sich Zeit und hetzen Sie nicht!

• Am besten ist es, wenn Erwachsene dir dabei helfen.

• Versuche, dein Modell beim Zusammenbauen so zu orientieren, dass es in die gleiche Richtung weist, wie es in den Anleitungen beschrieben und gezeigt wird.

• Die Produkte und Farben unterscheiden sich eventuell von denen auf den Abbildungen.

Informationen zu den Batterien

VORSICHT:

• Achte darauf dass die Batterien korrekt eingelegt werden und folge den Anweisungen der Spielzeug- und Ba-terienfabrikanten.

• Mische keine alten und neuen Batterien oder alkaline Batterien, Standardbatterien (Kohle-Zink) oder wiederaufladbare Batterien (Nickel-Cadmium). Verwende nur Batterien des gleichen Typs oder des empfohlenen äquivalenten Typs.

• Leere oder verbrauchte Batterien aus dem Spielzeug entfernen; darauf achten, dass die Pole der Batterie nicht kurzgeschlossen werden.

• Beim Einlegen der Batterien auf die korrekte Polarität (+/-), wie dargestellt, achten.

Wichtige Tipps

• Alkaline Batterien werden empfohlen.

• Wiederaufladbare Batterien sind nicht empfohlen.

• Bei Verwendung von wiederaufladbaren Batterien müssen diese aus dem Spielzeug entfernt werden, bevor sie wieder aufgeladen werden; das Wiederaufladen darf nur unter Aufsicht eines Erwachsenen stattfinden.

• Nichtwiederaufladbare Batterien dürfen nicht wieder aufgeladen werden.

• Die Komponenten von Staub freihalten; nicht in Wasser tauchen.

• Zu entsorgende Batterien nicht ins Feuer werfen; sie können auslaufen oder explodieren und Körperverlet-zungen verursachen.

• Wenn das Spielzeug längere Zeit nicht verwendet werden soll, alle Batterien entfernen.

• In keine der Öffnungen des Motor kleine Stangen einsetzen; sie beschädigen den Motor un können nicht entfernt werden.

Anweisungen zum Einlegen und Entfernen der Batterien

• 2 AA (Mignon oder LR6) Batterien gemäß Abbildung einlegen.

(Seite 3)

Grundlegende Bauanleitungen für K'NEX

Los geht's mit dem Bauen: Um mit dem Bauen deines Modells zu beginnen, suche die Nummer 1 und folge den laufenden Nummem. Jedes Teil hat seine eigene Form und Farbe. Schau dir einfach die Abbildungen an, such die Teile in deinem Bausatz, die so aussehen wie das, was du auf der Abbildung siehst und steck sie ineinander. Ver-suche, dein Modell beim Zusammenbauen so zu orientieren, dass es in die gleiche Richtung weist, wie es in den An-leitungen beschrieben und gezeigt wird. Blasse Farben weisen darauf hin, dass dieser Streckenabschnitt bereits zusammengebaut ist.

Steckanschlüsse: Blaue und silberfarbene Steckanschlüsse haben besonders lange Schlitzte. Wie du vauf der Abbildung sehen kannst, lassen sie sich ineinander schieben. Achte beim Aneinanderfügen dieser Teile darauf, dass du ein Klickgeräusch hörst. Erst dann sind die Teile fest miteinander verbunden.

Abstand Halten: An bestimmten Stellen in deinem Modell musst du Abstandshalter, sogenannte Spacer, einbauen. Diese Abstandshalter sind blau und silberfarben. Achte darauf, dass du die richtige Farbe wählst und dass du die richtige Anzahl davon verwendest

(**IT**) **Italiano** (Página 2)

Informazioni importanti per bambini e genitori

Tenere queste istruzioni a portata di mano. Contengono importanti informazioni di sicurezza.

Leggere tutte le avvertenze e le istruzioni prima di iniziare a costruire il modello e di farlo funzionare.

AVVERTENZA: PERICOLO DI SOFFOCAMENTO - Piccole parti. Non adatto a bambini di età inferiore ai 3 anni.

ATTENZIONE: Tenere i capelli, le dita, il viso e i vestiti lontano da tutte le parti in movimento.

ATTENZIONE: Fare attenzione non rovesciare il modello. Il modello dovrebbe essere collocato su un appartamento ed una superficie dura.

• Condividi l'esperienza di K'NEX con tuo figlio e rendi la costruzione con K'NEX un divertimento per tutta la famiglia.

• Prendi il tempo necessario per divertirti durante il processo di costruzione. Non ti affrettare!

• Si raccomanda l'aiuto di un adulto.

• Orienta il tuo modello nella stessa direzione indicata nelle istruzioni.

• Il prodotto e i colori possono variare.

Informazioni sulle batterie

ATTENZIONE:

• Accertarsi di inserire le batterie correttamente e seguire sempre le istruzioni del produttore delle batterie e del giocattolo.

• Non mettere insieme batterie nuove e vecchie o alcaline, standard (carbonio-zinco) e ricaricabili (nichel-cadmio).

• Usare sempre batterie raccomandate dello stesso tipo o di tipo equivalente.

• Rimuovere sempre batterie quasi scariche o completamente scariche dal prodotto; non causare corto circuito ai terminali di alimentazione.

• Inserire le batterie con la polarità corretta (+/-) come illustrato.

Consigli importanti

• Si raccomanda l'uso di batterie alcaline.

• Non si raccomanda l'uso di batterie ricaricabili.

• Rimuovere le batterie ricaricabili dal giocattolo prima della carica: devono essere caricate solo sotto la supervisione di un adulto.

• Le batterie non ricaricabili non devono essere ricariate.

• Mantenere i componenti privi di polvere; non immergere o usare in acqua.

• Non gettare le batterie nel fuoco, poiché potrebbero perdere o esplodere e causare lesioni.

• Rimuovere tutte le batterie se il giocattolo non verrà usato per un lungo periodo di tempo.

• Non inserire aste più corte di 5,1 cm (2 pollici) nei fori del motore, in quanto danneggerebbero il motore e non possono essere rimosse.

Come inserire e rimuovere le batterie

• Inserire 2 batterie AA (o LR6) come illustrato.

(Pagina 3)

Istruzioni di base per costruire con K'NEX

Comincia a costruire: Per iniziare il modello, cerca il numero 1 e segui i numeri. Ogni pezzo ha una sua forma e un suo colore. Guarda la figura, trova i pezzi corrispondenti nel set e mettili insieme. Cerca di tenere il modello nella stessa direzione della figura e in tal modo sarà più semplice attaccare i pezzi nei posti giusti. I colori spenti ti dicono che questa sezione è già stata costruita. Dovrai collegare la nuova sezione al punto indicato dalla punta della freccia.

Connettori: È molto importante posizionare i connettori blu e argento in una specifica direzione. Presta molta attenzione alle istruzioni e posiziona i connettori orizzontalmente o verticalmente proprio come illustrato. Spingi con forza fino ad udire un clic.

Spaziatori: Ci sono punti nel tuo modello a cui dovrai aggiungere spaziatori blu e argento. Accertati si contarli attentamente.

(**PT**) **Português** (Página 2)

Coisas importantes para os Pais e os Miúdos

Mantenha estas instruções num local de fácil acesso, pois contém informações importantes de segurança. Lê as instruções e advertências antes de começares a construir e a operar o modelo.

AVISO: PERIGO DE SUFOCAÇÃO - Peças pequenas. Não se destina a crianças com menos de 3 anos de idade.

CUIDADO: Mantém o cabelo, os dedos, a cara e a roupa afastados de todas as peças móveis.

CUIDADO: Tenha cuidado não virar o modelo. O modelo deve ser colocado numa superfície dura plana.

• Compartilhe da experiência K'NEX com os miúdos e faça com que o processo de construção com K'NEX se torne numa aventura entre família.

• Não te precipites para assim poderes desfrutar do processo de construção. Não o faças à pressa!

• Recomenda-se a ajuda de um adulto.

• Tenta fazer com que o teu modelo esteja virado exactamente na mesma direcção indicada nas instruções.

• Tanto o produto como as respectivas cores podem variar.

Informações sobre as pilhas

Cuidado:

• Certifique-se de que introduz as pilhas correctamente e siga sempre as instruções do fabricante da bateria e do brinquedo.

• Não combine pilhas usadas com pilhas novas, pilhas alcalinas, padrão (carbono-zinco) ou pilhas recarregáveis (níquel-cádmio).Deverão ser usadas apenas pilhas do mesmo tipo ou equivalentes ao tipo recomendado.

• Retire sempre as pilhas fracas ou gastas do produto; não provoque um curto-circuito nos terminais de alimentação.

• Introduza as pilhas com a polaridade correcta (+/-), conforme se mostra.

Conselhos importantes

• Recomenda-se o uso de pilhas alcalinas.

• Não se recomenda o uso de pilhas recarregáveis.

• Retire as pilhas recarregáveis do brinquedo antes de as carregar; estas pilhas devem ser recarregadas apenas sob vigilância de adultos.

- As pilhas não recarregáveis não devem ser carregadas.
- Mantenha os componentes livres de poeiras; não mergulhe em água nem use água.
- Não elimine as pilhas queimando-as; estas podem apresentar fugas ou explodir causando lesões.
- Retire todas as pilhas do brinquedo se não tencionar usá-lo durante um longo período de tempo.
- Não coloque varetas de tamanho inferior a 5,1 cm (2 pol.) em nenhuma abertura do motor; as varetas causarão danos no motor e não podem ser removidas.

Como inserir e remover as pilhas

- Introduza 2 pilhas AA (ou LR6), conforme se mostra.

(Página 3)

Pontos básicos para a construção K'NEX

Inicia a construção: Para começar o teu modelo, procura o 1 e segue os números. Cada peça tem a sua própria forma definida e cor. Basta simplesmente olharaes para a ilustração, procurar as peças do teu jogo correspondentes às que estás a ver e, em seguida, conectar umas nas outras. Enquanto estás a montar as peças, tenta manter o teu modelo na mesma direcção, conforme mostrado na ilustração, para assim ligares as peças correctamente. As cores desbotadas indicam que esta secção já está montada. Passarás então a fazer a conexão da nova secção no local indicado pelas setas.

Conectores: É muito importante que posições os conectores azuis e cor de prateados numa direcção específica. Presta muita atenção às instruções e coloca estes conectores horizontal ou verticalmente, exactamente conforme se mostra nas ilustrações. Junta as partes simultaneamente e com firmeza até ouvires um "estalido".

Espaçadores: Existirão certos pontos no teu modelo que necessitam a colocação de espaçadores azuis e prateados. Assegura-te que os contas cuidadosamente.

(NL) Nederlands ^(Bladzijde 2)

Belangrijke gegevens voor ouders en kinderen

Bewaar deze aanwijzingen op een gemakkelijk bereikbare plaats. Ze bevatten belangrijke veiligheidsgegevens. Gelieve alle waarschuwingen en aanwijzingen te lezen vóór je het model begint op te bouwen en te gebruiken.

WAARSCHUWING: VERSTIKKINGSGEVAAR - Kleine onderdelen. Niet geschikt voor kinderen onder 3 jaar.

OPGEPAST: Hou het haar, de vingers, het gezicht en kledij verwijderd van alle bewegende onderdelen.

OPGEPAST: Wees voorzichtig om het model over niet te tippen. Het model zou moeten geplaatst worden op een flat en kom hard boven.

- Deel de K'NEX ondervinding met je kind en maak van het bouwen met K'NEX een aangenaam familieavontuur.

- Neem je tijd tijdens het bouwen en monteren. Spoed je niet!

- Bijstand van een volwassene wordt aanbevolen.

- Tracht je model in dezelfde richting te plaatsen als de aanwijzingen terwijl je bouwt en monteert.

- Product en kleuren kunnen afwijken.

Batterijgegevens

OPGEPAST:

- Verzeker je ervan dat de batterijen er op de juiste manier in te steken en volg steeds de aanduidingen van de speelgoed- en batterijenfabrikanten.

- Meng geen oude en nieuwe batterijen of alkalische, gewone (koolstof-zink) of herlaadbaarse (nikkel-cadmium) batterijen met mekaar. Uitsluitend batterijen van dezelfde of van een aanbevolen equivalente soort dienen gebruikt te worden.

- Verwijder steeds uitgeputte of ontladen batterijen uit het product; veroorzaak geen kortsluiting van de voedingspolen.

- Steek de batterijen erin volgens de juiste polariteit (+/-) zoals afgebeeld.

Belangrijke tips

- Alkalische batterijen worden aanbevolen.

- Herlaadbare batterijen worden niet aanbevolen.

- Verwijder herlaadbare batterijen uit het speelgoed alvorens te ze herladen; ze moeten slechts herladen worden onder het toezicht van een volwassene.

- Niet-herlaadbare batterijen mogen niet herladen worden.

- Bescherm onderdelen tegen stof; dampel ze niet of gebruik ze niet in water.
- Werp de batterijen niet in het vuur; ze zouden kunnen lekken of ontploffen en verwondingen veroorzaken.

- Verwijder alle batterijen wanneer het speelgoed gedurende lange tijd niet gebruikt zal worden.

- Plaats staafjes in de openingen van het motor, zij zouden de motor beschadigen en kunnen niet worden verwijderd.

Insteken en verwijderen van batterijen

- Steek er 2 AA (of LR6) batterijen erin zoals afgebeeld.

(Bladzijde 3)

Basisstappen voor K'NEX bouwen

Begin te bouwen: Om met je model te beginnen, vind eerst het nummer 1 en volg de nummers. Elk stuk heet zijn eigen vorm en kleur. Kijk gewoonweg naar de afbeeldingen, vind de overeenstemmende stukken terug in je geheel en maak ze aan mekaar vast. Tracht je model in dezelfde richting te plaatsen als de aanwijzingen terwijl je bouwt en monteert. De vervaagde kleuren duiden aan dat dit deel reeds is opgebouwd. Gelieve het nieuwe deel vast te koppelen op de plaats aangeduid door de pijlen.

Koppelstukken: Er zijn blauwe en zilveren koppelstukken met speciale lange gleuven. Ze schuiven in mekaar zoals je kunt zien op de afbeeldingen. Duw deze onderdelen in mekaar tot je een "klik" hoort.

Tussenstukken: In je model zijn er plaatsen waar blauwe en zilveren tussenstukken moeten toegevoegd worden. Verzeker je ervan de juiste kleur te gebruiken en tel ze zorgvuldig.

(SV) Svenska ^(Sida 2)

Föräldrar! Så här kan ni hjälpa er barn bygga med K'NEX!

Förvara dessa instruktioner på ett lättåtkomligt ställe. De innehåller viktig säkerhetsinformation. Läs alla varningar och instruktioner innan du börjar bygga och använda modellen.

VARNING! RISK FÖR KVÄVNING—SMÅ DELAR. Inte för barn under 3 år.

VARNING! Håll håret, fingrarna, ansiktet och kläderna borta från alla rörliga delar.

VARNING! Var försiktig så att modellen inte faller. Modellen ska placeras på en plan och hård yta.

Batteri-information:

Varning! Undvik batteriläckage

- Sätt i batterierna rätt och följ alltid anvisningarna från leksakens och batteriernas tillverkare;
- Blanda inte gamla och nya batterier eller alkaliska, standard (kol-zink) eller laddningsbara (nikkel-cadmium) batterier. Endast batterier av samma eller motsvarande typ som de som rekommenderas får användas;
- Ta alltid bort svaga eller urladdade batterier från produkten; kortslut inte batteriets poler;
- Sätt in batterierna med rätt polaritet (+/-) enligt figuren;

Viktiga tips

- Alkaliska batterier 2 (LR6) rekommenderas;
- Laddningsbara batterier rekommenderas inte;
- Ta bort laddningsbara batterier från leksaken innan de laddas; de får laddas bara under loven övervakning;
- Luke-laddningsbara batterier får inte laddas;
- Håll komponenterna dammfria; sänk inte eller använd inte i vatten;
- Battrier får inte brännas; de kan läcka eller explodera och orsaka personskador;
- Ta ur alla batterier om leksaken inte kommer att användas på lång tid;
- Placera inga stänger som är mindre än 5,08 cm i någon öppning i motorn; de skadar motorn och kan inte avlägsnas.

Hur man sätter in och tar ut batterier:

- Använd en liten Phillips-skruvmejsel för att lossa skruven. Sätt i 2 nya AA batterier (eller LR6) i utrymmet med rätt polaritet enligt vidstående figur.

(Sida 3)

K'NEX grundläggande bygginformation

Börja bygga: Varje del har sin egen färg och form. Titta på bilden, hitta delarna som passar och sätt ihop dem. Försök att hålla din modell i samma riktning som på bilden så att du får delar på rätt ställe. De bleka färgerna anger sektioner som du redan byggt. Du ska koppla nästa delar till ställena som anges med pilarna. Det finns inte pilar för varje kopplingspunkt.

Kopplingar: Det finns blå och silverfärgade kopplingar med speciellt långa hål som skjuts samman. Tryck ihop delarna tills du hör ett klick-ljud.

Mellanstänger: Det finns ställen i din modell där du måste placera mellanstänger. Använd rätt typ och räkna dem omsorgsfullt.

(DA) Dansk ^(Side 2)

Førelære! Sådan kan I hjælpe jeres barn med at bygge med K'NEX!

Opbevar denne brugsanvisning på et praktisk sted. Den indeholder vigtig sikkerhedsinformation. Læs alle advarsler og anvisninger, inden påbegyndelse af bygning og betjening af modellen.

ADVARSEL: FARE FOR KVÆLNING PÅ GRUND AF SMÅ DELE. Ikke beregnet til børn under 3 år.

FORSIGTIG: Hold hår, fingre, ansigt og påklædning på afstand af alle bevægelige dele.

FORSIGTIG: Pas på ikke at vælte modellen. Modellen skal anbringes på en flad og hård overflade.

Oplysninger om batterier:

Forsigtig: Sådan undgås det. at batterierne lækker

- Sorg for at sætte batterierne rigtigt i og for altid at følge brugsanvisningen fra legetøjs- og batteriproducenten.
- Lad være at blande gamle og nye batterier sammen, eller at blande alkaliske, almindelige (kulstof-zink) eller genopladelige (nikkel-cadmium) batterier med hinanden. Det er kun tilladt at bruge batterier af samme eller tilsvarende type iflg. anbefaling.

- Tag altid svage elle ubrændte batterier ud af produktet, og pas på ikke at kortslutte polerne.

- Sæt batterierne i, så polariteten (+/-) er korrekt iflg. illustrationen.

Vigtige råd

- Det anbefales at bruge 2 (LR6) alkaliske batterier.
- Batterier, der kan genoplades, frarådes.
- Tag genopladelige batterier ud af legetøjet, inden de oplades; de må kun oplades under opsyn af en voksen.
- Batterier, som ikke er genopladelige, må ikke genoplades.
- Støv delene godt af. Lad være at nedsænke dem i vand.
- Batterier må ikke afskaffes ved at brænde dem; de risikerer at lække eller eksplodere, hvorved folk kan komme til skade.

- Tag alle batterier ud, hvis ingen skal lege med legetøjet i en længere periode.

- Undlad at stikke stænger mindre end 5,08 cm ind i nogen som helst åbninger i motoren; de vil beskadige mo-toren, og de kan ikke fjernes.

Sådan sættes der batterier i, og sådan tages de ud:

- Brug en lille stjerneskruetækker til at løsne skruen. Sæt 2 friske AA-batterier (eller LR6) i batterirummet, sorg for korrekt polaritet (+/-) iflg. illustrationen.

(Side 3)

K'NEX bygningsprincipper

Begynd at bygge: Hver del har sin egen farve og form. Se på billedet, find de dele, der matcher, og sæt dem sammen. Proov at holde din model i samme retning som billedet, så du kommer til at sætte delen fast på den rette plads. De falmede farver er de afsnit, du allerede har bygget. Du skal samle de næste dele på det sted, som pilene peger på. Der findes ikke nogen pil for hvert eneste samlingssted.

Samestykker: Der er blå og solvfarvede samlestykker med særlige lange slidser, som skydes sammen. Skub delene sammen, indtil du hører et "klik".

Afstandsstykker: Der er steder i modellen, hvor du får brug for at tilføje afstandsstykker. Sørg for at bruge de rette stykker og tæl den omhyggeligt.

(NO) Norsk ^(Side 2)

Førelære! Her ser du hvordan du kan hjelpe ditt barn med å bygge med K'NEX!

Oppbevar denne veiledningen lett tilgjengelig. Den inneholder viktig sikkerhetsinformasjon. Les alle advarsler og hele veiledningen før du begynner å bygge og kjøre modellen.

ADVARSEL: FARE FOR KVÆLNING—SMÅ DELER. Ikke for barn under tre år.

ADVARSEL: Hold hår, fingre, ansikt og klesplagg borte fra alle bevegelige deler.

ADVARSEL: Pass godt på å ikke vippe modellen overende. Modellen bør plasseres på en flat og hard overflate.

Batteriinformasjon:

Advarsel: For å unngå batterilekkasje

- Pass på å sette batteriene riktig inn og følg alltid leketøy- og batteriprodusentens veiledning.
- Ikke bland gamle og nye batterier eller alkaliske, standard (karbonsink) eller oppladbare (nikkelcadmium) batterier. Bare batterier av samme eller tilsvarende type som de anbefalte bør brukes.
- Ta alltid svake eller utladede batterier ut av produktet, ikke kortslutt leveringsnettene.
- Sett batteriene inn med riktig polaritet (+/-), som vist.

Viktige Tips

- Alkaliske batterier 2 (LR6) anbefales.
- Oppladbare batterier anbefales ikke.
- Ta oppladbare batterier ut av leketøyet før du lader dem opp; de må bare lades opp under oppsyn av en voksen person.
- Batterier som ikke er oppladbare, må ikke lades opp.
- Hold delene frie for støv; dypp dem ikke ned i eller bruk i vann.
- Ikke kast batteriene i lid eller flamme; de kan lekke eller eksplodere og forårsake skade.
- Ta alle batterier ut dersom leketøyet ikke skal brukes over tid.
- Putt ikke stenger på mindre enn 5,08 cm inn i noen av motorens åpninger; de vil skade motoren og kan ikke fjernes.

Howdan sette inn og fjerne batterier:

- Bruk et lite skrujern med krysshode til å løsne på skruen. Sett to nye AA-batterier (eller LR6) inn i feltet med riktig polaritet (+/-), som vist her.

(Side 3)

K'NEX grunnbygging

Sett i gang byggingen: Hver del har sin egen farge og fasong. Se på bildet, finn de delene som tilsvarer hverandre og sett de sammen. Forsøk å holde modellen din i samme retning som bildet slik at stykket festes til det rette stedet. Det bleke fargene er de seksjonene som du allerede har bygget. Du skal feste de neste de-lene der hvor pilene peker. Det finnes ikke en pil for hvert skjøtepunktsted.

Skjøtemunnstykker: Det er blå og solvfarvede skjøtemunnstykker med spesielt lange åpninger, som gir sammen. Skyv delene sammen inntil du hører et klikk.

Mellomlegg: Noen steder må du bruke mellomlegg i modellen din. Pass på å bruke de riktige mellomleggene og tell dem nøye.

(FI) Suomi ^(Sivu 2)

Vanhemmat! Näin voitte auttaa lapsianne rakentamaan K'NEX-sarjalla

Pida nämä ohjeet helposti saatavilla. Ne sisältävät tärkeää turvallisuus tietoa. Lue kaikki varoitukset ja ohjeet ennen kuin alat rakentaa ja käyttää mallia.

VAROITUS! Ei alle 3-vuotiaille lapsille.

VAROITUS! Pidä huikset, somet, kasvat ja vaatteet loitolla kaikista liikkuvista osista.

VAROITUS! Varo kaatamasta mallia. Malli on asetettava tasaiselle ja kovalle pinnalle.

VAROITUS! Ei alle 3-vuotiaille lapsille.

VAROITUS! Pidä huikset, somet, kasvat ja vaatteet loitolla kaikista liikkuvista osista.

VAROITUS! Varo kaatamasta mallia. Malli on asetettava tasaiselle ja kovalle pinnalle.

Tietoa paristoista:

Varoitus! Vältä paristovuotoja

- Asenna paristot oikein ja noudata aina lelun ja paristojen valmistajien ohjeita;
- Älä sekoita vanhoja ja uusia paristoja tai alkaali-, normaali- (hiili-sinkki) tai ladattavia (nikkeli-cadmium) paristoja. Vain samaa tai vastaavaa tyyppiä olevia paristoja saa käyttää;
- Poista aina heikot tai käytetyt paristot tuoteesta; älä oikosulje napoja;
- Asenna paristot navat oikein päin (+/-) kuvan mukaisesti;

Tärkeitä vihjeitä

- Alkaaliparistoja 2 (LR6) suositellaan;
- Ladattavia paristoja ei suositella;
- Poista ladattavat paristot luelusta ennen lataamista; ne saa ladata vain aikuisen valvonnan alla;
- Ei-ladattavia paristoja ei saa ladata;
- Pidä osat pölyttöminä; älä upota tai käytä niitä vedessä;
- Älä polta paristoja; ne saattavat vuotaa tai räjähtää ja aiheuttaa vammoja;
- Poista kaikki paristot mikäli luelu ei tulla käyttämään pitkään aikaan.
- Älä aseta 5,08 cm pienempiä tankoja moottorin aukkoon; ne vaurioittavat moottoria, eikä niitä pysty poistamaan.

Paristojen asentaminen ja poistaminen:

- Käytä pientä ristipäämeisseliä ruuvin avaamiseen. Aseta 2 uutta AA-paristota (tai LR6) paristolitaan navat oikein päin (+/-) kuvan mukaisesti.

(Sivu 3)

K'NEX perusrakennusohjeita

Aloita rakentaminen: Jokaisella osalla on oma värinsä ja muotonsa. Katso kuvaa, etsi käsiisi toisiinsa sopivat palat ja pane ne yhteen. Yritä pitää mallisi samassa suunnassa kuin kuvassa jotta varmasti kiinnität osan oikeaan kohtaan. Haaleat värit osoittavat rakenteita, jotka olet jo tehnyt. Liitä seuraavat osat nuolien osoittamiin kohtiin. Nuolia ei ole jokaisessa liitäntäkohdassa.

Liittimet: Sarjassa on joissain ja hopeanvärisiä liittimiä, joissa on erityisen pitkiä aukkoja, jotka työnnetään toisiinsa. Työnnä osat yhteen kunnes kuulet napsahduksen.

Välitangot: Mallissasi on paikkoja joihin sinun on lisättävä välitankoja. Varmista, että käytät oikeita ja laske ne huolellisesti.

KNEX.COM

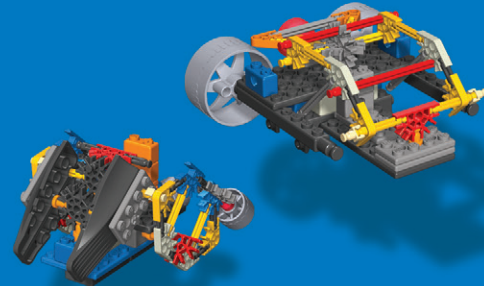

Sold separately.
Vendus séparément.
Se venden por separado.
Separat erhältlich.
Venduti separatamente.
Vendidos separadamente.
Afzonderlijk verkocht.
Säljes separat.
Sælges separat.
Myydään erikseen.

Product & colors may vary. Standard K'NEX parts made in the USA. Special components made in China. Pièces K'NEX courantes fabriqués aux États-Unis. Éléments spéciaux fabriqués en Chine. Assemblé en Chine. Piezas estándar de K'NEX hechas en EE.UU. Componentes especiales hechos en China. Armado en China.

K'NEX is a registered trademark of K'NEX Limited Partnership Group. K'NEX est une marque déposée de K'NEX Limited Partnership Group. K'NEX es una marca registrada de K'NEX Limited Partnership Group. Manufactured under U.S. Patents/Fabriqués sous brevets américains/Fabricado bajo patentes de EE.UU. 5,061,219; 5,199,919; 5,350,331; 5,137,486; D553,200; D553,203; D553,204; D550,784; D552,190; 7,267,598. Other U.S. and foreign patents pending.

Autres brevets américains et étrangers en instance. Otras patentes de EE.UU. y países extranjeros pendientes. Community Design No. 000 645338-001-0002. Conforms to ASTM F963-03. Conforme aux ASTM F963-03. Cumple con F963-03 de la ASTM.

- Identifies Genuine K'NEX Bricks.
- Identifie que ce sont d'authentiques briques K'NEX.
- Identifica los ladrillos genuinos de K'NEX.
- Identifiziert echte K'NEX-Bausteine.
- Edentifica i veri blocchi K'NEX.
- Identifica que são cubos genuinos da K'NEX.
- Identificeert K'NEX bakstenen voor.
- Anger äkta K'NEX klossar.
- Identifierer ægte K'NEX brikker.
- Identifiserer ekte K'NEX-murstein.
- Osoittaa aitoja K'NEX paloja.



US 1-800-KID-KNEX USA/Canada only (English only)

GB 00800-22427276 UK/Ireland only
Customer Service outside the USA, CAN, GBR
please contact local distributor.

Distributor information can be found at:
<http://www.knex.com/contact/international.php>



US Consumer Services
K'NEX Limited Partnership Group
P.O. Box 700
Hatfield, PA 19440-0700

GB K'NEX
Newport Consumer Services
Hasbro UK Ltd.,
Caswell Way
Newport, Gwent NP9 0YH



email@knex.com



©2008 K'NEX Limited Partnership Group
P.O. Box 700
Hatfield, PA 19440-0700

40847.11-V1-02/08