

TEACHER'S GUIDE

BRIDGES

INTRODUCTION TO STRUCTURES

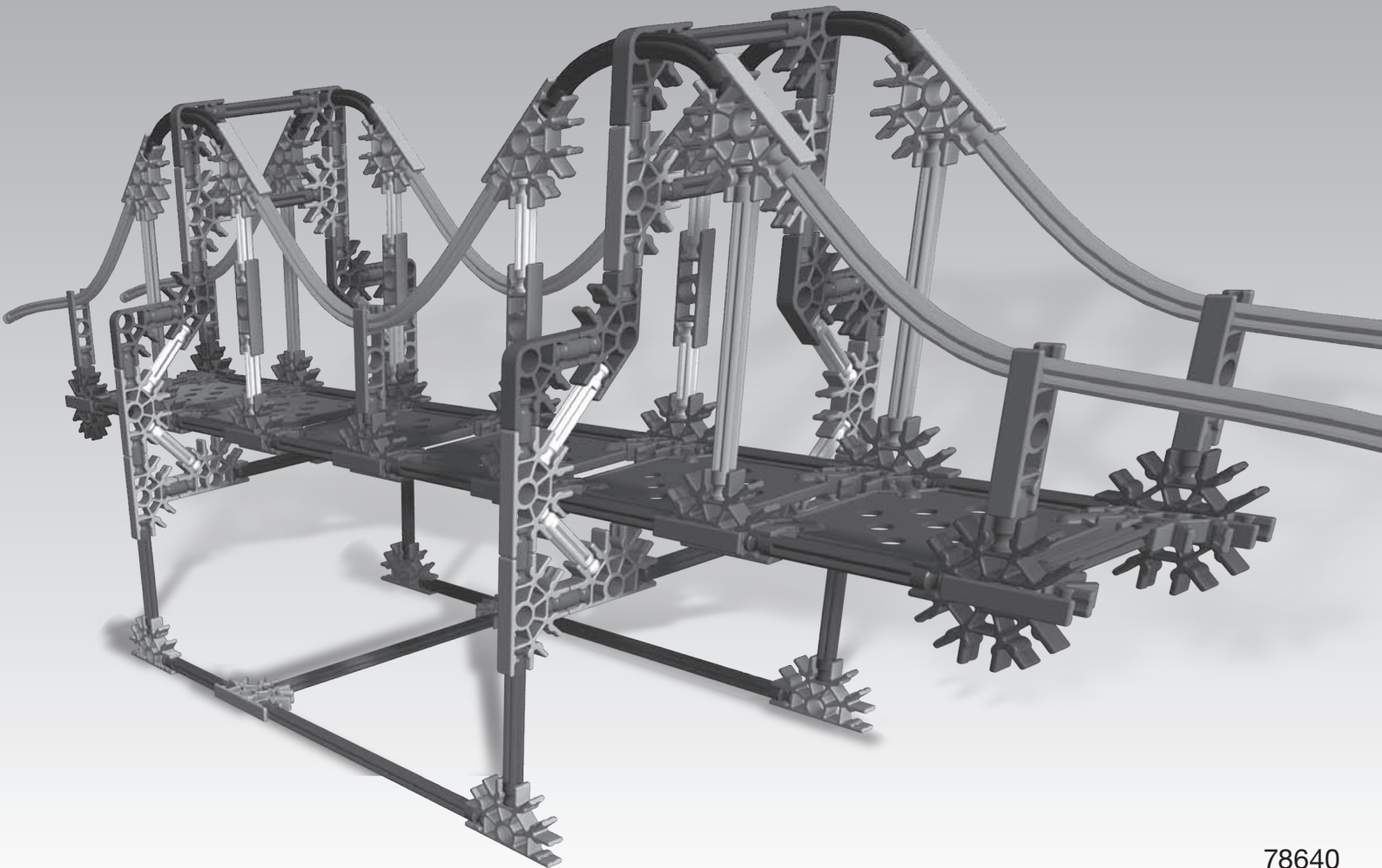
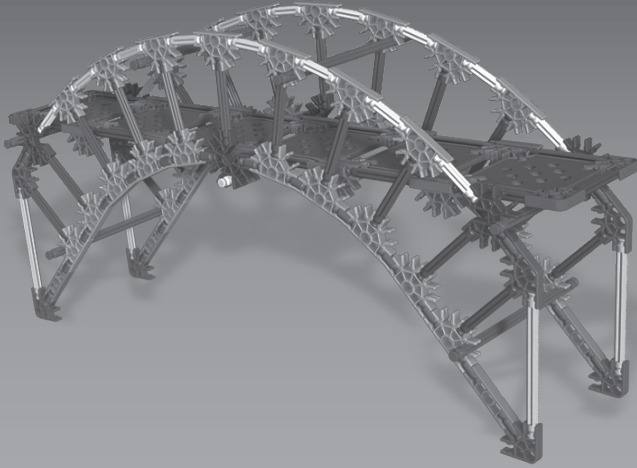

BRIDGES

Teacher's Guide

V3-08/14
©2014 K'NEX Limited Partnership Group
and its licensors.

K'NEX Limited Partnership Group
P.O. Box 700
Hatfield, PA 19440-0700

K'NEX Education is a registered trademark
of K'NEX Limited Partnership Group.
Protected by International Copyright.
All rights reserved.

Visit our website at www.knexeducation.com
Email: abcknex@knex.com
Phone: 1-888-ABC-KNEX (Toll Free)

 **WARNING:**
CHOKING HAZARD – Small parts.
Not for children under 3 years.

 **ATTENTION :**
RISQUE D'ÉTOUFFEMENT – Pièces de petite taille.
Ne convient pas aux enfants de moins de 3 ans.



Introduction:

OVERVIEW

This Teacher’s Guide has been developed to support you as your students investigate the K’NEX Introduction to Structures: Bridges set. In conjunction with the K’NEX materials and individual student journals that we suggest your students maintain throughout their investigations, the information and resources included here can be used to build your students’ understanding of scientific, technical and design concepts and to channel their inquiries into active and meaningful learning experiences.

K’NEX INTRO TO STRUCTURES: Bridges

This K’NEX construction set is designed to introduce students to the history, function, structural design, geometry and strength of bridges. An investigation of bridges helps students develop a good general understanding of the forces involved in structures. They will also gain knowledge of the physical properties of materials and their application in the design and construction of bridges. They will discover that bridge construction, although based on simple scientific concepts, often requires complex engineering solutions. As students use this K’NEX set, they will have the opportunity to acquire skills using a hands-on, inquiry-based approach to information and concepts. Working cooperatively, they are encouraged to interact with each other as they build, investigate, problem solve, discuss, and evaluate scientific and design principles in action.

TEACHER’S GUIDE

Designed as a resource for the teacher, this guide provides background information on the main types of bridges commonly found today, the materials used in their construction, and the engineering principles that have been applied to allow them to support loads. It identifies student objectives for each unit, and offers plans and scripts to successfully present each bridge model and its associated activities. A glossary of key terms and definitions associated with bridges is also included. Most of the units can be completed in 30-45 minutes. There are also extension activities and a selection of worksheets that can be used to explore the concepts more deeply. We recommend that teachers review their curriculum and state standards to identify which of the activities provided in this guide best meet their needs.

STUDENT JOURNALS

It is expected that student will always have journals available for recording information. They should be encouraged to enter initial thoughts at the start of an inquiry – what they “think” will happen. These initial thoughts may be amended, based on their ongoing inquiry and analysis, until the students feel comfortable about drawing conclusions. Their journal entries will help make a connection between the models they have built, the experiments they have conducted, and how this information is applied to the real-world bridges they use or see on a regular basis. The journals will also provide students with a place to practice making drawings and diagrams of structures. Finally, the journals will serve as a method of assessment for the Bridges unit. Journal Checklists are also included in the Teacher’s Guide for each of the models and their associated inquiry activities.

TABLE OF CONTENTS

Objectives	3
Key Terms and Definitions	3
Key Concepts	5
Introduction to Bridges: Preparatory activities (Optional)	19
Introduction to Bridges: What do bridges do?	21
Are All Bridges the Same? How bridges support their loads	25
The Beam Bridge	29
The Truss Bridge.	35
The Cantilever Bridge.	41
The Bascule Bridge.	49
The Arch Bridge	55
The Suspension Bridge.	61
The Cable-Stayed Bridge.	71
Designing a Bridge: Time and cost factors	77
Worksheets	81

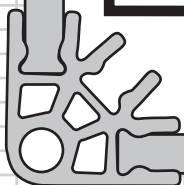

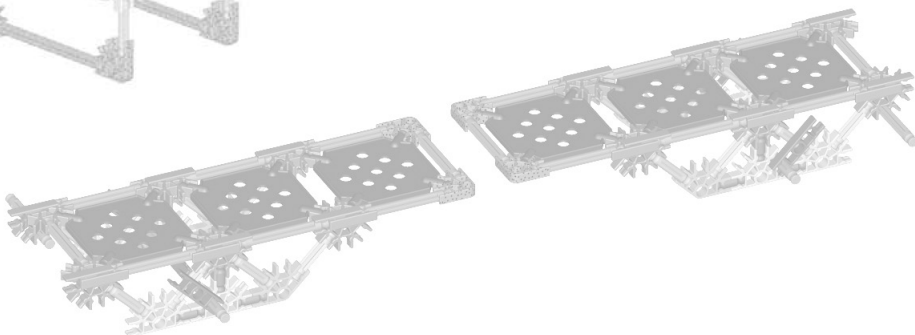
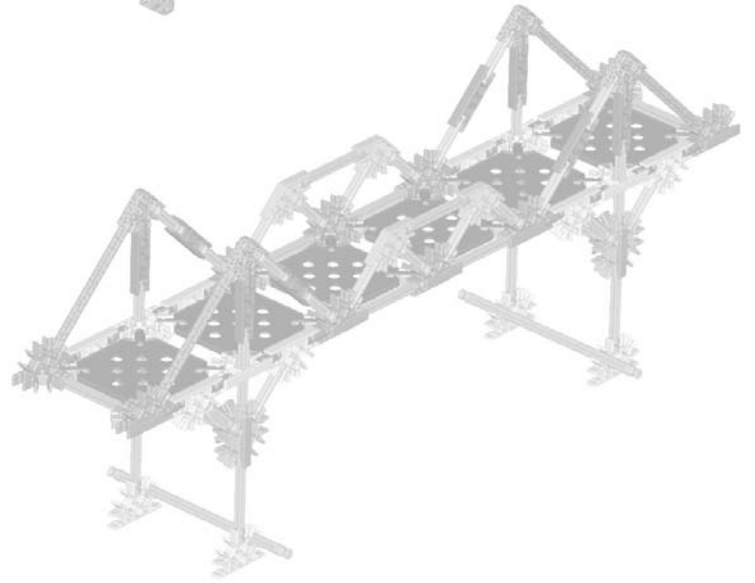
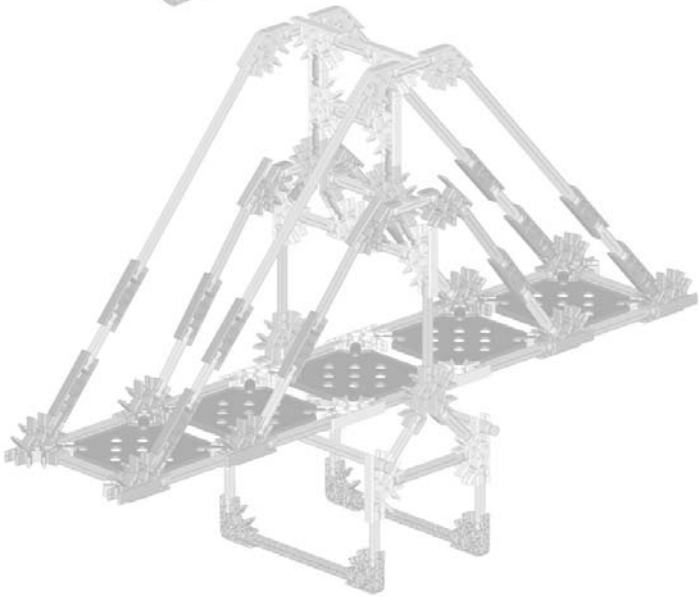
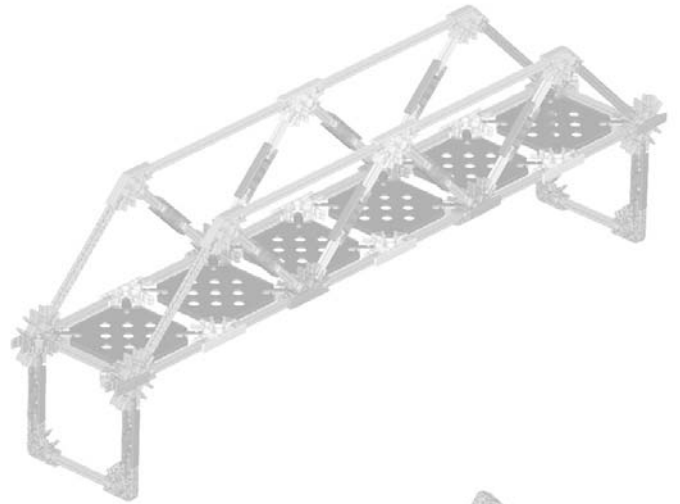
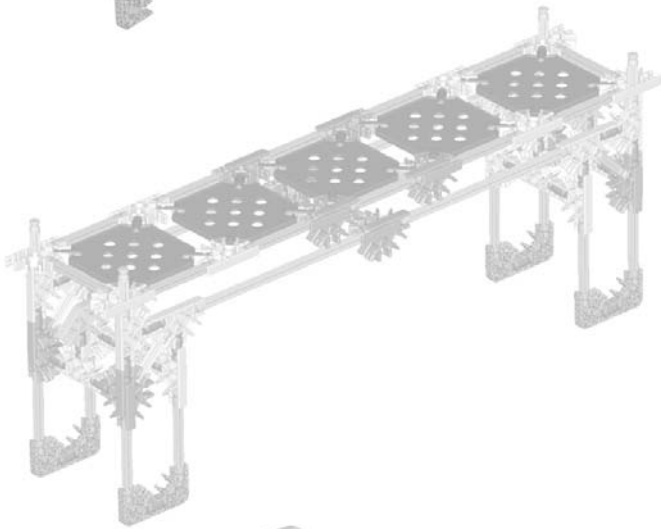
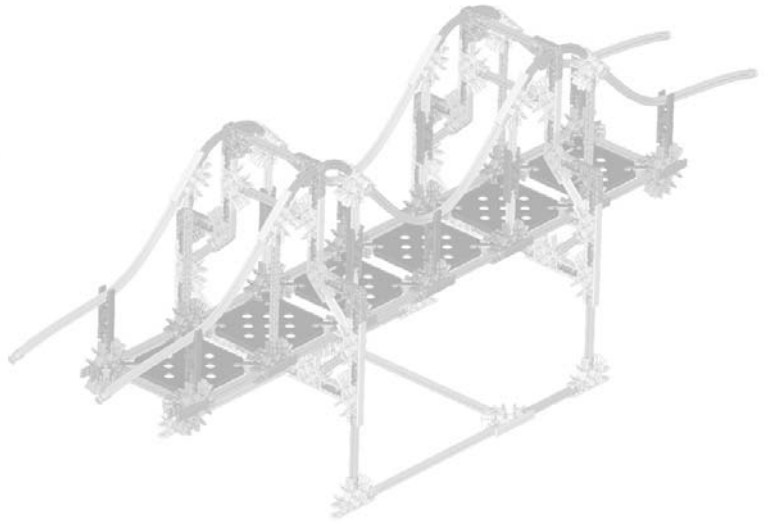

Introduction to Structures: BRIDGES

Background Information

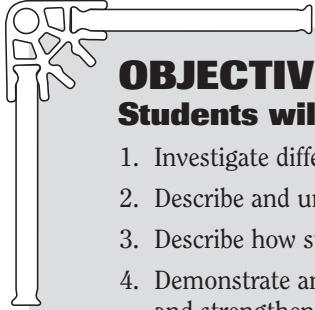
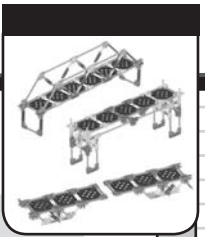

OBJECTIVES

Students will:

1. Investigate different bridges designs and demonstrate their understanding of how they work.
2. Describe and understand the forces that act on structures.
3. Describe how structures are made stable and how they are able to support loads.
4. Demonstrate and describe how structures can fail when loaded and investigate techniques for reinforcing and strengthening them.
5. Consider, describe, and explain some of the physical properties of materials and their application in the design and construction of bridges.
6. Demonstrate their understanding of the design, engineering, and construction processes used in bridge building.

KEY TERMS and DEFINITIONS for the teacher.

The following is intended as a glossary for the teacher. The age of the students, their abilities, their prior knowledge, and your curriculum requirements will determine which of these terms and definitions you introduce into your classroom activities. These items are not presented as a list for students to copy and memorize. Rather, they should be used to formalize and clarify operational definitions your students develop during their investigations.

Bridge:

A structure that provides a way across a barrier. Something that connects, supports, or links one thing to another.

Arch Bridge: A bridge having a curved structure. The arch design provides strength by exerting force downwards and sideways against the abutments.

Bascule Bridge: A hinged bridge that acts like a seesaw. Sections can be lifted using weights as a counterbalance.

Beam Bridge: The simplest type of bridge. It is made from a rigid, straight structure resting on supports at either end.

Cable-Stayed Bridge: A modern design of bridge in which the deck is supported by cables directly attached to towers.

Cantilever Bridge: Similar to the beam bridge, this design gets its support from counterbalanced beams meeting in the middle of the bridge rather than from supports at either end. The two arms of the beam are called cantilevers.

Suspension Bridge: A type of bridge in which the deck hangs from wires attached to thick cables. The cables themselves pass over towers and are securely anchored in concrete anchorages.

Truss Bridge: A type of beam bridge, reinforced by a framework of girders that form triangular shapes.

Loads and Forces:

Load: The distributions of weights on a structure. (See also Dead Load and Live Load below).

Force: A push or pull. In the case of bridges, force is applied to the bridge in the form of a load.

Stress: A force that tends to distort the shape of a structure.

Compression: A force that tends to shorten, push or squeeze a structure.

Tension: A force that tends to lengthen or stretch part of a structure.

Torsion: The strain produced when a material is twisted.

Shear: A force that acts to move a material in a sideways motion.

Symmetry: An arrangement that is balanced and equal on opposite sides of a central dividing line.

Buckle: A condition that occurs when structures bend under compression.

Dead Load: The weight of the bridge's structure.

Live Load: The weight of traffic using the bridge.

Bridge Features:

Abutment: The mass of rock or concrete at either end of an arch bridge that keeps the ends of the arch securely in place so they do not separate and cause the bridge to fall.

Anchorage: Foundations/concrete blocks into which the cables of a suspension bridge are secured.

Beam: A rigid, horizontal component of a bridge.

Cable: A bundle of wires used to support the decking of a suspension bridge or a cable-stayed bridge.

Caisson: A temporary structure used to keep out water during construction of the piers' foundations.

Decking: The surface of the bridge that serves as a walkway, roadway or railway.

Engineer: A professional who researches and designs bridges and other structures. There are many types, including civil, structural, and environmental engineers.

Framework: A skeletal arrangement of materials that give form and support to a structure.

Girder: A strong, supporting beam.

Hand or Guard Rail: A safety feature added to the sides of the bridge's deck to prevent people, animals or vehicles from falling from the bridge.

Keystone: The final wedge-shaped piece placed in the center of an arch that causes the other pieces to remain in place.

Obstacle: Something that stands in the way or acts as a barrier.

Pier: A vertical support for the middle spans of a bridge – a column, tower or pillar, for example.

Pulley: A wheel used for hoisting or changing the direction of a force.

Ramp: An inclined section connecting the shore to the deck of the bridge.

Roadway: The area of the bridge along which traffic travels; it rests on the decking.

Span: The section of the bridge between two piers.

Support: An object that holds up a bridge and serves as a foundation.

Suspender: A supporting cable for the deck; it is hung vertically from the main cable of the suspension bridge. Also known as a **Hanger**.

Strut: A structural support under compression.

Tie: A structural support under tension.

Tower: A tall, vertical support that carries the main cables of a suspension bridge and cable-stayed bridge.

Triangulation: A building concept, using triangles, made from squares, to enhance the strength of a structure.

Truss: A framework of girders, some in tension and some in compression, comprising triangles and other stable shapes.

Vousoir: A true arch made from wedge-shaped stone blocks that fit tightly together against abutments. (French: 'arch-stone.')

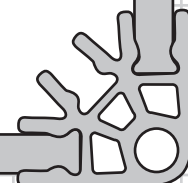

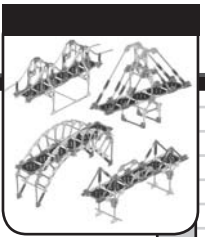

KEY CONCEPTS

The following provides a summary of some of the key concepts associated with bridges and is offered here as a resource for the teacher. You may find some of this material helpful as you prepare your classroom activities using the **K'NEX Introduction to Structures: Bridges** set.

What is a Bridge?

- It is a **STRUCTURE** that makes it easier to cross a barrier. Barriers, such as rivers, have always confronted travelers and traders, but today bridges are used to cross wide estuaries, to link chains of islands, to cross busy highways and to link one building to another. They carry motor vehicles, trains, pedestrians, pipelines, and channels of water.
- We can imagine that the earliest 'bridges' were fallen trees or a stone slab placed across a small stream or gap – what we would call a 'beam' bridge today.



Fig. 1



Fig. 2 - Simple beam bridge.

- As people attempted to cross wider barriers, carrying heavier loads, the beam solution was not always successful. The longer spans result in the beam bending in the middle, and while the beam can be strengthened, the increased weight can cause the bridge to collapse. The longest single span in a beam bridge is approximately 80 meters.



Fig. 3 - Long beam bending.

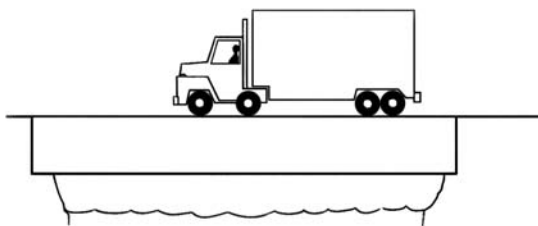

Fig. 4 - Strengthening beam by making it thicker.

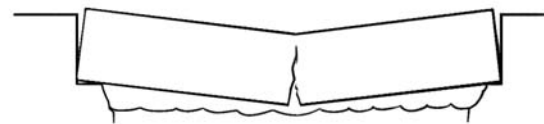

Fig. 5 - This bridge is too heavy.

- A bridge's design must take into account the following: the **LOAD** it will carry, the **FORCES** acting upon it, and the **MATERIALS** from which it will be built.

LOADS

⊗ **Live Load:** The weight of the traffic crossing the bridge. This load creates a downward force on the bridge and so the design must EITHER distribute this downward force into the foundations OR balance it with an opposing force.

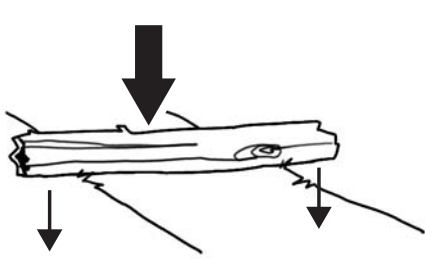

Fig. 6i

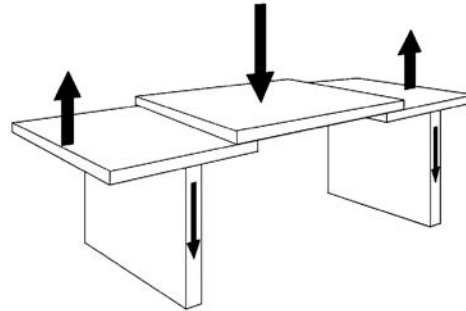

Fig. 6ii

⊗ **Dead Load:** This is the weight of the bridge structure itself. Engineers attempt to minimize this load by making the structure as light as possible.

⊗ **Shock Load:** Trains and heavy trucks produce a high impact (or shock) as they cross bridges at speed. Bridges carrying trains need to be very strong and for this type of traffic, suspension bridges cannot be used.

⊗ **Environmental Load:** Environmental factors such as strong winds, ice and snow build-up, and earthquakes can create an additional load for a bridge. Of particular concern are the effects of hurricane force winds on suspension and cable-stayed bridges in exposed locations such as wide estuaries.

FORCES

⊗ **Compression:** squeezing.

⊗ **Tension:** stretching.

⊗ **Torsion:** twisting.

⊗ **Shear:** sliding, cutting.

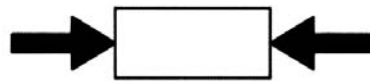

Fig. 7 - Compression (squeezing)

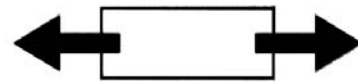

Fig. 8 - Tension (stretching)

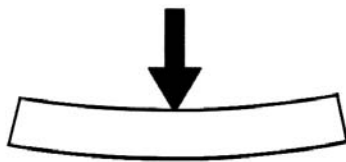

Fig. 9 - Bending: the combined effect of compression & tension

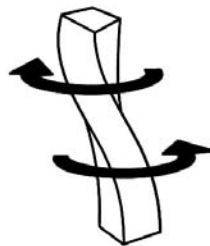

Fig. 10 - Torsion (twisting)

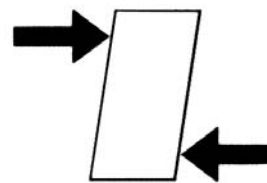

Fig. 11 - Shearing (sliding)

⊗ The most important forces affecting bridges are compression and tension. Their effects on a bridge structure can be modeled by taking a rectangular piece of foam rubber and drawing parallel lines with a marker along one side, as shown in the diagram below. Pushing down on the center portion of the foam will demonstrate where compression and tension occur.

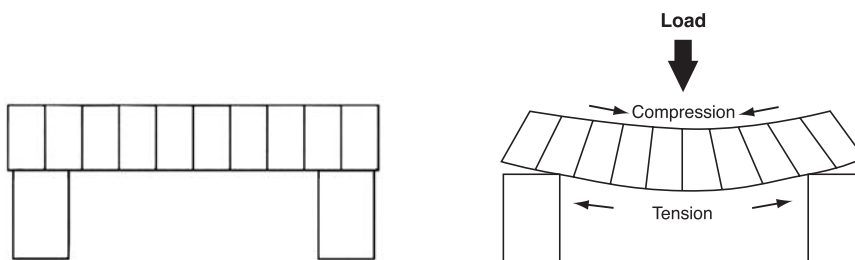
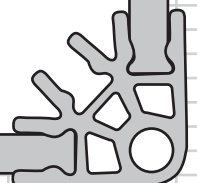
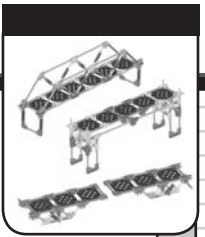

Fig. 12 - Forces acting on a beam.





MATERIALS

- ⦿ Design engineers must take into account the properties of the materials they are planning to use for a bridge.
 - ⦿ Materials that are strong under *compression*: wood, reinforced concrete, steel, and some plastics.
 - ⦿ Materials that are strong under *tension*: rope, wood - cut along the grain.
- ⦿ Reinforced concrete is a good choice for many structures, including bridges. It has steel bars running along its length and is strong under both tension and compression.

You may want to try some of the following as introductory activities with your students. (See also Introduction to Bridges: Preparatory Activities, Page 19.) **We also recommend that you visit the 'Forces Lab' at:** www.pbs.org/wgbh/buildingbig/bridge/

- ⦿ Can paper be used to make structures? What are its strengths and weaknesses?

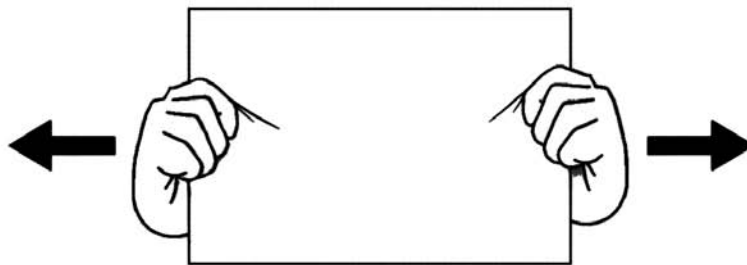

Fig. 13i - Try pulling a sheet of paper apart.



Fig. 13ii - Now squeeze it.

This test demonstrates that paper is strong under tension but weak under compression.

- ⦿ Can we change the physical properties of materials?

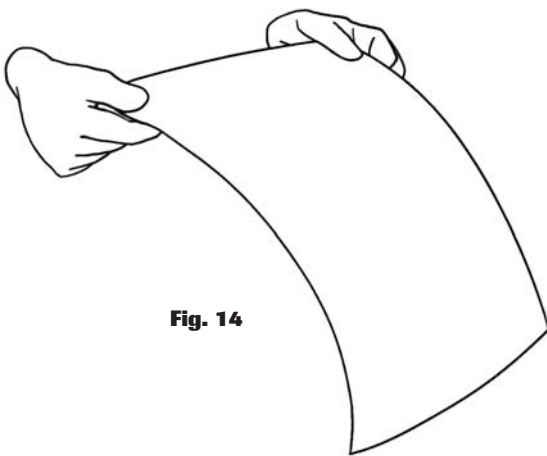

Fig. 14

When we hold a sheet of paper between our hands it flops down – it is not very rigid /stiff. But when folded it has different properties.

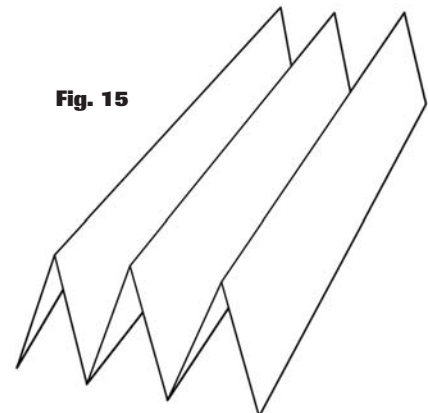

Fig. 15

The sheet of paper is now rigid and can support some surprisingly heavy loads.



Fig. 16i - Roll the sheet of paper around a broom handle or large diameter dowling.



Fig. 16ii - Strong: Compression, tension.



Fig. 16iii - Weak: Bending.

Rolling a sheet of paper to make a tube produces something that is surprisingly strong. This can be seen if you then try to compress (squeeze) the tube along its length. You may want to discover what type of load the tube of paper can carry before buckling (failing.)

Try folding a sheet of 8.5" x 11" paper into some of the shapes shown below and investigate how much weight the paper beams are able to support. Predictions on the strength of the designs can be made before the testing begins. To ensure a fair test the piers must be placed the same distance apart and only one sheet of paper can be used. Place each sheet (beam) in turn, onto the two piers and carefully place weights onto the center of the beam being tested. (Fig. 18.) Begin with the smallest unit of weight, gradually adding weights until the beam fails. Record the results in a table such as the one shown below. (Fig. 19.)

This method can also be used to investigate different types of paper and card.

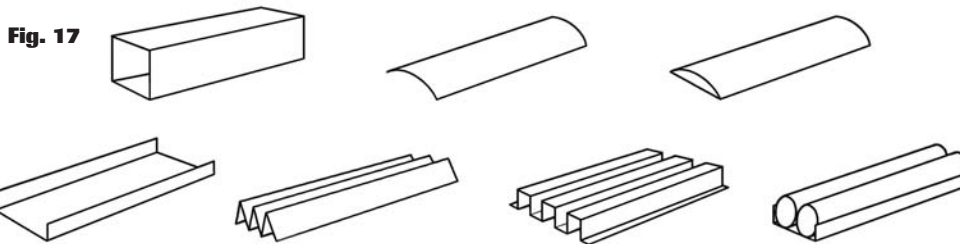
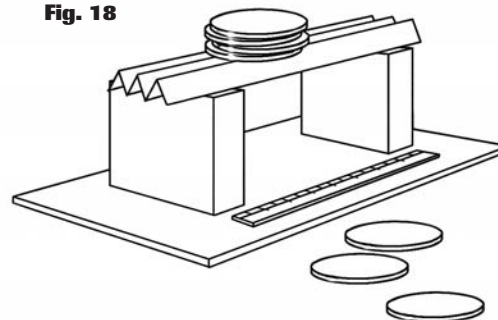

Fig. 19

Design (cross section)	Max. Weight

As these investigations demonstrate, by changing the shape of materials we can make what at first appears an inappropriate material into one that can be used to make strong structures.

Fig. 18



We would like to thank Paul Newham, Senior Technician, The South London Science & Technology Centre, London, UK for granting us permission to reproduce this activity and the accompanying diagrams.



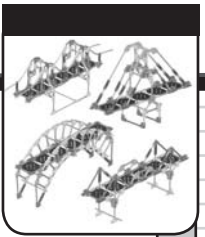

Shapes used in structures.

3 basic shapes are commonly used in structures: rectangles, triangles and arches.

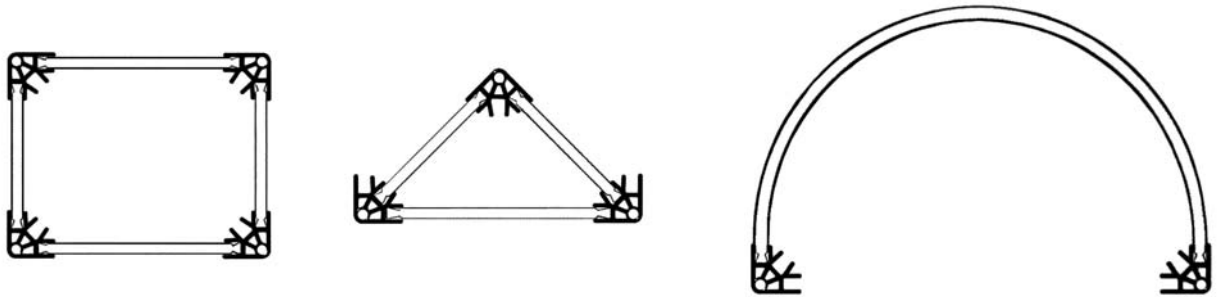

Fig. 20-22 - Shapes commonly used in structures. Use combinations of K'NEX Rods to make these shapes.

What happens to these shapes when forces are applied to them?

Rectangles

When pressure is applied to one corner of a rectangle it changes shape. The rectangle now becomes a parallelogram.

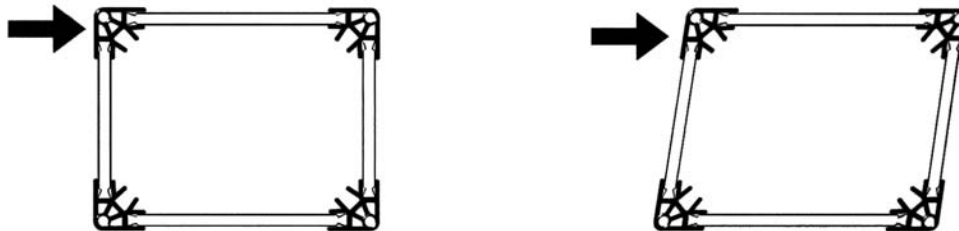

Fig. 23-24 - Rectangles: Pushing at a corner.

Adding a diagonal brace to a rectangle strengthens and reinforces it. It is now a rigid, stable structure. A brace is a strengthening or reinforcing component of a structure.

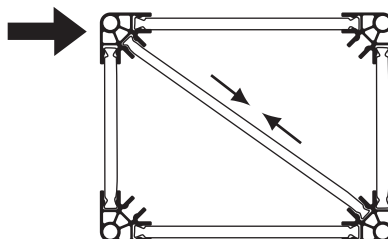

Fig. 25 - Compression acting on the strut.

The shape does not change when the corners are pushed or pulled because the forces are now transmitted along the length of the diagonal brace, which is strong under compression. The addition of a diagonal brace also creates two triangles. Braces that resist compression are called *struts*.

Triangles

If a load or force is applied on one of the sides of a triangle, the side may bend inwards. The side is the weakest point in a triangular structure.



Fig. 26 - Force applied to the side of a triangle.

However, if a load or force is applied at one of the angles, the triangle does not bend because the two sides are squeezed and the base is stretched. The forces are distributed around the whole structure and not just on one side. Used in the right way, triangles are the most stable and rigid shapes that can be incorporated into a structure's design.



Fig. 27 - Force applied to the angle of a triangle.

Arches

Arches have been used in building structures for thousands of years. Many arched bridges and aqueducts built by the Romans are still in use today - a testimony to their strength.

Fig. 28 - Examples of arch bridges.



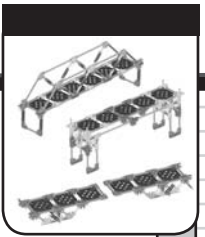

When a load is applied to the top of an arch, the top moves down while the sides will tend to move out to the side.

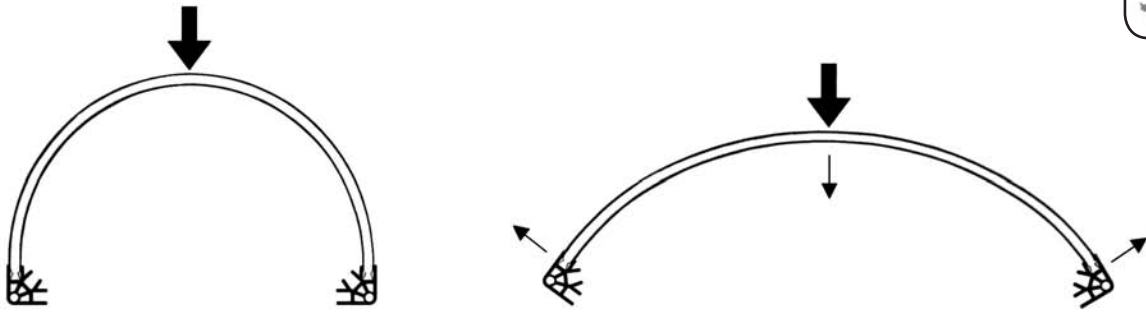

Fig. 29 - Force acting on an arch.

Supporting the sides, however, strengthens an arch and creates a very strong structure.

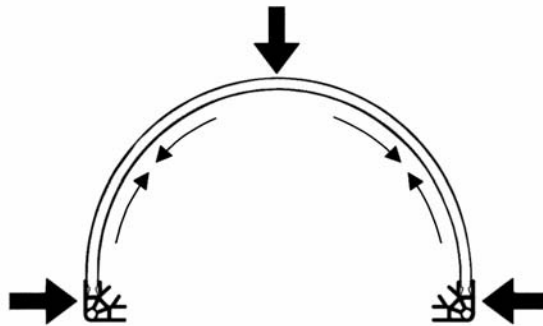

Fig. 30 - Reinforcing/strengthening an arch.

When a load is applied, the arms of the arch try to move sideways, but the external supports push back, stopping the sideways movement. The external supports are called *abutments*.

Arches, however, do have their limitations. If the arch span is too large, it is weakened. The largest single span arches today are approximately 250 meters wide.

Fig. 31 - Examples of steel arch bridges.



Not all arches are made from stone. Modern arches are made from steel frames.

DIFFERENT TYPES OF BRIDGES

There are several basic bridge types, but because the individual requirements for each bridge are different, there are numerous design variations.

The BEAM BRIDGE

This is the simplest type of bridge, made from a straight section - the beam - that rests on two supports, one at each end of the beam.

Construction and materials:

The beam bridge supports its own weight and its load, on upright, or vertical, piers. This type of bridge is typically used to span narrow distances over small streams or rivers, or over a highway. This is because longer beams tend to bend in the middle and need additional support.



Fig. 32 - Long beams are weaker than short ones.

While wood and stone were common materials in the past, modern beam bridges are usually constructed from steel and reinforced concrete.

Forces acting on the bridge:

The forces acting on a beam bridge compress the top, but stretch (place under tension) the bottom of the beam. The piers supporting the weight of the bridge are under compression.

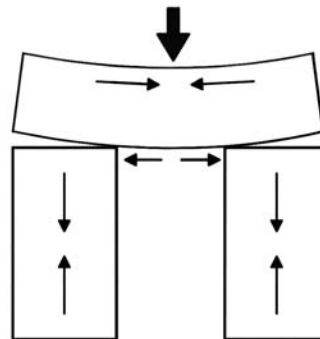

Fig. 33 - Forces acting on a beam bridge.

The TRUSS BRIDGE

A truss bridge is a type of beam bridge in which the beam is constructed with a latticework of straight sections, (usually steel,) joined together to form a series of triangles. This allows the beam to become thicker without significantly increasing the weight. A triangle will produce a strong and rigid structure because it prevents a structure from bending, twisting or pulling out of shape.

Constructions and materials

Early truss bridges included few triangles and were made of wood (See Figs. 34 and 35.) As better materials and designs were developed, trusses became more complex and today, they include large numbers of triangles.

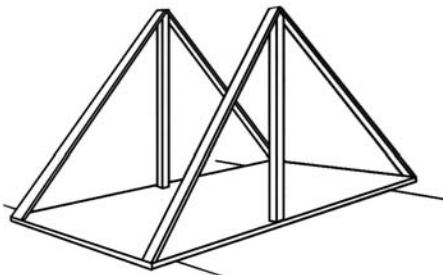

Fig. 34 - King Post Truss

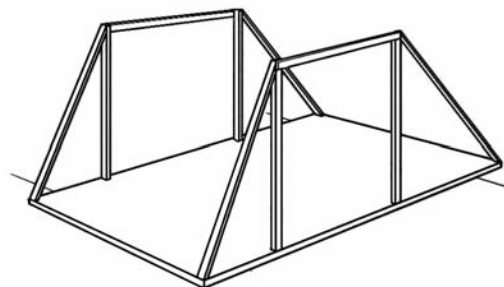

Fig. 35 - Queen Post Truss



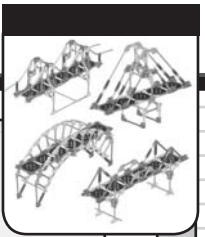
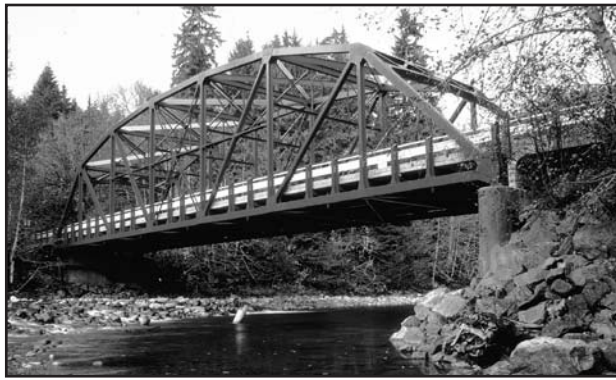

Fig. 36 - Truss Bridges.



While the addition of trusses increases the strength of a beam, truss bridges also have limits on their maximum practical length.

LONGER BRIDGES



Fig. 37a - How to span a wide gap.
Problem: The bridge bends and is weak.

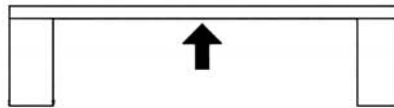

Fig. 37b - Solution:
Push up from below.

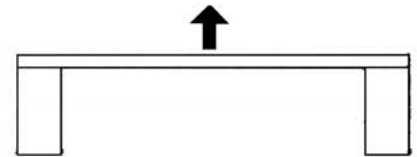

Fig. 37c - Solution:
Pull up from above.

As noted above, a long beam bridge will bend in the middle. Engineers have attempted to overcome this problem in two ways. They have designed bridges so that the weak point of the structure is either pushed up from below by a pier, or pulled up from above by cables. Below, we discuss variations on the beam bridge and review the arch bridge. Each represents a technique used to span wider barriers.

1. Support by making shorter spans.

Instead of using a long, single span with its inherent problems of bending in the middle, engineers have built bridges made of what are effectively hundreds of small beam bridges joined together. The Chesapeake Bay Bridge-Tunnel in the US is constructed in this way and is known as a **continuous span bridge**. The bridge, (and tunnel), extend across the shallow Chesapeake Bay for about 26 kilometers, but the largest single span is only 30 meters.

2. Using arches The ARCH BRIDGE

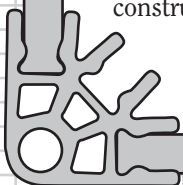

Fig. 38

Fig. 39



The arch was used in structures built by the Egyptian and Chinese civilizations, as well as in the bridges and aqueducts constructed by the Romans.



Construction and materials

The arch makes use of the ability of blocks of stone to withstand very large forces of compression. These forces hold the stones together between the ends (abutments) of the bridge. The central stone in the arch is known as the keystone and all the other stones push against this center stone. The shape of the stones used in the construction of an arch bridge is critical. They must be wedge-shaped, as it is this shape that allows the arch to hold itself up. As time passed and bridge materials improved, arch bridges were made with cast iron, steel, and today, concrete is used.

Fig. 40 - Arch Bridges

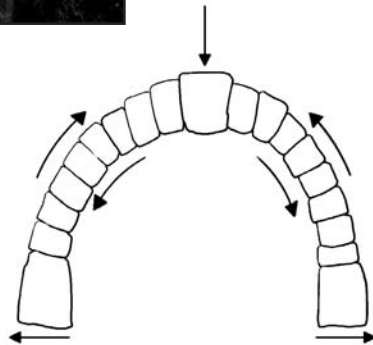

Fig. 41 - Forces acting on an arch.

**3a Supporting from below
The CANTILEVER BRIDGE**

A cantilever bridge is another variation of a beam bridge. A cantilever is a beam that is supported only at one end. One end of the beam could be anchored firmly to the land while the other end extends out into space, where it would connect with another cantilevered beam to form a whole bridge. Unlike other beam bridges, each beam does not require two piers to support its two ends. This is an advantage in situations where it is difficult to place piers, or where an unrestricted channel is required for shipping. As with beam bridges, however, many cantilever bridges include truss systems for added strength.

The cantilever concept can be easily demonstrated using 5 equal size books (or wood blocks). Stand two books vertically to represent the supporting piers then place a book on each of the piers to represent the cantilever. Each pier and cantilever should look like a letter T. Connect the two cantilevers by balancing a book across the gap or moving the two cantilevers together so they meet.

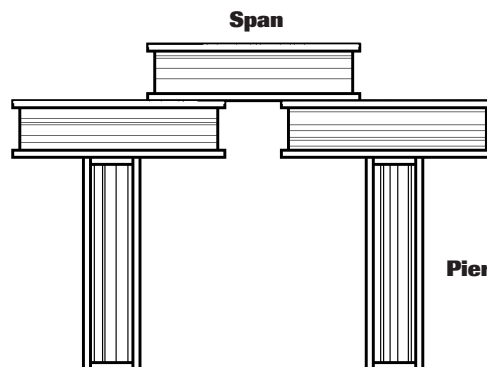

Fig. 42



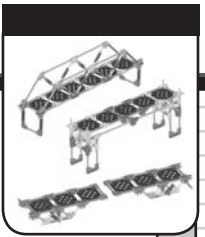
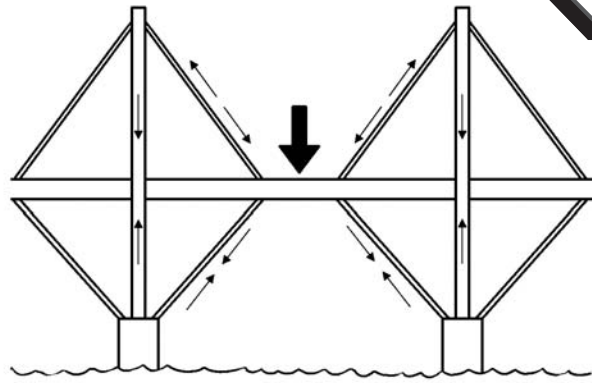

Fig. 43 - Forces in a cantilever bridge.



The Forth Railway Bridge that crosses the wide estuary of the Firth of Forth near Edinburgh, Scotland is one of the world's largest cantilever bridges, constructed of steel in 1890 with a length of about 2500 meters (approx. 1.5 miles.) Its central span between the two cantilevers, however, is only about 100 meters wide.

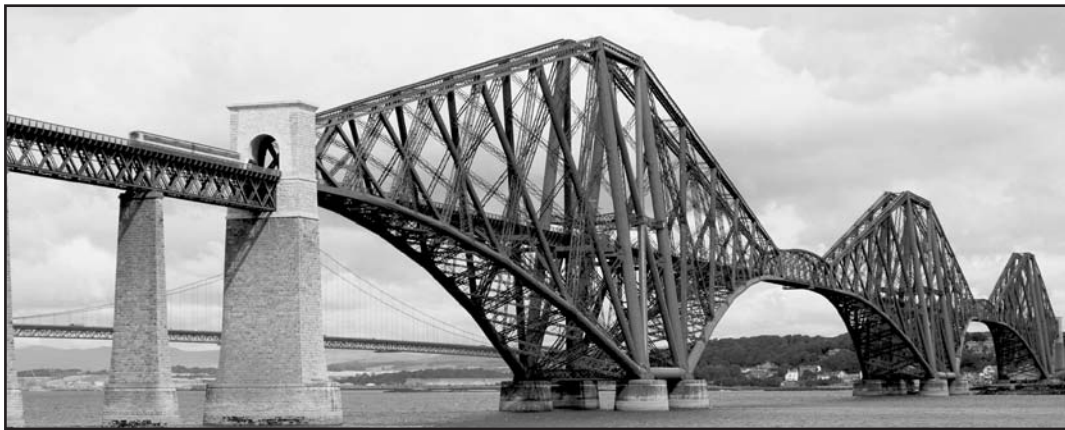

Fig. 44

Forth Rail Bridge, South Queensferry, Scotland.

In this example, the rail decking has supports both above and below as well as additional support provided by a latticework of triangles.

3b Pulling up from above The CABLE-STAYED BRIDGE

Cable-stayed bridges are a combination of cantilever and suspension bridges: the road decking of the bridge is the cantilever structure, suspended by cables from a tower. Each tower supports a balanced portion of the deck by way of its cables. While the design idea is not new, this type of bridge became increasingly popular from the mid-20th Century onwards, largely due to developments in the construction materials (pre-stressed concrete). It is also a relatively inexpensive design to build because, unlike a tower-to-tower suspension bridge, it does not require anchorages. As a result, this type of bridge is now selected for many locations where formerly a medium sized (under 1000 meters) suspension bridge would have been built.

Fig. 45 - Cable-stayed bridges.

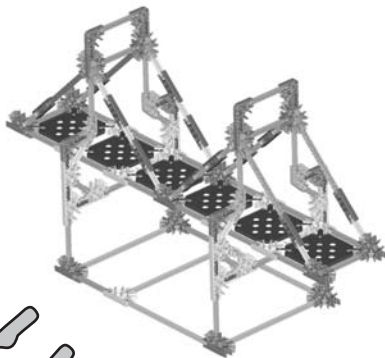
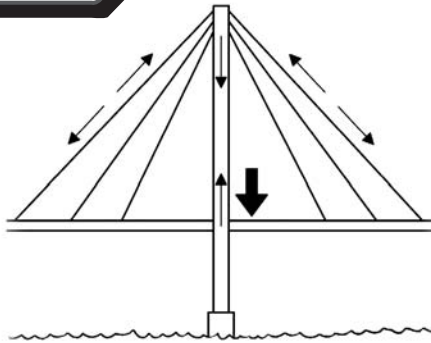

Fig. 46 - Forces acting on a cable-stayed bridge.



Construction and Materials

Cables, attached to a tall tower, are used to support the bridge road decking. The cables run directly from the tower to the deck. All the cables are under tension and the tower supports the total weight of the bridge and everything on it. Towers are typically constructed from concrete or steel, while the cables exhibit great variety in their design.

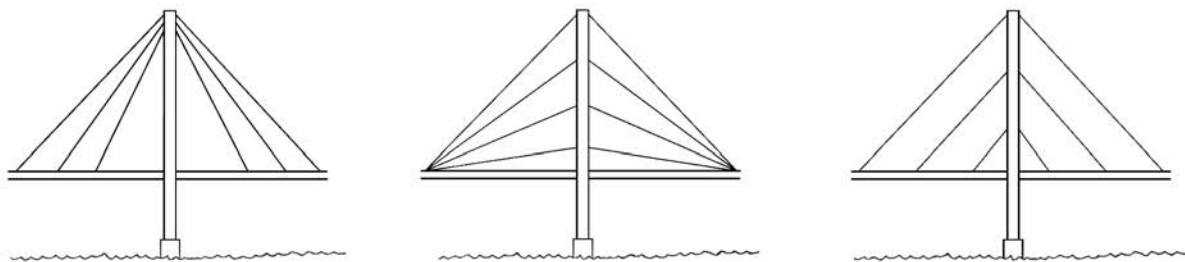

Fig. 47 - Cable designs.

The SUSPENSION BRIDGE

The concept of a suspension bridge quite possibly dates back to prehistory – vines in forested areas may have been used to construct footbridges across narrow valleys. Today, suspension bridges form some of the longest bridges in the world. Modern suspension bridges use cables strung between two towers – the cables either pass over or through the towers, which support the total weight of the bridge. The ends of the cables are anchored to the ground. The road decking itself is gently arched and has a truss structure to provide additional strength and rigidity. It is suspended from vertical cables called suspenders that hang down from the main cables.

The design of suspension bridges, like any other type of bridge, tries to ensure that the forces acting on the structure are balanced and are working together in harmony. With a suspension bridge, the cables and the suspenders are under tension as they are always being pulled, while the towers are under compression because the cables push down on them.

Fig. 48 - The parts of a suspension bridge.

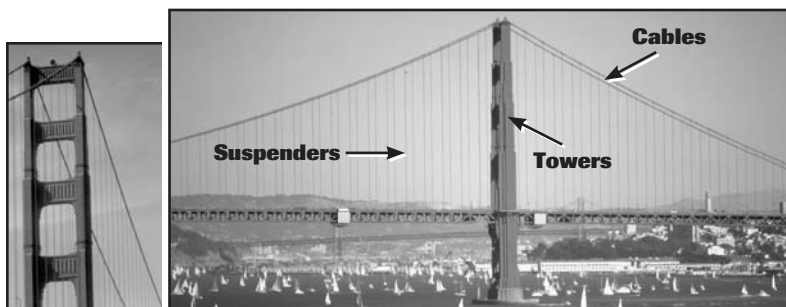

Golden Gate Bridge, USA



Anchorage

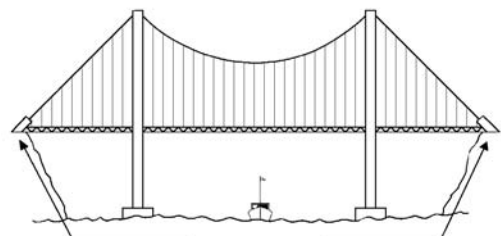

Anchorage

Fig. 49 - The use of trusses on the road decking of a suspension bridge.

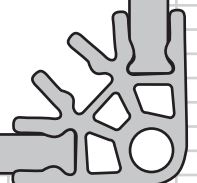

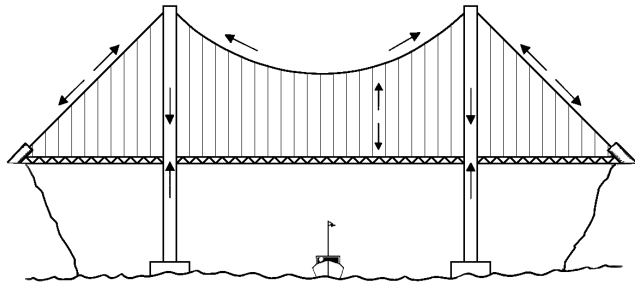
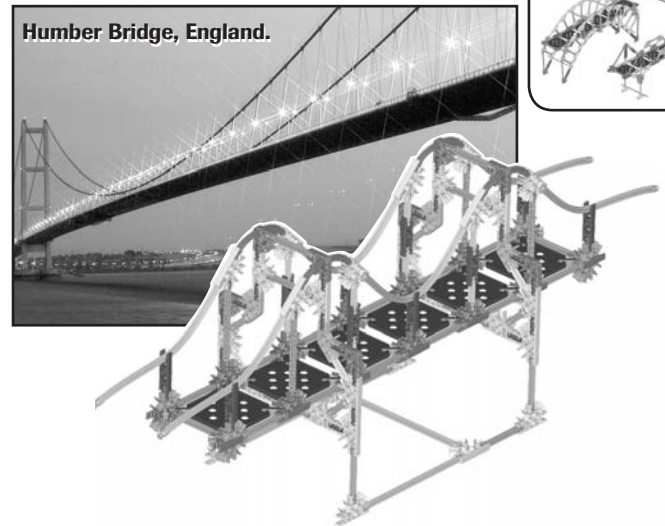

Fig. 50 - Forces acting on a suspension bridge.

Fig. 51



Humber Bridge, England.

The very longest bridges built today are suspension bridges. Currently, the Akashi Bridge linking the Japanese islands of Shikoku and Honshu holds the record, with a length of 3,911 meters (12,515 feet).

Moving Bridges

The BASCULE Bridge

The word BASCULE is French and means 'seesaw'. A bascule bridge is one that opens to allow the passage of ships. Its central span is divided and each end is counterbalanced to reduce the effort needed to raise it. The moveable sections that rotate upward are called leaves and are operated by a system of counterweights, gears and motors. The counterweights are typically made from concrete and are normally located below the roadway. A motor turns the gears that move the counterweights down, while the leaves move up and open a passage for shipping.

Tower Bridge, crossing the River Thames in London, England is a bascule bridge. Each bascule is approximately 33 meters (100 feet) long and each has a 422-ton counterweight attached at one end.



Fig. 52 Bascule Bridge opening for shipping.



Tower Bridge, London, England.

Useful web sites:

<http://www.brantacan.co.uk/> A valuable resource site with detailed information on all aspects of bridge design and construction. Offers an excellent selection of photos and diagrams that can be used in the classroom.

<http://www.icomos.org/studies/bridges.htm> This site is an excellent library of bridge types from around the world. Heavy on text and very detailed, but a good reference source.

http://eduspace.free.fr/bridging_europe/index.htm A good educational web site with links to other sites. It has informative ideas for lessons and activities.

www.pbs.org/wgbh/buildingbig/bridge/. This web site offers an excellent interactive section where Forces, Loads, Shapes and Materials can be investigated.

<http://www.pbs.org/wgbh/nova/bridge/>. A companion web site to the PBS television series SuperBridge. A useful source of information on bridge building, with interactive sections.

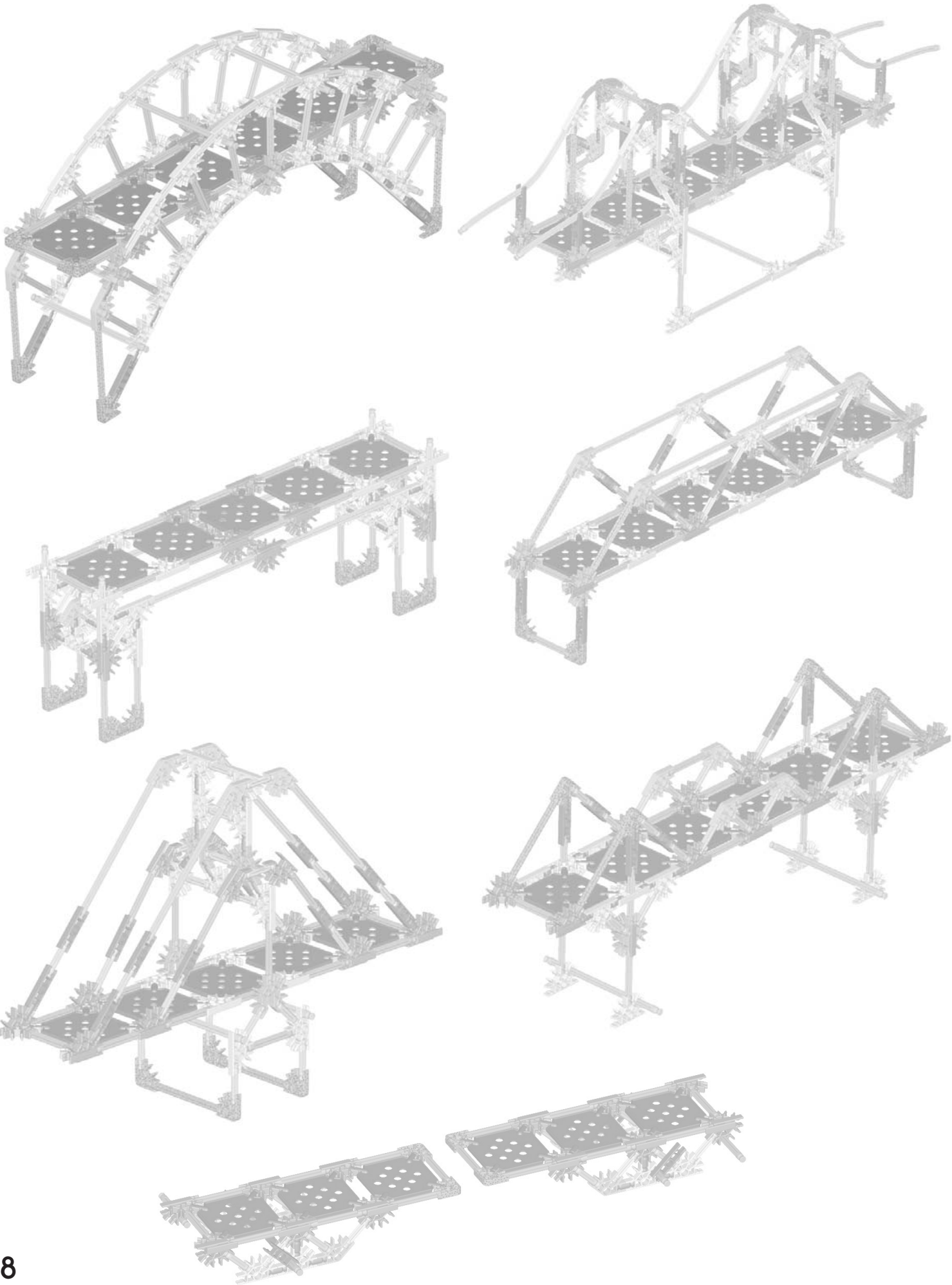

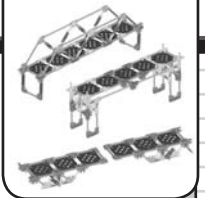

Introduction to Bridges:

Preparatory Activities.



OBJECTIVES

Students will:

1. Identify the forces that act on structures.
2. Demonstrate the ways in which selected materials respond to forces acting on them.
3. Explore the ways in which selected shapes respond to forces acting on them.

MATERIALS

Each student group will need: You will need:

- | | |
|--|--|
| <ul style="list-style-type: none"> - Sheets of 8½" x 11" paper - Rubber bands - Long K'NEX rods - Selection of K'NEX corner connectors | <ul style="list-style-type: none"> - A piece of solid foam rubber approx. 12 x 2 x 2 inches (30 x 6 x 6 cm) - Marker |
|--|--|

NOTE: The activities referenced below are intended for students with no prior knowledge of structures. Your judgment will determine which of these activities are appropriate for your students.

PROCEDURE

Introduction

- Begin by asking the class what we mean when we talk about STRUCTURES. Write their responses on the board.

Answers may include the following: Buildings including skyscrapers, stadiums, domes; roads/highways; bridges; tunnels; dams; harbors; breakwaters; jetties; cooling towers for power stations; transmission towers; pipelines; oil rigs and oil platforms; pyramids; amusement park rides.

- Encourage the students to describe the largest structure in which they have been. Ask them to describe their feelings while in the structure.

Possible answers: excited, anxious, amazed.

Probe to discover why they had the feelings they described.

- Ask the students if they can tell you the name given to the specialists who design structures such as buildings, roads, and bridges.

Engineers: civil engineers/ structural engineers.

- Ask the students: "If you were an engineer designing a large building, bridge, etc., what would you need to take into consideration as you planned the structure?" (Strength, beauty, safety, etc.) Use probing, questioning strategies to help students with this brainstorming activity. List responses on the board and use a mapping or webbing diagram to help students realize how many of their ideas are related.

Inquiry Activities

NOTE to the Teacher:

Information and suggested classroom activities for **FORCES**, **MATERIALS** and **SHAPES** are provided in the Key Concepts section on Pages 5-17 of this Guide. An activity focusing on bridge **LOADS** can be found in the lesson entitled, "Are All Bridges the Same?" on Page 25-28 of this Guide.

The www.pbs.org/wgbh/buildingbig/bridge/ web site provides a '**Forces Lab**' that demonstrates the effects of **FORCES** on different shapes, as well as addressing building **MATERIALS**, **SHAPES** and **LOADS**. It uses simple, clear graphics and animations. We highly recommend that you and your students explore the resources offered at this site.

☉ You may want to discuss, for example, the forces that act on structures:

- ☉ Squeezing/compression
- ☉ Stretching/tension
- ☉ Twisting/torsion
- ☉ Sliding/shear

☉ You may also want to explore the following with the students:

- ☉ some of the characteristic features of different types of building materials
- ☉ the ways in which different shapes respond to different forces
- ☉ the loads that structures are required to bear

All of these concepts are clearly and simply demonstrated at the web site we have referenced above.

SUGGESTED STEPS

Explain to the class that they will explore some of the factors that engineers must consider as they develop their designs.

1. If they appeared as responses in the earlier discussion, highlight the factors identified below. If they were not mentioned earlier, use questioning techniques to elicit them from the children and add them to the list/map:
 - ☉ **FORCES** acting on the structure
 - ☉ **MATERIALS** used for the structure
 - ☉ **SHAPES** used in the structure
 - ☉ **LOADS** to be carried by the structure
2. To introduce your students to these concepts please refer to the activities described in the Quick Guide section on Page 5-11 of this Guide. Resource materials for these activities are listed above on Page 22. The activities you may want them to undertake could include:
 - ☉ Demonstrating the effects of forces using a piece of foam rubber or visiting the Forces Lab at www.pbs.org/wgbh/buildingbig/bridge/
 - ☉ Activities demonstrating the ways in which the properties of materials can be changed, using sheets of 8.5" x 11" paper.
 - ☉ Investigating the strength of various shapes using K'NEX Rods and Connectors.
 - ☉ Using the Forces Lab at www.pbs.org/wgbh/buildingbig/bridge/ to investigate ways to strengthen shapes used in structures.

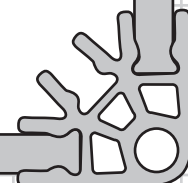

Introduction to Bridges

What do bridges do?

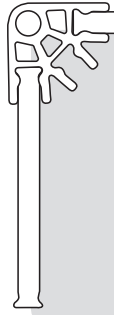
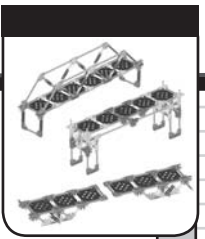

OBJECTIVES

Students will:

1. Form an operational definition of a bridge.
2. Investigate bridges in their local area.
3. Design and build a model of a bridge.

MATERIALS

Each group of 2-3 students will need:

- K'NEX Introduction to Structures: Bridges set with Building Instructions Booklet for photographs of bridges
- Graph paper or sheets of 8½" x 11" paper
- Markers or crayons

You will need:

- An example of a blueprint - your custodian or the town engineer may be an excellent resource for blueprints. (Optional)
- Useful Web sites for student research:
 - www.freefoto.com
 - www.brantacan.co.uk
 - www.howstuffworks.com/bridge
 - www.pbs.org/wgbh/buildingbig/bridge/
- These web sites allow free use of their images for educational purposes.

NOTE: It is assumed that students will have some basic knowledge of structures, (forces, shapes used, loads, building materials,) gained from undertaking the preparatory activities unit in this Guide and/or visiting www.pbs.org/wgbh/buildingbig/bridge/. A more detailed discussion on **loads** is found in the next unit.

PROCEDURE

Introduction

- Ask the students, "What is a bridge?" Record their comments on the board. You may want to use mapping strategies for this activity. Help them to form a definition of a bridge as a structure that provides a way for people, animals or vehicles to cross over a space or barrier.
- Encourage the students to use their imaginations and describe what they think the earliest bridges might have been like. Again, record their suggestions on the board.
- Ask the students to identify:
 - 3 reasons why we use bridges today.

A bridge is a structure that allows people/animals/vehicles to cross a barrier of some form. Some students may also mention that bridges carry pipelines and channels of water – aqueducts.

Answers will vary: fallen logs across streams; stones or boulders used as stepping stones; vines to swing across a stream; combinations of these.

To cross roads/highways safely; to cross rivers without getting wet; to move safely from one building to another; to drive cars across valleys.

- 3 barriers that prevent people from getting from place to place.

Rivers, valleys, ravines, estuaries, roads/highways, stretches of water between islands.

- How people crossed such barriers without bridges.

Waded across fords in rivers, used stepping stones, traveled up a valley or ravine to find a place to cross.

- You may want to refer the students to the photographs of bridges shown in the Building Instructions booklet, and the barriers they have been designed to cross. Encourage them to look carefully at the shape of the bridges and ask them to notice differences. At this stage it may be helpful to focus on just 3 types of bridge: beam (Pages 2-3;) arch (Page 10;) suspension (Page 12.)
- Encourage the students to cite examples of bridges in your community. If there is a bridge near to the school you could begin your students' inquiries into bridges by visiting it and exploring its characteristics. If this is not feasible ask the students to describe the characteristics of the bridges they identify, including their functions and the materials from which they are made. Students should be encouraged to visit at least one bridge in their community and either make a sketch or take a photo of the structure. They should pay particular attention to its design, its supports and the shapes that are included in the bridge. They should be encouraged to estimate the dimensions of the bridge and be prepared to explain the method they used. They should record their findings in their journals.
- Provide a local map and help students locate the bridges they have identified, together with bridges in the community that they may not have mentioned. Ask them to imagine what travel would be like in your area without these bridges. Encourage the students to trace routes on the map for getting from one point to another without using any bridges. Suggest that students count and list the bridges they cross as they walk, ride, or drive to school.
- Discuss how bridges have evolved from the simple stone slabs and logs placed across a stream to the massive bridges, with spans thousands of meters long, built to link islands and cross wide estuaries. Students should be made aware, however, that while many of the modern bridges are great feats of engineering skill and design, in many parts of the world simple bridges of stone slabs or logs or vines continue to be constructed. Explain that they will be using K'NEX to build models of different types of bridges and in the process they will gain knowledge and understanding of structures and the design problems that engineers have confronted in order to build longer and longer bridges, carrying heavier and heavier loads.

Building Activity

- Organize the class into groups of 2-3 students and distribute a K'NEX Bridges set to each group.
- Ask the students to open the materials and locate the Building Instructions booklet. If the class has not used K'NEX building materials, review the Building Tips page, particularly the information about the dark gray and blue Connectors. Allow the students some time to explore the materials – it is crucial that they grasp the building concept at this stage so that frustrations are avoided later.
- Provide some basic guidelines for keeping track of all the pieces in the set so that they will be available for future use.
- Remind students that they will need about 5 minutes at the end of the class period for clean up.

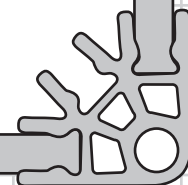

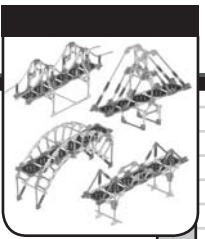

- Explain to the students that they will use the K'NEX materials to make a bridge. Discuss how, once they have developed the preliminary design drawings, engineers use small models to observe, study and test bridges for design, safety and strength. From the models, special building instructions called blueprints are made. Bridge builders follow these plans when constructing an actual bridge. If available, display an example of a blueprint - one of a house or your school would be acceptable – so that the students can identify the type of information that is typically provided on the document.
- You may need to draw the students' attention to the fact that blueprints, like all plans and maps, can only show 2 dimensions at a time. The **plan** can show the length and width of the structure while the **elevation** shows the height and *either* the length or the width (not both.) Make a sketch on the board to illustrate this.

Inquiry Activity:

Steps

1. Tell the students, "You are going to design a bridge using the following guidelines:
 - (i) It will connect two tables that are 30 – 40 cm apart.
 - (ii) You may only use pieces available in your K'NEX Set
 - (iii) The bridge must be able to support a shoe, sneaker, etc. for 15 seconds without falling.
 - (iv) You must decide what barrier it is designed to cross."
2. Explain that the bridge each group builds can be any size or shape, but their design must take into consideration:
 - (i) the characteristics of the barrier it is going to cross
 - (ii) who, or what, will be using it.
 - (iii) the load it has to bear (a shoe/sneaker)
3. Students should be given sufficient time to work with the K'NEX materials and develop a sturdy model that would allow passage across a physical barrier, whether it be an open space or an imagined river.
4. They should be encouraged to test its stability and to check that its load bearing capacity will accommodate a shoe.
5. Once the construction is complete the students should make a drawing that looks like a blueprint of their bridge on a piece of graph paper or a loose sheet of paper, using crayons or markers. Accuracy is important.

NOTE: If your students have the appropriate measurement skills and an understanding of the concept of scale, you may direct students to make their drawing to scale.

Applying The Idea (Assessment Activities)

- Students should take turns displaying their bridges to the rest of the class and describing:
 - The barrier the bridge was designed to cross.
 - Who, or what, the bridge is designed to transport.
 - The key design features they have incorporated into the construction.
- You can either have the students use their own working definitions or use this as an opportunity to introduce them to some bridge vocabulary. You may want to videotape or photograph the bridge designs.

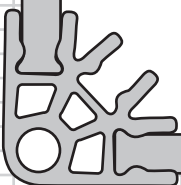

- Students should be prepared to demonstrate that their bridge passes the ‘shoe test.’

Ask the students to complete a definition for BRIDGE in their journals, which includes the words “structure” and “obstacle.”

BRIDGE: _____

- Encourage the students to list in their journals:

- 5 users of bridges.

To allow passage of people/pedestrians, animals, and road vehicles: cars, trucks, bicycles, trains, pipelines, canals etc.

- 5 obstacles that bridges span.

River, canal, creek, valley, ravine, estuary, marsh, water between islands, highway, rail track, gap between buildings, road intersections etc.

- 5 key words related to bridges.

Across, carry, support, join, connect, over, span etc.

NOTE: If possible, retain the models for the next class activity.

Extending The Idea

- Challenge the students to act as contractors and exchange plans/drawings with their classmates. Then ask them to build the bridge using the new blueprint. They should use only the blueprint and not the original model.
 - Ask the students to check each other’s bridges for accuracy.
 - Conduct a general discussion about the process and then ask the students to describe the blueprint and building process in their journals.
- Ask the students to work in pairs to collect photographs/pictures of bridges. Sources they can use include: www.brantacan.co.uk www.howstuffworks.com/bridge www.pbs.org/wgbh/buildingbig/bridge/
Suggest that they try to find different types of bridges and different types of barriers crossed by bridges. The emphasis should be on finding bridges that the students recognize as visually different from each other. At this stage in their inquiry they do not have identify the bridge design by name. The pictures can be displayed as a collage and annotated only after they are able to identify the **type** of bridge in each image from their inquiry activities.

JOURNAL CHECK: (Assessment Data)

Students should keep individual journals to record their findings. The following are examples of the types of items that could appear in each student’s journal:

- ✓ Description and sketch of a local bridge.
- ✓ Definition of a bridge.
- ✓ List of users and barriers.
- ✓ List of key words related to bridges.



Are All Bridges the Same?

How bridges support their loads.

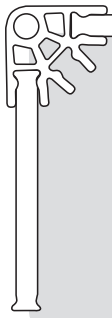
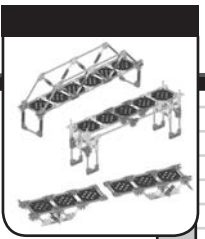

OBJECTIVES

Students will:

1. Review the forces acting on structures.
2. Differentiate between three types of bridges.
3. Investigate how a bridge supports its load.

MATERIALS

Each group of 2-3 students will need:

- Bridge models from the previous building activity
- Building Instructions booklet
- Items to represent a load (books, weights etc.)
- Crayons or markers
- Student Journals

You will need:

- A long board (light enough for the students to hold)
- Two bathroom scales or other weighing devices that will accommodate students
- 4 or 5 heavy books

PROCEDURE

Introduction

Ask the students to review the photos on Pages 3, 10, and 12 of the Building Instructions booklet. Encourage them to explain how they differ from one another. Ask them to check the names that are given to these different types of bridges and to suggest reasons why the particular bridge has been given that name.

Draw sketches of the bridges on the board based on their responses and add identification labels as well as some of the descriptive words that they use. The illustrations below can be used as the basis for your sketches, but at this stage omit the arrows.

The arrows will be added later in the activity.

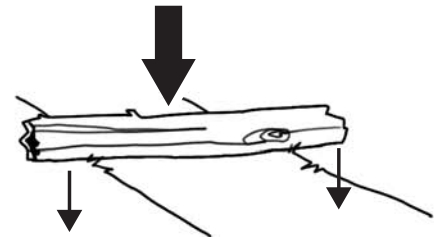
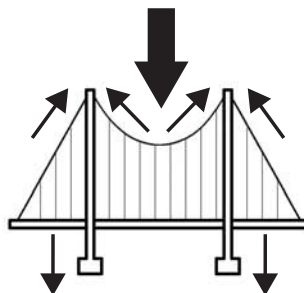
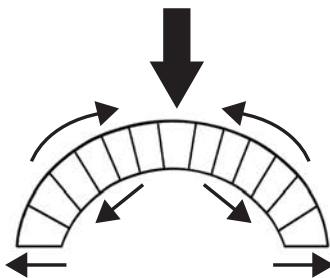

Inquiry Activity

Remind the students that forces are at work on any structure. Ask for volunteers to list examples of such forces.

Explain to the students that they can use the bridges that they built in the last activity to explore the possible forces at work on each type of bridge.

Squeezing/Compression; Pulling/Tension; Bending; Twisting/Torsion; Sliding/Shear.

If they disassembled the bridge they should be provided with the opportunity to build a new bridge.

NOTE: Please have students wear safety goggles as they test their bridges. This is sound safety practice for activities in the science classroom or lab.

Steps

1. Ask the students to examine the way their bridge is supported and then decide if it is a beam, arch or suspension bridge.

Most will have built a version of a beam bridge.

2. Encourage the students to place a load on their bridge (shoe, books, weights) and notice what happens to the various parts of the structure. They should continue to increase the load and identify what occurs. They should identify:

- which parts undergo bending, compression, tension;

Students may still feel more comfortable using terms such as bend, pushed together, pulled apart etc. Accept these terms and then encourage them to use the more formal terms.

- what happens to the supports of their bridge as the load increases;
- which parts of their bridge fail first.

Labeled sketches of their bridges with the effects of their load on the structure should be drawn in their journals. They should, for example, identify those parts of their bridge that are bending or leaning, or have shifted position.

3. Ask the students to apply their observations from their models to the diagrams of the three types of bridges drawn on the board previously. Encourage them to suggest where forces may be at work on each bridge. Draw arrows based on the students' suggestions.

With lower grade levels you may decide to focus on the forces acting on the beam bridge only.

NOTE: Arrows can be used on bridge diagrams to show the direction in which forces are applied and transferred along a bridge structure. Many of the websites you and the students investigated earlier used arrows to demonstrate the same thing. Using the board or overhead projector you can use color to differentiate between forces.

Arrow Key:



A fat arrow pointing down represents the load.



Arrows along the bridge cables, beam, or arch represent tensions and compressions,



Arrows at the abutments and piers represent transfer of weight to the ground.

For example: all the arrows on an arch bridge stand for compression while most on a truss or beam stand for a combination of compression and tension.

4. Engage the students in a discussion about the various types of **LOAD** that a bridge must support.
 - (a) Ask the students to brainstorm the types of loads that bridges are designed to support. Record their thoughts on the board. You may have to probe for the less obvious loads.
 - (b) Help the students to recognize the main categories of loads that a bridge must be able to carry:
 - **Dead load:** the weight of the materials making up the bridge. In most bridges, the greatest load a bridge must carry is the weight of the bridge itself.
 - **Live Load:** the weight of the people, vehicles, animals, and other commodities that use the bridge.



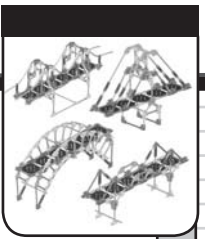

(Suitable for the upper grade levels:)

Environmental Load: the effect of strong winds, snow and ice build up, and earthquakes.

Shock Load: The sudden, high impact that certain users create as they cross the bridge.
For example: a heavy freight train or truck.

- (c) Invite the students to look at the list on the board and organize the loads into the categories discussed above. They should record this information in their journals.
5. Explain that a successful bridge must be able to either distribute the weight of these loads down and into their foundations, or balance them with opposing forces. Ask for two volunteers to help demonstrate this principle.

NOTE: It is probably not a good idea to have the students read out their personal weight when standing on the scales. If necessary, you should help them compute the changes in weight when they are holding the board.

- (a) Set out the 2 bathroom scales the same distance apart as the board the students will hold.
- (b) Invite one student to stand on one of the (bathroom or other) scales. Explain that this student represents a post or **PIER** that is a support for a bridge. Ask the student standing on the scale to make a mental note of his/her weight.
- (c) (i) Hand the student, still standing on the scale, a long board and ask him/her to first hold the board **horizontally**. The board represents the roadway or **DECK** of the bridge.
- (ii) The student should observe the new weight reading on the scale.
- (iii) Ask the student to then hold the board **vertically** and to note whether the scale reading changes with a change in the direction of the board. Ask the student to share his/her observations.

The weight reading on the scale remains the same regardless of the direction in which it is held.

- (d) Help the students to conclude that the weight of the whole length of the bridge including the pier presses down through the pier.
- (e) Ask the students to imagine that the weight travels along the deck of the bridge and then down the pier to the weighing scale. Ask for a volunteer to draw this on a diagram of a beam bridge, using arrows.
- (f) Weigh the board and record the result in Data Table 1.
- (g) Ask the second student to stand on the other scale and make a mental note of his/her weight. The two volunteers should each hold one end of the board. Ask the rest of the class for their predictions about the results/ distribution of weight.
- (h) To test the predictions have each student stand on a scale to identify how the weight of the board is distributed between them. Ask each student to state by how much the weight has increased on his/her scale. Answers can be recorded in a table such as the one shown below (Data Table 1.)
- (i) NOTE: You could add books to the board in Step (g) to represent a Live Load and to provide greater variation in the weight at each pier.

Answers will vary, but most should be able to predict that the weight will be evenly distributed.

Data Table 1

WEIGHT OF THE BOARD	INCREASE IN WEIGHT AT PIER #1	INCREASE IN WEIGHT AT PIER #2	TOTAL INCREASE WEIGHT ON THE PIERS

Applying the Idea (Assessment Activities)

- Students should include a brief description of the types of load supported by a bridge by completing the following:

LIVE LOAD: _____

DEAD LOAD: _____

(Upper grade levels)

ENVIRONMENTAL LOAD: _____

SHOCK LOAD: _____

- Discuss the results of the weight distribution experiment and ask the class to write a journal entry addressing this. They should include a copy of Data Table 1 showing the weights recorded.
- Ask the students to complete the sketches of the beam, arch and suspension bridges by adding arrows to indicate the direction in which the weight is transferred.

Extending The Idea

1. Encourage students to look at home and select at least three different structures (table, chair, bed, lamp etc.). They should make a drawing of each structure and demonstrate how each supports its load, using arrows to show the direction in which the weight is transferred.

JOURNAL CHECK: (Assessment Data)

- ✓ Labeled sketches of their bridges with effects of forces noted.
- ✓ Completed Data Table 1 with explanation.
- ✓ Annotated sketches of a beam, arch and suspension bridge, showing forces.
- ✓ Descriptions and categorization of types of loads.



The Beam Bridge:

Classifying components and finding ways to strengthen beam bridges.



OBJECTIVES

Students will:

1. Identify the basic characteristics of a simple beam bridge.
2. Understand and use vocabulary associated with a beam bridge.
3. Explore the advantages, disadvantages, and best application of a beam bridge.
4. Build models of beam bridges using K'NEX materials.

MATERIALS

Each group of 2-3 students will need:

- 1 K'NEX Bridges set with Building Instructions booklet
- Hooked/slotted masses or other weights (10-1000 grams)
- Student Journals

You will need:

- A pre-built K'NEX beam bridge
- A piece of solid foam rubber approx. 12" x 2" x 2" (30 x 6 x 6 cm) (This is the type of foam used in chair pads and cushions)
- Marker

PROCEDURE

Introduction

- Explain to the students that the lesson will focus on investigating a type of bridge called a beam bridge. This is the simplest of all bridges and may have been the first type of bridge used – perhaps taking the form of a fallen tree spanning a stream. Modern beam bridges are made from steel beams and can be quite complex structures, but all beam bridges are alike in the way they support their own weight and the load they bear on upright or vertical supports.

- Allow the students to look at the K'NEX beam bridge. Ask them to point out the parts of the bridge that serve as supports. Write on the board any terms they use to name these structures.



Supports, posts, pilings, towers, sticks, piers etc.

Remind them of the term **pier**, used by bridge builders to describe the vertical supports of a bridge. Ask the students to use their own words to identify other parts of the bridge and then introduce the following terms:

Beam - the horizontal framework that rests on the piers.

Span – the distance between piers.

Deck – the surface of the bridge that serves as a walkway, roadway or railway.

Ramp – the inclined section that connects the land to the deck.

Guardrails – the protective barrier that runs along the horizontal decking to keep the bridge users from falling/driving over the side.

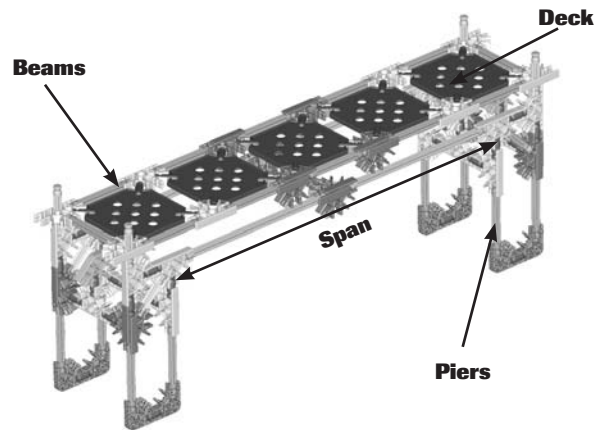

Develop a vocabulary list of these terms for future reference.

Inquiry Activity I: How long can a beam bridge be before it fails?

Steps

NOTE: Please have students wear safety goggles as they test their bridges. This is sound safety practice for activities in the science classroom or lab.

1. Explain to the students that their first investigation will be to see what happens to a simple structure as it becomes longer and longer. Before they begin their building activity ask them to think about the following questions:
 - What will happen to the load carrying ability of the bridge as it becomes longer?
 - How might they test their ideas?
 - What measurements will they need to make?
 - Where on the bridge will they actually take the measurements?
 - Where do they think the weakest parts of the structure occur?

Preliminary thoughts about these questions should be recorded in their journals.

2. (a) Divide the class into groups of 4-6 students and distribute 2 K'NEX Bridges sets to each group.

Explain that they can build their bridge between two desks or two chairs or two large boxes. Provide them with enough time to build and test their bridge.

NOTE: There should be enough room to hang conventional weights from the bridge. If these are not available the students may devise an alternate method of measuring the bridge's load bearing capacity.

The simplest place to load the bridge is in the center of the span. Students could make a beam bridge using the long K'NEX red Rods and yellow Connectors starting with 2, then 3, 4 ... 6. At each stage the load bearing capacity of the 'bridge' can be measured.

- (b) Students could be encouraged to plot the load against the bridge length. They could use the number of rods as non-standard measurements. They should record their observation through notes and and/or annotated drawings.

The most likely place for the K'NEX bridge to fail is at the joints (Connectors.)





3. Discuss the students' findings

They should have discovered that as the span of the beam bridge increases, the weaker it becomes. The beam will begin to bend under its own weight and may even break without any load being placed on it. In the case of the K'NEX beam bridge the failure will be at the joints (Connectors).

Careful observation of how the beam fails shows that the joints snap open at the bottom. This demonstrates that the beam is being stretched at the bottom i.e. put under tension. The top of the beam will be under squeezing forces or compression. Eventually even the Connectors will unsnap if enough tension is placed on them.

This provides an opportunity to review the effects of compression and tension on a structure. You may want to demonstrate this again using a piece of foam rubber with vertical lines drawn on the side. (See Page 6, Key Concepts.) Exerting pressure on the center of the piece of foam will compress the upper edge, causing the lines to move closer together, and create tension (stretching) in the lower edge, causing the lines to move further apart.

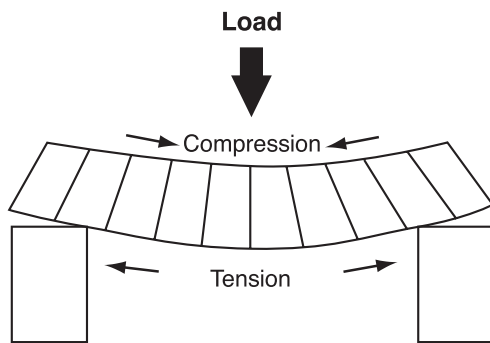

Ask the students to resort the K'NEX pieces before proceeding with the next building activity and then divide the class into groups of 2-3 students with a set for each group.

Building Activity

- Ask each group to build the K'NEX beam bridge on Pages 2 of the K'NEX Building Instructions booklet. When complete, allow them a few minutes to investigate how it works. They may want to pull/push a wheeled toy vehicle over the bridge.

Inquiry Activity II: How to expand and strengthen a beam bridge.

Steps

NOTE: Please have students wear safety goggles as they test their bridges.

- Ask the students to place their bridge on a piece of paper and carefully mark the inside front edges of the each of the piers. These marks will be their reference points for any separation of the piers. Suggest that the students press down hard with two fingers on the black plates at either end of the bridge and notice what happens (if anything) to the red Rods that span the two sides of the bridge and to the piers at either end.

They should notice that there is no change to the shape of the Rods and no movement of the piers. They will notice some depression in the black plates as they apply pressure to them.

2. They should then repeat the application of pressure to the center plate and notice what happens now to the red Rods and the piers.

In this location they should notice that pressure causes the red Rods and the Connectors to move and bend slightly, while the piers will begin to spread apart at the bottom. They can measure the distance the piers move by marking their new location and comparing it with the original.

3. Add weights, one unit at a time, to the center of the bridge and notice how much weight the bridge can carry before it begins to bend. Students can record their observations in a Data Table such as the one shown below. They should record the increasing weight in the spaces provided and indicate with a check mark the weight at which they first notice bending of the red Rods and movement of the piers. If time allows, they can continue to add weights to identify the maximum load, beyond which the bridge fails.

4. Hold a ruler against the bridge at the center of the span and measure the change in the distance from the deck to the table below as weight is added.

If the span begins to sag, the measurements should show this.

5. (a) Ask the students to build the Long Span bridge shown on Page 3 of the Building Instructions booklet and repeat Steps 2 and 3, noticing what changes, if any, occur to the red Rods and the piers.

Their findings should be similar to those in Steps 2 and 3 above.

- (b) Repeat Step 4 using weights. Record findings in the Data Table.
- (c) Students should compare their findings for the two versions of the bridge.

Data Table

SHORT SPAN BRIDGE	Weight	Weight	Weight	Weight	Weight
Bridge parts bend					
Piers move apart					
LONG SPAN BRIDGE	Weight	Weight	Weight	Weight	Weight
Bridge parts bend					
Piers move apart					

Students should find that the bending (sagging) of the bridge components is greater in the center of the Long Span bridge than in the Short Span version and the piers spread apart further. They should also find that the bridge fails carrying less weight than the Short Span bridge.

6. Next, ask the students to remove the black decking to the Long Span bridge and try Steps 2 and 3 once more, but this time applying pressure directly onto the connectors holding the red rods and the piers. They should note their observations in their journals.





Applying The Idea (Assessment Activities)

- Discuss the groups' findings concerning the application of pressure to the two points along both bridges and the application of weights.

- Ask the students to use their observations to answer the following questions in their journals:

- Where is the weakest part of each bridge?

Students may suggest the center of each bridge and its joints.

- Which bridge had the greater load bearing ability?

The Short Span bridge.

- What effect does the roadway or decking have on the load bearing capacity of the bridge?

The decking gives additional strength to the structure by adding another layer that helps to resist the bending forces acting on it.

- Discuss how structures can fail when loaded and how the weight of the structure itself must also be considered because, in bridges, this can also cause a beam to bend.

- Because of this problem, engineers must develop ways to reinforce the beams to add strength and reduce bending.

- What other modifications could be made to the bridge to help strengthen it?

*Adding more **PIERS**.*

- Encourage the class to brainstorm the advantages and disadvantages of adding more piers to strengthen the beam and creating more spans. Record their ideas on the board.

Building additional piers offer an increased number of locations to build a beam bridge; building piers on land is relatively easy; increase the cost of building; building becomes more difficult when piers have foundations in water; space is required for the passage of boats.

- Can they suggest why the K'NEX beam bridges do not behave like the beam bridges in the photographs?

When loaded, the two K'NEX piers will start to spread apart as the beam bends. In the photographs of real beam bridges, both ends of the bridges are firmly anchored. By stopping the bottoms of the K'NEX piers moving, the rigidity and strength of the K'NEX beam bridge can be greatly increased.

- Invite the students to complete **Worksheet 1: Beam Bridges**, to summarize the parts of a beam bridge.

- Discuss how the limitations of beam bridges influence where they can be used and how this makes other bridge designs necessary.

Extending The Idea

1. Ask the students to consider the following:
"If you were designing a bridge to cross a river, you might want the bridge to have as few piers as possible. List reasons why you would like the bridge to be designed this way." They should write their responses in their journals.
2. Encourage the students to find pictures of beam bridges or to refer to local examples in the community and then compare and contrast the piers, beams and spans of the various examples. Suggest that they think about the construction materials for the piers (wood/metal/concrete), their relative size (short/tall/ wide/narrow), spacing (close/distant), where anchored (water/land). Beams may be short or long, wide or narrow, wooden, metal or concrete, constructed for foot or vehicular traffic. Spans can vary in length and quantity.

JOURNAL CHECK (Assessment Data):

- ✓ Responses to Step 1 of Building Activity I.
- ✓ Graph and record of observations for test bridge.
- ✓ Completed Data Table for Building Activity II.
- ✓ Comparison of the Short and Long Span bridges with respect to load capacity.
- ✓ Effect of the decking on the beam bridge.
- ✓ Completed worksheet identifying the parts of a beam bridge.

NOTES:





The Truss Bridge:

Experimenting with the strength of truss bridge design



OBJECTIVES

Students will:

1. Identify that structures can fail and explore methods used to strengthen and reinforce them.
2. Understand the need for an experimental design that includes a fair test.
3. Design and carry out an experiment.
4. Evaluate the strength of a truss bridge through experimentation.
5. Explain why a truss is a useful structure for bridge building and other structures.



MATERIALS

Each group of 2-3 students will need:

- 1 K'NEX Bridges set with Building Instructions booklet
- Weights measured in designated amounts (actual weights: 10-1000 grams, books etc.)
- Paper
- Pencil
- Crayons/markers
- Scale
- String/cord to suspend weights
- Student Journals

PROCEDURE

Introduction

- 
 Remind your students of their investigations into the strength of beam bridges. Review methods of strengthening/stabilizing a beam bridge.
- 
 Remind the class that adding piers to a beam bridge is not always a practical option, especially if you need to bridge a very deep, or wide, river. Ask if they can give some reasons why.
- 
 Suggest to the students that what is needed is a long, strong span and ask students what other options they can think of if adding piers is not an alternative. List their ideas on the board and ask them to explain why they think their idea will work.

Students will most likely suggest the addition of piers.

Difficult to sink piers into the river bed, or too expensive, or they would be too long and unstable.

The students may suggest using more rigid materials or making the span thicker.

NOTE: The Forces Lab at www.pbs.org/wgbh/buildingbig/bridge/ provides some very useful background information on this topic.

- Ask the class what other types of structures are strong and rigid - what shapes are used in these structures. If necessary remind the students about the way in which rectangular structures can be made stronger by reinforcing them using diagonal braces i.e. triangulation. Students could be allowed the opportunity of investigating this point for themselves if you did not introduce them to it in the Preparatory Activities unit.

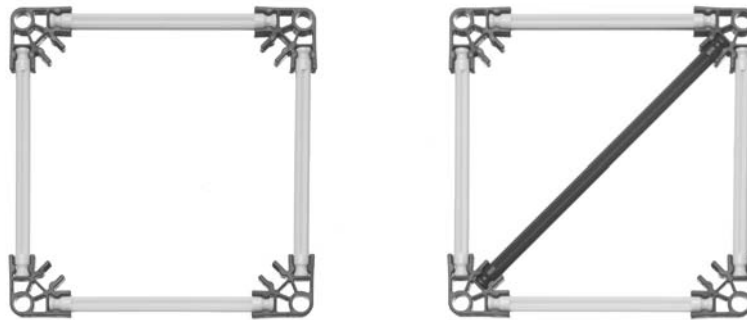

Optional Building Activity

- Ask the students to build a square using 8 K'NEX pieces. (Suggestion: Use 4 yellow Rods and 4 red 90-degree Connectors.)
- Encourage them to try to gently twist and bend the square. Next ask them to add one Rod to their square and ask what they notice. (They can use a red Rod to act as a diagonal.)
- Ask what shape was formed when they added the Rod to the square.

Students should respond that the addition of the Rod has made the square less flexible.

TWO triangles.

- Explain to the class that triangles are exceptionally strong shapes – they are the only geometric form that cannot be bent out of shape. Ask the class if they can think of any large structures that have a triangular shape.

Students may suggest the triangular standards on the end of their swing sets, the gable ends of houses, or the triangles used in the geodesic dome at the Epcot Center in Orlando, FL. Have pictures available, if possible.

- Explain how engineers use the strength of triangles to create a framework called a **TRUSS**. Trusses can be used to build long spans and enhance strength without adding to the weight of a bridge, as a thicker beam would do. The TRUSS bridge was designed as a latticework of triangles that helped to keep a structure from bending, twisting or pulling out of shape.

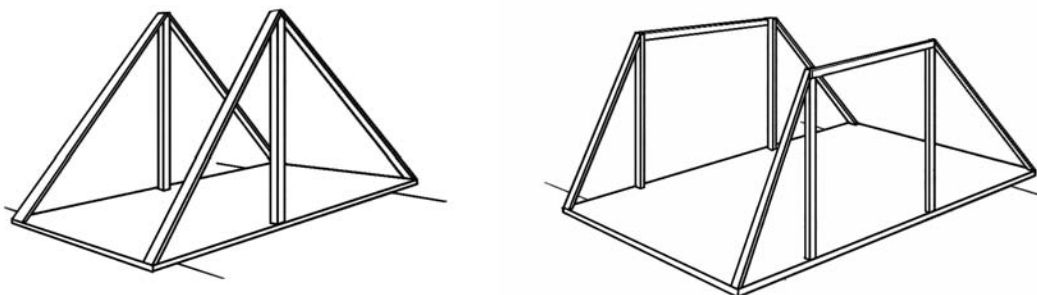



- You could take this opportunity to introduce the term stability as it relates to bridges i.e. stability is the ability to resist being deformed, or buckling, or collapsing when a force or load is applied. (Please refer to the Key Concepts section of this Guide for additional information on this topic.)
- Explain to the students that they will build a number of versions of the truss bridge and will investigate the strength of truss systems.
- Ask the students to work in groups of 2-3 students and distribute a K'NEX Bridges set, with a Building Instructions booklet, to each group.

Building Activity I:

- Ask each group to build STEP 1 of the Warren Truss Bridge on Page 4 of the Building Instructions booklet.
- Explain that they should not build Steps 2 and 3 until they have tested the load bearing capacity of the basic beam bridge first.

Inquiry Activity I: How strong is the bridge without its truss structure?

Steps

NOTE: Please have students wear safety goggles as they test their bridges. This is sound safety practice for activities in the science classroom or lab.

1. Ask the students to examine their basic beam bridge by pushing on it and then predict, with reasons, the weight their bridge might be able to support.
2. Ask the entire class what they think would be a fair test for measuring the strength of the bridge. They should be helped to understand that a fair comparison can only be made if testing methods are the same.
3. It is likely that the students will suggest using weights to measure the strength of the bridge. Use questioning strategies to explore how, and where, they will place the weights. You may want to introduce the term 'variable' at this point. Help the students understand that the way in which they place the weights should be the same in every test. In this way, the only *variable* is the amount of weight and not the way the weight is distributed.

NOTE: Hanging the weight underneath the bridge is a more consistent test than placing the weight on the decking or rails. If, however, they hang weights underneath the bridge they should make sure that the bridge is spanning the gap between two desks or chairs.

4. They should record the weight at which the bridge fails and make a note of the weak points. You should gather every group's findings and display it on the board.
5. Ask the students to look at the data on the board for the various groups in the class. Ask, "Do you see any information that is not consistent with the other groups in the class? Can you offer explanations for any data that seems to be different from the other groups?"

Building Activity II:

- Ask the students to undertake any necessary repairs to their bridge and then continue with Steps 2 and 3 in the Building Instruction booklet to complete the Warren Truss Bridge.

Inquiry Activity II: How strong is the bridge with the addition of a truss structure?

Steps

NOTE: Please have students wear safety goggles as they test their bridges.

1. Students should re-test their structure using the same experimental design as before.

2. When all the results have been recorded, invite the class to work in teams of 4-6 students and build 2 variations of Warren Truss Bridge: the **Howe Truss** and the **Baltimore Truss**. These are shown on Page 5 of the Building Instructions booklet.

You should have available for reference purposes one or two models of the Warren Truss Bridge.

3. (i) Once the group has built both bridges, ask them what they notice about the designs.

Students should notice that the number of triangular shapes incorporated into the design varies.

(ii) Encourage the class to make predictions about the number of triangles built into the structure and the strength of the bridge. These initial thoughts should be noted in their journals.

4. (i) Ask each team to test their new designs and record their findings in a table such as the one below. They should also make labeled diagrams.

(ii) Ask the students to count the number of triangles used in each of the different bridge structures. Their results should also be recorded in the Data Table.

(iii) What do they notice, if anything, about their findings?

Students should notice that creating an increasingly complex lattice of triangles increases the strength and stability of the bridge.

5. Review their findings. Ask why, if they had included the K-Truss Bridge model in their investigation, it would not have been a fair test. Ask them to look very carefully at the Building Instructions for the K-Truss and compare them with the other 3 bridges on Pages 4 and 5.

Students should be helped to see that the K-Truss model is a different length from the other bridge models.

Data Table

NAME OF BRIDGE DESIGN	MAXIMUM LOAD (WEIGHT)	NUMBER OF TRIANGLES IN STRUCTURE
Warren Truss		
Howe Truss		
Baltimore Truss		





Applying The Idea (Assessment Activities)

- Review the following with the class:

- What is the framework of triangles called that you added to a simple beam bridge?

Truss.

- By adding a framework of triangles what has happened to the height of the beam?

It has increased.

- Why do engineers use triangles for these structures?

*The triangle shape is known for its strength and will prevent the beam from bending and twisting out of shape. It has increased the **stability** of the structure by making it more rigid.*

- Refer to the students' findings about the relationship between the number of triangles and the weight tolerance of the structure. Encourage the students to summarize their findings in their journals using appropriate vocabulary.

- Ask the students to explain, in their journals, why they think their testing of the strength of the bridges was a "fair test."

- (Suitable for upper grade levels.)
Talk to the students about the **advantages** of a truss bridge design.

- Refer the students to the information on Page 5 of the Building Instructions booklet, which explains how this type of bridge was developed to carry heavy trains, with their problem of **SHOCK** Load across barriers. (See the Key Concepts section of this Guide for more information on this.) Bridge builders discovered that the addition of triangles to the structure allowed them to use tall beams to carry **LIVE** loads, weighing 100 tons (or more) that shifted weight as they moved.

- The trusses not only made the beam stiffer but they spread out the compression and tension forces through the structure when a load is applied. With beam bridges, the top of the beam was being compressed and the bottom to the beam was under tension and it began to bend. With the truss bridge, the tension on the bottom of the deck is transferred to the members that make up the trusses, thus the bottom of the deck remains rigid. This is important, especially as heavy loads are moved across the bridge.

- Have the students consider how effectively a truss bridge would withstand strong winds. Lead them to see that an open framework allows wind to pass through, reducing the effect of the wind's force (**ENVIRONMENTAL** load) on the bridge.

- Explore some of the **limitations** of this design when increasing the span. Ask the students to consider what will happen as they add more and more trusses to the bridge to enable it to extend over larger and larger barriers. If necessary remind the students about some of the effects they observed in the previous lesson.

*They should respond that the **DEAD** load of the bridge would increase until its own weight is so large that it would be unable to support itself. A longer span also means there is the potential for a larger live load on the bridge, as more traffic will fit on the structure.*

- Ask the students to write about the advantages and disadvantages of the Truss bridge in their journals. They should be encouraged to refer to the types of **LOADS** that the bridge must support in their answers.

Extending The Idea

1. Ask the students to tell how beam bridges and truss bridges are alike. How are they different?

Students may identify that both are beam bridges and have the same basic parts, but that truss bridges use a triangular framework and tend to be longer and stronger. They might also compare the materials from which each type of bridge could be made.

2. Working in pairs:
Ask the students to design and make plans for their own truss bridge pattern. Each pair may either make their own truss bridge or ask another group to build to their plans.

3. **Design Task** – Build a **truss** bridge that spans 50 cm and can bear the weight of a dictionary.

⊗ 2 groups combined as a bridge design team.

⊗ They have 10 minutes planning and 20 minutes to complete the building activity. They may use the contents of two kits.

⊗ Each group then tests their bridge, while the remaining groups observe. Encourage each group in turn to:

- (i) share any problems they had with their structure and describe how they overcame them.
- (ii) suggest ways in which their designs could be improved.

Encourage the use of correct terminology and vocabulary.

4. Ask the students to use **Worksheet 2: Truss Jumble**, to identify as many variations in truss design as they can. Those with which they are unfamiliar should be identified through library or Internet research.

JOURNAL CHECK (Assessment Data):

- ✓ Data on weight at which bridge fails with and without truss structure
- ✓ Completed Data Table comparing 3 types of truss bridge design.
- ✓ Relationship between the number of triangles used and the strength of a truss bridge.
- ✓ “Fair test” justification.
- ✓ Advantages and disadvantages of the truss bridge design. (Upper grade levels only.)





The Cantilever Bridge:

A balancing act: identifying the distinctive characteristics of cantilever bridges.

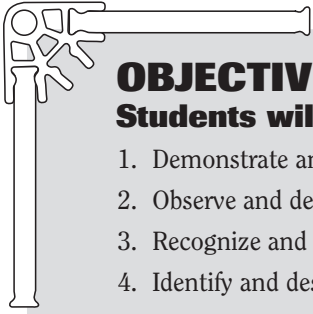

OBJECTIVES

Students will:

1. Demonstrate and explain the cantilever concept.
2. Observe and describe the forces acting on a single pier and span structure.
3. Recognize and understand the spatial relationship between the parts of a cantilever bridge.
4. Identify and describe the application of the cantilever concept in other structures.

MATERIALS

Each group of 2 students will need:

- K'NEX Introduction to Structures: Bridges with Building Instructions Booklet
- Hooked/slotted masses or other weights (10-1000 grams)
- 5 (or 9) similar sized books or blocks of wood
- Student Journals

You will need:

- 5 x meter sticks or yardsticks.
- 2 chairs
- 2 x 5-6 books tied together with string/cord

PROCEDURE

Introduction

- Explain how, as trade and travel between areas increased and as new forms of transport were developed, the need arose for engineers to design and make bridges that could carry heavy loads over longer distances. Remind the students that in the previous lesson they discovered how the TRUSS bridge overcame some of the engineers' problems. When faced with crossing a wide estuary, however, a new solution had to be found.

- Ask the class what they understand by the term **estuary**.

The mouth of a river where it enters a sea or ocean. It is usually the widest part of the river and is tidal.

- Ask what problems engineers may have when they build a bridge across an **estuary**.

Wide expanse of water; marshlands make it difficult to construct firm foundations; large ships may need to sail up river to a port; tides create a large daily range of water levels.

- Suggest that the students investigate "estuary" on the web to see if they can determine why the bridge designs they have studied so far may not be appropriate for this type of location.

- Explain that in some cases crossing an estuary can be accomplished by building a tunnel, but that is not always a practical solution. One alternative is a design known as a CANTILEVER bridge. This bridge design is not new - small wooden cantilever bridges were built in China and Tibet more than 2,000 years ago - but longer cantilever bridges, capable of handling heavy rail traffic, could not be built until steel became available for bridge building in the late 19th Century.

What is a cantilever?

- Help the students understand that the cantilever bridge is another variation of a truss bridge. Explain that unlike the truss, or the simple beam bridge, however, the beams in the cantilever do not require two piers for support, just one. Bridges using this design are made from multiple cantilevers and often include an additional beam that is supported by the cantilever structures.
- Ask the students to imagine two diving boards, one built on either side of a river. The 'boards' extend out over the river and either meet to form the completed span, or an additional beam is suspended on the two boards to form an even longer span.
- You may want to draw a sketch on the board to demonstrate the principle.

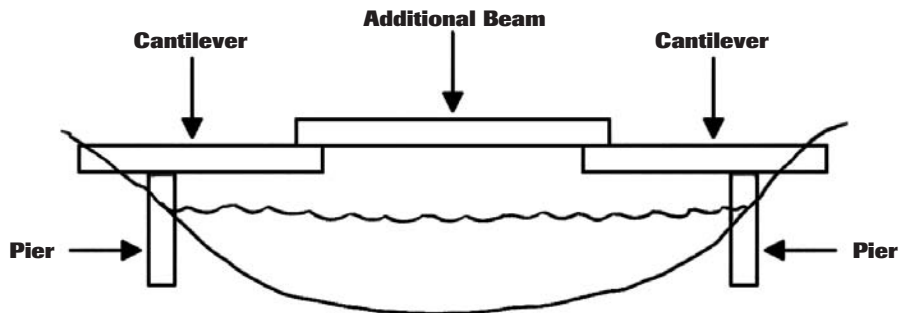

- Demonstrate the cantilever concept by asking the students to make a cantilever from books or blocks of wood.
 - ⊗ Working in groups, ask the students to use 5 equal size books (or blocks of wood). Stand two books up to represent the piers of the bridge. On top of each pier, place a book that will be the cantilever. Each pier and cantilever should look like a letter T. Next connect the two cantilevers by balancing a book across the gap between them.
 - ⊗ Encourage the students to experiment by moving the cantilevers closer together or farther apart to see how the whole structure balances.
 - ⊗ Alternatively, the cantilever can be made from a symmetrical stack of 9 books, with all the books lying horizontally. By arranging the books in this way, the students will see that the stack will need support as it is being built. As the stack is built sideways it will begin to topple over. This is the cantilever action. The structure has become unstable, yet upon completion, the whole structure is stable..

Cantilever

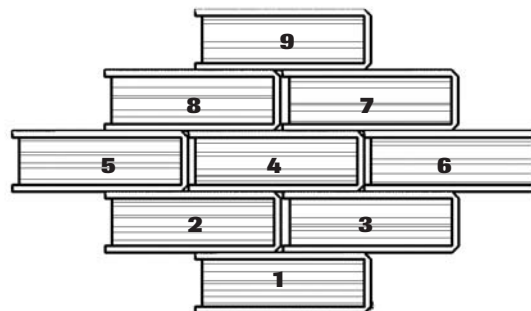
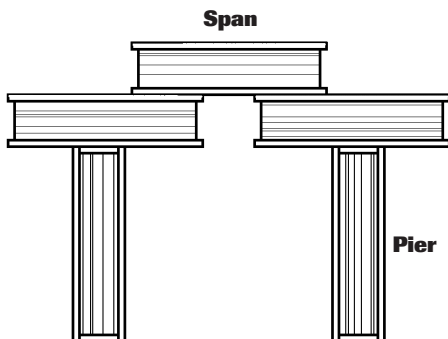



- Ask the students to compare the shape they produced with books, with the photograph of the Forth Railway Bridge in their Building Instruction Booklet on Page 6. Both are very similar. Can they identify the cantilevers in the real bridge?
- Explain to the students that they will investigate the features of a cantilever bridge by first building a model of one from K'NEX. Organize the class into groups of 2-3 students.





Building Activity I:

-  Distribute a K'NEX Intro to Bridges set to each group.
-  Asking them to build Step 1 only, (the road decking), of the K'NEX Cantilever model on Page 6 of the Building Instructions booklet. Two students should each build exactly one half of the decking.

Inquiry Activity I:

How can a cantilever be balanced?

Steps

1. Working in pairs (or taking turns), ask students to hold one end of their road decking in a horizontal position above their desk. This will help them feel the forces involved. What do they notice?

They should find that it is quite difficult to hold the decking in a horizontal position – forces act on it to pull it downwards. It is unstable. They may say that they have to press down hard with their thumb and fingers to hold it horizontal. Some may state that gravity is pulling the structure downwards.
2. Add small weights to the outer end to simulate a load on the bridge - what do they feel now?

The decking should feel even less stable or unbalanced.
3. Place the road decking on an upright book so that most of the decking is unsupported (as it was when you held the end of it in your hand.) Now add weight to the part of the decking that rests on the book. Can you balance the decking with this weight?

Students should notice that the deck does not have to be centered on the book to be balanced, so long as extra weight is added to the shorter end.
4. The students should be helped to understand that the cantilever has to balance and be able to stand on its own – this can be accomplished by:
 - (i) extending each span backwards, away from the center of the tower/pier to make a T-shaped structure.
 - (ii) adding counterweights, or anchors, to the ends of the cantilevers, where they meet the shore. These anchors serve as weight at one end of the cantilever system, so the portion of the deck extending beyond the pier, over the water, can be longer.

(Your judgment will determine if the next series of activities are appropriate for your students.)

5. Ask them to look again at their balanced decking on top of the upright book and to consider ways that they might enhance the cantilever system to make it even stronger. They cannot add more piers to the section of the bridge that extends over the water.

*They may suggest **adding supports**. You may need to talk about ways of supporting and reinforcing weak structures. Encourage them to think about techniques they have used before when they needed to push or pull up a structure. Students should suggest using diagonal braces/trusses/triangles. Ask how might they be used in this instance.*
6. Record their ideas on the board. Discuss their findings and possible solutions to providing additional support to the cantilever structure. Help them to see that the cantilever system can be enhanced and improved by the addition of other bridge building techniques like trusses.
7. Summarize by explaining:
A cantilever bridge is generally carried by 2 beams, each beam supported by one pier only. Weight on a cantilever bridge system is transferred to the piers and then to the ground or bedrock. Each pier is firmly embedded in bedrock and the deck, supported by the pier, extends out on either side of it. In the cantilever system, the weight of the deck (and/or the anchors/counter weights) on the landward side of the pier balances the weight of the deck extending over the water. The balance of the forces involved allows the deck to extend far over the water with a minimal amount of additional support.

Building Activity II:

-  Ask the students to complete Steps 2-6 of the Building Instructions and investigate how their K'NEX Cantilever bridge model functions.

Inquiry Activity I:

What are the distinctive parts of a cantilever bridge and what are their functions?

Steps

1. Invite the students to determine which parts of this bridge are similar to the other bridges that they have investigated. What features are different from the beam and truss bridges? They should record their observations in their journals.

2. Ask the students why their model bridge extends back from the supporting piers.

Students should recognize that this is to help balance the cantilever – it creates a T-structure.

3. Ask the students to add a weight (load) to the center span to simulate a train crossing the bridge. What do they notice about the supporting piers? All observations should be recorded.

In this model they will notice that the bases of the piers tend to separate outwards.

4. How is the road decking supported so that it remains rigid and strong enough to support the load?

There is a network of trusses above the bridge.

(Appropriate for upper grade levels.)

5. Suggest that the students re-enact the demonstration that Sir Benjamin Baker created to convince people that his cantilever design for a rail bridge across the Firth of Forth would work. Please look at the diagram below.

For safety reasons, this demonstration will not include the central span with a figure sitting on it.

- (a)
 - (i) Make 2 “counterweights” by tying piles of heavy books together.
 - (ii) Two chairs should be arranged with a gap of about 2-3 meters between them.
 - (iii) Place the “counterweights” about half a meter away from the outside edge of each chair.
 - (iv) Ask 2 students to sit on the chairs, holding a meter stick in each hand. One end of each stick should be wedged under their upper thighs so they keep it in place by sitting on it. The other end extends out at an angle. Their arms should be stretched straight out from their sides, firmly holding the sticks. Their backs should be as upright as possible.
 - (v) The 2 outer meter sticks, close to where there are being held, should be securely tied to the piles of 5 or 6 large books, placed on the floor to the side of each chair.
 - (vi) Ask a third student to hold a meter stick between the extended arms in the middle to represent a central span.

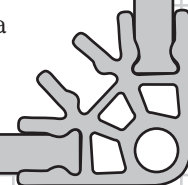

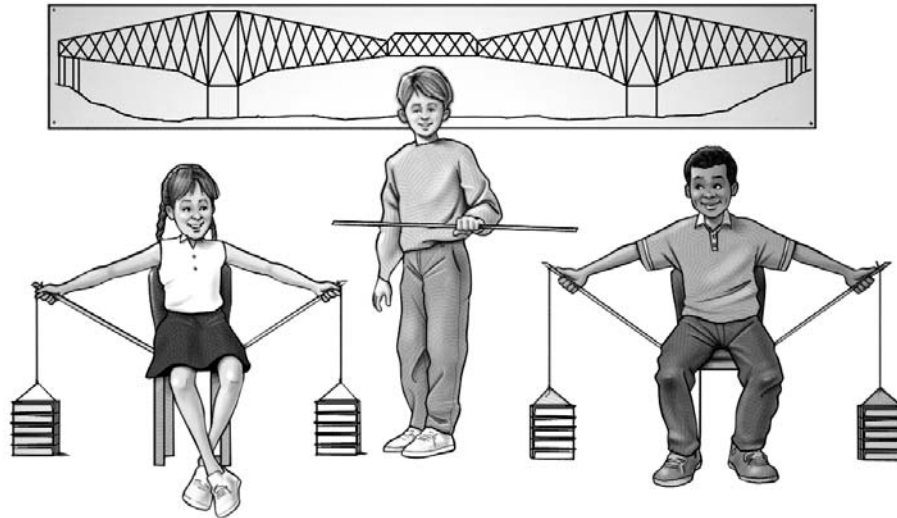

- (b) Hold up a model of the K'NEX cantilever bridge and relate the parts of that bridge to the students in the demonstration. Explain to the class that the two students who are seated represent two cantilever structures with their bodies acting as the piers/towers, their arms represent the upper parts of the cantilever and the meter sticks act as trusses or supports. The piles of books, on either side, represent the counter-weights or anchors, required to balance the cantilever structure. The third student holding a meter stick represents a middle span balanced on the two cantilevers.

- (c) Ask the class to notice what happens to the meter sticks held by the two students.

*They should notice that they bend or are pushed downward. They experience **compression**.*

- (d) Ask the two students who are seated to describe how their arms feel.

*They will probably say that it is hard to hold them out for long – help them to understand that what they are feeling is **tension** – their arms are being pulled or stretched.*

- (e) Ask the rest of the class what they notice about the students' bodies as they hold their position for a few minutes.

They will probably notice that the bodies are no longer sitting up straight but are beginning to sag – help the class to recognize that this suggests the bodies are experiencing the force of compression.

- (f) Help the students to recognize that two forces are in balance – the upper parts of the cantilever structure (the students' arms) are under tension, but this is balanced by the lower part of the structure (bodies and meter sticks) that is in compression.

(Appropriate for upper grade levels.)

6. Ask the students to examine their own models and observe, either by either pressing down gently on the structure, or by adding weights:

- (a) Which parts of the bridge are under compression?

The supporting piers/towers and the triangular trusses beneath the deck are under compression.

- (b) Which parts of the bridge are under tension?

The struts above the deck are under tension as the load presses down.

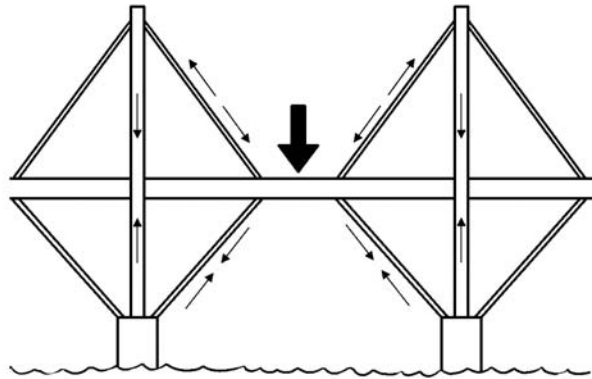

7. Encourage the students to examine their bridge models and find the middle point. Are both sides of the bridge a mirror image of each other? What word is used to describe this feature?

Students will find that the two sides of their bridge are mirror images of each other.

Symmetry or symmetrical.

You may want to explore this concept further with your students and explain that symmetry and balance are integral concepts in bridge building, Symmetry helps to keep the forces in balance, The building and design of a bridge keep push and pull forces working together in harmony, rather than fighting against each other, to support the weight of the bridge and those that use it. Most bridges tend to be symmetrical.

8. Ask each group to consider whether or not their cantilever bridge is a stable or unstable structure. They should be prepared to give reasons for their response.

Answers will vary because of the characteristics of the model.

Applying The Idea (Assessment Activities)

Review the cantilever concept with your students by asking the following questions:

1. In a cantilever bridge what is the minimum number of beams that are needed?

Two – one extending out from EACH side of the valley to meet in the middle.

2. In a cantilever system, how many supports does each beam have?

Only one – each pier/tower supports one half of the bridge.

3. How is each half of the cantilever bridge able to stand on its own?

The weight has to be balanced. This usually means extending the deck and thus the weight in both directions from the pier.





- Why are the two sides of the bridge mirror images of each other?

A symmetrical design helps to keep the forces acting on the bridge in balance. It is also aesthetically more pleasing to have a symmetrical bridge.

- Student should make a sketch of their model, labeling the parts and adding notes about their functions.

(Appropriate for upper grade levels.)

- Ask the students to describe the demonstration of Baker's cantilever principle that they re-enacted in the classroom. They should use labeled diagrams and colored markers/crayons to identify those parts of the bridge that experience tension and those that experience compression.
- Encourage the students to write an entry in their journals comparing symmetry and balance. They can illustrate their answer.

Extending The Idea

- Design Task**
2 groups combine as a bridge design team. Their brief is to design and build a cantilever bridge that can carry a load of 2 dictionaries over a span of 24 inches (60 cm). They have 10 minutes planning and 30 minutes to complete the building activity. They may use the contents of two kits.

Before constructing their bridge, ask each group to consider:

 - What method will they use to support the cantilever – where will the greatest support be needed?

Each group then tests their bridge, while the remaining groups observe. Encourage each group in turn to:

 - Share any problems they had with their structure and describe how they overcame them.
 - Suggest ways in which their designs could be improved.

Encourage the use of correct terminology and vocabulary.
- Encourage the students to research one of the world's largest cantilever bridges, the Forth Railway Bridge, spanning the Firth of Forth near Edinburgh, Scotland and completed in 1890. Explain that this bridge at one time held the world record for the longest bridge.
- Ask the students to use the Internet and the school library to complete research on different structures that use a cantilever system in their design. For example, the roofs of many football stadiums use cantilevers.

JOURNAL CHECK (Assessment Data):

- ✓ Labeled diagram of the model bridge, with notes describing the function of the parts.
- ✓ Compression and tension in the bridge structure. (Upper grade levels.)
- ✓ Description, with labeled diagram, of Baker's cantilever demonstration. (Upper grade levels.)
- ✓ Comparison of symmetry and balance.

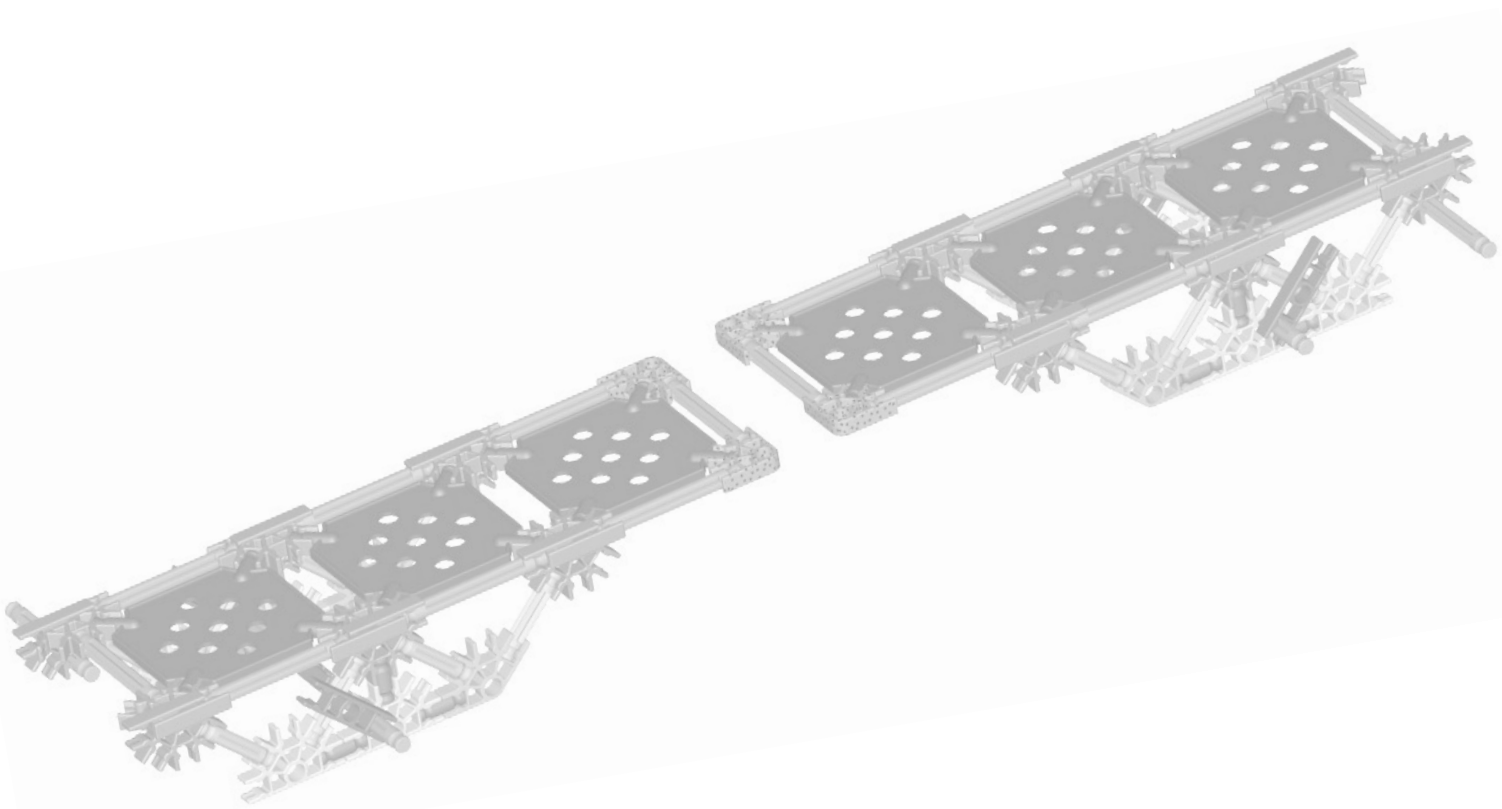

The Bascule Bridge:

A bridge that moves.

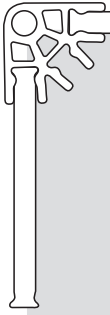

OBJECTIVES

Students will:

1. Build a model of a movable bridge and demonstrate how it works.
2. Identify the limitations of a bascule bridge.
3. Explain the operation of a bascule bridge system.
4. Understand and use vocabulary associated with bascule bridge systems.

MATERIALS

Each group of 2-3 students will need:

- K'NEX Introduction to Structures: Bridges with Building Instructions Booklet
- Hooked/slotted masses or other weights (10-1000 grams)
- Modeling clay (optional)
- Student Journals

You will need:

- Pictures of bascule bridges, such as Tower Bridge, London, UK.
- Pictures of sailing ships with tall masts and of large ships, such as container ships or oil tankers.

PROCEDURE

Introduction

- Review with the class how a bridge allows various types of traffic – pedestrians, cyclists, motor vehicles, and trains – to pass over a river, an estuary, or a water channel between two landmasses.
- Ask the students to look at the photo of the Forth Rail Bridge on Page 6 of their Building Instruction booklet and identify a problem for one type of transport that could be traveling in the area of the bridge. Help the class realize that certain types of ships would find it difficult to pass under the bridge and proceed further up the river because they are too large. Explain to the students that bridges have always caused this type of problem – in the days of sailing ships, masts were often too tall to pass under bridges, while today, it is the ships' hulls themselves that are sometimes too large to navigate under the decking of bridges.

Have some pictures of large ships available for the students to examine.
- Lead the students to understand that a cantilever bridge, like the Forth Rail Bridge, would need to be very tall to allow some modern river traffic to pass safely. Ask what additional problems this would pose to the engineers and designers.

Increased cost; greater support needed for tall piers; a heavier bridge that will need extra support, etc.

- How can this problem be solved?

Answers will vary. Accept and record these suggested solutions on the board. Once the ideas have been exhausted, review the list and comment on the practicality of each suggestion. For example, a high bridge might allow boats to pass, but building a high bridge is not always practical, especially across a narrow river, or in an area where the land is level or flat. If the students have suggested a **movable bridge** as a solution, ask how you could make a bridge move out of the way when boats are approaching.

Accept all suggestions, for example: the road deck rises or rotates. Encourage the students to think of bridges that led to most medieval castles. Ask them what they were called, when they were used and how they worked.

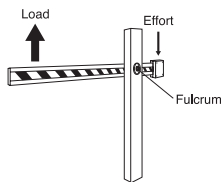

Students may have knowledge of the drawbridges that formed part of the defense system of medieval castles. They were raised from a horizontal position, where they formed a bridge across a moat, or a dry ditch, surrounding the castle, to a vertical position where they formed an additional barrier across the main gateway. Incorporating the principle of levers, and using a combination of pulleys and chains the structures could be quickly raised and lowered.

- You may want to draw a modern parallel. The principle involved in a drawbridge is similar to a parking lot or tollbooth barrier: a weight is needed at the shorter end to counterbalance the weight of the bridge or the barrier at the other end.
- Explain that this lesson will investigate one type of movable bridge – the **BASCULE BRIDGE**. Explain that the word *bascule* is French and means *seesaw*. Write the name of the bridge on the board and suggest the students record it in their journals.

Ask the students to look at the photo of a bascule bridge on Page 8 of the Building Instructions booklet.

Ask them how this is different from a castle drawbridge.

The bridge opens up from the middle to form two arms; it is not raised as a single structure.

Ask the students if the bascule bridge reminds them of another type of bridge that they have studied. Help the students to see that the bascule bridge in the photograph consists of two movable cantilevered bridge arms.

Explain how in a bascule bridge the weight of the roadway is counterbalanced by a heavy weight under the short end of the bridge. The large counterweight disappears into an opening in the pier of the bridge when the bridge is down - just like a castle drawbridge. Without the counterbalancing of the weight of the roadway, it would be almost impossible for the motors and gears to lift the arm.

- Arrange for the students to see photographs of movable bridges or use the Internet to allow the students to research the locations of bascule bridges, what they are used for and how their lengths compare to other bridges they have investigated.

The following Internet sites are useful sources of free photographs of bridges

www.freefoto.com; www.FreeImages.co.uk; www.brantacan.co.uk

Building Activity:

- Organize the class into groups of 2-3 students and distribute a K'NEX Bridges set to each group.
- Invite the students to build the **BASCULE BRIDGE** model (Pages 8-9 of the Building Instructions booklet.)
- Allow the students a couple of minutes to explore their bridge.

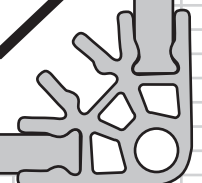



Inquiry Activity I: How does a bascule bridge open and close?

Steps

1. Ask the students to describe the main difference between this bridge design and the others they have examined.
2. How is it similar to other bridges they have studied? If necessary, suggest they think about the way in which each half of the bridge is supported.
3. Ask for volunteers to describe how their K'NEX bascule bridge **model** functions. Ask them to begin with the phrase, "To raise the K'NEX bascule bridge you first..."
4. Encourage the students to use their fingers to tip one half of the decking back and forth. Ask them what they are reminded of as they do this.
5. Invite the students to discuss with their partner(s) how they will measure the force needed to open the bridge? They should record their ideas in their journals and then carry out their investigation using their preferred method. Observations and findings should be noted in their journals.

The span is divided into two separate halves.

It is like the cantilever bridge because each half of the bridge is supported at one end only.

They should include the following: Apply a downward force to both blue Rods (levers) that extend out in a horizontal position at each end of the bridge. Because the K'NEX model has no counterweight, use additional force on the opening lever to overcome the entire weight of the road deck. The bridge deck pivots on another blue Rod into a vertical position. It is prevented from turning completely over on itself by the blue Rod (lever) which stops at the pier. To lower the bridge you must apply an upward force to the blue Rod (lever). The deck will pivot and return to a horizontal position. The red Rod extending between the piers prevents the deck from rotating any further.

Help them to recognize that the deck behaves like a seesaw, except that it is not pivoting in the middle of its span. If your students have studied levers you can remind them of some of their features.

Some students may use weights attached to the ends of the roadway; others may attach spring scales to measure the "pull" on the blue opening lever.

(Appropriate for upper grade levels.)

Inquiry Activity II: What are the limitations of a bascule bridge?

Steps

1. Ask the students to test the strength of the bridge by adding weights. These will represent a live load crossing the bridge. Suggest that they place the weights in different locations along the bridge and notice what occurs to the piers and to the bridge spans. They should repeat the experiment once or twice, increasing the weight applied each time. Their results could be recorded in Data Tables, as shown below.

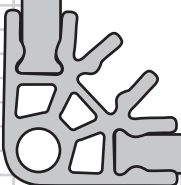

(a) Where are the weakest and the strongest parts of the bridge?

The weakest parts of the model bridge are found in the center of the decking and also the piers. A weight placed on the center of the roadway causes the spans to sag and the piers to move outwards and off the surface of the desktop. The strongest parts of the bridge are found towards the ends of the decking.

(b) In a real bascule bridge like the Tower Bridge, how would engineers solve the problem of the weak points you have identified? Think about some of the other types of bridges you have investigated and the methods that have been used to strengthen them.

Install anchors or abutments to keep the piers from moving. Add trusses under the deck to make the deck more rigid, etc.

(c) If weights are placed on the decking, between the piers, how much weight will the bridge hold before it becomes inoperable?

Answers will vary.

(d) What do they notice about the stability of their model bridge?

Many students will state that their bridge model is not particularly stable.

(e) How could they improve the structure?

Answers will vary, but most will suggest strengthening the piers and the base of the model. This will help prevent the piers from moving. Some will suggest placing a heavy weight on the base of the model to improve stability

Data Table 1

Weight applied = _____

Location of Weight	Between Plates 1 & 2	Center of Plate 2	Between Plates 2 & 3	Center of Plate 3	Middle of Bridge
Distance piers rise above desktop					

Data Table 2

Weight applied = _____

Location of Weight	Between Plates 1 & 2	Center of Plate 2	Between Plates 2 & 3	Center of Plate 3	Middle of Bridge
Distance piers rise above desktop					





2. Ask the students to separate the two halves of the bridge and take two black plates from one half and add them to the other span to make it longer. Using the same method as was used in Step 5, measure the force needed to raise the longer span. Measurements should be recorded in their journals and compared with those from Step 5.

NOTE: One student may need to hold down the base of the elongated half of the bridge while the measurements are taken.

Students should find that more force is needed to raise the longer span of the bridge.

Applying The Idea (Assessment Activities)

- Review how the bascule bridge operates and ask the students to write a step-by-step description of this. They should include a labeled drawing to show how it can be raised and lowered. Encourage them to identify the pivot point, or hinged point, and the mid-point of the bridge. Help them identify where, in a real bascule bridge, a counterweight would be located to help raise the bridge.
- Ask the students to look at the photo of the bascule bridge on Page 8 of the Building Instructions booklet (and/or a picture of Tower Bridge in London) and encourage them to write a few sentences about the function of the different shapes used in the real bridge design.

(Appropriate for upper grade levels.)

- Invite them to review their observations from Inquiry II, (how to open and close the bridge, how the spans respond to their loads, how much force was required to raise and lower different length spans), and then explain why they think bascule bridges only have short spans. Their thoughts should be recorded in their journals.

Students should recognize that if the spans of the bascule bridge are too long they could sag in the middle. If the span is too long it will also be harder to lift, or takes too long to move.

Extending The Idea (Assessment Opportunities)

1. **Design Task 1: To reduce the force needed to open the bascule bridge.**

Suggest that 2 groups combine as a bridge design team to tackle this problem.

Explain that they have 10 minutes planning time and 30-40 minutes to complete the building activity.

Before constructing the bridge ask each group to record in their journals two alternative solutions and give their reasons for selecting the one they will use.

Slotted weights or modeling clay could be made available as counterweights.

Ask the students to record and explain their findings with labeled drawings and notes. They should use the correct technical vocabulary.

Each team should test and demonstrate their improved bridge to the rest of the class. Teams should be prepared to:

- Share any problems they had and explain how they overcame them.
- Suggest ways in which their designs could be improved.

2. **Design task 2: Research how castle drawbridges may have worked.**

Design and make a castle drawbridge using a K'NEX set and other materials, where appropriate, to complete a working model.

Students should draw plans of their proposed drawbridge before they begin construction.

Each team should test and demonstrate their drawbridge to the other groups. They should be encouraged to:

- Share any problems they had and explain how they overcame them.
- Suggest ways in which their designs could be improved.
- Consider the application of counterweights to enhance the operation of their drawbridge system.

3. Encourage students to research other types of movable bridges using library and Internet resources.

JOURNAL CHECK (Assessment Data):

- ✓ Method used to measure force needed to raise the model bascule bridge, with results.
- ✓ Description, with labeled diagram, of how a bascule bridge works.
- ✓ A comparison of the features of bascule bridges to other bridges investigated.
- ✓ Measurements for Inquiry Activity II, Step 1, recorded in a data table. (Upper grade levels.)
- ✓ Explanation of the function of the different shapes used in real bascule bridge designs.
- ✓ Reasons why bascule bridges have short spans. (Upper grade levels.)

NOTES:

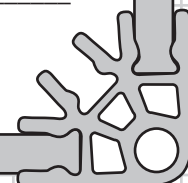



The Arch Bridge:

Identifying the features of single arch bridges.

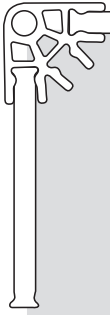

OBJECTIVES

Students will:

1. Identify and explain the function of the parts of an arch bridge.
2. Build and experiment with arch bridge models to compare the strength of different designs.
3. Understand terms and vocabulary associated with arch bridges.
4. Trace the transfer of force through an arch bridge system.







MATERIALS

Each group of 2-3 students will need:

- K'NEX Introduction to Structures: Bridges with Building Instructions Booklet
- Hooked/slotted masses or other weights (10-1000 grams)
- Student Journals
- Cardboard, cans, glue, books (optional)

PROCEDURE

Introduction

-  Remind students of their previous investigations to help them transfer existing knowledge about how engineers tackle bridge building problems to this new learning situation. This information will include:
 -  Structural strength and stability
 -  Engineering strategies to address strength and stability issues
 -  Engineering strategies to address problems with bridges that must span long distances
-  Explain how this lesson will be about a bridge design that has been used for thousands of years and is still used today.
-  Arrange for the students to see photographs of structures that use arches e.g. Roman aqueducts and bridges; medieval river bridges; 19th Century rail bridges.
-  The following Internet sites are useful sources of free photographs of bridges: www.freefoto.com; www.FreeImages.co.uk; www.brantacan.co.uk

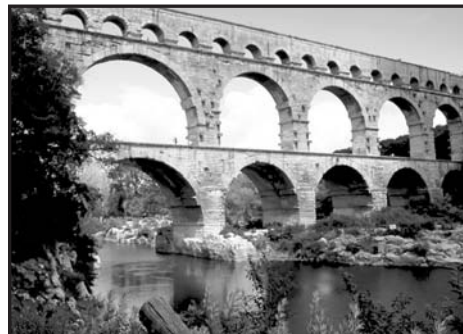

Pont du Gard, France



How strong is an arch?

● Demonstrate, using a green K'NEX flexi-rod, how an arch shape is produced and how it can be used to make stable structures. (For more information on arches please refer to the Key Concepts section of this Guide or visit the 'Forces Lab' at www.pbs.org/wgbh/buildingbig/bridge/)

● Organize the class into teams of 4 students, (similar heights and weights work best,) and explain that they are going to make a human-body arch. Instruct two from each team to stand back-to-back and lean into each other's backs. Both feet are planted a large stride in front of their bodies – they will need to bend their legs. Their legs will now form an arch shape. The other two students from the team ('helpers') should prevent the feet of the arch participants from sliding out from under them during the activity. They can simply place their feet in front of the experimenters' feet.

● Switch roles so that everyone has a chance to experience being part of an arch structure.

● Ask the students what it feels like to be part of an arch. Guide them to notice how their backs, arms, hands, shoulders and feet feel.

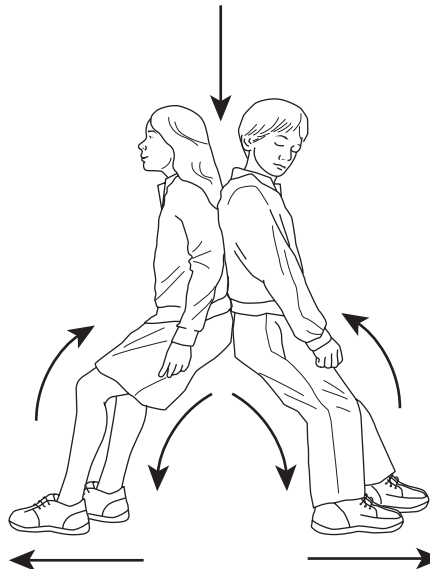

● Where do they feel the greatest forces?

On their backs as they pushed against each other.

● What stops their feet from sliding away?

Friction and the feet of the 'helper'.

● Show a picture of a stone arch bridge and compare it to the human arch bridges the students made. Point out that the top center stone in the arch, called the KEYSTONE, is at the same place where their upper backs press together on the human bridge. All the other stones in the bridge push, or squeeze, against this stone, just as all the weight of the students' bodies press against their upper backs.



● Encourage the students to describe the shape of the stones in the arch.

The stones are wedge shaped.





- Explain that it is this shape that makes it possible for the arch to hold itself up. The wedge shape ensures that each stone is caught between its neighboring stones, preventing it from falling downward.
- Make a drawing on the board of the wedge shape stones in the arch.
- Ask the students whether rectangular stones could be used. Why or why not?

Rectangular stones could slip out of place and cause the bridge to collapse. In those cases where rectangular stones or bricks are used, mortar is added to fill in the gap between them. In this way, the functional wedge shape is simulated, stability is assured and the construction process is speeded up.

- Ask the students if their feet felt as if they were going to slide forward as they made their bridges. The same thing happens in a stone arch bridge, as the weight of the bridge pushes downward and outward. The arch will only hold together if strong **abutments** are placed at each end of the bridge to keep the stones from pushing to the side. Point out the abutments in a stone bridge picture - the place where the ends of the bridge are braced by the land or rock. Write the word ABUTMENT on the board.

- Ask what/who acted as the abutments in their human-body arch.

The students who stopped the feet moving forward.

- Talk about how an arch can be used not only in bridges but also in buildings because it is a very strong shape. Some Roman bridges are still in use today, 2000 years after they were built. Some very old multi-arch bridges also continue to be used: the famous Ponte Vecchio in Florence, Italy, is one such example.

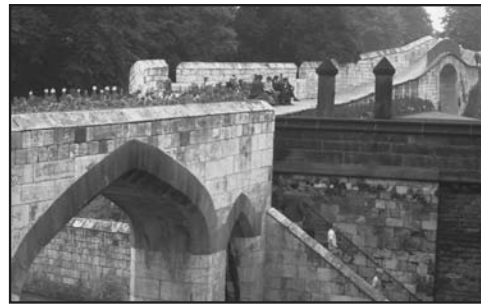

- Explain that the students will now investigate the stability of arch structures for themselves. They will be expected to record and report their findings through labelled drawings and notes.

Building Activity I:

- Organize the class into groups of 2-3 students and distribute a K'NEX Bridges set to each group.
- Before they begin construction, draw the students' attention to the three versions of the ARCH BRIDGE model (Pages 10-11 of the Building Instructions booklet.) and explain that an arch can be a very versatile structure when used for bridge building. Ask the class what are the differences between the three versions of the bridge.
- Invite all the groups to begin by building Steps 1-4 of the ARCH UNDER version of the bridge, shown on Page 10 of the Building Instructions.

The deck of this bridge can be located over, under or through the arch.

Assembling the two sides of the arch (Steps 2,3,4) must be a shared activity as more than one pair of hands will be required to attach the red connecting Rods.

Building Tip:

When completing Step 1 we recommend that students work from left to right, connecting top and bottom rims of the arch with blue Rods as they proceed. This is easier than first building all of the top and bottom rows and then attempting to join them with the blue Rods.

Inquiry Activity I: How stable is an arch when it stands alone?

Steps

1. Ask the following questions

(a) What happens to the arch when you press down on the center?

The center is depressed and the ends of the arch move outward.

(b) Does this appear to be a stable or unstable structure?

Students should notice that it is a somewhat unstable structure, although answers will vary.

2. Ask the students to look at the photograph on Page 10 of the Building Instructions booklet again and identify what the arch is built against.

The rock wall of the canyon.

3. Review with the students the name given to the structures that prevent the arch from spreading outwards.

Abutments.

4. Explain that abutments can either be constructed, or they can be the rock of a hillside. They prevent the ends of the arch from moving sideways. Ask the students what happens when the sides of the arch are prevented from moving sideways?

The arch becomes a stable structure.

Building Activity II:

 Organize the class into teams of 6 students and explain that each pair within the team will construct a different version of the arch bridge, and carry out a series of investigations. Results will be compared. The students should decide among themselves which pair will build which version of the bridge.

 Provide time for the students to explore their bridges.

Inquiry Activity II: Do different designs affect the strength of an arch bridge?

NOTE: Please have students wear safety goggles as they test their bridges. This is sound safety practice for activities in the science classroom or lab.

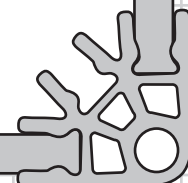



Steps

1. Ask the class to identify the parts of the arch bridge. Draw a diagram on the board and invite volunteers to point out bridge terms that they know from earlier discussions. You can accept their terms and formalize them in the subsequent discussion. The following features of the bridge may be identified:

Keystone, abutments, deck, wedge-shapes.

You may want to note that most modern arch bridges are constructed from steel and concrete. These bridges are unlikely to have a special block that could be identified as the keystone, but each bridge has a point in its arch from which the forces radiate. You may want to add the term *vousoir*: a true arch with wedge shaped pieces that fit tightly together against the abutments.

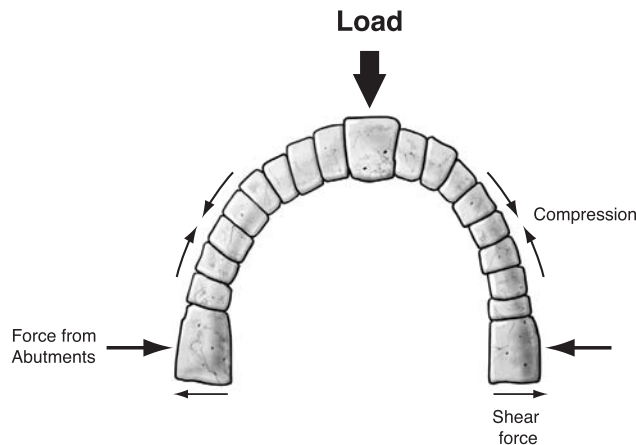

2. (a) Ask the teams to develop a fair test for investigating the strength of each version of the bridge. Measurements should be included. This information could be recorded in a table. Allow the students to develop their own version of the table.
- (b) Ask if adding the decking has affected the strength of the structure.

Teams will probably decide to add the same load/weight in the same location on each of the bridges and notice the effect on the deck and on the sides of the arch.

Students should find that the completed bridge is stronger and more stable, but a force will still need to be applied against the sides to give the bridge its overall stability.

(Appropriate for upper grade levels.)

3. Ask the students to discuss the following with their team members and record their responses in their journals.
 - (a) How is the road decking supported so that it remains rigid and strong enough to support the load?
 - (b) Which parts of the bridge are under compression?

Answers will vary – all should include reference to reinforcing frameworks.

The entire arch structure is under compression. You may want to help the students understand that the curved shape of an arch spreads out – dissipates – the compression forces toward the abutments. This is the natural strength of an arch shape. For additional information visit the 'Forces Lab' at www.pbs.org/wgbh/buildingbig/bridge/.

- (c) Which parts of the bridge are under tension?

The decking on top of the arch.

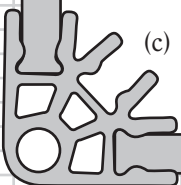

Applying The Idea (Assessment Activities)

- Ask the students to draw a clear, labeled diagram of an arch bridge in their journals and add notes describing the parts of the bridge and their function.
- As a class, discuss findings from the investigations into the strength of the three versions of the bridges. Help the students to explain any differences that they found. Encourage the students to write a short paragraph describing their findings.
- Ask the students to complete **Worksheet 3: Arch Bridge Fill-In.**

Extending The Idea

1. Invite each pair within the teams to research real-life examples of their type of arch bridge, using the Internet. They may want to investigate its size, location and function.
2. The following activity allows the students to put the arch concept into action by making an arch bridge out of flexible cardboard, as shown in the drawing below. They can form the curve piece by allowing a strip of wet cardboard to dry while wrapped around a can. Then the deck and side supports can be glued in place. Ask the students to press on the bridge as they complete each stage, to see where the bridge gets its strength.
3. The students could experiment with different sized spans and even build multi arch structures.
4. Encourage your students to research aqueducts and viaducts. They may want to consider where they originated, why they were necessary, and which ones are in use today.

JOURNAL CHECK (Assessment Data):

- ✓ Labeled diagram of an arch bridge.
- ✓ Notes describing the key parts of an arch bridge.
- ✓ Results of investigations into the strength of 3 versions of an arch bridge.
- ✓ Fill-In worksheet.

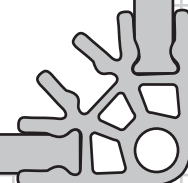



The Suspension Bridge:

Exploring the features of a suspension bridge.

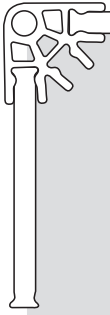

OBJECTIVES

Students will:

1. Build a suspension bridge.
2. Identify and describe the function of the parts of a suspension bridge.
3. Demonstrate and explain how forces are kept in balance on a suspension bridge.

MATERIALS

Each group of 2-3 students will need:

- K'NEX Introduction to Structures: Bridges with Building Instructions Booklet
- Hooked/slotted masses or other weights (10-1000 grams)
- Paper clips
- Student Journals

You will need:

- Large rubber band (optional)
- Piece of foam (optional)
- String or cord
- Bucket with weights
- Cardboard sheets, chairs, tables, rugs etc. (optional)

PROCEDURE

Introduction

⦿ Explain that during this lesson, students will be investigating suspension bridges. Display a large picture of a suspension bridge. Ask the students how they think a suspension bridge may be different from the other bridges that they have investigated. How is it the same? Record all their answers on the board.

⦿ Place two chairs approximately 3 meters apart and string two cords from one side of the room to the other, so that they pass over the backs of the chairs. Do not tie or secure the ends of the cords at this point.

⦿ Ask for suggestions as to how the cords could be used to make a bridge.

Students may suggest using the cords to travel hand-over-hand, or to make a walkway along the cords, or to hang a roadway from the cords.

⦿ Point out that each of these suggestions makes a suspension bridge. Direct their attention to the picture once again.

⦿ Distribute a paper clip to each student, and ask everyone to carefully bend his or her clip open to hang it along the length of the cord/string. Ask what they think should hang from the paperclips.

Students should grasp that the deck of the bridge hangs from these.

⦿ Next, have the students use a roll of tape or long strips of cardboard to hang a deck from the paper clip suspenders.

Ask the students to notice what has happened to the cords as they attached the clips and then the deck.

The structure will have slipped toward the floor.

Ask them what they need to do to raise and secure the bridge.

The students should suggest securing the ends of the cords.

Once their bridge is secured, refer to it and to the photo of the real bridge, as you introduce the parts of the suspension bridge. The students can describe its features and you can formalize their terms as necessary. Vocabulary should be written on the board and recorded in their journals.

The cords/strings act as the bridge's main **cables**. The chair backs over which the cords are draped act as the supporting **towers** of the bridge. The paper clips are the **suspenders** from which hangs the paper **deck**. The ends of the cord are tied to **anchorages** to prevent the towers from leaning and the bridge collapsing. Note that the deck of a real suspension bridge may be strengthened and made rigid with **truss** work.

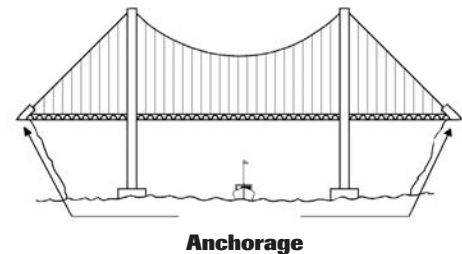
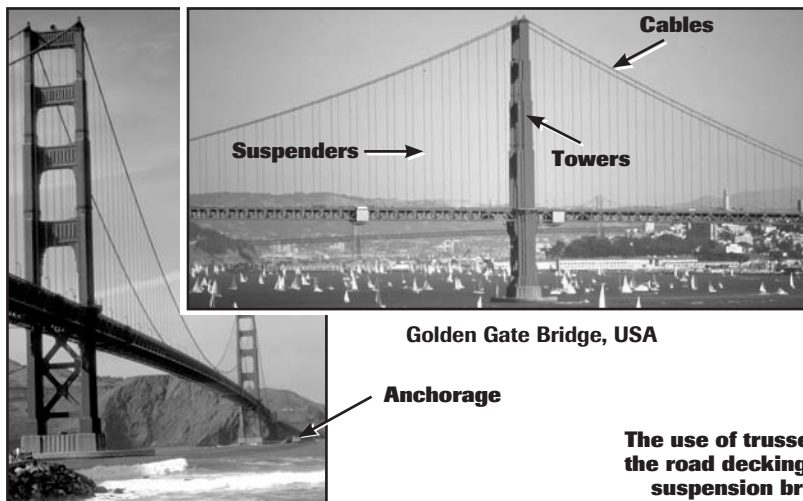

Ask for 5 volunteers to help demonstrate the elements of the suspension bridge and to experience the **forces** that are at work on it.

Place a rug on the floor and tell the students that this represents a large river that has to be crossed by a suspension bridge.

Refer to the picture of the suspension bridge and explain that there will be two chairs with a student sitting on each - these will represent the two towers of the bridge.

Ask where they should be located – in the river or on the banks?

The students should suggest locating them in the river.

Seat the students on the chairs. Drape the rope over their shoulders. Ask what the rope represents.

The main cables of the bridge.

Arrange for a bucket to hang from the middle of the rope. Ask the class what they think the bucket represents. If necessary, provide a hint: weight will be added to it.

The weight of the decking.





- Ask where the anchorages for the cables should be located.

On top of the banks/cliffs.

- Ask two students, who will play the role of the anchorages, to sit on the floor in locations that represent the two banks of the river.
- Hand the ends of the rope to these two students.
- Explain that weights will be added to the bucket and the aim is to keep the bucket at the same height above the level of the 'river'.
- Ask the remaining volunteer to add weight to the bucket and encourage the other 4 students to describe their experiences as this takes place. Those holding the ends of the rope should find that they must pull harder as more weight is added to the bucket, while the students on the chairs will find there is more weight pressing down on their shoulders.
- Ask what would happen if one student released the end of the rope.

The rope would collapse and the bucket would fall to the floor.

- Ask the students to describe their experiences as they role-played the parts of the bridge.

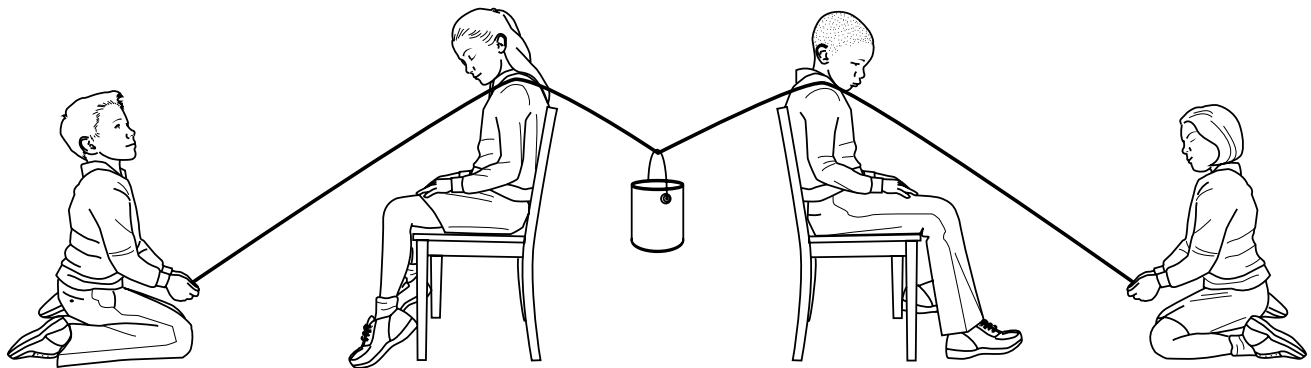

- Draw a diagram of the demonstration on the board and discuss how this represents a suspension bridge and the forces that act on it:

Review how:

- The rope acts as one of the bridge **cables** holding the weight of the roadway.
- The students supporting the cables and the load are the **supporting towers** of the bridge.
- Students holding each end of the rope are **anchorages**.
- The bucket handle suspending the weight (bucket) from the cable is one of the bridge **suspenders**.
- Add each of these labels to the diagram and encourage the students to make a similar labeled sketch in their journals.

Arrange for the students to see other photographs of suspension bridges. You can use the photograph of the Golden Gate Bridge in the K'NEX Building Instructions booklet (Page 12), or make use of the Internet to allow them to:

- Identify the main components of suspension bridges.
- Research the locations of suspension bridges.
- Research the uses of suspension bridges and how their **lengths** compare to other bridges they have investigated.

The following Internet sites are useful sources of free photographs of bridges:
www.freefoto.com; www.FreeImages.co.uk; www.brantacan.co.uk

Review some of the statistics that the students may have discovered from their research. They should have found that a suspension bridge design is used for some of the longest bridges in the world. Refer back to previous investigations related to the strength and stability of bridge structures and discuss possible problems engineers may have had to solve when designing and building long bridges. For example the main span may be 2000 meters in length – how can such a long beam be supported and still retain its rigidity and strength? Record any suggestions they may have.

From their introductory work on this design of bridge the students might identify the large number of supports [suspenders] that pull up the deck, and the tight cables that keep the structure rigid. They may have discovered that suspension bridges are lighter than the other bridges they have explored and so they can be built with longer spans.

Building Activity

- Organize the class into groups of 2-3 students and distribute a K'NEX Bridges set to each group.
- Explain to the groups that they will begin their investigation into suspension bridges by building the K'NEX model Suspension Bridge shown on Pages 12 and 13 of the Building Instruction booklet.
- Ask the students to build the bridge up to, and including, Step 4; they should not proceed to Steps 5-7 where they connect the green K'NEX flexi-rods to the road decking.

Inquiry Activity I: Is this a stable structure without the cables attached?

NOTE: Please have students wear safety goggles as they test their bridges. This is sound safety practice for activities in the science classroom or lab.

Steps

1. Ask the students to develop a test for stability using a load placed in the center of the bridge.
2. Each group should observe what happens, and answer the following questions:
 - What is the maximum weight that the bridge could carry before it would be unsafe to use?

Answers will vary. They can record answers in a DATA TABLE such as the one shown below.

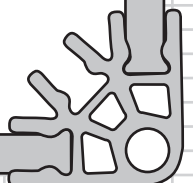



Where are the weakest parts of the bridge?

The students will probably respond that the whole structure is weak: the deck bends in the center and sways from end to end; the towers move and bend towards the center.

How do you explain your observations?

Insufficient support structures.

Is this structure stable, or unstable, as it is currently built?

Most will respond that it is very unstable.

3. Discuss their findings and encourage them to record their observations in their journals.

Data Table

Stage of Construction of bridge	Weight applied	Observations
No cables		
Cables un-tightened		
Cables tightened		

Building Activity continued.

Each group should then complete the model by connecting the cables (Steps 5-7.)

Inquiry Activity II: How has the addition of cables affected the strength and stability of the structure?

Steps

- Ask the students to identify the various parts of their suspension bridge model. They can refer back to the labeled diagram they made in the introductory stages of the lesson.
- Suggest that they look at the photo in their Building Instructions booklet and identify any differences between this bridge and their K'NEX model of a suspension bridge. Probe to see if they know what materials are used in the construction of modern suspension bridges. (See the Key Concepts section of this Guide for additional information.)

If necessary, help them to understand that their model does not have the anchorages in which the ends of the cables would be embedded and secured. The model also does not have cables that run the entire length of the bridge. The towers on the real bridge are proportionately higher than those on the model bridge. Contemporary suspension bridges are constructed from twisted steel wire cables, with concrete, or steel, sections for the towers and decks.



3. Ask the students to keep these differences in mind and then retest the bridge using exactly the same method as before. They should answer the questions and make use of the DATA TABLE to record their observations concerning the load:

(a) Has the load bearing capacity of the bridge increased, stayed the same, or decreased?

Students should find that it has increased.

(b) Can you give a reason for your answer?

There are additional suspenders, connected to cables, which help support the center of the bridge decking.

(c) What do you notice about the shape of the decking now that cables have been added?

The deck bends up in the middle – it has an arch shape because the suspenders and cables pull it up.

(d) How has the addition of cables affected the stability of the bridge?

Students should notice that the strength and stability of the structure has increased.

(Appropriate for upper grade levels.)

4. You may want to point out to the students that the weight of the deck and its live load is transferred to the cables by the suspenders (which are under tension). This places the cables under great tension. This tension pulls at the anchorages and the cables press down on the towers, compressing them and transferring the weight on the bridge to the bedrock below the riverbed. Help the students recognize that the design of the bridge balances the two main forces of compression and tension.

5. Ask the students if they think the cables on a real suspension bridge are attached to the tops of the towers or are free to move? Why or why not?

You will need to explain that on a real suspension bridge the cables rest on the top of the towers. This is so that (i) they can move to adjust for metal expansion and contraction and (ii) the pull from side to side on the tower as the load on the bridge changes is reduced. Help the students realize that this is another difference between their model and real suspension bridges.

6. Suggest that they now pull the ends of the flexi-rods on the K'NEX model and retest the load bearing capacity of the bridge. Answers should be recorded in the DATA TABLE.

They should notice that by tightening the flexi-rods, the load carried by the bridge could be increased. They should realize that they are playing the role of anchorages and thus the suspension bridge system can be most efficient when each of its subsystems are working at their peak.





7. Review their findings by asking:
- What is the function of the towers?
 - What is the function of the cables that are laid across the towers?
 - Why do these main cables need to be anchored at either end?
 - What is the function of the vertical cables?
 - How is the road decking being made strong and rigid?

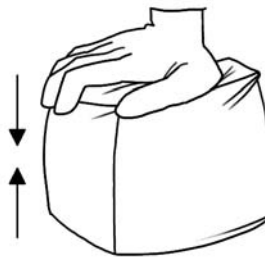
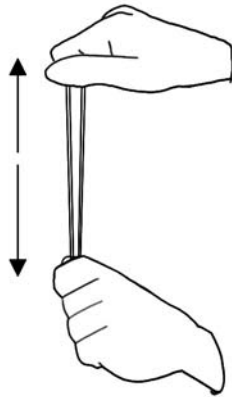

The towers carry the total weight of the bridge. The main suspension cables carry the weight of the decking. This weight causes the suspension cables to sag (come under tension). To stop the whole structure from being pulled inwards, the main suspension cables must be anchored at both ends. Vertical cables, suspenders, connect the deck to the suspension cables. The road decking is made strong and rigid by having a slight arch shape. This shape is maintained by the upward pull of the cables, via the suspenders.

(Appropriate for upper grade levels.)

8. (a) Review the way in which bridge construction attempts to use balancing forces to keep the structure from collapsing. Ask the students for the two main forces acting on a bridge.
- (b) Ask the class to think about the demonstration and the descriptions the volunteers gave of their experiences; from these they should describe where tension and where compression occurs in a suspension bridge. They can also press down on the center of the bridge model and observe again what happens. You may need to help them with this, perhaps using a rubber band and a piece of foam, as shown in the diagrams above.





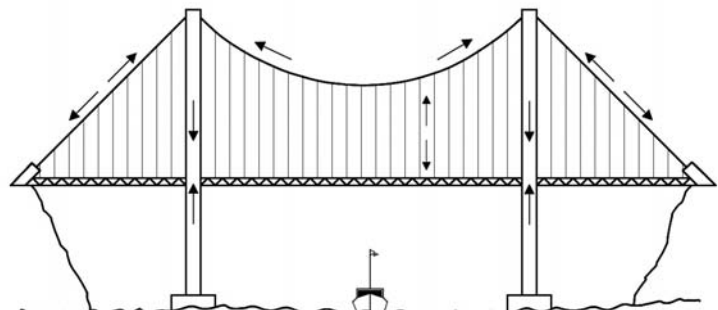

Tension and Compression or Pull and Push forces.

They should be able to explain that the towers experience compression because the cables push down on them, while the cables and suspenders experience tension as they are always being pulled. The forces acting on the decking (which simply hangs from the suspenders,) include bending and torsion from the live load. The arching of the road decking helps to reduce tension in the bottom of the deck.



Forces acting on a suspension bridge.

Applying The Idea (Assessment Activities)

-  Discuss the students' findings about suspension bridges.
-  Ask the students to list and briefly describe the functions of the parts of the suspension bridge.
-  Encourage your students to write about the main differences between their model and a real suspension bridge.
-  Ask the students to explain how the addition of cables affected the strength and stability of the suspension bridge.
-  Ask the students to identify the forces involved in the bridge structure, using a labeled drawing, colored markers or crayons, and the correct technical vocabulary.
-  Suggest that the students complete **Worksheet 4: The Scoop on Suspension Bridges**. If they think a statement is false, they should change it so it becomes true.

Suitable for upper grade levels, but can be modified for younger age groups.

Extending The Idea

1. Explain that, even though design engineers spend a great amount of time planning and preparing for the construction and use of bridges, things do not always work out as planned.

Ask the students to use the Internet to investigate the Tacoma Narrows, WA suspension bridge collapse.

Photographs of this event can be obtained from http://eduspace.free.fr/bridging_europe/index.htm. It also includes short film footage of the disaster.

Teacher Reference: While modern suspension bridges are designed to sway to some extent, a slight wind could cause the Tacoma Narrows Bridge, crossing the Puget Sound in Washington State, to whip, bounce and ripple. It soon became a tourist attraction and was given the name "Galloping Gertie." In November 1940, however, a moderate wind (40 m.p.h.) caused the bridge to twist and sway excessively until it failed. The design error lay in the shape of the bridge decking. It produced eddies of air that caused the bridge to oscillate. Had the designers first tested a model in a wind tunnel and then chosen decking with an aerofoil shape so that crosswinds can pass around and through the bridge, the oscillations would have been reduced. Ten years later the bridge was rebuilt using new specifications.

2. Invite the students to act out an imaginary story about building a suspension bridge. Set the scene by describing two high cliffs on either side of a wide river. Ask the students to set up chairs, tables, a rug and other props to represent the scene. Tell the students that a bridge is needed so that people and goods can cross from one side to the other. Explain that the only material available is rope. How can they make a simple bridge from this and what are the steps in the process?

A possible sequence might be:

1. Find a good site for the bridge, with trees to attach the ropes to for anchorage.
2. Construct several ropes from vines.





3. Attach one end of the rope to a tree and the other end to an arrow and shoot it across the river.
 4. Hike down the cliff, swim across the river, climb up the other side, find the arrow and attach the rope to the tree.
 5. Travel hand-over-hand on the rope, carrying more vine ropes to be part of the bridge.
 6. Lash the ropes together to make a walkway with handrails.
3. Lead the students to grasp that whatever method they use, the steps must be done in a certain order.
 4. Suggest that they research how modern suspension bridges are constructed and present a report to the rest of the class. Encourage them to include the following terms in their account: air-spinning, towers, suspenders, cable, catwalk, pilot rope, anchorages.

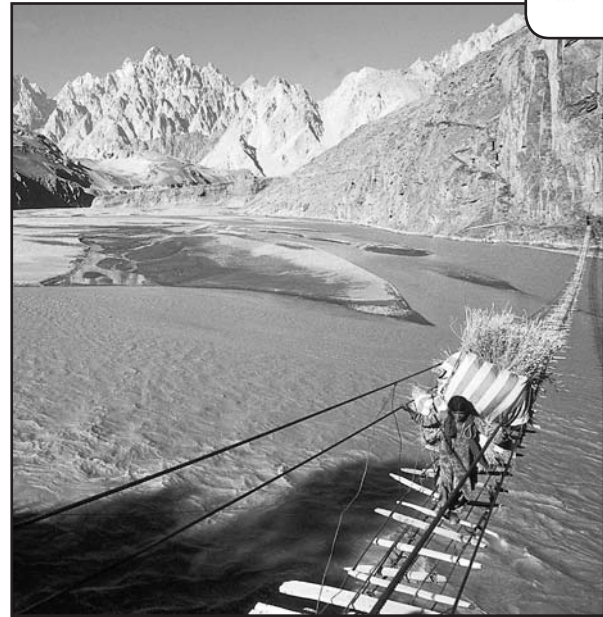

JOURNAL CHECK (Assessment Data):

- ✓ Sketch of a suspension bridge identifying its main component parts.
- ✓ Brief written description of the function of each component of the bridge.
- ✓ Differences between the K'NEX model and a real suspension bridge.
- ✓ Explanation of how cables affect the strength and stability of the bridge.
- ✓ Sketch to show the forces acting on the bridge.
- ✓ Completed worksheet (The Scoop on Suspension Bridges.)

NOTE: If possible, retain one built model of the suspension bridge so it can be compared with the cable-stayed bridge that is investigated in the next lesson.

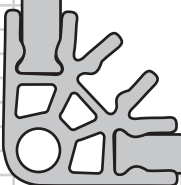

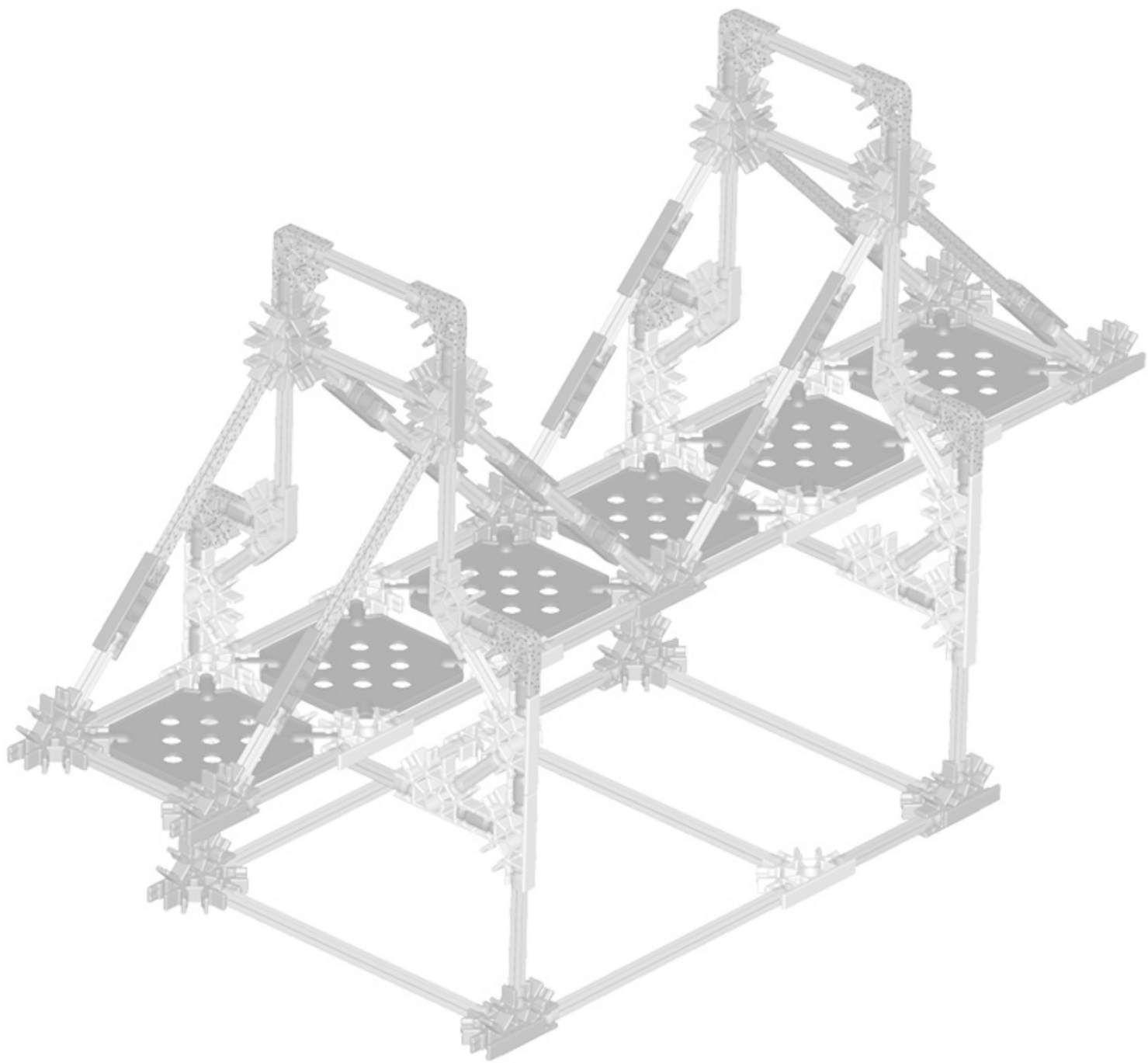



The Cable-Stayed Bridge:

Recognizing the attributes of cable-stayed bridges.



OBJECTIVES

Students will:

1. Build and investigate a model of a cable-stayed bridge.
2. Compare and contrast the design of cable-stayed and suspension bridges.
3. Use and explain vocabulary associated with cable-stayed bridges.

MATERIALS

Each group of 2-3 students will need:

- K'NEX Introduction to Structures: Bridges set with Building Instructions Booklet
- Hooked/slotted masses or other weights (10-1000 grams)
- String or cord
- Paper and pencils
- Scissors
- Student Journals

PROCEDURE

Introduction

1. Explain that this lesson will center on investigating cable-stayed bridges using a K'NEX model. Students will also use the Internet to research cable-stayed bridges.
2. Draw sketches of a simple suspension and a cable-stayed bridge on the board and / or create a worksheet and ask the children to compare the design of both bridges.
3. In what ways are the two designs similar and how do they differ?

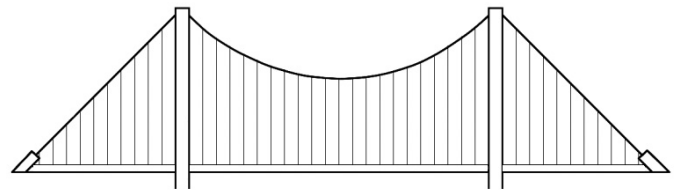
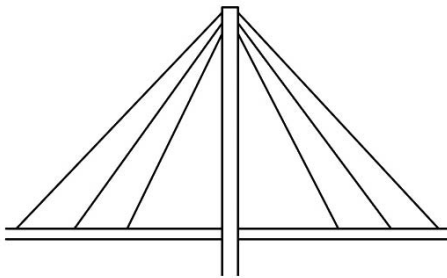





Similarities: Both have decks suspended from cables. Both transfer load to the ground or bed rock using towers.

Differences: In a suspension bridge the cable runs from tower to tower and the road deck is suspended from the cable, whereas in a cable-stayed bridge there is usually only a single tower from which the cables run directly to the road deck. NOTE: some cable-stayed bridges do employ two towers for long spans.

-  Explain to the students that one further difference between the two designs lies in the way in which the deck structures are built. The deck on a suspension bridge is installed only after the cables have been strung (air spun) across the towers and suspenders have been hung from them. With a cable-stayed bridge, because it demonstrates a cantilever design, the deck can be constructed by building out from the towers and the cables can be attached as each section is put into place.

Building Activity

-  Organize the class into groups of 2-3 students and distribute a K'NEX Bridges set to each group.
-  Ask the groups to construct the single tower CABLE-STAYED bridge shown on Page 14 of the Building Instruction booklet.
-  **NOTE:** Two pairs of hands will be needed to assemble the decking and the support structure.
-  Allow the students a minute or two to investigate the structure.

Inquiry Activity: What are the features of a cable-stayed bridge and what other bridge designs do they resemble?

Steps

- Display, or pass round the class, pictures of real cable-stayed bridges. Students should also examine the photo of the cable-stayed bridge in their Building Instructions booklet, Page 14. Ask the students to identify any differences between the real bridges and their model bridge. Remind the students to bear these differences in mind as they explore their model.

Answers may include: their model is a single tower version; there are no supporting piers extending towards the land in their model; real cable-stayed bridges have many more supporting cables.

- Explain to the class that the cable-stayed bridge is a relatively new design - the first bridge using this design was constructed in the 1950s. It combines elements from 2 bridges that they have already studied

- Ask them to name one bridge design it resembles.

*From the introductory activity they should remember that it has similarities with the **suspension** bridge.*

- Ask for suggestions for the other bridge upon which its design is based.

*Some will suggest a beam bridge. Help them to notice how the deck extends out evenly from the central tower and lead them to recognize the **cantilever** principle at work since the deck is balanced.*

- Ask the students to observe and explain what happens when they place a load at the end of either arm or press down.
 - What happens if they place a load in the center of the bridge?
 - Is this a stable structure?

In the K'NEX model the bridge is like a large seesaw – it is balanced in the middle but when a load is placed on one end the opposite end rises. In a real cable-stayed bridge both ends would have supporting piers – look at the photos of real bridges if necessary.





4. (a) To what are the ends of the cables attached?

To the tower and to the decking.

- (b) How does this differ from the suspension bridge?

The cables in the suspension bridge have to be anchored in huge concrete structures that extend into the ground. The cable-stayed bridge does not require these anchorages,

5. Examine the shape of the cables on your model bridge and in the photos of real bridges. What shape can you identify in their structure? What do you know about this shape?

Students should notice that the cables form a triangular shape and remember that this is a very strong shape to use in structures. You may want to take this opportunity to discuss some of the other cable patterns that engineers have used. Draw sketches on the board of radiating, harp and star patterns – see below.

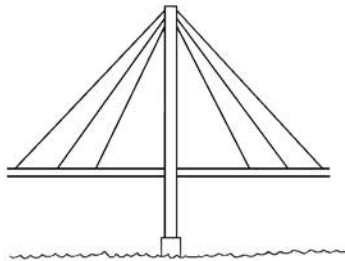

Radiating

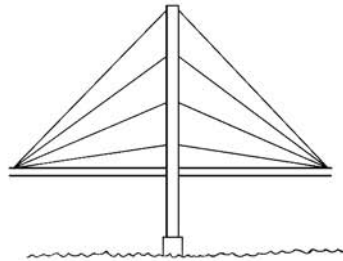

Star

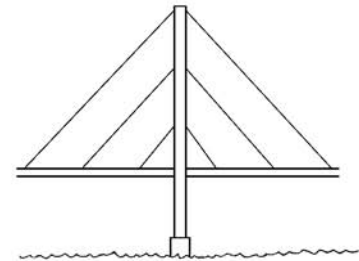

Harp

(Your judgment will determine if the following activities [STEPS 6-8] are appropriate for your students.)

6. To demonstrate the forces and support given by the cables, ask each group to remove the cables from one side of the bridge and place a small load on both ends. Observe what happens?
7. (a) Discuss with the students how both cable-stayed bridges and suspension bridges mainly rely on tension to create a stable structure. Ask them to infer from their model the parts of the bridge that will be under tension and the parts that will be experiencing compression.

The end without the cables attached will collapse.

They should be helped to see that the tower and the deck - when there is a live load on the bridge - are under compression, while the cables are under tension. You may want to develop this further by explaining that in a cable-stayed bridge, the resistance of the cables, now under tension, match the load of the bridge decking, while the towers support the weight of the bridge and are under compression.

- (b) What do they notice about the shape of the bridge decking?

The road decking is slightly arched. The arching of the road decking helps to reduce tension on the bottom of the road decking.

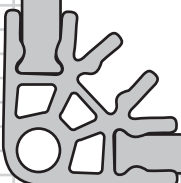

Forces acting on a cable-stayed bridge.

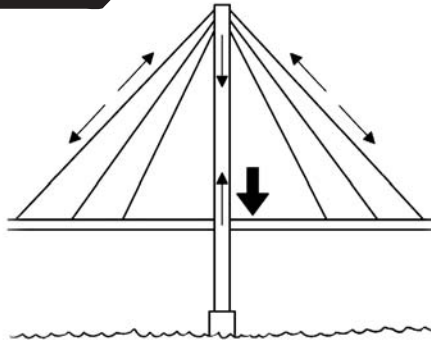

8. Refer back to previous work on strength and stability of bridge structures and talk about the possible problems engineers may have had to solve when designing and making cable-stayed bridges. For example, what might happen to the road deck as they build it outwards from the tower?

Students should be helped to see that unless they keep the structure balanced as they build outward, it can be vulnerable to collapse.

Applying The Idea (Assessment Activities)

- Ask the students to use illustrations and notes to identify the similarities and differences between the cable-stayed bridge and the suspension bridge.
- Review with the class the characteristic features of cable-stayed bridges by asking the following questions (students can refer to Page 15 of the Building Instructions booklet):

- Cable-stayed bridges are a combination of which two types of bridges?

They are a combination of a cantilever structure and a suspension bridge in which the tower supports a balanced portion of the road deck using cables.

- In what types of locations are they generally found?

They are usually medium sized bridges. More recently, however, longer bridges, using two and maybe even more cable-stayed towers, have been constructed.

- Ask the students to record and explain their observations of their model bridge using labeled drawings, notes, and correct technical vocabulary. Their journal entries should include answers to the following questions

- What is the function of the tower(s)?
- What is the function of the cables?

Both towers and cables support the weight of the road deck and its live load.

(Attempt if completed STEPS 6-8 above.)

- Which parts of the bridge are under (i) compression (ii) tension

i. Tower and the top of the deck, ii. Cables.

- How is the road decking made strong and rigid?

The cables pull on it to make it slightly arched. Students may also find during their research that the deck includes a truss system to add to its strength and rigidity.

- Invite the students to complete **Worksheet 5: Cable-stayed bridges.**

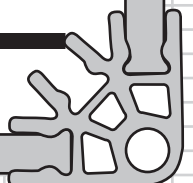



Extending The Idea (Assessment Options)

1. Ask the students to build the double tower cable-stayed bridge shown on Page 15 of the Building Instructions booklet. They should then research an actual example of this design, prepare an illustrated report on the bridge with bridge ‘facts and figures,’ and offer an explanation of why it is situated where it is. Would the students have used a cable-stayed bridge design for this site? They should be prepared to explain their answers. (EG: Sunshine Skyway Bridge, Tampa, FL or the second Severn Crossing Bridge, England.)

The following Internet sites are useful sources of free photographs of bridges
www.freefoto.com; www.FreeImages.co.uk; www.brantacan.co.uk

2. Research how the cables on a cable-stayed bridge are strung. Investigate the sequence involved in building a cable-stayed bridge and compare this to the building sequence for a typical suspension bridge.

JOURNAL CHECK (Assessment Data):

- ✓ Similarities and differences between a cable-stayed and a suspension bridge with illustration.
- ✓ Characteristic features of a cable-stayed bridge.
- ✓ Function of each of the parts of a cable-stayed bridge.

NOTES:

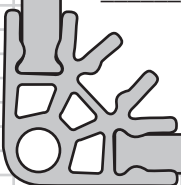

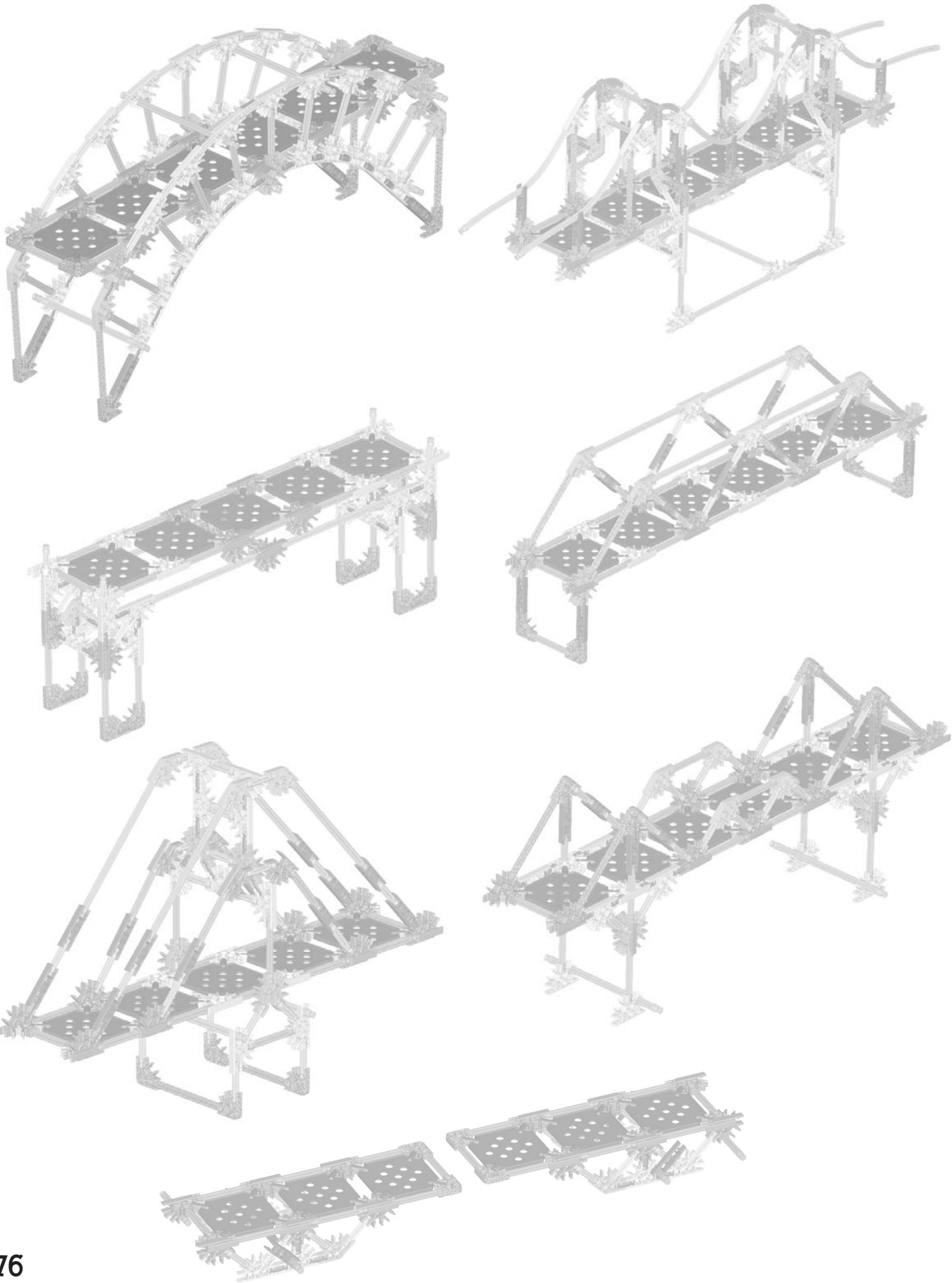

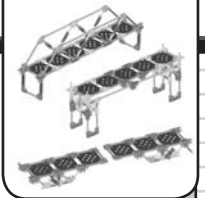

Designing a Bridge:

Time and cost factors.

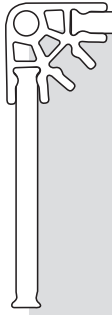

OBJECTIVES

Students will:

1. Design and build a model bridge to meet a series of criteria.
2. Calculate the costs of the materials they need for their bridge.
3. Compete with other teams to meet the design specification at the lowest cost and within the allotted time frame.

MATERIALS

Each team of 4-6 students will need:

- 1 or 2 K'NEX Introduction to Structures: Bridges sets
- String or cord
- 8½" x 11" Paper
- Pencils
- Scissors
- Paper clips
- Pipe cleaners
- Drinking straws
- Tape
- Student Journals

PROCEDURE

Introduction

- Having completed their survey of different types of bridges, students should understand that while engineers must consider the location and the function of the bridges they design, this is not all they have to take into account. The cost of the bridge and the timetable for its construction are also important factors. Although they cannot skimp on materials because of a potential loss of safety, they must keep within budget. They may also have to keep in mind that only certain materials may be available for the bridge and this may affect how the bridge is designed and built. Keeping to a schedule is important too – missing the deadlines means that the bridge will cost more and traffic will be congested for a longer period of time.
- Explain to the students that they will work as “company” design teams of 4-6 students to design a bridge that can carry a specific load. Each team should decide on their “company” name.

The design task

- To design and make a bridge that can span a 14" (40cm) gap and be able to support a 50g load in the middle. The bridge must have a roadway that allows vehicles to travel along it.

Competition conditions

- The activity will be a competition in which they will be asked to make their bridge from materials including 8½" x 11" paper, paper clips, tape, pipe cleaners, straws and string. Companies decide which materials are best for their designs.
- Companies cannot use K'NEX construction set parts in their designs, but they can use the sets to try out and test their ideas.
- The companies will be allowed 45 minutes **design time**, during which they will need to estimate and purchase the materials they will need for their bridge. A further 45 minutes will be allowed for the construction of the bridge.

☉ The materials can be purchased from the “Teacher’s Store” at the following prices:

8 ½” x 11” paper	\$5 per sheet
Tape	\$1 per 10cm strip
Paper Clips	\$0.50 each
Straws	\$1 each
Pipe cleaners	\$2 each
String/cord	\$1 per 10cm strip

☉ Those best able to plan will have no materials left at the end. Any surplus materials will be bought back by the “Teacher’s Store” at half the original cost. If any additional materials are needed after the initial purchase, they will cost twice the original price.

☉ Companies must create a name for their bridge design.

The Winner

☉ The winning company will be the one whose bridge meets the design specification at the lowest cost and within the allotted time frame.

Design and Build Activity

- ☉ Remind students that pre-planning and testing may be the key to a successful entry in the bridge competition. Students should be encouraged to use materials not found on the official materials list for testing purposes.
- ☉ Suggest that the companies record all of their design ideas on paper, along with their reasons for rejecting or accepting them. They should make notes and comments about any modifications made to their design during the design process.
- ☉ Encourage the members of the companies to make joint decisions and to assist one another as they work toward deadlines. Tell the companies that you will be monitoring for cooperative teamwork – everyone should have a chance to contribute to the bridge design and construction. They may decide to allocate a role for everyone on their design and construction team.
- ☉ Remind the companies to use their journals as log books to keep track of materials and costs. They may want to organize their information in chart form, listing the materials they used, the unit cost for each type of material, the amount used and the total cost for the bridge. They should check their calculations to make sure that they have tallied their costs correctly.
- ☉ When evaluating their design they should ask questions such as:
 - How can we make it stable?
 - How can we make it stronger?
 - What are the weak points in the design?
 - How can we reinforce it?
- ☉ Allow each company to test its bridge to make sure that it can support the 50g weight.
- ☉ Check the costs and the finish times for each group and award the bridge building contract to the firm that meets all the requirements for budget, time, bridge strength, and working together effectively as a team. (You may want to prepare an official-looking document to use for the “contract”.)

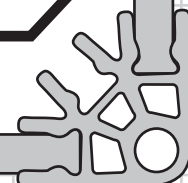

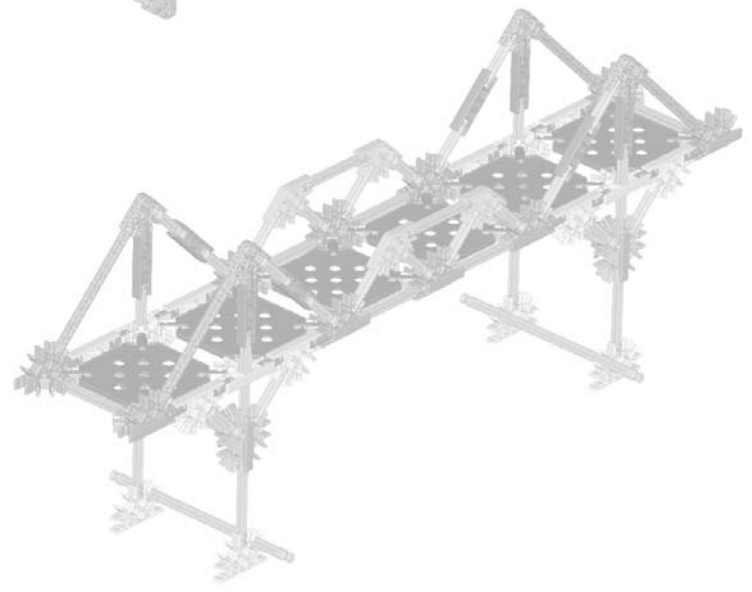
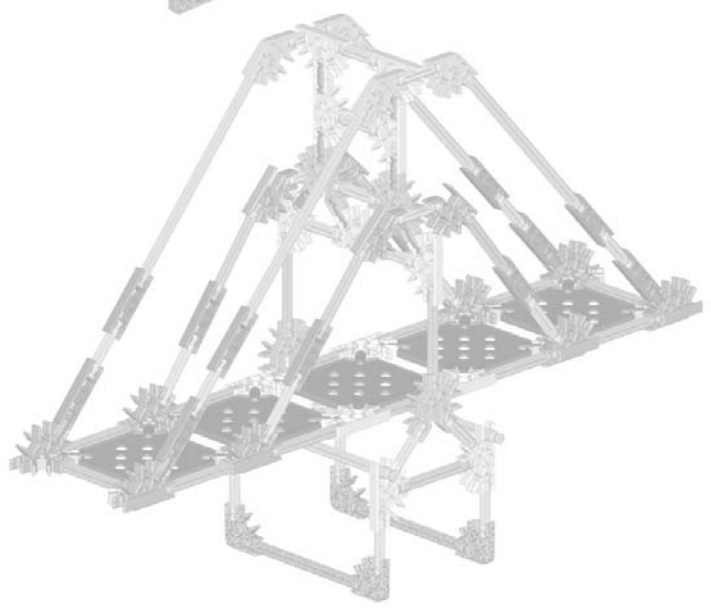
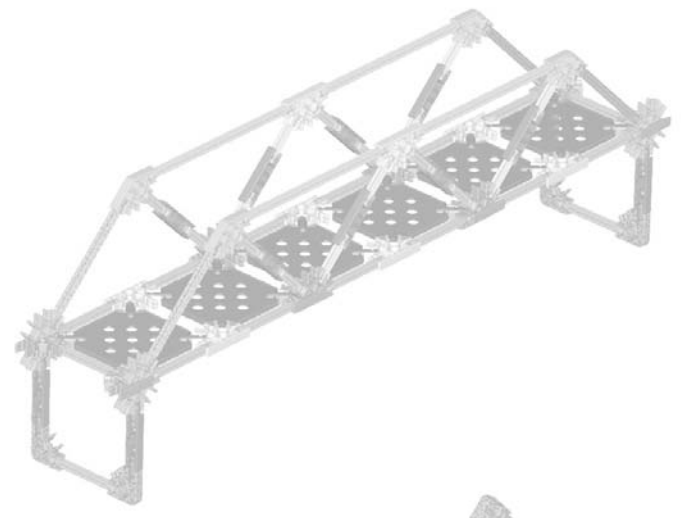
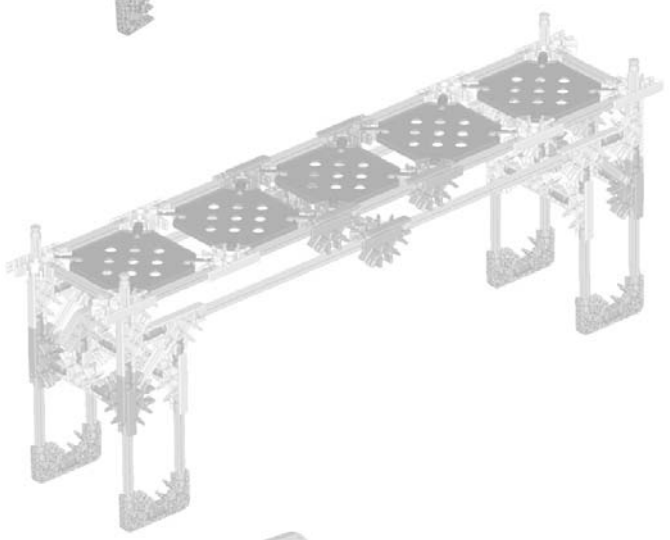
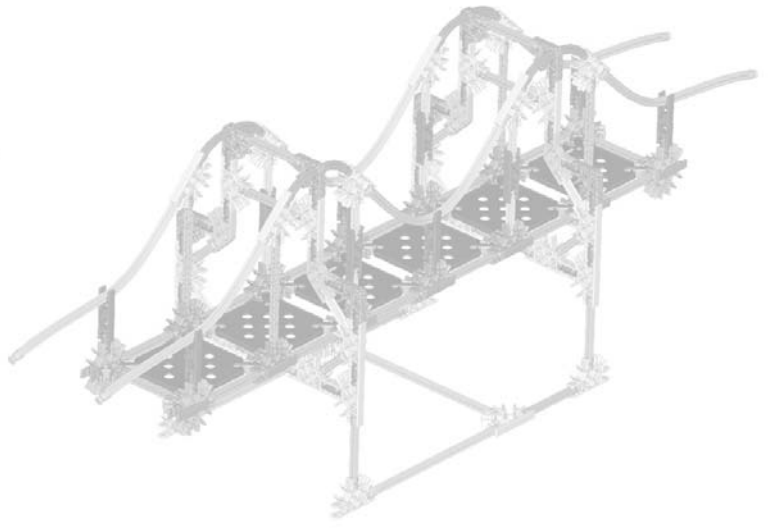

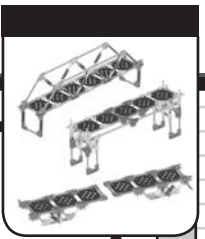
**WORKSHEET 1****BEAM BRIDGES**

Write short sentences to describe what each of these parts of a beam bridge do.

1. PIERS _____

2. BEAM _____

3. SPAN _____

4. DECK _____

5. RAMP _____

6. GUARDRAILS _____

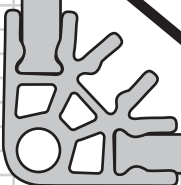

ANSWER KEY:

WORKSHEET 1: BEAM BRIDGES

PIERS: Vertical supports that hold up the beam bridge.

BEAM: Horizontal framework that rests on piers.

SPAN: Distance between the piers.

DECK: Foundation on which roadway/walkway is built on top of the beam.

RAMP: Inclined section that connects land to beam.

GUARDRAILS: Protective barriers along the deck which keep things from falling off the bridge.



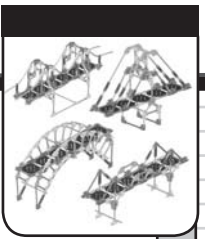

WORKSHEET 2

TRUSS JUMBLE

Match the pictures of different truss bridge designs with their correct names. Draw a line from the name of the bridge to its matching diagram.

BALTIMORE (PRATT)

WARREN

PENNSYLVANIA (PRATT)

LATTICE

PRATT

WHIPPLE

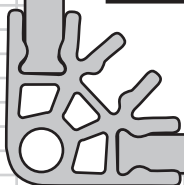
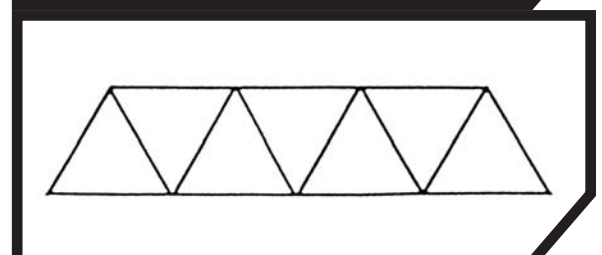
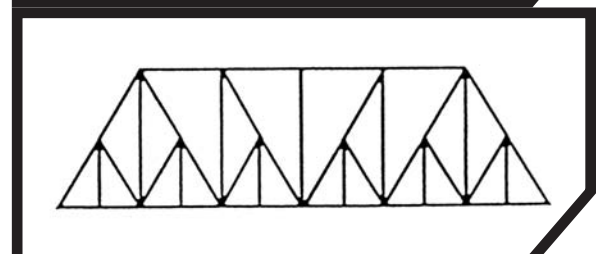
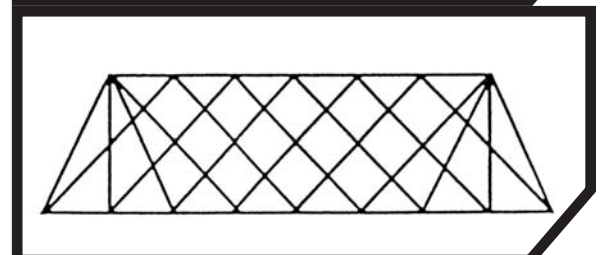
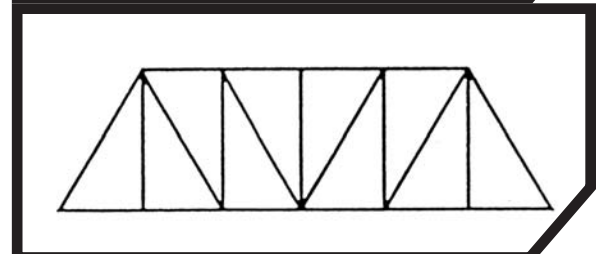
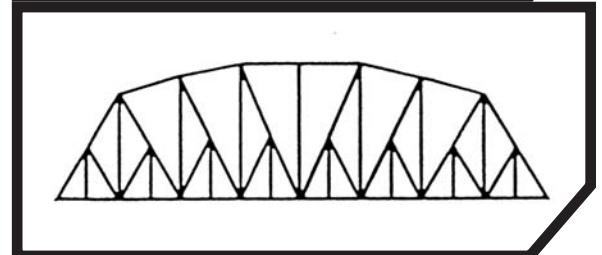
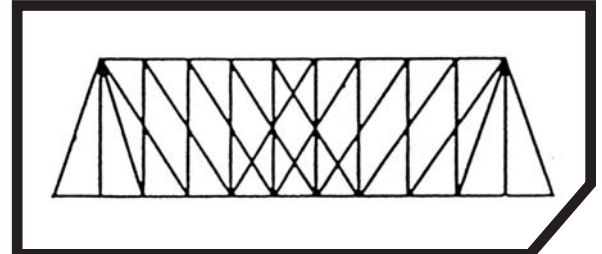

ANSWER KEY:

WORKSHEET 2: TRUSS JUMBLE

BALTIMORE (PRATT)

WARREN

PENNSYLVANIA (PRATT)

LATTICE

PRATT

WHIPPLE

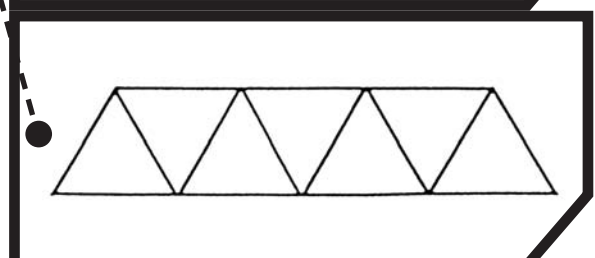
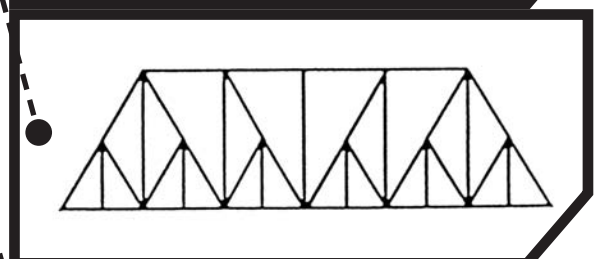
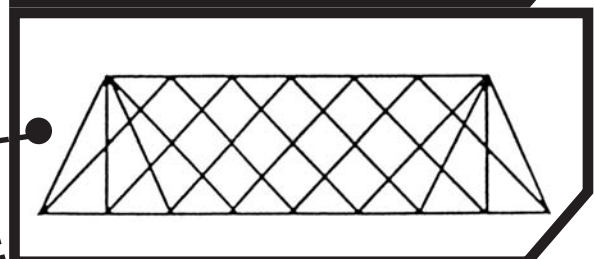
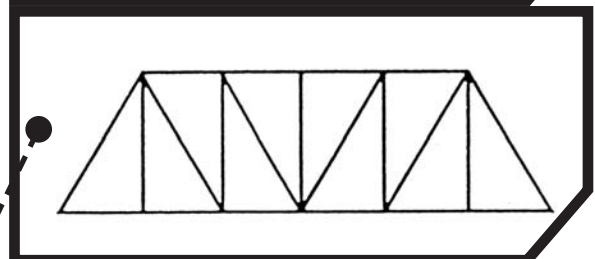
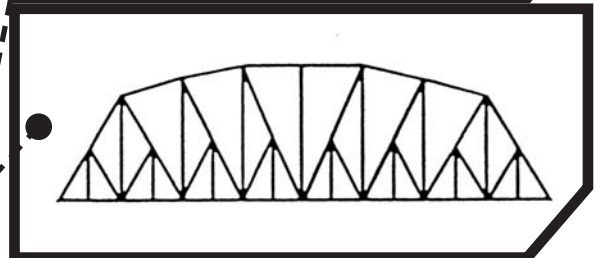
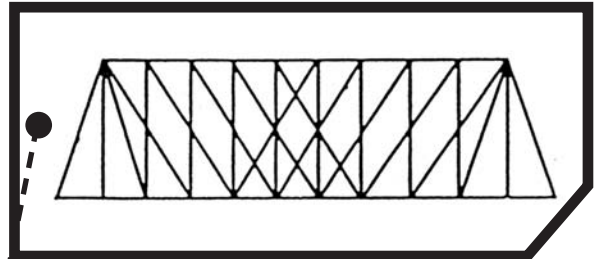

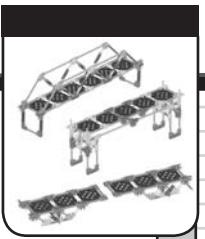

WORKSHEET 3

Arch Bridge Fill-In

Can you complete the following sentences about ARCH bridges using the words from the box? When you have filled in the missing letters for all the sentences, use the ones from the bolded spaces to answer the following question:

What were arches used for before bridge building?

1. The sides of the bridge, where they are attached to the land, which supports the arch:

_____ **t** _____

2. Three materials from which arch bridges are typically made:

_____ **o** _____

_____ **e** _____

_____ **l** _____

3. Special long arches that carry water from rivers to towns that need it:

_____ **e** _____

4. The force that has the most impact on arch bridges:

_____ **s** _____

5. The group of people responsible for developing the arch bridge:

_____ **m** _____

6. The top, center stone that all other stones in the arch bridge lean on, or push against, for support:

_____ **n** _____

STEEL

COMPRESSION

KEYSTONE

ROMANS

CONCRETE

AQUEDUCTS

ABUTMENTS

STONE

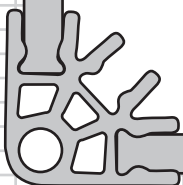

ANSWER KEY:

**WORKSHEET 3:
ARCH BRIDGE FILL-IN**

- | | |
|---------------------------|----------------|
| 1. Abutments | 4. Compression |
| 2. Stone, Concrete, Steel | 5. Romans |
| 3. Aqueducts | 6. Keystone |

Arches were used for decoration.

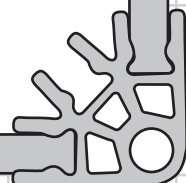

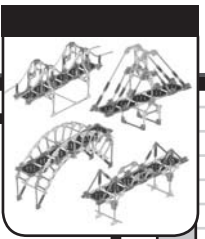
**WORKSHEET 4****THE SCOOP ON SUSPENSION BRIDGES**

Here are some statements about suspension bridges. Determine if they are true or false.

If a statement is false, change it so it becomes true.

- _____ 1. All suspension bridges have three things in common: two very tall towers; strong anchorages; cables made of many wires.

- _____ 2. The deck is hung from the cables.

- _____ 3. Suspension bridges usually have the longest single span of all bridges.

- _____ 4. The longer the suspension bridge, the shorter the towers need to be.

- _____ 5. The worst enemy of a suspension bridge is the rain because it can rust the steel cables.

- _____ 6. Some of the most famous bridges in the world are suspension bridges.

- _____ 7. The cables on a suspension bridge are not in a state of tension.

- _____ 8. One of the last steps in building a suspension bridge is anchoring the cables.

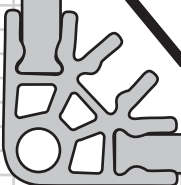

ANSWER KEY:

**WORKSHEET 4:
THE SCOOP ON SUSPENSION BRIDGES**

1. True
2. True
3. True
4. False: The longer the suspension bridge, the taller the towers need to be.
5. False: The worst enemy of a suspension bridge is the wind, because it can cause the bridge to sway and twist.
6. True
7. False: The cables on a suspension bridge are in a state of tension.
8. False: One of the last steps in building a suspension bridge is suspending the deck.

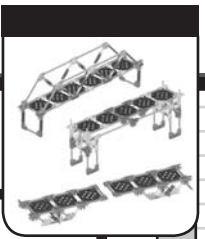

**WORKSHEET 5****CABLE-STAYED BRIDGES**

The following are characteristics of bridges. Put a check next to the statements that apply to cable-stayed bridges.

_____ Cables are strung from the tower to the deck.

_____ This type of bridge easily spans distances under 3000 feet (1000 meters).

_____ A tower supports a balanced portion of the deck.

_____ Anchorages are not necessary at the ends of the cables.

_____ The deck lifts up to allow boats to pass safely.

_____ Abutments are always found in this type of bridge.

_____ Tension is the force acting on the cables.

_____ A keystone helps keep the other pieces of the bridge in place.

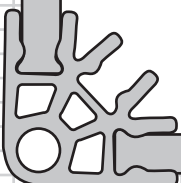

ANSWER KEY:

**WORKSHEET 5:
CABLE-STAYED BRIDGES**

The following principles apply to cable-stayed bridges:

- ✓ Cables are strung from the tower to the deck.
- ✓ These bridges easily span distances under 3000 feet (1000 meters).
- ✓ A tower supports a balanced portion of the deck.
- ✓ Anchorages are not necessary at the ends of the cables.
- ✓ Tension is the force acting on the cables.

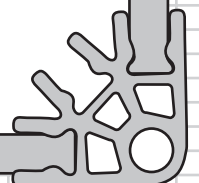

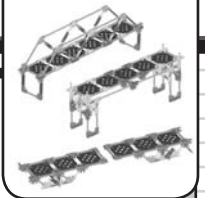

WORKSHEET 6

NAME THAT BRIDGE

Below are facts about the different types of bridges you have investigated. Match the fact with the name of a bridge from the list provided. You may use the bridge names more than once.

ARCH **BEAM** **TRUSS** **BASCULE**
CANTILEVER **SUSPENSION** **CABLE-STAYED**

1. Because bridges like me are long, light in weight, and high in the air, our greatest enemy is the wind. _____
2. Builders made the original versions of me out of wedge shaped stones that fit snugly together. They were held in place with the pressure of the weight of the bridge. _____
3. My bridge design is popular when the span is less than 3,000 feet (1,000 meters), mainly because I do not need anchorages or many piers. _____
4. My name means “seesaw” in French and the English dictionary describes me as a lever – something that is counterbalanced, so that when one end is lowered, the other is raised. _____
5. In the past I was commonly used to cross narrow distances like small streams or rivers. _____
6. The strength of my design lies in the use of triangles. _____
7. Bridges like me are usually made from two beams, each supported by one pier. _____
8. I am a new bridge design that includes elements from a cantilever and a suspension bridge, I am easier to build than either of those but I am limited to spanning shorter distances. _____
9. Two bridges that are like me are the Brooklyn Bridge and the Golden Gate Bridge. They both have decks that hang from cables made of hundreds of steel wires.
10. I am one of the oldest and simplest bridge designs. Today I can be quite a complex bridge, but like my ancestors, I support my own weight and the loads I have to bear, on vertical piers. _____

ANSWER KEY:

**WORKSHEET 6:
NAME THAT BRIDGE**

1. Suspension
2. Arch
3. Cable-stayed
4. Bascule
5. Beam
6. Truss
7. Cantilever
8. Cable-stayed
9. Suspension
10. Beam

