

HRDP and HRDPX H.264 DVR

Digital Recording and Transmission System

User Guide

Revisions

Issue	Date	Revisions
A	05/10	Initial Release
B	06/10	Updated Content
C	09/10	Updated Content
D	02/11	Added HRDPX H.264

Warnings and Safeguards

FCC STATEMENT

INFORMATION TO THE USER: This equipment has been tested and found to comply with the limits for a Class B digital device, pursuant to Part 15 of the FCC Rules. These limits are designed to provide reasonable protection against harmful interference in a residential installation. This equipment generates, uses and can radiate radio frequency energy and, if not installed and used in accordance with the instructions, may cause harmful interference to radio communications. However, there is no guarantee that interference will not occur in a particular installation. If this equipment does cause harmful interference to radio or television reception, which can be determined by turning the equipment off and on, the user is encouraged to try to correct the interference by one or more of the following measures:

Reorient or relocate the receiving antenna.

Increase the separation between the equipment and receiver.

Connect the equipment into an outlet on a circuit different from that to which the receiver is connected.

Consult the dealer or an experienced radio/TV technician for help.

Compliance Warning

Users of the product are responsible for checking and complying with all federal, state, and local laws and statutes concerning the monitoring and recording of video and audio signals. Honeywell video systems shall not be held responsible for the use of this product in violation of current laws and statutes.

CE Compliance Statement

The manufacturer declares that the equipment supplied with this guide is compliant with the essential protection requirements of the EMC directive 2004/108/EC and the Low Voltage Directive (LVD) 2006/95/EC, conforming to the requirements of standards EN 55022 for emissions, EN 50130-4 for immunity, and EN 60950 for Electrical Equipment safety.

Important Safeguards

1. **Read Owner's Manual** – After unpacking this product, read the owner's manual carefully, and follow all the operating and other instructions.
2. **Power Sources** – This product should be operated only from the type of power source indicated on the label. If not sure of the type of power supply to your home or business, consult product dealer or local power company
3. **Ventilation** – Slots and openings in the cabinet are provided for ventilation and to ensure reliable operation of the product and to protect it from overheating, and these openings must not be blocked or covered. The product should not be placed in a built-in installation such as a bookcase or rack unless proper ventilation is provided or Honeywell's instructions have been adhered to.
4. **Heat** – The product should be situated away from heat sources such as radiators, heat registers, stoves, or other products that produce heat.
5. **Water and Moisture** – Do not use this product near water. Do not exceed the humidity specifications for the product as detailed in this manual
6. **Cleaning** – Unplug this product from the wall outlet before cleaning. Do not use liquid cleaners or aerosol cleaners. Use a damp cloth for cleaning.
7. **Power Cord Protection** – Power-supply cords should not be routed so that they are likely to be walked on or pinched by items placed against them, paying particular attention to cords at plugs, receptacles, and the point where they exit the product.
8. **Overloading** – Do not overload wall outlets; extension cords, or integral convenience receptacles as this can result in a risk of fire or electrical shock.
9. **Lightning** – For added protection for this product during storm, or when it is left unattended and unused for long periods of time, unplug it from the wall outlet. This will prevent damage to the product due to lightning and power line surges.
10. **Object and Liquid Entry Points** – Never insert foreign objects into the DVR, other than the media types approved by Honeywell, as they may touch dangerous voltage points or short-out parts that could result in a fire or electrical shock. Never spill liquid of any kind on the product.
11. **Accessories** – Do not place this product on an unstable cart, stand, tripod, bracket, or table. The product may fall, causing serious personal injury and serious damage to the product.
12. **Disc Tray** – Keep fingers well clear of the disc tray as it is closing. Neglecting to do so may cause serious personal injury.
13. **Burden** – Do not place a heavy object on or step on the product. The object may fall, causing serious personal injury and serious damage to the product.
14. **Disc** – Do not use a cracked, deformed, or repaired disc. These discs are easily broken and may cause serious personal injury and product malfunction.
15. **Fuses** – CAUTION: For continued protection against risk of fire, replace only with same type and

rating of fuse.

16. **Replaceable Batteries** – CAUTION: Risk of Risk of Explosion if Battery is replaced by an Incorrect Type. Dispose of Used Batteries According to the Instructions
17. **Grounded Outlet** – This equipment shall be connected to a properly grounded outlet."
18. **Outlet Location** – This equipment must be installed within six feet of an easily accessible outlet.
19. **Damage Requiring Service** – Unplug the unit from the outlet and refer servicing to qualified service personnel under the following conditions:
 - When the power-supply cord or plug is damaged.
 - If liquid has been spilled, or objects have fallen into the unit.
 - If the unit has been exposed to rain or water.
 - If the unit does not operate normally by following the operating instructions. Adjust only those controls that are covered by the operating instructions as an improper adjustment of other controls may result in damage and will often require extensive work by a qualified technician to restore the unit to its normal operation.
 - If the unit has been dropped or the enclosure has been damaged.
 - When the unit exhibits a distinct change in performance - this indicates a need for service.
20. **Servicing** – Do not attempt to service this product. Opening or removing covers may expose the user to dangerous voltage or other hazards. Refer all servicing to qualified personnel.
21. **Replacement Parts** – When replacement parts are required, be sure the service technician has used replacement parts specified by Honeywell. Unauthorized substitutions may result in fire, electric shock or other hazards.
22. **Safety Check** – Upon completion of any service or repairs to this unit, ask the service technician to perform safety checks to determine that the unit is in proper operating condition.

Notes on Handling

Please retain the original shipping carton and/or packing materials supplied with this product. To ensure the integrity of this product when shipping or moving, repackage the unit as it was originally received from Honeywell. Do not use volatile liquids, such as aerosol spray, near this product. Do not leave rubber or plastic objects in contact with this product for long periods of time. They will leave marks on the finish. The top and rear panels of the unit may become warm after long periods of use. This is not a malfunction.

Notes on Locating

Place the unit on a level surface. Do not use it on a shaky or unstable surface such as a wobbling table or inclined stand. If this unit is placed next to a TV, radio, or VCR, the playback picture may become poor and the sound may be distorted. If this happens, place the DVR away from the TV, radio, or VCR.

Notes on Cleaning

Use a soft dry cloth for cleaning. For stubborn dirt, soak the cloth in a weak detergent solution, wring well and wipe. Use a dry cloth to wipe it dry. Do not use any type of solvent, such as thinner and benzene, as they may damage the surface of the DVR. If using a chemical saturated cloth to clean the unit, follow that product's instructions.

Notes on Maintenance

This DVR is designed to last for long periods of time. To keep the DVR always operational we recommend regular inspection maintenance (cleaning parts or replacement). For details contact the nearest dealer.

Notes on Moisture Condensation

Moisture condensation could damage the DVR. Read the following information carefully.

Moisture condensation might occur under the following circumstances:

- When this product is brought directly from a cool location to a warm location.
- When this product is moved to a hot and humid location from a cool location.
- When this product is moved to a cool and humid location from a warm location.
- When this product is used in a room where the temperature fluctuates.
- When this product is used near an air-conditioning unit vent.
- When this product is used in a humid place.

Do not use the DVR when moisture condensation may occur.

If the DVR is used in such a situation, it may damage discs and internal parts. Remove any CD discs, connect the power cord of the DVR to the wall outlet, turn on the DVR, and leave it for two to three hours. After two to three hours, the DVR will warm up and evaporate any moisture. Keep the DVR connected to the wall outlet and moisture will seldom occur.

Safety Instructions – Rack Mount

- A) Elevated Operating Ambient – If installed in a closed or multi-unit rack assembly, the operating ambient temperature of the rack environment may be greater than room ambient. Therefore, consideration should be given to installing the equipment in an environment compatible with the maximum ambient temperature (T_{ma}) specified by the manufacturer.
- B) Reduced Air Flow – Installation of the equipment in a rack should be such that the amount of air flow required for safe operation of the equipment is not compromised.
- C) Mechanical Loading – Mounting of the equipment in the rack should be such that a hazardous condition is not achieved due to uneven mechanical loading.
- D) Circuit Overloading - Consideration should be given to the connection of the equipment to the supply circuit and the effect that overloading of the circuits might have on overcurrent protection and supply wiring. Appropriate consideration of equipment nameplate ratings should be used when addressing this concern.
- E) Reliable Earthing - Reliable earthing of rack-mounted equipment should be maintained. Particular attention should be given to supply connections other than direct connections to the branch circuit (e.g. use of power strips)."

CAUTION

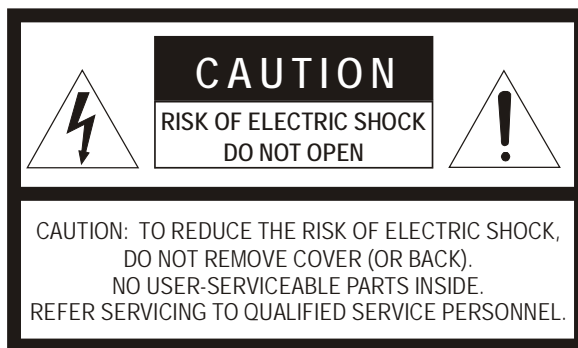

Contents

1 Warnings and Safeguards	5
2 Contents	11
3 Introduction	17
Product Description	17
Features	18
USB Flash Drive Approved List	19
PTZ Compatibility List	20
Quick Start Instructions	21
Logging In for the First Time	21
4 Installation	22
Front Panel Controls	22
Rear Panel Connectors	23
16 Channel	23
8 Channel	24
4 Channel	24
Remote Control	25
Connection Guide	26
Connecting the Monitor	26
Video Inputs and Looping Outputs	26
Connecting to a Network	26
Connecting Audio	26
Connecting a PTZ Camera	27
Connecting to a Sensor Input	27
Connecting to a Relay Output	27
Installing the Rackmount Kit	27
Turning on the DVR	28
Using the Power Button	28
Setting the Remote Controller ID	28
5 Setup	29
Setup Menus	29
Setup Wizard	30

Contents

System	31
System Configuration	31
Upgrade Firmware	32
Disk Configuration	33
Format	33
Overwrite	34
Check	34
SMART Check	35
User Configuration.....	36
Adding / Changing a User.....	37
Configuration	38
Shutdown.....	38
Camera.....	38
Camera Configuration	38
Color Setup (Adjust).....	39
PTZ Configuration.....	39
Spot / Sequence Configuration.....	40
Monitor Configuration.....	41
Record.....	42
Recording Configuration	42
Frame.....	42
Schedule.....	43
Holiday Setup	45
Instant Recording	45
Audio	45
Instant Recording	46
Using Instant Recording	46
Motion/Event Configuration.....	47
Input.....	47
Setting Up Motion Detection Recording	48
Sensor	49
Action.....	50
Alarm Monitor	51
Network	52
Network Configuration.....	52
Serial Configuration	54
E-mail Configuration	55
Information	56
System Log View	56
Version View	56
Status View	57

6 Operation	59
Login	59
Default Administrator Log In.....	59
Live Display Mode.....	60
Channel Selection	60
Icons	61
Mouse-Over Menu	62
Popup Menu	63
No Signal	63
No Permission	63
PTZ.....	64
PTZ Popup Menu	64
Create PTZ Preset Position.....	65
Search	65
Searching Recorded Data	65
Quick Search	66
Graphic Search.....	66
Quick Backup in Search Mode	66
Express Search.....	67
Jump to First Saved Data	67
Jump to Last Saved Data	67
Event Search.....	67
Daylight Savings Search	68
Search Popup Menu.....	68
Backup (Export)	69
Manual Export.....	69
Search Backup Data.....	70
Deinterlacing	70
Watermark	70
Using the Backup Viewer.....	71
Controlling Backup Viewer	71
Setup and Save Functions	72
Upgrade Firmware at the DVR.....	72
Play Back Backup Image.....	73
Screen Division Buttons	73
Save Settings	74
Save Settings.....	74
Import Settings	74
7 Remote Software	75
Set up a Remote Connection	75
Minimum System Requirements	75
Recommended System Requirements	75
Configuring the DVR.....	76
Creating a DVR Connection with Remote Software.....	76

- Default Remote Software Log in Information 77
- Access Remote Connection 77
 - Connecting Multiple DVRs..... 77
- Using the Remote Software 78
 - Setting the Time and Date 78
 - Live View Screen 79
 - Camera View 80
 - Screen Division Buttons 81
 - Setup Overview..... 81
 - Search Overview..... 82
 - Play Controls 83
 - Performing a Basic Search 83
 - Adjust the Brightness of an Image..... 83
 - Zooming in on an Image..... 83
 - Zooming in on a Portion of an Image 84
 - Printing an Image 84
 - Save Clip 84
 - Saving a Video Clip..... 85
 - Status Search 86
 - Performing a Status Search 86
 - PTZ Overview..... 87
 - Accessing PTZ Menus 87
 - Controlling a PTZ Camera..... 87
 - Using the Graphical PTZ Controller..... 88
 - Using the On-screen Compass..... 89
- Web Viewer Overview 90
 - Connecting to a DVR Using Web Viewer 91
 - Search Video Using Web Viewer 91
 - Performing a Basic Search 92
 - Status Search 92
 - Performing a Status Search..... 92
 - Clean Image 92
 - Print..... 93
 - Save..... 93
- Alarm Monitor..... 95
 - Assign Status Settings 95
 - Connecting to a DVR using Alarm Monitor..... 96
 - Set up Alarm Monitor Options..... 96
 - Add Items to Alarm Confirm List..... 97
 - Filter Alarm Events 97
- Search Alarm Window 98
 - View Recorded Video 98
 - Export Video 99

Digital Verifier Overview	100
Using the Digital Verifier	100
FVMS (option) Overview	101
Connecting to a DVR using FVMS	101
8 Appendix	102
Button Index	102
LED Status Indicators	102
Enter / Exit Buttons	103
Function Buttons	103
Numeric Buttons and Rec	103
Directional and Playback Control Buttons	104
DVR FAQ	105
General	105
Live Monitoring	105
Recording	106
Searching and Playing Video	106
Backup	106
Network	106
Miscellaneous	106
Troubleshooting	107
Specifications (HRDP H.264)	108
Specifications (HRDPX H.264)	109

Contents

Notes

Introduction

Product Description



Honeywell's HRDP H.264 DVR is a powerful, yet affordable, video management solution designed for easy installation and operation. Preconfigured for continuous recording, with no additional setup required, the DVR offers quick search, setup, and backup features.

The Honeywell Embedded DVR comes ready for fast and seamless integration within your existing IT infrastructure. The HRDP offers unparalleled stability, security, and ease of use in a 2U chassis. Accordingly, your security investment has never been easier to maintain. Multiple users may connect through digital networks such as LANs and WANs for simultaneous live viewing, and digital search. This powerful software enables users to view live video, perform searches, and operate PTZ cameras. It also provides system users and administrators with additional capabilities such as establishing recording schedules, and creating motion detection zones. With the latest advancements in the HRDP software, searching and indexing your video archive has never been easier.

Features

The HRDP H264 includes the following features:

- 4/8/16 Composite Video Input Connectors
- 4/8/16 Looping Video Outputs
- Compatible with Color (NTSC or PAL) and B&W Video Sources
- Multiple Search Methods (Calendar, Event)
- Records up to 240 NTSC Images Per Second / 200 PAL Images Per Second
- Records up to 480 NTSC Images Per Second / 400 PAL Images per Second (HRDPX only)
- Live Real Time Video Display (480 NTSC Images Per Second / 400 PAL Images Per Second)
- Auto Termination (75 Ohm) on Looping Outputs
- Continuous Recording with Disk Overwrite Mode
- Continuous Recording on Archiving, Transmitting to Remote, and Playback
- Motion Based Recording Uniquely Configurable for Each Channel
- Customizable Motion Detection Grids Uniquely Configurable for Each Channel
- Multiple Recording Modes (Manual / Schedule / Event)
- Audio (Mono) Recording and Playback
- 4/8/16 Built in Sensor Inputs (Normally Open or Normally Closed)
- 4 Built in Relay Outputs (Normally Open or Normally Closed)
- Remote Access via Ethernet and/or Modem
- PTZ Camera Control
- Internal DVD-RW supports CD-RW and DVD-RW media

USB Flash Drive Approved List

These USB flash drives have been tested and approved to work with the HRDP DVR. Other USB flash drives may also work with the HRDP DVR but have not yet been tested.

Manufacturer	Model
SanDisk	Cruzer
Talent	Flash
Corsair	Voyager
Lexar	JumpDrive
Kingston	Traveler

Note The USB ports on the HRDP H.264 only provide enough power for a flash based external device. To use an external hard disk drive (HDD), then you must use external power or a USB Y cable to provide sufficient power. Most external HDDs come with an external power supply or a USB Y cable.

PTZ Compatibility List

The Honeywell DVRs support a wide selection of PTZ camera protocols:

Honeywell MAXPRO	OpenEye – Pelco D
Honeywell VCL	ORX-1000
Honeywell (GC-655P)	Pelco-D
Honeywell (HSD-250)	Pelco-P
Honeywell (HSD-251)	PTC-400C
American Dynamics	RS-485 DIRECT
Cynix Speed Dome	SCC-641
DynaColor	SCC-645A
ERNITech	SDM-100
FastraxII	SJ-3728R1
Ganz-PT	SK-P
HISHARP	SK-S
HSDN 251/230	SPD-1600
KALATEL	SRX-1008
LG (LVC-A70X)	TBT-DOME
LILIN	Vison-360
OpenEye 500	Visiotech
OpenEye 510	WSD7425D
	WV-CS854
	YOKO-CCTV

Quick Start Instructions

1. Turn on the DVR. See the Turning on the DVR section for more details.
2. Log in -- Use the number buttons to enter the password when prompted
– The default password is <none> – Press ENTER.
3. Complete System Configuration to set up the date, time and system ID.
See the System Configuration section for more details.
4. Complete Disk Configuration to set overwrite options and enable SMART
Check. See the Disk Configuration section for more details.
5. Complete User Configuration to change the Admin password and add
additional users. See the System >User Configuration section for more
details.
6. Complete Camera Configuration for all attached cameras. See the
Camera Configuration section for more detail.
7. Complete PTZ Configuration for any attached Pan / Tilt / Zoom cameras.
See the PTZ Configuration section for more details.
8. Create a recording schedule. See the Record section for more details.
9. Complete Sensor Configuration to enable any external devices
connected to sensor inputs or relay outputs. See the Record >
Motion/Event Configuration section for more details.
10. Complete Motion/Event Configuration to trigger recording on an event:
motion, sensor, video loss. See the Motion/Event Configuration section
for more details.
11. The DVR is now configured to record, search and playback video. See
the Operation section in this manual for more information on using the
DVR.

Logging In for the First Time

The default administrative log in information:

ID: admin
Password: <none>

Installation

Front Panel Controls

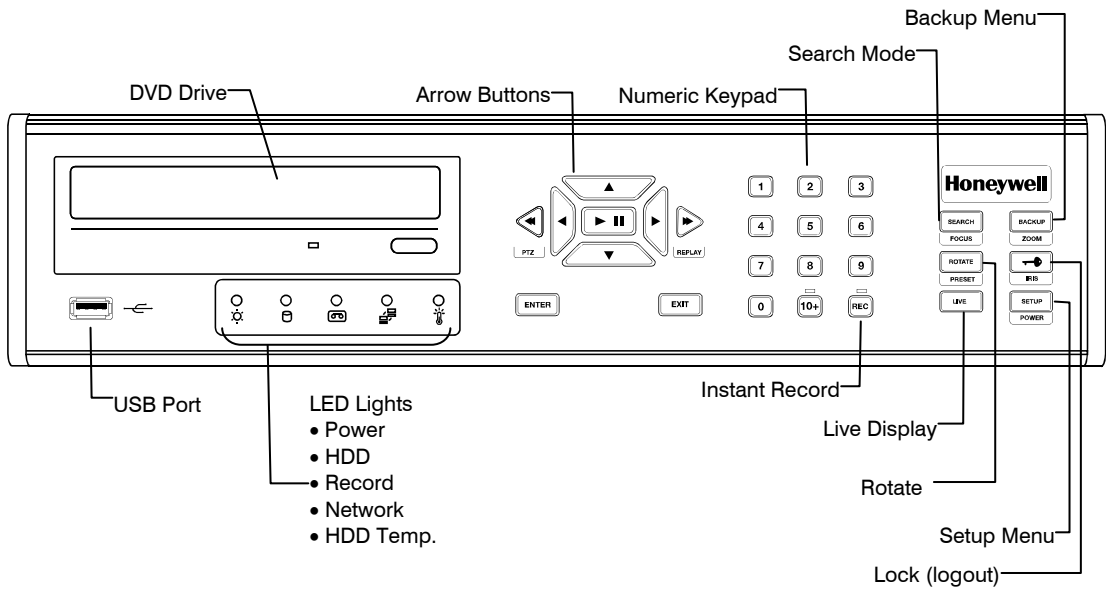

Rear Panel Connectors

The rear panel of the DVR contains virtually all of the connectors you will be using. The diagram below shows the location and description of each connector.

16 Channel

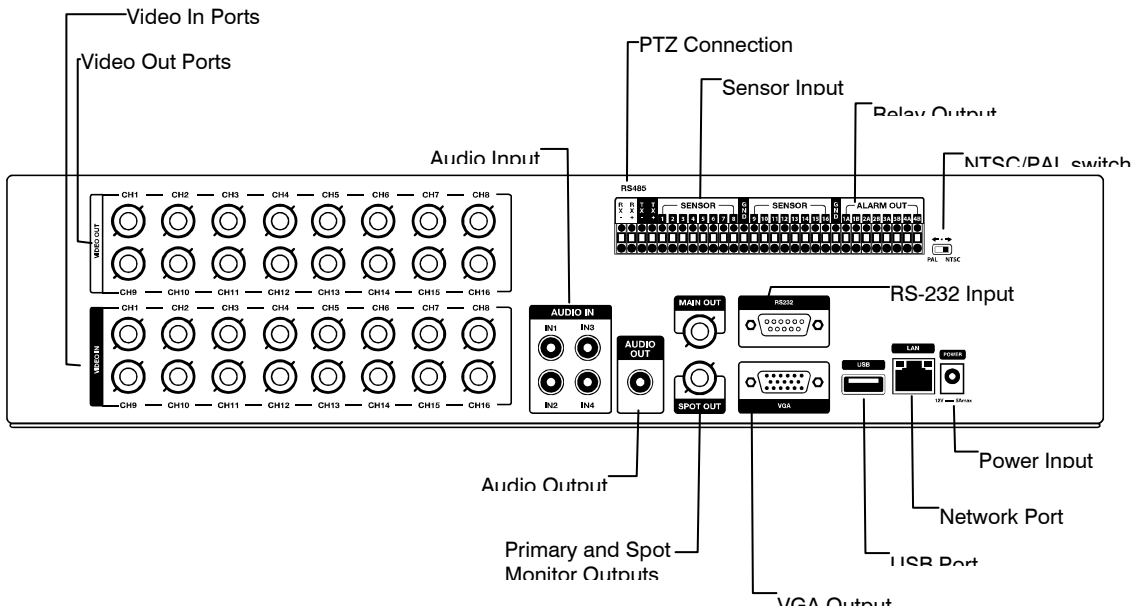

8 Channel

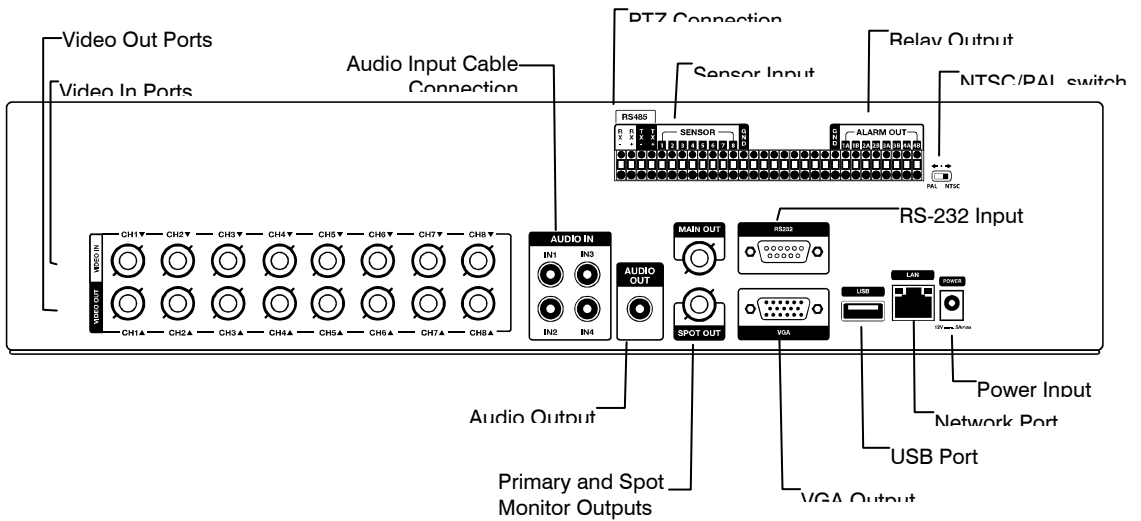

4 Channel

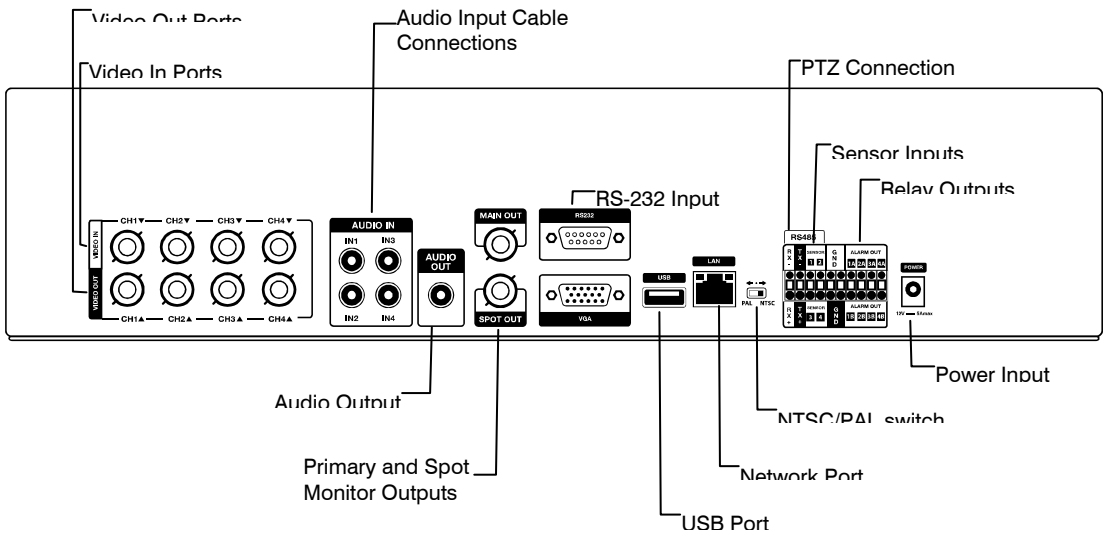

Remote Control

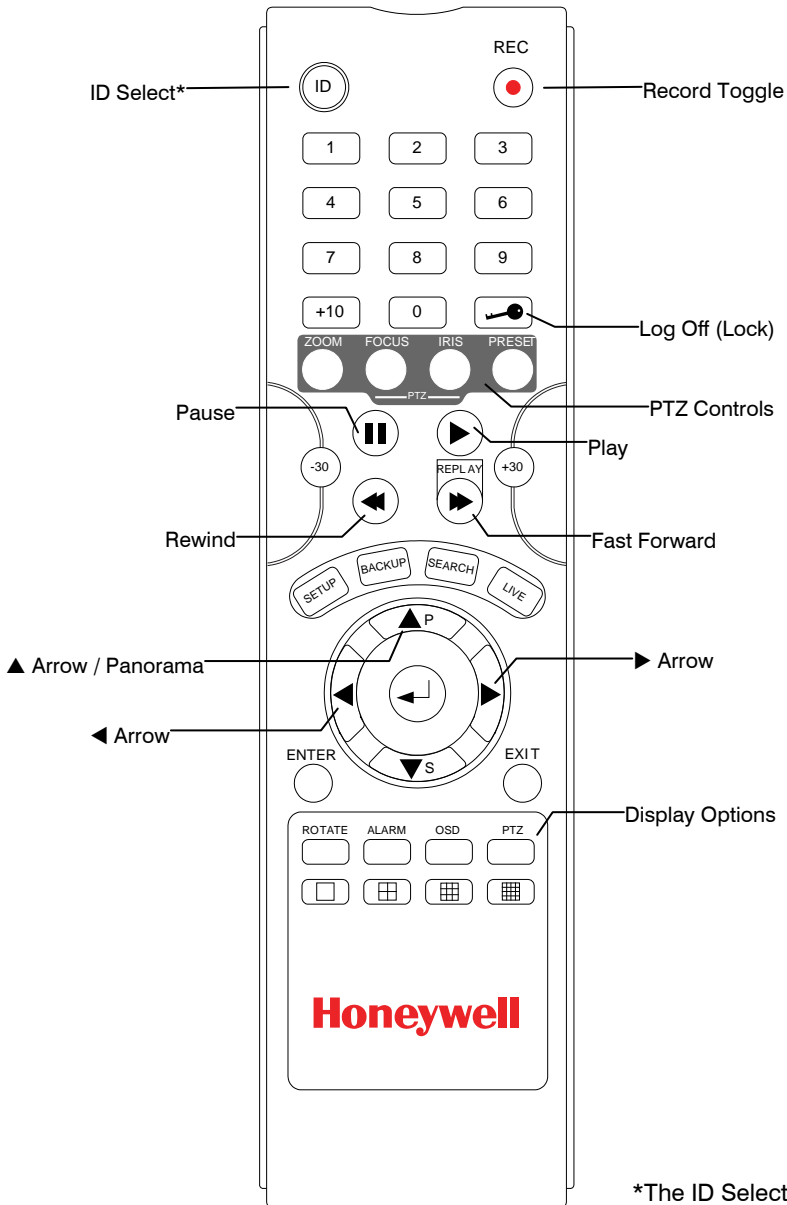

*The ID Select button allows you to use one remote control for several DVRs.

Connection Guide

Connecting the Monitor

There are three available monitor outputs on the DVR.

- Composite Monitor output for CCTV monitor – BNC (Marked MAIN)
- Spot monitor output for CCTV monitor - BNC (Marked SPOT)
- VGA output for VGA monitor – Mini-Sub D15

Video Inputs and Looping Outputs

The HRDP DVR comes with 4/8/16 BNC video inputs on the rear of its chassis. Each video input has a corresponding looping BNC output for passing the video signal to another monitoring/recording device.

Connecting to a Network

Use the RJ45 jack on the rear of the DVR when connecting to a network.



Connecting Audio

To record audio on the DVR connect the audio source to the connections on the audio ports on the back of the DVR.

To listen to live or recorded audio connect the Audio Out Port to an amplified speaker system.

Note The DVR audio output is a line level source which requires an amplified speaker system. The audio input can be from an amplified source or line level microphone.

Connecting a PTZ Camera

The RS485 connector can be used to control Pan / Tilt / Zoom (PTZ) cameras. See the PTZ camera manufacturer's manual for configuring the RS485 connection.

Note Use the RS485 connector for external control systems such as a control keyboard. Connect RX-/TX- and RX+/TX+ of the control system to the TX-/RX- and TX+/RX+ (respectively) of the DVR.

Connecting to a Sensor Input

To make connections on the Alarm Connector Strip: Press and hold the button and insert the wire into the hole below the button. To disconnect the wire press and hold the button above the wire and pull it out.

Alarm In

Use external devices to send a signal to the DVR when an event occurs. Mechanical or electrical switches can be wired to the Alarm In and Ground (GND) connectors.

Note All connectors marked GND are common. Connect the ground side of the alarm input and/or alarm output to the GND connector.

Connecting to a Relay Output

To make connections on the Alarm Connector Strip: Press and hold the button and insert the wire into the hole below the button. To disconnect the wire press and hold the button above the wire and pull it out.

Alarm Out

The DVR can activate external devices such as buzzers or lights. Connect the external device to the Alarm Out and Ground (GND) connectors. See Sensor Configuration in the manual for more details.

Installing the Rackmount Kit

Caution There must be a minimum 1U space between the DVR and any other items in the rack.

1. Attach the rackmount brackets with the screws provided on each side of the DVR. Do not remove the plastic edge guards.
2. Mount the DVR in your rack.

Turning on the DVR

1. Connect camera cables.
2. Connect a network cable and a monitor cable.
3. Connect the power cable to the DVR and wait until the main screen is displayed on the connected monitor; this process will take approximately two minutes.

Tip See the Connection Guide section for more details

Using the Power Button

To start the DVR:

Press and hold the Setup/Power button on the front panel of the DVR until the lights start to flash.

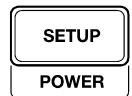

To shutdown the DVR:

Press and hold the Setup/Power button on the front panel of the DVR, log in when prompted and select OK to shut down.

Note Only authorized users can shut down the DVR.

Setting the Remote Controller ID

When more than one HRDP DVR is installed in the same location, you can use one remote controller to control multiple DVRs – up to 20 DVRs. To control multiple DVRs, you must change the remote controller ID to the DVR ID of the DVR.

To change the remote controller ID:

1. On the DVR, go to SYSTEM > SYSTEM CONFIGURATION.
2. Enter the desired DVR ID number.
3. On the remote controller, press and hold the ID button and enter the desired DVR ID number to operate the corresponding DVR.

Note The DVR ID must be input as two numbers on the remote controller. You must input 00 for the system ID 0 and input 01 for 1.

Setup

Setup Menus

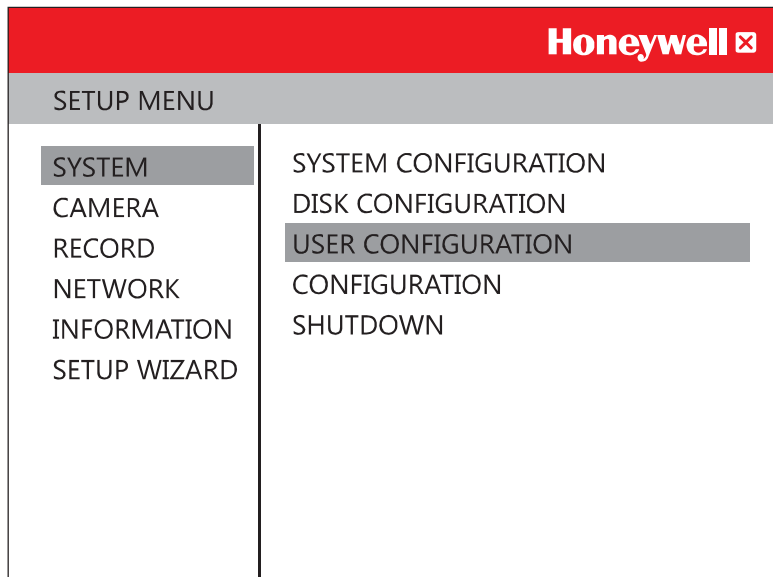

Use the setup menus to configure all of the DVR settings, schedule recording, networking and shutdown.

Press the SETUP key on the front of the DVR or remote control to enter the setup menus and log in. See the Logging In for the First Time section if entering setup for the first time. Use the ▲ and ▼ keys on the front of the DVR or remote control to navigate individual menus, and use the ◀ and ▶ keys to select a new setup menu.

Setup Wizard

The Setup Wizard allows you to define global recording settings for an easy and custom recording schedule on the DVR.

SETUP WIZARD	
GLOBAL RESOLUTION	352x240
RECORD MODE	CONTINUOUS
AVERAGE DAYS TO RECORD	116.3
IPS PER CHANNEL	1
PICTURE QUALITY	NORMAL

Global Resolution – 352 x240 / 704 x 240 / 704 x 480.

Record Mode – Continuous / Motion

Average Days to Record – [The estimated days of recording determined by resolution, IPS (Images Per Second), Picture Quality, and available storage size.]

IPS Per Channel – 1-30 [Maximum varies with resolution.]

Picture Quality – Low / Normal / High / Highest

System

System Configuration

SYSTEM CONFIGURATION	
VIDEO FORMAT	NTSC
LANGUAGE	ENGLISH
DVR ID	0
DATE FORMAT	MM-DD-YYYY 24H
DATE	04/06/2010
TIME	10:44:48
TIME ZONE	GMT-08:00 PST(US, Canada), Tijuana
USE DST	OFF
NTP TYPE	NTP SERVER
KEYPAD BEEP	OFF
AUTO LOG OFF	OFF
S/W UPGRADE	S/W UPGRADE
INFORMATION	
NTSC / PAL setting the rear panel DIP switch settings	
<input type="button" value="SAVE"/> <input type="button" value="CANCEL"/>	

To enter System Configuration, press the Setup key on the front of the DVR and press ENTER to select System Configuration. Use the arrow buttons on the front panel of the DVR or the remote control to navigate the display. Select Save and press ENTER to update settings.

Video Format – NTSC / PAL.

Language – ENGLISH / SPANISH / FRENCH / PORTUGUESE / GERMAN / DUTCH [User Selectable].

DVR ID - Required for the operation of multiple units using the supplied IR remote control. Each system must have a unique ID to function properly.

Date Format – US (MM-DD-YYYY) / EURO (DD-MM-YYYY) / ASIA (YYYY-MM-DD) – [User Selectable].

Date – Press ENTER to select the Date and use the number keys and/or arrow buttons to set the date. Press ENTER again to deselect.

Time – Press ENTER to select the Time and use the number keys and/or arrow buttons to set the time. Press ENTER again to deselect.

Time Zone – Press ENTER to open the Time Zone window. Use the arrow keys to navigate the list and press ENTER to make selection. Select Exit and press ENTER to close the window.

Note The date and time must be set manually; changing the time zone will not automatically change the Time/Date display.

System Configuration Continued

Use DST – After completing the Time Zone setup, highlight USE DST and press ENTER to turn Daylight Saving Time ON / OFF.

NTP Type – Highlight NTP (Network Time Protocol) and press ENTER to SYNC the DVR with the Network Time.

Keypad Beep – ON / OFF [Enables / Disables Audible keypad touch confirmation].

Auto Log Off – OFF or 1-10 Minutes [This feature will close the Configuration Menu after XX minutes of inactivity. This is a security feature.]

S/W Upgrade – Start firmware upgrade from selected media (USB or CD/DVD)

Upgrade Firmware

1. Press SETUP on the front panel or remote control.
or
Click MENU on the hover menu and select SETUP.
2. Select SYSTEM > SYSTEM CONFIGURATION.
3. Click S/W UPGRADE to open the UPGRADE FIRMWARE window.
4. Insert the CD/DVD or USB device.
5. Select the media type (DVD/CD-ROM / USB HDD/STICK).
6. Click SCAN.
7. Click OK to start the upgrade.

Disk Configuration

Format

Shows installed Hard Disk Drives and the status of other attached storage devices.

DISK CONFIGURATION-FORMAT

NO.	TYPE	MODEL	SIZE	FREE	STATUS
<input type="checkbox"/> 1	HDD	WDC WD5000AWS-6	458.2 GB	351.4 GB	REC
<input type="checkbox"/> 2	DVD/CD	DVDRAM GH22NS50	0.0 GB	0.0 GB	-
<input type="checkbox"/> 3					
<input type="checkbox"/> 4					
<input type="checkbox"/> 5					
<input type="checkbox"/> 6					

FORMAT
CANCEL
RESET

PROGRESS

0%

FORMAT	HDD OVERWRITE	CHECK	S.M.A.R.T.
--------	---------------	-------	------------

SAVE

CANCEL

To format a Hard Drive use the arrow keys to select the appropriate device and press ENTER. Select FORMAT and press ENTER, select YES to confirm formatting and press ENTER.

To format a USB device use the arrow keys to select the device and press ENTER. Select Format and press ENTER. Select YES to confirm and press ENTER.

Tip Refer to the list of Approved USB Flash Drives in the Introduction chapter.

To refresh the list of connected USB devices select RESET and press ENTER.

Caution All USB devices must be formatted as FAT32 before using with the DVR.

Note Upon formatting a drive, all video and other data stored on that drive will be permanently erased and cannot be recovered.

Overwrite

Sets options for overwriting data when the Hard Disk Drive is full.

DISK CONFIGURATION-HDD OVERWRITE			
WARNING CONDITION			
HDD OVERWRITE	ENABLE		
DISK-FULL WARNING	ON		
REMAINING TIME	10 MIN		
USED SPACE	90%		
<hr/>			
WARNING METHOD			
DISK-FULL ALARM	ON		
DISK-FULL BUZZER	OFF		
DISK FULL MESSAGE	OFF		
FORMAT	HDD OVERWRITE	CHECK	S.M.A.R.T.
SAVE		CANCEL	

Enable HDD OVERWRITE to allow the DVR to write over previously recorded data, starting with the oldest date, when the HDD is full. If set to DISABLE the DVR will not record any new data once the HDD becomes full. Enable a DISK FULL WARNING for notification when the HDD becomes full and HDD Overwrite is disabled.

Check

Checks the HDD for errors or failure.

DISK CONFIGURATION-CHECK			
START CHECK			
RECORDING START 03/01/2010			
RECORDING END 04/05/2010			
<div style="border: 1px solid black; width: 100%; height: 15px; display: flex; justify-content: space-between;"><div style="width: 50%;"></div>0%</div>			
AUTO DATA DELETION 0 DAYS			
FORMAT	HDD OVERWRITE	CHECK	S.M.A.R.T.
SAVE		CANCEL	

SMART Check

S.M.A.R.T. = Self Monitoring Analysis & Reporting Technology.
Enable SMART Check to detect signs of HDD failure.

DISK CONFIGURATION-S.M.A.R.T.			
ENABLE S.M.A.R.T.	ENABLE		
CHECK INTERVAL	2 HOUR		
TEMP THRESHOLD	50 C		
S.M.A.R.T. WARNING	POPUP		
CHECK NOW			
HDD INFORMATION			
FORMAT	HDD OVERWRITE	CHECK	S.M.A.R.T.
SAVE		CANCEL	

1. Set ENABLE S.M.A.R.T. to ENABLE or DISABLE.
2. Set a CHECK INTERVAL between 1 and 24 hours.
3. Define a TEMP THRESHOLD and select Celsius or Fahrenheit.

Note The recommended upper optimum operating temperature for the HDD is between 104F to 122F (40C to 50C).

4. Select a S.M.A.R.T. WARNING to be activated when the HDD reaches the defined threshold.
5. Select SAVE and press ENTER to save settings.

Tip Select HDD INFORMATION and press ENTER to view the current HDD, DVD, and USB drive information.

User Configuration

Use the User Configuration to Add or Delete users.

USER CONFIGURATION			
	USER		
1	admin	ADD/CHANGE	DEL
2	NONE	ADD/CHANGE	DEL
3	NONE	ADD/CHANGE	DEL
4	NONE	ADD/CHANGE	DEL
5	NONE	ADD/CHANGE	DEL
6	NONE	ADD/CHANGE	DEL
7	NONE	ADD/CHANGE	DEL
8	NONE	ADD/CHANGE	DEL
9	NONE	ADD/CHANGE	DEL
10	NONE	ADD/CHANGE	DEL
	PAGE2		

Adding / Changing a User

USER ADD/CHANGE

USER

PASSWORD

FUNCTION ACCESS PERMISSION ALL

SHUT DOWN SEARCH PTZ

EXPORT EXPORT VIEWER HEALTH CHECK

USE DVD/CD/USB NETWORK CONNECTION

MENU ACCESS PERMISSION ALL

SYSTEM CAMERA RECORD

NETWORK SETUP WIZARD

LIVE & PLAYBACK (SELECT CAMERA)

ALL 1 2 3 4 5 6 7 8

9 10 11 12 13 14 15 16

SHUT DOWN – Allow the user to shut down or restart the DVR.

EXPORT – Allow the user to perform an export or backup saved data.

USE CD/DVD/USB - Allow the user to use the DVD Drive. This is a Server side feature only.

SEARCH – Allow the user to perform a calendar, or event search and access data from the current day using the Replay button on the front panel.

EXPORT VIEWER – Allow the user to include a copy of the Backup Viewer application when a local backup is made. This is a server side feature only.

PTZ – Allow the user control of any connected PTZ cameras.

HEALTH CHECK – Allow the user to use the Health Check function of FVMS to connect to and monitor the DVR.

NETWORK CONNECTION – Allow the user to log in using Web Viewer.

MENU ACCESS PERMISSION – Allow the user to access the selected portion of the setup menu.

LIVE & PLAYBACK – Allow the user to view live and recorded data for only the selected cameras.

To add a new user:

1. Press MENU on the front panel or remote control.
or
Click MENU on the Mouse-over menu and select SETUP.
2. Select SYSTEM > USER CONFIGURATION.
3. Click ADD/CHANGE.
4. Enter a USER name.
5. Enter a PASSWORD and CONFIRM for the new user.
6. Select the FUNCTIONS and MENU ACCESS options for the user.
7. Select which cameras will be visible to the user in LIVE & PLAYBACK modes.

Configuration

Import and Export current settings. See details in the Save Settings section.

Shutdown

Use Shutdown to safely shutdown the system.

1. Select System > Shutdown.
2. Select OK to confirm and press ENTER to safely shutdown the system.
3. Turn the power off when shutdown is complete by unplugging the power adapter cord on the back of the DVR.

Note Improper shut down of the system can cause data loss and system corruption.

Camera

Camera Configuration

CH	NAME	HIDDEN	ADJUST
1	C1	OFF	▶
2	C2	OFF	▶
3	C3	OFF	▶
4	C4	OFF	▶
5	C5	OFF	▶
6	C6	OFF	▶
7	C7	OFF	▶
8	C8	OFF	▶

CH9-CH16

INFORMATION _____

ADJUST: Setting Brightness, Contrast, Color

SAVE CANCEL

CH –Camera Channels

NAME – Use the on-screen keyboard to enter a camera name [user defined]

HIDDEN – ON/OFF

Note HIDDEN on the CAMERA CONFIGURATION page hides cameras from the main monitor (VGA/MAIN BNC) when no users are logged in. To hide cameras from users, clear camera check boxes on the SYSTEM > USER CONFIGURATION > ADD/CHANGE.

ADJUST –Detailed camera display settings.

Color Setup (Adjust)

CAMERA – 1 ~ 16 [camera to apply color settings to]
BRIGHTNESS – 0 ~ 20
CONTRAST – 0 ~ 20
COLOR – 0 ~ 20
DEFAULT – Apply default system color settings.
APPLY ALL – Apply current color settings to all cameras

CAMERA CONFIGURATION

CAMERA ◀ 1 ▶

BRIGHTNESS 10

CONTRAST 10

COLOR 10

DEFAULT APPLY ALL

PTZ Configuration

PTZ CONFIGURATION

CH	BAUD RATE	ID	PROTOCOL
1	9600 BPS	1	NONE
2	9600 BPS	2	NONE
3	9600 BPS	3	NONE
4	9600 BPS	4	NONE
5	9600 BPS	5	NONE
6	9600 BPS	6	NONE
7	9600 BPS	7	NONE
8	9600 BPS	8	NONE

CH9-CH16

CH – Camera Channels

BAUD RATE – Sets the port information for the connected camera. [Consult the documentation provided by the camera manufacturer to obtain this information.]

ID – Sets the PTZ ID from 1-255

PROTOCOL – Select a PTZ protocol

Spot / Sequence Configuration

SPOT/SEQUENCE CONFIGURATION	
SPOT	
INTERVAL	3 SEC
POPUP	OFF
CHANNEL SELECT	
<input type="checkbox"/> ALL	<input type="checkbox"/> 1 <input type="checkbox"/> 2 <input type="checkbox"/> 3 <input type="checkbox"/> 4 <input type="checkbox"/> 5 <input type="checkbox"/> 6 <input type="checkbox"/> 7 <input type="checkbox"/> 8
	<input type="checkbox"/> 9 <input type="checkbox"/> 10 <input type="checkbox"/> 11 <input type="checkbox"/> 12 <input type="checkbox"/> 13 <input type="checkbox"/> 14 <input type="checkbox"/> 15 <input type="checkbox"/> 16
<hr/>	
SEQUENCE	
PAGE DWELL TIME	2 SEC
[SAVE] [CANCEL]	

Spot/Sequence Configuration allows you to set the parameters for the SPOT OUT on the DVR and the local live view sequencing.

SPOT – Configure the SPOT OUT connection.

INTERVAL – 1 ~ 100 seconds [Set the sequence interval time].

POPUP – ON / OFF [When set to ON, this function interrupts the sequencing when an event occurs, and switches to the event channel.]

CHANNEL SELECT – 1~16 / ALL [Select cameras to include in sequence.]

SEQUENCE – Configure the appearance of the sequence on the live view screen (MAIN/VGA).

PAGE DWELL TIME – 0 ~ 100 seconds [Set the sequence interval time for full page].

Monitor Configuration

MONITOR CONFIGURATION		
TRANSPARENCY SETUP	0	
VGA RESOLUTION	1280X1024	<input type="checkbox"/> FIT-IN VGA
<hr/>		
OSD	<input type="checkbox"/> ALL	
	<input type="checkbox"/> DATE	<input type="checkbox"/> TIME
	<input type="checkbox"/> PTZ	<input type="checkbox"/> RECORD
	<input type="checkbox"/> TITLE	<input type="checkbox"/> AUDIO
<hr/>		
INFORMATION		
FIT-IN VGA : Main Output is VGA(VGA or SPOT)		
<input type="button" value="SAVE"/> <input type="button" value="CANCEL"/>		

TRANSPARENCY SETUP – 0 ~ 20 [Set the transparency of the setup windows].

VGA RESOLUTION – Set monitor resolution.

FIT-IN VGA – Adjusts the display to display properly on a VGA monitor. When the FIT-IN VGA check box is cleared, the display is adjusted to display on a monitor connected to the MAIN BNC output.

OSD – Select the items to display on the screen (DATE, TIME, TITLE, PTZ, RECORD, AUDIO).

Record

Recording Configuration

Frame

RECORD CONFIGURATION-FRAME							
CH	ON/OFF	SIZE	IPS	QUALITY	INTENSIVE	PREALARM	POSTALARM
1	ON	352X240	15	NORMAL	OFF	OFF	OFF
2	ON	352X240	15	NORMAL	OFF	OFF	OFF
3	ON	352X240	15	NORMAL	OFF	OFF	OFF
4	ON	352X240	15	NORMAL	OFF	OFF	OFF
5	ON	352X240	15	NORMAL	OFF	OFF	OFF
6	ON	352X240	15	NORMAL	OFF	OFF	OFF
7	ON	352X240	15	NORMAL	OFF	OFF	OFF
8	ON	352X240	15	NORMAL	OFF	OFF	OFF

CH9-CH16

INFORMATION _____

USED FPS : 240 IPS/240 IPS

FRAME	SCHEDULE	AUDIO	INSTANT
-------	----------	-------	---------

SAVE CANCEL

- ON/OFF** – Enable or disable recording on individual camera channels.
- SIZE** – 352 × 240 / 704 × 240 / 704 × 480. [Resolution]
- IPS** – 1~30 [Recording Images Per Second]
- QUALITY** – Low / Normal / High
- INTENSIVE** – ON/OFF [Intensive Recording on sensor or motion event]

Note When a motion or sensor event occurs, **INTENSIVE RECORDING** automatically increases the recording rate to the maximum IPS that is available (based on your current recording configuration frame rate) up to 30 IPS per channel. If events occur on multiple channels with intensive recording enabled, the available IPS is evenly distributed across those channels.

- PREALARM** – 0~5 seconds [Pre-Alarm Recording]
- POSTALARM** – 0~30 seconds [Post Alarm Recording]
- USED FPS** – Displays the images per second (IPS) currently used, and the total available IPS. HRDP models have a maximum of 240 IPS and HRDPX models have a maximum of 480 IPS.

Schedule

Set the recording schedule for each camera:

1. Press MENU on the front panel or remote control.
or
Click MENU on the Mouse-over menu and select SETUP.
2. Select RECORD > SCHEDULE.
3. Select a camera to create a recording schedule, or select ALL.
4. Select the check box of the desired RECORD MODE.
5. Click hour block or the day of the week to set the entire day.

RECORD CONFIGURATION-SCHEDULE

CAMERA 1 2 3 4 5 6 7 8
 ALL 9 10 11 12 13 14 15 16

RECORD MODE

NO RECORDING CONTINUOUS MOTION SENSOR
 CONT+MOT CONT+SENS MOT+SENS

ALL	00	01	02	03	04	05	06	07	08	09	10	11	12	13	14	15	16	17	18	19	20	21	22	23
SUN																								
MON																								
TUES																								
WED																								
THU																								
FRI																								
SAT																								
H.DAY																								

HOLIDAY SETUP

FRAME
SCHEDULE
AUDIO
INSTANT

NO RECORDING
No Color

No recording.
Even if you set recording frames and select ON in RECORD > CAMERA, the DVR will not record anything if you set OFF in RECORD > SCHEDULE.

CONTINUOUS
Yellow

CONTINUOUS recording.

MOTION
Green

MOTION-detection recording.
In this mode, the DVR records only when motion is detected in the motion area, and stops recording when motion is not detected. Adjust motion area settings in RECORD > MOTION/EVENT CONFIGURATION > INPUT. If you set motion to OFF in RECORD > MOTION /EVENT CONFIGURATION and set CONT + MOT in SETUP > RECORD > SCHEDULE the DVR will NOT record when motion is detected.

SENSOR Orange	SENSOR-activated recording In sensor mode, the DVR will record when a sensor is triggered - during DURATION time as set in RECORD > MOTION /EVENT CONFIGURATION > ACTION.
CONT+MOT Sky Blue	CONTINUOUS + MOTION detection recording The DVR records in CONTINUOUS mode but switches toMOTION when motion is detected in the motion area. The DVR also will log a Motion Event and send the event to the Remote Monitoring software. If you set motion to OFF in RECORD > MOTION /EVENT CONFIGURATION and set CONT + MOT in SETUP > RECORD > SCHEDULE the DVR will NOTrecord when motion is detected.
CONT+SENS Brown	CONTINUOUS + SENSOR-activated recording In this mode, the DVR records continuously and switches to SENSOR recording mode when a sensor is triggered. The DVR also will log a Sensor Event and send the event to the Remote Monitoring software.
MOT+SENS Lilac	MOTION detection + SENSOR-activated recording The DVR will only record when motion is detected or a sensor is triggered.

Holiday Setup

Add a recording schedule for a specific date in HOLIDAY SETUP. You can add up to 32 individual HOLIDAY recording schedules. To add a new HOLIDAY schedule:

1. Press MENU on the front panel or remote control.
or
Click MENU on the Mouse-over menu and select SETUP.
2. Select RECORD > RECORD CONFIGURATION > SCHEDULE.
3. Create a recording schedule in the H.DAY row.
4. Select HOLIDAY SETUP.
5. Select DATE and set the date using the on-screen calendar.
6. Type a description in the box next to the DATE box using the on-screen keyboard.
7. Select ADD to add the holiday.

Instant Recording

The DVR remote controller has an Instant Recording button. Press the REC (INSTANT) button to start recording all the channels at the recording rate configured in Instant Record setup. All the channels, regardless of recording mode & recording on/off, will record.

I-REC will show in live mode and a red bar represents Instant Recording video in the graphic search bar.

Audio

RECORD CONFIGURATION-AUDIO			
MAPPING AUDIO TO VIDEO			
CH	AUDIO IN	AUDIO IN	
1	OFF	AUDIO IN CH1	OFF
2	OFF	AUDIO IN CH2	OFF
3	OFF	AUDIO IN CH3	OFF
4	OFF	AUDIO IN CH4	OFF
5	OFF		
6	OFF	AUDIO VOLUME	5
7	OFF	TWO WAY AUDIO	
8	OFF	TWO WAY AUDIO	OFF
CH9-CH16			
FRAME	SCHEDULE	AUDIO	INSTANT
SAVE		CANCEL	

Associate cameras to the appropriate audio channel and enable each audio channel for recording.

Instant Recording

Configure the recording settings for Instant Recording to use when it is activated.

RECORD CONFIGURATION-INSTANT	
IPS	15
QUALITY	NORMAL
SIZE	352X240

FRAME	SCHEDULE	AUDIO	INSTANT
-------	----------	-------	----------------

IPS – Set the IPS (recording rate per camera).

QUALITY – Set the picture quality (affects file size).

SIZE – Set the resolution of the video image.

Using Instant Recording

To activate Instant Recording on the DVR:

- Press the REC key on the front panel of the DVR or remote control, or click the Instant recording button on the mouse-over OSD menu. The I-REC recording icon will appear in the lower right corner of the screen.

To cancel Instant Recording on the DVR:

- Press the REC key on the front panel of the DVR or remote control. The DVR will resume scheduled recording.

Motion/Event Configuration

Motion / Event Configuration has four sections; Input, Sensor, Action, and Alarm Monitor. When an event comes in (Input) the DVR records the image according to its settings (Camera Configuration) and triggers an alarm (Action).

Input

MOTION/EVENT CONFIGURATION-INPUT					
CH	MOTION	SENSITIVITY	AREA	SENSOR	VIDEO LOSS
1	ON	5	ON	OFF	OFF
2	ON	5	ON	OFF	OFF
3	ON	5	ON	OFF	OFF
4	ON	5	ON	OFF	OFF
5	ON	5	ON	OFF	OFF
6	ON	5	ON	OFF	OFF
7	ON	5	ON	OFF	OFF
8	ON	5	ON	OFF	OFF
CH9-CH16					
INPUT		SENSOR		ACTION	
ALARM MONITOR		SAVE		CANCEL	

CH – ▲ Channels 1-8 / ▼ Channels 9-16

MOTION – ON / OFF [Specify whether to use motion input or not.]

SENSITIVITY – 1~10 (1 = least sensitive, 10 = most sensitive)

AREA – Define the motion detection area.

SENSOR – Associate a sensor with the camera channel.

VIDEO LOSS – Trigger recording on video loss events.

Setting Up Motion Detection Recording

To record data only when motion is detected:

MOTION/EVENT CONFIGURATION-INPUT					
CH	MOTION	SENSITIVITY	AREA	SENSOR	VIDEO LOSS
1	ON	5	ON	OFF	OFF
2	ON	5	ON	OFF	OFF
3	ON	5	ON	OFF	OFF
4	ON	5	ON	OFF	OFF
5	ON	5	ON	OFF	OFF
6	ON	5	ON	OFF	OFF
7	ON	5	ON	OFF	OFF
8	ON	5	ON	OFF	OFF
CH9-CH16					
INPUT		SENSOR		ACTION	
				ALARM MONITOR	
			SAVE		
			CANCEL		

1. Press **SETUP** on the front of the DVR or remote control.
2. Select **Record > Motion/Event Configuration** and set **MOTION** to **ON**.
3. Set the motion **SENSITIVITY** level. [1~10].
4. Select **AREA** and press **ENTER** to set a motion area (global setting; each channel can be configured individually).
5. Use the mouse to select or clear squares on the grid:
 - a) Right click and select **CHANNEL SELECT**.
 - b) Click the squares to include in the motion grid.
 - c) Right-click again and select **SAVE** to save the selected motion grid.
6. When finished selecting motion areas press **ENTER** on the front of the DVR or remote control to save changes.
7. Repeat as necessary for each channel.
8. When motion area setup is complete select **SAVE** to save settings and exit setup.

Sensor

MOTION/EVENT CONFIGURATION-SENSOR				
SENSOR		ALARM		
NO.	TYPE	POWER OFF	OFF	
1	N/O	S.M.A.R.T. ALARM	OFF	
2	N/O	NO.	SIGNAL	TYPE
3	N/O	1	OFF	N/O
4	N/O	2	OFF	N/O
5	N/O	3	OFF	N/O
6	N/O	4	OFF	N/O
7	N/O		SET	CLEAR
8	N/O			
CH9-CH16				
INPUT	SENSOR	ACTION	ALARM MONITOR	
SAVE		CANCEL		

Sensor Setup

1. Use the arrow buttons to select Sensor 1 and press ENTER to change to N/O (Normally Open) or N/C (Normally Closed).
2. Repeat for all sensors.
3. Select SAVE and press ENTER to save settings.

Alarm Setup

1. Use the arrow buttons to select Alarm1 and press ENTER to turn the SIGNAL to OFF or ON.
2. Set each Alarm to N/O (Normally Open) or N/C (Normally Closed).
3. Repeat for all relays.
4. Select SAVE and press ENTER to save settings.

Power Off

The POWER OFF option is a preset function that triggers an alarm relay when the DVR loses power. This function is preconfigured to set alarm relay No. 4 to ON and N/C. When a power loss occurs, alarm relay No. 4 will open. When power is restored the alarm will close.

S.M.A.R.T. Alarm

The S.M.A.R.T. ALARM option is a preset function that triggers an alarm relay when the DVR HDD exceeds the temperature threshold configured on the SYSTEM > DISK SETUP > S.M.A.R.T. page. This function is preconfigured to set an alarm relay to ON and N/C. When the HDD exceeds the temperature threshold, the alarm relay will open. When the temperature is at a safe level again the alarm will close.

Note SET and CLEAR are used to test the alarm relay operation. SET is used to manually activate all relays that are set to ON. CLEAR is used to manually deactivate all relays.

Action

MOTION/EVENT CONFIGURATION-ACTION				
ACTION				
CH	ALARM	DELAY	DURATION	PRESET
1	1	OFF	5 SEC	OFF
2	2	OFF	5 SEC	OFF
3	3	OFF	5 SEC	OFF
4	4	OFF	5 SEC	OFF
5	1	OFF	5 SEC	OFF
6	2	OFF	5 SEC	OFF
7	3	OFF	5 SEC	OFF
8	4	OFF	5 SEC	OFF
CH9-CH16				NOTIFY

INPUT	SENSOR	ACTION	ALARM MONITOR
<input type="button" value="SAVE"/>		<input type="button" value="CANCEL"/>	

- CH** – ▲ Channels 1~8 / ▼ Channels 9~16
- Alarm** – OFF / 1~4 [Associate an alarm relay with a channel].
- Delay** – 0~100 Seconds [Delay time before relay activates].
- Duration** – 0~100 Seconds [Time that the relay is active].
- Preset** – 0~100 [Enable PTZ camera to move to a preset position when an event occurs. See PTZ Control for more information.]
- NOTIFY** – BUZZER/POPUP [Type of alarm with event].

Alarm Monitor

Send event information to a remote client using the Alarm Monitor software.

MOTION/EVENT CONFIGURATION-ALARM MONITOR			
SEND TO ALARM MONITOR	OFF		
MOTION/SENSOR	MOTION		
NO.	IP ADDRESS	PORT	
1	0.0.0.0	4001	
2	0.0.0.0	4001	
3	0.0.0.0	4001	
4	0.0.0.0	4001	
5	0.0.0.0	4001	
INPUT	SENSOR	ACTION	ALARM MONITOR
SAVE		CANCEL	

1. Select SEND TO ALARM MONITOR and press ENTER to select ON.
2. Select the types of events to send to the Emergency Agent (MOTION, SENSOR, MOTION + SENSOR.)
3. Enter the IP ADDRESS of the remote client.
4. Enter the PORT number.

Note The port number selected is the port that Alarm Monitor uses on the remote PC. The port shown in this screen must match the port shown in Alarm Monitor or HFVMS and the port must be open on the remote PC.

Network

Network Configuration

Configure network settings.

NETWORK CONFIGURATION-NETWORK		
NETWORK		
HOST NAME	dvr	
NETWORK TYPE	STATIC IP	
IP ADDRESS	10.0.0.0	
SUBNET MASK	255.0.0.0	
GATEWAY	10.0.0.0	
DNS	0.0.0.0	
CLIENT CONFIGURATION	SETUP	
DDNS		
DDNS SERVER	HWDDNS.COM	
HOST NAME	host name	
ID	user	
PASSWORD	****	
ROUTER IP	OFF	
STATUS	CHECK	UNCHECKED

Network

HOST NAME – Hostname for the DVR on the network.

NETWORK TYPE – STATIC IP (User must manually define a static IP address. Contact your network administrator for this information.)

DHCP (System gets IP address automatically from a DHCP server.)

IP ADDRESS – DHCP or Static. Contact your network administrator for this information.

CLIENT CONFIGURATION – Set up the connection ports and Max transfer speed for remote connections.

CENTER PORT – The HRDP uses the Center port and the primary communication port to create remote connections. This port must be the same as the port setting on the remote PC.

VIDEO PORT – The HRDP uses multiple ports to create remote connections: the remote port is user defined (default 4000), and a secondary port is automatically assigned (default 4002). The DVR assigns the secondary port based on the remote port, in increments of two. (ex: if you set the remote port to 4222, then the secondary port will be 4224). Verify that all these ports are available when setting up Network Address Translation (NAT) or firewall.

Network Configuration continued

WEB PORT – Defines the port that Internet Explorer uses to connect over the web and view video. If this port is changed then the new port must be defined when attempting to web connect (ex: if your DVR IP address is 10.0.0.5 and you change the web port to 800, then you must type `http://10.0.0.5:800` in your browser).

MAX TRANSFER SPEED – Set network bandwidth. This feature is used for slower internet connections to throttle the amount of data the DVR sends across the network at a time.

DDNS – DDNS (Dynamic Domain Name Service) is a service that allows a connection to an IP address using a hostname (URL) address instead of a numeric IP address. Most Internet Service Providers use Dynamic IP Addressing that frequently changes the public IP address of your internet connection; this means that remote connections through HFVMS and HRDP Remote would require frequent updates. DDNS automatically redirects traffic to your current IP address when using the hostname address (i.e. `MyHRDP.HWDDNS.com`).

DDNS SERVER – The current DDNS server.

HOST NAME – Hostname for the DDNS server account.

ID – Username for the DDNS server account.

PASSWORD – Password for the DDNS server account.

STATUS – Checks DDNS settings by attempting to communicate with the DDNS Server.

Serial Configuration

Configure connected serial devices.

SERIAL CONFIGURATION			
RS 232		RS 485	
TYPE	NONE	TYPE	NONE
MODEL	NONE	MODEL	NONE
BAUD RATE	9600 BPS	BAUD RATE	9600 BPS
DATA BIT	8	DATA BIT	8
PARITY	NONE	PARITY	NONE
STOP BIT	1	STOP BIT	1
<input type="button" value="SAVE"/>		<input type="button" value="CANCEL"/>	

TYPE – None / External Controller.

MODEL – Select appropriate model.

Port Information

BAUD RATE / DATA BIT / PARITY / STOP BIT

E-mail Configuration

The DVR can send an email notification to up to six defined e-mail addresses when an event happens.

E-MAIL SERVER – DVR/SMTP [Configure the DVR to use selected e-mail server.]

The screenshot shows the 'E-MAIL CONFIGURATION' window. It has a title bar 'E-MAIL CONFIGURATION' and a sub-header 'E-MAIL SERVER'. Below that, 'E-MAIL ENABLE' is set to 'ON'. A table lists six email addresses with columns for 'NO.', 'OPTION', 'PIC', and 'E-MAIL ADDRESS'. The 'OPTION' column for row 3 is circled, and an arrow points to the 'E-MAIL' dialog box. The dialog box has a red title bar 'E-MAIL' and contains several checkboxes: MOTION, SENSOR, VIDEO LOSS, POWER, SETUP, LOGIN, LOGIN FAIL, DISK FULL, and S.M.A.R.T. At the bottom are 'OK' and 'CANCEL' buttons.

NO.	OPTION	PIC	E-MAIL ADDRESS
1	SET	OFF	email@HWddns.com
2	SET	OFF	ema
3	SET	OFF	ema
4	SET	OFF	ema
5	SET	OFF	ema
6	SET	OFF	ema

OPTION – Define the type of event that will trigger an e-mail notification.

MOTION – After a motion alarm is triggered.

SENSOR – After a sensor alarm is triggered.

VIDEO LOSS – After video loss on a camera.

POWER – When the DVR is shutdown and restarted.

SETUP – When a user accesses Setup.

LOG IN – When a user logs in.

LOGIN FAIL – After three failed login attempts.

DISK FULL – When the HDD reaches the user-defined maximum disk full percentage. See DISK MANAGEMENT – OVERWRITE.

SMART – When the HDD reaches the user-defined maximum temperature. See DISK MANAGEMENT – SMART.

PIC – ON / OFF [Enable to send a picture of the event.]

E-MAIL ADDRESS – Enter the e-mail address.

Information

System Log View

Displays system log information. System Log View displays the recent activity of all users on the DVR. You can export and save the System Log to review user activity.

SYSTEM LOG

DATE 04/15/2011

ALL SYSTEM SETUP NETWORK

NO.	DATE	SYSTEM LOG	
			▶
			▼

USER admin

Enter SETUP

TARGET HL-DT-ST DVD RAM GH22NS50 SCAN EXPORT

PROGRESS 0% EXPORT ALL

EXIT

Version View

Displays system information and software version information for the DVR.

VERSION

VIDEO FORMAT	NTSC
VIDEO MUX	80503.1
VIDEO CODEC	60115.0
VIDEO I/O	40618.0
FIRMWARE	1.0.1.6
MCU MODULE	5.3.0
PTZ MODULE	2.0
DRIVER MODULE	8.01-16-N
MAC ADDRESS	00:AA:BB:CC:AA:10

EXIT

Status View

Displays status screens for:

STATUS-DISK	
CONTENT	STATUS
RECORDING START	03/17/2010 13:04:36
RECORDING END	04/15/2010 15:00:00
DISK CAPACITY	458.2 GB
USED SPACE	106.8 GB(24%)
AVAILABLE SPACE	351.4 GB(76%)
HDD OVERWRITE	ENABLE

DISK	RECORD	AUDIO	SENSOR	NETWORK	EVENT
------	--------	-------	--------	---------	-------

EXIT

Disk

STATUS-RECORD			
CAM	IPS	RESOLUTION	QUALITY
1	15	352X240	NORMAL
2	15	352X240	NORMAL
3	15	352X240	NORMAL
4	15	352X240	NORMAL
5	15	352X240	NORMAL
6	15	352X240	NORMAL
7	15	352X240	NORMAL
8	15	352X240	NORMAL

CH9-CH16

DISK	RECORD	AUDIO	SENSOR	NETWORK	EVENT
------	--------	-------	--------	---------	-------

EXIT

Record

STATUS-AUDIO	
MAPPING AUDIO TO VIDEO	
CH	AUDIO IN
1	OFF
2	OFF
3	OFF
4	OFF
5	OFF
6	OFF
7	OFF
8	OFF

AUDIO IN	
AUDIO IN CH1	OFF
AUDIO IN CH2	OFF
AUDIO IN CH3	OFF
AUDIO IN CH4	OFF
AUDIO VOLUME	5
TWO WAY AUDIO	
TWO WAY AUDIO	OFF

CH9-CH16

DISK	RECORD	AUDIO	SENSOR	NETWORK	EVENT
------	--------	-------	--------	---------	-------

EXIT

Audio

STATUS-SENSOR					
SENSOR		ALARM			
NO.	TYPE	POWER OFF	ON		
1	N/O	S.M.A.R.T. ALARM	ON		
2	N/O	NO. SIGNAL	TYPE		
3	N/O	1	OFF	N/O	
4	N/O	2	OFF	N/O	
5	N/O	3	OFF	N/O	
6	N/O	4	OFF	N/O	
7	N/O				
8	N/O	SET	CLEAR		
CH9-CH16					
DISK	RECORD	AUDIO	SENSOR	NETWORK	EVENT
EXIT					

Sensor

STATUS-NETWORK					
CONTENT	STATUS				
HOST NAME	dvr				
NETWORK TYPE	DHCP				
IP ADDRESS	10.0.0.0				
SUBNET MASK	255.0.0.0				
GATEWAY	10.0.0.0				
DNS	0.0.0.0				
CENTER PORT	2000				
WEB PORT	80				
CLIENT					
DISK	RECORD	AUDIO	SENSOR	NETWORK	EVENT
EXIT					

Network

STATUS-EVENT					
CH	MOTION	SENSOR	VIDEO LOSS	ALARM	
1	ON	OFF	OFF	ON	
2	ON	OFF	OFF	ON	
3	ON	OFF	OFF	ON	
4	ON	OFF	OFF	ON	
5	ON	OFF	OFF	ON	
6	ON	OFF	OFF	ON	
7	ON	OFF	OFF	ON	
8	ON	OFF	OFF	ON	
CH9-CH16					
DISK	RECORD	AUDIO	SENSOR	NETWORK	EVENT
EXIT					

Event

Operation

Login

The LOG-IN window will display on the monitor until a user logs in with the correct ID & password.

Tip To prevent unauthorized changes to the system settings, the administrator should change the default administrator password and create a User account.

Default Administrator Log In

The default administrator account login is:
USER: admin
PASSWORD: <blank>

Live Display Mode

Channel Selection

A live image can be selected by pressing corresponding number key on the DVR front panel.

The images can be seen in real-time in the configuration of 1, 4, 9, 16 channels and PiP screen. To toggle through the viewing options press LIVE on the DVR.

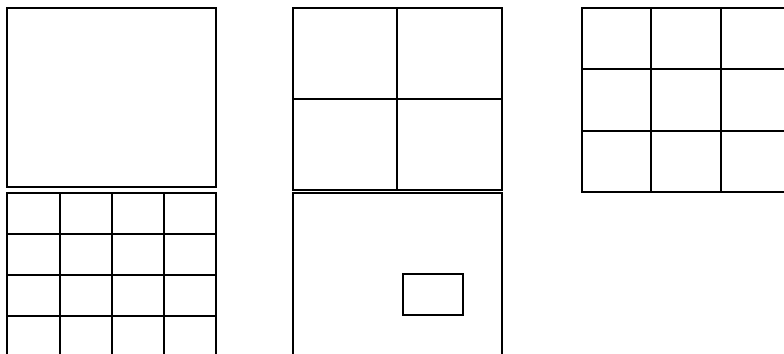











To select a channel using a mouse, double-click the video image. To return to a previous screen mode after selecting a viewing channel, double-click again.







Icons

In Live mode, icons or messages on the screen indicate the system mode or status.

Right-upper corner on each CH screen

	Continuous Recording
	Motion Detection Recording
	Sensor Activated Recording
	Continuous + Motion Alarm Recording
	Continuous + Sensor Activated Recording
	Motion Detection + Sensor Activated Recording
	Emergency Recording
	Sensor Activated
	Motion Detected
	PTZ Camera
	Audio Channel

Right-bottom corner on full screen.

	No HDD, Smart Alarm & HDD Failure
	Using Emergency Recording
	Using PTZ
	Warning when exceeding temperature
	Showing sequence mode
	Showing digital zoom mode

Mouse-Over Menu

Move the mouse to the bottom of the monitor in live mode. The mouse-over menu will instantly appear.

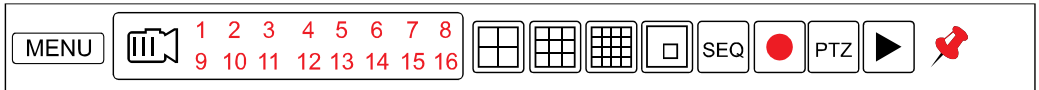

Sequence – Click to start camera sequence.



Instant Recording – Click to start instant recording. In instant recording mode, the records all channels at the recording rate configured in the Emergency Recording setup.



PTZ Mode – Click to enter PTZ mode. In PTZ mode, you can pan/tilt and zoom by moving the mouse pointer, referred to as a virtual joystick.



Quick Search – Click to automatically play back the most recent video clip.



Dock Tool Menu – Click to dock the Tool menu at the bottom of the screen. If the Tool menu is not docked, it will be shown only when the you places the mouse pointer in the lower portion of the screen.

Note If there is no icon in the upper right corner of the live screen mode, it means that the system is not currently recording. If this is the case, you should check the recording schedule or camera setup in the main setup menu.

Popup Menu

Right-click the live screen to open the Popup Menu.

HIDE LIVE VIEW – Hide the selected camera from Live view.

RECORD CHANGE – Change the recording settings for that channel including PPS, quality, resolution and event response.

PAGE SEQUENCE – The SEQ icon is shown on the bottom right of the screen and displayed channels will be sequentially changed.

FREEZE ALL – Pause all channels displayed on-screen.

SHOW MOTION AREA – Display the motion grid for the selected camera.

DISPLAY-PIP – Change screen display to PIP.

AUDIO – Select an audio channel to play (live).

LOGOFF – Select to log out the active user.

SEARCH – Open the Search Menu.

PTZ – Switch to PTZ mode.

MENU – Open the Setup Menu.

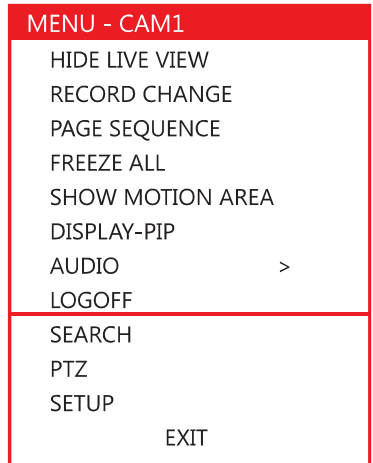

No Signal

If no camera is connected to a channel, NO SIGNAL is shown on the display screen. When a camera is disconnected, the DVR will generate a warning sound according to the system settings.

No Permission

The Administrator can set different levels of authorization for each user. If a user is not allowed to view a certain live or playback channel, a NO PERMISSION warning is shown on the display screen.

PTZ

To enter PTZ mode:

- Right-click the Live screen and select PTZ on the pop-up menu, or
- Click the PTZ icon on the Tool menu on the bottom of the main screen.

Drag the mouse up/down or left/right to move pan/tilt position of the camera. As you move the mouse away from the center of the screen, the camera movement speed increases. You can also zoom-in/out by using the scroll wheel on the mouse.

Note Full PTZ functions are available using the front panel buttons, a mouse, the IR remote control, or a keyboard controller.

PTZ Popup Menu

Right-click the desired camera to open the PTZ Popup menu while in PTZ mode.

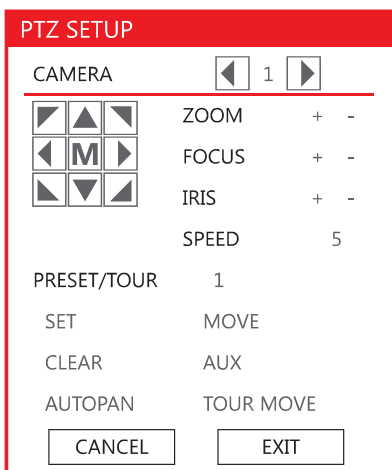

Arrow Buttons – Move Camera

M – Open camera’s on screen display menu (dependant on camera model support, see your camera’s manual for information)

ZOOM – Zoom in/out on PTZ camera. Enabled by default in PTZ mode

FOCUS – Adjust focus on PTZ camera.

IRIS – Adjust the iris on PTZ camera.

PRESET – Go to preset position. Select the preset number. The maximum preset number is 255

PRESET TOUR – Start preset tour. PRESET TOUR will sequence though all preset positions. Can only be enabled while in full screen mode.

Create PTZ Preset Position

1. Right-click the desired PTZ camera to open the PTZ Popup menu while in PTZ mode.
2. Select a PTZ Preset ID number.
3. Select MOVE under PRESET to move the camera to the desired position.
4. Select SET to save the preset position.

Search

Searching Recorded Data

Search recorded video on the DVR to find a specific time or event.

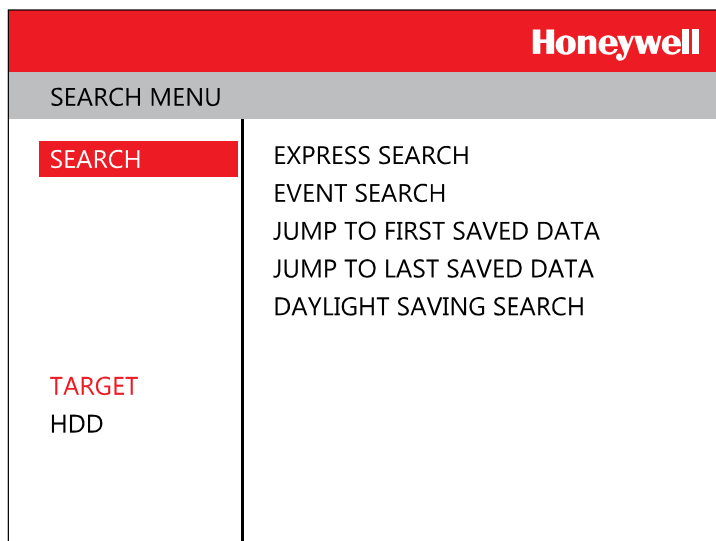

1. Press the SEARCH key on the front of the DVR or the remote control to enter Search Mode.
2. Select TARGET media (HDD, DVD-RW, USB).
3. Select the desired search method.

Quick Search

Click the  button on the Tool menu bar to automatically playback the latest video clip.

Using the playback control icons or the jog/shuttle wheel on the front panel, you can search recordings and control the speed of the playback by 2x, 4x, 8x, 16x, or 32 times to the forward or backward directions.

Graphic Search

In the search mode, click the colored time bar to search the desired section of recorded video.

- The white-vertical line indicates the current search time.
- The colors of the time bar are different according to the recording method selected.

Yellow – Continuous recording.

Green – Motion-detection recording.

Orange – Sensor-activated recording.

Sky Blue – Continuous + Motion detection recording.

Dark orange – Continuous + Sensor-activated recording.

Pink – Motion detection + Sensor-activated recording.

Red – Instant Recording.

Dark Blue – Data recorded during DST (Daylight Saving Time).



Quick Backup in Search Mode

You can easily archive video while watching a video playback.

In the search mode:

1. Press the BACKUP on the front panel to set the Start time. You will see S [Date/Time of clip] in right bottom of the playback monitor.
2. Continue video playback until you reach the end of the desired clip.
3. Press the BACKUP again to set the end time. The backup menu will open and you can select the backup media (CD/DVD or USB thumb drive) and execute the backup.

Express Search

Select a specific date and time to search for recordings:

1. Press SEARCH on the front panel or remote control and then EXPRESS SEARCH, or
Click MENU on the Tool menu, select SEARCH and then select EXPRESS SEARCH.
2. Select a date from the date list and press PLAY on the front panel or remote to begin playing that date from the beginning, or press Enter to select a time.
3. Select a time by scrolling to the timeline box and pressing enter. Use the left/right arrows to scroll forward and backward in time. Use the up/down arrows to change between hours and minutes view.

Tip Dates with an asterisk contain recorded video data.

Jump to First Saved Data

Go to the first frame of the recorded data. This is the oldest image recorded.

Jump to Last Saved Data

Go to the last frame of the recorded image. This is the latest image recorded.

Event Search

Use the Event Search to find particular events.

The 11 most recent events display on the first Event Search/Log page. Click the arrows at the top of the screen to view the remaining entries for each date. You can filter the log results by SENSOR, MOTION, VIDEO LOSS, and DISK FULL/

Write the Event log to a CD or connected USB device in text file format:

1. Insert a CD/DVD or USB device in the DVR.
2. Click SCAN, and then click EXPORT to copy the log information to the CD/DVD or USB device.
3. The Event Log is saved in a dated folder as a system.log file.

Daylight Savings Search

Daylight Savings Search is used to find recorded data after switching the time at the end of Daylight Savings Period. The System will record data with the same time stamp for two hours when they are repeated. If any overlapped time data exists the system will display the times on this page.

Search Popup Menu

Use to access display options in Search Mode.

- Right-click the desired channel to open the Search Popup Menu.

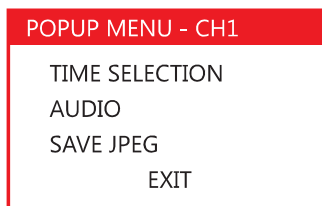

TIME SELECTION – Change the Date/Time to search.

AUDIO ON – ON/OFF.

SAVE JPEG – Save a JPEG still image of the current frame.

Note SAVE JPEG is only available when a single camera is selected. To activate, select a single channel (full screen), pause playback, and press ENT twice, or right click the channel to open the popup menu.

Backup (Export)

Manual Export

Back up recorded data on a CD-RW, DVD-RW or connected USB device.

Tip Refer to the USB Flash Drive Approved List in the Introduction chapter.

EXPORT			
TARGET		SCAN	FORMAT
FROM	04/15/2010 10:56.56		
TO	04/15/2010 11:56.56	<input type="checkbox"/> USE DST	
CAMERA	<input type="checkbox"/> ALL		
	<input type="checkbox"/> 1 <input type="checkbox"/> 2 <input type="checkbox"/> 3 <input type="checkbox"/> 4 <input type="checkbox"/> 5 <input type="checkbox"/> 6 <input type="checkbox"/> 7 <input type="checkbox"/> 8 <input type="checkbox"/> 9 <input type="checkbox"/> 10 <input type="checkbox"/> 11 <input type="checkbox"/> 12 <input type="checkbox"/> 13 <input type="checkbox"/> 14 <input type="checkbox"/> 15 <input type="checkbox"/> 16		
RECORDING START TIME	03/17/2010 13:04:36		
RECORDING END TIME	04/15/2010 11:00:00		
REQUIRED SPACE	3.0 MB		
FREE SPACE	0 MB	ESTIMATE	<input type="checkbox"/> EXPORT VIEWER
PROGRESS	<div style="border: 1px solid black; width: 100%; height: 15px; position: relative;"> 0% </div>		
EXPORT		CANCEL	
EXPORT		AUTO USB BACKUP	
<div style="border: 1px solid black; padding: 5px; display: inline-block;">CLOSE</div>			

To configure a data backup:

1. Press **BACKUP** on the front panel or remote control.
or
Click **MENU** on the hover menu and select **BACKUP**.
2. Connect a USB device or insert a CD/DVD.

Note The DVR supports DVD+R, and DVD-R. DVD-RW/+RW may not operate correctly.

3. Select **SCAN** to locate the device.

Caution If you are using a new USB device to back up your data, you must format it first as FAT32.

4. Select the desired **CAMERAs** and the **FROM** and **TO** time for the backup.
5. Select **ESTIMATE** to display estimated data size and free space available.

Note ESTIMATE must be selected first, before WRITE. If any backup parameters are changed (Date, Time, Channels) you must select ESTIMATE again.

6. Select the EXPORT VIEWER check box to add the Export Viewer to the backup file.

Tip Video data is saved in a proprietary format and must be viewed using the Export Viewer software.

7. Select EXPORT.

Caution Do not shutdown the system during the backup process.

Search Backup Data

Backup files are saved in folders by date.

To view a backup file:

1. Insert the backup file media in a computer.
2. Double-click the Export Viewer program to open.
3. Open the desired backup file (saved by date).
4. Use the controls on the Export Viewer screen to playback, zoom, print or save an image.
5. Right-click the playback screen to select additional options including, Audio Play, Deinterlace, Digital Zoom, Save, and Print.

Deinterlacing

De-interlacing is often required for smooth playback of video that is recorded in 704x480 (4CIF) resolution. The picture comparison below shows the difference between Interlaced video and a De-interlaced video clip.



Interlaced Image



De-interlaced image

Watermark

When playing back an AVI video clip in the Export Viewer, you can verify whether the AVI file has been altered or not by clicking the Watermark button.



Using the Backup Viewer

Play recorded video on a PC using Backup Viewer, the proprietary media player included with every backup file.

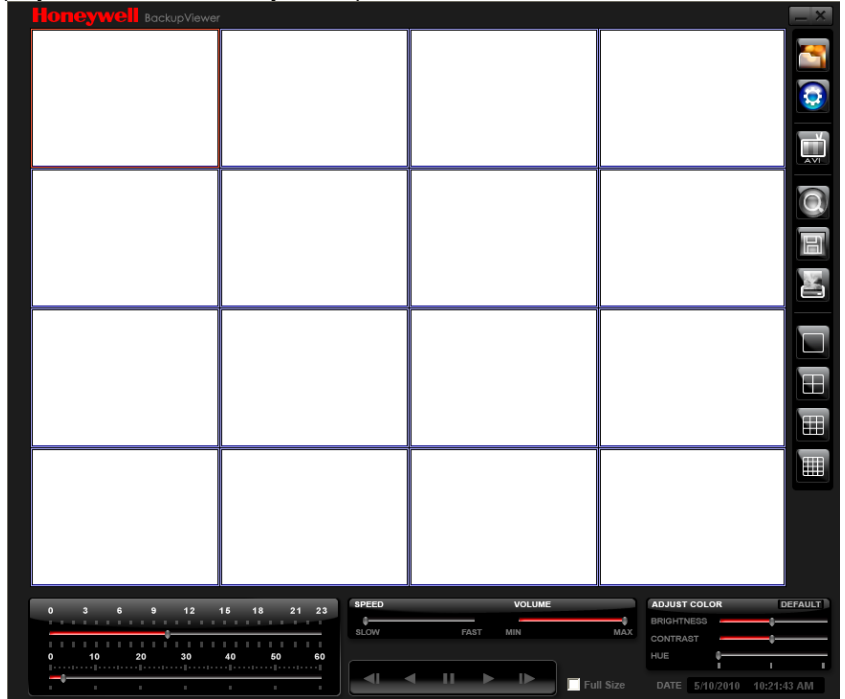

Controlling Backup Viewer

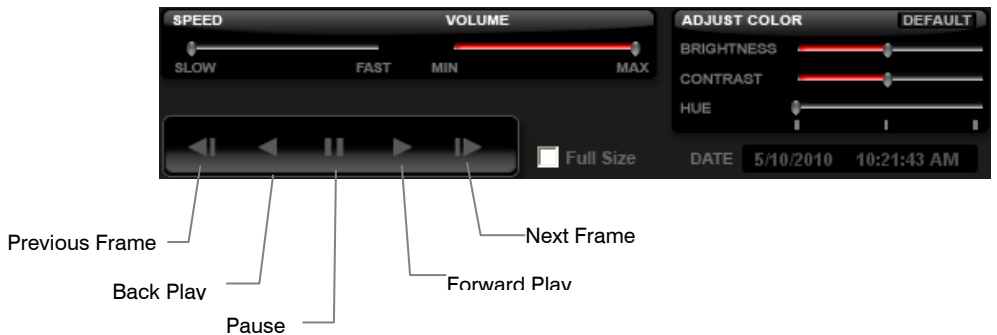

Setup and Save Functions

These function buttons allow you to configure the Backup Viewer and save a JPEG image or AVI video.



OPEN – Allows you to choose which data to open. When selecting data that is saved to your local hard drive, the video must be in a directory named DATA. Navigate to the folder above the DATA directory and click OK to see the available playback options.



SETTINGS – Select Direct Draw De-Interlacing for image viewing. Also allows you to include Image information when exporting a JPEG.



EXPORT AVI –To export an AVI file: Click this button, enter the desired Digital Signature, the AVI start time, the AVI end time and to include audio data (if desired) and press OK.



ZOOM – Select this button to turn your cursor into a magnifying glass and click the desired camera image to zoom in.



EXPORT JPEG – To save a JPEG: Click this button, enter the desired Digital Signature and click OK, then browse to the desired save location.



PRINT – Opens the print window on your computer.

Upgrade Firmware at the DVR

Obtain the latest software release and save the file to a CD, DVD or USB Device. Please check the product web site at www.honeywellvideo.com or contact Technical Support for the latest software. See back cover for contact information.

1. Insert a CD/DVD or USB Drive containing the update files.
2. Select System > System Configuration.
3. Select S/W UPGRADE to open the UPGRADE FIRMWARE window.
4. Select the media type (DVD/CD-ROM / TFTP / USB HDD/STICK).
5. Click SCAN.
6. Click OK to start the upgrade.

Play Back Backup Image

Play recorded video on a PC using the proprietary media player included with every backup file.

1. Insert CD, DVD or connect external USB device to the PC.
2. Navigate to the files on the CD, DVD, or USB drive.
3. Double-click the BKPlayer application.
4. Click the Open Video File icon and select the file to view from the desired date folder.

Screen Division Buttons

The Screen Division buttons allows you to view cameras in groups such as two by two, three by three and four by four. The button options are shown below.



Single Channel View – Displays one camera channel. To return to a different Multi-Camera View, select a different Screen Division button.



Four Channel View – Displays cameras 1-4 in the Video Display Area. Click the button again to rotate to cameras 5-8, 9-12, etc. To return to a different Multi-Camera View, select a different Screen Division button.



Nine Channel View – Displays cameras 1-9 in the Video Display Area. Click the button again to rotate to cameras 9-16. To return to a different Multi-Camera View, select a different Screen Division button.



16 Channel View – Displays cameras 1-16 in the Video Display Area. To return to a different Multi-Camera View, select a different Screen Division button.

Save Settings

Use the System Configuration menu to export and import saved or factory default system settings.

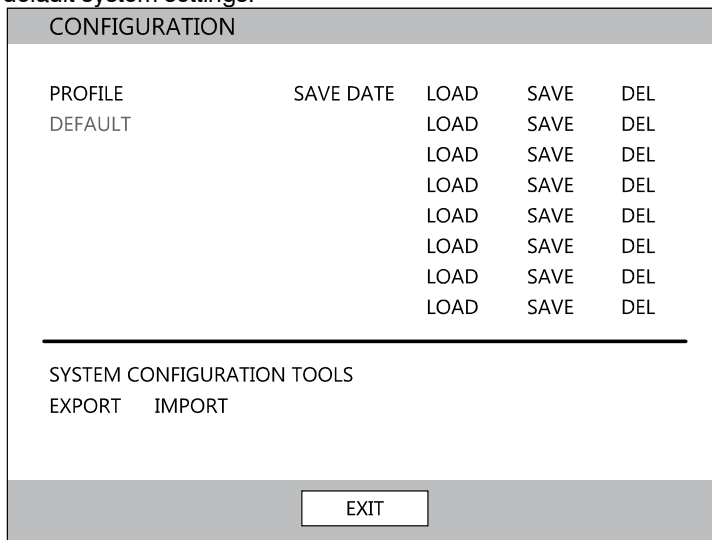

Save Settings

1. Press the SETUP key on the front of the DVR or remote control to log in.
2. Select SYSTEM > CONFIGURATION.
3. Select an empty PROFILE and define a name for the settings configuration. To save settings to a USB device, select EXPORT.
4. Select SAVE and confirm to continue the export process.

Import Settings

1. Press the SETUP key on the front of the DVR or remote control.
2. Select SYSTEM > CONFIGURATION and log in.
3. Select a previously saved PROFILE and select LOAD. To import a profile saved on a USB device, select IMPORT.
4. Select the types of settings to import (CAMERA – RECORD – SYSTEM – NETWORK).
5. Select OK and press ENTER on the front of the DVR to complete the import process.

Remote Software

Set up a Remote Connection

The administrator and up to nineteen additional users (four simultaneously) can access the DVR remotely using software installed on a personal computer.

Minimum System Requirements

Windows XP, Vista or 7 Operating System
Intel Dual Core Processor
1GB RAM
256 MB+ NVIDIA or ATI Video Card
DirectX 9 or higher
256k Network Connection
32-bit color
1280x1024 Resolution

Recommended System Requirements

Windows XP, Vista or 7 Operating System
Intel Core 2 Duo 2.8 GHz processor
2GB RAM
DirectX 9 or higher
256k Network Connection
32-bit color
1280x1024 Resolution

Configuring the DVR

1. Press the SETUP key on the front of the DVR or remote control to log in.
2. Select NETWORK > NETWORK CONFIGURATION (see the Network Configuration section of this manual for more details).
3. Change port settings or write down current port settings.
4. Select DHCP or STATIC IP depending on your network (Ask your network administrator for assistance).
5. If STATIC IP is selected - define the IP address and additional network information.
6. If DHCP is selected - write down the IP address supplied by the DVR system.

Note If the DVR does not display the IP Address after setting DHCP to ON, Select Save to change the network and open Network Configuration again.

7. Select SAVE to save current settings.

Creating a DVR Connection with Remote Software

1. Install the Remote Software on a PC using the disc provided with your DVR.
2. Open the Remote Software. The Local Setup window will open automatically.
3. Click New.
4. Select HRDP H.264 or HRDPX H.264 as the Site Type.
5. Enter a name for the system in the Site Name box.
6. Enter the IP address of the DVR - found in NETWORK > NETWORK CONFIGURATION on the DVR.
7. Enter the Port number found in NETWORK > NETWORK CONFIGURATION on the DVR (default is 4000).
8. Click OK.
9. Enter the user name and password of an authorized user as defined in SYSTEM > USER CONFIGURATION on the DVR.

Note User Name and Password are both case sensitive.

10. Click Connect.

Default Remote Software Log in Information

The default administrative log in information for the remote software:

User Name: admin
Password: <none>

Access Remote Connection

1. Open the Remote Software.
2. Click on the icon of the server as defined previously.
3. Enter the user name and password of an authorized user as defined in the SYSTEM > USER CONFIGURATION menu on the DVR.

Note User Name and Password are both case sensitive.

4. Click Connect.

Connecting Multiple DVRs

Connect up to four HRDP DVRs to the Remote Software to easily switch between DVRs.

1. Configure all DVR connections as described above in Configuring a Remote PC.
2. After connecting to the first DVR, click CONNECT on the Display screen to open the Local Setup window.
3. Select a second pre-configured DVR and click Connect.
4. Use the drop-down menu in the lower left corner of the display screen to switch between the connected DVRs.

Using the Remote Software

Setting the Time and Date

The Remote Software uses the system time of the PC. If the system time is not correct, follow the steps below to change it.

1. Exit to Windows by clicking the Exit button on the Live View screen and selecting Restart in Windows Mode.
2. Open Windows Explorer. Do this by right-clicking the My Computer Icon (located on the top left hand corner of the Desktop) and select Explore.
3. Click Control Panel to open it. If you do not see Control Panel listed, click My Computer to expand the folder tree.
4. Double-click Date and Time inside Control Panel.
5. Adjust the Date and Time.
6. When finished, close all open windows and restart the PC. Do this by clicking Start (located on the lower left hand side of the Desktop) and selecting Shut Down.

Live View Screen

Each time the software is restarted, the program defaults to the Live View screen. The following diagram outlines the buttons and features used on the Live View screen. It is important to be familiar with these options as this is the screen displayed the majority of the time.

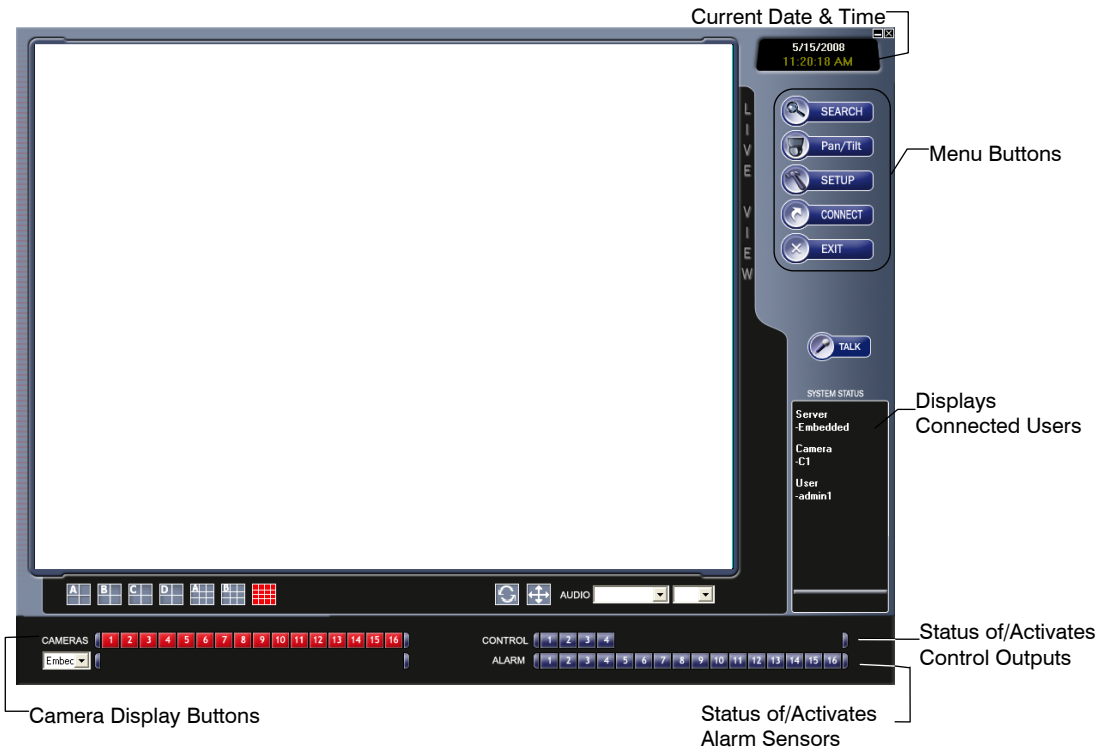



Camera View

The Camera status for each camera is displayed on the upper right corner of the video display area.



Recording Status Indicator

The following are the different states for each camera:

-  **Recording** Displayed when the camera is currently being recorded to the DVR.
-  **Motion Detection** Displayed when a camera (set up for motion detection) detects motion.
-  **Display** Displayed when the video from the camera is currently not being recorded to the DVR.

Screen Division Buttons

The Screen Division buttons allow you to view cameras in groups such as two by two, three by three and four by four. The button options are shown below.



1st Four Cameras View – Displays cameras 1-4 in the Video Display Area. To return to a different Multi-Camera View, select a different Screen Division option from the Screen Division Menu.



2nd Four Cameras View – Displays cameras 5-8 in the Video Display Area. To return to a different Multi-Camera View, select a different Screen Division option from the Screen Division Menu.



3rd Four Cameras View – Displays cameras 9-12 in the Video Display Area. To return to a different Multi-Camera View, select a different Screen Division option from the Screen Division Menu.



4th Four Cameras View – Displays cameras 13-16 in the Video Display Area. To return to a different Multi-Camera View, select a different Screen Division option from the Screen Division Menu.



16 Camera View – Displays cameras 1-16 in the Video Display Area. To return to a different Multi-Camera View, select a different Screen Division option from the Screen Division Menu.



Full Screen – The Full Screen Option allows you to view the Video Display Area using the entire viewable area on the monitor. When this is selected, no menu options are visible. You can activate the Full Screen Option by clicking Full Screen within the Screen Division Menu. You can deactivate Full Screen mode by right-clicking on the screen.



Auto Sequence – Sequences through the Screen Divisions sets. For example, selecting the 1A and then the Loop button will sequence through 1A, 2A, 3A, 4A and then repeat.

Setup Overview

The remote setup screen is designed to look and feel like the local HRDP interface. Remote users can access the System, Camera, Record, Network and Setup Wizard details.

For details on how to configure the DVR using the setup options, refer to the Setup chapter in this document.

Search Overview

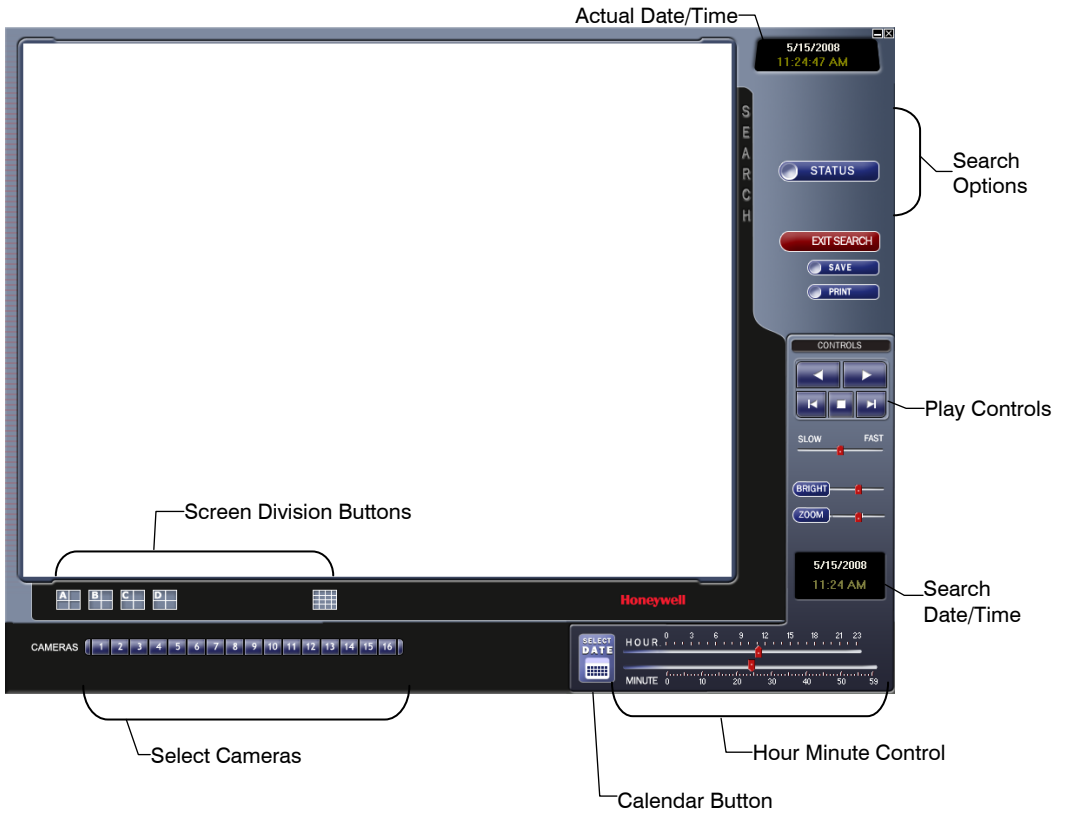

Play Controls

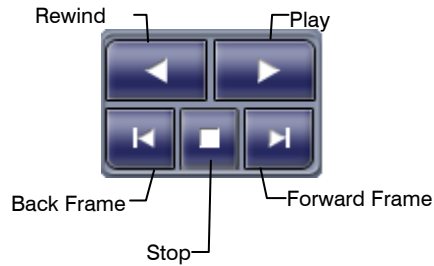

Back Frame	Moves video back one frame
Rewind	Rewinds video
Stop	Stops video playback
Play	Plays video
Forward Frame	Moves video forward one frame

Performing a Basic Search

1. Select a date using the Calendar button on the Date Display.
2. Select a time using the hour and minute control bars.
3. Select one or more cameras.
4. Click Play. (Video can be played forwards, backwards, or frame-by-frame.)

Adjust the Brightness of an Image

1. Pause the video and select an image to adjust by double-clicking the desired image. (Multiple images cannot be adjusted at one time.)
2. Move the Bright slide bar to the right or left to adjust the brightness.
3. Reset the Brightness by moving the slider back to the center of the bar.

Zooming in on an Image

1. Pause the video and select an image to adjust by double-clicking on the desired image. (Multiple images cannot be adjusted at one time.)
2. Move the Zoom slide bar to the right or left to zoom in or out of an image.
3. Reset the Zoom by moving the slider back to its original position on the bar.

Zooming in on a Portion of an Image

1. Using the mouse pointer, point to the area of interest on the image and click the right mouse button.
2. Keep clicking the right mouse button to zoom in further.
3. Continue clicking the right mouse button and the image zoom will cycle back to the original size.

Printing an Image

1. Using the Search screen, locate a frame to print and double-click the image.

Note Only one camera can be selected at a time for this function to work.

2. Click the Print button. (A Print Preview window appears. Depending on the printer being used, there may be several printing options available. Refer to the printer manual for more information.)
3. Click the Page Option button to add a memo to the printout and set the paper size and orientation.
4. Click the Print button to print the selected images.

Note The message “NO DEFAULT PRINTERS INSTALLED” will display if no printer is installed.

Save Clip

The DVR can export single images in the JPG file format, save video clips in the AVI format, or output to a VCR using the s-video port. The JPG and AVI file formats are extremely common with universal computer support making them ideal formats to use. A digital signature is also attached to every JPG and AVI file exported by the DVR for use with the bundled Digital Verifier application. This function is unique to the DVR and its verification software and should not interfere with viewing the files using other applications.

JPG The format (JPG) is optimized for compressing full-color or grayscale photographic images. JPG images are 24-bit (16.7 million color) graphics. JPG is used to export a single image or frame.

AVI AVI image data can be stored uncompressed, but it is typically compressed using a Windows-supplied or third party compression and decompression module called a codec. AVI files save a video clip.

Saving a Video Clip

1. Perform a basic search to locate the desired clip.
2. Click Save to open the Export Wizard.
3. Click JPEG or AVI to select the desired file type.

AVI File

- a. Select Mark Digital Signature.
- b. Select a Compression Codec. Each codec provides different levels of quality, compatibility and file-size.
- c. Enter the duration (seconds) to record. Although 50 is the longest time displayed, a longer recording may be entered manually.
- d. Select Quality - 50 > 100. When size is not an issue, set quality to 100.

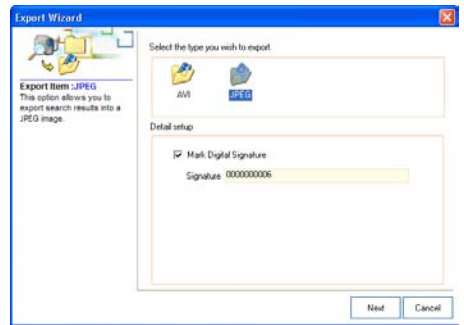

JPEG File

- a. Select Mark Digital Signature.
4. Click Next.

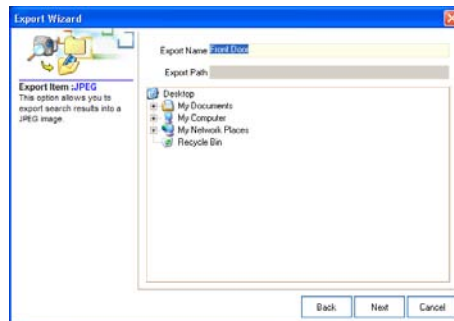

5. Define the file name in the Export Name box.
6. Define the location to save the file by using menu tree below Export Path.
7. Click Next.
8. A message displays to confirm that the save was successful.
9. Click OK. The Export Wizard will display the name, location and size of the file.
10. Click Finish.

Status Search

The Status Search option displays a timeline in graph format. Scroll through multiple cameras and easily locate hours with recorded video.

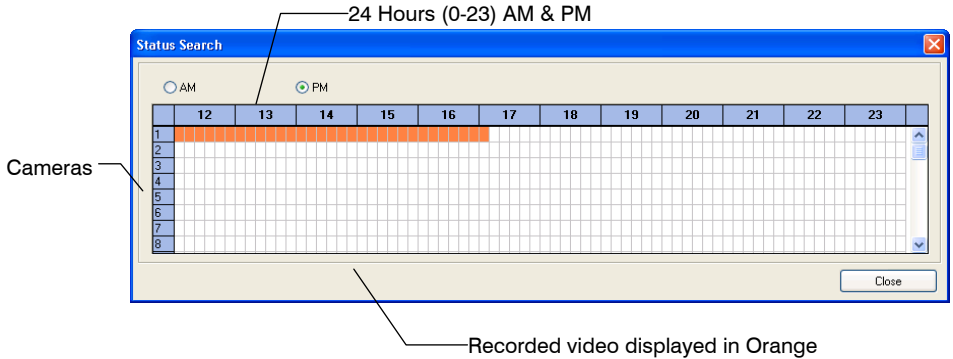

Performing a Status Search

1. In Search mode, click Status.
2. Click the Date button to open the calendar and select a date.
3. Click along the orange recorded video block to select a desired camera or time frame.
4. After locating the desired video, close the Status Search window and use the playback controls to play forward, reverse or frame-by-frame.

PTZ Overview

Accessing PTZ Menus

Some protocols support the ability to access the Internal PTZ Onscreen Menu. Click PAN/TILT on the remote software Live View screen to open the graphical PTZ controller.

Some protocols support the ability to access the Internal PTZ Onscreen Menu.

Since every PTZ camera is different, the functions of these options can vary slightly.

The DVR provides an easy way to access the cameras options. For explanations of what those options are please refer to the manual that came with the camera.

Note Use the arrow buttons on the PTZ controller move through the PTZ Menu options and/or highlight options.



Controlling a PTZ Camera

- The first method is to use the graphical PTZ Controller that appears when PAN/TILT is clicked on the Live View screen.
- The second method is to use the mouse to control the camera directly from the live video display.

Using the Graphical PTZ Controller

- Use the Arrow buttons to control the direction of the PTZ camera.
- To select a new camera, click the video display of a different camera on the Live View screen.

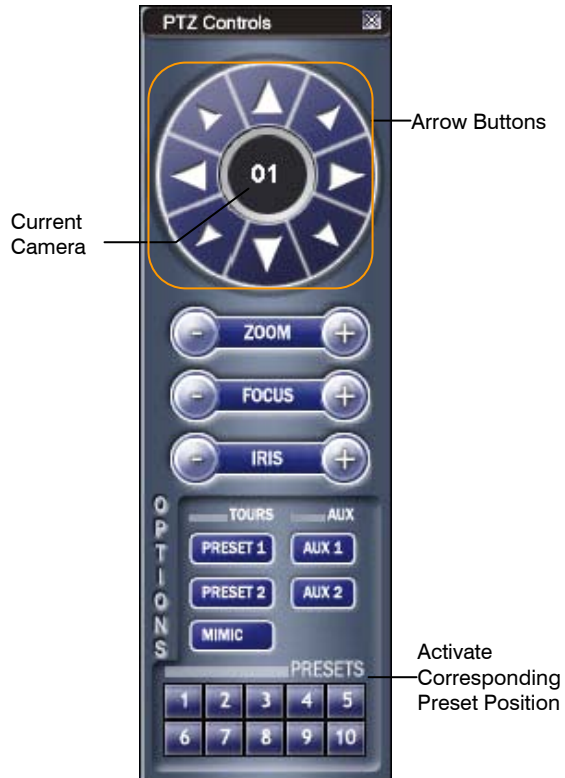

Note Eight directions are available only for select protocols. Only four of the PTZ Control buttons work for all protocols (UP, DOWN, LEFT, RIGHT).

Using the On-screen Compass



1. Click PAN/TILT on the Live View screen.
2. Control the PTZ by dragging the mouse on the screen in the desired direction.
3. A green line will appear to show the direction the PTZ will move. The shorter the line the less the PTZ will move. The longer the line the more the PTZ will travel in the specified direction.

Web Viewer Overview

The DVR allows access to the video using Microsoft® Internet Explorer® browser 6+.

To log in to the DVR server from the Web Viewer, a user account must be made for the user. This ensures that only authorized users are allowed to log in. In addition, each user can be assigned different privileges that allow or deny access to different functions.

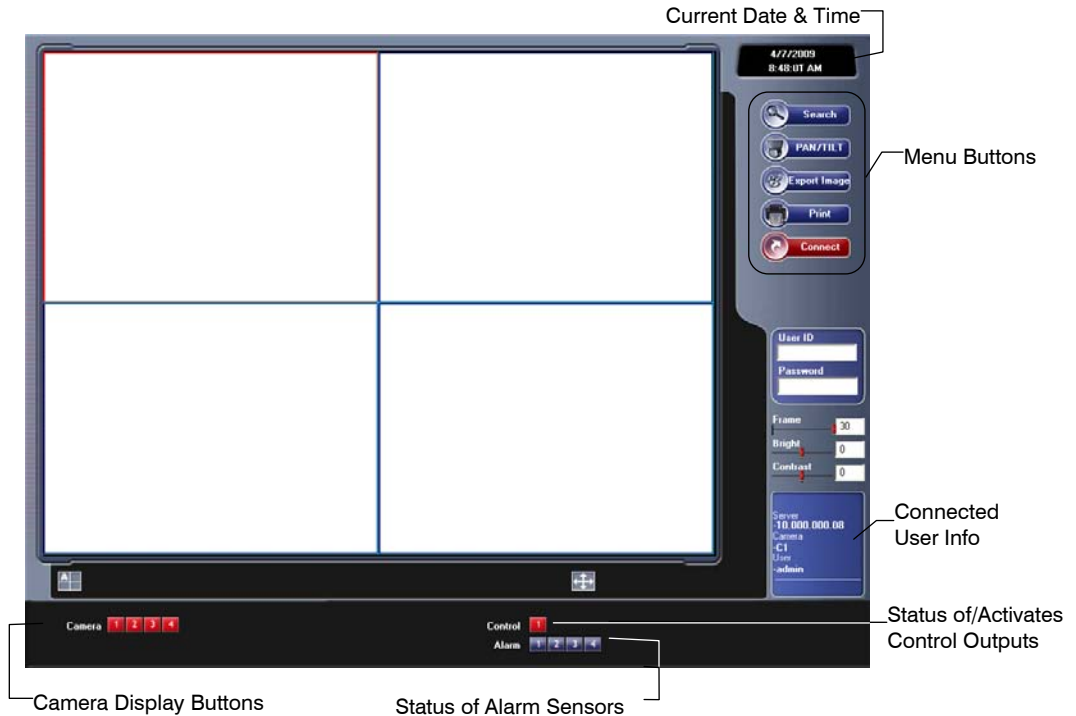

- Search** Open the Search screen.
- PAN/TILT** Open the PTZ controller.
- Export Image** Save JPG file of selected image.
- Print** Print selected image on connected printer.
- Connect** Connect to a DVR.
- Frame** Adjust the frames per second playback
- Bright** Adjust the brightness of the connected cameras
- Contrast** Adjust the contrast of the connected cameras

Connecting to a DVR Using Web Viewer

1. Open Microsoft Internet Explorer.
2. Enter the IP address of the DVR into the Address bar.
3. When attempting this for the first time you will be asked to accept an Active X installation. Click Yes.

Note If you receive a message saying Internet Explorer security settings do not allow you to download Active X components then you will need to adjust the browser security settings. Add the IP address of the DVR to the trusted sites list inside Internet Explorer settings. Contact the System administrator for additional help with adjusting Internet Explorer settings.

4. Type the User ID and Password of an authorized user.
5. Click Connect. The cameras will display.

Search Video Using Web Viewer

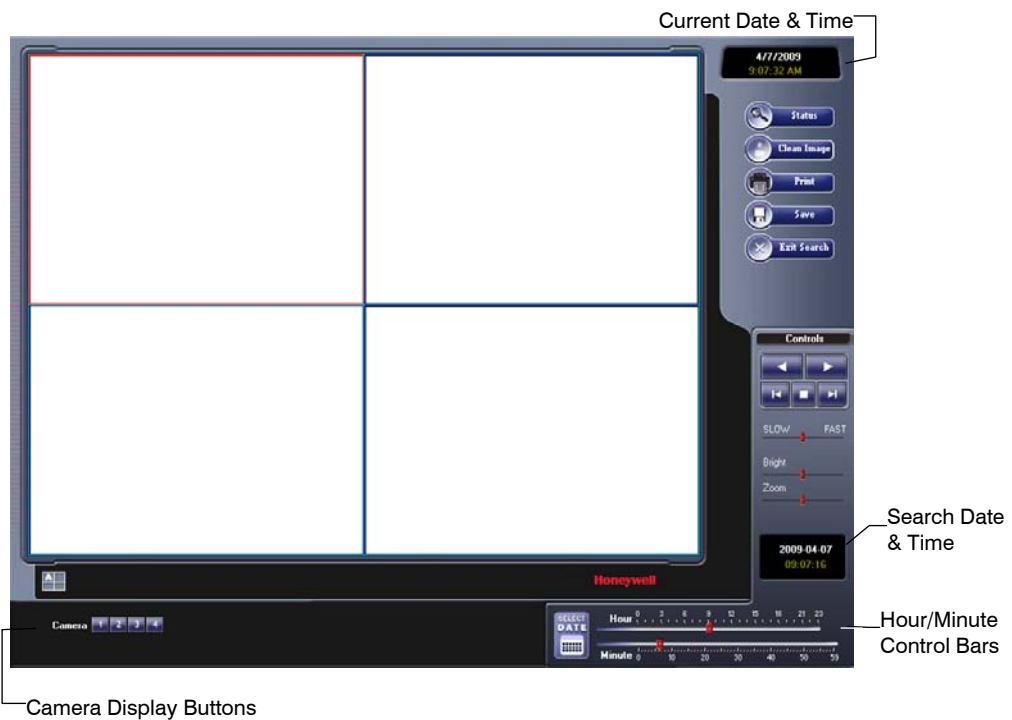

Performing a Basic Search

1. Click Select Date to open the calendar and select a date.
2. Select a time using the hour and minute control bars.
3. Select one or more cameras.
4. Click Play. (Video can be played forwards, backwards, or frame-by-frame.)

Status Search

The Status Search option displays a timeline in graph format. Scroll through multiple cameras and easily locate hours with recorded video.

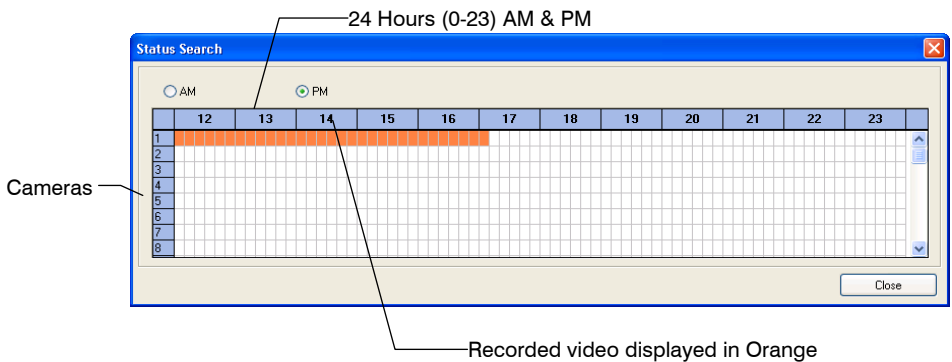

Performing a Status Search

1. In Search mode, click Status.
2. Click Select Date to open the calendar and select a date.
3. Click along the orange recorded video block to select a desired camera or time frame.
4. After locating the desired video, close the Status Search window and use the playback controls to play forward, reverse or frame-by-frame.

Clean Image

The DVR can record video using one of three different resolutions. When using the 704 x 480 resolution, two fields are mixed. Because of the timing gap between the two fields, according to the standardized image rules, after image might occur to high speed moving images. The HRDP DVR allows the user to remove this by clicking Clean Image.

Print

1. Use the Search screen to locate the desired frame. Double-click the image.

Note Only one camera can be selected at a time for this function to work.

2. Click Print. The Print Options window opens. Depending on the printer being used, there may be several printing options available. Refer to the printer manual for more information.
3. Click Print to print the selected images.

Note The message “NO DEFAULT PRINTERS INSTALLED” will display if no printer is installed.

Save

The HRDP can export single images in the Image file formats and save video clips in an .AVI format. Both .JPG and .AVI file formats are the most commonly used graphical formats today. Virtually every computer offers some type of support for these file formats which make them the most ideal formats to use.

JPEG – Optimized for compressing full-color or grayscale photographic images, JPEG images are 24-bit (16.7 million color) graphics. Use JPEG to export a single image or frame.

AVI – AVI image data can be stored uncompressed, but it is typically compressed using a Windows-supplied or third party compression and decompression module called a codec. AVI is used to export a video clip.

1. From the Search screen, click Save.
2. Select the export type, JPEG or AVI.

Note Different image format types provide different file-sizes, quality and compatibility

3. Select Mark Digital Signature if desired.

AVI File

- a) Select a compression Codec. Each codec provides different levels of quality, compatibility and file-size.
 - b) Enter the Time to Save (seconds) to record. Although 50 is the longest time displayed, a longer recording may be entered manually.
 - c) Select Quality - 50 > 100. When size is not an issue, set quality to 100.
4. Click Next to select a save location to save file.
 5. Click Next to start exporting the file. The Cancel button exits the window

Remote Software

without exporting file.

Alarm Monitor

The Alarm Monitor is used to view emergency alarms from the connected DVRs, including Video Signal Loss and Sensor alarms. Use the Filter Options to filter through the different types of alarms. After viewing event video, include a memo for future searches.

By double-clicking an alarm entry, the search window will open with the associated DVR, camera, and time related to the event already selected.

Note If all Alarm Event results are not visible, click Off to turn the Filter Options off.

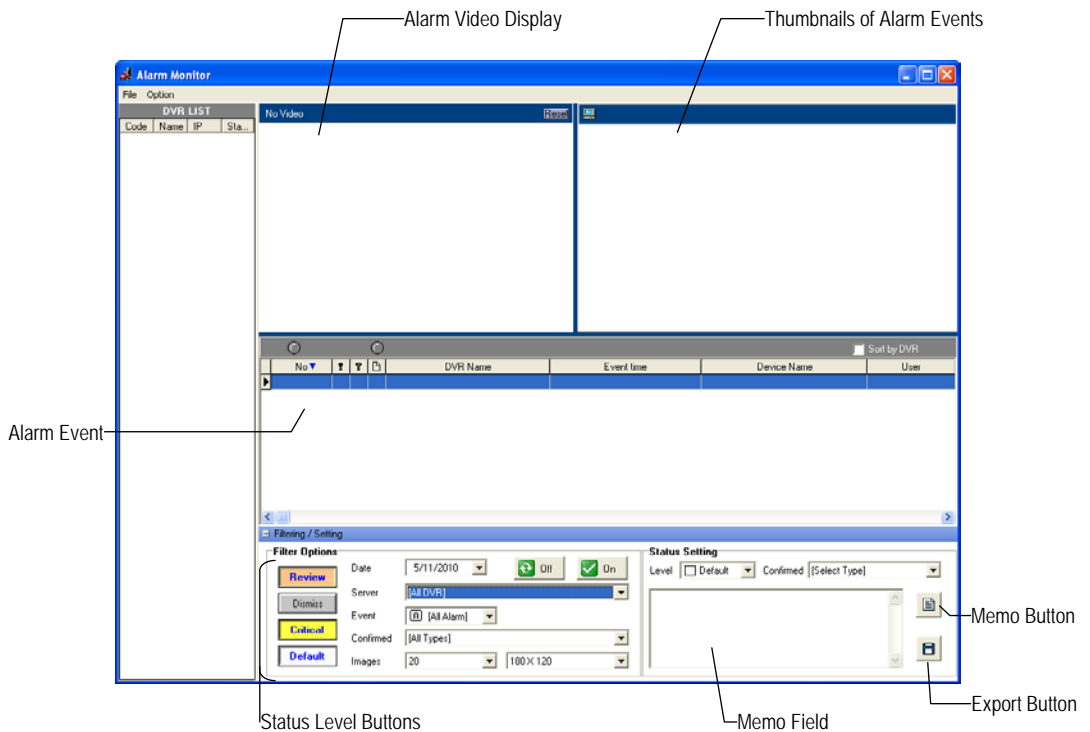

Assign Status Settings

1. Select an Alarm Event from the list.
2. Right-click the event and select a status level: Default, Review, Dismiss, Critical.
3. Select a defined Alarm Confirmed Type from the list under Status Setting.
4. Type a memo in the Memo box and click the memo button.

Connecting to a DVR using Alarm Monitor

1. On the HRDP DVR Open the Setup Menu.
2. Go to RECORD > MOTION/EVENT CONFIGURATION > ALARM MONITOR.
3. Set SEND TO ALARM MONITOR to ON.
4. Define the types of alarms to send to the Alarm Monitor software (MOTION, SENSOR, MOTION+SENSOR).
5. Enter the IP Address of the computer running the Alarm Monitor software.
6. Note the Port setting.

Note The Alarm Monitor uses one port to transfer the data through. The port can be adjusted inside the Network settings if necessary. It is recommended that the default setting should be used unless the port must be changed.

7. Create a schedule for the appropriate sensors and cameras.

Set up Alarm Monitor Options

1. From the Option menu, click Setup.
2. Enter the Network Port number. This port is located on the Alarm Monitor page on the HRDP DVR.
RECORD > MOTION/EVENT CONFIGURATION > ALARM MONITOR
3. Select Show Popup Messenger if desired.
4. Select a sound option for alarm events.
5. Add items to the Alarm Confirm List.
6. Click OK to save changes and close the window.

Add Items to Alarm Confirm List

1. Type the desired text in the box below the Alarm confirm list.

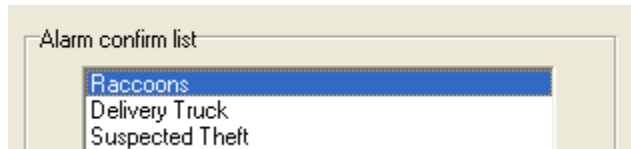

Note The items in the Alarm Confirm List will be available on a list under Status Setting in the Alarm Monitor window.

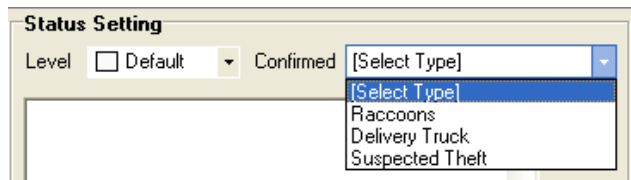

2. Click Add.
3. Click OK to save changes and close the window.

Filter Alarm Events

1. Select one or more Status Level buttons.
2. Select a date.
3. Select a DVR from the Server list.
4. Select the type of alarm event or select All Events.
5. Select Normal or Emergency Alarm or select All Alarms.
6. Select a Confirmed type.
7. Select the number and size of the thumbnail results.
8. Click On to filter results.

Search Alarm Window

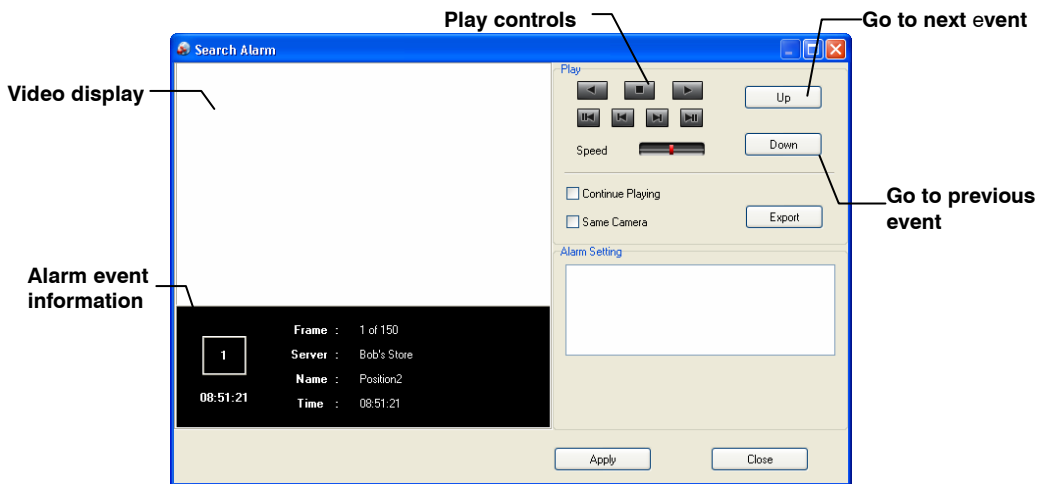

View Recorded Video

1. Double-click an event listing to open the Search Alarm window.
2. Use the play controls to locate the desired video frame.
3. Select the Continue Playing check box to watch all recorded events. When not selected, playback stops at the end of the alarm event.
4. Select the Same Camera check box to watch all events recorded by a single camera.
5. Click Apply after making any changes.

Export Video

1. Double-click an event listing to open the Search Alarm window.
2. Use the play controls to locate the desired video frame.
3. Click rewind to return to the beginning or desired spot in the video.
4. Click the stop button.
5. Select the Export Type – JPG or AVI.

Save JPG

- a. Select the Digital Signature Text check box to print the digital signature on the JPG file and click Next.
- b. Click Save As to define the save location and click Next.
- c. Click Start to save the image.

Save AVI

- a. Select a CODEC from the list and the number of frames to include in the AVI file. Reduce Export Quality only if necessary to reduce the size of the file.
- b. Click Next.
- c. Click Save As to define the save location and click Next.
- d. Click Start to save the video file.

Digital Verifier Overview

JPG images and AVI video files that are exported from the Digital Video Recorder are automatically embedded with a digital signature. Digital signatures are a way to verify the authenticity of the images to ensure that they have not been tampered with or edited in any way. Included on the Software Installation DVD, supplied with the DVR, is the Digital Signature Verification program. This program can be installed on any Windows XP or Windows Vista computer.

Using the Digital Verifier

1. Open the Digital Verification program by selecting Start > Programs > HRDP > Digital Verifier > Digital Signature Verifier.
2. Click the Browse button to load the JPG image.
3. Enter the Site Code of the DVR that the image was originally extracted from. (The Site Code is specified in the System Configuration Menu).
4. Click Verify to continue or Close to close the window without verifying.

If the image has not been tampered with, a blue square will appear around the image with the message “Original image file.”

If the image has been tampered with, a red square will appear around the image with the message “Entire image changed or wrong SITE CODE.”



FVMS (option) Overview

Connecting to a DVR using FVMS





FVMS (software part number HFVMSP) is available as an optional accessory for HRDP. FVMS software is Multi-Site Management Software; a powerful utility that allows 100 or more DVRs to be controlled using one computer. This software allows you to view live video, search saved video, edit and configure setup on each DVR, and import maps of buildings and other locations.

1. Configure the DVR for remote access as shown above in Set up a Remote Connection.
2. Follow the instructions in the FVMS manual for Adding a New Site.

Appendix

Button Index

LED Status Indicators

	Power	Illuminates when power is supplied to the DVR.
	HDD	Flashes when the hard drive is being accessed.
	Record	Flashes when live video is recording.
	Network	Illuminates when the DVR is connected to a network.
	HDD Temp	Illuminates when HDD temperature increases beyond the acceptable range.

Enter / Exit Buttons



Enter

Input data, make selections, and open pop-up menus.



Exit

Return to the previous mode or menu, without saving.

Function Buttons



Search

Open the search menu.

Focus

In PTZ mode, press to use the Focus function.

Use the buttons to adjust.



Backup

In live mode, press to open the backup menu.

For Quick Backup in the search mode, Press once, to set the start time.

Press again, to set the end time.

Press a third time, to complete Backup.

Zoom

In PTZ mode, press to use PTZ Zoom function.

Use the buttons to adjust.



Rotate

Rotate through to the remaining channels in the current display mode or rotate the display configuration.

Preset

In PTZ mode, press to use the Preset function.



Key

Log out the current user. Use to prevent accidental or unauthorized system-wide changes.

Irish

In PTZ mode, press to use the IRIS function.

Use the buttons to adjust.



Live

Change the display mode. Display switches in the following order when the LIVE key is pressed successively: (Single > 4 > 7 > 9 > 10 > 13 > 16 > Single > 4 > 7 > 9 ...split screen mode).





Setup

Open the setup menu.





Power

Press and hold to shutdown or start.

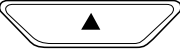

Numeric Buttons and Rec

	Numeric	In live and search modes, press to watch that channel full screen.
	Record	In live mode, press to start instant recording of all channels.

Directional and Playback Control Buttons

	Live	Go to PTZ mode.
	PTZ	Adjust zoom, focus, and iris on a PTZ channel.
	Search	Start reverse playback of recordings. Press successively to change the fast reverse speed.
	Search-Pause	Frame back (I-Frame Only).
	Live	Start playback of the latest recordings. (By default, the system searches recordings in the past 30 secs. If no recording is archived, the system will play back the latest one.)
	PTZ	Adjust zoom, focus, and iris on a PTZ channel.
	Search	Start playback of recordings. Press successively to change the fast forward speed.
	Search-Pause	Frame Forward.
	Navigation	Move up.
	PTZ	Move the camera view point up.
	Navigation	Move to the right.
	PTZ	Move the camera view point to the right.
	Search	Play recorded videos. When pressed successively, the search jumps forward in time by 30 minute increments.
	Search-Pause	Step forward one frame.

Directional and Playback Control Buttons continued

	Navigation	Move down.
	PTZ	Move the camera view point down.
	Navigation	Move to the left.
	PTZ	Move camera's view point to the left.
	Search	Play recorded videos in reverse. When pressed successively, the search jumps back in time by 30 minute increments.
	Search-Pause	Step back one frame.
	Live	Press once to enter channel selection mode, press again to open the camera popup menu.
	Search	Pause playback channels.
	Search-Pause	Resume playback.

DVR FAQ

General

- Q.** What does Embedded Linux mean?
- A.** Embedded Linux means that the operating system of the DVR has been imprinted into the CPU (Central Processing Unit). This means that the system response time is faster, more stable, and that the core of the DVR is protected against external factors, such as virus.
- Q.** Is the DVR upgradeable by CD or network?
- A.** Yes.
- Q.** How can I reset the DVR to the factory default settings?
- A.** Load the factory default settings from the System Configuration Menu.

Live Monitoring

- Q.** Is it possible to monitor the live video of specific cameras?
- A.** You can set the camera sequence through Spot/Sequence Configuration or by connecting to one of the 3 spot monitor outputs on the rear of the DVR unit.

Recording

- Q.** How do you record?
-
- A.** For information on this topic view the Recording Configuration section of this manual.
-
- Q.** What is Time Recording?
-
- A.** Time recording is recording scheduled to occur regardless of whether a motion or alarm event occurs.
-
- Q.** What is Event Recording?
-
- A.** Event Recording is recording which is activated when an event (motion or alarm) occurs.

Searching and Playing Video

- Q.** How do I play back recorded video?
-
- A.** For more information on this topic, see the Search section of this manual.
-
- Q.** Is it possible to back up recorded video?
-
- A.** Yes, for more information on this topic see the Backup section of this manual.

Backup

- Q.** Is it possible to back up to DVD media?
-
- A.** Yes, you have DVD-RW installed in your DVR.
-
- Q.** Can I back up to a USB memory stick?
-
- A.** Yes, for more information on this topic view the Backup section of this manual.

Network

- Q.** Does it support dynamic IP?
-
- A.** Yes. Enable DHCP in Network Configuration.
-
- Q.** Mail is not sent out.
-
- A.** Please check all the settings in the Network E-Mail Configuration.

Miscellaneous

- Q.** What types of cameras can be used?
-
- A.** The Honeywell DVR supports either NTSC or PAL analog cameras. Both standards may not be used simultaneously.
-

Troubleshooting

Problem	Possible Solutions.
No Power	Check the power cord connections. Check power at the outlet.
No Live Video	Check camera video cable and connections. Check monitor video cable and connections. Check camera power. Check camera lens setting .
Live Video Too Bright	If a cable is attached to the video channels looping output, make sure that it is properly terminated.
DVR has stopped recording	The HDD is full, delete video or set the DVR Overwrite Mode to On in Disk Configuration > Overwrite.

Specifications (HRDP H.264)

Specification		16 Channel
Video	Inputs	<ul style="list-style-type: none"> • 16 Channel Composite
	Outputs	<ul style="list-style-type: none"> • CCTV Monitor (NTSC/PAL), • CRT(VGA) Monitor • 16 CH Looping Composite • 3 Spot CCTV Monitor (NTSC/PAL)
Monitoring	Display	<ul style="list-style-type: none"> • NTSC : 480 fps • PAL : 400 fps
	Screen split	<ul style="list-style-type: none"> • 1/4/9/16/PIP
Recording	Performance	<ul style="list-style-type: none"> • NTSC: CIF(240 ips), 2CIF (120 ips), 4CIF (60 ips) • PAL: CIF (200 ips), 2CIF(100 ips), 4CIF (60 ips)
	Resolution	<ul style="list-style-type: none"> • NTSC: CIF(352x240), 2CIF(704x240), 4CIF (704x480) • PAL: CIF(352x288), 2CIF (704x288), 4CIF(704x576)
	Compression	<ul style="list-style-type: none"> • H.264
	Mode	<ul style="list-style-type: none"> • Motion detection, Sensor, Schedule • Variable compression rates, recording frame, motion sensitivity
Recording	Storage media	<ul style="list-style-type: none"> • Internal 2 x HDD (Option) • USB
	Audio	<ul style="list-style-type: none"> • 4 Channel, G.726 Compression
Playback	Mode	<ul style="list-style-type: none"> • Multi-channel playback (Max 16ch), Simultaneous playback
	Searching	<ul style="list-style-type: none"> • By Channel, Time, Date, Motion Detection, Sensor Events
Remote Monitoring S/W		<ul style="list-style-type: none"> • Remote Software / Web based viewer
Alarm		<ul style="list-style-type: none"> • 4
Sensor		<ul style="list-style-type: none"> • 16
Camera Control		<ul style="list-style-type: none"> • Pan/Tilt, Zoom, Focus, Iris
Back-up		<ul style="list-style-type: none"> • DVD+/-RW • USB
Hardware Spec.	Size	<ul style="list-style-type: none"> • 15.75" (W) x 3.46" (H) x 15.75" (D) (400 mm x 88 mm x 400 mm)
	Weight	<ul style="list-style-type: none"> • 18 lb (8.2 kg) W/O Packing
	Power	<ul style="list-style-type: none"> • Input Voltage is 110-230V ~ 47/63Hz 1.75-.85A
	UPS	<ul style="list-style-type: none"> • External UPS recommended

Specifications (HRDPX H.264)

Specification		16 Channel
Video	Inputs	<ul style="list-style-type: none"> • 16 Channel Composite
	Outputs	<ul style="list-style-type: none"> • CCTV Monitor (NTSC/PAL), • CRT(VGA) Monitor
Monitoring	Display	<ul style="list-style-type: none"> • NTSC : 480 fps • PAL : 400 fps
	Screen split	<ul style="list-style-type: none"> • 1/4/9/16/PIP
Recording	Performance	<ul style="list-style-type: none"> • NTSC: CIF(480 ips), 2CIF (240 ips), 4CIF (120 ips) • PAL: CIF (400 ips), 2CIF(200 ips), 4CIF (100 ips)
	Resolution	<ul style="list-style-type: none"> • NTSC: CIF(352x240), 2CIF(704x240), 4CIF (704x480) • PAL: CIF(352x288), 2CIF (704x288), 4CIF(704x576)
	Compression	<ul style="list-style-type: none"> • H.264
	Mode	<ul style="list-style-type: none"> • Motion detection, Sensor, Schedule • Variable compression rates, recording frame, motion sensitivity
Recording	Storage media	<ul style="list-style-type: none"> • Internal 2 x HDD (Option) • USB
	Audio	<ul style="list-style-type: none"> • 4 Channel, G.726 Compression
Playback	Mode	<ul style="list-style-type: none"> • Multi-channel playback (Max 16ch), Simultaneous playback
	Searching	<ul style="list-style-type: none"> • By Channel, Time, Date, Motion Detection, Sensor Events
Remote Monitoring S/W		<ul style="list-style-type: none"> • Remote Software / Web based viewer
Alarm		<ul style="list-style-type: none"> • 4
Sensor		<ul style="list-style-type: none"> • 16
Camera Control		<ul style="list-style-type: none"> • Pan/Tilt, Zoom, Focus, Iris
Back-up		<ul style="list-style-type: none"> • DVD+/-RW • USB
Hardware Spec.	Size	<ul style="list-style-type: none"> • 15.75" (W) x 3.46" (H) x 15.75" (D) (400 mm x 88 mm x 400 mm)
	Weight	<ul style="list-style-type: none"> • 18 lb (8.2 kg) W/O Packing
	Power	<ul style="list-style-type: none"> • Input Voltage is 12V DC
	UPS	<ul style="list-style-type: none"> • External UPS recommended

Honeywell Video Systems (Head Office)

2700 Blankenbaker Pkwy, Suite 150

Louisville, KY 40299, USA

www.honeywellvideo.com

☎ +1.800.796.2288

Honeywell Systems Group Europe/South Africa

Aston Fields Road, Whitehouse Industrial Estate

Runcorn, Cheshire, WA7 3DL, UK

www.honeywell.com/security/uk

☎ +44.01928.754028

Honeywell Systems Group Pacific

Unit 5, Riverside Center, 24-28 River Road West

Parramatta, NSW 2150, Australia

www.honeywellsecurity.com.au

☎ +61.2.8837.9300

Honeywell Systems Group Asia

35F Tower A, City Center, 100 Zun Yi Road

Shanghai 200051, China

www.asia.security.honeywell.com

☎ +86 21.5257.4568

Honeywell Security Middle East/N. Africa

Post Office Box 18530

LOB Building 08, Office 199

Jebel Ali, Dubai United Arab Emirates

www.honeywell.com/security/me

☎ +971.04.881.5506

Honeywell Systems Group Northern Europe

Ampèrestraat 41

1446 TR Purmerend, The Netherlands

www.honeywell.com/security/nl

☎ +31.299.410.200

Honeywell Systems Group Deutschland

Johannes-Mauthe-Straße 14

D-72458 Albstadt, Germany

www.honeywell.com/security/de

☎ +49.74 31.8 01.0

Honeywell Systems Group France

Immeuble Lavoisier

Parc de Haute Technologie

3-7 rue Georges Besse

92160 Antony, France

www.honeywell.com/security/fr

☎ +33.(0).1.40.96.20.50

Honeywell Systems Group Italia SpA

Via della Resistenza 53/59

20090 Buccinasco

Milan, Italy

www.honeywell.com/security/it

☎ +39.02.4888.051

Honeywell Security España

Avenida de Italia, n° 7

P.I. - C.T.C. Coslada

28820 Coslada, Madrid, Spain

www.honeywell.com/security/es

☎ +34.902.667.800

Honeywell

www.honeywellvideo.com
+1.800.796.CCTV (North America only)
HVSsupport@honeywell.com

Document 800-06801 Rev D- 02/11

© 2011 Honeywell International Inc. All rights reserved. No part of this publication may be reproduced by any means without written permission from Honeywell Video Systems. The information in this publication is believed to be accurate in all respects. However, Honeywell Video Systems cannot assume responsibility for any consequences resulting from the use thereof. The information contained herein is subject to change without notice. Revisions or new editions to this publication may be issued to incorporate such changes.