

# INSTRUCTIONS

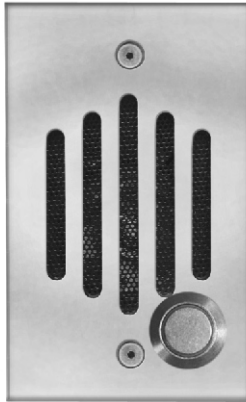

**IU-XXXX**

**IU-XXXXC**

**IU-XXXXP**

**IU-XXXXP8**

**Telephone Entry Door Intercom**

Channel Vision's IU-Series are 1/4" solid brass door plates that interface with a telephone entry controller to provide communication with the front door. They are available in a variety of configurations including options for a hidden camera and compatibility with Panasonic's popular KSU phone systems. A standard single gang junction box is supplied with each IU-series unit.

**Features:**

- 1/4" thick solid brass plate
- Discrete speaker and microphone
- Hidden camera option available
- Fits a single gang box
- Available in 9 different finishes

**Dimensions:**

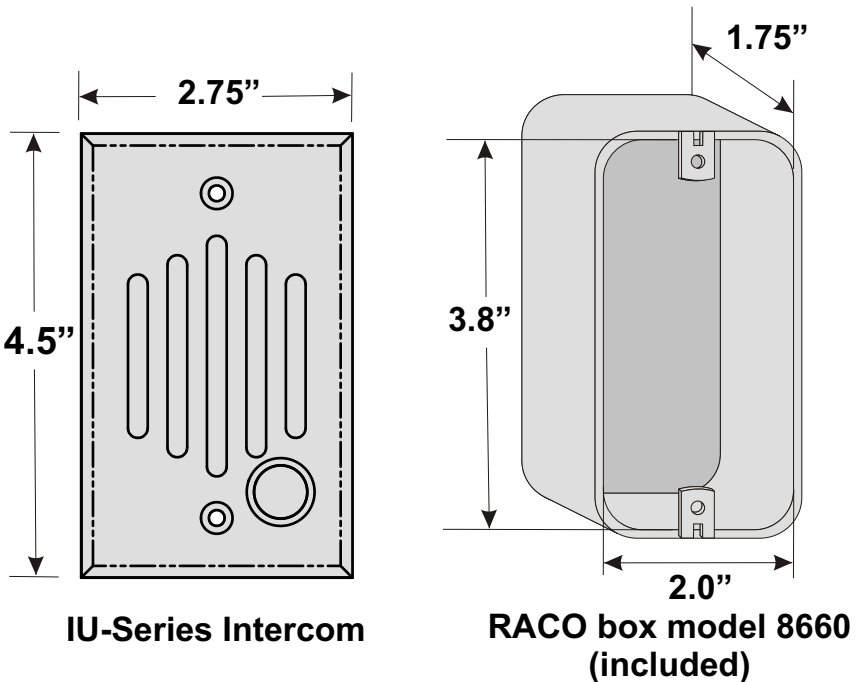

# Understanding the model number:

Part numbering: IU door plates	
<b>IU-0212C</b>	(IU-0212C shown for example only)
	Blank P-0920, P-0921, & TE110/C-0920 compatible
	C P-0930 compatible
	P Panasonic compatible (KX-TA624)
	P8 Panasonic compatible (KX-TA824/848, etc)
	212 White
	222 Polished Brass
	232 Antique Brass
	242 Chrome
	252 Oil Rubbed Bronze
262 Antique Copper	
272 Satin Silver	
282 Black	
302 Satin Nickel	
0 No camera	
6 Color camera (Note: camera option is not available on IU-xxxxP8 models.)	

## Understanding the compatibility options

There are three different types of systems that IU door plates can be used with. The compatibility for these different types of systems is indicated by the suffix of the model number which follows the 4-digit numerical code.

If there is not a letter suffix on the model number, such as IU-0212, that door plate is compatible with Channel Vision's telephone entry products including models P-0920, P-0921, C-0920, and TE110.

If the suffix is the letter "P", such as IU-0212P, then the door plate is compatible with Panasonic's phone systems which are designed to use the Panasonic door phone model: KXT-30865.

If the suffix is the letter "C", such as IU-0212C, then the door plate is compatible with Channel Vision's Whole-House CAT5 Intercom Hub, model P-0930.

Please double check to be sure that you have purchased the correct model number for your application.

# Attaching the Companion Board

This door intercom product consists of two sub assemblies which must be attached to each other before the final assembly can be installed. In this guide the electronic sub assembly will be referred to as the "Companion Board" and the mechanical assembly will be referred to as the "Door Plate." Review the following diagrams and assemble as shown.

## Companion Board Connection Details

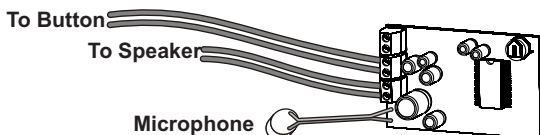

Remove the plastic cap that covers the microphone compartment on the door plate. Place the microphone in the compartment and replace the plastic cap over the microphone. Note that the plastic cap will form a friction fit over the top of the microphone wires holding them snug against the outer compartment wall until they exit at the base as shown. Remove the mounting screws which are already attached to the bracket and use them to attach the companion board. The companion board should mount on the front side of the bracket so that the screws pass through the companion board before threading into the bracket.

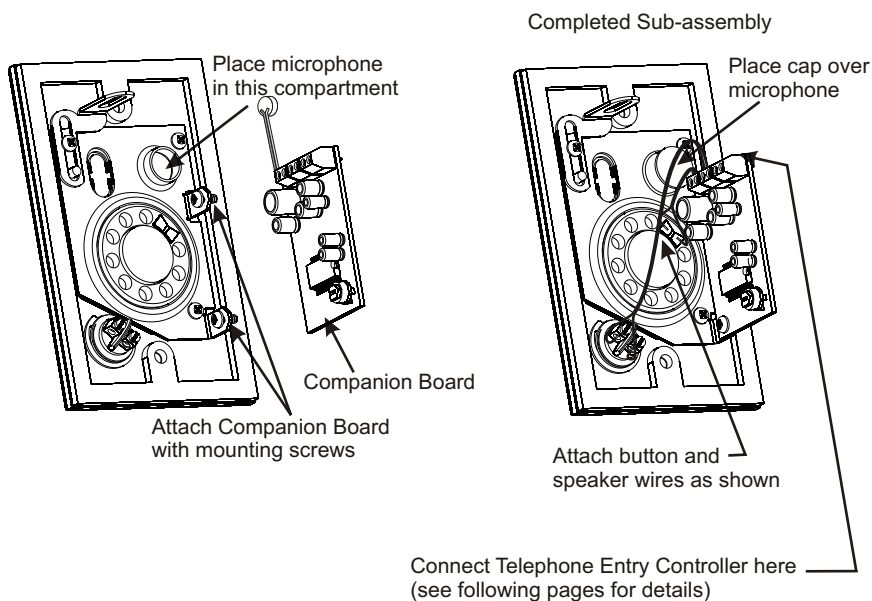

# Attaching the Camera

The IU-6xxx, and IU-6xxxP come with a mini camera that can be attached to the integrated mount that allows the camera to see through the opening in the plate. The illustrations bellow show how to mount the camera.

## Mini Pinhole Camera

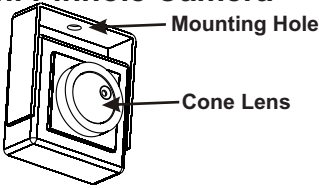

Break away the section of perforated metal screen that covers the camera opening by pushing a screwdriver through the slot on the front of the door plate. Press near the top or bottom of the section and the tabs that hold it in place will break free. Attach the camera to the mount so that the cone of the camera points through the opening. Adjust the camera to the desired position and secure it in place by tightening the screw on the mount.

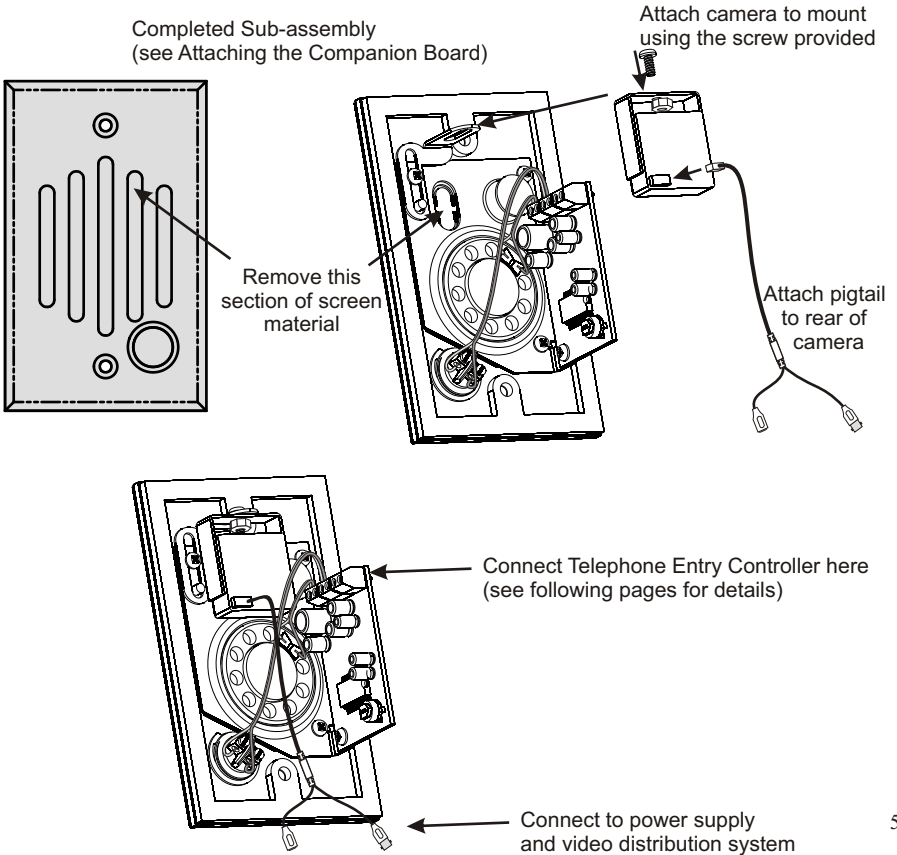

# Attaching the Companion Board (IU-XXXXC)

This door intercom product consists of two sub assemblies which must be attached to each other before the final assembly can be installed. In this guide the electronic sub assembly will be referred to as the "Companion Board" and the mechanical assembly will be referred to as the "Door Plate." Review the following diagrams and assemble as shown.

## Companion Board Connection Details

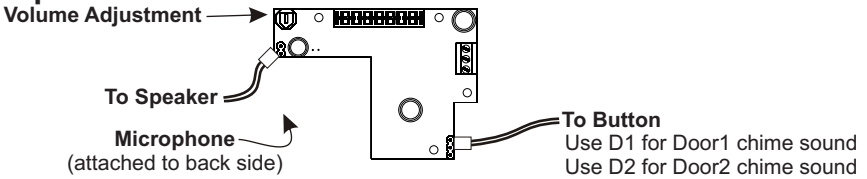

Position the companion board onto the three mounting tabs as shown below. The microphone attached to the back side of the companion board should line up with the microphone tube on the bracket. Bend the mounting tabs to secure the companion board. Connect the speaker and button wires by sliding the small connector over the exposed pins on the companion board as shown.

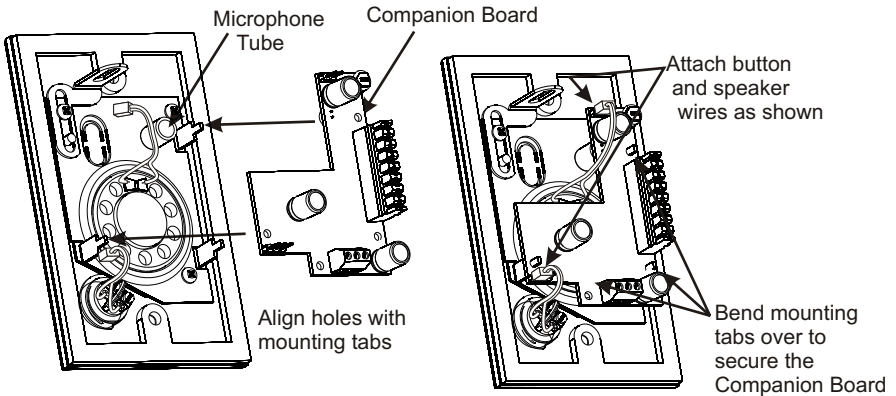

Completed Sub-assembly

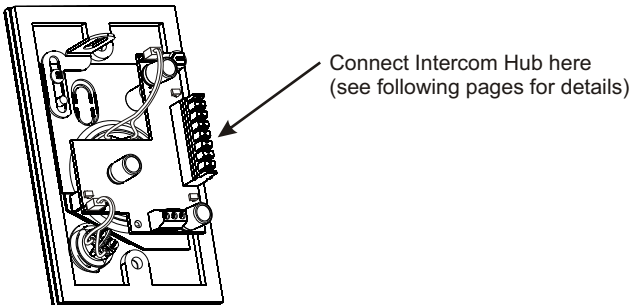

# Attaching the Camera (IU-XXXXC)

The IU-6xxxC comes with a mini color camera that can be attached to the integrated mount that allows the camera to see through the opening in the plate. The illustrations bellow show how to mount the camera.

## Mini Pinhole Camera

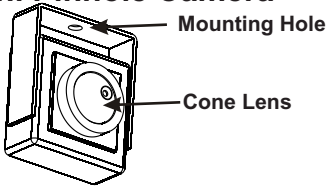

Break away the section of perforated metal screen that covers the camera opening by pushing a screwdriver through the slot on the front of the door plate. Press near the top or bottom of the section and the tabs that hold it in place will break free. Attach the camera to the mount so that the cone of the camera points through the opening. Adjust the camera to the desired position and secure it in place by tightening the screw on the mount.

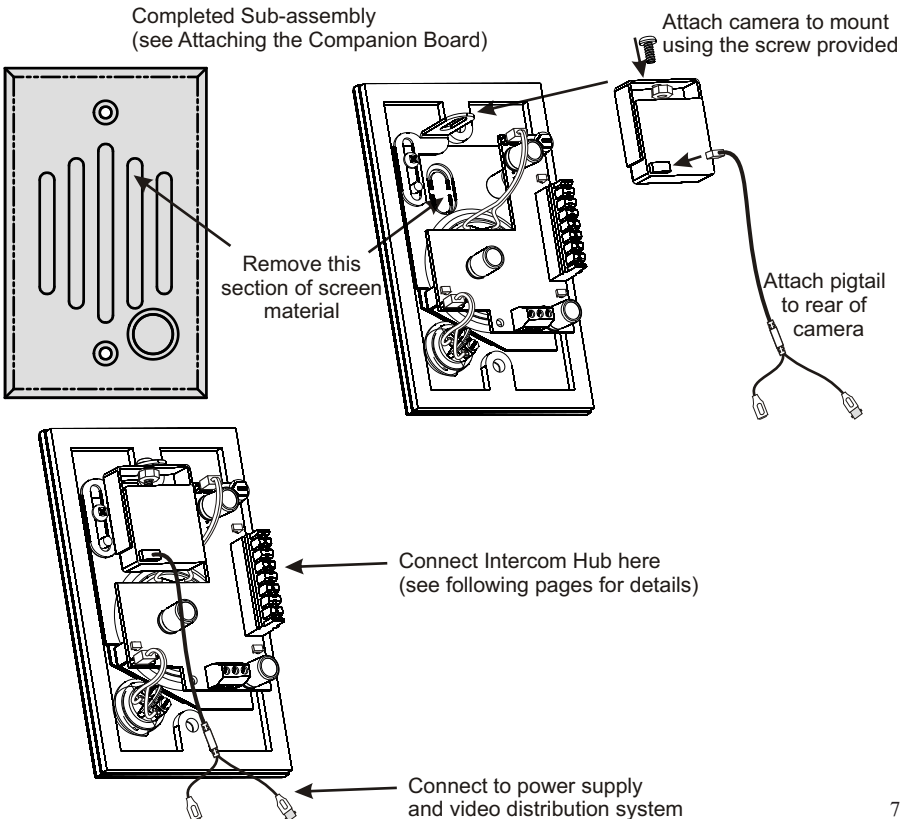

# Channel Vision Compatible (IU-xxxx)

Channel Vision's IU-0xxx does not come with a camera, but the IU-6xxx Series door plate comes with a mini color camera which attaches to the integrated camera mount. The IU-0xxx and IU-6xxx both interface with the Channel Vision's telephone entry controllers: TE110, C-0920, P-0920 and P-0921 to provide audio and video communication with the front door.

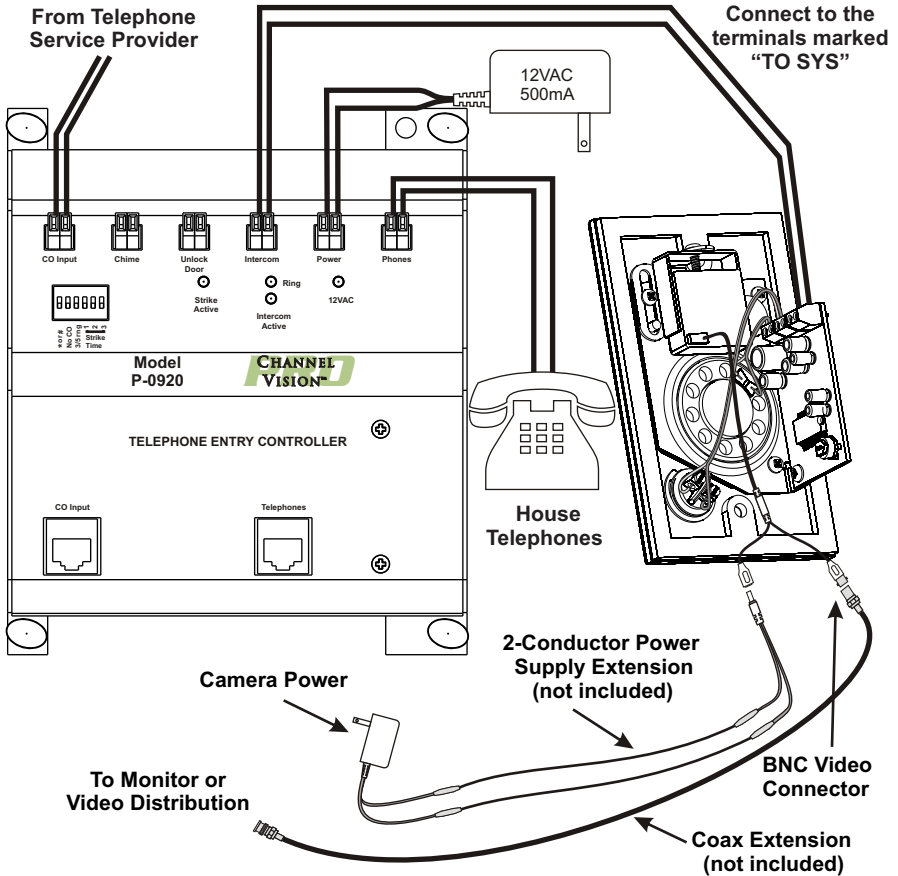

## Installation:

- Install a compatible single-gang mounting box at the desired location.
- Using a 2-conductor wire, connect the Telephone Entry Controller to the empty screw terminal block on the IU (see diagram).
- If necessary, attach the camera's video output to a coax extension that is long enough to reach your monitor or video distribution equipment.
- If necessary, cut the connector off of the end of the power supply and splice in an extension using crimp-on connectors.



# Channel Vision CAT5 Intercom Compatible (IU-xxxxC)

The diagram below shows how to connect the IU-xxxxC to Channel Vision's CAT5 Whole-House Intercom system. When the button is pressed on the IU-xxxxC the ST-2000 Intercom Stations will generate a door chime. Pressing Answer/End will open communication with the IU-xxxxC. Model IU-6xxxC includes a color camera and IU-0xxxC includes no camera.

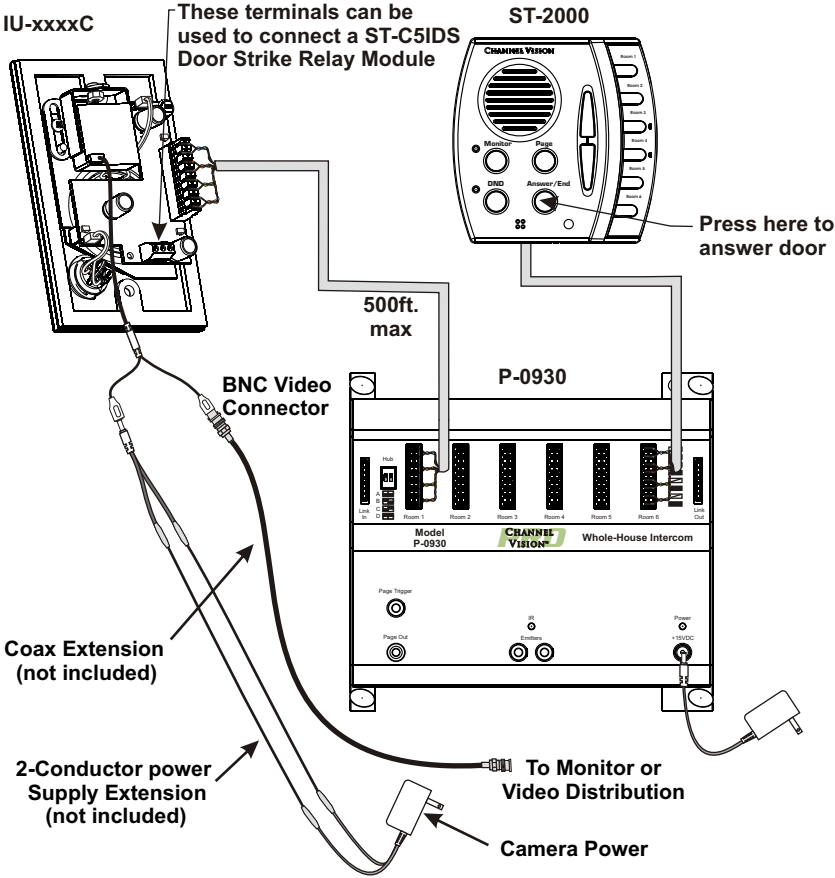

## Installation:

- Install a compatible mounting box at the desired location.
- Using CAT5 wire, connect the P-0930 to the 110 connector on the IU (see diagram).
- If necessary, attach the camera's video output to a coax extension that is long enough to reach your monitor or video distribution equipment.
- If necessary, cut the connector off of the end of the power supply and splice in an extension using crimp-on connectors.

# Panasonic® Compatible (IU-xxxxP)

Channel Vision's IU Panasonic Series models are a compatible replacement for the Panasonic KXT30865. These 1/4" solid brass door plates provide an attractive alternative to the standard plastic door station sold by Panasonic. This product interfaces with Panasonic's KSU phone systems to provide communication with the front door. Model IU-6xxxP includes a color camera and IU-0xxxP includes no camera.

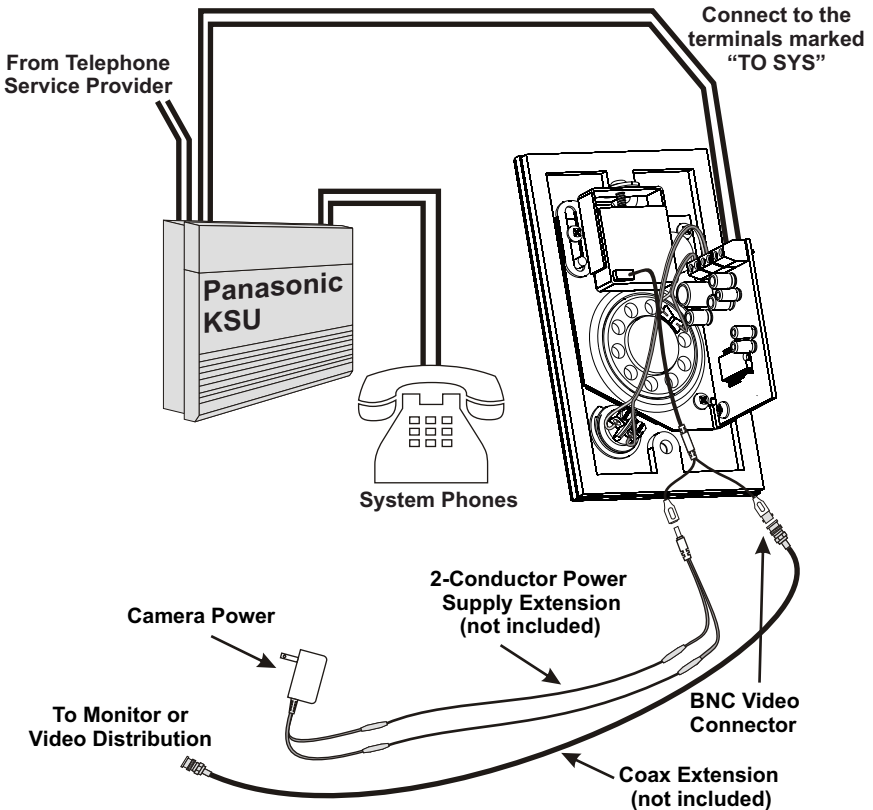

## Installation:

- Install a compatible single-gang mounting box at the desired location.
- Using a 2-conductor wire, connect the door phone output of your Panasonic KSU to the empty screw terminal block on the IU (see diagram).
- Consult your Panasonic manual for instructions regarding door phone operation.
- If necessary, attach the camera's video output to a coax extension that is long enough to reach your monitor or video distribution equipment.
- If necessary, cut the connector off of the end of the power supply and splice in an extension using crimp-on connectors.

# Panasonic® Compatible Amplified (IU-0xxxP8)

Channel Vision's IU-0xxxP8 Series models are a compatible replacement for the Panasonic KXT7775 which provides the amplified communication needed to work with newer Panasonic phone systems. These 1/4" solid brass door plates provide an attractive alternative to the plastic door station sold by Panasonic. This product interfaces with Panasonic's KSU phone systems to provide communication with the front door. There is no color camera option available for this model.

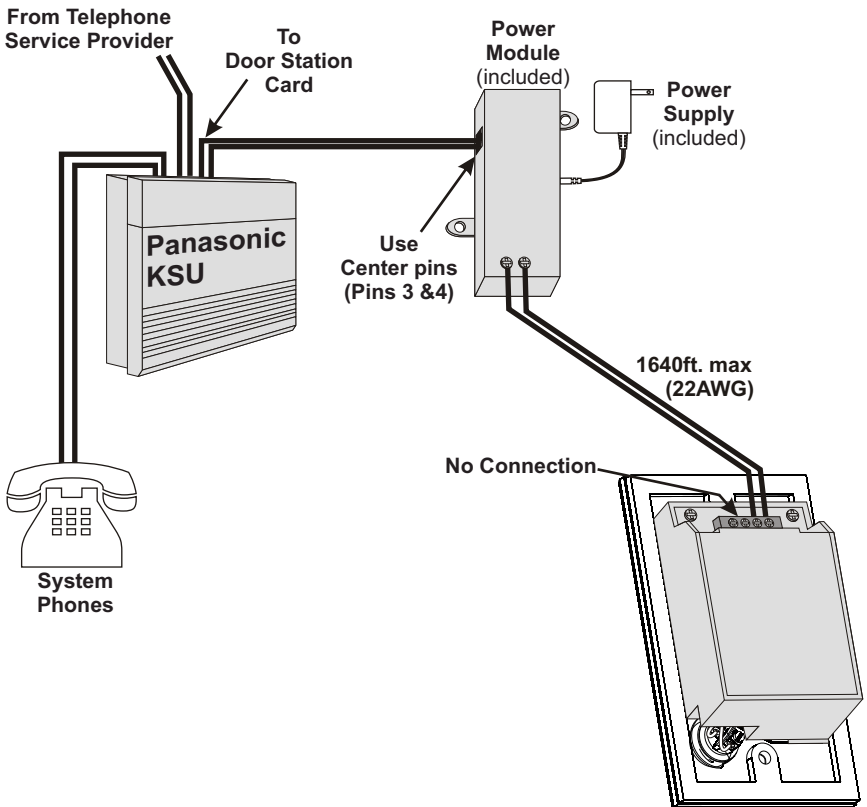

## Installation:

- Install a compatible single-gang mounting box at the desired location.
- Using a 2-conductor wire, connect the door phone output of your Panasonic KSU to the power module, then connect the screw terminals on the power module to the screw terminals on the IU station (see diagram).
- Consult your Panasonic manual for instructions regarding door phone operation.



## 1 Year Limited Warranty

Channel Vision Technology will repair or replace any defect in material or workmanship which occurs during normal use of this product with new or rebuilt parts, free of charge in the USA, for one year from the date of original purchase. This is a no hassle warranty with no mail in warranty card needed. This warranty does not cover damages in shipment, failures caused by other products not supplied by Channel Vision Technology, or failures due to accident, misuse, abuse, or alteration of the equipment. This warranty is extended only to the original purchaser, and a purchase receipt, invoice, or other proof of original purchase date will be required before warranty repairs are provided.

Mail in service can be obtained during the warranty period by calling (800) 840-0288 toll free. A Return Authorization number must be obtained in advance and can be marked on the outside of the shipping carton.

This warranty gives you specific legal rights and you may have other rights (which vary from state to state). If a problem with this product develops during or after the warranty period, please contact Channel Vision Technology, your dealer or any factory-authorized service center.

Channel Vision products are not intended for use in medical, lifesaving, life sustaining or critical environment applications. Channel Vision customers using or selling Channel Vision products for use in such applications do so at their own risk and agree to fully indemnify Channel Vision for any damages resulting from such improper use or sale.

### Specifications:

<b>Speaker Size (mm):</b>	40
<b>Speaker Depth (in):</b>	.73
<b>Speaker Impedance:</b>	8 Ohms
<b>Speaker Power Peak (W):</b>	0.2
<b>Speaker Frequency Range:</b>	500 Hz - 3.5 kHz

### Dimensions:

<b>IU-Series plate only:</b>	4.5" (L) x 3.75" (W) x .25" (D)
<b>IU-Series assembly:</b>	4.5" (L) x 3.75" (W) x 1.75" (D)
<b>Color Camera: (IU-6xxx, IU-6xxxC, &amp; IU-6xxxP only)</b>	
<b>Camera Lens:</b>	4.3mm
<b>Resolution:</b>	550 lines
<b>S/N Ratio:</b>	More than 48 dB
<b>Min Illumination:</b>	0.2 LUX @ F2.0
<b>Power Consumption:</b>	12VDC, 65mA
<b>Electronic Shutter:</b>	1/60s - 1/100,000s
<b>Iris Control:</b>	Automatic
<b>White Balance:</b>	Automatic
<b>Video Output:</b>	1 Vp-p @ 75 ohms
<b>Operating Temp:</b>	-10°C to 50°C (14°F to 122°F)

Specifications subject to change without notice.



234 Fischer Avenue, Costa Mesa, California 92626 USA  
(714)424-6500 • (800)840-0288 • (714)424-6510 fax  
email: techsupport@channelvision.com