Table of Contents

Introduction to BMW

Subject	Page
BMW Model Identification	3
External Designations	3
Internal Designations	4
1 Series	6
3 Series	7
5 Series	10
5 Series Gran Turismo	12
6 Series	13
7 Series	15
8 Series	18
Touring - Sports Wagon	19
Z Series	21
X Series	23
Motorsport Series	26
Vehicle Identification Numbers	33
VIN Location on Vehicle	34
Vehicle Production Dates	34
Vehicle Production Anti-Theft Labels	35
Paint Code Identification	36
Engine Identification	37
Engine Numbering System	38
Engine Displacement Identification	39
Engine Specification Plate Locations	41
Transmission Identification	43
Automatic Transmissions	44
Zahnradfabrik Friedrichshafen (ZF)	45
GM Hydramatic	47
Manual Transmissions	48
Transmission Data Plate	50
ZF Tag Location	50
GM Tag Location	50
BMW Group Numbering System	51
Basic BMW Abbreviations and Acronyms	52

Introduction to BMW

Model: All

Production: All

OBJECTIVES

After completion of this module you will be able to:

- Identify BMW models by their internal and external designations
- Be able to decipher a VIN
- Identify BMW engines and transmissions
- Understand the BMW Group Numbering system
- Recognize acronyms utilized internally by BMW

BMW Model Identification

BMW uses two different methods of identifying its products:

- External Designations are for customers to identify BMW products. These are marketing designations commonly referred to as trunk badges.
- Internal Designations are used by BMW and center personnel to identify a particular production version.

External Designations

External designations located on the trunk or tailgate are the model names. Customers and the public identify BMW products by these names.



The trunk badges consist of a combination of numbers and letters. The badge shown is typical of 1, 3, 5, 6 and 7 series vehicles. The first digit represents the series identification. The last two digits mark the engine displacement. The i represents the type of fuel delivery (injected).

The external designations are created by the sales and marketing department to position each model in a certain target segment of the vehicle sales market.

Occasionally there are examples where the actual engine displacement does not match the designation. This is a marketing decision to continue familiar name recognition from one version to the next and to create a spacing between models.

Examples are:

- E71 X6 xDrive50i - 4.4liter
- E9x 335i - 3.0 liter
- F01/F02 750i/Li - 4.4 liter



There is another series of badges that begin with a letter followed by a single digit. These are found on:

- Roadsters (E52, E85, E89)
- SAV (E53, E70, E83)
- SAC (E71, E72)
- Motorsport



Additional letters sometime follow the badge numbers and are used to further identify each model. Examples include:

- | | | |
|--------------------------------|---------------------|----------------------------|
| • xDrive - all-wheel drive | • i - Fuel Injected | • d - Diesel |
| • X - all-wheel drive | • M - Motorsport | • e - eta |
| • sDrive -sport/standard drive | • ActiveHybrid | • t - touring/sports wagon |
| • s - sport | • GT - Gran Turismo | • C or c - Coupe or Cabrio |
| • L - long wheel base | | |

Examples of these badges are:



Internal Designations

Internal designations are created and used by the Engineering and Technical Development departments to identify a new model during the design of the car. The use of the internal designations carries over to the Technical Support groups after production.

Internal designations refer to the entire vehicle series of a particular body design. For example, the E90 designation describes all 3 series cars of that design. BMW products start with an "E" (as of 2009 we started using the letter "F" on some of our vehicles) and are followed by a two digit number. Not all design concepts make production, so internal designations are usually not sequential. The table on the next page lists the internal designations, series number and the years produced.

The E designations can include an additional number separated by a slash (/) to indicate a different model within a particular chassis group. Example:

- E36/7- Z3
- E36/5- 318ti
- E46/3- Sport Wagon
- E46/2- Coupe
- E46/16- All-Wheel Drive

Engineering Designation	Series	Years Produced
E12	5	1975 - 1981
E21	3	1977 - 1983
E23	7	1978 - 1987
E24	6	1977 - 1989
E28	5	1982 - 1988
E30	3	1984 - 1991
E31	8	1991 - 1997
E32	7	1988 - 1994
E34	5	1989 - 1995
E36/7	Z3	1992 - 1999
E38	7	1995 - 2001
E39	5	1997 - 2003
E46	3	1999 - 2006
E52	8	2001 - 2003
E53	5 SAV	2000 - 2006
E65/66	7	2002 - 2008
E60/61	5	2004 - 2010
E63/64	6	2004 - 2010
E70	5 SAV	2007 -
E71	5 SAC	2008 -
E72	5 SAC ActiveHybrid	2010 -
E82	1	2008 -
E83	3 SAV	2004 - 2010
E88	1	2008 -
E85/86	Z4 Roadster	2003 - 2008
E89	Z4 Roadster	2009 -
E90/91	3	2006 -
E92/93	3	2007 -
F01/F02	7	2009 -
F04	7 ActiveHybrid	2011 -
F07	5 Gran Turismo	2010 -
F10	5	2011 -
F12	6	2011 -
F25	3 SAV	2011 -

1 Series



E82

2008 -

128i

2008 -

135i

2008 -



E88

2008 -

128i

2008 -

135i

2008 -

3 Series



E21

1977-1983

320i 1977 - 1983



E30

1984-1993

318i 1984 - 1985
 1991 - 1992

325e 1985 - 1988

325i 1987 - 1993



E36

1992-1999

318i 1992-1996

325i 1992-1995

323i 1998-1999

328i 1996-1999

E46

1999-2006

323i	1999-2000
325i	2001-2006
328i	1999-2001
330i	2001- 2006
M3	2002 - 2006



E90

2006 -

325i	2006 - 2007
330i	2006 - 2007
325xi	2006 - 2007
330xi	2006 - 2007
328i	2007 -
335i	2007 -
328xi	2007 -
335xi	2007 -



E92

2007 -

328i	2007 -
335i	2007 -
328xi	2007 -
335xi	2007 -
335is	2011 -



E93

2007 -

328i

2007 -

335i

2007 -

335is

2011 -



5 Series



E12

1975-1981

530i 1975 - 1978

528i 1979 - 1981



E28

1982-1988

528e 1982 - 1988

533i 1983 - 1984

535i 1985 - 1988

524td 1985 - 1986



E34

1988-1995

525i 1989-1995

530i 1994-1995

540i 1994-1995

E39

1997-2002

525i	2001
528i	1997 - 2000
530i	2001 - 2003
540i	1997 - 2003



E60

2004 - 2010

525i	2004 - 2007
530i	2004 - 2007
545i	2004 - 2007
550i	2006 - 2010
525xi	2006 - 2007
530xi	2006 - 2007
528i	2008 - 2010
535i	2008 - 2010
535xi	2008 - 2010



F10

2011 -

528i	2011 -
535i	2011 -
535i xDrive	2011 -
550i	2011 -
550i xDrive	2011 -



5 Series Gran Turismo

F07

2010 -

535i Gran Turismo

2011 -

535i xDrive Gran Turismo

2011 -

550i Gran Turismo

2010 -

550i xDrive Gran Turismo

2011 -



6 Series



E24

1977-1989

630CSi	1977
633CSi	1978 - 1984
635CSi	1985 - 1989
L6	1987



E63

2004 - 2010

645Ci	2004 - 2005
650i	2006 - 2010



E64

2004 - 2010

645Cic	2004 - 2005
650i	2006 - 2010

F12

2011

650i

2011



7 Series



E23

1978-1987

733i 1978 - 1984

735i 1985 - 1987

L7 1986 - 1987



E32

1988-1994

735i 1988-1991

740i 1992-1994

750iL 1988-1994



E38

1995-2001

740i 1995-2001

750iL 1995-2001

E65

2002 - 2008

745i 2002 - 2005

750i 2006 - 2008

760i 2005 - 2008



E66

2002 - 2008

745Li 2002 - 2005

750Li 2006 - 2008

760Li 2003 - 2008



F01/F02

2009 -

740i 2011 -

740Li 2011 -

750i 2009 -

750i xDrive 2010 -

750Li 2009 -

750Li xDrive 2010 -

760Li 2010 -

760Li xDrive 2010 -



F01/F02

2011 -

BMW ALPINA B7

2011 -

BMW ALPINA B7 xDrive

2011 -

BMW ALPINA B7 LWB

2011 -

BMW ALPINA B7 LWB xDrive

2011 -



F04

2011 -

ActiveHybrid 750i 2011 -

ActiveHybrid 750Li 2011 -



8 Series



E31

1990-1997

840Ci 1994 - 1997

850i 1991 - 1994

850Ci 1995 - 1997

850CSi 1994 - 1995

Touring - Sports Wagon



E36/5

1995-1999

318 ti

1995 - 1999



E46

2000 - 2003

323iT

2000

325iT

2001 - 2005

325xiT

2001 - 2005



E91

2006 -

325xiT

2006

328xiT

2007 -

328iT

2007 -

E34

1992-1995

525iT 1992 - 1995

530iT 1994 - 1995



E39

2001 - 2003

528iT 1999 - 2000

525iT 2001 - 2003

540iT 1999 - 2003



E61

2006 -

530xiT 2006 - 2007

535xiT 2008 -



Z Series



E36/7 Z3

1996-2002	
Z3 1.9	1996 - 1998
Z3 2.3	1999 - 2002
Z3 2.8	1997 - 2000
Z3 3.0	2001- 2002
Z3 Coupe 2.8	1999 - 2000
Z3 Coupe 3.0	2001 - 2002
M Roadster	1998 - 2002
M Coupe	1999 - 2002



E85 Z4

2003 - 2008	
Z4 2.5	2003 - 2005
Z4 3.0	2003 - 2005
Z4 3.0i	2006 - 2008
Z4 3.0si	2006 - 2008
Z4 Coupe	2006 - 2008
M Roadster	2006 - 2008
M Coupe	2006 - 2008



E89 Z4

2009 -	
Z4 sDrive30i	2009 -
Z4 sDrive35i	2009 -
Z4 sDrive35is	2011 -

E52 Z8

2001 - 2003

Z8 2001 - 2003

ALPINA Z8 2003



X Series



E83 X3

2004 - 2010

X3 2.5i 2004 - 2006

X3 3.0i 2004 - 2006

X3 3.0si 2007 - 2008

X3 xDrive30i 2009 -



F25 X3

2011 -

X3 xDrive28i 2011 -

X3 xDrive35i 2011 -

E53 X5

2000-2006

X5 4.4i	2000 - 2006
X5 3.0i	2001 - 2006
X5 4.6is	2002 - 2003
X5 4.8is	2004 - 2006



E70 X5

2007-

X5 3.0si	2007 - 2008
X5 4.8i	2007 - 2008
X5 xDrive30i	2009 - 2010
X5 xDrive35d	2009 -
X5 xDrive35i	2011 -
X5 xDrive50i	2011 -



E71 X6

2008 -

X6 xDrive35i 2008 -

X6 xDrive50i 2008 -



E72 X6

2010 -

X6 xDrive50i Hybrid

2010 -



Motorsport Series



E26 M1

1976-1981



E30 M3

1988-1992



E36 M3

1995-1999

E46 M3

2002 - 2006



E9x M3

2008 -

E90

2008 -

E92

2008 -

E93

2008 -



E28 M5

1988





E34 M5

1991 - 1993



E39 M5

2000 - 2003



E60 M5

2006 - 2010

E24 M6

1987 - 1988



E63/64 M6

E63 2006 - 2010

E64 2007 - 2010



E36/7 M Roadster

1998 - 2002





E36/7 M Coupe

1999 - 2002

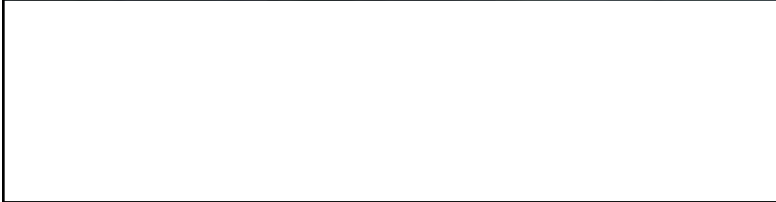

E85 M Roadster

2006 - 2008



E86 M Coupe

2006 - 2008



E82 M

2011 -



E70 X5 M

2010 -



E71 X6 M

2010 -

NOTES

PAGE

Vehicle Identification Numbers

Vehicle Identification Numbers are referred to as the VIN. BMW utilizes a VIN with a 17 character structure. The characters are grouped to include multiple information as follows:

WBA BR33 4 4 Y E A82019

Digit 1-3 are the manufacturer's code: ←

- WBA = BMW Cars and SAVs
- WBS = Motorsport
- 4US = Spartanburg (not used since 1999)

Digits 4-7 are the model code: ←

Digit 8 is the restraint system identifier: ←

- 0 = Seat belts
- 1 = Seat belts and Driver airbag
- 2 = Seat belts and Dual airbags
- 3 = Seat belts, Second generation dual front airbags
- 4 = Seat belts, Dual-stage advanced front airbags

Digit 9 is a check digit determined by VIN: ←

Digit 10 is the model year identifier (started in 1980): ←

A = 1980 model year, sequentially progresses every year. I, O, Q, U and Z are not used because they can be mistaken for numbers.

A=1980	G=1986	N=1992	W=1998	4=2004	A=2010
B=1981	H=1987	P=1993	X=1999	5=2005	B=2011
C=1982	J=1988	R=1994	Y=2000	6=2006	C=2012
D=1983	K=1989	S=1995	1=2001	7=2007	D=2013
E=1984	L=1990	T=1996	2=2002	8=2008	E=2014
F=1985	M=1991	V=1997	3=2003	9=2009	F=2015

Digit 11 is the Plant code: ←

- A, F, K = (Plant 1.1) Munich
- C, B, D, G = (Plant 2.4) Dingolfing
- E, J, P = (Plant 6.1) Regensburg
- L, M = (Plant 10) Spartanburg
- N = (Plant 9) Rosslyn
- W = (Plant) Graz, Austria
- V = (Plant) Leipzig

Digits 12-17 are the Sequential production number: ←

VIN Location on Vehicle

The VIN is located on the vehicle in the following locations:

- Left lower corner of the instrument panel. This is viewed through the windshield from outside the vehicle.
- B pillar compliance label. On the drivers side door jamb.

Additionally the VIN is stamped into the chassis in one of two locations:

- Under the hood on right side of engine compartment bulkhead.
- Under the hood on right side shock tower.



Vehicle Production Dates



The production date of the vehicle is included in the B pillar compliance label.

Production date information is required quite often when a repair procedure affects only a certain range of vehicles. The range is based on production dates.

The date shown on the label reflects the actual month and year the vehicle was produced. It is not a model year indicator.

Vehicle Production Anti-Theft Labels

Since 1987, the National Highway Traffic Safety Administration (NHTSA) requires that the VIN be marked on specific parts of the car during manufacture for theft identification. Some models are exempt if the total number of vehicles imported is below a certain number.

If equipped, the label is also a reference point for the VIN. The label is placed on the following locations:

- Engine
- Hood
- Front bumper
- Front Fenders
- Quarter panels.
- Firewall
- Transmission
- Trunk lid
- Rear Bumper
- Doors
- Shock Tower



*Please reference S.I.B 00 21 86 (1267) dated June 1990 for more information on Anti-theft labels.

Paint Code Identification

When ordering painted parts it is necessary to obtain the vehicle's paint code. The paint code consists of a three digit number printed on the color identification tag as shown below. All color identification tags are located in the engine compartment.



Engine Identification

BMW engines are identified by a combined alpha-numeric code. Like the internal model designation it is a code used by the Engineering and Technical development teams during the design stages of the engine:

- M - for standard production engines
- S - for Motorsport engines (Motorsport is a separate division of BMW)
- N -for New Generation engines

After the letter there are two digits that identify the engine. The table below lists engines by number of cylinders. Please refer to the BMW Technical Information Card for individual model application.

4 Cylinder	M10: 1.8 & 2.0L 2 valve inline	M42: 1.8L 4 valve inline	M44: 1.9L 4 valve inline	S14: 2.3L 4 valve inline				
	M20: 2.5 & 2.7L 2 valve inline	M21: 2.4L 2 valve inline diesel turbo	M30: 2.8, 3.0, 3.2 3.4 & 3.5L 2 valve inline	M50: 2.5L 4 valve inline	M50TU: 2.5L 4 valve inline	M52¹: 2.5 & 2.8 L 4 valve inline	M52TU¹: 2.5 & 2.8L 4 valve inline	M54¹: 2.5 & 3.0L 4 valve inline
6 Cylinder	M57D30T2¹: 3.0L 4 valve inline diesel bi-turbo	N52(K)¹: 3.0L 4 valve inline	N54^{1 3}: 3.0L 4 valve inline bi-turbo	N55^{1,2, 3}: 3.0L 4 valve inline twin-scroll single turbo	S38: 3.5 & 3.6L 4 valve inline	S50: 3.0L 4 valve inline	S52¹: 3.2L 4 valve inline	S54: 3.2L 4 valve inline
	M60: 3.0 & 4.0L 4 valve V config.	M62: 4.4L 4 valve V config.	M62TU¹: 4.4 & 4.6L 4 valve V config.	N62^{1 2}: 4.4L 4 valve V config.	N62^{1 2}: 4.8L 4 valve V config.	N62TU^{1 2}: 4.8L 4 valve V config.	N63^{1 3}: 4.4L 4 valve V config. bi-turbo reverse flow	S62¹ : 5.0L 4 valve V config.
8 Cylinder	S63^{1 3}: 4.4L 4 valve V config twin-scroll bi-turbo reverse flow	S65¹ : 4.0L 4 valve V config.						
	S85¹: 5.0L 4 valve V config.		M70: 5.0L 2 valve V config.	M73: 5.4L 2 valve V config.	M73TU: 5.4L 2 valve V config.	N73^{1 2 3}: 6.0L 4 valve V config.	N74^{1 3}: 6.0L 4 valve V config. bi-turbo	S70: 5.6L 2 valve V config.
10 Cylinder		12 Cylinder						

1 - VANOS: Variable Valve Timing. **2** - Valvetronic: Variable Valve Timing and Lift. **3** - Direct Injection

Engine Numbering System

In order to organize and classify the engines developed by BMW, a numbering system has been developed.

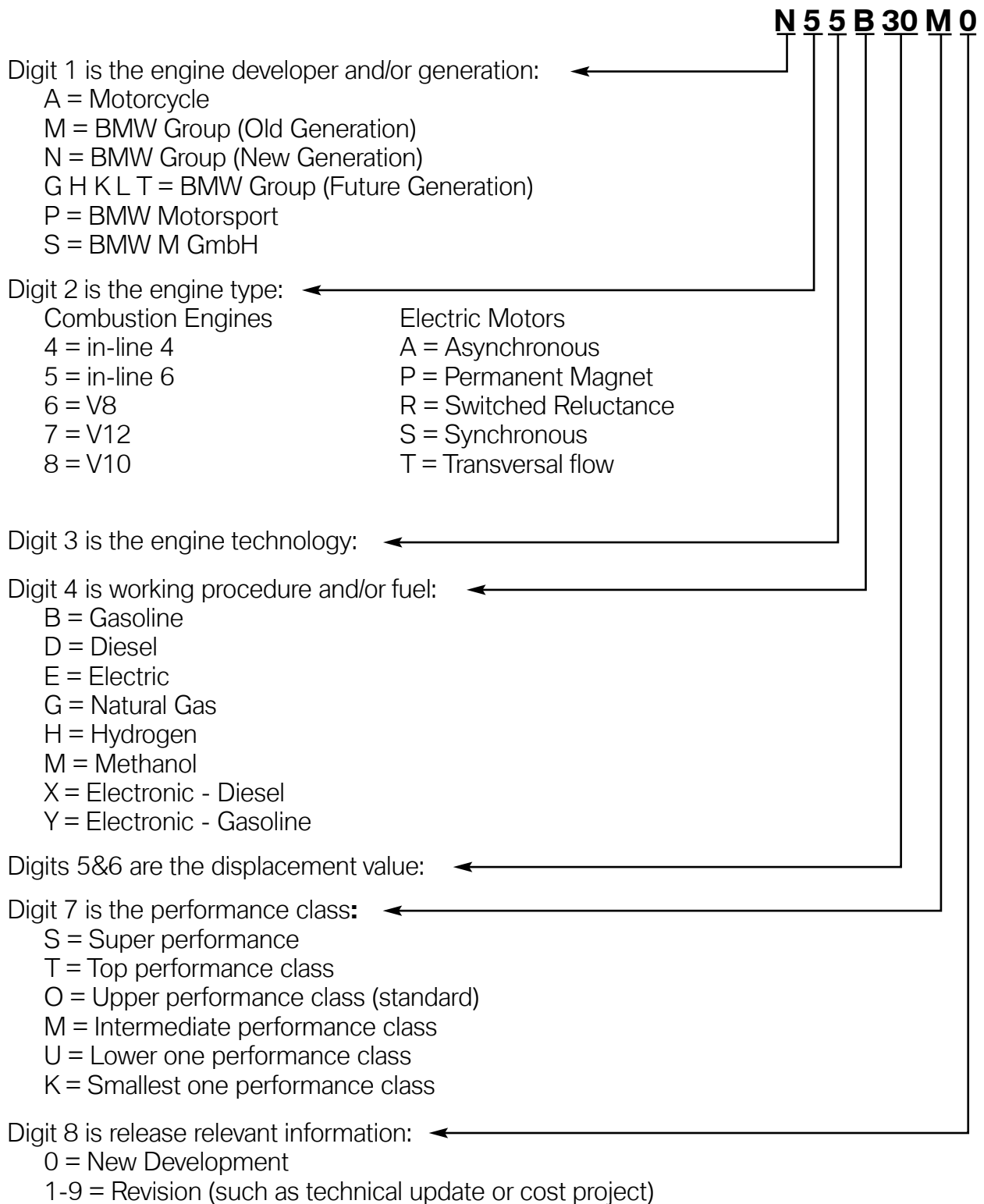

Engine Displacement Identification

In technical literature usually only the group of 3 digits that follow the basic engine code is utilized for engine identification. These digits identify the required fuel type of the engine and its displacement.

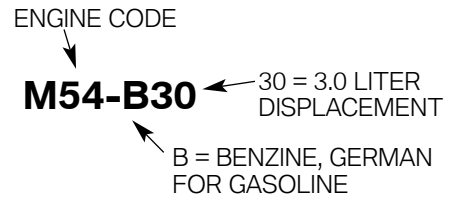

Engine displacement can always be determined by the engine specification plate. This plate is stamped onto the engines in various locations. There is a lot of information included in this identification plate. The breakdown of the information on this plate is as follows:

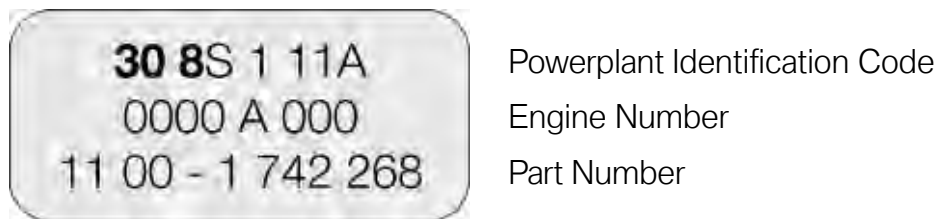

Powerplant Identification Number

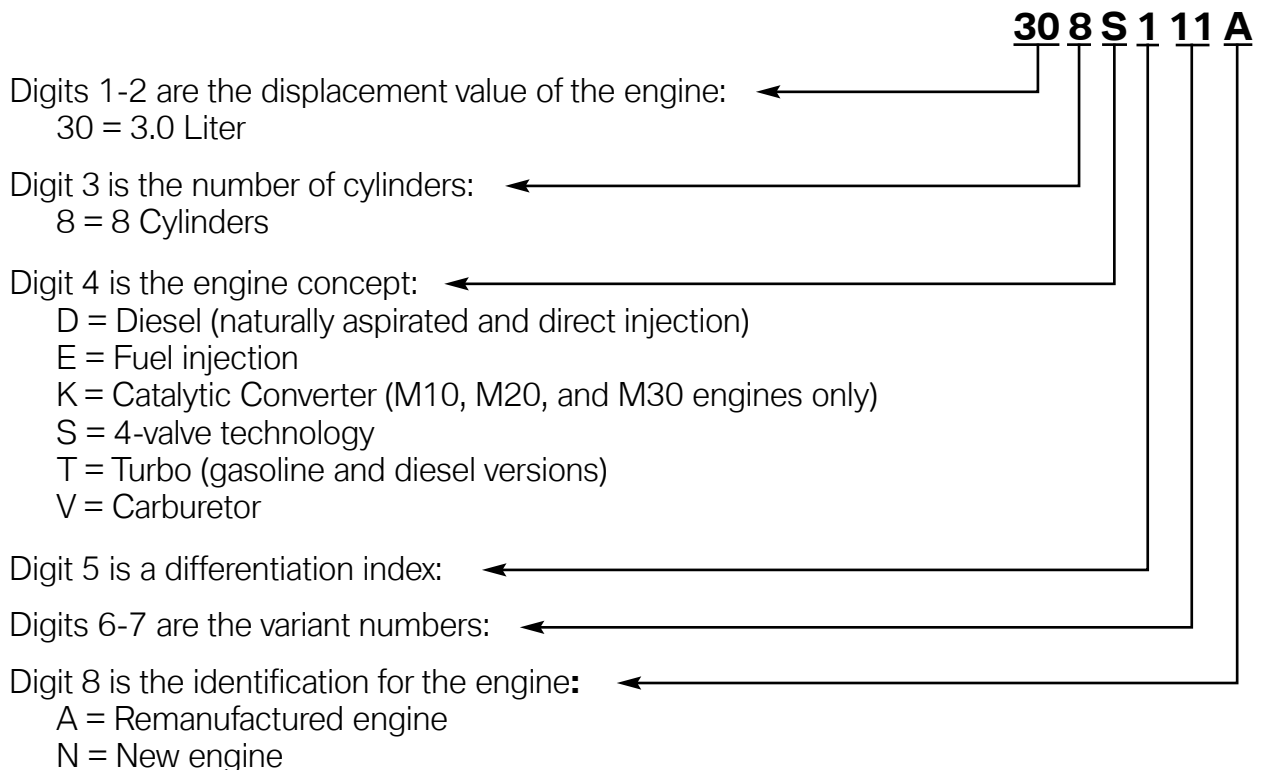

In recent time the Powerplant Identification Code changed from 8 digit to 7 digit. This mark is located on the crankcase to ensure unambiguous identification and classification. This engine identification is also necessary for approval by government authorities. Decisive here are the first seven positions. The first 6 positions are the same as the engine designation.

Item	Meaning	Index / explanation
1	Engine developer	M, N = BMW Group P = BMW Motorsport S = BMW M GmbH W = non-BMW engines
2	Engine type	5 = R6 (e.g. N55) 6 = V8 (e.g. N63) 7 = V12 (e.g. N73) 8 = V10 (e.g. S85)
3	Change to the basic engine concept	0 = basic engine 1 – 9 = changes, e.g. combustion process
4	Working method or fuel type and possibly installation position	B = petrol, longitudinal installation D = diesel, longitudinal installation H = hydrogen
5	Displacement in liters	1 = 1 liter (whole number of liters)
6	Displacement in 1/10 liter	8 = 0.8 liter (tenth of liter)
7	Type test concerns (changes that require a new type test)	A = Standard B – Z = Depending on requirement, e.g. RON 87

Engine Specification Plate Locations

M20

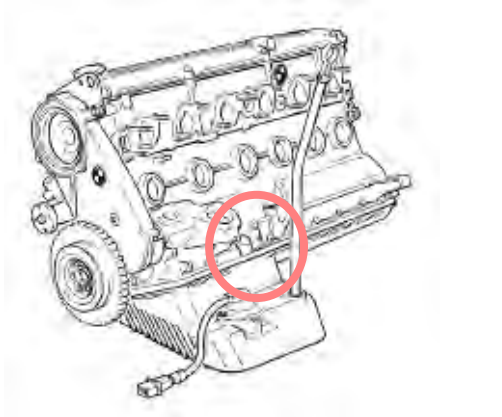

M30

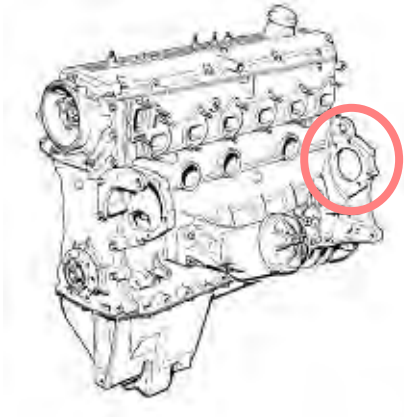

**M42
M44**

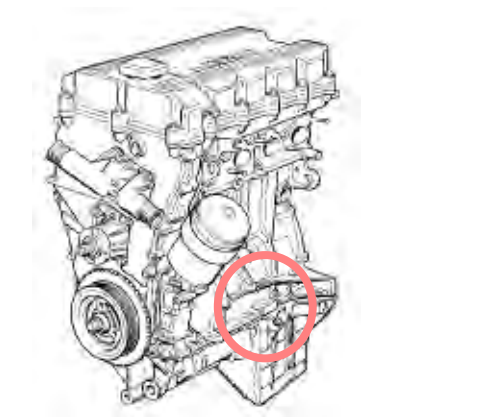

**M50
M52
M54
S50
S52
S54**

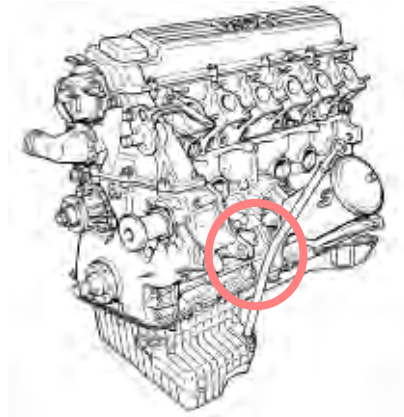

**M60
M62
N62
S62**

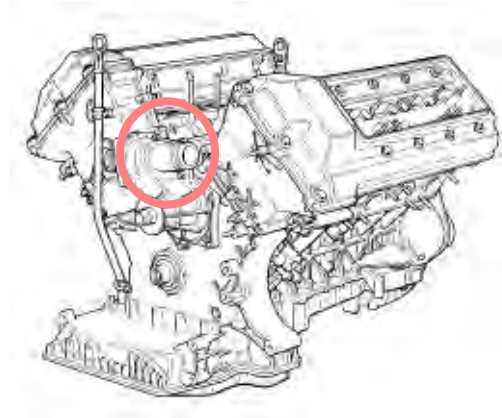

**M70
M73
S70**

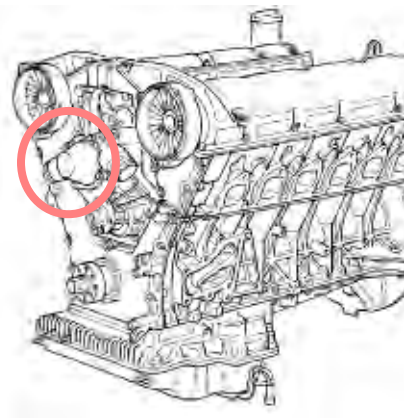

Engine Specification Plate Locations (Cont.)

**N52
N54
N55**



**N63
S63**

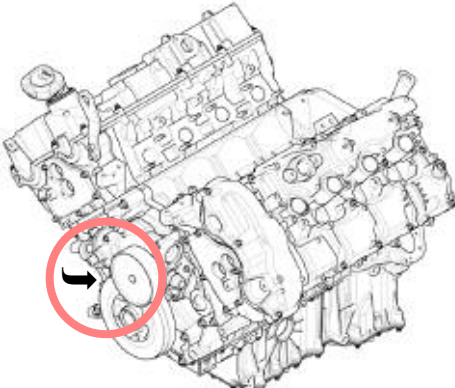

S65

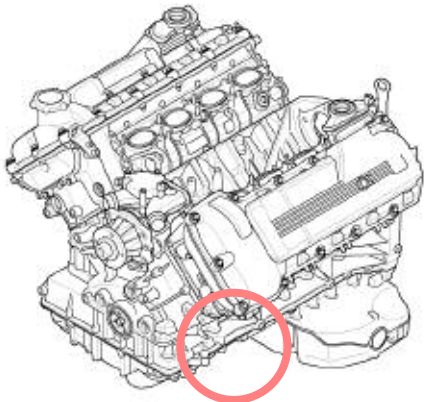

S85

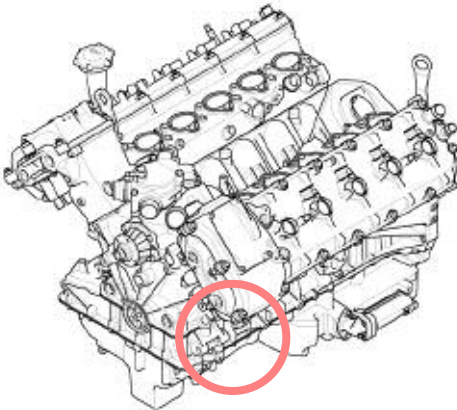

N74



Transmission Identification

BMW uses three different transmission suppliers.

1. Zahnradfabrik Friedrichshafen: A German supplier of BMW transmissions. Commonly referred to as ZF. ZF manufactures both manual and automatic transmissions.
2. Getrag: A German supplier of BMW manual transmissions.
3. Hydramatic: A French supplier of BMW automatic transmissions. Hydramatic is a manufacturing division of General Motors Powertrain.

BMW has developed an internal numbering system for their transmissions for parts ordering, information research, and identification. Each manufacturer uses their own internal identification system.

The breakdown of the BMW transmission identification code is as follows:

BMW Identification Code Breakdown

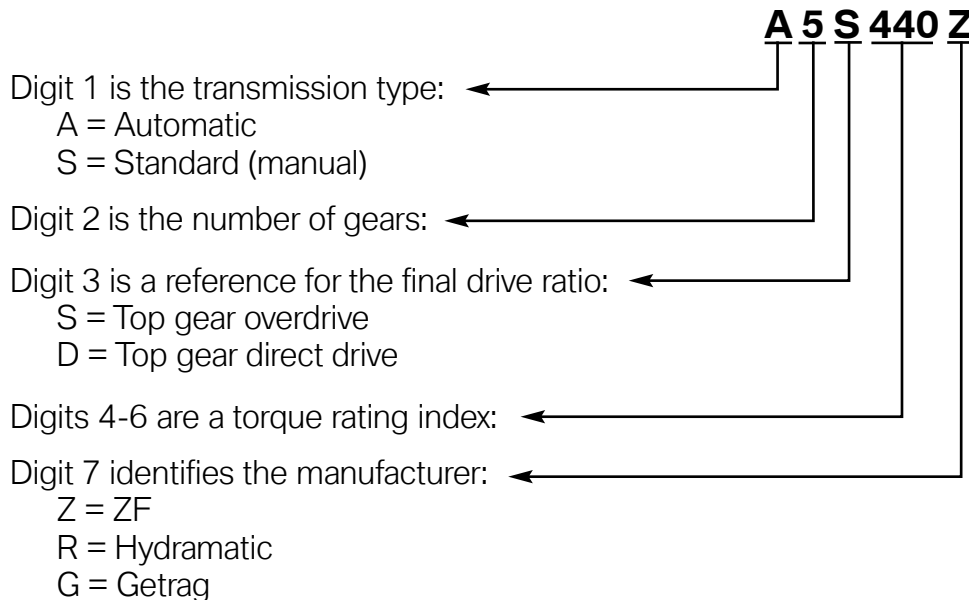

ZF Identification Code Breakdown

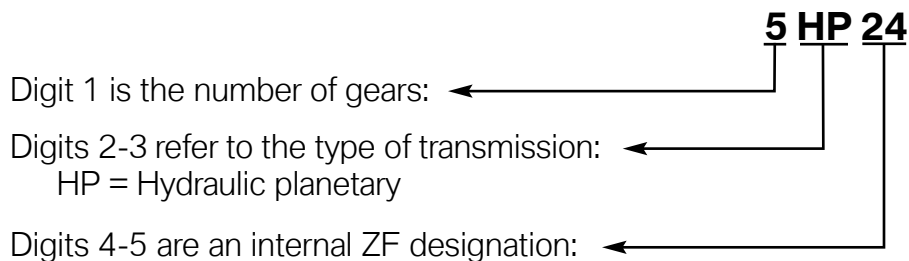

Automatic Transmissions

In technical documentation, the transmission designation is used to ensure the unambiguous identification of the transmission. Frequently, however, only an abbreviation is used. This short form is used to assign a transmission to a transmission family. For example, we often talk about the GA8HP transmission family, which consists of several transmissions such as the GA8HP45Z, the GA8HP70Z and the GA8HP90Z.

Position	Meaning	Index	Explanation
1	Description	G	Transmission
2	Transmission type	A	Automatic Transmission
3	Number of gears	6 8	Six forward gears Eight forward gears
4	Transmission type	HP L R	Hydraulic planetary gear train Designation by GMPT Designation by BGMPT
5 + 6	Transferable torque	19 26 32 45 (ZF) 45 (GMPT) 70 90 390	300 Nm gasoline engine 600 Nm gasoline engine 720 Nm gasoline engine 450 Nm gasoline engine, 500 diesel engine 350 Nm gasoline engine 700 Nm gasoline engine and diesel engine 900 Nm gasoline engine 390 Nm 4th gear 410 Nm gasoline engine
7	Manufacturer	G J R Z H	Getrag Jatco GMPT ZF In-house part

The tables on following three pages contain a list of automatic transmissions and the models they are used in.

Zahnradfabrik Friedrichshafen (ZF)			
Transmission BMW ID #	Manufacturer ID	Model/Year	Engine
4HP22 (EH)	4HP22 (EH)	86 535i 86 635i 86 735i	M30 M30 M30
4HP24 (EH)	4HP24 (EH)	88-9/91 750iL (E32) 92-94 750iL (E32) 90-94 850i/Ci (E31)	M70 M70 M70
A5S310Z	5HP18	93 530i/iT (E34) 94 530i/iT (E34) 95 M3 (E36) 96-99 M3 (E36)	M60 M60 S50 (US) S52
A5S325Z	5HP19	00 323i/Ci/CiC (3/00-8/00) 01 323iT (from 4/01) 01-04 325i/Ci/CiC to end of 04 02-05 325i SULEV (E46) 02- 06 325Ci SULEV (E46) 00-04 330i/Ci/CiC to end of 04 01- 03 525i/xi/xiT 3/01 to 9/03 01- 03 530i/xi/xiT3/01 to 3/03 03-05 Z4 (E85) 2.5i and 3.0i	M52 TU M52 TU M54 M56 M56 M54 M54-N52 M54-N52 M54
A5S440Z	5HP24	97 840Ci (E31) from 9/96 97 540i (E39) 1/97-8/97 97 740i/iL (1/97 - 4/97) 97 740i/iL (5/97-8/97) 98-03 540i 98-01 740i/iL 00- X5 4.4i (E53)	M62 M62 M62 M62 M62, M62 TU 99-02 M62, M62 TU 99-01 M62TU
A5S560Z	5HP30	93-94 740i/iL (E32) 93 540i (E34) 94-95 540i (E34) 94-95 840Ci (E31) 95 740i/iL (E38) 95-01 750iL (E38) 96-97 740i/iL (-1/97) 96 840Ci (E31) 95-97 850Ci	M60 M60 M60 M60 M60 M73/M73TU M62 M62 M73

Zahnradfabrik Friedrichshafen (ZF)

Transmission BMW ID #	Manufacturer ID	Model/Year	Engine
GA6HP26Z	6HP26	02-04 745i/Li (E65/E66) 05-08 750i/Li (E65/E66) 03- 760Li (E65/E66)) 03-3/07 545i/550i (E60) 03-9/06 X5 4.4/4.8iS (E53)	N62 N62/N62TU N73 N62/N62TU N62/N62S
GA6HP28Z	6HP26TU	3/07 545i/550i (E60) 9/07 645Ci/CiC (E63/E64) 9/07 650Ci/CiC (E63/E64) 10/06 X5 4.8i (E70) 9/08 X5 xDrive35d (E70) 1/08 X6 XDrive50i 4.4 (E71)	N62/N62/TU N62/N62/TU N62/N62/TU N62TU N57 N63
GA6HP19Z	6HP19	05-9/06 325i/xi (E90/E91) 05-9/06 330i/xi (E90) 06 Z4 3.0i/si (E85) 06 Z4 3.0i/si Coupe (E86)	N52 N52 N52 N52
GA6HP21Z	6HP19TU	4/06 335i/xi (E90) 9/06 328i/xi-335i/xi (E92) 12/06 335i (E93) 3/07 528i/xi-535i/xi (E60/E61) 1/08 135is Coupe (E82) 1/08 135is Convertible (E88) 10/06 X5 3.0si (E70) 1/08 X6 XDrive35i 3.0 (E71)	N54 N52K/N54 N54 N52K/N54 N54 N54 N54 N52K N54
GA8HP45Z	8HP45	3/10 535i/xi (F07) 3/10 528i (F10) 3/10 535i/xi (F10) 5/10 X5 xDrive35i (E70) 5/10 X5 xDrive50i (E70) 5/10 X5 xDrive35d (E70)	N55 N52 N55 N55 N63 M57
GA8HP70Z	8HP70	9/09 550i/x (F07) 9/09 760Li (F02) 3/10 550i/xi (F10)	N63 N74 N63

GM Hydrumatic

Transmission BMW ID #	Manufacturer ID	Model/Year	Engine
A4S310R (THM-R1)	4L30- E(A4S310R)	90-92 525i (E34) 93-95 525i (E34) 92 325i, is, ic (E36) 93-95 325i, is, ic (E36) 92-95 318ti (E36)	M50 M50 TU M50 M50 TU M42
A4S270R	4L30- E(A4S270R)	96-98 328i (is, ic -97) 96-98 318i (is, ic-97) 96-98 318ti (E36/5) 96-98 Z3 1.9 (E36/7) 96-98 Z3 2.8 97-98 528i (E39)	M52 M44 M44 M44 M52 M52
A5S360R (GM5)	5L40-E (A5S360R)	99-00 323i/Ci (7/98-3/00) 99-00 328i/Ci (6/98-5/00) 99-00 528i (E39) 9/99-8/00 99-00 Z3 (E36/7) 2.3/2.8	M52 TU M52 TU M52 TU M52 TU
A5S390R (GM5)	5L40-E (A5S390R)	00-8/06 X5 3.0i (4/00) 01 325iT (8/00-3/01) 01-3/05 325xi/xiT & 330Xi (-8/00) 01-6/06 325Ci/Cic/330Ci/Cic 01 525i/iT (9/00-3/01) 01 530i (9/00-3/01) 01-02 Z3 2.5/3.0 (6/00) 03-8/06 X3 2.5/3.0 (E83)	M54 M54 M54 M54 M54 M54 M54 M54
6L46R (GM6)	6 Speed Hydra-Matic	9/06 328i/xi/C/Cxi (E90/91/92) 12/06 328Cic (E93) 1/08 128is Coupe (E82) 1/08 128is Convertible (E88) 9/06 X3 3.0si (E83)	N52K/N51 N52K/N51 N52K/N51 N52K/N51 N52K

Manual Transmissions

In the technical documentation, the transmission designation is used to ensure the unambiguous identification of the transmission. Frequently, however, only an abbreviation is used. Thus we frequently speak of the I transmission, K transmission or G transmission. For the correct designation, refer to the following table.

Position	Meaning	Index	Explanation
1	Description	G	Transmission
2	Transmission type	S	Manual Transmission
3	Number of gears	1-9	Number of forward gears
4	Transmission type	- X S W D Y	Manual transmission Four-wheel drive with manual transmission Sequential manual transmission Four-wheel drive with sequential manual transmission Twin-clutch gearbox Four-wheel drive with twin-clutch gearbox
5 & 6	Transmission type	17 26 37 45 53	I transmission D transmission H transmission K transmission G transmission
7	Gear set	B D S P	Petrol engine ratio Diesel engine ratio Sport gear ratio Petrol engine gear ratio overhauled
8	Manufacturer	G J R Z H	Getrag Jatco GMPT ZF In-house part

The following table lists the manual transmissions and the vehicles they are used in.

Transmission Model	Vehicles	Engine	Model Year
S5D 200G	318i/iC (E36)	M42	1992 - 1995
S5D 250G	318ti (E36/5) 318i/iC (E36) 325i/iC (E36) 323i (E46)	M42, M44 M44 M50TU M52TU	1995 - 1999 1996 1992 - 1995 1999 -
S5D 280Z	X5 3.0i (E53) 325xi (E46/16) 330xi (E46/16)	M54 M54 M54	2001 - 2001 - 2001 -
S5D 310Z	M3 (E36) 525i (E34) 530i (E34)	S50 M50TU M60	1995 1991 - 1995 1994 - 1995
S5D 320Z	323i/iC, 328i/iC (E36) M3 (E36) Z3 roadster/Coupe M roadster/Coupe 528i (E39) 328i (E46)	M52 S52 M52TU S52 M52TU M52TU	1996 - 1999 1996 - 1999 1997 - 1998 - 1997 - 1999 -
S6S 420G	M3 (E46) 540i (E34) 540i (E39) M5 (E39) Z8 (E52)	S54 M60 M62TU S62 S62	2001 - 1994 - 1995 1997 - 2000 - 2001 -
S6S 560G	850i/Ci 850Csi	M70, M73 S70	1991 - 1997 1994 - 1995
GS6-17PG	528i (F10)	N52	2011
GS6-45BZ	535i (F10)	N55	2011
GS6-53BZ	550i (F10)	N63	2011

Transmission Data Plate

In order to identify BMW transmissions there are identification tags located externally on the transmission case. The tag contains information such as Manufacturer, Serial number, transmission type etc. This information is needed when ordering parts, referencing bulletins, or submitting a PuMA case.

ZF Tag Location

- Right hand side (passenger side) of transmission case. (5HP30 and 5HP18)
- Left hand side (drivers side) of transmission case. (6HP26Z, 5HP24, and all 4HP)
- Rear under output shaft. (5HP19)



ID Tag Location 5HP24



ID Tag Location 5HP19

GM Tag Location

- Left hand side (drivers side) of transmission case.



GM ID Tag (GM 5)

BMW Group Numbering System

BMW uses a group numbering system to aid internal and BMW Center personnel to identify vehicle components or BMW information resources.

The main group numbering system is made of two digits at the beginning of any BMW group number. The following information resources are all organized by the group numbering system.

- Part Numbers
- Service Information Bulletins
- Repair Manuals
- Tightening Torques
- Electrical Troubleshooting Manuals
- Warranty Labor and Defect codes
- Technical Reference Information
- Technical Data
- Special Tool Catalog
- Diagnosis Program Test Modules

Group	Description	Group	Description
0	Maintenance and General Hints	33	Rear Axle
1	Warranty	34	Brakes
2	Aftersales Development	35	Pedals
3	Technical Training	36	Wheels and Tires
4	Tools and Equipment	37	Special Suspension Systems
5	Information Systems	41	Body
6	Service Roundtable	51	Body Equipment
7	Workshop Environment Systems	52	Seats
8	GT1	54	Special Roofs
9	Programming/Coding Explanations	61	General Electrical Systems
10	TIS	62	Instruments
11	Engine	63	Lights
12	Engine Electrical Systems	64	Heating & Air Conditioning
13	Fuel Systems	65	Audio, Navigation, Monitors, Alarms,
14	Hydrogen System	66	Distance Systems, Cruise and Remote Control
16	Fuel Supply Systems	67	Electric drives/
17	Cooling System	71	Tools and Accessories (Engine-Chassis)
18	Exhaust Systems	72	Safety Belts and Accessories (Body)
21	Clutch	80	Bicycles/Bicycle Accessories
22	Engine and gearbox suspension	81	Books, Calendars and Collectibles
23	Manual Transmission	82	Lifestyle and Gift Items
24	Automatic Transmission	84	Communication Systems
25	Gear Shift Mechanism	91	Individual Equipment
26	Drive Shaft	97	Corrosion Protection
27	Intermediate and Special Transmission	98	Paints and Car Care Products
28	M Double-clutch Transmission w/Drivelogic	99	Paintwork
31	Front Axle		
32	Steering and Wheel Alignment		

Basic BMW Abbreviations and Acronyms

Throughout your career as a BMW Group Service Technician you will come across many acronyms in the various Technical publications. Even BMW is an acronym. An acronym is a word formed from the initial letters of a longer word. In the next two pages there is a list of acronyms describing various systems on BMW Group automobiles and SAVs.

Remember this is only a partial list. The BMW Group is a dynamic company and is always adding new systems to its products. Look for new systems and acronyms with new Technical Training courses, Service Information, and Technical Information Bulletins.

You can also refer to ISTA “FTD 000 103035 Abbreviations All models” for more than 1500 definitions.

AB	Airbag	CVT	Constantly Variable Trans.
ABL	Procedure	D-Bus	Diagnosis Bus (same as TXD)
ABS	Anti-lock Braking System	D-CAN	Diagnosis on Controller Area Network
ACSM	Advanced Crash Safety Module	DBC	Dynamic Brake Control
ADS	Engine Intake Air Control	DCS	Dealer Communication System
AGS	Adaptive Transmission Control	DDE	Digital Diesel Electronics
AIC	Automatic Interval Control (rain sensor)	DIN	German Industrial Standards
AL	Active Steering (also AS or AFS)	DIS	Diagnosis and Information System
ARS	Active Roll Stabilization	DISA	Differential Air Intake Control
ASC	All Season Traction	DK	Throttle Housing
ASC+T	ASC+Traction	DKI	Throttle Position
ASK	Audio System Controller	DME	Digital Motor Electronics
AST	Slip Control (Marketing term)	DM-TL	Diagnosis Module Tank Leakage
AUC	Automatic Air Recirculation	DSC	Dynamic Stability Control
AZD	Tightening Torque (AZD)	DSP	Digital Sound Processing
		DTC	Diagnostic Trouble Code
B	Benzene (gasoline)	DWA	Theft Deterrent System
BC	Board Computer	DWS	Tire Pressure Warning System
BC1	Body Controller 1		
BLS	Brake Light Switch	EBO	Installation Location
BMBT	Board Monitor	EBV	Electronic Brake Proportioning
BS	Block Diagram	ECM	Engine control module (SAE)
BSD	Bit Serial Data interface	EDC	Electronic Dampening Control
BST	Battery Safety Terminal	EDK	Electronic Throttle Valve
BZM	Center Console Control Center	EGS	Electronic Transmission Control
		EH	Electronic Hydraulic
CAS	Car Activation System	EHC	Electronic Height Control
CBC	Corner Braking Control	EKP	Electronic Fuel Pump
CAN-Bus	Controller Area Network(bus)	EKPS	Electronic Fuel Pump Control
CIC	Car Information Computer	ELV	Electronic Steering Lock
CID	Central Information Display	EM	Electro-Mechanical
CIM	Chassis Integration Module	EMF	Electro-Mechanical Emergency Brake
CVM	Convertible Top Module	EML	Electronic Motor Load Regulation

EO	Component Location	KAFAS	Camera-based driver assistance system
EPC	Electronic Parts Catalog	KAT	Catalytic Converter
ETM	Electronic Troubleshooting Manual	KATON	Converter Heating (signal)
Ethernet	Cabled data network technology for local data networks	K-Bus	Body Bus
EWS	Electronic Driveway Protection	K-CAN	Body controller area network
		KFA	Function changes to vehicle
FB	Function Description	KL	Terminal Designation
F-CAN	Chassis CAN	KO	Compressor "ON" Signal
FD	Rear display	KOMBI	Instrument Cluster
FEB	Fault Elimination	KOREL	Compressor Relay Signal
FBZV	Radio Frequency Locking	KW	Crankshaft
FLA	High beam assistant		
FlexRay	Fast, present and fault-tolerant bus system for use in automotive applications	LCM	Lamp Check Module
FRU	Flat Rate Unit	LDP	Leak Diagnosis Pump
FRM	Footwell module	LEV	Low Emissions Vehicle
FTD	Vehicle Technical Diagnosis	LIN-Bus	Local Interconnect Network bus
FUB	Functional Description	Local-CAN	Local controller Area Network
FZD	Roof function center	LL	Closed Throttle
		LRA	Vertical Headlight Aiming
GAL	Speed Dependent Volume	LSM	Steering Column Memory
GM	General Module	LSZ	Lamp Switching Center
GMR	Yaw Moment Control	LVA	Air Supply System
GPS	Global Positioning System	LWR	Vertical Headlight Aiming
GSW	Gear Selector Switch	LWS 5	Steering Angle Sensor
		MBC	Maximum Brake Control
HDC	Hill Decent Control	MDK	Motorized Throttle Valve
HFM	Hot Film Air Mass Meter	MFL	Multi-Function Steering Wheel
HKL	Luggage compartment lid lift	MFC	Multi-Function Controller
HSB3	Heating/Ventilation, 3rd row	MID	Multi-Information Display
HSR	Rear suspension slip angle control	MoDiC	Mobile Diagnostic Computer
HUD	Head Up Display	MOST	Media Oriented System Transport
		MRS	Multiple Restraint System
IB	Interior lighting Control Signal	MSR	Engine Drag Torque Reduction
ICM	Integrated Chassis Management		
I-Bus	Information Bus	NG	New Generation
IHKA	Automatic Heating and A/C	NVE	Night Vision Electronics
IHKR	Regulated Heating and A/C		
IHKS	Standard Heating and A/C	OBC	On-Board Computer
IKE	Instrument Cluster Electronics	OBD	On-Board Diagnosis (SAE)
IR	Infrared		
ISIS	Intelligent Safety Integration System	PB	Pin Assignments
ISN	Individual Serial Number	P-Bus	Periphery Bus
		PDC	Park Distance Control
JBE	Junction Box Electronic	PIB	Pin Assignment
		PT-CAN	Powertrain CAN
		PWG	Pedal Position Sensor

RDC	Tire Pressure Control	VL	Full load - wide open throttle
RDW	Tire Pressure Warning	VM	Video Module
REP	Repair Instructions	VSW	Video Switch
RPS	Rollover Protection System		
RPW	Tire Puncture Warning	WK	Converter Lock-up Clutch
RSE	Rear Seat Entertainment system	WUP	Wake Up line
RXD	Wake-up Diagnosis Line		
RZV	Direct Stationary Ignition	ZGM	Central Gateway Module
		ZKE	Central Body Electronics
SB	Fuse Assignments	ZV	Central Locking System
SBE	Seat Occupancy Detector	ZWD	Idle Control Valve
SCA	Soft Close Actuator		
SDARS	Satellite tuner (US)		
SG	Control Unit		
SGS	Seat Integrated Belt System	Terminals	
SHD	Sunroof Module	B+	Battery Positive
SIA	Service Interval Indicator	B-	Battery Negative
SIT	Service Information Technology	KL	Standardized Abbreviation for Clamp or Terminal Number
SM	Seat Module	KL_0	Ignition Switch Off
SP	Schematic	KL_R	Voltage Ignition Switch in ACC, Run Start. Hot in ACC/Run/Start
SPI	Vehicle Software Information		
ST	Connector View	KL_15	Voltage Ignition Switch in Run and Start. Hot (12V) in Run/Start.
STA	Connector View	KL_15N	F01/F02. Voltage Ignition Switch in Run and Start. Hot (12V) in Run/Start
SSP	Wiring Diagram	KL_15U15i	Voltage Ignition Switch in Run. Hot (12V) in Run.
SWW	Lane Change Warning		
SWZ	Special Tool	KL_30	12V at All Times (Relay Work Power). Hot (12V) All Times.
SZL	Steering column switch cluster	KL_30g	12V with time disconnection.
SZM	Central Switch Center Module	KL_30B	F01/F02. 12V with time disconnection.
		KL_30g-f	12V with fault disconnection.
TCU	Telematic Control Unit	KL_30F	F01/F02. 12V with fault disconnection.
TD	Engine Speed	KL_30H	Starter Signal
TED	Technical Data	KL_31	Ground
ti	Injector on time	KL_50	Voltage Ignition switch in Start. Hot (12V) in Start
TL	Part Throttle		
TLEV	Transitional Low Emission Vehicle	KL_58	Interior Lighting Dimmer Signal
TPMS	Tire Pressure Monitoring System	KL_61	Ground with Alternator Output, 12V with KL_15
TRS	Battery Isolation Switch		
TR SVC	Control unit for reversing and side view cameras	85	Relay Coil Ground (Signal) control side.
TU	Technical Update	86	Relay Coil B+ control side.
TXD	Transmitting Diagnosis Line	87	Relay Output Work Side.
		87a	Relay Output Work Side At Rest
ULF-SBX	Universal charger and hands-free unit, interface box (bluetooth telephony)		
VANOS	Variable Camshaft Timing		
VDM	Vertical Dynamics Management		