

User Guide

# LQ 4.0 User Guide



Part Number: 399G227 Rev B

Date: September 07, 2017

## Document reference

---

LQ Series 4.0 User Guide

399G227 Rev B

Legal disclaimers

Copyright © 2017 HME Clear-Com Ltd HME Clear-Com Ltd

All rights reserved

Clear-Com, the Clear-Com logo, and Clear-Com Concert are trademarks or registered trademarks of HM Electronics, Inc.

The software described in this document is furnished under a license agreement and may be used only in accordance with the terms of the agreement.

The product described in this document is distributed under licenses restricting its use, copying, distribution, and decompilation / reverse engineering. No part of this document may be reproduced in any form by any means without prior written authorization of Clear-Com, an HME Company.

Clear-Com Offices are located in California, USA; Cambridge, UK; Dubai, UAE; Montreal, Canada; and Beijing, China. Specific addresses and contact information can be found on Clear-Com's corporate website: [www.clearcom.com](http://www.clearcom.com)

### Clear-Com contacts:

Americas and Asia-Pacific Headquarters

California, United States

Tel: +1 510 337 6600

Email: [CustomerServicesUS@clearcom.com](mailto:CustomerServicesUS@clearcom.com)

Europe, Middle East, and Africa Headquarters

Cambridge, United Kingdom

Tel: +44 1223 815000

Email: [CustomerServicesEMEA@clearcom.com](mailto:CustomerServicesEMEA@clearcom.com)

China Office

Beijing Representative Office

Beijing, P.R. China

Tel: +8610 65811360/65815577

# Table of contents

---

1 Overview .....	8
1.1 About LQ .....	8
1.2 The LQ product line offers: .....	8
1.3 2-wire features .....	9
1.4 4-wire features .....	9
1.5 4-wire + GPIO features .....	9
1.6 Example applications: 2-wire connections .....	10
1.7 Example applications: LQ to matrix connections .....	11
1.8 Example applications: Radio connections (GPIO) .....	14
1.9 LQ and LQ-R series models .....	16
2 Powering your LQ .....	19
2.1 Using the power supply unit (PSU) .....	19
2.2 Using Power over Ethernet (PoE) with 2-port units .....	20
2.3 Power 2-wire beltpacks from the Partyline .....	21
2.4 Reboot system .....	21
3 Core Configuration Manager (CCM) walkthrough .....	22
3.1 How to Access the Core Configuration Manager (CCM) .....	22
3.2 Overview .....	22
3.3 Device .....	25
3.4 Network .....	27
3.5 Linking .....	28
3.6 Ports .....	31
3.7 Roles .....	39
3.8 Assignments .....	40
3.9 Accounts .....	43
4 Basic set up (LAN) .....	45
4.1 Setting up your LQ environment within a LAN .....	45
4.2 Creating a Link-Group .....	48
4.3 Using Channels to route audio .....	51
5 Front panel interface .....	53
5.1 How to access front panel menu options. ....	54
5.2 Programming network details from LQ device front screen .....	54
6 Linking .....	57
6.1 What is a Link-Group? .....	57

6.2 About Linking .....	58
6.3 The Link-Master role .....	59
6.4 The Link-Member role .....	60
6.5 How to link LQ units over a firewall .....	61
6.6 How to remove a device from a Link-Group .....	63
<b>7 About Channels and using them to route audio .....</b>	<b>64</b>
7.1 About Channels .....	64
7.2 Channel or 4-wire direct? .....	65
7.3 How many Channels can I use? .....	65
7.4 Connecting audio sources and routing them .....	66
7.5 Audio configuration for a Direct connection .....	67
7.6 Changing a Channel label .....	68
<b>8 Interface port configuration .....</b>	<b>71</b>
8.1 Call signaling and Remote Mic Kill (RMK) .....	71
8.2 2-wire specific port options .....	71
8.3 4-wire specific port options .....	71
8.4 4-wire + GPIO specific settings .....	72
8.5 GPIO action triggers (4-wire + GPIO and IVC-32 ports) .....	72
8.6 IVC-32 specific port settings .....	72
8.7 Port settings .....	73
8.8 VOX (audio-gating) .....	73
<b>9 Network settings (IP) .....</b>	<b>74</b>
9.1 Dynamic Host Configuration Protocol (DHCP) .....	74
9.2 DHCP or Static IP addressing? .....	74
9.3 Static IP configuration .....	74
9.4 Link-local environments .....	76
9.5 Accessing an LQ unit when in link-local mode .....	76
<b>10 Internet connectivity .....</b>	<b>78</b>
10.1 Port-forwarding .....	78
<b>11 Clear-Com Eclipse matrix connections .....</b>	<b>79</b>
11.1 How to create virtual ports and connect to a matrix .....	79
<b>12 What are Networked Control Events and how do I use them? .....</b>	<b>83</b>
12.1 About Networked Control Events .....	83
12.2 How to set up Networked Control Events .....	83
12.3 Examples of when to use Networked Control Events .....	86



12.4 Types of GPI (input) trigger .....	89
12.5 GPIO port pinout .....	90
12.6 GPIO: Examples and step-by-step set up .....	91
<b>13 Session Initiation Protocol (SIP) connectivity .....</b>	<b>98</b>
13.1 What is SIP? .....	98
13.2 Examples of LQ-SIP .....	98
13.3 LQ-SIP standalone .....	98
13.4 LQ-SIP and Clear-Com Eclipse matrix systems .....	100
13.5 Connecting matrix systems using LQ-SIP (long range) .....	101
13.6 Program LQ-SIP standalone .....	101
13.7 Program LQ-SIP and Clear-Com Eclipse .....	107
13.8 How to use SIP calls .....	116
Line Release option (MVX card) .....	118
Off-Hook Tally (IVC card) .....	119
13.9 SIP and the Internet .....	120
<b>14 LQ to HelixNet connectivity .....</b>	<b>123</b>
14.1 HelixNet/LQ Link-Group .....	123
14.2 Connecting HelixNet and LQ with analog connection .....	125
14.3 Programming a HelixNet/LQ Link-Group .....	125
<b>15 Agent-IC and LQ .....</b>	<b>131</b>
15.1 Agent-IC Profiles .....	131
15.2 Agent-IC Roles .....	131
15.3 Agent-IC default Role .....	132
15.4 Change Agent-IC default Role configuration .....	133
15.5 Program Agent-IC to LQ connectivity .....	135
<b>16 Licensing .....</b>	<b>138</b>
16.1 Add licenses online .....	138
16.2 Add licenses offline .....	139
<b>17 Using LQ to interconnect equipment .....</b>	<b>141</b>
17.1 Connecting 2-wire equipment .....	143
17.2 Connecting to 4-wire equipment .....	144
17.3 Connecting an Eclipse PiCo (or MVX card) to an Encore device using LQ .....	145
17.4 Connecting an Eclipse PiCo (or MVX card) to a panel using LQ .....	146
17.5 PiCo HX trunk to HX matrix (Eclipse HX 8.7 and above) .....	147

18 Upgrading your device .....	148
18.1 Import the upgrade file .....	148
19 FAQs .....	150
19.1 Device queries .....	150
19.2 2-wire and 4-wire specific queries .....	151
19.3 Interconnection queries .....	152
19.4 IP and network queries .....	159
19.5 Audio quality queries .....	165
19.6 Telephony queries .....	169
20 Technical specifications .....	172
20.1 System limits and capacities .....	172
20.2 Audio .....	173
20.3 Pinouts .....	173
20.4 4-wire pinouts .....	174
20.5 Partyline output current (2-wire) .....	175
20.6 Network quality settings .....	176
20.7 Connectors .....	176
20.8 Power supply .....	177
20.9 Environmental .....	177
20.10 Dimensions and weight .....	177
21 Terminology/glossary .....	178
22 Compliance .....	180

## Important Safety Instructions

---

- Intended Audience: Professional, Technical and Qualified Personnel
- Read these instructions.
- Keep these instructions.
- Heed all warnings.
- Follow all instructions.
- Do not use this apparatus near water.
- Clean only with dry cloth.
- Install in accordance with the manufacturer's instructions.
- Do not install near any heat sources such as radiators, heat registers, stoves, or other apparatus (including amplifiers) that produce heat.
- Do not defeat the safety purpose of the polarized or grounding-type plug. A polarized plug has two blades and a third grounding prong. The wide blade or the third prong is provided for your safety. If the provided plug does not fit into your outlet, consult an electrician for replacement of the obsolete outlet.
- Protect the power cord from being walked on or pinched particularly at plugs, convenience receptacles, and the point where they exit from the apparatus.
- Only use attachments/accessories specified by the manufacturer.
- Unplug this apparatus during lightning storms or when unused for long periods of time.
- Refer all servicing to qualified service personnel. Servicing is required when the apparatus has been damaged in any way such as; power-cord supply or plug is damaged, liquid has been spilled, objects have fallen into the apparatus, the apparatus has been exposed to heavy rain, the apparatus does not operate normally.
- Caution: Shielded Cable Requirement
- Shielded Cable is required for ALL LQ SERIES GPIO Port connectivity. Shielded Cable must be used to assure compliance with domestic and international emissions standards. Customers, Installers and or qualified Personnel failing to use shielded cables may cause radio interference in which case the user may be required to take adequate measures.

# 1 Overview

---

## 1.1 About LQ

LQ™ linking facilitates interfacing to any 2-wire partyline, 4-wire and 4-wire+GPIO endpoints either local or remote over any IP network.

The product line provides a unique combination of low latency with exceptional audio quality and an intuitive, easy to use design.

LQ 4.0 and above also offers connectivity to HelixNet systems, SIP lines and the Clear-Com mobile client, Agent-IC.

LQ is available in 8 models; the LQ-2W2, LQ-4W2 and LQ-4WG2 devices are small, robust 2-port throw-down boxes for fast and convenient installation.

The LQ-R devices (LQ-R4W8, LQ-R2W4-4W4, LQR-2W4, LQ-R4WG8, LQ-R2W4+4WG4) are single rack units providing 4 or 8 ports in a combination of 4-wire, 4-wire + GPIO and 2-wire options for more extensive installations.

## 1.2 The LQ product line offers:

- HelixNet linking. HelixNet to IVC connectivity via an LQ unit allows HelixNet to connect to a Clear-Com Eclipse matrix system.
- SIP connectivity. Up to 8 SIP clients can be connected to each LQ device.
- Agent-IC. Up to 8 Agent-IC clients can be connected to each LQ device.
- A mix of hardware and virtual ports of audio can be routed through the system using customizable Virtual Partylines. LQ Series 4.0 offers a mix of physical and 'virtual' ports.
- Each LQ-R unit allows up to 24 ports:
  - 8 hardware ports
  - 8 SIP ports
  - 8 virtual ports. IVC ports and Agent-IC ports are considered 'virtual' ports. Virtual ports can be used in any combination up to 8 in total.
- Up to six LQ units can be linked together providing a robust network for audio over IP

- Browser- based Core Configuration Manager (CCM)
- Adjustable audio quality settings to make the best use of available network resources
- Low latency OPUS codec
- LQ throw-down units: external power supply or Power over Ethernet (PoE)
- LQ 1-RU devices: dual redundant external power supply
- IVC-32 linking with Clear-Com Eclipse frames using G.722 codec (EHX 8.7 and above).

## 1.3 2-wire features

- 2-wire throw-down units can be powered locally by PoE or external PSU
- 2-wire line termination
- Auto nulling
- Clear-Com/RTS modes with both RMK/Call signaling pass-through (Clear-Com only).

## 1.4 4-wire features

- Port Function switching alleviates the need for crossover cables
- Panel data pass-through facilitates the connection of Clear-Com panels to matrix over any IP network
- Call signaling.

## 1.5 4-wire + GPIO features

- Network Control Events for flexible and scalable activation and passing of GPIO and controls
- Designed to work with low power 2-way radios (or any device that uses a relay trigger)
- Passes GPIO/control/data between LQ and Eclipse Matrix frame.

## 1.6 Example applications: 2-wire connections

### 1.6.1 Partyline to partyline (2-wire connection)

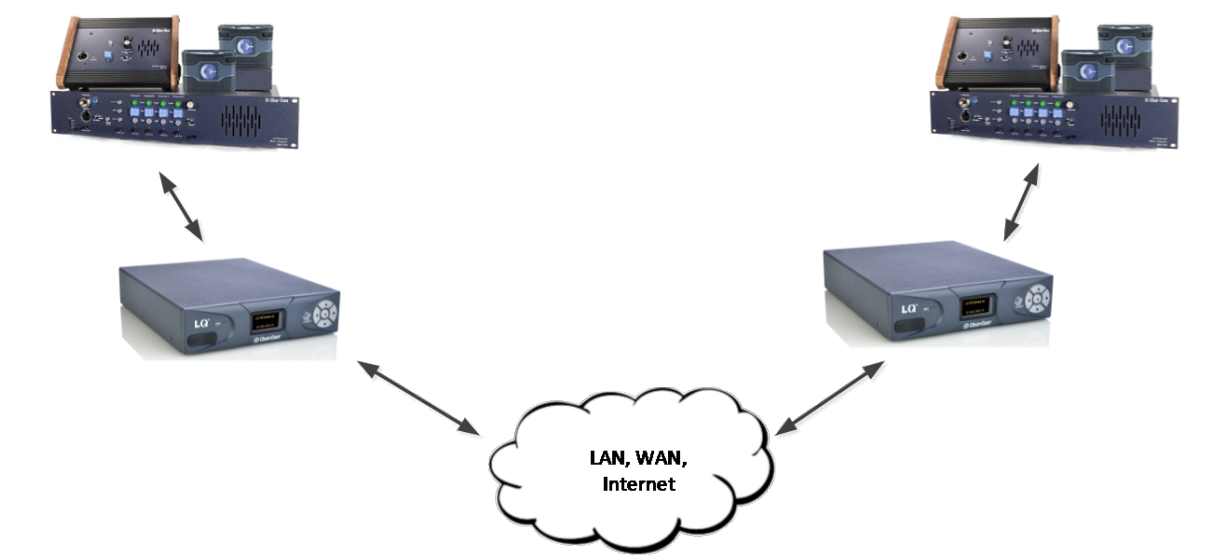

### 1.6.2 Partyline to partyline (2-wire connection) #2.

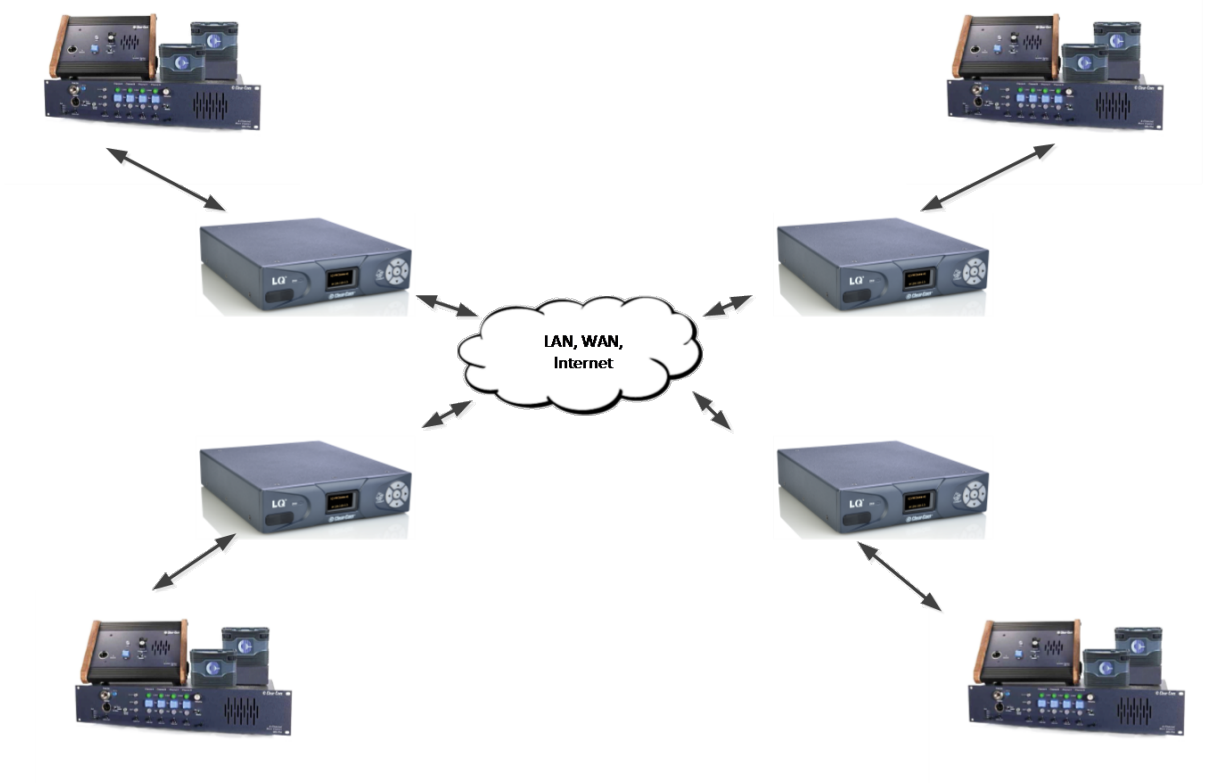

### 1.6.3 Partyline to beltpack

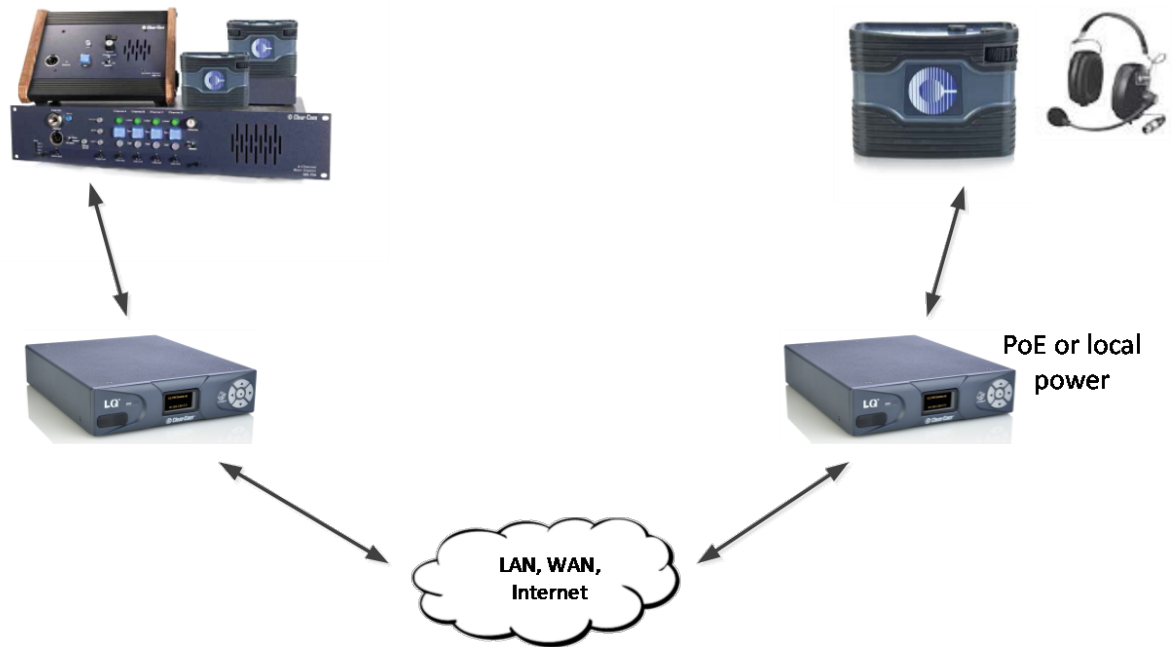

## 1.7 Example applications: LQ to matrix connections

### 1.7.1 Partyline to matrix (2-wire to 4-wire)

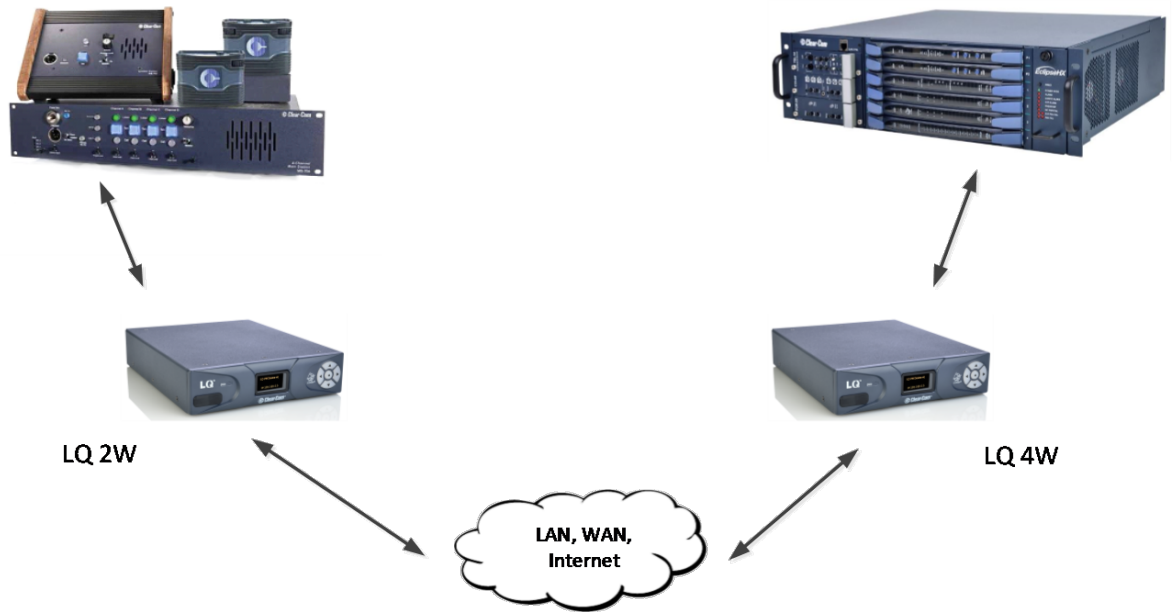

### 1.7.2 LQ 3.0 to matrix using an IVC-32 port.

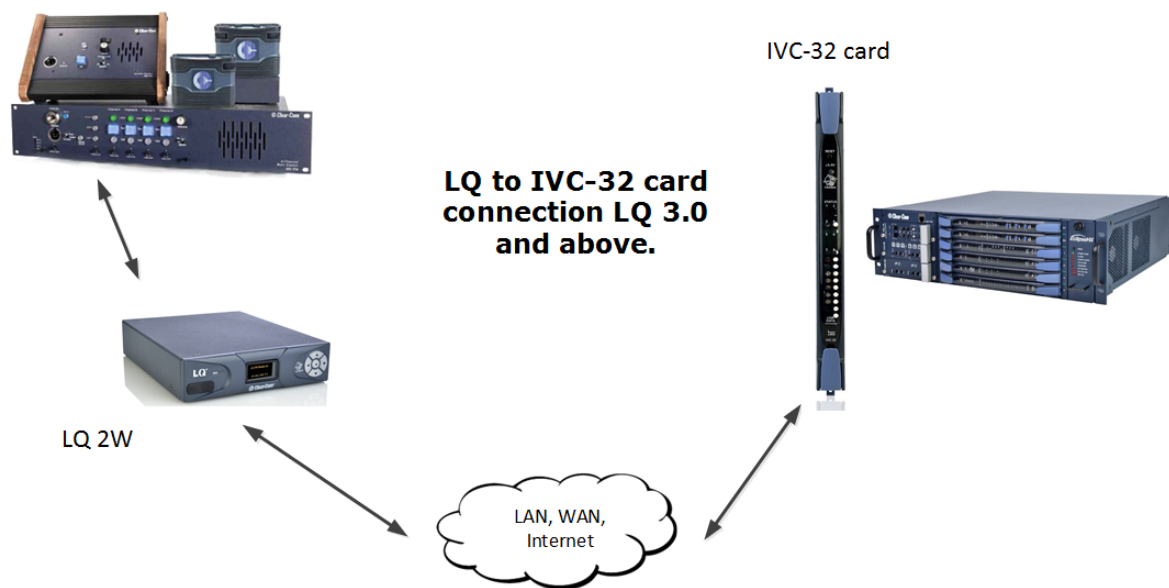

### 1.7.3 Remote panel to matrix connection

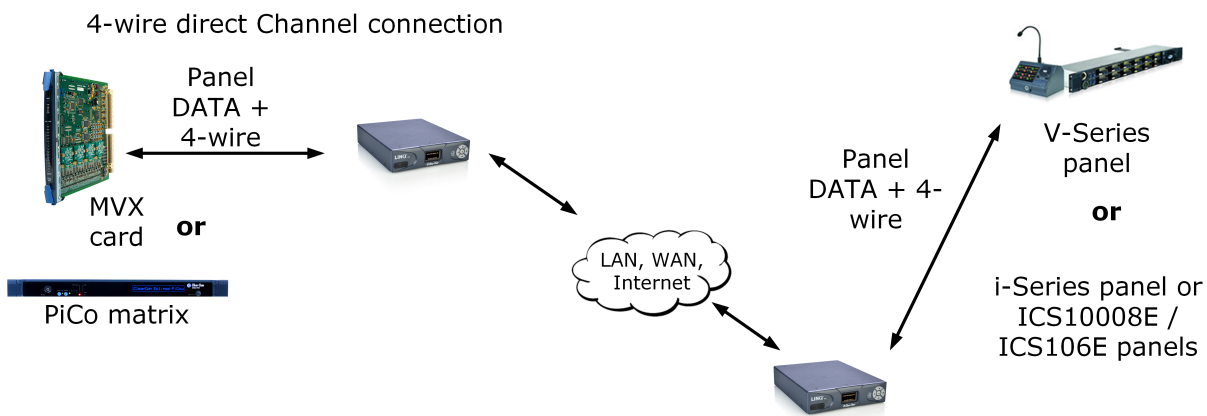



## 1.7.4 PiCo HX to Eclipse HX (8.7)

### IP trunking: Eclipse HX to PiCo HX (EHX 8.7 and above)

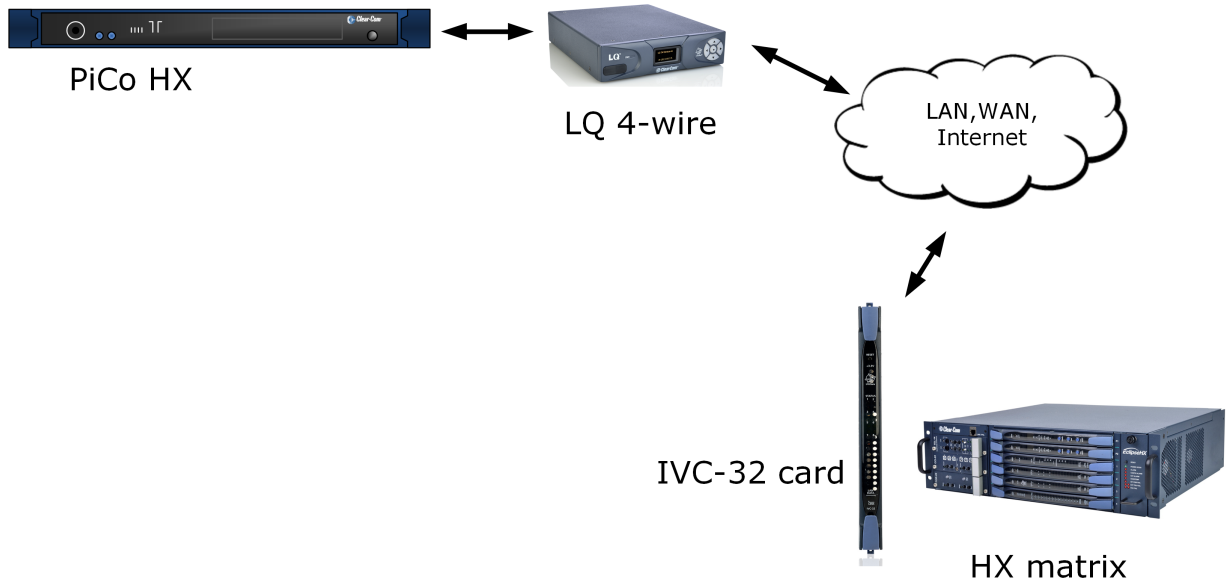

## 1.8 Example applications: Radio connections (GPIO)

GPIO signals are converted to digital signals and then passed across the IP infrastructure (as with a 2-wire call signal).

### 1.8.1 Radio to radio

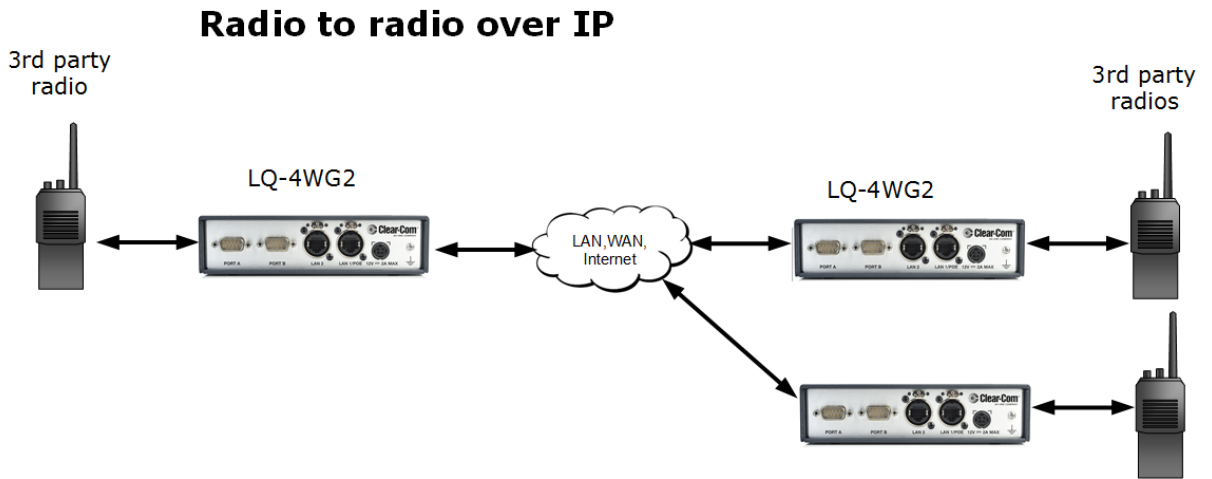

### 1.8.2 Panel to radio

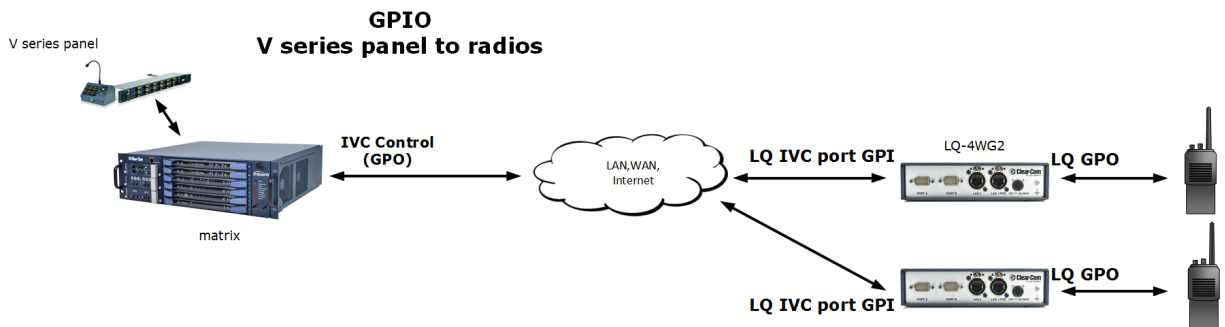

### 1.8.3 Call button to radio

#### GPO from beltpack to radio on Call button press

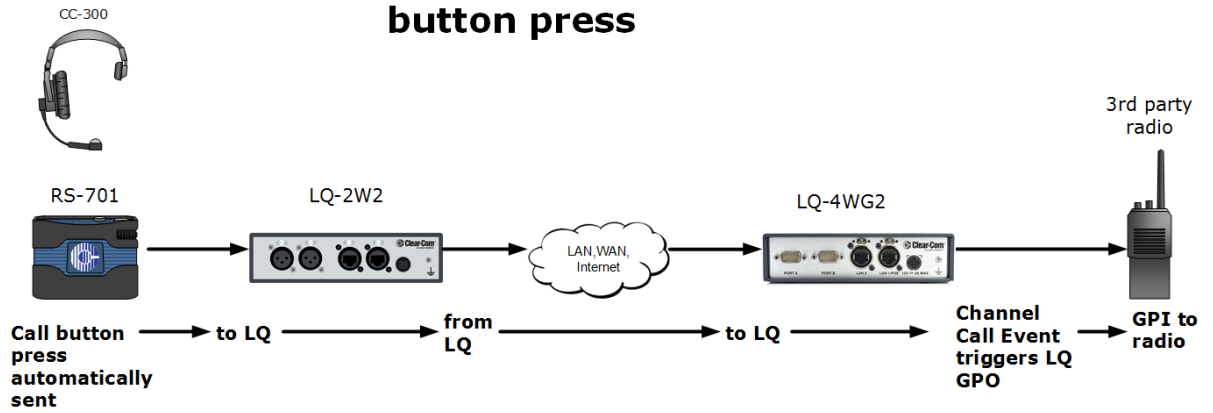

For configuration details see [What are Channel Logic Events and how do I use them?](#) and [GPIO: Examples and step-by-step setup, Example 1.a.](#)

### 1.8.4 LQ 4W+GPIO to and from matrix

#### LQ 4W+GPIO to matrix

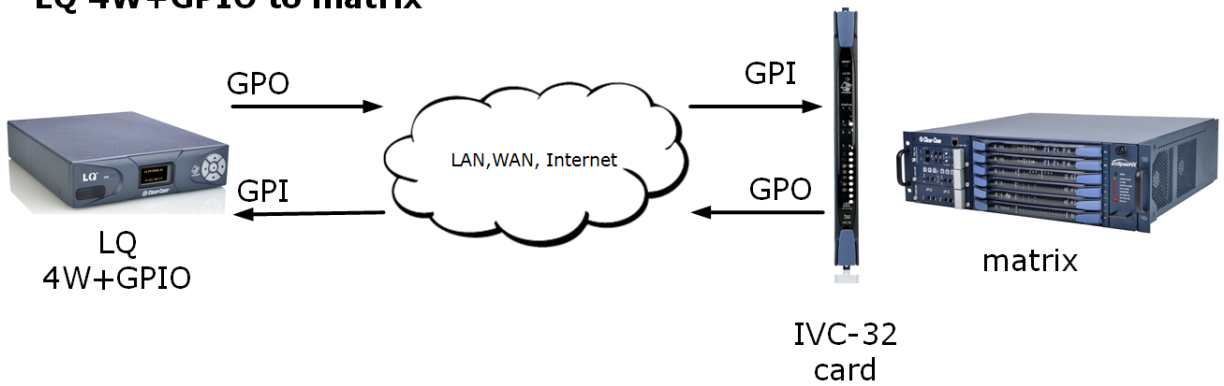

## 1.9 LQ and LQ-R series models

### 1.9.1 LQ-2W2 Throw-down unit



Two 2-wire Partyline connectors (XLR-3F)

### 1.9.2 LQ-4W2 Throw-down unit.



Two 4-wire connectors (etherCON RJ45)

### 1.9.3 LQ-4WG2 Throw-down unit.



Two 4-wire +GPIO connectors (DB-9M)

### 1.9.4 LQ-R2W4 1 RU unit.



Four 2-wire loop-through ports. (XLR-3M/XLR-3F)

Dual redundant power supply connectors

### 1.9.5 LQ-R4W8 1 RU unit.



Eight 4-wire connectors, (etherCON RJ45)

Dual redundant power supply connectors

### 1.9.6 LQ-R2W4-4W4 1 RU unit.



Four 2-wire connectors (XLR-3F)

Four 4-wire connectors (etherCON RJ45)

Dual redundant power supply connectors

### 1.9.7 LQ-R4WG8 1 RU unit.



Eight 4-wire +GPIO connectors (DB-9M)

Dual redundant power supply connectors

### 1.9.8 LQ-R2W4+4WG4.



Four 2-wire connectors (XLR-3F)

Four 4-wire +GPIO connectors (DB-9M)

Dual redundant power supply connectors



## 2 Powering your LQ

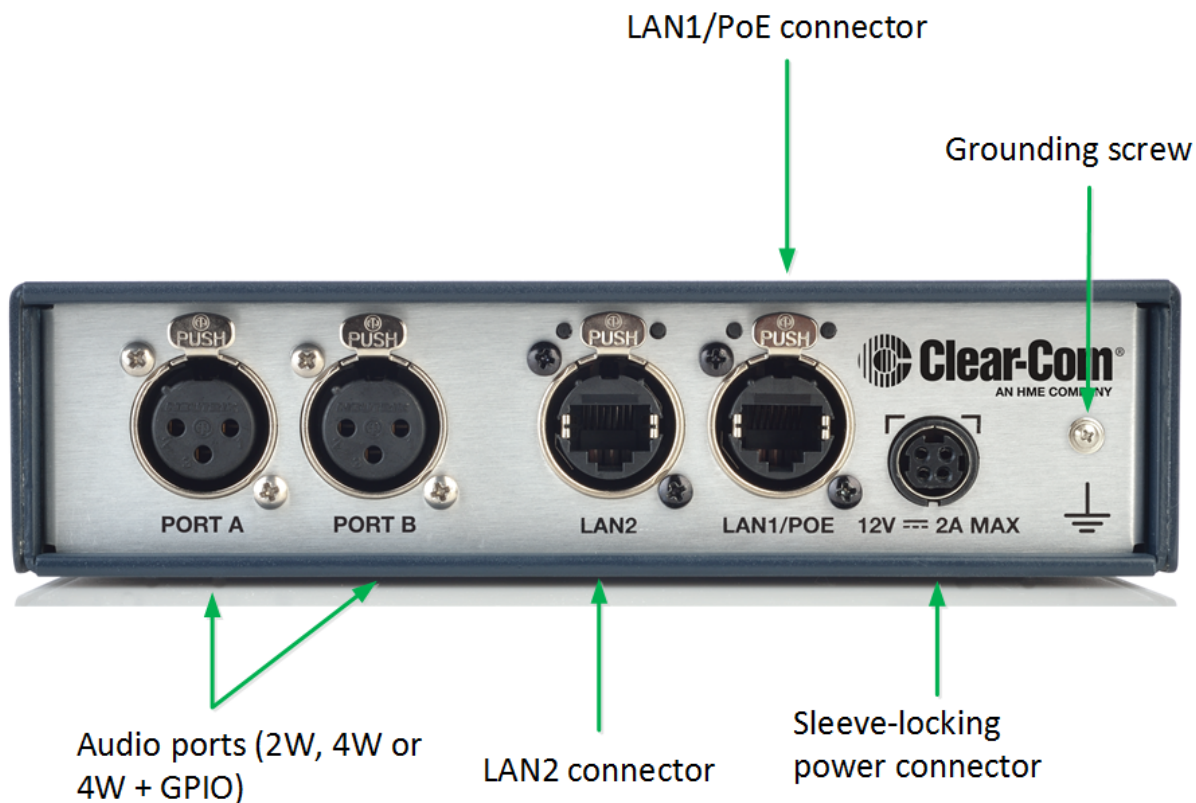

### 2.1 Using the power supply unit (PSU)

- LQ units are supplied with a 24 watt sleeve-locking power connector.
- LQ-R 1RU units are supplied with two 60 watt sleeve-locking power connectors. Use either power connector, or both to guard against one power supply failing.

**Note:** When connecting the sleeve-locking power cable, be sure to push until the connector locks into the device.

**Note:** The 60 watt PSU can be used with the throw-down units if necessary.

## 2.1.1 Understanding power display icons

You will be able to see the power status of your device from:

- The front panel of the unit
- The device icon in the web based configuration tool (the CCM).

These indicators will show if the unit is using PoE or the PSU (LQ throw-down units), and which of the two power supplies (or both) are in use for the LQ-R units.

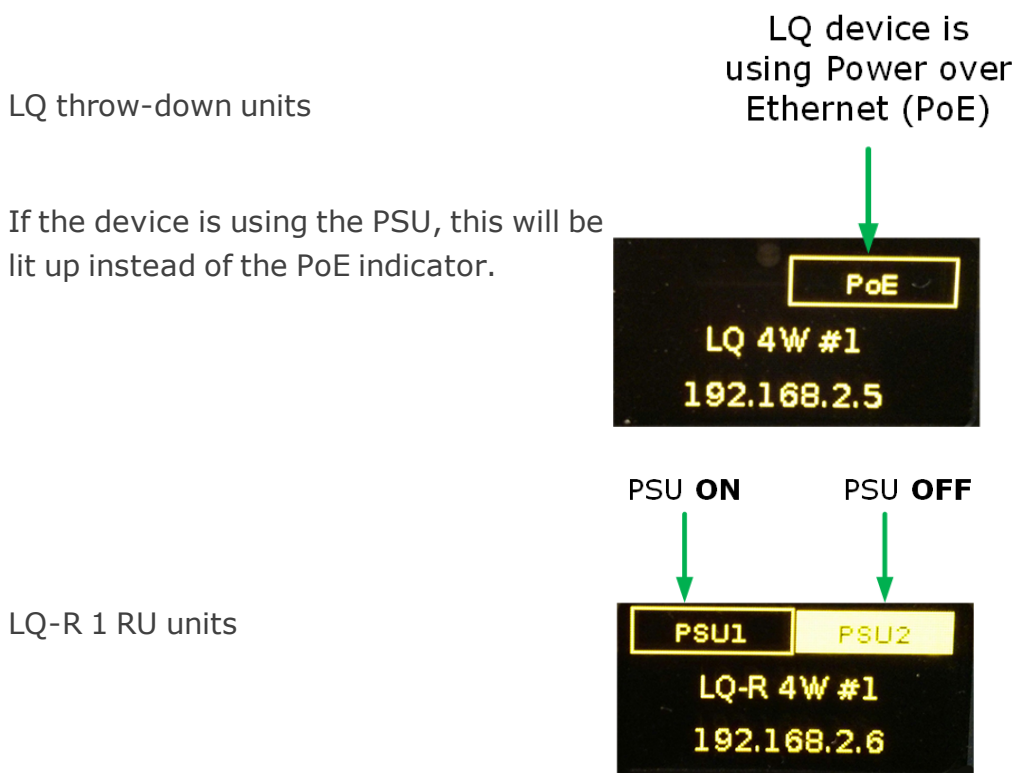

## 2.2 Using Power over Ethernet (PoE) with 2-port units

The 2-port units will receive power from the LAN1/PoE connector if required (this is not the case for the larger LQ-R units).

When using PoE the LQ-2W2 supplies approximately 70 mA of power to drive the wired beltpacks (about two beltpacks).

The units draw up to 12 watts of power (depending on what is connected to them), so when using PoE you should have at least a Class 3 PoE switch.

If you exceed the power of your switch or network, the LQ device(s) will show a persistent flashing green light, and not move beyond the Clear-Com splash screen.



This indicates that the device is continually booting and needs more power. Consider using the supplied sleeve-locking connector cable or a higher Class PoE switch.

## 2.3 Power 2-wire beltpacks from the Partyline

2-wire beltpacks take power from the Partyline. The maximum numbers are shown in the table below.

LQ series unit	Power supply	Number of beltpacks powered by the Partyline
LQ	24 watts	150 mA (~5 beltpacks) per device
LQ	PoE (device draws up to 12 watts)	70 mA (~2 beltpacks) per device
LQ-R	60 watts	250 mA (~10 beltpacks per pair of ports, max 20 per device)

## 2.4 Reboot system

The system will start its boot sequence immediately when power is applied. If you need to reboot for any reason, either cycle the power or press all four direction keys on the control panel on the front of the LQ unit at the same time.

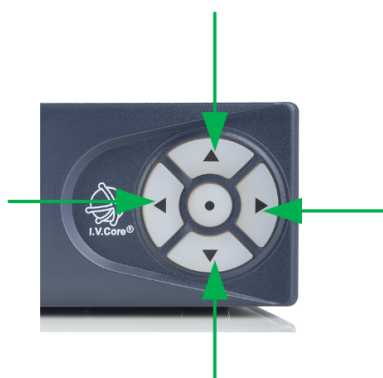

Press all four direction keys at the same time to reboot.

The system can also be rebooted using the front panel menu screens: **Menu > Administration > Reboot** and from the CCM: **Device > General > Maintenance > Reboot**.

## 3 Core Configuration Manager (CCM) walkthrough

This section gives you an overview of your configuration tool. Find context sensitive help in the user interface by clicking on the blue ? icon.

### 3.1 How to Access the Core Configuration Manager (CCM)

1. Make sure the LQ device is connected to a network (either LAN connector on back of device).
2. Open a browser (PC, tablet, mobile) on the same network as the LQ device and input the IP address of your LQ in the address field. Find the IP address in the front menu screens of your device.



#### 3.1.1 Minimum requirements for the CCM

Supported on the latest versions of all major web browsers (i.e. Google Chrome, Safari, Firefox, Internet Explorer, Opera).

### 3.2 Overview

This page shows an overview of all the devices in your system. Devices in the upper part of the page are the units in a Link-Group. As LQs are added to the group, they appear in this screen. A HelixNet device can also be included in a Link-Group (LQ 4.0 and above).

On the lower part of the screen you can see the external systems that your LQ device is connected to. These can be:

- IVC (matrix) connections
- SIP (telephony interface) connections
- Agent-IC (mobile client) connections.

If you have a HelixNet in your Link-Group, you will see the remote units that are connected to the HelixNet Main Station in the lower half of the Overview screen.

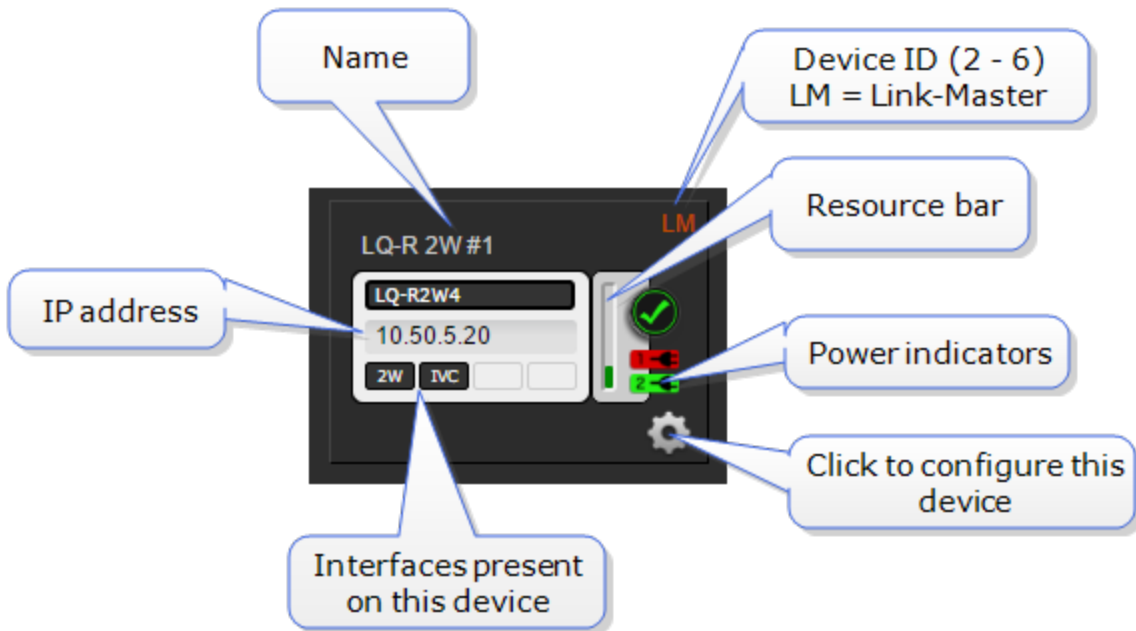
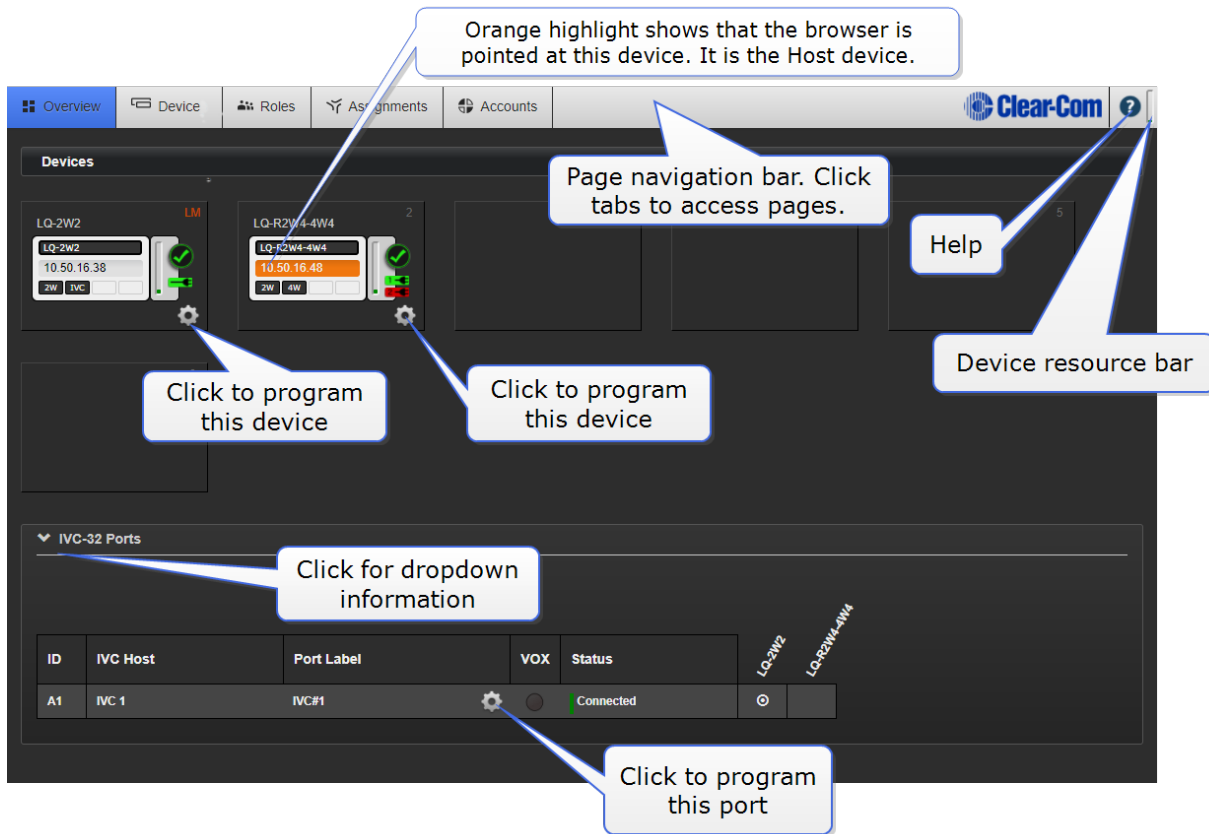

### 3.2.1 Device Configuration

Devices in a Link-Group can be configured either directly or by proxy, meaning that the configuration operations for a unit are routed through the host device. The host device is the unit which the browser is currently pointed to (orange highlight).

Click on the gear icon on any device.



You can use the Overview page to obtain diagnostic information for your all systems. Whenever you see a > symbol, click to see a drop-down section.

Clicking the gear icon in any part of the CCM always takes you to programming options.

### 3.2.2 Resource Bar



### 3.2.3 About the Resource Bar

The Resource Bar is a tool that indicates the amount of processor power currently allocated on that device.

- Bar orange = 70% of processing power reached
- Bar red = 80% of processing power reached

The device will work in the red zone, but the reliability of the audio response may decrease.

The CCM will start limiting demands on the unit (for example it will prevent a port being added to a Channel, or the addition of an IVC-32 or multi-Channel port) in order to maintain good audio quality and responsiveness.

### 3.2.4 To optimize resource usage

- Reduce the network quality in the local audio mixes. Higher network quality takes more resource.
- Reduce the number of ports that are in different Channels. Several ports in the same Channel do not take much resource. It is more demanding if the ports are spread over several Channels.
- Using a **LAN/WAN/Routed Network** Optimization mode will reduce the overall resource usage (set **Link-Group Optimization** mode in the **Linking** page of the CCM).

## 3.3 Device

The **Device** page takes you to the configuration options local to your LQ device. On the left you see configuration page buttons; **General**, **Network**, **Linking** and **Ports**. Switch between devices in a Link-Group using the dropdown menu just above the device icon.

The screenshot shows the 'Device' configuration page for an LQ-2W2 unit. The interface includes a top navigation bar with tabs for Overview, Device, Roles, Assignments, and Accounts. The main content area is divided into a left sidebar with configuration buttons (General, Network, Linking, Ports) and a main panel for the selected device. The device information panel shows the Name (LQ-2W2), Model (LQ-2W2), and Version (4.0.14.14). Below this, there are four expandable configuration sections: Change Password, License, Upgrade, and Maintenance. Callouts provide instructions: 'Click this dropdown to select different LQ devices. This allows access to devices and configuration by proxy.' points to the device selection dropdown; 'Orange highlight shows that the browser is pointed at this device. It is the Host device.' points to the orange highlight on the device icon; 'Click a button to access configuration pages' points to the General button; and 'Click an arrow to toggle dropdown configuration options' points to the arrow on the Change Password section.

### 3.3.1 General Settings

Configuration options local to your LQ Series 4.0 device. Click a heading to expand drop-down.

### 3.3.2 Re-name your LQ.

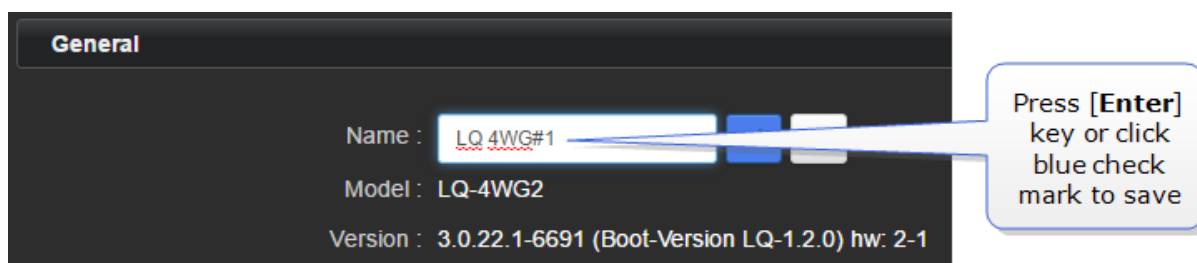

### 3.3.3 Change Password

Change the password to the Core Configuration Manager local to that device. You can only change the password from the Host device, not by proxy.

### 3.3.4 License

Click here to activate licenses for SIP or Agent-IC clients.

For more information, see:

**Licensing on page 138**

### 3.3.5 Upgrade

Click **Select File** and navigate to where you have stored the upgrade file (.gz extension). Then click **Upgrade** when the Upgrade button turns blue. Wait while the device reboots itself.

An LQ unit must be upgraded from the host device (the device that the browser is currently addressing). The units cannot be upgraded by proxy.

To access a device directly as a host you must input that unit's IP address into a browser to access the CCM. The host device always has an orange highlight.

**Note:** *All devices in a Link-Group MUST be running the same version of the software; you must upgrade all devices in the group.*

After upgrades you are advised to check linking connections and auto null partyline ports.

### 3.3.6 Maintenance

Reset the unit to default settings.

Reboot the system.

Create a support archive. **Support Info** provides a 'snapshot' of the device's operational information for troubleshooting purposes.

## 3.4 Network

Dynamic host control protocol (DHCP) or Static IP address allocation?

Default setting: **DHCP**

**It is recommended that the Link-Master in a Link-Group has a static IP address.**

Most networks use DHCP to allocate IP addresses. Because of this, DHCP is recommended for fast set-up as the devices can be immediately connected to any network that provides DHCP. The addresses provided are dynamic and may change from time to time. Because DHCP IP addresses can change, the Link-Master should have a static IP address, or it may lose connectivity to the group.

For more information, see:

**Network settings (IP) on page 74**

**Internet connectivity on page 78**

**Link-local environments on page 76**

External IP address and External Port setting

For efficient networking, these details should be set for any LQ device that connects over a firewall.

**Note:** *The Link-Master uses TCP port 80 for management, and TCP/UDP port 655 for audio. See **Linking over Internet or WAN** below for port addressing and port forwarding details.*

For more information, see:

**Linking over Internet or WAN on page 60**

**Internet connectivity on page 78**

See your network administrator if you require network details.

## 3.5 Linking

In this page you can program a Link-Group. A Link-Group is a method for connecting LQ devices over LAN, WAN or internet so they share audio and data between them.

A Link-Group can contain both LQ devices and HelixNet Main Stations (LQ 4.0 and above).

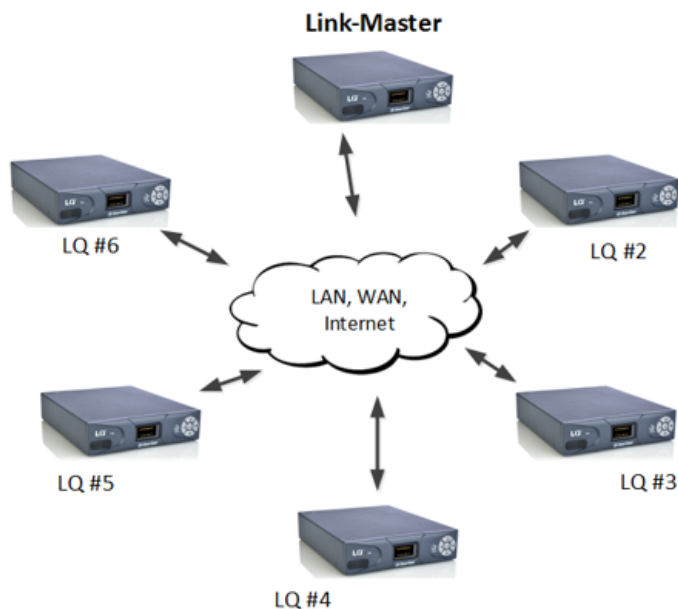

- 1 box is set to Link-Master
- Each LQ joins the group through the Link-Master
- Up to 6 LQs in a Link-Group

### Channels

There are 24 channels within each Link-Group (channels can be added or taken away as required). Any port on any LQ can be assigned to any of the channels. To assign ports to channels navigate to **Assignments** in the Core Configuration Manager.

Devices can be seen and programmed from any device in the group.



Once connected, devices in a Link-Group can be configured from any unit

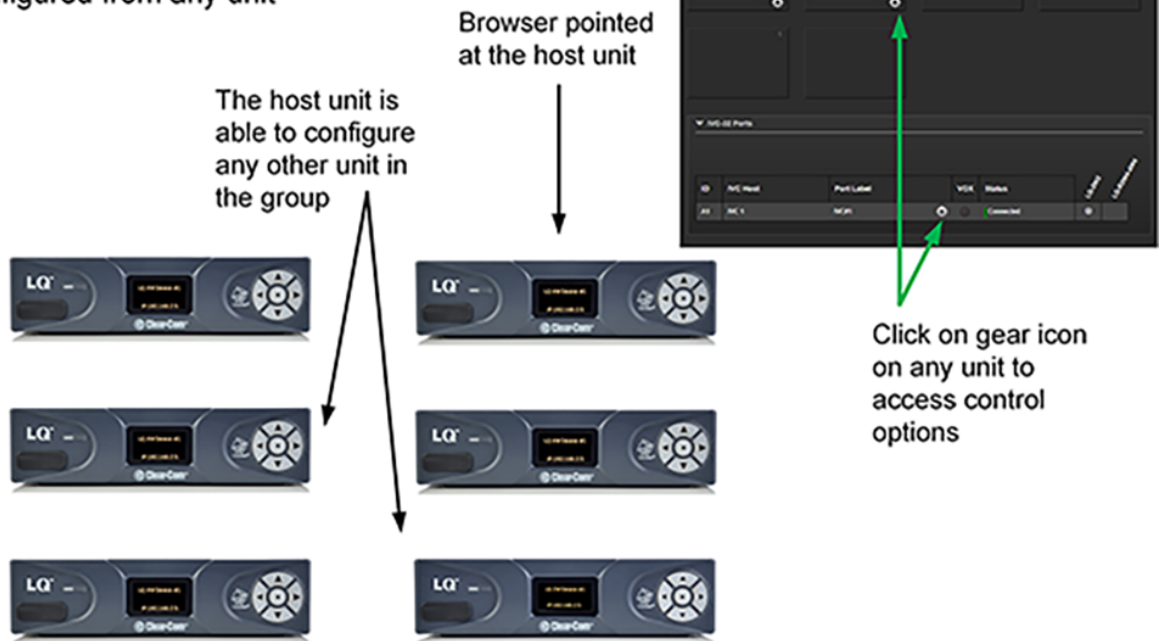

### 3.5.1 Link-Group Role

The Link-Master is responsible for synchronization and distribution of audio, Channel names and device availability throughout the Link-Group. Each group needs a Link-Master.

To create a group you must connect LQ member(s) to a Link-Master. Change this setting to **Link-Member** on the device to be connected to the master. When you change the role to Link-Member, you can then enter the Link-Master IP address here to link the devices. Find the device IP in the front menu screen of the device.

**Note:** *If linking with a HelixNet Main Station, the HelixNet device must always be designated the Link-Master.*

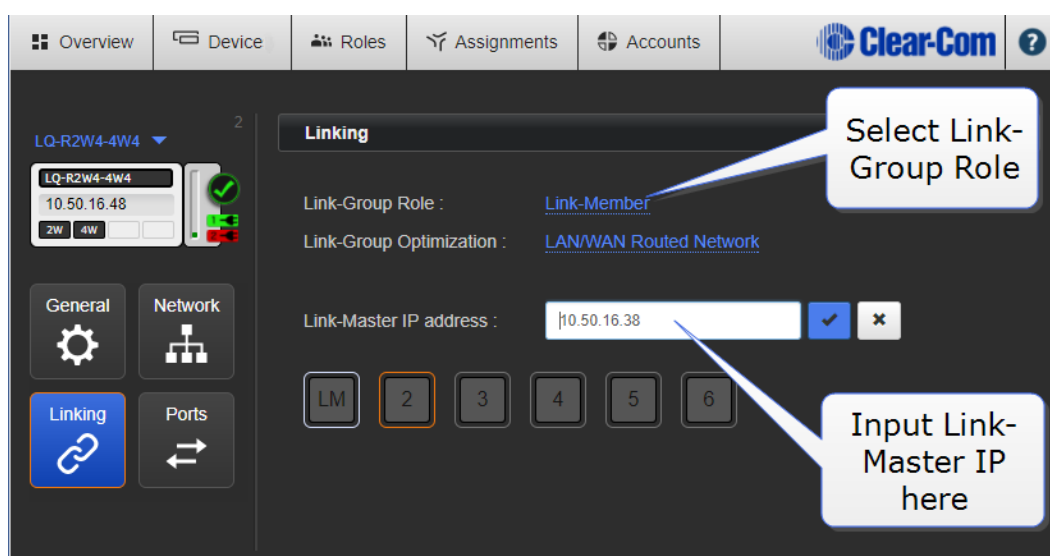

To take an LQ device out of a Link-Group, change it's role back to Link-Master here. This will disconnect the device from the group.

Related Links

**About Linking on page 58**

**Creating a Link-Group on page 48**

### 3.5.2 Link-Group Optimization

**Internet/NATed network** (Default mode)

Use this setting whenever the network you are using crosses firewalls. This is the default mode and will work with all networks. However, it requires more processing power of the LQ device and may affect latency.

### LAN/WAN network

Use this mode when using LQ in a private network. It uses less network and CPU resources and gives better latency than the default.

## 3.5.3 Link-Master IP

Enter the Link-Master IP address to link a device to a group. You only see this field when the device is set to **Link-Member**.

See **Creating a Link-Group on page 48** for step by step details.

If connecting over firewalls, this will be the Link-Master's external (public) IP address and the port mapped to TCP port 80 at the firewall.

See **Linking over Internet or WAN on page 60** for port forwarding details.

Related links

**Internet connectivity on page 78**

## 3.6 Ports

Settings vary according to port type.

LQ 4.0 and above allows five different port types: 2-wire, 4-wire, GPIO, IVC and SIP. You will see the port types available to your system in this page. Use the Port Selector to select ports for programming. Use the drop-down device selector for moving between different devices in a Link-Group.

In this page you can set port variables such as input gain (volume) and VOX detection. You can name the port here. More than one port can be selected for configuration at one time.

You can also program the GPIO triggers for your system, allowing relays to be sent to radios or other remote and third party equipment.

In LQ 3.0 and above, it is possible to put ports in more than one Channel.

VOX settings are available on all LQ port types.

The screenshot shows the 'Audio Ports' configuration page for device 'LQ 4W#1'. The interface includes a top navigation bar with 'Overview', 'Device', 'Roles', 'Assignments', and 'Accounts'. On the left, there are buttons for 'General', 'Network', 'Linking', and 'Ports'. The main area is divided into three sections: '4-Wire', 'IVC', and 'SIP'. The '4-Wire' section has two options: '1-4W-Port A' (selected and highlighted in orange) and '1-4W-Port B'. The 'IVC' section has one option: 'IVC SIP 49'. The 'SIP' section has six options: '2001', '2002', '3000', '4000', '2003', and '2004'. To the right is the 'Port Settings' section, which includes fields for 'Label', 'Multi Channel Support', 'Input Gain', 'Output Gain', 'VOX Mode', 'VOX Off Delay', 'VOX Threshold', 'VOX Action Triggers', 'Port Function', and 'Baud Rate'. A green vertical line highlights the 'Port Settings' section.

**Callout 1:** If you have Link-Group, navigate between devices here

**Callout 2:** LQ. 4.0 allows 5 different port types: 2-wire, 4-wire,GPIO, IVC and SIP. You only see IVC and SIP ports if they have been previously configured.

**Callout 3:** Use the port selector section to select required port type. Selected port has an orange highlight.

**Callout 4:** Click ports button

**Callout 5:** Port configuration options are here

### 3.6.1 2-Wire specific settings

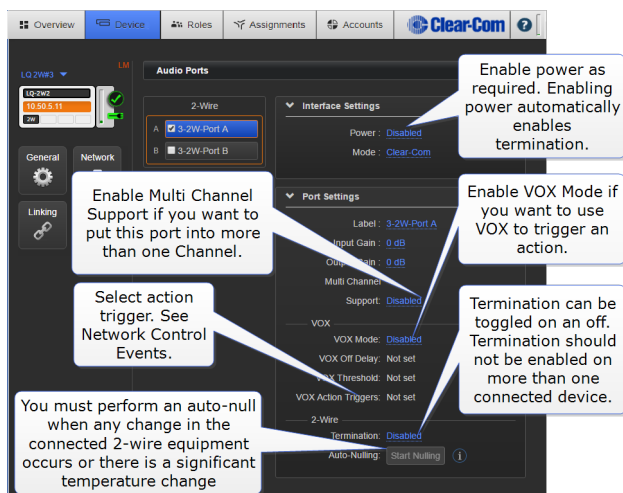

**Autonull:** You must perform auto-null when any change in the connected 2-wire equipment occurs or there is a significant temperature change.

**Termination:** Termination is enabled automatically when power is enabled on a 2-wire partyline. Termination should only be enabled on one device within a 2-wire circuit. Termination can be toggled off and on in the configuration user interface.

For more information, see:

**Power 2-wire beltpacks from the Partyline on page 21**

## 3.6.2 4-Wire specific settings

The screenshot displays the 'Audio Ports' configuration page for a device. The interface is organized into several sections:

- Navigation:** Overview, Device, Roles, Assignments, Accounts.
- Device Info:** LQ 4W#1, LQ-4W2, 10.50.12.21, with tabs for 4W, IVC, and SIP.
- Configuration Panels:**
  - 4-Wire:** A  1-4W-Port A, B  1-4W-Port B.
  - IVC:** A1  IVC SIP 49.
  - SIP:** A1  2001, A2  2002, A3  3000, A4  4000, A5  2003, A6  2004.
- Port Settings:**
  - Label: 1-4W-Port A
  - Multi Channel Support: Disabled
  - Input Gain: 0 dB
  - Output Gain: 0 dB
  - VOX Mode: Disabled
  - VOX Off Delay: Not set
  - VOX Threshold: Not set
  - VOX Action Triggers: Not set
  - 4-Wire:
    - Port Function: to Matrix
    - Baud Rate: 19200 (Eclipse)

Callout boxes provide the following instructions:

- Enable this option if you want to put this port into more than one Channel (referring to Multi Channel Support).
- Click to enable VOX mode. Enabling this option will activate VOX action triggers (referring to VOX Mode).
- See **Network Control Events** for more information (referring to VOX Off Delay, VOX Threshold, and VOX Action Triggers).
- Setting this option correctly avoids the use of a cross-over cable. See **Port Function**. (referring to Port Function).
- This setting depends on which equipment you are connecting to. It determines the data rate. The default is to Clear-Com equipment. (referring to Baud Rate).

### 3.6.3 4-Wire + GPIO specific settings

The screenshot displays the 'Audio Ports' configuration interface. The '4-Wire + GPIO' section is active, showing two ports: '1-4W-Port A' (checked) and '1-4W-Port B' (unchecked). The 'Port Settings' for '1-4W-Port A' are as follows:

- Label: 1-4W-Port A
- Input Gain: 0 dB
- Output Gain: 0 dB
- Output Level: Line Level (0dB)
- Multi Channel Support: Disabled
- VOX Mode: Disabled
- VOX Off Delay: Not set
- VOX Threshold: Not set
- VOX Action Triggers: Not set
- GPIO Action Triggers: Disabled
- GPO Triggered By: Disabled
- GPO Off Delay: None

Callout boxes provide the following details:

- Mic level option:** supports connection to devices that normally have a microphone connected directly to their audio input (handheld radios). Overall gain = Output Gain + Output Level.
- Multi Channel Support:** Enable Multi Channel Support if you want to put this port into more than one Channel.
- VOX Mode:** Enable VOX Mode if you want to use VOX to trigger an action.
- GPI and GPO:** GPI and GPO triggers. See Network Control Events for more information.
- Action Trigger:** Select action trigger. See Network Control Events.

**Note:** A 4-wire+GPIO port will not transmit call signals in the form of data. The **GPO Output Trigger** must be set to **Channel Call Event**, or a signal will not be sent.

### 3.6.4 IVC-32

You only see IVC32 ports in this screen if they have been previously created in the **Accounts** page.

The screenshot displays the 'Audio Ports' configuration page in the Clear-Com web interface. The page is divided into several sections: '4-Wire' (with checkboxes for '1-4W-Port A' and '1-4W-Port B'), 'IVC' (with a checked checkbox for 'ivc32' and checkboxes for 'B1', 'B2', and 'B3'), 'External System Settings' (with 'IVC-32 Label: IVC 1' and 'Eclipse Server: 10.50.17.135:6001'), and 'Port Settings' (with 'External Port Label: ivc32', 'Input Gain: 0 dB', 'Output Gain: 0 dB', 'Multi Channel Support: Disabled', 'Network Quality: EHX Managed', 'Silence Suppression: Disabled', 'VOX Mode: Disabled', 'VOX Off Delay: Not set', 'VOX Threshold: Not set', 'VOX Action Triggers: Not set', 'GPI Action Triggers: Disabled', and 'GPO Triggered By: Disabled'). A yellow warning icon is visible next to the 'Network Quality' setting. Callout boxes provide additional context: 'Enable VOX Mode if you want to use VOX to trigger an action.' points to the 'VOX Mode' setting; 'Select action trigger. See Network' points to the 'VOX Action Triggers' setting; 'GPI and GPO triggers. See Network Control Events.' points to the 'GPI Action Triggers' and 'GPO Triggered By' settings; 'Enable Multi Channel Support if you want to put this port into more than one Channel.' points to the 'Multi Channel Support' setting; 'EHX Managed (default) will use whatever network quality is set in the EHX software. The other options will override what is set in EHX.' points to the 'Network Quality' setting; 'Click here for error' points to the warning icon; and 'Enabling Silence Suppression will stop transmission when silence is detected on the line. This conserves network resources.' points to the 'Silence Suppression' setting.

### 3.6.5 SIP specific settings

You only see SIP ports if they have been previously created in the **Accounts** page.



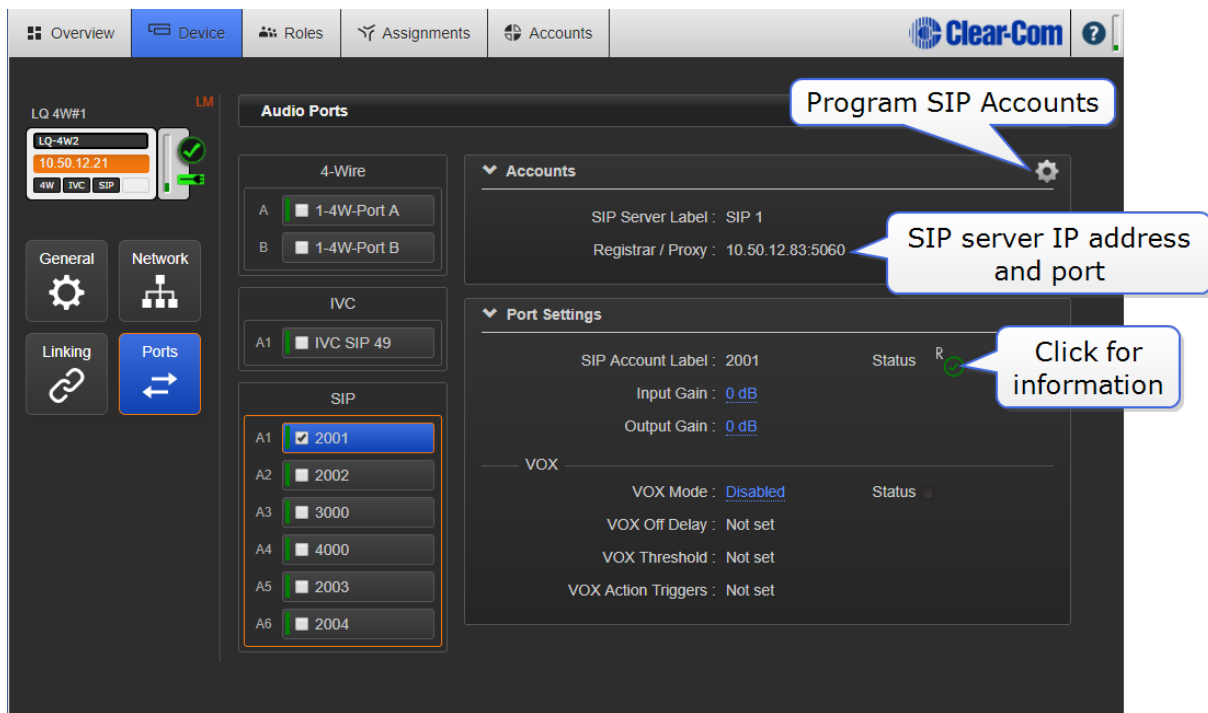

For more information, see:

**What are Networked Control Events and how do I use them? on page 83**

**Multi-Channel Ports on page 37**

**VOX (audio-gating) on page 73**

### 3.6.6 Multi-Channel Ports

It is possible to assign one port to many Channels. There is no limit on the amount of Channels a port can be put into, but the rules for device resource usage apply. When the unit is reaching the limits of its capacity, the user interface will stop you from assigning more ports.

#### When do I use multi-Channel ports?

An example of when to use multi-Channel ports might be if you have a program feed or stage announce that should be heard by several teams or groups.

### 3.6.7 Enable multi-Channel port feature

Navigate to required device

Select ports page

Select port

Select **Enabled**

Once enabled, multi-Channel ports are available in the Assignments page, ready to be assigned to more than one Channel.

Multi-Channel port icon.

Number of Channels the port is in

**Note:** *If the port has already been put into a Channel, it will be unassigned from the Channel when you enable multi-Channel support.*

For more information on how to put ports in Channels see **Assignments on page 40**.

**Note:** *Multi-Channel ports will not be placed in a local audio mix, they will be transported as a single audio stream. You can use the Resource Meter as a guideline for device capacity.*

For more information, see:

**Resource Bar on page 24**

## 3.7 Roles

When using LQ, some of the products you interconnect with use Roles for the purpose of intercom setup. Roles are preset configurations, used to simplify and control your intercom installation. You can work with default Roles which can be cloned or edited. You can also create your own Roles if required.

The products that use Roles when connecting to LQ devices are: HelixNet and Agent-IC.

When a HelixNet device is linked to LQ in a Link-Group set up, the Role configuration from the Master HelixNet device will override the LQ units.

For more information about HelixNet Role configuration, see the HelixNet User Guide, available from the Clear-Com website.

For more information about Agent-IC Role configuration see **Agent-IC and LQ on page 131**

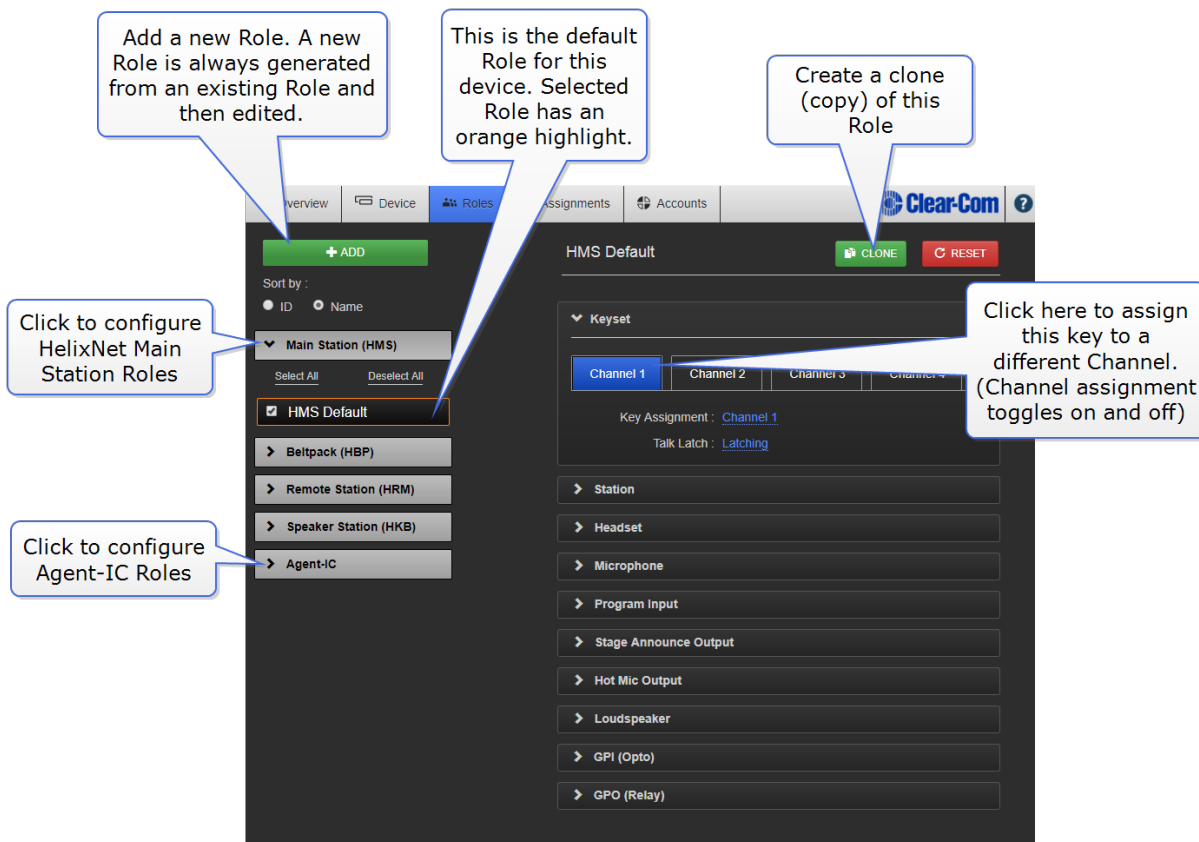

## 3.8 Assignments

Network transmission controls/transport settings are in this page (LQ only).

This is where you will assign ports to Channels. All devices, with their associated ports appear in the left margin of this page.

In the center are three tabs; chose from **All**, **Channels** and **Directs**.

Channels (up to 24 in total per Link-Group) are shown on the right.

To route audio:

1. Choose Channel type; Channel or Direct.
2. Click on an available Channel to select it or click '+' to create a new one.
3. With the Channel selected (orange highlight), click '+' next to the port you require to put into the Channel.
4. Repeat step 3 as often as required.

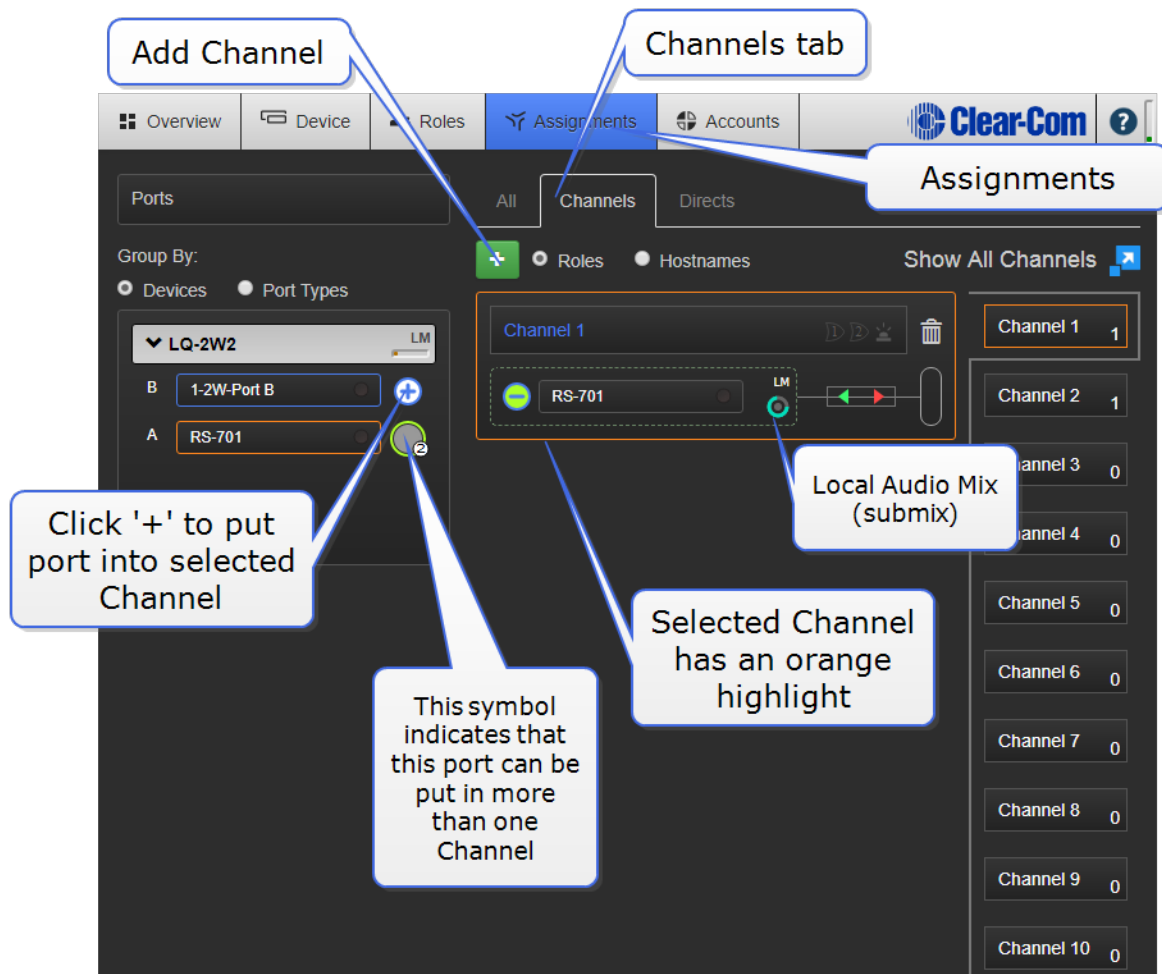

**Note:** Network transmission controls are in this page.

### 3.8.1 Channel or 4W Direct Channel?

An LQ Channel is made up of multiple audio sources which operate as a partyline. All sources in a Channel can hear and talk to each other. A 4-wire direct (panel) Channel, by contrast, is a connection between two ports only. A 4-wire direct (panel) connection cannot be included in a Channel and is configured separately.

**Note:** Direct Channels are not available in a HelixNet system.

### 3.8.2 Local Audio Mix (LAM)

Each LQ device within a Channel performs its own local audio mix (submix). The LAM mixes audio at a very early stage of the audio transport which reduces the latency of the audio streams (below 4ms) and improves audio processing. LAM is a

way of improving latency, increasing the capacity of an LQ device in certain user cases and reducing network usage.

The LAM is performed automatically when ports are added to a Channel.

**Note:** *The ports from each LQ appear within a box, with the local audio mix icon in the bottom right corner, where you can program network settings.*

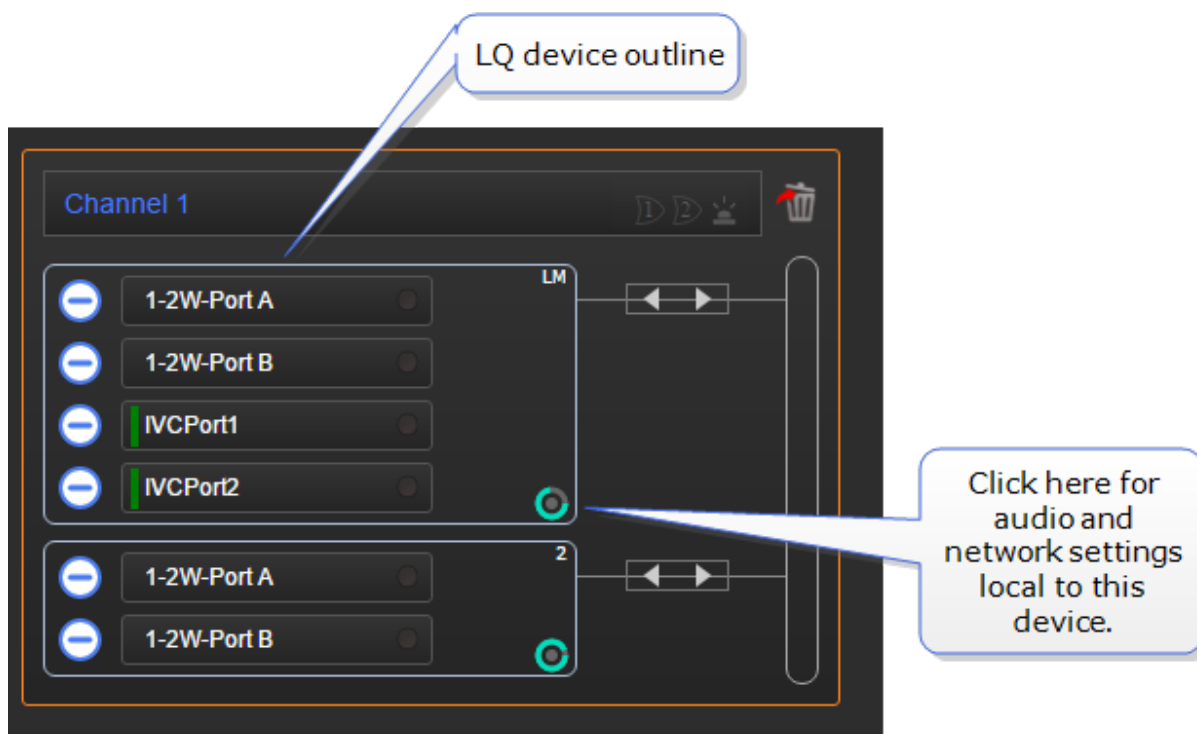

Network settings within a Channel are set on a per-device basis. To set differing network quality for ports from the same device, put the ports in separate Channels.

**Note:** *LAM is not available if you are using a HelixNet/LQ Link-Group.*

### 3.8.3 Local Audio Mix/transport settings

Click/touch a blue label in the CCM to access settings.

**Silence suppression.** Default = **Disabled**

Enabling this option will stop transmission and implement comfort noise when silence is detected. This is done to conserve network resources.

### 3.8.4 Recommended network settings

- Internet - **very low** or **low**

- LAN/WAN - **balanced** or **high**
- LAN only - **very high**. This option enables 20 kHz bandwidth.

### 3.8.5 Custom setting

The Custom option allows adjustment of the jitter buffer setting independent of bit rate and packet size.

The jitter buffer setting is designed to buffer audio received to prevent loss if there is network jitter. Note that the jitter buffer selection will directly affect the latency. This is because the lower number in the jitter range represents the amount the LQ unit will buffer audio before delivering it to the port. A bigger jitter buffer setting will increase latency in milliseconds.

**Note:** *The network setting is the bandwidth from the LQ device into the IP network.*

**Note:** *Within the Custom setting, selecting an Audio Bitrate of 128 Kbps will automatically set Bandwidth to 20 kHz,*

Network Quality. Click on the slider to set.	Default setting shown in Bold
<b>Transmit</b>	
Audio bitrate	16, 32, 48, <b>64</b> , 128 Kbps
Audio bandwidth	<b>12</b> , 20 kHz
Packet size	60, 40, 20, <b>10</b> , 5 ms
<b>Receive</b>	
Jitter (min-max)	60-200, 40-100, 20-60, <b>5-60</b> , 3-60 ms
Unit latency	80-220, 60-120, 40-80, <b>25-80</b> , 23-80 ms

## 3.9 Accounts

In this page you will generate and maintain accounts to external systems.

- Agent-IC client accounts
- PBX (SIP) accounts

- IVC (matrix) accounts

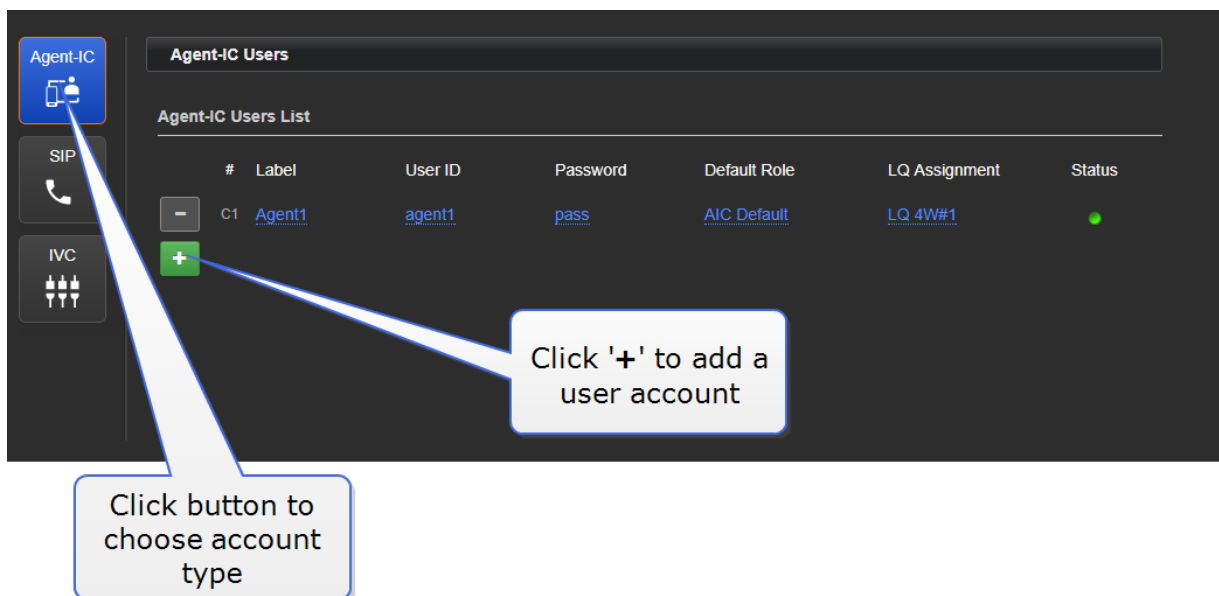

User log in credentials (**User ID** and **Password**) are stored in this page for each account.

Agent-IC and telephony (SIP) accounts need a license (see your Clear-Com representative for information).

For more information, see:

**Program Agent-IC to LQ connectivity on page 135**

**Program LQ-SIP standalone on page 101**

**Clear-Com Eclipse matrix connections on page 79**

**Licensing on page 138**



## 4 Basic set up (LAN)

---

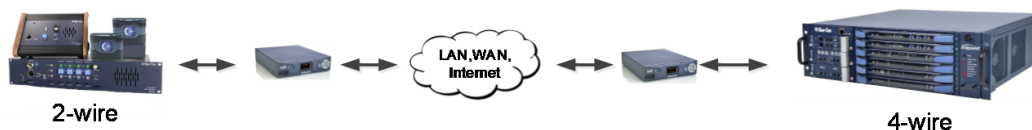

### 4.1 Setting up your LQ environment within a LAN

Gather the following equipment:

- 2 x LQ units (LQ #1 and LQ #2)
  - 2 x provided Power Supply Units (PSUs)
  - 2 x Straight-through RJ45 Ethernet cables
  - 1 x Network connection with Dynamic Host Control Protocol (DHCP) server present (preferred method)
  - 2 x 2-wire, 4-wire and/or GPIO equipment to provide an audio connection to each LQ
  - 2 x 2 Network connections available for connecting each LQ to your network.
1. Connect either LAN port of LQ #1 to the local network equipment.
  2. Connect either LAN port of LQ #2 to the local network equipment.
  3. Connect the provided PSU to each LQ device. Once booted, each device will display an IP address on the front panel display.

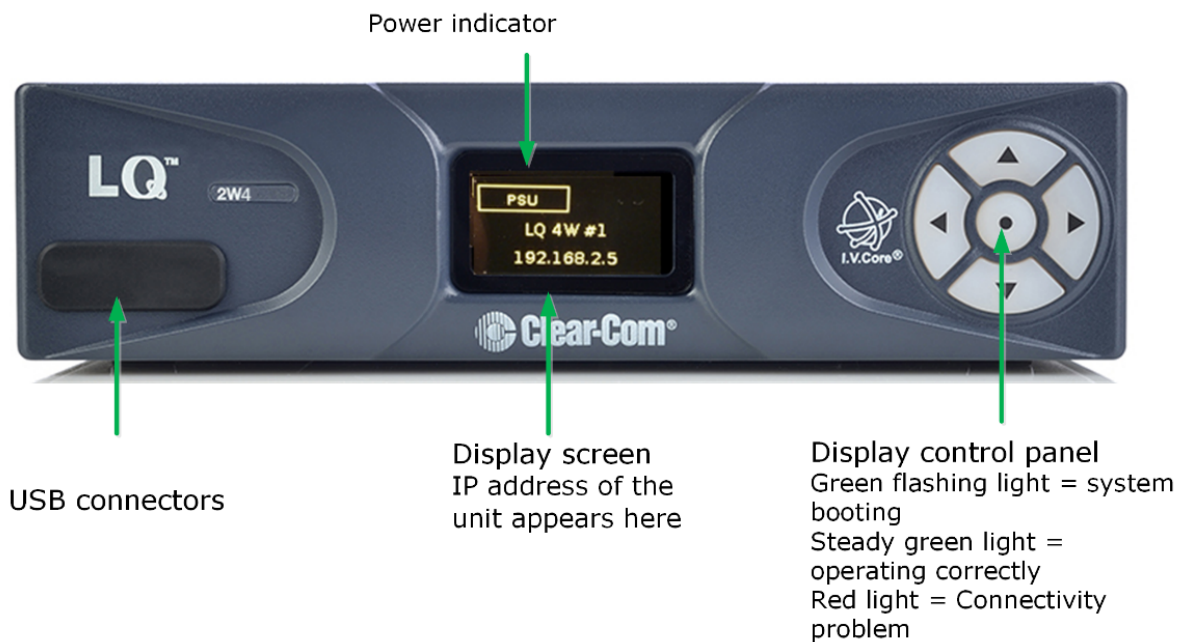

4. Once the devices are operational, you will program each device through the browser-based Core Configuration Manager (CCM).
5. Access the CCM. From a device connected to your network, open a Web browser. Enter the IP address as displayed on LQ #2 device in the address field of the Web browser (Chrome, Safari, Firefox, IE, Opera). This takes you to the CCM.
6. Default username and password for the CCM: admin, admin.

## Core Configuration Manager (CCM)

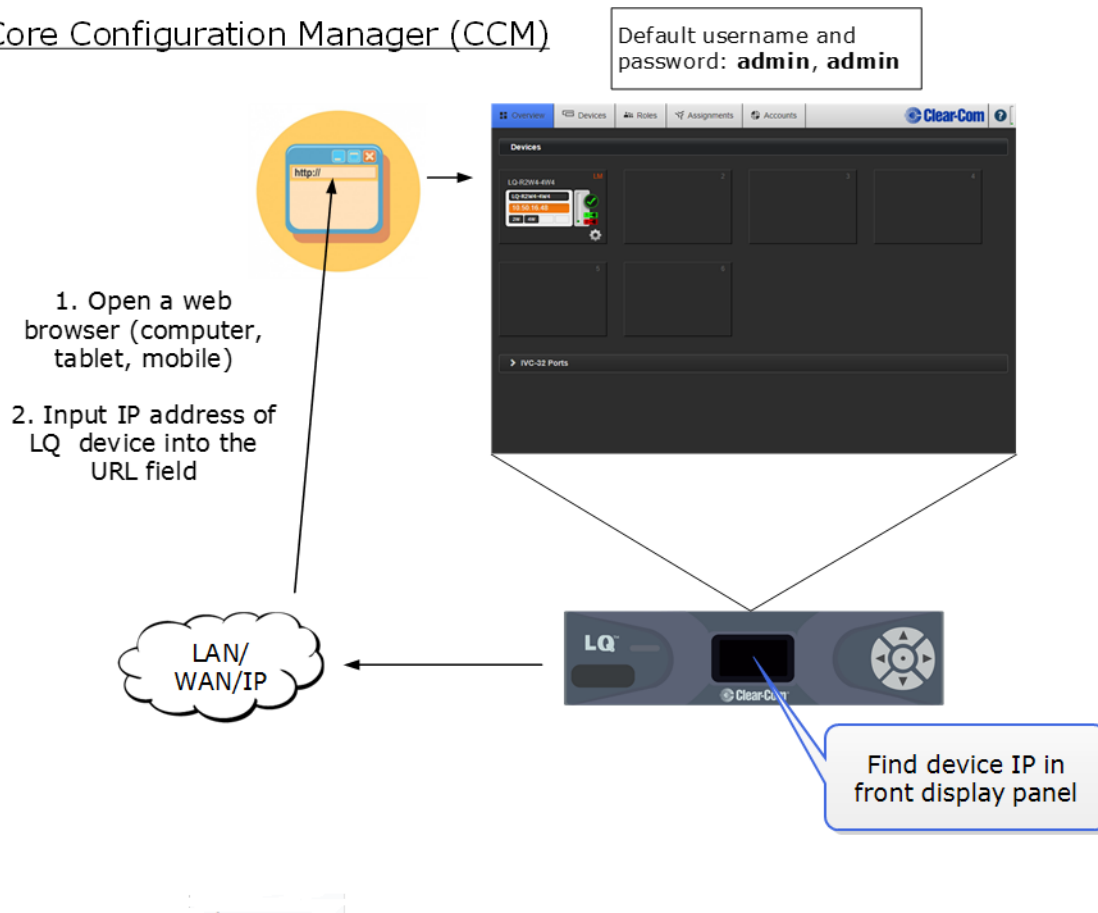

**Note:** The IP address will be allocated by DHCP (default mode). In the event that the network does not serve DHCP or there is no network connection, the IP address will revert to a link-local address. If necessary IP addresses for the devices can be configured in the **Network** page of the CCM. See information links at the bottom of this page if you require more information.

7. Connect the audio equipment to Port A of each LQ device.
8. Once the LQ devices are set up, proceed to **Creating a Link-Group on page 48**.

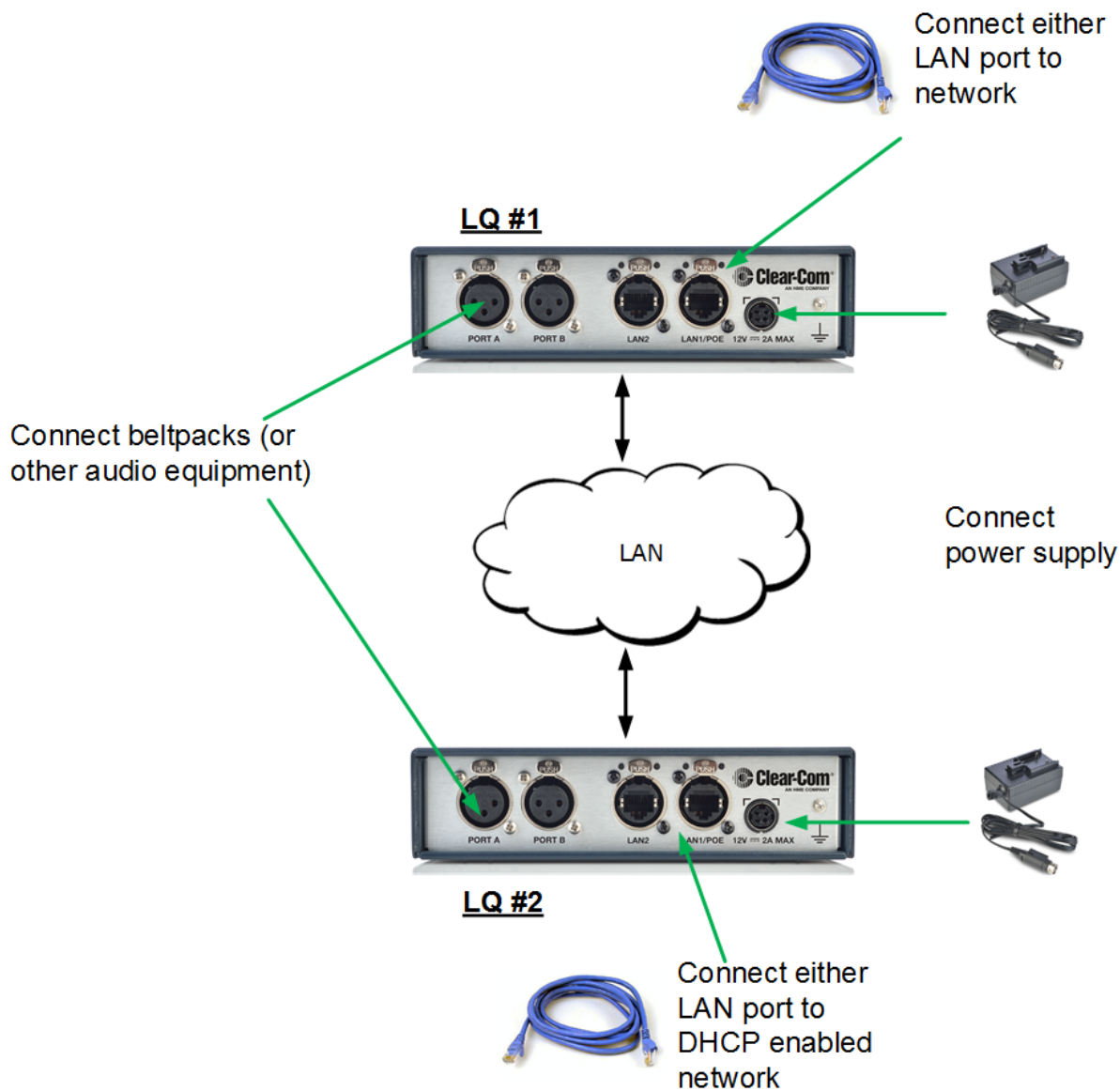

For more information see:

**Static IP configuration on page 74**

## 4.2 Creating a Link-Group

Before linking units together, one LQ device must first be designated as the Link-Master by setting that device's role to Link-Master. Every other LQ device within the Link-Group will then be set into a Link-Member role which allows the linking of those units directly to the Link-Master.

When creating a HelixNet/LQ Link-Group the HelixNet must always be designated the Link-Master.

In this example, LQ #1 will be left as Link-Master (default configuration) and LQ #2 will be linked to it.

## 4.2.1 How to create a Link-Group

1. Navigate to **Device > Linking** on the CCM of LQ #2.
2. Click Change Role to Link-Member.

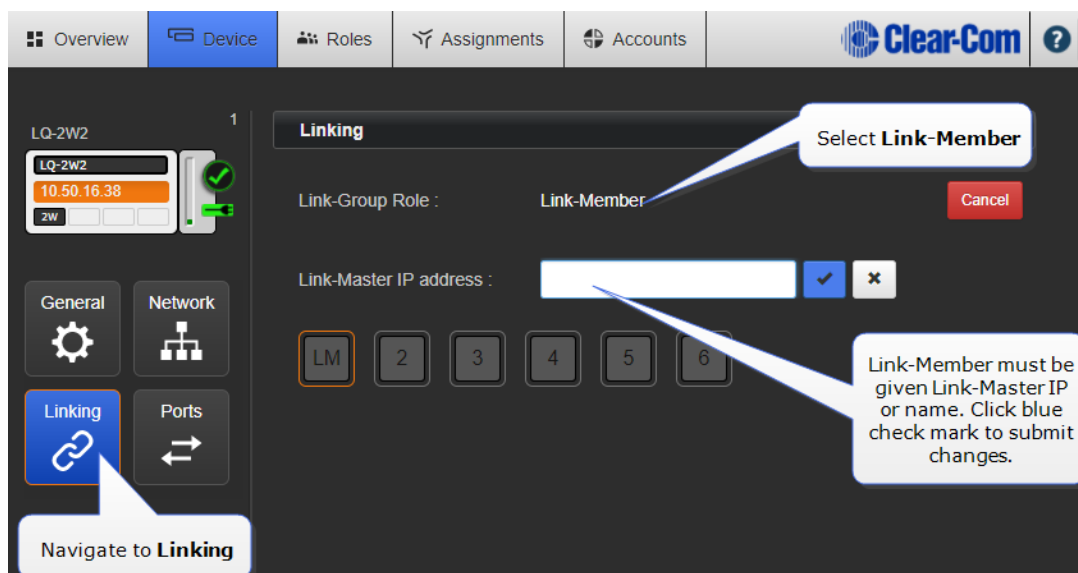

3. Within the Master IP address field, enter the IP address as displayed on the LQ #1 device. Click on blue check mark or press <ENTER> key to submit.
4. The next available Device ID will be selected by default (highlighted in blue) but can also be manually selected.

Overview Device Roles Assignments Accounts Clear-Com

LQ-2W2

LQ-2W2  
10.50.16.38  
2W

General Network Linking Ports

**Linking**

Link-Group Role : Link-Member Cancel Apply Changes

Configuration for Roles, Assignments/Channels and Accounts will be replaced by the configuration of the new Link-Master.

Link-Master IP address : [10.50.16.129](#)

Link-Group Member IDs :

LM 2 3 4 5 6

Slot #2 was automatically selected for this Device.

Select an available slot for registration of this Device within the Link-Group.

2. Apply changes

1. Select an available device ID if you do not wish to go with the default selection

Note that when linking a member to a master, the configuration from the master will over-ride the member

5. Click Apply changes.

LQ #1 and LQ #2 will now be linked (operation may take up to 30 seconds to complete). If there is existing configuration on the member LQ, this will be replaced by the configuration of the master.

6. Navigate to the Overview page (top navigation bar). Both LQ devices should be displayed on this page.

7. Before continuing, if either LQ device is a LQ-2W2 model, you may need to auto-null both ports (power must be present on the 2W circuit before auto-null is possible). For each device to be auto-nulled, navigate to **Device > Ports**.

- Expand port sections and click on the Auto-Nulling button for each port.

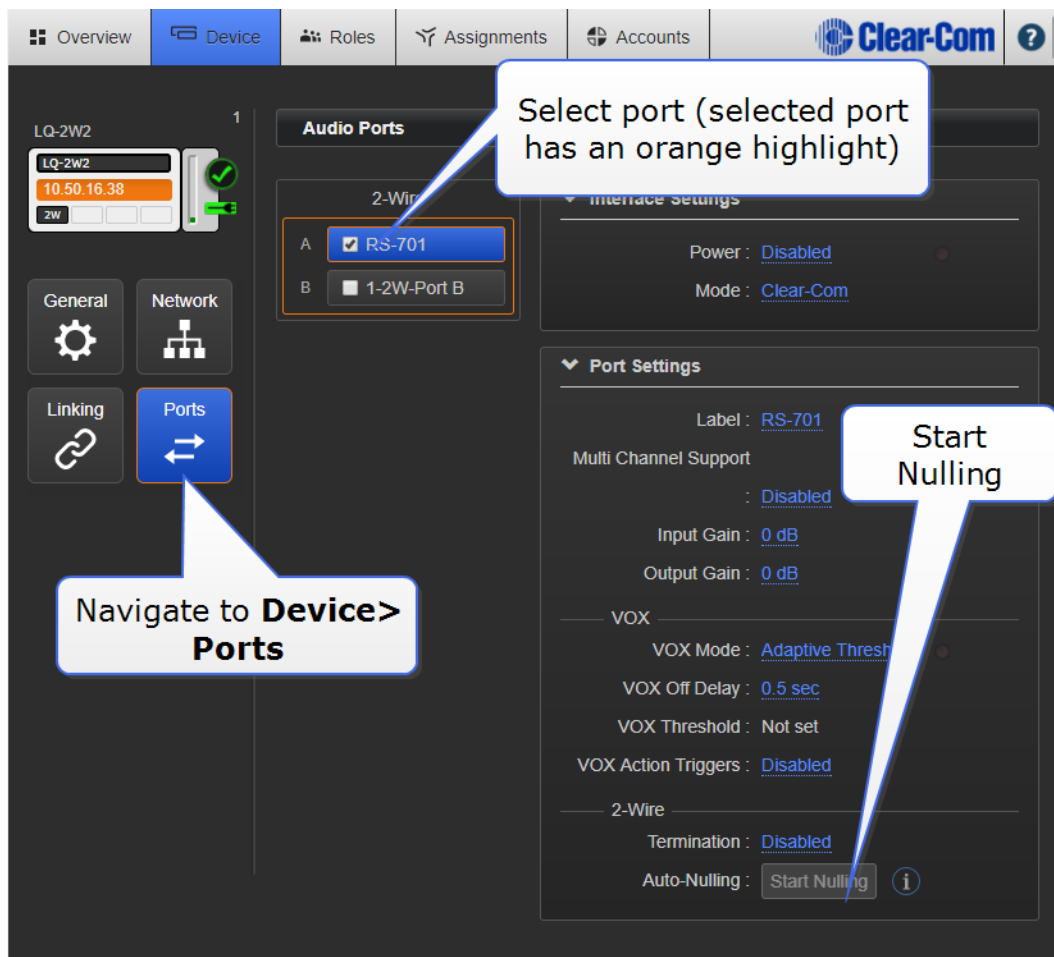

**Note:** The auto-nulling operation emits a loud hiss on the circuit. When auto-nulling, ensure that all talk buttons on external Partyline devices are turned off.

For more information, see:

**About Linking on page 58**

In LQ 4.0 and above a HelixNet Main Station can also be included in a Link-Group.

**LQ to HelixNet connectivity on page 123**

## 4.3 Using Channels to route audio

- Click on the Assignments button within the navigation bar.
- Select the Channels tab.
- Select Channel 1 (or other Channel) from list on the right of Assignments page.
- Add Port on each device to required Channel by clicking on the + symbol to the right of each port.

You should now be able to pass audio and call/RMK signaling to/from Port A on each device.

Channel 1 must be selected before audio can be assigned to it. This is shown by an orange highlight.

The screenshot displays the 'Assignments' tab in the Clear-Com web interface. The top navigation bar includes 'Overview', 'Device', 'Roles', 'Assignments', and 'Accounts'. The 'Assignments' tab is active, showing a 'Ports' section on the left and a 'Channels' section on the right. The 'Ports' section is grouped by 'Device Index' and shows a list of ports for 'LQ-2W2'. The ports are: '1-2W-Port B' (B), 'IVC#1' (A1), 'RS-701' (A), and 'SIP#1' (A1). The 'IVC#1' port is highlighted with an orange border, and a blue callout box with a '+' icon points to it, containing the text 'Click '+' to add port to Channel 1'. The 'Channels' section shows 'Channel 1' with a count of 2, and 'Channel 2' through 'Channel 6' with counts of 0. The 'Channel 1' entry is also highlighted with an orange border. The interface includes a 'Show All Connections' button and a 'Clear-Com' logo in the top right corner.



## 5 Front panel interface

---

From the front panel of the LQ you can:

- Set audio configuration
  - input gain
  - output gain
  
- Set VOX configuration
  - VOX
  - Threshold
  - Delay
  
- Set 2-wire specific settings
  - Powering of the line
  - Clear-Com/RTS mode
  - Auto-nulling
  - Termination
  
- Set 4-wire specific settings
  - Port Function: set port function of Ethernet cable 'to Matrix' or 'to Panel',
  - Vox levels
  - Baud rate
  
- See GPIO settings
  - Test GPO hardware trigger
  - Set Mic level/line level (mic level for use when connecting directly to a radio)
  
- Set device settings

- Brightness of OLED
  - Screensaver time-out
  - Reboot
  - Reset-to-default
- 
- Networking
  - Edit network details
- 
- Hang up SIP calls

## 5.1 How to access front panel menu options.

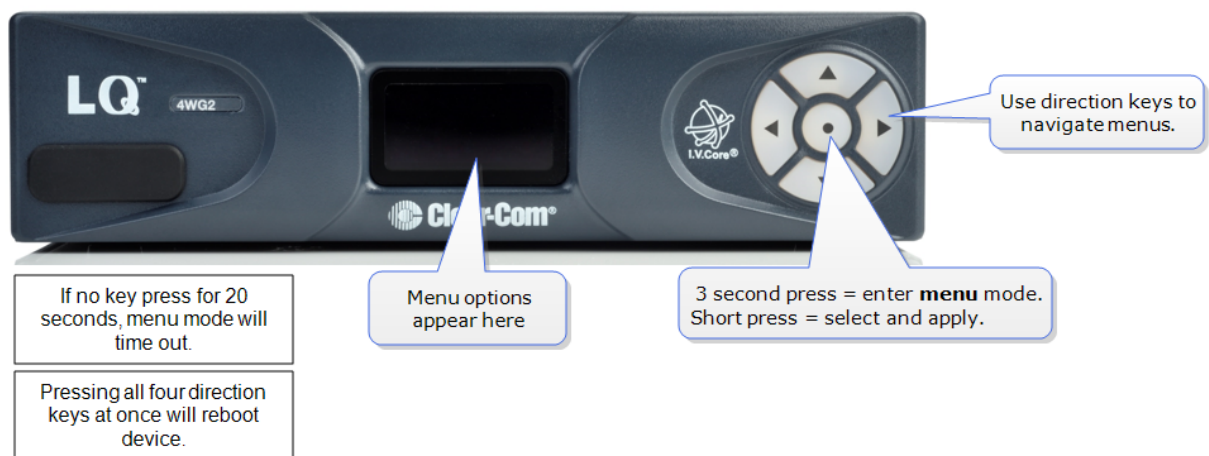

## 5.2 Programming network details from LQ device front screen

In LQ version 3.0 and above network details can be input and changed from the device front screen menu, as well as from the CCM.

**Note:** *You can also test that the device GPOs are firing correctly from the front screen menus. Navigate to **Menu/ports/port** and scroll down.*

## 5.2.1 How to edit network details from the device menus

1. Navigate to **Menu > Networking > Edit**. **Edit** is at the bottom of the networking list. Use the arrow keys to navigate menus.
2. Disable the DHCP setting on your device. This allows you to access network details.

Disable DHCP and select IP for editing.

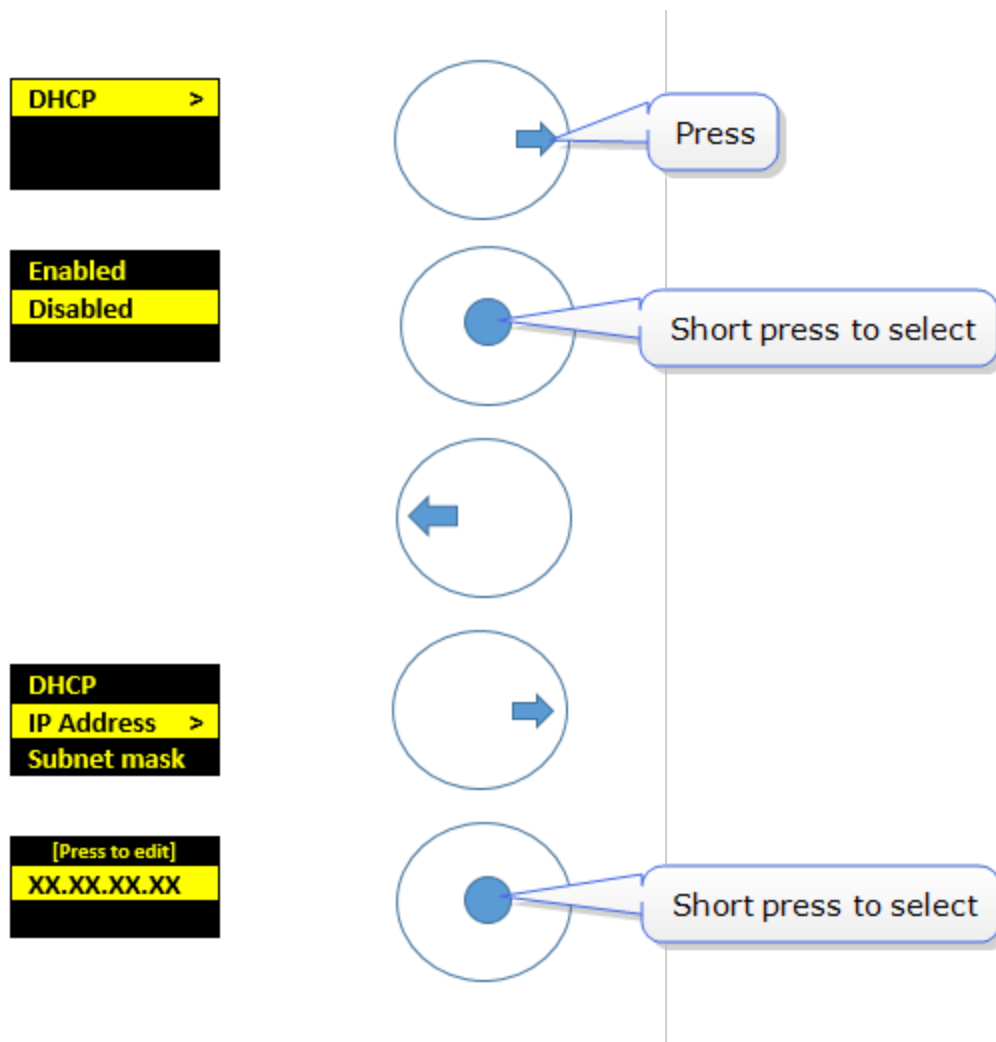

Edit and save IP address.

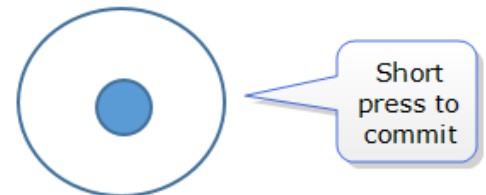
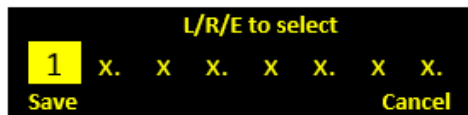
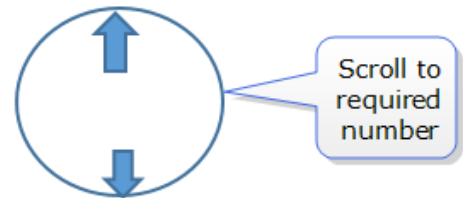
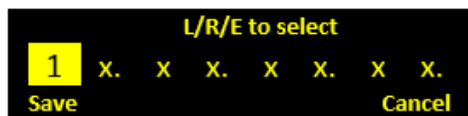
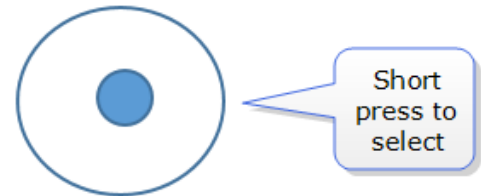
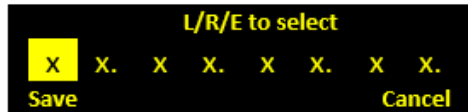
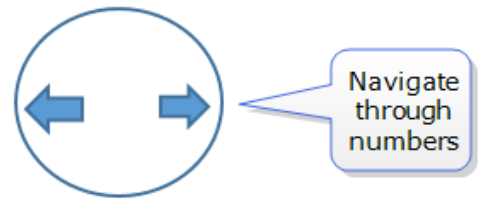
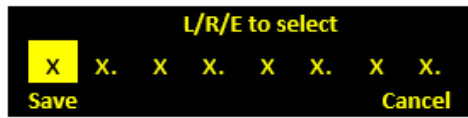

Repeat for each number. Then **Save**.

3. Repeat for Subnet mask, Gateway, and DNS as required.

## 6 Linking

### 6.1 What is a Link-Group?

A Link-Group is a set of LQ devices connected over IP so they share audio and data between them.

With LQ 4.0 and above a HelixNet device can also be included in a Link-Group. This increases the available ports and the range of a HelixNet system.

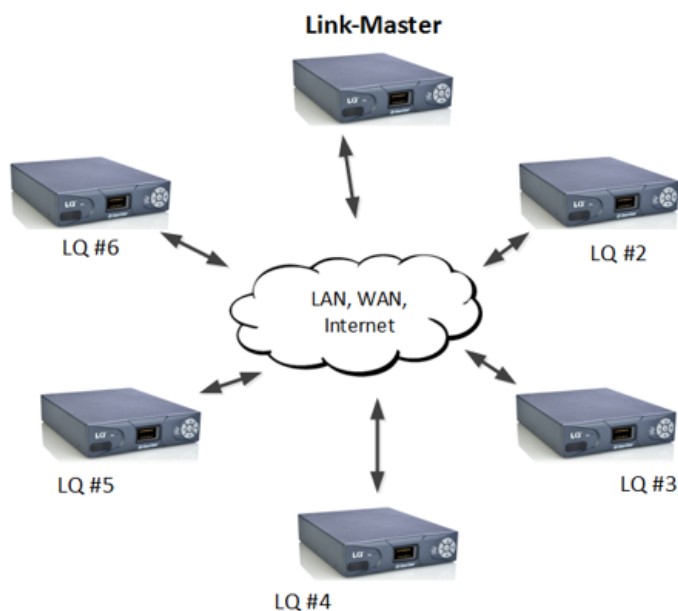

- 1 box is set to Link-Master
- Each LQ joins the group through the Link-Master
- Up to 6 LQs in a Link-Group

#### Channels

There are 24 channels within each Link-Group (channels can be added or taken away as required). Any port on any LQ can be assigned to any of the channels. To assign ports to channels navigate to **Assignments** in the Core Configuration Manager.

Once connected, devices in a Link-Group can be configured from any unit

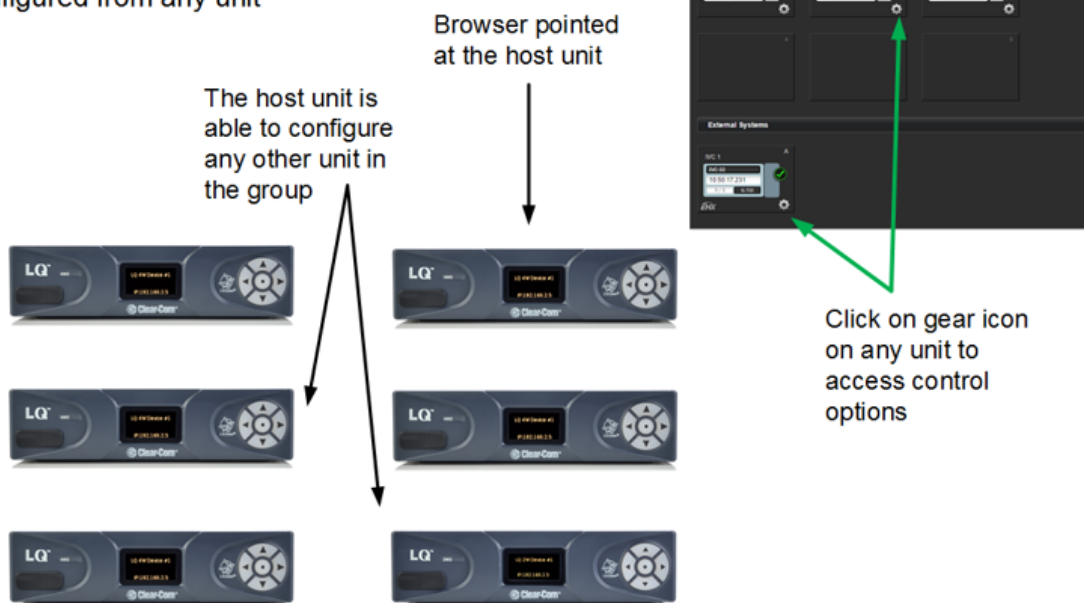

The Core Configuration Manager (CCM) for any LQ host can be accessed by entering the IP address as displayed on the front panel display of the LQ host into a web browser's address field. All devices in the Link-Group can be viewed and configured through any single host in the Link-Group.

**Note:** *A HelixNet Main Station can also be linked in a Link-Group formation. The basic principles are the same for a HelixNet/LQ Link-Group, though there are a few differences in operation.*

For more information, see:

**LQ to HelixNet connectivity on page 123**

## 6.2 About Linking

A Link-Group:

- Can contain up to 6 LQ devices or up to 6 of a combination of HelixNet Main Stations and LQ devices
- Must have one unit designated as Link-Master
- Performs a “best effort” approach to creating a mesh network between all the devices within the group.

## A Mesh Network

Once joined to the Link-Group, all devices attempt to connect to all other devices within the group.

- Configuration and control of any device is possible through any other unit in the group
- Configuration information is both distributed and persisted within every node of the group
- Significantly reduces loss of service

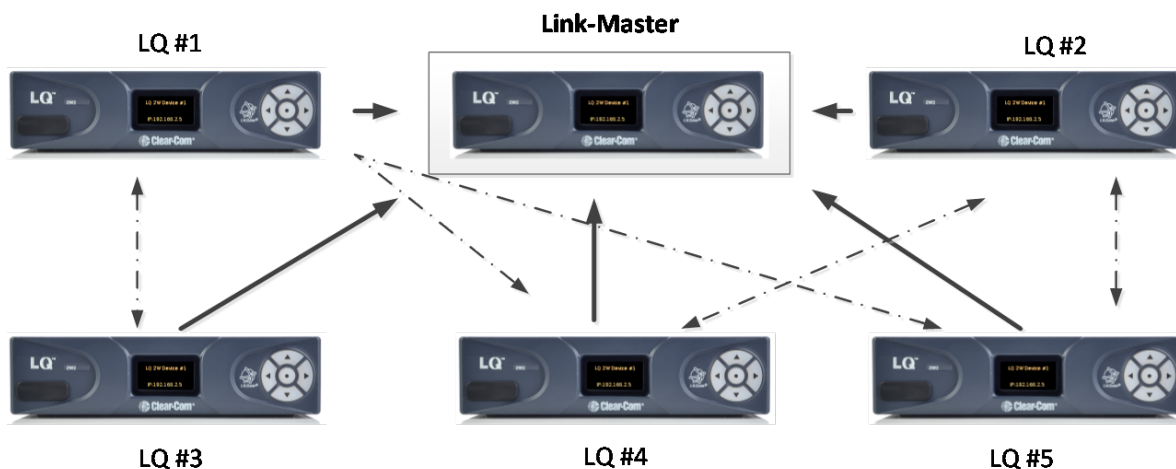

## 6.3 The Link-Master role

The Link-Master role serves three main purposes:

1. It facilitates Link-Group membership.
2. It is the owner of Channel names, meaning that Channel names will only persist (be maintained consistently) if the Link-Master is operational.
3. It is responsible for the synchronization and distribution of both configuration and device availability status throughout the Link-Group.

**Note:** *The Link-Master must be reachable on TCP port 80 and TCP/UDP port 655 by all devices within the Link-Group.*

**Note:** *It is recommended that the IP address of the Link-Master is allocated statically. When allocated by DHCP the IP address can change. If this happens the LQ devices will no longer be able to reach the Link-Master device.*

**Note:** *Any device can be set to Link-Master mode. Link-Master mode is the factory default setting.*

## 6.4 The Link-Member role

LQ devices that are not designated master will have the role of Link-Member. Joining a device to a Link-Group requires that device to be set to Link-Member role which will prompt the user to enter the address of the Link-Master.

If a Link-Member device loses connection to its Link-Master, the front panel LED of that device will turn red until the connection is restored.

### 6.4.1 Linking units

The only way to join devices to a Link-Group is through the Linking page of the CCM. Only the IP address of the Link-Master is required during this set up.

### 6.4.2 LQ restricted IP range

LQ units use the IP range 172.23.xx.xx for linking. Because of this, this IP range should not be used for any devices (including LQs) when working with the LQ Series system. Clear-Com cannot guarantee reliable behavior if this address range is used.

### 6.4.3 Linking over a LAN

This is the simplest way to link devices together. This type of environment enables the highest potential level of communication quality and the best availability of resources. When linking over a LAN, set Link-Group Optimization to **LAN/WAN routed network** in the **Linking** page of the Core Configuration Manager (CCM) for best latency performance and use of resources.

### 6.4.4 Linking over Internet or WAN

When linking over the public Internet, addressing of the Link-Master becomes more complicated as the Link-Master must be made externally reachable to all Link-Members. This is achieved by creating port forwarding rules within the firewall.

**Note:** *A HelixNet/LQ Link-Group does not operate over the Internet. This is because the codec that HelixNet uses (WavPack) is not optimised for the Internet. Internet connectivity when using HelixNet and LQ is achieved using a tie line.*



## 6.5 How to link LQ units over a firewall

### WAN or Public Internet Linking

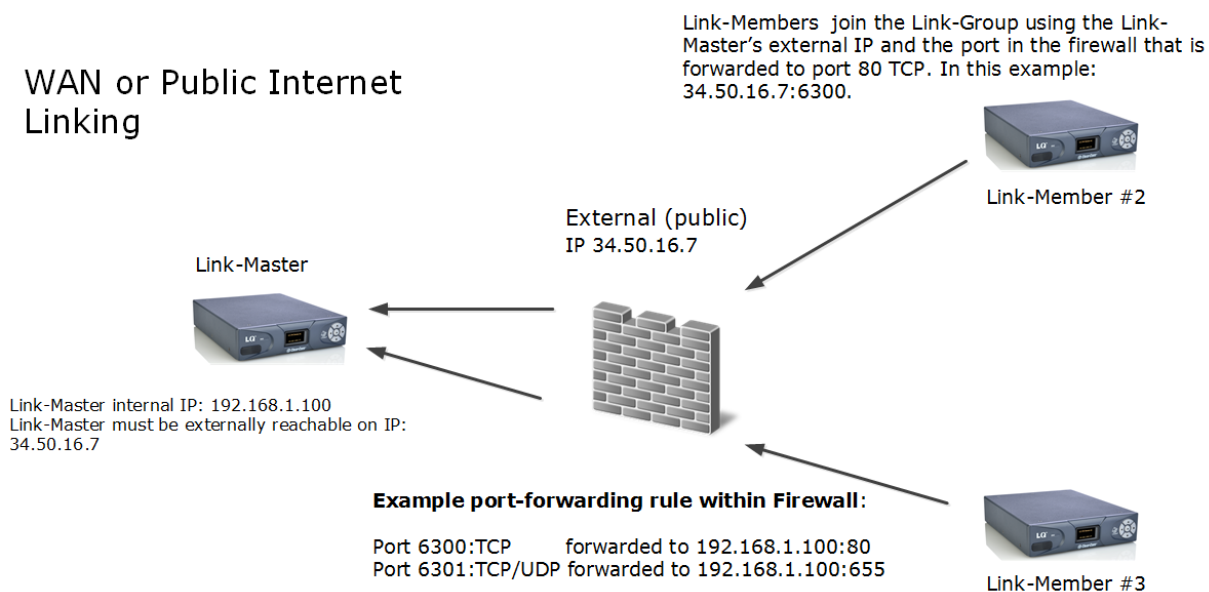

The Link-Master uses TCP port 80 for management and TCP/UDP port 655 for audio. You will need to create port-forwarding rules within your firewall to make these ports externally accessible to the Link-Master device.

When creating a Link-Group over the public internet, Link-Members need to be given the Link-Master's externally reachable IP address and the port that is forwarded to port 80. This information is entered in the **Linking** page of the CCM.

**Note:** *If no port forwarding rules have been applied the LQ devices will find the correct default ports automatically, so there is no need to specify a port.*

Once the devices are linked in a group, they will share network details with each other automatically. To facilitate this, the network details, including the port that is forwarded to TCP/UDP port 655 need to be configured in the Link-Master's **Network** page. If no port forwarding rules have been applied, it is not necessary to specify a port.

Overview | Device | Roles | Assignments | Accounts | Clear-Com

LQ-2W2

Linking

Link-Group Role : [Link-Member](#)

Link-Group Optimization : LAN/WAN Routed Network

Link-Master IP address :

LM 2 3 4 5 6

**Set Link-Group Optimization to Internet/NATed Network.**

**If Linking behind a firewall**  
Link-Master IP address (given to the Link-Members) is the external IP and the port mapped to **TCP port 80** at the firewall.

Overview | Device | Roles | Assignments | Accounts | Clear-Com

LQ-2W2

Network

LAN / WAN Connectivity

Mode :  Static  DHCP

IP Address : 10.50.16.38

Subnet Mask : 255.255.252.0

Gateway : 10.50.16.1

Primary DNS : 10.50.1.51

Secondary DNS : 10.50.1.151

External Connectivity

External IP Address :

External Port : Not set

**External IP**

**External port (port that is mapped to TCP/UDP port 655)**

For more information on linking over the Internet, see **Internet connectivity on page 78**.

## 6.6 How to remove a device from a Link-Group

### 6.6.1 Remove an on-line Link-Member from a group

1. Access the browser-based CCM for any device within the Link-Group.
2. In the Overview page, click on the device image of the unit that you want to remove from the group.
3. Navigate to Linking for that device.
4. Click Change Role to Link-Master.
5. Apply Changes.

The device will be reconfigured as a Link-Master and removed from the group.

### 6.6.2 Remove an off-line Link-Member from a group

1. Access the Core Configuration Manager for any device within the Link-Group.
2. In the Overview page, the off-line unit will show a red 'X'. Click on this device.
3. You will be asked if you want to remove this unreachable device. Click Delete.

The device will be removed from the Link-Group.

If this same device is powered on again, it will automatically seek the same Link-Master and ID slot. If the ID has been taken by another device, it will take the next available ID. If no ID is available (because there are already 6 devices in the group) it will not be able to join the group.

To re-use this device with a new Link-Master, it must be returned to the default role (Link-Master) and then re-linked.

## 7 About Channels and using them to route audio

Audio can be assigned to either Channels or 4-wire direct connections.

### 7.1 About Channels

In the context of the LQ product, a Channel represents a conduit or holder for routing audio and data (including GPIO triggers) through your intercom system. As well as routing audio, a Channel also connects audio and data sources.

#### **To use Channels:**

- Connect audio to the port connectors on the device
- Assign the port or ports to one or more Channels.

#### **LQ uses two different types of Channel**

LQ uses two different types of Channel: a regular Channel and a 4-wire direct Channel. A regular Channel operates like virtual Partyline or conference line. It comprises audio from multiple audio interfaces on the devices (ports A-F) that have been assigned to it. Within a regular Channel, all parties can hear and speak to each other. A 4-wire direct Channel is made up of only two audio sources in a one-to-one connection. A 4-wire direct Channel can be used to connect an analogue intercom panel over IP to an Eclipse matrix. A 4-wire direct is also used to route SIP calls to a matrix.

Once connected to the units, audio and data from the input/output ports on the back of the LQ devices can be assigned to any of the 24 available channels. When an audio route from a port is assigned to a Channel it will be able to talk and listen to any other ports also assigned to that channel.

Example of audio channels in a Link-Group.

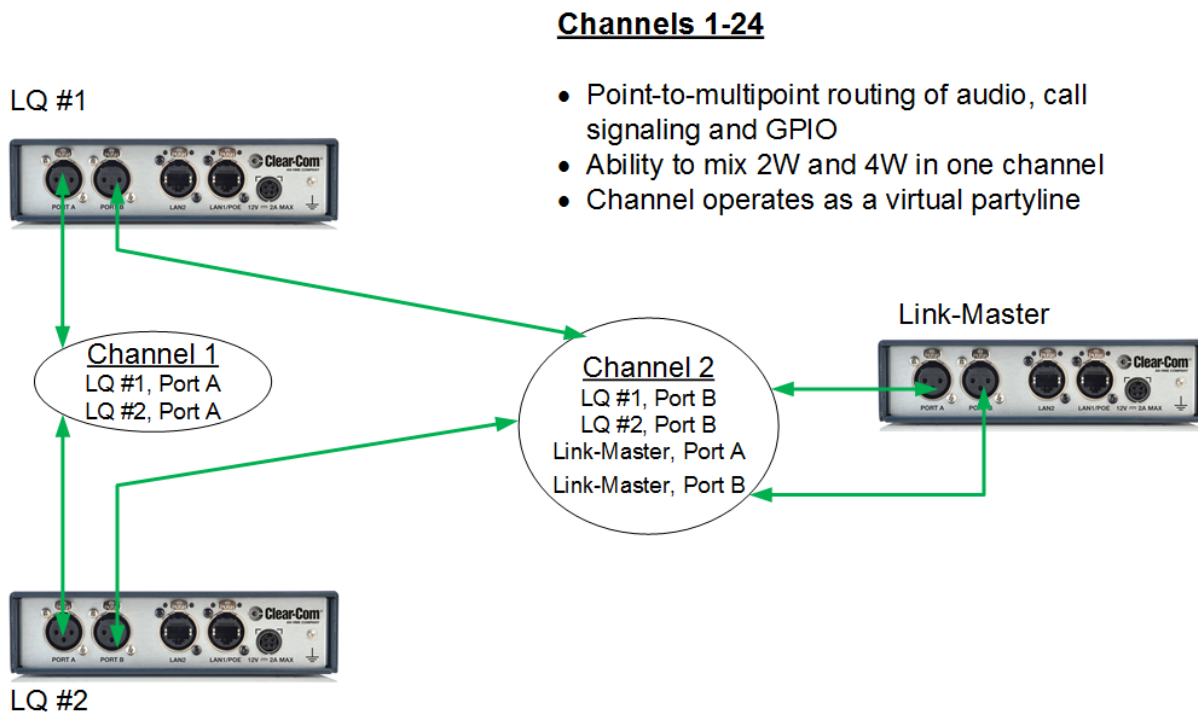

## 7.2 Channel or 4-wire direct?

- A Channel operates as a virtual partyline and can contain many audio sources
- A 4-wire direct connection is between two points only
- A 4-wire direct is used when connecting to Eclipse panels
- A 4-wire direct is used when routing SIP calls to a panel
- A 4-wire direct cannot be used with the HelixNet system.

## 7.3 How many Channels can I use?

LQ series units can provide up to 24 Channels (including 4-wire direct Channels) across a Link-Group. Use the green 'Add Channel' button on the Channel tab in the Assignments page of the Core Configuration Manager (CCM) to add Channels.

If an LQ unit is linked in a Link-Group setup with HelixNet it will have either 12 or 24 Channels, according to the Channel license of the HelixNet device. Unlike the LQ, HelixNet has a fixed number of Channels, according to license.

## 7.4 Connecting audio sources and routing them

1. Ensure that the relevant external devices are connected to the rear of the LQ unit.

**Note:** To minimize noise, use screened (shielded) cable when connecting 4-wire ports.

2. From the CCM, navigate to Assignments.
3. Select the Channel tab on the Assignments page.
4. Click on the Channel you want to assign a port to.
5. Navigate to Devices in the left hand margin of the screen.
6. Assign the required port to the Channel by clicking '+'.
7. You will see the interface port appear inside the Channel.
8. To unassign the port from the channel click '-' within the Channel.

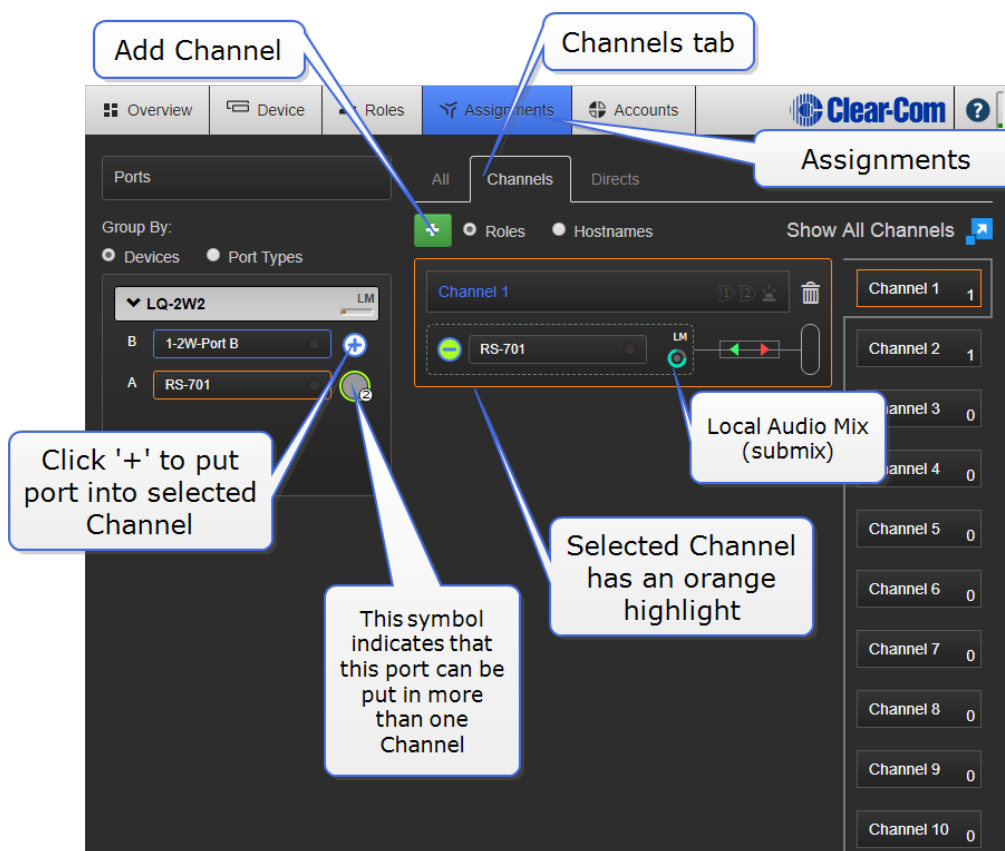

## 7.4.1 Port availability status

Port assignment status is represented by the following three colors:

- White: connected, audio is being transmitted
- Yellow: connection pending, connection status unknown
- Red: device is unreachable
- If one of the devices is displaying three yellow dots, the connection is pending.

## 7.4.2 Audio indicator

On the Assignments page you will see an audio indicator on ports and channels. This will light green when audio is flowing.

## 7.5 Audio configuration for a Direct connection

**Note:** *Unlike an LQ channel, which can contain multiple audio sources, a Direct connection is between two ports.*

1. Ensure that the ports are connected to the rear of the LQ unit.

**Note:** *To minimize noise, use screened (shielded) cable when connecting 4-wire ports.*

2. From the Core Configuration Manager (CCM), navigate to Assignments.
3. Select the **Direct** tab in the Assignments page.
4. Click on the '+' button to create a new direct connection box or select an existing direct connection box. Make sure the connection box you require to add a port to has an orange highlight to indicate that it is selected.
5. Navigate to Devices in the left hand margin of the screen.
6. Assign the required port to the direct connection by clicking '+'.

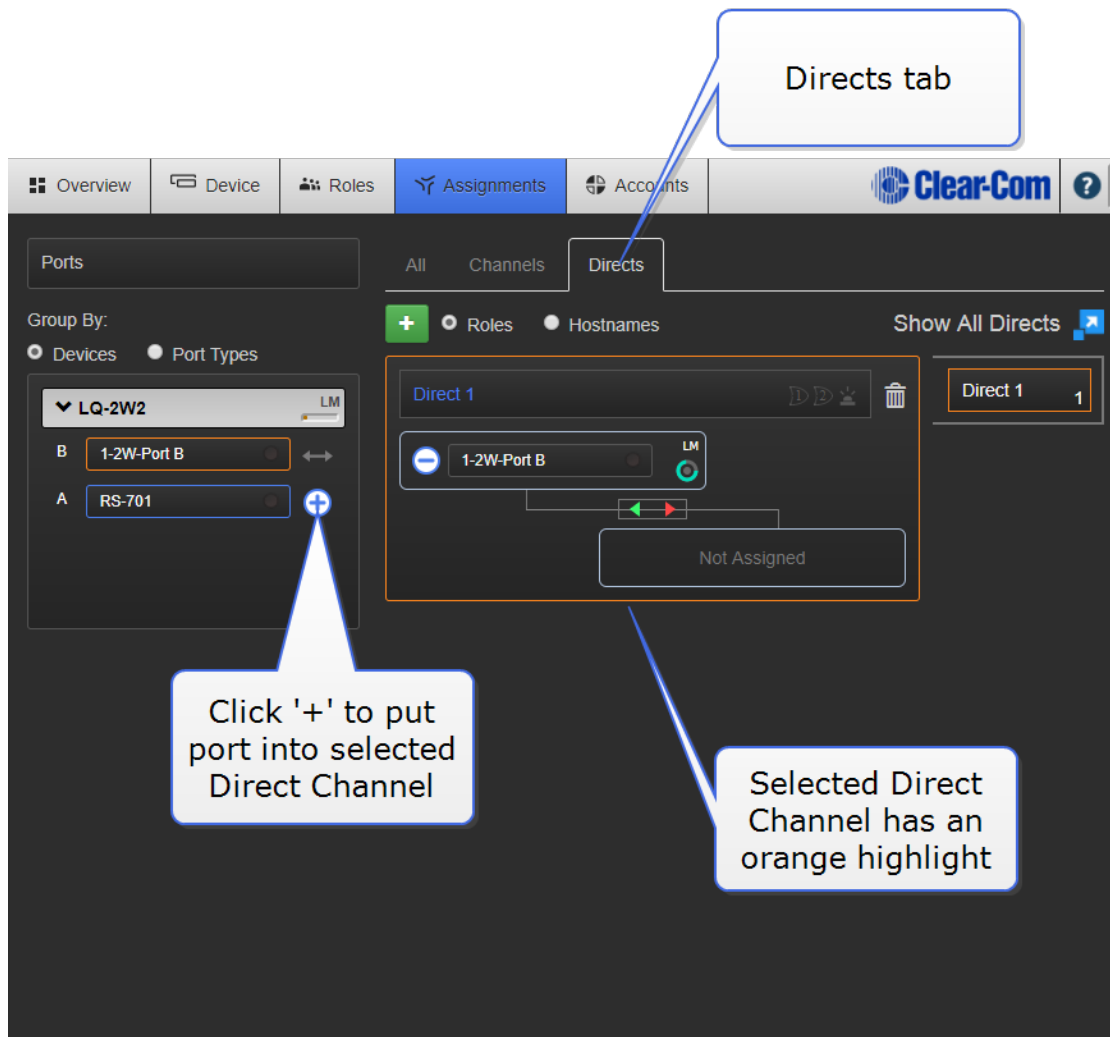

7. You will see the interface port appear inside the direct box.
8. Repeat steps 5 and 6 to add a second port to the direct box, connecting the ports within it.
9. To unassign the port from the direct connection click '-' within the direct box icon.

## 7.6 Changing a Channel label

Clicking on a blue channel/4-wire direct header will allow you to change the name of the Channel or Direct. Enter the new channel/direct name and press <ENTER> key or click the blue check mark to apply changes.



Click label and enter new name. Click the blue check mark or [ENTER] key to submit.

Overview Device Roles **Assignments** Accounts

Clear-Com

Ports

All Channels **Directs**

Group By:  
Devices Port Types

▼ LQ-2W2 LM

B 1-2W-Port B

A RS-701

Direct 1 [checkmark] [x]

1-2W-Port B LM

Not Assigned

Direct 1 1

## 7.6.1 Example audio assignment using a PiCo matrix

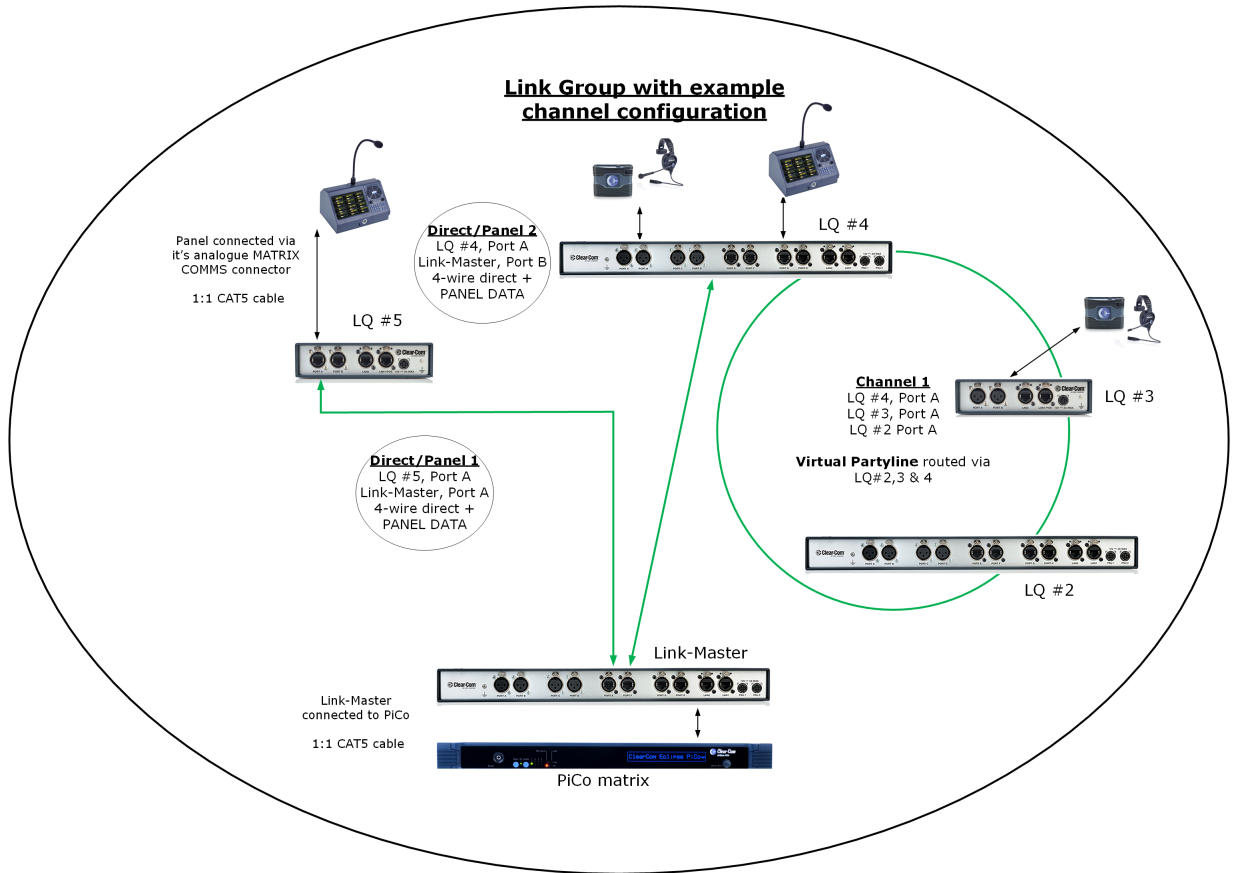

## 8 Interface port configuration

---

### 8.1 Call signaling and Remote Mic Kill (RMK)

Call signaling is automatic on all audio routes so a call signal can be routed to any destination (2-wire or 4-wire).

Call signaling will be passed to some third party intercom equipment, but it may not be recognized.

RMK is supported and passed through to 2-wire participants only.

### 8.2 2-wire specific port options

Default option is shown in **bold**.

#### 8.2.1 Device interface settings

Power: **Disabled**/Enabled. Enable power if you want to power partyline beltpacks from the line. See **Power 2-wire beltpacks from the Partyline on page 21** for more information.

**Note:** *Enabling power will enable termination by default.*

Mode: **Clear-Com**/RTS. For pinouts for each of these see **Pinouts on page 173**.

#### 8.2.2 2-wire specific port settings

- Input/Output gain: -3 to +3 dB. Default = **0**.
- Termination: **Disabled**/Enabled. Termination is used to eliminate echo and distortion when 2 or more 2-wire devices are connected. This setting is automatically enabled when power is enabled on the line. It can be toggled on and off as power should only be terminated once within any series of connected devices.
- Autonull. Autonull should be started whenever 2-wire devices are connected or re-wired. Do not listen in on the headset while autonull is being performed.

### 8.3 4-wire specific port options

**Note:** *To minimize noise, use screened (shielded) cable when connecting 4-wire ports.*

- Input/Output gain: -12 to +12 dB. Default = **0**.
- Port function (sets pin polarity of cable) : **to Matrix**/to Panel. .
- Baud rate: 9600 (Drake 4000)/**19200 (Eclipse)**. Select baud rate according to which type of equipment you are connecting.

## 8.4 4-wire + GPIO specific settings

- Output level: Mic Level (-55db)/**Line Level (0 dB)**.

This setting is used when connecting to devices (like a hand-held radio) where audio connects directly to the mic. This setting works in conjunction with the Output Gain; overall gain = **Output Level + Output Gain**.

## 8.5 GPIO action triggers (4-wire + GPIO and IVC-32 ports)

Default option is shown in **bold**.

GPI action trigger: **Disabled**/Network Control Event 1/Network Control Event 2/Channel Call Event.

Assign a Network Control Event on detection of a GPI signal).

GPO action trigger: **Disabled**/Network Control Event 1/Network Control Event 2/Channel Call Event (assign which Network Control Event will trigger the GPO).

GPO Off Delay: **None** to 2 seconds. This sets a delay on the deactivation of the GPO after a Network Control Event has disappeared.

Test: use to check that the GPO is firing (hardware).

For detailed explanation and examples of how to use Network Control Events see **What are Networked Control Events and how do I use them? on page 83**

## 8.6 IVC-32 specific port settings

Network Quality: **EHX Managed**/Very High (LAN)/High (WAN)/Low (internet). The default setting is **EHX Managed**.

Silence Supression: Enabled/**Disabled**. When enabled, Silence Supression will detect silence on the line, and will stop transmission and implement comfort noise when this occurs. This conserves network resources.

Settings available on all ports

## 8.7 Port settings

- Label: Clicking/touching the blue label header will allow you to change the name of the port. Enter the new name and click the blue check mark to apply changes.
- Multi-Channel support: Enabled/**Disabled**. Enable this option to use the audio source in more than one Channel or direct connection.

## 8.8 VOX (audio-gating)

The VOX setting has several functions:

- VOX can be used to maximise bandwidth efficiency by detecting when the line is silent and not transmitting at those times.
- VOX can be used to trigger a Network Control Event (used for sending and receiving GPIO signals) when audio is detected in the Channel.
- VOX can be used to eliminate unwanted noise, for instance, low level ambient or background noise.
- VOX mode: **Disabled**/Fixed Threshold/Adaptive.

If Disabled, VOX is not activated and Network Control Events cannot be configured. Audio is still detected in the Channel, so audio light will show.

Fixed Threshold: triggers VOX detection (audio gating) according to a fixed level . Enabling this option automatically enables **Threshold** and **VOX Delay**.

Adaptive: sets the audio trigger according to an automatically calculated 'noise floor'. This option implements comfort noise when silence is detected. Only the Off Delay option is activated with this setting. The Adaptive threshold is not suitable for transmitting music.

- VOX Off Delay: **0.5** to 4 seconds. Delays the deactivation of the noise gate to allow the signal to stabilize.
- VOX Threshold: 0 to -42 dB (default = **-22 dB**). Set the level at which audio is considered valid in the Channel.

## 9 Network settings (IP)

---

### 9.1 Dynamic Host Configuration Protocol (DHCP)

The default method for LQ devices to obtain an IP address is DHCP.

Most networks allocate IP addresses using DHCP.

### 9.2 DHCP or Static IP addressing?

DHCP can be used for quick set-up and the units will work with DHCP IP addressing. However, the address provided by DHCP are dynamic and can change, so in some cases it is better to allocate static IP addresses to ensure a completely stable system.

A static IP address is generally recommended for the Link-Master, while the Link Members should use DHCP.

If there are additional Port Forwarding rules created in the firewalls that enable external connectivity to the Link-Members as well as the Link-Master the Link-Member units should also be given static IP addresses.

See **Linking over Internet or WAN on page 60**

### 9.3 Static IP configuration

DHCP is not recommended for the Link-Master and is not recommended for units linked to the master in some situations.

In these cases you will allocate the network settings statically. To do this, navigate to: **Device > Network** in the Core Configuration Manager (CCM).

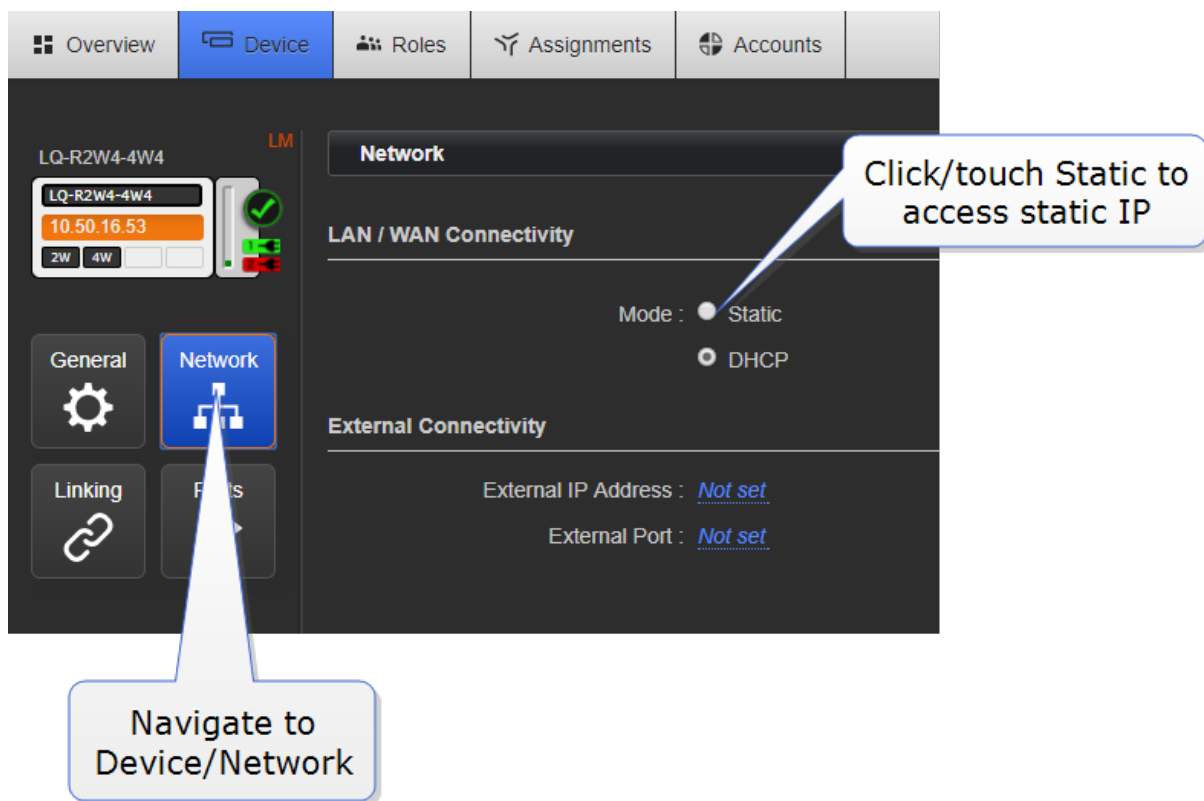

### 9.3.1 Netmask or Subnet

The netmask or subnet divides the network into sectors for more efficient routing and is required when allocating a static IP address to an LQ device.

### 9.3.2 Gateway

This setting is required when traversing across internets.

For more information, see:

**Linking over Internet or WAN on page 60**

## 9.4 Link-local environments

- Any networked device will enter link-local mode if it is set to DHCP and no DHCP server is detected on the network.

### Link-local mode

- If both the laptop and the LQ device are in DHCP mode, they will revert to link-local when connected. This means they can communicate with one another as they are both on the same subnet (169.254.xx.xx).

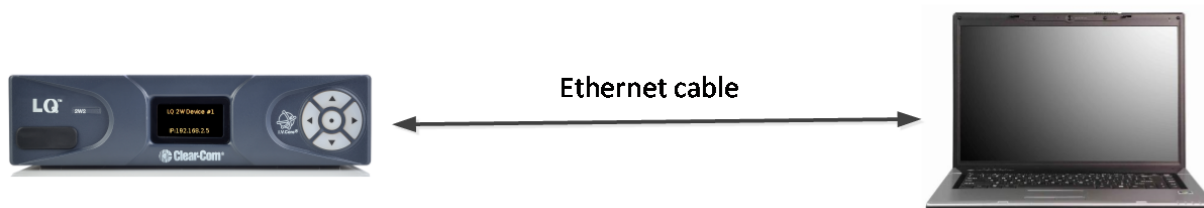

### 9.4.1 What is link-local?

A link-local address is an IP address within the local segment of any network. Routers do not pass information to these as link-local addresses are not guaranteed to be unique beyond a single network segment. When first connected to a network, your LQ device will attempt to get an IP address via Dynamic Host Configuration Protocol (DHCP). If no DHCP server is available the unit will automatically enter link-local IP mode. A link-local IP address will take the form: 169.254.xxx.xxx.

## 9.5 Accessing an LQ unit when in link-local mode

To access the CCM of an LQ unit in link-local, you must connect to it from a PC that is also in link-local mode.

Devices will revert to link-local mode if they are configured to DHCP and fail to find a DHCP address on the network or device they are attempting to connect to. A PC can be put into link-local mode by ensuring it is in DHCP mode and connecting it to the LQ unit that is in link-local with a standard Ethernet cable. The PC will look for a dynamically generated IP address (DHCP), and when it does not find one will enter link-local mode automatically.

Once the PC is connected to the LQ and in link-local mode, you can connect to your LQ unit by opening a browser window on the computer and inputting the unit's IP address (from the front panel display) into the address field. This takes you to the Core Configuration Manager where you can configure the device as usual.



**Note:** *The units will operate in link-local, but for optimum performance it is recommended that they are used with either static or DHCP network settings.*

## 10 Internet connectivity

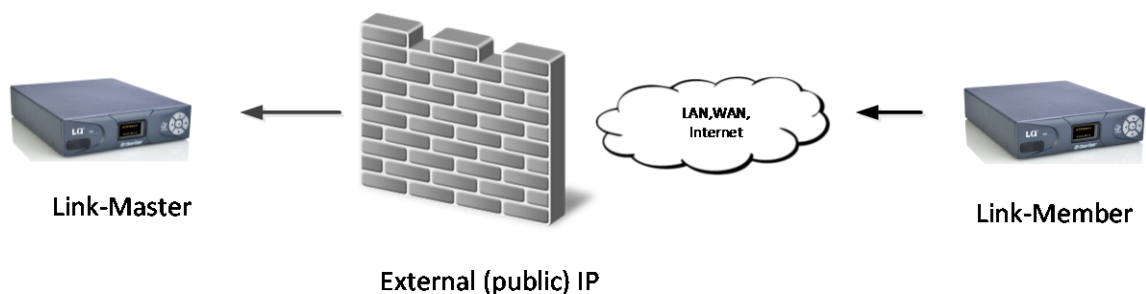

All devices within a Link-Group must have connectivity to the Link-Master on TCP port 80 and TCP/UDP port 655. When linking devices over the Internet, make sure that this connectivity is stable. Internet connection to an LQ device requires special configuration within your firewall (port-forwarding).

**Note:** *LQ devices cannot connect using the Internet if they have a HelixNet Main Station as link master.*

### 10.0.1 Getting an external IP address

When networking LQ devices over the Internet, an external IP address from which the Link-Master is reachable is required as a first step in making sure Link-Members can get to the Link-Master. The external (public) IP address must be static and non-changing. Normally an Internet Service Provider (ISP) will provide external addressing in Dynamic Host Configuration Protocol (DHCP) mode. This is not guaranteed to remain static but instead may change periodically. This will cause linking issues as the Link-Members will not be able to reach the master if the IP address changes. Therefore, it is suggested that you purchase a static address from your ISP. Failure to do this could result in a loss of service.

### 10.1 Port-forwarding

To connect to an LQ unit that is behind a firewall, certain ports must be mapped from your firewall to the LQ device. This mapping will forward traffic received on those ports from the Internet directly to the LQ unit.

- The Link-Group uses TCP port 80 for linking, data distribution and browser-based management.
- The Link-Group uses port 655 (TCP and UDP) for group connectivity and audio transmission.

For more information, see **Linking over Internet or WAN on page 60**

## 11 Clear-Com Eclipse matrix connections

Each LQ unit (LQ 3.0 and above) can support up to 8 IVC-32 ports, as well as its own hardware ports.

- Up to 8 IVC-32 ports per LQ device
- Up to 32 IVC-32 ports per Link-Group
- IVC-32 ports are generated in the **External Systems** page in the CCM
- All ports, LQ hardware ports and IVC-32 ports can then be used in the LQ Channels to transmit audio, Call and GPIO signals.

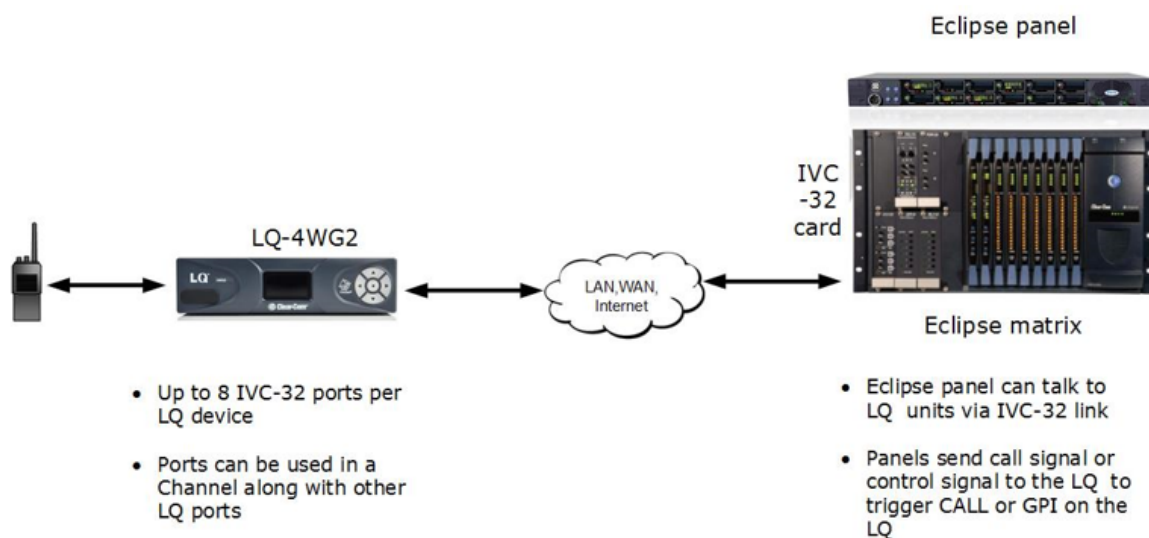

Each LQ-R unit supports up to 24 ports: 8 hardware ports, 8 SIP ports and 8 virtual ports. Agent- IC and IVC ports are considered 'virtual ' ports. Virtual ports can be used in any combination up to 8 in total.

### 11.1 How to create virtual ports and connect to a matrix

#### 11.1.1 General outline

Both matrix and LQ must be connected to a network and able to reach each other across the network settings.

To set up this connection:

- Define port slots on the IVC-32 in the EHX configuration software
- Define IVC-32 virtual ports in the External Systems page of the Core Configuration Manager (CCM) and connect to the IVC-32
- Put required ports together in a Channel
- Program audio and GPIO relays if required.

## 11.1.2 Program the EHX software

In EHX, program the ports you want to connect to.

Program ports in EHX. Navigate to **EHX>Cards and Ports**.

**1. Cards and Ports**

**2. Select IVC card from drop-down list**

**3. Select LQ from drop-down list, input label and description**

**4. Input User ID and Password**

Port Number	Port Function	Label	Description
3.1 (17)	LQ		LQ Direct
3.2 (18)	LQ SIP	IVC_SIP#2	LQ SIP client
3.3 (19)	Empty		
3.4 (20)	Empty		
3.5 (21)	Empty		
3.6 (22)	Empty		
3.7 (23)	Empty		
3.8 (24)	Empty		
3.9 (25)	Empty		
3.10 (26)	Empty		
3.11 (27)	Empty		
3.12 (28)	Empty		
3.13 (29)	Empty		
3.14 (30)	Empty		
3.15 (31)	Empty		

When you have set up the new ports, you must **Apply changes to Matrix**.

Find IVC32 card IP address.

The 'Cards and Ports' window shows four card slots. Slot 3 is occupied by an IVC-32 card. A callout bubble points to the IVC-32 card with the text 'Double click for IP address'. The 'IVC-32 Card Properties' window displays the following information:

IVC-32 Card Properties	
TCP/UDP Port:	6001
IP Address:	10.50.17.7
Subnet mask:	255.0.0.0
Default gateway:	255.255.255.255
External IP Address:	10.50.17.7
External TCP/UDP Port:	6001

### 11.1.3 Program the LQ CCM

In the LQ Core Configuration Manager (CCM), create the IVC-32 card, and enter the TCP/IP address and port of the IVC-32 to be connected to.

How to create IVC-32 card slots in the CCM.

The CCM interface shows the 'IVC Devices' configuration page. The 'Device Settings' section includes the following fields:

- Label: IVC 1
- IP / Hostname: 10.50.17.7
- IP Port: 6001

The 'Ports Settings' section shows a table with the following data:

#	Label	User ID	Pa	Status
A1	<u>IVC#1</u>	<u>matrixSIP2</u>	<u>pa</u>	

Callouts provide the following instructions:

- Click to create IVC-32 card slot (points to the '+' button in the IVC Devices list).
- Click to name IVC-32 card slot (points to the 'Label' field).
- Input IP address of IVC-32 card to be connected to (find in EHX software) (points to the 'IP / Hostname' field).
- Input IP port of IVC-32 card to be connected to (points to the 'IP Port' field).

## 11.1.4 Create 'virtual' ports in the CCM

Next, you need to create a port, or ports for the card. You must have to hand **User ID** and **Password** that you entered into the EHX interface.

The screenshot shows the 'Accounts' tab in the Clear-Com interface. Under 'IVC Devices', there is a device named 'A IVC 1' with a green plus icon next to it. Below this, the 'Device Settings' are listed: Label: IVC 1, IP / Hostname: 10.50.17.7, and IP Port: 6001. Under 'Ports Settings', there is a table with columns: #, Label, User ID, Password, LQ Assignment, and Status. A green plus icon is in the first column of the table. A callout bubble points to the plus icon with the text 'Click to create a new port'.



When the LQ is connected to the IVC-32 card, a green status LED shows. If the connection is not successful, a yellow warning displays. Click the yellow warning symbol for information.

## 11.1.5 Put new ports into a Channel.

Once ports are created, they can be seen in the **Assignments** page and put into Channels.

Once a virtual port is associated to an LQ device you can adjust the port setting. Click the cog icon to go straight to **Ports** page.

If you want to pass GPIO controls over the network using LQ you must program Network Control Events. See **What are Networked Control Events and how do I use them? on page 83**

## 12 What are Networked Control Events and how do I use them?

### 12.1 About Networked Control Events

Networked Control Events are used to program input and output triggers (GPIO) in your intercom system. They are designed to allow maximum flexibility and scalability in your use of GPIO events.

For example, Networked Control Events can be used to enable radio communication over IP, or send a control signal from a panel, via a matrix to a radio. The GPIO can also be used to turn on an 'on-air' light, or perform any other function you require.

A Networked Control Event occurs when the input trigger and the output trigger on ports in a Channel are set to the same value.

Active Networked Control Events can be viewed in the **Assignments** page in the CCM.

Networked Control Events

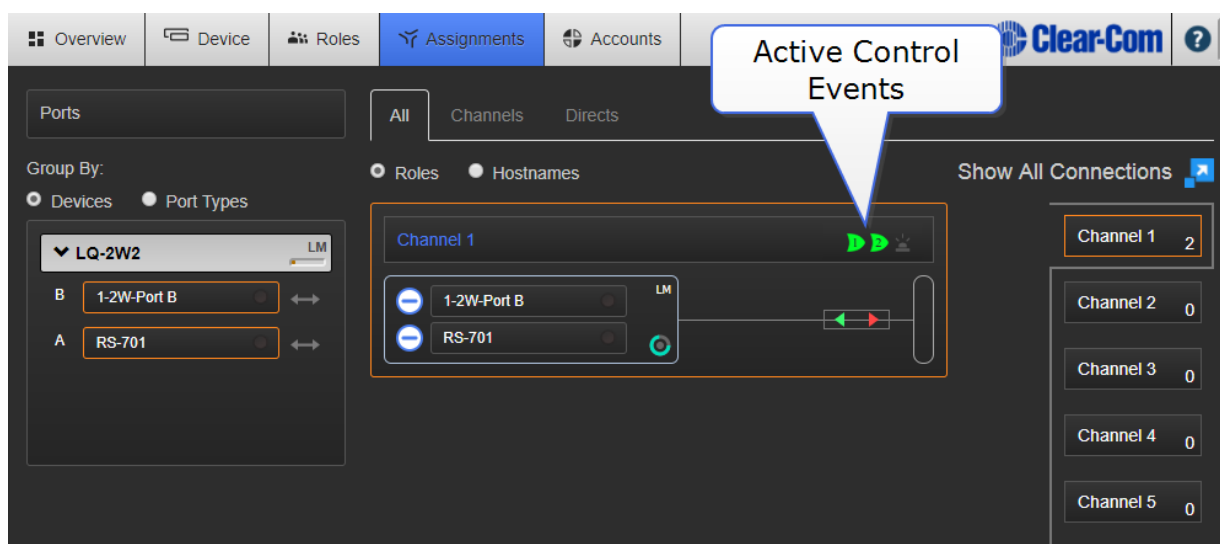

### 12.2 How to set up Networked Control Events

1. Configure the input trigger on a port. This example shows audio entering a 4-wire port (VOX) on an LQ 4W2 device that triggers the output relay on an LQ GPIO device.

Overview | Device | Roles | Assignments | Accounts | Clear-Com

LQ-R2W4-4W4

Audio Ports

2-Wire

A  RS-701

B  1-2W-Port B

C  1-2W-Port C

D  1-2W-Port D

4-Wire

E  1-4W-Port E

F  1-4W-Port F

G  1-4W-Port G

H  1-4W-Port H

Port Settings

Label: 1-4W-Port E

Multi Channel Support: Disabled

Input Gain: 0 dB

Output Gain: 0 dB

VOX

VOX Mode: Adaptive Threshold Status

VOX Off Delay: 0.5 sec

VOX Threshold: Not set

VOX Action Triggers: Control Event 1

4-Wire

Port Function: to Matrix

Baud Rate: 19200 (Eclipse)

VOX mode must be set to **Adaptive** (default) or **Fixed Threshold** before Control Events can be set

Set to Control Event 1

2. Configure the output (GPO) on a port.

Overview | Device | Roles | Assignments | Accounts | Clear-Com

LQ-4WG#4

Audio Ports

4-Wire + GPIO

A  4-4W-Port A

B  4-4W-Port B

IVC

A1  Iqalex3

SIP

A1  AlexSIP

Port Settings

Label: 4-4W-Port A

Multi Channel Support: Disabled

Program Output Enabled: Mute

Input Gain: 0 dB

Output Gain: 0 dB

Output Level: Line Level (0 dB)

RX Call Signal: Disabled

VOX

VOX Mode: Adaptive Threshold Status

VOX Off Delay: 0.5 sec

VOX Threshold: Not set

VOX Action Triggers: Disabled

GPIO

GPI Action Triggers: Disabled Status

GPO Triggered By: Channel Event 1 Status Test

GPO Off Delay: None

VOX mode set to Adaptive Threshold

GPO set to Control Event 1

3. Put both ports together in a Channel . This activates a Networked Control Event when an input and an output Networked Control Event setting match. A GPO is then fired.



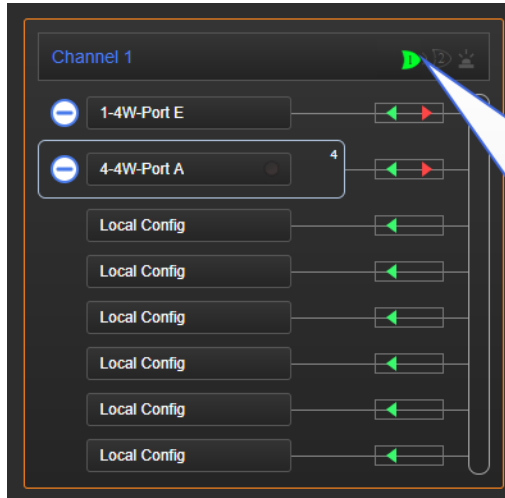

When audio triggers the VOX on Port E, Port A will fire a GPO. The **Network Control Event** icon lights when this happens.

## 12.3 Examples of when to use Networked Control Events

### Example 1. VOX trigger

#### LQ Networked Control Event Example

(VOX input trigger)

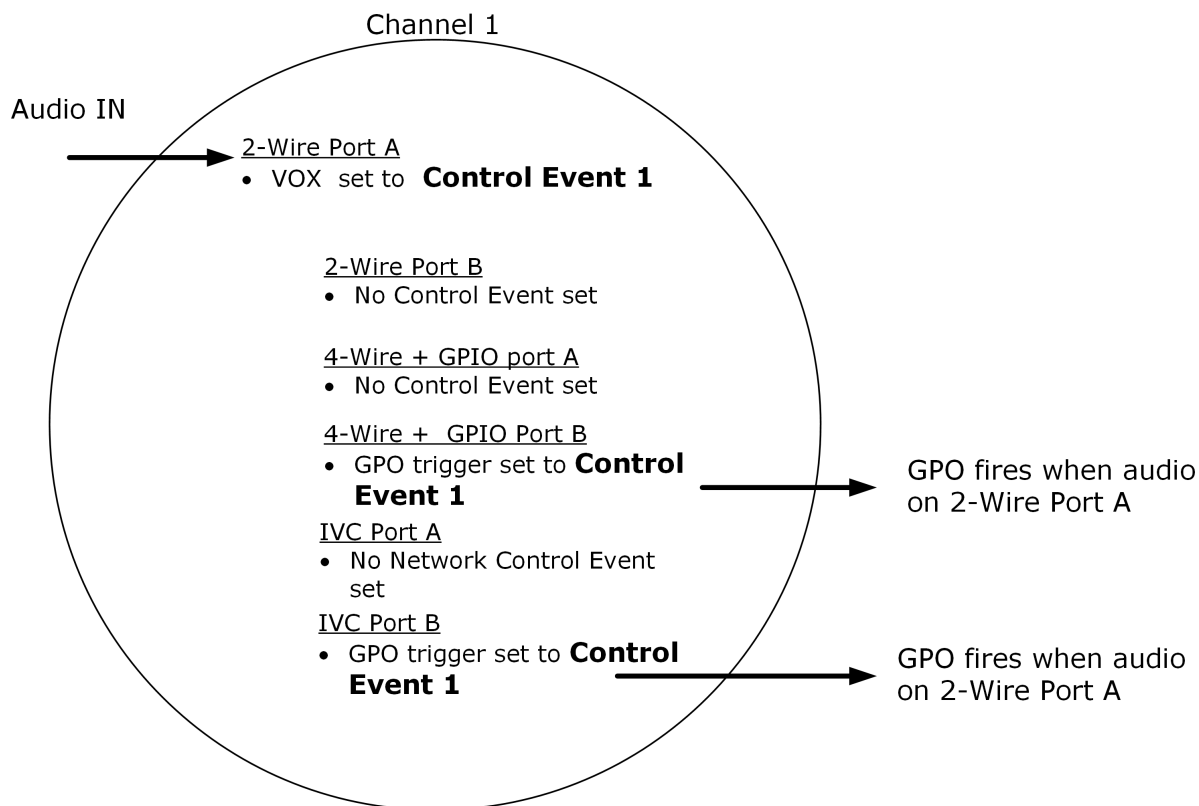

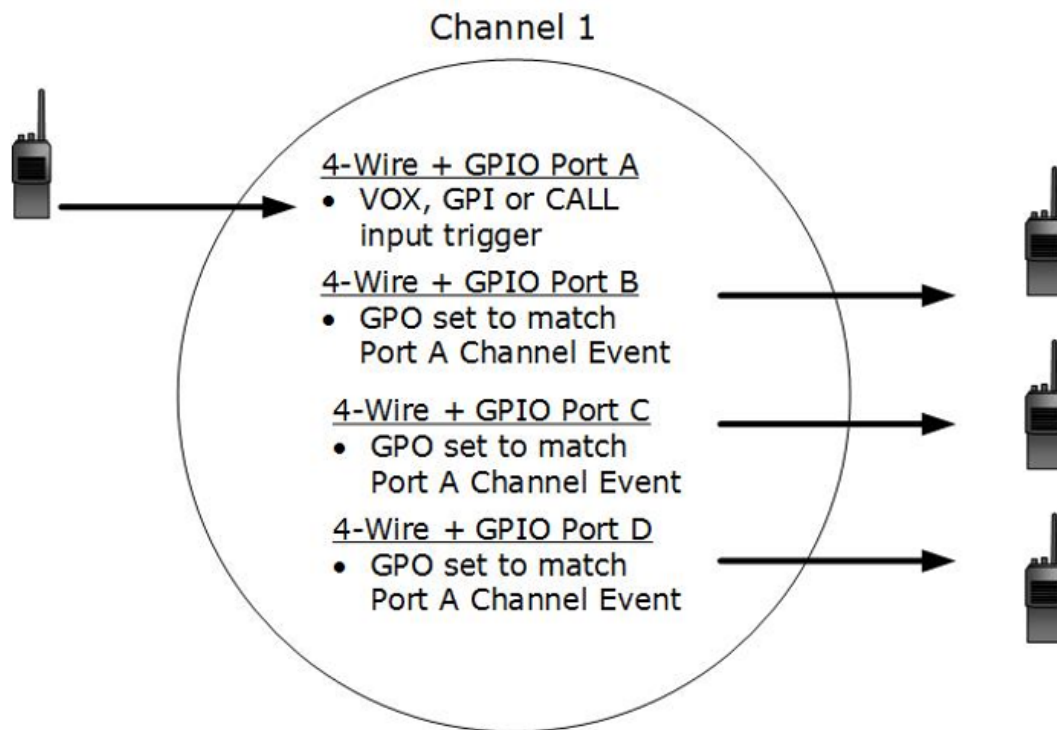
**Example 2. One-to-many**

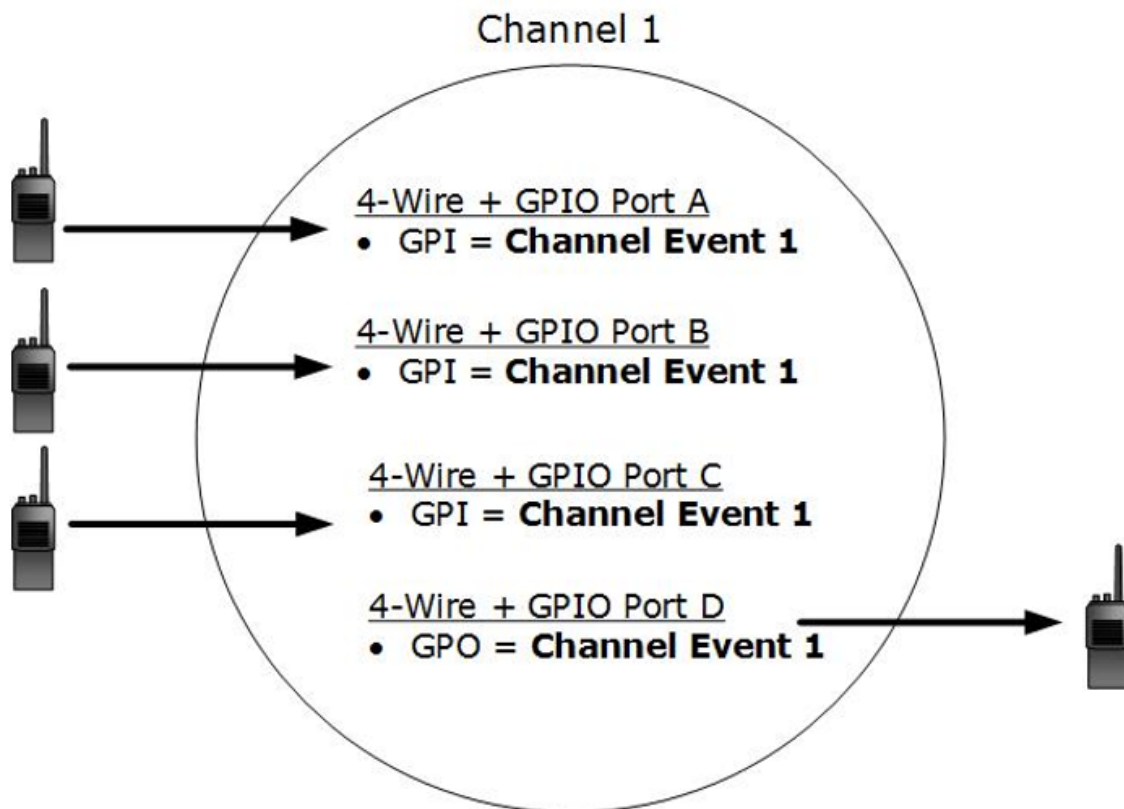
**Example 3. Many-to-one**

**Example 4. Call Event trigger. Passing call signals using GPIO**

**LQ Networked Control Event Example**

(Call signal input, automatic call propagation)

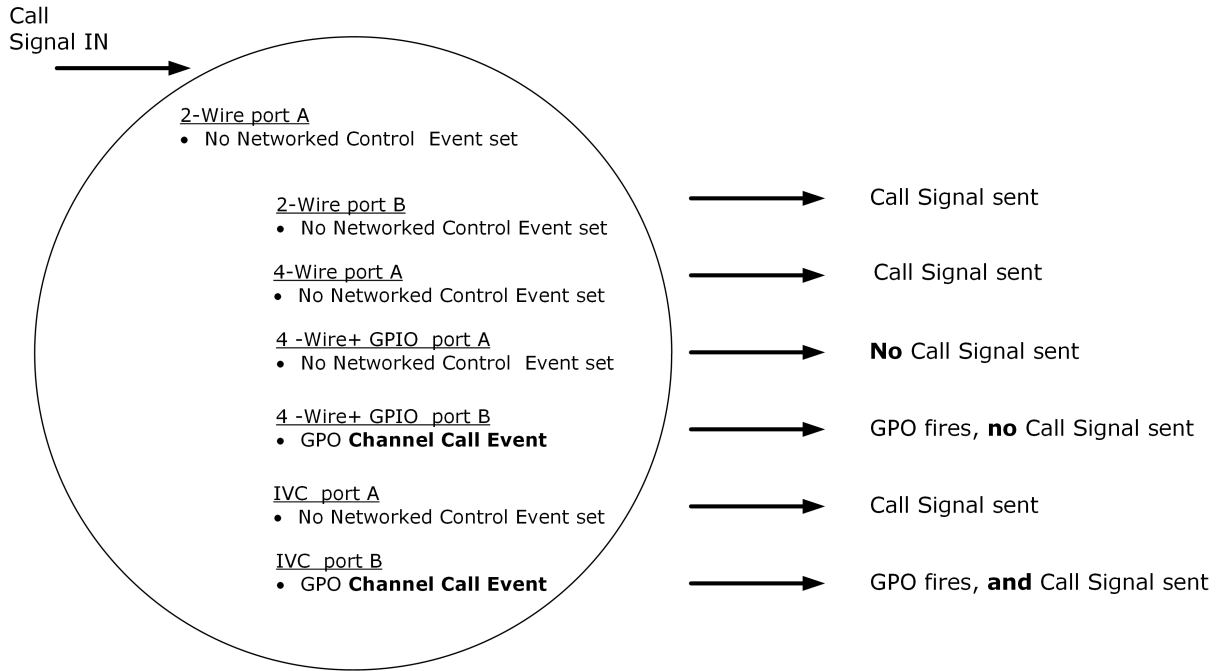

**Note:** Call signals are automatically propagated to all members of a Channel when using LQ so a GPI trigger is unnecessary. However, a GPIO interface will not send a call signal trigger unless a GPO Call Channel event is set on that port.

12.4 Types of GPI (input) trigger

4 LQ port types	Available GPI (input) trigger
LQ 2-Wire	1. Call 2. VOX
LQ 4-Wire	1. Call 2. VOX
LQ 4-Wire + GPIO	1. VOX 2. GPI
IVC-32	1. Call 2. VOX 3. GPI

## 12.5 GPIO port pinout

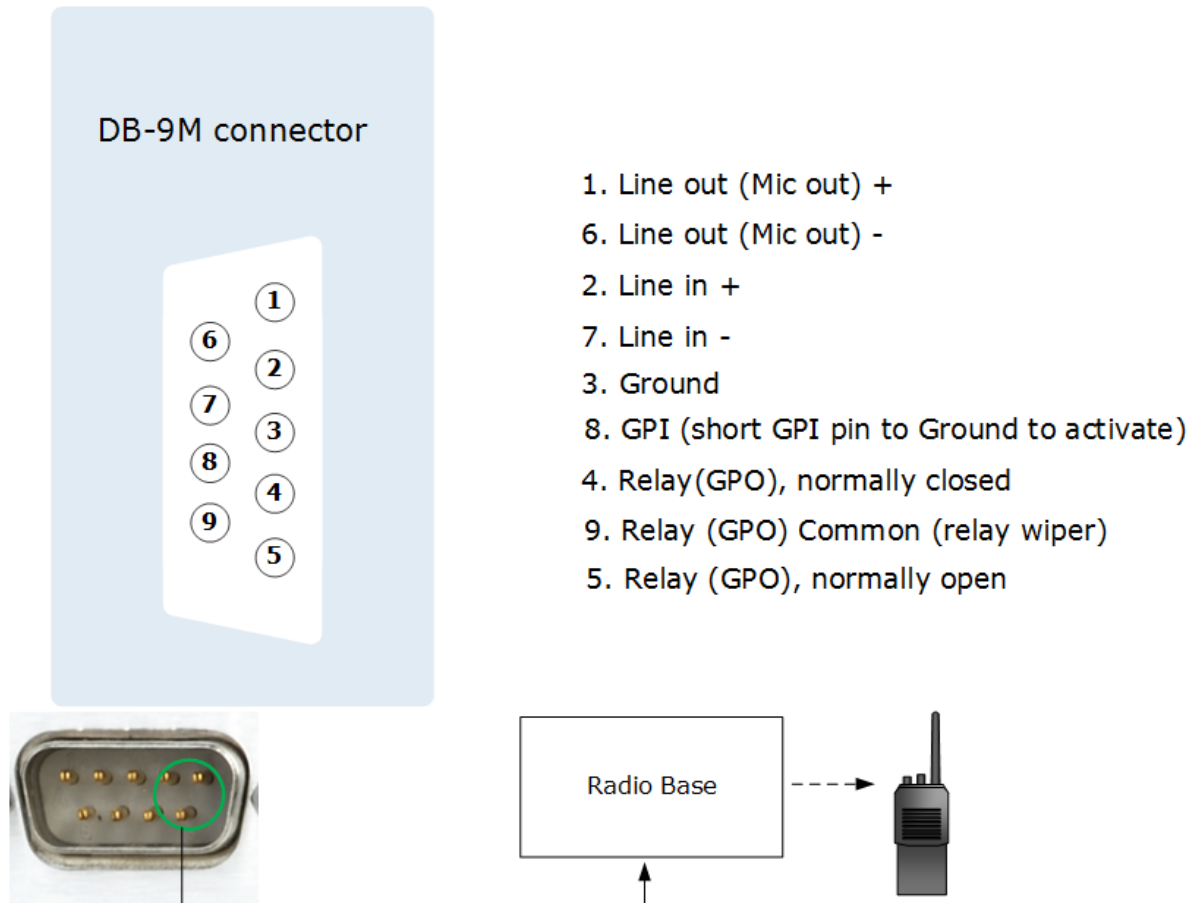

For more information, see:

**GPIO: Examples and step-by-step set up on page 91**

## 12.6 GPIO: Examples and step-by-step set up

### 12.6.1 Setting up a Partyline/2-Wire relay to a radio (VOX trigger).

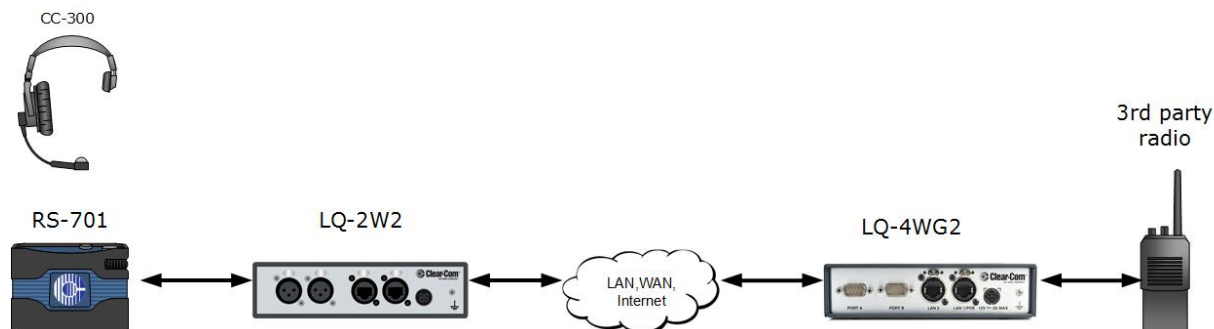

This example shows how to send a GPIO (General Purpose Output) trigger to a third party radio when audio comes in from an Encore RS701 beltpack. This can be used to open audio transmission on the radio; equivalent to pressing the Push To Talk (PTT) button on the radio.

The GPIO is triggered by LQ models that have a GPIO port; LQ-4WG2, GQ-R2WG8 and LQ-R2W4+4WG4.

**Note:** For this configuration Link Group must already be established. See **Creating a Link-Group on page 48** for more information.

### 12.6.2 General set up outline

1. In port settings, on the device and port connected to the beltpack, set the VOX (audio detection) to trigger Network Control Event 1
2. On the device and port connected to the radio, set the GPIO to trigger on Network Control Event 1
3. Bring both ports together into a Channel
4. When audio comes in from the beltpack, the GPIO will fire. You can test this relay using the TEST button.

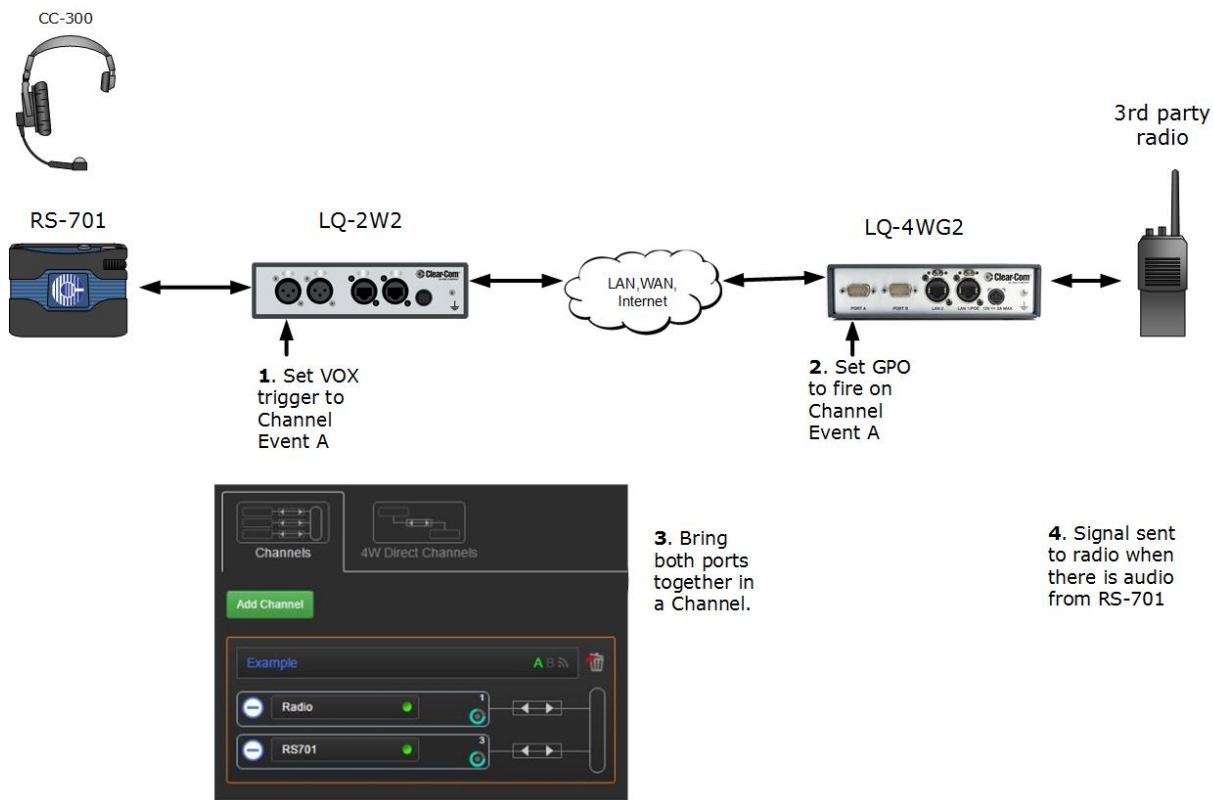

### 12.6.3 Beltpack to radio on VOX trigger

1. Connect the beltpack. For more information, see **Connecting 2-wire equipment on page 143**



2. Set Network Control Events in the CCM (Core Configuration Manager)
  - a. Set beltpack port.

1. Navigate to **Device/Ports** in the CCM of the LQ device that the beltpack is connected to.

2. Select port. Selected port has an orange highlight.

3. Set VOX mode.

4. Select Network Control Event 1

b. Set radio port.

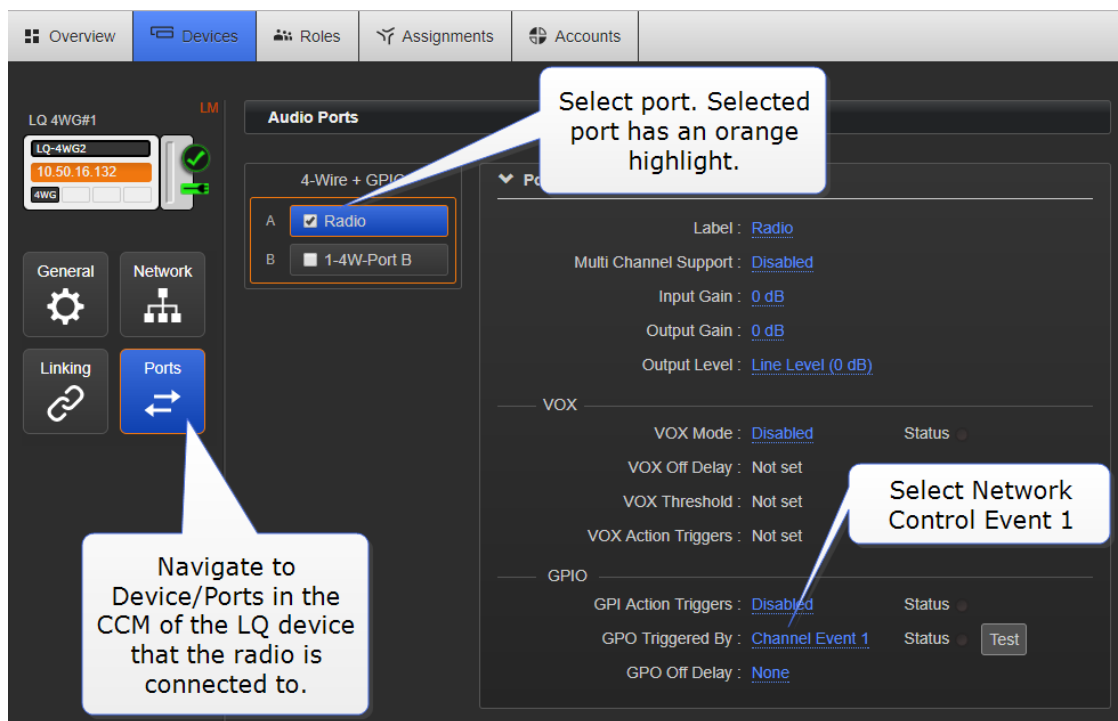
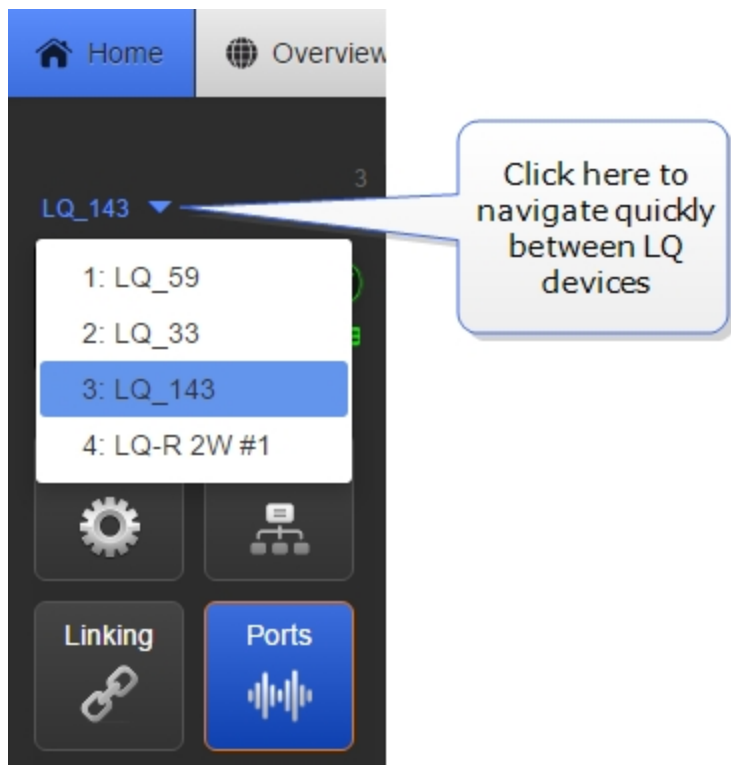

- Once you have set up the ports, navigate to Assignments in the CCM and put ports into a Channel.

The screenshot displays the 'Assignments' page in the CCM interface. It features a navigation bar at the top with 'Home', 'Overview', and 'Assignments'. The main area is divided into several sections:

- Devices:** Lists various radio models like 'LQ 4WG #1', 'LQ-R 2W+4WG#3', and 'LQ-R 4WG#4'. Each model has a list of ports with a '+' icon to add them to a channel and a '-' icon to remove them.
- Channels:** A central area where a channel is selected (e.g., 'Example'). It shows a diagram of a radio and a headset connected to a channel. Callouts explain that clicking '+' adds ports and that Network Control Event 1 will trigger the output to the radio when audio comes in from the headset.
- Channel List:** A vertical list of channels from Channel 1 to Channel 12, each with a status indicator (0 or 2).

Callouts provide the following instructions:

- Navigate to Assignments
- Select Channel (or create a new one)
- Click '+' to put ports into Channel
- Click/touch '-' if you want to remove port from Channel

Note: You will see Event 1 light at the top of the Channel box when the Event is triggered.

**Note:** You will see audio and Network Control Event status LEDs light when audio comes in and triggers Network Control Event 1.

## 12.6.4 2-Wire beltpack to radio on Call button press

This example shows how to set up a Call button press on an Encore 701 beltpack to open communication with a third party radio.

Call signals are automatically passed when using 2-Wire equipment, so no configuration of the beltpack port is necessary when using a CALL to trigger a relay to a radio.

## 12.6.5 Beltpack to radio on Call button press

1. Connect beltpack as above.
2. In the CCM, navigate to the port where the radio is connected (see Step 2.b of Example #1 above). Select **Channel Call Event** on the **GPO trigger**.
3. The output will fire on any Call event in the Channel.

**Note:** You can also set the beltpack to do 'call on talk' by setting dip switch 5 on the beltpack. See RS-701 datasheet available from the Clear-Com website, [www.clearcom.com](http://www.clearcom.com).

## 12.6.6 Setting up a 4-Wire radio GPIO over IP (LAN, WAN, internet)

Show me.

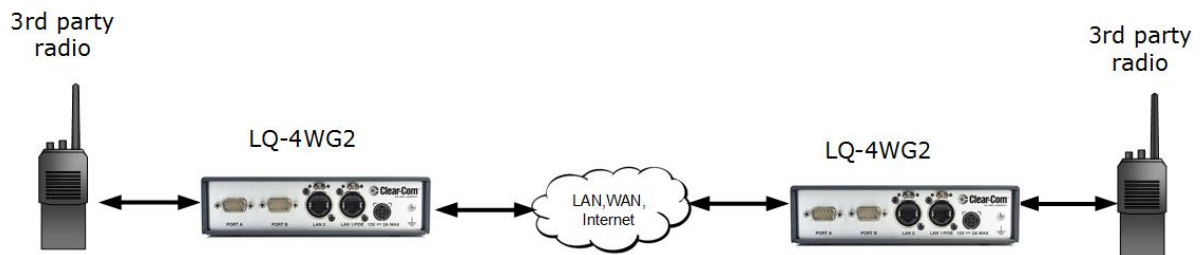

As with the examples above; to program this set up:

1. Configure the GPI and GPO triggers on the ports that the radios are connected to.
2. Bring both ports together into a Channel.

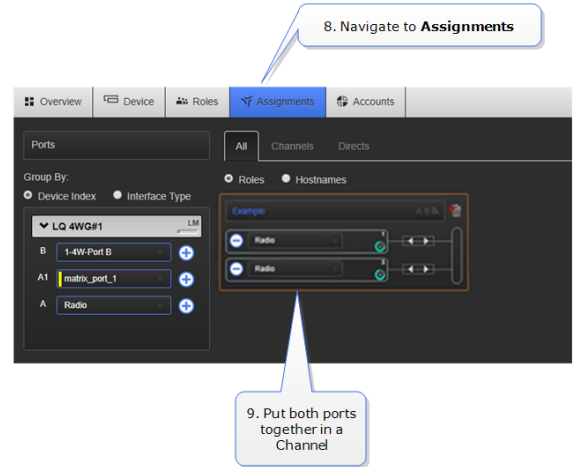
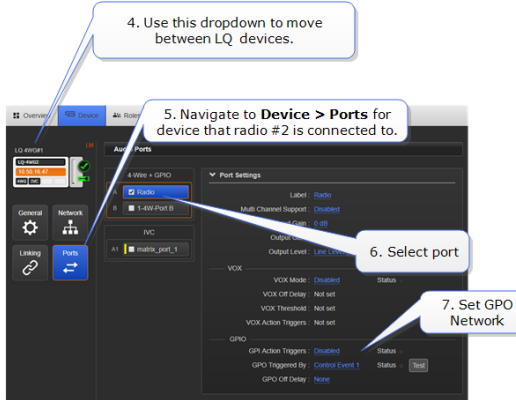
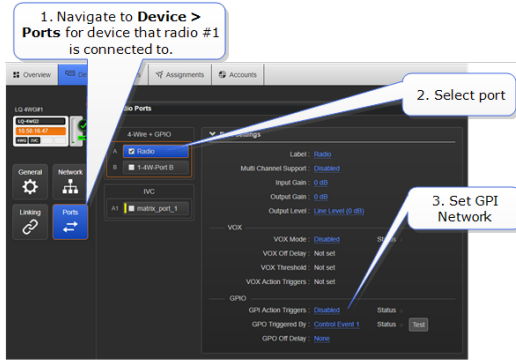

## 13 Session Initiation Protocol (SIP) connectivity

LQ 4.0 and above.

With LQ-SIP you can connect external telephones lines into your intercom system, expanding the reach of your communications.

You must purchase a license to use SIP connectivity. Contact your Clear-Com dealer for more information.

### 13.1 What is SIP?

SIP is an application layer (signaling) protocol defined by the Internet Engineering Task Force (IETF) in 2002. It is used for creating, modifying and terminating sessions for voice, video and instant messaging (IM) for one or more participants.

SIP User Agents

- SIP client: makes and terminates requests
- SIP server: accepts and administrates requests

### 13.2 Examples of LQ-SIP

### 13.3 LQ-SIP standalone

LQ-SIP can be used with 2-wire Partyline equipment to connect an external telephone to your LQ communications system. Use this set up to enable communication between a telephone user and a Partyline headset (or radio) user.

## Assignments page in the Core Configuration Manager (CCM)

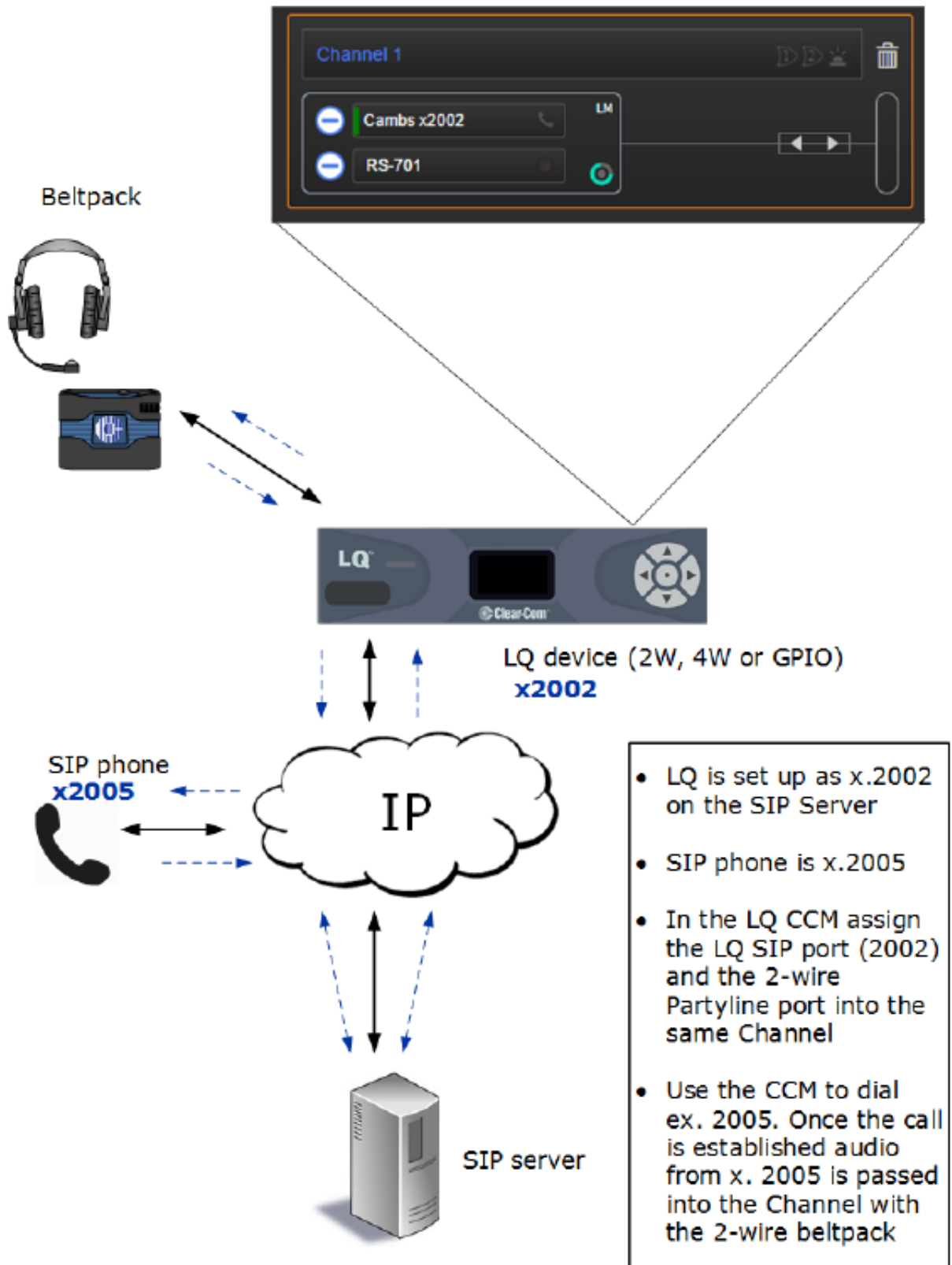

## 13.4 LQ-SIP and Clear-Com Eclipse matrix systems

LQ-SIP can be used to connect a telephone line to your matrix. This allows you to set up communication between a telephone user and a panel user.

**Note:** When connecting LQ-SIP to Eclipse use either a Clear-Com IVC card or a Clear-Com MVX card.

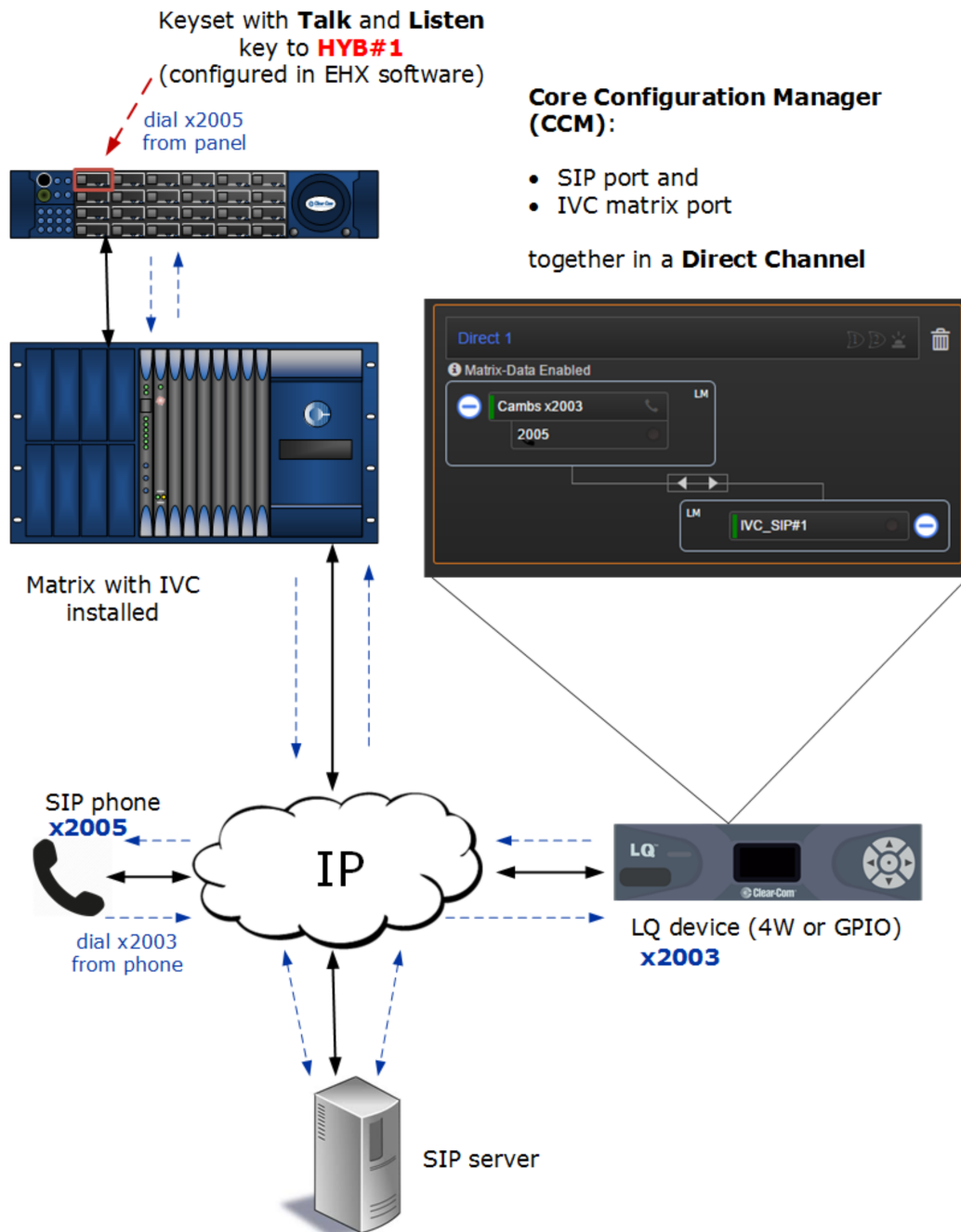



## 13.5 Connecting matrix systems using LQ-SIP (long range)

LQ-SIP can be used to link matrix systems, providing long range panel to panel communications between different systems.

Keyset with **Talk** and **Listen**

key to **HYB#x**  
(configured in EHX software)

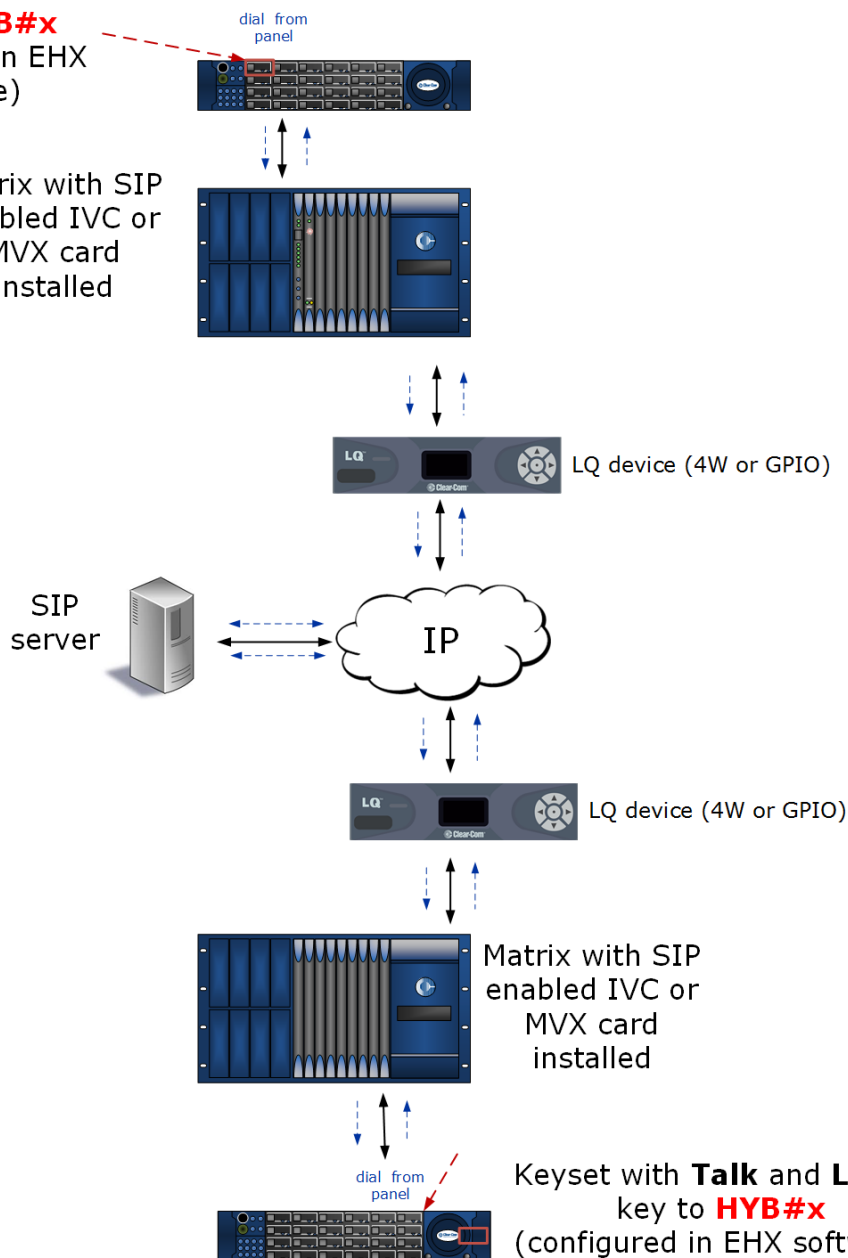

## 13.6 Program LQ-SIP standalone

- Required extension numbers must be set up on the SIP server before you begin. Refer to your SIP server documentation.

- Open the Core Configuration Manager (CCM): input the IP address of the LQ unit (found in the device front panel screen) into the address field of a browser that is on the same network as the LQ unit. Password and Username: **admin, admin**.
- For more detailed information on physically connecting devices, see *Chapter 4. Basic set up (LAN)* in the LQ user manual.
- If you don't have, or have not yet activated a license for SIP, you will not be able to generate SIP ports in the **Accounts** page of the CCM.

### 13.6.1 Set up: General outline

1. The LQ device must be connected to the same network as the SIP server. The LQ unit must be able to see (contact) the SIP server. See your network administrator you have any connectivity problems.
2. Connect the external 4-wire, 2-wire Partyline or radio to a port on the back of the LQ unit.
3. Open the CCM. Navigate to the **Accounts** page and register SIP client(s).
4. Navigate to the **Assignments** page in the CCM and put the SIP enabled port and the external port together in the same **Channel**.

Putting the two interfaces together in a Channel connects and routes audio in a Partyline (conference) setup.

**Note:** *Each LQ-R unit supports up to 24 ports: 8 hardware ports, 8 SIP ports and 8 virtual ports. Agent- IC and IVC ports are considered 'virtual' ports. Virtual ports can be used in any combination up to 8 in total.*

### 13.6.2 Demonstration: Program the CCM

1. Navigate to the Accounts page of the CCM and define the SIP server.

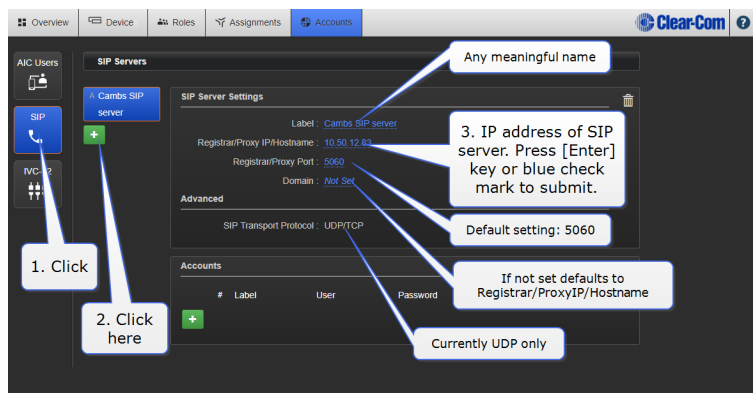

**Note:** You need to configure the **Domain** setting if your PBX is set up to work with more than one domain. Configuring the domain in the CCM is recommended as the PBX may have only one domain, but this can change. Please refer to your network and PBX administration if you need advice on this.

2. Register SIP clients. Give the LQ unit the **Username** and **Password** of an extension already set up in the SIP server. Assign this user extension to an LQ unit to register the client with the LQ. Register up to 8 SIP clients on each LQ device.

1. Click green '+'

Any meaningful name

2. User id and password exactly as in SIP server

3. Choose LQ from dropdown list

4. Click blue check mark to submit

**Note:** If the registration process times out the LQ will re-register. The unit renews registration every 5 minutes.

3. Successful registration is indicated. If registration is not successful, click the registration indicator for information.

4. Once registered to an LQ unit, SIP telephone lines are seen under the device icon in the left side of the **Assignments** page.

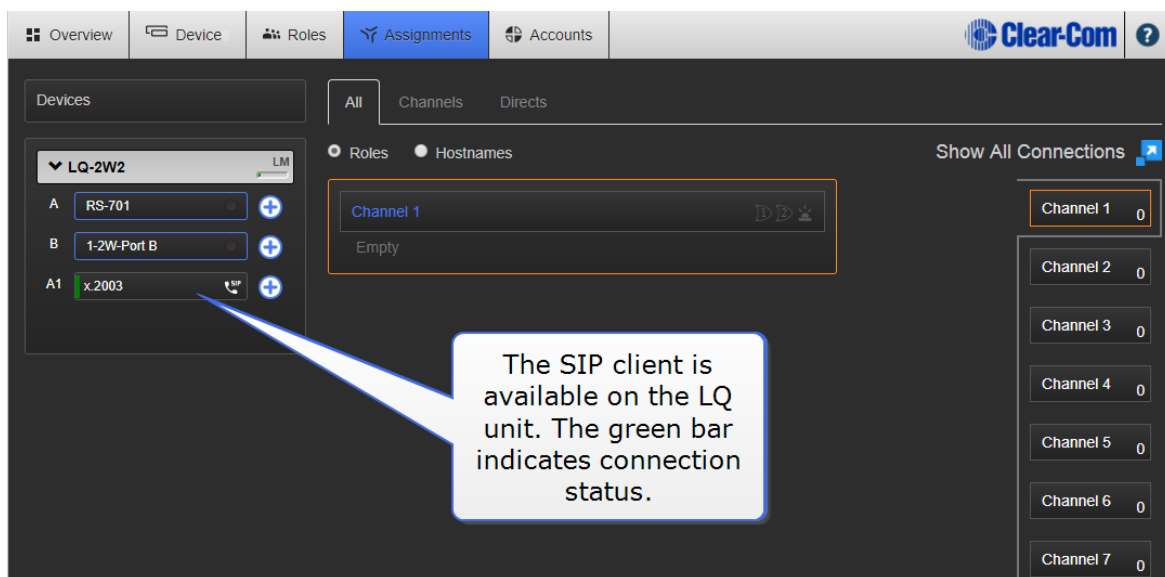

5. Go to the **Assignments** page of the CCM. Bring both the External port and the SIP port together in a **Channel**.

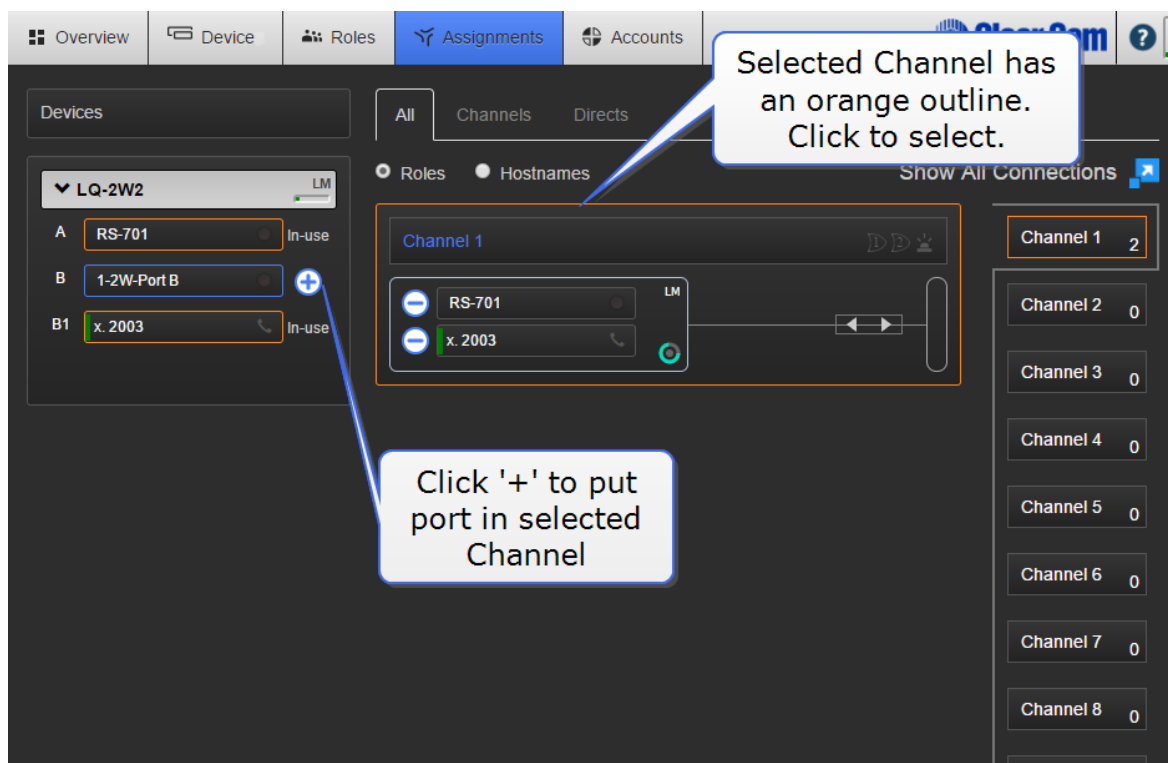

Audio sources are now connected in a Partyline (conference) setup. You can dial into Channel 1 from an external phone and dial out from Channel 1 using the CCM.

### 13.6.3 Making and accepting calls: LQ SIP standalone

**Note:** *The SIP enabled port MUST be put in a Channel before you can make and accept calls.*

1. Accept incoming calls:
  - a. If an external user (for example x.2005) dials into the LQ-SIP line then the LQ unit will auto-answer and establish the call. Audio will then pass between all members of the Channel associated with the SIP line.
  - b. The CCM will show the incoming caller number.
  - c. The CCM user can hang up the call by selecting the phone icon and hanging up.
2. Use the CCM to dial out:

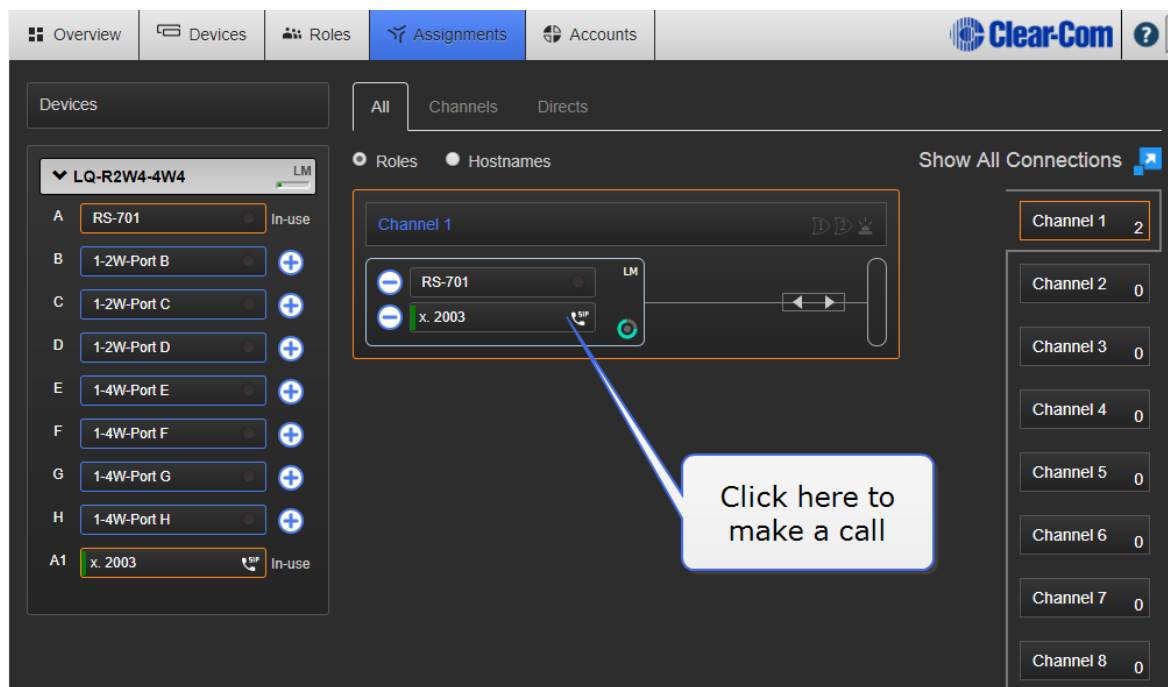

- a. Type in the dial-out window the phone number or address of the telephonenumber/extension you want to reach.
- b. Once the call is established, audio will pass between all members of the Channel associated with the SIP line.
- c. The CCM will show the dialed phone number.

- d. The CCM user can hang up the call by selecting the phone icon and hanging up.

**Note:** *SIP calls can also be hung up (ended) from the LQ device front panel menu.*

**Note:** *You can define as many SIP clients as you need, but only 8 can be registered (connected to an LQ device) at any one time.*

**Note:** *SIP line connection status bars: green; connected, yellow; connecting, connections pending.*

**Note:** *You will see a VOX light in the **Assignments** page. This lights green when audio is coming from a port.*

## 13.7 Program LQ-SIP and Clear-Com Eclipse

Connect a SIP telephone to your matrix.

When routing audio between LQ SIP and Eclipse, always use a **Direct Channel** in the LQ CCM setup.

- The Eclipse matrix must have EHX version 9.1 or later installed
- Connect via an MVX card: connect the MVX card and the LQ unit directly using a Cat5/6 cable
- Connect via an IVC (IP) card: LQ unit, matrix IVC card and SIP server must all be connected to the same IP network
- The LQ unit must be connected to the same network as the SIP server. The LQ unit must be able to see (contact) the SIP server, see your network administrator if you have any connectivity problems.

**Note:** *Each LQ-R unit supports up to 24 ports: 8 hardware ports, 8 SIP ports and 8 virtual ports. Agent- IC and IVC ports are considered 'virtual' ports. Virtual ports can be used in any combination up to 8 in total.*

Example setup:

### 13.7.1 General Outline

1. In the Eclipse Software, the matrix IVC port is setup as LQ SIP.
2. Create an IVC port in the LQ CCM to connect back to the Eclipse matrix IVC card.
3. The LQ unit is setup as x. 2003 on the SIP server.
4. A SIP phone is setup as x. 2005 on the SIP server.

5. In the LQ CCM assign the LQ SIP port (x.2003) and the LQ IVC port into a **Direct Channel**.
6. From the V-series panel select the HYB#1 key and dial '2005' (speed dial or keypad). The IVC card will send the dialed digits to the LQ unit which will dial x. 2005. Once the call is established audio will pass from x. 2005 to the LQ to the



IVC to the panel.

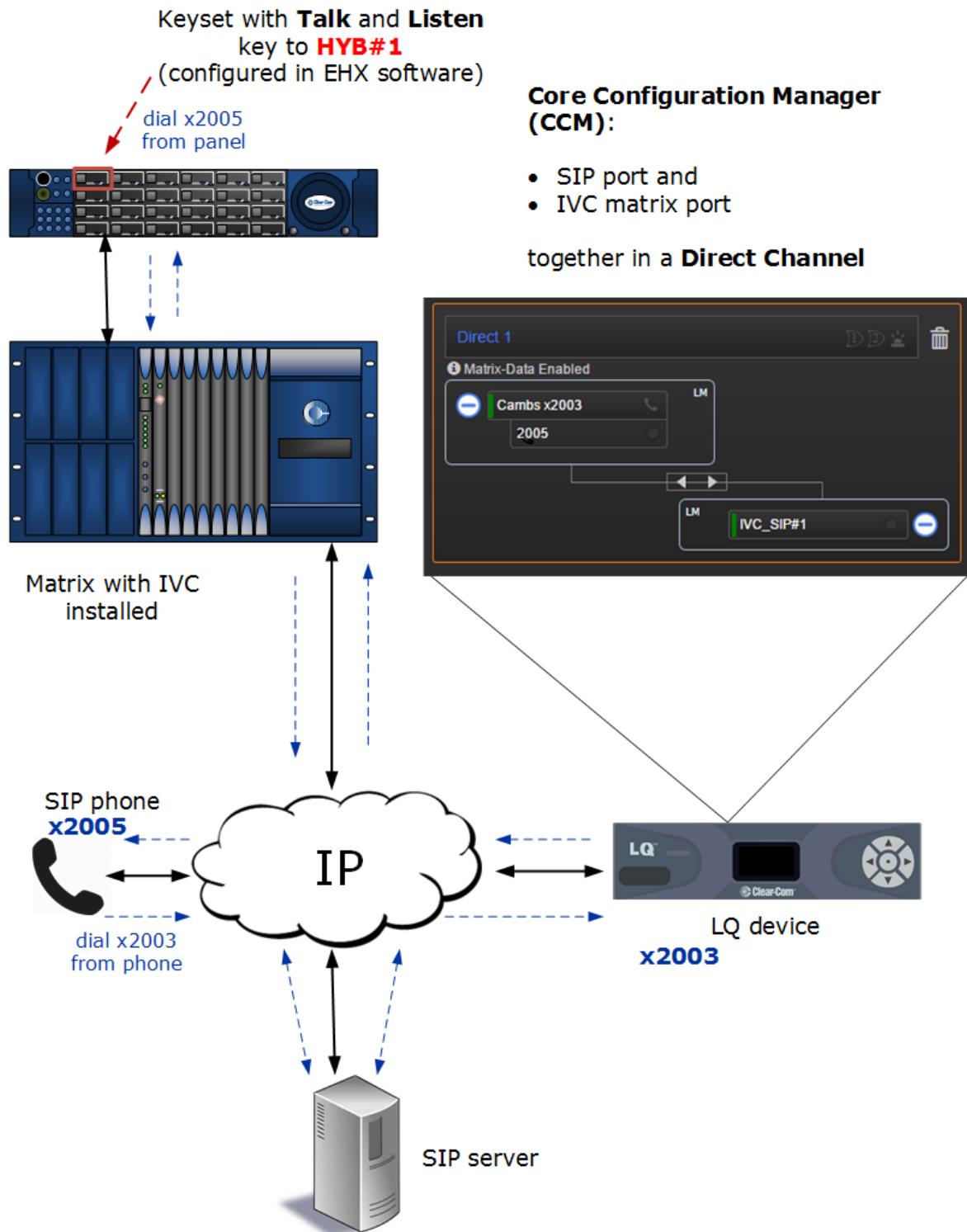

**Core Configuration Manager (CCM):**

- SIP port and
- IVC matrix port

together in a **Direct Channel**

## 13.7.2 Configure the EHX software

1. Program **Card and Ports**.

- a. In the EHX software, navigate to Hardware > **Cards and Ports**.

1. Click to select card, IVC or MVX

2. Click to select **LQ SIP** port function from dropdown list

3. Set **User ID** and **Password**. Make a note of these for configuration of LQ device.

4. Click **Off Hook Tally**

Port Number	Port Function	Label	Description
3.1 (17)	LQ SIP	LQ_SIP#1	LQ SIP Client
3.2 (18)	LQ SIP	LQ_SIP#2	LQ SIP Client
3.3 (19)	LQ SIP	LQ_SIP#3	LQ SIP Client
3.4 (20)	LQ SIP	LQ_SIP#4	LQ SIP Client
3.5 (21)	LQ SIP	LQ_SIP#5	LQ SIP Client
3.6 (22)	LQ SIP	LQ_SIP#6	LQ SIP Client
3.7 (23)	Empty		
3.8 (24)	Empty		
3.9 (25)	Empty		
3.10 (26)	Empty		
3.11 (27)	Empty		
3.12 (28)	Empty		
3.13 (29)	Empty		
3.14 (30)	Empty		
3.15 (31)	Empty		
3.16 (32)	Empty		
3.17 (33)	Empty		
3.18 (34)	Empty		
3.19 (35)	Empty		

- b. Make a note of the User ID and Password for each port (exactly as in the EHX software). You will need it to enable the connection between the LQ unit and the matrix card.
- c. Set preferences. Select the **Off Hook Tally** (click checkbox) under **Telephone Options** if required.

## 2. Program **Panels**.

- a. In the EHX software, navigate to **Configuration>Panels**.

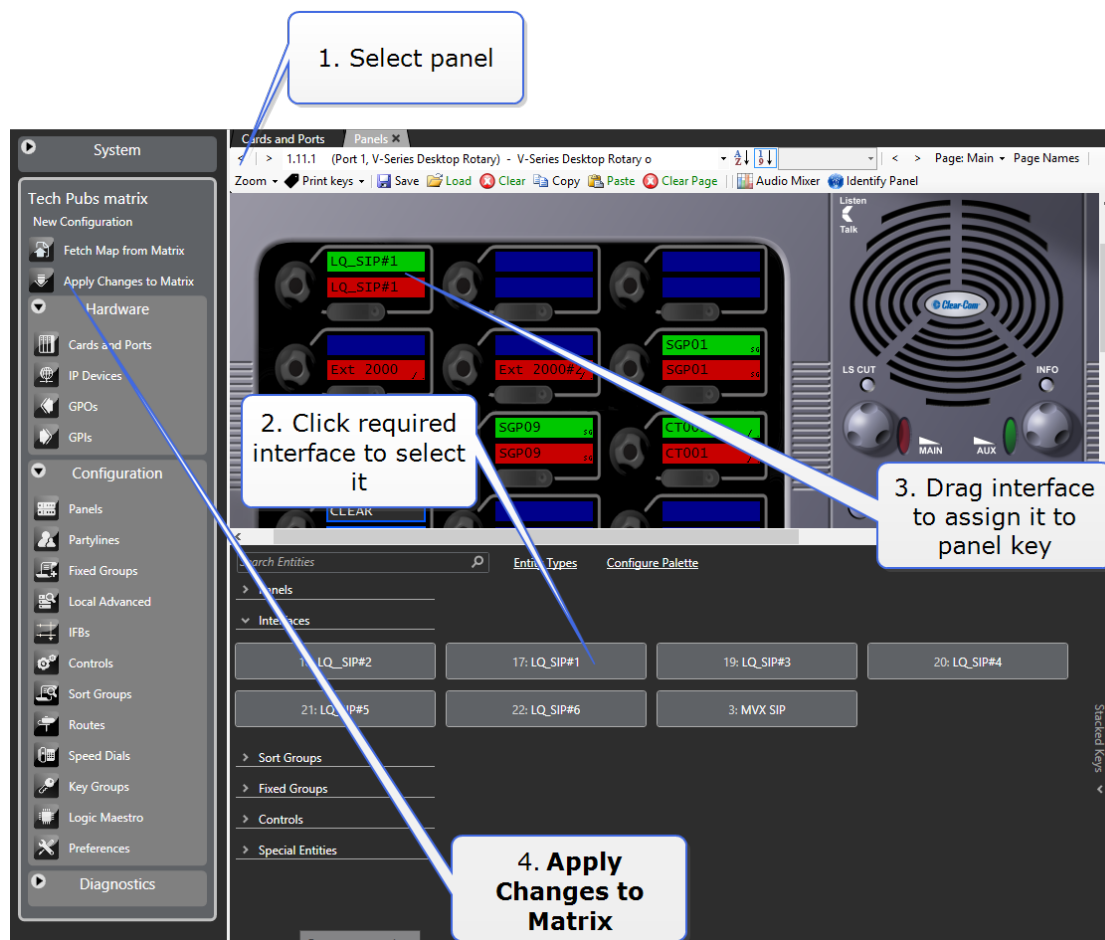

Normally for a telephone conversation you will assign a Talk and Listen to the panel key.

- b. Click **Apply Changes to Matrix** when done.

**Note:** You can dial an external number using the panel keypad. For convenience, you can program a speed dial. See Chapter 17, *Configuring audio and conference routing in the EHX Software User Guide* for more information on setting up a speed dial.

### 13.7.3 Program the CCM

1. Register the LQ unit to the SIP server. To do this, follow steps 1 - 4 in **Demonstration: Program the CCM on page 102**(LQ-SIP standalone section)

2. Generate IVC matrix ports in the CCM. Navigate to the **Accounts** page of the CCM and define the IVC matrix card. Give the LQ unit the IP address of the Eclipse IVC matrix card.

The screenshot displays the 'Accounts' page in the Clear-Com interface. The left sidebar contains 'AIC Users', 'SIP', and 'IVC-32'. The main area is titled 'IVC Devices' and shows a list of devices: 'A IVC 1' (selected), 'B IVC 2', and a green plus sign. The 'Device Settings' section for 'IVC 1' includes a 'Label' field with 'IVC 1', an 'IP / Hostname' field with '10.50.17.7', and an 'IP Port' field with '6001'. A callout box points to the IP field with the text: '3. IVC card IP address here. Press [Enter] key or blue check mark to submit'. Another callout box points to the IP Port field with the text: 'Default: 6001'. The 'Ports Settings' section below is a table with columns: '#', 'Label', 'User ID', 'Password', 'LQ Assignment', and 'Status'. A green plus sign is in the bottom left of this section. A callout box points to the 'IVC-32' icon in the sidebar with the text: '1. Click'. A callout box points to the 'IVC Devices' header with the text: '2. Click '+'.

1. Click

2. Click '+'

3. IVC card IP address here. Press [Enter] key or blue check mark to submit

Default: 6001

3. How to find the Eclipse IVC card IP address in the EHX software.

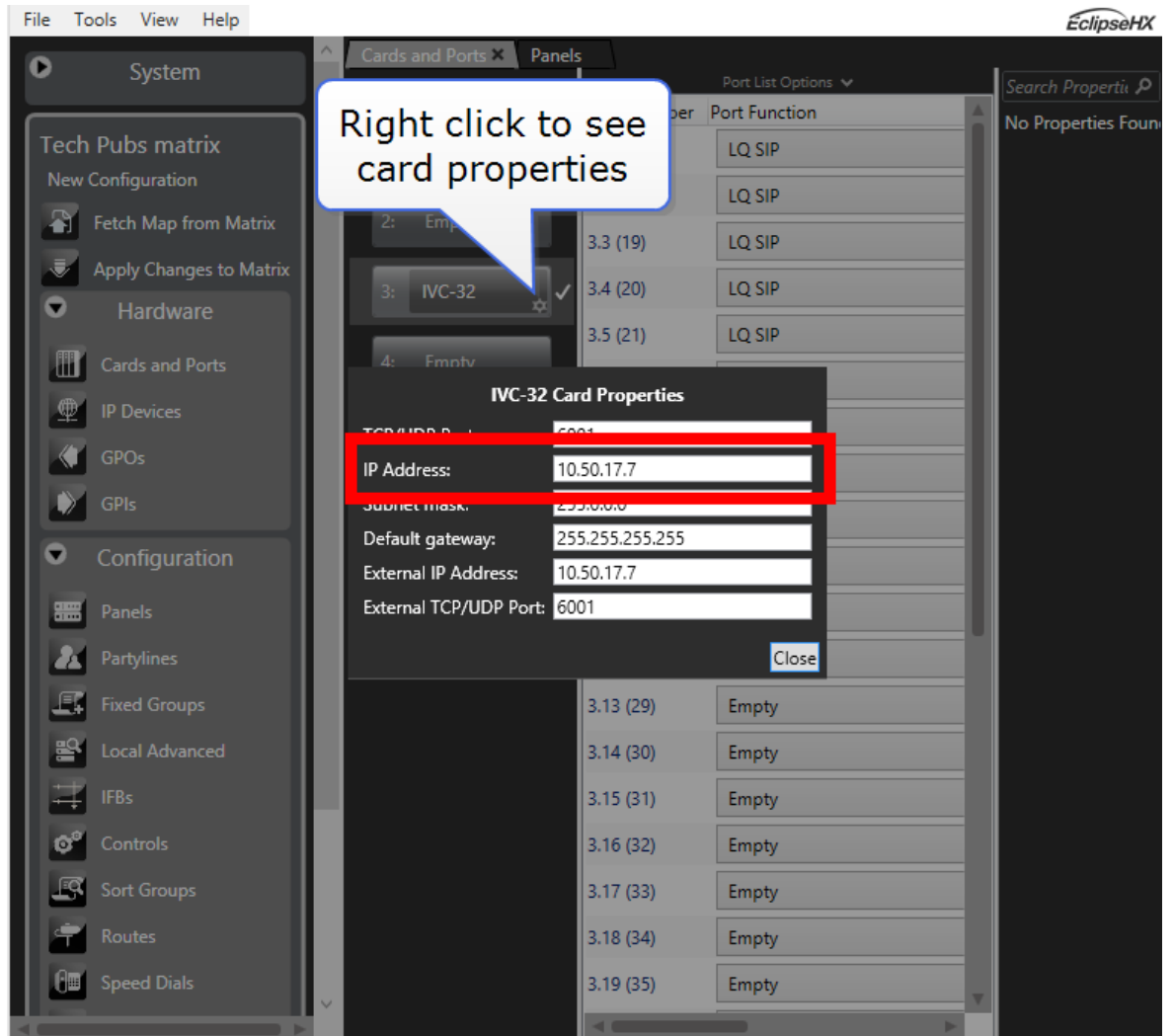

4. Generate IVC ports. Give the LQ unit the Username and Password already set up in the EHX software. Assign port to an LQ unit to connect.

1. Click '+'

2. **User ID** and **password** exactly as in EHX

3. Choose LQ unit

4. Press [Enter] key or blue check mark to submit

5. When connection is successful you see a green connection light. If you see a yellow triangle, click this for information.
6. Once assigned to an LQ unit, these ports are seen under the device icon on the left side of the Assignments page.

SIP port and matrix port available.  
Green bar indicates connection status

7. Bring both ports together in a **Direct Channel** to connect and route audio sources.

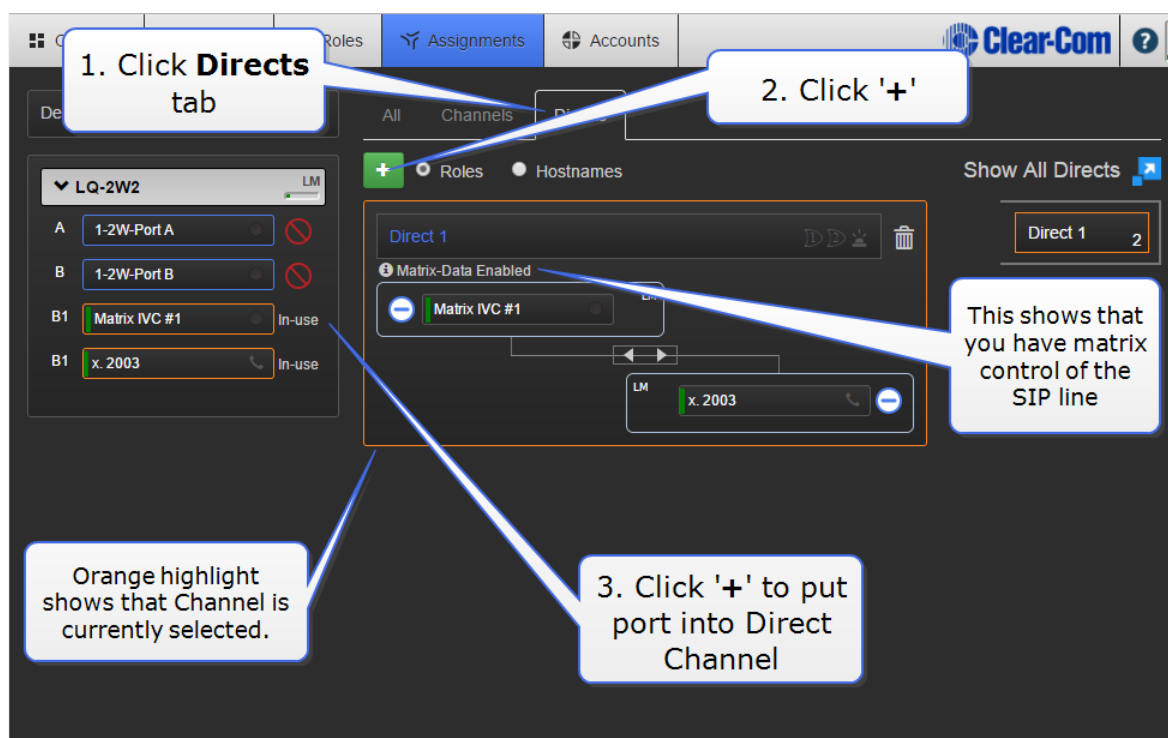

8. Once you have followed these steps you will be able to dial any external line that is available to your SIP server. you can dial in to your intercom system from an outside telephone, and dial out from LM your system using either a panel or the LQ CCM.

**Note:** IVC ports are 'virtual' ports, in contrast to the physical ports on the LQ unit. You can have up to 8 virtual ports assigned to an LQ unit. Virtual ports can be either IVC connections or up to eight Agent-IC connections.

**Note:** VOX light (green). This indicates audio coming from a port.

**Note:** If you are using an MVX port to connect to the LQ for dialing in/out via the LQ-SIP, place the LQ 4-wire port into a Direct Channel with the SIP line.

**Note:** SIP and IVC/MVX connection status bars: green; connected, yellow; connecting, connection pending.

SIP calls can also be ended either from the CCM or the LQ device front panel menu.

For how to use SIP calls on a panel see **Using SIP lines with a panel (Eclipse and LQ-SIP) on page 118**

## 13.8 How to use SIP calls

When a SIP call comes into a Channel (SIP-enabled ports must be placed in a Channel before they can be used) the LQ device answers the call automatically. How the call is monitored and responded to depends on which device you are working from how the client device is configured.

### 13.8.1 How to establish and end calls using the LQ unit CCM

SIP calls can be managed from the **Assignments** page of the CCM. You can:

- Dial out
- View numbers
- End calls.

#### 1. Incoming calls:

- a. If an external user (for example x.2005) dials into the LQ-SIP line then the LQ unit will auto-answer and establish the call. Audio will then pass between all members of the Channel associated with the SIP line.
- b. The CCM will show the incoming caller number.
- c. The CCM user can hang up the call by selecting the phone icon and hanging up.



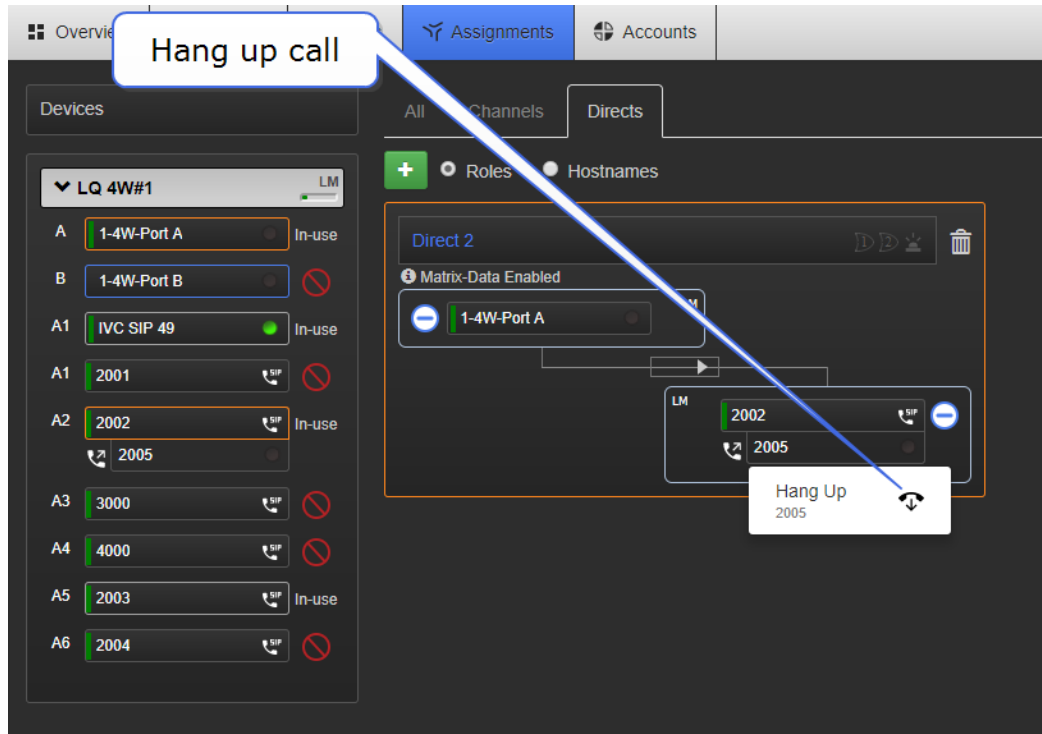

2. Use the CCM to dial out:

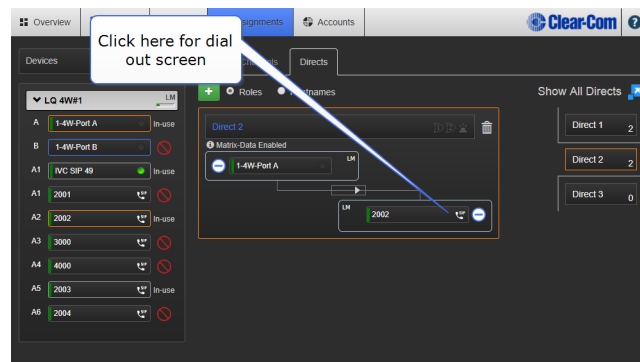

- Type in the dial-out window the phone number or address of the telephonenumber/extension you want to reach.
- Once the call is established, audio will pass between all members of the Channel associated with the SIP line.
- The CCM will show the dialed phone number.
- The CCM user can hang up the call by selecting the phone icon and hanging up.

## 13.8.2 Control calls from the LQ unit front menu screen

SIP calls can be ended (hung up) from the device front menu screens.

### 13.8.3 Using SIP lines with a panel (Eclipse and LQ-SIP)

SIP enabled ports are programmed in the EHX software. Of importance are **Line Release** and **Off-Hook Tally** options. Setting these options will control how telephone calls behave in your Eclipse system. The **Off-Hook Tally** is set to **ON** by default when you declare and LQ SIP interface in the EHX software.

If the Off-Hook Tally is set to On, an incoming call configured to a panel will flash on the interface key. Use the panel keyset to monitor and talk back to the calling party. An incoming call can be ended by the caller (or from the CCM and device front screen menu). If the Line Release option is set in EHX then the call can also be released by the panel.

#### Line Release option (MVX card)

The screenshot displays the EclipseHX software interface for configuring SIP lines. The interface is divided into several sections:

- Left Sidebar:** Contains navigation options such as "System", "Tech Pubs matrix", "Hardware", "Configuration", "Controls", "Routes", "Speed Dials", "Key Groups", "Logic", "Preferences", and "Diagnostics".
- Card Slot Section:** Shows a list of cards, with "1: MVX-A16" selected. A callout "2. Select MVX card" points to this selection.
- Table:** A table with columns "Port Number", "Port Function", "Label", and "Description". The table lists ports from 1.1 (1) to 1.16 (16). Port 1.3 (3) is configured as "LQ SIP" with the label "MVX SIP" and description "LQ SIP Client". A callout "3. Select port" points to the "Port Number" column.
- Right Sidebar:** Contains "Panel Options" such as "Reply Tally Auto Clear Time", "Display Brightness", "Display Dim Timer", "Dual Reply Keys", "Eavesdropping", "Expansion Panels", "Headset Mic Type", "Headset PTT Function", "Headset LS Cut", "Latchable Reply Key", "Listen Again Auto Delete", "LS Cut Button Operation", "Mute Relay", "Nearby Panel Partial", "Page Override Allowed", "Page Gain", "Gooseneck Mic Type", "Panel Text Orientation", "Line Release", "Enhanced Tallies", and "Screen Saver Timer". A callout "4. Panel options" points to this section. The "Line Release" checkbox is checked, with a callout "5. Line Release" pointing to it.

## Off-Hook Tally (IVC card)

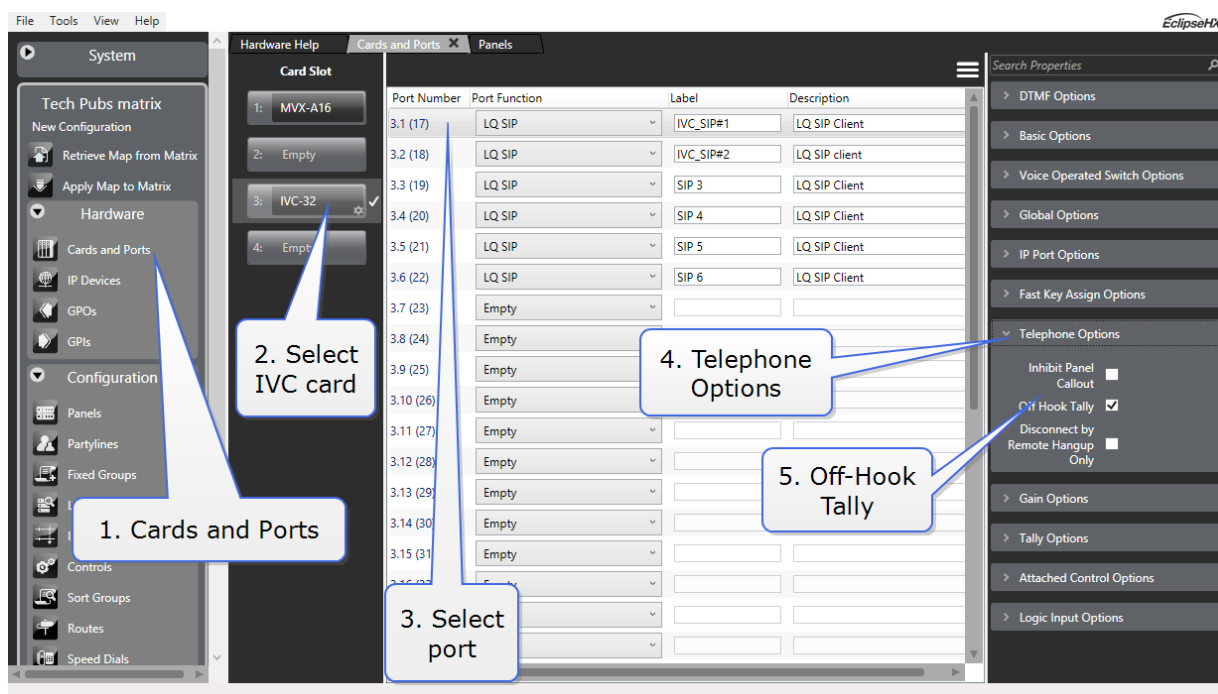

## Making outgoing SIP calls from the panel

The following methods are possible:

- Speed dials
- Prepared dialing

### 13.8.4 Speed dials

Speed dials can be set up in the EHX software to work with a specific interface and number. A speed dial is created and attached to a control in the EHX software, the control is put on a key and then this key is put on a panel. To use a speed dial once it is configured, latch the interface key and press the speed dial key (in any order).

When configuring a speed dial, the interface and the control (the number to dial) can be stacked on the same key to reduce the number of keys used to dial a set number. See **Speed Dial** and **Stacked Key** in the *EHX User Guide*.

### 13.8.5 Prepared dialing

When using prepared dialing, the number is dialed first (use the panel keypad or dial menu) and the interface (panel key) is selected second. This method of dialing

is more flexible when it comes to possible numbers to dial and the dial route.

**Note:** *Piecemeal dialing is only supported on the Tel-14 telephony interface.*

## 13.9 SIP and the Internet

### 13.9.1 Generic SIP ports

- Port 5060 (UDP or TCP) for SIP
- Port 5061 (TCP) for TLS communications –if using secure SIP
- Port 4000-32767 (UDP) (send & receive) for RTP/RTCP communications (2 ports per call)

LQ 4.0 will only use ports 4000 - 4015 locally but will still be able to connect to any other RTP/RTCP ports.

Secure SIP and TCP is not supported in LQ 4.0

### 13.9.2 Network Address Translation (NAT) and Firewall

NAT and many firewalls “hide” private networks behind a public IP address. This normally means that SIP calls can be initiated from a private network to the Internet but not the other way around. Also, firewalls commonly deny access to port numbers associated with Voice Over IP (VoIP) applications.

This aspect of SIP can be handled by technologies designed to traverse firewalls such as STUN, TURN and ICE. Some VoIP service providers use proprietary server side solutions that do not require STUN/TURN/ICE servers.

### 13.9.3 Using SIP with LQ

When using SIP with LQ Series units, you need an IP - Private Branch Exchange (IP - PBX) to act as a SIP server. This PBX can be a physical unit, or you can use a cloud-based IP-PBX service.

**Note:** *LQ SIP does not currently work with STUN/TURN/ICE.*

More information on firewall/NAT: [https://www.ingate.com/files/Solving\\_Firewall-NAT\\_Traversal.pdf](https://www.ingate.com/files/Solving_Firewall-NAT_Traversal.pdf)

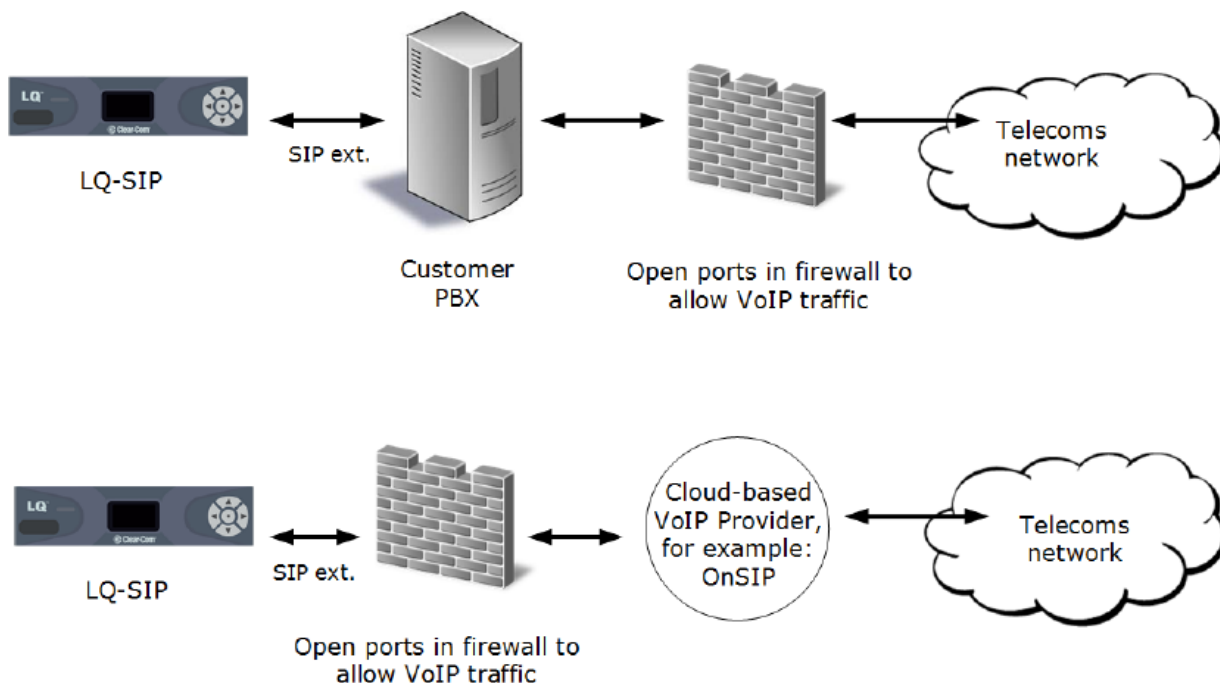

### 13.9.4 Hardware and cloud based PBXs

LQ has been extensively tested with a number of hardware and cloud-based PBXs, including:

- Grand Stream - a small budget hardware PBX
- Cisco PBX - a larger hardware PBX
- Mitel PBX - a larger hardware PBX
- ONSIP - a US cloud-based PBX ([www.onsip.com](http://www.onsip.com))
- YAY - a European cloud-based PBX ([www.yay.com](http://www.yay.com))

#### Configuring a cloud-based PBX in the CCM

If a hardware PBX is not available, both ONSIP and YAY offer low cost monthly subscription that will provide lines that can be assigned to LQ devices.

The screenshot shows the 'Accounts' tab in the Clear-Com interface. On the left sidebar, there are buttons for 'Agent-IC', 'SIP', and 'IVC'. The main content area is titled 'SIP Servers' and contains a list of servers: 'A CambsPBX', 'B ONSIP', and a green '+' button. The 'SIP Server Settings' for 'B ONSIP' are displayed in a dark-themed panel. The settings include:

- Label: [ONSIP](#)
- Registrar/Proxy IP/Hostname: [sip.onsip.com](#)
- Registrar/Proxy Port: [5060](#)
- Domain: [xxxxxx.onsip.com](#)

Under the 'Advanced' section, the SIP Transport Protocol is set to 'UDP/TCP'. Below the settings is an 'Accounts' table with columns: '#', 'Label', 'User', 'Password', 'LQ Assignment', and 'Status'. A green '+' button is located at the bottom left of the table.

User and Password as defined by the ONSIP account.

The screenshot shows the 'Accounts' tab in the Clear-Com interface. On the left sidebar, there are buttons for 'Agent-IC', 'SIP', and 'IVC'. The main content area is titled 'SIP Servers' and contains a list of servers: 'A CambsPBX', 'B ONSIP', 'C YAY', and a green '+' button. The 'SIP Server Settings' for 'C YAY' are displayed in a dark-themed panel. The settings include:

- Label: [YAY](#)
- Registrar/Proxy IP/Hostname: [talk.yay.com](#)
- Registrar/Proxy Port: [5060](#)
- Domain: [default](#)

Under the 'Advanced' section, the SIP Transport Protocol is set to 'UDP/TCP'. Below the settings is an 'Accounts' table with columns: '#', 'Label', 'User', 'Password', 'LQ Assignment', and 'Status'. A green '+' button is located at the bottom left of the table.

User and Password as defined by the YAY account.

For more information, see:

**How do I link an LQ device to a Public Branch Exchange (PBX)? on page 169**

## 14 LQ to HelixNet connectivity

---

LQ 4.0 and above.

HelixNet 4.0 and above.

Linking one or more LQ units to a HelixNet Main Station (HMS) in a Link-Group is a way of greatly increasing the number of I/O interfaces available in your HelixNet intercom system.

The HelixNet Main Station must be the Link Master in any Link-Group.

Linking HelixNet and LQ also brings Agent-IC, SIP and Eclipse (IVC) connectivity into your HelixNet system.

### 14.1 HelixNet/LQ Link-Group

Once an LQ unit is linked to an HMS in a Link-Group, all ports on the LQ unit are visible in the CCM and available to be placed in a HelixNet Channel. Once a port is in a Channel, audio from that port can be routed anywhere within the system.

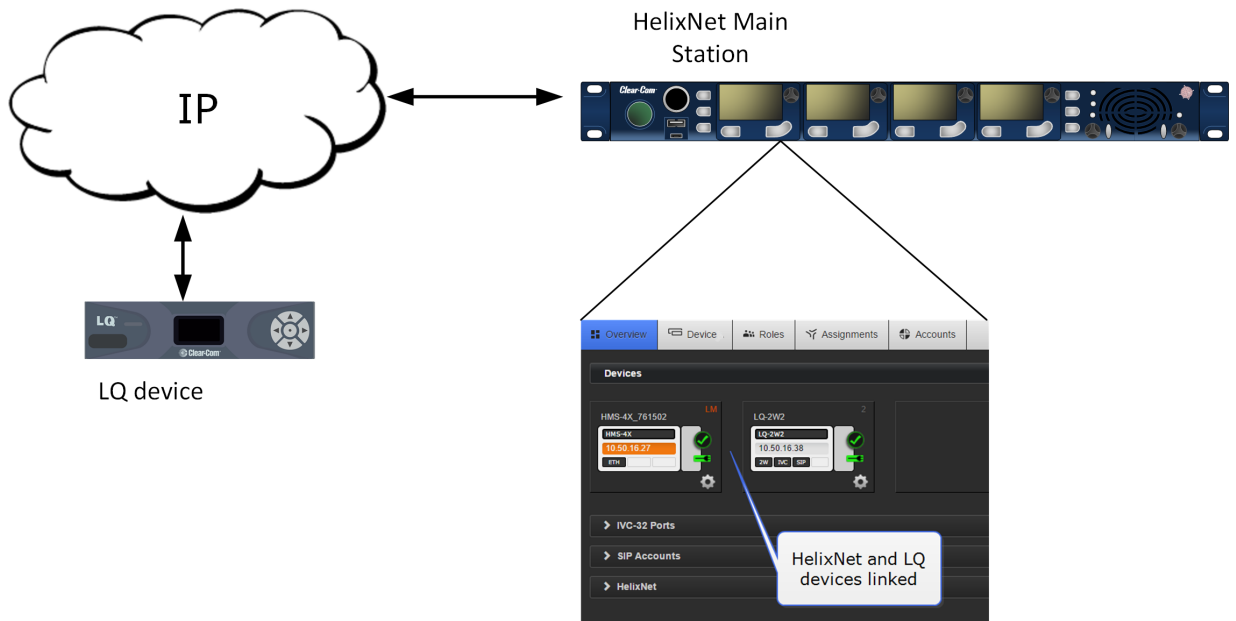

Core Configuration Manager (CCM): Overview page

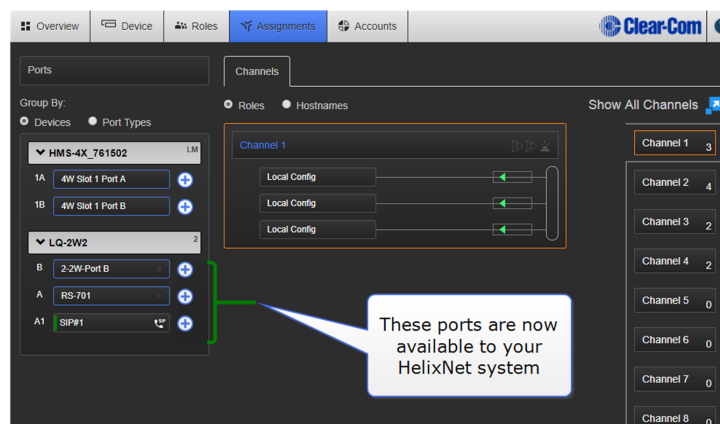

CCM: Assignments page

Connecting an HMS and an LQ unit also brings the possibility of Agent-IC, SIP and IVC connectivity into your HelixNet intercom system (according to license for Agent-IC and SIP).

**Note:** A HelixNet/LQ Link-Group supports up to 3 linked Main Stations and up to 3 linked LQ units (to a maximum of 6 devices in total).

**Note:** The HMS must always be the Link-Master in a HelixNet/LQ Link-Group.

**The following limitations are imposed when LQ devices are linked to a HelixNet Link-Group:**

- **No creation or use of Direct Connections**
- **No interconnection of Clear-Com panels over 4-wire**



- **No SIP hangup capability through the HMS Front panel**
- **No Internet connection between LQ units.**

**Note:** If you upgrade your HelixNet system when you have a Link-Group set up, the linking status will be reset and you will need to re-establish the Link-Group.

## 14.2 Connecting HelixNet and LQ with analog connection

Interconnecting HelixNet and LQ equipment using either 4-wire or 2-wire interfaces is possible and only serves as a means of transporting one channel of audio along with call signaling per connection.

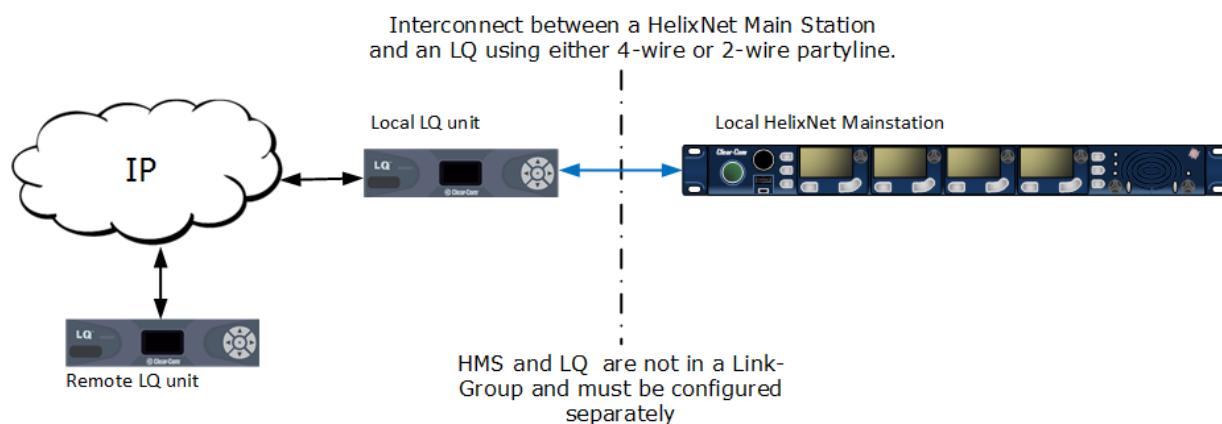

For more information, see:

**Programming a HelixNet/LQ Link-Group on page 125**

## 14.3 Programming a HelixNet/LQ Link-Group

- The HelixNet Main Station that has been designated as the Link-Master must be reachable on an IP network by all other Link-Memebers.

**Note:** The HLI-ET2 module must be fitted to the HelixNet Main Station for IP connectivity.

- To access the Core configuration manager (CCM), input the IP address of each device into the address field of a browser. Enter the default login credentials: admin, admin.
- Once LQ and HelixNet devices have been joined to a Link-Group, they can be monitored and configured from any device within that group.

- An LQ/HelixNet Link-Group supports up to three linked HelixNet Main Stations and up to three linked LQ units (a maximum of 6 devices in total).

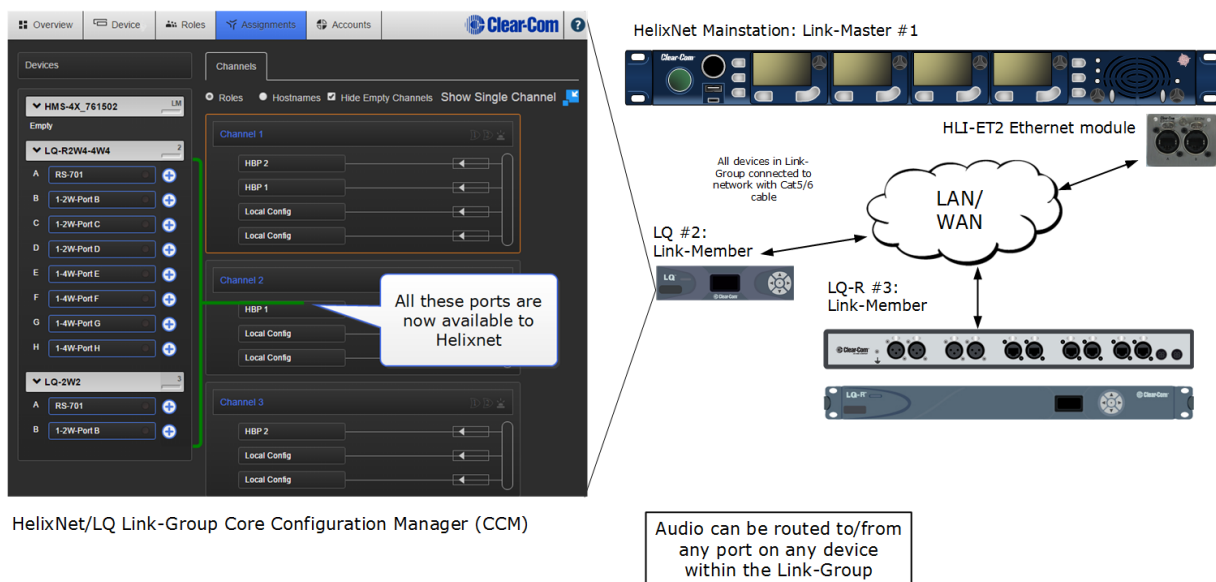

### 14.3.1 General outline: create a HelixNet/LQ Link-Group

1. Access the CCM of the HMS. Make sure the device Link-Group Role is set to Link-Master. Default setting: **Disabled**.
2. Access the CCM of the LQ unit. Make sure the device Link-Group Role is set to Link-Member. Default setting: Link-Master.
3. Give the LQ Link-Member device the IP address of the HelixNet Link Master. Repeat this step for each device to be linked to the Link-Master.
4. Once you have linked the members to the master, all devices in the Link-Group will be visible in the Overview page of the CCM.
5. Navigate to the Assignments page of any device in the Link-Group to view and configure available ports.

### 14.3.2 Demonstration: create a HelixNet/LQ Link-Group

1. Ensure the HelixNet device is set to Link-Master in the CCM of the Main Station. Navigate to **Device > Linking > Link-Group Role**.

The screenshot shows the 'Linking' configuration page for device HMS-4X. The 'Link-Group Role' is currently set to 'Link-Master'. The 'Link-Group Optimization' is set to 'LAN/WAN Routed Network'. Below these settings are buttons for 'LM', '2', '3', '4', '5', and '6'. The 'LM' button is highlighted in orange. A callout box points to the orange highlight with the text: 'Orange highlight indicates host device'. Another callout box points to the 'Link-Master' text with the text: 'Click to set Link-Group Role to Link-Master'.

**Note:** Default Link-Group Role for an HMS is **Disabled**

**Note:** The host device is the device your browser is currently pointing to.

2. Set Link-Group Role of LQ unit to **Link-Member**. Navigate to **Device > Linking > Link-Group Role**.

## 3. Input Link-Master IP address.

1. Click to set to Link-Member

2. Click to input IP address of HelixNet Link-Master. Blue check mark or [enter] key to submit

3. Link-Member slot is automatically selected

4. **Apply Changes** to link devices

4. For each device to be added to the Link-Group, input the device IP into the browser's address field to access the CCM, designate the device as **Link-Member** and give it the **Link-Master** IP address (this links the device to the group).
5. Linked devices can be seen in the **Overview** page.

The screenshot shows the 'Devices' page in the Clear-Com interface. The navigation bar includes 'Overview', 'Device', 'Roles', 'Assignments', and 'Accounts'. The main content area displays three device cards:

- HMS-4X\_761502 (LM)**: Shows IP address 10.50.16.27 and status '4W' and 'ETH'.
- LQ-2W2**: Shows IP address 10.50.16.38 and status '2W' and 'SIP'.
- LQ-R2W4-4W4**: Shows IP address 10.50.16.53 and status '2W' and '4W'.

Callout boxes provide instructions:

- 'Link-Members are displayed in their assigned positions within the Link Group' (pointing to the LQ-2W2 card).
- 'Click on the cog icon for device configuration' (pointing to the gear icon on the LQ-R2W4-4W4 card).
- 'Expand sections to view status and state information about each component type' (pointing to the 'HelixNet', 'Agent-IC', and 'SIP Accounts' sections).

- Navigate to the **Assignments** page to create, configure and view how audio is routed throughout the system. All ports on the LQ units will now be visible and

available for assignment into one or more channels.

The screenshot displays the HelixNet interface for managing port assignments. The top navigation bar includes 'Overview', 'Device', 'Roles', 'Assignments', and 'Accounts'. The 'Assignments' tab is selected, showing a 'Ports' list on the left and a 'Channels' list on the right. The 'Ports' list is grouped by device type: HMS-4X\_761502 (LM), LQ-2W2 (2), and LQ-R2W4-4W4 (3). The LQ-R2W4-4W4 device has ports B through H, each with a '+' icon. A green vertical bar highlights the LQ-R2W4-4W4 device and its ports. A callout box points to the '+' icon on port H, stating 'Click to add port to selected Channel'. Another callout box points to the LQ-R2W4-4W4 device, stating 'These LQ ports are now available to HelixNet'. The 'Channels' list on the right shows Channel 1 with 3 ports, Channel 2 with 4 ports, Channel 3 with 2 ports, Channel 4 with 2 ports, Channel 5 with 0 ports, Channel 6 with 0 ports, Channel 7 with 0 ports, Channel 8 with 0 ports, Channel 9 with 0 ports, Channel 10 with 1 port, Channel 11 with 0 ports, and Channel 12 with 0 ports. A 'Channel 1' configuration window is open, showing three 'Local Config' buttons and a 'Show All Channels' button.

## 15 Agent-IC and LQ

Use Agent-IC (version 2.0 or later) to connect a mobile user to your intercom system. Agent-IC connects directly to an LQ unit. Once connected to LQ, Agent-IC is also available to the HelixNet system or any other ports on the LQ device.

Each LQ-R unit supports up to 24 ports: 8 hardware ports, 8 SIP ports and 8 virtual ports. Agent- IC and IVC ports are considered 'virtual ' ports. Virtual ports can be used in any combination up to 8 in total.

### 15.1 Agent-IC Profiles

The Agent-IC client device (phone or tablet) connects to one of two possible a host systems using a profile. Connect to either:

- An LQ unit or
- An Eclipse matrix.

Each mobile client allows two user accounts per host system: EHX1 and EHX2, LQ1 and LQ2.

Profile credentials are set up in the host system before use.

When you connect with a profile for the first time you need to input your user credentials (**User ID** and **Password**) in **Settings**. You also need the IP address of the host unit you want to connect to.



### 15.2 Agent-IC Roles

Agent-IC uses Roles. A Role is a logical setup that a client (end) device selects from a set of pre-defined configurations. Roles are used to control setup and reduce installation time. Each Role can be given a name or label that corresponds to a common user workflow, for example; Director, Sound, A1. The Role or Roles are defined in the **Roles** page of the Core Configuration Manager (CCM).

The Role associated with a User ID can be seen in **Settings**.

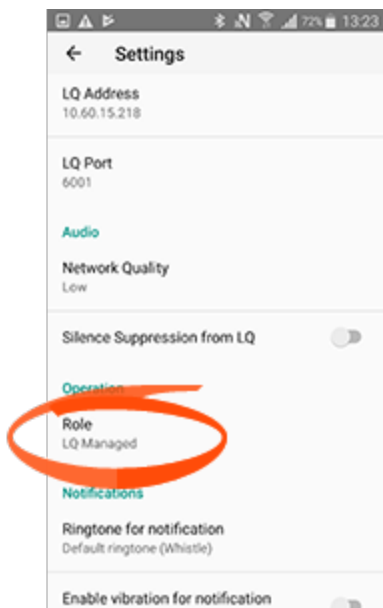

When using Agent-IC, the Role can be fixed for fast and easy deployment of the mobile client. When a Role is fixed, it is allocated in the CCM and another Role cannot be selected from the mobile client. This is known as an 'LQ managed' Role.

To allow the mobile user to select from a choice of Roles, the **Role** setting in the CCM is set to **None**.

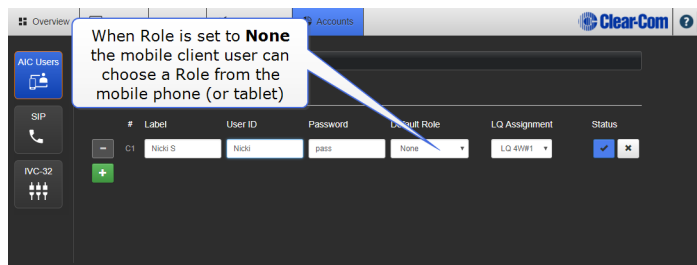

## 15.3 Agent-IC default Role

Agent-IC arrives with a default Role that you can use 'as is' or edit to suit your particular requirements. The default Role has 6 Channels. Keyset configuration is the same for each Channel when using the default Role; the keys all operate in the same way.



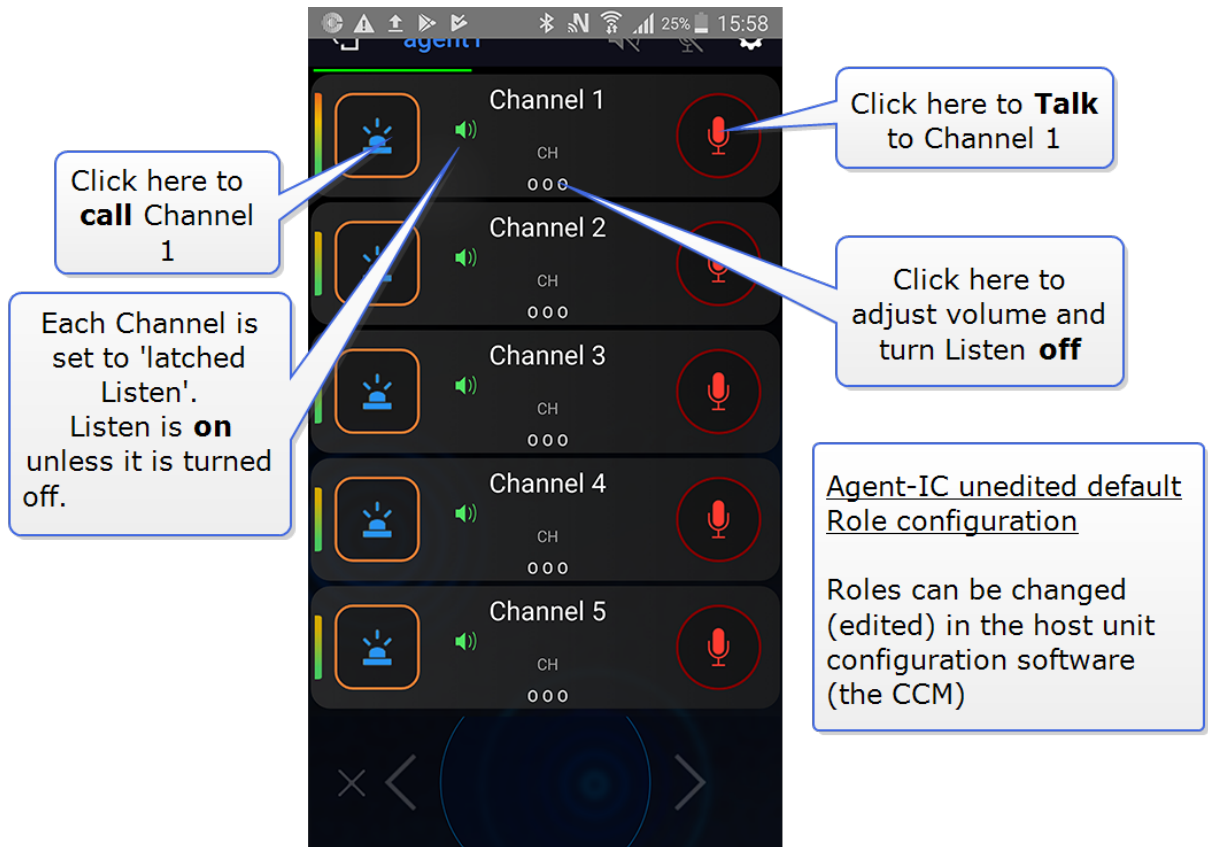

## 15.4 Change Agent-IC default Role configuration

Role configuration is changed in the **Roles** page of the Core Configuration Manager (CCM).

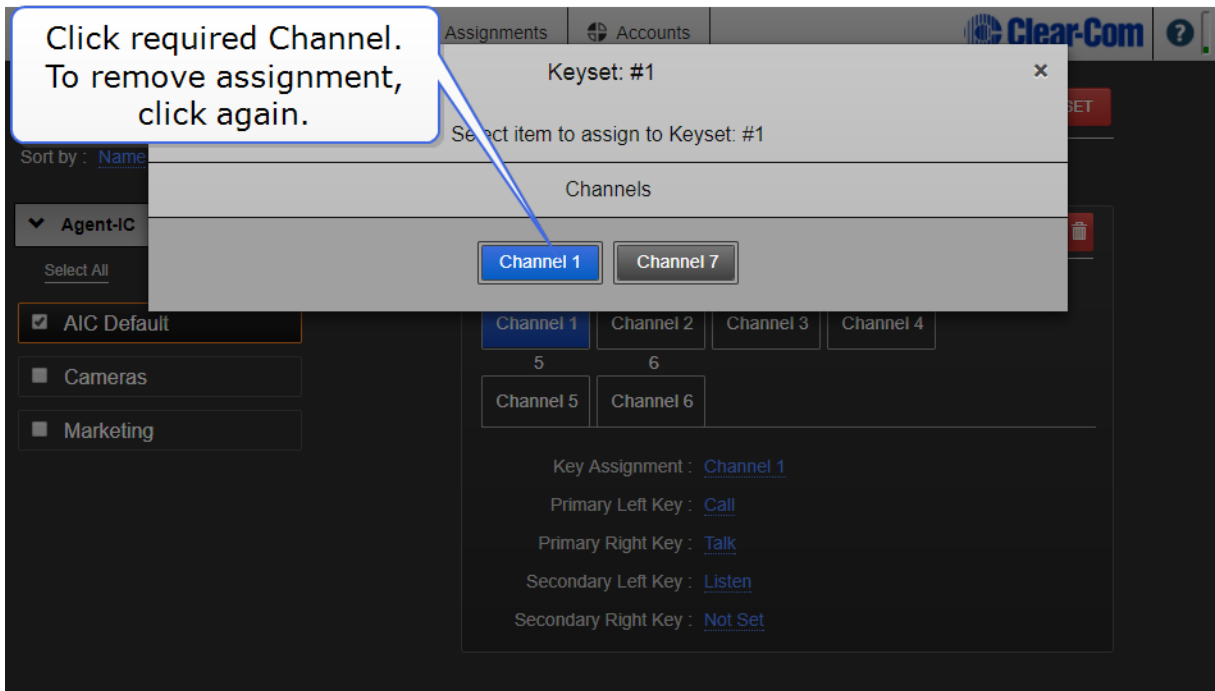
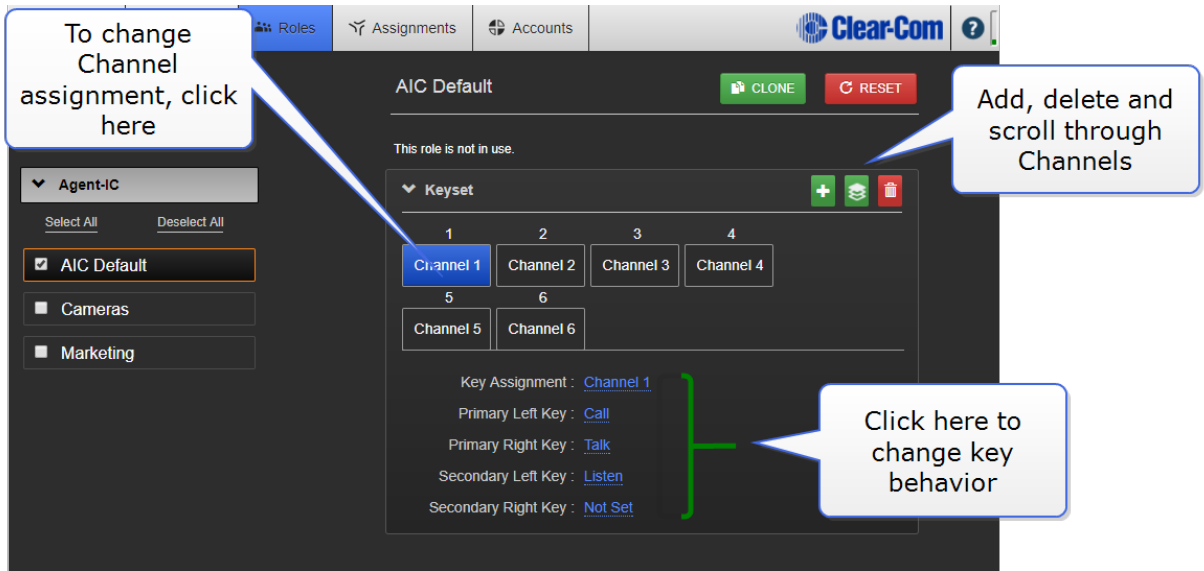

For more information, see:

**Program Agent-IC to LQ connectivity on page 135**

More information on how to use Agent-IC can be found in the embedded help.

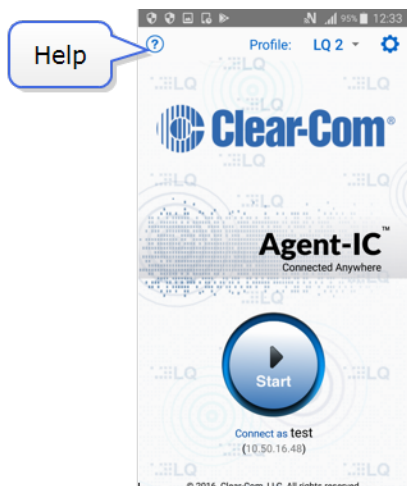

## 15.5 Program Agent-IC to LQ connectivity

From the CCM, use the following steps:

1. Set up Agent-IC users in the Accounts page of the CCM. Navigate to the Accounts page.
2. Create user account # 1.

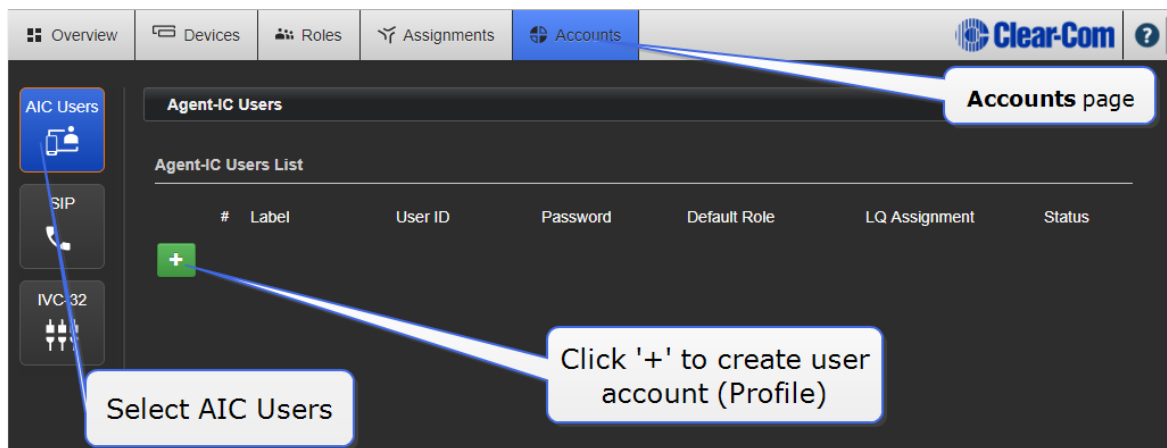

## 3. Create user account #2.

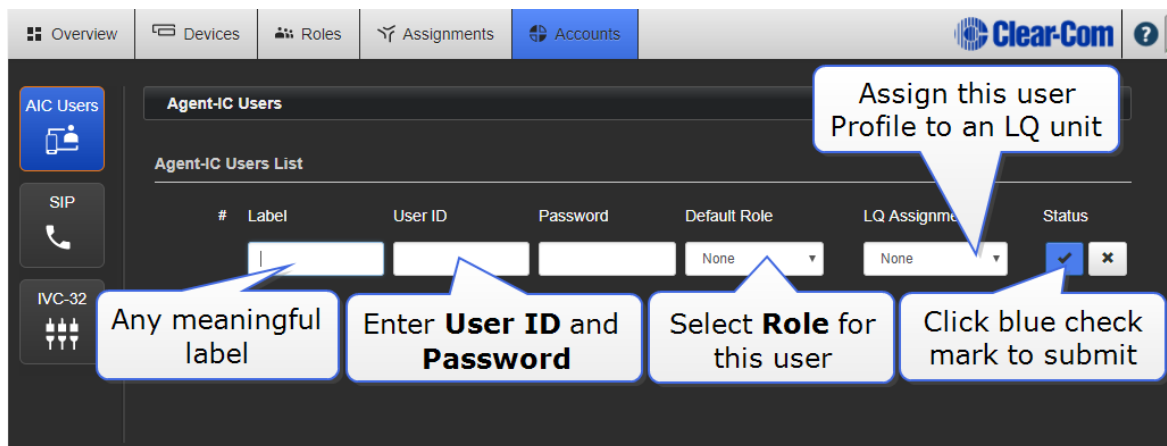

Your Agent-IC user profiles are now setup and the client device can chose a Profile and connect to the system.

### 15.5.1 Connect Agent-IC to LQ

1. From your phone or tablet, select an Agent-IC user profile from the 4 available. In this case you need to select an LQ profile, as LQ is the host device.
2. Click the **Settings** button.
3. Enter login credentials (**User ID** and **Password**).



4. Enter the LQ IP address.
  5. Press the round **Start** button to connect.
- Open the LQ Core Configuration Manager (CCM).

For more information, see:

**How to Access the Core Configuration Manager (CCM) on page 22**

## 16 Licensing

When creating SIP or Agent-IC accounts in LQ, you must first buy a license from your Clear-Com representative. Three license types are available:

- **SIP8-LQ (8 LQ-SIP clients)**. This is a bundle of 8 SIP licenses. This bundle of licenses must be assigned to one LQ device, it cannot be broken down into individual licenses.
- **Agent-IC-LQ**. (1 Agent-IC to LQ client). This is a single Agent-IC client.
- **Agent-IC8-LQ**. (8 Agent-IC to LQ clients). This is a bundle of 8 Agent-IC licenses. This bundle of licenses must be assigned to one LQ device, it cannot be broken down into individual licenses.

When you have purchased licenses, Clear-Com will send your license ticket number by email.

New units can be shipped ready licensed, or licenses can be added later.

These licenses can be allocated to any LQ unit. However, once a license has been activated on a unit, it CANNOT be changed, and re-allocated to a different unit. You might activate licenses on more than one LQ unit with the same ticket, but as licenses cannot be transferred once activated, take care when doing this.

Copy and paste the ticket number into the LQ Core Configuration Manager (CCM) in the **Licenses** page.

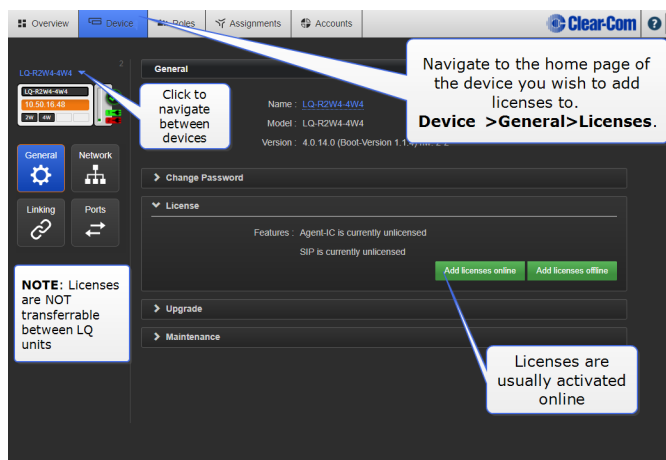

In most cases you will add licenses online. Chose the appropriate procedure from below.

### 16.1 Add licenses online

**Note:** *To add licenses online, the LQ device must be connected to the Internet.*

1. Click **Add Licenses Online**
2. Copy and paste the ticket number into the 'Enter ticket ID' space. Click blue check mark to submit.
3. This pulls up available licenses on this ticket. Decide which license or licenses you want to add to the current LQ unit.
4. Click to select a license checkbox. This tells the CCM that you want to add this feature to the current LQ. When you click an option, available licenses and constraints will be shown.
5. Click **Activate**.

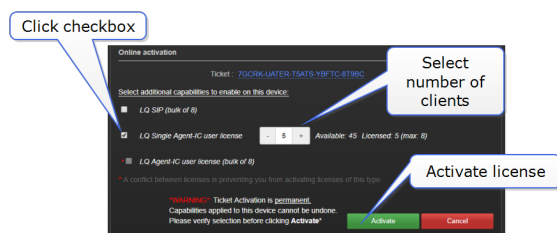

**Note:** *Select carefully as once a license has been added to a unit it cannot be re-allocated to a different unit.*

## 16.2 Add licenses offline

**Note:** *Activating LQ licenses offline means that the LQ unit cannot or does not have access to the Internet.*

When you add licenses to an LQ unit that is offline, (**Device>General>License**) you must first download the **Context File**. The Context File is basically an LQ 'holder' for your license that you will send to the third party license manager, who will load the new license codes into the Context File and send it back to you.

1. Click **Get Context File**. This downloads the Context File to your computer (.WibuCmRac extension).
2. Save the Context File to an appropriate location (a folder or USB stick).
3. Email the Context File to Clear-Com.
4. Clear-Com will 'load' the license into the Context File and email it back to you.
5. In the License page, click **Send Update File**. Navigate to where you have stored the updated Context file and click to upload it. This adds your licenses to the LQ unit.

**Note:** *Licenses belong to an LQ unit, they are NOT transferrable between units.*

- Note:** *If you don't have a license for an Agent-IC on a particular host unit, you can still connect in demo mode. Demo mode has an 85 second log in period and will automatically log out of the host after 24 hours.*
- Note:** *You can register as many clients as you need on an individual LQ unit, but only 8 'virtual' (IVC or Agent-IC) ports can be connected **at any one time**. The unit can support up to 8 SIP connections at any one time.*

## 17

## Using LQ to interconnect equipment

When connecting LQ units to other Clear-Com products and third party intercom systems, use the following guidelines:

Device type	Which LQ unit?	To Panel/To Matrix (configure pinout in software)	Supports call signaling?	Panel data?
HelixNet HLI-4W2	LQ-4W2LQ- R4W8LQ- R2W4-4W4	To panel	Yes	No
HelixNet HLI-2W2 (Note: this connection is not preferred for optimum audio quality)	LQ-2W2LQ- R2W4LQ- R2W4-4W4LQ- R2W4-4WG4	N/A	Yes	No
MVX-A16/Eclipse PiCo	LQ-4W2LQ- R4W8LQ- R2W4-4W4	To matrix (Identified as a CCI-22)	Yes	Yes
IVC-32 IP card/Clear-Com matrix	LQ-2W2LQ- R2W4LQ- R2W4-4W4LQ- R2W4-4WG4		Yes	Yes
Other matrices (third party)	LQ-4W2LQ- R4W8LQ- R2W4-4W4	Depends on third-party pinout	No	No
Encore MS-702/4	LQ-2W2LQ- R2W4LQ- R2W4-4W4LQ- R2W4-4WG4	N/A	Yes	No
Encore RS Beltpack 1/2/3	LQ-2W2LQ- R2W4LQ- R2W4-4W4LQ- R2W4-4WG4	N/A	Yes	No



Device type	Which LQ unit?	To Panel/To Matrix (configure pinout in software)	Supports call signaling?	Panel data?
RTS 2-wire equipment	LQ-2W2LQ- R2W4LQ- R2W4-4W4LQ- R2W4-4WG4	N/A	Yes, but does not pass call signaling to 4-wire audio routes.	No
HME DX210/DX410	LQ-4W2 LQ- R4W8LQ- R2W4- 4W4 LQ- 2W2*LQ- R2W4*	To panel	Yes	No
FreeSpeak/FreeSpeak II Base	LQ-4W2LQ- R4W8LQ- R2W4-4W4 LQ- 2W2*LQ- R2W4*	To panel	Yes**	No
V-Series panel i-Series panel	LQ-4W2LQ- R4W8LQ- R2W4-4W4	To panel	Yes	Yes
2-way radio or 4-wire device with relay activation	LQ-4WG2LQ- R2W4- 4WG4LQ- R4WG8	N/A	Yes (call signal can fire relay)	No

\*This connection is not preferred for optimum audio quality. LQ-4W2 is recommended.

\*\* On a FreeSpeak Base station, only ports 3 and 4 pass call signaling.

Table 1 Interconnection guidelines

## 17.1 Connecting 2-wire equipment

When connecting 2-wire equipment the following functions should be taken into consideration:

- Auto-null

Every time equipment is changed on a 2-wire port you should auto-null.

- Enable/Disable the partyline power
- Line Termination.

These functions can be found in the 2-wire port settings page of the CCM. Navigate to Device > **Ports** on any unit in the Link-Group.

Example:

The screenshot displays the CCM interface for configuring a 2-wire port. The navigation menu on the left shows 'Ports' selected. The main area is titled 'Audio Ports' and shows a list of 2-Wire ports (A, B, C, D) and 4-Wire ports (E, F, G, H). Port A is selected. The settings for Port A are shown on the right:

- Interface Settings:**
  - Power: [Enabled](#) (Status: ●)
  - Mode: [Clear-Com](#)
- Port Settings:**
  - Label: [1-2W-Port A](#)
  - Multi Channel Support: [Disabled](#)
  - Input Gain: [-1 dB](#)
  - Output Gain: [0 dB](#)
  - VOX:**
    - VOX Mode: [Adaptive Threshold](#) (Status: ●)
    - VOX Off Delay: [0.5 sec](#)
    - VOX Threshold: [Not set](#)
    - VOX Action Triggers: [Disabled](#)
  - 2-Wire:**
    - Termination: [Enabled](#)
    - Auto-Nulling: [Start Nulling](#)

Callouts provide the following instructions:

- Enable/Disable partyline power:** Points to the 'Power' setting in the Interface Settings section.
- Enable/Disable line termination:** Points to the 'Termination' setting in the 2-Wire section.
- Start Auto-Null. Do not listen in on the line while Auto-Null is in process.** Points to the 'Auto-Nulling' setting in the 2-Wire section.
- Navigate to Device/Ports:** Points to the 'Ports' button in the navigation menu.

Equipment	Port settings
Encore RS beltpack 701/2/3	Power: Enabled Termination: Enabled Auto-nulling: Start auto-nulling
Encore MS-702/4 Encore PK-7 Encore PS-702/4	Power: Disabled Termination: Disabled Auto-nulling: Start auto-nulling

## 17.2 Connecting to 4-wire equipment

To minimize noise, use screened (shielded) cable when connecting 4-wire ports.

### 17.2.1 Pin-out configuration

Pin-out configuration can be set on LQ Series 4-wire interfaces (not 4W + GPIO). This is a software switch that switches the configuration of the pins on the RJ45 etherCON connectors, according to the device you are connecting to. See **Interconnection Guidelines**.

Pin-out configuration is set 'to Matrix' by default. To set the pin configuration of a device:

1. Access the CCM for any unit in the Link-Group.
2. Navigate to Device > **Ports** .
3. Select either 'to Matrix' or 'to Panel'.

Overview Device Roles Assignments Accounts

LQ-R2W4-4W4 LM

General Network Linking Ports

**Audio Ports**

2-Wire

A  1-2W-Port A

B  1-2W-Port B

C  1-2W-Port C

D  1-2W-Port D

4-Wire

E  1-4W-Port E

F  1-4W-Port F

G  1-4W-Port G

H  1-4W-Port H

Port Settings

Label: [1-4W-Port E](#)

Multi Channel Support: [Disabled](#)

Input Gain: [0 dB](#)

Output Gain: [0 dB](#)

VOX

VOX Mode: [Adaptive Threshold](#)

VOX Off Delay: [0.5 sec](#)

VOX Threshold: [Not set](#)

VOX Action Triggers: [Control Event 1](#)

4-Wire

Port Function: [to Matrix](#)

Baud Rate: [19200 \(Eclipse\)](#)

Navigate to Device/Ports

Select Port Function (pinout configuration): To Matrix/To Panel (Not 4W+GPIO)

Select equipment type. (Not 4W+GPIO)

## 17.3 Connecting an Eclipse PiCo (or MVX card) to an Encore device using LQ

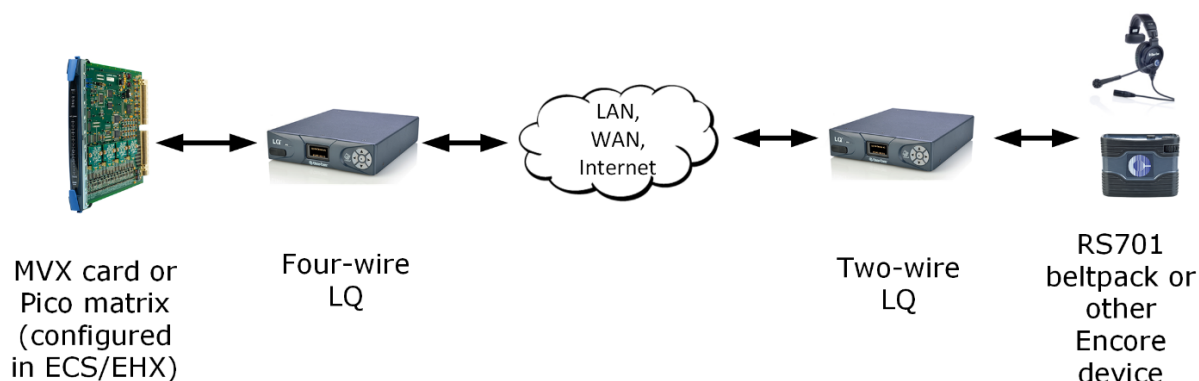

When setting up this connection, care must be taken to configure the port in the EHX software correctly. This is because, in this case, the port must be declared as a CCI-22 device as the port detection device on the LQ will recognise it as such.

1. From the EHX software, navigate to **EHX > System > Cards and Ports**.
2. Select the MVX card port.
3. Select a CCI-22 device from the list.
4. It is advisable to label the port as an LQ 4-wire device to avoid confusion.

Show me:

1. Navigate to EHX/Hardware/ Cards and Ports

2. Select MVX card

3. Set port as CCI-22

4. Label port as LQ 4-wire

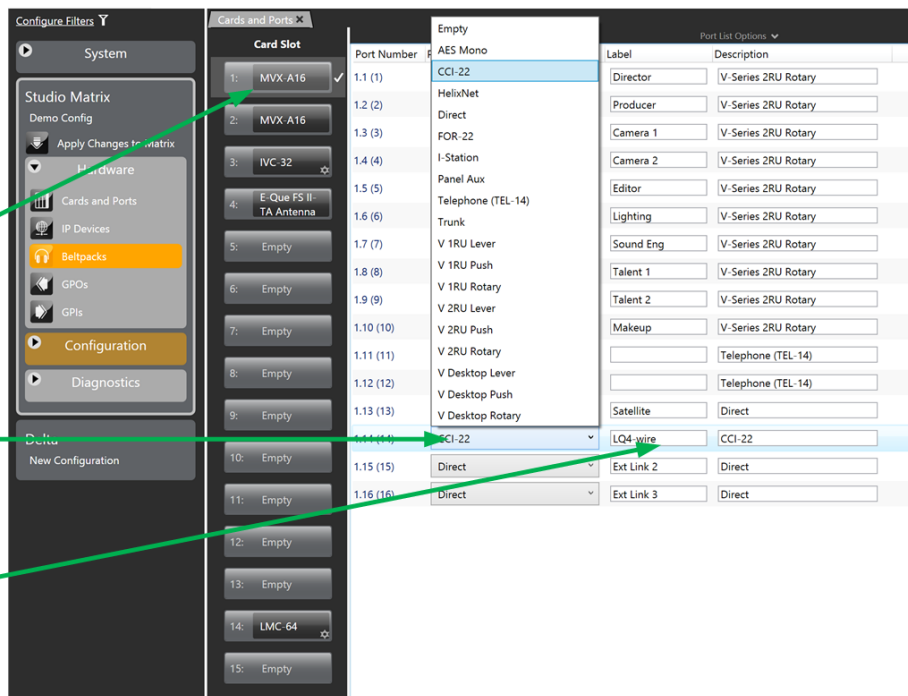

**Note:** The connection between the MVX or PiCo and the LQ device is a 4-wire connection, even though it is declared as a 2-wire connection.

For more information on port function, see 5.16 Port Function in the EHX Software User Guide .

## 17.4 Connecting an Eclipse PiCo (or MVX card) to a panel using LQ

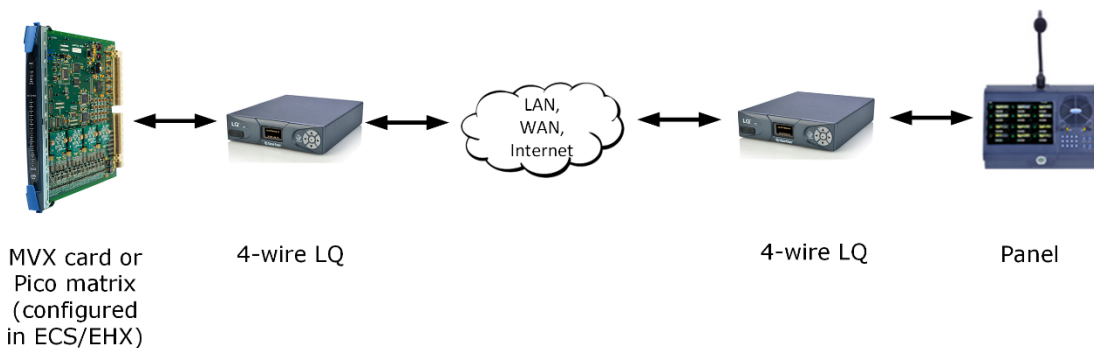

When setting up this connection, the MVX port to the LQ should be declared as a panel in the EHX software.

For more information on port function, see the Eclipse EHX Software User Guide.

## 17.5 PiCo HX trunk to HX matrix (Eclipse HX 8.7 and above)

### IP trunking: Eclipse HX to PiCo HX (EHX 8.7 and above)

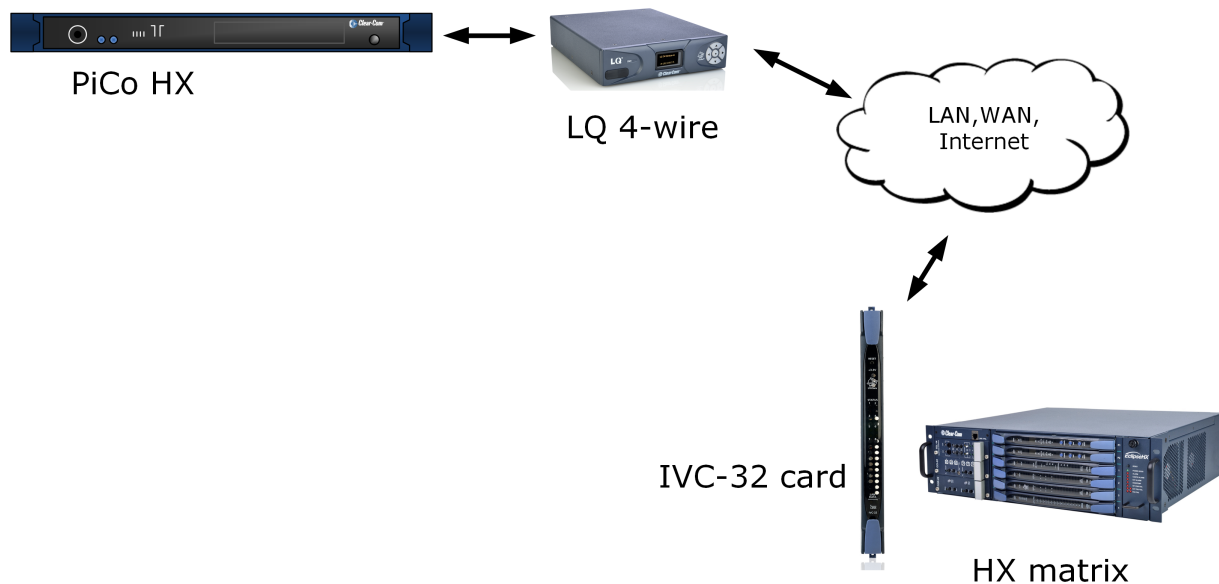

For this set up it is necessary to configure both EHX and the Core Configuration Manager (CCM).

1. In the EHX software, declare the PiCo port that connects to the LQ as a trunk.
2. In the EHX software, declare the IVC-32 card port on the HX matrix as an '**LQ trunk**'.
3. Generate an IVC-32 port in the Core Configuration Manager (CCM) of the LQ device.
4. Connect 1:1 CAT5 cables between the PiCo and the LQ unit.
5. Navigate to **Assignments** in the CCM, select and allocate a Channel. It is advisable to name this Channel 'Trunking'. Put both the LQ IVC port and the LQ 4-wire port into the Trunking Channel together. This generates a connection between the two ports

**Note:** *Don't assign other ports to this Trunking Channel as this will cause confusing transmission.*

## 18 Upgrading your device

---

Upgrades for your device will be available from the Clear-Com website.

<http://www.clearcom.com/support/firmware-software-downloads>

To upgrade your device, you must import the upgrade file provided by Clear-Com into the device via the unit's CCM (Core Configuration Manager). An LQ unit must be upgraded from the host device (the device that the browser is currently addressing). The units cannot be upgraded by proxy.

All devices in a Link-Group MUST be running the same version of the software.

### 18.1 Import the upgrade file

1. Open a browser window and input the IP address of the device into the address field to access the CCM. The device IP can be found on the front display of the unit when it is powered and booted.
2. Navigate to **Device > General** in the CCM.
3. Expand the Upgrade option (click on '+').
4. Click Select File and navigate to the upgrade file (.gz extension). Select the upgrade file to upload it.
5. When the upgrade file is loaded, Upgrade will light up. When this happens, click on it to upgrade. When the upgrade is finished, the unit will reboot by itself.

Overview Device Roles Assignments Accounts

LQ-R2W4-4W4 LM

LQ-R2W4-4W4  
10.50.16.53  
2W 4W

General Network  
Linking Ports

General

Name : LQ-R2W4-4W4  
Model : LQ-R2W4-4W4  
Version : 4.15.4 (Boot-Version)

Change Password

License

Upgrade

1 Select File

2 Upgrade

Maintenance

Click/touch to expand Upgrade option.

Click/touch and navigate to upgrade file (.gz extension)

When upgrade file is loaded, Upgrade will light up. When this happens, click on it to upgrade. Wait while unit reboots.

**Note:** *If you downgrade an LQ unit from Version 2 to Version 1, you will see a red light flashing on the front panel after the first reboot. Power cycle the unit one more time to reset the status.*



## 19 FAQs

---

The FAQs are divided into the following categories:

**Device queries on page 150**

**2-wire and 4-wire specific queries on page 151**

**Interconnection queries on page 152**

**IP and network queries on page 159**

**Audio quality queries on page 165**

**Telephony queries on page 169**

### 19.1 Device queries

**How can I find the IP address of my LQ unit? on page 150**

**What does a solid red light on the front panel keypad indicate? on page 150**

**What does a flashing red light on the front panel keypad indicate? on page 150**

**What does a persistent flashing green light (more than 2 minutes) on the front panel keypad indicate? on page 151**

**How are LQ Series devices powered? on page 151**

#### 19.1.1 How can I find the IP address of my LQ unit?

The IP address of an LQ device can be found on the front panel display of the units and also in the Web GUI. The IP address of a unit can be changed via the CCM (**Device > Network**) or from the device front menu screens (**Programming network details from LQ device front screen on page 54**).

#### 19.1.2 What does a solid red light on the front panel keypad indicate?

A solid red light on the keypad shows that the unit has lost its IP connection to the Link-Master.

Make sure that the Link-Master's IP address is reachable from the network point where the Link-Member is connected.

#### 19.1.3 What does a flashing red light on the front panel keypad indicate?

A flashing red light shows that there is an ID conflict within the LQ-Group, meaning that two LQ units are trying to connect to a Link-Group using the same link ID.

To resolve this you will need to undo the unit's link to the Link-Master and then re-apply the linking process to an available ID:

1. Within a Web browser, enter the IP address of the LQ device which is showing the flashing red LED. This takes you to the Core Configuration Manager (CCM) for that unit.
2. Navigate to the device's Linking page (**Device > Linking**).
3. Click the Change Role to Link-Master button and click Apply Changes.
4. Now reconfigure the link and the link ID. To do this, click the Change Role to Link-Member button, and enter the Link-Master IP. Click the blue check mark or <Enter>.
5. Select an available ID slot (available IDs will be highlighted in blue) and click Apply Changes.

#### 19.1.4 What does a persistent flashing green light (more than 2 minutes) on the front panel keypad indicate?

The devices boot automatically when power is supplied and show a flashing green light on the front panel keypad while the system is booting.

If the device is booting (the flashing green light does not turn into a solid green light) for more than 2 minutes, and the display screen does not move beyond the Clear-Com splash screen, the most likely explanation is that the unit does not have enough power. This can happen if too many LQ devices are drawing power from the same PoE switch or network.

Check the power supply provided by PoE to see if this is the case and consider using the supplied power connector cable to power the devices.

#### 19.1.5 How are LQ Series devices powered?

- LQ throw-down units use local power (24 watt sleeve-locking PSU) or Power over Ethernet (PoE).
- LQ-R 1RU rack units use local power only (2 x 60 watt sleeve-locking PSUs).

## 19.2 2-wire and 4-wire specific queries

**What types of 2-wire intercom do LQ Series units support? on page 152**

**Does the LQ-4W2 pass call signaling? on page 152**

## 19.2.1 What types of 2-wire intercom do LQ Series units support?

- Clear-Com

### Clear-Com 2-wire XLR pin-out

1. Ground
2. DC power (30V)
3. Duplex audio

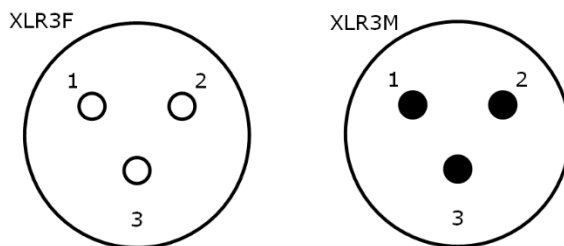

- RTS TW

### RTS TW 2-wire XLR pin-out

1. Ground
2. DC power (30V)  
Duplex audio 1
3. Duplex audio 2

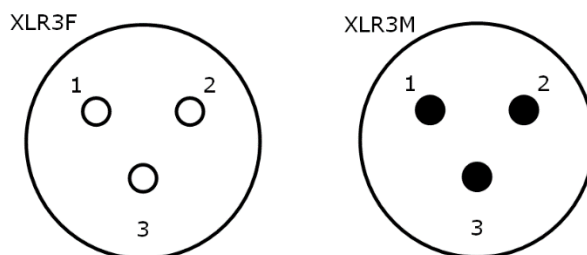

## 19.2.2 Does the LQ-4W2 pass call signaling?

Yes, but only call signaling originating from Clear-Com equipment. Call signaling to RTS equipment will be limited.

## 19.3 Interconnection queries

**Can I link LQ-2W to an LQ-4W? on page 152**

**Can I connect Clear-Com intercom panels to LQ 4-wire devices? on page 153**

**How do I set up LQ to work with RTS equipment? on page 153**

**How do I link an LQ device to HelixNet Main Station (HMS)? on page 154**

**How do I add an LQ port to a HelixNet Channel? on page 156**

**How do I get an Agent-IC client to connect to an LQ device via 3G/LTE/4G/Wifi? on page 157**

### 19.3.1 Can I link LQ-2W to an LQ-4W?

Yes, a 2-wire device can be linked to a 4-wire device.

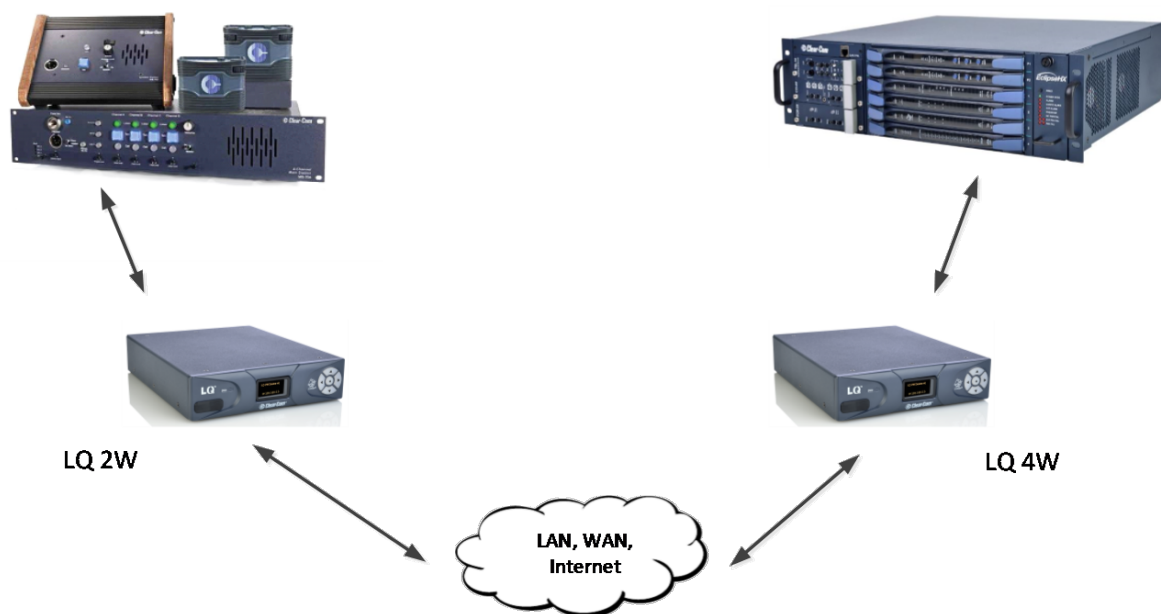

### 19.3.2 Can I connect Clear-Com intercom panels to LQ 4-wire devices?

Yes, Version 2 firmware and later supports Clear-Com Eclipse ECS/EHX matrix to panel connections.

Matrix+3 connections are not supported.

Drake 4000 panels are supported (baud rate 9600)

### 19.3.3 How do I set up LQ to work with RTS equipment?

To use RTS equipment you must set the **Mode** setting to **RTS** in the CCM:

1. Navigate to **Device>Ports>Interface Settings>Mode** for the required device.
2. Select RTS.

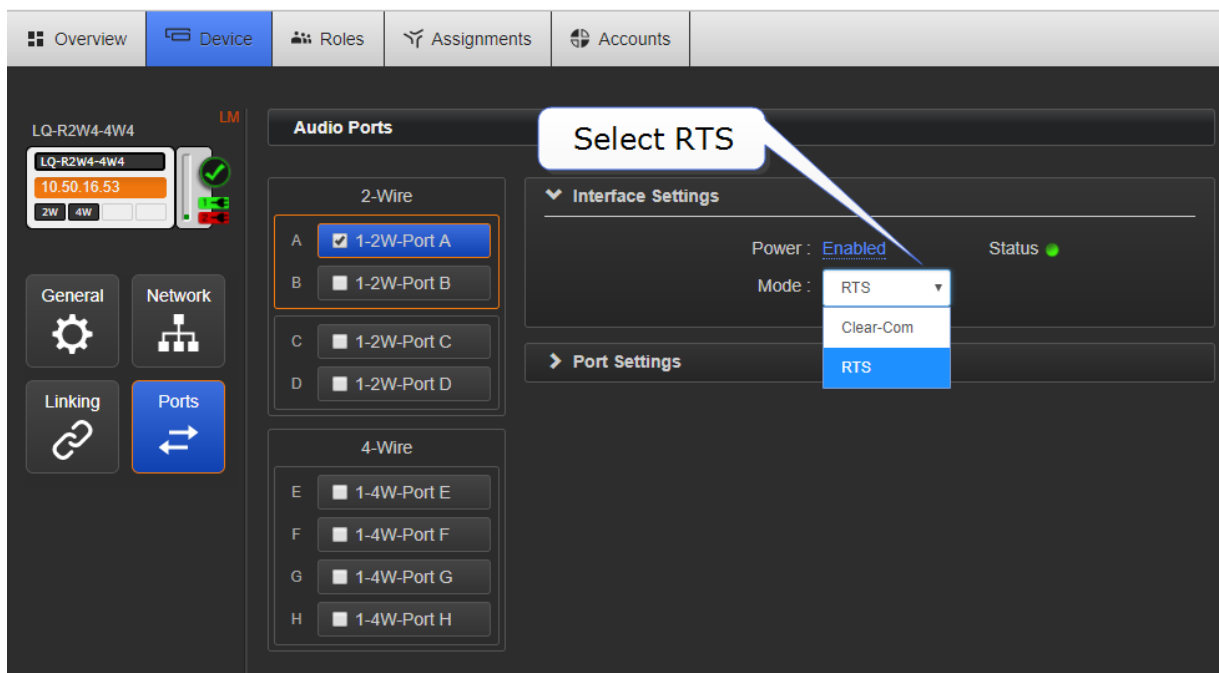

Port A will be channel 1 of the RTS

Port B will be channel 2 of the RTS

The two XLRs (pair) work in parallel, and the RTS device can be connected to either XLR.

### 19.3.4 How do I link an LQ device to HelixNet Main Station (HMS)?

Linking an LQ to an HMS follows the same procedure as linking LQ units in a Link-Group. The LQ manual, available from the Clear-com website gives an overview of linking.

Devices must be connected to the same network and able to see each other across the network.

To link devices:

1. In a browser, open the Core Configuration Manager (CCM) of the HMS. Navigate to **Device>Linking**.
2. Designate the **Link Group Role** of the HMS as **Link-Master**
3. Open the CCM of the LQ unit. Navigate to **Device>Linking**.
4. Designate the **Link Group Role** of the LQ unit as **Link-Member**
5. To link units, give the Link-Member the IP address of the Link-Master and click the blue check mark.

HMS device

Overview Device Roles Assignments Clear-Com

HMS-4X\_Mary LM

HMS-4X  
10.50.16.54  
ETH

General Network Linking Ports

Linking

Link-Group Role : Link-Master

Link-Group Optimization : LAN/WAN Routed Network

LM 2 3 4 5 6

Set Link Group Role of HMS as **Link-Master** (default = **Disabled**)

Navigate to **Device>Linking**

LQ device

Overview Device Roles Assignments Account

LQ-2W2 1

LQ-2W2  
10.50.16.51  
2W INC SIP

General Network Linking Ports

Linking

Link-Group Role : Link-Member

Link-Master IP address :

LM 2 3 4 5 6

Designate LQ as **Link-Member** (default = **Link-Master**)

Input IP address of Link-Master and click the blue check mark

**Note:** The HMS must occupy slot 1 in the Link-Group. This is the default setting.

**Note:** The **Role** settings of the LQ unit is over-ridden by that of the HelixNet master when devices are linked.

**Note:** The Link Group Role status of the HMS is set to **Disabled** by default. This stops the device from broadcasting its DNS to the network. The device is not visible to other devices on the network while Link Group Role is disabled.

### 19.3.5 How do I add an LQ port to a HelixNet Channel?

LQ ports are available to a HelixNet Main Station (HMS) when the devices are linked in a Link-Group configuration.

1. Open the Core Configuration Manager (CCM) of any device in the HMS/LQ Link-Group.

The screenshot shows the Clear-Com Core Configuration Manager (CCM) interface. The navigation bar includes 'Overview', 'Device', 'Roles', 'Assignments', and 'Accounts'. The 'Devices' section displays a grid of device cards. The 'LQ-2W2' card is highlighted in orange, indicating it is the host device. A callout box points to the 'Assignments' tab, and another points to the orange highlight. A table at the bottom shows the 'HelixNet' configuration for the HMS-4X\_Mary device.

Device Name	Model	Role
HMS-4X_Mary	HMS-4X	TechPubsMS

2. Navigate to the Assignments page.

**Note:** Direct Channels are not available to HelixNet. This means that panel control of audio sources is not available.

**Note:** Local Audio Mix (submix) is not available in HelixNet.

### 19.3.6 How do I get an Agent-IC client to connect to an LQ device via 3G/LTE/4G/Wifi?

There is one connection method for an Agent-IC client to an LQ unit, regardless of the connection medium.

**Note:** The device must have Agent-IC license or licenses installed. See **Licensing on page 138** for more information.

Agent-IC accounts must be set up in the **Accounts** page of the LQ CCM.



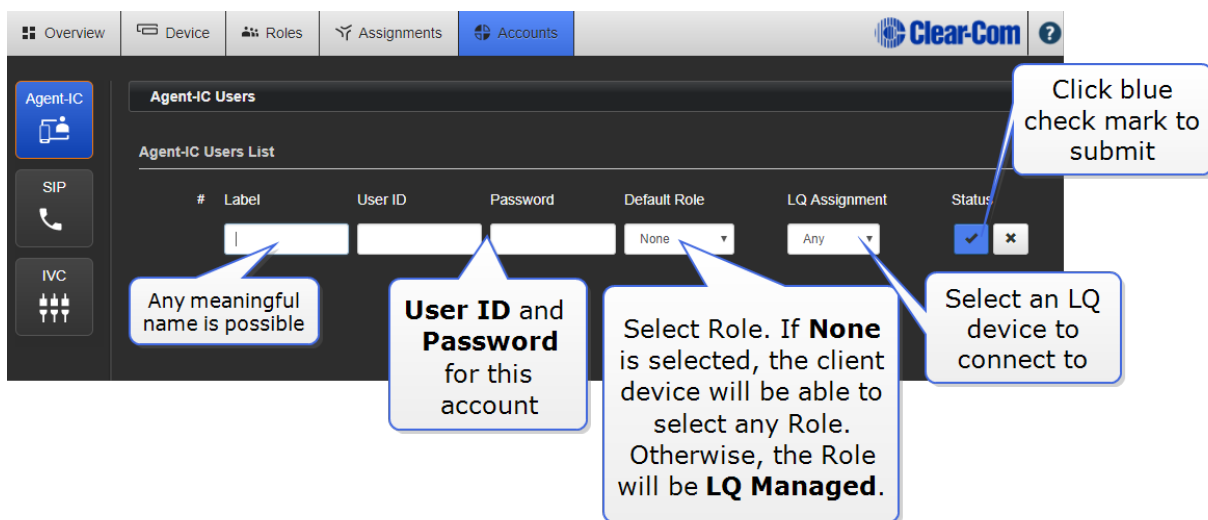
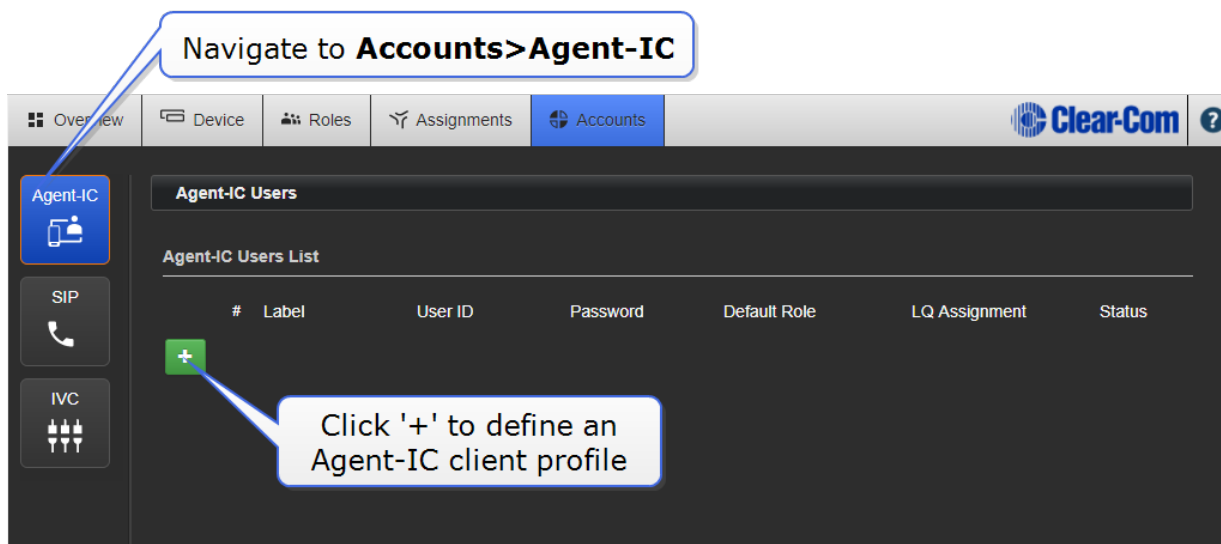

From the mobile client, input:

- LQ device IP address
- Login credentials (User ID and Password) in **Settings**.

Chose an LQ **Profile** (an EHX profile connects to an EHX system).

Press **Start** to connect the client to the LQ.



**Note:** When connecting Agent-IC to HelixNet via LQ, due to a heavier codec (WavPack), the data rate will increase. This may cause problems with the Agent-IC client in HelixNet Channels, particularly when using the slower 3G bandwidth connections.

## 19.4 IP and network queries

**How do I set the system up if I have to cross one or more firewalls? on page 159**

**Why must the Link-Master have a static IP address? on page 160**

**Connectivity, including Web access to my LQ unit is intermittent, even though I am accessing it from within the same LAN. on page 161**

**What happens if connection to the Link-Master is lost? on page 161**

**How do I connect an IVC card to a HelixNet Main Station (HMS) over IP infrastructure? on page 161**

### 19.4.1 How do I set the system up if I have to cross one or more firewalls?

As a minimum requirement for connectivity, the Link-Master must be reachable by all other Link-Members in the Link-Group. To achieve this, port-forwarding rules need to be created within the firewall which the Link-Master is behind. The ports that need to be forwarded are as follows:

1. 80:TCP. This is used for both link initiation and Web management.
2. 655:TCP/UDP. This is used for the transmission of all audio and data (call signaling) between Link-Group members.

To set up a Link-Group with devices behind one or more firewalls, observe the following example configuration:

Assume the following IP addresses and port-forwarding rules:

- 173.194.121.48 (external IP address)
  - 192.168.1.100 (Link-Master network address)
  - 6300 (arbitrary port chosen for port 80, the management port-forward rule)
  - 6301 (arbitrary port chosen for port 655, the audio/data port-forwarding rule)
1. Within the firewall, create a port-forward rule that forwards any TCP requests received on 173.194.121.48:6300 to 192.168.1.100:80.
  2. Within the firewall, create a port-forward rule that forwards any TCP/UDP requests received on 173.194.121.48:6301 to 192.168.1.100:655.
  3. Within the Link-Master's Network configuration page, configure the external IP and audio/data port:

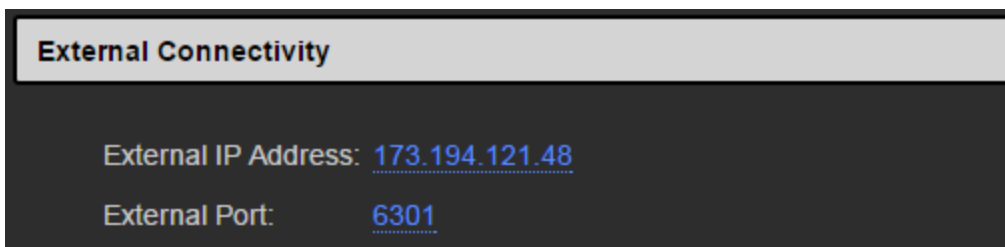

4. Within the remote unit's Linking configuration page, configure the Link-Master's external IP and management port:

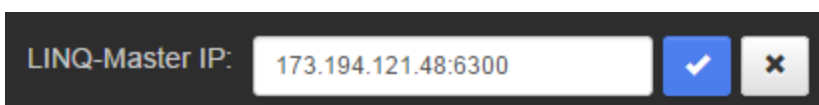

5. Repeat step 4 for each LQ unit to be part of the group.
6. For every Link-Member within the Link-Group that can be made externally reachable, navigate to the device's Network configuration page and configure the external IP and audio/data port as in step 3 (optional).

These configuration steps will ensure basic connectivity within the Link-Group. For more detailed information see **Internet connectivity on page 78**.

## 19.4.2 Why must the Link-Master have a static IP address?

The Link-Master must be statically addressed to prevent its IP address from changing. A changed IP address will result in loss of connectivity with the rest of the Link-Group.

**Note:** *Another alternative is to maintain DHCP addressing but use the Address Reservation feature available in most managed routers. This will instruct the router to allocate a specific DHCP address to an LQ device identified by its MAC address. The unit's MAC address can be retrieved through the LQ's front panel menu.*

### 19.4.3 Connectivity, including Web access to my LQ unit is intermittent, even though I am accessing it from within the same LAN.

The most probable cause for this is that an IP conflict exists. In this case, the IP address used by the LQ unit is already in use by another device within your LAN. The quickest and easiest way to check if this is the problem is to change the LQ unit's IP address to an address that is known to be available and observe if connectivity to the unit is once again consistent.

### 19.4.4 What happens if connection to the Link-Master is lost?

The Link-Master must be statically addressed to prevent its IP address from changing. A changed IP address will result in loss of connectivity with the rest of the Link-Group.

#### **A). Connection to the Link-Master is lost when a Link-Group is on a LAN**

In this case, existing audio routes will be maintained, but system-wide data, such as Channel names will not be updated. New data routes will not be possible.

#### **B). Connection to the Link-Master is lost when a Link-Group is on the Internet**

In this situation there is likely to be loss of audio. When connecting over the Internet, it is usually the case that the Link-Master is the only device that is reachable by the other units in the group. If this is the case, all audio will be routed through the Link-Master, creating the possibility of a single point of failure. To prevent this, be sure to facilitate connectivity between the LQ units in the group through port-forwarding, described in **Internet connectivity on page 78**.

**In both cases, on a LAN or the Internet, loss of connection to the Link-Master will have the following effects:**

- Prevents the ability of the LQ units to modify any of the Channel names.
- Prevents the distribution of device configuration changes throughout the Link-Group resulting in the possibility of inconsistent routing information.

### 19.4.5 How do I connect an IVC card to a HelixNet Main Station (HMS) over IP infrastructure?



To link an HMS to an IVC card over IP, the HMS must first be connected to an LQ unit in a Link-Group configuration. Once connected to an LQ in this way, the IVC

'virtual ports' are available to the HMS.

The Link-Group devices must be connected to the network and able to reach the IVC card over the IP infrastructure.

1. Open the Core Configuration Manager (CCM) of any device in the Link-Group

The screenshot displays the Clear-Com CCM interface with the 'Accounts' tab selected. The 'Devices' section shows a Link-Group containing two devices: HMS-4X\_Mary (Model: HMS-4X, IP: 10.50.16.54) and LQ-2W2 (Model: LQ-2W2, IP: 10.50.16.51). A callout box points to the 'Accounts' tab, stating: "In a Link-Group, the **Accounts** page becomes available to HelixNet". Another callout box points to the device cards, stating: "Linked devices". Below the devices, the 'HelixNet' section contains a table with the following data:

Device Name	Model	Role	
HMS-4X_Mary	HMS-4X	TechPubsMS	 

The 'IVC Ports' section below the table indicates: "There are no IVC Accounts configured."

2. Navigate to the **Accounts>IVC**

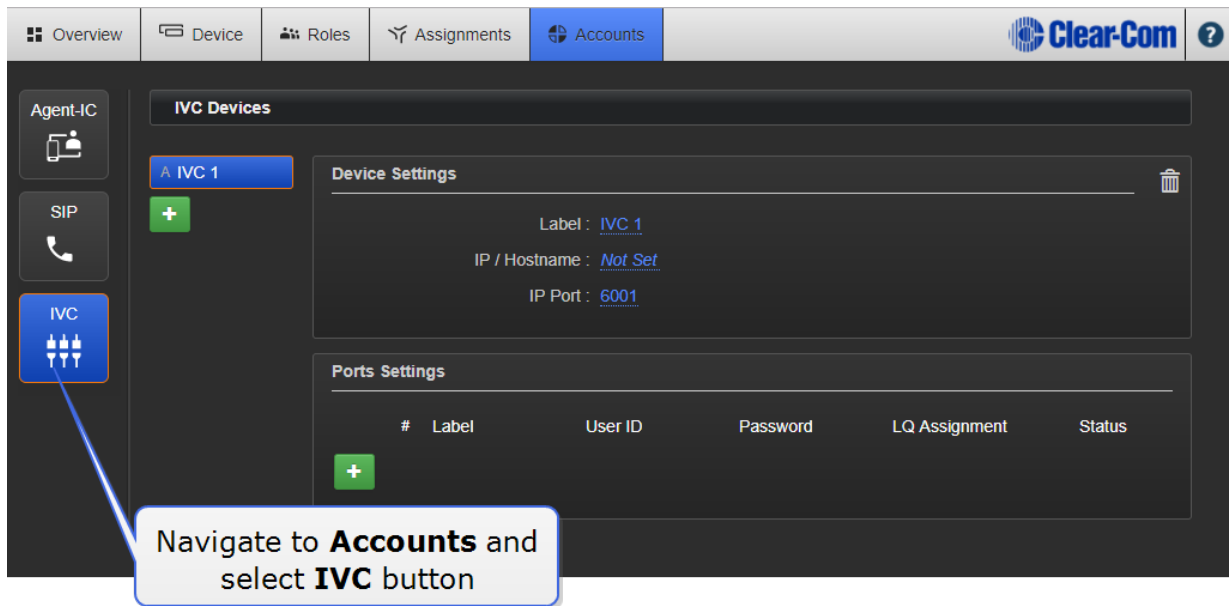

3. Open the EHX software and find the IP address of the IVC card.

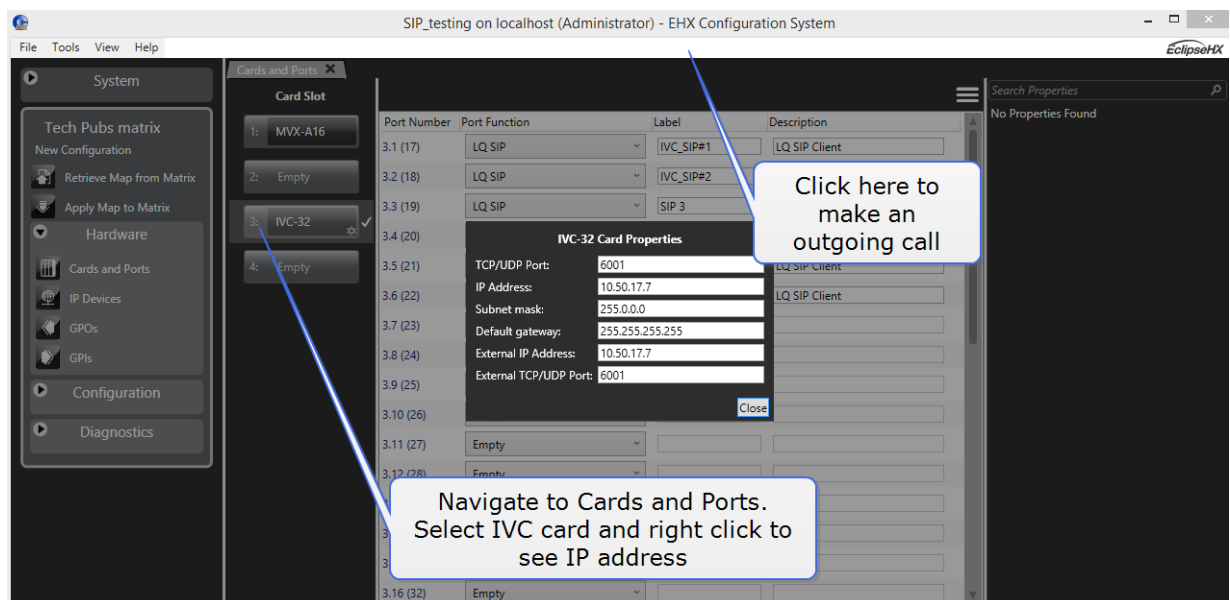

4. Define the port login credentials in EHX

File Tools View Help

System

Tech Pubs matrix  
New Configuration  
Retrieve Map from Matrix  
Apply Map to Matrix  
Hardware  
Cards and Ports  
IP Devices  
GPOs  
GPis  
Configuration  
Diagnostics

Hardware Help Cards and Ports

Card Slot

Port Number	Port Function	Label	Description
3.1 (17)	LQ SIP	IVC_SIP#1	LQ SIP Client
3.2 (18)	LQ SIP	IVC_SIP#2	LQ SIP client
3.3 (19)	LQ SIP	SIP 3	LQ SIP Client
3.4 (20)	LQ SIP	SIP 4	LQ SIP Client
3.5 (21)	LQ SIP	SIP 5	LQ SIP Client
3.6 (22)	LQ SIP	SIP 6	LQ SIP Client
3.7 (23)	Empty		
3.8 (24)	Empty		
3.9 (25)	Empty		
3.10 (26)	Empty		
3.11 (27)	Empty		
3.12 (28)	Empty		
3.13 (29)	Empty		
3.14 (30)	Empty		

Search Properties

- > DTMF Options
- > Basic Options
- > Voice Operated Switch Options
- > Global Options
- > IP Port Options
  - User ID: matrix\_1
  - Password: pass1
  - Network Connection: LAN
  - Audio Codec: G722
- > Fast Key Assign Options
- > Telephone Options
- > Gain Options
- > Tally Options

Navigate to **Cards and Ports>Card>Port>IP Port Options** and set up **User ID** and **Password**

When done, **Apply Map to Matrix**

5. Give the LQ Group the IP address of the IVC card, input login credentials and connect ports.

Overview Device Roles Assignments Accounts Clear-Com

Agent-IC

IVC Devices

A IVC 1

Device Settings

Label: IVC 1

IP / Hostname:

IP Port: 6001

Ports Settings

#	Label	User ID	Password	LQ Assignment	Status

Input IVC IP address and click the blue check mark to submit.

Click '+' to define ports to connect

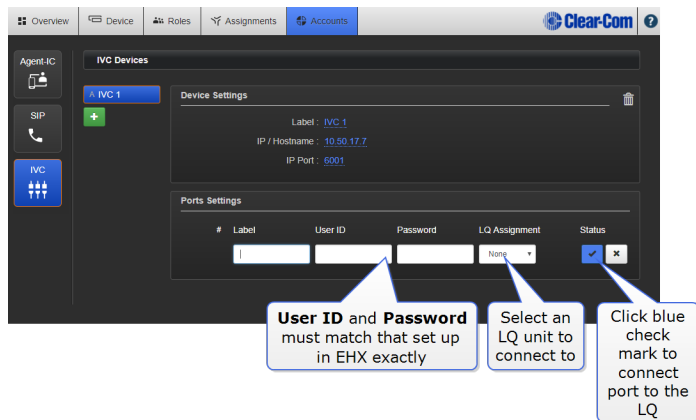

Successful connection is indicated by the connection status button. Click on this icon for information.

**Note:** *The expected latency of HelixNet to LQ to IVC is 100ms plus. This connection may not be suitable for a live environment.*

## 19.5 Audio quality queries

**How do I eliminate choppy audio being received by an LQ unit? on page 165**

**How do I use 20 kHz audio? on page 166**

**How do I change network quality settings? on page 167**

### 19.5.1 How do I eliminate choppy audio being received by an LQ unit?

Choppy audio is usually the result of a port that has a network quality setting that is too high for the IP network. Choppy audio can usually be resolved by adjusting network quality on either the transmitting or receiving devices.

For example, if the choppy audio is only on one receiving device, then the problem will probably be solved on that device. However, if the problem is on all devices except one, then the issue can probably be solved by adjusting network quality on the transmitting device.

**Note:** *If you want to resolve poor audio quality when using the 20 kHz audio feature, you may need to use the Custom network quality settings to keep the bitrate high at the same time as adjusting the jitter buffer. Do this on the device that is receiving choppy audio.*

### 19.5.2 Adjust network quality setting

Network quality problems should be resolved on a per Channel basis.



1. Within a web browser, input the IP address of the required LQ device, or any device within a Link-Group into the address field in order to open the Core Configuration Manager (CCM).
2. Select the **Assignments** page from the top navigation bar.
3. Select the Channel with audio problems from the Channel selector on the right side of the page.
4. Click/touch the Local Audio Mix button within the Channel.
5. Click/touch the Network Settings.
6. Adjust the network quality slider bar.
7. Repeat step 6 until the choppy audio is minimized.

**Note:** *The jitter buffer setting is designed to buffer audio received to prevent loss if there is network jitter. Be aware that the jitter buffer selection will directly affect the latency. This is because the lower number in the jitter range represents the amount of time the LQ unit will buffer audio before delivering it to the port. A bigger jitter buffer setting will increase latency in milliseconds.*

The Custom option within the Network Quality setting allows adjustment of the jitter buffer independent of other settings.

### 19.5.3 How do I use 20 kHz audio?

To use 20 kHz audio, the bitrate must be set to 128 Kbps in the Local Audio Mix (LAM).

Local Audio Mix is adjusted on a per Channel basis.

1. Within a browser, enter the IP address of the LQ device (or any member of the Link-Group if that configuration is being used) in the address field. This opens the Core Configuration Manager.
2. Navigate to **Assignments** using the top navigation bar.
3. Select the required Channel from the right side of the page.
4. Click the LAM button, then network settings and use the slider bar to adjust settings. 128 Kbps is available on **High** or **Custom** settings.

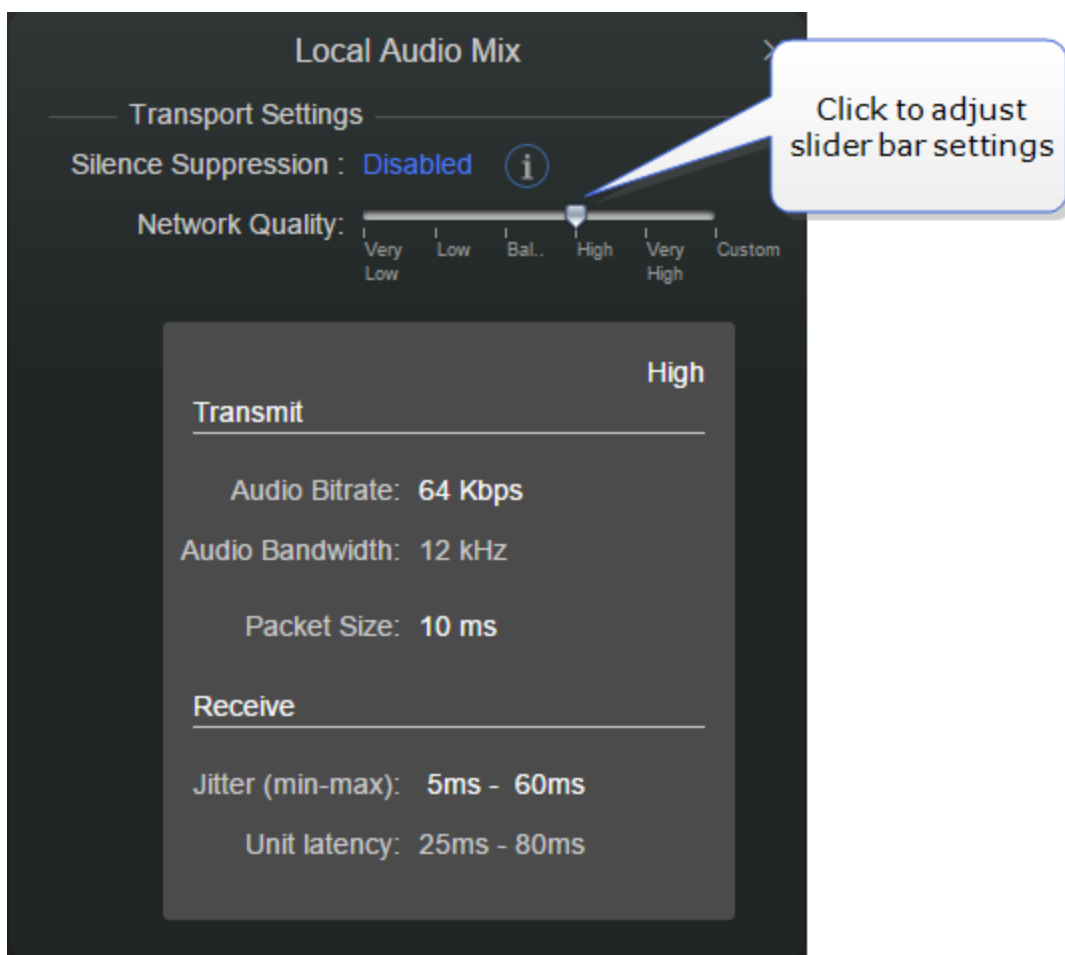
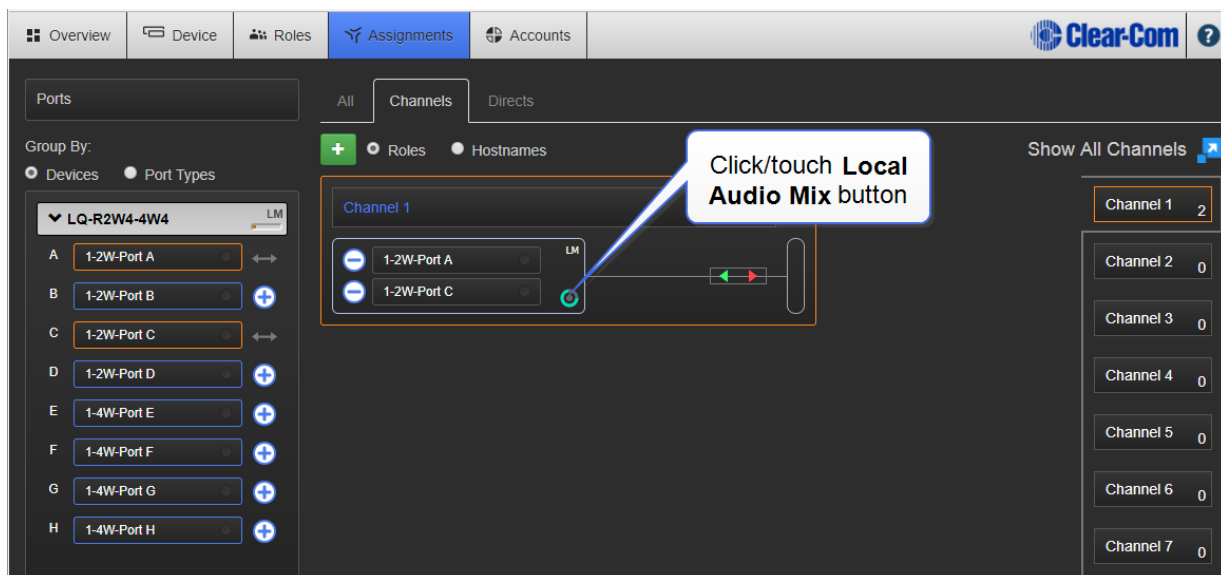

#### 19.5.4 How do I change network quality settings?

Network quality settings (the rate at which the LQ device transmits data to the network it is connected to) are set in the **Assignments** page of the Core Configuration Manager (CCM).

1. Go to the Assignments page of the LQ device (or any LQ device in a Link-Group, if you are using a Link-Group configuration).
2. Click on the Local Audio Mix (LAM) button within the currently selected Channel.
3. Click on the Network Quality setting.
4. Use the slider bar to adjust the setting (very low to very high, or Custom).

Suggested network settings:

- Low: Internet
- Balanced or High: WAN
- Very High: LAN

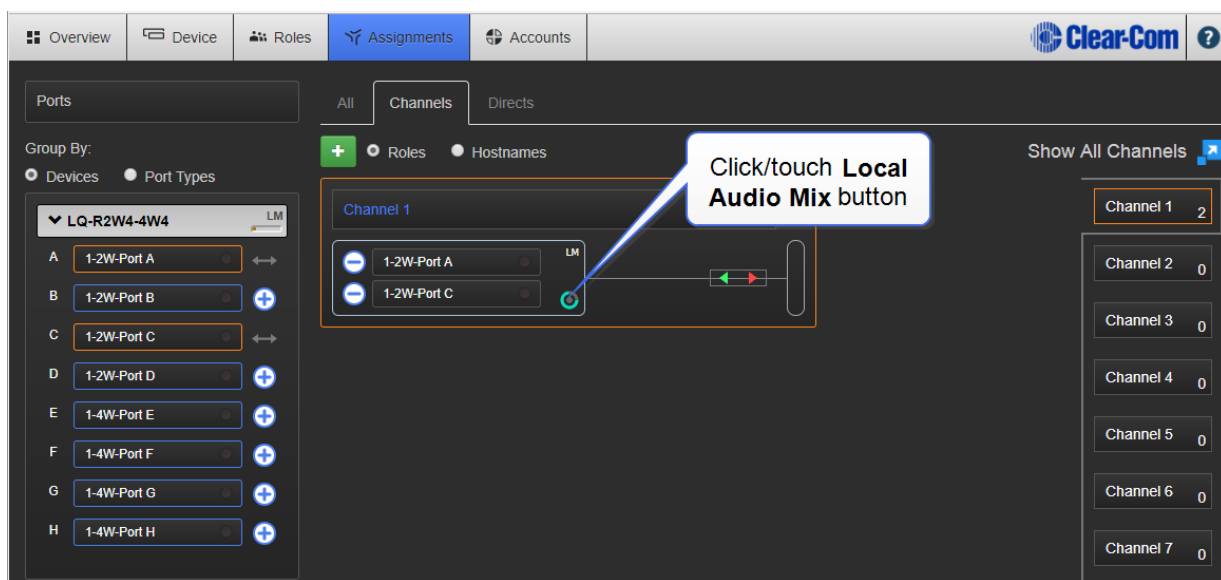

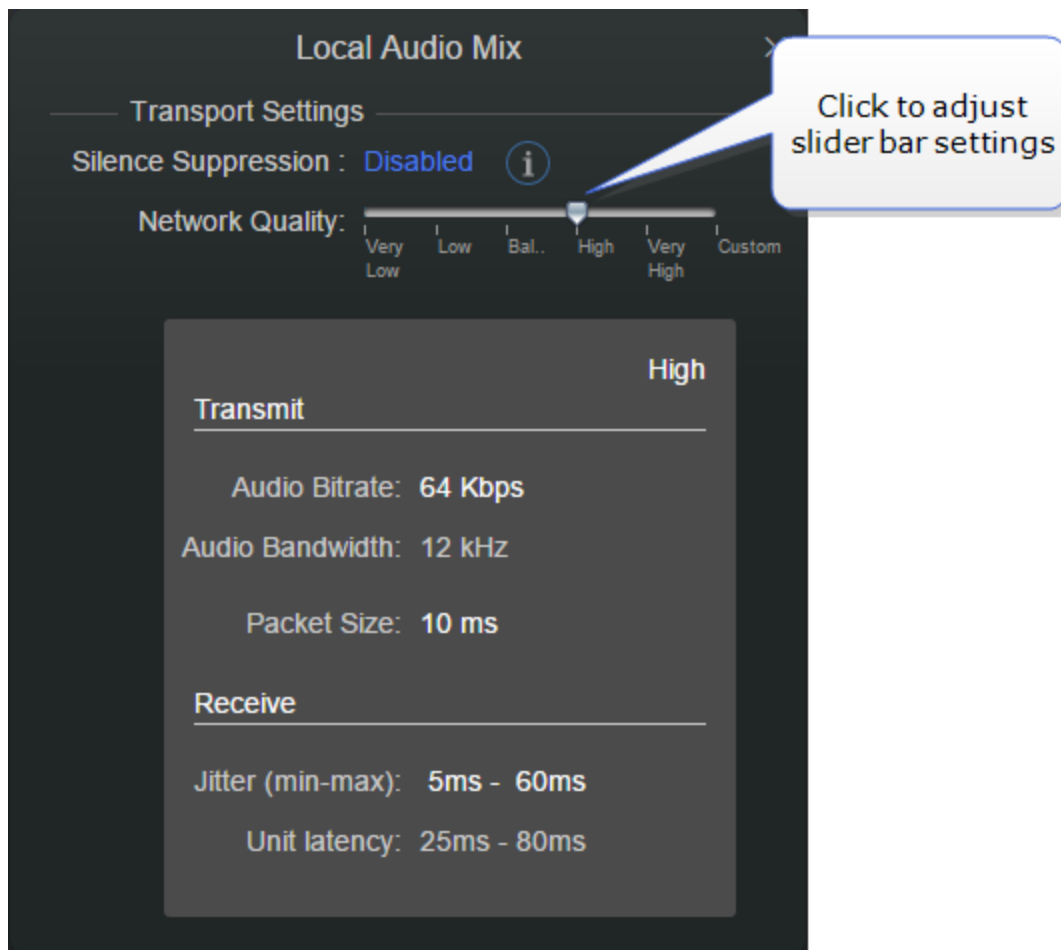

## 19.6 Telephony queries

**How do I link an LQ device to a Public Branch Exchange (PBX)? on page 169**

**Can I use DTMF tones when connecting to a telephone conference? on page 170**

### 19.6.1 How do I link an LQ device to a Public Branch Exchange (PBX)?

You must first create extensions within your PBX. Refer to your PBX documentation for this. Make a note of the PBX **IP address** and the **User ID** and **Password** of the extensions you require to connect to the LQ device.

The PBX and the LQ unit must be connected to the same network and be able to see each other across the network.

**Note:** *The PBX and the LQ must not be configured to the IP range 172.23.xx.xx .*

1. Open the LQ CCM in a browser.
2. Navigate to the **Accounts** page and select the **SIP** button from the left side of the page.
3. Click '+' to begin to define the PBX. Follow the steps illustrated below.

The screenshot shows the 'Accounts' page in the Clear-Com interface. The 'SIP Servers' section is active, showing settings for 'CampsPBX'. The 'Registrar/Proxy IP/Hostname' is set to '10.50.12.54'. Below this, the 'Accounts' table is visible with one entry: A1, SIP#1, 5000, pass123, LQ-2W2. The interface includes a sidebar with 'Agent-IC', 'SIP', and 'IVC' buttons. Callouts provide instructions: 1. Click '+' to define a PBX; 2. Click the IP address field to input the IP address; 3. Click '+' to add extension; User must match an extension set up in the PBX exactly; Password must match an extension set up in the PBX exactly; Select LQ unit; Click blue check mark to connect. A note indicates that the connection status icon (a green checkmark) indicates a successful connection, while a red 'x' indicates an unsuccessful connection.

**Note:** The **Registrar/Proxy Port** and the **Domain** are controlled by the PBX admin. The Proxy Port usually defaults to 5060.

## 19.6.2 Can I use DTMF tones when connecting to a telephone conference?

You can use DTMF dial tones when connecting to a telephone conference. The LQ SIP client can generate SIP information packets which a PBX can convert to DTMF tones. For example, a comma ( , ) represents a pause.

Navigate to **Assignments**

Overview | Device | Roles | **Assignments** | Accounts

Ports

All Channels Directs

Group By: Device Index Interface Type

Roles Hostnames Show All Connections

Channel 1 2

Channel 2 0

Channel 3 0

Channel 4 0

Channel 5 0

Channel 6 0

Channel 7 0

Channel 8 0

Channel 9 0

Channel 10 0

Click here to make an outgoing call

SIP#1

SIP Dial Out

033 xxxxxxxx ,,,, xxxx

Ready to dial

Enter number, 033  
xxxxxxx ,,,, xxxx  
where xxxxxxxx represents  
the number, a coma (,) represents  
a pause and xxxx represents a  
pass code

Click to dial out

## 20 Technical specifications

### 20.1 System limits and capacities

The following system limits and capacities apply.

Entity	Maximum number that can be created in the CCM
Roles	100
Channels	24
Directs	24
Accounts (Agent-IC, SIP and IVC)	No limit

Entity	Maximum number that can be created in the Accounts page for a single LQ device
Agent-IC	<p>No limit</p> <p><b>Note:</b> Any number over eight will result in the user being logged into demo mode of the Agent-IC client.</p>
SIP	8
IVC	8

## 20.2 Audio

2-wire LQ		4-wire LQ	
Frequency response	50 Hz - 10 kHz	Frequency response	100 Hz - 20 kHz
Codec	OPUS	Codec	OPUS
Input/output gain	-3 to +3 dB	Input/output gain	-12 to +12 dB
Maximum input Clear-Com	0dBu (nominal - 18dBu)	Input impedance	100K transformer isolated
Maximum input RTS	+6dBu (nominal - 12 dBu)	Output impedance	120R transformer isolated
Termination	200R selectable	Maximum output	+18dBu (nominal 0dBu)
On-Noise	<-70dBu	Noise	<-75dBu
Off-Noise	<-85dBu		
Call drive voltage Call sense voltage Clear-Com	>11V<4V	Call drive and sense	Clear-Com
Call drive voltage Call sense voltage RTS	-7dBu 20kHz- 32dBu 20kHz		
RMK (Remote microphone kill)	Clear-Com and RTS		

## 20.3 Pinouts

2-wire pinouts.



- Clear-Com

Clear-Com 2-wire  
XLR pin-out

1. Ground
2. DC power (30V)
3. Duplex audio

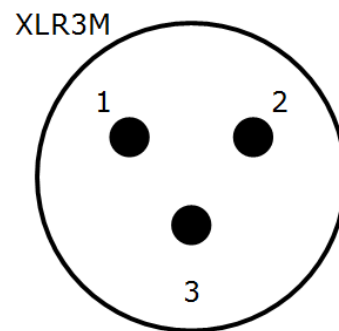
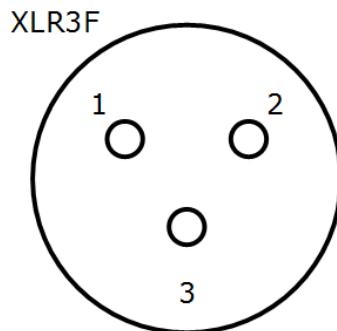

- RTS

RTS TW 2-wire  
XLR pin-out

1. Ground
2. DC power (30V)  
Duplex audio 1
3. Duplex audio 2

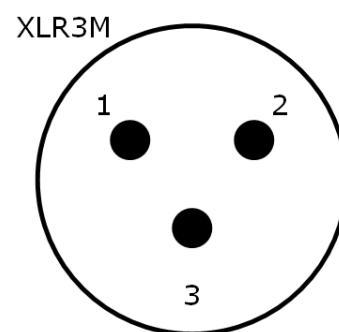
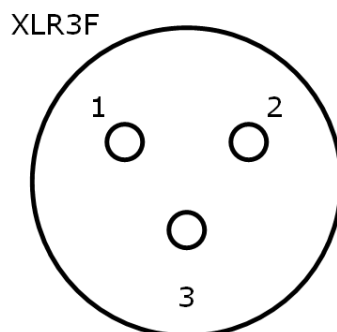

## 20.4 4-wire pinouts

Pin	To panel	To matrix
Pin 1	RS-422 input + (into matrix)	RS-422 output + (from panel)
Pin 2	RS-422 input - (into matrix)	RS-422 output - (from panel)
Pin 3	Audio input + (into matrix)	Audio output + (from panel)
Pin 4	Audio output + (from matrix)	Audio input + (into panel)
Pin 5	Audio output - (from matrix)	Audio input - (into panel)
Pin 6	Audio input - (into matrix)	Audio output - (from panel)
Pin 7	RS-422 output + (from matrix)	RS-422 input + (into panel)
Pin 8	RS-422 output - (from matrix)	RS-422 input - (into panel)

## 4-wire GPIO pinouts

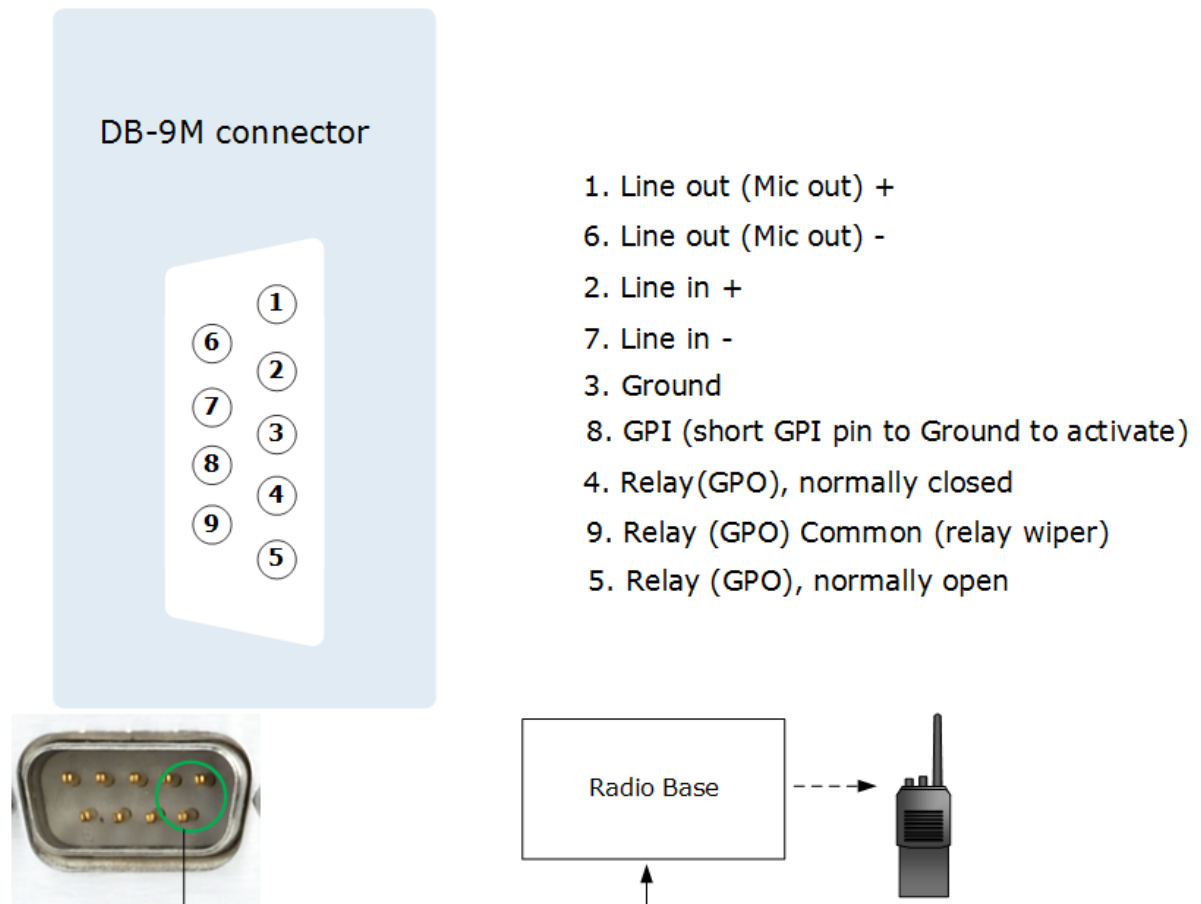
**Caution: Shielded Cable Requirement**

Shielded Cable is required for ALL LQ SERIES GPIO Port connectivity. Shielded Cable must be used to assure compliance with domestic and international emissions standards. Customers, Installers and or qualified Personnel failing to use shielded cables may cause radio interference in which case the user may be required to take adequate measures.

## 20.5 Partyline output current (2-wire)

Line voltage (selectable)	
LQ: PoE	26V 70mA max
LQ: DC power connector (12V PSU)	26V 150mA max
LQ-R: DC power connector (12V PSU)	26V 250mA max

**Note:** LQ units will draw up to 12 watts for a Partyline (depending on how many devices are connected to the line).

## 20.6 Network quality settings

Default option is in **bold**

Bitrates	16, 32, 48, <b>64</b> , 128 kbps
Packet size	5, <b>10</b> , 20, 40ms, 60ms
Jitter buffer	200 – 1000ms, 100 – 500ms, 60 – 200ms, 40 – 100ms, 20 – 60ms, <b>5 – 60ms</b> , 0 – 60ms

## 20.7 Connectors

### LQ Throw Down Units

2-wire (LQ-2W2)	4-wire (LQ-4W2)	4-wire + GPIO (LQ-4WG2)
2 x etherCON (F) : network 2 x 3 pin XLR-F: audio	4 x etherCON (F): 2 for network, 2 for audio	2 x etherCON (F) : network 2 x DB-9M + GPIO

### LQ Rack Units

2-wire (LQ-R2W4)	4-wire (LQ-R4W8)	Combined (LQ-R2W4-4W4)	4-wire + GPIO (LQ-R4WG8)	Combined GPIO (LQ-R2W4+4WG4)
2 x etherCON (F) : network 4 x 3 pin XLR-F 4 x 3 pin XLR-M	2 x etherCON (F) : network 8 x etherCON RJ45 F	2 x etherCON (F) : network 4 x etherCON RJ45 F 4 x 3-pin XLR-F	2 x etherCON (F) : network 8 x DB-9M + GPIO	2 x etherCON (F) : network 4 x 3-pin XLR-F 4 x DB-9M + GPIO

## 20.8 Power supply

LQ-R Rack Units	LQ Throw Down Unit
Input: 100-240V, 47-63Hz, 0.58A max Output: DC 12V, 2A, 60W max	Input: 100-240V, 47-63Hz, 0.58A max Output: DC 12V, 2A, 24W max
2 x Plug-in adapter with sleeve locking connector US, UK, Europe, AUS and China sockets included	1 x Plug-in adapter with sleeve locking connector US, UK, Europe, AUS and China sockets included

## 20.9 Environmental

Environmental variable	Measurement
Operating temperature	32 - 104°F (0 - 40°C)
Storage temperature	-67 - 158°F (-55 - 70°C)
Humidity	90% non-condensing

## 20.10 Dimensions and weight

	LQ Throw Down Unit	LQ-R Rack Unit
Dimensions	6.8w x 1.79h x 8.45d inches (173 x 46 x 215 mm)	19w x 1.79h x 8.8d inches (484 x 46 x 224 mm)
Weight	1.83lbs (.83kg)	4.29lbs (1.95kg)

## 21

## Terminology/glossary

4-wire direct	A 4-wire connection is characterized by two pairs of twisted copper wire which transmit in opposite directions. A 4-wire circuit gives a full-duplex interface which is often used to connect to third party devices. When used with the LQ Series, a 4-wire direct connection (as opposed to a channel) provides point-to-point and panel connections over IP. The 4-wire direct interface will pass panel data as well as audio. 2-wire connections are inactive in the 4-wire direct tab of the Assignments page in the CCM and cannot be used in this context.
CCM	Core Configuration Manager. This is the browser-based configuration tool that each LQ device is supplied with. It can be accessed by entering the IP address of your device (shown on the device front panel) into the address field of a Web browser.
Channel	In the context of the LQ product, a Channel represents a conduit or holder for routing audio and data (including GPIO triggers) through your intercom system. As well as routing audio, a Channel also connects audio and data sources. To use Channels, connect audio to the port connectors on the device, and assign the port or ports to one or more Channels. LQ uses two different types of Channel; a regular Channel and a 4-wire direct Channel. A regular Channel operates like virtual party or conference line. It comprises audio from multiple audio interfaces on the devices (ports A-F) that have been assigned to it. Within a regular Channel, all parties can hear and speak to each other. A 4-wire direct Channel is made up of only two audio sources in a one-to-one connection.
Networked Control Events	Network Control Events are settings on a port that allow GPIO signals and controls to be passed through your intercom system. GPIO signals are converted to digital signals and then passed across the IP infrastructure (as with a 2-wire call signal). There are three Network Control Events to choose from: 1, 2 and Call. See <b>What are Networked Control Events and how do I use them?</b> on page 83 for more information.

Host device	The LQ device whose browser-based configuration tool (CCM) your browser is currently directed to.
Linking	The act of joining multiple LQ devices together in one group.
Link-Group	A set of devices linked together forming their own isolated network.
Link-Master	Role of a device within a Link-Group that provides central reachability within the group as well as ownership of both configuration and distribution of information.
Link-Member	Role of a device within a Link-Group that shares client privileges within the group.
Partyline	In a Partyline, all the participants on the line are involved in the same conversation, and they can hear and talk to all members. In some contexts a Partyline is known as a conference line. Partylines can be 2-wire or 4-wire.
Proxy device	A device within a Link-Group that can be configured via the browser-based configuration tool (CCM) of another unit in the group.
Virtual Partyline	A virtual Partyline is a digital audio channel that is made up of several different audio sources. In terms of audio, a virtual Partyline behaves in the same way as a Partyline; all participants can hear and talk to each other.

## 22 Compliance

---

### **Regulatory Models: LQC and LQ-R**

**Manufacturer: Clear-Com LLC, 1301 Marina Village Parkway, Suite 105, Alameda Ca., 94501**

**Brand: Clear-Com**

**Product name: LQ Series**

**Country of Origin: USA**

### **FCC notice**

This device complies with Part 15 of the FCC rules. Operation is subject to the following two conditions: (1) This device may not cause harmful interference, and (2) This device must accept any interference received, including interference that may cause undesired operation.

NOTE: This equipment has been tested and found to comply with the limits for a Class A digital device, pursuant to Part 15 of the FCC rules. These limits are designed to provide reasonable protection against harmful interference when the equipment is operated in a commercial environment. This equipment generates, uses and can radiate radio frequency energy and, if not installed and used in accordance with the instruction manual, may cause harmful interference to radio communication. Operation of this equipment in a residential area is likely to cause harmful interference, in which case the user will be required to correct the interference at his own expense.

### **Warning:**

Changes or modifications not expressly approved by Clear-Com, LLC, an HM Electronics, Inc. company could void the user's authority to operate this equipment.

*This is a Class A product. In a domestic environment this product may cause radio interference in which case the user may be required to take adequate measures.*

### 22.0.1 **Industry Canada Compliance Statement**

This Class[A] digital device complies with Canadian ICES-003.

Avis de conformité à la réglementation d'Industrie Canada

Cet appareil numérique de la class[A] est conforme à la norme NMB-003 du Canada.

## 22.0.2 Korean KC EMC Registration

For Class A Equipment

이 기기는 업무용(A급) 전자파 적합기기로서 판매자 또는 사용자는 이 점을 주의하시길  
바라며, 가정 외의 지역에서 사용하는 것을 목적으로

## 22.0.3 Australia and New Zealand

This product has been tested and found compliant with applicable AS/NZS  
Standards Australia RCM Marking:

New Zealand R-NZ Marking if applicable: R-NZ

## 22.0.4 European Union

Directives:

EMC Directive 2014/30/EU

Low Voltage Directive 2014/35/EU

RoHS Directive 2011/65/EU

Standards:

EN55022

EN55024

EN55032

EN/IEC60950-1

## 22.0.5 Waste Electrical and Electronic Equipment (WEEE)

The European Union (EU) WEEE Directive (2012/19/EU) places an obligation on producers (manufacturers, distributors and/or retailers) to take-back electronic products at the end of their useful life. The WEEE Directive covers most Clear-Com products being sold into the EU as of August 13, 2005. Manufacturers, distributors and retailers are obliged to finance the costs of recovery from municipal collection points, reuse, and recycling of specified percentages per the WEEE requirements.

Instructions for Disposal of WEEE by Users in the European Union

The symbol shown below is on the product or on its packaging which indicates that this product was put on the market after August 13, 2005 and must not be disposed of with other waste. Instead, it is the user's responsibility to dispose of the user's waste equipment by handing it over to a designated collection point for the



recycling of WEEE. The separate collection and recycling of waste equipment at the time of disposal will help to conserve natural resources and ensure that it is recycled in a manner that protects human health and the environment. For more information about where you can drop off your waste equipment for recycling, please contact your local authority, your household waste disposal service or the seller from whom you purchased the product.

