

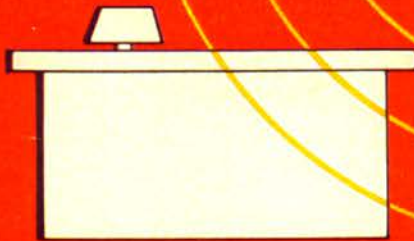

AUDIO EQUIPMENT



A DIVISION OF SONOTEC INCORPORATED • Export: Simonrice
503 South Grand Avenue, Santa Ana, California

CATALOG 405

PRICE \$1.00

HOW TO BUY LANGEVIN PROFESSIONAL AUDIO PRODUCTS

Users of Langevin audio products are served by qualified distributors of professional audio equipment in key cities throughout the world. If you do not know the name of the nearest Langevin distributor contact the factory sales department or call your nearest representative whose name appears on the right column of this page.

IF REMOTELY LOCATED

If you are not served by a Langevin representative or distributor in your area, place your order with the factory at the professional net prices shown in this catalogue.

TERMS

Terms are cash in advance to unrated accounts unless credit has been established with the factory. Open accounts are billed 1%, 10 days, 30 days net, FOB Santa Ana, California.

HOW TO BUY

Rated accounts, or others who have established agreeable credit relationships, may order open account. For speedy service, new customers may accompany their order with a check. It is normal practice to ship freight charges collect for the convenience of the customer and also for the convenience of Langevin, as this simplifies billing procedures. If otherwise instructed, Langevin will ship prepaid and bill for charges.

SPECIFY SHIPPING METHOD

The customer should specify the shipping method, otherwise Langevin will ship the best way at lowest cost. This will in many cases be by motor freight if the shipment approaches 100 lbs., or heavier. 35 lbs. approximately is the breaking point for Railway Express, and is somewhat faster. United Parcel Service is available from Santa Ana and gives good service into Chicago and New York at Parcel Post rates; check the UP office in your city.

Langevin positively will not ship amplifiers or equipment sensitive to rough handling by regular Parcel Post except at the customers request.

If in doubt as to the manner in which shipment should be made, mark your order "Ship Best Way", and Langevin's skilled Traffic Department will insure most economical freight charges consistent with speed and safety of arrival.

WORLD EXPORT

Export correspondence regarding orders should be referred directly to: Langevin Export Division, M. Simons & Son Co., Inc. 25 Warren Street, New York 7, N. Y., Telephone: BARclay 7-5513. Cable: "SIMONTRICE"

CANADA

MA forms should accompany order and be sent direct to the factory.

OVERSEAS POSSESSIONS

Correspondence and orders should be addressed directly to the factory.

EXPORT PACKAGING

A nominal charge is made for export packaging.

FACTORY FIELD REPRESENTATIVES

Atlanta 13, Georgia

Maitland K. Smith Co., 208 14th Street, N.W.
Telephone: TRinity 5-8031

Birmingham 13, Alabama

Maitland K. Smith Co., 2805½ Cahaba Road
Telephone: TRemont 9-7197

Burbank, California

I. R. Stern & Company, 4109 Burbank Blvd.
Telephone: VICTORIA 9-1195

Charlotte 5, North Carolina

Maitland K. Smith Co., 1605 Chatham Avenue
Telephone: FRanklin 6-5951

Chicago 41, Illinois

Irving W. Rose Associates, 4358 Montrose Avenue
Telephone: AVenue 2-6835

Clearwater, Florida

Maitland K. Smith Co., 117 N. Keystone Drive
Telephone: 4425704

Cleveland 15, Ohio

Schroeder Sales Co., 2254 Euclid Ave., Telephone: MAIn 1-5075

Dallas 17, Texas

Jack Yount Company, P. O. Box 17270, 1431 Pleasant Drive
Telephone: EXpress 1-1631

Detroit 27, Michigan

Wayne Beitel Company, 13209 Fenkell
Telephone: VErmont 8-9100

Indianapolis 26, Indiana

Harrison J. Blind Associates, 5762 Cadillac Drive
Telephone: CHapel 4-0191

Kailua, Hawaii

Doughterty Enterprises, P. O. Box 188, 334 Hialiala Loop
Cable Address: DOUGH
Telephone: 253666

Manlius, New York

William M. Ferguson Co., 117 Fayette Street
Telephone: OVerbrook 2-9301

Minneapolis 17, Minnesota

A. J. Warner Co., 5022 29th Ave.
Telephone: PARKway 9-7371

Muskegon, Michigan

Wayne Beitel Co., 2918 Glenside Blvd.
Telephone: VErmont 8-9100

New York City 14, New York

Robert J. Marcy Associates, 80 - 8th Ave.
Telephone: YUKon 9-2950

Ormond Beach, Florida

Maitland K. Smith Co., 322 Riverside Drive
Telephone: ORange 7-2298

St. Louis 19, Missouri

Robert Shaw Co., 7800 Kenridge Lane
Telephone: WOODland 2-7429

San Carlos, California

Farrow & Dobbs Co., 1225 Laurel Street, Telephone: LYtel 1-0339

Seattle 1, Washington

William R. Lanphear Co., 3215 Western Avenue
Telephone: ATwater 4-8150

Springfield, Pennsylvania

R. F. O'Sullivan Company, 777 West Springfield Road
Telephone: KINGSwood 4-1455

Toronto 15, Canada

David R. Beattie Co., 1415 Lawrence Avenue West
Telephone: CHerry 9-4401

World Export

M. Simons & Son Co., Inc., 23 - 25 Warren Street
New York 7, N.Y. — Cable Address: SIMONTRICE

New England Area

Rocky Mountain Area

Langevin, 503 South Grand Avenue, Santa Ana, California
Telephone: KImberly 7-6204

INDEX

| GENERAL | PAGE | IMPEDANCE MATCHING NETWORKS | PAGE | PLUGS AND RECEPTACLES | PAGE |
|--|-------------|--|-------------|---|-------------|
| GENERAL INFORMATION ABOUT THIS CATALOGUE | 5 | AT-SERIES PRECISION ROTARY IMPEDANCE MATCHING NETWORKS .. | 59 | P-1367 DOUBLE PLUG | 31 |
| RECOMMENDED CABLING AND GROUNDING PRACTICES | 12-13 | INPUT PANELS FOR MUSICAST LINE | | P-607 TIP, RING, SLEEVE SINGLE PLUG | 31 |
| SUBJECTIVE EFFECTS OF EQUALIZATION | 42-43 | INP-A Line Level Input Panel for AM-128-101 Series | 24 | CN-33-S CANNON PLUG RECEPTACLE for AM-116-B Amplifier | 10 |
| AMPLIFIERS, LOW LEVEL | | INP-B Low Z High Gain Input Panel for AM-128-101 Series | 24 | POTENTIOMETERS | |
| PREAMPLIFIERS, BOOSTERS, PROGRAM AMPLIFIERS AND MONITORS | | INP-E High Z High Gain Input Panel for AM-128-101 Series | 24 | GENERAL INFORMATION — CIRCUIT TYPES | 54 |
| 5000 MINIATURE SERIES AMPLIFIERS | | INP-G Low Z Microphone Input Panel for AM-138 Series | 22 | AT-SERIES POTENTIOMETERS for Fader use | 57 |
| AM-5116 Preamplifier or Booster Amplifier | 6 | INP-H Disc Playback Input Panel for AM-128-101 Series | 25 | GC-SERIES GRID CONTROL POTENTIOMETERS | 61 |
| AM-5117 Booster, Program or Monitor Amplifier | 7 | INP-J High Z Input Panel for AM-128-101 Series | 25 | POWER SUPPLIES | |
| AM-5116-B Universal Preamplifier, Booster or Program Amplifier (Nova) | 8 | INP-K Disc Playback Input Panel for AM-138 Series | 22 | HIGH VOLTAGE POWER SUPPLIES | |
| STANDARD SERIES AMPLIFIERS | | INP-L High Z Input Panel for AM-138 Series | 22 | PS-5208-A 90 ma plate, 3 amp filament supply | 16 |
| AM-116-B Preamplifier or Booster Amplifier | 10 | INP-M Monitor Bridging Input Panel for AM-138 Series | 22 | PS-208-A 110 ma plate, 4.5 amp filament supply | 16 |
| AM-117-A Program, Booster or Monitor Amplifier | 11 | INP-Q Monitor Input Panel, with control, for AM-128-101 Series .. | 25 | PS-5206 210 ma plate, 6.5 amp filament supply | 16 |
| 5000 SERIES COMPRESSOR-LIMITER AMPLIFIER | | INP-R Monitor Input Panel, without control, for AM-128-101 Series .. | 25 | PS-206-B 210 ma plate, 8 amp filament supply | 16 |
| AM-5301 Leveline Amplifier (Nova) | 14 | JACKS, JACK STRIPS, AND ACCESSORIES | | PS-210-A 425 ma plate, 16 amp filament supply | 17 |
| AMPLIFIERS, POWER | | JS-7161 JACK STRIP Single Row Less Jacks | 32 | PS-205-B 425 ma plate, 16 amp filament supply | 17 |
| 8 WATT MUSICAST AMPLIFIERS | | JS-7160 JACK STRIP Double Row Less Jacks | 32 | LOW VOLTAGE POWER SUPPLIES | |
| AM-138 Basic Amplifier and General Specifications | 21 | JS-7181-B JACK STRIP Single Row with Jacks | 32 | PS-211-B 3 amps at 24 volts DC — regulated | 17 |
| AM-138S-G Low Z Microphone Amplifier | 22 | JS-7182-B JACK STRIP Double Row with Jacks | 32 | PS-212-B 10 amps at 24 volts DC — regulated | 17 |
| AM-138S-K Disc Playback Amplifier | 22 | DS-1219 DESIGNATION STRIP For Single or Double Row JACK STRIPS | 32 | 3102 SERIES MUSICAST LINE | |
| AM-138S-L High Z Input Amplifier | 22 | JS-7190 SPACER STRIP for JS-7192, JS-7193 | 33 | PS-201-B Power Supply for AM-3102 Amplifier | 29 |
| AM-138S-M Monitor Bridging Amplifier | 22 | JS-7192 JACK STRIP AND JACK ASSEMBLY — 10 Jacks | 33 | RANGE EXTENDERS | |
| 20 WATT MUSICAST AMPLIFIERS | | JS-7193 JACK STRIP AND JACK ASSEMBLY — 20 Jacks | 33 | ATX SERIES VU RANGE EXTENDERS | 57 |
| AM-128X Basic Amplifier, General Information | 23 | JS-7191 DESIGNATION SPACER STRIP for JS-7192, JS-7193 | 33 | RESISTORS | |
| AM-128X Ordering Information and Accessories | 24-25 | J-1399-AM JACK 2 Circuit for Double Plug | 33 | RWW SERIES TERMINATING AND LOAD RESISTORS | 64 |
| 50 WATT MUSICAST AMPLIFIERS | | J-1399-BN JACK 2 Circuit Normal for Double Plug | 33 | TABLES | |
| AM-101-3101 Amplifiers, General Information | 26 | J-7111-A JACK 3 Circuit for Single Tip, Ring and Sleeve | 33 | VOLTAGE RATIO TABLE — General Information & Instruction | 63 |
| AM-101-3101 Ordering Information and Accessories | 27 | J-7111-B JACK 3 Circuit Tip and Ring Normal for Single Tip, Ring & Sleeve | 33 | PAD LOSS TABLE — General Information & Instruction | 65 |
| 3102 SERIES MULTI-CHANNEL DRIVER AMPLIFIER | | KEYS | | WATTS, VU-DBM, VOLTS CONVERSION CHART | 67 |
| AM-3102 Basic Amplifier, General Information | 28 | KY SERIES TELEPHONE TYPE SWITCHBOARD KEYS | 34 | MIXER COMBINING LOSSES | 48 |
| AM-3102 Basic Amplifier, Ordering Information | 29 | KC SERIES ROTATING CAM KEYS | 35 | MINIMUM LOSS-MATCHING, Common Values | 66 |
| AM-102-F Line Amplifier | 29 | KB SERIES PUSH BUTTON KEYS | 35 | TRANSFORMERS | |
| ATTENUATORS | | KNOBES | | GENERAL INFORMATION | 69 |
| GENERAL INFORMATION | 46-47 | K SERIES KNOBS | 39 | POWER TRANSFORMERS | 70 |
| AT-SERIES ATTENUATORS AND GAIN CONTROLS | 58 | METERS | | SATURABLE REACTORS | 70 |
| AT-SERIES DECADE ATTENUATORS | 60 | MTR-506 TUBE CHECK METER | 6 | OUTPUT TRANSFORMERS | 71 |
| CABINETS, WALL | | MTR-507 BIAS VOLTMETER for AM-5301 Limiter Amplifier | 15 | LINE TO VOICE COIL TRANSFORMERS | 71 |
| WC-1201 WALL CABINET for AM-101-3101 Series Amplifiers | 27 | VU METERS, VU METER PANELS | 37 | INPUT TRANSFORMERS | 72 |
| WC-1202 WALL CABINET for AM-128 Series Amplifiers | 25 | MIXERS | | TRANSFORMERS FOR LANGEVIN AMPLIFIERS & POWER SUPPLIES .. | 72 |
| DIALS | | GENERAL INFORMATION | 46-47 | FILTER REACTORS | 73 |
| D-SERIES DIALS | 39 | CIRCUITS | 48 | LINE ISOLATION AND BRIDGING TRANSFORMERS | 73 |
| ENGRAVED DIALS | 39 | FORM | 49 | TRAYS | |
| CALIBRATED DIALS | 39 | MX-111 SERIES STRAIGHT LINE MIXER | 50 | TRY-5016 TRAY for AM-5116, AM-5116-B Amplifiers | 9 |
| ETCHED DIALS | 39 | MX-200 SERIES ON | 56 | TRY-5017 TRAY for AM-5117, AM-5301 Amplifiers & PS-5208-A Power Supply | 9 |
| BLANK DIALS | 39 | MODIFICATION GROUPS | | TRY-5019 TRAY for PS-5206 Power Supply | 9 |
| EQUALIZERS | | MG-7-A MODIFICATION GROUP for AM-101-D, 3101-B & 3101-E Amplifier | 25 | TRY-16-B TRAY for AM-116-B Amplifier | 10 |
| EQ-251-A Program Equalizer | 44 | MG-21-A MODIFICATION GROUP for AM-128X Amplifier | 25 | TRY-17-A TRAY for AM-117-A Amplifier | 11 |
| EQ-252-A Graphic Equalizer | 45 | MG-22-A MODIFICATION GROUP for AM-101-D Amplifier | 25 | TRY-17-B TRAY for AM-117-A Amplifier & PS-208-A Power Supply .. | 11 |
| EQ-257-A RIAA Pick-up Equalizer | 19 | MG-23-A MODIFICATION GROUP for AM-101-D Amplifier | 25 | TRY-19-A TRAY for PS-206-BB Power Supply | 16 |
| ESCUOTCHEONS | | MOUNTING FRAMES | | TRY-20-A TRAY for PS-210-A Power Supply | 17 |
| MX-E SERIES ESCUOTCHEONS for MX-111 Series Mixers | 51 | MF-5010 MOUNTING FRAME for TRY-5016, TRY-5017 & TRY-5019 Trays | 9 | TUBE KITS | |
| SLPP-E SERIES ESCUOTCHEONS for Straight Line Pan Pots | 52-53 | MF-10-B MOUNTING FRAME for AM-116-B Amplifier | 10 | TK-5116 TUBE KIT for AM-5116 Amplifier | 6 |
| FILTERS | | MF-3-A FRAME for PS-201-B Power Supply | 29 | TK-5117 TUBE KIT for AM-5117 Amplifier | 7 |
| EQ-255-A HIGH PASS FILTER | 40 | PANELS, FRONT | | TK-5116-B TUBE KIT for AM-5116-B Amplifier | 8 |
| EQ-255-B LOW PASS FILTER | 40 | FP-5032 FRONT PANEL for MF-5010 Mounting Frame | 9 | TK-116 TUBE KIT for AM-116-B Amplifier | 10 |
| FIXED NETWORKS | | PANELS, RACK | | TK-117 TUBE KIT for AM-117-A Amplifier | 11 |
| FIXED ATTENUATOR NETWORKS — General Information | 62 | MP SERIES MAT PANELS 19" Standard | 31 | TK-5301 TUBE KIT for AM-5301 Limiter Amplifier | 15 |
| FNT-SERIES "T" NETWORKS | 64 | RP SERIES RACK PANELS 19" Standard | 31 | TK-5208 TUBE KIT for PS-5208-A Power Supply | 16 |
| FNH-SERIES "H" NETWORKS | 64 | PAN POTS | | TK-208 TUBE KIT for PS-208-A Power Supply | 16 |
| MINIMUM AND FIXED LOSS PADS | 66 | RPP SERIES STEREO PAN POTS — Rotary | 52-53 | TK-5206 TUBE KIT for PS-5206 Power Supply | 16 |
| FTM SERIES FIXED NETWORKS for VU Meters & Panels | 67 | SLPP SERIES STEREO PAN POTS — Straight Line | 52-53 | TK-138S-L TUBE KIT for AM-138S-G, K & L Amplifiers | 22 |
| FNW "T" PAD for Bridging of VU Meters | 67 | PATCH CORDS | | TK-138S-M TUBE KIT for AM-138-M Amplifier | 22 |
| FNB SERIES BRIDGING PADS | 68 | PC-1368 SERIES PATCH CORDS — double plug | 31 | TK-128X TUBE KIT for AM-128X Basic Amplifier | 25 |
| | | PC-1369 SERIES PATCH CORDS — cords only | 31 | TK-101 TUBE KIT for AM-101-D Amplifier | 25 |
| | | PC-710 SERIES PATCH CORDS — cords only | 31 | TK-3101 TUBE KIT for AM-3101-B Amplifier | 25 |
| | | PC-7107 SERIES PATCH CORDS — single tip, ring & sleeve | 31 | TK-22 TUBE KIT for MG-22-A Modification Group | 25 |
| | | PHONOGRAPH PICKUPS AND ACCESSORIES | | TK-3102 TUBE KIT for AM-3102 Amplifier | 29 |
| | | PU-381 Stereo-Mono phono pickup, 600 ohms | 19 | TK-102-F TUBE KIT for AM-102-F Amplifier | 29 |
| | | ST-D3807-A .0007 stylus — stereo | 19 | TK-201-B TUBE KIT for PS-201-B Power Supply | 29 |
| | | ST-D3810-C .001 stylus — mono | 19 | VARIABLE RESISTORS | |
| | | ST-D3827 .0027 Stylus for 78 rpm records | 19 | VR-111 VARIABLE RESISTOR FOR VU Meter Panels | 37 |
| | | | | VR-112 VARIABLE RESISTOR FOR AM-5301 Limiter Amplifier | 15 |
| | | | | VR-113 VARIABLE RESISTOR FOR AM-128-3102 Amplifier | 25 |
| | | | | VR-114 VARIABLE RESISTOR FOR AM-3102 Amplifier | 29 |



THE 5000 SERIES MINIATURE LINE AND THE STANDARD LINE

In the succeeding pages you will find three general classes of amplifiers listed. The first is the popular 5000 series of miniaturized plug-in units which exceed FCC requirements. The second is the Standard Line as exemplified by the AM-116-B and AM-117-A units which provide higher performance, exceeding FCC requirements for FM.

AM-5117

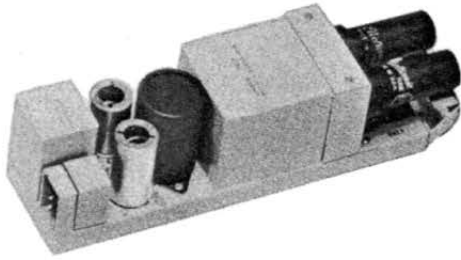

5000 SERIES

AM-5116

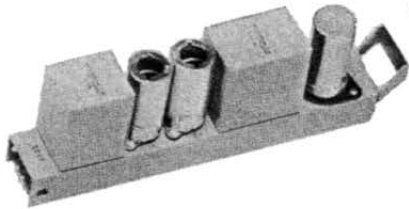

AM-117-A

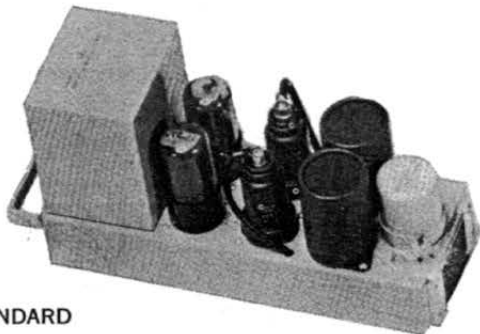

STANDARD

AM-116-B

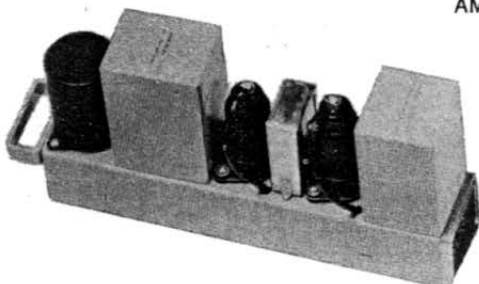

INTRODUCING THE NOVA LINE



A third category, new to Langevin customers, is the Nova Series which embraces still higher performance standards. Some of these units now form part of the 5000 series miniature class. They employ new techniques in manufacture which include printed circuits and miniaturized transformers.

It is anticipated that the Nova series will in time obsolete both the first 5000 series units as well as the Standard Line. To preserve continuity of supply for the convenience of Langevin customers who have standardized on certain components, these units will be retained indefinitely until such time as no hardship will be invoked by their deletion.

In this way Langevin sustains its tradition of service to its customers, accompanied by continued improvement and excellence of design. Langevin is also proud of its product reliability, joined with fine quality at prices which represent good value.

AM-5301 LEVELINE



AM-5116-B

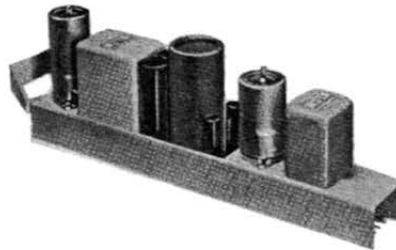

ABOUT TRANSISTORIZED AMPLIFIERS

Langevin maintains an alert, aggressive engineering staff whose combined experience totals literally hundreds of years. Vigorous and continuing research is engaged in to exploit new processes and new materials for better performance and value.

To date no transistor has been found which allows the low noise, isolation and flexibility necessary for the first stage of a quality low-level preamplifier, although progress has been achieved. At this writing tubes are best. While it is true that the less rigid requirements of booster and program amplifiers allow transistor use, the diversification of power supplies and other components make the partial use of transistors uneconomical at this time in Langevin's opinion.

ABOUT SPECIFICATIONS

CONSERVATIVE SPECIFICATIONS

It is the policy of Langevin to rate its equipment conservatively. The specifications you find on each page are derived from the lower side of production averages in order that the user may depend on certain standards of performance, year in and year out, with continuous duty cycles. Tubes employed in establishing ratings supplied by the tube manufacturer are "bogies", or those tubes possessing *average* performance characteristics only, not having the highest performance and lowest noise, nor just borderline acceptability.

PHILOSOPHY OF DESIGN

TERTIARY WINDINGS ON OUTPUT COILS

Langevin uses *both* tertiary windings and plate feedback in its designs. Certain problems exist in the phasing of tertiary feedback circuits which are inherent. In the Langevin Nova Series Amplifiers, plate feedback is employed. This allows the transformer turnover point to be extended almost another octave to 45kc rather than 25kc as when tertiary windings are employed. This results in phase shift of only 18 degrees in the pass band. Through these means higher stability,

flatter response and low distortion is achieved; as many as four Nova Amplifiers can be employed in tandem at full gain with no oscillation resulting.

STABILITY

Through Langevin amplifiers flow programs daily worth hundreds of dollars per minute; peak performance must be coupled with utmost reliability. When inordinately large amounts of feedback are employed, lower distortion products, even with poor transformer components, are possible. In these cases reliability and stability suffer. Langevin employs proper feedback values to insure stability and obtains its performance ratings from good transformer design and materials.

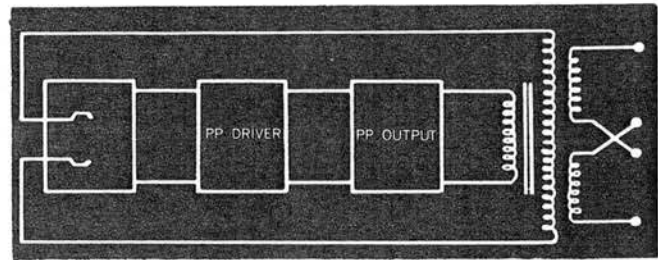

HOW SPECIFICATIONS IN THIS CATALOGUE HAVE BEEN DETERMINED

METHODS OF MEASUREMENT

Langevin measurements can be duplicated by the user employing the following equipment and method.

FREQUENCY RESPONSE - Frequency response is measured by a General Radio 1304-B Audio Oscillator operating a General Radio 1501 Graphic Curve Tracer, resulting in a machine run response curve to insure accuracy.

DISTORTION AND OUTPUT POWER - The diagram below discloses the equipment employed for distortion measurements. The residual distortion of the Hewlett-Packard Distortion Analyzers is not subtracted from the total readings to give a net result.

NOISE MEASUREMENT - While there is an absolute method of measuring noise, a practical method is employed by Langevin which can be duplicated almost anywhere in the field. An amplifier of approximately 80 db gain employing a gain control is required employing a VU meter on the output. The amplifier under test is measured for gain and the figure noted. Then this amplifier input is terminated in a resistor equal to its input impedance and connected to the input of the first amplifier. The gain is varied until the reading on the VU meter is 0 dbm. The gain of this amplifier is then measured. The figure derived is added to the known gain of the amplifier under test and the sum is subtracted from 0 dbm. The resultant figure is the noise at the input below 0 dbm. (1 milliwatt in a 600 ohm line)

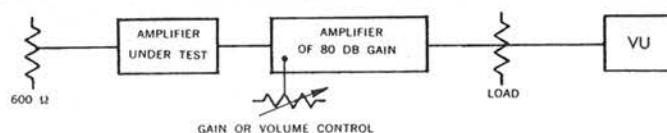
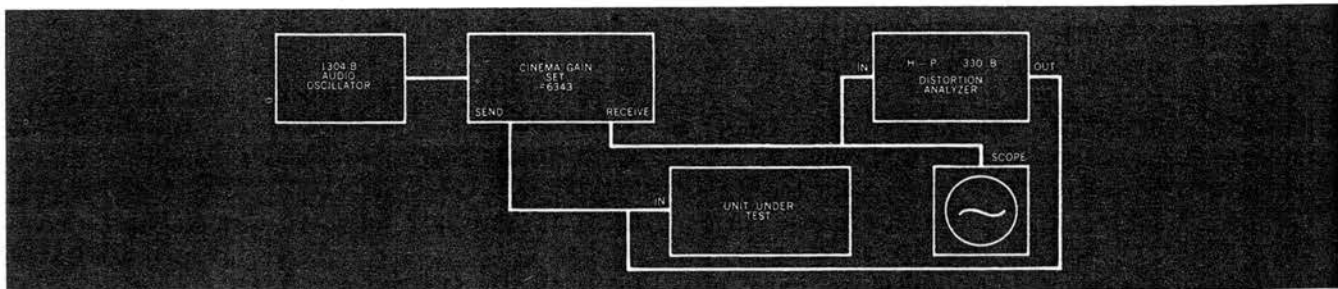
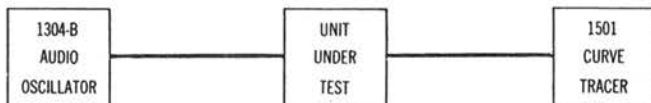

MODEL AM-5116 PRE-AMPLIFIER OR BOOSTER AMPLIFIER

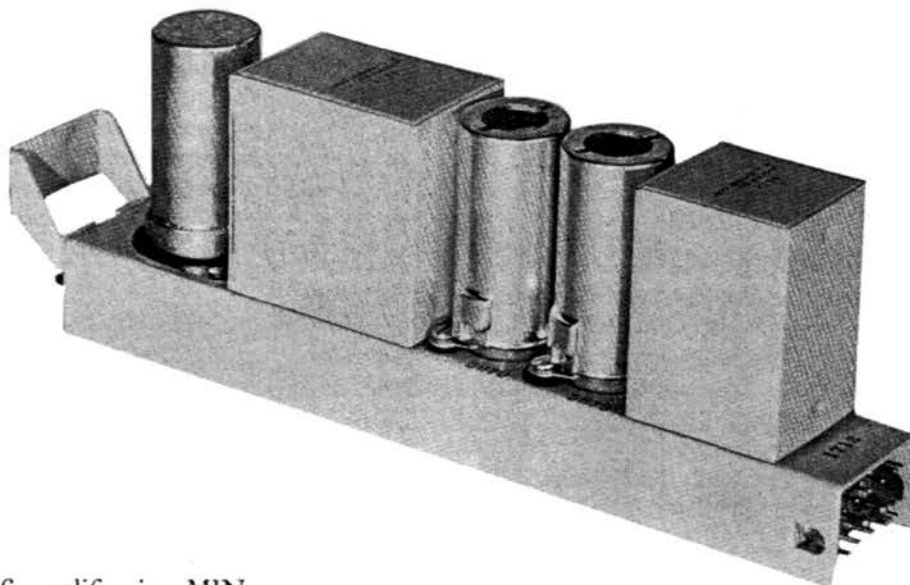

The Langevin model AM-5116 amplifier is a MINATURE PLUG-IN two stage, low noise pre-amplifier or booster amplifier designed for use in radio and television broadcast stations, recording studios and sound systems. It is the smallest high performance amplifier of its type yet developed exceeding FCC requirements. Because of its small size, excellent design and plug-in feature, the model AM-5116 is ideal for installation in consoles as well as equipment racks.

The use of a gold plated miniature plug to prevent maintenance problems due to oxidation is typical of the traditional high quality built into this and all Langevin equipment.

Tube metering facilities have been incorporated in the design of the model AM-5116 amplifier. Miniature precision push-buttons are provided to permit noiseless measurement of the cathode current of each tube with an external tube check meter while the amplifier is in service.

ELECTRICAL CHARACTERISTICS

- GAIN:** 40 db (loaded input transformer).
INPUT SOURCE IMPEDANCE: 30/150/250/600 ohms.
 Center tap available when connected for 150 or 600 ohms.
OUTPUT LOAD IMPEDANCE: 150 or 600 ohms. Center tap available when strapped for 600 ohms.
OUTPUT POWER: +18 dbm (.063 watts) with less than 0.5% rms total harmonic distortion over the range 50 to 15,000 cps and less than 1% at 30 cps.
OUTPUT NOISE: Unweighted, equivalent to input of -120 dbm over the band 30 to 15,000 cps.
FREQUENCY CHARACTERISTICS: ± 0.5 db 30 to 15,000 cps.

POWER REQUIREMENTS: Filament: 6.3 volts 0.3 amps.
 dc or ac

Plate: 275 volts dc, 7.5 ma.

TUBE COMPLEMENT: 2 Type 5879 miniature tubes.

DUTY CYCLE: Continuous.

MECHANICAL SPECIFICATIONS

SIZE: Length 9 in., width $1\frac{3}{8}$ in., height $3\frac{1}{8}$ in.

WEIGHT: 1 lb., 1 oz. net, $1\frac{1}{2}$ lbs. shipping

FINISH: Light grey baked enamel over 18 gauge bonderized (rustproofed) steel.

MOUNTING TRAY: Langevin model TRY-5016.

ORDERING INFORMATION

- MODEL AM-5116 AMPLIFIER**, includes tubes and is strapped for 600 ohms in and out, Price, Net, \$109.30
MODEL TK-5116 TUBE KIT for above, consists of 2 each type 5879 tubes, Price, Net, \$4.30
MODEL TRY-5016 TRAY for above, with plug socket complete, Price, Net, \$7.00
MODEL AM-5116 AMPLIFIER LESS TUBES, same as model AM-5116, but less tubes, Price, Net, \$105.00
MODEL MTR-506 TUBE CHECK METER, Price, Net, \$27.50

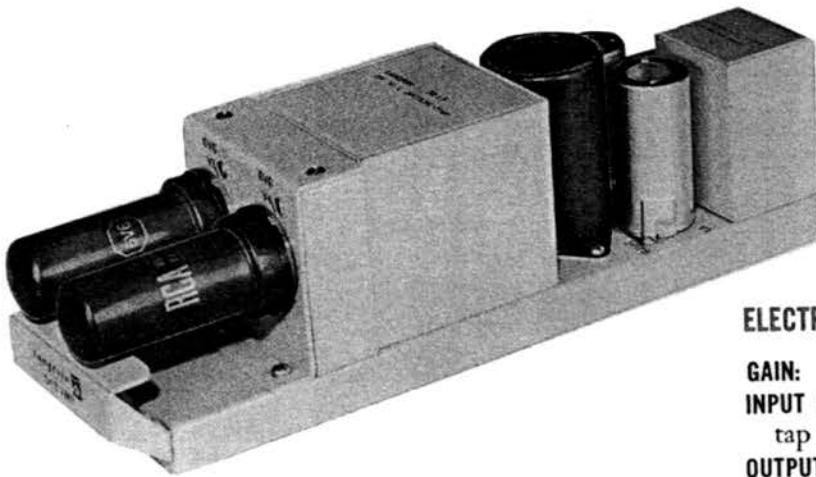

MODEL AM-5117 PROGRAM BOOSTER OR MONITOR AMPLIFIER

The Langevin Model AM-5117 amplifier is a MINIATURE PLUG-IN three-stage, push-pull, fixed gain audio amplifier designed specifically for use in radio and television broadcast audio systems, recording studios and sound systems. Undoubtedly the most compact 8-watt audio amplifier yet developed, its quality is unmatched. It has many applications where outstanding performance and maximum flexibility are required.

Like the Model AM-5116 amplifier, push-button metering facilities are provided in the model AM-5117 amplifier. A gold plated miniature plug permits rapid installation, removal and replacement of these tiny amplifiers.

SPECIAL FEATURES

A low B + drain of only 35 ma., 300 volts dc when used as a program Amplifier reduces power supply requirements. This is accomplished by unstrapping 2 pins on the tray receptacle. When pins are strapped for use as a Monitor Amplifier, the unit draws 75 ma, 300 volts dc. The amplifiers are identical for either service.

The 6V6 tubes are replaceable without unplugging the amplifier. Excellent cooling, offered by the location of the 6V6 tubes, makes more compact installations possible.

ELECTRICAL CHARACTERISTICS

- GAIN:** 55 db.
- INPUT SOURCE IMPEDANCE:** 30/150/600 ohms. Center tap available when connected for 150 or 600 ohms.
- OUTPUT LOAD IMPEDANCE:** 150 or 600 ohms. Center tap available when using 600 ohm connection.
- OUTPUT POWER:** As a Program Amplifier, +26 dbm (0.40 watts) with less than 0.5% rms total harmonic distortion over the range 50 to 15,000 cps.
- OUTPUT POWER:** As a Monitor Amplifier, +39 dbm (8 watts) with less than 1% rms total harmonic distortion over the range 50 to 15,000 cps.
- OUTPUT NOISE:** Unweighted, equivalent to an input signal of -110 dbm or less, depending upon tubes, over the band 30 to 15,000 cps.
- FREQUENCY CHARACTERISTICS:** ± 0.5 db, 30 to 15,000 cps.
- POWER REQUIREMENTS:** Plate: 300 volts dc. As Program Amplifier: 35 ma; as Monitor Amplifier: 75 ma. Filament: 6.3 volts 1.2 amps dc or ac.
- TUBE COMPLEMENT:** 2 Type 5879 miniature.
2 Type 6V6 Octal Base. (6V6GT optional)
- DUTY CYCLE:** Continuous.

MECHANICAL SPECIFICATIONS

- SIZE:** Length 10½ in., width 2⅞ in., height 3 in.
- WEIGHT:** 4 pounds net, 5 pounds shipping.
- FINISH:** Light gray baked enamel over 18 gauge bonderized (rustproofed) steel.
- MOUNTING TRAY:** Langevin Model TRY-5017.

ORDERING INFORMATION

- MODEL AM-5117 AMPLIFIER**, includes tubes and is strapped for 600 ohms in and out. **Price, Net, \$127.20**
- MODEL TK-5117 TUBE KIT** for above, consists of 2 each type 5879 and 2 each type 6V6 metal tubes. **Price, Net, \$9.70**
- MODEL AM-5117 AMPLIFIER LESS TUBES**, same as model AM-5117, but less tubes. **Price, Net, \$117.50**
- MODEL TRY-5017 TRAY** for above, with plug socket complete. **Price, Net, \$8.25**
- MODEL MTR-506 TUBE CHECK METER** **Price, Net, \$27.50**



NEW MODEL AM-5116-B FOR ALL USES UP TO BUSS LEVEL

**PRE-AMPLIFIER, BOOSTER AMPLIFIER
OR PROGRAM AMPLIFIER**

MAXIMUM GAIN: 46 db, -70db input
to +24 dbm output with one amplifier.

NOISE LEVEL: -123 dbm

PRINTED CIRCUITS, MINIATURIZED TRANSFORMERS

This amplifier is a *MINIATURE PLUG-IN* two stage, all push-pull unit and directly replaces the Model AM-5116 Amplifier physically, but offers more features.

The AM-5116-B Amplifier allows all amplifier components up to buss level to be completely interchangeable. The high gain of 46 db allows it to be employed in insensitive microphone circuits, normal microphone input levels of -55 db, as a booster or a program amplifier, all by simply strapping the proper load resistor or resistors on the Model TRY-5016 Tray plug socket.

THIS ALLOWS INSTANT AND COMPLETE INTERCHANGEABILITY FOR ALL FUNCTIONS BELOW BUSS LEVEL WITHOUT RESTRAPPING THE INPUT AND OUTPUT TRANSFORMERS.

Tube metering facilities consisting of push-buttons allow measurement of each tube while the amplifier is in service. Langevin Model MTR-506 Tube Check Meter is available for this use.

PRINTED CIRCUITS FOR UNIFORMITY

Performance from one Model AM-5116-B Amplifier to another is identical through the employment of precision printed circuit techniques. Glass epoxy forms the printed circuit base and is one eighth inch thick for rigidity and strength. Etching and other processing conforms to military specifications for dependability and long life. Solder is contained at component terminations by cup-shaped rivets in accord with the requirements for missile electronic work.

Because the interconductor capacitance is almost non-existent, no difference in noise level between ac and dc can be discerned when used on the heater circuits.

MECHANICAL SPECIFICATIONS:

Size: Length 9 in., width 1 3/8 in., height 3 1/2 in.
Weight: 1 lb., 2 ounces net; 1 1/2 lbs. shipping.
Finish: Light gray baked enamel over 18 gauge bonderized (rustproofed) steel.



ELECTRICAL CHARACTERISTICS

PHASE SHIFT: Less than 18 degrees from 20 to 20,000 cps.

POWER REQUIREMENTS: Plate 300 Volts dc; 25 ma for output power of +24 dbm, 12 ma for power of +18 dbm (strap removed).

FILAMENT: 6.3 Volts at .9 amperes ac or dc.

TUBE COMPLEMENT: 1 type 12AX7, select, (Langevin Model TUS-12AX7) and 1 type 12BH7. (Langevin TU-12BH7)

DUTY CYCLE: Continuous.

| | |
|------------------------------|-----------------------|
| GAIN: Unloaded Input: | Maximum Signal Input: |
| 46 db | -20 dbm |
| 40 db | -10 dbm |
| 35 db | - 5 dbm |
| With 600 ohm input | |
| 42 db | -16 dbm |
| 36 db | -10 dbm |
| 31 db | - 5 dbm |

INPUT SOURCE IMPEDANCE: Matches all sources; see chart on page 18 for proper resistor or loading.

OUTPUT LOAD IMPEDANCE: To work into 50, 150, 200, 250, 500 or 600 ohms, balanced and floating.

DISTORTION: .2% at 1000 cps at +24 dbm with IM at 1%.

OUTPUT POWER: +24 dbm over the range 20 to 20,000 cps at less than .5% distortion with 1% distortion at 20 cps.

OUTPUT NOISE: Unweighted, equivalent to an input signal of -123 dbm, tubes supplied with ac on heaters. Selected 12AX7 1st stage (Langevin TUS-12AX7) average 12BH7 2nd Stage.

FREQUENCY CHARACTERISTIC: ±0.5 db at 20 and 20,000 cps at any level up to +24 dbm.

ORDERING INFORMATION

MODEL AM-5116-B AMPLIFIER, includes tubes and is strapped 600 ohms in and out. Price, Net, \$105.00

MODEL TK-5116-B TUBE KIT for above, consists of 1 each 12AX7, select, (Langevin Model TUS-12AX7) and 1 each 12BH7. Price, Net, \$4.70

MODEL AM-5116-B AMPLIFIER, LESS TUBES, Price, Net, \$100.30

MODEL TRY-5016 TRAY for above, with plug socket complete, Price, Net, \$7.00

MODEL MTR-506 TUBE CHECK METER, Price, Net, \$27.50

(Note: Tube Kit Model TK-5116-B is recommended to insure -123 dbm noise figure shown in specifications.)

PLUG IN BROADCAST AMPLIFIERS

THE 5000 SERIES RACK MOUNTING DETAILS

Complete mounting accessories are available for the 5000 Series. They consist of the Models TRY-5016 and TRY-5017 Mounting Trays for the Models AM-5116-B and AM-5117 Amplifiers; Models TRY-5017 and TRY-5019 Mounting Trays for the Models PS-5208-A and PS-5206 power supplies respectively.

The rack mounting assembly for the miniature plug-in in 5000 Series is the Model MF-5010 Mounting Frame which occupies only 3½" of standard equipment rack space. This frame can accommodate various combinations of the 5000 Series as shown below.

REMOVABLE MOUNTING TRAYS

All mounting trays are supplied with gold-plated receptacles for mating with the plug on the amplifier or power supply. In addition, all mounting trays are provided with a locking clip to prevent upward lift of the unit until plug is disengaged. Grounded tabs are provided to assure positive electrical ground.

The model MF-5010 Mounting Frame allows tray installation from the front or back of the rack. The PLUG-IN Model FP-5032 Front Panel is available as a front cover for the MF-5010 Frame.

In the illustration above, trays are mounted for a combination of three pre-amplifiers AM-5116 or AM-5116-B, one program amplifier AM-5117, or Leveline AM-5301 and one PS-5208-A power supply.

CONSTRUCTION

All mounting trays are made of 18 gauge steel with light grey baked enamel finish. The Model MF-5010 Frame combines heavy 14 gauge side brackets firmly welded to a 16 gauge rigidized metal base, both finished with light grey baked enamel.

CABLING

Cabling may be run in the space adjacent to the plug receptacles, either at the front or rear of the MF-5010 Frame. Complete accessibility for wiring to receptacle pins is offered by recessed tray and frame construction.

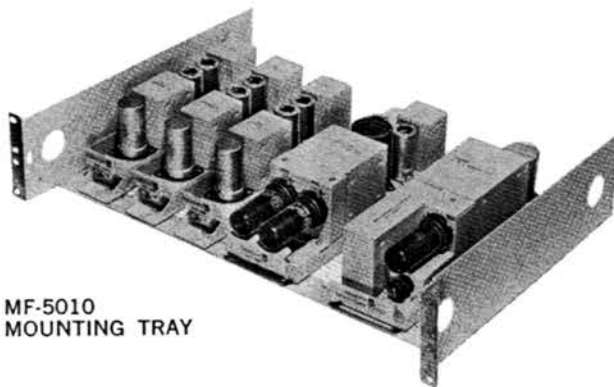

MF-5010 MOUNTING TRAY

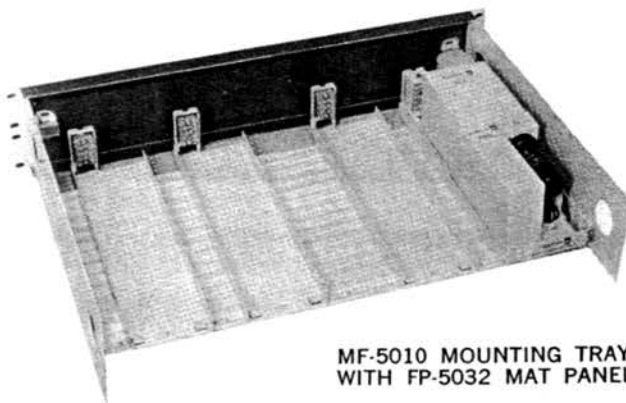





MF-5010 MOUNTING TRAY WITH FP-5032 MAT PANEL

POSSIBLE TRAY COMBINATIONS ON A MODEL MF-5010 MOUNTING FRAME

| TRY-5016 TRAY | TRY-5017 TRAY | TRY-5019 TRAY |
|---------------|---------------|---------------|
| 11 | 0 | 0 |
| 0 | 6 | 0 |
| 0 | 0 | 2 |
| 9 | 1 | 0 |
| 7 | 2 | 0 |
| 5 | 3 | 0 |
| 3 | 4 | 0 |
| 1 | 5 | 0 |
| 0 | 3 | 1 |

GENERAL SPECIFICATIONS AND ORDERING INFORMATION

| |  |  |  |  |  |
|-----------------|---|---|---|---|---|
| | MODEL TRY-5016 MTG. TRAY | MODEL TRY-5017 MTG. TRAY | MODEL TRY-5019 MTG. TRAY | MODEL MF-5010 MTG. FRAME | MODEL FP-5032 FRONT PANEL |
| FOR USE WITH | AM-5116 AM-5116-B | AM-5117, AM-5301 PS-5208-A | PS-5206 | TRY-5016 TRY-5017 TRY-5019 | MF-5010 |
| DEPTH | 9¾" | 9¾" | 9¾" | 13" | |
| WIDTH | 1-1½" | 2¾" | 7⅞" | 19" | 19" |
| HEIGHT | ⅝" | 1⅜" | 1¾" | 3⅜" | 3⅜" |
| WEIGHT | 6 oz. | 7½ oz. | 1 lb. 1 oz. | 4 lb. 14 oz. | 11 lb. 8 oz. |
| SHIPPING WEIGHT | 1 lb. | 2 lbs. | 2 lbs. | 6 lbs. | 13 lbs. |
| PRICE, NET | \$7.00 | \$8.25 | \$13.75 | \$16.50 | \$7.00 |

ALL PRICES INCLUDE CONNECTORS IF APPLICABLE

MODEL AM-116-B PRE-AMPLIFIER OR BOOSTER AMPLIFIER

ELECTRICAL CHARACTERISTICS

GAIN: 40 db with provision for adjusting to 34 db.

TUBE COMPLEMENT: Two type 1620.

OUTPUT POWER: +18 dbm (.063 watts) with less than .5% rms total harmonic distortion over the range 50 to 15,000 cps, and less than 1% total distortion over the range 30 to 15,000 cps.

OUTPUT NOISE: Unweighted, equivalent to an input signal of -124 dbm, depending upon input tube, over the band 50 to 15,000 cps.

FREQUENCY CHARACTERISTICS: ± 1 db over the range 30 to 15,000 cps.

INPUT SOURCE IMPEDANCE: 30/150/250/600 ohms. Center taps are available when strapped for 150 or 600 ohms.

OUTPUT LOAD IMPEDANCE: 150 or 600 ohms. Center tap is available when strapped for 600 ohms.

EXTERNAL POWER REQUIREMENTS: Filament: 6.3 volts ac at 0.6 amperes Plate: 275 volts dc, 8 ma.

METERING: Tube metering facilities have been incorporated in the design of the AM-116-B Amplifier. Precision push-buttons are provided to permit noiseless measurement of the cathode current of each tube with an external tube check meter while the amplifier is in service.

MECHANICAL CHARACTERISTICS

SIZE: Length, 10 in., width, 2 in., height, 5 in.

WEIGHT: 4 lbs., net, 5½ lbs. shipping.

FINISH: Light grey baked enamel over 16 gauge bonderized (rustproofed) steel.

MOUNTING TRAY: Langevin Model TRY-16-B.

ORDERING INFORMATION

MODEL AM-116-B AMPLIFIER, complete with tubes, strapped for 600 ohms in and out, weight 4 lbs. net., shipping 5½ lbs. **Price, Net, \$126.50**

MODEL AM-116-B AMPLIFIER, LESS TUBES, same as above but less tubes, **Price, Net, \$112.50**

MODEL TK-116 TUBE KIT, for above, consists of 2 each Type 1620 tubes, **Price, Net, \$14.00**

MODEL TRY-16-B MOUNTING TRAY for above, with Model CN-33-S Cannon Plug Receptacle, Weight 7½ oz. net, shipping ½ lb., **Price, Net, \$16.00**

MODEL CN-33-S CANNON PLUG RECEPTACLE for Model TRY-16-B Mounting Tray, **Price, Net, \$10.50**

MODEL TRY-16-B MOUNTING TRAY, LESS RECEPTACLE, same as Model TRY-16-B, but less Cannon receptacle Model CN-33-S, **Price, Net, \$5.00**

MODEL MF-10-B MOUNTING FRAME, width inside is 16¼ in., fits 19 in. relay rack, height 7 in., depth 13 in., weight 10 lbs. net, 13½ lbs. shpg. . **Price, Net, \$12.50**

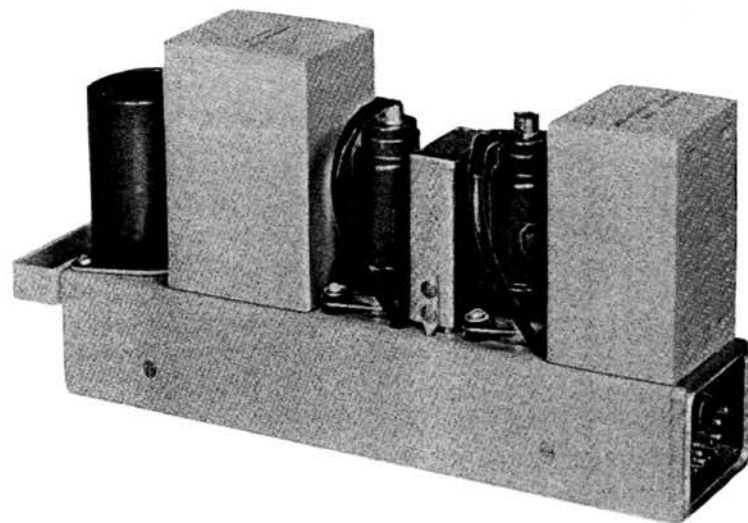

The Langevin Model AM-116-B and AM-117-A PLUG-IN Amplifiers were designed in conjunction with the General Engineering Department of the Columbia Broadcasting System. These amplifiers are small, versatile, easy-to-use units with better than FM quality performance.

MICROPHONE TO TRANSMITTER

Complete broadcast audio facilities can be fabricated with only these two amplifiers in the system from microphone to transmitter input, using the Model AM-116-B as pre-amplifier and booster and the Model AM-117-A as program amplifier, booster, and monitor.

GOLD PLATED PLUGS

The amplifiers utilize Cannon Plugs, built to Langevin specifications, with gold-plated, non-oxidizing terminals, and a shielded TWIN-AX input connection.

SMALL SIZE

Rack space can be used to the fullest advantage with these PLUG-IN Amplifiers, as it is possible to mount 6 pre-amplifiers (Model AM-116-B) or 4 Program amplifiers (Model AM-117-A) in 7 inches of rack space. The small physical size of the PLUG-IN units makes them readily adaptable to console installation.

MAINTENANCE ADVANTAGES

PLUG-IN Amplifiers are easily removed from equipment racks or consoles for preventive maintenance checks at the service bench. Studio operation can be maintained with replacement amplifiers.

OVERALL ECONOMY

Simplification of broadcast audio facilities to only two models of amplifiers, and only two types of tubes, 1620's and 6V6's, makes possible station economies by decreasing tube and amplifier inventories.

STANDARD PLUG IN BROADCAST AMPLIFIERS

MODEL AM-117-A PROGRAM, BOOSTER OR MONITOR AMPLIFIER

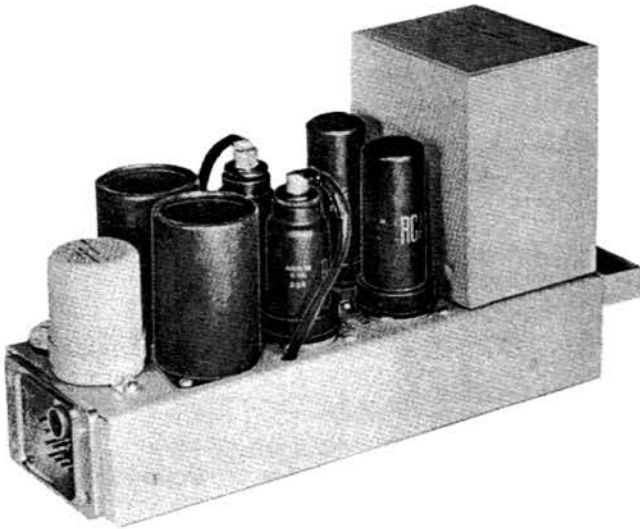

RACK MOUNTING DETAILS

The Langevin Rack Mounting Assembly for Plug-In Amplifiers is a unit which occupies only 7 inches of standard equipment rack space, and can accommodate various combinations of these amplifiers. Rack space of 8 3/4 inches is required for the Model PS-210-A Power Supply.

REMOVABLE TRAYS

The assembly is constructed with two sizes of removable trays, Model TRY-16-B and Model TRY-17-B, each having a plug receptacle mounted on it. Trays may be arranged on the basic frame, Model MF-10-B, so that the following combinations of amplifiers can be achieved:

6 Model AM-116-B Pre-Amplifiers or 4 Model AM-117-A Program Amplifiers or 3 Model AM-116-B Pre-Amplifiers and 2 Model AM-117-A Program Amplifiers or 4 Model AM-116-B Pre-Amplifiers and 1 Model AM-117-A Program Amplifier

CABLING

All cabling is run through the channel located directly behind the plug receptacles, and a removable cover over the cable channel allows easy access to the plugs for wiring purposes.

OVERALL SPECIFICATIONS

Height 7 in., width 16 3/4 in., depth 13 in.
weight: 10 lbs. net, 13 1/2 lbs. shipping

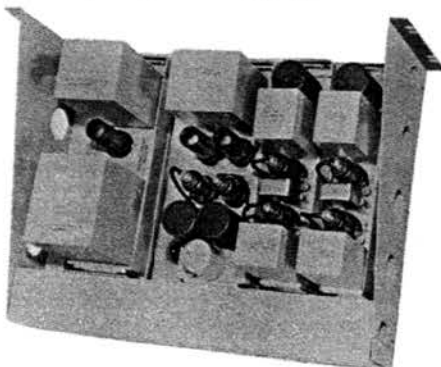

ELECTRICAL CHARACTERISTICS

GAIN: 50 db.

TUBE COMPLEMENT: Two Type 1620, two Type 6V6.

OUTPUT POWER: 30 dbm (1 watt) with less than .5% rms total harmonic distortion over the range 50-15,000 cps and less than 1% total distortion over the range 30-15,000 cps. As a monitor amplifier, 39 dbm (8 watts) with less than 1% total rms harmonic distortion over the range 50-10,000 cps.

OUTPUT NOISE: Unweighted, equivalent to an input signal of -110 to -114 dbm, depending upon tubes, over the band 50 to 15,000 cps.

FREQUENCY CHARACTERISTIC: ± 1 db over the range 30 to 15,000 cps.

INPUT SOURCE IMPEDANCE: 30/150/250/600 ohms. Center taps are available when strapped for 150 or 600 ohms.

OUTPUT LOAD IMPEDANCE: 150 or 600 ohms. Center tap is available when strapped for 600 ohms.

EXTERNAL POWER REQUIREMENTS: Filament 6.3vac at 1.5 amperes. Plate: 300 volts dc at 75 ma.

METERING: Like the Model AM-116-B amplifier, push-button metering facilities are provided in the AM-117-A amplifier.

MECHANICAL CHARACTERISTICS

SIZE: Length, 10 in., width, 3 1/4 in., height, 5 1/2 in.

WEIGHT: 6 1/2 lbs. net, 8 lbs. shipping.

FINISH: Light grey baked enamel over 16 gauge bonderized (rustproofed) steel.

MOUNTING TRAY: Langevin Model TRY-17-B

ORDERING INFORMATION

MODEL AM-117-A AMPLIFIER, complete with tubes and strapped for 600 ohms in and out, weight 6 1/2 lbs. net, shipping 8 lbs., **Price, Net, \$149.40**

MODEL AM-117-A AMPLIFIER, LESS TUBES, same as above, but less tubes, **Price, Net, \$130.00**

MODEL TK-117 TUBE KIT, for above, consists of 2 each Type 1620, 2 each Type 6V6 Tubes **Price, Net, \$19.40**

MODEL TRY-17-B MOUNTING TRAY for above, with Model CN-33-S Cannon Plug Receptacle, weight, 7 1/2 oz. net, shipping 1/2 lb. **Price, Net, \$17.00**

MODEL CN-33-S CANNON PLUG RECEPTACLE for Model TRY-17-A Mounting Tray, **Price, Net, \$10.50**

MODEL TRY-17-A MOUNTING TRAY LESS RECEPTACLE, same as Model TRY-17-A, but less Cannon Receptacle Model CN-33-S, **Price, Net, \$6.00**

MODEL MF-10-B MOUNTING FRAME, width, inside is 16 3/4 in., fits 19 in. relay rack, height 7 in., depth 13 in., weight 10 lbs. net, shpg. 13 1/2 lbs. **Price, Net, \$12.50**

RECOMMENDED WIRING AND GROUNDING PRACTICES

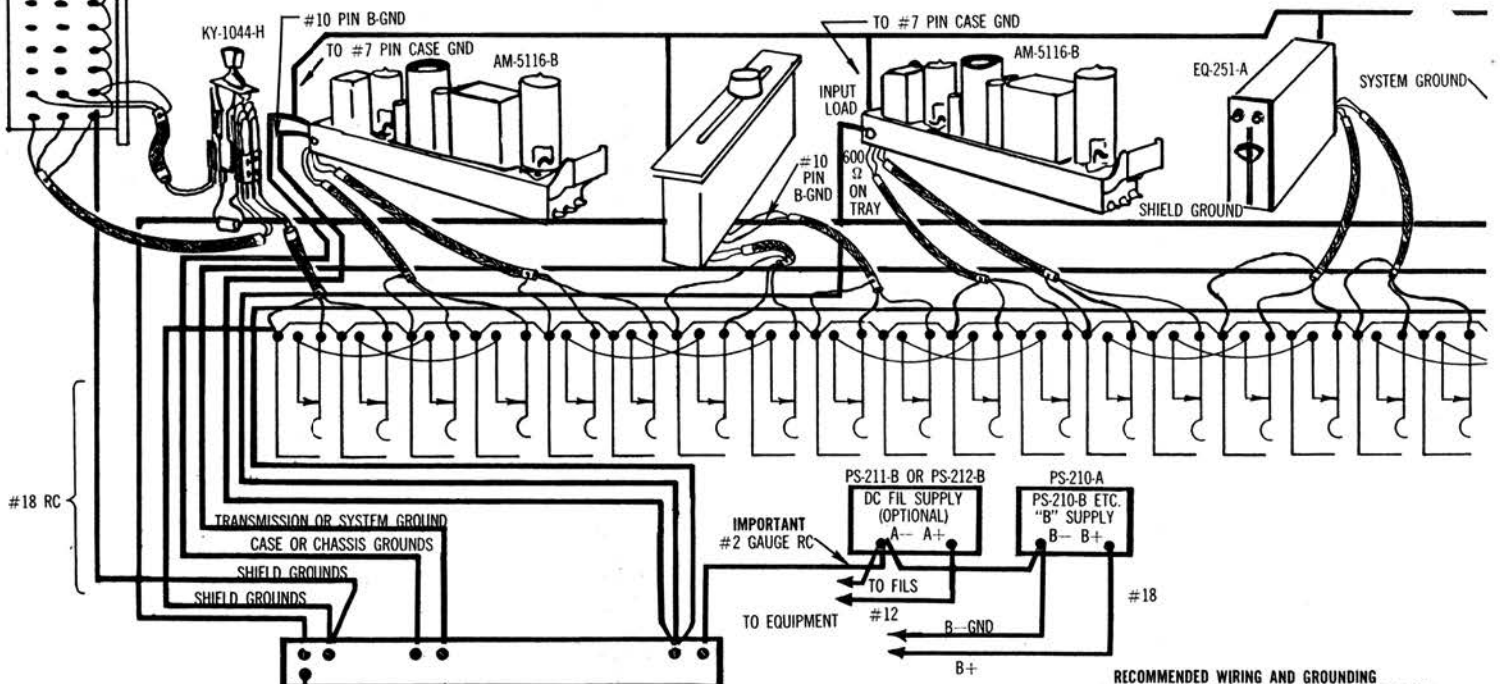
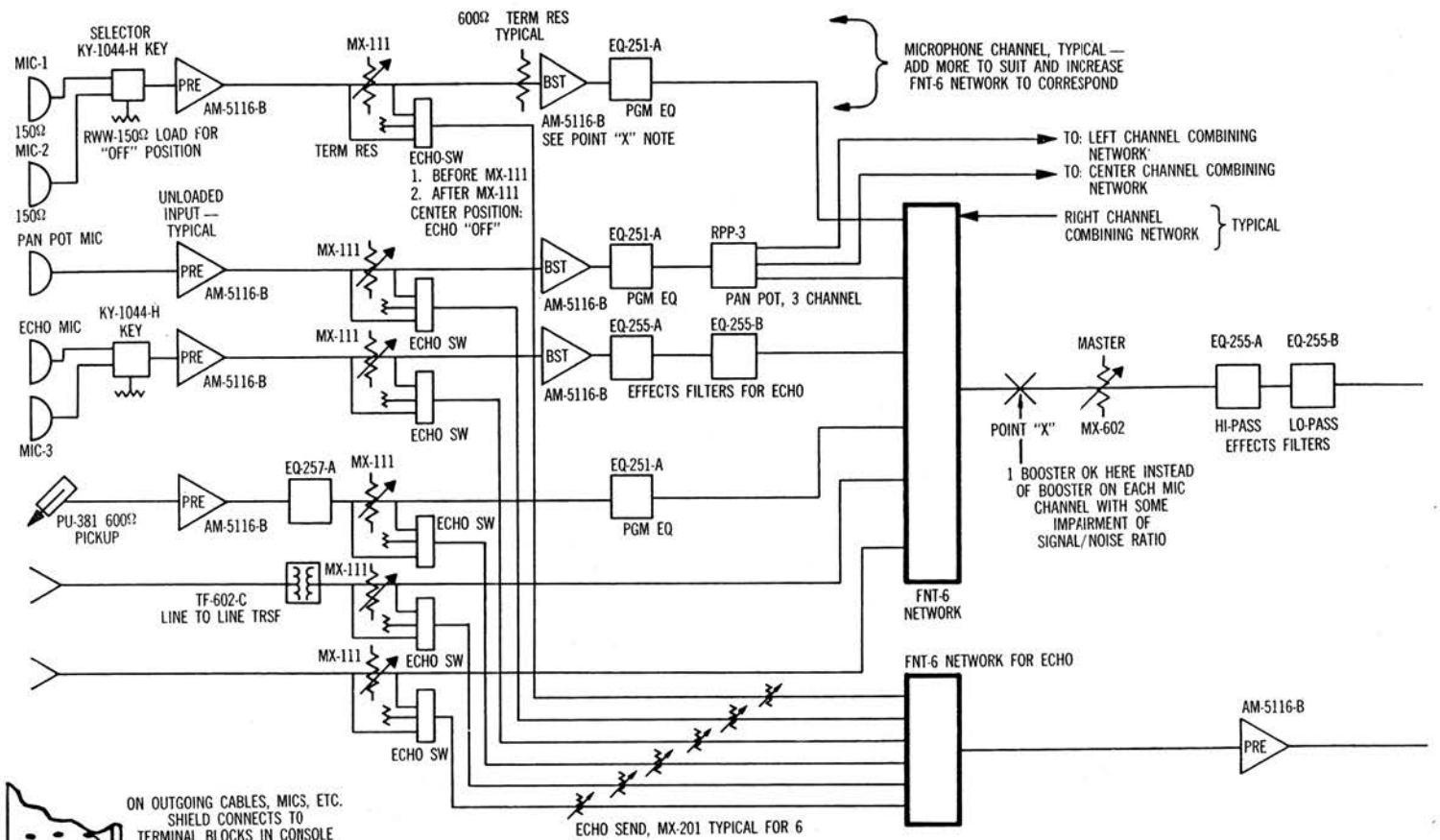

RECOMMENDED WIRING AND GROUNDING TYPICAL MICROPHONE CHANNEL AS IN SCHEMATIC ABOVE (ECHO NOT SHOWN FOR CLARITY)

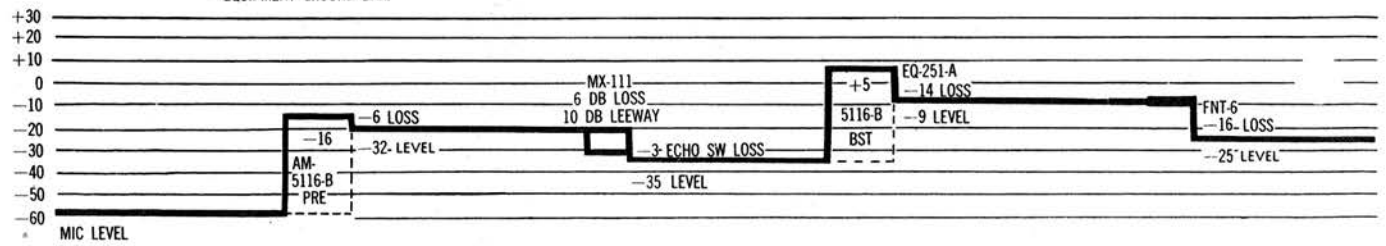

RECOMMENDED WIRING AND GROUNDING PRACTICES

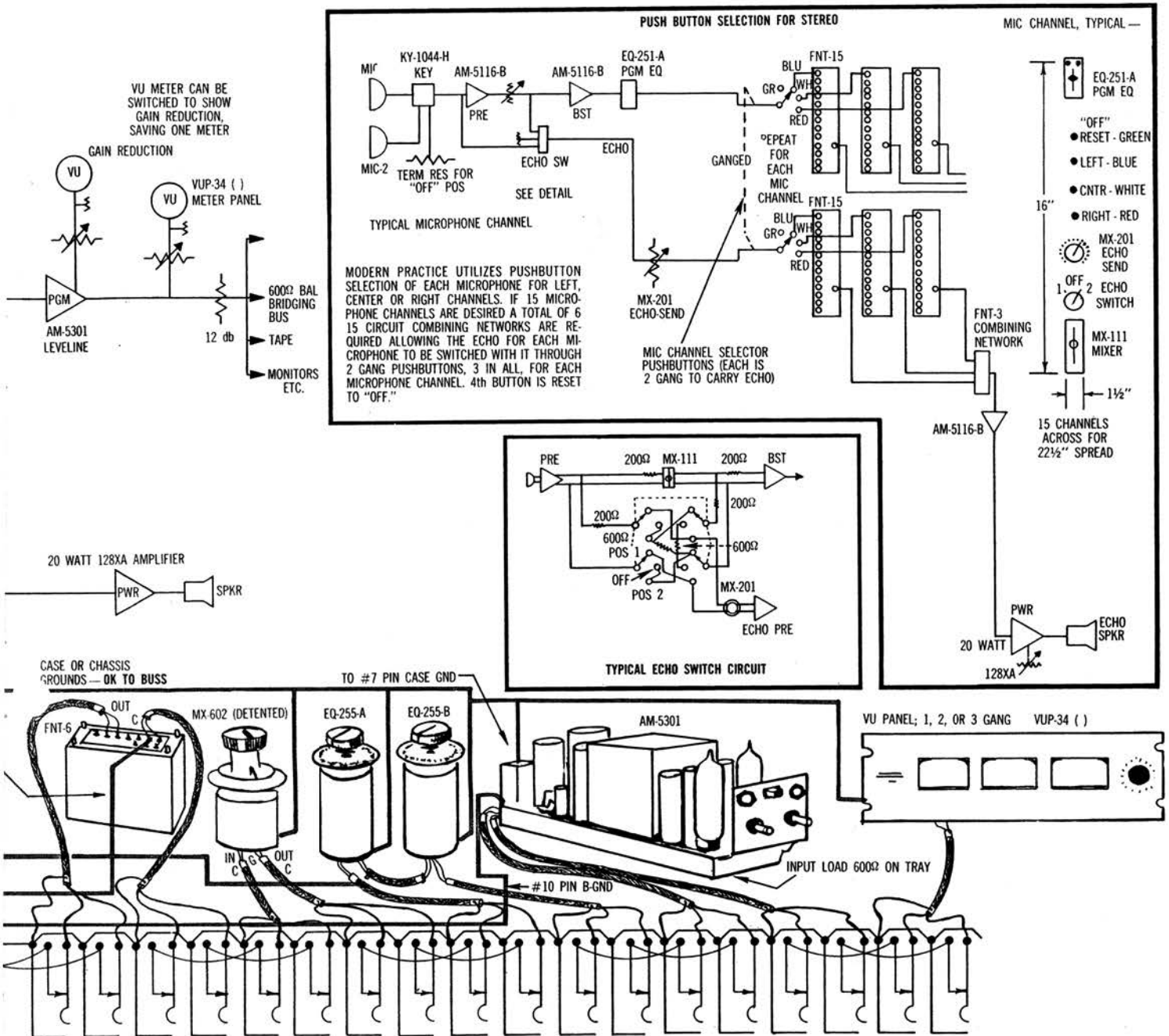

NOTES:

- GROUND THE SHIELD OF A CABLE AT ONE END ONLY!
- CONNECTION BETWEEN ONE SYSTEM AND ANOTHER MUST BE THROUGH TF-602-C LINE TO LINE COILS FOR ISOLATION, OR ONE SYSTEM MUST OUTRANK THE OTHER AND SUPPLY THE EARTH GROUND.
- FOR CONSISTENCY — WHEN CABLES APPEAR BETWEEN TERMINAL BLOCKS OR STRIPS AND JACKS, GROUND THE SHIELD AT THE JACK. IF THE CABLE APPEARS ON A TERMINAL BLOCK OR STRIP BUT NOT AT JACKS GROUND AT THE TERMINAL BLOCK OR STRIP. FOR CABLES BETWEEN PIECES OF EQUIPMENT, FOR EXAMPLE, AMPLIFIERS, HI AND LO PASS FILTERS, ETC., TIE THE SHIELD THROUGH A SEPARATE WIRE TO THE MAIN GROUND BAR IN THE CONSOLE OR EQUIPMENT.
- MAKE CERTAIN THAT SHIELDS NEVER CARRY SIGNAL NOR CURRENT.

SEE PAGE 74 FOR PHYSICAL LAYOUT OF COMPLETE CONSOLE CONTROL PANEL LAYOUT.

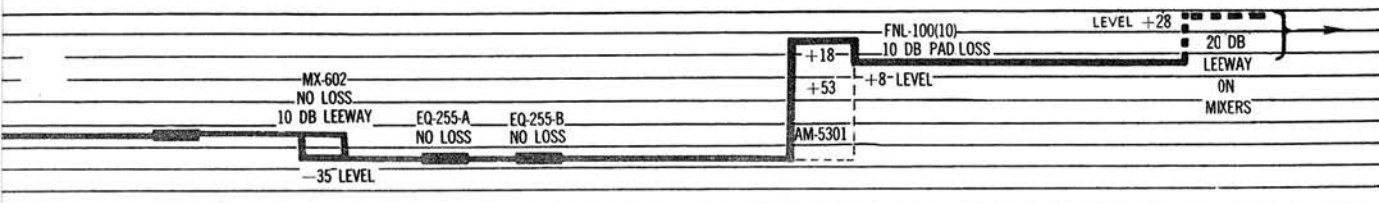

THE MODEL AM-5301 LEVELINE AMPLIFIER

+ 37 dbm OUTPUT (6 WATTS)

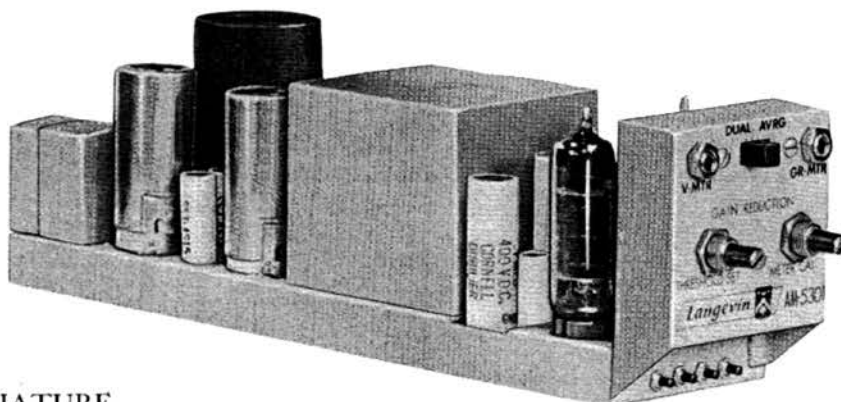

INTRODUCTION

This new limiter amplifier is a MINIATURE PLUG-IN unit which acts as an automatic averaging or as a peak level amplifier in TV-Broadcast, Microwave, Recording and Industrial Sound applications. It operates with a push-pull variable gain input stage driving a 2 stage push-pull program amplifier. Silicon rectifiers provide bias to regulate gain of the input stage. Decals are furnished to convert a VU meter to a Gain Reduction Meter.

Maximum program variations up to 30 db can be controlled, thus relieving studio personnel of many exacting level adjustments. In recording, this unit allows higher signal-to-noise ratios by loading the tape or disc; thus the engineer is not required to anticipate overloads. This anticipation results in lower signal to noise and lower maximum levels than those otherwise possible. The unit is equipped with a chassis control to set limiting and compressing action, along with a metering jack.

For recording use, accessories are available which include an extension bias meter and a threshold control, allowing continuously variable control of limiting during the program with console panel accessibility.

APPLICATIONS

EXPANDER-COMPRESSOR - With an average program material level sufficient to produce 15 db of gain reduction, the output signal will be compressed for incoming signals exceeding 15 db, and expanded for incoming signals below 15 db. Excellent for background music applications where the dynamic range should be compressed.

AUTOMATIC MASTER GAIN CONTROL - Simply replace the program amplifier by plugging in the Leveline Amplifier; the AM-5301 Leveline Unit replaces directly an AM-5117 used as a program amplifier or as a monitor amplifier of 6 watts by employing the same strapping used for the AM-5117.

AUTOMATIC LEVEL CONTROL FOR A REMOTE LINE --- The Leveline units permit unattended operation of the remote line.

AUTOMATIC CONTROL OF LEVEL DIFFERENCES BETWEEN 2 OR MORE PROGRAM SOURCES - Controls differences between turntables, projectors, network programs and microphone preamplifier sources.

USE AS A "DUCKER" - The AM-5301 permits automatic "ducking". A program can be automatically lowered the recommended 8 db (one-half loudness) to allow an announcer to override without apparent program interruption. The announcer begins to speak, and the background automatically lowers while allowing full announce level.

USE AS A NORMAL PROGRAM AMPLIFIER - If the Console Panel Accessory Controls are not employed, turning off the integral chassis bias limiting control allows operation as a conventional program amplifier; otherwise, regulating the console accessory bias limiting control to extreme "High" will accomplish the same action.

ELECTRICAL CHARACTERISTICS

| | |
|----------------------|---|
| GAIN: | 53 db with 600 ohm input source |
| INPUT SOURCE: | 125 to 600 ohms balanced or unbalanced |
| IMPEDANCE: | See chart on page 18 for proper loading resistor |
| OUTPUT POWER: | +37 dbm when strapped for monitor, +26 dbm strapped for Leveline operation. |
| OUTPUT NOISE: | Unweighted, equivalent to an input signal of -110 dbm or less over the band 20 - 20,000 cps |

LIMITER AMPLIFIER

- FREQUENCY RESPONSE:** $\pm .5$ db 20-20,000 cps
- DISTORTION:** Less than 1% at +36 dbm operating levels including compression. Less than .5% at +26 dbm
- COMPRESSION RATIO:** Adjustable from 1.6:1 to 5:1 over a 30 db range at input with 4:1 being optimum
- ATTACK TIME:** 11 Milliseconds as supplied; resistor change permits lowering in increments down to 100 microseconds.
- RELEASE TIME:** For 63% recovery, .5 seconds in "dual" position; 3 seconds in "average" position.
- TUBE COMPLEMENT:**
- 1 - 12AY7-select (Langevin Model TUS-12AY7)
 - 1 - 6ES8 Variable Gain Input Amplifier (Langevin Model TUS-6ES8)
 - 2 - 6005 5 Star Output Amplifiers (Langevin Model TUS-6005)
- BIAS RECTIFIER:** 2 - Silicon Bias Rectifiers
- POWER REQUIREMENTS:** 6.3 Volts ac or dc at 1.5 amperes; 300 vdc at 90 ma strapped for monitor; 50 ma strapped for Levelline operation

MECHANICAL SPECIFICATIONS

- MOUNTING TRAY:** Langevin Model TRY-5017
- FINISH:** Light gray baked enamel over 18 gauge bonderized (rustproofed) steel
- WEIGHT:** 4 lbs. net, shipping 5 lbs.
- SIZE:** Length 10 $\frac{1}{4}$ in., width 2 $\frac{5}{8}$ in., height 3 in.



METER

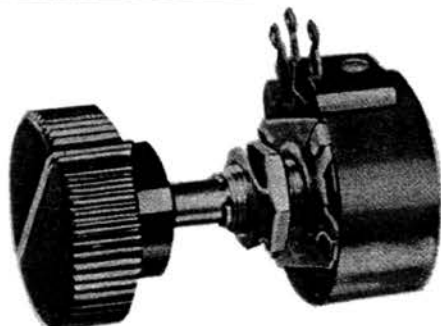

RESISTOR

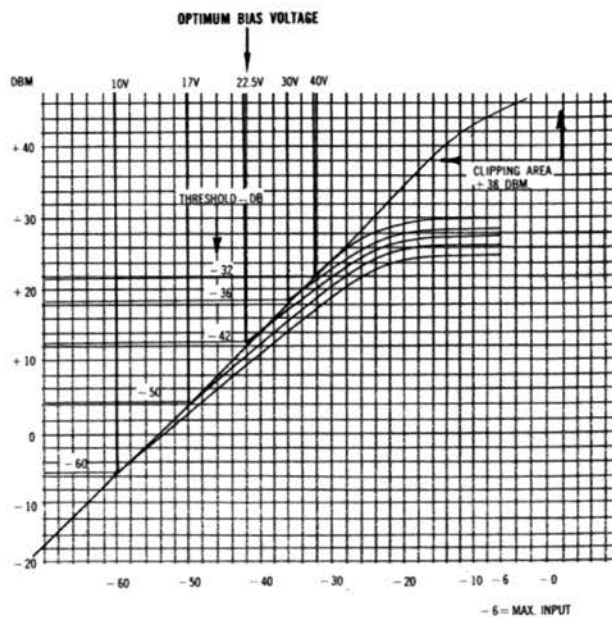

RECOMMENDED ACCESSORIES

- Model MTR-507 Bias Voltmeter
- Model TRY-5017 Mounting Tray
- Model VR-112 100K Extension Bias Control
- Model TK-5301 Tube Kit

ORDERING INFORMATION

- MODEL AM-5301 LEVELINE AMPLIFIER**, complete, with tubes, weight 4 lbs. net, shpg. 5 lbs., **Price, Net, \$158.80**
- MODEL AM-5301 LEVELINE AMPLIFIER LESS TUBES**, same as above but less tubes, **Price, Net, \$145.00**
- MODEL TK-5301 TUBE KIT** for above, consisting of 1 each (Langevin Model TUS-6ES8), 2 each 6005 5 star (Langevin Model TUS-6005) and 1 each 12AY7, select, (Langevin Model TUS-12AY7). Weight, net $\frac{1}{4}$ lb., shipping $\frac{1}{2}$ lb., **Price, Net, \$13.80**
- MODEL MTR-507 BIAS VOLTMETER**, special scale marked for optimum operating point of AM-5301 Leveline Amplifier. Panel size is 1 $\frac{13}{16}$ in. round opening for rear panel mount, 1 $\frac{1}{8}$ in. square overall, depth is 1 $\frac{1}{8}$ in.; reading is 0-70 vdc, weight 3 oz. net, shipping 10 ozs., **Price, Net, \$15.00**
- MODEL VR-112 100K** continuously variable moulded composition resistor for panel mount bias limiting control of AM-5301, includes knob but no dial, weight 4 oz. net, shipping $\frac{1}{2}$ lb., ... **Price, Net, \$5.00**
- MODEL TRY-5017 MOUNTING TRAY** for above, with plug socket complete, **Price, Net, \$8.25**







POWER SUPPLIES

HIGH VOLTAGE POWER SUPPLIES

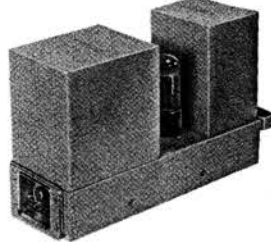
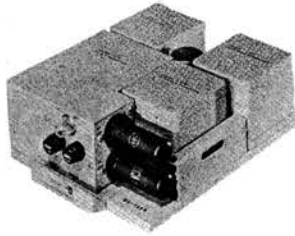
The Langevin Models PS-5206 and PS-5208-A Power Supplies were designed specifically for use with the 5000 Series Amplifiers.

Models PS-5208-A, PS-208-A, PS-5206 and PS-206-B all provide ac for amplifier filaments and well filtered dc for amplifier plate requirements. The PS-5208-A Power Supply will provide adequate power to operate up to 10 Model AM-5116 Amplifiers. Model PS-5206 will power 22 of these amplifiers.

The Langevin Models PS-205-B and PS-210-A Power Supplies are selenium cell rectifier type units providing a maximum of 425 ma at 300 volts for plate power, and two sources of 6.3 volts at 8 amperes each for filament power. These power supplies have been designed for use with the Standard Langevin plug-in amplifiers and pre-amplifiers or equivalent.

| | | | | |
|--------------------------------------|---|---|--|--|
| |  |  |  |  |
| MODEL | PS-5208-A | PS-208-A | PS-5206 | PS-206-B |
| INPUT: | 105 to 125 vac, 50/60 cycles | 105 to 125 vac, 50/60 cycles | 105 to 125 vac, 50/60 cycles | 105-125/210-250 vac, 50/60 cycles |
| DC OUTPUT: | 300 volts, 90 ma continuous | 300 volts, 110 ma continuous | 300 volts, 210 ma continuous. (A 275 volt tap is provided which will furnish up to 70 ma continuous. However, the sum of the simultaneous currents at 300 volts and 275 volts must not exceed 210 ma.) | 300 volts, 210 ma continuous. (A 275 volt tap is provided which will furnish up to 70 ma continuous. However, the sum of the simultaneous currents at 300 volts and 275 volts must not exceed 210 ma.) |
| OUTPUT RIPPLE: | Less than 10 millivolts @ full load | Less than 10 millivolts @ full load | Less than 10 millivolts @ 300 volt tap. Less than 2 millivolts @ 275 volt tap | Less than 10 millivolts @ 300 volt tap. Less than 2 millivolts @ 275 volt tap |
| AC OUTPUT: | 6.3 volts, 3 amperes continuous | 6.3 volts, 4.5 amperes, continuous | 6.3 volts, 6.5 amperes continuous | 6.3 volts, 8 amperes continuous |
| RECTIFIER OR TUBE COMPLEMENT: | 1 type 5Z4 | 1 type 5Y3 | 2 type 5Z4 | Selenium cells |
| POWER CONSUMPTION: | 100 va @ full load | 110 va @ full load | 160 va @ full load | 170 va @ full load |
| SIZE: | Length 10 $\frac{1}{4}$ in., width 2 $\frac{3}{8}$ in., height 3 in. | Length 10 in., width 3 $\frac{1}{4}$ in., height 5 $\frac{3}{4}$ in. | Length 9 $\frac{3}{4}$ in., width 7 $\frac{1}{2}$ in., height 3 $\frac{1}{4}$ in. | Length 10 in., width 7 $\frac{1}{4}$ in., height 6 $\frac{3}{4}$ in. |
| WEIGHT: | 6 lbs., 5 oz. | 13 $\frac{1}{2}$ lbs. | 17 lbs., 6 oz. | 25 lbs. |
| SHIPPING WEIGHT: | 6 lbs., 13 oz. | 15 lbs. | 18 lbs. | 30 lbs. |
| FINISH: | Light gray baked enamel over 20 gauge bonderized (rustproofed) steel | Light gray baked enamel over 20 gauge bonderized (rustproofed) steel | Light gray baked enamel over 16 gauge bonderized (rustproofed) steel | Light gray baked enamel over 16 gauge bonderized (rustproofed) steel |
| MOUNTING: | Plug-in, Langevin Model TRY-5017 Mounting Tray | Plug-in Langevin Model TRY-17-B Mounting Tray | Plug-in Langevin Model TRY-5019 Mounting Tray | Plug-in, Langevin Model TRY-19-A Mounting Tray |
| PRICE, NET: | Model PS-5208-A \$110.00, Less Tubes. Model TK-5208 Tube Kit for above, includes 1 type 5Z4, Price, Net, \$2.80. Model TRY-5017 Mounting Tray, Price, Net, \$8.25 | Model PS-208-A, \$118.75, Less Tubes. Model TK-208 Tube Kit for above, includes 1 type 5Y3 tube, Price, Net, \$1.00 Model TRY-17-B Mounting Tray, Price, Net, \$17.00 | Model PS-5206 \$192.50, Less Tubes. Model TK-5206 Tube Kit for above, includes 2 type 5Z4 tubes, Price, Net, \$5.60. Model TRY-5019 Mounting Tray, Price, Net, \$13.75 | Model PS-206-B, \$218.75; Model TRY-19-A Mounting Tray, Price, Net, \$17.90 |
| TRAYS: | TRY-5017  | TRY-17-B  | TRY-5019  | TRY-19-A  |

POWER SUPPLIES

LOW VOLTAGE POWER SUPPLIES

The Langevin Models PS-211-B and PS-212-B Power Supplies are selenium cell rectifier type units which provide 3 amperes and 10 amperes respectively at 24 volts dc regulated power. These power supplies have been designed to supply dc power for filaments, relays, and control equipment. All tubes in the Langevin Power Supplies are mechanically located for easy replacement without un-plugging the power supply or taking it out of its rack installation.



PS-210-A

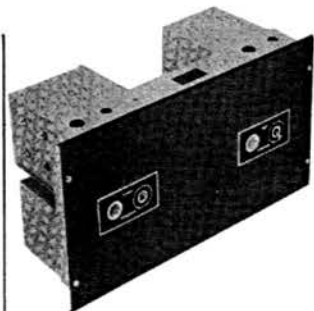

PS-205-B

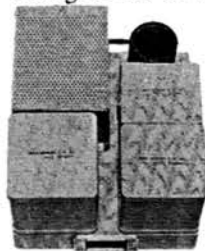

PS-211-B

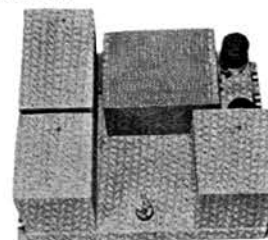

PS-212-B

| | | | |
|--|---|--|--|
| Same as Model PS-205-B | 105 to 125/210 to 250 vac, 50/60 cycles | 117 vac, 50/60 cycles | 105 to 125 vac, 50/60 cycles |
| Same as Model PS-205-B | 2 Section Filter: 425 ma max. @ 220 to 300 volts. 3 Section Filter: 150 ma max. @ 180 to 260 volts. Total current drain—425 ma max. | 3 amperes max. @ 24 vdc (regulated) | 10 amperes max. @ 24 vdc (regulated) |
| Same as Model PS-205-B | 2 Section Filter: Less than 25 millivolts, full load 3 Section Filter: Less than 1 millivolt, full load | Less than 3% @ full load | Less than 3% @ full load |
| Same as Model PS-205-B | 2 transformers, 6.3 volts at 8 amperes each transformer | None | None |
| Same as Model PS-205-B | Selenium cells | Selenium cell type | Selenium cell type |
| Same as Model PS-205-B | 350 va @ full load | 150 va @ full load | 500 va @ full load |
| Length 14 $\frac{1}{2}$ in., width 10 in., height 6 $\frac{3}{4}$ in. 42 lbs. | Length 18 $\frac{3}{4}$ in., width 8 $\frac{3}{4}$ in., height 10 $\frac{1}{4}$ in. 52 lbs. | Length 7 $\frac{3}{4}$ in., width 10 in., height 6 $\frac{3}{4}$ in. 27 lbs. | Length 18 $\frac{3}{4}$ in., width 13 $\frac{3}{4}$ in., height 10 $\frac{3}{2}$ in. 102 lbs. |
| 60 lbs. | 70 lbs. | 30 lbs. | 107 lbs. cardboard carton, 130 lbs. crated |
| Light gray baked enamel over 16 gauge bonderized (rustproofed) steel | Light gray baked enamel over 16 gauge bonderized (rustproofed) steel | Light gray baked enamel over 16 gauge bonderized (rustproofed) steel | Light gray baked enamel over 16 gauge bonderized (rustproofed) steel |
| Plug-in Langevin Model TRY-20-A Mounting Tray | Rack; mat panel supplied | Plug-in TRY-19-A Mounting Tray. MF-10-B Mounting Frame. | Rack; mat panel supplied |
| Model PS-210-A, \$243.75. Model TRY-20-A Mounting Tray, Price, Net, \$22.90 | Model PS-205-B, \$235.00 | Model PS-211-B Power Supply, \$150.00; Model TRY-19-A Tray, Price, Net, \$17.90; MF-10-B Mounting Frame, Price, Net, \$12.25 | Model PS-212-B Power Supply, \$355.00 |

TRY-20-A



**RACK
MAT PANEL
SUPPLIED**



TRY-19-A

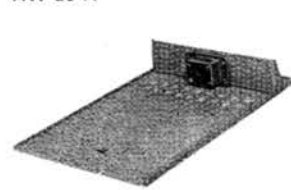

**RACK
MAT PANEL
SUPPLIED**



APPLICATION OF NOVA AMPLIFIERS

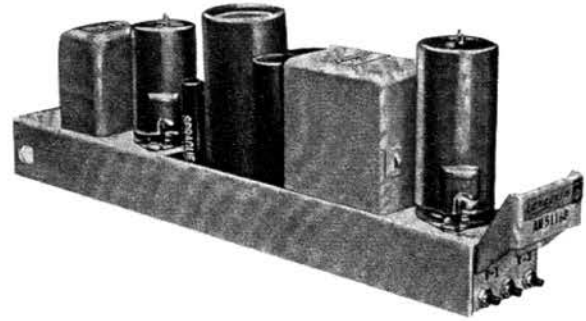
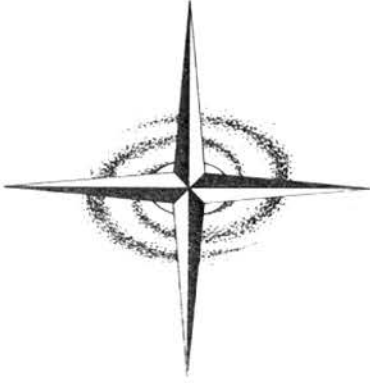

AM-5116-B

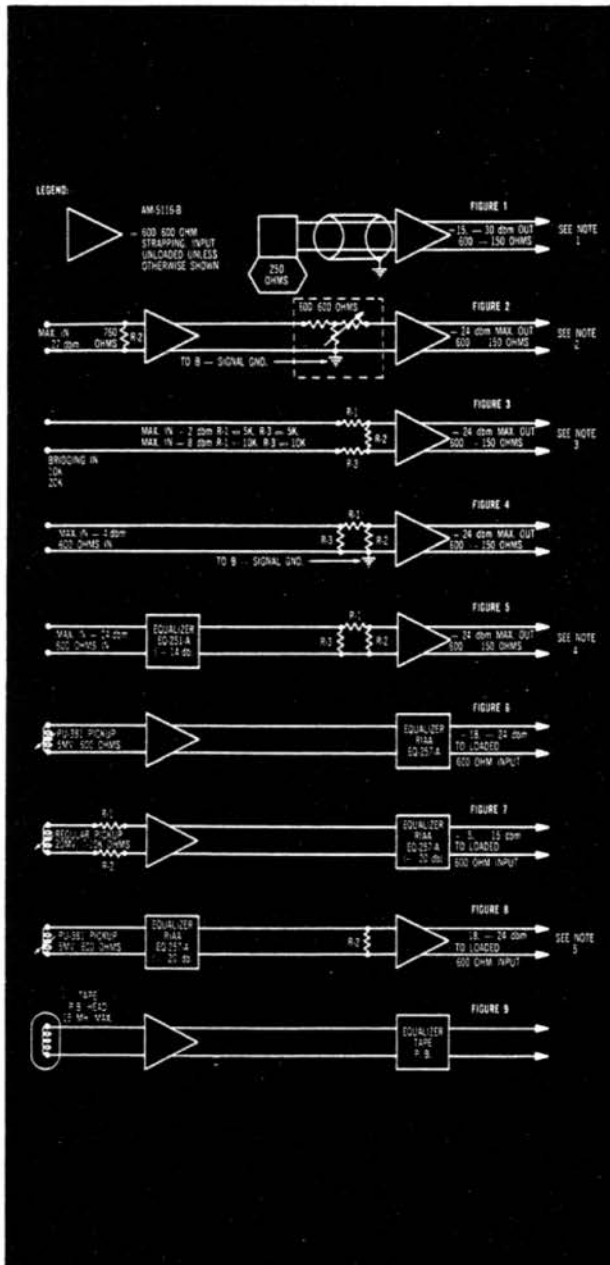

| PURPOSE | FIGURE | R-1 | R-2 | R-3 | GAIN in db | REMARKS |
|---|--------|--|-----|-----|------------|---|
| MICROPHONE PREAMPLIFIER | | | | | | EFFECTIVE GAIN OVERALL, MICROPHONE TO AMPLIFIER OUTPUT. SEE NOTE 1. |
| MICROPHONE STRAPPED: 50 OHMS | 1 | — | — | — | 46 | |
| 150 OHMS | 1 | — | — | — | 46 | |
| 250 OHMS | 1 | — | — | — | 46 | |
| HIGH GAIN LINE AMPLIFIER WITH CONTROL | 2 | 600/600 LADDER e.g., MX-201, MX-III etc. | | | 76 | SEE NOTE 2 |
| BRIDGING AMPLIFIER | 3 | 5K | 800 | 5K | 22 | SEE NOTE 3. |
| BRIDGING AMPLIFIER | 3 | 10K | 800 | 10K | 16 | |
| BOOSTER AMPLIFIER | 4 | 10K | 800 | 620 | 16 | |
| BOOSTER AMPLIFIER | 4 | 8K | 800 | 700 | 20 | |
| LINE AMPLIFIER | 2 | — | 760 | — | 41 | |
| EQUALIZER BOOSTER | 5 | 4K | 760 | 760 | 0 | SEE NOTE 4. |
| PHONO PRE-AMP, LO Z PICKUP 600 OHMS WITH EQUALIZER | 6 | — | — | — | 22 | PREFERRED CIRCUIT |
| PHONO PRE-AMP, HIGHER Z PICKUP 7-10K OHMS WITH EQUALIZER | 7 | 3K | 3K | — | 22 | |
| PHONO PRE-AMP, LO Z PICKUP 600 OHMS AND EQUALIZER (ALTERNATE) | 8 | — | 760 | — | 22 | SEE NOTE 5. |
| TAPE HEAD PRE-AMP AND EQUALIZER | 9 | — | — | — | 26 | |

NOTES

- NOTE 1. RECOMMENDED PRACTICE IS TO OPERATE MICROPHONE AMPLIFIER WITH UNLOADED INPUT FOR HIGHEST GAIN AND BEST SIGNAL TO NOISE.
- NOTE 2. CONTROLS EMPLOYING T CIRCUIT MUST HAVE COMMON TERMINAL TIED TO SIGNAL GROUND OR B- OF AMPLIFIER TO ALLOW COMPLETE GAIN CUT-OFF. NOT REQUIRED FOR H CIRCUITS. ADD 6 db GAIN FOR T AND H CONTROLS.
- NOTE 3. R-2 CAN BE MADE VARIABLE IF GAIN CONTROL IS DESIRED.
- NOTE 4. ADDED 10 db GAIN AVAILABLE IF R-1 AND R-3 ARE DELETED WITH ONLY R-2 REMAINING.
- NOTE 5. THIS CIRCUIT IS AN ALTERNATE FOR THE ONE SHOWN IN FIGURE 6. NOT RECOMMENDED IF FIGURE 6 CAN BE EMPLOYED AS EQUALIZING AFTER THE PRE-AMP DELIVERS BEST SIGNAL TO NOISE RATIO. FREQUENCY RESPONSE IS IDENTICAL IN BOTH CIRCUITS.

PHONO PICKUPS

TRANSCRIPTION PICKUP MODEL PU-381

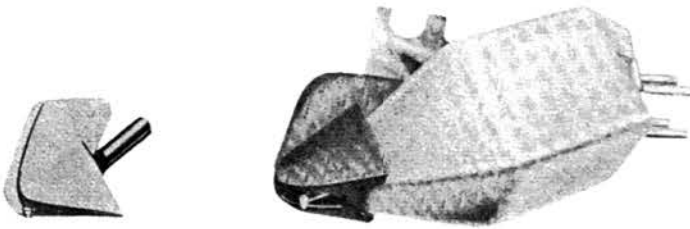

- STEREO OR MONOPHONIC
- LOW IMPEDANCE: 600 OHMS
- FLAT ± 2 db 20-17,000 CPS
- CALIBRATED: INDIVIDUAL TEST REPORT
- LOWEST HUM PICKUP
- NO PREAMP REQUIRED AT PICKUP
- EQUALIZATION AFTER PREAMPLIFICATION
- REPLACEABLE STYLII

GENERAL

The Model PU-381 Professional Transcription Pickup is manufactured to Langevin specifications by the Pickering Company to satisfy the need for a unit which will make use of the advantages of standard transmission circuitry. These specifications deliver stable, flat, hum-free response at 600 ohms impedance.

600 ohm shielded leads can be run over a distance of one hundred feet from the pickup to the preamplifier without frequency discrimination or hum pickup. Recommended equalization for the velocity characteristic and also for high-frequency de-emphasis is accomplished through the Langevin Model EQ-257-A 600 ohm RIAA Pickup Equalizer after preamplification through a standard preamplifier; if circuit reasons demand the Model EQ-257-A equalizer can be inserted ahead of the preamplifier with increased susceptibility to stray hum fields.

ELECTRICAL CHARACTERISTICS

Impedance: For 500/600 ohm systems; **Inductance:** 10 mh per channel; **Resistance dc:** 34 ohms per channel. **Channel Separation:** Exceeds 25 db at 1 kcps. Minimum 15 db at 10 kcps; **Frequency Response Range:** ± 1 db 20-10 kcps ± 2 db to 17 kcps; **Output:** Exceeds 5 mv per channel.

MECHANICAL CHARACTERISTICS

Weight: 12¼ grams; **Stylus Withdrawal Force:** ¼ to 2 lbs; **Tracking Force:** 3-5 grams; **Mounting:** 7/16 and ½ in. centers; **Size:** ¾ in. high above record surface by 35/64 in. wide by 1¾ in. long overall.

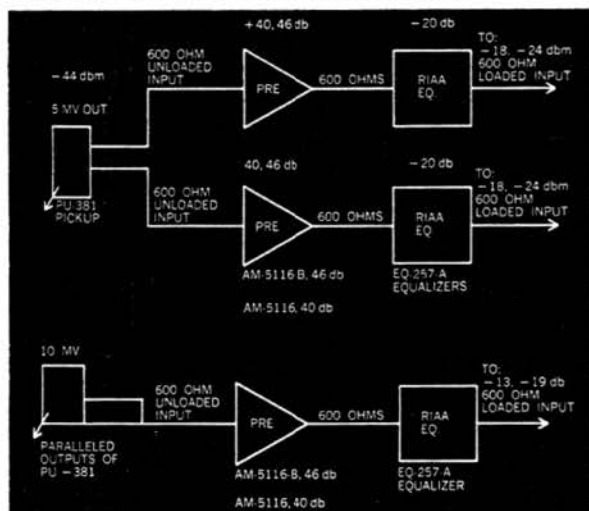

MODEL EQ-257-A PICK-UP EQUALIZER

FEATURES

- Compact Design
- Stereophonic Application
- Optional Mounting
- Hum Pick-up Eliminated

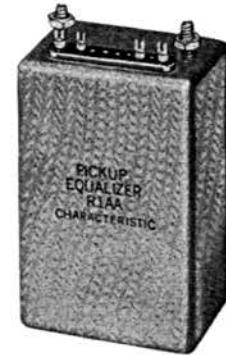

The EQ-257-A Pick-up Equalizer by Langevin is an extremely compact, self-contained unit, employing a passive two-section Constant "K" Bridged T circuit. This instrument produces the desired RIAA curve characteristic approved by AES and NARTB for playback of either monaural or stereophonic records.

Two units are required for stereophonic operation. Hum pick-up has been eliminated in this unit by using toroid coils.

The accuracy of the EQ-257-A Equalizer of ± 3 db combined with the linear response of the PU-381 pickup, delivers overall flatness ± 1.3 db from 20-10,000 cps, and ± 2.3 db to 17,000 cps.

TECHNICAL SPECIFICATIONS

- INPUT LEVEL** Minimum: -60 dbm.
Maximum: +24 dbm.
- INSERTION LOSS** 20 db at 1000 cps.
- MOUNTING** Two mounting studs on 1¼-inch centers.
Brackets furnished for base mounting.
- FINISH** Grey enamel.
- DIMENSIONS** 2½ inches high, by 1¾ inches deep, by 1¼ inches wide.

ORDERING INFORMATION

Model PU-381 Professional Transcription Pickup, Stereo and Monophonic, complete with Model ST-D3807-A replaceable diamond stylus with .0007 radius (Yellow). When used with this stylus, for stereo records only. Includes calibration chart. Weight, Net, 2 oz.; shipping ¼ lb.
Price, Net, \$48.00.

Model PU-381 Professional Transcription Pickup, Less Stylus, same as above but less stylus and calibration chart.
Price, Net \$28.35.

Model ST-D3807-A Stylus, for stereo records, diamond with .0007 radius (Yellow); replaceable.
Price, Net, \$19.65.

Model ST-D3810-C Stylus, for monophonic microgroove records, diamond with .001 radius (Gray); replaceable.
Price, Net, \$15.00.

Model ST-D3827 Stylus, for 78 rpm records, diamond with .0027 radius (Blue); replaceable.
Price, Net, \$15.00.

Model EQ-257-A Pickup Equalizer, complete with brackets for base mounting. Weight, Net, 6 oz., shipping, 1 lb.
Price, Net, \$35.00.

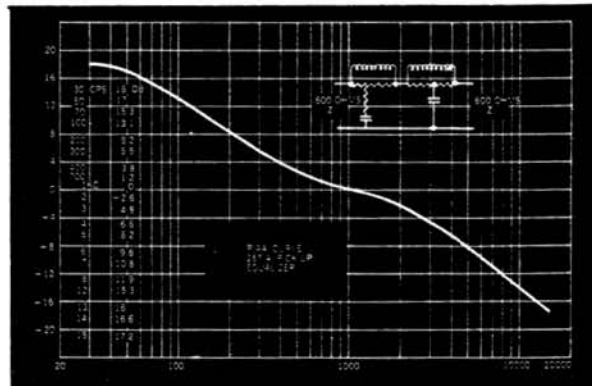



MAJOR POINTS TO CONSIDER IN CHOOSING POWER AMPLIFIERS

SECURITY COUNCIL CHAMBER UNITED NATIONS

WHAT CONSTITUTES A GOOD AMPLIFIER

In the early development of any art the establishment of standards serves to deter progress. The design, development and manufacture of amplifiers is no exception, for nowhere do specifications attain meaning without confusing qualifications. This is especially true where the consumer compares the data sheets of one amplifier manufacturer with another and attempts a decision on the basis of range response, power output, distortion and price.

For these considerations do not deliver a clue to quality, reliability and value. Such factors are the most difficult for there are no measuring instruments calibrated in these terms.

But the discriminating user knows that somewhere good, reliable amplifiers at a fair price are produced. Langevin, for thirty five years, has recognized this demand — and takes this opportunity to tell you something about its product.

LANGEVIN AMPLIFIERS ARE RELIABLE They Run Cool

The enemy of reliability is heat. Langevin power amplifiers are large, well ventilated and run cool on continuous, year in, year out duty cycle. Transformers are two to four times the size of those used in other amplifiers of comparable power, and provide high efficiency and generous heat dissipation. Wire sizes are 2 or 3 gauges larger than usual; insulation is rated at 180 degrees centigrade instead of the ordinary 120 degrees.

They Have Long Life

The best components available are used in Langevin amplifiers: Allen Bradley potentiometers, Sprague condensers, Ward Leonard and Allen Bradley resistors in important circuits. Filter capacitors are always operated far below their usual rating.

LANGEVIN AMPLIFIERS ARE VERSATILE

In the succeeding pages you find proof of versatility. This means that Langevin amplifiers give good value, for the various accessories, modification groups and multiple input panels available guarantee the complete fulfillment of the function you require. Whether the amplifier is for monitoring, wired music installations, high quality public address or musicasting, you find full accommodation to your need without paying for excess circuits that you cannot use.

LANGEVIN AMPLIFIERS HAVE QUALITY

You take wide-range, distortion-free response at low or high powers for granted with these amplifiers, for the ratings are ultra-conservative. Langevin amplifiers perform not only on the test bench with resistive loads, but under dynamic operating conditions with reactive speaker loads, high or low capacity, with or without the load connected. Phase shift is kept low and they will not oscillate under adverse conditions.

These amplifiers fulfill your expectations.

LANGEVIN MUSICAST 8 WATT AUDIO AMPLIFIERS

**LOW Z MICROPHONE AMPLIFIER
DISC PLAYBACK AMPLIFIER
HIGH Z INPUT AMPLIFIER
MONITOR BRIDGING AMPLIFIER**

- SELF-CONTAINED POWER SUPPLY
- 4 INTERCHANGEABLE INPUT PANELS
- POWER OUTPUT OF 8 WATTS
- CONTINUOUS DUTY CYCLE
- COMPACT
- RUGGED CONSTRUCTION OF 16 GAUGE COLD ROLLED STEEL CHASSIS
- PLUG-IN TYPE CONNECTORS

Specifically designed for the highest quality sound systems the Langevin AM-138 Series Amplifiers provide low noise, low distortion performance over a wide frequency range. Special design features contained in these amplifiers ease the task of the audio engineer in creating newer and superior sound systems.

All the amplifiers in the AM-138 Series have self-contained power supply. They feature 4 interchangeable input panels. Taps on the output transformer for the entire AM-138 Series permit easy matching at 4, 8, 16, 150, and 600 ohms.

Small and compact, these amplifiers can be mounted in consoles and cabinets or directly in a monitor speaker housing. Where several AM-138 Amplifiers are required, as in a rack installation, as many as four may be mounted on a standard Langevin MF-10-B Mounting Frame. See page 11.

The overall construction of the AM-138 Series Amplifiers adheres to the usual Langevin standard of quality.

The Langevin AM-138 Series Audio Amplifiers are indispensable where ever fine sound reproduction is specified.

ACCESSORIES PROVIDED

Along with the AM-138 Series Amplifiers are provided the following accessories:

- 1 - Miniature type Hubbel plug receptacle for supplying the ac to the unit.
- 1 - 4 pin Jones Connector and cover for the output stage.
- 1 - 10 pin Jones Connector and cover for the input stage.

These accessories are automatically provided with the Model AM-138 Series at no additional cost.

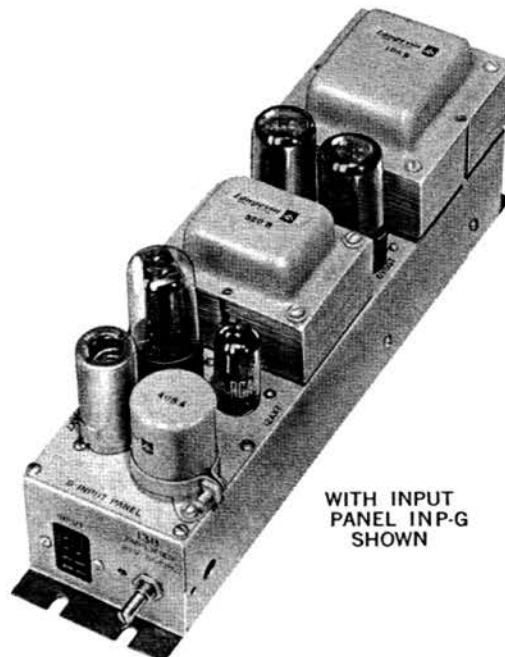

WITH INPUT
PANEL INP-G
SHOWN

PERFORMANCE CHARACTERISTICS

HARMONIC DISTORTION: All models: less than 2.0%, 50 to 15,000 cps at +39 dbm.

AM-138S-G LOW Z MICROPHONE AMPLIFIER: Includes pre-amplifier input for low impedance microphones.
SOURCE IMPEDANCE: 30, 150, 250, 600 ohms.
GAIN: 104db, 600 ohms input, 600 ohms output at 1 kc.
OUTPUT NOISE: -63 db below full output.
RESPONSE: ± 1.5 db 30 to 15,000 cps.

AM-138S-K DISC PLAYBACK AMPLIFIER: Includes pre-amplifier equalized for GE or Pickering type pick-ups.
SOURCE IMPEDANCE: 6800 ohms.
GAIN: 75.3 db bridging 600 ohms at 1 kc.
OUTPUT NOISE: -52 db below full output.

AM-138S-L AMPLIFIER WITH HIGH Z INPUT: Includes pre-amplifier input for high impedance microphones or crystal pick-up.
SOURCE IMPEDANCE: 1 megohm.
GAIN: 77 db bridging 600 ohms at 1 kc.
OUTPUT NOISE: -63 db below full output.
RESPONSE: ± 1.5 db 30 to 15,000 cps.

AM-138S-M MONITOR BRIDGING AMPLIFIER: Includes an input panel designed for bridging or cueing.
SOURCE IMPEDANCE: 150, 600, 5,000 and 20,000 ohms.
GAIN: 58 db, 600 ohm input, 600 ohm output at 1 kc.
OUTPUT NOISE: -76 db below full output.
RESPONSE: ± 1.0 db 30 to 15,000 cps.

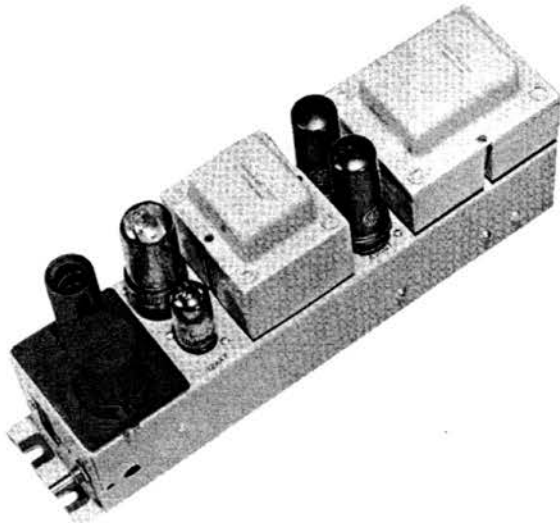

ORDERING INFORMATION

- MODEL AM-138S-G LOW Z MICROPHONE AMPLIFIER**, complete with tubes, **Price, Net, \$150.05**
- MODEL AM-138S-G LOW Z MICROPHONE AMPLIFIER LESS TUBES**, same as model AM-138S-G Low Z Microphone Amplifier but less tubes **Price, Net, \$143.75**
- MODEL AM-138S-K DISC PLAYBACK AMPLIFIER**, complete with tubes, **Price, Net, \$126.30**
- MODEL AM-138S-K DISC PLAYBACK AMPLIFIER, LESS TUBES**, same as model AM-138S-K Disc Playback Amplifier, but less tubes, **Price, Net, \$120.00**
- MODEL AM-138S-L AMPLIFIER WITH HIGH Z INPUT**, complete with tubes, **Price, Net, \$125.05**
- MODEL AM-138S-L AMPLIFIER WITH HIGH Z INPUT, LESS TUBES**, same as model AM-138S-L Amplifier with high Z input, but less tubes, **Price, Net, \$118.75**
- MODEL TK-138S-L TUBE KIT**, for AM-138S-G, K and L, consists of 2 each 6V6GT (Langevin TU-6V6GT), 2 each 12AX7 (Langevin TU-12AX7), and 1 each 5Y3GT (Langevin TU-5Y3GT). Weight, Net, ¼ lb.; shipping ½ lb. **Price, Net, \$6.30**
- MODEL AM-138S-M MONITOR BRIDGING AMPLIFIER**, complete with tubes, **Price, Net, \$127.35**
- MODEL AM-138S-M MONITOR BRIDGING AMPLIFIER, LESS TUBES**, same as model AM-138S-M Monitor Bridging Amplifier, but less tubes, **Price, Net, \$122.50**
- MODEL TK-138S-M TUBE KIT** for above, consists of 2 each 6V6GT (Langevin TU-6V6GT), 1 each 12AX7 (Langevin TU-12AX7) and 1 each 5Y3GT (Langevin TU-5Y3GT). Weight, Net, ¼ lb., shipping ½ lb. **Price, Net, \$4.85**
- MODEL AM-138S BASIC AMPLIFIER**, less tubes and input panel; requires appropriate input panel INP-G, INP-K, INP-L, or INP-M as listed below and appropriate tube kit. **Price, Net, \$100.00**
- MODEL TU-12AX7 TUBE KIT**, consists of one type 12AX7 Tube (Langevin TU-12AX7) for Models INP-G, INP-K and INP-L input panels above. Weight, Net, 3 oz.; shipping, 6 oz. **Price, Net, \$1.45**
- MODEL MF-10-B MOUNTING FRAME**, for rack mounting up to 4 model AM-138 Series Amplifiers. Weight, Net, 5½ lbs.; shipping, 9 lbs. **Price, Net, \$12.25**
See page 11.

MECHANICAL CHARACTERISTICS

SIZE: Length, 12 ¾ in., width, 3¼ in., height, 5¼ in.

WEIGHT: 13½ lbs. net, 15 lbs. shipping.

FINISH: Light grey baked enamel over 16 gauge bonderized (rustproofed) steel.

MODEL INP-G LOW Z MICROPHONE INPUT PANEL, for model AM-138S basic amplifier, less 12AX7 tube, weight, net ¼ lb., shipping, ½ lb. **Price, Net, \$41.25**

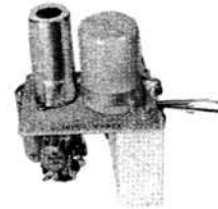

MODEL INP-K DISC PLAYBACK INPUT PANEL, has necessary gain and equalization for magnetic pick-up, for model AM-138S basic amplifier, less 12AX7 tube. Weight, Net, ¼ lb.; shpg., ½ lb. **Price, Net, \$22.50**

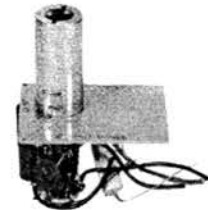

MODEL INP-L HIGH Z INPUT PANEL, has necessary gain for high Z microphones or ceramic and crystal pick-up, for model AM-138S basic amplifier, less 12AX7 tube. Weight, ¼ lb.; shpg., ½ lb. .. **Price, Net, \$16.25**

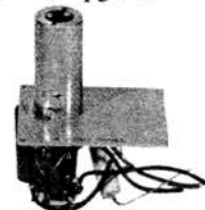

MODEL INP-M MONITOR BRIDGING INPUT PANEL, includes transformer, no tube required, for model AM-138S basic amplifier. **Price, Net, \$21.25**



LANGEVIN MUSICAST 20 WATT AUDIO AMPLIFIER

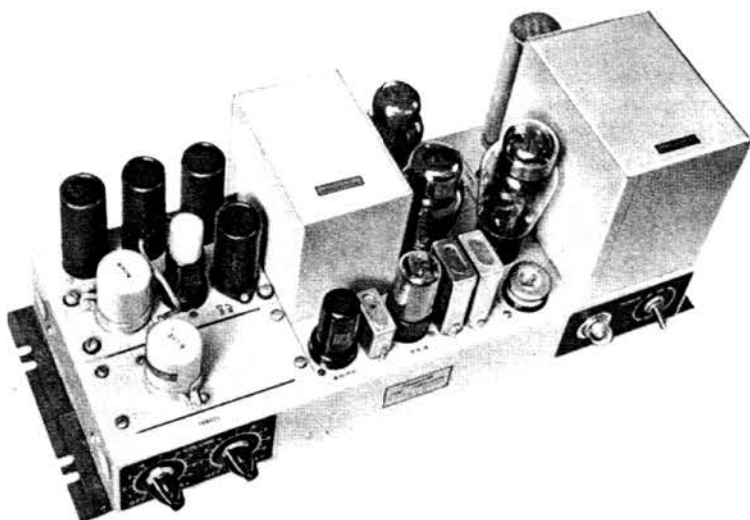

MODEL AM-128X SERIES SOUND SYSTEMS EQUIPMENT

The Langevin Model AM-128X Series Amplifiers are 20 watt units designed for high quality sound systems. Quiet, low distortion performance over a wide frequency range at rated power output highlights the electrical characteristics which make these amplifiers desirable where fine sound reinforcement or reproduction is required.

DESIGN FEATURES

Design features of the Model AM-128X Series make these amplifiers adaptable to the varied requirements of sound installations. These features include seven interchangeable input panels as shown on page 24-5.

Taps on the output transformer permit matching the amplifier output to any load impedance from 1 to 1,000 ohms.

The low output noise characteristic and low internal output impedance of these units make them ideal for use as the power unit to drive a low impedance buss across which many power amplifiers can be bridged in large sound installations.

Good regulation of output is provided in the Langevin AM-128X Series by very low internal output impedance; the change in output level from a condition of "no load" to a condition of "full load" is only 1 db. As measured with a complex wave form such as speech or music, the internal output impedance averages about 1/6 of the nominal load impedance.

IDEAL FOR MULTI-CHANNEL STEREO

It has been shown in the literature that a level difference of only 3 db between right and left sound sources is enough to completely displace the apparent source from one side of the sound field to the other. In these amplifiers, whether used in 2 channel or 3 channel array, Langevin ganged and detented attenuators can be used as volume controls to give absolute tracking at all level settings.

On those input panels providing bridging inputs and lower, standard ganged Langevin step type attenuators are to be found in this catalogue for any impedance desired, either for bridging or 600 ohms and lower. Trimming of the amplifiers for accurate balance can be accomplished by inserting a Langevin Model VR-111 continuously variable calibration control in series with 1 leg. See attenuator section.

ELECTRICAL SPECIFICATIONS

Specifications vary on this series of amplifiers according to the input panel employed. Listed in this section are those specifications common to all combinations of input panels and the AM-128X Basic unit:

LOAD IMPEDANCE: Nominal 2, 8, 16, 32, 150, or 600 ohms.

OUTPUT POWER: Output level 43 vu (20 watts). Total rms harmonic distortion 50 to 15,000 cycles, less than 2%.

TUBE COMPLEMENT: 1 type 6SJ7, 1 type 6V6GT, 2 type 6L6GA and 1 type 5U4G.

ADDITIONAL SPECIFICATIONS FOR MODEL AM-128X AMPLIFIER WITH PRE-AMPLIFIER INPUT FOR LOW IMPEDANCE MICROPHONES AND PHONO PICK-UPS

MODEL AM-128X-B

SOURCE IMPEDANCE: 30 or 250 ohms.

MAXIMUM GAIN: Approximately 103 db.

OUTPUT NOISE: Unweighted, 53 db below full output power (+43 dbm).

VOLUME CONTROL: Electronic . . . Varies resistance in cathode circuit of 1612 tube . . . can be used in remote positions.

ADDITIONAL TUBE COMPLEMENT: 1 type 1612 or selected 6L7.

ADDITIONAL SPECIFICATIONS FOR MODEL AM-128X AMPLIFIER WITH PRE-AMPLIFIER INPUT FOR HIGH IMPEDANCE MICROPHONES

MODEL AM-128X-C

SOURCE IMPEDANCE: 1 megohm.

MAXIMUM GAIN: 84 db.

OUTPUT NOISE: Unweighted, 60 db below full output power (+43 dbm).

VOLUME CONTROL: Electronic . . . varies resistance in cathode circuit of 1612 tube . . . can be used in remote positions.

ADDITIONAL TUBE COMPLEMENT: 1 type 1612 or selected 6L7.

ONE OR TWO INPUT CHANNELS CAN BE USED

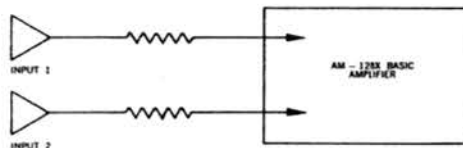

The basic AM-128X Amplifier can be supplied with any one or any combination of two of these input panels already installed. Assemblies are available for adding pre-amplifier input panels to a single channel amplifier already in service.

LANGEVIN MUSICAST 20 WATT AUDIO AMPLIFIER

INPUT PANELS

DESCRIPTION

- INP-A** Line level input panel with transformer for matching 600 ohms; 35,000 ohms for bridging.
- INP-B** Pre-amplifier input panel for source impedance of 30 or 250 ohms.
- INP-E** Pre-amplifier input panel for high impedance inputs.
- INP-H** Pre-amplifier, equalized for GE or Pickering pick-ups.
- INP-J** Input panel for high impedance radio tuners or equivalent.
- INP-R** Input panel for Monitor (broadcast use) for source impedance of 30/150/250/600 ohms.
- INP-Q** Input panel similar to INP-R, except supplied with 100K volume control, and the input circuit is arranged for minimum "cross-talk" effect.

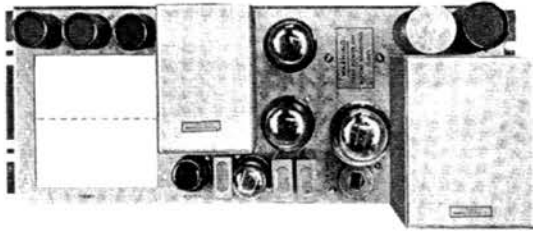

MOUNTING DETAILS

The Model AM-128X Amplifier can be either rack or cabinet mounted. When rack mounted, a modification is required. (Modification Group Model MG-21-A). This modification includes brackets to remount the power switch, pilot light and volume controls, and a mat panel. The amplifier will fit the standard 19 inch equipment rack.

MECHANICAL SPECIFICATIONS

SIZE: Length, 18 3/4 in., width, 7 3/4 in., height, 7 3/4 in. (requires 7 in. of panel space when rack mounted).

FINISH: Light grey baked enamel on zinc-plated, 16 gauge steel.

CABINET MOUNTING

A Langevin Model WC-1202 cabinet is available for wall, ceiling or shelf mounting this amplifier. It is constructed of steel, finished in baked dark grey enamel and is equipped with a removable cover held in position by two knurled thumb screws.

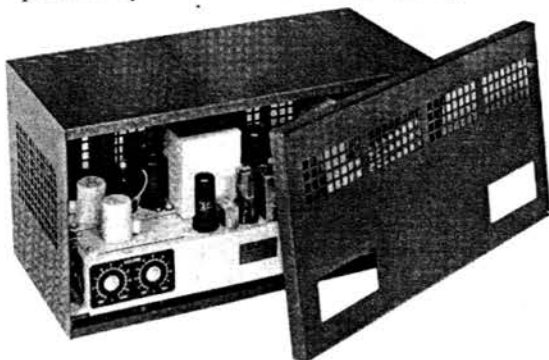

ORDERING INFORMATION FOR MODEL AM-128X SERIES

When ordering a Model AM-128X Series Amplifier, add the model designation letters of the input panels required to the model number of the basic amplifier, as follows:

MODEL AM-128X-AB = Basic Model AM-128X Amplifier with Models INP-A and INP-B Input Panels added.

The AM-128X Series Amplifiers may be ordered with the desired input panels installed at the factory, \$2.50 per panel, net, or input panels may be ordered separately if desired.

MODEL AM-128X BASIC AMPLIFIER, Less tubes, input panels and pilot light assembly.

Weight, Net, 26 lbs.; Shpg., 30 lbs. . . **Price, Net, \$133.75**

MODEL INP-A LINE LEVEL INPUT PANEL

600 ohms input, 35,000 ohms bridging; includes 1/4 megohm volume control on secondary of transformer. Gain with AM-128X Basic is 63 db matching 600 ohms, 45 bridging 600 ohms; noise -78 db below full output (+43 dbm) unweighted. Input level is -20 dbm. Weight, Net, 1/4 lb.; shipping, 1/2 lb.

Price, Net, \$29.50. Inst. Chg. \$2.50

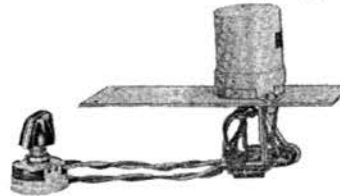

MODEL INP-B LOW Z HIGH GAIN INPUT PANEL

Pre-amplifier with 30 or 250 ohm microphone input. Includes 4K volume control working in cathode circuit. Can be remotely controlled. Gain is 103 db with AM-128X Basic; Noise -53 db below full output (+43 dbm) unweighted. Type 1612 tube should be ordered separately. Input level is -16 dbm. Weight, Net, 1/4 lb.; shpg.; 1/2 lb.

Price, Net, \$35.00. Inst. Chg. \$2.50

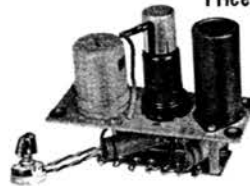

MODEL INP-E HIGH Z HIGH GAIN INPUT PANEL for high impedance microphones.

Includes 4K volume control working in cathode circuit. Can be remotely controlled. Input is 1 megohm. Gain is 84 db with AM-128X Basic; Noise is -60 db below full output (+43 dbm). Type 1612 tube should be ordered separately. Input is 13 mv at 400 cps. Weight, Net, 1/4 lb.; shipping, 1/2 lb.

Price, Net, \$15.00. Inst. Chg. \$2.50



LANGEVIN MUSICAST 20 WATT AUDIO AMPLIFIER

MODEL INP-H DISC PLAYBACK INPUT PANEL, with proper gain and equalization for Pickering and GE pick-up; includes $\frac{1}{4}$ megohm volume control. Gain is 55 db with AM-128X Basic. Noise is 55 db below full output (+43 dbm). Type 1612 tube should be ordered separately. Input level is 5.8 mv. at 400 cps; equalization is provided to RIAA characteristic. Weight, Net, $\frac{1}{4}$ -lb.; shpg., $\frac{1}{2}$ lb.

Price, Net, \$18.75. Inst. Chg. \$2.50

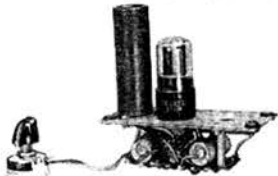

MODEL INP-J HIGH Z INPUT PANEL, for high impedance radio tuners or equivalent. Includes variable 1 megohm maximum level chassis control and additional 1 megohm volume control for panel mount. Gain is 76 db with AM-128X Basic. Noise is -60 db below full output (+43 dbm). Input signal 1-6 volts. Weight, Net, $\frac{1}{4}$ lb.; shpg., $\frac{1}{2}$ lb. .

Price, Net, \$15.00. Inst. Chg. \$2.50

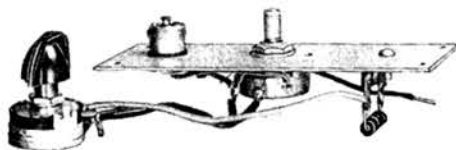

MODEL INP-R MONITOR INPUT PANEL, for input source of 30-150-250-600 ohms; for monitor, broadcast and recording use. External variable low Z attenuator (30-150-250 or 600 ohms) required to control level. Gain is 62 db with AM-128X Basic. Noise is -78 db below full output (+43 dbm). Input signal -20 dbm. Weight, Net, $\frac{1}{4}$ lb.; shipping, $\frac{1}{2}$ lb.

Price, Net, \$22.00. Inst. Chg. \$2.50

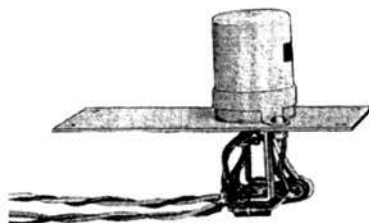

MODEL INP-Q MONITOR INPUT PANEL, same as Model INP-R except equipped with 100K volume control and input is arranged for minimum "crosstalk" effect. Gain is 62 db with AM-128X Basic. Noise is -75 db below full output, (+43 dbm). Input signal -20 dbm. Weight, Net, $\frac{1}{4}$ lb.; shipping, $\frac{1}{2}$ lb.

Price, Net, \$28.00. Inst. Chg. \$2.50

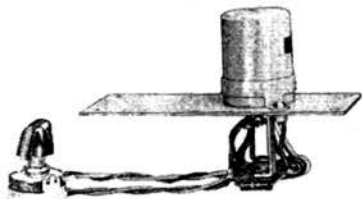

RECOMMENDED ACCESSORIES

MODEL MP-1-A BLANK PLATE

Covers one pre-amplifier space when only one input panel is employed. Includes 4 mounting screws. Weight, Net, 3 oz.; shpg., 5 oz.



MODEL PL-1A PILOT LIGHT ASSEMBLY.

..... **Price, Net, \$2.50**

MODEL MG-21-A MODIFICATION GROUP FOR RACK MOUNTING AM-128X AMPLIFIER. Includes mat panel and brackets to remount power switch, pilot light and volume controls. Weight, Net, $3\frac{1}{2}$ lbs.; shpg., $4\frac{1}{2}$ lbs.

Price, Net, \$21.00

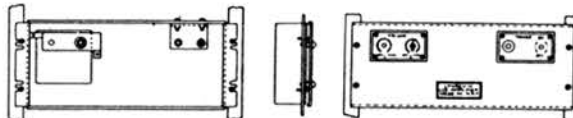

MODEL WC-1202 WALL CABINET for mounting AM-128X Amplifiers on wall, ceiling or shelf, complete with brackets and hardware. Weight, Net, 18 lbs.; shipping, 25 lbs.

Price, Net, \$32.50

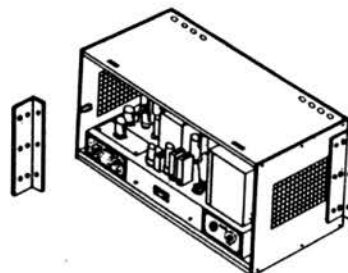

MODEL TK-128X TUBE KIT FOR AM-128X BASIC AMPLIFIER, consists of 1 each 6SJ7 (Langevin TU-6SJ7), 2 each 6L6GT (Langevin TU-6V6GT), 2 each 6L6GA (Langevin TU-6L6GA), and 1 each 5U4G (Langevin TU-5U4G). Weight, Net, $\frac{1}{2}$ lb.; shipping, $\frac{3}{4}$ lb.

Price, Net, \$10.25

MODEL TUS-1612 TUBE, Type 1612 selected for low noise and for use in appropriate input panels above. Weight, Net, 3 oz.; shipping, $\frac{1}{4}$ lb. ...

Price, Net, \$4.15



MODEL VR-113 VARIABLE CARBON 4K RESISTOR, special, Allen Bradley, used as volume control. Weight, Net, 2 oz.; shipping $\frac{1}{4}$ lb.

Price, Net, \$4.00

LANGEVIN 50 WATT AUDIO AMPLIFIER THE 101-3101 SERIES LINE

The Langevin Model AM-101-D Amplifier meets the need for a "year-in, year-out" dependable 50 watt power amplifier for use as the basic unit in high quality sound systems. This amplifier has proved its dependability in many large installations, such as race tracks, stadia and open air pageants, as well as indoor installations where **DEPENDABLE AUDIO POWER** is required.

The AM-101-D bridges 1 to 25,000 ohms, and matches 600 ohms. An additional stage of amplification for microphones and phono pick-ups can be added to the Model AM-101-D Amplifier. Two different modification groups are available to the user . . . one to adapt to low impedance microphones or phono pick-ups, the other to adapt it to high impedance microphones and ceramic or crystal phono cartridge inputs. Each modification group consists of a pre-amplifier, volume control, and all necessary brackets.

MOUNTING DETAILS

The Model AM-101-D amplifier can be either shelf or wall mounted using a Model WC-1201 cabinet, or it can be mounted in a standard 19" equipment rack.

CABINET MOUNTING

Model WC-1201 wall or shelf mounting cabinet is available for mounting the Model AM-101-D amplifier. This cabinet is constructed of 16 gauge steel, is bonderized, and finished in baked-on grey enamel.



MODEL AM-3101-B Low Z High Gain Amplifier, and MODEL AM-3101-E High Z High Gain Amplifiers, same in appearance except that Amphenol coax input connector takes place of 402-B input coil.

Knockouts are provided for wiring conduits and proper ventilation is assured by grill work on three sides. The cabinet is equipped with a detachable front cover secured by two knurled thumb screws. Brackets are supplied for mounting the cabinet to wall, ceiling or shelf surfaces.

RACK MOUNTING

When it is desired to mount the Model AM-101-D Amplifier in a standard 19" equipment rack, Modification Group Model MG-7-A is required. This modification provides a specially drilled mat panel, es-cutcheon plate and brackets for re-mounting the amplifier volume control and power switch to make them accessible from the front of the equipment rack.

| MODEL | SOURCE IMPEDANCE | MAXIMUM GAIN | OUTPUT NOISE AND DISTORTION | FREQUENCY CHARACTERISTIC | TUBE COMPLEMENT |
|----------|--|---|--|---|---|
| AM-101-D | Match 600 ohms; bridge 1 to 25,000 ohms. | 60 db matching 600 ohms; 45 db bridging connection. | Unweighted, -80 db below full output level (+47 dbm) (-33 dbm). Less than 3% total rms distortion from 100 to 8000 cps at 50 watts. | Within ± 2 db from 30 to 15,000 cycles. | 2 each 6SJ7, 4 each 6L6G, 2 each 5U4G. |
| M-3101-B | 30 or 250 ohms. | Approximately 104 db. | 57 db below full output (+47 dbm), (-10 dbm). Less than 3% total rms distortion from 100 to 8000 cps at 50 watts. | ± 2 db from 50 to 15,000 cycles. | As above but add 1 each 1612 or selected 6L7. |
| M-3101-E | 1 megohm. | 75 db. | -57 db below full output (+47 dbm), (-10 dbm). Less than 3% total rms distortion from 100 to 8000 cps at 50 watts. | ± 1.5 db from 50 to 15,000 cycles. | As above but add 1 each 1612 or selected 6L7. |

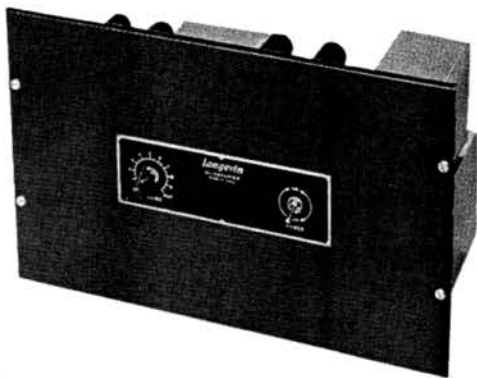
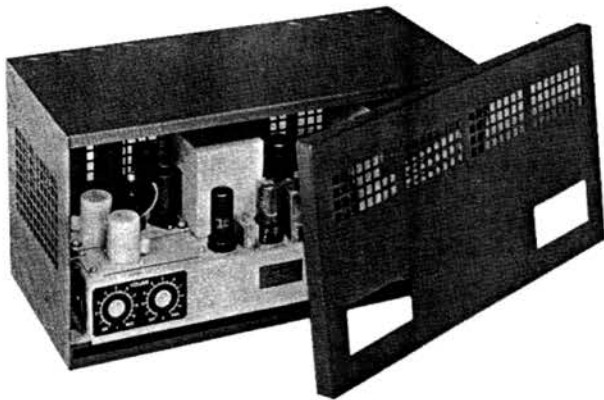

MECHANICAL CHARACTERISTICS

- LENGTH:** 18 13/16" (fits standard 19" equipment rack).
WIDTH: 10 1/4" (occupies 12 1/4" of standard rack space).
HEIGHT: 8 3/4"
WEIGHT: Approximately 45 lbs. net; shpg., 64 lbs.
FINISH: Light grey, baked-on enamel over 16 gauge bonderized (rustproofed) steel.

ACCESSORIES

MODEL TK-101 TUBE KIT for Model AM-101-D Amplifier, consists of 2 each 6SJ7 (Langevin TU-6SJ7), 4 each 6L6G (Langevin TU-6L6G) and 2 each 5U4G (Langevin TU-5U4G), Weight, net, 1/4 lb., shipping 1/2 lb. **Price, Net, \$15.05**

MODEL TK-3101 TUBE KIT, for AM-3101-B or AM-3101-E Amplifiers. Same as TK-101 Tube Kit but with 1 each 1612 (Langevin TUS-1612) added. Weight, net, 1/4 lb.; shpg., 1/2 lb. **Price, Net, \$19.17**

MODEL WC-1201 WALL CABINET, complete with brackets and hardware, used for mounting AM-101-D, AM-3101-B or AM-3101-E to wall, ceiling or shelf. Weight, net, 25 lbs.; shpg., 27 lbs. **Price, Net, \$40.00**

MODEL MG-7-A MODIFICATION GROUP, complete with mat panel MP-36-A modified to include escutcheon plate and switch of AM-101-D, AM-3101-B and AM-3101-E Weight, net, 4 lbs.; shpg., 5 lbs. **Price, Net, \$26.25**

MODEL MG-22-A MODIFICATION GROUP, includes Model INP-B Low Z High Gain Input Panel, for converting AM-101-D Bridging Amplifier to low impedance microphone input (converts to AM-3101-B). Comes with bracket, resistors, condensers, wire and instructions for relocating filter condenser and removing bridging input transformer from AM-101-D. Has rectangular remount can but less 1612 tube. Weight, net, 1/2 lb.; shpg., 3/4 lb. **Price, Net, \$35.15**

MODEL MG-23-A MODIFICATION GROUP, includes model INP-E High Z High Gain Input Panel for converting AM-101-D Bridging Amplifier to high impedance microphone, ceramic or crystal phono cartridge input (converts to AM-3101-E). Comes with bracket, resistors, condensers, wire and instructions for relocating filter condenser and removing bridging input transformer from AM-101-D. Has rectangular remount can but less 1612 tube. Weight, net, 1/2 lb., shipping, 3/4 lb. **Price, Net, \$23.25**

MODEL TK-22 TUBE KIT for MG-22-A and MG-23-A Modification groups. Consists of 1 each 1612 tube (Langevin TUS-1612). Weight, net, 3 oz., shipping, 1/4 lb. **Price, Net, \$4.15**

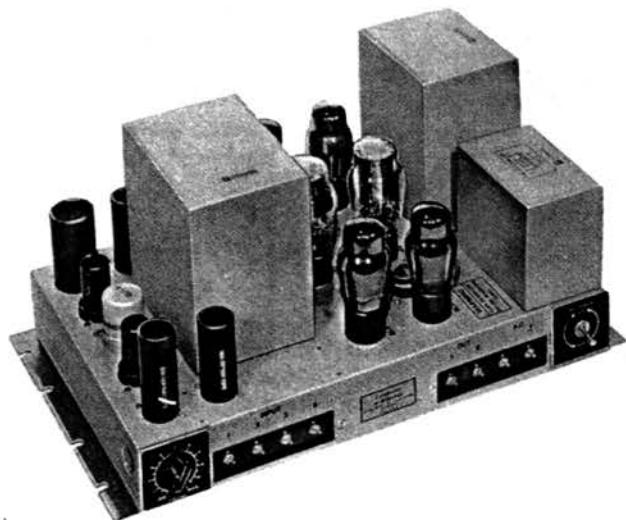

| VOLUME CONTROL | PRICE, NET |
|--|---|
| 25,000 ohm volume control in bridging input only provides continuous adjustment over 40 db range. | MODEL AM-101-D BRIDGING AMPLIFIER , complete with tubes, \$284.80. MODEL AM-101-D BRIDGING AMPLIFIER, LESS TUBES , (Requires TK-101 Tube Kit), \$269.75. |
| Electronic...varies resistance in cathode circuit of 1612 tube... can be used in remote positions. | MODEL AM-3101-B LOW Z HIGH GAIN AMPLIFIER , complete with tubes, \$327.92. MODEL AM-3101-B LOW Z HIGH GAIN AMPLIFIER LESS TUBES (Requires TK-3101 Tube Kit) \$308.75. |
| Electronic...varies resistance in cathode circuit of 1612 tube... can be used in remote positions. | MODEL AM-3101-E HIGH Z HIGH GAIN AMPLIFIER , complete with tubes, \$315.25. MODEL AM-3101-E HIGH Z HIGH GAIN AMPLIFIER WITHOUT TUBES , (Requires TK-3101 Tube Kit) \$296.25. |

THE 3102 SERIES LINE LANGEVIN MULTI-CHANNEL DRIVER AMPLIFIER

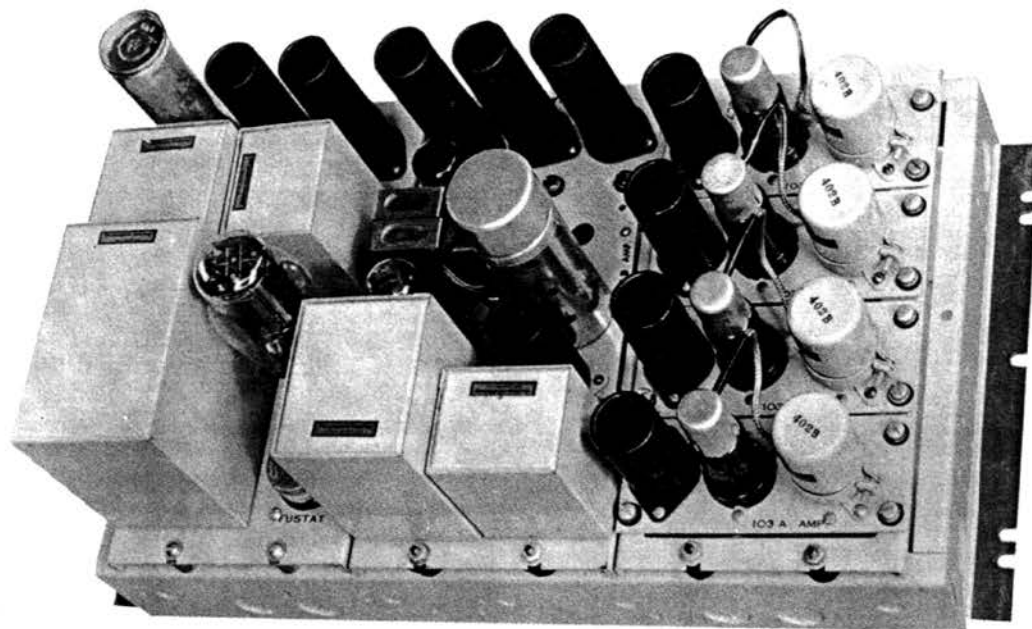

The Langevin Model AM-3102 amplifiers are multi-channel driver units suitable for use as the preamplifier, line amplifier input stages in sound system installations.

Designed to feed directly into a power amplifier (i.e. Langevin Model AM-101-D) or a program bus which feeds a bank of power amplifiers, the 3102 series provides four pre-amplifier input channels, a master mixing stage, a line amplifier, and a self-contained power supply. It is an ideal unit to use for feeding a line connecting a remote microphone location with a central power amplifier control room.

DESIGN FEATURES

Design features of the Model AM-3102 series make these amplifiers adaptable to the varied requirements of sound installations. These features include the six interchangeable input panels used with the AM-128X Basic 20 Watt amplifier. Any four can be used at one time.

For detailed specifications on the six Input Panels used with this Amplifier, see page 22 dealing with the AM-128 Series.

Provisions have been made for electronic gain control of each of the pre-amplifier input stages and of the master control stage. Connections are available for inserting a 4000 ohm volume control in the cathode circuit (not cathode follower) of each of the pre-amplifiers and a 2500 ohm control in the cathode circuit of the master control stage. These controls can be mounted locally or at remote points up to a maximum distance of 5,000 feet.

GENERAL SPECIFICATIONS

MODEL AM-3102 BASIC AMPLIFIER consisting of one Langevin Model AM-102-F Line Amplifier with master control stage, and one Langevin Model PS-201-B Power Supply, mounted on a Model MF-3-A Frame.

INPUT IMPEDANCE: 150,000 ohms

LOAD IMPEDANCE: Nominal 150 or 600 ohms.

MAXIMUM OUTPUT LEVEL: +28 dbm (.6 watts).

MAXIMUM GAIN: 50 db.

EXTERNAL POWER REQUIREMENTS: 105 to 125 vac, 50 or 60 cycles single phase.

TUBE COMPLEMENT: 1 type 1612 or selected 6L7, 1 type 6SJ7, 1 type 6V6GT and 1 type 5Y3 or 5U4G.

SIZE: Length 18-13/16 in., width 10¼ in., height 7-¾ in.

FINISH: Light grey baked-on enamel over 16 gauge bonderized (rustproofed) steel.

MOUNTING: Individual component amplifiers and power supply mounted to frame with rubber shock mounts.

WEIGHT: Approximately 20 lbs.

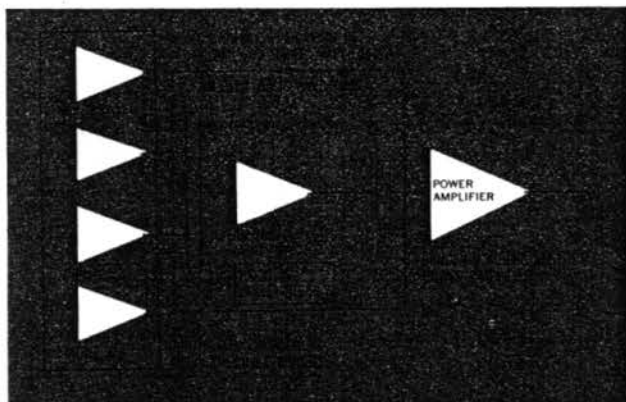

REFERENCE CHARACTERISTICS

MODEL AM-102-F LINE AMPLIFIER

SOURCE IMPEDANCE: 150,000 ohms.

LOAD IMPEDANCE: Nominal 150 or 600 ohms.

OUTPUT POWER: +28 dbm (approximately 0.6 watt) with less than 1.5% total rms harmonic distortion @ 400 cycle single frequency.

MAXIMUM GAIN: Approximately 50 db with provision for decreasing to 40 or 30 db maximum.

FREQUENCY CHARACTERISTIC: ± 2 db over the range 30 to 15,000 cps.

OUTPUT NOISE: Unweighted 55 db below +28 dbm (27 db below .001 watt).

EXTERNAL POWER REQUIREMENTS: Filament, 6.3v, 1.05 amp. Plate, 275 v, 32 ma.

TUBE COMPLEMENT: 1 type 1612 or selected 6L7 or 6L7G, 1 type 6SJ7, and 1 type 6V6 or 6V6GT.

MODEL PS-201-B POWER SUPPLY

The Model PS-201-B Power Supply has been designed to supply plate and filament power for the 3102 Series of rack mounting "microphone to line amplifiers" and similar units. The Model PS-201-B is a 75 ma power supply and operates from a 105 to 125 vac, 50 or 60 cycle source.

ORDERING INFORMATION

MODEL AM-3102 BASIC AMPLIFIER, consists of Model AM-102-F Line Amplifier and Model PS-201-B Power Supply mounted on a Model MF-3-A Frame supplied. Complete with tubes, but less input panels. Weight, Net, 20 lbs.; shipping, 25 lbs. **Price, Net, \$257.10**

MODEL AM-3102 BASIC AMPLIFIER LESS TUBES. Same as Model AM-3102 Basic Amplifier, but less tubes. **Price, Net, \$248.75**

MODEL AM-102-F LINE AMPLIFIER, converts to Model AM-3102 Basic Amplifier when used with a Model PS-201-B Power Supply and a Model MF-3-A Frame. Complete with INP-F Input Panel (used only on 102-F) and tubes. Weight, Net, 7 lbs.; shipping, 9 lbs. **Price, Net, \$123.20**

MODEL AM-102-F LINE AMPLIFIER LESS TUBES. Same as Model AM-102-F Line Amplifier, but less tubes. **Price, Net, \$120.00**

MODEL PS-201-B POWER SUPPLY. Converts to Model AM-3102 Basic Amplifier when used with a Model AM-102-F Line Amplifier and Model MF-3-A Frame. Complete with tubes. Weight, Net, 10 lbs.; shipping, 12 lbs. **Price, Net, \$96.00**

MODEL PS-201-B POWER SUPPLY LESS TUBES. Same as Model PS-201-B Power Supply but less tubes. **Price, Net, \$95.00**

MODEL MF-3-A FRAME for above. Mounts the Model AM-3102 Basic Amplifier and four input panels. Weight, Net, 3 lbs.; shipping, 4 lbs. **Price, Net, \$13.50**

MODEL TK-3102 TUBE KIT for Model AM-3102 Basic Amplifier. Consists of 1 type 1612 (Langevin TUS-1612), 1 type 6SJ7 (Langevin TU-6SJ7), 1 type 6V6GT (Langevin TU-6V6GT), and 1 type 5Y3GT tubes. Weight, Net, ¼ lb.; shpg, ½ lb. **Price, Net, \$8.35**

MODEL TK-102-F TUBE KIT for Model AM-102-F Line Amplifier. Consists of 1 type 1612 (Langevin TUS-1612), 1 type 6SJ7 (Langevin TU-6SJ7), and 1 type 6V6GT (Langevin TU-6V6GT) tubes. Weight, Net, ¼ lb.; shipping, ½ lb. **Price, Net, \$7.35**

MODEL TK-201-B TUBE KIT for Model PS-201-B Power Supply. Consists of 1 type 5Y3GT (Langevin TU-5Y3GT) tube. Weight, Net, 2 oz.; shipping, ¼ lb. **Price, Net, \$1.00**

MODEL INP-A LINE LEVEL INPUT PANEL for Model AM-3102 Basic Amplifier. Weight, Net, ¼ lb.; shipping, ½ lb. **Price, Net, \$29.50. Inst. Chg. \$2.50**

MODEL INP-B LOW Z HIGH GAIN INPUT PANEL for Model AM-3102 Basic Amplifier. Weight, Net, ¼ lb.; shipping, ½ lb. **Price, Net, \$35.00. Inst. Chg. \$2.50**

MODEL INP-E HIGH Z HIGH GAIN INPUT PANEL for Model AM-3102 Basic Amplifier. Weight, Net, ¼ lb.; shpg., ½ lb. **Price, Net, \$15.00. Inst. Chg. \$2.50**

MODEL INP-H DISC PLAYBACK INPUT PANEL for Model AM-3102 Basic Amplifier. Weight, Net, ¼ lb.; shpg., ½ lb. **Price, Net, \$18.75. Inst. Chg. \$2.50**

MODEL INP-J HIGH Z INPUT PANEL for Model AM-3102 Basic Amplifier. Weight, Net, ¼ lb.; shipping, ½ lb. **Price, Net, \$15.00. Inst. Chg. \$2.50**

MODEL INP-R MONITOR INPUT PANEL for Model AM-3102 Basic Amplifier. Weight, Net, ¼ lb.; shipping, ½ lb. **Price, Net, \$22.00. Inst. Chg. \$2.50**

MODEL VR-113 VARIABLE CARBON 4K RESISTOR, Special, Allen Bradley, used as volume control. Weight, Net, 2 oz.; shpg., ¼ lb. **Price, Net, \$4.00**

MODEL VR-114 VARIABLE CARBON 2.5K RESISTOR, Special, Allen Bradley, used as Master volume control on AM-102F Amplifier in AM-3102 series only. Weight, Net, 2 oz.; shpg., ¼ lb. **Price, Net, \$4.00**

IMPORTANT NOTICE

When ordering a Model AM-3102 Series Amplifier, add the Model number of the Input Panels as follows: Model AM-3102-BBHJ = Model AM-3102 Basic Amplifier with two Model INP-B, one Model INP-H and one Model INP-J Input Panels.

The AM-3102 Series Amplifiers may be ordered with the desired Input Panels installed at the factory or Input Panels may be ordered separately if desired.

PATCH CORDS AND PLUGS



P-1367



PC-1368-2



P-607

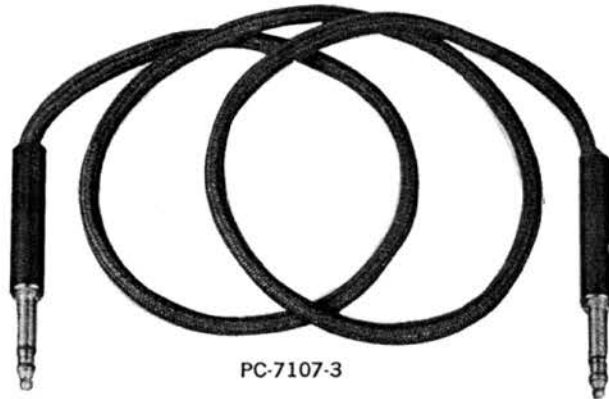

PC-7107-3

GENERAL

Two types of plugs are used in transmission work. These are the single plug, using tip and ring to carry signal with sleeve ground, and the double plug in which the two tips carry signal and both sleeves are ground.

The standard plug for patching sound circuits in motion picture and broadcast studios has for many years been the double type. The chief advantage of this plug has been its reliability and the ability in balanced circuits to turn the plug over to reverse the phase of the program material. The availability of the two plug screws on the rear of the plug allows accessibility to the circuit under operating conditions with bare wire ends, test prods, or the tips of another plug.

The disadvantages of the double plug circuit are the increased space required, and the cost.

In present day transmission circuits the phasing of all elements is carefully checked while initial cabling of the components is engaged in, an absolute necessity in multi-channel stereo circuits. This means that part of the advantage of the double plug circuitry is lost, for the ability to change phase relationships is neither required, nor, in most cases, is it desirable. In fact the possibility of turning over a plug by accident makes the dual arrangement less satisfactory than the tip ring and sleeve single plug system.

Both types of plugs are offered here, as both operate in the Langevin JS-7160 and JS-7180 series Jack Strips. Custom has given the double plug circuitry

the widest usage, and it is for this reason that jack strips for double plugs are featured, although jacks for single plugs may be installed in them by ordering the jack strips and appropriate jacks separately, or by ordering the complete JS-7191 or JS-7192 jack strip and jack assemblies for tip and ring and sleeve plugs only.

MODEL P-1367 DOUBLE PLUG

The Model P-1367 unit is a highly developed twin plug employing both tips to carry the signal. The shield ground of the circuit is connected to both sleeves. The metal conducting parts are formed of brass for easy cleaning by buffing with a plug polisher, or other means. The tip and sleeve are insulated by a bakelite washer, rather, than hard rubber which softens under the heat of polishing. Thus, critical alignment is consistently maintained.

The shell is molded of bakelite and polished to maintain a permanently sharp, clean appearance. The thumb side of the shell is notched to mark polarity. The sleeve and tip mounting assembly is terminated in a spring which makes both tip and sleeve assemblies self aligning upon insertion into the jack strip. This eliminates sticking, and insures positive, smooth insertion under all conditions. Ample room is allowed in the body of the plug for making connections. Especially important in Langevin plugs is the shape

of the tip. This shape prevents shorting of the jack contacts to ground, ordinarily causing noise and clicks. Equivalent in function to the WE 218-A.

Precise attention to detail in design and manufacture make Langevin Double Plugs the peer among all plugs in the field.

Similar in construction to the P-1367 Double Plug, the Model P-607 Tip Ring and Sleeve Single Plug carries the signal on the tip and ring with ground on the sleeve. All parts are of the same fine quality found in the double plug, including the formation of the tip to avoid shorting jack elements with consequent noise.

ORDERING INFORMATION

Model P-1367 Double Plug. Price, Net \$4.50.

Model P-607 Tip Ring and Sleeve Single Plug. Price, Net, \$3.50.

PATCH CORDS WITH DOUBLE PLUGS

Utilizing the Model P-1367 Double Plugs, these Patch Cords are available in convenient lengths and colors. Conductors are shielded with special, highly flexible tinsel and covered with long wearing mercerized cotton braid. This allows complicated circuit patching without tangles and kinks between patch cord assemblies. Shield is attached to one plug assembly only to avoid ground loops and cannot be used as a conductor. The shortest cord length should always be used between jack positions to avoid confusion and tangles from excess cord.

ORDERING INFORMATION

PATCH CORDS WITH DOUBLE PLUGS

| MODEL* | LENGTH, FEET | PRICE, NET |
|-----------|--------------|------------|
| PC-1368-1 | 1 | \$10.25 |
| PC-1368-2 | 2 | 10.50 |
| PC-1368-3 | 3 | 10.75 |
| PC-1368-4 | 4 | 11.00 |
| PC-1368-5 | 5 | 11.25 |
| PC-1368-6 | 6 | 11.50 |

PATCH CORDS WITH TIP RING AND SLEEVE SINGLE PLUGS

Uses the Model P-607 Tip Ring and Sleeve Single Plugs with same cords as employed on Langevin Patch Cords with Double Plugs.

| MODEL* | LENGTH, FEET | PRICE, NET |
|-----------|--------------|------------|
| PC-7107-1 | 1 | \$ 8.25 |
| PC-7107-2 | 2 | 8.50 |
| PC-7107-3 | 3 | 8.75 |
| PC-7107-4 | 4 | 9.00 |
| PC-7107-5 | 5 | 9.25 |
| PC-7107-6 | 6 | 9.50 |

PATCH CORDS ONLY

| For P-1367 | For P-607 | LENGTH, FEET | PRICE, NET |
|------------|-----------|--------------|------------|
| PC-1369-1 | PC-710-1 | 1 | \$ 1.25 |
| PC-1369-2 | PC-710-2 | 2 | 1.50 |
| PC-1369-3 | PC-710-3 | 3 | 1.75 |
| PC-1369-4 | PC-710-4 | 4 | 2.00 |
| PC-1369-5 | PC-710-5 | 5 | 2.25 |
| PC-1369-6 | PC-710-6 | 6 | 2.50 |

*Normally supplied in Black colored cord. For other colors add suffix to Model No.: W, white; R, red; G, green; BR, brown.

19" RACK PANELS

Two types of rack panels are offered by Langevin, Mat Panels and Instrument Panels. Mat Panels are made of 16 gauge steel, bonderized (rust-proofed) with 19/64" lips formed top and bottom to give proper clearance for mounting frame retaining screws. Rolled edges mate neatly with Instrument Panels which are 3/16" thick aluminum. Mat Panels have

standard mounting hole spacing and are furnished with chrome finish binder head screws and spacers. Instrument Panels have standard EIA (WE) notching. In addition to Langevin dark gray baked enamel Instrument Panels are offered also in Langevin light gray and unpainted. These panels are carefully made and well finished.

| Sizes: 19" By | 16 GAUGE STEEL RACK MAT PANELS | | | 3/16" ALUMINUM INSTRUMENT RACK PANELS | | | | | |
|------------------|--------------------------------|------------------|--------------|---------------------------------------|------------------|--------------|------------------------|-----------------------|--------------|
| | Langevin Dark Gray | | | Unfinished | | | Langevin | | |
| | Model | Shpng. Weight | Price Net | Model | Shpng. Weight | Price Net | Light Gray Model | Dark Gray Model | Price Net |
| 1 3/4" | MP-31-B | 1 lb. | \$4.00 | RP-31-U | 1 1/4 lbs. | \$4.00 | RP-31-LG | RP-31-DG | \$4.25 |
| 3 1/2" | MP-32-A | 1 lb. | 4.25 | RP-32-U | 1 1/2 lbs. | 4.25 | RP-32-LG | RP-32-DG | 4.50 |
| 5 1/4" | MP-33-A | 2 lbs. | 4.50 | RP-33-U | 2 1/4 lbs. | 4.50 | RP-33-LG | RP-33-DG | 5.00 |
| 7" | MP-34-A | 3 lbs. | 4.75 | RP-34-U | 3 1/2 lbs. | 5.00 | RP-34-LG | RP-34-DG | 5.50 |
| 8 3/4" | MP-35-A | 4 lbs. | 5.25 | RP-35-U | 4 1/4 lbs. | 5.25 | RP-35-LG | RP-35-DG | 5.75 |
| 10 1/2" | MP-36-A | 5 lbs. | 5.30 | RP-36-U | 5 1/2 lbs. | 5.50 | RP-36-LG | RP-36-DG | 6.00 |
| 12 1/4" | MP-37-A | 5 1/2 lbs. | 5.75 | RP-37-U | 6 lbs. | 6.50 | RP-37-LG | RP-37-DG | 7.00 |
| 14" | MP-38-A | 6 lbs. | 6.00 | RP-38-U | 7 lbs. | 7.50 | RP-38-LG | RP-38-DG | 8.00 |

JACK STRIPS

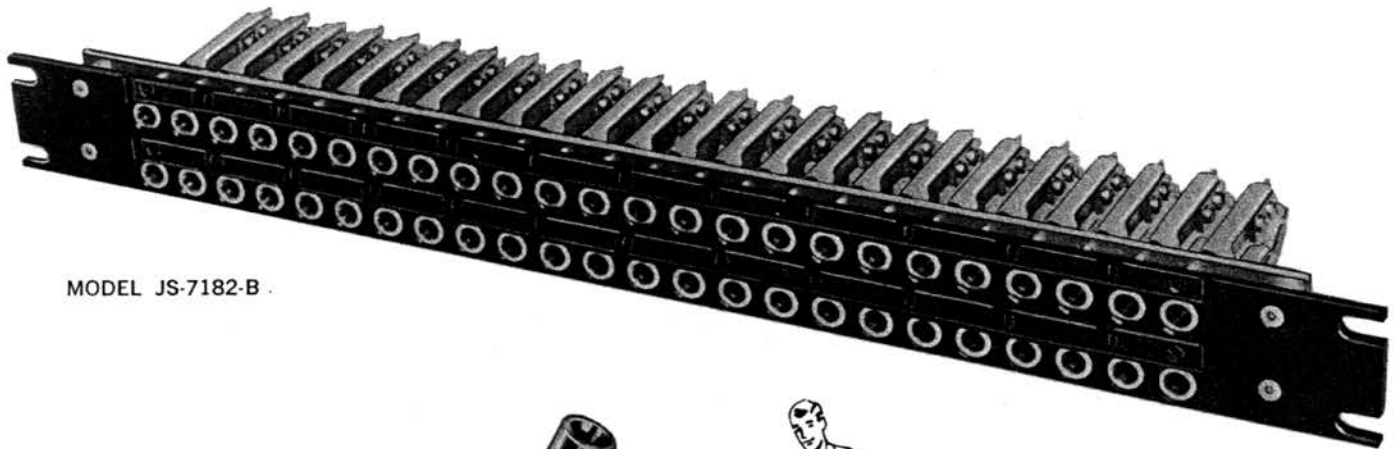

MODEL JS-7182-B



MODEL J-1399-BN



APPLICATION

Langevin Jack Strips are designed for use in consoles and equipment racks. They give rapid isolation, monitoring and selection of individual amplifiers for test. The use of jack strips also permits "patching" of various program sources to selected monitoring, remote or audition channels, as well as providing the ability to insert pads, equalizers, VU meters and other equipment optionally into any line.

DESCRIPTION

Langevin Jack Strips have black nickel plated panels, strongly reinforced with plated steel members. Mounting ears facilitate installation on standard relay racks and cabinets. Designation strips with clear plastic covers are standard on Langevin Jack Strips, and on both single and double row strips are directly over the respective rows, a unique feature which eases patching and avoids confusion. Importantly, the height of both single and double Langevin jack strips is 1 1/4", a proper rack multiple, unlike telephone company strips which are non-standard 2 1/8" height.

Langevin Jack Strips are available with Model J-1399-BN double circuit, tip normal jacks, or may be supplied without jacks so that any of the jack types listed below may be employed.

Model JS-7160 and JS-7180 series jack strips afford the use of the conventional double plug, Langevin Model P-1367, with two tips and two sleeves. Jack mounting holes are spaced 3/8" apart horizontally, and accept not only Langevin Model P-1367 double plugs, but WE 241-A double plugs in addition. Double

plugs can be inserted into any two adjacent jacks, but not vertically. All jack sleeves contact the strip panel. Panel is standard 3/16" thick.

ORDERING INFORMATION

- Model JS-7161** Single Row Jack Strip, less jacks, 12 pairs of holes, size 19" x 1 1/4" with 3/16" mounting panel, slotted for standard rack mounting, with designation strip and plastic covers. Weight, Net, 1 lb.; shipping, 2 lbs. . . **Price, Net, \$22.00**
- Model JS-7160** Double Row Jack Strip, less jacks, 24 pairs of holes, size 19" x 1 1/4" with 3/16" mounting panel, slotted for standard rack mounting, Weight, Net, 1 1/4 lb.; Shipping, 2 lbs. . . **Price, Net, \$28.80.**
- Model JS-7181-B** Single Row Jack Strip, same as Model JS-7161 but with Model J-1399-BN 2 circuit tip normal jacks and designation strip Weight, Net, 2 lbs.; Shpg., 2 1/2 lbs. **Price, Net, \$ 50.88**
- Model JS-7182-B** Double Row Jack Strip, same as Model JS-7160 but with Model J-1399-BN 2 circuit tip normal jacks and designation strips (2) Weight, Net, 2 1/2 lbs.; Shpg., 3 lbs. **Price, Net, \$86.56**
- Model DS-1219** Designation Strip, for above Jack Strips, **Price, Net, \$2.10 ea.**

JACK STRIPS



JS-7190

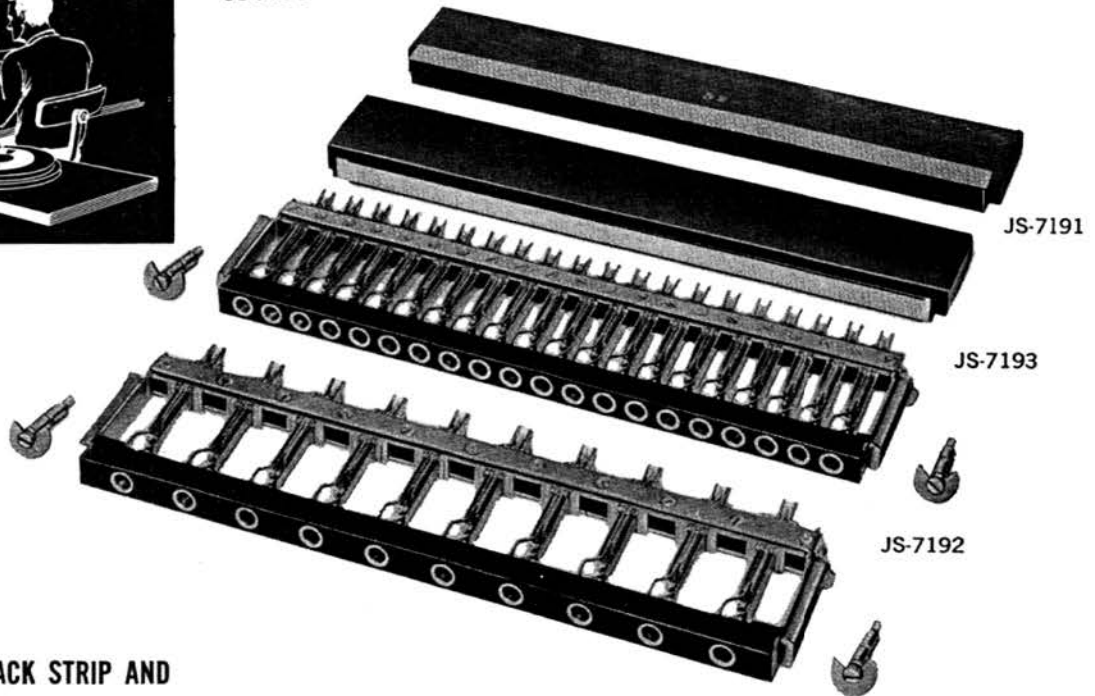

TIP RING AND SLEEVE JACK STRIP AND JACK ASSEMBLIES

To conserve space in the jack field and to simplify patching, the tip ring and sleeve jack strip and jack assemblies shown here are available with complementary combination spacer and designation strips. These assemblies are stocked only in 3 circuit tip and ring normal configurations on the jacks, (same circuit as J-7111-B) but may be ordered special in other forms. Any number of units may be stacked.

ORDERING INFORMATION

All jack strips and designation-spacer strips are 10 15/32 inch long across the face and mount 2 holes on 11 inch centers with length 11 15/32 inch overall. Width of each is 1/2 inch, depth of jack and jack strip assembly is 3 inches.

JS-7191 Designation Spacer Strip, for JS-7192 or JS-7193 Jack Strip and Jack Assemblies. Includes mounting screws. Weight, Net, 3 oz.; shipping, 1/4 lb. . . .
Price, Net, \$4.80.

JS-7190 SPACER STRIP, same as above but without designation holder.
Price, Net, \$4.00.

JS-7192 Jack Strip and Jack Assembly, with 10 3 circuit tip and ring normal jacks integrally mounted. Uses P-607 Plug. Includes mounting screws. Weight, Net, 8 ozs.; shipping, 3/4 lb.
Price, Net, \$34.80.

JS-7193 Jack Strip and Jack Assembly, same as above but 20 jacks. Weight, Net, 1 lb.; shipping, 1 1/4 lb.
Price, Net, \$54.60.

TELEPHONE SWITCHBOARD JACKS

Langevin Jacks are the preferred long frame type, designed especially for highest quality communica-

tion equipment at low levels of operation. The rugged nickle plated steel frame is press welded to provide dimensional stability. Springs are especially fabricated of long wearing, rust-free nickle alloy guaranteeing maximum life and corrosion resistance. This jack uses cross-bar palladium contacts in all switching circuits. The circuits listed are those common to most console and rack transmission equipment, but more complex circuits are available on order.

Frame and Stack screws are cadmium plated steel with iridescent irridite dip. Springs are formed of spring tempered nickle-silver alloy with lugs hot tin dipped. Bushings in the stacks are half-hard brass and bright nickle plated. Insulation is effected by high quality XXXP phenolic spacers, (Type PBE-D per Mil-D-3115-A) with phenolic tubing employed in the stack.

| Model No. | Schematic Circuit | Height, Max. | Price Net | | Remarks |
|-----------|-------------------|--------------|-----------|------------|---|
| | | | 1-23 | Pkg. of 24 | |
| J-1399-AN | | 7/16" | \$1.08 | \$23.33 | 2 Circuit, for double plugs. |
| J-1399-BN | | 1/2" | 1.24 | 26.78 | 2 Circuit tip normal, for double plugs. |
| J-7111-A | | 9/16" | 1.24 | 26.78 | 3 Circuit for single tip ring & sleeve plugs. |
| J-7111-B | | 5/8" | 1.44 | 31.10 | 3 Circuit tip & ring normal for single tip ring & sleeve plugs. |

LANGEVIN TELEPHONE TYPE SWITCHBOARD KEYS

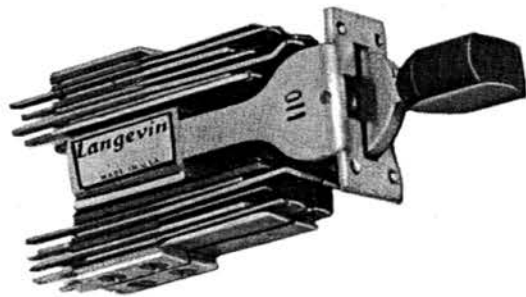

Langevin Series KY-1044 Telephone Switchboard Type Keys find invaluable application in transmission work, especially on console control panels. They are used for transferring one part of a circuit to another, for cueing, "keying" in effects filter and preset equalizers, for operating signal lights, relays, talk-back circuits, and are employed over mixer positions to allow keying in the circuit on demand. In addition, the 3 position key permits a choice of two inputs for each preamplifier and mixer.

Langevin keys are rugged, reliable, well constructed assemblies, the frame of which is formed of heavy, press-welded steel stampings. Nylon rollers actuate the nickel silver springs and provide smooth, positive action. Long springs without forms at the point of flexing insure dependable spring life. These springs each terminate in tinned solder lug terminals. Cross-bar contacts are palladium; these are rated 3 amperes at 120 vac non-inductive load.

The springs in Langevin 3 position key switches are operated by a lever which has 3 positions normally, the center being the unoperated position. In position 1, the lever operates only the springs on the associated side, and in the opposite position 2 operates only the springs associated with that side. Normally keys shipped locking in both positions can be adjusted by the user to be non-locking in either or both positions if desired.

Langevin Lever Type Keys are listed below in standard spring and circuit configurations, two and three positions, but unusual requirements may be ordered by referring to the Table of Basic Forms and requesting the circuitry desired for both positions 1 and 2.

Round, black bakelite key handles are supplied with each switch, but WE Type Tab Handles, Langevin Model K-115, are available as an additional accessory. These are normally supplied in black, but are available in colors also by specifying W, white; R, red; OR, orange; Y, yellow; GR, green; B, blue; P, purple and GRY, gray.

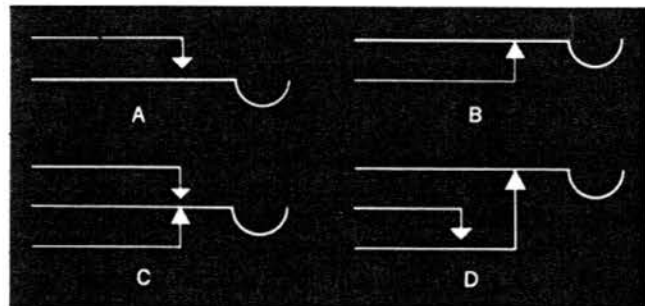

NOTE: When "B" Contacts are required use a key with the number of "C" Contacts needed. "C" Contacts may be wired for either "A" or "B" function.

ORDERING INFORMATION — TWO POSITION KEYS

| LOCKING IN ALL POSITIONS | NON-LOCK IN ONE POSITION | CONTACT ARRANGEMENT (ONE SIDE) | HEIGHT OVER CONTACTS | PRICE NET EACH |
|--------------------------|--------------------------|--------------------------------|----------------------|----------------|
| KY-1044-A | KY-1044-AN | 2A | 1" | \$4.35 |
| KY-1044-E | KY-1044-EN | 2C | 1" | 4.75 |
| KY-1044-G | KY-1044-GN | 4C | 1½" | 6.60 |
| KY-1044-O | KY-1044-ON | 2D / 1A | 1½" | 5.25 |
| KY-1044-P | KY-1044-PN | 4D | 1½" | 7.00 |

THREE POSITION KEYS

| LOCKING IN ALL POSITIONS | NON-LOCK IN ONE POSITION | NON-LOCK IN TWO POSITIONS | CONTACT ARRANGEMENT | | HEIGHT OVER CONTACTS | PRICE NET EACH |
|--------------------------|--------------------------|---------------------------|---------------------|------------|----------------------|----------------|
| | | | UPPER | LOWER | | |
| KY-1044-B | KY-1044-BN | KY-1044-B2N | 2A | 2A | 1¾" | \$ 7.00 |
| KY-1044-F | KY-1044-FN | KY-1044-F2N | 2C | 2C | 1¾" | 7.60 |
| KY-1044-H | KY-1044-HN | KY-1044-H2N | 4C | 4C | 1¾" | 11.50 |
| KY-1044-S | KY-1044-SN | KY-1044-S2N | 2D | 2D | 1½" | 5.25 |
| KY-1044-M | KY-1044-MN | KY-1044-M2N | 4D | 4D | 1¾" | 7.75 |
| KY-1044-R | KY-1044-RN | KY-1044-R2N | 2D / A / B | 2D / A / B | 1½" | 10.50 |

LANGEVIN SERIES 1044

ROTATING CAM KEYS

While standard Langevin Series 1044 Switchboard Type Lever Keys are used in all applications, many console designers feel that the round lever or WE tab presents a hazard when it appears over a mixer control because of the height. This is for the reason that many recording engineers are forced to wear formal attire during sessions, allowing the coat sleeve to engage a key tab and open a microphone circuit unknowingly. A partial remedy is to mount the lever switch horizontally. However, a direct cure for the hazard is to use the smaller and shorter Langevin Series 1042 cam operated keys. This sacrifices some of the ease of operation and reliability afforded by the larger lever type switch. Cam operated keys are offered with 2 of either the C or D spring combinations, and have only 2 positions, normal, and operated.

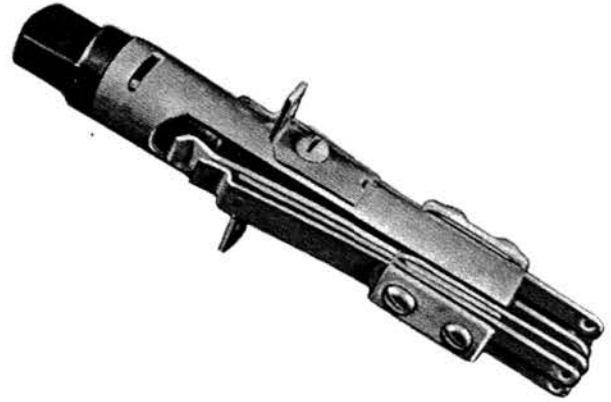

ORDERING INFORMATION

-CAM OPERATED KEYS

| LOCKING IN TWO POSITIONS | NON-LOCK IN ONE POSITION | CONTACT ARRANGEMENT | HEIGHT OVER CONTACTS | PRICE NET EACH |
|--------------------------|--------------------------|---------------------|----------------------|----------------|
| KC-1042-E | KC-1042-EN | 2C | 1" | \$4.75 |
| KC-1042-O | KC-1042-ON | 2D | 1½" | 5.25 |

LANGEVIN SERIES 1055

PUSH BUTTON KEYS

Usual application of the pushbutton type key is for buzzer signals on order wires, as an impulse switch for relays and motor starters, and also for talk-back microphones. There is no locking position on this key. The same fine construction is found in these pushbutton keys as in the Langevin lever type switches.

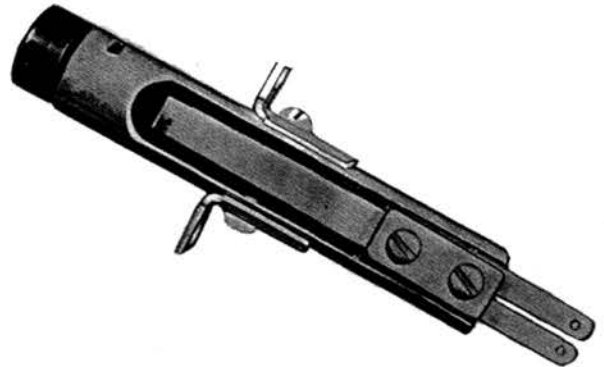

ORDERING INFORMATION

PUSH BUTTON KEYS

| NON-LOCKING | CONTACT ARRANGEMENT | HEIGHT OVER CONTACTS | PRICE NET, EACH |
|-------------|---------------------|----------------------|-----------------|
| KB-1055-EN | 2C | 1" | \$4.75 |
| KB-1055-ON | 2D | 1½" | 5.25 |

MODEL K-115 WE TYPE TAB HANDLE, for KY-1044 Series Keys, complete with set screw, normally supplied in black but available in W, white; R, red; Y, yellow; OR, orange; GR, green; B, blue; P, purple and GRY, gray if specified. **Price, Net, \$0.50.**



Here are the things you should consider in choosing VU METERS—

The considerations in the choice of a monitoring instrument for music and voice frequency powers are fairly complex and seldom engaged in. These points are discussed briefly so that proper weight may be given to their importance:

Frequency Response — The reading should be constant regardless of the frequency range from 20 to 15 kcps. In addition to monitoring the program material, the VU Meter is also called upon to measure system response linearity during routine maintenance. Many VU Meters are inaccurate in this respect, varying 7 and 8 db at the high end of the spectrum particularly.

Accuracy Because of the advent of stereo in 2 and 3 channel array, critical balance from channel to channel during operation is of prime importance. These meters are accurate within .2 db over the prominent portions of the scale. Most VU meters depart far from this. Vernier adjustments consisting of Langevin Model VR-111 500 ohm series variable wire wound resistors permit accurate adjustment for correlation.

Ballistics — Two things happen in all meters to confuse readings. Peaks reached on transient signals are 10 db higher than the meter movement can follow. The best VU meter averages the peaks. To do this high magnetic damping is required so that speed of action is not sacrificed as in mechanical damping. Inferior meters are too slow in action for accurate readings because of mechanical damping employed at sacrifice of large, more costly magnet structure. To gain even reasonable speed mechanical damping must be reduced to a value which causes pointer overshoot and erratic, hard-to-read action.

GENERAL DESCRIPTION — The Weston meters and Langevin meter panels listed here are used for the measurement of noise level and other audio frequency energy where the established dynamic characteristics give a common result for measurements and levels established in different laboratories and on different consoles.

These meters are designed for use with an external 3600 ohm resistance between them and the line. In meter panels, a 500 ohm variable wire wound resistor with a slotted shaft is employed in series with a 3200 ohm resistor or with a rotary attenuator to permit calibration, along with extending the range of the meters to higher levels of operation.

For recording consoles and equipment racks the "A" scale is employed as standard. This scale reads predominately in VU, with percentage of modulation appearing below the line of the VU scale. For broadcast use the "B" scale is available when so ordered, and shows percentage of modulation on top of the scale line.

Features — Meets ASA Standards. ASA Standard C16.5 dated 1954 is complied with fully.

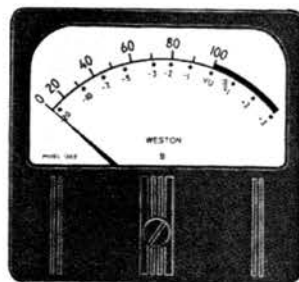

MODEL VU-1332
VU METER

MODEL VU-862-X AND
MODEL VU-962 VU METERS

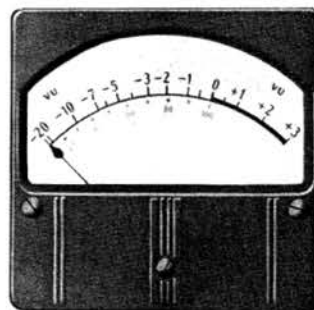

Highest Sensitivity. Both types of meters described here incorporate a special copper oxide rectifier and a highly sensitive movement employing a stable, well shielded, Alnico V magnet of exceptional weight. This "CORMAG" construction permits the use of the meter on either aluminum or steel panels without affecting the calibration.

Large Easy-to-Read, Illuminated Scale. — Two type 47 6.3V panel lamps illuminate the scale of Models VU-862 and VU-1332 against a non-halation buff colored field, and provide a shadowless background which eliminates confusion in readings. VU Scale is supplied in prominent black figures with an underline in black dividing the VU from the percentage of modulation underneath. VU designations from 0 to +3 VU are printed in red in the overshoot area.

Connections. — These VU meters use a total external series resistance of 3600 ohms, and when so connected across a 600 ohm line and load, a 1000 cps sine wave of 1.228 volts applied to the instrument and series resistor will cause the meter to read "0" VU. This value represents 4 db above 1 milliwatt in a 600 ohm line, the standard level used in most transmission practice. A Langevin step-type, constant impedance attenuator of 3900 ohms, calibrated in VU may be inserted between the external resistances and the meter to read higher line levels, thus serving as an extension of the reading above +4 VU. These extensions are covered in the Attenuator Section of this catalogue.

Two Classes of Meters Are Offered. — Two classes of meters are offered by Langevin, the traditional deluxe 862-962 Weston Series, and the 1332 lower cost Weston unit. The differences are these:

The 862 Westons have a larger bakelite case, and offer the illuminated feature with translucent dial and teardrop pointer. The 962 is the same meter, non-illuminated, at slightly less cost. These meters are 4 in. high by 4¼ in. deep. The 1332 unit has a scale 3/16 in. shorter, no teardrop on the pointer, and is almost 4 in. wide by 3.5 in. high by 1.5 in. deep. The "Cormag" movement, like the larger meter, meets ASA standards, a feature of vital importance, for this fact sets these meters apart from all others. When sold as a separate unit, the 1332 is not illuminated. Langevin has standardized on this meter for its VU Panels with rear mounting hardware and modifications which provide illumination.

The high advantage of the 1332 type meter is that it provides a modern instrument as modified, with no sacrifice in performance, at approximately one-half the cost of the 862-962 Series. The absence of the tear-drop on the pointer, Langevin feels, is more than offset by the greatly reduced cost; the difference in scale length is insignificant.

VU METER PANELS

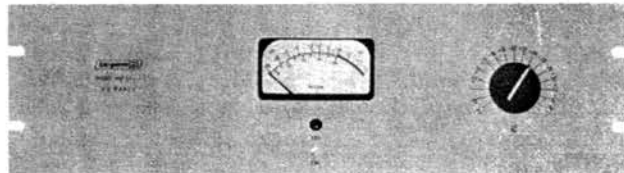

MODEL VUP-34

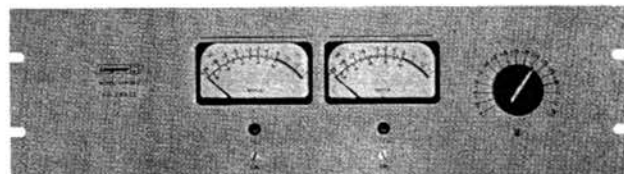

MODEL VUP-34-2

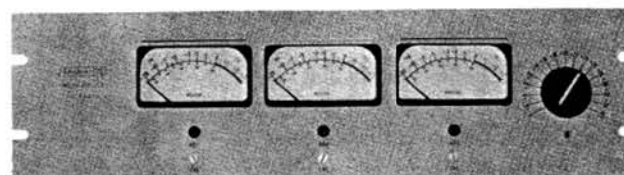

MODEL VUP-34-3

METER PANELS Langevin Illuminated VU Meter Panels come in standard 19" rack widths and 5¼" height. These are available from stock in 1, 2 and 3 meter configurations. Panels are 3/16" aluminum finished in Langevin gray with standard WE notching. Each Model VU-1332 BX meter has an extension attenuator, and is equipped also with VR-111 500 ohm wire wound variable resistor for calibration and balance. Terminations are on Jones terminal blocks.

| Model | Range | Steps VU | Price, Net | Double Model | Price, Net | Triple Model | Price, Net |
|----------|---------------|----------|---------------------------------|--------------|---------------------------------|--------------|---------------------------------|
| VUP-24 | +4 to +24-off | 2 | \$83.00 | VUP-24-2 | \$149.00 | VUP-24-3 | \$215.00 |
| * VUP-34 | +4 to +34-off | 2 | 85.00 | VUP-34-2 | 153.50 | VUP-34-3 | 223.00 |
| VUP-44 | +4 to +44-off | 2 | 88.50 | VUP-44-2 | 156.50 | VUP-44-3 | 226.00 |
| Weight | | | Net, 6 lbs. Shipping, 7 lbs. | | Net, 7 lbs. Shipping, 8 lbs. | | Net, 8 lbs. Shipping, 9 lbs. |

See Attenuator Section of this Catalog for complete Data and Prices on Range Extenders and Multiplier Pads.

* Preferred Model

SPECIAL VU PANELS TO ORDER

Combinations of VU meters and Gain Reduction Meters can be ordered in one, two and three channel arrays; include Limiter Accessory Controls if desired with your order. Prices and details available on request.

RECOMMENDED ACCESSORIES

Model FTM-1 — 0 to 1 db adjust pad in .1 db steps, for VU Meter, **Price, Net, \$8.00.**

Model FTM-12 — 2, 4, 6, 8, 10, 12 db 3900/3900 VU Meter Multiplier Network consisting of combination 3600 ohm resistors and fixed 3900/3900 ohm "T" Networks for extending range of VU Meter. **Price, Net, \$7.00.**

Model FNVU-4 — "T" Pad for Meter Bridging to read +4 VU, 7000 - 7500/3900 ohms. **Price, Net, \$5.00.**

Model VR-111 — 500 ohm Variable Wire Wound Resistor for balance and calibration; screwdriver slot adjustment. **Price, Net, \$2.75.**

ORDERING INFORMATION

All meters are supplied with "A" scale unless otherwise specified.

Model VU-862-X Weston VU Meter, illuminated through translucent dial, equipped with standard "A" scale; Size — 4" high, by 4¼" wide by 2¾" deep over-all. Weight, Net, ¼ lb.; Shpg., 1 lb. **Price, Net, \$80.00.**

Model VU-962 Weston VU Meter, same as above but non-illuminated. **Price, Net, \$70.00.**

Model VU-1332 VU Meter, 4" high by 3½" wide by 1½" deep, non-illuminated. Weight, Net, ¼ lb.; Shipping, 1 lb. **Price, Net, \$32.50.**

Model VU-1332-BX VU Meter, same as above but illuminated; modified for rear panel mounting; includes VR-111 calibration control and frosted pilot lights. Weight, Net, ½ lb.; Shipping, 1 lb. (Specify if gain reduction decal is desired on meter face.) **Price, Net, \$40.00.**

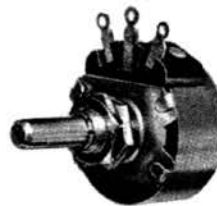

MODEL VR-111

KNOB AND DIALS

Three Styles Are Offered

Standards of the motion picture, recording and TV-Broadcast industry are the RCA type and WE type knobs. Langevin offers both in a variety of each to fill all needs. Offered also are the economical K-1032 knobs.

Langevin RCA and WE type knobs are provided in standard functional transmission color codes, with the color molded *entirely through the knob*. Importantly, the blue color, ordinarily sensitive to UV and sunlight, is highly resistant to fading and discoloration. Langevin knobs are rugged; formed of high impact phenolic they retain their strength and fine appearance for an indefinite length of time. Two set screws are used on all types to insure positive, non-slip gripping action. No flats are required on control shafts.

Standard Color Code to Denote Function — Please Specify When Ordering

The complexities of present day recording and broadcast, especially with the advent of stereo in two and three channel array, demand functional color coding of controls to ease the task of the mixer or engineer during intense sessions. Standard color coding related to function is as follows:

| Control and Approximate Level | Color |
|---|----------------|
| Microphone Mixers and Associated Keys (— 55 dbm) | Blue |
| Remote Input Mixers, Turntables | |
| Limiters, Metering, VU Range Extenders and Associated Keys (— 20 to + 10 dbm) | White |
| Equalizers and Associated Keys (— 40 to + 20 dbm) | Black |
| Submaster Controls and Associated Keys (— 40 to 0 dbm) | Green |
| Master Controls (— 30 to + 24 dbm) | Red |
| Pan Pot Controls | Red |
| Monitor Controls (Power Levels) | Yellow |
| Pan Pot Dials, Stereo VU Meter Designations, Stereo Switching | |
| Recordist Right (Stage Left) | Blue |
| Center | White |
| Recordist Left (Stage Right) | Red |
| TV Functions (Not completely standardized) | Orange |
| Available from Langevin in Key Tabs Only | Gray Purple |

DESCRIPTION AND ORDERING INFORMATION

Langevin RCA Type Knobs

This knob has become almost the universal standard as a mixer knob since the disappearance of the WE type knob from the market some years ago. The upper portion of the knob has 8 gentle detents to provide gripping action. An extension of the indicator line follows down the side of the knob out to the edge of the skirt on a protrusion of the knob body. This assists in positioning the knob in the dark by feel with the index finger. The shape of the knob as it joins the skirt provides a recess for the rest of the fingers and is comfortable when gripped by the hand.

Model K-108 RCA Type Mixer Knob; size is 2 1/16" diameter by 1 1/4" high. Accepts standard shaft .250 diameter and comes complete with 2 Allen 8/32 set screws. Normally supplied in black unless otherwise specified. Weight, Net, 3 ozs.; shipping, 1/4 lb.

Price, Net, \$2.50.

Model K-109 RCA Type Instrument Knob; same as K-108 above but 1 7/16" diameter by 3/4" high; suitable for use as a small mixer knob. Normally supplied in black unless otherwise specified. Weight, Net, 1 oz.; shipping 1/4 lb. **Price, Net, \$1.50.**

Model K-110 RCA Type Instrument Knob; same as K-109 above but 1 1/16" diameter by 5/8" high and set screws are 6/32. For use as calibration control knob, or anywhere when space is at a premium. Normally supplied in black unless otherwise specified. Weight, Net, 1 oz.; shipping, 1/4 lb. **Price, Net, \$1.00.**

LANGEVIN WE TYPE KNOBS

Probably the most highly functional mixer knob ever designed, the WE type knob represents the culmination of many thousands of dollars spent in human engineering. This graceful knob fits the hand; its long extension above the skirt has been tailored to allow precise dynamic control of the mixer pot. Tapered serrations around the top of the knob allow "rolling" with the palm of the hand for fast fades. An extrusion on the skirt carries the index line, and can be used to effect delicate control with either or both of the first two fingers in the dark. A heavy, detented line on the top of the knob is plainly visible, and can also be felt with the fingers. As a service to its customers, Langevin returns this peer of all mixer knobs to the market after an absence of many years. Available in all colors, it is normally supplied in black unless otherwise specified.

Model K-111 WE Type Mixer Knob; size is 2 1/16" diameter by 1 1/2" high; accepts .250 inch shaft. Supplied complete with 2 8/32 Allen set screws; supplied normally in black unless otherwise specified. Weight, Net, 3 ozs.; shipping, 1/4 lb. **Price, Net, \$2.50.**

Model K-111-X WE Type Mixer Knob; same as above but with 2 5/16" skirt. **Price, Net, \$2.75.**

Model K-112 WE Type Instrument Knob; this is a handsome control for switches, volume controls and other uses; has flat top with chrome pointer inserted; serrated edge corresponding to mixer knob K-111. Size is 1 1/2" diameter by 3/4" high over insert; for .250 inch shaft. Equipped with 2 8/32 Allen set screws. Supplied in black unless otherwise specified. Weight, Net, 2 ozs.; shipping, 1/4 lb. **Price, Net, \$1.50.**

Model K-113 WE Type Instrument Knob; same as above but 1 3/16" diameter by 5/8" high and 6/32 Allen set screws; suitable for calibration control knob or other use where space is at a premium. Supplied in black unless otherwise specified. Weight, Net, 1 oz.; shipping, 1/4 lb. **Price, Net, \$1.00.**

Model K-115 WE Type Key Tab; handsome tab type key handle, detented sides for non-slip finger control. Has 4/40 Allen set screw. Used on all standard keys and certain Langevin equipments. Size is 25/32 inch long by 3/8 inch wide by 3/8 inch thick. Normally supplied in black unless otherwise specified. All standard colors available and also in Video gray, orange and purple. **Price, Net, \$0.50.**

KNOB AND DIALS



LANGEVIN ECONOMY KNOBS

Model K-1032 Knob; this is a familiar knob type which has achieved wide popularity where economy is a factor. Eight contiguous and gentle detents allow a firm grip comfortable to the hand. A detachable skirt supplies versatility. 2 slotted 8/32 set screws; accepts .250 inch shaft. Excellent for mixer, switch or volume control applications. Size is 2 1/16" diameter by 29/32 inch high; black only. Weight, Net, 2 ozs.; shipping, 1/4 lb. **Price, Net, \$1.00.**

Model K-1031 Knob; same as above but 1 1/2" diameter by 13/16 inch high and set screws are 6/32; black only. Weight, Net, 1 oz.; shpg., 1/4 lb. **Price, Net, \$0.75.**

Model K-1050 Knob; for Langevin Straight Line mixers. Size is 3/4 inch diameter by 1/2 inch high; uses 4/40 Allen set screw. Index line scribed on both sides. Supplied in RED unless otherwise specified. Weight, Net, 1 oz.; shipping, 1/4 lb. **Price, Net, \$0.50.**

DIALS

These dials are fine appearing precision plates fabricated of 3/32 inch thick aluminum so that the component mounting screws will be flush with the dial face. They are anodized in flat black non-halation satin matte finish. Markings are etched with modern lettering and figures specially styled by Langevin. On the 2-3/4" diameter dials two mounting centers are available, 1-1/2" and the recommended 1-1/4" so that screw heads are covered completely by knob. The 2-1/4" dial has 1-1/4" mounting centers. Center hole in all dials is 3/8" clearance. Mounting holes are counter-sunk. Blank dials are also available to be engraved either by the customer or by Langevin.

ENGRAVING CHARGE

9 cents for each letter, character or numeral; indicator line counts as letter. Arrows 9 cents per lineal inch including point and tail. Drawing must accompany order showing degrees spacing, size of characters and all diameters. If dial is for Langevin product no drawing is required if product is specified.

ORDERING INFORMATION

| Dial Model | Steps | Dia. | Mtg. Ctrs. | Price, Net |
|----------------|--------------------------|--------|------------|------------|
| D-1001 (B-850) | — | 2 1/4" | 1 1/4" | \$2.00 |
| D-1002 (B-828) | — | 2 3/4" | 1 1/4" | 2.00 |
| D-1002 (B-843) | — | 2 3/4" | 1 1/2" | 2.00 |
| D-1002 (B-827) | etched for 32 step mixer | 2 3/4" | 1 1/4" | 2.00 |
| D-1002 (B-829) | etched for 20 step mixer | 2 3/4" | 1 1/4" | 2.00 |



K-108



K-109



K-110



K-111-X



K-111



K-112



K-113



K-115



K-1050



K-1032



K-1031



D-1001 (B-850)



D-1002 (B-828)



D-1002 (B-843)



D-1002 (B-827)



D-1002 (B-829)

MODELS EQ-255-A AND EQ-255-B VARIABLE HIGH PASS AND LOW PASS SOUND EFFECTS FILTERS

FEATURES

- Self-Contained: Independent high and low pass units.
- Compact: Uses no more space than a Rotary Attenuator.
- Versatile: Tandem installation.
- Maximum Flexibility: Overlapping cut-off frequencies.
- Flat response except at cut-off points.
- Broad scope, without hum or extraneous noise pickup.
- No phase distortion.

The Langevin Models EQ-225-A and EQ-255-B High Pass and Low Pass Filters have been carefully engineered to combine the flexibility of a complete "sound effects" filter with the versatility afforded by independent, miniaturized units. This variable filter provides instantaneous selective band restriction over a wide range of transmitted sound. Independent controls for high and low frequency units, each equipped with eleven positions, including "OFF", allow overlapping of sound over the entire spectrum to produce a wide variety of possible sound effects. When several of these filters are used in tandem there is no insertion loss or distortion, and the curves will be additive.

TECHNICAL SPECIFICATIONS

EQ-255-A (HIGH PASS)

11 positions: "Off" - full frequency transmission.
Cut-off frequencies: 70, 100, 250, 500, 1000, 2000, 3000, 4000, 5000, and 7500 cps.

EQ-255-B (LOW PASS)

11 positions: "Off" - full frequency transmission.
Cut-off frequencies: 10000, 8000, 6000, 5000, 4000, 3000, 2000, 1000, 500 and 250 cps.

SWITCH AND BRUSH CONTACTS

Gold plated for low noise (-140 dbm)

CIRCUIT

Constant "K" of 600 ohms in and out

IMPEDANCE

500 to 600 ohms. For other impedances use Langevin Model TF-602-C Transformers.

INSERTION LOSS

Zero

INPUT LEVEL

Minimum: -70 dbm.
Maximum: +24 dbm.



HIGH PASS



LOW PASS

CONNECTIONS

Solder terminals on rear with added case ground connection.

POWER REQUIREMENT

None.

MOUNTING

Three different mounting centers, 1- $\frac{1}{8}$ ", 1- $\frac{1}{4}$ " and 1- $\frac{1}{2}$ " on universal mounting bracket. Single $\frac{3}{8}$ " hole mounting also provided by removal of mounting bracket.

DIMENSIONS

2 $\frac{1}{4}$ " diameter by 4- $\frac{7}{8}$ " long

DIAL AND KNOBS

Dial is Model D-1002, 2- $\frac{3}{4}$ " diameter, 1/32" thick aluminum, black satin anodized and engraved to suit. Model K-112 1 $\frac{1}{2}$ " WE type Instrument Knob is supplied.

ORDERING INFORMATION

MODEL EQ-255-A HIGH PASS FILTER, complete with Model K-112 Instrument Knob and Model D-1002 engraved dial. Weight, Net, 1 $\frac{1}{2}$ lbs.; shipping, 3 lbs. **Price, Net, \$135.00.**

MODEL EQ-255-B LOW PASS FILTER, Complete with Model K-112 Instrument Knob and Model D-1002 engraved dial. Weight, Net, 1 $\frac{1}{2}$ lbs.; shipping, 3 lbs. **Price, Net, \$125.00.**

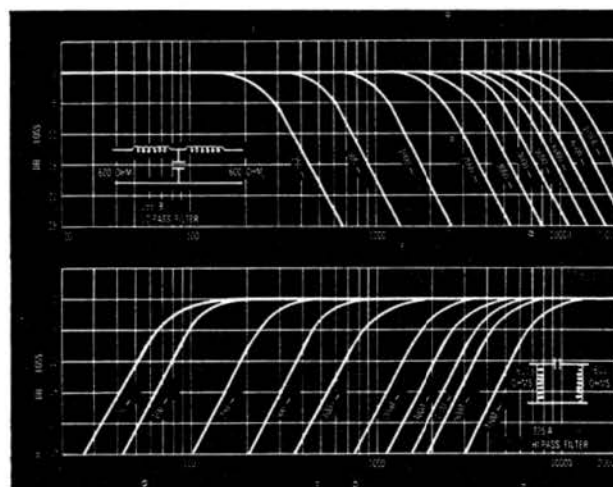

LANGEVIN PROGRAM EQUALIZERS

SUBJECTIVE CRITERIA IN SOUND RECORDING AND REPRODUCTION

Program Equalizers were pioneered by Langevin engineers; the philosophy of design, selection of equalization points and the degree to which compensation should be engaged in was determined many years ago by Langevin personnel working principally with the motion picture studios. Today, function has been married to form; the complex requirements of modern recording for stereo call for miniaturization and accessibility to many controls within the reach of a single operator.

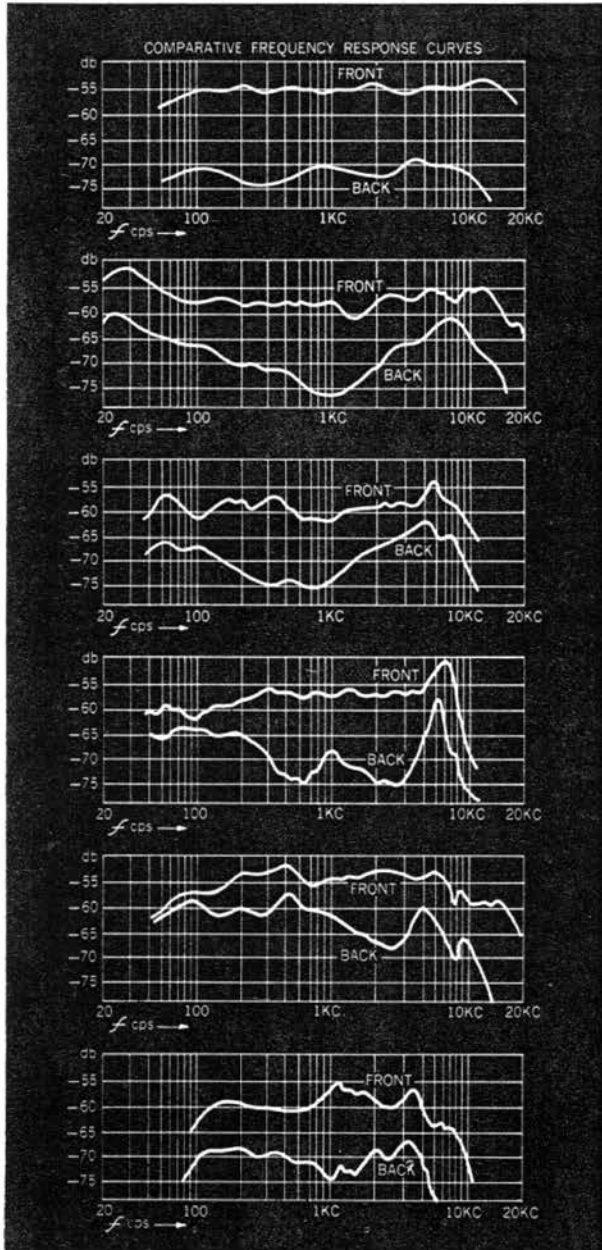

VARIATIONS IN MICROPHONES

It is true that for ideal stereo results the quality of the various channels should be identical. This conflicts with the recording engineer's desire to use microphones of different make and type to display

favorably certain sections of the orchestra and to enhance vocals. The pickup pattern of the microphone, coupled with back noise rejection govern this choice principally, but these features are accompanied by wide variations in response. The figure shows these variations in some of the popular microphones in tests conducted under the same conditions at the same time. The channel with the flattest, highest quality response will take command over the direction, whether the virtual source is from this channel or not. A solution to the problem of matching dissimilar microphones lies in the use of equalization. This close matching assists especially those performances where instruments and vocalists move around the sound field.



HIGH FREQUENCY ATTENUATION THROUGH AIR

There is a growing tendency to employ microphones farther away from the subject to induce perspective for better stereo. The intimate effects which add to the appreciation of monaural presentation are found to detract from stereo because they are "unnatural", and tend to confuse proper geometry. Many times the best perspective is achieved by longer pickup distances with pronounced room effects. In this case quality suffers for lack of high response, as attenuation through air of frequencies in the region of 10KC often reaches 6 to 10 db under operating conditions.

Past practice has included changing the microphone for such applications to one with a *rising* high end characteristic. This same compensation can be handled easily and economically by equalization.

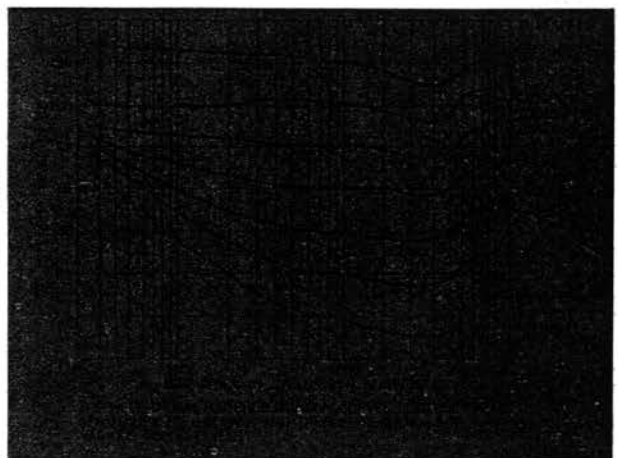

The Recording Engineer as

The Critical Portions of the Audible Spectrum Requiring Spectral Control

**VERY LOW BASS—
POWER RANGE—16-64 cps
1st and 2nd Octaves**

In this region, from 16 to 64 cycles per second, we find the threshold of feeling, where the lowest sounds, like wind and room effects—the sound of distant thunder—are felt, rather than heard. In the upper half of the first octave, just below 32 cps, J. C. Stienberg[®] shows that the fundamentals of the piano, organ and harp, reach well into this range; he shows also that the memory of the ear for these lowest sounds is long—they need occur but seldom in a three or four minute passage to achieve feeling of power and fullness, to balance aesthetically what would otherwise be a preponderance of higher tones.

But Fletcher has charted the sensitivity of the ear for various parts of the spectrum at lower than the levels of real existence. His compensation requirement for equal loudness in this range at lower recorded and reproduced levels shows requirements for tremendous boosts, on the order of 10, 20 and 30 db, or anywhere from 10 to 1,000 times.

Precise control of this range is required to subdue stage rumble and outside traffic noise, an acute problem in New York Studios. Overemphasis through microphone placement, especially those ribbon microphones which are velocity sensitive, can muddy the sound. The option to attenuate this range is as important as the ability to boost it.

**BASS—RHYTHM AND MUSICAL FOUNDATION
3rd and 4th Octaves—64-256 cps**

Most of the low, grave tones of the drum and piano are generated in this range; here we find the fundamentals of the rhythm section of the dance orchestra, as well as the foundation of all musical structure.

It was Leopold Stowkowski who said "If I had a thousand bass viols I could use them all!"—This is not as extreme as it may sound. For instance, such string instruments, while reinforced by sounding boards, generally play single tones, weak in level and possess little dynamic range. In a large, comprehensive orchestra, as many as eight bass viols may be used. A total of 1,000 bass viols in this case would give only an additional 21 db of level, a not inordinate amount if a glance be given to the equal loudness contours for the ear on the previous page. Profound attention should be given to equalization or attenuation in this range, for the musical balance of the entire program can be controlled at 100 cps.

Most pressure microphones are subject to "proximity effect," or non-linear bass increase at low frequencies in close talking positions. The use of attenuation for dialogue restores normal perspective and quality.

**MID-RANGE—256 to 2048 cps
5th, 6th and 7th Octaves—"Telephone-Like" Quality**

The ear is reasonably sensitive in this range, and almost all

OCTAVES & F

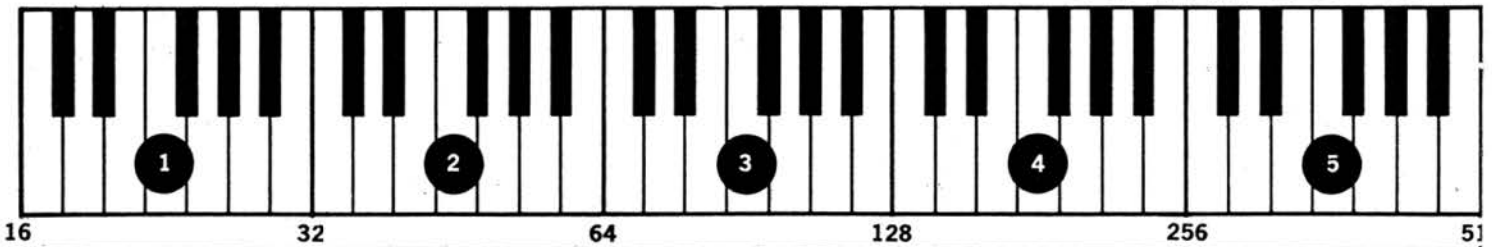

BASS

POWER

RHYTHM

FUNDAMENTALS of most musical instruments— 128 - 512 cps



Sound of Distant Thunder—
Wind and Room Effects—
Threshold of Feeling

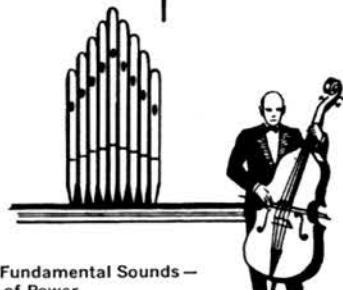

Lowest Fundamental Sounds—
Feeling of Power



Rhythm—Body—Fullness—Richness



The Recording Engineer is Vitally Concerned With 5 Things

1. Musical Range—The equipment with which the recording engineer works is capable of reproducing almost the entire world of sound—a range of nearly 10 octaves, embracing vibrations from 20 to over 16,000 cycles or beats per second. But certain restrictions are imposed on the recordist in accomplishing this totality, both physical and practical ones. These restrictions can be overcome to a high degree by *equalization*.

2. Rhythm—The framework of the musical performance is *rhythm*. While control of rhythm would seem to lie solely in the domain of the performers, the engineer is charged with the interpretation of rhythm by controlling bass and mid-bass balance to the rest of the sound. This is accomplished by choosing and placing the microphones, regulating their intensity, and influencing their spectral sensitivity through *equalizers*.

3. Variety—The brain, through the ear, delights in variety. It follows that the widest range accompanied by best spectral balance, delivers the most auditory pleasure. Through good judgment, and careful regulation of the microphones by means of their volume and equalization controls, the recording engineer insures maximum listener enjoyment.

4. Dynamics—The transition in music from a soft passage to a louder one is calculated by most composers to achieve a physiological effect. While the ear perceives a dynamic range of one in a trillion (120 db), the recording engineer must limit this to one in a million (60 db) for this is the maximum capability of present day equipment. To accomplish this compression unnoticeably requires skill at the volume controls with the help of equalizers; the spectral sensitivity of the ear changes when the volume level is varied from that of the original performance.

5. Spectral Control—This is a descriptive name for the term "equalization." It implies the option to raise or lower the intensity of critical sections of the musical range. Further, it connotes a subjective appreciation of the physiological effects achieved through these means to compensate for the limits of the recording and reproducing equipment. Here, more than in any other function of the recording engineer, lies the highest, most sustained expression of the recordists art.

an Artist-Equalizing for Spectral Character

recording and reproducing equipment manages this mid-range with facility.

If the 6th octave is made louder with respect to other octaves, the music has a horn-like character. If the 1000-2000 cps range is emphasized a "tinny" effect is achieved.

The fundamental tones in most music lie equally above and below middle C, from 128 to 512 cps. As most instruments are rich in the first overtones, the majority of the sound energy is found up to the 2,500 cps range. Music editors, and others engaged in listening to music over long periods find that "listening fatigue" can be reduced by attenuating the 5th, 6th and 7th octaves by about 5 db from the normal level.

LISPING QUALITY — Between the 7th and 8th Octaves—3 kcps

The 3 kc range delivers a generous stimulus to the ear. At very loud levels the region of greatest ear sensitivity shifts downward from 5 kc, and accounts partly for the high sensitivity of most public address loudspeakers in the 3 kc band. Characteristic of low-level signals peaked at 3 kc is a "lisp" quality, and the total inability to distinguish labial sounds such as m, b and v.

In wide-range lower level systems, a peak in the region of 3 kc has a masking effect on important recognition sounds, and on others which lie above 4 kc. Brilliance and clarity are lost, and without attenuation an unconscious strain with increasing fatigue is felt according to the height of the 3 kc rise.

PRESENCE RANGE — Between the 8th and 9th Octaves— 4750 to 5 kcps

The usual band which affects clarity in a man's speech is 3,000-6,000 cps. In a woman's voice the fundamentals are roughly an octave higher than a man's, and her range of consonant clarity is achieved between 5,000 and 8,000 cps, a region the higher end of which approaches an insensitive range of the ear. In addition, the total range of a woman's voice is about one-half that of a man's, stimulating fewer hearing nerves, and is consequently still weaker upon reception for this reason.

Wide range sounds, especially those of singing voices, have fundamentals with harmonics in the 5 kc region of good ear sensitivity. Voices, powerful or rich with harmonics at 5 kc sound especially pleasing, clear and full. Male opera singers are particularly favored with 5 kc sounds, women less so, although there are notable exceptions. It follows that deficient voices, especially those of women, can be enhanced in listening value by a generous boost at the 5 kc point, on the order of 5 to 8 db. Definition is increased by added power given to the recognition sounds like t, s, ch and k. A collateral benefit of this boost is the apparent increase in level; a 6 db rise at 5 kc frequently gives an apparent increase of 3 db to the overall signal.

The attenuation of the 5 kc range on instrumentals can give a "transparent" quality to the performance, provided that it is otherwise wide-range. This quality is common to European orchestral recording, has found some popularity, and may be desirable. Usually, vocals on microphones with a "saddle" in

this range lack the "punch," or "presence" to which we have grown accustomed in this country.

BRILLIANCE — Part of the 9th through the 10th Octave—6500 to 16000 cps

Unvoiced consonants attributed to tooth, tongue and lip sounds are high in frequency, and reach the 10 kc range. These frequencies account for some clarity and most brilliance, even though they purvey less than 2% of the total speech energy. The same effect holds true for musical instruments, and especially for percussion. Thus, in order properly to convey all the effects in recording independently of microphone placement and sensitivity in the last octave, the ability to boost this range in an easy, continuing slope on the individual microphone is helpful.

On some undamped microphones of the diameter of about one-half inch, an opposite correction is required, especially on speech and vocals. The extension of the higher range in good microphones exploits the "baffle" effect investigated by Mueller, Black and Davis in 1934. It has been determined that extra sound pressures build up on the diaphragm by a value of 9.8 db over an appreciable band, and that the predominant frequency of this band is directly associated with the diameter. In this way a microphone of 3/8 inch diameter is approximately one-half the wave length of 9 kc. On improperly damped microphones a distinct rise at this frequency is found which produces annoying sibilant distortion on speech. On Latin and other types of music using gourds and rattles, this peak results frequently in an astonishing and pleasing feeling of clarity.

HOW CONTROL IS ACHIEVED OVER GEOMETRY, TONALITY AND EFFECTS.

It would appear specious to suggest the multiplicity of corrections and precise control of spectral quality in the preceding without showing how it may be achieved. It is obvious that individual control of each microphone is needed for purposes of matching quality from left, center and right groups. It is plain to see that each microphone is confronted with the task of purveying qualitatively the sound from different instruments and artists, and that each microphone must be controlled throughout portions of its spectral range to accomplish special effects.

It has become good practice in monaural recording to provide a multiplicity of equalizers on the mixer console. In most cases this equalization has offered control at two points only, generally at 100 and 10,000 cps. While more control was desired, the unavailability of equipment small enough to provide more control and at other frequencies has in the past militated against needful additions.

With the advent of stereo and three-channel recording, nearly three times the equipment, with more elaboration, seems indicated, and expansion of console area in the horizontal plane offers the only direction in which to proceed. But a single engineer has arms only so long.

Succeeding pages describe Langevin Program Equalizers small enough to fit on the control panel over the mixer controls.

① J. C. Stienberg "Fundamentals of Speech, Hearing and Music."
② eg., Rosemary Clooney, Doris Day

REQUENCIES

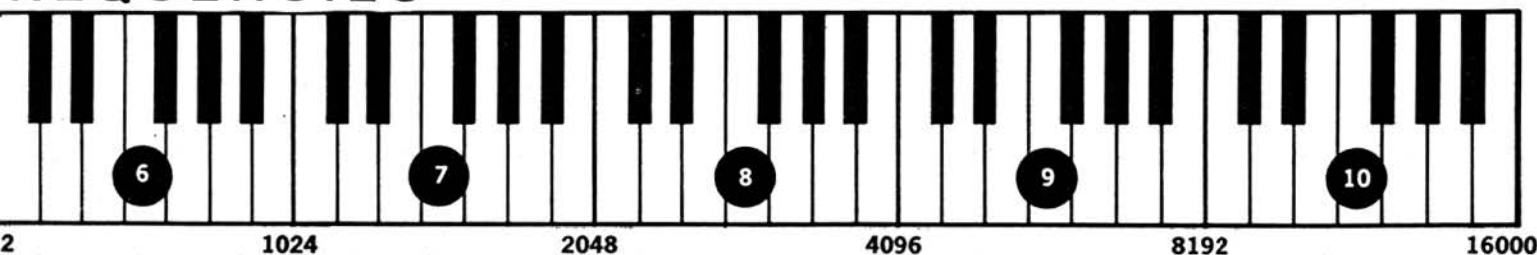

TREBLE

PRESENCE - 5 KCPS

BRILLIANCE

"HORN-LIKE"
Quality - 512-1024 cps

"TINNY"
effect - 1 kcps



Sounds Required for Bare
Communication of Intelligence

"LISPING"
Quality - 3 kcps



Overtone - Realism -
Region of Labial and Recognition
Sounds in Speech and Singing



Brilliance - Sparkle -
Life-like Quality

Equalizing for Spectral Character

MODEL EQ-251-A PROGRAM EQUALIZER

New Concept Gives Variable Equalization at 6 Important Points.

Only 1½ Inches Wide— 10 units require panel space of 3½ inches high by 15 inches wide.

Flexible— 2 rotating cam switches for high and low peak settings.

No tubes or power required— all passive circuits.

Low Insertion loss of only 14 db.

Uses etched circuits of military quality for super-compactness.

Toroid coils— no hum.

GENERAL

The Model EQ-251A Equalizer is Langevin's miniaturization of an instrument that has long been standard for corrective equalization in recording and reproduction of sound. The diminutive size of this precision instrument permits mounting adjacent to mixer controls, thereby making possible multiple installations of several units in close proximity.

The Model EQ-251-A Equalizer's improved design features two sliding levers for equalization and attenuation. The perpendicular sliding action is more functional than rotary action, and facilitates reading of knob positions. Adjustable in 2 db steps at specified frequencies, with a range of 12 db maximum equalization to 16 db maximum attenuation, this instrument is an ideal tool for dubbing and frequency response corrections.

This assembly is a passive, L/C/R, bridged T network, and does not require power supply, tubes or additional connections. It can be inserted directly into a transmission line with only input and output connections.

Two rotating cam switches are provided on the face panel. The switch at the right gives high frequency equalization peaks at 3 kc, 5 kc, 10 kc or 15 kc. The left switch provides low frequency equalization peak settings of 40 cps or 100 cps.

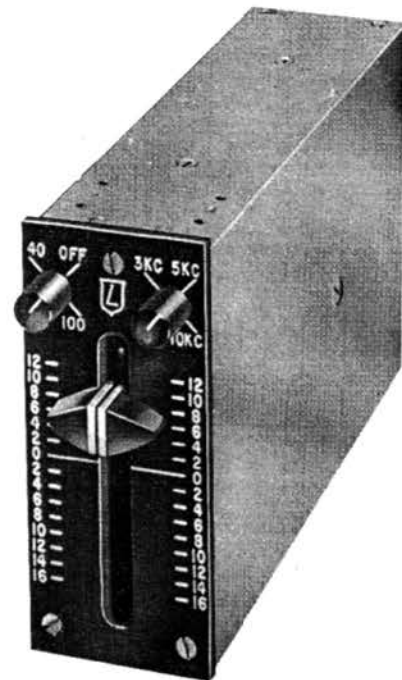

TECHNICAL SPECIFICATIONS

Circuit, Bridge T; Impedance, 600/600 ohms; Insertion Loss, 14 db; Input Level, minimum: -70 dbm, maximum: +20 dbm; Phase Shift, negligible; Power Requirements, none; Terminals, plug-in; Finish, black non-halation, satin finish, anodized aluminum with engraved markings. Chassis parts are nickel plate on brass. Dimensions, panel: 1½ inches wide by 3½ inches high; 5½ inch depth behind mounting panel.

ORDERING INFORMATION

MODEL EQ-251-A PROGRAM EQUALIZER, complete with female plug receptacle, mounting hardware and instructions; Weight, Net, 1¾ lbs., shipping 3 lbs. Price, Net, \$260.00

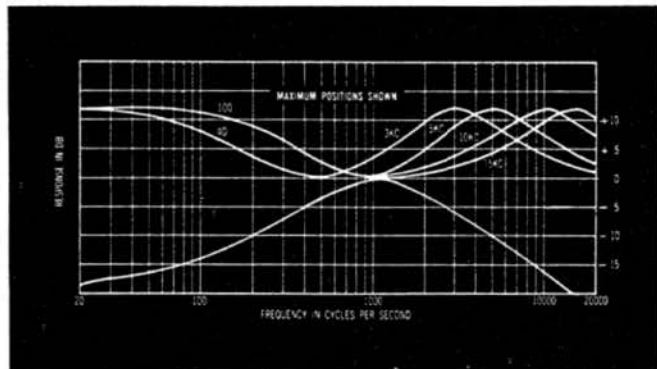
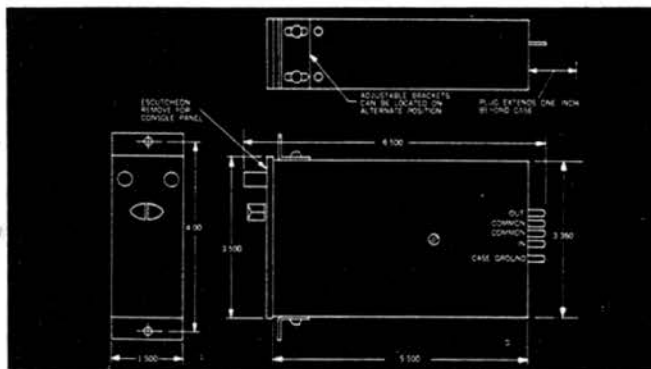

LANGEVIN PROGRAM EQUALIZERS

MODEL EQ-252-A GRAPHIC EQUALIZER

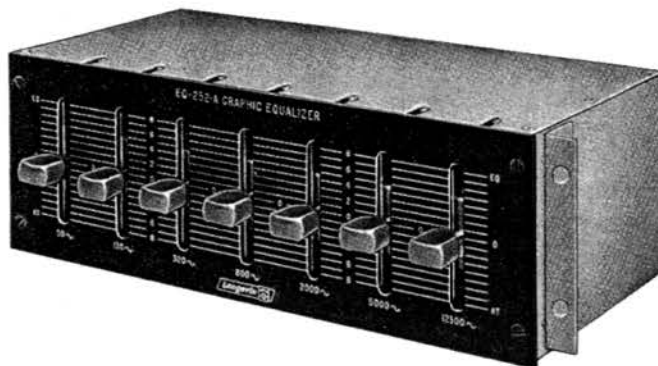

7 POSITIONS FOR ULTIMATE CONTROL OF SPECTRAL QUALITY IN RECORDING, TV-BROADCAST AND MOTION PICTURES

FEATURES

- 7-Selected Positions of Variable Hi-Lo Equalization and Attenuation.
- Gold plated, Noise-free, Switching through ± 8 db in 1 db steps during active use.
- Hum-free performance through toroid coils from -70 to $+24$ dbm.
- No tubes or power required—all passive Bridge T circuits in one integrated unit.
- Small size: $3\frac{1}{2}'' \times 10\frac{1}{2}'' \times 5\frac{3}{4}''$ deep.

GENERAL

The Langevin Model EQ-252-A Graphic Equalizer fulfills the critical need for multiple control at the subjectively important points of the audio range. It employs miniaturized, military quality, gold plated, etched circuitry in each of the 7 plug-in filter units, resulting in a passive assembly requiring no tubes or power supplies. Only input and output connections are required. Sliding Levers permit 8 db of equalization and 8 db of attenuation in 1 db steps at 50, 130, 320, 800, 2000, 5000 and 12,500 cps during the program through noise-free gold-plated switching. Modern controls give quiet operation at -70 up to $+24$ dbm.

Filter assemblies use sealed toroid coils for hum-free operation. Careful design delivers $\pm\frac{1}{2}$ db accuracy. Overlap from one filter to the next gives combined flat output when levers are in a straight line in any equalized or attenuated position (see curves). Special frequencies are available to order; overlap may or may not provide combined flat output between adjacent positions as the standard frequencies shown have been calculated for this effect. In zero position each or all filters are flat (resistive only, 16 db loss) from input to output. Because all passive circuitry is used there is no distortion when operated up to plus 24 dbm. Impedance is 600 ohms in and out; for other impedances use Langevin line to line transformers, Model TF-602-C. The model EQ-252-A is limited to 600 ohms impedance for the reason that lower impedances would double the size of the equalizer components every time the impedance is halved.

SPECIFICATIONS

Circuit: Bridged T; Impedance: 600/600 ohms; Insertion Loss: 16 db; Operating Level: -70 to $+24$ dbm; Positions: 7, with 8 db of equalization and 8 db of attenuation at 50, 130, 320, 800, 2000, 5000 and 12,500 cps in 1 db steps; Distortion: none; Coils: Sealed toroids; Power Requirements: none; Response: See curves; Panel Finish: Black, satin finish, non-halation, anodized aluminum; Terminals: solder type, turret; Filter Sections: 7 plug-in, printed circuit type; Size: $3\frac{1}{2}''$ high by $10\frac{1}{2}''$ long by $5\frac{3}{4}''$ deep overall.

ORDERING INFORMATION

Model EQ-252-A Graphic Equalizer equipped with red knobs, complete with mounting hardware and instructions. Weight, net 9 lbs.; 14 lbs. shipping. Price, Net \$475.00.

Recommended Accessories

When lower impedances than 600 ohms are required, use the following matching coils in and out:

Model TF-602-C Line to Line Transformer, Weight, Net, 2 $\frac{3}{4}$ lbs.; 3 $\frac{1}{2}$ lbs. shipping. Price, Net, \$25.50.

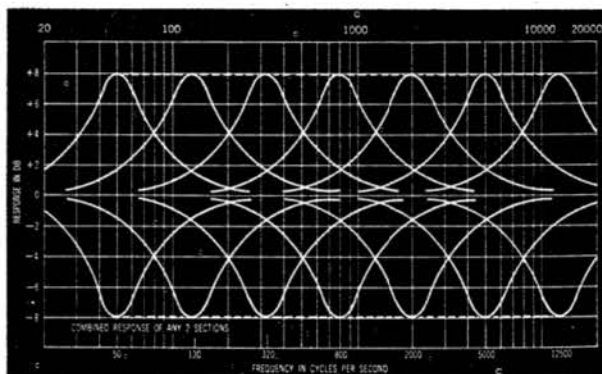

MIXERS AND ATTENUATORS

INTRODUCTION

A mixer is a device used to *increase* smoothly with unrecognizable steps the signal in the line from a point of infinite attenuation. This is called "fading-in" the program material. Secondly, the function of a mixer control is to raise and lower the level of the program material during a performance over a range within the dynamic, or the working limits, of the associated equipment. Thus, either the maximum, or a lower desired dynamic range can be maintained without overloads, without signal reduction into the noise threshold of the equipment, and without recognizable frequency discrimination during the process.

A variable attenuator is defined here as a resistive device used in audio transmission circuits to reduce level uniformly at all frequencies flowing through the interconnecting line. Philosophically, then, a mixer control is a specialized type of attenuator.

Attenuators used in some measuring equipment, for instance, reduce the signal a certain number of db and sometimes cut off to infinite attenuation on the last step. This abrupt transition makes it unsuitable for use as a mixer, all other things being equal. A mixer is designed so that the last few steps attenuate to infinity rapidly but without abrupt or noticeable transitions during the last few degrees of travel.



HERE IS THE DIFFERENCE

This leads us to the heart of the problem in selecting a good mixer: smooth transition from one degree of attenuation to another. The greater the number of steps, the smoother and less noticeable is the mixing operation in the sound output.

A comparison of signal levels only 1 db apart requires close study by AB comparison to detect a level change. A change of $1\frac{1}{2}$ db is perceptible by study, but under program operating conditions cannot be discerned. Thus, 30 steps $1\frac{1}{2}$ db apart determines the number of transitions required for high quality mixing and is standard throughout the industry for rotary mixers.

Smaller, less expensive mixer controls are limited to 20 steps. This allows 2 db of attenuation per step. Sometimes, especially in portable equipment, space is the vital consideration and this limits the choice to units with this number of steps. Operation can be classed as good.

SLIDE WIRE MIXERS

Smoothest operation is achieved by slide wire mixers, where the transitions from one level to another are only one tenth of a db apart. For this reason they are employed in music scoring and other critical applications where best quality is demanded.



ROTARY TYPES



STRAIGHT LINE TYPES

CIRCUIT TYPES for MIXERS AND ATTENUATORS

There are two classes of circuits for mixers and attenuators. These are the *unbalanced* and *balanced* types.

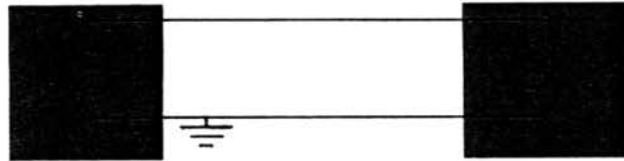

UNBALANCED CIRCUITS

In unbalanced circuits one side of the line must be grounded. In a mixer control the position in the equipment circuit is usually predetermined, allowing unbalanced operation where provision is made to insure against induced hum resulting from a ground loop. In the case of attenuators, their use in gain sets and balanced lines invokes a determination as to whether a ground on one side will short out parts of the circuit or cause an undesirable ground loop.

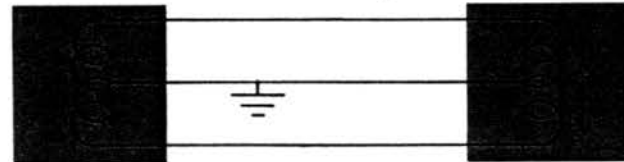

BALANCED CIRCUITS

Symmetrical components with the central part of the configuration going to ground characterize a balanced circuit. This circuit is not susceptible to hum from loops due to misplaced grounds. In addition the balanced characteristic eliminates the shorting out of circuit components if the ground is used and if it is centrally located with respect to each side of the line.

STEREO'S MOST MODERN MIXER

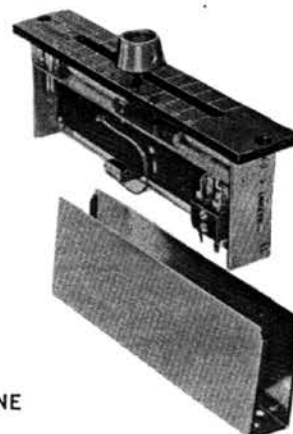

SLIDE-WIRE
LADDER
STRAIGHT LINE

CHOOSING THE MIXER FOR CIRCUIT, FORM AND TYPE

While Langevin supplies all classes, forms and circuit types in mixer controls, it would be remiss in its obligation to the user if it did not make recommendations and cite advantages and disadvantages in the use of the various kinds available. Accordingly we will treat on these recommendations in three sections: the choice of circuit for mixing, submastering and mastering; the choice of attenuator form, that is, rotary or straight-line, and the choice of step type versus continuous slide wire.

THE MIXER CIRCUIT LOW OR HIGH LEVEL MIXING

Mixing in low-level circuits before preamplification saves on the number of preamplifiers, as the inputs can be combined in varied proportions through the mixers and then fed to a single preamplifier. Referring to the illustrations succeeding, it will be seen that beyond a certain number of inputs the paralleling losses cannot be overcome by the amplifier with Ladder networks, whereas "T" networks, with lower insertion loss, allow a greater number. Thus, the designer's judgement enters the picture, considering at the same time the higher susceptibility to contact noise because of amplification *after* the mixing operation and other system noise. Thus, low-level mixing is distinctly a compromise, and finds favor usually in cases of portable, light weight mixer designs whose application is not critical in final output quality. The cost of "T" networks is higher than that of ladders.

LADDER VERSUS "T" CIRCUITS

The ladder circuit allows virtually an infinite cut-off to about -120 db; the "T" circuit extends down to the order of only -100 db. But the "T" circuit still has proponents who point out, for example, that in the last six positions of a 600 ohm ladder 30 step mixer there is a 30% drop in impedance at the output of the mixer to about 400 ohms. The argument holds that mixers are employed in multiple, and that the slight mismatch, as shown by the illustration, will preclude virtually any measurable discrimination due to mismatch.

Here, then, is a listing of the points in favor of the ladder circuit for mixers:



1. As attenuation takes place, contact noise decreases in proportion. This is the converse of "T" circuits, where the contact noise remains the same in any position.
2. Mismatch effects, however theoretical, decrease in direct proportion to the number of units that are paralleled into the next circuit, so that with 3 or 4 units or more operating in a bank of ladder mixers, impedance mismatch practically vanishes.
3. In the smaller units, size, too, must be taken into account, for the added parts of the "T" circuit require more space.
4. The last consideration, if not the most important one, is cost, for double the circuitry and moving parts are necessary for "T" configurations.

"T" AND BALANCED "H" ATTENUATORS

After a group of mixers have been paralleled it is standard practice to add further amplification in the form of a booster amplifier to offset the paralleling or matching losses occasioned by the restoring of the 600 ohm circuit impedance. After the booster amplifier, a submaster or master control is employed to feed this group on to other circuits containing equalizers, limiters, or perhaps the bridging bus. Because the latter parts of the circuit sometimes are located in racks distant from the mixer section, balanced lines may be desirable to provide insurance against hum from ground loops as well as for other circuit reasons. In these cases the submasters and masters may be balanced as well. Because we are dealing with one circuit after all combining has taken place and now have higher levels, possible contact noise from "T" and "H" attenuators presents less hazard. In addition, these controls are usually preset, and accordingly may be provided with detents to facilitate changes in precise increments as well as return to marked positions. Moreover, after preamplification and subsequent matching and equalizing, it is desirable to introduce as few other losses into the circuit as possible, and the zero loss feature of the "T" and "H" circuits becomes helpful.

"T", "H", and "L" circuits also find use in measuring equipment, and Langevin lists these further on without taper, as well as with tapered cut-offs, with and without detents. All mixers are also available with cue circuits.

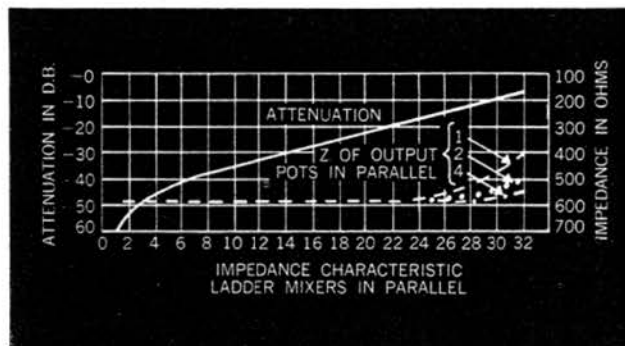

MIXER CIRCUITS

There are a number of different circuits which may be used to combine mixer outputs to form a composite program channel. Several types are illustrated with the advantage and disadvantages listed for each. While it is not the policy of Langevin to dictate design, it is felt that the making of recommendations is a duty of the equipment manufacturer.

HIGH LEVEL PARALLEL LADDER MIXER

The most highly recommended circuit for combining mixer outputs is shown below. This circuit is used to combine equal impedances to form a single program channel with a master gain control of the same impedance. Any number of circuits may be combined in this way by selecting the proper fixed network as shown on another page in this catalog. In the illustration 4 circuits are shown which would result in a loss of 24 db if a ladder master control is used.

Note that the attenuator cases are shown grounded. But signal grounds (common) are taken on individual wires to a single point ground.

The phase relationships of all inputs are the same, and this configuration may be duplicated for additional stereophonic channels as required.

PARALLEL LADDER MIXER WITH MINIMUM LOSS NETWORK

This is a special application of the mixer circuit shown above. It is used where more mixer circuits may have been added or losses otherwise have been incurred, and more gain would be advantageous to offset these losses. It is only applicable where an unloaded input is available in the booster stage. It should be noted that the series output resistor has been eliminated. The master gain control must be used after the booster amplifier.

All phase relationships are maintained and the circuit may be duplicated for additional stereo channels.

The advantage of this circuit is displayed when a large number of mixer attenuators must be combined. In all cases this will produce a loss of 6 db less than the conventional mixer network first treated on.

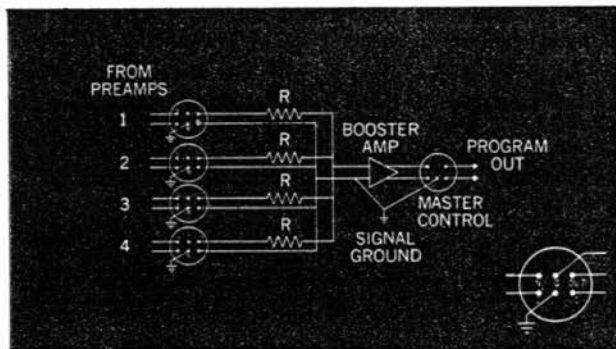
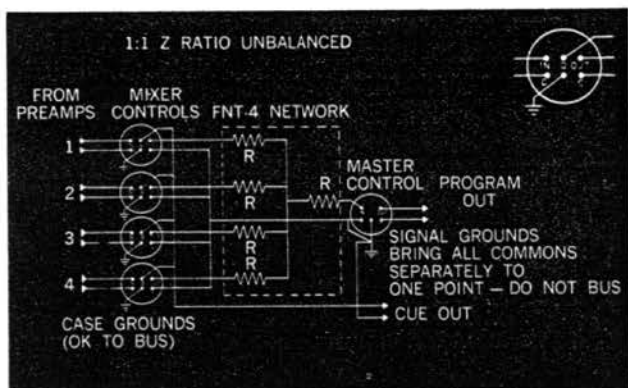

HIGH LEVEL SERIES MIXER CIRCUIT

Mixers in series with a balanced master gain control have been used in some applications, such as in lower cost, lighter weight portable units. Where quality is not paramount, low level mixing may be employed, saving on the number of preamplifiers. 3 db less loss is typical of this configuration. The disadvantage of this circuit is the presence of unequal impedances, the phasing is not maintained in all circuits, and the master must be a balanced control. This circuit is *not* recommended for stereo applications because of multiple microphone phasing problems, but can be used, probably with complete satisfaction, for monophonic radio remotes.

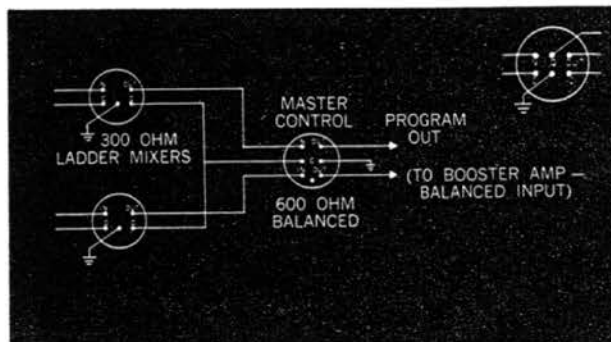

| TOTAL CHANNELS COMBINED | LOSS IN DB DUE TO PARALLELING | | TOTAL LOSS IN DB IF MASTER IS USED | |
|-------------------------|-------------------------------|--------|------------------------------------|--------|
| | "T" | LADDER | "T" OR "H" | LADDER |
| 2 | 6 | 12 | NO ADDED LOSS | 18 |
| 3 | 9.5 | 15.5 | | 21.5 |
| 4 | 12 | 18 | | 24 |
| 5 | 14 | 20 | | 26 |
| 6 | 15.6 | 21.6 | | 27.6 |
| 7 | 16.9 | 22.9 | | 28.9 |
| 8 | 18.1 | 24.1 | | 30.1 |
| 9 | 19.1 | 25.1 | | 31.1 |
| 10 | 20 | 26 | | 32 |
| 11 | 20.8 | 26.8 | | 32.8 |
| 12 | 21.6 | 27.6 | | 33.6 |
| 13 | 22.3 | 28.3 | | 34.3 |
| 14 | 22.9 | 28.9 | | 34.9 |
| 15 | 23.5 | 29.5 | | 35.5 |
| 16 | 24.1 | 30.1 | | 36.1 |

MIXER FORM

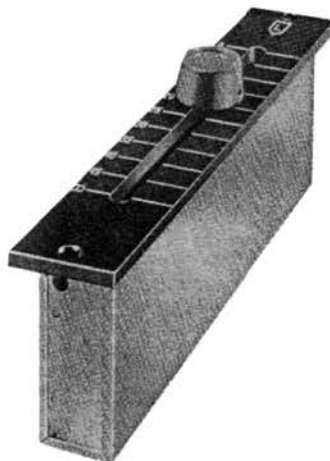
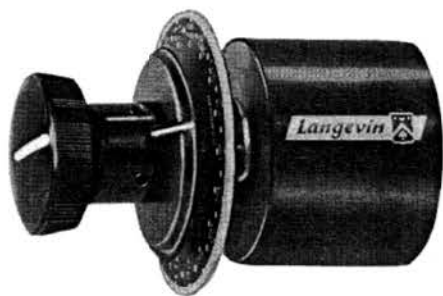

MIXER FORM

SHOULD YOU CHOOSE STRAIGHT LINE OR ROTARY MIXERS?

The advent of stereo recording has vastly increased the complexity of control consoles. Precise regulation of individual sections of the orchestra and soloists in monaural recording has called for the use of a multiplicity of mixer controls. The use of a complex of mixers has been virtually trebled by the demands of 3 channel stereo.

An expansion of the console in the horizontal plane has been called for. But a recording engineer has arms only so long, so that when we consider practicalities, the following calculations should enter into the choice of mixer control form:

Rotary mixers have a diameter usually of 2 to 3 inches; dial and knob or panel engravings are on approximately 6" centers. It can be seen that horizontal console dimensions can become inordinately large. On the other hand, Langevin Straight Line Mixers present an ideal solution to the problem in a number of ways.

These narrow vertical mixers require only 1½ inches between mounting centers (1¼" on order with narrower escutcheon), permitting a full complement of control for 3 channels, all within easy reach. Moreover, at least two mixer controls can be operated with one hand; many recordists operate three, and for some effects, as many as four. To facilitate this multiple use, sometimes practice dictates the patching in of the reverberation control adjacent to the mixer regulating the main signal in a particular bank.

There are other advantages to the Langevin Straight Line units. Full recognition of the mixer level setting is apparent from the vertical position of the knob, giving better indication of position than a round knob affords. Operation is smoother than with rotary mixers, as only two grams of static friction need be overcome to change position of the control. While it is true that rotary mixer knobs allow "rolling" with the side of the palm for effects, the vertical mixer exceeds in flexibility because the knob can actually be "snapped", as well as faded rapidly. This can be done with only one finger if necessary.

CHOICE OF MIXER TYPE

It is true that convention and habit enter into the choice of mixer form, so Langevin makes all types. Remember that smoothest mixing is delivered by straight line slide wire mixers because of the small .1 db increments. But the use of straight line mixers calls for the development of new skills by the recording engineer; as long as fifteen years ago the motion picture studios employed vertical mixers on 20 channel re-recording consoles for best quality and as the sole solution to human requirements. Stereo has intensified operations to the end that Langevin Straight Line Mixers present a practical manner of achieving high quality and complete stereo control within physiological limits.

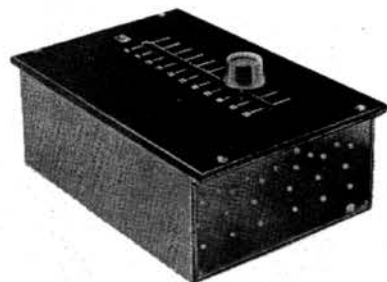
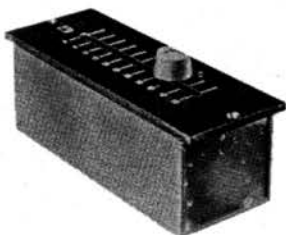

MX-111-2
2-GANG MIXER

MX-111-3
3-GANG MIXER

MX-111-4
4-GANG MIXER

MX-111-6
6-GANG MIXER

MODEL MX-111 STRAIGHT LINE MIXER CONTROL

*"Between the Artist
and the finest recording"*

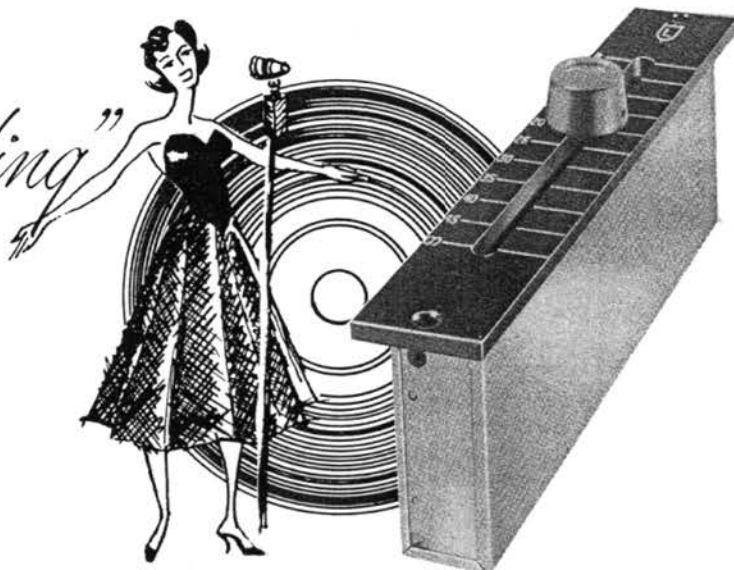

The MX-111 Straight Line Mixer Control is a highly developed slide-wire unit using resistances in a ladder configuration to afford unusual facility in operation on control consoles. It is used to blend signals of various origin for music scoring, re-recording, high quality public address, radio and TV broadcasting. It requires only 1½" of horizontal panel space (1¼" with alternate escutcheon) and is 6½" long. It is the most compact unit of this type available, and extends only 2¼" below the top of the mounting surface. Several units can be operated with one hand when mounted adjacent.

FEATURES

1. SMOOTH, SILKY OPERATION FOR EASY CONTROL

Most important to the operator is the overcoming of friction in the mixer control. In the MX-111 precision-built mixer, a nylon bearing rides along a longitudinally honed, hardened chrome-plated shaft. Smooth operation is the result of the exceedingly low coefficient of friction; only 2 grams of pressure is required to overcome the inertia and bearing friction of the control assembly.

2. LOW CONTACT NOISE FOR CLEAN, CLEAR SIGNAL

A single contact brush fabricated of the same material as the resistance wire prevents generation of thermal voltages, contact oxidation and consequent noise. This brush is connected to the input circuit by a beryllium copper spring strip, eliminating the need for additional noise inducing brushes.

3. EXCLUSIVE DIRT AND LINT BARRICADE FOR TROUBLE-FREE PERFORMANCE

An accessible lint and dirt trap over the windings eliminates the cleaning nuisance formerly associated

with this form of control. In addition, the contact portion of the winding itself is upside down, so that the tendency of foreign matter is to fall *off* rather than *on*.

4. PLUG-IN DESIGN FOR EASY MAINTENANCE

Connections are made by an integral plug to the connecting cable socket. This permits rapid disassembly for inspection and cleaning.

IMPORTANT NOTICE

ALL SLIDE WIRE MIXERS REQUIRE PERIODIC CLEANING.

5. FRICTION ADJUSTING SCREW FOR ANGLE OR VERTICAL MOUNTING

For those recording engineers who desire less freedom of movement in the control, or for the designers who wish to incorporate a steep or vertical slope to the control panel, a friction adjusting screw on the guide shaft is accessible through the front slot on the control in which the knob assembly rides.

6. AVAILABLE IN 2, 3, 4, AND 6 GANGS FOR STEREO

For stereophonic controls the MX-111 is available in 2, 3, 4 and 6 gang assemblies operating from a single knob. This vastly simplifies console controls.

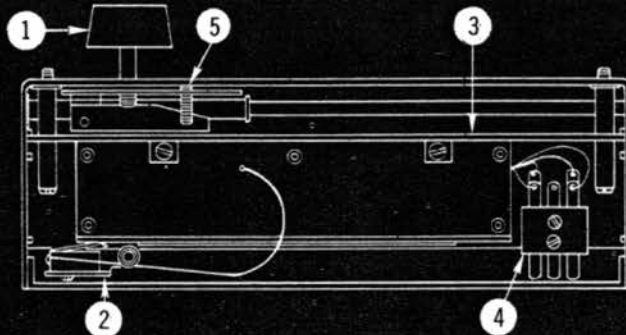

SPECIFICATIONS

SPECIFICATIONS

| | |
|------------------------------------|--|
| Circuit | Ladder. |
| Frequency Response | Flat, within $\pm .5$ db at all settings from 0 to 20 kc. |
| Accuracy of Resistors | $\pm 2\%$. |
| Input Level | Maximum: 1 watt or 25 volts rms. |
| Slider Pressure | 20 grams. |
| Static Friction | Within 2 grams of sliding friction. |
| Insertion Loss | 6 db. |
| Total Excursion | $4\frac{1}{8}$ ". |
| Impedance | Standard 600/600 ohms. Special impedance of 150/150 ohms may be obtained on order. |
| Knob | Supplied with red knob as standard. |
| Dimensions | $6\frac{1}{4}$ " long by $15/16$ " wide by $2\frac{1}{4}$ " high. Height with knob: $3\frac{1}{4}$ ". |
| Escutcheon Plate Dimensions | $1\frac{1}{2}$ " or $1\frac{1}{4}$ " wide by 7" long by $3/16$ " thick. Escutcheon must be ordered separately. |
| Panel Finish | Engraved black anodized dural. |
| Multiple Mounting | $1\frac{1}{2}$ " or $1\frac{1}{4}$ " centers between adjacent units according to escutcheon used. |

ORDERING INFORMATION

MODEL MX-111 STRAIGHT LINE MIXER CONTROL with red knob, cable socket and plug, complete less escutcheon. Weight, net, $\frac{1}{2}$ lb., 1 lb. shpg.

Price, Net Each \$40.00

MODEL MX-111-EW STANDARD ESCUTCHEON FOR ABOVE, $1\frac{1}{2}$ " wide by 7" long by $3/16$ ", black satin finished anodized dural with engraved designations **Price, Net Each \$4.00**

MODEL MX-111-ES ESCUTCHEON: Same as Model MX-111-EW Escutcheon but $1\frac{1}{4}$ " wide . **Price, Net Each \$4.00**

COLORED KNOBS AVAILABLE

Red knob is standard. White, Blue, Yellow, Green and Black are available at no increase in price. Please specify these alternate colors when ordering from the factory.

MODEL MX-111-2, 2 GANG STRAIGHT LINE MIXER CONTROL. Same as MX-111, but ganged. Size, $1\frac{1}{8}$ " wide by $6\frac{1}{4}$ " long by $2\frac{1}{4}$ " deep below mounting panel. Weight, net, 1 lb., $1\frac{1}{2}$ lbs. shpg.

Price, Net Each \$87.50

MODEL MX-111-E2 ESCUTCHEON FOR MODEL MX-111-2. Size, $1\frac{1}{4}$ " wide by 7" long by $3/16$ " thick **Price, Net Each \$5.00**

MODEL MX-111-3, 3 GANG STRAIGHT LINE MIXER CONTROL. Same as MX-111, but ganged. Size, $2\frac{1}{2}$ " wide by $6\frac{1}{4}$ " long by $2\frac{1}{4}$ " deep below mounting panel. Weight, net, 1 lb. 3 oz., $1\frac{1}{2}$ lbs. shpg.

Price, Net Each \$130.00

MODEL MX-111-E3 ESCUTCHEON FOR ABOVE. Size, $2\frac{3}{8}$ " wide by 7" long by $3/16$ " thick . . . **Price, Net Each \$5.50**

MODEL MX-111-4, 4 GANG STRAIGHT LINE MIXER CONTROL. Same as MX-111, but ganged. Size, $3\frac{3}{16}$ " wide by $6\frac{1}{4}$ " long by $2\frac{1}{4}$ " deep below mounting panel. Weight, net, $1\frac{1}{2}$ lbs., 2 lbs. shpg.

Price, Net Each \$175.00

MODEL MX-111-E4 ESCUTCHEON FOR ABOVE. Size, $3\frac{1}{4}$ " wide by 7" long by $3/16$ " thick. **Price, Net Each \$6.00**

MODEL MX-111-6, 6 GANG STRAIGHT LINE MIXER CONTROL. MX-111 but ganged. Size, $4\frac{3}{8}$ " wide by $6\frac{1}{4}$ " long by $2\frac{1}{4}$ " deep below mounting panel. Weight, net, $1\frac{1}{4}$ lbs., 2 lbs. shpg.

Price, Net Each \$265.00

MODEL MX-111-E6 ESCUTCHEON FOR ABOVE. Size, $4\frac{1}{4}$ " wide by 7" long by $3/16$ " thick . . . **Price, Net \$6.50**

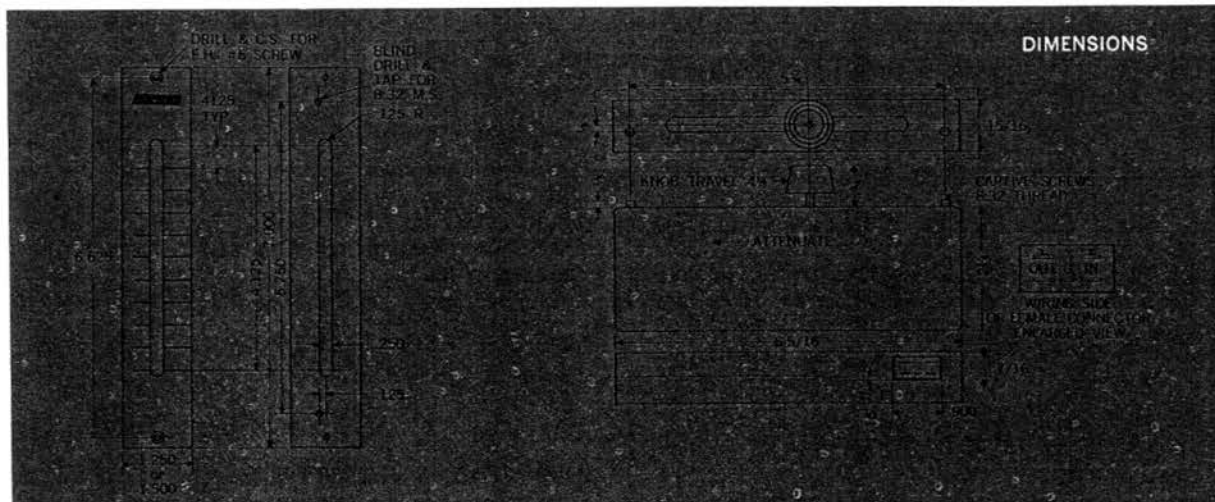

STEREO PAN POTS

FOR POSITIONING THE SOURCE BY INTENSITY CONTROL

GENERAL INFORMATION

As early as 1934 it was well-established that a level change of 3 db was sufficient to displace the apparent source of an instrument or vocalist completely across the recorded field. Langevin engineers developed the first controls for this application, known as "Pan Pots".

While it is known also that arrival time of the sound influences the position of the apparent source, it has been proven that intensity can offset the effects of arrival time satisfactorily. In motion picture work at least two screen processes, Vistavision and Perspectasound, clearly demonstrate the complete success of Pan Pots in achieving control over position.

The configurations of these mixer control assemblies are different from those usually encountered in regular transmission work. In two-channel systems two oppositely wound controls are ganged so that the 3 db down point of each control occurs at zero degrees. For 3 channel systems three controls are ganged, and the windings of each so constituted that the 3 db down points occur 45 degrees each side of zero degrees or center. At either 90 degree position the extreme opposite channel is at infinite attenuation. While it is possible to make arrays which traverse an angular field up to 360 degrees, only 180 degree fields are listed here. Special Pan Pots for unusual applications are available on order from Langevin.

Pan Pots are available in both the rotary type and straight line type, in either ladder or bridge "T" circuits.

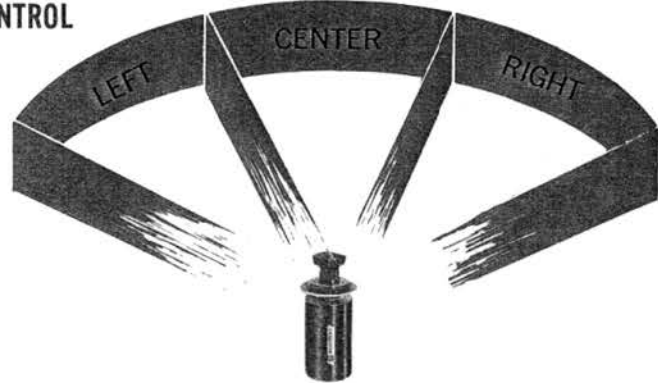

APPLICATIONS RECORDING FOR PROPER GEOMETRY

Pan Pots can be employed to change the position of one section of the recording field to another. Either the 2 gang or 3 gang Pan Pots can also be used to pick up a monaural source, and place this monaural source in any geometrical position in the final stereo recording.

DESCRIPTION

Pan Pots do not adapt themselves to slide wire arrays for reasons of space. Moreover, the unusual taper of each winding demands only 16 positions in each for smoothest transition throughout the audible range of control; it will be discerned by study of the figures that attenuation at the extremes is unusually rapid, and that it is very slow in the regions of overlap from one section to another. The rate of attenuation is precise, and conforms to the exact calculations governing angular displacement in the sound field with change in level.



2 CHANNEL LADDER

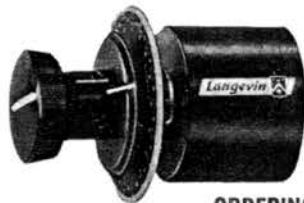

ORDERING INFORMATION



3 CHANNEL LADDER



MODEL RPP-2 ROTARY PAN POT, for mixing 1 channel into 2. 600 ohms impedance in and out. Ladder type, insertion loss 12 db. 270° rotation with -3 db point at 0°, 90° at extreme right and left. 16 steps used per section with special geometrically accurate taper.

Size is 1½" diameter by 2⅞" long.

Standard ¼" shaft extends 15/16" from rear of mounting surface.

Weight, net 6½ oz., 1 lb. shpg. **Price, Net Each \$24.00**

MODEL D-111 DIAL FOR ABOVE, engraved black satin anodized aluminum, with standard color code for geometry, recordist left blue, right red. Size, 2¼" diameter by 3/32" thick. **Price, Net Each \$2.00**

MODEL K-111 KNOB, WE Type, with skirt, glossy black bakelite normally supplied, but available also in R, Red, W, White, BL, Blue, G, Green, and Y, Yellow. Please specify.

Size, 2⅞" diameter by 1½" high. **Price, Net Each \$2.50**

MODEL RPP-2T ROTARY PAN POT, 1 channel into 2 channel, bridge "T", all other details same as Model RPP-2 above but 2¼" diameter and 6 db insertion loss.

Weight, net 13 oz, 1½ lbs. shpg. **Price, Net Each \$40.00**

MODEL SLPP-2 STRAIGHT LINE PAN POT, 1 channel into 2, same as Model RPP-2 above but straight line form, for horizontal panel placement. Supplied with red knob. Size is 15/16" wide by 6¼" long by 2¼" deep behind mounting plane. Extends 3¼" to top of knob.

Weight, net 6½ oz., 1 lb shpg. **Price, Net Each \$60.00**

MODEL SLPP-2T STRAIGHT LINE PAN POT, 1 channel into 2 channel, bridge "T", 6db insertion loss, 1¼" wide, all other details same as Model SLPP-2 above.

Weight, net 6½ oz., 1 lb. shpg. **Price, Net Each \$90.00**

MODEL SLPP-2E ESCUTCHEON FOR ABOVE, 3/16" dural black satin anodized engraved. Recordist left track

ROTARY AND STRAIGHT LINE TYPES

is colored blue and right track red. -3 db point is at 0° center with infinite attenuation at 90° each side.

Size is 1½" wide by 7" long by 3/16" thick. Price, Net Each \$4.00

MODEL RPP-3 ROTARY PAN POT, for mixing 1 channel into 3. Same as Model RPP-2 but with 3 elements and insertion loss of 12 db; left range tapers from zero attenuation to infinite in center at 0°. Right side of control is opposite on same contact row diameter. Center ganged control is zero attenuation at 0° with infinite attenuation at extreme right and extreme left rotation. Uses Model K-111 knob, not supplied, as well as Model D-112 dial listed below which must be ordered separately. Size is 3" diameter and 2⅞" deep. Weight, net 13 oz., 1½ lbs. shpg. Price, Net Each \$42.00

MODEL D-112 DIAL FOR ABOVE, same as D-111 but recordist left channel, blue, is infinite attenuation at 0° center, right channel, red, is opposite and center channel, white, is zero attenuation center and infinite attenuation at extreme right and extreme left.

Size is 2¼" diameter by 3/32" thick. Price, Net Each \$2.00

MODEL RPP-3T ROTARY PAN POT, same as Model RPP-3 but bridge "T" and 9.5db insertion loss. Weight, net 13 oz., 1½ lbs. shpg. Price, Net Each \$75.00

MODEL SLPP-3 STRAIGHT LINE PAN POT, 1 channel into 3, same as Model SLPP-2 but with pots ganged and 12 db insertion loss; includes red knob. Weight, net 13 oz., 1½ lbs. shpg. Price, Net Each \$97.50

MODEL SLPP-3T STRAIGHT LINE PAN POT, 1 channel into 3, bridge "T", all other details same as Model SLPP-3 above except 2" wide and 9.5db insertion loss. Weight, net 13 oz., 1½ lbs. shpg. Price, Net Each \$146.25

MODEL SLPP-3E ESCUTCHEON FOR ABOVE, same as Model SLPP-2E above but recordist left channel, blue, is infinite attenuation at 0° center, right channel, red, is opposite and center channel, white, is zero attenuation center and infinite attenuation at extreme right and extreme left. Size is 1¼" wide by 7" long by 3/16" thick. Price, Net Each \$5.00

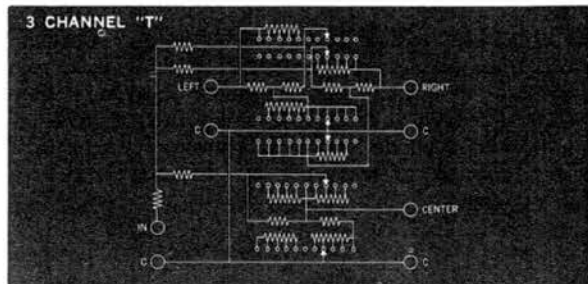
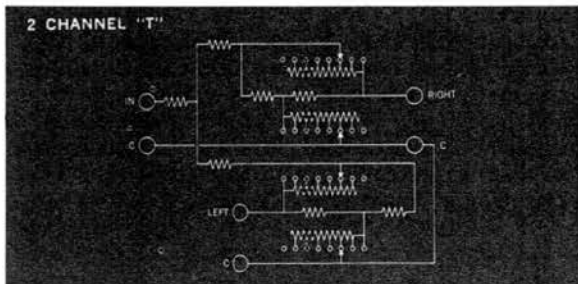
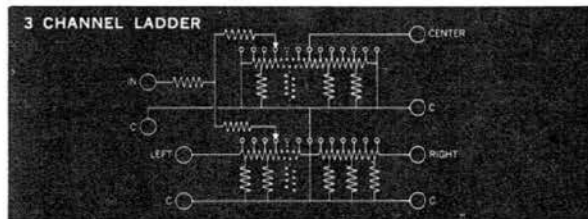
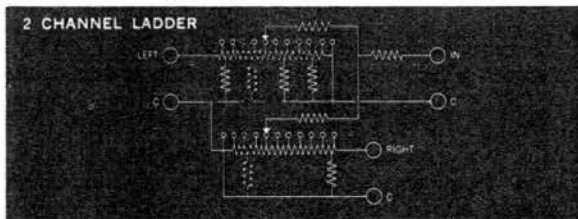
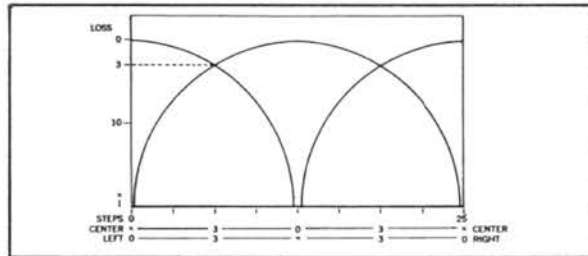
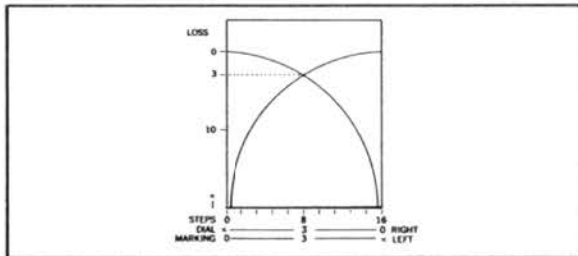
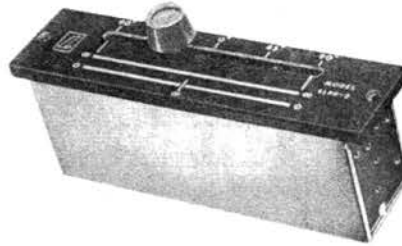
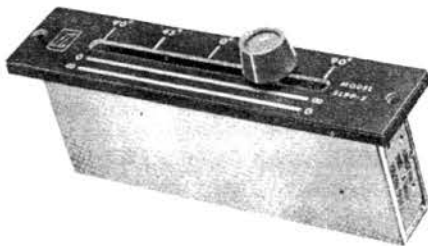

GENERAL INFORMATION — CIRCUIT TYPES

UNBALANCED OR
ASSYMMETRICAL
NETWORKS

BALANCED OR
SYMMETRICAL
NETWORKS

LADDER

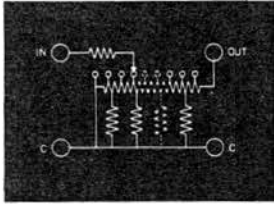

USED FOR MIXER,
SUBMASTER AND MASTER

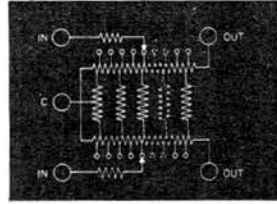

USED FOR MIXER,
SUBMASTER AND MASTER



LADDER

The ladder attenuator is not only the simplest but the most popular circuit form used in attenuators for transmission networks. It derives greatest usage as a mixer and consists of a series of pi sections which combine, through a control lever, to give the proper terminal impedances with changes in signal level. The insertion loss of these units in various parallel mixer combinations is shown in the table on page 48. As balanced networks, shown in the diagram, the circuit configuration exhibits double the number of components, and allows more freedom in grounding.

"T"

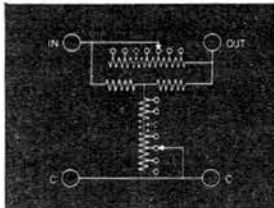

USED FOR MIXER (INFREQUENTLY),
SUBMASTER, MASTER, VU RANGE
EXTENDER AND IN MEASURING
EQUIPMENT

"H"

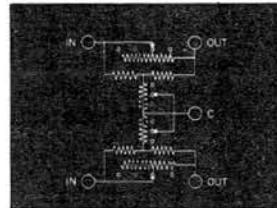

USED AS SUBMASTER,
MASTER AND IN MEASURING
EQUIPMENT

POTENTIOMETERS

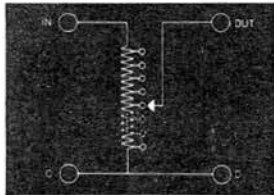

USED FOR HIGH IMPEDANCE
LEVEL CONTROL TO 1 GRID

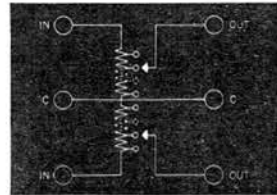

USED FOR HIGH IMPEDANCE
LEVEL CONTROL TO 2 GRIDS

"L"

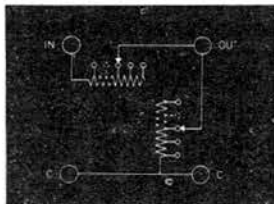

USED PRINCIPALLY
IN MEASURING EQUIPMENT

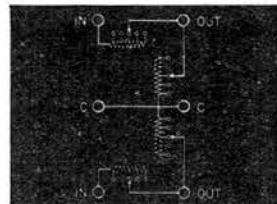

USED PRINCIPALLY
IN MEASURING EQUIPMENT

"L"

The "L" circuit adapts itself to low impedance operation because the impedance looking in remains constant. Its principal use is found in measuring equipment although it finds application also at voice coil impedances in multiway loudspeaker systems as a level control for respective mid-bass, treble and vhf driver units.

"T"

"T" attenuators have features differing from ladder types. For instance, the insertion loss of a "T" network is zero, and in the case of certain mixer configurations for portable equipment afford the advantage of less loss in parallel use. The table on page 48 shows just what this saving amounts to in comparison with ladder units, and the illustrations of typical mixer circuits shown later disclose that some series parallel arrangements allow still lower losses. Proper design of portable equipment coupled with "T" units may save the weight of several low-level amplifiers.

BALANCED "H"

Balanced "H" networks are simply two opposed "T" configurations to achieve grounding facility in balanced lines. They find use in measuring equipment, and are popular as submaster and master volume controls where higher levels are found and insertion losses are to be minimized. As mixers, read the later paragraph dealing with choice of mixer circuits.

POTENTIOMETERS

Potentiometers are voltage dividers. They find application as level controls in grid circuits at impedances of 25,000 ohms, 50,000 ohms and higher. Looking back into the line the resistance remains fairly constant, but into the succeeding circuit the resistance varies from zero to maximum. These units cannot be used satisfactorily as a mixer control in low impedance circuits because they change violently in impedance looking into the next circuit, thus affecting frequency response. In their usual application they are shielded by placement within the amplifier chassis, and the leads are kept as short as possible to reduce hum pickup as well as high frequency attenuation due to shunt capacitance. Where the first stage in an amplifier is push-pull a balanced potentiometer should be employed in the grid circuits.

ROTARY MIXERS AND ATTENUATORS

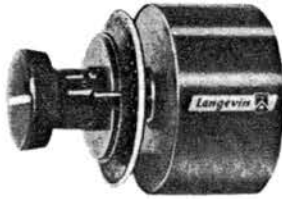

SINGLE

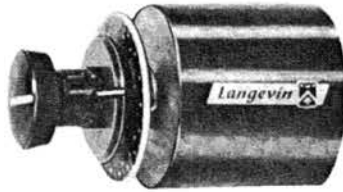

2-GANG

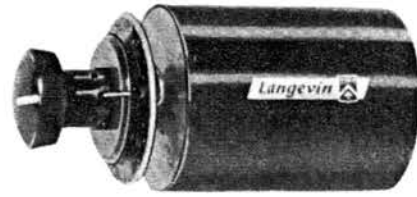

3-GANG

SMOOTH ACTION FOR EFFORT-FREE CONTROL

Only four grams of static friction need be overcome to accomplish rotation of Langevin Mixers. This applies also to Attenuators without detents. Effortless control is the result of long research into the mechanical requirements of friction-free bearings and brushes along with the employment of modern printed circuit techniques for the contact rows.

SUPER ACCURACY THROUGH PRINTED CIRCUITS

Correct contact positioning is guaranteed through printed circuitry derived from master layouts made on dividing heads. This insures satin-smooth, low-drag, bump-free action as the control is rotated.

LONG, TROUBLE-FREE LIFE IN EXCESS OF 100,000 CYCLES

Langevin controls have a life expectancy in excess of 100,000 cycles. Low, uniform contact pressures decrease wear and give decades of service.

SEALED AGAINST DIRT AND CORROSION

Langevin Mixers and Rotary Attenuators are pre-lubricated and sealed against moisture, corrosion and dirt for life-time use. Cycling and accelerated aging tests prove quiet operation for the life of the control.

GOLD PLATED CONTACTS FOR LOW NOISE OPERATION

All contacts in Langevin Controls are gold-plated. Gold is a noble metal and does not form noise producing oxides. Alloys such as nickel, nickel silver and brass

do form oxides, which are insulators and produce noise as time passes. Contrary to popular belief, the gold does not wear off of the contact, but, rather, galls and works its way into the pores of the base metal through usage. This increases conductivity and smoothness with age.

BRUSH CONTACT IS GOLD PLATED

Brush contacts are also formed of gold. Thus, no electrolysis takes place between the contacts and brushes, further insuring quiet operation.

QUIET OPERATION IN LOW-LEVEL SERVICE

The combination of accurate printed circuitry for uniform contact, non-oxidizing gold and low brush pressures give noise free operation at -130 dbm. This means satisfactory operation *before* preamplification for low-level service.

CUE CIRCUITS

Cue circuits are available on all mixers by simply adding a "Q" suffix to the type number when ordering. Add \$3.00 for Rotary Mixers and \$5.00 to Straight Line Mixers for this feature.

Net and Shipping Weight—Rotary Mixers and Attenuators

| Diameter | Single | | Double | | Triple | |
|----------|--------|--------|--------|-------------|--------|-------------|
| | Net | Shpg. | Net | Shpg. | Net | Shpg. |
| 1½" | 3 oz. | 11 oz. | 5 oz. | 13 oz. | 7 oz. | 15 oz. |
| 2¼" | 5 oz. | 13 oz. | 8 oz. | 1 lb. | 10 oz. | 1 lb. 2 oz. |
| 3" | 7 oz. | 15 oz. | 10 oz. | 1 lb. 2 oz. | 12 oz. | 1 lb. 4 oz. |

GENERAL DESCRIPTION

Langevin Rotary Mixers and Attenuators are available in three diameters, as well as in single, double and triple gangs for two and three channel stereo use. Printed circuitry is employed throughout for precision and uniformity. Contact decks are formed of non-hygrosopic phenolic, type FBE. Stainless steel shafts and brass bearings are used for long life, non-seizing properties, and to give friction-free action. Frames are formed of satin-black anodized aluminum. A universal mounting bracket allows replacement of all attenuators and mixers of alternate make because of three different mounting centers provided. These are 1¾", 1¼" and 1½". All connections are conveniently made to solder terminals at the rear of the control, facilitating wiring and making a neater ap-

pearance. An extra "C" center or common terminal is provided on each control to eliminate two wires to the usual "common".* This also gives balanced circuitry on the interior of the control, allows maximum cut-off, and eliminates crosstalk. In addition, this makes for easy test and wiring changes. Case grounds on all Langevin controls appear on another terminal, completely separated from signal ground, or "C" common. Controls are sealed against dirt, moisture and corrosion. All units are available with and without detents, with and without Cue Circuit.

*See other sections of Langevin literature dealing with recommended cabling practice where special attention is called to balanced grounds in mixer circuits.

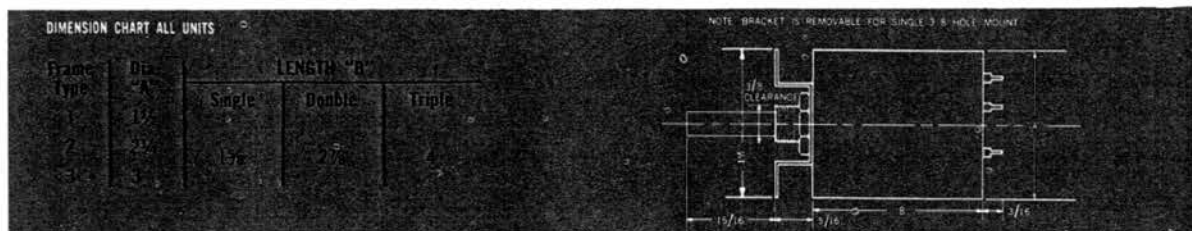

HOW TO ORDER — MIXERS AND ATTENUATORS

ROTARY MIXERS — PLEASE READ BEFORE ORDERING

The "MX" suffix on the units listed below denotes "mixer" function and these attenuators are not supplied with detents unless specified (no added charge for detents). Units are tapered to infinity, come supplied complete with model K-1032 knob, Model D-1002 dial plate etched to suit and universal mounting bracket. Standard impedance unless otherwise specified is 600 ohms in and out. Other standard impedances of 150,

200, 250, 500 and 600 ohms in or out supplied in any combination if specified at no additional charge; add 15% for impedances in or out not standard to prices shown. Specify if cue position is desired; charge is \$3.00 single, \$6.00 dual and \$9.00 triple gang. If no K-1032 knob or D-1002 dial is desired, please specify; deduct allowance of \$0.75 for knob and \$0.75 for dial.

| Model | Circuit | Steps | DB/Step | Curve | Insertion Loss in DB | Model D-1002-() Dial, Dia. | Model K-1032 Knob, Dia. | Diameter "A" | Length "B" | SINGLE | | 2 GANG | | 3 GANG | | | | |
|--------|-----------------------------|-------|---------|-------|----------------------|-----------------------------|-------------------------|-----------------|------------|-----------------|----------|------------|-------|------------|-------|-------|----------|-------|
| | | | | | | | | | | Price, Net | Model | Price, Net | Model | Price, Net | Model | | | |
| MX-201 | Ladder | 20 | 2 | A | 6 | 2 3/4" | 2-1/16" | 1 1/2" | 1 3/4" | 12.00 | MX-201-2 | 2 3/4" | 22.50 | MX-201-3 | 4 | 31.50 | | |
| MX-202 | Balanced Ladder | 20 | 2 | A | 6 | | | 2 1/4" | | 24.50 | MX-202-2 | | 45.00 | MX-202-3 | | 66.00 | | |
| MX-203 | Ladder | 32 | 1 1/2 | B | 6 | | | 1 1/2" | | 19.50 | MX-203-2 | | 36.00 | MX-203-3 | | 52.50 | | |
| MX-204 | Balanced Ladder | 32 | 1 1/2 | B | 6 | | | 2 1/4" | | 28.00 | MX-204-2 | | 51.00 | MX-204-3 | | 74.00 | | |
| MX-601 | "T" | 20 | 2 | A | 0 | | | 2 1/4" | | 24.50 | MX-601-2 | | 45.00 | MX-601-3 | | 66.00 | | |
| MX-604 | Balanced "H" | 20 | 2 | A | 0 | | | 2 1/4" | | 57.00 | | | | | | | | |
| MX-602 | "T" | 32 | 1 1/2 | B | 0 | | | 2 1/4" | | 28.00 | MX-602-2 | | 51.00 | MX-602-3 | | 74.00 | | |
| MX-605 | Balanced "H" | 32 | 1 1/2 | B | 0 | | | 2 1/4" | | 60.00 | | | | | | | | |
| MX-612 | Potentiometer 25K | 20 | 2 | A | | | | *SEE NOTE BELOW | | *SEE NOTE BELOW | 1 1/2" | | 11.00 | MX-612-2 | | 22.50 | MX-612-3 | 31.50 |
| MX-613 | Potentiometer 50K | 20 | 2 | A | | | | | | | 1 1/2" | | 11.00 | MX-613-2 | | 22.50 | MX-613-3 | 31.50 |
| MX-614 | Potentiometer 100K | 20 | 2 | A | | | | | | | 1 1/2" | | 11.00 | MX-614-2 | | 22.50 | MX-614-3 | 31.50 |
| MX-615 | Balanced Potentiometer 25K | 20 | 2 | B | | | | | | | 2 1/4" | | 24.50 | MX-615-2 | | 45.00 | MX-615-3 | 66.00 |
| MX-616 | Balanced Potentiometer 50K | 20 | 2 | B | | | | | | | 2 1/4" | | 24.50 | MX-616-2 | | 45.00 | MX-616-3 | 66.00 |
| MX-617 | Balanced Potentiometer 100K | 20 | 2 | B | NOT APPL. CABLE | | | | | | 2 1/4" | | 24.50 | MX-617-2 | | 45.00 | MX-617-3 | 66.00 |
| MX-618 | Potentiometer 25K | 32 | 1 1/2 | A | | | | 2 3/4" | | 2-1/16" | 1 1/2" | | 19.50 | MX-618-2 | | 36.00 | MX-618-3 | 52.50 |
| MX-619 | Potentiometer 50K | 32 | 1 1/2 | A | | | | | | | 1 1/2" | | 19.50 | MX-619-2 | | 36.00 | MX-619-3 | 52.50 |
| MX-620 | Potentiometer 100K | 32 | 1 1/2 | A | | | | | | | 1 1/2" | | 19.50 | MX-620-2 | | 36.00 | MX-620-3 | 52.50 |
| MX-621 | Balanced Potentiometer 25K | 32 | 1 1/2 | B | | | | | | | 2 1/4" | | 28.00 | MX-621-2 | | 51.00 | MX-621-3 | 74.00 |
| MX-622 | Balanced Potentiometer 50K | 32 | 1 1/2 | B | | | | | | | 2 1/4" | | 28.00 | MX-622-2 | | 51.00 | MX-622-3 | 74.00 |
| MX-623 | Balanced Potentiometer 100K | 32 | 1 1/2 | B | | | | | | | 2 1/4" | | 28.00 | MX-623-2 | | 51.00 | MX-623-3 | 74.00 |

*With K-111 WE Type Mixer Knob Add 1.50

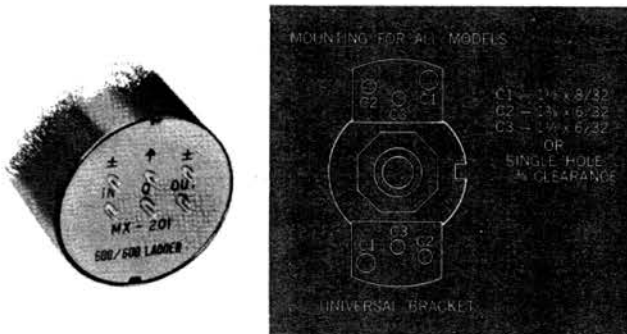
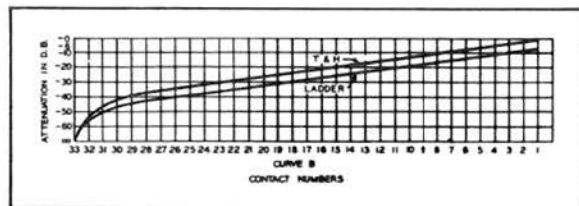
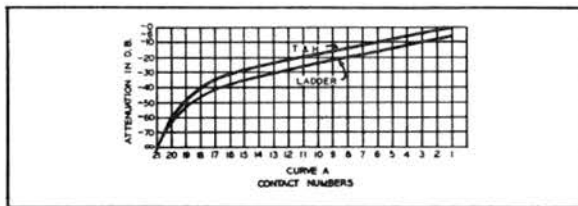
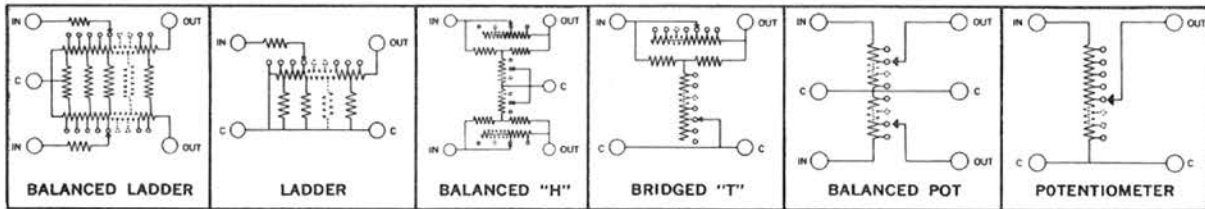

CUE CIRCUITS

Cue circuits are available on all mixers by simply adding a "Q" suffix to the type number when ordering. Add \$3.00 for Rotary Mixers and \$5.00 to Straight Line Mixers for this feature.

VU RANGE EXTENDERS

VU meters are adjusted to 3900 ohms. Rotary range extenders should be of the "T" configuration and 3900 ohms impedance. In order properly to read +4 VU a 3600 ohm series resistor is required. Langevin Bridge "T" attenuators for such applications provide two fixed resistors in series, one of 3300 ohms and the other of 300 ohms, the terminals of which appear on the back plate of the VU Range Extender Attenuator. This permits the use of the Langevin Model VR-111 Variable Wire-Wound Resistor for stereo balance or calibration by selecting the appropriate solder terminal.

All units are shipped complete with engraved dial and Langevin Model K-112 WE Instrument Knob.

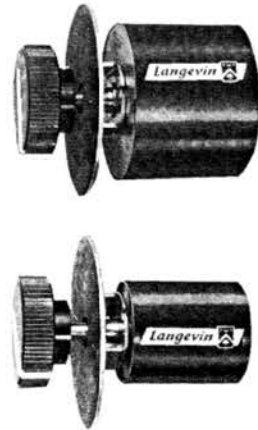
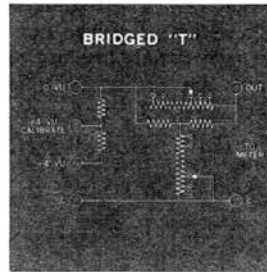

BRIDGED "T" VU RANGE EXTENDERS

| MODEL NO. | ELECTRICAL | | | MECHANICAL | | 1 GANG | | | 2 GANG | | 3 GANG | |
|-----------|------------|-------------|----------|------------|-----------------|-----------|-----------|-----------|-----------|-----------|--------|--|
| | NO. STEPS | DB PER STEP | RANGE | DIA. FRAME | CONTACT DEGREES | NET PRICE | MODEL NO. | NET PRICE | MODEL NO. | NET PRICE | | |
| ATX-300 | 10 | 1 | +4 - +14 | 1½" | 15 | 18.50 | ATX-300-2 | 34.00 | ATX-300-3 | 49.50 | | |
| ATX-301 | 10 | 2 | +4 - +24 | 1½" | 15 | 18.50 | ATX-301-2 | 34.00 | ATX-301-3 | 49.50 | | |
| ATX-305 | 15 | 2 | +4 - +34 | 2¼" | 15 | 21.00 | ATX-305-2 | 39.00 | ATX-305-3 | 57.00 | | |
| ATX-303 | 20 | 2 | +4 - +44 | 2¼" | 15 | 24.00 | ATX-303-2 | 45.00 | ATX-303-3 | 66.00 | | |

MOTION PICTURE PROJECTION AND TURNTABLE FADERS

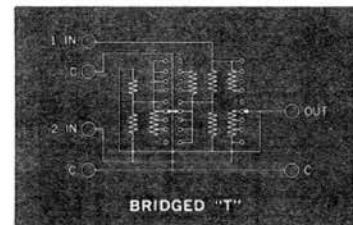
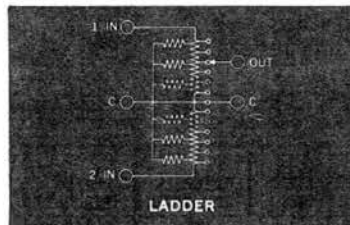
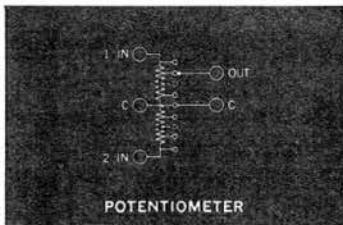

Purpose: Faders are employed in motion picture projection to blend the sound from one machine to another as changeover in picture occurs. They are used also in sound effects consoles and in radio broadcast turntables to blend from one recording to another in a continuous rotary motion.

Langevin Faders are available in matched ladder as well as grid control.

The calibrated dials are marked white operator left side and red right side of infinity center. These controls are normally supplied without detent but may be ordered with detent by so specifying. Impedances up to 600 ohms are supplied as well as values up to 500,000 ohms for potentiometers; please specify when ordering.

LANGEVIN SERIES 200 FADERS

SPECIFY IMPEDANCE UP TO 600 OHMS IN AND OUT, POTENTIOMETERS UP TO 500K OHMS, AND IF DETENT IS DESIRED.

| Model | Range | No. of Steps Each Side of ∞ | Degrees Between Steps | Curve | DB Per Step | Wattage | Dia. "A" | Length "B" | Model D-1002-() Dial, Dia. | Model K-112 Knob, Dia. | Circuit | Insertion Loss | Mounting | Price, Net |
|--------|-------|-----------------------------|-----------------------|-------|-------------|----------------------------|----------|------------|-----------------------------|------------------------|---------------|----------------|--------------------------|------------|
| AT-200 | 0-∞-0 | 16 | 10 | "A" | 2 | 1 Watt | 2¼" | 1½" | 2¾" | 1½" | Potentiometer | N/A | Universal See Page 56 | 21.50 |
| AT-201 | | | | | | Sine Wave, 5 Watts Program | | | | | Ladder | 6 DB | | 24.00 |

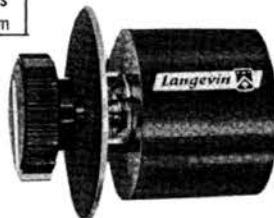

TRANSMISSION LINE ATTENUATORS AND GAIN CONTROLS

GENERAL

Transmission line attenuators and gain controls have the same general characteristics of mixer controls except that they differ in two details because of their employment. First, detents are ordinarily used to facilitate return to exact settings; "T" and some balanced "H" units are used frequently as masters and submasters because of the zero insertion loss feature. Secondly, they are used without taper and "off" position.

EMPLOYMENT

These units are usually employed as master and submaster gain controls in consoles; they may be used to increase the over-all relative level to achieve compression action from compressor and limiter amplifiers in rerecording, or in other cases where the dynamic range of program material is to be compressed to avoid subsequent overload.

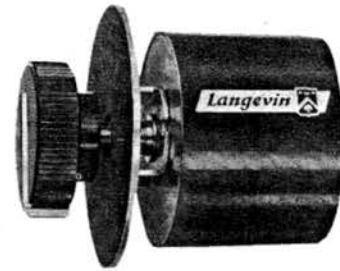
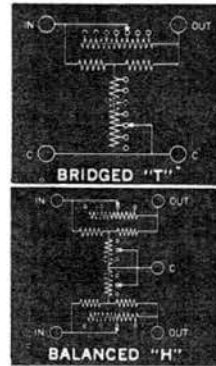

PLEASE READ BEFORE ORDERING

Characteristic of these controls is zero insertion loss at 1:1 impedance ratios. These controls are available in any standard impedance in and out. The minimum or insertion loss for unequal impedance ratios can be determined from the table on Page 66.

These units are supplied normally 600/600 ohms; other standard impedances available in or out in any combination are 150, 200, 250, 500 and 600 ohms at no additional charge but must be specified. For non-standard impedances add 15% to prices shown. Because these units are customarily employed to enable return to fixed settings in precise increments of decibels, detents are used and no taper is employed. Please specify if other action is desired.

TRANSMISSION LINE ATTENUATORS OR GAIN CONTROLS

AT Series for use as Attenuator or Gain Control is supplied normally 600 ohms in and out, detented and not tapered.

For use as Master, Submaster and in measuring equipment.

Length "B": Single gang 1 7/8"; 2 gang 2 7/8"; 3 gang 4". Includes D-1002 Engraved, Calibrated Dial and K-1032 Knob.

| MODEL | STEPS | CKT | RANGE | DB PER STEP | TOTAL LOSS DB | DEGREES BET. STEPS | FRAME DIA. "A" | PRICE, NET | 2 GANG | | 3 GANG | |
|---------|-------|-----|-------|-------------|---------------|--------------------|----------------|------------|----------|------------|----------|------------|
| | | | | | | | | | MODEL | PRICE, NET | MODEL | PRICE, NET |
| AT-612 | 10 | T | 0-1 | .1 | 1 | 15 | 1 1/2 | 18.00 | AT-612-2 | 33.00 | AT-612-3 | 48.00 |
| AT-613 | 10 | T | 0-5 | .5 | 5 | 15 | 1 1/2 | 18.00 | AT-613-2 | 33.00 | AT-613-3 | 48.00 |
| AT-606 | 10 | T | 0-10 | 1 | 10 | 15 | 1 1/2 | 18.00 | AT-606-2 | 33.00 | AT-606-3 | 48.00 |
| AT-600 | 10 | T | 0-20 | 2 | 20 | 15 | 1 1/2 | 18.00 | AT-600-2 | 33.00 | AT-600-3 | 48.00 |
| AT-614 | 20 | T | 0-2 | .1 | 2 | 15 | 2 1/4 | 23.00 | AT-614-2 | 43.00 | AT-614-3 | 63.00 |
| AT-607 | 20 | T | 0-20 | 1 | 20 | 15 | 2 1/4 | 23.00 | AT-607-2 | 43.00 | AT-607-3 | 63.00 |
| AT-601 | 20 | T | 0-40 | 2 | 40 | 15 | 2 1/4 | 23.00 | AT-601-2 | 43.00 | AT-601-3 | 63.00 |
| AT-615 | 30 | T | 0-3 | .1 | 3 | 10 | 2 1/4 | 30.00 | AT-615-2 | 57.00 | AT-615-3 | 84.00 |
| AT-608 | 30 | T | 0-30 | 1 | 30 | 10 | 2 1/4 | 30.00 | AT-608-2 | 57.00 | AT-608-3 | 84.00 |
| AT-602 | 30 | T | 0-60 | 2 | 60 | 10 | 2 1/4 | 30.00 | AT-602-2 | 57.00 | AT-602-3 | 84.00 |
| AT-616 | 10 | H | 0-1 | .1 | 1 | 15 | 2 1/4 | 25.00 | AT-616-2 | 47.00 | AT-616-3 | 69.00 |
| AT-617 | 10 | H | 0-5 | .5 | 5 | 15 | 2 1/4 | 25.00 | AT-617-2 | 47.00 | AT-617-3 | 69.00 |
| AT-609 | 10 | H | 0-10 | 1 | 10 | 15 | 2 1/4 | 25.00 | AT-609-2 | 47.00 | AT-609-3 | 69.00 |
| AT-603 | 10 | H | 0-20 | 2 | 20 | 15 | 2 1/4 | 25.00 | AT-603-2 | 47.00 | AT-603-3 | 69.00 |
| AT-620 | 15 | H | 0-1.5 | .1 | 1.5 | 10 | 2 1/4 | 32.00 | AT-620-2 | 61.00 | AT-620-3 | 90.00 |
| AT-621 | 15 | H | 0-15 | 1 | 15 | 10 | 2 1/4 | 32.00 | AT-621-2 | 61.00 | AT-621-3 | 90.00 |
| AT-222 | 15 | H | 0-30 | 2 | 30 | 10 | 2 1/4 | 32.00 | AT-622-2 | 61.00 | AT-622-3 | 90.00 |
| AT-610* | 20 | H | 0-20 | 1 | 20 | 10 | 2 1/4 | 45.00 | | | | |
| AT-604* | 20 | H | 0-40 | 2 | 40 | 10 | 2 1/4 | 45.00 | | | | |
| AT-611* | 30 | H | 0-30 | 1 | 30 | 10 | 2 1/4 | 60.00 | | | | |
| AT-605* | 30 | H | 0-60 | 2 | 60 | 10 | 2 1/4 | 60.00 | | | | |

*LENGTH "B" 2 7/8" INSTEAD OF 1 7/8"

2% ACCURACY

MEASURING EQUIPMENT — Precision Rotary Impedance Matching Networks

GENERAL CONSIDERATIONS

The most common measuring device in transmission work is the gain set. From this device simpler forms of measuring transmission levels are derived.

A gain set consists of an oscillator, a facility for matching the impedance of the input to the equipment or circuit under test, a series of decade attenuators, and another impedance matching facility for receiving the results of the test along with suitable metering.

Note point "X" on the diagram. By no means should a transformer be employed here for matching or isolation. This coil would be called upon to operate over a range of 120 db or better; no transformers ordinarily available can do this.

On this page we are concerned only with the impedance matching controls calibrated for relative losses due to matching of unequal impedance ratios. These controls are treated on first, and are then followed by the decade attenuators on the next page.

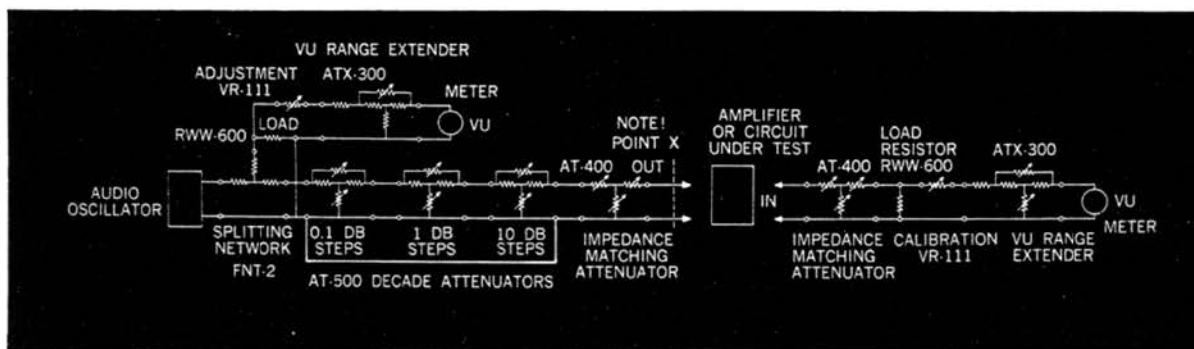
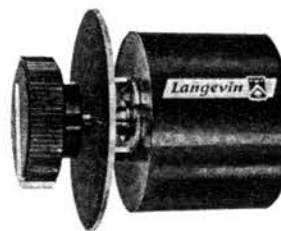
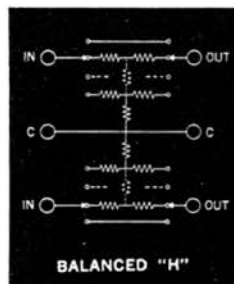
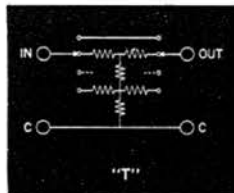

ROTARY IMPEDANCE MATCHING NETWORKS

Langevin Rotary Impedance Matching Controls consist of a series of "T" and "H" networks without taper and offer a constant impedance to the input with a series of varied impedances on the output. These controls are reversible by simply exchanging input and output leads, thus allowing them to match either input or output circuit impedances.

In the form of a gain control the balanced "H" units are actually two bridged "T" units opposing

each other to offer a balanced circuit to common center or ground. This type of "H" circuit utilizes four brushes to achieve its purpose.

Since these circuits permit high precision they form the ideal method of matching impedance in gain sets and other equipment requiring extreme accuracy. The same standards of construction are employed on these units as in other Langevin controls. They do not introduce phase shift, and leakage is low. At 100 kc no measurable leakage is evidenced.

LANGEVIN SERIES 400 PRECISION ROTARY IMPEDANCE MATCHING NETWORKS

| MODEL | CIRCUIT | INPUT Z (OUTPUT) | DB LOSS AT OUTPUT Z OF | | | | | | | DIA. "A" | LENGTH "B" | MODEL D-1002 () DIAL, DIA. | MODEL K-112 KNOB, DIA. | WATTS SINE WAVE | RESISTOR ACCURACY | PRICE, NET | | |
|--------|---------|------------------|------------------------|----|----|-----|-----|-----|-----|----------|------------|-----------------------------|------------------------|-----------------|-------------------|------------|---------|-------|
| | | | 16 | 30 | 50 | 125 | 150 | 200 | 250 | | | | | | | | 500 | 600 |
| AT-400 | "T" | 600 | 20 | 20 | 20 | 20 | 20 | 10 | 10 | 10 | 0 | 2 3/4" | 1 3/8" | 2 3/4" | 1 1/2" | 1/2 WATT | ± 1/2 % | 30.00 |
| AT-401 | "T" | | 20 | 20 | 20 | 20 | 20 | 20 | 20 | 20 | 0 | | | | | | | 30.00 |
| AT-402 | "H" | | 20 | 20 | 20 | 20 | 20 | 10 | 10 | 10 | 0 | | | | | | | 47.50 |
| AT-403 | | | 20 | 20 | 20 | 20 | 20 | 20 | 20 | 20 | 20 | | | | | | | 47.50 |

MEASURING EQUIPMENT — PRECISION DECADE ATTENUATORS

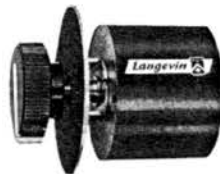
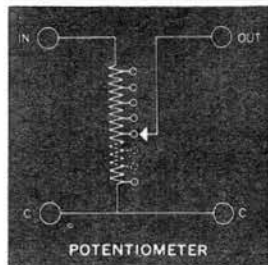
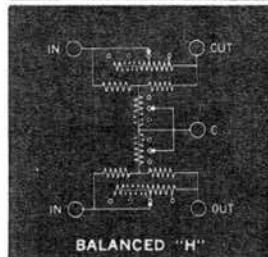
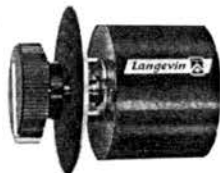
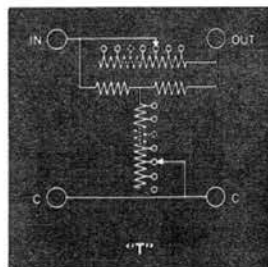

PRECISION DECADE ATTENUATORS

The Langevin Series 500 Precision Decade Attenuators are 10 step units for use in transmission measuring equipment such as gain sets. They are also ideal for use in noise meters and audiometers; for these equipments they are offered in potentiometers as well as "T" and balanced "H" configurations. All resistors are calibrated to better than $\pm 1/2\%$. For best results, steady sine wave power input levels should be limited to 1 watt or less to insure accuracy over an indefinite period. 5 watts of program material can be handled for an unlimited time. Units capable of higher levels are available on order.

10 STEPS .1DB 1 DB TOTAL

| MODEL | CIRCUIT | IMPEDANCE | DIA. "A" | LENGTH "B" | DEGREES SPACING | MODEL D-1002-() DIAL DIA. | MODEL K-112 KNOB, DIA. | WATTS SINE WAVE | RESISTOR ACCURACY | PRICE, NET |
|--------|---------------|-----------|----------|------------|-----------------|----------------------------|------------------------|-----------------|-------------------|------------|
| AT-500 | "T" | 600 | 2 1/4" | 1 5/8" | 15 | 2 3/4" | 1 1/2" | 1 WATT | $\pm 1/2\%$ | 24.50 |
| AT-501 | "H" | 600 | | | | | | | | 52.00 |
| AT-502 | Potentiometer | 25K | | | | | | | | 21.00 |
| AT-503 | | 50K | | | | | | | | 21.00 |
| AT-504 | | 100K | | | | | | | | 21.00 |

10 STEPS 1DB 10 DB TOTAL

| MODEL | CIRCUIT | IMPEDANCE | DIA. "A" | LENGTH "B" | DEGREES SPACING | MODEL D-1002-() DIAL DIA. | MODEL K-112 KNOB, DIA. | WATTS SINE WAVE | RESISTOR ACCURACY | PRICE, NET |
|--------|---------------|-----------|----------|------------|-----------------|----------------------------|------------------------|-----------------|-------------------|------------|
| AT-505 | "T" | 600 | 2 1/4" | 1 5/8" | 15 | 2 3/4" | 1 1/2" | 1 WATT | $\pm 1/2\%$ | 24.50 |
| AT-506 | "H" | 600 | | | | | | | | 52.00 |
| AT-507 | Potentiometer | 25K | | | | | | | | 21.00 |
| AT-508 | | 50K | | | | | | | | 21.00 |
| AT-509 | | 100K | | | | | | | | 21.00 |

10 STEPS 10DB 100 DB TOTAL

| MODEL | CIRCUIT | IMPEDANCE | DIA. "A" | LENGTH "B" | DEGREES SPACING | MODEL D-1002-() DIAL DIA. | MODEL K-112 KNOB, DIA. | WATTS SINE WAVE | RESISTOR ACCURACY | PRICE, NET |
|--------|---------------|-----------|----------|------------|-----------------|----------------------------|------------------------|-----------------|-------------------|------------|
| AT-510 | "T" | 600 | 2 1/4" | 1 5/8" | 15 | 2 3/4" | 1 1/2" | 1 WATT | $\pm 1/2\%$ | 24.50 |
| AT-511 | "H" | 600 | | | | | | | | 52.00 |
| AT-512 | Potentiometer | 25K | | | | | | | | 21.00 |
| AT-513 | | 50K | | | | | | | | 21.00 |
| AT-514 | | 100K | | | | | | | | 21.00 |

GRID CONTROL POTENTIOMETERS

PRECAUTIONS IN CHOOSING IMPEDANCES

The potentiometers listed in this section are designed to insure calibration into an open circuit such as the grid of a Class "A" amplifier tube.

In choosing the proper resistance of the potentiometer for your application make certain that the lowest possible value is chosen. A number of reasons for this exist. In a high gain triode the grid input impedance at the highest frequencies may be quite low, thus requiring a low value of potentiometer resistance of about 50,000 ohms.

In addition the capacity of the input circuit to ground governs high frequency attenuation. The lower the value of the potentiometer, the smaller is this effect.

In good transmission design high impedance leads should be limited to inches in length and kept as short as possible. A line to grid transformer is always recommended, with the potentiometer on the amplifier side of the coil. Make certain that no grid current is flowing or the potentiometer will be noisy in operation.

TYPES OFFERED

Langevin grid control potentiometers are offered unbalanced for single grids and in balanced configurations for push-pull grids. They are also available in single, as well as 2 gang and 3 gang units for 2 channel

and 3 channel amplifiers for stereo, unbalanced or balanced, 20, 32 and 45 steps. These are normally supplied without taper and with no "off" position. All units are detented; if desired without detents please specify.

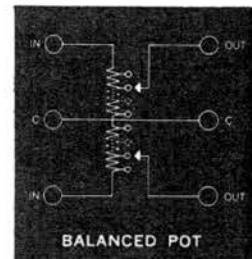
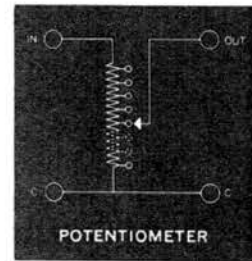
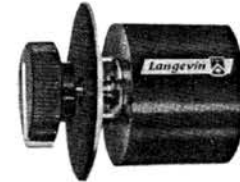

Length "B": Single gang 1 1/2"; 2 gang 2 3/8"; 3 gang 4". Includes D-1002 Engraved, Calibrated Dial and K-1032 Knob. Please specify Standard Values of 25K, 50K, 100K, or 250K; other values add 15% to prices shown.

UNBALANCED

| MODEL | NO. STEPS | DB RANGE | DB PER STEP | MAX. ATT. DB | DEGREES BETWEEN CONTACTS | FRAME DIA. "A" | PRICE, NET | 2 GANG | | 3 GANG | |
|--------|-----------|----------|-------------|--------------|--------------------------|----------------|------------|----------|------------|----------|------------|
| | | | | | | | | MODEL | PRICE, NET | MODEL | PRICE, NET |
| GC-333 | 10 | 0-50 | 5 | 50 | 15 | 1 1/2 | 12.00 | GC-333-2 | 21.00 | GC-333-3 | 30.00 |
| GC-334 | 15 | 0-75 | 5 | 75 | 15 | 1 1/2 | 15.00 | GC-334-2 | 27.00 | GC-334-3 | 39.00 |
| GC-335 | 20 | 0-40 | 2 | 40 | 15 | 1 1/2 | 18.00 | GC-335-2 | 33.00 | GC-335-3 | 48.00 |
| GC-336 | 20 | 0-60 | 3 | 60 | 15 | 1 1/2 | 18.00 | GC-336-2 | 33.00 | GC-336-3 | 48.00 |
| GC-337 | 30 | 0-30 | 1 | 30 | 10 | 1 1/2 | 21.00 | GC-337-2 | 39.00 | GC-337-3 | 57.00 |
| GC-338 | 30 | 0-60 | 2 | 60 | 10 | 1 1/2 | 21.00 | GC-338-2 | 39.00 | GC-338-3 | 57.00 |
| GC-339 | 45 | 0-45 | 1 | 45 | 7.5 | 2 1/4 | 36.00 | GC-339-2 | 69.00 | GC-339-3 | 102.00 |

BALANCED

| MODEL | NO. STEPS | DB RANGE | DB PER STEP | MAX. ATT. DB | DEGREES BETWEEN CONTACTS | FRAME DIA. "A" | PRICE, NET | 2 GANG | | 3 GANG | |
|--------|-----------|----------|-------------|--------------|--------------------------|----------------|------------|----------|------------|----------|------------|
| | | | | | | | | MODEL | PRICE, NET | MODEL | PRICE, NET |
| GC-340 | 10 | 0-50 | 5 | 50 | 15 | 1 1/2 | 18.00 | GC-340-2 | 33.00 | GC-340-3 | 48.00 |
| GC-341 | 15 | 0-75 | 5 | 75 | 10 | 1 1/2 | 19.50 | GC-341-2 | 36.00 | GC-341-3 | 52.50 |
| GC-342 | 20 | 0-40 | 2 | 40 | 15 | 2 1/4 | 23.00 | GC-342-2 | 43.00 | GC-342-3 | 63.00 |
| GC-343 | 20 | 0-60 | 3 | 60 | 15 | 2 1/4 | 23.00 | GC-343-2 | 43.00 | GC-343-3 | 63.00 |
| GC-344 | 30 | 0-30 | 1 | 30 | 10 | 2 1/4 | 30.00 | GC-344-2 | 57.00 | GC-344-3 | 84.00 |
| GC-345 | 30 | 0-60 | 2 | 60 | 10 | 2 1/4 | 30.00 | GC-345-2 | 57.00 | GC-345-3 | 84.00 |
| GC-346 | 45 | 0-45 | 1 | 45 | 7 1/2 | 2 1/4 | 45.00 | GC-346-2 | 87.00 | GC-346-3 | 129.00 |

2% ACCURACY

FIXED ATTENUATOR NETWORKS

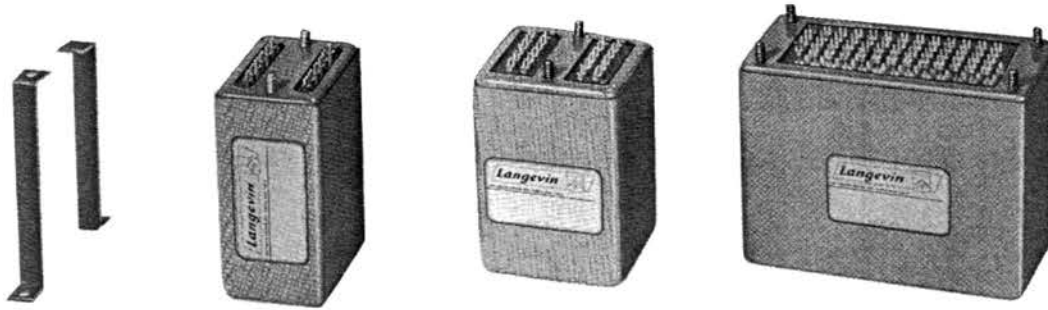

MIXER NETWORKS • TERMINATING RESISTORS • MINIMUM LOSS MATCHING NETWORKS
FIXED LOSS NETWORKS • V U MULTIPLIERS

GENERAL

Fixed attenuators, comprising resistance networks, or "pads", have varied uses in transmission work. For ease in classification these are broken down according to employment into six general groups in the sections to follow. It will be seen that many network configurations are used in unbalanced lines, and the diagrams and formulae for computation head the respective sections dealing with each. The Voltage Ratio Table on page 63 shows the value of K to be used in the equations.

uniform in depth and height; only the width varies to accommodate more circuit elements. In this way the required components for the entire circuit array may be grouped and mounted uniformly, conserving space and simplifying cable forms. All solder terminals are plainly marked and arranged for neat appearance and convenience in service and test. Resistances in networks are held to $\pm 1\%$ and are potted in sealing compound for long life.

DESCRIPTION

Containers for all Langevin Fixed Pads, Line to Line coils, Fixed Oscillators, and other components are

Balanced networks in all forms are derived by dividing series arm resistors by one half and inserting them in each side of the line.

MOUNTING DIMENSIONS

Three container widths are used on all appropriate Langevin components. Mounting is facilitated by brackets furnished with each unit. If it is desired to

use cutouts in the mounting surface for concealed cabling, the cases may be inverted so that terminations emerge from the bottom.

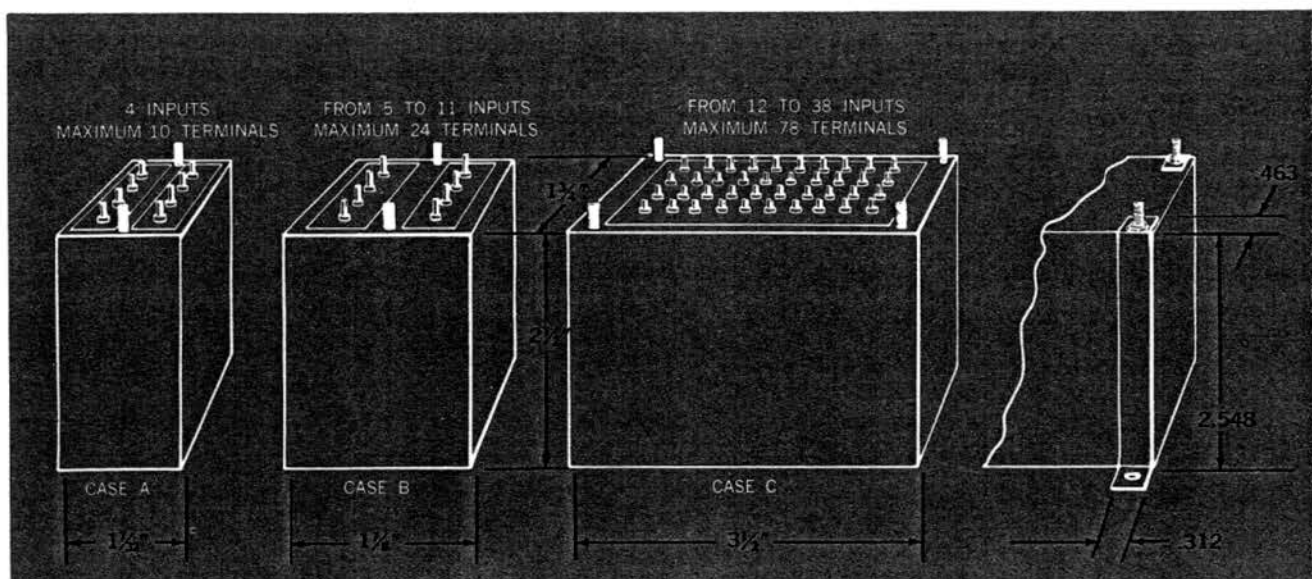

VOLTAGE RATIO TABLE

V

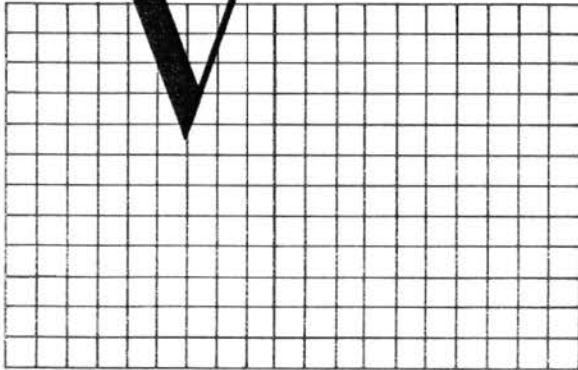

Here is a tool to assist you in the choice of networks, in the determination of their characteristics, and to allow you to design your own. The formulae appearing at the head of fixed network sections include values of "K" which may be determined from this table.

INSTRUCTION

Note that the table covers values up to 20 db only. For higher values revert to the beginning of the table and move the decimal to the right one place for the "K", or Gain column, and one place to the left for the "L", or Loss column. For example, to find the value of "K" at 24.3 volts, locate the value of "K" at 4.3 volts; this is 1.641. Move the decimal to the right one point, and the value for 24.3 volts becomes K=16.41. It will be seen from this that the table repeats numerically every 20 db for decibel voltage

VOLTAGE RATIOS

| Decibel Voltage | $\frac{1}{K}$ Loss | K Gain | Decibel Voltage | $\frac{1}{K}$ Loss | K Gain | Decibel Voltage | $\frac{1}{K}$ Loss | K Gain | Decibel Voltage | $\frac{1}{K}$ Loss | K Gain |
|-----------------|--------------------|--------|-----------------|--------------------|--------|-----------------|--------------------|--------|-----------------|--------------------|--------|
| 0 | 1.0000 | 1.000 | 5.0 | 5.623 | 1.778 | 10.0 | 3.162 | 3.162 | 15.0 | 1.778 | 5.623 |
| 1 | 9886 | 1.012 | 1 | 5559 | 1.799 | 1 | 3126 | 3.199 | 1 | 1758 | 5.689 |
| 2 | 9772 | 1.023 | 2 | 5495 | 1.820 | 2 | 3090 | 3.236 | 2 | 1738 | 5.754 |
| 3 | 9661 | 1.035 | 3 | 5433 | 1.841 | 3 | 3055 | 3.273 | 3 | 1718 | 5.821 |
| 4 | 9550 | 1.047 | 4 | 5370 | 1.862 | 4 | 3020 | 3.311 | 4 | 1698 | 5.888 |
| 5 | 9441 | 1.059 | 5 | 5309 | 1.884 | 5 | 2985 | 3.350 | 5 | 1679 | 5.957 |
| 6 | 9333 | 1.072 | 6 | 5248 | 1.905 | 6 | 2951 | 3.388 | 6 | 1660 | 6.026 |
| 7 | 9226 | 1.084 | 7 | 5188 | 1.928 | 7 | 2917 | 3.428 | 7 | 1641 | 6.095 |
| 8 | 9120 | 1.096 | 8 | 5129 | 1.950 | 8 | 2884 | 3.467 | 8 | 1622 | 6.166 |
| 9 | 9061 | 1.109 | 9 | 5070 | 1.972 | 9 | 2851 | 3.508 | 9 | 1603 | 6.237 |
| 10 | 8913 | 1.122 | 6.0 | 5012 | 1.995 | 11.0 | 2818 | 3.548 | 16.0 | 1.585 | 6.310 |
| 1 | 8810 | 1.135 | 1 | 4955 | 2.018 | 1 | 2786 | 3.589 | 1 | 1567 | 6.383 |
| 2 | 8710 | 1.148 | 2 | 4898 | 2.042 | 2 | 2754 | 3.631 | 2 | 1549 | 6.457 |
| 3 | 8610 | 1.161 | 3 | 4842 | 2.065 | 3 | 2723 | 3.673 | 3 | 1531 | 6.531 |
| 4 | 8511 | 1.175 | 4 | 4786 | 2.089 | 4 | 2692 | 3.715 | 4 | 1514 | 6.607 |
| 5 | 8414 | 1.189 | 5 | 4732 | 2.113 | 5 | 2661 | 3.758 | 5 | 1496 | 6.683 |
| 6 | 8318 | 1.202 | 6 | 4677 | 2.138 | 6 | 2630 | 3.802 | 6 | 1479 | 6.761 |
| 7 | 8222 | 1.216 | 7 | 4624 | 2.163 | 7 | 2600 | 3.846 | 7 | 1462 | 6.839 |
| 8 | 8128 | 1.230 | 8 | 4571 | 2.188 | 8 | 2570 | 3.890 | 8 | 1445 | 6.918 |
| 9 | 8035 | 1.245 | 9 | 4519 | 2.213 | 9 | 2541 | 3.936 | 9 | 1429 | 6.998 |
| 20 | 7943 | 1.259 | 7.0 | 4467 | 2.239 | 12.0 | 2512 | 3.981 | 17.0 | 1.413 | 7.079 |
| 1 | 7852 | 1.274 | 1 | 4416 | 2.265 | 1 | 2483 | 4.027 | 1 | 1396 | 7.161 |
| 2 | 7762 | 1.288 | 2 | 4365 | 2.291 | 2 | 2455 | 4.074 | 2 | 1380 | 7.244 |
| 3 | 7674 | 1.303 | 3 | 4315 | 2.317 | 3 | 2427 | 4.121 | 3 | 1365 | 7.328 |
| 4 | 7586 | 1.318 | 4 | 4266 | 2.341 | 4 | 2399 | 4.169 | 4 | 1349 | 7.413 |
| 5 | 7499 | 1.334 | 5 | 4217 | 2.371 | 5 | 2371 | 4.217 | 5 | 1334 | 7.499 |
| 6 | 7413 | 1.349 | 6 | 4169 | 2.399 | 6 | 2344 | 4.266 | 6 | 1318 | 7.586 |
| 7 | 7328 | 1.365 | 7 | 4121 | 2.427 | 7 | 2317 | 4.315 | 7 | 1303 | 7.674 |
| 8 | 7244 | 1.380 | 8 | 4074 | 2.455 | 8 | 2291 | 4.365 | 8 | 1288 | 7.762 |
| 9 | 7161 | 1.396 | 9 | 4027 | 2.483 | 9 | 2265 | 4.416 | 9 | 1274 | 7.852 |
| 30 | 7079 | 1.413 | 8.0 | 3981 | 2.512 | 13.0 | 2239 | 4.467 | 18.0 | 1.259 | 7.943 |
| 1 | 6998 | 1.429 | 1 | 3936 | 2.541 | 1 | 2213 | 4.519 | 1 | 1245 | 8.035 |
| 2 | 6918 | 1.445 | 2 | 3890 | 2.570 | 2 | 2188 | 4.571 | 2 | 1230 | 8.128 |
| 3 | 6839 | 1.462 | 3 | 3846 | 2.600 | 3 | 2163 | 4.624 | 3 | 1216 | 8.222 |
| 4 | 6761 | 1.479 | 4 | 3802 | 2.630 | 4 | 2138 | 4.677 | 4 | 1202 | 8.318 |
| 5 | 6683 | 1.496 | 5 | 3758 | 2.661 | 5 | 2113 | 4.732 | 5 | 1189 | 8.414 |
| 6 | 6607 | 1.514 | 6 | 3715 | 2.692 | 6 | 2089 | 4.786 | 6 | 1175 | 8.511 |
| 7 | 6531 | 1.531 | 7 | 3673 | 2.723 | 7 | 2065 | 4.842 | 7 | 1161 | 8.610 |
| 8 | 6457 | 1.549 | 8 | 3631 | 2.754 | 8 | 2042 | 4.898 | 8 | 1148 | 8.710 |
| 9 | 6383 | 1.567 | 9 | 3589 | 2.786 | 9 | 2018 | 4.955 | 9 | 1135 | 8.811 |
| 40 | 6310 | 1.585 | 9.0 | 3548 | 2.818 | 14.0 | 1995 | 5.012 | 19.0 | 1.122 | 8.913 |
| 1 | 6237 | 1.603 | 1 | 3508 | 2.851 | 1 | 1972 | 5.070 | 1 | 1109 | 9.016 |
| 2 | 6166 | 1.622 | 2 | 3467 | 2.884 | 2 | 1950 | 5.129 | 2 | 1096 | 9.120 |
| 3 | 6095 | 1.641 | 3 | 3428 | 2.917 | 3 | 1928 | 5.188 | 3 | 1084 | 9.226 |
| 4 | 6026 | 1.660 | 4 | 3388 | 2.951 | 4 | 1905 | 5.248 | 4 | 1072 | 9.333 |
| 5 | 5957 | 1.679 | 5 | 3350 | 2.985 | 5 | 1884 | 5.309 | 5 | 1059 | 9.441 |
| 6 | 5888 | 1.698 | 6 | 3311 | 3.020 | 6 | 1862 | 5.370 | 6 | 1047 | 9.550 |
| 7 | 5821 | 1.718 | 7 | 3273 | 3.055 | 7 | 1841 | 5.433 | 7 | 1035 | 9.661 |
| 8 | 5754 | 1.738 | 8 | 3236 | 3.090 | 8 | 1820 | 5.495 | 8 | 1023 | 9.772 |
| 9 | 5689 | 1.758 | 9 | 3199 | 3.126 | 9 | 1799 | 5.559 | 9 | 1012 | 9.886 |
| | | | | | | | | | 20.0 | 1.000 | 10.000 |

MIXER NETWORKS

Mixer Networks are employed to restore the original line impedance after paralleling various numbers of mixer circuits. Langevin Mixer Networks are available in Unbalanced "T" and Balanced "H" configurations. The popular and recommended form is the Unbalanced "T". Mixer Networks are stocked in any number of branches up to 16, and sustain steady sine wave tones up to + 30 dbm. Transient signals or program material have a safe limit in operation up to five times this power.

Mixing Networks are normally designed for the same input and output impedances. Under unusual circumstances it may be desirable to mix line inputs of several different impedances, or to provide an

input impedance which varies from the input lines. Other cases may demand added losses for input lines which operate at higher levels than the remainder of the lines to be mixed.

In cases of mixed impedances and varied losses, three courses are open to the designing engineer. One course is to refer to the table on page 65, "MATCHING AND MISMATCHING LOSSES", to see if the resulting levels will be satisfactory; if not, the second alternative is to order special networks from Langevin to your specification. The third alternative is to design the network from the data provided in this section and to construct it from such components as may be locally available.

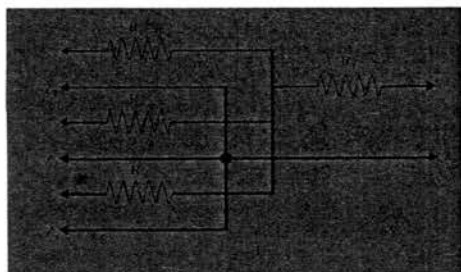

$$\frac{N-1}{N+1}Z = R_i$$

Where:

N = number of inputs
Z = impedance in ohms
R = resistance in ohms
and
Z₁ input = Z₂ output

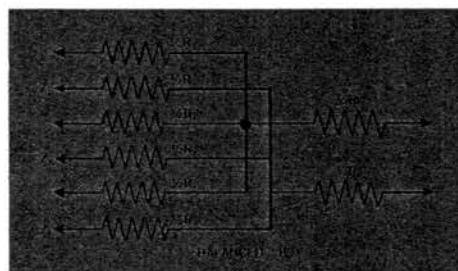

"T" MIXER NETWORKS

| MODEL | NUMBER OF INPUTS | DB LOSS | CASE SIZE | PRICE, NET |
|--------|------------------|---------|-----------|------------|
| FNT-2 | 2 | 6 | A | 6.00 |
| FNT-3 | 3 | 9.5 | | 7.00 |
| FNT-4 | 4 | 12 | | 8.00 |
| FNT-5 | 5 | 14 | B | 9.00 |
| FNT-6 | 6 | 15.6 | | 10.00 |
| FNT-7 | 7 | 16.9 | | 11.00 |
| FNT-8 | 8 | 18.1 | | 12.00 |
| FNT-9 | 9 | 19.1 | | 13.00 |
| FNT-10 | 10 | 20 | | 14.00 |
| FNT-11 | 11 | 20.8 | C | 15.00 |
| FNT-12 | 12 | 21.6 | | 16.00 |
| FNT-13 | 13 | 22.3 | | 17.00 |
| FNT-14 | 14 | 22.9 | | 18.00 |
| FNT-15 | 15 | 23.5 | | 19.00 |
| FNT-16 | 16 | 24.1 | | 20.00 |

BALANCED "H" MIXER NETWORKS

| MODEL | NUMBER OF INPUTS | DB LOSS | CASE SIZE | PRICE, NET |
|--------|------------------|---------|-----------|------------|
| FNH-2 | 2 | 6 | A | 8.00 |
| FNH-3 | 3 | 9.5 | | 10.00 |
| FNH-4 | 4 | 12 | | 12.00 |
| FNH-5 | 5 | 14 | B | 14.00 |
| FNH-6 | 6 | 15.6 | | 16.00 |
| FNH-7 | 7 | 16.9 | | 18.00 |
| FNH-8 | 8 | 18.1 | | 20.00 |
| FNH-9 | 9 | 19.1 | | 22.00 |
| FNH-10 | 10 | 20 | | 24.00 |
| FNH-11 | 11 | 20.8 | C | 26.00 |
| FNH-12 | 12 | 21.6 | | 28.00 |
| FNH-13 | 13 | 22.3 | | 30.00 |
| FNH-14 | 14 | 22.9 | | 32.00 |
| FNH-15 | 15 | 23.5 | | 34.00 |
| FNH-16 | 16 | 24.1 | | 36.00 |

TERMINATING AND LOAD RESISTORS

Langevin supplies high quality wire wound resistors for all applications, but lists here popular values and those complementary to console design around Langevin transmission equipment. Especially popular are the 600 and 150 ohm values used for most line terminations.

This series of resistors is wound on ceramic bob-

bins of steatite material especially selected to inhibit moisture. The assemblies are impregnated to provide stable, noise-free operation over an indefinite period of time. Manufacturing is controlled in detail to eliminate electrolytic action at terminations, the most prevalent cause of wire-wound resistor failure.

WIRE WOUND TERMINATING RESISTORS

| MODEL | OHMS | USAGE | PRICE, NET |
|---------|------|--------------------------|------------|
| RWW-800 | 800 | LANGEVIN AMPLIFIER LOADS | 1.50 |
| RWW-760 | 760 | | 1.50 |
| RWW-700 | 700 | | 1.50 |
| RWW-620 | 620 | | 1.50 |
| RWW-600 | 600 | LINE TERMINATION | 1.50 |
| RWW-270 | 270 | LANGEVIN | 1.50 |
| RWW-185 | 185 | AMPLIFIER LOADS | 1.50 |
| RWW-150 | 150 | LINE TERMINATION | 1.50 |

| MODEL | OHMS | USAGE | PRICE, NET |
|----------|------|--------------------------|------------|
| RWW-20K | 20 K | LANGEVIN AMPLIFIER LOADS | 1.50 |
| RWW-10K | 10 K | | 1.50 |
| RWW-8K | 8 K | | 1.50 |
| RWW-4K | 4 K | | 1.50 |
| RWW-500 | 500 | VU SERIES RESISTORS | 1.50 |
| RWW-3600 | 3600 | | 1.50 |
| RWW-3100 | 3100 | | 1.50 |

PAD LOSS TABLES

MINIMUM LOSS — IMPEDANCE MATCHING PADS LOSS — MISMATCHED IMPEDANCE

INTRODUCTION

The minimum loss for exactly matching lines of different impedances in the frequently used values is shown (p.66). Infrequently it is desirable to match lines of impedances other than those in the shorter table, and also to mismatch lines where smaller losses are desired than the minimum matching loss caused by the matching pad. It is to be noted that this table applies equally to "T" or Balanced "H" circuits.

COLUMN 1, RATIO Z/Z

In this column select the figure which represents the ratio between the input and output impedances. If one is 600 ohms and the other 300 ohms the ratio is 2 to 1; in this case select the line showing the figure "2"

COLUMN 2, MINIMUM MATCHING LOSS

In this column the minimum loss in db will appear reading directly to the right of the impedance selected. In the case of a 600 ohm source and a 300 ohm load (or vice-versa) the impedance ratio of 2 shows a

minimum loss for the impedance pad of 7.665 db.

COLUMN 3, MISMATCH LOSS

In this column is shown the loss in db caused by "improper" termination. In reactive circuits the use of the term "improper" is appropriate for audio transmission work because of more or less frequency discrimination due to reflections caused by differing phase angles. But in a line whose elements are purely resistive a mismatched circuit may be proper indeed where the lowest possible loss is desired. Thus it will be seen in the case of a 600/300 ohm, 2:1 purely resistive mismatch the loss is .510 db versus the loss through the matching pad of 7.665 db.

For ratios not shown matching losses are found as follows:
Let R^2 = impedance ratio.
Let N = db loss.

$$\text{For minimum loss, matching } N = 20 \log_{10} (R + \sqrt{R^2 - 1})$$

$$\text{For mismatch loss } N = 20 \log_{10} \left(\frac{R^2 + 1}{2R} \right)$$

PAD LOSS TABLES

Note: Balanced Networks are derived by dividing all series arms by one-half and inserting them in both sides of the line.

| Column 1 Ratio Z/Z | Column 2 Minimum Loss "T" Matching | Column 3 Impedance Mismatch Loss | Column 1 Ratio Z/Z | Column 2 Minimum Loss "T" Matching | Column 3 Impedance Mismatch Loss | Column 1 Ratio Z/Z | Column 2 Minimum Loss "T" Matching | Column 3 Impedance Mismatch Loss | Column 1 Ratio Z/Z | Column 2 Minimum Loss "T" Matching | Column 3 Impedance Mismatch Loss |
|-----------------------|---|---|-----------------------|---|---|-----------------------|---|---|-----------------------|---|---|
| 1.0 | 0 | 0 | 6.0 | 13.41 | 3.090 | 12.0 | 16.63 | 5.470 | 32.0 | 21.00 | 9.320 |
| 1 | 2.743 | 0.0989 | 1 | 13.49 | 3.155 | 2 | 16.70 | 5.545 | 5 | 21.07 | 9.360 |
| 2 | 3.770 | 0.3604 | 2 | 13.57 | 3.208 | 4 | 16.77 | 5.600 | 33.0 | 21.13 | 9.440 |
| 3 | 4.548 | 0.778 | 3 | 13.65 | 3.240 | 6 | 16.84 | 5.650 | 5 | 21.21 | 9.480 |
| 4 | 5.180 | 1.223 | 4 | 13.71 | 3.293 | 8 | 16.92 | 5.708 | 34.0 | 21.28 | 9.560 |
| 5 | 5.723 | 1.72 | 5 | 13.79 | 3.341 | 13.0 | 16.97 | 5.750 | 5 | 21.34 | 9.600 |
| 6 | 6.190 | 2.20 | 6 | 13.87 | 3.400 | 2 | 17.03 | 5.820 | 35.0 | 21.40 | 9.660 |
| 7 | 6.615 | 3.08 | 7 | 13.92 | 3.453 | 5 | 17.12 | 5.875 | 5 | 21.46 | 9.710 |
| 8 | 6.990 | 3.66 | 8 | 14.00 | 3.490 | 6 | 17.18 | 5.930 | 36.0 | 21.51 | 9.770 |
| 9 | 7.340 | 4.40 | 9 | 14.07 | 3.540 | 8 | 17.25 | 5.990 | 5 | 21.57 | 9.840 |
| 10 | 7.665 | 5.10 | 10 | 14.13 | 3.600 | 14.0 | 17.32 | 6.050 | 37.0 | 21.67 | 9.890 |
| 1 | 7.955 | 5.70 | 1 | 14.20 | 3.630 | 2 | 17.38 | 6.093 | 5 | 21.73 | 9.940 |
| 2 | 8.225 | 6.60 | 2 | 14.27 | 3.683 | 4 | 17.43 | 6.150 | 38.0 | 21.77 | 10.00 |
| 3 | 8.490 | 7.32 | 3 | 14.32 | 3.735 | 6 | 17.50 | 6.205 | 5 | 21.83 | 10.05 |
| 4 | 8.740 | 8.04 | 4 | 14.40 | 3.778 | 8 | 17.57 | 6.248 | 39.0 | 21.90 | 10.10 |
| 5 | 8.970 | 8.83 | 5 | 14.46 | 3.810 | 5 | 17.63 | 6.300 | 5 | 21.93 | 10.17 |
| 6 | 9.185 | 9.62 | 6 | 14.51 | 3.853 | 15.0 | 17.65 | 6.300 | 40.0 | 21.97 | 10.21 |
| 7 | 9.388 | 1.030 | 7 | 14.56 | 3.908 | 5 | 17.73 | 6.420 | 5 | 22.07 | 10.28 |
| 8 | 9.580 | 1.088 | 8 | 14.65 | 3.948 | 16.0 | 17.77 | 6.550 | 41.0 | 22.11 | 10.31 |
| 9 | 9.775 | 1.168 | 9 | 14.70 | 3.985 | 5 | 17.92 | 6.666 | 5 | 22.15 | 10.37 |
| 10 | 9.960 | 1.244 | 10 | 14.77 | 4.025 | 17.0 | 18.18 | 6.790 | 42.0 | 22.20 | 10.42 |
| 1 | 10.01 | 1.312 | 1 | 14.83 | 4.085 | 5 | 18.32 | 6.890 | 5 | 22.26 | 10.47 |
| 2 | 10.30 | 1.387 | 2 | 14.88 | 4.105 | 18.0 | 18.43 | 7.010 | 43.0 | 22.32 | 10.51 |
| 3 | 10.47 | 1.468 | 3 | 14.92 | 4.160 | 5 | 18.57 | 7.110 | 5 | 22.36 | 10.57 |
| 4 | 10.67 | 1.527 | 4 | 14.97 | 4.206 | 19.0 | 18.68 | 7.220 | 44.0 | 22.40 | 10.60 |
| 5 | 10.76 | 1.598 | 5 | 15.05 | 4.255 | 5 | 18.80 | 7.340 | 5 | 22.47 | 10.66 |
| 6 | 10.90 | 1.670 | 6 | 15.10 | 4.285 | 20.0 | 18.92 | 7.475 | 45.0 | 22.51 | 10.69 |
| 7 | 11.04 | 1.733 | 7 | 15.15 | 4.320 | 5 | 19.07 | 7.610 | 5 | 22.54 | 10.77 |
| 8 | 11.18 | 1.807 | 8 | 15.20 | 4.360 | 21.0 | 19.13 | 7.660 | 46.0 | 22.60 | 10.81 |
| 9 | 11.31 | 1.868 | 9 | 15.25 | 4.400 | 5 | 19.22 | 7.700 | 5 | 22.67 | 10.87 |
| 10 | 11.43 | 1.938 | 10 | 15.30 | 4.440 | 22.0 | 19.33 | 7.795 | 47.0 | 22.70 | 10.88 |
| 1 | 11.56 | 2.000 | 1 | 15.36 | 4.480 | 5 | 19.42 | 7.895 | 5 | 22.77 | 10.93 |
| 2 | 11.68 | 2.070 | 2 | 15.40 | 4.510 | 23.0 | 19.52 | 7.980 | 48.0 | 22.77 | 10.97 |
| 3 | 11.80 | 2.130 | 3 | 15.44 | 4.550 | 5 | 19.67 | 8.055 | 5 | 22.83 | 11.02 |
| 4 | 11.88 | 2.200 | 4 | 15.50 | 4.600 | 24.0 | 19.73 | 8.140 | 49.0 | 22.90 | 11.06 |
| 5 | 12.02 | 2.266 | 5 | 15.54 | 4.640 | 5 | 19.83 | 8.213 | 5 | 22.93 | 11.10 |
| 6 | 12.13 | 2.318 | 6 | 15.60 | 4.660 | 25.0 | 19.91 | 8.300 | 50.0 | 22.96 | 11.14 |
| 7 | 12.23 | 2.391 | 7 | 15.67 | 4.700 | 5 | 20.00 | 8.380 | 55.0 | 23.38 | 11.55 |
| 8 | 12.33 | 2.421 | 8 | 15.70 | 4.740 | 26.0 | 20.10 | 8.460 | 60.0 | 23.36 | 11.83 |
| 9 | 12.41 | 2.490 | 9 | 15.74 | 4.780 | 5 | 20.17 | 8.540 | 65.0 | 24.11 | 12.23 |
| 10 | 12.53 | 2.551 | 10 | 15.79 | 4.800 | 27.0 | 20.24 | 8.630 | 70.0 | 24.44 | 12.55 |
| 1 | 12.63 | 2.607 | 1 | 15.87 | 4.880 | 5 | 20.39 | 8.680 | 75.0 | 24.74 | 12.84 |
| 2 | 12.72 | 2.667 | 2 | 15.95 | 4.950 | 28.0 | 20.40 | 8.760 | 80.0 | 25.02 | 12.97 |
| 3 | 12.83 | 2.725 | 3 | 16.05 | 5.010 | 5 | 20.49 | 8.845 | 85.0 | 25.12 | 13.37 |
| 4 | 12.91 | 2.778 | 4 | 16.13 | 5.090 | 29.0 | 20.55 | 8.920 | 90.0 | 25.53 | 13.62 |
| 5 | 13.00 | 2.837 | 11.0 | 16.22 | 5.150 | 5 | 20.63 | 8.970 | 95.0 | 25.77 | 13.81 |
| 6 | 13.08 | 2.893 | 2 | 16.31 | 5.220 | 30.0 | 20.70 | 9.040 | 100.0 | 25.99 | 14.07 |
| 7 | 13.17 | 2.932 | 7 | 16.38 | 5.290 | 5 | 20.78 | 9.095 | | | |
| 8 | 13.26 | 2.977 | 8 | 16.47 | 5.340 | 31.0 | 20.87 | 9.160 | | | |
| 9 | 13.33 | 3.050 | 9 | 16.53 | 5.410 | 5 | 20.94 | 9.250 | | | |

MINIMUM LOSS MATCHING PADS

$$Z_1 > Z_2$$

$$A = \sqrt{Z_1(Z_1 - Z_2)}$$

$$B = \frac{Z_1 Z_2}{A}$$

$$C = 0$$

$$\text{DB Loss} = 20 \log_{10} \frac{A+B}{B}$$

This is the table referred to on the preceding page on which appears the PAD LOSS TABLE. Commonly used values of input and output impedances are shown, and the price for each is the same for matching a low impedance to a higher impedance, or vice-versa. Note that these are actually "T" pads with the C series arm having a value of zero.

Many occasions arise when the minimum loss caused by a matching pad is too high. For instance it may be necessary to match a 150 ohm line to a 600 ohm line with the loss shown as 11.43 db. The solution to this problem is to use the Langevin Model T-602 () line to line matching transformers which reduce the loss to approximately 1 db.

ORDERING INFORMATION

Specify the Model number of the Minimum Loss Matching Pad, and designate the two impedance values required.

Model FNML-100 Minimum Loss Matching Pad. (Specify impedances in and out) Mounted in Case A, dimensions 1 7/32" wide by 2 1/2" high by 1 1/4" deep.

Price, Net Each \$5.00

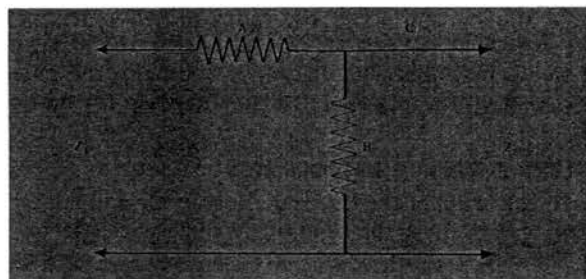
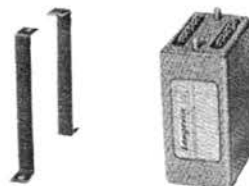

MINIMUM LOSS MATCHING PADS — LOSS IN DB

| FROM | TO | 30 | 50 | 125 | 150 | 200 | 250 | 500 | 600 |
|------|----|-------|-------|-------|-------|-------|-------|-------|-------|
| 30 | | 0 | 6.47 | 11.63 | 12.53 | 13.91 | 14.95 | 18.11 | 18.92 |
| 50 | | 6.47 | 0 | 8.97 | 9.96 | 11.44 | 12.54 | 15.79 | 16.63 |
| 125 | | 11.63 | 8.97 | 0 | 3.76 | 6.19 | 7.65 | 11.43 | 12.33 |
| 150 | | 12.53 | 8.96 | 3.76 | 0 | 4.74 | 6.47 | 10.52 | 11.43 |
| 200 | | 13.91 | 11.44 | 6.19 | 4.74 | 0 | 6.18 | 8.96 | 9.95 |
| 250 | | 14.95 | 12.54 | 7.65 | 6.47 | 4.18 | 0 | 7.65 | 8.73 |
| 500 | | 18.11 | 15.79 | 11.43 | 10.52 | 8.96 | 7.65 | 0 | 3.76 |
| 600 | | 18.92 | 16.63 | 12.33 | 11.43 | 9.95 | 8.73 | 3.76 | 0 |

FIXED LOSS PADS

If we were to consider an amplifier as a "package" of gain in a transmission circuit, it would follow that the fixed gain must be offset by a fixed loss in order to achieve the desired gain in db from the package, except in cases where the amplifier has exactly the gain required. These are required so that equipments in succeeding sections of the line can be safeguarded from over-load; this holds true particularly in the case of the input stage of a following amplifier. This explains briefly the use of fixed loss pads, and serves as an explanation of why only 600 ohm impedances are supplied unless otherwise specified on the user's order.

ORDERING INFORMATION

When ordering the Model FN-100 Fixed Loss Pads specify number of db attenuation required. These pads are available in any loss up to 60 db. Stock impedance is 600 ohms; specify impedances other than 600 ohms if desired.

Model FN-100-T Fixed Loss Pad, () db attenuation, "T" Circuit, size 1 7/32" wide by 2 1/2" high by 1 3/4" deep, Case Size A. Specify if for other than 600 ohm impedance.

Weight, net 1/4 lbs., 1/2 lbs. shpg. Price, Net Each \$5.00

Model FN-100-H Fixed Loss Pad, () db attenuation, same as above, but balanced "H" circuit.

Weight, net 1/4 lbs., 1/2 lbs. shpg. Price, Net Each \$8.00



$$Z_1 = Z_2$$

$$\left(\frac{K-1}{K+1}\right) Z = A$$

$$\left(\frac{K}{K^2-1}\right) Z = B$$

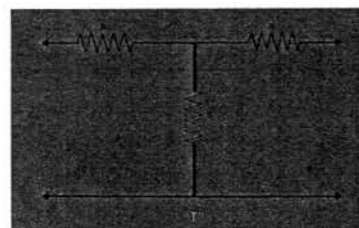

$$Z_1 = Z_2$$

$$(K-1) Z = A$$

$$\left(\frac{1}{K-1}\right) Z = B$$

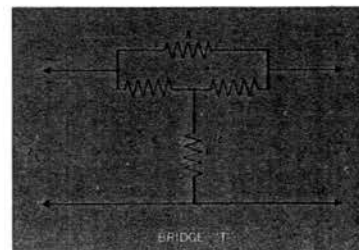

VU METER MULTIPLIERS

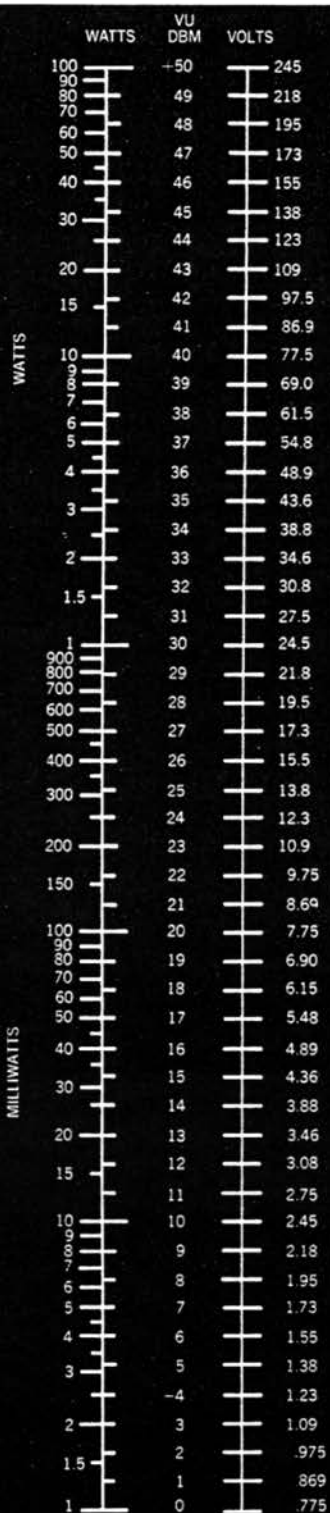

VOLTS MEASURED ON 600 Ω LINE.
FOR OTHER IMPEDANCES (Z):

$$E_r = V \sqrt{\frac{Z}{600}}$$

EXAMPLE: FOR 150 OHMS AT -4 VU

$$E = 1.23 \sqrt{\frac{150}{600}} = 615 \text{ VOLTS}$$

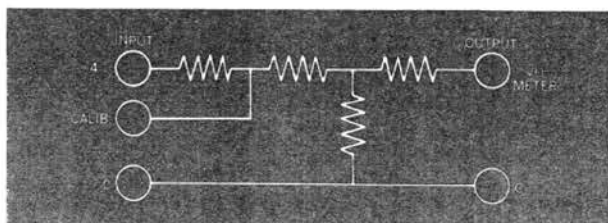

VU Meters use a total external series resistance of 3600 ohms to deliver a reading of "O" VU when a 1000 cps sine wave of 1.228 volts is applied. This represents 4 db above 1 milliwatt in a 600 ohm line, the standard level used in most transmission work. It is desirable at times to extend this range either by a variable rotary range extending network (covered in previous pages under Rotary Attenuators) or to extend the range with a Fixed Multiplier Pad. Noted in the listings below is a calibrating adjust pad in .1 db steps for fixed matching of meters and for use in meter circuits of measuring equipment such as Gain Sets.

ALL INPUTS ARE APPROPRIATELY TAPPED SO THAT VR-111 VARIABLE WIRE WOUND CALIBRATING RESISTOR MAY BE EMPLOYED IF DESIRED.

TAPPED "T" MULTIPLIERS

| MODEL | TAPS | CASE SIZE | PRICE NET |
|--------|--------------------|-----------|-----------|
| FTM-4 | 1 DB - .1 DB Steps | A | 8.00 |
| FTM-12 | 1, 2, 3, 10, 20 DB | A | 7.00 |

FOR METER BRIDGING

INDIVIDUAL MULTIPLIERS

"T" CIRCUIT

| MODEL | EXTENSION IN DB | | CASE SIZE | PRICE NET |
|---------|-----------------|------------|-----------|-----------|
| | AT 600 OHMS | AT 16 OHMS | | |
| FNVU-4 | +4 | +20 | A | 6.00 |
| FNVU-6 | +6 | +22 | | |
| FNVU-8 | +8 | +24 | | |
| FNVU-10 | +10 | +26 | | |
| FNVU-12 | +12 | +28 | | |
| FNVU-14 | +14 | +30 | | |
| FNVU-16 | +16 | +32 | | |
| FNVU-18 | +18 | +34 | | |
| FNVU-20 | +20 | +36 | | |
| FNVU-22 | +22 | +38 | | |
| FNVU-24 | +24 | +40 | | |
| FNVU-26 | +26 | +42 | | |
| FNVU-28 | +28 | +44 | | |
| FNVU-30 | 1 Watt | +46 | | |
| FNVU-40 | 10 Watts | +56 | C | 8.00 |
| FNVU-44 | 25 Watts | +60 | | 10.00 |
| FNVU-47 | 50 Watts | +60 | | 12.00 |
| FNVU-50 | 100 Watts | +50 | | 14.00 |

BRIDGING PADS

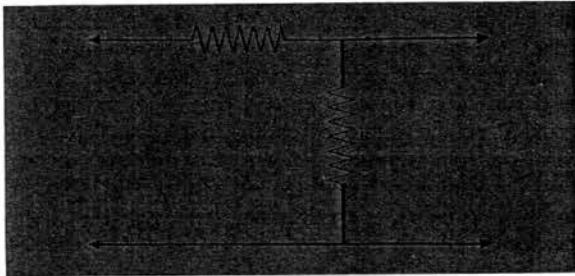
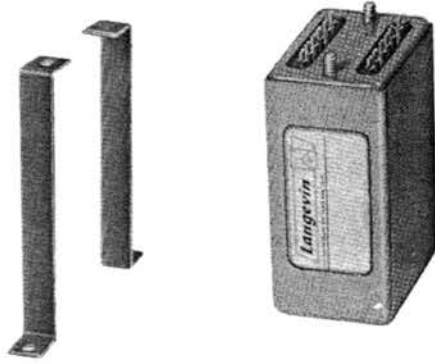

The figure illustrates the usual bridging pad. This pad is of the "L" configuration but may actually be treated on as a "T" pad with a series arm of zero ohms on the output. This pad is used to present a high impedance input to a 600 ohm line output, thus leaving the line virtually unaffected by the increased load. Typical employment would be between a high gain power amplifier and the bridging bus.

Balanced networks are also available, however infrequently they may be used. They are derived simply by halving the series arms and inserting them in both sides of the line and also by allowing the "B" or shunt arm to be center tapped for the common or ground connection. If a balanced network is desired, specify "Balanced" after the model number.

BRIDGING PADS

| MODEL | LOSS | IMPEDANCES | CASE SIZE | PRICE, NET |
|--------|-------|---------------------------|-----------|------------|
| FNB-20 | 20 DB | 3000 OHMS IN 600 OHMS OUT | A | 5.00 |
| FNB-30 | 30 DB | 9500 OHMS IN 600 OHMS OUT | | 5.00 |
| FNB-40 | 40 DB | 9500 OHMS IN 600 OHMS OUT | | 5.00 |

HOW TO ORDER SPECIAL NETWORKS

To order networks other than those listed on these pages, specify the following data:

CIRCUIT _____

INPUTS AND OUTPUTS _____

IMPEDANCES _____

LOSS _____

SIZE _____

1. "T" CIRCUIT OR BALANCED "H"

Hold in mind that twice as many components are required for the balanced "H" and that this calls for *double* the space of "T" configurations.

2. NUMBER OF INPUT CIRCUITS AND OUTPUT CIRCUITS

Each input and output circuit has separate ground to preserve balance and to prevent crosstalk.

3. IMPEDANCE OF INPUT AND OUTPUT CIRCUITS

It is possible to order different impedances on various inputs and outputs in the same network.

4. SPECIFY LOSS OR LOSSES DESIRED

It is possible to order various losses on different inputs, provided that they are above the minimum losses required by the circuit ratios concerned. Refer to MINIMUM LOSS TABLE.

5. SIZE OF CONTAINER

Size of container depends on the number of resistive elements necessary and space for the terminals. Refer to drawings on page 62.

PRICES

Any T Pad, Case "A"
Weight, net. ¼ lb., ½ lb. shpg. . . . Price, Net Each \$6.00
Each added "T" element Price, Net Each \$2.00

Any H Pad, Case "A"
Weight, net. ¼ lb., ½ lb. shpg. . . . Price, Net Each \$8.00
Each added "H" element Price, Net Each \$2.00

Any Branching or Combining "T" Network,
2 in and 1 out, or 1 in 2 out Price, Net Each \$6.00

Each additional input or output for above
Price, Net Each \$1.00

Any Branching or Combining "H" Network,
2 in 1 out, or 1 in 2 out
Weight, net. ¼ lb., ½ lb. shpg. . . . Price, Net Each \$8.00

Each additional input or output for above
Price, Net Each \$2.00

TRANSFORMERS

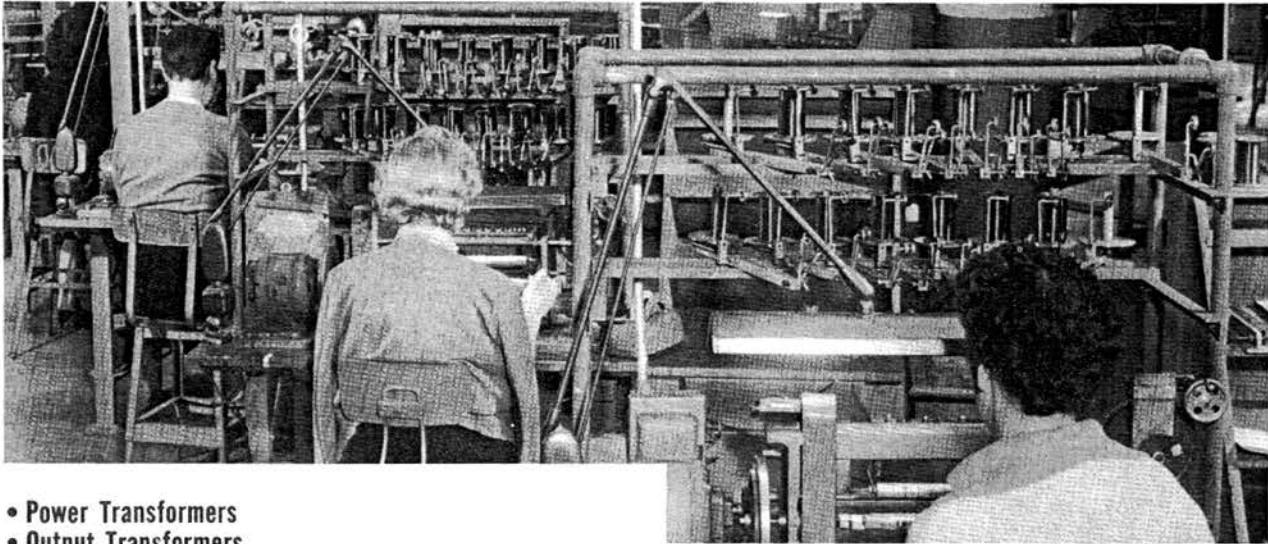

- Power Transformers
- Output Transformers
- Filter Reactors
- Input Transformers
- Line Isolation and Bridging Transformers
- Line to Voice-Coil Transformers

Langevin makes available all the transformers and reactors used in its own equipments, along with line-to-line transformers, bridging transformers and line-to-voice coil units. Thus, a complete service is offered to its customers who desire to construct specialized amplifiers or to match existing Langevin components to other equipment.

(In Inches)

| TYPE | A | B | C | D | E |
|----------------------------------|--------------------------------|--------------------------------|--------------------------------|--------------------------------|--------------------------------|
| 0A | 1 ⁵ / ₄ | 1 ¹ / ₄ | 3 | Single Stud Mounting | 1 ¹ / ₁₆ |
| 1-A | 2 ⁷ / ₁₆ | 2 | 2 ⁷ / ₈ | 3 ⁵ / ₈ | 1 ³ / ₁₆ |
| 2-A | 2 ³ / ₄ | 2 ³ / ₈ | 3 ³ / ₁₆ | 3 ¹ / ₄ | 1 ³ / ₁₆ |
| 3-A | 3 ³ / ₁₆ | 2 ⁵ / ₁₆ | 3 ⁵ / ₈ | 7 ¹ / ₈ | 1 ³ / ₁₆ |
| 4-A | 4 ¹ / ₂ | 3 | 3 ⁷ / ₈ | 1 | 1 ³ / ₄ |
| 5-A | 5 | 3 ³ / ₈ | 5 | 1 ¹ / ₁₆ | 2 |
| 5 ¹ / ₂ -A | 5 | 4 ¹ / ₂ | 5 | 1 ¹ / ₁₆ | 2 |
| 6A | 5 | 5 ¹ / ₈ | 5 | 2 ¹ / ₁₆ | 2 |

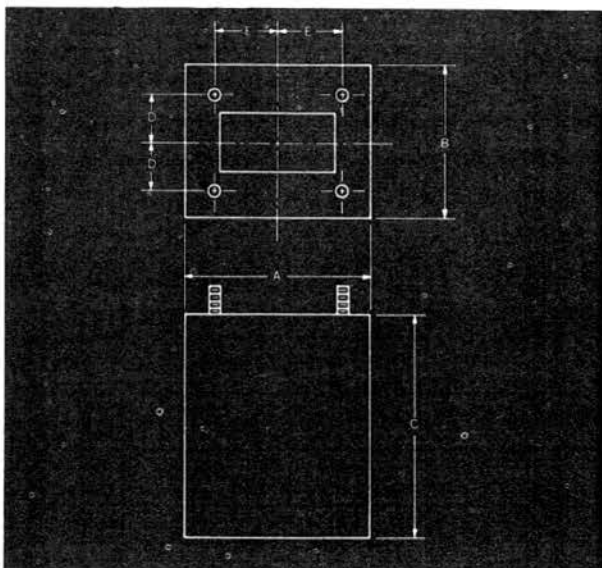

DESIGN PHILOSOPHY

Langevin exploits the latest techniques in fabrication and employs only high quality materials. Coupled with Langevin's philosophy of exceeding long component life, all structures are oversize to provide 300 and 400 percent overload capacity along with cool operation.

HIGH TEMPERATURE WIRE EMPLOYED

Langevin coils employ Alkanex wire. This wire has the ability to withstand operation at 180° centigrade in excess of 80,000 hours.

CORE MATERIAL

The proper core material is always selected to suit the job; while usual practice on a particular coil may be to stack 2 to 1, Langevin stacks 1 to 1 to guarantee best copper to core ratio for widest pass band. Closed cores are employed with minimum gaps to confine fields; hypersil loops are used to maintain copper to core ratios when performance dictates. All cores are properly grounded.

WINDINGS

Input coils employ multiple section interleaved windings to reduce leakage reactance and distributed capacitance. Semi-toroidal construction confines pick-up field for low hum and conserves space.

VARNISHES AND POTTING COMPOUNDS

Varnishes are specially selected for mechanical as well as dielectric strength. Potting compounds are applied with vacuum impregnation with generous use being made of latest epoxy types for secure seal and long life.

HUM-BUCKING CONSTRUCTION

Highly conductive outer cases, multiple permalloy and copper shield nests, semi-toroid design and hum-bucking coil configuration all serve to make Langevin coils ideal for use in quality transmission circuits.

DISTORTION PRODUCTS

Advanced design, good materials, care in manufacture and test give low distortion without the need for excessive and consequently unstable feed-back loops.

TRANSFORMERS

POWER TRANSFORMERS

| MODEL | PRIMARY VOLTAGE RANGE 50/60 CYCLES | PLATE WINDINGS | FILAMENT WINDINGS | CASE NO. OR SIZE* WIDTH X DEPTH X HEIGHT | WEIGHT | PRICE NET |
|-----------------------|------------------------------------|--|---------------------------------------|--|---|-----------|
| TF-100-B | 105-125 | 430-0-430, 300 MA | 5V-6A 6.3V CT-8A | SPECIAL 5A 5 $\frac{1}{8}$ HIGH | NET 16 lbs SHPG 18 lbs | \$35.00 |
| TF-101-E | 105-125 | 430-395-0-395-430 140 MA | 5V-3A 6.3V CT-5A | 5A | NET 11 $\frac{1}{2}$ lbs SHPG 13 lbs | \$38.00 |
| TF-102-A | 105-125 | 260-230-0-230-260 75 MA | 5V-3A 6.3V CT-8A | 4A | NET 5 $\frac{3}{4}$ lbs SHPG 6 $\frac{1}{2}$ lbs | \$27.50 |
| TF-105-B | 100-130 200-260 | 60-380-395-410-425 | NONE | 5 $\frac{1}{2}$ A | NET 12 lbs SHPG 15 lbs | \$40.00 |
| TF-106-B | 100-130 200-260 | NONE | 6.3V CT-8A | 4A | NET 5 $\frac{3}{4}$ lbs SHPG 6 $\frac{1}{2}$ lbs | \$29.00 |
| TF-107-C | 105-125 | 0-40-420-430-440-450 210 MA | NONE | 5A | NET 11 $\frac{1}{2}$ lbs SHPG 13 lbs | \$35.00 |
| TF-108-C | 110-125 | 350-0-350, 100 MA | 5V-2A 6.3V-2.3A | 3 $\frac{1}{8}$ x 3 $\frac{1}{8}$ x 3 | NET 4 lbs SHPG 5 lbs | \$15.00 |
| TF-111-B | 105-125 210-250 | NONE | 6.3-8A | 3A | NET 3 $\frac{1}{2}$ lbs SHPG 4 $\frac{1}{2}$ lbs | \$25.00 |
| TF-112-B | 105-125 | 440-400-0-400-440 110 MA | 5V-2A 6.3V-4.5A | 3 $\frac{1}{8}$ x 3 $\frac{1}{8}$ x 3 $\frac{1}{8}$ | NET 6 $\frac{1}{2}$ lbs SHPG 7 $\frac{3}{4}$ lbs | \$43.75 |
| TF-116-A | 105-125 | SECONDARY WINDING 50 (WITH 3 AGING TAPS) | | 3 $\frac{1}{2}$ x 3 $\frac{3}{4}$ x 4 | NET 4 $\frac{1}{2}$ lbs SHPG 5 $\frac{1}{2}$ lbs | \$30.00 |
| TF-117-A | 105-125 | | 7 $\frac{1}{2}$ x 5 x 7 $\frac{1}{2}$ | NET 16 lbs SHPG 18 lbs | \$48.50 | |
| TF-118-A | 105-125 210-250 | 350-315-0-315-350 235 MA | 5V-5A | 4 x 3 $\frac{1}{8}$ x 2 $\frac{7}{8}$ | NET 5 $\frac{1}{2}$ lbs SHPG 6 $\frac{1}{2}$ lbs | \$28.75 |
| TF-119-A | 105-125 | NONE | 6.3V-6.5A C.T. | 3 $\frac{1}{4}$ x 3 x 2 $\frac{7}{8}$ | NET 3 lbs SHPG 4 lbs | \$18.00 |
| TF-120-C (HUMBUCKING) | 105-125 | 425-375-0-375-425 125 MA | 5V-2A 6.3V-3A C.T. | 3 $\frac{5}{8}$ x 2 $\frac{1}{32}$ x 2 $\frac{1}{8}$ | NET 3 lbs SHPG 4 lbs | \$36.00 |
| TF-120-B | 105-125 | 425-375-0-375-425 125 MA | 5V-2A 6.3V-3A C.T. | 3 $\frac{5}{8}$ x 2 $\frac{1}{32}$ x 2 $\frac{1}{8}$ | NET 3 lbs SHPG 4 lbs | \$30.00 |



TF-100-B



TF-101-E
TF-107-C



TF-102-A
TF-106-B



TF-105-B



TF-108-C



TF-111-B



TF-116-A
TF-902-A



TF-112-B



TF-117-A



TF-118-A



TF-119-A



TF-120-B
TF-120-C



TF-901-A

SATURABLE REACTORS

| MODEL | DC CONTROL WINDING | AC WINDING | INSULATION TEST | CASE | WEIGHT | PRICE NET |
|----------|--------------------|------------|-----------------|---------------------------------------|---|-----------|
| TF-901-A | 10A | 500VA | 1250 | 5 $\frac{1}{2}$ x 5 x 7 $\frac{1}{2}$ | NET 20 lbs SHPG 23 $\frac{1}{2}$ lbs | \$72.50 |
| TF-902-A | 3A | 175VA | 1000 | 3 $\frac{1}{4}$ x 2 $\frac{1}{8}$ x 5 | NET 6 lbs SHPG 7 $\frac{1}{2}$ lbs | \$32.50 |

TRANSFORMERS

OUTPUT TRANSFORMERS

| MODEL | PRIMARY IMPEDANCE | SECONDARY IMPEDANCE | OPERATING LEVEL | CASE NO. OR SIZE WIDTH X DEPTH X HEIGHT | WEIGHT | PRICE NET |
|---------------------------------------|------------------------------------|---|-----------------|--|---------------------------------|-----------|
| TF-129-A | 20,000 OHMS | 600/250 | +26 DBM | 1 1/4 x 1 1/4 x 2 | NET 3/4 lb SHPG 1 1/4 lbs | \$23.75 |
| TF-308-A | 4000 OHMS | 600/150 | 1 WATT | 3 A (Electro-Magnetic Shielding) | NET 3 1/2 lbs SHPG 4 1/2 lbs | \$23.00 |
| TF-311-C (HUMBUCKING CONSTRUCTION) | 10,000 OHMS Plate to Plate C.T. | 600/150 Tertiary Feedback Winding | 10 WATTS | 3 A (Electro-Magnetic Shielding) | NET 3 1/2 lbs SHPG 4 1/2 lbs | \$36.25 |
| TF-313-A | 16,000 OHMS | 600/150 Tertiary Feedback Winding | +20 DBM | 2 1/8 x 1 3/4 x 3 1/4 (Electro-Magnetic Shielding) | NET 1 lb SHPG 1 1/2 lbs | \$23.75 |
| TF-314-A | 16,000 OHMS | 600/150 | +16 DBM | 3 A (Electro-Magnetic Shielding) | NET 3 1/2 lbs SHPG 4 1/2 lbs | \$22.00 |
| TF-316-A | 3700 OHMS Plate to Plate C.T. | 600/150/32/16/8/2 Tertiary Feedback Winding | 50 WATTS | 6 x 4 1/2 x 5 1/8 | NET 19 lbs SHPG 22 lbs | \$61.00 |
| TF-317-A | 6800 OHMS Plate to Plate C.T. | 600/150/32/16/8/2 Tertiary Feedback Winding | 20 WATTS | 4 A | NET 5 3/4 lbs SHPG 6 1/2 lbs | \$37.50 |
| TF-320-C | 10,000 OHMS Plate to Plate C.T. | 600/6.4/3.2 Tertiary Feedback Winding | 10 WATTS | 3 x 2 1/2 x 2 1/8 | NET 3 1/2 lbs SHPG 4 1/2 lbs | \$21.00 |
| TF-321-B | 16,000 OHMS | 150/150 Tertiary Feedback Winding | +18 DBM | 2 x 1 3/8 x 1 1/8 | NET 1 lb SHPG 1 1/2 lbs | \$22.50 |
| TF-322-B | 10,000 OHMS Plate to Plate C.T. | 600/150 Tertiary Feedback Winding | +40 DBM | 2 1/2 x 2 1/8 x 2 3/8 | NET 2 1/2 lbs SHPG 3 lbs | \$23.00 |

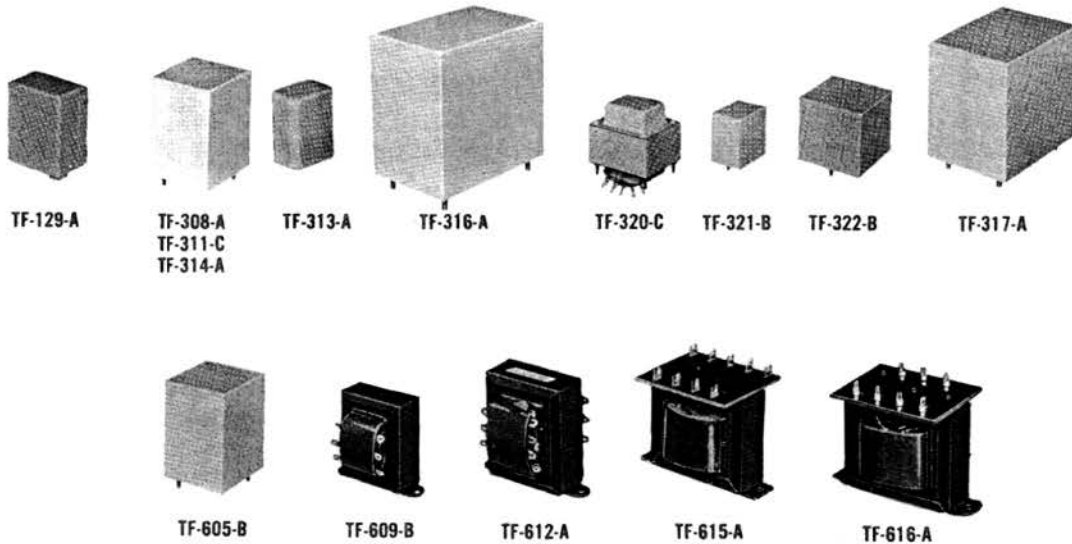

LINE TO VOICE COIL TRANSFORMERS

| MODEL | PRIMARY IMPEDANCE (OHMS) | SECONDARY IMPEDANCE (OHMS) | INSERTION LOSS AT 1000 CYCLES | FREQUENCY RESPONSE | MAXIMUM OPERATING LEVEL | CASE NO. OR SIZE HEIGHT-MTG CTRS. | WEIGHT | PRICE NET |
|----------|--|----------------------------|-------------------------------|----------------------------------|-------------------------|-----------------------------------|---------------------------------|-----------|
| TF-605-B | 250/500/750/1000 | 16 | .65 db | ± 1 db from 50 to 15,000 cycles | 20 WATTS | 3 A | NET 3 1/2 lbs SHPG 4 1/2 lbs | \$15.00 |
| TF-609-B | 500/1000/1500/2000/3000/3500/4000/6000/8000 | 3.2/6.5 | .7 db | ± 1 db from 50 to 10,000 cycles | 5 WATTS | Channel Construction 2 3/4 2 1/8 | NET 1 1/4 lbs SHPG 2 1/4 lbs | \$10.50 |
| TF-612-A | 1000 to 128,000 (5 watts to 10 milliwatts in 3 db steps) | 3.2/6.5 | .5 db | ± 1 db from 50 to 10,000 cycles | 5 WATTS | Channel Construction 3 1/8 3 1/8 | NET 2 1/2 lbs SHPG 3 1/2 lbs | \$9.00 |
| TF-615-A | 1000/1500/2000/2500/3000/4000/750/500 | 6-8 | .7 db | ± 1 db from 50 to 10,000 cycles | 10 WATTS | Channel Construction 3 1/8 3 1/8 | NET 2 1/4 lbs SHPG 3 1/2 lbs | \$13.75 |
| TF-616-A | 37.5/150/600 | 6.5/13 | .5 db | ± .5 db from 50 to 15,000 cycles | 10 WATTS | Channel Construction 2 3/4 3 1/8 | NET 2 1/4 lbs SHPG 3 lbs | \$12.50 |

TRANSFORMERS

INPUT TRANSFORMERS

| MODEL | SOURCE IMPEDANCE (OHMS) | SECONDARY IMPEDANCE (OHMS) | MAXIMUM OPERATING LEVEL (DBM) | REMARKS | CASE NO. OR SIZE WIDTH x DEPTH x HEIGHT | WEIGHT | PRICE NET |
|----------|---------------------------|---------------------------------------|-------------------------------|--|---|--------------------------------|-----------|
| TF-132-B | 600 | 60,000 to Push-Pull Grids | 0 | Electromagnetic Shield | 1 1/4 x 1 x 1 1/2 | Net 1/4 lb. Shpg 1/2 lb. | \$23.75 |
| | | | | | CASE NO. OR SIZE DIAMETER—HEIGHT | | |
| TF-400-D | 600 and bridging (15,000) | 60,000 to Single Grid | +10 | Electromagnetic Shield | 1 3/8 1 3/8 | Net 1/2 lb. Shpg 3/4 lb. | \$13.00 |
| TF-401-B | 30/250/600 | 30,000 Single or Push-Pull Grids C.T. | +10 | Electromagnetic Shield | 1 3/8 1 3/8 | Net 1/2 lb. Shpg 3/4 lb. | \$12.00 |
| TF-402-B | 30/120 nominal | 50,000 to Single Grid | +10 | Electromagnetic Shield working range of 120 ohm tap, 60 to 250 ohms | 1 3/8 1 3/8 | Net 1/2 lb. Shpg 3/4 lb. | \$13.25 |
| TF-408-A | 600/150 C.T. 37.5/340 | 65,000 Single or Push-Pull Grids C.T. | +10 | Magnetic Shield, also Electrostatic Shield brought out for external connection | 1 3/8 1 3/8 | Net 1/2 lb. Shpg 3/4 lb. | \$17.75 |
| TF-408-B | 600/150 C.T. 37.5/340 | 65,000 Single or Push-Pull Grids C.T. | +10 | Triple Magnetic Shielding, also Electrostatic Shield brought out for external connection | 0A | Net 1 lb. Shpg 1 1/2 lbs. | \$28.00 |
| TF-408-D | 600/340 150/37.5 | 65,000 to Single Grid | +10 | Electromagnetic Shield, also Electrostatic Shield brought out for external connection | 1 1/2 2 1/8 | Net 1/2 lb. Shpg 3/4 lb. | \$18.50 |
| TF-412-B | 150/600 5000/20,000 | 60,000 to Single Grid | +10 | Magnetic Shield | 1 3/8 1 3/8 | Net 1/2 lb. Shpg 3/4 lb. | \$15.00 |
| TF-413-A | 150/600 C.T. 340/37.5 | 50,000 to Single Grid | +10 | Electromagnetic Shield, also Electrostatic Shield brought out for external connection | 1 1/2 2 1/8 | Net 1/4 lb. Shpg 1 1/4 lbs. | \$23.50 |



TF-132-B



TF-400-D
TF-401-B
TF-402-B
TF-408-A
TF-412-B



TF-408-B



TF-408-D



TF-413-A

TRANSFORMERS USED IN LANGEVIN AMPLIFIERS AND POWERS SUPPLIES

| AMPLIFIERS-AM- | OUTPUT | POWER | INPUT | CHOKE |
|--------------------------|----------|----------|----------|----------|
| 101-D | TF-316-A | TF-100-B | TF-400-D | TF-200-B |
| 102 BASIC | TF-308-A | | | TF-201-A |
| 116-B | TF-313-A | | TF-408-B | |
| 117-A | TF-311-C | | TF-408-A | |
| 128-X BASIC | TF-317-A | TF-101-E | | |
| 138S BASIC | TF-320-C | TF-108-C | | |
| 5116 | TF-321-B | | TF-413-A | |
| 5116-B | TF-129-A | | TF-132-B | |
| 5117 | TF-322-B | | TF-408-D | |
| 5301 | TF-322-B | | TF-132-B | |
| INPUT PANELS-INP- | | | | |
| A | | | TF-400-D | |
| B | | | TF-402-B | |
| G | | | TF-408-A | |
| M | | | TF-412-B | |
| Q | | | TF-408-A | |
| R | | | TF-408-A | |

| POWER SUPPLIES-PS- | POWER | CHOKE | FILAMENT | SAT. REACT. |
|--------------------|--|--------------------------|--------------|-------------|
| 201-B | TF-102-A | TF-201-A TF-204-A | | |
| 205-B | TF-105-B | TF-211-A (2) TF-212-A | TF-106-B (2) | |
| 206-B | TF-107-C | TF-215-A | TF-111-B | |
| 208-A | TF-112-B | TF-216-A | | |
| 210-A | TF-105-B | TF-211-A (2) | TF-106-B (2) | |
| 211-B | TF-116-A | TF-218-A | | TF-902-A |
| 212-B | TF-117-A | TF-217-A | | TF-901-A |
| 5206 | TF-118-A | TF-219-A (2) | TF-119-A | |
| 5208-A | TF-120-B OR TF-120-C (Humbucking) | TF-220-A | | |

TRANSFORMERS

FILTER REACTORS

| MODEL | INDUCTANCE | D.C. RATING FOR STATED INDUCTANCE | D.C. RESISTANCE | INSULATION TEST VOLTAGE | CASE NO. OR SIZE WIDTH X DEPTH X HEIGHT | WEIGHT NET | PRICE NET |
|--------------------------|----------------|-----------------------------------|----------------------|-------------------------|---|----------------------------|-----------|
| TF-200-B | 6 HY | 280 MA | 100 OHMS | 1500 | 4 A | NET 5½ lbs SHPG 7 lbs | \$15.00 |
| TF-201-A | 30 HY | 30 MA | 800 OHMS | 1000 | 1 A | NET 1¾ lbs SHPG 2¾ lbs | \$16.25 |
| TF-202-A | 5½ HY | 140 MA | 200 OHMS | 1000 | 2½ x 2¾ x 2 | NET 2 lbs SHPG 2¾ lbs | \$12.00 |
| TF-204-A | 12 HY | 80 MA | 250 OHMS | 1500 | 2 A | NET 2¾ lbs SHPG 4½ lbs | \$16.00 |
| TF-205-A | 10 HY | 140 MA | 200 OHMS | 1500 | 3 A | NET 3½ lbs SHPG 4½ lbs | \$9.25 |
| TF-211-A | 1¾ HY | 425 MA | 27 OHMS | 1500 | 4 A | NET 5¾ lbs SHPG 6½ lbs | \$11.50 |
| TF-212-A | 18 HY | 150 MA | 230 OHMS | 1250 | 4 A | NET 5¾ lbs SHPG 6½ lbs | \$16.75 |
| TF-213-A | 4½ HY | 210 MA | 100 OHMS | 1500 | 3 A | NET 3½ lbs SHPG 4½ lbs | \$10.00 |
| TF-215-A (DUAL CHOKE) | 4 HY 4 HY | 210 MA 210 MA | 70 OHMS 70 OHMS | 1500 1500 | SPECIAL 3 A 5 | NET 5½ lbs SHPG 5¾ lbs | \$22.50 |
| TF-216-A (DUAL CHOKE) | 12 HY 12 HY | .124 A .124 A | 182 OHMS 182 OHMS | 1000 1000 | 2½ x 2¾ x 5 | NET 6 lbs SHPG 7 lbs | \$39.50 |
| TF-217-A | .043 HY | 2.A | .017 OHMS | 1250 | 5½ x 5 x 7½ | NET 23 lbs SHPG 26 lbs | \$51.25 |
| TF-218-A | .060 HY | 2.A | .50 OHMS | 1000 | 3¼ x 3¾ x 4 | NET 5½ lbs SHPG 6½ lbs. | \$20.00 |
| TF-219-A | 4 HY | .235 ADC | 100 OHMS | 1500 | 3¼ x 3 x 2¾ | NET 3½ lbs SHPG 4½ lbs | \$12.00 |
| TF-220-A (DUAL CHOKE) | 5 HY 5 HY | .125 ADC .125 ADC | 180 OHMS 180 OHMS | 1000 1000 | 4½ x 1¼ x 2¾ | NET 2 lbs SHPG 2½ lbs | \$16.25 |



TF-200-B
TF-211-A
TF-212-A

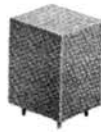

TF-201-A



TF-202-A



TF-204-A



TF-205-A
TF-213-A



TF-215-A



TF-216-A



TF-602-A
TF-602-C
TF-606-A
TF-607-A



TF-217-A



TF-218-A



TF-219-A



TF-220-A

LINE ISOLATION AND BRIDGING TRANSFORMERS

| MODEL | PRIMARY IMPEDANCE (OHMS) | SECONDARY IMPEDANCE (OHMS) | INSERTION LOSS AT 1000 CYCLES | FREQUENCY RESPONSE | MAXIMUM OPERATING LEVEL | CASE SIZE | WEIGHT | PRICE NET |
|---|---|----------------------------|-------------------------------|---------------------------------|------------------------------|-----------|---------------------------|-----------|
| TF-602-A (Balanced Line and Isolation) | 150/600 (Hum-Bucking Construction) | 150/600 | .5 db | ±1 db from 30 to 20,000 cycles | +18-DBM | 2 A | NET 2¾ lbs SHPG 3½ lbs | \$23.75 |
| TF-602-C (Balanced Line and Isolation) | 150/600 C.T. (Hum-Bucking Construction) | 150/600 C.T. | 1.6 db | ±.5 db from 20 to 20,000 cycles | +18 DBM | 2 A | NET 2¾ lbs SHPG 3½ lbs | \$25.50 |
| TF-606-A (BRIDGING) | 48,000/12,000 (Hum-Bucking Construction—One Magnetic Shield) | 600/150 | Bridging loss: 24 db | ±.5 db from 30 to 20,000 cycles | Bridge 600 OHM Line + 40 DBM | 2 A | NET 2¾ lbs SHPG 3½ lbs | \$27.50 |
| TF-607-A (BRIDGING) | 20,000/5,000 | 600/150 C.T. | Bridging loss: 18 db | ±.3 db from 50 to 15,000 cycles | Bridge 600 OHM Line + 39 DBM | 2 A | NET 2¾ lbs SHPG 3½ lbs | \$36.25 |

FREE TECHNICAL SERVICE

As a service to users of Langevin equipment, free recommendations on components, layout and transmission techniques are offered.

In this regard Langevin will make preliminary suggestions in the form of block schematics to satisfy customer performance requirements listing appropriate Langevin components along with approximate costs of the total system. Since only general layout sketches and suggestions are offered by Langevin, the execution of actual construction drawings is left to the customer. Recommended cabling and grounding practices are shown on pages 12 and 14.

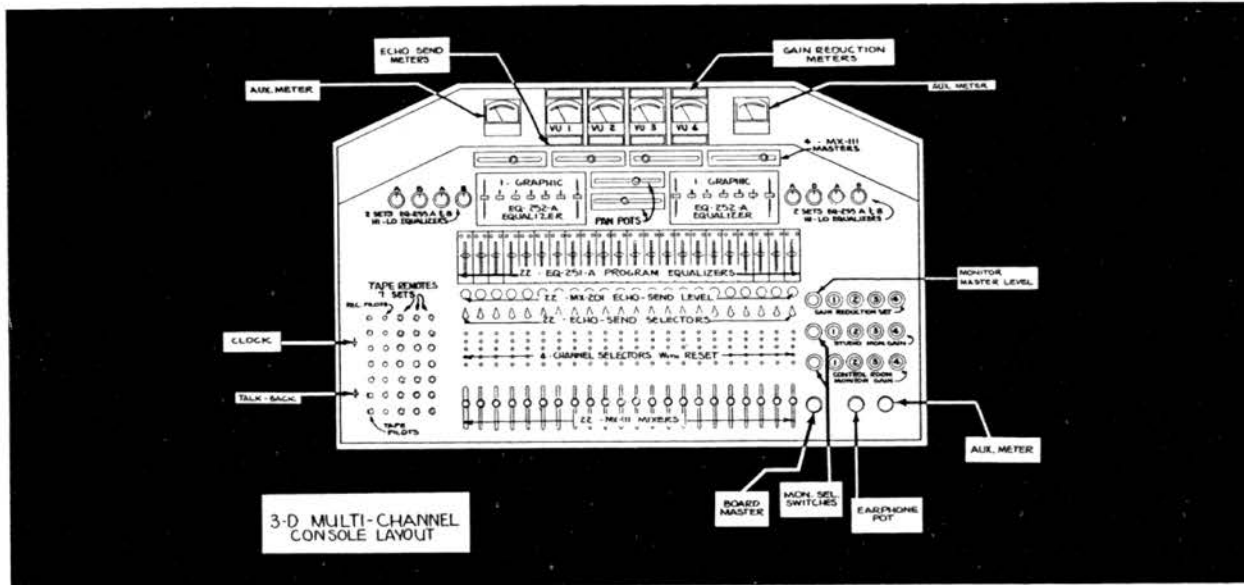

Shown in the layout sketch pictured here are some of the considerations invoked by Langevin's technical assistance. This is a 4 channel recording console exhibiting complete facility, and combines most of the compatible features exploited by console designers during the last 2 years. The use of 4 tracks over the usual 3 permits, for instance, separate track for a soloist so that the performer can repeat or refine his performance.

Starting at the front of the control panel, 22 MX-111 slide wire mixers are shown requiring horizontal space of only 33 inches, all within easy reach of the operator. The shallow depth of Langevin mixers eliminates interference with the recordists knees at the lowest part of the control panel slope.

Any microphone is instantly switchable to any channel through the 4 color coded channel selector pushbuttons. Each pushbutton has 2 circuits, so that the individual echo for the particular microphone is switched with it. The 5th pushbutton is used for reset, disengaging the microphone circuit from the system. Appearing directly above the pushbuttons are the echo selector switches which connect the Echo-Send line ahead of the MX-111 mixer control, or after the mixer control. In the "ahead" position the echo is not affected by the mixer control; in the "after" position, echo fades with the signal as the mixer is closed. The center position of the switch is "off". Intensity of the echo in proportion to the original signal is controlled by the small, 1-1/2 inch diameter 20 step MX-201 ladder controls. The MX-201 diameter is actually slightly less than 1-1/2 inches, but careful panel drilling is necessary to permit easy mounting and alignment; adjacent units can touch.

On pages 41 through 43 the importance of individual spectral control over each microphone channel is treated on. For this reason an EQ-251-A Program Equalizer is shown in each microphone circuit. As an added facility in rerecording to the composite 2 track product for eventual processing to tape or

disc, 2 model EQ-252-A Graphic Equalizers give precise control over the entire spectrum at the 7 subjectively significant frequency bands. 4 sets of variable high and low pass effects filters, models EQ-255-A and B, are indicated at upper right and left, normalled into 4 channels. Inasmuch as all components appear on the jack field (not shown) for routine test, these units can be patched into any channel desired as well as cascaded for violent effects in a single channel.

Situated between the 2 Graphic Equalizers are 2 1:3 channel Pan Pots. These are normalled into 2 microphone channels. Pan Pots provide the ability to shift the apparent source smoothly from one position to left, center or right as desired during the recording.

Four masters (actually board submasters) appear on the control panel nearest the dashboard. These are mounted horizontally to conserve control panel depth and to allow easy reach. An overall rotary board master control is located at lower right.

Standard Model VU-862-X illuminated VU meters form the nucleus of the meter cluster; 4 Simpson VU meters of the horizontal type indicate Gain Reduction, and 4 additional of the same read Echo-Send level in each channel. 2 auxiliary VU meters operate from a dual switch on the lower right. These may be connected to monitor amplifier outputs while monitor amplifier gains are balanced prior to each session. They may be used for balancing studio speaker levels, and for easy monitoring of 2 channel rerecording to disc or tape.

CONCLUSION

The console control panel shown is probably the most elaborate in use today, and has been chosen as an example in this section to indicate the numerous facilities which can be placed within the reach of a single operator. Without Langevin's modern, miniaturized components designed specifically for stereo, fewer controls become necessary.

Warranty

LANGEVIN AUDIO EQUIPMENT IS GUARANTEED AGAINST DEFECTS IN MATERIAL AND WORKMANSHIP.

GENERAL — Langevin feels that its products have built into them years of trouble-free service, day in, day out, on continuous duty cycle.

To maintain this philosophy of long and satisfactory product life it is the policy of Langevin to consider free repairs under normal usage and conditions of operation as a factory obligation.

It must be recognized that a liberal policy of this nature in the ordinary course is difficult to administer; unknown conditions of use, poor ventilation, excessive line voltages, shorted tubes, and many other causes make it impossible in many cases to lay the reason for failure on the user or on the factory.

But Langevin has chosen arbitrarily to be liberal, for statistically its products have proved a remarkably low failure rate in the field. Accordingly, the question of failure caused by abuse and charges therefor are evaluated by our repair department on the basis of whether value in years of service has been given the user. Tubes, however, are subject to the usual EIA Warranty by the tube manufacturer.

Satisfactory operation over long periods of time with trouble-free performance has been Langevin's greatest asset in constantly accelerating growth.

Langevin distributors, field representatives and factory staff have been enjoined, therefore, **always to give the user the benefit of the doubt.**

LANGEVIN



HOWARD SOUTHER
Executive Vice President
and Sales Manager

RETURNED MERCHANDISE

Units for repair should be returned freight prepaid to the factory with a note wired or taped directly on the equipment giving the customer's name, address, return shipping instructions and an explanation of the difficulty. Charges for repair, if any, are nominal.

BANK OF LANGEVIN STOCK AMPLIFIERS installed by MUZAK CORPORATION in the building of MUTUAL LIFE INSURANCE COMPANY OF NEW YORK
55th Street and Broadway, New York City

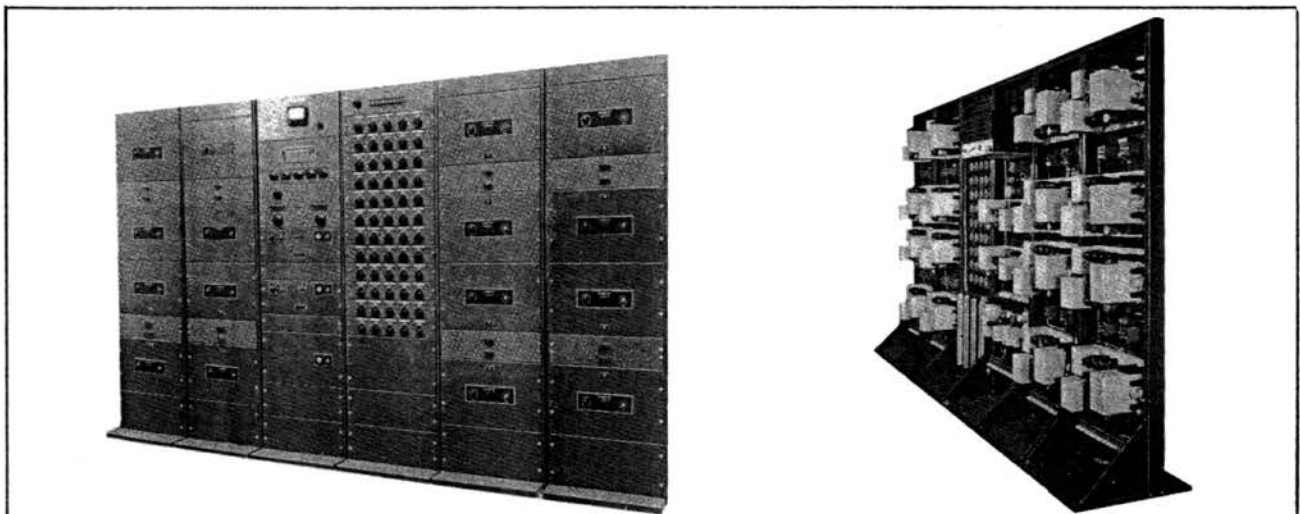

The Recording Engineer as an Artist—Equalizing for Spectral Character



The Recording Engineer is Vitaly Concerned With 5 Things

- 1. Musical Range**—The equipment with which the recording engineer works is capable of reproducing almost the entire world of sound—a range of nearly 10 octaves, embracing vibrations from 20 to over 16,000 cycles or beats per second. But certain restrictions are imposed on the recordist in accomplishing this totality, both physical and practical ones. These restrictions can be overcome to a high degree by *equalization*.
- 2. Rhythm**—The framework of the musical performance is *rhythm*. While control of rhythm would seem to lie solely in the domain of the performers, the engineer is charged with the interpretation of rhythm by controlling bass and mid-bass balance to the rest of the sound. This is accomplished by choosing and placing the microphones, regulating their intensity, and influencing their spectral sensitivity through *equalizers*.
- 3. Variety**—The brain, through the ear, delights in variety. It follows that the widest range accompanied by best spectral balance, delivers the most auditory pleasure. Through good judgment, and careful regulation of the microphones by means of their volume and equalization controls, the recording engineer insures maximum listener enjoyment.
- 4. Dynamics**—The transition in music from a soft passage to a louder one is calculated by most composers to achieve a physiological effect. While the ear perceives a dynamic range of one in a trillion (120 db), the recording engineer must limit this to one in a million (60 db) for this is the maximum capability of present day equipment. To accomplish this compression unnoticeably requires skill at the volume controls with the help of equalizers; the spectral sensitivity of the ear changes when the volume level is varied from that of the original performance.
- 5. Spectral Control**—This is a descriptive name for the term "equalization." It implies the option to raise or lower the intensity of critical sections of the musical range. Further, it connotes a subjective appreciation of the physiological effects achieved through these means to compensate for the limits of the recording and reproducing equipment. Here, more than in any other function of the recording engineer, lies the highest, most sustained expression of the recordists art.

The Critical Portions of the Audible Spectrum Requiring Spectral Control

VERY LOW BASS— POWER RANGE—16-64 cps 1st and 2nd Octaves

In this region, from 16 to 64 cycles per second, we find the threshold of feeling, where the lowest sounds, like wind and room effects—the sound of distant thunder—are felt, rather than heard. In the upper half of the first octave, just below 32 cps, J. C. Stienberg¹ shows that the fundamentals of the piano, organ and harp, reach well into this range; he shows also that the memory of the ear for these lowest sounds is long—they need occur but seldom in a three or four minute passage to achieve feeling of power and fullness, to balance aesthetically what would otherwise be a preponderance of higher tones.

But Fletcher has charted the sensitivity of the ear for various parts of the spectrum at lower than the levels of real existence. His compensation requirement for equal loudness in this range at lower recorded and reproduced levels shows requirements for tremendous boosts, on the order of 10, 20 and 30 db, or anywhere from 10 to 1,000 times.

Precise control of this range is required to subdue stage rumble and outside traffic noise, an acute problem in New York Studios. Overemphasis through microphone placement, especially those ribbon microphones which are velocity sensitive, can muddy the sound. The option to attenuate this range is as important as the ability to boost it.

BASS—RHYTHM AND MUSICAL FOUNDATION 3rd and 4th Octaves—64-256 cps

Most of the low, grave tones of the drum and piano are generated in this range; here we find the fundamentals of the rhythm section of the dance orchestra, as well as the foundation of all musical structure.

It was Leopold Stowkowski who said "If I had a thousand bass viols I could use them all!"—This is not as extreme as it may sound. For instance, such string instruments, while reinforced by sounding boards, generally play single tones, weak in level and possess little dynamic range. In a large, comprehensive orchestra, as many as eight bass viols may be used. A total of 1,000 bass viols in this case would give only an additional 21 db of level, a not inordinate amount if a glance be given to the equal loudness contours for the ear on the previous page. Profound attention should be given to equalization or attenuation in this range, for the musical balance of the entire program can be controlled at 100 cps.

Most pressure microphones are subject to "proximity effect," or non-linear bass increase at low frequencies in close talking positions. The use of attenuation for dialogue restores normal perspective and quality.

MID-RANGE—256 to 2048 cps 5th, 6th and 7th Octaves—"Telephone-Like" Quality

The ear is reasonably sensitive in this range, and almost all

recording and reproducing equipment manages this mid-range with facility.

If the 6th octave is made louder with respect to other octaves, the music has a horn-like character. If the 1000-2000 cps range is emphasized a "tinny" effect is achieved.

The fundamental tones in most music lie equally above and below middle C, from 128 to 512 cps. As most instruments are rich in the first overtones, the majority of the sound energy is found up to the 2,500 cps range. Music editors, and others engaged in listening to music over long periods find that "listening fatigue" can be reduced by attenuating the 5th, 6th and 7th octaves by about 5 db from the normal level.

LISPING QUALITY— Between the 7th and 8th Octaves—3 kcps

The 3 kc range delivers a generous stimulus to the ear. At very loud levels the region of greatest ear sensitivity shifts downward from 5 kc, and accounts partly for the high sensitivity of most public address loudspeakers in the 3 kc band. Characteristic of low-level signals peaked at 3 kc is a "lisp" quality, and the total inability to distinguish labial sounds such as m, b and v.

In wide-range lower level systems, a peak in the region of 3 kc has a masking effect on important recognition sounds, and on others which lie above 4 kc. Brilliance and clarity are lost, and without attenuation an unconscious strain with increasing fatigue is felt according to the height of the 3 kc rise.

PRESENCE RANGE— Between the 8th and 9th Octaves— 4750 to 5 kcps

The usual band which affects clarity in a man's speech is 3,000-6,000 cps. In a woman's voice the fundamentals are roughly an octave higher than a man's, and her range of consonant clarity is achieved between 5,000 and 8,000 cps, a region the higher end of which approaches an insensitive range of the ear.² In addition, the total range of a woman's voice is about one-half that of a man's, stimulating fewer hearing nerves, and is consequently still weaker upon reception for this reason.

Wide range sounds, especially those of singing voices, have fundamentals with harmonics in the 5 kc region of good ear sensitivity. Voices, powerful or rich with harmonics at 5 kc sound especially pleasing, clear and full. Male opera singers are particularly favored with 5 kc sounds, women less so, although there are notable exceptions.³ It follows that deficient voices, especially those of women, can be enhanced in listening value by a generous boost at the 5 kc point, on the order of 5 to 8 db. Definition is increased by added power given to the recognition sounds like t, s, ch and k. A collateral benefit of this boost is the apparent increase in level: a 6 db rise at 5 kc frequently gives an *apparent* increase of 3 db to the overall signal.

The attenuation of the 5 kc range on instrumentals can give a "transparent" quality to the performance, provided that it is otherwise wide-range. This quality is common to European orchestral recording, has found some popularity, and may be desirable. Usually, vocals on microphones with a "saddle" in

this range lack the "punch," or "presence" to which we have grown accustomed in this country.

BRILLIANCE— Part of the 9th through the 10th Octave—6500 to 16000 cps

Unvoiced consonants attributed to tooth, tongue and lip sounds are high in frequency, and reach the 10 kc range. These frequencies account for some clarity and most brilliance, even though they purvey less than 2% of the total speech energy. The same effect holds true for musical instruments, and especially for percussion. Thus, in order properly to convey all the effects in recording independently of microphone placement and sensitivity in the last octave, the ability to boost this range in an easy, continuing slope on the individual microphone is helpful.

On some undamped microphones of the diameter of about one-half inch, an opposite correction is required, especially on speech and vocals. The extension of the higher range in good microphones exploits the "baffle" effect investigated by Mueller, Black and Davis in 1934. It has been determined that extra sound pressures build up on the diaphragm by a value of 9.8 db over an appreciable band, and that the predominant frequency of this band is directly associated with the diameter. In this way a microphone of 3/8 inch diameter is approximately one-half the wave length of 9 kc. On improperly damped microphones a distinct rise at this frequency is found which produces annoying sibilant distortion on speech. On Latin and other types of music using gourds and rattles, this peak results frequently in an astonishing and pleasing feeling of clarity.

HOW CONTROL IS ACHIEVED OVER GEOMETRY, TONALITY AND EFFECTS.

It would appear specious to suggest the multiplicity of corrections and precise control of spectral quality in the preceding without showing how it may be achieved. It is obvious that individual control of each microphone is needed for purposes of matching quality from left, center and right groups. It is plain to see that each microphone is confronted with the task of purveying qualitatively the sound from different instruments and artists, and that each microphone must be controlled throughout portions of its spectral range to accomplish special effects.

It has become good practice in monaural recording to provide a multiplicity of equalizers on the mixer console. In most cases this equalization has offered control at two points only, generally at 100 and 10,000 cps. While more control was desired, the unavailability of equipment small enough to provide more control and at other frequencies has in the past militated against needful additions.

With the advent of stereo and three-channel recording, nearly three times the equipment, with more elaboration, seems indicated, and expansion of console area in the horizontal plane offers the only direction in which to proceed. But a single engineer has arms only so long.

Succeeding pages describe Langevin Program Equalizers small enough to fit on the control panel over the mixer controls.

¹ J. C. Stienberg "Fundamentals of Speech, Hearing and Music."
² eg., Rosemary Clooney, Doris Day

OCTAVES & FREQUENCIES

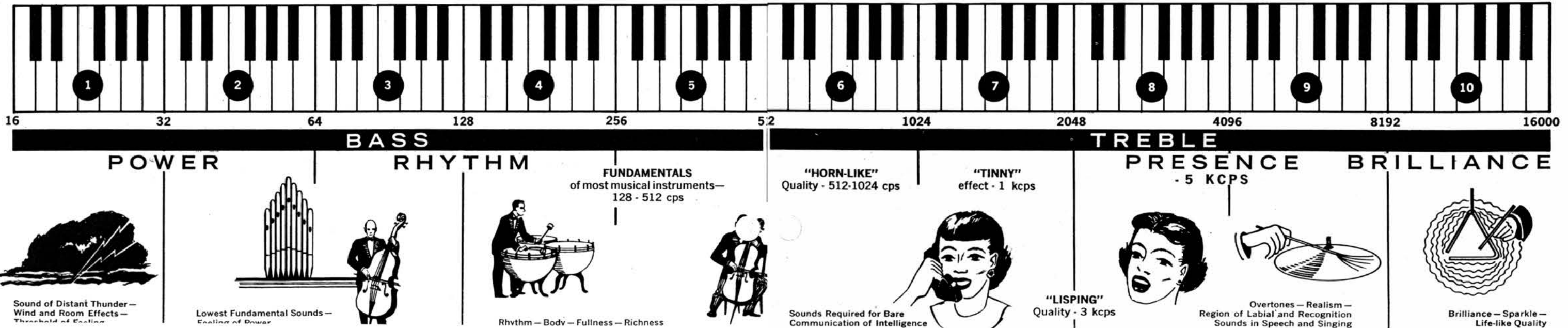

REFERENCES

MOST FREQUENTLY USED BY THE PROFESSIONAL SOUND ENGINEER

| | See Page |
|---|-------------|
| WATTS-DBM-VOLTS CONVERSION CHART..... | 67 |
| MIXER COMBINING LOSSES..... | 48 |
| MINIMUM LOSS MATCHING-COMMON VALUES..... | 66 |
| VOLTAGE RATIOS-DECIBEL VOLTAGE-GAIN-LOSS..... | 63 |
| MINIMUM LOSS MATCHING AND MISMATCH LOSS TABLE..... | 65 |
| SUBJECTIVE EFFECTS OF EQUALIZATION ON THE SOUND SPECTRUM..... | 42 |

Over Thirty Years of Experience . . .

Since 1923 the Langevin name has been identified with the best in sound systems and audio equipment. Its commercial products include a line of amplifiers, power supplies and transformers for radio broadcast and television stations and studios, recording studios, public address systems, industrial inter-communication systems and music services. The acceptance of these products by such organizations as Columbia Broadcasting System, Voice of America, Muzak and the Armed Forces Radio Service attest to the high standing of Langevin equipment among radio and sound engineers.



A DIVISION OF SONOTEC INCORPORATED • Export: Simonrice
503 South Grand Avenue, Santa Ana, California