



A CLEAR-COM COMPANY

***Mentor RG  
Master Reference Generator  
User Guide***

ISSUE 1.5

TRILOGY COMMUNICATIONS LIMITED  
26 Focus Way  
Andover  
Hampshire  
SP10 5NY  
United Kingdom  
Telephone. +44 (0) 1264 384000  
[www.trilogycoms.com](http://www.trilogycoms.com)

The Copyright of the information and drawings in this document is the property of Trilogy Communications Limited of Andover, Hampshire and is neither to be reproduced in whole or in part, nor disclosed to a third party, without the prior written consent of Trilogy Communications Limited.

The information in this document has been carefully compiled and checked for accuracy. However, Trilogy Communications Limited accepts no responsibility for inaccuracies which may occur and, further, reserves the right to make changes to specification or design without prior notice.

Comments or correspondence concerning this manual should be addressed to the Publications Manager at the address given at the front of this User Guide.

**DOCUMENT NUMBER****36090600.docx****Issue 1.5**

<b>Issue</b>	<b>Date</b>	<b>Reason for Change</b>
1.0	30 September 2017	Initial release
1.1	13 December 2017	Software v06.00.01.00
1.2	10 May 2018	Software v06.00.01.10
1.3	12 September 2018	Updated option part numbers, NTP
1.4	5 December 2018	Updated safety notice
1.5	25 January 2019	SMPTE EPOCH / Backup PSU

**CONTENTS**

<b>1. APPLICATION</b> .....	<b>6</b>
1.1 INTRODUCTION.....	6
1.2 VECTOR - WEB BROWSER BASED MANAGEMENT OF MENTOR RG .....	6
1.3 AVAILABLE FEATURES AND OPTIONS .....	7
1.4 TECHNICAL SUPPORT .....	8
1.5 WARRANTY.....	8
1.6 COMMON CONFIGURATIONS.....	8
<b>2. INSTALLATION</b> .....	<b>9</b>
2.1 UNPACKING .....	9
2.2 RACK MOUNTING .....	9
2.3 EARTHING REQUIREMENTS.....	9
2.4 MAINS CONNECTION AND FUSING.....	10
2.5 BATTERY.....	10
2.6 REAR PANEL CONNECTIONS .....	11
2.7 ANALOGUE AUDIO / REMOTE CONNECTOR PINOUT.....	12
2.8 AES CONNECTOR PINOUT .....	15
2.9 LTC CONNECTOR PINOUT.....	15
2.10 ETHERNET.....	15
<b>3. OPERATION</b> .....	<b>16</b>
3.1 FRONT PANEL.....	16
3.2 POWER ON DISPLAY .....	17
3.3 FRONT PANEL CONTROLS.....	17
3.4 BASIC OPERATIONAL TECHNIQUE .....	18
3.5 SELECTING A FUNCTION.....	18
3.6 CHANGING VALUES .....	19
3.7 MENU TIMEOUT .....	19
3.8 FRONT PANEL LOCK.....	19
3.9 USING VECTOR   WEB BROWSER BASED MANAGEMENT.....	20
3.10 TOP LEVEL MENU .....	21
3.11 UPDATING MENTOR RG.....	22
<b>4. HELP</b> .....	<b>23</b>
4.1 HELP   INFO.....	23
4.2 HELP   MANUALS .....	23
4.3 HELP   CONTACT .....	24
<b>5. SDI: DIGITAL VIDEO</b> .....	<b>25</b>
5.1 DIGITAL VIDEO   STANDARD .....	26
5.2 DIGITAL VIDEO   SETTINGS .....	27
5.3 DIGITAL VIDEO   AUDIO.....	31
5.4 DIGITAL VIDEO   TIMECODE.....	31
5.5 DIGITAL VIDEO   IDENT.....	32
5.6 DIGITAL VIDEO   FRONT PANEL MENUS .....	33
<b>6. AV: ANALOGUE VIDEO</b> .....	<b>37</b>
6.1 ANALOGUE VIDEO   CONFIGURE CHANNELS.....	37
6.2 ANALOGUE VIDEO   STANDARD .....	38
6.3 ANALOGUE VIDEO   SETTINGS.....	39
6.4 ANALOGUE VIDEO   VITC .....	41
6.5 ANALOGUE VIDEO   IDENT.....	41
6.6 ANALOGUE VIDEO   FRONT PANEL MENUS .....	42
6.7 ANALOGUE VIDEO   AVAILABLE TEST PATTERNS .....	50

<b>7.</b>	<b>AUDIO</b> .....	<b>52</b>
7.1	AUDIO   STANDARD .....	52
7.2	AUDIO   AES .....	52
7.3	AUDIO   ANALOGUE .....	53
7.4	AUDIO   FRONT PANEL MENUS .....	54
<b>8.</b>	<b>GENLOCK</b> .....	<b>56</b>
8.1	GENLOCK   LOCK MENU .....	56
8.2	GENLOCK   FRONT PANEL MENU .....	58
<b>9.</b>	<b>SETUP</b> .....	<b>59</b>
9.1	SETUP   GPI .....	59
9.2	SETUP   FRONT PANEL MENU .....	61
<b>10.</b>	<b>STATUS</b> .....	<b>67</b>
10.1	STATUS   MAIN .....	67
10.2	STATUS   PTP .....	68
10.3	STATUS   LOGGING .....	68
10.4	STATUS   FRONT PANEL MENU .....	69
<b>11.</b>	<b>ADMIN</b> .....	<b>70</b>
11.1	ADMIN   CONFIGURATION MANAGEMENT .....	70
11.2	ADMIN   SYSTEM SETTINGS .....	71
11.3	ADMIN   PASSWORD .....	71
11.4	ADMIN   SOFTWARE UPDATE .....	71
11.5	ADMIN   SOFTWARE DELETE .....	72
11.6	ADMIN   FEATURE UPGRADE .....	72
11.7	ADMIN   SYSTEM ERRORS .....	72
<b>12.</b>	<b>OPTIONS AND FEATURES</b> .....	<b>73</b>
12.1	INTRODUCTION .....	73
12.2	HARDWARE OPTIONS .....	74
12.3	SOFTWARE FEATURES .....	75
<b>13.</b>	<b>SOFTWARE FEATURE: 360-22-00 TIMECODE</b> .....	<b>76</b>
13.1	TIMECODE   INTRODUCTION .....	76
13.2	TIMECODE   EXTENDED SETUP MENU .....	77
13.3	TIMECODE   SDI .....	79
13.4	TIMECODE   ANALOGUE VIDEO .....	80
13.5	TIMECODE   EXTENDED FRONT PANEL SETUP MENU .....	81
13.6	TIMECODE   ANALOGUE VIDEO – FRONT PANEL MENU .....	83
13.7	TIMECODE   SDI - FRONT PANEL MENU .....	85
<b>14.</b>	<b>OPTION: 360-15-12 GPS TIME REFERENCE</b> .....	<b>87</b>
14.1	GPS   INTRODUCTION .....	87
14.2	GPS   DISCLAIMER .....	87
14.3	GPS   INSTALLATION .....	87
14.4	GPS   ANTENNA – INTERNAL RECEIVER .....	89
14.5	GPS   EXTERNAL RECEIVER / ANTENNA COMBINATION .....	91
14.6	GPS   ACQUISITION PROCESS .....	93
14.7	GPS   1 PULSE PER SECOND (1 PPS) SIGNAL WAVEFORM .....	93
14.8	GPS   MENU STRUCTURE .....	94
14.9	GPS   ABSOLUTE TIME REFERENCE (ATR) .....	96
14.10	GPS   FRONT PANEL MENU .....	97

<b>15.</b>	<b>OPTION: 360-16-01 TRI-LEVEL SYNC (TLS)</b> .....	<b>98</b>
15.1	TLS   INTRODUCTION .....	98
15.2	TLS   MENU STRUCTURE .....	98
15.3	TLS   AVAILABLE STANDARDS .....	99
15.4	TLS   FRONT PANEL MENU .....	100
<b>16.</b>	<b>SOFTWARE FEATURES: NTP AND SNMP</b> .....	<b>101</b>
16.1	360-18-02 NTP (NETWORK TIME PROTOCOL) SUPPORT .....	101
16.2	360-19-00 SNMP (SIMPLE NETWORK MANAGEMENT PROTOCOL) SUPPORT .....	102
<b>17.</b>	<b>OPTION: 360-20-00 HD/3G-SDI MODULE</b> .....	<b>104</b>
17.1	360-20-00   VECTOR MENU .....	104
17.2	360-20-00   AVAILABLE VIDEO STANDARDS .....	105
17.3	360-20-00   AVAILABLE TEST PATTERNS .....	106
17.4	360-20-00   FRONT PANEL MENU .....	107
<b>18.</b>	<b>SOFTWARE FEATURE: 360-21-00 PTP</b> .....	<b>108</b>
18.1	PTP   INTRODUCTION.....	108
18.2	PTP   CONFIGURE .....	109
18.3	PTP   FRONT PANEL MENUS .....	112
<b>19.</b>	<b>COMMON CONFIGURATIONS</b> .....	<b>113</b>
19.1	GPS LOCKED SPG AND TIMECODE GENERATOR. ....	113
19.2	GPS LOCKED NTP SERVER. ....	113
19.3	DAYLIGHT SAVING TIME .....	114
19.4	VITC AS A JAM! SOURCE .....	114
<b>20.</b>	<b>SPECIFICATION</b> .....	<b>115</b>
20.1	GENERAL .....	115
20.2	EMC .....	115
20.3	POWER .....	115
20.4	INTERNAL REFERENCE OSCILLATOR STABILITY.....	115
20.5	GENLOCK VIDEO INPUT PERFORMANCE .....	116
20.6	GENLOCK OPERATIONAL CONTROL .....	116
20.7	10 MHZ INPUT PERFORMANCE .....	117
20.8	SD-SDI OUTPUTS .....	117
20.9	HD-SDI OUTPUTS .....	118
20.10	3G SDI OUTPUTS .....	118
20.11	ANALOGUE VIDEO OUTPUT PERFORMANCE .....	119
20.12	AES/EBU OUTPUTS .....	120
20.13	ANALOGUE AUDIO OUTPUT PERFORMANCE.....	120
20.14	CLOCK OUTPUT .....	120
20.15	GPI INPUTS AND OUTPUTS .....	121
20.16	LTC (LONGITUDINAL TIMECODE) .....	121
20.17	MISCELLANEOUS.....	121

## 1. APPLICATION

### 1.1 INTRODUCTION

The Trilogy 360-00-05 Mentor RG Synchronising Reference Generator is one of the most flexible units available on the market today. It is suitable for any digital or mixed format environment where a high quality digital SPG is required.

- 5 analogue outputs, with outputs 4 and 5 supporting TLS standards.
- 3 SD-SDI black outputs with 4 channels of embedded AES silence and EDH
- 2 AES-3 silence outputs: full range of audio tones unlocked by optional software key
- 10 MHz / 27 MHz/Word Clock output
- Each output individually timed
- Each output selectable to either 525 or 625 operation
- 10 MHz reference input
- Looping Genlock input supporting PAL, NTSC and TLS standards

All SDI and Analogue black/burst outputs offer full control over timing and are individually selectable for 525 / 625 standard operation.

Mentor RG is fitted, as standard, with an oven-controlled reference oscillator allowing the unit to be used either as station master, or as a slave.

The main black/burst generator provides 5 independently timed outputs, giving total timing freedom with adjustment of  $\pm 4$  fields ( $\pm 2$  fields 525) relative to the main timing plane in 0.5 ns steps.

Additional software features are available to add HD-SDI capability, test patterns (for Analogue and/or digital outputs), audio test signals, full field test patterns, LTC, VITC, D-VITC, ATC, NTP, PTP and SNMP. Optional hardware options are available to add a GPS module for high stability time and oscillator referencing, an HD tri-level sync option module and SDI option modules providing additional SD, HD and 3G SDI outputs.

In addition, an internal redundant power supply is available to increase MTBF, or to allow AC power diversity in critical applications.

An Ethernet port is provided for the browser-based management feature which also facilitates software upgrades and time synchronisation by means of NTP (Network Time Protocol) or PTP (Precision Time Protocol).

This User Guide concentrates on the operational aspects of the unit and includes a full technical specification.

### 1.2 VECTOR - WEB BROWSER BASED MANAGEMENT OF MENTOR RG

A web-browser based configuration tool is provided, offering:

- Online editing of Mentor RG configurations
- Partial or incremental updates without causing disruption (where possible)
- The ability to copy, backup and restore configuration data.

Please see section 3.9 of this manual for information on getting started with this feature.

### 1.3 AVAILABLE FEATURES AND OPTIONS

Three option card slots are available. The Mentor RG auto detects which type of option card is fitted and presents the user with appropriate menu options.

A number of additional hardware options and software features are available for the Mentor RG. At the time of writing in August 2018, these are:

<b>Part Code</b>	<b>Description</b>	<b>Note</b>
<b>360-09-05</b>	Optional redundant power supply	Hardware option
<b>360-10-00</b>	Video test signals	Software feature to add composite analogue and SDI test signals.
<b>360-12-00</b>	Full field test patterns	Software feature to generate FUBK test pattern, selectable 4:3 & 16:9. Requires 360-10-00 video test signals or 360-13-01 video test patterns as pre-requisite.
<b>360-13-01</b>	Video test patterns	Software feature to add composite analogue and SDI test patterns. Requires 360-10-00 video test signals feature as pre-requisite.
<b>360-15-02</b>	Unbalanced AES Output card	Hardware option - activates the 2 x AES unbalanced outputs. Requires 360-23-00 feature as pre-requisite. Not required if GPS option (360-15-12) fitted.
<b>360-15-03</b>	GPS Antenna and Universal mount	Bullet III Dome 5V antenna. Supplied with F - type connector. See section 14.
<b>360-15-04</b>	GPS Smart Antenna and Universal Mount	Trimble Accutime Smart Antenna, includes mating connectors but excludes cable. See section 14.
<b>360-15-12</b>	GPS Time Reference	Hardware option: includes receiver module. Replaces 360-15-10 and 360-15-11. See section 14.
<b>360-16-01</b>	TLS (tri-level sync)	Hardware option – when fitted, provides 4 independently timeable TLS outputs. See section 15.
<b>360-18-00</b>	NTP Feature	Software feature – selectable as either server or client mode via menus. See section 16.
<b>360-19-00</b>	SNMP Support	Software feature to enable Simple Network Management Protocol support. See section 16.
<b>360-20-00</b>	HD/3G-SDI Expansion Module	Hardware option - provides 4 additional HD or 3G-SDI outputs in any combination. Requires option 360-13-01 (HD) as pre-requisite. See Note 1 (below) and section 17.
<b>360-21-00</b>	PTP feature	Software feature allows Mentor RG to act as PTP Master, Slave or Master/Slave. See section 18.
<b>360-22-00</b>	Timecode feature (LTC input and output)	Software feature to provide two balanced LTC outputs with VITC, D-VITC and ATC. An LTC input is also provided: when there is a valid LTC input present it is possible to lock the timecode to this LTC input. See section 13.
<b>360-23-00</b>	Audio test tones feature	Software feature to add analogue and AES test tones (including GLITS interrupted channel ident tone)

Notes:

1. Normally only a single 360-20-00 will be fitted to each Mentor RG.

Please see section 12 of this manual for more information on setup and configuration of options and features. Additional hardware options and software features will be offered in the future: please contact your supplier or Trilogy for more information.

## **1.4 TECHNICAL SUPPORT**

### UK & International

Please contact Trilogy at the UK headquarters.

Trilogy Communications Ltd  
26 Focus Way  
Andover  
Hampshire  
SP10 5NY  
United Kingdom  
E-mail: [support@trilogycomms.com](mailto:support@trilogycomms.com)  
Tel: +44 (0)1264 384000

Alternatively please contact your reseller. Contact details may be found at [www.trilogycomms.com](http://www.trilogycomms.com).

## **1.5 WARRANTY**

Conditions of the warranty may vary according to your terms of purchase. Please consult your sales documentation or if in doubt, contact your original supplier or Trilogy, quoting date of purchase and unit serial number.

## **1.6 COMMON CONFIGURATIONS**

To cater for different system design philosophies and installations of varying complexity, we have tried to make the Mentor RG as flexible as possible. Some common system modes and configurations are described in section 19 on page 108.



## **2. INSTALLATION**

### **2.1 UNPACKING**

Carefully unpack the unit from its transit material and check the unit for signs of damage. Check the contents of the box against our despatch note and your original order to ensure that you have received the correct parts.

In the event that the unit has been damaged or does not match your order, immediately contact your supplier or Trilogy at the address given at the front of this guide.

### **2.2 RACK MOUNTING**

The 1U rack frame has integral 19" mounting ears for direct mounting in a standard 19" rack. Carefully place the unit in your rack and firmly attach it to the rack using four bolts.

**IMPORTANT:** This unit has air intakes on one side of the unit and fan assisted exhaust vents on the other side of the unit. Ensure that these have an unobstructed air flow, otherwise the unit may overheat. Pay particular attention to ensure that any rack wiring or cable trays do not obstruct the vent. 60mm of clear space should be allowed between the vents and any potential obstruction.

### **2.3 EARTHING REQUIREMENTS**

The unit is provided with a single 4mm earthing stud on the rear panel. Incoming mains earth from the IEC connector is internally bonded to both the chassis and technical 0V to meet safety requirements and performance specifications. The stud allows the addition of an earth strap, if required, in rack installations.

## 2.4 MAINS CONNECTION AND FUSING

### **Important Power Supply Cord(s) Used as Disconnect Means**

**CAUTION: THE POWER SUPPLY CORDS ARE USED AS THE MAIN DISCONNECT DEVICE. ENSURE THAT THE SOCKET-OUTLETS ARE LOCATED / INSTALLED NEAR THE EQUIPMENT AND ARE EASILY ACCESSIBLE.**

**THIS UNIT HAS MORE THAN ONE POWER SUPPLY CORD.  
DISCONNECT TWO POWER SUPPLY CORDS BEFORE SERVICING TO AVOID ELECTRIC SHOCK.**

**ATTENTION: LES CORDONS D'ALIMENTATION SONT UTILISÉS COMME DISPOSITIF DE DÉBRANCHEMENT PRINCIPAL. ASSUREZ-VOUS QUE LES PRISES DE SOCKET SONT SITUÉES / INSTALLÉES PRÈS DE L'APPAREIL ET SONT FACILEMENT ACCESSIBLES.**

**CET APPAREIL COMPORTE PLUS D'UN CORDON D'ALIMENTATION.  
AFIN DE PRÉVENIR LES CHOCS ÉLECTRIQUES, DEBRANCHER LES DEUX CORDONS D'ALIMENTATION AVANT DE FAIRE LE DÉPANNAGE.**

The power supplies within the unit are a switched mode design and will cope automatically with a wide input voltage range (see specification, section 20.3).

The standard Mentor RG is fitted with a single mains power supply unit (PSU), with an option to fit a second PSU. Each PSU has its own, dedicated, IEC mains plug on the rear of the Mentor RG. These should be wired according to the instructions provided with a mating mains socket using suitable cable. See above for earthing requirements.

Mains cable conductors are to be three-core (two-wire with ground), wire gauge 18 AWG (cross sectional area 0.75mm<sup>2</sup>) Jacket to be type SJT.

Covers are only to be removed by trained personnel. Shock hazard exists with covers removed; therefore disconnect mains supply before removal. See the warning notice above. Interconnection between circuit boards and panels are all safety extra low voltage (SELV) as defined by IEC/EN/CSA/UL 60950-1-200X. The equipment signal connections must only be connected to SELV circuits to prevent hazards from improper connection.

## 2.5 BATTERY

Mentor RG is fitted with an internal lithium battery.

**CAUTION:  
RISK OF EXPLOSION IF BATTERY IS REPLACED BY AN INCORRECT TYPE.  
DISPOSE OF USED BATTERIES ACCORDING TO THE INSTRUCTIONS.**

**ATTENTION  
IL Y A RISQUE D'EXPLOSION SI LA BATTERIE EST REMPLACÉE PAR UNE BATTERIE  
DE TYPE INCORRECT.  
METTRE AU REBUT LES BATTERIES USAGÉES CONFORMÉMENT AUX INSTRUCTIONS.**

## 2.6 REAR PANEL CONNECTIONS

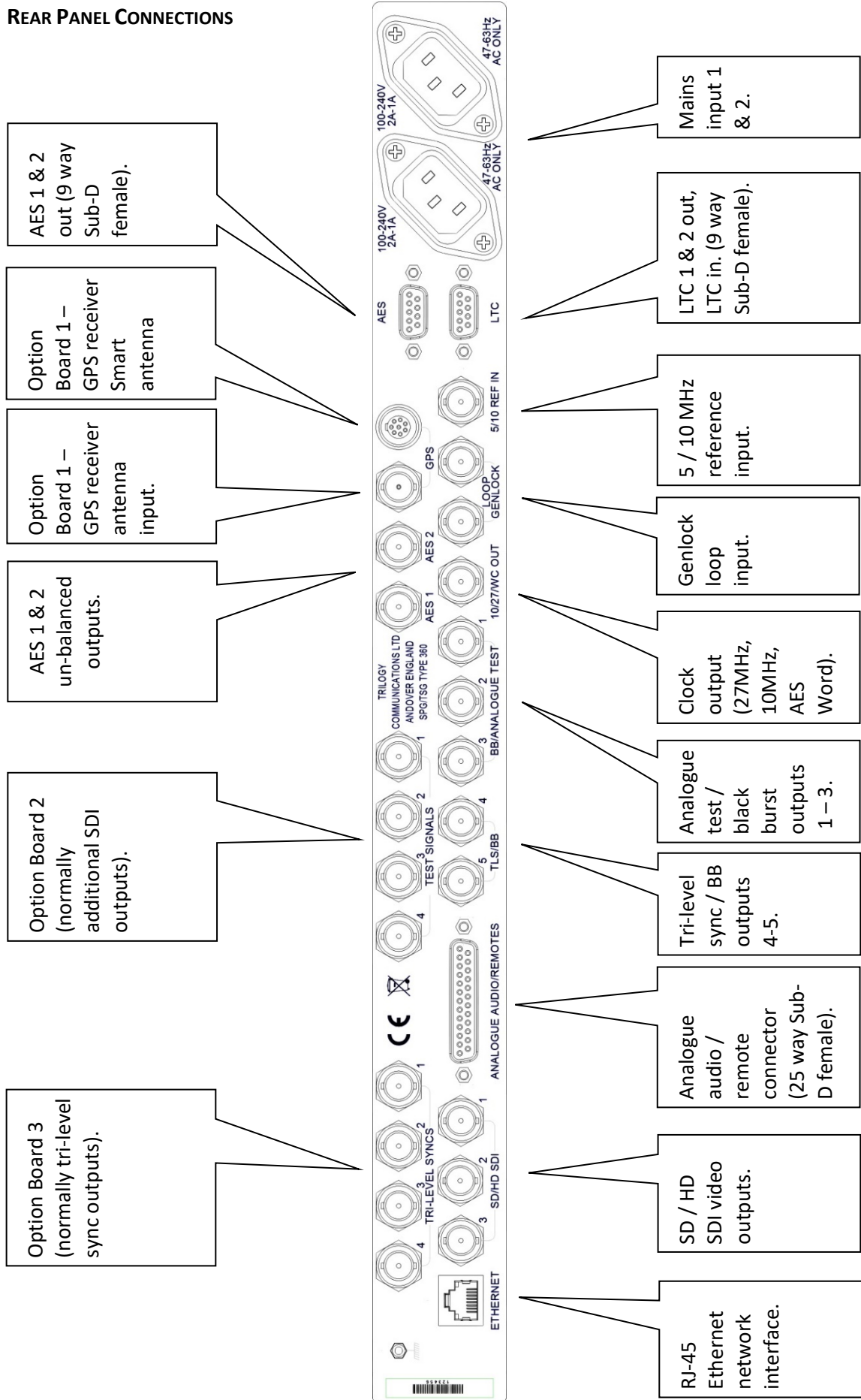

## 2.7 ANALOGUE AUDIO / REMOTE CONNECTOR PINOUT

The chassis is fitted with a fixed D25 socket.

Pin	Description	Notes
1	Fan OK - 1	Pair with 16. Closed if OK.
2	RS422 CTS-	
3	RS422 RXD+	or RS232 RX
4	RS422 TXD+	or RS232 TX
5	RS422 RTS-	
6	RS422 TXD-	
7	GND	
8	RS422 RXD-	
9	GND	
10	+ 12V DC./ 0.3A	Internal 0.5A self-resetting thermal fuse.
11	Analogue Audio Out 1+	
12	Analogue Audio Out 2 +	
13	GND	
14	Power OK 1	Pair with 15. Closed if OK.
15	Power OK 2	Pair with 14. Closed if OK.
16	Fan OK - 2	Pair with 1. Closed if OK.
17	GPI - Output 1	
18	GPI - Input 2	
19	GPI - Input 1	
20	RS422 CTS+	or RS232 CTS
21	GPI - Output 2	
22	RS422 RTS+	or RS232 RTS
23	Analogue Audio Out 1-	
24	Analogue Audio Out 2-	
25	GND	

### 2.7.1 Remote Connector

#### 2.7.1.1 Serial Communications Port

The serial port is used during manufacturing test and alignment. The port may be configured for RS232 or RS422 operation from the System menu. The configuration menu is shown in section 9.

#### 2.7.1.2 Analogue Audio Outputs

The Analogue audio output is provided by an independent audio generator.

#### 2.7.1.3 Power Fail Output

This is a status output provided by a single relay contact. During normal operation, the contact is closed. The unit senses a failure of any internal voltage rail, causing the relay contact to open.

#### 2.7.1.4 Fan Fail Output

This open collector status output indicates correct operation of the internal cooling fan. Open circuit / short circuit and stalled fans are detected.

### 2.7.1.5 GPI Inputs 1 and 2

The general purpose interface inputs (GPI) 1 and 2 are configured in software, using the menus described in section 9.2.2, to provide any of the following functions:

- Force free run mode
- Force genlock mode
- Force external 10MHz lock mode
- Step through SDI output 1 test patterns
- Step through SDI output 2 test patterns
- Step through SDI output 3 test patterns
- Step through set-up memory locations

### 2.7.1.6 Connecting to GPI Inputs

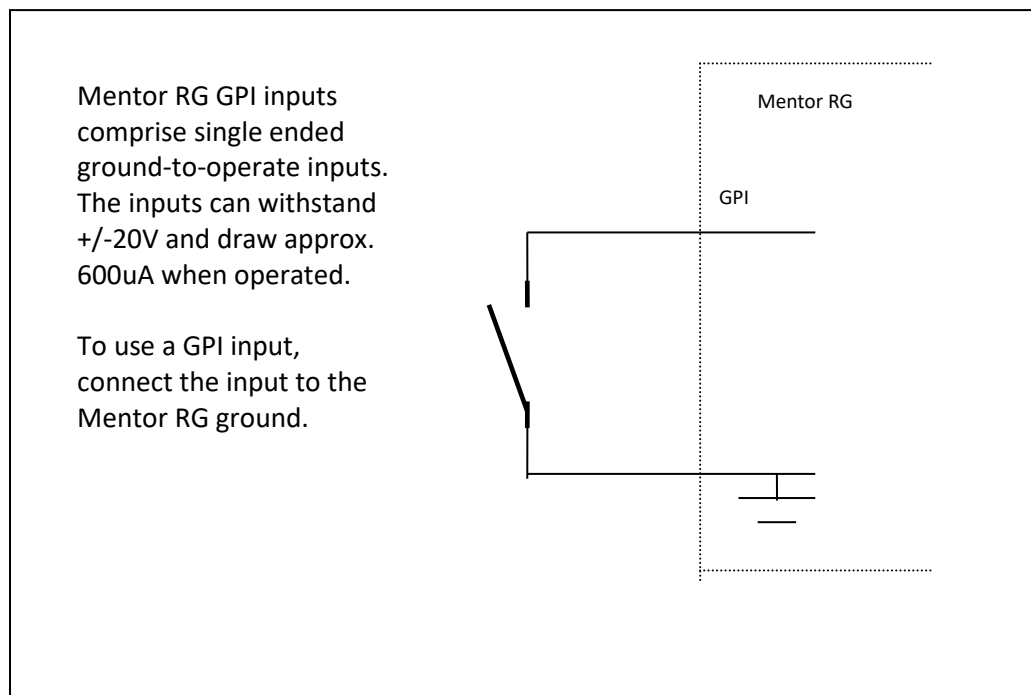

### 2.7.1.7 GPI Outputs 1 and 2

General purpose interface outputs 1 and 2 are configured in software, using the menus described in section 9.2.2 to provide any combination of the following functions:

- Loss of genlock input
- Loss of external 10MHz reference
- Line lock error
- Field lock error
- Subcarrier lock error
- Illegal input ScH
- Diagnostic state alert
- Currently locked to external clock reference 5 / 10 MHz
- Currently locked to external genlock
- Currently internal/free-run mode

By combination it is intended that the output can be asserted when one or more conditions is true (for example, loss of genlock input and/or line lock error).

### 2.7.1.8 Connecting to GPI Outputs

GPI outputs comprise single ended open collector outputs with a 30V / 190mA rating, 600mW dissipation.

To use an output, a load should be connected between the output and an external power supply, with the negative end of the power supply connected back to the ground pin on the D type. As an alternative to an external power supply, a +12V, 300 mA feed is available on pin 10 of the D25 connector.

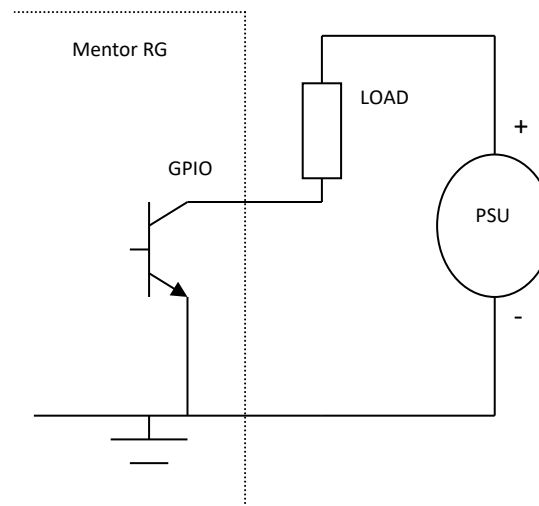

## 2.8 AES CONNECTOR PINOUT

Full AES functionality is enabled by the additional software feature, 360-23-00. If the feature is not enabled, the AES outputs provide AES digital silence only. The chassis is fitted with a fixed D9 socket.

Pin	Description
1	AES 1 + (out)
2	AES 1 - (out)
3	Shield
4	n/c
5	0V GND
6	Shield
7	AES 2 + (out)
8	AES 2 - (out)
9	Shield

A parallel, unbalanced output for each AES signal may be provided on rear panel BNC connectors as an option.

## 2.9 LTC CONNECTOR PINOUT

Two balanced LTC outputs plus one balanced LTC input are provided. When there is a valid LTC input present it is possible to lock the time code to this LTC input. LTC functionality is enabled by the additional software feature, 360-22-00. The chassis is fitted with a fixed D9 socket.

Pin	Description
1	LTC 1 + (out)
2	LTC 1 - (out)
3	Shield
4	LTC + (in)
5	0V GND
6	Shield
7	LTC 2 + (out)
8	LTC 2 - (out)
9	LTC - (in)

## 2.10 ETHERNET

The Mentor RG is equipped with a 10/100 Base-T Ethernet port. This port may be configured for either dynamic (DHCP) address mode, or static address mode. In most instances, we recommend the static mode. These options are located in the Setup menu. The Mentor RG should be connected to the network in the same way as any other networked device (e.g. computer or laptop) using a 1:1 CAT 5 RJ45 cable (not provided).

If connected directly to a computer or laptop, either a crossover or straight through style Ethernet cable may be used.

### 3. OPERATION

#### 3.1 FRONT PANEL

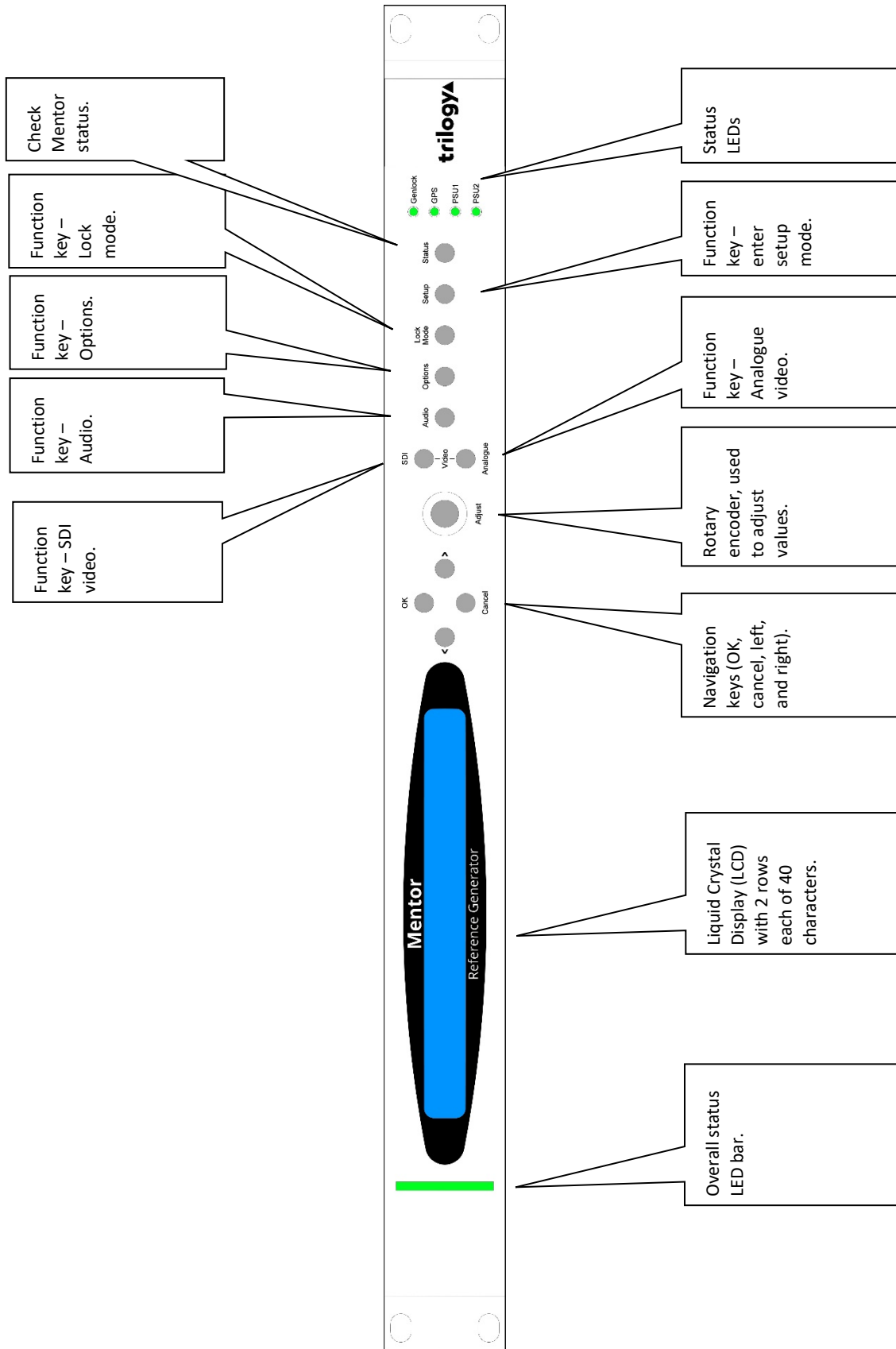



### 3.2 POWER ON DISPLAY

When the unit is powered, the LCD will display initialisation messages, as it configures the internal hardware of the unit. Once initialisation is complete, a message indicating a normal operational status is displayed, as shown below.

MENTOR RG Main Menu  
<SDI> AV Audio Lock Setup Status

The top line gives the name of this unit (i.e. Mentor RG). The lower line displays the first available main menu items. If any hardware options are fitted, an additional **Options** entry appears following **Status**.

The preferred method of setup and control is via the built in browser interface. Before using the browser, some initial steps must be carried out from the front panel. See section 3.9.2 for details.

### 3.3 FRONT PANEL CONTROLS



The front panel has six functional areas, from left to right:

- A Status Indicator Bar:
  - Green indicates the Mentor is fault-free
  - Red indicates one or more of the following fault(s) are present
    - Fan 1 or 2 failure
    - DHCP connection failed
    - NTP Connection failed
    - Black/burst genlock input Loss
    - Genlock mode set to free run or external but 10Mhz Loss
    - Genlock synchronisation set to clock only but not locking to set line
    - Genlock set to manual or external phasing but sub carrier not locked
    - Black/burst enabled with AES S318 but S318 is not present or locked
    - Black/burst present and set to PAL but not present
    - Power supply 1 or 2 failure
    - Option boards 1, 2 or 3 present but failure detected
    - GPS option board serial failure
    - GPS option board receive failure
    - GPS option board 1pps failure
    - GPS option board 1pps lock error
    - PTP state is faulty
- A Liquid Crystal Display (LCD) used to show information to guide the user through operating the various functions and show status information

- Front panel navigation buttons:
  - LEFT, RIGHT buttons for menu navigation
  - OK and CANCEL buttons to select or exit the currently selected option.
- Rotary encoder for parameter adjustment and/or left/right menu navigation
- Individual feature buttons:
  - SDI button to access menus for main board SDI outputs
  - ANALOGUE VIDEO button to access menus for main board Analogue video outputs
  - AUDIO button, to access menus for Analogue audio and AES audio outputs
  - OPTIONS button to access option board menus
  - LOCK MODE button to configure genlock modes
  - SETUP button, for miscellaneous configuration options
  - STATUS button used to access diagnostic and status information
- A group of 4 status LEDs:
  - Genlock – Green when unit is locked, off when not locked.
  - GPS Lock – Green when locked to 1PPS from GPS receiver. Off when not locked.
  - PSU1/2
    - If the PSU is present and operational the LED will be green.
    - If the PSU is present and not operational the LED will be red.
    - If PSU is not present, the LED will be off.

### 3.4 BASIC OPERATIONAL TECHNIQUE

There are a number of basic concepts, which once appreciated, will simplify the use of the Mentor RG.

- Valid button pushes are indicated by a lamp lit in a button. In most cases, buttons without a lamp lit will not be prohibited, allowing rapid changes between functions of different types.
- Invalid button pushes will result in an informative message on the LCD.

### 3.5 SELECTING A FUNCTION

To change any parameter, the appropriate function button must first be pushed. Once a function button is pushed, that button will illuminate to provide a reminder of which function is active.

Pushing a function button that has sub-functions under the first menu will cause the bottom row of the LCD to show the lower level functions.

To choose which of these sub-functions is required, the encoder or left – right keys may be used to step between the sub-functions. The current selection is marked with chevron symbols < >.

The top row of the LCD provides a fuller explanation of the function.

Once the required sub-function is selected, the OK button is used to choose it. Depending on the sub-function chosen, either a further set of sub-functions or the current value of that function is displayed. Where appropriate, the currently active option is indicated by square brackets (e.g. [ON]). If the active option is also selected, it is indicated by asterisks (e.g. \*ON\*).

### 3.6 CHANGING VALUES

To change a setting, the encoder control or left – right buttons may be used.

In the case of numerical values there are two functional modes:

- If the overall range of adjustment is small the encoder always alters the value by the smallest possible amount.
- If a wider range of adjustment is required, a “Delta value” system is used. Use the left/right buttons to switch between the setting and delta values and use the rotary encoder to adjust the selected value.

As the parameter is changed, the new value will be shown on the LCD. For some functions the unit responds by altering that value immediately - it is not necessary to confirm or otherwise activate the change. Otherwise the new value is applied when the **OK** button is pressed.

#### 3.6.1 Leaving the Selected Function

Once the parameter has been set the unit can be returned to its normal operating mode, or another function chosen by one of three methods:

- Pressing the current (lit) function button will step up through the menu structure one level at a time. Thus another parameter related to that function button may be changed without having to start again at the top-level menu.
- The **OK** button allows you to descend the menu structure and the current Function or **CANCEL** key allows you to ascend the menu structure.
- At any time, any other function button may be pressed to access a different menu. For example, having set an **OUTPUT CONTROL** function, the **SETUP** key may be pushed without having to first step back up through the menus.

### 3.7 MENU TIMEOUT

There is an in-built time-out mechanism that will automatically step back up through the front panel menu structure one level at a time, until the top level is reached, if a key is not pressed within a pre-set time period.

The option to configure this feature is located under the Setup >> More >> Display >> Menu Timeout menu.

### 3.8 FRONT PANEL LOCK

Front panel controls may be locked to prevent inadvertent changes of settings. To lock or unlock the controls, press the **LEFT** and **RIGHT** buttons simultaneously.

## 3.9 USING VECTOR | WEB BROWSER BASED MANAGEMENT

### 3.9.1 Introduction

Vector, a web browser based configuration tool is provided, offering:

- Greatly simplified initial setup
- Online editing of Mentor RG configurations
- Partial or incremental updates without causing disruption (where possible)
- The ability to copy, backup and restore configuration data

### 3.9.2 Getting started

To start using Vector, follow these simple steps:

- Power up the Mentor RG and wait until it has initialised: this takes around 60 seconds.
- Using the front panel controls, navigate to: SETUP >> MORE >> COMMS >> NETWORK.
- Enter IP ADDRESS and SUBNET MASK values which are appropriate for your network. The gateway address is optional. Static IP addresses are preferred although DHCP is also offered. If you are unsure, consult your IT Administrator.
- Connect the Ethernet port on the Mentor RG to your network, using a standard RJ-45 cable (not supplied).
- On a PC connected to the same network as the Mentor RG, open your web browser.
- Navigate to the address <http://<address>> where <address> is that which you entered on the Mentor RG front panel. For example, <http://192.168.1.50>.

At the log-in screen, enter the username and password which by default are both set as **admin**. The landing page for Vector will then be displayed.



### 3.10 TOP LEVEL MENU

From the web browser, the top level menu is always displayed within the blue horizontal bar.

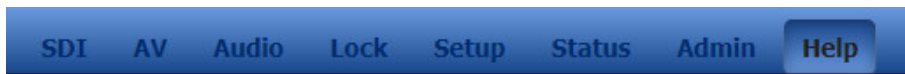

The selected item is indicated by a “pressed button” image and the second navigation layer appears immediately below. The selected item of menu layer 2 is then shown by white text. The example below shows SDI Channel 1 has been selected.

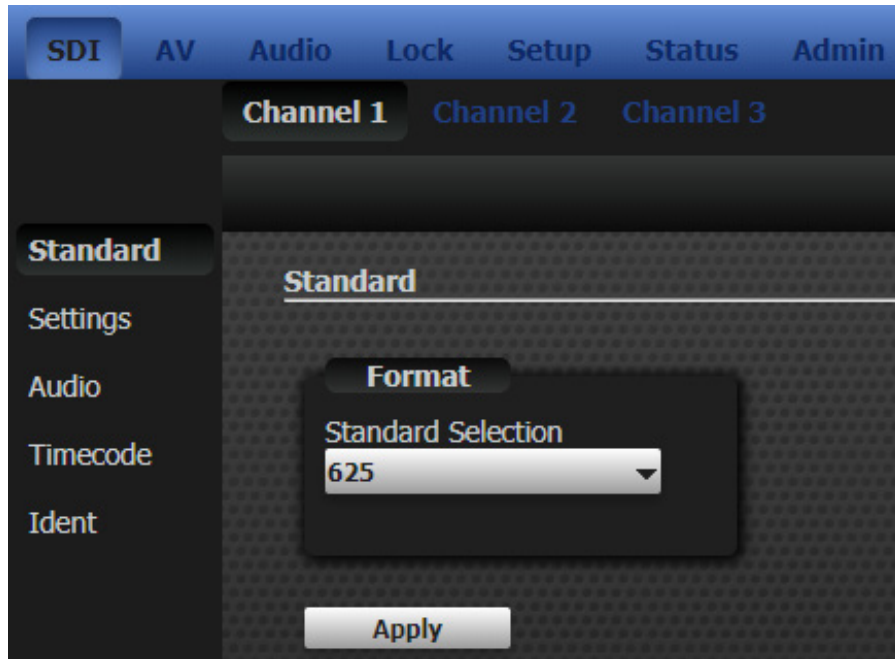

The third navigation layer is a vertical side-bar and the selected item, in this case “Standard”, is repeated on screen.

On the front panel, the top level menu can be reached by repeated press of the “cancel” button. The top level menu currently holds these branches:

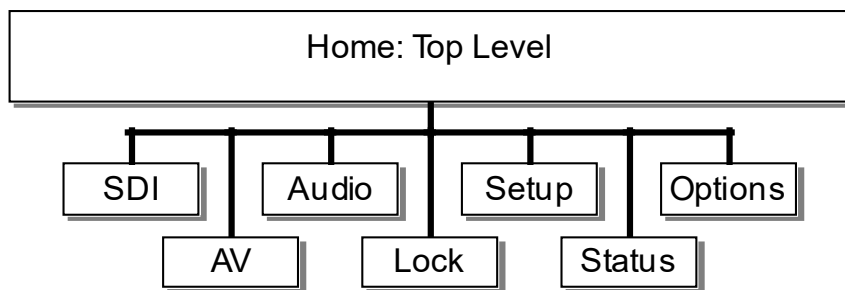

The content and features of each branch are explained in later sections of this manual and may be found by following the links below.

Section 4-- Help -- page 23  
Section 5 -- SDI: Digital Video -- page 25  
Section 6 – AV: Analogue Video -- page 37  
Section 7 – Audio -- page 52  
Section 8 -- Lock – page 56  
Section 9 -- Setup – page 59  
Section 10 – Status -- page 63  
Section 11 – Admin – page 70  
Section 12– Options and Features -- page 73

Note that the Options branch is only displayed if hardware option modules have been installed.

### **3.11 UPDATING MENTOR RG**

From time to time, new code may be released for the Mentor RG. This falls into one of three categories:

- Software
- Changes to test patterns
- Changes to menu structure

This is most easily carried out from the admin web pages of Vector; please see section 11.6 for details. Please contact your supplier or Trilogy Technical Support for more information.

## 4. HELP

The Vector web interface includes a number of pages to assist the user in set up and operation of the Mentor RG.

### 4.1 HELP | INFO

The **INFORMATION** sub-menu and the **VERSIONS**, **OPTION VERSIONS** and **ENABLED FEATURES** panels provides complete information about all aspects of the hardware and software. If you contact Trilogy Technical Support, our engineers will request version information from this menu to assist in answering your question. An example screen is shown below.

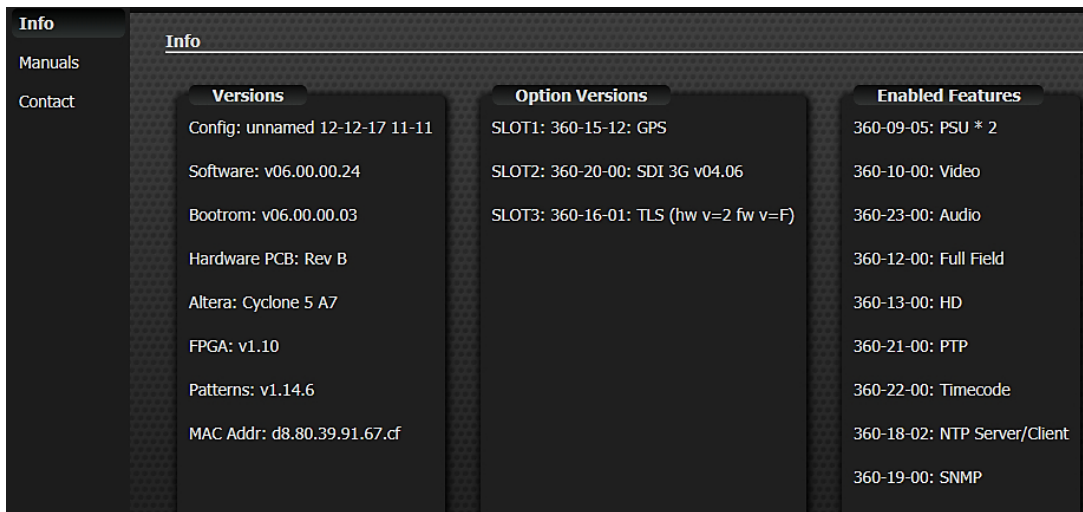

### 4.2 HELP | MANUALS

PDF versions of the Mentor RG User Guides can be downloaded from the support website by clicking the short links on this page. QR codes provide an easy way for smartphone users to download the documents.

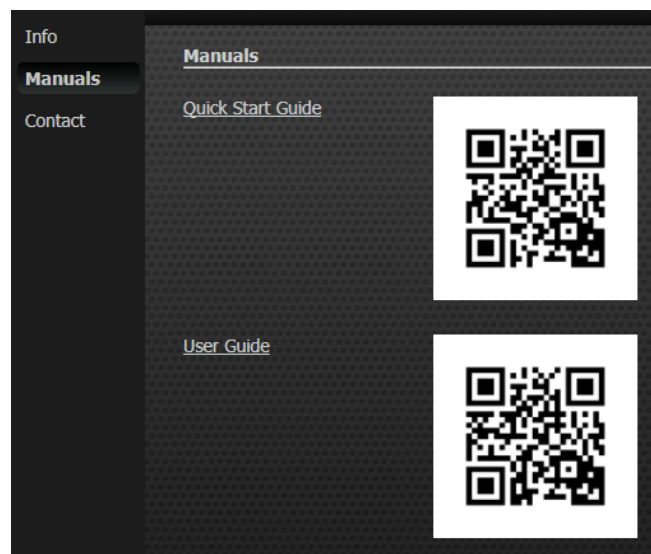

### 4.3 HELP | CONTACT

**Contact Information**



[trilogycomms.com](http://trilogycomms.com)

[twitter.com/trilogycomms](https://twitter.com/trilogycomms)

Trilogy Communications Ltd  
26 Focus Way, Andover, Hampshire  
SP10 5NY, United Kingdom

Trilogy USA Inc  
1301 Marina Village Parkway  
Suite 105  
Alameda, CA 94501, USA

Telephone. +44 (0) 1264 384000

Telephone. +1 847-461-1480

Email. [support@trilogycomms.com](mailto:support@trilogycomms.com)

Toll Free. +1 855-237-4624



## 5. SDI: DIGITAL VIDEO

As explained in the introductory sections, Mentor RG management is available either from the front panel controls, or via the built-in web management facility. The latter is the preferred approach and is described below. The front panel menu structure may be different to the web pages but most options are available albeit in a slightly different format. Front panel menus are grouped together in the manual, at the end of this section.

The SDI: Digital Video menus provide control and configuration of the three SDI video outputs. If the HD video or timecode option(s) have been enabled, the menus are extended to include further options. See section 13.7 for more details of the timecode option.

From the first page, SDI Channels 1, 2 and 3 are available. For clarity, only SDI 1 is shown: the other channels are identical.

The SDI 1 page then branches into additional sub-menus, selected on the side-bar, as shown later in this section.

## 5.1 DIGITAL VIDEO | STANDARD

Select the required video standard and press “Apply”.

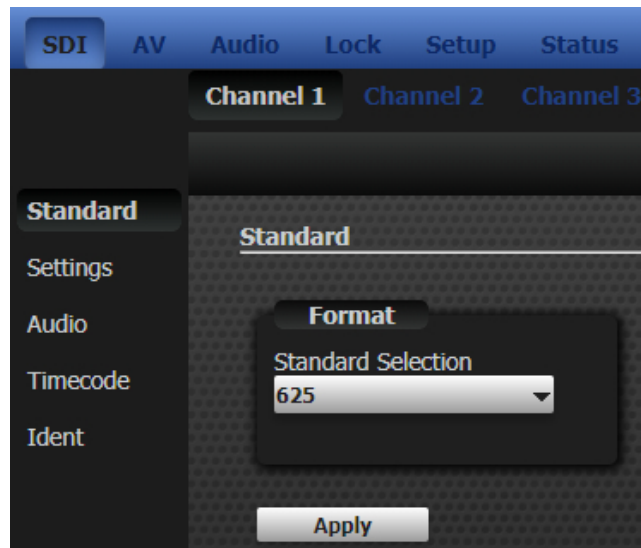

Currently available standards from the mainboard outputs are shown in the table below. For details of the standards supported by the 360-20-00 option board, see section 17.2.

Description	Lines/ Frame	Frame Rate (Hz)	Scan
525			
625			
1080i / 60	1080	60	I
1080i / 59.94	1080	59.94	I
1080i / 50	1080	50	I
1080p / 30	1080	30	P
1080p / 29.97	1080	29.97	P
1080p / 25	1080	25	P
1080p / 24	1080	24	P
1080p / 23.98	1080	23.98	P
1080/24 sF	1080	24	PsF
1080/23.98 sF	1080	23.98	PsF
720p / 60	720	60	P
720p / 59.94	720	59.94	P
720p / 50	720	50	P
720p / 30	720	30	P
720p / 29.97	720	29.97	P
720p / 25	720	25	P
720p / 24	720	24	P
720p / 23.98	720	23.98	P

Note:

- I denotes Interlace scan
- P denotes Progressive scan
- PsF denotes Progressive scan – segmented frame.

## 5.2 DIGITAL VIDEO | SETTINGS

### 5.2.1 Digital Video – Settings Menu

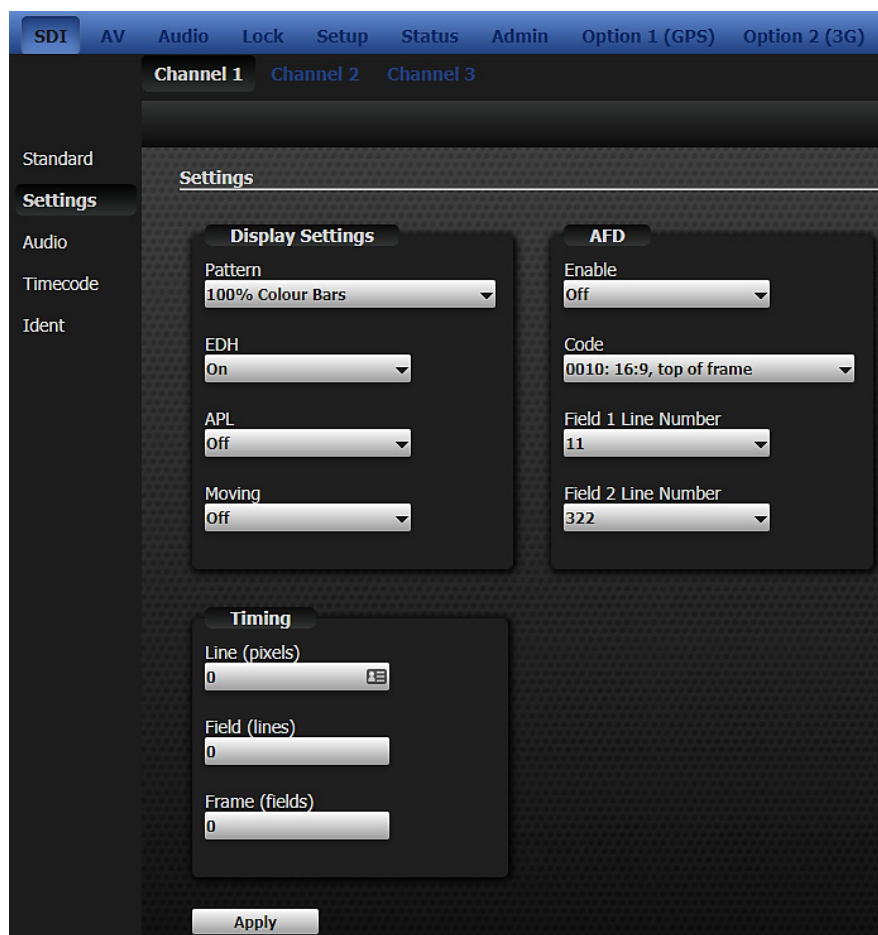

### 5.2.2 Digital Video – Settings -- Available Patterns

The range of available patterns depends on the line standard selected. Additional patterns are available if the HD SDI option is enabled. See the tables in 5.2.2.1 and 5.2.2.2 for details.

## 5.2.2.1 SD SDI Patterns

Pattern	525	625
Full Field Black	•	•
75% White Field	•	
Full Field White	•	•
Full Field Yellow	•	•
Full Field Cyan	•	•
Full Field Green	•	•
Full Field Magenta	•	•
Full Field Red	•	•
Full Field Blue	•	•
Digital Grey	•	•
100% Colour Bars	•	•
100% Colour Bars & Split	•	•
75% Colour Bars	•	
75% Colour Bars & Split	•	
EBU Bars		•
EBU Bars & Split		•
100% VT Bars	•	•
VT Bars & Split	•	•
SMPTE Bars	•	
Co-Siting Check	•	•
SDI Check Field	•	•
SDI Green Check Field		•
Linearity Grille		•
Convergence Grille		•
17x14 Convergence Grille	•	
3T 2T Pulse and Bar	•	•
5 Riser Luma Stair	•	•
5 Riser Stair	•	•
Valid 5 Riser Stair	•	•
Luminance Ramp	•	•
Limit Ramp	•	•
Valid Ramp	•	•
Shallow Ramp	•	•
PLUGE	•	•
SPLUGE		•
Multiburst	•	•
Sin(x)/x	•	•
6.0 MHz Line Sweep	•	•
25Hz Lip Sync		•
Bowtie	•	•
30Hz Lip Sync	•	
Clean_Aperture_4_3	•	
Clean_Aperture_16_9	•	
4:3 Test Card		•
16:9 Test Card		•
Clean Aperture		•

## 5.2.2.2 HD SDI Patterns

<b>Pattern</b>	<b>720</b>	<b>1080</b>
Full Field Black	•	•
Full Field White	•	•
Full Field Yellow	•	•
Full Field Cyan	•	•
Full Field Green	•	•
Full Field Magenta	•	•
Full Field Red	•	•
Full Field Blue	•	•
Digital Grey	•	•
100% Colour Bars	•	•
100% Colour Bars & Split	•	•
75% Colour Bars	•	•
EBU Bars & Split		•
75% Colour Bars & Split	•	
SMPTE Bars	•	•
100% VT Bars		•
100% VT Bars & Split		•
VT Colour Bars	•	
VT Colour Bars & Split	•	
SDI Check Field	•	•
16x9 Grille	•	•
10 Riser Stair	•	•
Valid Ramp	•	•
RP219 Option 1	•	•
RP219 Option 2	•	•
RP219 Option 3	•	•
RP219 Option 4	•	•
Multiburst 100		•
PLUGE	•	•
Multiburst	•	
Bowtie	•	•
Clean Aperture		•
24Hz Lip Sync	•	•
25Hz Lip Sync	•	•
30Hz Lip Sync	•	•
50Hz Lip Sync	•	
60Hz Lip Sync	•	

### 5.2.3 Digital Video – Active Format Description (AFD)

Active Format Description (AFD) is a standard set of codes that can be sent in the video signal that carries information about their aspect ratio and active picture characteristics. It is used by television broadcasters to enable both 4:3 and 16:9 television sets to optimally present pictures transmitted in either format. It is also used by broadcasters to dynamically control how down-conversion equipment formats widescreen 16:9 pictures for 4:3 displays.

Three menu entries allow the AFD feature to be turned on or off, the insertion line to be selected (on Fields 1 & 2) and the AFD code to be set according to the table below. Note that the precise interpretation of the code may depend on the standards authority being studied. The code may be represented as decimal or 4 bit binary.

Decimal	Binary	Summary
2	0010	16:9 top of frame
3	0011	14:9 top of frame
4	0100	16:9 vertically centred
8	1000	4:3 same as frame
9	1001	4:3 same as frame
10	1010	16:9 vertically centred
11	1011	14:9 vertically centred
13	1101	4:3 – alternate 14:9 centre
14	1110	16:9 - alternate 14:9 centre
15	1111	16:9: alternate 4:3 centre

### 5.3 DIGITAL VIDEO | AUDIO

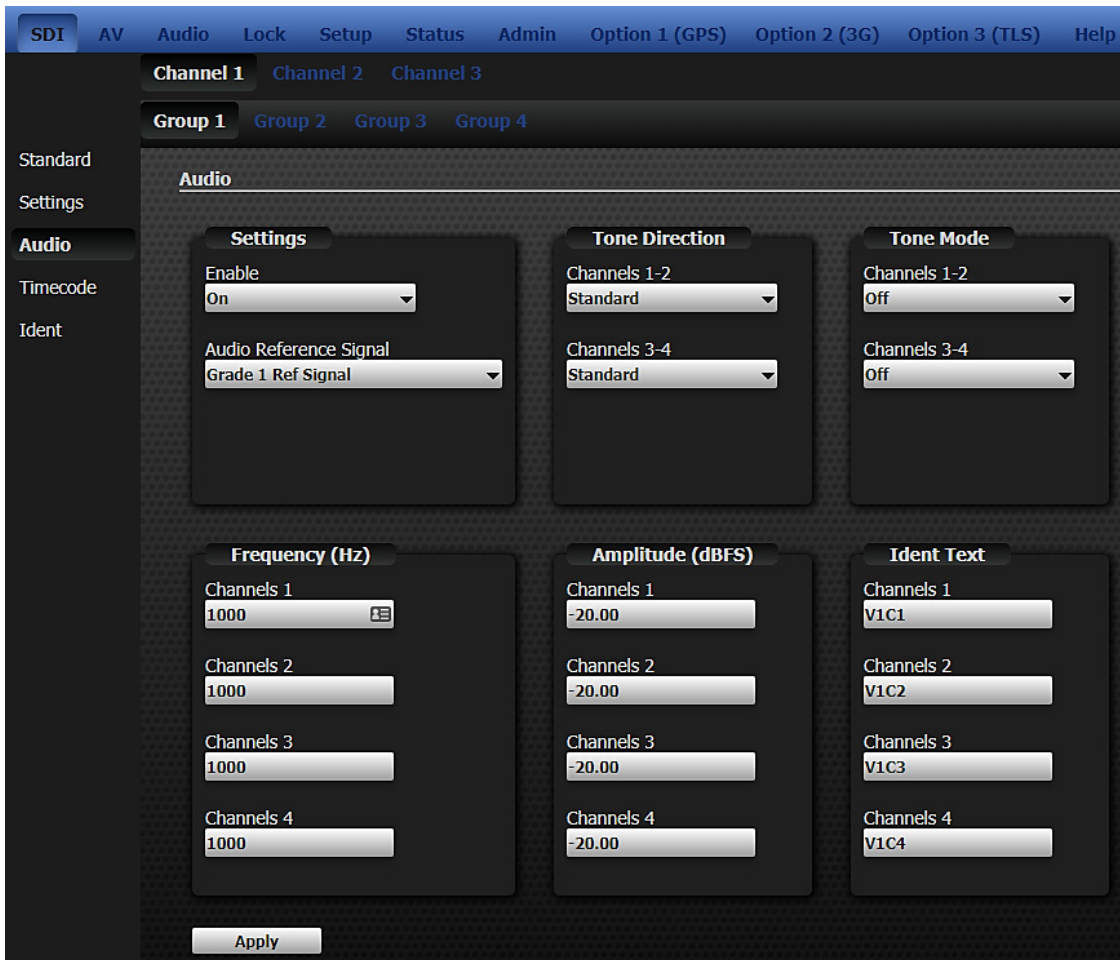

Four simultaneous AES Groups are available from both the mainboard outputs and the 360-20-00 HD/3G-SDI option board if fitted.

The factory default setting for each Group is for the embedded AES to be enabled “On”. However, the factory default setting is for the Tone Mode to be “Off”, which means the tones are initially set to silence and should be configured using the Tone Mode menu to the right of this page.

Setting the Group Enable mode to “Off” will remove Tones and Source Ident from the stream, regardless of any settings in the Tone Mode sub-menu.

Setting Tone mode to “Off” mutes the signal but retains the AES data within the stream. Setting Tone Mode to “On” will provide continuous tone.

### 5.4 DIGITAL VIDEO | TIMECODE

The extended timecode menus are displayed when the 360-22-00 Timecode option has been activated. Please see section 13 for more information.

### 5.5 DIGITAL VIDEO | IDENT

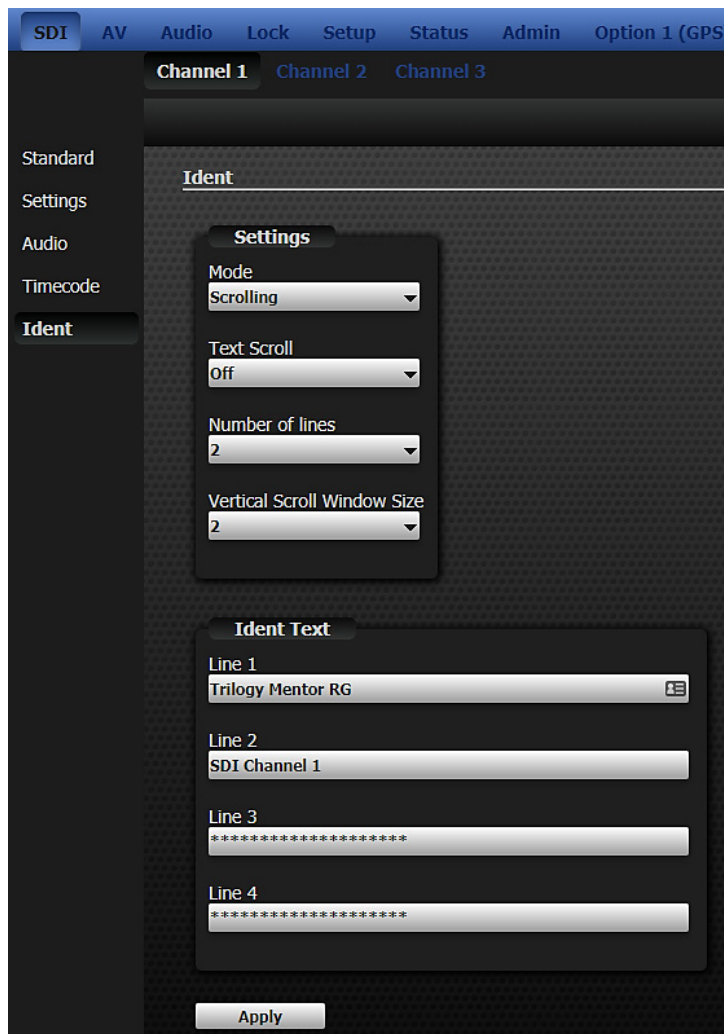

Using the ident menu, choose the “Number of Lines” of text before entering text using the “Ident Text” fields. Lines which are not available are indicated by a string of asterisks.



## 5.6 DIGITAL VIDEO | FRONT PANEL MENUS

### 5.6.1 Top Level

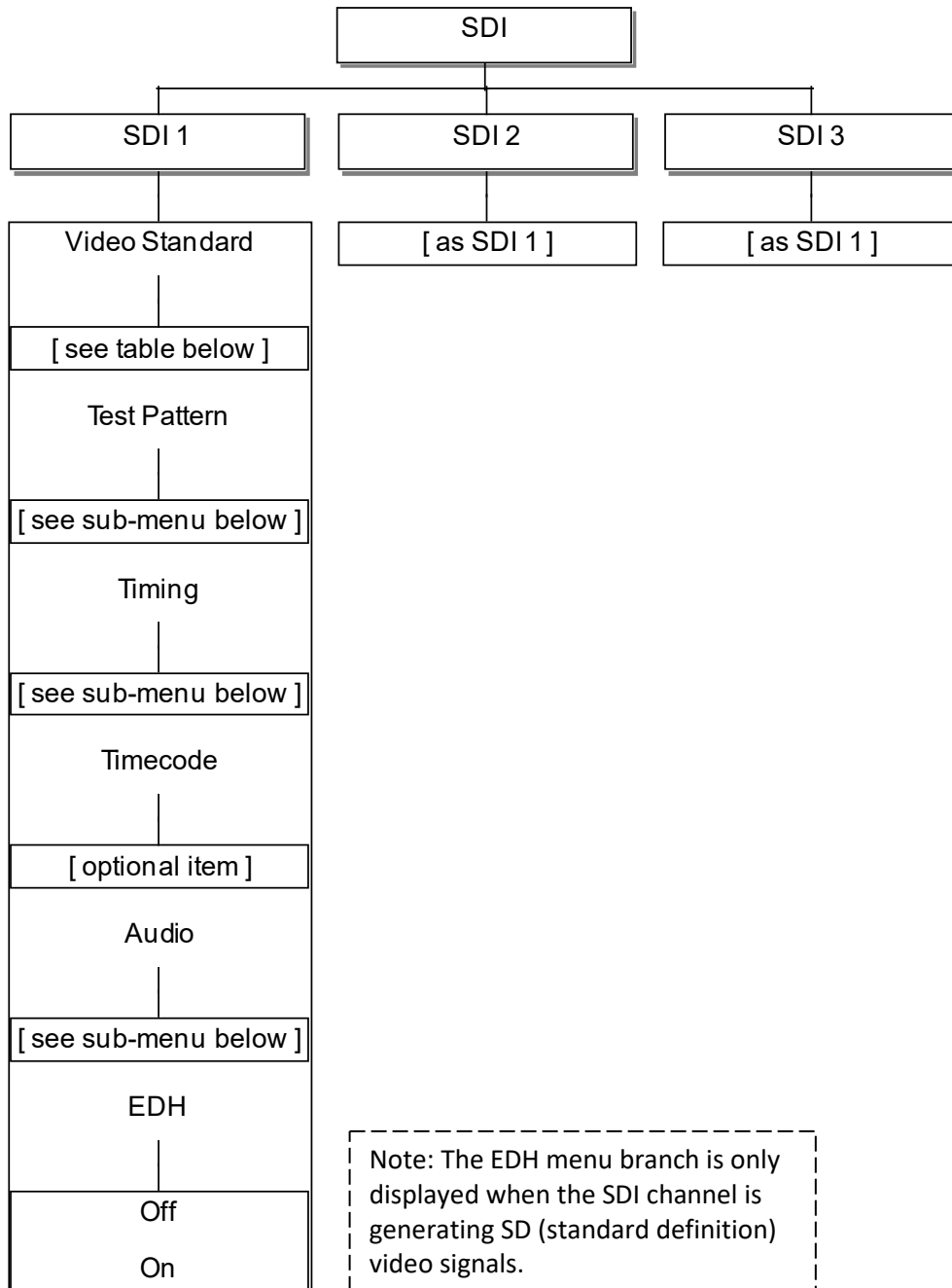

### 5.6.2 Select test Pattern

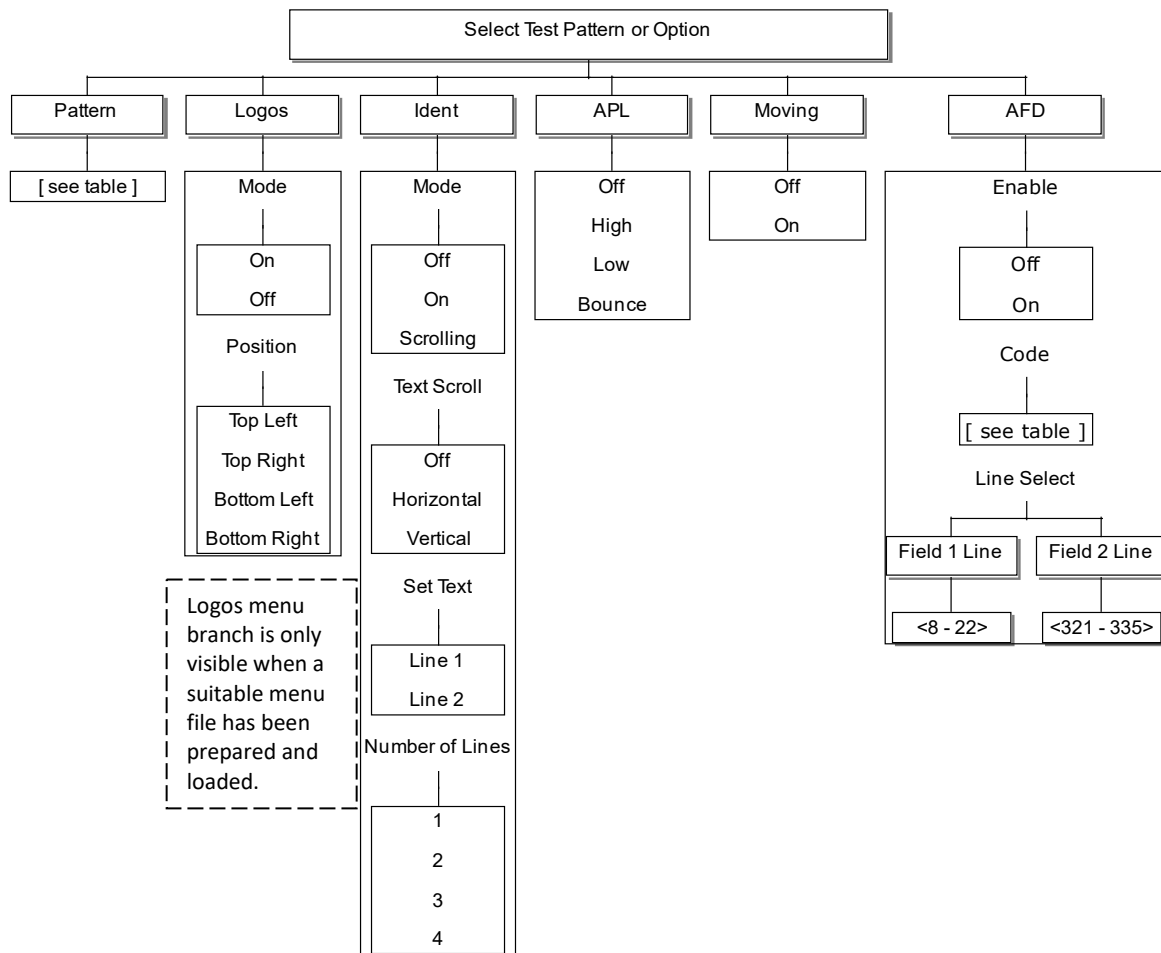

### 5.6.3 Timing

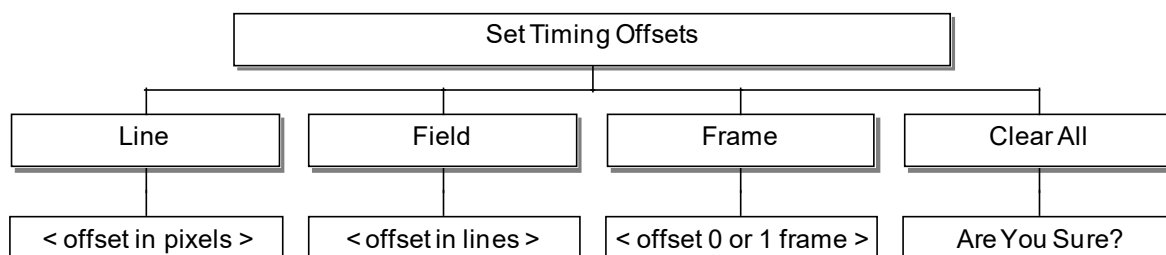

### 5.6.4 Audio Configuration

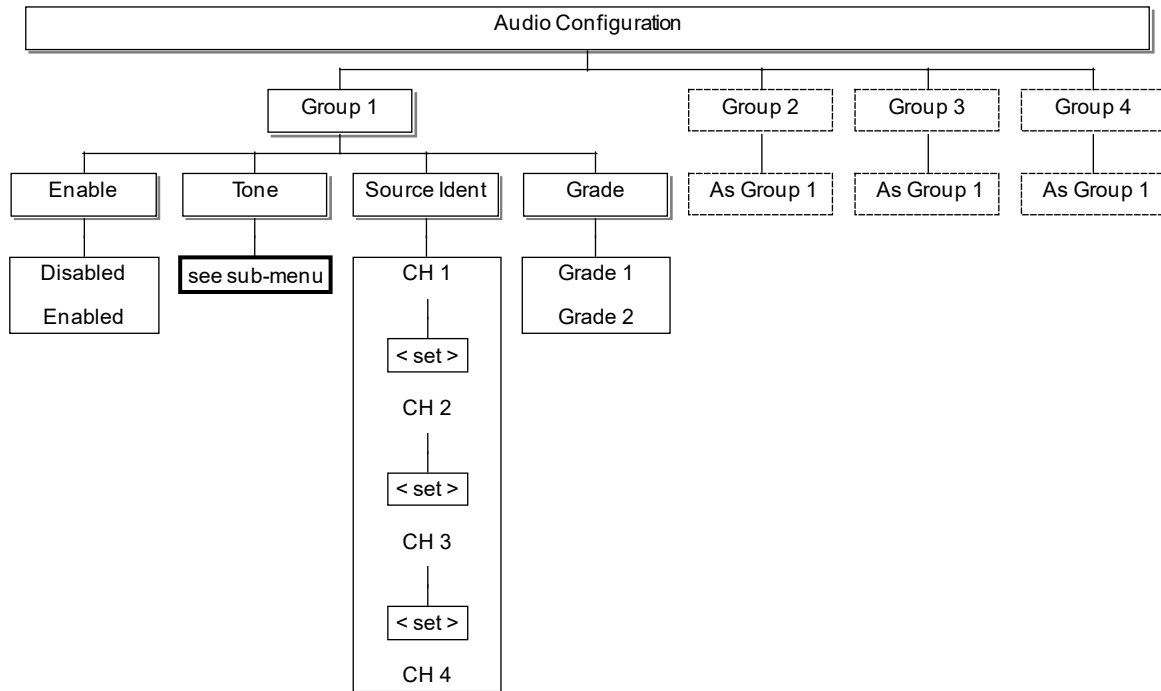

5.6.5 AES Tone Sub- menu

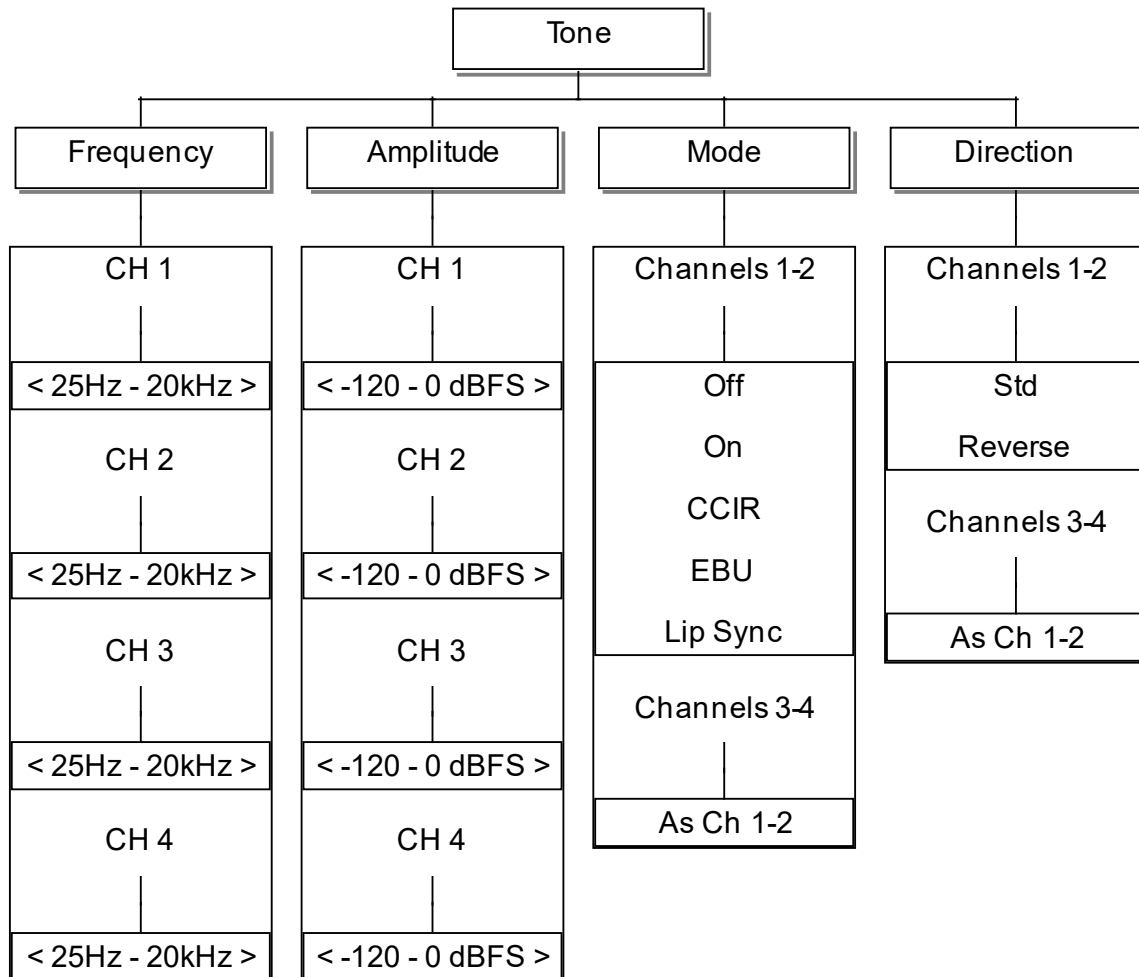

Four simultaneous AES Groups are available from both the mainboard outputs and the 360-20-00 HD/3G-SDI option board if fitted.

The factory default setting for each Group is for the embedded AES to be enabled “On”. However, the factory default setting is for the Tone Mode to be “Off”, which means the tones are initially set to silence and should be configured using the Tone Mode menu to the right of this page.

Setting the Group Enable mode to “Off” will remove Tones and Source Ident from the stream, regardless of any settings in the Tone Mode sub-menu.

Setting Tone mode to “Off” mutes the signal but retains the AES data within the stream. Setting Tone Mode to “On” will provide continuous tone.

## 6. AV: ANALOGUE VIDEO

As explained in the introductory sections, Mentor RG management is available either from the front panel controls, or via the built-in web management facility. The latter is the preferred approach and is described below. The front panel menu structure may be different to the web pages but most options are available albeit in a slightly different format. Front panel menus are grouped together in the manual, at the end of this section.

The five available analogue output channels are arranged as:

- A group of three, configured as:
  - All Black and Burst.
  - YUV test pattern.
  - A single composite video signal, plus two Black and burst outputs.
  - RGB test pattern.
  - YC test pattern plus a single black and burst output.
- Output # 4, configured as:
  - Black and Burst.
  - TLS (tri-level sync)
- Output # 5, configured as:
  - Black and Burst.
  - TLS (tri-level sync)

### 6.1 ANALOGUE VIDEO | CONFIGURE CHANNELS

The five available channels are arranged primarily as a group of three, followed by two individual channels, numbered 4 and 5. Where appropriate, individual detailed control of each channel is provided. In other instances, for example when Channels 1-3 are set to YUV, a single web page groups settings together.

The opening page is used to set the signal format for the five channels. The example page below shows all five channels configured a Black and Burst: the menu text reflects this and will change accordingly for other configurations.

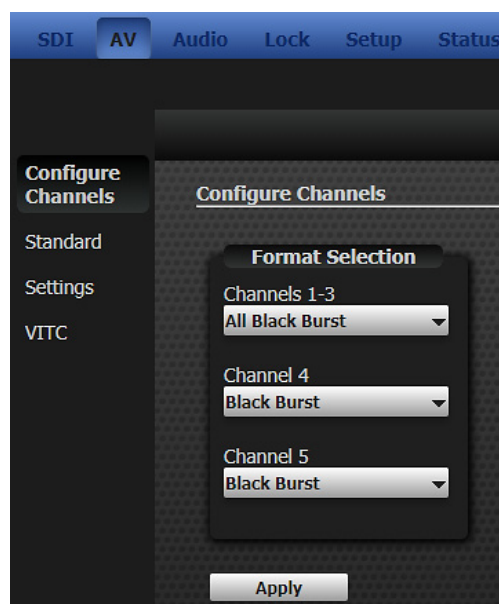

Additional side bar menu entries will appear, again depending on the channel configuration and options which have been activated.

## 6.2 ANALOGUE VIDEO | STANDARD

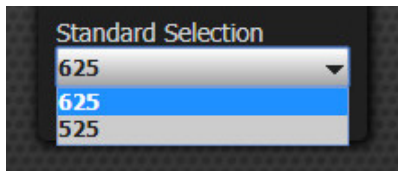

For configurations of channels 1-3, the video standard selection is limited to 525 or 625.

For outputs 4 and 5, when configured as Tri-Level Sync (TLS), a full range of standards is provided. Both the channel configuration and standard settings are totally independent for channels 4 and 5. The standard of each output channel may be individually configured from the menu according to the following table. The scan format is indicated by P (Progressive) or I (Interlaced). “sF” within the description is used to denote “segmented frame”.

Some timing options are not available with specific standards as indicated in the following table.

Description	Lines/ Frame	Frame Rate	Scan	Timing		
				Line	Field	Frame
1920x1080/60/1:1	1125	60	P	Y	N	Y
1920x1080/59.94/1:1	1125	60	P	Y	N	Y
1920x1080/50/1:1	1125	50	P	Y	N	Y
1920x1080/60/2:1	1125	60	I	Y	Y	Y
1920x1080/59.94/2:1	1125	60	I	Y	Y	Y
1920x1080/50/2:1	1125	50	I	Y	N	Y
1920x1080/30/1:1	1125	30	P	Y	N	Y
1920x1080/29.97/1:1	1125	30	P	Y	N	Y
1920x1080/25/1:1	1125	25	P	Y	N	Y
1920x1080/24/1:1	1125	24	P	Y	N	Y
1920x1080/23.98/1:1	1125	24	P	Y	N	Y
1920x1080/30/sF	1125	30	I	Y	Y	Y
1920x1080/29.97/sF	1125	30	I	Y	Y	Y
1920x1080/25/sF	1125	25	I	Y	Y	Y
1920x1080/24/sF	1125	24	I	Y	Y	Y
1920x1080/23.98/sF	1125	24	I	Y	Y	Y
1280x720/60/1:1	750	60	P	Y	N	Y
1280x720/59.94/1:1	750	60	P	Y	N	Y
1280x720/50/1:1	750	50	P	Y	N	Y
1280x720/30/1:1	750	30	P	Y	N	Y
1280x720/29.97/1:1	750	30	P	Y	N	Y
1280x720/25/1:1	750	25	P	Y	N	Y
1280x720/24/1:1	750	24	P	Y	N	Y
1280x720/23.98/1:1	750	24	P	Y	N	Y

### 6.3 ANALOGUE VIDEO | SETTINGS

The Settings page is provided for all configurations but content displayed on the page will vary according to both the channel configuration and line standard previously selected. For channel 4/5 set to TLS standard, the Settings menu entry is renamed “Timing” and only the appropriate fields are shown. For all other configurations, output timing is present.

In addition, fields to set a Test Pattern are shown when channels 1-3 are configured as YUV, Composite, RGB or YC. The example page below shows the Settings menu when channels 1-3 are configured as RGB. Test Pattern settings are on the left of the main panel, timing on the right side.

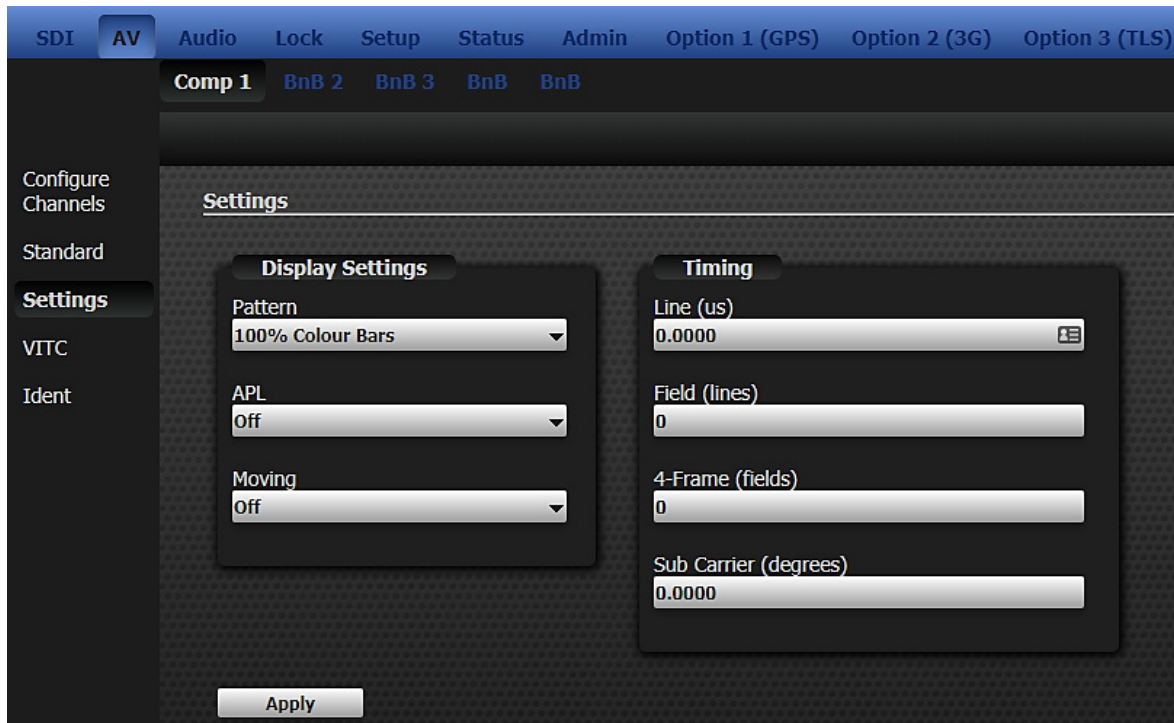

The range of available patterns depends on both the line standard selected and the output configuration (composite, YUV etc.).

### 6.3.1 Test Patterns: 525 Line Standard

Pattern	Composite/YC	RGB	YUV
Full Field Black	•	•	•
Full Field White	•	•	•
Full Field Red	•	•	•
Full Field Red 75%	•	•	•
Luminance Ramp	•	•	•
75% Colour Bars	•	•	•
5 Step Stair	•	•	•
SMPTE Bars	•	•	•
PLUGE	•	•	•
Multiburst	•	•	
Sin(x)/x	•	•	•

### 6.3.2 Test Patterns: 625 Line Standard

Pattern	Composite/YC	RGB	YUV
Full Field Black	•	•	•
Full Field White	•	•	•
Full Field Red	•	•	•
100% Colour Bars	•	•	•
100% Colour Bars & Split	•	•	•
EBU Colour Bars & Split	•	•	•
EBU Colour Bars	•	•	•
VT Colour Bars	•	•	•
VT Bars & Split	•	•	•
2T Pulse & Bar	•	•	•
20T Chroma + 2T Pulse & Bar	•		•
Valid Stair			•
5 Riser Luma Stair	•	•	•
5 Riser Chroma Stair	•		•
Luminance Ramp	•	•	•
Valid Ramp			•
14 x 19 Grille	•	•	•
Linearity Grille	•	•	•
Convergence Grille	•	•	•
PLUGE	•	•	•
SPLUGE	•	•	•
15% White Window	•	•	•
100% White Window	•	•	•
Multiburst	•	•	
Sin(x)/x	•	•	•



### 6.3.3 TLS Timing

When channel 4/5 is set to TLS standard, the menu items are restricted to Standard and Timing. Example timing page are shown below: the fields shown on-screen are dependent on the TLS standard. The example shows a progressive video standard (left), interlaced video standard (right).

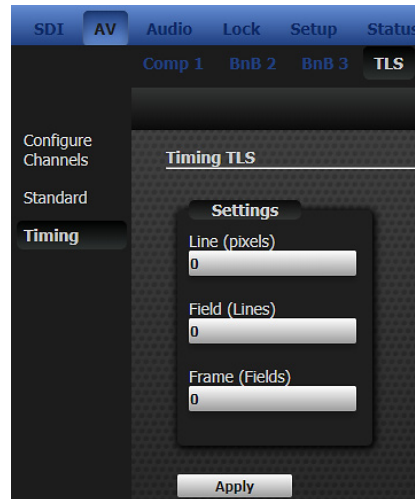
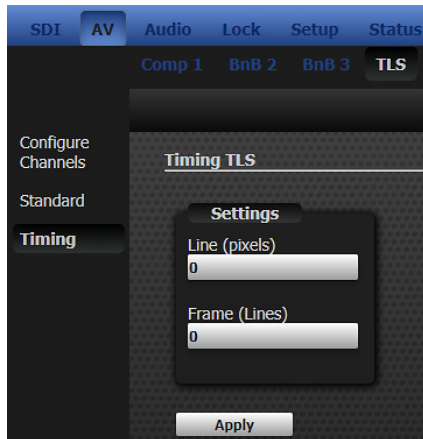

### 6.4 ANALOGUE VIDEO | VITC

The extended timecode menus are displayed when the 360-22-00 Timecode option has been activated. Please see section 13 for more information.

### 6.5 ANALOGUE VIDEO | IDENT

The Ident page is displayed when appropriate, for configurations which support a test pattern. For Channels 1-3, this is:

- YUV
- Comp/BnB/BnB
- RGB
- YC/BnB

An example page is shown below.

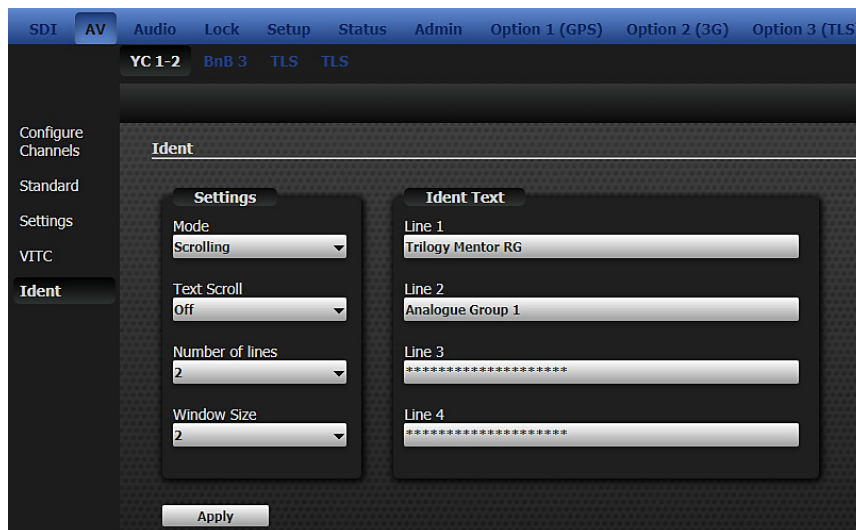

## 6.6 ANALOGUE VIDEO | FRONT PANEL MENUS

### 6.6.1 Top Level Menu

The five available analogue output channels are arranged as:

- A group of three, configured as:
  - All Black and Burst.
  - YUV test pattern.
  - A single composite video signal, plus two Black and burst outputs.
  - RGB test pattern.
  - YC test pattern plus a single black and burst output.
- Output # 4, configured as:
  - Black and Burst.
  - TLS (tri-level sync)
- Output # 5, configured as:
  - Black and Burst.
  - TLS (tri-level sync)

The analogue video top level menu is shown below. The menus follow two common themes, either for the Test Pattern signals, or for Black and Burst configuration.

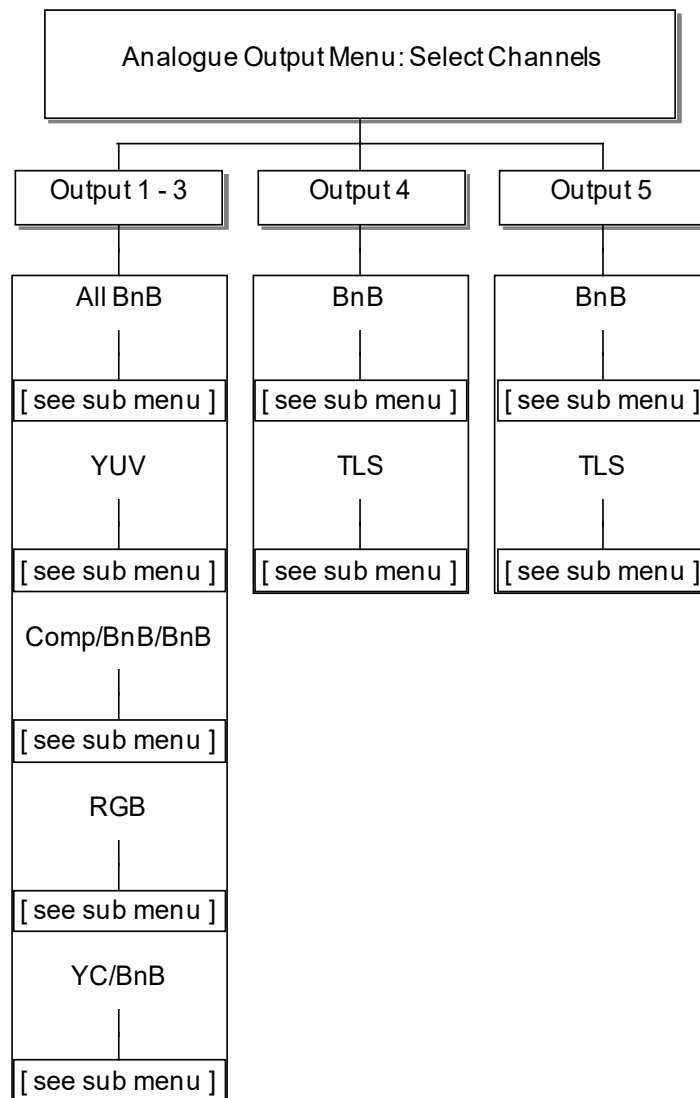

## 6.6.2 Analogue Video Output 1-3 – All Black &amp; Burst

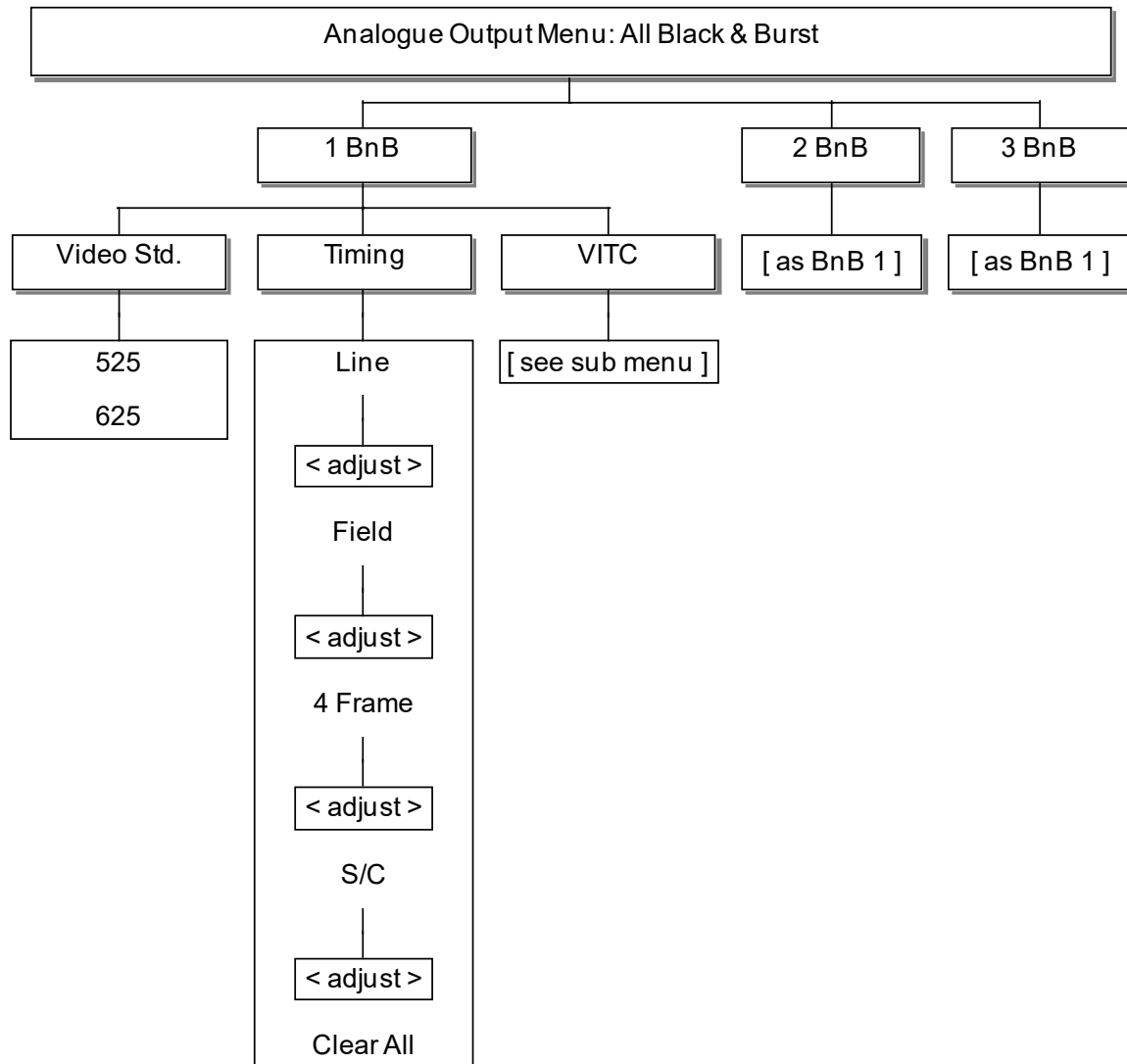

**Note 1:** VITC menu branch is only displayed when Timecode software feature is enabled.

### 6.6.3 Analogue Video Output 1-3 – YUV

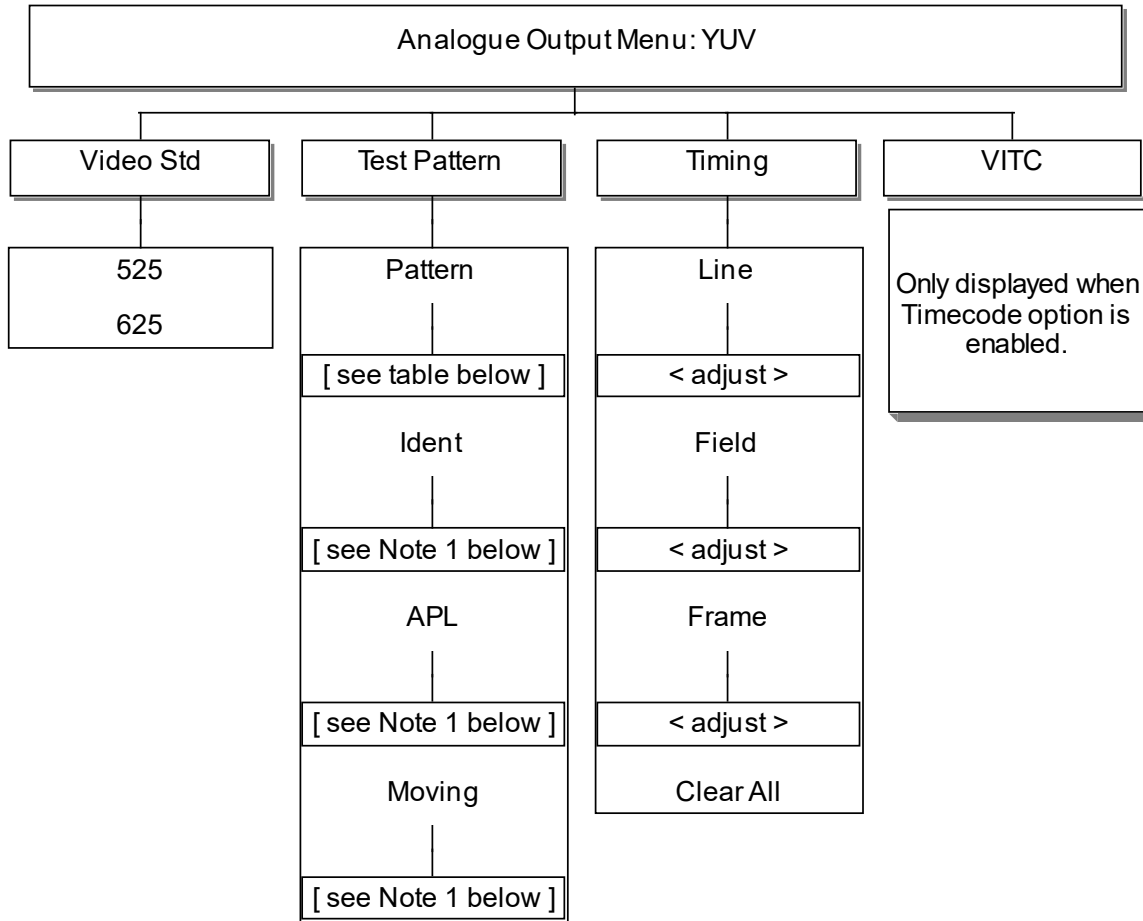

**Note 1:** For details of these menus, see section 5.2.

**Note 2:** Within the Timing menu, “4 Frame” is shown for PAL: “2 Frame” for NTSC.

**Note 3:** VITC menu branch is only displayed when Timecode software feature is enabled.

### 6.6.4 Analogue Video Output 1-3 – Comp / BB / BB

This follows the patterns established in preceding sections.

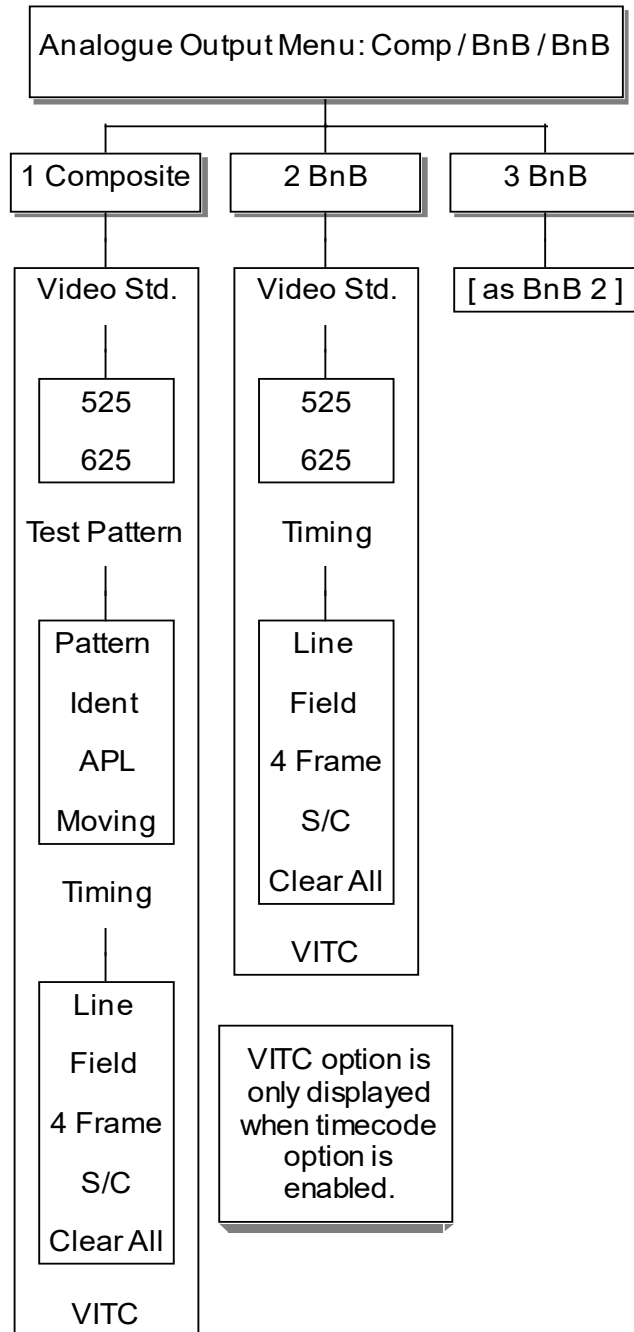

**Note 1:** For the list of available patterns, see section 6.7.

**Note 2:** For details of the Test Pattern menu, see section 5.2.1.

### 6.6.5 Analogue Video Output 1-3 – RGB

This follows the patterns established in preceding sections.

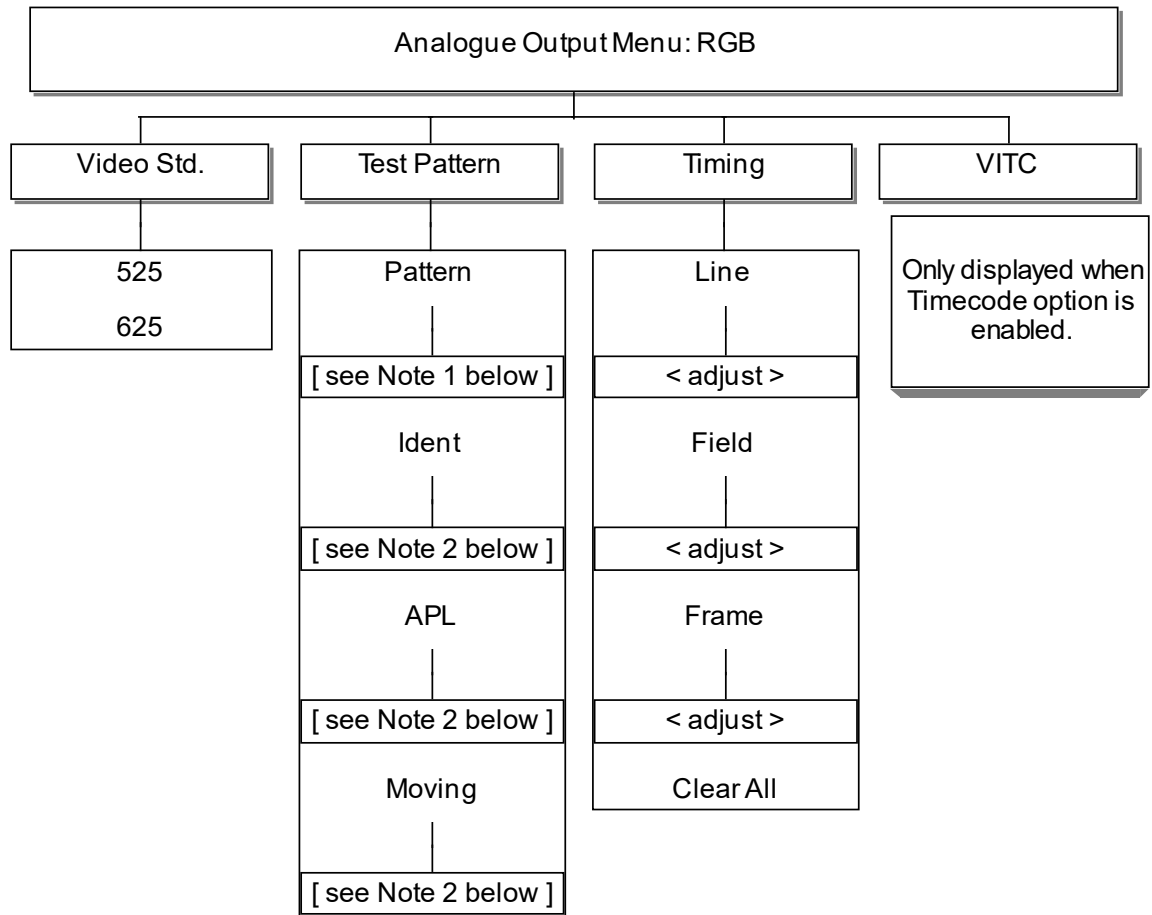

**Note 1:** For the list of available patterns, see section 6.7.

**Note 2:** For details of the Test Pattern menu, see section 5.2.1.

### 6.6.6 Analogue Video Output 1-3 – YC / BB

This follows the patterns established in preceding sections.

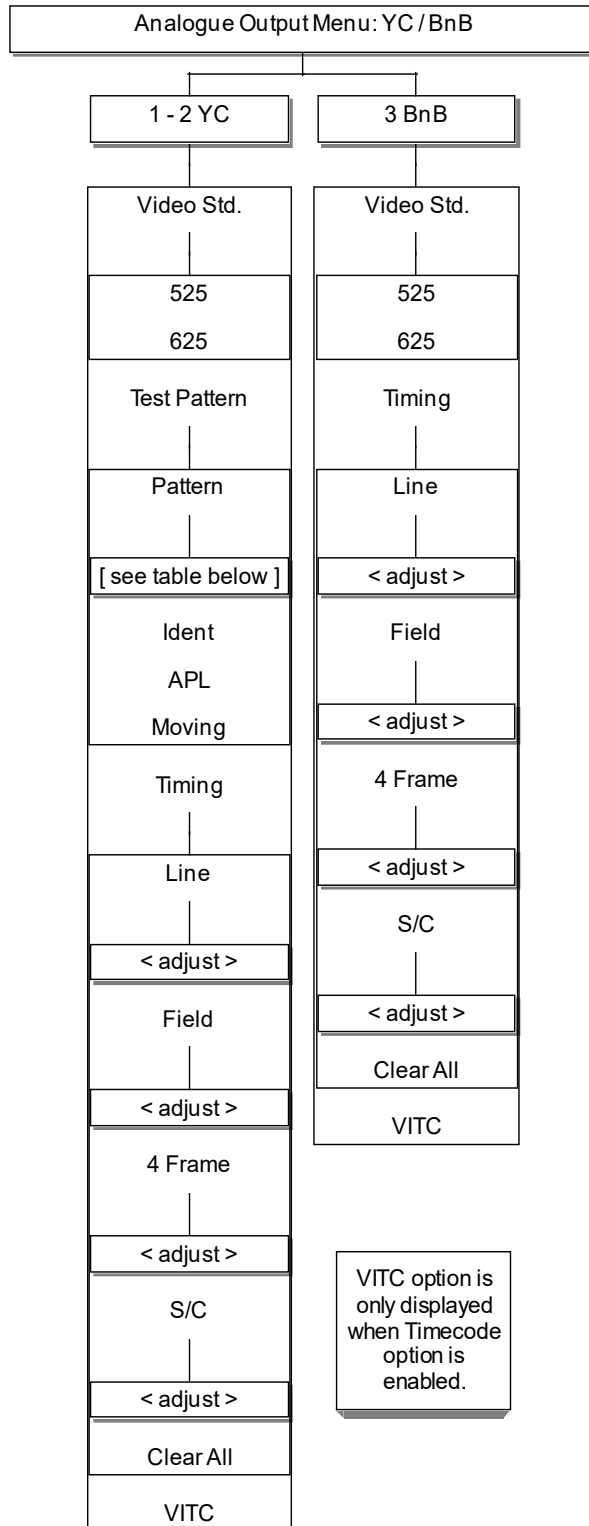

**Note 1:** For the list of available patterns, see section 6.7.

**Note 2:** For details of the Test Pattern menu, see section 5.2.1.

### 6.6.7 Analogue Video Output 4/5 – B&B

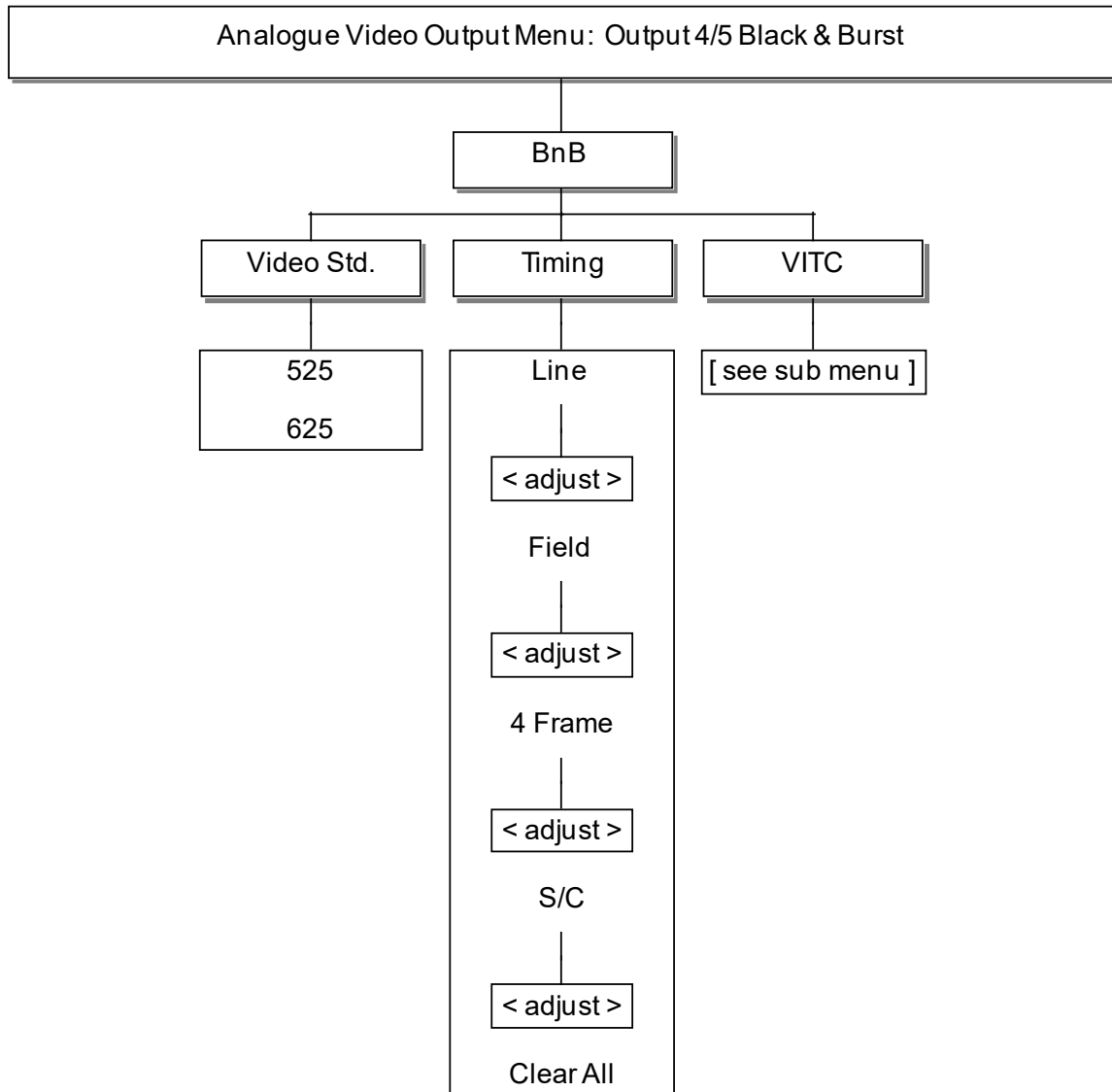



### 6.6.8 Analogue Video Output 4/5 – TLS

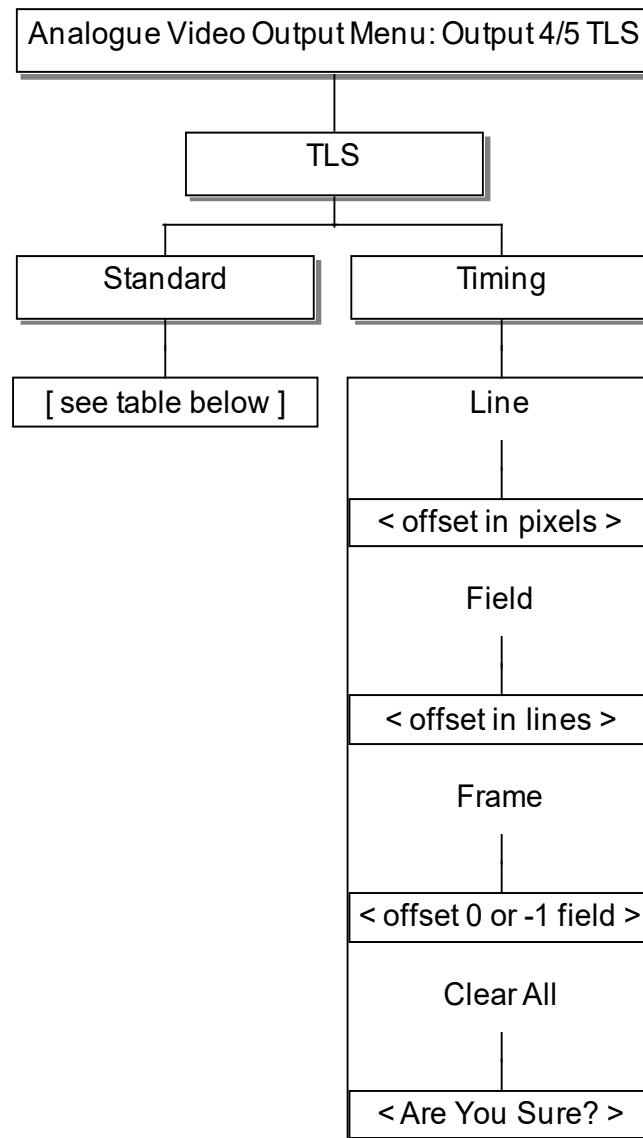

Note: the option for Timing at Field level is only displayed for “interlaced” video standards, not for “progressive” standards.

## 6.7 ANALOGUE VIDEO | AVAILABLE TEST PATTERNS

The range of available patterns depends on both the line standard selected and the output configuration (composite, YUV etc.).

### 6.7.1 Test Patterns: 525 Line Standard

Pattern	Composite/YC	RGB	YUV
Full Field Black	•	•	•
Full Field White	•	•	•
Full Field Red	•	•	•
Full Field Red 75%	•	•	•
Luminance Ramp	•	•	•
75% Colour Bars	•	•	•
5 Step Stair	•	•	•
SMPTE Bars	•	•	•
PLUGE	•	•	•
Multiburst	•	•	
Sin(x)/x	•	•	•

### 6.7.2 Test Patterns: 625 Line Standard

Pattern	Composite/YC	RGB	YUV
Full Field Black	•	•	•
Full Field White	•	•	•
Full Field Red	•	•	•
100% Colour Bars	•	•	•
100% Colour Bars & Split	•	•	•
EBU Colour Bars & Split	•	•	•
EBU Colour Bars	•	•	•
VT Colour Bars	•	•	•
VT Bars & Split	•	•	•
2T Pulse & Bar	•	•	•
20T Chroma + 2T Pulse & Bar	•		•
Valid Stair			•
5 Riser Luma Stair	•	•	•
5 Riser Chroma Stair	•		•
Luminance Ramp	•	•	•
Valid Ramp			•
14 x 19 Grille	•	•	•
Linearity Grille	•	•	•
Convergence Grille	•	•	•
PLUGE	•	•	•
SPLUGE	•	•	•
15% White Window	•	•	•
100% White Window	•	•	•
Multiburst	•	•	
Sin(x)/x	•	•	•

### 6.7.3 TLS Standards

The standard of each output channel may be individually configured from the menu according to the following table. The scan format is indicated by P (Progressive) or I (Interlaced). “sF” within the description is used to denote “segmented frame”.

Some timing options are not available with specific standards as indicated in the following table.

Description	Lines/ Frame	Frame Rate	Scan	Timing		
				Line	Field	Frame
1920x1080/60/1:1	1125	60	P	Y	N	Y
1920x1080/59.94/1:1	1125	60	P	Y	N	Y
1920x1080/50/1:1	1125	50	P	Y	N	Y
1920x1080/60/2:1	1125	60	I	Y	Y	Y
1920x1080/59.94/2:1	1125	60	I	Y	Y	Y
1920x1080/50/2:1	1125	50	I	Y	N	Y
1920x1080/30/1:1	1125	30	P	Y	N	Y
1920x1080/29.97/1:1	1125	30	P	Y	N	Y
1920x1080/25/1:1	1125	25	P	Y	N	Y
1920x1080/24/1:1	1125	24	P	Y	N	Y
1920x1080/23.98/1:1	1125	24	P	Y	N	Y
1920x1080/30/sF	1125	30	I	Y	Y	Y
1920x1080/29.97/sF	1125	30	I	Y	Y	Y
1920x1080/25/sF	1125	25	I	Y	Y	Y
1920x1080/24/sF	1125	24	I	Y	Y	Y
1920x1080/23.98/sF	1125	24	I	Y	Y	Y
1280x720/60/1:1	750	60	P	Y	N	Y
1280x720/59.94/1:1	750	60	P	Y	N	Y
1280x720/50/1:1	750	50	P	Y	N	Y
1280x720/30/1:1	750	30	P	Y	N	Y
1280x720/29.97/1:1	750	30	P	Y	N	Y
1280x720/25/1:1	750	25	P	Y	N	Y
1280x720/24/1:1	750	24	P	Y	N	Y
1280x720/23.98/1:1	750	24	P	Y	N	Y
6Hz(30/24)	6Hz	-	-	N	N	N
6Hz(29.97/23.97)	6Hz	-	-	N	N	N
625/50	625	50	I	Y	Y	Y
525/59.94	525	60	I	Y	Y	Y

## 7. AUDIO

As explained in the introductory sections, Mentor RG management is available either from the front panel controls, or via the built-in web management facility. The latter is the preferred approach and is described below. The front panel menu structure may be different to the web pages but most options are available albeit in a slightly different format. Front panel menus are grouped together in the manual, at the end of this section.

### 7.1 AUDIO | STANDARD

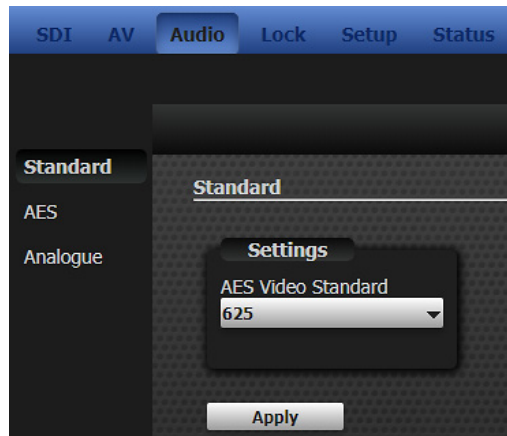

### 7.2 AUDIO | AES

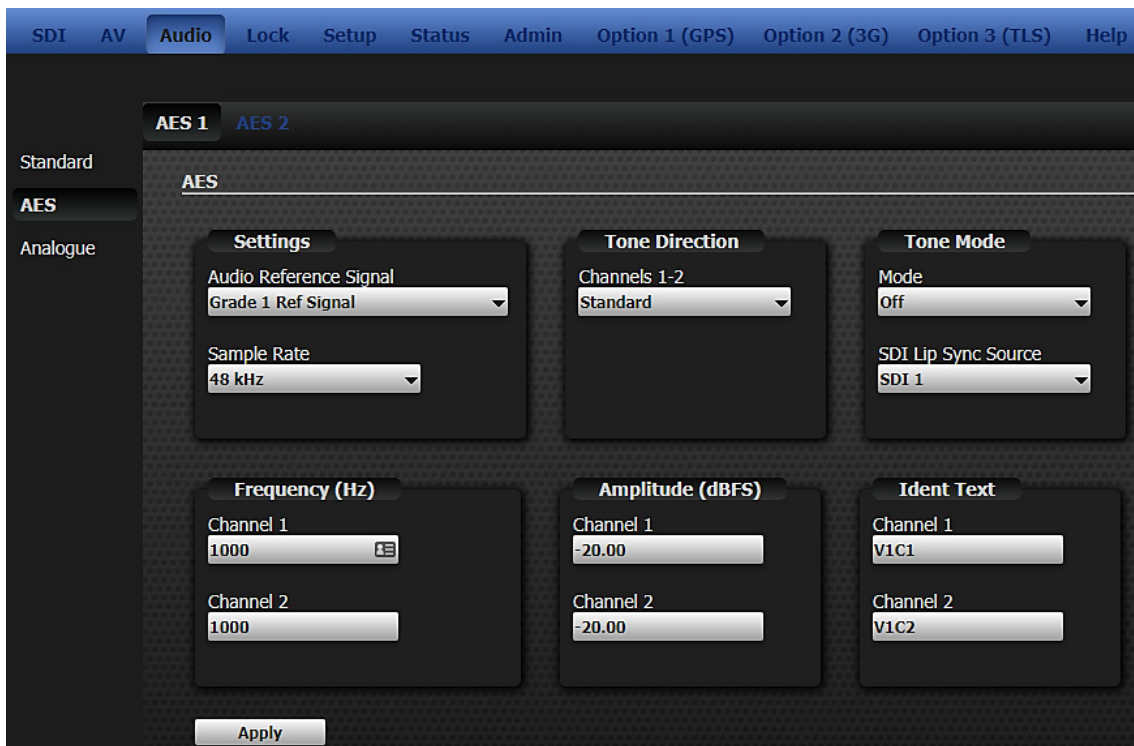

### 7.3 AUDIO | ANALOGUE

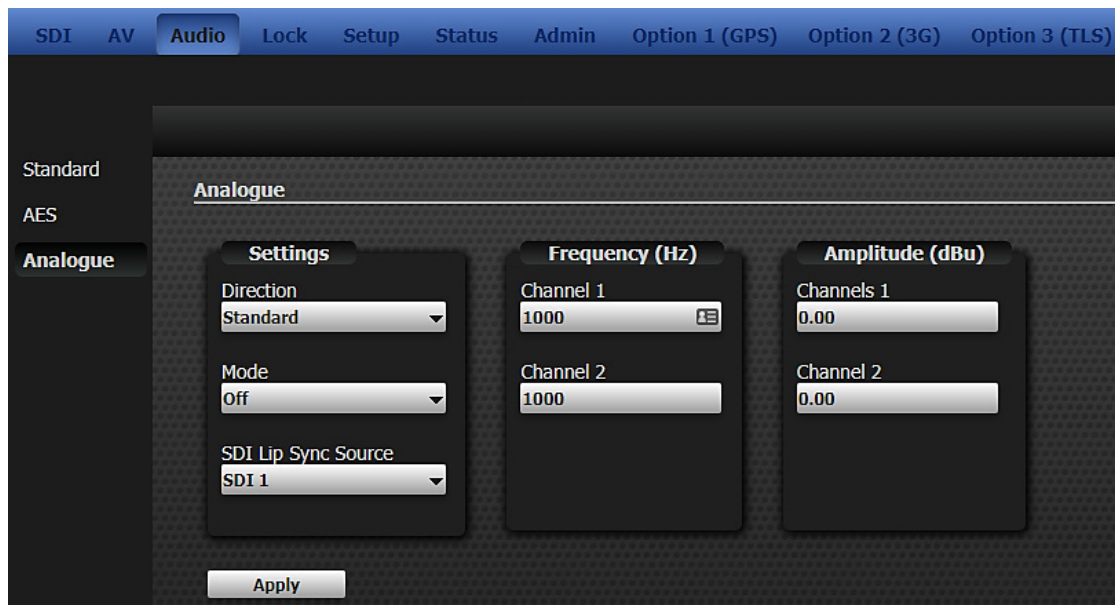

### 7.4 AUDIO | FRONT PANEL MENUS

The Audio menu has two branches, AES and Analogue.

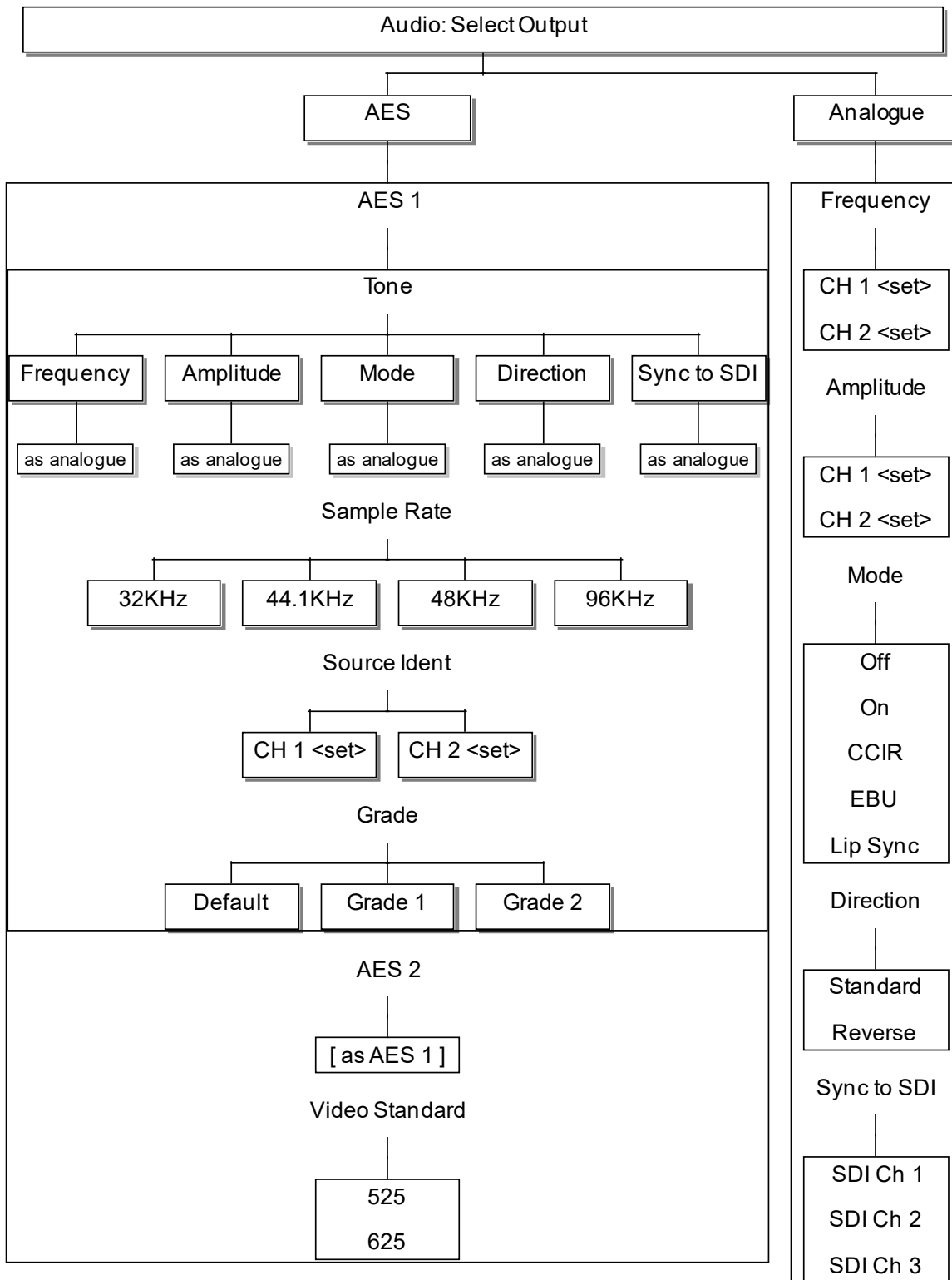

#### **7.4.1 Audio: AES 1 / AES 2.**

The AES 2 sub-menu is identical to AES 1.

#### **7.4.2 Audio: Analogue**

The Direction option swaps the CCIR/EBU tone blips between left and right channels

## 8. GENLOCK

Genlock or “Generator Lock” is the process of adjusting the timing of generated video signals such that they are co-timed with an external, supplied reference. Settings allow operators to decide what happens as lock is acquired and if the external signal is lost.

As explained in the introductory sections, Mentor RG management is available either from the front panel controls, or via the built-in web management facility. The latter is the preferred approach and is described below. The front panel menu structure may be different to the web pages but most options are available albeit in a slightly different format. Front panel menus are grouped together in the manual, at the end of this section.

### 8.1 GENLOCK | LOCK MENU

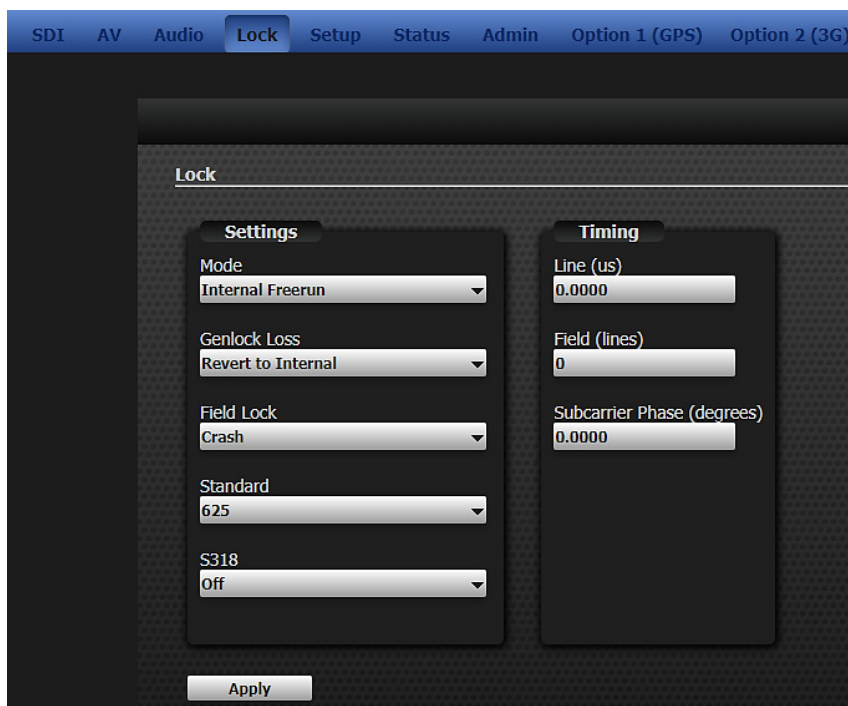

The Genlock (or Generator Lock) settings of the unit (for example, the current Genlock mode and timing offsets) may be changed as follows:

- Mode: changes the basic genlock mode i.e. internal (free run), lock to video etc. See section 8.1.1.
- Genlock Loss sets the behaviour of the unit following loss of the genlock signal. See section 8.1.2.
- Field Lock: alters the field lock action - instantaneous or slow lock. See section 8.1.3
- Input Standard: See section 8.1.4.

To enter any of these sub-menus, press **OK**. The sub-menus are described below.



### 8.1.1 Genlock - Mode

Select the mode required using the encoder control. Please be aware that the mode will change immediately each option is selected.

- **Internal Free Run:** sets the unit to be free running, relying on the internal oven oscillator for stability. The Sch. of the unit will be set to zero. **Note:** the Mentor RG **must** be set to free run when locking to a GPS signal.
- **External 10MHz:** sets the unit to genlock to the 10MHz input. There will be no fixed phase relationship with any other units locked to this signal. The Sch. of the unit will be set to zero.
- **Manual SC Phasing:** sets the unit to genlock to the video input. The subcarrier phase offset may be adjusted as required.
- **Force Strict Sch:** sets the unit to genlock to the video input. The Sch. of the outputs of the unit is forced to be zero regardless of the genlock input Sch. This is achieved by moving the line timing with respect to the genlock input until the correct Sch. phase results.
- **Follow External SC Phase:** sets the unit to genlock to the video input. The subcarrier output phase is set to be the same as the input genlock video.
- **Sync Lock Only:** sets the unit to genlock to the video input. The system is genlocked using only the sync information of the genlock video input. The Sch. phase of the output is forced to be zero - i.e. "correct".

### 8.1.2 Genlock - Loss

Set the operational mode of the unit following loss of the genlock signal.

- **Revert to Internal:** If the external reference input is removed, the unit will use the internal oven maintained oscillator or GPS signal (when available) as its master oscillator.
- **External 10 MHz:** If the genlock video input is removed, the unit will use the 10 MHz input as its master oscillator. If the 10 MHz input is not present when the video input fails, the unit will use the internal oven maintained oscillator or GPS signal (when available) as its master oscillator.
- **Flywheel:** If the genlock video input is removed, the unit will continue to operate - "flywheel" - at the same frequency as the genlock input just removed. Note that if the unit is powered up in this mode with no genlock input applied, the Mentor RG timing may not be within specification.

### 8.1.3 Genlock – Field Lock

Select the mode required using the encoder control or left – right keys.

- **Crash:** Sets the unit to lock near instantaneously to the field information of an applied genlock video input. This is the normal mode of operation.
- **Line Drop:** Sets the unit to lock to the field information of an applied genlock video input by moving the outputs one line nearer to the genlock video input every 5 fields until the unit is locked. This mode is useful if the instant locking of the crash mode is found to upset any downstream equipment.
- **Slow:**

### 8.1.4 Genlock – Input Standard

Select the video line standard of the input signal.

- 525
- 625
- Auto detect (follow input)

### 8.2 GENLOCK | FRONT PANEL MENU

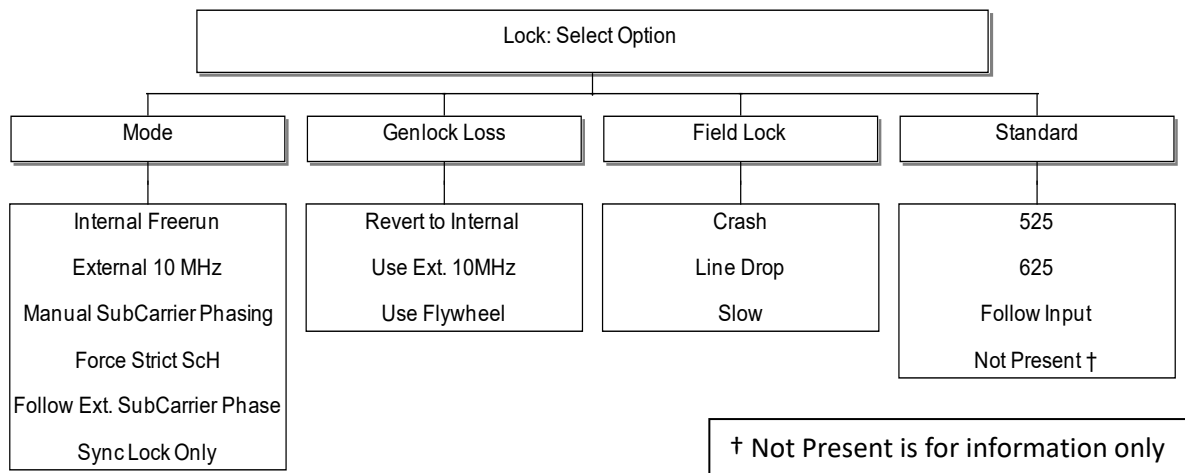

## 9. SETUP

As explained in the introductory sections, Mentor RG management is available either from the front panel controls, or via the built-in web management facility. The latter is the preferred approach and is described below. The front panel menu structure may be different to the web pages but most options are available albeit in a slightly different format. Front panel menus are grouped together in the manual, at the end of this section.

Due to complexity, the majority of PTP settings are only available on the web interface.

The Setup section has the following side-bar menu items:

- GPI
- Timecode
- LTC
- PTP
- Misc

Additional menu items will be displayed as options are activated.

### 9.1 SETUP | GPI

#### 9.1.1 GPI Input

Input 1 and 2 pages are identical.

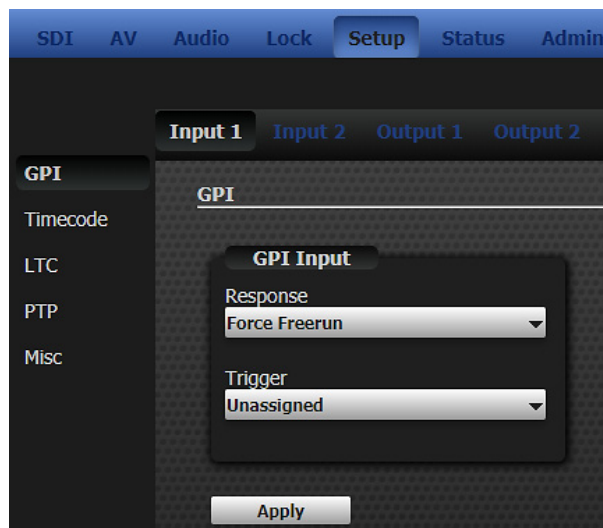

When a GPI input is asserted, it can cause one of a number of responses. The menus also provide choice of the trigger point, e.g. rising or falling edge. Choices of Response and Trigger are shown below.

#### Response

- Unassigned
- Force Freerun
- Force Genlock
- Force External 10MHz
- Step Through SDI 1 Patterns
- Step Through SDI 2 Patterns
- Step Through SDI 3 Patterns
- Step Through Memories 1..4

#### Trigger

- Unassigned
- Rising Edge
- Falling Edge
- Active High
- Active Low

### 9.1.2 GPI Output

Output 1 and 2 pages are identical.

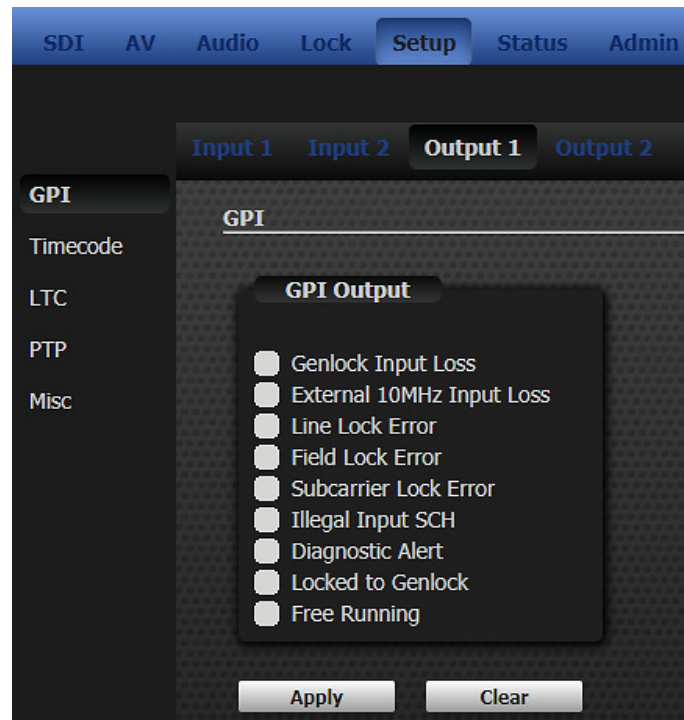

The image above shows the events which can be used to “fire” GPI output 1: GPI output 2 is independent but configured in exactly the same manner. Any number of events may be checked, they will act as a logical “OR”.

## 9.2 SETUP | FRONT PANEL MENU

### 9.2.1 Setup - Top Level Menu

The Setup menu provides control of the configuration of the Mentor RG, and will be used primarily during the installation phase.

The top level Setup menu contains a maximum of 14 sub menus although some of these are related to optional software features and only appear if those features are enabled.

Menu options comprise:

- **Timecode** (optional feature – see section 13.2)
- **LTC** (optional feature – see section 13.2.2)
- **Clock Output** – see sub menu below
- **GPI** - comprehensive control of GPI Inputs and Outputs, see section 9.2.2, including
  - the input signal response mode
  - the action resulting from a GPI input trigger
  - the event causing a GPI output state change
- **Config Memory** – management of internal memory banks 1-4. A complete operational setup may be stored or retrieved at any time
- **RTC Setup** – set the real time clock options
- **PTP** (optional feature, Precision Time Protocol, see section 18)
- **NTP** (optional feature, Network Time Protocol, see section 16.1)
- **SNMP** (optional feature, Simple Network Management Protocol, see section 16.2)
- **Comms**
  - configuration of the Ethernet port
  - configuration of the serial port
- **Display**
  - Enable / disable and timing of the menu timeout
  - the display contrast
- **Master/Slave** - configuration of the Mentor as “Slave”, allowing settings to be retrieved from a “Master”.
- **Upgrades** - upgrading the Mentor RG, including the addition of new features and test patterns.
- **Boot Delay** – 0 to 10 minutes

### 9.2.2 Setup – Clock Output

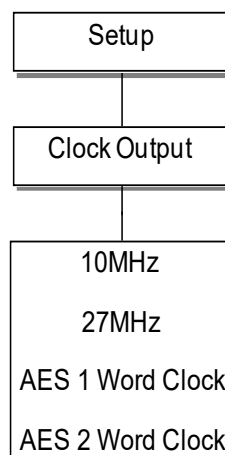

### 9.2.3 Setup – GPI Control

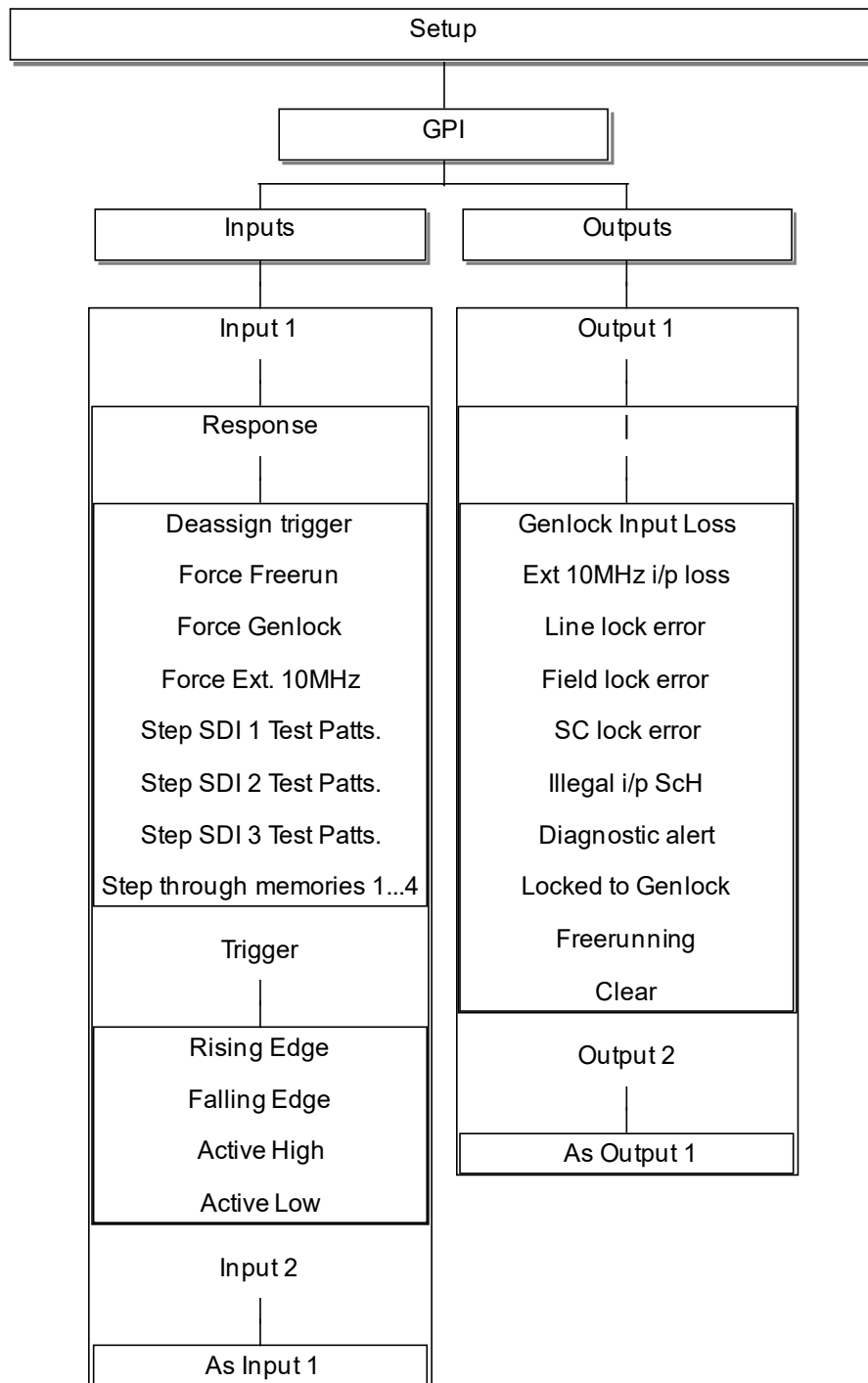

The charts above show:

- **Inputs:** the actions which the Mentor RG will carry out when a control signal (trigger) is applied to GPI input 1 or 2.
- **Outputs:** the events which will trigger the Mentor RG GPI outputs. The available output conditions include error and status indications.

For connector wiring, see section 2.7.

### 9.2.4 Setup – Config Memory

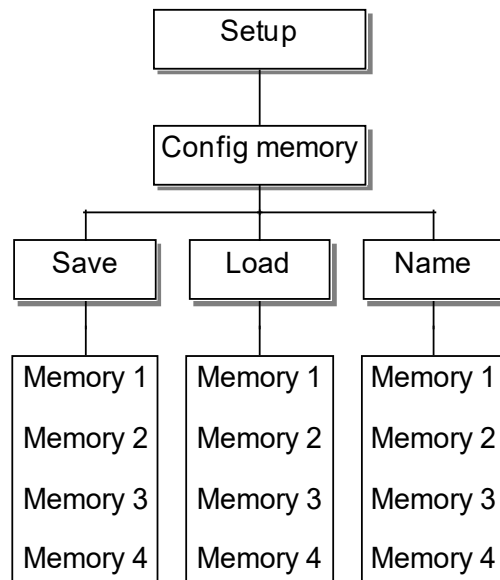

**Note:** The “Load” option is not displayed until any one of the four memory banks is populated. If all four are empty, it is not shown.

### 9.2.5 Setup – RTC (Real Time Clock)

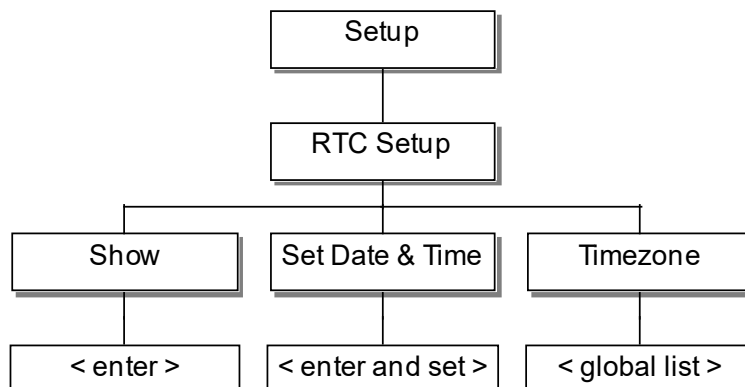

### 9.2.6 Setup – Comms

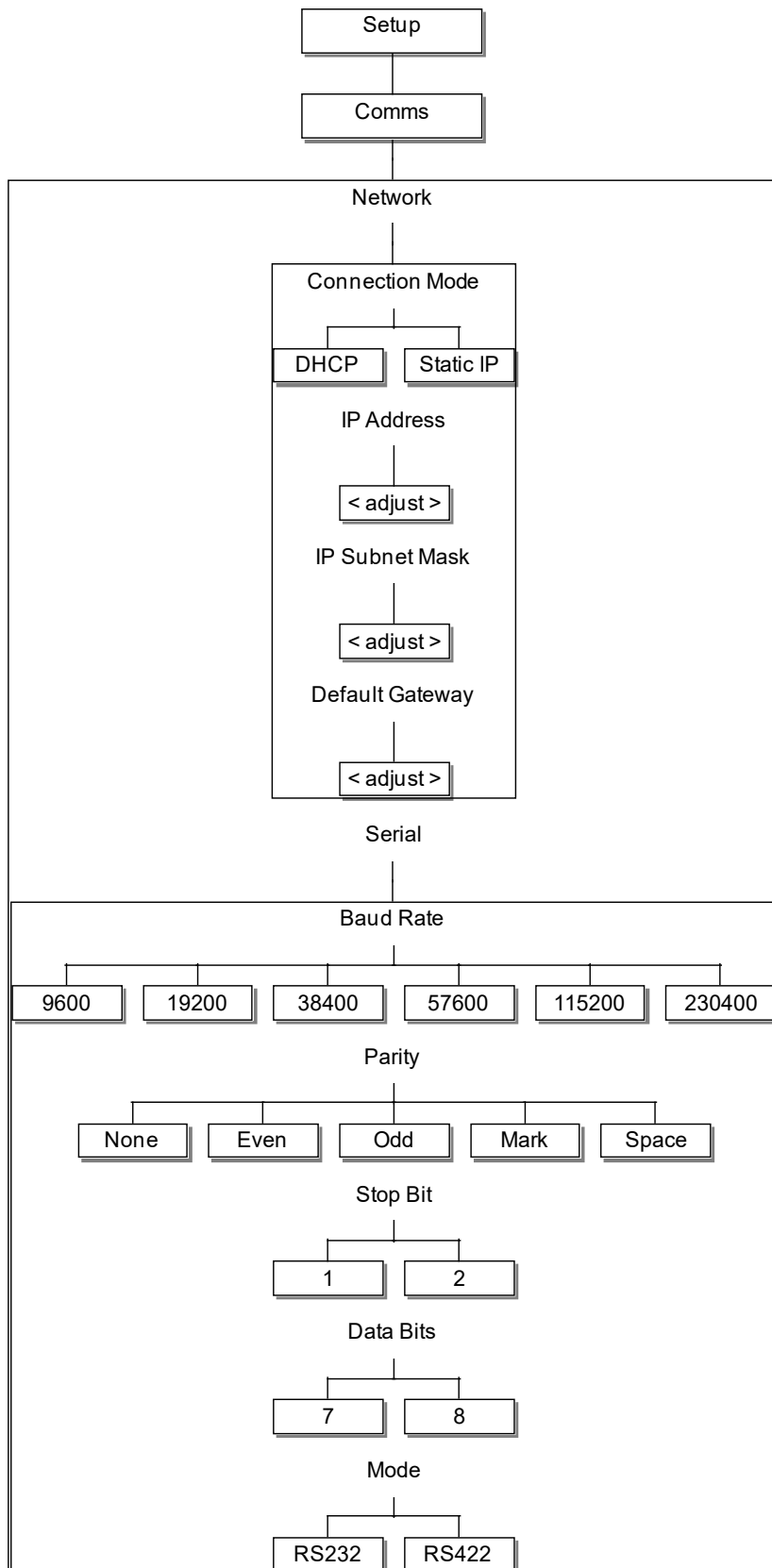



### 9.2.7 Setup – Display

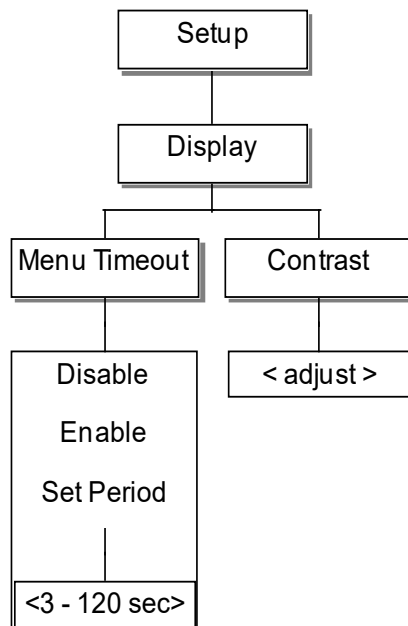

### 9.2.8 Setup – Master/Slave

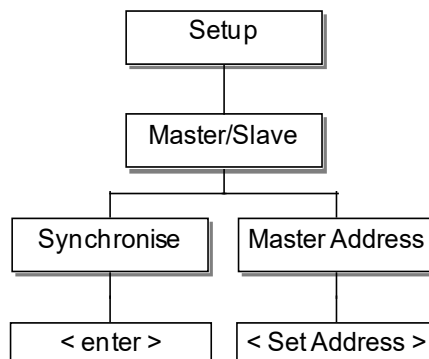

### 9.2.9 Setup – Upgrades

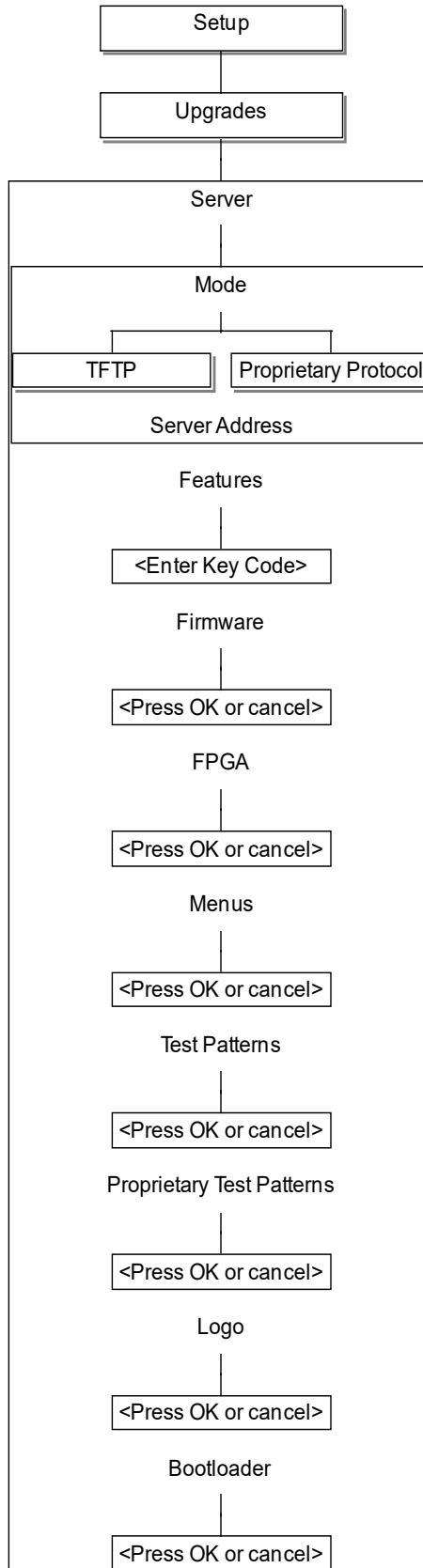

## 10. STATUS

### 10.1 STATUS | MAIN

A dedicated **STATUS** web page provides diagnostic and status information. LED style indicators show real-time information, in one of three states:

- Red: Error
- Amber: Passive (don't care)
- Green: OK

The screenshot displays the 'Mentor RG Vector' status page. The navigation bar includes SDI, AV, Audio, Lock, Setup, Status (selected), Admin, Option 1 (GPS), and Help. The main content area is titled 'Status' and features a 'System Status' section with a 'Key' legend. The 'System Status' section lists various components and their status:

Component	Status	Outages
NTP server connection	Passive	0
PTP	Passive	Disabled
Genlock input	Passive	0
Video standard input	Passive	0
Ext 10MHz input	Passive	0
S318 present	Passive	0
Line lock	Passive	0
Subcarrier lock	Passive	0
Genlock input Sch	Passive	0
Backup power supply	Passive	3, last: 14:17:42 27/4/2018
Fan status	Passive	2, last: 13:21:47 23/12/1999
Options status	OK	OK
Configuration status	OK	Configuration verified
RTC	OK	Locked to GPS
CPU usage	OK	0%

The 'Key' legend indicates: Red for Error, Amber for Passive, and Green for OK. Below the System Status section is the 'GPS Status' section:

Component	Status	Outages
Serial data	OK	22, last: 09:03:59 9/5/2018
1 pps	OK	43, last: 09:26:56 9/5/2018
1 pps lock	OK	11, last: 10:32:32 9/5/2018
Receiver state	OK	Receiver locked to satellites
Satellites	OK	Satellites: Used 12

The footer of the page includes the 'trilogy' logo and 'Trilogy Communications'.

There are additional web pages for PTP status, PTP statistics and logging.

### 10.2 STATUS | PTP

There are two pages dedicated to PTP: status and statistics. Both provide read-only information and examples are shown below.

**Status**

Clock Identity: **d88039-ffe-d85b09:1**  
 Master Identity: d88039-ffe-d85b09:0  
 Offset From Master: **n/a**  
 Delay Mechanism: Supporting SMPTE  
 One Way Delay: **n/a**  
 Mode: **Disabled**  
 State: **Disabled**  
 Domain Number: **0**  
 TTL Multicast: n/a  
 TTL Unicast: n/a  
 DSCP: n/a  
 Unicast Negotiation: n/a  
 Sync Interval: -3 (125 ms)  
 Announce Interval: -2 (250 ms)  
 Delay Request Interval: 2 (4 s)  
 PDelay Request Interval: 2 (4 s)  
 Receipt Timeout Multiplier: 3  
 PTP Version: 2

Refresh

**Statistics**

Message Type	Inbound Messages		Outbound Messages	
	Packets	Bytes	Packets	Bytes
Sync	0	0	3592	158048
Followup	0	0	0	0
Announce	0	0	1080	69120
Delay Req	0	0	0	0
Delay Resp	13	702	0	0
Pdelay Req	0	0	0	0
Pdelay Resp	0	0	0	0
Pdelay Followup	0	0	0	0
Management	0	0	0	0
Total	13	702	4672	227168

Refresh Reset

### 10.3 STATUS | LOGGING

Significant system events are captured in a system log which may be viewed on screen. The most recent events are at the end of the log. An example is shown below.

**Logging**

```

13:18:48 23/12/1999, Backup Power Supply: Failed
13:21:39 23/12/1999, Fans: Failed
13:21:44 23/12/1999, Fans: OK
13:21:47 23/12/1999, Fans: Failed
13:21:50 23/12/1999, Fans: OK
11:12:19 20/3/2018, Backup Power Supply: Failed
14:17:42 27/4/2018, Satellites Used: OK
14:17:42 27/4/2018, Backup Power Supply: Failed
14:17:42 27/4/2018, GPS Serial Data: Failed
14:17:42 27/4/2018, Ipps Lock: Failed
14:17:42 27/4/2018, GPS Receiver (0x8): Failed
14:18:14 27/4/2018, GPS Serial Data: OK
14:25:44 27/4/2018, Backup Power Supply: OK
14:32:41 27/4/2018, Satellites Used: OK
14:32:41 27/4/2018, GPS Serial Data: Failed
14:32:41 27/4/2018, Ipps Lock: Failed
14:32:41 27/4/2018, GPS Receiver (0x8): Failed
14:32:57 27/4/2018, GPS Serial Data: OK
14:34:16 27/4/2018, GPS Serial Data: Failed
14:34:18 27/4/2018, GPS Serial Data: OK
14:34:23 27/4/2018, Ipps: Failed
14:34:27 27/4/2018, Ipps: OK
14:40:04 27/4/2018, Ipps Lock: OK
14:40:13 27/4/2018, Satellites Used: OK
14:40:13 27/4/2018, Ipps Lock: Failed
14:41:08 27/4/2018, Ipps Lock: OK
14:45:11 27/4/2018, Satellites Used: OK
14:45:11 27/4/2018, Ipps Lock: Failed
14:45:11 27/4/2018, GPS Receiver (0x41): Failed
    
```

Clear Logs

The same information may be accessed from the front panel **STATUS** menu. If an error condition such as loss of genlock occurs, the lamp in the **STATUS** button will flash. The display text, which can be displayed by pressing the **STATUS** key, will change to indicate that an error message is available. Error logs also carry a date and time stamp and may be viewed or cleared from their sub-menu.

10.4 STATUS | FRONT PANEL MENU

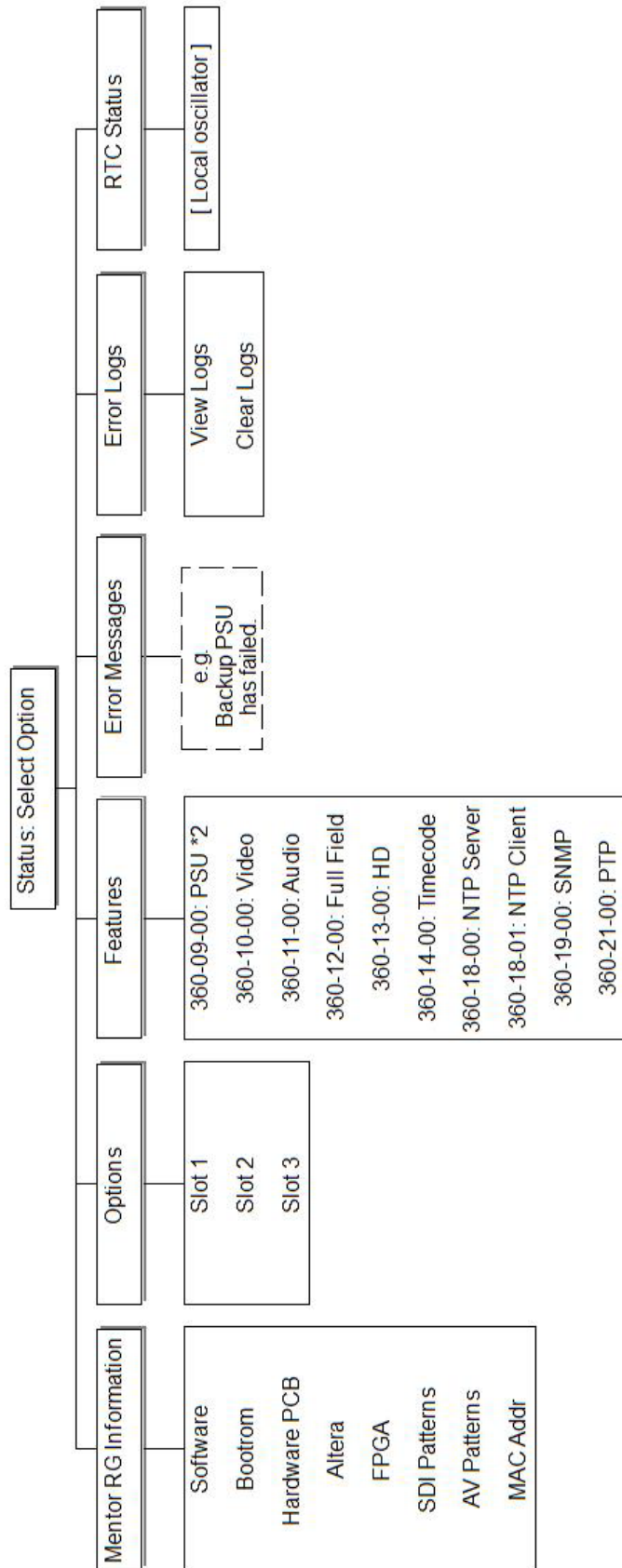

## 11. ADMIN

The Admin series of web pages brings together all of the administrative features and settings in one convenient place. Many of these are also available through different areas of the front panel menus.

There are 7 sub-menus which are explored in subsequent sections.

- Configuration
- System Settings
- Admin Password
- Software Update
- Software Delete
- Feature Upgrade
- System Errors (only shown if system errors present)

### 11.1 ADMIN | CONFIGURATION MANAGEMENT

Mentor RG has four memory slots dedicated to configuration storage. Each one allows all current settings to be saved as a configuration file for future use. In addition, files can be backed up or transferred to or from other Mentor RG by using the Vector management page shown below.

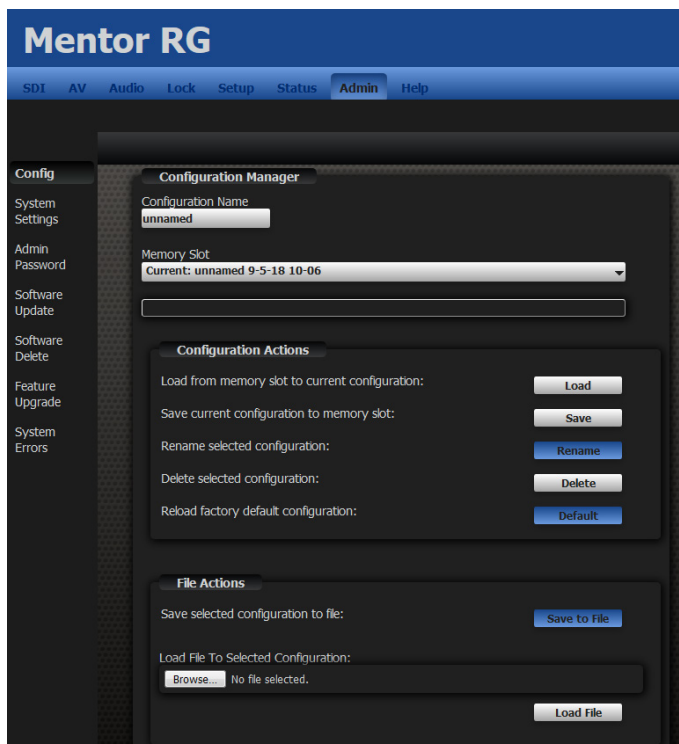

The “Configurations” drop-down list allows selection of either the current (active) memory or one of the four memory slots.

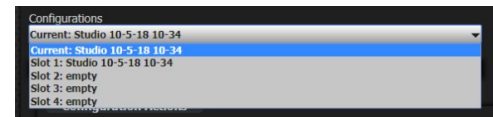

After selecting one of the five entries from the list, all actions are available. Note that the “Reload factory default” option can be used to reset the active configuration to factory default values and should be used with caution.

### 11.2 ADMIN | SYSTEM SETTINGS

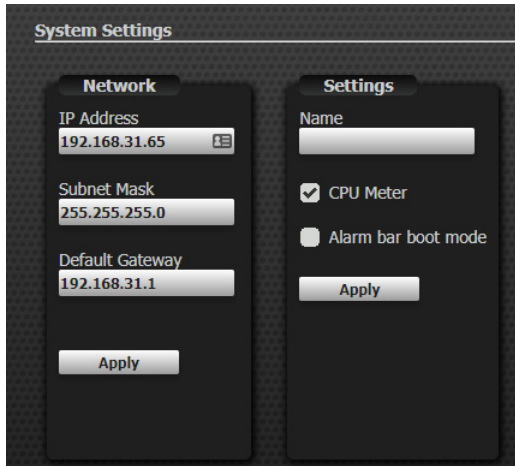

Mentor RG network settings can be changed here: remember that if you change the network address to a different subnet, you may lose contact from your current PC address.

“Name” allows an on-screen label to be set, which will appear in the Vector page header.

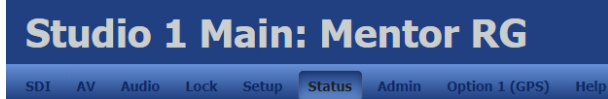

CPU Meter checkbox enables / disables the CPU % value from the status page.

Alarm bar boot mode checkbox enables / disables any warnings from appearing on the front panel alarm bar during the boot sequence. Any new alarms post boot will be displayed.

### 11.3 ADMIN | PASSWORD

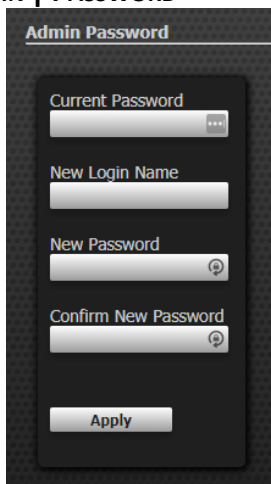

The default login name and password are both **admin**. This page allows a new name and password to be set.

### 11.4 ADMIN | SOFTWARE UPDATE

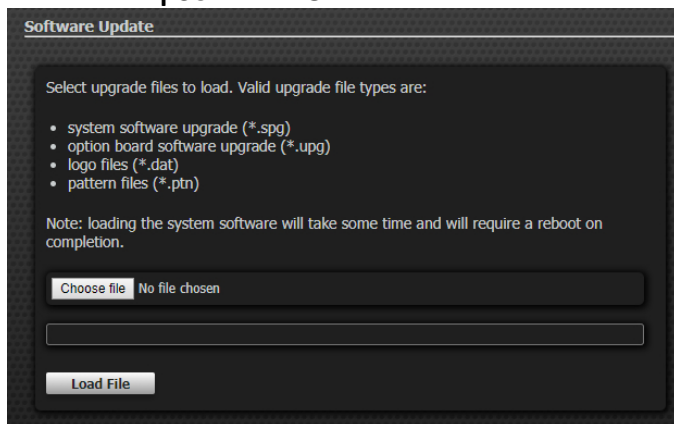

Remember to back up the current configuration before carrying out any update. Although the update only takes 5 minutes, it may take longer for your Mentor RG to settle after the update, so always allow sufficient time. Update files will be supplied by Trilogy Technical Support – please contact them for more information.

### 11.5 ADMIN | SOFTWARE DELETE

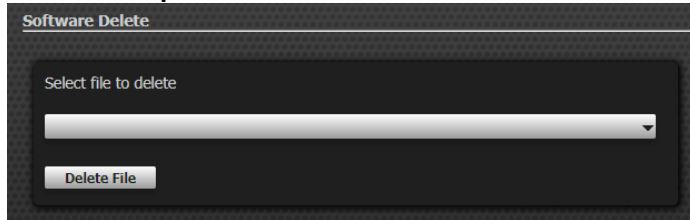

Pattern and logo files which are no longer required may be deleted by selecting them from the list.

### 11.6 ADMIN | FEATURE UPGRADE

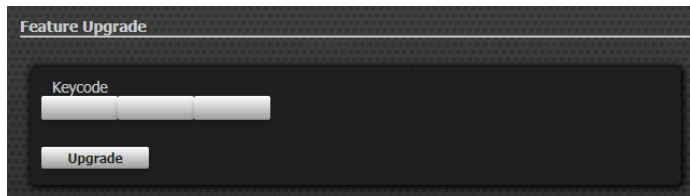

Additional software features are enabled by entering a keycode here. Keycodes are unique for each mentor RG and cannot be re-used. A list of currently available features is provided in section 12.1.

### 11.7 ADMIN | SYSTEM ERRORS

This menu entry is only visible if system errors are present.



## 12. OPTIONS AND FEATURES

### 12.1 INTRODUCTION

A number of additional hardware options and software features are available for the Mentor RG. At the time of writing in August 2018, these are:

<b>Part Code</b>	<b>Description</b>	<b>Note</b>
<b>360-09-05</b>	Optional redundant power supply	Hardware option
<b>360-10-00</b>	Video test signals	Software feature to add composite analogue and SDI test signals.
<b>360-12-00</b>	Full field test patterns	Software feature to generate FUBK test pattern, selectable 4:3 & 16:9. Requires 360-10-00 video test signals or 360-13-01 video test patterns as pre-requisite.
<b>360-13-01</b>	Video test patterns	Software feature to add composite analogue and SDI test patterns. Requires 360-10-00 video test signals feature as pre-requisite.
<b>360-15-02</b>	Unbalanced AES Output card	Hardware option - activates the 2 x AES unbalanced outputs. Requires 360-23-00 feature as pre-requisite. Not required if GPS option (360-15-12) fitted.
<b>360-15-03</b>	GPS Antenna and Universal mount	Bullet III Dome 5V antenna. Supplied with F - type connector. See section 14.
<b>360-15-04</b>	GPS Smart Antenna and Universal Mount	Trimble Accutime Smart Antenna, includes mating connectors but excludes cable. See section 14.
<b>360-15-12</b>	GPS Time Reference	Hardware option: includes receiver module. Replaces 360-15-10 and 360-15-11. See section 14.
<b>360-16-01</b>	TLS (tri-level sync)	Hardware option – when fitted, provides 4 independently timeable TLS outputs. See section 15.
<b>360-18-00</b>	NTP Feature	Software feature – selectable as either server or client mode via menus. See section 16.
<b>360-19-00</b>	SNMP Support	Software feature to enable Simple Network Management Protocol support. See section 16.
<b>360-20-00</b>	HD/3G-SDI Expansion Module	Hardware option - provides 4 additional HD or 3G-SDI outputs in any combination. Requires option 360-13-01 (HD) as pre-requisite. See Note 1 (below) and section 17.
<b>360-21-00</b>	PTP feature	Software feature allows Mentor RG to act as PTP Master, Slave or Master/Slave. See section 18.
<b>360-22-00</b>	Timecode feature (LTC input and output)	Software feature to provide two balanced LTC outputs with VITC, D-VITC and ATC. An LTC input is also provided: when there is a valid LTC input present it is possible to lock the timecode to this LTC input. See section 13.
<b>360-23-00</b>	Audio test tones feature	Software feature to add analogue and AES test tones (including GLITS interrupted channel ident tone)

Notes:

1. Normally only a single 360-20-00 will be fitted to each Mentor RG.

### 12.2 HARDWARE OPTIONS

The Mentor RG has three internal option slots. The suggested configuration for option boards is:

#### Slot 1

*Either* - 360-15-12 GPS receiver. See section 13.  
*Or* -- 360-15-02 Unbalanced AES Output card may be fitted.

#### Slot 2

360-20-00 which provides four additional HD or 3G SDI outputs in any combination. Requires software feature 360-13-00 (HD) as pre-requisite. See section 17.

#### Slot 3

360-16-01 Tri-level sync option board. See section 15.

The rear panel is engraved accordingly. Note:

- Any option module **other than** the GPS receiver may be fitted to any slot but fitting any board to slot 1 other than the GPS board or the 360-15-02 Unbalanced AES Output board, removes the unbalanced AES output facility.
- The GPS receiver must **only** be fitted to option slot 1.
- Option boards are automatically recognised and the correct menus and web pages displayed.

The top level Vector menu is extended with additional entries to show fitted hardware.



The front panel menu will show an additional entry, "Options", which then branches to show fitted hardware.

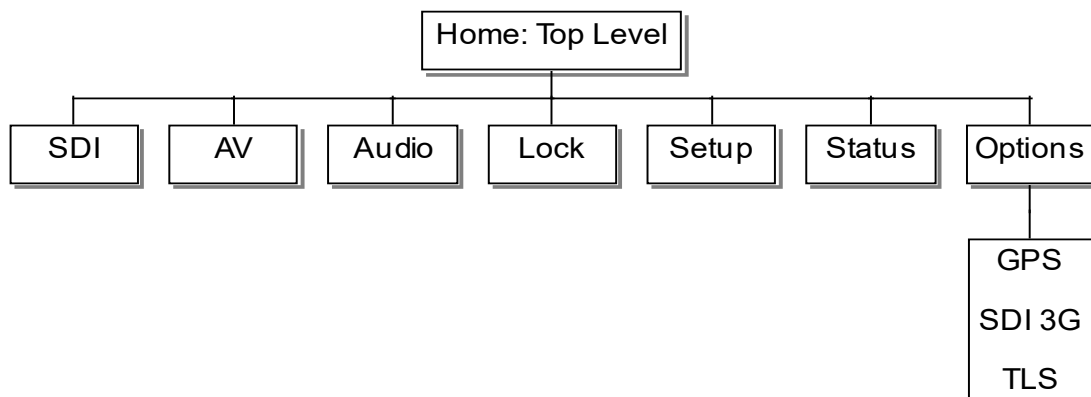

As explained above, this is a typical arrangement although others are possible. Further information on the menus for each option board are given in the following chapters.

### 12.3 SOFTWARE FEATURES

If you wish to purchase any of the currently available features, please contact your usual Trilogy sales representative with the following information:

- The part number of the feature you require
- The serial number of the Mentor RG which you wish to upgrade. Alternatively, if the serial number is difficult to find, please supply the unit MAC address which may be read from the Status >> Information menu
- A valid e-mail address

After purchase, you will receive by e-mail a unique unlock code for each Mentor RG. For multiple features on the same Mentor RG, a single consolidated code per Mentor RG will be provided.

#### 12.3.1 Enabling additional Mentor RG features using the browser

Web browser management provides full control over all aspects of the Mentor RG. To enable a feature, open the browser, log in and navigate to *Admin >> Feature Upgrade*. Enter the unique 12 character code and press “Upgrade”.

#### 12.3.2 Enabling additional Mentor RG features via the front panel

Alternatively, enter the code directly on the front panel of the Mentor RG. This avoids the requirement for any network connection or additional software. From the front panel menus, navigate to **Setup >> More >> Upgrades >> Features** and enter the 12 character code using the rotary control and <enter> key.

## 13. SOFTWARE FEATURE: 360-22-00 TIMECODE

### 13.1 TIMECODE | INTRODUCTION

Timecode is available as a software only feature for the Mentor RG. The unit will then provide:

- Two outputs of Longitudinal Timecode (LTC) on the D9 connector (see section 2.9 for connector pin-out).
- An LTC input on the D9 connector (see section 2.9 for connector pin-out). When a valid LTC input is present, it may be used to lock timecode outputs.
- Vertical Interval Timecode (VITC) superimposed on analogue waveforms. This is enabled or disabled in accordance with the current group arrangement of the analogue signal outputs.
- Each SDI output offers a combination of:
  - Digital VITC (SMPTE S266) for standard definition SDI signals only.
  - Ancillary Timecode (ATC) -- (SMPTE RP188) for standard definition or high definition SDI signals.

Additional menu items appear as follows:

- Within the Setup menu branch, “Timecode” and “LTC” as shown in the diagrams in 13.2. Corresponding front panel menus are shown in 13.5.
- Additional entries also appear in the relevant sections of both AV and SDI video menus. See 13.3 and 13.4.

Timecode can be:

- synced to RTC (real-time clock)
- set manually and frequency locked to the internal clock
- time and frequency locked to VITC which is present on the Genlock input feed
- time and frequency locked to a valid LTC input signal

**Timecode jamming** is the process of setting the time carried on the timecode stream. To avoid discontinuity, it is important to carry this out carefully. Some menu options apply to all “base” clock frequencies and are presented under the “All Frequencies” branch. Other options are available under individual frequencies (e.g. 23.98 Hz etc.) used to derive specific output signals. For example, to jam the timecode for a 625 PAL signal, follow the 25 Hz menu branch.

If the GPS Option is present and the Mentor RG real-time clock is locked to GPS, it follows that timecode is synced to GPS when the first of the three options above is used.

Note that menu options to “show clock” are only available via the front panel menus.

For some common configuration suggestions, please see section 19.

## 13.2 TIMECODE | EXTENDED SETUP MENU

When the timecode feature is enabled, additional entries for timecode and LTC appear on the Vector Setup page:

### 13.2.1 Timecode

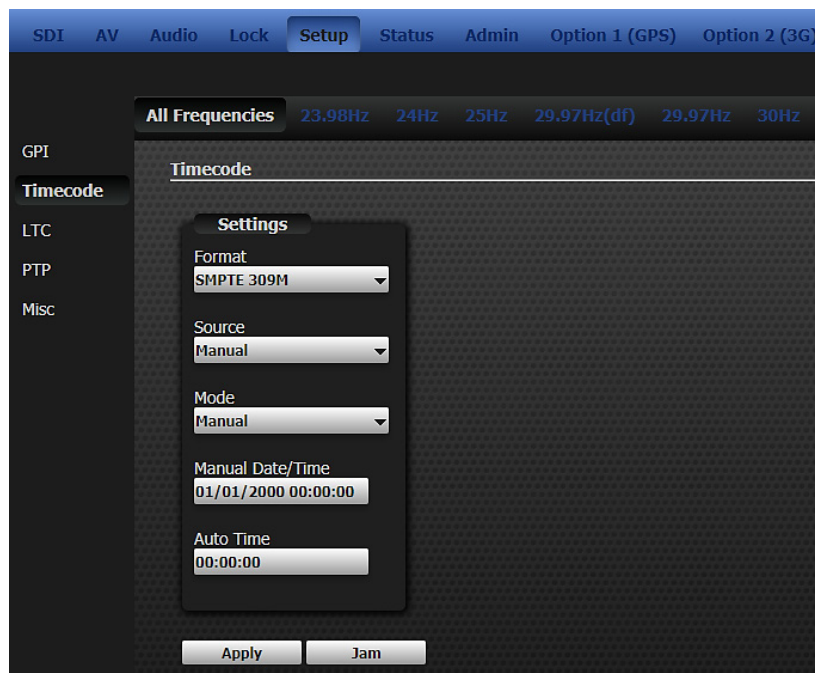

Four timecode formats are supported from the format menu: the chosen format applies to all timecode generated by the Mentor RG. The different format options place date/time data into the binary groups of the VITC/LTC codeword in a different sequence. See the table (below) for more detail.

- Format
  - SMPTE 309M
  - Non SMPTE
    - European
    - US
    - Leitch
- Source
  - Manual: enter values manually from the front panel or browser
  - RTC: uses the Real Time clock
  - VITC: jams the timecode by sampling VITC on the Mentor RG Genlock input. Note: This option is only available when a suitable signal is detected and is only available under the “All frequencies” branch of the menu.
  - LTC: jams the timecode by sampling LTC on the LTC input. This option is only available when a valid signal is detected and is only available under the “All frequencies” branch of the menu.
- Mode
  - Auto: sets a scheduled time for jamming to take place. This is a recurring action
  - Manual: on command
- **JAM:** initiates the JAM procedure with OK / cancel options.

**Timecode formats: SMPTE and non-SMPTE**

	SMPTE 309M	----- Non-SMPTE 309M -----		
		European	US	Leitch
Binary Group 1	Day units			
Binary Group 2	Day tens			Day units
Binary Group 3	Month units	Day units	Month units	Month units
Binary Group 4	Month tens	Day tens	Month tens	Month tens/Day tens
Binary Group 5	Year units	Month units	Day units	
Binary Group 6	Year tens	Month tens	Day tens	Year units
Binary Group 7		Year units	Year units	
Binary Group 8		Year tens	Year tens	Year tens

**13.2.2 LTC**

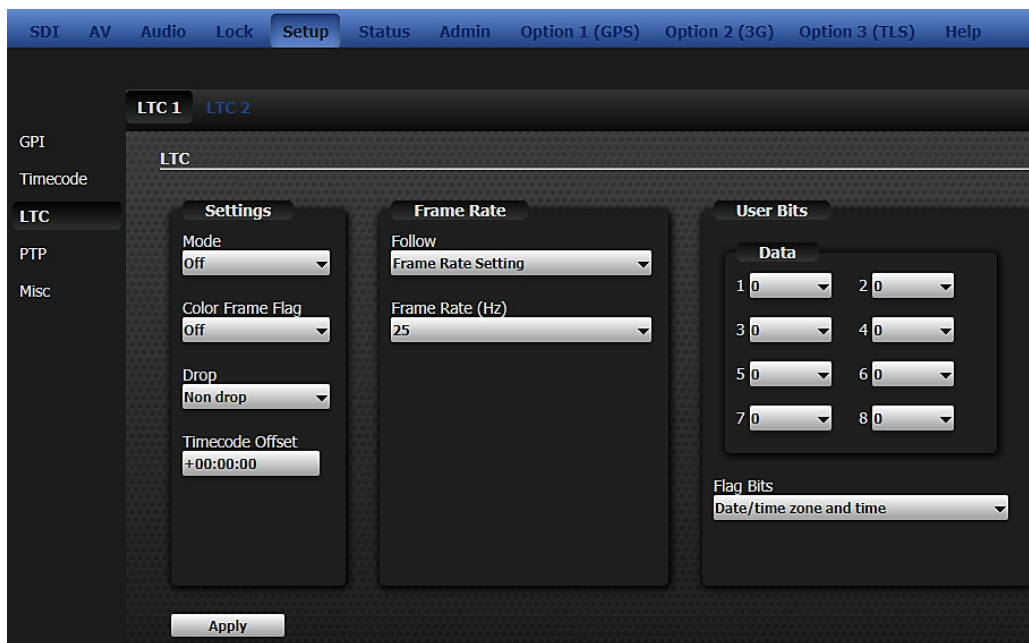

- **Mode:** turns the LTC timecode on and off. Factory default setting is “Off”.
- **Colour Frame Flag.** This is a single bit within the data stream which indicates whether timecode is related to the video signal. This menu option allows the operator to turn this bit on or off.
- **Drop / Non-Drop.** Relates to 525/NTSC line timecode and determines whether frames are dropped to compensate for the non-integer number of NTSC frames per second.
- **Timecode Offset.** An additional offset may be applied to any timecode output, with a value between -23h: 59m: 59s and +23h: 59m: 59s. The default is 0h: 0m: 0s. This offset is applied immediately. Timecode outputs using the same oscillator frequency will remain “in-step”, using the Timecode JAM settings applied in section 13.1.
- **Follow | Frame Rate Setting.** Since LTC is not encoded within a video signal, the frame rate must be set either explicitly or by linked association with another system output.
- **User Bits:** the primary function of the User Bits is to allow the operator to embed a date code within the data stream since timecode represents only embedded time. This conforms to SMPTE S309.

### 13.3 TIMECODE | SDI

Once the software feature has been enabled, an extra item, Timecode, is shown in the side bar menu for each SDI output.

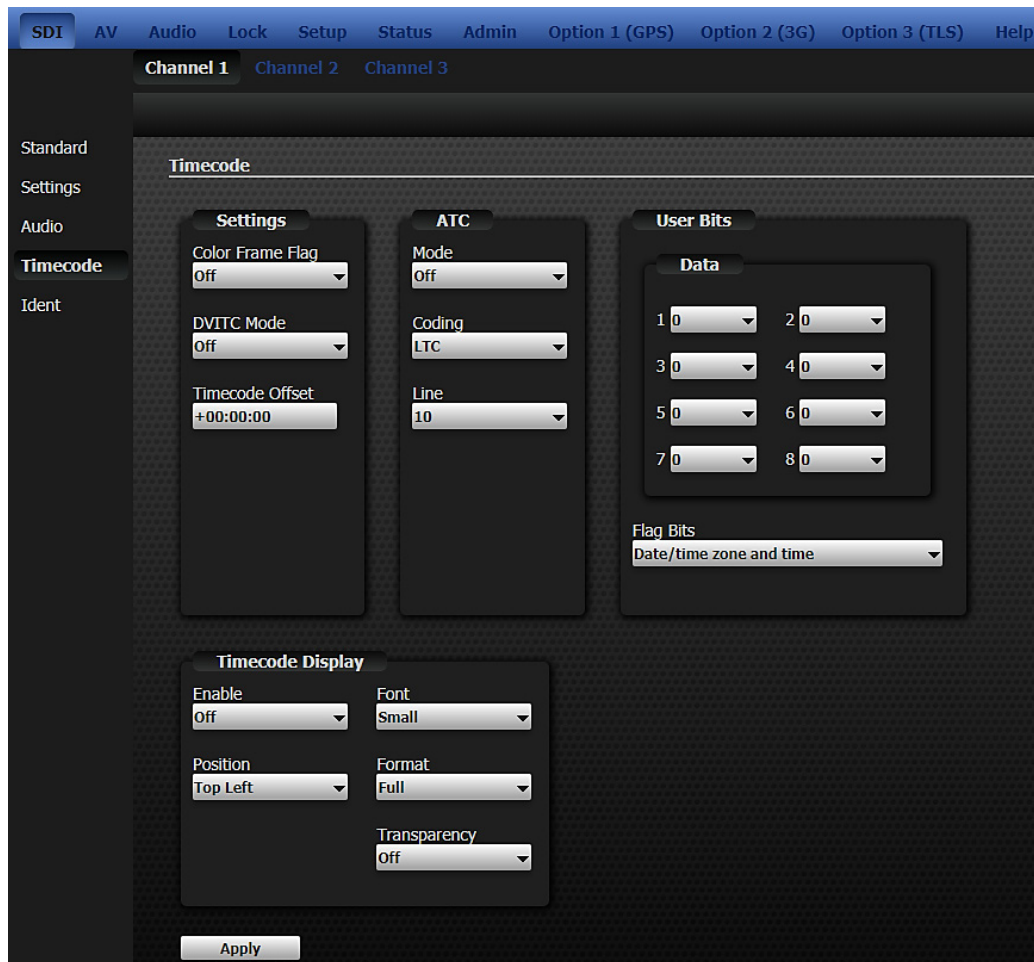

#### 13.3.1 DVITC mode

The factory default mode for DVITC is “Off”. DVITC is only available with standard definition SDI outputs.

#### 13.3.2 ATC sub-menu

The factory default mode for ATC is “Off”. ATC is available with both standard and high definition SDI outputs.

- **ATC Coding:**
- **ATC Line:** were the ATC data to be re-encoded as a VITC signal, it would appear on the line number defined here. Default is line 10.

#### 13.3.3 On-screen Timecode Display

The following SDI outputs are capable of displaying on-screen timecode:

- Main unit
- 360-20-00 HD/3G SDI Expansion module

Once enabled, the on-screen timecode position may be set to each of the four corners of the screen (top left, top right, bottom left or bottom right) using the “Position” menu.

### 13.3.4 Timecode User Bits

The primary function of the User Bits is to allow the operator to embed a date code within the data stream since timecode represents only embedded time. This conforms to SMPTE S309.

Drop down menus allow the value of each user bit to be set from 0 to F. A further drop down allows a range of settings for the Flag Bits, as shown below.

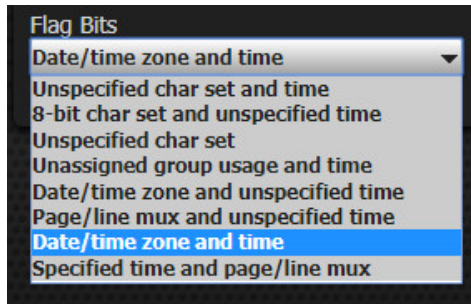

## 13.4 TIMECODE | ANALOGUE VIDEO

### 13.4.1 VITC Menu

Once the software feature has been enabled, an extra item, VITC, is shown in the side bar menu for each AV output.

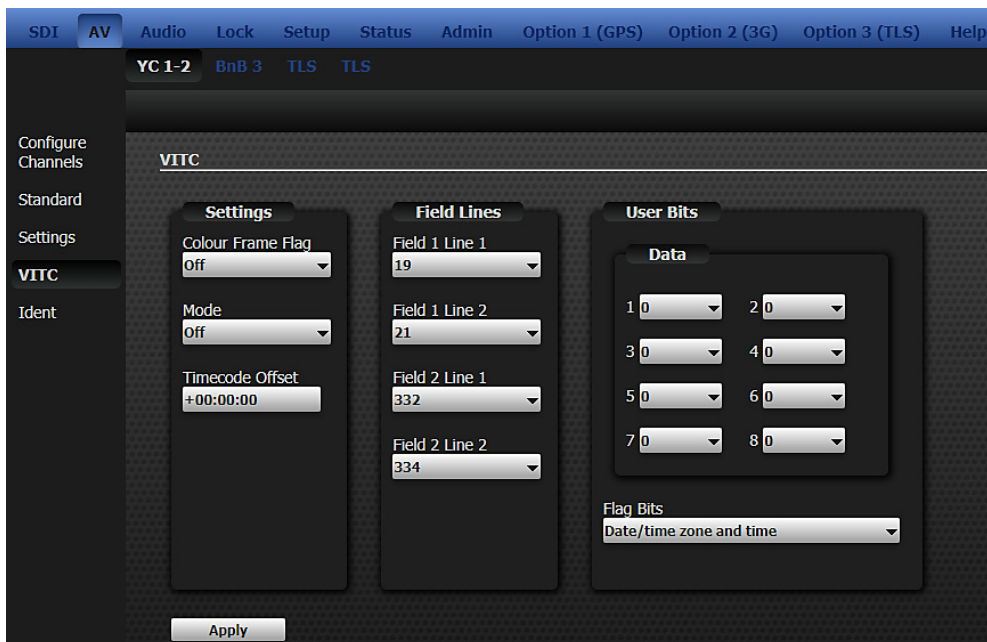

### 13.4.2 Notes

1. The factory default setting for VITC mode is “Off”.
2. The sub menu for User Bits is the same as for SDI: see section 13.3.4.
3. An additional “Drop” entry is shown on screen when the output is set to 525 standard.

### 13.4.3 Lines sub-menu

The “Lines” option menu provides selection of the line where VITC is inserted. Here, “Line1” or “Line 2” indicates the first and second lines in each field which have VITC inserted.



### 13.5 TIMECODE | EXTENDED FRONT PANEL SETUP MENU

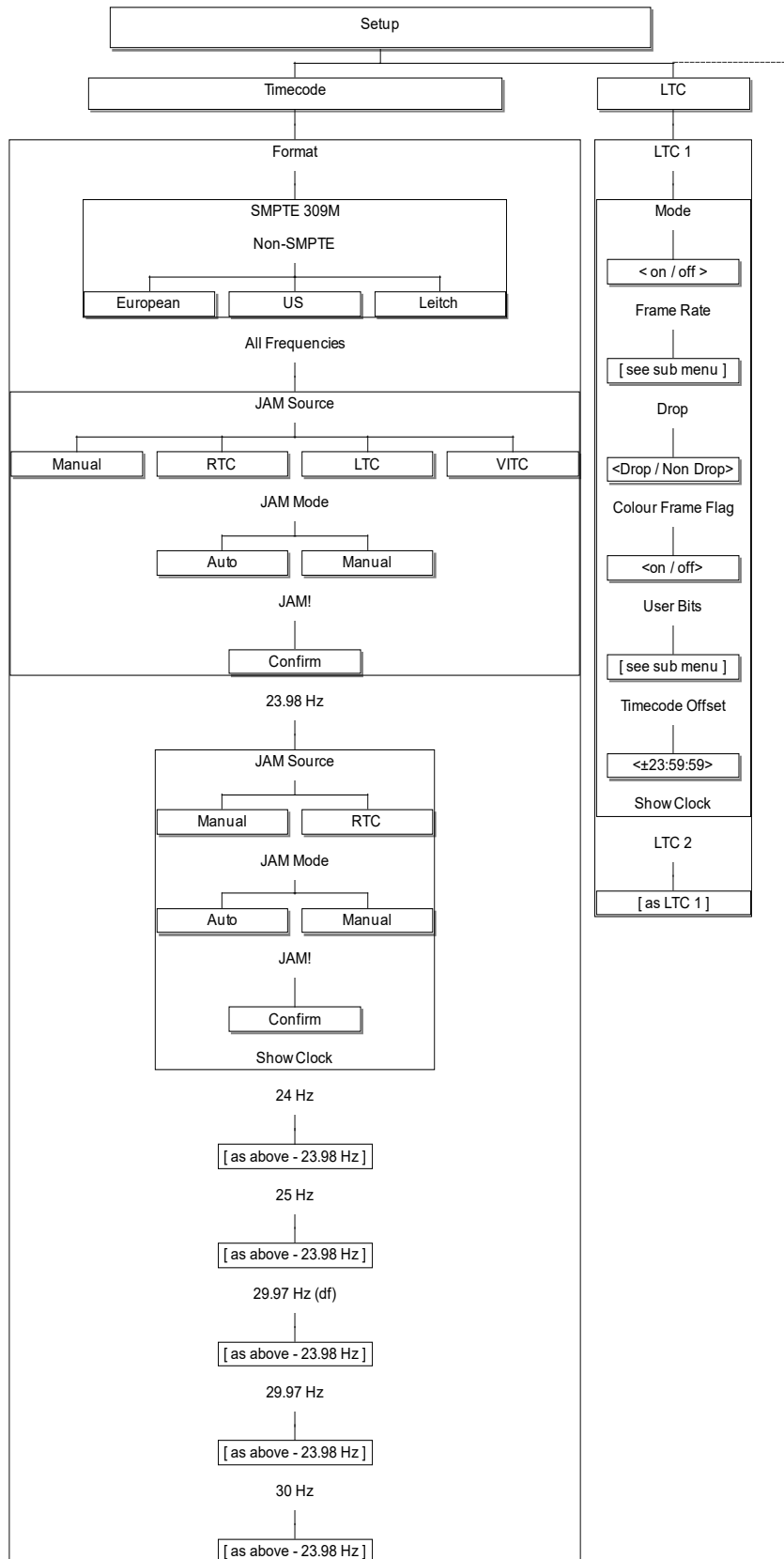

### 13.5.1 Timecode | LTC – Frame Rate menu

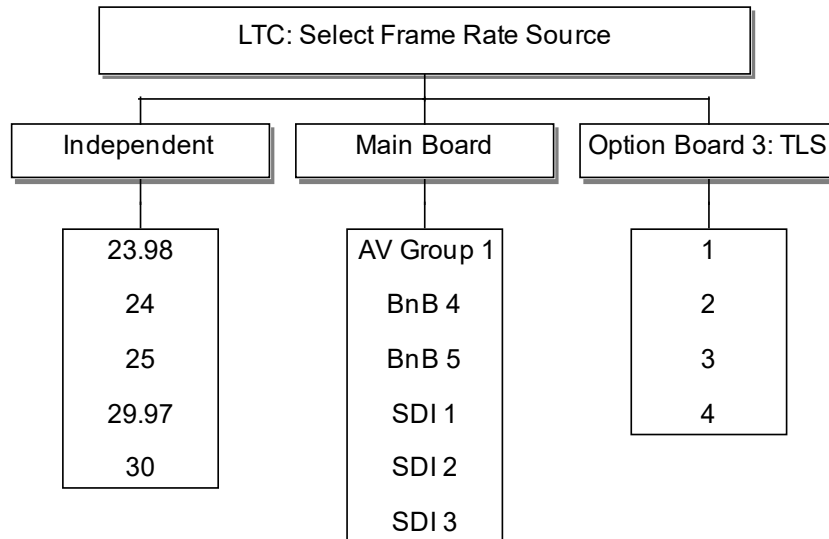

Since LTC is not contained within a video waveform, the timing must either be set explicitly or allied to one of the signal outputs.

### 13.5.2 Timecode | LTC – User Bits menu

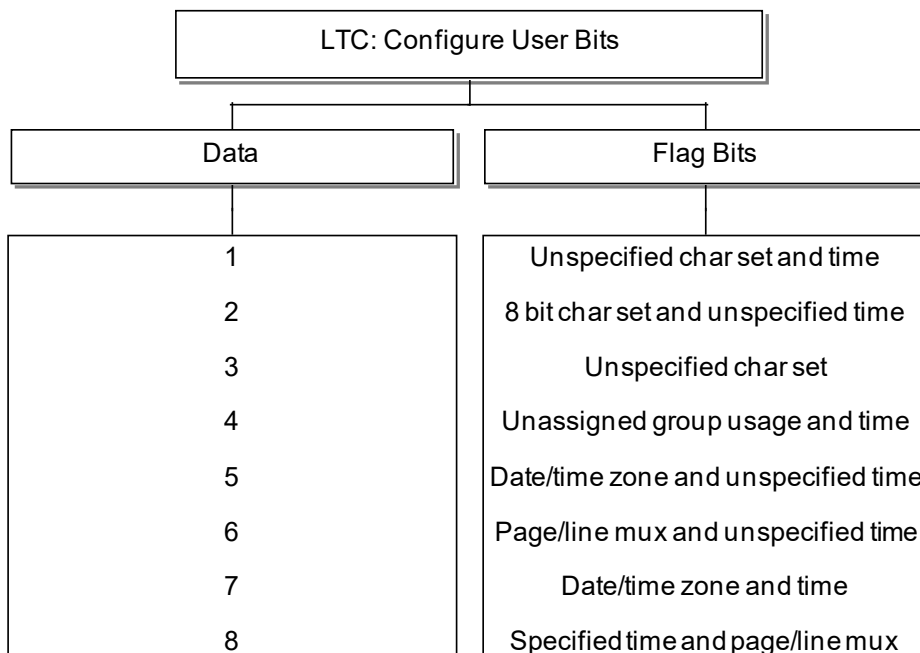

The primary function of the User Bits is to allow the operator to embed a date code within the data stream since timecode represents only embedded time. This conforms to SMPTE S309.

Data for each user bit may be set to a value between 0 and F.

### 13.6 TIMECODE | ANALOGUE VIDEO – FRONT PANEL MENU

#### 13.6.1 VITC Menu

Once the timecode software feature has been enabled, an extra menu item will be shown. The example below shows the VITC item added to the Black & Burst o/p 2 menu tree.

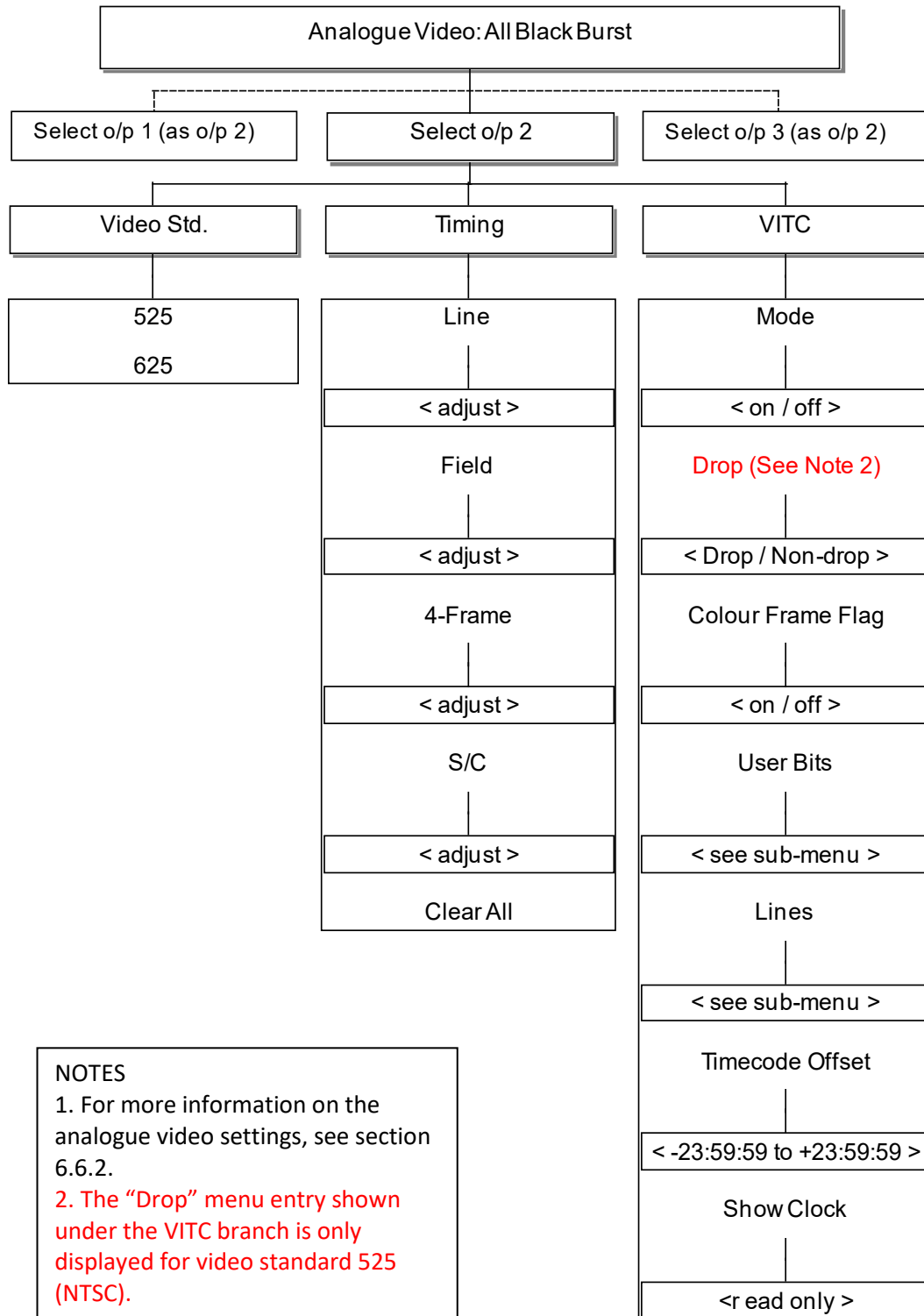

**NOTES**  
 1. For more information on the analogue video settings, see section 6.6.2.  
 2. The “Drop” menu entry shown under the VITC branch is only displayed for video standard 525 (NTSC).

### 13.6.2 Notes

1. The factory default setting for VITC mode is "Off".
2. The sub menu for User Bits is the same as for LTC: see section 0.
3. There is no "Drop" entry on the menu when the output in question is set to PAL mode.

### 13.6.3 Lines sub-menu

The "Lines" option menu provides selection of the line where VITC is inserted.

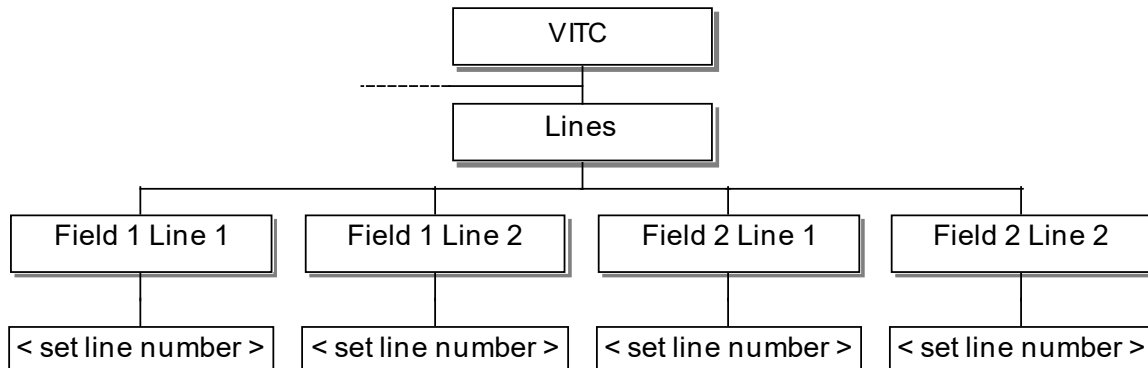

Here, "Line1" or "Line 2" indicates the first and second lines in each Field which have VITC inserted.

### 13.7 TIMECODE | SDI - FRONT PANEL MENU

#### 13.7.1 VITC menu

Once the software feature has been enabled, an extra item will be shown in the menu tree for each SDI output. For more information on the general SDI settings, see section 13.6.

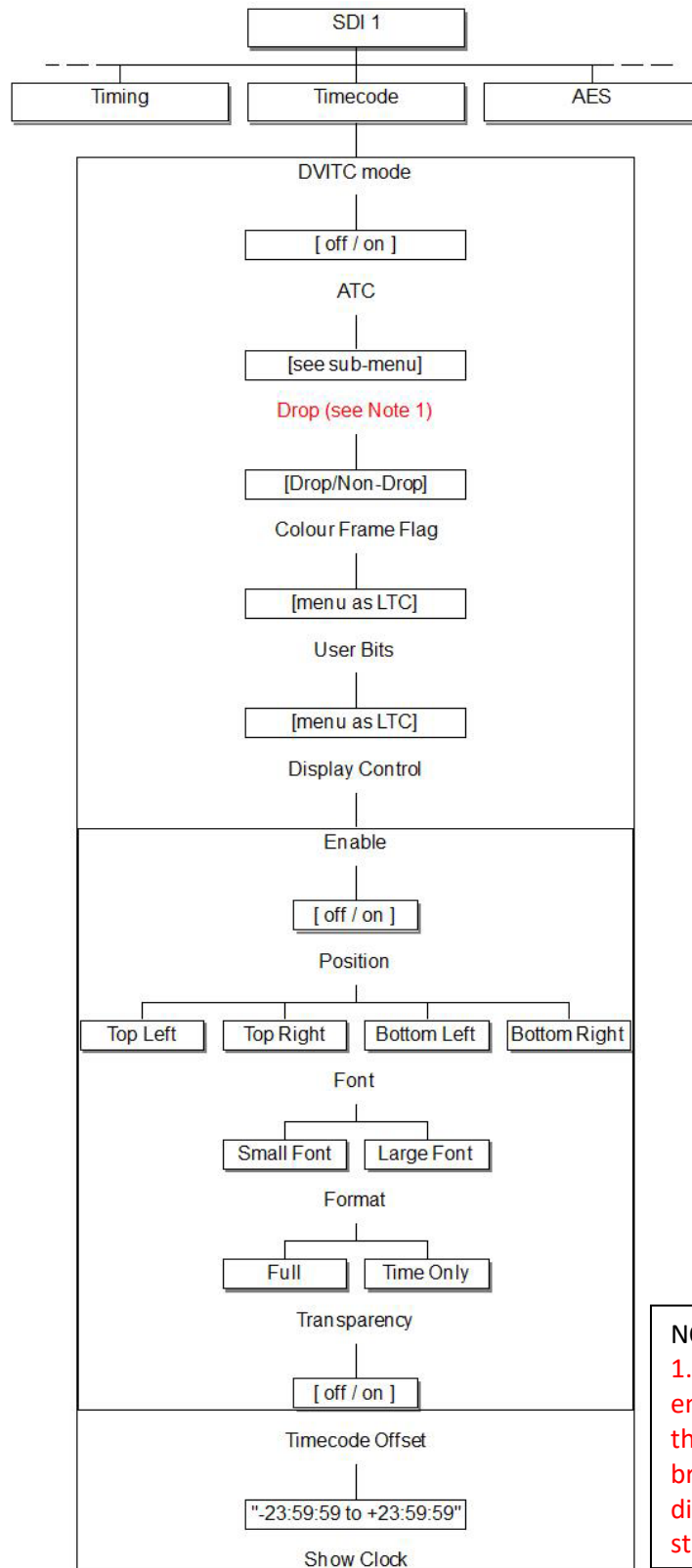

**NOTES**  
 1. The “Drop” menu entry shown under the DVITC Mode branch is only displayed for video standard 525 (NTSC).

### 13.7.2 DVITC mode

The factory default mode for DVITC is “Off”. DVITC is only available with standard definition SDI outputs.

### 13.7.3 ATC sub-menu

The factory default mode for ATC is “Off”. ATC is available with both standard and high definition SDI outputs.

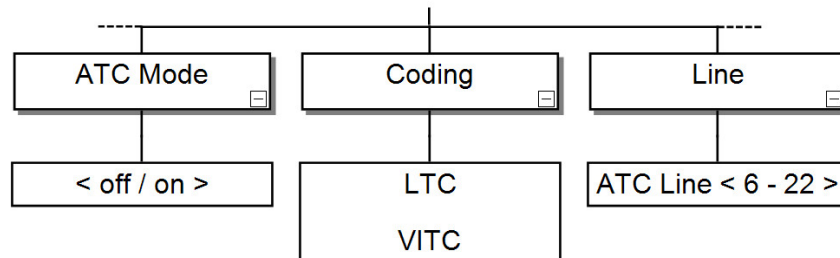

- **ATC Coding:**
- **ATC Line:** were the ATC data to be re-encoded as a VITC signal, it would appear on the line number defined here. Default is line 10.

### 13.7.4 On-screen timecode

The following SDI outputs are capable of displaying on-screen timecode:

- Main unit
- 360-20-00 HD/3G SDI Expansion module

Once enabled, the on-screen timecode position may be set to each of the four corners of the screen (top left, top right, bottom left or bottom right) using the “Position” menu. The hardware revision of any fitted expansion modules may be checked from the Status menu: see section 9.2.4 for details.

## 14. OPTION: 360-15-12 GPS TIME REFERENCE

### 14.1 GPS | INTRODUCTION

The **Global Positioning System (GPS)**, is currently the only fully-functional **Global Navigation Satellite System (GNSS)**. More than two dozen GPS satellites are in medium Earth orbit, transmitting signals allowing GPS receivers to determine the receiver's location, speed and direction. GPS also provides a precise time reference used in many applications including synchronisation of telecommunications networks.

The 360-15-12 option module may be connected to either a conventional GPS antenna, utilising the internal receiver (see 14.4), or alternatively to an external receiver / antenna (see 14.5). This choice is largely driven by consideration of the distance between the antenna site and the Mentor RG. Please see the following sections for information on recommended antennas.

### 14.2 GPS | DISCLAIMER

Trilogy is not connected in any way with any of the companies mentioned in this manual. The information is given in good faith from information in the public domain at the time of going to press. Many different antennas are available and specifications change over time. Some degree of experimentation may be required if the location is shrouded by adjacent structures, buildings etc. Excessive cable length will adversely affect performance.

Trilogy has no control over the local conditions in which the equipment is installed and the customer is expected to have carried out a site survey to ensure that that sufficient signal can be provided for the equipment to work in a satisfactory manner. Trilogy will not be held responsible for failures caused by poor installation, maintenance or changes in local conditions in which the required signals have been degraded such that time synchronisation is lost.

### 14.3 GPS | INSTALLATION

#### 14.3.1 Hardware

This is a hardware option, module type 360-15-12. It must only be fitted in option slot 1: if fitted into any other position, an error message will be displayed. After installation, the module is automatically detected and new menus displayed. See section 14.8.

Viewed from the rear of the unit, the connectors are:

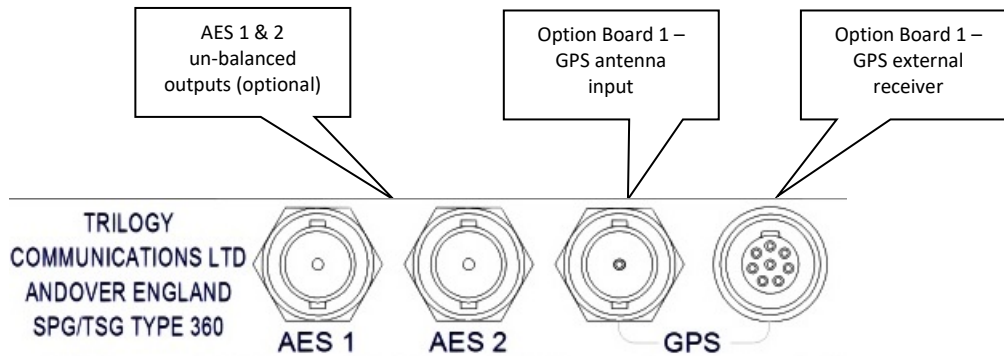

- A GPS Antenna or receiver is required.
  - **Either** - the antenna input should be connected to a high quality 50Ω GPS antenna. See section 14.4 for more information.
  - **Or** - the external receiver input connector is designed specifically for the Trimble Acutime 360 external GPS receiver and antenna. This permits installations with cable lengths greater than 80 m between the Mentor RG and the antenna site. With appropriate wiring, a single external receiver / antenna can support a pair (main plus reserve) of Mentor RG reference generators.
- The AES 1 & 2 outputs provide an unbalanced duplicate of the signals on the D9 connector (see section 2.8). These are not related to GPS operation and are merely provided here for convenience. If GPS functionality is **not** required then a 360-15-02 board may be fitted which simply provides the duplicate AES outputs described above.

### 14.3.2 Antenna Location – site considerations

Ideally, the GPS antenna should have an unobstructed line of sight to the sky. Rooftops that are clear of other structures or geographic features overhead, with views to the horizon, generally make good installation locations. Such a clear view allows the antenna to track the maximum number of satellites throughout the day. A location on the side of a building can also offer good results but should be tested before completing the installation. Installations with obstructed views may experience impaired reception quality and may not be able to track simultaneously the maximum number of satellites.

When installing a GPS antenna, select a site at which the antenna will not become buried in drifting or accumulated snow. It should not be covered by foliage, fallen leaves or placed in a position where it could become obstructed in this way.

Whenever possible, avoid placing the GPS antenna in close proximity to broadcast antennae or near television or FM radio transmitters. Certain frequencies are harmonics of the GPS signal and can impair reception.



#### 14.4 GPS | ANTENNA – INTERNAL RECEIVER

When using the internal receiver, each Mentor RG fitted with the 360-15-12 GPS Module requires a separate outdoor antenna with the following characteristics:

- Active single antenna powered from the receiver module via the Mentor RG antenna connector.
- The 360-15-12 requires a 5 V dc antenna.
- Reception frequency optimised for 1575.42 MHz
- 10 dB to 50 dB gain as measured at receiver input (antenna performance dictated by antenna manufacturer). Antenna types with lower gain performance cannot support longer cable runs: please see antenna and cable recommendations below.
- Connection by co-axial cable terminated at the Mentor RG rear panel with 50Ω BNC male connector.

Magnetic patch antennae suitable for vehicle mounting will also be satisfactory but only with very short cable runs (10 metres or less).

##### 14.4.1 Recommended antenna type

- Trimble Bullet III with TNC or F termination. 5 V dc.

This antenna provides a maximum gain of 38 dB when powered with 5 V dc. Trilogy can provide the Trimble Bullet III, 5V model suitable for the 360-15-12 GPS module, complete with Universal Mount. Order as Trilogy part no. **360-15-03**.

Other antennae may be suitable: please check manufacturer's specifications.

##### 14.4.2 Cable considerations

Theoretically, 50Ω cable should be used to connect the GPS antenna. However, extensive testing by Trimble, manufacturer of our recommended antenna, has shown negligible attenuation differences between 50Ω and 75Ω cable types. In practice, it is far more important to select a cable with low attenuation characteristics around 1.6 GHz.

Using the recommended antenna, the overall attenuation of the installed antenna cable run should not exceed 20 dB. In addition to the attenuation specified by the cable supplier, a number of additional factors can adversely influence the overall result:

- Quality of terminations. Incorrectly terminated connectors can each contribute an additional 2 dB to the overall attenuation.
- Multiple cables joined with barrels. Each join of this type can contribute an additional 3 dB to the overall attenuation figure. Use a single, continuous cable.
- Cable location. Do not allow the cable to rest in standing water: the water will gradually permeate the cable jacket and degrade the signal. If a cable is run over a flat roof, suspend the cable from suitable cable hangers.
- At the point of connection to the antenna, arrange the cable to form a drip loop, to eliminate water ingress.

### 14.4.3 Suggested cable types

- For cable runs <35 m (120 feet) use RG59 cable. This is a low cost 75Ω cable but is relatively easy to source and terminate.
- For cable runs <70 m (230 feet) use cable type CT125 (known as CX125 in some markets). This is a 75Ω cable used for CCTV and Satellite TV installations.
- For cable runs <100 m (320 feet) use cable type LMR-400. This is a high quality 50Ω cable. An ultra-flexible version is also available but with slightly higher attenuation, reducing the maximum cable length to 85 m. BNC connectors are available for the LMR-400 series. Cable type CT150 can also be used for cable runs approaching 100 m but it has 75Ω impedance so LMR-400 is preferred.
- For cable lengths >80m, consider the use of the external receiver described in section 14.5.

<b>Recommended Cable Types For Use With Trimble Bullet III Antenna</b>				
	RG59	†CT125	CT167	LMR400
<b>Nominal Impedance (Ω)</b>	75	75	75	50
<b>Nominal Diameter (mm)</b>	6.15	7.8	10.1	10.3
<b>Cable &lt; 35 metres</b>	✓	✓	✓	✓
<b>Cable &lt; 50 metres</b>		✓	✓	✓
<b>Cable &lt; 75 metres</b>		✓	✓	✓
<b>Cable &lt; 100 metres</b>			✓	✓
†CT125 is also marketed as CX125				

## 14.5 GPS | EXTERNAL RECEIVER / ANTENNA COMBINATION

Use of an external receiver / antenna combination is recommended for installations where the antenna cable length exceeds 80 m. The Trilogy 360-15-12 GPS module has been optimised to work with the Trimble Acutime 360 Multi-GNSS Smart antenna. Similar devices from other manufacturers may be suitable but they will require changes to the antenna settings before operating correctly. Trilogy has not tested and cannot endorse any other products.

### 14.5.1 Recommended external receiver / antenna

- Trimble Acutime 360 Multi-GNSS smart antenna

Trilogy can supply the recommended antenna complete with Universal Mount. Order Trilogy part no. **360-15-04**.

### 14.5.2 Connection

The following tables show the connector types and interconnecting cable.

	Fixed connector	Mating connector	Available as
<b>360-15-12</b>	8 pin Lemo socket	Lemo FGG.1B.308.CLAD62Z	Farnell 3817349
<b>Trimble Acutime 360 Smart Antenna</b>	12 pin †	Deutsch IMC26-2212X PLUG, IN-LINE, 12 pin	Farnell 1019239
		Deutsch 6862-201-22278 CRIMP SOCKET, 22AWG	Farnell 1019253
		Deutsch 681020720012250 BOOT, PVC, 6.35MM	Farnell 2072428

† The 3 Deutsch parts comprising the antenna mating connector are available from Trilogy as part **360-15-07**.

Mentor RG Lemo Pin Number	Mentor RG Signal	Acutime 360 Pin Number	Acutime Signal
1	Serial TX+ (output)	3	Port B: Receive +
2	Serial TX- (output)	2	Port B: Receive -
3	Serial RX+ (input)	10	Port A: Transmit +
4	Serial RX- (input)	8	Port A: Transmit -
5	1PPS+ (input)	11	1PPS Transmit +
6	1PPS- (input)	12	1PPS Transmit -
7	24V	1	DC Power
8	GND	9	DC Ground

### 14.5.3 Cable Specification

Cable type	Four twisted pair, 8 conductors
Conductor size	22 AWG
Shielded	Yes
Outer sheath	PVC-U/V: outdoor, weather resistant
Outer diameter (max)	6.2mm

Trimble supply a range of ready-made cables – please contact them directly for further details. These are available either un-terminated or terminated with a D25 plug (male) connector. The terminated version interfaces directly to the Trilogy break-out cable assembly (see 14.5.5).

### 14.5.4 Connecting a single external receiver to two Mentor RG

A single external receiver may be deployed and connected to a pair of Mentor RG generators. This simplifies the installation but will require a small amount of additional wiring adjacent to the Mentor RG. Some data signals require termination and this should be configured using the appropriate setup menus as shown in section 14.8. The table below shows wiring appropriate for a pair of Mentor RG. A cable break out assembly is included with every smart antenna purchased from Trilogy. See below for details.

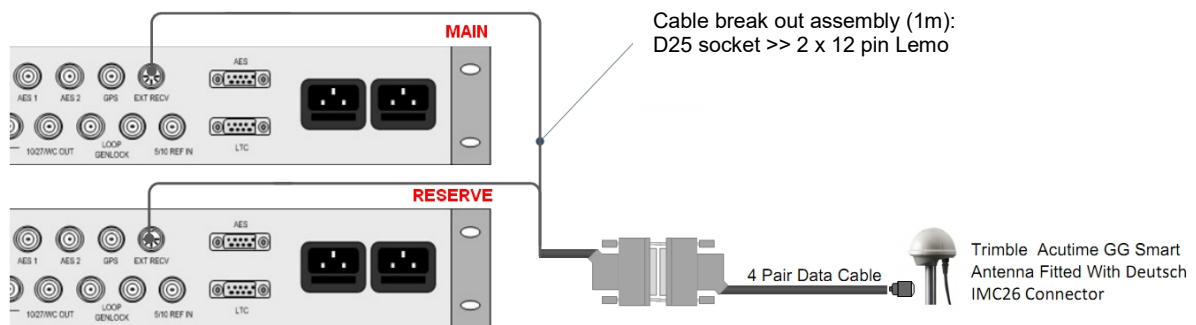

The quantity of break-out cables required for particular applications is shown in the table below.

	Number of Mentor RG	Number of smart antennas	Number of cable assemblies needed
Single SPG - single antenna	1	1	1
Main / reserve dual SPG – single antenna	2	1	1
Main / reserve dual SPG – dual antenna †	2	2	2 †

† Connect each SPG using the connectors marked “Main”. Do not connect the “Reserve” connectors.

### 14.5.5 Mentor RG Break-out cable 360-15-06

Trilogy includes a break-out cable assembly, to be fitted at the rear of a main / reserve pair of Mentor RG generators. This is fitted with two Lemo connectors, to connect to main and reserve GPS option boards, plus a single D25 socket (female) which interfaces directly with a cable assembly purchased from Trimble, or with custom external wiring. The Lemo connectors are marked to indicate “main” and “reserve”.

Acutime 360	D25 Male	D25 Female	Main Mentor RG (set to unterminated)	Reserve Mentor RG (set to terminated)
3	13	13	1	No connection
2	25	25	2	No connection
10	22	22	3	3
8	10	10	4	4
11	21	21	5	5
12	9	9	6	6
1	1	1	7	7
9	7	7	8	8

### 14.6 GPS | ACQUISITION PROCESS

With satisfactory reception, the acquisition process commences automatically and takes around 15 minutes. The front panel display provides information on used satellites. An indication of suitable values is given below for guidance. The figure can vary during the day so we would advise taking readings at various times to get an idea of the trend. For example, a single “snap” reading of 8 may well be the peak: the value could slip as low as 5 later, which may well lead to loss of 1 PPS. The GPS receiver has an automatic “site survey” function. A site survey can take some time to complete and may occur during the initial installation phase.

Satellites Used	Minimum	Optimum	Notes
	5	8-10	

### 14.7 GPS | 1 PULSE PER SECOND (1 PPS) SIGNAL WAVEFORM



The leading edge of the positive going pulse provides the timing reference plane for locking external equipment. There is no agreed standard for the pulse width.

With “Lock to 1 PPS” turned on, this signal locks the internal 27 MHz PLL oscillator such that PAL output signals are both frequency locked and phase locked. Any NTSC output signals are frequency locked but cannot be phase locked. In addition, the real-time clock (RTC) is locked to GPS time.

## 14.8 GPS | MENU STRUCTURE

After the option board is added, an extra entry “Option 1 (GPS)” will appear on the top level Vector menu bar.

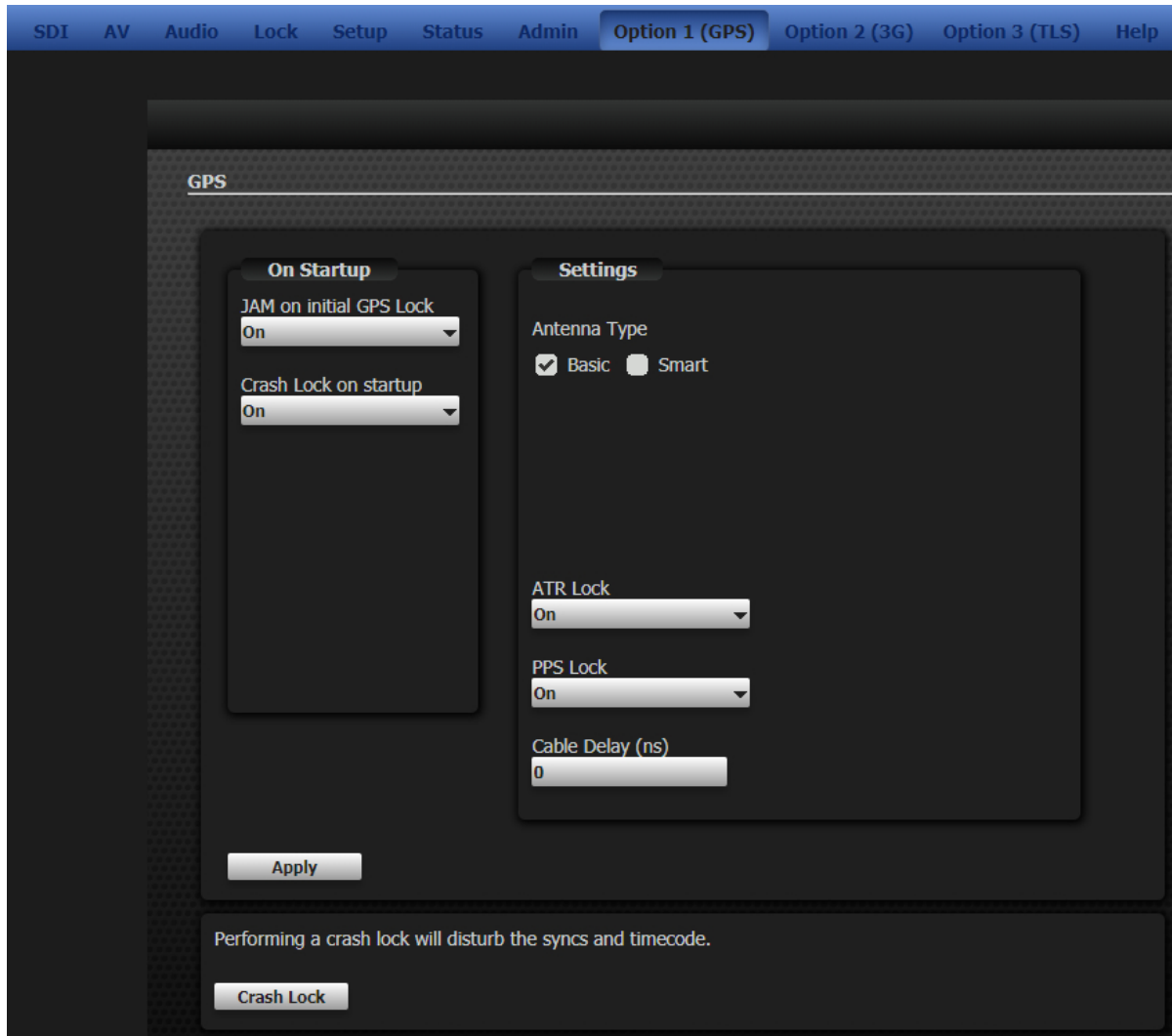

- **On Start-up:**
  - Time code **Jam** on first 1PPS lock will Jam the timecode clock to the RTC automatically when a system is reset or powered on and it achieves its first 1 PPS lock. The Mentor RG will not Jam on subsequent loss and return of 1 PPS lock.
  - Crash Lock will cause sync timing to be very unstable until 1 PPS lock has occurred although it will considerably speed up the process.
- **Settings:**
  - **ATR Lock.** ATR (Absolute Time Reference) is explained in section 14.9. If ATR Lock Mode is ON, the unit will also perform a fast lock, independently of the Crash Lock mode described above.
  - **PPS Lock.** If the PPS Lock mode is set to ON, it only affects the “Internal Free Run” mode of genlock. The internal oscillator is then locked to the GPS reference.
  - **Cable Delay (ns).** Provides compensation for the propagation delay of the antenna cable.

- **Antenna Type** must be configured during installation:
  - **Basic** is appropriate for all antenna types connected by BNC; no other options are presented on-screen.
  - **Smart** should be selected for antennas connected to the Hirose multi-pin connector. Once the box is ticked, further optional settings are shown.

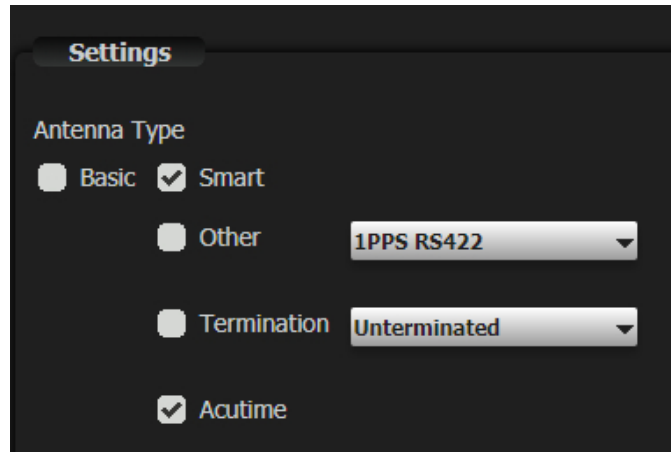

- **Acutime** is selected by default and refers to the Trimble Acutime 360 smart antenna, supported and supplied by Trilogy as part number 360-15-04.
- **Data Input Termination.** If a single external receiver / antenna is feeding a pair of Mentor RG reference generators, this parameter must be set to “terminated” for one SPG and “unterminated” for the second unit. When an external receiver / antenna is feeding a single Mentor RG reference generator, this parameter must be set to “terminated”. See 14.5.4 for more details.
- **Other** should be selected for smart antenna / external receiver antenna combinations other than the supported Trimble Acutime 360. We have not tested the 360-15-12 GPS Option module with other manufacturers’ receivers and some adjustment of those products may be required. Please contact Trilogy Technical Support for assistance with other receiver type options.

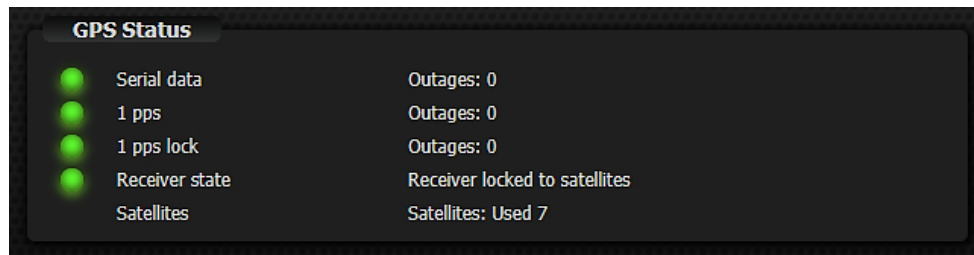
**GPS Status Menu (read only – part of Status page)**

The information is provided, in read-only format.

- **Serial Data <OK / Not OK>**: indicates whether the serial data from the receiver is present or not.
- **1 PPS <OK / Not OK>**: reports the presence of 1 PPS as a general diagnostic aid.
- **1 PPS lock <OK / Not OK>**: indicates whether the option board is locked to the GPS 1 PPS signal.
- **Receiver state <Locked / Not Locked>**: indicates the current status of the GPS receiver.
- **Satellites <number used>**: displays the number of satellites actively used. The time taken to acquire satellites can be 10 or 15 minutes, since the almanac data is broadcast fairly infrequently. On first power up after installation, this process can take much longer.

**14.9 GPS | ABSOLUTE TIME REFERENCE (ATR)**

The concept of ATR is covered by SMPTE document ST 2059-1, which defines the “SMPTE EPOCH”. It defines a starting point of 00:00:00 TAI (International Atomic Time) on January 1<sup>st</sup> 1970, at which time all generating equipment is deemed to be phase locked. This is the same EPOCH used in the SMPTE profile for IEEE 1588 Precision Time Protocol.

In order to make use of the ATR definition, precise date/time provided by the GPS receiver is required. This allows the current state of the Mentor RG to be computed with regard to the epoch as defined by ATR. By accurate determination of current time, any ATR equipped items may be locked together again.



**14.10 GPS | FRONT PANEL MENU**

After the option board is added, an extra entry “GPS” will appear on the Options branch of the top level menu. This opens the following sub-menu.

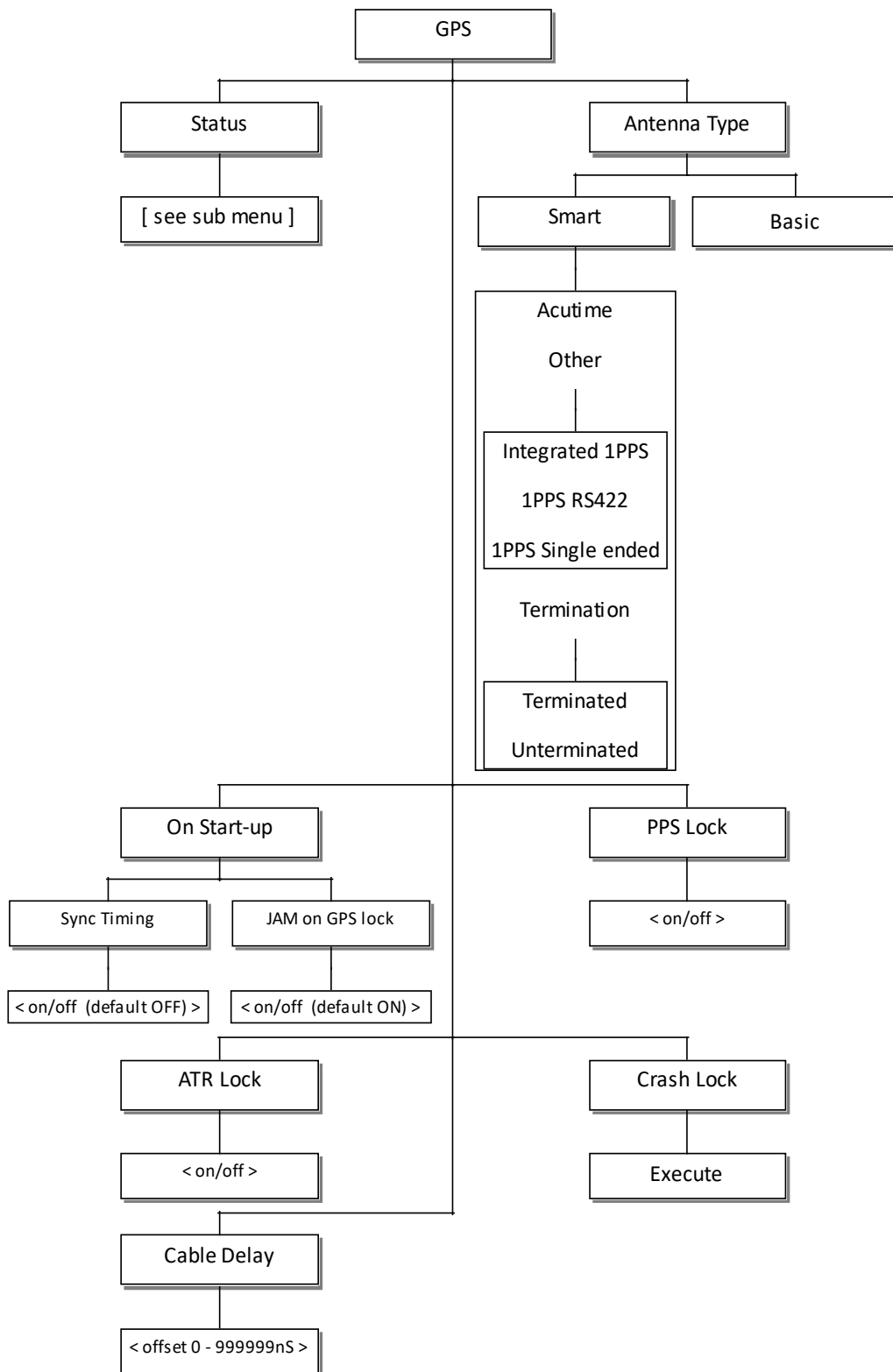

All of these settings, are also presented in the Vector web management pages. See 14.8.

## 15. OPTION: 360-16-01 TRI-LEVEL SYNC (TLS)

### 15.1 TLS | INTRODUCTION

High definition (HD) applications require a special synchronising signal which is termed “tri-level sync” or TLS. This differs from conventional reference signals since the horizontal and vertical timing components are combined within a single waveform. The four channel 360-16-01 module allows each output to be individually configured and timed. After the option board is added, an extra entry “Option 3 (TLS)” will appear on the top level Vector menu bar.

### 15.2 TLS | MENU STRUCTURE

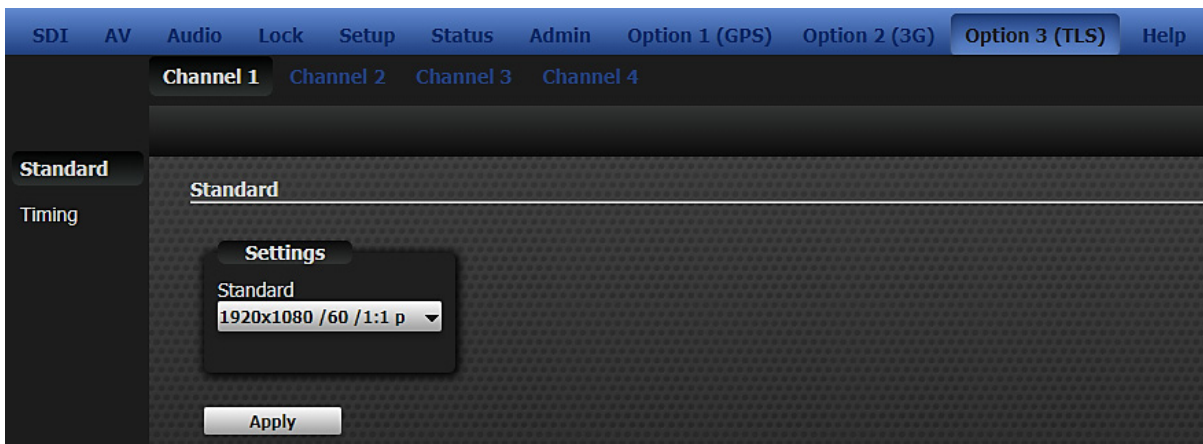

The range of available TLS standards is shown in section 15.3. The chart also shows which timing options are available for the different standards. The timing menu will follow one of the two formats shown below.

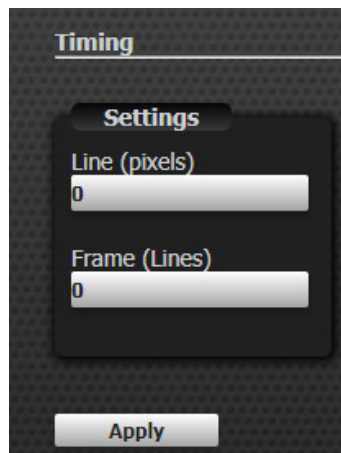
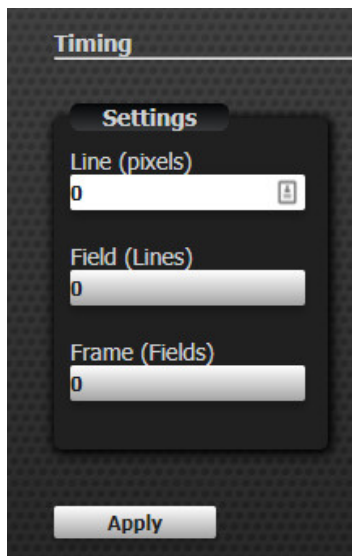

### 15.3 TLS | AVAILABLE STANDARDS

The standard of each output channel may be individually configured from the menu according to the following table. The scan format is indicated by P (Progressive) or I (Interlaced). “sF” within the description is used to denote “segmented frame”.

Some timing options are not available with specific standards as indicated in the following table.

Description	Lines/ Frame	Frame Rate	Scan	Timing		
				Line	Field	Frame
1920x1080/60/1:1	1125	60	P	Y	N	Y
1920x1080/59.94/1:1	1125	60	P	Y	N	Y
1920x1080/50/1:1	1125	50	P	Y	N	Y
1920x1080/60/2:1	1125	60	I	Y	Y	Y
1920x1080/59.94/2:1	1125	60	I	Y	Y	Y
1920x1080/50/2:1	1125	50	I	Y	N	Y
1920x1080/30/1:1	1125	30	P	Y	N	Y
1920x1080/29.97/1:1	1125	30	P	Y	N	Y
1920x1080/25/1:1	1125	25	P	Y	N	Y
1920x1080/24/1:1	1125	24	P	Y	N	Y
1920x1080/23.98/1:1	1125	24	P	Y	N	Y
1920x1080/30/sF	1125	30	I	Y	Y	Y
1920x1080/29.97/sF	1125	30	I	Y	Y	Y
1920x1080/25/sF	1125	25	I	Y	Y	Y
1920x1080/24/sF	1125	24	I	Y	Y	Y
1920x1080/23.98/sF	1125	24	I	Y	Y	Y
1280x720/60/1:1	750	60	P	Y	N	Y
1280x720/59.94/1:1	750	60	P	Y	N	Y
1280x720/50/1:1	750	50	P	Y	N	Y
1280x720/30/1:1	750	30	P	Y	N	Y
1280x720/29.97/1:1	750	30	P	Y	N	Y
1280x720/25/1:1	750	25	P	Y	N	Y
1280x720/24/1:1	750	24	P	Y	N	Y
1280x720/23.98/1:1	750	24	P	Y	N	Y
6Hz(30/24)	6Hz	-	-	N	N	N
6Hz(29.97/23.97)	6Hz	-	-	N	N	N
625/50	625	50	I	Y	Y	Y
525/59.94	525	60	I	Y	Y	Y

15.4 TLS | FRONT PANEL MENU

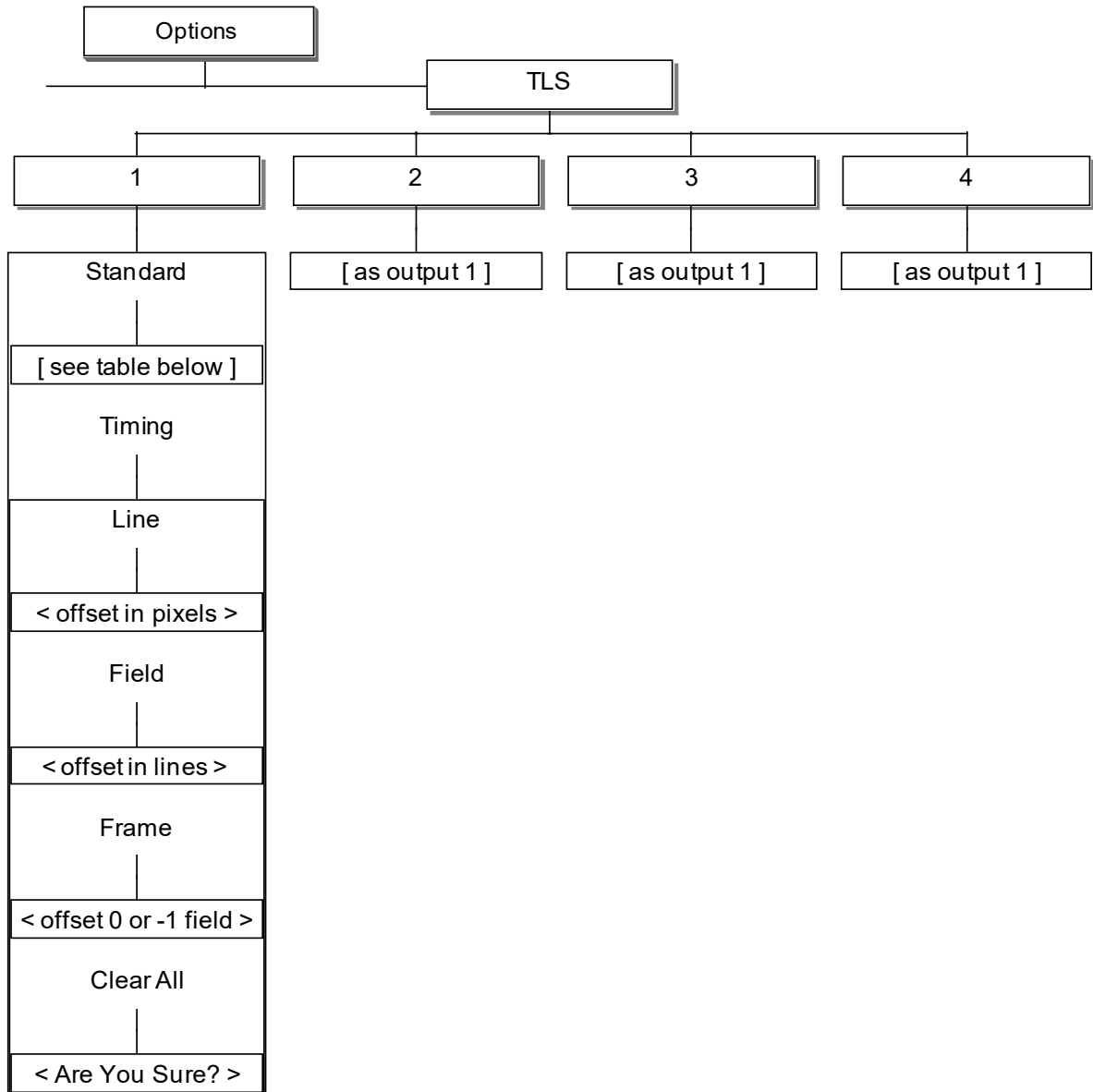

## 16. SOFTWARE FEATURES: NTP AND SNMP

### 16.1 360-18-02 NTP (NETWORK TIME PROTOCOL) SUPPORT

This is an optional software only feature: please contact your usual Trilogy sales representative for details.

- If enabled, the menu will offer “Server”, “Client” and “Disabled”: client and server are mutually exclusive.
- When acting as a client, Mentor RG can sync to any Internet NTP server.
- When acting as a server the Mentor RG should, ideally, be fitted with a GPS board but this is not essential. Even if the server is free running, a client can still sync to Mentor RG.

The Vector settings appear on the Setup >> Misc web page. Server address and Server Timeout are only available while Client mode is selected.

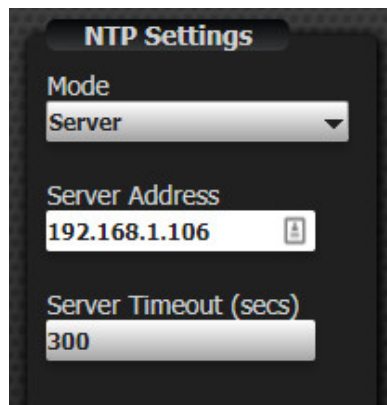

#### Front Panel Menu

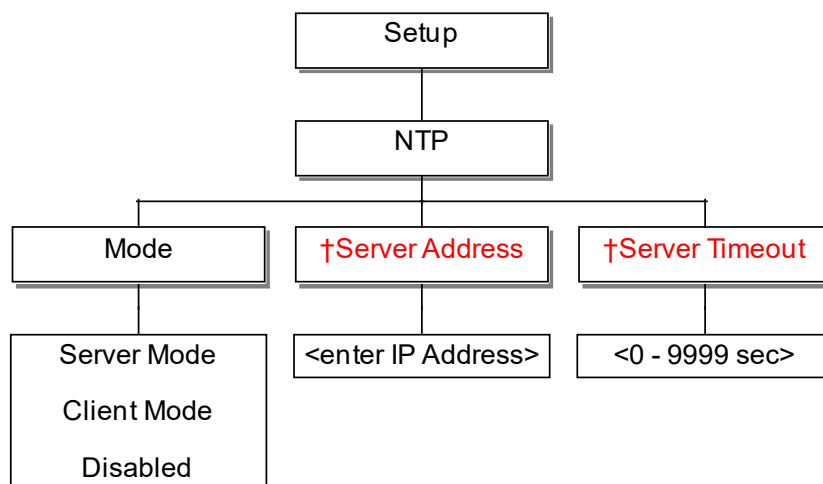

Note: Fields to set server address and server timeout are only displayed in “Client” mode.

## 16.2 360-19-00 SNMP (SIMPLE NETWORK MANAGEMENT PROTOCOL) SUPPORT

SNMP is a component of the Internet Protocol Suite as defined by the Internet Engineering Task Force (IETF). SNMP is used in network management systems to monitor network-attached devices for conditions that warrant administrative attention.

The 360-19-00 software feature implements an SNMP agent on the Mentor RG, allowing events on the Mentor RG to be monitored by a third-party management system.

The following conditions and events are reported:

State information is provided as per the Mentor RG error message screen:

- DHCP server status
- NTP server status
- External 5 / 10MHz status
- S318 presence
- Line lock status
- Subcarrier lock status
- Genlock input status
- Genlock Sch status
- Genlock video standard status
- Power supply status

GPS status reporting (if GPS option is fitted):

- GPS status
- GPS antenna status
- GPS 1pps lock status
- GPS: number of visible satellites
- GPS: number of tracked satellites

The GPI Outputs may also be controlled using SNMP.

Vector settings appear on the Setup >> Misc web page.

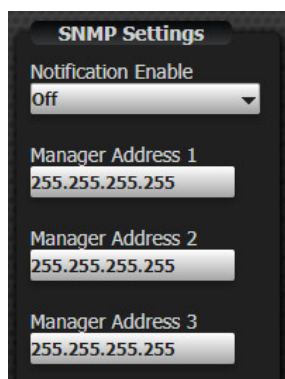

The following SNMP relevant variables can be set:

- If notification is enabled the Mentor RG will generate a trap on the change in value of any of the state variables.
- The IP addresses of the SNMP Managers where notification traps are sent. Up to three SNMP manager addresses may be configured.

Front Panel Menu

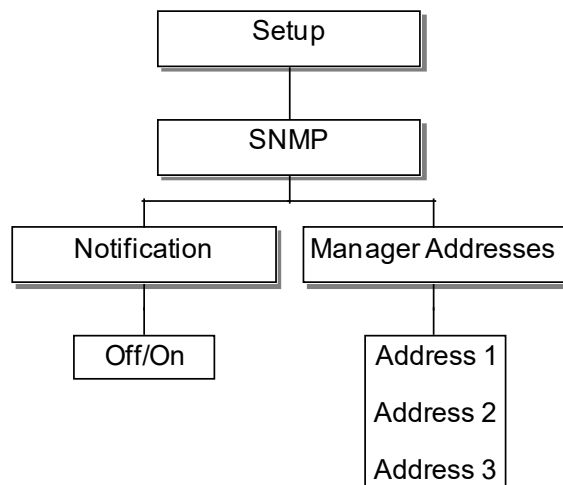

Please contact your usual representative or Trilogy Support to request the Mentor RG MIB (Management Information Base).

### 17. OPTION: 360-20-00 HD/3G-SDI MODULE

The 360-20-00 module has 3G capability, and offers three additional video standards as shown in section 17.2. The 360-20-00 expansion module does not support SD SDI standard signals. It requires software option 360-13-00 (HD) as pre-requisite. 3G Level B is supported, in accordance with SMPTE 424M.

Normally, only a single 360-20-00 will be fitted in expansion slot 2 of the Mentor RG.

#### 17.1 360-20-00 | VECTOR MENU

After the option board is added, an extra entry “Option 2 (3G)” will appear on the top level Vector menu bar.

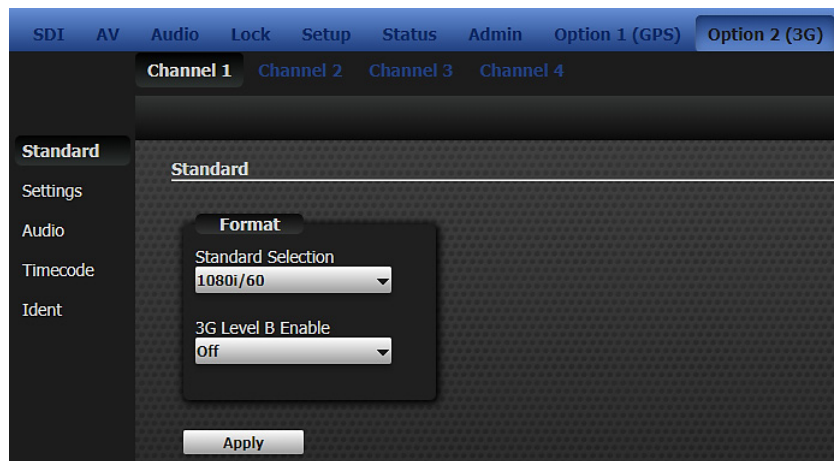

The table in section 17.2 shows the available standards. This page includes the option to enable / disable 3G Level B.

Other menus follow the same layout as the main-board SD/HD SDI signals – see section 5. The only exceptions occur when 3G Level B is enabled.

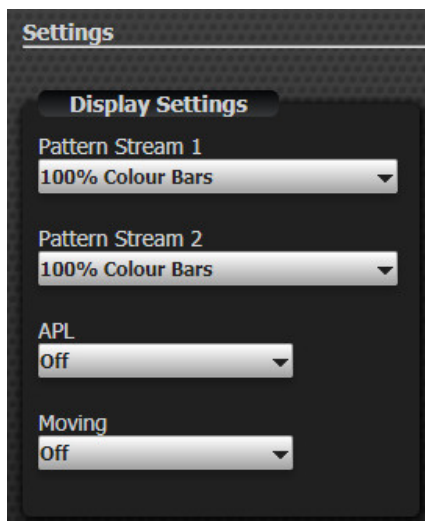

“Display Settings”, allowing Pattern Streams 1 & 2 to be selected.

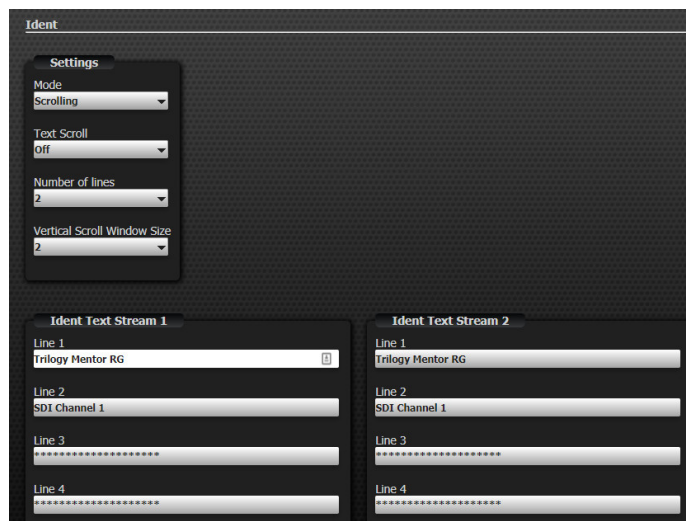

“Ident” now includes all settings for Text Streams 1 and 2.



## 17.2 360-20-00 | AVAILABLE VIDEO STANDARDS

Description	Lines/ Frame	Frame Rate (Hz)	Scan	360-20-00	Mentor RG main board
525				NO	YES
625				NO	YES
1080i / 60	1080	60	I	YES	YES
1080i / 59.94	1080	59.94	I	YES	YES
1080i / 50	1080	50	I	YES	YES
1080p / 60	1080	60	P	YES	NO
1080p / 59.94	1080	59.94	P	YES	NO
1080p / 50	1080	50	P	YES	NO
1080p / 30	1080	30	P	YES	YES
1080p / 29.97	1080	29.97	P	YES	YES
1080p / 25	1080	25	P	YES	YES
1080p / 24	1080	24	P	YES	YES
1080p / 23.98	1080	23.98	P	YES	YES
1080 / 24sF	1080	24	PsF	YES	YES
1080 / 23.98sF	1080	23.98	PsF	YES	YES
720p / 60	720	60	P	YES	YES
720p / 59.94	720	59.94	P	YES	YES
720p / 50	720	50	P	YES	YES
720p / 30	720	30	P	YES	YES
720p / 29.97	720	29.97	P	YES	YES
720p / 25	720	25	P	YES	YES
720p / 24	720	24	P	YES	YES
720p / 23.98	720	23.98	P	YES	YES

## Note:

- I denotes Interlace scan
- P denotes Progressive scan
- PsF denotes Progressive scan – segmented frame.

### 17.3 360-20-00 | AVAILABLE TEST PATTERNS

The 360-20-00 does not support SD SDI. The patterns listed below are available in both HD and 3G SDI formats.

Pattern	720	1080
Full Field Black	•	•
Full Field White	•	•
Full Field Yellow	•	•
Full Field Cyan	•	•
Full Field Green	•	•
Full Field Magenta	•	•
Full Field Red	•	•
Full Field Blue	•	•
Digital Grey	•	•
100% Colour Bars	•	•
100% Colour Bars & Split	•	•
75% Colour Bars	•	•
EBU Bars & Split		•
75% Colour Bars & Split	•	
SMPTE Bars	•	•
100% VT Bars		•
100% VT Bars & Split		•
VT Colour Bars	•	
VT Colour Bars & Split	•	
SDI Check Field	•	•
16x9 Grille	•	•
10 Riser Stair	•	•
Valid Ramp	•	•
RP219 Option 1	•	•
RP219 Option 2	•	•
RP219 Option 3	•	•
RP219 Option 4	•	•
Multiburst 100		•
PLUGE	•	•
Multiburst	•	
Bowtie	•	•
Clean Aperture		•
24Hz Lip Sync	•	•
25Hz Lip Sync	•	•
30Hz Lip Sync	•	•
50Hz Lip Sync	•	
60Hz Lip Sync	•	

### 17.4 360-20-00 | FRONT PANEL MENU

Front panel menus follow the same layout as the main-board SD/HD SDI signals – see section 5. Four outputs are provided and the menu includes the option to enable / disable 3G Level B. Sub menus are identical to those of the main board in Section 5.

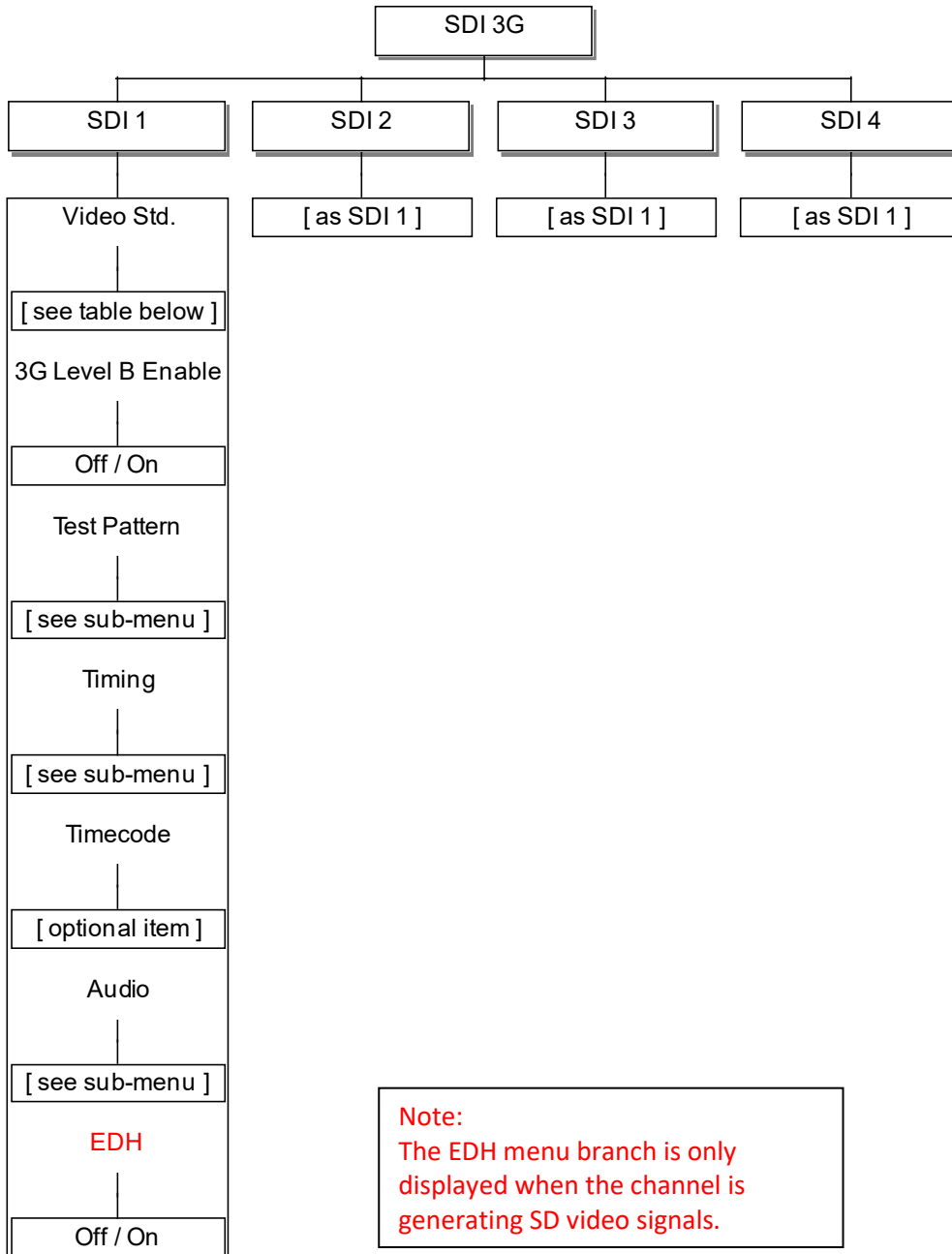

## 18. SOFTWARE FEATURE: 360-21-00 PTP

### 18.1 PTP | INTRODUCTION

The Precision Time Protocol (PTP) is a protocol used to synchronize clocks throughout an IP based computer or broadcast network. On a local area network, it achieves clock accuracy in the sub-microsecond range, making it suitable for measurement and control systems. Mentor RG is fully compliant with IEEE 1588-2008 also known as PTP Version 2. Note that PTP Version 2 is not backwards compatible with Version 1, hence Version 1 is not actively supported.

The scope of this manual does not permit a full explanation of the theory of PTP and the user should refer to IEEE 1588-208 for more information.

In most deployments, Mentor RG will act as a PTP Master, one of the three main modes of operation explained below.

The Trilogy GPS option allied with the highly stable internal oscillator allow Mentor RG to operate in the highest sub-category of master, named "grandmaster".

Only network hardware certified as fully compliant with IEEE 1588-2008 should be used for the infrastructure. Other hardware may degrade timing performance.

From the web pages, the user is offered a choice of one of four pre-defined profiles, described below.

- Delay Request-Response 00-1B-19-00-01-00 (default PTP for use with the delay request-response mechanism)
- Peer-to-Peer 00-1B-19-00-02-00 (default PTP for use with the peer delay mechanism)
- AES Media 00-0B-5E-00-01-00 (profile for media applications)
- SMPTE 68-97-E8-00-01-00 (SMPTE profile for synchronisation in a professional broadcast environment)

Each profile loads a set of individual parameter values appropriate for that profile. The user can choose to adjust the value of each parameter within a limited range to suit his circumstances. The range of adjustment for each parameter varies according to the profile selected.

To return a profile to the preset defaults, select it again and click "Apply".

The front panel menus only offer selection of the operational mode and choice of one of the four pre-defined profiles, as shown in section 18.3. The full range of parameter settings is provided via the Vector web interface.

## 18.2 PTP | CONFIGURE

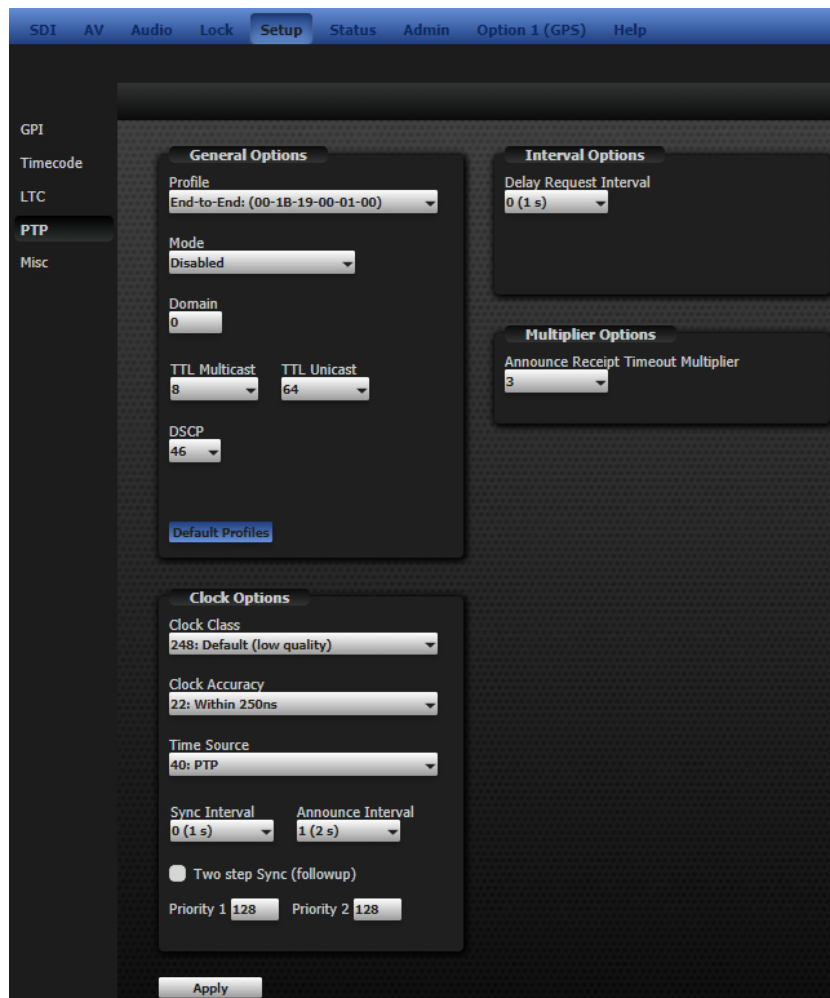

### 18.2.1 General options

Four preset profiles are provided, as explained in the preceding section. The default parameter values will provide correct operation in most applications but a window of adjustment is available.

#### Mode

	<ul style="list-style-type: none"> <li>• When set to Disabled, Mentor RG takes no part in any network PTP activity.</li> <li>• When Master is selected, Mentor RG will accept connections from slave devices</li> <li>• When Master/Slave is selected, Mentor RG will simultaneously             <ul style="list-style-type: none"> <li>○ Accept connections from slave devices – and –</li> <li>○ Lock to a higher status device</li> </ul>             This essentially defines a three level hierarchy</li> <li>• When Slave is selected, Mentor RG is locked to a higher status master device.</li> </ul>
--	---

Domain

	<p>A domain consists of one or more PTP devices communicating with each other as defined by the protocol. Different PTP domains may be defined on the same LAN segment. Multiple PTP domains may co-exist but will not have visibility of each other. Normally only one will exist and the default domain, identifier 0, will be loaded with the selected Profile. Note that domain 127 is loaded for the SMPTE profile.</p>
---	--

18.2.2 Clock Options

- Two step (clock) - provides time information using a combination of an event message and subsequent general message.
- One step (clock) – provides time information using a single event message.

Clock Class

<ul style="list-style-type: none"> <li>6: GrandMaster (PTP timescale)</li> <li>7: GrandMaster (No Synchronize)</li> <li>9: Reserved</li> <li>10: Reserved</li> <li>13: GrandMaster ARB</li> <li>14: GrandMaster ARB No Sync</li> <li>52: GrandMaster A Degraded 7</li> <li>58: GrandMaster A Degraded 14</li> <li>150: Alternate PTP Profile</li> <li>158: Alternate PTP Profile</li> <li>166: Alternate PTP Profile</li> <li>187: GrandMaster B Degraded 7</li> <li>193: GrandMaster B Degraded 14</li> <li>220: Alternate PTP Profile</li> <li>228: Alternate PTP Profile</li> <li style="background-color: #0070C0; color: white;">248: Default (low quality)</li> <li>251: Reserved</li> <li>255: Slave Only (unreachable)</li> </ul>	<p>When Mentor RG is operating in Master Mode, the class of clock available is the highest, GrandMaster. When operating in Slave mode, other devices cannot connect, hence the clock cannot be reached.</p>
---	---

Clock Accuracy

<ul style="list-style-type: none"> <li>20: Within 25ns</li> <li>21: Within 100ns</li> <li style="background-color: #0070C0; color: white;">22: Within 250ns</li> <li>23: Within 1us</li> <li>24: Within 2.5us</li> <li>25: Within 10us</li> <li>26: Within 25us</li> <li>27: Within 100us</li> <li>28: Within 250us</li> <li>29: Within 1ms</li> <li>2A: Within 2.5ms</li> <li>2B: Within 10ms</li> <li>2C: Within 25ms</li> <li>2D: Within 100ms</li> <li>2E: Within 250ms</li> <li>2F: Within 1s</li> <li>30: Within 10s</li> <li>31: Within 10+s</li> <li>FE: Unknown</li> </ul>	<p>This characterizes a clock for the purpose of the best master clock (BMC) algorithm. It is represented in hex (as per IEEE-1588). Select the required clock accuracy from the list.</p>
---	--

**Time Source**

10: ATOMIC_CLOCK 20: GPS <b>40: PTP</b> 50: NTP 60: HAND_SET 90: OTHER A0: INTERNAL_OSCILLATOR F0: ALTERNATE PTP PROFILE F1: ALTERNATE PTP PROFILE	This is represented in hex (as per IEEE-1588) - this information-only attribute indicates the source of time used by the grandmaster clock.
--	---

**Other**

Item	Range	Definition
Sync Interval	Range and default value differ per profile.	Specifies the mean time interval between successive sync messages.
Announce Interval	Range and default value differ per profile.	Specifies the mean time interval between successive announce messages.
Two step sync (follow-up)	Checkbox: default on	If enabled, transports the timestamps recorded at the master clock to the slave clock.
Priority 1	Range and default value differ per profile.	User configurable designation that a clock belongs to an ordered set of clocks from which a master is selected.
Priority 2	Range and default value differ per profile.	User configurable designation that provides finer grained ordering among otherwise equivalent clocks.

**18.2.3 Interval Options**

Item	Range	Definition
Delay Request Interval (s)	Range and default value differ per profile.	A dynamic attribute determined and advertised by a master clock based on the ability of the master clock to process the Delay Req message traffic.
PDelay Request Interval (s)	Range and default value differ per profile.	Specifies the minimum permitted mean time interval between successive Pdelay_Req messages
Two step PDelay (follow-up)	Checkbox: default on	If enabled, contains the departure time for the PDelay_Resp

**18.2.4 Multiplier Options**

Announce Repeat Timeout Multiplier	Range and default value differ per profile.	Specifies the number of announce intervals that have to pass without receipt of an Announce message before the occurrence of the event.
------------------------------------	---	---

### 18.3 PTP | FRONT PANEL MENUS

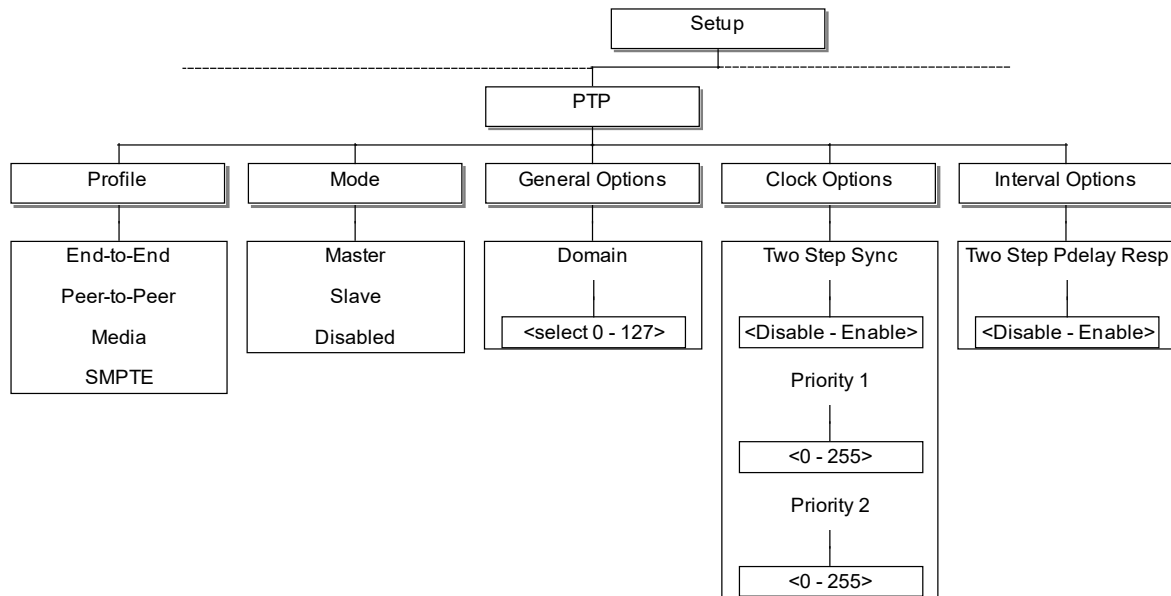

The front panel menus offer a limited selection of the available settings, as shown above. The full range of parameter settings is provided via the Vector web interface.

The “Options” menu branches are visible or hidden according to the current selection of both Profile and Mode. Details are shown in the table below, where:

- G = “General options” visible
- C = “Clock Options” visible
- I = “Interval Options” visible
- none = no options branches are visible

		Profile			
		End-to-end	Peer-to-peer	Media	SMPTE
Mode	Master	C	C I	G C I	G C I
	Slave	none	none	G	G
	Disabled	none	none	G	G



## 19. COMMON CONFIGURATIONS

This section provides instructions on setting up your Mentor RG in a number of commonly used modes. Some of these require certain hardware and software options to be present: these are outlined within each sub-section.

### 19.1 GPS LOCKED SPG AND TIMECODE GENERATOR.

Ensure you have the 360-15-12 GPS Board fitted, and connect a suitable 50Ω cable and antenna. The 360-22-00 Timecode option is also required. See section 14.4 for guidance on selecting antenna and cable.

1. Press Options on the front panel and select GPS. Set PPS lock and ATR lock on.
2. With version 5.0 and later software, Crash Lock will default to “off” on start-up. Use of Crash lock will cause sync timing to be unstable until PPS lock is achieved although it will speed the process.
3. Select Options >> GPS >> Status and wait for <Locked to 1 PPS> to be indicated.
4. Navigate to Setup >> More >> RTC Setup >> Sync Source and select <GPS>.
5. Go to Setup >> Timecode >> All Frequencies, ensure <RTC> is selected in Jam Source. Then press <JAM!>.
6. Press Options on the front panel and select GPS. From the “on start-up” menu, set Crash lock to off.

The Mentor RG Timecode will now reflect GPS time and the Black and Burst outputs will be locked to the GPS 1 PPS signal.

### 19.2 GPS LOCKED NTP SERVER.

Ensure you have the 360-15-12 GPS Board fitted, and connect a suitable 50Ω cable and antenna. See section 14.4 for guidance on selecting antenna and cable. The 360-18-02 NTP server option is also required.

1. Press Options on the front panel and select GPS. Set PPS lock, Crash lock and ATR lock on.
2. Select Options >> GPS >> Status and wait for <Locked to 1 PPS> to be indicated.
3. Navigate to Setup >> More >> RTC Setup >> Sync Source and select <GPS>.
4. Go to Setup >> More >> NTP >> Mode and select <Server Mode>.
5. Go to Setup >> More >> Comms >> Network and enter appropriate values for IP Address, IP Subnet Mask and Default Gateway. The Mentor RG must be configured with a fixed (static) IP Address: DHCP is not suitable for this application.

The Mentor RG will now be serving requests for NTP time at the configured IP Address.

### 19.3 DAYLIGHT SAVING TIME

Mentor RG has an automatic daylight saving time adjustment feature. To enable this from the front panel controls, go to:

1. Setup >> More >> RTC Setup >> Time zone
2. Select your locale from the list and press OK to confirm

The real-time clock will now automatically adjust at the start and end of daylight saving time.

However, to ensure continuity, timecode will not change until Jam! occurs. For more information on the different Jam modes available, please see section 13.1.

### 19.4 VITC AS A JAM! SOURCE

The 360-22-00 Timecode feature is required for this mode. DVITC, ATC and LTC are optionally able to Jam to VITC on a genlock input. VITC input timecode lock is activated from the front panel menus as follows:

- Setup >> Timecode >> All Frequencies >> JAM Source >> VITC
- Setup >> Timecode >> All Frequencies >> JAM! >> OK

Upon jamming, the VITC on the genlock input is sampled and all timecode outputs are updated.

Timecode outputs then increment from this point, until another Jam! is initiated. If the Mentor RG is genlock referenced and is set to output the same frame rate as the genlock input, then timecode will remain locked to the genlock input.

If the input genlock VITC changes, the Mentor will require a Jam! to reflect this change. This ensures continuity of output timecode.

## 20. SPECIFICATION

Note. All measurements are made assuming, where appropriate, that the various offsets controlled from the front panel are set to zero unless otherwise stated. All signal measurements are made with inputs and outputs terminated in 75Ω unless otherwise stated.

### 20.1 GENERAL

Width	19" rack mounting
Height	44 mm (1U)
Depth	433 mm (excluding connectors)
Weight	4kg with no option boards 5kg max. with all option boards
Operating temperature range	0°C to 50°C
Storage temperature range	-20°C to 60°C
Operating humidity	20% - 90% (non-condensing when operating at 40°C)

### 20.2 EMC

Emissions	EN 55032:2015 FCC CFR 47 Part 15.107 & 15.109 and ICES-003 Issue 6
	EN 61000-3-2:2014, EN 61000-3-3:2013
	ETSI EN 301 489-3 V2.1.0
Immunity	EN 55103-2:2009
Safety	IEC 60950-1:2005/A2:2013

NOTE: Immunity is specified to criterion B - the outputs may suffer some degradation during the disturbance, but will recover on removal of the disturbance source and continue to operate as intended.

### 20.3 POWER

Mains input x 2	100-240 VAC, 50/60 Hz, auto select
Power consumption	60VA max. (depending on number of option boards fitted)
Internal Fuse	3.15A

### 20.4 INTERNAL REFERENCE OSCILLATOR STABILITY

Frequency Stability (per year)	< ±50ppb
Temperature stability (over operating temperature range)	< ±10ppb
Ageing rate (per day)	< ±0.5ppb
Warm up settling time to <±10ppb	10 minutes @ +20°C

## 20.5 GENLOCK VIDEO INPUT PERFORMANCE

The lock mode is assumed set to manual subcarrier phasing, correct Sc.H or follow-external subcarrier phase, unless otherwise stated.

Video input type	2 BNC high impedance loop through
Return loss @ subcarrier	< -40dB
Video D.C. range	< $\pm 12V$
Video signal amplitude (to keep unit within specification)	300mV sync/burst $\pm 6$ dB (285mV 525 operation)
Sync attenuation below which signal will be indicated as missing.	-8dB (with respect to 300mV/625 or 285mV/525)
Burst attenuation below which signal will be indicated as monochrome.	-8dB (with respect to 300mV/625 or 285mV/525))
Sync frequency lock range	15.625kHz $\pm 1.5$ Hz ( $\pm 100$ ppm) - 625 15.734kHz $\pm 1.5$ Hz ( $\pm 100$ ppm) - 525
Subcarrier lock range	4.43361875MHz (625) 3.579545MHz (525) $\pm 200$ Hz ( $\pm 50$ ppm) (see note 1)
Genlock video lock up time	< 7 seconds
Output sync jitter with respect to 'clean' genlock video input	< $\pm 3$ ns
Output subcarrier jitter with respect to 'clean' genlock video input, lock mode = EXT1/2/3	< $\pm 0.25^\circ$
Output subcarrier jitter with respect to 'clean' genlock video input, lock mode = EXT 4	< $\pm 2^\circ$
Input video ScH. phase over which ScH. error is indicated.	+90 $\pm 15^\circ$ , -90 $\pm 15^\circ$ (approx.)
Genlock video sync to output sync timing accuracy, over full operating temperature range	< 5ns
Genlock video subcarrier to output subcarrier phase accuracy over full operating temperature range	< $5^\circ$
Vertical lock up rate, genlock video to output, when unit set to line drop mode	1 line / 5 field

Note1: Assumes 15625Hz (15734.268Hz NTSC) line frequency and subcarrier varied about nominal subcarrier frequency.

## 20.6 GENLOCK OPERATIONAL CONTROL

Horizontal offset adjustment range	$\pm 32$ $\mu S$
Horizontal offset resolution	1ns
Horizontal offset accuracy	$\pm 5$ ns over full range
Subcarrier phase adjustment range	0 to 359.9 $^\circ$
Subcarrier phase resolution	0.1 $^\circ$
Line offset adjustment range	1 line steps over entire 525/625 range

## 20.7 10 MHz INPUT PERFORMANCE

The lock mode is assumed set to external 10 MHz.

10MHz input type	1 BNC, 75Ω terminated
10MHz input return loss @ 10 MHz	< -35dB
10MHz D.C. range	< ±3V
10MHz signal amplitude (to keep unit within specification)	0.5V to 3V pk to pk (terminated)
Signal amplitude below which signal will be indicated as missing.	0.4V
10MHz frequency lock range	10 MHz ±200 Hz (±20 ppm.)
Lock up time	< 0.1 seconds
Output sync jitter with respect to 'clean' 10MHz input	< ±2 ns
Output subcarrier jitter with respect to 'clean' 10MHz input	< ±0.2°

## 20.8 SD-SDI OUTPUTS

General		
Format	270 Mbit/s 10 bit	
Standards	ITU-R BT 601, 656, EBU Tech 3267, SMPTE 125M, 244M, 259M, 272M, RP165, RP178)	
Video		
Output impedance	75Ω	
Amplitude	800 mV pk-pk ±10%	
Return loss to 270MHz	> 15dB	
Overshoot	<10%	
Jitter	<0.2UI, above 10Hz jitter frequency	
Rise/Fall times	0.4 to 1.5ns (20-80%)	
DC offset (AC coupled)	0 ±0.5V	
Time offset with respect to Main black burst signal	< ±100 ns	
Embedded audio		
Active channels	4	
Group	1, 2, 3, 4 any / all, freely selected.	
Sample frequency	48kHz	
Digital coding	24 bits	
Audio Tone	25 Hz to 20 kHz in 25 Hz steps	
Audio Level	0 to -120dBfs	
Tone modes	On, Off, CCIR and EBU	

**20.9 HD-SDI OUTPUTS**

General	
Standards	SMPTE 272M, 292M, 296M
Formats	1080i 60Hz, 59.94 Hz, 50 Hz 1080p 30 Hz, 29.97 Hz, 25 Hz, 24 Hz, 23.98 Hz 1080psF 30 Hz, 29.97 Hz, 25 Hz, 24 Hz, 23.98 Hz 720p 60 Hz, 59.94 Hz, 50 Hz, 30 Hz, 29.97 Hz, 25 Hz, 24 Hz, 23.98 Hz
Video	
Output impedance	75Ω
Amplitude	800mV pk-pk ±10%
Return loss to 270MHz	>15dB 5 MHz – 750 MHz >10dB 750 MHz – 1.485 GHz (typical)
Overshoot	<10%
Jitter	<135ps
Rise/Fall times	<270ps (20-80%)
DC offset (AC coupled)	0 ±0.5V
Embedded audio	
Active channels	4
Group	Selectable 1, 2, 3 or 4.
Sample frequency	48kHz
Digital coding	24 bits
Audio Tone	25 Hz to 20 kHz in 25 Hz steps
Audio Level	0 to –120dBfs
Tone modes	On, Off, CCIR and EBU

**20.10 3G SDI OUTPUTS**

As above with the following additional formats in accordance with SMPTE 424 M standards:

- 1080p/50 Hz
- 1080p/59.94 Hz
- 1080p/60 Hz

**20.11 ANALOGUE VIDEO OUTPUT PERFORMANCE**

Output impedance	75Ω ±0.2%
Sync amplitude	300mV ± 3mV (625) 285mV ± 3mV (525)
Burst amplitude	300mV ± 9mV (625) 285mV ±9mV (525)
Black level D.C.	0V ± 20mV
Noise to 20MHz	< -60dB (with respect to 700mV)
Noise above 20MHz	< -40dB (with respect to 700mV)
ScH. accuracy, all controls set to zero	± 5°
Sync edge rise-time	250ns, Gaussian (625) 140ns, Gaussian (525)
Burst edge rise-time	350ns, Gaussian (625) 300ns, Gaussian (525)
Difference in timing between any analogue video output and any other (all controls set to zero)	±10 ns
Difference in timing between any black/burst output and the genlock video input (all controls set to zero).	±10 ns
Generation Accuracy	10bit
Timing Accuracy channel to channel	<±5ns
Level, 0dB:pk-pk:	1V±1%
Black level DC:	0V ±25mV
Chrominance/Luminance gain:	<1%
Chrominance/Luminance delay:	<5ns
Chrominance phase accuracy:	<±5°
Linearity:	<0.25%
Frequency Response to 6MHz	±0.2dB
Diff. Gain:	< 0.5%
Diff. Phase:	< 0.5°
2T K rating:	< 0.5%K
ScH accuracy:	±5°
Line tilt:	<0.5%
Field tilt:	<0.5%
Channel crosstalk 0-5.8MHz	<-60dB

**20.12 AES/EBU OUTPUTS**

Standard	ANSI S4.40 (AES3)
Output Channels	4 (2 AES/EBU pairs)
Synchronism	The signal timing is derived from the video clock source, either the internal oven oscillator or the genlock feed. 48kHz signal is related to video frame as per SMPTE/EBU recommendations.
Grade * see note 1	Meets grade 1 when genlock lock mode = internal or stable 10MHz reference used.
Clock jitter * see note 1	< 1ns
Output Connectors	9 way Sub-D Socket (balanced) BNC (unbalanced) - optional
Signal amplitude	5V $\pm$ 0.3V
Impedance	110 $\Omega$ $\pm$ 10%
Tone resolution	24 bit
Tone linearity error	< 1ppm
Sample frequency control	Selectable, 32kHz, 44.1kHz, 48kHz, 96kHz
Tone frequency adjustment	25Hz to 20kHz in 25Hz steps. Left/right channel independent adjustment.
Tone amplitude adjustment	0 to -120dBfs left/right channel independent adjustment.
Tone identification	Left/right channels can pulse according to EBU/CCIR recommendations.
Grade	Grade bit manually adjustable between grade 1 and grade 2.
User data	User configurable
Other	Both channels may be set to silence. Channels can be swapped.

Note 1. When the unit is locked to a genlock feed, the frequency stability of the AES signal is dependent on the quality of that feed.

**20.13 ANALOGUE AUDIO OUTPUT PERFORMANCE**

Signal source	Independent audio generator.
Number of Channels	2
Output type	Differential, electronically balanced
Output impedance	Low impedance, < 10 $\Omega$ .
Tone Amplitude	+20dBu to -40dBu adjustable.
Tone Frequency	100Hz to 20kHz in 25Hz steps. Left/right channel independent adjustment.
Tone identification	Left/right channels can pulse according to EBU/CCIR recommendations.

**20.14 CLOCK OUTPUT**

Frequency	Selectable 10MHz, 27MHz or Word Clock
Output Impedance	75 $\Omega$ $\pm$ 1%
Word Clock	CMOS compatible 32kHz, 44.1 kHz, 48kHz or 96kHz (AES1 or AES2 sample frequency)
10MHz	1.2V $\pm$ 100mV
27MHz	1V $\pm$ 100mV



**20.15 GPI INPUTS AND OUTPUTS**

GPI Inputs	
Number	2
Type	Grounding
Max voltage	±20V
Operating current	≈600μA
GPI Outputs	
Number	2
Type	Open Drain
Max Voltage	30V
Max Current	190mA
Max dissipation	600mW

**20.16 LTC (LONGITUDINAL TIMECODE)**

Standard	SPMTE S12M, S309M
Output Channels	2, electronically balanced
Input Channels	1, electronically balanced
Connector	9 way Sub-D Socket
Level	2V peak-peak into 1kR
Impedance	<25 Ω per leg
Rise-time	40 ±10μSec between 10% and 90% points
Jitter	<2μSec
Overshoot	<5%

**20.17 MISCELLANEOUS**

Setup data retention when unit not powered	>1000 hours. Unit must have been powered for >24 hours prior to this.
Serial communication type	RS422 / 232 (software configured).
Power fail indication	Relay contact, closed under normal operation, open for any failure state.
Fan fail indication	Relay contact, closed under normal operation, open for any failure state.
Option interfaces	Up to three single width option boards may be fitted to the unit.
Ethernet	RJ-45 interface. Software configured for DHCP or static IP address.