

SCIFIT[®]

Scientific Solutions for Fitness.

Users' Operations Manual

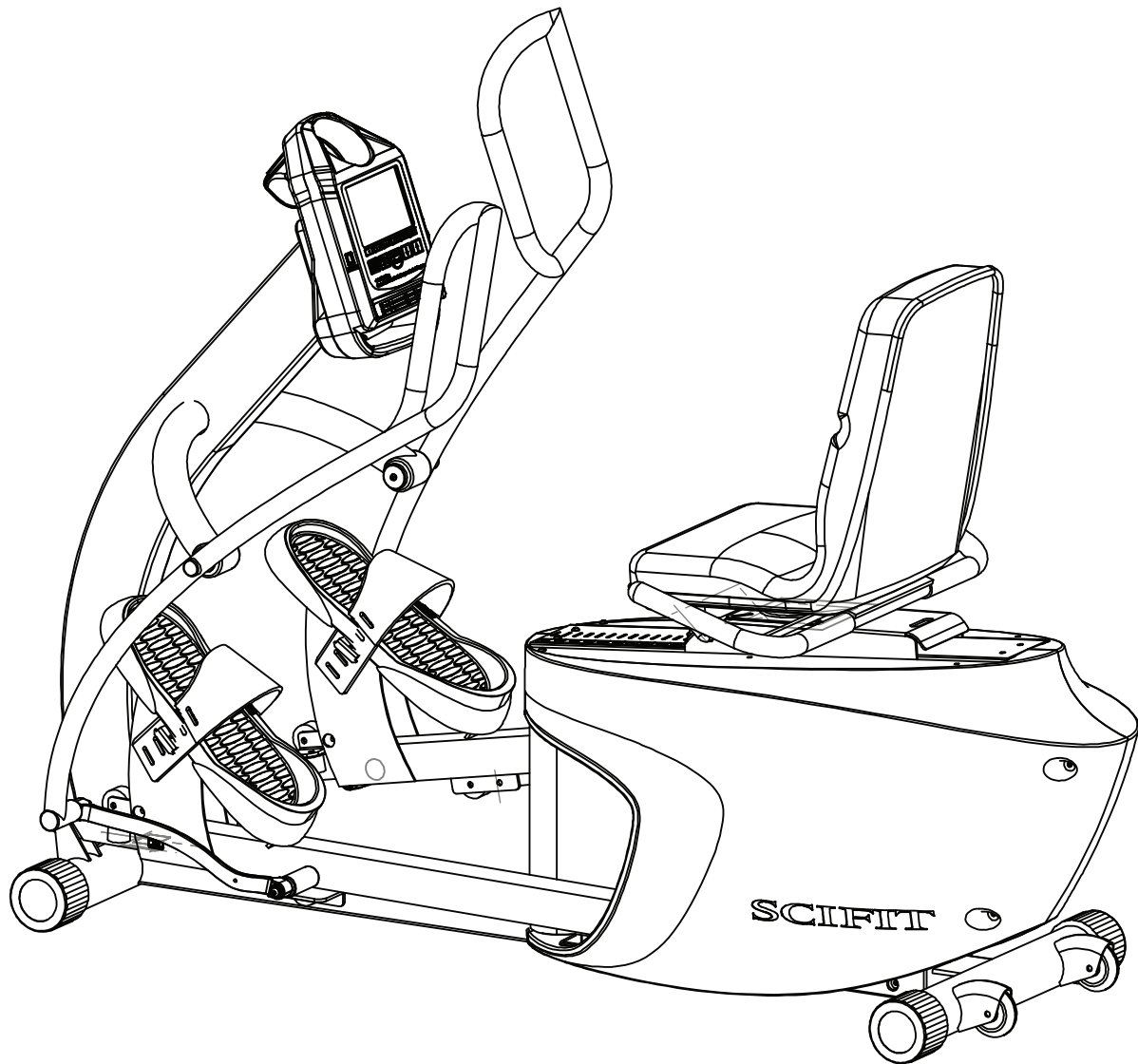

REX™ Orbi-Linear™ Trainer



Before using this product, read this manual and follow all safety rules and operating instructions.



This page purposely left blank

TABLE OF CONTENTS

SAFETY INFORMATION.....	1
INTRODUCTION	2
SPECIFICATIONS	3
SETUP & INSTALLATION	4
ASSEMBLY	5
PRODUCT OVERVIEW	6
KEYPAD FUNCTIONS	7
BIOMECHANICAL POSITIONING	8
HEART RATE TRANSMITTER STRAP & CONTACT GRIPS.....	9
PROGRAM INSTRUCTIONS	10 - 16
MAINTENANCE & SERVICE	17
WARRANTY	18 - 22

Order Online 24/7 at www.SCIFIT.com

SAFETY INFORMATION

The purpose of safety symbols is to attract your attention to possible dangers. The safety symbols, and their explanations, deserve your careful attention and understanding. The safety warnings do not, by themselves, eliminate any danger. The instructions or warnings they give are not substitutes for proper accident prevention measures.

Look for these symbols to point out important safety precautions. It means attention! Your safety is involved.

WARNING

Failure to obey a safety warning **can** result in injury to yourself and others. Always follow the safety precautions to reduce the risk of personal injury.

CAUTION

Failure to obey a safety caution **can** result in injury to yourself and others. Always follow the safety precautions to reduce the risk of personal injury.

Read all instructions before using your SCIFIT exercise machine. Save these instructions for future reference.

Close supervision is necessary when exercise machine is being used by or near children, or individuals with disabilities. Keep children away from extended hand and foot supports.

Use the exercise machine only for its intended use as described in this manual. Do not use attachments not recommended by the manufacturer.

Never drop or insert any object into any opening.

Do not use outdoors or in a harsh environment where water is present (i.e. pool or spa areas).

INTRODUCTION

Thank you for your purchase of the SCIFIT REX™ Orbi-Linear™ Trainer. We have incorporated the finest technology and ergonomic design into this machine to assist you in achieving your fitness goals. However, for your safety, please adhere to the following recommendations before you begin to exercise.

The SCIFIT REX™ Orbi-Linear™ Trainer is designed for Class "S" (Studio), Class "I" (Special Needs) and Class "II a" (Medical Device Directive) applications. The intended uses are for Cardio & Pulmonary Rehabilitation as well as Sports Medicine, Physical Therapy, Physical Conditioning and Strength Training. SCIFIT equipment is suitable for placement in fitness, medical rehab, sports performance and recreational facilities. REX has 200 levels of computer controlled resistance, which ensures that users of all fitness levels will be able to get a challenging but not overwhelming workout.

Consult Your Physician

Consult your physician or medical specialist before participating in any exercise program, especially if you are pregnant, or if you are suffering from: heart disease, respiratory disease, diabetes, hypertension, high blood pressure, elevated cholesterol, arthritis, or any other diseases or physical complaints.

Adult Usage

SCIFIT equipment is designed and intended for adult usage and children of appropriate ages while being supervised. Young children should be kept a safe distance away from equipment.

Cool Down

To prevent muscle injuries and soreness, you should always cool down (at least 5 minutes) by doing a series of stretches after each workout.

CAUTION

Always stretch after a workout session to reduce the risk of personal injury. Failure to stretch properly **may** result in injury to yourself.

Guidelines for Healthy Adults

The American College of Sports Medicine (ACSM) and the American Heart Association (AHA) are continuously updating guidelines and recommendations for physical activity.

The current basic recommendations from ACSM and AHA is:

Do moderately intense cardio 30 minutes a day, five days a week.

OR

Do vigorously intense cardio 20 minutes a day, three days a week.

AND

Do eight to ten strength-training exercises, eight to twelve repetitions of each exercise twice a week.

Moderate-intensity physical activity means working hard enough to raise your heart rate and break a sweat, yet still being able to carry on a conversation. It should be noted that to lose weight or maintain weight loss, 60 to 90 minutes of physical activity may be necessary. The 30 minute recommendation is for the average healthy adult to maintain health and reduce the risk for chronic disease.

To review the latest guidelines and recommendations, visit the American College of Sports Medicine website: www.acsm.org

WARNING

Stop exercising immediately if you feel nausea, dizziness, sharp pain, or any other physical discomfort. Failure to stop exercising **can** result in injury or death to yourself.

Train Intelligently

To ensure a future of good health, you should always eat well balanced meals, drink plenty of fluid/water during a workout, and stay fit by exercising intelligently. Always follow training guidelines that are specific for your own physical condition.

WARNING

Injuries to health may result from incorrect or excessive training. Failure to stop exercising **can** result in injury or death to yourself.

SPECIFICATIONS

Weight	322 lbs. / 146 Kg.
Max User Weight . .	500 lbs. / 227 Kg.
Power	Self generating w/auto recharge battery back-up. Optional Low Voltage AC adapter available.
Resistance System .	Electromagnetic Self Generating Bi-directional Resistance
Programs	Manual, Fit Quik, Constant Workout, ISO-Strength, 7-Preprogrammed Hill profiles, Heart rate, Power Fit Test, Power Fit Training, Heart Fit Test, Heart Fit Training, Stress Test and Random
Accuracy Class. . . .	Class A
Warranty	Within U.S. & Canada 3 years parts, 1 year labor Outside U.S. 3 years parts, no labor

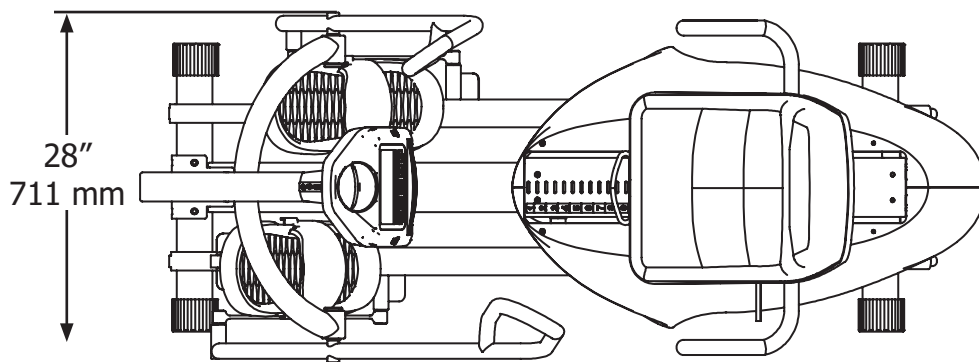
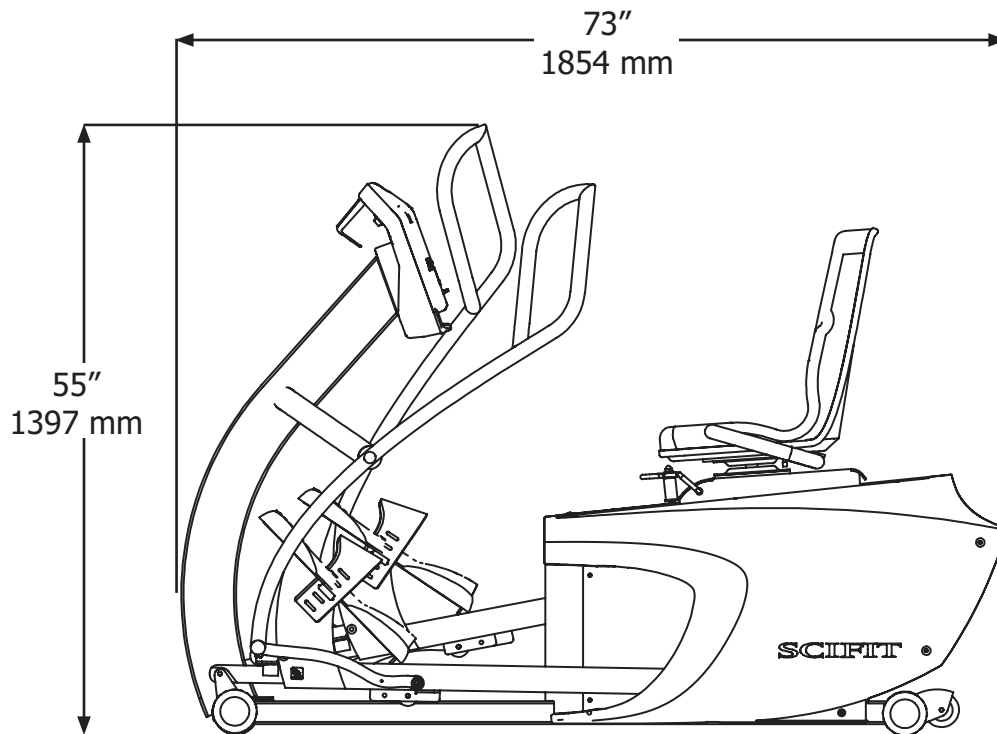

SETUP & INSTALLATION

Placement of Cardiovascular Machine

To aid in the placement of equipment, two wheels are located on the rear of the unit. Movement of machine should be done with two people. Carefully lift the front of unit until wheels are engaged on floor and position unit in desired location.

Position the unit in a location that has a stable and level sub-floor. Equipment should be positioned in a location that is not in direct sunlight, in areas of extreme temperature and humidity, or where the equipment may be splashed with water or fluids. This machine is intended for indoor use only.

Equipment should be positioned with a safety perimeter of 40" or 1 meter around unit.

WARNING

Failure to place the equipment on a stable and level sub-floor with a safety perimeter can result in injury to yourself and others.

Level Cardiovascular Machine

If the sub-floor is unlevel, the unit is equipped with leveling end caps. The end caps are designed with the recess of end cap off centered. This allows you to rotate the endcap(s) to a position that will level the equipment. After adjustment, check and make sure end caps are fully seated against base frame tubes.

Offset Endcap

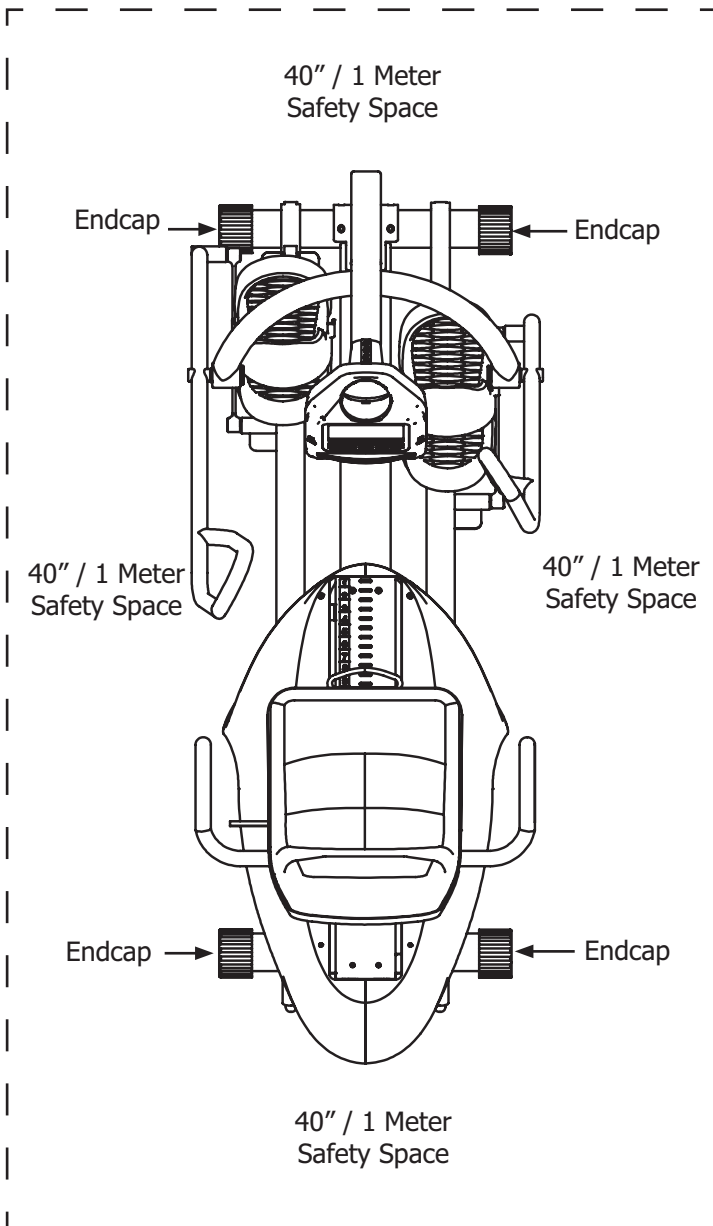
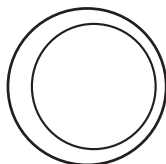

Proper Supervision

Close supervision is required when the exercise machine is being used by or near individuals with disabilities. Keep unsupervised children outside the safety perimeter.

Cleaning

Never clean the machine with organic solvents, alcohol or bleach based cleaners. To promote a healthy environment, wipe any sweat off of unit with a commercially manufactured wipe designed for the fitness industry, or a damp cloth.

ASSEMBLY

Assembly

For equipment that is shipped overseas, some assembly is required. Follow the steps below for assembly.

Attaching The Console

Step 1 - Align the console in front of the console mount plate and attach the 16-pin main cable to location P1 on the rear of the console.

NOTE: Verify the two securing latches of P1 are over the cable connector to indicate it is secure.

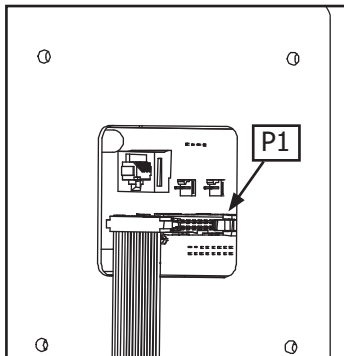

Step 2 - Attach the grey RJ45 communication cable to P6 on the rear of the console.

NOTE: Listen for a clicking sound to indicate the cable is secure.

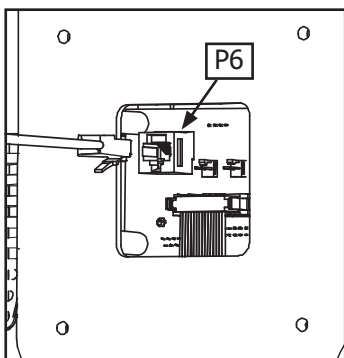

Step 3 (CHR Models Only)
If your machine model has the Contact Heart Rate option, attach the two CHR cables to P3 and P4 on the rear of the console.

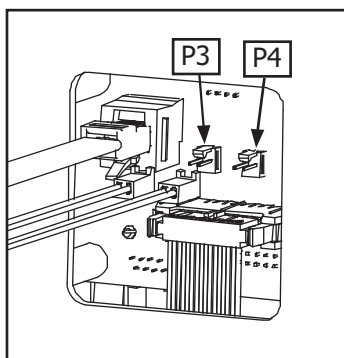

Step 4 - Using a Phillips screw driver, secure the console to the mast with (Qty. 4) supplied M5 x 12mm screws

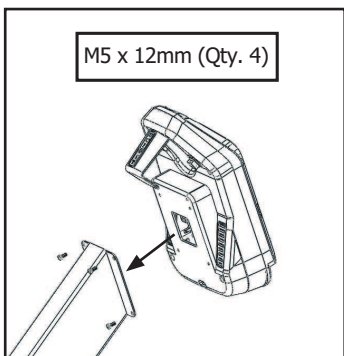

Upper Body Handles (two people may be required)

The upper body handles of the machine will come partially disconnected and will require installation before use.

Step 1 - The upper body handles will be laying against the body of the machine and will need to be rotated upwards (See drawing)

Step 2 - Unwrap the connecting link from handle and lower the connecting link to align with the mounting hole on the Teleraill (see drawing).

Step 3 - Using a 3/16 Hex bit, secure the connecting link with the supplied (Qty.1) 5/16 Flat washer, (Qty.1) 5/16 Split washer and (Qty.1) 5/6-18 x 1.75 Button Head Socket bolt in that order (see drawing).

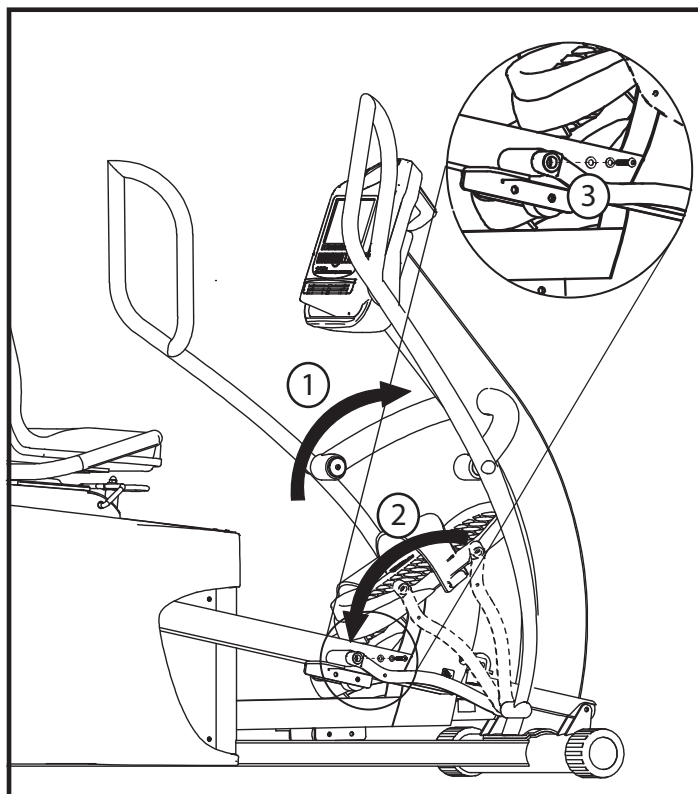

PRODUCT OVERVIEW

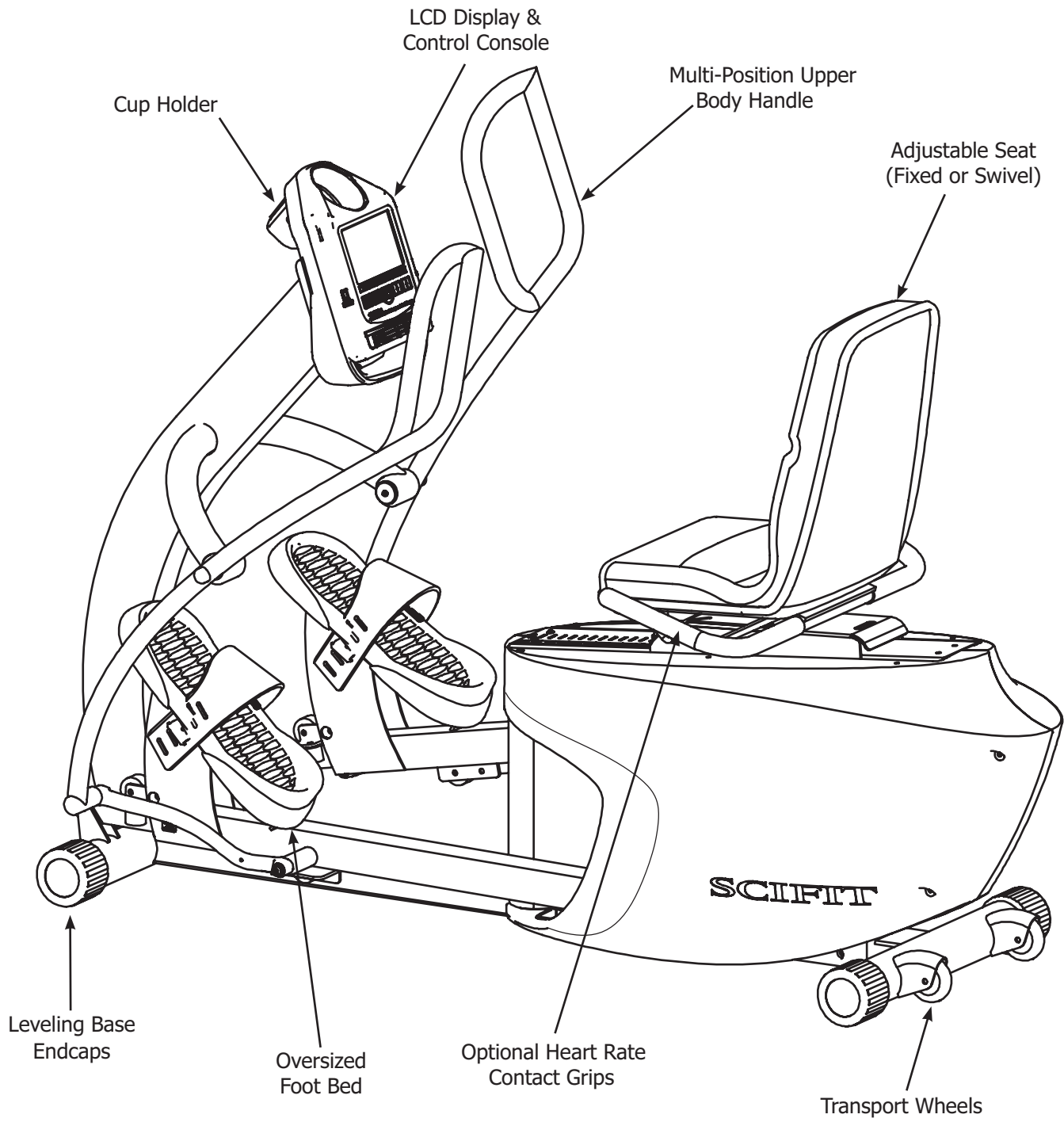

KEYPAD FUNCTIONS

Work Level Status LCD Screen -

The Work Level Status LCD Screen gives a progressive real-time indication of the current work level of any and all programs

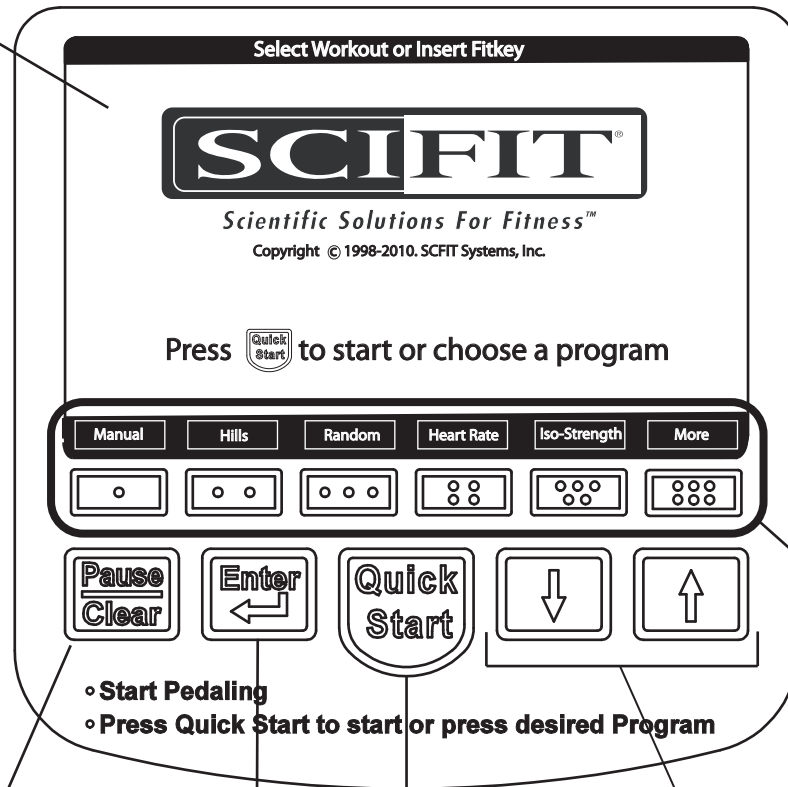

Profile Selection Area - Allows the user option to choose from 12 different workout profiles

- **Start Pedaling**
- **Press Quick Start to start or press desired Program**

PAUSE/ CLEAR - The [Pause/Clear] key will pause the workout. Pressing [Pause/Clear] a second time when in the pause mode will stop the workout and return to the main screen.

To restart in the paused mode press the [Quick Start] key.

ENTER - The Enter Key is pressed to enter selected values for the workout parameters.

Up Arrow and Down Arrow - These keys increase or decrease values of the workout parameters.

QUICK START - This key provides a one-touch "Quick Start" into the Manual mode, or after logging into a program. The Quick Start key will activate the selected program.

BIOMECHANICAL POSITIONING

Seat Adjustment

Proper seat position is essential to achieving the proper biomechanical position. The seat can be adjusted in 1" increments and is held in place with a spring loaded adjustment pin. The seat system is easily adjusted by pulling the seat pin up and sliding the mechanism forward or backward. Adjust the seat so your legs have a slight bend at full extension. The foot can be located in the most comfortable area on the flat surface of the foot bed.

Swivel Seat

On models equipped with a swivel seat, push release lever to rear of unit and swivel seat 90 degrees until seat locks in position. Repeat procedure to return to original position.

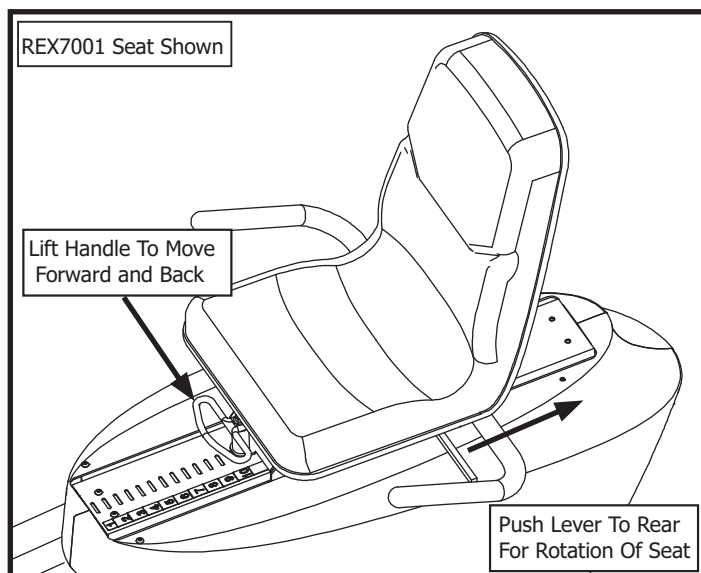

Handlebar Grips

The dual position handles allow users of varied heights to exercise comfortably. Taller individuals will find the rear handle more accommodating while shorter users will find the front handle ideal.

These dual handles also allow most users to change muscle groups during use.

The rear handle encourages a pushing movement similar to a chest press.

The front handle encourages a pulling movement that simulates a seated rowing exercise.

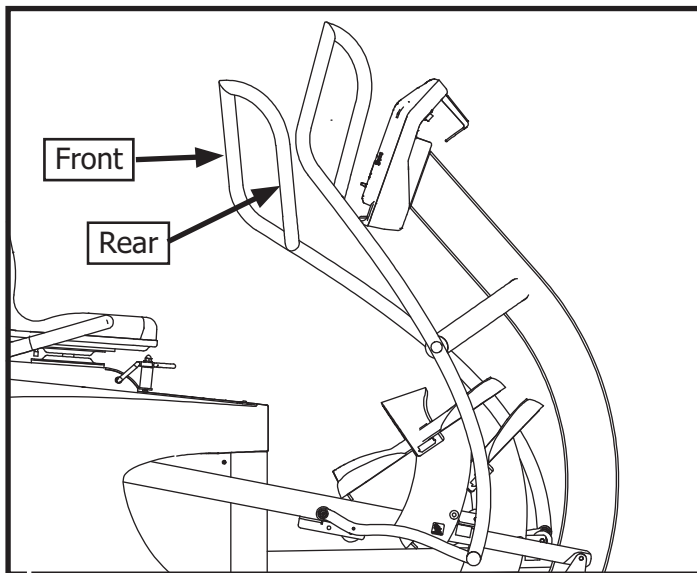

Upper Body Posture

The seat assemblies (Bucket or Low profile seat back) promote proper posture and encourage core muscle activity. When seated properly the movement should promote mild torso rotation ideal for strengthening the abdominal regions and the back.

HEART RATE TRANSMITTER STRAP & CONTACT GRIPS

Use of the Heart Rate Transmitter Strap

The optional wireless heart rate transmitter accessory is a useful device if you desire continuous feedback on your current heart rate during a workout. In addition, the REX includes a Heart Rate Control program which requires use of the strap.

The Heart Rate Control program enables the user to set-up a target heart rate. Through real-time monitoring of the user's heart rate, the computer maintains the user's heart rate at or below this established target rate by decreasing the workload if the user's heart rate exceeds the target.

Activating & Deactivating Transmitter

Heart Rate Transmitter Straps come in a variety of styles and manufacturers. To properly activate, secure strap to the chest, and to deactivate follow the instructions that come with the Transmitter Strap.

CAUTION

Always follow manufacturers instructions for proper care and use. Failure to follow manufacturers instructions may result in injury to yourself.



WARNING

Heart Rate monitoring systems may be inaccurate. If you feel faint, stop exercising immediately. Over exercising may result in serious injury or death.

Use of the Heart Rate Contact Grips

For those models with contact heart rate grips, simply grip the contact pads lightly. After a short delay the pulse reading will appear on the display. If a heart rate transmitter strap is worn, it will override the contact pickup.

The contact grips are not designed for use with SCIFIT's Heart Rate Control program. This program requires a steady, continuous telemetry signal which can not be provided using contract heart rate grips.

While the contact grips provide a good barometer for monitoring the users heart rate, they are not recommended for medical where accuracy of monitoring is vital.

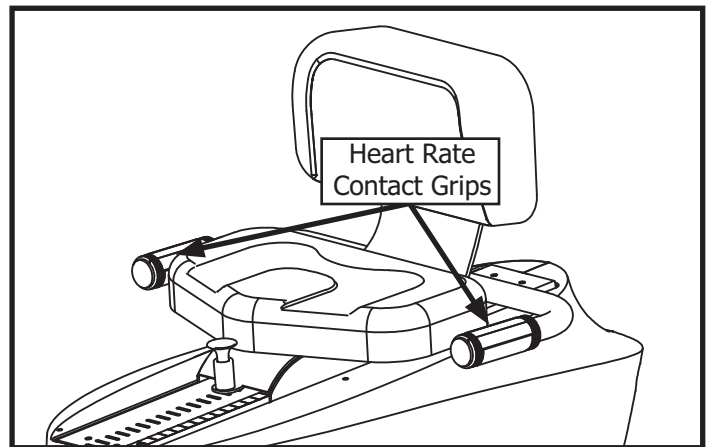

Calculating Target Heart Rate Zone

Your approximate **Maximum Heart Rate (MHR)** is equal to 220 minus your age. The upper limit of your target zone is equal to 0.85 times your MHR. The lower limit of your target zone is equal to 0.60 times your MHR.

For Example:

Your age is 40:

$$220 - 40 = 180$$

$$180 \times .85 = 153 \text{ (max MHR)}$$

$$180 \times .65 = 108 \text{ (min MHR)}$$

These values are based upon averages, always consult your physician to establish the proper Heart Rate Zone for your individual health condition.

PROGRAM INSTRUCTIONS

Programs

SCIFIT products have 200 levels of computer controlled resistance, which ensures that users of all fitness levels will be able to get a challenging but not overwhelming workout. Because the resistance is adjustable in .1 increments, it is easy for the user to track progress. SCIFIT products feature one of the highest resistance capabilities available on any cardio equipment.

SCIFIT products are self generated and have an extremely low starting resistance. One pedal movement or crank revolution activates the console and the screen will remain lit at the most minimal levels of movement.

SCIFIT products have a battery back up which will keep the screen lit for a short period after exercise or if the user stops. This varies between 0 seconds and 5 minutes and can change with the amount of use each product gets.



If you prefer the console to remain lit before and after use, an optional wall pack can be plugged in to accomplish this. This is common in medical settings and with Fit-Key Programs.

Manual Workout



Allows the user to set the intensity at any level. This level will not change unless the user manually increases or decreases the intensity using the [UP] or [DOWN] arrow keys.

Press **MANUAL** Then 



Time	15:00
Level	1.0
Weight	150

Adjust workout time with the   keys, then press 

Time	15:00
Level	1.0
Weight	150

Adjust level intensity with the   keys, then press 

Time	15:00
Level	1.0
Weight	150

Enter user weight with the   keys, then press  and begin exercise.

Fit Quik

Allows the user to select a two stage program of cardiovascular work with ISO-strength (Isokinetic) work loads and duration determined within the factory set up.

Press **Fit-Quik** Then 

PROGRAM INSTRUCTIONS

Fit-Quik Cont'd

The categories displayed will depend on the workout that is selected in the factory setting. The following will be seen for the workout chosen.

Manual or Hills

Level	1
Weight	150

Adjust the Level and Weight with the

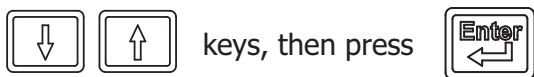

Constant Workout

Weight	150
---------------	------------

Adjust the Weight with the

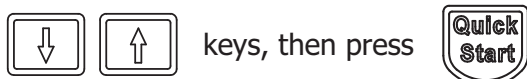



Constant Work

Pedal resistance is automatically adjusted to compensate for any change in pedal speed (RPM), thus workload (Watts) will remain constant at any given setting.



Press **CONSTANT WORK** Then 

Time	15:00
Watts	20
Weight	150

Adjust workout time with the  



keys, then press 

Time	15:00
Watts	20
Weight	150

Adjust target watts with the  

keys, then press 

Time	15:00
Watts	20
Weight	150

Enter the user weight with the  

keys, then press  and begin exercise



PROGRAM INSTRUCTIONS

ISO-Strength Program



ISO-Strength is a isokenitic program, meaning that the unit will resist your movements in order to force you to stay at a set speed. This type of strength workout will not cause excessive soreness because it is accommodating. The computer will adjust resistance to keep the user at the target RPM speed.

Press **ISO-STRENGTH** Then 



Time	15:00
RPM	35
Weight	150

Adjust workout time with the   keys, then press 

Time	15:00
RPM	35
Weight	150

Adjust target RPM with the   keys, then press 

Time	15:00
RPM	35
Weight	150



Enter user weight with the   keys, then press  and begin exercise

Hills Program

Allows the user to select from seven different Hill profiles at various pre-programmed intensities. The following profiles are available: Hill Course, Sprints, Twin Peaks, Peak, Progressive, Multi-Peaks and Ramp.

Press **HILLS** Then 



Profile		Course
Time		15:00
Level		1.0

Select 1 of 7 profiles with the   keys, then press 



PROGRAM INSTRUCTIONS

Hills Cont'd



Profile		Course
Time		15:00
Level		1.0

Adjust workout time with the   keys, then press 

Profile		Course
Time		15:00
Level		1.0

Adjust level intensity with the   keys, then press 

Time		15:00
Level		1.0
Weight		150

Enter user weight with the   keys, then press  and begin exercise

MORE

Pressing this key will enter the user into the 2nd of three workout program selection screens. This screen will show an additional five more pre-programmed workout profiles.

Press 

A new screen will appear with additional programs: Heart Rate, Stess Test, Random, Power Fit and Heart Fit.

Heart Rate Program

The Heart Rate Transmitter Strap is required for this program. Refer to page 9 for a complete instruction on using the strap and to understand how to calculate your Target Heart Rate.

• Put on Heart Rate Transmitter Strap

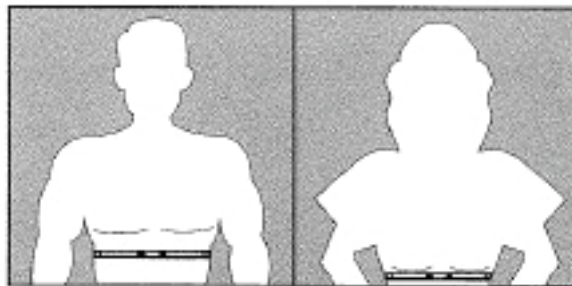

Press  Then 

Time	15:00
Heart Rate	120
Weight Rate	150

Adjust the workout time with the   keys, then press 

PROGRAM INSTRUCTIONS

Heart rate Cont'd

Time	15:00
Heart Rate	120
Weight	150

Adjust the target Heart Rate with the

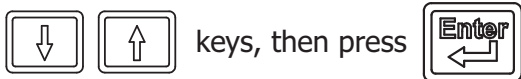

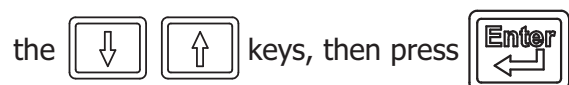

First Target	50
Increment	5
Interval	5:00

Select wattage increments after each interval with



Time	15:00
Heart Rate	120
Weight	150

Enter the user weight with the  
keys, then press  and begin exercise

First Target	50
Increment	5
Interval	5:00

Select the length of each interval with the

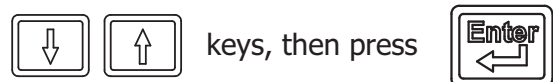



Stress Test

A designed step test to be used as training program or use with other diagnostic devices (if appropriate). The user sets a target wattage with timed intervals and preset wattage increments.

First Target	50
Increment	5
Interval	5:00

Select target wattage with the  
keys, then press 

Increment	5
Interval	5:00
Weight	150

Enter user weight with the  

keys, then press  and begin exercise

PROGRAM INSTRUCTIONS

Random Program

The Intelli-Fit console will randomly display different workout profiles each with its own level of difficulty. The operator only has to choose the type of the profile, then select the time length of the workout and the level difficulty.

Note: The highest column of the profile represents the workout level you selected. Columns below it are percentages of the level selected.

Press

RANDOM

Then

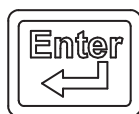

Profile		Random
Time		15:00
Level		1.0

Select a random profiles with the



keys, then press



Profile		Random
Time		15:00
Level		1.0

Adjust workout time with the



keys, then press



Profile		Random
Time		15:00
Level		1.0

Adjust level intensity with the



keys, then press



Time		15:00
Level		1.0
Weight		150

Enter user weight with the



then press



and begin exercise

PROGRAM INSTRUCTIONS

Power Fit Programs

This key displays two options "Test" and "Training". These programs are power and strength indicators for the user.

Press **Power Fit** and the screen will display a choice of "Test" or "Training" as shown below.

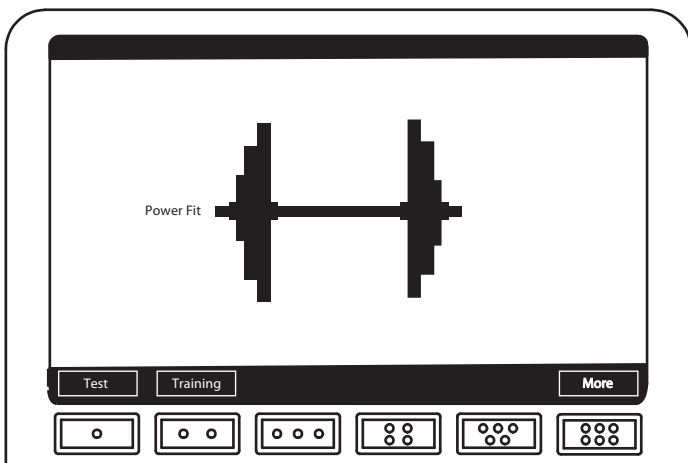

Test

This program is based on a pre-programmed workout designed to evaluate your "Power Drop %", which gives a fitness indication of power and strength using wattage as the main measurement.

Press **TEST** Then **Enter** and begin exercise

Training

Specifically designed preset wattage training programs based off user Power Fit test evaluation. Three programs and four levels (Beginner, Intermediate, Advanced and Sport Performance) are available.

Press **TRAINING** Then **Enter**

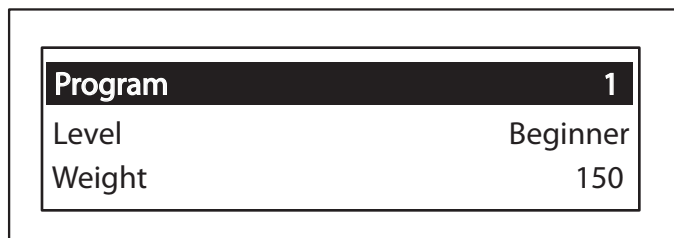

Select 1 of 3 programs with the **↓** **↑** keys, then press **Enter**

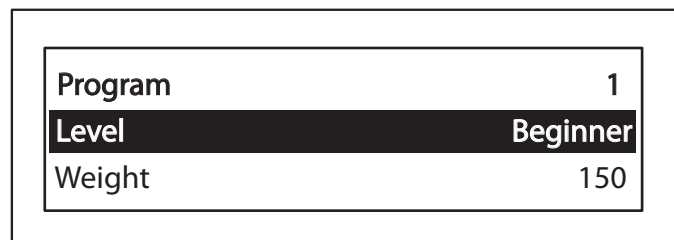

Select 1 of 4 levels with the **↓** **↑** keys, then press **Enter**

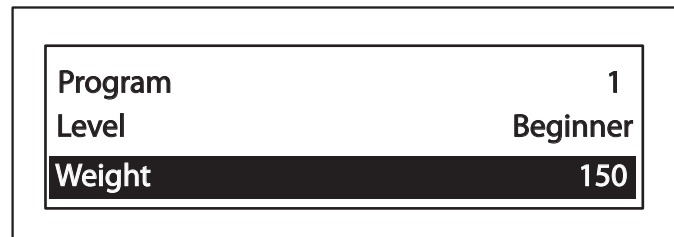

Enter user weight with the **↓** **↑** keys, then press **Quick Start** and begin exercise

PROGRAM INSTRUCTIONS

Heart Fit Programs (Use Chest Strap)

This key displays two options "Test" and "Training". These programs are Heart Rate recovery indicators for the user.

Press **Heart Fit** and the screen will display a choice of "Test" or "Training" as shown below.

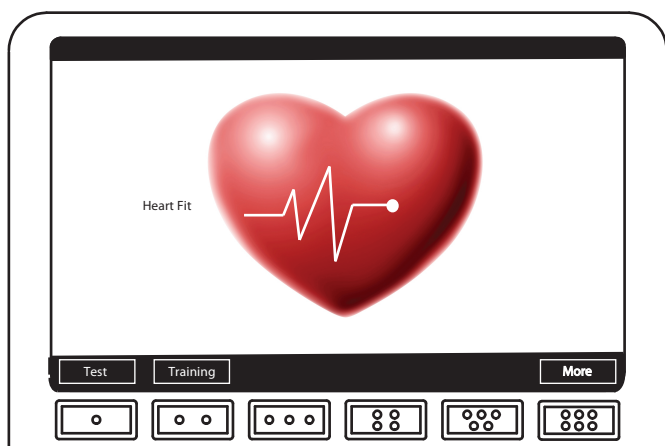

Test

This program is based on a pre-programmed workout designed to evaluate your Heart Rate recovery. The user can select from 1 to 4 levels: Beginner, Intermediate, Advanced and Sports Performance.

Press **TEST** Then

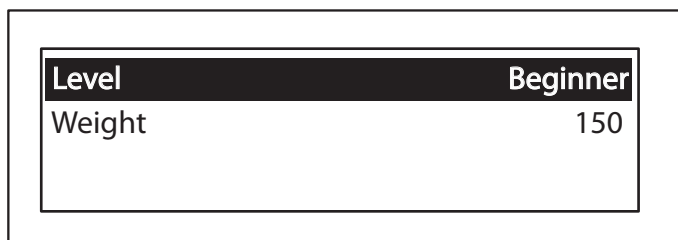

Select 1 of 4 levels with the keys, then press

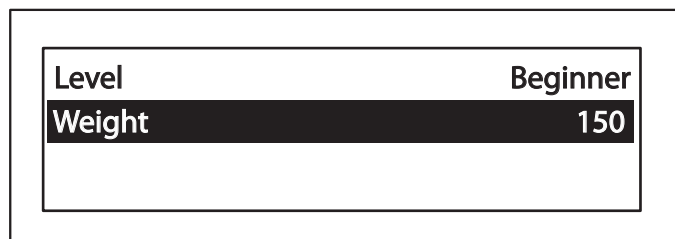

Enter user weight with the keys, then press and begin exercise

Training

Designed training programs based on the user's evaluated Heart Fit test. A training schedule with retesting is recommended. The user has three programs and four levels: Beginner, Intermediate, Advanced and Sports Performance to choose from.

Press **TRAINING** Then

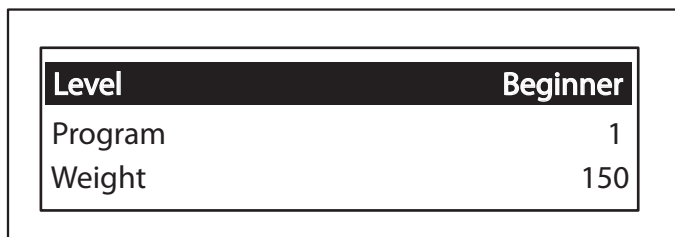

Select 1 of 4 level with the keys, then press

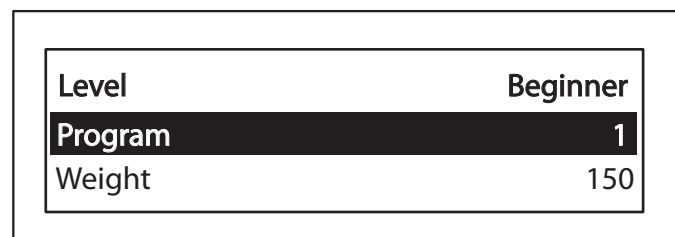



Select 1 of 3 programs with the keys, then press

PROGRAM INSTRUCTIONS

Training Cont'd

Level	Beginner
Program	1
Weight	150

Enter user weight with the   keys, then press  and begin exercise

Additional Key Features

SCIFIT has also included extra user friendly key features the user may use during a workout.



Allows the user to change the viewing format of the workout profile and data displayed on the LCD screen during the workout.



The console contains two 3-speed cooling fans that can be activated by the user at anytime.



When activated a count down will display on the screen for the user to prepare to pedal faster for a small duration of time. This time duration can be increased or decreased in the "User Set-up".



If at anytime the user may want to pause during a workout, this may done by pressing the [Pause/Clear] key. The screen workout will then minimize and provide the user three options

1. **Continue** - Maximizes the workout screen and continues the workout where the user had stopped.
2. **Change** - Returns to a sub-menu where information may changed that was previously entered by the user.
3. **Stop** - Exits the workout and returns to the main menu.

Note: The console will reset to the main menu after a short period of time if no selection is made.

MAINTENANCE & SERVICE

Maintenance

The REX is virtually maintenance free. After training, always wipe down your SCIFIT exercise product. Perspiration that continuously settles on the frame, upholstery, casings, and control console may eventually cause rust or damage. Damage resulting from lack of maintenance is not covered under warranty.

If defective components are identified and require replacement, the equipment should be put out of service until repaired.

CAUTION

In order to maintain a safe level of operation, equipment must be inspected on a routine basis for damaged or worn parts. Failure to inspect equipment may result in injury to yourself or others.

REX Maintenance Schedule

Any mechanical or electrical work conducted within the main body of a medical CE class IIa unit MUST be recalibrated. The generic maintenance schedule below should be applied to medical CE and non-medical CE products

COMPONENT	USE	WHEN	BY WHOM
Covers, Seat, Handlebars and Console	Damp Cloth	Daily	Club Maintenance
LCD Screen	LCD TV Screen soft cleaning cloth	Weekly	Club Maintenance
Nuts and Bolts	Tighten When necessary	Bimonthly	Club Maintenance
Roller Guide Track	Damp Cloth	Monthly	Club Maintenance

UNITED STATES CUSTOMER SERVICE

For assistance in the service of SCIFIT products;

phone : (800) 745-1373 or (918) 359-2040
fax : (918) 359-2045
e-mail: service@scifit.com

The Product Support department is staffed from 7:00 AM to 6:00 PM CST Monday through Friday. A voice mail service is available 24 hours a day for recording messages to request technical support and to order replacement parts. Our mailing address is:

SCIFIT Systems Inc.
5151 S. 110th E. Ave.
Tulsa, OK 74146
USA

UK & EUROPEAN CUSTOMER SERVICE

phone : +44 1344 300022
fax: +44 1344 868838
e-mail: info@scifit.uk.com

SCIFIT LTD (UK)
Lexham House
Forest Road
Binfield
Berkshire, RG42 4HP
UK

Company Number: 5970624 (UK)

***COUNTRIES OUTSIDE OF UK & EUROPE
PLEASE USE USA CONTACT NUMBERS***

Order online 24/7 at www.SCIFIT.com

WARRANTY

It is very important that your SCIFIT machine is registered. This can be done online at <http://www.SCIFIT.com/warrantyregistration.shtml> or fill out and mail the registration form at the back of this manual.

SCIFIT Statement of Warranty

SCIFIT warranties new products against defective workmanship and/or materials under normal and proper use subject to the following limitations:

(a) SCIFIT's obligation to the original purchaser shall apply to:
Within the United States and Canada both parts and the cost of labor required to replace or repair a defective product for a period of one (1) year from user/dealer purchase date as documented by *warranty card and if warranty card has not been returned by user/dealer, then date of shipment from the factory. Thereafter, for a period of two (2) years, such obligation shall extend only to the supply of replacement parts or products with any labor costs associated with such replacement or repair to be at Buyer's expense. Refer to clause (e) for components outside this policy clause.

Outside the United States and Canada replace defective product with no labor for a period of three (3) years from user purchase date as documented by *warranty card and if warranty card has not been returned by user then date of shipment from factory.

*Note: Original purchaser must register their purchased products either by warranty card return, web site registration or fax to activate warranty period or shipment date is extant for start of warranty period. A ninety (90) day period is to be given for warranty registration to allow stock rotation and showroom stock thereafter none registration will be shipment date for the start of the warranty period.

(b) SCIFIT's obligation shall be limited to repairing or replacing defective parts. No allowance shall be granted for repairs made by Buyer without SCIFIT's prior written approval. The decision to replace or repair shall be solely at SCIFIT's discretion.

(c) SCIFIT's warranty does not apply to parts requiring replacement or repair due to normal and abnormal wear and tear, improper use, corrosion (perspiration), improper maintenance, improper installation, improper rated, grounded or dedicated electrical circuits or improper storage, nor does it apply where all or part of the product has been altered from its original state by Buyer or a third party.

(d) THIS WARRANTY IS IN LIEU OF ALL OTHER WARRANTIES, EXPRESSED OR IMPLIED, ARISING BY LAW OR OTHERWISE INCLUDING WARRANTY OR MERCHANTABILITY OF FITNESS FOR PARTICULAR PURPOSE, AND IS IN LIEU OF ALL OTHER LIABILITIES OF SCIFIT INCLUDING DIRECT, INDIRECT, SPECIAL AND CONSEQUENTIAL DAMAGES OR PENALTIES EXPRESSED OR IMPLIED WHETHER ARISING OUT OF CONTRACT, NEGLIGENCE OR OTHER SORT.

WARRANTY

SCIFIT STATEMENT OF WARRANTY

(e) The below listed items have the following warranty coverage unless determined to be defective. These items include, but are not limited to:

Treadmills – AC5000 models only	Warranty Period
Treadmill belts	12 months
Treadmill belts decks	12 months
Treadmill structure & frame	5 years
Treadmill drive system inclusive of motor & inverter	5 years
Treadmill Handrails & Handles	3 years
Treadmill Heart rate grips	12 months
Treadmill water bottle holders	90 days
Treadmill trays	90 days

Rotary Products	Warranty Period
Upholstery	12 months
Saddles/Seats	12 months
Rotary Pedals	12 months
Rubber grips	12 months
Heart rate grips	12 months
Rotary structure & Frame	5 years
Rubber foot Pads (BioFlex)	12 months
Rotary water bottle holders	90 days
Rotary trays	90 days

Accessories Products	Warranty Period
Pedal straps	Normal wear & tear
Heart Rate Receiver/Transmitter	90 days
Low support boots	12 months
High support boots	12 months
Assist gloves	90 days
USB Keys and Lanyards	90 days

(f) Fires, floods, and acts of God, are not covered under this warranty.

WARRANTY

Freight and Shipping

SCIFIT is not responsible for the repair or replacement of any unit or part damaged during transit or installation. The customer is responsible for inspection of each unit and part for shipping damage at time of delivery or installation, and prior to signing receiving paperwork. The customer is responsible for pursuing all freight damage claims with the appropriate transit company. **If the customer signs an unqualified receipt for freight or damage goods, the customer is solely responsible for the cost of the repair or replacement for such freight damage.**

.....

Maintenance

After training, always wipe down your SCIFIT exercise product. Perspiration that continuously settles on frame, upholstery, castings and control panels may eventually cause rust or damage. Damage resulting from lack of maintenance will NOT be covered under warranty. To clean upholstery, use mild soap and warm water. Dry with a clean towel. Refer to the Treadmill maintenance schedule.

.....

Product Support

Assistance for the service of **SCIFIT** products is available by calling (800) 745-1373 or fax (918) 359-2045. The product support department is staffed from 7 AM to 5 PM Central Time Monday through Friday. A voicemail service is available 24 hours daily for recording messages to request technical support and to order replacement parts. Our goal is to return every voicemail call within 30 minutes of when it is placed during our normal business hours.

Please have the following information prior to calling technical support:

- Model number of equipment
- Serial number of equipment
- Point of contact name and phone number
- Detailed description of symptoms encountered.

WARRANTY

Installation

SCIFIT is not responsible for the repair or replacement of any unit or part damaged during installation. The customer is responsible for inspection of each unit and part for damage at the time of installation. The customer is responsible for pursuing all damage claims with the installer.

.....

Software, Trademarks, Copyrights, and Patents

If an order includes software, such computer software is transferred by SCIFIT to the customer pursuant to a single user license, the royalty, terms, and conditions of that are set forth on or in the package accompanying such software.

KeyMaster software will receive 1 year of call-in technical support and owners will be eligible for product upgrades for one year following purchase.

SCIFIT has trademarked several names to uniquely identify its business and products. These names must not be used by other entities in the fitness business.

SCIFIT decals, user's manuals, and service manuals are copyrighted and may not be copied without prior approval from SCIFIT.

SCIFIT has obtained several patents on features and designs that are unique to its products. SCIFIT will defend these patents against those who attempt to utilize these features and designs in other products.

.....

Parts Shipment

During the first 30 days warranty parts will be shipped via overnight delivery. Determination must be made before 2:00 PM Central Time on any given weekday for next day delivery. During the remainder of the first year warranty period, parts requirements will be filled via ground shipment. The customer is welcome to request overnight or 2nd day parts shipping, at customer's expense. If requested, SCIFIT will charge the customer's UPS account, or COD the difference in freight cost between ground shipment and overnight or 2nd day.

.....

WARRANTY

Return of Parts

SCIFIT is committed to continual improvement in the equipment we market. In order to meet this commitment, the rapid return of defective parts is essential. The examination of the parts by our engineering department leads to changes that insure the same problem does not re-occur. Thank you in advance for your assistance!

When requested by SCIFIT, defective parts must be returned to the SCIFIT factory within 20 days of receipt of replacement part. Otherwise SCIFIT will expect payment on the parts invoice net 30 days.

Please follow these three easy steps for returning parts.

Step 1

Keep the box and packing material in which the new parts arrived.

Step 2

Wrap the defective part and place in the box for safe return. Please take the brief moment needed to fill in the return parts form that is enclosed in the box with the new parts.

Step 3

A UPS prepaid Return Label will be in the part box for only those parts that need to be returned. When ALL of the parts are received and inspected at the factory, a credit will be issued for the original parts invoice. Attention service companies - labor invoices will NOT be paid until defective parts are returned to the factory.

Service Labor

Where applicable, the SCIFIT product support personnel will arrange a local field service technician to provide field support. Every effort will be made to schedule service during 48 business hours (8 hours per business day) following notification of a problem or as soon as repair parts are available to the field service technician. Where possible, parts will be supplied in advance of the field service technicians so that the product is repaired with one call.

Purchased Parts

All purchased parts will carry a 12 month warranty. Refer to Purchased parts shipments and installation for more details.

This Limited Commercial Warranty supercedes the limited commercial warranty printed in the "Users Operation Manual" for all SCIFIT Systems, Inc. products.

If you have questions or require additional information, please contact SCIFIT Systems, Inc. at 1-800-745-1373 or service@scifit.com

This page purposely left blank



SCIFIT® Warranty Card

Register online at <http://www.SCIFIT.com/warrantyregistration.shtml> or complete this form, fold it and return it to SCIFIT. We request you send this card within 2 weeks after your equipment has been delivered to insure proper warranty registration.

Company Name _____

Contact Name _____

Address _____

City/State/Zip _____

Email Address _____

Home Phone (____) _____ Business Phone (____) _____

Model Purchased _____

Date Received _____ Serial Number _____

Entity Purchased From _____

City/State _____

Please rank the following reasons (1 through 6) for selecting SCIFIT with 1 being most important:

____ Features ____ Quality ____ Price ____ Dealer ____ User Friendly ____ Appearance

Please Check the appropriate box(s) on how you were introduced to SCIFIT:

Saw in _____ Magazine Introduced by SCIFIT Dealer

Saw at _____ Tradeshow Referred by SCIFIT User

Other _____

Comment _____

Thank You For Choosing



Scientific Solutions For Fitness™

www.SCIFIT.com

Warranty Card

5151 South 110th East Avenue
Tulsa, OK 74146

SCIFIT

_____ From

Important: Please keep this page for “Recalibration records”

Model Number: _____

Serial Number: _____

Date of Purchase: _____

**Calibration Date
(Medical units):** _____

Supplied By: SCIFIT Systems Inc.

User Manual: #P4765A (2/2011)

	DATE	CLUB OR CERTIFICATION LOCATION	CERTIFIED SERVICE COMPANY	TECH INITIALS
1st Recalibration				
2nd Recalibration				
3rd Recalibration				
4th Recalibration				
5th Recalibration				

Please make extra blank chart copies for future use





Scientific Solutions for Fitness.

5151 South 110th East Avenue
Tulsa, Oklahoma 74146
USA

Sales: 1-800-278-3933 • 1-918-359-2000
Customer Service: 1-800-745-1373

Order online 24/7 at www.SCIFIT.com