

# SOUNDSTREAM

## VR-622HB

BEFORE OPERATING THE UNIT.PLEASE READ THIS MANUAL  
THROUGHLY AND RETAIN IT FOR FUTURE REFERENCE

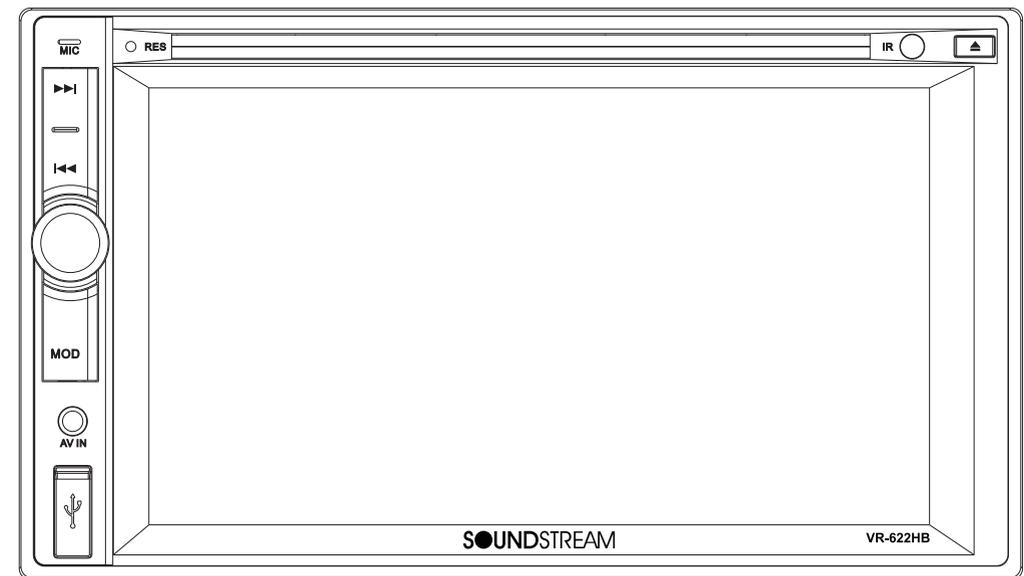

Double Din Touch Screen TFT Monitor DVD Player

## Contents

NOTES ON INSTALLATION
PRECAUTIONS
PANEL
REMOTE CONTROL
REMOVE BATTERY
WIRING DIAGRAM
MAIN MENU
• RADIO
• MOBILE LINK
• BLUETOOTH
• DISC
• USB
• AV IN
• SETTING
OTHER FUNCTIONS
INSTALLATION
ACCESSORIES
SPECIFICATION

## Notes on installation

The unit is designed for 12V DC, negative ground operation system only. Before installing the unit, make sure your vehicle is connected to 12V DC negative grounded electrical system.

The negative battery terminal must be disconnected before making connections, which can reduce damaging to the unit due to short circuit.

Be sure to connect the speaker (-) leads to the speaker (-) terminal. Never connect the left and right channel speaker cables each other or to the vehicle body. Do not block vents or radiator panels. Blocking the will cause heat to build up inside and may result in fire.

After the completion of the installation and begin to operate the unit (including replacing the battery), please press the reset button on the front panel with pointed objects (such as ball pen) to set the unit to initial status.

## Specification

General	
Power Supply Requirement:	12V DC
Speaker Load Impedance:	4 Ω
Max. Power Output:	4×35W
Tone Controls:	10dB(Bass 100Hz,Treble 10KHz)
Dimensions:	Approx. 188×58×180mm(D×W×H)
Mounting Dimensions:	Approx. 178×50×165mm(D×W×H)
Weight:	Approx. 2395G
Video System:	Auto
Mounting Angle:	0 ~ 30 degree
Video Section	
Video System:	16:9 Wide Screen
Video Output Level:	1.0V <sub>pp</sub> / 75 Ω
Horizontal Resolution:	800×480
Audio Section	
Max. Output Level:	2V <sub>rms</sub> (+3dB)
Frequency Response:	20Hz ~ 20KHz
Signal to Noise ratio:	60dB
Separation:	60dB
FM Tuner Section:	
Tuning Range:	87.5 ~ 107.9 MHz
IF Range:	10.7MHz
Usable Sensitivity:	(FM -30dB) 12dBu
Signal to Noise ratio:	60dB
Stereo Separation:	30dB(1KHz)
Frequency Response:	30 ~ 15KHz
AM Tuner Section:	
Tuning Range:	530 ~ 1710KHz
IF Range:	450 KHz
Usable Sensitivity:	(AM -20dB) 37dBu
Signal to Noise ratio:	50dB
Frequency Response:	10 ~ 2000 Hz

## ACCESSORIES

Package contains the following accessories for installation and operation of the unit.

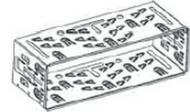
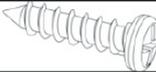
(1) Washer, Spring Washer, M5 Nut	1 each	
(2) Mounting Strap	1	
(3) Bolt	1	
(4) Mounting Collar	1	
(5) Release Key	2	
(6) Screw	1	



Remote Control

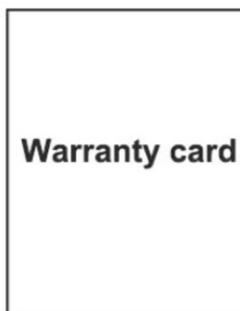

Warranty card

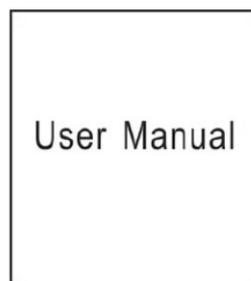

User Manual



Power Cable

Note:  
Product image may vary from the actual delivery.



Trim ring

## Precautions

The unit can play the following disc only

Type of Disc	Label On The Disc	Recorded Material	Size of disc
DVD		Video and Audio	12cm
VCD		Video and Audio	12cm
CD		Audio	12cm
MPEG4 / DIVX		Video and Audio	12cm
MP3 / WMA/JPEG	<b>MP3</b>	Compressed Digital Audio	12cm

Note: The unit is compatible with DVD,DVD+/-R, VCD 1.0/2.0/3.0, SVCD, CD, CD-R, CD-RW and JPEG

- ❗ DO NOT ATTEMPT TO MODIFY THE UNIT, MODIFYING THE UNIT MAY CAUSE AN ACCIDENT.
- ❗ STOP THE VEHICLE BEFORE CARRYING OUT ANY OPERATION THAT COULD INTERFERE WITH YOUR DRIVING.
- ❗ DO NOT TURN ON THE UNIT IF THE TEMPERATURE INSIDE THE VEHICLE IS OUT OF -20C TO 60C.
- ❗ THIS PRODUCT IS DESIGNED FOR ONE SINGLE VIDEO OUTPUT, PLEASE USE A SPLITTER IF YOU WOULD LIKE TO CONNECT FOR MULTIPLE VIDEO OUTPUT.



Handle the disc by its edge to keep the disc clean, and do not touch the surface.

Do not use your CDs with paste residue or ink attached.

Do not use CDs with labels or stickers attached, which may leave a sticky residue while beginning to peel off.

Clean the discs with an optional cleaning cloth. Wipe each disc from center out.

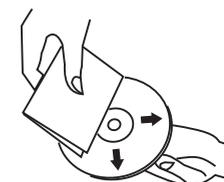

## Panel

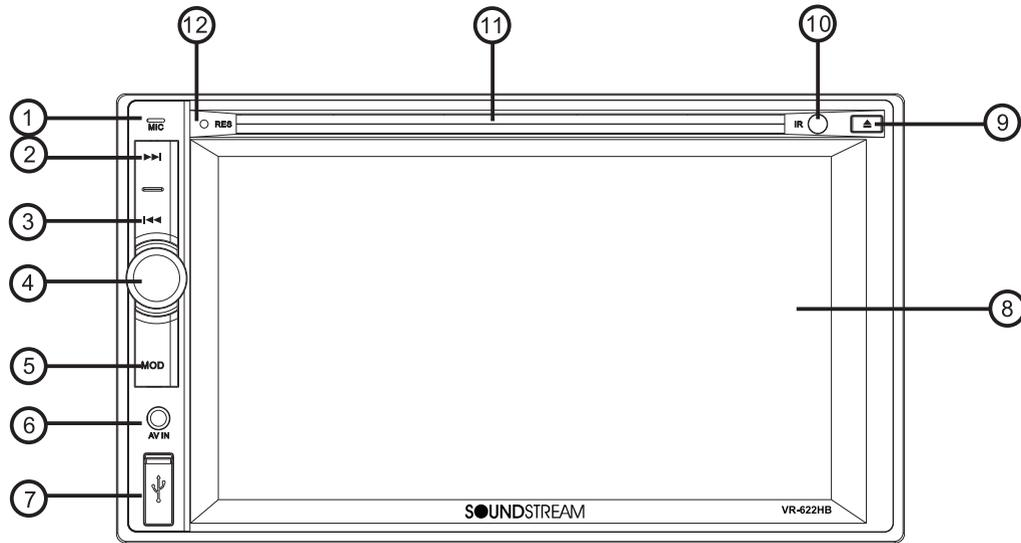

- 1.MIC
- 2.Fast Forward Button/Next Track
- 3.Fast Reverse Button/Previous Track
- 4.Power/Volume Button
- 5.Mode Button
- 6.AV IN
- 7.USB Jack
- 8.TFT-LCD Display
- 9.Eject Button
- 10.IR Sensor
- 11.Disc Slot
- 12.Release Button

## Installation

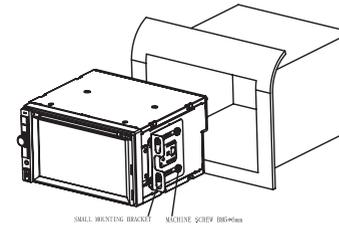
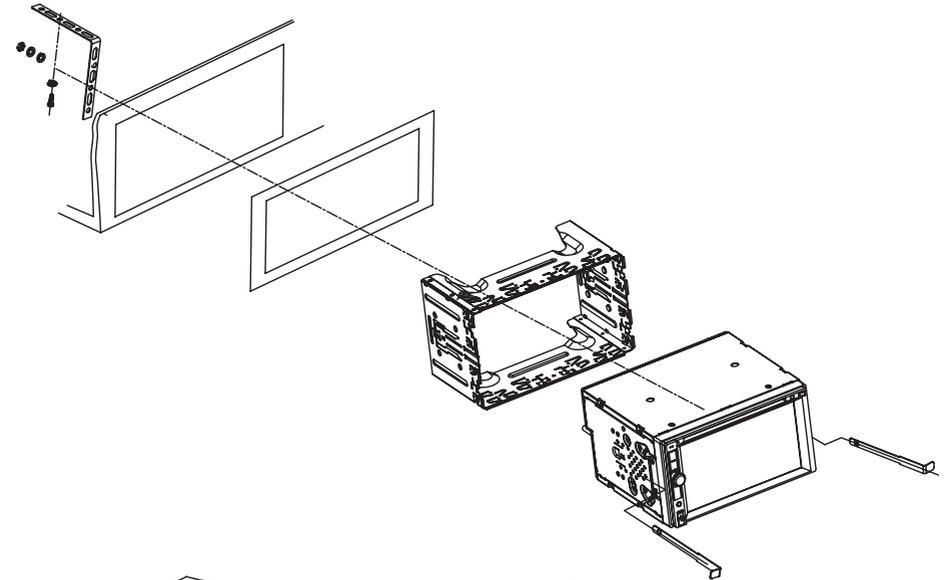

Through the mounting bracket front and rear adjustment and micro rotate up and down to adjust to install most of the cars, and finally fasten the screws can be!

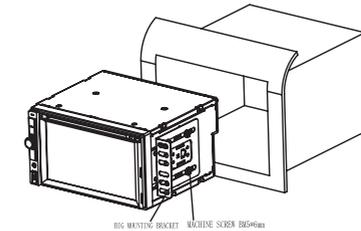

Through the mounting bracket front and rear adjustment and micro rotate up and down to adjust to install most of the cars, and finally fasten the screws can be!

## Note:

- ✧ Choose the mounting location where the unit will not interfere with the normal driving function of driver.
- ✧ Before finally installing the unit ,connect the wiring and make sure that the unit works properly.
- ✧ Consult with your nearest dealer if installation requires the drilling of holes or other modifications of the vehicle.
- ✧ Install the unit where it does not get in the driver's way and can not injure the passenger if there is a sudden stop,like an emergency stop.

# Remote Control

You can also choose the resolution for the screen size and type. If you're converting an original file that is super high quality resolution, you might consider the HD options, but most commonly you should choose Normal Quality or Original Quality.

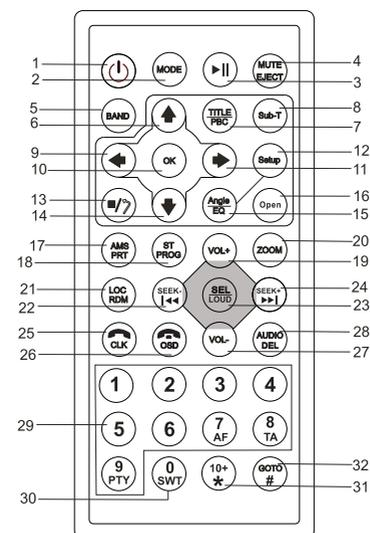
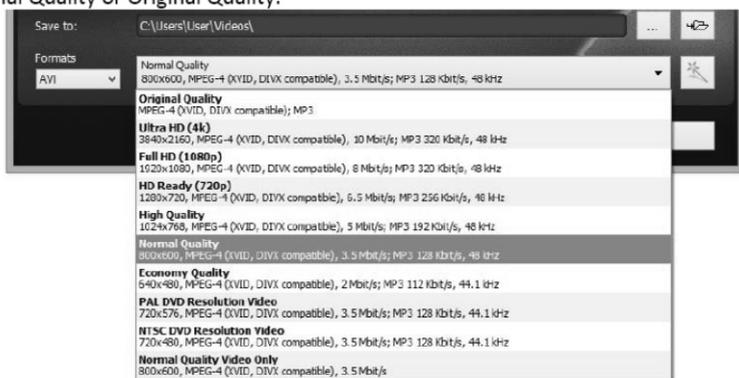

There are some fantastic options to change the standard codec, bit & frame rates, blood types, and so on, but we suggest keeping everything preset as the app recommends. It's these crazy variables that brought you here in the first place.

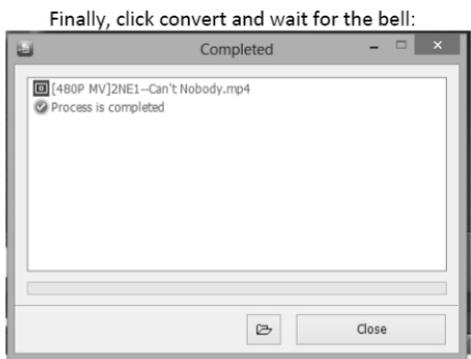

Finally, click convert and wait for the bell:

- 1.Power Button(TFT ON/OFF)
- 2.MODE Button
- 3.▶|⏸ Button
- 4.MUTE /EJECT Button
- 5.BAND Button
- 6.▲ Button
- 7.TITLE(in DVD playing) PBC(in VCD playing) Button
- 8.Sub-T Button
- 9.◀ Button
- 10.OK Button
- 11.▶ Button
- 12.Setup Button
- 13.◻/? Button
- 14.▼ Button
- 15.Angle (long press)/EQ (short press)
- 16.Open Button
- 17.AMS (in radio & TV searching) RPT (in DVD/CD/MP3 repeated) Button
- 18.ST (in radio)/PROG (in DVD/CD/MP3) Button
- 19.VOL+Button
- 20.ZOOM Button
- 21.LOC (a remote in radio)/RDM (a random broadcast in DVD/CD/MP3)Button
- 22.SEEK /◀◀ Button
- 23.SEL / LOUD Button
- 24.SEEK / ▶▶ Button
- 25.CLK (for time switching) 📞 (for answering in BT) Button
- 26.OSD (in DVD) / 📞 (for cutting off in BT) Button
- 27.VOL- Button
- 28.AUDIO (for channel switching in DVD/CD/MP3)/DEL(in BT) Button
- 29.1-9 Number Button
- 30.0 /SWT Number Button
- 31.10+(the selection key for DVD)/\* (in BT) Button
- 32.GOTO (the selection key for DVD)/#(in BT) Button

## Remove Battery

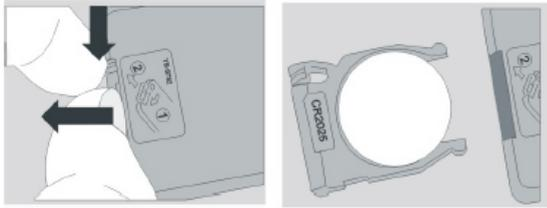

### Note:

- The distance may vary according to the brightness of ambient light.
- If the remote is not used for an extended period of time, remove the battery to prevent possible damage from battery leakage and corrosion.
- Do not place any objects between the remote control unit and the sensor on the unit.
- Do not drop the remote control onto the floor; it will damage it beyond repair.
- Do not use the remote control unit, while simultaneously operating the remote control unit of any other equipment; they may interfere resulting in improper operation.
- The battery normally last for about one year although depending how often the remote control is used. If the remote control unit isn't working even when it is operated near the unit, replace the battery with a new battery of the same make and use only a lithium cell battery type: CR2025 (3V).
- Dispose empty batteries in accordance with your local governmental regulations.
- Do not short-circuit, disassemble, heat or dispose of fire or flames the battery.
- Keep the battery out of reach of children, should the battery be swallowed, immediately consult a doctor.

## Wiring Diagram

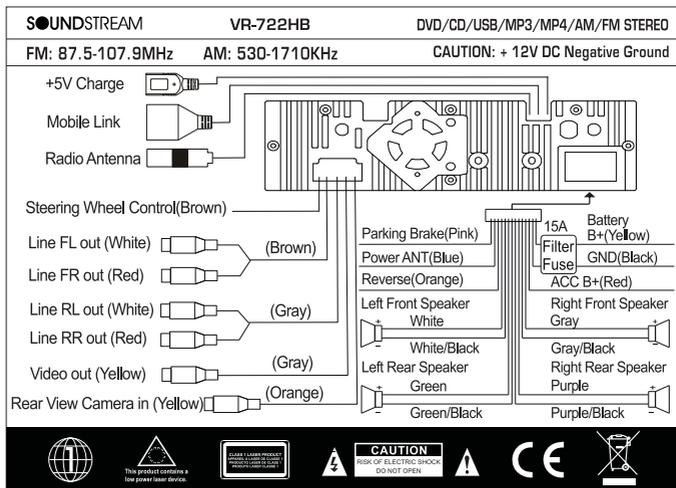

After the app downloads and installs, it's pretty simple to convert your files. Select the Add File button and browse your computer to find the alien file type you need to convert. The file info should appear at the top:

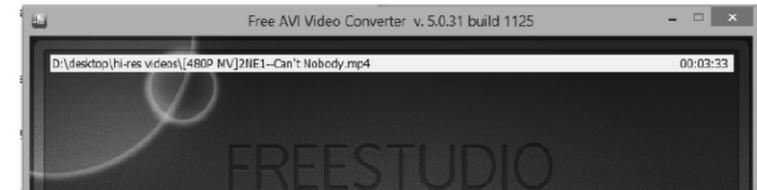

There are some optional choices after the file is selected, like changing the name to protect the innocent, or change the location the converted file is saved. If you feeling frisky go for it:

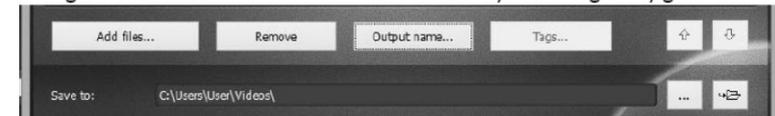

Otherwise, choose the file format you want to convert your movie to. May we recommend the AVI.....?

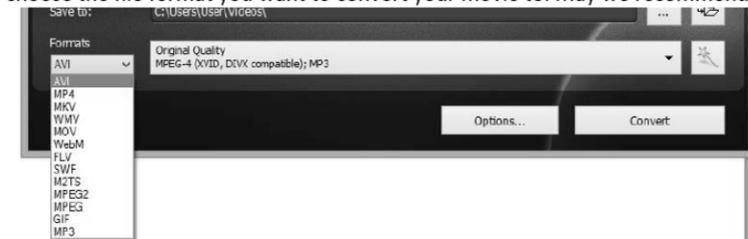

another position, tap and hold at the center of the new target. Repeat each time to complete the calibration process. When the calibration has been completed, the device switches back to the previous operating mode and retain the previous setting.

## Other Functions

### PACKING

When the car is stopped and the parking brake is working, the screen can display the video image, otherwise the screen can't display the video image.

### REAR VIEW CAMERA

This unit is equipped with rear view camera output. The camera is used to observe the situation behind the vehicle when you are backing the car. Please connect your rear view camera with the back car video input. And connect the reverse wire for back a car with the rear gear light. Rear view camera picture will be enabled when you are backing the car.

### VIDEO FILE

File compression seems to be name of the game to see who can fit the most music and video onto today's media devices. Unfortunately with so many compression formats and codecs, it becomes virtually impossible for your head unit to support the multitude of song and video file types. To overcome the confusion of what video formats are compatible with this head unit, we suggest using a file converter to align the stars and change the many video file types you have to one standard.

Surely there are many file conversion apps available on the line, but CNet seems to be a reliable source and has a good file conversion app available. Check out:  
[http://download.cnet.com/Free-AVI-Video-Converter/3000-2194\\_4-75685273.html](http://download.cnet.com/Free-AVI-Video-Converter/3000-2194_4-75685273.html)  
Drop by our website for the link instead of typing a million letters and symbols into your web browser....

## Main Menu

The best way to discover the program is to explore each screen in detail, and to find out how to move from one to another. Read this chapter for a guided tour.

Unit starts by displaying the Main menu.

This is the root of the screen hierarchy, and you can simply access all features by tapping on the touch screen buttons.

Tap the icons to enter a desired mode.

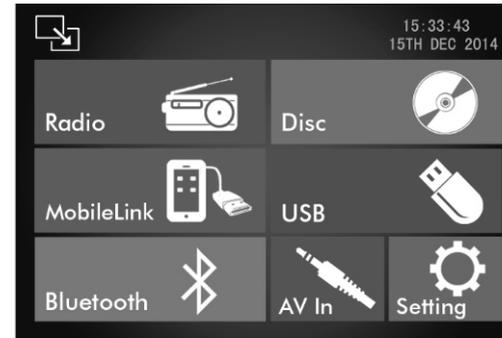

## Radio

To start Radio, tap RADIO button on main menu screen.

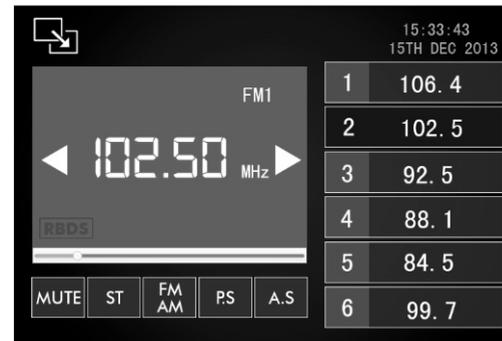

**MUTE** Mute the sound

**ST** Touch ST to select Stereo

**FM AM** Exchange AM/FM

**PS** Touch this button can scan the stations from 1-6

**A.S** Auto store each station

## MOBILE LINK

To start mobile link ,control head unit through your smart phone and enjoy mobile features on car unit with a simple connection. Mobile link works for both iPHONE and MHL software system.

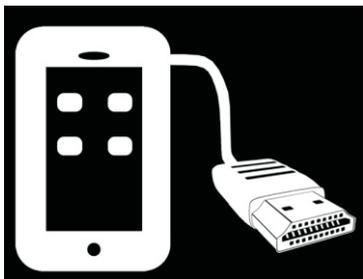

## Bluetooth

**Warning:** Driving and having a Telephone conversation at the same time is dangerous, please park your car before having a telephone conversation. The supplier waves any and all liability when this warning is not followed.

To enter Bluetooth mode, you can tap Bluetooth icon on Main menu or long press the mute/Bluetooth button on the Remote Control or press mode button on remote or on front panel.

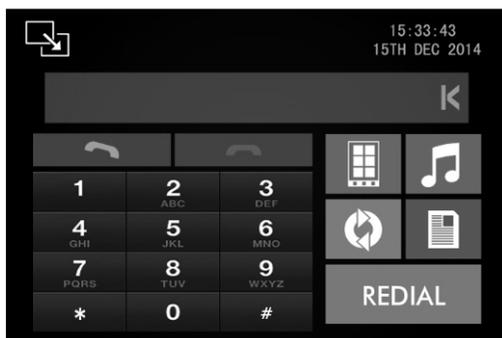

This item is for selecting Com.

Screen brightness:1-2

Deep:ON/OFF

Brightly off time:ON/ 30s/ 1min/ 5min/15min/ OFF



This item is for selecting Audio.

Treble:-7/ 7

BASS: -7/ 7

EQ: User/ Jazz/ Rock/ Classic/ Pop/ Flat

LOUD: OFF/ ON



System information.



This item is for setting time.

You can adjust each item by pressing the icon

◀ or ▶ on the screen. MODE item is for time

Required for 12 / 24 hours.



This item is for setting Audio Position.

You can adjust each item by pressing the icon

◀ or ▶ on the screen.



This item is useful when some malfunction

Occur with the touch screen and it needs adjustment.

Calibration procedure of the touch screen is

described as below:When the target moves to

There are all the functions in 2 pages. This is the first /second page.

Mute the sound.

Touch it to select previous or next track.

Touch it to play / pause.

Touch it to stop.

Touch it to select RANDOM ON/ OFF.

Touch it to select REP 1 / ALL / OFF.

Touch it to REPEAT A-B.

Touch it to set SYSTEM SETUP.

## AV IN

Tap on AV In button from main menu screen to start AV In mode. Connect the external audio/video signal source to this unit.

Note: If there is no external video input, the TFT displays "AV IN NO SIGNAL".

## Setting

Your device has default system settings. You can customize the settings to suit your personal needs. Once you change settings, your new settings will remain until you change it again.

Tap Setting button from main menu screen to start SETTING.

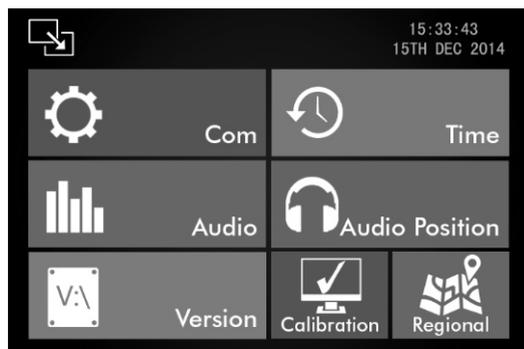

## Pairing Mode

At the 1st time when using BLUETOOTH, you need to pair the mobile phone first. When a phone has not been paired with the unit, the BT icon and Pairing mark will blink continually on the panel.

When the unit has connected with a phone, the BT icon will turn on and the Mobile phone name (if available) will be displayed on the panel.

According to the mobile pairing device manual, after searching for a new device, select it, input password "0000" and confirm OK, device pairing is finished.

The text 'Enter Number' will show on the panel after the pairing is completed. It means the device is connected and ready for BLUETOOTH communication.

Auto-connect - Disconnect

When power on the unit, the last paired phone will be connected to the device via Bluetooth automatically, after searching for about one minute. If the device cannot find the paired phone, it will stop searching. When in standby mode (unconnected), long press the Bluetooth button on the remote control to activate the auto-connect function and the device will search for the last paired phone. If you want to disconnect the Bluetooth connection, turn off the Bluetooth on the phone.

Tap on this button to enter call mode

In Call mode, the unit can be used as your phone. Making and receiving calls are possible with BLUETOOTH. Simply tap the phone number and tap button to make a call, and tap button to hang up. Tap button shortly to delete a wrong digit, or press it for 3-4 seconds to delete all the numbers at once. During a call, you can change a call from Bluetooth mode to phone by tapping button. To have a call in Bluetooth mode again, tap button.

Tap on this button to listen music in Bluetooth mode.

In this main menu, you can select the function with the key for previous, play/pause and next.

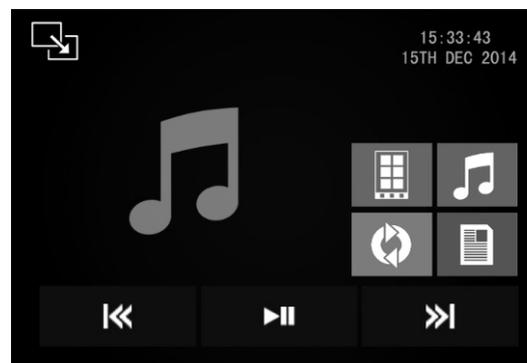

Tap on this button to see the history mode.

The unit can downloading the data from phone automatically when the pairing between a phone and the unit be completed.

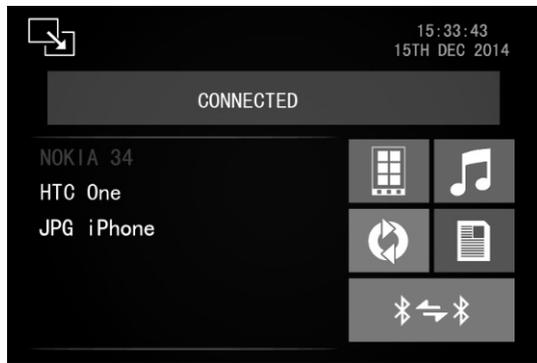

Tap on this button to see history mode.

The unit can download automatically all the data from the mobile phone. Missed/Received/ Dialed calls are saved in history mode.

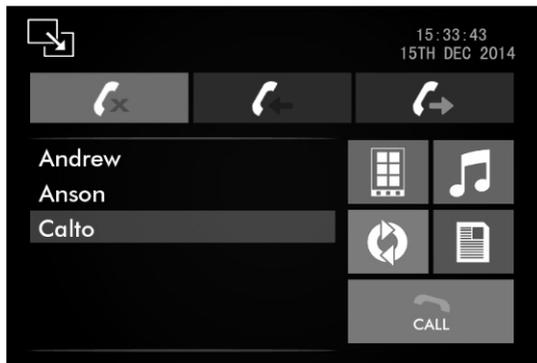

## Disc

Tap on Disc button from main menu screen to start DVD/VCD play. When a file disc is played, the screen will show following interface:



## Note:

Disc will automatically start playing when you insert any DVD/VCD disc. Warning displays if the vehicle is moving for driver's safety. Disc will not play video, but also picture and music files as well.

1/3 2/3 3/3 There are all the functions in 3 pages. This is the first /second / third page.

- Mute the sound.
- Touch it to select previous or next track.
- Touch it to play / pause.
- Touch it to stop.
- Touch it to select Stereo / Mono L / Mono R / Mix Mono.
- Touch it to select RANDOM ON/ OFF.
- Touch it to select REP 1 / ALL / OFF.
- Touch it to REPEAT A-B.
- Touch it to select file Number.
- Touch it to select PBC ON/ OFF.
- Touch it to select INVALID KEY.
- Touch it to change to 16:9.
- Touch it to change the ZOOM.
- Touch it to set SYSTEM SETUP.

## USB

When a file USB is played, the screen will show following interface:

