

User Guide



Eclipse® V-Series Panels



A guide to the set-up
and functions of
V-series panels.



Part Number: 399G206 Rev B
Date: 12 March, 2019

Document Reference

V-Series Panels User Guide
Part Number: 399G206 Revision: B
Legal Disclaimers

Copyright © 2019 HME Clear-Com Ltd.
All rights reserved.

Clear-Com and the Clear-Com logo are trademarks or registered trademarks of HM Electronics, Inc.

The software described in this document is furnished under a license agreement and may be used only in accordance with the terms of the agreement.

The product described in this document is distributed under licenses restricting its use, copying, distribution, and decompilation/reverse engineering. No part of this document may be reproduced in any form by any means without prior written authorization of Clear-Com, an HME Company.

Clear-Com Offices are located in California, USA; Cambridge, UK; Dubai, UAE; Montreal, Canada; and Beijing, China. Specific addresses and contact information can be found on Clear-Com's corporate website:
www.clearcom.com

Clear-Com Contacts

Americas and Asia-Pacific Headquarters

California, United States

Tel: +1 510 337 6600

Email: CustomerServicesUS@clearcom.com

Europe, Middle East, and Africa Headquarters

Cambridge, United Kingdom

Tel: +44 1223 815000

Email: CustomerServicesEMEA@clearcom.com

China Office

Beijing Representative Office

Beijing, P.R.China

Tel: +8610 65811360/65815577

Table of Contents

1	Important Safety Instructions	8
	<i>Safety symbols</i>	9
	<i>Mains power cord</i>	9
2	Introduction	10
2.1	<i>V-Series Panels covered by this guide</i>	11
2.2	<i>Further information</i>	11
3	Overview	12
3.1	<i>Headset connector options</i>	12
3.2	<i>Expansion panel options</i>	12
3.3	<i>Front panel lights and controls</i>	13
3.3.1	V12LD.....	13
3.3.2	V12PD	13
3.3.3	V12RD	14
3.3.4	V24LD.....	14
3.3.5	V24PD	14
3.3.6	V24RD	15
3.3.7	V32LD.....	15
3.3.8	V12LDE.....	16
3.3.9	V12PDE.....	16
3.3.10	V1RDE	17
3.3.11	V16LDE.....	17
3.3.12	V12LDD.....	18
3.3.13	V12PDD	19
3.3.14	V12RDD	20
3.4	<i>Key display window</i>	20
3.4.1	<i>Navigating the key display window</i>	21
3.4.2	<i>Key display window controls</i>	22
3.4.3	<i>Navigating the Reply key display window</i>	23
3.5	<i>Supported fonts in V-Series panels</i>	24
3.6	<i>What's new in Eclipse-HX v. 9.0</i>	25
4	Installing V-Series panels	26
4.1	<i>Placing panels</i>	26
4.1.1	<i>Placing rack mounted panels</i>	26
4.1.2	<i>Placing desktop panels</i>	26
4.1.3	<i>Placing expansion panels</i>	29
4.2	<i>Wiring V-Series panels</i>	31
4.2.1	<i>V-Series main panel rear connectors (no AES-3 or T-Adapter)</i>	32
4.2.2	<i>V-Series main panel rear connectors (AES-3)</i>	32
4.2.3	<i>V-Series main panel rear connectors (T-Adapter) (Now obsolete)</i> 32	

4.2.4	V Series expansion panel rear connectors.....	33
4.2.5	V-Series desktop panel rear connectors (no AES-3 or T-Adapter)	33
4.2.6	V-Series desktop panel rear connectors (AES-3)	34
4.2.7	V Series desktop panel rear connectors (T-Adapter) (Now obsolete)	34
4.2.8	Mains power cord	35
4.2.9	Power connector wiring	35
4.2.10	Analog matrix to panel wiring.....	36
4.2.11	Matrix panel GPIO connector wiring	37
4.2.12	Programmable Relay contacts	38
4.2.13	Opto-isolated inputs.....	39
4.2.14	Auxiliary audio connector	40
4.2.15	AES-3 option to AES-6 interface card	41
4.2.16	T-Adapter option to DIG-2/DIF-102 interface	43
4.2.17	LAN connector.....	44
4.2.18	Expansion panel output	44
4.3	<i>IP connection to matrix.....</i>	45
4.3.1	Adding one extra IP channel	46
4.3.2	Adding two extra IP channels.....	48
4.3.3	Binaural audio.....	52
4.3.4	Advanced multi IP channel configurations.....	52
4.4	<i>Front panel connectors</i>	52
4.4.1	Microphone connector	53
4.4.2	Headset connectors	53
4.5	<i>Mains AC Power</i>	55
4.6	<i>Panel parameters in ECS / EHX.....</i>	55
4.6.1	Headset sidetone.....	55
4.6.2	Headset autodetect	55
4.6.3	Panel microphone gain	56
4.6.4	Speaker dim	57
4.6.5	Page Override	57
4.7	<i>Panel-to-matrix card baud rate.....</i>	57
5	Using the Front Panel Controls	58
5.1	<i>Mic On.....</i>	58
5.2	<i>Shift Page</i>	58
5.2.1	Selectable Shift Pages.....	58
5.2.2	Cyclic Shift Pages	59
5.3	<i>Headset Select</i>	59
5.4	<i>Menu.....</i>	59
5.5	<i>LS Main levels (volume) control</i>	60
5.6	<i>Auxiliary levels (volume) control</i>	60
5.7	<i>Listen Again</i>	60
5.8	<i>Up / Down buttons on lever key and pushbutton panels.....</i>	60
5.9	<i>Alternative text key.....</i>	61

5.10	Rotary control on rotary panels.....	62
5.11	Dial pad (2RU and desktop panels).....	62
5.12	Push-To-Talk (PTT) operation	62
5.13	Status LEDs (Tallies)	63
5.14	Communication errors	64
5.15	Lever key panels.....	64
5.15.1	Reply key general purpose input (GPI) functionality on lever key panels	64
5.15.2	V32LD function keys	64
5.15.3	Change function key options on a V32LD panel	66
5.15.4	Using a Scrolling Assignment function key on a V32LD panel ...	67
5.16	Pushbutton panels.....	68
5.16.1	Pushbutton Reply key GPI operation	68
5.17	Rotary panels	68
5.17.1	Using rotary panel keys.....	69
5.17.2	Rotary panel Reply key	69
5.17.3	Assignment Panel (AP) mode and the INTERCOM key.....	70
5.17.4	Rotary panel interruptible foldback (IFB) operation	70
5.17.5	Rotary panel Forced Listen.....	71
5.17.6	Rotary panel Reply key GPI operation	71
6	Using the Menu System	73
6.1	Navigating the menu system	73
6.2	Fast Key Assign	74
6.2.1	The Dial code.....	75
6.2.2	Dial code validation	75
6.3	Scrolling assignment	77
6.4	Top level menu.....	77
6.5	SYS INFO (System Information) menu	79
6.5.1	VIEW KEYS menu	80
6.5.2	PARTY LINE menu	82
6.5.3	FIXED GRP menu	84
6.5.4	NEAR PNLS menu	85
6.5.5	MONITORS Menu.....	86
6.5.6	FL SOURCE Menu	87
6.5.7	FL DEST menu	88
6.6	LOCAL PREF (Local Preferences) menu	89
6.6.1	TIMEOUTS menu	91
6.6.2	LEVEL ADJ (Level Adjust) Menu.....	93
6.6.3	BRIGHTNESS menu	94
6.6.4	MESSAGE menu	95
6.6.5	RESET XPTS (Reset Crosspoints) menu	97
6.7	SYS CONFIG (System Configuration) menu	97
6.7.1	PARTY LINE configuration menu	99
6.7.2	FIXED GRP configuration menu	101

6.7.3	LOCAL PNL (Local Panel) configuration menu	103
6.7.4	LOCAL KEYS configuration menu	104
6.7.5	ATTRIBUTES menu	107
6.7.6	REMOTE PNL menu	107
6.7.7	FL CONFIG (Forced Listen configuration) menu	110
6.7.8	INPUT LVLS (Input Levels) configuration menu	112
6.7.9	OUTPUT LVL (Output Levels) configuration menu	116
6.8	<i>DIAGNOSTIC menu</i>	118
6.8.2	SYSTEM DATA menu	121
6.8.3	UPGRADE menu	122
6.9	<i>CALL menu</i>	123
6.10	<i>DIAL menu</i>	126
6.11	<i>LOCAL EXCL (Local Exclusive) menu</i>	128
6.12	<i>LOCAL PAGE (Local Page override) menu</i>	128
6.13	<i>ASSNMT PNL (Assignment Panel) menu</i>	129
6.13.1	Assigning interruptible foldback (IFB) sources to an IFB destination	131
6.13.2	Assigning partyline members	133
6.13.3	Assigning Fixed Group members.....	133
6.14	<i>SUPERVISE menu</i>	134
6.15	<i>SHIFT menu</i>	139
6.16	<i>Menu map</i>	141
6.17	<i>Accessing the IP configuration menus</i>	142
6.18	<i>IP SETUP menu</i>	142
6.18.1	CONNECT menu	143
6.18.2	USER ID menu	146
6.18.3	PASSWORD menu.....	147
6.18.4	CNTL DELAY (Control Delay) menu	148
6.19	<i>NET SETUP menu</i>	150
6.19.1	IP ADDRESS menu.....	152
6.19.2	IP GATEWAY menu	153
6.19.3	DNS SERVER menu.....	154
6.19.4	LOGIN IP menu	155
6.19.5	LOGIN PORT menu	156
6.19.6	DHCP menu	157
6.19.7	SUBNETMASK (Subnet Mask) menu	157
6.19.8	CON TYPE (Connection Type) menu	158
6.19.9	DNS/IP.....	160
6.20	<i>CONFIRM CLEAR menu</i>	160
6.21	<i>IP menu map</i>	161
7	Maintaining V-Series panels	162
7.1	<i>Accessing the Local Maintenance Menu (LMM)</i>	162
7.2	<i>Navigating the LLM menu</i>	163

7.2.1	Use of displays.....	163
7.3	<i>Commands</i>	164
7.3.1	Version	165
7.3.2	xpoint.....	165
7.3.3	Level	167
7.3.4	Control.....	167
7.3.5	Limit.....	169
7.3.6	Filter.....	170
7.3.7	la (Listen Again).....	171
7.3.8	Mixer	172
7.3.9	Setup	173
7.3.10	Voicerec	173
7.3.11	Voiceplay.....	174
7.3.12	intrim.....	174
7.3.13	outtrim.....	175
7.3.14	gpio	176
7.3.15	Module.....	177
8	Compliance	178
9	Specifications	180
9.1	<i>Front panel controls and connectors</i>	180
9.2	<i>Main panel rear connectors</i>	180
9.3	<i>AES-3 option rear connectors</i>	180
9.4	<i>T-Adapter option rear connector (now obsolete)</i>	180
9.5	<i>Expansion panel rear connectors</i>	181
9.6	<i>Panel microphone input</i>	181
9.7	<i>Headset microphone input</i>	181
9.8	<i>Auxiliary loudspeaker output</i>	181
9.9	<i>Audio input/output</i>	181
9.10	<i>AC mains power supply (external)</i>	182
9.11	<i>Temperature</i>	182
9.12	<i>Humidity</i>	182
9.13	<i>Dimensions (1RU panels)</i>	182
9.14	<i>Dimensions (2RU panels)</i>	182
9.15	<i>Dimensions (Desktop panels)</i>	183
10	Glossary	184

1 *Important Safety Instructions*

1. Read these instructions.
2. Keep these instructions.
3. Heed all warnings.
4. Follow all instructions.
5. Do **not** use this apparatus near water.
6. Clean only with dry cloth.
7. Do **not** block any ventilation openings. Install in accordance with the manufacturer's instructions.
8. Do **not** install near any heat sources such as radiators, heat registers, stoves, or other apparatus (including amplifiers) that produce heat.
9. Do **not** defeat the safety purpose of the polarized or grounding-type plug. A polarized plug has two blades and a third grounding prong. The wide blade or the third prong are provided for your safety. If the provided plug does not fit into your outlet, consult an electrician for replacement of the obsolete outlet.
10. Protect the power cord from being walked on or pinched particularly at plugs, convenience receptacles, and the point where they exit from the apparatus.
11. Only use attachments/accessories specified by the manufacturer.
12. Use only with the cart, stand, tripod, bracket, or table specified by the manufacturer, or sold with the apparatus. When a cart is used, use caution when moving the cart/apparatus combination to avoid injury from tip-over.
13. Unplug this apparatus during lightning storms or when unused for long periods of time.
14. Refer all servicing to qualified service personnel. Servicing is required when the apparatus has been damaged in any way, such as power-cord supply or plug is damaged, liquid has been spilled or objects have fallen into the apparatus, the apparatus has been exposed to rain or moisture, does not operate normally, or has been dropped.
15. **Warning:** To reduce the risk of fire or electric shock, do not expose this product to rain or moisture.

Safety symbols

Familiarize yourself with the safety symbols in **Figure 1-1: Safety symbols**. These symbols are displayed on the apparatus and warn you of the potential danger of electric shock if the system is used improperly. They also refer you to important operating and maintenance instructions in the product user manual.

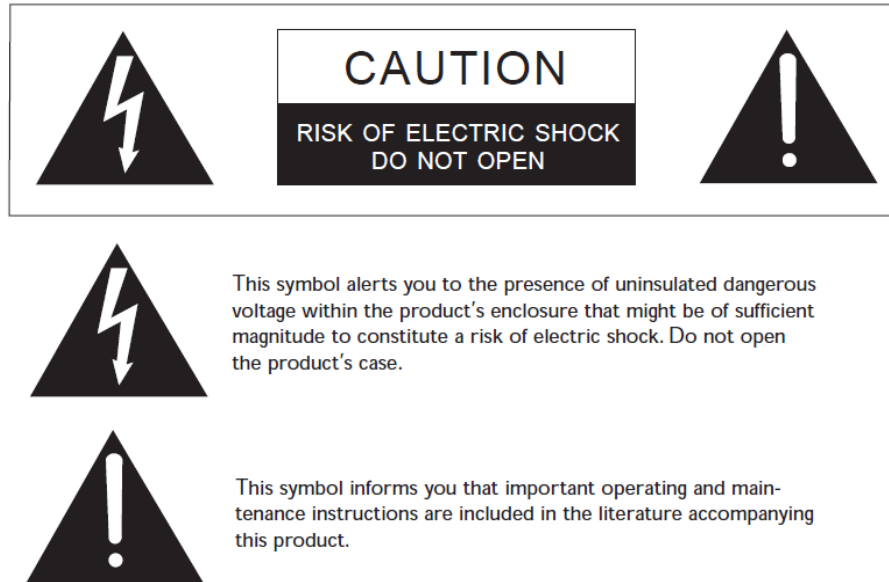

Figure 1-1: Safety symbols

Mains power cord

V-Series panels are powered by an external power supply. The cord to connect the external power supply to the mains supply must conform to the following:

- The mains power cord shall have an **IEC C13 connector** at one end and a mains power plug at the other end.
- An **IEC C13 plug** has three pins, the center pin carrying the earth / ground. The other two pins carry neutral and live circuits.
- The conductors of the mains cords shall have adequate cross-sectional area for rated current consumption of the equipment.
- The mains plug that connects to the mains supply must be approved for use in the country where the equipment is to be used.
- The mains power cord must be an **IEC mains power cord** complying with standard **IEC60320; IEC320/C13**.
- Mains power cords used in the U.S. must also comply with standard **UL817**.

2 *Introduction*

This guide describes how to install, use and maintain V-Series™ user panels from HME Clear-Com®

V-Series user panels are fully compatible with both the Eclipse and Eclipse HX digital matrix systems, and are available in 12-key, 24-key and 32 key pushbutton, rotary and lever key formats.

Note: Up to 32 panels can be connected to an Eclipse HX matrix using an E-MADI64 card over a suitable infrastructure. See the Eclipse HX matrix user guides for more information.

The panels incorporate a wide range of advanced features to enhance usability and audio performance, including:

- Advanced Digital Signal Processing.
- 10-character displays.
- Listen Again memory.
- Clear-Com IP technology.

2.1 V-Series Panels covered by this guide

The V-Series family of panels comprises:

Format	Product number	Description
Lever Key	V12LD	19" rack mount 1RU 12 lever key panel.
	V24LD	19" rack mount 2RU 24 lever key panel with dial pad.
	V12LDD	Desktop 12 lever key panel with dial pad.
	V12LDE	19" rack mount 1RU 12 lever key expansion panel.
	V32LD	19" rack mount 2RU 32 lever key panel with improved dial pad and function keys.
	V16LDE	19" rack mount 1 RU 16 lever key expansion panel.
Pushbutton	V12PD	19" rack mount 1RU 12 pushbutton panel.
	V24PD	19" rack mount 2RU 24 pushbutton panel with dial pad.
	V12PDD	Desktop 12 pushbutton panel with dial pad.
	V12PDE	19" rack mount 1RU 12 pushbutton expansion panel.
Rotary	V12RDX4	19" rack mount 1RU 12 rotary control panel.
	V24RDX4	19" rack mount 2RU 24 rotary control panel with dial pad.
	V12RDDX4	Desktop 12 rotary control panelwith dial pad.
	V12RDE	19" rack mount 1RU 12 rotary control expansion panel.

Table 1: V-Series Panels covered by this guide

2.2 Further information

V-Series documentation is available from your product CD-ROM. For more information about the V-Series family of panels, see:

<http://www.clearcom.com/product/digital-matrix/user-panel>

For more information about the Eclipse and Eclipse HX digital matrix systems, referenced by this guide, see:

<http://www.clearcom.com/product/digital-matrix>.

For sales information, see your Clear-Com sales representative. For contact information and legal disclaimers, see Page 2 of this guide.

3 Overview

This chapter provides an overview of the V-Series family of panels, including:

- Headset connector and expansion panel options.
- Front panel lights and controls.
- Key display and fonts.

Note: For a brief description of all the V-Series panels covered by this guide, including product numbers, see Table 1 in this guide.

3.1 Headset connector options

The following headset connector options (one connector only) are available to V-Series panels:

- XLR-4M locking headset connection.
- XLR-5F headset connection.
- XLR-7M headset connection.

3.2 Expansion panel options

Panel	Expansion panel support
V12LD	Up to eight V12LDE expansion panels in a daisy chain.
V24LD	
V12LDD	
V12PD	Up to eight V12PDE expansion panels in a daisy chain.
V24PD	
V12PDD	
V12RD	Up to eight V12RDE expansion panels in a daisy chain.
V24RD	
V12RDD	
V16LDE	Up to four V16LDE expansion panels in a daisy chain.

Table 2: Expansion panel options

Note: Expansion panel types (lever key, push button or rotary control) may not be mixed in a daisy chain. Each expansion panel (lever, push button or rotary control) must be connected to a main panel of the same type.

3.3 Front panel lights and controls

3.3.1 V12LD

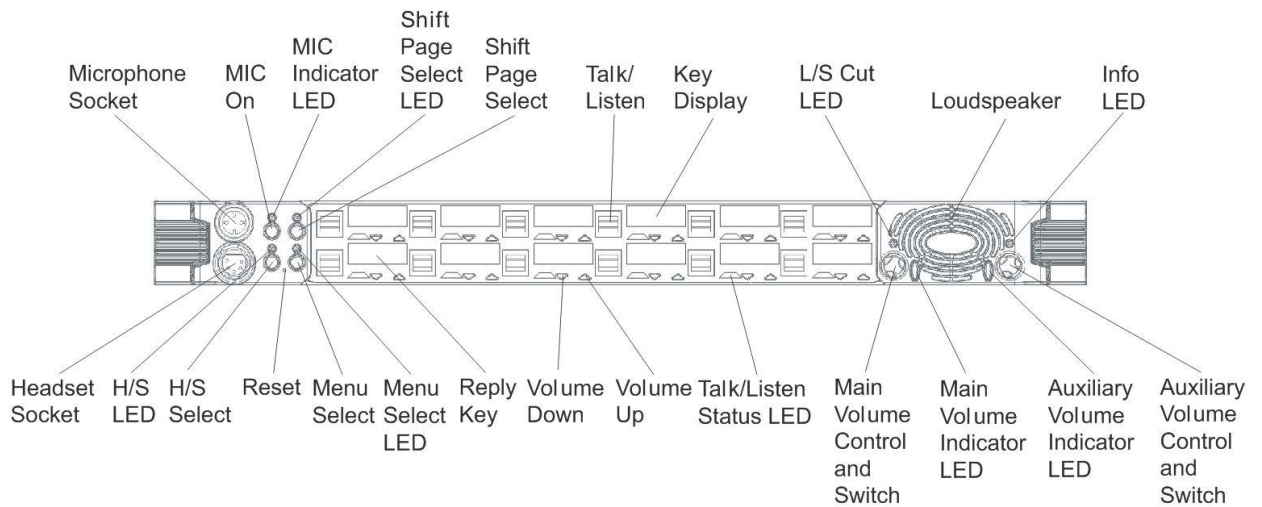

Figure 3-1: V12LD front panel lights and controls

3.3.2 V12PD

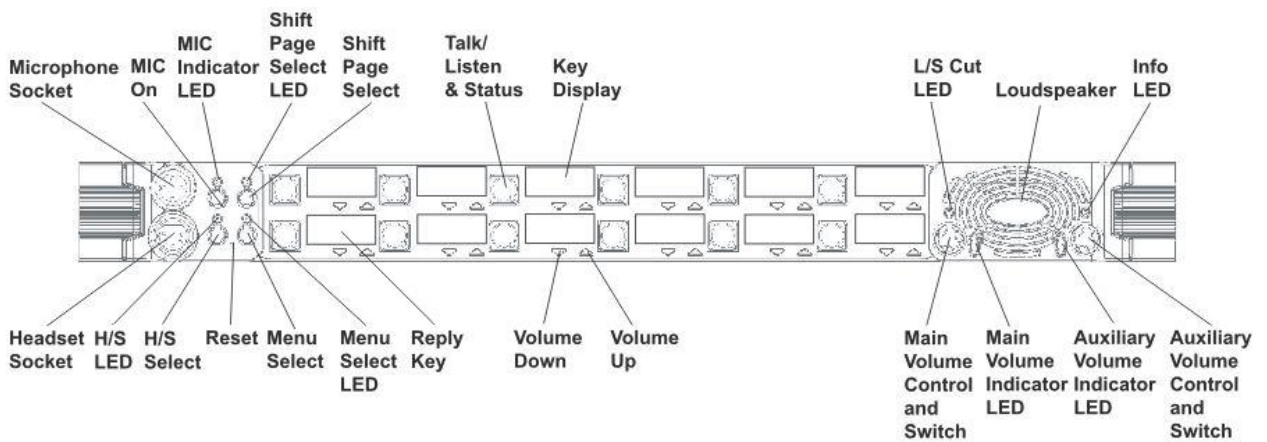

Figure 3-2: V12PD front panel lights and controls

3.3.3 V12RD

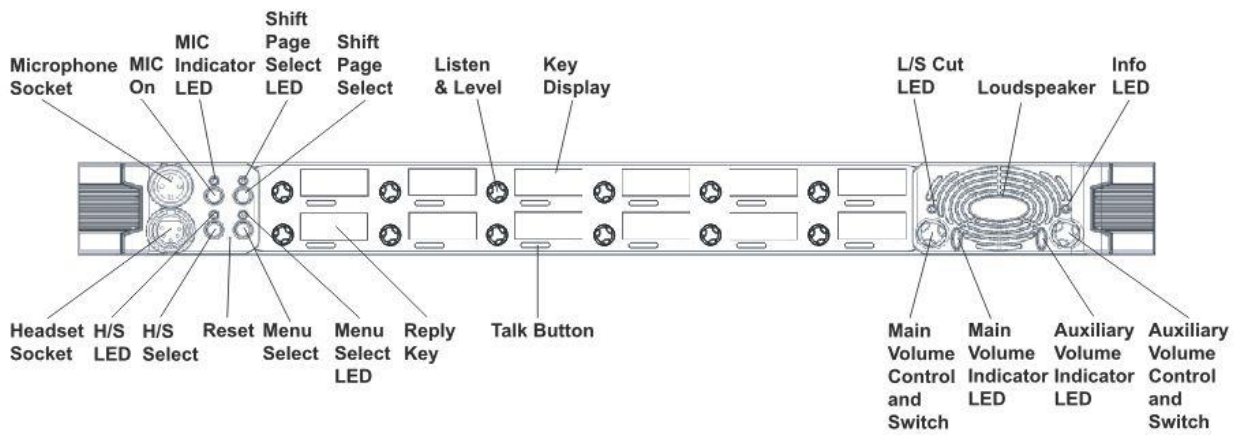

Figure 3-3: V12RD front panel lights and controls

3.3.4 V24LD

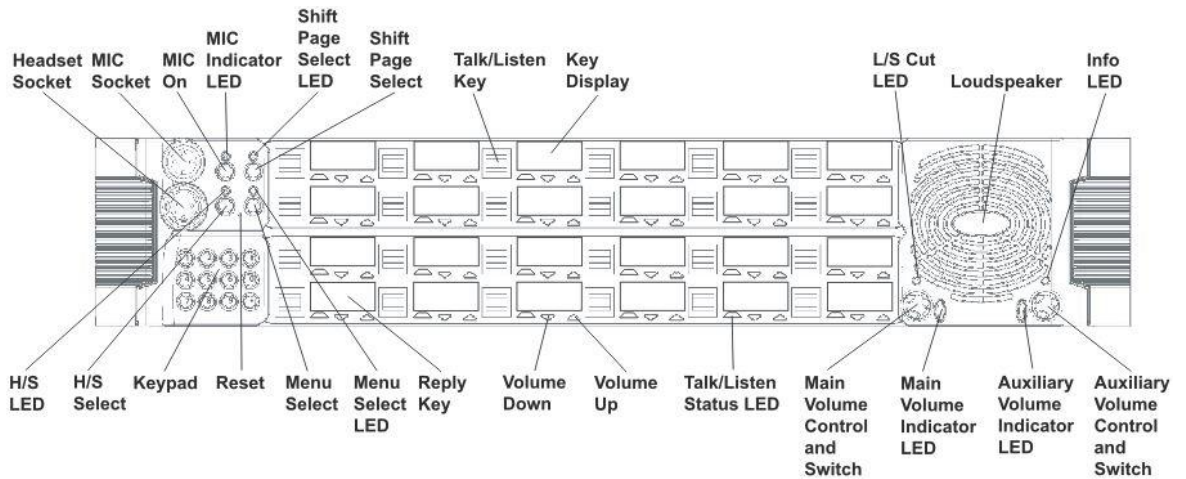
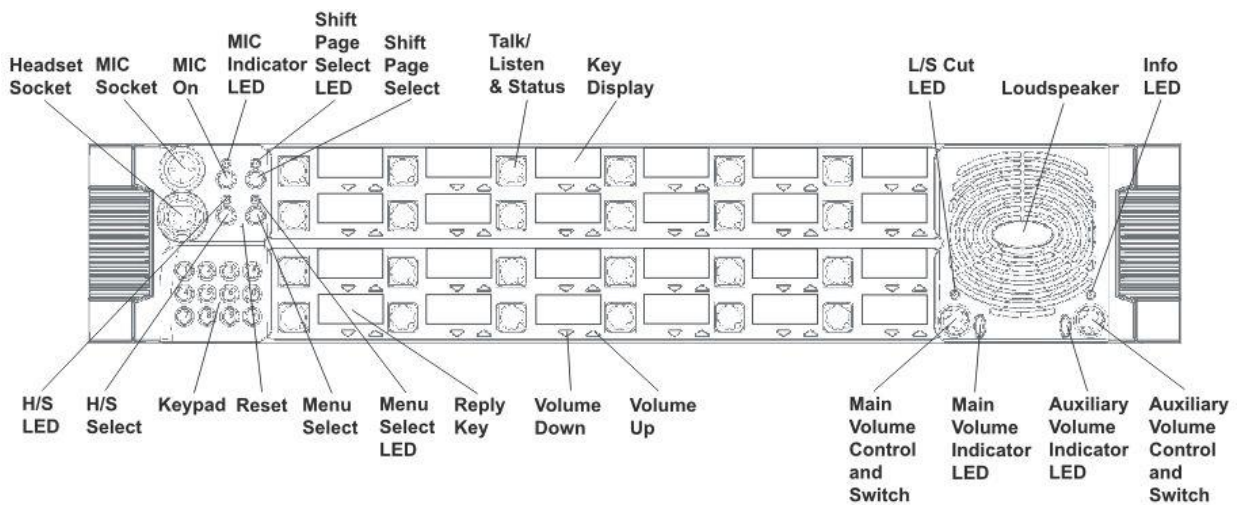

Figure 3-4: V24LD front panel lights and controls

3.3.5 V24PD



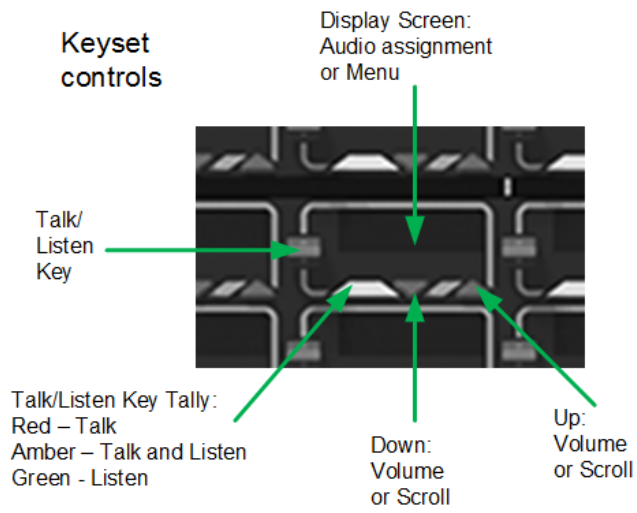

Figure 3-7 V32LD front panel controls

3.3.8 V12LDE

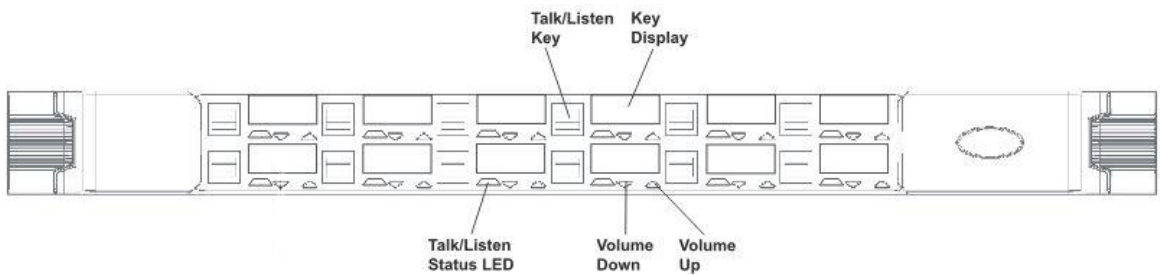

Figure 3-8: V12LDE front panel lights and controls

3.3.9 V12PDE

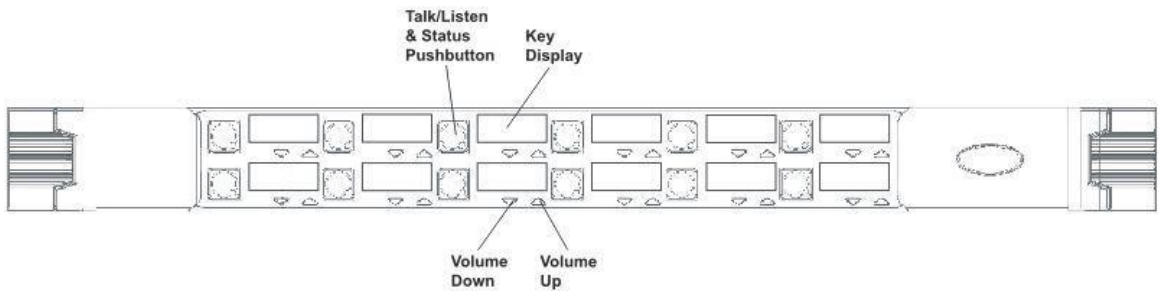

Figure 3-9: V12PDE front panel lights and controls

3.3.10 V1RDE

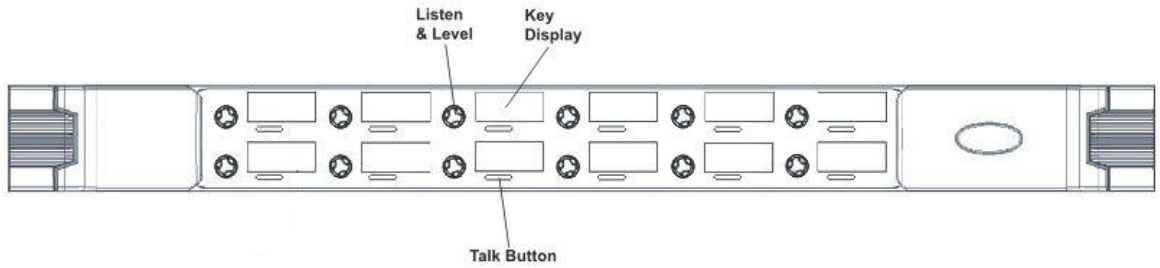

Figure 3-10: V12RDE front panel lights and controls

3.3.11 V16LDE

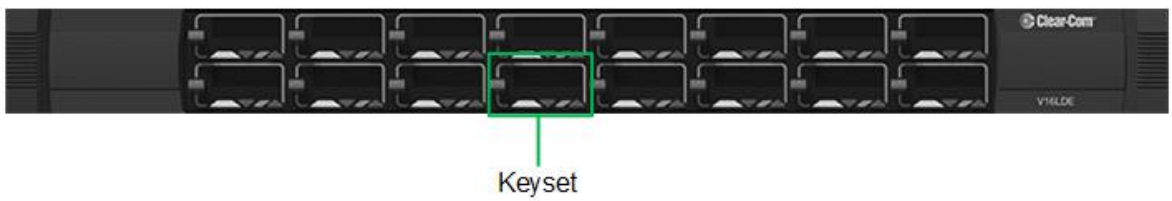

Figure 3-11 V16LDE expansion panel

See Figure 3-7 V32LD front panel controls above for keyset controls.

3.3.12 V12LDD

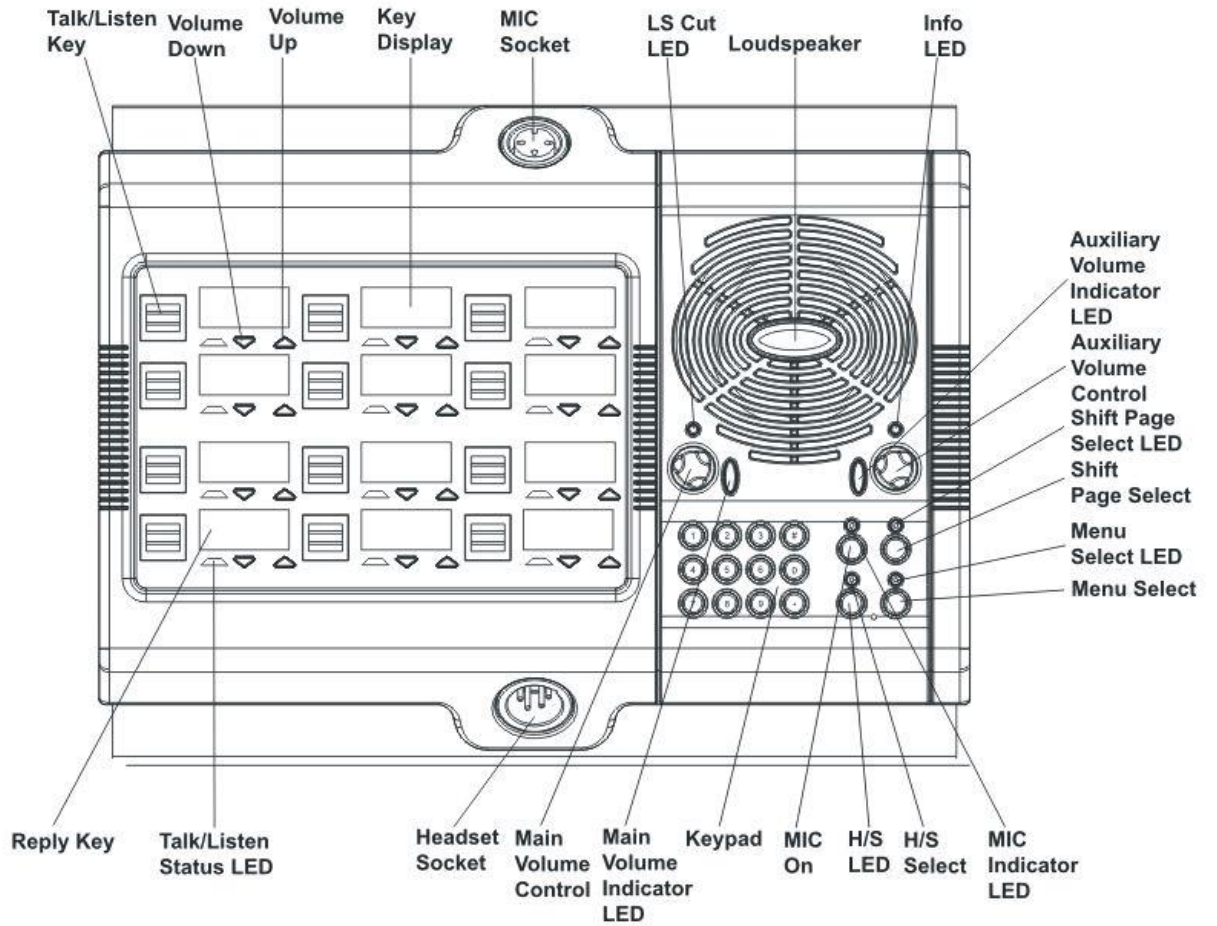

Figure 3-12: V12LDD front panel lights and controls

3.3.13 V12PDD

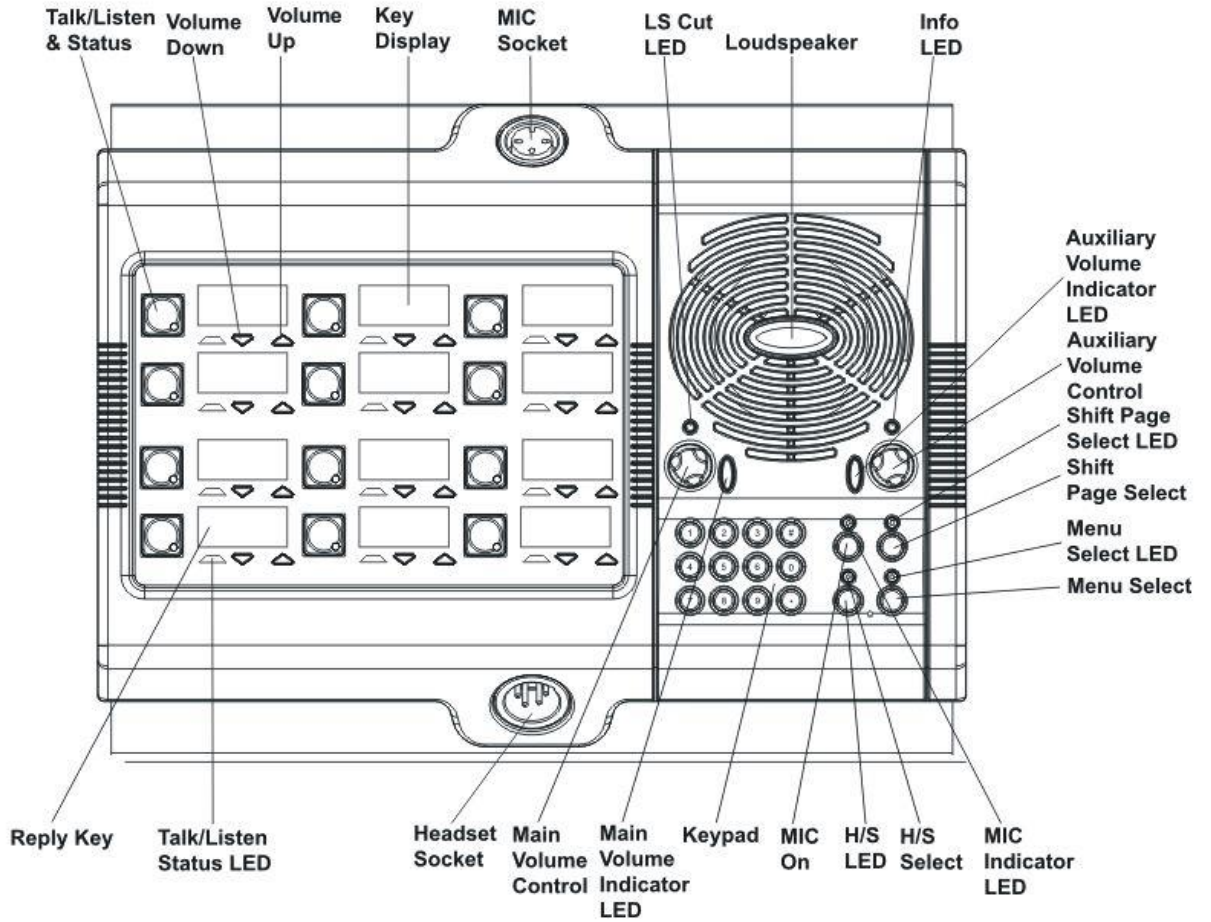

Figure 3-13: V12PDD front panel lights and controls

3.3.14 V12RDD

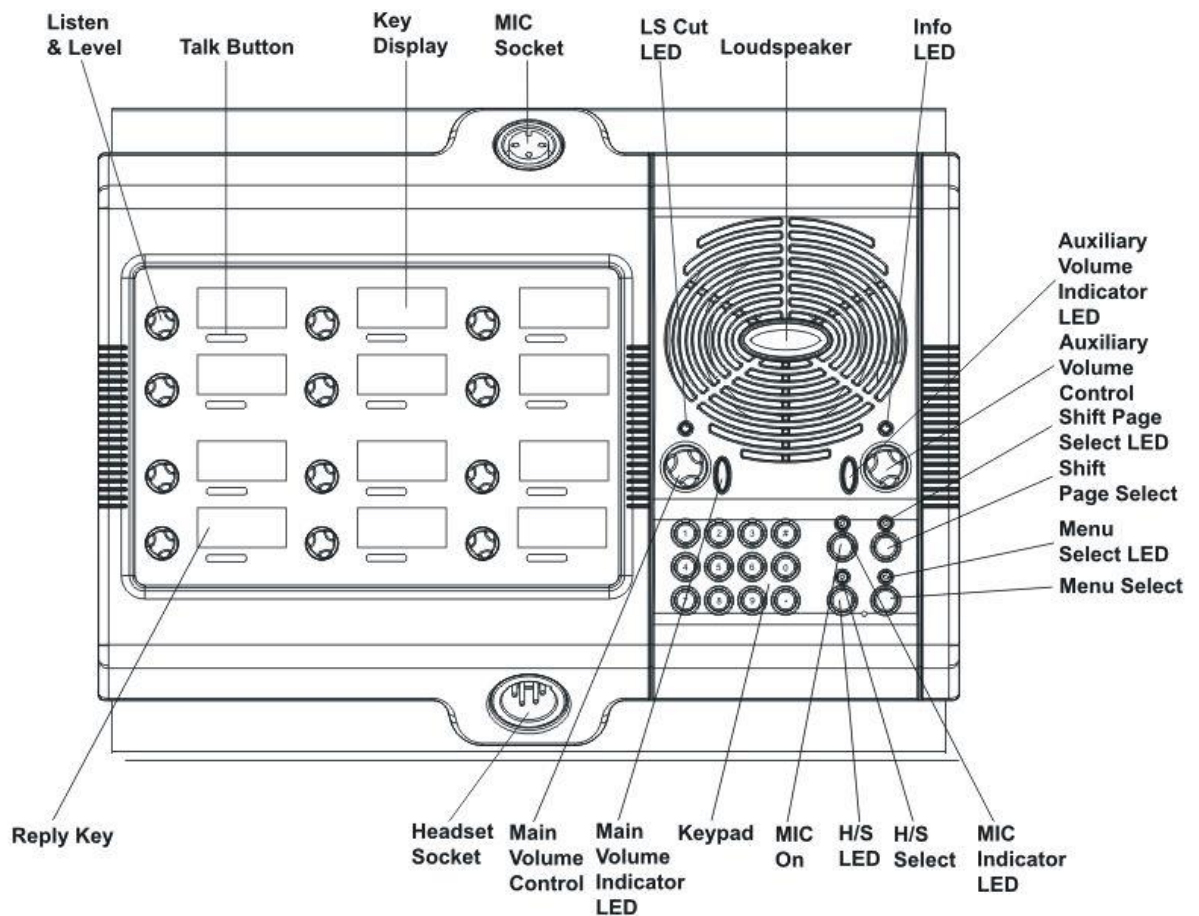

Figure 3-14: V12RDD front panel lights and controls

3.4 Key display window

The key display window is located next to the selection pushbutton, lever key or rotary control.

You can access assigned labels either by pushing the selection control (pushbutton and rotary panels) or toggling (lever key panels). Each key display window can be assigned as many as nine labels, one each from the main page and the eight shift pages. A label may either:

- Represent a talk or listen path to a panel, interface card or module, Fixed Group, or partyline.
- Activate a programmable control function.

The key display window can display up to ten Latin or Katakana characters, or five Kanji characters, together with status indicators for the key. These status indicators are:

- Currently selected page.
- Latched talk indicator.
- Latched listen indicator.
- Panel monitoring indicator.

- Microphone indicator.
- Incoming VOX indicator.
- Antenna active indicator.
- Destination type indicator (for example, a partyline, IFB, or Fixed Group).
- Remote panel connection.

3.4.1 Navigating the key display window

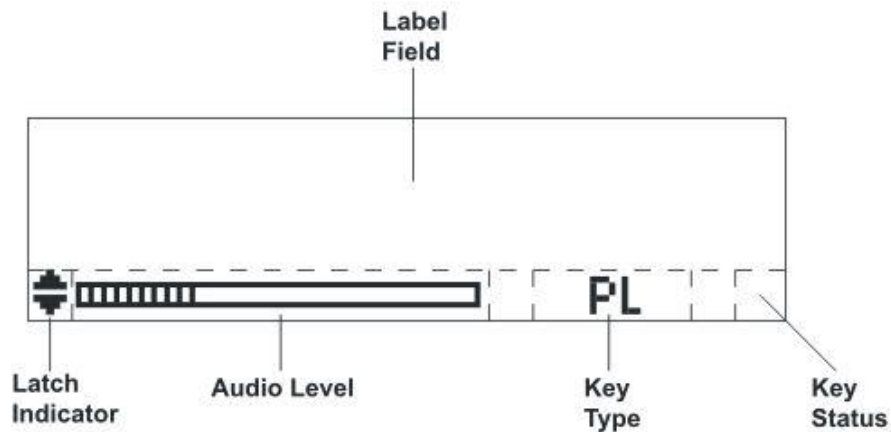

Figure 3-15: Navigating the key display window

Feature	Description / comments
Label Field	10 character field for the key label.
Latch Indicator	Indicates the talk/listen status of the key. A down arrow indicates that the key is a latched talk key, an up arrow indicates a latched listen key. Both arrows together indicate a latched talk and listen key. If no arrows are displayed the key is not latched.
Audio Level	A bar graph indicating the audio level set on that route.
Key Type	Indicates the type of route or action the panel key is connected to: <ul style="list-style-type: none"> • PL = Party Line • IFB = Interruptible Foldback • FG = Fixed Group (includes stacked keys)
Key Status	Displays an icon indicating the status of this key (see Figure 3-16: Key Status icons).

Table 3: Navigating the key display window



Figure 3-16: Key Status icons

3.4.2 Key display window controls

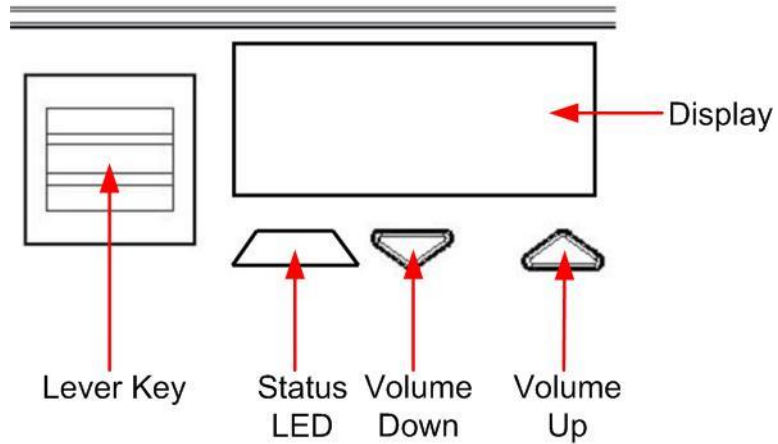

Figure 3-17: Lever key display window controls

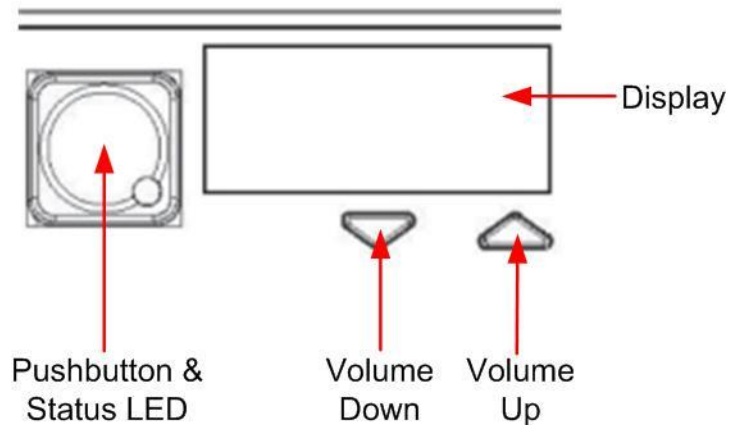

Figure 3-18: Pushbutton key display window controls

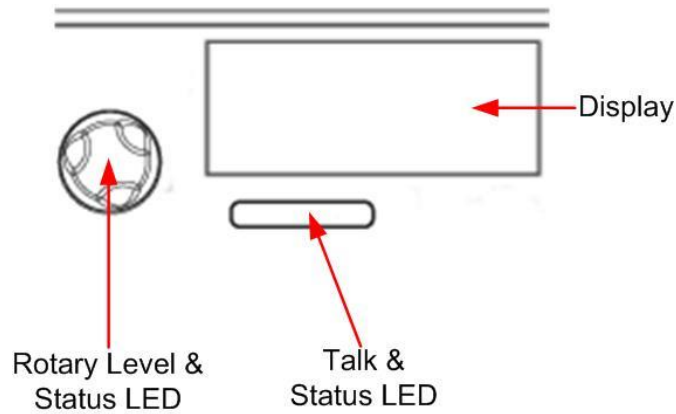

Figure 3-19: Rotary key display window controls

3.4.3 Navigating the Reply key display window

By default, the Reply key is placed in the lower left corner of the panel. You can move this to any other position from panel programming in the EHX software.

Note: From the EHX Software, you can enable dual Reply keys. The second Reply key appears by default directly to the right of the first Reply key. If this position is already in use, you can either overwrite it or select another position on the panel. For more information, see the **EHX Software User Guide**.

Note: You can only reply to the last two calls. Calls are not stacked.

The following points apply to dual Reply keys:

- If neither Reply key has incoming calls, the first Reply key is always populated first.
- If both Reply keys have incoming calls, another incoming call replaces the older of the two original incoming calls.
- If a Reply is latched, it will not be replaced by another incoming call.
- If both Reply keys are latched, further incoming calls will be heard but will not appear on the Reply keys.

Only available on V-Series panels.

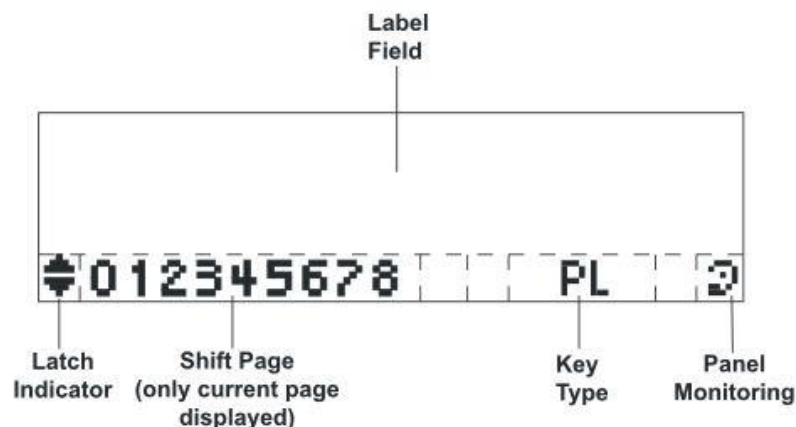

Figure 3-20: Navigating the Reply key display window

Feature	Description / comments
Label Field	10 character field for the Reply / caller label.
Latch Indicator	Indicates the latch status of the key. As the Reply key is non-latching these indicators are not displayed.
Shift Page	The number of the current shift page. Only the current page number is displayed, with the digit in the position shown in the illustration.
Key Type	Indicates the type of route or action the Reply key is connected to. When replying to an incoming call from a partyline, Fixed Group or IFB the caller port is displayed rather than the partyline, Fixed Group or IFB. The reply key only connects to the caller.
Panel Monitoring	Displays an ear icon if the panel is being monitored.

Table 4: Navigating the reply key display window

3.5 Supported fonts in V-Series panels

Font	Description / comments
Basic Latin	The backslash is a Yen character. This is a size-maximized font (no descenders, lower-case characters are not relative in size to upper-case characters). This covers Unicode 32 to 127 (decimal), 0x20 to 0x7F (hex). The V-Series panel display will support ten characters.
Cyrillic	This is a normal, relatively-sized font. Covers Unicode 1024 to 1279 (decimal), 0x400 to 0x4FF (hex) with some missing characters. The V-Series panel display will support ten characters.
Hiragana	This covers the codepoint range 12352 to 12447 (decimal), 0x3040 to 0x309F (hex). The V-Series panel display will support five characters.
Full-width Katakana	The V-Series panel display will support five characters, as this is a normal width font. This covers the codepoint range 12448 to 12543 (decimal), 0x30A0 to 0x30FF (hex) with some missing characters.
Kanji	Displays 17,000 out of the 21,000 characters. This covers the codepoint range 19968 to 40895 (decimal), 0x4E00 to 0x9FBF (hex). The V-Series panel display will support five characters.
Hangul	The range is 44032 to 55215 (decimal), 0xAC00 to 0xD7AF (hex). The V-Series panel display will support five characters.

Font	Description / comments
Half-width Katakana	The codepoint range is 65376 to 65440 (decimal), 0xFF60 to 0xFFA0 (hex). The V-Series panel display will support ten characters.
Arabic	The character range supported on the V-Series panel is the Basic Arabic character set 0x0600 to 0x06FF.

Table 5: Supported fonts

3.6 What's new in Eclipse-HX v. 9.0

- 2RU 32 lever panel (V32LD)with:
 - Improved dial pad
 - 4 programmable function keys for easier panel operation
- 1 RU 16 lever key panel (V16LDE)

4 Installing V-Series panels

This chapter describes how to install V-Series panels, including expansion panels. It also describes how to install the optional two additional IP channels that are available.

4.1 Placing panels

4.1.1 Placing rack mounted panels

Locate all panels at comfortable heights for operation and leave at least 2 inches (51 mm) of clearance behind the rear of the panel's chassis to allow for cable connectors.

Expansion panels are usually installed next to or near the main panel. Leave at least 2 inches (51 mm) of clearance behind the rear of each expansion panel to allow for cable connectors.

Connect expansion panels using straight through 8-way shielded CAT5 cable with RJ45 connectors.

Note: Expansion panels can be connected to the main panel in a daisy chain using cables not more than 16 ft (5 m) long between each panel. The cable length of any daisy chain of panels must not exceed 24 ft (7.5 m) in total.

4.1.2 Placing desktop panels

Desktop panels can be placed on a flat surface or they may be used as wall mounted panels. Where desktop panels are placed on a flat surface leave at least 2 inches (51 mm) of clearance behind the rear of the panel to allow for cable connectors.

To wall mount a desktop panel:

- 1) Check the contents of the panel fixing kit provided with the desktop panel as shown below:

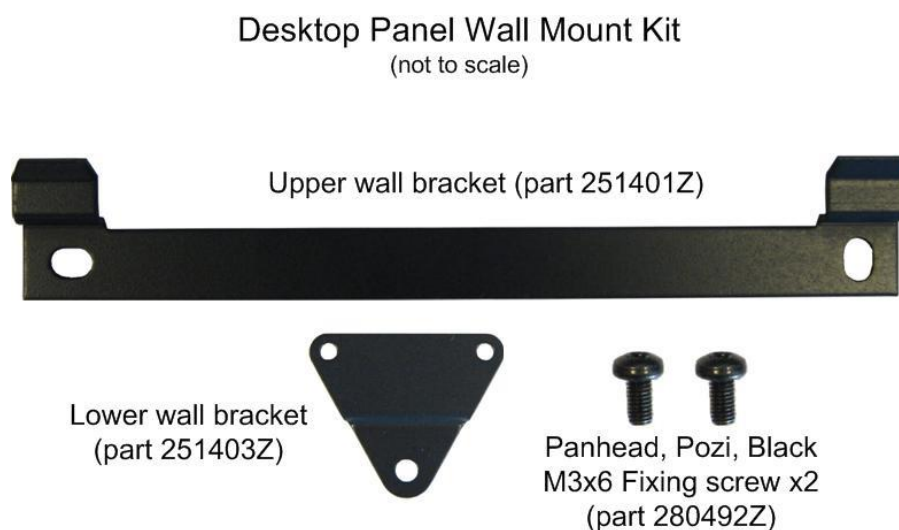

Figure 4-1: Desktop panel wall mounting kit

- 2) Rotate the front panel, so that the controls and display will face upwards when wall mounted:
- 3) Remove the eight countersunk screws that hold the front of the panel in place (the countersunk screws are located on the ends of the panel, four on each end)

Note: Retain all the screws and remove the front panel assembly.

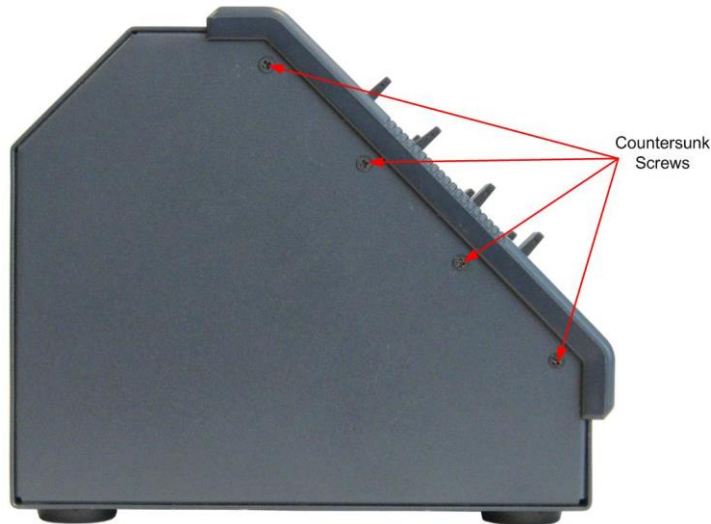

Figure 4-2: Countersunk screws in desktop panel

Note: The cables connecting the front panel electronics to the main PCB are long enough to allow the panel front to be removed and rotated without having to unplug any of the cables.

- 4) Rotate the front panel 180 degrees taking care not to pull on any of the cables and reposition it. Ensure that no cables are trapped before refitting the screws.
- 5) Apply pressure to the panel front to align the screw holes and fit the top and bottom screws loosely on each side before fitting the remaining screws and tightening all the screws.

When completed the front panel will be **upside down** when the panel is standing on a flat surface.



Figure 4-3: 'Upside down' desktop panel (for wall mounting)

- 6) Attach the upper wall bracket to the wall in the required position using suitable fixings. Allow enough clearance below for the panel for the lower fixing plate and the cable connections.

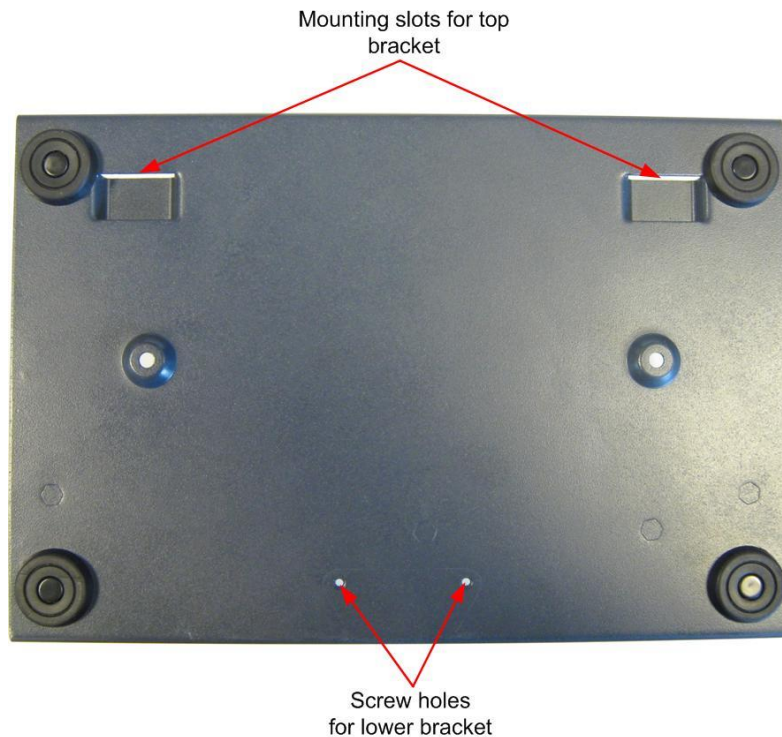
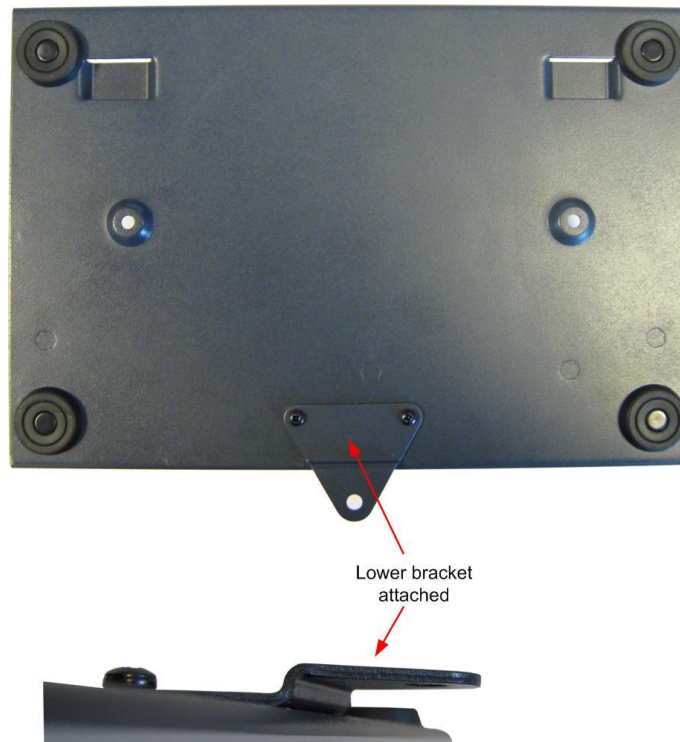

Figure 4-4: Desktop casing (without lower bracket)

- 7) Use the two fixing screws to attach the lower wall bracket to the rear of the desktop panel so that the offset part of the plate faces away from the panel body.

Desktop with Lower Bracket Fitted**Figure 4-5: Desktop casing (with lower bracket attached)**

- 8) Hang the panel on the upper wall bracket and mark the position of the screw hole for the lower bracket on the wall. Remove the panel and place a suitable fixing for the lower wall bracket.
- 9) Replace the panel on the upper bracket and attach the lower wall bracket to the fixing. Attach the cables to the connectors and power the panel up.

4.1.3 Placing expansion panels

The following section describes how to install the following optional, accessory key panels:

- The V12LDE Lever Key Expansion Panel adds 12 lever key talk/listen selectors to a panel.
- The V12PDE Pushbutton Expansion Panel adds 12 pushbutton talk/listen selectors to a panel.
- The V12RDE Rotary Expansion Panel adds 12 rotary talk/listen selectors to a panel.
- The V16LDE Lever Key Expansion Panel adds 16 lever key talk/listen selectors to a panel.

The installation procedure is identical for these panels.

Note: Expansion panel types (lever key, pushbutton or rotary) may not be mixed in a daisy chain of such panels and must be connected to a main panel of the same type.

Note: The V16LDE expansion panel can only be used with the V32LD panel.

Only one rack unit (1RU) of a standard Electronics Industry Association equipment rack is required for each expansion panel. The panels' compact size makes them ideal for use in TV control rooms, edit suites, mobile OB vans, and any other location where many talk/listen keys are necessary but space is at a premium.

All panels provide 12 or 16 additional selectors with displays.

4.1.3.1 Mounting

All accessory panels are mounted in a standard 19-inch wide (48.3 cm) standard Electronics Industry Association rack, requiring one unit of rack space each. Leave at least 2 in. (51 mm) of clearance behind the rear of the chassis to allow for cable connectors.

4.1.3.2 Power

Each expansion panel is powered by an external power supply which may be mounted on the back of the panel using the mounting clip provided. To connect the power supply to an expansion panel, route the transformer's output lead to the power connector on the back of the panel. This is a 4 pin connector.

4.1.3.3 Panel connection

A cable is supplied with each panel to connect it to a main panel or to additional expansion panels. The cable is a 6-ft. long (1.8 m) CAT5 cable with RJ45 connectors at each end. If custom length cables are to be made, they should be made with cable with 22 to 24 AWG wire. The pins should be wired one-to-one between the RJ45 connectors. The maximum distance between the panel and the last expansion panel should be 25 ft. (7.6 m).

To connect an expansion panel to a main panel:

- 1) Plug one end of the CAT5 cable into the RJ45 expansion socket on the back of the main panel.
- 2) Plug the other end of the CAT5 cable into the input connector on the back of the expansion panel.

To connect an additional accessory panel:

- 1) Plug the CAT5 cable into the output connector of the last expansion panel in the chain.
- 2) Plug the other end of the CAT5 cable into the input connector of the new expansion panel. More panels can be added by using this daisy-chaining method.

The numbering of expansion selectors follows the order of the daisy chaining.

4.1.3.4 Panel configuration

After physically placing the expansion panels and connecting them to a main panel, the expansion panels must be programmed in ECS / EHX. For more information, see your **ECS / EHX documentation**.

4.2 Wiring V-Series panels

This section provides detailed wiring diagrams for V-Series panels. Eclipse / Eclipse HX uses shielded CAT5 cable between the panel and the matrix, and between panels and expansion panels using the industry standard RJ-45 connector.

Note: For detailed wiring information concerning Eclipse / Eclipse HX connections, see the **Eclipse / Eclipse HX Installation Guide**.

V Series panels also provide a LAN connection using the industry standard RJ-45 connector. If the connection is directly to a PC, use a CAT5 crossover cable to connect to the LAN port. If a hub or switch is being used, use a straight CAT5 cable.

To connect to external devices, use the GPIO connector with the DB-25F connector, and the auxiliary audio connector with the DB-25M connector. The external panel power supply is normally held in a mounting bracket on the rear of the panel. If required, you can place the power supply away from the panel. This enables you to remove the power supply mounting bracket from the panel, saving space.

The following sections describe:

- Connecting the panel to the matrix.
- Connections between panels and local devices.
- Connections between panels and expansion panels.

Note: In the V-Series rear panel diagrams in this section, the Matrix Connector (RJ-45) corresponds to the EXT0 connection that is used when panels have additional IP channels. See **4.3 IP connection to matrix**.

4.2.1 V-Series main panel rear connectors (no AES-3 or T-Adapter)

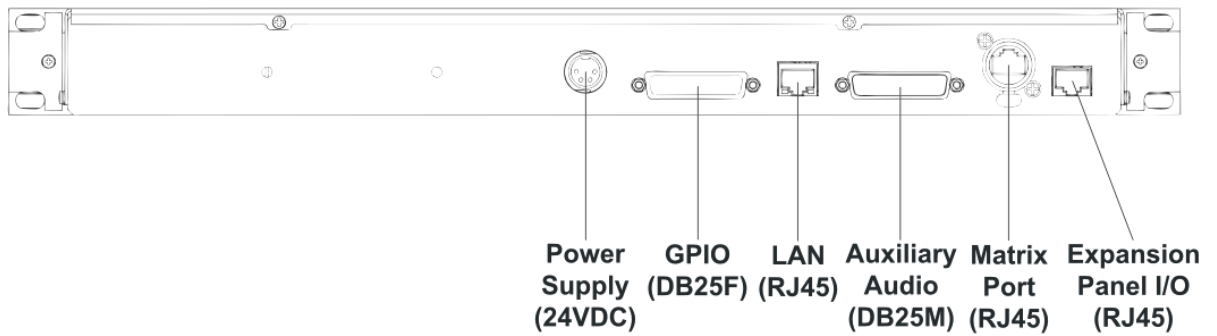

Figure 4-6: V Series main panel rear connectors (no AES-3 or T-adapter)

4.2.2 V-Series main panel rear connectors (AES-3)

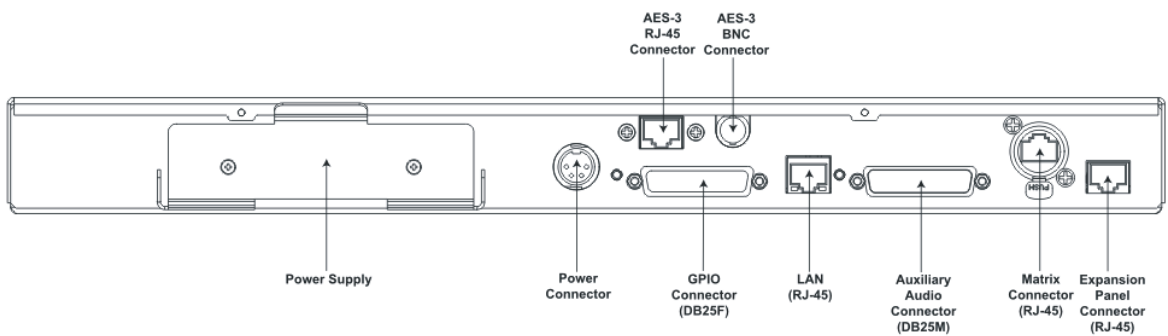

Figure 4-7: V Series main panel rear connectors (AES-3)

4.2.3 V-Series main panel rear connectors (T-Adapter) (Now obsolete)

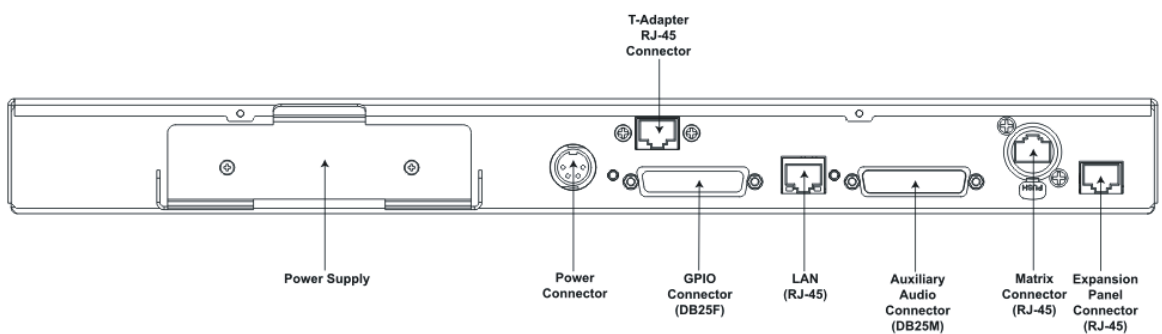

Figure 4-8: V-Series main panel rear connectors (T-Adapters)

4.2.4 V Series expansion panel rear connectors

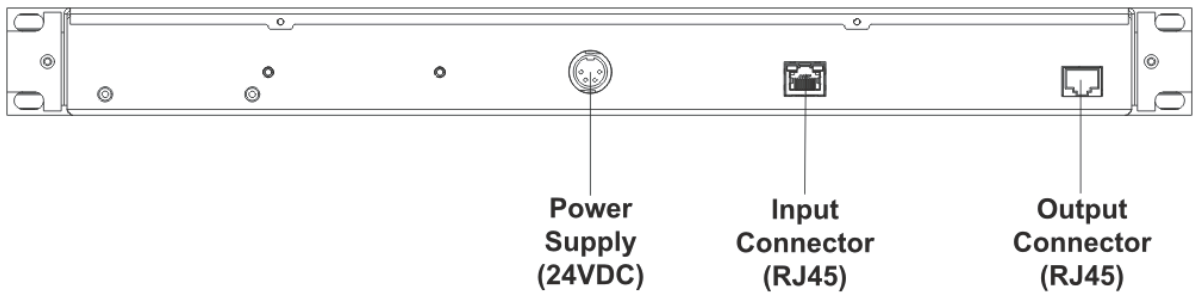

Figure 4-9: V-Series expansion panel rear connectors

4.2.5 V-Series desktop panel rear connectors (no AES-3 or T-Adapter)

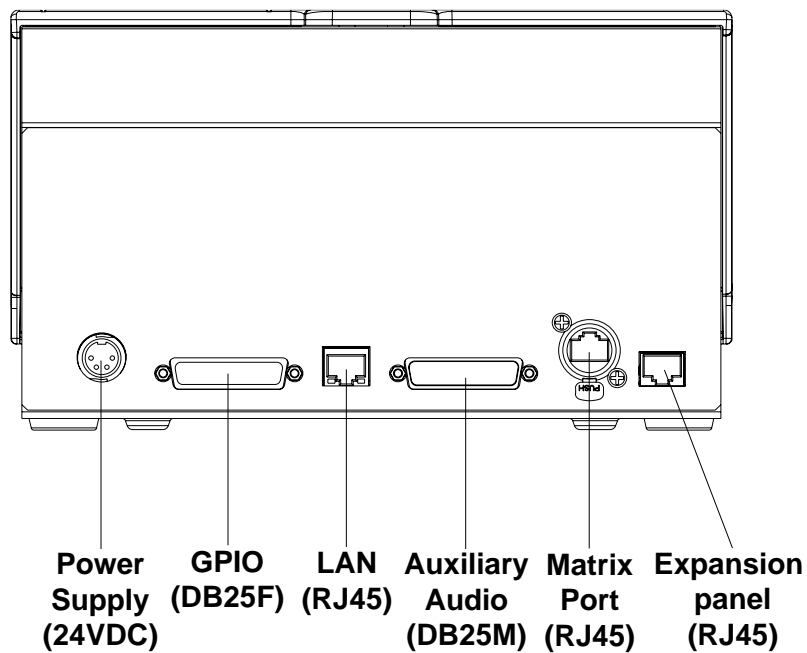

Figure 4-10: V-Series desktop panel rear connectors (no AES-3 or T-Adapter)

4.2.6 V-Series desktop panel rear connectors (AES-3)

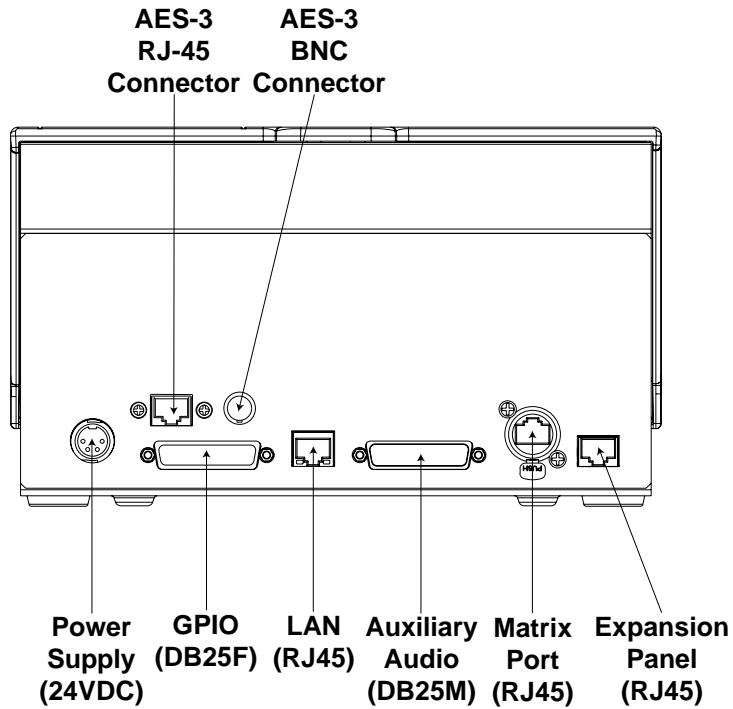

Figure 4-11: V-Series desktop panel rear connectors (AES-3)

4.2.7 V Series desktop panel rear connectors (T-Adapter) (Now obsolete)

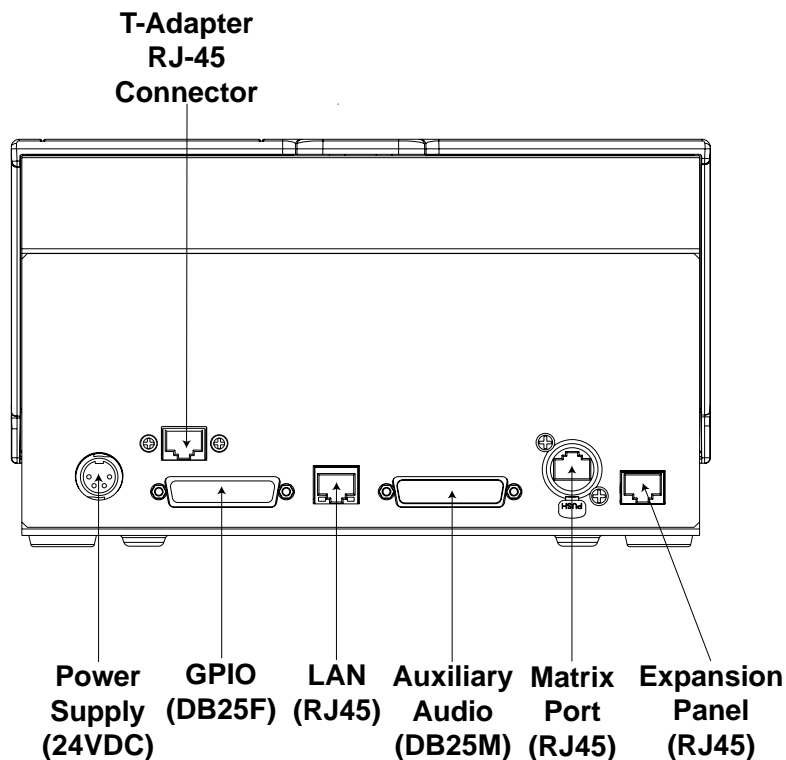

Figure 4-12: V-Series desktop panel rear connectors (T-Adapter)

4.2.8 Mains power cord

The V-Series panels are powered by an external power supply which may be mounted in a clip on the back of the panel or located away from the panel. If the power supply is not mounted in the clip on the rear of the panel the clip can be detached to save space by removing the two mounting screws. The cord to connect the external power supply to the mains supply must conform to the following:

- The mains power cord shall have an IEC C13 connector at one end and a mains power plug at the other end.
- An IEC C13 plug has three pins, the center pin carrying the earth / ground. The other two pins carry neutral and live circuits.
- The conductors of the mains cords shall have adequate cross-sectional area for rated current consumption of the equipment.
- The mains plug that connects to the mains supply must be approved for use in the country where the equipment is to be used.
- The mains power cord must be an IEC mains power cord complying with standard IEC60320; IEC320/C13.
- Mains power cords used in the U.S. must also comply with standard UL817.
- The equipment must be connected to a mains socket outlet with a protective earthing connection.
- Where the mains plug or an appliance coupler is used as the disconnect device, the disconnect device shall remain readily operable.

4.2.9 Power connector wiring

The power supply is a 4 pin socket which is connected to an external 24V power supply. The pinout for the connector is shown below.

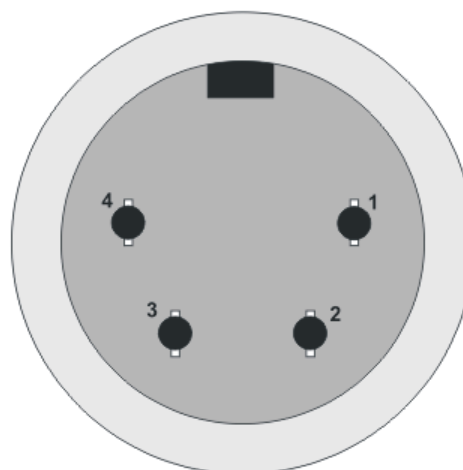

Figure 4-13: 4-pin power socket

Pin	Description / comments
1	Not connected
2	24VDC
3	Not connected
4	0V

Table 6: 4-pin power socket

4.2.10 Analog matrix to panel wiring

The analog audio RS-422 data communications module uses a 4-pair wiring scheme between the matrix and panels. This module requires an MVX-A16 card in the matrix.

Four-pair analog wiring is wired with shielded CAT5 RJ-45 cable:

- **Pair 1** transmits analog audio from the matrix port to the panel.
- **Pair 2** transmits RS-422 data from the panel back to the matrix card port.
- **Pair 3** transmits analog audio from the panel to the matrix card port.
- **Pair 4** transmits RS-422 data from the matrix port back to the panel.

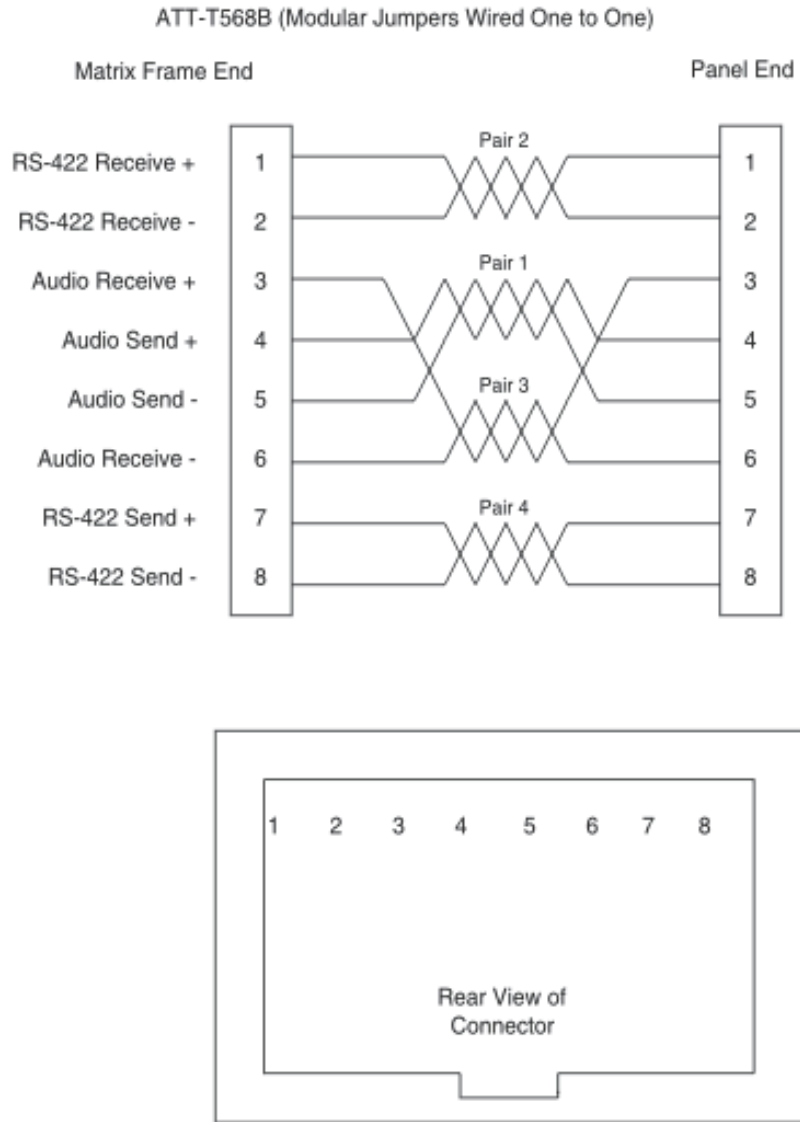

Figure 4-14: Matrix to panel wiring (analog)

4.2.11 Matrix panel GPIO connector wiring

Most input/output devices (other than the matrix, expansion panels and auxiliary audio devices) are connected to the panel via the GPIO connector. This connector is also used to connect up to two channels over IP. These channels

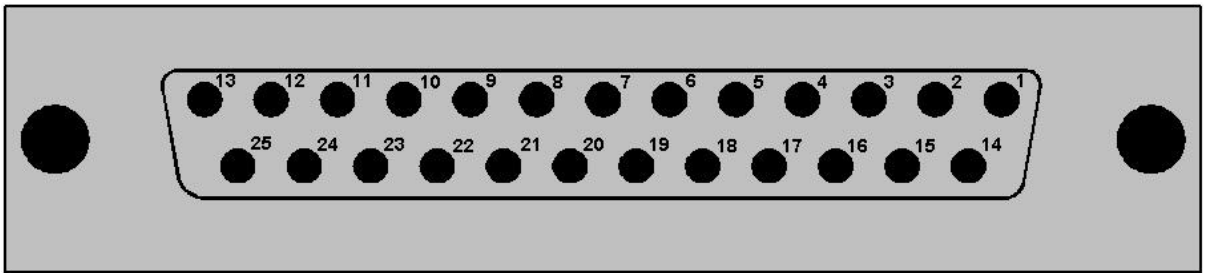

Figure 4-15: GPIO connector pinout

Pin	Description	Pin	Description
1	Panel Mute relay output Normally Closed	14	Panel Mute output relay Common
2	Panel Mute relay output Normally Open	15	Panel Aux output relay Normally Closed
3	Panel Aux output relay Common	16	Panel Aux output relay Normally Open
4	Not connected	17	Not connected
5	Not connected	18	Not connected
6	Not connected	19	Not connected
7	Not connected	20	5V
8	0V	21	5V
9	0V	22	Opto-isolated input A1
10	Opto-isolated input B1	23	Opto-isolated input A2
11	Opto-isolated input B2	24	Opto-isolated input A3
12	Opto-isolated input B3	25	Opto-isolated input A4
13	Opto-isolated input B4		

Table 7: GPIO connector pinout

Note: The **Relay 1** and **2** outputs on the GPIO connector are referred to in ECS / EHX Controls as **Panel mute relays** and **Panel AUX relays** respectively.

4.2.12 Programmable Relay contacts

Each panel includes two relays which are:

- Controlled by the matrix.
- Independent of the local panel function.

These relays can be assigned to any label(s) in the system, which will activate whenever a talk or listen is set to that label(s).

Note: If you simply wish to trigger a relay, assign the relay to a control label. For more information, see your **ECS / EHX documentation**.

The relay can activate an external device, such as an applause light in a studio, a cue light, or a security door lock. Any programmable relay in the system can

be activated from any panel in the system, including a direct-inward-access caller.

Figure 4-15: GPIO connector pinout shows the wiring of the relay contacts to the GPIO connector.

Both normally open and normally closed contacts are provided. They are rated at 1 Amp at 24 V DC. This relay is not designed for switching mains AC line voltage. To switch an external device running on mains AC line voltage, use an external relay (or other switching mechanism) activated by this relay.

4.2.13 Opto-isolated inputs

Each main panel provides four opto-isolated inputs using the GPIO interface. Each input consists of a pair of pins on the GPIO with an operating range of 4V to 30V DC or AC. These inputs can be used for user programmable functions set up by ECS / EHX to execute other actions within the system such as switching a microphone on or off.

Input 3 (pins A3/B3) is preassigned in ECS to trigger the Reply Key function while **inputs 1 and 2 (pins A1/B1 and A2/B2)** are available for assignment in ECS / EHX in **Advanced Settings > Logic Inputs**.

Input 4 (pins A4/B4) is not currently used.

The inputs are operated by applying a voltage between 4V and 30V DC or AC across the pins so that a current flows through the circuit and is detected by the opto-coupler.

The voltage may be derived from the panel itself using the 5V and 0V pins on the GPIO or it may be from an external source. An example is a circuit using a footswitch to activate the panel microphone using logic input 1.

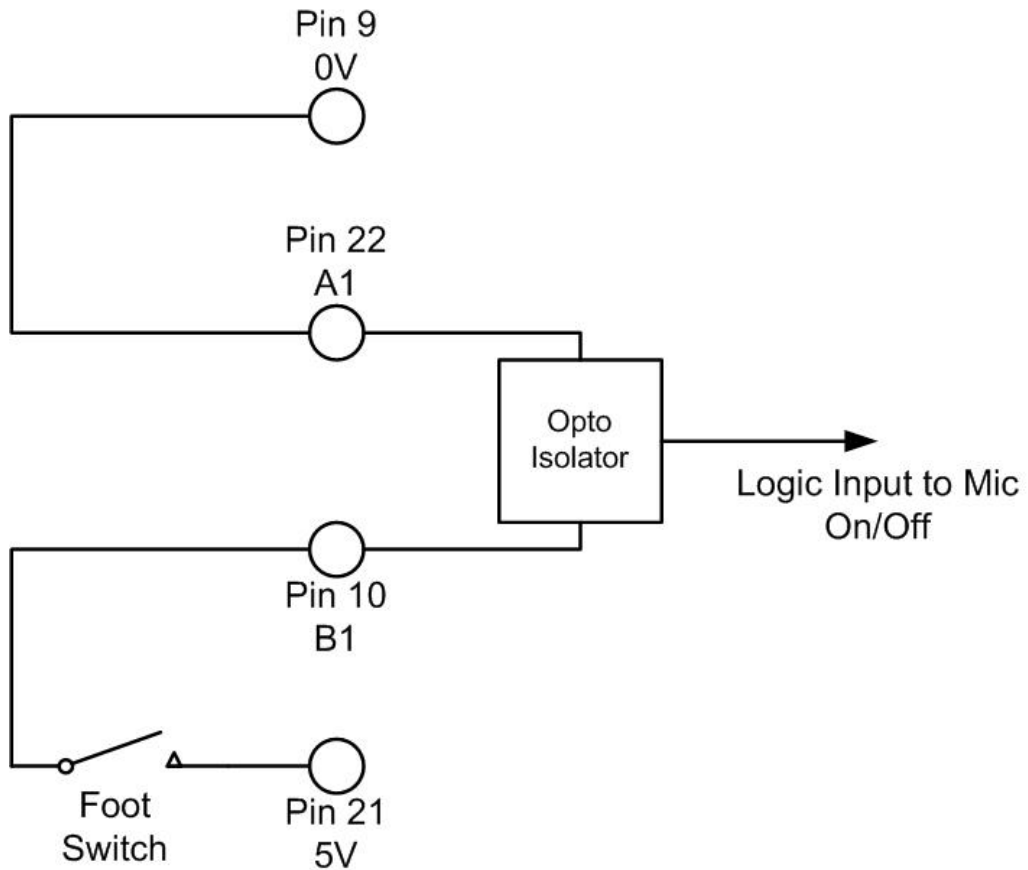

Figure 4-16: Example GPIO logic input wiring

In the above example, pressing the footswitch applies 5V DC from the panel between B1 and A1. This enables the detection of a logic input. If logic input 1 has been configured in ECS / EHX to activate the Mic On/Off function the footswitch could be used to control the panel microphone.

4.2.14 Auxiliary audio connector

The auxiliary audio connector allows additional audio inputs and outputs to be connected to the panel.

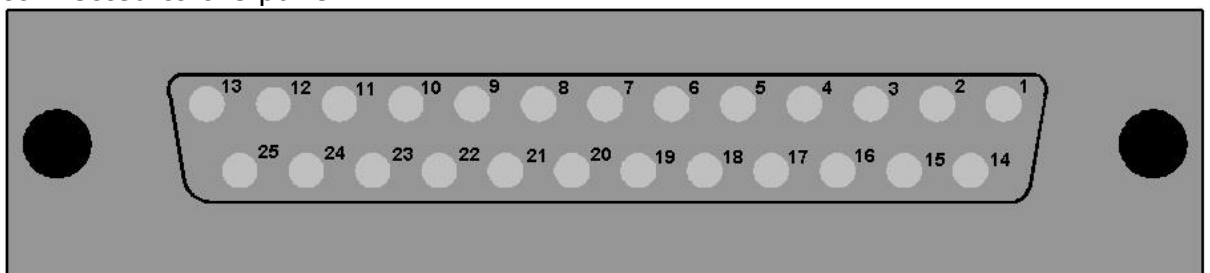

Figure 4-17: Auxiliary audio connector

Pin	Description	Pin	Description
1	Headset 2 MIC +ve	14	Headset 2 MIC -ve
2	Headset 2 Left Ear	15	Headset 2 Left Ear Ground
3	Headset 2 Right Ear	16	Headset 2 Right Ear Ground
4	Headset 2 PTT 1	17	Headset 2 PTT 2

5	0V	18	0V
6	0V	19	0V
7	External Output 2 +ve	20	External Output 2 -ve
8	External Output 1 +ve	21	External Output 1 -ve
9	Hot MIC Output +ve	22	Hot MIC Output -ve
10	Auxiliary Loudspeaker Output +ve	23	Auxiliary Loudspeaker Output -ve
11	External Input 2 +ve	24	External Input 2 -ve
12	External Input 1 +ve	25	External Input 1 -ve
13	0V		

Table 8: Auxiliary connector pinout

Note: When wiring headset 2 to use the auxiliary audio connector, Clear-Com recommends using good quality headphone cable to avoid pickup of electronic noise by the microphone connection.

Wire the Headset 2 PTTs (pins 4 and 17) so that PTT connects the pin to ground.

The auxiliary loudspeaker output is at line levels, and auxiliary loudspeakers cannot be connected directly. Auxiliary loudspeakers must be driven through a suitable audio amplifier. The line output levels are given in the product specifications.

4.2.15 AES-3 option to AES-6 interface card

The AES-3 option module adds digital input and output using RJ-45 or coax to V-Series main panels.

If the AES-3 digital interface option is used to connect the V-Series main panel to the matrix it **must** be connected to an AES-6 Digital Interface instead of the MVX-16 serial ports on the matrix.

Note: For more information about the AES-6 digital interface, see the **AES-6 Manual**.

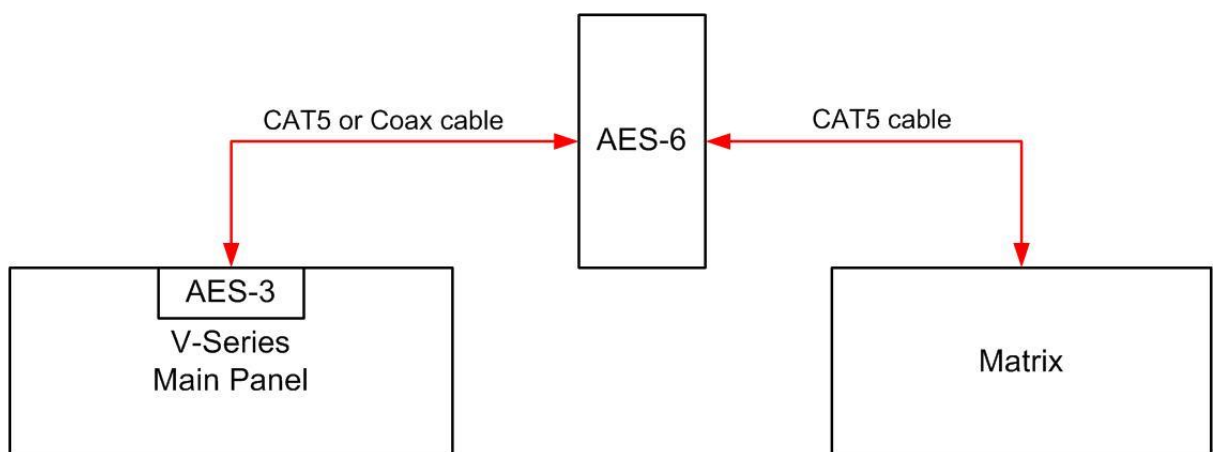

Figure 4-18: V-Series panel with AES-3 connection

The pinout for the CAT5 cable to connect an AES-6-RJ to a V-Series panel AES-3 interface is given in the table below.

Pin	Wire color	Description / function
1	White/Orange	not used
2	Orange	not used
3	White/Green	Rx (+)
4	Blue	Tx (+)
5	White/Blue	Tx (-)
6	Green	Rx (-)
7	White/Brown	not used
8	Brown	not used

Table 9: AES-6 to panel wiring (CAT5 cable)

The AES-3 interface RJ45 connection is capable of operation with up to 200m of screened Cat5e cabling of 110 ohm +/- 10 ohm impedance, with 24 AWG cores.

If 26AWG or smaller cable is used the maximum cable run may be severely reduced.

The specification for the coaxial cable required to connect V-Series panels AES-3 interfaces to an AES-6-CX card is given below.

Characteristic	Requirement
Nominal impedance	75 Ohm
Insulation	solid polyethylene
Screen	double braided copper
Capacitance	68pF/m or better
Equivalents	BBC PSF 1/3M BICC TM 3304 Brand Rex GT 851

Table 10: Coaxial cable specification

This type of cable will allow up to 500 meters of cable run between the AES-6-CX interface and the panel at the standard 48K sample rate.

Note: A ferrite core must be added to the socket end of each cable. A suitable ferrite core is **Würth Elektronik part: 74271132**.

If the AES-3 option/AES-6 interface is used to connect the V-Series panel using a 3rd-party AES-3 network the system setup is as shown below.

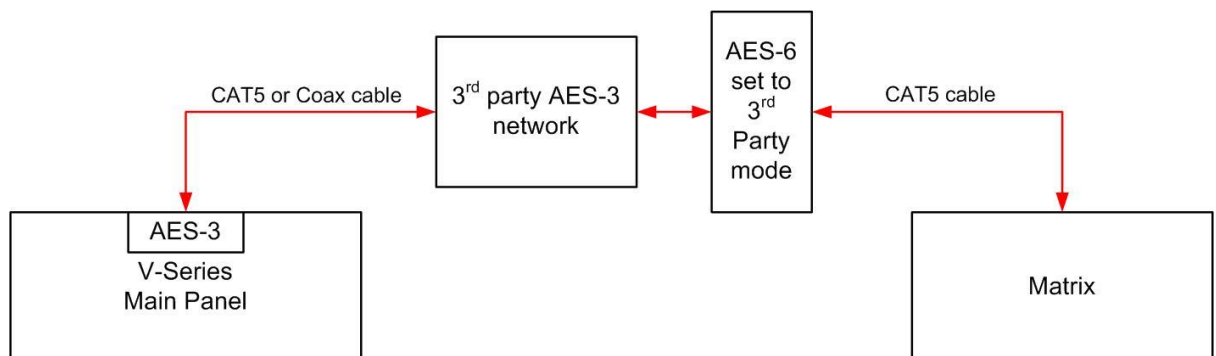

Figure 4-19: Panel connected by 3rd party AES-3 network

Note: The cable specifications are as stated previously unless the connections to the 3rd party network require different cable specifications. In this case the customer should contact Clear-Com for advice.

4.2.16 T-Adapter option to DIG-2/DIF-102 interface

Note: The information in this section no longer applies to recent version of EHX software.

The T-Adapter option module adds 2-wire digital input and output via RJ-45 to V-Series main panels. If the T-Adapter digital interface option is used to connect the V-Series main panel to the matrix it must be connected via a DIG-2 Digital Interface instead of directly to an MVX-16 analog port on the matrix.

Note: For information on the DIG-2/DIF-102 digital interface, see the DIG-2 manual and the Interface Module Frames manual.

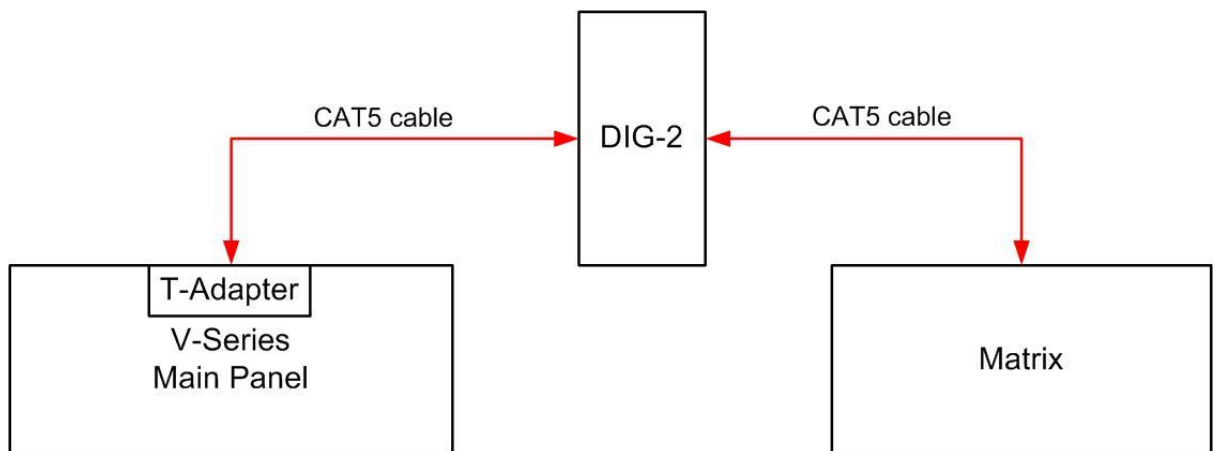

Figure 4-20: Panel with T-Adapter interface

The pinout for the CAT5 cable to connect a DIG-2 interface to a V-Series panel T-Adapter interface is given below.

Pin	Wire color	Description / function
1	White/Orange	not used
2	Orange	not used
3	White/Green	not used
4	Blue	Tx/Rx (+)
5	White/Blue	Tx/Rx (-)
6	Green	not used
7	White/Brown	not used
8	Brown	not used

Table 11: DIG-2-6 to panel wiring (T-Adapter interface)

The T-Adapter interface RJ45 connection is capable of operation with up to 3000m (10,000ft) of screened 24 AWG Cat5e cabling of 110 ohm +/- 10 ohm impedance.

If 26 AWG screened CAT5e cable is used the maximum cable run is reduced to 2,200m (7,300ft).

Note: A ferrite core must be added to the socket end of each cable. A suitable ferrite core is **Würth Elektronik part: 74271132**.

4.2.17 LAN connector

The LAN connector is an industry standard RJ45 socket that enables you to connect the panel to either a network or the Ethernet port of a PC. The LAN connection is reserved for panel firmware upgrades and future use. This port can support connection of panel to matrix with one, two or three audio channels.

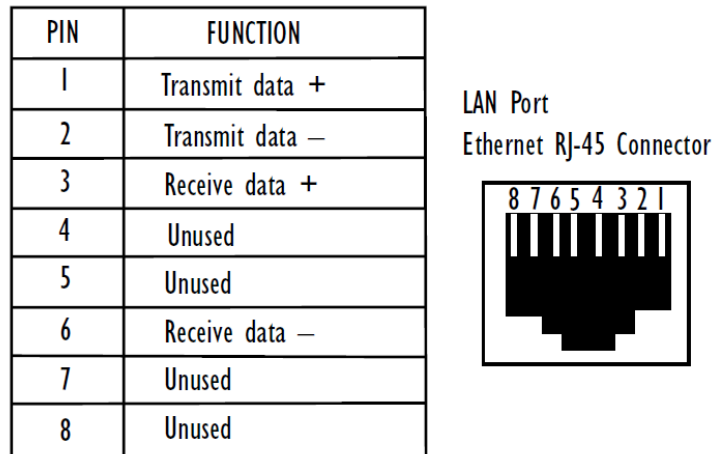

Figure 4-21: LAN connector pinout

4.2.18 Expansion panel output

V-Series main panels have an industry standard RJ45 socket allowing up to eight V Series expansion panels to be daisy chained from it.

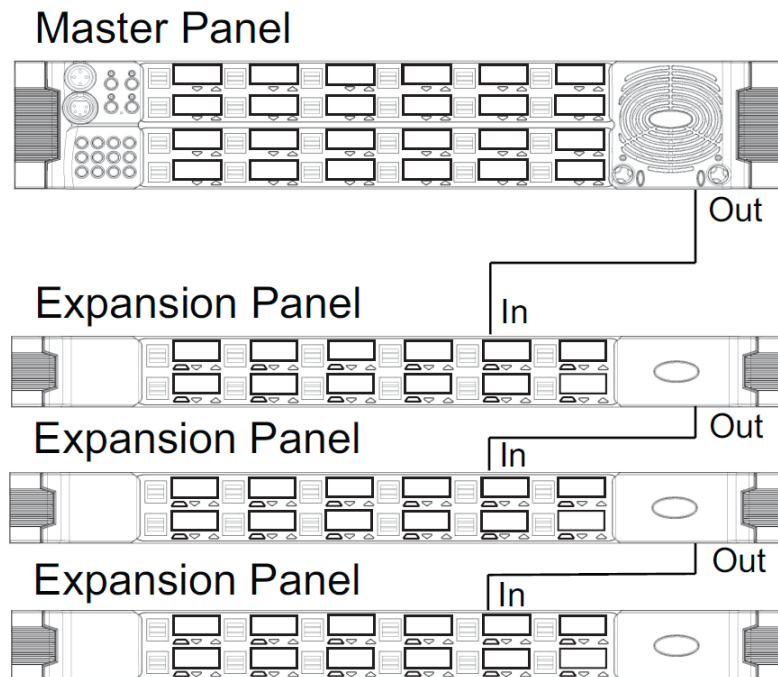
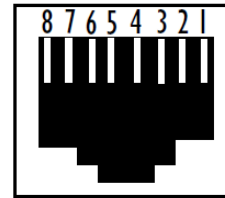

Figure 4-22: Example of daisy chained panels

The pinout for the expansion panel cable RJ45 connector is given below:

PIN	FUNCTION
1	Expansion panel detect
2	Expansion panel detect
3	0V
4	Chain length detect
5	Expansion address assign
6	Unused
7	0V
8	Expansion reset

Expansion Port
Ethernet RJ-45 Connector

**Figure 4-23: Expansion panel connector pinout**

The CAT5 cables used to connect V Series main panels to expansion panels and expansion panels to further expansion panels are wired as straight through and the same signals are present along the daisy chain.

Each cable connecting a V Series main panel to an expansion panel or an expansion panel to another expansion panel must not exceed 5 meters in length, and the total length of any expansion panel daisy chain must not exceed 7.5metres in length.

- Note:** If power is removed from an expansion panel within a chain that panel and all expansion panels after it in the chain will no longer work.
- Note:** For connections to V12LDE (regulatory model UP160), a ferrite core must be added to the socket end of CAT5 cable. A suitable ferrite core is **Fair-rite part: 0431164951.**

4.3 IP connection to matrix

All V-Series panels have a built-in Ethernet/IP interface which can support multiple independent audio channels to an HX Omega, HX Median or HX Delta via an IVC-32 matrix card. When you add a V-Series panel in the EHX Configuration Software, you are prompted to choose the number of additional IP channels that you require, see **4.3.1 Adding one extra IP channel.**

According to your choice, the EHX software automatically provides the V-Series audio mixer with default settings to make configuration as simple and fast as possible. The default mixer settings reflect the typical user scenarios, but you can also manually adjust the mixer settings in the EHX software to customize your system, or for more advanced requirements. See **4.3.4 Advanced multi IP channel configurations.**

This section describes how to implement more than one audio channel via the Ethernet/IP connection. The extra audio channels are typically used to connect to:

- A CCI-22 Interface Module for matrix to 2-wire partyline connections.

- A FOR-22 Interface Module for connecting the matrix to a 4-wire device with call signaling.
- Headsets. These can be binaural, with or without Push To Talk (PTT).

There are also more advanced options including matrix inputs and mixer control.

There are three connectors on the rear panel of the V-Series panel that can be routed to the matrix via the IP channels. These are labelled:

- Control – this is a DB25 female connector
- Aux Audio – this is a DB25 male connector
- Matrix (Analogue) – this is an RJ-45 connector

Internally, these are represented as EXT0, EXT1 and EXT2. If there is more than one IP channel, EXT0 appears at the Matrix (Analogue) connector at the rear of the panel. When two extra IP channels are added, EXT1 and Ext2 are on the cable assembly used to implement the added IP channels. If there is only one IP channel, EXT1 and EXT2 appear at the Control and Aux. Audio connectors on the rear of panel.

The following sections describe the workflow for typical scenarios where one or two extra IP channels are required. There is also a section describing more advanced configurations. See also, the *Eclipse HX Configuration Software Manual*.

4.3.1 Adding one extra IP channel

This is typically used if you want to configure the extra IP channel to connect to a 4-wire interface, or to an analogue or digital partyline. To add on extra IP channel:

- 1) From the EHX software, navigate to **Cards and Ports > IVC-32 > Port Function** and add the V-Series Panel. The following screen appears:

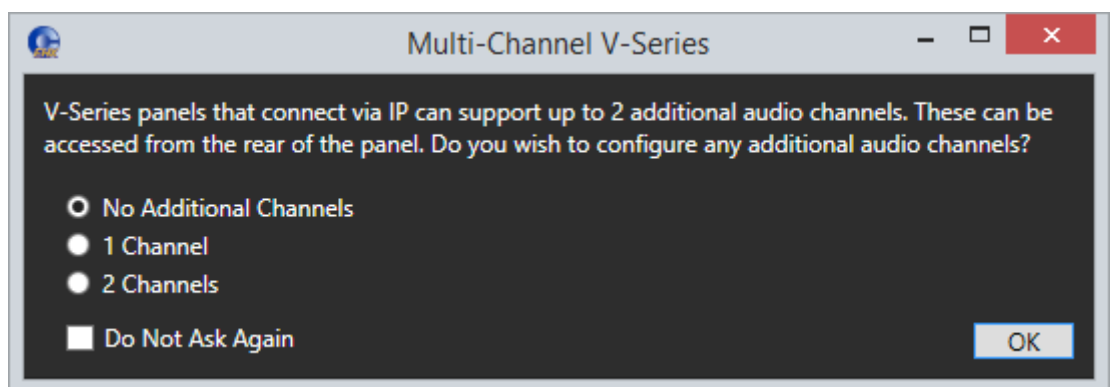

Figure 4-24 Multi-Channel V-Series

- 2) Select **1 Channel**. A port labeled **Hosted Direct** appears under the V-Series Panel.
- 3) The Audio Mixer settings automatically set the default layout for one extra IP channel.

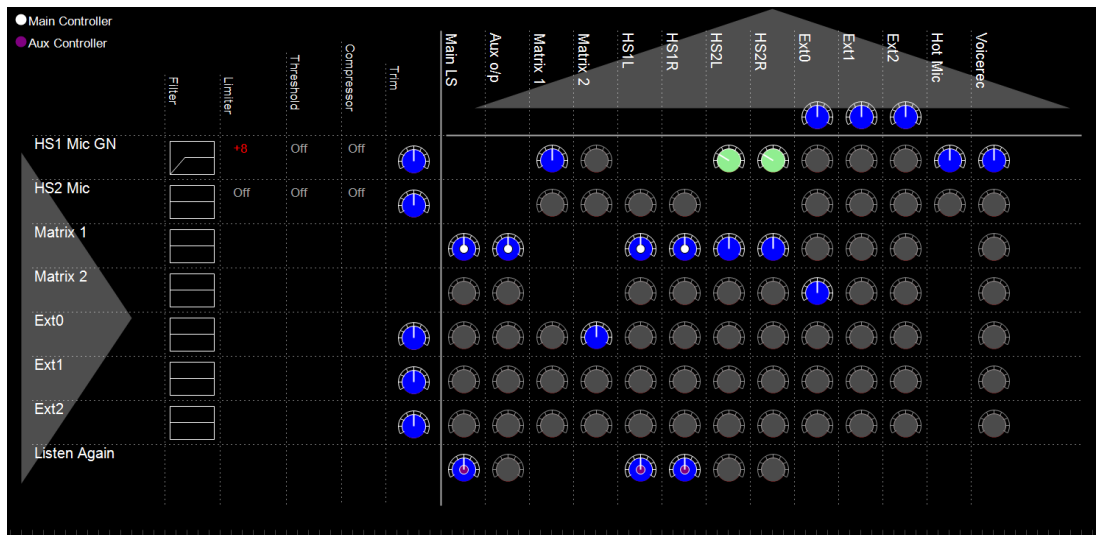
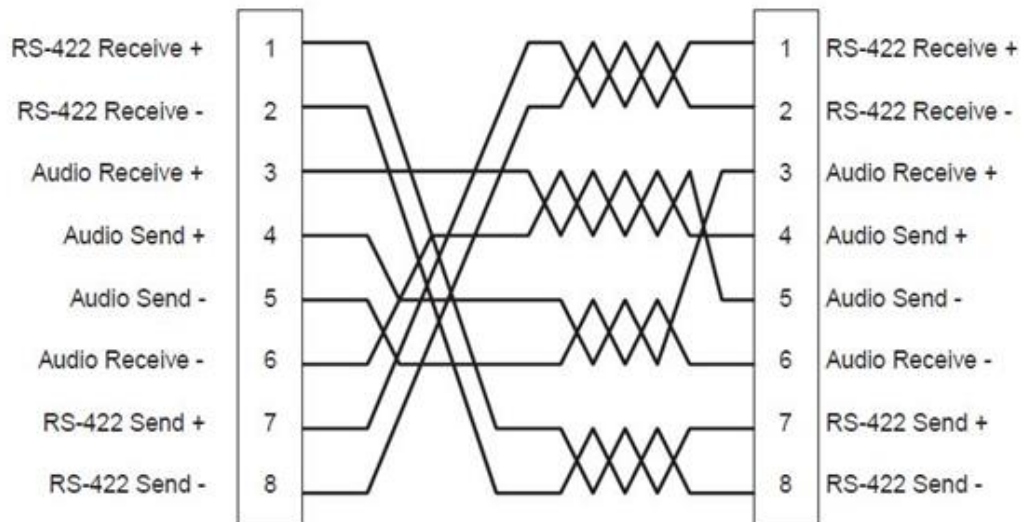

Figure 4-25 Audio Mixer for one extra IP channel

Matrix 2 is the added Hosted Direct channel. The default single IP channel mixer setting has matrix 2 audio routed to and from Ext 1. For more information about the Audio Mixer, see the *Eclipse HX Configuration Software User Guide*.

Note: If required, you can change the default settings. See **4.3.4 Advanced multi IP channel configurations**.

- 4) Connect the V-Series Panel **EXT0** connector to the FOR-22, CCI-22 or HelixNet unit using an RJ-45 crossover cable. The pinouts are shown below.

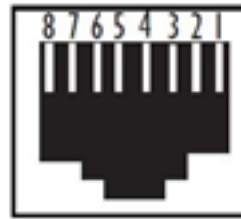

Ethernet RJ-45 Connector

**Figure 4-26 Pinouts for RJ-45 crossover cable**

By default, the extra IP channel is configured as Direct, which is used for a 4-wire connection. You can change this to make it suitable for a different application.

- 5) In the EHX software, navigate to **Cards and Ports**, and select the added IP port.
- 6) From the right-hand side of the window, select **Basic Options**.
- 7) From the Module Application list box, select from
 - **Partyline** – to connect to an analogue partyline using the CCI-22 Interface Module.
 - **Two-Way Radio** – to connect to a third-party two-way radio system by using the FOR 22 Interface Module.
 - **Direct** – to connect to a 4-wire interface.
 - **HelixNet** – to connect to the digital HelixNet partyline.

A partyline, two-way radio or HelixNet interface connected to EXT 0 in this way provides the same functionality as the same interface connected directly to an MVX port, for example call signaling Tx and Rx in the case of the Partyline port application setting.

4.3.2 Adding two extra IP channels

This is typically used if you want to configure two extra IP channels to connect to a 4-wire interface, or to an analogue or digital partyline.

Note: This configuration requires a cable assembly, see Figure 4-29. Clear-Com support can assist in the sourcing of this and similar cables.

To add two extra IP channels:

- 1) From the EHX software, navigate to **Cards and Ports > IVC-32 > Port Function** and add the V-Series Panel. The following screen appears:

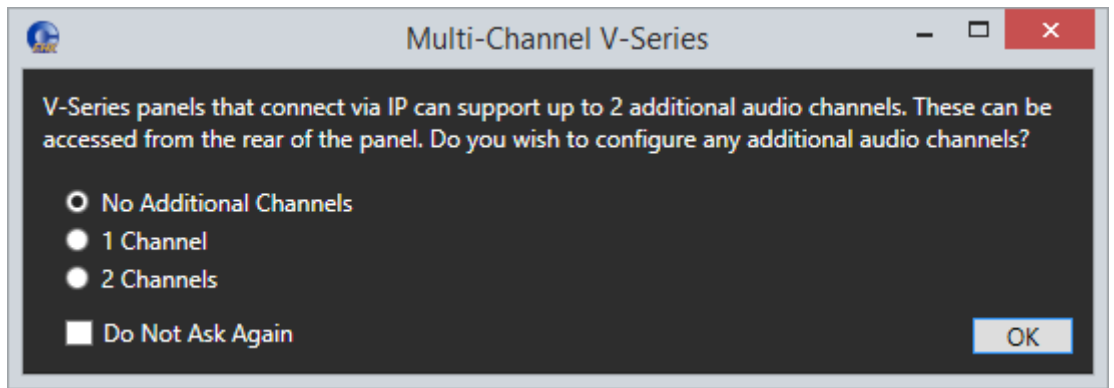

Figure 4-27 Multi-Channel V-Series

- 2) Select **2 Channels**. Two ports labeled **Hosted Direct** appear under the V-Series Panel.
- 3) The Audio Mixer settings automatically set the default layout for one extra IP channel.

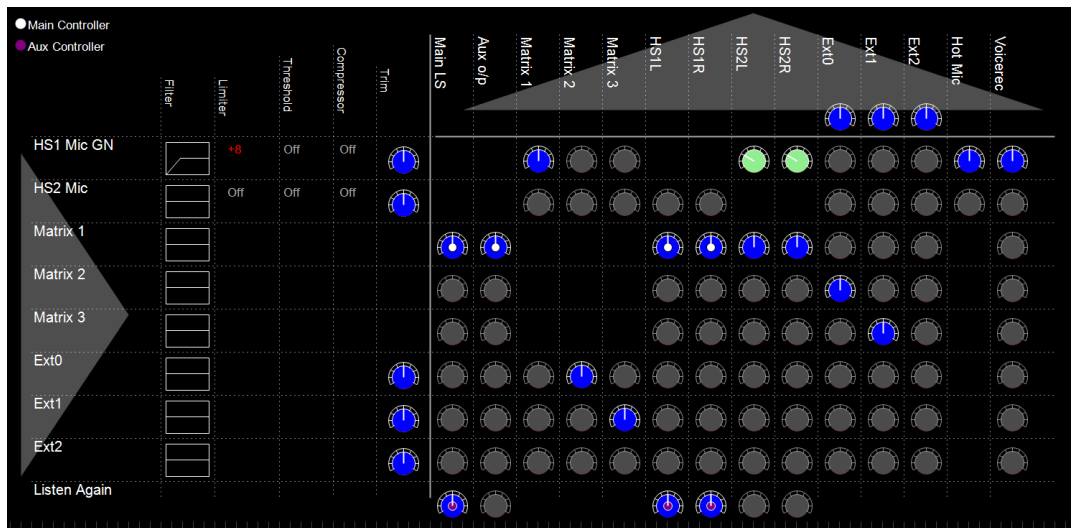

Figure 4-28 Audio Mixer for two extra IP channels

Matrix 2 and Matrix 3 are the additional IP connections to the IVC-32. The default mixer settings when two additional channels are selected are to route Ext 0 to/from Matrix 2 and Ext 1 to/from Matrix 3. This routing can be changed using the Audio Mixer. For more information about the Audio Mixer, see the *Eclipse HX Configuration Software User Guide*.

Note: If required, you can change the default settings. See **4.3.4 Advanced multi IP channel configurations**.

- 4) Connect the V-Series Panel **Matrix (Analogue)** port to the one of the ports in the IVC-32 card in the matrix using an RJ-45 crossover cable. The pinouts are shown in the section above.
- 5) Connect the third-party cable harness as follows:

- Male DB-25 connector to **Control** on V-Series panel
- Female DB-25 connector to **Aux.Audio** on V-Series panel.
- The pinouts for this connector are shown on the next page.

By default, the extra IP channels are configured as Direct, which is used for a 4-wire connection. You can change this to make it suitable for a different application.

- 1) In the EHX software, Navigate to **Cards and Ports**, and select the added IP port.
- 2) From the right-hand side of the window, select **Basic Options**.
- 3) From the Module Application list box, select from
 - **Partyline** – to connect to an analogue partyline by using the CCI-22 Interface Module.
 - **Two-Way Radio** – to connect to a third-party two-way radio system by using the FOR 22 Interface Module.
 - **Direct** – to connect to a 4-wire interface.
 - **HelixNet** – to connect to the digital HelixNet partyline.

By default, the extra IP channel is configured as Direct, which is used for a 4-wire connection. You can change this to make it suitable for a different application.

A partyline, two-way radio or HelixNet interface connected to EXT 0 in this way provides the same functionality as the same interface connected directly to an MVX port, for example; call signaling, Tx and Rx, in the case of the Partyline port application setting.

With this default mixer setting FOR-22 or CCI-22 can be connected to EXT0 and EXT1. This setting supports both Call signaling and/or PTT signaling to the external device.

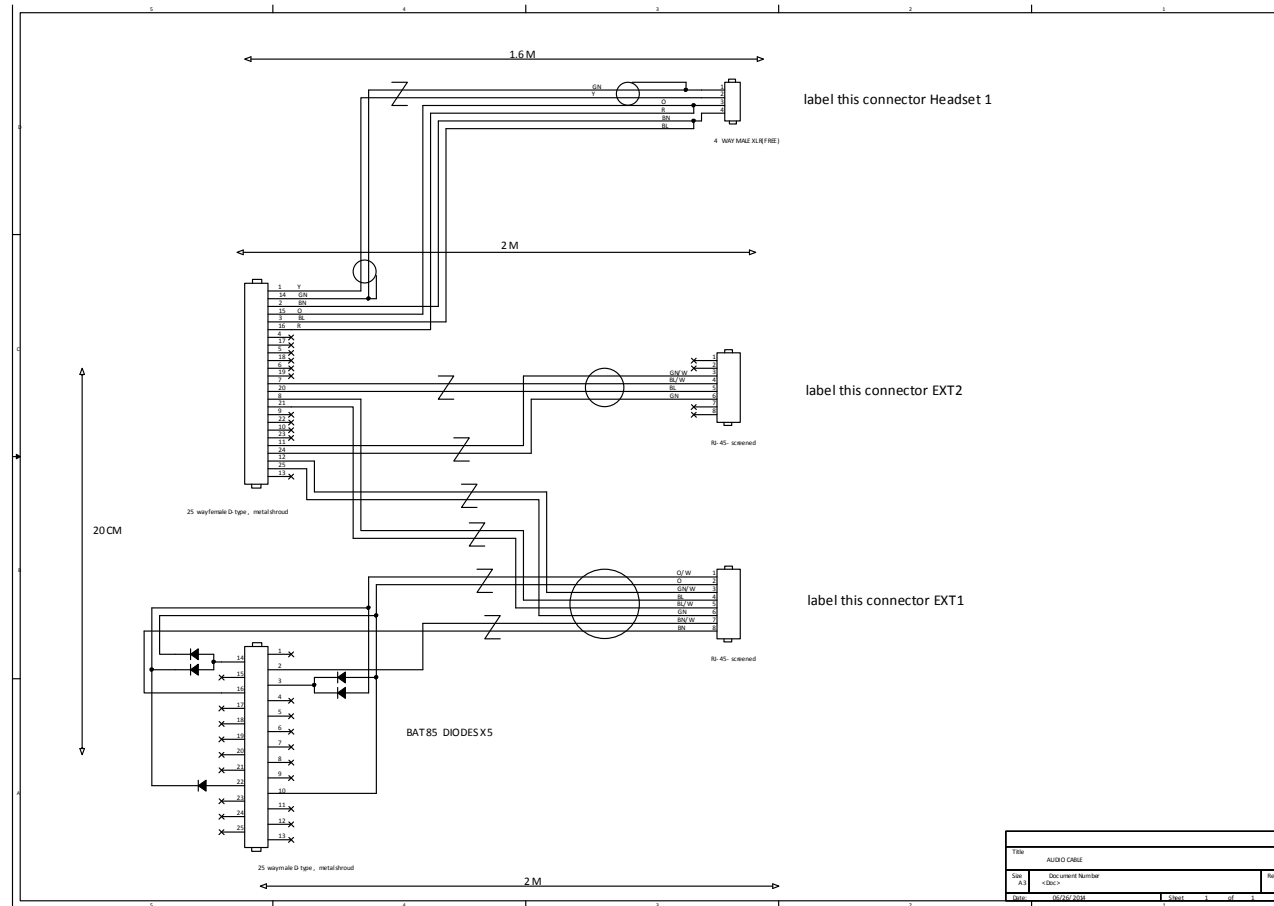

Figure 4-29 Pinout diagram for cable harness

4.3.3 Binaural audio

If you configure the panel for binaural audio, the following default mixer settings appear in the panel Audio Mixer. This mode is useful for situations when you require separate audio channels in the left and right headphone inputs.

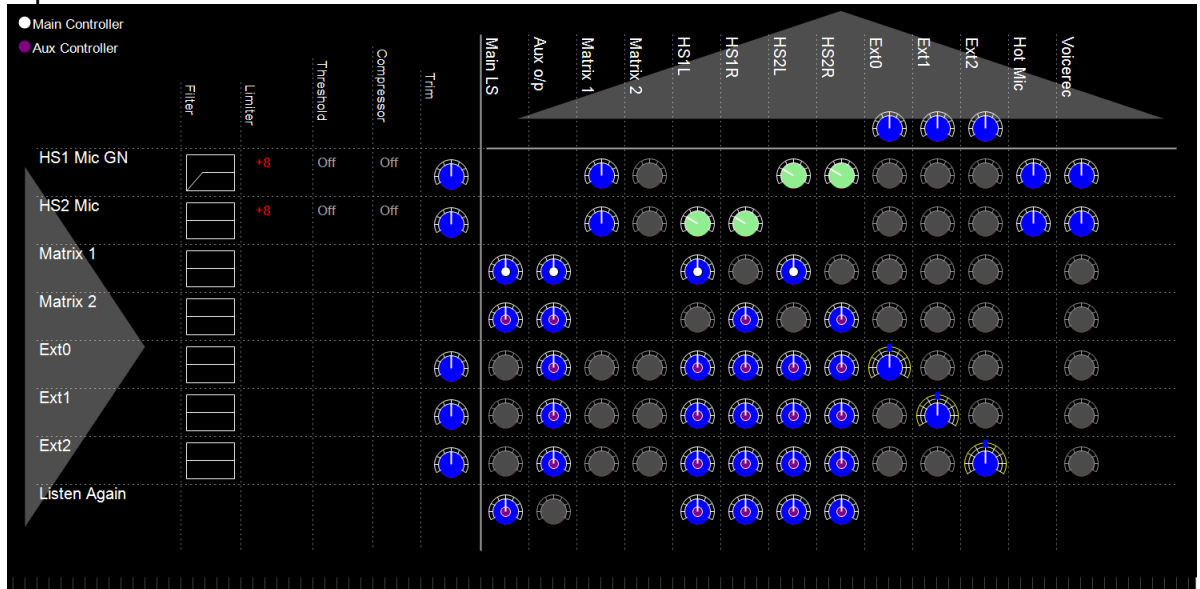

Figure 4-30 Audio Mixer for binaural

4.3.4 Advanced multi IP channel configurations

The additional one and two IP channel configurations automatically activate default settings in the Audio Mixer when they are selected in the EHX software. You can change these default settings to create a custom configuration. For example, you can change the default routing in the Audio Mixer.

When port applications other than direct are selected for the hosted ports panel, GPIOs will be automatically allocated by the software to provide the requested functionality, for example call signal in the case of partyline. These GPIOs will continue to be available in the EHX GPI and GPO screens and the logic of the parallel usage will be OR'd.

For more information about using the Audio Mixer, see the *EHX Configuration Software User Guide*.

4.4 Front panel connectors

The V-Series main panels have a microphone connection and a headset connection on the front.

The microphone connection is always a three pin socket while the headset connector may be an **XLR-4M**, **XLR-5F** or **XLR-7M** connector.

The pinouts for the connectors are given below.

4.4.1 Microphone connector

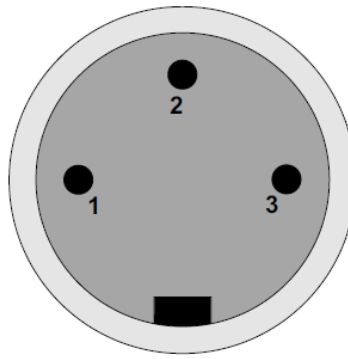

Figure 4-31: Microphone connector

Pin	Description / comments
1	Screen
2	Microphone input +
3	Microphone input -

Table 12: Microphone connector pinout

Note: Configuration of the wrong type of microphone or headset will degrade or nullify the audio from the panel or worse still, damage the microphone or headset.

4.4.2 Headset connectors

The headset connector may be one of three types: **XLR-4M**, **XLR-5F** or **XLR-7M**.

The pinouts for each type are shown below.

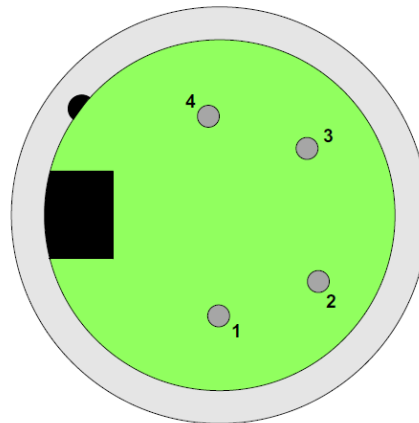

Figure 4-32: XLR-4M headset connector

Pin	Description / comments
1	Microphone Screen
2	Microphone Input
3	Headphone Return
4	Headphone Output

Table 13: XLR-4M headset connector pinout

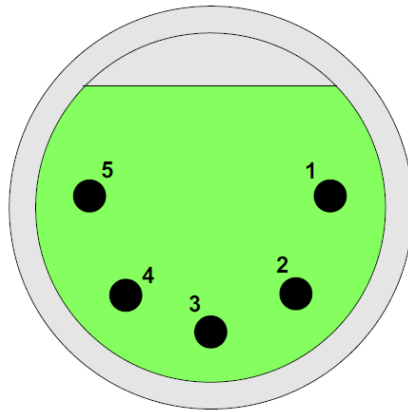

Figure 4-33: XLR-5F headset connector

Pin	Description / comments
1	Microphone Screen
2	Microphone Input
3	Headphone Return
4	Left Headphone Output
5	Right Headphone Output

Table 14: XLR-5F headset connector pinout

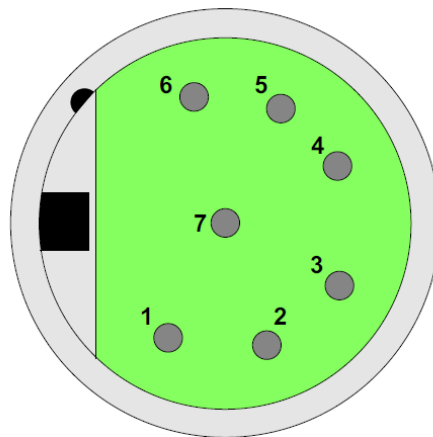

Figure 4-34: XLR-7M headset connector

Pin	Description / comments
1	Microphone -ve
2	Microphone +ve
3	Ground
4	Left Headphone Output
5	Right Headphone Output
6	PTT1
7	PTT2

Table 15: XLR-7M headset connector pinout

Note: Configuration of the wrong type of microphone or headset will degrade or nullify the audio from the panel or worse still, damage the microphone or headset.

The PTT1 and PTT2 functions on an XLR-7 headset or a second headset connected via the auxiliary audio connector are connected to the logic 1 and logic 2 inputs.

Headset 1 PTT 1 or headset 2 PTT 1 active will have the same effect as Logic 1 active.

Headset 1 PTT 2 or headset 2 PTT 2 active will have the same effect as Logic 2 active.

PTT is activated by grounding the PTT line.

4.5 Mains AC Power

The panel has a separate, external DC power supply.

The power supply is **universal**, operating over a voltage range of 100 to 240 VAC and 50 to 60 Hz. The maximum power dissipation is 50 W.

A bracket has been provided to mount this external supply if necessary.

4.6 Panel parameters in ECS / EHX

The following panel parameters are adjustable by selecting options in ECS / EHX:

- Panel Headset Microphone Gain
- Headset 2 Microphone Gain
- Panel Microphone Gain
- Input Level (Volume)
- Output Level (Volume)
- Aux Level (Volume) Off Limit
- Main Level (Volume) Off Limit
- Speaker Dim
- Page Volume Level
- Headset Detect Loudspeaker Cut

All these parameters are set to factory defaults. Most panels should operate at these default setting. However, some applications may required adjustment.

4.6.1 Headset sidetone

Sidetone is the sound of the user's voice in his headset.

For information about adjusting sidetone, see your *ECS / EHX documentation*.

4.6.2 Headset autodetect

V-Series panels can autodetect headsets 1 and 2 and automatically enable them. Headset auto detect can be set to enabled or disabled via a DIP switch (SW2) on the main board. As headset insertion can cause a noise on the panel some users may wish to disable automatic headset detect and use the front panel button instead to enable and disable the headsets.

To access the DIP switch the rear cover must be removed from the panel.

The DIP switch is located on the right hand edge of the main PCB (looking from the rear) behind the headset connector.

Panel Front

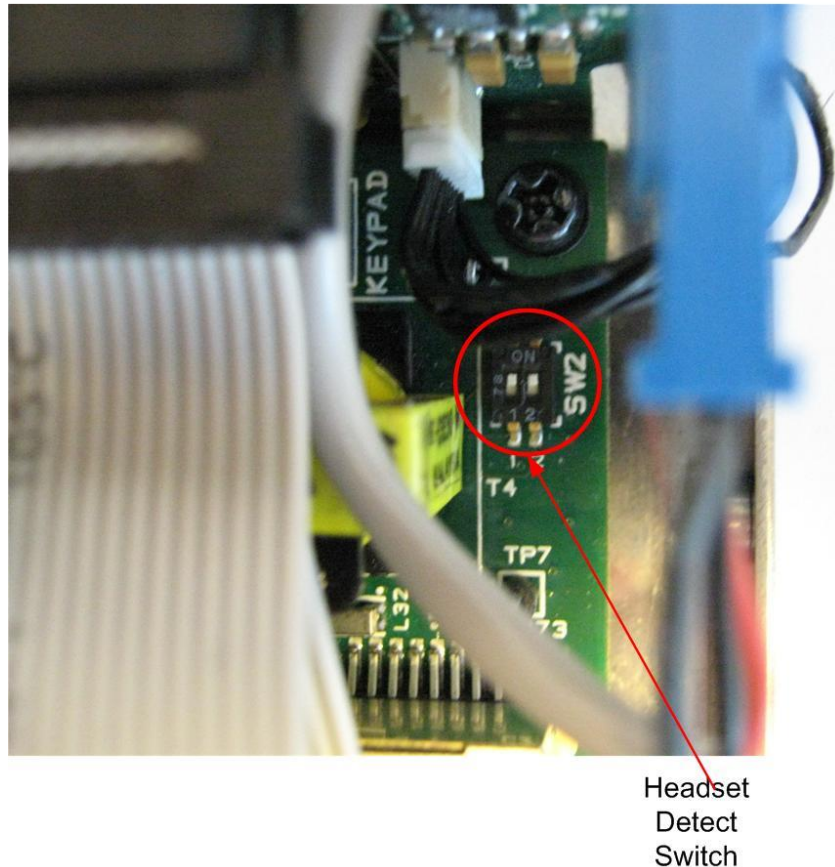
Headset
Detect
Switch**Figure 4-35: DIP switch location (headset detect)**

Headset 1 auto detect is controlled by switch 1 on SW2 and headset 2 auto detect is controlled by switch 2 on SW2.

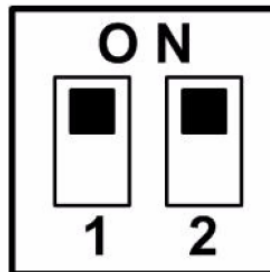
**Figure 4-36: Headset detect DIP switch settings**

To enable headset auto detect for a headset set the appropriate switch to **ON** (towards the front of the panel).

To disable headset auto detect set the appropriate switch to **OFF** (towards the rear of the panel).

4.6.3 Panel microphone gain

The preamplifier gain of the panel microphone can be adjusted over a range of +20 to +70 dB; the panel microphone gain's default setting is 50 dB. However, if two panels are talking to each other at the same time with the panel microphone gain set to maximum, feedback may occur even if the speaker dim is set to maximum in ECS / EHX.

In this case, it will be necessary to turn the panel microphone gain down. Similarly, in some noisy environments it may be necessary to turn the panel microphone gain down and have the operator talk more closely into the microphone.

Note: For information on adjusting panel microphone gain, see your *ECS / EHX documentation*.

4.6.4 Speaker dim

When a panel microphone and a speaker are used together, feedback is possible.

To reduce this possibility, the panel software will mute (turn down) the speaker level by some predetermined amount when both the microphone and speaker are enabled. The speaker mute can be adjusted from 0 to 15 dB (its default setting is 6 dB).

Note: For information on adjusting speaker mute settings, see your *ECS / EHX documentation*.

4.6.5 Page Override

When Page Override is assigned to a label, the audio level at the destination panel(s) is predetermined.

This function enables you to talk to someone even if their panel volume control is off (if the destination speaker was off, it will turn on).

The panel speaker output will operate at the predetermined level regardless of the volume control setting, unless this control is set higher than the predetermined level.

The page volume level can be adjusted from 0 to 10 in steps of 1 with 0 being off and 10 being full volume. The page volume level's default setting is 5.

Note: For information about enabling Page Override, see your *ECS / EHX documentation*.

4.7 Panel-to-matrix card baud rate

The RS-422 serial data communication between a panel and other devices operates at 19.2 k baud by default.

5 Using the Front Panel Controls

This chapter describes the functionality of the V-Series front panel controls in detail, including the small functional differences between lever key panels, pushbutton panels and rotary control panels.

Note: For a brief description of all the V-Series panels covered by this guide, including product numbers, see **Table 1: V-Series Panels covered by this guide**.

5.1 Mic On

The **Mic On/Off** button turns the currently selected microphone (gooseneck microphone or headset microphone) on or off.

When the microphone is, on the **red** LED will come on to indicate that the microphone is active. If a panel key is used to establish a talk connection the panel microphone is automatically enabled and the indicator light is lit.

When the connection is terminated the microphone is automatically disabled.

5.2 Shift Page

By momentarily pressing and releasing the **Shift Page** button, you can toggle between the main page and the currently selected shift page.

When you press and hold the Shift Page button for more than 500ms, the panel is placed in **Shift Page mode**. The Shift Page menu is shown on the display and the **red** indicator LED is lit.

From the EHX Software, you can also enable the shift button to cycle through consecutive shift pages.

The software now supports named shift pages. This allows the user to give any shift page a 1 - 10 character name to better identify the use of the page. See EHX user guide for information on the naming of shift pages.

From the EHX Software, you can select two shift page options:

- Selectable Shift Page
- Cyclic Shift Pages

To find these options in the EHX Software, navigate to:

Configuration > Preferences > Panel & Key Operation

The V-Series Specific Settings area is located at the bottom of the Panel & Key Operation window.

Note: If you latch any key on a shift page, it remains latched if you select a different shift page.

Note: Shift Page Mode: when the Shift Page Menu is open, the keys on the panel will be color coded.

- Bright green: page currently selected
- Dim green: keys are configured on the page

5.2.1 Selectable Shift Pages

If this option is enabled in EHX software, the shift button behaves as follows:

- From the Main page (page 0), a short press or tap displays the last selected shift page. If no shift page has previously been selected, the panel displays shift page 1. The Shift LED is lit.
- To return to the Main page, short press or tap the shift button. The Shift LED is off. Pressing and releasing the shift page button toggles between the Main page and the last selected shift page.
- From the Main page, a long press (more than 500 ms) displays a list of shift pages on the panel display, with an underline on the last selected shift page. Use the panel button, switch or lever to select any shift page. The Shift LED is lit.
- To return to the Main page, short press or tap the shift page. The Shift LED is off.

5.2.2 Cyclic Shift Pages

If this option is enabled in EHX Software, the shift button behaves as follows:

- From the Main page, a short press or tap displays the next consecutive shift page in ascending numerical order.
For example, if you have a main page with five shift pages numbered as follows: **M, 1, 2, 3, 5**, then a short press or tap on the shift button will cycle through the shift pages as follows:
M, 1, 2, 3, M, 1, 2, 3 and so on.
Only consecutive pages are cycled, so 5 is not cycled, but can still be accessed using the shift menu.
- Note:** The Shift LED is lit on any page other than the Main page.
- Note:** If shift pages have Local Assignment enabled, a shift page can cycle even if no keys are assigned to it. For more information, see the **EHX Software User Guide**.
- From the Main page, a long press (more than 500 ms) displays a list of shift pages on the panel display. Use the panel button, switch or lever to select any shift page. The Shift LED is lit.
 - After selecting a page, short press or tap the shift button to cycle consecutive pages or long press to return to the list of shift pages.

5.3 Headset Select

The Headset Select button enables you to select the panel headset for audio output.

When you have selected a headset, the **red** LED indicator is lit. The panel microphone is deselected, if active.

5.4 Menu

V-Series panel functions are configured in **Menu mode**. You enter Menu mode by pressing and releasing the **Menu** button.

When the panel enters Menu mode, the display windows are cleared of labels and the panel menus are displayed. The **blue** menu LED is lit.

To exit an active menu, press the Menu button again.

Note: Access to some panel menus can be disabled in ECS (Eclipse Configuration Software) / EHX (Eclipse HX configuration software) through **Advanced Settings > Menu Options** in **Cards and Ports**. A PIN code (set in the configuration software) must be entered to disable access to these menus. When the PIN code is entered on the panel, access is granted. For more information, see your *ECS / EHX documentation*.

5.5 LS Main levels (volume) control

The **main levels (volume) control** comprises a rotary encoder with push-switch action and a tri-color loudspeaker volume indicator LED.

The LED volume indications are:

- **Red** - high volume.
- **Amber** - intermediate volume.
- **Green** - low volume.

Turn the volume control clockwise to increase the loudspeaker volume and anticlockwise to decrease loudspeaker volume.

The loudspeaker cut indicator LED is lit **red** when the loudspeaker output is muted. Press the volume control to toggle the loudspeaker cut.

5.6 Auxiliary levels (volume) control

The **auxiliary panel levels (volume) control** comprises a rotary encoder with push-switch action and a tri-color loudspeaker volume indicator LED. The LED volume indications are:

- **Red** - high volume.
- **Amber** - intermediate volume.
- **Green** - low volume.

The auxiliary levels (volume) control sets the volume on the optional external loudspeaker that you can connect to the auxiliary audio port on the rear of the panel. Turn the volume control clockwise to increase the loudspeaker volume and anticlockwise to decrease loudspeaker volume.

Press and release the auxiliary volume control to play back messages stored on the **Listen Again** system (see next section).

5.7 Listen Again

Note: The **Listen Again** feature is configured in ECS / EHX. For more information, see your *ECS / EHX documentation*.

Pressing the auxiliary volume control switch momentarily activates the **Listen Again** feature. The last stored audio will be replayed (this feature is configured in ECS / EHX).

Repeatedly pressing the auxiliary volume control will step back through the stored messages.

5.8 Up / Down buttons on lever key and pushbutton panels

There is a pair of buttons to adjust the volume level on the connection beneath each key display window on lever key and pushbutton panels (see **Figure**

3-17: Lever key display window controls and **Figure 3-18: Pushbutton key display window controls**).

Use the left (**Down**) button to reduce the volume and the right (**Up**) button to increase the volume.

You can also use the volume buttons to release a **telephone line**, in the same way as the **TEL RELEASE** function in the diagnostic menu.

To release the telephone line, press both of the Up and Down buttons together. The label display changes to **TEL RELEAS**, and the telephone is put back on the hook. All latched keys on the local system are unlatched, killing all routes to the telephone. After approximately 5 seconds, the display starts displaying the configured label again.

If the panel does not have Remote Line Release configured, then the call signal is sent to the label instead.

Note: The volume buttons are also used to adjust some settings that are accessed through the panel menu, such as **Sidetone Gain**.

5.9 Alternative text key

Within the EHX software, you can define alternate text for display on a panel. You can then assign an Alt Text key on the panel.

When selected it will turn red, and inverse video. If alternate text is available for that label the panel will show this.

Alias, VSM and PM text labels will override whichever state the panel is in.

One possible use of alternate text is to set up a dual language configuration on the panel, for example to allow panels to display Arabic by default in a particular Middle Eastern broadcast installation. English speakers could then select the Alt Text key on a panel to see the English equivalents to the Arabic labels.

Another use could be that both the role name and user name could be configured for each panel or belt-pack port. This would allow panel users to see either the name or the role depending on the Alt Text mode selected.

You can enter alternate text on all the entity screens. The column with the text can be shown or hidden from EHX using the button in the Port List options. See Figure 4-1 below.

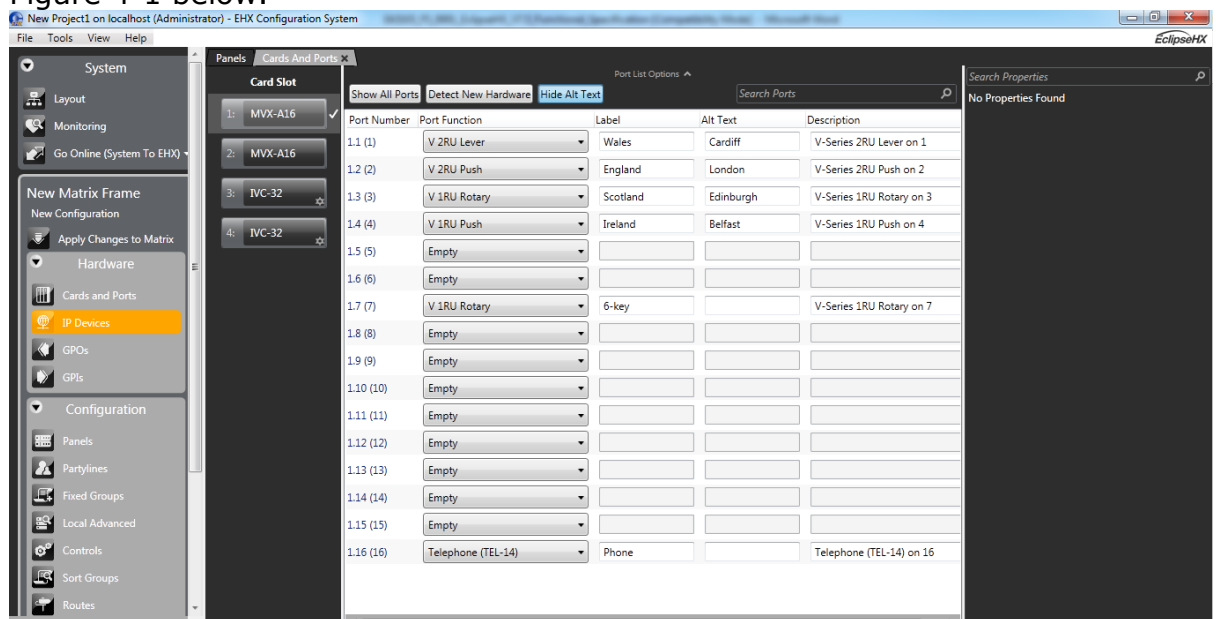

Figure 5-1: EHX Port List Options

5.10 Rotary control on rotary panels

The rotary control located next to the key window display on rotary panels is used to adjust the volume on the connection. Turn the rotary control clockwise to increase the volume and anticlockwise to decrease the volume.

Holding the talk key and turning the rotary adjusts the IFB send level.

You can also use the rotary control to release a **telephone line**, in the same way as the **TEL RELEASE** function in the diagnostic menu.

To release the telephone line, press and hold the rotary control.

The label display changes to **TEL RELEAS**, and the telephone is put back on the hook. All latched keys on the local system are unlatched, killing all routes to the telephone. After approximately 5 seconds, the display starts displaying the configured label again.

If the panel does not have Remote Line Release configured, then the call signal is sent to the label instead.

Note: The rotary control is also used to adjust some settings that are accessed through the panel menu, such as **Sidetone Gain**, and scrolling through lists.

5.11 Dial pad (2RU and desktop panels)

Use the dial pad on 2RU panels and desktop panels to:

- Access some menu pages directly (as a shortcut).
- Enter dialcodes, to dial out through a telephone interface, such as the TEL-14 interface module.

The menu shortcuts available from the dial pad are as follows:

Dial pad key	Menu shortcuts
1	Dial menu
2	Local Exclusive
3	Local page override
4	Assignment Panel menu
5	Local Key Assign menu
7	Local Preferences menu
8	Fast Key Assign menu
9	Diagnostics menu

Table 16: Dial pad menu shortcuts

When the dial pad keys are used to access a menu function, the **blue** menu LED is lit.

5.12 Push-To-Talk (PTT) operation

Push-To-Talk (PTT) operation on V-Series panels is performed using a PTT switch on either:

- The panel headset.

- The auxiliary audio connector on the rear of the panel.

The operation of PTT on the V-series panels is configured in **Logic Input Options** ECS / EHX. You can set the Headset PTT Function to one of three options:

Option	Description / comments
No Function	The headset PTT does not activate any talk or listen routes.
Activate All Talk Keys	The headset PTT activates the audio routes for all latched talk keys. Unlatched talk and listen keys are not activated.
Activate Two-Way Radio Talk Keys	The headset PTT activates the audio routes on all latched talk keys attached to two-way radios. Unlatched talk keys and listen keys are not activated.

Table 17: Headset PTT options

5.13 Status LEDs (Tallies)

Status LEDs (tallies) indicate the status of a key, audio route, or menu option.

Note: In the case of lever key panels, the status LEDs are set under the display windows. In pushbutton panels, the push buttons themselves act as status indicators, and there are no separate LEDs. In rotary panels, the rotary controls and the talk buttons act as status indicators.

The status LEDs (tallies) signal the following:

LED action / state	Description / comments
Solid red	A talk path (audio route) is active.
Solid green	A listen path (audio route) is active.
Solid amber	A talk and listen path (audio route) is active.
LED is off	Key is either not configured or the menu option is not selectable.
LED flashing	Either user action is required, or there is an incoming call or call signal.
LED is dim red	Key is configured as a talk key or a menu option is selectable.
LED is dim green	Key is configured as a listen key or menu option is selectable
LED is dim amber	Key is configured as a talk and listen key or menu option is selectable.
LED is blue	Menu mode is active.

Table 18: LED actions / states

Note: Specific information on the operation / action of status LEDs (tallies) is provided by sections describing specific functionality and / or menu operations.

5.14 Communication errors

If the panel loses data communication with the matrix, the following message is displayed:

Waiting for Eclipse

When data communication is restored, the panel automatically returns to normal operation.

5.15 Lever key panels

Lever keys can:

- Have both talk and listen labels assigned to the same key in ECS / EHX.
- Be used as either talk or listen keys, depending on whether the key is moved up or down. If the key is moved upwards then the listen function is selected while if the key is moved down then the talk function is selected.

The lever keys normally default to latching unless the non-latching option is configured in ECS / EHX under **Global Settings (Latch Disable set to True)** for the destination port. In the default state (latching), pressing the lever key momentarily up or down latches the key.

If you hold the lever key in the talk or listen position for more than 200ms, the lever key does **not** latch and the connection terminates as soon as the key is released.

When the key is inactive, the talk/listen status indicator below the key is lit **amber**. When a talk path is active (key pressed down) the status light is lit **red**, and when a listen path is active (key pressed up) the status light is lit **green**.

An incoming call to the panel will cause the Reply key indicator to **flash red**. To take the call, press the reply key down. To clear the call press the Reply key up.

5.15.1 Reply key general purpose input (GPI) functionality on lever key panels

If you connect a footswitch (or other type of switch) to GPI 3, which is pre-assigned to the Reply key, the panel clears the item that is currently being viewed on the reply stack when you release the switch.

You can use the Reply key up/down to scroll through the Reply key stack if more than one call is present on the answerback stack. To move to the next call, press the up button. To return to the previous call, press the down button. For more information, see [Opto-Isolated Inputs] and your *ECS / EHX documentation*.

5.15.2 V32LD function keys

The V32LD panel has programmable function keys.

Use the default settings or change the key operation settings in the EHX configuration software.

Default settings	
F1	Scrolling assign: scroll through Sort Groups and choose which member of the group to communicate with.
F2	Alt text: toggle between text labels and alternative text labels. For example; toggle between English and French, or role name (lighting) and person name (John).
F3	Message menu: access the menu that allows you to control message function options.
F4	Reset crosspoint gain. Reset volume adjustments on all audio sources coming into the panel to 0dB.

Table 19 VL32LD function key default options

V32LD function key options

V32LD function keys can be set in the EHX configuration software to perform the following tasks:

Function key options		
Option	Description	Function key LED behavior
Activate all pre-selected Talk keys.	When this option is selected, no configured audio routes are activated for latched keys until the associated function key is pressed (and held).	LED is on while the key is pressed.
Activate all pre-selected two-way radio Talk keys.	When this option is selected, no configured audio routes to two-way radios are activated until the associated function key is pressed (and held).	LED is on while the key is pressed.
Activate configured action	This option allows the user to allocate a control sequence or macro to a function key. Use the EHX configuration software to generate control sequence. See the <i>Eclipse EHX Software User Guide</i> .	LED is on while the key is activating the control sequence. Note: this is not the same as indicating when the control is active, if the control is activated via another means then the LED will not be lit.

Reset panel crosspoint gains to OdB.	Opens the Reset Xpts (Yes/No) dialogue box. Selecting Yes resets the volume adjustment on all incoming audio sources to OdB.	LED is on while the Reset Xpts menu is open.
Alternate text	Enables/disables the Alt Text mode on the panel. Pressing this key will cause the key displays to show alternative text. Press the key again to return to standard text.	LED is on while the Alt Text mode is enabled.
Scrolling assignment	When this option is selected, pressing the function key will result in all keys programmed with Sort Groups flashing. You can then use the up and down keys on the Keypad controls to scroll through group members. When a group member is visible in the key display, Talk and Listen to that member.	LED is on while Scrolling Assignment mode is enabled. Pressing the function key again will exit from scrolling assignment mode. This mode has a 10 second timeout.
Supervisor	When this option is allocated to a function key, pressing the key will enable the first stage of Supervisor mode. See Supervise mode in the <i>Eclipse V-Series User Guide</i> .	LED is on while Supervise mode is enabled. To exit Supervise mode, press and hold the Menu key. Please note that the method of exiting Supervise mode is not the same as for other function keys.
Message menu	Access the menu that allows you to control message function options.	LED is on while the Message menu is open.

Table 20 V32LDE function key options (can be set in EHX software)

5.15.3 Change function key options on a V32LD panel

Use the EHX configuration software to change function key settings on a V32LD panel.

Open EHX and navigate to **Cards and Ports**.

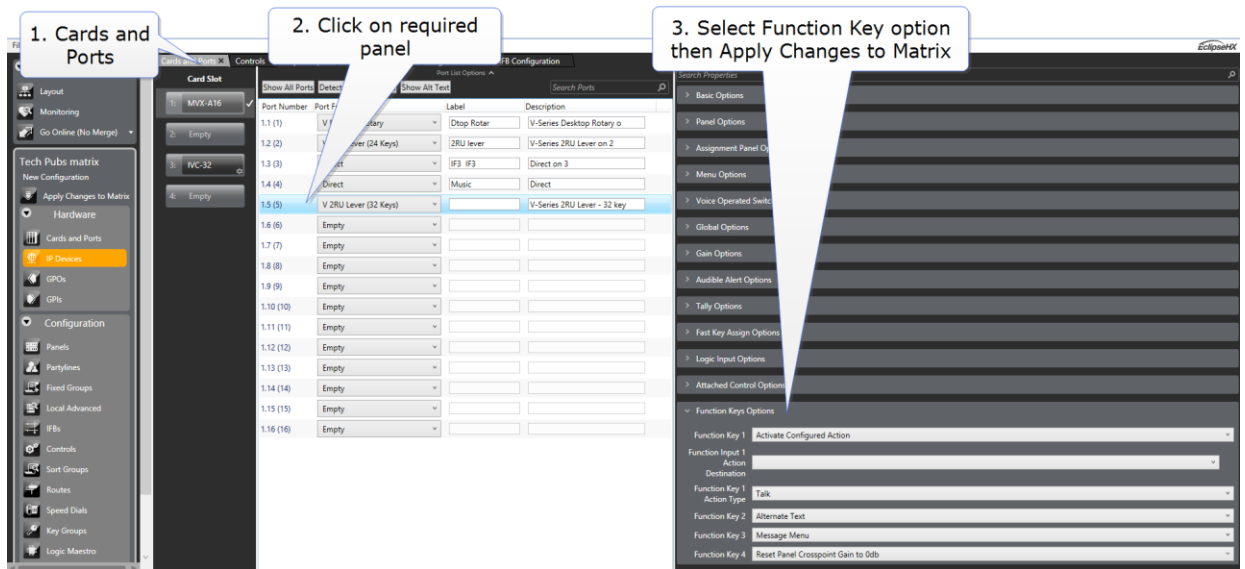

Figure 5-2 Change function key options in EHX

5.15.4 Using a Scrolling Assignment function key on a V32LD panel

The Scrolling Assign feature allows you to scroll through members of a Sort Group in order to access individual group members quickly.

This is the default option on Function Key 1.

To use Scrolling Assign, Sort Groups must be already created and assigned to a panel key. This is done in the EHX configuration software. See *Eclipse EHX Configuration Software User Guide* for more information.

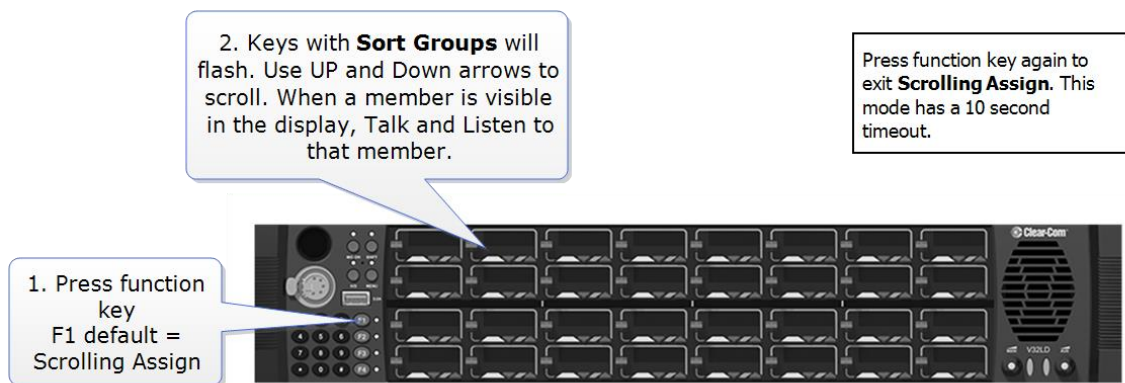

Figure 5-3 How to use Scrolling Assignment mode

Note: When in Scrolling Assign mode, pressing the Assign lever key will have the same effect as pressing the function key again; you will exit the mode and return to normal operation.

5.16 Pushbutton panels

Pushbuttons are **either** talk or listen keys, according to how they have been assigned in ECS / EHX.

Pushbuttons normally default to latching unless the non-latching option is configured in ECS / EHX under **Global Settings (Latch Disable set to True)** for the destination port. In the default state (latching), pressing the button momentarily latches the key.

If you hold the pushbutton for more than 200ms, the lever key does **not** latch and the connection terminates as soon as the key is released.

When the pushbutton is inactive, the pushbutton is lit either **dim red**, **green** or **amber** (depending on whether it is configured as a talk (**red**), listen (**green**) key, or talk and listen (**amber**) key.

When the pushbutton is active, the pushbutton is lit either **bright red**, **green**, or **amber**, according to how it is assigned.

To cancel a connection, press the pushbutton. The button returns to dim illumination.

An incoming call is signaled by a **flashing red** Reply pushbutton. To pick up the call, press the Reply pushbutton.

5.16.1 Pushbutton Reply key GPI operation

Connecting a footswitch (or other type of switch) to GPI 3, which is pre-assigned to the Reply key, the panel will **not** clear the item that is currently being viewed on the reply stack when you release the switch.

You can use the Reply key up/down to scroll through the Reply key stack if more than one call is present on the answerback stack. To move to the next call, press the up button. To return to the previous call, press the down button. For more details, see **7.2.13 Opto-isolated inputs** and your *ECS / EHX documentation*.

Note: For an audio block diagram for V-Series panels, see **Figure 5-6: V-Series audio block diagram**. The diagram shows all the allowed audio routes and valid crosspoints allowed by V-Series panels. Some of the audio paths shown by the diagram are only available with the audio mixer function in ECS / EHX.

5.17 Rotary panels

Rotary panels can have talk and listen labels assigned to the same key in ECS / EHX. The talk and listen functions are divided between the rotary control (listen) and the pushbutton under the display (talk).

If the rotary control is pressed then the listen function is selected. The rotary control light is lit **green**.

If the pushbutton (talk button) under the display is pressed, then the talk function is selected and the talk button is lit **red**.

If listen is latched while talking, then the rotary control is lit **green** and the pushbutton (talk button) is lit **red**.



Figure 5-4: Rotary panel display: latched listen while talking

5.17.1 Using rotary panel keys

By default, the talk label is displayed on a key, unless a listen only label is configured for the key.

In assignment panel mode, the talk labels are shown on possible IFB destinations and the listen labels are shown when the user is selecting an IFB source.

The rotary control and talk button normally default to latching unless the non-latching option is configured in ECS / EHX under **Global Settings (Latch Disable)** set to **True** for the destination port.

In the default state (latching), pressing the rotary control or talk button momentarily latches the key.

If you hold the rotary control or talk button for more than 200ms, the key does **not** latch and the connection terminates as soon as the key is released.

When the rotary control is inactive, the center of the control is lit **dim green**.

When the talk button is inactive, the button is lit **dim red**.

If the brightness control is turned down further, the dimmed lighting of the rotary control and talk button is turned off entirely.

When you press the rotary control to establish a listen route, the center of the control is lit **bright green**. When you press a talk button to establish a talk route, the button is lit **bright red**.

To cancel the connection press the rotary control or talk button.

An incoming call is signaled by a **flashing red** Reply key talk button. To pick up the call press the reply key talk button.

5.17.2 Rotary panel Reply key

The Reply key on a rotary panel can be overwritten with other talk and listen labels in ECS / EHX without being deleted. This enables the creation of:

- 12 listen and 12 talk pairs for each 1RU panel.
- 24 listen and 24 talk pairs for each 2RU panel.

If you enter Menu mode and the reply key has been overwritten / is no longer available, the **Assignment Panel (AP)** functions are disabled. If the labels placed on the Reply key are removed in ECS / EHX, the Reply key becomes available again and Assignment Panel functions are restored.

You can use the Reply key rotary control to scroll through the Reply key stack if more than one call is present on the answerback stack. To move to the next call, turn the rotary control clockwise. To return to the previous call, turn the rotary control anticlockwise.

5.17.3 Assignment Panel (AP) mode and the INTERCOM key

Assignment Panel (AP) mode is enabled in ECS / EHX. AP mode enables you to add members to local partylines (conferences), local Fixed Groups, and route local audio sources to IFBs.

Note: IFBs can be added to Fixed Groups in AP mode.

There are three ways to access AP mode on rotary panels:

- Press Menu and then select ASSNMT PNL.
- Press the dial pad 4 key (a shortcut to the ASSNMT PNL menu).
- Press an assigned INTERCOM button.

You can assign a special **INTERCOM** button to any key on a rotary panel including the Reply key in ECS / EHX. The position of the INTERCOM key on the panel determines which buttons are available for making assignments and which remain in intercom mode. This feature extends to expansion panels, enabling you to perform intercom and assignment operations simultaneously. When the INTERCOM key is selected, the panel enters **Assignment Panel (AP)** mode *without* entering **Menu mode**. If you select an INTERCOM key that has been placed on an expansion panel, then the expansion panel (and any other expansion panels in the daisy chain) is placed in AP mode and can be used normally.

You use the INTERCOM key in **exactly** the same way as the Reply key in Menu mode when making assignments.

For detailed information about making assignments, and the appearance of the panel displays, see **6.13 ASSNMT PNL (Assignment Panel) menu**

For more information about using the dial pad to perform tasks, see **5.11 Dial pad (2RU and desktop panels)**

Note: If the Reply key has **not** been reassigned in ECS / EHX, the talk button on the Reply key will also flash when in AP mode, mimicking the INTERCOM key status.

5.17.4 Rotary panel interruptible foldback (IFB) operation

When a rotary panel key is assigned as an IFB source, you can use the rotary control to adjust the audio level sent from the panel to the destination or the listen level at the panel.

If you latch the call to the IFB destination by momentarily pressing the talk button, you can adjust the level of the audio sent to the IFB destination by turning the rotary control.

If the call to the IFB destination is not latched (the talk button is held down) the audio level is adjusted by pressing and turning the rotary control.

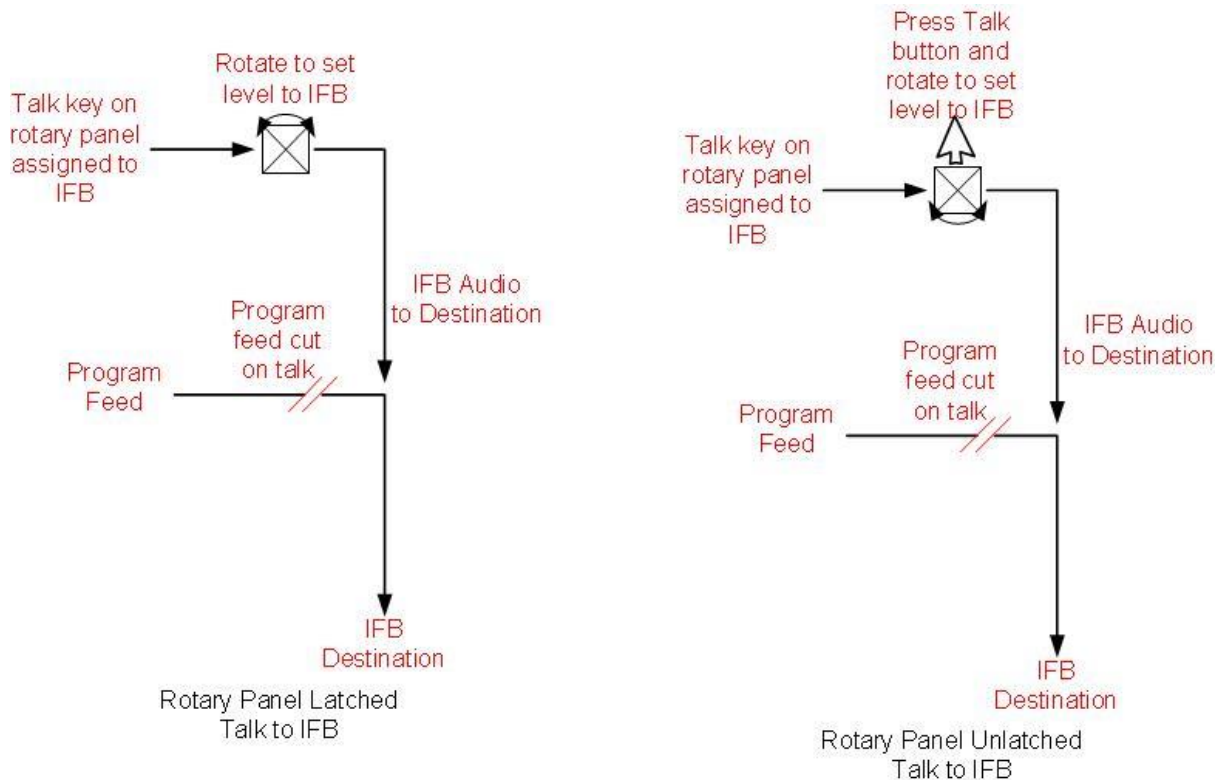

Figure 5-5: Rotary Panel latched and unlatched talk to IFB

5.17.5 Rotary panel Forced Listen

Forced listen key operation on rotary panels differs from lever key and pushbutton panels. A forced listen key on a rotary panel will show the rotary control lit **bright green** to indicate active listen.

Pressing the rotary control, when it is configured as a forced listen, will mute the audio from the forced listen. Pressing the rotary encoder again restores the forced listen audio.

5.17.6 Rotary panel Reply key GPI operation

Connecting a footswitch (or other type of switch) to GPI 3, which is pre-assigned to the Reply key, the panel will **not** clear the item that is currently being viewed on the reply stack when you release the switch.

For more details, see Opto-Isolated Inputs and your *ECS / EHX documentation*.

Note: For an audio block diagram for V-Series panels, see [figure cross-ref]. The diagram shows all the allowed audio routes and valid crosspoints allowed by V-Series panels. Some of the audio paths shown by the diagram are only available with the audio mixer function in ECS / EHX.

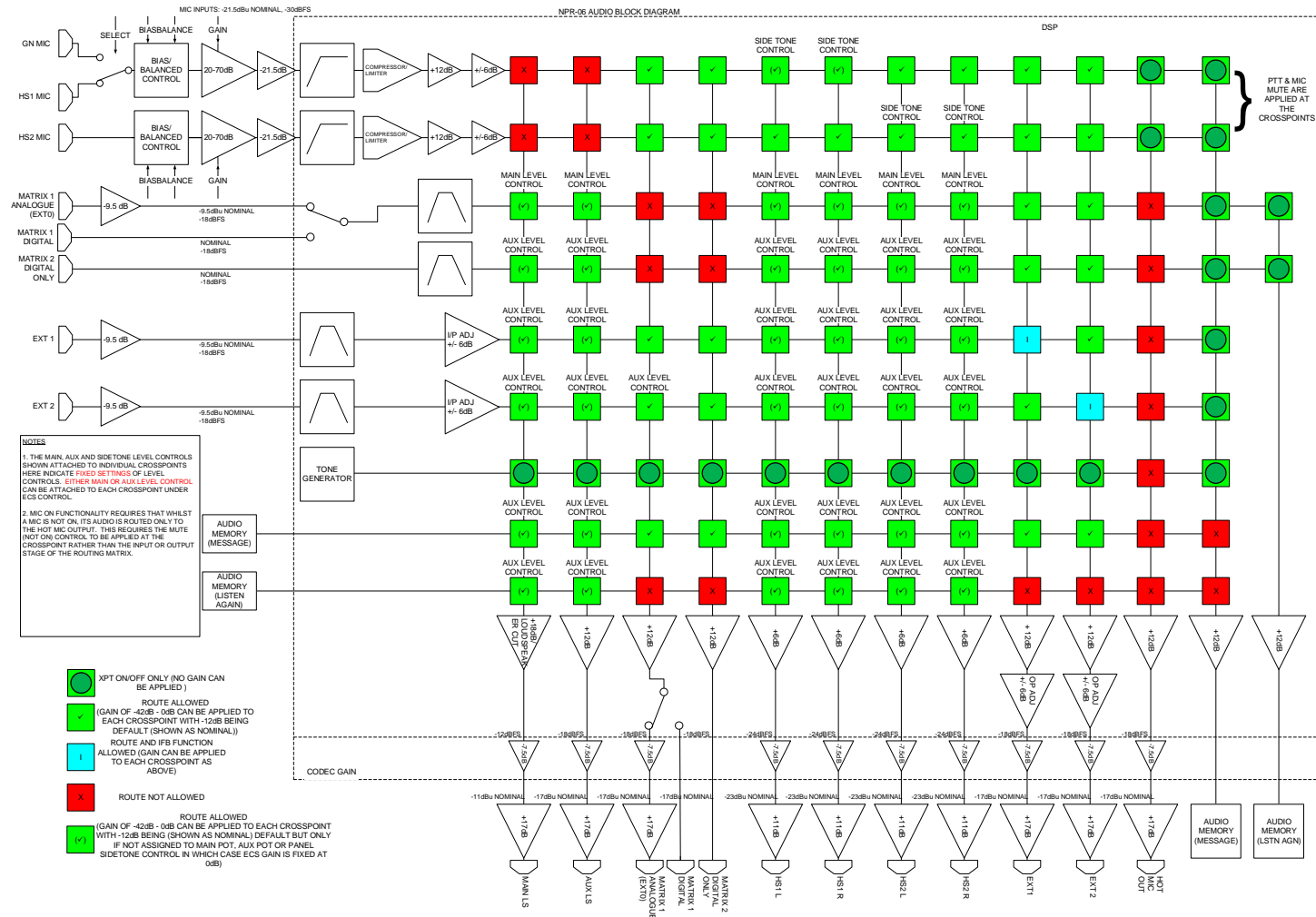

Figure 5-6: V-Series audio block diagram

6 Using the Menu System

This chapter describes the structure and functionality of the V-Series menu system.

Note: For a brief description of all the V-Series panels covered by this guide, including product numbers, see **Table 1** in this guide.

6.1 Navigating the menu system

To enter menu mode, press the menu button on the front panel to display the top level menu.

The menu LED will light and various menu options are displayed on the key displays.

Note: Access to the **System Configuration**, **Local Preferences** and **Diagnostic** menus is set from ECS / EHX. Depending on the configuration, access to some or all of these menus may be disabled on the panel.

To navigate each menu level:

- **On lever key or pushbutton panels**, use the lever keys or pushbuttons associated with a particular menu option to select that option.
 - Note:** Press lever keys down (Talk) to select menu options. The up (Listen) direction is not active except in the case of the View Keys and Local Keys menus, where you can use both up and down (Talk and Listen) key presses to select menu options.
- **On rotary panels**, use the talk button associated with the displayed menu option to select that option.

The selected menu options are then displayed on the panel and the process is repeated until you reach the setting you want to enable, disable or adjust.

To return to the previous menu use the Reply key talk button (which displays the name of the current menu).

To scroll through label lists:

- **On lever key and pushbutton panels**, use the up/down volume control buttons.
- **On rotary panels**, use the rotary control.

Note: You can access the following menus directly using the dial pad on the 2RU and desktop panels:

- 1 - Dial menu
- 2 - Local Exclusive
- 3 - Local page override

- 4 - Assignment Panel menu
- 5 - Local Key Assign menu
- 7 - Local Preferences menu
- # - Fast Key Assign

For more information, see section **5.11 Dial pad (2RU and desktop panels)**.

6.2 Fast Key Assign

The **Fast Key Assign** facility on V-Series panels with dial pads enables you to create and delete local key assignments through the dial pad (see **Table 16: Dial pad menu shortcuts**)

This facility is enabled in ECS / EHX in Advanced Settings (see your ECS / EHX documentation).

To enter Fast Key Assign mode on a panel press the # key on the dial pad. The Reply key displays **FAST ASSN** in inverted text.

	Label 01	Label 03	Label 05	Label 07	Label 09
▼ ▲	▼ ▲	▼ ▲	▼ ▲	▼ ▲	▼ ▲
FAST ASSN	Label 02	Label 04	Label 06	Label 08	Label 10
▼ ▲	▼ ▲	▼ ▲	▼ ▲	▼ ▲	▼ ▲

Figure 6-1: Fast Key Assign for rack mount panels

Label 01	Label 02	Label 03
▼ ▲	▼ ▲	▼ ▲
Label 04	Label 05	Label 06
▼ ▲	▼ ▲	▼ ▲
	Label 07	Label 08
▼ ▲	▼ ▲	▼ ▲
FAST ASSN	Label 09	Label 10
▼ ▲	▼ ▲	▼ ▲

Figure 6-2: Fast Key Assign for desktop panels

6.2.1 The Dial code

The fast key assign requires 3 to 5 key presses for a dial code number to use. The dial code number will be displayed on the reply key as the user is dialing it. The first port number dial code will be 1 and all entity types will be 1 indexed.

6.2.2 Dial code validation

To terminate a Dial Code number the user must press the * key. At this point the Dial Code number is verified to see if the user is allowed to assign the entity to the panel through the sort group rules. If it is an invalid or disallowed operation then "Invalid" will be displayed on the reply key. If it is valid, then the label for the entity will be displayed on the reply key and the key labels which it can be assigned to will flash. The rack will determine if the entity is assignable by looking in the entity table to see if the "Protect Port from Assignment" bit has been set and if the talk and listen bits are cleared. Also the Sort groups will be checked to see if the user panel is allowed to assign the entity.

Whether the key assigned has its talk or listen bits set will be determined by the default settings on the port set in ECS. Note if the talk and listen bits are set, a Talk + Listen key will be configured not a Talk + Forced Listen. On a lever or rotary V-Series panel the talk will be placed on the talk key and the listen on the listen key. The rotary encoder panel will also support talk forced listen. The force listen will be assigned to the encoder key and the talk to the push button key.

6.2.2.1 Sort groups

If the destination is a member of a valid local sort group, you can scroll the members of the sort group until you reach the desired destination by using the up/down buttons or rotary controller on the Reply key. Any member of the sort group may be selected for assignment.

Note: If the destination port is a member of a sort group that is blocked for the panel the word **BLOCKED** is displayed in the reply key. Sort group permissions are set in ECS / EHX. For more information, see your *ECS / EHX documentation*.

6.2.2.2 Assigning keys

Select one of the flashing keys by pressing one of the following:

- The pushbutton on pushbutton panels.
- The key down on lever key panels.
- The talk button on rotary panels.

The selected destination port will be assigned to that key. When a key has been assigned, the talk/listen attributes are defined in ECS / EHX. You can change the assigned key attributes later from the local panel menu.

To exit assign mode press **Menu** on the panel.
Fast Key Assign Sequence

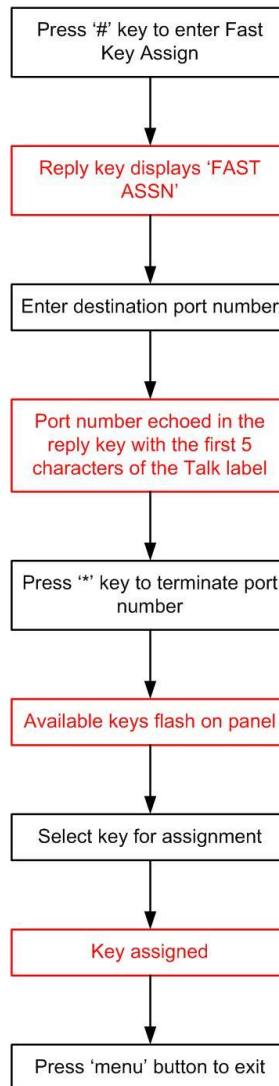

Figure 6-3: Fast Key Assign sequence

6.2.2.3 Deleting key assignments

To delete a key assignment, press the # key followed by the * key. The Reply key displays **DELETE?** and all the keys that can be deleted flash.

To delete the assignments on one of the flashing keys, press:

- The associated pushbutton (pushbutton panels).
- The associated key down (lever key panels).
- The associated talk button (rotary panels).

To exit delete mode press the **Menu** button.

6.3 Scrolling assignment

Note: For a description of how to configure and assign sort groups from the EHX Configuration Software, see the EHX User Guide.

You can quickly assign a key to a sort group entity using the ASSIGN key. To do this:

- 1) From the EHX Configuration Software, configure one or more keys as Sort Group keys. For more information, see the EHX Software Configuration Guide.
- 2) To enter Scrolling Assignment Mode, latch the ASSIGN key. All keys that have been configured as sort group keys will flash.

Note: By default the first member of the sort group (sorted alphabetically) is assigned to a key.
- 3) To select the required sort group entity, use the up/down button or rotary controller to scroll to the entity.

Note: After 10 seconds of inactivity, you can no longer scroll through the entities.
- 4) To exit Scrolling Assignment Mode, press the ASSIGN key.

Note: While in Scrolling Assignment Mode, standard talk and listen keys on the panel behave as normal.

6.4 Top level menu

To enter the menu system press the **Menu** button on the front panel. The top level menu is displayed and the **blue** menu LED is lit.

Note: From the EHX software (**Configuration > Preferences > Panel & Key Operation**), you can configure the Menu key to only open the Main menu after holding down the key for three seconds or longer. For more information, see the EHX Software User Guide.

Press **Menu** again to exit Menu mode.

SYS INFO	LOCAL PREF	SYS CONFIG	DIAL	LOCAL EXCL	ASSNMT PNL
▼ ▲	▼ ▲	▼ ▲	▼ ▲	▼ ▲	▼ ▲
MENU	MESSAGE	CALL	DIAGNOSTIC	LOCAL PAGE	SUPERVISE
▼ ▲	▼ ▲	▼ ▲	▼ ▲	▼ ▲	▼ ▲

Figure 6-4: Main menu display for rack mounted panels

DIAL	LOCAL EXCL	ASSNMT PNL
▼ ▲	▼ ▲	▼ ▲
DIAGNOSTIC	LOCAL PAGE	SUPERVISE
▼ ▲	▼ ▲	▼ ▲
SYS INFO	LOCAL PREF	SYS CONFIG
▼ ▲	▼ ▲	▼ ▲
MENU	MESSAGE	CALL
▼ ▲	▼ ▲	▼ ▲

Figure 6-5: Main menu display for desktop panels

The main menu options are as follows:

Menu option	Description / comments
SYS INFO	Comprises menu options that enable panel keys and nearby panels to be viewed.
LOCAL PREF	Comprises menu options that enable you to configure preferences on the panel, such as brightness levels, timeouts and audio levels.
SYS CONFIG	Comprises menu options that enable local panel configuration, input levels adjustment and output levels adjustment.
DIAL	Enables manual dialing on panel types without a dial pad.
LOCAL EXCL	Used to temporarily deactivate latched keys during talk or listen. Requires the matrix to be online.
ASSNMT PNL	Comprises menu options that enable keys to be assigned locally to IFBs, partylines and Fixed Groups.
MESSAGE	Used to record and review an outgoing audio message.
CALL	Used to place labels on the reply stack, creating a temporary user key.
DIAGNOSTIC	Provides access to the diagnostic menu options, where you can view system information, reset the panel and test audio links.
LOCAL PAGE	Enables the user to override the destination volume settings, and talk to the connected panels.
SUPERVISE	Places the panel in Supervisor mode , enabling you to supervise (take control of) other panels.

Menu option	Description / comments
	The supervise option must be enabled in ECS / EHX, otherwise this menu option is not displayed. For more information, see your ECS / EHX documentation.

Figure 6-6: Main menu options

6.5 SYS INFO (System Information) menu

The System Information (**SYS INFO**) menu enables you to view all the partylines and Fixed Groups programmed on the local system.

VIEW KEYS	PARTY LINE	FIXED GRP	NEAR PNLS		
▼ ▲	▼ ▲	▼ ▲	▼ ▲	▼ ▲	▼ ▲
SYS INFO	MONITORS	FL SOURCE	FL DEST		
▼ ▲	▼ ▲	▼ ▲	▼ ▲	▼ ▲	▼ ▲

Figure 6-7: Sys Info menu on rack mounted panels

VIEW KEYS	PARTY LINE	NEAR PNLS
▼ ▲	▼ ▲	▼ ▲
	FIXED GRP	MONITORS
▼ ▲	▼ ▲	▼ ▲
	FL SOURCE	FL DEST
▼ ▲	▼ ▲	▼ ▲
SYS INFO		
▼ ▲	▼ ▲	▼ ▲

Figure 6-8: Sys Info menu on desktop panels

The **SYS INFO** menu provides access to the following options:

Menu option	Description / comments
VIEW KEYS	Enables you to view the panel key settings.
PARTY LINE	Lists both the available partylines and members of partylines.

FIXED GRP	Lists both the available Fixed Groups and members of Fixed Groups.
NEAR PNLS	List of panels configured as nearby panels in ECS / EHX.
MONITORS	List of panels monitoring this panel.
FL SOURCE	List of forced listen sources available to the panel.
FL DEST	List of forced listen destinations available to the panel.

Figure 6-9: SYS INFO menu options

Note: To return to the main menu, press the Reply key / Reply key talk button (**SYS INFO**).

6.5.1 VIEW KEYS menu

Use the up/down volume buttons or rotary encoder on the Reply key (**VIEW KEYS**) to scroll through the list of key labels.

Each label displayed allows access to the configuration information for that label. To display the information (**KEY INFO** menu), select the label by pressing the corresponding talk/listen key or talk button.

Note: To return to the **SYS INFO** menu, press the Reply key / Reply key talk button (**VIEW KEYS**).

Label 01	Label 02	Label 04	Label 06	Label 08	Label 10
▼ ▲	▼ ▲	▼ ▲	▼ ▲	▼ ▲	▼ ▲
VIEW KEYS	Label 03	Label 05	Label 07	Label 09	Label 11
▼ ▲	▼ ▲	▼ ▲	▼ ▲	▼ ▲	▼ ▲

Figure 6-10: VIEW KEYS menu on rack mounted panels

Label 01		Label 02		Label 03	
▼	▲	▼	▲	▼	▲
Label 04		Label 05		Label 06	
▼	▲	▼	▲	▼	▲
Label 07		Label 08		Label 09	
▼	▲	▼	▲	▼	▲
VIEW KEYS		Label 10		Label 11	
▼	▲	▼	▲	▼	▲

Figure 6-11: VIEW KEYS menu on desktop panels

6.5.1.1 KEY INFO menu

The **VIEW KEYS > KEY INFO** menu provides information about the selected key.

Label 01	Label 01 Alias	<i>Attributes</i>	<i>Label entity</i>		
▼	▲	▼	▲	▼	▲
KEY INFO	<i>Sys Name</i>	LIST			
▼	▲	▼	▲	▼	▲

Figure 6-12: KEY INFO menu on rack mounted panels

▼ ▲	▼ ▲	▼ ▲
<i>Attributes</i>		
▼ ▲	▼ ▲	▼ ▲
Label 01	Label 01 Alias	Sys Name
▼ ▲	▼ ▲	▼ ▲
KEY INFO	<i>Label entity</i>	LIST
▼ ▲	▼ ▲	▼ ▲

Figure 6-13: KEY INFO menu on desktop panels

The items in italics in the above figures (together with LIST) are system and configuration dependent as follows:

Variable	Description / comments
<i>Attributes</i>	May be any of the following: Talk , Talk + Lstn , Talk + FL (<i>Forced Listen</i>), Dual T+L , Listen or Force Lstn
<i>Sys Name</i>	Name of the system that the entity the label refers to belongs to.
<i>Label Entity</i>	The type of label. May be any of the following: PORT , PL (<i>Partyline</i>), IFB , FG. CONTROL
LIST	Displayed if the label is a Fixed Group. Pressing this key displays a list of Fixed Group members (see [link to Fixed Group menu])

Table 21: KEY INFO variables

Note: To return to the **VIEW KEYS** menu, press the Reply key / Reply key talk button (**KEY INFO**).

6.5.2 PARTY LINE menu

The **PARTY LINE** menu option displays the partylines available to the panel. Use the up/down volume buttons or the rotary control on the Reply key (**VIEW PL**) to scroll through the available partylines on the panel display. Select one of the partylines to display the membership menu for that partyline.

Note: To return to the **SYS INFO** menu, press the Reply key or Reply key talk button (**VIEW PL**).

	PL01	PL03	PL05	PL07	PL09
▼ ▲	▼ ▲	▼ ▲	▼ ▲	▼ ▲	▼ ▲
VIEW PL	PL02	PL04	PL06	PL08	PL010
▼ ▲	▼ ▲	▼ ▲	▼ ▲	▼ ▲	▼ ▲

Figure 6-14: Partyline menu for rack mounted panels

PL01	PL02	PL03
▼ ▲	▼ ▲	▼ ▲
PL04	PL05	PL06
▼ ▲	▼ ▲	▼ ▲
	PL07	PL08
▼ ▲	▼ ▲	▼ ▲
VIEW PL	PL09	PL010
▼ ▲	▼ ▲	▼ ▲

Figure 6-15: Partyline menu for desktop panels

6.5.2.1 PL MEMBERS menu

PL01	Label 01	Label 03	Label 05	Label 07	Label 09
▼ ▲	▼ ▲	▼ ▲	▼ ▲	▼ ▲	▼ ▲
PL MEMBERS	Label 02	Label 04	Label 06	Label 08	Label 10
▼ ▲	▼ ▲	▼ ▲	▼ ▲	▼ ▲	▼ ▲

Figure 6-16: Partyline members menu for rack mounted panels

Label 01		Label 02		Label 03	
▼	▲	▼	▲	▼	▲
Label 04		Label 05		Label 06	
▼	▲	▼	▲	▼	▲
PL01		Label 07		Label 08	
▼	▲	▼	▲	▼	▲
PL MEMBERS		Label 09		Label 10	
▼	▲	▼	▲	▼	▲

Figure 6-17: Partyline members menu for desktop panels

The **PARTY LINE > PL MEMBERS** menu shows you the members of the partyline you selected in the PARTY LINE menu.

Use the volume up/down buttons or the rotary control on the Reply key (**PL MEMBERS**) will scroll through the list of party line members.

Note: Any members that were assigned to a partyline using Production Maestro Pro, rather than ECS / EHX, are not displayed. This is because Production Maestro Pro assignments are temporary, rather than fixed, as in the ECS / EHX configuration.

Note: To return to the **PARTY LINE** menu, press the Reply key or Reply key talk button (**PL MEMBERS**).

6.5.3 FIXED GRP menu

The **FIXED GRP** menu displays a list of all the Fixed Groups available to the panel.

	FxG 01	FxG 03	FxG 05	FxG 07	FxG 09
▼	▲	▼	▲	▼	▲
VIEW FG	FxG 02	FxG 04	FxG 06	FxG 08	FxG 10
▼	▲	▼	▲	▼	▲

Figure 6-18: Fixed Group menu for rack mounted panels

FxG 01		FxG 02		FxG 03	
▼	▲	▼	▲	▼	▲
FxG 04		FxG 05		FxG 06	
▼	▲	▼	▲	▼	▲
		FxG 07		FxG 08	
▼	▲	▼	▲	▼	▲
VIEW FG		FxG 09		FxG 10	
▼	▲	▼	▲	▼	▲

Figure 6-19: Fixed Group menu for desktop panels

Use the Reply key (**VIEW FG**) up/down volume buttons or rotary control to scroll through the available fixed groups on the panel display. Select one of the fixed groups to display the membership for that fixed group.

Note: To return to the **SYS INFO** menu, press the Reply key or Reply key talk button (**VIEW FG**).

6.5.3.1 FG MEMBERS menu

The FG MEMBERS menu displays the members of the Fixed Group that you selected in the main FIXED GRP menu.

Use the volume up/down buttons or rotary control on the Reply key (FG MEMBERS) to scroll through the devices that are members of the fixed group.

Note: To return to the **FIXED GRP** menu, press the Reply key or Reply key talk button (**FG MEMBERS**).

6.5.4 NEAR PNLS menu

Selecting the **NEAR PNLS** menu option on the main menu will display the labels associated with panels configured as **Nearby Panels** in ECS / EHX.

Note: Panels designated as Nearby Panels are within hearing distance of each other, which means that an audio link between panels could result in an audio feedback loop (howlround). Audio paths to panels designated as nearby panels cannot be established.

Use the up/down volume buttons or rotary control on the Reply key (NEAR PNLS) to scroll through the list of nearby panels.

Note: To return to the **SYS INFO** menu press the Reply key or Reply key talk button (**NEAR PNLS**).

	Label 01	Label 03	Label 05	Label 07	Label 09
▼ ▲	▼ ▲	▼ ▲	▼ ▲	▼ ▲	▼ ▲
NEAR PNLS	Label 02	Label 04	Label 06	Label 08	Label 10
▼ ▲	▼ ▲	▼ ▲	▼ ▲	▼ ▲	▼ ▲

Figure 6-20: Nearby panels menu for rack mounted panels

Label 01	Label 02	Label 03
▼ ▲	▼ ▲	▼ ▲
Label 04	Label 05	Label 06
▼ ▲	▼ ▲	▼ ▲
	Label 07	Label 08
▼ ▲	▼ ▲	▼ ▲
NEAR PNLS	Label 09	Label 10
▼ ▲	▼ ▲	▼ ▲

Figure 6-21: Nearby panels for desktop panels

6.5.5 MONITORS Menu

The **MONITORS** menu displays a list of the ports monitoring the current panel. Use the up/down buttons or rotary control on the Reply key (**MONITORS**) to scroll through the list of monitoring ports.

Note: To return to the **SYS INFO** menu press the Reply key or Reply key talk button (**MONITORS**).

	Label 01	Label 03	Label 05	Label 07	Label 09
▼ ▲	▼ ▲	▼ ▲	▼ ▲	▼ ▲	▼ ▲
MONITORS	Label 02	Label 04	Label 06	Label 08	Label 10
▼ ▲	▼ ▲	▼ ▲	▼ ▲	▼ ▲	▼ ▲

Figure 6-22: Monitors menu for rack mounted panels

Label 01	Label 02	Label 03
▼ ▲	▼ ▲	▼ ▲
Label 04	Label 05	Label 06
▼ ▲	▼ ▲	▼ ▲
	Label 07	Label 08
▼ ▲	▼ ▲	▼ ▲
MONITORS	Label 09	Label 10
▼ ▲	▼ ▲	▼ ▲

Figure 6-23: Monitors menu for desktop panels

6.5.6 FL SOURCE Menu

The **FL SOURCE** menu option lists all the forced listen sources configured in the system.

Note: A forced listen is a permanently enabled audio path set up in ECS / EHX between a source and a destination, allowing the destination to listen to the source without the source having to activate a talk key. For more information, see your ECS / EHX documentation.

	Label 01	Label 03	Label 05	Label 07	Label 09
▼ ▲	▼ ▲	▼ ▲	▼ ▲	▼ ▲	▼ ▲
FL SOURCE	Label 02	Label 04	Label 06	Label 08	Label 10
▼ ▲	▼ ▲	▼ ▲	▼ ▲	▼ ▲	▼ ▲

Figure 6-24: Force listen source menu on rack mounted panels

Label 01	Label 02	Label 03
▼ ▲	▼ ▲	▼ ▲
Label 04	Label 05	Label 06
▼ ▲	▼ ▲	▼ ▲
	Label 07	Label 08
▼ ▲	▼ ▲	▼ ▲
FL SOURCE	Label 09	Label 10
▼ ▲	▼ ▲	▼ ▲

Figure 6-25: Force listen source menu on desktop panels

Use the up/down volume buttons or rotary controller on the Reply Key (**FL SOURCE**) to scroll through the list of forced listen sources.

Note: To return to the **SYS INFO** menu press the Reply key or Reply key talk button (**FL SOURCE**).

6.5.7 FL DEST menu

Pressing the FL DEST key or talk button will display all the forced listen destinations configured on the panel.

	Label 01	Label 03	Label 05	Label 07	Label 09
▼ ▲	▼ ▲	▼ ▲	▼ ▲	▼ ▲	▼ ▲
FL DEST	Label 02	Label 04	Label 06	Label 08	Label 10
▼ ▲	▼ ▲	▼ ▲	▼ ▲	▼ ▲	▼ ▲

Figure 6-26: Forced listen destination menu on rack mounted panels

Label 01		Label 02		Label 03	
▼	▲	▼	▲	▼	▲
Label 04		Label 05		Label 06	
▼	▲	▼	▲	▼	▲
		Label 07		Label 08	
▼	▲	▼	▲	▼	▲
FL DEST		Label 09		Label 10	
▼	▲	▼	▲	▼	▲

Figure 6-27: Forced listen destination menu on desktop panels

Use the volume up/down buttons or rotary control on the Reply Key (**FL DEST**) to scroll through the list of forced listen destinations.

Note: To return to the **SYS INFO** menu press the Reply key or Reply key talk button (**FL DEST**).

6.6 LOCAL PREF (Local Preferences) menu

Select the **LOCAL PREF** (Local Preferences) menu option from the main menu to display the panel setups that may be changed locally rather than in ECS / EHX.

If the PIN code has been enabled in ECS / EHX, the panel will request PIN code entry before allowing access to the local preferences menu.

0	1	2	3	4	5	6	7	8	9	*	#
▼	▲	▼	▲	▼	▲	▼	▲	▼	▲	▼	▲
LOCAL PREF		ENTER PIN		****							
▼	▲	▼	▲	▼	▲	▼	▲	▼	▲	▼	▲

Figure 6-28: Local preferences PIN entry on rack mounted panels

1	2	3	4	5	6
▼	▲	▼	▲	▼	▲
7	8	9	0	*	#
▼	▲	▼	▲	▼	▲
ENTER PIN			****		
▼	▲	▼	▲	▼	▲
LOCAL PUF					
▼	▲	▼	▲	▼	▲

Figure 6-29: Local preferences PIN entry on desktop panels

On lever key and pushbutton panels enter the PIN code using the volume up/down buttons under each number. On rotary panels, press the rotary control to select the left hand digit and the talk button to select the right hand digit in the display.

The PIN code digits will be echoed as **X** in the PIN code entry window.

TIMEOUTS	LEVEL ADJ				
▼	▲	▼	▲	▼	▲
LOCAL PUF	BRIGHTNESS		RESET XPTS		
▼	▲	▼	▲	▼	▲

Figure 6-30: Local preferences menu for rack mounted panels

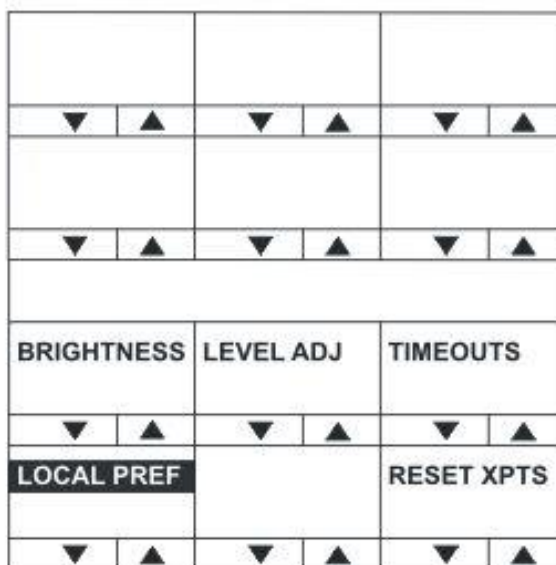

Figure 6-31: Local preferences menu for desktop panels

The **LOCAL PREF** menu provides access to the following menu items:

Menu option	Description / comments
TIMEOUTS	Displays the timeouts setting menu.
LEVEL ADJ	Displays the menu to set the audio levels for the microphones, headset and loudspeaker.
BRIGHTNESS	Displays the brightness setup menu that allows the brightness of all labels and LEDs to be adjusted.
RESET XPTS	Displays the menu for resetting the panel crosspoints to default level.

Table 22: LOCAL PREF menu options

Note: To return to the main menu, press the Reply key / Reply key talk button (**LOCAL PREF**).

6.6.1 TIMEOUTS menu

The **LOCAL PREF > TIMEOUTS** menu displays the Answerback and Listen Again timeout settings.

The **Answerback timeout** controls the length of time an unanswered call remains in the Reply key stack. If the value is set to **OFF** (0 seconds) or the function is disabled, calls will remain in the Reply key stack until actioned.

The **Listen Again timeout** controls the length of time before recorded messages are auto deleted and may be set to a value of 0 t- 99 minutes in units of 1 minute.

Note: If the timeout is set to 99 the messages are **not** auto-deleted. If the timeout is set to 0 the Listen Again facility is disabled, so no audio is recorded. You can

use this timeout to ensure that recorded conversations are not left on a panel where they may be accessed later by other operators.

ANSWERBACK	10	DISABLE			
▼ ▲	↓ ↑	▼ ▲	▼ ▲	▼ ▲	▼ ▲
TIMEOUTS	MSG A DEL	10			
▼ ▲	▼ ▲	↓ ↑	▼ ▲	▼ ▲	▼ ▲

Figure 6-32: Timeouts menu for rack mounted panels

ANSWERBACK	MSG A DEL	
▼ ▲	▼ ▲	▼ ▲
10	10	
↓ ↑	↓ ↑	▼ ▲
▼ ▲	▼ ▲	▼ ▲
ENABLE		
▼ ▲	▼ ▲	▼ ▲
TIMEOUTS		
▼ ▲	▼ ▲	▼ ▲

Figure 6-33: Timeouts menu for desktop panels

The **TIMEOUTS** menu provides access to the following menu items:

Menu option	Description / comments
ANSWERBACK	Enables you to set the panel answerback timeout. Values range from 0 (OFF) to 60 seconds in 10 second steps.
DISABLE	Disables Answerback timeout.
MSG A DEL	Enables you to set the Listen Again timeout. Values range from 0 to 99 minutes. If the timeout is set to 0 the Listen Again facility is disabled (no audio recorded). If the timeout is set to 99 the messages are not auto-deleted.

Figure 6-34: TIMEOUTS menu options

Note: To return to the **LOCAL PREF** menu, press the Reply key / Reply key talk button (**TIMEOUTS**).

6.6.2 LEVEL ADJ (Level Adjust) Menu

The **LEVEL ADJ** (Level Adjust) menu displays the audio levels setup menu.

	GN MIC 40 ↓ ↑	HS MIC 40 ↓ ↑	HS2MIC 40 ↓ ↑	LS DIM -12 ↓ ↑	
▼ ▲	▼ ▲	▼ ▲	▼ ▲	▼ ▲	▼ ▲
LEVEL ADJ	L SIDETONE -----	R SIDETONE -----	L2 SIDETONE -----	R2 SIDETONE -----	
▼ ▲	▼ ▲	▼ ▲	▼ ▲	▼ ▲	▼ ▲

Figure 6-35: Level adjust menu for rack mounted panels

	HS2MIC 40 ↓ ↑	
▼ ▲	▼ ▲	▼ ▲
	L2SIDETONE ---	R2SIDETONE -----
▼ ▲	▼ ▲	▼ ▲
GN MIC 40 ↓ ↑	HS MIC 40 ↓ ↑	LS DIM -12 ↓ ↑
▼ ▲	▼ ▲	▼ ▲
LEVEL ADJ	L SIDETONE -----	R SIDETONE -----
▼ ▲	▼ ▲	▼ ▲

Figure 6-36: Level adjust menu for desktop panels

This menu adjusts the audio gain values for gooseneck panel microphone and headset microphones to preset levels of 20, 40, 50, 60, 70 or 80 db. The sidetone levels can be set for the first headset (front panel connector) and the second headset (auxiliary audio connector).

Adjust the gain values and sidetone levels using the up / down buttons or the rotary control.

Note: If you change these parameters locally, the EHX software can only change It by performing a black reset. Otherwise, the EXH software can download changes without a black reset.

Menu option	Description / comments
GN MIC	Gooseneck microphone gain.
HS MIC	First headset microphone gain.
HS2MIC	Second headset microphone gain.

Menu option	Description / comments
LS DIM	The amount the loudspeaker is dimmed by when a talk key is pressed (-70dB, -20dB, -12dB, -6dB, -3dB, 0dB).
L SIDETONE	First headset left sidetone level. The key status (lever key) or pushbutton or talk button (rotary) is lit red when the left sidetone is on. To toggle left sidetone between ON and OFF press the pushbutton or press the lever key down or press the talk button (rotary). The default sidetone level is -9dB, the minimum level is -15.5dB.
R SIDETONE	First headset right sidetone level. The key status (lever key) or pushbutton or talk button (rotary) is illuminated red when the right sidetone is on. To toggle right sidetone between ON and OFF press the key pushbutton or press the lever key down or press the talk button (rotary). The default sidetone level is -9dB, the minimum level is -15.5dB.
L2SIDETONE	Second headset left sidetone level. The key status (lever key) or pushbutton or talk button (rotary) is illuminated red when the left sidetone for the second headset is on. To toggle left sidetone between ON and OFF press the key pushbutton or press the lever key down or press the talk button (rotary). The default sidetone level is -9dB, the minimum level is -15.5dB.
R2SIDETONE	Second headset right sidetone level. The key status (lever key) or pushbutton or talk button (rotary) is illuminated red when the right sidetone for the second headset is on. To toggle right sidetone between ON and OFF press the key pushbutton or press the lever key down or press the talk button (rotary). The default sidetone level is -9dB, the minimum level is -15.5dB.

Table 23: LEVEL ADJ menu options

Note: When a monaural headset is used only the headset **left** sidetone adjust operates. The right sidetone adjust has no effect.

Note: To return to the **LOCAL PREF** menu, press the Reply key / Reply key talk button (**LEVELADJ**).

6.6.3 BRIGHTNESS menu

The **BRIGHTNESS** menu enables you adjust the brightness settings for the panel.

brightness	brightness	brightness	brightness	brightness	brightness
▼ ▲	▼ ▲	▼ ▲	▼ ▲	▼ ▲	▼ ▲
BRIGHTNESS	brightness	brightness	brightness	brightness	brightness
▼ ▲	▼ ▲	▼ ▲	▼ ▲	▼ ▲	▼ ▲

Figure 6-37: Brightness menu for rack mounted panels

brightness	brightness	brightness
▼ ▲	▼ ▲	▼ ▲
brightness	brightness	brightness
▼ ▲	▼ ▲	▼ ▲
brightness	brightness	brightness
▼ ▲	▼ ▲	▼ ▲
BRIGHTNESS	brightness	brightness
▼ ▲	▼ ▲	▼ ▲

Figure 6-38: Brightness menu for desktop panels

Use the up/down buttons or rotary control on the Reply key to alter the brightness of the displays.

Note: If you change the display brightness locally, the EHX software can only change it by performing a black reset. Otherwise, the EXH software can download changes without a black reset.

The displays automatically dim after the time limit set in ECS / EHX Panel Options (from 0 to 60 minutes) where 0 minutes sets the panel display to dim mode permanently.

After a further period the display will change to provide a screensaver to increase the lifetime of the displays.

Note: To return to the **LOCAL PREF** menu, press the Reply key / Reply key talk button (**BRIGHTNESS**).

6.6.4 MESSAGE menu

Use the **MESSAGE** menu to enable outgoing messages to be recorded, reviewed, output to audio and erased.

	RECORD	REVIEW			
▼ ▲	▼ ▲	▼ ▲	▼ ▲	▼ ▲	▼ ▲
MESSAGE	PLAY	ERASE			
▼ ▲	▼ ▲	▼ ▲	▼ ▲	▼ ▲	▼ ▲

Figure 6-39: Message menu for rack mounted panels

▼ ▲	▼ ▲	▼ ▲
▼ ▲	▼ ▲	▼ ▲
	RECORD	REVIEW
▼ ▲	▼ ▲	▼ ▲
MESSAGE	PLAY	ERASE
▼ ▲	▼ ▲	▼ ▲

Figure 6-40: Message menu for desktop panels

The **MESSAGE** menu provides access to the following menu options / actions:

Menu options / actions	Description / comments
RECORD	When you press the RECORD button, you can record up to 10 seconds of audio from the microphone into an audio file on the panel. Text inverts while the button is pressed.
REVIEW	When you press the REVIEW button, the outgoing message is played to the currently selected output device (Headset or Loudspeaker). Text inverts while the button is pressed.
PLAY	When you press the PLAY button, the outgoing message is output to the route configured by ECS / EHX. This will normally be Matrix 1 or Matrix 2 but may be the EXT1 or EXT2 output. Text inverts while the button is pressed.

ERASE	When you press the ERASE button, the current outgoing message is erased.
Configurable Messaging	<p>Enables access to the Messaging menu on v-series panels. If the tick box is disabled, the panel will not show the MESSAGE menu.</p> <p>If the option is enabled, the panel is in the messaging menu and the PLAY button is on:</p> <ol style="list-style-type: none"> 1. Panels with a listen to this panel will hear the recorded audio. 2. Another panel talking to this panel will also get a listen route and will be able to hear the recorded message. Note that only a maximum of 10 panels simultaneously talking to that panel will hear the recorded message if the PLAY button is on.

Figure 6-41: MESSAGE menu options

Note: To return to the **LOCAL PREF** menu, press the Reply key / Reply key talk button (**MESSAGE**).

Note: You can use the recorded output message to verify audio paths between ports. Select a talk path set up on the panel, then enter the **MESSAGE** menu and press **PLAY**. If the talk path connects to another panel, the message is heard as an incoming talk on the target panel.

6.6.5 RESET XPTS (Reset Crosspoints) menu

The **RESET XPTS** menu enables you to reset the panel crosspoints to their default levels.

Press the **YES** key or pushbutton or talk button to reset the panel crosspoint levels to their default settings or the **NO** key to cancel the operation and return the user to the local preferences (**LOCAL PREF**) menu.

Note: To return to the **LOCAL PREF** menu, press the Reply key / Reply key talk button (**RESET XPTS**).

6.7 SYS CONFIG (System Configuration) menu

The **SYS CONFIG** (System Configuration) menu comprises menu options that enable local panel configuration, input levels adjustment and output levels adjustment.

Note: If the PIN code has been enabled in ECS / EHX, you must enter a PIN code entry before you can access this menu.

On lever key or pushbutton panels, enter the PIN code using the volume up/down buttons under each number. On rotary panels press the rotary encoder to select the left hand digit and the talk button to select the right hand

digit in the display. The PIN code digits will be shown as * in the PIN code entry window.

PARTY LINE	FIXED GRP	LOCAL PNL	REMOTE PNL		
▼ ▲	▼ ▲	▼ ▲	▼ ▲	▼ ▲	▼ ▲
SYS CONFIG	FORCE LSTN		INPUT LVLS	OUTPUT LVL	
▼ ▲	▼ ▲	▼ ▲	▼ ▲	▼ ▲	▼ ▲

Figure 6-42: System configuration menu on rack mounted panels

	PARTY LINE	FIXED GRP
▼ ▲	▼ ▲	▼ ▲
	FORCE LSTN	
▼ ▲	▼ ▲	▼ ▲
	LOCAL PNL	INPUT LVLS
▼ ▲	▼ ▲	▼ ▲
SYS CONFIG	REMOTE PNL	OUTPUT LVL
▼ ▲	▼ ▲	▼ ▲

Figure 6-43: System configuration menu for desktop panels

The **SYS CONFIG** menu displays the following menu options:

Menu options	Description / comments
PARTY LINE	Displays the partyline configuration menu (PL CONFIG on the Reply key). Enables interfaces and panels to be assigned to a partyline.
FIXED GRP	Displays the Fixed Group configuration menu (FG CONFIG on the Reply key). Enables interfaces and panels to be assigned to a Fixed Group.
LOCAL PNL	Displays the local panel’s configuration menu.
REMOTE PNL	Displays the remote panel’s configuration menu.
FORCE LSTN	Displays the Forced Listen configuration menu. Enables sources and destinations configured as keys on the current panel to be set as forced listens.

Menu options	Description / comments
INPUT LVLS	Enables you to set input audio levels.
OUTPUT LVLS	Enables you to set output audio levels.

Table 24: SYS CONFIG menu options

Note: To return to the main menu, press the Reply key / Reply key talk button (**SYS CONFIG**).

6.7.1 PARTY LINE configuration menu

The **SYS CONFIG > PARTY LINE** menu (**PL CONFIG** on the Reply key) enables you to configure partylines 1 - 10 by adding panels and interfaces to the partylines as members.

	PL01	PL03	PL05	PL07	PL09
▼ ▲	▼ ▲	▼ ▲	▼ ▲	▼ ▲	▼ ▲
PL CONFIG	PL02	PL04	PL06	PL08	PL010
▼ ▲	▼ ▲	▼ ▲	▼ ▲	▼ ▲	▼ ▲

Figure 6-44: Partyline configuration menu for rack mounted panels

PL01	PL02	PL03
▼ ▲	▼ ▲	▼ ▲
PL04	PL05	PL06
▼ ▲	▼ ▲	▼ ▲
	PL07	PL08
▼ ▲	▼ ▲	▼ ▲
PL CONFIG	PL09	PL010
▼ ▲	▼ ▲	▼ ▲

Figure 6-45: Partyline configuration menu for desktop panels

Use the up/down volume buttons (lever key or pushbutton panels) or rotary control on the Reply Key (**PL CONFIG**) will scroll through the available partylines on the panel display.

Selecting one of the partylines displays the membership menu for that partyline.

Note: To return to the **SYS CONFIG** menu, press the Reply key / Reply key talk button (**PL CONFIG**).

6.7.1.1 PL MEMBERS (Partyline membership) menu

The **PL CONFIG > PL MEMBERS** (Partyline membership) menu enables you to add / remove interfaces and panels to / from a partyline.

PL01	INTERFACES	PANELS			
▼ ▲	▼ ▲	▼ ▲	▼ ▲	▼ ▲	▼ ▲
PL MEMBERS					
▼ ▲	▼ ▲	▼ ▲	▼ ▲	▼ ▲	▼ ▲

Figure 6-46: Partyline membership menu for rack mounted panels

▼ ▲	▼ ▲	▼ ▲
▼ ▲	▼ ▲	▼ ▲
PL01	INTERFACES	PANELS
▼ ▲	▼ ▲	▼ ▲
PL MEMBERS		
▼ ▲	▼ ▲	▼ ▲

Figure 6-47: Partyline membership menu for desktop panels

Select **INTERFACES** to list the interfaces that may be members of the partyline. Select **PANELS** to list the panels that may be members of the partyline.

Note: To return to the **PARTY LINE (PL CONFIG)** menu, press the Reply key / Reply key talk button (**PL MEMBERS**).

6.7.1.2 PL INTS (Interfaces) and PL PANELS (Panels) menus

Use the volume up/down buttons (lever key and pushbutton panels) or rotary control on the Reply Key (**PL INTS** (interfaces) or **PL PANELS** (panels)) to scroll through the list of possible interfaces / panels.

If the interface or panel is a member of the partyline a selection bar is displayed under the interface or panel name. To select or deselect a label or panel press the lever key/button or talk button next to the required label. The interface is either added to or removed from the party line membership.

Note: To return to the **PL MEMBERS** menu, press the Reply key / Reply key talk button (**PL INTS** or **PL PANELS**).

6.7.2 FIXED GRP configuration menu

The **SYS CONFIG > FIXED GRP (FG CONFIG** on the Reply key) menu enables you to configure Fixed Groups by adding and removing panels and interfaces as members.

	FxG 01	FxG 03	FxG 05	FxG 07	FxG 09
▼ ▲	▼ ▲	▼ ▲	▼ ▲	▼ ▲	▼ ▲
FG CONFIG	FxG 02	FxG 04	FxG 06	FxG 08	FxG 10
▼ ▲	▼ ▲	▼ ▲	▼ ▲	▼ ▲	▼ ▲

Figure 6-48: Fixed Group configuration menu for rack mounted panels

FxG 01	FxG 02	FxG 03
▼ ▲	▼ ▲	▼ ▲
FxG 04	FxG 05	FxG 06
▼ ▲	▼ ▲	▼ ▲
	FxG 07	FxG 08
▼ ▲	▼ ▲	▼ ▲
FG CONFIG	FxG 09	FxG 10
▼ ▲	▼ ▲	▼ ▲

Figure 6-49: Fixed Group configuration menu for desktop panels

Use the volume up/down buttons (lever key or pushbutton panels) or rotary control on the Reply Key (**FG CONFIG**) to scroll through the available fixed groups on the panel display. Selecting one of the fixed groups will display the membership menu for that fixed group.

Note: To return to the **SYS CONFIG** menu, press the Reply key / Reply key talk button (**FG CONFIG**).

6.7.2.1 FG MEMBERS menu

When a fixed group is selected from the **FIXED GRP** configuration menu (**FG CONFIG** on the Reply key) the Fixed Group membership menu (**FG MEMBERS**) will be displayed.

FxG01	INTERFACES	PANELS			
▼ ▲	▼ ▲	▼ ▲	▼ ▲	▼ ▲	▼ ▲
FG MEMBERS					
▼ ▲	▼ ▲	▼ ▲	▼ ▲	▼ ▲	▼ ▲

Figure 6-50: Fixed Group members menu for rack mounted panels

▼ ▲	▼ ▲	▼ ▲
▼ ▲	▼ ▲	▼ ▲
FxG01	INTERFACES	PANELS
▼ ▲	▼ ▲	▼ ▲
FG MEMBERS		
▼ ▲	▼ ▲	▼ ▲

Figure 6-51: Fixed Group members menu for desktop panels

Select **INTERFACES** to list the interfaces that may be members of the Fixed Group. Select **PANELS** to list the panels that may be members of the Fixed Group.

Note: To return to the **FIXED GRP (FG CONFIG)** menu, press the Reply key / Reply key talk button (**FG MEMBERS**).

6.7.2.2 FG INTS (Interfaces) and FG PANELS (Panels) menus

Use the volume up/down buttons (lever key and pushbutton panels) or rotary control on the Reply Key (**FG INTS** (interfaces) or **FG PANELS** (panels)) to scroll through the list of possible interfaces / panels.

If the interface or panel is a member of the Fixed Group a selection bar is displayed under the interface or panel name. To select or deselect a label or panel press the lever key/button or talk button next to the required label. The interface is either added to or removed from the Fixed Group membership.

Note: To return to the **FG MEMBERS** menu, press the Reply key / Reply key talk button (**FG INTS** or **FG PANELS**).

6.7.3 LOCAL PNL (Local Panel) configuration menu

Select the **LOCAL PNL** item in the **SYS CONFIG** (System Configuration) menu to display the local panel configuration menu.

LOCAL KEYS	ATTRIBUTES				
▼ ▲	▼ ▲	▼ ▲	▼ ▲	▼ ▲	▼ ▲
LOCAL PNL					
▼ ▲	▼ ▲	▼ ▲	▼ ▲	▼ ▲	▼ ▲

Figure 6-52: Local panel configuration menu for rack mounted panels

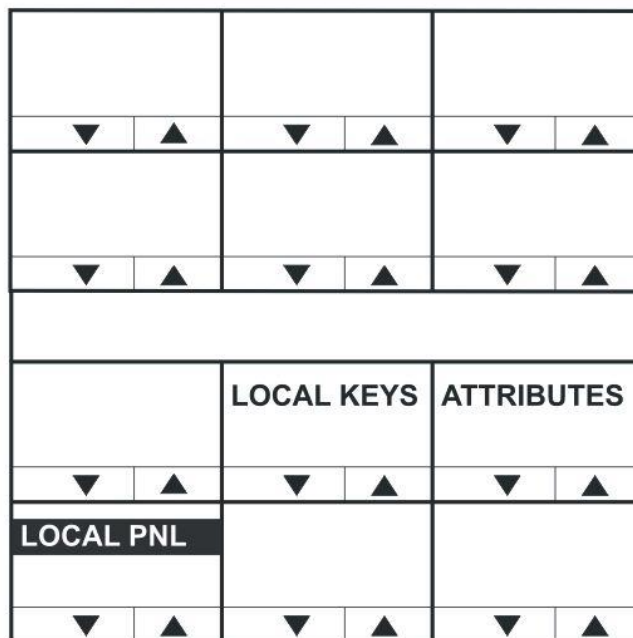

Figure 6-53: Local panel configuration menu for desktop mounted panels

The **LOCAL PNL** menu displays the following menu options:

Menu options	Description / comments
LOCAL KEYS	Use this menu to assign keys on the panel.
ATTRIBUTES	Use this menu to set the attributes of the panel keys.

Table 25: LOCAL PNL menu options

Note: To return to the **SYS CONFIG** menu, press the Reply key / Reply key talk button (**LOCAL PNL**).

6.7.4 LOCAL KEYS configuration menu

The **LOCAL KEYS** menu enables you to both select a key and display what is configured on that key.

For lever key panels, press the key up to display the listen label, and down to display the talk label. In the case of pushbutton panels pressing the pushbutton will display the talk or listen label that is configured for that key (only one can be configured per key on a pushbutton panel).

For rotary panels press the rotary control to display the listen label and the talk button to display the talk label.

Note: To return to the **SYS CONFIG** menu, press the Reply key / Reply key talk button (**LOCAL KEYS**).

Label 01	Label 02	Label 04	Label 06	Label 08	Label 10
▼ ▲	▼ ▲	▼ ▲	▼ ▲	▼ ▲	▼ ▲
LOCAL KEYS	Label 03	Label 05	Label 07	Label 09	Label 11
▼ ▲	▼ ▲	▼ ▲	▼ ▲	▼ ▲	▼ ▲

Figure 6-54: Local Keys menu for rack mounted panels

Label 01	Label 02	Label 03
▼ ▲	▼ ▲	▼ ▲
Label 04	Label 05	Label 06
▼ ▲	▼ ▲	▼ ▲
Label 07	Label 08	Label 09
▼ ▲	▼ ▲	▼ ▲
LOCAL KEYS	Label 10	Label 11
▼ ▲	▼ ▲	▼ ▲

Figure 6-55: Local Keys menu for desktop panels

6.7.4.1 KEY ASSIGN menu

Select a label on the **LOCAL KEYS** menu to display the **KEY ASSIGN** menu. The **KEY ASSIGN** menu displays the labels that are attached to that key. On lever key panels, press a lever key down to show what is configured on the talk key for a label, and down to show what is configured on the listen key. Press a pushbutton key to display the talk or listen label configured for that key.

On rotary panels, use the rotary control to scroll through the label list. Up to four labels can be configured (stacked) on a key.

You can also use **KEY ASSIGN** to assign a label to a key locally (*without* using ECS / EHX). The highlight bar is displayed below the first label on the key.

Use the up/down buttons or the rotary control on the Reply key (**KEY ASSIGN**) to move the highlight bar to the next key to the right (up) or left (down).

Alternatively, select the next label by pressing the label pushbutton or lever key or talk button (rotary). The highlight bar is then displayed on that label.

Controls	Description / comments
CLEAR / Talk key	Removes the highlighted label and shuffle the labels to the left.
GET LABEL / Talk key	Displays the available Sort Groups. When you select a label from a group, the label is assigned to the selected key.
OK / Talk key	Confirms the settings and returns you to the LOCAL PNL menu.

Table 26 ASSIGN KEY menu controls

6.7.4.2 GET LABEL Menu

The **KEY ASSIGN > GET LABEL** menu displays the available sort groups. Use the up / down buttons (lever key and pushbutton panels) or rotary control on the Reply key to scroll through the list of available Sort Groups. To select a sort group from the list, use the pushbutton or lever key or talk button corresponding to the display window.

The Sort Group membership menu is displayed for the selected Sort Group. Pressing the Reply key or Reply key talk button (**GET LABEL**) will return to the key assign menu.

Note: For information setting up Sort Groups, see the *EHX Eclipse Configuration Software User Guide*. The Sort Group menu options comprise the following:

Menu option	Description / comments
Label	Label for currently displayed key in Sort Group.
Alias Label	Alias of currently displayed key.
START	Takes you to the start of the current Sort Group.
MIDDLE	Takes you to the middle of the current Sort Group.
END	Takes you to the end of the current Sort Group.
OK	Accepts the currently displayed item and places it in the KEY ASSIGN menu.

Table 27 Sort Group menu options

The Reply key displays the label of the selected Sort Group. The top row shows the first member of the Sort Group.

Pressing and releasing the down button (lever key and pushbutton panels) or turning the rotary encoder anti-clockwise on the reply key will step down through the Sort Group (towards the end).

Pressing and releasing the Up button (lever key and pushbutton panels) or turning the rotary control clockwise on the Reply key will step up through the sort group (towards the start).

Pressing the Reply key or Reply key talk button will return you to the Get Label menu.

6.7.5 ATTRIBUTES menu

The **LOCAL PNL > ATTRIBUTES** menu enables you to set the attributes of a panel key to **TALK**, **LISTEN**, **TALK + LSTN**, **TALK + FL** or **DUAL T+L**.

Attribute	Description / comments
TALK	Sets a talk from this panel to a destination with no automatic listen to the destination.
LISTEN	Sets a key to listen to the source without talking to the destination at the same time. Use as a monitor key. Use the volume level up/down buttons under the display (lever key and pushbutton panels) or rotary control to increase listen level.
TALK + LSTN	Sets a talk key with listen. Use the volume level up/down buttons under the display (lever key and pushbutton panel) or rotary encoder to increase or mute the listen level.
TALK + FL	Sets a talk key with permanently made listen. Use the volume level up/down buttons under the display (lever key and pushbutton panels) or rotary encoder to increase or mute the listen level.
DUAL T + L	Sets a dual talk and listen key (used only on pushbutton panel types). Press and hold to activate a talk and listen, or press and release(less than 200ms) to latch a listen on the same pushbutton.

Table 28 Available attributes in ATTRIBUTES menu

Note: To return to the **SYS CONFIG** menu, press the Reply key / Reply key talk button (**ATTRIBUTES**).

6.7.6 REMOTE PNL menu

The **REMOTE PNL** menu enables you to program keys on a remote panel. Select the remote panel from a list of available panels using the Sort Groups.

Note: You can only use the **REMOTE PNL** menu to program keys on other V-Series panels. It **cannot** be used to program keys on other panel types.

	SG:01Label	SG:03Label	SG:05Label	SG:07Label	SG:09Label
▼ ▲	▼ ▲	▼ ▲	▼ ▲	▼ ▲	▼ ▲
REMOTE PNL	SG:02Label	SG:04Label	SG:06Label	SG:08Label	SG:10Label
▼ ▲	▼ ▲	▼ ▲	▼ ▲	▼ ▲	▼ ▲

Figure 6-56: Remote panel menu for rack mounted panels

SG: 01	SG: 02	SG: 03
▼ ▲	▼ ▲	▼ ▲
SG: 04	SG: 05	SG: 06
▼ ▲	▼ ▲	▼ ▲
	SG: 07	SG: 08
▼ ▲	▼ ▲	▼ ▲
REMOTE PNL	SG: 09	SG: 10
▼ ▲	▼ ▲	▼ ▲

Figure 6-57: Remote panel menu for desk top panels

Use the up / down buttons (lever key and pushbutton panels) or rotary control on the Reply key to scroll through the list of available Sort Groups. To select a sort group from the list, use the pushbutton or lever key or talk button corresponding to the display window.

The Sort Group membership menu is displayed for the selected Sort Group.

Note: To return to the **SYS CONFIG** menu, press the Reply key (**REMOTE PNL**).

Note: For information setting up Sort Groups, see the [link to Eclipse Configuration Menu].

The Sort Group menu options comprise the following:

Menu option	Description / comments
Label	Label for currently displayed key in Sort Group.
Alias Label	Alias of currently displayed key.
START	Takes you to the start of the current Sort Group.
MIDDLE	Takes you to the middle of the current Sort Group.
END	Takes you to the end of the current Sort Group.

Menu option	Description / comments
OK	Accepts the currently displayed item and you to the REMOTE PNL menu where the remote keys can be selected and the attributes of the selected remote keys set.

Table 29 Sort Group menu options

The Reply key displays the label of the selected Sort Group. The top row shows the first member of the Sort Group.

Pressing and releasing the down button (lever key and pushbutton panels) or turning the rotary encoder anti-clockwise on the reply key will step down through the Sort Group (towards the end).

Pressing and releasing the Up button (lever key and pushbutton panels) or turning the rotary control clockwise on the Reply key will step up through the sort group (towards the start).

Pressing the Reply key or Reply key talk button will return you to the **REMOTE PNL** menu.

RMT KEYS	ATTRIBUTES				
▼ ▲	▼ ▲	▼ ▲	▼ ▲	▼ ▲	▼ ▲
REMOTE PNL					OK
▼ ▲	▼ ▲	▼ ▲	▼ ▲	▼ ▲	▼ ▲

Figure 6-58: Remote panel menu (RMT keys and attributes mode) for rack mounted panels

OK		
▼ ▲	▼ ▲	▼ ▲
▼ ▲	▼ ▲	▼ ▲
	RMT KEYS	ATTRIBUTES
▼ ▲	▼ ▲	▼ ▲
REMOTE PNL		
▼ ▲	▼ ▲	▼ ▲

Figure 6-59: Remote panel menu (RMT keys and attributes mode) for desktop panels

Menu option	Description / comments
RMT KEYS	Press to assign keys on the remote panel
ATTRIBUTES	Press to set the properties of the remote panel keys.

Table 30 Remote panel menu (RMT keys and attributes mode)

Note: To return to the Sort Group version of the menu, press the Reply key or Reply key talk button (**REMOTE PNL**).

6.7.6.1 RMT KEYS menu

Use the **REMOTE PNL > RMT KEYS** menu to assign keys on the remote panel.

6.7.6.2 ATTRIBUTES menu

The **REMOTE PNL > ATTRIBUTES** menu allows the user to set the attributes of a panel key to **TALK, LISTEN, TALK + LSTN, TALK + FL** or **DUAL T+L**. For definitions of the available attributes, see **Table 28 Available attributes in ATTRIBUTES menu**.

Note: To return to the **REMOTE PNL** menu, press the Reply key or Reply key talk button (**ATTRIBUTES**).

6.7.7 FL CONFIG (Forced Listen configuration) menu

The **Forced Listen** configuration menu (**FL CONFIG** on the Reply key) enables you to select a key and set the source or destination of that key to forced listen.

	SOURCE	DEST			
▼ ▲	▼ ▲	▼ ▲	▼ ▲	▼ ▲	▼ ▲
FL CONFIG					
▼ ▲	▼ ▲	▼ ▲	▼ ▲	▼ ▲	▼ ▲

Figure 6-60: Forced Listen configuration menu for rack mounted panels

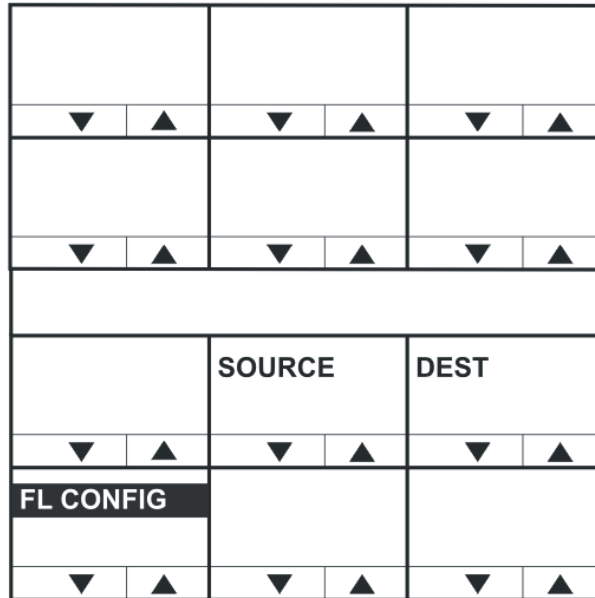

Figure 6-61: Forced listen configuration men for desktop panels

Menu option	Description / comments
SOURCE	Press to select forced listen sources (FL SOURCE menu).
DEST	Press to select forced listen destinations (FL DEST menu).

Table 31: FL CONFIG menu options

Note: To return to the **SYS CONFIG** menu, press the Reply key or Reply key talk button (**FL CONFIG**).

6.7.7.1 FL SOURCE configuration menu

Selecting **FL CONFIG > SOURCE** takes you to the **FL SOURCE** menu. Configuring a forced listen source creates a forced listen from the selected source to the selected key on the panel being configured. This results in the configured panel always receiving the audio from the forced listen source on that key.

Note: To return to the **FL CONFIG** menu, press the Reply key or Reply key talk button (**FL SOURCE**).

In the **FL SOURCE** menu, select **INTERFACES** or **PANELS** to display a list of interfaces or panels that may be forced listen sources.

Press the volume up/down buttons (lever key and pushbutton panels) or turn the rotary control on the Reply key (**FL SRC INT** (Interfaces) or **FL SRC PN** (Panels)) to scroll through the list of possible interfaces / panels. Press a key or talk button for a source interface / panel to select the label, and display the **forced listen destination (FL DEST)** menu.

6.7.7.2 FL DEST configuration menu

Selecting **FL CONFIG > DEST** takes you to the **FL DEST** menu. **FL DEST** is also displayed when you have selected a **forced listen source** (see previous section).

Configuring a forced listen destination creates a forced listen from the panel being configured to the selected destination. This results in the configured panel always sending audio to the forced listen destination.

Note: To return to the **FL CONFIG** menu, press the Reply key or Reply key talk button (**FL SOURCE**).

In the **FL DEST** menu, select **INTERFACES** or **PANELS** to display a list of interfaces or panels that may be forced listen destinations.

Press the volume up/down buttons (lever key and pushbutton panels) or turn the rotary control on the Reply key (**FL DST INT** (Interfaces) or **FL DST PN** (Panels)) to scroll through the list of possible interfaces / panels.

Press a key or talk button for a source interface / panel to select the label / destination, and display the **forced listen source (FL SOURCE)** menu.

6.7.8 INPUT LVLS (Input Levels) configuration menu

The **INPUT LVLS** menu displays the Sort Groups available to the panel. Selecting one of the Sort Groups displays the membership menu for that sort group.

	SG:01Label	SG:03Label	SG:05Label	SG:07Label	SG:09Label
▼ ▲	▼ ▲	▼ ▲	▼ ▲	▼ ▲	▼ ▲
INPUT LVLS	SG:02Label	SG:04Label	SG:06Label	SG:08Label	SG:10Label
▼ ▲	▼ ▲	▼ ▲	▼ ▲	▼ ▲	▼ ▲

Figure 6-62: Input levels configuration menu for rack mounted panels

SG: 01		SG: 02		SG: 03	
▼	▲	▼	▲	▼	▲
SG: 04		SG: 05		SG: 06	
▼	▲	▼	▲	▼	▲
		SG: 07		SG: 08	
▼	▲	▼	▲	▼	▲
INPUT LVLS		SG: 09		SG: 10	
▼	▲	▼	▲	▼	▲

Figure 6-63: Input levels configuration menu for desk top panels

Press the up / down volume buttons (lever key and pushbutton panels) or turn the rotary control on the Reply key to scroll through the list of Sort Groups. When a Sort Group is selected by pressing the corresponding lever key, pushbutton or talk button the **Sort Group membership menu** is displayed.

Note: To return to the **SYS CONFIG** menu, press the Reply key or Reply key talk button (**INPUT LVLS**).

Setting the input levels for a label

The **INPUT LVLS > Sort Group membership menu** enables you to select an individual label from a Sort Group and to set the input levels for that label.

Label	Alias Label	LIST			
▼	▲	▼	▲	▼	▲
SG:02Label	START	MIDDLE	END		OK
▼	▲	▼	▲	▼	▲

Figure 6-64: Input levels Sort Group membership menu for rack mounted panels

OK		
▼ ▲	▼ ▲	▼ ▲
START	MIDDLE	END
▼ ▲	▼ ▲	▼ ▲
label	Alias label	
▼ ▲	▼ ▲	▼ ▲
SG:02 label		LIST
▼ ▲	▼ ▲	▼ ▲

Figure 6-65 Input levels Sort Group membership menu for desktop panels

The Sort Group menu options comprise the following:

Menu option	Description / comments
START	Takes you to the start of the current Sort Group.
MIDDLE	Takes you to the middle of the current Sort Group.
END	Takes you to the end of the current Sort Group.
OK	Press the OK key or talk button to select the port label to be configured.

Table 32 Sort Group menu options

The Reply key displays the label of the selected Sort Group. The top row shows the first member of the sort group.

Pressing and releasing the down button (lever key and pushbutton panels) or turning the rotary control anticlockwise on the Reply key will step down through the Sort Group towards the end of the Sort Group.

Pressing and releasing the up button (lever key and pushbutton panels) or turning the rotary control clockwise on the Reply key steps you up through the Sort Group.

Pressing the **OK** key or talk button to selects the port label to be configured.

6.7.8.1 Setting the input levels for the selected label

▼	▲	▼	▲	▼	▲
INPUTLEVEL	Label 01	+0 dB			RESET
▼	▲	▼	▲	▼	▲

Figure 6-66: Input levels menu (selected label mode) for rack mounted panels

▼	▲	▼
▼	▲	▼
Label 01	+0 dB	
▼	▲	▼
INPUT LEVEL	RESET	
▼	▲	▼

Figure 6-67: Input levels menu (selected label mode) for desktop panels

The **+0 dB** represents the input level for the audio source of the label and may be adjusted using the up and down buttons below the level display or the rotary encoder.

Select the **RESET** key or talk button to reset the input levels to the default of 0dB. Pressing the Reply key or Reply key talk button (**INPUT LEVEL**) will return you to the Sort Group menu.

Note: When you set the input level for an audio source, you are setting the input levels for the **entire** matrix and not just an individual panel.

Input and output settings can only be made for the local matrix. Gains for other matrices can be achieved within ECS / EHX.

6.7.9 OUTPUT LVL (Output Levels) configuration menu

The **OUTPUT LVL** (Output Levels) menu displays the Sort Groups available to the panel. Selecting one of the Sort Groups displays the membership menu for that Sort Group.

	SG:01Label	SG:03Label	SG:05Label	SG:07Label	SG:09Label
▼ ▲	▼ ▲	▼ ▲	▼ ▲	▼ ▲	▼ ▲
OUTPUT LVL	SG:02Label	SG:04Label	SG:06Label	SG:08Label	SG:10Label
▼ ▲	▼ ▲	▼ ▲	▼ ▲	▼ ▲	▼ ▲

Figure 6-68: Output levels configuration menu (available Sort Groups) for rack mounted panels

SG: 01	SG: 02	SG: 03
▼ ▲	▼ ▲	▼ ▲
SG: 04	SG: 05	SG: 06
▼ ▲	▼ ▲	▼ ▲
	SG: 07	SG: 08
▼ ▲	▼ ▲	▼ ▲
OUTPUT LVL	SG: 09	SG: 10
▼ ▲	▼ ▲	▼ ▲

Figure 6-69: Output levels configuration menu (available Sort Groups) for desktop panels

The Sort Group menu options comprise the following:

Menu option	Description / comments
START	Takes you to the start of the current Sort Group.
MIDDLE	Takes you to the middle of the current Sort Group.
END	Takes you to the end of the current Sort Group.
OK	Press the OK key or talk button to select the port label to be configured.

Table 33: Sort Group menu options

The Reply key displays the label of the selected Sort Group. The top row shows the first member of the sort group. Pressing and releasing the down button (lever key and pushbutton panels) or turning the rotary control anticlockwise on the Reply key will step down through the Sort Group towards the end of the Sort Group.

Pressing and releasing the up button (lever key and pushbutton panels) or turning the rotary control clockwise on the Reply key steps you up through the Sort Group.

Pressing the **OK** key or talk button to selects the port label to be configured.

6.7.9.1 Setting the Output Levels for the selected label

Label	Alias Label	LIST			
▼ ▲	▼ ▲	▼ ▲	▼ ▲	▼ ▲	▼ ▲
SG:02Label	START	MIDDLE	END		OK
▼ ▲	▼ ▲	▼ ▲	▼ ▲	▼ ▲	▼ ▲

Figure 6-70: Output levels menu (selected label mode) for rack mounted panels

OK			
▼	▲	▼	▲
START		MIDDLE	END
▼	▲	▼	▲
Label		Alias label	
▼	▲	▼	▲
SG:02Label			LIST
▼	▲	▼	▲

Figure 6-71: Output levels menu (selected label mode) for desktop panels

The **+0 dB** represents the output level for the audio source of the label and may be adjusted using the up and down buttons below the level display or the rotary encoder.

Select the **RESET** key or talk button to reset the output levels to the default of 0dB. Pressing the Reply key or Reply key talk button (**OUTPUT LEVEL**) will return you to the Sort Group menu.

Note: When you set the output level for an audio source, you are setting the input levels for the **entire** matrix and not just an individual panel.

Input and output settings can only be made for the local matrix. Gains for other matrices can be achieved within ECS / EHX.

6.8 DIAGNOSTIC menu

The **DIAGNOSTIC** menu is accessed from the top level menu.

		Version number					
UPGRADE	0.25.0	SYSTEMDATA					
▼	▲	▼	▲	▼	▲	▼	▲
DIAGNOSTIC	TEST TONE	RESET PANL	TEL RELEAS				
▼	▲	▼	▲	▼	▲	▼	▲

Figure 6-72: Diagnostic menu for rack mounted panels

▼ ▲	▼ ▲	▼ ▲
		TEL RELEASE
▼ ▲	▼ ▲	▼ ▲
UPGRADE Version SYSTEM DATA		
▼ ▲	▼ ▲	▼ ▲
DIAGNOSTIC	TEST TONE	RESET PANL
▼ ▲	▼ ▲	▼ ▲

Figure 6-73: Diagnostic menu for desktop panels

The **DIAGNOSTIC** menu options are as follows:

Menu option	Description / comments
SYSTEMDATA	Displays the system data menu.
TEST TONE	Selecting TEST TONE turns the LED indicator red and sends a 1KHz test tone to the matrix output. Selecting Test Tone again disables the tone, and turns off the red LED. Exiting the DIAGNOSTIC menu also turns off the test tone.
RESET PANL	Selecting RESET PANL resets the panel to factory defaults. It will also delete all locally assigned keys and reset all crosspoint levels to the factory default (0dB). Panel brightness is reset to the brightness level configured for that panel in ECS / EHX.
TEL RELEAS	Selecting TEL RELEAS returns the user to the Direct Access Key (DAK) page. If a telephone key is pressed the line is released. Note: <i>The panel must also have Remote Line Release enabled in ECS / EHX for this to take effect. This function can also be performed using the up/down volume control buttons or rotary control.</i>
UPGRADE	Only displayed if an update is available from the matrix. Selecting this option displays the UPGRADE menu.

Table 34: Diagnostic menu options

Note: To return to the top level menu, press the Reply key or Reply key talk button (**DIAGNOSTIC**).

6.8.1.1 Version numbers and IP address

Waiting	for	Eclipse	U 0.0.11	K 2.6.16	A 0.19.0
▼ ▲	▼ ▲	▼ ▲	▼ ▲	▼ ▲	▼ ▲
M 0.20.0	- -	- -	M 0.20.0	172.16	86.101
▼ ▲	▼ ▲	▼ ▲	▼ ▲	▼ ▲	▼ ▲

Figure 6-74: Diagnostic menu (offline display) for rack mounted panels

0.0.0.11	U 2.6.17	A 0.24.0
▼ ▲	▼ ▲	▼ ▲
M 0.21.0		
▼ ▲	▼ ▲	▼ ▲
Waiting	for	Eclipse
▼ ▲	▼ ▲	▼ ▲
M 0.21.0	172.16	86.101
▼ ▲	▼ ▲	▼ ▲

Figure 6-75: Diagnostic menu (offline display) for desktop panels

The version number displayed in the **DIAGNOSTIC** menu is for the panel application **only**. To obtain the version numbers of all panel firmware and the IP address of the V-Series panel, you must take the panel off line. The information given (from the example information in **Figure 6-74** and **Figure 6-75** above) is as follows:

Example diagnostic information	Description / comments
M 0.20.0	Module application code version
U 0.0.11	Panel boot loader version
K2.6.16	Panel kernel version
A0.19.0	Panel application version
172.16.86.101	Panel IP address (if set, otherwise blank).

Table 35: Example diagnostic information

Note: The version and IP address information is for main panels only. Expansion panels do not display this information. You can also access version information through ECS / EHX.

6.8.2 SYSTEM DATA menu

Select the **SYSTEMDATA** menu to display system information for the panel.

LD: 16:24	09/01/06	MAP: Name	NET: 12345	6789A BCDE	
▼ ▲	▼ ▲	▼ ▲	▼ ▲	▼ ▲	▼ ▲
SYSTEMDATA	PORT: 001	Label			
▼ ▲	▼ ▲	▼ ▲	▼ ▲	▼ ▲	▼ ▲

Figure 6-76: System data menu for rack mounted panels

LD: 16:14	NET: 12145	6789ADCDEF
▼ ▲	▼ ▲	▼ ▲
09/01/07		
▼ ▲	▼ ▲	▼ ▲
PORT: 001	Label	SYSTEM
▼ ▲	▼ ▲	▼ ▲
SYSTEMDATA	MAP: name	
▼ ▲	▼ ▲	▼ ▲

Figure 6-77: System data menu for desktop panels

The **SYSTEM DATA** menu displays the following information:

System information	Description / comments
LD	Time and date of last configuration / map download.
MAP	Name of configuration / map.
NET	Systems configured and connected to the panel
PORT	Port number of the panel
Label	Panel label

Table 36: System information

Note: To return to the **DIAGNOSTIC** menu, press the Reply key or Reply key talk button (**SYSTEMDATA**).

6.8.3 UPGRADE menu

The **UPGRADE** menu is displayed if:

- A panel upgrade is available from the matrix.
- The **Panel Prompt** option was selected in ECS / EHX.

You have the option to accept or refuse any upgrade that is offered. You can access the UPGRADE menu from the DIAGNOSTIC menu. The menu is also displayed when a panel comes back online after an upgrade has been downloaded to the matrix. Flashing keys also prompt you that an upgrade is available.

Upgrade To	Version	0.29.0			
▼ ▲	▼ ▲	▼ ▲	▼ ▲	▼ ▲	▼ ▲
	YES	NO			
▼ ▲	▼ ▲	▼ ▲	▼ ▲	▼ ▲	▼ ▲

Figure 6-78: Upgrade menu for rack mounted panels

▼ ▲	▼ ▲	▼ ▲
▼ ▲	▼ ▲	▼ ▲
Upgrade To	Version	0.29.0
▼ ▲	▼ ▲	▼ ▲
	YES	NO
▼ ▲	▼ ▲	▼ ▲

Figure 6-79: Upgrade menu for desktop panels

6.8.3.1 Confirming the upgrade

If you select **YES**, the upgrade confirmation menu is displayed.

Are You	Sure	0.29.0			
▼ ▲	▼ ▲	▼ ▲	▼ ▲	▼ ▲	▼ ▲
	YES	NO			
▼ ▲	▼ ▲	▼ ▲	▼ ▲	▼ ▲	▼ ▲

Figure 6-80: Upgrade confirmation menu for rack mounted panels

▼ ▲	▼ ▲	▼ ▲
▼ ▲	▼ ▲	▼ ▲
Are You Sure 0.29.0		
▼ ▲	▼ ▲	▼ ▲
	YES	NO
▼ ▲	▼ ▲	▼ ▲

Figure 6-81: Upgrade confirmation menu for desktop panels

If you are sure about the upgrade, select **YES**. The panel is upgraded with the new download.

If you select **NO**, the upgrade prompt is not displayed again until the upgrade is downloaded from the matrix again.

The panel displays a message when the upgrade is complete, and then reboots to load the new application.

Note: During the upgrade process the message **UPDATE IN PROGRESS** is displayed, with an indication of how far the upgrade has progressed.

6.9 CALL menu

The **CALL** menu displays a list of sort groups from which a label can be selected and placed on the answerback stack to create a temporary key.

	SG:01Label	SG:03Label	SG:05Label	SG:07Label	SG:09Label
▼ ▲	▼ ▲	▼ ▲	▼ ▲	▼ ▲	▼ ▲
CALL	SG:02Label	SG:04Label	SG:06Label	SG:08Label	SG:10Label
▼ ▲	▼ ▲	▼ ▲	▼ ▲	▼ ▲	▼ ▲

Figure 6-82: Call menu for rack mounted panels

SG: 01	SG: 02	SG: 03
▼ ▲	▼ ▲	▼ ▲
SG: 04	SG: 05	SG: 06
▼ ▲	▼ ▲	▼ ▲
	SG: 07	SG: 08
▼ ▲	▼ ▲	▼ ▲
CALL	SG: 09	SG: 10
▼ ▲	▼ ▲	▼ ▲

Figure 6-83: Call menu for desktop panels

Use the up/down buttons (lever key and pushbutton panels) or rotary control on the Reply key to scroll through the available Sort Groups and select the name of the Sort Group containing the required label using the lever key or pushbutton or talk button.

This will display the Sort Group label selection menu. Press the Reply key or Reply key talk button (**CALL**) to return to the main menu.

6.9.1.1 Selected Sort Group in the CALL menu

Label	Alias Label				
▼ ▲	▼ ▲	▼ ▲	▼ ▲	▼ ▲	▼ ▲
SG:02Label	START	MIDDLE	END		OK
▼ ▲	▼ ▲	▼ ▲	▼ ▲	▼ ▲	▼ ▲

Figure 6-84: Selected Sort Group menu for rack mounted panels

OK		
▼ ▲	▼ ▲	▼ ▲
START	MIDDLE	END
▼ ▲	▼ ▲	▼ ▲
Label	Alias label	
▼ ▲	▼ ▲	▼ ▲
SG:02 label		
▼ ▲	▼ ▲	▼ ▲

Figure 6-85: Selected Sort Group menu for desktop panels

The selected Sort Group label / name is displayed on the Reply key and the first member of the sort group is displayed on the top row of the display. Selecting **START** will take the user to the start of the sort group. Selecting **MIDDLE** will take the user to the middle of the sort group, and selecting **END** will take the user to the end of the sort group. Selecting **OK** will select the currently displayed member of the sort group and place it at the top of the answerback stack and return the user to the main **CALL** menu.

Note: To call the selected label, press the Reply key to access the label from the answerback stack and call. The label is not removed from the answerback stack.

To return to the **CALL** menu, press the Reply key or Reply key talk button.

6.10 DIAL menu

The **DIAL** menu is provided on 1RU panels to allow users to dial telephone numbers. 2RU and desktop panels also have a dial pad for dialing telephone numbers.

To use the DIAL facility, you must first set up a key on the panel to a TEL-14 interface module. To dial out:

- 5) Select the **TEL-14** interface module.
- 6) Use either the dial pad (if available) or the DIAL menu to dial the telephone number.

0	1	2	3	4	5	6	7	8	9	*	#
▼	▲	▼	▲	▼	▲	▼	▲	▼	▲	▼	▲
DIAL		XXXXXXX		XXXXXXX		XXXXXXX		RELEASE		REDIAL	
▼	▲	▼	▲	▼	▲	▼	▲	▼	▲	▼	▲

Figure 6-86: Dial menu for rack mounted panels

1	2	3	4	5	6
▼	▲	▼	▲	▼	▲
7	8	9	0	*	#
▼	▲	▼	▲	▼	▲
xxx xxx		xxx xxx		xxx xxx	
▼	▲	▼	▲	▼	▲
DIAL		RELEASE		REDIAL	
▼	▲	▼	▲	▼	▲

Figure 6-87: Dial menu for desk top panels

On lever key and pushbutton panels, pressing the up / down buttons under the numbers will dial the numbers as they are selected and enter them into the dial display on the lower line (shown as **XXXX**).

On rotary panels pressing the rotary control will select the left digit, while pressing the talk button will select the right digit. Telephone numbers up to 30 digits in length may be displayed.

If the initial number dial is unsuccessful, select the **RELEASE** key to release the telephone line.

Select **REDIAL** to dial the number saved on the lower line of the display. If you exit **DIAL** mode, the redial number is cleared.

The **RELEASE** and **REDIAL** keys perform the same function on 2RU panels whether the keypad or panel keys are used to dial the number.

Note: To return to the main menu, press the Reply key or Reply key talk button (**DIAL**).

6.10.1.1 Using the DIAL menu with dial pads

Using the dial pad on 2RU rack mount panels and desktop panels to access the DIAL menu by pressing 1 will enter a different dial menu. The labels operate as normal, and dialing out is achieved using the dial pad.

	Label 01	Label 03	Label 05	Label 07	Label 09
▼ ▲	▼ ▲	▼ ▲	▼ ▲	▼ ▲	▼ ▲
DIAL	Label 02	Label 04	Label 06	Label 08	Label 10
▼ ▲	▼ ▲	▼ ▲	▼ ▲	▼ ▲	▼ ▲

Figure 6-88: Dial menu (from dial pad shortcut) for rack mounted panels

Label 01	Label 02	Label 03
▼ ▲	▼ ▲	▼ ▲
Label 04	Label 05	Label 06
▼ ▲	▼ ▲	▼ ▲
	Label 07	Label 08
▼ ▲	▼ ▲	▼ ▲
DIAL	Label 09	Label 10
▼ ▲	▼ ▲	▼ ▲

Figure 6-89: Dial menu (from dial pad shortcut) for desktop panels

When you dial out through a TEL-14 interface module, using the DIAL menu, no outgoing audio is transmitted until you exit the DIAL menu. Incoming audio from the TEL-14 interface module can be heard, however.

6.11 LOCAL EXCL (Local Exclusive) menu

The **LOCAL EXCL** (Local Exclusive) menu enables you to select a single key for talk and temporarily deactivate all other latched keys on the panel.

The required key is non-latching and so must be kept pressed while local exclusive is in operation. Releasing the key will return the deactivated latched keys to their previous state.

The menu can also be entered by pressing **2** on the dial pad.

	Label 01	Label 03	Label 05	Label 07	Label 09
▼ ▲	▼ ▲	▼ ▲	▼ ▲	▼ ▲	▼ ▲
LOCAL EXCL	Label 02	Label 04	Label 06	Label 08	Label 10
▼ ▲	▼ ▲	▼ ▲	▼ ▲	▼ ▲	▼ ▲

Figure 6-90: Local exclusive menu for rack mounted panels

Label 01	Label 02	Label 03
▼ ▲	▼ ▲	▼ ▲
Label 04	Label 05	Label 06
▼ ▲	▼ ▲	▼ ▲
	Label 07	Label 08
▼ ▲	▼ ▲	▼ ▲
LOCALEXCL	Label 09	Label 10
▼ ▲	▼ ▲	▼ ▲

Figure 6-91: Local exclusive menu for desktop panels

If local exclusive is selected but no key is pressed in five seconds local exclusive mode is cancelled and the panel returns to its previous state. The local exclusive functionality is only available when the panel is connected to a matrix and online.

6.12 LOCAL PAGE (Local Page override) menu

The **LOCAL PAGE** override menu allows you to talk to one or more destinations, regardless of the destination panel settings for the panel loudspeaker.

Note: Local page override can also be accessed by pressing **3** on the panel dial pad.

	Label 01	Label 03	Label 05	Label 07	Label 09
▼ ▲	▼ ▲	▼ ▲	▼ ▲	▼ ▲	▼ ▲
LOCAL PAGE	Label 02	Label 04	Label 06	Label 08	Label 10
▼ ▲	▼ ▲	▼ ▲	▼ ▲	▼ ▲	▼ ▲

Figure 6-92: Local page override menu for rack mounted panels

Label 01	Label 02	Label 03
▼ ▲	▼ ▲	▼ ▲
Label 04	Label 05	Label 06
▼ ▲	▼ ▲	▼ ▲
	Label 07	Label 08
▼ ▲	▼ ▲	▼ ▲
LOCAL PAGE	Label 09	Label 10
▼ ▲	▼ ▲	▼ ▲

Figure 6-93: Local page override menu for desktop panels

Select any key with a label to override the local loudspeaker settings for all the destination panels associated with that key.

When the talk key is released the override function ceases, and the loudspeaker settings at the destination panels revert to their normal settings. If no key is pressed for five seconds after entering local page override mode the panel exits local page override automatically.

Note: To enable local page override on the panel, you must enable both page override and ensure that the page volume levels for the destination panel are set in ECS / EHX. For more information, see your ECS / EHX documentation.

6.13 ASSNMT PNL (Assignment Panel) menu

Use the **ASSNMT PNL** menu, to assign (and remove) sources and destinations for IFBs, partylines and Fixed Groups.

In the assignment mode, the REPLY key displays the assignment types (IFB, PL, FG) that have been enabled in ECS / EHX. Pressing the REPLY key will cycle through the available assignment types.

Note: In addition to the main menu, you can also enter assignment panel mode through an **INTERCOM** key on rotary panels. The **INTERCOM** key will function in exactly the same way as the **REPLY** key.

	Label 01	Label 03	Label 05	Label 07	Label 09
▼ ▲	▼ ▲	▼ ▲	▼ ▲	▼ ▲	▼ ▲
IFB	Label 02	Label 04	Label 06	Label 08	Label 10
▼ ▲	▼ ▲	▼ ▲	▼ ▲	▼ ▲	▼ ▲

Figure 6-94: Assignment panel menu (IFB assignment shown) for rack mounted panels

Label 01	Label 02	Label 03
▼ ▲	▼ ▲	▼ ▲
Label 04	Label 05	Label 06
▼ ▲	▼ ▲	▼ ▲
	Label 07	Label 08
▼ ▲	▼ ▲	▼ ▲
IFB	Label 09	Label 10
▼ ▲	▼ ▲	▼ ▲

Figure 6-95: Assignment panel menu (IFB assignment shown) for desktop panels

Assignment mode	Description / comments
IFB	To assign IFB sources and destinations, press the ASSNMT PNL key or talk button. IFB is displayed on the Reply key, and status LED is lit red .
PL	To make partyline assignments, press the Reply key again (currently showing IFB). PL is displayed on the Reply key.
FG	To make Fixed Group assignments, press the Reply key again (currently showing PL). FG is displayed on the Reply key.

	To exit assignment mode all together, press the Reply key again.
--	--

Table 37: Assignment menu modes

6.13.1 Assigning interruptible foldback (IFB) sources to an IFB destination

Note: By default only one source per destination is configured. If multiple sources for an IFB destination are required, then the option to assign multiple sources to an IFB from an assignment panel (AP) must be enabled in your ECS / EHX software. For more information, see your *ECS/EHX documentation*.

To assign a source to an IFB destination:

- 1) Press **MENU** to select it.

Press the **ASSMNT PNL** key to access the assignment menu. The **REPLY** key status LED lights up **red** and displays the available assignment modes. Toggle through the available assignment modes using the reply key until IFB ASSIGN is displayed. Valid IFB destinations will **flash red**.

Only assignment modes that have been configured in the ECS / EHX software will be available.

- 2) Press the appropriate key for the required IFB destination. The status LED for the selected key is now lit **solid red**.

Note: Pressing the key again deactivates the assignment.

- 3) Valid IFB sources are indicated by the status LEDs **flashing green**. Press the appropriate key for the required IFB source. The status LED for the selected key is now **solid green** and the source is assigned to the destination.

- 4) Pressing the key again deactivates the assignment.

Note: To exit IFB assignment mode, press either the **REPLY** key or the **MENU** key.

6.13.1.1 Rotary panel IFB assignment using the INTERCOM key

On a rotary control panel, the **INTERCOM** key can be used to access the assignment mode directly. See 5.17.3 in this manual for more information.

- 1) Press the **INTERCOM** key. The panel will enter **Assignment Panel** mode and valid IFB destinations will flash **red**.
- 2) Follow steps 3 and 4 above.

6.13.1.2 Rotary panel IFB setup: setting the audio levels

On rotary panels, you can set the **audio levels** when assigning IFB sources and destinations using the rotary controls.

To change the audio levels:

- 3) Select the **IFB destination** (see above procedure).
- 4) Turn the rotary control associated with the selected **IFB destination** key. The display changes to show the audio level and the type of level being adjusted. When the talk button is pressed the **output level** to the IFB destination is set.
- 5) Select the **IFB source(s)** (see above procedure).
- 6) Turn the rotary control associated with the selected **IFB source** key. The display changes to show the audio level and the type of level being adjusted. When the talk button or rotary control is pressed the **input level** to the matrix is set.

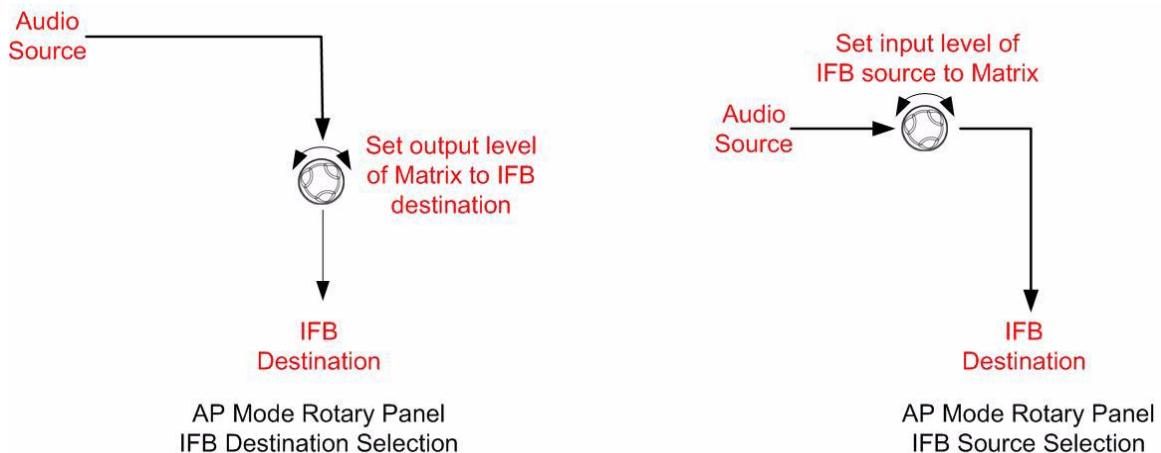

Figure 6-96: Rotary panel IFB audio level setup

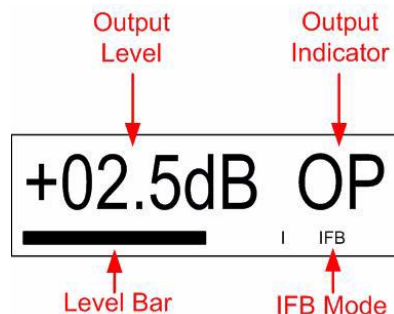

Figure 6-97: Rotary panels: Setting the output level

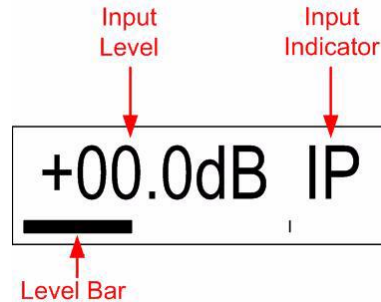

Figure 6-98: Rotary panels: Setting the input level

6.13.2 Assigning partyline members

To assign partyline members to a talk or listen key:

- 1) Press the **MENU** button to access the menu mode.
- 2) Press the **ASSMNT PNL** key and use the **REPLY** key to toggle to the partyline (**PL**) mode. In partyline assignment mode all available partyline status LEDs, **flash red**.

Note: Only assignment modes that have been configured in the ECS /EHX software will be available.

- 3) Press the key for the required partyline. The key's status LED is lit **solid red** and all available members' status LEDs **flash green**.

In the case of rotary panels if a talk label is available the talk button will flash green and if a listen label is available the rotary encoder will flash green.

- 4) Press the appropriate key for the required partyline member. The status LED for the selected key is now **solid green** and the member is added to the partyline.

Pressing the key again deactivates the assignment.

- 5) Repeat step 4 until the partyline contains all desired members.
- 6) To exit partyline assignment mode, press either the **REPLY** key or the **MENU** key.

6.13.3 Assigning Fixed Group members

To assign Fixed Group members to a talk or listen key:

- 1) Press the **MENU** button to access the menu mode.

- 2) Press the **ASSMNT PNL** key and use the **REPLY** key to toggle to the Fixed Group (**FG**) mode. In Fixed Group assignment mode all available Fixed Group status LEDs, **flash red**.
Note: Only assignment modes that have been configured in the ECS /EHX software will be available.
- 3) Press the key for the required Fixed Group.
 The key's status LED is lit **solid red** and all available members' status LEDs **flash green**. In the case of rotary panels, if a talk label is available the talk button will flash green and if a listen label is available the rotary encoder will flash green.
- 4) Press a key with the associated flashing green status LED of an available member to add it to the Fixed Group.
 The key's status LED becomes **solid green** to indicate the member has been added to the Fixed Group.
- 5) Repeat step 4 until the Fixed Group contains all desired members.
Note: To remove a member from the Fixed Group, press that member's key. The solid green status LED associated with that key **flashes green** to indicate it is available again.
- 6) To exit Fixed Group assignment mode, press either the **REPLY** key or the **MENU** key.

6.14 SUPERVISE menu

The **SUPERVISE** menu can be accessed either via an assigned 'hot key' (see 6.14.1.3 in this manual) on the panel or via the **MENU** system.

The **SUPERVISE** menu allows the user to select another panel to supervise from the panels listed in the sort groups.

Note: The target panel **cannot** be the current panel (an error message will be displayed if this is selected) and must be a V-Series panel with the same number of keys or fewer keys than the supervising panel.

Note: The supervise option must be enabled in EHX, otherwise this menu option is not displayed. This checkbox is found in **Hardware/Cards and Ports/Properties/Menu Options** within the EHX configuration software.

**EHX/Hardware/cards and ports/
Properties/Menu Options/Supervisor Mode
Access**

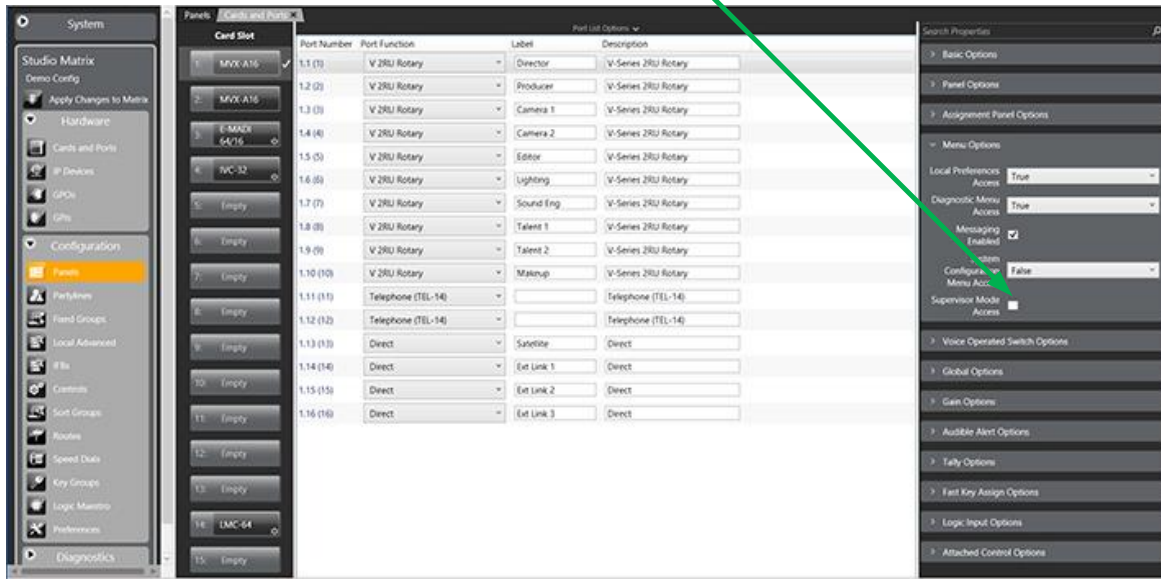

Figure 6-99 Enable Supervise mode in EHX configuration software

To access SUPERVISE via the panel MENU system:

- 1) Press the **MENU** key to enter menu mode.
- 2) Press the key labeled **SUPERVISE**.
- 3) In **SUPERVISE** mode (see below) follow the instructions to select a panel to control.

	SG:01Label	SG:03Label	SG:05Label	SG:07Label	SG:09Label
▼ ▲	▼ ▲	▼ ▲	▼ ▲	▼ ▲	▼ ▲
SUPERVISE	SG:02Label	SG:04Label	SG:06Label	SG:08Label	SG:10Label
▼ ▲	▼ ▲	▼ ▲	▼ ▲	▼ ▲	▼ ▲

Figure 6-100: Supervise menu for rack mounted panels

SG: 01	SG: 02	SG: 03
▼ ▲	▼ ▲	▼ ▲
SG: 04	SG: 05	SG: 06
▼ ▲	▼ ▲	▼ ▲
	SG: 07	SG: 08
▼ ▲	▼ ▲	▼ ▲
SUPERVISE	SG: 09	SG: 10
▼ ▲	▼ ▲	▼ ▲

Figure 6-101: Supervise menu for desktop panels

Use the up/down buttons (lever key and pushbutton panels) or rotary control on the Reply key to scroll through the available Sort Groups and select the name of the Sort Group containing the required label using the lever key or pushbutton or talk button.

This will display the Sort Group label selection menu.

Note: To return to the main menu, press the Reply key or Reply key talk button (**SUPERVISE**).

Selected Sort Group in the SUPERVISE menu

Label	Alias Label	LIST			
▼ ▲	▼ ▲	▼ ▲	▼ ▲	▼ ▲	▼ ▲
SG:02Label	START	MIDDLE	END		OK
▼ ▲	▼ ▲	▼ ▲	▼ ▲	▼ ▲	▼ ▲

Figure 6-102: Selected Sort Group menu for rack mounted panels

OK			
▼	▲	▼	▲
START		MIDDLE	END
▼	▲	▼	▲
Label		Alias label	
▼	▲	▼	▲
SG:02 label			LIST
▼	▲	▼	▲

Figure 6-103: Selected Sort Group menu for desktop panels

The selected Sort Group label / name is displayed on the Reply key and the first member of the sort group is displayed on the top row of the display. Selecting **START** will take the user to the start of the sort group. Selecting **MIDDLE** will take the user to the middle of the sort group, and selecting **END** will take the user to the end of the sort group. Selecting **OK** will select the currently displayed member of the sort group and place the panel corresponding to the label into supervised mode. If the panel is unable to supervise the panel an **error screen** is displayed.

	Unable to	Supervise			
▼	▲	▼	▲	▼	▲
ERROR	Panel	Offline			
▼	▲	▼	▲	▼	▲

Figure 6-104: Supervise error message for rack mounted panels

▼	▲	▼
▼	▲	▼
Unable to Supervise		
▼	▲	▼
ERROR	Panel	Offline
▼	▲	▼

Figure 6-105: Supervise error message for desktop panels

The **Panel Offline** error message (shown above) is displayed if the target panel cannot be supervised because it is offline.

For other errors, such as an invalid port or panel type, the **Unable to Supervise** message is displayed.

When the panel is actively supervising another panel the keys displayed on both panels are inverted to indicate the current state (instead of light text on a dark background the key displays will show dark text on a light background).

6.14.1.1 Supervising panels

When in Supervise mode, the V-Series panel can mimic and control other V-Series panels in the local system. This involves remote actioning of key presses and displaying a mimic of the target panel's display. While in Supervise mode, all key presses are processed at the target panel.

V12LD, V24LD, V12PD and V24PD panel types can be selected as target panels to be supervised from other lever key and pushbutton panels. Rotary panels can only supervise other rotary panels, and cannot be supervised by lever key or pushbutton panels.

The following target panel features can be mimicked or controlled:

- Audio to the target panel.
- Display text.
- Display level control bars.
- Key presses and releases.

- Cross-point level control.
- Microphone gain.
- Loudspeaker cut.
- Head-set select.
- Microphone mute.
- Side-tone control

General purpose inputs and outputs are **not** mimicked or remotely controllable as they may not be connected to the same hardware on the supervisor and target panels.

In particular, some of the general-purpose inputs and outputs have dedicated functions on a Supervisor Panel. Busy Feedback is not mimicked.

Pushbutton panels can supervise lever key panels but will not be able to mimic or control lever key up assignments. Only the lever key down assignments will be supervised.

6.14.1.2 Exiting supervise mode

To exit Supervise mode, hold down the Menu button on the dial pad for at least 3 seconds. The key displays on both panels will then return to the normal (non-supervised) state.

6.14.1.3 Supervisor hot key

A supervisor hot key can be configured in EHX to enable rapid entry to Supervise mode. When the supervisor hot key is selected the labels to panels which may be supervised will flash and the Reply key will display **SUPERVISE** in highlighted mode.

Pressing the Reply key or Reply key talk button will exit this mode.

6.15 SHIFT menu

The **SHIFT** (Shift Page) menu enables access to the eight shift pages. Each shift page displays a different set of key labels.

Shift Page Mode: when the Shift Page Menu is open, the keys on the panel will be color coded.

- Green: Keys are configured on the page
- Red: No keys are configured on the page

Note: From the EHX software (**Configuration > Preferences > Panel & Key Operation**), you can configure the panel shift key to only open the shift menu after holding down the key for three seconds or longer. The usual time delay is about 500 ms. For more information, see the EHX Software User Guide.

Note: From the EHX software (**Configuration > Preferences > Panel & Key Operation**), you can configure the panel shift key to only open the shift menu if there are two or more shift pages with at least one key configured (not including unassigned key groups or Reply keys). For more information, see the EHX Software User Guide.

Note: Shift pages are only available on main panels and **not** on expansion panels.

Note: The shift page labels flash if there is an unanswered call on any key on the page.

Main	Shift 01 -----	Shift 03	Shift 05	Shift 07	
▼ ▲	▼ ▲	▼ ▲	▼ ▲	▼ ▲	▼ ▲
SHIFT	Shift 02	Shift 04	Shift 06	Shift 08	
▼ ▲	▼ ▲	▼ ▲	▼ ▲	▼ ▲	▼ ▲

Figure 6-106: Shift page menu for rack mounted panels

	SHIFT 07	SHIFT 08
▼ ▲	▼ ▲	▼ ▲
	SHIFT 05	SHIFT 06
▼ ▲	▼ ▲	▼ ▲
Main	SHIFT 03	SHIFT 04
▼ ▲	▼ ▲	▼ ▲
SHIFT	SHIFT 01	SHIFT 02
▼ ▲	▼ ▲	▼ ▲

Figure 6-107: Shift page menu for desktop panels

6.16 Menu map

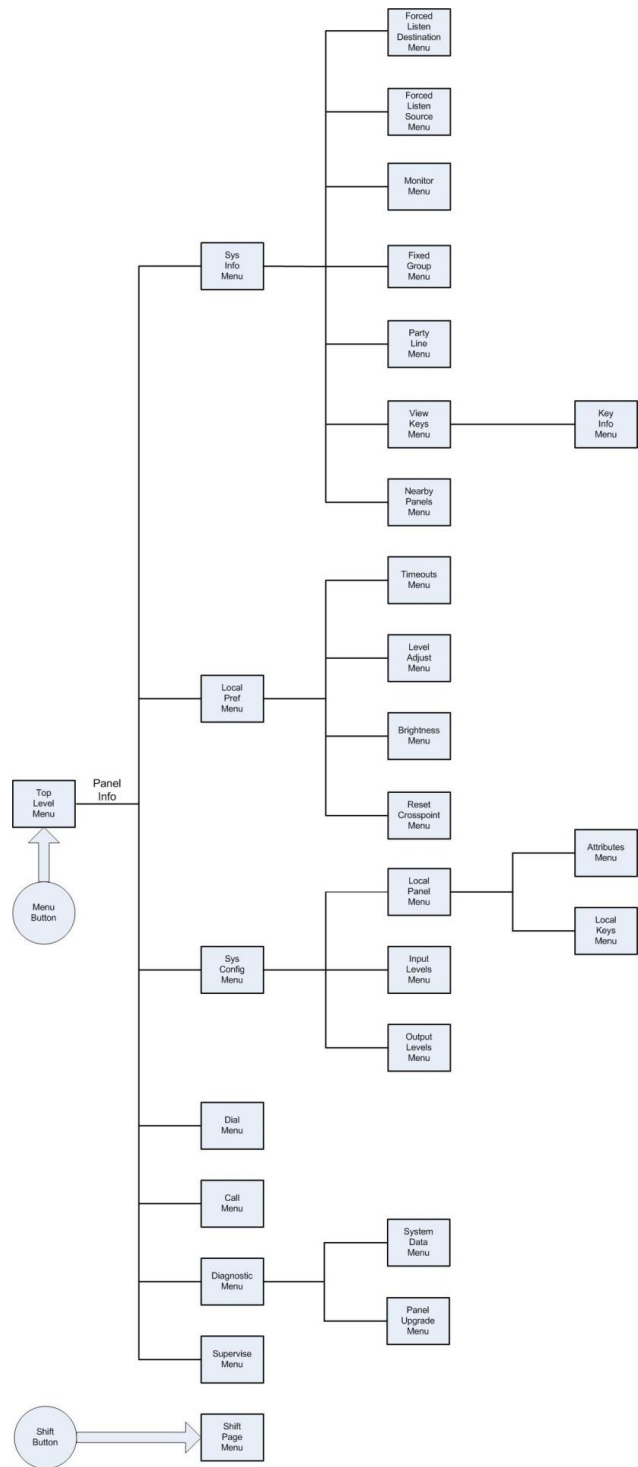

Figure 6-108: V-Series panel menu map IP Configuration

IP-enabled V-Series panels can connect to an Eclipse or Eclipse HX matrix over a standard Ethernet network using an IVC-32 card. Each IVC-32 card can support up to 32 V-Series panels using IP.

IP-enabled V-Series panels also support an additional two channels using IP that you can use to connect 4-wire devices directly to the panel.

The IP settings for the panel are configured using the IP configuration menus, described in this chapter.

V-Series panels running application code V1.73 or above are automatically IP-enabled. V-Series panels running earlier versions of the application code must be enabled for IP operation by either:

- Inputting a ten digit passcode to the panel.
- Upgrading to V1.73 or above of the application code.

6.17 Accessing the IP configuration menus

To access the IP menus, select **Menu** and then **Info**. The panel displays the Local **Maintenance Menu (LLM)**. Select **IP SETUP** to enter the IP configuration menus.

Note: If you enter **PANEL INFO** instead, you enter the maintenance menus. See **7 Maintaining V-Series** panels.

To communicate to ECS / EHX that the panel is ready to be identified, select **IDENTIFYME**.

The panel buttons or LEDs **flash red** and **IDENTIFYME** is displayed in the bottom left display screen. Select **IDENTIFYME** again (the Reply key) to cancel identify mode.

Identification mode can also be initiated in ECS /EHX, in which case the same display mode is seen.

Note: If the LAN port is the only connection with the panel, the panel will automatically display the IP SETUP menu, prompting the user to enable the panel for IP access (if it is not already enabled (see above)).

6.18 IP SETUP menu

NET SETUP	CONNECT	DISABLE			
▼ ▲	▼ ▲	▼ ▲	▼ ▲	▼ ▲	▼ ▲
IP SETUP	USER ID	PASSWORD	CNTL DELAY		
▼ ▲	▼ ▲	▼ ▲	▼ ▲	▼ ▲	▼ ▲

Figure 6-109: IP Setup menu for rack mounted panels

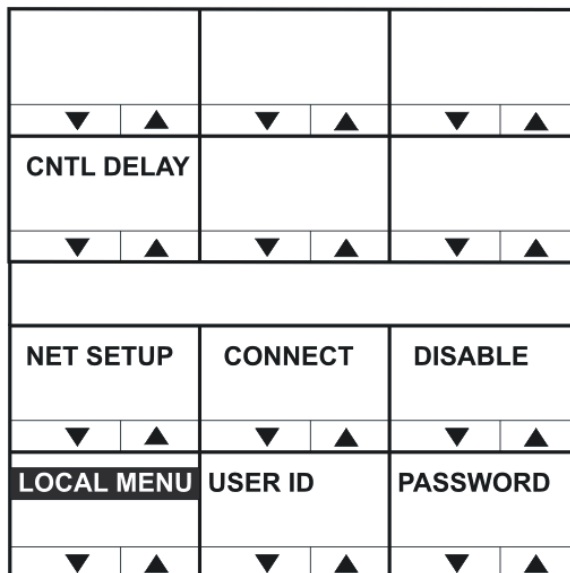

Figure 6-110: IP Setup menu for desktop panels

The **IP SETUP** menu features the following menu options:

Menu option	Description / comments
NET SETUP	Selects the NET SETUP menu (see 6.19 NET SETUP menu).
CONNECT	Select to initiate panel login to the matrix.
DISABLE	Disables IP connectivity on the panel. If this is selected the panel passcode must be reentered in order to enable panel IP again.
USER ID	Select to enter the user identifier the panel must use when logging in to the matrix.
PASSWORD	Select this item to enter the user password the panel must use when logging in to the matrix.
CNTL DELAY	Select to configure a delay on processing of the key up for intercom keys.

Table 38: IP SETUP menu options

6.18.1 CONNECT menu

Select **CONNECT** to initiate panel login to a matrix.

The panel login process has three phases:

- 1) The panel checks the network and attempts to reach the address of the login server.
- 2) The panel verifies the user ID and user password.
- 3) The panel completes the connection process.

Panel Conn	ecting...				
▼ ▲	▼ ▲	▼ ▲	▼ ▲	▼ ▲	▼ ▲
IP SETUP	USER ID	PASSWORD			
▼ ▲	▼ ▲	▼ ▲	▼ ▲	▼ ▲	▼ ▲

Figure 6-111: Panel connecting display for rack mounted panels

▼ ▲	▼ ▲	▼ ▲
▼ ▲	▼ ▲	▼ ▲
Panel Conn	ecting...	
▼ ▲	▼ ▲	▼ ▲
LOCAL MENU	USER ID	PASSWORD
▼ ▲	▼ ▲	▼ ▲

Figure 6-112: Panel connecting display for desktop panels

During phase 1 of the panel connection process, only progress messages will be displayed without status codes.

If an error occurs then one of the following status messages is displayed:

Error / status message	Description / comments
Network not connected	LAN cable not inserted. If DHCP mode selected, a DHCP server was not found.
IVC Server not found	The login server is inaccessible or not running.
Login USER xyz denied	The login server could not find an online IVC to log the panel into.

Table 39: CONNECT menu: phase 1 status / error messages

The second connection phase begins with the panel identifying itself to the host matrix. During this phase, error and status messages are displayed with status codes and sub-codes.

Code	Error / status message	Description / comments
Err 1:0	Check User ID	The name or password supplied were invalid.
Err 4:0	Media busy	The system is busy and will try again shortly.
Info 3:0	Connecting...	OK, connecting to the IVC.
Info 5:0	Reconnecting	OK (the call is being made again with new codec settings).
Err 8:0	Connection lost	The IVC connection was lost.

Table 40: CONNECT menu: phase 2 status / error messages

If the IVC-32 card is reachable, but another error occurs that indicates a more detailed networking or configuration issue, then the error code starts with 6:

Code	Error / status message	Description / comments
Err 6:0	Local call cleared	
Err 6:1	Call rejected locally	
Err 6:2	Locally declined	
Err 6:3	Remote cleared call	IVC-32 has cleared the call
Err 6:4	Remote refused call	IVC-32 has refused to accept the call from the panel
Err 6:5	Remote ans. timeout	The IVC-32 has not replied to the call within the timeout period
Err 6:6	Remote stopped	IVC-32 card has stopped responding
Err 6:7	Transport cleared	
Err 6:8	Transport connection	
Err 6:9	Gatekeeper cleared	
Err 6:10	Cannot find user	The user name specified by the panel is not known to the target system
Err 6:11	Not enough bandwidth	The network did not have enough bandwidth available for a connection
Err 6:12	No common capabilities	
Err 6:13	Call was forwarded	
Err 6:14	Bad password	The panel name or the password is incorrect
Err 6:15	Local end busy	Network congested
Err 6:16	Local end busy	Network congested
Err 6:17	Remote end busy	Network congested or IVC-32 busy
Err 6:18	Remote end busy	Network congested or IVC-32 busy
Err 6:19	Remote party unavailable.	Target IVC-32 could not be contacted

Code	Error / status message	Description / comments
Err 6:20	Remote disconnected OK	The IVC-32 has terminated the connection
Err 6:21	Remote offline	The IVC-32 could not be reached
Err 6:22	Remote may retry	IVC-32 may retry the connect.
Err 6:23	Remote unmapped	
Err 6:24	Call duration exceeded	
Err 6:25	Invalid conference ID	
Err 6:26	Connection timed out	Network load caused disconnect

Table 41: CONNECT menu: phase 2 status / error messages starting with 6

Note: Errors are often caused by an invalid user ID or password being used. However, if the error indicates a network problem (such as insufficient bandwidth), you are advised to contact your network administrator.

6.18.2 USER ID menu

-----		01abc	2def	3ghi	4jkl
▼ ▲	▼ ▲	▼ ▲	▼ ▲	▼ ▲	▼ ▲
USER ID	5mno	6pqr	7stu	8vwx	9yz
▼ ▲	▼ ▲	▼ ▲	▼ ▲	▼ ▲	▼ ▲

Figure 6-113: User ID setup menu for rack mounted panels

01abc	2def	63ghi
▼ ▲	▼ ▲	▼ ▲
4jkl	5mno	6pqr
▼ ▲	▼ ▲	▼ ▲
7stu	8vwx	9yz
▼ ▲	▼ ▲	▼ ▲
USER ID	-----	
▼ ▲	▼ ▲	▼ ▲

Figure 6-114: User ID setup menu for desktop panels

The **USER ID** menu is used to set up the user ID that enables the panel to log in to the matrix.

The user ID:

- **Must** correspond to a user ID that has already been set up in ECS / EHX for a port on an IVC-32 card (**Matrix Hardware > Advanced Settings >IP Panel Settings**).
- Is a string of up to ten characters (0 to 9 and A to F).

Enter up to ten characters using the up/down volume buttons (lever key and pushbutton panels) or the talk button (rotary panels) to select the characters. After each character has been selected the input will advance to the next character. Pressing the lever key down, or the pushbutton, or the rotary control will step back to the previous character.

When the user ID has been set up, exit the menu using the **USER ID** key or talk button.

6.18.3 PASSWORD menu

-----		01abc	2def	3ghi	4jkl
▼ ▲	▼ ▲	▼ ▲	▼ ▲	▼ ▲	▼ ▲
PASSWORD	5mno	6pqr	7stu	8vwx	9yz
▼ ▲	▼ ▲	▼ ▲	▼ ▲	▼ ▲	▼ ▲

Figure 6-115: Password setup menu for rack mounted panels

01abc	2def	63ghi
▼ ▲	▼ ▲	▼ ▲
4jkl	5mno	6pqr
▼ ▲	▼ ▲	▼ ▲
7stu	8vwx	9yz
▼ ▲	▼ ▲	▼ ▲
PASSWORD	-----	
▼ ▲	▼ ▲	▼ ▲

Figure 6-116: Password setup menu for desktop panels

Use the **PASSWORD** menu to set up the password the panel uses to log into the matrix. The password:

- **Must** correspond to a password that has already been set up in ECS / EHX for a port on an IVC-32 card (**Matrix Hardware > Advanced Settings > IP Panel Settings**).
- Is a string of up to ten characters (0 to 9 and A to F).

Enter up to ten characters using the up/down volume buttons (lever key and pushbutton panels) or the talk button (rotary panels) to select the characters. After each character has been selected the input will advance to the next character. Pressing the lever key down, or the pushbutton, or the rotary control will step back to the previous character.

When the password has been set up, exit the menu using the **PASSWORD** key or talk button.

6.18.4 CNTL DELAY (Control Delay) menu

The **CNTL DELAY (Control Delay)** menu enables you to configure a delay on key up processing for intercom keys.

The delay is only applied to dumb panel intercom page keys (keys used to make or break of audio routes). Menu access keys are not affected.

You may want to apply a delay with certain audio links with multiple IP encodes and decodes in place, as the link control data can overtake the audio on the link resulting in truncation of the audio.

The default setting for a delay on key up processing is 0.

The setting is held locally on the panel, which means that if the panel is moved to another port on the system, the control delay setting comes with it. The control delay must stay with the panel as it is based on geographical location, and therefore the size of audio and control latency.

The control delay range is **0ms - 9999ms**. The granularity of this setting is in blocks of 50ms with the delay set being rounded down to the nearest multiple of 50ms. For example, if less than 50ms is set no delay is applied. If a multiple between 50 and 100ms is set, 50ms will be applied.

Note: Although the **CNTL DELAY** menu is accessed from the top level IP settings menu, you can apply a delay to any type of connection to the matrix (enabling it to be used on four-wire based VoICE unit connections).

0	msecs		0 1	2 3	4 5
▼ ▲	▼ ▲	▼ ▲	▼ ▲	▼ ▲	▼ ▲
CNTL DELAY	CLEAR		6 7	8 9	
▼ ▲	▼ ▲	▼ ▲	▼ ▲	▼ ▲	▼ ▲

Figure 6-117: Control delay menu on rack mounted panels

0 1	2 3	4 5
▼ ▲	▼ ▲	▼ ▲
6 7	8 9	
▼ ▲	▼ ▲	▼ ▲
0	msecs	
▼ ▲	▼ ▲	▼ ▲
CNTL DELAY	CLEAR	
▼ ▲	▼ ▲	▼ ▲

Figure 6-118: Control delay menu on desktop panels

Use the **CLEAR** key to clear the current control delay, and then enter the new control delay.

In lever key and pushbutton panels, use the up / down buttons to select the digits. For rotary panels, press the rotary control to select the left digit and the talk button to select the right digit.

Each time a digit is selected the cursor will advance to the next digit automatically. Pressing the lever key down or the pushbutton or the rotary control will step back to the previous digit.

When the control delay has been entered exit the menu using the **CNTL DELAY** key or talk button.

6.19 NET SETUP menu

IP ADDRESS	IP GATEWAY	DNS SERVER	LOGIN IP	LOGIN PORT	
▼ ▲	▼ ▲	▼ ▲	▼ ▲	▼ ▲	▼ ▲
NET SETUP	DHCP	SUBNETMASK	CON TYPE	DNS/IP	
▼ ▲	▼ ▲	▼ ▲	▼ ▲	▼ ▲	▼ ▲

Figure 6-119: Net setup menu for rack mounted panels

MATRIX IP	LOGIN PORT	
▼ ▲	▼ ▲	▼ ▲
CON TYPE	DNS/IP	
▼ ▲	▼ ▲	▼ ▲
IP ADDRESS	IP GATEWAY	DNS SERVER
▼ ▲	▼ ▲	▼ ▲
NET SETUP	DHCP	SUBNETMASK
▼ ▲	▼ ▲	▼ ▲

Figure 6-120: Net setup menu for desktop panels

The **NET SETUP** menu options are used to configure IP addresses and network connection parameters:

Menu option	Description / comments
IP ADDRESS	Used to set the IP address of the panel.
IP GATEWAY	Used to set the IP address of the gateway that the panel uses when connecting to the matrix.
DNS SERVER	Used to set the IP address of the Domain Name server used by the panel.
LOGIN IP	Used to set the IP address of the matrix the panel will connect to. The address refers to the IVC-32 card address that is set up in ECS / EHX.
LOGIN PORT	Used to set up the IP port that the panel uses when logging in to the matrix. The login port must be the same as the port set up in ECS / EHX under System Preferences > IP Panels . When the panel logs in, the panel will be sent the IP address and port to use when communicating with the IVC-32 card. This is configured in ECS / EHX under Matrix Hardware .
DHCP	Used to enable or disable DHCP (Dynamic Host Configuration Protocol). If enabled, the panel can be assigned an IP address, subnet mask, gateway address and DNS server automatically from the DHCP server rather than having to manually configure the panel. When DHCP is enabled, pushbutton panels will show the DHCP pushbutton flashing green . Lever key panels will show the talk/listen indicator flashing green . IVC-32 cards should be assigned automatically to ensure manually assigned addresses do not clash with those assigned by the DHCP server. When DHCP is disabled, the panel can be configured manually with network parameters including the DNS server.
SUBNETMASK	Used to set the subnet mask for the IP network the panel is to be used on. Commonly the subnet mask will be 255.255.255.0 .
CON TYPE	Used to determine the connection type (WAN (Wide Area Network), LAN (Local Area Network) or INTERNET). The connection type may determine whether DHCP and DNS are used.
DNS/IP	Used to switch between DNS and IP server modes. In DNS server mode, you can enter a login name for the IVC server that the panel connects to. In IP server mode you must enter the IP address of the IVC server.

Table 42: NET SETUP menu options

6.19.1 IP ADDRESS menu

123.456.	789.012		0 1	2 3	4 5
▼ ▲	▼ ▲	▼ ▲	▼ ▲	▼ ▲	▼ ▲
IP ADDRESS	CLEAR		6 7	8 9	
▼ ▲	▼ ▲	▼ ▲	▼ ▲	▼ ▲	▼ ▲

Figure 6-121: IP address menu for rack mounted panels

0 1	2 3	4 5
▼ ▲	▼ ▲	▼ ▲
6 7	8 9	
▼ ▲	▼ ▲	▼ ▲
123.456.	789.012	
▼ ▲	▼ ▲	▼ ▲
IP ADDRESS	CLEAR	
▼ ▲	▼ ▲	▼ ▲

Figure 6-122: IP address menu for desktop panels

Use the **CLEAR** key to clear the current IP address for the panel, and then enter the new IP address.

In lever key and pushbutton panels, use the up / down buttons to select the digits. For rotary panels, press the rotary control to select the left digit and the talk button to select the right digit.

Each time a digit is selected the cursor will advance to the next digit automatically. Pressing the lever key down or the pushbutton or the rotary control will step back to the previous digit.

When the IP address for the panel has been entered exit the menu using the **LOGIN PORT** key or talk button.

6.19.1.1 Assigning IP addresses

It is important to ensure that the panel IP address does **not** clash with any other IP address on the network (another device is using the same IP

address). If there is an IP address clash, the panel may repeatedly lose the connection with the IVC-32 card, and may also cause the IVC-32 card to crash.

Note: Clear-Com recommends that DHCP is used wherever possible to automatically assign IP addresses rather than assigning IP addresses manually in order to reduce the risk of an address clash. For more information, see **6.19.6 DHCP menu**.

6.19.2 IP GATEWAY menu

123.456.	789.012		0 1	2 3	4 5
▼ ▲	▼ ▲	▼ ▲	▼ ▲	▼ ▲	▼ ▲
IP GATEWAY	CLEAR		6 7	8 9	
▼ ▲	▼ ▲	▼ ▲	▼ ▲	▼ ▲	▼ ▲

Figure 6-123: IP Gateway menu for rack mounted panels

	0 1	2 3	4 5
	▼ ▲	▼ ▲	▼ ▲
	6 7	8 9	
	▼ ▲	▼ ▲	▼ ▲
123.456.	789.012		
▼ ▲	▼ ▲	▼ ▲	▼ ▲
IP GATEWAY	CLEAR		
▼ ▲	▼ ▲	▼ ▲	▼ ▲

Figure 6-124: IP Gateway menu for desktop panels

Use the **CLEAR** key to clear the current IP Gateway address for the panel, and then enter the new IP Gateway address.

In lever key and pushbutton panels, use the up / down buttons to select the digits. For rotary panels, press the rotary control to select the left digit and the talk button to select the right digit.

Each time a digit is selected the cursor will advance to the next digit automatically. Pressing the lever key down or the pushbutton or the rotary control will step back to the previous digit.

When the IP Gateway for the panel has been entered exit the menu using the **IP GATEWAY** key or talk button.

6.19.3 DNS SERVER menu

123.456.	789.012		0 1	2 3	4 5
▼ ▲	▼ ▲	▼ ▲	▼ ▲	▼ ▲	▼ ▲
DNS SERVER	CLEAR		6 7	8 9	
▼ ▲	▼ ▲	▼ ▲	▼ ▲	▼ ▲	▼ ▲

Figure 6-125: DNS Server menu for rack mounted panels

0 1	2 3	4 5
▼ ▲	▼ ▲	▼ ▲
6 7	8 9	
▼ ▲	▼ ▲	▼ ▲
123.456.	789.012	
▼ ▲	▼ ▲	▼ ▲
DNS SERVER	CLEAR	
▼ ▲	▼ ▲	▼ ▲

Figure 6-126: DNS Server menu for desktop panels

Use the **CLEAR** key to clear the current DNS Server address, and then enter the new address.

In lever key and pushbutton panels, use the up / down buttons to select the digits. For rotary panels, press the rotary control to select the left digit and the talk button to select the right digit.

Each time a digit is selected the cursor will advance to the next digit automatically. Pressing the lever key down or the pushbutton or the rotary control will step back to the previous digit.

When the DNS Server address has been entered exit the menu using the **DNS SERVER** key or talk button.

6.19.4 LOGIN IP menu

123.456.	789.012		0 1	2 3	4 5
▼ ▲	▼ ▲	▼ ▲	▼ ▲	▼ ▲	▼ ▲
MATRIX IP	CLEAR		6 7	8 9	
▼ ▲	▼ ▲	▼ ▲	▼ ▲	▼ ▲	▼ ▲

Figure 6-127: Matrix IP menu for rack mounted panels

0 1	2 3	4 5
▼ ▲	▼ ▲	▼ ▲
6 7	8 9	
▼ ▲	▼ ▲	▼ ▲
123.456.	789.012	
▼ ▲	▼ ▲	▼ ▲
MATRIX IP	CLEAR	
▼ ▲	▼ ▲	▼ ▲

Figure 6-128: Matrix IP menu for desktop panels

The **MATRIX IP** menu enables you to clear and enter a new matrix IP address. In lever key and pushbutton panels, use the up / down buttons to select the digits. For rotary panels, press the rotary control to select the left digit and the talk button to select the right digit.

Each time a digit is selected the cursor will advance to the next digit automatically. Pressing the lever key down or the pushbutton or the rotary control will step back to the previous digit.

When the matrix IP address has been entered exit the menu using the **MATRIX IP** key or talk button.

6.19.5 LOGIN PORT menu

6001			0 1	2 3	4 5
▼ ▲	▼ ▲	▼ ▲	▼ ▲	▼ ▲	▼ ▲
LOGIN PORT	CLEAR		6 7	8 9	
▼ ▲	▼ ▲	▼ ▲	▼ ▲	▼ ▲	▼ ▲

Figure 6-129: Login port menu for rack mounted panels

	0 1	2 3	4 5
▼ ▲	▼ ▲	▼ ▲	▼ ▲
	6 7	8 9	
▼ ▲	▼ ▲	▼ ▲	▼ ▲
6001			
▼ ▲	▼ ▲	▼ ▲	▼ ▲
LOGIN PORT	CLEAR		
▼ ▲	▼ ▲	▼ ▲	▼ ▲

Figure 6-130: Login port menu for desktop panels

Use the **CLEAR** key to clear the current login port number, and then enter the new login port number.

In lever key and pushbutton panels, use the up / down buttons to select the digits. For rotary panels, press the rotary control to select the left digit and the talk button to select the right digit.

Each time a digit is selected the cursor will advance to the next digit automatically. Pressing the lever key down or the pushbutton or the rotary control will step back to the previous digit.

When the login port number has been entered exit the menu using the **LOGIN PORT** key or talk button.

Note: The IP port that the panel uses when logging in to a matrix must be the same as the port set up in ECS / EHX for the matrix to listen for logins.

Note: This may not be the same port number used by the panel to communicate with an IVC-32 card set up in ECS / EHX under Matrix Hardware.

Note: When a panel logs in to a matrix, the matrix sends the IP address of the IVC-32 card and the port number to use back to the panel.

6.19.6 DHCP menu

ENABLE	<u>DISABLED</u>				
▼ ▲	▼ ▲	▼ ▲	▼ ▲	▼ ▲	▼ ▲
DHCP					
▼ ▲	▼ ▲	▼ ▲	▼ ▲	▼ ▲	▼ ▲

Figure 6-131: DHCP menu for rack mounted panels

▼ ▲	▼ ▲	▼ ▲
▼ ▲	▼ ▲	▼ ▲
ENABLE <u>DISABLED</u>		
▼ ▲	▼ ▲	▼ ▲
DHCP		
▼ ▲	▼ ▲	▼ ▲

Figure 6-132: DHCP menu for desktop panels

The **DHCP** menu enables you to enable or disable the panel using a DHCP server.

The current DHCP state is indicated by an underline. Use the **ENABLE** or **DISABLE** keys to enable or disable DHCP, and the **DHCP** key or talk button to exit the menu.

6.19.7 SUBNETMASK (Subnet Mask) menu

255.255.	255.000		0 1	2 3	4 5
▼ ▲	▼ ▲	▼ ▲	▼ ▲	▼ ▲	▼ ▲
SUBNETMASK	CLEAR		6 7	8 9	
▼ ▲	▼ ▲	▼ ▲	▼ ▲	▼ ▲	▼ ▲

Figure 6-133: Subnet mask menu for rack mounted panels

0	1	2	3	4	5
▼	▲	▼	▲	▼	▲
6	7	8	9		
▼	▲	▼	▲	▼	▲
255.255.		255.000			
▼	▲	▼	▲	▼	▲
SUBNETMASK		CLEAR			
▼	▲	▼	▲	▼	▲

Figure 6-134: Subnet mask menu for desktop panels

Use the **CLEAR** key to clear the current subnet mask, and then enter the new subnet mask.

In lever key and pushbutton panels, use the up / down buttons to select the digits. For rotary panels, press the rotary control to select the left digit and the talk button to select the right digit.

Each time a digit is selected the cursor will advance to the next digit automatically. Pressing the lever key down or the pushbutton or the rotary control will step back to the previous digit.

When the subnet mask has been entered exit the menu using the **SUBNETMASK** key or talk button.

6.19.8 CON TYPE (Connection Type) menu

WAN	<u>LAN</u>	INTERNET			
▼	▲	▼	▲	▼	▲
CON TYPE					
▼	▲	▼	▲	▼	▲

Figure 6-135: Connection type menu for rack mounted panels

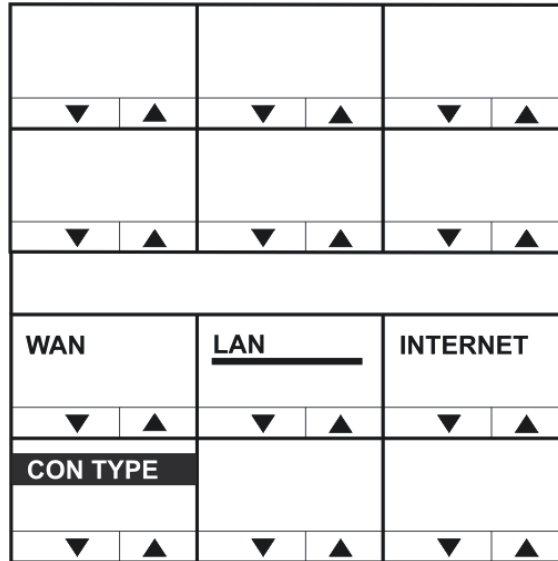

Figure 6-136: Connection type menu for desktop panels

V-Series panels support three types of IP network connection:

Connection type	Description / comments
WAN	WANs (Wide Area Networks) cover a broad area and may include a number of local area networks (LANs).
LAN	LANs (Local Area Networks) usually cover a small area, such as an office, a single building or business.
Internet	Global network that may be used to connect local networks in various locations around the world.

Table 43: Connection types

The currently selected connection type is highlighted with a bar under the network type.

To select a connection type, press the key or talk button corresponding to the network type. The indicator bar will move to the selected type.

Press the **CON TYPE** key or talk button to exit.

6.19.9 DNS/IP

DNS		IP			
▼	▲	▼	▲	▼	▲
DNS/IP					
▼	▲	▼	▲	▼	▲

Figure 6-137 DNS/IP menu

Connection type	Description / comments
DNS	Allows you to specify a login name for the IVC server. This name can contain up to 239 characters including the host name.
IP	Allows you to specify a login IP address for the IVC server.

Note: You can use the DNS/IP option to toggle between DNS mode and IP mode. The login name and login address will be saved. See **Table 42: NET SETUP menu options**.

6.20 CONFIRM CLEAR menu

When you use the CLEAR key to clear an item (such as the current IP address or IP Gateway), a confirmation menu is displayed.

To confirm the action, select YES. To cancel the action, select NO.

The original menu is then redisplayed, with the item cleared / not cleared.

6.21 IP menu map

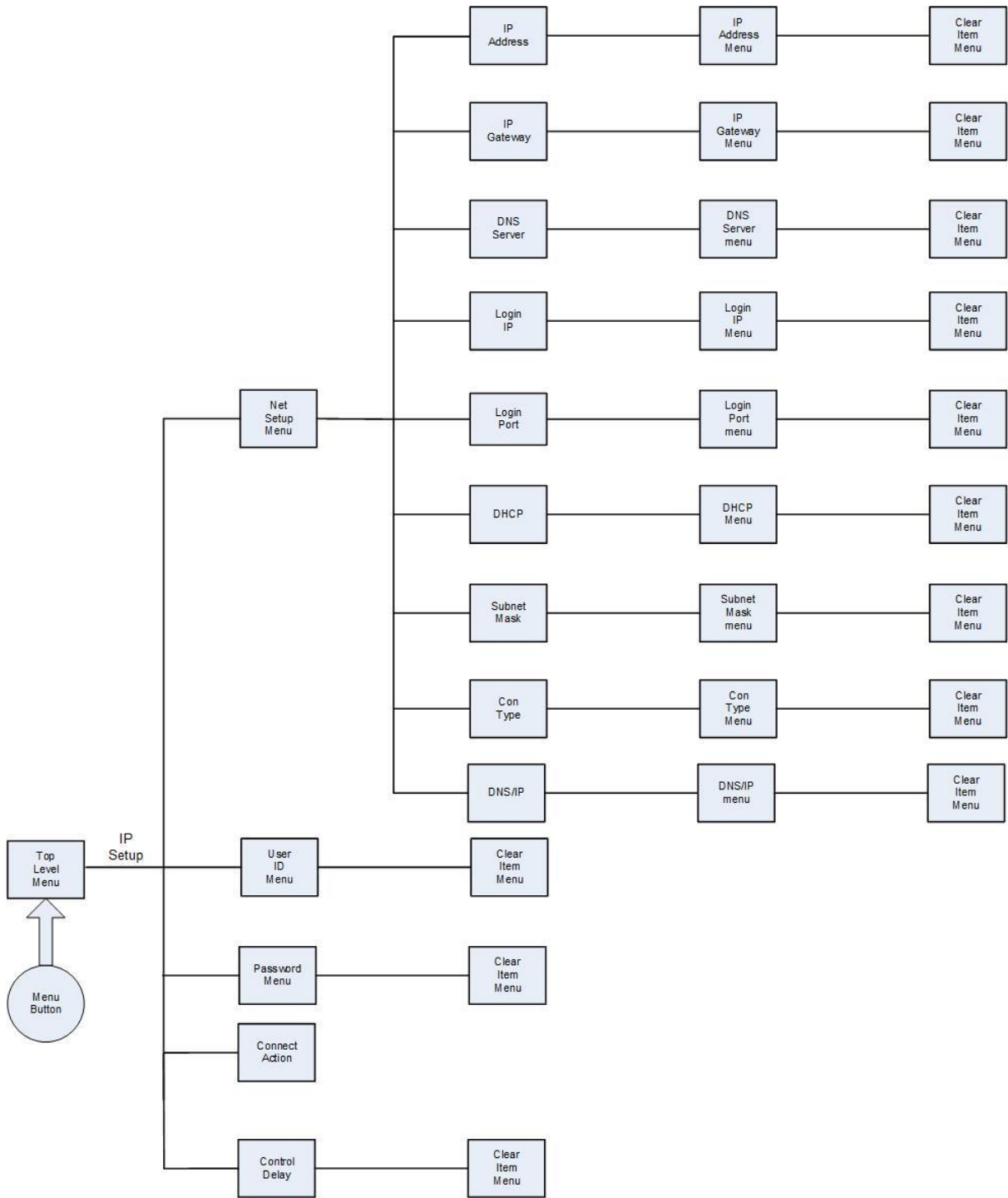

Figure 6-138: IP menu map

7 Maintaining V-Series panels

This chapter describes how to use the Local Maintenance Menu (LMM) on V-Series panels. The menu is a read-only diagnostic tool, designed to help users and support engineers retrieve information about the settings and performance of panels.

7.1 Accessing the Local Maintenance Menu (LMM)

To access the Local Maintenance Menu (LMM), select **Menu** and then push the **Info** button (far bottom right on panel). Enter **Panel Info**. The panel displays the **Local Maintenance Menu (LLM)**.

To exit the LLM, select **Exit Local**.

Note: If you enter **IP SETUP** instead, you enter the IP configuration menus. See **0 IP Configuration**.

Note: For V-Series panel releases before v1.21 with the LMM, press **Menu** and then press and hold **Menu** again for about 7 seconds to enter the LMM when the matrix is connected. When the matrix is not connected, access the LMM by pressing and holding **Menu** for about 7 seconds.

PANEL INFO	IP SETUP	IDENTIFYME			
▼ ▲	▼ ▲	▼ ▲	▼ ▲	▼ ▲	▼ ▲
EXIT					
▼ ▲	▼ ▲	▼ ▲	▼ ▲	▼ ▲	▼ ▲

Figure 7-1: Top menu (Press Panel Info to enter LLM) in rack mounted panels

▼	▲	▼
▼	▲	▼
PANEL INFO		
▼	▲	▼
EXIT		
▼	▲	▼

Figure 7-2: Top menu (Press Panel Info to enter LLM) in desktop panels

7.2 Navigating the LLM menu

To change the commands and values use either:

- The up / down buttons under the display.
- The talk or listen lever keys associated with the display.

On a pushbutton panel, the pushbutton can also be used to scroll forwards through commands and the up button to scroll back through the commands or values.

In rotary panels, pressing the rotary control steps you forward through the commands and values. Pressing the talk button steps you back through the commands and values.

The numerical value of a command may be changed using either the **Main** or **Aux** level (volume) control.

If a command leads to an action, the relevant display will show **DO IT**.

Pressing any key on this display actions the command, and the display will change to **DONE**.

7.2.1 Use of displays

The position of the Local Maintenance Menu (LLM) in the panel display on V-Series panels is shown below:

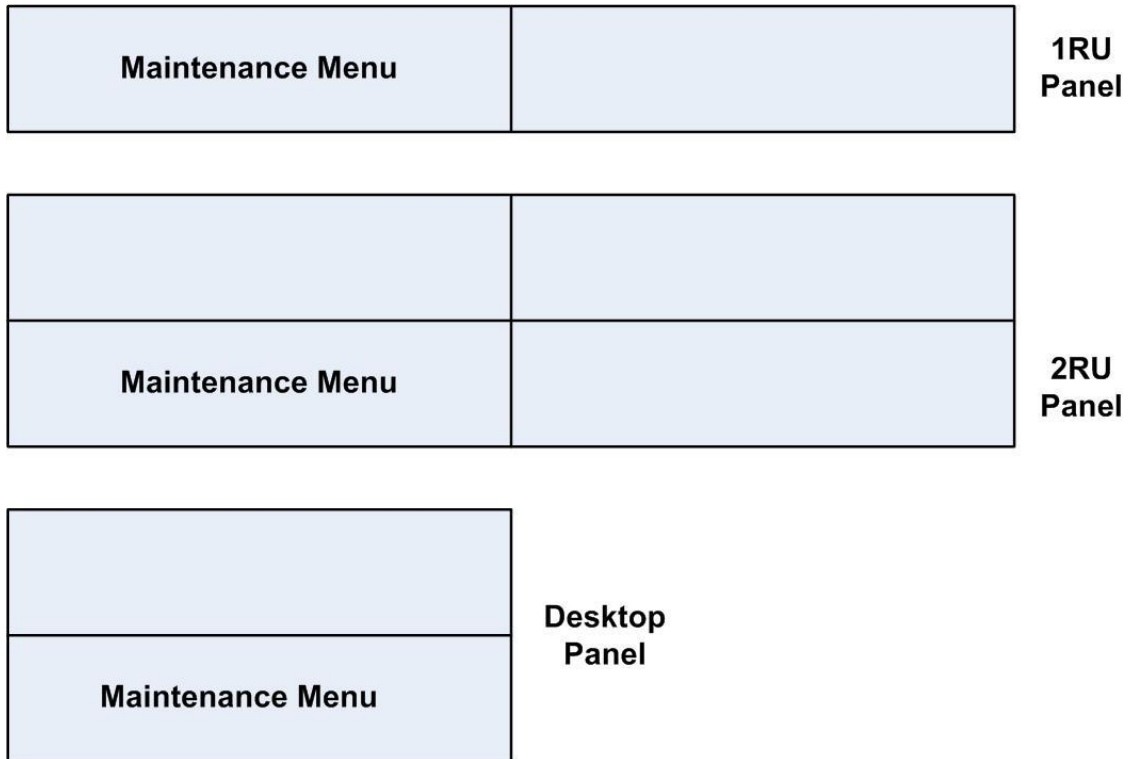

Figure 7-3: Position of Local Maintenance Menu (LLM) on panels

The layout for the LLM is numbered as shown below:

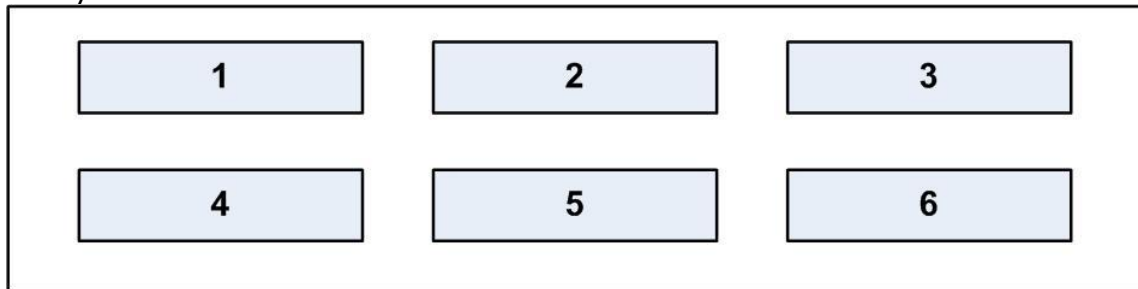

Figure 7-4: Layout of the Local Maintenance Menu (LLM)

The **main** command appears in display **1**. Displays **2-5** may show subtypes or parameters for that command. Display 6 always shows **Exit Local**.

7.3 Commands

The command always appears in window 1. To scroll through the commands, use the up/down buttons (lever key and pushbutton panels) under the command window. On rotary panels use the rotary control and the talk button.

7.3.1 Version

The **version** command shows the versions of various components of the system.

Display **2** shows the component and may be adjusted. Display **3** shows the version of that component.

Note: The versions are **not** adjustable.

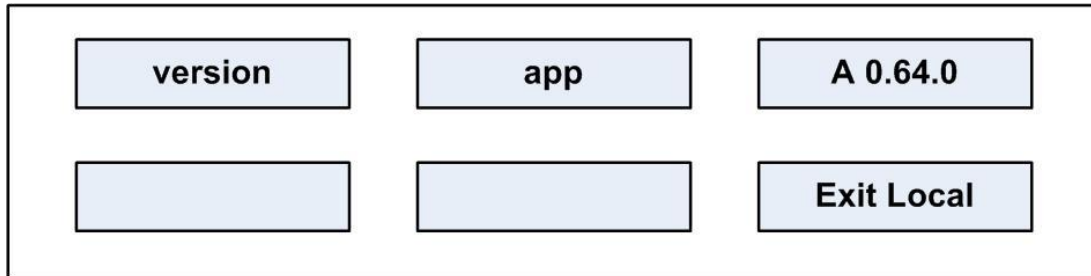

Figure 7-5: version display

To scroll through the panel software components, press the up/down keys (lever key and pushbutton panels) or use the rotary control and talk button (rotary panels) under the **app** display.

The components shown in display **2** are as follows:

Component	Description / comments
app	The panel application version
kernel	The linux kernel version
rootfs(v)	The version (v) of the kernel root file system
rootfs(d)	The date (d) of the kernel root file system
modules	The version of the module firmware and bootloader
sound	The version of the sound drivers

Table 44: version components in display 2

7.3.2 xpoint

The **xpoint** command enables you to adjust the values of the crosspoints in the panel's audio mixer.

Display **2** displays the output audio stream.

Display **3** shows the input audio stream.

Display **4** shows the value of the crosspoint in dB. A value of -80 signifies no audio, and a value of 0 signifies **all on**.

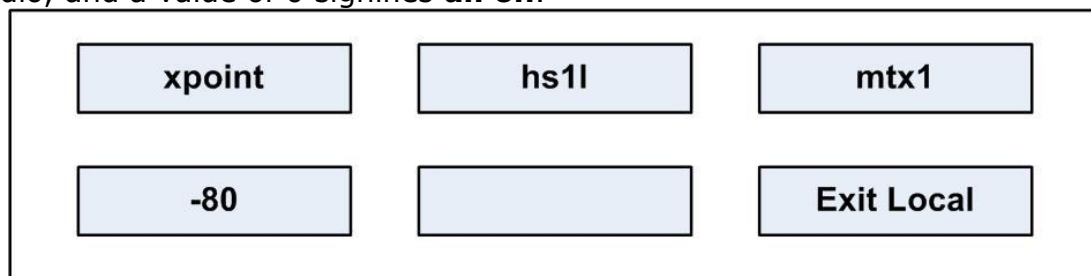

Figure 7-6: xpoint display

The output streams displayed in window 2 can be scrolled through using the up/down volume keys under display 2 (lever key and pushbutton panels). On rotary panels use the rotary control and talk button to scroll through the output streams.

The **output** audio stream crosspoint options are:

Crosspoint options	Description / comments
hs1l	Headset 1 left ear
hs1r	Headset 1 right ear
hs2l	Headset 2 left ear
hs2r	Headset 2 right ear
ls	Main loudspeaker
auxls	Auxiliary loudspeaker
mtx1	Mono audio to the matrix via the analogue connection or one channel of stereo via an AES-3 card
mtx2	Second channel of stereo to matrix via AES-3 card
ext1	External output 1 on auxiliary audio connector
ext2	External output 2 on auxiliary audio connector
hotmic	Output to hot microphone on auxiliary audio connector
larec	Listen again output
voicerec	Message recording output

Table 45: Crosspoint options in display 2 (output)

The input audio stream crosspoint options are:

Crosspoint options	Description / comments
mtx1	Input mono audio from the matrix using the analog connection or one channel of stereo using an AES-3 card
mtx2	Input a second channel of stereo from the matrix via the AES-3 card
ext1	Input from external input 1 on the auxiliary audio connector
ext2	Input from external input 2 on the auxiliary audio connector
hs1	Input from headset 1 microphone
hs2	Input from headset 2 microphone
tone	Test tone input
laplay	Listen again input
voiceplay	Message recording input

Table 46: Crosspoint options in display 3 (input)

7.3.3 Level

The **level** command enables you to change the internal level (volume) controls.

Display **2** shows the controller name.

Display **3** shows the controller value.

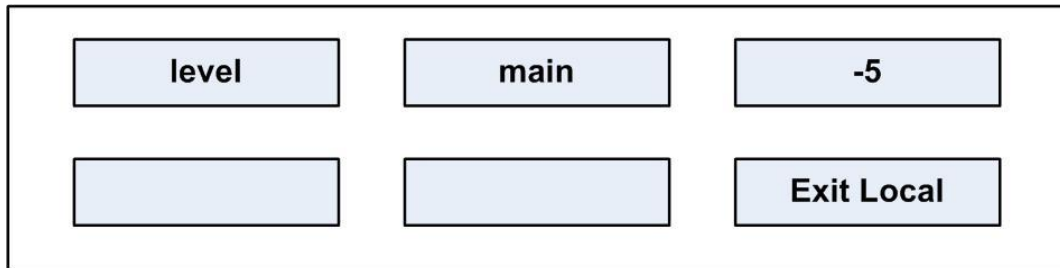

Figure 7-7: level display

Five level options shown in display 2 can be set using the up/down buttons (lever key and pushbutton panels) or the rotary encoder and talk button (rotary panels).

The level options are:

Level options	Description / comments
main	Main internal level (volume) controller
aux	Auxiliary internal level (volume) controller
st1	Sidetone 1 internal level (volume) controller
st2	Sidetone 2 internal level (volume) controller
po	Page override controller

Table 47: level options

7.3.4 Control

This command allows the controller of a crosspoint to be changed.

Display **2** shows the output streams.

Display **3** shows the input stream.

Display **4** shows the controller name for that crosspoint.

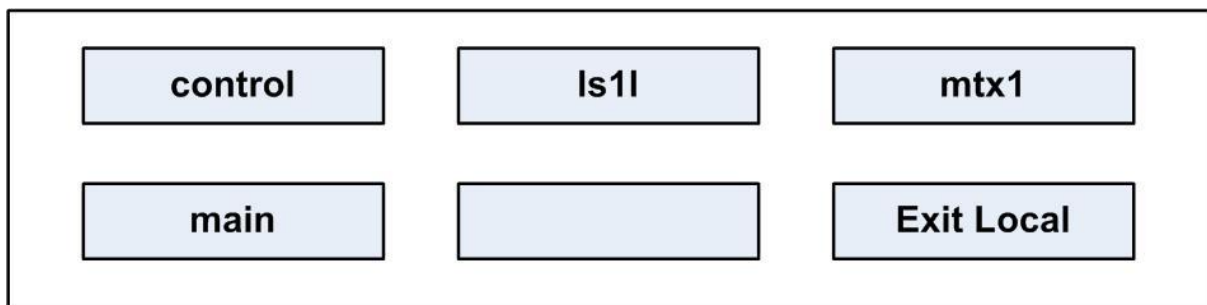

Figure 7-8: control display

The output audio stream crosspoint options are:

Crosspoint options	Description / comments
hs1l	Headset 1 left ear
hs1r	Headset 1 right ear
hs2l	Headset 2 left ear
hs2r	Headset 2 right ear
ls	Main loudspeaker
auxls	Auxiliary loudspeaker
mtx1	Mono audio to the matrix via the analogue connection or one channel of stereo via an AES-3 card
mtx2	Second channel of stereo to matrix via AES-3 card
ext1	External output 1 on auxiliary audio connector
ext2	External output 2 on auxiliary audio connector
hotmic	Output to hot microphone on auxiliary audio connector
larec	Listen again output
voicerec	Message recording output

Table 48: Crosspoint options in display 2 (output)

The input audio stream crosspoint options are:

Crosspoint options	Description / comments
mtx1	Input mono audio from the matrix using the analog connection or one channel of stereo using an AES-3 card
mtx2	Input a second channel of stereo from the matrix via the AES-3 card
ext1	Input from external input 1 on the auxiliary audio connector
ext2	Input from external input 2 on the auxiliary audio connector
hs1	Input from headset 1 microphone
hs2	Input from headset 2 microphone
tone	Test tone input
laplay	Listen again input
voiceplay	Message recording input

Table 49: Crosspoint options in display 3 (input)

The crosspoint controller options are:

Crosspoint options	Description / comments
main	Main internal level (volume) controller assigned
aux	Auxiliary internal level (volume) controller assigned
none	No controller assigned

Table 50: Crosspoint controller options (display 4)

7.3.5 Limit

The **limit** command allows various operating parameters of the digital limiters to be viewed and adjusted.

Display **2** shows the input stream of the limiter being accessed.

Display **3** shows the parameter for the limiter.

Display **4** shows its current value.

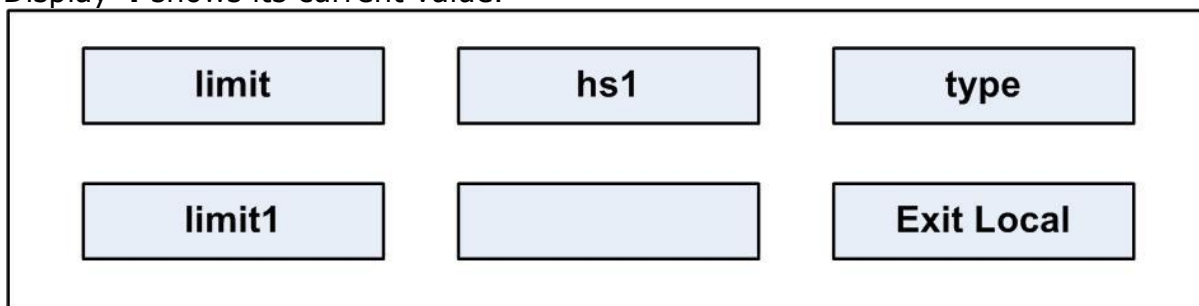

Figure 7-9: limit display

The available input streams shown in display 2 are:

Options	Description / comments
hs1	Input from headset 1 microphone
Hs2	Input from headset 2 microphone

Table 51: Input stream options (display 2)

The available limiters are shown in display 3 and the limiter parameters and units are shown in display 4.

The limiters are described below:

Options	Description / comments
type	Select a preset limiter from the range limit1 - limit6 shown in display 4.
enable	Select yes or no in display 4 to enable/disable this limiter
decay	Decay time in ms shown in display 4
attack	Attack time in ms shown in display 4
knee	Knee in dB shown in display 4
comp	Compression shown in display 4
gain	Markup gain of limiter in dB shown in display 4
thresh	The threshold below which the limiter has no effect shown in display 4

Table 52: Limiters (display 3)

7.3.6 Filter

The **filter** command allows the current filter to be displayed and changed.

Display **2** shows the input stream of the filter being accessed.

Display **3** shows the action.

Display **4** shows the action status.

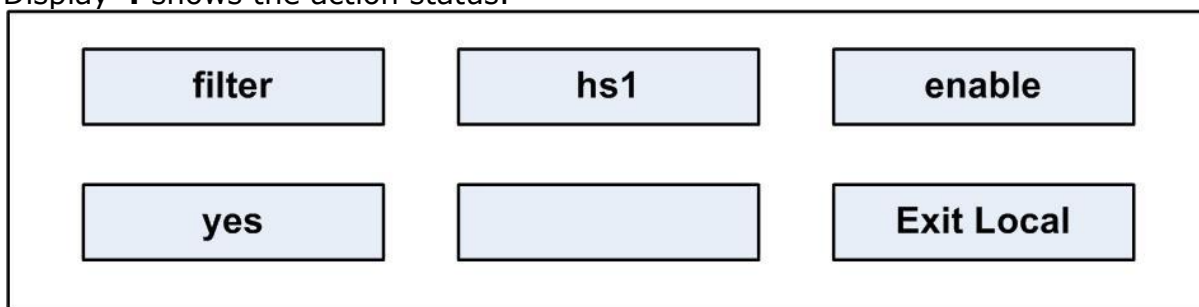

Figure 7-10: filter display

The available input streams in display 2 are:

Options	Description / comments
hs1	Input from headset 1 microphone
hs2	Input from headset 2 microphone
ext1	Input from external input 1 on the auxiliary audio connector
ext2	Input from external input 2 on the auxiliary audio connector
mtx1	Input mono audio from the matrix via the analogue connection or one channel of stereo via an AES-3 card
mtx2	Input a second channel of stereo from the matrix via the AES-3 card

Table 53: filter input streams (display 2)

The available filter options in display 3 are:

Options	Description / comments
enable	Action to enable the filter

Table 54: filter options (display 3)

The available action options in display 4 are:

Options	Description / comments
yes	Enable filter
no	Disable filter

Table 55: action options (display 4)

7.3.7 **la (Listen Again)**

The **la** command allows various controls for the Listen Again system to be displayed and changed.

Display **2** shows the parameter name.

Display **3** shows the parameter value.

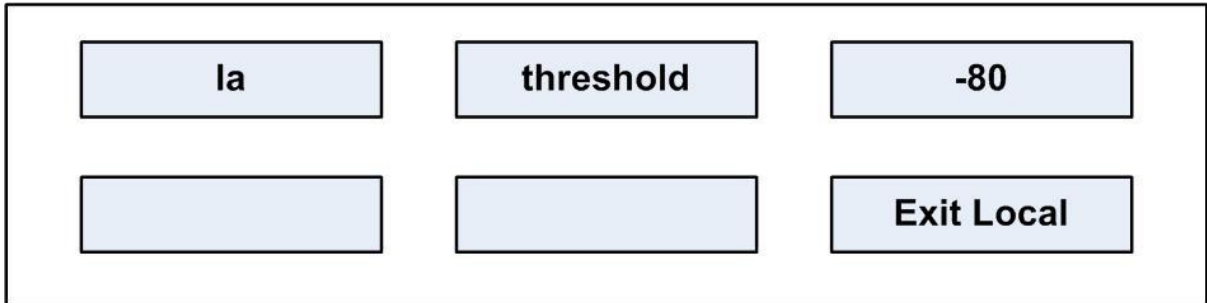

Figure 7-11: la (Listen Again) display

The parameter names and values are shown below:

Parameter	Description / comments
threshold	The signal level in dB needed to trigger the Listen Again recording
maxsilence	The maximum time in ms that silence will not cause fragmentation of a message
stale	The time in seconds after which a message will be deleted
startsil	The duration in ms of silence preceding message playback
starttone	The duration in ms of the start tone during playback
endsilence	The duration in ms of the silence after playing back a message
endtone	The duration in ms of the end of messages tone during playback

Table 56: la parameters and values

7.3.8 Mixer

The mixer control enables control of a number of mixer inputs and outputs.

Display **2** displays inputs or outputs.

Display **3** shows the number of inputs or outputs.

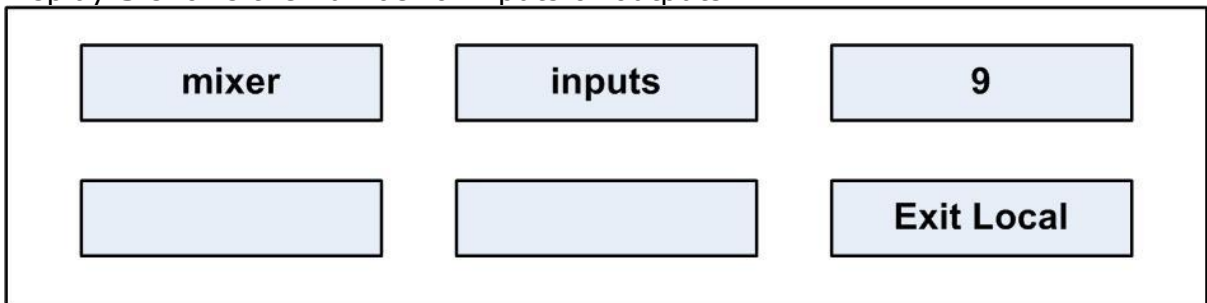

Figure 7-12: mixer display

7.3.9 Setup

The **setup** command allows all the audio settings to be saved and restored from a file in nonvolatile memory on the panel. This is an action command.

Display **2** shows **save** or **restore**.

Display **3** shows **DO IT**, and when the command is executed shows **DONE**.

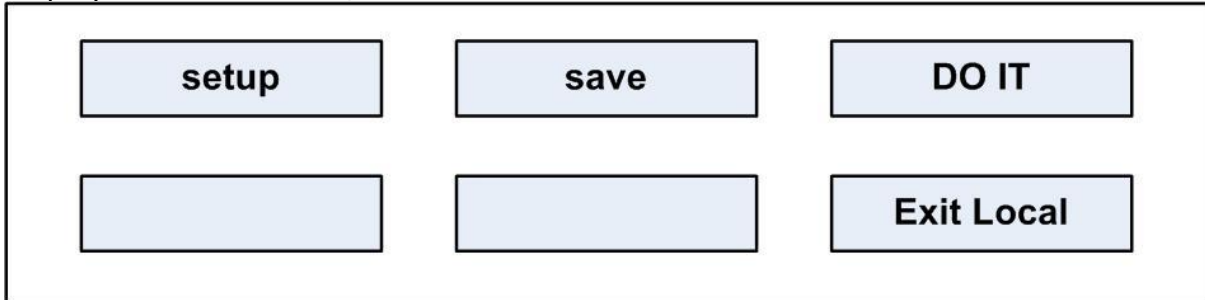

Figure 7-13: setup display

The action options in display 2 are:

Options	Description / comments
save	Save the settings to a file
restore	Restore settings to a file

Table 57: action options (display 2)

The options in window 3 are:

Options	Description / comments
DO IT	Execute the save or restore action
DONE	Save or restore action completed

Table 58: action options (display 3)

7.3.10 Voicerec

The **voicerec** command allows the voice message recording system to be controlled. They are all action commands.

Display **2** shows the command.

Display **3** shows the action.

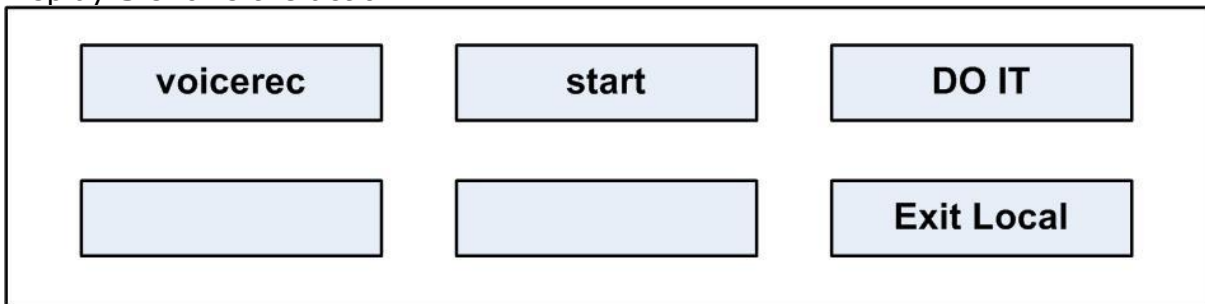

Figure 7-14: voicerec display

The commands in display 2 are as follows:

Options	Description / comments
start	Start the voice recording system
stop	Stop the voice recording system
erase	Erase the recorded message

Table 59: commands (display 2)

The action in display 3 is:

Options	Description / comments
DO IT	Execute or restore action.

Table 60: action options (display 3)

7.3.11 Voiceplay

This command controls the playback of the voice recording system. Display 2 shows the command and display 3 shows the available action.

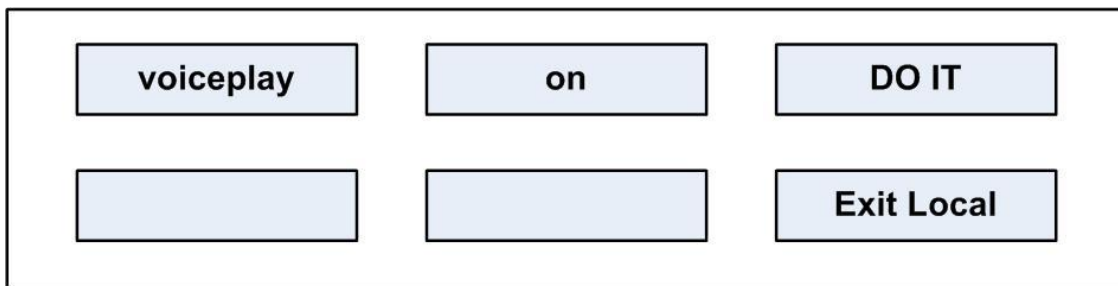

Figure 7-15: voiceplay display

The available commands in display 2 are:

Options	Description / comments
on	Turn voice recording playback on
off	Turn voice recording playback off

Table 61: Commands (display 2)

The action in display 3 is:

Options	Description / comments
DO IT	Execute or restore action.

Table 62: action options (display 3)

7.3.12 intrim

The **intrim** command allows the trim, or gain, to be adjusted on each of the input streams.

Display **2** shows the stream name.

Display **3** shows the trim in dB.

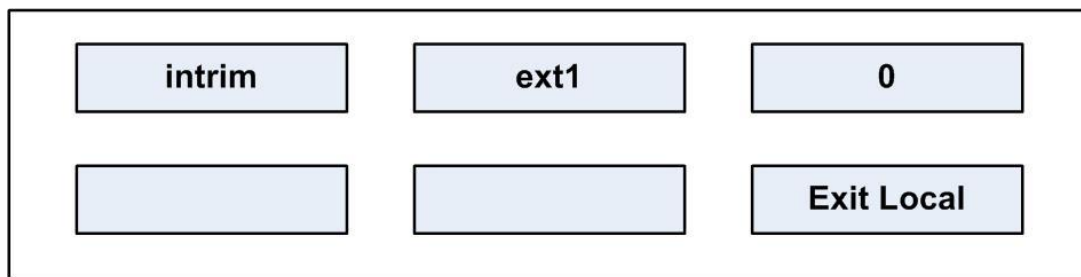

Figure 7-16: intrim display

The available input channels where the trim can be set are:

Options	Description / comments
ext1	Input from external input 1 on the auxiliary audio connector
ext2	Input from external input 2 on the auxiliary audio connector
hs1	Input from headset 1 microphone
hs2	Input from headset 2 microphone on the auxiliary audio connector

Table 63: Input channels (display 2)

7.3.13 outtrim

The **outrim** command allows the trim, or gain, to be adjusted on each of the input streams.

Display **2** shows the stream name.

Display **3** shows the trim in dB.

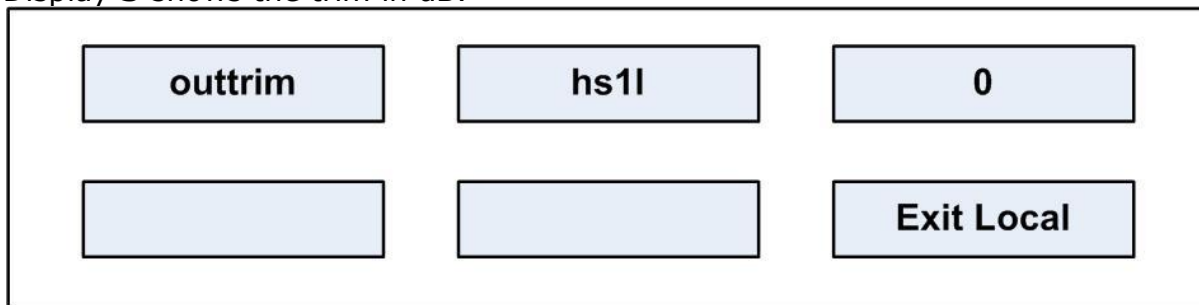

Figure 7-17: outrim display

The available output channels where the trim can be set are:

Options	Description / comments
hs1l	Headset 1 left ear
hs1r	Headset 1 right ear
hs2l	Headset 2 left ear
hs2r	Headset 2 right ear
ls	Main loudspeaker
auxls	Auxiliary loudspeaker

mtx1	Mono audio to the matrix via the analogue connection or one channel of stereo via an AES-3 card
mtx2	Second channel of stereo to matrix via AES-3 card
ext1	External output 1 on auxiliary audio connector
ext2	External output 2 on auxiliary audio connector
hotmic	Output to hot microphone on auxiliary audio connector

Table 64: output channels (display 2)

7.3.14 gpio

This menu shows the current setting of the discrete digital inputs in the panel General Purpose Input (GPIO) facility.

Display **2** shows the input name.

Display **3** shows its value.

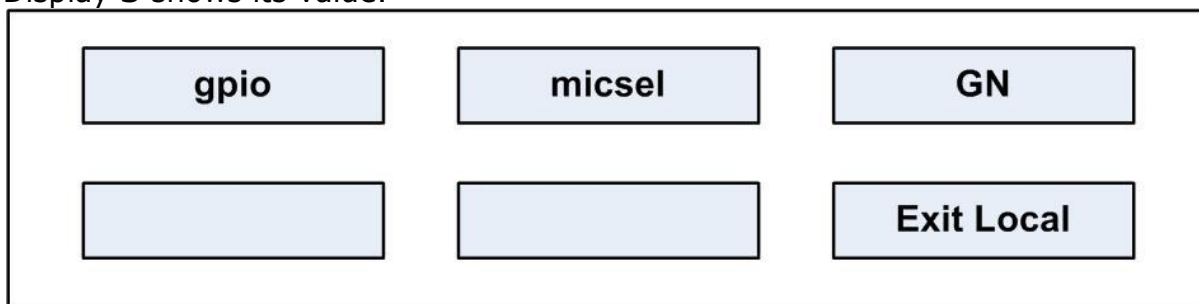

Figure 7-18: gpio display

The input names and permissible values are shown in the table below:

Input names	Values
micsel	GN/HS
mic1gain	number 0..15
mic1bal	bal/unbal
mic1bias	on/off
hs2gain	number 0..15
hs2bal	bal/unbal
hs2bias	on/off
fled0	on/off. This controls the function LED 0 on the front panel
fled1	on/off. This controls the function LED 1 on the front panel
fled2	on/off. This controls the function LED 2 on the front panel
fled3	on/off. This controls the function LED 3 on the front panel
lscut	cut/uncut
xlvl	on/off
lev0	number 0..15

lev 1	number 0..15
relay0	closed/open
relay1	closed/open

Table 65: Input names and permissible values

7.3.15 Module

The **module** command allows commands to be sent to the display modules. Display **2** shows the command. Display **3** shows the value.

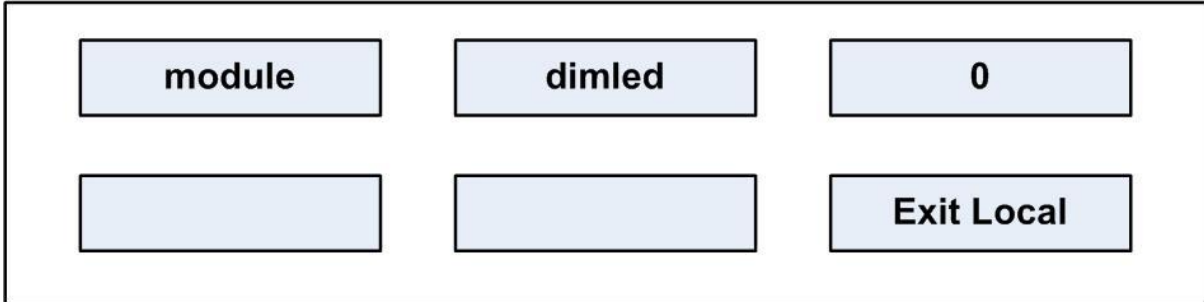

Figure 7-19: module display

The commands and permissible values are as follows:

Input names	Values
dimled	Number 0..50. This sets the brightness level for the LEDs.

Table 66: commands and permissible values

8 Compliance

- Applicant Name: Clear-Com LLC
- Applicant Address: 1301 Marina Village Pky, Suite 105, Alameda CA 94501, USA
- Manufacturer Name: HM Electronics, Inc.
- Manufacturer Address: 14110 Stowe Drive, Poway, CA 92064, USA
- Country of Origin: USA

- Brand: CLEAR-COM
- Product Name: Eclipse V-Series Panel
- Product Regulatory Model Number: UPXXX (where suffix X can be any alpha-numeric character 0-9, A-Z or blank)
- Product Regulatory Model Number: VxxxyyyzzY-AAA-BB (where suffix x, y, z, Y, A, B can be any alpha-numeric character 0-9, A-Z or blank)
- Country of Origin: USA

Caution: All products are compliant with regulatory requirements detailed in this document when installed correctly in Clear-Com product per Clear-Com specifications.

Caution: Product modification not expressly approved by the party responsible for compliance can void the user's authority to operate the equipment

USA FCC EMC Class A

This device complies with part 15 of the FCC Rules. Operation is subject to the following two conditions: (1) This device may not cause harmful interference, and (2) this device must accept any interference received, including interference that may cause undesired operation.

Note: This equipment has been tested and found to comply with the limits for a Class A digital device, pursuant to part 15 of the FCC Rules. These limits are designed to provide reasonable protection against harmful interference when the equipment is operated in a commercial environment. This equipment generates, uses, and can radiate radio frequency energy and, if not installed and used in accordance with the instruction manual, may cause harmful interference to radio communications. Operation of this equipment in a residential area is likely to cause harmful interference in which case the user will be required to correct the interference at his own expense.

Canada ICES-003 EMC Class A

Industry Canada ICES-003 Compliance Label: CAN ICES-3 (A)/NMB-3(A)

This Class A digital apparatus complies with Canadian ICES-003.
Cet appareil numérique de la classe A est conforme à la norme NMB-003 du Canada.

European Union (CE)



Directives:

EMC Directive 2014/30/EU
Low Voltage Directive 2014/35/EU

Standards:

EN55022
EN55024
EN55032

Korea KCC EMC Registration



For EMC Class A Equipment

이 기기는 업무용(A급) 전자파 적합기기로서 판매자 또는 사용자는 이 점을 주의하시길 바라며, 가정 외의 지역에서 사용하는 것을 목적으로

9 Specifications

Note: 0 dBu is referenced to 0.775 V RMS

9.1 Front panel controls and connectors

Control / Connector	Description / comments
Talk/Listen Switches	11 or 23
Answer Back Switch	1
Volume Controls	2
Headset Connector	1 XLR-4M or XLR-5F or XLR-7M
Panel Mic Connector	1 3-pin

Table 67: Front Panel controls and connectors

9.2 Main panel rear connectors

Connector	Description / comments
GPIO	DB-25F
To Matrix	RJ-45 in XLR shell
Auxiliary Audio	DB-25M
Expansion	RJ-45
LAN	RJ-45
DC Power	4 Pin

Table 68: Main panel rear connectors

9.3 AES-3 option rear connectors

Connector	Description / comments
To Matrix (CAT5)	RJ-45
To Matrix (Coax)	BNC

Table 69: AES-3 option rear connectors

9.4 T-Adapter option rear connector (now obsolete)

Connector	Description / comments
To Matrix (CAT5)	RJ-45

Table 70: T-Adapter option rear connector

9.5 Expansion panel rear connectors

Connector	Description / comments
Expansion In	RJ-45
Expansion Out	RJ-45
DC Power	4 Pin

Table 71: Expansion panel rear connectors

9.6 Panel microphone input

Characteristic	Description / comments
Type	Electret
Input Level	-70 to -40dBu
Impedance	1700 Ohms +/- 10% Electret mic 1000 Ohms +/- 10% Dynamic mic

Table 72: Panel microphone input

9.7 Headset microphone input

Characteristic	Description / comments
Type	Electret or Dynamic
Input Level	-70 to -40dBu

Table 73: Headset microphone input

9.8 Auxiliary loudspeaker output

Characteristic	Description / comments
Nominal Output	0dBu
Maximum Output	+18dBu
Output Impedance	100 Ohms

Table 74: Auxiliary loudspeaker output

9.9 Audio input/output

Characteristic	Description / comments
Bandwidth	30 Hz - 22 kHz
Headroom	+18 dBu
Noise	<-70 dBu rms (20-22 kHz)
THD	<0.02% @ 1kHz

Input impedance	120 kOhms
Output impedance	50 Ohms

Table 75: Audio input / output

9.10 AC mains power supply (external)

Characteristic	Description / comments
Voltage	100 - 240VAC
Frequency	50 - 60 Hz
Power	50W maximum

Table 76: AC mains power supply (external)

9.11 Temperature

Characteristic	Description / comments
Operating	Range: 0° - 50° C (32 to 125 F)
Storage	Range 0° - 70° C (32 to 150 F)

Table 77: Temperature

9.12 Humidity

Characteristic	Description / comments
Operation and storage	Between 20% and 90% Non-Condensing

Table 78: Humidity

9.13 Dimensions (1RU panels)

Characteristic	Description / comments
Height	1.82 in. (4.63 cm), (1 RU, EIA rack)
Width	19.0 in. (48.26 cm)
Depth	6.75 in. (17.15 cm) with PSU mount 3.5 in (8.9 cm) without PSU mount
Weight	1.5 lbs. (1.6 kg)

Table 79: Dimensions (1RU)

9.14 Dimensions (2RU panels)

Characteristic	Description / comments
Height	3.5 in. (8.89 cm), (2 RU, EIA rack)
Width	19.0 in. (48.26 cm)

Depth	6.75 in. (17.15 cm) with PSU mount 3.5 in (8.9 cm) without PSU mount
Weight	7.5 lbs. (4.0 kg)

Table 80: Dimensions (2RU)

9.15 Dimensions (Desktop panels)

Characteristic	Description / comments
Height	5.9 in. (15.00 cm)
Width	10.25 in. (26.00 cm)
Depth	6.8 in. (17.50 cm)
Weight	6.4 lbs. (2.9 kg)

Table 81: Dimensions (Desktop)

Notice about specifications

While Clear-Com makes every attempt to maintain the accuracy of the information contained in its product manuals, that information is subject to change without notice. Performance specifications included in this manual are design-center specifications and are included for customer guidance and to facilitate system installation. Actual operating performance may vary.

10 Glossary

Term	Definition
Analog Port	Any of the matrix's analog input/output RJ-45 connectors that are used to connect cable from the matrix to panels and interfaces. Each port connects to a separate audio channel in the matrix.
Alias label	A label that is temporarily assigned and replaces a previously labeled port or conference.
Bus	A bus is the channel or path between the components in the matrix along which electrical signals flow to carry information from one component to the next. In the Eclipse matrix the bus is located in the etched surface of the midplane.
Call signal	A call signal is an electronic signal sent from one panel or interface to another. A call signal can be audible and/or visual. Typically a call signal is sent to get the attention of a panel operator who may have turned down their intercom speaker's volume or removed their headset. It can also be sent to activate an electronic relay.
Canvas	The assignment area of the Production Maestro software which can save any user labeled background.
Category-5 (CAT-5) cable	EIA/TIA 568 category specification relating to network cabling. Shielded category-5 cabling is required for Eclipse matrix wiring.
CellCom[®]	Digital wireless communications product. Sold under the CellCom name in USA and as FreeSpeak in Europe and Asia.
Central matrix	The term central matrix is used to differentiate the central hardware and software of the intercom system from the connected audio devices. The central matrix consists of: <ul style="list-style-type: none"> • The metal housing for the circuit cards and power supplies. • The circuit cards. • The power supplies. • The rear panel connectors which connect the matrix's hardware to panels and interfaces.
Conference	An internal matrix virtual partyline or busbar where many panels and interfaces can talk onto or listen from the party line without talking to themselves.

Term	Definition
Destination	A device such as an intercom panel, belt-pack, or interface to which audio signals are sent. The device from which audio signals are sent is called a source .
Duplex	All real-time communication between individuals talking face to face is full duplex, meaning that they can both talk and listen simultaneously. The Eclipse matrices provide full-duplex audio.
ECS	ECS is the Eclipse configuration software. ECS guides the operation of the matrix circuit cards and connected panels.
Ethernet	International standard which describes how information is transmitted across a network. Provides for the efficient organization of network components.
Fiber optic cable	A fiber-optic cable consists of a glass core covered with a reflective material called cladding and several layers of buffer coating to protect the cable from the environment. A laser sends light pulses through the glass core to the other end of the cable.
Fixed Group	In a Fixed Group communication configuration, an operator speaks to all members of a group at once, in the manner of an announcer. However, if a group member responds by calling the operator back with their answer-back key, the audio path goes to the operator panel only. This mode can be contrasted with a conference or partyline configuration in which all members of a group can speak to all other members at the same time.
FreeSpeak®	Digital wireless communications product. Sold under the FreeSpeak name in Europe and Asia and CellCom name in USA.
FreeSpeak II™	Digital wireless communications product.
Full duplex	Refers to transmission of signals in two directions simultaneously.
Hopping	Refers to making a trunk connection through other matrices to a destination matrix.
Hosted Direct	Refers to the default port function when one or two extra IP channels are configured.
IFB	Interruptible Foldback. The term foldback refers to sending program audio / feed, or some other audio mix, back to announcers while they are on the air. Doing so allows announcers to monitor themselves, other announcers, videotapes of commercials, or some mix of sources, while they on the air. This is typically found in television news and live broadcast events.

Term	Definition
	Announcers usually wear a small ear piece so they can hear the selected foldback audio mix. When a director wants to give directions to an announcer on air, or to announce changes in the program, the director must interrupt the foldback. To do this, the director uses a channel specifically set up to interrupt the foldback audio.
Interface module	A piece of electronic hardware designed to convert the 4-wire signals of a central matrix port to some other form of communication, such as 2-wire partyline, telephone, etc. The interface module is connected to a central matrix port. The external non-4-wire device is then connected to the interface module.
ISO	The ISO function, short for panel ISolation , allows a panel operator to call a destination and interrupt all of that destination's other audio paths and establish a private conversation. When the call is completed the destination's audio pathways are restored to their original state before the interruption.
Keygroup	KeyGroups provide a way of assigning a label to multiple panels simultaneously even within a networked matrix system. Once the KeyGroups have been defined using ECS, all the keys within a KeyGroup can be changed with a single assignment in Production Maestro (Pro mode only).
Label	A label is an alphanumeric name of up to five characters that identifies a source, destination, or control function accessed by an intercom panel. Labels appear in the displays of the intercom panel. Labels can identify panels, ports interfaced to other external equipment, fixed groups, party lines, and special control functions.
MADI	Multichannel Audio Digital Interface. The MADI or AES10 electronic communications protocol defines the data format and electrical characteristics of an interface carrying multiple channels of digital audio.
Multiplexing	The process by which two or more signals are transmitted over a single communications channel. Examples include time division and wavelength division multiplexing.
Non-volatile Memory	Data stored in the CPU's firmware (ROM) that is not lost when the power is turned off.
Palette	The port, KeyGroup and Monitor selection screen in Production Maestro Pro.

Term	Definition
Panel	Any intelligent intercom device connected to the rear-panel analog ports of the central matrix. This term does not refer to devices connected through interface modules.
Partyline	A wired shared communication system based on a single screened pair of wires. See the Encore range. Matrix requires the CCI-22 to interface to it.
Port	Any of the input/output connections (RJ-45 connectors) on the back panel of the central matrix. These connectors and the attached cables connect the central matrix to remote intercom devices. The term port emphasizes that the connection is a portal between the central matrix and the remote intercom devices.
Program	Any separate audio source that is fed into the intercom channels. In television applications, for example, the program audio is the audio that is broadcast on air.
Rack Unit (RU)	Standardized unit of mounting space on a rack panel. Each rack unit is 1.75 inches (44.45 mm) of vertical mounting space. Therefore 1 RU is 1.75 inches (44.45 mm) of vertical mounting space, 2 RU is 3.5 inches (88.9 mm), 3 RU is 5.25 inches (133.35mm), and so on.
Remote panel	Any intelligent intercom device connected to the back-panel ports of the system frame (matrix). This term does not refer to devices connected through interfaces.
Sidetone	The sound of the panel operator's voice, as heard in their own earphone(s) as they speak.
Source	In this guide, the term source refers to a device (such as an intercom panel, interface, or belt-pack) that sends audio into the matrix. The device to which audio is sent is called a destination.
VOX	In the Eclipse / Eclipse HX system, when audio at a panel exceeds a threshold, a light switches on at the panel's port card to visually cue the operator. The threshold level is set in the ECS / EHX configuration software.