



## ***USER GUIDE***

*A downloadable, printable guide to your phone's features.*

onetouch® *Elevate™*

# TABLE OF CONTENTS

INTRODUCTION .....	1
About the User Guide .....	1
GET STARTED .....	2
Parts and Functions .....	2
SIM Card .....	3
Handling a SIM Card .....	3
Insert SIM Card .....	4
Remove SIM Card .....	6
SD Card .....	8
Insert SD Card .....	8
Unmount the SD Card .....	10
Remove SD Card .....	10
Erase SD Card .....	11
Battery Use .....	12
Insert the Battery .....	12
Remove the Battery .....	13
Charge the Battery .....	14
Turn Your Phone On and Off .....	16
Use the Touchscreen .....	17
Activation and Service .....	18
Complete the Setup Screens .....	19
BASIC OPERATIONS .....	23
Basics .....	23
Home Screen and Applications (Apps) List .....	23
Select Options and Navigate Screens .....	23
Recent Applications .....	23
Phone Settings Menu .....	23
Portrait and Landscape Screen Orientation .....	23
Capture Screenshots .....	24
Applications .....	24
Launch Applications .....	24
Silent Mode .....	25
Vibrate Mode .....	26

Airplane Mode .....	26
Enter Text .....	27
Touchscreen Keyboards .....	27
Swype .....	28
English (US) Google Keyboard .....	29
Google Voice Typing .....	30
Tips for Editing Text .....	31
Google Account .....	32
Create a Google Account .....	32
Sign In to Your Google Account .....	33
Google Play Store .....	34
Find and Install an App .....	34
Request a Refund for a Paid App .....	35
Update an App .....	35
Uninstall an App .....	36
Get Help with Google Play .....	36
Lock and Unlock Your Screen .....	36
Update Your Phone .....	37
Update Your Phone Software .....	37
YOUR PHONE INTERFACE .....	40
Home Screen Basics .....	40
Home Screen Layout .....	40
Extended Home Screens .....	41
Status Bar .....	41
Notifications Window .....	43
Customize the Home Screen .....	43
Change the Wallpaper .....	44
Add Shortcuts to the Home Screen .....	44
Add Widgets to the Home Screen .....	44
Add Folders to the Home Screen .....	45
PHONE APP .....	46
Place and Answer Calls .....	46
Call Using the Phone Dialer .....	46
Answer Phone Calls .....	48
In-Call Screen Layout and Operations .....	50
Place Calls from Contacts/Call Logs .....	51
Place a Call from Contacts .....	52

Call from Call Logs .....	52
Optional Services .....	52
Voicemail Setup .....	52
Listen to Multiple Voicemail Messages .....	54
Caller ID Blocking .....	55
Call Waiting .....	56
Conference Calling .....	56
Call Forwarding .....	57
Call Settings .....	58
Contacts .....	59
Add a Contact .....	59
Check Contacts .....	61
Contacts Screen Layout .....	62
Edit a Contact .....	63
Delete a Contact .....	63
Import Contacts from an SD Card or Storage .....	64
Back Up Contacts to an SD Card .....	64
MESSAGING AND INTERNET .....	66
Text and Multimedia Messaging .....	66
Send a Text Message .....	66
Send a Multimedia Message (MMS) .....	67
Save and Resume a Draft Message .....	71
New Messages Notification .....	71
Manage Message Conversations .....	72
Text and MMS Options .....	73
Gmail .....	75
Create and Send a Gmail Message .....	75
Check Received Gmail Messages .....	76
Open New Gmail Messages .....	76
Open Gmail Messages .....	76
Manage Gmail Messages .....	77
Use Gmail Labels .....	77
Delete Gmail Threads .....	77
Search Gmail Messages .....	77
Report Spam or Phishing Gmail .....	78
Add Another Google (Gmail) Account .....	78
Switching Between Gmail Accounts .....	79

Email .....	79
Set Up an Email Account .....	79
Add an Email Account .....	79
Compose and Send Email .....	80
Open New Email Messages .....	81
Open Email Messages .....	81
Delete an Email Account .....	82
Chrome Browser .....	82
CAMERA AND VIDEO .....	83
Take Pictures and Record Videos .....	83
Take a Picture .....	83
Viewfinder Screen .....	83
Record Videos .....	84
View Pictures and Videos Using Gallery .....	84
Edit Pictures .....	85
Share Pictures and Videos .....	86
Send Pictures or Videos by Email .....	86
Send a Picture or Video by Multimedia Message .....	87
Send Pictures or Videos Using Bluetooth .....	87
Camera Settings .....	88
Switch Cameras .....	88
Set Camera Functions .....	88
Scan Barcodes .....	88
USEFUL APPS AND FEATURES .....	90
Navigation .....	90
Google Maps .....	90
Hangouts .....	91
Google Search .....	91
Use Google Search .....	91
Use Google Voice Search .....	92
Calculator .....	92
Calendar .....	92
Add an Event to the Calendar .....	93
View Calendar Events .....	93
Sync Calendars .....	94
Time .....	94
Set Alarms .....	94

Additional Clock Features .....	95
YouTube .....	95
View YouTube Videos .....	96
Post a Video to YouTube .....	96
Google Play Music App .....	96
Play Music with Google Play Music .....	97
Google Play Music Screen Layout .....	97
Create Playlists in Google Play Music .....	97
Notes .....	98
CONNECTIVITY .....	99
Transfer Files between Your Phone and a Computer .....	99
Wi-Fi .....	100
Turn Wi-Fi On and Connect to a Wireless Network .....	100
Wi-Fi Settings .....	101
Disconnect Wi-Fi .....	101
Wi-Fi Direct .....	102
Bluetooth .....	102
Bluetooth Information .....	103
Enable the Bluetooth Feature .....	103
Pair Bluetooth Devices .....	103
Connect to a Paired Bluetooth Device .....	104
Send Information Using Bluetooth .....	105
Receive Data via Bluetooth .....	105
SETTINGS .....	107
Basic Settings .....	107
Wi-Fi Settings Menu .....	108
Bluetooth Settings .....	109
Data Usage Settings .....	110
More Settings .....	111
Default Messaging App Settings .....	112
Sound & Notification Settings .....	112
Display Settings .....	113
Storage Settings .....	114
Battery Settings .....	114
Apps Settings .....	114
Location Settings .....	115
Security Settings .....	116

Screen Lock .....	117
Disable the Screen Lock .....	117
Language & Input Settings .....	118
Backup & Reset .....	119
Accounts .....	120
Date & Time Settings .....	120
Accessibility Settings .....	121
Printing .....	122
Activate this Device .....	122
System Updates .....	123
About Phone .....	123
Copyright Information .....	124
FOR ASSISTANCE .....	125
Troubleshooting .....	125
Specifications .....	126
Virgin Mobile Account Information and Help .....	126
Manage Your Account .....	127
Top-Up Your Account .....	127
REGULATORY INFORMATION .....	128
Specific Absorption Rates (SAR) for Wireless Phones .....	128
FCC Radio Frequency Emission .....	128
Using Your Phone with a Hearing Aid Device .....	128
Warning Statements .....	130
INDEX .....	131

# ***INTRODUCTION***

The following topics describe the basics of using this guide and your new phone.

## ***ABOUT THE USER GUIDE***

Thank you for purchasing your new ALCATEL ONETOUCH Elevate. The following topics explain how best to use this guide to get the most out of your phone.

Accessible services may be limited by subscription contract conditions.

### ***Descriptions in the User Guide***

Note that most descriptions in this guide are based on your phone's setup at the time of purchase. Unless otherwise noted, instructions begin from the phone's Home screen, which is displayed by touching . Some operation descriptions may be simplified.

### ***Screenshots and Key Labels***

Screenshots in the user guide may appear differently on your phone. Key labels in the user guide are simplified for description purposes and differ from your phone's display.

### ***Other Notations***

In the user guide, the phone may be referred to either as "phone," "device," or "handset." A microSD™ or microSDHC™ card is referred to as an "SD card" or a "memory card."



# GET STARTED

The following topics give you all the information you need to set up your phone and wireless service the first time.

## PARTS AND FUNCTIONS



These topics illustrate your phone's primary parts and key functions.

### Phone Layout

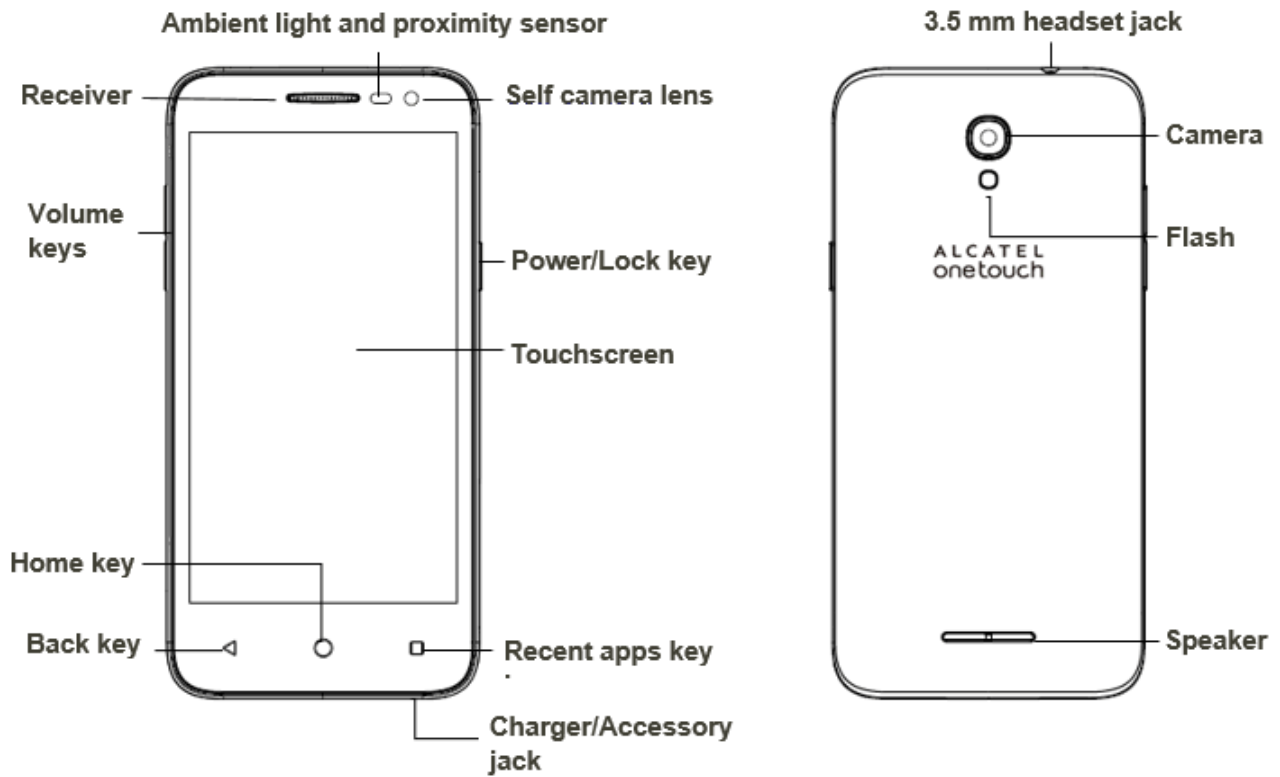
The following illustration outlines your phone's primary external features and buttons.



Part	Description
<b>Ambient light and proximity sensor</b>	Detects how close an object is to the surface of the screen. This is typically used to detect when your face is pressed up against the screen, such as during a phone call.  While talking on the phone, the sensor detects talk activity and locks the keypad to prevent accidental key press.
<b>Self camera lens</b>	Takes pictures and records videos while facing the screen, and allows you to video conference.
<b>Receiver</b>	Let you hear the caller and automated prompts.

Part	Description
<b>Touchscreen</b>	Displays all the information needed to operate your phone, such as the call status, the Contacts list, and the date and time. Also provides one-touch access to all of your features and applications.
<b>Back key</b> 	Let you return to the previous screen, or close a dialog box, options menu, the Notifications panel, or onscreen keyboard.
<b>Home key</b> 	Returns you to the Home screen.
<b>Recent apps key</b> 	Displays a list of recently used applications.
<b>Power/Lock key</b>	Let you turn the phone on or off or turn the screen on or off, or switch your phone to silent mode, vibration mode, or airplane mode.
<b>Speaker</b>	Let you hear the different ringtones and sounds. The speaker also lets you hear the caller's voice in speakerphone mode.
<b>Charger/Accessory jack</b>	Allows you to connect the phone charger or the USB cable (included).
<b>Flash</b>	Helps illuminate subjects in low-light environments when the camera is focusing and capturing a picture or video.
<b>Volume keys</b>	Allows you to adjust the ringtone or media volume or adjust the voice volume during a call.
<b>Camera</b>	Lets you take pictures and videos.
<b>3.5 mm headset jack</b>	Allows you to plug in either a stereo headset or an optional headset for convenient, hands-free conversations.

**CAUTION!** Inserting an accessory into the incorrect jack may damage the phone.

## ***SIM CARD***

The SIM card is an IC card containing phone number and other customer information.

### ***Handling a SIM Card***

Keep the following in mind when handling a SIM card.

- Customer is responsible for any damage caused by inserting SIM card in another-brand IC card reader, etc. Virgin Mobile is not responsible in such case.
- Always keep the IC chip clean.
- Wipe clean with a dry, soft cloth.
- Avoid applying labels. May damage SIM card.
- View instructions included with SIM card for handling.
- SIM card is the property of Virgin Mobile.

- SIM card is replaceable (at cost) in case of loss/damage.
- Return SIM card to Virgin Mobile when cancelling subscription.
- Returned SIM cards are recycled for environmental purposes.
- Note that SIM card specifications and performance may change without notice.
- It is recommended that you keep a separate copy of information that is stored on SIM card. Virgin Mobile is not responsible for damages from stored information that is lost.
- Always follow emergency procedures to suspend service if your SIM card or phone (SIM card inserted) is lost or stolen. For details, contact Customer Service.
- Always power off phone before inserting/removing SIM card.

### *Insert SIM Card*

Follow these instructions to insert a SIM card. Remember to power off your phone before inserting a SIM card.

**Note:** Your phone's SIM card is preinstalled. These instructions are for reference only.

1. Remove the battery cover.

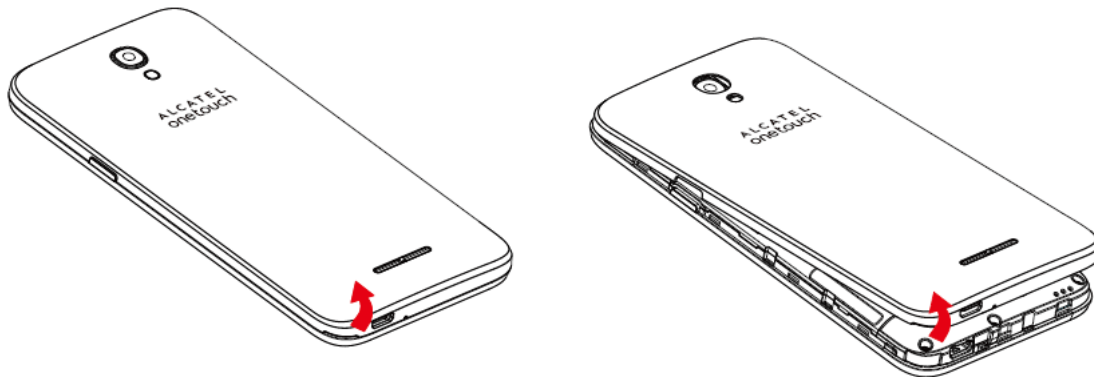

2. Remove the battery.

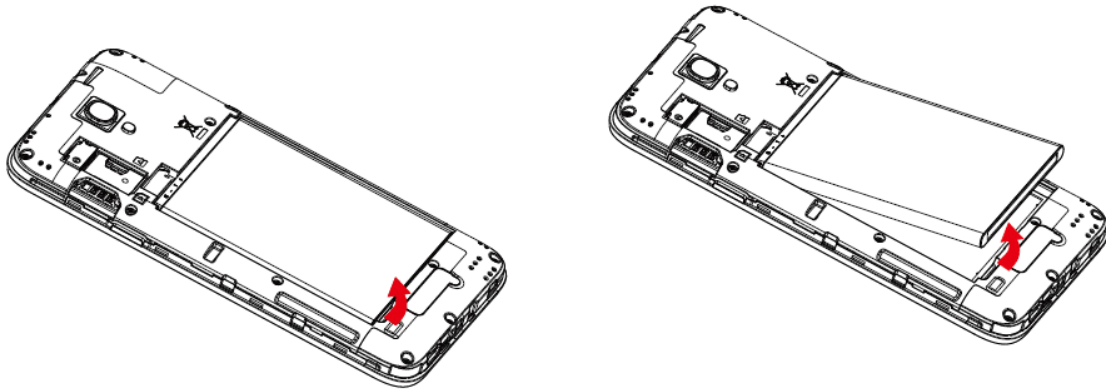

3. Push SIM card into the slot.

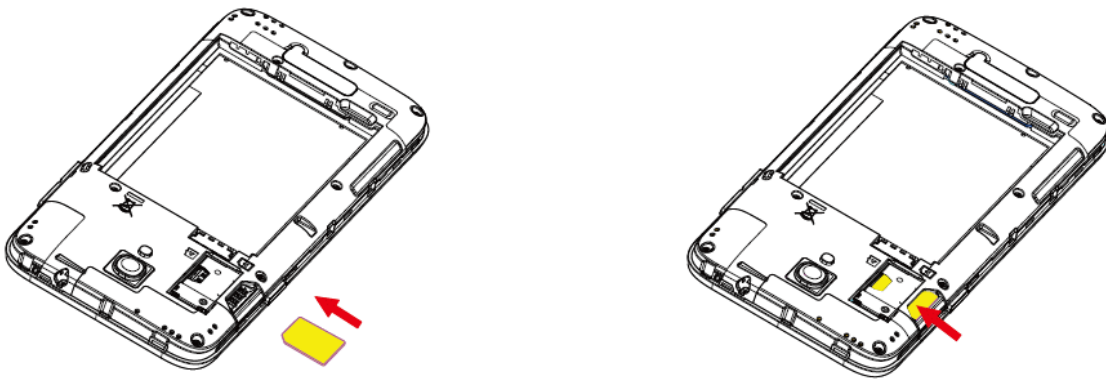

- Insert gently with gold IC chip facing downward.

**Note:** Your phone only supports Micro-SIM cards. Do not attempt to insert other SIM card types such as mini and nano cards, as they may cause damage to your phone.

4. Insert the battery.

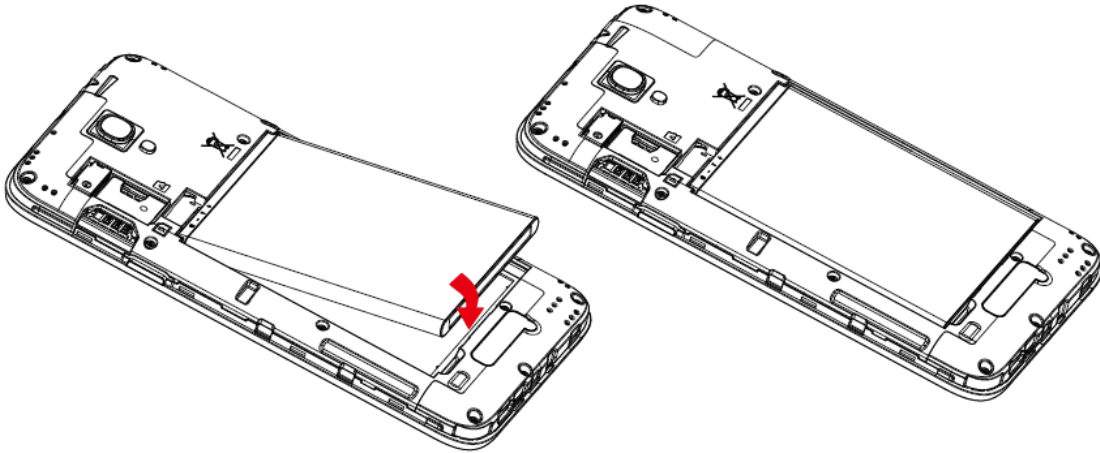

- Align the contacts of the battery with the contacts in the phone.

5. Attach the battery cover.

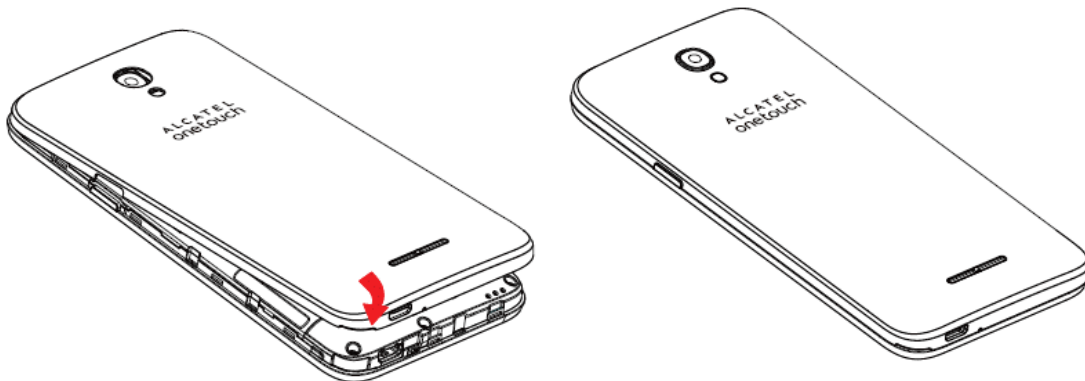

- Make sure all the tabs are secure and there are no gaps around the cover.

### ***Remove SIM Card***

Follow these instructions to remove a SIM card. Remember to power off your phone before removing a SIM card.

1. Remove the battery cover.

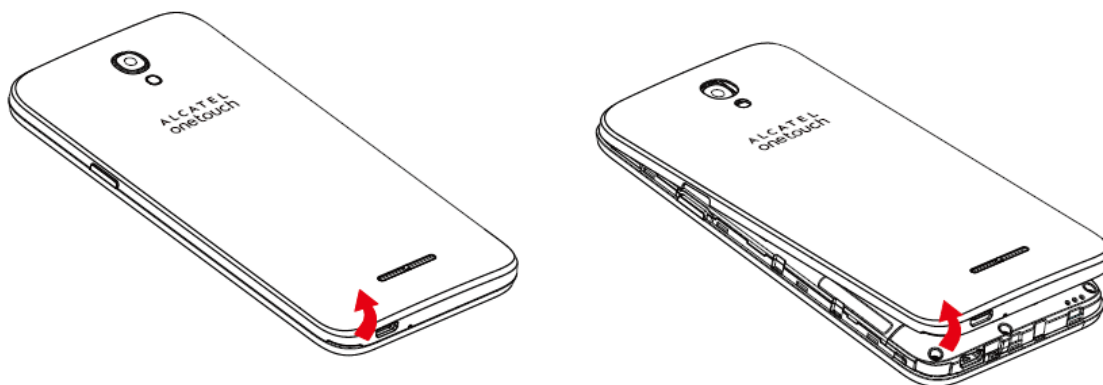

2. Remove the battery.

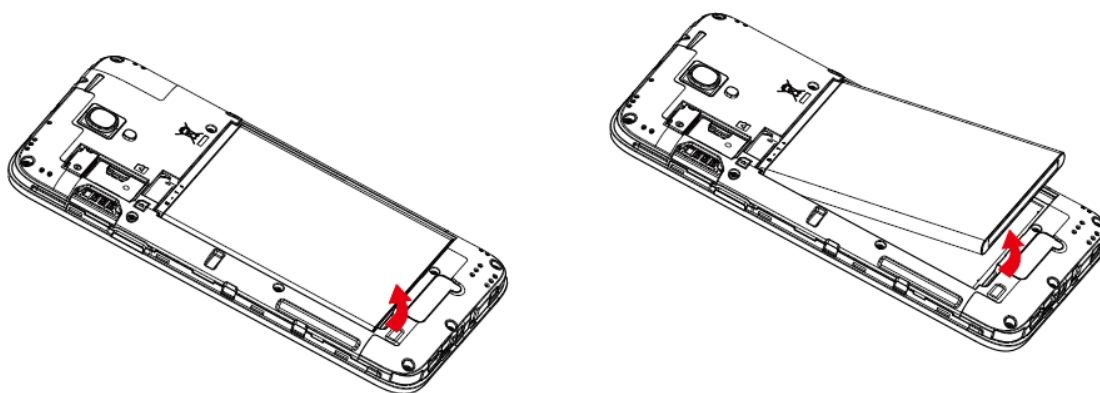

3. Push SIM card out of the slot.

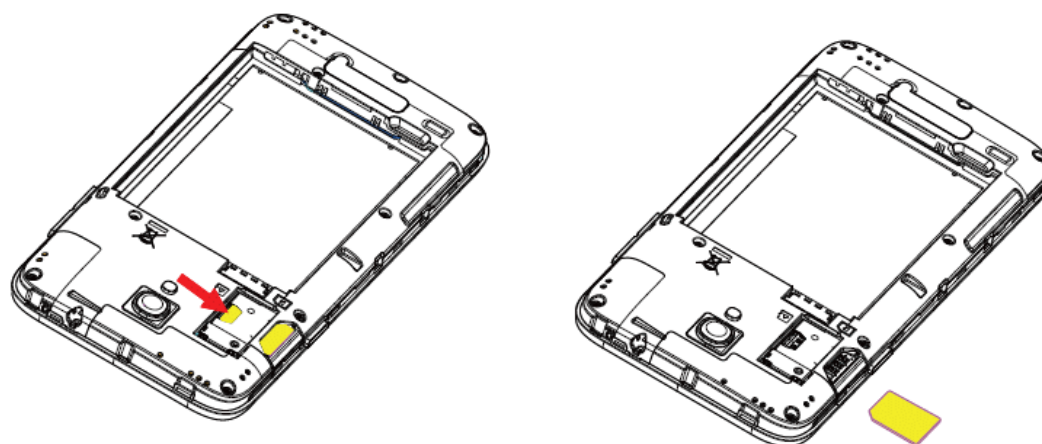

## SD CARD

Your phone supports the use of an optional SD card (not included) to expand its storage capacity. It supports cards up to 32 GB. Some cards may not operate properly with your phone.

### ! SD Card Cautions

**Data:** Information stored on SD card can become lost or changed accidentally or as a result of damage. It is recommended that you keep a separate copy of important data. Virgin Mobile is not responsible for damages from data that is lost or changed.

**Reading/Writing Data:** Never power off while reading or writing data.

**Battery Level:** A low battery charge may prevent reading/writing to SD card.

**Handling SD card:** Use/store SD cards away from the reach of infants. Otherwise it may cause choking if swallowed.

### Insert SD Card

Follow these steps to insert an optional SD card (not included). Make sure to power your phone off before inserting or removing an SD card.

1. Remove the battery cover.

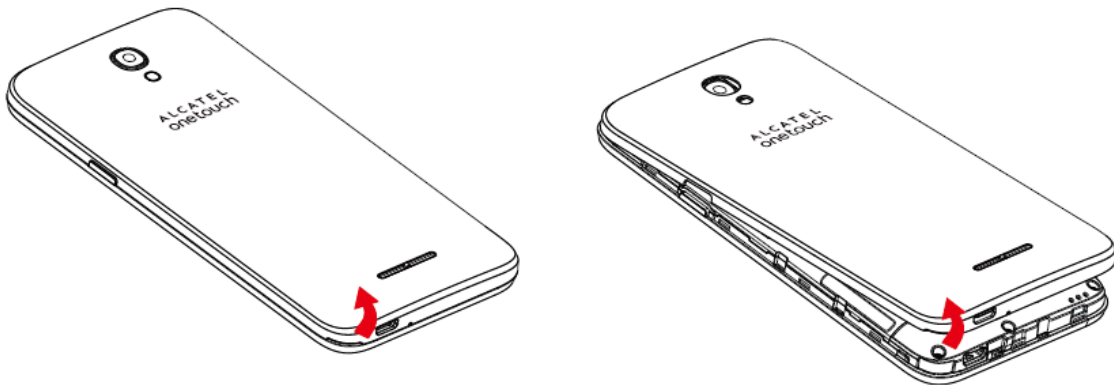

2. Remove the battery.

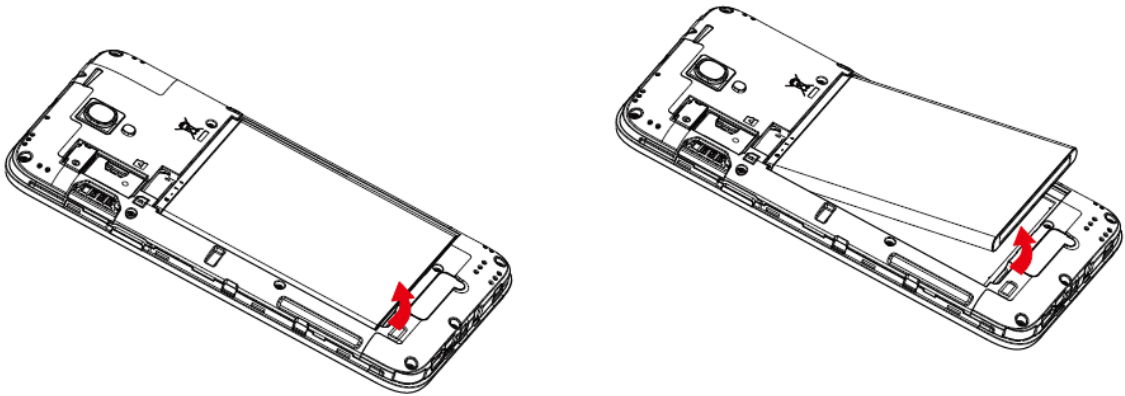

3. Push SD card into the slot.

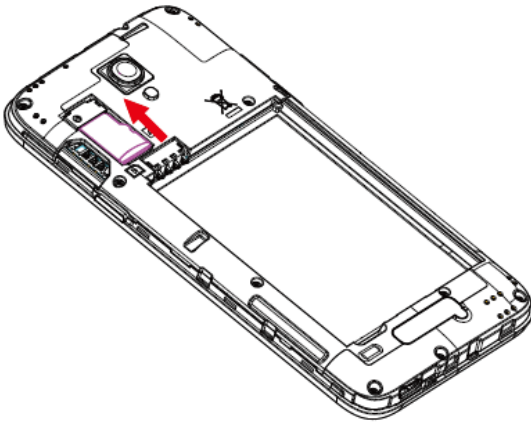

- Insert gently with gold IC chip facing downward.

4. Insert the battery.

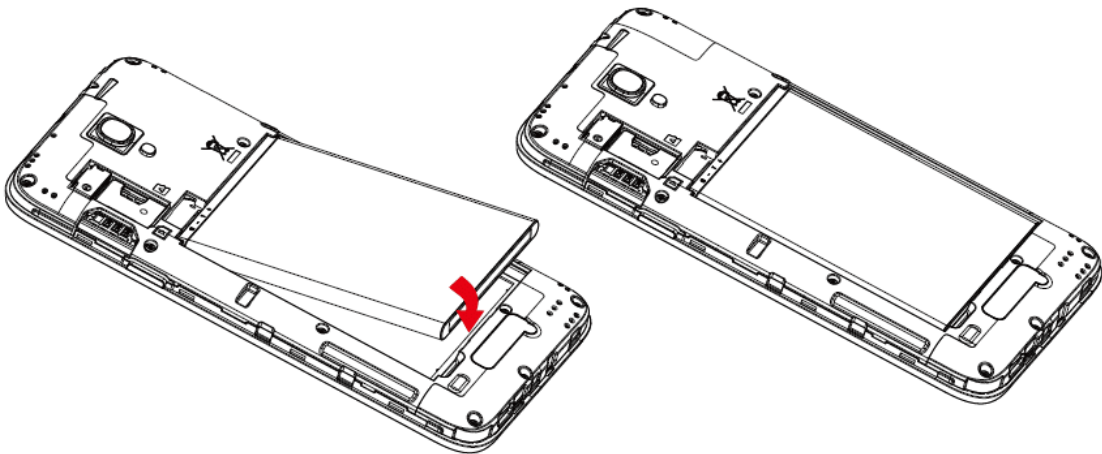



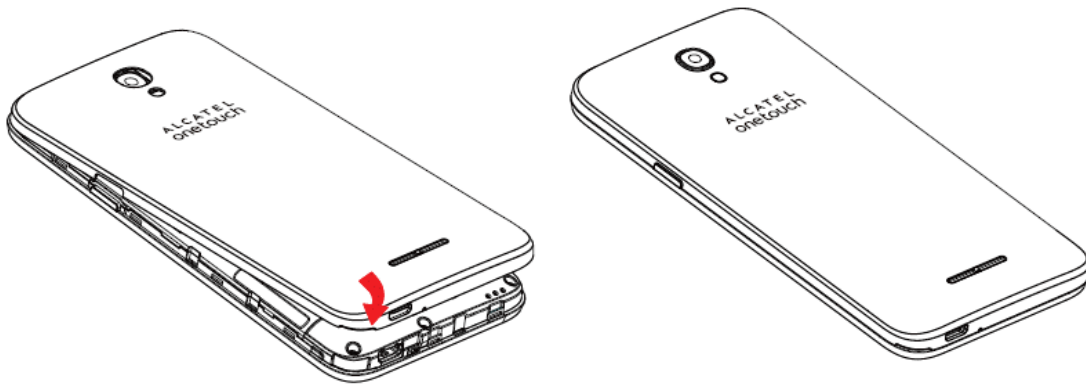

- Align the contacts of the battery with the contacts in the phone.
5. Attach the battery cover.



- Make sure all the tabs are secure and there are no gaps around the cover.

### *Unmount the SD Card*

Always unmounts the SD card before removing it from your phone.

1. From home, touch **Apps**  > **Settings** .
2. Touch **Storage**.
3. Touch **Unmount SD card** > **OK**.

- ❖ The menu option name changes from **Unmount SD card** to **Mount SD card**.

### *Remove SD Card*

Follow these instructions to remove an SD card. Always power the phone off before inserting or removing an SD card.

1. Remove the battery cover.

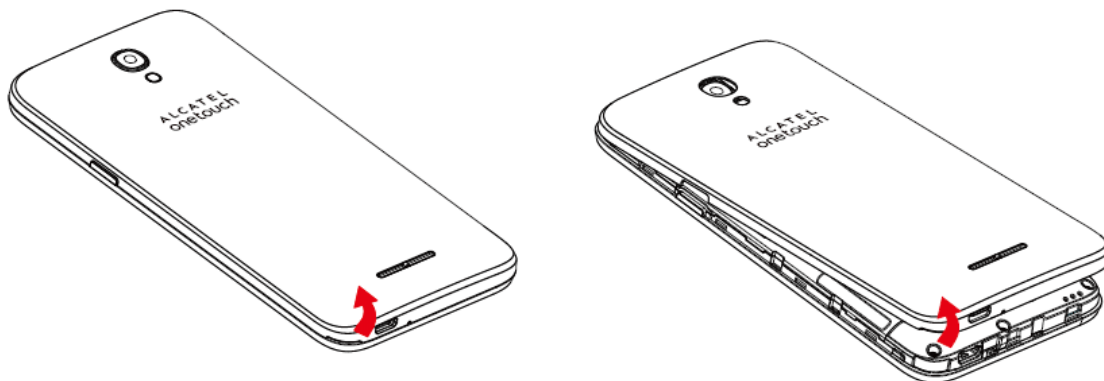

2. Remove the battery.

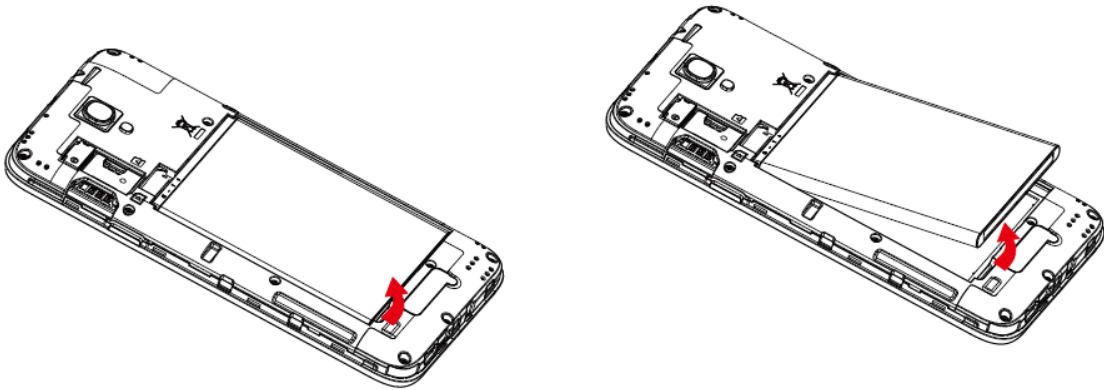

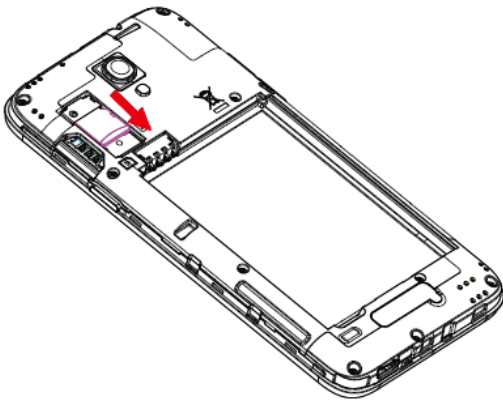

3. Push SD card out of the slot.



## *Erase SD Card*

When you insert an optional SD card for the first time, it is recommended that you format it on your phone.

1. From home, touch **Apps**  > **Settings** .
2. Touch **Storage**.
3. Touch **Erase SD card**.
4. Touch **ERASE SD CARD**.
5. Touch **ERASE EVERYTHING** to confirm.

❖ All data on the SD card is erased, and the card is formatted for use on your phone.

# BATTERY USE

The following topics explain how to insert and remove your phone's battery.

## Battery Cautions

**Storage:** Avoid storing or leaving battery with no charge remaining. Saved information and settings may become lost or changed, or battery may become unusable. Charge once every six months before storing or leaving unused for a long period.

**Bulges:** Depending on use, bulges may appear near end of battery life. This does not affect safety.

## *Insert the Battery*

Follow these instructions to insert your phone's battery safely and properly.

1. Remove the battery cover.

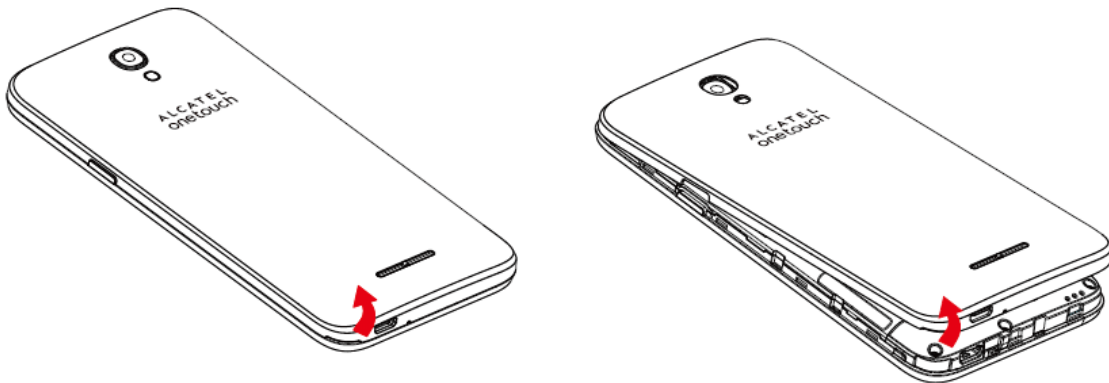

- Lift gently in the direction shown.

2. Insert the battery.

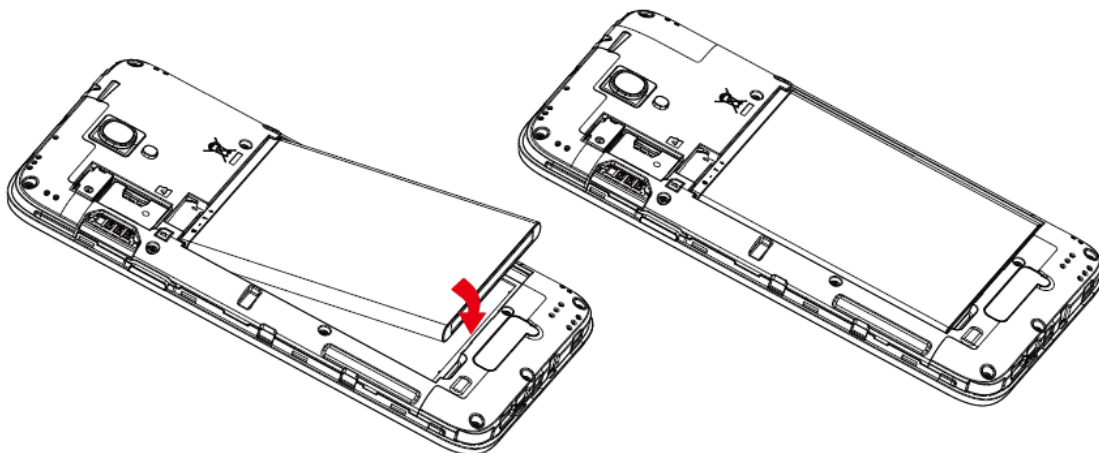

3. Attach the battery cover.

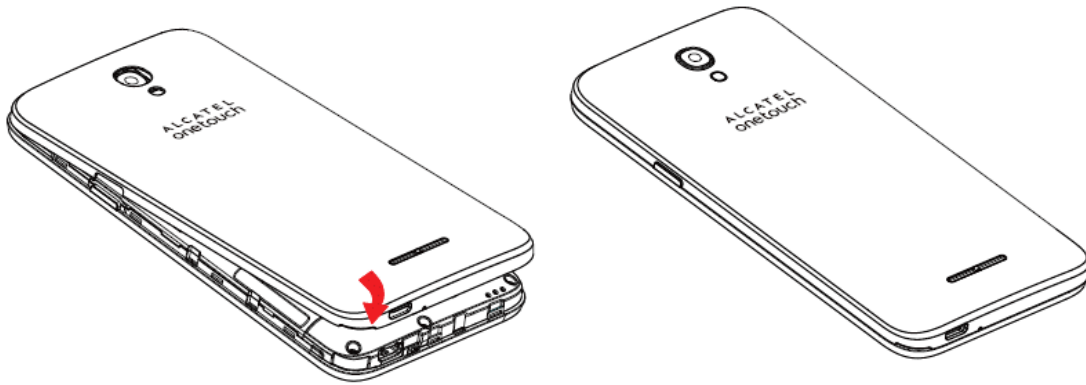

### *Remove the Battery*

Follow these instructions to remove your phone's battery. Always power the phone off before removing the battery.

1. Remove the battery cover.

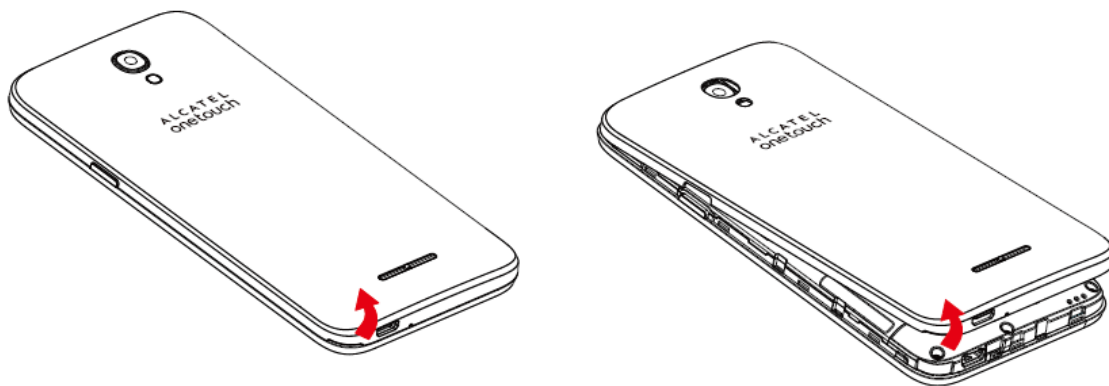

- Lift gently in the direction shown.

2. Remove the battery.

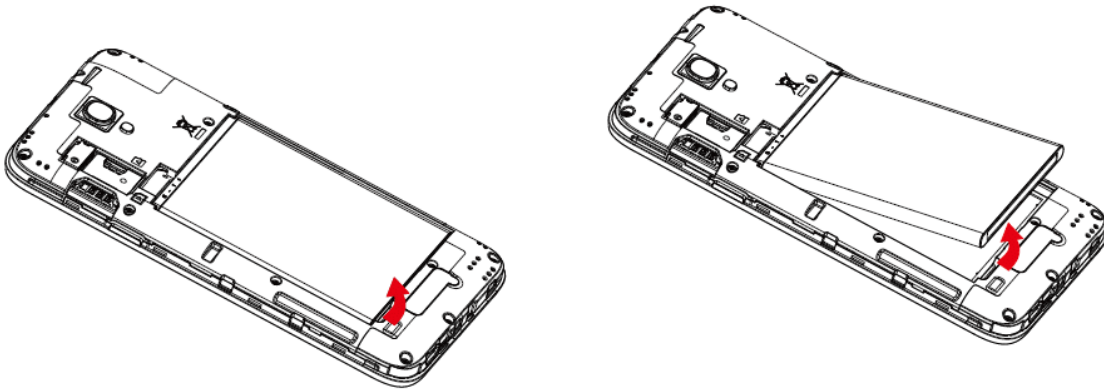

3. Attach the battery cover.

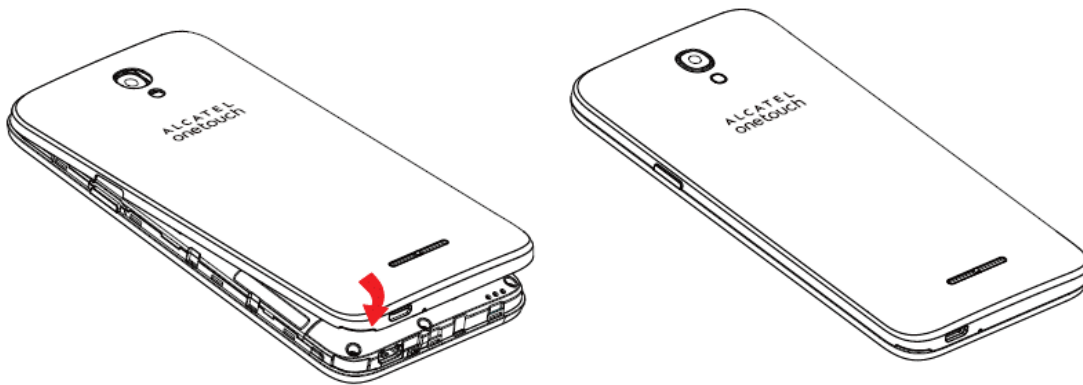

- Make sure all the tabs are secure and there are no gaps around the cover.

### *Charge the Battery*

Follow these instructions to charge your phone's battery using either the included AC adapter or via a USB connection on your computer.

### **Charge Using the AC Adapter**

1. Plug the USB connector into the charger/accessory jack on the right bottom of your phone.

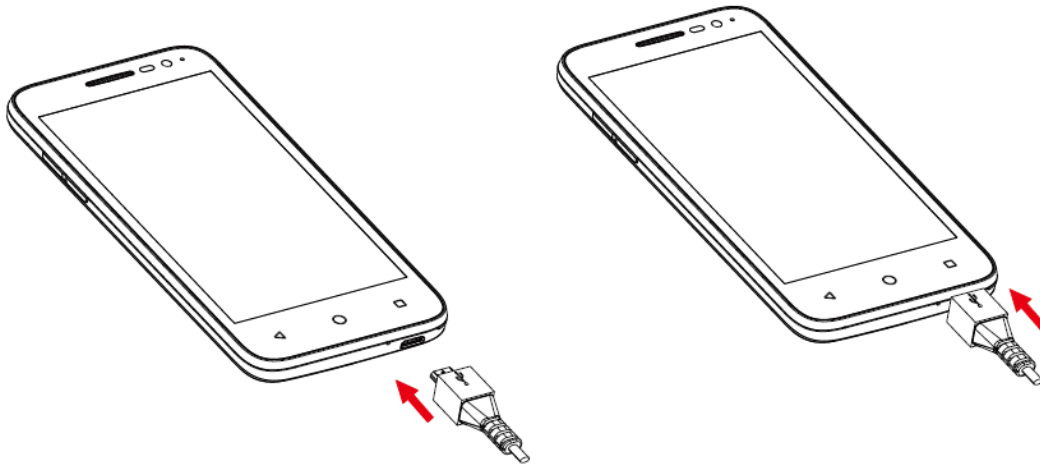

2. Plug the other end of the USB cable into the AC adapter.
3. Plug the AC adapter into an electrical outlet.
  - ❖ The indicator light becomes red when charging starts. The light turns green when the battery is fully charged. Fully charging a battery may last about 2.5 hours.
4. After charging, disconnect the phone from the charger.

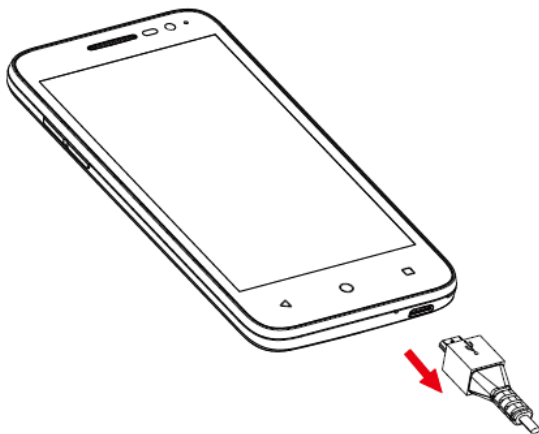

- Unplug the AC adapter from the outlet, and remove the micro USB cable from the phone and the AC adapter.

### **Charge Using a PC Connection**

Before using a PC connection to charge your phone, ensure that the computer is turned on. Depending on the type of connection, your phone's battery may not charge.

1. Insert the small end of the micro USB cord into the charger/accessory jack on the right bottom of your phone.

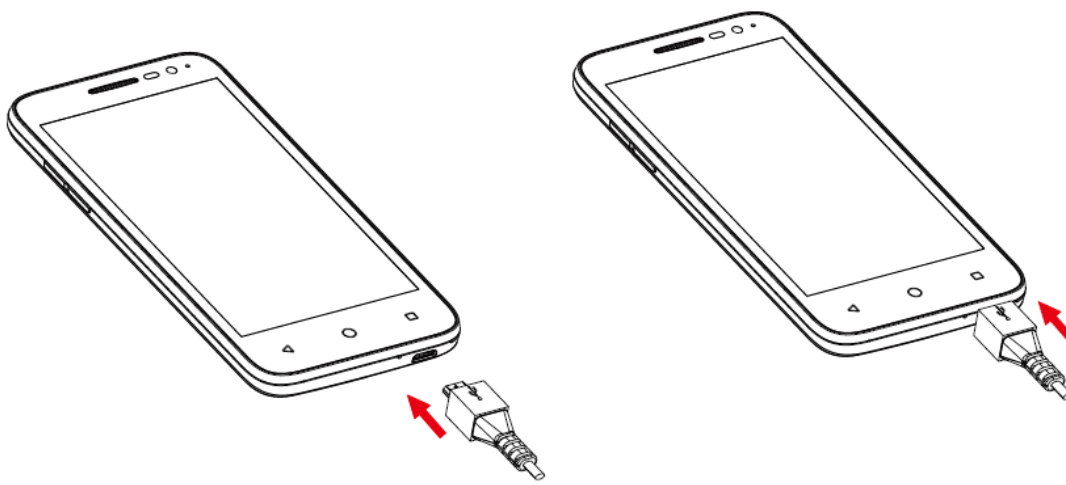

2. Insert the large end of the micro USB cord into an external USB port on your computer.
3. After charging, remove the micro USB cable from both the phone and the computer.

## ***TURN YOUR PHONE ON AND OFF***

The instructions below explain how to turn your phone on and off.

### ***Turn Your Phone On***

- Press and hold the **Power/Lock key**.
- ❖ Your phone will power on. Depending on the settings, you may see the lock screen.
  - See [Lock and Unlock Your Screen](#) and [Screen Lock](#) for information about using the screen lock.
  - The first time you turn on the phone, you will see the setup screens. See [Complete the Setup Screens](#) for details.
  - If your phone is not yet activated, see [Activation and Service](#) for more information.

### ***Turn Your Phone Off***

1. Press and hold the **Power/Lock key** to open the phone options menu.
2. Touch **Power off** to turn the phone off.
  - ❖ Your phone will power off.

Your screen remains blank while your phone is off (unless the battery is charging).

# USE THE TOUCHSCREEN

Your phone's touchscreen lets you control actions through a variety of touch gestures.

## **Touch**

When you want to type using the onscreen keyboard, select items onscreen such as application and settings icons, or press onscreen buttons, simply touch or touch them with your finger.



## **Long press**

To open the available options for an item (for example, a contact or link in a Web page), long press the item.



## **Swipe or Slide**

To swipe or slide means to quickly drag your finger vertically or horizontally across the screen.



## **Drag**

To drag, press and hold your finger with some pressure before you start to move your finger. While dragging, do not release your finger until you have reached the target position.



## **Flick**

Flicking the screen is similar to swiping, except that you need to swipe your finger in light, quick strokes. This finger gesture is always in a vertical direction, such as when flicking the contacts or message list.







## **Rotate**

For most screens, you can automatically change the screen orientation from portrait to landscape by turning the phone sideways. When entering text, you can turn the phone sideways to bring up a bigger keyboard.



**Note:** The Auto-rotate check box needs to be selected for the screen orientation to automatically change. From home, touch **Apps**  > **Settings**  > **Display** > **When device is rotated**.

**Tip:** You can also access the screen rotation setting from the notifications window. Pull down the status bar and touch **Auto-rotate/Portrait** to select or deselect the option.

## **Pinch and Spread**

“Pinch” the screen using your thumb and forefinger to zoom out or “spread” the screen to zoom in when viewing a picture or a Web page. (Move fingers inward to zoom out and outward to zoom in.)



# **ACTIVATION AND SERVICE**

Before using your phone, you must set up your service with Virgin Mobile. You will need your phone’s serial number (MEID), printed on a sticker inside the battery compartment.

For more information about your Virgin Mobile account, see [Virgin Mobile Account Information and Help](#).

## **Create Your Account and Pick Your Plan**

Set up your Virgin Mobile account.

1. From your computer, visit [virginmobileusa.com](http://virginmobileusa.com) and click **Activate**.
2. Choose an activation option and click **Next**. Then enter your zip code and click **Next**.
3. When prompted, enter the serial number (MEID) printed on the sticker located on the back of your phone in the battery compartment. This number can also be found on the bottom panel of the phone’s package.
4. Follow the remaining instructions to choose your plan and select a payment method.
5. Follow the activation instructions below and you’ll be able to start using your phone.

## Activate Your Phone

After setting up your account on [virginmobileusa.com](http://virginmobileusa.com), simply turn your device on. Your device is designed to activate automatically. If you are swapping from another Virgin Mobile device to a new one, be sure to turn off the old device before swapping the serial number (MEID). Once the MEID swap is complete, turn on the new device and the programming information will be pushed to your device automatically.

You can also start the activation process manually.

- From home, touch **Apps**  > **Settings**  > **Activate this device**.

## COMPLETE THE SETUP SCREENS

The setup screens help you set up certain features and preferences on your phone. Once your phone has been turned on, you will see a Welcome message. You can then complete the setup process.

**Note:** You may be able to complete the setup screens before your phone has been activated on your account.

1. From the Welcome screen, select a language (if prompted) and touch  to get started.

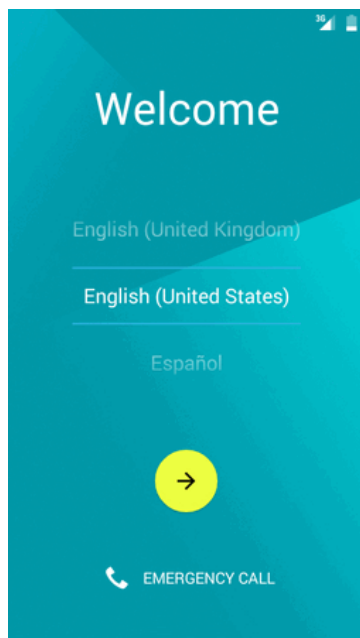

2. Follow the onscreen instructions to complete each section. For each topic, you will have the option to skip it and continue to the next screen.
  - **Select Wi-Fi** – If prompted, follow the prompts to sign in to an available Wi-Fi network. For secured Wi-Fi networks, you will need to enter a password. See [Wi-Fi](#) for more details. If you don't want to set Wi-Fi, touch **SKIP** > **SKIP ANYWAY** to next step.

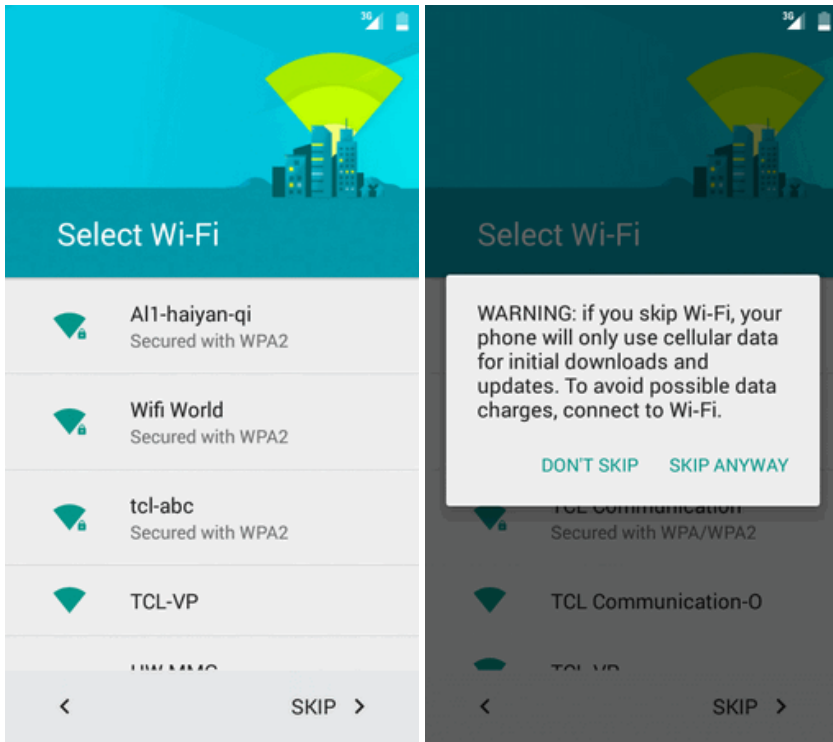

- **Name** – Enter your name to personalize some apps, or touch **NEXT** to skip to next screen.

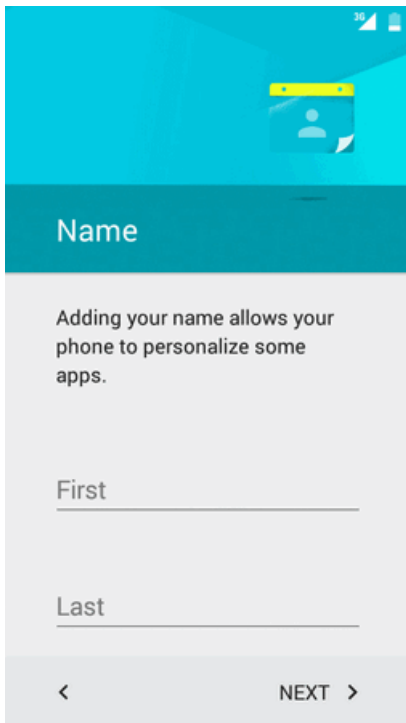

- **Protect your phone** – Touch **SET SCREEN LOCK NOW** to choose screen lock pattern, or touch **SKIP > SKIP ANYWAY** to next screen.

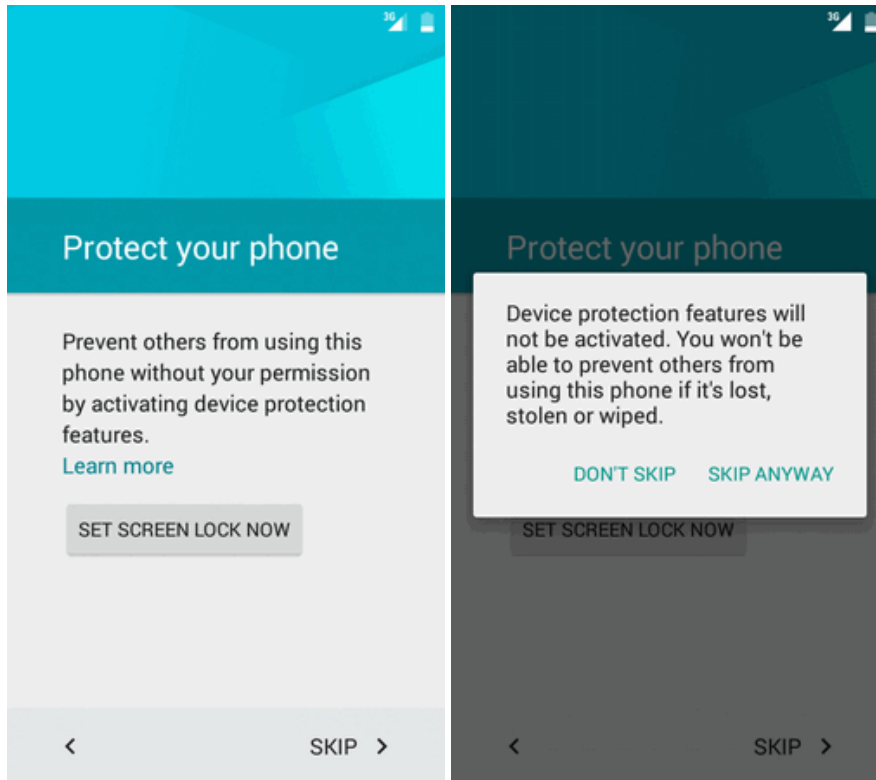

- **Google services** – Mark the check box to improve location services or improve Android experience.

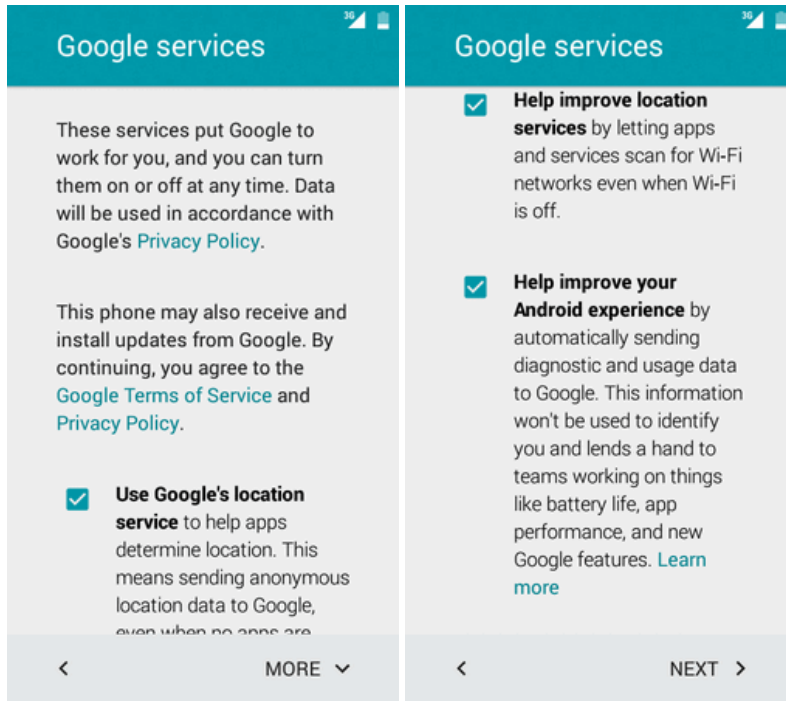

- Touch **NEXT**. Your setup is now complete.
- ❖ Your phone is now set up for use. If you skipped any part of the setup, you can access additional options through the Apps screen or through Settings.

# ***BASIC OPERATIONS***

The following topics outline basic features and operations of your phone.

## ***BASICS***

The following topics offer an overview of your phone's basic operations.

### ***Home Screen and Applications (Apps) List***

Most of your phone's operations originate from the Home screen or the apps list.

For information about using the Home screen, see [Home Screen Basics](#).

### ***Select Options and Navigate Screens***

Touch icons, onscreen keys, and other items to open or activate the assigned function.

- Touch **Back**  to return to the previous screen.

### ***Recent Applications***

You can display a list of recently used applications using the recent apps key.

- Touch **Recent Apps**  to view a list of recently used applications.

### ***Phone Settings Menu***

You can customize your phone's settings and options through the Settings menu.

- From home, touch **Apps**  > **Settings** .

– or –



Drag the status bar down and touch **Settings** .

For more information, see [Settings](#).

### ***Portrait and Landscape Screen Orientation***

The default orientation for your phone's screen is portrait (vertical), but many apps will change to landscape orientation (widescreen) when you rotate the phone sideways. Not all screens will adjust for landscape orientation.





**Note:** The Auto-rotate check box needs to be selected for the screen orientation to automatically change. From home, touch **Apps**  > **Settings**  > **Display** > **When device is rotated**.

**Tip:** You can also access the screen rotation setting from the notifications window. Pull down the status bar and touch **Auto-rotate/Portrait** to select or deselect the option.

## *Capture Screenshots*

You can use your phone's power and volume keys to capture screenshots.

- Press and hold the **Power/lock Key** and **Volume Down Key** at the same time to capture a screenshot of the current screen.
- ❖ The current screenshot will be captured and stored in the Screenshots album in the phone's Gallery. From home, touch **Apps**  > **Gallery** .

## *APPLICATIONS*

The following topics describe how to access the applications (apps) list and launch apps on your phone.

### *Launch Applications*

All installed apps can be accessed and launched from the apps list.

1. From home, touch **Apps** .



- ❖ The apps list opens.

2. Touch an app icon to launch the corresponding application.

- ❖ The application opens.

## ***SILENT MODE***

Silent mode mutes your phone's ringtone, operation sounds, notifications, etc., to avoid disturbing others around you.

**Note:** Camera shutter, video start/stop tones, and certain other sounds may still be active during silent mode.

To set silent mode:

1. Press and hold the **Power/Lock key** to display the device options menu.
2. Touch .

- ❖ Your phone is now in silent mode.

To restore sound settings:



1. Press and hold the **Power/Lock key** to display the device options menu.
2. Touch .

❖ Your phone's sound settings are now restored.

## *Vibrate Mode*

Vibrate mode mutes your phone's ringtone, operation sounds, notifications, etc., to avoid disturbing others around you.

**Note:** Camera shutter, video start/stop tones, and certain other sounds may still be active during silent mode.

To set vibrate mode:

1. Press and hold the **Power/Lock key** to display the device options menu.
2. Touch .

❖ Your phone is now in vibration mode.

To restore vibrate settings:

1. Press and hold the **Power/Lock key** to display the device options menu.
2. Touch .

❖ Your phone's vibrate settings are now restored.

## *Airplane Mode*

Airplane mode turns off all functions that emit or receive signals, while leaving your phone on so you can use apps that don't require a signal or data.

To turn on airplane mode:

1. Press and hold the **Power/Lock key** to display the device options menu.
2. Touch **Airplane mode**.

❖ Your phone is now in airplane mode. You will see the airplane mode icon  in the status bar.

To turn off airplane mode:

1. Press and hold the **Power/Lock key** to display the device options menu.
2. Touch **Airplane mode**.

❖ Your phone's wireless connection features are now restored.

## ENTER TEXT

You can type on your phone using one of the available touchscreen keyboards or Google voice typing.

### *Touchscreen Keyboards*

Your phone offers you a choice of Swype touchscreen keyboards for entering text. The keyboard appears automatically onscreen when you touch a text entry field, and they can be used in either portrait or landscape mode. You can also use the Google Voice typing option to enter text using your voice (see [Google Voice Typing](#) for details).

The methods available include:

- **Swype** lets you enter letters and words in one continuous motion by swiping your finger across the letters. See [Swype](#) for details.

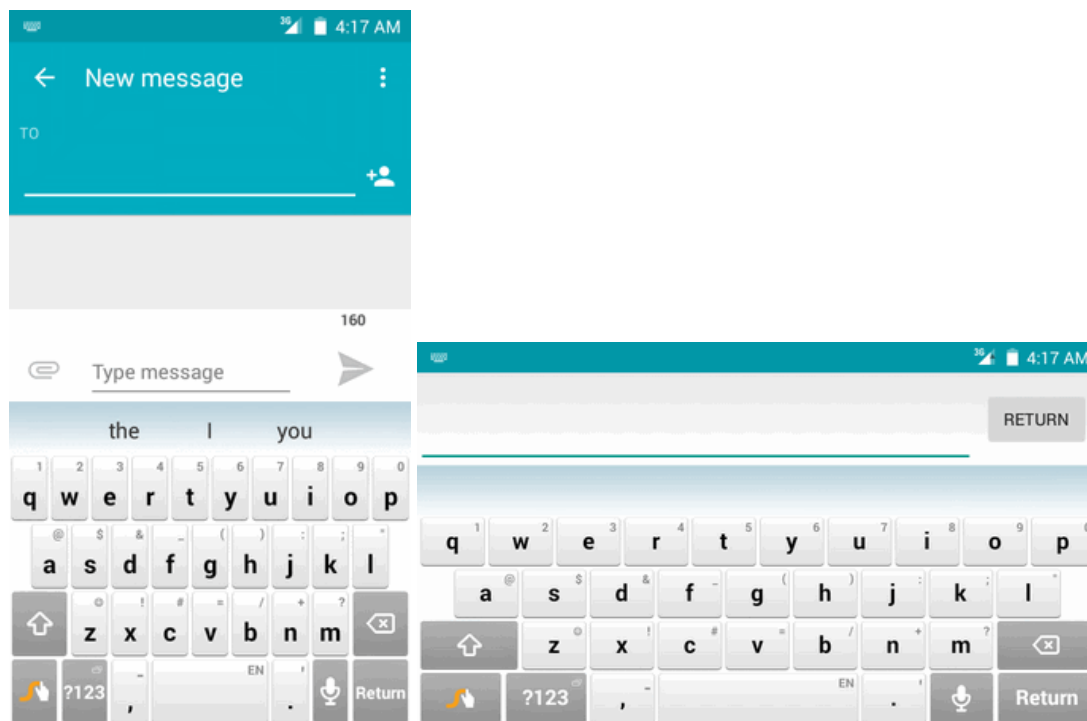

- **English (US) Google Keyboard** lets you use a traditional QWERTY setup to enter text. Additional options expand your ability to enter text faster and more accurately. See [English \(US\) Google Keyboard](#) for details.

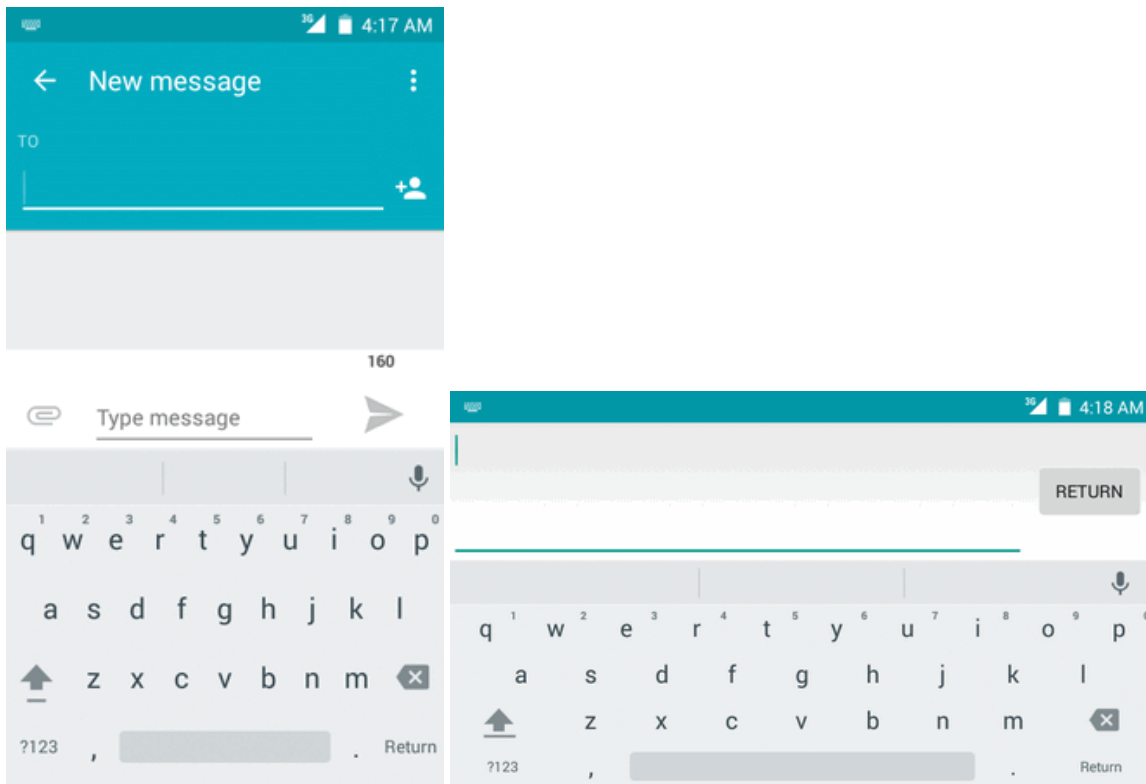

**Note:** Keyboard layouts and options may change depending on where you're using them. For example, if you're entering text to do a Web search, a search icon may be available instead of an enter key.

## Swype

The Swype™ keyboard lets you enter words by drawing a path from letter to letter in one continuous motion. When you lift your finger after the last letter of a word, a space is automatically added.

### Assigning Swype for Text Entry

Swype is typically the default entry type.

- From home, touch **Apps**  > **Settings**  > **Language & input** > **Current keyboard** > **Swype**.

### Using Swype

Swype lets you enter a word with one continuous motion: just drag your finger over the letters in the word.

- Place your finger on the key with the first letter of the word and drag your finger to each subsequent letter without lifting your finger off the screen.
- Continue until you have finished the word. Lift your finger after the last letter.

- If Swype cannot clearly determine your word, the word choice window opens. Select an alternative word from the list.

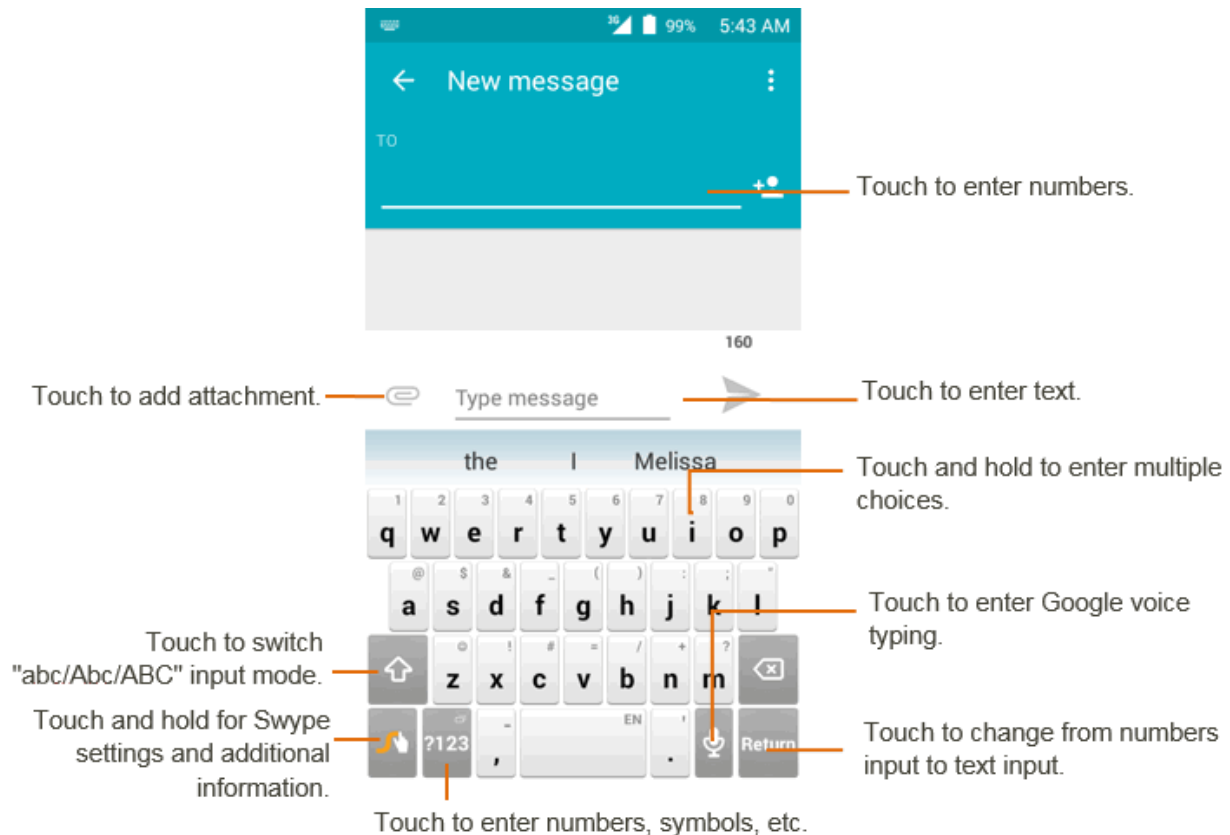

For more information about using Swype and its additional capabilities, including using voice entry and personalizing your Swype dictionary, long press  from the Swype keyboard display. You can also visit [swype.com](http://swype.com) for more information.

## *English (US) Google Keyboard*

The English (US) Google Keyboard offers a traditional QWERTY keyboard setup for entering text by touching keys (like on a computer), along with enhancements and options that allow you to enter text faster and more accurately, such as continuous key input, personalized usage dictionaries, and more.

### **Assigning English (US) Google Keyboard for Text Entry**

- From home, touch **Apps**  > **Settings**  > **Language & input** > **Current keyboard** > **English (US) Google Keyboard**.

### **Using English (US) Google Keyboard**

Below illustration clearly describe how to use English (US) Google Keyboard.

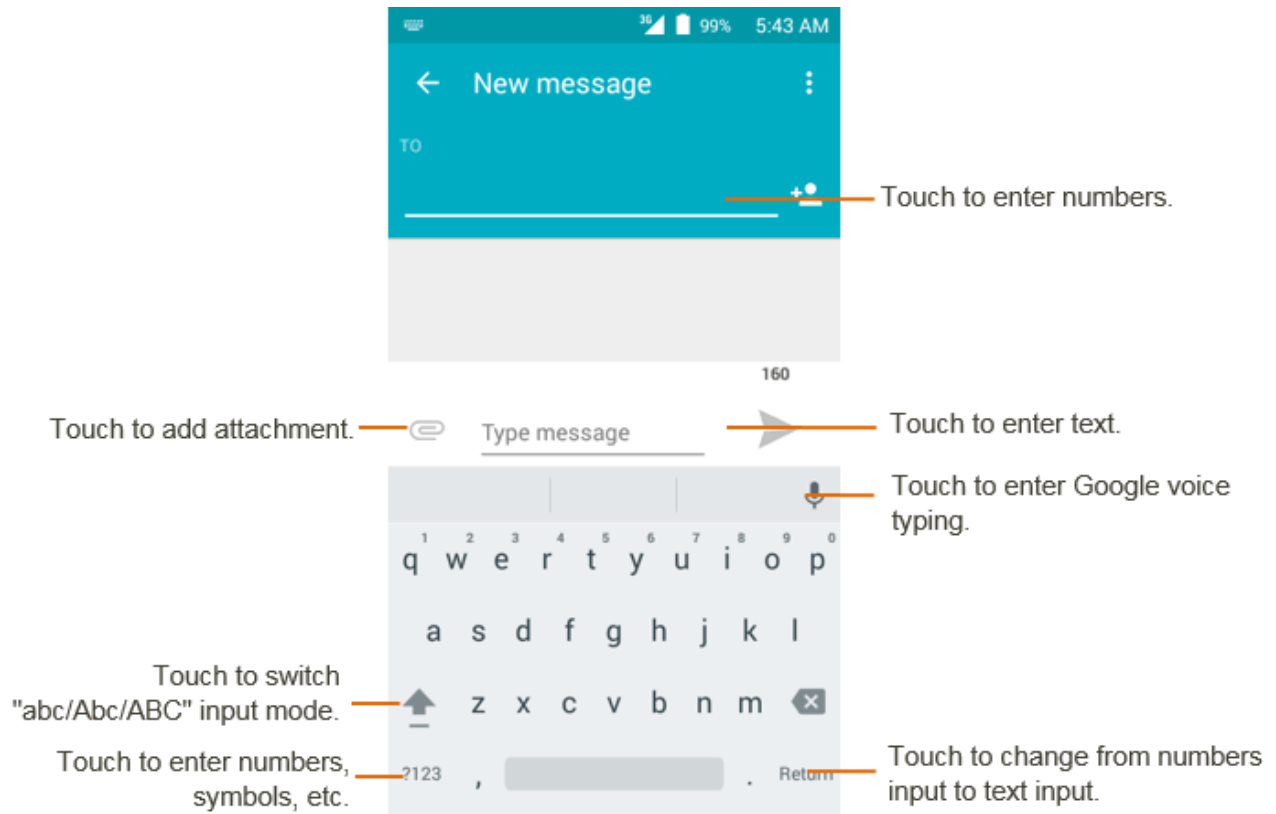

## Google Voice Typing

Google Voice typing uses Google voice recognition to convert speech to text.



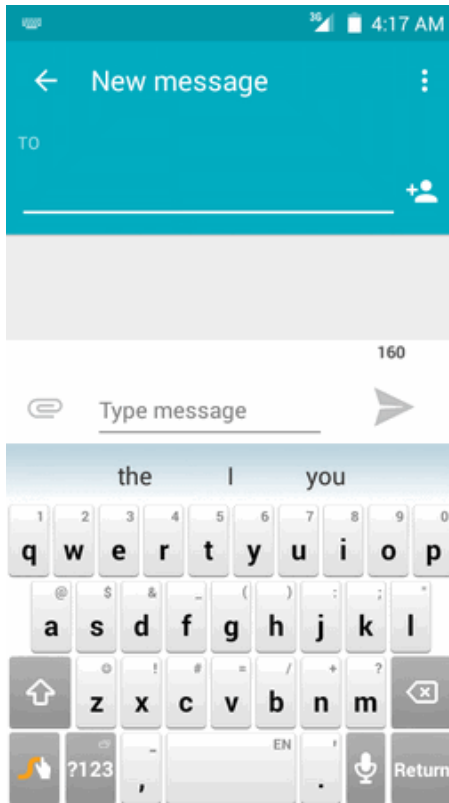

- Touch  from the Search bar to display a dialog screen.
- Speak the word/phrase you want to search for. A list of search results will display for you to select from.



### *Tips for Editing Text*

Your phone gives you many options to make entering text easier, including copying, cutting, and pasting text, using voice-to-text input, customizing the user dictionary, using predictive text, and more.

To edit text you have entered:

1. Long press or double touch within the text you would like to edit.
2. Drag the tabs to change the highlighted selection.
3. The following options will appear: **Select all** , **Cut** , **Copy**  and **Paste** .

To insert new text:

1. Touch where you want to type, or long press a blank space, the cursor will blink and the tabs will show. Drag the tab to move the cursor.
2. If you have selected any text, touch the tab to show PASTE icon which allows you to paste any text you have previously copied.

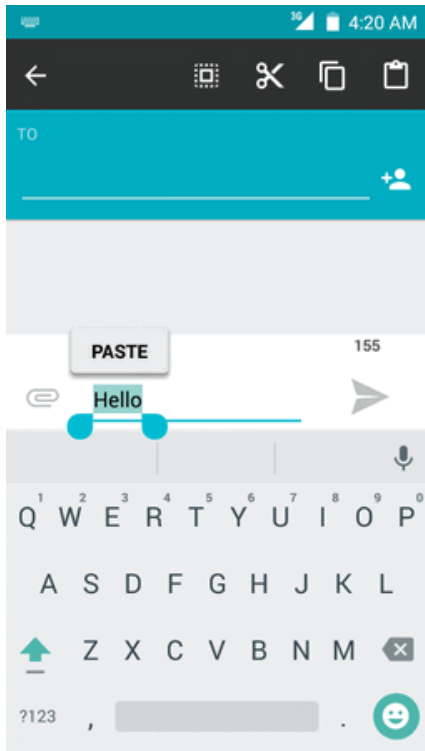

## GOOGLE ACCOUNT

You will need a Google account to access several phone features such as Gmail, Google Maps, Hangouts, and the Google Play applications. Before you are able to access Google applications, you must enter your account information. These applications sync between your phone and your online Google account.

### ! Google Account Cautions

Be sure not to forget your Google account ID or password.

### Create a Google Account

If you do not already have a Google account, you can create one online or using your phone.

**Note:** You can also create and sign into your Google/Gmail account through your phone's Setup application.



**Note:** Although you need a Gmail account to use certain features of your phone, such as Google Play, you do not need to use Gmail as the default account for your phone.

### Create a Google Account Online

1. From a computer, launch a Web browser and navigate to [google.com](http://google.com).
2. On the main page, click **Sign-in > Create an account now**.
3. Follow the onscreen prompts to create your free account.

4. Look for an email from Google in the email box you provided, and respond to the email to confirm and activate your new account.

### **Create a Google Account Using Your Phone**



1. From home, touch **Apps**  > **Settings**  > **Accounts** > **Add account**.
2. Touch **Google** and then touch **Or create a new account**.
3. Enter your **First name** and **Last name**, and then touch **NEXT**.
4. Enter a desired **Username**, and then touch **NEXT**.
5. Create password and confirm the password, then touch **NEXT**.
6. Enter a phone number (it helps you get back into your Google account in case you forget your password) and touch **VERIFY**, enter the verification code and touch **NEXT**. If you don't want to enter a phone number, touch **Skip** or **NEXT** and go to next step.
7. On the Privacy and Terms screen, touch **AGREE** to continue.
8. You can see your Google account is ready to go, touch **NEXT**.
9. After your phone connects with the Google servers, select the items you would like to sync with your phone and then touch **NEXT**.
10. Set up your payment information or touch **Remind me later**, and then touch **Next**.

❖ You are signed in to your Google account, and your phone will synchronize the selected items.

**Note:** When setting up a new Google account, either on your phone or online, you will be prompted to add a secondary email address. Enter a second Gmail address or any other email address from which you currently send and receive email. This address is used to authenticate your account should you ever encounter problems or forget your password. It is strongly encouraged for Android users so you can regain access to Google services and purchases on your phone.

### **Sign In to Your Google Account**

If you have a Google account but have not yet signed in with your phone, follow these instructions to sign in to your Google account.

1. From home, touch **Apps**  > **Settings**  > **Accounts** > **Add account**.
2. Touch **Google**, and then enter your Gmail address and touch **NEXT**.
3. Enter your Gmail password, and then touch **NEXT**.

❖ You are signed in to your Google account, and your phone will synchronize the selected items.



# GOOGLE PLAY STORE

Google Play™ is the place to go to find new Android apps, books, movies, and music for your phone. Choose from a wide variety of free and paid content ranging from productivity apps and games to bestselling books and blockbuster movies and music. When you find what you want, you can easily download and install it on your phone.

To access the Google Play store app, you must first connect to the Internet using your phone's Wi-Fi or mobile data connection and sign in to your Google account. See [Chrome Browser](#) and [Sign In to Your Google Account](#) for details.



## ! Installing Applications

Many different kinds of applications can be installed on your phone from Google Play (provided by Google Inc.). Virgin Mobile is not responsible in any way for user-installed applications (quality, reliability, legality, fitness for a purpose, credibility, accuracy, etc.) or resulting malfunctions (viruses, etc.).

**Important:** Our policies often do not apply to third-party applications. Third-party applications may access your personal information or require us to disclose your customer information to the third-party application provider. To find out how a third-party application will collect, access, use, or disclose your personal information, check the application provider's policies, which can usually be found on their website. If you aren't comfortable with the third-party application's policies, don't use the application.

## Find and Install an App

When you install apps from Google Play app and use them on your phone, they may require access to your personal information (such as your location, contact data, and more) or access to certain functions or settings of your phone. Download and install only apps that you trust.

1. From home, touch **Apps**  > **Play Store** .
2. When you open the Google Play store app for the first time, the Terms of Service window will appear. Touch **Accept** to continue.
3. Browse through the categories (**Apps**, **Games**, **Movies** or **Books**), find an item you're interested in, and touch the name.
  - Browse through featured apps. Scroll through the list of featured apps when you open Google Play.
  - Search for an app. Touch the search bar on the Google Play Home screen, enter the name or type of app you're looking for, and then touch  on the keyboard.
4. Touch an app to read a description about the app and user reviews.
5. Touch **Install** (for free applications) or the price (for paid applications).

**Note:** You need a Google Wallet account to purchase items on Google Play. Set up a Google Wallet account if you do not have one.

6. The subsequent screen notifies you whether the app will require access to your personal information or access to certain functions or settings of your phone. If you agree to the conditions, touch **ACCEPT** (for free apps) or the price tag (for paid apps) to begin downloading and installing the app.
    - If you selected a paid application, you're redirected to the Google Wallet screen to pay for the application before it's downloaded to your phone.
- ❖ The selected app is downloaded and installed on your phone.

**Warning: Read the notification carefully!** Be especially cautious with applications that have access to many functions or a significant amount of your data. Once you touch **OK** on this screen, you are responsible for the results of using this item on your phone.



### **Purchasing Applications**

Purchase apps at your own risk. Virgin Mobile is not responsible for any harm to you or third parties resulting from the use of purchased applications.

### *Request a Refund for a Paid App*

If you are not satisfied with an app, you can ask for a refund within 15 minutes of the purchase. Your credit card is not charged and the app is uninstalled from your phone.



If you change your mind, you can install the app again, but you can't request a refund a second time.

1. From home, touch **Apps**  > **Play Store** .
2. Touch **Menu**  > **My apps**.
3. Touch the app to uninstall for a refund. The details screen for the app opens.
4. Touch **Refund**, and then touch **Yes** to confirm. Your app is uninstalled and the charge is cancelled.



### *Update an App*

Depending on your settings, many apps will update automatically, or you can update apps directly from the Play Store app.

#### **Update an App Directly**

1. From home, touch **Apps**  > **Play Store** .
  2. Touch **Menu**  > **My apps**.
  3. Touch the app you want to update, and then touch **Update** > **Accept**.
- ❖ The app update is downloaded and installed.



## **Set Automatic App Updates**

1. From home, touch **Apps**  > **Play Store** .
2. Touch **Menu**  > **Settings** > **Auto-update apps**, select auto-update apps conditions.

**Note:** Automatic updates are unavailable for some apps.



## **Uninstall an App**

You can uninstall any app that you have downloaded and installed from Google Play.

1. From home, touch **Apps**  > **Play Store** .
2. Touch **Menu**  > **My apps**.
3. On the Installed screen, touch the app you want to uninstall, and then touch **UNINSTALL** > **OK**.
  - ❖ The app is uninstalled and removed from your phone.

## **Get Help with Google Play**

The Google Play store app offers an online help option if you have questions or want to know more about the app.

1. From home, touch **Apps**  > **Play Store** .
2. Touch **Menu**  > **Help & Feedback**.
  - ❖ The Web browser will take you to the Google Play Help Web page, where you will find comprehensive, categorized information about Google Play.

## **LOCK AND UNLOCK YOUR SCREEN**

Your phone allows you to quickly turn the screen off when not in use and to turn it back on and unlock it when you need it.

### **Turn the Screen Off When Not in Use**

- To quickly turn the screen off, press the **Power/Lock key**. Pressing the **Power/Lock key** again or receiving an incoming call will turn on your phone screen and show the lock screen.

To save battery power, the phone automatically turns off the screen after a certain period of time when you leave it idle. You will still be able to receive messages and calls while the phone's screen is off.

**Note:** For information on how to adjust the time before the screen turns off, see [Display Settings](#).

### **Turn the Screen On and Unlock It**

1. To turn the screen on, press the **Power/Lock key**.
  - ❖ The lock screen appears.

2. Swipe your finger across the screen to unlock it.

❖ The screen is unlocked.

- If you have set up a screen lock, you will be prompted to draw the pattern or enter the password or PIN. See [Screen Lock](#).

## UPDATE YOUR PHONE

From time to time, updates may become available for your phone. You can download and apply updates through the **Settings > System updates** menu.

### ! Software Update Cautions

**During update:** The phone cannot be used until the software update is complete. It may take time to update your phone's software.

**Signal during update:** Update your phone where signal reception is good, and do not change location during the update process. Make sure the battery is adequately charged before beginning an update. A weak signal or low battery during an update may cause the update to fail. An update failure may disable the phone.

**Other functions during update:** Other phone functions cannot be used during a software update.

### *Update Your Phone Software*



You can update your phone's software using the **System Updates** option.

#### **Before Updating Your Phone**



Updating your phone may result in a loss of saved data depending on the condition of your phone (malfunctioning, damaged, water seepage, etc.). You must back up all critical information before updating your phone firmware.

#### **Back Up All Data Prior to Update**



To back up your Gmail information:

1. From home, touch **Apps**  > **Settings**  > **Accounts > Google**.
2. Touch account to enable the feature (checkmark).
3. If the Auto-sync option is off, touch **Menu**  and then touch **Sync now** to sync your Google account information.



To back up stored text messages:

1. From home, touch **Apps**  > **Messaging** .
2. Select the text message from the list to view the message thread.
3. Long press on a portion of the text message from the string. The Message options context menu appears.



**Note:** You can back up stored text messages by forwarding them to your own phone number. Open the messages after you have updated your firmware.

4. Touch .
5. Enter your phone number and touch **Send** .

To back up your Google apps:



1. From home, touch **Apps**  > **Play Store** .
2. Touch **Menu**  > **My apps** > **ALL** tab.
3. Scroll through the list of previously downloaded Google apps and choose those you wish to reinstall.
4. Follow the onscreen instructions.

**Note:** Your Google app purchases are reloaded remotely and can be re-installed after the update is applied.



As an added precaution, to preserve any data on your microSD card, unmount it from your phone prior to starting the update process. From home, touch **Apps**  > **Settings**  > **Storage** > **Unmount SD card**.

### ***Update Your Phone's Software***

Once you have backed up all your data, use the **Update now** option to update your phone's software.

1. From home, touch **Apps**  > **Settings**  > **System updates**.
2. Touch **System updates**. Press  to check for updates.
  - ❖ Your phone automatically downloads and installs any available updates. You may be required to power your phone off and back on to complete the software upgrade.

Alternatively, you can access system updates through the notifications window.

1. Locate the **System Update Available** icon () in notifications.
2. Drag the status bar down.
3. Touch  to open the System Updates screen.

4. Touch **Download** and follow the onscreen instructions.

❖ The downloading icon (↓) appears within the status bar to indicate the phone is downloading the necessary files.

5. Touch **Restart** and install to complete the process.

### ***Confirm Your Current Phone Firmware***

1. From home, touch **Apps**  > **Settings**  > **About phone**.

2. Locate the Baseband version read-only field.

# YOUR PHONE INTERFACE

The following topics describe how to use and customize your phone's Home screen, understand the status bar, and use the notifications window.

## HOME SCREEN BASICS





The Home screen is the starting point for your phone's applications, functions, and menus. You can customize your Home screen by adding application icons, shortcuts, folders, widgets, and more.

### Home Screen Layout

Your Home screen extends beyond the initial screen. Swipe the screen left or right to display additional screens.



Item	Description
Status bar	The status bar displays icons to notify you of your phone's status (on the right side) and notifications (on the left side).

Item	Description
<b>Notifications area</b>	The notification area of the status bar (on the left) displays notifications for incoming messages, missed calls, application updates, and more.
<b>Status area</b>	The status area of the status bar (on the right) displays phone and service status information such as signal strength, battery status, Wi-Fi and data connectivity, ringer status, and time.
<b>Widget</b>	Widgets are self-contained onscreen apps that reside on your phone's Home screen.
<b>Application icons</b>	Application icons are shortcuts to favorite applications. You can add and remove these shortcuts as you wish.
<b>Primary shortcuts</b>	Primary shortcuts are application shortcuts that appear in the same location on all of your phone's Home screens. These are customizable except for the Applications (Apps) shortcut, which remains static.
<b>Applications (Apps) list key</b> 	Touch to open the applications (apps) list. The apps list key is a primary shortcut available from all Home screens.
<b>Recent apps key</b> 	Touch to display a list of recently used applications.
<b>Home key</b> 	Touch to display the main Home screen.
<b>Back key</b> 	Touch to return to the previous screen.

**Note:** Your phone's Home screens cycle through so that you can keep swiping in one direction and make it back to the main Home screen. The small circles above the primary shortcuts let you know your current screen position.

**Tip:** Touch  to return to the main Home screen from any other screen.

## Extended Home Screens















In addition to the main Home screen, your phone features extended Home screens to provide more space for adding icons, widgets, and more. Touch  to display the main Home screen and then drag across the screen to move from the main screen to an extended screen.

## STATUS BAR





The status bar at the top of the Home screen provides phone and service status information on the right side and notification alerts on the left. To view the notifications window or access the quick settings menu, touch the status bar and drag it down.











### Main Notification Icons

Icon	Notification
	Missed call
	New voicemail
	New email
	New Gmail
	New text or MMS message
	New Hangout message
	Event
	USB connection
	Alarm
	Warning
	Update available
	Update downloading
	Update successful
	Keyboard active

### Main Status Icons

Icon	Status
	Bluetooth® active
	GPS active
	Wi-Fi® active
	Downloading
	Vibrate

Icon	Status
	Speakerphone active
	Network (full signal)
	Network (roaming)
	Enhanced 4G LTE data service
	3G (data service)
	Airplane mode
	Sync active
	Battery (charging)
	Battery (full charge)

## NOTIFICATIONS WINDOW

Drag the status bar down to open the notifications window. From there, you can check notifications, download updates, open messaging apps, use the quick settings menu, and more.

### Open the Notifications Window

- Drag the status bar down. (Slide your finger down from the top of the screen.)
- ❖ The notifications window opens. To check notifications, touch an item in the list.

### Close the Notifications Window

- Drag the notifications window up. (Slide your finger up from the bottom of the screen.)

– or –

- Touch **Back**  to close the notifications window.

### Notifications Window Layout

The notifications window gives you access both to notifications and the quick settings menu.

## CUSTOMIZE THE HOME SCREEN



Learn how to set the wallpaper and add, move, or remove shortcuts, widgets, and folders from the Home screen.

## ***Operations for Rearranging the Home Screen***

- **Moving Widgets and Icons:** From home, long press an item and then drag it to the desired location.
- **Deleting Widgets and Icons:** From home, long press an item and then drag it to **Remove**.

## ***Change the Wallpaper***

Select and assign your phone's background wallpaper.

1. From home, long press an empty space, and then touch **WALLPAPERS**.
  - You can also access the wallpaper menu through settings. Touch **Apps**  > **Settings**  > **Display** > **Wallpaper**.
2. Choose wallpaper from:
  - Gallery
  - Live Wallpapers
  - Photos
  - Wallpapers
3. Select a wallpaper and then touch **Set wallpaper**.

❖ The wallpaper is set.

**Note:** If you select **Gallery**, you will need to select an album and a picture. Once selected, use the crop tool to resize and position the image and then touch **Done**.

## ***Add Shortcuts to the Home Screen***

You can add shortcuts for quick access to favorite apps from the Home screen.

1. From home, touch **Apps** .
  - ❖ The Apps list opens.
2. Long press an app icon.
  - ❖ The icon will disengage and you will see thumbnails of your Home screens.
3. Drag the icon to an empty location on one of the Home screens.
  - ❖ The shortcut is added to the Home screen.

## ***Add Widgets to the Home Screen***

You can add widgets to your phone's Home screen. Widgets are self-contained apps that display on a Home screen. Unlike a shortcut, the Widget works like an onscreen application. There are all kinds of widgets, including links to a specific contact, Internet bookmarks, Facebook® status

windows, Gmail and email accounts, and many others.

1. Long press an empty space on the Home screen.
  - ❖ The Widgets tab shows.
2. Touch **WIDGETS**.
3. Long press a widget icon.
  - ❖ The icon will disengage and you will see thumbnails of your Home screens.
4. Drag the icon to an empty location on one of the Home screens.
  - ❖ The widget is added to the Home screen.

### *Add Folders to the Home Screen*

You can group Home screen shortcuts into folders for convenient access.

1. Drag a shortcut and release it over another shortcut on the Home screen to create a folder.
2. To add more app shortcuts to the folder, drag a shortcut and drop on top of the new folder.
  - ❖ The new shortcut is added to the folder.

### **Change Folder Names**

Once you have added folders, you can change the name easily from the folder display.

1. Touch a folder on the Home screen to open it and then touch the folder name or **Unnamed Folder**.
2. Type a new name and then touch **Done**.

# PHONE APP

The following topics outline the use of your device's phone app to place and receive calls, use voicemail, set up and manage contacts, and more.

## PLACE AND ANSWER CALLS

The following topics describe how to directly dial calls, how to answer incoming calls, and how to use the in-call screen options.

### ***Adjust In-Call Volume***

- **Adjusting Call Volume:** Press the **Volume Keys** during the call.

### ***Troubleshooting***

**Question:** Difficulty during call.

**Answer 1:** It may not be possible to make a call properly in a noisy location.

**Answer 2:** When calling using Speaker, check the call volume. Raising the call volume may make calling difficult.

**Question:** Sound pops momentarily during a call.



**Answer:** Are you changing location while calling? Sound pops when signal is weak and the phone switches to a different area.

### ***Emergency Call Cautions***

Emergency calls are restricted in Airplane mode.

## ***Call Using the Phone Dialer***

The most "traditional" way to place a call is by using the phone's dialer screen.

1. From home, touch **Phone**  to display the phone screen.
  - ❖ The phone app opens. If necessary, touch  to display the dialer screen.
2. Touch the number keys on the dial pad to enter the phone number.
  - As you enter digits, Smart Dial searches for contacts that match. If you see the number you want to dial, touch it to place the call immediately without entering the rest of the number.

3. Touch  to call the number.

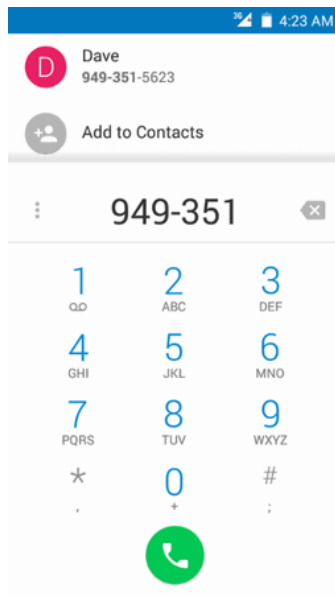

- ❖ The phone dials the number. The call begins when the other party answers.

4. To end the call, touch .

- ❖ The call ends.

### **Troubleshooting**

**Question:** Call does not connect.

**Answer 1:** Was the number dialed using the area code? If not, try dialing using the full 10-digit number including the area code.

**Answer 2:** Are you in an area with poor wireless coverage? Try calling again from another area.

### **Call Emergency Numbers**

You can place calls to 9-1-1 even if the phone's screen is locked or your account is restricted.







To call the 9-1-1 emergency number when the phone's screen is locked with a screen lock:

1. From the lock screen, touch **Emergency call**.

2. Touch .

- ❖ As long as you are in an area covered by wireless service, the emergency call is placed.

To call the 9-1-1 emergency number normally or when your account is restricted:

1. Unlock the screen. For more information, see [Lock and Unlock Your Screen](#).
2. From home, touch **Phone**  > .
3. Touch    .

❖ As long as you are in an area covered by wireless service, the emergency call is placed.

### ***Enhanced 9-1-1 (E 9-1-1) Information***

This phone features an embedded Global Positioning System (GPS) chip necessary for utilizing E 9-1-1 emergency location services where available.

When you place an emergency 9-1-1 call, the GPS feature of your phone seeks information to calculate your approximate location. Depending on several variables, including availability and access to satellite signals, it may take up to 30 seconds or more to determine and report your approximate location.

**Important:** Always report your location to the 9-1-1 operator when placing an emergency call. Some designated emergency call takers, known as Public Safety Answering Points (PSAPs), may not be equipped to receive GPS location information from your phone.



### ***Answer Phone Calls***

The following information lets you know how to answer incoming calls, mute the ringer on incoming calls, reject incoming calls, and more.

When you receive a phone call from a contact, the Incoming call screen appears and displays the caller ID icon, name, and phone number of the calling party. When you receive a phone call from someone who is not stored in People, only the default caller ID icon and phone number appear on the Incoming call screen.

**Note:** If your phone is turned off, all calls automatically go to voicemail.

### ***Answer or Dismiss an Incoming Call [When the phone is unlocked]***

1. When a call arrives, drag  left from the center of the circle to dismiss the call; drag  right from the center of the circle to answer the call.

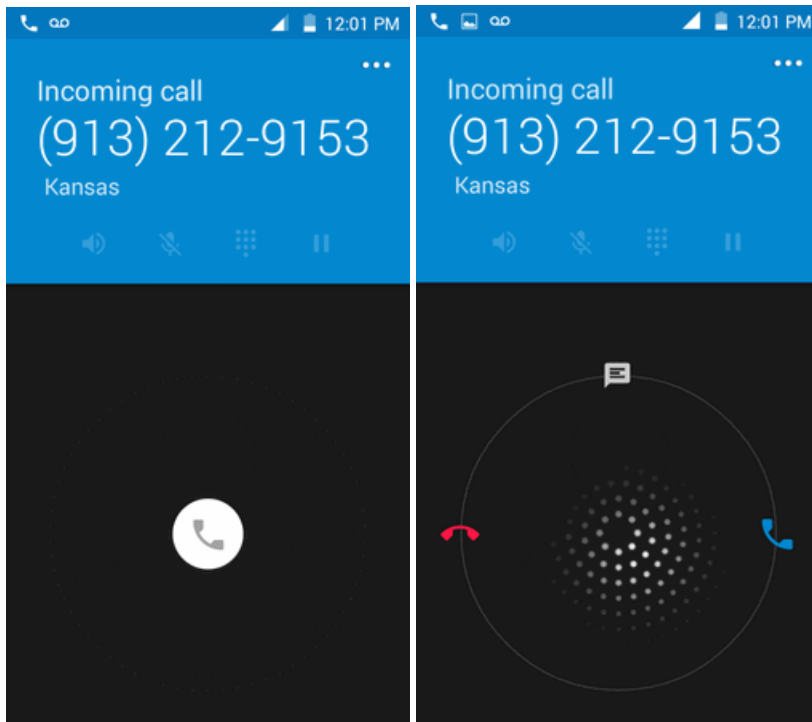

2. To end the call, touch .

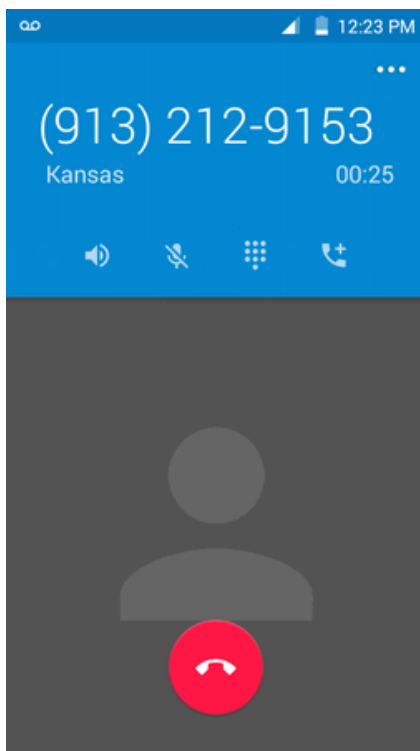

### ***Mute the Ringing Sound***

To mute the ringer without rejecting the call, you can do any of the following:



- Press the **Volume Key**.

### ***Reject a Call and Send a Text Message [When the phone is unlocked]***

You can reject an incoming call and automatically send a text message to the caller.

1. When a call arrives, drag  up from the bottom of the screen.
  - ❖ The ringtone or vibration will stop and you will see a list of preset text messages.

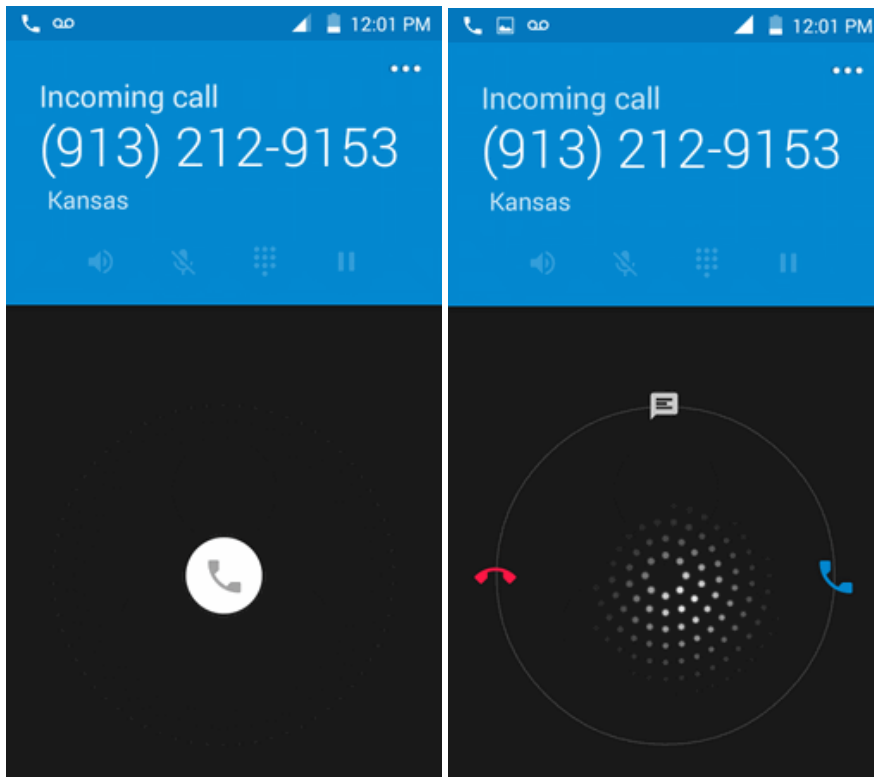

2. Choose a preset message to send it to the caller.
  - ❖ The selected message will be delivered to the caller.
    - You can edit the reject messages through the Call settings menu. From the phone app, touch **Menu** > **Settings** > **General settings** > **Quick Responses** and edit or create the reject messages.





### ***In-Call Screen Layout and Operations***

While you're on a call, you will see a number of onscreen options.

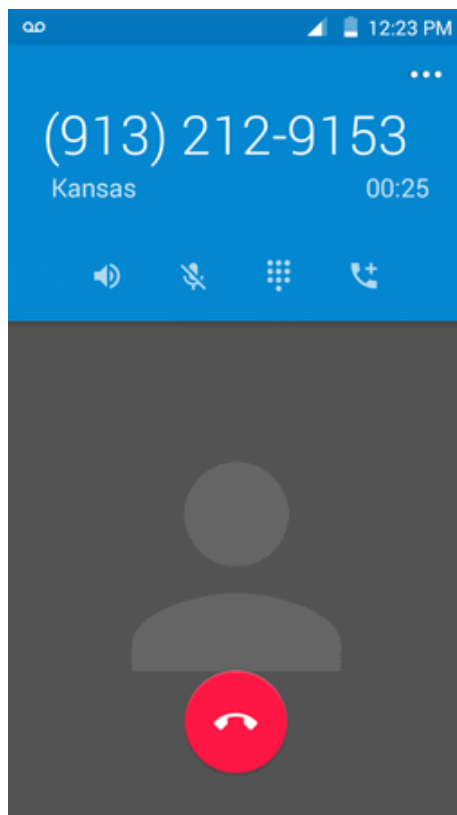
## ***In-Call Screen Layout***

Touch options to activate them during a call.



- : Touch to change mode to **Speaker, Handset earpiece**.
- : Mute the microphone during an active call. Touch again to unmute the microphone.
- : Toggle the appearance of the onscreen keypad.
- : Long press to initiate a conference call (3-way call).
- : End the current call.

**Warning:** Because of higher volume levels, do not place the phone near your ear during speakerphone use.



**Note:** If Mute is activated, the speaker mode is deactivated.

## ***PLACE CALLS FROM CONTACTS/CALL LOGS***

Make calls quickly using Contacts and Call Logs.



## Place a Call from Contacts

You can place phone calls directly from entries in your Contacts list.

1. From home, touch **Phone**  to display the phone app.
2. Touch **CONTACTS** to display the Contacts list.
  - ❖ The contacts list appears.
3. Touch a contact.
4. Touch **Call**  next to the number you want to call.
  - ❖ The phone dials the number. The call begins when the other party answers.
5. To end the call, touch .
- ❖ The call ends.

## Call from Call Logs

The Call logs list lets you quickly place calls to recent incoming, outgoing, or missed numbers.

1. From home, touch **Phone**  to display the phone app.
2. Touch **RECENTS** to display the Call logs list.
  - ❖ The call logs list appears.
3. Touch an entry to display the call details.
4. Touch **CALL BACK** to place a call.
  - ❖ The phone dials the number. The call begins when the other party answers.
    - For additional options, touch the name or number.
5. To end the call, touch .
- The call ends.

## OPTIONAL SERVICES

The following topics outline additional voice-related services available with your phone, including call services, voicemail, and more.

### *Voicemail Setup*

You should set up your voicemail and personal greeting as soon as your phone is activated. Always use a password to protect against unauthorized access. Your phone automatically transfers all unanswered calls to your voicemail, even if your phone is in use or turned off.

1. From home, touch **Phone**  >  > **Settings** > **Call settings** > **Voicemail**.

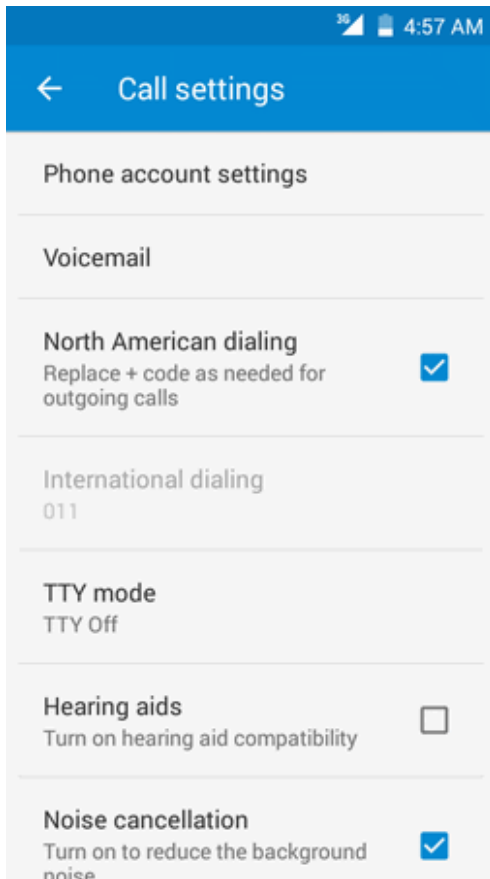

2. Touch Setup to set for voicemail.

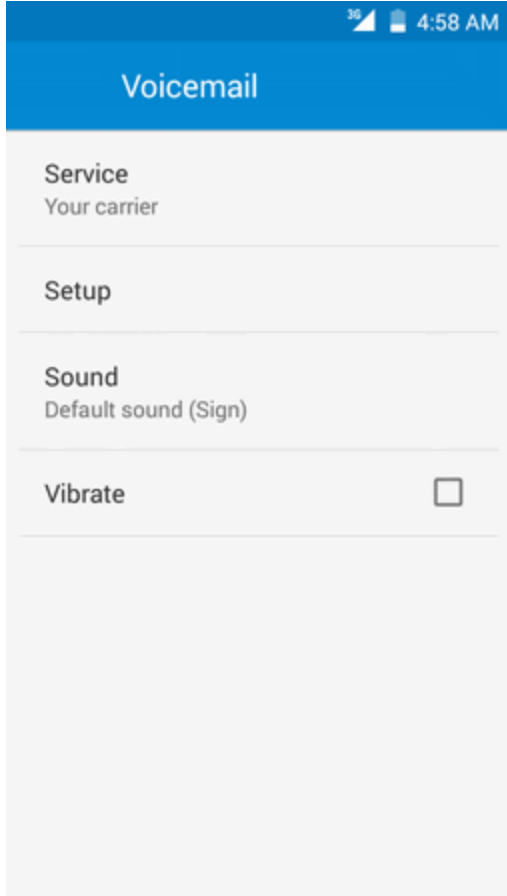

**Important: Voicemail Password** – It is strongly recommended that you create a password when setting up your voicemail to protect against unauthorized access. Without a password, anyone who has access to your phone is able to access your voicemail messages.

### *Listen to Multiple Voicemail Messages*

When you are done listening to a voicemail message you can easily access other voicemail messages without returning to the main voicemail screen.

1. Listen to the current voicemail message.
2. Swipe your finger left or right to display the next or previous message.

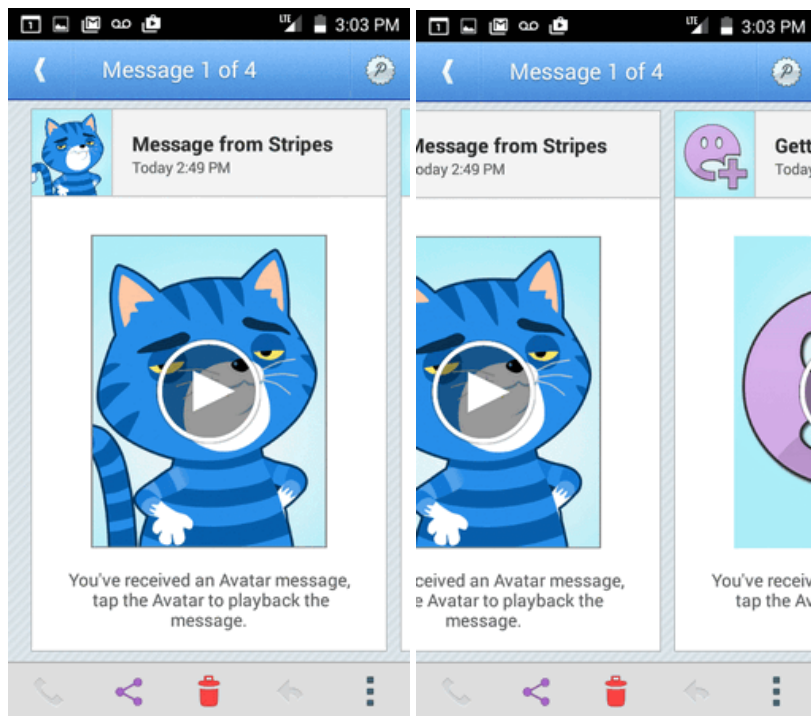





- ❖ The next or previous message will begin playing automatically.

You can navigate through voicemail messages as frequently as you'd like. You can even move to the next or previous message before you're finished listening to the current one.

## Caller ID Blocking

Caller ID identifies a caller before you answer the phone by displaying the number of the incoming call. If you do not want your number displayed when you make a call, follow these steps.

1. From home, touch **Phone**  > .
2. Touch  **67**  
MNO PQRS.
3. Enter a phone number.
4. Touch .

- ❖ Your caller information will not appear on the recipient's phone.

To permanently block your number, call Virgin Mobile Customer Service.

## Call Waiting

When you're on a call, Call Waiting alerts you to incoming calls by sounding two beeps. Your phone's screen informs you that another call is coming in and displays the caller's phone number (if it is available).

To respond to an incoming call while you're on a call:

- Slide  to the right. (This puts the first caller on hold and answers the second call.)



To switch back to the first caller:

- Touch **Swap**.

**Note:** For those calls where you don't want to be interrupted, you can temporarily disable Call Waiting by pressing  **7 0** before placing your call. Call Waiting is automatically reactivated once you end the call.

## Conference Calling

With conference calling, also known as 3-way calling, you can talk to two people at the same time. When using this feature, the normal airtime rates will be charged for each of the two calls.

1. On the Phone screen, enter a number and touch  (or place a call from Log or Contacts).
2. Once you have established the connection, touch , and dial the second number (or place the call from Logs or Contacts).

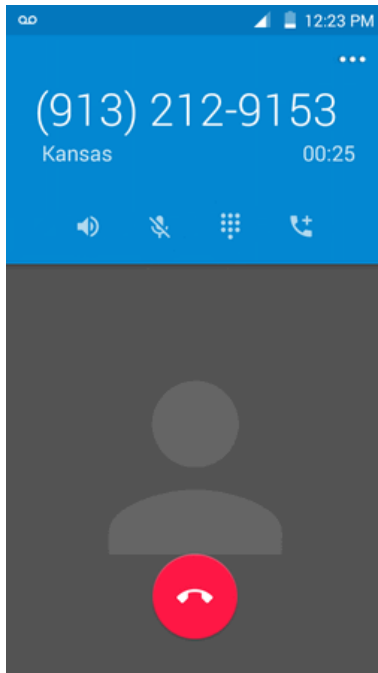

- When you're connected to the second party, touch . Your conference call is now in session.

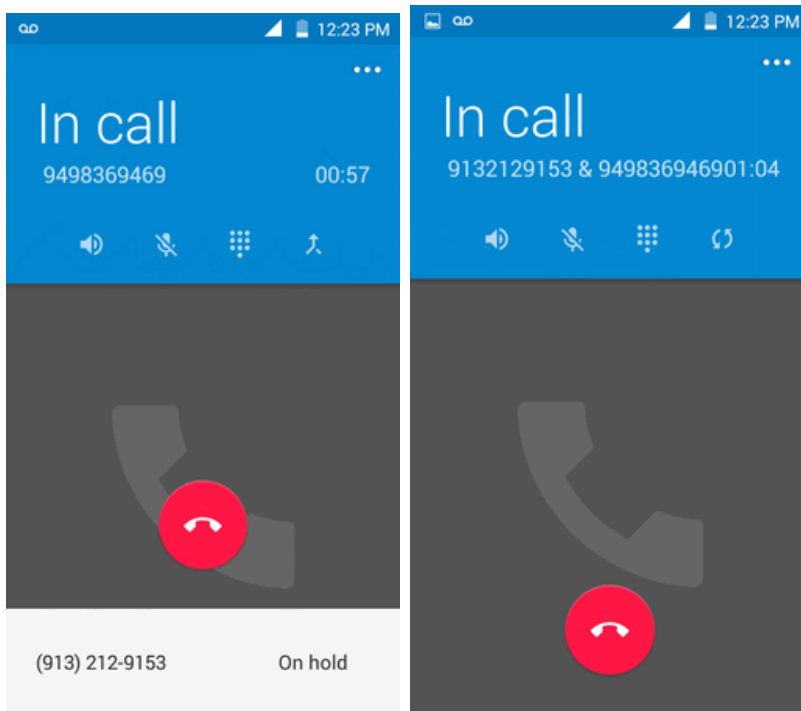

- To end the three-way call, touch .







**Note:** If one of the people you called hangs up during your call, you and the remaining caller stay connected. If you initiated the call and are the first to hang up, all callers are disconnected.

## Call Forwarding

Call Forwarding lets you forward all your incoming calls to another phone number – even when your phone is turned off. You can continue to make calls from your phone when you have activated Call Forwarding.

**Note:** You are charged a higher rate for calls you have forwarded.





To activate Call Forwarding:

- From home, touch **Phone**  > .
- Touch  **7 2**  .
- Enter the area code and phone number to which you want your calls forwarded.
- Touch .



- ❖ You will hear a tone to confirm the activation of Call Forwarding. All calls to your wireless number will be forwarded to the designated phone number.

To deactivate Call Forwarding:

1. From home, touch **Phone**  > .
2. Touch  **7 2 0** .  
PQRS ABC +.
3. Touch .

- ❖ You will hear a tone to confirm the deactivation.

## CALL SETTINGS



Your phone's Call Settings menu lets you configure your voicemail options and a number of other settings for the phone application.

### Call Settings Options

Use the Call Settings menu to adjust the following settings:

Setting	Description
<b>Phone account settings</b>	Touch to set up SIP (Session Initiation Protocol, such as <u>Internet telephony</u> for voice and video calls) account.
<b>Voicemail</b>	Touch to set up voicemail.
<b>North American dialing</b>	Replace “+” code as needed for outgoing calls.
<b>International dialing</b>	Touch to set international dialing.
<b>TTY mode</b>	TTY (Text Telephone) mode can be used by people who are deaf, have poor hearing or speech impairments.
<b>Hearing aids</b>	Mark the check box to turn on hearing aid compatibility.
<b>Noise cancellation</b>	Mark the check box to reduce the background noise.
<b>DTMF tones</b>	Set the duration of DTMF tones.
<b>Turn on proximity sensor</b>	Mark the check box to turn off screen when answering a call.
<b>Vibrating after connected</b>	Mark the check box to vibrate when answering a call.
<b>IP call setting</b>	Touch to input the IP prefix.
<b>Speed dial settings</b>	Touch to set up speed dial.
<b>Blocked Call List</b>	Add numbers to blacklist, those numbers will be blocked when calling your phone.
<b>Voice privacy</b>	Mark the check box to enable enhanced privacy mode.

## Use the Call Settings Menu

1. From home, touch **Phone** .
  - ❖ The phone app opens.
2. Touch **Menu**  > **Settings** > **Call settings**.
  - ❖ The call settings menu appears.
3. Configure your options.
  - Touch a menu item to display its options.
  - Select your options and follow the prompts to set them.
  - ❖ Your call settings options are set.

## CONTACTS





The Contacts application lets you store and manage contacts from a variety of sources, including contacts you enter and save directly in your phone as well as contacts synchronized with your Google account, your PC, compatible email programs (including Exchange Server), and your Facebook friends.

### **Contacts Cautions**

Information saved in Contacts may be lost or changed if the battery is removed for a long period or not charged. Accident or malfunction may also cause loss or change to information. It is recommended that you keep a separate copy of contacts and other important information. Virgin Mobile is not responsible for any damages from lost or changed contacts.

## Add a Contact

You can add contacts from your phone's Phone application. Enter details such as name, phone numbers, email addresses, mailing addresses, and more.

1. From home, touch **Phone**  > **CONTACTS** tab.
  - ❖ You will see the Contacts list.
    - You can also access contacts directly from the Contacts shortcut or the apps list. From home, touch **Contacts** , or if there's no shortcut, touch **Apps**  > **Contacts** .
2. Touch  to add a contact.
  - ❖ The Add Contact screen appears.
3. If you have multiple account types associated with your phone, select a contact type.

- Select **Google** if you want to save contacts to your Google account; these will be synced automatically with your Google account online.
  - Select **PHONE** as the sync account if you want your contacts on your phone only; they will not be synced with your Google account.
4. Use the keyboard to enter as much information as you want.
- [Picture]: Touch the picture icon to assign a picture to the contact.
  - Name
  - PHONE
  - EMAIL
  - ADDRESS
  - SPECIAL DATES
  - GROUPS
  - Add another field: Touch **ADD ANOTHER FIELD** to include additional information such as IM address, Notes, Nickname, Website, etc.

**Note:** To select a type (label) for a phone number, an email address, or postal address (such as Mobile, Home, Work, etc.), touch the type to the left of the field and select the appropriate type.

**Note:** To add more phone numbers, email addresses, etc., touch **Add new** on the right side of the entry field.

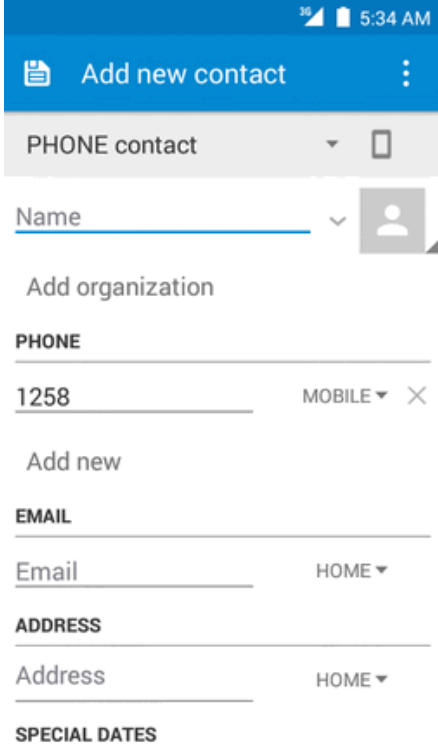

- When you have finished adding information, touch .



 The contact is added.

### ***Save a Phone Number***

You can save a phone number to Contacts directly from the phone dial pad.

- From home, touch **Phone**  > .
- Enter a phone number and touch **Add to contacts**.
- To add the number to an existing contact, touch the target contact you want to update. To add a new contact, touch **Create new contact**.
  - For an existing contact, touch the contact name and select a number type for the new number.
  - For a new contact, enter the name and any additional information.
- Touch **OK** or .



 The contact is added.

### ***Check Contacts***

View a contact's details by displaying a contact entry.

1. From home, touch **Phone**  > **CONTACTS** tab.

❖ You will see the Contacts list.

- You can also access contacts directly from the Contacts shortcut or the apps list. From home, touch **Contacts** , or if there's no shortcut, touch **Apps**  > **Contacts** .

2. Touch a contact to view its details.

❖ The contact's detailed listing appears.

## Contacts Screen Layout

The following illustration show's your Contacts app layout and describes the various features.









Item	Description
Groups tab	Show contact groups.
Favorites tab	Show favorite contacts.
Contacts tab	Show all contacts.
Contact	Touch to show contact's details.

Item	Description
<b>Image</b>	Touch to show thumbnail of contact entry. Touch an icon to place a call, send a message, etc.
<b>Search</b>	Search contacts.
<b>Index</b>	Browse contacts by letter.
<b>Add new</b>	Add a new contact.

## Edit a Contact





Once you've added a contact, you can add or edit any of the information in the entry, assign a caller ID picture, customize with a unique ringtone, and more.

- From home, touch **Contacts** .
  - You will see the Contacts list.
    - You can also access contacts directly from the Contacts shortcut or the apps list. From home, touch **Contacts** , or if there's no shortcut, touch **Apps**  > **Contacts** .
- Touch a contact to view its details.
  - The contact's detailed listing appears.
- Touch **Edit** .
- Touch any field you want to change or add. See [Add a Contact](#).
- Add or edit the information, and then touch .
  - Your changes are saved to the contact entry.

**Note:** To select a type (label) for a phone number, email address, or postal address (such as Mobile, Home, Work, etc.), touch the type to the left of the field.

## Delete a Contact

You can delete a contact from the contacts details page.

- From home, touch **Phone**  > **CONTACTS** tab.
  - You will see the Contacts list.
    - You can also access contacts directly from the Contacts shortcut or the apps list. From home, touch **Contacts** , or if there's no shortcut, touch **Apps**  > **Contacts** .
- Touch a contact to view its details.
  - The contact's detailed listing appears.

3. Touch **Menu**  > **Delete**.

4. Touch **OK**.

❖ The contact is deleted.

## **IMPORT CONTACTS FROM AN SD CARD OR STORAGE**

Import (load) contacts which have been backed up on an SD card.

### ***Before Importing Contacts from an SD Card***

You will need to have installed an SD card with previously backed up contacts information into your phone before you can import contacts. See [SD Card](#) for SD card information.

### ***Import Contacts from an SD Card or Storage***

1. From home, touch **Contacts** .

❖ You will see the Contacts list.

2. Touch **Menu**  > **Import/export**.

❖ You will see the Import/export contacts menu.

3. Touch **Import from SD storage** or **Import from storage**.

4. Select a destination for the imported contacts.

5. Follow the onscreen instructions to complete the import.

❖ The contacts are imported and stored in the selected account.

## **BACK UP CONTACTS TO AN SD CARD**

If you are saving contacts to an account that does not automatically back them up via the Cloud, you can manually back them up for re-import if needed.

### ***Before Backing Up Contacts to an SD Card***

You will need to have installed an SD card with previously backed up contacts information into your phone before you can back up your contacts. See [SD Card](#) for SD card information.

### ***Back Up Contacts to Your SD Card***

1. From home, touch **Contacts** .

❖ You will see the Contacts list.

2. Touch **Menu**  > **Import/export**.

❖ You will see the Import/export contacts menu.

3. Touch **Export to storage**.

4. Select the contacts you want to import and then touch .

5. Select path as **SD card**, touch **OK** to confirm.

6. Touch **OK** again to confirm the export.

❖ The contacts are exported and saved to the installed SD card.



# MESSAGING AND INTERNET

With wireless service and your phone's messaging and data capabilities, you have the opportunity to share information through many different channels and accounts, including Gmail (Google), personal and corporate email, text and multimedia messaging, social networking accounts, and Hangouts.

## TEXT AND MULTIMEDIA MESSAGING





With Text Messaging (SMS), you can send and receive instant text messages between your wireless phone and another messaging-ready phone.

Multimedia messages, or MMS, can contain text and pictures, recorded voice, audio or video files, picture slideshows, contact cards (vCard), or appointments (vCalendar).

See your service plan for applicable charges for messaging.

### *Send a Text Message*

Quickly compose and send text messages on your phone.

1. From home, touch **Apps**  > **Messaging** .
2. On the Messaging screen, touch .
- ❖ The Compose screen opens.
3. Fill in one or more recipients. You can:
  - Enter phone numbers directly in the "To" box. As you enter information, any matching phone numbers from your contacts list are displayed. Touch a match to enter that number or address directly.
  - Touch the  icon, and then select the contacts to who you want to send the message. You can also select contact groups as recipients. When you have selected all the message recipients, touch .

4. Touch the “Type message” box and then start composing your message.

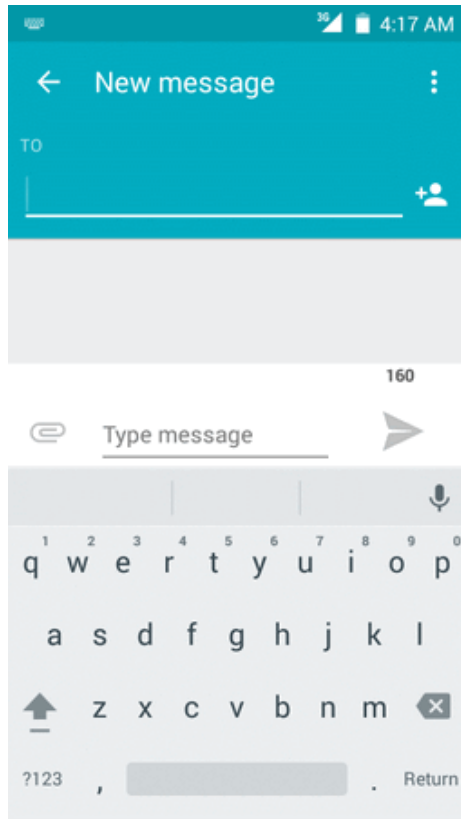







**Note:** A counter appears above the **Send** button (➤) to tell you how many characters you have entered and how many characters are left. Once you go over the 160-character limit, a new message is created but automatically joined into one when received.

5. When done, touch ➤ to send the text message.

### ***Send a Multimedia Message (MMS)***

When you need to add a little more to a text message, you can send a multimedia message (MMS) with pictures, voice recordings, audio or video files, contact cards (vCard), or appointments (vCalendar).

1. From home, touch **Apps**  > **Messaging** .
2. On the Messaging screen, touch .  
 The Compose screen opens.
3. Fill in one or more recipients. You can:

- Enter phone numbers directly in the “To” box. As you enter information, any matching phone numbers from your contacts list are displayed. Touch a match to enter that number or address directly.
- Touch the  icon, and then select the contacts to who you want to send the message. You can also select contact groups as recipients. When you have selected all the message recipients, touch .

**Note:** You can add a subject line by touching **Menu**  **> Add subject.**

4. Touch the “Type message” box, and then start composing your message.
5. Touch  to add attachment.
6. In the Attach window, select from the following file attachments:
  - **Pictures:** Attach a stored picture from **Gallery**.
  - **Capture picture:** Select **Camera** to take a picture and attach it.
  - **Videos:** Access the Gallery or File manager to select a video as an attachment.
  - **Capture video:** Access the **Camcorder** to record a new video for attaching.
  - **Audio:** Access a selection of audio files for attaching.
  - **Record audio:** Enter the voice message recorder to record a voice message for attaching.
  - **Slideshow:** Enter the Edit slide show screen, touch **Add slide** to create a new slide, and touch a currently existing slide to edit it (see following picture).
  - **Insert contact info:** Enter a contact and send the contact’s detailed info.
  - **Contact vCard:** Select a contact from your phone, and then select which contact information you want to attach.
  - **Calendar event:** Select the calendar event you want to attach.

7. To make changes to your attachment, touch **REPLACE** or **REMOVE** to start over.

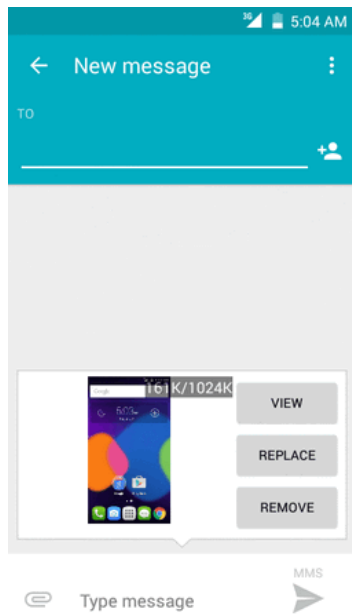

8. Touch **Send** <sup>MMS</sup> to send the MMS message.

### ***Create a Slideshow***

In a multimedia message, you can add slides, each containing a picture, video, or audio.

1. In the multimedia message you're composing, touch  > **Slideshow** to add space for a new slide.
2. Touch **slide 1** or **Add slide** to attach slides.



3. To compose your slideshow, touch **Menu**  and do any of the following:

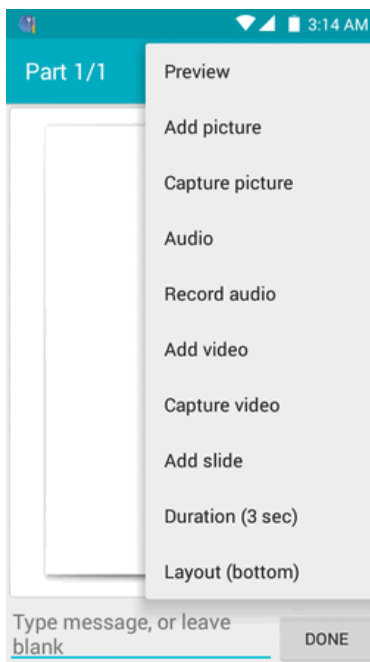



- **Preview:** Touch to preview your slide.
  - **Add picture:** Touch to select a picture from Gallery.
  - **Capture picture:** Touch to capture picture.
  - **Audio:** Touch to select an audio and attach.
  - **Record audio:** Touch to record audio and attach.
  - **Add video:** Touch to select a video. (You cannot add both a picture and a video on the same slide.)
  - **Capture video:** Touch to capture video.
  - **Add slide:** Touch to add a new slide.
  - **Duration (3 sec):** Touch to set duration for slide.
  - **Layout (bottom):** Touch to set slide layout, you can choose Text on top or Text on bottom.
  - View the next or previous slide. Touch **up** or **down**.
4. When you have finished composing the multimedia message, touch **DONE**.

### *Save and Resume a Draft Message*

While composing a text or multimedia message, touch the **Home key**  to automatically save your message as a draft.

To resume composing the message:

1. From home, touch **Apps**  > **Messaging** .
2. On the Messaging screen, touch the message to resume editing it.
3. When you finish editing the message, touch .

### *New Messages Notification*

Depending on your notification settings, the phone will play a ringtone, vibrate, or display the message briefly in the status bar when you receive a new text or multimedia message. To change the notification for new text and multimedia messages, see [Text and MMS Options](#) for details.

A new message icon () also appears in the notifications area of the status bar to notify you of a new text or multimedia message.

- To open the message, drag the status bar down to open the notifications window. Touch the new message to open and read it. For information on reading and replying to messages see [Manage Message Conversations](#).

## Manage Message Conversations

Text and multimedia messages that are sent to and received from a contact (or a number) are grouped into conversations or message threads in the Messaging screen. Text or MMS conversations let you see exchanged messages (similar to a chat program) with a contact on the screen.

### Read a Text Message

- Do one of the following:
  - On the Messaging screen, touch the text message or conversation to open and read it.
  - If you have a new message notification, drag the status bar down to open the notifications window. Touch the new message to open and read it.



To return to the Messaging screen from a conversation, touch .

**Note:** To view the details of a particular message, in the conversation, long press the message to open the options menu, and then touch  > **Message detail**.

**Note:** If a message contains a link to a Web page, touch the message and then touch the link to open it in the Web browser.



**Note:** If a message contains a phone number, touch the message and then touch the phone number to dial the number or add it to your contacts.

### View a Multimedia Message (MMS)

1. From home, touch **Apps**  > **Messaging** .
2. On the Messaging screen, touch a multimedia message or conversation to open it.
3. Touch the attachment to open it.
  - If the attachment is a vCard contact, it is imported to your phone's contacts list. For more information, see [Contacts](#).
  - If the attachment is a vCalendar file, you can choose the calendar where you want to save the event. For information on using Calendar, see [Calendar](#).

**Note:** If you are concerned about the size of your data downloads, check the multimedia message size before you download it.



### Reply to a Message

1. From home, touch **Apps**  > **Messaging** .
2. On the Messaging screen, touch a conversation to open it.
3. Touch the Type message box at the bottom of the screen, enter your reply message, and then touch .



**Note:** To reply to a text message with a multimedia message, open the text message, touch **Menu**  and then touch **Add subject**, or **Attach**. The text message is automatically converted into a multimedia message.

### ***Protect (Lock) a Message***



You can lock a message so that it will not be deleted even if you delete the other messages in the conversation.

1. From home, touch **Apps**  > **Messaging** .
2. On the Messaging screen, touch a conversation.
3. Long press the message that you want to lock.
4. Touch  > **Lock** on the options menu. A lock icon is displayed at the right hand side of the message.

### ***Delete a Conversation***

1. From home, touch **Apps**  > **Messaging** .
2. On the Messaging screen, touch the conversation that you want to delete.
3. Touch **Menu**  > **Delete thread**.
4. When prompted to confirm, touch **DELETE**. Any locked messages in the thread will not be deleted unless you select the **Delete locked messages** check box.

### ***Delete a Single Message***

1. While viewing a conversation, long press the message that you want to delete.
  - If the message is locked, long press it, then touch  > **Unlock** on the options menu and hold the message to display the options menu again.
2. Touch  on the options menu.
3. When prompted to confirm, touch **OK**.



### ***View Contact Information from a Message***

When you have received a message from someone in your stored contacts, you can touch the contact's picture or icon in the conversation to open a menu of options. Depending on the stored contact information, you can view the contact details, place a phone call or send an email message to the contact, and more.

## ***Text and MMS Options***

The messages settings menu lets you control options for your text and MMS messages including message limits, size settings, and notifications.



1. From home, touch **Apps**  > **Messaging** .
2. On the Messaging screen, touch **Menu**  > **Settings**. You can set the following:
  - **SMS Enabled**: Touch to set your default SMS app.

### **Storage**

- **Delete old messages**: Automatically delete older messages, except for locked messages, when the set limits are reached.
- **Text message limit**: Choose the maximum number of text messages to store in each conversation. (This does not include locked messages.)
- **Multimedia message limit**: Choose the maximum number of MMS messages to store in each conversation. (This does not include locked messages.)

### **Text Message (SMS) Settings**

- **Delivery delay**: Select message delivery interval.
- **Delivery reports**: Receive a report on the delivery status of your message.
- **Message template**: View or edit your message template.
- **Manage SIM messages**: Touch to view or manage messages on your SIM card.
- **Import/export messages**: Import or export messages between phone, SIM card, and microSD card.
- **Validity period**: Select your SMS validity period.

### **SMS Signature**

- **Signature**: Mark the check box to enable SMS signature function.
- **Edit SMS signature**: Touch to edit SMS signature.

### **Multimedia Message (MMS) Settings**

- **Auto-retrieve**: Select this option to automatically retrieve all your multimedia messages completely. When selected, the multimedia message header plus the message body and attachments will automatically download to your phone. If you clear this check box, only the multimedia message header will be retrieved and shown in your Messaging screen.
- **Roaming auto-retrieve**: Automatically retrieve all your messages completely when roaming. This may incur significant phone charges.
- **Maximum message size**: Enter the maximum message size.
- **MMS Send Priority**: Set the message priority of text messages sent.

## **Notifications**

- **Notifications:** Select this option if you want to receive a notification in the status bar when a new text or multimedia message arrives.
- **Sound:** Select a ringtone that is specific to new text and multimedia messages. Note that the ringtone briefly plays when selected.
- **Vibrate:** Select this option if you want the phone to vibrate when a new text or multimedia message arrives.

## **SMSC Settings**

- **Set the SMSC number:** View or edit the SMSC number.

## **Auto Push Service Message Setting**

- **Enable WAP PUSH Service:** Mark the check box to enable receiving service message.

## **Quick Message and Reply**

- **Use dark theme:** Mark the check box to enable dark theme.
- **Show Quick Message:** Mark the check box to display the Quick Message popup for incoming SMS messages.
- **Wake and unlock:** Wake and unlock device on incoming message.
- **Close all:** Close button to close all messages.

## **Extra Settings**

- **Blocked Call List:** Enable this function to block incoming messages from phone numbers in the blocked call list.

## **CMAS**

- **Emergency alerts settings:** Touch to set which alert types to receive.

# **GMAIL**

Use Google's Gmail service and your Google account to send, receive, and manage your Gmail messages. Before using Gmail, you must register a Google (Gmail) Account on your phone. See [Google Account](#) for details.

## **! Gmail Cautions**

Gmail is handled as email from a PC. Restricting email from PCs on your phone prevents your phone from receiving Gmail.

## **Create and Send a Gmail Message**

Use your phone to create and send Gmail messages.

1. From home, touch **Apps**  > **Gmail** .

❖ The Gmail inbox opens.





2. From the inbox, touch  to compose a new Gmail message.

❖ The Gmail composition window opens.

3. Enter the message recipient(s), subject, and message, and then touch **Send** .

❖ The Gmail message is sent.

### ***Gmail Composition Options***

- **Adding Cc/Bcc:** In the mail composition window, touch  near **To** bar, and then add recipients.
- **Attaching Pictures or Videos:** In the mail composition window, touch  > **Attach file**. Locate and then touch the picture or video you want to attach.
- **Save as a Draft (Send Later):** While composing your message, touch **Menu**  > **Save draft**, or press the back key  to save as a draft.
- **Delete Mail Being Composed:** In the mail composition window, touch **Menu**  > **Discard**.

**Note:** To view your draft email messages, touch  and then touch **Drafts**.

**Note:** To view your sent messages, touch  and then touch **Sent**.

## ***CHECK RECEIVED GMAIL MESSAGES***

Your phone allows you to access, read, and reply to all your Gmail messages.

### ***Open New Gmail Messages***

When new Gmail arrives, you will see  in the status bar.

1. Drag the status bar down to display the notifications window.

2. Touch the new message from the notifications window.

❖ The new Gmail message opens.

- If you have two or more new Gmail messages, touching the notification opens the Gmail inbox.

### ***Open Gmail Messages***

You can also read and reply to all your Gmail messages from the Gmail inbox.



1. From home, touch **Apps**  > **Gmail** .

❖ The Gmail inbox opens.



2. Touch the message thread you want to view.

❖ The message thread opens, with the newest message displayed.

### **Options When Reviewing Gmail Messages**

- **Replying to Gmail Messages:** With the Gmail message open, touch **Reply** , compose your reply message, and touch **Send** .

  - To reply to all, touch **Options**  > **Reply all**.

- **Forwarding Gmail Messages:** With the Gmail message open, touch **Options**  > **Forward**, enter a recipient and an additional message, and touch **Send** .

## **MANAGE GMAIL MESSAGES**

Your phone give you control over how you manage your Gmail messages, with labels, thread management, search capabilities, adding multiple Google accounts, and more.

### **Use Gmail Labels**

Gmail saves all mail in one box, but you can add labels that allow you to sort your Gmail conversation threads. For example, when a new thread starts with a received mail, the label "Inbox" is automatically added to the thread. By then adding the label "travel," all threads with "travel" are shown in a list.

1. From home, touch **Apps**  > **Gmail** .

❖ The inbox opens.

2. Long press a conversation thread to add a checkmark to it, and then touch **Options**  > **Change labels**.

3. Touch a label for the thread.

❖ The thread is added to the selected label.

### **Delete Gmail Threads**

If you no longer wish to keep a Gmail conversation thread, you can simply delete it from the inbox.

1. From home, touch **Apps**  > **Gmail** .

❖ The inbox opens.

2. Long press a conversation thread to add a checkmark to it, and then touch **Delete**  > **OK**.

❖ The thread is deleted.

### **Search Gmail Messages**

If you need to find a specific message or message thread, you can search Gmail from the inbox.

1. From home, touch **Apps**  > **Gmail** .

❖ The inbox opens.

2. Touch .

3. Enter your search text and touch .

❖ The search results appear. Touch a message or thread from the list to display it.

## *Report Spam or Phishing Gmail*

You can report spam or phishing Gmail messages from your phone's Gmail inbox.

1. From home, touch **Apps**  > **Gmail** .

❖ The inbox opens.

2. Long press a conversation thread to add a checkmark to it, and then touch **Options**  > **Report spam**.

❖ The selected message is reported as spam or phishing Gmail.

## *Add Another Google (Gmail) Account*

If you have multiple Gmail accounts you wish to view on your phone, you can add them from the **Settings** > **Accounts** menu.

1. From home, touch **Apps**  > **Settings**  > **Accounts** > **Add account**.

2. Touch **Google** and then touch **Or create a new account**.

3. Enter your **First name** and **Last name**, and then touch **NEXT**.

4. Enter a desired **Username**, and then touch **NEXT**.

5. Create password and confirm the password, then touch **NEXT**.

6. Enter a phone number (it helps you get back into your Google account in case you forget your password) and touch **VERIFY**, enter the verification code and touch **NEXT**. If you don't want to enter a phone number, touch **Skip** or **NEXT** and go to next step.

7. On the Privacy and Terms screen, touch **AGREE** to continue.

8. You can see your Google account is ready to go, touch **NEXT**.



9. After your phone connects with the Google servers, select the items you would like to sync with your phone and then touch **NEXT**.

10. Set up your payment information or touch **Remind me later**, and then touch **Next**.

- ❖ You are signed in to your Google account, and your phone will synchronize the selected items.

## *Switching Between Gmail Accounts*

If you have more than one Gmail account set up, you can switch between them in the Gmail app.

1. From home, touch **Apps**  > **Gmail** .
2. Touch .
3. Touch the account you want to view from the list at the top of the menu.

- ❖ The selected account inbox is displayed.

## *EMAIL*

Use the Mail application to send and receive email from your webmail or other accounts, using POP3 or IMAP, or access your Exchange ActiveSync account for your corporate email needs.

## *Set Up an Email Account*

Your phone supports several types of email accounts and allows you to have multiple email accounts set up at one time.

Before setting up an email account, make sure you have the username (user ID), password, server name, etc., so you can get set up successfully.

1. From home, touch **Apps**  > **Email** .

- ❖ A popup window for adding an account appears if no email account has been previously set up.

2. Follow the onscreen instructions to set up your email account.

- ❖ The email account is set up and you will begin receiving email.

## *Add an Email Account*

You can add several types of personal email accounts, such as POP3 and IMAP accounts, on your phone.

### ***Add an Email Account from the Email App***

You can add email accounts directly from the email app, even if you have another email account set up.



1. From home, touch **Apps**  > **Email** .

- ❖ The email inbox opens.

2. Touch the **Menu key** > **Settings**.
3. Touch **ADD ACCOUNT** on the top right corner.
4. Follow the onscreen instructions to complete the account setup.
  - ❖ The email account is added and you will begin receiving email for the account.

### ***Add an Email Account from the Settings Menu***



You can also set up email accounts from the **Settings** > **Accounts** menu.

1. From home, touch **Apps**  > **Settings**  > **Accounts** > **Add account** > **Personal (POP3)**.
2. Enter the **Email address** for the email account and then touch **NEXT**.
  - ❖ Touching **NEXT** prompts your phone to attempt a "regular" email setup and test the incoming and outgoing servers.
    - If you have custom settings you need to configure, touch **MANUAL SETUP** and enter your settings. These may include mail type, username, password, server, security type, etc.
3. Enter the **Password** for the email account and then touch **NEXT**.
4. Enter the incoming server settings, confirm the settings information and touch **NEXT**.
5. Enter the outgoing server settings, confirm the settings information and touch **NEXT**.
6. Select your sync settings and then touch **NEXT**.
7. Enter an account name and a display name and touch **NEXT** to complete setup.
  - ❖ The email account is set up and you will begin receiving email for the account.

**Important:** If the account type you want to set up is not in the phone database, you will be asked to enter more details. You should get all pertinent information for the email account, such as incoming and outgoing server settings, before you proceed.

### ***Compose and Send Email***

Compose and send email using any account you have set up on your phone. Increase your productivity by attaching files such as pictures, videos, or documents to your email messages.

1. From home, touch **Apps**  > **Email** .
- ❖ The email inbox opens.
  - If you want to switch to a different email account, touch the account name at the top of the screen and select another account.
2. From the inbox, touch  to compose a new email message.
  - ❖ The email composition window opens.

3. Enter the message recipient(s), subject, and message.

4. Touch **Send** .

❖ The email message is sent.

## *Open New Email Messages*

When new Gmail arrives, you will see  in the status bar.

1. Drag the status bar down to display the notifications window.

2. Touch the new message from the notifications window.

❖ The new email message opens.

- If you have two or more new email messages, touching the notification opens the email inbox. Touch a message to open it.

## *Open Email Messages*

You can also open and read email messages directly from the email inbox. Reading and replying to email on your phone is as simple as on your computer.

1. From home, touch **Apps**  > **Email** .

❖ The email inbox opens.







2. Touch the message you want to view.

❖ The email message opens.

**Tip:** Touch the account name at the top of the screen to switch to a different email account.

3. Touch **Reply**  or touch **Menu**  > **Reply all** to reply to the message.



### **Options When Reviewing Email Messages**

- **Mark Mail as Unread:** Long press a read email message and then touch .
- **Deleting Email:** Long press the email message and then touch **Delete** .
- **Replying to Email Messages:** With an email message open, touch **Reply**  or touch **Menu**  > **Reply all**, compose your reply message, and touch **Send** .
- **Forwarding Email Messages:** With the email message open, touch **Menu**  > **Forward**, enter a recipient and an additional message, and touch **Send** .





## Delete an Email Account

You can delete an email account from your phone if you no longer wish to receive messages for the account on your phone.

1. From home, touch **Apps**  > **Email** .
- ❖ The email inbox opens.
2. Touch **Menu**  > **Settings**.
3. Select the account(s) to delete, and then touch **Remove account**.
4. Touch **CONTINUE** to confirm.
- ❖ The account is deleted from your phone.

## CHROME BROWSER

Your phone supports the Chrome mobile Web browser. If you are signed in with a Google account, the Chrome browser will import all your bookmarks and other Web preferences for use on your phone.

1. From home, touch **Apps**  > **Chrome** .
- ❖ Chrome opens.
2. Touch the address bar at the top and enter search words (for a Google search) or a Web address (URL).
- ❖ The search results appear or a Web page opens.

**Tip:** For more information, from your computer, visit: [google.com/intl/en/chrome/browser/mobile/](https://google.com/intl/en/chrome/browser/mobile/).

# CAMERA AND VIDEO

You can use the camera or video camera to take and share pictures and videos. Your phone comes with a 5 megapixel camera with an autofocus feature that lets you capture sharp pictures and videos.

## TAKE PICTURES AND RECORD VIDEOS

The following topics teach you how to take pictures and record videos with your phone's camera.

### **Capturing Pictures/Videos**

- **File Format for Pictures:** File format for pictures is JPEG.
- **File Format for Videos:** File format for videos is MPEG4.

### **! Camera Cautions**

**If Lens Becomes Dirty:** Fingerprints/smudges on lens prevent capturing of clear still images/videos. Wipe lens with a soft cloth beforehand.

**Avoid Exposure to Direct Sunlight:** Be careful not to expose lens to direct sunlight for long periods. May discolor color filter and affect color of images.





### **! Mobile Light Warning**

Do not shine Mobile Light close to eyes. Do not look directly at Mobile Light when shining. Do not shine Mobile Light at other people's eyes. This may affect eyesight, etc.

## Take a Picture

You can take high-resolution pictures using your phone's camera.







**Note:** Pictures and videos are saved to your phone's memory.

1. From home, touch **Apps**  > **Camera** .
- ❖ The camera viewfinder appears.
2. Aim the camera at your subject and then long press .
- ❖ Auto focus activates.
3. Touch  to take the picture.
- ❖ The shutter clicks and the picture is captured and saved to your phone or SD card.

## Viewfinder Screen

The Viewfinder screen lets you view your subject and access camera controls and options.







The following features are available from the viewfinder screen:

-  **Flash mode:** Touch to enable flash mode , disable flash mode  or choose flash mode automatically  when capturing a picture.
-  **Switch view mode:** Switch between the back camera lens and the front-facing camera lens (for self-portraits, video chatting, etc.).
-  **HDR mode:** Select HDR mode for the camera.
-  **Settings:** Opens the camera settings menu and lets you change additional camera settings. See [Camera Settings](#).

## Record Videos

Use your phone's video camera to record high-quality videos.

**Note:** Pictures and videos are saved to your phone's memory.

1. From home, touch **Apps**  > **Camera** .
  - ❖ The camera viewfinder appears.
2. Aim the camera at your subject, touch  and then touch **Record** .
  - ❖ Touch , video recording begins.
3. Touch  to pause recording. Touch  to stop recording.
  - ❖ The camera stops recording and the video is captured and saved to your phone or SD card.



## VIEW PICTURES AND VIDEOS USING GALLERY

Using the Gallery application, you can view pictures and watch videos that you've taken with your phone's camera, downloaded, or copied onto your storage card or phone memory. You can also take a look at your pictures and your friends' pictures that are on your social networks (Facebook, Flickr etc.).

For pictures that are on your storage card or phone memory, you can do basic editing such as rotating and cropping. You can also easily assign a picture as your contact picture or wallpaper and share pictures with your friends.

### View Pictures and Videos

You can access and view all your stored pictures and videos from your phone's Gallery.

1. From home, touch **Apps**  > **Gallery** .
  - ❖ The album list opens.
2. Touch an album (such as Camera).

- ❖ The list of pictures and videos for the album opens.
  - To select another album, touch **Back**  to return to the Albums tab.

3. Touch an image to view the picture or video.

- ❖ The picture opens or the video begins playing.
  - Touch a picture or video to view it full screen.
  - When viewing pictures and videos, you can long press an image to open a selection menu and choose what to do with the picture or video.

### ***Pictures and Videos: Review Screen***

After capturing a picture or video, from the camera screen, touch the thumbnail image at the bottom left corner of the screen to see the item in the review screen. From there, you can access options such as view, edit, or delete the picture or video.

### ***Pictures and Videos: Options While Viewing***

- **Zoom In or Out on a Picture or Video:** Touch the screen twice or pinch the screen to zoom in or out on a picture or video.
- **Viewing Videos:** Use the onscreen controls to play, pause, or stop the video playback.



After selecting an album from the Albums tab, you can browse through the pictures and videos of that album. Touch a picture or video to view it in full screen. By default, the pictures and videos in an album are displayed in grid view.

**Note:** When viewing pictures, you can long press on a picture or video to open a selection menu and choose what to do with the picture or video.



## ***EDIT PICTURES***

Whether you're browsing pictures in filmstrip or grid view in the Gallery application, you can long press on a picture to open a selection menu and choose to delete the picture, rotate or crop it, and more.

### ***Rotate and Save a Picture***

1. From home, touch **Apps**  > **Gallery** .
- ❖ The album list opens.
2. Touch an album (such as Camera).
  - ❖ The list of pictures and videos for the album opens.
3. Touch the picture you want to rotate.
4. Touch **Menu**  and then select either **Rotate left** or **Rotate right**.
  - ❖ The picture is rotated and saved to the phone or SD card, depending on your settings.

## ***Crop a Picture***



1. From home, touch **Apps**  > **Gallery** .
- ❖ The album list opens.
2. Touch an album (such as Camera).
- ❖ The list of pictures and videos for the album opens.
3. Touch the picture you want to crop.
4. Touch **Menu**  > **Crop**.
- ❖ A crop box appears on the picture.
5. To adjust the crop box size, long press the edge of the box. When directional arrows appear, drag your finger inward to or outward to resize the crop box.
  - To move the crop box to the part of the picture that you want to crop, drag the crop box to the desired size and position.
6. Touch **SAVE** to apply the changes to the picture.
- ❖ The cropped picture is saved in the album as a copy. The original picture remains unedited.

## ***SHARE PICTURES AND VIDEOS***

The Gallery application lets you send pictures and videos using email or multimedia messages. You can share pictures on your social networks (such as Facebook, Flickr, Picasa, and Twitter) and share videos on YouTube. You can also send them to another phone or your computer using Bluetooth.

### ***Send Pictures or Videos by Email***

You can send several pictures, videos, or both in an email or Gmail message. They are added as file attachments in your email. For more information about using email and Gmail, see [Compose and Send Email](#) or [Create and Send a Gmail Message](#).

1. From home, touch **Apps**  > **Gallery** .
- ❖ The album list opens.
2. Touch an album (such as Camera).
- ❖ The list of pictures and videos for the album opens.
3. Touch the album that contains the pictures or videos you want to share.
4. Long press the pictures or videos you want to share.
  - To select multiple items, long press an image to turn on multiple select. Touch all the items you want to include.

5. Touch  > **See all**, and then touch **Email** or **Gmail**.

❖ Follow onscreen prompts to complete and send the message.

**Note:** If you selected **Mail** and you have multiple email accounts, the default email account will be used.

For more information about using email and Gmail, see [Compose and Send Email](#) or [Create and Send a Gmail Message](#).

## *Send a Picture or Video by Multimedia Message*

Multimedia Messaging (MMS) lets you send pictures and videos using your phone's messaging app. Although you can send several pictures or videos in a multimedia message, it may be better to just send one at a time, especially if the files are large in size.

1. From home, touch **Apps**  > **Gallery** .

❖ The album list opens.

2. Touch an album (such as Camera).

❖ The list of pictures and videos for the album opens.

3. Touch the album that contains the pictures or videos you want to share.

4. Long press the pictures or videos you want to share.

- To select multiple items, long press an image to turn on multiple select. Touch all the items you want to include.

5. Touch  > **Messaging**.

❖ Follow the onscreen prompts to complete and send the message.

For more information about sending multimedia messages, refer to [Text and Multimedia Messaging](#).

## *Send Pictures or Videos Using Bluetooth*

You can select several pictures, videos, or both and send them to someone's phone or your computer using Bluetooth.

1. From home, touch **Apps**  > **Gallery** .

❖ The album list opens.

2. Touch an album (such as Camera).

❖ The list of pictures and videos for the album opens.

3. Touch the album that contains the pictures or videos you want to share.

4. Long press the pictures or videos you want to share.

- To select multiple items, long press an image to turn on multiple select. Touch all the items you want to include.

5. Touch  > **See all**, and then touch **Bluetooth**.

- ❖ Follow the onscreen prompts to complete and send the files.

For more information, see [Bluetooth](#).

## *CAMERA SETTINGS*

You can adjust your camera's settings using the icons on the main camera screen and the full camera settings menu.

### *Switch Cameras*

Your phone lets you use different types of cameras depending on your settings and downloads.

1. From home, touch **Apps**  > **Camera** .

- ❖ The camera viewfinder appears.

2. Touch .

- ❖ The window to switch cameras opens.

3. Touch a camera type.

- ❖ The camera switches type.

### *Set Camera Functions*

You can configure your camera's settings to fit any situation or event.

1. From home, touch **Apps**  > **Camera** .

- ❖ The camera viewfinder appears.

2. Touch **Settings** .

- ❖ The camera settings menu opens.

3. Select your desired settings.

- ❖ The settings are applied.

- Settable items differ depending on the camera type in use.

### *Scan Barcodes*

Your Camera app allows you to scan barcodes.

1. From home, touch **Apps**  > **Camera** .

❖ The camera viewfinder appears.

2. Aim the camera at your subject, touch  and then touch .

3. Focus on the barcode and start scanning.



# USEFUL APPS AND FEATURES

The following topics detail many of your phone's tools and features such as maps and navigation, calendar, clock, social networking apps, music, memos, and more.

## NAVIGATION

Your phone offers a number of location-based navigation programs to help you figure out where you are and get you where you're going.

### **Enable Location Services on Your Phone**



Before using any location-based services, you must enable your phone's location feature. For information about setting your phone's location options, see [Location Access Settings](#).

### **Google Maps**





Use the Google Maps app to determine your location, find directions, browse local businesses and attractions, rate and review places, and more.

#### **View Maps of Specified Places**

Use Google Maps to locate and map a specific address or destination.

1. From home, touch **Apps**  > **Maps** .
  - ❖ Google Maps opens.
    - If prompted, follow the onscreen instructions to accept terms of use.
2. Enter an address, city, facility name, etc., and then touch **Search** .
  - ❖ A map of the specified location opens.



#### **Google Maps Operations**

- **Viewing Current Location:** From the Maps app, touch .
- **Obtain Useful Area Information for Current Location:** From the Maps app, touch the search bar, enter the information you're looking for, and then touch a result to view it.
- **View Traffic Information, Aerial Photos, Etc., in Maps:** From the Maps app, touch **Menu**  and then touch **Traffic, Satellite, Google Earth**, etc.
- **Check Route to Destination:** From the Maps app, touch , enter your current location and your destination, touch a method of transport (car, public transit, or on foot).
  - Route candidates appear in a list.
- **Check Detailed Operation for Maps:** From the Maps app, touch **Menu**  > **Help**.



# HANGOUTS

Hangouts is Google's instant messaging service. Use to communicate with other Hangout users, and also use video calling. Log in to a Google account beforehand (see [Google Account](#)).

## Using Hangouts

1. From home, touch **Apps**  > **Hangouts** .
- ❖ The Hangouts app will open.
2. Touch **Add**  to start a new Hangout.
3. Type a name, email, number, or circle, or select a contact from the list.
4. Type a message start a call to chat.
- ❖ A chat window or a video chat window opens.
  - Each time text is entered, the corresponding friend appears.
  - If a friend is not in a Hangout, you will see a message. Touch **INVITE** to invite them to join the Hangout.

## Hangouts Operations

- **Ending a Chat:** In the Hangouts window, flick the chat from left to right.
- **Ending a Video Chat:** In the video chat window, touch .
- **Disabling Chat History:** If you don't want to keep chat history, in the chat window, touch **Menu**  > **Turn history off**.
- **Delete Chat History:** To delete all your chat history in the chat window, touch **Menu**  > **Delete** > **Delete**.





**Note:** You can use Hangouts as your phone's default messaging app, or as a standalone IM app. If you set Hangouts as the default messaging app, the Messages app will be disabled. For more information, see [Default Messaging App Settings](#).

# GOOGLE SEARCH

Search information saved on the phone and in phone applications as well as on the Internet.



## Use Google Search

Type search terms in the Google Search bar to find information on your phone and around the globe.

1. From the Home screen, touch the Google search bar or touch **Apps**  > **Google** .
  2. Type your search keywords and touch **Search** .
- ❖ Search results appear.
    - To search by voice, touch  in the search bar and speak your search terms.



## *Use Google Voice Search*

Use your voice to search instead of typing, with Google Voice Search.

1. From home, touch **Apps**  > **Voice Search** .
- ❖ The Voice Search window opens.
2. Speak your search terms.
- ❖ Search results appear.

## *CALCULATOR*

Your phone's convenient built-in calculator lets you perform basic mathematical equations.



1. From home, touch **Apps**  > **Calculator** .
- ❖ The calculator app launches.
2. Touch onscreen keys for calculations.
- ❖ Calculation results appear.

## *CALENDAR*

Use Calendar to create and manage events, meetings, and appointments. Your Calendar helps organize your time and reminds you of important events. Depending on your synchronization settings, your phone's Calendar stays in sync with your Calendar on the Web, Exchange ActiveSync calendar, Google Calendar, and Outlook calendar.

In order to sync with your Google calendar, you must sign in to a Google account on your phone. See [Google Account](#).

### ***Calendar Operations***

- **View Today's Calendar:** From the Calendar, touch .
- **Change Calendar View:** From the Calendar, touch  to choose **Day**, **Week**, **Month**, **Agenda** or **Year** to change the current view.
- **View Next/Previous Day (Day View):** From the Calendar, flick the screen left or right.

- **View Next/Previous Week (Week View):** From the Calendar, touch **July 2015** to choose **Week** and flick the screen left or right.
- **View Next/Previous Month (Month View):** From the Calendar, touch **July 2015** to choose **Month** and flick the screen up or down.

## Add an Event to the Calendar

Add events to your calendar directly from the Calendar application.

1. From home, touch **Apps** > **Calendar**.
  - ❖ The Calendar app opens.
2. Touch **+** or long press an empty place and choose **New event**.
  - ❖ The add event window opens.
3. Enter an event title, start date/time, end date/time, etc., and then touch **DONE**.
  - ❖ The event is added to your calendar.

## Selecting a Calendar

- If you have more than one calendar, select a calendar in which to add events:
  - Select **My Calendar** to create an event that will appear only on your phone.
  - Select your Google account to create a Google Calendar event. If you have several Google Calendars on the Web, select one in which to add your event.
    - You can create multiple Google Calendars only in Google Calendar on the Web. After creating them in Google Calendar on the Web, you'll be able to see them in the Calendar application on your phone. For more information about creating and managing multiple Google Calendars, visit the Google website: [calendar.google.com](http://calendar.google.com).
  - If you have synchronized your phone with an Exchange ActiveSync account or Outlook on your computer, you can also select these calendars.
  - Select **PC Sync** to create an Outlook Calendar event to sync with your computer.
  - Select **Exchange** to create an Exchange ActiveSync calendar event.



## View Calendar Events

You can display the Calendar in daily, weekly, monthly, or agenda view. To change the Calendar view, touch the **Year, Month, Week, Day, Agenda**.

1. From home, touch **Apps** > **Calendar**.
  - ❖ The Calendar app opens.

2. Touch a date and then touch an event.

❖ The event details appear.

- In event details, touch  to edit the event.
- In event details, touch **Delete**  and follow the prompts.

## Sync Calendars

You can select which calendars you'd like to sync on your phone, along with what types of information you want to sync.

1. From home, touch **Apps**  > **Calendar** .

❖ The Calendar app opens.

2. Touch **Menu**  > **Calendars to display**.

3. Select sync options by adding or removing check marks from the items.

❖ The sync settings have been updated.

## TIME

Your phone has a time app that lets you set alarms, view time in time zones around the world, use a stopwatch, set a timer, and use your phone as a desk clock.

### Checking the Time

You can check the time on your phone. The current time displays in the upper right corner of the status bar. Many widgets and lock screens also display the time and provide options for how time is displayed.

## Set Alarms

Set multiple alarms using your phone's Time app.

1. From home, touch **Apps**  > **Time** .

❖ The time appears.

2. Touch the **Alarm** tab  and then touch .

3. Set the alarm options, including time, days, repeat pattern, alarm type, alarm tone, and volume, and then touch .



❖ The alarm is set.

### **Phone at Alarm Time**

- At the setting alarm time, the phone sounds the alarm and/or vibrates.
- Stopping an alarm: When the alarm sounds, swipe  to the right to dismiss it.

### **Additional Clock Features**

Your phone's time app provides additional useful features including world clock, stopwatch, and timer functions. All features are available from the clock app display.

- From home, touch **Apps**  > **Time** .
- ❖ The time appears.



### **World Clock**

The world clock lets you keep track of the current time in multiple cities around the globe.

1. From the time app, touch **World Clock** .
2. Select a city.
3. Repeat to add multiple cities.



### **Stopwatch**

The stopwatch lets you time events down to the hundredth of a second.

1. From the clock app, touch **Stopwatch** .
2. Set the time and touch  to begin timing.
3. Touch  to stop timing.
  - Additional options include Lap to keep track of laps, Restart to continue timing, and Reset to reset the stopwatch to zero.

### **Timer**

The timer provides a countdown timer for up to 99 hours, 59 minutes, and 59 seconds.



1. Touch **Timer** .
2. Set the time and touch  to begin timing.
3. Touch  to stop timing.

## **YOUTUBE**

View videos uploaded to YouTube and upload your own videos to your YouTube account.



## View YouTube Videos

You can use the YouTube app to view videos on YouTube even if you aren't signed in to a YouTube account.

1. From home, touch **Apps**  > **YouTube** .
- ❖ The YouTube app launches.
  - If you're prompted to provide confirmation to use the site, follow the onscreen instructions to continue.
2. Search through the YouTube channels and touch a video you want to see.
- ❖ The video plays on your phone screen.
  - Touch the screen to pause or resume play while watching.

## Post a Video to YouTube

You can post videos to your YouTube account from your phone. Before posting, you must set up a YouTube account and sign in to it on your phone.

1. From home, touch **Apps**  > **YouTube** .
- ❖ The YouTube app launches.
2. Touch **Options**  > **Uploads**.
- ❖ The Open from menu appears.
3. Select a video to upload.
  - Enter a title, description, and tags, and select a privacy setting.
4. Touch upload.
- ❖ The video is uploaded to your YouTube channel.

## GOOGLE PLAY MUSIC APP



The Google Play Music app lets you browse, shop, and play back songs purchased from Google Play as well as songs you have loaded from your own music library. The music you choose is automatically stored in your Google Play Music library and instantly ready to play via streaming or download.

For more information about Google Play Music, visit [play.google.com/about/music](http://play.google.com/about/music).

**Note:** For information about loading music onto your phone, see [Transfer Files Between Your Phone and a Computer](#).

## Play Music with Google Play Music

Use the Google Play Music app to listen to all your music on your phone. Compatible music file formats include: mp3, wma, wav, mod, etc.

1. From home, touch **Apps**  > **Play Music** .
- ❖ The Play Music app opens to the library.
2. Flick the screen left or right to select a library category such as Artist or Albums.
3. Touch an item from the category window and then touch a song.
- ❖ The song begins playing.

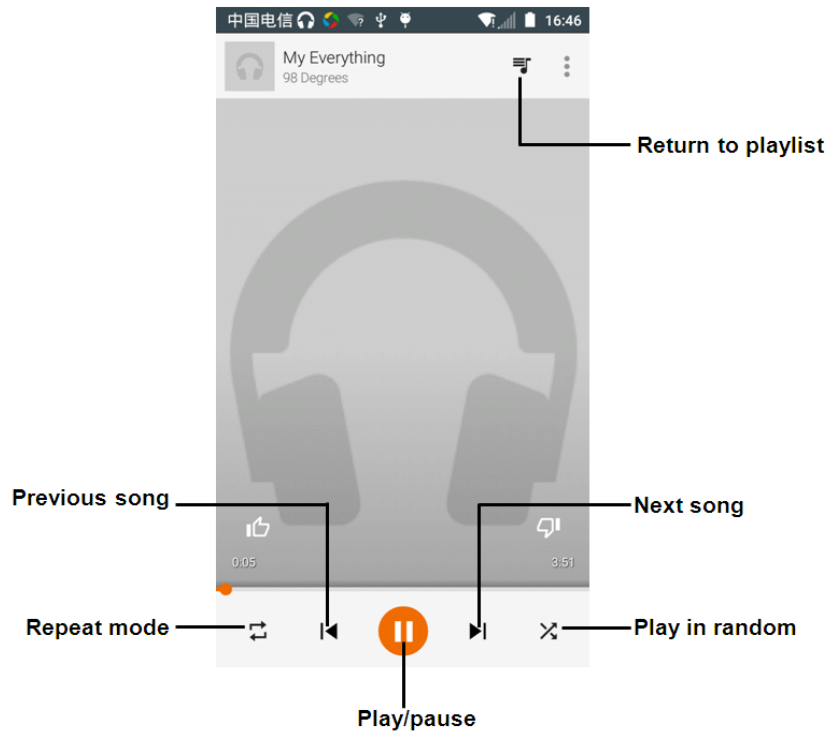

## Google Play Music Screen Layout

The following picture outlines the main features of the Play Music app player screen.





## Create Playlists in Google Play Music

Organize music into playlists to fit every occasion.

1. From home, touch **Apps**  > **Play Music** .
- ❖ The Play Music app opens to the library.







2. Touch  and select **My Library** category to choose Artist or Albums.
3. Touch  and select **Playlists** to create Playlists.

### ***Adding Currently Playing Music to a Playlist***

- From the player view, touch  > **Add to playlist**, you can add to the existing playlist or create a new playlist.
- ❖ The music is added to the playlist.

## **NOTES**

Use your phone's Notes app to save text, memos, lists, and more.

1. From home, touch **Apps**  > **Notes** .
- ❖ The Notes list appears.
2. Touch  and enter your notes.
3. Touch .
- ❖ The memo is saved.

# CONNECTIVITY

The following topics address your phone's connectivity options, including USB file transfer and tethering, Wi-Fi, Bluetooth and more.

## TRANSFER FILES BETWEEN YOUR PHONE AND A COMPUTER

You can use the supplied USB connector to connect your phone directly to your computer and transfer music, pictures, and other content files.

For example, if you have a music album stored on your computer that you want to listen to on your phone with any of the music apps, just attach your phone to the computer and copy the files to the music folder.

### File Transfer Tips

- If you want to save data to an SD card on your phone, make sure the SD card is installed and active. See [SD Card](#).
- Avoid removing the battery or SD card while transferring data.
- Data exchange may use the methods outlined in the following table:

Method	Description
Media Device (MTP)	Transfer files between your phone and PC such as pictures, videos, and music.
Camera (PTP)	Transfer picture and video files between your phone and PC.
Mount SD card	Transfer media files in the SD card on computer.

### Transfer Files between the Phone and a Computer

1. Connect your phone to your computer using the supplied USB/charging cable.
  - Insert the larger end of the cable to the charger/accessory jack at the bottom of the phone.
  - Insert the USB end of the cable into an available USB port on your computer. You may need to remove the USB cable from the charging head to access it.
2. When  appears in the notifications area, drag the status bar down to display the notifications window.
3. You will see either **Connected as a media device (MTP)** or **Connected as a camera (PTP)**.

- ❖ The files on your phone can now be accessed via your computer.
  - For most transfers, you'll want to use **Connected as a media device**.
  - To change the option, touch it in the notifications window to open **Connected as a media device**, and then touch the desired option.
- 4. On your computer, navigate to the detected device (such as through My Computer menu) and open it.
- 5. If available, select a drive (**Card** for SD card, **Phone** for internal storage).
- 6. Select a folder (for example, **Music** for songs and albums) and copy files to it from your computer.
- 7. When you are done, disconnect your phone from your computer.
  - ❖ The transferred files are now saved to your phone or SD card.





## WI-FI

Wi-Fi provides wireless Internet access over distances of up to 300 feet. To use your phone's Wi-Fi, you need access to a wireless access point or "hotspot."

The availability and range of the Wi-Fi signal depends on a number of factors, including infrastructure and other objects through which the signal passes.

### *Turn Wi-Fi On and Connect to a Wireless Network*

Use the Wireless & networks setting menu to enable your phone's Wi-Fi radio and connect to an available Wi-Fi network.





1. From home, touch **Apps**  > **Settings** .
2. Touch **Wi-Fi**.
  - ❖ The Wi-Fi settings menu appears.
3. Touch the Wi-Fi slider to turn Wi-Fi on .
- ❖ Wi-Fi is enabled. You will see the names and security settings of in-range Wi-Fi networks.
  - To disable Wi-Fi, touch the slider again .
4. Touch a Wi-Fi network to connect, enter the password (if it's not an open network), and then touch **CONNECT**.
  - ❖ Your phone is connected to the Wi-Fi network. You will see (  ) in the status bar.
    - The password, for a household wireless LAN router, is sometimes found on a sticker on the router (WEP, WPA, KEY, etc.). Contact the router manufacturer for information. For password for a public wireless LAN, check with user's service provider.
    - Entering a password is not required if an access point is not security protected.

**Note:** The next time your phone connects to a previously accessed secured wireless network, you will not be prompted to enter the password again, unless you reset your phone to its factory default settings, you instruct the phone to forget the network or the password changed.

**Note:** Wi-Fi networks are self-discoverable, which means no additional steps are required for your phone to connect to a Wi-Fi network. It may be necessary to provide a username and password for certain closed wireless networks.



## Wi-Fi Settings

Use the Wi-Fi settings menu to manually set your Wi-Fi connection options.

1. From home, touch **Apps**  > **Settings** .
2. Touch **Wi-Fi**.
  - ❖ The Wi-Fi settings menu appears.
3. Touch the Wi-Fi slider to turn Wi-Fi on .
- ❖ Wi-Fi is enabled. You will see the names and security settings of in-range Wi-Fi networks.
  - To disable Wi-Fi, touch the slider again .
4. Touch **Menu**  > **Advanced**.
  - ❖ The advanced Wi-Fi settings menu appears.
5. Configure your Wi-Fi settings.
  - ❖ Your Wi-Fi settings changes are saved.





## Disconnect Wi-Fi

You may wish to disconnect from a connected Wi-Fi network without turning Wi-Fi off.

1. From home, touch **Apps**  > **Settings** .
2. Touch **Wi-Fi**.
  - ❖ The Wi-Fi settings menu appears.
3. Touch the name of the connected access point and then touch **FORGET**.
  - ❖ Wi-Fi is disconnected.
    - After disconnecting from an access point, you may need to re-enter the password to reconnect.

## Wi-Fi Direct

Use Wi-Fi Direct to connect directly to other Wi-Fi Direct devices simply via Wi-Fi, without an access point or via the Internet.

1. From home, touch **Apps**  > **Settings** .
2. Touch **Wi-Fi**.
  - ❖ The Wi-Fi settings menu appears.
3. Touch the Wi-Fi slider to turn Wi-Fi on .
- ❖ Wi-Fi is enabled. You will see the names and security settings of in-range Wi-Fi networks.
4. Touch **Menu**  > **Advanced** > **Wi-Fi Direct**.
  - ❖ The Wi-Fi Direct settings menu appears.
    - Wi-Fi Direct and Wi-Fi are unavailable at the same time.
5. Touch a device with which to connect.
  - If connected via Wi-Fi, you will see a confirmation. Follow the onscreen instructions.
6. Accept the connection on the other device.
  - ❖ The phone is connected via Wi-Fi Direct.
    - If a connection is not accepted after a certain period, the connection request is cancelled.
    - To stop a connection, touch the connected device name, touch **OK** to confirm disconnection.

## BLUETOOTH

Bluetooth is a short-range communications technology that allows you to connect wirelessly to a number of Bluetooth devices, such as headsets and hands-free car kits, and Bluetooth-enabled handhelds, computers, printers, and wireless phones. The Bluetooth communication range is usually approximately 30 feet.

### **Bluetooth Hints**

**Question:** Why can't I use Bluetooth?

**Answer:** Is your phone in airplane mode? Bluetooth is unavailable in airplane mode.

### **Bluetooth Function Cautions**

Information may not appear correctly on connected devices depending on the transferred data.

## Bluetooth Information

Bluetooth is a technology that enables wireless connection with PCs, Bluetooth devices with hands-free features, etc.





Function	Description
Audio output	Listen to music, etc., wirelessly.
Hands-free calls	Call hands-free, using Bluetooth-capable hands-free devices and headsets.
Data exchange	Exchange data with Bluetooth devices.

## Enable the Bluetooth Feature

Use the settings menu to enable or disable your phone's Bluetooth capabilities.

- Wireless connection to all Bluetooth functions is not guaranteed for the phone.
- The phone may not connect properly depending on the other device.
- Noise may be experienced with wireless calls and hands-free calls depending on the conditions.

To enable Bluetooth:

1. From home, touch **Apps**  > **Settings** .
2. Touch **Bluetooth**.
  - ❖ The Bluetooth settings open.
3. Touch the slider to turn Bluetooth on .
- ❖ Bluetooth is enabled.
  - To disable Bluetooth, touch the slider again .

**Tip:** You can also turn Bluetooth on or off with the toggle menu in the notifications window. Drag the status bar down to display the notifications window and then touch **Bluetooth** to turn Bluetooth on or off.



**Note:** Turn off Bluetooth when not in use to conserve battery power, or in places where using a wireless phone is prohibited, such as aboard an aircraft and in hospitals.

## Pair Bluetooth Devices

Search for and pair nearby Bluetooth devices. Registered Bluetooth devices can be connected simply.

- Enable the Bluetooth function on the Bluetooth devices being paired beforehand.

To pair Bluetooth devices:



1. From home, touch **Apps**  > **Settings** .
2. Touch **Bluetooth**.
  - ❖ The Bluetooth settings open.
    - Nearby devices appear in the “Available devices” list.
    - If a target device is not detected, touch  > **Refresh** to search again.
3. Touch a device from the “Available devices” list, and follow the onscreen instructions to pair with the device.
  - ❖ The Bluetooth device is paired to your phone.
    - Methods to accept a Bluetooth connection differ depending on the devices used.

### ***Forgetting from a Paired Device***

1. From the Bluetooth settings menu, touch **Settings**  next to the paired device you wish to unpair.
2. Touch **FORGET**.
  - ❖ The device is unpaired from your phone. To make another connection with the device, you will need to pair again.

### ***Connect to a Paired Bluetooth Device***

You can listen to music over a Bluetooth stereo headset, or have hands-free conversations using a compatible Bluetooth headset or car kit. It’s the same procedure to set up stereo audio and hands-free devices.

1. From home, touch **Apps**  > **Settings** .
2. Touch **Bluetooth**.
  - ❖ The Bluetooth settings open.
    - Paired Bluetooth devices appear in the “Paired devices” list.
3. Touch a device from the “Paired devices” list.
  - ❖ Your phone connects to the paired device.

The pairing and connection status is displayed below the device’s name in the Bluetooth devices section. When the device is connected to your phone, the Bluetooth paired icon  is displayed in the status bar. Depending on the type of device you have connected, you can then start using the headset or car kit to listen to music or make and receive phone calls.

**Note:** Due to different specifications and features of other Bluetooth-compatible devices, display and operations may be different, and functions such as transfer or exchange may not be possible with all Bluetooth-compatible devices.

## Send Information Using Bluetooth

You can use Bluetooth to transfer information between your phone and another Bluetooth-enabled device such as a phone or notebook computer.



### Types of Data You Can Send via Bluetooth

You can send the following types of information, depending on the device you are sending to:

- Images and videos
- Calendar events
- Contacts
- Audio files

In the instructions below, Contacts data is being used as an example.

### Sending Contacts Data via Bluetooth

1. From home, touch **Phone**  > **CONTACTS** tab.
  - ❖ You will see the Contacts list.
2. Touch a contact to send.
3. Touch **Menu**  > **Share** > **Bluetooth**.
4. Touch a paired device to receive the data.
  - ❖ The contact information is sent.
    - If you see a message to confirm, follow the onscreen instructions.

## Receive Data via Bluetooth

Your phone is capable of receiving a wide variety of file types with Bluetooth, including pictures, music tracks, and documents such as PDFs.

1. When another device attempts to send a file to your phone via Bluetooth, you will see a request to accept the file.
2. Touch **Accept**.
  - ❖ The file is sent to your phone.
    - When your phone receives a file, you will see a notification. To open the file immediately, drag the status bar down to display the notifications window, and then touch the notification.
    - When you open a received file, what happens next depends on the file type:
      - Media files and documents are usually opened directly in a compatible application. For example, if you open a music track, it starts playing in the Music application.



- For a vCalendar file, select the calendar where you want to save the event, and then touch **Import**. The vCalendar is added to your Calendar events. (For more information on using the Calendar, see [Calendar](#).)
- For a vCard contact file, if there are multiple vCard files on your storage card, you can choose to import one, several, or all of those contacts to your contacts list.

# SETTINGS

The following topics provide an overview of items you can change using your phone's **Settings** menus.

## BASIC SETTINGS

From the Home screen, touch **Apps**  > **Settings**  to access your phone's settings menu.

- Alternatively, you can drag the status bar down and touch **Settings** .





The table below outlines the top-level settings categories.

Category	Description
Wi-Fi	Enable and set Wi-Fi options.
Bluetooth	Enable Bluetooth connections.
Data usage	Check data usage status.
More...	Set your phone's Airplane mode, VPN, Mobile networks, etc.
Buttons	Select functions for your Power key/Volume key/Home key/Menu key.
Status bar	Enable battery percentage displays on the status bar.
Display	Set wallpaper, brightness, etc.
Sound & notification	Set ringtone, operation tones, etc.
Storage	Check your phone and SD card's storage.
Battery	Check your battery use.
Apps	Check all of your apps.
System profiles	View and set system profiles.
Location	Select your phone's location access options.
Security	Set your phone's lock screen options.
Accounts	Set your accounts.
Language & input	Set your display language and input method.
Backup & reset	Set your backup options and reset your phone.
Date & time	Set your phone's date and time.
Accessibility	Set accessibility options such as screen magnification, hearing aid compatibility, etc.
Printing	Use your phone to do printing job.
Activate this Device	Activate your phone.
System updates	Check available updates.
About phone	Check information about your phone.

## WI-FI SETTINGS MENU



The Wi-Fi settings menu lets you turn Wi-Fi on or off, set up and connect to available Wi-Fi networks, and configure advanced Wi-Fi options.







For more information about Wi-Fi settings, see [Wi-Fi](#).

1. From home, touch **Apps**  > **Settings** .
2. Touch **Wi-Fi**.
  - ❖ The Wi-Fi settings menu appears.
3. Touch the Wi-Fi slider to turn Wi-Fi on .
- ❖ Wi-Fi is enabled. You will see the names and security settings of in-range Wi-Fi networks.
  - To disable Wi-Fi, touch the slider again .
4. Touch a Wi-Fi network, enter the password, and touch **Connect**.
  - ❖ Your phone is connected to the selected Wi-Fi network.
5. Configure your Wi-Fi settings.
  - ❖ Your Wi-Fi settings changes are saved.
    - The password, for a household wireless LAN router, is sometimes found on a sticker on the router (WEP, WPA, KEY, etc.). Contact the router manufacturer for information. For password for a public wireless LAN, check with user's service provider.
    - Entering a password is not required if an access point is not securely protected.

### **Advanced Wi-Fi Settings**



The advanced Wi-Fi settings menu lets you set up and manage wireless access points.

- **Enable Notification when Open Networks Are Available:** From Wi-Fi settings, touch **Menu**  > **Advanced** > **Network notification**.
  - The setting is available when Wi-Fi is turned on.
  - Touch **Network notification** to turn the option on or off.
- **Scanning Always Available:** From Wi-Fi settings, touch **Menu**  > **Advanced** > **Scanning always available**
  - The setting is available when Wi-Fi is turned on.
  - Touch **Scanning always available** to turn the option on or off.

- **Set Timing for Pausing a Connection:** From Wi-Fi settings, touch **Menu**  > **Advanced** > **Keep Wi-Fi on during sleep mode** and then select a setting.
- **Install Certificates:** From Wi-Fi settings, touch **Menu**  > **Advanced** > **Install certificates** and then select a setting.
- **Wi-Fi Direct:** From Wi-Fi settings, touch **Menu**  > **Advanced** > **Wi-Fi Direct** to select a setting.
- **WPS Push Button:** From Wi-Fi settings, touch **Menu**  > **Advanced** > **WPS Push Button** to select a setting.
- **WPS Pin Entry:** From Wi-Fi settings, touch **Menu**  > **Advanced** > **WPS Pin Entry** to select a setting.
- **Check MAC Address:** From Wi-Fi settings, touch **Menu**  > **Advanced**.
  - MAC Address appears below “MAC Address.”
- **Check IP Address:** From Wi-Fi settings, touch **Menu**  > **Advanced**.
  - IP Address appears below “IP Address.”







## BLUETOOTH SETTINGS





Your phone’s Bluetooth capabilities let you use wireless headsets, send and receive pictures and files, and more. For details on your phone’s Bluetooth usage, see [Bluetooth](#).

1. From home, touch **Apps**  > **Settings** .
2. Touch **Bluetooth**.

 The Bluetooth settings open.



### *Bluetooth Settings Operations*

- **Enable Bluetooth:** In Bluetooth settings, touch the slider  or .
  - When enabled, confirmation appears for your phone to be discoverable by other devices. Follow the onscreen instructions.
  - Touch  to enable and  to disable.
  - Alternatively, touch **Bluetooth** >  or .
- **Pairing Bluetooth Devices:** Make sure the other devices are set to be discovered. From Bluetooth settings, touch the device name in “Available devices” and follow the onscreen instructions.
  - Depending on the device, you may be required to enter or accept a passkey.
  - If the target device does not appear, touch **Refresh** to search again.

- This setting is available when Bluetooth is enabled.
- **Change the Name of a Paired Device:** From Bluetooth settings, touch **Settings**  next to a paired device name, touch **Name**, enter a new name, and touch **OK**.
  - Emoji cannot be used in a device name.
  - This setting is available when Bluetooth is enabled.
- **Cancelling Pairing:** From Bluetooth settings, touch **Settings**  next to a paired device name, and then touch **FORGET**.
  - This setting is available when Bluetooth is enabled.
- **Enable Service from Paired Device:** From Bluetooth settings, touch **Settings**  next to a paired device name, and then mark **Internet access** or **Contact sharing**.
- **Search for Other Devices:** From Bluetooth settings, touch **Menu**  > **Refresh**.
  - This setting is available when Bluetooth is enabled.
- **Check Files Received via Bluetooth Transfer:** From Bluetooth settings, touch **Menu**  > **Show received files**, and follow the onscreen instructions.



## DATA USAGE SETTINGS







The Data usage menu lets you view your phone's mobile and Wi-Fi data usage, set data limits, restrict hotspot usage, and more.

1. From home, touch **Apps**  > **Settings** .
2. Touch **Data usage**.

 The data usage window opens.

### Data Usage Settings Operations

- **Cellular data:** In Data usage window, touch the slider  for Mobile data to enable the service.
  - When enabled, confirmation appears for your phone to be discoverable by other devices. Follow the onscreen instructions.
  - Touch  to enable and  to disable.
- **Set Amount for Alert when Data Usage Increases:** From the Data usage window, insert a check mark next to **Set mobile data warning**, and then drag the horizontal warning slider up and down to set an amount.
  - Data usage amounts are approximate. Actual amounts may differ.
  - This setting is available when Mobile data is enabled.

- **Enable Restrictions on Mobile Data Usage:** From the Data usage window, touch **Set cellular data limit** to enable restriction.
  - When enabled, confirmation appears for your phone to be discoverable by other devices. Follow the onscreen instructions.
  - Touch  to enable and  to disable.
  - With restriction turned on, drag the horizontal Limit slider up or down to set the data usage limit.
  - This setting is available when Mobile data is enabled.
- **Enable Restriction on Mobile Data in Background:** From the Data usage window, touch **Menu**  > **Restrict background data** > **OK**.
  - This setting stops some apps and services from working unless your phone is connected to a Wi-Fi network.
  - If a confirmation appears, touch **OK**.
  - This setting is available when **Limit mobile data usage** is on.
- **View Both Mobile Data and Wi-Fi Usage:** From the Data usage window, touch **Menu**  > **Show Wi-Fi**.
  - Touch **Show Wi-Fi usage** to toggle on and off. Touch  to enable and  to disable.
  - When **Show Wi-Fi usage** is enabled, you will see a Wi-Fi tab at the top of the Data usage window. Touch to view your phone's Wi-Fi data usage.

## MORE SETTINGS



The More settings menu provides access to additional wireless and network options, such as default messaging app, mobile networks, VPN, roaming and more.

### More Settings Options

Setting	Description
Airplane mode	Disable all settings that emit or receive signals. Phone stays powered on.
Default SMS app	Set a default SMS/MMS app.
VPN	Add a Virtual Private Network (VPN).
Cellular networks	Set cellular network options.
Mobile networks	Set a network mode, etc.
Emergency broadcast	Set emergency broadcast options.

## DEFAULT MESSAGING APP SETTINGS

If you have multiple messaging apps installed on your phone, you can choose the app your phone uses for messaging. The app you select here will be used when you choose Messages in other apps, such as when sharing items like pictures or video.

1. From home, touch **Apps**  > **Settings** .
2. Touch **More...** > **Default SMS app**.
3. Choose a messaging app.

❖ The default messaging app is set.

**Note:** If you choose a default messaging app other than Messages (for example, Google Hangouts), you will not be able to use the standard Messages app unless you restore it as the default messaging app.

## SOUND & NOTIFICATION SETTINGS



The Sound settings menu lets you control your phone's audio, from ringtones and alerts to touch tones and notifications.

### Sound & Notification Settings Overview

The sound settings menu allows you to configure the following options:

Sound & notification Setting	Description
Sound	Set volume for ringtones, alarms, system features, etc.
Also vibrate for calls	Touch the on/off switch to enable or disable vibrate for calls.
Interruptions	Set your phone's interruptions.
Phone ringtone	Set a tone for incoming calls.
Default notification ringtone	Set a tone for default phone notifications.
Other sounds	Set a tone for dial pad, screen lock, etc.
Pulse notification light	Touch the on/off switch to enable or disable pulse notification light.
When device is locked	When device is locked, set to show or not show notification content.
App notifications	Touch to see all app notifications.
Notification access	Touch to check notification access.

### **Access Sound Settings**

1. From home, touch **Apps**  > **Settings** .
2. Touch **Sound & notification**.
3. Set your sound options.

❖ Your sound settings are saved and applied.

## **DISPLAY SETTINGS**



Adjusting your phone's display settings not only helps you see what you want, it can also help increase battery life.

### **Display Settings Overview**

The display settings menu allows you to configure the following options:

<b>Display Setting</b>	<b>Description</b>
<b>Brightness level</b>	Set the display brightness.
<b>Adaptive brightness</b>	Touch the on/off switch to enable or disable Adaptive brightness.
<b>Wallpaper</b>	Set wallpaper.
<b>Sleep</b>	Set a screen timeout duration. <b>Note:</b> Longer durations discharge the battery more quickly.
<b>Daydream</b>	Touch the on/off to enable or disable daydream.
<b>Ambient display</b>	Touch on the switch to wake up screen when device picked up or notifications arrive.
<b>Font size</b>	Set font size for display.
<b>When device is rotated</b>	Set whether to allow the screen to rotate the display with the phone orientation, where applicable.
<b>Blur effect</b>	<a href="#">View and set blur effect for items.</a>

### **Access Display Settings**

1. From home, touch **Apps**  > **Settings** .
2. Touch **Display**.
3. Set your display options.

❖ Your display settings are saved and applied.



## STORAGE SETTINGS



The Storage settings menu lets you manage internal storage on your phone and provides options for your micro SD card.

### Storage Settings Overview

The sound settings menu allows you to configure the following options:



Storage Setting	Description
SD card	View the total space/free space in your SD card. This option only appears when an SD card inserted.
Internal storage	View the total space/free space in your phone memory.
Unmount SD card	If an optional SD card is installed, touch to unmount the card to allow for safe removal.
Mount SD card	If an optional SD card is installed, touch to mount the card and make it available for use.
Erase SD card	If an optional SD card is installed, touch to erase all data stored on the card and prepare it for use by your phone.

### Access Storage Settings

1. From home, touch **Apps**  > **Settings** .
2. Touch **Storage**.
3. Check or touch items.
  - ❖ Review your storage settings.

## BATTERY SETTINGS

Monitor your phone's battery usage through this settings menu. View which functions are consuming your battery's charge and show usage percentage.

1. From home, touch **Apps**  > **Settings** .
2. Touch **Battery**.
3. Touch items to view details.
  - ❖ Check your battery condition and access additional options.

## APPS SETTINGS



Check installed applications and running applications.

## Apps Settings Overview

Items that can be checked in the Apps settings menu are the following.

Apps Setting	Description
DOWNLOADED	Check downloaded apps.
ON SD CARD	Check apps on your optional installed SD card.
RUNNING	Check running apps.
ALL	Check all apps.

## Access Apps Settings

1. From home, touch **Apps**  > **Settings** .
2. Touch **Apps**.
3. Touch items to view details.
  - ❖ Check your application settings condition and access additional options.
    - Depending on the app and its location, you may be able to force the app closed, uninstall or disable the app, clear cache and data, and more.

## LOCATION SETTINGS

Your Location Services settings menu lets you select how your phone determines its location (using the wireless networks, GPS satellites, both, or neither).



## Location Settings Overview

Your Location settings menu allows you to configure the following options.

Location Setting	Description
Mode	Select a locating method: High accuracy, Battery saving, or Device only.
Recent location requests	Check your recent location requests.
Location services	Check location services.



## Enable Location Services

Before using any features that require location assistance, you must enable your phone's location services.

1. From home, touch **Apps**  > **Settings** .
2. Touch **Location**.
3. Touch the on/off switch to enable location services.

- ❖ Your phone's location services are enabled.
  - If you see a confirmation, follow the onscreen instructions to connect.

### **Access Location Settings**

1. From home, touch **Apps**  > **Settings** .
2. Touch **Location**.
3. Configure the desired settings.

- ❖ Your location settings are applied and saved.

## **SECURITY SETTINGS**



The Security settings menus let you set encryption options, password visibility, administrator settings, and credential storage options.

### **Security Settings Overview**

Many security settings are dependent on Screen lock settings, SIM lock settings, etc. The following table outlines the settings available through the Security settings menu:

<b>Security Setting</b>	<b>Description</b>
<b>Screen lock</b>	Touch to set your screen lock.
<b>Owner info</b>	Touch to input owner information which will display on the lock screen.
<b>Lock screen shortcuts</b>	Touch an icon to reassign a lock screen shortcut.
<b>Smart lock</b>	Touch to set smart lock.
<b>Encrypt phone</b>	Touch to encrypt your phone.
<b>SMS message limit</b>	Touch to set SMS message sending frequency.
<b>Make passwords visible</b>	Toggle to show or hide passwords when entering form data.
<b>Device administrators</b>	View or turn off device administrators.
<b>Unknown sources</b>	Allow or deny installation of apps from sources other than the Google Play Store app.
<b>Storage type</b>	Check your storage type.
<b>Trusted credentials</b>	Display trusted CA certificates.
<b>Install from SD card</b>	Touch to set install certificates from SD card.
<b>Clear credentials</b>	Touch to remove all credentials.
<b>Trusted agents</b>	View or deactivate trusted agents.
<b>Apps with usage access</b>	Touch to set apps with usage access.
<b>Blocked call list</b>	Touch the switch on to block calls and messages from phone numbers in the blocked call list.

## ***Access Security Settings***

1. From home, touch **Apps**  > **Settings** .
2. Touch **Security**.
  - ❖ The Security settings menu opens.
3. Set your security options.
  - ❖ Your security settings are applied and saved.

## ***Screen Lock***



You can increase the security of your phone by creating a screen lock. When enabled, you have to draw the correct unlock pattern on the screen, enter the correct PIN, or enter the correct password to unlock the phone's control keys, buttons, and touchscreen.

In order from least secure to most secure, the available screen lock options are:

- None
- Swipe
- Pattern
- PIN
- Password



**Important:** To protect your phone and data from unauthorized access, it is recommended that you use the highest security level available (Password protection). It is also recommended you frequently change your password to ensure the safety of your phone and personal data.

## ***Access Screen Lock Settings***

1. From home, touch **Apps**  > **Settings**  > **Security**.
2. Touch **Screen Lock**.
  - ❖ The Screen lock settings menu opens.

## ***Disable the Screen Lock***

Follow the instructions below to turn off your current screen lock.

1. From home, touch **Apps**  > **Settings**  > **Security**.
2. Touch **Screen Lock**.
  - ❖ The Lock screen settings menu opens.
3. Touch **None**.

❖ The screen lock is disabled.

- If you fail to enter the correct password after five attempts, you will be prompted to wait for 30 seconds before you can try again.

## LANGUAGE & INPUT SETTINGS



Your phone's language and input settings let you select a language for the phone's menus and keyboards, select and configure keyboard settings, configure speech input settings, and set your phone's mouse/trackpad options.

### *Language and Input Settings Overview*

You can set the following options in the Language and input settings menu:

Language and Input Setting	Description
Language	Set the language for your display and menus.
Spell checker	Touch the on/off switch to enable or disable the system to show suggested words.
Personal dictionary	Touch to open a list of the words you've added to the dictionary. Touch a word to edit or delete it. Touch the add button (+) to add a word.
Current keyboard	Set the default method for entering text.
Google Keyboard	Set Google Keyboard options.
Swype	Set Swype options.
Google voice typing	Set Google voice typing options.
Voice input	Set options for Voice input.
Text-to-speech output	Set text-to-speech options.
Pointer speed	Set the speed of the pointer for a mouse/trackpad.

### *Access Language and Input Setting Options*

1. From home, touch **Apps**  > **Settings** .
2. Touch **Language & input**.
  - ❖ The Language and input settings menu opens.
3. Set options.
  - ❖ The language and input settings are applied and saved.

## BACKUP & RESET

Your phone's **Backup & reset** menu lets you back up your phone's data and settings to Google servers before resetting your phone to the original factory settings. The Factory data reset erases all data from the phone's application storage, including:

- Your Google account
- All other email and social networking accounts
- System and application data and settings
- Downloaded applications



### **Backup and Reset Overview**

The following options are available in the Backup and reset menu:



<b>Backup and Reset Option</b>	<b>Description</b>
<b>Back up my data</b>	Enable backup for application data, Wi-Fi passwords, and other settings to Google servers.
<b>Backup account</b>	Select the account used to back up data.
<b>Automatic restore</b>	When reinstalling an application, backup settings and data will be restored.
<b>Factory data reset</b>	Reset all settings and delete all data on phone.

- Performing a factory data reset erases all data on the phone. It is recommended that you back up important data before performing a factory data reset.
- Erased information cannot be restored. Only erase data after you are sure you have saved everything you need.

### **Access Backup and Reset Options**

1. From home, touch **Apps**  > **Settings** .
2. Touch **Backup & reset**.
  - ❖ The Backup and reset menu opens.
3. Set options.
  - ❖ The backup and reset settings are applied and saved.
    - If you're performing a Factory Data Reset, follow the prompts to confirm the data removal. The phone will erase all data and reboot.

## **Factory Data Reset**



**Tip:** Before performing a factory data reset on your phone, you may want to unmount the microSD card to avoid losing any data you may have stored on it. From home, touch **Apps**  > **Settings**  > **Storage** > **Unmount SD card** to unmount the storage card.

1. From the Backup and reset menu, touch **Factory data reset**.
2. Read the factory data reset information page and touch **RESET PHONE**.
3. Touch **ERASE EVERYTHING**.
  - ❖ Your phone will power down and reset itself, which may take up to 10 minutes.
    - Once the phone has reset, it will run through the Hands Free Activation and update processes again. When finished, you will see the Welcome screen and Setup application. See [Complete the Setup Screens](#) to start over.



## **ACCOUNTS**

The Accounts settings menu lets you add and manage all your email, social networking, and picture and video sharing accounts.

### **Set Up a New Account**

1. From home, touch **Apps**  > **Settings** .
2. Touch **Accounts** > **Add account**.
  - ❖ An Add account window appears.
3. Touch an account type and then follow the onscreen instructions to add the required account information, and then touch **Done**.
  - ❖ The account is added to the accounts list.

### **Manage Existing Accounts**

1. From home, touch **Apps**  > **Settings** .
2. Touch **Accounts** > <account name>.
  - ❖ The account settings menu appears.
3. Select your account settings, and then touch **Done**.
  - ❖ The account options are updated.

## **DATE & TIME SETTINGS**



Use the Date & Time settings menu either to automatically use the network-provided date and time or manually set these values, as well as select time and date format options.

## Date and Time Overview

The following Date and time options may be configured:

Date and Time Option	Description
Automatic date & time	Set the date and time automatically via the connected wireless network.
Automatic time zone	Set the time zone automatically via the connected wireless network.
Set date	Set the date manually (only available when Automatic date and time option is disabled).
Set time	Set the time manually (only available when Automatic date and time option is disabled).
Select time zone	Set the time zone manually (only when Automatic time zone is disabled).
Use 24-hour format	Enable or disable 24-hour format.

## Access Date and Time Options

1. From home, touch **Apps**  > **Settings** .
2. Touch **Date & time**.
3. Set available date and time options.  
 Your date and time settings are applied and saved.

# ACCESSIBILITY SETTINGS

The Accessibility menu lets you enable and manage accessibility-related applications.

## Accessibility Settings Overview



The following Accessibility options may be configured:

Accessibility Option	Description
TalkBack	When Talkback is on, your device provides spoken feedback to help blind and low-vision users.
Switch access	Switch access allows you to control your device using configurable key combinations.
Captions	Touch to set captions settings.
Magnification gestures	Touch to turn on/ off the Magnification gestures.
Large text	Mark the checkbox to enlarge the screen text.
High contrast text	Mark the checkbox to enable high contrast text.
Power button ends call	Mark the checkbox to enable this function.



Accessibility Option	Description
Auto-rotate screen	Set the screen to rotate automatically when the phone is rotated.
Speak passwords	Set the phone to read passwords as they are entered.
Accessibility shortcut	Touch to turn on/ off the Accessibility shortcut.
Text-to-speech output	Set text-to-speech options.
Touch & hold delay	Touch to adjust the duration of long press delay. This function enables your phone to differ touch and touch & hold, which may avoid incorrect operations.
Stereo and mono	Touch to set Stereo or mono.
Sound balance	Touch to set sound balance.
Persistent alerts	Mark the checkbox to enable persistent alerts.
Color inversion	Set color inversion may affect performance.
Color correction	Touch to set color correction.

### Access Accessibility Options

1. From home, touch **Apps**  > **Settings** .
  2. Touch **Accessibility**.
  3. Set available accessibility options.
-  Your accessibility settings are applied and saved.

## PRINTING

The Printing menu lets you configure Google's Cloud Print service. You can connect your printer to your Google account and then add the printer on your phone in the Printing menu. After that, you can send documents, pictures, emails, or Web pages from your phone to the printer wirelessly and have them printed out.



1. From home, touch **Apps**  > **Settings** .
2. Touch **Printing** > **Cloud Print** > **Print jobs**.

**Note:** To use Cloud Print, you need to add a Google account to your device.

## ACTIVATE THIS DEVICE

The Activate this device menu lets you activate a new phone or use additional self-service options such as checking the status of an in-service phone.

### **Access Activate this Device Options**

- From home, touch **Apps**  > **Settings**  > **Activate this Device**.
  - **Reset Cellular Data:** Reset the cellular data programming.
  - **Check for updates:** Check the latest version and update.
  - **About DSS:** DSS (Device Self Service) allows you to activate your device and check your usage.

**Note:** To use this feature, turn on network.



## **SYSTEM UPDATES**

System updates allows the device to search for the latest software version and update your phone's software.

### **System Updates Overview**

<b>System updates Item</b>	<b>Description</b>
<b>Update PRL</b>	Update the phone's coverage area.
<b>Update profile</b>	Update the phone's voice and data settings.
<b>UICC unlock</b>	Set UICC unlock options.
<b>System updates</b>	Check and enable software updates.

### **Access System Updates Options**

1. From home, touch **Apps**  > **Settings** .
2. Touch **System updates**.

## **ABOUT PHONE**



The About Phone menu lets you access important phone information, search for and apply updates, and view legal and safety information.

### **About Phone Overview**

<b>About Phone Item</b>	<b>Description</b>
<b>Status</b>	Check your phone's status.
<b>Legal information</b>	Check copyright information, terms of use, etc.
<b>4G settings</b>	Check the network provider and IP address.
<b>Model number</b>	Check the phone's model number.
<b>HW version</b>	Check the phone's hardware version.

About Phone Item	Description
SW version	Check the phone's software version.
Processor info	Check the phone's processor info.
Android version	Check the Android version number.
Baseband version	Check the phone's baseband version.
Kernel version	Check the phone's kernel version.
Build number	Check the current phone build number.

### ***Access About Phone Options***

1. From home, touch **Apps**  > **Settings** .
2. Touch **About phone**.
3. Select or view available options.
  - ❖ Your phone information is displayed.

## ***COPYRIGHT INFORMATION***

©2015 Virgin Mobile USA, L.P. All rights reserved. The Virgin Mobile name and signature and the Virgin Mobile name and logo are registered trademarks of Virgin Enterprises Ltd. and used under license by Virgin Mobile. Other marks are trademarks of their respective owners.

# FOR ASSISTANCE

The following topics address areas of support for your phone, including troubleshooting, specifications, account information, warranty information, and customer service contact information.

## TROUBLESHOOTING

Check the questions and answers below for troubleshooting solutions for common phone issues.

### **Check Here First**

**Question:** Phone freezes/operation is unstable.

**Answer:** Turn the phone on again. If you are unable to turn the phone off, remove and replace the Battery, and then turn the phone on again. Data that was being edited is erased after your phone is powered on again.

**Question:** Operation is unstable after a new application was installed.

**Answer:** The newly installed application may be the cause. Uninstall the application in Safe mode. See [Uninstall an App](#). To turn the phone on in Safe mode:

- Press and hold the **Power/Lock key** > long press **Power off**, read the disclaimer for safe mode, and then touch **OK**.
  - After turning the phone on in Safe mode, "Safe Mode" appears at lower left.
  - After restarting in Safe mode, your phone can be powered on as usual.
  - Before turning the phone on in Safe mode, it is recommended that you back up important data.
  - By powering the phone on in Safe mode, added widgets may be deleted.

**Question:** Cannot use phone, mail, or Internet.

**Answer 1:** Check whether you are where signal is weak or out of service area.

**Answer 2:** Power the phone on again.

**Answer 3:** Is the phone in Airplane mode? To check that Airplane mode is cancelled:

- From home, touch **Apps**  > **Settings**  > **More...** > **Airplane mode**.

**Answer 4:** Is data communication disabled? To check that data communication is enabled:

- From home, touch **Apps**  > **Settings**  > **Data usage** > **Cellular data**.

**Question:** Battery level goes down quickly.

**Answer:** Are you staying where signal is weak or have been out of service area for a long period? Calling where signal is weak or being out of service area uses a lot of Battery.

**Question:** Cannot install applications.

**Answer:** Applications cannot be installed with only a little free space on the phone or SD card. To check free space, see [Storage Settings](#). Applications not supported by your phone cannot be installed.

**Question:** Cannot unlock screen.

**Answer:** Power the phone on again. If you are unable to turn the phone off, remove and replace the Battery, and then power the phone on again. Data that was being edited is erased after the phone is powered on again.

## **SPECIFICATIONS**

The following tables list your phone's and battery's specifications.

### **Phone Specifications**

<b>Item</b>	<b>Description</b>
<b>Weight with Battery</b>	125g
<b>Continuous Talk Time</b>	Approx. 4 hours
<b>Continuous Standby Time</b>	Approx. 190 hours
<b>Charging Time</b>	Approx. 2.5 hours
<b>Dimensions</b>	Approx. 133.5 x 66 x 9.9 mm
<b>Maximum Output</b>	3G: 0.25 W
<b>Communication Speed</b>	CDMA 2K1X: DL / UL 307.2 kbps EVDO: uplink 1.8Mbps, downlink 3.1Mbps 4G: 150M downlink 50M uplink

### **Battery Specifications**

<b>Item</b>	<b>Description</b>
<b>Type</b>	Removable
<b>Capacity</b>	2000 mAh

## **VIRGIN MOBILE ACCOUNT INFORMATION AND HELP**

Find out about managing your account online and on your phone, buying additional minutes for your plan, and getting help.

For more information about your Virgin Mobile account, as well as other Virgin Mobile services, visit us at: [virginmobileusa.com](http://virginmobileusa.com).

## *Manage Your Account*

View information about your account. You can:

- Check your minutes.
- Add money (Top-Up).
- Change plans.
- And more!

### ***From Your Phone***

Access your account from the special My Account app.

- From home, touch **Apps**  > **My Account** .

### ***From Your Computer***

- Log in with your phone number and account PIN at [virginmobileusa.com](http://virginmobileusa.com).

## *Top-Up Your Account*

Sign up for Auto Pay to keep your service working month after month. Or, you can buy Top-Up cards at thousands of retailers and add money to your account from your phone or by logging in at [virginmobileusa.com](http://virginmobileusa.com).

### ***Auto Pay***

Auto Pay is the easiest way to keep your service working. Once you register your credit card, debit card or PayPal account, you can set it to automatically pay your monthly plan. Then you can keep emailing, IMing, Tweeting with Twitter, surfing, and talking with no interruptions. Set up Auto Pay anytime by logging into My Account at [virginmobileusa.com](http://virginmobileusa.com), and adjusting your payment settings.

### ***From Your Phone***

- From home, touch **Apps**  > **My Account** .

## ***REGULATORY INFORMATION***

The following topics provide important regulatory information.

### ***SPECIFIC ABSORPTION RATES (SAR) FOR WIRELESS PHONES***

The SAR value corresponds to the relative amount of RF energy absorbed into the head of a user of a wireless handset.

The SAR value of a phone is the result of an extensive testing, measuring and calculation process. It does not represent how much RF the phone emits. All phone models are tested at their highest value in strict laboratory settings. But when in operation, the SAR of a phone can be substantially less than the level reported to the FCC. This is because of a variety of factors including its proximity to a base station antenna, phone design and other factors. What is important to remember is that each phone meets strict federal guidelines. Variations in SARs do not represent a variation in safety.

All phones must meet the federal standard, which incorporates a substantial margin of safety. As stated above, variations in SAR values between different model phones do not mean variations in safety. SAR values at or below the federal standard of 1.6 W/kg are considered safe for use by the public.

The highest reported SAR values of the ALCATEL ONETOUCH Elevate are:

**Head:** 0.93 W/kg (1g)

**Body-worn:** 1.46 W/kg (1g)

For body-worn operation, this device has been tested and meets the FCC RF exposure guidelines when used with an accessory that contains no metal and that positions the handset a minimum of 1.0 cm from the user's body.

### ***FCC RADIO FREQUENCY EMISSION***

This phone meets the FCC Radio Frequency Emission Guidelines.

**FCC ID number:** 2ACCJB011

More information on the phone's SAR can be found from the following FCC website:

<http://fcc.gov/oet/ea/>

### ***USING YOUR PHONE WITH A HEARING AID DEVICE***

A number of Virgin phones have been tested for hearing aid device compatibility. When some wireless phones are used with certain hearing devices (including hearing aids and cochlear implants), users may detect a noise which can interfere with the effectiveness to the hearing device.

Some hearing devices are more immune than others to this interference noise, and phones also vary in the amount of interference noise they may generate. ANSI standard C63.19 was developed to provide a standardized means of measuring both wireless phone and hearing devices to determine usability rating categories for both.

Ratings have been developed for mobile phones to assist hearing device users find phones that may be compatible with their hearing device. Not all phones have been rated for compatibility with hearing devices. Phones that have been rated have a label located on the box. Your ALCA TEL ONETOUCH Elevate has an M4/T4 rating.

These ratings are not guarantees. Results will vary depending on the user's hearing device and individual type and degree of hearing loss. If a hearing device is particularly vulnerable to interference noise; even a phone with a higher rating may still cause unacceptable noise levels in the hearing device. Trying out the phone with your hearing device is the best way to evaluate it for your personal needs.

**M-Ratings:** Phones rated M3 or M4 meet FCC requirements for hearing aid compatibility and are likely to generate less interference to hearing devices than unrated phones. (M4 is the better/higher of the two ratings.)

**T-Ratings:** Phones rated T3 or T4 meet FCC requirements and are likely to be more usable with a hearing device's telecoil ("T Switch" or "Telephone Switch") than unrated phones. (T4 is the better/higher of the two ratings. Note that not all hearing devices have telecoils in them.)

**Note:** New Technologies, Including Wi-Fi. This phone has been tested and rated for use with hearing aids for some of the wireless technologies that it uses. However, there may be newer wireless technologies (including Wi-Fi) used in this phone that have not been tested for use with hearing aids.

Hearing aid devices may also be measured for immunity to interference noise from wireless phones and should have ratings similar to phones. Ask your hearing healthcare professional for the rating of your hearing aid. Add the rating of your hearing aid and your phone to determine probable usability:

- Any combined rating equal to or greater than six offers excellent use.
- Any combined rating equal to five is considered normal use.
- Any combined rating equal to four is considered usable.

Thus, if you pair an M3 hearing aid with an M3 phone, you will have a combined rating of six for "excellent use." This is synonymous for T ratings.

It is further suggested you experiment with multiple phones (even those not labeled M3/T3 or M4/T4) while in the store to find the one that works best with your hearing aid device. Should you experience interference or find the quality of service unsatisfactory after purchasing your phone, promptly return it to the store. More information about hearing aid compatibility may be found at: [fcc.gov](http://fcc.gov), [fda.gov](http://fda.gov), and [accesswireless.org](http://accesswireless.org).

This equipment complies with the hearing aid compatibility technical requirements of Section 20.19 of the rules. HAC Ratings: M4 T4 -2011.



## **WARNING STATEMENTS**

THIS DEVICE COMPLIES WITH PART 15 OF THE FCC RULES. OPERATION IS SUBJECT TO THE FOLLOWING TWO CONDITIONS: (1) THIS DEVICE MAY NOT CAUSE HARMFUL INTERFERENCE, AND (2) THIS DEVICE MUST ACCEPT ANY INTERFERENCE RECEIVED, INCLUDING INTERFERENCE THAT MAY CAUSE UNDESIRE OPERATION.

The user manual for an intentional or unintentional radiator shall caution the user that changes or modifications not expressly approved by the party responsible for compliance could void the user's authority to operate the equipment.

**Note:** THE GRANTEE IS NOT RESPONSIBLE FOR ANY CHANGES OR MODIFICATIONS NOT EXPRESSLY APPROVED BY THE PARTY RESPONSIBLE FOR COMPLIANCE. SUCH MODIFICATIONS COULD VOID THE USER'S AUTHORITY TO OPERATE THE EQUIPMENT.

**Note:** This equipment has been tested and found to comply with the limits for a Class B digital device, pursuant to part 15 of the FCC Rules. These limits are designed to provide reasonable protection against harmful interference in a residential installation.

This equipment generates, uses and can radiate radio frequency energy and, if not installed and used in accordance with the instructions, may cause harmful interference to radio communications. However, there is no guarantee that interference will not occur in a particular installation. If this equipment does cause harmful interference to radio or television reception, which can be determined by turning the equipment off and on, the user is encouraged to try to correct the interference by one or more of the following measures:

- Reorient or relocate the receiving antenna.
- Increase the separation between the equipment and receiver.
- Connect the equipment into an outlet on a circuit different from that to which the receiver is connected.

Consult the dealer or an experienced radio/TV technician for help.

# INDEX

## 3

3-way Calling 56

## A

About Phone 123  
Accessibility Settings 121  
Accessory Jack 3  
Accounts  
    Add new 120  
    Manage 120  
    Settings 120  
Activate This Device 122  
Activation 18  
Airplane Mode 26  
Alarm 94  
Android Keyboard 29  
Answer a Call 48  
Apps  
    Find and install 34  
    Request refunds 35  
    Uninstall 36  
    Update 35  
Apps Settings 114  
Auto Rotate Screen 113

## B

Back Key 3  
Back Up Phone 119  
Basics 23  
Battery  
    Charge 14  
    Insert 12  
    Remove 13  
    Settings 114  
Battery Use 12  
Bluetooth 102  
    Connect 104  
    Pair devices 103  
    Receive information 105  
    Send information 105  
    Settings 109  
    Share pictures and videos 87  
    Turn on or off 103  
Bluetooth Information 103

## C

Calculator 92  
Calendar 92  
    Add event 93  
    View events 93  
Call Forwarding 57  
Call Logs  
    Make call from 52  
Call Settings 58  
Call Waiting 56  
Caller ID Blocking 55  
Camera  
    Settings 88  
    Take a picture 83  
    Viewfinder 83  
Camera and Video 83  
Capture Screenshots 24  
Car Kit  
    Connect 104  
Charger/Accessory Jack 3  
Check Contact 61  
Chrome 82  
Clock  
    Additional Features 95  
    Alarm 94  
    Stopwatch 95  
    Timer 95  
    World Clock 95  
Conference Calling 56  
Connectivity 99  
Contacts 59  
    Add contact 59  
    Delete 63  
    Edit 63  
    Import 64  
    Make call from 52  
    Save a phone number 61  
Contacts Screen Layout 62  
Credentials 116

## D

Data Usage Settings 110  
Date & Time Settings 120  
Default Messaging App Settings 112

- Device Administrators 116
- Disable the Screen Lock 117
- Display Settings 113
- Drag 17

## E

- Edit Pictures 85
- Editing Text 31
- Email 79
  - Add account 79
  - Compose and send 80
  - Delete account 82
  - Open new messages 81
  - Setup 79
  - Share pictures 86
  - View and reply 81
- Emergency Numbers 47
- Enhanced 9-1-1 (E 9-1-1) 48
- Enter Text 27
- Extended Home Screen 41

## F

- Factory Data Reset 120
- Files
  - Transfer between phone and computer 99
- Flash 3
- Flick 17
- Folders 45
- Font
  - Size 113
- For Assistance 125

## G

- Gallery 84
  - View pictures and videos 84
- Get Started 2
- Gmail 75
  - Add Account 78
  - Create account 32
  - Create and Send Message 75
  - Delete threads 77
  - Labels 77
  - Manage Messages 77
  - New messages 76
  - Read and reply 76
  - Read messages 76
  - Report phishing 78

- Report spam 78
- Search 77
- Share pictures 86
- Switch accounts 79

## Google

- Chrome 82
- Create account 32
- Hangouts 91
- Sign in 33
- Voice search 92
- Google Account 32
- Google Maps 90
- Google Play
  - Find and install apps 34
  - Help 36
  - Store 34
- Google Play Music 96
  - Create Playlists 97
  - Play music 97
  - Screen Layout 97
- Google Search 91
- Google Voice Typing 30, 118
- GPS Satellites 115

## H

- Hangouts 91
- Headset
  - Connect 104
- Headset Jack 3
- Home Screen 40
  - Add Folders 45
  - Add Shortcuts 44
  - Add Widgets 44
  - Customize 43
  - Extended 41
- Home Screen and Apps List 23
- Home Screen Layout 40

## I

- Import Contacts 64
- In-Call Screen Layout and Operations 50
- Incoming Call
  - Answer 48
- Input Settings 118
- Internet 66

**K**

Keyboard  
 Android keyboard 29  
 Default settings 118  
 Swype 28  
 Touchscreen 27

**L**

Language 118  
 Language Settings 118  
 Launch Applications 24  
 Location  
 GPS satellites 115  
 Wireless networks 115  
 Location Services 115

**M**

Maps 90  
 Memory 114  
 Messaging 66  
 microSD Card  
 Format 114  
 Mount 114  
 Unmount 114  
 MMS  
 Options 73  
 Send messages 67  
 More Settings 111  
 Multimedia Messaging  
 Share pictures and videos 87  
 Music  
 Google Play Music 96

**N**

Navigation 90  
 Google Maps 90  
 Notes 98  
 Notification Icons 42  
 Notifications 42  
 Notifications Window 43

**O**

Optional Services 52

**P**

Parts and Functions 2

Phone  
 Dialer 46  
 Phone App 46  
 Phone Calls  
 Answer 48  
 Emergency numbers 47  
 Using Call Logs 52  
 Using contacts 52  
 Using phone keypad 46  
 Phone Interface 40  
 Phone Layout (illustration) 2  
 Phone Number  
 Save to contacts 61  
 Phone Settings Menu 23  
 Phone Status 123  
 Phone Update  
 Software 37  
 Pictures  
 Crop 86  
 Rotate 85  
 Share via Bluetooth 87  
 Share via email 86  
 Share via messaging 87  
 Take with camera 83  
 View 84  
 Pinch 18  
 Place and Answer Calls 46  
 Play Music 96  
 Play Store 34  
 Find and install apps 34  
 Pointer Speed 118  
 Portrait and Landscape Screen  
 Orientation 23  
 Power Key 3  
 Power Off 16  
 Power On 16  
 Printing 122

**R**

Recent Applications 23  
 Rotate 18

**S**

Save a Phone Number 61  
 Scan Barcodes 88  
 Screen Lock 117  
 Screen Rotation 113  
 Screen Timeout 113

- Sd Card
  - Remove 10
- SD card
  - Format 114
- SD Card 8
  - Back Up Contacts 64
  - Erase 11
  - Insert 8
  - Mount 114
  - Unmount 10, 114
- Search
  - Google 91
- Security Settings 116
- Select Options and Navigate Screens 23
- Set Camera Functions 88
- Settings 107
  - Overview 107
- Setup Screens 19
- Share Pictures and Videos 86
- Silent Mode 25
- SIM Card 3
  - Handling 3
  - Insert 4
  - Remove 6
- Slide 17
- Sound Settings 112
- Speaker 3
- Specifications 126
- Spread 18
- Status Bar 41
- Status Icons 42
- Stopwatch 95
- Storage
  - Settings 114
- Swipe 17
- Switch Cameras 88
- Swype 28
- Sync calendars 94
- System Updates 123

## T

- Take Pictures and Record Videos 83
- Tap 17
- Text-to-Speech 118
- Text and Multimedia Messaging 66
- Text Editing 31
- Text Entry 27
- Text Messaging
  - Conversations 72

- Draft messages 71
- Notifications 71
- Options 73
- Send messages 66
- Time 94
- Timer 95
- Touch 17
- Touch and Hold 17
- Touchscreen
  - Keyboard 27
  - Turn off 36
  - Turn on 36
- Troubleshooting 125
- Turn Device Off 16
- Turn Device On 16
- Turn Your Phone On and Off 16
- Typing 27

## U

- Update Your Phone 37
- Use the Touchscreen 17
- Useful Apps and Features 90

## V

- Vibrate Mode 26
- Video Camera
  - Record video 84
- Videos
  - Record 84
  - Share via Bluetooth 87
  - Share via messaging 87
  - View 84
- Virgin Mobile Account Information and Help 126
- Visual Voicemail
  - Listen to multiple messages 54
- Voice Search 92
- Voice Typing 30
- Voicemail
  - Setup 52
- Volume
  - Key 3

## W

- Wallpaper 44, 113
- Wi-Fi 100
  - Disconnect 101
  - Settings 101, 108

- Turn on and connect 100
- Wi-Fi Direct 102
- Widgets 44
- World Clock 95

**Y**

- YouTube 95
  - Post a Video 96
  - View Videos 96

**Z**

- Zoom 18