

# HIGH SPEED DOME OPERATION MANUAL

---

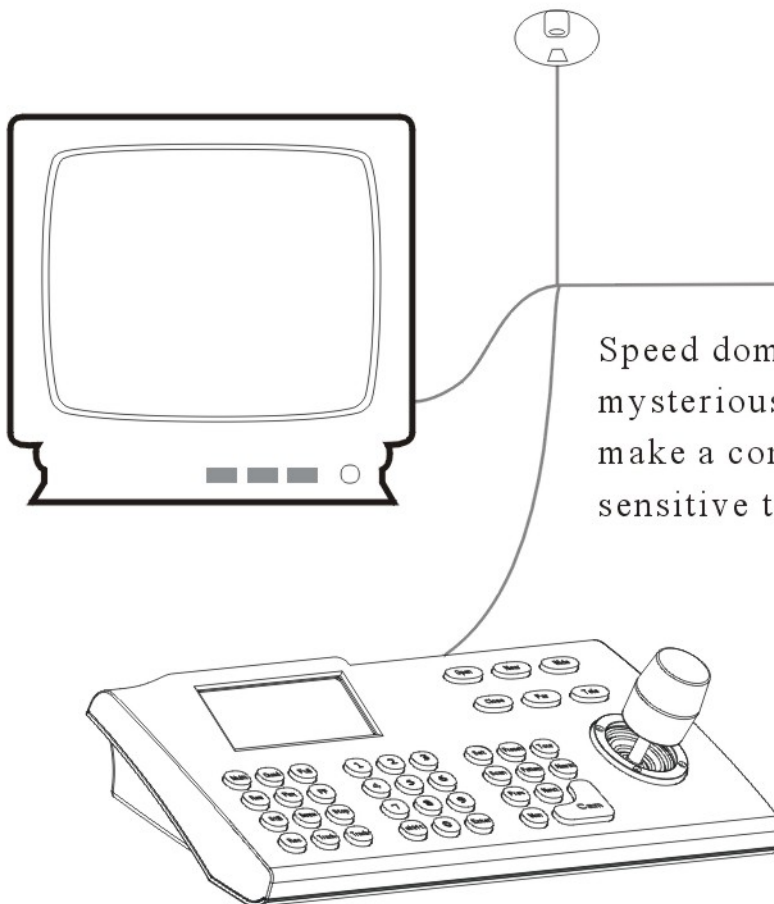

Speed dome camera looks like a mysterious owl at night, quiet, make a comprehensive view, be sensitive to catch.

# TABLE OF CONTENT

1. Notice-----	1
2. Performance-----	2
2.1 Speed dome technology parameter-----	2
2.2 Camera parameter-----	2
2.3 Performance & Feature-----	3
3. Function and operation instruction-----	4
3.1 Set camera ID-----	4
3.2 Auto-run motion-----	4
3.3 Camera control-----	5
3.4 Monitor function-----	5
4. System setting-----	7
4.1 Basic operation-----	7
4.1.1 Self-testing-----	7
4.1.2 Call the main menu-----	7
4.1.3 The operational ways of keyboard and menu-----	7
4.2 Edit dome label-----	8
4.3 Display initial information-----	9
4.4 Display setting-----	10
4.5 System setting-----	11
4.5.1 Auto flip-----	11
4.5.2 Speed proportion pan-----	11
4.5.3 Park action-----	12
4.5.4 Power up action-----	12
4.5.5 Fan startup by temperature-----	12
4.6 Clear -----	13
5. Camera setting-----	14
5.1 Zoom speed-----	14
5.2 Digital zoom control-----	15
5.3 Back light compensation-----	16
5.4 Slow shutter-----	17
5.5 IR cut filter-----	18
5.6 Line Sync control-----	19
5.7 WDR control-----	19
5.8 Advance setting-----	20
5.8.1 AE mode-----	20
5.8.2 White balance mode-----	21

6. Function setting	22
6.1 Preset	22
6.2 Scan	23
6.3 Pattern	24
6.4 Tour	25
6.5 Zone	26
7. Privacy zone masking	27
8. Alarm function	28
9. Appendix	29
9.1 Menu index	29
9.2 Troubleshooting	30
9.3 The cleaning of the down cover	30
9.4 24VAC Wire Diameter and Transmission Distance Comparison chart	31
9.5 Domestic and Board Wire Gauge Conversion Chart	32
9.6 Rs485 Bus Basic Knowledge	33
9.7 DIP switch setup	35
9.7.1 Baud rate setting	35
9.7.2 Protocol setting	35
9.7.3 ID setting	35

## 1. Precaution

### Electrical safety

Conform to country and local electrical safety standard when using or installing the product.

### Transportation

The dome should be protected against extremes of pressure, vibration and humidity during storage installation and transportation. It should be shipped in parts disassembled as the original packing did during the transportation. Damage caused by improper transportation is not within the warranty.

### Installation of care

Do not install it in any other orientation. Do not squeezed structure parts, which may cause mechanical damage. Down cover is a precise optical product. Do not touch it directly to avoid scratches which can affect image quality.

### Requirements to service personnel

All the service work should be done by qualified technicians.

### Do not disassemble the pan/tilt module

Do not disassemble screws or open the dome cover, and don't maintain the parts in the Pan/Tilt by yourself. Only qualified and authorized personnel can undertake repairs.

### Environmental requirements

Requirements for Indoor dome:

Environmental temp: -10~+50°C

Humidity: <90%

Air pressure: 86~106Kpa

AC Power supply: 24V/1000MA, 50/60HZ

Requirements for Outdoor dome:

Environmental temp: -40~+60°C

Humidity: <90%

Air pressure: 86~106Kpa

AC Power supply: 24V/2500MA, 50/60HZ

### Don't place the camera to be shoot by strong light objects

Don't place the camera to be shoot by strong light objects. Don't point the dome to the sun or other bright objects when in use or not. It may affect image quality.

### Function of waterproof

The outdoor dome has perfect function of water-proof, moisture-proof and dust-proof and It can reach IP66 International standard. The indoor dome doesn't install in outdoor environment where there is filled with hydrosphere. No matter Indoor dome or outdoor dome should avoid dropping which affect element quality.

# Performance

## 2. 1 Technology parameter

Electrical:		Setting:	
Power supply	AC24V	Baud rate (RS485)	2400/4800/9600/19200bps
Consumption	Indoor10W, outdoor45W	Protocol	Pelco, Kalatel, Philips, Diamond, and seventeen protocols, etc.
Decoder	Built-in	Address setting	0-255
Operation:		Environmental:	
Pan rotation	360° continuously	Operational environment	Outdoor: -40— +60°C Indoor:-10— +50°C
Tilt rotation	Tilt90° , with auto flip	Environmental humidity	0—95% no compensation
Rotation speed	Pan0.4~320°/S Tilt0.4~150°/S	Protection grade	IP66, Weather proofhousing, (outdoor) TVS1500w lightning proofsurge proof (indoor/outdoor)
Alarm function	7 alarm input/2 alarm output	Physical:	
Preset	128presets	Mount	Wall、Pendant、Corner、Pole、Insert
Surveillance	Preset、Tour、Scan、Pattern	Weight	4.25Kg(Outdoor)/3.85Kg(Indoor)
Speed	Magnification and proportion pan		

## 2. 2 Camera parameter

TYPE	A :18X Color	B :18X Color	C :18X Color&D/N	D :26X Color&D/N	H :22X Color	K :22X Color	J :23X Color&D/N	R:16X Color	Q:16X Color	S:18X Color&D/N	P:27X Color&D/N	
Sync system	Internal		External/Internal					Internal				
CCD	1/4"											
Scan system	2:1interlacing											
Definition	470Lines	480 Lines	480 Lines	480 Lines	480 Lines	480 Lines	480/570 Lines	420 Lines	480 Lines	480 Lines	480 Lines	
Sensitivity	0.9Lux	0.7Lux	Color0.7Lux Black/white0.01Lux	Color0.7Lux Black/white0.01Lux	0.9Lux	0.01Lux	Color0.8Lux Black/white0.01Lux					
Iris	Auto/manual											
Focus	Auto/manual											
Magnification	216X (18X,12X)		312X (26X,12X)	264X (22X,12X)	230X (23X,10X)	128X (16X,8X)	216X (18X, 12X)	270X (27X, 10X)				
Zoom length	4.1—73.8mm		3.5—91mm	4—88mm	3.6—82.8mm	3.9—63mm		3.6—97.2mm				
View of angle	W48° T2.7°		W54° T2.2°	W47° T2.2°	W54° T2.4°							
Back light compensation	Off/Auto						Off					
Gain control	Auto/manual											
Shield window	setable			None	setable			None				
Signal format	PAL/NTSC						PAL					
S/N	≥50dB			≥48dB	≥50dB			≥48dB				
Video output	1.0±0.2V <sub>P-P</sub>											
Video output	Female BNC											
Slow shutter	None	setable			None	setable			None			

### 2. 3 Performance and feature

A series of intelligent high speed dome is latest design with AMP electrical outlet, built-in constant device, convenient installation, and black cover which make an invisible surveillance. The camera rotates smartly with little noise, and has all kinds of functions, in order to supply perfect image to customer.

#### **Built-in receiver**

- All configurable options stored in main control board to protect against power cuts
- Integrate design and high durability
- 01-80 preset support auto-tour, and each tour can store up to 32 presets.
- 4 pattern tours
- Built-in direction indicator
- RS485 Bus communication or American Dynamics Manchester code or coaxial video cable
- Support 24 masking zones at most ( This function is decide by the parameter of built-in camera, if the camera has not this function, this option is invalid. )
- 7 alarm input, 2 alarm output ( This function is relative with the type of the dome, if zoom camera hasn't this function, it is invalid ).
- 128 presets can be randomly stored
- 1 scan
- Built-in temperature indicator

#### **Built-in pan/tilt**

- Pan/tilt can be divided as two kinds of material: aluminum and PC plastic
  - (→) Aluminum alloy material, high intensity, good radiate the heat.
  - (→) PC plastic, airily and high intensity
- Precise stepping motor drives the pan to run smoothly and react sensitivity.
- Integrated design, compact structure, easy to remove.
- Exquisite mechanical drive, support to rotate pan 360° continuously and tilt 0-90° , and may rotate 180° with auto flip.
- Pan 0.4° /s to rotate slowly, and the image doesn't vibrate.

#### **Built-in digital camera**

- High sensitivity, high resolution, and integrated digital processing
- Auto-focus
- Auto brightness control
- IR cut filter
- Auto slow shutter
- Auto-Iris
- Auto white balance
- Auto back light compensation

#### **OSD menu**

- All English menu can be selected.
- Visual OSD menu. Revising the speed dome's information and parameter by keyboard and OSD menu, and it is easy to operate.
  - Set park action function and set presets, or run scan, pattern, tour, etc during out of service.
  - Auto-resume movement or carry out pointed movements after power up.

#### **Internal temperature test**

- Set time display
- When the temperature exceeds the limit, the screen will display alarm information.
- When the temperature is under the limit, the speed dome will delay to startup, and when the heat device is heated and got higher than low limit temperature to startup.
  - According to the temperature, the fan measures if it is to start or not, and prolong the life of fan.

### 3. Function Instruction

This passage mainly describes the main function and general principle of integrative speed dome, and does not refer to the concrete operation methods. Different system platform has different operation methods, generally, we should according to the system manufactory's operation manual. Please contact dealer to get necessary information, under some conditions there are have some particular requirements and operations.

#### 3.1 Camera ID

There are two 8-bit switch sw1 and sw2 on the commutator, and Sw2 is for setting communication baud rate and controlling protocol. (For detail setting, please refer to 9.7 DIP switch setting)

Except the factory protocol(FACTORY), the speed dome is compatible with various popular protocols, such as PECLO-D、PECLO-P、ERNITEC、VCL、MOLYNX、VICON、SANTACHI、PANASONIC、SAMUNG、DIAMOND、KALATEL、LILIN、PHILIPS、VIDO B02、AD and so on.

Any controlling command must base on the objective camera address, and the camera only answer to the controlling command the address which coincide with itself. There are three kinds of camera address:

- Common address: Use camera's switch number to set address 1-8 bits, the address range is 1-254.
- Broadcast address:(Only factory protocol and Pelco can be set) If user chooses broadcast address to control, all the cameras connected with the control system will react to the same commands. When set as factory protocol, the broadcast address is 255.
- Debug address: (Only factory protocol and PELCO can be set) if camera ID is set 0, user may select any address to control the dome.

#### 3.2 Auto-run motion

##### Focus/speed proportion pan

When manually adjusting, for far focus situation, the dome responds at a high-speed so that touching rocker slightly may make picture move rapidly, thus cause the picture to lose. To base on humanized design, the dome automatically adjust pan and tilt rotation according to zoom near and far, which make it is convenient to operate manually to make tracks for the object. In the menu, you may change system parameter setting proportion pan as ON, thus you may run this function.

##### Auto flip

If user holds the joystick in the down position, the camera rotates pan 180 degrees, then the camera rotates tilts up to 90 degrees, you may directly watch the rear view to realize surveillance all processes in portrait 180 degrees . In the menu, you may set the system parameter setting AUTO FLIP as ON, thus you may run this function.

##### Park action

By the menu “ park time” and “park action” , user may set auto-call preset or run tour, pattern, and scan, etc after pointing a few minutes if the dome doesn't run any motions.

##### Power up action

By the menu “ power up action” , after the dome powers up or restarts, user may set auto- resume movements before power up and auto- call preset or run tour, pattern, and scan etc .

### 3. 3 Camera control

#### Magnification control

The user can control “Wide/Tele” to adjust zoom far and near of the image by keyboard controller to obtain panoramic image or close view that you need. The speed dome support digital zoom and optical zoom.

#### Focus control

System defaults Auto focus. When the lens changes, camera will auto-adjust focus according to the centre of the image to get legible image; user also can manually focus to get desire image by operating keyboard “FAR/NEAR” . When operating keyboard joystick, camera resumes to auto focus.

The camera cannot auto focus in the following status:

- Target is not the centre of the image
- Observation the target near and far at the same time, can not be clear at the same time.
- Target is a strong light object, such as spotlight & etc.
- Target moves too fast
- Target area such as wall
- Target is too dark or vague
- Target image is too small

#### Iris control

System defaults Auto Iris. Camera can rapidly adjust size of Iris, through the automatically induct the changing of environment ray, and thus make the brightness of deferent image stable.

User may adjust Iris by controller keyboard “open/close” to get required brightness that you need. User also can resume auto Iris by joystick operation. When controlling the Iris manually, the dome locks current position you manually controlled; when operating joystick, the dome resume auto Iris.

#### Auto back light compensation

Camera sub-area can carry out auto back light compensation. Under a strong light background, camera will auto compensate light for the darker object and adjust daylight to the bright background. In order to avoid making the image lack fidelity by the back line is too bright, and the object is unable to recognize because of darkness, thus gain legible image.

#### Auto white balance

Camera can automatically adjust white balance in accordance with the alteration of background lightness to reach a true colour.

### 3. 4 Monitor function

#### Set and call preset

Preset function is that dome stores current pan/tilt angle, zoom and other position parameters into the memory. When necessary dome recalls these parameters and adjust camera to that position. User can store and recall presets easily and promptly by using keyboard controlling. The dome can store up to 128 presets.

#### Tour

Auto tour is the built-in function in the speed dome, is to make preset arranged in needful order in tour queue by programming in advance. To make camera tour between presets by inserting presets in cruise tour. It is feasible to program tour order, each time as you run tour, you can set the park time of preset. A tour can store 32 presets.



## **Scan**

The operator can prompt set right limit and left limit in advance by keyboard and menu, so as to make the camera repeatedly scanned between right and left limit at a setting speed.

## **Pattern**

Pattern is built-in function in camera; the speed dome can record tracks that are no less than 180s, when running pattern, the dome moves repeatedly according to the recorded tracks. A dome can set up to 4 pattern tours.

## **Alarm input/output controlling function**

The dome receive an external alarm message, to implement the action that you pre-set, till the alarm release to resume, if abnormality, it will send another alarm message. The dome can set up to 7 alarm input and 2 alarm output. ( This function is decided by the parameter of built-in camera, if the camera has not this function, this option is invalid N/A.)

## **Privacy zone masking**

The user can set a black shadow to mask the area so that it will not appear on the monitor to protect privacy. ( This function is relative with the type of the dome, if zoom camera hasn't this function, it is invalid).

## **Lens position display**

The position that the speed dome has finished to auto-checking as 0 point of pan movement and tilt movement. The pan range is 0-360° , and tilt range is 0-90° . According to the displayed information, to set the position of camera lens, and the position can display on the screen.

## 4. System setting

### 4.1 Basic operation

#### 4.1.1 Current-carrying to dome and Self-testing

The dome conducts self-testing after current-carrying, and it rotates slowly until displaying pan origin that is default setting, then moving to tilt origin, the lens is adjusted from far zoom to near zoom, then from near zoom to far zoom, when self-testing is finished, there is relevant system information displaying on the screen, as follow:

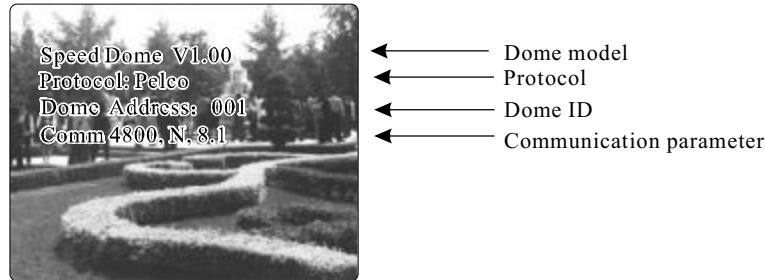

The information will not disappear until you stop to operate the system. If you set “power up action”, the dome will automatically activate motions after self-testing. How to operate the function? We will explain detail introduction in following passages.

#### 4.1.2 Call the main menu

The system enters into the main menu by calling 95 preset or by calling 9 preset twice within 3 seconds. All the menu setting must enter into the main menu at first.

#### 4.1.3 Menu and keyboard operation

##### Keyboard operation:

**【OPEN】** when choosing pictures, it means to increase Iris; when setting menu, it means to enter into the next menu or setting, or means to save after setting.

**【CLOSE】** when choosing pictures, it means to reduce Iris; when setting menu, it means to exit without saving setting.

**【NEAR】** Focus to near

**【TELE】** Increase magnification

**【WIDE】** Reduce magnification

Joystick to up: When choosing menu, it means to choose the former one; when choosing picture, it means camera tilt up.

Joystick to down: when choosing menu, it means to choose the next one; when choosing picture, it means camera tilt down.

Joystick to left: when choosing menu, it is equal with **【CLOSE】**, when choosing picture, it means camera tilt left.

Joystick to right: when choosing menu, it is equal with **【OPEN】**, when choosing picture, it means camera tilt right.

Press **【TELE】** and **【WIDE】** at the same time, it means 3D joystick rotates joystick cap.

##### Menu operation

“BACK” : Back to the former menu

“EXIT” : Exit to menu

“ON” : Open some setting

“OFF ” : Close some setting

## System setting

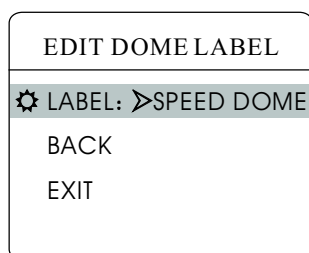
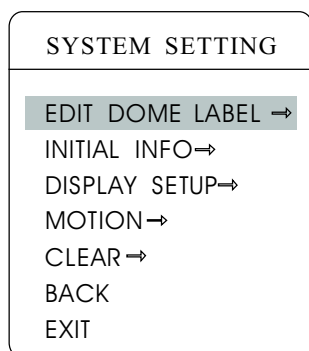
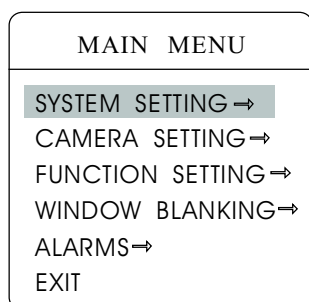

### 4. 2 Edit dome label

When using a lot of domes' systems, in order to identify each dome, the systems support title setting. The setting ways as follow:

- 1、 The system enters into the main menu by calling 95 preset or by calling 9 preset twice within 3 seconds.
- 2、 Moving joystick up and down to move the cursor to **【SYSTEM SETTING】** , and pressing **【OPEN】** to enter into the next menu.
- 3、 Moving joystick up and down to move the cursor to **【EDIT DOME LABEL】** , and pressing **【OPEN】** to enter into the label setting menu.
- 4、 Moving joystick up/down to move the cursor to **【LABEL】** , and pressing **【OPEN】** to edit current label.
- 5、 When the cursor is twinkling in the first character of the label, to move joystick to choose character, after editing, pressing **【OPEN】** to save.
- 6、 Moving joystick to **【BACK】** and pressing **【OPEN】** to back to the former menu.



NOTICE

The label may set 16 characters, and doesn't need editing characters. Pressing **【OPEN】** continuously to jump over and using spacebar to replace the deleted characters. When you finish to edit a character, press **【OPEN】** to enter into the next editing character; when you editing the last character, pressing **【OPEN】** to save. Press **【Close】** to exit.

Character of label is suitable for choosing as follow: 0- 9、 A-Z、 :<>-.、 Space.  
Other labels' input ways are the same as above.

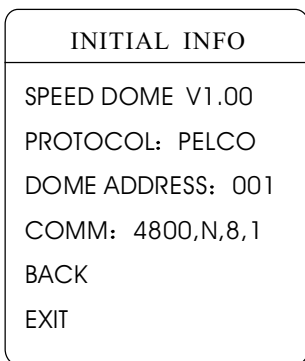
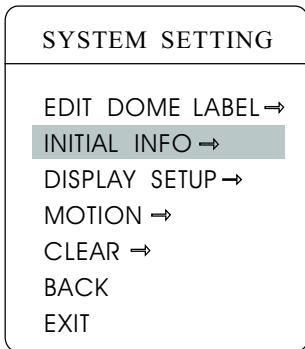
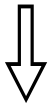
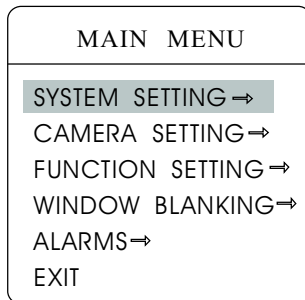

### 4.3 Display initial information

- 1、 The system enters into the main menu by calling 95 preset or by calling 9 preset twice within 3 seconds.
- 2、 Tilt up/down joystick to **【SYSTEM SETTING】** , press **【OPEN】** to enter submenu.
- 3、 Tilt up/down joystick to **【INITIAL INFO】** , press **【OPEN】** to display initial information which as below the left picture shows:

Initial information includes the name of manufacturer, soft edition, camera address, communication parameter. System setting may change the numerical value of initial information.

# System setting

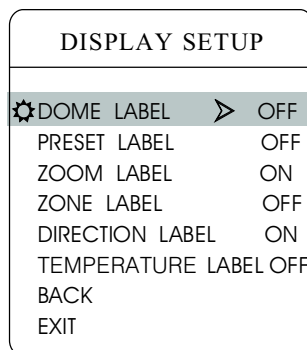
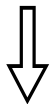
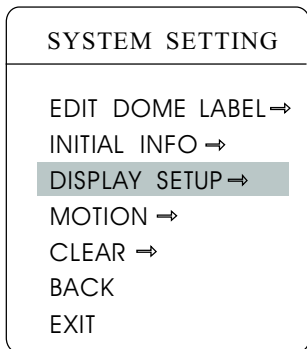
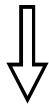
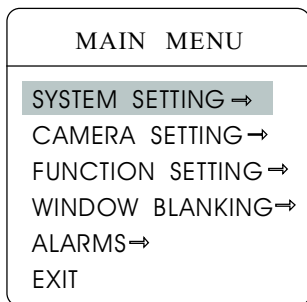

## 4. 4 Display setup

1、 The system enters into the main menu by calling 95 preset or by calling 9 preset twice within 3 seconds.

2、 Tilt up/down joystick to **【SYSTEM SETTING】** , press **【OPEN】** to enter submenu.

3、 Tilt up/down joystick to **【DISPLAY SETUP】** , press **【OPEN】** to enter “display setup” menu, May setting the content of the display setup as follow:

- **【DOME LABEL】**
- **【PRESET LABEL】**
- **【ZOOM LABEL】**
- **【ZONE LABEL】**
- **【DIRECTION LABEL】**
- **【TEMPERATURE LABEL】**

4、 Taking display dome label as an example to explain the operation process. Tilt up/down joystick to move cursor to **【DOME LABEL OFF】** , press **【OPEN】** , there is a sign  besides **【DOME LABEL】** , the cursor is twinkling besides **【OFF】** , as left picture shows;

5、 Joystick tilts up/down, setting number changes between ON/OFF, when setting **【ON】** , it means to display “dome label” ;when setting **【OFF】** , it means not to display “dome label” .when pressing **【OPEN】** , the cursor jump back in front of **【DOME LABEL】** , means label setting is finished, when moving the cursor to **【EXIT】** , it means exiting the menu setting.

The displaying information on the screen will change with the dome rotation; Through the information on the screen, user can see current dome inside temperature, magnification, display zone etc. When all the label are displayed, the dome works as the following picture shows,:(In the picture “305” means pan angle, “45” means tilt angle.)

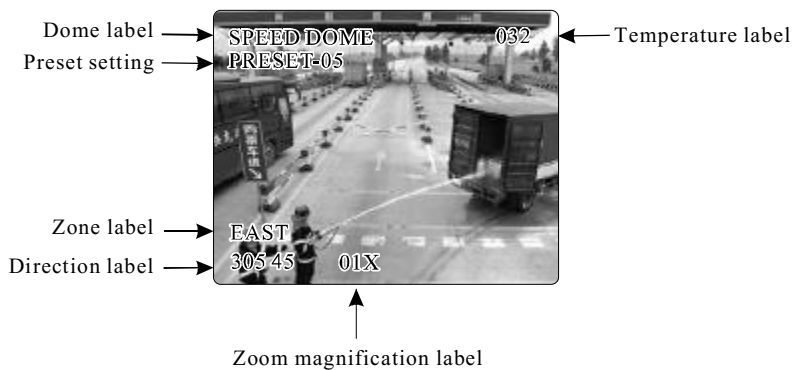

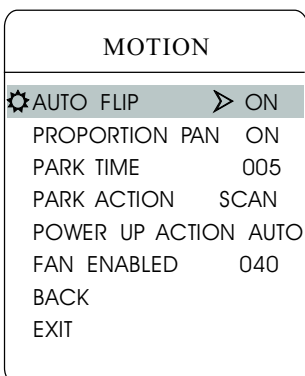
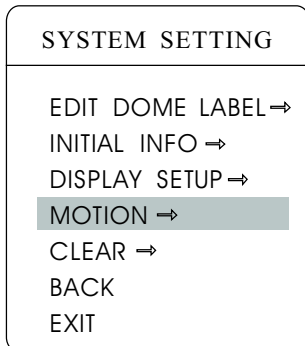
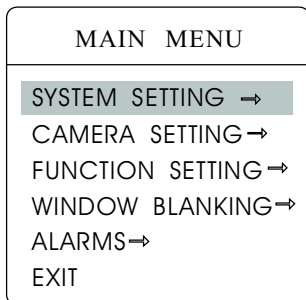

## 4. 5 Systematic motion control

Systematic motion controlling may control a series of canonical movement of the dome, and plays an important role in controlling the image of the dome.

1、 The system enters into the main menu by calling 95 preset or by calling 9 preset twice within 3 seconds.

2、 Tilt up/down joystick to **【SYSTEM SETTING】** , press **【OPEN】** to enter submenu.

3、 Tilt up/down joystick to **【MOTION】** , press **【OPEN】** to enter systematic motion controlling menu, as left picture shows.

### 4. 5. 1 Auto flip

1、 Operate joystick, move the cursor to **【AUTO FLIP】** : press **【OPEN】** to enter “ auto flip ” setting, tilt up/down joystick, for example: choosing ON to open “ auto flip ” ; choosing OFF to close “auto flip” .

Press **【OPEN】** to save.

#### OPERATION KNACKS

When opening the auto flip function, user holds the joystick in the down position, the camera rotates pan 180 degrees, after the camera rotates tilts up to 90 degrees, you may directly watch the rear view to surveillance all processes in portrait 180 degrees .

### 4. 5. 2 Speed proportion pan

Operate joystick, move the cursor to **【PROPORTIONAL PAN】** ; press **【OPEN】** to enter “ proportion pan ” setting, tilt up/down joystick to choose, if choosing **【ON】** , it means to open proportion pan; if choosing **【OFF】** , it means to close proportion pan , press **【OPEN】** to save.

#### OPERATION KNACKS

When manually adjusting, for far focus situation, the dome responds at a high-speed so that touching rocker slightly may make picture move rapidly, thus cause the picture to lose. To base on humanized design, the dome automatically adjust pan and tilt rotation according to zoom near and far, which make it is convenient to operate manually run after object.

MOTION	
AUTO FLIP	ON
PROPORTION PAN	ON
 PARK TIME	➤ 005
PARK ACTION	SCAN
POWER UP ACTION	AUTO
FAN ENABLED	040
BACK	
EXIT	

MOTION	
AUTO FLIP	ON
PROPORTION PAN	ON
PARK TIME	005
PARK ACTION	SCAN
 POWER UP ACTION	AUTO
FAN ENABLED	040
BACK	
EXIT	

MOTION	
AUTO FLIP	ON
PROPORTION PAN	ON
PARK TIME	005
PARK ACTION	SCAN
POWER UP ACTION	AUTO
 FAN ENABLED	➤ 040
BACK	
EXIT	

### 4. 5. 3 Park action

This setting allows the dome to run an appointed action after it enters vacancy for a few time (1-240minutes). If default sets as 0, it means not to run this action.

1、 Operate joystick, move the cursor to **【PARK TIME】** , press **【OPEN】** to tilt up/down joystick to set park time, the range is 0-240 (minute), press **【OPEN】** to save. **【PARKACTON】** is running action at park time, when **【PARK TIME】** sets as 0, this item can't be set.

2、 Operate joystick, move the cursor to **【PARKACTON】** , press **【OPEN】** there will be a sign  in the front of **【PARKACTON】** , the cursor jump to right, after tilting up/down joystick to choose “park action” , there are options for choosing as follow, press **【OPEN】** to save.

- **【NONE】** - (default) none action
- **【PRESET】** -use preset 1
- **【SCAN】** -run scan
- **【PAT1】** - run pattern X
- **【TOUR】** - run tour

### 4. 5. 4 Power up action

The dome startup to run actions after self-testing, if nobody intervenes with it , the dome will repeatedly run this action continuously ,if default sets as **【NONE】** .

1、 Operate joystick, move the cursor to **【POWER UP ACTION】** : press **【OPEN】** to jump to the following choice, tilt up/down joystick to choose “power up action” , press **【OPEN】** to save.

- **【NONE】** - none action
- **【AUTO】** - the dome resumes the primary action and direction before power up.

- **【PRESET】** - use preset 1
- **【SCAN】** - run scan
- **【PAT1】** - run pattern X
- **【TOUR】** - run tour

### 4. 5. 5 Fan startup by temperature

The temperature of the dome will rise when its environment is in high temperature. The fan will open automatically when the temperature reaches to a temperature value in order to make sure the stability of the dome.

Operate joystick, move the cursor to **【FANENABLED】** : press **【OPEN】** , the cursor will skip to the back option. The user can choose the fan to start up temperature, and press **【OPEN】** to save it in actual condition.

The default setting temperature of the fan startup is 40°C. The user also can enter into the fan startup setting to adjust the temperature of fan startup. As picture shows: the temperature range is 0-60°C.

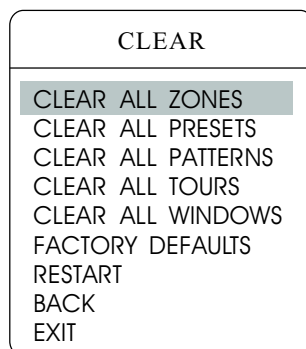
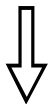
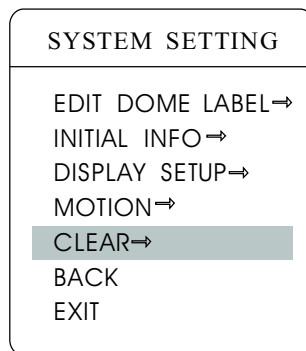
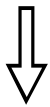
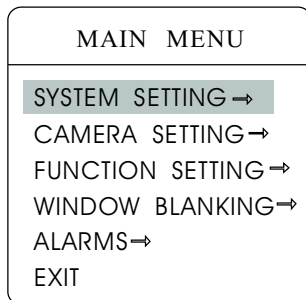

### 4. 6 Clear and restart

1、 The system enters into the main menu by calling 95 preset or by calling 9 preset twice within 3 seconds.

2、 Tilt up/down joystick to **【SYSTEM SETTING】** , press **【OPEN】** to enter submenu.

3、 Tilt up/down joystick to **【CLEAR】** , press **【OPEN】** to enter submenu, as left picture shows.

- **【CLEAR ALL ZONES】**
- **【CLEAR ALL PRESETS】**
- **【CLEAR ALL PATTERNS】**
- **【CLEAR ALL TOURS】**
- **【CLEAR ALL WINDOWS】**
- **【FACTORY DEFAULTS】** :resume the factory default. Run this function, the camera parameter and system parameter will resume before production, clear all windows and alarm setting. Please be cautious to use this function.
- **【RESTART】**

4、 Set clear zone as an example to explain the process. Tilt up/down joystick to **【CLEAR ALL ZONES】** , press **【OPEN】** to clear all zones.



NOTICE

once clear all commands in the controlling menu, they doesn't resume, so please be careful of using.



# Camera setting

---

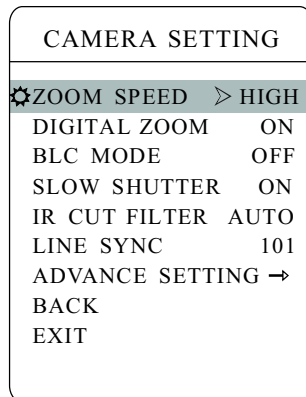
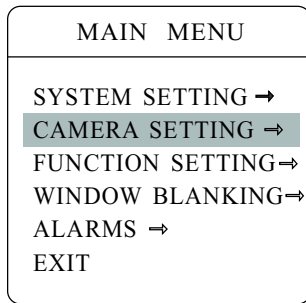

## 5. Camera setting

### 5. 1 Zoom speed

- 1、 The system enters into the main menu by calling 95 preset or by calling 9 preset twice within 3 seconds.
- 2、 Tilt up/down joystick to **【CAMERA SETTING】** , press **【OPEN】** to enter submenu;
- 3、 Operate joystick, move the cursor to **【ZOOM SPEED】** ; press **【OPEN】** will appear a sign  in the front of **【ZOOM SPEED】** , the cursor moves to right, tilt up/down joystick to choose **【HIGH】** or **【LOW】** ;
- 4、 Press **【OPEN】** to save, press **【CLOSE】** to cancel.

MAIN MENU	
SYSTEM SETTING →	
<b>CAMERA SETTING →</b>	
FUNCTION SETTING →	
WINDOW BLANKING →	
ALARMS →	
EXIT	

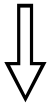

CAMERA SETTING	
ZOOM SPEED	HIGH
<b>⚙️ DIGITAL ZOOM</b>	<b>➤ ON</b>
BLC MODE	OFF
SLOW SHUTTER	ON
IR CUT FILTER	AUTO
LINE SYNC	OFF
WDR MODE	ON
ADVANCE SETTING →	
BACK	
EXIT	

### 5. 2 Digital zoom control

- 1、 The system enters into the main menu by calling 95 preset or by calling 9 preset twice within 3 seconds.
- 2、 Tilt up/down joystick to **【CAMERA SETTING】** , press **【OPEN】** to enter camera setting;
- 3、 Operate joystick, move the cursor to **【DIGITAL ZOOM】** , press **【OPEN】** to enter digital zoom setting, tilt up/down joystick, to choose ON means open digital zoom control which is digital zoom is pulled near, if pulling the digital zoom near again, the dome enters into “ digital zoom increase” ; to choose OFF means to close digital zoom control.
- 4、 Press **【OPEN】** to save.

#### OPERATION KNACKS

When digital zoom be set as ON, the maximum zoom magnification of the dome is digital zoom magnification times optical zoom magnification; when digital zoom be set as OFF, the maximum zoom magnification of the dome is optical zoom magnification.



**NOTICE**

The option of the digital zoom is ON/OFF when the camera module is SONY 、 LG、 CNB、 HITACHI.

MAIN MENU	
SYSTEM SETTING →	
<b>CAMERA SETTING →</b>	
FUNCTION SETTING →	
WINDOW BLANKING →	
ALARMS →	
EXIT	



CAMERA SETTING	
ZOOM SPEED	HIGH
DIGITAL ZOOM	ON
<b>⚙️ BLC MODE</b>	<b>➤ OFF</b>
SLOW SHUTTER	ON
IR CUT FILTER	AUTO
LINE SYNC	OFF
WDR MODE	ON
ADVANCE SETTING →	
BACK	
EXIT	

## 5. 3 Back light compensation

- 1、 The system enters into the main menu by calling 95 preset or by calling 9 preset twice within 3 seconds.
- 2、 Operate joystick, move the cursor to **【CAMERA SETTING】** to enter submenu.
- 3、 Operate joystick, move the cursor to **【BLC MODE】** , press **【OPEN】** , There will be a sign  in the front of **【BLC MODE】** , the cursor jump to right, tilt joystick to open or close back light compensation function. If choosing ON means to open back light compensation mode; if choosing OFF means to close back light compensation mode;
- 4、 Press **【OPEN】** to save.

### OPERATION KNACKS

Strong background ray can make backlighting objects engender shadow, (back light compensation), the speed dome can auto-adjust iris to match with the changes of various ray, and auto-revise the main lightness to make the pictures more legible.



#### NOTICE

This function relates to models and parameters of the built-in camera in the dome, when open black compensation, it has two functions which are auto-adjust (when you choose ON) or manual adjust(0-255) according to the different of the camera.



Non-use back light compensation, in strong sunshine, the backlight side is subject to dark.



Use back light compensation, the image is in gear.

MAIN MENU	
SYSTEM SETTING →	
CAMERA SETTING →	
FUNCTION SETTING →	
WINDOW BLANKING →	
ALARMS →	
EXIT	



CAMERA SETTING	
ZOOM SPEED	HIGH
DIGITAL ZOOM	ON
BLC MODE	OFF
⚙️ SLOW SHUTTER	➤ ON
IR CUT FILTER	AUTO
LINE SYNC	OFF
WDR MODE	ON
ADVANCE SETTING →	
BACK	
EXIT	

### 5. 4 Slow shutter control

- 1、 The system enters into the main menu by calling 95 preset or by calling 9 preset twice within 3 seconds.
- 2、 Operate joystick, move the cursor to **【CAMERA SETTING】** to enter submenu.
- 3、 Operate joystick, move the cursor to **【SLOW SHUTTER】** , press **【OPEN】** , there will be a sign ⚙️ in the front of **【SLOW SHUTTER】** , the cursor moves to right, tilt up/down joystick to “slow shutter” choice, if choosing ON means to open slow shutter function, if choosing OFF means close “slow shutter” function.
- 4、 Press **【OPEN】** to save.

#### OPERATION KNACKS

When the dome monitors at night or dark environment, because the ray is not enough, the image on the screen is too dark, setting slow shutter can lengthen the time of lighting so that make the picture that is shoot in dark more legible.



#### NOTICE

This function depends on the models and parameters of built-in camera in dome, if the camera haven't this function, then this function is invalid.

MAIN MENU	
SYSTEM SETTING →	
CAMERA SETTING →	
FUNCTION SETTING →	
WINDOW BLANKING →	
ALARMS →	
EXIT	



CAMERA SETTING	
ZOOM SPEED	HIGH
DIGITAL ZOOM	ON
BLC MODE	OFF
SLOW SHUTTER	ON
 IR CUT FILTER	➤ AUTO
LINE SYNC	OFF
WDR MODE	ON
ADVANCE SETTING →	
BACK	
EXIT	

## 5.5 IR cut filter

- 1、 The system enters into the main menu by calling 95 preset or by calling 9 preset twice within 3 seconds.
- 2、 Operate joystick, move the cursor to **【CAMERA SETTING】** to enter submenu.
- 3、 Operate joystick, move the cursor to **【IR CUT FILTER】** ; press **【OPEN】** , there will be a sign  in the front of **【IR CUT FILTER】** , the cursor jumps to right, move joystick to “ IR cut filter” , choices as follow, **【AUTO】** is default.
  - **【AUTO】** IR cut filter mode, it means the dome automatically transfers according to sensitivity.
  - **【COLOR】** set as color mode
  - **【BLACK】** set as black and white mode
- 4、 Press **【OPEN】** to save.

### OPERATION KNACKS

IR cut filter function uses color in day; use black and white at night. This function not only guarantees the quality of image, but also saves the room of storage.



#### NOTICE

This function depends on the models and parameters of built-in camera in dome, if the camera haven't this function, then this function is invalid.(N/A)

MAIN MENU
SYSTEM SETTING →
CAMERA SETTING →
FUNCTION SETTING →
WINDOW BLANKING →
ALARMS →
EXIT



CAMERA SETTING
ZOOM SPEED    HIGH
DIGITAL ZOOM    ON
BLC MODE        OFF
SLOW SHUTTER    ON
IR CUT FILTER    AUTO
⚙️ LINE SYNC      > OFF
WDR MODE        ON
ADVANCE SETTING →
BACK
EXIT

CAMERA SETTING
ZOOM SPEED    HIGH
DIGITAL ZOOM    ON
BLC MODE        OFF
SLOW SHUTTER    ON
IR CUT FILTER    AUTO
LINE SYNC        OFF
⚙️ WDR MODE       > ON
ADVANCE SETTING →
BACK
EXIT

### 5. 6 Line sync control

- 1、 The system enters into the main menu by calling 95 preset or by calling 9 preset twice within 3 seconds.
- 2、 Operate joystick, move the cursor to **【CAMERA SETTING】** , press **【OPEN】** to enter submenu.
- 3、 Operate joystick, move the cursor to **【LINE SYNC】** ; press **【OPEN】** , tilt up/down joystick to set line sync. Line sync can divide two kinds: internal/external, choose OFF is internal sync; choose ON is external sync; press **【OPEN】** to save.

#### OPERATION KNACKS

When a lot of domes use a line in the same time, if the image is twinkling as switching, please set each dome as external line and adjust the numerical value of external line.



**NOTICE**

This function is relative with the model and parameter of the camera module which insert in the dome. The option is useless(N/A) when the camera module has no such function.

### 5. 7 WDR Control

- 1、 The system enters into the main menu by calling 95 preset or by calling 9 preset twice within 3 seconds.
- 2、 Operate joystick, move the cursor to **【CAMERA SETTING】** press **【OPEN】** to enter submenu.
- 3、 Operate joystick, move the cursor to **【WDR MODE】** ,press **【OPEN】** , tilt up/down joystick to set WDR; Choose ON means open WDR, choose OFF means close WDR, Press **【OPEN】** to save.



**NOTICE**

This function is relative with the model and parameter of the camera module which insert in the dome. The option is useless(N/A) when the camera module has no such function.

MAIN MENU	
SYSTEM SETTING →	
<b>CAMERA SETTING →</b>	
FUNCTION SETTING →	
WINDOW BLANKING →	
ALARMS →	
EXIT	



CAMERA SETTING	
ZOOM SPEED	HIGH
DIGITAL ZOOM	ON
BLC MODE	OFF
SLOW SHUTTER	ON
IR CUT FILTER	AUTO
LINE SYNC	OFF
WDR MODE	ON
<b>ADVANCE SETTING →</b>	
BACK	
EXIT	



ADVANCE SETTING	
<b>⚙️ AE MODE</b>	<b>➤ AUTO</b>
SHUTTER	N/A
IRIS	N/A
BRIGHT	N/A
BW MODE	AUTO
R GAIN	N/A
B GAIN	N/A
ALC	83
PLC	16
BACK	
EXIT	

## 5. 8 Advance setting

1、 The system enters into the main menu by calling 95 preset or by calling 9 preset twice within 3 seconds.

2、 Operate joystick, move the cursor to **【CAMERA SETTING】** to enter submenu.

3、 Operate joystick, move the cursor to **【ADVANCE SETTING】** ; press **【OPEN】** to enter submenu, as left picture shows;

### 5. 8. 1 AE mode

1、 Operate joystick, move the cursor to **【AE MODE】** , press **【OPEN】** , tilt up/down joystick to choose AE mode, modes for choosing as follow:

- **【AUTO】** : default setting, auto Iris mode
- **【BRIGHT】** : brightness priority mode
- **【IRIS】** : iris priority mode
- **【SHUTTER】** : shutter priority mode

2、 Choose Iris priority mode **【IRIS】** , press **【OPEN】** to save.

3、 Move joystick to the sub-choices of AE mode **【IRIS F1.4】** , press **【OPEN】** to choose adequate Iris, press **【OPEN】** to save.

- **【SHUTTER 1/50】** it means shutter speed, when AE mode is shutter priority, this function can be set.
- **【IRIS F1.4】** it means the size of iris, when AE mode is iris priority, this function can be set.
- **【BRIGHT F2.0/ODB】** it means brightness, when AE mode is brightness priority, this function can be set.

#### OPERATION KNACKS

Quality of photo relates to exposure amount, that is to say how much light can make CCD receives legible image. Exposure amount is relative to the time of lighten (be up to shutter speed) and the area of lighten (be up to the size of iris).

The camera can automatically calculate suitable exposure amount according to brightness of scenery and CCD sensitivity, in the situation that the exposure amount is certain: **【SHUTTER】** (shutter priority) is to fix shutter speed, the camera will auto decide to use how much iris; **【IRIS】** (iris priority) is to fix the size of iris, and auto-decide to use shutter speed. **【BRIGHT】** (brightness priority) is point that the camera TTL check the light directly and control the brightness of image.

MAIN MENU	
SYSTEM SETTING →	
CAMERA SETTING →	
FUNCTION SETTING →	
WINDOW BLANKING →	
ALARMS →	
EXIT	



CAMERA SETTING	
ZOOM SPEED	HIGH
DIGITAL ZOOM	ON
BLC MODE	OFF
SLOW SHUTTER	ON
IR CUT FILTER	AUTO
LINE SYNC	101
ADVANCE SETTING →	
BACK	
EXIT	



ADVANCE SETTING	
AE MODE	AUTO
SHUTTER	N/A
IRIS	N/A
BRIGHT	N/A
⚙️ BW MODE	▶️ AUTO
R GAIN	N/A
B GAIN	N/A
ALC	83
PLC	16
BACK	
EXIT	

### 5. 8. 2 White balance mode

System supports **【AUTO】**、indoor mode **【INDOOR】**、outdoor mode **【OUTDOOR】**、auto track mode **【ATW】**、single mode **【OPW】**、**【OPT】** mode、manual mode **【MANUAL】** and kinds of white balance modes, etc. Detail setting as follow:

1、The system enters into the main menu by calling 95 preset or by calling 9 preset twice within 3 seconds. click each command enter into “ advanced setting ” menu according to the order in left picture .

2、Operate joystick, move the cursor to **【BW MODE】** to choose white balance mode, press **【OPEN】** to save.

Auto mode **【AUTO】** is the default mode of speed dome, which is auto-revert real color after the white balance sensor check the environment by camera. When choosing manual mode **【MANUAL】** , adjust the numerical value of **【R GAIN】** and **【B GAIN】** .

- **【R GAIN】** the range is 1-225; the numerical value is bigger, it means that adding red is more, the tone changes to be warm.
- **【B GAIN】** the range is 1-225; the numerical value is bigger, it means that adding green is more, the tone changes to be cold.

Indoor mode **【INDOOR】** , and the tone leans to cold.

Outdoor mode **【OUTDOOR】** , and the tone leans to warm.

Average Level Control **【ALC】** range is 000-255.

Peak Level Control **【PLC】** range is 000-127.

It is possible that different camera has not the setting of **【INDOOR】** , **【OUTDOOR】** , **【ALC】** , **【PLC】** ; That means the current camera has no such function when the setting options shows N/A.

**NOTICE**



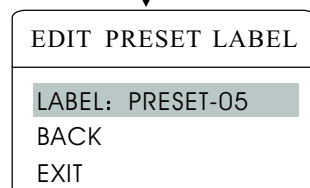
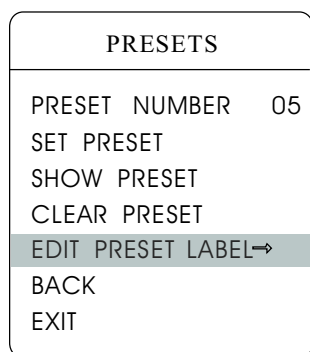
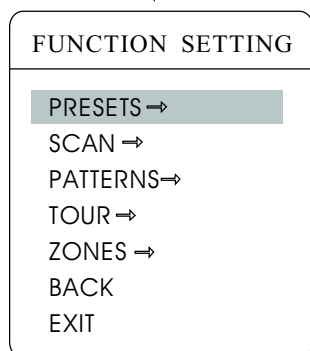
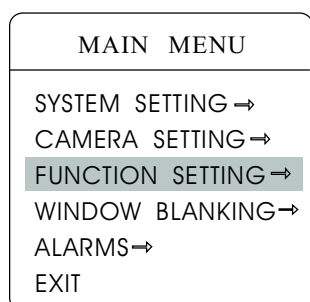

## 6. Function setting

### 6.1 Preset

1、 The system enters into the main menu by calling 95 preset or by calling 9 preset twice within 3 seconds. click each command to enter “ preset menu” according to the order of the left picture. As following:

- **【PRESET NUMBER】**
- **【SET PRESET】**
- **【SHOW PRESET】**
- **【CLEAR PRESET】**
- **【EDIT PRESET LABEL】**

Define preset and call preset function can be set by keyboard operation, input preset number at first, then click the key “save /call preset” to carry out.

2、 Define current preset number: move the cursor to **【PRESET NUMBER】** ,press **【OPEN】** to choose preset number, the range is 01-128 as the left picture show, here chooses number 5 as current preset, the following operations aim at the current preset.

3、 Define current preset: move the cursor to **【SET PRESET】** ,press **【OPEN】** , by operating joystick to adjust magnification, to choose good objective image, press **【OPEN】** to save. If the image is very near, the image is belong in digital zoom; when setting preset, the image will jump to maximal optical zoom.

#### OPERATION KNACKS

Preset function is that dome stores current pan/tilt angle, zoom and other position parameters into the memory. When necessary dome recalls these parameters and adjust camera to that position.

4、 Display current preset: move the cursor to **【SHOW PRESET】** , press **【OPEN】** , the screen will display the current preset;

5、 Clear current preset: move the cursor to **【CLEAR PRESET】** , press **【OPEN】** , the current preset is cleared.

6、 Edit current preset label: move the cursor to **【EDIT PRESET LABEL】** , press **【OPEN】** to enter into editing preset submenu, system auto-sets label as PRESET-XX, press **【OPEN】** to revise label.



#### NOTICE

1. When running to program, display, clear preset and edit label, should choose preset number at first.
2. The label may setup to 16 characters, and doesn't need editing characters. Press **【OPEN】** continuously to jump over and use spacebar to replace the deleted characters.

When you finish to edit a character, press **【OPEN】** to enter into the next editing character;  
 when you finish to edit the last character, pressing **【OPEN】** to save. Press **【CLOSE】** to exit. Character of label is suitable for choosing as follow: 0-9、 A-Z、 :<>-. , space.

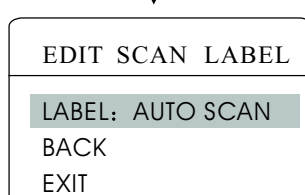
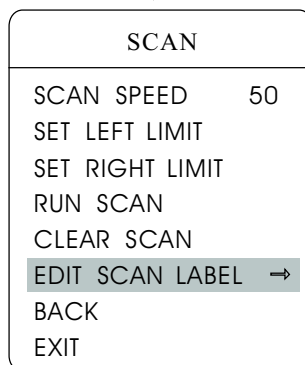
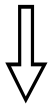
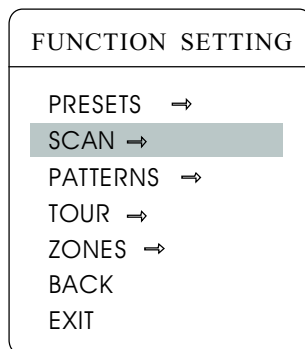
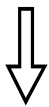
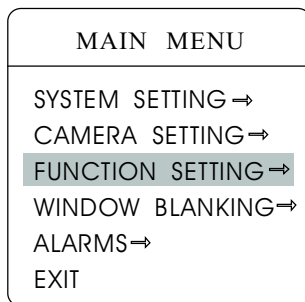

### 6. 2 Scan

Scan is that pre-set two points, then the camera repeatedly scan between the two points at a stable speed, the same magnification and pan. A dome only has one scan tour.

1、 The system enters into the main menu by calling 95 preset or by calling 9 preset twice within 3 seconds. click menu to enter “scan” menu, as the left picture shows.

- 【SCAN SPEED】
- 【SET LEFT LIMIT】
- 【SET RIGHT LIMIT】
- 【RUN SCAN】
- 【CLEAR SCAN】
- 【EDIT SCAN LABEL】

2、 Scan speed setting: operate joystick to 【SCAN SPEED】 , press 【OPEN】 , tilt up/down joystick to adjust scan speed, press 【OPEN】 to save.

3、 Left limit setting: operate joystick to 【SET LEFT LIMIT】 , press 【OPEN】 , operate joystick to choose objective image, press 【OPEN】 to save. Right limit setting is the same as left limit setting.

4、 Edit scan label: operate joystick, move the cursor to 【EDIT SCAN LABEL】 , press 【OPEN】 to enter submenu “edit label” , move the cursor to 【LABEL】 , the system will auto-set the label as AUTO SCAN, press 【OPEN】 to revise.



**NOTICE**

The label can set up to 16 characters, and doesn't need editing characters. Pressing 【OPEN】 continuously to jump over and using spacebar to replace the deleted characters. When you finish to edit a character, pressing 【OPEN】 to enter into the next editing character when you finish to edit the last character, pressing 【OPEN】 to save. Press 【CLOSE】 to exit.

Character of label is suitable for choosing as follow: 0-9、 A-Z、 :、 <>-.、 Space. The editing ways of other labels are the same as above.

5、 Run scan: operate joystick to 【RUN SCAN】 , press 【OPEN】 to exit the menu, and it starts to run scan.



**NOTICE**

1. left limit and right limit of scan can't be set the same point.
2. Under scan process, speed, magnification and tilt direction won't change, if the speed, magnification and tilt direction of the two limits are inconsistent, run scan is base on left limit.

## Function setting

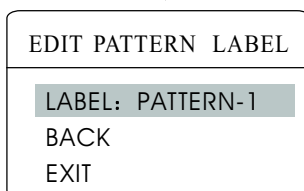
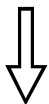
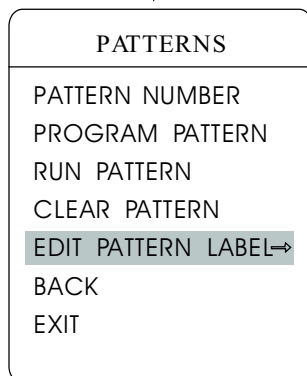
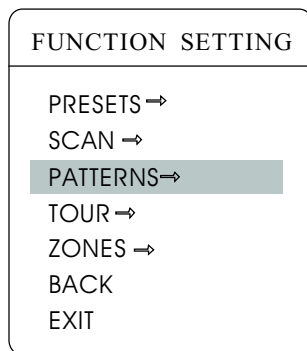
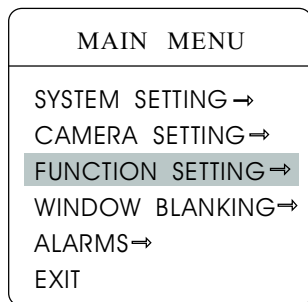

### 6.3 Pattern

Pattern is built-in function in camera; the speed dome can record tracks that are no less than 180s. (A series of pan/tilt controlling and lens controlling command). A dome may set up to 4 pattern tours.

1、 The system enters into the main menu by calling 95 preset or by calling 9 preset twice within 3 seconds.

2、 Operate joystick, move the cursor to **【FUNCTION SETTING】** , press **【OPEN】** to enter submenu.

3、 Operate joystick to **【PATTERN】** , press **【OPEN】** to enter menu “Pattern” .

- **【PATTERN NUMBER】**
- **【PROGRAM PATTERN】**
- **【RUN PATTERN】**
- **【CLEAR PATTERN】**
- **【EDIT PATTERN LABEL】**

4、 Choose pattern number: move the cursor to **【PATTERN NUMBER】** , press **【OPEN】** , pattern you choose as current pattern, the following operations aim at the current pattern;

5、 Define current pattern tour: move the cursor to **【PROGRAM PATTERN】** , press **【OPEN】** to set pattern track, move the image random, and draw the focus. The dome has a tour that is no less than 180s, a series of park time, magnification, focus will be recorded, press **【OPEN】** to save.

6、 Run pattern: operate joystick to **【RUN PATTERN】** , press **【OPEN】** to run, the dome will continuously and repeatedly record the specific track.



When carry out program, run, clear pattern and edit label, should choose pattern number at first.

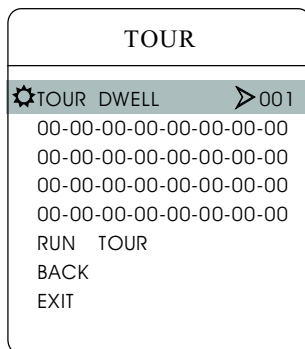
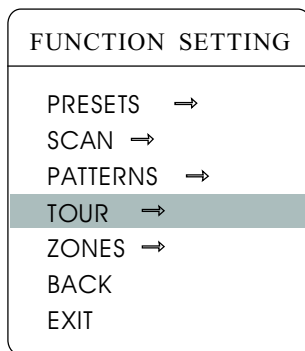
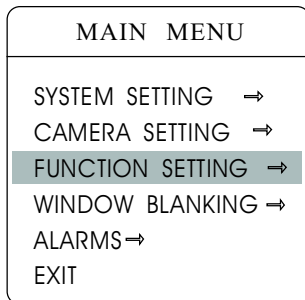

### 6. 4 Tour

Tour is the built-in function in the speed dome, it will arrange the presets into the queue of auto-tour, and can set how long it will park at preset. Operate auto-tour is a process of incessantly transfer each preset. One tour can store 32 presets at most.

- 1、 The system enters into the main menu by calling 95 preset or by calling 9 preset twice within 3 seconds.
  
- 2、 Operate joystick, move the cursor to **【FUNCTION SETTING】** , press **【OPEN】** enter submenu.
  
- 3、 Operate joystick, move the cursor to **【TOUR】** , press **【OPEN】** to enter menu “tour” ;
  
- 4、 Set the park time of preset: Operate joystick, move the cursor to **【TOUR DWELL】** , press **【OPEN】** , there will be a sign ⚙️ in the front of **【TOUR DWELL】** , the cursor jumps to right, tilt up/down to set park time, and the range is 000-255(s);
  
- 5、 Set tour: move the cursor to tour dwell [00-00-00...00], press **【OPEN】** , the first dwell is activated, tilt up/down joystick to choose preset number, press **【OPEN】** , the cursor jumps to the next dwell, press **【CLOSE】** , the cursor jumps to the former dwell. After finishing the last dwell of a line, press **【OPEN】** to save. Press **【CLOSE】** to exit. If set the presets of the second line, move the cursor to the second line, press **【OPEN】** to edit continue inuously. When the numerical value is 00, the following presets are invalid. A tour can setup to 32 presets.
  
- 6、 Run tour: Operate joystick, move the cursor to **【RUN TOUR】** , press **【OPEN】** to exit the menu, it stars to run tour.

## Function setting

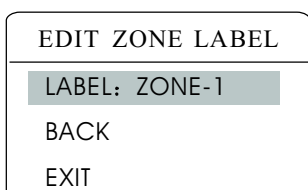
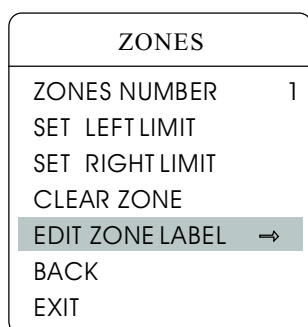
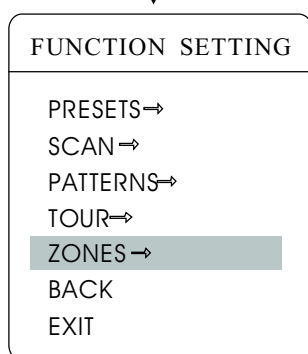
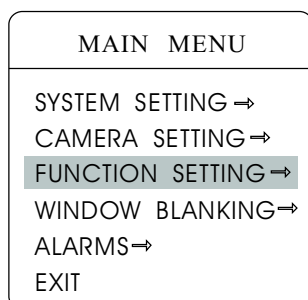

### 6. 5 Zone

A dome may be set up to 8 zones; the regional scene can't be overlapped. User will set label for each zone. When setting **【ZONE LABEL】** as ON, the dome will display zone label as it runs some zone. It is convenient to know the zone that the camera shoots by setting zone label.

- 1、 The system enters into the main menu by calling 95 preset or by calling 9 preset twice within 3 seconds.
- 2、 Operate joystick, move the cursor to **【FUNCTION SETTING】** , press **【OPEN】** to enter submenu.
- 3、 Operate joystick, move the cursor to **【ZONES】** , press **【OPEN】** to enter submenu, as the left picture shows.
  - **【ZONES NUMBER】**
  - **【SET LEFT LIMIT】**
  - **【SET RIGHT LIMIT】**
  - **【CLEAR ZONE】**
  - **【EDIT ZONE LABEL】**

Regard the left/right limit as the demarcation line, and set the middle part as a zone. Various operational ways are the same as other settings in the menu. Therefore we won't explain it again.

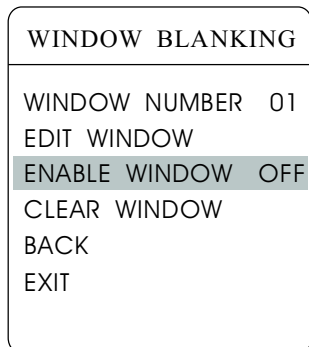
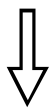
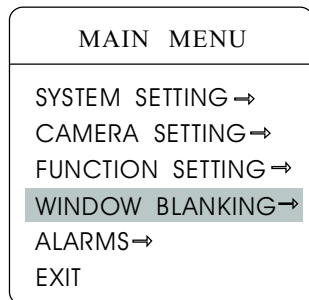

Privacy zone masking



## 7. Privacy zone masking

Privacy function can show someone piece of regional shielding while protecting. For example, protect the window of bedroom or ATM of bank. A dome can setup to 24 privacy windows. (Masking setting function is relative with the model of camera module. The masking numbers will be different according to the different cameras.)

**Hitachi Camera:** It can be set 8 masking at most in 360° surveillance range, can set 2 masking at most per screen. The screen will note " please move " when the position can not be set. It can not set masking when the dome rotates down in the level  $\geq 45^\circ$ .

**Sony Camera:** It can be set 24 masking at most in 360° surveillance range. ( Sony 45 series can be set 8 masking at most ). It can not set masking when the dome rotates down in the level  $\geq 20^\circ$ . LG, CNB Camera module have no masking function.

- 1、 The system enters into the main menu by calling 95 preset or by calling 9 preset twice within 3 seconds.
- 2、 Operate joystick to **【WINDOW BLANKING】**, press **【OPEN】** to enter menu " window blanking".
  - **【WINDOW NUMBER】** choose window number as current privacy window, other choices in the menu just aim at current privacy window;
  - **【EDIT WINDOW】** program current window;
  - **【ENABLE WINDOW】** permit/prohibit current privacy window, there are two choices: ON---permit current privacy window/OFF---prohibit current privacy window
  - **【CLEAR WINDOW】** clear current privacy window, after clearing it, the window will auto- change as OFF.
- 3、 Program current privacy window: Firstly choose window number, then do the following operations:
  - a. Operate joystick, move the cursor to **【EDIT WINDOW】**, press **【OPEN】** to move the image that need privacy window to display in the screen.
  - b. Press **【OPEN】**, there will be a square displaying in the centre of the screen, operate joystick, and move the square to the central place that need to conceal.
  - c. Press **【OPEN】**, operate joystick to adjust the size of privacy zone: joystick to up, the height is increased; joystick to down, the height is reduced; joystick to right, the width is increased; joystick to left, the width is reduced.
  - d. Press **【OPEN】** to save the current privacy zone setting, and the window will auto-change as ON at the same time.



NOTICE

This function is decide by the parameter of built-in camera, if the camera has not this function, this option is invalid. (N/A)

# Alarm Function

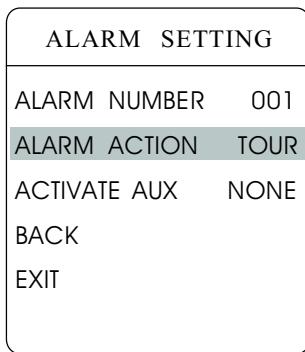
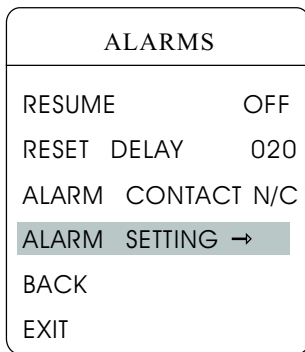
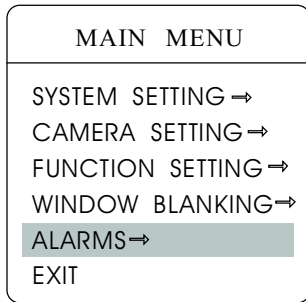

**NOTICE** This function is relative with the type of the dome, if zoom camera has't this function, it is invalid.

## 8. Alarm function

Speed dome may connect with 7 alarm input, 2 alarm output, and support alarm linkage. The external alarm message sends to the dome, then the dome sends to alarm point shoot (to call preset, auto scan, auto cruise and auto pattern), and choose that to run alarm output or not.

1、 The system enters into the main menu by calling 95 preset or by calling 9 preset twice within 3 seconds. click each menu according to the left picture, then enter menu alarm, choices as follow:

- **【RESUME】** resume mode after relieving alarm input, there are two choices: ON---clear alarm output, the dome will stop.  
OFF---just clear alarm output.
- **【RESET DELAY】** set alarm reset and delay the time (1-225s), how long to relieve and run [RESUME] after the dome receives alarm message.
- **【ALARM CONTACT】** set state of the relay. N/C---often close the state, N/O---often hold the state. If setting as often closing the state, the relay is in closing the state when there is no alarm to output;when there is alarm to output, the relay is in holding the state.
- **【ALARM SETTING】**

2、 Operate joystick, move the cursor to **【ALARM SETTING】**, press **【OPEN】** to enter the menu alarm setting

- **【ALARM NUMBER】** alarm number is corresponding with 12 bits plug in the external switching board of the dome(as below shows). 001 priority is the highest, 007 priority is the lowest. The two lines alarm input at the same time, the dome run alarm that the highest priority.
- **【ALARM ACTION】** as current alarm input, to run the action. Choices for choosing as follow. NONE---none action/SCAN/PAT X---run a pattern tour /TOUR---run tour/PRESET---call preset, when the dome number is set as 1, to call preset 1; when the dome number is set as 2, to call preset2.
- **【ACTIVATE AUX】** as current alarm input, to run alarm output or not. NONE---none alarm output/AUX 1---the first alarm output/AUX 2---the secondary alarm output/BOTH--- two alarms output.

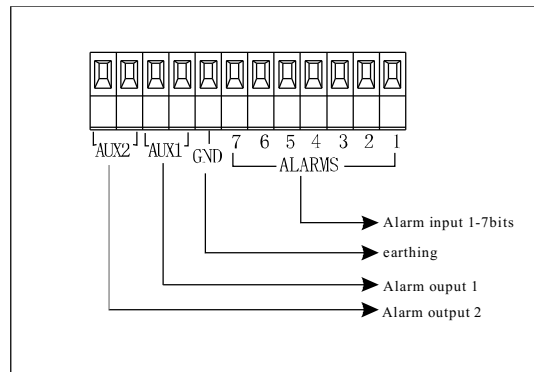

## 9. 1 Menu Index

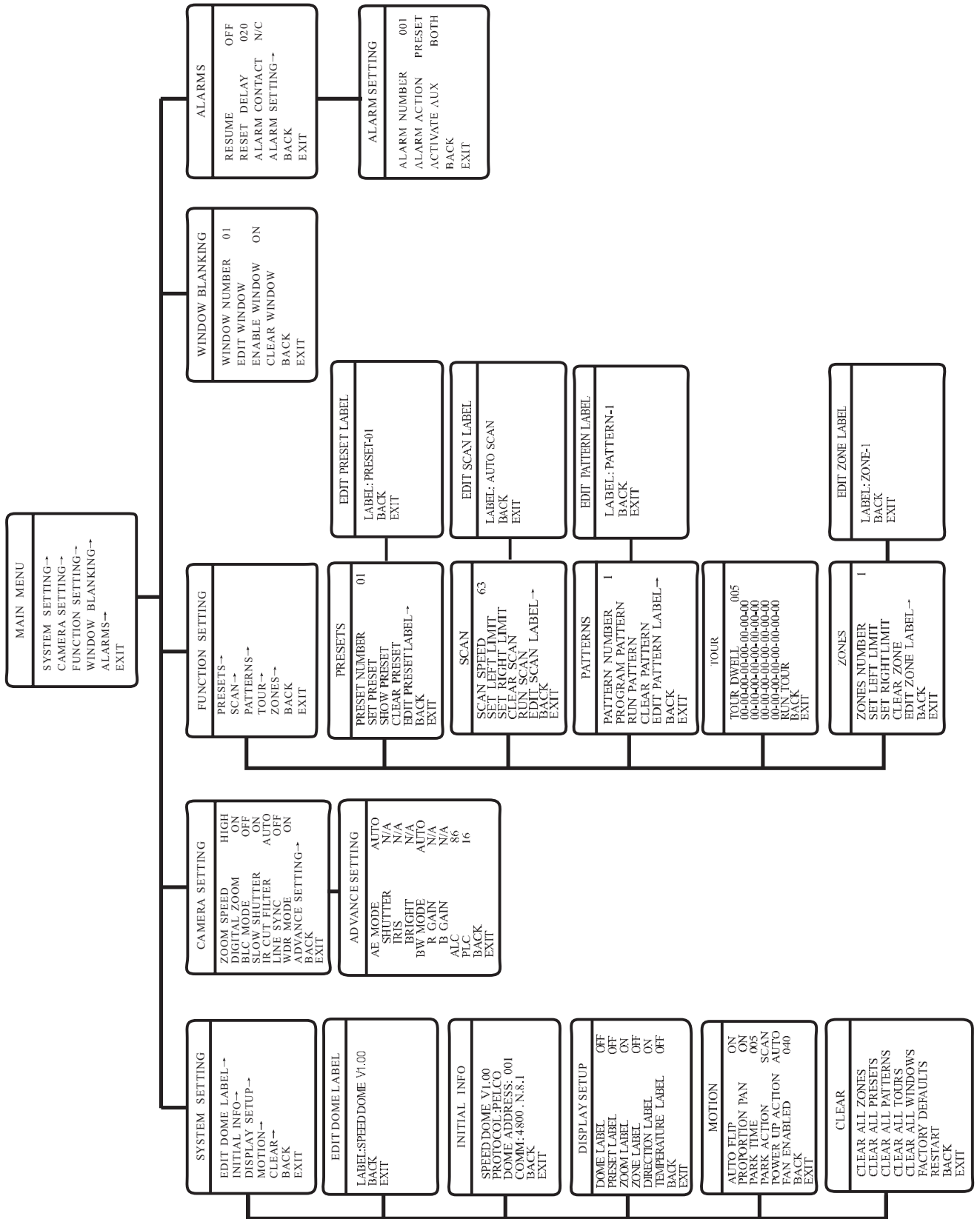



## 9. 2 Troubleshooting

Trouble	Possible causes	Solution
No action , no Video after power up	<ol style="list-style-type: none"> <li>1.The 24vAC power supply is Not connected to the port of the Circuit connection board or the contact is not good.</li> <li>2、 The municipal power has been cut off or the transformer is in malfunction.</li> </ol>	<ol style="list-style-type: none"> <li>1.Check the powersupply to see if it is connected or confirm if the plugcontact well.</li> <li>2.Check to see the municipal power supply has been cut off. Check to see if the 24V AC transformer is OK.</li> </ol>
Self-testing and image Are normal but the dome is uncontrollable	<ol style="list-style-type: none"> <li>1.The dome Dipswitch setting is incorrect.</li> <li>2.RS485 may carve out a way</li> <li>3.RS485 is in malfunction.</li> </ol>	<ol style="list-style-type: none"> <li>1. Reset the Dip switch as per the Dip switch setting chart.</li> <li>2. Check RS485 and confirm the connection is correct and good in contact.</li> <li>3. Please consult appendix 9.6RS485 Bus acknowledge.</li> </ol>
Vague image	<ol style="list-style-type: none"> <li>1.Manual focus has been set.</li> <li>2.Unclean down cover.</li> </ol>	<ol style="list-style-type: none"> <li>1.Operate dome and set the state of focus as auto or call any preset.</li> <li>2.Clean the down cover.</li> </ol>

## 9. 3 The cleaning of clear down cover

To obtain constant clear videos, user should clean the down cover periodically.

- Be caution when cleaning, Hold the down cover ring only to avoid direct touch to the acrylic downcover. The acid sweat mark of fingerprint will corrode the coating of down cover and scratch on down cover will cause vague image.
- Use soft dry cloth or the substitute to clean the inner and outer surfaces.
- For hard contamination, use neutral detergent. Any cleanser for high grade furniture is applicable.

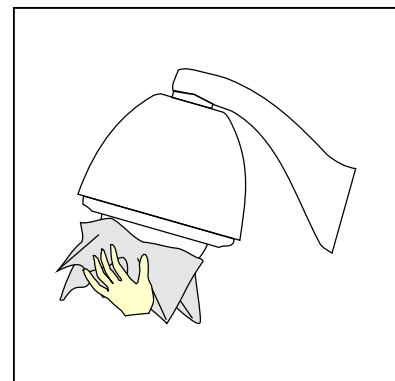

## 9. 4 24VAC Wire Diameter and Transmission Distance Comparison chart

The transmission distances listed below are farthest ones recommended for each giving wire diameter when the 24VAC voltage loss ratio is below 10%(for equipment powered by AC, the allowed maximum voltage loss ratio is 10%).For example, 5 sets of indoor equipment with nominal power as 12 VA and 2sets outdoor equipment with nominal power as 50 VA, install 28 feet (8m) away from transformer, need total power of 160VA(5×12VA+2×50VA), need a wire with a minimum diameter of 1.0mm.

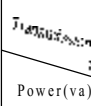
 <div style="display: inline-block; transform: rotate(-45deg); font-size: small;">                     Wire Diameter (mm)                      Power(va)                 </div>	0. 800	1. 000	1. 250	2. 000
10	283 (86)	451 (137)	716 (218)	1811 (551)
20	141 (42)	225 (68)	358 (109)	905 (275)
30	94 (28)	150 (45)	238 (72)	603 (183)
40	70 (21)	112 (34)	197 (54)	452 (137)
50	56 (17)	90 (27)	143 (43)	362 (110)
60	47 (14)	75 (22)	119 (36)	301 (91)
70	40 (12)	64 (19)	102 (31)	258 (78)
80	35 (10)	56 (17)	89 (27)	226 (68)
90	31 (9)	50 (15)	79 (24)	201 (61)
100	28 (8)	45 (13)	71 (21)	181 (55)
110	25 (7)	41 (12)	65 (19)	164 (49)
120	23 (7)	37 (11)	59 (17)	150 (45)
130	21 (6)	34 (10)	55 (16)	139 (42)
140	20 (6)	32 (9)	51 (15)	129 (39)
150	18 (5)	30 (9)	47 (14)	120 (36)
160	17 (5)	28 (8)	44 (13)	113 (34)
170	16 (4)	26 (7)	42 (12)	106 (32)
180	15 (4)	25 (7)	39 (11)	100 (30)
190	14 (4)	23 (7)	37 (11)	95 (28)
200	14 (4)	22 (6)	35 (10)	90 (27)

## 9. 5 Domestic and Board Wire Gauge Conversion Chart

Bare Wire Diameter Metric Size(mm)	AWC (Approximate)	SWC (Approximate)	Bare Wire Cross-Sectional Area (mm <sup>2</sup> )
0. 050	43	47	0. 00196
0. 060	42	46	0. 00283
0. 070	41	45	0. 00385
0. 080	40	44	0. 00503
0. 090	39	43	0. 00636
0. 010	38	42	0. 00785
0. 110	37	41	0. 00950
0. 130	36	39	0. 01327
0. 140	35		0. 01539
0. 160	34	37	0. 02011
0. 180	33		0. 02545
0. 200	32	35	0. 03142
0. 230	31		0. 04115
0. 250	30	33	0. 04909
0. 290	29	31	0. 06605
0. 330	28	30	0. 08553
0. 350	27	29	0. 09621
0. 400	26	28	0. 1257
0. 450	25		0. 1602
0. 560	24	24	0. 2463
0. 600	23	23	0. 2827
0. 710	22	22	0. 3958
0. 750	21		0. 4417
0. 800	20	21	0. 5027
0. 900	19	20	0. 6362
1. 000	18	19	0. 7854
1. 250	16	18	1. 2266
1. 500	15		1. 7663
2. 000	12	12	3. 1420
2. 500			4. 9080
3. 000			7. 0683

## 9. 6 Rs485 Bus Basic Knowledge

### Characteristics of Rs485 Bus

As specified by Rs485 standard, Rs485 Bus is of half-duplexed data transmission cables with characteristic impedance as 120Ω. The maximum load capacity is 32 unit loads (including main controller and controlled equipment.)

### Transmission distances of Rs485 Bus

When user selects the 0.56mm(24AWG)twisted pair wires as data transmission cable, the maximum theoretical transmitting distance are as follows:

Baud rate	Max distance
2400BPS	1800m
4800BPS	1200m
9600BPS	800m
19200BPS	600m

If user selects thinner cables, or installs the dome in an environment with strong electromagnetic interference, or connects lots of equipment to the Rs485 Bus, the maximum transmitting distance will be decreased. To increase the maximum transmitting distance, do the contrary.

### Connection and termination resistor

The Rs485 standards require a daisy-chain Connection between the equipment. There must be termination resistors with 120Ω (as the picture 9-6.1). Please refer to picture 9-6.2 for simple connection. "D" should not exceed 7m.

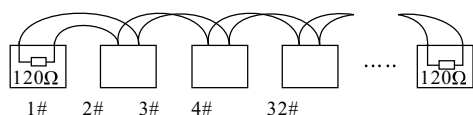

Picture9-6.1

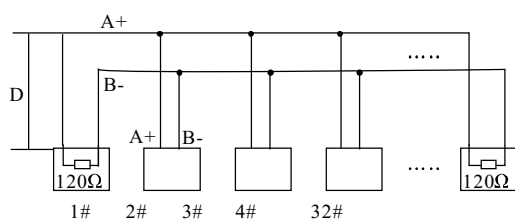

Picture9-6.2

### The connection of 120Ω termination resistor:

The termination resistor is ready on the protocol PCB. There are two kinds of connection (as shown in 9-6.3). It is the factory default connection. The jumper cap of the switchboard is seated on pin 2 & pin 3 and the termination resistor 120Ω is not connected.

When connecting the 120Ω termination resistor, user should pull out the protocol PCB and plug the jumper on pin 1 & pin 2. Install the PCB back and the termination resistor is connected. (as shown in the picture 9-6.3)

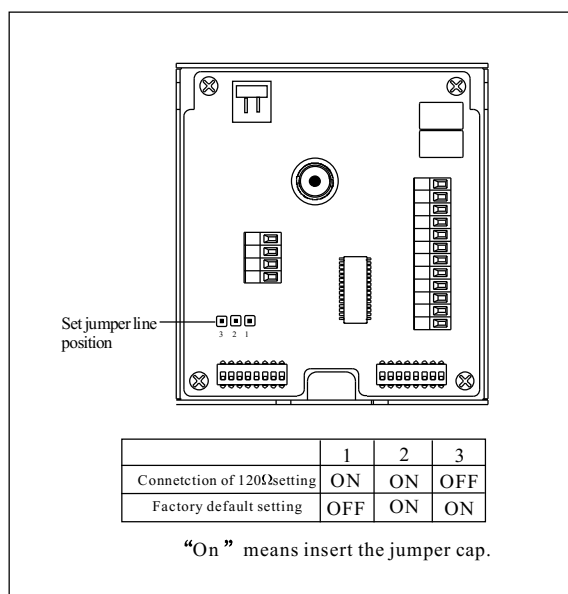

Picture9-6.3

## Problems in practical connections

In some circumstances user adopts a star configuration in practical connection. The termination resistors must be connected to the two equipment 1# and 5# in Picture 9-6.4. As the star configuration is not in conformity with the requirements of RS485 standards, problems such as signal reflections, lower anti-interference performance arise when the cables are long in the connection. The reliability of control signals is decreased with the phenomena that the dome does not respond to or just responds at intervals to the controller, or does continuous operation without stop.

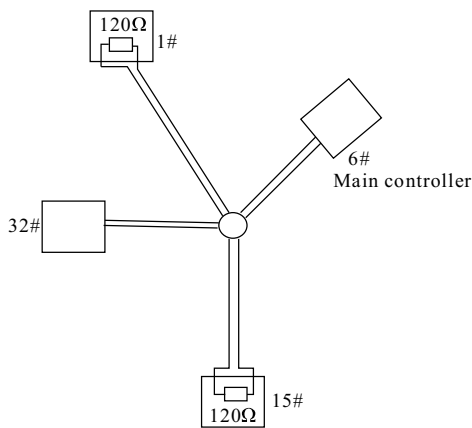

Picture 9-6.4

In such circumstances the factory recommends the usage of RS485 distributor. The distributor can change the star configuration connection to the mode of connection stipulated in the RS485 standards. The new connection achieves reliable data transmission. (Refer to Picture 9-6.5).

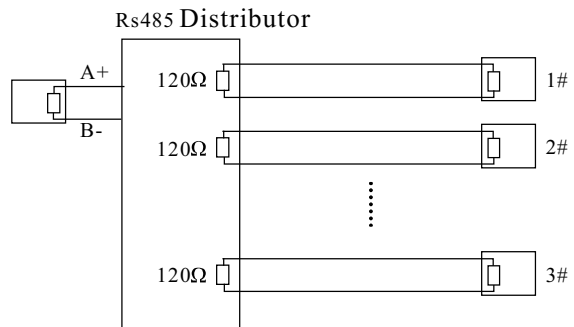

Picture 9-6.5

## Rs485 Bus troubleshooting

Trouble	Possible cause	Solution
Dome can do self-testing but cannot be controlled	A、 The address and baud rate setting of dome are not in conformity with those of controller. B、 The "+" and "-" connection of Rs485 Bus is incorrect. C、 The dome is very far away from controller. D、 There are too many domes connected in the System.	A、 Change the address and baud rate of controller or dome B、 Replace Rs485 Bus wires C、 Make sure the connections are fully seated
The dome can be controlled but the operation is not smooth.	A、 The Rs485 Bus line is not in good contact with the connectors. B、 One wire of the Rs485 Bus is broken. C、 The dome is very far from controller. D、 There are too many domes connected in the system.	A、 Secure the connection; B、 Replace Rs485 Bus Wires C、 Add termination resistors to the system D、 Install Rs485 distributor

## 9. 7 DIP switch setup

There is a switchboard in the upper cover of dome, lift the metallic button can open the switchboard. There are two 8-bit DIP switches on it. Sw2 is for protocol and baud rate setting and Sw1 is for dome address setting.

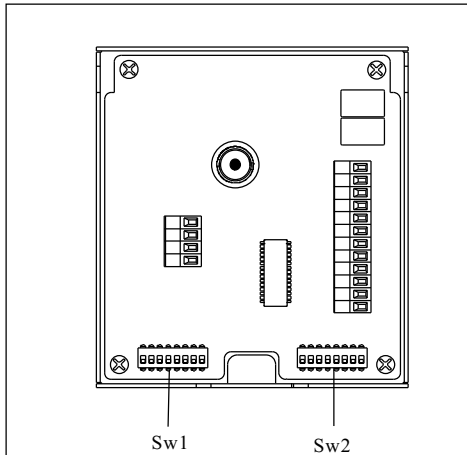

Picture 9-7.1

In the following list, “1” set DIP as “ON” 0 set DIP as “OFF”

### 9. 7. 1 Baud rate setup (SW2) :

Please according to "AppdienxRs485 Bus Basic knowledge", to check whether Baud rate is satisfied with the demand of transmission distance.

Baud rate	Switch number(Sw2)
	(Bit)7 8
2400bps	0 0
4800bps	1 0
9600bps	0 1
19200bps	1 1

### 9. 7. 2 Protocolsetup (SW2)

PROTOCOL	SWITCH NUMBER (SW2)					
	(Bit) 1	2	3	4	5	6
FACTORY (FACTORY PROTOCOL)	0	0	0	0	0	0
PELCO	1	0	0	0	0	0
ERNITEC	0	1	0	0	0	0
VCL	1	1	0	0	0	0
MOLYNX	0	0	1	0	0	0
VICON	1	0	1	0	0	0
SANTACHI	0	1	1	0	0	0
PANASONIC	1	1	1	0	0	0
SAMSUNG	0	0	0	1	0	0
DIAMOND	1	0	0	1	0	0
KALATEL	0	1	0	1	0	0
LILIN	1	1	0	1	0	0
VIDO B02	0	0	1	1	0	0
HUNDA	1	0	1	1	0	0
PHILIPS	0	0	0	0	0	1
AD	1	0	0	0	0	1
UNIVISION	0	1	0	0	0	1
RESERVED	OTHERS					

### 9. 7. 3 IDsetting (SW1)

In a system, a decoder includes speed dome camera and common decoder, there aren't the same ID between them. The ID switch in decoder and the ID setting of the dome as follow, in the picture, "1" set DIP switch as "NO", "0" set DIP switch as OFF.

## Appendix

ID	Switch number (Sw1)								ID	Switch number (Sw1)									
	(Bit)	1	2	3	4	5	6	7		8	(Bit)	1	2	3	4	5	6	7	8
Factory defaults set as debug address	0	0	0	0	0	0	0	0	0	34	0	1	0	0	0	0	1	0	0
1	1	0	0	0	0	0	0	0	0	35	1	1	0	0	0	0	1	0	0
2	0	1	0	0	0	0	0	0	0	36	0	0	1	0	0	0	1	0	0
3	1	1	0	0	0	0	0	0	0	37	1	0	1	0	0	0	1	0	0
4	0	0	1	0	0	0	0	0	0	38	0	1	1	0	0	0	1	0	0
5	1	0	1	0	0	0	0	0	0	39	1	1	1	0	0	0	1	0	0
6	0	1	1	0	0	0	0	0	0	40	0	0	0	1	0	1	0	0	0
7	1	1	1	0	0	0	0	0	0	41	1	0	0	1	0	1	0	0	0
8	0	0	0	1	0	0	0	0	0	42	0	1	0	1	0	1	0	0	0
9	1	0	0	1	0	0	0	0	0	43	1	1	0	1	0	1	0	0	0
10	0	1	0	1	0	0	0	0	0	44	0	0	1	1	0	1	0	0	0
11	1	1	0	1	0	0	0	0	0	45	1	0	1	1	0	1	0	0	0
12	0	0	1	1	0	0	0	0	0	46	0	1	1	1	0	1	0	0	0
13	1	0	1	1	0	0	0	0	0	47	1	1	1	1	0	1	0	0	0
14	0	1	1	1	0	0	0	0	0	48	0	0	0	0	1	1	0	0	0
15	1	1	1	1	0	0	0	0	0	49	1	0	0	0	1	1	0	0	0
16	0	0	0	0	1	0	0	0	0	50	0	1	0	0	1	1	0	0	0
17	1	0	0	0	1	0	0	0	0	51	1	1	0	0	1	1	0	0	0
18	0	1	0	0	1	0	0	0	0	52	0	0	1	0	1	1	0	0	0
19	1	1	0	0	1	0	0	0	0	53	1	0	1	0	1	1	0	0	0
20	0	0	1	0	1	0	0	0	0	54	0	1	1	0	1	1	0	0	0
21	1	0	1	0	1	0	0	0	0	55	1	1	1	0	1	1	0	0	0
22	0	1	1	0	1	0	0	0	0	56	0	0	0	1	1	1	0	0	0
23	1	1	1	0	1	0	0	0	0	57	1	0	0	1	1	1	0	0	0
24	0	0	0	1	1	0	0	0	0	58	0	1	0	1	1	1	0	0	0
25	1	0	0	1	1	0	0	0	0	59	1	1	0	1	1	1	0	0	0
26	0	1	0	1	1	0	0	0	0	60	0	0	1	1	1	1	0	0	0
27	1	1	0	1	1	0	0	0	0	61	1	0	1	1	1	1	0	0	0
28	0	0	1	1	1	0	0	0	0	62	0	1	1	1	1	1	0	0	0
29	1	0	1	1	1	0	0	0	0	63	1	1	1	1	1	1	0	0	0
30	0	1	1	1	1	0	0	0	0	64	0	0	0	0	0	0	1	0	0
31	1	1	1	1	1	0	0	0	0	65	1	0	0	0	0	0	1	0	0
32	0	0	0	0	0	1	0	0	0	66	0	1	0	0	0	0	1	0	0
33	1	0	0	0	0	1	0	0	0	67	1	1	0	0	0	0	1	0	0

ID	Switch number (Swl)								ID	Switch number (Swl)							
	(Bit)1	2	3	4	5	6	7	8		(Bit)1	2	3	4	5	6	7	8
68	0	0	1	0	0	0	1	0	102	0	1	1	0	0	1	1	0
69	1	0	1	0	0	0	1	0	103	1	1	1	0	0	1	1	0
70	0	1	1	0	0	0	1	0	104	0	0	0	1	0	1	1	0
71	1	1	1	0	0	0	1	0	105	1	0	0	1	0	1	1	0
72	0	0	0	1	0	0	1	0	106	0	1	0	1	0	1	1	0
73	1	0	0	1	0	0	1	0	107	1	1	0	1	0	1	1	0
74	0	1	0	1	0	0	1	0	108	0	0	1	1	0	1	1	0
75	1	1	0	1	0	0	1	0	109	1	0	1	1	0	1	1	0
76	0	0	1	1	0	0	1	0	110	0	1	1	1	0	1	1	0
77	1	0	1	1	0	0	1	0	111	1	1	1	1	0	1	1	0
78	0	1	1	1	0	0	1	0	112	0	0	0	0	1	1	1	0
79	1	1	1	1	0	0	1	0	113	1	0	0	0	1	1	1	0
80	0	0	0	0	1	0	1	0	114	0	1	0	0	1	1	1	0
81	1	0	0	0	1	0	1	0	115	1	1	0	0	1	1	1	0
82	0	1	0	0	1	0	1	0	116	0	0	1	0	1	1	1	0
83	1	1	0	0	1	0	1	0	117	1	0	1	0	1	1	1	0
84	0	0	1	0	1	0	1	0	118	0	1	1	0	1	1	1	0
85	1	0	1	0	1	0	1	0	119	1	1	1	0	1	1	1	0
86	0	1	1	0	1	0	1	0	120	0	0	0	1	1	1	1	0
87	1	1	1	0	1	0	1	0	121	1	0	0	1	1	1	1	0
88	0	0	0	1	1	0	1	0	122	0	1	0	1	1	1	1	0
89	1	0	0	1	1	0	1	0	123	1	1	0	1	1	1	1	0
90	0	1	0	1	1	0	1	0	124	0	0	1	1	1	1	1	0
91	1	1	0	1	1	0	1	0	125	1	0	1	1	1	1	1	0
92	0	0	1	1	1	0	1	0	126	0	1	1	1	1	1	1	0
93	1	0	1	1	1	0	1	0	127	1	1	1	1	1	1	1	0
94	0	1	1	1	1	0	1	0	128	0	0	0	0	0	0	0	1
95	1	1	1	1	1	0	1	0	129	1	0	0	0	0	0	0	1
96	0	0	0	0	0	1	1	0	130	0	1	0	0	0	0	0	1
97	1	0	0	0	0	1	1	0	131	1	1	0	0	0	0	0	1
98	0	1	0	0	0	1	1	0	132	0	0	1	0	0	0	0	1
99	1	1	0	0	0	1	1	0	133	1	0	1	0	0	0	0	1
100	0	0	1	0	0	1	1	0	134	0	1	1	0	0	0	0	1
101	1	0	1	0	0	1	1	0	135	1	1	1	0	0	0	0	1



## Appendix

ID	Switch number (Sw1)								
	(Bit)	1	2	3	4	5	6	7	8
136	0	0	0	1	0	0	0	0	1
137	1	0	0	1	0	0	0	0	1
138	0	1	0	1	0	0	0	0	1
139	1	1	0	1	0	0	0	0	1
140	0	0	1	1	0	0	0	0	1
141	1	0	1	1	0	0	0	0	1
142	0	1	1	1	0	0	0	0	1
143	1	1	1	1	0	0	0	0	1
144	0	0	0	0	1	0	0	0	1
145	1	0	0	0	1	0	0	0	1
146	0	1	0	0	1	0	0	0	1
147	1	1	0	0	1	0	0	0	1
148	0	0	1	0	1	0	0	0	1
149	1	0	1	0	1	0	0	0	1
150	0	1	1	0	1	0	0	0	1
151	1	1	1	0	1	0	0	0	1
152	0	0	0	1	1	0	0	0	1
153	1	0	0	1	1	0	0	0	1
154	0	1	0	1	1	0	0	0	1
155	1	1	0	1	1	0	0	0	1
156	0	0	1	1	1	0	0	0	1
157	1	0	1	1	1	0	0	0	1
158	0	1	1	1	1	0	0	0	1
159	1	1	1	1	1	0	0	0	1
160	0	0	0	0	0	1	0	0	1
161	1	0	0	0	0	1	0	0	1
162	0	1	0	0	0	1	0	0	1
163	1	1	0	0	0	1	0	0	1
164	0	0	1	0	0	1	0	0	1
165	1	0	1	0	0	1	0	0	1
166	0	1	1	0	0	1	0	0	1
167	1	1	1	0	0	1	0	0	1
168	0	0	0	1	0	1	0	0	1
169	1	0	0	1	0	1	0	0	1
170	0	1	0	1	0	1	0	0	1
171	1	1	0	1	0	1	0	0	1
172	0	0	1	1	0	1	0	0	1
173	1	0	1	1	0	1	0	0	1
174	0	1	1	1	0	1	0	0	1
175	1	1	1	1	0	1	0	0	1
176	0	0	0	0	1	1	0	0	1
177	1	0	0	0	1	1	0	0	1
178	0	1	0	0	1	1	0	0	1
179	1	1	0	0	1	1	0	0	1
180	0	0	1	0	1	1	0	0	1
181	1	0	1	0	1	1	0	0	1
182	0	1	1	0	1	1	0	0	1
183	1	1	1	0	1	1	0	0	1
184	0	0	0	1	1	1	0	0	1
185	1	0	0	1	1	1	0	0	1
186	0	1	0	1	1	1	0	0	1
187	1	1	0	1	1	1	0	0	1
188	0	0	1	1	1	1	0	0	1
189	1	0	1	1	1	1	0	0	1
190	0	1	1	1	1	1	0	0	1
191	1	1	1	1	1	1	0	0	1
192	0	0	0	0	0	0	1	0	1
193	1	0	0	0	0	0	1	0	1
194	0	1	0	0	0	0	1	0	1
195	1	1	0	0	0	0	1	0	1
196	0	0	1	0	0	0	1	0	1
197	1	0	1	0	0	0	1	0	1
198	0	1	1	0	0	0	1	0	1
199	1	1	1	0	0	0	1	0	1
200	0	0	0	1	0	0	1	0	1
201	1	0	0	1	0	0	1	0	1
202	0	1	0	1	0	0	1	0	1
203	1	1	0	1	0	0	1	0	1

ID	Switch number (Sw1)							
	(Bit)	1	2	3	4	5	6	7
204	0	0	1	1	0	0	1	1
205	1	0	1	1	0	0	1	1
206	0	1	1	1	0	0	1	1
207	1	1	1	1	0	0	1	1
208	0	0	0	0	1	0	1	1
209	1	0	0	0	1	0	1	1
210	0	1	0	0	1	0	1	1
211	1	1	0	0	1	0	1	1
212	0	0	1	0	1	0	1	1
213	1	0	1	0	1	0	1	1
214	0	1	1	0	1	0	1	1
215	1	1	1	0	1	0	1	1
216	0	0	0	1	1	0	1	1
217	1	0	0	1	1	0	1	1
218	0	1	0	1	1	0	1	1
219	1	1	0	1	1	0	1	1
220	0	0	1	1	1	0	1	1
221	1	0	1	1	1	0	1	1
222	0	1	1	1	1	0	1	1
223	1	1	1	1	1	0	1	1
224	0	0	0	0	0	1	1	1
225	1	0	0	0	0	1	1	1
226	0	1	0	0	0	1	1	1
227	1	1	0	0	0	1	1	1
228	0	0	1	0	0	1	1	1
229	1	0	1	0	0	1	1	1
230	0	1	1	0	0	1	1	1
231	1	1	1	0	0	1	1	1
232	0	0	0	1	0	1	1	1
233	1	0	0	1	0	1	1	1
234	0	1	0	1	0	1	1	1
235	1	1	0	1	0	1	1	1
236	0	0	1	1	0	1	1	1
237	1	0	1	1	0	1	1	1

ID	Switch number (Sw1)							
	(Bit)	1	2	3	4	5	6	7
238	0	1	1	1	0	1	1	1
239	1	1	1	1	0	1	1	1
240	0	0	0	0	1	1	1	1
241	1	0	0	0	1	1	1	1
242	0	1	0	0	1	1	1	1
243	1	1	0	0	1	1	1	1
244	0	0	1	0	1	1	1	1
245	1	0	1	0	1	1	1	1
246	0	1	1	0	1	1	1	1
247	1	1	1	0	1	1	1	1
248	0	0	0	1	1	1	1	1
249	1	0	0	1	1	1	1	1
250	0	1	0	1	1	1	1	1
251	1	1	0	1	1	1	1	1
252	0	0	1	1	1	1	1	1
253	1	0	1	1	1	1	1	1
254	0	1	1	1	1	1	1	1
255	1	1	1	1	1	1	1	1



**Notice:** 1. Debug address: (Only factory protocol and Pelco can be set): if the camera address is set as 0, user can select any protocols to control the dome.

2. Broadcast address(Only factory protocol and Pelco can be set): if user selects “255” to control, all the systematic connection cameras will carry our the same motions.