

INSTRUCTION MANUAL

MULTI-STAGE DRY VACUUM PUMP

MODEL ESA25-D

CE / SEMI / NRTL MODEL

200V(50Hz),200-220V(60Hz)

380-400V(50Hz),380-440V(60Hz)



FOR SALES AND SERVICE PLEASE CALL:

PTB SALES T :: 866.332.0500
F :: 626.334.2151
www.ptbsales.com

DATE SERVICED: _____

VIEW OUR INVENTORY



Caution:

Please read and understand this INSTRUCTION MANUAL thoroughly before using this equipment.

Be sure to keep this INSTRUCION MANUAL on hand for future reference.

To Facility and Tool Manufactures:

Be sure to distribute this INSTRUCTION MANUAL to all end-user personnel actually operation this equipment.

「Model OOO」 in this INSTRUCTION MANUAL is our model code.

ISSUED BY PRECISION MACHINERY COMPANY

Do not reproduce or reprint any portion of this manual without permission.
Manufacturer reserves the right to discontinue or change any specifications
or designs without notice and without incurring obligations.
Model OOO in this catalog is our model code.

All rights reserved, copyright EBARA Corporation.

Environmental Basic Policies

It is our responsibility, as people of the earth, to protect nature's irreplaceable treasures and to pass them on to future generations.

As we undertake our business activities, we will establish environmental management systems and implement ongoing improvements and reviews, while striving to promote harmony between technology and nature, prevent environmental pollution, and improve the overall results of our environmental management activities. We are aware that environmental protection and management activities are the responsibility of all managers and employees of the Corporation, and each person will demonstrate this awareness when carrying out his or her duties.

We will widely publicize these basic policies to regional societies and the general public and work to make Ebara's position on the environment clear to society in general.

Safety Information

It is essential that those operating this pump should have the knowledge to identify and avoid hazardous conditions associated with the pump.

Inadequate or rash operation may cause dangerous and serious accidents.

Before installation and operation, the operator should first have a good knowledge of the pump construction, operation procedure, and its hazards.

The operator should read through this instruction manual and others documents issued by EBARA in detail.

If you have any questions on pump operation, safeties, and maintenance, please do not hesitate to contact EBARA directly. Refer to Global network for contact address.

Three terms designating the level of hazard are used in this manual.



DANGER

indicates an imminently hazardous situation which, if not avoided, will result in death or serious injury.



WARNING

indicates a potentially hazardous situation which, if not avoided, could result in death or serious injury.











CAUTION

indicates an imminently hazardous situation which, if not avoided, may result in minor or moderate injury.

This term may also be used as a warning for situations liable to damage to equipment.

Important Prior Warnings

-  **DANGER** Keep out from under the pump when lifted.
Only qualified personnel shall unload and lift the pump.
-  **WARNING** Be careful not to overturn the pump when pushing and pulling it sideways, because the width of the pump is small to its height.
-  **WARNING** All electrical works must be performed by only a qualified electrician.
All national and local electrical regulations must be observed.
-  **WARNING** Turn power off and lockout before starting on wiring and maintenance work.
Do not switch on the power supply to the pump until work is completed.
-  **WARNING** Supply N₂ gas to the exhaust piping when necessary to dilute the inflammable or toxic gas up to a safe concentration.
-  **WARNING** Purge with sufficient N₂ gas before removing and washing the vacuum and exhaust piping.
Do not let inflammable, toxic or dangerous materials disperse and guard against contact with the human body.
Always work in a location with an escape route in an emergency.
-  **WARNING** Do not use the pump for another process without a previous overhaul. Gases or reaction products remaining in the pump will react and lead to accidents with the formation of large amounts of products.

 **WARNING** To avoid any hazard induced by toxicity, flammability and explosiveness of the process gases used in the tool, be sure to operate the tool according to the operations safety guidelines supplied by tool suppliers.

Appendix 6 lists typical process gases used in a semiconductor-processing tool. However, details concerning the tool gases and other concerns specific to your tool should be directed to the respective tool suppliers.

 **WARNING** Check for gas leaks after installing and maintaining the piping. Gas leaks will result in the discharge of harmful and dangerous substances and in abnormal reactions due to the ingress of air into the pump. When checking for gas leaks by pressurization, please pressurize by less than 0.05 MPa into the purge port and do check.

 **WARNING** Do not alter the pump member nor change any parts without the EBARA's consent or approval.

 **WARNING** The pump casing and exhaust piping become extremely hot during operation and for some time after stopping. Be sure that pump and exhaust piping do not come in contact with humans or inflammable substances. Do not remove the pump cover during operation.

 **WARNING** Check Safety Interlock functions periodically (every 6 months) to confirm the interlocks will work correctly.

 **CAUTION** Disposal of process by-products shall be strictly in accordance with all local and national environmental and safety regulations.

 **CAUTION** Disposal of Printed circuit board containing Lithium battery shall be strictly in accordance with all local and national environmental and applicable regulations.

 **WARNING** In designing the dry pumps, Ebara does not assume risks caused by hazardous chemical reactions resulted from simultaneous injection or mixture of multiple process gases in the pumps, and the pump is not equipped with a protection against the dangers from such pump usage. The tool suppliers and users must pay attention not to simultaneously inject or mix those gases.

 **WARNING** Do not perform a withstand voltage test. Failure to comply could result in damage to the sensitive devices.

 **CAUTION** Never operate the pump without pump cover for safety.

 **CAUTION** This pump might break down if the voltage setting is not correctly changed. The default voltage setting is indicated on the pump cover with label. Please indicate the new voltage setting on the pump, when the voltage setting was changed.

(vi)

Following safety warning labels are attached to pump covers.

1. High temperature warning
2. Hazardous voltage warning
3. Hazardous materials warning
4. Electric charge mark
5. Hazardous weight danger
6. High temperature eyebolt warning

1. High temperature warning

Hot surface may burn or cause injury.

Allow the piping and casing to cool before servicing.

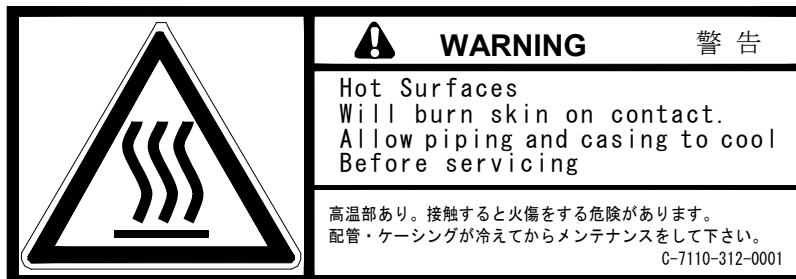

2. Hazardous voltage warning

Hazardous Voltage may shock, burn, or cause death.

Turn power off and lockout before servicing.

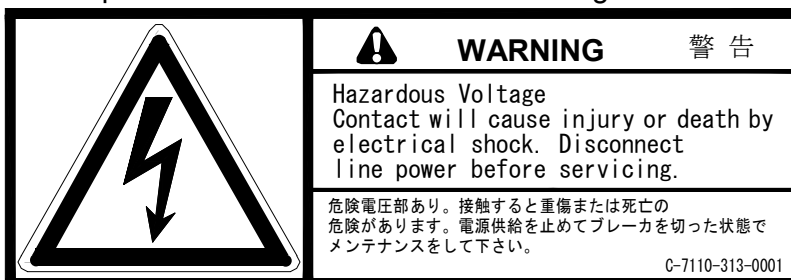

3. Hazardous materials warning

In case of hazardous materials are handled. Run the pump only with N₂ gas purge before servicing. Take adequate measures against dangerous reaction and contact with human body.



4. Electric charge mark

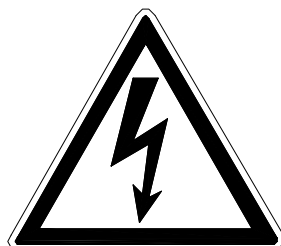

5. Hazardous weight danger

Heavy weight may cause severe injury or death due to overturning or falling pump. Keep out from under the lifted pump.
 Raise all adjuster-feet fully when moving.

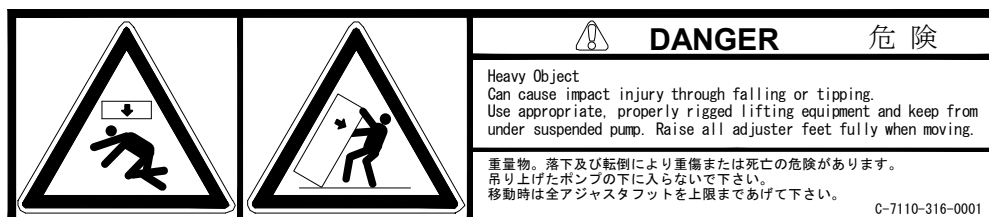

(viii)

6. High temperature eyebolt warning
Hot surface may burn or cause injury.
Allow the eyebolt to cool before servicing.

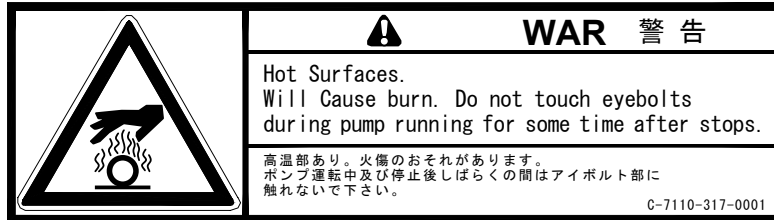

Safety Interlocks

WARNING

Check Safety Interlock functions periodically (every 6 months) to confirm the interlocks will work correctly.

EMERGENCY OFF (EMO)

A manually activated button breaks a low-voltage control circuit that, in turn, interrupts line power. Restarting the pump(s) requires a manual reset of the twist-lock button.

NITROGEN FLOW LOW

A normally open flow switch breaks when nitrogen supply to the pump (oil bearing(s) and inter stage injection) drops below its factory set point, opening the motor starter relay(s) and shutting down the pump. Restoration of sufficient nitrogen flow permits restarting the pump.

MOTOR OVERLOAD

Motor thermostat protect the pump motor from overheating due to extended current draws in excess of the motor rating. Under a persistent overload condition, motor thermostat opens a contact, which interrupts the motor run circuit. A brief cool down interval permits restarting the pump.

OVER CURRENT PROTECTION

The nearly instantaneous current rise from a line-to-line or line-to-ground short very rapidly opens a main fuse and interrupting power supply to the electrical panel. Manual reset, which requires clearing the fault condition, is necessary before restarting the pump.

Standard Limited Warranty

The terms of this Warranty limit the liability of EBARA CORPORATION. Please read it carefully.

Duration

For new pumps, the Warranty period shall be one (1) year from the date of commencing operation by user or 18 months from shipment by EBARA, whichever comes first. This Warranty does not apply to service beyond these time periods.

For overhauled pumps, the warranty period shall be six (6) months from shipment by EBARA.

Coverage

For the duration of the Warranty period, EBARA warrants this ESA pump from failure due to defects in materials or workmanship. For such failures, EBARA will, at its option, either replace or repair the pump free of charge

Such repair or replacement will not extend the duration of the warranty beyond the original period.

For repairs not covered under this Warranty, EBARA will charge the customer for parts and labor.

Exclusions and Limitations

This Warranty does not cover the following:

1. Failure due to operating the pump in a manner or under conditions other than as described in the instruction manual.
2. Failure due to corrosion, byproducts or foreign material entering the pump.
3. Failure due to fire, flood, earthquake, Acts or God, Acts of War or other circumstances beyond EBARA's control.

Disassembly or repair of the pump by parties other than EBARA or EBARA-authorized suppliers will void this Warranty.

EBARA's liability is limited to repair or replacement of the pump under Warranty. EBARA accepts no liability for consequential damages, including injury to personnel and damage to facilities, tools or product.

EBARA makes no Warranty of merchantability, beyond statutory requirements, or of fitness for a specific purpose.



EC DECLARATION OF CONFORMITY

Manufacturer: EBARA CORPORATION

Address of manufacturer: 11-1, Haneda Asahi-cho Ota-ku Tokyo 144-8510, Japan

Herewith declares that:

Type of product : Dry Vacuum Pump

Model : ESA25-D

Serial Number : _____

- does comply with the provisions of the "Low Voltage Directive 2006/95/EC".
- does comply with the provisions of the "EMC Directive 2004/108/EC".
- does comply with the provisions of the "Machine Directive 2006/42/EC".

- And declares that following (parts/clauses of) harmonized standards have been applied:

EN 1012-2:1996	Compressors and vacuum pumps - Safety requirements - Part 2: Vacuum Pumps
EN 60204-1:2006	Safety of machinery - Electrical equipment of machines - Part 1: General requirements
EN 6100-6-2:2005	Electromagnetic compatibility (EMC) -- Part 6-2: Generic standards - Immunity for industrial environments
EN 6100-6-4:2007	Electromagnetic compatibility (EMC) -- Part 6-4: Generic standards - Emission standard for industrial

The Technical Construction File for this machinery is retaining at the following address:

EBARA Corporation, Precision Machinery Company
4-2-1 Honfujisawa, Fujisawa, Kanagawa Pref., 251-8502, Japan

Date of Issue : Jan. 5 '10

Signature : Y. Niimura

Yasuhiro Niimura

General Manager, Components Engineering Department, Components Division
EBARA CORPORATION, Precision Machinery Company

CONTENTS

Environmental Basic Policies.....	i
Safety Information.....	ii
Important Prior Warnings.....	iii
Safety Interlocks.....	x
Standard Limited Warranty.....	xii
Declaration of conformity.....	xii
CONTENTS.....	xiv
1. Foreword.....	1
2. Introduction.....	1
2.1 Introduction.....	1
2.2 Environmental Concerns.....	2
3. Product Description.....	3
3.1 Outline.....	3
3.1.1 Pump Module.....	3
3.1.2 N2 Gas.....	3
3.1.3 Cooling Water.....	4
3.1.4 Exhaust.....	4
3.2 Control System.....	4
3.2.1 Warning.....	4
3.2.2 Operation Status Control.....	5
3.3 The way of pump moving.....	5
3.3.1 Preparation.....	5
3.3.2 Moving method.....	6
3.4 Release and shut off residual internal energy.....	7
3.4.1 Electrical Power - Lockout and Tagout.....	7
3.4.2 Cooling water.....	7
3.4.3 Nitrogen (N2).....	8
3.4.4 Returning to Service.....	8
3.5 Detailed Specifications.....	9
4. Installation.....	13
4.1 Movement and Fixation.....	13
4.1.1 Location.....	13
4.1.2 Caster and adjustment foot.....	13
4.1.3 Pump Fixation.....	14

4.2 Piping.....	16
4.2.1 Vacuum and Exhaust Piping	16
4.2.2 Cooling Water Piping.....	17
4.2.3 N2 Gas Piping	18
4.2.4 Ventilation Duct	19
4.3 Electrical Wiring.....	20
4.3.1 Grounding.....	20
4.3.2 Power Supply Wiring	21
4.3.3 Control Signal Wiring.....	22
4.3.4 Additional Emergency Off (EMO) input	27
4.4 Voltage Change.....	28
4.4.1 Method of changing transformer terminal wiring.....	28
4.4.2 Change of DIP switch	28
4.4.3 Method of changing wiring in motor terminal box	29
4.4.4 Method of exchanging the main fuses	29
5. Power Supply for accessories.....	30
6. LCD Controller	31
6.1 LCD Outline	31
6.2 LCD Indication	32
6.3 Setting the operational mode.....	36
6.3.1 Setting the pump operation control mode.....	38
6.3.2 Setting the DIP switch	39
6.3.3 Setting the WARNING value for N2 flow rate	40
6.4 Dip Switch.....	41
6.5 DIP Switch setting display	44
6.6 Starting/stopping the pump with the LCD controller.....	46
7. Operation	47
7.1 Before Starting.....	47
7.2 START/STOP	49
7.2.1 LOCAL (Pump Side) Start/Stop.....	50
7.2.2 REMOTE Start/Stop	51
7.2.3 COMMUNICATION Start/Stop	51
8. Maintenance and Inspection.....	52
8.1 Internal energies.....	52
8.1.1 Power source	52
8.1.2 Cooling water	52
8.1.3 Nitrogen gas	52
8.2 Routine Inspection.....	53

8.3 Vacuum and Exhaust Piping.....	55
8.4 Lubricant Oil	56
8.5 Spare (Maintenance) Parts List	59
8.6 List of wastes during maintenance	60
8.7 Overhaul.....	61
9. Disconnection and Transportation	62
10. Troubleshooting	64
10.1 Troubleshooting (1) Basic trouble.....	64
10.2 Troubleshooting (2) WARNING	66
10.3 Troubleshooting (3) ALARM	68
10.4 Troubleshooting (4) option.....	70

1. Foreword

We appreciate that you have selected an EBARA Model ESA25-D dry vacuum pump. This pump has been manufactured with much care and attention so that it can be operated safely and satisfactorily.

Incorrect operation will result in lack of performance and cause accidents and injuries to personnel.

[**NOTE**] This instruction manual contains all necessary information on operation and maintenance of the pump.

Be sure to operate the pump correctly in accordance with these instructions to ensure a long service life.

Keep this instruction manual in a suitable place for immediate reference whenever needed.

2. Introduction

2.1 Introduction

Check the following items on receipt of the pump package.

(1) Check that the nameplate affixed to the outer cover of the pump to confirm that the pump supplied agrees with your order.

Check the accessories against the packing list and the previously submitted drawings and documents to confirm that the all ordered accessories have been supplied.

(2) Check whether damage has occurred or screws/bolts have worked themselves loose in transit.



CAUTION Notify EBARA without delay when damage is discovered or when components are missing. Do not use when a leak is present as this will result in accident.

(3) Store the pump in a dry and clean place if it is not installed at once after delivery.

Temperature : 5-40°C
Humidity : 80% or less

(4) Do not stack the pump. Pump must be placed in an upright position.

2.2 Environmental Concerns

Handling or operating the unit other than specified may induce adverse impacts on the environment. Follow the descriptions below to handle, operate, and maintain the unit.

- (1) Ask an authorized waste-disposal company to dispose packing materials from uncrating according to laws and ordinances applicable to the waste.
- (2) Failure to do the unit maintenance (including overhaul) may trigger accidents causing injury or death, unit troubles, or environmental pollution. Plan the maintenance and perform it periodically to operate the unit efficiently.
- (3) To dispose the unit, follow effective laws and ordinances applicable in the area where the unit is installed.
- (4) To dispose the lubricant oil and chemicals, follow effective laws and ordinances applicable in the area where the unit is installed.

 **WARNING** If the pump becomes damaged during shipment or if parts are missing, immediately contact EBARA. If a leaking or damaged product is used, an accident resulting in injury or death could occur or the product could become further damaged. Even if leakage occurs, take measures to ensure they will not be directly discharged from the site, as such leakage also wastes resources.

 **CAUTION** If the product is not to be immediately installed, store it in a clean, dry location.

3. Product Description

3.1 Outline

This pump has a compact design and includes various sensors and controls to enhance reliability and operation.

3.1.1 Pump Module

The pump is a Roots type vacuum pump which rotates a pair of non-contact multi-stage rotors synchronized by timing gears.

The timing gears and bearings are enclosed in a compartment that is independent of the casing. For lubrication Perfluoro-Polyether (PFPE) oil are used.

The pump is filled with lubricating oil at the factory. Use only the recommended lubrication oil grades shown in specification Table 3.1 for replenishing or replacing.

3.1.2 N₂ Gas

Introduce nitrogen gas to dilute the hazardous gases to an unarmful level. Properly connect the nitrogen gas line to the purge port provided according to the instructions in Table 3.1 and the descriptions in Section 4.2.3. In the cases the gas concentration may become higher than the specified for safe gas exhaust, introduce the nitrogen gas to lines to the exhaust outlet. The tool user shall provide the purge port for this purpose.

N₂ gas is also required to supply to seal the shaft section. This protects the penetration to bearing section, such as corrosive gas.

To reduce pump corrosion due to process gas or accumulation of reaction by-products, N₂ gas is supplied to each pump component as dilution purge gas.

Stopping the dilution N₂ with a selector valve can save N₂ gas, when process does not produce corrosion and reaction by-products.

The correct amount of N₂ gas is supplied for those two types of purge operation, by adjusting the regulation pressure to the specified value.

The nitrogen gas selector is locating on the right side of the unit, facing the LCD controller and other utility connectors.

3.1.3 Cooling Water

Because the pump compresses gas from a vacuum to atmospheric pressure, compression heat is generated. Therefore, cooling water should be supplied through the motor and cooling plate of casing. The cooling water connector takes the form of a coupler for easy connection and disconnection.

3.1.4 Exhaust

A check valve is provided to prevent reverse flow of gas from the exhaust through the pump to the vacuum chamber when pump is stopped.

3.2 Control System

This pump has a built-in measuring unit consisting of a fuse for power line, an electro-magnetic switch and a control circuit.

To improve reliability and safety, the condition of each utility and pump section is monitored by a sensor.

During pump operation all operating conditions are monitored, including power supply, cooling water flow, N₂ gas flow, casing and motor coil temperature, and motor current.

Continuous operation is possible when there is a momentarily power failure of 1 sec or less.

3.2.1 Warning

To assure the reliability of the pump as a vacuum exhaust system, the pump protection system generates two levels of alarm: WARNING and ALARM.

A WARNING signal is generated when pump operation exceeds the normal range. It therefore only draws attention that the normal operating values are not adhered to but does not signify that danger is imminent. The pump will continue to operate in this condition.

An ALARM signal output is generated and the pump will stop automatically when the upper mechanical safety limit is reached during pump operation.

When an ALARM output is suddenly generated, while the plant unit is operational, a WARNING signal will be generated to ensure that the plant operation is not discontinued. This enables the operator to check the pump after the equivalent of one cycle has been completed.

Be sure to contact EBARA Corporation for details on checking the WARNING and ALARM setting conditions.

- Note that the warning indications of the Model ESA25-D dry pump are different from the conventional pumps like as UERR, A, AA, AAS series, based on SEMI standard E-73.

	UERR,A,AA, and AAS	Model ESA25-D
Alarm 1 (Pump operation continued)	ALARM	WARNING
Alarm 2 (Pump stop)	TRIP	ALARM

3.2.2 Operation Status Control

The sensor data are displayed on the LCD display provided on the controller to facilitate operation status control and daily inspection.

All WARNING and ALARM signals are displayed on the LCD display. For remote operation and monitoring, the signals are available as individual and group outputs.

3.3 The way of pump moving

3.3.1 Preparation

Before pump moving, all adjuster feet shall be raised fully at four places.

In case of being not raised fully, pump may be tripped over by obstacle on floor.

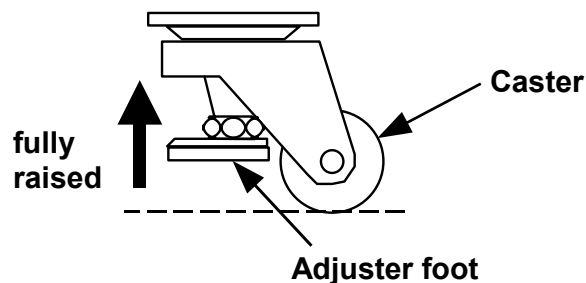

3.3.2 Moving method

Move pump slowly by pushing eye bolt toward direction A. Be sure not to be caught by toes. If pump needs to be moved toward direction B in order to be set at a corner or narrow spaces, two persons shall move the pump by pushing its terminal portion alternately as directed below.

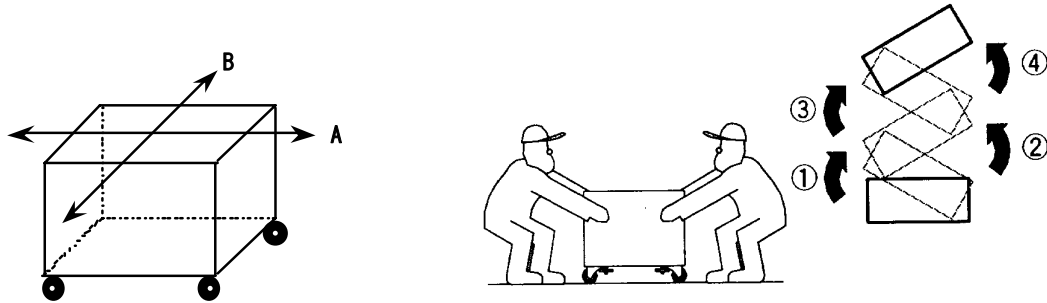

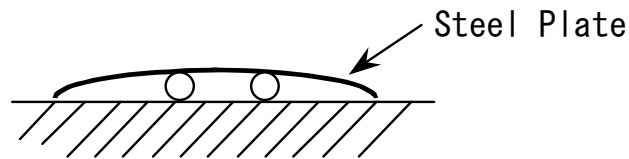

If pump needs to be moved on steps or ditches, spread steel plate or the like which can sustain the pump weight over the steps / ditches and pump shall be moved on it by two persons with care.



If pump should lose its balance when moving and start tripping over, never try to sustain the pump, get away from the pump immediately.

3.4 Release and shut off residual internal energy

 WARNING	To avoid dangers potentially encountered during maintenance, transportation or storage, follow instructions below to shut off power.
 WARNING	Capacitors within the control panel retain residual energy after interruption of power supply. Wait five (5) minutes after shutting off breaker before opening the control panel. Carefully check that bleed circuits have discharged the residual energy before servicing the control panel.
 WARNING	To comply with SEMI S2, install lockable shutoff devices on electrical, nitrogen and cooling water supplies. These devices should be adjacent to and within sight of the pump.

3.4.1 Electrical Power - Lockout and Tagout

Lock the branch circuit in the OFF position and tag it out to perform maintenance or troubleshooting. The operator should keep the key with himself while working. Padlock with key and tagout label shall be prepared at user side. The Lockout/Tagout procedures must comply with OSHA 29 CFR 1910.147 and 1910.331-335.

1. Verify that the LCD display is lit (confirming that pump is powered).
2. Turn the branch circuit disconnect off.
3. Insert padlock through holes on locking device. Close padlock and attach tag.
4. Verify that LCD display is unlit (confirming that pump is unpowered).
5. If unable to confirm interruption of power via LCD display, use a voltmeter to probe contacts at Connector CN-C. Potential between any two pins indicates that electrical power to the pump is not interrupted.

3.4.2 Cooling water

1. Close [facility] water supply to stop water supply to the pump, then close water return valve. Follow [facility] procedures for locking these valves in the off position.
2. Push the knurled outer ring of the quick-connect couplers toward the pump to disconnect the water hoses. Carefully remove the male coupling halves from the hoses and remake the quick-connects to drain the pump lines. Have a catchment vessel and absorbent cloths at hand before removing the couplings.
3. Make sure water outflow stops from both the facility lines and the pump.

3.4.3 Nitrogen (N2)

1. Close [facility] nitrogen supply valve and follow facility procedures for locking this valve in the off position.
2. Verify that the nitrogen pressure gauge (on front panel of the pump) drops to 0 MPa, confirming that no pressurized gas energy is stored in the pump.
3. Pull out the red detent ring on the N2 regulator.
4. Turn knob counterclockwise until pressure gauge reads 0 MPa. (Both N2 regulator knob and nitrogen pressure gauge are located on front panel of the pump.)
5. Disconnect tube connection of N2 supply line by turning tube nut counterclockwise.
6. Plug (cap) ¼" tube connector on the pump with a tube fitting cap.

3.4.4 Returning to Service

1. Unlock and open water and nitrogen valves.
2. Remove handle stop bracket and switch circuit breaker on.
Restart pump and open foreline valve only after appropriate leak checks and safety verifications.

3.5 Detailed Specifications

The following tables and figures should be consulted for pump specification, dimension and performance details.

Table 3.1 Specification

Model		Model ESA25-D		
Pumping Speed(50/60Hz)		2500 / 3000 L/min		
Ultimate Pressure(50/60Hz)		5.3/4.0 Pa		
Connection	Gas Inlet	NW50		
	Gas Outlet	NW40		
MOTOR		2P 3.7 kW		
Uti- lity	Cooling Water	Connection	Coupler(Rc3/8)	
		Pressure [Gauge Press.]	Supply: Max. 0.4MPa Differential Press. : Min. 0.1MPa	
		Flow rate	3.5 - 8 L/min	
		Temperature	Max. 30 deg C	
	N ₂ Gas	Connection	1/4" Tube Fitting(Same as Swagelok or equivalent)	
		Pressure [Gauge Press.]	Supply : 0.1 - 0.7MPa [Setting : 0.04 - 0.07MPa]	
		Approx. Flow rate [N ₂ -0 Mode]	17 - 20 Pa m ³ /s [3.8 Pa m ³ /s]	
	Duct Venti- lation *	Connection	d 50 mm x L 50 mm	
		Pressure	-196 Pa	
		Approx. Flow rate	0.5 m ³ /min	
Lubrication Oil	Brand	BARRIERTA J100ES (NOK) BARRIERTA J100 (NOK)		
	Quantity	0.4 L		
Approx. Weight		240 kg		
Power Supply	Phase/Volt/Freq.	[200V mode] 3 Phase,200V(50Hz)/200-220V(60Hz) [400V mode] 3 Phase ,380-400V(50Hz),/380-440V(60Hz)		
	Current Rating	[200V mode] 17.8 / 17.0 A (50/60 Hz) [400V mode] 8.9 / 8.5 A (50/60 Hz)		
	Connection	Japan Aviation Electronics Industry Co.,Ltd. JL04HV-2E22-22PE-B		
	SCCR	5kA		
Control Signal		D-sub 15 Pin + D-sub 25 Pin		
Airborne noise test data [dB (A)] **		63		

[Note] * The ambient temperature of the pump installation place shall be 30 degrees of centigrade of lower.

** Test condition

- (1) Pump is operating under ultimate pressure.
- (2) Measured at 1m distance from cover and 1.6m height from floor.

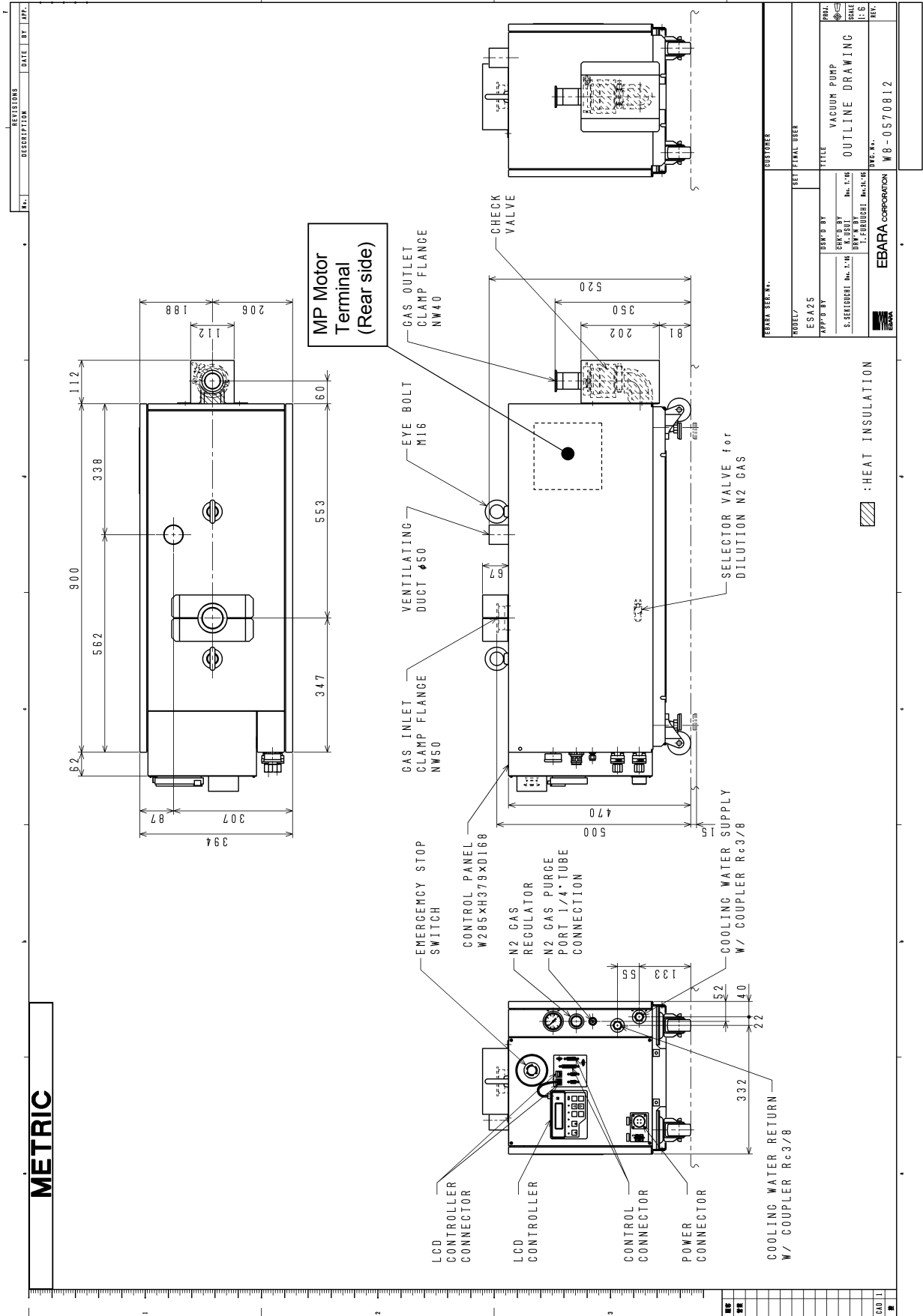

Model ESA25-D Performance Curve

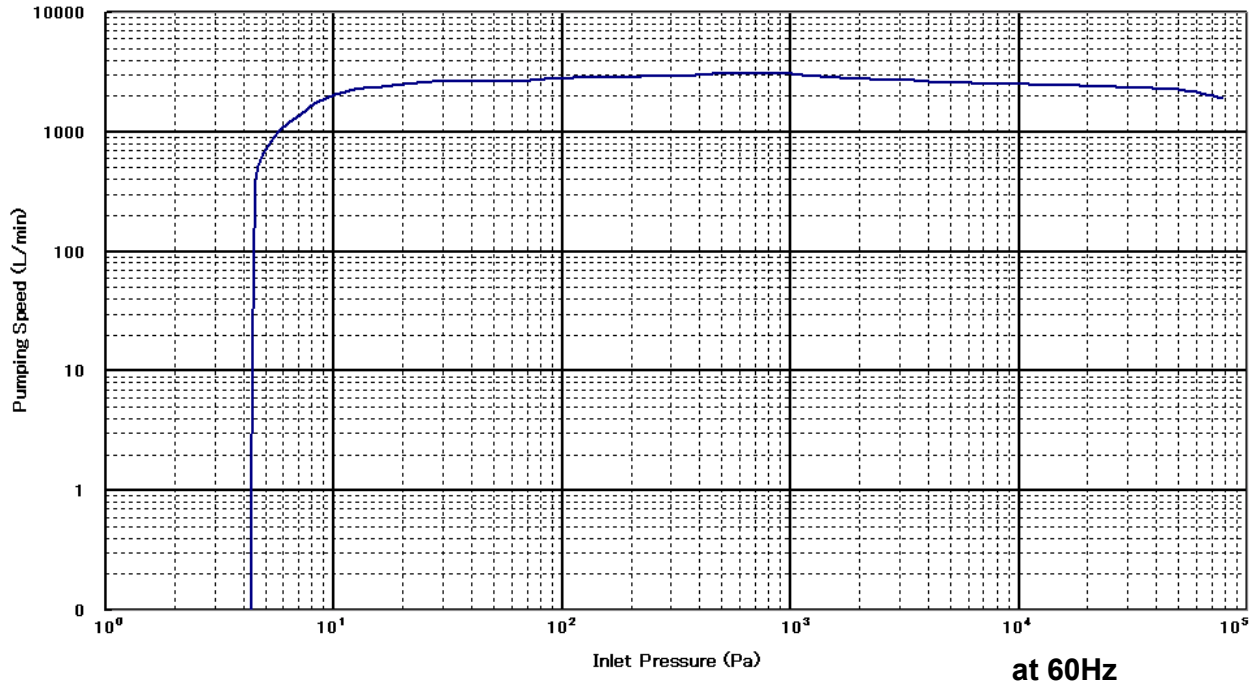
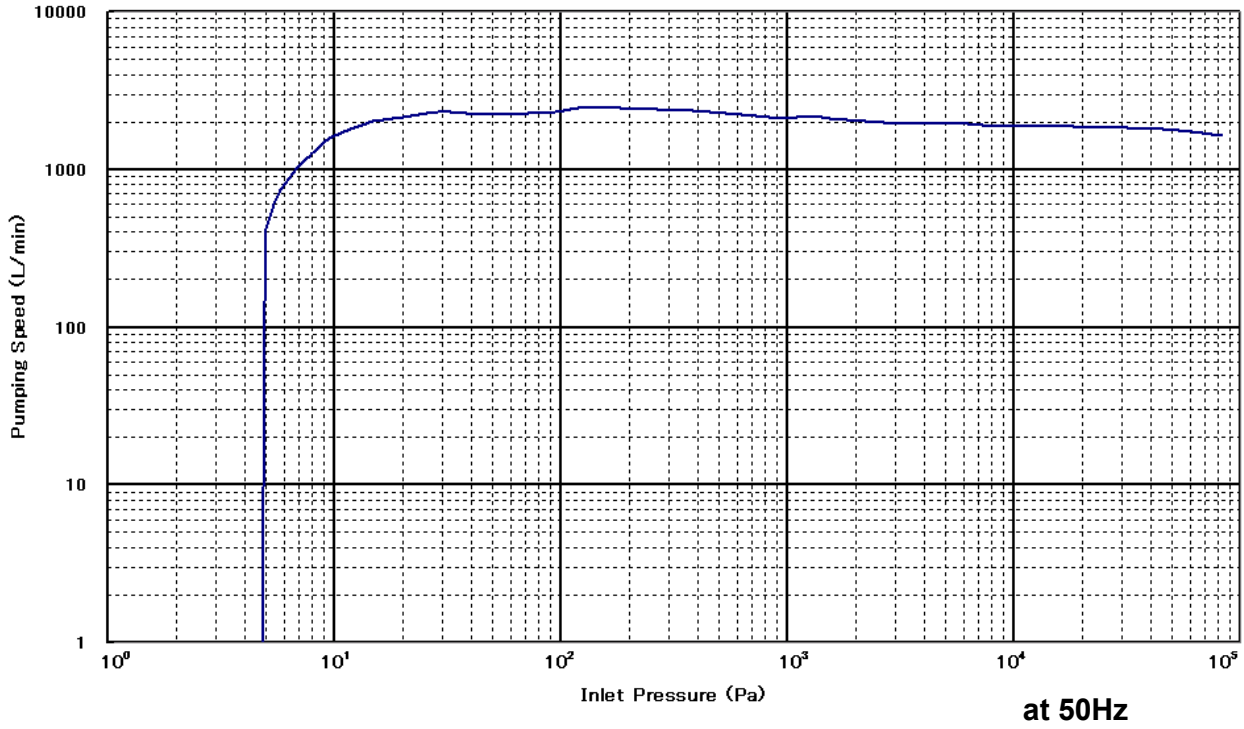

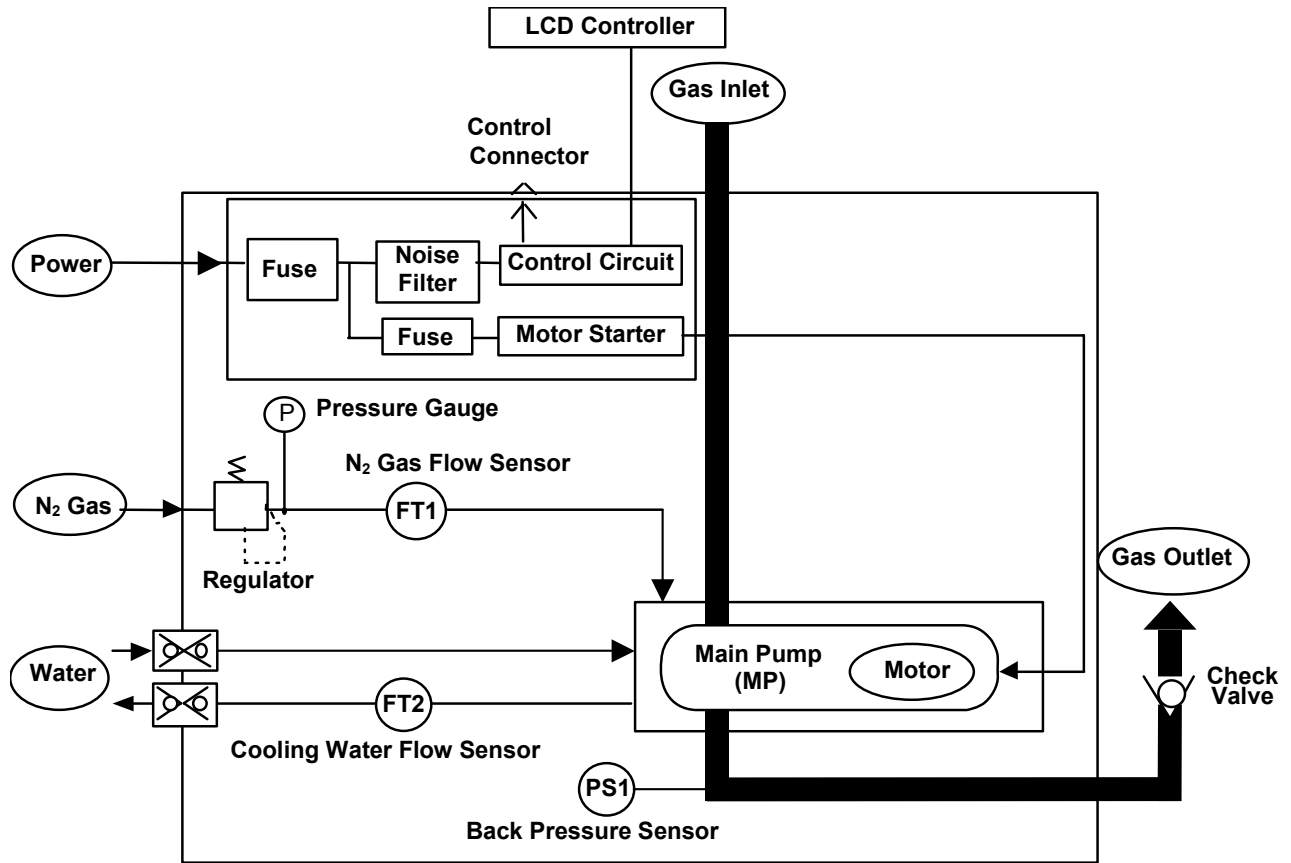

Fig. 3.1 System Flow

4. Installation

Be sure to take the following cautions and instructions into account when installing the pump.

4.1 Movement and Fixation

4.1.1 Location

This pump is designed for indoor installation. To install the pump, select a place with little exposure to dust and humidity and not subject to dew condensation. Also allow for sufficient space to ensure easy pump installation and disassembly for maintenance.

In case of installing interface box to the pump, the distance between pump and interface box shall be 3m or less.

CAUTION Install pump in a location at an ambient not exceeding 30°C. Particular caution is required when the pump is operated in an enclosed room.

CAUTION A gap of at least 50mm should be left open for ventilation between the pump cover and the adjacent equipment.

4.1.2 Caster and adjustment foot

Four integral mobile support units consisting of a caster and a height-adjustment foot each are provided underneath the pump base. To move the pump, raise the four adjustment feet by turning the holding nuts in the counterclockwise direction.

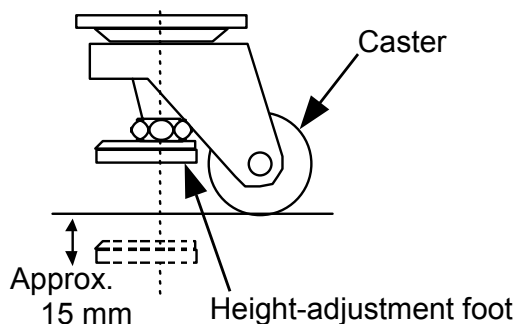





Fig. 4.1 Caster

 **WARNING** Be careful not to overturn the pump when pushing and pulling it sideways, because the width of the pump is small to its height.

 **CAUTION** The neck portion of the casters will vibrate during caster movement. Be sure to keep your fingers and feet out.

 **CAUTION** Do not step on the pump or place objects on it.

(1) To fix the pump, turn the adjusters to the right to lower them.

(2) Adjust the height of the feet evenly to ensure that the pump base is level.

The difference in height between the two sides of the pump base shall not exceed 1mm.

The adjustment allowance is approximately 15 mm.

[**NOTE**] If the pump is not leveled, shortage of the lubrication oil supply to the bearing may be caused.

[**NOTE**] To prevent vibrations and airborne noises, keep horizontal level of pump with the adjustment feet.

4.1.3 Pump Fixation

The pumps are provided with casters for easy transportation and foot adjustments for anchoring and height adjusting, as described in Section 4.1.2. The pump, however, may unexpectedly move or fall down when an earthquake occurs. To prevent such events, this model can be equipped with the anchor plate to secure the pump body to the floor. Fix the pump to the floor or other firm ground with the anchor plate at the installation.

Anchor plate is a standard part of the SEMI model. It's optional in other models.

For dimensions of the anchor plate, see the accompanying drawing.

Anchor bolts should be fit for conditions of the floor where the pump is anchored.

4.2 Piping

4.2.1 Vacuum and Exhaust Piping

Connect the vacuum and exhaust pipes to the inlet and exhaust flanges.

A narrow clearance is maintained in the pump for rotor rotation. The ingress of foreign objects into the pump interior will therefore prevent the pump from operating. Be sure that therefore to heed the following cautions when making the pipe connections.

- a) Remove all foreign matter from inside the piping.
- b) When connecting be sure that no dirt or dust particles adhere to the flange surfaces and/or that the flange surfaces are not damaged.
Provide a suitable means of preventing the ingress of reaction by-products adhering to the APC valve and wafer fragments. For this purpose, equip with a filter may be recommended.
- c) The weight of the pipes attached to the pump can cause misalignment and leaks from the flange connections. Be sure that therefore to support the piping properly and not to apply undue force when aligning the flange faces.
It is recommended to insert flexible bellows when connecting the pipes to the suction and exhaust flanges of the pump.
The length of the flexible bellows on the vacuum (suction) side will vary according to the vacuum drawn. Be sure to connect so that no undue force can be applied to the flexible bellows.



WARNING Be sure to check for leaks after you have installed the pump. Leaks will cause serious danger due to the discharge of harmful and hazardous substances and the occurrence of unpredictable reactions associated with the admission of air into the pump. When checking for gas leaks by pressurization, please pressurize by less than 0.05 MPa into the purge port and do check.

4.2.2 Cooling Water Piping

Be sure to connect the cooling water pipes to the correct inlet and outlet ports.

The connector ports are provided with couplers. Push in the plug till the end of socket. Socket sleeve returns to front. (Fig. 4.2)

Be sure that the supply/return plugs are not connected in reverse. The diameters are slightly different. In/Out markings are provided on each plugs.

When the coupler is pulled out the water pipe will be automatically blocked. Use cooling water corresponding to the specifications of Table 4.1 below.

Table 4.1 Industrial Water Supply Quality Specification

(Japan Industrial Water Association, Industrial Water Quality Standards Committee)

Turbidity	(ppm)	20
pH		6.5-8.0
Alkalinity(CaCO ₃)	(ppm)	75
Hardness(CaCO ₃)	(ppm)	120
Evaporation residue	(ppm)	250
Chlorine ion	(ppm)	80
Iron	(ppm)	0.3
Manganese	(ppm)	0.2

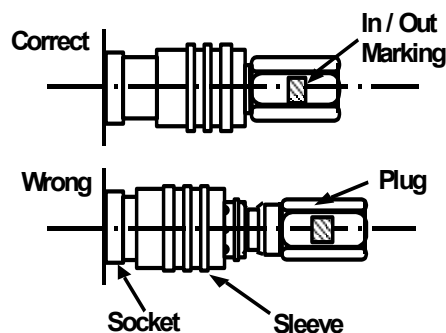

Fig.4.2 Coupler



CAUTION Even when the cooling water flow rate drops, the pump will continue to operate until the pump part reach a temperature corresponding to the safety limit.

The material selected for the water piping of facility side should have a heat resistance so that it can withstand a maximum temperature of at least 70 °C at the operating pressure.



CAUTION When several pumps are used, be sure to connect the cooling water pipes to each pump in parallel. The cooling water will flow more or less easily according to the type of pump and the piping. Be sure to select the correct piping so as to ensure the appropriate cooling water flow rate for all pipes used.

⚠ CAUTION When the cooling water connections are incorrect and the flow is reversed, a flow rate different from the normal value will be displayed. Pump may not be cooled properly under this condition, and this cause serious problem.
Be sure therefore to connect correctly to avoid problems.

⚠ CAUTION When the cooling water supply is left on while the pump is stationary dew condensation will form on the water-cooled parts in locations with high humidity.
Make it a rule therefore to stop the cooling water when water droplets can be detected on the outer surface of the pump cooling water piping as this suggests the possibility of dew condensation in the pump.

4.2.3 N₂ Gas Piping

Cut tube at right angles and make the end-face perfectly smooth. Then connect the tube to the tube fitting assembly of the N₂ gas purge port. The tube is a push-fit onto the shoulder of the tube fitting assembly.

Secure the tube fitting assembly properly and tighten the retaining nut by hand. After this, use a tool to tighten the nut further by 1 + 1/4 turns.

To connect the tube again after this, install the tube already fitted to the ferrule and re-tighten the retaining nut slightly after the initial tightening (generally, tighten by a further quarter turn after tightening by hand).

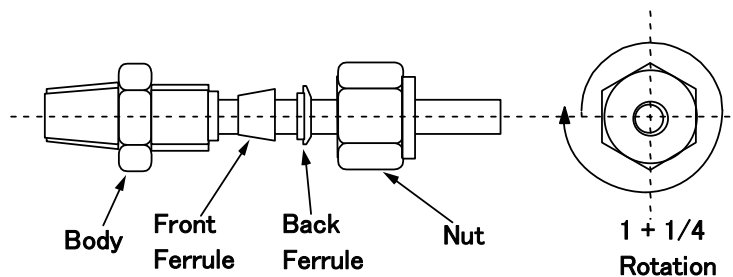

Fig. 4.3 Tube Fitting Assembly

⚠ CAUTION For safety, be sure to use N₂ gas which purity is more than 99.999%. Impurities of N₂ gas may cause an accident when the pump is used for exhausting toxic and/or inflammable gases.

4.2.4 Ventilation Duct

Proper ventilation is necessary not only to prevent the hazardous gases to leak but also release heat generated and accumulated in the pump module through the pump operation. Without proper ventilation, the temperature inside the cover will continue to rise until an ALARM is generated. This will result in serious problems.

Connect the ventilation duct, locating on the top of the pump, to a duct that the user provides. The user side duct shall have exhaust capability listed in Table 3.1 and shall be independent from the duct connected to the pump exhaust outlet.

A substance, which is not corroded with used gas, shall be used as the material of the exhaust duct.

The pump does not have gas leak detector. So it is recommended to attach gas leak detector on detector port of duct piping to take exhaust flow interlock. Leak detector shall be NRTL approved or equivalent.

In case of find gas leakage, stop the gas introduced into the equipment and pump. It is strongly recommended to wire the control circuit such that the pump immediately stops its operation upon leak detection by connecting the leak detector output to the EMO external signal input of the pump. Refer to Section 4.3.4 in this manual for connecting the leak detector output.



CAUTION For safety, be sure to ventilate through the ventilation duct when the pump is used to exhaust toxic, inflammable, and/or other hazardous gases. Do not combine the ventilation duct with the pump exhaust piping.





CAUTION Even when the pump is used for exhausting process gases that are not toxic and/or inflammable, do not combine the ventilation duct with the pump exhaust piping. The exhaust noise of the pump will give rise to acoustic resonance inside the pump unit and result in an abnormal noise being generated.



CAUTION Never operate the pump without pump cover for safety.

4.3 Electrical Wiring

 **WARNING** Be sure to keep the power supply to the pump turned off and lock-outed until you have finished the wiring and connecting work.

 **WARNING** Electrical wiring shall be carried out only by qualified electricians.

 **CAUTION** Do not apply the power supply from the pump's power pack to any other equipment as this will result in malfunctioning of the control units and in pump failure.

4.3.1 Grounding

This product should be grounded. In the event of an electrical short circuit, grounding reduces the risk of electric shock by providing an escape wire for the electric current. This product is equipped with a cord having a grounding wire with an appropriate grounding plug. The plug must be plugged into an outlet that is properly installed and grounded in accordance with all local codes and ordinances.

 **DANGER** Improper installation of the grounding plug can result in a risk of electric shock. If repair or replacement of the cord or plug is necessary, do not connect the grounding wire to either flat blade terminal. The wire with insulation having an outer surface that is green with or without yellow stripes is the grounding wire.

Check with a qualified electrician or serviceman if the grounding instructions are not completely understood, or if in doubt as to whether the product is properly grounded. Do not modify the plug provided; if it will not fit the outlet, have the proper outlet installed by a qualified electrician.

4.3.2 Power Supply Wiring

! WARNING For compliance with SEMI S2, install an Approved lockout/tagout device on the branch circuit supplying the pump.

! CAUTION Use the correct wiring materials and size to match the operating conditions in accordance with the power consumption rating and ambient air temperature of the pump.

! CAUTION Be sure to connect the grounding wire.

! CAUTION Wiring should be hard-wired or using twist-lock Hubbel type connector at power source side.

Wire the connector for the main power supply. Fig. 4.4 and Tables 4.2 and 4.3 show the connector pin assignment.

Table 4.2 Pin Assignment of Power Supply Receptacle

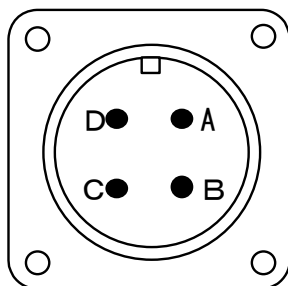

No.	Phase
A	R
B	S
C	T
D	GND

Fig 4.4 Power Supply Receptacle

(As seen from out side,
just unplugged)

Table 4.3 Receptacle Specification

Pump model	Model ESA25-D
Receptacle type	JL04HV-2E22-22PE-B
Recep. Manufacturer	Japan Aviation Electronics Industry Co., Ltd.
Adapted plug type	JL04V-6A22-22SE-EB
Suitable wire	AWG #10
Power capacity kVA	6.2

4.3.3 Control Signal Wiring

This pump is equipped with signal input and output connectors, which allow external tools and control devices to remotely operate and monitor the pumps. Connect wires to the control connector for remote operation and remote monitoring. Tables 4.4 , 4.5 , 4.6 and 4.7 and Figs. 4.5 and 4.6 show the pin assignment.

The pumps also have an Emergency Off (EMO) input connector for user error monitoring device, such as a gas leak sensor to monitor the in-box gas leakage, to receive its error detection output for pump emergency stop. Refer to section 4.3.4 of this manual for EMO input.

Table 4.4 Receptacle Specification

Connector No.	Connector type
CN-Z	15 pin D sub-miniature Female receptacle (in accordance with SEMI E73)
CN-Y	25 pin D sub-miniature Female receptacle

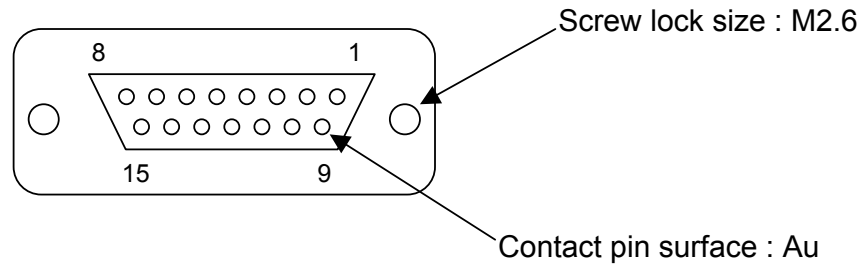

Fig. 4.5 15 Pin D Sub-Miniature Female Receptacle
(As seen from connecting side)

Table 4.5 Control Connector Pin Assignment(CN-Z)

Pin. No.	Signal name	I/O	Signal type
1	MP START (+)	IN	Run : CLOSE, Alternate
2	RESERVED (+)	IN	
3	MP START STATUS (+)	OUT	Run : CLOSE, Alternate
4	RESERVED (+)	OUT	
5	WARNING STATUS (+)	OUT	WARNING : OPEN, Alternate
6	ALARM STATUS (+)	OUT	ALARM : OPEN, Alternate
7	REMOTE STATUS (+)	OUT	REMOTE : ON
8	-		
9	MP START (-)		
10	RESERVED (-)		
11	MP START STATUS (-)		
12	RESERVED (-)		
13	WARNING STATUS (-)		
14	ALARM STATUS (-)		
15	REMOTE STATUS (-)		

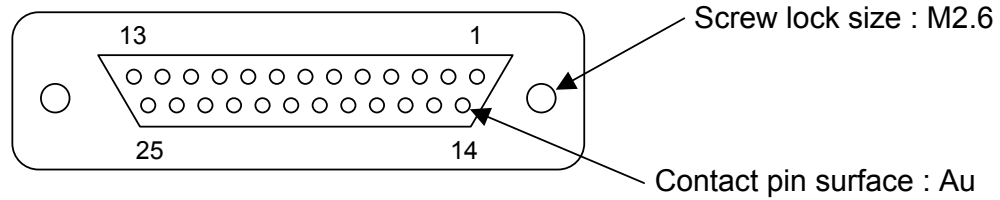

Fig. 4.6 25 Pin D Sub-Miniature Female Receptacle
(As seen from connecting side)

Table 4.6 Control Connector Pin Assignment(CN-Y)

Pin No.	Signal name	I/O	Signal type
1	RESET (+)	IN	RESET:CLOSE
2	RESERVED (+)	IN	
3	RESERVED (+)	IN	
4	RESERVED (+)	IN	
5	RESERVED (+)	IN	
6	EMO STATUS (+)	OUT	Abnormality : OPEN,Alternate
7	PUMP N ₂ WARNING STATUS (+)	OUT	Abnormality : CLOSE,Alternate**
8	RESERVED (+)	OUT	
9	RESERVED (+)	OUT	
10	BACK PRESSURE WARNING STATUS (+)*	OUT	Abnormality : CLOSE,Alternate**
11	RESERVED (+)	OUT	
12	RESERVED (+)	OUT	
13	-		
14	RESET (-)		
15	RESERVED (-)		
16	RESERVED (-)		
17	RESERVED (-)		
18	RESERVED (-)		
19	EMO STATUS (-)		
20	PUMP N ₂ WARNING STATUS (-)		
21	RESERVED (-)		
22	RESERVED (-)		
23	BACK PRESSURE ALARM STATUS (-)		
24	RESERVED (-)		
25	RESERVED (-)		

* : As optional

** : It can change to "Abnormality:OPEN, Alternate" by DIP SW. setting.

Table 4.7 CN-Z & CN-Y Signal Contacts

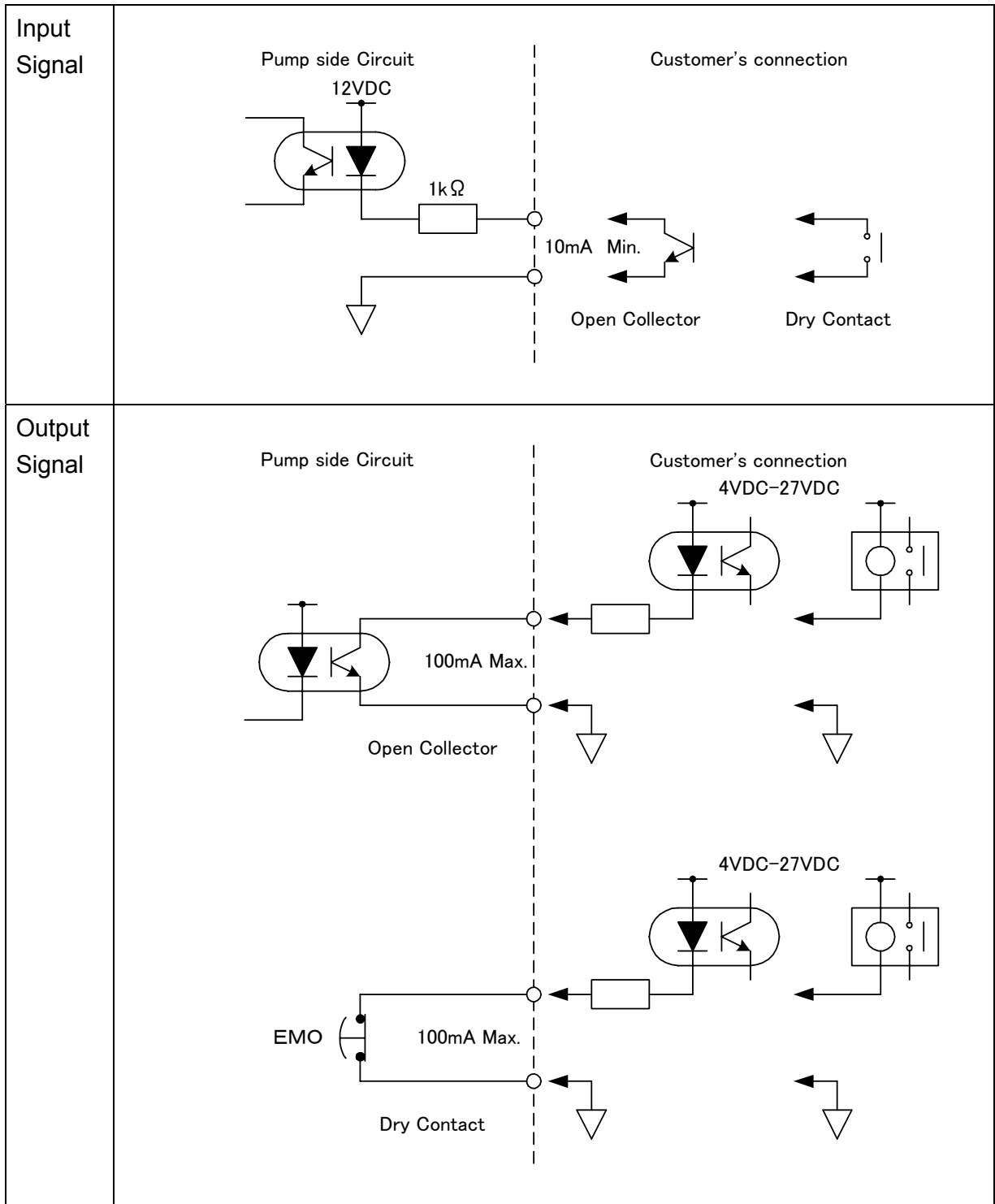

 **CAUTION** Do not wire vacant pins.

 **CAUTION** Apply a 12V DC power for input signals on the pump side. Do not apply this voltage on the equipment side.
The output signals are generated from an open collector output.
Please use it by the equipment side, impressing the power supply of DC4V to DC27V.

 **CAUTION** Be sure to wire all signals with the correct polarity (SIG./COM.)

 **CAUTION** When output signals are used to energize an inductive load such as a relay, be sure to insert a diode (100V. 1A class) in order to absorb the back electromotive force due to surge currents.

4.3.4 Additional Emergency Off (EMO) input

Although the pumps are equipped with the emergency button to stop its operation upon any emergency event, an additional connector for emergency input signal is provided for user's error detection device to connect. For instance, by connecting a gas leakage detector, which detects gas leakage in the pump, the pump operation is stopped upon leakage detection.

Additional EMO input connector "EXT. IO" is located on front panel. Refer to outline drawing shown in section 3.5.

 **CAUTION** Dummy plug should be connected on "EXT.IO" receptacle during operation. Pump does not run without dummy plug, because it means same as EMO signal was input.

Table 4.8 Additional EMO input Specification

Plug	HIROSE DF1B-2EP-2.5RC
Pin	HIROSE DF1-PD2428SCB
Suitable wire size	UL1007 AWG#24
Required capacity of user side facility	DC12V 20mA added by pump side. NO voltage required from outside
Signal input at NORMAL condition	Close between two pins of the plug
Signal input at EMERGENCY condition	Open between two pins of the plug

4.4 Voltage Change

This pump can change the voltage as follows,

- (1) Change transformer in the control panel at the front of the pump.
- (2) Change DIP switch at the display of the pump. See page 40 and 42.
- (3) Changing wiring in the motor terminal box from the Main pump.
- (4) Exchanging the main fuses (16A/32A) in the control panel at the front of the pump. Fuse 25A from Main pump remain.



CAUTION This pump might break down if the voltage setting is not correctly changed. The default voltage setting is indicated on the pump cover with label. Please write the new voltage setting on the pump, when the voltage setting was changed.

4.4.1 Method of changing transformer terminal wiring

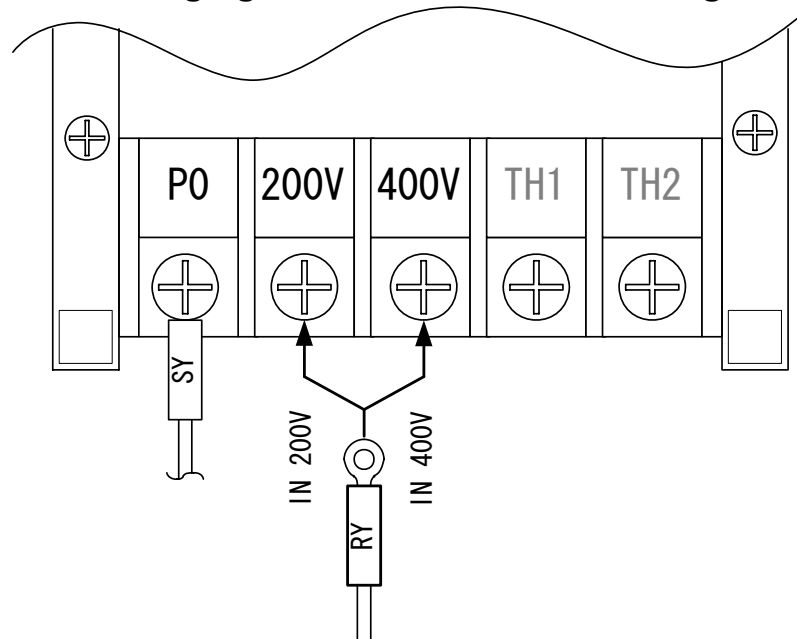

Fig. 4.7 Changing transformer terminal wiring

[200V AC at 3-phase and 50Hz, 200-220V AC at 3-phase and 60Hz]

Connect cable "RY" to "200V" terminal.

[380-400V AC at 3-phase and 50Hz, 380-440V AC at 3-phase and 60Hz]

Connect cable "RY" to "400V" terminal.

4.4.2 Change of DIP switch

Set the DIP-SW-C.7,8 according to operating voltage.(see Table 6.8)

4.4.3 Method of changing wiring in motor terminal box

Figure 4.8 shows the method of changing wiring in motor terminal box from Main pump.

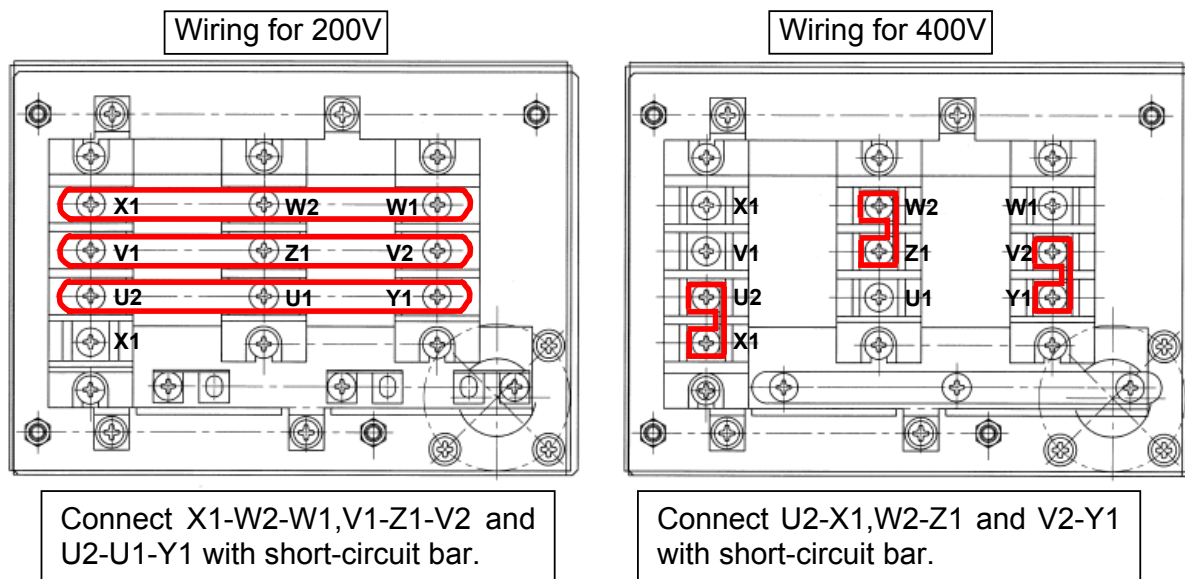

Fig. 4.8 Wiring for 200V and 400V

4.4.4 Method of exchanging the main fuses

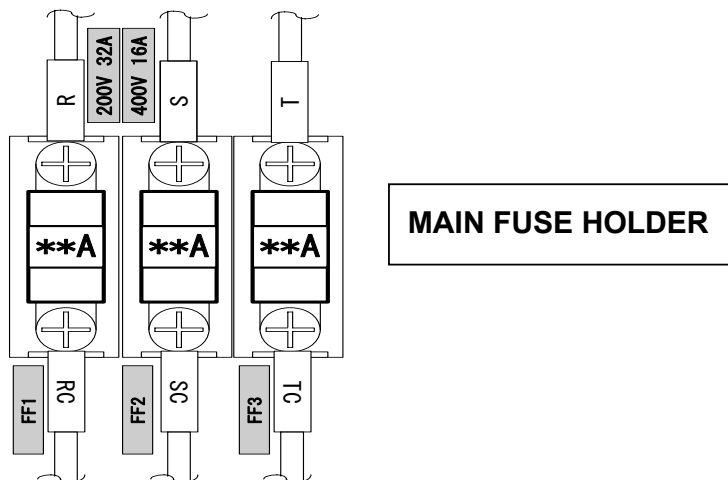

Fig. 4.9 Exchanging the main fuses

[200V AC at 3-phase and 50Hz, 200-220V AC at 3-phase and 60Hz]

The fuse of "32A" is installed in the fuse holder of FF1, 2, and 3.

[380-400V AC at 3-phase and 50Hz, 380-440V AC at 3-phase and 60Hz]

The fuse of "16A" is installed in the fuse holder of FF1, 2, and 3.

5. Power Supply for accessories

Power supply connector for accessory is equipped beside main power supply connector. This power supply is used for standard option that is listed below.

(Shall not be used for other purposes.)

ADAPTER for Central Monitoring System
Interface Controller



DANGER Power Supply for the options is kept applying voltage during the pump is supplied the power.



WARNING Do not use the power supply for other purposes.

6. LCD Controller

6.1 LCD Outline

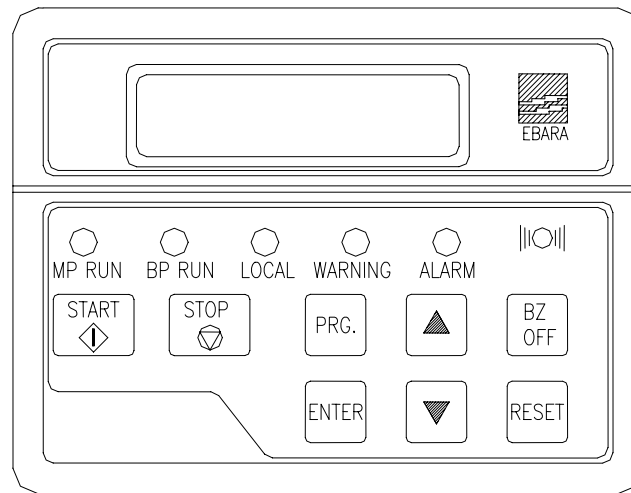

[Buttons]	START	For start Main pump(MP)
	STOP	For stop MP
	▲ ▼	For changing LCD indication
	RESET	For resetting WARNING and ALARM
	BZ. OFF	For "buzzer mute in WARNING / ALARM "
	PRG.	For changing screen of pump status and change hierarchy of screen
	ENTER	For using at DIP switch selection And change hierarchy of screen
[LED]	B.P. RUN	BP running (N/A)
	M.P. RUN	MP running
	LOCAL	LOCAL mode
	WARNING	WARNING condition
	ALARM	ALARM condition

Fig 6.1 LCD controller

6.2 LCD Indication

The operating status of the pump is displayed on the LCD display of the controller. For details of display, see Tables 6.1.

Table 6.1 LCD controller indication

No	ITEM	INDICATION
1	Motor current	M P : # # . # A
2	Control mode Pump running mode	C O N T R O L : L O C A L M O D E : N O R M A L
3	Alarm history (Indication of history)	A L A R M / W A R N I N G H I S T O R Y ?
4	Pump unit No.	U N I T N O . * * * * *
5	Pump type	P U M P T Y P E & & & & & &
6	Total operation time	O P E . T I M E # # # # # h
7	Back pressure (option)	B A C K P R E S S U R E # # . # k P a
8	Pump N ₂ gas flow	P U M P N 2 F L O W # # . # P a m ³ / s
9	Cooling water flow	W A T E R F L O W # # . # L / m i n
10	Pump casing temperature	C A S I N G T E M P . # # # ° C
11	WARNING/ALARM	\$ \$ \$ \$ \$: \$ \$ \$ \$ \$ \$ \$ \$ % \$ \$ \$ \$ \$ \$ \$ \$ \$ \$ \$ \$ \$ \$ \$ \$ \$ \$ \$

1. Three control modes are available : “LOCAL” (local operation) , “REMOTE” (remote operation) and “COM” (Communication operation).
2. " %" shows present number of WARNING/ALARM.
3. Upper row "\$\$\$\$\$" distinguishes between WARNING/ALARM and indicates the position where WARNING/ALARM has occurred.
Lower row "\$\$\$\$\$" displays details of WARNING/ALARM.

4. Total pump operating time gives the total hours of operation after shipment from the factory.
5. The display will return to the motor current indication when no operation takes place after the lapse of 1 minute.
6. Use the Display Select Switch (▲ ▼) to change the display.
The WARNINGS/ALARMS that have currently been generated can be displayed with the Display Select Switch.

See Fig. 6.2 for the key operation of the pump operation status display.

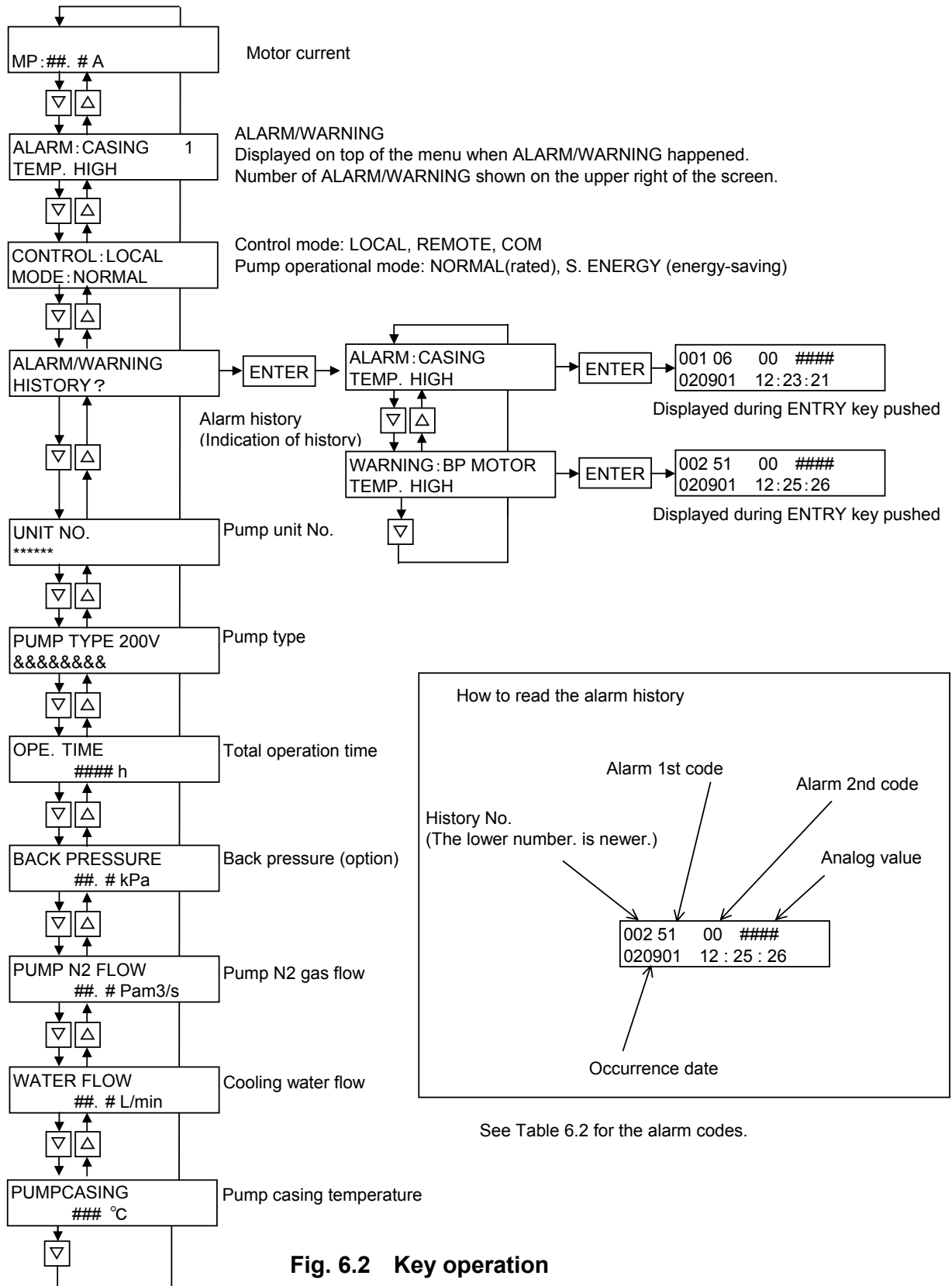

Fig. 6.2 Key operation for the pump operation status display

Table 6.2 Alarm code list

ALARM name	Code		WARNING name	Code	
	1st code	2nd code		1st code	2nd code
MP casing temp.	50	01	Cooling water flow low	00	01
MP motor temp.	52	00	MP casing temp. high	05	01
MP no current	60	00	Oil level low	08	00
Back pressure high	63	00	Pump box temp. high	13	00
Emergency off	71	00	Pump N ₂ flow low	18	01
EXT. interlock	74	00	Back pressure high (▲)	21	01
IO communication error	81	01	Back pressure sensor damaged (▲)	21	02
			IO communication error(IO board)	26	03
			IO communication error(C_IO board)	26	07
			Pump N ₂ valve error	27	02
			MP current high	31	15

“▲” indicates that the item is optional.

6.3 Setting the operational mode

This section describes how to set the operational mode. In the normal state, the LCD controller displays pump status. To display the operational mode setting screen, press the key “**PRG.**” for three seconds or longer. Pressing the key for one second or longer again returns to the pump status display screen. Table 6.3 below shows indications and the details of the operational mode setting.

Table 6.3 Operational mode setting screen

Item	Indication	Description
Setting the pump operation control mode	SET CONTROL MODE?	Switches the control modes: local ,remote, communication.
Setting the DIP switch	SET DIP SW?	Performs the DIP switch settings (see 6.4).
Setting the WARNING value for N ₂ flow rate	SET POINT N2 WARNING?	Sets WARNING value for N ₂ flow rate.

Keys work as below for the setting screen.

- START : Valid
- STOP : Stops the pump.
- RESET : Resets WARNING and /or ALARM.
- BZ.OFF : Switches the DIP switch No.
- ▲ : Sets the DIP switch to ON. Switches the display of the operational mode setting screen.
- ▼ : Sets the DIP switch to OFF. Switches the display of the operational mode setting screen.
- ENTER : Determines the selected setting.

See Fig. 6.3 for how to set the operational modes.

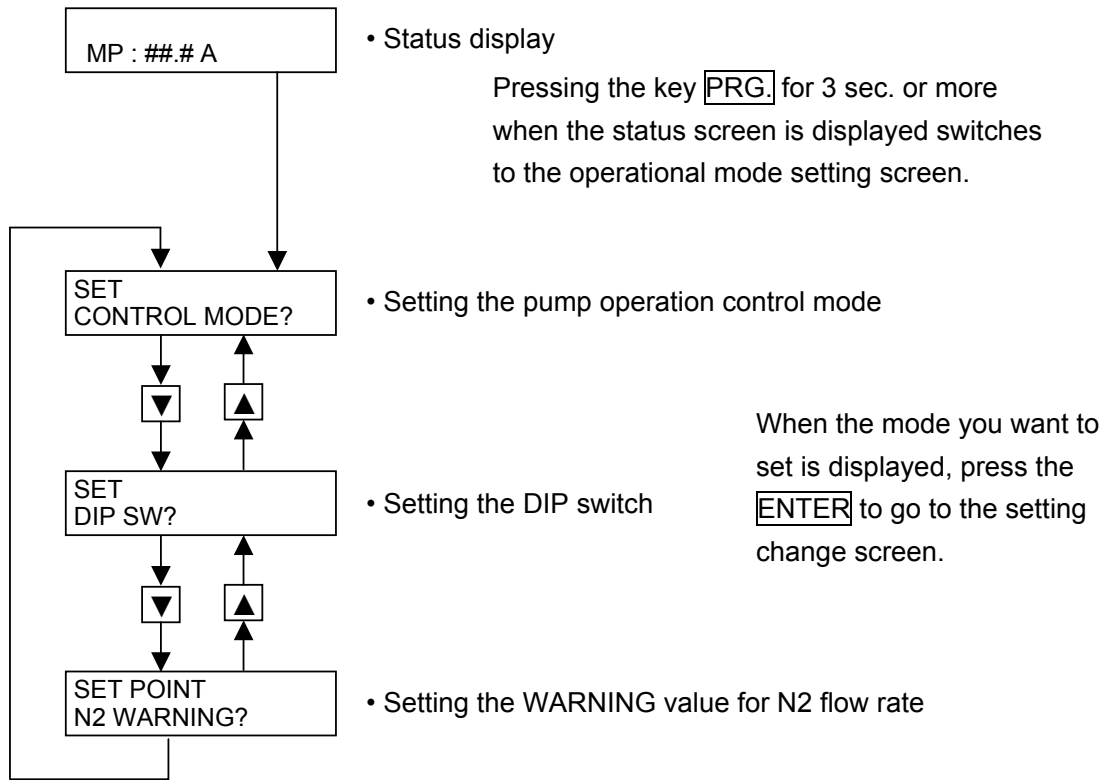
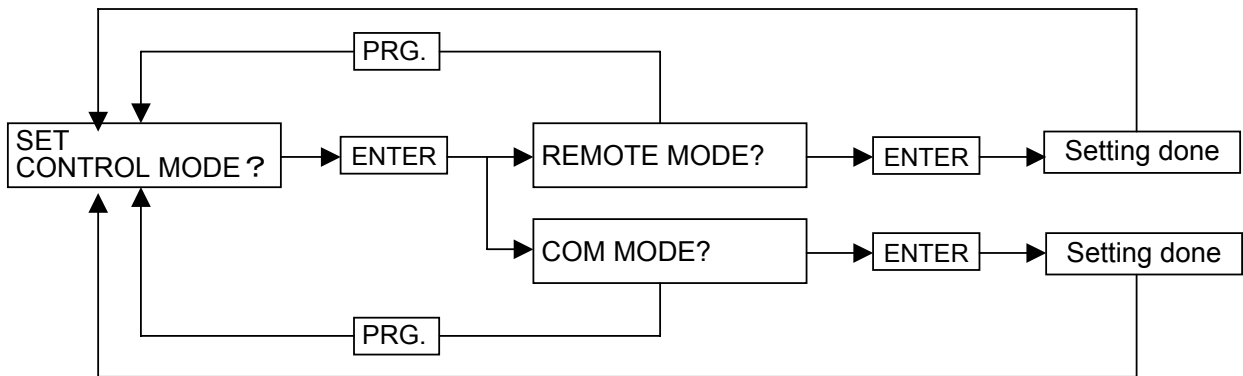

Fig. 6.3 How to set the operational mode

6.3.1 Setting the pump operation control mode

A case of display if Local mode selected.



REMOTE MODE : Enables the remote operation
(start/stop with external signals)

LOCAL MODE : Enables the local operation
(start/stop with the LCD controller)

COM MODE : Enables the communication operation
(start/stop with RS232C communication)

The mode that is currently not set is displayed.

If you do not need to set, press **PRG.** key to go back to the previous screen.

6.3.2 Setting the DIP switch

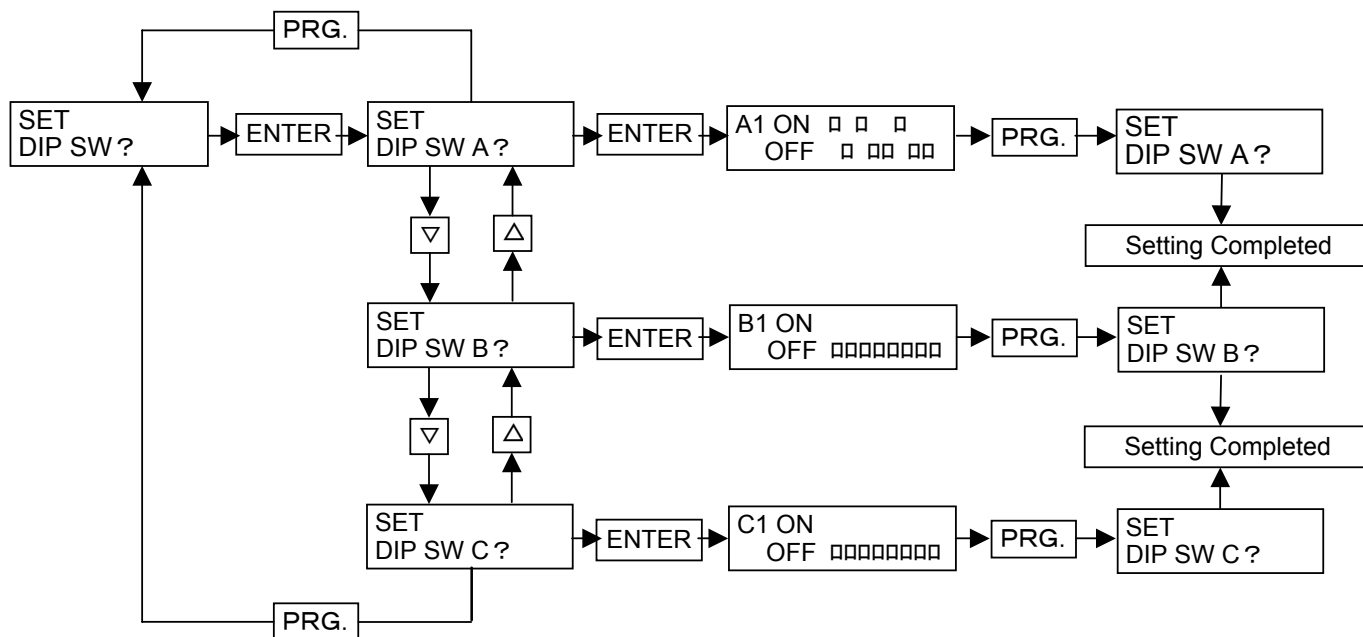

The up and down arrow keys, “▲” and “▼”, turn On and OFF the DIP switch.
 The key **BZ.OFF** switches the selection from 1 to 8.

See 6.4 for details of the DIP switch.

6.3.3 Setting the WARNING value for N2 flow rate

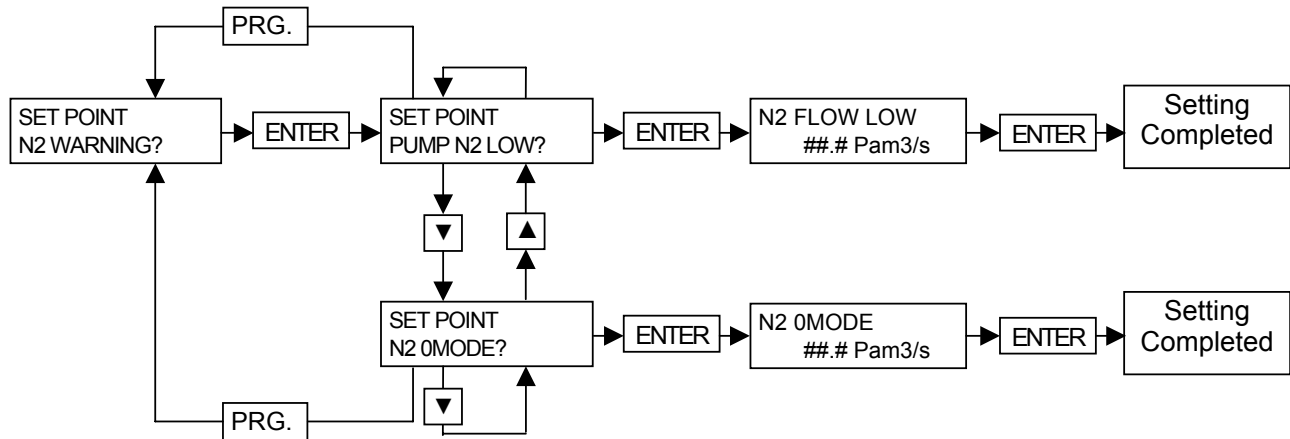

“▲” “▼” Use the up down arrow keys to change the setting value.

“▲” : Increase the setting value by 0.1 Pam³/s

“▼” : Decrease the setting value by 0.1 Pam³/s

Upper limit : 81.0 Pam³/s

Lower limit : 2.2 Pam³/s(PUMP N2 LOW)/1.0 Pam³/s(N2 0MODE)

Factory setting : 12.0 Pam³/s(PUMP N2 LOW)/7.4 Pam³/s(N2 0MODE)

Reset value for WARNING : Set value+1.0 Pam³/s

6.4 Dip Switch

Set the dipswitches to select the operating modes as shown in Table 6.4 ,6.5 and 6.6.

Table 6.4 Dip Switch-A Settings

No.	Mode	Off	On	Factory setting
1	Data Length	7bits	8bits	ON
2	Monitor Cooling water and N ₂	Always	Only during operation	OFF
3	Buzzer	Not used	Use	ON
4	Operation switched to Remote	According to signal	Automatically stop	OFF
5	External start/stop signal	Alternate (Level)	Momentary (Pulse)	OFF
6	----	----	----	----
7	Dilution N ₂ mode	Standard mode	Dilution N ₂ -0 mode	OFF
8	----	----	----	----

Table 6.5 Dip Switch-B Settings

No.	Mode	Off	On	Factory setting
1	----	----	----	----
2	----	----	----	----
3	----	----	----	----
4	----	----	----	----
5	----	----	----	----
6	Remote Interface (IF)	Exclusive special IF	No use / standard IF	ON
7	----	----	----	----
8	LCD screen initialize	Carry out initialize	Do not initialize	OFF

Table 6.6 Dip Switch-C Settings

No.	Mode	Off	On	Factory setting
1	Pump N ₂ Warning Output	Normal Open	Normal Close	OFF
2	----	----	----	----
3	Back Pressure ALARM Output	Normal Open	Normal Close	OFF
4	----	----	----	----
5	----	----	----	----
6	Remote Interface (IF)	Exclusive special IF	No use / standard IF	ON
7	Operating Voltage	*	*	OFF
8		*	*	OFF

DIP SW-A. No.1 In case of observing pump running status with RS232C communication port, Data Length can be selected out of 7bits and 8bits.

-
- DIP SW-A. No.2 Sets the monitoring mode for the cooling water and N₂:
“Always” or “During operation only.”
In the mode “During operation only” for the cooling water,
the monitoring continues for 15 minutes after operation stop
for cooling the pump.
It is recommended that N₂ purge should be continuously
active during operation stoppage to reduce by-product
accumulation and corrosion in the pump.
- DIP SW-A. No. 3 dip switch-A No. 3 lets you select whether an acoustic
alarm
(buzzer) should be sounded or not when a
WARNING/ALARM signal has been generated.
- DIP SW-A. No. 4 When the toggle switch is moved from the LOCAL to the
REMOTE position, dip switch-A No.4 lets you select "PUMP
START/STOP in Response to External Start Signal
(According to Signal)" or "PUMP STOP Regardless of
External Signal (PUMP STOP)".
- [NOTE]** Dip switch-A No.3 (BUZZER) and toggle for select Local / Remote
switch can change always.
When parameter setting of the dip switches, other than dip switch-A
No.3 (BUZZER), is performed, the LCD controller counts down 10
seconds, the same as at the power on state, right after the
completion of the parameter setting.
- DIP SW-A. No. 5 Dip switch-A No. 5 lets you select "ALTERNATE Signal
(START Signal ON/OFF)" or "MOMENTARY Signal (2
types of signal: ON or OFF)" for pump start and stop under
external signal control.
- DIP SW-A. No. 7 (dip switch-A No. 7 lets you select whether dilution N₂ gas
is used or not. Set dip switch-A No. 7 to ON when the
production process does not lead to the formation of
reaction by-products in the pump or when the process uses
non-corrosive gases. Then close the N₂ gas selector valve
to save N₂ gas. Be sure always to use the N₂ gas selector
valve and dip switch-A No. 7 in combination.

[NOTE] The N₂ gas selector valve is positioned on the front panel at the right when viewing facing the pump front panel (operating panel).

[NOTE] It takes ten odd seconds until the flow has stabilized after you have operated the N₂ gas selector valve.

DIP SW-B. No.6 Activate or inactive the special interface.
 · Set this to OFF to activate the interface (optional).
 · Set this to ON to inactivate the interface (default).

DIP SW-B. No.8 Locks or unlocks the currently selected operation status display, which usually returns to the power display in 60 seconds.

DIP SW-C. No.1 Can be select Normal Open / Normal Close of Pump N₂ WARNING.

DIP SW-C. No.3 Can be select Normal Open / Normal Close of Back Pressure ALARM.

DIP SW-C. No.7,8 Set the DIP SW-C.7,8 according to operating voltage.(see Table 6.7)

Table 6.7 Setting DIP SW-C.7,8 (Operating Voltage)

Operating Voltage	200V	400V
C7	OFF	ON
C8	OFF	OFF

6.5 DIP Switch setting display

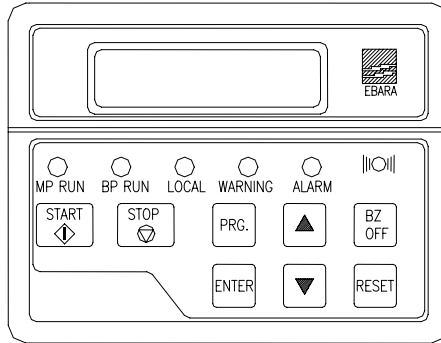

Fig 6.4 LCD controller

Key functions will be as follows on the setting display.

- START : Invalid
- STOP This stops pump operation.
- RESET This resets trip and alarm.
- BZ.OFF This switches the dip switch numbers.
- ▲ This sets the selected dip switch ON.
- ▼ This sets the selected dip switch OFF.
- ENTER This indicates the next page of the display.

DIP Switch-A

A *	ON							
	OFF	<input type="checkbox"/>	<input type="checkbox"/>	<input type="checkbox"/>	<input type="checkbox"/>	<input type="checkbox"/>	<input type="checkbox"/>	<input type="checkbox"/>

DIP Switch-B

B *	ON							
	OFF	<input type="checkbox"/>	<input type="checkbox"/>	<input type="checkbox"/>	<input type="checkbox"/>	<input type="checkbox"/>	<input type="checkbox"/>	<input type="checkbox"/>

* indicate the dip switch number (1 to 8) currently you are setting.

Fig 6.5 DIP Switch

[NOTE] Duration of pump operation, dip switches, except A-3 (BUZZER), can not be used for parameter setting.

[NOTE] When parameter setting of the dip switches, other than dip switch-A No.3 (BUZZER), is performed, the LCD controller counts down 10 seconds, the same as at the power on state, right after the completion of the parameter setting.

[NOTE] If any warning or alarm occurs during the parameter setting, the setting session will be stopped automatically and the display will be changed to the warning & alarm display screen.

6.6 Starting/stopping the pump with the LCD controller

Maximum two LCD controllers can be connected. Note only one of them can start and stop the pump (the other shows the pump operational statuses). The controller of which LED "LOCAL" is lit on has precedence over the other to control the start and stop operation.

If only one controller is connected, the controller starts and stops the pump.

	One controller connected	Two controller connected
START/STOP	Allowed	The one with its LED "LOCAL" lit on is allowed.

When you use two controllers, disconnect the one which you will not use for the operation from the pump once. Then, attach it again.

7. Operation

7.1 Before Starting

- (1) Turn on the cooling water supply and check that there are no leaks at the pipe connections.

 **CAUTION** Without sufficient cooling water, the pump temperature will rise and problems such as rotor contact will occur.

[**NOTE**] The pump unit itself has no cooling water flow adjustment valve.

- (2) Turn on the N₂ gas supply.

Check that the regulator attached to the pump is closed. (It is closed when the pressure adjustment knob is fully turned in the counterclockwise direction.) Open the main valve and check that there are no N₂ gas leaks from the pipe connections.

Slowly turn the pressure adjustment knob clockwise to set the pressure (gauge pressure) to 0.05 MPa first. Then press the red stopper to lock the knob in position.

 **WARNING** Be sure to purge with N₂ gas in order to prevent corrosion and reduce the formation/deposition of reaction by-products in the pump. When inflammable and/or toxic gases are diluted with N₂ to the safe concentration, be sure to maintain a separate supply of N₂ gas to the pump exhaust pipe.

 **CAUTION** Abrupt rotation of the pressure adjustment knob will cause the pressure indicator needle of the regulator to wobble and result in an inaccurate pressure display.

 **CAUTION** Unless a sufficient supply of N₂ gas is maintained, serious problems will occur such as oil back flow or pump corrosion and accretion of reaction by-products.

Operate the N₂ gas selector valve in accordance with the dilution N₂ mode set by DIP switch-A No. 7.

If DIP Switch is set to OFF	Open Valve.
If DIP Switch is set to ON	Close Valve.

[NOTE] For normal operation, open the N₂ gas selector valve. To save N₂ gas set close the valve when the production process does not lead to the formation of reaction by-products in the pump or when the process uses non-corrosive gases.

[NOTE] The N₂ gas selector valve is positioned on the front panel at the right when viewing facing the pump front panel (operating panel).

[NOTE] It takes 10 odd seconds until the flow has stabilized after you have operated the N₂ gas selector valve.

- (3) Turn on the power supply to the pump.
- (4) Check on the WATER FLOW display of the LCD Controller that the cooling water flow rate is 3.5L/min. or more.
- (5) Re-check on the PUMP N₂ FLOW display of the LCD Controller that the dilution N₂ gas flow rate is within the 17 - 20Pam³/s range. Also check that the pressure gauge shows a reading of 0.04 - 0.07MPa.
After setting the pressure, press the red stopper to lock the knob in position.
In this condition, the shaft sealing N₂ flow rate is 3.0 – 4.5 Pam³/s.
(The shaft sealing N₂ flow rate is contained in pump N₂ flow rate currently displayed on the LCD controller.)
- (6) When the WARNING/ALARM display appears on the LCD controller or when any abnormal symptoms are found other than the display, take action in accordance with 10. "Troubleshooting."
Even when the cause of the WARNING/ALARM display has been removed, it is maintained until the RESET signal is entered. Either press the RESET button or enter an external RESET signal from the control signal connector.
In the BUZZER Enabled mode using DIP switches, it is possible to stop the buzzer by pressing the BZ.OFF button when the alarm is being generated.
- (7) When the pump exhaust pipe is equipped with a valve, open this valve before starting the pump.



CAUTION Problems will occur when the pump is operated with the valve closed as the exhaust pipe will be pressurized.

(8) Checking the sense of pump motor rotation.

Look through the sight glass for monitoring the rotation of the pump motor to check the direction of rotation. The sense of rotation is correct when the motor rotates in the direction of arrow (counterclockwise direction as seen from the motor side). When the motor rotates in the reverse direction, please check the power supply wiring.

When the pump has a vacuum gauge on the suction side, you can also check the sense of motor rotation from this gauge. If the motor rotates in the correct direction, the pressure will drop while the pump is being operated.

(9) Check for correct pump operation by turning the start switch on and off a few times.



CAUTION To check the direction of motor rotation, allow pump to run for about 1 second.

7.2 START/STOP

DIP switches can be set at any time to select the LOCAL / REMOTE / COMMUNICATION modes and BUZZER Enabled function. Set in accordance with the operating conditions. (See 6.3. Setting the operational mode.)



WARNING The pump will remain at a very high temperature even after it has been stopped. Be sure therefore to leave the cooling water on for about one(1) hour after the pump has been stopped. When the cooling water is stopped at once after the pump stops, pressure in the cooling water piping rises. And there is a possibility to cause the water leak.



WARNING The pump and exhaust piping will remain at a high temperature during operation and for a short time after the pump has stopped. Be sure to avoid contact and keep inflammable substances out of reach.
Do not remove the outer cover during operation.



CAUTION When the production process leads to react by-products in the pump or when the process handles corrosive gases, be sure not to stop the pump until after at least 30 minutes of stopping the process gases.

! CAUTION Process gases will remain in the vacuum pipes and the pump even after the pump has been stopped.
Be sure that therefore to purge for at least 1 hour after the pumps has been stopped.
Do not discontinue the N₂ purge when the pump is stopped only for a short time.

[**NOTE**] It will take approx. 30 min. to reach the prescribed ultimate pressure when pump starts under the state of cold start.

[**NOTE**] Do not exhaust the process gases until at least 30 minutes after the pump has been started. The pump casing temperature will stabilize after about 4 hours and it is recommended not to start exhausting the process gases earlier than this.

When DIP switch-A No. 4 is placed into the ON position and the toggle switch is changed from the LOCAL to the REMOTE setting the pump will stop regardless of the external signal input.

7.2.1 LOCAL (Pump Side) Start/Stop

a) START

Press the START button on the controller.

The Main Pump (MP) will start and the M.P. RUN lamp on the controller will light.

The current is indicated on the display during pump operation.

For other status display indications, refer to Table 6.1.

[**NOTE**] The pump will not start when an WARNING/ALARM has been generated. When the START button is pressed, "STARTFAIL" will appear on the display.

b) STOP

Press the STOP button on the controller. The pump will stop.

The RUN lamp goes out and the display gives a power reading of 0.0A.

7.2.2 REMOTE Start/Stop

a) START

Enter the external "MP" start signal input from the control connector.

The MP starts.

The power is indicated on the display during pump operation. For other status display indications, refer to Table 6.1.

[**NOTE**] The pump will not start when a WARNING/ALARM has been generated. When a START signal is entered, "STARTFAIL" will appear on the display.

b) STOP

Interrupt the external MP start signal and the pump will stop.

7.2.3 COMMUNICATION Start/Stop

a) START

Enter the external "MP" start command input from the control connector.

The MP starts.

The power is indicated on the display during pump operation. For other status display indications, refer to Table 6.1.

[**NOTE**] The pump will not start when a WARNING/ALARM has been generated. When a START signal is entered, "STARTFAIL" will appear on the display.

b) STOP

Interrupt the external MP start command and the pump will stop.

*Please refer to the COMMUNICATION SPECIFICATIONS in detail.

8. Maintenance and Inspection

8.1 Internal energies

Following items show internal energies that shall be considered before start service maintenance.

8.1.1 Power source

This pump is supplied with AC200V/AC400V/AC460V power source. Aside from the pump, the accessory power source locating in the vicinity of the power connectors are supplied with voltage even when the pump is completely stopped. To conduct pump maintenance or service, be sure to keep the power supply to the pump turned off and lock-outed and then unplug the power cable.

8.1.2 Cooling water

This pump is supplied with cooling water at pressure of maximum 0.4 MPa. Disconnection of the cooling water resulted from improper handling may cause electrification and unit damage. For service and transportation, unplug the cooling water connection plugs on the inlet and outlet, and seal off with plastic cap. The self-sealing plug is used for the cooling water connection plug in these pumps.

8.1.3 Nitrogen gas

This pump is supplied with nitrogen gas at pressure of maximum 0.7 MPa for diluting and sealing inside the pump. For service and transportation, close the supply-source valve to reduce the pressure with the regulator and detach the gas connection. Close nitrogen port with blank off plug. If the pump has already operated with process gases, purge the residual gases with nitrogen gas after stopping the pump operation. Then, conduct maintenance.

8.2 Routine Inspection

Check periodically that ALARM signal is not output on the LCD controller or remote output.

Table 8.1 Typical check items

No.	Item	Sensor	Interval (recommended)
1	Motor Current	Current Transformer	Every 1 week
2	N ₂ Gas Flow	Flow sensor	
3	Vibration / Noise	-----	
4	Lubrication oil Quantity	Oil Level switch and level gauge	
5	Cooling water flow	Flow sensor	
6	Pump casing Temp.	Thermo- Couple	
7	Color of lubricant oil	-----	Every 1 month

When the WARNING/ALARM display appears, take action in accordance with Section 10. "Troubleshooting."

If the lubrication oil amount is lower than the lower limit line of the oil level gauge, supply the lubrication oil. See the section 8.3 "Lubrication oil" when adding the oil.



WARNING Switch off the power supply to the pump first and lockout before you start on maintenance.





WARNING The pump and exhaust piping will remain at a high temperature during operation and for a short time after the pump has stopped.

Be sure to avoid contact and keep inflammable substances out of reach.

Do not remove the outer cover during operation.

Even when the cause of the WARNING/ALARM signal has been removed the signal will be maintained until the RESET signal is entered. After you have taken the remedial action, press the RESET button on the controller or enter the RESET signal from the control signal connector to reset the WARNING.

 **CAUTION** The pump will not stop when an WARNING signal is generated. When pump operation is continued in this condition a ALARM signal will be generated or a serious breakdown will occur. Be sure therefore to check the pump in accordance with the instructions of Section 10. "Troubleshooting" after the process plant has completed 1 cycle.

 **CAUTION** When a ALARM signal has been generated in the REMOTE operating mode, do not start the maintenance tasks until you have interrupted the external start signal. When the external ALTERNATE start signal input is maintained, the pump will start while the ALARM is being reset.

If any abnormal symptoms other than those displayed on the LCD controller appear, take action in accordance with the instruction of Section 10. "Troubleshooting".

When the BZ.OFF button is pressed in the BUZZER Enable mode, the buzzer will stop even during an warning status.

8.3 Vacuum and Exhaust Piping

**WARNING**

Maintenance on the vacuum and exhaust piping shall be performed by taking proper action to avoid the dispersion of inflammable, toxic and/or hazardous substances and to prevent physical contact with, and absorption of, these substances.

**WARNING**

The pump and exhaust piping will remain at a high temperature

during operation and for a short time after the pump has stopped.

Be sure to avoid contact and keep inflammable substances out of reach.

Do not remove the outer cover during operation.

**WARNING**

Be sure to check for gas leaks after you have finished pipe maintenance work. Leaks will cause serious danger due to the discharge of harmful and hazardous substances and the occurrence of unpredictable reactions associated with the admission of air into the pump. When checking for gas leaks by pressurization, please pressurize by less than 0.05 MPa into the purge port and do check.

Toxic gases may be generated from by-products in the piping or pump in pump disconnection from the tool piping for repair and replacement or flange removal for maintenance. Gain relevant information about the process gases from your tool suppliers, and be sure that the gas concentrations in the work areas are at quarter or under the acceptable values specified using appropriate measurement equipment.

Without assurance of gas safety, instruct the workers to wear proper personnel protective equipment if necessary to protect them from gas hazards. The personnel protective equipment must include at least gloves, safety goggles, and a gas mask.

Be sure to following the instructions below when carrying out maintenance work on the vacuum and exhaust piping of the pump.

- (1) Before you remove and wash the piping be sure to purge with a sufficient volume of N₂ gas.

- (2) When an exhaust gas scrubber unit is used, close the inlet valve of the exhaust gas scrubber after the N₂ gas purge has been discontinued and then remove the piping.
- (3) Be sure to switch off the power supply.
- (4) After you have washed the piping do not reconnect until it has dried completely.

8.4 Lubricant Oil

 **CAUTION** Do not start filling oil until the interior pump pressure has reached atmospheric pressure. The chamber containing the oil is under low pressure (vacuum) so that a significant leak will occur causing substantial damage to the pump when the oil-filling plug is removed with the pump operating.

 **CAUTION** Waste oil shall be disposed of by industrial waste disposal dealer in accordance with Material Safety Data sheets. (appendix1,2)

When oil low alarm is generated ,please refill the oil as following procedure.

- (1) Stop the pump and remove the left-hand side pump cover to the utilities.
- (2) After you have waited until the internal pump pressure returns to atmospheric (normal) pressure, remove the plug from the oil-filler inlet.
(See Fig. 8.1 and 8.2)
- (3) Check the level through the window of the gauge. Then, add the oil so that the level is between the upper and lower limit lines.
(See Figs. 8.1 , 8.2 and 8.3)
- (4) After you have checked that there are no depositions and fragments adhering to the O ring attached to the plug, close the oil-filler inlet.
- (5) Fit a waste oil container (PVC bag) to the bottom of the oil drain hole of the secondary reservoir and remove the drain plug. (See Figs. 8.1 and 8.2)
- (6) When you have drained off the waste oil close the drain hole after you have checked that there are no deposition and fragments adhering to the O-ring attached to the plug.

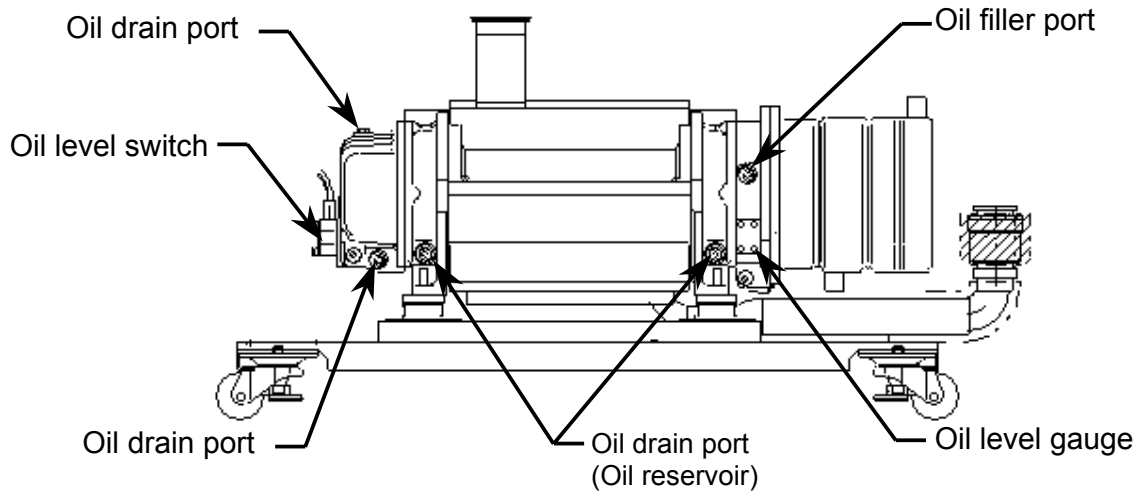

**Fig. 8.1 Oil filler port, oil level gauge, and oil drain port positions
(See from the right-hand side to the utility)**

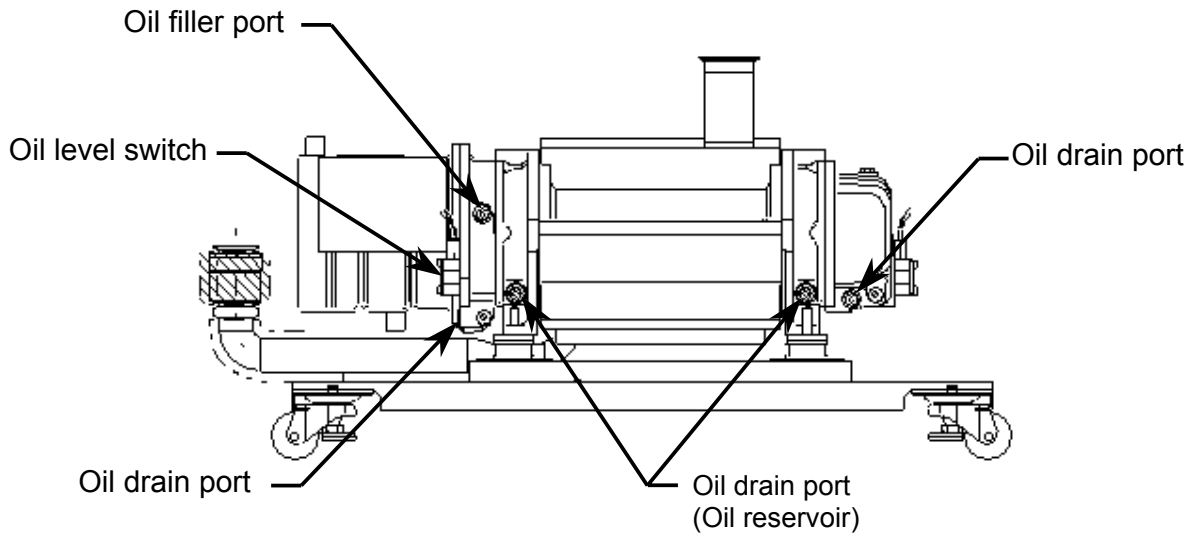

**Fig. 8.2 Oil filler port, oil level gauge, and oil drain port positions
(See from the left-hand side to the utility)**

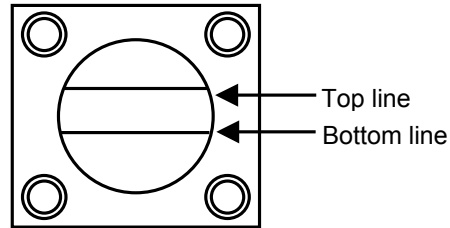

Fig. 8.3 Oil level gauge

! CAUTION Be sure to use the lubricant oils listed in specification table 3.1 only.

! CAUTION When the lubrication oil level exceeds the upper limit, the oil may leak to the pump side. Thus, be sure not to exceed the upper limit line when adding the oil.

! CAUTION When the lubrication oil level is lower than the lower limit line, serious failure may be caused. If you find out the shortage, add the oil immediately.

8.5 Spare (Maintenance) Parts List

Following parts are needed for maintenance in customer's site.

Table 8.2 Spare parts lists

1. Standard consumption Part.

Parts' Name	Type	Order No.
Lubricant oil	BARRIERTA J100	C-0402-000-0011
Lubricant oil	BARRIERTA J100ES	C-0402-000-0111

2. Recommendable Part for Safe Operation.

Parts' Name	Type	Order No.
O-ring (Viton A)	For NW25 center ring	C-1210-351-0001
	For NW40 center ring	C-1210-352-0001
	G55 (For Exh. check valve)	C-1210-089-0201

3. Recommendable Parts for Quick Maintenance.

Parts' Name	Type	Order No.
Exhaust check valve	32X80L	C-2244-031-0001

4. Recommendable Spare Parts. (Not needed for each pump.)

Parts' Name	Type	Order No.
Oil level switch	-----	C-5222-005-0011
Oil level gauge	-----	C-5222-004-0001
Water flow sensor	10 L/min	C-5137-008-0001
N ₂ flow sensor	84.4 Pa m ³ /s	C-5138-062-0001
Thermo couple sensor bolt	T TYPE, M8	C-1019-121-0001
N ₂ gas pressure regulator	R31-200-C121	C-2250-101-0001
Fuse (200V)	660GH-32UL-F	C-5314-097-0001
Fuse (400V)	660GH-16UL-F	C-5314-095-0001
Fuse (Primary transformer)	FLQ1	C-5314-094-0001
Fuse (Secondary transformer)	UXM250V1A	C-5500-000-3500
ZNR Harness	-----	C-5550-007-5600

Following labels are attached to pump covers. When they are hard to read for discoloring or peeling off, please stick them again as directed.

Table. 8.3 Labels

Label's Name	Parts No.
[DANGER] HAZARDOUS WEIGHT DANGER LABEL	C-7110-316-0001
[WARNING] HAZARDOUS VOLTAGE WARNING LABEL	C-7110-313-0001
[WARNING] HIGH TEMPERATURE WARNING LABEL	C-7110-312-0001
[WARNING] HAZARDOUS MATERIAL WARNING LABEL	C-7110-314-0001
[WARNING] HIGH TEMPERATURE EYEBOLT WARNING LABEL	C-7110-317-0001
[CAUTION] CHARGE MARK LABEL	C-7110-315-0001

8.6 List of wastes during maintenance

Table 8.4 lists wastes from general user maintenance. Dispose the wastes properly according to your local waste disposal regulations in each area.

Table 8.4 List of wastes during maintenance

Part	Equipped on	Remarks
Lubricant oil	Inside of pump module. See section 8.4.	Refer to Appendix 1,2 for Material Safety Data Sheet.
Lithium battery	CPU board. (No necessary to replace at usual maintenance.)	Refer to Appendix 3 for Material Safety Data Sheet.
O-ring	Connection of vacuum line	Usual industrial waste.

8.7 Overhaul

Some parts used in this pump are consumables. Overhauls including periodical component replacement and inspections ensure safe and high-performance pump operations.

The overhauls require well-trained personnel who have up-to-date knowledge of the pump structure and are familiar with hazardous chemical gases and safe work procedures. Factories where the overhauls are conducted must be equipped with special tools and facilities as well as exhaust air ducts to protect against toxic gas hazards.

Ebara-designated overhaul factories provide services with well-trained personnel and relevant facilities supported by an established supply system of up-to-date pump information and genuine brand name parts. These advantages offer users superior overhaul services for the pumps in various states.

Ebara recommends the users to send the pumps for the periodical overhaul to the Ebara-designated factories. These factories equip special tools, sufficient evacuation duct

Contact EBARA Sales office or Overhaul service center for detail.

To avoid dangers potentially encountered during pump overhauls, follow instructions below to send your pump to an Ebara-designated factory for overhaul or repair.

- (1) Fill all necessary items in a form shown in Appendix 5 and fax it in advance to Ebara Service Center or one of the agents listed in Section 11 of this manual. Ask Ebara service center for latest form. The original copy must accompany the pump you send. Failure to meet these requirements may restrict Ebara from providing any overhaul services to avoid associated risks.
- (2) When you send back the pump to service center in the United States, contact Ebara Service Center first to obtain a RMA number for identification. Enter this RMA number to an Environmental Health & Safety Clearance Form shown in Appendix 5. Ask Ebara Service Center for latest form. Then, fax it in advance to Ebara Service Center and attach its original copy to the pump you send. Be sure to take these prior actions; otherwise Ebara refuses any overhaul services to avoid associated risks.

9. Disconnection and Transportation

 **WARNING** When the pump has been used for exhausting highly toxic gases such as arsenic and mercury compounds, be sure to contact EBARA Corporation before you return the pump. Refer to Appendix 4 or 5 for the format required when customer returns their pump to Ebara service center for overhaul or rebuild.

 **CAUTION** In the interest of safety during the transportation, disassembly and cleaning of the pump, be sure to take note of the gases that have been handled.

Toxic gases may be generated from by-products in the piping or pump in pump disconnection from the tool piping for repair and replacement or flange removal for maintenance. Gain relevant information about the process gases from your tool suppliers, and be sure that the gas concentrations in the work areas are at quarter or under the acceptable values specified using appropriate measurement equipment.

Without assurance of gas safety, instruct the workers to wear proper personnel protective equipment if necessary to protect them from gas hazards. The personnel protective equipment must include at least gloves, safety goggles, and a gas mask.

To disconnect and transport the pump, proceed as follows.

- (1) Stop the pump and replace all gases inside the pump by purging them with N₂ gas.
- (2) Turn off the power supply to the pump and unplug the power and signal cables.
- (3) After you have fully closed the N₂ regulator, remove the N₂ pipe, seal off the N₂ purge port with a sealing flange.
- (4) Remove the cooling water pipes.
- (5) Remove the vacuum and exhaust pipes and completely seal off the inlet and exhaust ports of the pump with a blind flange or similar seal. Seal off all process gas discharge points such as the differential port by using a blind flange.
- (6) Attach the LCD controller on the front panel of the control board. Fix it with the tape.

- (7) Wrap the pump in a vinyl sheet.
- (8) Use the eyebolts provided on the pump for slinging the pump to load and unload. Fasten eyebolts completely and push in until flush with the seating surface. For sling, use a wire with a length so that the slinging angle (that is, the angled subtended by the two wires) is within 60 degrees.

 **DANGER** Do not enter the zone underneath the suspended pump.

 **WARNING** For lifting the pump, use only qualified operator personnel. Be sure that the wire rope and crane used for lifting the pump are in proper order and match the weight of the pump. To prevent unequal weight distribution, suspend the pump by ensuring that the slinging angle remains symmetrically centered.

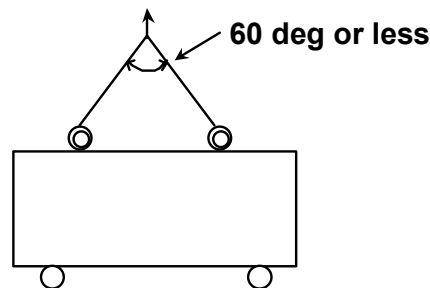



Fig. 9.1 Slinging the Pump

- (9) When options such as an interface box are attached to the pump, be careful to avoid damage due to contact by the wire rope.
- (10) For transportation, secure the pump by lowering the adjustment feet. Place a protective cloth around the pump to avoid shock and position protective members between the outer cover and the wires in order to distribute the load of the fastening wires.

To avoid dangers potentially encountered during pump overhauls, follow instructions shown in section 8.7, Appendix 4 or 5 to send your pump to an Ebara-designated factory for overhaul or repair.

10. Troubleshooting

10.1 Troubleshooting (1) Basic trouble

 **WARNING** Interrupt the power before starting on wiring and maintenance work.

Do not switch on the power supply to the pump until work is completed.

 **WARNING** The pump casing and exhaust piping become extremely hot during operation and for some time after stopping.

Be sure that pump and exhaust piping do not come in contact with humans or inflammable substances.

Do not remove the pump cover during operation.

 **WARNING** Check for gas leaks after installing and maintaining the piping. Gas leaks will result in the discharge of harmful and dangerous substances and in abnormal reactions due to the ingress of air into the pump. When checking for gas leaks by pressurization, please pressurize by less than 0.05 MPa into the purge port and do check.

Abnormal symptom	Check Item	Corrective Action
Open the fuse	Incorrect wiring	Check wiring.
	Short circuit	Replace or overhaul pump.
	Input wrong voltage	Check power supply voltage.
Power LED does not come on.	No power supply to pump.	Check power supply.
	Incorrect wiring	Check wiring.
	Input wrong voltage	Check power supply voltage.
Nothing appears on LCD	Open the fuse	Check FUSE and wiring
	Disconnection of the LCD's connector	Connect LCD's connector
	Instrument failure	Replace instruments.
MP does not start when applying START button.	"Remote" mode has been selected.	Set switch to "Local" mode.
	Start-up conditions are not satisfied. ("Startfail" is displayed.)	Satisfy all start-up conditions.
	Instrument failure	Replace instrument.
MP does not start when entering external "MP start" signal input.	"Local" mode has been selected.	Set switch to "Remote".
	Start-up conditions are not satisfied. ("Startfail" is displayed.)	Satisfy all start-up conditions.
	Instrument failure	Replace instrument.
Reverse rotation	Incorrect wiring	Check wiring.
Abnormal noise Excessive vibration	Adjustment feet are not applied.	Use the adjustment feet.
	Some object is making contact with the outer cover.	Remove the object.
	The fastening screws of the outer cover have worked themselves loose.	Tighten the fastening screws.
	Parts of the pump are damaged.	Replace or overhaul pump.
Vacuum pressure increase.	Accumulation of by-products in pipes.	Clean piping.
	N ₂ pressure setting is high.	Set pressure for correct value.
	Leak from vacuum piping.	Check piping.
	Accumulation of by-products in pumps.	Replace or overhaul pump.
MEMORY ERROR is displayed on LCD changing the dip switch setting	None	Need "Countermeasure against electric Noise" to pump.
WATCH DOG TIMER ERROR is displayed on LCD.	None	Need "Countermeasure against electric Noise" to pump.

10.2 Troubleshooting (2) **WARNING**

 **WARNING** Interrupt the power before starting on wiring and maintenance work.

Do not switch on the power supply to the pump until work is completed.

 **WARNING** The pump casing and exhaust piping become extremely hot during operation and for some time after stopping.

Be sure that pump and exhaust piping do not come in contact with humans or inflammable substances.

Do not remove the pump cover during operation.

 **WARNING** Check for gas leaks after installing and maintaining the piping. Gas leaks will result in the discharge of harmful and dangerous substances and in abnormal reactions due to the ingress of air into the pump. When checking for gas leaks by pressurization, please pressurize by less than 0.05 MPa into the purge port and do check.

Display	Symptom	Check Item	Corrective Action
WARN: WATER FLOW LOW	Water flow is reduced.	Coupler is disconnected.	Connect coupler.
		Pressure is not sufficient.	Apply sufficient pressure.
		Root valve is closed.	Open valve.
		Water pipe is clogged.	Clean or replace piping.
		Tube fittings are loosened.	Re-tighten.
		Instrument failure	Replace instrument.
		Outlet & inlet pipes are reverse. (flow value 0 L/min)	Connect pipes correctly.
WARN: PUMP N2 FLOW LOW	Pump N ₂ flow is reduced.	N ₂ port is not connected.	Connect N ₂ pipe fitting.
		Primary pressure is insufficient.	Apply sufficient pressure.
		Regulator setting value LOW.	Increase pressure setting.
		N ₂ pipe is clogged.	Replace N ₂ piping.
		Leaks on N ₂ pipe.	Check the fittings.
		Instrument failure	Replace instrument.
WARN: MP CASING TEMP HIGH	Casing temperature rises.	Duct ventilation insufficient	Ventilate sufficiently.
		Pump back pressure rises.	Check exhaust pipe
		Increase of the gas load.	Reduce the inflow gas amount.
		Accumulation of by-product	Replace or overhaul pump.
		Cooling water flow is reduced.	Increase cooling water flow.
WARN: MP OIL LEVEL LOW	Oil level is low.	Check oil level. (See Fig.8.1,8.2)	Charge lubrication oil.
WARN: BACK PRESS HIGH	Exhaust pressure rises.	Exhaust valve is closed.	Check exhaust pipe.
		Instrument failure	Replace instrument.
WARN: BACK PRES WIRE BROKE	Wire of back pressure sensor is broken.	Instrument failure	Replace instrument.
WARN: MP CURRENT HIGH	MP motor current rises.	Back press. rises.	Check exhaust pipe.
		Increase of the gas load.	Reduce the gas flow rate.
		Rotor makes contact. (Accumulation of by-products) (Substance plunge)	Replace or overhaul pump.
		Open phase	Check wiring.
WARN: ## COMM.ERROR	Communication is not established.	Connection error of the instrumented units	Check the connection of the instrumented unit.
		Instrument failure	Replace instrument.
WARN: PUMP BOX TEMP HIGH	Temp. rises in pump cover.	Duct ventilation not sufficient	Ventilate sufficiently.
WARN:PUMP N2 VALVE ERROR	N2 valve open.	Setting is N2 0 mode.	Close N2 valve. (at the side of pump)

After you have taken the remedial actions above, reset the pump. If the problem that has caused the WARNING signal still remains, the WARNING display will appear again even after you have reset.

10.3 Troubleshooting (3) ALARM

 **WARNING** Interrupt the power before starting on wiring and maintenance work.

Do not switch on the power supply to the pump until work is completed.

 **WARNING** The pump casing and exhaust piping become extremely hot during operation and for some time after stopping.

Be sure that pump and exhaust piping do not come in contact with humans or inflammable substances.

Do not remove the pump cover during operation.

 **WARNING** Check for gas leaks after installing and maintaining the piping.

Gas leaks will result in the discharge of harmful and dangerous substances and in abnormal reactions due to the ingress of air into the pump. When checking for gas leaks by pressurization, please pressurize by less than 0.05 MPa into the purge port and do check.

Display	Symptom	Check Item	Corrective Action
ALARM: MP CASING TEMP HIGH	Pump casing temp. rises.	Insufficient ventilation	Ventilate sufficiently
		Pump back press. rises.	Check exhaust pipe & silencer.
		Increase of the gas load.	Reduce the inflow gas amount.
		Cooling water flow is reduced.	Cool pump thoroughly and reset.
		Accumulation of by-products	Replace or overhaul pump.
ALARM:MP MOTOR TEMP H.HIGH	Main Pump (MP) motor coil temp. rises.	Cooling water flow is reduced.	Cool pump thoroughly and reset.
		Motor failure	Replace or overhaul pump.
		Open phase	Check wiring.
ALARM: MP NO CURRENT	No current.	Incorrect wiring	Check wiring.
		Open phase	Check wiring.
ALARM: BACK PRESS HIGH	Exhaust pressure rises.	Exhaust valve is closed.	Check exhaust pipe.
		Instrument failure	Replace instrument.
ALARM: EMERGENCY OFF	Input the emergency stop switch.	Stop by emergency Stop switch.	Check that pump can be operated and turn the button head to release lock.
ALARM: IO COMM.ERROR	Communication is not established.	Connection error of the instrumented units	Check the connection of the instrumented unit.
		Instrument failure	Replace instrument.
ALARM:STARTFAIL ALARM/WARN EXIST	Start fault	Starting during WARNING/ALARM status	Make sure that all starting conditions are met.
		Instrument failure	Replace instrument.
ALARM: EXT. INTERLOCK	Interlocked	External interlock is effective.	Check the external interlock signal.

After you have taken the remedial actions above, reset the pump. If the problem that has caused the ALARM signal still remains, the ALARM display will appear again even after you have reset.

During REMOTE operation carry out the above procedures after you have turned off the external start signal.

When the external start signal remains on in the ALTERNATE mode, the pump will start immediately when the RESET signal is applied.

10.4 Troubleshooting (4) option

 **WARNING** Interrupt the power before starting on wiring and maintenance work.

Do not switch on the power supply to the pump until work is completed.

 **WARNING** The pump casing and exhaust piping become extremely hot during operation and for some time after stopping.

Be sure that pump and exhaust piping do not come in contact with humans or inflammable substances.

Do not remove the pump cover during operation.

 **WARNING** Check for gas leaks after installing and maintaining the piping.

Gas leaks will result in the discharge of harmful and dangerous substances and in abnormal reactions due to the ingress of air into the pump. When checking for gas leaks by pressurization, please pressurize by less than 0.05 MPa into the purge port and do check.

Display	Symptom	Check Item	Corrective Action
ALARM: WATER LEAKAGE	Water leakage	Tube fittings are loosened.	Re-tighten.
		Instrument failure	Replace instrument.
ALARM: BACK PRESS. HIGH	Exhaust pressure rises.	Exhaust valve is closed.	Check exhaust pipe.
		Exhaust pipe is clogged with by products.	Check exhaust pipe.
ALARM: EMERGENCY STOP	Emergency Stop switch	Stop by emergency Stop button.	Check that pump can be operated and turn the button head to release lock.
WARN: BACK PRESS. HIGH ##.#	Disconnection of back pressure sensor	Connector of back pressure sensor is not connected.	Connect back pressure sensor connector.
		Back pressure sensor failure	Replace back pressure sensor.
WARN: BACK PRESS WIRE BROKE	Back press sensor is broken	Instrument failure	Replace instrument.

After you have taken the remedial actions above, reset the pump. If the problem that has caused the ALARM signal still remains, the ALARM display will appear again even after you have reset.

During REMOTE operation carry out the above procedures after you have turned off the external start signal. When the external start signal remains on in the ALTERNATE mode, the pump will start immediately when the RESET signal is applied.