

SOUND DEVICES



 **MUSICIAN**

Kashmir™
MICROPHONE PREAMPS

MixPre-3M

Multitrack Recorder | USB Audio Interface

User Guide

Legal Notices

Product specifications and features are subject to change without prior notification.

Copyright © 2018 Sound Devices, LLC. All rights reserved.

This product is subject to the terms and conditions of a end-user license agreement provided in this guide, and may be used in accordance with the license agreement.

This document is protected under copyright law. An authorized licensee of this product may reproduce this publication for the licensee's own personal use. This document may not be reproduced or distributed, in whole or in part, for commercial purposes, such as selling copies or providing educational services or support.

This document is supplied as a technical guide. Special care has been taken in preparing the information for publication; however, since product specifications are subject to change, this document might contain omissions and technical or typographical inaccuracies. Sound Devices, LLC does not accept responsibility for any losses due to the use of this guide.

Trademarks

The "wave" logo is a registered trademark and Kashmir is a trademark of Sound Devices, LLC. iPad, iPhone, Mac and OS X are trademarks of Apple Inc., registered in the U.S. and other countries. Windows is a registered trademark of Microsoft Corporation in the U.S. and other countries. Bluetooth Smart is a registered trademark of Bluetooth SIG, Inc. ASIO is a registered trademark of Steinberg Media Technologies. All other trademarks herein are the property of their respective owners.

WEEE Statement



If you wish to discard a Sound Devices product in Europe, contact Sound Devices (Germany) for further information.

MixPre-3M User Guide • Sept 2018

This document is distributed by Sound Devices, LLC in online electronic (PDF) format only. E-published in the USA.

Revision History

This table provides the revision history for this guide.

Rev#	Date	Firmware Version	Description
2-A	June 2018	2.21	Initial release
2-B	July 2018	2.21	Added Output Muting
3-A	Dec 2018	3.00	Revised Remote Control chapter w/ info on Wingman for Music projects. Also added new chapter for USB Controllers.

www.sounddevices.com

support@sounddevices.com

Sound Devices, LLC

E7556 Road 23 and 33

Reedsburg, Wisconsin 53959 USA

Direct: +1 (608) 524-0625

Toll Free: (800) 505-0625

Fax: +1 (608) 524-0655

Table of Contents

Quick Start

Multitrack Recording Step-by-Step5

Intro

Powering

Flexible Powering Options11

Panels

Front Panel13

Left Side Panel13

Right Side Panel14

Back Panel14

Screens & Navigation

Home Screen15

Main Menu Screen17

Music Control Menu18

Input Channels

Accessing Channel Screen Settings19

Track Names20

Setting Input Source20

Enabling Monitoring21

Setting the Gain21

Using Solo/Mute21

Arming a Track22

Understanding Pan22

Using Reverb22

Rendering a Vocal Air Effect23

Setting the Low Cut Filter23

Toggling Phase Inversion24

Stereo Track Linking24

Configuring Aux In Mode24

Track Bank Selector25

Outputs

Adjusting Output Level27

Output Muting27

Headphone Output and Presets28

Metering

LEDs and Metering29

Channel Knob Ring LEDs29

Channel Screen Meter29

Meter View30

Projects

Creating Projects32

Import Recording32

Opening Projects33

Trashing Projects33

Project History34

Project Folder Structure34

Sharing Projects35

Recording and Playback

Formatting SD Cards	37	Clearing & Deleting Cue Points	42
Transport Controls	38	Locating to Cue Marks	42
Record Arming	38	Punching In/Out	42
Working with Cue Points	39	Bouncing	43
Moving Cue Points	41	Metronome	45
Previewing Cue Point Positions	42	Record Settings	46

USB

USB Audio Interface	49	USB Keyboard	51
Low-latency Monitoring	50	USB Keyboard Shortcuts	51
USB File Transfer	50		

User Presets and System Settings

Saving and Recalling Presets	53	System Settings	54
--	----	---------------------------	----

Remote Control

Wingman Application	55	Music Projects via Wingman	58
Connecting to a MixPre Recorder	57		

Third-Party USB Controllers

Connecting the MixPre to a Controller	61	Korg NanoKontrol 2 Interface	64
Map User-Definable Buttons to Shortcuts	62	Korg NanoKontrol Studio Interface	66
Controller Interfaces	62	Novation LaunchControl XL Interface	67
Akai MidiMix Interface	63		

Specifications

Audio Inputs	71	Remote Control	73
Audio Outputs	72	Power	73
Recorder	72	Environmental	73
USB	72	Dimensions and Weight	73
Touch Screen	72		

Software License

FCC & ISED Compliance Statements

Quick Start

Multitrack Recording Step-by-Step

This Quick Start chapter is meant as a “step-by-step, how-to” reference for setting up the recorder and making music with the MixPre-3M right out of the box.

For more information on features and steps mentioned in this procedure, refer to later chapters in this User Guide.

To begin multitrack recording:

1. Connect power.
 - ▶ Provide at least one power source, either batteries (via included sled) or via USB-C.
- ① *If using battery power, be sure to insert your Class 10 SD card into the SD slot before attaching the sled to rear panel.*
2. Power up the MixPre.
 - ▶ Slide the power switch (left side panel) to On. The MixPre will boot and light up.
3. Connect an audio source.
 - ▶ Connect an audio source, either a microphone, line or instrument line-level signal to one of the input jacks on the side panels.
4. Connect headphones.
 - ▶ Connect your preferred headphones to the headphone jack on the right side panel.
5. Format Media — The MixPre supports SD, SDHC, or SDXC, but the card must be formatted by the MixPre prior to recording.

(A) Tap . The Main menu appears with multiple pages of settings.



(B) Tap  (the Dots icon) to “page” through the sub-menu.

- ① *The number of dots indicate the number of pages; the solid dot shows what page is displayed.*

- (C) Tap SD Card > Edit > Format.
- (D) Tap OK to confirm formatting of the card.

Warning - all data on the SD card will be erased!

- (E) Tap  to return to the Home screen.

6. Create a project.

- (A) Tap .
- (B) Tap Project > New.



- (C) Tap Name to customize the name of the new project.

① *If no custom name is provided, the MixPre creates new projects with unique names, such as Song 1, Song 2, etc. by default.*

- (D) Tap Sample Rate to select from available rates.
- (E) Tap Create.

7. Configure an input.

- (A) Press the Channel knob associated with the track onto which you want to record. For example, press knob 1 to record on track 1.

The Channel screen appears.



- (B) Tap Input and use the HP encoder to select a source for the track. Options include: Mic, Line, Aux In, and USB In.
- (C) Select Phantom if your microphone, DI or other device requires +48v phantom power to operate.
- (D) Tap Back to return to Channel screen.
- (E) Tap Arm to arm the track for recording. The circle on the button appears

red when track is armed.

- (F) To hear the input as you adjust gain, first turn the Channel knob until fader setting is 0dB. Then, tap Gain (on Channel screen) and turn the HP encoder to adjust input sensitivity for the source.

If possible, adjust with signal coming in at the intended level and observe the LED ring around the Channel knob. Aim for the LED ring to remain green for the majority of the time. If unsure where to start, set the gain to 35dB for mic sources, 10dB for line sources, and make adjustments as needed.

① *The Gain adjustment will time out after five seconds.*

- (G) Tap the Dots icon to access "page" 2 of settings, such as Pan, Reverb, Air, etc. Set any/all of them as desired.

- (H) Enable Linking if your source is a stereo instrument such as a keyboard, drum machine, or computer output.

- (I) Tap  to return to the Home screen.

8. Set up metronome.

- (A) Tap .



- (B) Page through submenu and tap Metronome. You will hear a preview of the metronome in headphones while in this sub-menu.

- (C) Make adjustments to the volume and to fit your intended time signature and tempo.

- (D) Tap Count-in to select how many measures the metronome will count at the beginning before recording begins.

- (E) On page 2 of the Metronome sub-menu, tap On During... to determine when you'll hear the metronome. Options include: Count-in, Record, or Play.

- (F) Tap . The metronome preview will stop.



- (G) Tap  to access the Music Control menu. Then tap  to activate the metronome. The Metronome icon will illuminate orange when active.

① *The metronome will only start when the MixPre enters record and/or play according to the On During... settings previously configured.*

9. From the Home screen, ensure the track number you intend to record is red, indicating it is armed and ready to record. You should also see input levels on the meter view.
10. Push REC button to record and play music!
11. Press Stop button to stop recording. Press it again (twice) to return to the beginning of the recording.
12. Push Play button to playback the recording. During playback, you can

change the track Level, Reverb, Air, Pan, Solo, and Mute settings.

① *You can only use Air on one track at a time.*

13. (Optional) Should you want to scrap the recording and try again, tap  and then tap History. Using the HP encoder, rotate to highlight and select Restart Song.
14. To lay another track over the just-recorded track, configure an input and proceed from there. See step 7. *Configure an input.*
15. After laying down all of your tracks, play your song and adjust track mix levels, pans, reverb, air, etc.
16. When you have a mix that you like, you can easily share your file by using the Render feature.
 - (A) Tap  and then tap Render.
 - (B) Select the format you want to use to render (export) the file. Options include: Wav stereo, AAC stereo, or Wav All Isos.

This will perform a real-time render of your project. Feel free to dynamically adjust mix levels, pans, reverbs etc during the render process.
17. Most importantly, have fun creating music! No saving of the project need be done, since the MixPre automatically takes care of that for you.

Hi and a big thanks for buying the MixPre-3M! At Sound Devices, we are passionate about great sounding audio. We've unleashed our design and engineering team, many of whom are musicians, and asked them to create a groundbreaking device that sets new standards for what's possible from a super compact and affordable, multitrack audio recorder.

From the ground up, we've designed the MixPre-3M to be a versatile tool for musicians and singer/songwriters who want to record sound with unrivalled quality. Whether you are gigging, multitracking a new song or capturing a live performance, the MixPre-3M is your best friend on stage, in the studio, and out on the road.

We've harnessed our storied heritage in portable recording to create an incredible piece of kit! We think that you'll find the unique mix of functionality, performance, size, ease-of-use, design and build quality to be an invaluable part of your life and creative passion for many years to come.

The MixPre has been meticulously engineered to offer extreme flexibility and sound quality, operating in a variety of fundamental ways:

- 12-channel multitrack recorder/mixer, up to 96kHz/24-bit
- 3 simultaneous inputs including 3 ultra low noise mic preamplifiers
- 5-in, 2-out USB computer audio interface

The MixPre-3M includes many indispensable features for musicians including:

- Track Laying
- Overdubbing
- Punch In/Out
- Q-Points
- Track Bouncing
- Reverb and Vocal Air Effects
- Metronome
- Export

The MixPre-3M works in a similar fashion to a DAW such as Protools, Logic, Cubase, Reaper etc, however, with its dedicated hardware it allows musicians to focus on their art rather than getting bogged down in all the technical stuff that a typical computer-based system brings. Musicians and songwriters now have an easy to use, portable tool for creating high quality, multi-layered songs anywhere and anytime that inspiration grabs them.

The MixPre-3M lets you record up to three tracks at once from either the three XLR inputs, Aux in connectors, or USB inputs. The built-in metronome helps you to keep your performance in time, while the reverb and vocal air effects add character to your recording and can aid in inspiring a great performance. The vocal air effect is an easily dialled-in combination of EQ and compression that results in an airy sheen and intimacy to vocals, popular today with singer/song-

writers.

Of course, the possible uses for the MixPre-3M are virtually unlimited, but a few common ones are:

- Creating a multi-layered song using the track laying and overdubbing features
- Mixing and recording small ensemble live performance
- Playback of multichannel backing tracks
- Recording live events, concerts, jam sessions, and so forth.
- Premium-quality 5x2 USB audio interface for any DAW application

The MixPre-3M's versatility is augmented by the various powering options. Whether you want to power the MixPre-3M from a USB connection, AA batteries, L-mount batteries, or optional AC wall plug adapter, it's ready, willing and able to go anywhere, anytime—always handling your audio needs with grace.

We sincerely hope that you enjoy working with the MixPre-3M as much as we've enjoyed creating it! Please drop us an email at support@sounddevices.com and share your experiences as we'd love to see how the MixPre-3M is furthering your passion.

Powering

Flexible Powering Options

In designing the MixPre-3M, we felt that it was important for it to be able to operate in a wide array of applications and environments. To support that goal, power can be supplied from several possible sources:

- Four AA NiMH rechargeable or Lithium primary batteries installed in the provided 4-AA battery sled, called MX-4AA (included).
- Eight AA NiMH rechargeable or Lithium primary batteries installed in the provided 8-AA battery sled, called MX-8AA.
- One or two Sony-type L-mount batteries installed in the optional L-mount battery sled accessory, called MX-LMount.
- USB-C to USB-C cable connected to a USB-C host computer or AC wall adapter.
- USB-A to USB-C cable connected to a USB-A host computer or AC wall adapter.
- Dual USB-A to USB-C cable connected to a USB-A host computer. Use this cable option if your computer is unable to provide adequate power for the MixPre with only one USB-A port.
- MX-PSU AC wall adapter (included) to USB-C power supply.

① *Batteries not included.*

The power switch is located in the upper right corner of the left side panel.

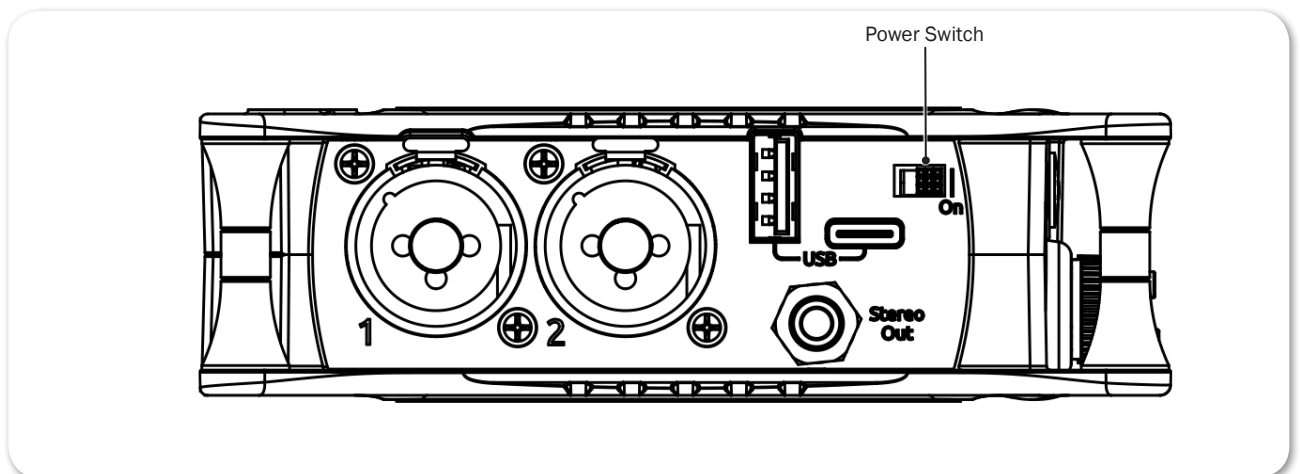

To ensure Battery Status indicator displays accurate levels/status:

1. Tap .
2. Page through submenu and tap Power.

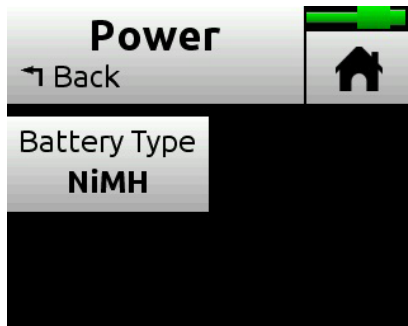

3. Select the type of batteries being used in the sled. Options include: NiMH, Alkaline, L-Mount

Panels

Front Panel

Power light, Star button for shortcuts, Channel knobs, Channel knob ring LEDs, backlit Transport buttons, and touch screen

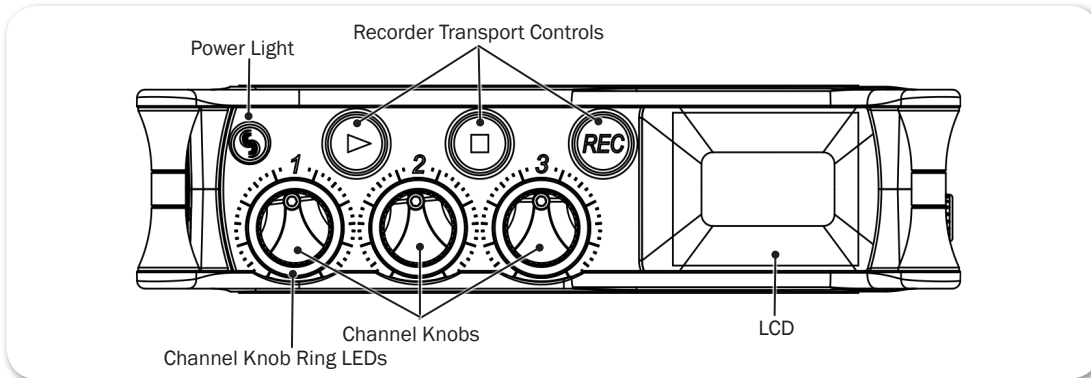

The Channel knobs on the front panel have two purposes:

- Rotate to adjust the level of the selected track in the LR mix.
- Press to access the selected track's Channel screen.

Left Side Panel

USB connections, XLR inputs 1-2, 2-channel 3.5 mm output, and power switch

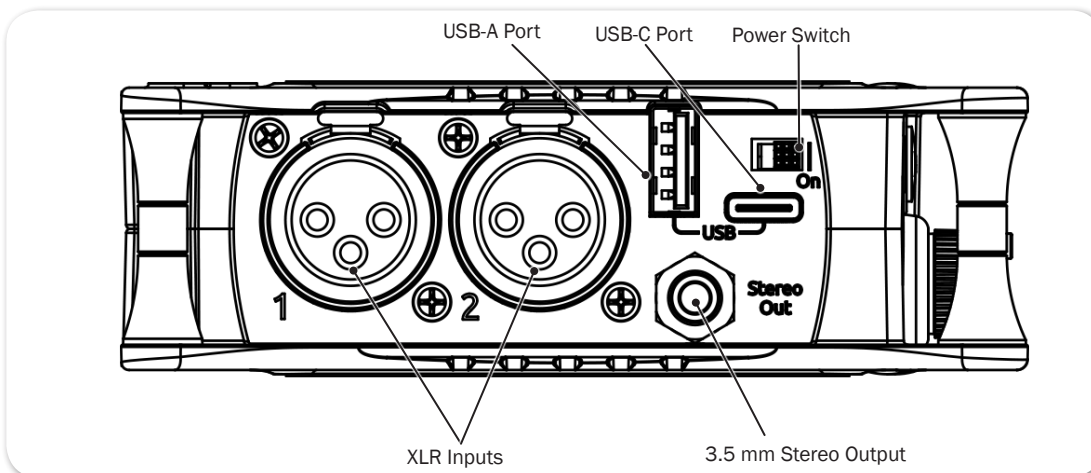

Right Side Panel

3.5mm headphone output, 3.5mm Aux/Mic input, XLR input 3, headphone encoder

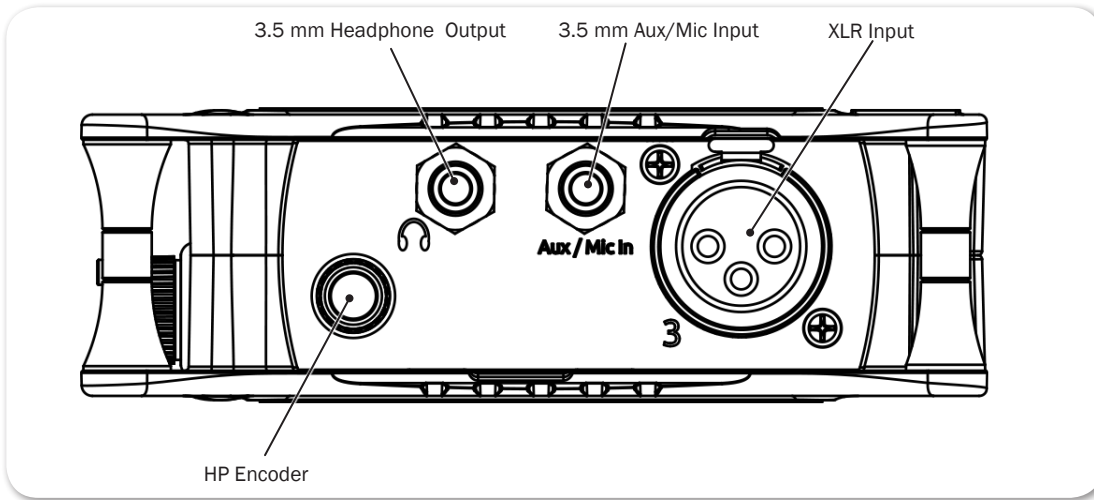

Back Panel

Battery mounts, SD memory card slot, Allen wrench (for ¼-inch-20-thread captive screw), and anti-rotational pin

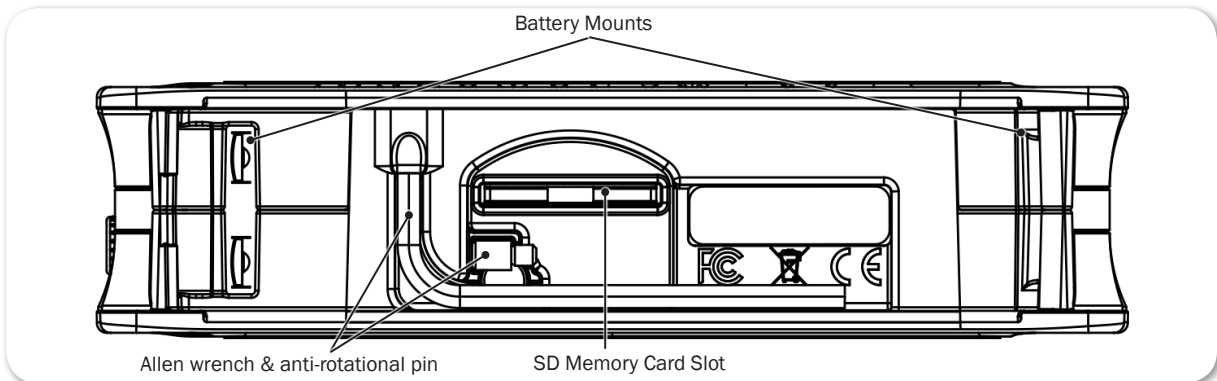

Screens & Navigation

The MixPre-3M has a sunlight-viewable, high-resolution, touch-screen-based user interface. The touch screen interface displays the Home screen, Main Menu screen, Channel screens and various other views.

For information on Channel screens, see [Accessing Channel Screen Settings](#) in the [Input Channels](#) chapter.





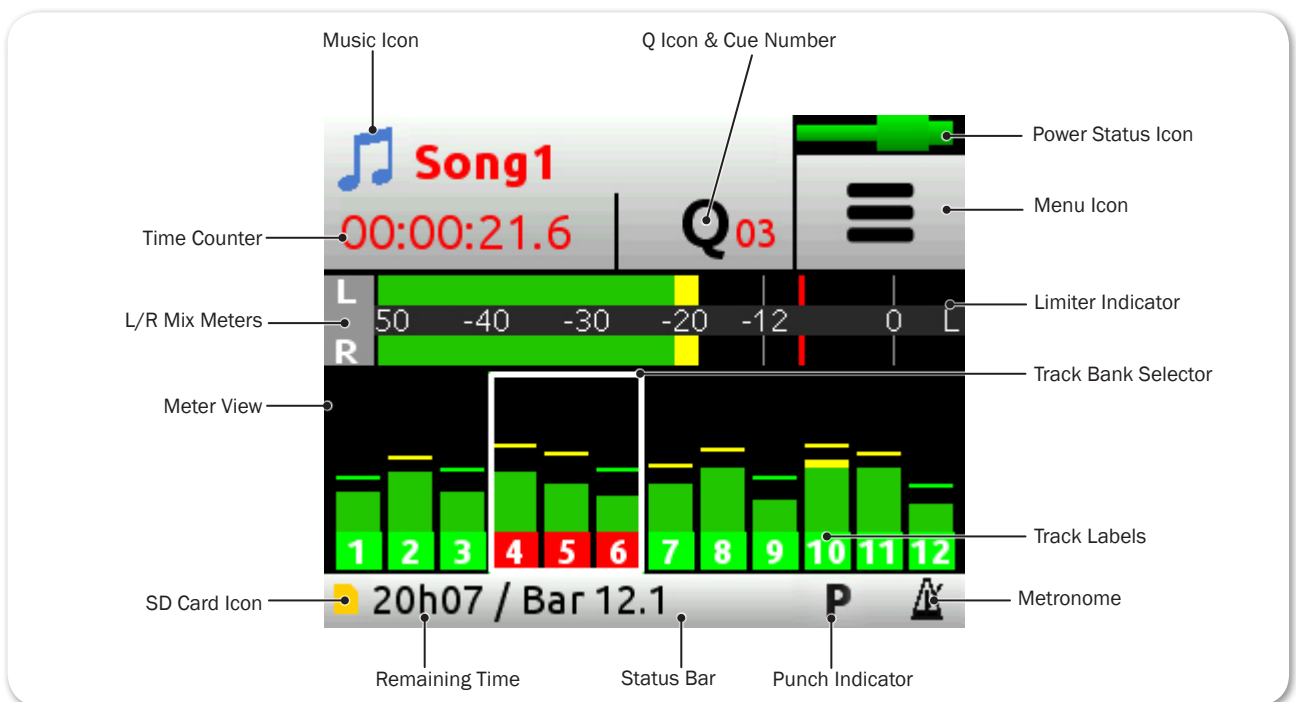

There are several tap zones on the touch screen allowing you to easily interact with the MixPre. As you become familiar with the user interface, changing settings for inputs, outputs, recording and metering will become fast and intuitive.

Home Screen

The Home screen view is the default view that appears on the touch screen when the device is powered up. The Home screen looks like this:



You will find on the Home screen numerous items, such as:

NAME	ICON	DESCRIPTION
Music Notes icon		Access the Music Control menu by touching this region of the Home screen.
Current name		Displays name of current Music project.
Time counter		Indicates the current song position in hh:mm:ss:tenths. All songs start at 00:00:00:0. Access the Music Control menu by touching this region of the Home screen.
Q icon		<p>Indicates current cue number: 01, 02, etc. A cue point stores a song position so that you can easily locate to that point—ideal for quickly jumping to the start of a verse, chorus, or bridge.</p> <p>When stopped, tap the Q icon to open the Cue Points menu, which provides access to the Cue List and other options.</p> <p>While recording or during playback, tap the Q icon to create a cue mark at the current location in the song. Cue marks may be set as Play In, Record In, Record Out, or Stop cue points via the Cue Points menu.</p> <p>For more information, see Working with Cue Points.</p>
Power Status Icons	 (Green USB)	USB power source is ideal.
	 (Orange USB)	USB power source low. Brightness dimmed, USB-A port disabled, 48v phantom on 2 channels only.
	 (Green Battery)	Healthy battery. Plan to change batteries when green level drops to about ¼ full.
	 (Flashing Red Battery)	Battery power is critically low. Change batteries.
Menu icon		Provides access to Menu screen.
Meter View		<p>Displays the metering for the 12 tracks and stereo mix, LR. White-outlined boxes surround meters to indicate which tracks are being controlled by the Channel knobs.</p> <p>Tap the L (left) horizontal meter to open Record submenu and quickly adjust L&R Gain.</p> <p>Switch track banks by touching different groups of meters. See Track Bank Selector for more information.</p>
Status bar		<p>Cycle status information by touching:</p> <ul style="list-style-type: none"> • Song status: current bar position as well as Punch and Metronome indicators, rendering status, and remaining time: In idle or record, the remaining time field displays remaining time on the SD card. In play, the field displays remaining time to the end of the song. • Date & Time

Main Menu Screen

The Menu screen is where most of the features and functions are selected and set up.

To enter the Menu screen:

- ▶ Tap  on the Home screen.

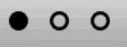
There are three Menu pages. These pages are indicated by the Dots icon . Tapping it will toggle between the three Menu pages.



The Menu has its own submenus, which may be displayed by tapping them.

PAGE	SUBMENU	DESCRIPTION
1	Presets	Lets you save and load user presets to and from SD card and internal memory. Also allows resetting all settings to factory default.
1	Project	Lets you create new projects, open or trash existing projects.
1	Inputs	Provides settings for the 3.5 mm Aux/Mic input.
1	Outputs	Provides routing and gain settings for the stereo output, as well as ability to mute the stereo output.
2	Reverb	Provides access to Reverb settings.
2	Metronome	Provides access to Metronome settings.
2	Record	Provides access to L&R Gain and AAC export quality.
2	SD Card	Displays SD card and allows for format and empty trash card functions.
3	System	Provides settings for file transfers, setting and sending a tone signal, limiters, Date/Time settings, adjusting LCD/LED brightness, updating firmware, and viewing version and regulatory information.
3	Power	Select the type of batteries (Alkaline, NiMH, L-Mount) being used to ensure that the Power Status icon on the Home screen accurately displays remaining battery level or power status.

To return to the main Menu from a submenu at any time:

- ▶ Tap .

To return directly to the Home screen from the main Menu:

- ▶ Tap .

Music Control Menu

The Music Control Menu provides fast access to the the Q-List, the Solo/Mute screen, metronome on/off, project render, and access to project history.

For more information, see [Working with Cue Points](#), [Using Solo/Mute](#), [Metronome](#), [Project History](#) and [Sharing Projects](#).

To access the Music Control menu:

- ▶ Tap  in the top left corner of the Home screen.

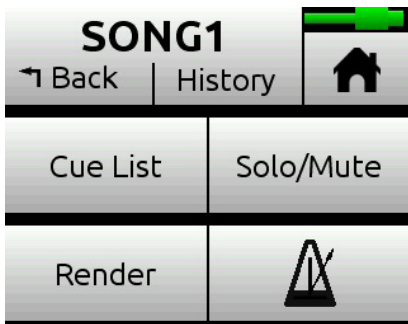

Input Channels

An input channel is the path an audio source travels before it can be mixed and recorded along with other channels. In the MixPre-3M, think of an input channel as the same as a 'track' in a DAW. An input channel can be fed by any of the XLR mic/line sources, a 3.5mm Aux line/mic source (with or without plug-in-power), or from USB channels 1-4 from a computer.

You can also select the MixPre-3M's mixer outputs, or a metronome click. With its overdub capability, the MixPre-3M allows recording of up to 12 tracks, a maximum of 3 at a time.

An input channel's settings are adjusted in its Channel screen.

Accessing Channel Screen Settings

To access the Channel screen:

- ▶ Push in a Channel knob.

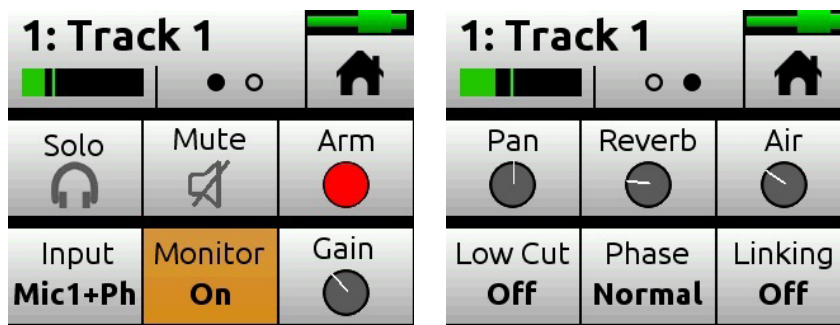

Each Channel screen provides two pages of settings—indicated by Dots icon. Tap the Dots icon to switch pages.

SETTINGS	FOR MORE INFORMATION
Solo & Mute	Using Solo/Mute
Arm	Arming a Track
Input	Setting Input Source
Monitor	Enabling Monitoring
Gain	Setting the Gain
Pan	Understanding Pan
Reverb & (Vocal) Air	Using Reverb & Rendering a Vocal Air Effect
Low Cut	Setting the Low Cut Filter
Phase	Toggling Phase Inversion
Linking	Stereo Track Linking

Since the MixPre-3M has more tracks (up to twelve) than its three physical Channel knobs, settings for tracks 4 and higher are accessed using the Track Bank selector. For more information, see [Track Bank Selector](#).

Track Names

You can edit a song's individual track names from its associated Channel screen. For example, changing the default names Track 1 to Drums, Track 2 to Keyboard, Track 3 to Lead Vocals, etc.:

To edit Track 1's name:

1. Press Channel 1 knob.
2. Tap top left corner of the Channel screen.
3. Enter a new name for Track 1 and tap OK.

The edited name will appear at the top of the track's Channel screen and will also be embedded in the metadata of rendered ISO (isolated) files when using Render > Wav All Isos. See [Sharing Projects](#) for more information.

Setting Input Source

Input, on the Channel screen, lets you select the input source for a track.

Any input can be routed to any channel. This reduces the need to rearrange instruments plugged into inputs when you want to record that input to a different track. You can also select the MixPre-3M's mixer outputs (see [Bouncing](#)), a metronome click (see [Metronome](#)) or turn on Phantom power.

To route inputs:

1. Enter the Channel screen, tap Input. The Routing screen appears, as shown in the following examples.



2. Select an input for the track. A track can only have one live input source.
3. Select Phantom if you want to turn on Phantom power for a Mic source. Phantom toggles 48V Phantom on and off. Turn Phantom on if a condenser microphone is being used.

① *Notice in the previous screenshots how Phantom is only an option when a Mic source is selected.*

4. Select Click as an input for your track if you want to record the metronome click into your song. This is useful should you want to later import the song into a DAW to develop the song further. The recorded metronome will allow

you to set the DAW's tempo and internal metronome so that it is perfectly aligned with the MixPre recording. For more information, see [Metronome](#).

① *The Click option is not available if the track is stereo linked.*

Enabling Monitoring

The Monitoring feature lets you hear the live input signal during playback. This is particularly useful when practicing along with already recorded tracks or performing live to a backing track.

To enable monitoring:

- ▶ Enter the Channel screen, tap Monitor. The button appears orange when on, except if input is off.



Setting the Gain

Gain sets the trim gain (pre-fader gain) for the channel. This gain determines the signal level on the channel's individual track—i.e. the ISO track level.

The gain range is dependant on the input type selected.

- Mic: 6dB - 76dB
- Line: -20dB - 30dB
- Aux Mic : 10dB - 40dB
- Aux Line: -10dB - 20dB
- USB: -20dB - 30dB

Using Solo/Mute

The MixPre-3M offers a few different ways to mute or solo tracks.

- From each track's Channel screen, tap Mute to mute the selected track. This removes the signal from recorded tracks, mix and all outputs. When muted, its LED ring will glow red. Multiple tracks may be muted at the same time.
- From each track's Channel screen, tap Solo to hear only the selected track (pre-fade/pre-effects) in both ears of the headphone output. When a track is soloed, its LED ring will flash orange.

Like Mute, soloing is non-exclusive, meaning any number of inputs may be soloed at the same time.

You can quickly solo/mute several tracks from the Solo/Mute screen. All 12 tracks' Solos and Mutes may be viewed and set from this screen.

To solo or mute tracks from the Solo/Mute screen:

1. Tap . The Music Control screen appears.
2. Tap Solo/Mute. The Solo/Mute screen appears.

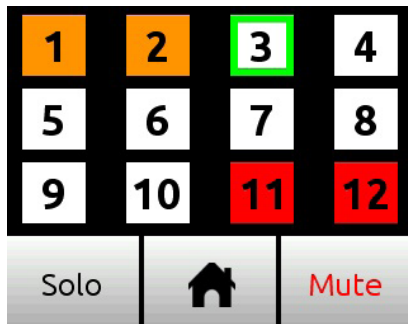

3. Do either of the following:
 - ▶ Tap either Solo or Mute and then tap track(s) to select them. Soloed channels appear orange; muted tracks appear red.
 - ▶ Use the HP encoder to highlight (green outline) a track and then tap either Solo or Mute.
4. Tap  to exit the screen.

Arming a Track

Armed tracks appear with red numbered boxes on the Home screen's Meter view.

To arm/disarm a track:

- ▶ From the Channel screen, tap Arm to enable or disable a track for recording.

Understanding Pan

Pan sets the position of the track in the LR stereo mix.

Pan range has 33 positions from L16 (fully left) to C (Center) to R16 (fully right).

Using Reverb

Reverb sets how much reverb is added to a track in the LR mix. Only the mix is affected, not the individual recorded tracks.

To render the reverb effect into the individual recorded tracks, you must use the Bounce feature.

① *Reverb is unavailable when recording at 96kHz sample rate.*

To adjust reverb:

- ▶ From the Channel screen, tap Reverb and turn encoder. Range is Off, -50dB to 0 dB in 1 dB increments.

You can also select different reverb characteristics—such as type, decay, predelay, etc.

To configure Reverb:

1. Tap .
2. Page through submenu and tap Reverb.
3. Tap any of the following settings and adjust values accordingly:

SETTING	OPTIONS
Reverb Type	Off, Plate, Hall, Room
Reverb Decay	0.1 - 5.0 seconds
Reverb Pre-Delay	0 - 40 ms
Reverb HF Damp	Off, 0-20

Rendering a Vocal Air Effect

Applying Air to a lead vocal can help it stand out in a mix. It adds a desirable 'airy' sheen to vocals.

Vocal Air sets how much "Air" is added to a track in the LR mix. The range is Off, 1%-100%. Only the mix is affected, not the individual recorded tracks.

To render the Air effect into the individual recorded tracks, you must use the Bounce feature.

① *Air can only be applied to one track at a time. If you want to apply Air to a track, but it appears grayed out on that track's Channel screen, and is therefore unavailable, you must first turn Air off on the track to which it is currently applied. If you want to add Air to multiple vocals, you can use the Bounce feature.*

Setting the Low Cut Filter

Use Low Cut to attenuate undesirable low frequencies such as mic handling noise and wind noise.

The Low Cut setting activates and sets the Low Cut filter. Range is Off, 40-160 Hz in 40 Hz steps.

Toggling Phase Inversion

Phase inversion, also known as polarity reversal, can be used to prevent signal cancellation when a source is dual-mic'd from opposite directions (e.g. snare top/bottom on a drum kit) or to compensate for incorrectly wired, balanced cables.

The Phase setting toggles Phase Inversion on and off.

To toggle a track's phase inversion:

- ▶ From the Channel screen, tap Phase.

Stereo Track Linking

Used to link a pair of tracks when the input is a stereo source. Linking enables control of the overall level of the pair using a single channel knob. If using a stereo source, such as keyboard or drum machine, plug that instrument into a neighboring pair of inputs such as 1-2, 3-4, etc. Link the tracks by setting the pair's first Channel Screen > Linking menu to 1-2, 3-4, etc. Linking allows you to control the level of both channels with just the odd-numbered knob.

For example, the following procedure links tracks 1 and 2.

To link tracks 1-2:

1. Push Channel 1 knob to access that Channel screen.
2. Tap Linking.
3. Select 1-2 for a stereo source.

You'll now be able to control the level of both tracks 1 and 2 with the Channel 1 knob.

Configuring Aux In Mode

To configure the Aux/Mic In connector:

1. Tap .
2. Tap Inputs > Aux In Mode.
3. Select one of the following options:
 - **Mic:** Select this option when the Aux/Mic In is to be used with a mic. The MixPre provides bias voltage for PiP (plug-in-power) mics.
 - **Line:** Select this option when the Aux/Mic In is to be used with an

unbalanced 2ch line source, such as smartphone headphone output, stereo line source, etc.

When any of the options above are selected as the Aux In Mode, they are available as input sources to any track by selecting an Aux.

- **Off:** Select this option to turn off the Aux/Mic input.

Track Bank Selector

Since there are more tracks (twelve) than physical Channel knobs (three), a Track Bank selector—shown as a white box in the meter view—is used to select which group of tracks you want to control.

In the following example, tracks 10-12 are controlled by Channel knobs on the recorder's front-panel.

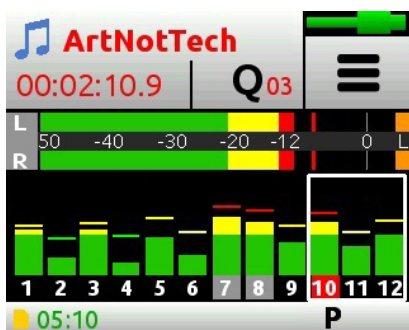

To switch track banks:

- ▶ Tap meters to toggle through each trio of tracks: 1-3, 4-6, 7-9, and 10-12. For instance, when the white box is around tracks 10-12, you can control tracks 10-12 with the knobs. A tap on the meters moves the box to around 1-3, which indicates you can now control tracks 1-3 with the knobs. Another tap moves control to tracks 4-6, and so forth.

When a track bank is switched, rotating a Channel knob in the newly selected bank will not have an effect on level until it reaches its previously stored fader value. As soon as it reaches that value, the gain will adjust normally in relation to the knob's rotational position.

- ① *Upon switching track banks, if the knob's rotational position is not aligned with its fader value, the LEDs for that knob will illuminate with a pulsing orange light. This will stop once position and value are re-aligned.*

When adjusting the Channel knob, its fader value along with the previously stored value is shown in orange text at the top of the Home screen and Channel screens until it reaches its previously stored value, at which point it changes to black text.

For example:

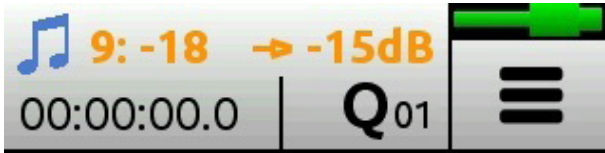

In this example, the Channel knob for track 9 must be rotated clockwise, as indicated by the arrow, from its current fader value of -18dB. Once it reaches the track's previously stored value of -15dB, the mix level will start to be affected.

- ① *Adjust the Channel knob a small fraction to display the stored value and arrow in orange text. The displayed arrow and stored value will inform you which way to rotate the knob.*

Outputs

The MixPre-3M has a 3.5mm unbalanced output on its left side panel.

To route the L/R stereo output:

1. Tap .
2. Tap Outputs.
3. Tap Stereo Out to route 3.5mm output.

The stereo outputs can be fed from the LR mix (stereo or mono) or can be set to follow whatever is being output in the headphones (stereo or mono). This is useful for providing a secondary headphone output feed.

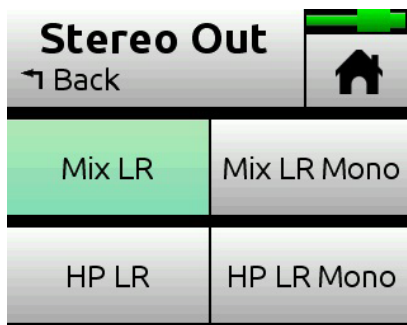

Adjusting Output Level

Adjust output gains to optimize the level feeding downstream devices, such as active speakers, external mixers, PA gear, etc.

To adjust output gain:

1. Tap .
2. Tap Outputs.
3. Select St. Out Gain.

You can adjust L/R output gains from Off, -40 to +20dB.

Output Muting

On the MixPre-3M, the 3.5mm stereo output may be muted.

To mute outputs:

1. Tap .

2. Tap Outputs.
3. Tap St Out Mute.
This toggles Mute on/off.

Headphone Output and Presets

The MixPre-3M's audiophile-grade headphone amplifier provides high power and very low noise performance so that you can accurately hear the audio being handled, regardless of headphones or environment. Connect headphones via 3.5mm jack to the headphone jack (located on the right side panel). The volume of the headphones can be set with the encoder directly adjacent to the headphone jack.

Since the headphone amplifier is capable of very high output levels, please use caution when wearing headphones as hearing damage could result with inappropriate volume levels.



From the main Menu screen, the headphone presets (HP Presets) may be accessed by pressing this icon in the upper left corner of the screen. Above this icon, the currently selected HP preset is displayed.

From the HP Presets menu, you may select various HP presets.

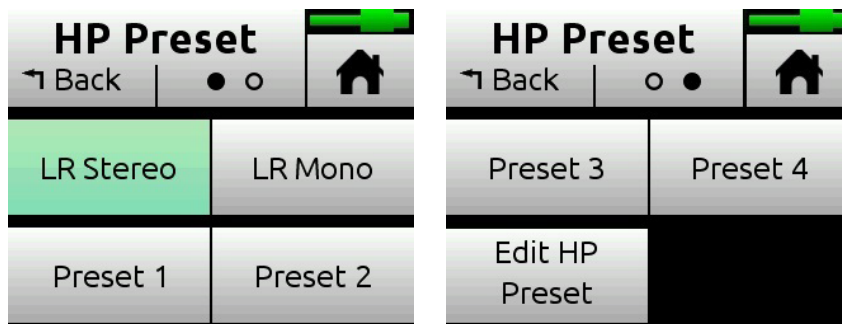

Options include: LR Stereo, LR Mono, Preset 1-4 and Edit HP Preset.

To create a custom HP Preset:

- ▶ In the HP Preset submenu, select Edit HP Preset to edit and name any of the four User HP Presets.



Metering

LEDs and Metering

There are several basic methods for observing input and output levels on the MixPre-3M: Channel knob ring LEDs, Channel screen meter, and Home screen's meter view.

Channel Knob Ring LEDs

Channel knob ring LEDs - Each LED ring is capable of displaying green, orange and red colors. The brightness of the light ring indicates the level of the input: green = signal present, red = signal peaking, orange = signal limiting. In addition, a channel's ring LED will flash orange when soloed or illuminate solid red when muted.

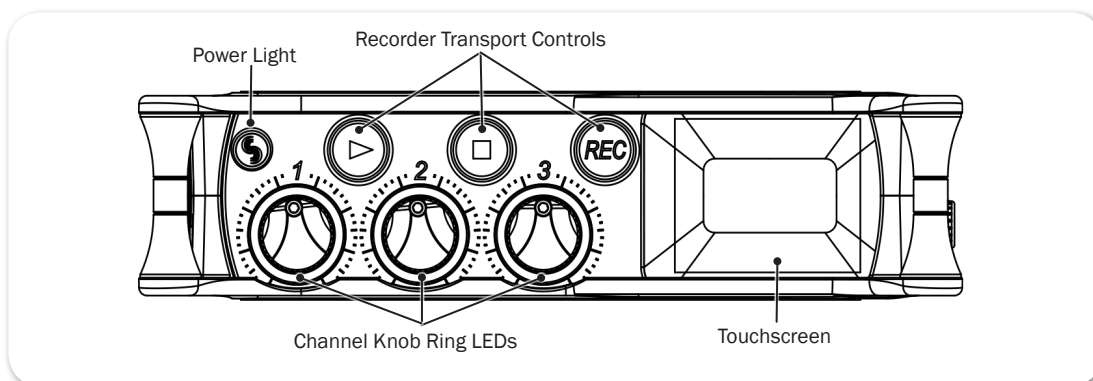

The LEDs around any of the three knobs will also pulse orange if, upon changing track banks, the knob's rotational position is not aligned with its fader value; this pulsing stops once position and value are realigned. For more information, see [Track Bank Selector](#).

Channel Screen Meter

The Channel screen provides a meter beneath the Track name.



For more information, see [Accessing Channel Screen Settings](#).

Meter View

The Home screen’s meter view displays vertical metering for the 12 tracks and horizontal stereo L/R mix. The meter view also provides the Track Bank selector, which is a white-outlined box (or boxes) surrounding a group of neighboring meters in the meter view. For instance, the Track Bank selector in the following example shows tracks 10-12 selected. For more information, see [Track Bank Selector](#).

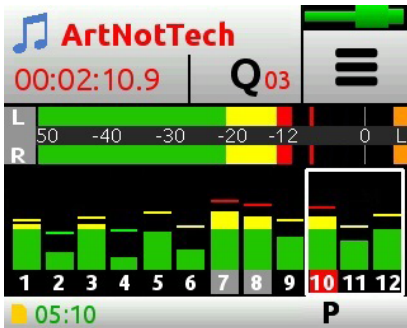

Track labels, each bearing the track number, appear along the bottom of the meter view and will change color based on routing and transport status.

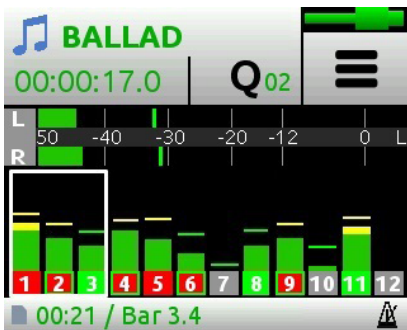

The following table shows the various options you may see during the music creation process:

TRACK LABEL	DESCRIPTION
Solid red	Track is armed for recording and is monitoring live input.
Red with green outline	Track is armed for recording, but is currently monitoring track playback. (Input monitor is off.)
Solid green	Track is currently playing back and is not armed for recording.
Gray (Stop only)	Track has an input source routed to it but is not armed for recording.
Black	Track has no input source routed to it.

Projects

Each song or composition in the MixPre-3M is known as a Project. A Project is essentially a folder on the SD card that stores all your song's audio files and settings. This makes it easy to organize, share, and copy your musical creations. The project folder also includes a special 'session' file that enables the MixPre-3M to control precisely where on the timeline and on which track the project's recorded audio files should be played back.

Conceptually, a Music project operates like a typical DAW and as such you can visualize it in much the same way. A play cursor moves across a horizontal timeline and audio tracks (referred to as 'channels' in the MixPre) are laid out as rows. A song always starts at 00:00:00:0 (hh:mm:ss:tenths), bar 1.

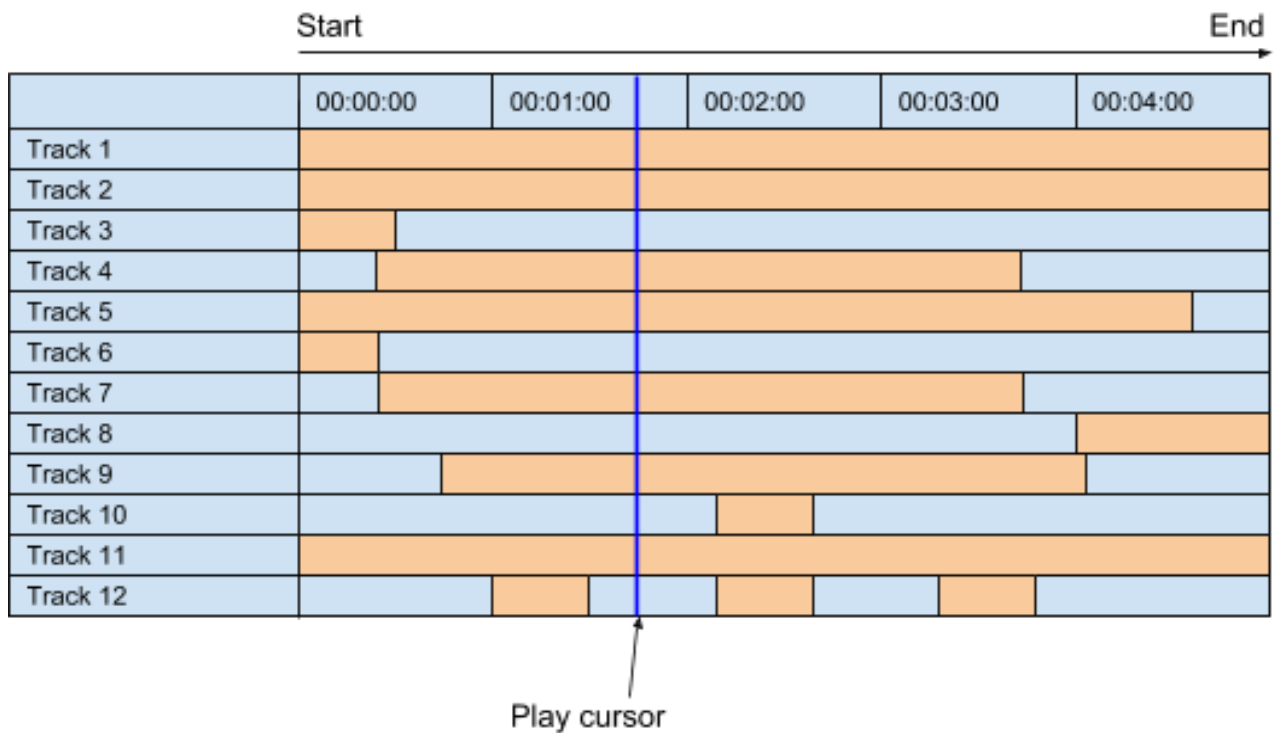

You can store many projects on an SD card, which is great if you are working on multiple songs or an album, because you can quickly switch between them.

Only one project is active at any one time.

All project audio files and settings (e.g. mix parameters, track names, project history, etc.) are saved automatically so don't worry about having to manually save.

If power is lost in the middle of recording, the MixPre returns to the project state prior to the loss of power, and no previously recorded audio is lost or corrupted.

On power up, the MixPre-3M automatically loads the last open project.

Creating Projects

MixPre-3M will automatically create a project if record is pressed without first creating a new project.

To create a new Music project:

1. Tap .
2. Tap Project > New.



3. When the New Project screen appears, you can do any of the following:
 - ▶ Name the project.
 - ▶ Set the sample rate. Options include: 44.1kHz, 48kHz, or 96kHz.

① *Be sure to choose the correct sample rate when you create a new project; you cannot change it once created.*

When using the MixPre as a USB audio interface, ensure that you set the computer OS, DAW application, and the MixPre project to the same sample rate. This prevents clocking and/or off-speed playback issues.

Reverb is unavailable when sample rate is set at 96kHz.

4. Tap Create when you're ready to create the new Music project.

① *The new project's name is shown at the top of the Home screen.*

For more information, see [Project History](#) and [Project Folder Structure](#).

Import Recording

When creating a new project, you may choose to import a .wav audio file (up to 12 tracks) as the foundation for your project. This is ideal for importing multitrack audio from a DAW should you want to continue developing your composition in the MixPre. Or perhaps you've created a backing track in your DAW for a live performance and want to use the MixPre as your all-in-one playback device and mixer during the show.

① *You may also import .wav files from Audio projects recorded using the MixPre-3, MixPre-6, or MixPre-10T models.*



To create a project based on a non-native poly WAV file:

1. Tap .
2. Tap Project > New > Import Recording.
3. Select your file from the those available on the SD card:
 - ▶ Use the HP encoder to select a .wav file from the root of the SD card.
 - ▶ Scroll to and select the an Audio project folder first, then choose a .wav file to import it from within the folder.

Opening Projects

When switching from the current project to another project, you do not need to worry about saving the current one; the MixPre automatically saves the current project's state.

To open an existing project:

1. Tap .
2. Tap Project > Open. A list of all projects, identified by a  music notes icon, on the SD card is displayed.
3. Rotate the HP encoder to highlight the chosen project; push in encoder to open the project.

Once selected, the project is opened and the Home screen is displayed. You are ready to start recording.

Trashing Projects

Since SD cards are capable of holding many gigabytes of data, the list of projects can become quite long. You can trash any project apart from the one that is currently active.

To trash a project:

1. Tap .
2. Tap Project > Trash Project.
3. Select a project to trash.
4. Tap OK to confirm deletion of selected project. This actually moves the selected project and all its files to the TRASH folder on the SD card. Projects in this folder are still accessible using a computer.

① To free up space on the SD card, you can permanently delete projects in the SD card's TRASH folder from the MixPre-3M's SD Card > Empty Trash sub-menu.

Project History

Each recording is logged as an item (revision) in the History list. This makes it easy to “undo” to an earlier recording or “redo” to a later recording—ideal for quickly redoing a bad take or comparing different takes. The History list is in chronological order with the most recent recording at the top.

To access the History list and switch to an earlier or later recording:

1. Tap  at the top left corner of the Home screen.
2. Tap History. The History list appears.

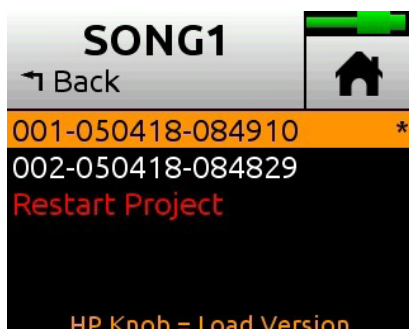

3. Use the HP encoder to select a file in the list. The current recording is indicated by an asterisk (*) after its revision’s file name.

① *The revision’s file name is derived from the date and time the recording was finished. For example, a recording finished at 2:22 PM (14:22) on the 12th of March 2018 would have a name like this: 001-031218-142200*

To restart the current project from scratch:

- ▶ From the History list, scroll to the bottom, and select Restart Song.

This will clear all audio from the project and cannot be undone. However, the audio files themselves are not actually deleted; they remain in the project folder, which can be accessed using a computer.

Project Folder Structure

A Project folder contains the following files:

- The project’s recorded audio WAV files. Each track is represented by a single monophonic WAV file.
- ① *The file name is derived from the date and time the recording was finished. For example, a recording finished at 1:33 PM (13:33) on the 23rd of March 2018 would have a name like this: 001-032318-133300*
- A render folder containing all rendered audio files and a SESSION.XML file which manages how audio files are played back as well as storing settings for the project.

You can view the contents of a Project folder on a computer.

Sharing Projects

Sharing projects is as easy as transferring to a computer (see [USB File Transfer](#)) and uploading to colleagues via the internet or simply handing them an SD card.

There are multiple ways to share a project:

- Copy Project Folder - ideal for collaborating with other MixPre-3M users. They can load the whole project from an SD card and continue working from where you left off.
- Render a Wav or AAC Stereo File - ideal for sharing your latest mix with friends and band members
- ① *An AAC file is like an .mp3 audio file, except it has better quality for similar bit rates.*
- Render all individual tracks (also known as ISOs) as monophonic files - ideal for importing into a DAW for further production.

To render a project:

1. Tap .
2. Tap Render.



3. Select a format. Options include:
 - Wav Stereo - performs a real-time render of the LR mix to an uncompressed 2ch stereo wav file. All track level, pan, mute, reverb and air adjustments made during rendering are reflected in the resulting stereo wav file.
 - AAC Stereo - performs a real-time render of the LR mix to a compressed 2ch stereo AAC file. AAC files are much smaller in size than a WAV file and so are faster to share over the internet. All track level, pan, mute, reverb and air adjustments made during rendering are reflected in the resulting AAC file.
 - ① *The bit rate for AAC rendering is set via Main Menu > Record > AAC Quality. Options for AAC bit rates are: 32, 64, 128, 192, or 256 kbps. The higher the number, the better the quality. See Record Settings for more information.*
 - Wav All Isos - performs a real-time render of all isolated (individual) tracks each to their own monophonic wav file. This is the ideal option for importing all tracks into a DAW. Just drag them all to zero on your DAW's timeline to sync all of them up perfectly.

Recording and Playback

The MixPre-3M can record and playback up to twelve audio tracks at 96 kHz, 24-bit to an SD card (SD, SDHC, or SDXC).

You can record to the SD card even when using the MixPre-3M as a USB audio interface. This opens up cool opportunities for recording the computer's USB audio output and mixing it with other mic and line sources plugged into the MixPre.

This simultaneous recording/USB audio streaming capability also makes the MixPre ideal as a backup to a computer - highly desirable in mission critical applications where relying on a computer might be a risk.

Formatting SD Cards

SD cards must be formatted by the MixPre-3M for reliable recording and playback.

Be sure to backup any wanted audio recordings or data before formatting since the formatting process erases all data.

We highly recommend using Sound Devices branded SD cards as these have been optimized to provide the best performance. If these are not available, most reputable manufacturers' cards (such as SanDisk or Delkin) that meet or exceed class 10 speeds are acceptable.



To format an SD card:

1. Insert an SD card in the slot located on the rear panel.
2. Tap .
3. Tap SD Card > Edit > Format.
4. When asked to confirm the command to format the card, tap OK.

Cards with a capacity of 32 GB or less will be formatted with the FAT32 file system. Cards with a capacity greater than 32 GB will be formatted with the exFAT file system.

Transport Controls

On the MixPre-3M, the transport controls work in a similar fashion to how transport controls work in a typical DAW, i.e. they control a playback cursor (typically indicated by a moving vertical line in most DAWs) that moves horizontally across a timeline indicating the current position in the song. The current position is indicated by the time counter at the top of the Home screen. All projects start at 00:00:00.0.

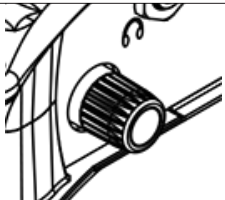
FUNCTION	CONTROL	ACTION
Record		The button illuminates red while recording is underway. Push the REC button to manually start recording from the current position on the timeline. You can manually start recording during playback or when stopped. Only armed channels are recorded.
Stop		Press Stop to stop recording or playback at the current position. Pressing Stop when already stopped returns the playback cursor to the start of the song. While stopped, press and hold the headphone encoder, then rotate it to move the playhead forward or backward in 1/10 second steps
Play		The button illuminates green while playback is underway. Press to start playback from the current position. Press again during playback to pause at the current position. If at the end of the song, pressing play does nothing.
Scrub		While playing or paused, press the headphone encoder to enter Scrub mode. Then rotate clockwise for fast forward or counter-clockwise for rewind at speeds of 0x, 1/8x, 1/4x, 1/2x, 1x, 2x, 4x, 8x and 16x. The audio may be heard in Scrub mode up to 2x speed. TO exit scrub mode, press the headphone encoder again.

Record Arming

Armed tracks are recorded when REC is activated. They play back when Play is activated.

Disarmed tracks play back during recording and playback unless their input monitor is on, in which case they monitor the live input.

To arm a channel:

1. Press the Channel knob.
2. Tap Arm.





Armed tracks are indicated in the Home screen's meter view by red track labels surrounding the channel number. See [Meter View](#) for more information on possible colors of track labels and what they mean.

If neighboring channels are linked, their labels are merged to indicate that they are linked. See [Stereo Track Linking](#) for more information regarding linking.

Working with Cue Points

The MixPre-3M uses cue points to make it easy to locate quickly to points of interest and set up automatic punch in/out regions.

There are different types:

ICON	TYPE	DESCRIPTION
	Cue mark (01, 02, etc)	Cue marks are cue points that define a specific position of interest within a song, which may be used to "cue" or relocate to that point quickly and easily. For example, set a cue at the start of a verse or chorus. You can name cues for easy identification. A cue mark may also be set as any other type of cue point.
	Play In	Defines when playback begins. Typically used as pre-roll before punch in (Record In).
	Record In	Defines when automatic recording begins (the start of the Punch In/Out region).
	Record Out	Defines when automatic recording ends (the end of the Punch In/Out region).
	Stop	Defines when playback stops. Typically used as post-roll after a punch out (Record Out).

To add Play In and Record In/Out and Stop cue points:

1. While stopped, tap the Q icon , located at the top of the Home screen. The Cue Points menu appears.



2. Tap each button (according to icons shown in previous table) to add that cue point at current song position. This may be done while stopped, paused, or during playback.



① *It is not possible to place an In point after an Out point. It is also not possible to have more than one In or Out point of each type (Play or Record).*

Alternatively, you can create cue marks and set them as Play In, Record In/Out, or Stop points from the Cue-List.

To add cues marks:

- ▶ During recording, playback, or pause, tap **Q**, the Q icon at the top of the Home screen to add a cue mark exactly at that point in the song. A cue mark number (starting from 01 and incrementing each time a new cue mark is added) is displayed next to the Q icon.
- ▶ Alternatively, when stopped, tap **Q**, the Q icon at the top of the Home screen to access the Cue Points menu. Then, tap **Q**, the Q button to add a cue at current song position.

The MixPre automatically rennumbers cue marks if one is inserted between existing cue marks to maintain their ascending numerical order from the start of the song—01, 02, 03, etc.

Cues appear in numerical order in the Cue List, such as 01 shown in following image, below the Play In, Record In/Out and Stop points.



You may have up to 99 such cues per song. Cues may be named, moved, deleted or set as Play In, Record In/Out, or Stop points from the Cue List.

① *You cannot rename Playback or Record In/Out points.*

To access the Cue List:

- ▶ Tap Cue List from the Music Control menu.
- ▶ Tap Cue List from the Cue Points menu.

To custom name a cue mark :

1. Access the Cue List. The Cue List screen appears.
2. Select a cue mark, using the HP encoder.
3. Tap Name and enter a new name, such as Chorus or Bridge.

**To set a cue as a Play In, Record In/Out, or Stop point:**

1. From the Cue List, select a cue.
2. Tap Set As.
3. Tap Play In, Record In, Record Out, or Stop to set the selected cue mark as an In/Out point for recording or playback.

Moving Cue Points

You can finely tune the position of In and Out points in 0.1 second increments.

To move Cue Points:

1. Tap Cue List.



2. Use the HP encoder to select a cue point.
3. Tap Move and rotate the HP encoder to adjust the selection in 0.1 second increments.

Previewing Cue Point Positions

To aid in fine tuning the position of any cue point, you can preview it. Preview plays a few seconds from the cue point. If the cue point is slightly late or early, use the move function to fine tune its position. Preview is available only within the Musician Plugin or for MixPre-M models.

To preview Cue Points:

1. Select one in the Cue List and press Play.

Clearing & Deleting Cue Points

You can delete cue marks and clear Play In, Record In/Out, or Stop points via the Cue Points menu or Cue List screen.

To clear all In and Out stored values:

- ▶ Tap Clr In/Out.

To clear an individual Play In, Record In/Out, or Stop point:

- ▶ Select one from the Cue List and tap Disable.

To delete a cue mark:

1. From the Cue List, select a cue mark.
2. Tap Delete.

Locating to Cue Marks

You can “cue” the song to a certain point—that is, quickly jump to specific cue marks within a song using the Play button and HP encoder.

To jump between cue marks:

- ▶ While playing, paused or stopped, press in and hold the Play button, and then turn the HP encoder to jump to the next or previous cue mark.

Punching In/Out

Punching allows you to drop in and out of record on armed tracks while playing back existing unarmed tracks. Automatic punching is a commonly used technique that allows you to play along with existing audio and have the recorder automatically and seamlessly drop into and out of record at predetermined points—a cool tool for getting just the right performance. You can punch in/out on a new track or over existing tracks.

Punching in/out over existing material (known as overdubbing) replaces the existing track audio between the Record In and Out points with new audio.

To manually punch in/out:

1. Arm the tracks on which you want to punch in/out.
2. While playing back, at the desired point, press REC to punch in; the MixPre will start recording on the armed tracks. The REC control illuminates solid red.
3. Press REC again to punch out; the MixPre will stop recording but continue playing back.

To automatically punch in/out:

1. Set Record In and Record Out points to where you want the MixPre to automatically punch in and out. If a Record In or Out point is set, a 'P' is displayed in the status bar to indicate that automatic punching is enabled. See *Working with Cue Points*.
2. Use Play In and Stop cue points to set pre-roll and/or post-roll as necessary. Setting a few bars of pre-roll allows you to play along with existing audio to help you get up to speed and 'into the groove' before the Record In point. Use the Track 'Monitor' button to monitor either track playback or your live input during pre-roll and post-roll, depending on your preference.
3. Press REC. The Play button will illuminate green and the MixPre will start playing from the Play In point if set, or from the current playback cursor position if not set. Once the Record In point is reached, the MixPre will automatically start recording on the armed tracks and REC button will illuminate red. Recording will continue until the Record Out point is reached (if set) at which point the MixPre will return to playback and the Play button will illuminate green. Playback will stop when the Stop point (if set) is reached.

See *Working with Cue Points* for more information on clearing Play In, Record In/Out, and Stop points.

Bouncing

The MixPre-3M offers up to 12 tracks which is enough for many situations. For example, four for drums, one for bass, two for vocals, two for guitars, two for keyboards plus a spare!

However, sometimes you may want to add more layers. Bouncing, sometimes known as Ping-Ponging, is a technique dating back to the days of the Beatles and Beach Boys that allows you to combine multiple tracks into just one or two thereby freeing up tracks for further overdubbing. It is also used to simplify mixdowns by grouping multiple tracks, or burning in reverb or air effects into an ISO track.

In the MixPre, the bounce mix is derived from the LR mix.

To bounce:

1. Decide which track(s) you want to bounce. Let's call these the destination tracks.
2. In the destination tracks' channel screens, set Input to MixL, MixR, or both. Your choice will depend on whether you want to do a mono, stereo, or dual mono bounce. For instance, if you are doing a stereo bounce to tracks 1 and 2, set track 1 to MixL and track 2 to MixR. If you are doing a mono bounce to track 3, set track 3 to both MixL and MixR.

① Any track that is set to MixL or MixR is removed from the LR mix to prevent feedback. You can adjust the level of the recorded bounce using the LR gain control - tap the L(left) mix meter in the home screen to quickly access LR gain.
3. Decide which track or tracks you want to bounce from. Let's call these the source tracks.
4. Mute all tracks except the source and destination tracks.
5. Disarm all tracks except for the destination tracks.
6. Set the source track levels, pans, reverb and air effects as required. Effects are burned in to the destination track(s).
7. You are now ready to bounce.
8. Manually start recording or use auto-punch to begin bouncing from the required location. As with normal recording, bouncing is a real-time process where you can dynamically adjust the source track levels, pans, and effects.
9. Press stop to finish the bounce at any time.
10. Disarm and unroute MixL and MixR from the destination tracks.
11. To hear your bounce, start playback from roughly where the bounce started. Adjust mix level, pan, reverb and air accordingly.

You may want to mute or clear the original source tracks so that you can hear your bounce in isolation.

To clear a track:

1. Access its Channel screen.
2. Tap Input, and then tap Clear.



Clear is only displayed if the track contains audio.

Clearing tracks removes them from the project entirely. The files still exist, but they can only be accessed from a computer.

3. Tap Yes to confirm removal of track audio from the project.

Metronome

The metronome is an audible click that may be used to help you perform in time while recording and also provide a count-in so that you know when to start playing. The first beat of the bar is represented by a higher pitched click than the other beats of the bar. The metronome click is summed with the LR mix and as such can be heard when the headphones or outputs are set to LR.

The metronome may also be recorded to a track. Select Click in a track's Input screen.

To set up the metronome:

1. Tap
2. Tap Metronome, then do any or all of the following:

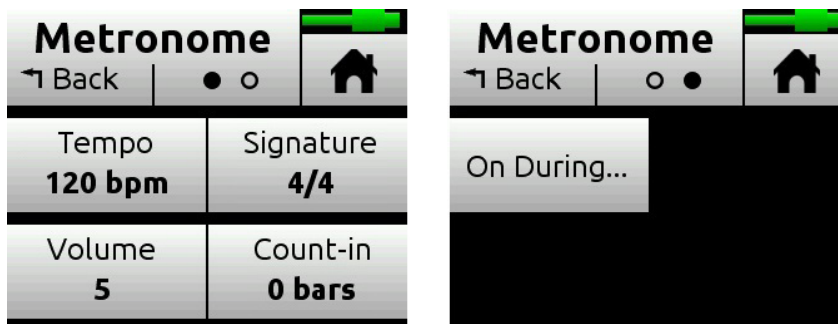

i You will hear a preview of the metronome while in this screen.

- ▶ Tap Signature and set the beat (time signature) for the song. Options include: 1/4, 2/4, 3/4, 4/4, 5/4, 6/4, 7/4, 8/4, 6/8, 7/8, 9/8.
- ▶ Tap Tempo and set the song tempo (metronome click rate) by tapping the arrows or using the HP encoder to adjust the tempo bpm (beats per minute) value. Range is 40 to 240 bpm.

- ▶ Tap Volume to set the volume of the metronome click.
- ▶ Tap Count-in to set the number of count-in bars you want before recording starts. Range is 0 to 8 bars.
- ▶ Tap On During... to set when the metronome is active. Options include: Record, Play, or Count-in.

To enable the metronome, do either of the following:

- ▶ From the Music Control menu, tap the  Metronome button. The Metronome icon will illuminate orange when active.

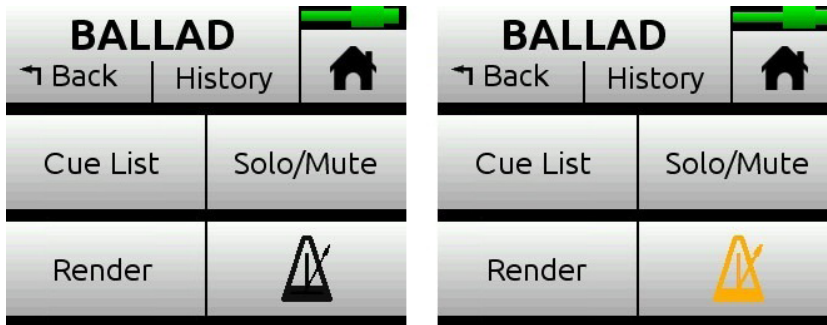

① *The Metronome button will be disabled (appearing grayed out but with an orange icon) whenever Click is assigned as a track's input source.*

Record Settings

The Record submenu provides access to the settings detailed in the following table:

SUB-MENU	DESCRIPTION	OPTIONS
L&R Gain	Sets the gain for the LR mix.	• -30 - 0 dB (1 dB increment)
	① <i>Tip: You can quickly access L&R Gain by tapping the L (left) horizontal meter on the Home screen.</i>	
AAC Quality	Sets the quality value for AAC rendering. For more information, see Sharing Projects .	<ul style="list-style-type: none"> • 32 kbps • 64 kbps • 128 kbps • 192 kbps • 256 kbps

To access the Record submenu:

- ▶ Tap , then Record.

USB Audio Interface

The MixPre-3M has an integrated 5-in, 2-out core audio-compatible interface for use with a Mac or PC computer.

For PC users, the MixPre-3M will appear as a 2x2 audio interface unless a specific ASIO® driver is installed. The latest ASIO driver, along with install instructions, is available for free at www.sounddevices.com/support/downloads. See the MixPre-3M's Downloads page.

To work with the USB audio from a host computer, it is necessary to route the USB 1 - 4 sources appropriately. Should you want to mix the USB audio from the host computer with live audio from the MixPre-3M's inputs to the LR bus, use the channel screen and select input source.

The MixPre-3M is capable of recording and streaming audio to a USB host simultaneously. It is also capable of recording the USB audio stream out of a computer directly to its SD recorder. This is an amazingly useful feature for recording any computer-based audio.

See the table below detailing the MixPre-3M's channel to output assignments.

TRACKS	USB OUTPUT ASSIGNMENT
Track 1	USB stream 1
Track 2	USB stream 2
Track 3	USB stream 3
Track 4	USB stream 4
Track 5	USB stream 5

Low-latency Monitoring

We've worked really hard with our hardware and software design teams to minimize latency. We've found that in many scenarios, latency when monitoring through a DAW (digital audio workstation) is perfectly acceptable, depending upon DAW software, computer hardware and plug-ins.

In situations where the throughput latency is higher than desired, the input to the MixPre-3M can be directly monitored in the headphone output.

For example...

To monitor with zero-latency through the MixPre-3M:

1. Connect MixPre-3M to computer.
2. Confirm that the LR Stereo HP Preset is selected.
3. Select USB1 for Channel 1 source and Pan L.
4. Select USB2 for Channel 2 source and Pan R.
5. Connect microphone or other input to Channels 3.
6. Select Mic for Channel 3 source. This input will appear to your computer as USB stream 3.
7. Setup your DAW software for a new track with its source being Channel 3 and be sure that record monitoring is disabled for this track. (Optionally, you may mute the channel's output in the DAW).
8. You should now be able to hear and adjust the output of your DAW audio through Channels 1 and 2 while adjusting your low-latency feed in your headphones and to the DAW with Channel 3. Use the channel 3 knob to adjust the send level to the DAW. Use channel 1 and 2 knobs to adjust the mix of the DAW audio with channel 3 to taste.

USB File Transfer

The MixPre-3M supports USB file transfer between its SD card and a computer by connecting the MixPre-s USB-C port to a host computer's USB port. To use this feature, connect the recorder to a computer and then put the MixPre-3M into File Transfer mode. (USB audio will be suspended.)

To enter File Transfer mode:

1. Tap .
2. Tap System > File Transfer.
3. When file transfer is complete, disconnect the recorder from the computer, then tap Exit on the USB-C File Transfer Mode screen to return to the previous operating state.

USB Keyboard

The use of standard USB computer keyboards is supported with the USB-A port on the recorder's left panel for situations such as text entry.

- ① *Keyboards with an embedded USB hub and Apple brand keyboards are not compatible. Additionally, some keyboards must be connected only after the recorder is turned on.*

A connected wired or wireless USB keyboard may also be used as a wired remote control for certain functions of the MixPre-3M. See the table below for available USB keyboard shortcuts.

USB Keyboard Shortcuts

When a USB keyboard is attached, the following key-combinations or shortcuts are available.

KEYSTROKES	ACTION
F1 or Menu key	Accesses the Main menu
F12	Home
Ctrl + R	Record
Ctrl + S	Stop
Spacebar	Play
Left Arrow	Main screen: Rewind, skip back to Q-point Menu and Channel screens: Toggles through pages
Right Arrow	Main screen: Fast forward, skip forward to Q-point Menu and Channel screens: Toggles through pages
Up / Down Arrows	Main screen: Adjusts headphone volume In menus: Duplicates encoder rotation, such as moves highlight, scrolls list While editing parameters: Changes the value
Enter	In menus: Activates current selection. (Same as encoder press.) Also, same as choosing OK when virtual keyboard is on screen
Q	In menus: select top left option in quad button view
W	In menus: select top right option in quad button view
A	In menus: select bottom left option in quad button view
S	In menus: select bottom right option in quad button view
1-3	Channel screen for 1-3



User Presets and System Settings

Saving and Recalling Presets

Flexibility is the MixPre-3M's M.O. To make it easy for you to use the recorder in a wide variety of situations, we created a slick feature where you can store and recall snapshots of all of MixPre settings. There are four internal Preset slots available. Also, the SD card can store virtually unlimited Presets.

To save a Preset:

1. Tap .
2. Tap Presets > Save to Internal 1-4 or SD Card
3. Enter a Preset Name and tap OK.

To recall a Preset

1. Tap .
2. Tap Presets > Load Preset.
3. Select preset with encoder.
4. Tap OK.

System Settings

To access system settings:

1. Tap .
2. Tap System.

PAGE	SUB-MENU	DESCRIPTION
1	USB-C	Lets you indicate whether you intend to use the USB-C port for power only or as an audio input.
1	USB Audio	Lets you set the USB Audio interface to output only two channels to increase compatibility with applications that do not support multichannel USB audio. Options include: Normal or Stereo Out <i>① When set to Stereo Out, the MixPre does not receive USB audio from a computer.</i>
1	File Transfer	Lets you transfer files between the MixPre and a host computer.
1	Tone	Lets you turn tone on/off, set the tone's level (from -20dBFS to 0dBFS in 1 dBFS increments) and mode (to either Continuous or L-Ident).
2	Limiters	Lets you turn limiters on/off.
2	Brightness	Lets you independently adjust the brightness of the touch screen and the ring LEDs.
2	Date/Time	Provides access to set the date, time, and formats for both.
2	Regulatory	Provides full Federal Communications Commission (FCC) compliance information specific to MixPre-3M. FCC ID: 2AKLX-739M3 IC: 22225-739M3 HVIN: MIXPRE3M
3	Version	Provides the current firmware version and serial number.
3	Update Firmware	Lets you update the MixPre firmware from a file on the SD card. The latest MixPre firmware can be downloaded from the Sound Devices website: www.sounddevices.com/support/downloads

Remote Control

Wingman Application

Sound Devices Wingman is a free app that allows wireless remote control of the Bluetooth Smart-enabled MixPre Series from iOS or Android devices.

To enable Bluetooth on the MixPre recorder:

1. Tap .
 2. Tap System > Bluetooth. This toggles Bluetooth On and Off.
- ① *If a remote password is configured on the recorder in the System>Wingman Password menu, Wingman will prompt for that password to be entered prior to making the connection.*

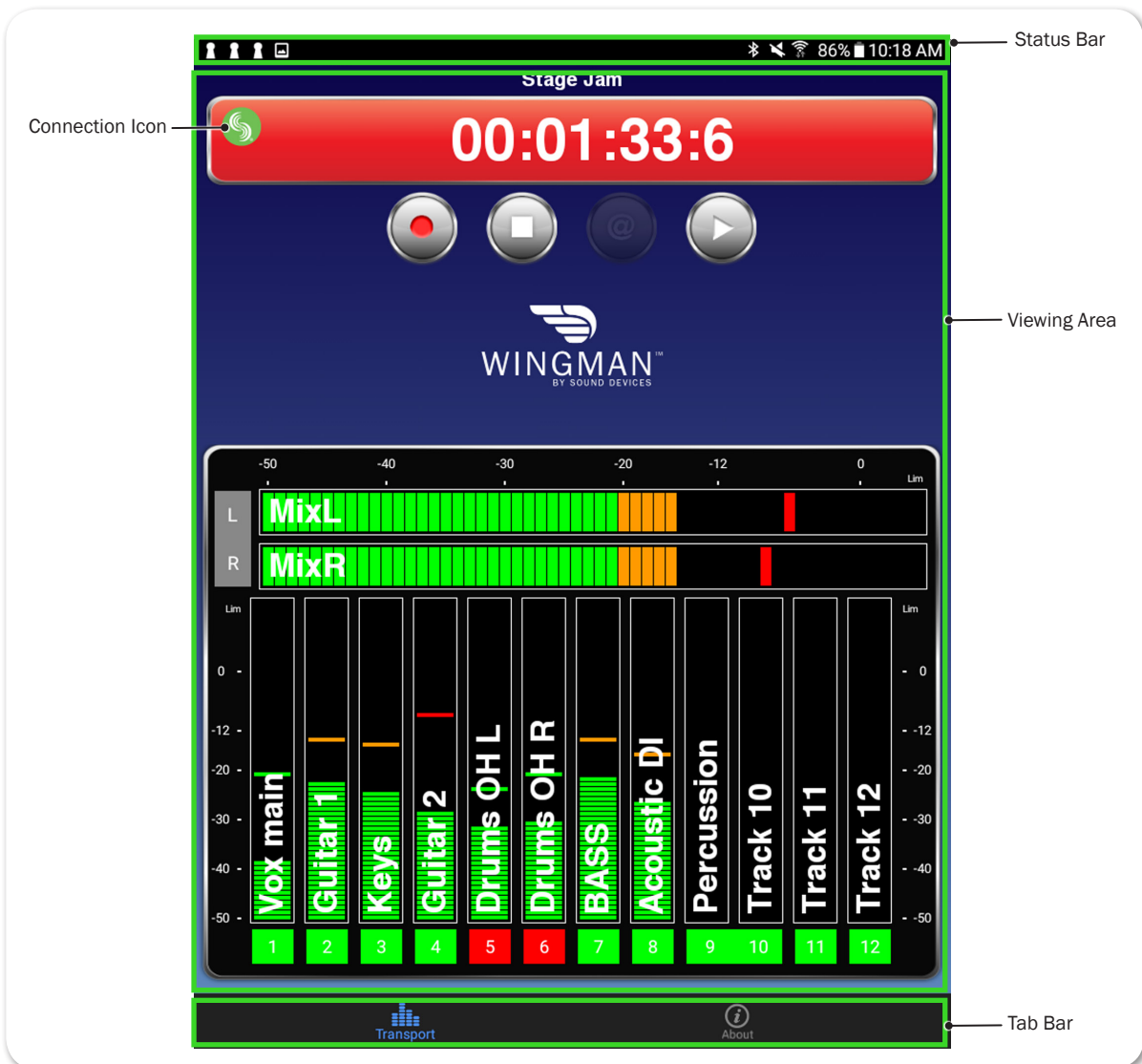

Wingman’s touch-screen user interface offers easy navigation and monitoring with three main areas of interest:

- **Status** - Shows device-specific status information.
- **Viewing area** - Displays different screen views, such as the Transport view with its transport control buttons and meters. Swiping horizontally toggles between Transport and Track views, handy when using Wingman app on devices with smaller screens.

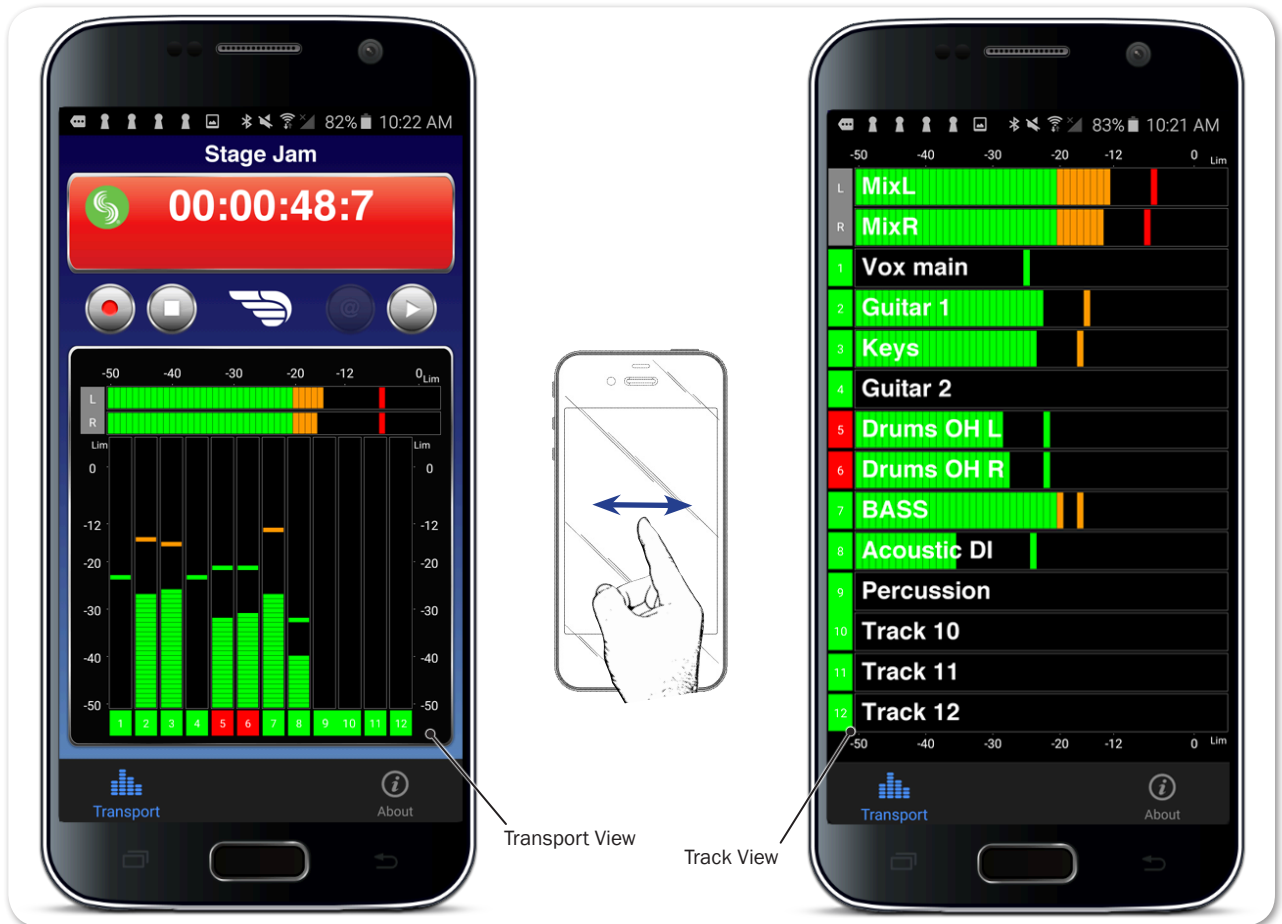

① *Editing track names may be done in Transport view on tablets, but on smartphones, it is achieved in Track view.*

- **Tab bar** - Remaining on screen all the time, the bar has icons enabling access to other views, such as the About screen, which provides links to guides and device/app-specific information.

① *Not all buttons, icons, or views are enabled or used for functionality on MixPre models.*

Connecting to a MixPre Recorder

If multiple Wingman-enabled devices are on set, Wingman will display all available devices within range. You may tap the Connection icon to efficiently switch connection from one device to another from within the app.

- ① *For productions with multiple recorders of the same model, tapping the Circled-I icon helps identify the correct device, by displaying an "Identifying from Wingman" message on the chosen recorder's screen.*



When running Wingman, the Connection icon, which bears the Sound Devices logo, displays different colors. The color of the icon is significant:

COLOR	ICON	STATUS
Gray		Disconnected - either no activity or scanning for devices
Orange		Bluetooth connection in progress
Yellow		Connected - authentication underway
Green		Connected and authenticated

Music Projects via Wingman

Beginning with version 3.20, the Wingman app includes support of Bluetooth connection to all M-models of the MixPre Series as well as support of Music projects in models with the Musician Plugin activated.



① *Custom naming and arming of tracks may be done in Transport view (shown above) on large screen mobile devices, like tablets, or in Track view on smaller screen mobile devices, like smartphones.*

To rename tracks:

1. Do either of the following:
 - ▶ On large mobile devices, from the Transport view, tap anywhere in a vertical meter for the track you want to edit.
 - ▶ On small mobile devices, swipe horizontally to display the Track view, then tap anywhere in a horizontal meter for the track you want to edit.
2. Use the virtual on-screen keyboard to modify the track name.
3. Tap Done when finished to save the changes.

① *Tap anywhere on screen other than the keyboard to exit without saving changes.*

To arm/disarm tracks:

- ▶ Tap the meter label. When armed the label turns red. When on but disarmed, the label is gray. When the input is off, the label is black and cannot be armed. And in Music projects, when playing back or overdubbing, labels for on but disarmed tracks appear green.
- ① *Meter labels are joined (displayed as a single label) to indicate when channels are linked. This is shown in the previous example; see the meter labels for 9 and 10.*



USB Controllers

Beginning with firmware v3.00 and higher, the MixPre Series (including M models) can be connected to selected third party controllers for tactile control of mixing and recording.

No matter whether you are creating music, podcasts or recording sound for picture, these control surfaces provide yet another cool way to interact with your MixPre in addition to operating MixPre direct from its front panel or from the Bluetooth Wingman App for iOS and Android.

The MixPre-Series can be controlled by the following USB controllers:

- Korg NanoKontrol Studio
- Korg NanoKontrol 2
- Novation LaunchControl XL
- Akai MidiMix

These control surfaces provide a varied range of physical sliders, pots, and buttons to set fader levels, trim gains, pans, reverb sends, solos, mutes, record arming, transport control and more. Functionality varies depending on controller model and whether you are working in Music or Audio projects.

① *Not all functions are supported by all controllers.*

Connecting the MixPre to a Controller

Power and control is provided via a single USB cable to better facilitate simple connection between the MixPre and controller. To ensure compatibility with the connected controller, the MixPre must first configure itself accordingly.

① *For the MixPre-3 and -6, USB Controllers will only function if the MixPre is adequately powered.*

To connect a controller:

1. Connect one end of a USB cable to the MixPre's USB-A port and the other end to the controller's USB port which can be a USB-B, Micro USB, or Mini USB port depending on the controller model.

We recommend using the USB cable supplied with the controller.

① *It is okay to connect the MixPre to the controller while powered up.*

2. The MixPre automatically starts setting itself up to work with the attached controller. During this short time, a popup displays the controller model. After a few seconds, the popup closes and the controller is ready to use.

① *When connected to the MixPre, some functions are taken over by the controller*

and are therefore disabled on the MixPre. Depending on the controller model, these functions may include faders, trims, pans, reverb sends, and low cut filters.

Map User-Definable Buttons to Shortcuts

You can customize designated buttons/knobs on a controller to operate certain functions on the MixPre. Functions that may be assigned include:

- Tone
- L/R Mute
- X1/X2 Mute
- Undo (Audio project only)
- Slate Mic (Audio project only)
- Metronome (Music project only)
- Add Q
- Record
- Stop
- Play
- Rewind
- Fast Fwd
- Shuttle (not all controllers)

To map controller buttons to perform MixPre functions:

1. Connect a controller.
2. On the MixPre, access Menu > * Shortcuts > Control Surface
3. Set any of the user-definable shortcut buttons to your required function.

Controller Interfaces

Each third-party controller has different capabilities. The following tables [Akai MidiMix Interface](#) | [Korg NanoKontrol 2 Interface](#) | [Korg NanoKontrol Studio Interface](#) | [Novation LaunchControl XL Interface](#) describe the functionality of each controller in Music and Audio projects:

① *The MixPre M-Series models do not support Audio projects.*

Akai MidiMix Interface



FUNCTION	MUSIC PROJECTS	AUDIO PROJECTS
Fader Bank Switching	Bank Left = Select fader bank to the left Bank Right = Select fader bank to the right	--
User-Definable Shortcut Buttons	Solo + Bank Left Solo + Bank Right	Solo + Bank Left Solo + Bank Right
Record	via user-definable shortcut	via user-definable shortcut
PLAY	via user-definable shortcut	via user-definable shortcut
STOP	via user-definable shortcut	via user-definable shortcut
FFWD X2, X16	via user-definable shortcut	via user-definable shortcut
RWD X2, X16	via user-definable shortcut	via user-definable shortcut
Skip Next File	--	via user-definable shortcut (Tap Fast Forward)
Skip Prev File	--	via user-definable shortcut (Tap Rewind)
Skip Next Mark	via user-definable shortcut (Fast Forward)	via user-definable shortcut (Fast Forward)
Skip Prev Mark	via user-definable shortcut (Rewind)	via user-definable shortcut (Rewind)
Return to Zero	via user-definable shortcut (Stop twice)	via user-definable shortcut (Stop)
Shuttle	Only via MixPre	Only via MixPre
Record Arm	REC Arm button	REC Arm button
Record Arm Status	Red REC Arm button when armed	Red REC Arm button when armed
Input Monitor	Solo + REC Arm buttons	--
Input Monitor Status	Red REC Arm button when Solo is pressed	--

FUNCTION	MUSIC PROJECTS	AUDIO PROJECTS
Channel Screen Access	Press Bank Left/Right and REC Arm to access channel screen	Solo + REC Arm buttons
Faders	Linear faders 1-8	Linear faders 1-8
Trims	Top row knobs	Top row knobs
Pans	Bottom row knobs	Bottom row knobs
Reverb	Middle row knobs	--
Low Cut	Only via MixPre	Middle row knobs
Mute	Mute button	Mute button
Solo	Solo + Mute buttons	Solo + Mute buttons
Mute Status	Yellow Mute button	Yellow Mute button
Solo Status	Yellow Mute button when Solo is pressed	Yellow Mute button when Solo is pressed
L/R (Stereo) Output Gain	Master fader	Master fader
L/R (Stereo) Output Mute	via user-definable shortcut	via user-definable shortcut
X1/X2 Mute (10M/10T only)	via user-definable shortcut	via user-definable shortcut
Tone	via user-definable shortcut	via user-definable shortcut
Metronome	via user-definable shortcut	--
Create Q	via user-definable shortcut	via user-definable shortcut
Undo	Only via History List on MixPre	via user-definable shortcut
Internal Mic (10M/10T only)	Only via Input patchbay	via user-definable shortcut
SEND ALL Button	Sends all current fader, knob settings to MixPre	Sends all current fader, knob settings to MixPre

Korg NanoKontrol 2 Interface



FUNCTION	MUSIC PROJECTS	AUDIO PROJECTS
Fader Bank Switching	Track < button = Select fader bank to the left Track > button = Select fader bank to the right	--
User-Definable Shortcut Buttons	Cycle + Marker Set Cycle + Marker < Cycle + Marker > Cycle + << Cycle + >>	Cycle + Marker Set Cycle + Marker < Cycle + Marker > Cycle + << Cycle + >>

FUNCTION	MUSIC PROJECTS	AUDIO PROJECTS
Record	Record button	Record button
PLAY/Pause	Play button	Play button
STOP	Stop button	Stop button
FFWD X2, X16	Hold >> button	Hold >> button
RWD X2, X16	Hold << button	Hold << button
Skip Next File	--	Tap >> button
Skip Prev File	--	Tap << button
Skip Next Mark	Tap >> button	Tap >> button
Skip Prev Mark	Tap << button	Tap << button
Return to Zero	Tap Stop when stopped	Tap Stop
Shuttle	Only via MixPre	Only via MixPre
Record Arm	R button	R button
Record Arm Status	Red R button when armed	Red R button when armed
Input Monitor	Cycle + M button	--
Input Monitor Status	Red M button when Cycle pressed	--
Channel Screen Access	Cycle + S button	Cycle + S button
Faders	Linear faders 1-8	Linear faders 1-8
Trims	Rotary knobs (set to trim)	Rotary knobs (set to trim)
Pans	Rotary knobs (set to pan)	Rotary knobs (set to pan)
Reverb	Rotary knobs (set to reverb)	--
Low Cut	Only via MixPre	Rotary knobs (set to low-cut)
Mute	M button	M button
Solo	S button	S button
Mute Status	Red M button	Red M button
Solo Status	Red S button	Red S button
L/R (Stereo) Output Gain	Only via MixPre	Only via MixPre
L/R (Stereo) Output Mute	via user-definable shortcut	via user-definable shortcut
X1/X2 Mute (10M/10T only)	via user-definable shortcut	via user-definable shortcut
Tone	via user-definable shortcut	via user-definable shortcut
Metronome	via user-definable shortcut	--
Create Q	Marker Set button	Marker Set button
Undo	Only via History List on MixPre	via user-definable shortcut
Internal Mic (10M/10T only)	Only via Input patchbay	via user-definable shortcut

Korg NanoKontrol Studio Interface



FUNCTION	MUSIC PROJECTS	AUDIO PROJECTS
Fader Bank Switching	Track < button = Select fader bank to the left Track > button = Select fader bank to the right	--
User-Definable Shortcut Buttons	Cycle + Marker Set Cycle + Marker < Cycle + Marker > Cycle + << Cycle + >>	Cycle + Marker Set Cycle + Marker < Cycle + Marker > Cycle + << Cycle + >>
Record	Record button	Record button
PLAY	Play button	Play button
STOP	Stop button	Stop button
FFWD X2, X16	Hold >> button	Hold >> button
RWD X2, X16	Hold << button	Hold << button
Skip Next File	--	Tap >> or Marker > button
Skip Prev File	--	Tap << or Marker < button
Skip Next Mark	Tap >> or Marker > button	Tap >> or Marker > button
Skip Prev Mark	Tap << or Marker < button	Tap << or Marker < button
Return to Zero	Tap < or Stop when stopped	Tap < or Stop
Shuttle	Press MixPre HP encoder or set Shuttle as a shortcut, then use selected shortcut and scrub wheel.	Press MixPre HP encoder or set Shuttle as a shortcut, then use selected shortcut and scrub wheel.
Record Arm	REC Arm button	REC Arm button
Record Arm Status	White REC Arm button when armed	White REC Arm button when armed
Input Monitor	Select button	--
Input Monitor Status	White Select button	--

FUNCTION	MUSIC PROJECTS	AUDIO PROJECTS
Channel Screen Access	Press Cycle so that it's illuminated, then press a Select button	Select button
Faders	Linear faders 1-8	Linear faders 1-8
Trims	Scene 1 then use knobs	Scene 1 then use knobs
Pans	Scene 3 then use knobs	Scene 3 then use knobs
Reverb	Scene 2 then use knobs	--
Low Cut	Only via MixPre	Scene 2 then use knobs
Mute	Mute button	Mute button
Solo	Solo button	Solo button
Mute Status	White Mute button	White Mute button
Solo Status	White Solo button	White Solo button
L/R (Stereo) Output Gain	Only via MixPre	Only via MixPre
L/R (Stereo) Output Mute	via user-definable shortcut	via user-definable shortcut
X1/X2 Mute (10M/10T only)	via user-definable shortcut	via user-definable shortcut
Tone	via user-definable shortcut	via user-definable shortcut
Metronome	via user-definable shortcut	--
Create Q	Marker Set button	Marker Set button
Undo	Only via History List on MixPre	via user-definable shortcut
Internal Mic (10M/10T only)	Only via Input patchbay	via user-definable shortcut

Novation LaunchControl XL Interface



FUNCTION	MUSIC PROJECTS	AUDIO PROJECTS
Fader Bank Switching	Track Select < button = Select fader bank to the left Track Select > button = Select fader bank to the right	--

FUNCTION	MUSIC PROJECTS	AUDIO PROJECTS
User-Definable Shortcut Buttons	UP DOWN Device + UP Device + Down Device + Left Device + Right	UP DOWN Device + UP Device + Down Device + Left Device + Right
Record	via user-definable shortcut	via user-definable shortcut
PLAY	via user-definable shortcut	via user-definable shortcut
STOP	via user-definable shortcut	via user-definable shortcut
FFWD X2, X16	via user-definable shortcut	via user-definable shortcut
RWD X2, X16	via user-definable shortcut	via user-definable shortcut
Skip Next File	--	via user-definable shortcut
Skip Prev File	--	via user-definable shortcut
Skip Next Mark	via user-definable shortcut	via user-definable shortcut
Skip Prev Mark	via user-definable shortcut	via user-definable shortcut
Return to Zero	via user-definable shortcut (Stop twice)	via user-definable shortcut (Stop)
Shuttle	Only via MixPre	Only via MixPre
Record Arm	Select Record Arm, then Track Control button	Select Record Arm, then Track Control button
Record Arm Status	Red Track Control button when Record Arm is selected	Red Track Control button when Record Arm is selected
Input Monitor	Track Focus buttons	--
Input Monitor Status	Illuminated Track Focus button Monitor is On	--
Channel Screen Access	Hold Device button, then Track Focus button	Track Focus buttons
Faders	Linear Faders 1-8	Linear Faders 1-8
Trims	Top row of knobs	Top row of knobs
Pans	Bottom row of knobs	Bottom row of knobs
Reverb	Middle row of knobs	--
Low Cut	Only via MixPre	Middle row of knobs
Mute	Select Mute, then Track Control button	Select Mute, then Track Control button
Solo	Select Solo, then Track Control button	Select Solo, then Track Control button
Mute Status	Red Track Control button when Mute is selected	Red Track Control button when Mute is selected
Solo Status	Flashing Track Control button when Solo is selected	Flashing Track Control button when Solo is selected
L/R (Stereo) Output Gain	Only via MixPre	Only via MixPre
L/R (Stereo) Output Mute	via user-definable shortcut	via user-definable shortcut
X1/X2 Mute (10M/10T only)	via user-definable shortcut	via user-definable shortcut
Tone	via user-definable shortcut	via user-definable shortcut

FUNCTION	MUSIC PROJECTS	AUDIO PROJECTS
Metronome	via user-definable shortcut	--
Create Q	via user-definable shortcut	via user-definable shortcut
Undo	Only via History List on MixPre	via user-definable shortcut
Internal Mic (10M/10T only)	via Input patchbay only	via user-definable shortcut

Specifications

Specifications are subject to change without prior notice.

For the latest information available on all Sound Devices products, visit our website at: www.sounddevices.com.

Audio Inputs

NAME	DESCRIPTION
Frequency Response	10 Hz to 40 kHz +/- 0.5dB re 1 kHz @ 96 kHz sample rate
Total Harmonic Distortion (THD)	0.005% max (@1 kHz, 22-22 kHz BW, gain=20 dB, -10 dBu in)
Equivalent Input Noise (EIN)	-130 dBV (-128 dBu) max (A-weighting, gain=76 dB, 150 ohm source impedance)
Inputs	<ul style="list-style-type: none">• Mic: XLR active-balanced; 4k input Z• Line: XLR active-balanced; 4k input Z• Line: ¼-inch TRS active-balanced; 4k input Z• Aux/Mic in: 3.5mm TRS, 2-channel unbalanced; 100k input Z• USB Audio: 4 channels• All inputs fully RF-filtered and overload protected.
Gain	<ul style="list-style-type: none">• Mic input: +6 dB to +76 dB• Line input: -20 dB to +30 dB• Fader: -inf to +20 dB• Total, Mic-to-recording (max): +96 dB• Aux In (Mic): +10 dB to +40 dB• Aux In (Line): -10 dB to +20 dB• Total Aux Gain including Fader, Mic-to-recording: +60 dB
ADC Dynamic Range	32 bit precision; 120 dB dynamic range min (A-weighted, gain=10 dB, fader=0 dB)
Maximum Input Level	<ul style="list-style-type: none">• Mic XLR: +14 dBu (limiters on or off)• Line XLR / ¼-inch: +28 dBu (limiters on or off)• Aux In (Mic): -10 dBu• Aux In (Line): +10 dBu
Limiters	<ul style="list-style-type: none">• Limiter at all gain stages, range > 40 dB.• First stage analog, subsequent stages digital
Low Cut Filters	40 Hz to 160 Hz (adjustable), 18 dB/oct. First stage analog, subsequent stages digital
Microphone Powering	<ul style="list-style-type: none">• Mic XLRs: 48 V via 6.8k resistors, 10 mA each• Mic 3.5 mm: 3 V @ 3k source Z

Audio Outputs

NAME	DESCRIPTION
Stereo Out	3.5 mm TRS stereo unbalanced, 500 ohm output impedance, +7.8 dBu max output level
DAC feeding Stereo Out, Headphone Out	32 bit precision; 115 dB dynamic range (A-weighted)
Headphone Out	3.5 mm TRS stereo unbalanced, 300 mW, for use with any impedance headphones
Output Limiters	Digital

Recorder

NAME	DESCRIPTION
Maximum Record Tracks	12 tracks
Sampling Frequency	<ul style="list-style-type: none"> • 44.1 kHz • 48 kHz • 96 kHz
Bit Depth	24
Media Type	<ul style="list-style-type: none"> • Secure Digital Extended Capacity (SDXC) • Secure Digital High Capacity (SDHC) • Secure Digital (SD)
Maximum Storage Size	512 GB (SDXC)
Card Format	<ul style="list-style-type: none"> • FAT32 formatted (32GB or less), exFAT for (>32GB)
File Type	<ul style="list-style-type: none"> • Monophonic WAV • AAC (render) • Stereo WAV (render)
Max WAV File Size	<ul style="list-style-type: none"> • 4GB; Files seamlessly auto-split at 4GB
Effects	<ul style="list-style-type: none"> • Reverb types: Plate, Room, Hall (48 kHz max sampling rate) • Vocal Air

USB

NAME	DESCRIPTION
Audio Interface (USB-C)	5-in/2-out; 44.1 to 96 kHz; 16/24 bit; Class compliant USB 2.0 high speed or ASIO driver (supplied via download from Sound Devices' website)
Mass Storage (USB-C)	USB 2.0 high speed
Keyboard (USB-A)	Text entry and control

Touch Screen

NAME	DESCRIPTION
Display	1.6-inch, color, sunlight-viewable IPS LCD
Resolution	320 x 256

Remote Control

NAME	DESCRIPTION
Keyboard (USB-A)	Text entry and control

Power

NAME	DESCRIPTION
AA Batteries	4x AA sled or 8x AA sled (NiMH or Lithium recommended)
L-Mount Batteries	MX-LMount: 2x L-mount sled for hot-swappable Li-Ion batteries
From Computer	Bus-powered via USB-C port. Use either: <ul style="list-style-type: none"> • USB-C to USB-C cable • MX-USBY: USB-C to dual USB-A Y-cable
AC Adapter	MX-PSU: 15W PSU w/USB-C connector; includes wall adapter plugs for US, UK, Australia, and Europe

Environmental

NAME	DESCRIPTION
Operation and Storage	<ul style="list-style-type: none"> • Operating: -20° C to 60° C • Storage: -40° C to 85° C • 0 to 90% relative humidity (non-condensing)

Dimensions and Weight

NAME	DESCRIPTION
Size (H x W x D)	<ul style="list-style-type: none"> • 1.4 in x 5.68 in x 4.35 in • 36 mm x 144 mm x 110 mm
Weight	<ul style="list-style-type: none"> • 16.8 oz (unpackaged, without batteries) • 0.48 kg (unpackaged, without batteries)

① All specifications at 48 kHz sample rate unless otherwise noted.



Software License

End-user license agreement for Sound Devices MixPre Series Software / Embedded Firmware

Important Read carefully:

This Sound Devices, LLC end-user license agreement ("EULA") is a legal agreement between you (either an individual or a single entity) and Sound Devices, LLC for the Sound Devices, LLC software product identified above, which includes computer software, embedded firmware, and may include associated media, printed materials, and "online" or electronic documentation ("SOFTWARE PRODUCT"). By using, installing, or copying the SOFTWARE PRODUCT, you agree to be bound by the terms of this EULA. If you do not agree to the terms of this EULA, do not use or install the SOFTWARE PRODUCT.

Software Product License

The SOFTWARE PRODUCT is protected by copyright laws and international copyright treaties, as well as other intellectual property laws and treaties. The SOFTWARE PRODUCT is licensed, not sold.

Grant of license. This EULA grants you the following limited, non-exclusive rights: In consideration of payment of the licensee fee, Sound Devices, LLC, as licensor, grants to you, the licensee, a non-exclusive right to use this copy of a Sound Devices, LLC software program (hereinafter the "SOFTWARE") on a single product and/or computer. All rights not expressly granted to licensee are reserved to Sound Devices, LLC.

Software ownership. As the licensee, you own the hardware on which the SOFTWARE is recorded or fixed. Sound Devices, LLC shall retain full and complete title to the SOFTWARE and all subsequent copies of the SOFTWARE, regardless of the media or form on or in which the original copies may exist. The license is not a sale of the original SOFTWARE.

Copyright

All rights, title, and copyrights in and to the SOFTWARE PRODUCT (including, but not limited to, any images, photographs, animations, video, audio, music, text, and "applets" incorporated into the SOFTWARE PRODUCT) and any copies of the SOFTWARE PRODUCT are owned by Sound Devices, LLC or its suppliers. The SOFTWARE PRODUCT is protected by copyright laws and international treaty provisions. Therefore, you must treat the SOFTWARE PRODUCT like any other copyrighted material, except that you may make copies as only provided below. You may not copy the printed materials accompanying the SOFTWARE PRODUCT.

Restrictions on use. Licensee may not distribute copies of the SOFTWARE or accompanying materials to others. Licensee may not modify, adapt, translate, reverse engineer, decompile, disassemble, or create derivative works based on the SOFTWARE or its accompanying printed or written materials.

Transfer restrictions. Licensee shall not assign, rent, lease, sell, sublicense, or otherwise transfer the SOFTWARE to another party without prior written consent of Sound Devices, LLC. Any party authorized by Sound Devices, LLC to receive the SOFTWARE must agree to be bound by the terms and conditions of this agreement.

Termination

Without prejudice to any other rights, Sound Devices, LLC may terminate this EULA if you fail to comply with the terms and conditions of this EULA. In such event, you must destroy all copies of the SOFTWARE PRODUCT and all of its component parts.

Limited Warranty

No warranties. Sound Devices, LLC expressly disclaims any warranty for the SOFTWARE PRODUCT. The SOFTWARE PRODUCT and any related documentation is provided "as is" without warranty or condition of any kind, either express or implied, including, without limitation, the implied warranties and conditions of merchantability, fitness for a particular purpose, or non-infringement. The entire risk arising out of use or performance of the SOFTWARE PRODUCT remains with you.

No liability for damages. In no event shall Sound Devices, LLC or its suppliers be liable for any damages whatsoever (including, without limitation, damages for loss of business profits, business interruption, loss of business information, or any other pecuniary loss) arising out of the use of or inability to use this Sound

Devices, LLC product, even if Sound Devices, LLC has been advised of the possibility of such damages. In any case, Sound Devices, LLC's entire liability under any provision of this evaluation license shall be limited to the greater of the amount actually paid by you for the SOFTWARE PRODUCT or U.S. \$5.00. Because some states/jurisdictions do not allow the exclusion or limitation of liability for consequential or incidental damages, the above limitation may not apply to you.

Governing Law

This agreement and limited warranty are governed by the laws of the state of Wisconsin.

FCC & ISED Compliance Statements



This device complies with part 15 of the FCC Rules. Operation is subject to the following two conditions: (1) This device may not cause harmful interference, and (2) this device must accept any interference received, including interference that may cause undesired operation. FCC Part 15.19 (a) (3)

Changes or modifications not expressly approved by the party responsible for compliance could void the user's authority to operate the equipment.

FCC Interference Statement

This equipment has been tested and found to comply with the limits for a Class B digital device, pursuant to part 15 of the FCC Rules. These limits are designed to provide reasonable protection against harmful interference in a residential installation. This equipment generates, uses and can radiate radio frequency energy and, if not installed and used in accordance with the instructions, may cause harmful interference to radio communications. However, there is no guarantee that interference will not occur in a particular installation. If this equipment does cause harmful interference to radio or television reception, which can be determined by turning the equipment off and on, the user is encouraged to try to correct the interference by one or more of the following measures:

- Reorient or relocate the receiving antenna.
- Increase the separation between the equipment and receiver.
- Connect the equipment into an outlet on a circuit different from that to which the receiver is connected.
- Consult the dealer or an experienced radio/TV technician for help.

FCC & ISED User Statement

This device complies with FCC and ISED RF Exposure SAR limits exposure limits for general population / uncontrolled exposure.

Cet appareil est conforme à la norme FCC et USED RF Exposure SAR limite les limites d'exposition pour la population générale / l'exposition incontrôlée.

This Device complies with Industry Canada License-exempt RSS standard(s). Operation is subject to the following two conditions: 1) this device may not cause interference, and 2) this device must accept any interference, including interference that may cause undesired operation of the device.

Cet appareil est conforme avec Industrie Canada, exempts de licence standard RSS (s). Son fonctionnement est soumis aux deux conditions suivantes: 1) ce dispositif ne peut pas causer d'interférences, et 2) ce dispositif doit accepter toute interférence, y compris les interférences qui peuvent causer un mauvais fonctionnement de l'appareil.



Sound Devices, LLC
E7556 Road 23 and 33
Reedsburg, Wisconsin 53959
USA

Phone: +1 (608) 524-0625
Fax: +1 (608) 524-0655

Customer Support

Toll Free: (800) 505-0625

Email: support@sounddevices.com
<http://www.sounddevices.com/support>
<http://forum.sounddevices.com>

Product Information

For more information about products and accessories, visit us on the web at www.sounddevices.com.

Report Documentation Error

Email: techpubs@sounddevices.com

